

HP Archive

This vintage Hewlett Packard document was preserved
and distributed by

[www. hparchive.com](http://www.hparchive.com)

Please visit us on the web !

On-line curator: Glenn Robb



1972
HEWLETT PACKARD
ELECTRONIC INSTRUMENTS
AND SYSTEMS
FOR MEASUREMENT/ANALYSIS/COMPUTATION

Acoustical Instruments
Amplifiers
Automatic Test Systems
Calculators and Peripherals
Communications Test Equipment
Components
Computers and Peripherals
Data Acquisition Systems
Electronic Counters
Electro-optical Instruments

Frequency and Time Standards
Graphic Recorders
Magnetic Recorders
Meters
Microwave Test Equipment
Network Analyzers
Oscilloscopes
Power Supplies
Signal Analyzers
Signal Sources



What's In This Catalog:

GET ACQUAINTED with the many ways Hewlett-Packard can help solve your measurement problems in the opening pages. They describe the company, give some information about the HP capabilities that are beyond this catalog's scope, list local offices, give facts on HP services, and tell you how to order. There is an *alphabetical index* and an index by *model number*, to help locate solutions to measurement, analysis, or computation problems. NEW HP products are flagged and noted by the word NEW in bold, blue type throughout.

For More Information:

FURTHER INFORMATION on any HP product is yours for the asking. Use the *Information Assistance Request Cards* between pages 400 and 401.

Catalog Prices:

PRICES which appear in this catalog apply only to domestic USA customers; they were current when approved for printing and do not include applicable surcharges on imported products. Where prices are not given, or for latest price information, *call your nearest Hewlett-Packard sales office.*



Contents

About Hewlett-Packard	1B
Delcon Telephone Cable Maintenance Instruments	1
Medical Electronics	2
Analytical Instruments and Systems	4
Sales and Service Offices	6
How To Order	8
Services	9
Training	10
Alphabetical Index of Products	12
Model Number Index of Products	18
Product Sections	
Amplifiers	26
Measuring Devices	33
Transducers	82
Displays	83
Oscilloscopes	92
Power Supplies	148
Recorders, Printers and Couplers	172
Electronic Counters	207
Frequency and Time Standards	235
Signal Sources	249
Microwave Test Equipment	315
Communications Test Equipment	345
Network Analyzers	356
Automated Network Analyzers	370
Signal Analyzers	371
Automated Spectrum Analyzers	381
Automated Noise Monitoring Systems	395
Computers and Peripherals	399
Information/Assistance Request Card	401A
Automated Test Systems	405
Electronic Calculators and Peripherals	408
Solid State Components and Circuits	410
Temperature Measuring Instruments	412
Cabinets and Enclosures	414
Information/Assistance Request Card	401A

A BRIEF SKETCH



ABOUT HEWLETT-PACKARD

Hewlett-Packard is a major designer and manufacturer of electronic, medical, analytical, and computing instruments and systems. From its founding in 1939, the company has conscientiously followed its basic philosophy of offering only products representing significant technological advancements. The company's first instrument—an economically priced audio oscillator far more stable and easier to use than any such instrument available at the time—met this demanding criterion, as have the many Hewlett-Packard products that have followed.

The company manufactures more than 2,000 products, most of which fall into the category of electronic test and measurement equipment. This includes many of the "work-horse" products such as oscillators, voltmeters, oscilloscopes, counters, and microwave equipment, as well as a variety of instruments and systems for specialized applications.

However, the company has also entered several additional and important new product areas over the course of the years, and today the company name is seen on instruments and systems for medical diagnosis and monitoring, on others for biophysical and chemical measurement and analysis, and on an impressive selection of solid-state devices.

The growth in the amount of data generated within our technically-oriented society, and the increasing need to automate testing and control functions, led Hewlett-Packard in recent years into the field of computational equipment. The company now offers an impressive family of general purpose digital computers, and electronic calculators and systems. Hewlett-Packard computers easily interface with the company's electronic test and measuring instruments to form data acquisition and automatic test systems. They are also being used increasingly from the elementary through the university level for problem solving, computer-assisted instruction, computer science education, and complex model simulation. Complementing Hewlett-Packard's computer and calculator hardware is an extensive library of software for programming purposes. As a result, Hewlett-Packard's desktop calculators, like Hewlett-Packard computers, are versatile instruments that can handle a wide variety of special needs.

To maintain its leadership in instrument technology, Hewlett-Packard invests heavily in new product development. Research and development expenditures traditionally average about 10 percent of sales revenue, and some 1,500 engineers and scientists are assigned the responsibilities of carrying out the company's various R&D projects. As a result of this effort, about half of the company's current business is represented by products that were not in existence six years ago.



The company has also shown leadership in manufacturing techniques, developing many innovations that make it possible to offer high quality products at moderate cost. Engineering and production of solid-state devices, integrated circuits, and hybrid microcircuitry are prime examples. In many cases, specialized equipment is required for the production of these components as well as other unique parts. Often this equipment is designed and built in-house either because it is not available on the outside, or because it allows Hewlett-Packard an extra measure of control in maintaining the quality and performance expected of its products.

Hewlett-Packard is a well-established, multi-national company that has controlled its growth so that expansion is financed generally from income on a pay-as-you-go basis. From its modest beginnings in Palo Alto, California, the company now has nine manufacturing plants in California, two in Colorado, two in New Jersey, one in Pennsylvania and one in Massachusetts. Hewlett-Packard's overseas manufacturing facilities are located in Scotland, West Germany, France, Japan, and Singapore.

However, for the customer, Hewlett-Packard is no farther away than the nearest telephone. There are more than 50 field offices in the United States, and the company's products are marketed in over 100 countries abroad. All of these offices offer immediate assistance in solving measurement problems and providing advice on equipment selection, or with any help needed to keep equipment already in service in first-class operating condition. The field offices are staffed by trained engineers, each of whom has the primary responsibility of providing technical assistance and data to customers. A vast communications network has been established to link each field office with the factories and with corporate offices. No matter what the product or the request, a customer can be accommodated by a single contact with the company.

Hewlett-Packard is guided by a set of written objectives. One of these is "to provide products and services of the greatest possible value to our customers." Through application of advanced technology, efficient manufacturing, and imaginative marketing, it is the customer that the more than 16,000 Hewlett-Packard people strive to serve. Every effort is made to anticipate customer's needs, to provide products that will enable him to operate more efficiently, to offer him the kind of service and reliability that will merit his highest confidence, and to provide all of this at a reasonable price.



DELCON TELEPHONE CABLE MAINTENANCE INSTRUMENTS



ABOUT HEWLETT-PACKARD

Hewlett-Packard's Delcon Division is dedicated to the development and manufacture of instruments for telephone cable plant maintenance. Of prime interest is the location of physical damage to the cable.

Fault location has become an especially acute problem in recent years as more cable is placed underground. Although better protected from the environment, the cable is subject to new dangers and the telephone craftsman is faced with locating damage hidden by several feet of earth. In addition, higher traffic density on cables and demands for higher quality transmission have placed more emphasis on cable reliability and quality.

From the standpoint of the cable maintenance supervisor, fault location problems can be divided into five categories:

1. Maintaining the integrity of pressurized cable systems. Since pressurization is a preventive measure to keep moisture out of the cable, it is essential that leaks be located and repaired quickly before more serious damage results.
2. Locating conductor faults before they become catastrophic. High resistance shorts and grounds are usually indicative of water in the cable, which, if not located and repaired quickly, can result in complete cable failure.
3. Locating catastrophic faults. Time and location accuracy are of the essence in these cases in order to return the cable to service quickly with a minimum of excavation.
4. Cable utilization. This problem becomes most apparent when most of the pairs in the cable have been assigned and it is no longer possible to pick up a "spare" pair to replace a faulty pair. Faults on abandoned pairs must then be located and repaired in order to more fully utilize the cable's capacity.
5. Cable path and depth determination. This information is necessary in conjunction with accurately locating the fault. It is also necessary for accurately marking the cable location to protect it from construction and excavation work being performed in the vicinity of the cable.

Delcon Division strives to solve these problems with instruments that are easily operated by non-technical personnel and that will withstand the rigors of the outside plant environment.

Ultrasonic leak detection

As pressurized gas escapes through an aperture it creates considerable noise in the ultrasonic region of 36 to 44 kHz. The Delcon Ultrasonic Translator Detector (such as Model 4905A) detects this characteristic sound with a sensitive, directional Barium Titanate microphone and translates the signal to audio by mixing it with a 40 kHz local oscillator signal. The audio signal is then amplified and monitored on a speaker and level meter.

To detect leaks in aerial cables, the craftsman merely scans the cable from the ground with the flashlight-size microphone, listening for the characteristic hissing sounds of a leak. By simultaneously observing the level meter, he can "peak in" on the leak and determine its exact location. Pole mounted accessories are also available for closer scanning of the cable.

Leaks in ducted underground systems are located with a unique "Duct Probe" accessory. Consisting of a miniature microphone connected to a system of aluminum rods, the Duct Probe can be used to explore up to 500 feet into a cable conduit. The leak is thereby pinpointed precisely, permitting repair of the damage with a minimum of excavation.

Direct reading fault locators

Fault locators that provide a direct distance-to-fault reading in feet (or meters) have the benefit of relieving the craftsman of the drudgery of performing manual calculations. Locating faults becomes faster, requires less training and is less error prone than with manual bridge techniques.

The Model 4912F Conductor Fault Locator is a direct reading, automatic calculating bridge operating on the Varley principle. This instrument is designed to locate extremely high resistance shorts, crosses and grounds, such as might occur from minute amounts of moisture in plastic insulated cable (PIC). The 4912F is connected to an access point on the

cable and the far-end of the cable is strapped to form a bridge configuration. The distance-to-fault result is obtained by a simple sequence of adjustments of the instrument controls. The 4912F is battery powered, light and compact. It is housed in a rugged fiberglass case and is designed to withstand the demands of field use.

Similar in construction and operation to the 4912F, the Model 4910F Open Fault Locator is designed to provide direct distance readings to open faults in paired telephone cable. The 4910F operates on a capacitance charge sampling principle. Since the capacitance per unit length of a pair is known for a particular type of cable, this capacitance can be related to the length of the pair. The 4910F measures this length by charging the pair capacity, C_L , with a known dc voltage; transferring a portion of this charge to a standard capacitor, C_S , in the instrument for a given length of time; and measuring the charge across C_S with a voltmeter calibrated in feet. This entire sequence is performed automatically by the 4910F, providing an answer in just a few thousandths of a second.

Tone type fault locators

The tone type locator, such as the Model 4904A, places a 990 Hz signal on the faulted circuit which is traced by an inductive pickup coil and a sensitive tuned receiver. At the point of the fault, the signal drops in level, thereby indicating the exact physical location of the fault. The tone locator also has the advantage of being able to precisely trace the path of the cable and, by triangulation, determine its depth at any point. The tone locator system is designed such that only the transmitted signal is detected, so that interfering signals (such as power line harmonics) do not interfere with the measurement. Output power of the transmitter is kept low to prevent interference with other working circuits in the cable and to prevent "carry-by" of the signal beyond the fault.

MORE INFORMATION ON DELCON PRODUCTS

U.S.A. Customers: Delcon products are sold directly to the customer from the manufacturing division. Please direct all orders and inquiries to:

Hewlett-Packard Company
 DELCON DIVISION
 333 Logue Avenue
 Mountain View, California 94040
 Telephone (415) 969-0880

Customers outside the U.S.A.: Orders should be directed to your local Hewlett-Packard distributor or representative.



An evolution for an involvement

Hewlett-Packard's service to the medical community is at the Medical Electronics Division (MED) in Waltham, Massachusetts, where more than 250 products for health care including diagnostic instruments, patient monitoring equipment, medical systems instrumentation, and computerized medical systems are manufactured.

Sanborn Company's (*Hewlett-Packard's predecessor*) first principal products were a water level recorder, a blood pressure gauge, the Benedict Metabolism Tester, the first string-galvanometer electrocardiograph, and the first portable ECG. These were followed by the present line of cardiological measurement instrumentation, which includes several models of electrocardiographs, heart sound instrumentation, and a vector-cardiography system.

In 1961, Sanborn became a division of Hewlett-Packard. The combined strengths of Sanborn, with its acknowledged leadership in understanding and providing for the needs of the medical community together with its experienced sales and service personnel, and Hewlett-Packard, with its leadership in development and support of electronic instrumentation, resulted in well-conceived, well-designed, and well-supported product lines.

MED's product lines

The product lines, which are listed in the Medical Instrumentation Catalog

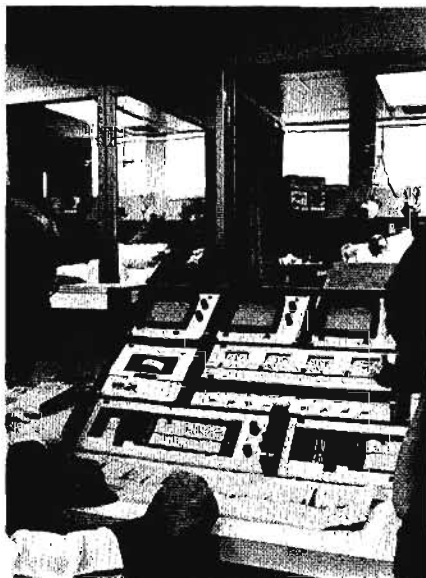

(5952-3389), of Hewlett-Packard's Medical Electronics Division (MED) currently contains more than 250 instruments comprising patient monitors, medical systems (for the operating room, cath lab, etc.), diagnostic instruments, and computerized medical systems. Current engineering efforts are expanding to telemetry for progressive coronary care monitoring, and monitoring equipment for new born intensive care units.

780 series patient monitors

Continuous monitoring of coronary and critically-ill patients is undoubtedly among the most important innovations in patient care in the last decade. In response to this innovation, Hewlett-Packard designed the 780 Series of patient monitors for coronary care units, intensive care units, and recovery room monitoring.

The units of the 780 series electronically monitor various physiological phenomena such as ECG, arterial and venous pressures, temperature, and respiration. Monitoring is done on a round-the-clock basis; the patient is effectively never left alone. 780 bedside monitoring units are small, compact, self-contained instruments used to monitor various combinations of patient parameters. Patient data is displayed in analog or digital form on a variety of readout devices for convenient and effortless monitoring by the medical staff.

Because of the building block design of the 780 Series, units can be combined into an almost unlimited variety of systems to meet each hospital's specific monitoring needs. Other advantages of the building block approach are economy—cost reflects only those monitoring capabilities needed; and expandability—systems are easily enlarged to monitor more patients or more parameters per patient.

The Hewlett-Packard 780 Series also includes resuscitation capability. Defibrillation can be performed asynchronously for emergency treatment of ventricular fibrillation or the defibrillator can be used synchronously for the elective cardioversion of arrhythmias such as atrial fibrillation or atrial flutter. Pacing can be done in either the fixed-rate or demand (as-required-by-the-patient) mode.

8800 series medical systems

Late in the '60's the need for monitoring systems for clinical and research applications became apparent. This prompted Hewlett-Packard into developing the 8800 Series of Medical Systems comprising transducers, signal conditioners, recorders, and other display devices. The versatility of 8800 instrumentation permits customer configuration of systems for research, operating rooms, cath labs, and teaching applications.

The equipment provides substantial flexibility in meeting the requirements of the individual clinician and researcher. By combining standard sub-assemblies in building block fashion, virtually a limitless number of different configurations is possible. These range from two-channel systems in a small mobile cart, to highly sophisticated multichannel systems including chart recorders, oscilloscopes, numerical readouts, analog meters, and magnetic tape recorders.

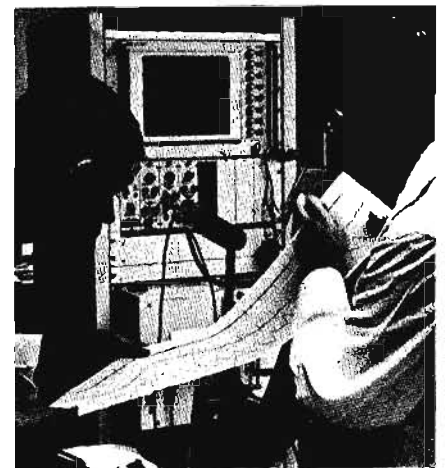

Diagnostic Instrumentation

Hewlett-Packard has developed an extensive group of instruments primarily for clinical applications. These instruments monitor and/or display ECGs, VCGs, heart sounds, simultaneous fetal ECGs and labor contractions, nerve conduction and muscle voltages, and internal body structures. This was followed by our present single-channel electrocardiographs which provide all solid state circuitry and the most modern electronic technology available.

Electrocardiography

Hewlett-Packard offers two 3-channel electrocardiographs. One allows the nurse or physician to obtain a complete 12-lead electrocardiograph automatically in ten seconds. The second unit includes facilities for obtaining automatic cardiographs and/or provides a 3-channel display for electrocardiograph, phonocardiograph and pressure signals.

Electromyography

The Hewlett-Packard compact, 2-channel clinical electromyograph provides all of the sophisticated electronic gear necessary to do electromyography and nerve conduction studies in one package. It also utilizes a Hewlett-Packard developed variable persistence oscilloscope, which is unique to our instrument.

Diagnostic ultrasound

Hewlett-Packard's oscilloscopes were also combined with sophisticated electronics to provide two diagnostic ultrasound units. These instruments utilize the sonar principle and have found wide usage in neurological and radiological diagnostic procedures, while other areas such as cardiology and obstetrics are also beginning to develop procedures where diagnostic ultrasound is useful. These instruments, like the Electromyograph, can be combined with the variable persistence or storage scope, allowing Hewlett-Packard to provide a unique feature in this type of instrumentation.

Fetal monitoring

Recently, a fetal monitoring instrument has been developed by our manufacturing facility in Boblingen, Germany, in conjunction with Dr. Konrad Hamacher of Dusseldorf. It combines both the phonocardiograph and fetal ECG techniques and allows the obstetrician to monitor fetal heart rate during the last trimester of pregnancy, or at the time of labor, and compare it with recorded labor contractions. In this way, the number of Caesarean sections can be reduced and the baby can be continually monitored during the most traumatic time of labor. The idea of monitoring the fetus is not new, but instrumentation that will eliminate extraneous noises and maternal heart sounds is, and all of this is combined in the new Cardiotocograph, which uses logic circuitry to eliminate heart sounds or other extraneous noises.

Computerized medical systems

One of the goals of Hewlett-Packard's Medical Electronics Division is to provide medical systems and support that allow the computer to be a time-saving, accurate tool of the physician and researcher. To implement this goal, the concept of staellite, or dedicated, computers has been developed. Separate small computers perform their functions in the various areas of the hospital—intensive care, cath lab, operating room, etc.—and, if desired, communicate with a larger machine containing patient files and billing information. Three total system packages (both hardware and software) are currently available for medical systems applications. They are the Computerized Catheterization Laboratory, the ECG Interpretive System and the Computerized ICU/CCU Monitoring System. Additional available software includes a set of 52 statistical programs (the "Stat-Pac") written for biostatistical applications.

Computerized cardiac cath lab

This package aids the physician by reducing the analog data obtained during the catheterization procedure to a useful set of calculated values such as heart rate, systolic and diastolic pressure values, pressure gradients, cardiac output, etc. At the conclusion of the procedure, a report is generated for inclusion with other patient documentation.

ECG Interpretive system

A specially-developed operating system controls the user's choice of two programs for ECG analysis, Mayo or USPHS, each based on different diagnostic criteria and both widely field-tested. Designed for operation by an ECG technician, the system merges patient history cards with ECG records and prints history, ECG, and interpretation in less than one minute. Results can be printed at both the computer site and the ECG terminal location. The system also produces patient billing reports upon request.

ICU/CCU monitoring system

A computerized, integrated, hardware/software system for patient monitoring is currently being developed and tested at Peter Bent Brigham Hospital, Boston, Massachusetts. This system is modular in nature, making it easily adaptable to any monitoring situation. Application tasks include scheduled automatic sampling of signals from bedside monitors (ECGs, pressures, respiration, temperature); plotting trends on a scope; logging nurses notes; cardiac output by dye curve; pulse waveform analysis; arrhythmia monitoring in conjunction with a preprocessor; acid-base analysis; and generating patient summary reports at the end of each nursing shift.

Hewlett-Packard's abiding commitments

Responsible concern is not confined to creating designing and manufacturing medical instruments alone. Since the ultimate value of medical instruments to physicians and hospital personnel must be measured by intrinsic benefits, the administrative staff of Hewlett-Packard's Medical Electronics Division has spent hundreds of man-years developing a "total concept" package, existing from the earliest stages of a medical instrument's definition and continuing throughout the useful life of the product.

Currently the full-time responsibility of more than 100 Hewlett-Packard professionals, the total concept package comprises regularly scheduled training programs, complete publications complements, on-site calibration and checkout procedures, extensive sales and service capabilities, emergency service loaner equipment, and systems analyst and field engineering support.



ABOUT HEWLETT-PACKARD



ANALYTICAL INSTRUMENTATION

Gas Chromatographs and Spectrometers

For chemical analysis

Widely recognized as the nation's foremost supplier of electronic measuring instruments for the engineer, Hewlett-Packard is fast developing a similar position in analytical instrumentation for the scientist. Fully described in a separate Hewlett-Packard catalog "Analytical Instruments for Chemistry," these instruments are briefly characterized in these two pages.

Gas chromatographs

Although less than 20 years old, gas chromatography (GC) has taken over from classical and other instrumental methods the bulk of analytical work performed in laboratories around the world. There is an excellent reason for the revolutionary popularity of the gas chromatograph in analytical chemistry: no other method gets more accurate results, at greater speed, and for less cost.

For the scientist whose interest is the chemical analysis of unknown samples, Hewlett-Packard offers four basic types of gas chromatographs, a more complete line than is available from any other manufacturer in the world:

Series 7600A Chromatograph System, a fully automatic GC that takes over the traditional work of the chromatographer, from sample measurement and injection to the final report of the analysis. Operating completely unattended, it performs the GC analysis more accurately and reliably than a skilled technician, at a fraction of the operating cost.

Series 7620A and 5750B Research GC's, multiple-detector instruments that permit the highest possible level of performance for a great variety of analyses. They are designed expressly for the research laboratory that requires an extremely versatile instrument.

Series 5700A Laboratory GC, the most modern instrument on the market, available in a variety of configurations for dedicated applications. Its modular design makes possible the most economical GC at the highest performance level for laboratories that specialize in specific analyses such as drugs, pesticides, natural gas and air pollution.

Series 7610A and 402B High-Efficiency GC's, whose large oven accommo-

dates glass U-tube columns for the analysis of materials that are difficult to chromatograph. These instruments incorporate other design features that make them especially effective with biological samples and thermally sensitive or polar materials.

Model 5795B Preparative GC Attachment which converts analytical GC's to fully automatic small-scale preparative work. The 5795B is used to separate and collect pure components for further chemical studies, without interfering in any way with the gas chromatograph's analytical capability.

Model 7670A/7671A Automatic Sampler, an accessory that automates the measurement and injection of samples into a gas chromatograph. Operating unattended overnight and even over weekends, the 7670A/7671A reduces operating costs so significantly that even the smallest labs can justify its purchase.

Data handling

Since GC produces both qualitative and quantitative information on large

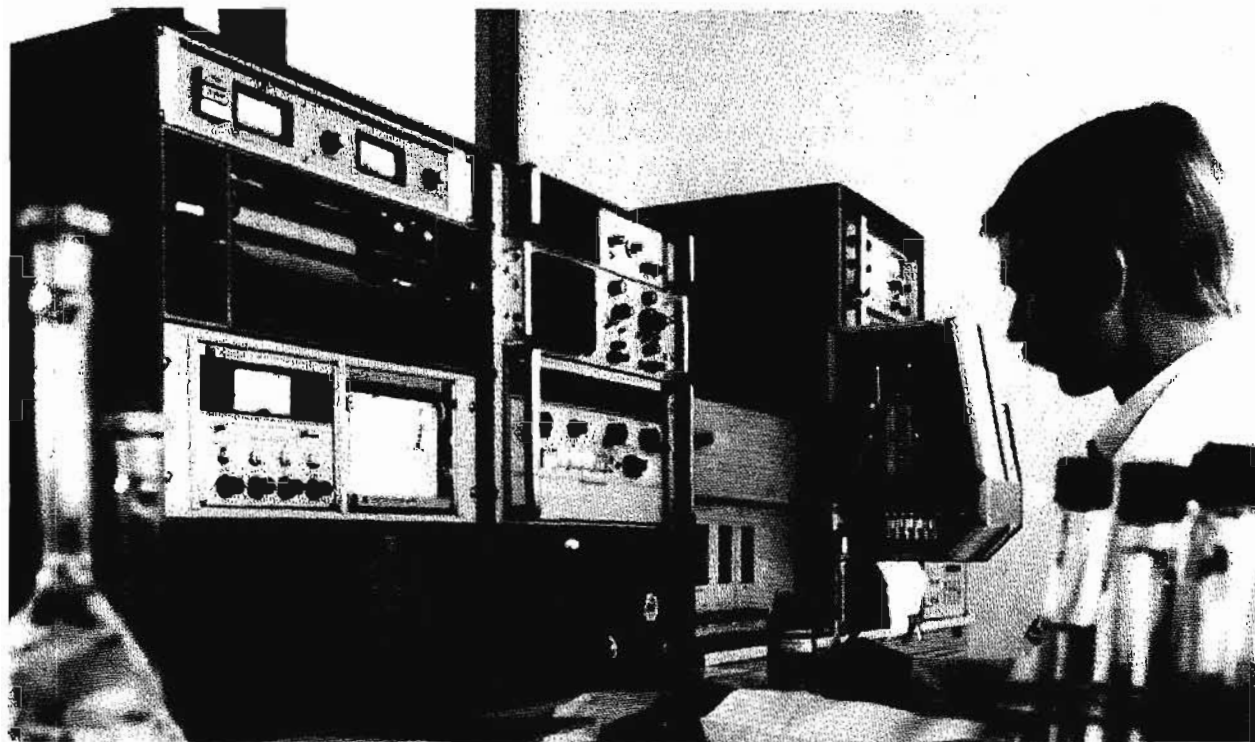

The gas chromatograph and mass spectrometer form the most powerful tool available to the scientist for rapid, positive and accurate analyses of unknown samples, especially when they are integrated with a computer as they are in the Hewlett-Packard GC/Mass Spec/Computer System.

numbers of complex samples in a very short time, its data output is so large that automatic methods for handling it are economical if not essential. Hewlett-Packard manufactures a variety of instruments and systems for automatic data handling to satisfy all budget levels:

3360A GC Data Processing System.

Complete automation of the data handling process is achieved with the 3360A which can handle the output of up to eight GC's simultaneously, without intervention by the chromatographer. It prepares a full analytical report for each sample and is easily operated even by laboratory technicians who have literally no previous computer experience.

3370B Digital Integrator. An electronic integrator, the 3370B automatically measures the retention time and area of each peak on a chromatogram. It presents the data either on a built-in printer, on punched paper tape for use with time-share computers, or directly to a digital computer in real time.

Strip Chart Recorders. Several Hewlett-Packard recorders are available with special input circuitry for use in GC: Models 7127A, 7128A, 7143A/B, 680. All solid-state instruments, they offer a choice of one or two recording pens and five or ten-inch calibrated charts.

Hewlett-Packard manufactures a broad line of other data handling instruments including digital computers, programmable calculators, magnetic tape recorders and oscillographic recorders which are described elsewhere in this catalog.

Mass spectrometer

It is generally agreed among scientists that the most powerful tool for the qualitative and quantitative identification of unknown materials is the combination of a gas chromatograph and mass spectrometer. In the Hewlett-Packard system, these two instruments are fully integrated with a computer, further increasing their analytical power and operator convenience. All three components—gas chromatograph, mass spectrometer and computer—are manufactured and serviced world-wide by Hewlett-Packard.

The 5930A Mass Spectrometer can be operated either manually or automatically. In the automatic mode, the computer controls the operation of the spectrometer and accumulates the analytical data while it performs the necessary calculations. It does a complete mass scan

every two seconds, fast enough to analyze every peak separated by the gas chromatograph, and stores all the analytical data for as many as 1000 scans on a single tape cassette. Later, the computer can search the cassette, find the scan of interest and type out a list of every peak, identifying each peak by mass number and relative abundance.

MRR spectrometer

Molecular rotational resonance spectroscopy (MRR) measures the absorption of microwave energy by molecules in the vapor state at low pressures. The technique has been widely used in fundamental molecular research for a number of years. With the introduction of the 8460A MRR Spectrometer, which is easy to use and more versatile than previous instrumentation, the technique has been extended to the analysis of complex gas mixtures, especially in air pollution studies and quantitative mixture determinations.

Microwave absorption occurs in any molecule that has a permanent dipole moment. The absorption pattern, or MRR spectrum, consists of sharp individual lines which always occur at the same frequencies regardless of sample composition and total pressure. Measurement resolution is so high that molecular conformers and non-radioactive isotopes can be separately identified. Compounds of molecular weight up to 350 can be measured. Impurities do not interfere and no sample preparation is required.

ESCA spectrometer

Electron spectroscopy for chemical analysis (ESCA) is a relatively new technique for measuring the binding energies of core and valence electrons in atoms and molecules. It has great potential in both structural and analytical chemistry, with applications in the study of surface chemistry, oxidation states, molecular structure and chemical analysis generally.

The HP 5950A ESCA Spectrometer advances the state-of-the-art in some extremely significant ways. It incorporates an X-ray monochromator and dispersion-compensated electron optics, each an entirely unique technological break-through. When combined with the 5950A's position-sensitive detector, these design features serve to eliminate the line-width of the exciting radiation without introducing any slits in the spectrometer. The result is an instrument that can be operated

under optimum conditions of both sensitivity and resolution at all times.

The main performance characteristics of the 5950A include freedom from background and freedom from satellites as well as greatly improved resolution and sensitivity.

CHN analyzer

The Model 185B Carbon Hydrogen Nitrogen Analyzer performs a complete elemental analysis of organic materials simultaneously and automatically in less than 10 minutes. The 185 has gained considerable acceptance among microchemists, because of its ability to perform, even under difficult circumstances, elemental analyses whose accuracy is well within the accepted allowable error of $\pm 0.3\%$, at a speed advantage of 4 to 8 times over classical methods.

Molecular weight instruments

A polymer solution invariably consists of a number of different molecules of different chain lengths and weights. It is often useful to the polymer chemist to make different kinds of molecular weight determinations because each gives him a better idea of the actual molecular weight of the sample and also tells him something of the distribution of the type of molecules in his sample.

Hewlett-Packard offers the polymer chemist a choice of two instruments to help him make fast and accurate molecular weight determinations of all sizes of molecules: Model 302B Vapor Pressure Osmometer for number-average molecular weight determinations between 50 and 25,000; Series 500 Membrane Osmometers for the same type of determination between 10,000 and 1,000,000.

Quartz thermometer

The Model 2801A Quartz Thermometer measures absolute or differential temperature with a resolution of 0.0001° over the range -80 to $+250^\circ\text{C}$. It employs a small quartz disc transducer that operates as a piezoelectric resonator for a sensor oscillator. The resonant frequency of the quartz crystal varies as the temperature in such a manner that the frequency of the sensor oscillator output signal is a linear function of temperature. Probe temperature is displayed as a direct digital readout in $^\circ\text{C}$ or $^\circ\text{F}$. A BCD output is also provided for input to computers and other data handling systems.

SALES & SERVICE OFFICES

UNITED STATES, CANADA
CENTRAL AND SOUTH AMERICA

SALES & SERVICE OFFICES

UNITED STATES

ALABAMA

P.O. Box 4207
2003 Byrd Spring Road S.W.
Montevallo 35802
Tel: (205) 881-4381
TWX: 810-728-2204

ARIZONA

2326 E. Magnolia St.
Phoenix 85034
Tel: (602) 252-5061
TWX: 910-951-1330
5737 East Broadway
Tucson 85718
Tel: (602) 298-2313
TWX: 910-952-1162

CALIFORNIA

1430 East Orangefloras Ave.
Fullerton 92631
Tel: (714) 870-1060
3935 Lanserchim Boulevard
North Hollywood 91604
Tel: (213) 877-1782
TWX: 910-499-2170

1101 Embarcadero Road
Palo Alto 94303
Tel: (415) 327-8500
TWX: 910-373-1280

2220 Watt Ave
Sacramento 95825
Tel: (916) 482-1453
TWX: 910-307-2092

9606 Aero Drive
San Diego 92123
Tel: (714) 279-3200
TWX: 910-335-2000

COLORADO

7865 East Prentice
Englewood 80110
Tel: (303) 771-3485
TWX: 910-935-0705

CONNECTICUT

608 Toland Street
East Hartford 06108
Tel: (203) 285-9384
TWX: 710-426-3416
111 East Avenue
Norwalk 06851
Tel: (203) 853-1251
TWX: 710-468-3750

FLORIDA

P.O. Box 24710
2808 W. Oakland Park Blvd.
Ft. Lauderdale 33307
Tel: (305) 731-2020
TWX: 510-955-4099

P.O. Box 20907
Herndon Station 32814
821 Commonwealth Avenue
Orlando
Tel: (805) 841-3970
TWX: 810-850-0113

Effective April 1, 1977
P.O. Box 13910
6177 Lake Ellenor Dr.
Orlando, 32809
Tel: (305) 859-2900
TWX: 810-850-0113

GEORGIA

P.O. Box 28234
450 Interstate North
Atlanta 30328
Tel: (404) 438-6181
TWX: 810-768-4889

ILLINOIS

5500 Howard Street
Oakdale 60076
Tel: (312) 677-0400
TWX: 910-223-3873

INDIANA

3819 Meadows Drive
Indianapolis 46205
Tel: (317) 546-4891
TWX: 810-341-3283

LOUISIANA

P.O. Box 456
1942 Williams Boulevard
Kenner 70062
Tel: (504) 721-6201
TWX: 810-955-5524

MARYLAND

6707 Whitestone Road
Baltimore 21207
Tel: (301) 944-5400
TWX: 710-882-9157

P.O. Box 1648

2 Choka Cherry Road
Rossville 20860
Tel: (201) 948-6370
TWX: 710-828-9684

MASSACHUSETTS

32 Hartwell Ave.
Lynnington 02173
Tel: (617) 851-8860
TWX: 710-326-8904

MICHIGAN

21840 West Nine Mile Road
Southfield 48075
Tel: (313) 353-9100
TWX: 810-224-8882

MINNESOTA

2459 University Avenue
St. Paul 55114
Tel: (612) 648-9481
TWX: 810-353-3734

MISSOURI

1131 Colorado Ave.
Kansas City 64137
Tel: (816) 763-8000
TWX: 910-771-2087

2812 South Brentwood Blvd.
St. Louis 63144
Tel: (314) 962-5000
TWX: 910-760-1870

NEW JERSEY

W. 120 Chabory Road
Paramus 07652
Tel: (201) 765-5000
TWX: 710-990-4951

1050 N. Kings Highway
Cherry Hill 08034
Tel: (609) 827-4000
TWX: 710-492-4945

NEW MEXICO

P.O. Box 8386
Sitllon C
6501 Lomas Boulevard N.E.
Albuquerque 87108
Tel: (505) 265-5713
TWX: 910-989-1665

156 Wyatt Drive
Las Cruces 88001
Tel: (905) 626-2485
TWX: 910-993-0950

NEW YORK

1702 Central Avenue
Albany 12205
Tel: (518) 869-8462
TWX: 710-441-8270
1219 Campville Road
Ladysmith 13760
Tel: (607) 754-0050
TWX: 510-252-0850

82 Washington Street
Poughkeepsie 12601
Tel: (914) 464-7330
TWX: 510-248-0012

19 Saginaw Drive
Rochester 14629
Tel: (716) 473-8500
TWX: 510-253-5981

5858 East Melloy Road
Syracuse 13211
Tel: (315) 454-2486
TWX: 710-541-3482

1 Crossways Park West
Woodbury 11797
Tel: (516) 921-0300
TWX: 510-223-0831

NORTH CAROLINA

P.O. Box 5188
1823 North Main Street
High Point 27282
Tel: (919) 858-8161
TWX: 510-928-1516

OHIO

25276 Center Ridge Road
Cleveland 44145
Tel: (216) 838-0200
TWX: 810-427-9129

3480 South Dixie Drive
Dayton 45439
Tel: (513) 296-0361
TWX: 810-458-1925

1120 Morse Road
Columbus 43229
Tel: (614) 846-1300

OKLAHOMA

2919 United Founders Boulevard
Oklahoma City 73112
Tel: (405) 620-2801
TWX: 910-430-6882

OREGON

Westhill Mall, Suite 158
4475 S.W. Scholls Ferry Road
Portland 97225
Tel: (503) 292-9171
TWX: 910-464-6103

PENNSYLVANIA

2500 Moss Side Boulevard
Monroeville 15146
Tel: (412) 271-0724
TWX: 710-797-3850

1621 8th Avenue
King of Prussia Industrial Park
King of Prussia 19406
Tel: (215) 268-7000
TWX: 510-460-2670

RHODE ISLAND

273 Waterman Ave.
East Providence 02914
Tel: (401) 434-5535
TWX: 710-381-7573

*TENNESSEE

Memphis
Tel: (901) 274-7272

TEXAS

P.O. Box 1270
701 E. Arapaho Rd.
Richardson 75080
Tel: (214) 231-6101
TWX: 910-467-4723

P.O. Box 22813
6300 Westpark Drive
Suite 100
Houston 77027
Tel: (713) 781-6000
TWX: 910-881-2645

231 Billy Mitchell Road
San Antonio 78226
Tel: (512) 434-4171
TWX: 910-871-1170

UTAH

2690 South Main Street
Salt Lake City 84115
Tel: (801) 487-0715
TWX: 910-925-8681

VERMONT

P.O. Box 2287
Keeney Drive
South Burlington 05401
Tel: (802) 688-4455
TWX: 510-298-2025

VIRGINIA

P.O. Box 6514
2111 Spence Road
Richmond 23230
Tel: (703) 265-3451
TWX: 710-956-0157

WASHINGTON

433-108th N.E.
Bellevue 98004
Tel: (206) 434-3971
TWX: 910-443-2303

*WEST VIRGINIA

Charleston
Tel: (304) 768-1232

*WEST VIRGINIA

Charleston
Tel: (304) 768-1232

*WEST VIRGINIA

Charleston
Tel: (304) 768-1232

*WEST VIRGINIA

Charleston
Tel: (304) 768-1232

*WEST VIRGINIA

Charleston
Tel: (304) 768-1232

*WEST VIRGINIA

Charleston
Tel: (304) 768-1232

*WEST VIRGINIA

Charleston
Tel: (304) 768-1232

*WEST VIRGINIA

Charleston
Tel: (304) 768-1232

*WEST VIRGINIA

Charleston
Tel: (304) 768-1232

*WEST VIRGINIA

Charleston
Tel: (304) 768-1232

*WEST VIRGINIA

Charleston
Tel: (304) 768-1232

*WEST VIRGINIA

Charleston
Tel: (304) 768-1232

*WEST VIRGINIA

Charleston
Tel: (304) 768-1232

*WEST VIRGINIA

Charleston
Tel: (304) 768-1232

*WEST VIRGINIA

Charleston
Tel: (304) 768-1232

*WEST VIRGINIA

Charleston
Tel: (304) 768-1232

*WEST VIRGINIA

Charleston
Tel: (304) 768-1232

*WEST VIRGINIA

Charleston
Tel: (304) 768-1232

*WEST VIRGINIA

Charleston
Tel: (304) 768-1232

*WEST VIRGINIA

Charleston
Tel: (304) 768-1232

*WEST VIRGINIA

Charleston
Tel: (304) 768-1232

*WEST VIRGINIA

Charleston
Tel: (304) 768-1232

*WEST VIRGINIA

Charleston
Tel: (304) 768-1232

*WEST VIRGINIA

Charleston
Tel: (304) 768-1232

*WEST VIRGINIA

Charleston
Tel: (304) 768-1232

*WEST VIRGINIA

Charleston
Tel: (304) 768-1232

*WEST VIRGINIA

Charleston
Tel: (304) 768-1232

*WEST VIRGINIA

Charleston
Tel: (304) 768-1232

*WEST VIRGINIA

Charleston
Tel: (304) 768-1232

*WEST VIRGINIA

Charleston
Tel: (304) 768-1232

*WEST VIRGINIA

Charleston
Tel: (304) 768-1232

FOR U.S. AREAS NOT LISTED:

Contact the regional office nearest you: Atlanta, Georgia... North Hollywood, California... Paramus, New Jersey... Skokie, Illinois. Their complete addresses are listed above.
*Service Only

FOR U.S. AREAS NOT LISTED:

Contact the regional office nearest you: Atlanta, Georgia... North Hollywood, California... Paramus, New Jersey... Skokie, Illinois. Their complete addresses are listed above.
*Service Only

FOR U.S. AREAS NOT LISTED:

Contact: Hewlett-Packard (Canada) Ltd. in Pointe Claire, at the complete address listed above.

FOR U.S. AREAS NOT LISTED:

Contact: Hewlett-Packard (Canada) Ltd. in Pointe Claire, at the complete address listed above.

FOR U.S. AREAS NOT LISTED:

Contact: Hewlett-Packard (Canada) Ltd. in Pointe Claire, at the complete address listed above.

FOR U.S. AREAS NOT LISTED:

Contact: Hewlett-Packard (Canada) Ltd. in Pointe Claire, at the complete address listed above.

FOR U.S. AREAS NOT LISTED:

Contact: Hewlett-Packard (Canada) Ltd. in Pointe Claire, at the complete address listed above.

FOR U.S. AREAS NOT LISTED:

Contact: Hewlett-Packard (Canada) Ltd. in Pointe Claire, at the complete address listed above.

FOR U.S. AREAS NOT LISTED:

Contact: Hewlett-Packard (Canada) Ltd. in Pointe Claire, at the complete address listed above.

CANADA

ALBERTA

Hewlett-Packard (Canada) Ltd.
1145 Jasper Ave.
Edmonton
Tel: (403) 482-5581
TWX: 610-831-2431

BRITISH COLUMBIA

Hewlett-Packard (Canada) Ltd.
4519 Canada Way
North Burnaby 2
Tel: (604) 433-8213
TWX: 610-922-5059

MANITOBA

Hewlett-Packard (Canada) Ltd.
511 Bradford Ct.
Winnipeg
Tel: (204) 786-7581
TWX: 610-871-3531

NOVA SCOTIA

Hewlett-Packard (Canada) Ltd.
2745 Dutch Village Rd.
Suite 206
Halifax
Tel: (902) 455-0511
TWX: 610-271-4482

ONTARIO

Hewlett-Packard (Canada) Ltd.
889 Lash, Ellen Place
Ottawa 3
Tel: (613) 265-6180, 255-6530
TWX: 610-582-1952

Hewlett-Packard (Canada) Ltd.
50 Dalrymple Blvd.
Markham
Tel: (416) 677-8611
TWX: 610-482-4246

QUEBEC

Hewlett-Packard (Canada) Ltd.
275 Hymus Boulevard
Pointe Claire
Tel: (514) 697-4222
TWX: 610-422-3022
Telex: 01-20607

FOR CANADIAN AREAS NOT LISTED:

Contact: Hewlett-Packard (Canada) Ltd. in Pointe Claire, at the complete address listed above.

CENTRAL AND SOUTH AMERICA

ARGENTINA

Hewlett-Packard Argentina
S.A.C. S.
Lavalle 1171 - 3.
Buenos Aires
Tel: 35-0436, 35-0627, 36-0431
Telex: 012-1009
Cable: HEWPACARG

BRAZIL

Hewlett-Packard Do Brasil
I.e.C. Ltda.
Rua Frei Caneca 1119
Sao Paulo - 3. SP
Tel: 285-9111, 287-5858
Cable: HEWPACB Sao Paulo
Hewlett-Packard Do Brasil
Praça Dom Feliciano 78
Sao Paulo 806/808
Porto Alegre
Rua Grande do Sul (RS)-Brasil
Tel: 25-8470
Cable: HEWPACB Porto Alegre
Hewlett-Packard Do Brasil
I.e.C. Ltda.
Rua da Matrix 29
Botafogo 20-02
Rio de Janeiro, RJ
Tel: 246-4417
Cable: HEWPACB Rio de Janeiro

CHILE

Mótor Cakagni & Cia. Ltda.
Bustos, 3323-3er Piso
Casilla 32947
Santiago
Tel: 423 98
Cable: CALCAGNI Santiago

COLOMBIA

Instrumentación
Henrik A. Langebaek & Kier
Ltda.
Carrera 7 No. 48-59
Apartado Aéreo 6287
Bogotá, D.C.
Tel: 45-78-06, 45-55-46
Cable: AARIS Bogotá
Telex: 44400 INSTCO

COSTA RICA

Lic. Alfredo Callegos Gurdíán
Apartado 10139
San José
Tel: 21-86-13
Cable: CALGUR San José

ECUADOR

Laboratorios de Radio-Ingeniería
Calle Guayaquil 1246
Post Office Box 3199
Quito
Tel: 212-498; 219-185
Cable: HORVATH Quito

EL SALVADOR

Electronic Associates
Apartado Postal 1682
Centro Comercial Gigante
San Salvador, El Salvador
Pasaje Escalon 4649-4th Piso
Tel: 23-44-50, 23-32-37
Cable: ELECSA

MEXICO

Hewlett-Packard Mexicana, S.A.
de C.V.
622 Adolfo Prieto
Cst. del Valle
Mexico 12, D.F.
Tel: 543-4232; 523-1874
Telex: 0017-74607

NICARAGUA

Roberto Terán C.
Apartado Postal 689
Edificio Tarán
Managua
Tel: 2451, 2452
Cable: ROTERAN Managua

PANAMA

EUROPE AFRICA, ASIA, AUSTRALIA



SALES & SERVICE OFFICES

EUROPE

AUSTRIA
Hewlett-Packard Ges.m.b.H.
Innstrasse 23/2
Postfach 45
A-1204 Vienna
Tel: (0222) 33 66 06-09
Cable: HEWPAK Vienna
Telex: 75923 hewpak a

BELGIUM
Hewlett-Packard Benelux
S.A./N.V.
Avenue du Col-Vert, 1
B-1170 Brussels
Tel: (02) 72 22 40
Cable: PALOBEN Brussels
Telex: 23 494

DENMARK
Hewlett-Packard A/S
Datavej 38
DK-3460 Birkerød
Tel: (01) 81 88 40
Cable: HEWPAK AS
Telex: 16640 hp as

Hewlett-Packard A/S
Torvet 9
DK-8000 Silkeborg
Tel: (06) 82-71-66
Telex: 18640 hp as
Cable: HEWPAKAS

FINLAND
Hewlett-Packard Oy
Bulevardi 25
P.O. Box 13185
SF-00120 Helsinki 12
Tel: 13-730
Cable: HEWPAKCOY-Helsinki
Telex: 12-1583

FRANCE
Hewlett-Packard France
Quartier de Courtabouff
Boulevard Pasteur No. 6
F-91 Orsay
Tel: (1) 907 78 25
Cable: HEWPAK Orsay
Telex: 60048

Hewlett-Packard France
4 Quai des Etoiles
F-69 Lyon 6ème
Tel: (78) 42 63 45
Cable: HEWPAK Lyon
Telex: 31817

Hewlett-Packard France
29 rue de la Gare
F-31 Blagnac
Tel: (61) 95 82 29
Telex: 51987

**GERMAN FEDERAL
REPUBLIC**
Hewlett-Packard Vertriebs-GmbH
Berliner Strasse 117
Postfach 580749
D-6 Miesdorf-Eschbach/Ffm 58
Tel: (0611) 50-04-1
Cable: HEWPAKSA Frankfurt
Telex: 41 32 49 FRA

Hewlett-Packard Vertriebs-GmbH
Herrenbergersstrasse 110
D-7030 Böblingen, Württemberg
Tel: (07031) 69 72 86
Cable: HEWPAK Böblingen
Telex: 72 65 739

Hewlett-Packard Vertriebs-GmbH
Vogelwanger Weg 38
D-4 Düsseldorf
Tel: (0211) 63 80 31/35
Telex: 85/86 533

Hewlett-Packard Vertriebs-GmbH
Wendenstr. 23
D-2 Hamburg 1
Tel: (0411) 24 05 31/52
Cable: HEWPAKSA Hamburg
Telex: 21 53 32

Hewlett-Packard Vertriebs-GmbH
Unterhägering Strasse 28
ISAR Center
D-8012 Obermunn
Tel: (031) 60 13 061-7
Telex: 05-24985
Cable: HEWPAKSA München
Telex: 31817

(West Berlin)
Hewlett-Packard Vertriebs-GmbH
Wilmerdorfer Strasse 119/114
D-1000 Berlin W. 12
Tel: (031) 3137065
Telex: 18 34 05

GREECE
Kostas Karayannia
18, Ermou Street
Athens 126
Tel: 230301,3,5
Cable: RAKAR Athens
Telex: 21 59 82 RAKAR GR

IRELAND
Hewlett-Packard Ltd.
224 Bath Road
Slough, SL1 4 DS, Bucks
Tel: Slough 753-3334
Cable: HEWPIE Slough
Telex: 84413

ITALY
Hewlett-Packard Italiana S.p.A.
Via Amerigo Vesputcci 2
I-20124 Milan
Tel: (2) 6251 (10 lines)
Cable: HEWPAKIT Milan
Telex: 32048

Hewlett-Packard Italiana S.p.A.
Via Marocco, 7
I-50144 Roma - Eur
Tel: (6) 591254/5, 5915347
Cable: HEWPAKIT Rome
Telex: 61514

LUXEMBURG
Hewlett-Packard Benelux
S.A./N.V.
Avenue du Col-Vert, 1
B-1170 Brussels
Tel: (02/02) 72 22 40
Cable: PALOBEN Brussels
Telex: 23 494

NETHERLANDS
Hewlett-Packard Benelux, N.V.
Weerdesteijn 117
P.O. Box 7825
Amsterdam, 2 11
Tel: 020-42 77 77
Cable: PALOBEN Amsterdam
Telex: 13 216

NORWAY
Hewlett-Packard Norge A/S
Box 148
Nesvegan 13
N-1344 Haslum
Tel: (02) 53 83 50
Telex: 16621

PORTUGAL
Teletra-Empresa Técnica de
Equipamentos
Eléctricos S.A.,r.l.
Rua Rodrigo de Fonseca 103
P.O. Box 2531
Lisbon 1
Tel: 68 60 72
Cable: TELETRA Lisbon
Telex: 1559

SPAIN
Hewlett-Packard Española, S.A.
Jerez No 8
Madrid 18
Tel: 458 28 00

SWEDEN
Hewlett-Packard Sverige AB
Eolighetsvägen 1-3
Fack
S-161 20 Bromma 20
Tel: (08) 98 12 50
Cable: MEASUREMENTS
Stockholm
Telex: 10721

Hewlett-Packard Sverige AB
Högskolegatan 9C
S-431 41 Malmö
Tel: (031) 27 68 00/01
Telex: 21 312 hpmlndis

SWITZERLAND
Hewlett-Packard (Schweiz) AG
Zürcherstrasse 20
CH-8052 Schlieren Zurich
Tel: (01) 98 18 21/24
Cable: HPAG CH
Telex: 53533

Hewlett-Packard (Schweiz) AG
Rue du Bois-du-Lan 7
P.O. Box 85
1217 Meyrin 2 Geneva
Tel: (022) 41 54 00
Cable: HEWPAKSA Geneva
Telex: 27353 HPSCA CH

TURKEY
Telekom Engineering Bureau
P.O. Box 376
Karaköy
Istanbul
Tel: 49 40 40
Cable: TELEKOM Istanbul

UNITED KINGDOM
Hewlett-Packard Ltd.
724 Bath Road
Slough, SL1 4 DS, Bucks
Tel: Slough (0753) 33341
Cable: HEWPIE Slough
Telex: 84413

Hewlett-Packard Ltd.
"The Craftsmen"
Stamford New Road
Attilackham, Cheshire
Tel: (061) 978-8626
Telex: 68A068

YUGOSLAVIA
Belron S.A.
83 avenue des Mimozas
Brussels 1150, Belgium
Tel: 34 33 32, 34 28 19
Cable: BELDAMEL Brussels
Telex: 21790

**SOCIALIST COUNTRIES
PLEASE CONTACT:**
Hewlett-Packard Ges.m.b.H.
Innstrasse 23/2
Postfach 45
A-1204 Vienna, Austria
Tel: (0222) 33 66 06-09
Cable: HEWPAK Vienna
Telex: 75923 hewpak a

**ALL OTHER EUROPEAN
COUNTRIES CONTACT:**
Hewlett-Packard S.A.
Rue du Bois-du-Lan 7
1217 Meyrin 2 Geneva
Switzerland
Tel: (022) 41 54 00
Cable: HEWPAKSA Geneva
Telex: 2.24.88

AFRICA, ASIA, AUSTRALIA

ANGOLA
Teletra Empresa Técnica
de Equipamentos Eléctricos
S.A.
Rua de Barbosa Rodrigues
42-1
Box 5487
Luanda
Cable: TELETRA Luanda

AUSTRALIA
Hewlett-Packard Australia
Pty. Ltd.
22-26 Weir Street
Glen Iris, 3146
Victoria
Tel: 20-1271 (6 lines)
Cable: HEWPAK Melbourne
Telex: 31024

Hewlett-Packard Australia
Pty. Ltd.
61 Alexander Street
Crows Nest 2065
New South Wales
Tel: 43-7886
Cable: HEWPAK Sydney
Telex: 21661

Hewlett-Packard Australia
Pty. Ltd.
97 Churchill Road
Prangins 5082
South Australia
Tel: 65-2366
Cable: HEWPAK Adelaide

Hewlett-Packard Australia
Pty. Ltd.
2nd Floor, Suite 13
Casablanca Buildings
196 Adelaide Terrace
Perth, W.A. 6000
Tel: 21-3330
Cable: HEWPAK Perth

Hewlett-Packard Australia
Pty. Ltd.
10 Woolley Street
P.O. Box 391
Dickson A.C.T. 2602
Tel: 45-8194
Cable: HEWPAK Canberra ACT

Hewlett-Packard Australia
Pty. Ltd.
4 Harward Street
P.O. Box 135
Newmore 4069 Queensland
Tel: 78 6069

CEYLON
Unilak Electricals Ltd.
P.O. Box 641
Yahala Buildings
Staples Street
Colombo 2
Tel: 8456
Cable: HOTPOINT Colombo

CYPRUS
Myronides
19 Gregorios & Xenopoulos Road
P.O. Box 1152
Nicosia
Tel: 628-78028
Cable: HEI-NAM

ETHIOPIA
African Salespower & Agency
Private Ltd., Co.
P.O. Box 718
58/59 Cunningham St.
Addis Ababa
Tel: 12285
Cable: ASACO Addisababa

HONG KONG
Schmidt & Co. (Hong Kong) Ltd.
P.O. Box 297
1511, Prince's Building 15th Floor
10, Chater Road
Hong Kong
Tel: 24018A, 232735
Cable: SCHMIDTCO Hong Kong

INDIA
Blue Star Ltd.
Kasturji Buildings
Jambhodji Tata Rd.
Bombay 20BR, India
Tel: 29 50 21
Telex: 2156
Cable: BLUEFROST

Blue Star Ltd.
Band Box House
Prabhadevi
Bombay 25DD, India
Tel: 45 73 01
Telex: 2156
Cable: BLUESTAR

Blue Star Ltd.
14/40 Civil Lines
Kampan, India
Tel: G 88 82
Cable: BLUESTAR

Blue Star Ltd.
7 Hara Street
P.O. Box 506
Calcutta 1, India
Tel: 23-0311
Telex: 655
Cable: BLUESTAR

Blue Star Ltd.
Blue Star House,
34 Ring Road
Lampat Nagar
New Delhi 24, India
Tel: 62 32 76
Telex: 463
Cable: BLUESTAR

Blue Star Ltd.
17-C Unsoor Road
Bangalore-8

Blue Star, Ltd.
96 Park Lane
Sacundrabad 2, India
Tel: 7 63 91
Cable: BLUEFROST

Blue Star, Ltd.
23/24 Second Line Beach
Mumbai 1, India
Tel: 2 39 55
Telex: 379
Cable: BLUESTAR

Blue Star, Ltd.
18 Kaiser Sunzawel
Dindli Road
Jamshedpur, India
Tel: 38 02
Cable: BLUESTAR

INDONESIA
Bah Balam Trading Coy. N.V.
Djajah Merdeka 29
Bandung
Tel: 4915; 51560
Cable: IKMU
Telex: 08-809

IRAN
Telecom, Ltd.
P.O. Box 1812
240 Kh. Sabz Shomal
Tehran
Tel: 43850, 48111
Cable: BASCOM Tehran
Telex: 2884

ISRAEL
Electronics & Engineering
Div. of Motorola Israel Ltd.
17 Aminadav Street
Tel-Aviv
Tel: 36841 (3 lines)
Cable: BASTEL Tel-Aviv
Telex: Bastel TV 033-569

JAPAN
Yokogawa-Hewlett-Packard Ltd.
Omahi Building
1-59-1 Yoyogi
Shibuya-ku, Tokyo
Tel: 03-370-2781/7
Telex: 232-2024YHP
Cable: YHPMARKET TOK 23-724

Yokogawa-Hewlett-Packard Ltd.
Nishi Ibaragi Bldg.
2-2-B Keage
Ibaragi-Shi
Osaka
Tel: (0726) 23-1643
Telex: 845-8332 YHPOSAKA

Yokogawa-Hewlett-Packard Ltd.
Ito Building
No. 59, Katori-cho
Nakamura-ku, Nagoya City
Tel: (052) 651-0215

Yokogawa-Hewlett-Packard Ltd.
Nitto Bldg.
2300 Shinonara-cho,
Koboku-ku
Yokohama 222
Tel: (405) 432-1604/5

JORDAN
Constantin E. Macridis
Clemenceau Street
P.O. Box 7213
Beirut, Lebanon
Tel: 220848
Cable: ELECTRONUCLEAR Beirut

KENYA
Kanya Kinetics
P.O. Box 18311
Nairobi, Kenya
Tel: 57728
Cable: PROTON

KOREA
American Trading Co.,
Korea, Ltd.
Seoul P.O. Box 1103
718 & 8th floors, Daekyung Bldg.
107 Sejong Rd.
Chongno-Ku, Seoul
Tel: 75-2841 (4 lines)
Cable: AMTRACOE Seoul

LEBANON
Constantin E. Macridis
Clemenceau Street
P.O. Box 7213
Beirut
Tel: 220848
Cable: ELECTRONUCLEAR Beirut

MALAYSIA
MECOMB Malaysia Ltd.
2 Lorong 13/6A
Section 13
Petaling Jaya, Selangor
Cable: MECOMB Kuala Lumpur

MOZAMBIQUE
A. N. Gouveias, LDA.
4-1 Av. 14 Av. D. Luis
P.O. Box 107
Lourammarques
Cable: NEGON

NEW ZEALAND
Hewlett-Packard (N.Z.) Ltd.
94-98 Orlson St.
P.O. Box 9442
Wellington, N.Z.
Tel: 55-355
Cable: HEWPAK Wellington
Hewlett-Packard (N.Z.) Ltd.
Box 11092
Pukeranga
Tel: 559-651
Cable: HEWPAK, Auckland

PAKISTAN (EAST)
Mushko & Company, Ltd.
1, Jinnah Avenue
Dacca 2
Tel: 280058
Cable: NEWDEAL Dacca

PAKISTAN (WEST)
Mushko & Company, Ltd.
Osman Chambers
Abdullah Hareem Road
Karachi 3
Tel: 511027, 512027
Cable: COOPERATOR Karachi

Mushko & Company, Ltd.
38B, Sahibul Towh
Rawalpindi
Tel: 41924
Cable: FEMUS Rawalpindi

PHILIPPINES
Electromex Inc.
5th Floor, Architects
Center Bldg.
Ayala Ave., Makati, Rizal
C.P.O. Box 1028
Manila, Rizal
Tel: 88-18-87, 67-76-77
Cable: ELEMEX Manila

SINGAPORE
Mechanical and Combustion
Engineering Company Ltd.
5, Jalan Kilang
Red Hill Industrial Estate
Singapore, 3
Tel: 642161-3, 832811
Cable: MECOMB Singapore

Hewlett-Packard Far East
Area Office
P.O. Box 87
Alexandria Port Office
Singapore 3
Tel: 633022
Cable: HEWPAK SINGAPORE

SOUTH AFRICA
Hewlett-Packard South Africa
(Pty.), Ltd.
P.O. Box 31716
Braamfontein Transvaal
Miltoner
38 De Beer Street
Johannesburg
Tel: 725-2080, 725-2030
Telex: 0226 JW
Cable: HEWPAK Johannesburg

Hewlett-Packard South Africa
(Pty.), Ltd.
Breechale House
Bree Street
Cape Town
Tel: 34019, 3-8545
Cable: HEWPAK Cape Town
Telex: 5-0006

Hewlett-Packard South Africa
(Pty.), Ltd.
841 Ridge Road, Durban
P.O. Box 99
Overport, Natal
Tel: 88-6102
Cable: HEWPAK

Hewlett-Packard South Africa
(Pty.), Ltd.
841 Ridge Road, Durban
P.O. Box 99
Overport, Natal
Tel: 88-6102
Cable: HEWPAK

TAIWAN
Hewlett-Packard Taiwan
39 Chung Shiao West Road
Sec. 1
Overseas Insurance
Corp. Bldg. 7th Floor
Taipei
Tel: 389180, 1.2, 375121,
Ext. 240
Telex: TP824 HEWPAK
Cable: HEWPAK Taipei

THAILAND
The International
Engineering Co., Ltd.
P.O. Box 95
614 Sukhumvit Road
Bangkok
Tel: 910722 (7 lines)
Cable: 6780M
TLX INTENCO 8X-22 Bangkok

UGANDA
Uganda Tele-Electric Co., Ltd.
P.O. Box 4449
Kampala
Tel: 57279
Cable: COMCO Kampala

Vietnam
Pindular Trading Inc.
P.O. Box M-3
238 Men-Vuong
Saigon
Tel: 20806, 63394
Cable: PENTRA, SAIGON 242

ZAMBIA
R. J. Tibury (Zambia) Ltd.
P.O. Box 2792
Lusaka
Zambia, Central Africa
Tel: 37393
Cable: ARJAYTEE, Lusaka

**MEDITERRANEAN AND
MIDDLE EAST COUNTRIES
NOT SHOWN PLEASE
CONTACT:**
Hewlett-Packard
Co-ordinating Office for
Mediterranean and Middle
East Operations
Via Marocco, 7
I-50144 Roma-Eur, Italy
Tel: (8) 59 40 29
Cable: HEWPAKIT Rome
Telex: 61514

**OTHER AREAS NOT
LISTED, CONTACT:**
Hewlett-Packard
INTERCONTINENTAL
2200 Hillview Ave.
Palo Alto, California 94304
Tel: (415) 328-7000
(Feb. 71 485-1501)
TWX: 910-373-1287
Cable: HEWPAK Palo Alto
Telex: 634-8461

ABOUT HEWLETT-PACKARD



GENERAL INFORMATION

Although Hewlett-Packard products are manufactured throughout the United States and other parts of the world, the Hewlett-Packard field office or distributor in your area is best equipped to handle all your needs concerning products described in this catalog, and for parts and service on Hewlett-Packard products you already own. The worldwide listing of field offices, representatives, and distributors, current at the time of publication, is found on pages 6 and 7.

Order by model number

Technical assistance in selecting equipment and preparing orders is available, without charge, from field engineers at all sales offices. When you place your order, please specify the catalog model number as well as the name of the product desired. Whenever you want special options or features, such as special color or non-standard power line voltage, ask your Hewlett-Packard field engineer about availability of these options, then, to prevent misunderstanding, include significant specifications and specific instructions in your order.

Many Hewlett-Packard instruments are supplied in cabinets along with easily attached hardware for direct mounting in

standard 19-inch equipment racks. Others are available in two configurations: one a cabinet for bench use and the other with a 19-inch panel for rack mounting. Catalog listings indicate the availability of cabinet or rack mounting arrangements.

Pricing policy and delivery information

Prices appearing in this catalog are net prices prevailing at the time of printing and are FOB USA factory or warehouse. They apply only to domestic USA customers and do not include an import surcharge on applicable products. Such surcharge is to be added to the price shown. Prices prevailing at the time the order is received will apply. Please consult your nearest field sales office to confirm prices at your location and to obtain current delivery information. Customers outside the USA should consult their local Hewlett-Packard sales organization for price information. Although the illustrations and product information in this catalog were current at the time the catalog was approved for printing, Hewlett-Packard, in a continuing effort to offer the finest equipment available, reserves the right to change specifications, designs, models or prices without notice.

FOR CUSTOMERS IN USA

Where to send your order

Your order should be made out to the Hewlett-Packard Company and sent to the Hewlett-Packard office nearest you. Each field office has special communication channels to Hewlett-Packard manufacturing facilities to assure prompt and efficient handling of your order.

Shipping methods

Shipments to destinations in the USA are made directly from local factories or warehouses. Unless specifically requested otherwise, express or truck transportation is used, whichever is less expensive and most serviceable to you. Small items are sent parcel post. If fast delivery is needed, we gladly ship by air freight, air express, or air parcel post, when specified on your order, at prevailing rates. In many parts of the USA, a

consolidated air freight service provides the speed of air transport at surface rates. Ask your field engineer for details.

Terms in the USA

Terms are net 30 days from invoice date. Leasing and extended financial terms are available. Your local Hewlett-Packard sales office will be pleased to discuss your requirements. Unless credit with Hewlett-Packard has already been established, shipments will be made COD or on receipt of cash in advance.

Quotations

Upon request, quotations including destination prices, will be furnished to you by your local Hewlett-Packard sales office.

FOR CUSTOMERS OUTSIDE THE USA

Pricing

Prices as listed in this catalog, unless otherwise noted, apply only to domestic USA customers; all other customers should consult their local Hewlett-Packard sales organization for price information.

Where to send your order

In many countries, your order can be placed directly with your local Hewlett-Packard distributor or representative. If there is none as yet in your area, your order should be placed directly with the office indicated for your part of the world.

Shipping methods

Shipments to customers outside the USA or Western Europe are made from the appropriate Hewlett-Packard facility by

either surface or air, as requested. Sea shipments usually require commercial export packaging at a nominal extra charge.

Terms

Terms for orders from countries outside the United States of America which are placed with the Hewlett-Packard Company, Hewlett-Packard S.A., or Hewlett-Packard Inter-Americas, are irrevocable letter of credit or cash in advance, unless other terms have been arranged previously. Terms for orders placed with authorized Hewlett-Packard distributors are mutually determined between customer and distributor.

Quotations and pro forma invoices

FAS, CIF, C&F, etc. quotations or pro forma invoices, as well as exportation and importation assistance, are available on request from local authorized Hewlett-Packard sales offices or representatives.

WHAT YOU CAN EXPECT WITH YOUR H. P. EQUIPMENT



SERVICES

Warranty

All Hewlett-Packard products are warranted against defects in materials and workmanship. The period of coverage is specified in the Operating and Service Manuals provided with each product. We will repair or replace, at our option, products which prove to be defective during the warranty period.

Certification

Products, materials, parts, and services furnished on this order have been provided in accordance with all applicable Hewlett-Packard specifications. Actual inspection and test data pertaining to this order is on file and available for examination.

Hewlett-Packard's calibration measurements are traceable to the National Bureau of Standards to the extent allowed by the Bureau's calibration facilities.

The Hewlett-Packard Quality Program satisfies the requirements of MIL-Q-9858, MIL-I-45208, and MIL-C-45662.

Assurance that your equipment will continue to perform as expected for years to come is provided by Hewlett-Packard's world-wide Customer Service organization. There is a Hewlett-Packard field office not far from you—you don't have to correspond with a factory several thousand miles away to get information, replacement parts, or service assistance when you need it. This customer service program is one of the major factors in Hewlett-Packard's reputation for integrity and responsibility towards its customers.

Customer Service Agreements

Your instrument maintenance needs in many cases may be handled most economically by entering into a Hewlett-Packard Customer Service Agreement. When you have a customer service agreement, Hewlett-Packard assumes your maintenance responsibilities for a basic annual charge, relieving you of the need for hiring your own trained specialist, for maintaining replacement parts inventories, and for doing the paperwork needed for maintenance scheduling.

Contact your nearby Hewlett-Packard field office for details.

Replacement Parts

Hewlett-Packard makes every effort to shorten spare parts delivery time and as a result, over 90% of the replacement parts orders are filled the same day they are received.

To sustain equipment operation in remote areas, or where equipment downtime is extremely critical, spare parts kits are available.

When ordering a replacement part, please specify the Hewlett-Packard part number listed in the table and give the complete name.

If circumstances require your ordering a part without specifying the part number, please include in your order the instrument model number, its serial number, a complete description of the part, its function, and its location in the equipment.

Repair Service

Help in maintaining your Hewlett-Packard equipment in first-rate operating condition is as close as a phone call to the nearest Hewlett-Packard field office. Whether you want to repair an instrument yourself, or send it to a Hewlett-Packard facility for repair, recalibration, or overhaul, your local Hewlett-Packard field office can offer a complete range of technical assistance.

Local repair facilities are backed up by Regional Repair Centers, located in major industrial areas around the world. The Regional Repair Centers have more sophisticated test equipment, factory-trained specialists, and a full line of replacement parts.

If your equipment installation is fixed, and if justified by the type of service required, Hewlett-Packard will perform service at your facility.

You have access to all of Hewlett-Packard's extensive service network through your local Hewlett-Packard field office.

Service Publications

The Operating and Service Manual supplied with each Hewlett-Packard product contains maintenance, calibration, diagnostic and repair procedures, with trouble-shooting charts and complete circuit diagrams. All replaceable parts are listed. Extra manuals are available at reasonable cost from your nearby Hewlett-Packard field office. Most operating and service manuals with changes and service notes are now available on COSATI standard, positive microfiche.

New or special calibration procedures, instrument modifications, and special repair procedures are described in detail in the Hewlett-Packard Service Notes. This series of publications serves as a convenient means for updating Operating and Service Manuals.

Bench Briefs, a periodic newsletter, has servicing tips, new modifications and other suggestions to help repair and maintenance personnel get maximum performance from Hewlett-Packard instruments. It describes new Service Notes and other company publications as they become available. To become a regular subscriber, merely ask your local Hewlett-Packard field office to place your name on the mailing list.

TRAINING



TECHNICAL TRAINING

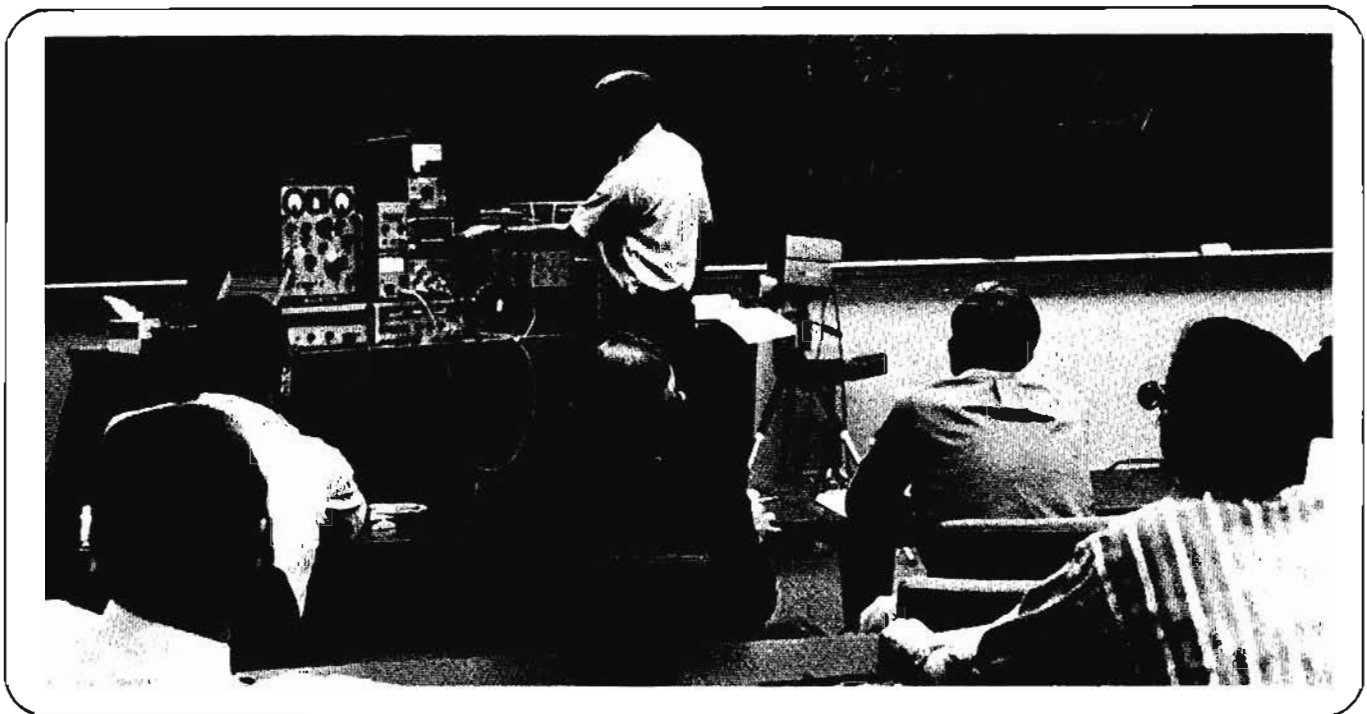

Hewlett-Packard Technical Training Seminars are held at your local Hewlett-Packard sales office or at the Hewlett-Packard Corporate Training Department in Palo Alto, California.

These seminars are instructed by Hewlett-Packard engineers, each a specialist in his field.

Purpose of seminars

To offer you the skill and knowledge necessary to assure the correct use and maintenance of your Hewlett-Packard instruments.

Facilities

Hewlett-Packard has modern facilities available. These include separate labs for various instrument groups, lecture rooms with the latest audio-visual capabilities, and videotape viewing rooms with a complete library of Hewlett-Packard videotapes.

Types of seminars

Applications Oriented Seminars: In these seminars engineers and technicians will be instructed in the use of Hewlett-Packard products:

- a. Basic Microwave Measurement
- b. Microwave Measurement Techniques
- c. RF Measurement Techniques
- d. Network Analyzer—Operation & Maintenance
- e. Spectrum Analyzer—Operation & Maintenance
- f. Voltmeter—Application & Operation
- g. Frequency Measurements Techniques
- h. Oscilloscope Applications
- i. Calculators
- j. Computers (fee charged)

Service Oriented Maintenance Seminars: Service oriented seminars are held only in the field. These seminars train service personnel in the maintenance, calibration and repair of Hewlett-Packard products making it possible for you to have factory trained maintenance technicians in your own service department.

- a. Analog Voltmeter, Distortion Analyzer & Oscillator
- b. Digital Voltmeter
- c. Electronic Counter
- d. Oscilloscope
- e. Medical Instrumentation*
- f. Sampling Oscilloscope
- g. Solid State Power Supply*
- h. Spectrum Analyzer & Sweep Oscillator

* These seminars are held in-plant and in the field.

Seminar duration

The seminars are from one to five days in length, depending upon the complexity of the subject; included will be lectures, demonstrations and hands-on experience with the instruments.

Expense

Seminar attendees need provide only their own travel and living expenses. (Special seminars may be arranged in your plant for a limited charge.)

Detailed information

Contact your local Hewlett-Packard sales office, or
 Corporate Training Department
 640 Page Mill Road
 Palo Alto, California, 94304
 (415) 493-1212

VIDEO TAPES

A Better Way to Learn



TRAINING

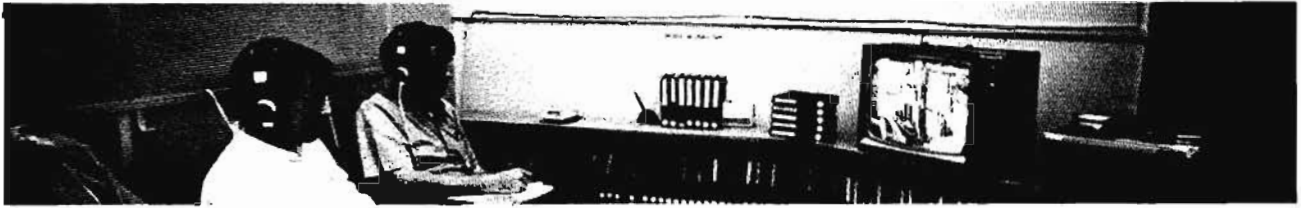

More effective: Hewlett-Packard programs are proof that videotape can be a highly effective training medium. Hewlett-Packard videotapes convey more information in less time, and with higher retention, than even the best live instruction. Hewlett-Packard programs are produced with measurable instructional objectives. They consider what the student already knows, emphasize what he needs to know, and omit what he does not need to know.

More flexible: With videotapes, you can tailor your training program to better suit the many different needs of your organization. You can select training programs for individuals with different backgrounds and specific needs, present effective programs to audiences of 1 or hundreds, and offer a library of technical programs your staff members can easily consult on their own for new information or for refresher purposes.

Less time-consuming: It's our experience that Hewlett-Packard video programs compress learning time by a factor of four to one. A videotape library also reduces the time needed to organize and schedule your training. You

can schedule highly professional presentations anywhere, anytime and anyplace—without arranging for outside instructors, or juggling the detailed "logistics" that often are required for live training sessions.

More convenient: Videotape programs come on small, easy-to-file reels of magnetic tape. Inexpensive playback equipment is easily operated by unskilled personnel. Programs may be viewed on small portable monitors, or on full screen TV sets. Videotapes can be quickly searched for specific information via fast forward or fast rewind, and many recorders can stop on a single frame for detailed study.

More valuable: "Instant replay" is only one benefit of video training. On many videotapes, split-screen techniques let your students simultaneously watch a procedure demonstrated on one half of the screen, and see the effect of that action on the other half. Videotapes also clarify sequences that are difficult to follow in print, and provide close-ups that are impossible to show in a conventional classroom lecture.



Consider What We Offer

A BEST SELLER

George Stanley's *Practical Transistor Course* (15 tapes with text and exams)

The most valuable "How To" Series.

HOW TO:
Use HP Instruments
Maintain HP Instruments



The Incomparable

HP Medical Series
Nurses' Training (ECG, ICU/CCU, and many more)
Maintaining HP Medical Instruments

Just to name a few



For more information on

- Tapes
- Formats
- Equipment
- Prices

Contact:

Your local Hewlett-Packard Field representative, or,
Hewlett-Packard Company
Corporate Training Department
640 Page Mill Road
Palo Alto, California 94304
(415) 493-1212

ALPHABETICAL INDEX



A

AC/DC Converter	177
AC/DC Meter Calibrator	251
A/D, D/A Converters	170
Accessories	
Acoustics	396
Analog Meter	39, 40, 54, 57, 77
Analog Tape Recorder	199
Blank Plug-ins (140 and 180 Series)	142
Cables	40, 256, 348, 413
Cases and Enclosures	414-416
Decade Capacitor	56
Digital Meter	73
Electronic Counter	216
Oscilloscope	119, 140
Oscilloscope Plug-in Extenders	142
Power Supply	166
Sampling Oscilloscope	110, 119
Signal Source/Generator	256, 266, 269
Sweep Drive for 302A/310A	378
Time Domain Reflectometry	119
Transit Cases	416
Acoustic Analyzer	389, 394
Active Probes	141, 363, 395
Adapters	
Coaxial & Waveguide	342
50 to 75 ohm	119
Probe	141
Airport Noise Monitoring System	395
Ammeters	
AC Current	57
Analog	37-39, 41, 49, 57
Clip on	39, 57
DC Current	37, 41, 49, 68, 71
Digital	37-39, 61, 68, 69
Amplifiers	
AC	27, 28
Cable	396
Charge Sensitive	397
Data	29
Differential	26, 30
Frequency Standard Distribution	243
General-Purpose	27-31
Linear	398
Microphone	396
Logarithmic	47
Power/DC Source	27
Precision	28
Pulse	28
RF/Microwave	31
Video (for counters)	217
Wideband	30
Amplifier/Low Pass Filter	393
Amplifier/Power Supply	168
Analog Meters, see Meters, Analog	
Analog Tape Recorders	197

Analyzers

Audio Spectrum	389, 391-394
Distortion	372, 373
Fourier	389-391
Microwave Link	354, 355
Multichannel	397-398
Network	356-370
Power Spectrum	389
Real Time, Spectrum	389, 394
Signal, Digital	389, 394
Spectrum	379, 394
Transistor Noise	77
Vibration	389
Wave	350, 374
Wave, Digital	388-394
Arithmetic Unit, Fast Fourier	389
Atomic Clock	238, 240
Attenuators	
75 ohm	355
600 ohm	56
Coaxial	327
Telephone Test	348
Waveguide	329
X-Y Recorder	176
Automatic Compensator	78
Automatic Test Systems	370, 381, 405
Averager, Signal	390

B

Bit Error Detector	311
--------------------	-----

C

Cabinets & Enclosures	414-416
Cable Fault Locators	1
Cables, General-Purpose Accessory	256, 413
Calculator & Peripherals	408, 409
Calibrators	
AC Voltmeter	251, 255
AC/DC Voltmeter/Ammeters	252
DC Voltmeter	251, 253
Horizontal Gain	140
Sound Level	396
Camera, Oscilloscope	143
Camera, Oscilloscope Accessories	145
Capacitance Meters	
Bridge	50, 54, 55
R,C,L, & D	50, 53
Card Readers, Mark/Sense	402
Carrier Preamplifier	195
Chart Advance	180
Chart Recorders	182
Clip, Logic	81
Clock, Atomic	238, 240

Clock, Digital	200	Couplers, Directional (Coax & Waveguide)	330
Coaxial Instrumentation and Accessories	324-342	Crystal Detectors	333
Communication Test Equipment			
Microwave Link Analyzer	354		
Portable Test Set	348		
Psophometer	346		
Selective Voltmeter	350-352		
Sweep Oscillator	353		
Test Oscillator	347, 349		
Transmission and Noise	346		
Comparators			
Analog	55		
Digital	70, 71		
Logic	81		
Components	410		
Computerized Data System	230		
Computer of Average Transients	390		
Computers and Peripherals			
Data Logger	403		
Digitally Programmable Power Supplies ..	170, 171, 404		
Displays	83		
Fast Fourier Arithmetic Unit	389		
Systems interface	404		
Computing Counter	230		
Converters			
AC to DC	45, 177		
A/D, D/A	170		
D to A	185		
Frequency	216		
Logarithmic	47		
RF to IF	355		
Rise Time	119		
V to F	72, 260-261, 263		
Controller, Pre-set count/rate	217, 230, 233		
Correlator	389, 391		
Counters, Electronic			
Accessories	216		
Automatic Ranging	218, 230, 234		
Computing	230		
Counter/Timers, Electronics	207-234		
Digital Voltmeter for	216		
Heterodyne Converter for	216		
Microwave	216, 228		
Normalizing Unit for	217		
Plug-in Type	213-215		
Portable Battery Operated	218		
Prescaler for	217		
Pre-set Normalizing	217, 233		
Reciprocal Taking	230, 234		
Snap-Together Type	218		
Summary	212		
Time Interval	217-218, 222, 230		
Timer, Built-In DVM	222		
Transfer Oscillator	216		
Video Amplifier	217		
Coupler/Controller	203		
		D	
		D/A Converters	170
		Data Acquisition Systems	
		Computerized	406
		Coupler/Controller	203-206
		Data Loggers	64, 403
		DC Offset for X-Y Recorder	176
		DC Power Supplies	
		Digitally programmable	170
		Industrial and Laboratory	148-168
		Modular	169
		Options and Accessories	166
		Delay Generator	233, 308
		Detectors	
		Bit Error	311
		Crystal, Coaxial and Waveguide	333
		Directional	351-353
		Null	37
		Optical, Radiant Flux (Power)	76
		Slotted Line	335
		Differential Amplifier	26
		Differential Voltmeters	36, 253
		Digital	
		AC Meters	61-71, 73
		Clock	200
		Ammeters	61, 68-69
		Computer Peripherals	170, 404
		DC Meters	61-71, 73-75
		Decibel Meters	62, 63
		Multimeters	61-71, 73
		Ohmmeters	61, 64-71
		Output Control	390
		Panel Meter	60
		Power Meters (RF/Microwave)	316
		Ratio Meter	70-71
		Recorders	200
		Signal and Spectrum Analyzers	388
		Tape Recorders	401
		Transistor Noise Meter	77
		True RMS Meters	62, 64-67, 70-71
		Voltmeters, DC	61-71, 73-75, 216, 222
		Digitally Programmable Power Supplies	170
		Directed Beam Display	84, 90
		Directional Couplers	
		Coaxial	330
		Waveguide	332
		Directional Detectors	331, 353
		Disc Recorders	400
		Discriminator, FM	234
		Displacement Transducers	82

ALPHABETICAL INDEX



Displays	
Computer Graphic	84
Directed Beam	90
Graphic, Storage	86
Large Screen X-Y	88
Panel Meter	60
Precision Raster	91
Spectrum	391
System	89
Distance Measuring Instruments	
Distance Meter	79
Laser Interferometer	78
Distortion Analyzers	372
Distortion Test Set	354
Down Converter	216, 355
Dual Channel Sampler	108

E

Electronic Counters (see: Counters)

F

Fast Fourier Transform Arithmetic	389
Filters	
Coaxial and Waveguide	338
High-Pass	119
Low Pass	393
Tracking/Tunable	386
FM Discriminator	234
Fourier Analyzer	389
Frequency Limit Detector	230, 233
Frequency Meters	
Analog	234
Coaxial and Waveguide	339
Frequency Standards	
Cesium	240
Distribution Amplifier	243
Quartz	237
Reference System	243
Rubidium	238
Standby Power Supply	244
VLF Receiver	242
Frequency Synthesizers	245, 264, 270
Function Generator	249, 259, 263

G

Galvanometric Recorders	188-196
Generators	
Function	249, 259, 263
Marker	286
Pseudorandom Bit Sequence	311

Pseudorandom Noise	392, 396
Pulse	296
Signal	267-283, 286
Square Wave	296
Sweep	260, 263, 353, 359, 284-295
Tracking	386
Word	298, 312
Graphic Plotter	402

H

Histogram Computer	390
Horizontal Gain Calibrator	140

I

IC Troubleshooters	81
Incremental Chart Advance	180
Interferometer, Laser	78

K

Keyboard, Computing Counter	232
-----------------------------------	-----

L

Laser Interferometer	78
Loads/Terminations, Coaxial and Waveguide	337
Logarithmic	
Amplifier	47
Voltmeter	44, 47
Logic	
Clip	81
Comparator	80
Probe	81
Troubleshooting	80

M

Mark/Sense Card Reader	402
Marker Generator	140, 286
Medical Instrumentation	2, 3
Memories, Disc/Tape	400
Meter Calibrator, AC/DC	252
Meters, Analog	
AC Voltage	40-46
Current	37, 41, 49, 57
DC Voltage	36-38, 40, 41

Differential	36, 253, 254
Frequency	234
Impedance	49, 50, 53, 55, 360
Logarithmic Voltmeters	44, 45, 47
Noise Figure	320
Multi-Function	36-38, 40, 41, 49
Power	315-319
Phase	53
Ohmmeter	38, 40, 41, 49
Q Meter	51, 52
Radiant Flux (Optical Power)	76
RMS Responding	46
SWR	343-344
Meters, Digital	
AC Voltage	61-71, 73
Current	61, 68, 69
DC Voltage	61-71, 73-75
Decibel	62, 63
Multi-Function	61-71, 73
Power (RF/Microwave)	316
Ratio	70, 71
Resistance	61, 64-71, 73
Transistor Noise	77
True RMS	62, 64-67, 70, 71
Microphone, Condenser	396
Microwave Link Analyzer	354
Microwave Test Equipment	216, 228, 315-344
Mixers, Coaxial and Waveguide	269, 341, 387
Modular Power Supplies	169
Modulators	283
Monitor, TV	91
Multichannel Analyzer	397, 398
Multimeters	
Analog	36-38, 40, 41, 49, 253-254
Digital	61-71, 73
Multiparameter Analyzer	398
Multiphase Clock Generator	312
Multiprogrammers	404

N

Narrow Band TDR	118
Network Analyzers	356-370
Noise Analyzers	
Transistor	77
Transmission and Noise	346
Noise Figure Measurement Equipment	320
Noise Generator, Pseudorandom	392, 396
Noise Sources	320
Noise Monitoring System	395
Nuclear Instrumentation	397, 398

O

OEM Recorders	179, 186
Ohmmeters	
Analog	38, 40, 41, 49
Digital	61, 64-71
Optical Mark/Sense Card Reader	402
Optical Radiant Flux Meter/Detector	76
Oscillators	
Audio	256
Communications	262, 347, 349
Digital	258
Low Frequency	256
Quartz	237
RF	272
Sine/Square	257
Sweep	260, 263, 284-295, 353
Test	262, 347, 349
Transfer	216
Wideband	251, 256, 257, 262
Oscillographic Recorders	188
Oscilloscopes	
140 Series: Plug-in, DC-20 MHz, 18 GHz Sampling	130
180 Series: Plug-in, DC-6 MHz, 18 GHz Sampling	96
1200 Series: 500 kHz, 7 MHz	135
1700 Series: DC-150 MHz, Portable	120
Accessories	140
Bezel Adapters, Camera	145
General Information	92-95
High Writing Speed	99
Large Screen	98, 132
Low Frequency	139
Testmobiles	146, 147
TV Waveform	139
Variable Persistence/Storage	100, 124, 132, 135

P

Panel Covers	142
Panel Meters	60
Phase Measurement Equipment (see Network Analyzers)	
Phase Sensitive Demodulator	195
Phase Shifters, Waveguide	341
Plotters, X-Y	173, 402
Point Plotter	176
Point Plotting System	177
Portable Oscilloscopes	120-124
Potentiometric Chart Recorders	182
Power Measurement Equipment	315-319
Power Supplies	
Atomic Clock	244
DC Modular	169
Digitally Programmable	170, 171
Frequency Standards	244

ALPHABETICAL INDEX



Industrial and Laboratory	148-168
Microphone	396
Options and Accessories	166
Printer Interface	221, 390
Printers, Digital	200
Probe, Logic	81
Probe Power Supply	141
Probes, Voltage divider	57, 140
Processor, Fourier	389
Programmer, Computing Counter	231
Pulse Generators	119, 233, 296-314

Q

Q-Meters, Direct-reading	51
Quartz Thermometer	412

R

Radiant Flux Meter/Detectors (Optical Power)	76
Raster Display, Precision	91
Rate Generators	307
Rate Limit Detector	233
Ratio Meters	36, 70, 344
Receiver, VLF	242
Recorders	
Analog Chart	182-196
Analog Tape	197-199
Digital Printer	200
Digital Tape	401
Disc	400
Oscillographic	188-196
Strip Chart	182
X-Y	173
Remote Interferometer	78
RF to IF Converter	355
Rise Time Converters	119

S

Sampler, 4 or 18 GHz	109
Sampling Head, 12.4 GHz	118
Sampling Head, 18 GHz	110, 134
Sampling Time Bases	134
Sampling Vertical Amplifier	134
Scanner, for X-Y Recorder	176
Sensors, Displacement & Velocity	82
Servo Chart Recorders	182
Shorts, coaxial & waveguide	337
Signal Analyzers	388-394
Signal Averager	390
Signal Generators	
Accessories	269
Avionics	282

RF/Microwave	267-283, 286, 359
Telemetry	276, 282
Slides, Oscilloscope	142
Slot Power Supplies	169
Slotted Lines, coaxial & waveguide	334-336
Sound Analysis	388-396
Sound Level Calibrator	396
Spectrum Analyzers	379-398
Spectrum Display	391
Spectrum Stabilizer, Nuclear	398
Standards	
DC	253
Frequency (see Frequency Standards)	
Transfer	251
Standing-Wave-Ratio (SWR) Meters	343
Strip Chart Recorders	182
Sweep Oscillators	260, 263, 284-295, 359
Swept Frequency Indicator	
Switches, coaxial	341
Synchronizers, Phase-lock	274, 295
Synthesizers, Frequency	245, 264, 270

T

Tachometer Readout	233, 234
TDR	116
Temperature Module, for Chart Recorder	183
Terminations, coaxial & waveguide	337
Test Sets and Noise Analyzers	
Psophometer	346
Telephone Test Set	348
Transistor Noise	77
Transmission and Noise	346
Testmobiles	146
Thermistor Mounts, coaxial & waveguide	317
Thermometer, Quartz	412
Time Base, for X-Y Recorders	180
Time Base and Sweep Expanders	112
Time Domain Reflectometer	116, 134
Time Interval Counters	213, 218, 222, 230, 233
Time Interval Generator	233
Time Mark Generator	140
Time Standard	238, 240, 243
Time Standard Reference System	243
Tracking Generators	386
Transducers	
Angle	78
Displacement	78, 82
Linear Velocity	78, 82
Transistor Testing Instrumentation	363, 365, 367
Trigger Countdown	110
Tuners, Microwave	341
Tunnel Diode	110, 118
TV Monitor	91

V

VLF Receiver	242
Vibration Analyzer	389, 391, 394
Viewing heads	142
Voltage Calibrators	
AC	251, 255
AC and DC	251
DC	251, 253, 254
Voltage Source, Precision AC	255
Voltage Source, Precision AC/DC	252
Voltage Standards	
AC	255
DC	253
DC Transfer	251
Voltmeters	
Accessories	39, 40, 52, 54, 57, 73, 74
Analog	33-38, 40-46, 253
Digital	58-71, 73-75
Differential	36, 253
Logarithmic	44, 45, 47
RF	42
Selective	350-352
Vector	361

W

Waveform Analyzers	350, 374, 388-391
Waveguide Instrumentation & Accessories	326-342
Wideband Oscilloscope	101
Word Generator	298, 312

X-Y

X-Y Plotter	402
X-Y Recorders	173-182

MODEL NUMBER INDEX



2FA 2-Pen X-Y Recorder	178
3LV series Linear Velocity Transducers	82
6LV series Linear Velocity Transducers	82
7LV series Linear Velocity Transducers	82
7DCDT Displacement Transducer	82
24DCDT Displacement Transducer	82

100

105A Quartz Oscillator	237
105B Quartz Oscillator	237
117A VLF Receiver	242
120B Oscilloscope	139
130C Oscilloscope	139
136A 2-Pen X-Y Recorder	178
140B Oscilloscope Mainframe	132
140T Spectrum Analyzer-Display Section	385
141B Variable Persistence/Storage Mainframe	132
141T Spectrum Analyzer-Display Section	385
143A Large Screen Oscilloscope	132
143S Spectrum Analyzer-Display Section	385
180 series Oscilloscopes	96
180C/D High Writing Speed Oscilloscope Mainframe	99
181A/AR Variable Persistence/Storage Mainframe	100
182A Large Screen Oscilloscope Mainframe	98
183A-183D Wideband Oscilloscope Mainframe	101
190A Q Meter	52
191A TV Waveform Oscilloscope	139
195A Oscilloscope Camera	144
197A Oscilloscope Camera	143
198A Oscilloscope Camera	143

200

200AB Audio Oscillator	256
200CD Oscillator, Wideband	256
201C Oscillator Audio	256
202C Oscillator Low Frequency	256
202H FM-AM Signal Generator	276
202J FM-AM Signal Generator	276
203A Oscillator, Variable Phase	259
204C Oscillator	257
204D Oscillator	257
207H Univector	276
209A Sine/Square Oscillator	257
211A Crystal-Monitored Signal Generator	282
211B Square Wave Generator	314
214A Pulse Generator	314
221A Square Wave Generator	314
226A Time Mark Generator	140
230B RF Power Amplifier	32
232A Glide Slope Signal Generator	282
236A Telephone Test Oscillator	347
236A Option H10 Telephone Test Oscillator (CCIT)	347
250B RX Meter	53
281 series Coaxial-Waveguide Adapters	342
292 series Waveguide-Waveguide Adapters	342
297A Sweep Drive	378

300

302A Wave Analyzer	378
310A Wave Analyzer	378
312A Selective Voltmeter	350
313A Tracking Oscillator	350
320 2-Channel Oscillographic Recorder	188
321 2-Channel Oscillographic Recorder	188
322A 2-Channel Oscillographic Recorder	188
331A Distortion Analyzer	373
332A Distortion Analyzer	373
333A Distortion Analyzer	373
334A Distortion Analyzer	373
340B Noise Figure Meter	320
342A Noise Figure Meter	320
343A VHF Noise Source	320
345B IF Noise Source	320
347A series Noise Sources	320
349A Noise Source	320
350D Attenuator Set	56
353A Patch Panel	348
354A Step Attenuator	328
355 series Step Attenuators	328
360 series Coaxial Low-Pass Filters	338
362A series Waveguide Low-Pass Filters	338
375 series Waveguide Variable Attenuators	329
382 series Waveguide Precision Variable Attenuators	329
393A Coaxial Variable Attenuator	328
394A Coaxial Variable Attenuator	328

400

400D AC VTVM	44
400E AC Voltmeter	45
400EL AC Voltmeter	45
400F AC Voltmeter	45
400FL AC Voltmeter	45
400GL Logarithmic AC Voltmeter	45
400H AC VTVM	44
400L Logarithmic AC VTVM	44
403A AV Voltmeter	43
403B AC Voltmeter	43
410C Multifunction Voltmeter	41
412A DC Volt-Ohm-Ammeter	38
415B SWR Indicator	344
415E SWR Meter	343
416B Ratio Meter	344
419A DC Null Volt-Ammeter	37
420B Coaxial Crystal Detectors	333
422A series Waveguide Crystal Detectors	333
423A Coaxial Crystal Detector	333
424A series Waveguide Crystal Detectors	333
425A DC Micro-Volt-Ammeter	38
427A Multi-Function Meter	40
428B Clip-on Milliammeter	39
430C Power Meter	318
432 series Power Meters	316
434A Calorimetric Power Meter	319
440A Detector Mount	336

442B Slotted Line RF Probe	336
444A Slotted Line Detector	335
446B Slotted Line Detector	336
447B Slotted Line Detector	335
448A Slotted Line Sweep Adapter	336
456A Current Probe for Voltmeters	57
461A AC Amplifier	28
462A Pulse Amplifier	28
463A Precision AC Amplifier	28
465A AC Amplifier	27
467A Power Amplifier/Supply	27
477B Coaxial Thermistor Mount	318
478A Coaxial Thermistor Mount	317
X485A Waveguide Detector Mount	333
486A series Waveguide Thermistor Mounts	317
487B series Waveguide Thermistor Mounts	318
489A Microwave Amplifier	32
491C Microwave Amplifier	32
493A Microwave Amplifier	32
495A Microwave Amplifier	32

500

532 series Waveguide Frequency Meters	339
536A Coaxial Frequency Meter	339
537A Coaxial Frequency Meter	339
562A Digital Recorder	202
580A Digital to Analog Converter	185
581A Digital to Analog Converter	185

600

606A Signal Generator	274
606B Signal Generator	274
608E Signal Generator	275
608F Signal Generator	275
612A Signal Generator	277
614A Signal Generator	279
616B Signal Generator	279
618C Signal Generator	280
620B Signal Generator	280
626A Signal Generator	281
628A Signal Generator	281
651B Test Oscillator	262
652A Test Oscillator	262
653A Test Oscillator	349
653A Opt. H01 Test Oscillator	349
654A Test Oscillator	262
675A Sweeping Signal Generator	359
675A/676A Network Analyzer	359
680 Strip Chart Recorder	184

700

712C DC Power Supply	168
721A DC Power Supply	157
735A DC Transfer Standard	251
738BR Opt. E02 Voltmeter Calibrator	251

740B DC Standard/ Δ Voltmeter	253
741B AC-DC Differential Voltmeter/DC Standard	254
745A AC Calibrator	255
746A High Voltage Amplifier for 745A	255
752 series Waveguide Directional Couplers	332
774D Coaxial Dual Directional Coupler	330
775D Coaxial Dual Directional Coupler	330
776D Coaxial Dual Directional Coupler	330
777D Coaxial Dual Directional Coupler	330
778D Coaxial Dual Directional Coupler	330
779D Coaxial Directional Coupler	331
784A Coaxial Directional Detector	353
786D Coaxial Directional Detector	331
787D Coaxial Directional Detector	331
788C Coaxial Directional Detector	331
789C Coaxial Directional Detector	331
796D Coaxial Directional Coupler	331
797D Coaxial Directional Coupler	331
798C Coaxial Directional Coupler	331

800

805C Coaxial Slotted Line	334
809C Universal Carriage	335
810B series Waveguide Slotted Sections	335
814B Carriage	336
815B series Waveguide Slotted Sections	336
816A Coaxial Slotted Section	335
817A Coaxial Swept Slotted Line System	334
870A series Waveguide Slide-Screw Tuners	340
885A series Waveguide Phase Shifters	340
895A DC Power Supply	164

900

905A Coaxial Sliding Load	337
907A Coaxial Sliding Load	337
908A Coaxial Termination	337
909A Coaxial Termination	337
910 series Waveguide Terminations	337
911A Coaxial Sliding Load	337
914 series Waveguide Sliding Loads	337
920 series Waveguide Moving Shorts	337
X923A Waveguide Sliding Short	337
X930A Waveguide Shorting Switch	337
P932A Waveguide Harmonic Mixer	341
934A Coaxial Harmonic Mixer	341
938A Frequency Doubler Set	281
940A Frequency Doubler Set	281

1000

1051A Combining Case	415
1052A Combining Case	415
11046A Combining Case	415
1104A Trigger Countdown	110
1105A-1106B 20 ps Pulse Generator	119
1105A-1108A 60 ps Pulse Generator	119
1106A Tunnel Diode	118

01-MIS
15-A FAE

MODEL NUMBER INDEX



1106B Tunnel Diode	110
1108A Tunnel Diode	110, 118
1109B High-Pass Filter (Type N)	119
1116A Testmobile	147
1117B Testmobile	146
1118A Testmobile	147
1119A,B,C,D Testmobiles	146
1120A 500 MHz Active Probe	141
1121A AC Probe	363
1122A Probe Power Supply	141
1124A 100 MHz Active Probes	141
1129A High-Pass Filter (GR 874)	119
1200A,B Dual Trace Oscilloscope, 100 μ V/div	135
1201A,B Dual Trace Storage Oscilloscope, 100 μ V/div	135
1202A,B 500 kHz, 100 μ V/div Oscilloscope	135
1205A,B Dual Trace Oscilloscope 5mV/div	135
1206A,B 5 mV/div, 500 kHz Oscilloscope	135
1208A,B Display	89
1217A,B 7 MHz, 5 mV/div Dual Trace Oscilloscope	135
1300A X-Y Display	88
1310A Computer Graphic Display	84
1311A Computer Graphic Display	84
1330A X-Y Display	86
1331A X-Y Display, Storage	86
1331C X-Y Display, Storage	86
1400B Differential Amplifier	133
1402A Dual Trace Amplifier	133
1403A Differential Amplifier	133
1404A Four Channel Amplifier	133
1405A Dual Trace Amplifier	133
1406A Differential Amplifier	133
1408A Dual Trace Amplifier	133
1410A Sampling Vertical Amplifier	134
1411A Sampling Vertical Amplifier	134
1415A Time Domain Reflectometer	134
1416A Swept Frequency Indicator	134
1421A Time Base & Delay Generator	133
1423A Time Base	133
1424A Sampling Time Base	134
1425A Sampling Time Base & Delay Generator	134
1430C Sampling Head, 18 GHz	110, 134
1432A Sampling Head, 4 GHz	110, 134
1580A Narrow Band TDR	118
1700 series Portable Oscilloscopes	120
1700A Portable Oscilloscope	122
1701A Portable Delayed Sweep Oscilloscope	122
1702A Portable Storage Oscilloscope	124
1703A Portable Storage Oscilloscope, Delayed Sweep	124
1706A Portable Oscilloscope 75 MHz	126
1707A Portable, Delayed Sweep Oscilloscope 75 MHz	126
1710A 150 MHz Portable Oscilloscope	128
1801A Dual Channel Vert Amp 50 MHz	102
1803A Differential/DC Offset Amplifier	104
1804A Four Channel Vertical Amplifier	104
1805A Dual Channel Vertical Amplifier (100 MHz)	106
1806A 100 μ V Dual Differential	105
1807A Dual Channel Vertical Amplifier 35 MHz	103
1808A Dual Channel Vert Amp 75 MHz	102
1810A 1 GHz Dual Channel Sampler	108
1811A 4 or 17 GHz Sampler	109
1815A-1815B TDR/Sampler	117
1816A Sampling Head, 4 GHz	118
1817A Sampler, 12.4 GHz	118
1818A Time Domain Reflectometer	116
1820C Time Base	111
1821A Time Base/Delay Generator	111
1824A Time Base and Sweep Expander	112
1825A Time Base and Delay Generator	113
1830A Dual Channel Vertical Amplifier (250 MHz)	107
1831A Direct Access Vertical (600 MHz)	107
1831B Direct Access Vertical (500 MHz)	107
1840A Time Base	114
1841A Time Base/Delay Generator	115
1900 series Plug-in Pulse/Digital Generators	306
1900A/1901A Pulse Generator Mainframe	307
1900A-6936S Programmable Pulse Generator	313
1905A Rate Generator (25 MHz)	307
1906A Rate Generator (125 MHz)	307
1908A Delay Generator (25 MHz)	308
1910A Delay Generator (125 MHz)	308
1915A Variable Transition Time Output	309
1917A Variable Transition Time Output	310
1920A Pulse Output, <350 ps Rise Time	309
1921A Positive Output Plug-in	310
1922A Negative Output Plug-in	310
1925A Word Generator	312
1927A Fan-In Amplifier	313
1928A Fan-Out Amplifier	313
1930A PR Binary Sequence Generator	311
1934A Multiphase Clock Generator	312
2000	
21070A Data Logger for 3480A/B	64
2100A Digital Computer	399
2102A Disc Operating System	407
2070A-5055A Data Logger	403
2212B V to F Converter	72
2402A Integrating Digital Voltmeter	73
2470B Amplifier, Data	29
2471A System Data Amplifier	30
2570A Coupler/Controller	203
2575A Coupler/Controller	203
2761A Optical Mark/Sense Card Reader	402
2761B Optical Mark/Sense Card Reader	402
2801A Quartz Thermometer	412
2940A Cabinet, Instrument	414, 415
2940B Cabinet, Instrument	414, 415
3000	
3200B VHF Oscillator	272
3205A FM Signal Generator	282
3260A Marked Card Programmer	266
3300A Function Generator	260

3301A	Auxiliary Plug-in	260
3302A	Trigger/Phase Lock Plug-in	261
3304A	Sweep/Offset Plug-in	261
3305A	Sweep Plug-in	261
3310A	Function Generator	263
3310B	Function Generator	263
3320A	Frequency Synthesizer	264
3320B	Frequency Synthesizer	264
3400A	RMS Voltmeter	46
3403A	True RMS Voltmeter	62
3403B	True RMS Voltmeter	62
3406A	RF Voltmeter	42
3420A	DC Voltmeter/Ratiometer	36
3420B	DC Voltmeter/Ratiometer	36
3431A	Digital Panel Meter	60
3431B	Digital Panel Meter	60
3431C	Digital Panel Meter	60
3439A	Digital Voltmeter	68
3440A	Digital Voltmeter	68
3441A	Range Selector for 3439A/3440A	68
3442A	Automatic Range Selector (3439A/3440A)	68
3443A	High Gain/Auto-Range Unit (3439A/3440A)	68
3444A	DC Multi-Function Unit (3439A/3440A)	68
3445A	AC/DC Range Unit (3439A/3440A)	68
3446A	AC/DC Remote Unit (3439A/3440A)	68
3450A	Multi-Function Meter	70
3460A	Digital Voltmeter	74
3460B	Digital Voltmeter	74
3469B	Multimeter	61
3480A	Multi-Function Digital Voltmeter	64
3480A	Multi-Function Digital Voltmeter	64
3481A	Buffer Amplifier for 3480A/B	65
3482A	DC Range Unit for 3480A/B	65
3484A	Multi-Function Unit for 3480 A/B	65
3485A	Scanning Unit for 3480 A/B	65
3529A	Opt. C11 Magnetometer Probe	39
3529A	Magnetometer Probe	39
3550B	Portable Test Set	348
3555B	Transmission & Noise Measuring Set	346
3556A	Psophometer	346
3590A	Wave Analyzer	376
3591A	Selective Voltmeter	352
3592A	Auxiliary Plug-in	377
3593A	Sweeping Local Oscillator Plug-in	377
3594A	Sweeping Local Oscillator Plug-in	377
3595A	Sweeping Local Oscillator Plug-in	377
3603A	Automatic Tape Degausser	199
3604A	Voice Channel	199
3680A	AC Power Supply	199
3681A	Tape Servo	199
3702B	IF/BB Receiver	354
3703B	Group Delay Detector Plug-in for 3702B	354
3705A	Differential Phase Detector Plug-in for 3702B	354
3710A	IF/BB Transmitter	354
3715A	BB Transmitter Plug-ins for 3710A	354
3716A	BB Transmitter Plug-ins for 3710A	354
3720A	Spectrum Display	391

3721A	Correlator	391
3722A	Noise Generator	392
3730A	Down Converter: RF to IF	355
3731A	Oscillator Plug-in for 3730A	355
3732A	Oscillator Plug-in for 3730A	355
3733A	Oscillator Plug-in for 3730A	355
3750A	Attenuator: 75 Ω	355
3800A	Distance Meter	79
3800B	Distance Meter	79
3801A	Power Unit—3800A	79
3801B	Power Unit—3800B	79
3907-11A	Remote Control Unit	199
3950	series Instrumentation Tape Recorder	197
3955	series Instrumentation Tape Recorder	197
3960	series Instrumentation Tape Recorder	198

4000

4050A	Analog Comparator	55
4204A	Digital Oscillator	258
4260A	Universal Bridge	50
4270A	Capacitance Bridge	54
4328A	Milliohmmeter	49
4329A	Resistance Meter	49
4332A	LCR Meter	50
4342A	Q Meter	51
4350A	High Capacitance Meter	55
4350B	High Capacitance Meter	55
4436A	Attenuator	56
4437A	Attenuator	56
4440B	Decade Capacitor	56
4470B	Transistor Noise Analyzer	77
4800A	Vector Impedance Meter	53
4815A	Vector Impedance Meter	360

5000

5010A	Logic Troubleshooting Kit	81
5050B	Digital Recorder	200
5055A	Digital Recorder	201
5061A	Cesium Beam Frequency Standard	240
E10-5061A	Frequency & Time Reference System	243
E21-5061A	Flying Clock (cesium)	241
5065A	Rubidium Frequency Standard	238
E21-5065A	Portable Rubidium Time Standard	238
K02-5065A	Standby Power Supply	244
5085A	Standby Power Supply	244
5087A	Distribution Amplifier	243
5100B	Frequency Synthesizer	246
5105A	Frequency Synthesizer	246
5110B	Synthesizer Driver	246
5201L	Scaler-Timer	398
5210A	Frequency Meter	234
5210B	Frequency Meter	234
5245L	Electronic Counter	213
5245M	Electronic Counter	213
5246L	Electronic Counter	213
5248L	Electronic Counter	213

MODEL NUMBER INDEX

5248M Electronic Counter	213
5252A Prescaler Plug-in	217
5253B Frequency Converter Plug-in	216
5254C Frequency Converter Plug-in	216
5255A Frequency Converter Plug-in	216
5256A Frequency Converter Plug-in	216
5257A Transfer Oscillator Plug-in	216
5258A Prescaler Plug-in	217
5261A Video Amplifier Plug-in	217
5262A Time Interval Plug-in	217
5264A Preset Plug-in	217
5265A Digital Voltmeter Plug-in	216
5267A Time Interval Plug-in	217
5300A Measuring System	218
5301A 10 MHz Counter Module	218
5302A 50 MHz Universal Counter Module	218
5303A 500 MHz Counter Module	218
5304A Timer/Counter Module	218
5310A Battery Pack	218
5323A Automatic Counter	234
5326A Universal Timer/Counter	222, 234
5326B Universal Timer/Counter/DVM	222
5326C Multi-Function Counter	222
5327A Universal Timer/Counter	222
5327B Universal Timer/Counter/DVM	222
5327C Multi-Function Counter	222
5330A Preset Counter	233
5330B Preset Counter	233
5332B Preset Counter	233
5340A Microwave Frequency Counter	228
5360A Computing Counter	230
K01-5360A Serial-Parallel Converter (for 5360A)	232
5365A Input Module (for 5360A)	231
5375A Computing Counter Keyboard	232
5376A Systems Programmer	231
5379A Time Interval Plug-in	231
5401B Multichannel Analyzer	398
5402A MCA/Basic System	398
5403A MCA/Calculator System	398
5406B Nuclear Analyzer System	398
5451A Fourier Analyzer System	389
5470A Fast Fourier Transform Arithmetic Unit	389
5471A Fast Processor	389
5480S Signal Analyzer	390
5481A Signal Analyzer System	390
5489A Low Pass Filter-Amplifier	393
5494A Digital Output Control	390
5510A Automatic Compensator	78
5525B Laser Interferometer	78
5554A Preamplifier	398
5580B NIM Power Supply	398
5582A Linear Amplifier	398
5583A Single Channel Analyzer	398
5584A Dual Timing Pickoff	398
5585A Fast Coincidence Module	398
5586A Spectrum Stabilizer	398
5590A Scaler-Timer Module	398

6000

6101A-6525A Laboratory and Industrial Power Supplies	152-165
6129B-6131B Digitally Controlled Voltage Source	170
6177B-6186B DC Current Source	167
6610A Directed Beam Display	90
6823A, 6824A Power Supply/Amplifier	168
6920B Meter Calibrator	252
6933B Digital-to-Analog Converter	171
6936S Multiprogrammer	313
6940A Multiprogrammer	404
6941A Multiprogrammer Extender	404
6947A Raster Display	91

7000

7001A X-Y Recorder	180
7004B X-Y Recorder	174
7005B X-Y Recorder	173
7034A X-Y Recorder	174
7035B X-Y Recorder	173
7040A X-Y Recorder	179
7041A X-Y Recorder	179
7100B Strip Chart Recorder, 2 Pen	182
7101B Strip Chart Recorder, 1 Pen	182
7123A Strip Chart Recorders	186
7123B Strip Chart Recorders	186
7127A Strip Chart Recorder, 1 Pen	182
7128A Strip Chart Recorder, 2 Pen	182
7143A Strip Chart Recorders	186
7143B Strip Chart Recorders	186
7200A Graphic Plotter	402
7201A Graphic Plotter	402
7202A Graphic Plotter	402
7414A 4-Channel Oscillographic Recorder	190
7562A Log Voltmeter/Converter	47
7563A Log Voltmeter/Amplifier	47
7591A Point Plotting System	177
7702B Oscillographic Recorder, 2-Channel	189
7706B 6-Channel Oscillographic Recorder	191
7708B 8-Channel Oscillographic Recorder	191
7727A 6-Channel Oscillographic Recorder	191
7729A 8-Channel Oscillographic Recorder	191
7731A 16-Channel Oscillographic Recorder	191
7858B 8-Channel Oscillographic Recorder	192
7878A 8-Channel Oscillographic Recorder	192
7900A Disc Drive	400
7970 series Digital Magnetic Tape Unit	401

8000

8002A Pulse Generators	299
8003A Pulse Generators	299
8004A Pulse Generator	300
8005A Pulse Generator	302
8006A Word Generator	298

8007A Pulse Generator	303	8620 series Sweep Oscillators	287
8008A Pulse Generator	305	8620A Sweeper Mainframe	289
8010A Pulse Generator	301	8620B Sweeper Mainframe	288
8012A Pulse Generator	304	8621A RF Drawer for 8620A/B	291
8013A Pulse Generator	304	8651A RF Oscillator	272
8056A Filter Set	396	8654A Signal Generator	273
8057A Precision Noise Generator	396	8660A Synthesized Signal Generator	270
8064A/65A Real Time Audio Spectrum Analyzer	394	8660B Synthesized Signal Generator	270
8320 series Stabilized Sweep Osc. Systems	295	8690B Sweep Oscillator	292
8321 series Stabilized Sweep Osc. Systems	295	8691A-8697A RF Units (Grid-levelled BWO)	
8322 series Leveled Hi-Power Sweep Osc. Systems	295	for 8690B	293
8324 series Stabilized Sweep Osc. Systems	295	8691B-8695B RF Units (PIN Leveled BWO)	
8330A Radiant Flux Meter	76	for 8690B	293
8334A Radiant Flux Detector	76	8692C RF Unit for 8690B	292
8403A Modulator	283	8698B RF Unit for 8690B	292
8404A Leveling Amplifier	294	8699B RF Unit for 8690B	292
8405A Vector Voltmeter	361	8700A RF Drawer for 8690B	292
8406A Comb Generator	387	8701A Sequential Sweep Control	294
8407 series RF Network Analyzer family	362	8705A Signal Multiplexer	294
8407A Network Analyzer Mainframe	363	8706A Control Unit for 8690B	294
8410A Network Analyzer Mainframe	368	8707A RF Unit Holder	294
8410S series Network Analyzers	365	8708A Synchronizer	274
8411A Harmonic Frequency Converter	368	8709A Synchronizer	295
8412A \emptyset -Magnitude Display	363, 368	8717B Transistor Bias Supply	367
8413A \emptyset -Gain Indicator	368	8721A Coaxial Directional Bridge	364
8414A Polar Display	363, 368	8728A Network Comparator	363
8418A Auxiliary Power Supply	368	8731-8735 series PIN Modulators	283
8430A-8436A Bandpass Filters	338	8740A Transmission Test Unit	369
8443A Tracking Generator/Counter	386	8741A Reflection Test Unit	369
8443B Tracking Generator	386	8742A Reflection Test Unit	369
8444A Tracking Generator	386	8743A Reflection/Transmission Test Unit	369
8445A Automatic Preselector	386	8745A S-Parameter Test Set	367, 369
8447 series Amplifiers	31	8746B S-Parameter Test Set	367, 369
8457 series Microwave Synthesizers	295	8747A series Waveguide Reflection/Transmission Test Units	369
8470A Coaxial Crystal Detector	333	8761A,B Coaxial Switch	341
8471A Coaxial Crystal Detector	333	8801A Low Gain Preamplifier	194
8472A Coaxial Crystal Detector	333	8802A Medium Gain Preamplifier	194
8477A Power Meter Calibrator	317	8803A High Gain Preamplifier	194
8478B Coaxial Thermistor Mount	317	8805A Carrier Preamplifier	195
8491 series Coaxial Fixed Attenuators	327	8805B Carrier Preamplifier	195
8492 series Coaxial Fixed Attenuators	327	8806B Phase Sensitive Demodulator	195
8493 series Coaxial Fixed Attenuators	327	8807A AC/DC Converter	196
8540 series Automatic Network Analyzers	370	8808A Logarithmic Converter	196
8552A Spectrum Analyzer-IF Section	385	8809A Signal Coupler	196
8552B Spectrum Analyzer-IF Section	385	8820A Amplifier for Recorder	193
8553B Spectrum Analyzer-Tuning Section	384	8821A Amplifier for Recorder	193
8554L Spectrum Analyzer-Tuning Section	384	8875A Differential Amplifier	26
8555A Spectrum Analyzer-Tuning Section	384	8900B Peak Power Calibrator	318
8556A Spectrum Analyzer-Tuning Section	384	8925A DME/ATC Test Set	282
8580 series Automatic Spectrum Analyzers	281		
8600A Digital Marker	286		
8601A Generator/Sweeper	286		
8605A Sweep Oscillator	353		
8614A Signal Generator	278		
8614B Signal Source	278		
8616A Signal Generator	278		
8616B Signal Source	278		
		9000	
		9211 Transit Case	416
		9211 Field Cases	416
		9211 Operating Cases	416
		9500 series Automatic Test Systems	405

MODEL NUMBER INDEX

9600 series Data Acquisition Systems Computerized ..	406
9800 series Calculator	408

00000-10000

00513A Q Standard	52
00518A Q Standard	52
10001A 10:1 Divider Probe	140
10001B 10:1 Divider Probe	140
10002A 50:1 Divider Probe	140
10002B 50:1 Divider Probe	140
10003A 10:1 Divider Probe	140
10004B 10:1 Divider Probe	140
10004C 10:1 Divider Probe	140
10005B 10:1 Divider Probe	140
10006B 10:1 Divider Probe	140
10006C 10:1 Divider Probe	140
10007B 1:1 Probe	140
10008B 1:1 Probe	140
10010C BNC Adapter Tip	141
10011A BNC Adapter Tip	141
10011B BNC Tip, Probe	142
10012B 10:1 Divider Probe	140
10014C 10:1 Divider Probe	140
10016C 10:1 Divider Probe	140
10020A 700 MHz Passive Probe	141
10036A Probe Tip Kit	142
10037A Probe Tip Kit	142
10090A 50 ohm Attenuators	141
10091A 50 ohm Attenuators	141
10092A 50 ohm Attenuators	141
10100B 100 ohm Feed-Thru	141
10100C 50 ohm Feed-Thru	141
10110A BNC to Banana Post	142
10111A Adapter BNC to Banana	142
10166A Panel Cover 180 series Cabinet	142
10111A BNC to Banana Plug Adapter	40
10167A Flexible Covers 180 series Cabinet Models	142
10170A Flexible Covers 180 series Cabinet Models	142
10172A Flexible Covers 180 series Cabinet Models	142
10169A Panel Cover 1200 series Cabinet	142
10175A Viewing Hood	142
10175B Viewing Hood	142
10176A Viewing Hood	142
10352A Graflok Back	145
10353A Pack Film Back	145
10355A Camera Bezel Adapters	145
10356A Camera Bezel Adapters	145
10357A Camera Bezel Adapters	145
10358B Camera Carrying Case	145
10360A Camera Bezel Adapters	145
10361A Camera Bezel Adapters	145
10362A Camera Bezel Adapters	145
10363A Camera Bezel Adapters	145
10106A Camera Bezel Adapters	145
10365A Roll Film Back	145
10406A Plug-in Extender Cable (140 series)	142
10407A Plug-in Extender (180 series)	142
10408A-10410A Blank Plug-ins (180 series)	142
10411A Horizontal Gain Calibrator (180 series)	140
10452A 0.5 ns Rise Time Converter	119
10453A 1 ns Rise Time Converter	119
10454A 2 ns Rise Time Converter	119
10455A 5 ns Rise Time Converters	119
10456A 10 ns Rise Time Converter	119
10457A Adapter, 50 to 75 ohm (Type N)	119
10458A Adapter, 50 to 75 ohm (Type F, CATV)	119
10477A-10478A Blank Plug-Ins (140 series)	142
10501A Cable	413
10502A Cable	413
10503A Cable	413
10511A Spectrum Generator	269
10514A Double Balanced Mixer	269
10515A Frequency Doubler	269
10525A Logic Probe	81
10528A Logic Clip	81
10529A Logic Comparator	80
10531A Filter Kit (for 5201A)	234
10532A Extender Board (for 5326/27)	223
10533A Printer Interface (for 5300A Counter)	219
10534A Double Balanced Mixer	269
10536A Adapter (for 5360A)	232
10542A Remote Program Interface (for 5326/27)	223
10565A Remote Interferometer	78

11000

11000A Cable Assembly	256,413
11001A Cable Assembly	40, 256, 413
11002A Test Lead	40, 413
11003A Test Lead	40, 413
11004A Line Matching Transformer	256
11005A Line Matching Transformer	256
11018A Adapter for 410C AC Probe	57
11028A 100 to 1 Current Divider	57
11035A Cable	348, 413
11036A AC Probe for 410C	57
11039A Capacitive Voltage Divider	57
11040A Capacitive Voltage Divider	57
11042A Probe Coaxial "T" Connector	57
11043A Probe Coaxial "N" Connector	57
11045A DC Voltage Divider for 410C	57
11046A Combining Case	348, 415
11048B Feed-Thru Termination	262
11048C 50Ω Feedthrough	266
11065A Input Cable for 3460A	74
11074A Voltage Divider Probe	57
11075A High Impact Case	40
11085A Remote Control Cable	74
11086A Cable	413
11094B 75Ω Feedthrough	266
11096A High Frequency Probe	40, 57
11135A AC Power Pack for 204 C/D	257
11136A Mercury Power Pack for 204 C/D	257
11137A Rechargeable Battery/AC Pack for 204C/D	257
11500A Cable	413

11501A Cable	413
11507A Output Termination	269
11508A Terminated Output Cable	269
11509A Fuseholder	269
11510A Carrying Case for 805C	334
11511A Type N Short	337
11512A Type N Short	337
11517A Mixer	387
11518A Mixer Taper Section	387
11519A Mixer Taper Section	387
11520A Mixer Taper Section	387
11524A APC7-N Adapter	342
11525A APC7-N Adapter	342
11527A Thermistor Mount Adapter	317
11528A Thermistor Mount Adapter	317
11531A Test Unit for 8690B	295
11533A APC7-SMA Adapter	342
11534A APC7-SMA Adapter	342
11536A Tee (for 8405A)	361
11539A Reproduce Track Selector	199
11540A Waveguide Stand	342
11543A-11548A Waveguide Clamps	342
11549A Power Splitter	361
11550A DC Test Set for 434A	319
11553A Pack Sensor	199
11565A APC-7 Short	337
11570A Accessory Kit for 8405A	361
11581A Attenuator Set	327
11582A Attenuator Set	327
11583A Attenuator Set	327
11587A Accessory Kit for 8410 Series	368
11588A Rotary Joint	342
11589A Bias Network	368
11590A Bias Network	368
11599A Quick-Connect Adapter for 8745A	369
11600B Transistor Fixture	367
11602B Transistor Fixture	367
11604A Universal Extension for 8745A	369
11605A Flexible Arm for 8743A	369
11606A Rotary Air Line	342
11607A Small Adapter for 8745A	369
11608A Transistor Fixture	367
11650A Accessory Kit for 8410 series	368
11652A Reflection/Transmission Kit for 8407A	363
11654A Passive Probe Kit for 8407A	363
11655A Impedance Probe for 8407A	363
11658A Matching Resistor for 84047A	364
11661A Extension Module for 8660A,B	270
11675A Leveling Cable Assembly for 784A	353

13000

13060A Remote Start/Stop Switch	199
13061A,B DC-AC Inverter (for 3960)	199
13062A Tape Loop Adapter	199
13063A Voice Channel	199
13065A Rack Mount Kit	199
13066A Fiber Glass Transit Case	199

13068A/B Rack Slide Mounting Kit	199
13181A Controller (for 7970)	401
13215A Disc Power Supply	400
13219A Disc Service Unit	400
13515A Frequency Doubler Probe	272

15000

15108A Microphone Preamplifier	396
15109B Condenser Microphone	396
15114A Microphone Power Supply	396
15117A Sound Level Calibrator	396
15118A Microphone Preamplifier	396
15119C/D Condenser Microphone	396
15127A Cable Amplifier	396
15550A Accessory Kit for 3702B	355

16000

16009A Transistor Socket Kit	77
16014A Series Loss Test Adapter	52
16150A Interface Kit (327A)	54
16151A Interface Kit (4270A)	54
16462A Auxiliary Capacitor	52
16470A-16490A Reference Inductors	52

17000

17005A Incremental Chart Advance	180
17012B Point Plotter	176
17012C Point Plotter	176
17108A Time Base	180
17170A DC Coupler	175
17171A DC Amplifier	175
17172A Time Base	175
17173A Null Detector	175
17174B DC Offset	176
17175A Filter	176
17176A Scanner	176
17177A AC/DC Converter/DC Preamplifier	177
17178A DC Attenuator	176
17500A Multiple Span Input Module	183
17501A Multiple Span Input Module	183
17502A Temperature Module	183
17505A High Sensitivity Module	183
17506A Single Span Input Module	183

33000-86632A

33300 series Step Attenuators	328
60063A-60246B DC Power Supply	169
80500A Aircraft Noise Monitoring System	395
85404B S-Parameter Test Set	363
85426A Bias Insertion Network	363
85428A Matching Network	363
86200 series RF Plug-ins for 8620A,B	290
86300 series RF Modules for 8620A,B; 8700A	291
86601A RF Section for 8660A,B	270
86602A RF Section for 8660A,B	270
86631A Auxiliary Section for 8660A,B	270
86632A Modulation Section for 8660A,B	270



DIFFERENTIAL AMPLIFIER

Wideband amplifier for data acquisition systems
Model 8875A

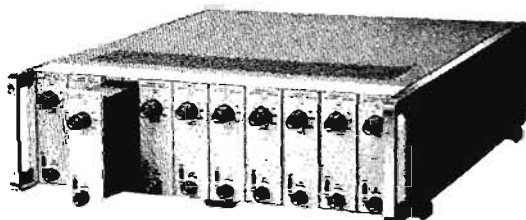

8875A

The Model 8875A is a differential dc amplifier that provides high gain (up to 3000) and wide bandwidth. It features low drift for reliable, long term measurements, a common mode rejection of at least 120 dB at 60 Hz (500 ohm source unbalance, gain of 1000) and a common mode tolerance of ± 20 V. Intermodulation distortion is avoided by use of direct-coupled input circuits (no choppers or modulators are used). An output having a capability of ± 10 V at ± 100 mA is standard, with a second independent output of ± 10 V at ± 10 mA optional. The 8875A is available as a single unit, in banks of up to 10 channels for rack mounting or in portable cases.

The 8875A is ideal for use with thermocouples, dc excited strain gages and other low level sources, with read out to devices such as digital voltmeters, oscillographs, analog-digital converters and similar units. Applications include space vehicle checkout, monitoring of physical variables, wind tunnel tests and arrangements with either input or output multiplexers.

Performance Specifications

Bandwidth: dc to 75 Hz within 3 dB, at fixed gain steps. Can be narrowed to as low as dc to 2 Hz with optional switch-selectable filter.

Gain: fixed steps of 1, 3, 10, 30, 100, 300, 1000 plus OFF; on any range, variable gain potentiometer may be switched to provide uncalibrated gain up to 3X gain switch setting. Gain accuracy $\pm 0.1\%$; gain vernier allows setting any one fixed gain to an accuracy of 0.01%.

Input circuit: differential, active guarded; will accept floating input without ground return; may be used single-ended.

Input impedance: differential, 20 M Ω ($\pm 5\%$) with less than 0.001 μ F shunt; common mode (guarded), greater than 2000 M Ω with less than 2 pF shunt.

Common mode rejection: at least 120 dB from dc to 60 Hz for up to 500 Ω source impedance either side of input at gain of 1000; 66 dB minimum at gain of 1.

Common mode tolerance: ± 20 V.

Bandwidth	Noise	Bandwidth	Noise
dc-10 Hz	1 μ V pp	dc-10 kHz	3 μ V rms
dc-100 Hz	3 μ V pp	dc-50 kHz	4 μ V rms
dc-1 kHz	6 μ V pp	dc-250 kHz	5 μ V rms

Slewing: gain of 1 or 3, 0.7 μ V/s; gain greater than 3, 1 μ V/s referred to output, for 10 mV dc offset at output with resistive load of 100 Ω or greater.

Input-output isolation: greater than 200 M Ω shunted by less than 2 pF.

Temperature range: 0°C to 55°C.

General Specifications

Power: 115/230 V $\pm 10\%$, 50 to 400 Hz, 6 VA.

Dimensions: 4 $\frac{3}{4}$ " high, 1-9/16" wide, 15" deep (121 x 40 x 381 mm).

Weight: 3.5 lb (1.6 kg).

Prices: 8875A Differential Amplifier, \$550.

Option 01: dual outputs (10 mA and 100 mA capability; short on one has negligible effect on other), add \$75.

Option 02: switch selected filters (single-pole, low pass, with corner frequencies of 2, 200, 2000 and 20,000 Hz), add \$75.

Option 03: gain ranges of 10, 20, 50, 100, 200, 500 and 1000, add \$25.

Option 04: 14010A Cord Connector Set for bench-top use (required for single-channel operation), add \$65.

Option 05: combines Option 01 and 02 (filters on 10 mA output only), add \$150.

Option 06: combines Option 02 and 03, add \$100.

Note: must order 1069-01A case for multichannel banks of 10 or less, \$365. Sufficient blank panels (01069-61069) to fill case are required to maintain temperature stability specifications, \$10 each.

SOLID-STATE AMPLIFIERS

Precision general-purpose amplifiers
Models 465A, 467A



AMPLIFIERS

HP 465A Amplifier

The HP Model 465A is a general purpose amplifier and an excellent impedance converter (10 megohms to 50 ohms). This amplifier has extremely stable 20 dB or 40 dB gain over a continuous frequency range of 5 Hz to 1 MHz. Either gain may be selected rapidly with a switch on the front panel.

This solid-state amplifier is ideal for increasing the power output of solid-state oscillators or amplifiers. The output stage provides low output impedance and wide dynamic range. The HP 465A is a three-terminal device isolated from chassis and may be floated up to 500 volts dc above chassis ground.

465A Specifications

Voltage gain: 20 dB (X10) or 40 dB (X100), open circuit.

Gain accuracy: ± 0.1 dB ($\pm 1\%$) at 1000 Hz.

Frequency response: ± 0.1 dB, 100 Hz to 50 kHz; < 2 dB down at 5 Hz and 1 MHz.

Output: > 10 V rms open circuit; > 5 V rms into 50Ω (0.5 W).

Distortion: $< 1\%$, 10 Hz to 100 kHz; $< 2\%$, 5 Hz to 10 Hz and 100 kHz to 1 MHz.

Input impedance: 10 M Ω shunted by < 20 pF.

Output impedance: 50 Ω .

Noise: < 25 μ V rms referred to input (with 1 M Ω source resistance).

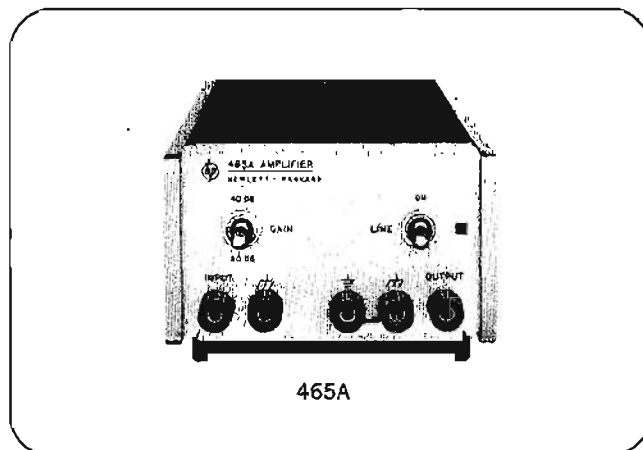

465A

Temperature range: 0°C to +50°C.

Power: 115 or 230 V $\pm 10\%$, 48 to 440 Hz, 10 VA max.

Dimensions: 5 $\frac{1}{8}$ " wide, 3" high (without removable feet), 11" deep (130 x 76 x 279 mm).

Weight: net, 4 lbs (1,8 kg); shipping, 7 lbs (3,2 kg).

Price: HP 465A, \$245.

HP 467A Amplifier/Power Supply

The solid-state HP 467A Power Amplifier/Supply is a 10-watt peak power amplifier and -20 to $+20$ volt dc power supply. The power amplifier has a wide bandwidth and low dc drift, suitable for many applications wherever a power source is required. Unique features are low distortion ($< 0.01\%$), low drift and high-gain accuracy.

An output greater than ± 20 volts peak and ± 0.5 A peak is available from dc up to 1 MHz. At full output the distortion of the 467A is less than 3% up to 1 MHz. The amplifier is a three-terminal device isolated from chassis and may be floated up to 200 volts dc above chassis ground.

467A Specifications

Power amplifier

Voltage gain (non-inverting): fixed steps: X1, X2, X5, X10.

Variable: 0-10 resolution is better than 0.1% of full output.

Accuracy: $\pm 0.3\%$ from dc to 10 kHz; $\pm 1.0\%$ from 10 kHz to 100 kHz; $\pm 10\%$ from 100 kHz to 1 MHz with load of $> 40\Omega$.

Output: ± 20 V p at 0.5 A p.

Distortion: $< 0.01\%$ at 1 kHz; $< 1\%$ at 100 kHz; $< 3\%$ at 1 MHz.

Input impedance: 50 k Ω shunted by 100 pF.

DC power supply

Voltage range: $> \pm 20$ V, ± 10 V, ± 4 V, ± 2 V, ± 1 V; with adjustable vernier. Resolution: better than 0.1% of full output.

Current: ± 0.5 A p.

Load regulation: (front panel) < 10 mV, no load to full load.

Line regulation: < 10 mV for a $\pm 10\%$ change in line voltage.

General

Output impedance: (front panel): 5 m Ω in series with 1 μ H.



467A

Capacitance load: 0.01 μ F or less does not cause instability.

Ripple and noise: < 5 mV p-p (referred to output) for amplifier and power supply.

Current limit: < 800 mA.

Temperature coefficient: $< \pm 0.05\%/^{\circ}\text{C}$ of output or ± 2 mV/ $^{\circ}\text{C}$ at output, whichever is greater.

Input-output terminals: front panel: $\frac{3}{4}$ " spaced banana terminals for input, output, and chassis. Rear panel: BNC terminals. Circuit ground can be floated 200 V dc above chassis ground.

Operating temperature range: 0°C to +50°C.

Power required: 115 or 230 V $\pm 10\%$, 48 to 440 Hz; 60 VA max.

Dimensions: 5 $\frac{1}{8}$ " wide, 6 $\frac{1}{4}$ " high (without removable feet), 11" deep (130 x 159 x 279 mm).

Weight: net, 10 lbs (4,5 kg); shipping, 15 lbs (6,8 kg).

Price: HP 467A, \$610.

AMPLIFIERS



SOLID STATE AMPLIFIERS

Wide band, 40 dB solid-state amplifiers
Models 461A, 462A, 463A



461A

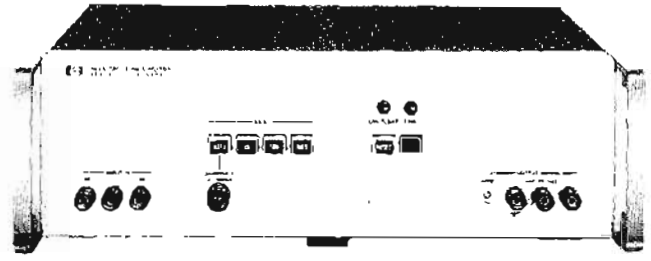

463A

SPECIFICATIONS* 461 /462A

		461A	462A
FREQ. RANGE:	1 kHz - 150 MHz		Leading edge and trailing edge rise time, < 4 ns, overshoot, < 5%.
PULSE RESPONSE:			
FREQ. RESPONSE	± 1 dB, 1 kHz to 150 MHz when operating into a 50 Ω resistive load (500 kHz ref.)		Overload recovery, < 1 μ s for 10 times overload. Duration for 10% droop: 30 μ s. Delay: nominally 12 to 14 ns
OVERLOAD RECOVERY	< 1 μ s for 10 times overload.		
PULSE OVERLOAD/DURATION/DELAY:			
GAIN (selected by front panel switch)	At 500 kHz: 40 dB +0.5 dB or 20 dB +1.0 dB (inverting)		20 or 40 dB (inverting).
INPUT Z	Nominal 50 Ω		
MAX. INPUT	1 V rms or 2 V p-p pulse		
MAX. DC INPUT	± 2 V (for protection of the input circuitry)		
INPUT NOISE	< 40 μ V in 40 dB position (50 Ω load)		
OUTPUT	0.5 V rms into 50 Ω		1 V p-p into 50 Ω
DIMENSIONS	5 1/8" wide, 3" high (without removable feet), 11" deep (130 x 76 x 279 mm)		
WEIGHT	Net 4 lbs. (1.8 kg); shipping 6 lbs. (2.7 kg.)		
POWER	115 or 230 V $\pm 10\%$, 48 to 440 Hz, 12 VA max.		
ACCESSORIES	11048B 50 Ω feed-through termination \$10.00		
PRICE	HP 461A \$360		HP 462A \$360

Specifications* 463A

FIXED GAIN (DC COUPLED)				
Range		DC-10Hz	10Hz-20kHz	10kHz-100kHz
X10	Accuracy	< $\pm 0.3\%$ **	< $\pm 0.01\%$	< $\pm 0.1\%$
	Distortion		< 0.01%	< 0.1%
X100	Accuracy	< $\pm 3\%$ **	< $\pm 0.1\%$	< $\pm 1.0\%$
	Distortion		< 0.03%	< 0.1%
X1000	Accuracy	< $\pm 30\%$ **	< $\pm 0.3\%$	< $\pm 3.0\%$
	Distortion		< 0.1%	< 0.5%

Precision AC Amplifier

Fixed gain (ac coupled): identical to dc coupled except coupling capacitor causes 0.01% error at 250 Hz to 3 dB error at 3.5 Hz.

Adjustable gain (ac or dc coupled): gain may be adjusted from 0 to 100% of the fixed gain range.

LONG TERM STABILITY (FIXED GAIN):			
Frequency	X10	Gain, X100	X1000
10 Hz to 10 kHz	0.003%/mo or 0.01%/yr	0.03%/mo or 0.1%/yr	0.3%/mo or 1%/yr
10 kHz to 100 kHz	0.03%/mo	0.3%/mo	3%/mo

Distortion: same as fixed gain range.

Temperature coefficient: see data sheet.

Input Impedance: fixed gain, 100 k Ω ($\pm 5\%$), < 35 pF; adjustable gain, 30 k Ω (max.) to 50 k Ω (min.), < 200 pF.

Maximum input voltage: protected to ± 150 V. AC coupling capacitor ± 500 V p.

Noise: refer to data sheet.

Output characteristics

Voltage: dc: 100 V, 20 mA, ac: 100 V rms, 50 mA.†

Power: 5 W continuous.

Impedance: from 0.05 Ω to 20 Ω .

Minimum resistive load: 100 Ω .

Maximum capacitance: capacitive drive capability of 463A is increased with a resistor in series with the output.

General

Temperature range: 0°C to +50°C.

Power: 115 or 230 V $\pm 10\%$, 48 to 440 Hz, 75 VA max.

Dimensions: 16 3/4" wide, 5" high (without removable feet), 13 1/4" deep (426 x 127 x 337 mm).

Weight: net, 19 lbs (8.6 kg); shipping, 24 lbs (10.8 kg).

Accessories furnished: rack mounting kit for 19" rack.

Price: HP 463A, \$735.

* For complete data, refer to Technical Data Sheet.

** Includes temperature coefficient and short term stability.

† From 11 Hz to 50 kHz.

DATA AMPLIFIER

Solid-state, wideband differential amplifier
Model 2470B



AMPLIFIERS

The HP 2470B Amplifier is a flexible wideband differential amplifier exhibiting low drift and noise, achieved without the use of a chopper. The instrument will supply up to 1 watt output to a resistive or reactive load. Exceptionally high reliability and accuracy are achieved by the use of silicon semiconductors.

Applications include amplification of strain gage bridge, thermocouple and other low-impedance sensors. Amplifier provides an output suitable for data acquisition devices, in-

cluding recording galvanometers and oscillographs, analog recorders, servo control systems. Low instrument cost keeps per-channel price to the minimum. The 2470B also applies directly to many general-purpose laboratory uses, both differential and single-ended.

The amplifier with its power supply is packaged compactly. Ten instruments fit side-by-side in 5¼" of standard 19" rack space, or two instruments may be installed in a portable case.

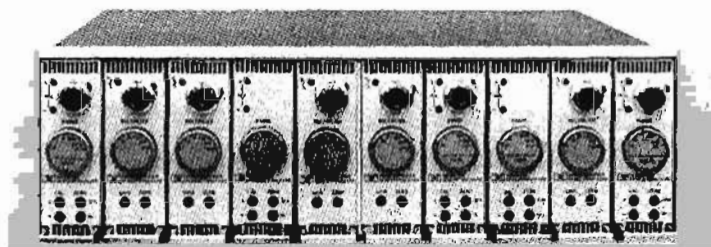

2470B Amplifiers shown in combining case.

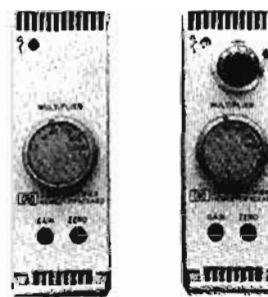

2470B

2470B Option 003

Specifications

Specifications include $\pm 10\%$ line voltage variation, hold for 1K max. source resistance, any unbalance, and assume calibration after specified warmup.

DC gain: 6 fixed steps of x1, x10, x30, x100, x300, x1000. Optional vernier (10-turn potentiometer) extends gain to x3.5.

DC gain accuracy: calibrated gain: .01% of output; other gains: .03%, consisting of .02% gain-to-gain accuracy and .01% gain trim resolution.

Gain stability: dc: $\pm .005\%$ of output per month; ac: $\pm .1\%$ per month, for ac to 2 kHz; temp. coeff: $\pm .001\%$ per °C.

Linearity: dc: $\pm .002\%$ of full scale, referred to straight line through zero and full scale output. AC: $\pm .01\%$ of full scale; inputs to 2 kHz.

Zero drift (offset): per day: $\pm 5 \mu\text{V}$ rti (referred to input) $\pm 200 \mu\text{V}$ rto (referred to output); per month: $\pm 25 \mu\text{V}$ rti $\pm 500 \mu\text{V}$ rto; temp. coeff: $\pm 1 \mu\text{V} \pm .5 \text{ namp}$ rti $\pm 40 \mu\text{V}$ rto per °C.

Maximum input signal: $\pm 11 \text{ V}$, differential plus common mode.

Differential input impedance: 10^6 ohms shunted by .001 μF .

Common mode rejection: 120 dB at 60 Hz for gains of x30 and higher.

Common mode return: from input common to output common; 1 megohm, max.

Noise: 0 to 10 Hz: 1 μV p-p rti and 10 μV p-p rto; to 50 kHz: 5 μV rms rti and 500 μV rms rto.

Output: $\pm 10 \text{ V}$ max, 0 to 100 mA. Self-limits.

Output impedance: 0.1 ohm in series with 10 μH max.

Load capability: 100 ohms or .01 μF for full output.

Slewing: 10^6 V/sec at gain of 1; $5 \times 10^4 \text{ V/sec}$ at gain of 1000.

Bandwidth: for any gain step, 0 to 50 kHz $\pm 3 \text{ dB}$; 0 to 15 kHz $\pm 1 \text{ dB}$; 0 to 5 kHz $\pm 1\%$; 0 to 1.5 kHz $\pm .1\%$; 0 to 500 Hz $\pm .01\%$.

Settling time: 100 μs to within .01% of final value.

Overload recovery: 200 μs to within .01% of final value for signal of 10 times full scale, but less than 10 V; less than 5 ms for signal plus common mode up to 20 V.

Overload signal: -17.5 to -19.5 V with no overload, 0 to -1 V in overload; 5 mA drive capability; front panel lamp indication.

Operating conditions: ambient temperatures 0 to 55°C; relative humidity to 95% at 40°C.

Warmup: operates immediately after turn-on, but requires 3 hours in free air, 30 minutes in Portable Case or Combining Case (plus 1 hour additional warmup for each 10°C difference between storage temperature and operating ambient) for specified accuracy and zero drift.

Reliability: predicted MTBF (90% confidence) 20,000 hours when operated at 25°C ambient.

Power: 115 or 230 V $\pm 10\%$, 48 to 440 Hz, 10 VA max.

Dimensions: 1-9/16" wide, 4 7/8" high, 15" deep (39.7 x 123.9 x 381 mm).

Weight: net 4 lbs (1.8 kg); shipping 6 1/2 lbs (2.9 kg).

Accessories available: mating rear connector; mating rear connector with power cord, input/output cables; combining case: holds up to 10 instruments in 5¼" of standard 19" rack space (mating connectors furnished) includes power cord and fan; portable case: holds two amplifiers (mating connectors furnished) and includes power switch, pilot light, power cord and fan.

Price: HP 2470B, \$725; option 003 with vernier add \$100.

AMPLIFIERS



SYSTEM DATA AMPLIFIER

Excellent performance at lower cost
Model 2471A

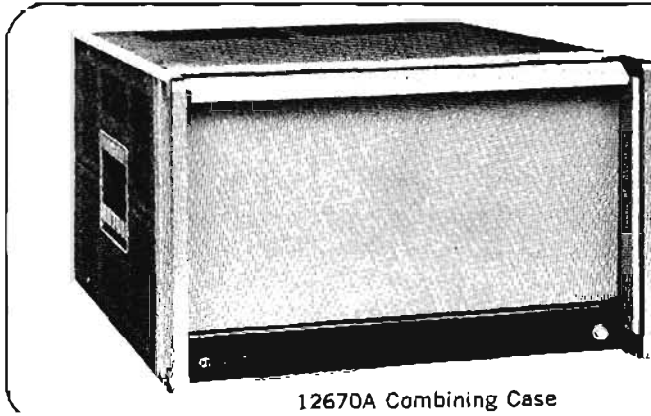

12670A Combining Case

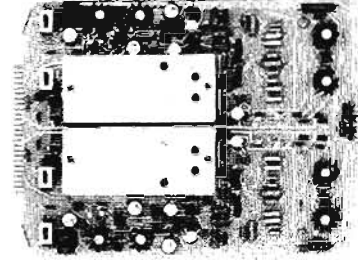

2471A System Data Amplifier

The HP 2471A System Data Amplifier is a wideband differential-input amplifier featuring excellent system performance at low per-channel cost through extensive use of integrated circuits and modern plug-in-design packaging techniques.

The 2471A is a single plug-in circuit board which consists of two identical and independent amplifier channels, each providing up to ± 10 V, 50 mA full-scale output. Each channel has four switch-selectable calibrated gains from 1 to 1000 in decade multiple steps. Bandwidths are also selectable for each channel by plug-in jumpers with a choice of 10 Hz, 100 Hz, 1 kHz, and 10 kHz controlled bandwidths with 12 dB-per-octave rolloff, and full bandwidth (greater than 50 kHz). Common mode rejection is >80 dB at the

two lowest gains and >120 dB at the highest gain.

Up to 10 amplifier boards (20 channels) may be installed in a model 12670A Combining Case which includes power supplies and connectors for all boards. The case occupies only $10\frac{1}{2}$ inches of rack space. A pull-down front panel allows direct access to the boards. The amplifier boards are furnished with mating connectors, simplifying installation where the combining case is not used.

The system data amplifier is ideally suited for amplification of strain gage bridge, thermocouple and other low-impedance sources. The amplifier output is compatible with high-speed analog-to-digital converters such as used in computerized data acquisition systems.

Specifications, 2471A*

DC gain: selectable in 4 fixed steps of $\times 1$, $\times 10$, $\times 100$, $\times 1000$.

DC gain accuracy: $\pm 0.01\%$.

DC gain stability: $\pm 0.02\%$ of output for 6 months; temp. coeff. $\pm 0.005\%$ per $^{\circ}\text{C}$.

DC linearity: $\pm 0.01\%$ of full scale, referred to straight line through zero and \pm full scale output.

Zero drift: per day: ± 10 μV rti ± 1 mV rto. Voltage temp. coeff.: ± 1 μV rti ± 0.2 mV rto per $^{\circ}\text{C}$. Current temp. coeff.: ± 0.5 nA rti per $^{\circ}\text{C}$.

Maximum input signal: ± 11 V differential plus common mode; combined input of ± 20 V will not damage the amplifier.

Common mode rejection (CMR): dc to 60 Hz, up to 1 K Ω line unbalance:

Gain	CMR
1000	>120 dB
100	>100 dB
10,1	>80 dB

Common mode return: from input common to output common: 10 megohms max.

Noise:

(with source resistance <1 k Ω)	Bandwidth	Noise
	0 - 10 Hz	3 μV peak-to-peak
	0 - 50 kHz	<5 μV rms rti, <0.5 mV rms rto

Output: ± 10 V max. 0 to 50 mA. Short-circuit proof.

Output impedance: <0.1 ohm in series with 10 μH .

Load capability: 200 ohms resistive. Capacitive load up to 0.01 μF will not cause instability.

Slewing rate: >1 V per μsec .

Bandwidth: selectable in 5 steps: 10 Hz, 100 Hz, 1 kHz, 10 kHz with 12 dB-per-octave rolloff and max. amplifier bandwidth of >50 kHz.

Operating conditions: ambient temperature 0 to 55°C ; relative humidity to 95% at 40°C .

Power required: +30 V @ 50 mA, -30 V @ 50 mA, +15 V @ 60 mA plus 50 mA max. load current, -15 V @ 60 mA plus 50 mA max. load current.

Power supply immunity: ± 30 V, >120 dB rti; ± 15 V, >40 dB rto.

Dimensions: $7\frac{3}{4}$ " H (197 mm), $1\frac{1}{4}$ " W (31,8 mm), $10\frac{5}{8}$ " D (269 mm).

Weight: net $1\frac{1}{4}$ lb (567 gm); shipping 2 lb (0,91 kg).

HP 12670A Combining Case: (includes integral power supply and holds up to ten 2471A Amplifiers (20 channels).

Power: 115 or 230 V $\pm 10\%$, 50-400 Hz, 110 watts (for full complement of 20 channels).

Dimensions: $10\frac{1}{2}$ " H (267 mm), 19" W (483 mm), $20\frac{5}{8}$ " D (508 mm).

* rti; referred to input; rto: referred to output.

WIDE BAND AMPLIFIERS

Low noise, flat response

Models 8447A, 8447B, 8447C, 8447D, 8447E, 8447F



AMPLIFIERS

Thin film hybrid integrated circuit amplifiers have been combined with fully regulated, solid state power supplies to form a series of general purpose amplifiers. The HP 8447 series of amplifiers embodies the inherently high reliability of integrated circuits and the convenience of a small, lightweight package.

The series features low noise and wide bandwidth. Flat frequency response and low distortion enhance the general utility of the amplifiers. Long term stability and reliability is assured by the use of microelectronic amplifier circuits.

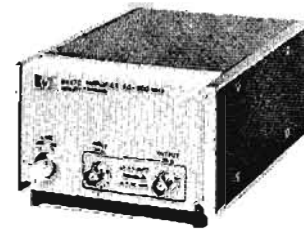

8447C

Specifications

	8447A Preamp	8447B Preamp	8447C Power Amp	8447D Preamp	8447E Power Amp	8447F Preamp- Power Amp
Frequency Range	0.1 - 400 MHz	0.4 - 1.3 GHz	30 - 300 MHz	100 kHz - 1.3 GHz	100 kHz - 1.3 GHz	100 kHz - 1.3 GHz
Typical 3 dB Bandwidth	50 kHz - 700 MHz	0.35 - 1.35 GHz	10 - 400 MHz	50 kHz - 1.4 GHz	50 kHz - 1.4 GHz	50 kHz - 1.4 GHz
Mean Gain	20 dB \pm 0.5 dB at 10 MHz	> 20 dB 22 dB Typical	30 dB \pm 1 dB	25 dB \pm 1.5 dB (20° - 30°C)	22 dB \pm 1.5 dB (20° - 30°C)	
Gain Flatness across full Frequency Range	\pm 0.5 dB	\pm 1.5 dB	\pm 1 dB	\pm 1.5 dB	\pm 1.5 dB	
Noise Figure	< 5 dB	< 5 dB 0.4 - 1.0 GHz < 6 dB 1.0 - 1.3 GHz	< 11 dB	< 8.5 dB	< 11 dB Typical	
Output Power for 1 dB Gain Compression	> +7 dBm	> -3 dBm	> +17 dBm	> +7 dBm Typical	> +15 dBm	
Harmonic Distortion	-35 dB for 0 dBm output	-30 dB for -15 dBm output	-35 dB for +10 dBm output	-30 dB for 0 dBm output (typical)	-30 dB for +10 dBm output	
Typical Output for < -60 dB Harmonic Distortion	-25 dBm	-45 dBm	-15 dBm	-30 dBm	-20 dBm	
VSWR	< 1.7	< 2.0 Input < 2.2 Output	< 2.0	< 2.0 Input < 2.2 Output 1 - 1300 MHz	< 2.2 1 - 1300 MHz	
Impedance	50 Ω	50 Ω	50 Ω Opt 002 75 Ω	50 Ω	50 Ω	
Reverse Isolation	> 30 dB	> 40 dB	> 35 dB	> 40 dB	> 40 dB	
Maximum DC Voltage Input	\pm 10 V	\pm 10 V	\pm 10 V	\pm 10 V	\pm 10 V	

8447D AND 8447E COMBINE IN A SINGLE PACKAGE

General

Power requirements: 110 or 230 V ac \pm 10%, 48-400 Hz
15 watts.

Dimensions: 8 1/2" (216 mm) deep by 5 1/8" (130 mm)
wide by 3 3/8" (85.8 mm) high.

Weight: net, 3 lb, 7 oz (1.56 kg); shipping, 5 lb, 1 oz (2.30 kg).

Price: Model 8447A, \$550; Model 8447B, \$600; Model 8447C, \$450; Model 8447D, \$650; Model 8447E, \$700; Model 8447F, \$1175.

Options Available

	Option 001 Dual Channel BNC Connectors	Option 010 Type N Connectors	Option 011 Dual Channel Type N Connectors	Option 002 75 Ω Input and Output Impedance
8447A	Add \$400	-	-	-
8447B	Add \$450	Add \$50	Add \$500	-
8447C	-	-	-	Add \$10
8447D	Add \$500	Add \$25	Add \$550	-
8447E	-	Add \$25	-	-
8447F	-	Add \$50	-	-

AMPLIFIERS



MICROWAVE/POWER AMPLIFIERS

Broadband, high-gain, high power amplification

Model 489A, 491C, 493A, 495A, 230B



489A

Advantages:

DC-coupled modulation circuitry allows power leveling and remote programming
Periodic-permanent-magnet focusing means fewer alignment problems

Uses:

Antenna efficiency and pattern measurements
Extends attenuation measuring systems capability by at least 30 dB.

Amplification of frequencies from 1 to 12.4 GHz is accomplished in four ranges by the Hewlett-Packard microwave amplifiers. Each delivers over 1 watt with an input of 1 mW or less, a gain of at least 30 dB.

Specifications

Input/output: impedance, 50Ω; connectors, type N female.

Amplitude modulation:

Sensitivity: modulation input of > -20 V peak reduces RF output by more than 20 dB from dc to 50 kHz.

Frequency response: dc to 500 kHz (3 dB).

Pulse response: < 1 μs rise and fall times.

Dimensions: 16 $\frac{3}{4}$ " wide, 5 $\frac{1}{2}$ " high, 18 $\frac{3}{8}$ " deep (426 x 140 x 467 mm).

Weight: net, 33 lbs (14,9 kg); shipping 40 lbs (18,0 kg).

	489A	491C	493A	495A
Frequency range (GHz)	1-2	2-4	4-8	7-12.4
Power output (with 1 mW or less input)	1 W	1 W	1 W	1 W
Gain at rated output	30 dB	30 dB	30 dB	30 dB
Gain variation with freq. at rated output small signal	≤ 6 dB	≤ 6 dB	≤ 6 dB	≤ 6 dB
across any 10% of band	≤ 5 dB	≤ 5 dB	≤ 5 dB	≤ 5 dB
across full band	≤ 12 dB	≤ 12 dB	≤ 12 dB	≤ 10 dB
Noise max. noise figure	30 dB	30 dB	30 dB	30 dB
Price	\$2450	\$2450	\$2800	\$2800

230B Tuned RF power amplifier

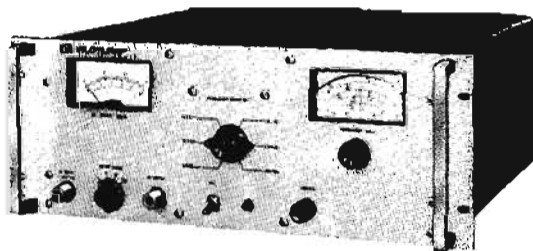

230B

The HP 230B is a tuned RF power amplifier covering 10 to 500 MHz in six continuous ranges. It provides up to 30 dB of gain, and has a maximum rated power output of 4.5 watts. With a typical noise figure of 6 to 9 dB, it is also suitable for low-level applications. High and low-level applications of the power amplifier are discussed in Application Note 76.

Specifications, 230B

Frequency range: 10 to 500 MHz in six bands: 10 to 18.5 MHz, 18.5 to 35 MHz, 35 to 65 MHz, 65 to 125 MHz, 125 to 250 MHz, 250 to 500 MHz.

RF gain: 30 dB (10 to 125 MHz), 27 dB (125 to 250 MHz), 24 dB (250 to 500 MHz), with 10 volts output into 50 ohms.

RF bandwidth: > 700 kHz (10 to 150 MHz), > 1.4 MHz (150 to 500 MHz), with 10 volts output into 50 ohms.

RF output:

Level: up to 15 volts across external 50-ohm load (4.5 watts).

Level monitor: full scale ranges of 3, 10, and 30 volts, accurate to 10% from 10 to 500 MHz.

AM range: reproduces 0 to 100% modulation of driving source.

Connectors: type N female.

Dimensions: 16 $\frac{3}{4}$ " wide, 7 $\frac{3}{16}$ " high, 18 $\frac{1}{16}$ " deep (425 x 183 x 459 mm).

Weight: net, 35 lbs (15,8 kg); shipping 52 lbs (23,4 kg).

Price: \$1190.



Analog Instruments

Voltage, current and resistance measurements are easy, fast, and accurate with electronic instruments using meter movements. Most electronic voltmeters, ammeters and ohmmeters use rectifiers, amplifiers and other circuits to generate a current proportional to the quantity being measured, which then drives a meter movement. Devices of this type are called analog instruments.

Meter movements—the meter-movement readout should continue to be popular since it is economical and suitable for many jobs. It also lends itself well to special, nonlinear scales such as dB scales. The pivot-jewel suspension has been replaced by taut-band suspension. This has resulted in excellent repeatability with hysteresis virtually eliminated. This repeatability, in turn, makes practical the individually-calibrated meter scale. Both of these improvements are standard in most Hewlett-Packard analog voltmeters.

DC measurements

The dc voltmeter represents a straightforward application of electronics to measuring instruments. This instrument usually has a dc amplifier preceding the meter movement. For most dc current measurements, the meter movement by itself serves the purpose admirably. For lower current measurements, the sensitivity of the meter movement must be increased. Electronic instruments overcome this difficulty by measuring the small voltage drop across a low value resistance placed in series with the current to be measured.

AC voltage measurements

Analog (meter) indicating ac voltmeters fall into three broad categories: average-responding, peak-responding, and rms-responding. AC voltmeters in general use are average and peak-responding types, although rms values are of principal interest.

Average-responding voltmeters

Probably the most widely used measurement technique combining acceptable accuracy and reasonable cost is the average-responding (absolute average) method. Figure 1 shows a typical arrangement for making an average measurement.

The average value of an ac voltage is simply the average value of voltage values measured point by point along the waveform. The average value of a sine wave is really zero, because the waveform

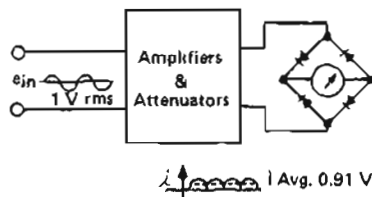

(Figure 1. Average-responding voltmeter.)

has equal positive and negative values when averaged for one whole cycle. Since the equivalent dc or energy content in the waveform usually is the quantity of interest, the average value of a sine wave is taken to mean the average rectified value. The average value of one-half cycle of a sine wave is 0.636 times the peak value.

The use of average responding is a consequence of the wide use of sine waves in electronic measurements. In calibrating an average responding meter, a pure sine wave with an rms amplitude of 1 volt can be applied to the meter, and the resulting pointer deflection marked on the scale as 1 volt. Actually, the average value of this sine wave is 0.91 volts, but since pointer deflection is linearly proportional to input voltage, an average responding meter calibrated in rms volts provides reliable indications of rms voltage if the input is a sine wave. This indication is not affected more than 3% by as much as 25% second harmonic content in the input waveform, and useful indications are obtained on waveforms with even more distortion. For this reason, average responding voltmeters are widely accepted as low-cost substitutes for true-rms-responding voltmeters, as long as sinusoidal signals are being measured.

Peak-responding voltmeter

There are situations where the peak amplitude of an ac signal is significant, such as the monitoring of a transmitter modulating signal, or in studies of vibration components, or in other situations where peak energy must be known. However, the dominant reason for the use of peak-responding ac voltmeters lies in the nature of their circuitry. Peak-responding circuits allow a voltmeter to serve as a multifunction meter and, what is more important, enables it to be used at much higher frequencies. Here again, since the majority of measurement situations involve sine waves, peak-responding meters

usually are calibrated in rms volts. Figure 2 shows a typical arrangement for making a peak measurement. A calibrating sine wave of 1 volt rms amplitude causes a pointer deflection equivalent to 1.414 volts, but this point can be marked as 1 volt rms on the scale. As long as the input waveform is a sine wave, the peak-responding indication is proportional to the rms value. However, the peak-responding meter is more susceptible to errors caused by harmonic distortion in the input waveform than the average responding meter. Another consideration is the maximum sensitivity of the instrument which is limited by the instrument probe diode characteristics. For this reason, careful design is required to achieve even 0.5 volt full scale deflection sensitivity on the lowest range of a peak-responding meter. Conventional voltmeters responding to the absolute average of an ac waveform may sometimes be limited in sensitivity and bandwidth. These restrictions may be relieved by sampling the signal prior to detection and amplification. Hewlett-Packard's RF voltmeter uses a sampling technique (see page 42).

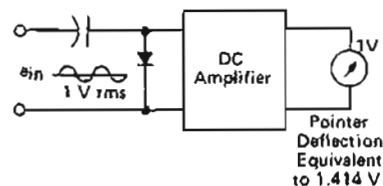

(Figure 2. Peak-responding voltmeter.)

For a detailed discussion of the limits of error introduced into peak and average-responding voltmeters by various harmonics, refer to Hewlett-Packard's Application Note 60.

RMS-responding voltmeter

The true-rms measurements technique is most often used when a high degree of accuracy is required. Instrument indication is proportional to the rms heating value of the impressed waveform. The root-mean-square (rms) value of any complex quantity is obtained by summing the squares of each component and taking the square root of the sum; this is defined as the equivalent heating power of the waveform.

This operation is performed by sensing the waveform's heating power. Heating power is measured by feeding an amplified version of an input waveform to

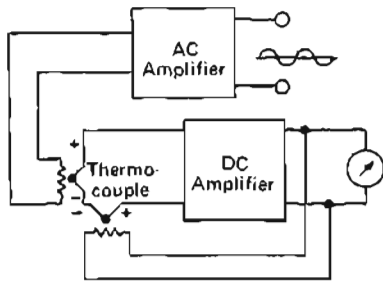

(Figure 3. RMS-responding voltmeter).

the heater of a thermocouple. The voltage output is proportional to the waveform's heating power. The true rms value is measured independently of the wave-shape, provided that the peak excursions of the measured waveform does not exceed the dynamic range of the instrument. Harmonic distortion is not an error contributing factor. This arrangement allows accurate readings of the rms value of complex waveforms having high crest factors. Crest factor is defined as the ratio of the peak voltage to the rms voltage of a waveform with the dc component removed. A voltmeter with a high crest factor rating is able to read accurately the rms values of periodic signals that have waveforms significantly different from sinusoidal. High crest factor performance is not obtained easily. An rms voltmeter with a high crest factor must have ampli-

ifiers with sufficient dynamic range to pass signals that have a peak amplitude many times larger than full scale rms value. A wide dynamic range is not the only consideration. To prevent thermocouple burn-out, the amplifier design should include some provision for power limiting. Because amplitude limiting would limit the crest factor, the voltmeter must be designed with a limit on the voltage-time product so that thermocouple burn-outs are prevented without restricting wide dynamic range.

In general, true-rms meters reveal only the rms value of an ac signal. Because they are ac coupled, most voltmeters have a frequency cut-off around 20 Hz. This restriction keeps the true-rms voltmeter from accounting for any low frequencies or dc components in a signal. Hewlett-Packard digital voltmeters solve this problem. Refer to pages 62-67.

Voltmeter considerations

Accuracy—Before we can discuss meter accuracy, we must have a familiarity with the various meter scales available. Many instruments have meter scales marked in both volts and decibel (dB) units. It should be noted that dB and voltage are complements of each other. That is, if a voltage scale is made linear, the dB scale on the same meter face will be logarithmic or nonlinear. Likewise, if the dB scale is made linear, the voltage scale becomes nonlinear. The term "linear-log scale" is applied to an instrument that has a linear dB scale and therefore a nonlinear voltage scale. Several different types of meter faces are illustrated in Figure 4.

Analog meters (Figure 5) usually have nonlinearities and/or offsets present in the attenuators and amplifiers. The meter movement itself can have nonlinearities . . . even with individually calibrated meter scales. Nonlinearities cause percent of reading errors, and offsets cause percent of full scale errors. Percent of reading errors are constant no matter where the meter pointer is. Percent of full-scale error increases as the pointer goes further down scale.

Looking at instrument specification sheets, accuracy specifications are usually expressed in one of three ways: 1. (percent of the full-scale value) 2. (percent of the reading) 3. (percent of reading +

percent of full-scale). The first is probably the most commonly used accuracy specification. The second (percent of reading) is more commonly applied to meters having a logarithmic scale. The last method has been used more recently to obtain a tighter accuracy specification on a linear-scale instrument.

Hewlett-Packard uses the two-part accuracy specification to take advantage of the upper-scale accuracy and yet maintain a reasonable specification for the lower portion of the scale.

For a thorough evaluation of accuracy, the following should be considered: Does it apply at all input-voltage levels up to maximum overrange point? (Linearity specifications may be added to qualify this point.) Does it apply to all frequencies throughout its specified bandwidth? Does it apply on all ranges? Does it apply over a useful temperature range for the application? If not, is temperature coefficient specified?

Selecting an Analog Voltmeter

Basic specs for Hewlett-Packard analog meters are in Table 1. Guidelines are restated below.

(1) For measurements involving dc applications, select the instrument with the broadest capability meeting your requirements.

(2) For ac measurements involving sine waves with only modest amounts of distortion (<10%), the average-responding voltmeter can perform over a band-width extending to several megahertz.

(3) Most broadband average-responding voltmeters are limited in sensitivity (100 μ V full-scale) by inherent noise and spurious signals. For ac measurements involving low level signals that may be obscured by noise or other unrelated signals, the tuned voltmeter provides the best accuracy and most sensitivity per dollar (refer to 3410A data sheet).

(4) For high-frequency measurements (>10 MHz), the peak-responding voltmeter with the diode-probe input is the most economical choice. Peak-responding circuits are acceptable if inaccuracies caused by distortion in the input waveform can be tolerated.

(5) For measurements where it is important to determine the effective power of waveforms that depart from a true sinusoidal form, the true rms-responding voltmeter is the appropriate choice.

(6) For very wide bandwidths (up to 1 GHz) and high-sensitivity measurements of sinusoidal or non-sinusoidal waveforms, the HP 3406A is the proper choice. Although the 3406A is average-responding, it has a sample hold output which makes analysis of waveforms possible.

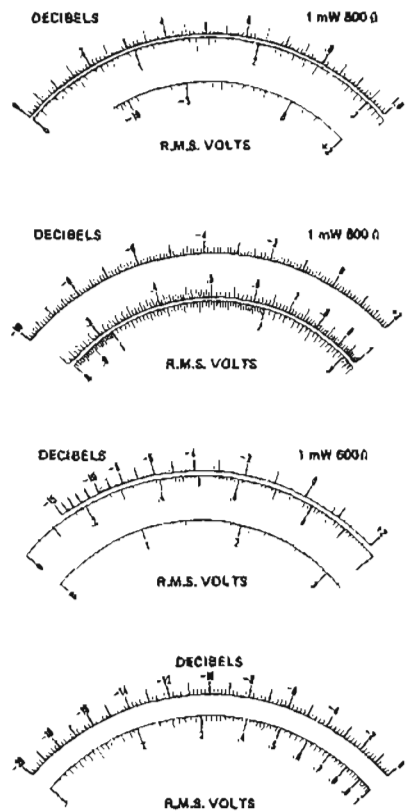

Figure 4. Four different types of meter scales available. (a) Linear 0-3 V and 0-10 V scales plus a dB scale. (b) Linear dB scale plus nonlinear (logarithmic) voltage scales. (c) dB scale placed on larger arc for greater resolution. (d) Linear -20 to 0 dB scale useful for acoustical and communications applications.

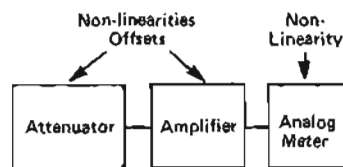

Figure 5. Nonlinearities cause % of reading errors. Offsets cause % of full scale errors.

Table 1. HP Analog Instruments

DC VOLTMETERS	Voltage Range	Frequency Range Accuracy at FB*	Input Impedance	Model	See Page
DC NULL VOLTMETER	$\approx 3 \mu\text{V} - 1 \text{ kV}$ end scale 0.1 μV resolution (18 ranges)	dc $\pm 2\% \pm 1 \mu\text{V}$	100 k - 100 M Ω depending on range (Infinite when nulled)	419A	37
DC DIFFERENTIAL VOLTMETER	1 V to 1 kV (4 ranges)	dc $\pm (0.002\% \text{ reading} + 0.0002\% \text{ range})$	$> 10^{11}$ at null	3420 A/B	36
DC DIFFERENTIAL VOLTMETER	1 mV - 1 kV (7 ranges)	dc $\pm (0.005\% \text{ rdg} + 0.0004\% \text{ rge})$	$> 10^{10}$	740B	253
AC VOLTMETERS	Voltage Range	Frequency Range Typical Accuracy	Response Input Impedance	Model	See Page
BATTERY OPERATED AC VOLTMETER	1 mV - 300 V (12 ranges)	1 Hz - 1 MHz $\pm 3\% - \pm 5\%$	Average 2 M Ω / $< 25 - < 60$ pF	403A	43
RECHARGEABLE BATTERY AC VOLTMETER	1 mV - 300 V (12 ranges)	5 Hz - 2 MHz $\pm 2\% - \pm 5\%$	Average 2 M Ω / $< 30 - < 60$ pF	403B	43
VACUUM-TUBE VOLTMETER, also useful as ac amplifier. 400L has linear 12 dB log scale.	1 mV - 300 V - 70 dB - +52 dB (12 ranges)	10 Hz - 4 MHz = 2% to $\pm 10\%$; 400 Hz = 1% to 10%; 400L: ± 1 to $\pm 5\%$	Average 10 M Ω / $20 - 35$ pF	400D 400L 400H	44
FAST-RESPONSE AC VOLTMETER 100 kHz low-pass filter ac amplifier	100 $\mu\text{V} - 300 \text{ V} - 90 \text{ dB} -$ +52 dB	20 Hz - 4 MHz = 1% - $\pm 4\%$	Average 10 M Ω / $10 - 25$ pF	400F 400FL	45
HIGH ACCURACY dB VOLTMETER 20 dB log scale (0 dB = 1 V)	-100 dB - +60 dB (8 ranges)	20 Hz - 4 MHz = 0.2 dB - 0.4 dB	Average 10 M Ω / $< 15 - < 30$ pF	400GL	45
HIGH ACCURACY AC VOLTMETER has dc output ($\pm 0.5\%$) for driving recorder	1 mV - 300 V - 70 dB - +52 dB	10 Hz - 10 MHz = 1% - $\pm 5\%$	Average 10 M Ω / $< 12 - < 25$ pF	40E 40DEL	45
AC DIFFERENTIAL VOLTMETER also dc $\Delta\text{VM}/\text{dc}$ standard	1 V - 1 kV (4 ranges)	20 Hz - 20 kHz $\pm (0.02\% \text{ reading} + 0.01\% \text{ range})$ †	1 M Ω / < 5 pF	741B	254
AC MICROVOLTMETER; measures signals obscured by noise	3 $\mu\text{V} - 3 \text{ V}$ (13 ranges) -110 dBm to +10 dBm	5 Hz - 600 kHz = 3% - $\pm 10\%$	Average 10 M Ω / $< 10 - 20$ pF	3410A	See data sheet
RMS VOLTMETER provides rms readings of complex signals. Has dc output for driving DVM's or recorders	1 mV - 300 V (12 ranges)	10 Hz - 10 MHz = 1% - $\pm 5\%$	10 M Ω / $15 - 40$ pF	3400A	46
SAMPLING RF VOLTMETER provides true rms measurements when used with 3400A. Many accessories	1 mV - 3 V (8 ranges)	10 kHz to $> 1.2 \text{ GHz}$ $\pm 3\% - \pm 13\%$	Statistical Average; Input Z depends on probe tip used	3406A	42
RF MILLIVOLTMETER	10 mV - 10 V (7 ranges)	500 kHz to 1 GHz = 3% 1 dB	Average Input Z depends on probe tip used	411A	See data sheet
VECTOR VOLTMETER phase and amplitude measurements	100 $\mu\text{V} - 10 \text{ V}$ (9 ranges)	1 MHz - 1 GHz = 0.5 dB - ± 1 dB	Average 0.1 m Ω / 2.5 pF	8405A	361
MILLOHMETER; two probes used when making 4 terminal measurements	0.001 to 100 Ω FS (11 ranges)	1 kHz (fixed) $\pm 2\%$ FS	Max. output Voltage: 20 mV	4328A	49
HIGH RESISTANCE METER and picoammeter	0.5 M Ω to $2 \times 10^{14} \Omega$ FS (7 ranges) 0.05 pA - 20 μA	Voltage: $\pm 10\%$ Current: $\pm 5\%$	Max. output Voltage: 1 kV	4329A	49
MULTIFUNCTION METERS	Voltage Range (Accuracy)	Current Range (Accuracy)	Resistance Range (Accuracy)	Model	See Page
BATTERY-OPERATED MULTIFUNCTION METER has 10 M Ω dc input impedance and 10 M Ω /20 pF ac input impedance	DC: $\pm 100 \text{ mV}$ to 1000 V ($\pm 2\%$) 9 ranges AC: 10 mV - 300 V 10 Hz - 1 MHz ($\pm 2\%$) 10 ranges		10 Ω - 10 M Ω midscale $\pm 5\%$; from 3 to 3 on the meter scale 7 ranges	427A	40
VERSATILE VOLTMETER has 100 M Ω dc input impedance and 10 M Ω /1.5 pF ac impedance	DC: $\pm 15 \text{ mV}$ to $\pm 1500 \text{ V}$ ($\pm 2\%$) 11 ranges AC: 0.5 V - 300 V 20 Hz - $> 700 \text{ MHz}$ ($\pm 3\%$ at 400 Hz) 7 ranges	DC: $\pm 1.5 \mu\text{A}$ to $\pm 150 \text{ mA}$ ($\pm 3\%$) 11 ranges	10 Ω - 10 M Ω (center scale) 0 to midscale; $\pm 5\%$ or $\pm 2\%$ of mid- scale (whichever is greater) 7 ranges	410C	41
VACUUM-TUBE VOLTMETER has 122 M Ω dc input impedance and 10 M Ω /1.5 pF ac impedance	DC: $\pm 1 \text{ V} - \pm 1000 \text{ V}$ ($\pm 3\%$) 7 ranges AC: 1 - 300 V 20 Hz - 700 MHz ($\pm 3\%$ at 400 Hz) 6 ranges		10 Ω - 10 M Ω midscale; $\pm 5\%$ from 3 to 30 on meter scale (1 Ω on X1 range) 7 ranges	410B	See data sheet
DC VACUUM-TUBE VOLTMETER has 10 M Ω to 200 M Ω input impedance	DC: $\pm 1 \text{ mV} - \pm 1000 \text{ V}$ ($\pm 1\%$) 13 ranges	DC: $\pm 1 \mu\text{A}$ to $\pm 1 \text{ A}$ ($\pm 2\%$) 13 ranges	1 Ω - 100 M Ω ($\pm 5\%$ midscale) 9 ranges	412A	38
DC MICROVOLT-AMMETER has 1 M Ω input impedance (Vollmeter)	DC: $\pm 10 \mu\text{V} - \pm 1 \text{ V}$ ($\pm 3\%$) 11 ranges	DC: $\pm 10 \text{ pA}$ to $\pm 3 \text{ mA}$ ($\pm 3\%$) 18 ranges		425A	38
BATTERY OPERATED DC VOLT-AMMETER: 10 M Ω minimum input impedance, all ranges	DC: $\pm 1 \text{ mV} - \pm 300 \text{ V}$ ($\pm 3\%$) 12 ranges	$\pm 1 \text{ nA} - \pm 300 \mu\text{A}$ ($\pm 3\%$) 12 ranges		4304A	See data sheet
CURRENT METERS	Current Range	Accuracy	Frequency Range	Model	See Page
DC MILLIAMMETER with clip-on probe eliminates direct connection	1 mA - 10 A FS (9 ranges)	$\pm 3\%$	dc - 400 Hz	428B	39
AC CLIP-ON CURRENT PROBE makes measurements without breaking circuit	1 mA - 1 A rms (to 25A with divider)	$\pm 2\%$ to 3 dB	25 Hz - 20 MHz	456A	57

*For exact accuracy refer to page designated.

†Mid-frequency (50 mV - 100 V).



DC Δ VOLT/RATIOMETER

1 ppm stability with ±0.002% accuracy
Models 3420A & 3420B

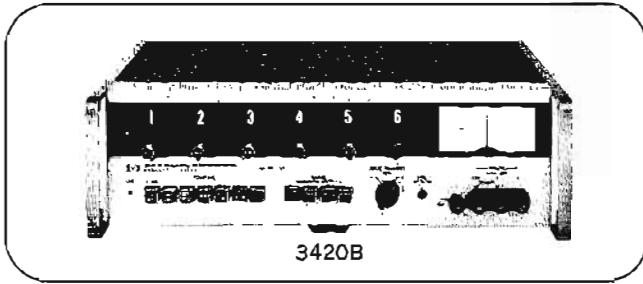

Description

The Hewlett-Packard Models 3420A and 3420B are precision dc differential voltmeters and ratiometers. The 3420A is operated from ac line power only, while the 3420B operates from either ac line power or internal rechargeable batteries.

Functioning as a dc differential voltmeter, the 3420A/B measure dc voltages within ±(20 ppm of reading + 2 ppm of range) on all ranges. As a dc ratiometer, both instruments measure ratios within ±(20 ppm of reading + 4 ppm of range) on all ratio ranges.

Specifications

DC Differential Voltmeter

Ranges

Voltage: ±1 V, ±10 V, ±100 V and ±1000 V with up to 10% overranging available on all ranges.

Resolution: 6-digit readout yields resolution of 1 ppm of range; 0.2 ppm of range indicated on meter.

Performance rating

Accuracy

30 day: ±(0.002% of reading + 0.0002% of range) at 23°C ±1°C, <70% RH.

90 day: ±(0.003% of reading + 0.0002% of range) at 23°C ±1°C, <70% RH.

Stability: (at 23°C ±1°C, <70% RH): 1 hr: <1 ppm of reading; 24 hr: <5 ppm of reading.

Temperature coefficient: <4 ppm of range /°C (20°C-30°C); <5 ppm of range /°C (10°C-20°C and 30°-40°C).

Zero adjustment range: >±12 ppm of range.

Meter noise: <0.2 ppm of range p-p.

Input characteristics

Inputs: floated binding posts on front panel can be operated up to ±500 V dc (350 V rms) with respect to chassis ground.

Input resistance: >10¹⁴Ω at null, <70% RH; at least 10 MΩ ±0.05% off null (1 V, 10 V ranges); 10 MΩ ±0.05% (100 V, 1000 V ranges).

Effective common-mode rejection (ECMR)

DC: >140 dB on 1 V and 10 V ranges, <70% RH.

>110 dB on 100 V and 1 kV ranges, <70% RH.

60 Hz and above: >150 dB on all ranges, <70% RH.

Normal mode-rejection (NMR)

60 Hz and above: >102 dB.

Maximum normal-mode signal: 25 V rms on 1 V range; 200 V rms on 10 V, 100 V, 1000 V ranges.

Overload protection: ±1100 V dc may be applied on any range or sensitivity for up to 1 min without damaging

instrument. Meter indicates within 5 s after removal of overload.

DC Ratiometer

Ranges

Ratio: X1, X.1, X.01 and X.001.

Resolution: 6-digit readout yields resolution of 1 ppm of range; 0.2 ppm of range indicated on meter.

Performance rating

Accuracy: (23°C ±1°C, <70% RH).

30 day: ±(0.002% of reading + $\frac{0.0004\% \text{ of range}}{E_{(A \text{ to COM})}}$).

90 day: ±(0.003% of reading + $\frac{0.0004\% \text{ of range}}{E_{(A \text{ to COM})}}$).

Stability: (at 23°C ±1°C, <70% RH) 1 hr: <1 ppm of reading; 24 hr: <5 ppm of reading.

Temperature coefficient: (10°C to 40°C) X1 range: <1 ppm of range per °C.

X.1, X.01, X.001 ranges: <5 ppm of range per °C.

Zero adjustment range: >±12 ppm of range.

Meter noise: <0.2 ppm of range (p-p).

Input characteristics

Input: 3 terminals, A, B, Common.

Displayed Voltage Ratio = $\frac{E_{(B \text{ to COM})}}{E_{(A \text{ to COM})}}$

with; $E_{(A \text{ to COM})} > |E_{(B \text{ to COM})}|$
and of same polarity.

Range	Input Voltage	Input Resistance	
		A to Common	B to Common
X1	10 V	10 kΩ ±0.05%	>10 ¹⁰ Ω at null; at least 10 MΩ ±0.05% off null
X.1	70 V	100 kΩ ±0.05%	
X.01	500 V	1 MΩ ±0.05%	
X.001	1000 V	10 MΩ ±0.05%	

DC Voltmeter

Ranges: ±10 μV to ±1 kV in 9 decade ranges.

Accuracy: ±3% of range.

Input resistance: ±10 μV to ±10 mV ranges: 1 MΩ.
±100 mV to 1 kV ranges: 10 MΩ.

General

Recorder output: fully adjustable 0 to ±1 V supplies 1 mA to 1 kΩ minimum resistance (in ratiometer mode, recorder ground must be isolated from COM terminal by >10¹⁰Ω).

Recorder output noise: <50 mV p-p (<0.5 ppm of range referred to input at maximum sensitivity).

Operating temperature: instrument will operate within rated specifications from 10°C to 40°C unless otherwise specified.

Power: 3420A: 115 V or 230 V ±10%, 48 Hz to 440 Hz, 6 VA max. 3420B: 115 V or 230 V ±10%, 48 Hz to 440 Hz, 6 VA max. or rechargeable batteries (8 furnished) 30 hours operation per recharge; input for fast charge mode.

Dimensions: 16¾" wide, 5-7/32" high, x 11¼" deep (425 x 132 x 286 mm).

Weight: 3420A net 20 lbs (9 kg); shipping 26 lbs (11.7 kg). 3420B net 21 lbs (9.3 kg); shipping 26 lbs (11.7 kg).

Accessories furnished: rack mount kit for 19" rack.

Price: HP 3420A, \$1400; HP 3420B, \$1550.

DC NULL VOLT-AMMETER

18 Voltage, 7 current ranges; 0.1 μV resolution
Model 419A



MEASURING DEVICES

Eighteen voltage ranges with 0.1 μV resolution on the lowest range set this HP solid-state DC Null Voltmeter apart from previous dc null meters. The accuracy of this rechargeable battery-operated instrument is $\pm 2\%$ of end scale $\pm 0.1 \mu\text{V}$ on all ranges. Noise is less than 0.3 μV p-p, and drift is less than 0.5 μV /day.

An internal bucking source allows input voltages up to 300 mV to be nulled giving an infinite input impedance. Input impedance above the 300 mV range is 100 megohms.

Pushbutton Selection Provides Convenience-versatility

Seven pushbuttons allow the operator to select rapidly the desired function of the HP 419A. This dc null voltmeter operates from the ac line or from the internal rechargeable batteries. During operation from the ac line, the batteries are trickle-charged. A fast-charge pushbutton is provided to increase the charging rate, recharging the batteries in approximately 16 hours. Battery voltage may be easily checked with the battery-test pushbutton. The zero pushbutton enables the operator to compensate for any internal offsets before making a measurement. When this pushbutton is depressed, the positive leg of the voltmeter is disconnected from the positive input terminal and connected to the negative input terminal.

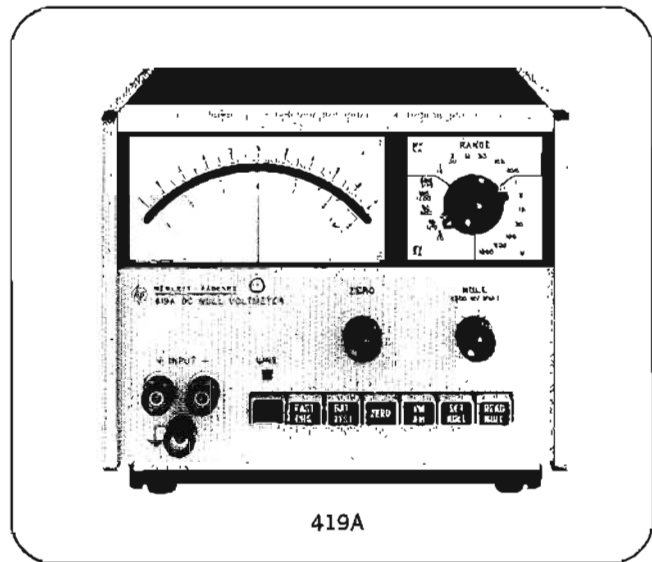

419A

When the VM pushbutton is depressed, the HP 419A functions as a zero-center scale 3 μV to 1000 V dc voltmeter.

When the AM pushbutton is depressed, the HP 419A functions as a zero-center scale 30 pA to 30 nA ammeter.

Specifications

DC null voltmeter

Ranges: $\pm 3 \mu\text{V}$ to $\pm 1000 \text{ V}$ dc in 18 zero-center ranges.

Accuracy: $\pm (2\%$ of range $\pm 0.1 \mu\text{V})$.

Zero control range: $> \pm 15 \mu\text{V}$.

Zero drift: $< 0.5 \mu\text{V}/\text{day}$ after 30 min warm-up.

Zero temperature coefficient: $< 0.05 \mu\text{V}/^\circ\text{C}$.

Response time: 3 s to within 95% of final reading on 3 μV range; 1 s to within 95% of final reading on 10 μV to 1000 V ranges.

Noise: $< 0.3 \mu\text{V}$ p-p, input shorted.

[Noise amplitude approximates Gaussian distribution. RMS value (standard deviation) is $< 0.075 \mu\text{V}$, p-p noise value is $< 0.3 \mu\text{V}$ 95% of the time.]

Input characteristics

At null: infinite resistance on 3 μV through 300 mV ranges in SET NULL mode. Negative input terminal can be floated up to $\pm 500 \text{ V}$ dc from powerline ground.

Off null:

Voltage range	Input resistance
3 μV - 3 mV	100 k Ω
10 mV - 30 mV	1 M Ω
100 mV - 300 mV	10 M Ω
1 V - 1000 V	100 M Ω

Negative input terminal can be floated up to $\pm 500 \text{ V}$ dc from powerline ground.

AC normal-mode rejection: ac voltages 50 Hz and above and 80 dB greater than end scale affect reading $< 2\%$. Peak ac voltage not to exceed maximum overload voltage.

DC ammeter

Ranges: $\pm 30 \text{ pA}$ to $\pm 30 \text{ nA}$ in 7 zero-center ranges.

Accuracy: $\pm (3\%$ of range $+ 1 \text{ pA})$.

Zero control range: $> \pm 150 \text{ pA}$.

Zero drift: $< 5 \text{ pA}/\text{day}$ after 30 min warm-up.

Zero temperature coefficient: $< 0.5 \text{ pA}/^\circ\text{C}$.

Noise: $< 3 \text{ pA}$ p-p, input shorted.

Input resistance: 100 k Ω on all ranges.

Amplifier

Gain: 110 dB on 3 μV range, decreases 10 dB per range.

Output: 0 to $\pm 1 \text{ V}$ at 1 mA maximum for end-scale reading.

Output level adjustable for convenience when used with recorders.

Output resistance: depends on setting of output level control. $< 35 \Omega$ when output control is set to maximum.

Noise: 0.01 Hz to 5 Hz: same as voltmeter (referred to input). $> 5 \text{ Hz}$: $< 10 \text{ mV rms}$ (referred to output).

General

Overload protection: the following voltages can be applied without damage to instrument.

1 V to 1000 V range: 1200 V dc.

10 mV to 300 mV range: 500 V dc.

3 μV to 300 mV range: 50 V dc.

Operating temperature: instrument will operate within specifications from 0°C to 50°C .

Operating humidity: $< 70\%$ RH.

Storage temperature: -20°C to $+50^\circ\text{C}$.

Power: 115 V or 230 V $\pm 10\%$, 48 Hz to 440 Hz, 2 VA max. or 4 internal rechargeable batteries (furnished). 30-hr operation per recharge. Operation from ac line permissible during recharge.

Dimensions: 7 $\frac{3}{4}$ " wide, 6 $\frac{1}{4}$ " high (without removable feet), 8" deep (197 x 156 x 203 mm).

Weight: net, 8.3 lb (3.7 kg); shipping, 12 lb (5.4 kg).

Price: HP 419A, \$475.



DC VOLT-OHM-AMMETER

1% accuracy vtvm is also ohmmeter, ammeter
Model 412A

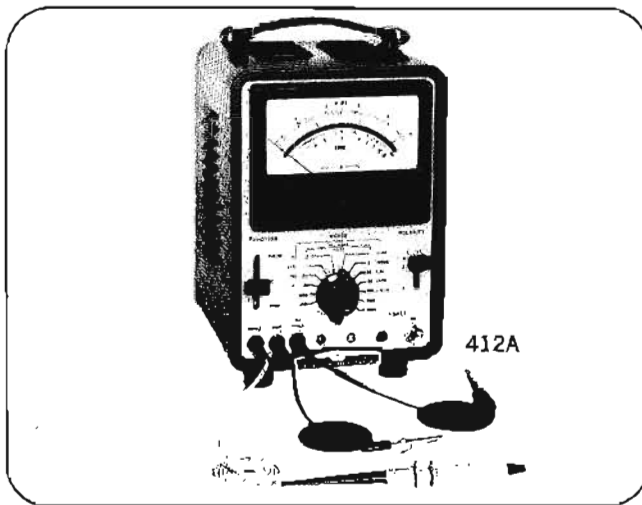

Description

The HP Model 412A is a multipurpose meter designed to measure dc voltage, current, and resistance with laboratory accuracy.

Specifications

Voltmeter

Voltage range: pos. and neg. voltages from 1 mV to 1000 V full scale, 13 ranges.

Accuracy: $\pm 1\%$ of full scale on any range.

Input resistance: 10 M Ω $\pm 1\%$ on 1 mV, 3 mV and 10 mV ranges; 30 M Ω $\pm 1\%$ on 30 mV range; 100 M Ω $\pm 1\%$ on 100 mV range; 200 M Ω $\pm 1\%$ on 300 mV range and above.

AC rejection: a voltage at power line or twice power line frequency 40 dB > full scale affects reading < 1%. Peak voltage must not exceed 1500 V.

Ammeter

Current range: pos. and neg. currents from 1 μ A to 1 A full scale, 13 ranges.

Accuracy: $\pm 2\%$ of full scale on any range.

Input resistance: decreasing from 1000 Ω on 1 μ A range to 0.1 Ω on 1 A range.

Ohmmeter

Resistance range: resistance from 1 Ω to 100 M Ω center scale, 9 ranges.

Accuracy: $\pm 5\%$ of reading at center scale.

Short circuit current: from 0.01 μ A on the X100 M Ω range to 10 mA on the 1 Ω range.

Amplifier*

Voltage gain: 1000 maximum.

DC bandwidth: dc to 0.7 Hz on all voltage ranges.

Output: proportional to meter indication; 1 V at full scale; max. current, 1 mA (full scale corresponds to 1 on upper scale).

General

Power: 115 or 230 V $\pm 10\%$, 50 to 60 Hz, 60 VA max.

Dimensions: cabinet: 7 $\frac{1}{2}$ " wide, 11 $\frac{1}{2}$ " high, 10" deep (191 x 292 x 254 mm); rack mount: 19" wide, 5-7/32" high, 7 $\frac{1}{2}$ " deep behind panel (483 x 134 x 191 mm).

Weight: net: 12 lbs (5,5 kg); shipping 14 lbs (6,4 kg) (cabinet); net 12 lbs (5,5 kg); shipping: 21 lbs (9,5 kg) (rack mount).

Price: HP 412A, \$475 (cabinet).

HP 412AR, \$480 (rack mount).

* Refer to data sheet for complete specifications.

DC MICROVOLT-AMMETER

10 μ V, 10 pA full scale sensitivity

Model 425A

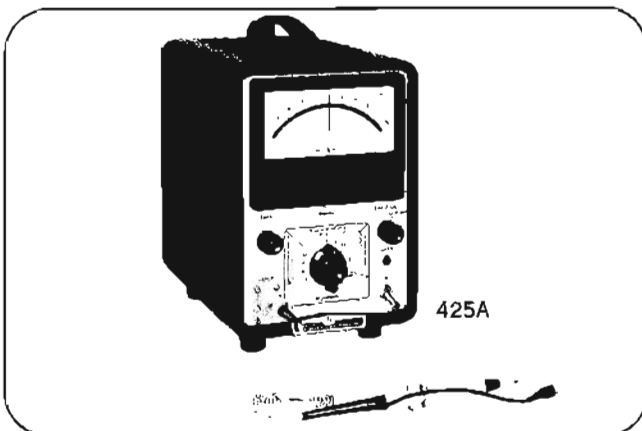

Description

Hewlett-Packard's 425A, DC Microvolt-Ammeter, makes measurements of extremely small dc voltages from 1 μ V to 1 V; dc currents, from 1 pA to 3 mA.

Specifications

Microvolt-ammeter

Voltage range: pos. and neg. voltages from 10 μ V end scale to 1 V end scale, 11 steps, 1, 3, 10 sequence.

Current range: pos. and neg. currents from 10 pA end scale

to 3 mA end scale, 18 steps, 1, 3, 10 sequence.

Input impedance: voltage ranges, 1 M Ω $\pm 3\%$; current range, depends on range, 1 M Ω to 0.33 Ω .

Accuracy: within $\pm 3\%$ of range; line frequency variations ± 5 Hz affect accuracy $< \pm 2\%$.

Amplifier*

Gain: 100,000 maximum.

DC bandwidth:

dc to 0.1 Hz on 10 μ V range.

dc to 0.3 Hz on 30 μ V range.

dc to 0.7 Hz on 100 μ V range and above.

Output: 0 to 1 V for end-scale reading, adjustable (5000 Ω shunt potentiometer), 1 mA maximum at 1 V output.

General

Power: 115 or (230 V must be specified) $\pm 10\%$, 60 Hz, 50 VA max.; 50 Hz operation is available as option 001.

Dimensions: cabinet: 7 $\frac{3}{8}$ " wide, 11 $\frac{3}{4}$ " high, 12" deep (186 x 299 x 305 mm); rack mount: 19" wide, 7" high, 11" deep behind panel (483 x 178 x 279 mm).

Weight: net 17 lbs (7,7 kg); shipping 18 lbs (8,2 kg) (cabinet); net 21 lbs (9,5 kg); shipping 31 lbs (14 kg) (rack mount).

Price: HP 425A, \$585 (cabinet). HP 425A Option 001, for operation from 50 Hz power, no extra charge.

* Refer to data sheet for complete specifications.

CLIP-ON MILLIAMMETER

Measures current without interrupting circuit
Model 428B and probes



MEASURING DEVICES

Description

Direct current from 0.02 milliamperes to 10 amperes can be measured with the HP 428B without interrupting the circuits and without the error-producing loading of conventional methods.

For any measurement of dc within its range, simply clamp the jaws of the 428B around a wire and read.

This ease and speed of operation are unparalleled, especially for applications where many dc measurements must be made. Wide current range of the 428B will handle most signals directly. For even greater sensitivity, several loops may be put through the probe, increasing the sensitivity by the same factor as the number of loops.

In addition to making current measurements directly, the 428B is also valuable for measuring sums and differences of currents in separate wires. When the probe is clipped around two wires carrying current in the same direction, their sum is indicated on the meter; when one of the wires is reversed, their difference is measured. Thus, current balancing is possible by obtaining a zero difference reading.

Model 428B provides an output voltage proportional to the measured current, which is useful for driving recorders or making low-frequency (dc to 400 Hz) current measurements.

Specifications

- Current range:** 1 mA to 10 A full scale, nine ranges.
Accuracy: $\pm 3\%$ of full scale ± 0.15 mA, from 0°C to 55°C (when instrument is calibrated to probe).
Probe inductance: $< 0.5 \mu\text{H}$.
Probe inducted voltage: < 15 mV p (worst case at 20 kHz and harmonics).
Output: variable linear output level with switch position for calibrated 1 V into open circuit (corresponds to full scale deflection). 1.5 V max. into open circuit in uncalibrated position. 0.73 ± 0.1 V into 1 k Ω in calibrated position.
Noise: 1 mA range, < 15 mV rms across 1 k Ω .
 3 mA range, < 5 mV rms across 1 k Ω .
 10 mA through 10 A ranges, < 2 mV rms across 1 k Ω .
Frequency range: dc to 400 Hz (3 dB point).
AC rejection: signals above 5 Hz with p value $<$ full scale affect meter accuracy $< 2\%$ (except at 40 kHz carrier frequency and its harmonics). On the 10 A range, ac p value is limited to 4 A.
Power: 115 or 230 V $\pm 10\%$, 50 to 60 Hz, approx. 75 VA max.
Operating temperature range: -20°C to $+55^\circ\text{C}$.
Storage temperature: -40°C to $+65^\circ\text{C}$.
Probe insulation: 300 V maximum.
Probe tip size: approximately $\frac{1}{2}$ " by $2\frac{1}{32}$ "; aperture diameter $\frac{5}{32}$ ".
Dimensions: $7\frac{1}{2}$ " wide, $11\frac{1}{2}$ " high, $14\frac{1}{2}$ " deep (191 x 292 x 368 mm); rack mount: 19" wide, 6-31/32" high, 13" deep (483 x 177 x 330 mm).
Weight: net 19 lbs (8,6 kg), shipping 24 lbs (10,9 kg) (cabinet); net 24 lbs (10,8 kg); shipping 32 lbs (14,4 kg) (rack mount).
Price: HP 428B, \$675 (cabinet); HP 428BR, \$680 (rack mount).

Accessories Available

3529A Magnetometer Probe

The HP 3529A Magnetometer Probe is useful in applications where determination must be made of the direction or magnitude of a magnetic field. It is useful in applications ranging from acoustical transducer design to investigations involving the Zeeman effect.

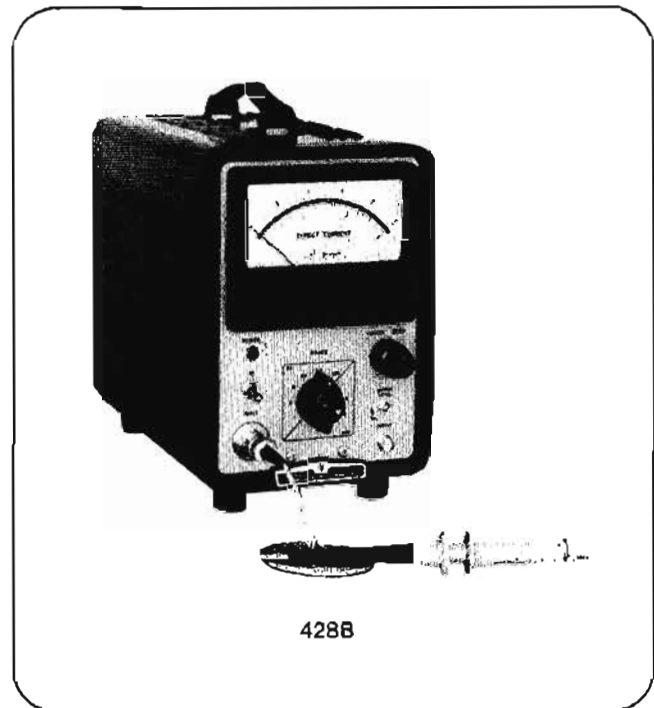

428B

Conversion factor is 1:1, producing a reading on the 428B in milliamperes which is directly equal to the measured field strength in milligauss. Range is 1 milligauss to 10 gauss with the 428B. The bandwidth is dc to 80 Hz, and accuracy is $\pm 3\%$ of full scale when the probe is calibrated with the instrument.

Price: HP 3529A, \$95.

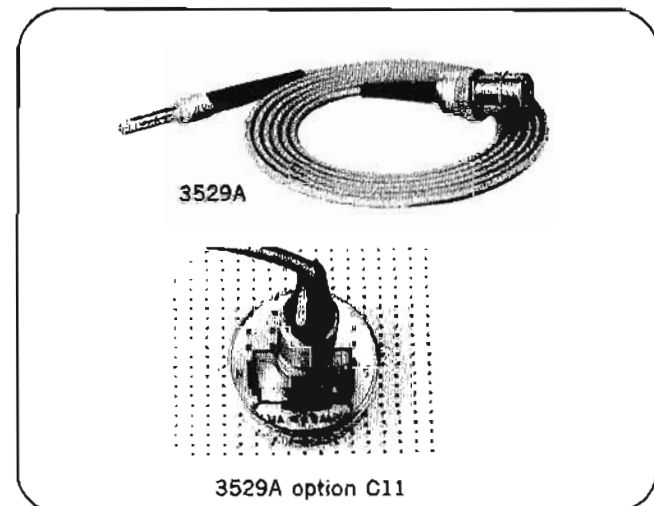

3529A

3529A option C11

3529A Option C11 Magnetometer Probe

The 3529A Option C11 is a special magnetometer probe used to convert the Hewlett-Packard 428A or 428B DC Milliammeter into a direct reading magnetometer (1 G = 1 mA indication on 428 A/B meter). The 3529A Option C11 Magnetometer Probe is specifically designed to measure the relative magnetic field strength of individual bar magnets on twistor memory cards used in the Western Electric Electronic Switching System (No. 1ESS). Refer to data sheet for further information.

Price: HP 3529A, Option C11, \$170.



MULTI-FUNCTION METER

Low-cost, solid state, battery operated
Model 427A

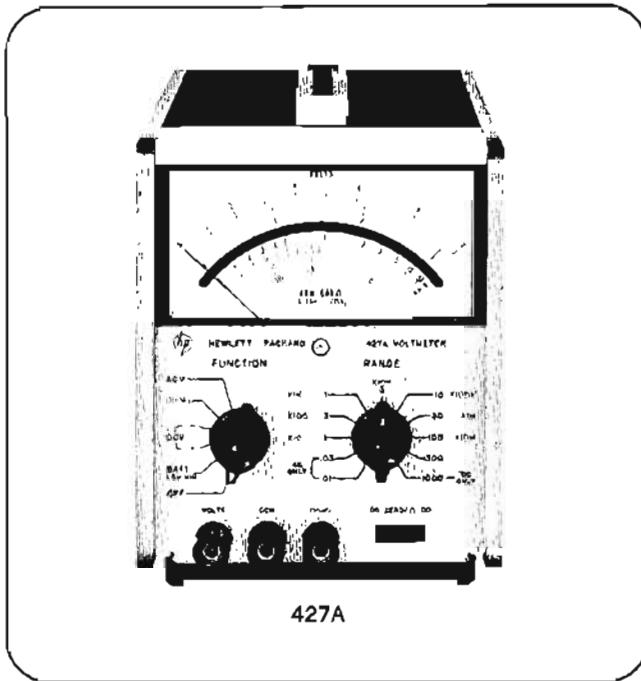

Description

The Hewlett-Packard Model 427A is a portable, versatile, low cost multi-function meter which is valuable in any laboratory, production line, service department, or in the field. It is capable of measuring dc voltages from 100 mV to 1 kV full scale; ac voltage from 10 mV to 300 V full scale at frequencies up to 1 MHz (>500 MHz with the 11096A High Frequency Probe); and resistance from 10 Ω to 10 M Ω center scale.

The 427A will operate continuously for more than 300 hours on its internal 22.5 V dry cell battery. AC line and battery operation is available as an option.

Specifications

DC voltmeter

Ranges: ± 100 mV to ± 1000 V in 9 ranges in 10 dB steps.

Accuracy: $\pm 2\%$ of range.

Input resistance: 10 M Ω .

AC normal-mode rejection (ACNMR): ACNMR is the ratio of the normal-mode signal to the resultant error in read-out. 50 Hz and above: >80 dB.

Overload protection: 1200 V dc.

AC voltmeter

Ranges: 10 mV to 300 V in 10 ranges in 10 dB steps.

Frequency range: 10 Hz to 1 MHz.

Response: responds to average value, calibrated in rms.

Accuracy

Frequency	Range	
		0.01 V to 30 V
10 Hz to 100 kHz	2% of range	2% of range
100 kHz to 1 MHz		

Input impedance: 10 mV to 1 V range, 10 M Ω shunted by <40 pF; 3 V to 300 V range, 10 M Ω shunted by <20 pF.
Overload protection: 300 V rms momentarily, 1 V range and below; 450 V rms max. above 1 V range.

Ohmmeter

Ranges: 10 Ω to 10 M Ω center scale in 7 decade ranges.

Accuracy (from 0.3 to 3 on scale): $\pm 5\%$ of reading.

Source current (ohms terminal positive). Short circuit current: from 10 mA on the X10 range to 0.1 μ A on the X10 M range.

Open circuit voltage: from 0.1 V on the X10 range to 1 V on the X10 M range.

General

Input: may be floated up to ± 500 V dc above chassis ground. Ohms input open in any function except ohms. Volts input open when instrument is off.

Operating temperature: 0°C to 50°C.

Power: >300-hr operation per battery.

HP 427A: 22.5 V dry cell battery, Eveready No. 763 or RCA VS102. **HP 427A Option 001:** battery operation or ac line operation, selectable on rear panel. 115 V or 230 V $\pm 20\%$ 48 Hz to 440 Hz, 2 VA max.

Dimensions (standard 1/2 module): 5 1/4" wide, 6 1/4" high (without removable feet), 8" deep (130 x 159 x 203 mm).

Weight: net, 5.3 lb (2.4 kg); shipping, 8 lb (3.6 kg).

Price (includes battery): HP 427A, \$250.

HP 427A Option 001, add \$25.

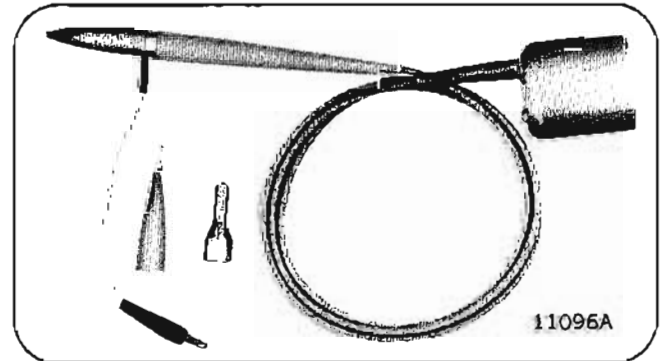

Accessories available

HP 11096A High Frequency AC Probe extends range to >500 MHz. With the 11096A you can measure 0.25 to 30 V rms signals out to 500 MHz with better than ± 1 dB accuracy. Usable relative measurements can be made up to 1 GHz (3 dB point at 700 MHz). The 11096A is a peak-responding detector calibrated to produce a dc output proportional to the rms value of a sine wave input. Input impedance is 4 M Ω shunted by 2 pF.

Price: HP 11096A, \$75.

HP 11075A High Impact Case. A rugged case for carrying, storing and operating the 427A, \$60.

HP 11001A 45" test lead, dual banana plug to male BNC, \$7.

HP 11002A 60" test lead, dual banana plug to alligator clips, \$8.

HP 11003A 60" test lead, dual banana plug to pencil probe and alligator clip, \$10.

HP 11039A 1000: 1 capacitive voltage divider, 25 kV max, \$250.

HP 10111A BNC female to dual banana adapter, \$10.

MULTIFUNCTION VOLTMETER

All-purpose instrument measures to 700 MHz
Model 410C



MEASURING DEVICES

Description

The HP Model 410C is a versatile general purpose instrument for use anywhere electrical measurements are made. This one instrument measures dc voltages from 15 mV to 1500 V, direct current from 1.5 μ A to 150 mA full scale, and resistance from 0.2 Ω to 500 M Ω . With a standard plug-in probe, ac voltages at 20 Hz to 700 MHz from 50 mV to 300 V and comparative indications to 3 GHz are attainable.

410C Specifications

DC voltmeter

Voltage ranges: ± 15 mV to ± 1500 V full scale in 15, 50 sequence (11 ranges).

Accuracy: $\pm 2\%$ of full scale on any range.

Input resistance: 100 M Ω $\pm 1\%$ on 500 mV range and above, 10 M Ω $\pm 3\%$ on 150 mV range and below.

AC voltmeter

Voltage ranges: 0.5 V to 300 V full scale in 0.5, 1.5, 5 sequence (7 ranges).

Frequency range: 20 Hz to 700 MHz.

Accuracy: $\pm 3\%$ of full scale at 400 Hz for sinusoidal voltages from 0.5 V to 300 V rms. The ac probe responds to the positive peak-above-average value of the applied signal. The meter is calibrated in rms.

Frequency response: $\pm 2\%$ from 100 Hz to 50 MHz (400 Hz ref.); 0 to -4% from 50 MHz to 100 MHz; $\pm 10\%$ from 20 Hz to 100 Hz and from 100 MHz to 700 MHz.

Input impedance: input capacitance 1.5 pF, input resistance >10 M Ω at low frequencies. At high frequencies impedance drops off due to dielectric loss.

Safety: the probe body is grounded to chassis at all times for safety. All ac measurements are referenced to chassis.

DC ammeter

Current ranges: ± 1.5 μ A to ± 150 mA full scale in 1.5, 5 sequence (11 ranges).

Accuracy: $\pm 3\%$ of full scale on any range.

Input resistance: decreasing from 9 k Ω on 1.5 μ A range to approximately 0.3 Ω on the 150 mA range.

Special current ranges: ± 1.5 , ± 5 and ± 15 nA may be measured on the 15, 50 and 150 mV ranges using the dc voltmeter probe, with $\pm 5\%$ accuracy and 10 M Ω input resistance.

Ohmmeter

Resistance range: resistance from 10 Ω to 10 M Ω center scale (7 ranges).

Accuracy: Zero to midscale: $\pm 5\%$ of reading or $\pm 2\%$ of midscale, whichever is greater.

$\pm 7\%$ from midscale to scale value of 2.

$\pm 8\%$ from scale value of 2 to 3.

$\pm 9\%$ from scale value of 3 to 5.

$\pm 10\%$ from scale value of 5 to 10.

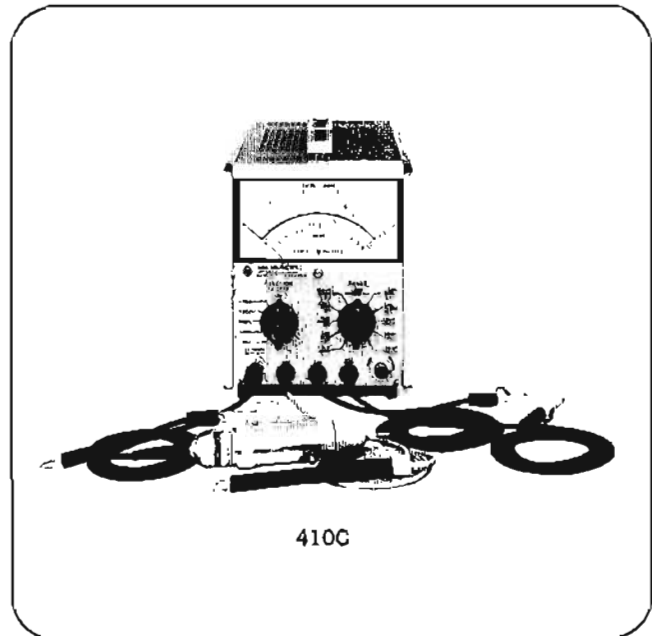

Amplifier

Voltage gain: 100 maximum.

AC rejection: 3 dB at 0.5 Hz; approximately 66 dB at 50 Hz and higher frequencies for signals <1600 V p or 30 times full scale, whichever is smaller.

Isolation: impedance between common and chassis is >10 M Ω in parallel with 0.1 μ F. Common may be floated up to 400 V dc above chassis for dc and resistance measurements.

Output: proportional to meter indication; 1.5 V dc at full scale, maximum current, 1 mA.

Output Impedance: <3 Ω at dc.

Noise: $<0.5\%$ of full scale on any range (p-p).

DC drift: $<0.5\%$ of full scale/yr at constant temperature; $<0.02\%$ of full scale/ $^{\circ}$ C.

Overload recovery: recovers from 100:1 overload in <3 s.

General

Maximum input: (see overload recovery) dc: 100 V on 15, 50 and 150 mV ranges, 500 V on 0.5 to 15 V ranges, 1600 V on higher ranges. ac: 100 times full scale or 450 V p whichever is less.

Power: 115 V or 230 V $\pm 10\%$, 48 Hz to 440 Hz, 26 VA max.

Dimensions: 5 $\frac{1}{8}$ " wide, 6 $\frac{1}{4}$ " high (without removable feet), 11" deep (130 x 159 x 279 mm) behind panel.

Weight: net 8 lb (4 kg); shipping 12 lb (5.44 kg).

Accessories furnished: detachable power cord, NEMA plug.

Accessories available: see page 57.

Price: HP 410C with HP 11036A Detachable AC Probe, \$515. 410C Option 002 (less ac probe), deduct \$50.



RF VOLTMETER

20 μV sensitivity; average-response
Model 3406A

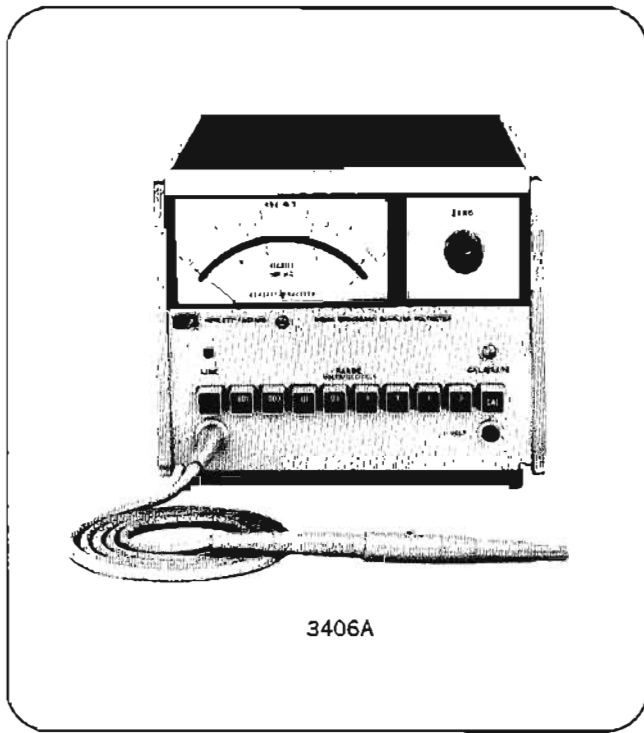

Description

Average-response (calibrated in rms of a sine wave) of high frequency signals previously impractical can now be made easily with the HP 3406A Sampling Voltmeter. Employing incoherent sampling techniques, the HP 3406A has extremely wide bandwidth (10 kHz to 1.2 GHz) with high input impedance. Signals as small as 50 μV can be resolved on the sampling voltmeter's linear scale. Full scale sensitivity from 1 mV to 3 V is selected in eight 10 dB steps and may be read directly from -62 dBm to $+23$ dBm for power measurements. Accessory probe tips make the HP 3406A suitable for voltage measurements in many applications such as receivers, amplifiers and coaxial transmission lines.

Measurement indications can be retained on the 3406A meter by depressing a push-button located on the pen-type probe. This feature is useful when measurements are made in awkward positions where the operator cannot observe the meter indication and probe placements at the same time. Other features include a dc recorder output and sample hold output for connection to oscilloscopes, and peak or true rms voltmeters if other than absolute average measurements are required.

Specifications

Voltage range: 1 mV to 3 V full scale in 8 ranges; decibels from -50 to $+20$ dBm (0 dBm = 1 mW into 50 Ω); average-responding instrument calibrated to rms value of sine wave.

Frequency range: 10 kHz to 1.2 GHz; useful sensitivity from 1 kHz to beyond 2 GHz.

Full-scale accuracy (%) with appropriate accessory (after probe is properly calibrated)

10 kHz	20 kHz	25 kHz	100 kHz	100 MHz	700 MHz	1 GHz	1.2 GHz
± 13	± 8	± 5	± 3	± 5	± 8	± 13	

Input impedance: input capacity and resistance will depend upon accessory tip used. 100,000 Ω shunted by < 2.1 pF at 100 kHz with bare probe; < 10 pF with 11072A isolator tip supplied.

Sample hold output

Provides ac signal whose unclamped portion has statistics that are narrowly distributed about the statistics of the input, inverted in sign (operating into > 200 k Ω load with < 1000 pF). Output is 0.316 V at f.s. on any range.

Noise: < 175 μV rms referred to input.

Accuracy (after probe is properly calibrated): 0.01 V range and above: same as full scale accuracy of instrument.

0.001 V to 0.003 V range: value of input signal can be computed by taking into account the residual noise of the instrument.

Jitter: meter indicates within $\pm 2\%$ p of reading 95% of time (as measured with HP 3400A True RMS Voltmeter).

RMS crest factor: 0.001 V to 0.3 V, 20 dB; 1 V, 13 dB; 3 V, 3 dB.

Meter

Meter scales: linear voltage, 0 to 1 and 0 to 3; decibel, -12 to $+3$. Individually calibrated taut-band meter.

Response time: indicates within specified accuracy in < 3 s.

Jitter: $\pm 1\%$ peak (of reading).

General

DC recorder output: adjustable from 0 to 1.2 mA into 1000 ohms at full scale, proportional to meter deflection.

Overload recovery time: meter indicates within specified accuracy in < 5 s (30 V p-p max.).

Maximum input: ± 100 V dc, 30 V p-p.

RFI: conducted and radiated leakage limits are below those specified in MIL-6181D and MIL-1-16910C except for pulses emitted from probe. Spectral intensity of these pulses are nominally 50 nV/ $\sqrt{\text{Hz}}$; spectrum extends beyond 2 GHz.

Temperature range: instrument, 0°C to $+55^\circ\text{C}$; probe, $+10^\circ\text{C}$ to $+40^\circ\text{C}$.

Power: 115 or 230 V $\pm 10\%$, 48 Hz to 440 Hz, 25 VA max.

Dimensions: 7 $\frac{3}{4}$ " wide, 6 $\frac{1}{4}$ " high (without removable feet), 11" deep (197 x 159 x 279 mm); $\frac{1}{2}$ module.

Weight: net 12 lbs (5.4 kg); shipping 15 lbs (6.8 kg).

Accessories: refer to data sheet.

Price: HP 3406A, \$795.

AC VOLTMETERS

Solid-state, battery-operated, portable
Model 403A, 403B



MEASURING DEVICES

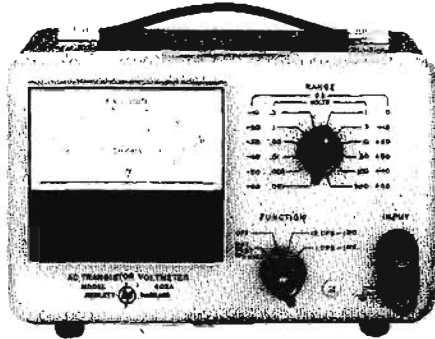

403A

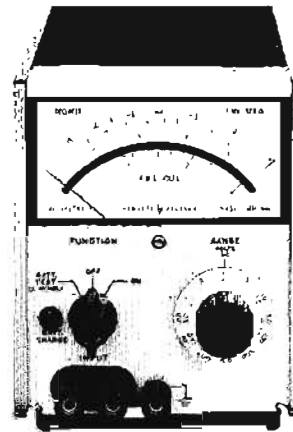

403B

Description

Models 403A and 403B ac voltmeters are versatile, general purpose instruments for laboratory and production work and are ideal for use in the field since they are solid-state, battery-operated, and portable.

Both measure from 100 microvolts to 300 volts, the 403A covering 1 Hz to 1 MHz and the 403B covering 5 Hz to 2 MHz. Both operate from internal batteries and thus may be completely isolated from the power line and external grounds, permitting accurate measurements at power-line frequency and its harmonics without concern for beat effects. Isolation from external ground also permits use where ground loops are troublesome. Turnover effect and waveform errors

are minimized because the meters respond to the average value of the input signal.

The 403B operates from an ac line as well as from the internal battery pack, and batteries recharge during ac operation. Battery charge may be easily checked with a front-panel switch to assure reliable measurements. Normally, about 60 hours of ac operation recharge the batteries; but an internal adjustment is provided which nearly doubles the charging rate. The Model 403B can be used while its batteries charge. A sturdy taut-band meter eliminates friction and provides greater precision and repeatability.

For improved resolution in dB measurements, the 403B option 001 is available. This version spreads out the dB scale by making it the top scale of the meter.

HP Model	403A	403B	403B Option 001
Range	0.001 to 300 V rms full scale. 12 ranges. in a 1, 3, 10 sequence. -60 dB to +50 dB in 12 ranges with 10 dB steps.		
Meter	responds to average value of input waveform, calibrated in the rms value of a sine wave.		
Frequency range	1 Hz to 1 MHz	5 Hz to 2 MHz	5 Hz to 2 MHz
Accuracy	within = 3% of full scale, 5 Hz to 500 kHz; within = 5% of full scale, 1 to 5 Hz and 500 kHz to 1 MHz	within = 2% of full scale from 10 Hz to 1 MHz; within = 5% of full scale from 5 to 10 Hz and 1 to 2 MHz, except = 10% 1 to 2 MHz on the 300 V range (0 to 50°C)*	within = 0.2 dB of full scale from 10 Hz to 1 MHz; within = 0.4 dB of full scale from 5 to 10 Hz and 1 to 2 MHz, except = 0.8 dB 1 to 2 MHz on the 300 V range (0 to 50°C)*
Input impedance	2M Ω shunted by <60 pF, 0.001 to 0.1 V ranges; 2M Ω shunted by <25 pF on 0.3 to 300 V ranges	2M Ω ; shunted by <60 pF; 0.001 to 0.03 V ranges; <30 pF, 0.1 to 300 V ranges	same as 403B
Maximum input	600 Vp, 0.3 V and higher ranges; 25 V rms or 600 Vp on 0.1 V and lower ranges (fused).	Fuse protected (signal ground can be = 500 V dc from chassis).	same as 403B
Power	5 standard radio-type mercury cells. Battery life approx. 400 hours	4 rechargeable batteries, 40 hr operation per recharge, up to 500 recharging cycles; self-contained recharging circuit functions during operation from ac line	same as 403B
Dimensions	8 $\frac{1}{4}$ " wide, 5 $\frac{1}{2}$ " high, 6 $\frac{1}{8}$ " deep (210 x 140 x 162 mm)	5 $\frac{1}{8}$ " wide, 6 $\frac{1}{4}$ " high (without removable feet), 8" deep (130 x 159 x 203 mm)	same as 403B
Weight	net 4 $\frac{1}{4}$ lbs (2,1 kg); shipping 8 lbs (3,6 kg)	net 6 $\frac{1}{2}$ lbs (2,9 kg); shipping 8 lbs (3,6 kg)	same as 403B
Price	\$380	\$350	\$375



VACUUM TUBE VOLTMETERS

Quality linear and log voltmeters

Models 400D, 400H, 400L



400D



400H



400L

Description

Model 400D is a precision voltmeter offering wide voltage range, 2% accuracy, and the broad frequency coverage of

accuracy of $\pm 2\%$ of reading or $\pm 1\%$ of full scale, whichever is more accurate. The 5" meter is mirror backed.

	400D,DR	400H,HR	400L,LR
Voltage range:	1.0 mV to 300 V full scale, 12 ranges	1.0 mV to 300 V full scale, 12 ranges	-70 dB to +52 dB in 12 ranges 1.0 mV to 300 V full scale, 12 ranges
Frequency range:	10 Hz to 4 MHz		
Accuracy:	10 Hz to 20 Hz: $\pm 10\%$ f.s. 20 Hz to 1 MHz: $\pm 2\%$ f.s. 1 MHz to 2 MHz: $\pm 3\%$ f.s. 2 MHz to 4 MHz: $\pm 10\%$ f.s.	10 Hz to 20 Hz: $\pm 10\%$ f.s. 20 Hz to 50 Hz: $\pm 2\%$ f.s. 50 Hz to 500 kHz: $\pm 1\%$ f.s. 500 kHz to 1 MHz: $\pm 2\%$ f.s. 1 MHz to 2 MHz: $\pm 3\%$ f.s. 2 MHz to 4 MHz: $\pm 10\%$ f.s.	10 Hz to 20 Hz: $\pm 5\%$ of rdg. 20 Hz to 50 Hz: $\pm 3\%$ of rdg. or $\pm 2\%$ of f.s.† 50 Hz to 500 kHz: $\pm 2\%$ of rdg. or $\pm 1\%$ of f.s.† 500 kHz to 1 MHz: $\pm 3\%$ of rdg. or $\pm 2\%$ of f.s.† 1 MHz to 2 MHz: $\pm 4\%$ of rdg. or $\pm 3\%$ of f.s.† 2 MHz to 4 MHz: $\pm 5\%$ of rdg.
Calibration:	reads rms value of sine wave; voltage indication proportional to average value of applied wave; linear voltage scale 0 to 3 and 0 to 1; dB scale -12 to +2 dB (0 dB = 1 mW in 600 Ω); 10 dB interval between ranges		reads rms value of sine wave; logarithmic voltage scale 0.3 to 1 and 0.8 to 3; linear dB scale, -10 dB to +2 dB (based on 0 dB = 1 mW in 600 Ω); 10 dB intervals between ranges
Input impedance:	10 M Ω shunted by <20 pF on ranges 1 to 300 V; <35 pF on ranges 0.001 to 0.3 V		
Amplifier:	output 0.15 V max.; output impedance 50 Ω ; max. gain 150 on 0.001 range		
Power:	115 or (230 V must be specified) = 10%, 48 to 440 Hz; 80 VA max.		
Dimensions	cabinet mount: 7 $\frac{1}{2}$ " wide, 11 $\frac{1}{2}$ " high, 12" deep (191 x 292 x 305 mm) rack mount: 19" wide, 7" high, 10 $\frac{3}{4}$ " deep behind panel (483 x 389 x 276 mm)		
Weight:	net 18 lbs (8.1 kg), shipping 20 lbs (9.0 kg) (cabinet mount); net 21 lbs (9.45 kg), shipping 32 lbs (14.4 kg) (rack mount)		
Price.	HP 400D, \$385* HP 400DR, \$390**	HP 400H, \$395* HP 400HR, \$400**	HP 400L, \$395* HP 400LR, \$400**

AC VOLTMETERS

10 Hz to 10 MHz, 100 μ V to 1 kV
Models 400E, EL, F, FL, GL



MEASURING DEVICES

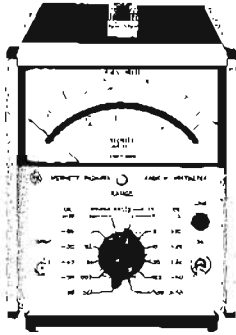

400E

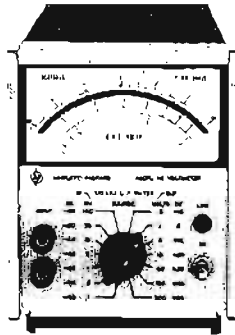

400FL

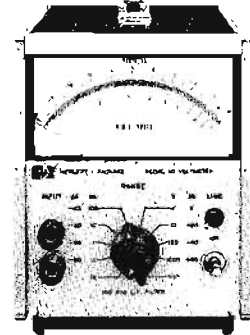

400GL

SPECIFICATIONS *

	400E	400F	400EL/400FL	400GL
Calibration	reads rms value of sine wave: voltage indication proportional to absolute average of applied wave.			
	scale -10 to +2 dB, 10 dB between ranges; 100 divisions on 0 to 1 scale		linear dB scale -10 dB to +2 dB, 10 dB between ranges: Log voltage scales 0.3 to 1 and 0.8 to 3; 120 divisions from -10 to +2 dB	linear dB scale, 100 divisions from -20 to 0 dB. Log voltage scale 0 dB = 1 V
Input Impedance	Resistance: 10 M Ω on all ranges			
	<25 pF to <12 pF depending on ranges	<25 pF to <10 pF depending on ranges	400EL: same as 400E 400FL: same as 400F	<30 pF to <15 pF depending on ranges
Recovery from Overload	<2 s for 80 dB overload			
	300 V max input			1200 V max input
Power	AC: 115 or 230 V \pm 10% 400E, EL: 48 to 440 Hz, 5 VA max. 400F, FL, GL: 48 to 440 Hz, 6 VA max. DC External Batteries: + and - voltages between 35 V and 55 V.			
Dimensions	5 1/8" wide, 6 1/4" high (without removable feet), 11" deep (130 X 159 X 279 mm)			
Weight	same as 400GL	net 6 lbs (2,7 kg) shipping 9 lbs (4,1 kg)	400EL: same as 400GL 400FL: same as 400F	net 6 lbs (2,7 kg) shipping 9 lbs (4,1 kg)
Price	\$345	\$330	400EL: \$355 400FL: \$340	\$350

* Refer to data sheet for special options and complete specifications.

ACCURACY SPECIFICATIONS

	10	20	40	60	80	100	100	500	1	2	4	10
	Hz						kHz			MHz		
400E/EL 12 ranges 3 mV - 300 V 1 mV \pm (% F.S. + % Rdg)	(2,5 + 2,5)						(1 + 0)				(1,5 + 1,5) (2,6 + 2,5)	
400F 14 ranges 300 μ V - 300 V 100 μ V \pm (% F.S. + % Rdg)	(2 + 2)		(1 + 1)				(1/2 + 1/2)		(1 + 1)		(2 + 2)	
400FL 14 ranges 300 μ V - 300 V 100 μ V % Rdg	\pm 4		\pm 2				\pm 1		\pm 2		\pm 4	
400GL 8 ranges 300 V - 1 kV 1 mV - 300 V 100 μ V % dB of Rdg	\pm 0,4		\pm 0,2						\pm 0,4		0,2 dB - 0,8 dB	



RMS VOLTMETER

True RMS ac to dc converter
Model 3400A

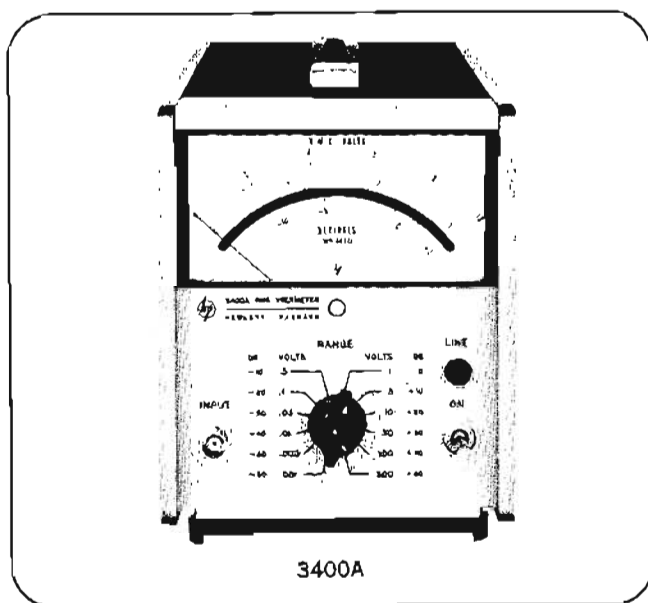

Description

The Hewlett-Packard Model 3400A is a true root-mean-square (rms) voltmeter, providing a meter indication proportional to the dc heating power of the input waveform. In addition to its meter indication, the Model 3400A provides a dc output proportional to meter deflection making it a useful true rms detector for graphic recording and digitizing with a dc digital voltmeter, such as the HP Model 3440A.

Versatility

Versatility of the Model 3400A is enhanced by its wide 10-Hz to 10-MHz frequency response, high crest factor, 1-mV to 300-Volt full-scale sensitivity and 10-M Ω input impedance. Six-decade frequency coverage makes the 3400A extremely flexible for all audio and most rf measurements and permits the measurement of broadband noise and fast-rise pulse. A wide range of sensitivity (12 ranges) allows measurement of anything from "down in the grass" signal and noise, to transmitter and amplifier outputs (with 30-dB overload protection). Pulses or other non-sinusoids with crest factors (ratio of peak to rms) up to 10:1 can be measured full scale. Crest factor is inversely proportional to meter deflection, permitting up to 100:1 crest factor at 10% of full scale. The ability of the 3400A to accept waveforms with such large crest factors insures accurate noise and pulse measurements without the need for correction factors. Permanent plots of measured data and higher resolution measurements can be obtained by connecting an X-Y plotter, strip chart recorder or digital voltmeter to the convenient rear-panel dc output. The dc output provides a linear 0 to 1-volt drive proportional to meter deflection.

RMS current

True-rms current measurements can be made conveniently by using the HP Model 456A Current Probe with the Model 3400A. See page 57.

Specifications

Voltage range: 1 mV to 300 V full scale, 12 ranges.

DB range: -72 to +52 dBm (0 dBm = 1 mW into 600 Ω).

Frequency range: 10 Hz to 10 MHz.

Response: responds to rms value (heating value) of the input signal for all waveforms.

Meter accuracy: % of full scale (20°C to 30°C)*

10 Hz	50 Hz	1 MHz	2 MHz	3 MHz	10 MHz
±5%	±1%	±2%	±3%	±3%	±5%

Ac-to-dc converter accuracy: % of full scale (20°C to 30°C)*

10 Hz	50 Hz	1 MHz	2 MHz	3 MHz	10 MHz
±5%	±0.75%	±2%	±3%	±3%	±5%

Crest factor: (ratio of peak to rms amplitude of input signal): 10 to 1 at full scale (except where limited by maximum input) inversely proportional to meter deflection, (e.g., 20 to 1 at half-scale, 100 to 1 at tenth scale).

Maximum continuous input voltage: 500 V ac peak at 1 kHz on all ranges; 600 V dc on all ranges.

Input impedance: from 0.001 V to 0.3 V range: 10 M Ω shunted by < 50 pF. From 1.0 V to 300 V range: 10 M Ω shunted by < 20 pF. ac-coupled input.

Response time: for a step function, < 5 s to final value.

AC overload: 30 dB above full scale or 800 V p, whichever is less, on each range.

Output: negative 1 V dc into open circuit at full-scale deflection, proportional to meter deflection from 10-100% of full scale. 1 mA maximum; nominal source impedance is 1000 Ω . Output noise < 1 mV rms.

Power: 115 or 230 V ±10%, 48 to 440 Hz, 12 VA max.

Dimensions: 5 1/8" wide, 6 1/4" high (without removable feet), 11" deep (1/3 module). (130 x 159 x 279 mm).

Weight: net: 7 1/4 lbs (3,3 kg); shipping: 10 lbs (4,5 kg).

Accessories furnished: 10110A Adapter, BNC to dual banana jack.

Accessories available: 11001A Cable, 45 in. long, male BNC to dual banana plug, \$7.00. 10503A Cable, 4 ft. long, male BNC connectors, \$13.00. 11002A Test Lead, dual banana plug to alligator clips, \$8.00. 11003A Test Leads, dual banana plug to probe and alligator clip, \$10. 11076A Carrying Case, \$60. HP Model 456A AC Current Probe, 1 mV; 1 mA, \$250.

Price: HP 3400A, \$600.

HP Model 3400A option 001 spreads out the dB scale by making it the top scale of the meter, add \$25.

Rear terminals in parallel with front panel terminals and linear log scale uppermost on the meter face are available on special order.

*TC: ±0.1% from 0°C to 20°C and 30°C to 55°C.

LOGARITHMIC VOLTMETERS

Convert ac or dc signals to logarithmic scaling
Models 7562A and 7563A



MEASURING DEVICES

Log Voltmeter/Converter Model 7562A

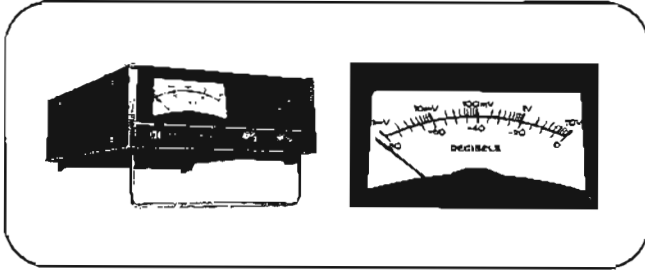

The Model 7562A is a wide range (80 dB), single channel logarithmic voltmeter/converter designed to produce dc output voltages in a logarithmic relationship to dc input voltages or the true RMS value of an ac input voltage. The 7562A contains a true RMS detector which, inherently, is not dependent on pure sinusoidal signals to achieve measurement accuracy. A self-contained meter calibrated in volts and dB makes the 7562A an accurate voltmeter. A constant amplitude oscilloscope output makes the converter compatible with a variety of oscilloscope readout and phase meter applications.

Specifications

Performance specifications

Ac and dc modes

Input:

Dynamic range: 80 dB.

Voltage range: 1 mV to 10 V or 10 mV to 100 V selectable by front panel switch. Accepts either ac or positive signals.

Output:

Voltage: 0 to 800 mV dc corresponding to 10 mV/dB.

Output impedance: 100 ohms.

Dc mode

Accuracy: ± 0.25 dB at 25°C.

Input impedance: 100 k Ω , shunted by less than 100 pF; single ended.

Temperature coefficient: ± 0.02 dB/°C maximum.

Zero stability: ± 0.25 dB.

Ac mode

Input impedance: 1 M Ω , shunted by less than 100 pF; single ended.

Accuracy and frequency response: (at 25°C).

RANGE SETTING	0.5Hz	2	5	20	50	200Hz	50KHz	100KHz
0.5Hz	± 1 dB					± 0.5 dB		± 1 dB
5Hz			± 1 dB			± 0.5 dB		± 1 dB
50Hz				± 1 dB		± 0.5 dB		± 1 dB

Temperature coefficient: ± 0.04 dB/°C maximum.

Slewing speed:

Range setting	Minimum slewing speed
0.5 Hz	1 dB/s
5 Hz	10 dB/s
50 Hz	60 dB/s

Oscilloscope output: approx. 0.5 V rms regardless of input.

Crest factor: 5:1 unless limited by max. input voltage.

General specifications

Maximum peak input voltage: ± 25 V on 1 mV to 10 V range; ± 250 V on 10 mV to 100 V range.

Operating temperature: 10°C to 40°C.

Warm-up time: 20 minutes nominal.

Connectors: front and rear-input and output-BNC connectors.

Power requirements: 115/230 Vac, 50 to 400 Hz, 40 VA.

Dimensions: 3-7/16" high, 7 $\frac{3}{4}$ " wide, 11 $\frac{1}{2}$ " deep (88 x 197 x 292 mm).

Weight: net, 8 lb (3.6 kg); shipping, 12 lb (5.4 kg).

Price: Model 7562A \$1045.

Log Voltmeter/Amplifier Model 7563A

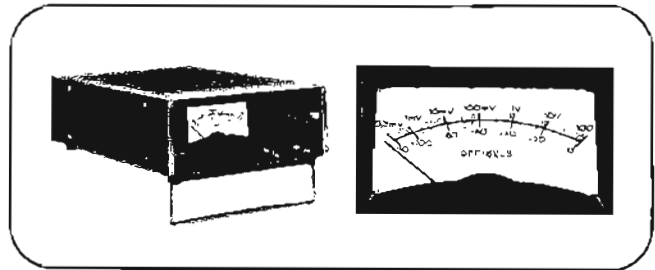

The Model 7563A Logarithmic Voltmeter/Amplifier is a low cost, single channel, dc logarithmic amplifier with a very high dynamic range (110 dB) designed to produce a logarithmic-related dc output voltage for a very wide range of dc input voltages. A single input range of 316 μ V to 100 V is coupled with an input polarity switch for ease and versatility of operation. A high (100 k Ω) input impedance and low (less than 5 Ω) output impedance allows the 7563A to be used in systems or on the bench. A front panel meter calibrated in dB and mV provides instantaneous visual indication of operating levels. Applications include: log scaling of recorder axes, pulse height analyzers, scope displays, and almost any circumstance where log compression of dc voltage ranges is required. The 7563A is an accurate voltmeter. Dual or single rack mounting capability is afforded by a field installable rack mounting adapter, utilizing a minimum of rack space.

Specifications

Performance specifications

Input

Dynamic range: 110 dB.

Voltage range: 316 μ V to 100 V. Accepts either positive or negative signals, selectable by front panel switch.

Output

Voltage: 0 to 1.1 V dc corresponding to 10 mV/dB. Rear Terminals; adjustable 1 to 10 mV/dB.

Output Impedance: less than 5 Ω front panel, 300 Ω rear.

Meter accuracy: reading accurate to ± 1.5 dB, referred to output.

Input impedance: 100 k Ω , shunted by less than 100 pF; single ended.

Accuracy: (at 25°C).

316 μ V	1 mV	10 V	31.6 V	100 V
± 0.5 dB	± 0.25 dB	± 1.0 dB	± 1.5 dB	

Temperature coefficient: ± 0.02 dB/°C maximum and ± 3 μ V/°C referred to input.

Zero stability: ± 0.25 dB at constant temperature.

Rise time:

Maximum Rise Time	
Signal Level	1 mV-10 V Range
316 μ V- 1 mV	2000 μ s
1 mV- 10 mV	400 μ s
10 mV-100 mV	40 μ s
100 mV- 1 V	4 μ s
1V-100 V	2 μ s

General specifications

Operating temperature: 10°C to 40°C.

Warm-up time: 20 minutes nominal.

Connectors: front and rear-input and output-BNC connectors.

Power requirements: 115/230 V ac, 50 to 400 Hz, 40 VA.

Dimensions: 3-7/16" high, 7 $\frac{3}{4}$ " wide, 11 $\frac{1}{2}$ " deep (88 x 197 x 292 mm).

Weight: net, 8 lb (3.6 kg); shipping, 12 lb (5.4 kg).

Price: Model 7563A \$745.

IMPEDANCE



LOW and MEDIUM FREQUENCIES

Impedance/Z/ θ , C, R, L, D & Q

Hewlett-Packard's family of impedance measurement instruments combine the familiar null measurement techniques with digital logic and feedback circuits, to achieve simple and rapid operation without a sacrifice in precision. The basic specifications for Hewlett-Packard's impedance family is summarized in table 1. This table will help you select the best impedance instrument for your needs. Frequency, Q, capacitance, inductance, resistance and basic accuracy can be traded off to select the most suitable instrument. For some instruments, capacitance and inductance are not the principal parameters but are secondary to the primary readout. An example is the Vector impedance meter, which displays Z and θ directly on two separate meters.

Impedance considerations

There are two basic types of impedance measuring instruments: bridge instruments and meters. In general, bridge type instruments have the best accuracy specifications. This type of instrument has found wide application and is the basis for the HP 4260A Universal Bridge, 4270A Automatic Capacitance Bridge, and 250B RX Meter.

In the past, bridge instruments have required considerable operator skill to

obtain consistent results. However, the Universal Bridge was specifically designed to achieve rapid and consistent audio frequency measurements. This instrument has been used extensively as a manual instrument for the general characterization of components.

The evolution of bridge measurements has created the need for completely automatic instruments to rapidly characterize multi-conductor cables, variable capacitor diodes, and discrete capacitors. To satisfy these customer requirements, the 4270A Automatic Capacitance Bridge was developed. This instrument is completely programmable and displays capacitance and dissipation/conductance in digital form. BCD outputs are available for remote processing.

Impedance meters in general utilize constant current/voltage sources to excite the unknown impedance. Amplitude and phase sensitive voltmeters detect the real and reactive voltage/current components of the unknown. The display for most impedance meters is an analog meter. Although impedance meters do not have the accuracy of bridge instruments, they are less expensive and very easy to use. The 4350A High Capacitance Meter, 4800A Vector Impedance Meter, and the 4332A LCR Meter utilize this principal. Impedance meters have analog outputs

proportional to the displayed function. This signal may be used with the 4050A Analog Comparator to select components on a High/Go/Low basis.

Summary

To help you select an impedance meter suitable to your needs, the following guidelines may be used:

- (1) For a desired accuracy and cost range, select the instrument with the broadest capability in C, L, R & Q.
- (2) Bridge instruments will provide the best accuracies (.1% to 1%). However, only the higher priced bridges offer the speed and convenience in measurement available in meter type instruments.
- (3) The best value where parts selection is desired is a meter instrument where an analog signal is available for use with an analog comparator.
- (4) To obtain meaningful results, a parts user should make measurements at the same frequency specified by the manufacturer.
- (5) Hewlett-Packard's impedance instruments have been used in numerous diverse applications from the measurement of the dielectric constant of liquids, to the wing to fuselage continuity on aircraft. If you have an unusual application and need assistance, contact your nearest Hewlett-Packard sales office for application information.

TABLE 1. HP IMPEDANCE METERS

Instrument	Frequency				Q or $\frac{1}{D}$		C in farads, L in henries or R in ohms				Basic Accuracy			See Page
	1 Hz	1 kHz	1 MHz	1 GHz	10 ⁰	10 ⁺³	10 ⁻¹²	10 ⁻⁶	10 ⁰	10 ⁺³	.1%	1%	10%	
RX Meter 250B							C							53
Universal Bridge 4260A							C							50
Auto C-Bridge 4270A							C							54
Milliohm Meter 4328A														49
High Resistance Meter 4329A														49
LCR Meter 4332A							C							50
Q Meter 4342A							C							51
High C Meter 4350A/B							C							55
Vector Z/ Meter 4800A							C							53

MILLIOHMETER

Convenient two probe measurements
Model 4328A



MEASURING DEVICES

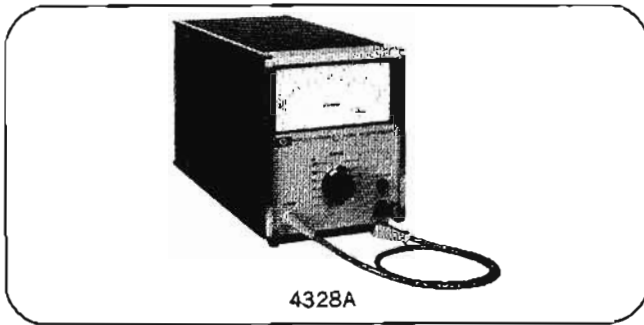

Description

The HP 4328A Milliohmeter is a portable instrument for ac measurement of low resistances. Maximum sensitivity is 20 μ ohms, making it ideal for measuring the contact resistance of switches, relays and connectors; it is also useful for safe testing of fuses and squibs.

A unique phase discriminator permits accurate resistive measurements on samples with a series reactance up to twice full scale resistance.

Specifications

Range: 0.001 to 100 ohms full scale in a 1, 3, 10 sequence.

Accuracy: $\pm 2\%$ of full scale.

Measuring frequency: 1000 Hz ± 100 Hz.

Voltage across sample: 200 μ V peak at full scale.

Maximum voltage across sample: 20 mV peak.

External superimposed dc: 150 V dc maximum.

Recorder output: 0.1 V dc output at full scale.

DISSIPATION IN SAMPLE

Range (ohms)	Applied Current (mA)	Maximum Dissipation in Samples (μ W)
0.001	150	23
0.003	50	8
0.01	15	2.3
0.03	5	0.8
0.1	1.5	0.23
0.3	0.5	0.08
1	0.15	0.023
3	0.05	0.008
10	0.015	0.0023
30	0.005	0.0008
100	0.0015	0.00023

General

Power requirements: 115/230 V switch $\pm 10\%$, 50 to 60 Hz, 1.65 VA max.

Weight: net, 7 lbs (3.2 kg); shipping, 12 lbs (5.4 kg).

Dimensions: 5 $\frac{1}{8}$ " wide, 6-3/32" high, 11" deep (130 x 158 x 279 mm).

Accessories furnished: Model 16005 Probe (clip-on), 16006A Probe (pin-contact) and 16007A/B Test Leads. Detachable power cord.

Price: HP 4328A, \$620; Option 001 (rechargeable battery operation), add \$25.

RESISTANCE METER

Wide range for high resistance, low current
Model 4329A

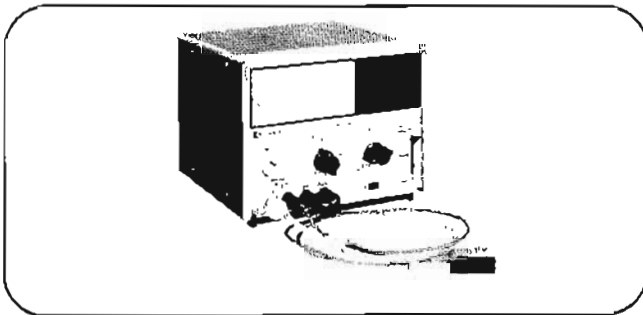

Description

The HP Model 4329A is a solid-state insulation resistance meter designed for easy, accurate and direct readings of the very high resistance values typically found in synthetic resins, porcelain, insulating oils and similar materials. It is also useful for leakage measurements of capacitors, transformers, switches and cables. Seven regulated dc test voltages (between 10 and 1000 V) are provided as test source. Test voltage shorts or sample breakdown currents will not damage instrument circuitry. The HP 4329A also has a current measurement capability. Minute currents as low as 0.05 pA can be readily measured.

Specifications

Resistance measurement

Range: 500 k Ω to 2 x 10¹⁶ Ω .

Accuracy: at low resistance end of each scale, accuracy is $\pm 3\%$; near center scale $\pm 5\%$; and, near the specified upper limit on the meter scale (see table below), accuracy is $\pm 10\%$. Above these limits, accuracy is not specified.

On all voltage ranges, if multiplier is set to Rmax, an additional $\pm 3\%$ is included.

AVAILABLE RESISTANCE READINGS

Test Voltage	Available Resistance Readings	Meter Scale	Accuracy Upper Limit
10 V	5 x 10 ⁵ Ω to 2 x 10 ¹⁴ Ω	.5 to 20	5
25 V	1.25 x 10 ⁶ Ω to 5 x 10 ¹⁴ Ω	.13 to 5	1.25
50 V	2.5 x 10 ⁶ Ω to 1 x 10 ¹⁵ Ω	.25 to 10	2.5
100 V	5 x 10 ⁶ Ω to 2 x 10 ¹⁵ Ω	.5 to 20	5
250 V	1.25 x 10 ⁷ Ω to 5 x 10 ¹⁵ Ω	.13 to 5	1.25
500 V	2.5 x 10 ⁷ Ω to 1 x 10 ¹⁶ Ω	.25 to 10	2.5
1000 V	5 x 10 ⁷ Ω to 2 x 10 ¹⁶ Ω	.5 to 20	5

Current measurement

Range: 0.5 x 10⁻¹³ to 2 x 10⁻¹⁵ A in 8 ranges.

Input resistance: 10⁹ to 10¹¹ Ω $\pm 1\%$, depending on range.

Accuracy: $\pm 5\%$ of full scale deflection (there can be an additional $\pm 3\%$ error at the top decade).

General

Recorder output: 0 to 100 mV dc; 1 k Ω output resistance.

Power: 115/230 V $\pm 10\%$, 50-60 Hz, 3.3 VA max.

Dimensions: 6 $\frac{1}{2}$ " high (166 mm), 7-25/32" wide (198 mm), 8-25/32" deep (223 mm).

Weight: net, 8 lbs (3.5 kg); shipping, 12 lbs (5.4 kg).

Accessory furnished: HP 16117A Low Noise Test Leads.

Price: HP 4329A, \$840.



UNIVERSAL BRIDGE LCR METER

Models 4260A, 4332A

Universal Bridge

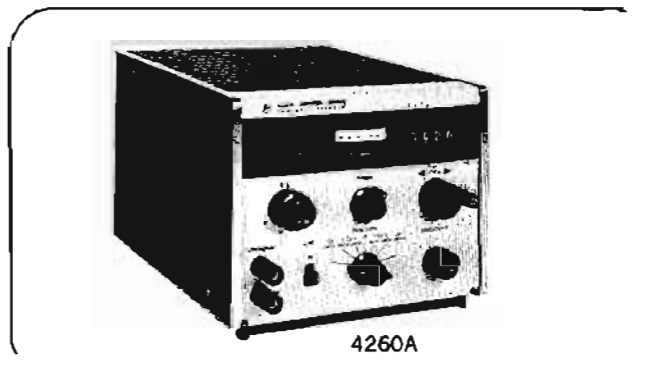

LCR Meter

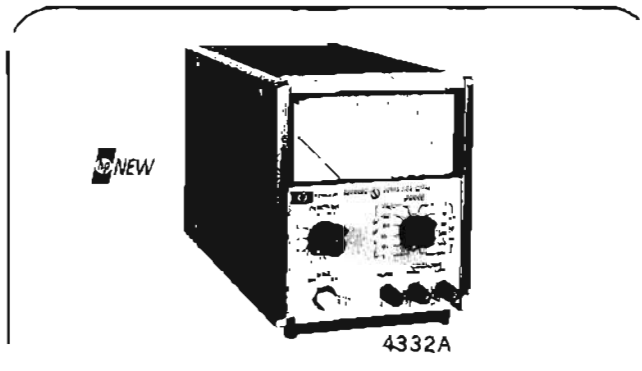

Advantages

Measurements of C, L, R, D and Q with five-bridge circuits; FUNCTION switch which selects the appropriate equivalent circuit.

3-digit readout for C, R, L; RANGE switch selection automatically determines the unit, and decimal point.

Electronic AUTO-BALANCE; AUTO position FUNCTION switch provides fast nulling by single control of CRL dial, D or Q measurement is done by switching out of AUTO and adjusting only DQ control.

Direction indicators (<CRL>); direction of range selection and CRL control is automatically indicated for fast nulling.

External oscillator (20 Hz - 20 kHz), dc bias supply and detector; terminals for interfacing are provided on the rear panel.

Specifications*

Range and accuracy

Range (7 ranges, maximum resolution 1 μ H, 1 pF, 10 m Ω)			
Inductance	Capacitance	Resistance	Accuracy
1 μ H - 1 mH	1 pF - 1000 pF	10 m Ω - 10 Ω	$\pm(2\% + 1 \text{ count})$
1 mH - 100 H	1000 pF - 100 μ F	10 Ω - 1 M Ω	$\pm(1\% + 1 \text{ count})$
100 H - 1000 H	100 μ F - 1000 μ F	1 M Ω - 10 M Ω	$\pm(2\% + 1 \text{ count})$

LOW D series C	0.001 - 0.12	$\pm \sqrt{D \text{ reading}} \%$
HIGH D parallel C	0.05 - 50	$+(10 \times D \text{ reading} + 4)\%$ $-(10 \sqrt{D \text{ reading}} + 2)\%$
LOW Q series L	0.02 - 20	$+(10/Q \text{ reading}) + 4 \%$ $-(10/\sqrt{Q \text{ reading}}) + 2 \%$
HIGH Q parallel L	8 - 1000	$\pm 2 \sqrt{Q \text{ reading}} \%$

Hewlett-Packard Model 4332A LCR Meter measures inductance, capacitance, and resistance with speed and accuracy. The instrument provides direct-readings of L, C and R with linear meter scales. The 4332A is extremely useful for measurements of both linear and non-linear components such as semiconductor capacitor values, inductance of coils with ferrite core. Combining the 4332A analog output with the 4050A Analog Comparator provides a rapid GO/NO-Go test system.

Specifications

Inductance measurement

Range: 3 μ H to 1 H full scale, 12 ranges.

Measuring frequency

3 μ H to 1000 μ H ranges: 100 kHz $\pm 5\%$.

3 mH to 1000 mH ranges: 1 kHz $\pm 5\%$.

Voltage across sample: <1.5 mV rms.

Accuracy (at 25°C): $\pm[1\% \text{ reading} + (1.5 + \frac{3}{Q})\% \text{ of full scale} + 0.03 \mu\text{H}]$.

Capacitance measurement

Range: 3 pF to 1 μ F full scale, 12 ranges.

Measuring frequency

3 pF to 1000 pF ranges: 100 kHz $\pm 5\%$.

3 nF to 1000 nF ranges: 1 kHz $\pm 5\%$.

Voltage across sample: approximately 70 mV rms.

Accuracy (at 25°C): $\pm[1\% \text{ reading} + (1.5\% + \frac{3}{Q})\% \text{ of full scale} + 0.03 \text{ pF}]$.

Resistance measurement

Range: 3 Ω to 1 M Ω full scale, 12 ranges.

Measuring frequency: 1 kHz $\pm 5\%$.

Voltage across sample: <1 mV rms.

Accuracy (at 25°C)

3 Ω to 30 k Ω ranges: $\pm(0.5\% \text{ reading} + 2\% \text{ full scale} + 0.03\Omega)$.

100 k Ω to 1000 k Ω ranges: $\pm(1\% \text{ reading} + 2\% \text{ full scale})$.

General

Temperature range: 0 to 50°C.

Temperature coefficient (0 to 50°C): $\pm 0.05\% \text{ full scale}/^\circ\text{C}$.

Analog outputs

1 V dc at any full scale range.

1 V or 0.3 V dc full scale.

Input power: 115 V/230 V $\pm 10\%$, 48 to 66 Hz, 8.8 VA max.

Dimensions: 5 1/8" wide, 6 1/4" high (without removable feet), 11" deep (130 x 152 x 279 mm).

Weight: net, 7 4/5 lbs (3.5 kg); shipping, 10 1/2 lbs (4.7 kg).

Price: \$720.

Q METER

Measures Q, L, C, & resonant frequency
Model 4342A



MEASURING DEVICES

Description

The direct-reading expanded scale of the 4342A permits measurement of Q from 5 to 1000 and readings of very small changes in Q resulting from variation in test parameters. The 4342A is solid state with the elimination of specially matched, fragile thermocouple components.

The Q meter consists of a stable, continuously variable oscillator, with automatic level-control. The output is applied in series with an external unknown and an internal variable capacitor. A Q voltmeter with high input Z is connected across the internal variable capacitor portion of the tuned circuit to measure the reactive voltage in terms of circuit Q.

Usefulness

The 4342A will measure dissipation factor and dielectric constant of insulating materials. The Q meter can measure coefficient of coupling, mutual inductance, and frequency response of transformers. RF resistance, reactance, and Q of resistors and capacitors can also be determined.

Internal oscillator

The internal oscillator covers a frequency range from 22 kHz to 70 MHz (10 kHz to 32 MHz in Option 001) in seven bands. This source is automatically leveled to provide a constant injection voltage. This ALC feature eliminates the Q multiplier control found on other Q meters.

Q voltmeter

High stability of the Q Voltmeter eliminates Q-zero adjustment for routine measurements. Accurate information on changes in Q is obtainable on all Q-ranges through the greater resolution ($\times 10$) of delta-Q measurement.

Constant voltage injection system

The 4342A utilizes a constant voltage injection system eliminating the fragile thermocouple system found in other Q meters. The low impedance of this injection system increases Q accuracy.

Rapid inductance measurement

A single "L" point on the frequency dial eliminates the necessity to readjust frequency during inductance measurements.

GO/NO-GO Q selector

The Q-Limit selector will be especially useful for rapid Go/No-Go testing. The high response speed of the Go/No-Go indicator compared to the meter movement is an added feature. External devices may be remotely controlled by the Go/No-Go over limit signal.

Simple, Easier operation

Push-button operation of frequency range and Q/ Δ Q range selection provides straight forward measurement. Automatic indication of meter scales, frequency dials and frequency multipliers are featured, adding to simplicity and reading speed.

Specifications

RF characteristics

RF range: 22 kHz to 70 MHz in 7 bands: 22 to 70 kHz, 70 to 220 kHz, 220 to 700 kHz, 700 to 2200 kHz, 2.2 to 7 MHz, 7 to 22 MHz, 22 to 70 MHz.

RF accuracy: $\pm 1.5\%$ from 22 kHz to 22 MHz; $\pm 2\%$ from 22 MHz to 70 MHz; $\pm 1\%$ at "L" point on frequency dial.

RF increments: approximately 1% resolution.

Q measurement characteristics

Q range: 5 to 1000 in 4 ranges: 5 to 30, 20 to 100, 50 to 300, 200 to 1000.

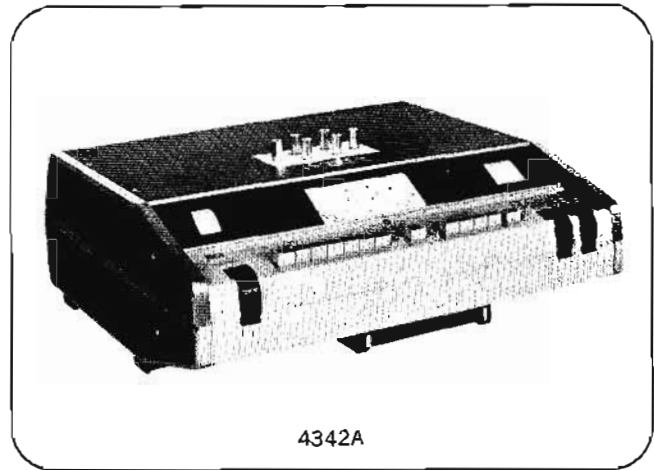

4342A

Q accuracy: % of indicated value. (at 25°C).

Q \ Freq.	22 kHz - 30 MHz	30 MHz - 70 MHz
5 - 300	± 7	± 10
300 - 600	± 10	± 15
600 - 1000	± 15	± 20

Q increments: upper scale: 1 from 20 to 100, lower scale: 0.5 from 5 to 30.

Δ Q range: 0 to 100 in 4 ranges: 0 to 3, 0 to 10, 0 to 30, 0 to 100.

Δ Q accuracy: $\pm 10\%$ of full scale.

Δ Q increments: upper scale: 0.1 from 0 to 10, lower scale: 0.05 from 0 to 3.

Inductance measurement characteristics

L range: 0.09 μ H to 1.2 H, direct reading at 7 specific frequencies.

L accuracy: $\pm 3\%$ after substitution of residuals (approx. 10 nH).

Resonating capacitor characteristics

Capacitor range: main dial: 25 to 470 pF; vernier dial —5 to +5 pF.

Capacitor accuracy: main dial: $\pm 1\%$ or 1 pF, whichever is greater; vernier dial ± 0.1 pF.

Capacitor increments: main dial: 1 pF from 25 to 30 pF, 2 pF from 30 to 200 pF, 5 pF from 200 to 470 pF; vernier dial: 0.1 pF.

General

Rear panel outputs

Frequency monitor: 170 mV rms min. into 50 Ω .

Q analog output: 0 to 1 V ± 50 mV dc after 15 minutes warm-up, proportional to meter deflection. Output impedance approximately 1 k Ω .

Over limit signal output: contact closure at the rear panel. Relay contact capacity 0.5A/15 VA.

Over limit display time: selectable, 1 s or continuously on, after limit exceeded.

Temperature range: 0°C to 50°C.

Power: 115 or 230 V $\pm 10\%$, 48-440 Hz, 27.5 VA max.

Dimensions: 16 $\frac{3}{4}$ " wide, 5-7/16" high, 16-5/16" deep (425 x 138 x 414 mm).

Weight: net, 31 lbs (14 kg); shipping, 41 lbs (18.45 kg).

Price: Model 4342A, \$1665.

MEASURING DEVICES *continued*

Measures Q, L, C, & resonant frequency
Model 4342A

4342A Opt 001

(Changes from the standard specifications)

RF characteristics

RF range: 10 kHz to 32 MHz in 7 bands: 10 to 32 kHz, 32 to 100 kHz, 100 to 320 kHz, 320 to 1000 kHz, 1 to 3.2 MHz, 3.2 to 10 MHz, 10 to 32 MHz.

RF accuracy: $\pm 1.5\%$ from 10 kHz to 10 MHz.

$\pm 2\%$ from 10 MHz to 32 MHz.

$\pm 1\%$ at "L" point on frequency dial.

Q measurement characteristics

Q accuracy: % of indicated value (at 25°C).

Q		
5 - 300	300 - 600	600 - 1000
± 7	± 10	± 15

Price: Model 4342A Opt 001, add \$100 to base price.

Accessories for 4342A Q Meter*

16014A

Series loss test adaptor

The 16014A Series Loss Test Adaptor is designed for measuring low impedance components, low-value inductors and resistors, and also high-value capacitors. Using the adaptor adds convenience in connecting components in series with the test circuit of the 4342A Q Meter. This adaptor consists of a teflon printed-circuit base on which are mounted binding posts, to accept the Reference Inductors, and a pair of low-inductance series terminals for the unknown.

Specifications, 16014A

Usable frequency range: 10 kHz to 10 MHz.

Measurable capacitance range: 450 pF to 0.225 μ F.

Measurable resistance range: 4 Ω to 8 k Ω at 10 kHz. 10 m Ω to 80 Ω at 10 MHz.

Equivalent parallel capacitance between unknown terminals: 3 pF.

Equivalent parallel resistance between unknown terminals: approximately 10 M Ω at 1 MHz.

Residual inductance: approximately 30 nH.

Price: HP 16014A, \$38.

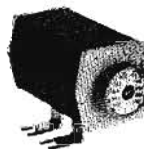

16462A

Auxiliary capacitor

The 16462A Auxiliary Capacitor is designed to extend the Q and L measurement capability of the 4342A Q Meter. It is especially useful for measuring small inductors at low frequencies.
Price: HP 16462A, \$165.



16471A

Reference Inductors*

A range of 20 inductors, any of which can be supplied separately, is available for use with the 4342A Q Meter for measuring the RF characteristics of capacitors, resistors, and insulating materials. These inductors have 3 terminals. One terminal is connected to the case to stabilize measurements.

Price: HP 16471A through HP 16490A, and HP 16465A, \$28. each. HP 16470A set of twenty (16471A-16490A), \$445.

Q standards*

The 00513A and 00518A Q standards are hermetically sealed reference inductors having accurately measured, highly stable inductance and Q characteristics. These Q standards are particularly useful for checking the overall operation and accuracy of Q-meters.

Prices: HP 00513A, HP 00518A, \$125 each; set of one HP 00513A and five HP 00518A, \$675.

* Refer to data sheet for complete specifications.

Q METER

Direct Q measurement 20 to 260 MHz

Model 190A

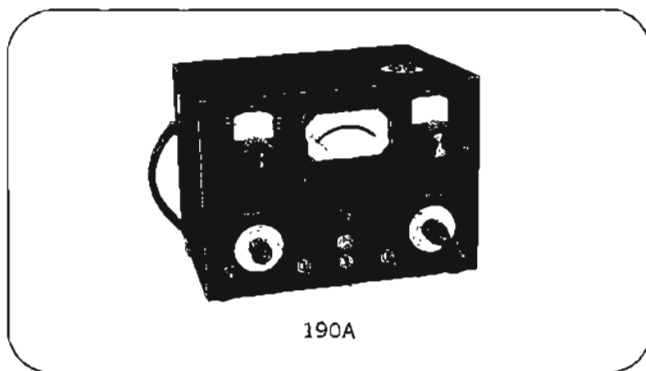

190A

Description

The Hewlett-Packard 190A Q Meter finds applications in the VHF range of frequencies. This instrument employs a special coupling impedance to introduce voltage across the resonant circuit. This voltage, as well as the voltage across the internal Q capacitor, is measured by two vacuum tube voltmeters and indicated on a single meter.

Specifications

Frequency range: 20 to 260 MHz; 4 bands.

RF accuracy: $\pm 1\%$.

Q measurement

Q range: total range: 5 to 1200; low range: 10 to 100.

Δ range: 0 to 100.

Q accuracy: $\pm 7\%$ 20 to 100 MHz; $\pm 15\%$ 100 to 260 MHz (for circuit Q of 400 read directly).

Resonating capacitor characteristics

Capacitor range: 7.5 to 100 pF.

Capacitor accuracy: ± 0.2 pF, 7.5 to 20 pF; ± 0.3 pF, 20 to 50 pF; ± 0.5 pF, 50 to 100 pF.

Capacitor calibration: 0.1 pF increments.

Accessories available: 00590A Reference Inductors.

Physical characteristics

Dimensions: 14 $\frac{1}{4}$ " wide, 10 $\frac{1}{8}$ " high, 10 $\frac{1}{2}$ " deep (362 x 257 x 267 mm).

Weight: net, 25 lbs (11.3 kg); shipping, 32 lbs (14.4 kg).

Power: 190A: 95 to 130 V, 60 Hz, 60.5 VA max.; 190 AP: 115/230 V, 50 Hz, 60.5 VA max.

Price: HP 190A, AP, \$1475.

VECTOR IMPEDANCE METER

Quickly measure Z & θ , 5 Hz to 500 kHz

Model 4800A



MEASURING DEVICES

Description

The Hewlett-Packard 4800A Vector Impedance Meter will make fast measurements of impedance to 10 megohms and phase to $\pm 90^\circ$ of unknown two-terminal networks. Measurement can be made at a particular frequency or over a continuous range from 5 Hz to 500 kHz. The instrument may be mechanically swept to produce continuous measurements over its full frequency range. Analog outputs are available for X-Y recording.

Specifications

Frequency

Range: 5 Hz to 500 kHz in five bands.

Accuracy: $\pm 2\%$ from 50 Hz to 500 kHz, $\pm 4\%$ from 5 to 50 Hz, $\pm 1\%$ at 15.92 on frequency dial from 159.2 Hz to 159.2 kHz, $\pm 2\%$ at 15.92 Hz.

Impedance measurement

Range: 1Ω to 10 M Ω in 7 ranges.

Accuracy: $\pm 5\%$ of reading.

Phase angle measurement

Range: 0° to $\pm 90^\circ$; accuracy: $\pm 6^\circ$.

Direct inductance measurement range: 1 μ H to 100,000 H.

Accuracy: $\pm 7\%$ of reading for $Q > 10$ from 159.2 Hz to 159.2 kHz; $\pm 8\%$ of reading for $Q > 10$ at 15.92 Hz.

Direct capacitance measurement range: 0.1 pF to 10,000 μ F.

Accuracy: $\pm 7\%$ of reading from $D < 0.1$ from 159.2 Hz to 159.2 kHz, $\pm 8\%$ of reading for $D < 0.1$ at 15.92 Hz.

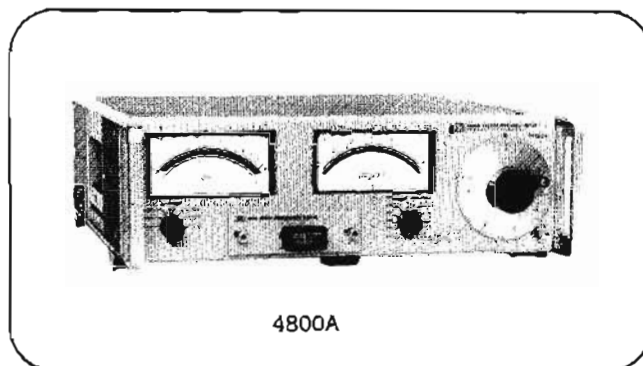

4800A

Measuring terminal characteristics

Configuration: terminals above ground.

Waveshape: sinusoidal.

Recorder outputs

Frequency: level, 0 to 1 V nominal.

Impedance: level, 0 to 1 V nominal.

Phase angle: level, 0 to ± 9 V nominal.

Accessories furnished: 13525A Calibration Resistor, 00610A.

Dimensions: 16 $\frac{3}{4}$ " wide, 5 $\frac{1}{4}$ " high, 18 $\frac{3}{8}$ " deep (426 x 133 x 467 mm).

Weight: net, 24 lbs (10.8 kg); shipping, 30 lbs (13.5 kg).

Power: 105 to 125 V or 210 to 250 V, 48 to 440 Hz, 29.7 VA.

Price: HP 4800A, \$1650.

RX METER

Self-contained rf bridge, 500 kHz to 250 MHz

Model 250B

Description

The Hewlett-Packard 250B RX Meter is a self-contained instrument for measuring the equivalent parallel resistance and capacitance or inductance of two-terminal networks. The instrument contains a continuously tuned oscillator, high-frequency bridge and amplifier-detector.

The oscillator is mounted inside a rigid casting to obtain a high degree of accuracy, stability and low leakage.

Specifications

Frequency range: 500 kHz to 250 MHz; 8 bands.

RF accuracy: $\pm 2\%$.

Resistance measurement characteristics

Resistance range: 15 to 100,000 Ω .

Resistance accuracy: $\pm [2 + \frac{F}{200} + \frac{R}{5000} + \frac{Q}{20}] \%$

$\pm 0.2\%$; F = frequency (MHz), R = RX Meter R_p reading (ohms), $Q = \omega CR \times 10^{-12}$, where C = RX Meter C_p reading (pF).

Capacitance measurement

Capacitance range: 0 to 20 pF (extended by auxiliary coils).

Capacitance accuracy: $\pm (0.5 + 0.5 F^2 C \times 10^{-5}) \%$ ± 0.15 pF; F = frequency (MHz), C = RX Meter C_p reading (pF).

Inductance measurement

Inductance range: 0.001 μ H to 100 mH.

Inductance accuracy: same as capacitance accuracy.

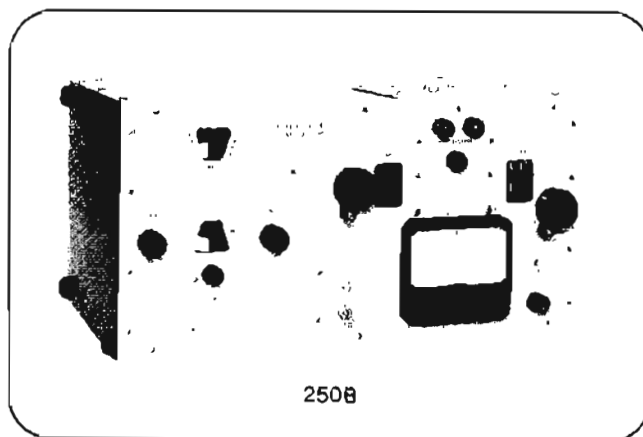

250B

Measurement voltage level

RF: 0.05 to 0.75 V, depending on frequency. RF level adjustable to 20 mV.

DC: 0 V; (50 mA, external dc, max. may be passed through RX meter terminals).

Accessories available: 00515A Coax Adapter Kit. (Type "N" male connector), \$75; 13510A Transistor Test Jig, \$250.

Dimensions: 20" wide, 10 $\frac{3}{8}$ " high, 13 $\frac{1}{2}$ " deep (508 x 264 x 343 mm).

Weight: net, 40 lbs (18 kg); shipping, 50 lbs (22.5 kg).

Power: 105 to 125 V or 210 to 250 V, 48 to 440 Hz, 66 VA.

Price: HP 250B, \$2475.



CAPACITANCE BRIDGE

Fully automatic, 1 kHz to 1 MHz
Model 4270A

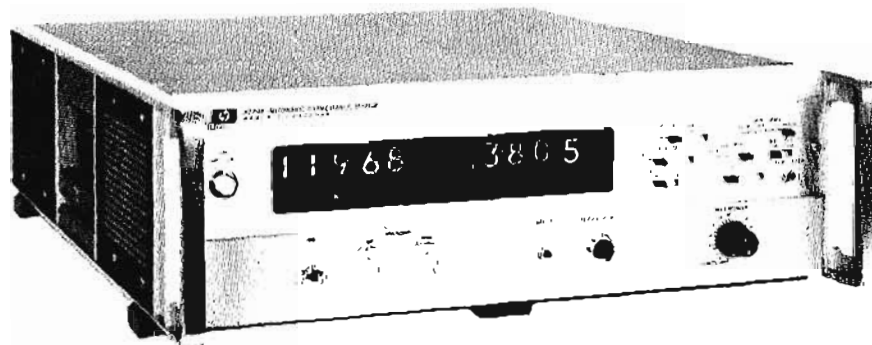

4270A

Description

A new instrument from Hewlett-Packard, the 4270A Automatic Capacitance Bridge provides a wide variety of high speed measurements of both active and passive capacity values. Five-digit readout of capacitance from full-scale ranges of 18.000 pF to 1.2000 μ F is complemented by .001 pF resolution and measurement speed of 0.5 seconds. In addition, a second in-line 4-digit Nixie® display of capacitor loss is given simultaneously in terms of parallel conductance (G) or dissipation factor (D). In the laboratory, the 4270A will be extremely useful for examination of semiconductor junction capacities, input capacitances of amplifiers and other active devices, as well as the analysis of stray capacity values, cables and simple capacitors. DC biasing, four frequencies from 1 kHz to 1 MHz and a fully guarded measurement will add to laboratory flexibility.

Specifications

Measuring circuit

Float: guarded terminals of unknown are floated from ground.

L-ground: one side of known terminals is grounded, guard is retained.

Parameters measured: capacitance, equivalent parallel conductance and dissipation factor.

Measuring frequency: 1 kHz, 10 kHz, 100 kHz and 1 MHz.

Range modes

Auto: range selection and balance performed automatically.

Hold: range is held on fixed position, balance begins with most significant digit. Range determined by previous AUTO or TRACK range selected or by manually stepping RANGE STEP.

Track: range held on fixed position, balance begins with last digit.

Balancing time: typically 0.5 s.

Measuring rate: measurement cycle equals balance time plus display time. Balance time typically 0.5 s; display times selected by MEAS RATE are 70 ms, 2 secs, 5 secs and MANUAL.

Test voltage across unknown

Normal: 1 V rms constant, at capacitance units displayed in pF or nF; 100 mV rms constant at μ F.

Low: 200 mV rms constant at pF or nF. 20 mV rms constant at μ F.

Repeatability: ± 2 digits at NORMAL TEST VOLTAGE, ± 10 digits at LOW TEST VOLTAGE.

DC bias: INTERNAL or EXTERNAL to ± 200 V, in HOLD and TRACK mode.

Internal bias at float measurement

Voltage: 0 to 20 V dc; 0 to 200 V dc; continuously variable on front panel, monitored on rear panel.

Dial accuracy: $\pm 5\%$ of full scale.

Source resistance: 100 k Ω .

Polarity: LOW unknown terminal (—), HIGH unknown terminal (+) in FLOAT position of MEAS CKT control.

Remote: programmable by resistor with 250 Ω /V rate at 20 V range. 25 Ω /V rate at 200 V range.

Remote accuracy: $\pm 2\%$ of full scale.

Internal bias at L-ground: an additional connection using a blocking capacitor and a coaxial cable is necessary for INTERNAL source.

Basic accuracy

		Frequency	1 kHz \pm 10 kHz	100 kHz	1 MHz
C	Basic	D < .1	$\pm 1\%$ ± 1 digit	$\pm 3\%$ ± 1 digit	$\pm 1\%$ ± 1 digit
	Accuracy	.1 < D < 1	$\pm .01$ pF $\pm 2\%$ ± 1 digit $\pm .01$ pF	$\pm .01$ pF $\pm 5\%$ ± 1 digit $\pm .01$ pF	$\pm .01$ pF $\pm 2\%$ ± 1 digit $\pm .01$ pF
G	Basic accuracy		$\pm 1\%$ ± 10 digits	$\pm 3\%$ ± 10 digits	
D	Basic accuracy		$\pm 1\%$ $\pm (10 + Cs/Cx)$ digits	$\pm 3\%$ $\pm (10 + Cs/Cx)$ digits	

Outputs: 4 line BCD.

Inputs

Trigger hold off level: level must be between 10 V and 15 V.

Remote programming: eight front-panel functions can be remotely controlled by external contact closure to ground with impedance less than 400 Ω . Programmable functions are RESET, FREQUENCY, RANGE MODE, TEST VOLTAGE, LOSS MEAS, RANGE STEP, DC BIAS, BIAS VERNIER.

Operating temperature: 0°C to 50°C.

Power requirements: 115 or 230 V ac $\pm 10\%$, 50 to 60 Hz.

Weight: net, 34 lb (15.5 kg); shipping, 48 lb (21.6 kg).

Price: HP 4270A, \$4640.

Interface kit

Interface kits 16150A Control Card and 16151A Data Card are available for interface with Hewlett-Packard computers. Each kit includes mating cable, BCS HP 4270A driver and diagnostic tape.

Price: HP 16150A, \$1110; 16151A, \$1455.

HIGH CAPACITANCE METERS

Analog comparator
Models 4350A/B, 4050A



MEASURING DEVICES

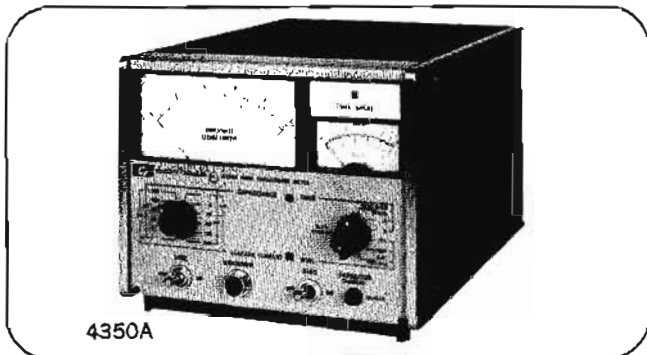

4350A

Description

The Hewlett-Packard Models 4350A/B High Capacitance Meters measure high capacitances from 0.02 μF to 300 mF and simultaneously measure dissipation factor. Leakage current can be measured with the 4350A. The 4350A/B provides analog outputs proportional to meter deflection. Combining the 4350A/B with the 4050A Analog Comparator increases the speed in sorting applications.

Specifications, 4350A/B*

capacitance measurement

Capacitance

Range: 1 μF to 300 mF full scale in 12 ranges.

Accuracy (% of full scale):

Tan δ range	Capacitance Range Full Scale	
	1 μF to 100 mF	300 mF
0 to 1	$\pm 3\%$	$\pm 4\%$
1 to 5	$\pm 4\%$	$\pm 5\%$

Tan δ

Range: 0.5 or 5 full scale in 2 ranges.

Absolute accuracy

$$0.5 \text{ full scale: } \pm 0.025$$

$$5 \text{ full scale: } +0.06 + \frac{(\text{reading})^2}{20}$$

$$-0.06 + \frac{(\text{reading})^2}{25}$$

Internal test signal

Frequency: 120 Hz ± 5 Hz.

Internal dc bias

Voltage range: 0 to 6 V dc, continuously adjustable.

Response time (C and tan δ): typically 1 s.

Tan δ uncal

Indicates the reading of tan δ is uncalibrated when the deflection of the capacitance meter is below 10% or above 130% of full scale.

Leakage current measurement (4350A only)

Current

Range: 1 μA to 10 mA full scale in 9 ranges.

Accuracy: $\pm 3\%$ of full scale.

DC bias voltage

Internal: up to 100 V dc in 2 ranges.

External: 600 V dc max.

Warning lamp

Indicates "DANGER" when dc voltage across an unknown is higher than 1.5 V dc.

Analog outputs

Capacitance

1 V dc all ranges: for use with analog comparator.

1 V dc or 0.3 V dc full scale: for use with DVM.

Overrange: 25% of full scale.

Accuracy:

Tan δ	Capacitance Range Full Scale	
	1 μF to 100 mF	300 mF
0 to 1	$\pm (1.5\% \text{ of reading} + 0.5\% \text{ of full scale})$	$\pm 3\% \text{ of full scale}$
1 to 5	$\pm (1.5\% \text{ of reading} + 1.5\% \text{ of full scale})$	$\pm 4\% \text{ of full scale}$

Loss angle (δ)

Tan δ vs. analog output voltage: 0.1 V/degree.

Tan δ	δ	Output voltage
0 to 0.5	0° to 26.6°	(0 to 2.66 V dc) ± 0.13 V dc
0.5 to 5	26.6° to 78.7°	(2.66 to 7.87 V dc) ± 0.3 V dc

Residual noise: 40 mV p-p max.

General

Temperature range: 0°C to 50°C .

Power: 115 V or 230 V $\pm 10\%$, 48 Hz to 440 Hz, 38.5 VA max.

Dimensions: 7-25/32" wide, 6-17/32" high, 12" deep (198 x 166 x 305 mm).

Weight: net 11 lbs (4.8 kg); shipping 15 lbs (6.8 kg).

Accessories furnished: 16035A Test Cable with four alligator clips; 16036A Test Cable with two alligator clips.

Price: HP 4350A, \$955.

HP 4350B, \$845.

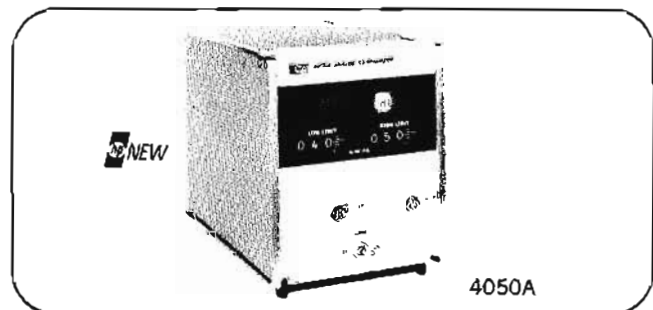

4050A

Description

The Hewlett-Packard Model 4050A Analog Comparator compares the unknown voltage to preset high and low limits. Contact closures with the corresponding (HI-GO-LO) lights will operate external devices. The 4050A increases the speed at which the 4350A/B Hi-C Meter or 4332A LCR Meter will operate in sorting applications.

Specifications, 4050A*

Input

Analog voltage: 0.1, 1, 10 V full scale.

Resistance: 0.1, 1 V range, 1 M Ω ; 10 V range, 100 k Ω .

Output

Limit indications: HI, GO, and LO lights.

Relay contact: 3 SPST contacts, 50 V dc, 0.5 A max.

Connector: binding post.

Limit controls: 000 to 125 are set on digital dials.

Accuracy: $\pm 0.6\%$ of full scale (at 25°C).

Response time: typically 0.1 s.

Operating temperature: 0°C to 50°C .

Power: 115/230 V $\pm 10\%$, 48 Hz to 440 Hz, 3.85 VA max.

Dimensions: standard 1/3 module, 6 3/32" high, 5 1/8" wide, 8" deep (155 x 130.1 x 203.2 mm).

Weight: net, 6 lbs, 4 oz (2.8 kg); shipping 8 lbs (3.6 kg).

Price: \$500.

* Refer to data sheet for complete specifications.



ATTENUATORS & CAPACITOR

Variable with increments of 0.1 dB or 2 pF

Models 4440B, 4436A, 4437A, 350D

Decade Capacitor, Model 4440B

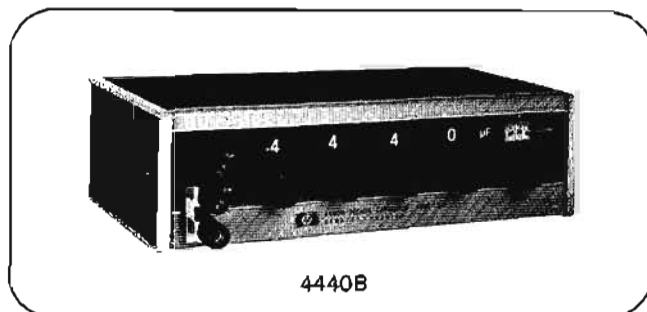

4440B

The Hewlett-Packard 4440B Decade Capacitor is a high accuracy instrument providing usable capacitances from 40 pF to 1.2 μ F. Its 0.25% accuracy makes it an ideal aid for circuit design or as a working standard.

Use of silvered-mica capacitors in four decades of 100 pF provides higher accuracy, low dissipation factors and good temperature coefficient. An air capacitor vernier provides 100 pF (from 40 pF to 140 pF) with resolution of 1 pF. Capacitors are housed in a double shield in such a way that increased

capacitance from two terminals to three terminals is held to 1 pF.

Specifications, 4440B

Capacitance: 40 pF to 1.2 μ F in steps of 100 pF with a 40 pF to 140 pF variable air capacitor providing continuous adjustment to better than 2 pF between steps.

Direct reading accuracy: $\pm(0.25\% + 3 \text{ pF})$ at 1 kHz for three-terminal connection.

Resonant frequency: typical values of the resonant frequency are 450 kHz at 1 μ F, 4 MHz at 0.01 μ F and 40 MHz at 100 pF.

Dissipation factor: 0.001 maximum at 1 kHz.

Temperature coefficient: +70 ppm/ $^{\circ}$ C.

Insulation resistance: 5 G Ω minimum, after 5 minutes at 500 V dc.

Maximum voltage: 500 V peak.

Weight: net, 5½ lbs (2.5 kg); shipping, 8 lbs (3.6 kg).

Dimensions: 11" wide (264 mm), 6" deep (152 mm), 3" high (76 mm).

Price: HP 4440B, \$340.

Attenuators, Models 4436A/4437A

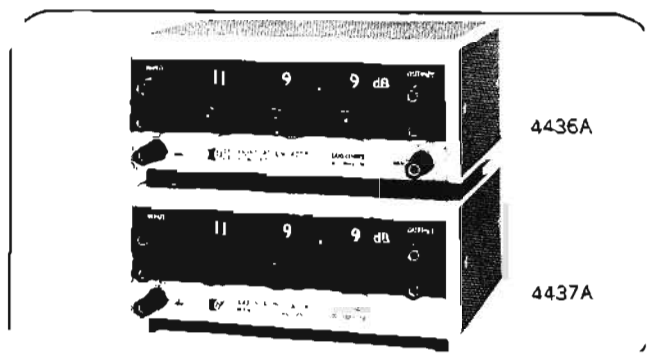

4436A

4437A

The Hewlett-Packard Models 4436A/4437A Attenuators provide accurate steps of attenuation with 0.1 dB resolution for power-level measurements, communication system tests, and gain or loss measurements on filters and amplifiers, and similar equipment.

Specifications, 4436A

Maximum attenuation: 119.9 dB.

Attenuation increments: 0.1 dB.

Input/output impedance: 600 Ω , balanced.

Frequency range: dc to 1.5 MHz (0 to 110 dB) dc to 1 MHz (0 to 119.9 dB).

Accuracy

Attenuation	100 kHz	1 MHz	1.5 MHz*
0 ~ 60 dB	± 0.1 dB	± 0.2 dB	± 0.2 dB
60 ~ 90 dB	± 0.1 dB	± 0.3 dB	± 0.3 dB
90 ~ 110 dB	± 0.2 dB	± 0.5 dB	± 0.5 dB
110 ~ 119.9 dB	± 0.3 dB	± 0.1 dB	

*Typical value

Maximum input power: +30 dBm.

DC isolation: signal ground may be ± 300 V dc from external chassis.

Dimensions: 7¼" wide, 3" high, 6⅞" deep (198 x 77 x 167 mm).

Weight: net, 3.3 lbs (1.5 kg); shipping, 6 lbs (2.7 kg).

Price: Model 4436A, \$500.

Specifications, 4437A

The Model 4437A is a 600 ohms unbalanced type, and its specifications are identical to the 4436A.

Price: Model 4437A, \$345.

Attenuator, Model 350D

Two attenuator sections make up the Hewlett-Packard 350D Attenuator. One section is a 100 dB attenuator, adjustable in 10 dB steps. The other is a 10 dB attenuator, adjustable in 1 dB steps.

Specifications, 350D

Attenuation: 0 to 110 dB, 1 dB and 10 dB steps.

Power capacity: 600 Ω unbalanced; 5 W (55 V dc or rms) max, continuous duty.

DC isolation: signal ground may be ± 500 V dc from chassis.

Accuracy

10 dB section

	0 dB	10 dB
dc to 100 kHz	$< \pm 0.125$ dB/step	
100 kHz to 1 MHz	$< \pm 0.25$ dB/step	

100 dB section

	0 dB	70 dB	100 dB
dc to 100 kHz	$< \pm 0.25$ dB	$< \pm 0.5$ dB/step	
100 kHz to 1 MHz	$< \pm 0.5$ dB	$< \pm 0.75$ dB/step	

Dimensions: standard Hewlett-Packard 1/3 module 5⅞" wide, 6¼" high, 8" deep (130 x 159 x 203 mm).

Weight: net, 4 lbs (1.8 kg); shipping, 6 lbs (2.7 kg).

Price: HP 350D, \$165.

VOLTMETER ACCESSORIES

Voltage dividers, current probe for VM's
Model 456A, 11000 Series



MEASURING DEVICES

Description

456A AC Current Probe

The conventional voltmeter or oscilloscope can measure current quickly and dependably—without direct connection to the circuit under test or any appreciable loading to the test circuit. The HP 456A AC Current Probe clamps around the current-carrying wire and provides a voltage output you can read on a voltmeter or scope. Model 456A's 1 mA to 1 mV conversion permits direct reading up to 1 ampere rms.

Specifications, 456A

Sensitivity: 1 mV/mA $\pm 1\%$ at 1 kHz.

Frequency response: $\pm 2\%$, 100 Hz to 3 MHz; $\pm 5\%$, 60 Hz to 4 MHz; -3 dB at < 25 Hz and > 20 MHz.

Pulse response: rise time is < 20 ns, sag $< 16\%/ms$.

Maximum input: 1 A rms, 1.5 A p; 100 mA above 5 MHz.

Effect of dc current: no appreciable effect on sensitivity and distortion from dc current up to 0.5 A.

Input impedance: (impedance added in series with measured wire by probe) < 50 m Ω in series with 0.05 μ H (this is approximately the inductance of $1\frac{1}{2}$ " of hookup wire).

Probe shunt capacity: approx. 4 pF added from wire to ground.

Distortion at 1 kHz: for 0.5 A input at least 50 dB down; for 10 mA input at least 70 dB down.

Equivalent input noise: < 50 μ A rms (100 μ A when ac powered).

Output impedance: 220 Ω at 1 kHz; approximately +1 V dc component; should work into load of not less than 100,000 Ω shunted by approximately 25 pF.

Power: two Mallory TR 233R and one TR 234 batteries (1420-0017 and 1420-0006); battery life approximately 400 hrs; ac power supply optional, 115 or (230 V must be specified) $\pm 10\%$, 48 to 440 Hz, 1 VA max.

Dimensions: 5" wide, $1\frac{1}{2}$ " high (127 x 38 x 152 mm), 6" deep; probe cable is 5' long; 2' output cable terminated with dual banana plug. Probe aperture: $5/32$ " (4mm) diameter.

Weight: net 3 lbs (1.35 kg); shipping 4 lbs (1.8 kg).

Accessory available: 456A-11B AC Supply for field installation; 11028A 100:1 Current Divider, \$60.

Price: HP 456A with batteries, \$250.

Option 001: ac supply installed in lieu of batteries, add \$20.

Voltmeter Accessories

11039A Capacitive Voltage Divider

For 400 and 410 series voltmeters. Safely measures power voltages to 25 kV; accuracy $\pm 3\%$. Division ratio, 1000:1. Input capacity, 15 pF ± 1 . Maximum voltage ratings (sea level) 60 Hz, 25 kV; 100 kHz, 22 kV; 1 MHz, 20 kV; 10 MHz, 15 kV; 20 MHz, 7 kV. Usable for dielectric heating, power and ultrasonic voltages. **Price:** HP 11039A, \$250. (HP 11018A should be used to connect the 410 series voltmeter).

11074A Voltage Divider Probe

For 400 series voltmeters. Provides low-input capacitance and high-input resistance at the point of measurement. Division ratio 10:1 $\pm 2\%$ (400 Hz reference), 10:1 $\pm 2\%$ (100 kHz reference depends on adjustment of compensating capacitor). Bandwidth, dc to 10 MHz. Maximum input voltage 1 kV rms.

Input impedance: 10 M Ω shunted by 10 pF (when connected to an input impedance of 10 M Ω shunted by not more than 25 pF). **Price:** HP 11074A, \$75.

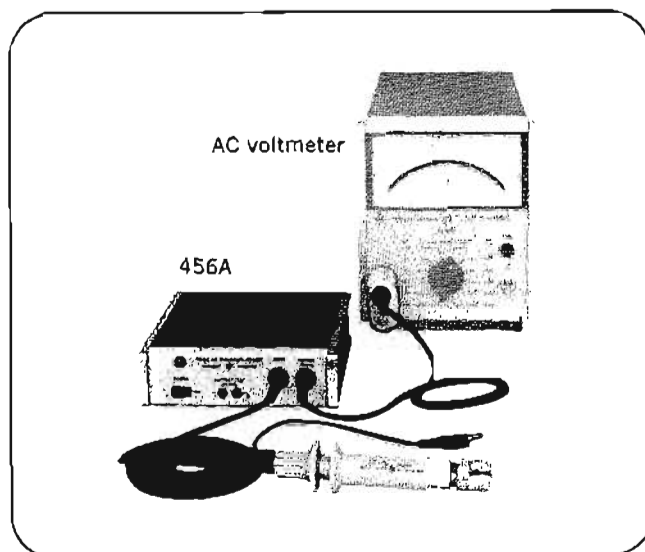

11096A High Frequency Probe

Converts dc voltmeter with 10 M Ω input resistance to high frequency ac voltmeter. Compatible voltmeters: HP 427A, HP 3430A, HP 3439A and HP 3440A. Voltage range, 0.25 to 30 V rms; transfer accuracy (10-30°C) $\pm 5\%$, 100 kHz to 100 MHz. Usable for relative measurements from 10 kHz to 1 GHz; peak responding, calibrated to read rms value of a sine wave; input impedance, 4 M Ω shunted by 2 pF; max. input, 30 V rms ac, 200 V dc; accessories provided include a straight tip, a hook tip, a ground clip, and a high frequency adapter that fits available Hewlett Packard adapters for BNC (HP 10218A); GR Type 874 (HP 10219A), Microdot connectors (HP 10220A) and that also fits a 50 Ω tee (HP 11536A).

Price: HP 11096A, \$75.

11018A Adapter: connects 410 series ac probe to dual banana plugs. **Price:** HP 11018A, \$35.

11036A Probe: ac probe for the 410C. **Price:** HP 11036A, \$80.

11040A Capacitive Voltage Divider

For 410 series voltmeters. Increases range so transmitter voltages can be measured quickly, easily. Accuracy, $\pm 1\%$; division ratio, 100:1; input capacity, approximately 2 pF. Maximum voltage, 2000 V at 50 MHz, decreasing to 100 V at 400 MHz. Frequency range, 10 kHz to 400 MHz.

Price: HP 11040A, \$40.

11042A Probe Coaxial "T" Connector

For 410 series voltmeters. Measures voltages between center conductor and sheath of 50 Ω transmission line. Maximum SWR, 1.1 at 500 MHz, 1.2 at 1 GHz. Male and female Type N fittings. **Price:** HP 11042A, \$60.

11043A Probe Coaxial "N" Connector

For 410 series voltmeters. Measures at open end of 50 Ω transmission line (no terminating resistor). Has male Type N fittings. **Price:** HP 11043A, \$45.

11045A DC Voltage Divider

For 410C Voltmeter. Gives maximum safety and convenience for measuring high voltages as in television receivers, etc. Accuracy, $\pm 5\%$; division ratio, 100:1. Input impedance, 10 G Ω . Maximum voltage, 30 kV. Max current drain, 2.5 μ A.

Price: HP 11045A, \$60.



Digital voltmeters

Digital voltmeters (DVM's) offer many advantages over other types of voltmeters. Among the advantages of DVM's are greater speed, greater accuracy and resolution, reduction of operator errors, and the ability to be remotely controlled or to remotely control another device such as a printer.

Digital voltmeters display measurements as discrete numerals, rather than as a pointer deflection on a continuous scale, which is commonly used in analog devices. Direct numerical readout in DVM's reduces human error and tedium, eliminates parallax error and increases reading speed. Automatic polarity and range-changing features reduce operator training, measurement error and possible instrument damage through overload.

Digital instruments are available to measure ac and dc voltages, dc currents, resistance, and ratio. Other physical variables can also be measured by use of suitable transducers. Many DVM's have outputs which can be used to make permanent records of measurements with printers, card and tape punches, and magnetic tape equipment. With data in digital form, it may be processed with no loss of accuracy.

Converters

The digital voltmeter is primarily a dc device, and as such requires that quantities to be measured be presented to it in the form of a dc voltage. This necessitates the use of a converter when making ac voltage or ohms measurements. A variety of converters are available for use with Hewlett-Packard digital voltmeters, either as plug-in drawers, plug-in boards, or as separate instruments.

AC converters designed for use with digital voltmeters can be classified according to their response to the input signal. The average responding converter is relatively inexpensive and was designed primarily for measurement of sine waves having little or no distortion. This type of converter measures the average value of the rectified waveform, which is then multiplied by a scale factor to provide the rms value.

The true rms converter responds to the effective dc heating value of the waveform. A thermocouple measures the heating value of the input, regardless of its distortion content. Hewlett-Packard now has two instruments (the 3480A/B with 3484A plug-in, pages 64-67, and 3403A/B, pages 62-63), that are capable of measuring ac plus dc; that is they

measure $\sqrt{(dc)^2 + (ac\ rms)^2}$. The advantage of this is that ac signals can be measured all the way down in frequency to dc; also the sum of an ac signal plus a dc offset can be measured. The true rms converter, while costing more than an average converter, is much more versatile. Its frequency limit is much greater than that of an average responding converter, and it gives accurate readings independent of distortion.

Ohms converters fall into three categories: two-wire, three-wire, and four-wire. The two-wire converter is the most common and the most economical, but it is sensitive to lead resistance. For example, if low resistance values are being measured at a remote location, lead resistance will cause an error in the measurement. A three-wire converter may have four terminals on the front panel, and may even be called a four-wire converter. It is also sensitive to lead resistance, especially on the low side of the input, but it may be possible to null out the error caused by the lead resistance with an internal adjustment. The true four-wire converter has a fully isolated current source and is insensitive to lead resistance. It makes low ohms ranges useful for remote measurements. This scheme offers the ultimate in performance for ohms measurements.

Selecting a digital voltmeter

The first consideration in selecting a DVM is to determine the requirements necessary for the measurements to be made. Then select a voltmeter that will meet these requirements. For long range use, try to anticipate all the needs for the future.

If the DVM is to be used in a data acquisition system, binary-coded decimal (BCD) output and remote programming capability are necessities. Compatibility with the related equipment should be determined before purchase.

Hewlett-Packard offers a digital instrument for nearly every application. For example, the 3431A Digital Panel Meter (page 60) is a single range DVM designed to replace analog panel meters where accuracy, resolution, and unambiguous display are important.

If more than one electrical property is to be measured in the specific applications, a multi-function meter is an advantage. Hewlett-Packard has many multi-function digital meters with different accuracies and different capabilities. The 3450A Multimeter (pages 70-71) with plug-in cards gives a large

variety of options including a true RMS ac digital voltmeter and a Hi-Go-Lo Comparator. The 3469A (page 61) is a portable, low cost multi-function instrument that provides twenty-six different range and function combinations to allow a wide variety of ac volts, dc volts, ohms, and dc current measurements. High performance ac volts and ohms functions make the 3469A useful for many lab and specialty applications. An ideal systems multimeter is the 3480A/B with the 3484A (pages 64-67) multi-function plug-in. This unit can make up to 1000 dc or ohms readings per second, and also has true rms ac capability as well as BCD output. The 2402A Integrating DVM (page 73) is a dc voltmeter to which ac voltage, resistance, and frequency measurement capability can be added. Other Hewlett-Packard digital multimeters are the 3439A and 3440A (pages 68-69) with multi-function plug-in drawers.

The art of dc voltage measurements has reached levels of accuracy which were formerly obtained only in the standards laboratory. When selecting a voltmeter to make accurate measurements in the presence of noise, the DVM must discriminate between the real signal and the noise appearing at its input. These noise signals take the form of either superimposed noise or common-mode noise.

Besides the usual external source of common-mode voltages, the measuring instrument can also contribute additional common-mode voltages. Internal double shielding is effective in eliminating the internal causes of common-mode voltages; a third shield or guard can be used to reduce the effects of external common-mode signals.

Superimposed noise upon the input voltage can also cause inaccuracies. A low-pass filter added to the input circuitry of the voltmeter can solve this problem but it does cause a considerable slowing of the digitizing process. Superimposed noise rejection by integration permits high accuracy in the presence of severe noise.

If high resolution is needed, Hewlett-Packard offers the ultimate: the 3462A (page 75) has a resolution of 1 part in 1,200,000 and a sensitivity of $1\ \mu\text{V}$.

When purchasing a digital instrument the maintenance cost should always be considered. Sometimes a DVM is selected with more accuracy than is required so that the calibration period can be extended and still maintain the necessary accuracy.

SELECTION GUIDE

Table 1. Hewlett-Packard Digital Voltmeters

Model	Accuracy (% of reading)	Number Digits	Overrange %	Speed (Max) Readings/sec	AC Volts	DC Volts	DC Amps	Ohms	Ratio	Auto Ranging	Floating Input	Guarding (CMR)	Printer Output	Remote Ranging	Remote Triggering	Plug-ins	Systems Application	Limit Test
3431A/B/C (pg 60)	0.1	3	100	15		X					X	X	X		X		X	
3469A (pg 61)	0.1	3	100	15	X	X	X	X			X							
3430A (see data sheet)	0.1	3	60	2		X			Opt.		X							
3403A/B (pgs 62-63)	0.2	3	90	4	X (dB Opt.)	3403A only				3403A Opt. only	X		Opt.	3403A Opt. only			X	
3439A (pgs 68-69)	0.05	4	5	5	•	•	•	•		•	X			•		•		
3440A (pgs 68-69)	0.05	4	5	5	•	•	•	•		•	X		X	•	X	•	X	
3480A/B ** (pgs 64-67)	0.01	4	50	1000	Opt.	X		Opt.	Opt.	X	X	X	Opt.	Opt.	X	•	X	
2401C (see data sheet)	0.01	5	200	1*		X				Opt.	X	X	X	X	X		X	
2402A (pg 73)	0.01	5	30	43	Opt.	X		Opt.		Opt.	X	X	X	X	X	Δ	X	
3450A (pgs 70-71)	0.008	5	20	16	Opt.	X		Opt.	†	X	X	X	Opt.	Opt.	X	Δ	X	Δ
3460B (pg 74)	0.004	5	20	15		X				X	X	X	X	X	X		X	
3462A (pg 75)	0.004	6	20	1		X				X	X	X	X	X	X		X	

* 4 digits/9 readings per sec; 3 digits/50 readings per sec.

Δ plug-in circuit cards.

** Sample and hold, and data storage optional.

† Ratio for ac, dc, and ohms

• plug-in drawer.

Table 2. Hewlett-Packard AC/Ohms Converters

Converter type (refer to page)	Companion HP DVM	Ranges	Auto-ranging	Floating	Guarding	Remote ranging	Remote triggering	Systems application	Accuracy (% of reading) 20°C to 30°C	Can be used with other 1 V range DVM's
AC to DC										
3445A/3446A (pg 69)	Plug-in drawer for 3439A/3440A	10 V to 1000 V 3 ranges	X	X		X	X	X	(50 Hz to 100 kHz) ±0.1% to ±0.3%	No
3450A Opt 001 True rms (pgs 70-71)	Plug-in card for 3450A	1 V to 1000 V 4 ranges	X	X	X	X	X	X	True rms (45 Hz to 1 MHz) ±0.05% to ±2.1%	No
3484A Opt 043 True rms (pgs 64-67)	Plug-in drawer for 3480A/B	100 mV to 1000 V 5 ranges	X	X	X	X	X	X	True rms (1 Hz to 10 MHz) ±0.1%	No
457A* (see data sheet)		1 V to 1000 V 4 ranges		X					(50 Hz to 600 kHz) ±0.3% to ±0.75%	Yes
3400A* (true rms) (pg 46)	3439A/3440A	1 mV to 300 V 12 ranges							(10 Hz to 10 MHz) ±0.75% to ±5.0%	Yes
400E/EL* (avg) (pg 45)	3439A/3440A	1 mV to 300 V 12 ranges							(10 Hz to 10 MHz) ±0.5% to ±5.0%	Yes
2402A Opt 002 (pg 73)	Plug-in card for 2402A	1 V to 1000 V 4 ranges	X	X	X	X	X	X	(50 Hz to 100 kHz) ±0.12% to ±0.31%	No
OHMS to DC										
3444A (pg 69)	Plug-in drawer for 3439A/3440A	1 kΩ to 10 MΩ 5 ranges		X					±0.3% to ±1.0%	No
3450A Opt 002 (pgs 70-71)	Plug-in card for 3450A	100Ω to 10 MΩ 6 ranges	X	X	X	X	X	X	±0.01% ±0.02%	No
3484A Opt 042 (pgs 64-67)	Plug-in drawer for 3480A/B	100Ω to 10 MΩ 6 ranges	X	X	X	X	X	X	±0.01% + ±0.02%	No
2402A Opt 003 (pg 73)	Plug-in card for 2402A	1 kΩ to 10 MΩ 5 ranges	X	X	X	X	X	X	±0.055%	No

* Accuracy of converter only. Accuracy of readout device should be added to determine accuracy of measurement.



DIGITAL PANEL METER

High performance meter replacement
Models 3431A,B,C,

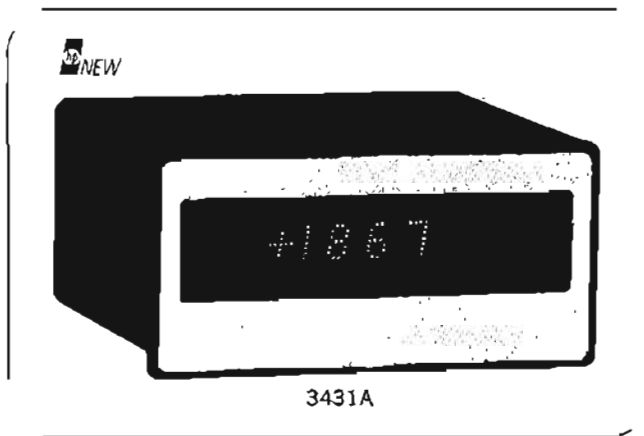

Description

The Hewlett-Packard 3431A Digital Panel Meter is a single range digital voltmeter designed to replace analog panel meters where accuracy, resolution, and an unambiguous display are important. Applications for the 3431A include such areas as medical, analytical, process control, test, optical, and data acquisition instrumentation. Instruments using digital panel meters are often very complex and expensive indicating that reliability is especially important. For this reason, the Hewlett-Packard DPM is designed with a low parts count and an extremely reliable GaAsP light emitting diode display. Power has also been minimized to keep heat rise low so that reliability is improved both in the panel meter and in the user's instrument. Quality and maximum usefulness has been assured by using only instrument grade components. The 3431A is the most serviceable, reliable, portable, flexible, and aesthetically appealing DPM available. These features are detailed in the following sections.

Design flexibility

Hewlett-Packard's new DPM is smaller and lighter than any other on the market with a power supply. This means the 3431A can be used with even the new small IC instruments and portable instruments. A choice of either line or low-level dc power supplies allows use in applications where power requirements are unusual.

The 3431A's many electrical features offer unique flexibility. If autoranging is a goal, the 3431A provides full scale and 10% full scale ranging signals with hysteresis. Where measure rate control is important, as in data logging applications, 5 digitally programmed rates are available between 1/s and 15/s along with programmable hold and trigger. Other programmable functions include digit blanking for indicating "illegal" or "overload" information, decimal locating, and autopolarity override for proper display of zero offset functions.

Serviceability

The 3431A can be removed through the front panel without opening the user's instrument. Once two screws and front panel are removed, the extractors are pulled and the meter slides out of its extruded case. The operation is extremely simple and takes less than a minute.

Modular service is possible due to plug-in circuit board construction. Troubleshooting through board substitution can be completed in a minimal 5 to 10 minutes even by unskilled personnel. If component level troubleshooting is desired, complete information is available in the manual.

Portability

Size, weight, power, and ruggedness are always serious considerations when designing portable instrumentation and the 3431A is the leader in adaptability to portable applications. It is the smallest, lightest, and most rugged complete panel meter available. By using few parts and a unique power supply, size is minimal and weight is kept to only 12 oz. by eliminating the conventional bulky and heavy power transformer. A dc version of the power supply operating efficiently at battery levels between 5 V and 15 V is available on an optional basis. Without this dc supply, an inverter would be required which would consume half the battery power in the inverter.

Specifications*

Full scale voltage range: ± 1.999 V.
Accuracy (20°C to 30°C): $\pm (0.1\% \text{ reading} + 1 \text{ digit})$.
Operating temperature range: 0°C to 60°C.
Temperature coefficient (0°C to 20°C, 30°C to 60°C): ± 0.1 mV/°C.
Input impedance: > 10 M Ω .
Input bias current: < 35 nA.
Zero to full scale response time: < 55 ms.
Overload protection: $< \pm 60$ V.
Effective common mode rejection (with 1 k Ω imbalance): > 90 dB at dc; > 60 dB at 60 Hz.
Normal mode rejection: > 35 dB at 60 Hz.
Floating: ± 500 V dc, input low to power ground.

General

Measure rates: 15/s, 8/s, 4/s, 2/s, 1/s.
Programmable functions: measure rate, hold, trigger, decimal location, annunciators, autopolarity override, and overload digit blanking.
Output information: BCD serial character, parallel bit with character identification; flags at > 1999 , > 999 , and < 190 ; polarity data; valid data ready signal.
Weight: net, 12 oz (0.4 kg); shipping, 1.5 lbs (0.68 kg).
Dimensions: 3.54" wide, 1.7" high, 2.9" deep (90 x 43 x 74 mm).

3431 options

Option 002: 3 GaAsP annunciator lamps with divider.
Option 003: input voltage range: 0 V to ± 19.99 V; input impedance: > 100 k Ω ; maximum input: ± 100 V.
Option 005: connector, Viking part number 000201-4238.

3431 ordering information

Note: 3431A, B, and C differ only in type of power supply offered.
3431A (AC supply): 90 V to 130 V, 48 Hz to 440 Hz, 5 W, 8 VA.
3431B (DC supply): 4.8 V dc to 9.2 V dc, 5 W. Allowable ac ripple is $\leq 10\%$ of supply level.
3431C (DC supply): 8.8 V dc to 15.2 V dc, 5 W. Allowable ac ripple is $\leq 10\%$ of supply level.

Price: HP 3431A, B, or C

1 -	9	\$295
10 -	49	\$275
50 -	99	\$250
100 -	249	\$225
	250 +	on request

HP 3431 option 002 (GaAsP annunciator lamps), add \$7.
 HP 3431 option 003 (19.99 V input range), no charge.

* Refer to data sheet for complete specifications.

DIGITAL MULTIMETER

High performance multimeter

Model 3469B



MEASURING DEVICES

Description

The Hewlett-Packard 3469B is a versatile, low cost digital multi-function meter. Twenty-six different range and function combinations allow a wide variety of measurements of ac volts, dc volts, ohms, and dc current. High performance ac volts, ohms, and dc current functions make the instrument useful in many lab, bench and specialty applications.

Digital ac voltmeter

High sensitivity (2 mV to 500 V full scale) wide bandwidth (20 Hz to 10 MHz), and high accuracy ($\pm 0.6\%$ to 5%), offer unique value to users in communications, broadcast, and audio applications areas.

Digital milliohmmeter

The 1 milliohm sensitivity of the 3469B allows fast and accurate measurements of contact resistances, components, and plated-through circuit board hole resistances. A unique two-terminal input permits direct measurements with varying probe lead lengths while eliminating errors introduced by cable resistance or EMF offsets. Once the leads are attached to the instrument, the operator simply shorts the ends and makes an adjustment to zero out the lead resistance. A 60 Hz square wave ac current source is used on the 1 ohm range to eliminate the possibility of problems due to thermal offsets.

Digital dc ammeter

High current sensitivity (2 μA to 200 mA full scale) allows current measurement capability approaching electrometer type performance at a modest price. The extra sensitivity and floating capability of the 3469B make it a natural choice to measure capacitor and semi-conductor leakage currents.

DC voltmeter

With the fast dc measure rate (15 samples per second), good sensitivity (200 mV to 1000 V full scale), and good accuracy ($\pm 0.2\%$ to $\pm 3\%$), the 3469B is an especially useful instrument for production applications where measurement time and clarity are prime concerns. Production trouble shooting is also enhanced by the full multimeter capability of the 3469B.

Specifications*

AC voltmeter

Ranges: 1 mV, 10 mV, 100 mV, 1 V, 10 V, 100 V, 1000 V (500 V max input).

Accuracy $\pm(\% \text{ reading} + \% \text{ range})$, 20°C to 30°C .

1 mV range (0.3 mV and above):

20 Hz 100 kHz 4 MHz

1 + 0.75	2.5 + 2.5
----------	-----------

10 mV to 1 V ranges:

20 Hz 100 Hz 100 kHz 1 MHz 10 MHz

0.5 + 0.5	0.3 + 0.3	1 + 1	2.5 + 2.5
-----------	-----------	-------	-----------

10 V, 100 V, 1000 V ranges:

20 Hz 100 Hz 100 kHz 1 MHz 4 MHz

1 + 0.5	0.4 + 0.3	1 + 1	2.5 + 2.5
---------	-----------	-------	-----------

Input Impedance: 10 M Ω shunted by <25 pF. Input common connected to chassis.

Overload protection: 500 V at frequencies ≤ 60 Hz.

Residual noise: <75 μV .

DC voltmeter

Ranges: 100 mV, 1 V, 10 V, 100 V, 1000 V.

Accuracy (20°C to 30°C)

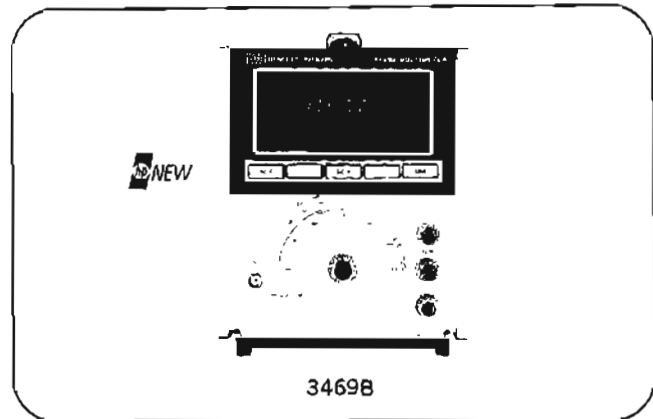

100 mV range: $\pm(0.2\% \text{ reading} + 0.1\% \text{ range})$.
1 V to 1000 V ranges: $\pm(0.1\% \text{ reading} + 0.1\% \text{ range})$.

Input impedance: 10 M Ω .

Response time: 70 ms.

Overload protection: 1000 V.

Normal mode rejection

60 Hz: 40 dB.

Common mode rejection

DC: 60 dB.

60 Hz: 40 dB.

Floating voltage: ± 500 V max.

Ohmmeter

Ranges: 1 Ω , 10 Ω , 100 Ω , 1 k Ω , 10 k Ω , 100 k Ω , 1 M Ω , 10 M Ω .

Accuracy (20°C to 30°C)

1 Ω range: $\pm(0.25\% \text{ reading} + 0.5\% \text{ range})$.

10 Ω range: $\pm(0.3\% \text{ reading} + 0.2\% \text{ range})$.

100 Ω to 10 M Ω range: $\pm(0.2\% \text{ reading} + 0.2\% \text{ range})$.

Open circuit voltage: 10 V negative with respect to common (common connected to chassis).

Response time

10 Ω to 10 M Ω ranges: 70 ms.

DC input protection: ± 100 V max.

AC input protection: 130 V rms max.

DC ammeter

Ranges: 1 μA , 10 μA , 100 μA , 1 mA, 10 mA, 100 mA.

Accuracy (20°C to 30°C): $\pm(0.2\% \text{ reading} + 0.2\% \text{ range})$.

Full scale voltage drop: 100 mV.

Response time: 70 ms.

Overload protection: 5 times full scale.

Floating voltage: ± 500 V max.

General

Sample rate: 15/s.

Overrange: 100%.

Display: GaAsP light emitting diodes.

Out of range and illegal range indication: 3 least significant digits blank.

Polarity: automatic.

Operating temperature range: 0°C to 55°C .

Warmup: 10 min.

Power: 115 V or 230 V $\pm 10\%$, 48 Hz to 440 Hz, 10 VA.

Dimensions: $5\frac{1}{8}$ " wide, $6\frac{1}{4}$ " high (without removable feet), 11" deep (130 x 159 x 279 mm).

Weight: net, 7 lbs (3,15 kg); shipping, 10 lbs (4,5 kg).

Price: HP 3469B, \$595.

*Refer to data sheet for complete specifications.



TRUE RMS VOLTMETER

Wideband digital measurements

Model 3403A, 3403B

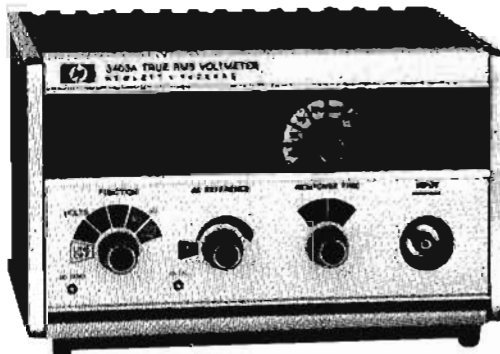

NEW

3403A



NEW

3403B

Description

The Hewlett-Packard 3403A and 3403B are companion instruments which cover a broad range of ac measurement applications. Both are true rms, 3-digit voltmeters which provide bench and systems capability. The 3403B provides six ranges of ac measurement and the 3403A adds five ranges of ac + dc for low frequency capability and five ranges of dc.

In addition to the systems options such as BCD output and remote control, a dB display option is available to permit measurements directly in dB. Autoranging is also available as an option for the 3403A.

Features

The dc and 2 Hz to 100 MHz bandwidth of the 3403A and 25 Hz to 100 MHz bandwidth of the 3403B will allow usage throughout the frequency spectrum. The 3403A/B are not only general meters for audio and low RF use, but they also can be used in the upper RF and IF bands. The 3403A, in addition, is a low frequency measurement instrument and a five range dc meter.

True RMS

The 3403A/B are true rms responding instruments utilizing the Hewlett-Packard thermopile as the rms sensing element. Their rms capability enables the 3403A/B to make meaningful measurements of noise, multiplexed signals or other complex or distorted waveforms as well as providing the assurance that any general purpose measurement will be made accurately.

Wide voltage range

The 3403A and 3403B have six ac voltage ranges from 10 mV full scale to 1000 V full scale, enough to satisfy an extremely wide range of applications. In addition, the 3403A provides five dc ranges and five dc + ac ranges for dc and low frequency measurement capability. This wide measuring span covers virtually any ac requirement and makes the instruments truly general purpose devices.

dB display

The dB display option provides readings directly in dB, a major convenience to ac users. The dB reference to which the measurement is made is conveniently adjustable from the front

panel both to provide referenced dB measurements or to provide a convenient means to adjust the reading to 0 or the nearest 10 dB, and then to measure deviations from this established level.

Systems

A full complement of systems options is available, both isolated and nonisolated, to insure systems compatibility.

3403A specifications

Ranges

Full range display: 10.00 mV (ac only); 100.0 mV, 1.000 V, 10.00 V, 100.0 V, 1000 V.

Overrange: >90% on all ranges except as limited by max input voltage.

Ranging information: front panel annunciators indicate over-range (approximately 190% of full range) or under-range (approximately 17% of full range) conditions.

Performance

AC frequency range

Slow response: 2 Hz to 100 MHz.

Fast response: 25 Hz to 100 MHz

Response time

Fast response: 1 s.

Slow response: 10 s.

Instrument reads final reading $\pm 0.1\%$ of input change in stated response time.

Display rate

Fast response: 4 readings per s.

Slow response: 1 reading per s.

Functions

DC: responds to dc component of input signal.

AC: responds to true rms value of ac coupled input signal.

AC + dc: responds to true rms value of dc and ac input signal; reading is $\sqrt{(dc)^2 + (ac\ rms)^2}$.

Temperature coefficient: $\pm 0.1 \times$ reading accuracy*/ $^{\circ}C$ outside the $25^{\circ}C \pm 5^{\circ}C$ temperature range.

* data from accuracy charts.

Accuracy: 90 days ($25^{\circ}C \pm 5^{\circ}C$, <95% RH, 17% of range to 190% of range).

READING ACCURACY = ± % OF RANGE		± % OF READING													
RANGE	VOLTS			FREQUENCY (Hz)											
	DC	DC+AC	AC	DC	25	100K	1M	10M	100M						
1000V	.3	.3	.3	.1	.4	.2									
100V	.2	.2	.2	.1	.4	.2	1								
10V	.2	.2	.2	.1	.4	.2	.5	1							
1V	.2	.2	.2	.1	.4	.2	.5	1	2.5	10					
100mV	.6	.6	.2	.1	.4	.2	.5	2	2.5	10					
10mV			.2			.3	1	3							

CAUTION frequencies and ranges in this area may result in invalid readings without ranging indication.

* DC + AC FUNCTION AND SLOW RESP. TIME ONLY

Input characteristics

Input impedance: <10 MHz.

1 V to 1000 V range: 10 MΩ ±10% shunted by 19 pF ±10%.

10 mV and 100 mV range: 20 MΩ ±10% shunted by 16 pF ±10%.

10 MHz to 100 MHz: the following table gives maximum loading due to input shunt impedance across a terminated source.

System impedance (source and load)	Frequency	
	10 MHz	100 MHz
50Ω	1%	10%
75Ω	2%	20%
Crest factor		
2 Hz to 25 Hz	2:1 at full range input.	
>25 Hz	10:1 at full range input.	

Maximum Input voltage

Hi to Lo:

1000 V rms, 1500 peak or 10⁹ V-Hz on any range. Maximum dc voltage in ac mode: 500 V dc.

Lo to chassis:

±500 V dc, when floated with special banana to BNC adapter.

3403B specifications

The 3403B specifications are identical to those of the 3403A with the following exceptions:

AC frequency range: 25 Hz to 100 MHz except 10 mV range. 10 mV range 50 Hz min.

Response time: 1 s.

Functions: ac volts, ac dB (optional).

Input: BNC grounded to chassis—non-floating.

The 3403B is available with: Option 002—digital output. Option 006—dB display.

Options

Autoranging (3403A Option 001)

Automatic ranging: uprange at approximately 190% of full range; downranges at approximately 17% of full range.

Autorange time: fast response: 1 s per range change. Slow response: 10 s per range change.

Digital output (3403A/B Option 002)

The digital output option provides data outputs in digital form for printer and systems applications. In addition, input lines are included for external triggering of the instrument.

Isolated digital output (3403A Option 004)

In addition to the features of Option 002 isolated digital output provides isolation between the measurement input terminals

and digital output lines. Output lines and programming input lines are referenced to earth ground (instrument chassis) and are well isolated from the measurement terminals. Instrument will maintain all normal and common mode rejection specifications when the data and control lines are utilized.

Remote control + digital output + autoranging (3403A Option 003)

Option 003 provides all features of digital output and autoranging (Options 001 and 002) plus remote programming of all front panel functions.

Isolated remote control + digital output + autoranging (3403A Option 005)

In addition to the features of Option 003, Option 005 provides the same isolation characteristics as isolated digital output (Option 004).

dB display (3403A/B Option 006)

Measurement range: 108 dB (-48 dB V to +60 dB V).

Accuracy: 90 days (25°C ±5°C, <95% RH).

READING ACCURACY = ± dB		± dB											
RANGE	dB		FREQUENCY (Hz)										
	AC	DC+AC	DC	25	100K	1M	10M	100M					
1000V	.15	.15	.01	.04	.02								
100V	.15	.15	.01	.04	.02	1							
10V	.15	.15	.01	.04	.02	.05	1						
1V	.15	.15	.01	.04	.02	.05	1	2.5	1				
100mV	.15	.15	.01	.04	.02	.05	2	2.5	1				
10mV	.15				.03	.1	.3						

CAUTION frequencies and ranges in this area may result in invalid readings without ranging indication.

* DC + AC FUNCTION AND SLOW RESP. TIME ONLY

Calibrated dB reference: 0 dB = 1.000 V; reference level may be set for 0 dBm (600Ω) by adjusting front panel dB calibration adjustment.

Variable dB reference: reference level may be shifted downward from calibrated position by >13 dB.

dB recorder output: output voltage: 200 mV for 20 dB. Output resistance: 1 kΩ ±500Ω.

General

Operating conditions

Temperature range: 0°C to 50°C.

Humidity: <95% RH.

Recorder output

Output voltage: 1 V dc open circuit for full range input.

Output resistance: 1 kΩ ±10%.

Power: 115 V or 230 V ±10%, 48 Hz to 440 Hz, 35 VA max. (including all options).

Input terminals: BNC front panel connector standard for Lo and Hi terminals; rear panel connector available by internally reversing position of ac converter module.

Net weight: including all options: 11 lbs (5 kg).

Shipping weight: including all options: 16 lbs (7.2 kg).

Accessories furnished: floating adapter—banana to BNC.

Price: HP 3403A, \$1400; **HP 3403B, \$1150; Option 001 autoranging, add \$125; Option 002 digital output, add \$150; Option 003 remote control + digital output + autoranging, add \$290; *Option 004 isolated digital output, add \$290; *Option 005 isolated remote control + digital output + autoranging, add \$450; *Option 006 dB display, add \$250.

* Option 004, 005, 006 are available only as factory installed options.
** Only Options 002 and 006 available with 3403B.



DVM and DATA LOGGER

Complete measurement capabilities
Models 3480A/B and 2070A

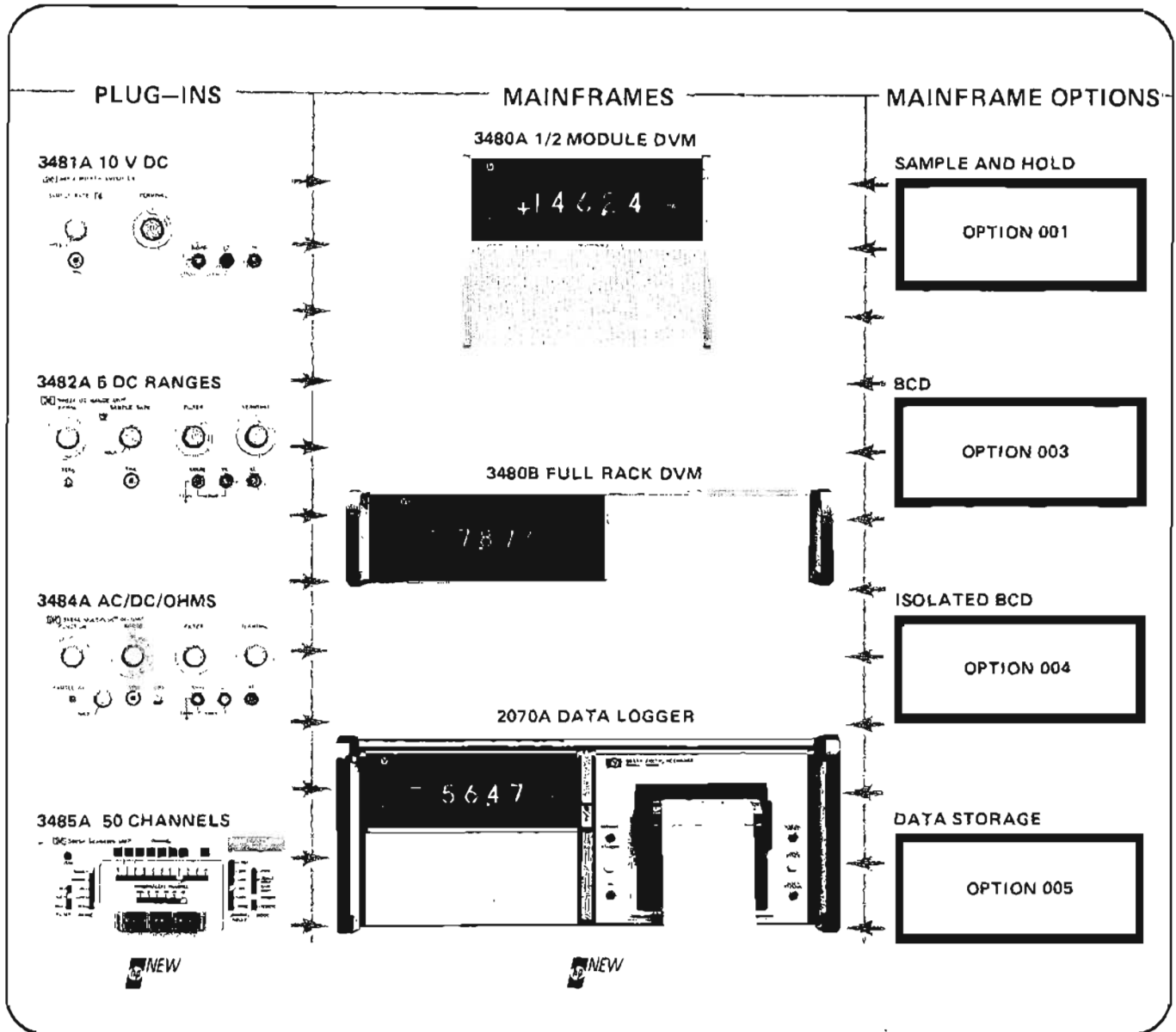

Description

The 3480 is a high performance 4-digit DVM designed for bench or systems use. The 2070A Data Logger is a 1/2 module 3480A DVM combined with a digital recorder into one portable package. A wide range of measurement capability is available using combinations of any of four plug-in units, any of three mainframes and any of four mainframe options. This capability covers anything from simple ac/dc/ohms measurements to multichannel data logging.

DC or ohms measurements may be made with 4-digit precision at speeds up to 1000/s. Two true rms ac converters are available; one able to measure ac signals down to 1 Hz and the other able to make 10 readings/s. Both converters are able to measure ac plus dc, a unique measurement for multifunction DVM's.

Up to 50 dc inputs may be scanned at up to 1000 channels/s. Single scan, continuous scan, step and random modes are available. Remote control is available to allow random selection of any channel or dc range.

Sample-and-hold option for any mainframe turns the 3480 or 2070A into a low-cost A-to-D converter able to digitize a variety of low frequency wave shapes. Sample and Hold may also be used for peak readings and transient analysis.

Data storage is able to store up to 50 complete readings at up to 1000/s for output on a digital recorder at 10 lines/s. Data storage makes it possible to scan up to 50 channels at 1000 channels/s or take readings at 1000/s, yet employ a low-cost printer to output the data.

Plug-In Units

Specifications*	3481A	3482A	3484A	3485A
Functions DC True RMS AC Fast True RMS AC Ohms	Standard	Standard	Standard Option 043 Option 044 Option 042	Standard
Ranges DC True RMS AC Fast True RMS AC Ohms	$\pm 10,000$ V	± 100.00 mV to ± 1000.0 V	± 100.00 mV to ± 1000.0 V ± 100.00 mV to ± 1000.0 V ± 100.00 mV to ± 1000.0 V 100.00 Ω to 10,000 M Ω	± 100.00 mV to $\pm 10,000$ V
Overrange	50%, ± 1200 V max.			50%, ± 15 V max.
Measuring Speed Reading Rate	Manual; internal, 1 to 40 rdg/s; external, 0 to 1000 rdg/s			Manual, 3 rdg/s; internal using 6 selectable channel delays; external 0 to 1000 rdg/s
Response Time DC Filter Out Filter A or In Filter B True RMS AC VAC (AC) VAC (DC) Fast True RMS AC VAC (AC) VAC (DC) Ohms 100 Ω to 100 k Ω 1000 k Ω 10 M Ω	1 ms	1 ms 200 ms 1 s	1 s 15 s 100 ms 1 s 1 ms 200 ms 2 s	1 ms 250 ms
Input Channels	Single input channel			Up to 50 floating input channels using FET switches, purchasable in blocks of 10 channels
Accuracy DC 100 mV 1000 mV 10 V 100 V and 1000V	$\pm(0.01\% \text{ rdg.} + 0.01\% \text{ range})$	$\pm(0.01\% \text{ rdg.} + 0.02\% \text{ range})$ $\pm(0.01\% \text{ rdg.} + 0.01\% \text{ range})$		$\pm(0.01\% \text{ rdg.} + 0.04\% \text{ range})$ $\pm(0.01\% \text{ rdg.} + 0.01\% \text{ range})$
Accuracy ¹ True RMS AC ² DC Component AC Component ⁴ 100mV and 1000mV (1 Hz to 10 MHz) 10 V and 100 V (1 Hz to 1 MHz) 1000 V (1 Hz to 100 kHz) Fast True RMS AC ² DC Component AC Component ⁵ 100mV and 1000mV (20 Hz to 10 MHz) 10 V and 100 V (20 Hz to 1 MHz) 1000 V (20 Hz to 100 kHz) Ohms 1000 Ω to 1000 k Ω 100 Ω 10 M Ω			1% of reading $\pm 0.1\%$ of reading to ³ $\pm 2\%$ of reading $\pm 0.1\%$ of reading to ³ $\pm 1\%$ of reading $\pm 0.1\%$ of reading to ³ $\pm 1\%$ of reading 1% of reading $\pm 0.1\%$ of reading to ³ $\pm 2\%$ of reading $\pm 0.1\%$ of reading to ³ $\pm 0.4\%$ of reading $\pm 0.1\%$ of reading to ³ $\pm 0.2\%$ of reading $\pm(0.01\% \text{ rdg} + 0.01\% \text{ rge})$ $\pm(0.02\% \text{ rdg} + 0.05\% \text{ rge})$ $\pm(0.1\% \text{ rdg} + 0.01\% \text{ rge})$	

* For complete specifications, refer to data sheets

1. Accuracy specifications applies for 90 days, 25°C \pm 5°C, 95% RH 5 VAC (DC) mode used below 300 Hz.
2. Accuracy for 60% to 150% of range.
3. Accuracy depends on frequency.
4. VAC (DC) mode used below 10 Hz.

MEASURING DEVICES *continued*

DVM and Data Logger
Models 3480A/B and 2070A

Plug-In Units

Specifications (Cont'd)*	3481A	3482A	3484A	3485A
AC Response VAC (AC) VAC (DC)			True rms value of ac coupled function True rms value of ac and dc input signal Reading equals: $\sqrt{(dc)^2 + (ac\ rms)^2}$	
Crest Factor True RMS AC Fast True RMS AC			7:1 at full scale, de-rated linearly from 35 Hz to 2.2:1 at 5 Hz. 7:1 at full scale, de-rated linearly from 100 Hz to 7.2:1 at 30 Hz.	
Input Characteristics Input Resistance DC 100mV and 1000mV 10 V 100 V and 1000 V AC Front Term. Rear Term.	>10 ¹⁰ Ω		>10 ¹⁰ Ω >10 ¹⁰ Ω 10 MΩ±0.1%	>10 ⁷ Ω >10 ⁷ Ω
Common Mode Rejection	>80 dB, dc to 60 Hz with 1kΩ in either lead			
Normal Mode Rejection Filter Out Filter A Or In Filter B	0 dB		0 dB >27 dB at 50 Hz; >30 dB 60 Hz and above >77 dB at 50 Hz; >80 dB 60 Hz and above	
Prices (Basic Unit) Ohms AC Fast AC 10 Channels	\$350	\$700	\$900 Option 042 \$200 Option 043 \$900 Option 044 \$1000	\$1300 Option 051 to 055 \$100 increments

* For complete specifications refer to data sheets.

Remote Control For Plug-In Units

Remote	3481A	3482A	3484A	3485A
Non-Isolated Remote Measure Filter Range Function Flag	Yes	Standard Yes Yes Yes Yes	Standard Yes Yes Yes Yes Yes	
Isolated Remote Measure Filter Range Function Flag Program Program Initiate Program Execute Program Acknowledge Scan Modes Channel Select Scan Inhibit Reset		Option 021 Yes Yes Yes Yes Yes Yes Yes Yes	Option 041 Yes Yes Yes Yes Yes Yes Yes Yes	Option 057 Yes Yes Yes Yes Yes Yes Yes Yes Yes Yes
Price		Add \$200	Add \$200	Add \$300

Mainframes

	3480A	3480B	2070A
Size	½ Module 6-3/32" High	Full rack width 3-3/8" High	Full rack width 6-3/8" High
Output	BCD (optional)		Digital Recorder
Power	115 V or 230 V \pm 10%, switchable 40 Hz to 440 Hz 60 VA max.		115 V \pm 10% 40 Hz to 440 Hz 115 VA max. 230 V \pm 10% optional
Operating Temperature	0°C to 55°C		
Price (Excluding Options and Plug-ins)	\$800	\$900	\$2675

Sample-and-hold Option 001

Acquisition time: time to respond to a plus or minus full scale step input to within $\pm 0.01\%$ of final value.

Note: a delay of $105 \mu\text{s} \pm 10 \mu\text{s}$ may be added prior to aperture time by using delay on.

Accuracy: (90 days, $25^\circ\text{C} \pm 5^\circ\text{C}$, 95% RH) for any mode.

ACQUISITION TIME:	Plug-In Unit			
Range	3481A	3482A	3484A	3485A
$\pm 100.00 \text{ mV}$		100 μs	100 μs	100 μs
$\pm 1000.0 \text{ mV}$		70 μs	70 μs	70 μs
$\pm 10.000 \text{ V}$	25 μs	70 μs	70 μs	70 μs
$\pm 100.00 \text{ V}$		25 μs	25 μs	
$\pm 1000.0 \text{ V}$		25 μs	25 μs	

ACCURACY:	Plug-In Unit			
Range	3481A	3482A	3484A	3485A
$\pm 100.00 \text{ mV}$		$\pm (0.01\% \text{ of rdg} + 0.1\% \text{ of range})^*$		
$\pm 1000.0 \text{ mV}$		$\pm (0.01\% \text{ of rdg} + 0.01\% \text{ of range})$		
$\pm 10.000 \text{ V}$		$\pm (0.01\% \text{ of reading} + 0.01\% \text{ of range})$		
$\pm 100.00 \text{ V}$		$\pm (0.01\% \text{ of reading}$		
$\pm 1000.0 \text{ V}$		$+ 0.01\% \text{ of range})$		

Maximum dV/dT: 10% of range/ μs , sample-and-hold enabled.

Modes of operation (selection, manually or remotely)

Sample-and-hold

On: sample-and-hold enabled.

Off: normal 3480 operation.

Remote: remote control.

Delay

On: $105 \mu\text{s}$ delay added before hold.

Off: no delay.

Remote: remote control over delay.

Aperture time: time from command to take a reading to when the signal is actually held: $110 \text{ ns} \pm 20 \text{ ns}$.

*Improves to $\pm (0.01\% \text{ of reading} + 0.02\% \text{ of range})$ when there is no Delay and the trigger is issued to the Sample-and-Hold trigger input.

Analog output: sample-and-hold output for use with an oscilloscope for the measurement and display of repetitive waveforms. Full scale inputs equal $1 \text{ V} \pm 2\%$; source resistance $1 \text{ k}\Omega \pm 2\%$.

Sample-and-hold trigger: initiates hold mode and encoding. Actuated by "Low" state for $> 1 \mu\text{s}$. Line must be "High" $> 20 \mu\text{s}$ prior to "Low" state. Used in place of measure to eliminate $105 \mu\text{s}$ delay.

Mainframe Options

	Digital Output (Option 003)	Isolated Digital Output (Option 004)	Data Storage (Option 005)
BCD Output Columns 5 Measurement 1 Function 1 Polarity 1 Range 2 Channel I.D.		3481A, 3482A, 3484A, 3485A 3482A, 3484A 3481A, 3482A, 3484A, 3485A 3482A, 3484A, 3485A 3485A	
2 Storage I.D.			For all plug-in units
Control Lines Measure Flag Printer Hold-off Internal Measure Inhibit	Yes Yes Yes Yes	Yes Yes Yes Yes	Yes Yes Yes Yes
Storage Limit Storage Flag Status Flag Cycle Hold Jump Preset Trigger			Yes Yes Yes Yes Yes Yes
Storage Capacity			Up to 50 readings
Input Rate			1000 readings/s
Output Rate		1000 readings/s	50,000 readings/s
Isolation From Input Terminals	None	Yes, maintains all noise rejection specifications	
Price	Add \$200	Add \$375	Add \$1000



DIGITAL VOLTMETERS

Interchangeable plug-ins provide versatility
Models 3439A, 3440A and plug-ins

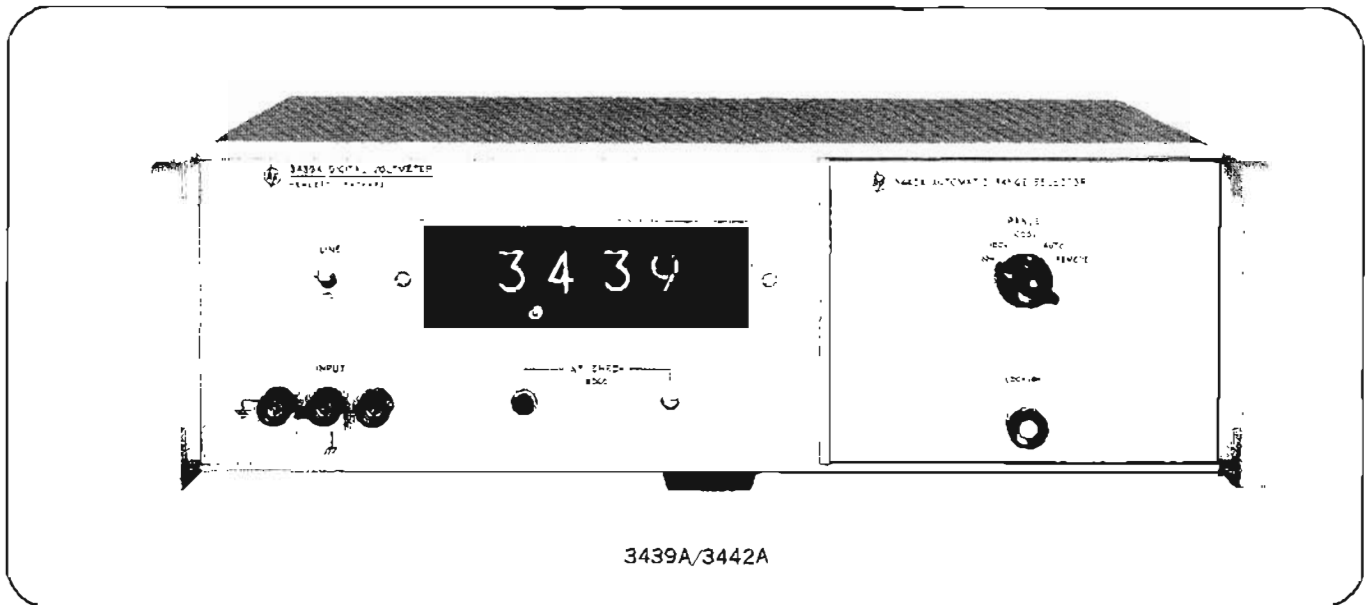

Interchangeable plug-ins increase voltmeter versatility

The Hewlett-Packard Models 3439A and 3440A are versatile multi-function digital voltmeters. The choice of automatic ranging, remote, and manual operation is obtained by using the 3441A, 3442A, 3443A, 3444A, 3445A or 3446A plug-ins, which are interchangeable with any 3439A or 3440A. The basic voltmeter is solid-state with easy-to-service plug-in circuit cards.

DC voltages up to 999.9 V of either polarity are displayed in four significant digits with an accuracy of better than $\pm 0.05\%$ of reading ± 1 digit and with the polarity of the applied signal indicated automatically. Modes of range selection available for the plug-ins include manual, remote, and automatic. Refer to Table 1 for data. The bright, easy-to-read display reduces operator fatigue. A polarized light filter reduces the reflection of external light so that a good contrast results when the digits are lighted.

Feature	HP 3439A	HP 3440A
Sample rate:	3/s fixed	"HOLD" and variable 1/s to 5/s
DC input floating:	500 V above chassis ground	500 V above chassis ground
Printer output:	None	BCD (1-2-2-4) for data, polarity, function, print command and decimal. BCD (1-2-4-8) Opt HO2
Overrange	5%	
Power	115 or 230 V $\pm 10\%$, 48 to 440 Hz, approx 20 to 30 W depending on plug-in (45 VA max)	
Operating temperature	$+ 0^{\circ}\text{C}$ to $+ 50^{\circ}\text{C}$	
Weight:	Net 18 lbs (8 kg); shipping 24 lbs (10,8 kg).	
Dimensions:	16 3/4" wide x 5 7/32" high x 11 1/4" deep (425.5 x 132.5 x 285.6 mm)	
Price:	\$1075	\$1300

Table 1. Features Chart.

Plug-in units

Table 2 illustrates the features obtained by using the 3441A, 3442A, 3443A, 3444A, 3445A or 3446A plug-ins with any 3439A or 3440A.

Performance

The operator can instantly verify the accuracy of the 3439A and 3440A by pressing a front-panel button. Typical performance on the 3440A internal calibration source is better than 0.002%/°C TC with stability typically better than $\pm 0.05\%$ over a three-month period. The linearity is approximately $\pm 0.01\%$ for the 10, 100, and 1000 V ranges with 0.03% linearity full scale for the 100 mV and 1000 mV range. The stability of reading is approximately ± 1 count.

Plug-in function chart						
Plug-in*	3441A	3442A	3443A	3444A	3445A	3446A
AC volts 10V to 100V	**	**	**	**	X	X
DC volts 10V to 1000V	X	X	X	X	X	X
DC volts 100mV to 1000V			X	X		
DC amps				X		
Ohms				X		
Manual ranging	X	X	X	X	X	X
Autoranging		X	X		X	
Floating input	X	X	X	X	X	X
Remote ranging		X	X		X	X
Remote function						X

*3439A and 3440A require a plug-in to operate.
**Average response measurements: 100 μV to 300 V, 50 Hz to 500 kHz use HP 457A; 1 mV to 300 V, 10 Hz to 10 MHz use HP 400E/EL. True rms measurements: 1 mV to 300 V, 10 Hz to 10 MHz, use HP 3400A.

Table 2. Plug-in Function Chart.

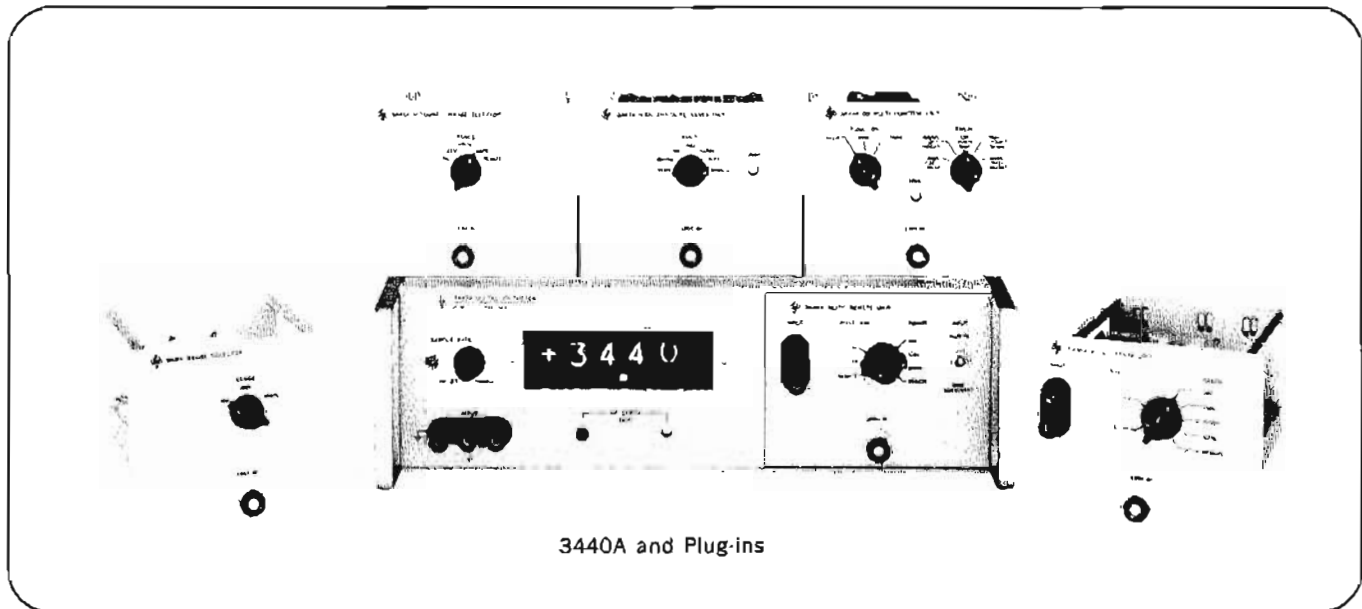

3440A and Plug-ins

Specifications*

	3441A/3442A	3443A	3444A	3445A/3446A
DC voltage				
Ranges	$\pm 9.999\text{V}$, $\pm 99.99\text{V}$, $\pm 999.9\text{V}$	$\pm 99.99\text{mV}$, $\pm 999.9\text{mV}$, $\pm 9.999\text{V}$, $\pm 99.99\text{V}$, $\pm 999.9\text{V}$	$\pm 99.99\text{mV}$, $\pm 999.9\text{mV}$, $\pm 9.999\text{V}$, $\pm 99.99\text{V}$, $\pm 999.9\text{V}$	$\pm 9.999\text{V}$, $\pm 99.99\text{V}$, $\pm 999.9\text{V}$
Accuracy	$\pm (.05\% \text{ Rdg} \pm 1 \text{ digit})$	$\pm (.05\% \text{ Rdg} \pm 1 \text{ digit})$	$\pm (.05\% \text{ Rdg} \pm 1 \text{ digit})$	$\pm (.05\% \text{ Rdg} \pm 1 \text{ digit})$
Input impedance	10.2M Ω	10.2M Ω	10.2 M Ω	10.2M Ω
Range selection	3441A: manual 3442A: manual, auto, remote	Manual, auto, remote	Manual	manual, auto, remote
AC voltage				
Ranges				9.999V, 99.99V, 999.9V
Accuracy (50Hz to 20kHz) (20kHz to 50kHz) (50kHz to 100kHz)				$\pm (.1\% \text{ Rdg} \pm .02\% \text{ FS})$ $\pm .12\% \text{ FS}$ $\pm .1\% \text{ FS to } \pm .3\% \text{ FS}$ linearly derated with frequency
Input impedance	None	None	None	10 M Ω , 20 pF
Range selection				Manual, auto, remote
Response time				3 seconds
Ohms				
Ranges			999.9 Ω , 9.999 k Ω , 99.99 k Ω , 999.9 k Ω , 9.999 M Ω	
Accuracy	None	None	$\pm (.3\% \text{ Rdg} \pm 1 \text{ digit})$	None
Range selection			Manual	
DC current				
Ranges			$\pm 99.99\mu\text{A}$, $\pm 999.9\mu\text{A}$, $\pm 9.999\text{mA}$, $\pm 99.99\text{mA}$, $\pm 999.9\text{mA}$	
Accuracy	None	None	$\pm (.2\% \text{ Rdg} \pm 1 \text{ digit})$	None
Range selection			Manual	
General				
Weight	3441A: 1 lb net (0,45 kg); 4 lbs shipping (1,8 kg) 3442A: 1.5 lbs net (0,7 kg); 5 lbs ship- ping (2,3 kg)	3 lbs net (1,35 kg) 6 lbs shipping (2,7 kg)	3 lbs net (1,35 kg) 6 lbs shipping (2,7 kg)	2.75 lbs net (1,24 kg) 6 lbs shipping (2,7 kg)
Price	3441A: \$50 3442A: \$165	\$565	\$655	3445A: \$655 3446A: \$640

*Refer to data sheet for complete specifications.



MULTI-FUNCTION METER

12 modes of operation, true rms

Model 3450A

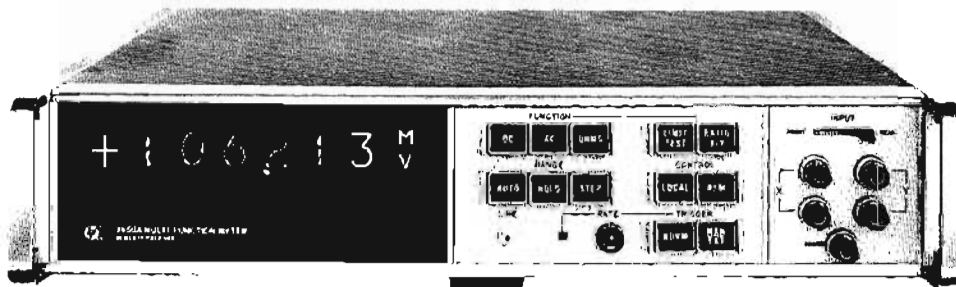

3450A

General description

The Hewlett-Packard Model 3450A Multi-Function Meter is a five-digit, integrating digital voltmeter. The basic instrument measures dc voltage and dc voltage ratios. Added measurement capability is achieved by the addition of plug-in options.

Optional Functions

AC and ac ratio	Option 001
Ohms and ohms ratio	Option 002
Limit test	Option 003
Digital output	Option 004
Remote control	Option 005
Rear terminals	Option 006

Specifications^{1,2}

DC Voltages

Ranges

Full range display: ± 100.000 mV; ± 1.00000 V; ± 10.0000 V; ± 100.000 V; ± 1000.00 V.

Overranging: 20% on all ranges

Performance

Accuracy: 30 day ($25^{\circ}\text{C} \pm 5^{\circ}\text{C}$).

Range	Specification
1 V thru 3000 V	$\pm(0.008\%$ of reading $+0.002\%$ of range)
100 mV	$\pm(0.008\%$ of reading $+0.01\%$ of range)

Measuring speed: 380 ms (1/10 s gate); 65 ms (1/60).

Input characteristics

Input resistance: 100 mV through 10 V ranges, $10^{10} \Omega$; 100 V, 1000 V ranges, 10 M Ω .

Normal mode rejection: extremely high rejection at harmonics of gate time.

Effective common mode rejection: extremely high rejection at harmonics of gate time. Specified with 1 k Ω unbalance. Applies to dc and ohms.

DC Ratio

Ranges

Full range display: ± 1.00000 ; ± 10.0000 ; ± 100.000 ; ± 1000.00 .

Performance

Accuracy: 30 day ($25^{\circ}\text{C} \pm 5^{\circ}\text{C}$), $\pm[0.01\%$ of readings[#] + 0.002% of ratio range + (Y range/Y voltage) x 0.003%].

*Add 0.005% of reading for X input >100 V.

Measuring speed: 840 ms (1/10 s gate); 210 ms (1/60 s).

Input characteristics

Input configuration: isolation 4-terminal, guarded. No common ground necessary between signals.

Input resistance: same as dc voltage for X and Y inputs.

AC Voltage Option 001

(True RMS-Responding, 45 Hz to 1 MHz)

Ranges

Full range display: 1.00000 V; 10.0000 V; 100.000 V; 1000.00 V.

Overranging: 20% on all ranges (1500 V p on 1 kV).

Performance

Accuracy: 90 day ($25^{\circ}\text{C} \pm 5^{\circ}\text{C}$).

Depends on: frequency, input, amplitude, % of full scale. Mid-band accuracy: $\pm(0.04\%$ of reading + 0.01% of range).

Measuring speed: 2.7 s (1/10 s gate).

Input characteristics

Input impedance: front terminals, 2 M Ω shunted by 90 ± 10 pF in series with 0.1 μF ; rear terminals, 2 M Ω shunted by 135 ± 15 pF in series with 0.1 μF .

AC Ratio Option 001

(True RMS-Responding)

Ranges

Full range display: 1.00000; 10.0000; 100.000; 1000.00.

^{1,2} For complete specifications refer to Technical Data Sheet.

Performance

Accuracy: 90 day ($25^{\circ}\text{C} \pm 5^{\circ}\text{C}$), $\pm(0.02\%$ of reading + 0.01% of ratio range + sum of measurement accuracy of each input).

Measuring speed: 8.1 s (1/10 s gate).

Input characteristics

Input configuration: isolated 4-terminal, guarded.

Input impedance: same as ac voltage for X and Y.

Interterminal capacitance between X and Y: <10 pF.

Crest factor: 7:1 ($f >1$ kHz, bandwidth = 1 MHz).

Maximum input voltage: same as dc voltage, except $< \pm 1000$ V dc offset voltage on X terminals.

Ohms Option 002**Ranges**

Full range display: 100.000 Ω ; 1.00000 k Ω ; 10.0000 k Ω ; 1000.00 k Ω ; 10000.0 k Ω .

Accuracy: 30 day ($25^{\circ}\text{C} \pm 5^{\circ}\text{C}$). Depends on reading, % of scale and range. Accuracy for 1 k Ω - 100 k Ω ranges is $\pm(0.01\%$ of reading + 0.002% of range).

Measuring speed: 380 ms (1/10 s gate); 65 ms (1/60 s gate), 165 ms on 10 M Ω range.

Input characteristics

Input configuration: 4-wire, guarded.

Current through resistance.

Range	Signal Current
100 Ω 1 k Ω 10 k Ω	1 mA
100 k Ω 1000 k Ω	10 μA
10000 k Ω	1 μA

Effective common-mode rejection (ECMR): same as dc voltage.

Normal-mode rejection: same as dc voltage.

Overload protection: ± 200 V p for X or Y input.

Ohms Ratio Option 002**Ranges**

Full range ratio display: 1.00000; 10.0000; 100.000; 1000.00.

Performance

Accuracy: 30 day ($25^{\circ}\text{C} \pm 5^{\circ}\text{C}$ at terminals): $\pm(\%$ of ratio range error + $\%$ of ratio reading error) where $\%$ of ratio range error = $+(0.004\% + \frac{Y \text{ range}}{Y \text{ resistance}} \times 0.002\%)$; $\%$ of ratio reading error is the greater percentage given below for either the X or Y resistance.

6	0.55	0.1	0.05	0.02*	0.05	0.2	%
0	100	1k	2k	9k	500k	5M	12M Ω

*0.01% for ratios between 0.95 and 1.05 if X and Y are between 10k and 500 k.

Measuring speed: 840 ms (1/10 s gate); 210 ms (1/60 s gate).

Input characteristics

Input configuration: isolated 4-terminal, guarded. Two wires per resistor.

Current through X and Y resistance: same as ohms function.

Effective common-mode rejection (ECMR): same as dc voltage for X input.

Normal-mode rejection: same as dc voltage for X input.

Overload protection: ± 200 V p for X or Y input.

Limit Test Option 003**Capability**

Applicable to: dc, dc ratio, ac, ac ratio, ohms, and ohms ratio. No degradation in performance of above six functions.

Limit selection

Two 4-digit limits (with 20% overranging), including polarity, are selectable in 1-2-4-8 BCD form.

Digital Output Option 004

4-line BCD (1-2-4-8) "1" state positive, 9 columns: 2 columns for function and polarity, 1 column for range, 6 columns for data.

BCD levels

State	12 V Level	Output Characteristics
"0"	+0.5 V ± 0.5 V	12 mA max sink current
"1"	+11.5 V ± 0.5 V	12 k Ω source resistance

State	5 V Level*	Output Characteristics
"0"	+0.5 V ± 0.5 V	20 mA max sink current
"1"	+4.5 V ± 0.3 V	12 k Ω source resistance

*5 V level may be selected by moving jumper wire on Digital Output PC board.

BCD reference levels

Ref Level	12 V Level	5 V Level	Source Resistance
Negative	+1 V	+0.4 V	3 k Ω
Positive	+6 V	+3 V	10 k Ω

Holdoff on internal trigger or print command may be selected by moving jumper wire.

Remote Control Option 005

All remote control lines are selected by an external closure to ground through <3 k Ω (2.8 mA max) or application of -0.5 V to $+2.5$ V for the "0" state as shown below.

State	12 V Level	5 V Level*
"0"	-0.5 V to 2.5 V	-0.5 V to +1.0 V
"1"	+5.5 V to +12 V	2.5 V to 5.0 V

*5 V level may be selected by moving jumper wire on Remote Control PC board.

General

Operating temperature: 0°C to 50°C , unless otherwise specified.

Storage temperature: -40°C to $+75^{\circ}\text{C}$.

Power: 115 V or 230 V $\pm 10\%$, 48 Hz to 440 Hz, 110 VA max (including all options, normal environmental conditions).

Dimensions: 16 3/4" wide, 3 15/32" high, 21 3/8" deep (425 x 88 x 542 mm).

Weight

Basic instrument: net 31 lbs (14.1 kg); shipping 41 lbs (18.5 kg).

Including all options: net 36 lbs (16.3 kg); shipping 49 lbs (22.1 kg).

Accessories available: HP 11133A Rear Input Cable assembly, \$30; HP 11112A Limit Selector, \$175. The standard HP 5050B Printer is compatible with the 3450A. The HP 5050B Opt. H089 Printer is equipped with special alphameric wheels for use with the 3450A. The following accessory numbers are for ordering optional capabilities not included with initial purchase: HP 11077A Ohms Converter, \$425; HP 11078A AC Converter, \$1250; HP 11079A Limit Test, \$375; HP 11080A Digital Output, \$225; HP 11099A Remote Control, \$260.

Accessories furnished: rack mounting kit; lamp replacement kit; extender kit for Option 001; connector kit for Option 003; connector kit for Option 004; HP 11133A Rear Input Cable assembly for Option 006.

Price: HP 3450A (includes dc and dc ratio), \$3300, HP 3450A Option H50, Optimum Noise Rejection for 50 Hz line, add \$60; HP 3450A Option H01, Optimum Noise Rejection for 60 Hz line with programmable filter, add \$300; HP 3450A Option H13, Optimum Noise Rejection for 50 Hz line with programmable filter, add \$360; Option 001 AC Converter (adds ac, ac ratio), add \$1250; Option 002 Ohms Converter, add \$425; Option 003 Limit Test (adds limit test capability), add \$375; Option 004 Digital Output (adds BCD output, 1-2-4-8 code), add \$225; Option 005 Remote Control (adds remote control capability), add \$260; Option 006 Rear Input Terminals (adds front/rear selector switch and rear terminals), add \$70.



V-TO-F CONVERTER

Accurate bipolar, low-level dc V-to-F conversion
Model 2212B

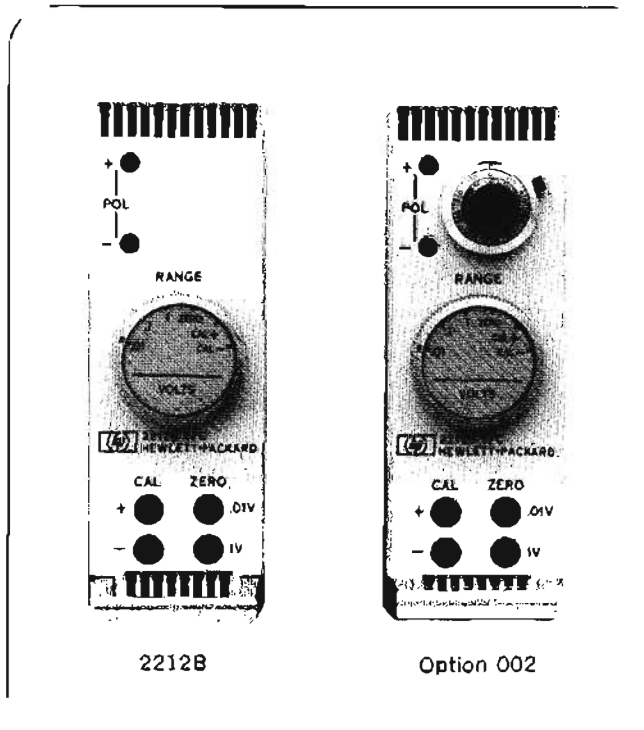

The HP 2212B is a compact Voltage-to-Frequency Converter, well suited to low-level signal applications. Low input drift and high common mode rejection (114 dB at 60 Hz) are achieved without a chopper by differential circuits. The VFC produces an output pulse train with a rate directly proportional to the magnitude of an applied dc voltage. Pulse rate rises linearly and instantaneously from 0 to 100,000 pulses per second as the dc input level is increased from zero to full scale. The 2212B provides outstanding linearity, stability and noise immunity.

The output of the HP 2212B, when connected to an electronic counter provides a convenient method of making digital measurements of dc voltages; the converter provides a polarity signal. This converter-counter combination can be connected directly to a digital printer or through an output coupler to other common digital recording devices.

The converter-counter combination integrates dc voltages over any period of time and can therefore be used to read the average of the input over a selected sample period, or over an externally-controlled period. This provides accurate dc measurements in the presence of noise superimposed on the signal. Combining the VFC with an HP 5321B all-JC Counter, provides an Integrating DVM with .01, .1, 1 and 10 seconds sample periods.

The modular package with self-contained power supply allows the 2212B to be used in both bench and systems applications. An inexpensive combining case is available to mount 10 instruments side-by-side in only 5¼" of 19" rack panel space.

Specifications

Specifications include $\pm 10\%$ line voltage variation, hold for 1 k Ω max. source resistance, any unbalance, and assume daily calibration after specified warmup.

DC voltage ranges: 3 ranges; 0 to 10 mV, 100 mV, 1 V. Vernier option 002 (10-turn potentiometer) extends range to $\times 3.5$, for any setting. Overrange: to 250% of full scale, all ranges. Instrument is sensitive to positive and negative inputs; polarity indication and output signal provided.

Accuracy: 'Worst case' accuracy of pulse rate over 1-second sample period with respect to the source used for calibration is as follows:

	.01 V		.1 V		1 V	
	% rdg = % fs	% rdg = % fs	% rdg = % fs	% rdg = % fs	% rdg = % fs	% rdg = % fs
Stability	.07	.06	.05	.015	.02	.011
Linearity	.01		.01		.01	
Temp. Ceff.	.004	.017	.004	.0035	.004	.0022

Internal calibration source: 1 V standard for self-calibration. Accurate to within $\pm 0.02\%$ for six months; temp. coeff of $\pm 0.005\%$ per $^{\circ}\text{C}$ (0° to 55°C).

Differential input impedance: 1000 M Ω shunted by 0.001 μF .

Common mode rejection: 120 dB at dc; 114 dB at 60 Hz.

Common mode return: From input common to output common, 1 megohm, max.

Normal mode rejection: More than 40 dB at 55 Hz with 1 second sample period; increases 20 dB per decade increase in noise frequency. Infinite rejection cusp every cycle.

Slewing: 10° V/sec rti (referred to input) with dc offset caused by slew limiting less than 0.1% of peak ac, provided 250% of full scale is not exceeded.

Maximum input signal: ± 11 V, signal plus common mode.

Combined input up to ± 20 V will not damage instrument.

Output (dc coupled): 0 to 100 kHz fs, overranging to 250 kHz; 5 mA available; short circuit will not damage instrument.

Settling time: 100 μs to within 0.01% of final pulse rate.

Overload recovery: 200 μs to 0.01% of final pulse rate for signal to 10 times full scale. Less than 5 ms for signal plus common mode input up to 20 V.

Polarity indication: electrical and visual for + and -.

Operating conditions: Ambient temperatures (from 0° to 55°C ; relative humidity to 95% at 40°C).

Warmup: operates immediately after turn-on, but requires 1½ hours in free air, 30 minutes in portable case or combining Case (plus 1 hour additional warmup for each 10°C difference between storage temperature and operating ambient) for specified accuracy and zero drift.

Reliability: predicted MTBF (with 90% confidence) is 10,000 hours when operated at 25°C ambient.

Power: 115 or 230 V $\pm 10\%$, 48 to 440 Hz, 10 VA max.

Dimensions: 1¼" wide, 4⅞" high, 15" deep (39.7 x 123.8 x 381 mm).

Weight: net 4 lb (1.8 kg), shipping 6½ lb (2.9 kg).

Accessories available: mating rear connector; mating rear connector with power cord, input/output cable; combining case: holds up to 10 instruments in 5¼" of 19" rack space (mating connectors furnished), includes power cord and fan; portable case: holds two VFC's (mating connectors furnished) and includes power switch, pilot light, power cord and fan.

Price: HP 2212B, \$1325; option 002 (Vernier) add \$100.

INTEGRATING DVM

Precise measurements despite severe noise
Model 2402A



MEASURING DEVICES

Description

The 2402A Integrating Digital Voltmeter combines 43 measurements per second sampling rate and the precision and measurement flexibility expected from a laboratory instrument with the programming and electrical output features necessary for data acquisition systems use both computerized and non-computerized. It achieves high speed and high accuracy at low levels, without preamplifiers.

High accuracy in a DVM is of little practical value unless this accuracy can be maintained in the presence of noise and under the far from ideal conditions of everyday use. The 2402A is average-reading, which greatly reduces the effects of superimposed noise. A floated and guarded input circuit eliminates common mode noise error. Combined, these techniques yield effective common mode noise rejection greater than 126 dB (2 million to 1) at any frequency, including dc.

AC voltages to 750 V peak can be measured on four ranges from 1 V to 1000 V when the 2402A is equipped for optional ac voltage measurement. Resistance measurements to 13 megohms can be made on five ranges from 1 k Ω to 10 M Ω when the 2402A is equipped with this option. The 2402A may be equipped for frequency measurements to 199.999 kHz. Frequency measurement is a plug-in option.

Specifications†

DC voltage measurement

Noise rejection: overall effective common mode rejection: (ratio of common mode signal to its effect upon readings): 160 dB at dc, decreasing to 126 dB above 30 Hz (infinite rejection cusp gives 168 dB effective cmr at 60 Hz \pm 15%). Overall rejection combines common mode rejection and superimposed noise rejection.

Ranges: 100 mV and 1, 10, 100, and 1000 V full scale selected by front panel switch, external programming or autoranger. **Internal calibration standard:** (independent of measuring circuit). Derived from stabilized reference diode operating in a constant temperature oven; maintains specified accuracy for 6 months.

Accuracy: 6 months (25°C \pm 1°C). 1 V - 1000 V range: \pm (0.01% reading + .003% F.S.); 100 mV range: \pm (0.01% reading + .005% F.S.).

Measurement speed: to 43 measurements per second when triggered externally.

AC voltage measurement option

Input impedance: 1 M Ω \pm 1% shunted by 200 pF (maximum).

AC only operation: frequency range: 50 Hz to 100 kHz.

Ranges: 1, 10, 100, and 1000 V full scale, selected by front panel switch, external programming or autoranger.

Accuracy: midband \pm (0.06% reading + .03% F.S.).

Measurement speed: to 1.9 externally-triggered measurements per second.

Resolution: 1 part in 130,000 on 6-digit display; 10 μ V on 1 V range.

Resistance measurement option

Noise rejection: measurement circuit enclosed in same guard as dc circuit, reducing effect of ac common mode noise when guard is connected to low side of test resistance.

Input circuit: guarded, modified four-terminal circuit, unknown resistor can be either grounded or floating.

Ranges: 1 k Ω , 10 k Ω , 100 k Ω , 1 M Ω , and 10 M Ω full scale, selected by front panel switch, external programming or optional autoranger.

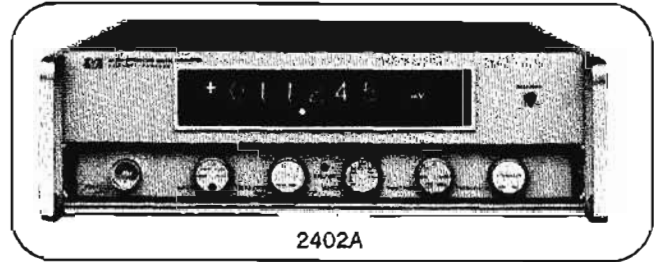

Absolute accuracy

Resistance range	1 k Ω	10 k Ω	100 k Ω	1 M Ω	10 M Ω
Measurement current	1 mA	1 mA	100 μ A	10 μ A	1 μ A
Accuracy at 25°C	\pm (% rdg + % fs) 0.016	0.003	\pm (0.013% rdg \pm 0.003% fs)		\pm (% rdg + % fs) 0.025
Temperature effect	\pm (0.004% rdg + 0.0003% fs) per °C difference of ambient with respect to 25°C over 10 to 50°C range				

* Calibration of 2402A against internal standard at operating temperature decreases % rdg temperature effect to 0.0015% per °C, to 0.0025% rdg per °C.

Measurement speed: to 8 externally triggered readings per second.

Resolution: 1 part in 130,000; 0.01 Ω on 1 k Ω range.

Frequency measurement option

Frequency range: 5 Hz to 199.999 kHz.

Gate time: 1 second; provides 1 Hz resolution.

Accuracy: \pm (1 count + time base stability); time base aging rate: 2 ppm per week over 20 to 30°C; time base temperature effect: 100 ppm over range 10 to 50°C.

Input

Amplitude range: 0.1 to 100 V rms.

Pulse or square wave input: negative 1 to 100 V amplitude, 2 μ s minimum duration, 50% maximum duty cycle.

Impedance: 1 M Ω shunted by 150 pF.

Maximum voltage: 150 V peak dc plus ac or pulse.

Autorange option

Range selection: dc voltage ranges; each time autoranger is programmed, it starts on 1 V range to take advantage of fast up-ranging. While autoranging is continuously programmed, autoranger starts at range selected for previous reading, sequences to higher or lower range as required. AC voltage range: autoranger starts at 1000 V range, sequences to lower range as required. Up-ranges at 136% of full scale, down-ranges at 10.2%.

General

Display and system interface: 6-digit display, BCD output and program inputs. Polarity, decimal, measurement units, calibration, and overload conditions indicated automatically and included in output as function and decimal digits.

Operating conditions: specifications apply for ambient temperatures 10 to 50°C, relative humidity to 90% at 40°C, altitude to 15,000 feet.

Power: 115 or 230 V \pm 10%, 50 to 60 Hz, 150 VA max.

Dimensions: 16 $\frac{3}{4}$ " wide, 5 $\frac{1}{4}$ " high, 19 $\frac{1}{2}$ " deep behind panel (425 x 133 x 494 mm); hardware furnished for 19" wide rack mount.

Weight: net 49 lbs (22.2 kg); shipping 56 lbs (25.4 kg).

Price: 2402A for DC measurements, \$5950; AC, add \$675; resistance, add \$775; frequency, add \$350; autoranging, add \$265.

†Refer to data sheet for complete specifications.



DIGITAL VOLTMETER

±0.004% accuracy, lab precision, systems speed
Model 3460B

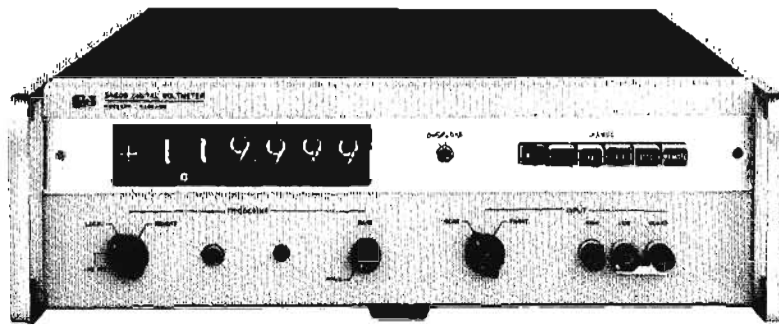

3460B

The Hewlett-Packard Model 3460B is a full five-digit digital voltmeter which combines in one instrument the benefits of high accuracy, high speed, and high noise rejection. The unique method by which the potentiometric and integrating techniques are combined in this instrument is primarily responsible for this combination of outstanding features. A unique two-sample system enables 15 independent readings to be made in one second at this accuracy. Integration during the second of these two samples plus guarding results in excellent effective common-mode rejection and ac normal-mode rejection characteristics. Voltage ranges and integration periods can be selected by contact closures to ground.

DC Voltage Specifications*

Ranges

Full range display: ±1.00000 V; ±10.0000 V; ±100.000 V; ±1000.00 V.

Overranging: 20% on all ranges.

Range selection: manual, automatic or remote.

Performance rating

Accuracy (accuracy applies over a temperature range of 25°C ±5°C):

90 day calibration cycle: ±(0.004% of reading + 0.002% of range).

180 day calibration cycle: ±(0.007% of reading + 0.003% of range).

Stability: ±(0.002% of reading + 0.001% of range) 24 hr, constant temperature ±1°C.

Temperature coefficient: ±(0.0002% of reading + 0.0001% of range) per °C (from 0°C to 20°C and 30°C to 50°C).

Reading period

10, 100, 1000 V ranges: <66 ms; **1 V range:** <150 ms.

Integration period: 1/10 s (1/60 s selectable by external contact closure to ground on 10, 100 and 1000 V ranges).

Response time: reads within specified accuracy when triggered coincident with step input voltage.

Autorange time: 33 ms per range change. Remote ranging time: 8 ms.

Input characteristics

Input resistance: 1 V and 10 V ranges, >10¹⁰Ω within ±5% of null, otherwise 10 MΩ ±0.03%; 100 V and 1000 V range, 10 MΩ ±0.03%.

Isolation parameters: floated and guarded input terminals; guard can be operated up to ±500 V p with respect to chassis ground, low can be operated up to ±50 V p with respect to guard.

Noise rejection: overall effective common-mode rejection (ratio of indicated error voltage to common-mode voltage) 145 dB at all frequencies (0.1 s sample period); common-mode rejection 160 dB at dc, 120 dB at 60 Hz with 1000Ω between low side of input and the point where the guard is connected; superimposed noise rejection; >20 dB at 55 Hz for 0.1 s sample period increased 20 dB per decade of frequency; infinite rejection at frequencies divisible by 10 (0.1 s sample period) or 60 (1/60 s sample period).

*For complete specifications refer to Data Sheet.

Remote control

Range selection: remote: all ranges can be selected by a contact closure to ground with impedance of <100Ω for a period >100 μs. Automatic: automatic mode of range selection can be programmed by a contact closure to ground with impedance <100Ω.

D/A converter reset: contact closure to ground of <100Ω.

Trigger hold-off: hold-off voltage is +3 to +10 V with a maximum current of 6.3 mA (provided by an external device).

Input resistance: 10 MΩ ±0.03% can be programmed by contact closure to ground of <100Ω.

Recorder data

BCD outputs: 4-line BCD (1-2-4-8) "1" state positive, 9 columns of information: function, decimal, overload, and 6 of digit data.

General

Operating temperature: instrument will operate within specifications from 0°C to 50°C unless otherwise specified.

Storage temperature: -40°C to +75°C.

RFI: conducted and radiated leakage limits are below those specified in MIL-I-6181D.

Power: 115 V or 230 V ±10%, 50 Hz to 60 Hz, 90 VA max.

HP 3460B is available on special order for operation with power-line frequencies between 50 Hz and 400 Hz.

Dimensions: 16¾" wide, 5-7/32" high, 19¾" deep (425 x 133 x 492 mm).

Weight: net, 38 lbs (17.6 kg); shipping, 55 lbs (24.8 kg).

Accessories furnished

HP 11065A 6-ft rear input cable, guarding preserved; \$20.

HP 11085A remote control cable, \$30; rack mount kit for 19" rack.

Accessories available: HP 562A/AR Digital Recorder; HP 5050A Digital Recorder.

Optional Filter

An optional programmable filter can be added (as indicated in the table below) to increase the ac normal-mode rejection by 26 dB at 60 Hz (24 dB at 50 Hz). With this added rejection the 3460B accommodates ac normal-mode signals up to 100% of range (peak value).

When using the filter, 725 ms is added to the reading period and 363 ms is added to the auto-range time listed in the 3460B specifications.

Price: HP 3460B, 1-2-4-8 BCD "1" state positive, \$3850.

Options	BCD Data ("1" state positive)		3481A Compatibility	Filter	Additional Price
	1-2-4-8	1-2-2-4			
001		X			N/C
002	X		X		\$150
003		X	X		\$150
004	X			X	\$250
005		X		X	\$250
006	X		X	X	\$400
007		X	X	X	\$400

HP 3460B option H50, optimum noise rejection for 50 Hz line frequency (3460B Options in chart apply).

DIGITAL VOLTMETER

Resolution: 1 μ V on 1 V; 1 mV on 1000 V range
Model 3462A



MEASURING DEVICES

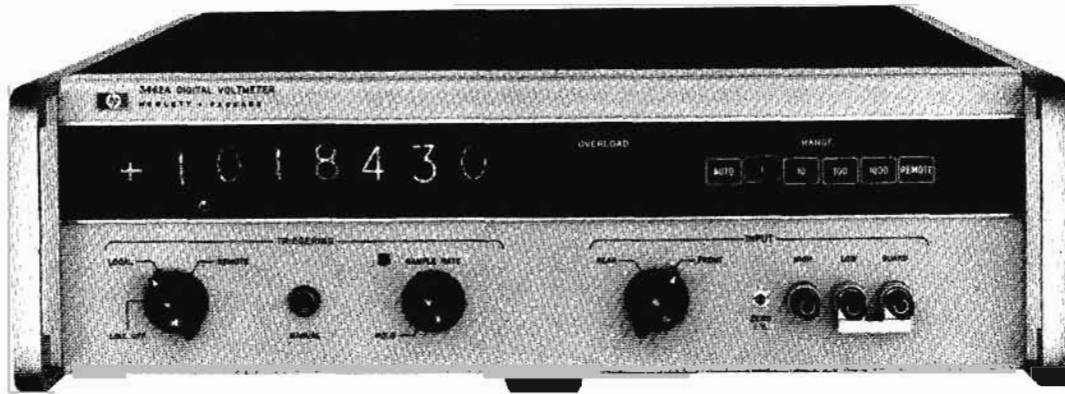

3462A

Description

The solid-state Model 3462A, 6-digit DVM, offers a resolution of 1 part in 1,200,000 at 20% overrange—four times more resolution than any other digital voltmeter in its price range. Accuracy is $\pm(0.004\%$ of reading + 0.0002% of range) over a 10°C temperature variation for a period of 90 days.

Null measurements can be performed with 1 μ V sensitivity. A front-panel, high-resolution zero adjust is provided to compensate for any thermals in connections to external circuitry. BCD output capability permits recording of data, and remote programmability permits system applications.

Specifications*

Ranges

Full range display: ± 1.000000 V; ± 10.00000 V; ± 100.0000 ; ± 1000.000 .

Overranging: 20% on all ranges.

Range selection: manual, automatic, or remote.

Performance

Accuracy (90 days, 25°C \pm 5°C, <50% RH): $\pm(0.004\%$ of reading + 0.0002% of range).

Accuracy (90 days, 25°C \pm 5°C, <95% RH): $\pm(0.004\%$ of reading + 0.0004% of range).

Stability (constant temperature \pm 1°C, <50% RH)

24 hr: $\pm(0.0015\%$ of reading + 0.0002% of range).

180 day: $\pm(0.006\%$ of reading + 0.0004% of range).

Temperature coefficient (0°C to 50°C): $\pm(0.0002\%$ of reading + 0.00002% of range) per °C.

Measuring speed

Range	Integration Interval	Reading Period (without range change)	Auto-range Time	Remote Range Time	Polarity Selection Time
1 V 10 V 100 V 1000 V	1 s	1.1 s	60 ms	8 ms	no delay

Range	Specifications
1 V and 10 V	$10^{10} \Omega$ within $\pm 5\%$ of null, otherwise $10^7 \Omega = 0.03\%$
100 V and 1000 V	$10^7 \Omega = 0.03\%$

Effective common-mode rejection: 160 dB at dc; extremely high at harmonics of power line.

Normal mode rejection: >100 dB at 60 Hz; extremely high at harmonics of power line.

Remote control

Range selection

Automatic: pushbutton selector or a switch closure to ground through $<100\Omega$ provides autorange operation. 60 ms is required per range change, 180 ms max.

Remote: a switch closure to ground through $<100\Omega$ for a period $>100 \mu$ s selects range desired.

Manual: pushbutton selector.

Voltmeter reset: switch closure to ground through $<100\Omega$ assures minimum reading period.

Trigger hold-off: hold-off level is +3 V to +10 V with max current of 6.3 mA (provided by an external device).

Input resistance: $10^7 \Omega \pm 0.03\%$ can be programmed by contact closure to ground of $<100\Omega$.

Recorder data

BCD outputs: 4-line BCD (1-2-4-8), 9 columns, consisting of polarity and decimal location, overload, and 7 digits of data (HP 3462A Option 001 is available for 1-2-2-4 BCD).

General

Operating temperature: 0°C to 50°C unless specified otherwise.

Power: 115 V or 230 V $\pm 10\%$, 50 Hz to 60 Hz, 90 VA max. Available on special order for operation with powerline frequencies between 50 Hz and 400 Hz.

Dimensions: 16 $\frac{3}{4}$ " wide, 5" high, 21 $\frac{3}{8}$ " deep (425 x 127 x 543 mm).

Weight: net, 38 lbs (16 kg); shipping, 55 lbs (24.8 kg).

Accessories furnished

HP 11065A 6-ft rear input cable, guarding preserved, terminated end mates with 3462A, \$20; HP 11085A remote control cable, \$30; HP rack mount kit.

Price: HP 3462A, \$4995; HP 3462A Option 001 (1-2-2-4 BCD output), \$4995; HP 3462A Option H50 (optimum noise rejection for 50 Hz line frequency), add \$60.

* Refer to data sheet for complete specifications.



RADIANT FLUX METER AND DETECTOR

Measure UV, visible and infrared radiation

Model 8330A, 8334A

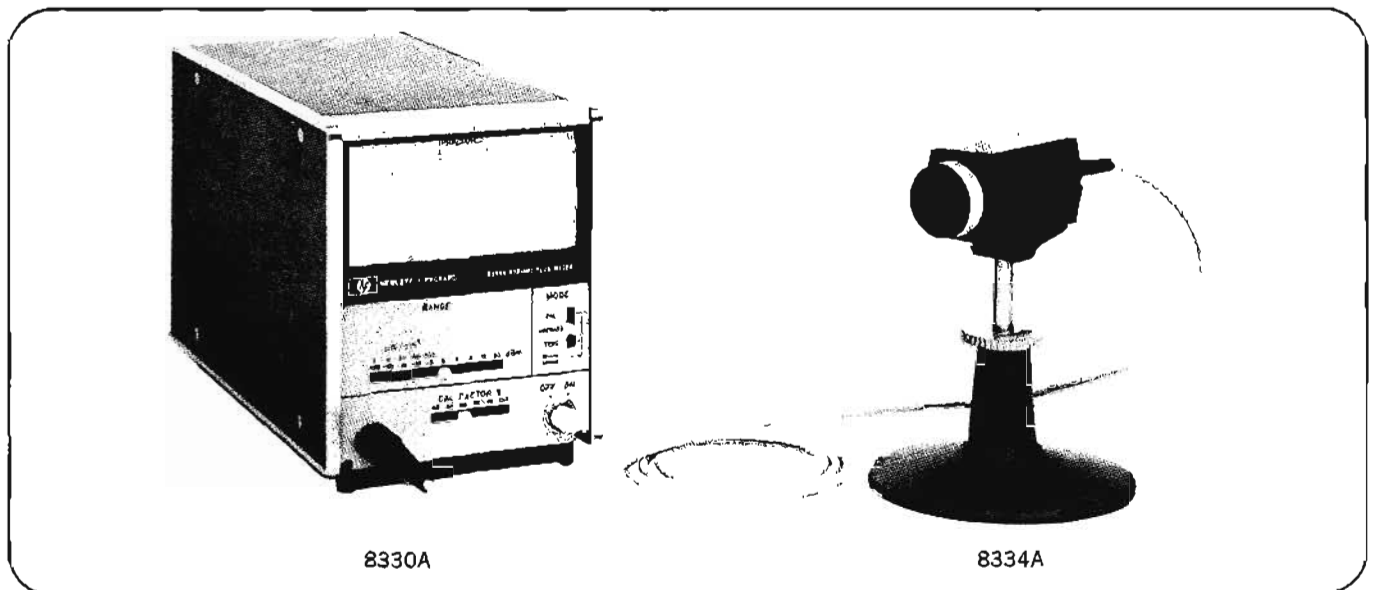

8330A

8334A

Description

The Model 8330A Radiant Flux Meter and Model 8334A Radiant Flux Detector combine to form a complete, multi-purpose optical radiometer system ideally suited for use in a wide variety of exacting applications involving the accurate measurement of radiant power density in the ultraviolet, visible and infrared regions of the electromagnetic spectrum.

Direct readout in absolute units

The complete system is fully calibrated and reads directly in absolute radiometric units of watts per cm^2 at any wavelength and at any power level within the range of the detector. The uniform, flat spectral response of the detector eliminates the need for inconvenient spectral calibration curves, thus enabling the convenient measurement of monochromatic radiation as well as the accurate measurement of spectrally-distributed (non-monochromatic) radiation from optical sources such as thermal blackbody radiators.

Specifications, 8330A/8334A

Dynamic range: irradiance measured in 10 overlapping (1:3:10 sequence) ranges from $3 \mu\text{W}/\text{cm}^2$ to $100 \text{ mW}/\text{cm}^2$ full scale.

Accuracy: absolute measurement uncertainty of broadband irradiance is less than $\pm 5\%$ of full scale on any range.

Spectral range and flatness: standard version of Model 8334A is equipped with Infrasil quartz optical window and responds from at least 0.3 to more than 3.0 microns, flat to within $\pm 3\%$ or less (measured with grating monochromator with better than 0.1 micron resolution). Spectral range is extendable beyond these limits using specified alternate optical window materials. Windows are not interchangeable.

Response time, 10-90%: measured at recorder/DVM output is: $< 70 \text{ msec}$ on 3, 10, 30, $100 \text{ mW}/\text{cm}^2$ ranges; $< 0.7 \text{ sec}$ on 100, $300 \mu\text{W}/\text{cm}^2$ and $1 \text{ mW}/\text{cm}^2$ ranges, $< 2.7 \text{ sec}$ on 3, 10, $30 \mu\text{W}/\text{cm}^2$ ranges.

Thin-film Thermopile Detector

Key to the exceptionally high performance of the complete system is the unique, Hewlett-Packard-designed and manufactured thin-film thermopile detector. This multijunction thermocouple-type detector exhibits a combination of flat spectral response, fast rise time and mechanical ruggedness not found in conventional designs.

Convenient to use

The instrument is particularly convenient and easy to use compared with previously available optical radiometers. The front panel meter can be automatically zeroed by simply depressing the front-panel MODE switch. No manual zero knob adjustment is needed. A pushbutton-operated, built-in electrical substitution-type calibrator keeps the fully integrated system operating at maximum accuracy at all times.

Applications

The 8330A/8334A system is useful in a wide range of laboratory, industrial and field applications in a number of different areas such as optical science and engineering, process control, biological science and many others.

Zero drift: typically less than $3.0 \mu\text{W}/\text{cm}^2/\text{hr}$ in laboratory environment with reasonably constant ambient temperature.

Recorder/DVM output: 0-1 volt dc. BNC connector.

Power requirements: 115/230 V ac $\pm 10\%$, 50-400 Hz, 2.5 watts.

Weight: 8330A: net, 6 lbs 15 oz (3.2 kg); shipping, 9 lbs 14 oz (4.6 kg). 8334A: net, 1 lb 5 oz (0.8 kg); shipping, 1 lb 15 oz (1 kg).

Dimensions: (approximate), 8330A: $6\frac{1}{2}$ " high, $5\frac{1}{8}$ " wide, $11\frac{1}{2}$ " deep (165 x 130 x 285 mm). 8334A: (including stand) $6\frac{1}{4}$ " high, $4\frac{3}{4}$ " wide, 5" long (160 x 121 x 127 mm).

Accessories furnished: $7\frac{1}{2}$ ' (2.3 m) power cable. Adjustable height stand and $\frac{3}{8}$ " diameter support rod (pin mount) for detector.

Price: Model 8330A, \$650. Model 8334A, \$450 with Infrasil quartz window; detectors with alternate types of optical windows can be supplied on special order at extra cost.

TRANSISTOR NOISE ANALYZER

Measures i_n , e_n , NF for bipolar and FET's

Model 4470B



MEASURING DEVICES

Description

The HP 4470B Transistor Noise Analyzer evaluates accurately transistor noise voltages (e_n), noise currents (i_n) as well as direct measurement of noise figure (NF).

This Noise Analyzer performs "spot" frequency measurements at 9 frequencies between 10 Hz and 100 kHz. Noise is carried by the spot frequency "pilot" signal in sidebands at 10 Hz above and below the pilot frequency. Total noise measured, equivalent to transistor noise at the spot frequency, is the average of the noise in the two sidebands.

Specifications

Noise parameters measured

Voltage noise: (e_n) referred to the input of the transistor under test, in both bipolar and FET's.

Current noise: (i_n) referred to the input of transistor under test, in bipolar transistors.

Spot noise figure: (NF) for both bipolar and FET.

Available ranges

Voltage noise: 3 nV, 10 nV, 30 nV, 100 nV, 300 nV, 1 μ V and 3 μ V F.S. at 1 Hz bandwidth. Two meter scales of 0 to 3, 0 to 10 and X1, X10, X100 multipliers. Ranges as a function of spot frequency are: all ranges at 10 and 30 Hz, 3 nV to 1 μ V at 100 and 300 Hz; 3 nV to 300 nV at 1 k and 3 kHz; 3 nV to 100 nV at 10 k and 30 kHz; 3 nV to 30 nV at 100 kHz.

Current noise: refer to chart for applicable noise current measurement limits (Referred to 1 Hz bandwidth). Max. freq. for each current noise range is shown in chart.

COLLECTOR/ DRAIN CURRENT SETTING	NOISE CURRENT RANGES AS FUNCTION OF DRAIN CURRENT USED:											
	100 μ A	300 μ A	1000 μ A	3 mA	10 mA	30 mA	100 mA	300 mA	1000 mA	3 A	(EXCESSIVE NOISE LEVELS)	
1, 3 μ A	30k	10k	3k	1k	300	100	30	10	3	1		
10, 30 μ A	100k	30k	10k	3k	1000	300	100	30	10	3		
100, 300 μ A		100k	30k	10k	3000	1000	300	100	30	10		
1, 3 mA	(LESS THAN THEORETICAL MINIMUM)		100k	30k	10k	300	100	30	10	3		
10, 30 mA			100k	30k	10k	300	100	30	10	3		

(NOTE: 1A = 1000 μ A, 10mA = 10000 μ A, 100mA = 100000 μ A, 1A = 1000000 μ A)

Spot noise figure: (NF) 0-40 dB; meter scaled from -5 dB to +10 dB.

Ranges are: -5 dB to +10 dB; +5 dB to +20 dB; +15 dB to +30 dB; +25 dB to +40 dB.

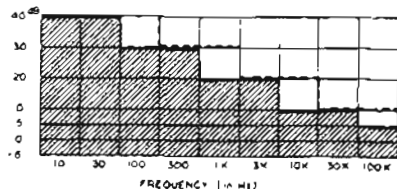

Noise level below the heavy line is measurable for the bipolar transistor. Noise level below the broken line is measurable for FET.

Spot frequencies: 10 Hz, 30 Hz, 100 Hz, 300 Hz, 1 kHz, 3 kHz, 10 kHz, 30 kHz, and 100 kHz.

Noise bandwidth: 4 Hz. Noise is measured in pilot signal sidebands centered at ± 10 Hz from spot frequency. Sidebands are 4 Hz wide. Pilot signal equals spot frequency except at 10 and 30 Hz where 100 Hz carrier is used.

Collector/Drain power supplies: currents of 1, 3, 10, 30, 100 μ A, 0.3, 1, 3, 10 and 30 mA are provided with continuous adjustment between values. Voltages of 0 to 15 V dc, continuously variable. Both supplies are independent of each other. Current supply seeks desired setting.

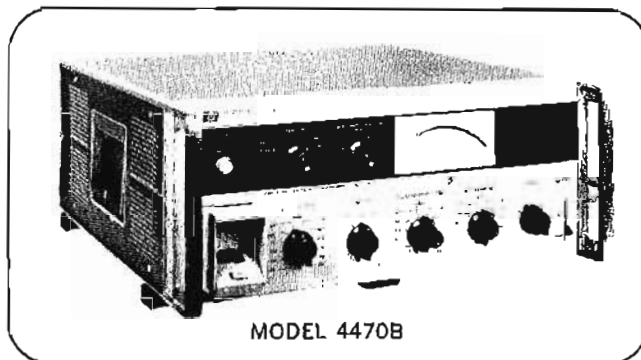

MODEL 4470B

Transistor types: bipolar NPN and PNP, P-channel or N-channel FET noise may be analyzed.

β -Range: Bipolar Transistors with h_{FE} from 10 to 1000 are measurable.

gm-Range: See chart:

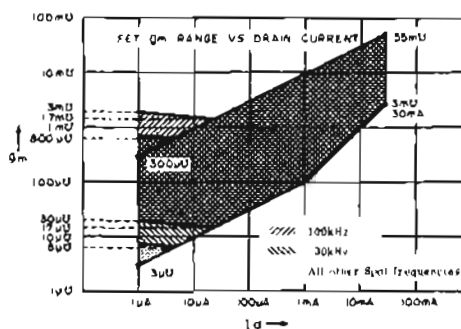

Source resistance

Values provided for use when measuring Noise Figure are 50 Ω , 100 Ω , 500 Ω , 1 k Ω , 5 k Ω , 10 k Ω , 50 k Ω , 100 k Ω , 500 k Ω , 1 M Ω , 5 M Ω and 10 M Ω .

Meter response: Time for meter fluctuation to be averaged is determined by the Response switch setting and will vary from a fast response of 4 s to a slow response of > 24 s.

Transistor bias/supply outputs: Collector/Drain current, Collector/Drain Voltage, Base/Gate Voltage.

Recorder output: proportional to meter deflection. 0 to 1 V dc, 1 k Ω output resistance.

Accuracies

Collector/Drain voltage: $\pm 3\%$ at monitor jack; $\pm 10\%$ at front panel; $\pm 3\%$ at calibrated front panel settings except 1 μ A where accuracy is $\pm 5\%$.

Collector/Drain current: $\pm 3\%$ at monitor jack; $\pm 3\%$ at calibrated front panel settings.

Spot freq.: $\pm 3\%$. Noise bandwidth: $\pm 3\%$. Total accuracy: $< \pm 1$ dB.

(NOTE: accuracy for NF measurements on bipolar devices is unspecified if the product of base current and source resistance exceeds β volts and for e_n and NF if V_{GS} exceeds ± 12 V on FET's).

Transistor socket configurations: 6 sockets provided.

Power required: 115/230 V ac, $\pm 10\%$, 50 or 60 Hz, 66 VA max. Dimensions: 16 3/4" wide, 6 31/32" high, 18 3/8" deep (425 x 177 x 467 mm).

Weight: net, 32 lbs (14,5 kg); shipping, 41 lbs (18,5 kg).

Accessories provided: power cord, Transistor socket kit (includes six sockets.)

Accessories available: transistor socket kit including six modular sockets, HP No. 16009A, \$80.

Modular sockets: \$10 each.

Price: HP 4470B, \$4390.



LASER INTERFEROMETER

Linear and angular displacement

Models 5525B, 10565A, 5510A

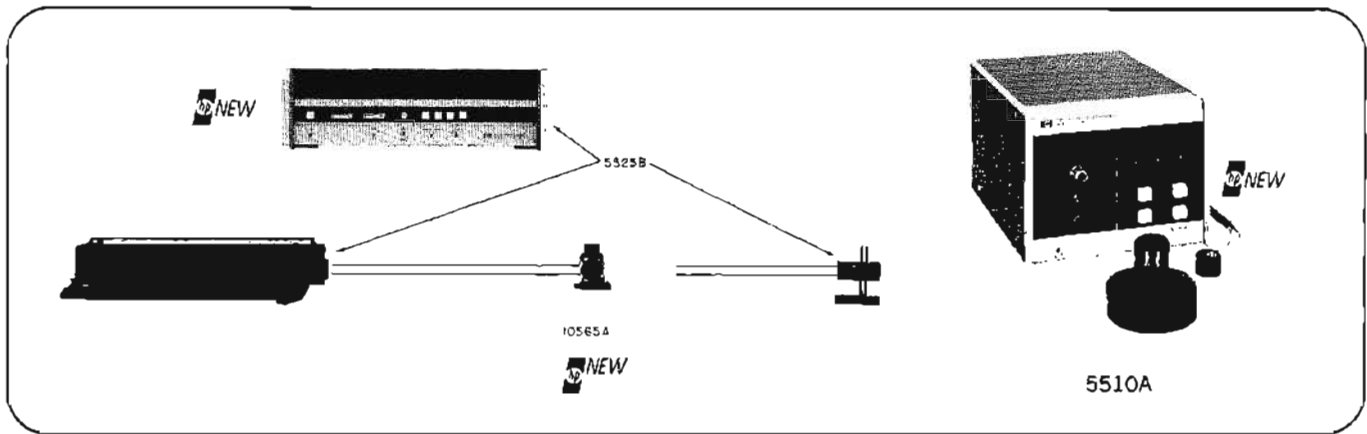

Model 5525B Laser Interferometer

The Model 5525B is a precise linear and angular displacement measuring instrument. It measures and displays distance and flatness to a resolution of 1 microinch, velocity to a resolution of .01 in/min, and pitch/yaw to a resolution of .1 arc-second. It consists of three parts—the 5500 laser head, 5505 display chassis and 10550 retroreflector. The 5525B is self tuning and has instant warm-up. Using a unique method of optical heterodyning, the 5525B is an A-C system, quite superior to D-C systems used in other laser interferometers. It functions well in adverse environments such as a machine shop. Even the small vibrations which perturb the ordinary interferometer can be averaged out if desired.

Applications of the 5525B: It is ideal for calibration of precision metrology instruments and step-and-repeat cameras, parts inspection, and machine tool calibration. Back-panel BCD output allows easy computer interfacing or use in closed-loop servo systems. Further applications include vibration analysis, when used in conjunction with an HP 5452A Fourier Analyzer.

Options available include bending optics to facilitate use in tight places, a *digital recorder*, and *quadrature/up-down* real-time pulse output. A custom *error-plotting* scheme using the HP 7035B X-Y recorder is ideal for operational machine tool certification. A *resolution extender* offers an order of magnitude increase in resolution.

Model 10565A Remote Interferometer

When the Model 10565A is inserted into the beam of the 5525B, only movement of the retroreflector with respect to the remote interferometer is measured. This makes possible a great reduction in the measurement path and allows the laser source to be removed some distance from the measurement area. With the addition of a few simple optical components, the 10565A can be used to measure pitch, yaw, straightness/flatness, and make differential or non-contacting measurements.

Model 5510A Automatic Compensator

The Model 5510A provides the 5525B Laser Interferometer with continuous, on-line automatic compensation for

the effects of air temperature, pressure and humidity on the wavelength of light with one ppm accuracy. It also compensates for the effect of material temperature on measured dimensions. Sensor values and other compensation factors may be read out on the interferometer display.

Specifications, 5525B

Accuracy: 5 parts in 10^7 , ± 1 count.

Resolution: (English/Metric units selected by front panel switch).

Normal and smooth modes: 0.000,01 in (0.1 microns).

X10 mode: 0.000,001 in (0.01 microns).

Velocity: 0.000,1 in/sec; 0.01 in/min (0.001 mm/sec; 0.1 mm/min).

Max. operating range: distance: 200 ft (60 m); velocity: 720 in/min (300 mm/sec).

Power requirements: 115 or 230 V $\pm 10\%$; 50 to 60 Hz.

Power consumption: 150 watts.

Overall dimensions: display: 5.53" high x 16.75" wide x 13.25" deep (141 mm x 436 mm x 337 mm).

Interferometer head: 5.00" high x 7.00" wide x 20.70" long (127 mm x 179 mm x 526 mm).

Weight: display: 24 lbs (10,9 kg).

Interferometer head and retroreflector: 19.5 lbs (8,94 kg).

Specifications, 5510A

Accuracy: ± 1.0 ppm.

Temperature: $\pm 0.2^\circ\text{F}$ (0.1°C), range of 55-105 $^\circ\text{F}$ (13-40 $^\circ\text{C}$).

Pressure: ± 0.03 in Hg (0.75 mm), range of 22-31 in (560-790 mm).

Humidity: $\pm 10\%$ RH, range of 10-100% RH.

Laser Interferometer/automatic compensator system accuracy: ± 1.5 ppm ± 1 count in least significant digit (2 counts in metric).

Coefficient of expansion range: ± 29.9 ppm/ $^\circ\text{F}$ or $^\circ\text{C}$.

Power requirements: power supplied by 5505A Laser Display.

Dimensions: 6.25" high x 7.75" wide x 11" deep (159 mm x 197 mm x 280 mm).

Weight: 10.8 lbs (4,9 kg).

Price: 5525B Laser Interferometer		\$11,500
Option 002 Quadrature/Pulse Output	add	\$350
Option 010 Error Plotting Output	add	\$700
Option 011 Error Plotting System	add	\$1,685
Option 020 Digital Recorder	add	\$1,210
Option 040 Beam Bender/Alignment Mirror	add	\$595
Option K02 Resolution Extender	add	\$800
5510A Automatic Compensator		\$3,750
10565A Remote Interferometer		\$2,450

DISTANCE METER

Direct readout—lightweight
Models HP 3800A, HP 3800B



MEASURING DEVICES

Description

The HP Models 3800A and 3800B Distance Meters are low cost, direct readout, electro-optical distance measuring instruments employing an infra-red "light" source. The Distance Meter combines a range of 10,000 feet or 3,000 meters, high accuracy and ease of operation into one lightweight, rugged instrument. The use of graphic symbol notation on the operating panel serves as a constant reminder of the measurement sequence. A short demonstration is all that is necessary for operator training. Visual display of the total measured distance, corrected for atmospheric conditions, is accomplished in less than two minutes. Because of the Distance Meter's unique circuitry, momentary interruptions of the beam will not affect the distance readout. The compact power unit with atmospheric correction dial and built in charger gives long operating time and provision for operating from an external 12 V dc source. One Model 3800 plus 3801 power unit and passive reflector comprise the measuring package. The versatile Model 3800 Distance Meter is suited for such applications as hydrographic, boundary, subdivision, construction, control, geophysical and mine surveys. When connected to a recorder the distance meter can be used to continuously monitor movements of structures or other objects.

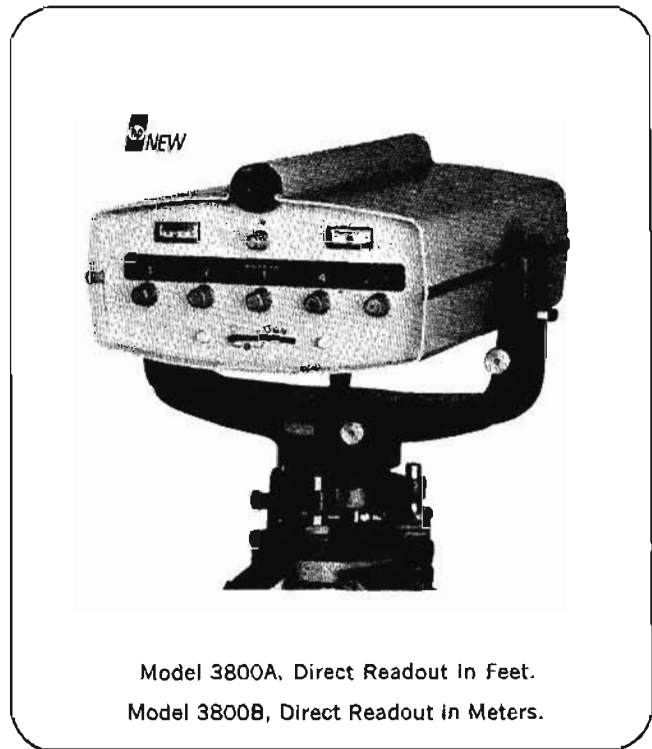

Model 3800A, Direct Readout In Feet.
Model 3800B, Direct Readout In Meters.

Specifications

Range:

10,000 feet/3,000 meters with triple prism assembly.
(During favorable conditions).

7,500 feet/2,300 meters with triple prism assembly.
(During average conditions).

Favorable conditions are those found when heat shimmer is minimal (at night or on overcast days) or when measuring between elevated points (e.g. from hilltop to hilltop). Average conditions are those found during the day when heat shimmer is quite evident and the line of sight generally parallels the ground.

Accuracy: 3800A

$\pm (.01 \text{ feet} + 0.01 \text{ feet per } 1000 \text{ feet})$
Mean square error

@ $+15^{\circ}\text{F}$ to $+105^{\circ}\text{F}$

$\pm (.02 \text{ feet} + .04 \text{ feet per } 1000 \text{ feet})$ Mean square error

@ -5°F to $+15^{\circ}\text{F}$ and

$+105^{\circ}\text{F}$ to $+130^{\circ}\text{F}$

Accuracy: 3800B

$\pm (5 \text{ mm} + 7 \text{ mm per km})$ Mean square error
 -10°C to $+40^{\circ}\text{C}$

$\pm (1 \text{ cm} + 33 \text{ mm per km})$ Mean square error

@ -20°C to -10°C and

$+40^{\circ}\text{C}$ to $+55^{\circ}\text{C}$

Readout: 0000.00 to 9999.99 feet/meters.

Least count: 0.002 feet—2 mm.

Aiming scope: internal focus, 18x, 1:100 stadia cross hairs.

System power consumption: 12 watts.

Power unit 3801A/3801B

(Model 3801A/3801B is required for operation of Model 3800A/3800B).

Internal battery and battery charger, provision to operate from external 12 volt dc source.

General

Dimensions

Instrument HP 3800A (13" x 10.3" x 5.8")
HP 3800B (33cm x 26.2cm x 14.7cm)

Power Unit HP 3801A (6.9" x 6.9" x 8.6")
HP 3801B (17.5cm x 17.5cm x 21.8cm)

Tilt range:

$\pm 30^{\circ}$.

Weight:

Instrument HP 3800A/B, net, 17 lbs (7,71 kg); shipping, 39 lbs (17,6 kg).

Power Unit HP 3801A/B, net, 13 lbs (5,9 kg); shipping, 21 lbs (9,5 kg).

Measuring time: less than two minutes.

Price: HP 3800A, \$3550; HP 3801A, \$560; HP 3800B, \$3550.



THE IC TROUBLESHOOTERS

The Clip-and-read IC tester
Model 10529A Logic Comparator



Troubleshooting TTL and DTL IC's often calls for specialized measurements. Spotting 25 nanosecond transients, tracing pulse activity through complex systems, trying to see exactly what an IC is doing, or determining if an IC is actually working are common problems in design, production, and service. These measurements do not require expensive equipment—not if the equipment is designed for the task!

The three HP IC Troubleshooters are a new breed of test equipment: handheld, low cost instruments designed specifically for the job of easing your troubleshooting burdens. The IC Troubleshooters each isolate a characteristic of digital circuits—an attribute—and then display this attribute. For example the 10525A Logic Probe (next page) captures pulse activity to 20 MHz and indicates this activity by a light at your finger tips; the 10528A Logic Clip (next page) attaches to an IC package, borrows power from it, and gives state indication—logic high and low—for each of the 14 or 16 pins; the 10529A Logic Comparator can isolate faulty IC's without removing them from their circuit and then display the failed pins.

The IC Troubleshooters are the vanguard of a new era of instrumentation—instruments designed for IC troubleshooting. Don't let their small size and low price mislead you: the IC Troubleshooters are rugged, quality instruments.

Model 10529A Logic Comparator

- In-circuit IC testing (no unsoldering or removal of IC required)
- No controls, no adjustments—not even a power cord
- Dynamic errors captured and stretched for visual observation
- TTL/DTL compatible

Simply attach the 10529A Logic Comparator to the IC to be tested and slip a reference IC in the Comparator's drawer. That's all there is to testing IC's these days! The inputs to the "IC under test" are paralleled with the "reference IC"—the reference sees the same signal pattern as the IC in the circuit. If any outputs differ, an LED corresponding to the bad pin is lit on the Logic Comparator's display! No fancy equipment, no difficult set-ups, no unsoldering or breaking traces; DTL and TTL IC's can be tested *in the circuit* with this hand-held instrument. You save hours of troubleshooting and frustration in servicing, designing, or production. No controls, no settings, no power cables, no adjustments: an IC is tested in seconds.

Dynamic errors as short as 200 nanoseconds are stretched for a visual display. A power ON indicator tells you that the clip is on properly. A self-test-board is included which automatically tests all 16 comparators, the stretchers, the LED display, and the cable continuity. All this for \$295. Quantity discounts available.

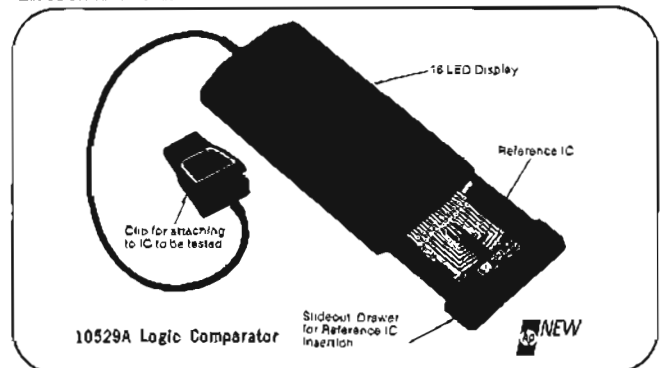

Model 10529A Logic Comparator with reference IC drawer open. Snap in a good IC and tester's ready for use.

THE IC TROUBLESHOOTERS

Test IC logic at a glance

Model 10525A Probe, 10528A Clip, 5010A Kit



MEASURING DEVICES

Model 10525A Logic Probe

- 25 nanosecond pulse detector
- High-low logic level indicator at end of probe
- High input impedance with overload protection
- Response to 20 MHz and higher

Tracing pulse activity and logic levels through IC circuitry for troubleshooting in design, production, and service becomes easy with HP's Model 10525A Logic Probe. When the probe tip is touched to a high level, a band of light appears around the tip; when touched to a low level, the light goes out. No ambiguity, no question whether the level is high or low—the indication is right at your finger tips. There is no need to look away from your circuit. Pulse activity to 20 MHz and higher is indicated by the light blinking, allowing you to trace pulse activity while operating at speed.

Pulses as narrow as 25 nanoseconds—high or low going—are captured by the Logic Probe and stretched for a visual display. If you touch the tip to the wrong spot, there's no problem because it's protected to 200 volts. Power requirements are simple, just any 5 volt supply.

With no adjustments needed and with an indicator at your finger tips, the 10525A Logic Probe will free you to concentrate on your problem rather than measurement technique. Quite a bargain for \$95. Quantity discounts available.

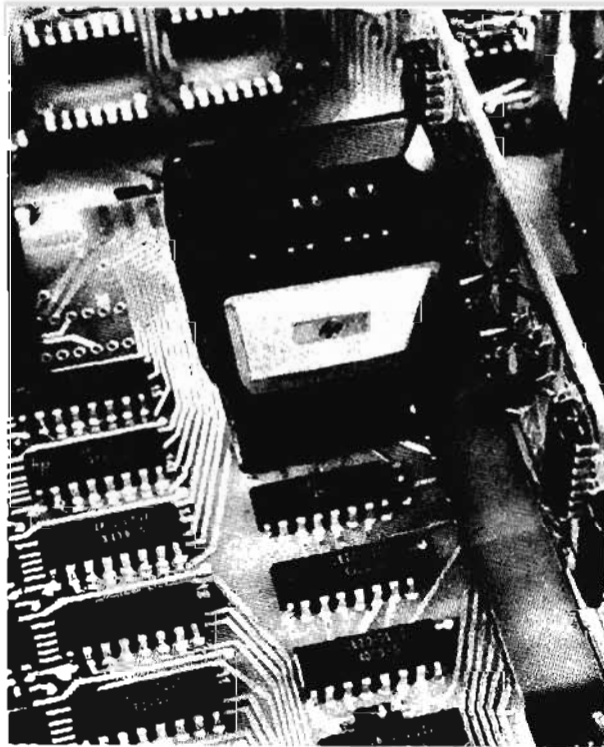

Model 10528A Logic Clip

- Displays all states of the IC
- No power cords, no cables, just clip and observe all pins
- No adjustments, no controls

16 voltmeters onto a single IC? HP's Model 10528A Logic Clip is 16 binary voltmeters that attach to any 14 or 16 pin dual in-line TTL or DTL IC. An LED corresponds to each pin and lights corresponding to a logic high or doesn't light if the pin is low. Thus all states of an IC may be viewed with a single glance. Are the input signals right? Are the outputs correct? Is the IC operating? All these questions and more are answered by the Logic Clip.

The Clip has no cables or controls. What's more it operates on any pin configuration. It automatically seeks V_{cc} and ground no matter what pins they are. The display is obvious: two rows of 8 LED's—it's like looking into the IC to see how it's operating. The intuitive relationship of the pin logic level to the light display greatly simplifies the troubleshooting procedure. You are free to concentrate your attention on your circuit rather than on measurement technique. Any way you look at the clip, it's quite a buy at \$125. Quantity discounts are available.

Model 5010A Logic Troubleshooting Kit

The IC Troubleshooters are really a synergistic trio. The static readout of all 14 (or 16) pins with the Clip, the probing capability of the Logic Probe and its high speed pulse catcher, and the error detection of the Comparator make the combination of all three a viable Troubleshooting Kit. The Model 5010A gives you a place to keep all your Troubleshooters together and lets you save a few dollars too. Price for the 5010A Logic Troubleshooting Kit is \$495; quantity discounts are available.



TRANSDUCERS

Sensors of linear motion and velocity

Linear Displacement (DC excitation), Model 7DCDT/24DCDT

The 7DCDT and the 24DCDT linear displacement transducers are extremely convenient to use for measuring, monitoring or controlling mechanical displacement. No external carrier system is required nor are phase shift and balancing adjustments necessary. Each DCDT has a built-in carrier oscillator and demodulator which produces a high-level dc output voltage proportional to the linear displacement of the

core. Both series have extremely high resolution, zero hysteresis and non-linearity less than $\pm 0.5\%$ of the total stroke. The 24DCDT's have approximately three times the sensitivity of the 7DCDT's and an operating temperature to 120°C (7DCDT, 60°C). Excitation of 7DCDT models is 5 to 7 volts dc; for 24DCDT models, 20 to 28 volts dc.

OEM discounts are available on all models.

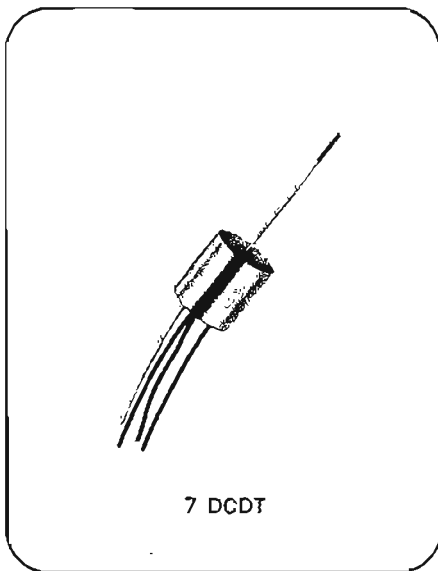

Model	Model 7 DCDT/24 DCDT						
	—050	—100	—250	—500	—1000	—3000	
Stroke (in.)	≈ 0.05	≈ 0.1	≈ 0.25	≈ 0.5	≈ 1	≈ 3	
Output, (volts f.s.)	7 DCDT 24 DCDT	1.5 5.0	2.8 9.0	1.5 7.0	3.3 12.5	4.8 18.0	5.0 13.0
Output impedance	7 DCDT 24 DCDT	2.2 k 2.5 k	3.0 k 3.5 k	5.0 k 5.2 k	5.3 k 5.5 k	5.5 k 5.6 k	5.0 k 5.6 k
Dimensions, diameter	7 DCDT } 24 DCDT }	0.75 in. (19.2 mm)					
length	7 DCDT (in.)	0.81	1.06	3.00	3.50	4.50	10.50
	(mm)	20.6	27.0	76.2	89.2	115	267
24 DCDT (in.)	0.87	1.12	3.21	3.71	4.71	10.52	
	(mm)	22.2	28.5	81.8	94.2	120	286
Weight (gm)	Armature	1.6	2.1	3.4	3.8	4.3	8.1
	Assembly						
	net	23	28	68	78	100	210
shipping		84	84	168	168	196	308
Price	7 DCDT	\$115	\$120	\$140	\$150	\$160	\$185
	24 DCDT	\$165	\$170	\$190	\$200	\$215	\$240

Linear Velocity (no excitation), Model LVsyn Series

LVsyn® Linear Velocity Transducers are designed for sensitive measurements of relative velocity. The basic design eliminates the need for external excitation and makes the transducers easy to set up and use. DC voltages are generated by moving a high flux-density permanent magnet in the bore of differentially wound coils. Voltage amplitude is proportional to core velocity. Resolution of an LVsyn output is nearly un-

limited—sensitivity over the rated stroke range is constant within 5%—temperature range is from -46°C to 93°C . Linearity is better than 1%. LVsyn's can be operated single-ended or push-pull; while immersed in non-corrosive fluids; without end stops or displacement limits. Each transducer is supplied with a calibration record.

OEM discounts are available on all models.

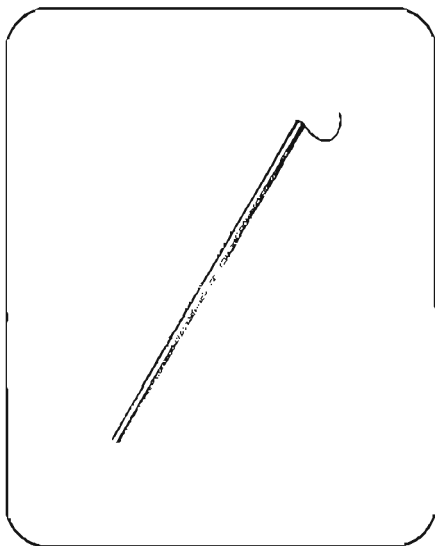

Model	3LV45	3LV1	6LV1	6LV2	6LV3	6LV4	7LV8	7LV9
Sensitivity (mV/in/sec)	120 40*	90 35*	500 250*	500 250*	500 250*	500 250*	350 150*	350 150*
Resistance (k ohms)	2	2.5	13	19	25	32	11.5	17
Inductance (henrys)	0.085	0.065	1.6	2.9	3.2	4	1.69	2.8
Stroke								
Inches	0.5	1	1	2	3	4	6	9
(mm)	13	25	25	51	76	101	152	229
Dimensions								
diameter: (in.)	0.37	0.37	0.63	0.63	0.63	0.63	0.75	0.75
(mm)	10	10	16	16	16	16	19	19
length: (in.)	3.16	4.22	5	7	9	11.25	15.75	22.75
(mm)	80	108	128	178	230	275	410	580
Weight (gm)								
armature assembly	3.5 2.5*	4.5 3.8*	11 10*	15 14*	17 17*	22 23*	34 49*	69 66*
coil	20	25	110	150	200	250	420	610
core	3.5	4.5	11	15	17	22	54	69
shipping	84	84	224	252	308	336	544	756
Price	\$65	\$65	\$65	\$65	\$65	\$75	\$100	\$115

*With non-breakable magnet cores, Option 01. Prices same as standard models.

GENERAL INFORMATION



DISPLAYS

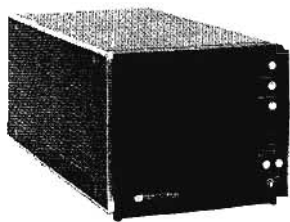

1331A

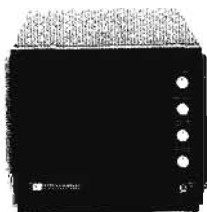

1330A

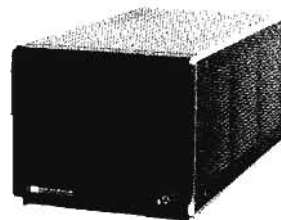

1331C

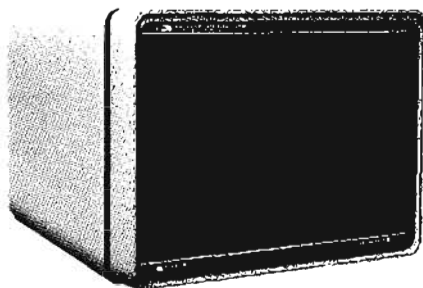

6610A

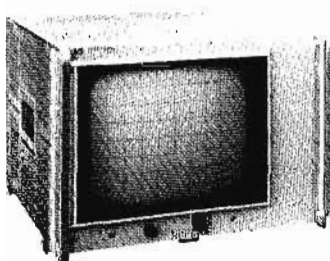

1300A

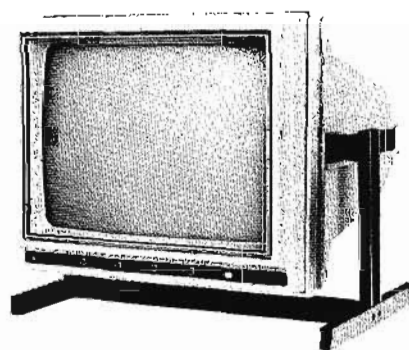

1310A

These displays are representative of Hewlett-Packard's selection available to you.

Hewlett-Packard's X-Y and graphic displays will complement the performance and appearance of any OEM console or system.

Investing in a display from Hewlett-Packard assures you of a high quality, commercially manufactured product. This will allow you to concentrate your valuable time on the design of your system. These displays are complete units with self-contained cathode-ray tube, vertical and horizontal deflection amplifiers, video input, and all power supplies needed for operation.

Selection available

Displays from Hewlett-Packard offer a selection in both size and type of CRT. This provides a choice which lets you match the display to your application.

Available are display sizes from 8 x 10 cm up to big-screen sizes of 14, 17, or 19-inches (diagonal measurement). All can be adapted for a free-standing (desktop) use or for standard 19-inch racks or special-purpose cases.

Hewlett-Packard displays are satisfying a variety of requirements around the

world. These diverse uses include: medical diagnostic systems, vibration analyzers, fourier analyzers, pulse height analyzers, spectrum and network analyzers, computer graphic systems, and process control equipment.

Special requirements

If you have a special requirement for a display which is different from the standard models shown in this catalog, check with your Hewlett-Packard field engineer. He specializes in solving measurement problems and can advise you on how a display can be tailored to fit your needs.

External appearance can be modified to give you special graticules or phosphors on the CRT, special paint, special knobs, or special panels and enclosures. Electrical performance can be altered to your needs if necessary to do the job.

HP contributions in displays

Hewlett-Packard has pioneered in the development of X-Y and graphic displays which are fast, bright, compact, and lightweight. Other performance char-

acteristics have also been significantly improved by Hewlett-Packard.

All Hewlett-Packard displays have solid-state circuitry. This provides greater reliability and ensures a longer instrument life. It has also reduced power requirements, contributing to reliability and reduction of maintenance costs. Weight and bulk are likewise considerably reduced.

Hewlett-Packard storage displays bring all of the unique advantages of such a technique, but, in addition, have Hewlett-Packard's variable persistence. This feature is especially useful to eliminate flicker on low rep-rate information.

Another area where Hewlett-Packard CRT technology has benefitted you is in large-screen displays. Here, a Hewlett-Packard-developed expansion-mesh has resulted in larger display size with substantially shorter CRT's and smaller instrument packages.

Hewlett-Packard will service your display wherever your console or system goes throughout the world.

And remember, OEM discounts are available on Hewlett-Packard X-Y and graphic displays.

DISPLAYS



COMPUTER GRAPHIC DISPLAYS

1 μ s Large Step Jump Time

Models 1310A, 1311A

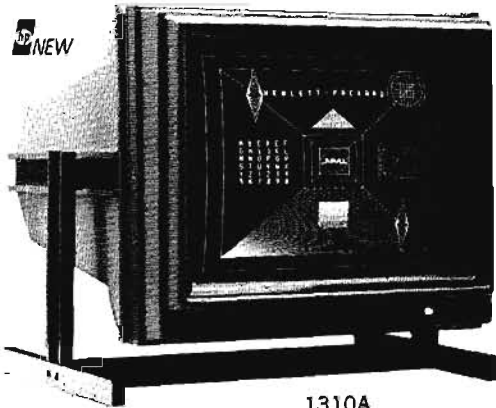

1310A

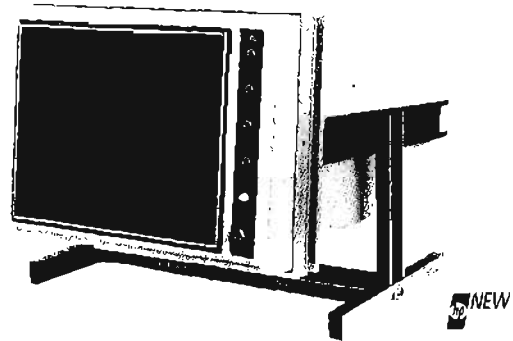

1311A

Advanced display performance

Models 1310A and 1311A are directed beam, high speed 19" and 14" graphic displays that offer unexcelled dynamic performance. For the first time, a display matches speed with computer generated graphic information. This speed is made possible through significant advances in large screen cathode-ray tube design. The electrostatic CRT provides a crisp, small spot anywhere in the large quality area of the CRT. Also, the CRT has a more rectangular shape than previous displays and information can be written anywhere in this large viewing area. Bright, easy-to-see displays result from the 28.5 kV accelerating potential while X-ray emissions are unmeasurable, ensuring a safe operating environment.

Electrostatic deflection

Electrostatic deflection replaces deflection coils needed by magnetic CRTs and the high powered circuits to drive the coils. Power consumption of these displays is a scant 100 watts which eliminates noisy fans and bulky mechanical cooling assemblies. Electrostatic deflection ends the need for major and minor deflection systems with multiple input connections. The single differential input for each axis significantly reduces the effects of common mode signals. Input RC is 10 kohms shunted by 40 pF with switchable 50 ohm terminations available when required.

Modular construction

Internal construction is modular, rugged, and very serviceable. Plug-in circuit cards reduce calibration or trouble shooting time. Also, a board exchange program assures minimum down time since fully tested circuit boards are air-parceled from the HP parts center.

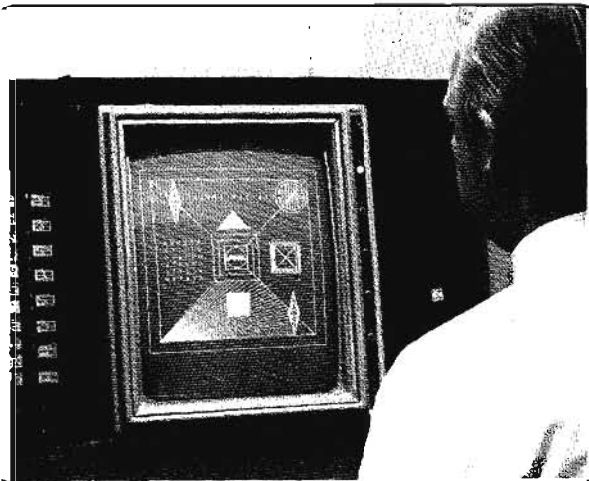

Computer-generated graphics courtesy of The Boeing Company.

High writing speeds

Linear writing speed is an unsurpassed 10 inches per microsecond which allows character strokes to be written in less than 100 nanoseconds. Maximum slew rate of the electronics is 100 inches per microsecond. The large-step jump and settle time is 1 μ s. This offers tremendous programming simplicity since characters and vectors can be plotted in random fashion from anywhere in the display area. Point plotting time for small steps is less than 200 ns per point thus, matrix type displays are written in minimal time.

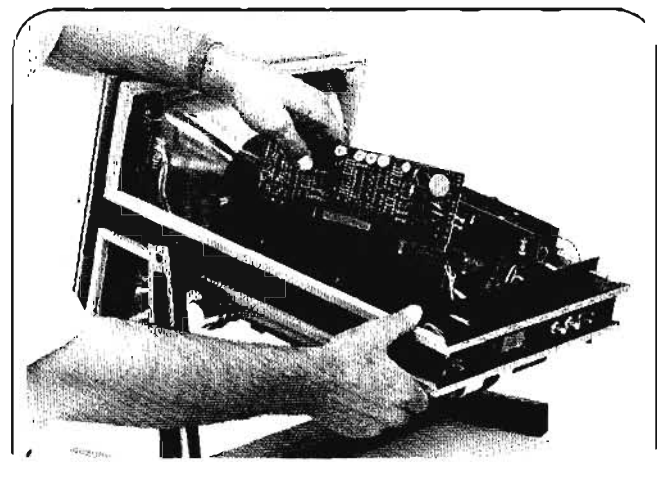

These displays are supplied with open frame construction for mounting in a standard 19-inch rack or in your custom designed enclosures. Covers and a tilt stand are available for free standing applications. Refer to Options and accessories in the specifications for listings of the standard items that are available. Contact your HP Field Engineer for information about items not contained in this catalog.

COMPUTER GRAPHIC DISPLAYS

10 in./ μ s Writing Speed

Models 1310A, 1311A



DISPLAYS

Specifications, 1310A, 1311A

Vertical and horizontal amplifiers

Risetime: 70 ns, 10% to 90% points for full screen deflection or less.

Bandwidth: dc to 5 MHz (3 dB down at 5 MHz) with 3.5 in. deflection in 1311A and 5 in. deflection in 1310A.

Phase shift: $<0.1^\circ$ to 50 kHz and $<1^\circ$ to 250 kHz for full screen signals.

Linear writing time: <100 ns/inch.

Linear writing speed: >10 inches/ μ s.

Diagonal settling time: signal settles to within 1 spot diameter of final value in $<1 \mu$ s for any on screen movements.

Sequential point plotting time: signal settles to within 0.01 in. of final value in <200 ns for any 0.1 in. step.

Repeatability: $<0.15\%$ of full screen error for re-addressing a point from any direction on screen.

Crosstalk: <0.015 inch with one input shorted and the other input excited by 500 kHz.

Deflection factor*

Model	Vertical	Horizontal
1310A	1 volt for 11 in. deflection	1 volt for 15 in. deflection
1311A	1 volt for $8\frac{1}{2}$ in. deflection	1 volt for 11 in. deflection

*Horizontal and vertical deflection factors adjustable from front panel control with attenuation of 1.75:1.

Spot jitter and motion: <0.025 inch.

Position: zero input can be set to any on screen position.

Polarity: positive vertical input moves beam up; positive horizontal input moves beam right. Polarity can be reversed by changing internal lead connections.

Input RC: driven side 10 k ohms shunted by <40 pF. Shield input is 47 ohms to ground. This can be replaced with 10 k ohms for differential input. A switchable 50 ohm termination between shield and center conductor is also provided.

Maximum input: ± 50 V (dc + peak ac) with 10 k ohm internal termination ± 5 V (dc + peak ac) with 50 ohm internal termination.

Linearity: 1% of full scale display along major axes.

Drift: 0.05 in./hr and 0.10 in. in 24 hr with covers installed.

Z-axis amplifier

Risetime: <14 ns.

Sensitivity: 1 V provides full blanking or intensity.

Input polarity: internal switch selects polarity (switch is normally set so negative voltage unblanks signal).

Gain adjust: internal, adjustable over 2.5:1 attenuation ratio.

Balance: internal adjustment provides ± 1 V offset.

Input RC: approx 10 k ohms shunted by approx 60 pF. 50 ohm termination may be selected with internal switch.

Maximum input: ± 50 V (dc + peak ac) with 10 k ohm internal termination, ± 5 V (dc + peak ac) with 50 ohm internal termination.

Cathode-ray tube

Viewing area: Model 1310A (19 in.), 11 in. high, 15 in. wide; Model 1311A (14 in.), $8\frac{1}{2}$ in. high, 11 in. wide.

Type: post-accelerator, 28.5 kV accelerating potential, P31 aluminized phosphor is standard (refer to options for other phosphors). Electrostatic focus and deflection.

Resolution: 67 lines/inch using shrinking raster method.

Brightness: at least 50 fr-L, measured at 0.1 in./ μ s, 60 Hz rate, with spot size of 0.020 in. in 1310A and 0.015 in. on 1311A.

Contrast ratio: 4:1 or greater.

X-ray emission: CRT emission not measurable, with Victoreen Model 440RF/C. in background noise.

Spot size

Model	Spot Size in Quality Area	Size of Quality Area
1310A	0.020 inch	11" x 11"
1311A	0.015 inch	$8\frac{1}{2}$ " x $8\frac{1}{2}$ "

Implosion protection: rim and tension banding prevents implosive devacuation.

Phosphor protection: circuit detects absence of deflection and limits beam current. (Protection is designed for P31 phosphor).

General

Front panel controls: Knob, intensity; Screwdriver adjustments, focus, astigmatism, vertical position, horizontal position; Screwdriver adjustments (behind front panel mask), trace align, vertical gain, horizontal gain, orthogonality.

X, Y, and Z input connectors: BNC type mounted to rear panel.

Weight: Model 1310A, net 53 lb (24 kg), with covers 59 lb (26.8 kg); shipping, 71 lb (32.2 kg). Model 1311A, net 40 lb (18.1 kg), with covers 45 lb (20.4 kg); shipping, 62 lb (28.1 kg).

Dimensions: dimensional drawings are too numerous for presentation in this catalog. Contact your local HP Field Engineer for a data sheet with these drawings

Power: 115 V ac $\pm 10\%$ or 230 V ac $\pm 10\%$, 48 Hz to 440 Hz, maximum power 115 VA.

Environment: temperature, 0° to $+55^\circ$ C operating, -40° C to $+70^\circ$ C non-operating; Humidity, up to 95% relative humidity to 40° C; Altitude, up to 15,000 ft. operating; up to 25,000 ft. non-operating; Shock, 30 g level with 11 ms duration and $\frac{1}{2}$ sine wave shape; Vibration, vibrated in three planes for 15 min. each with 0.010 inch excursion, 10 to 55 Hz.

Price (OEM discounts are available.)

Model 1310A: 19-inch Display \$3000.

Model 1311A: 14-inch Display \$2875.

Accessories supplied: rack mount adapter kit, front panel mask.

Options (order by option number)

003: top and bottom covers with tilt stand, add \$100. (Rack mount adapter not supplied with Option 003 instruments.)

005: neutral-density contrast screen improves trace contrast for easier viewing. Add \$40 for 1310A or \$30 for 1311A.

604: P4 aluminized phosphor in lieu of P31, no charge.

607: P7 aluminized phosphor, with amber filter, in lieu of P31, no charge.

639: P39 aluminized phosphor in lieu of P31, no charge.

Accessories

Cover kits: field installation of top and bottom covers. For stand alone operation, a tilt stand is required since the covers are not designed to support an instrument.

Price: Model 1310A Cover kit (HP Part No. 01310-68703) \$60.

Price: Model 1311A Cover kit (HP Part No. 01311-68703) \$60.

Tilt stand kits: field installation of tilt stand for stand alone operation. Price, Model 1310A Tilt Stand kit (HP Part No. 01310-68702) \$50; Price, Model 1311A Tilt Stand kit (HP Part No. 01311-68702) \$50.

Rack mounting kits: rack mounting adapter kits are supplied with standard instruments on initial order or may be ordered later as a kit. Price, Model 1310A Rack Mount Adapter kit (HP Part No. 01310-68701) \$10; Price, Model 1311A Rack Mount Adapter kit (HP Part No. 01311-68701) \$10.

Chassis slide kits: fixed slides, HP Part No. 01310-68704 for 1310A or HP Part No. 01311-68704 for 1311A, Price \$100; pivot slides for 1311A only, HP Part No. 01311-68705, Price \$120.

DISPLAYS



SYSTEM DISPLAYS

Graphic Displays, Bright Storage
Models 1330A, 1331A, 1331C

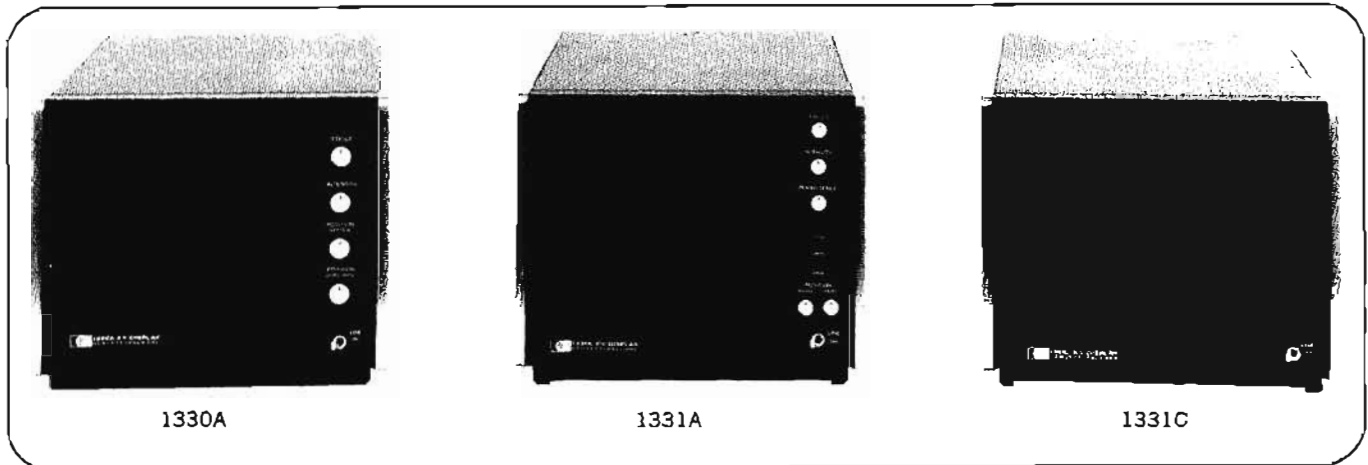

Description, 1330A, 1331A, 1331C

Models 1330A, 1331A, and 1331C Displays are compact half-rack size instruments for displaying analog computer-processed data and real time information. The high frequency response of these instruments make them extremely useful read-out devices in applications such as system display monitors, graphic displays, nuclear spectrometer, semi-conductor curve tracer, swept-frequency measurements, frequency ratios, phase shift measurements, raster displays, and amplitude versus time displays.

The 5 MHz X-axis bandwidth provides sharp, high resolution displays in raster and directed beam applications. Differential input amplifiers on vertical and horizontal inputs reduce noise common to the inner and outer conductors of the input cables. Careful design of the solid-state X and Y amplifiers provides stable operation, long-term reliability, minimum maintenance, and low power consumption.

Storage displays

Model 1331A has front panel controls for convenient manual operation of X-Y position and storage or variable persistence controls where spot deflection and dot writing speed varies. Model 1331C has rear panel operating controls and remotely

programmed inputs needed for computer or graphic display systems.

Both instruments write and store shades of gray, which adds a third dimension to the display. Full spot blanking is obtained with -1 V, and $+1$ V turns beam full on with in-between voltages providing shades of gray.

Model 1331C remote programming functions are DTL and TTL compatible which allows the display to interface directly with most systems. If desired, transfer from WRITE to VIEW modes and erase may be accomplished by contact closure to ground at the remote program plug. Transition from STORE to Write and back to STORE, including dot writing time, can be made in approximately $7 \mu\text{s}$. This effectively increases the "store time" by allowing the display to take advantage of the inherent longer storage time offered by the view mode between writing commands.

The Hewlett-Packard developed mesh type storage tube in these displays eliminates the need for memory devices to constantly refresh the display. Other advantages of this type tube which makes it ideal for system applications are: bright stored displays which allows viewing in high ambient light conditions; long life, comparable to standard CRT tube life, with no reduction in storage characteristics or brightness; and use in the storage mode does not reduce tube life.

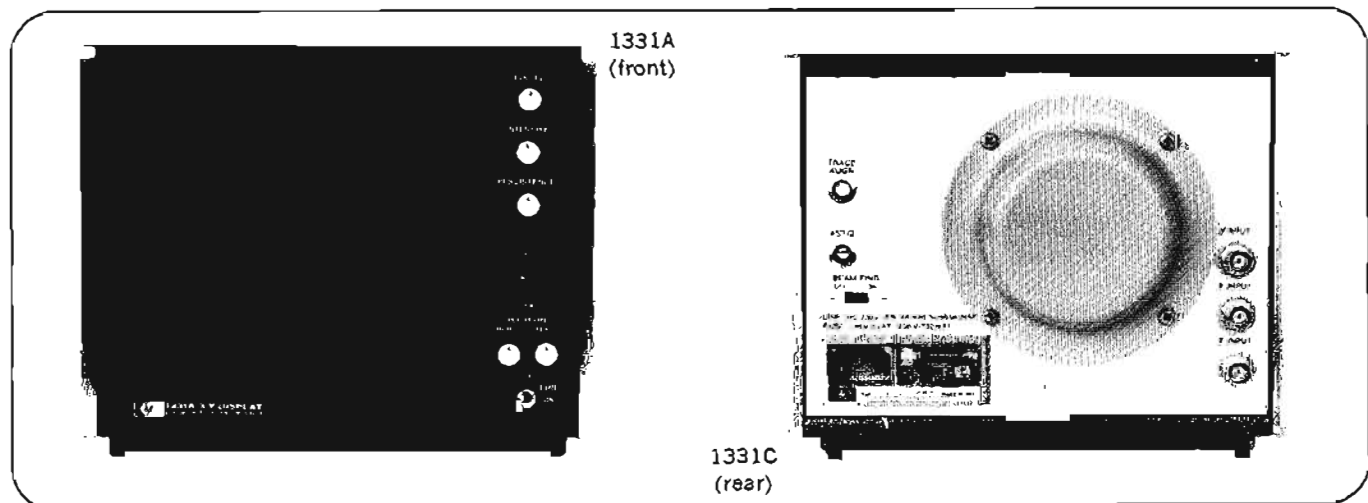

Specifications, 1330A, 1331A, 1331C

(Unless otherwise noted, specifications apply to all models.)

Vertical and horizontal amplifiers

Bandwidth: dc to 1 MHz (3 dB down at 1 MHz).

Phase shift: $< 1^\circ$ to 500 kHz.

Settling time: signal settles to within 1 spot diameter of final value in $< 1 \mu\text{s}$, for any on-screen movement.

Deflection factor

Vertical: 1 V for 8 div deflection. Internally adjustable from 0.09 V/div to 0.14 V/div.

Horizontal: 1 V for 10 div deflection. Internally adjustable from 0.09 V/div to 0.14 V/div.

Common mode rejection ratio: 40 dB to 10 kHz for differential input of 3 V maximum between outer and inner coaxial input leads.

Maximum input: ± 50 V (dc + peak ac).

Input: differential between center conductor and shield, shield may be grounded with internal connection.

Input RC

Single ended: 100 k ohms shunted by approx 80 pF to ground.

Differential: 200 k ohms shunted by approx 80 pF.

Recommended source impedance: ≤ 20 k ohms between center conductor and shield and ≤ 1 k ohm from shield to ground.

1330A cathode-ray tube and controls

Type: mono-accelerator, 3 kV accelerating potential; P31 phosphor standard (refer to options for other phosphors).

Graticule: 8 x 10 div internal graticule, 1 div = 1 cm. Subdivisions markings of 0.2 div on major horizontal and vertical axis.

Display linearity: horizontal, $< 5\%$ difference between any two div; vertical, $< 5\%$ difference between any two div.

Beam finder: returns beam to screen regardless of setting of horizontal, vertical, or intensity controls. Rear panel switch.

1331A/1331C cathode-ray tube and controls

Type: post-accelerator storage tube 10.5 kV accelerating potential, aluminized P31 phosphor.

Graticule: 8 x 10 div internal graticule, 1 div = 0.95 cm. Subdivisions of 0.2 div marked on major axis.

Storage writing speed: > 20 div/ms.

Dot writing time: $< 4 \mu\text{s}$.

Display linearity: horizontal, $< 5\%$ difference between any two div; vertical, $< 5\%$ difference between any two div.

Information storage rate: 200 thousand dots per second.

Brightness: > 100 foot lamberts.

Storage time: writing mode, 1 minute minimum; store mode, 15 minutes minimum.

Variable persistence (Model 1331A): variable from 0.2 s to 1 min.

Erase time: < 1 s.

Beam finder: returns beam to screen regardless of setting of X and Y position controls. Rear panel switch.

Model 1331C programmable functions (write, store, erase)

All program inputs are TTL/DTL compatible.

Input levels: high state is $+2.0$ V or greater, low state is $+0.8$ V or less for all program plug inputs. For high state = 2.4 V, $I_{\text{sink}} = 0.4$ mA max. For low state = 0.4 V, $I_{\text{source}} \leq 1$ mA.

Remote erase: low state for 10 μs minimum initiates erase cycle.

Remote mode transfer: high state is View Mode, low state is Write Mode.

Dotting writing using mode transfer: dot may be written by transferring to Write Mode for 7 μs per dot. No degradation of View/Storage time occurs.

Erase Verify: indicates end of erase cycle. The output voltage is high approx 125 ms after start of erase cycle. Voltage then drops to low state and remains low to the end of the erase cycle. High state is 2.4 V minimum with $I_{\text{source}} = 80 \mu\text{A}$ maximum. Low state 0.4 V maximum with $I_{\text{sink}} = 3.2$ mA maximum.

General

Input connectors

X, Y, and Z inputs: rear panel BNC.

Model 1331C program connector: Cannon Model 15P.

Power: 115 or 230 V $\pm 10\%$, 48 to 440 Hz, approx 60 watts at normal line.

Weight: net, 19½ lbs (8.85 kg); shipping, 25 lbs (11.34 kg).

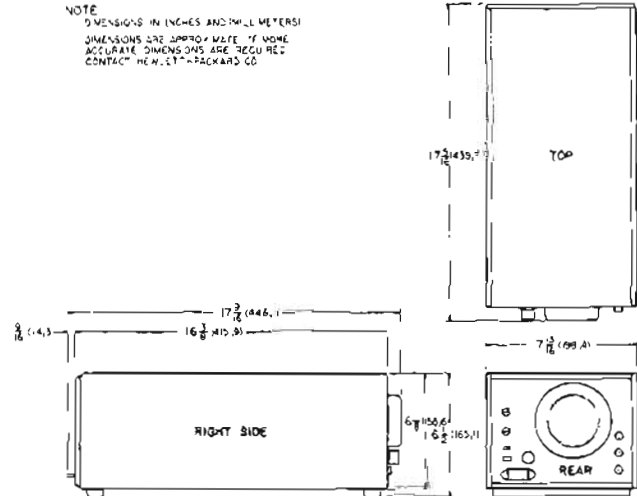

Dimensions: refer to outline drawing.

Price: OEM discounts are available for all models.

1331A X-Y Display \$800.

1331A or 1331C X-Y Storage Displays \$1575

Options

002 (1330A): P2 phosphor in lieu of P31 no charge.

003: 5 MHz bandwidth X and Y amplifiers Add \$150.

007 (1330A): P7 phosphor with amber filter in lieu of P31 no charge.

011 (1330A): P11 phosphor in lieu of P31 no charge.

Note: beam finder intensification function is removed from Option 011 displays.

631: non-internal graticule CRT with P31 phosphor... Add \$20 for 1330A and add \$30 for 1331A or 1331C.

Special order: a Model 1330A is available with a post-accelerator CRT to provide a brighter display for application in high ambient light locations. Add \$100. (Order 1330A option H02.)

Options for 1331C

016: provides direct connection of the 1331C to a 12555A interface kit for displays using HP computers Add \$150.

H01: variable persistence controlled with analog voltage through a rear panel connector. 0 V dc provides minimum persistence and +10 V dc provides maximum persistence Add \$100.

H02: variable persistence controlled by analog voltage through a rear panel connector. 0 V dc provides minimum persistence and -10 V dc provides maximum persistence Add \$100.

Accessories

Rack adapter: allows two Models 1331's to be mounted side-by-side in a standard 19-inch rack, HP Part No. 5060-0797. Price: \$25.

Filler panel: covers half of the Rack Adapter when only one Model 1331 is in the Rack Adapter, HP Part No. 5050-0794. Price: \$7.

Camera adapter: Model 10366B adapter allows mounting of HP Model 195A, 197A, or 198A camera. Price: Model 10366B, \$10.



LARGE SCREEN DISPLAY

20 MHz, 8 x 10 in. screen
Model 1300A

Description, 1300A

The extremely wide dc to 20 MHz bandwidth of the Model 1300A X, Y, and Z amplifiers provide capabilities for displaying both alphanumeric and graphic data as well as analog system monitoring. An 8 x 10-inch viewing area with a bright display provides high resolution readouts needed for many system measurement applications.

Fast 20 ns risetime, 200 ns settling time, and 80 ns point plotting time allow rapid switching of input data without flicker. This, coupled with less than 0.15% repeatability error and 1% linearity, provides accurate, stable graphic displays even with several unsynchronized multiplexed inputs. Resolution and plotting speed is such that 2000 well defined characters may be written within the 8 x 10-inch viewing area in 40 rows of 50 columns.

Specifications, 1300A

X-Y amplifiers

Bandwidth (8-inch reference at 50 kHz): dc-coupled, dc to 20 MHz; ac-coupled, 2 Hz to 20 MHz.

Risetime: <20 ns (10% to 90% points).

Deflection factor: at least 0.1 V/in.; gain control allows deflection factor to be adjusted between approx 0.1 V/in. and 0.25 V/in.

Drift: <0.5% of full screen/hr after 1/2 hr warmup; <1%/8 hr.

Jitter and movement: <0.01 in.

Settling time: (jump scan time) <200 ns to within a trace width of final value for any on screen movement.

Repeatability: <0.15% error for re-addressing a point from any direction from a source impedance of <4 k ohms.

Input RC: 1 megohm shunted by approx 20 pF.

Input: single-ended; maximum input ± 500 V (dc + peak ac).

Linearity: over 8 x 10-in. screen, $\pm 1\%$ of full screen; any in. with respect to any other in., within 10%. Includes geometric distortion caused by pincushion, symmetry, and orthogonality.

Phase shift: 0.1° to 50 kHz, up to 100-inch signal; 1° to 1 MHz, up to 10-inch signal.

Cross talk: 40 dB at 20 MHz with full scale input signals; imperceptible below 5 MHz.

Z axis amplifier

Analog input: dc to 20 MHz bandwidth over the 0 to 1 V range; +1 V for full blanking, -1 V for full intensity; gain control allows deflection factor to be adjusted between approx 0.1 V/in. and 0.25 V/in. balance adjustment allows intensity reference level adjustment of ± 1 V, maximum input ± 500 V (dc + peak ac); differential delay with either X or Y amplifier, ± 2 ns.

Rise time: <20 ns (10% to 90% points).

Sweep blank input: digital dc blanking with <1 k ohm source and -0.7 V to +5 V; unblanking with >20 k ohm source and 0 V to -5 V. Repetition rates to 1 MHz.

Chop blank input: ac-coupled blanking, +50 V blanks CRT. Input grounded when not in use.

Calibrator: line frequency square wave of 0.5 V $\pm 2\%$.

Cathode-ray tube

Viewing area: 8 x 10-inches.

Accelerating potential: >20 kV.

Writing speed

Photographic: >20 in/ μ s. Using Polaroid® CU-5 camera and 3000 speed film.

Visual (for 3 ft lamberts brightness at 60 Hz refresh rate): vector, >2 inches/ μ s; dot writing time, 40 ns.

Sequential point plotting time: <80 ns for 3 ft lamberts brightness at 60 Hz refresh rate.

Brightness: 30 ft lamberts line brightness at 0.1 inch/ μ s refreshed at 60 Hz rate.

Spot size: <30 mils throughout 8 x 10-inch screen at 30 ft lam-

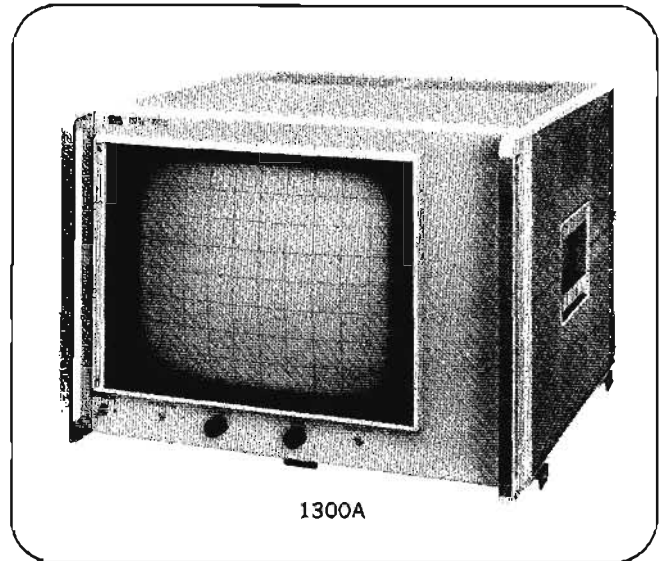

1300A

berts light output; nominally 20 mils at center screen (shrinking raster).

Phosphor and graticule: aluminized P31 phosphor with 1-inch grid and 0.2-inch subdivisions on major axis of internal graticule. Other phosphors are available, refer to Options; other graticules are available on special order. A light green filter supplied with Model 1300A provides increased contrast.

Control and input locations

Front panel: intensity, focus and on-off switch. Astigmatism and trace align are recessed screwdriver adjustments.

Rear panel: X-Y-Z inputs, calibrator, X-Y gain, position and ac-dc input switches, Z axis gain and balance.

Dimensions: 16 3/4" wide, 12-7/32" high, 19 7/8" deep over-all 18 1/2" behind panel rack mount (425, 310, 505, 470 mm).

Weight: net, 45 lbs (20.41 kg); shipping, 66 lbs (29.94 kg).

Power: 115 V or 230 V $\pm 10\%$; 48 to 440 Hz; approx 175 W.

Price: Model 1300A, X-Y monitor, \$2300. OEM discounts are available.

Options (order by option number)

001: neutral density contrast filter with light transmission of $\approx 30\%$, add \$15.

002: P2 aluminized phosphor in lieu of P31, no charge.

004: P4 aluminized phosphor in lieu of P31, no charge.

007: P7 aluminized phosphor with amber filter in lieu of P31, no charge.

011: P11 aluminized phosphor in lieu of P31, no charge.

631: non-internal graticule CRT with P31 aluminized phosphor, add \$20.

Accessories

Anti-reflection filters: consists of nylon mesh attached to a colored contrast filter to reduce reflections from the large screen CRT. Model 10181A, amber for P7 phosphor, \$35. Model 10182A, green for standard phosphors, \$35.

Chassis slides: fixed slides, HP Part No. 1490-0714, \$32.50; pivot slides, HP Part No. 1490-0718, \$40.

Slide adapter kit: one adapter kit required for mounting one pair of slides, HP Part No. 1490-0721, \$40.

Special order

A number of special modifications are available. They include: front panel X and Y inputs and controls, X10 preamplifier for 10 mV/in X and Y deflection factors, binary Z axis to provide eight gray scales, attenuators for X and Y amplifiers. Contact your local Hewlett-Packard Field Engineer for details about these or any other special requirements you may have.

SYSTEM DISPLAY

5¼ in. high rack monitor
Models 1208A/B



DISPLAYS

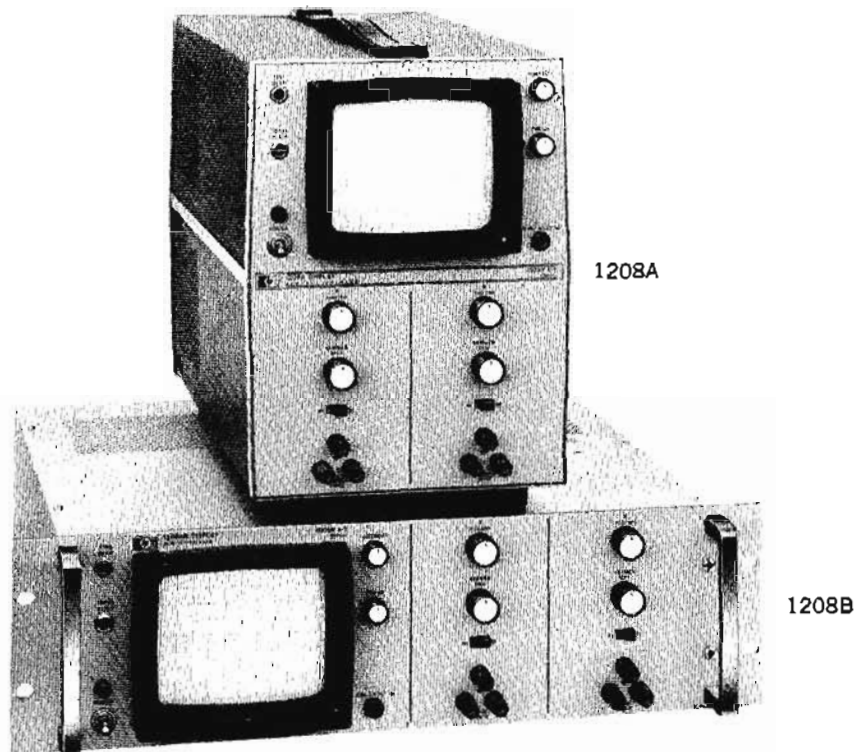

Specifications, 1208A/B

Vertical and horizontal amplifiers

Bandwidth: dc to 600 kHz when dc-coupled; 20 Hz to 600 kHz when ac-coupled. (3 dB down from 8-div reference signal.)

Deflection factor: continuously variable from <0.1 V/div to >1 V/div.

Input: differential or single-ended.

Input coupling: front panel selection of ac or dc.

Input RC: approx 100 k ohms shunted by approx 70 pF.

Maximum input: ± 200 V (dc + peak ac).

Common-mode

Rejection ratio: 40 dB (100:1).

Signal maximum: up to ± 4 V (dc + peak ac).

Frequency: dc to 10 kHz.

Phase shift

Same X and Y deflection factor (with + inputs): $<1^\circ$ to 500 kHz for deflection factors below 0.2 V/div, $<1^\circ$, to 100 kHz for deflection factors above 0.2 V/div.

Different X and Y deflection factors (with + input, - input, or differential): $<3^\circ$, to 100 kHz.

Cathode-ray tube and controls

Type: monoaccelerator, 3 kV accelerating potential; P31 phosphor standard (see options for other phosphors); etched safety glass faceplate reduces glare.

Graticule: 8 x 10 divisions, internal graticule. 0.2-div subdivision markings on major axes. 1 div = 1 cm. Front panel recessed screwdriver adjust aligns trace with graticule.

Beam finder: returns trace to CRT screen regardless of setting of horizontal, vertical, or intensity controls.

Intensity modulation: +2-volt signal blanks trace of normal

intensity; +8-volt signal blanks any intensity. DC-coupled input on rear panel; amplifier risetime approx 200 ns; input R is 5 k ohms.

Calibrator

Type: line frequency square wave.

Output: 1 volt $\pm 1.5\%$, front panel connector (banana plug).

General

Weight

Model 1208A (cabinet): net, 21½ lbs (9.8 kg); shipping, 31 lbs (14.1 kg).

Model 1208B (rack): net, 20½ lbs (9.3 kg); shipping, 33 lbs (15.0 kg).

Power: 115 or 230 V $\pm 10\%$, 48 to 440 Hz, approx 35 watts.

Dimensions

Cabinet: 8-5/17" wide, 11¾" high, 18⅛" deep (211.1 x 298.5 x 474.4 mm).

Rack: 19" wide, 5¼" high, 16⅞" deep over-all (483, 132.5, 428.6) 15⅜" (390.5) behind front panel.

Price: Model 1208A or 1208B X-Y display, \$590.

Options (specify by option number)

002: P2 phosphor, no charge.

006: (1208B) rear input terminals wired in parallel with front panel input terminals. Increases input shunt capacitance to approx 120 pF. Add \$55.

007: P7 phosphor, no charge.

011: P11 phosphor, no charge. Beam finder intensification is removed from Option 011 displays.

Specials: special versions available with deflection factor ranges to either 5 mV/div or 100 μ V/div. Consult your Hewlett-Packard field engineer for latest information.



DIRECTED BEAM DISPLAY

Unexcelled brightness

Model 6610A

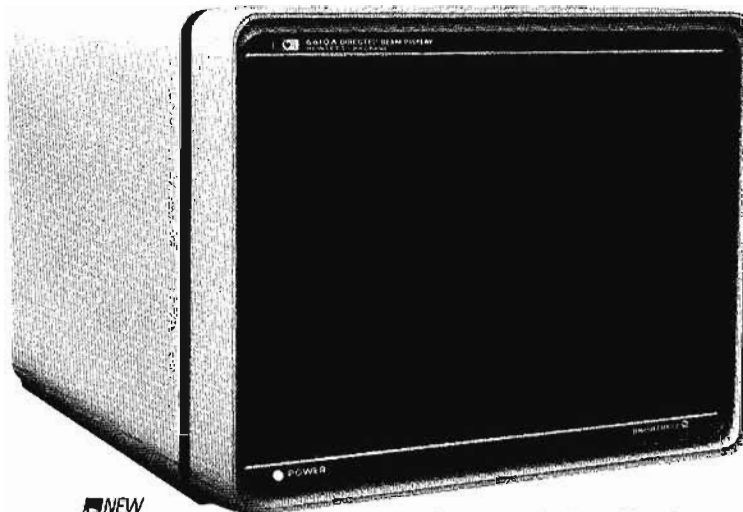

6610A Optional Cabinet Model

Description, 6610A

Model 6610A is a large screen, directed beam, graphic display used to output computer and instrument generated graphic information. Extremely fine spot resolution combined with superior brightness provide a high quality, easy-to-interpret display. The 6610A has a large 17 inch diagonal CRT but uses only an average of 140 watts power and can operate indefinitely while deflected off screen in any direction. The low power requirement eliminates noisy fans and allows operation on line frequencies from 48 to 440 Hz. The display is available in the standard open frame model or an optional cabinet model.

Specifications^a, 6610A

Vertical and horizontal amplifiers

- Linear writing speed:** >0.3 in./ μ s.
- Diagonal setting time:** beam settles to within 0.010 in. of final value in <40 μ s for full screen jump scan movement.
- Sequential point plotting time:** beam settles to within 0.010 in. of final value in <1.2 μ s for any 0.10 inch step.
- Repeatability:** <0.020 inch error for re-addressing a point from any position on screen.
- Crosstalk:** <0.010 inch with no signal on one input and full linear operation of other input.
- Deflection factor:** 0.2 V/inch; adjustable over 2:1 range by means of independent X and Y rear panel attenuation controls.
- Spot jitter and motion:** <0.010 inch.
- Position:** zero input can be set to any on-screen position.
- Polarity:** positive vertical input moves beam up; positive horizontal input moves beam right. Polarity can be reversed by changing internal input connections.
- Input characteristics:** single ended, 10 k ohms, dc-coupled.
- Maximum input:** ± 35 V (dc + peak ac) with 10 k ohm internal termination.
- Display stability, position, and size:** beam will return to original position on CRT screen within 0.020 inch $\pm 0.2\%$ of displacement/ $^{\circ}$ C when measured over an 8 hour period.
- Offset operation:** will operate indefinitely with full offset.

^a All specifications refer to 25°C $\pm 5^{\circ}$ C.

Z-axis amplifier

- Risetime:** 40 ns.
- Video response:** dc to 10 MHz (3 dB down).
- Sensitivity:** 1 volt provides full blanking or intensity.
- Input polarity:** polarity reversal switch on rear panel.
- Gain control:** rear panel contrast control adjustable over 6:1 attenuation ratio.
- Input characteristics:** 10 k ohms single ended (unbalanced), dc-coupled, input shield is grounded.
- Maximum input:** ± 35 V (dc + peak ac) with 10 k ohm internal termination.
- Delay:** 50 ns matched to x-y amplifiers.

Cathode-ray tube

- Viewing area^{*}:** 10 in. high x 13 in. wide usable, 17 in. diagonal.
- Type:** 70°, 12 kV, P4 phosphor is standard.
- Focus:** electrostatic.
- Deflection:** magnetic.
- Spot size:** 0.015 inch.
- Brightness:** at least 150 ft. L measured at 0.15 in./ μ s, 60 Hz rate, spot size at 0.015 in., P4 phosphor.
- Implosion protection:** bonded CRT faceplate.
- Phosphor protection:** detects beam speed and protects by overriding the z-axis. Also protects during line on/off cycles and in the quiescent state.

General

- X, Y, and Z input connectors:** BNC type mounted to rear panel.
- Weight:** net, 85 lbs (38,6 kg); shipping, 100 lbs (45,4 kg).
- Dimensions:** open frame model, 14 $\frac{1}{8}$ " high, 17" wide, 22 $\frac{7}{8}$ " deep (358,6 x 431,8 x 581,2 mm).
- Power:** 115 V ac $\pm 10\%$, 208 V ac $\pm 10\%$, 230 V ac $\pm 10\%$; 48 to 440 Hz; 140 W average, 280 W max.
- Operating temp range:** 0° - $+55^{\circ}$ C.
- Price:** Model 6610A Display, open frame model, \$2700. OEM discounts available.
- Accessories supplied:** rack mount adapter kit.
- Options (order by option number)**
 - 003: rounded corner cabinet model, add \$100.
 - 004: chassis slides; for open frame model only, add \$100.

^{*} Specifications apply to 10 inch x 10 inch area.

PRECISION RASTER DISPLAY

Unexcelled picture quality
Model 6947A



DISPLAYS

The HP Model 6947A is a monochrome precision raster display that employs new circuit concepts and techniques. In this unique design, special consideration is given to the display's resolution, frequency and phase response, sweep linearity, and stability. Extensive use of feedback throughout the circuitry reveals results in a high degree of performance stability over a wide range of environmental conditions.

Specifications

Model 6947A conforms to EIA standards RS-170, RS-330, and RS-343.

Video circuits

Input circuit: 75 ohms unbalanced to ground; 124 ohms balanced. Return loss greater than 40 dB from dc to 4.5 MHz. Protection for up to 100 V peak transients appearing on the input balanced line. Input impedance (unterminated): 12K ohms.

Input connectors: BNC with loop-through facility.

Input level: 0.5 to 4 V p-p for 85-volt signal at kinescope.

Rise time: less than 40 ns for a step change input viewed at the picture tube modulating grid.

Input polarity: differential input; black can be positive or negative.

Frequency response: flat up to 8 MHz (± 0.5 dB); less than -1 dB at 10 MHz decreasing smoothly to -3 dB at 18 MHz. Low frequency tilt is less than 2% for a 60 Hz squarewave.

Signal-to-noise ratio: rms visible noise is greater than 50 dB below p-p signal present at picture tube when a 0.5 V sinusoid is applied to the input.

Sine-squared response: overshoot symmetry is better than 1% on a 62.5 ns input pulse appearing on the picture tube control grid. Maximum overshoot is less than 3% of pulse amplitude.

DC restoration: keyed back-porch clamp.

Horizontal deflection circuits

Horizontal AFC: standard unit locks on either EIA 525/60 Hz or CCIR 625/50 Hz line systems. Horizontal sync is maintained with a composite picture signal-to-noise ratio of 24 dB.

Horizontal width: more than 5% overscan of the usable visible area of the kinescope. Horizontal width control range is 25% of horizontal dimension.

Vertical deflection circuits

Field rate: vertical lock and interlace is automatic. Front panel switch maintains the picture aspect ratio for either 50 or 60 Hz field rate. Vertical sync is maintained with a composite picture signal-to-noise ratio of 12 dB.

Vertical height: more than 5% overscan of the usable visible area of the kinescope. Vertical height control range is 25% of vertical dimension.

Display

Display size: 14" diagonal; may be switched between full and reduced size.

Full size mode: vertical and horizontal independently adjustable between +10% and -15% of normal raster size.

Reduced size mode: vertical and horizontal independently adjustable between -15% and -30% of normal raster size.

Geometric raster distortion: less than 1.5% overall; less than 1% in safe title area (center 80% of full picture).

Interlace: 2:1.

Interlace factor: unity (equal spacing between raster lines), maintained with a signal-to-noise ratio of 24 dB.

Pulse cross display: enables inspection of the relative phasing and duration of the synchronizing information transmitted with the video signal. The vertical interval is expanded so that the

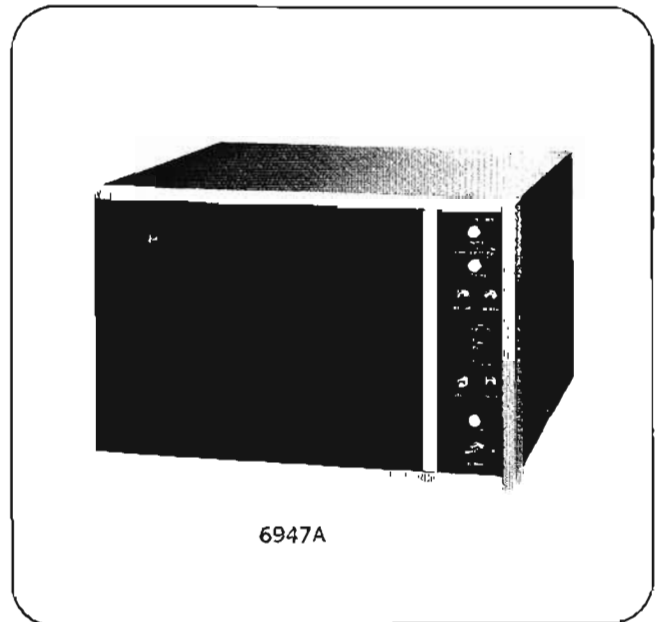

6947A

individual scanning lines may be observed and measured easily. A front panel switch activates the pulse cross circuit located within the monitor.

Spot size: less than 0.010 (10 mils) at 30 footlamberts. Picture tube and safety glass: standard unit has clear safety glass and rectangular tube with medium short persistence P-4 phosphor, aluminized.

General

External sync inputs: in addition to composite video input, the SYNC switch EXT position allows the following external inputs: 3 cable: video—horizontal—vertical.

2 cable: video—horizontal and vertical.

Sync input must be negative, from -1 V to -8 V. Separate vertical sync input must be negative, from -3 V to -5 V.

Temperature ratings: operating: 0°C to +55°C; storage: -40°C to +75°C.

Altitude: operating: up to 15,000 ft; storage: up to 50,000 ft.

Controls: front-panel off-on ac switch, contrast, brightness, focus, height, width, sync, 50/60 Hz field rate switch, size switch, pulse cross display switch, and video input selector switch.

Input power: switchable between 115 and 230 Vac $\pm 10\%$. 48-440 Hz, 75 W at 115 Vac.

Weight: net, 43.8 lbs (19.8 kg); shipping, 64.5 lbs (29.2 kg).

Rack mounting: rack mounting kit, consisting of two angle brackets, is provided with each unit.

Dimensions: 17-1/16" (43.3 cm) W x 10 1/2" (26.6 cm) H x 20-9/16" (52.2 cm) D.

Price: \$1250.

Options

033: UHF input connectors, add \$30.

034: circularly polarized laminated safety glass, add \$50.

High line rate options

The standard display will operate at either 525/60 or 625/50 line rates. Models can be ordered with optional higher line rates from 675 to 1029. The field rate for these higher line rates is 60 Hz, and the 10 mil CRT spot size and video amplifier response are compatible with the number of lines. Add \$200.

Option	001	002	003	004	005
Lines	675	729	875	945	1029

OSCILLOSCOPES



GENERAL INFORMATION

If you are thinking about buying an oscilloscope or display, the more than 60 pages in this catalog should help you make the choice. You'll find a complete line of Hewlett-Packard oscilloscopes which will meet your requirements in a wide variety of measurement applications.

SCOPES ARE CHANGING. ARE YOU?

What do we mean by that?

First, it's recognition of the fast-moving technological advances in oscilloscopes, many of which have been pioneered by Hewlett-Packard (to name just a few: internal graticule CRT, beam finder, expansion-mesh CRT, general-purpose sampling, time domain reflectometry, and variable persistence storage).

Second, Hewlett-Packard understands how important a scope is to your job. It's the screwdriver of the electronics industry. Because we recognize the fact that you need to change as your job and the world around you are changing,

Hewlett-Packard stands ready with the scopes designed to help you make the change—easily.

What can HP offer you?

Practically every known measurement problem which can be solved by an oscilloscope can be solved with a scope from Hewlett-Packard.

These catalog pages present as comprehensive a picture of Hewlett-Packard scopes as space will allow. But there's more. Technical data sheets and demonstrations by Hewlett-Packard field engineers around the world will complete the picture.

The oscilloscopes shown in Figure 1 are representative of Hewlett-Packard's full line. Perhaps it will help you make a decision about looking further. A descriptive selection chart, Table 1, may also help.

Other benefits in HP scopes?

Increasingly complex measurement requirements have evolved new techniques and tools to cope with the requirements.

CRT displays are bigger and brighter, bandwidths are up, sweep speeds are faster, operating controls are simpler. In general, the most versatile of all electronic test instrumentation—the oscilloscope—has, by popular demand, become even more versatile.

These changes in requirements and the scopes to do the job have made the business of selling and servicing scopes a bit more complex, too. Here Hewlett-Packard's cumulative experience, technological leadership in many fields, and worldwide sales/service organization can be focused on your specific needs.

Special modifications

We welcome the challenge of your special requirements in scopes. It's that simple. Whether it be a special panel paint or a substantial electrical modification, we'd like to do it for you.

Applications assistance

Solving your measurement problems is what Hewlett-Packard field engineers have built their excellent reputation on. Our field engineers attend frequent seminars which keep them abreast of latest developments. Oscilloscope application notes and technical data sheets are readily available from Hewlett-Packard.

Service and repair

Hewlett-Packard scopes are designed to perform faithfully for extended periods of time and to be easily and inexpensively serviced when required. You have the assurance that your scope will perform as expected for years to come because of Hewlett-Packard's world-wide customer service organization. Replacement parts and service assistance are available at a Hewlett-Packard field office near you.

Training aids

Training on new scopes and new applications has a high priority at Hewlett-Packard. We can help you learn more about our measurement capabilities, how to operate or use a scope, and how to properly repair or calibrate our products. In the Hewlett-Packard library of video tapes are hours of valuable information to bring you and others in your organization to almost any desired level of competence.

How do you select an oscilloscope?

Today's choice of an oscilloscope should be a pleasant one for the objective individual who recognizes the technological progress made recently and the wide range of price and performance now available.



Figure 1. Representative oscilloscopes and displays from Hewlett-Packard's product line.

Start with the immediate measurement application for which you are considering purchase of a scope. Using that as a reference point, look to the past as well as to the future.

Here are some questions which should help narrow your selection:

—Will it be used as a general-purpose scope in the lab or on a production line, or on a short-term project?

—What are the operating environment requirements?

—Is wide bandwidth (fast risetime) required, such as for designing or testing state-of-the-art computers?

—Will the new oscilloscope be in use five hours or 24 hours a day?

—It it to be carried around in a vehicle or aboard a commercial jet?

—Will the display be viewed from up close or from perhaps ten feet away?

Of course, there are many other pertinent subjects to explore, such as reliability, company reputation, availability of service and parts, and value-added considerations like training seminars and technical literature.

Basic types of scopes

When you examine essentially all of the possible measurement requirements fulfilled by oscilloscopes, there are really perhaps only four types. In somewhat broad categories, these are: (1) plug-in/mainframe, (2) nonplug-in, (3) portable, and (4) monitor (or display). Following are some characteristics and typical applications for each type. Figure 2 shows representative scopes.

Mainframe/plug-ins

Here is where a first-order decision is usually made: Do you need plug-in capability? Mainframe and plug-ins can be selected for the combination closest to each potential application, and characteristics can be changed to accomplish varying tasks. If a mainframe is selected carefully, it will allow upgrading through newer plug-ins as they become available and as the job requires them.

General purpose laboratory scopes (i.e., mainframe and plug-ins) are used

in basic circuit design for almost every electronic product. Choosing a scope to do only today's job in the lab may be unwise since its useful life will likely be diminished.

Available plug-ins might include bandwidths up to at least 100 MHz; differential/dc offset; two or four channels; standard, delayed or mixed sweep operation; sampling at bandwidths to 18 GHz; and time domain reflectometry. These give specialized measurement capability without investing in a whole new scope!

Hewlett-Packard offers such general-purpose laboratory oscilloscopes and is therefore committed to anticipating your future design needs and to having the plug-ins there when you need them.

Nonplug-In

Nonplug-in scopes are frequently referred to as "dedicated." They are often dedicated to one specific task because the performance characteristics can perform that task for the useful life of the scope. As an initial investment, a nonplug-in instrument will cost less for comparable capability than a plug-in type.

By far the most common nonplug-in scopes are low frequency. Such a low frequency scope will have a bandwidth of perhaps 500 kHz (some extend to a few megahertz). High sensitivity low frequency scopes are used in applications in many different engineering and scientific disciplines.

Hewlett-Packard has made many significant contributions in nonplug-in low

Table 1. Oscilloscope Selection

<p>1300 Series X-Y Displays</p> <p>Standard size CRT and large-screen X-Y or graphic displays. Both standard CRT and storage/variable persistence models. Large-screen graphic displays with up to a 19-inch CRT have bright traces and the speed to keep up with a computer. OEM discounts are available. See Page 83</p>
<p>180 System High Frequency Plug-in Scope</p> <p>The one plug-in instrument to solve nearly any general-purpose laboratory or production line measurement problem. Bandwidths of 500 kHz, 35 MHz, 50 MHz, 75 MHz, 100 MHz, 250 MHz, or >600 MHz. Standard, storage/variable persistence, or big-screen. Sampling to 18 GHz. See Page 96</p>
<p>1700 Series Portable Scopes</p> <p>Rugged, light-weight instruments adequate for almost any field service or laboratory application. Bandwidths of 35 MHz, 75 MHz, and 150 MHz. Storage with variable persistence at 35 MHz bandwidth. Operation from ac line, dc line or source, or from an optional battery. Economically priced, too. See Page 120</p>
<p>140 System General-Purpose Plug-in Scope</p> <p>A valued performer for Hewlett-Packard customers around the world. Standard and storage/variable persistence models and a mainframe with 8 x 10 inch display area. Real-time plug-ins to 20 MHz, sampling to 18 GHz. TDR, swept frequency, and spectrum analyzer plug-ins. See Page 130</p>
<p>1200 Series Low Frequency Scopes</p> <p>Low frequency, non-plug-in scopes of proven, all-solid-state circuit design. Many operating features normally found only on much wider bandwidth, more expensive scopes. Bandwidths of 500 kHz or 7 MHz in standard or storage/variable persistence. Deflection factors as low as 100 $\mu\text{V}/\text{div}$. See Page 135</p>
<p>Oscilloscope Accessories</p> <p>Supporting accessories to get the most out of your scope investment. Cameras and adapters, testmobiles, active and passive probes, and cables and adapters to meet most any need. See Page 140</p>

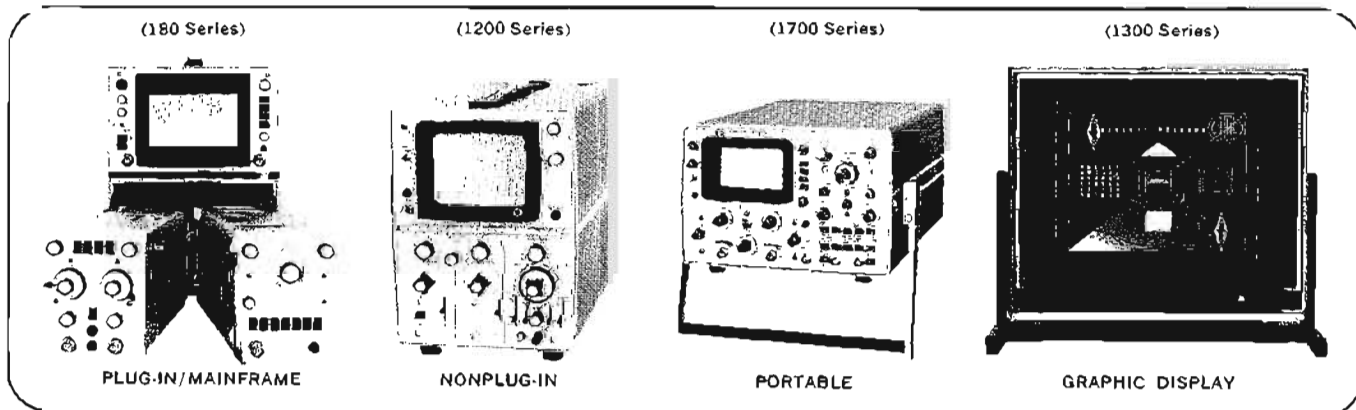

Figure 2. Hewlett-Packard scopes of four basic measurement types.

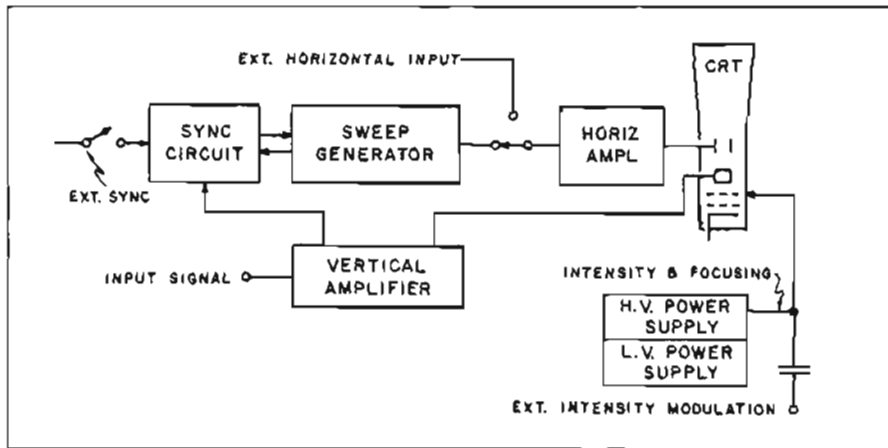

Figure 3. Typical oscilloscope block diagram.

frequency scopes. Hewlett-Packard's low frequency scopes are all solid-state instruments which provide laboratory quality, accuracy, and reliability—at competitive prices.

Portables

Portable oscilloscopes are a category which usually refers to whether or not the instrument was designed to be hand-carried from one measurement location to another.

Most portable scopes are nonplug-in, with performance characteristics selected at purchase time to remain adequate for the life of the instrument. Prudent selection of options will still make a portable scope invaluable for years to come.

Most often, a portable scope is used for field service work, such as maintaining a computer. However, because of lab option packages available, a portable scope may still provide a good buy for design work.

One should carefully consider the characteristics inherent to the word portable: weight, size and form factor, ruggedness, power requirements, and reliability.

Hewlett-Packard has economically priced portable scopes to meet practically any requirement. In addition, Hewlett-Packard's portable line can be operated from an ac, dc, or battery (optional) source.

Monitors (displays)

Most monitors, or displays, are permanently located in a console or system, and dedicated to displaying a given signal or set of signals. Most do not contain a time base.

Displays come in all sizes. You can purchase a display having a standard size oscilloscope CRT with an 8 x 10 cm display area. There are many intermediate sizes and the large-screen versions range up to about 19 inches (measured diagonally).

Physical size and power requirements vary, especially among large-screen displays. This is largely determined by

whether electromagnetic or electrostatic CRT deflection is used.

Most displays can be adapted for either a free-standing (desktop) or rack use. External appearance can usually be modified by the manufacturer to obtain special graticules or phosphors on the CRT, special paint, special knobs, or special panels and enclosures.

Hewlett-Packard has pioneered in the development of displays (e.g., large-screen electrostatic deflection CRT's and variable persistence coupled with storage). For help in solving any of your display problems, consult Hewlett-Packard.

Oscilloscope basics

Because the oscilloscope can display electrical signals which vary with time, it has become today's most widely used electronic measuring instrument. It produces a visual display of any physical quantity which can be represented as a voltage. This permits precise measurement and analysis of the phenomenon represented by the voltage.

The block diagram in Figure 3 shows the essential parts of an oscilloscope. In addition a 36-minute video tape on "Oscilloscope Basics" (HP I.D. #800360) may be useful. A copy of oscilloscope terms and definitions is available from Hewlett-Packard.

The cathode-ray tube

A CRT produces an electron beam whose movement is controlled by the vertical and horizontal amplifiers and by the power supplies which form, shape, and accelerate it. This electron beam strikes a phosphor screen and a visible glow results as the beam is moved around.

Since the beam deflection can be calibrated against a grid (graticule) on the CRT face, amplitude and time measurements can be made. All Hewlett-Packard graticules are internal and in the same plane as the phosphor, eliminating parallax.

Hewlett-Packard manufactures all its own CRT's and technological leadership

has accompanied this.

An expansion mesh, used first by Hewlett-Packard in 1962, with a voltage on it produces an electrostatic field which bends the beam after its initial deflection at the electron gun structure. By controlling mesh radius, Hewlett-Packard CRT designers have produced increasingly larger display areas while simultaneously reducing the over-all length of the tube.

Storage scopes are now available from Hewlett-Packard with variable persistence (the time it takes for the trace to fade to 10% of its original brightness). This is made possible by use of a storage mesh immediately behind the phosphor. Control circuits then determine the rate at which a display fades away after being stored as a charged pattern on the mesh. Hewlett-Packard storage scope theory is further explained in a 29-minute video tape, HP I.D. #800449.

Ask for a copy of Application Note 115, covering CRT's and scope photography.

Vertical deflection system

Since the CRT is limited as to the range of deflection voltages which can be applied, a vertical amplifier and attenuator are used. These are accurately calibrated to provide a deflection factor related to the graticule (e.g., 5 mV/division).

A sharing of amplifier technology between Hewlett-Packard engineers in different design labs directly resulted in the use of monolithic transistor arrays in an integrated circuit package for HP's 250 MHz real-time scope introduced in mid-1969.

Hewlett-Packard vertical deflection systems have been made more useful with simplified, yet functional, controls. As better circuits have been designed, adjustments previously adding to front panel confusion have been eliminated or located inside for use only in periodic calibration. A recent example of functional and innovative amplifier design by Hewlett-Packard is a selectable input impedance, either 50Ω or high Z.

Horizontal deflection system

To deflect the electron beam horizontally, an amplifier and sweep generator are used. A sawtooth waveform generator sweeps the beam at a selectable uniform rate. With such a linear rate of sweep, calibration to the graticule is possible (e.g., 1 ms/division).

For meaningful displays, the horizontal deflection system must provide synchronizing circuits to start the sweep at a specific instant with respect to the measured waveform. Automatic triggering on Hewlett-Packard scopes makes starting of the sweep a quick, easy step. And preset adjustments produce synchronized

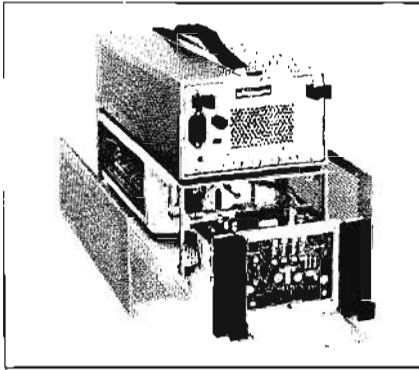

Figure 4. Power supply module can be operated outside the mainframe to facilitate maintenance.

sweeps with little or no knob adjustment.

A recent improvement on Hewlett-Packard time bases now gives stable, one-knob triggering on signals to beyond 500 MHz.

In addition to a direct-reading expander control, which minimizes errors, one new time base in the HP 180 System also features a X100 sweep expansion. This allows detailed examination of selected portions of a display, a feature normally found only on more expensive delaying time bases.

Power supplies

Scopes contain low and high voltage power supplies and determine, with the CRT, the maximum capability of a scope, especially of a mainframe.

Low voltage power supplies give operating power to scope circuits such as the vertical and horizontal amplifiers. The high voltage power supply forms and controls the CRT electron beam.

Hewlett-Packard has made contributions in power supplies, too, and two examples will show their significance:

1. The new 1700 Series portable scope has an advanced design LVPS. It is highly efficient and has a newly designed dc-to-dc converter. The result is a scope which consumes approximately 25 watts and operates from ac line, dc line or source, or optional battery.

2. Newest mainframes in the 180 System have a more reliable LVPS which, when repair may be required, can be removed from the instrument in a fully operating status; refer to Figure 4. Repair or calibration time is greatly reduced.

Input probes

Probes are often used to transfer a signal from a circuit or device under test to the vertical input of a scope. Because of differing impedances and frequency effects, a variety of voltage and current probes have evolved.

Proper selection of well-designed probes will minimize circuit loading effects and provide the most accurate and useful waveform information. Improper

matching of probe to circuit measurement point or of probe to scope will cause risetime errors in pulse measurements and cause both amplitude and phase errors in CW measurements.

The effects of resistive loading have been recognized for some time. High input impedances have been used to reduce the voltage division between circuit and measuring device. This technique will cause minimal error if measurements are at low frequencies and the circuit test point has a low impedance.

When these probing requirements are not met, inaccuracies result for one big reason: CAPACITANCE. And the effects of capacitance in the probe or scope input change drastically because of frequency.

Obviously, the answer would be to eliminate capacitance. This is not possible with present technology, but it can be reduced greatly. Borrowing a technique from microwave and sampling instrumentation, high frequency measurements become even more accurate.

This technique is a 50-ohm transmission system. It eliminates capacitive effects and can be adapted successfully for probing source impedances greater than 50 ohms. Low-capacitance (<0.7 pF) resistive dividers can be used, providing the best-known compromise for minimizing capacitance without creating resistive loading problems. Active probes with divider tips offer the flexibility of higher resistance input while shunt capacitance is held to only a few picofarads.

Hewlett-Packard has pioneered in helping solve the capacitance problem in high frequency measurements. Here are three examples:

Example 1: In 1968, Hewlett-Packard introduced the Model 1802A plug-in with 50-ohm inputs—a first for real-time scopes.

Example 2: In 1969, Hewlett-Packard provided the first general-purpose real-time scope with 250 MHz bandwidth—the 183, also with 50-ohm inputs.

Example 3: In this catalog are two 180 System plug-ins and a portable scope with a selectable input impedance—50 ohms or a high Z with low capacitance. This measurement convenience is available because of Hewlett-Packard's innovative design which uses thick-film attenuators, illustrated in Figure 5, a first for the scope industry.

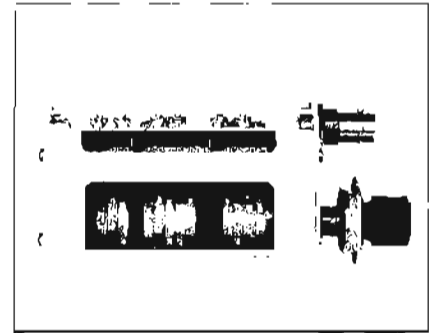

Figure 5. Hewlett-Packard innovation uses thick-film substrate in cam-operated attenuators, allowing selection of 50Ω or high input impedance.

Because of Hewlett-Packard's dedication to developing better scopes for you, we offer a complete selection of compatible probes. Ask your Hewlett-Packard field engineer for a copy of Application Note 152, oscilloscope probing techniques.

Sampling oscilloscopes

Sampling oscilloscopes use a technique which is similar in principle to use of a stroboscope for study of periodic or varying motion.

Samples are taken on successive recurrences of a waveform. As each amplitude sample is taken later in time on the waveform, the CRT beam is deflected to the corresponding point where a visible dot is then displayed. The rate at which sampling occurs is very fast; thus the dots are displayed as a coherent appearing waveform on the CRT. Figure 6 illustrates the sampling technique.

Samples are obtained when a pulse "turns on" the sampling circuit for an extremely short time. During this interval the input waveform amplitude is measured, the samples are then effectively "stretched" in time, and amplified at relatively low bandwidths.

Thanks to fast-switching diodes developed by Hewlett-Packard—some even for use in other types of instrumentation—sampling scope bandwidths have progressed to the 18 GHz point. Hewlett-Packard introduced the first commercially available sampling scope over ten years ago. Once again, cumulative technology has kept Hewlett-Packard sampling scopes a leader, both in performance and price, typified by the Model 1810A 1 GHz sampling plug-in that's low in price and as easy to operate as a real-time scope.

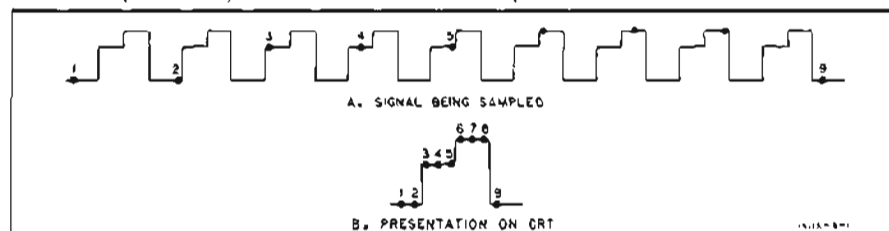

Figure 6. Sampling scope technique reconstructs waveform from consecutive samples.



GENERAL PURPOSE TO 18 GHz

Solid-state, compact, plug-in design
180 Series

High Standard For Oscilloscope Measurements

The growing 180 Oscilloscope System establishes the standard for high-performance, high-frequency, general-purpose oscilloscope design. This modern plug-in system allows you to match your oscilloscope capability to your particular application. These small all solid-state scopes are ideal for all types of high frequency measurements. This reliable, accurate performance has been proven in applications varying from shipboard testing, to flight-line checkout, to exacting measurements of computer memories. This system is designed to meet today's requirements and still provide capabilities for future growth.

Complete Selection For Any Measurement Need

A wide selection of mainframes and plug-ins assure you the right combination to fit a particular measurement at the minimum cost. All controls are logically arranged to allow quick familiarization for easy, fast, accurate measurements.

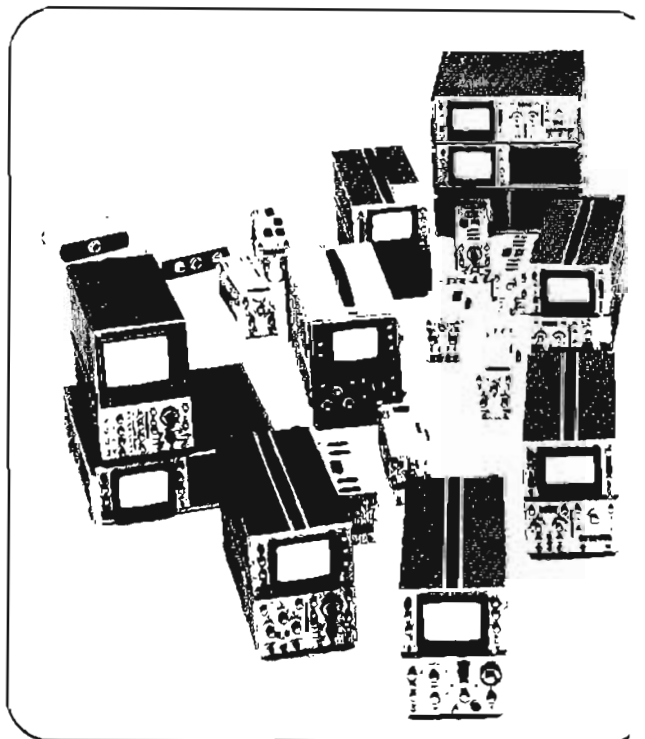

Mainframes

The wide selection of mainframes provides a choice of bandwidths to cover present and future needs. For measurements to 100 MHz, the 180C and D have bright, fast writing displays, the 181A and AR provide variable persistence and storage, and the 182A has a large screen for easier to see displays. Models 183A/B/C/D have bandwidths greater than 600 MHz with writing speeds of 4 and 8 ns/div for high speed pulse and CW measurements. All mainframes, except the 182A, are available in compact cabinet or 5 1/4" high rack styles, which take little bench or rack space.

Vertical Plug-ins

The wide selection of plug-ins assures the right plug-in for almost any measurement application. To fit your application, the realtime vertical plug-in is available in 500 kHz, 35 MHz, 50 MHz, 75 MHz, 100 MHz, and 250 MHz bandwidths with deflection factors of 100 μ V, 10 mV, 5 mV, 5 mV, and 10 mV, respectively. Differential/dc offset measurements are provided by the 1803A which measures offset voltages with an accuracy of 0.5%. Large signal, single-shot measurements are available in 183 mainframes in excess of 600 MHz with the direct access 1831A plug-in.

Time Bases

For accurate timing measurements, the time base plug-ins give you a choice of single, expanded, and delayed sweeps with sweep times of 5 ns/div in 180 mainframes and 1 ns/div in 183 mainframes. Applications that only require sweep expansion are provided by the 1824A at considerably lower cost than a delayed sweep time base. The 1824A not only provides an expansion of up to 100 times but it maintains the $\pm 3\%$ sweep accuracy that is often lost in a display magnification. If a delayed sweep is required, the 1825A provides calibrated delayed and mixed sweeps for accurate measurements. Also, by using a single reference line on the CRT, you can make differential timing measurements with approximately 1% accuracy.

Sampling Plug-ins

The new generation sampling plug-ins provide the easiest and fastest low level, high frequency measurements available at this time. The 1810A operates and looks like a real time plug-in and provides fast, accurate, low-level measurements to 1 GHz. Measurements to 4 GHz and 18 GHz are provided by the 1811A and its remote feedthru sampling heads, 1432A and 1430C. The remote sampling heads reduce measurement errors by eliminating long high frequency interconnecting lines and the feedthru characteristic allows measurements to be made while the system is operating normally with its own loads.

TDR

Time Domain Reflectometry is a fast, convenient technique of measuring the electrical characteristics of transmission systems. For wideband applications, Models 1815A/B and 1818A will display an impedance profile of a system that shows magnitude, nature, and distance of a discontinuity from the test point. Model 1818A is a low cost, easy-to-use 150 ps rise time system for installation evaluation and servicing of transmission systems. For design work or critical system installations, the 1815A/B with its remote sampling heads provides calibrated 35 ps rise times which will display discontinuities as close as 1/4-inch apart.

Waveguide transmission systems can also be checked by using the 1580A narrow band TDR system. This narrow band TDR clearly shows the magnitude of discontinuities with the location directly calibrated in feet or optionally meters from the source. This allows rapid system set-up or repair of faults caused by misaligned or corroded waveguide flanges, coaxial cable connectors or damaged waveguide.

Operation In Extreme Environment

A 180 system has been developed to meet the extreme environmental requirements of the military. This system, which includes plug-ins and front panel cover with accessories, is available as an AN/USM-281A. The same ruggedized system can also be obtained as a 180F mainframe and with 1801F and 1821F plug-ins or as a rack mount model in the 180ER.



180 System Selection Charts*

MAINFRAMES		
Model No.	DESCRIPTION	Price
180C	Cabinet style for up to 100 MHz real time plug-ins	\$ 950
180D	5¼ -inch high rack/bench style version of 180C	1050
181A	Cabinet style, variable persistence and storage CRT, 100 MHz	1950
181AR	5¼ -inch high rack/bench style version of 181A	2025
182A	Large screen, 100 MHz, cabinet style	950
183A	Cabinet style, >500 MHz bandwidth, 4 cm/ns writing speed	1950
183B	5¼ -inch high rack/bench style version of 183A	2050
183C	Cabinet style, >500 MHz bandwidth, selectable scan, 4 or 8 cm/ns writing speed	2500
183D	5¼ -inch high rack/bench style version of 183C	2600

* Refer to Model Number Index for page references.

Vertical Plug-ins

Model No.	1801A	1803A	1804A	1805A	1806A	1807A	1808A	ⓐ1810A*	ⓑ1811A	ⓒ1830A	ⓓⓔ1831A/B
Bandwidth, MHz	50	40 (30)	50	100	0.5	35	75	1 GHz (sampling)	4 or 18 GHz (sampling)	250	>600 (A) >500 (B)
Min. Deflection factor/div	5 mV (500 μV Opt 001 cascaded)	5 mV (1 mV)	20 mV	5 mV	100 μV	10 mV	5 mV	2 mV	2 mV	10 mV	≈6 V
Channels	2 (1 cas- caded)	1 diff	4	2	2	2	2	2	2	2	1
Differential Input	Yes	Yes (with dc offset)	No	Yes	Yes	Yes	Yes	Yes	Yes	Yes	1831A only
Price	\$680 (Opt 001 \$830)	\$950	\$1050	\$1400	\$675	\$450	\$880	\$1650	\$1200	\$900	\$375 (A) \$425 (B)

Time Base Plug-ins

TIME BASE PLUG-INS									TDR	TDR/SAMPLING
Model No	1820C	1821A	1824A	1825A	ⓐ1810A	1811A	ⓑ1840A	ⓒ1841A	ⓓ1818A	ⓔ1815A/B
Ext Trig	150 MHz	100 MHz	150 MHz	150 MHz	>1 GHz	18 GHz (with countdown)	>500 MHz	>500 MHz	<150 ps risetime TDR system	35 ps calibrated rise time TDR, 12.4 GHz single channel sampl- ing 1815A calibrated in feet. 1815B calibrated in meters. Plug-in re- quires sampling head and tunnel diode.
Int Trig	100 MHz	75 MHz	100 MHz	100 MHz	1 GHz		250 MHz	250 MHz		
Sweep Speeds/div	5 ns - 1 s	10 ns - 1 s	5 ns - 1 s	5 ns - 1 s	100 ps (expanded) -50 μs	10 ps (expanded) -5 μs	1 ns - 0.1 s	1 ns - 0.1 s		
Delayed and Mixed Sweep	No	Yes	X100 Expanded	Yes	No	No	No	Delayed		
Price	\$400	\$700	\$550	\$800	\$1650	ⓐ\$1700	\$650	\$1150	\$1200	ⓔ\$1250.

Mainframe/Vertical/Time Base Compatibility Chart

MAINFRAME	Verticle Plug-In									Time Base Plug-In					TDR/Sampling					
	1801A	1803A	1804A	1805A	1806A	1807A	1808A	1830A	1831A/B	1820C	1821A	1824A	1825A	1840A	1840A Opt 035	1841A	1810A	1811A	1815A/B	1818A
180C/D	X	X	X	X	X	X	X	X	X	X	X	X	X				X	X	X	X
181A/AR	X	X	X	X	X	X	X	X	X	X	X	X	X				X	X	X	X
182A	X	X	X	X	X	X	X	X	X	X	X	X	X				X	X	X	X
183	<100 MHz	X	X	X	X	X	X	X	X	X	X	X	X				X	X	X	X
	>100 MHz	X	X	X	X	X	X	X	X					X	X		X	X	X	X
A/B/C/D	Opt 035	X	X	X	X	X	X	X	X					X						

NOTES:

- Operates in 183 mainframes only.
- Double size plug-in.
- Requires option 035 to 183 mainframes and 1840A Time Base.
- Price is without sampling heads and tunnel diodes.



LARGE SCREEN, 100 MHz

Plug-in flexibility

Model 182A

Description, 182A

Model 182A plug-in oscilloscope mainframe provides large screen, 100 MHz bandwidth in the proven 180 oscilloscope system. The parallax free, internal graticule is 8 x 10 divisions with each division equal to 1.29 cm, which makes it easier to view displays from a distance. This larger CRT area, 66% larger than 8 x 10 cm displays, also improves viewing of displays such as four-channel, differential/dc-offset, and time domain reflectometer measurements.

Another feature of this mainframe is its design for maintainability. Plug-in circuit modules that connect to a printed circuit mother board almost eliminate internal cabling, which increases reliability and makes it easier and quicker to get an instrument back into service. For example: the horizontal amplifier is on a plug-in circuit board that includes a section of front panel with knobs and switches mounted on it. This allows a complete, pre-tested board to be quickly installed which keeps instrument down-time to a minimum. Also, the function of major circuit areas, test points, and adjustment values are printed on the circuit boards so a knowledgeable technician can easily adjust or repair the circuits.

Specifications, 182A

Cathode-ray tube and controls

Type: post accelerator, 19 kV accelerating potential; aluminized P31 phosphor (other phosphors available, see Options).

Graticule: 8 x 10 div internal graticule. 0.2-div sub-divisions on major axes. 1 div = 1.29 cm. Front panel recessed screwdriver adjustment aligns trace with graticule. Edge lighted graticule.

Beam finder: returns trace to CRT screen regardless of setting of horizontal, vertical, or intensity controls.

Intensity modulation: approx +2 V, ≥ 50 ns pulse width (≤ 10 MHz CW) will blank trace of normal intensity. Input R, approx 5 k ohms. Maximum Input voltage, ± 20 V (dc + peak ac).

Calibrator

Type: approx 1 kHz square wave, < 3 μ s rise time.

Voltage: two outputs, 250 mV p-p and 10 V p-p; accuracy, $\pm 1\%$.

Horizontal amplifier

External input

Bandwidth: dc-coupled, dc to 5 MHz; ac-coupled, 5 Hz to 5 MHz.

Deflection factor: 1 V/div, x1; 0.1 V/div, x10; accuracy, $\pm 5\%$. Vernier provides continuous adjustment between ranges.

Dynamic range: ± 20 V.

Maximum input: ± 300 V (dc + peak ac).

Input RC: 1 megohm shunted by approx 30 pF.

Internal sweep

Sweep magnifier: x10; accuracy, $\pm 5\%$ (including 3% accuracy time base).

Outputs: four emitter follower outputs on rear for main and delayed gates, main and delayed sweeps or vertical and horizontal outputs when used with sampling plug-ins; maximum current available, ± 3 mA; outputs will drive impedance ≥ 1000 ohms without distortion.

General

Weight: (without plug-ins) net, 26½ lb (12,02 kg); shipping 38½ lb (17,46 kg).

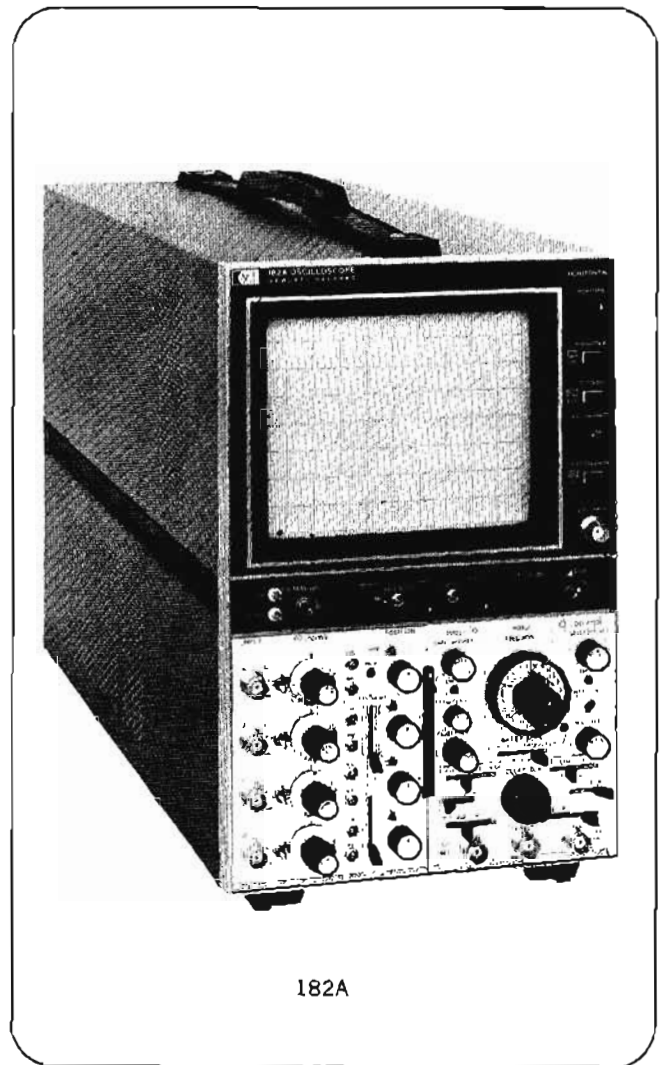

182A

Power: 115 or 230 V $\pm 10\%$, 48 to 440 Hz, < 110 watts with plug-ins at normal line. Max. mainframe power, 200 VA.

Environment: (Mainframe operates within specifications over the following ranges.) Temperature, 0°C to +55°C; Humidity, up to 95% relative humidity at 40°C. Altitude, up to 15,000 ft; Vibration, vibrated in three planes for 15 minutes each with 0.010 inch excursion, 10 to 55 Hz.

Dimensions: 7 15/16 in. wide x 13 5/16 in. high x 19 5/8 in. deep over-all (201,6 x 338,1 x 498,5 mm).

Accessories furnished: metallic mesh contrast filter; power cord.

Price: (mainframe less plug-ins)

Model 182A Oscilloscope Mainframe\$950

Model 182A Option 010 Oscilloscope Mainframe\$900

Options

002: aluminized P2 phosphor in lieu of P31, no charge.

007: aluminized P7 phosphor in lieu of P31, no charge.

010: mainframe without rear panel main and delayed sweep and gate outputsLess \$50

011: aluminized P11 phosphor in lieu of P31, no charge. Beam-finder does not intensify display on Option 011 oscilloscopes.

HIGH WRITING SPEED

Plug-in flexibility
Models 180C, 180D



OSCILLOSCOPES

Description, 180C/D

Models 180C (cabinet style) and 180D (rack style) mainframes contain the basic functional circuits and power supplies for real time 1800 series plug-ins to 100 MHz, TDR and 12.4 GHz sampling and dual channel 1 GHz and 18 GHz sampling plug-ins. Basic mainframe features are: 8 x 10 division (1 div = 1 cm) internal, parallax-free graticule; internal flood gun for scale illumination; x 5 and x 10 sweep magnifier; external horizontal input; two calibrator outputs of 250 mV and 10 V; and the Hewlett-Packard developed beam finder.

The cathode-ray tube has 15 kV accelerating potential for fast visual and photographic writing speeds which makes it easy to measure low duty cycle pulses. Photographic writing speed with P31 phosphor is 1500 cm/ μ s and is measured using an HP 195A Camera, 10,000 ASA film without film fogging techniques.

To facilitate servicing, the modular power supply may be simply unplugged and removed from the mainframe for complete access to all components. In addition, the power supply may be operated in this exposed condition without requiring separate extenders which further simplifies and speeds up maintenance procedures. A horizontal gain calibrator, Model 10411A, is available to provide fast calibration of the mainframe horizontal amplifier. This and other accessories are listed in the accessories section.

Specifications, 180C/D

Cathode-ray tube and controls

Type: post accelerator, approx 15 kV accelerating potential; aluminized P31 phosphor (see Options for other phosphors).

Graticule: 8 x 10 div internal graticule, 1 div = 1 cm, 0.2 div subdivisions on major axes. Front panel recessed screwdriver adjustment aligns trace with graticule. Scale control illuminates CRT phosphor when viewing with hood or taking photographs.

Beam finder: returns trace to CRT screen regardless of setting of horizontal, vertical, or intensity controls.

Intensity Modulation (External Input)

Input: approx +2 V, ≥ 50 ns pulse width (≤ 10 MHz sine wave) will blank trace of normal intensity.

Input R: approx 5 kohms.

Maximum input: ± 20 V (dc + peak ac).

Photographic writing speed: 1500 cm/ μ s. Measured using P31 phosphor, 10,000 ASA film without film fogging and HP Model 195A camera (1.3 lens, 1:0.5 object-to-image ratio). Writing speed may be increased substantially by using film fogging techniques, P11 phosphor, and faster camera lenses.

Calibrator

Type: approx 1 kHz square wave, < 3 μ s rise time.

Voltage: two outputs, 250 mV p-p and 10 V p-p into ≥ 1 megohm; accuracy, $\pm 1\%$.

Horizontal amplifier

External input

Bandwidth: dc to 5 MHz dc-coupled; 5 Hz to 5 MHz ac-coupled.

Deflection factor: 1 V/div, x1; 0.2 V/div, x5; 0.1 V/div, x10; accuracy $\pm 5\%$. Vernier provides continuous adjustment between ranges.

Dynamic Range: ± 20 V.

Maximum input: 600 Vdc (ac-coupled input).

Input RC: approx 1 megohm shunted by approx 30 pF.

Internal sweep

Magnifier: x5, x10, accuracy $\pm 5\%$ (with 3% accuracy time base).

Outputs: four rear panel, emitter follower outputs provide main and delayed gates, main and delayed sweeps, or vertical and horizontal outputs when used with TDR/Sampling plug-ins. Maxi-

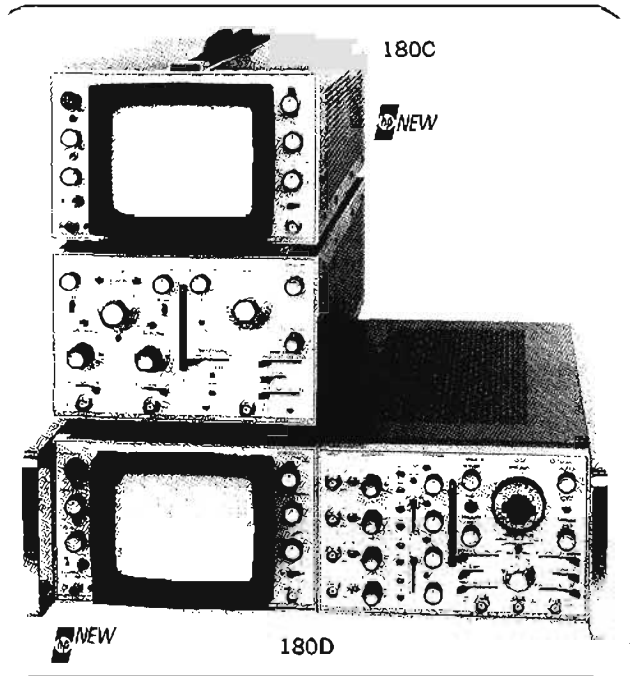

imum current available, ± 3 mA. Output will drive impedances of ≥ 1000 ohms without distortion.

General

Weight (without plug-ins)

Model 180C (cabinet): net 24 lb (10.9 kg); shipping, 36 lb (16.3 kg).

Model 180D (Rack): net, 26 lb (11.8 kg); shipping, 40 lb (18.1 kg).

Power: 115 or 230 V, $\pm 10\%$; 48 to 440 Hz; normally < 110 watts with plug-ins at normal line. Max. mainframe power, 200 VA.

Environment (Mainframe operates within specifications over the following ranges.): Temperature, 0 to $+55^{\circ}\text{C}$; Humidity, to 95% relative humidity to 40°C ; Altitude, to 15,000 ft; Vibration, vibrated in three planes for 15 min. each with 0.010 inch excursion, 10 to 55 Hz.

Dimensions

Cabinet Model 180C: 7 $\frac{7}{8}$ " wide, 11 $\frac{3}{8}$ " high, 21 $\frac{1}{4}$ " deep behind panel (200 x 289 x 540 mm).

Rack Model 180D: 16 $\frac{3}{4}$ in. wide, 5 $\frac{7}{32}$ in. high, 21 $\frac{3}{8}$ in. deep over-all (425, 132.6, 543 mm), 14 $\frac{3}{8}$ in. (493 mm) deep behind rack mount tabs.

Accessories furnished: 7 $\frac{1}{2}$ foot power cord; Model 10179A mesh contrast filter; rack mounting hardware and 2 probe holders (HP P/N 5050-0464) are also supplied with the 180D rack model.

Price (mainframe less plug-ins)

Model 180C Oscilloscope Cabinet Style Mainframe\$950

Model 180C Option 010 (See options)\$900

Model 180D Oscilloscope, Rack Style Mainframe\$1050

Model 180D Option 010 (See Options)\$1000

Options

The following options are available to modify a mainframe to fit your application. If other mainframe changes are required, contact your Hewlett-Packard Field Engineer.

002: aluminized P2 phosphor in lieu of P31, no charge.

007: aluminized P7 phosphor in lieu of P31, no charge.

010: deletes the rear panel outputs for main and delayed gates and main and delayed sweepsLess, \$50

011: aluminized P11 phosphor in lieu of P31, no charge. Beam-finder does not intensify display on Option 011 oscilloscopes.

OSCILLOSCOPES



100 MHz, STORAGE CRT

Plug-in flexibility

Models 181A, 181AR

Description, 181A/AR

Models 181A (cabinet style) and 181AR (rack style) mainframes provide plug-in flexibility, 100 MHz bandwidth capability with a variable persistence/storage cathode-ray tube. The storage mesh CRT allows you to adjust the amount of time a trace is retained to match your measurement requirement. In addition, the 181 offers storage capability for over one hour to permit you to study or photograph a display at your convenience.

Variable persistence and storage is useful for displaying many types of signals, especially low repetition rate or single shot events. Variable persistence allows you to adjust the trace retention time to match your signal requirements, thus eliminating annoying slow sweep flicker.

The single shot Writing speed in the 181 is variable from 20 div/ms to greater than 1000 div/ms. This allows adjustment of the writing speed to match the measurement requirement which provides more versatile scope operation. The integrating capability inherent in this storage CRT allows fast rise repetitive pulses to be displayed even though they may be well beyond the single shot writing capability of the CRT.

The wide selection of plug-ins allows you to match today's measurement requirements and still provide capability for future growth at minimum expense. Refer to the 180 system selection chart for the main features of 1800 series plug-ins.

Specifications, 181A/AR

Cathode-ray tube and controls

Type: post-accelerator storage tube; 8.5 kV accelerating potential; aluminized P31 phosphor.

Graticule: 8 x 10 div internal graticule, 0.2 div subdivisions on major axes. 1 div = 0.95 cm. Front panel adjustment aligns trace with graticule.

Beam finder: returns trace to CRT screen regardless of setting of horizontal or vertical controls.

Intensity modulation: approx +2 V, ≥ 50 ns pulse width (≤ 10 MHz CW) blanks trace or normal intensity. Input R, 5100 ohms.

Persistence

Normal: natural persistence of P31 phosphor (approx 40 μ s).

Variable: from <0.2 s to >1 min.

Storage writing speed

Write mode: >20 div/ms.

Max write mode: >1000 div/ms.

Brightness: >100 foot Lamberts.

Storage time: from Write mode to Store, traces may be stored at reduced intensity for >1 hour. To View mode, traces may be viewed at normal intensity for >1 minute. From Max Write mode to Store, traces may be stored at reduced intensity for >5 minutes. To View mode, traces may be stored at normal intensity for >15 seconds.

Erase: manual, pushbutton erasure takes approx 300 ms.

Horizontal amplifier

External input

Bandwidth: dc-coupled, dc to 5 MHz; ac-coupled, 5 Hz to 5 MHz.

Deflection factor: 1 V/div in x1; 0.2 V/div in x5; 0.1 V/div in x10.

Dynamic range: ≈ 20 V.

Maximum input: 600 V dc (ac-coupled input). Input RC approx 1 megohm shunted by approx 30 pF.

Internal sweep

Magnifier: x5, x10; accuracy, $\pm 5\%$ (with 3% accuracy time base).

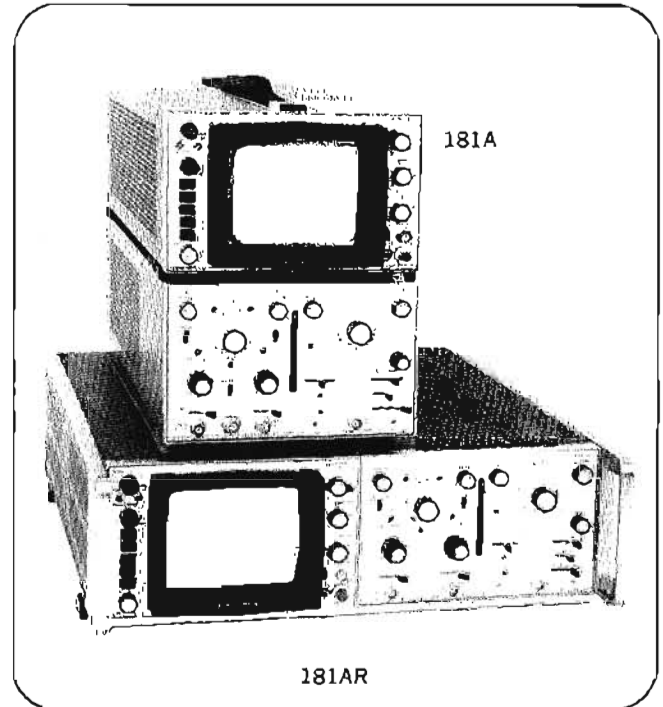

General

Calibrator

Type: approx 1 kHz square wave, 3 μ s rise time.

Amplitude: 10 V p-p; accuracy, $\pm 1\%$.

Outputs: four rear panel emitter follower outputs for main and delayed gates, main and delayed sweeps or vertical and horizontal outputs when used with TDR/Sampling plug-ins. Maximum current available, ± 3 mA. Will drive impedances ≥ 1000 ohms without distortion.

Weight (without plug-ins)

Model 181A (cabinet): net, 24 lbs (10.9 kg); shipping, 40 lbs (18.1 kg).

Model 181AR (rack): net, 26 lbs (11.8 kg); shipping, 40 lbs (18.1 kg).

Environment (operates within specifications over the following ranges): temperature, 0° to +55°C; humidity, to 95% relative humidity to 40°C; altitude, to 15,000 ft; vibration, vibrated in three planes for 15 min each with 0.010 inch excursion, 10 to 55 Hz.

Power: 115 or 230 V $\pm 10\%$, 48 to 440 Hz, 115 watts at normal line with plug-ins. Max mainframe power, 225 VA.

Dimensions

Model 181A (cabinet): 7 $\frac{7}{8}$ " wide x 11 $\frac{3}{8}$ " high x 21 $\frac{1}{4}$ " deep (200 x 289 x 530 mm).

Model 181AR (rack): 16 $\frac{3}{4}$ " wide x 5 $\frac{1}{4}$ " high x 21 $\frac{3}{8}$ " deep over-all (425 x 132.6 x 543 mm) 19 $\frac{3}{8}$ " (493 mm) deep behind rack mounts.

Accessories furnished: 7 $\frac{1}{2}$ ft power cord, Model 10178A mesh contrast filter; rack mounting hardware and two probe holders (HP P/N 5050-0464) are supplied with rack models.

Price (mainframe less plug-ins)

Model 181A Oscilloscope, Cabinet Style Mainframe \$1950

Model 181AR Oscilloscope Rack Style Mainframe \$2025

Options (order by option number)

H49: Model 181A or 181AR with remote programming capability for Write, Max, Write, Normal, Store, View, and Erase functions. Programming accomplished through contact closure, DTL, or TTL logic sources. Price: Model 181A Option H49, \$2450. Model 181AR Option H49, \$2525.

4 and 8 cm/ns WRITING SPEED

Plug-in flexibility, 600 MHz real time

Models 183A, 183B, 183C, 183D



OSCILLOSCOPES

Models 183A/B/C/D mainframes, with their related plug-ins, provide real time frequency response through the VHF region. This high frequency response is accomplished without sacrificing viewing ease, accuracy, operating simplicity, or plug-in versatility in wide band general purpose applications.

The fast writing speed of these main frames allows easy viewing of slow rep rate digital words or other groups of fast-rise pulses in computers and high speed digital systems. In communication system analysis, the wide band response allows undistorted displays of modulation envelopes on rf carriers.

All four mainframes offer full 6 x 10 cm displays at 4 cm/ns writing speed. In addition, the 183C/D offers increased writing speeds of 8 cm/ns in a reduced scan mode. This fast writing speed allows easy photographic recording of high-speed, single-shot transients thru the capabilities of either the 10 mV 250 MHz dual channel plug-in or direct access plug-ins extending to 600 MHz.

To take advantage of this fast writing speed, two time bases are available which provide accurate expanded sweep times to 1 ns/div. Both the standard and delaying time bases provide ultra stable triggering to 500 MHz giving clear clean jitter free displays for all general purpose applications.

Specifications, 183A/B/C/D

Cathode-ray tube and controls

Type: post accelerator, 20 kV accelerating potential; aluminized P31 phosphor (other phosphors available, see options); safety glass faceplate.

Writing speed:* Models 183A/B, 4 cm/ns; Models 183C/D, 4 cm/ns in normal scan; 8 cm/ns in reduced scan.

Graticule

Models 183A/B: 6 x 10 division internal graticule. 1 div = 1 cm. 0.2 division subdivisions on major axes.

Models 183C/D: normal scan, 6 x 10 division internal graticule. 1 div = 1 cm. 0.2 division subdivisions on major axes; reduced scan, 6 x 10 div internal graticule superimposed in center of normal scan graticule. 1 div = 0.5 cm.

Flood gun: illuminates CRT phosphor. Normal or pulsed mode of operation selected with rear panel switch. Scale control adjusts graticule illumination in normal mode and pulse width in pulsed mode which increases photographic writing speed.

Beam finder: returns trace to CRT screen regardless of setting of horizontal or vertical controls.

Intensity modulation: approx +2 V, 50 ns pulse width (≤ 15 MHz CW) blanks trace of normal intensity. Input R, 4700 ohms. +15 V blanks trace of any intensity.

Calibrator

Pulse timing: selectable, 2 kHz rep rate (0.5 ms period), 50 μ s pulse width; 1 MHz rep rate (1 μ s period), 100 ns pulse width. Accuracy, $\pm 0.5\%$ +10°C to +40°C; $\pm 1\%$ to +55°C.

Amplitude: selectable, 50 mV or 500 mV, $\pm 1\%$ into a 50 ohm $\pm 0.5\%$ load.

Source R: 50 ohms, nominal.

Pulse shape (measured with 1 GHz bandwidth sampler): rise time (negative slope), 1 ns; overshoot and ringing, $\pm 3\%$ max; flatness, $\pm 0.5\%$ after 5 ns with pulse top and base line perturbations averaged.

External calibrator input: calibrator shaping network shapes an external negative input that exceeds -0.5 V peak. Rep-rate extends to >10 MHz. Input R, approx 10 k ohms. Rear panel input selected with rear panel switch and front panel light indicates when switched to external position.

* With 10,000 ASA film, P31 phosphor, f/1.3 lens, 1:0.5 object-to-image ratio, and pulsed flood gun fogging.

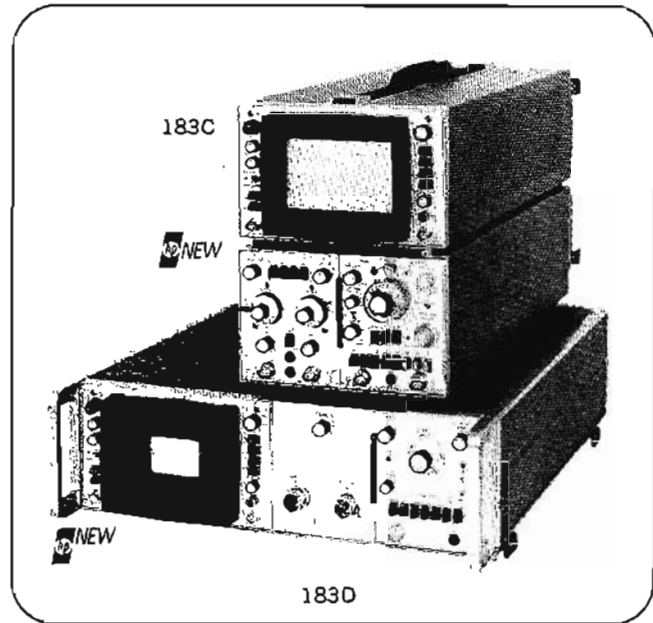

Horizontal amplifier

External input: bandwidth, dc-coupled, dc to 8 MHz; ac-coupled, 2 MHz; deflection factor, 1 V/div, X1; 100 mV/div, X10; accuracy $\pm 5\%$, vernier provides continuous adjustment between ranges and extends deflection factor to at least 10 V/div; dynamic range, ± 20 V; maximum input, ± 350 V (dc + peak ac); input RC, approx 1 megohm shunted by approx 20 pF.

Internal sweep magnifier: X10; accuracy, $\pm 5\%$.

General

Outputs: two rear panel emitter follower outputs for main or delayed gates (vertical or horizontal outputs when used with sampling plug-ins). Output amplitude is approx ± 0.75 V with 1840A time base plug-in. Will drive impedances ≥ 1000 ohms without distortion.

Weight (without plug-ins): Models 183A/C (cabinet) net, 33 lbs (15.0 kg); shipping, 46 lbs (20.9 kg); Models 183B/D (rack) net, 35 lbs (15.9 kg); shipping, 48 lbs (21.8 kg).

Environment (mainframe operates within specifications over the following ranges): temperature, 0°C to 55°C; humidity, to 95% relative humidity to 40°C; altitude, to 15,000 ft; vibration, vibrated in three planes for 15 minutes each with 0.010 inch excursion, 10 to 55 Hz.

Power: 115 or 230 V $\pm 10\%$, 48 to 440 Hz, approx 115 watts with 1830A and 1840A plug-ins at 115 V and 60 Hz. Maximum mainframe power at normal line, 155 watts.

Dimensions

Models 183A/C (cabinet): 7 $\frac{7}{8}$ " wide, 11 $\frac{3}{8}$ " high, 22 $\frac{3}{4}$ " deep behind front panel (100 x 289 x 578 mm).

Models 183B/D (rack): 16 $\frac{3}{4}$ " wide, 5-7/36" high, 24" deep over-all (425.5, 132.6, 543 mm), 22" (558.5 mm) deep behind rack mount tabs.

Accessories supplied: Model 10179A mesh contrast filter, 7 $\frac{1}{2}$ ft power cord; reduced scan mask for 183C/D (HP Part No. 00183-04111). Rack mounting hardware and two clip-on probe holders (HP Part No. 5050-0464) with 183B and D rack models.

Price (mainframe less plug-ins)

Model 183A Oscilloscope, Cabinet Style Mainframe \$1850
 Model 183B Oscilloscope, Rack Style Mainframe \$1925
 Model 183C Oscilloscope, Cabinet Style Mainframe \$2500
 Model 183D Oscilloscope, Cabinet Style Mainframe \$2600

OSCILLOSCOPES



75 & 50 MHz, 2 CHANNEL 5 mV/div; High Z or 50 ohms at 75 MHz Models 1808A, 1801A

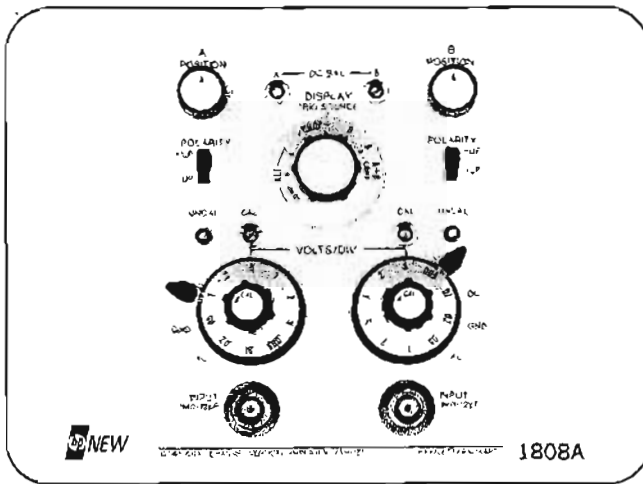

Description, 1808A

Model 1808A is an ideal vertical amplifier for design or trouble-shooting logic circuits using ECL components. This plug-in provides low drift and flexible triggering for accurate CW and timing measurements. Other convenience features are: 5 mV/div to 5 V/div; dc to 75 MHz bandwidth on all ranges; selectable display polarity on each channel; and selectable high Z or 50 ohm inputs.

General purpose probing is provided by a one megohm input with a very low 12 pF shunt capacitance to reduce phase shift and signal loss in CW measurements. A switchable, high quality, 50 ohm input is also provided, which allows matching to a 50 ohm source with minimum reflections due to the low 1.2:1 VSWR. This 50 ohm input provides accurate rise time measurements with virtually no reflections to degrade the input signal or introduce phase shift. The 50 ohm input also allows active and passive probes with very low input capacitance to be used which further reduces signal degradation.

Specifications, 1808A

Modes of operation: channel A; channel B; channels A and B displayed alternately on successive sweeps (ALT); channels A and B displayed by switching between channels at approx 400 kHz rate (CHOP), with blanking during switching; and channel A plus channel B (algebraic addition).

Each channel (2)

Bandwidth: (3 dB down from 8 div reference signal from a terminated 50 ohm source): dc-coupled, dc to 75 MHz; ac-coupled, approx 8 Hz to 75 MHz.

Rise time: <4.7 ns (measured from 10% to 90% points of 6 div input step from a terminated 50 ohm source).

Deflection factor

Ranges: 5 mV/div to 5 V/div (10 calibrated positions) in 1, 2, 5 sequence. $\pm 2\%$ attenuator accuracy. Vernier provides continuous adjustment between deflection factor settings and extends maximum deflection factor to at least 12.5 V/div.

Polarity: + up or - up, selectable.

Signal delay: input signals are delayed sufficiently to view leading edge of input pulse without advanced trigger.

Input coupling: selectable, ac and dc (1 megohm), 50 ohms, or ground. Ground position disconnects input connector and grounds amplifier input.

Input (selectable)

1 megohm: 1 megohm $\pm 1\%$ shunted by approx 12 pF.
50 ohm: 50 ohms $\pm 1\%$. VSWR, <1.2:1 at 75 MHz on all ranges.

Maximum input

1 megohm: ± 300 V (dc + peak ac) at 1 kHz or less; ± 150 V (dc + peak ac) on 5 mV/div range at 1 kHz or less.

50 ohm: 10 V rms (dc-coupled input).

Drift: <100 $\mu\text{V}/^\circ\text{C}$.

A + B operation

Amplifier: bandwidth and deflection factors unchanged; either channel may be inverted for $\pm A + B$ operation.

Differential input (A-B) common mode: for frequencies from dc to 2 MHz, CMRR is at least 40 dB on 5 mV/div and at least 20 dB on other ranges for common mode signals of 24 div or less.

Triggering

Source: A, B, or composite (A + B) modes, on the signal displayed; chop mode, on A or B signal; alternate mode, on A, B, or successively (comp) from the displayed signal on each channel.

Frequency: dc to 75 MHz on signals causing 0.5 div p-p or more vertical deflection in all display modes (1820A, 1821A require 1 div p-p) except dc to 100 kHz in chop mode.

General

Environment: same as Model 180C/D mainframe.

Weight: net, 5 lbs (2.3 kg); shipping, 9 lbs (4.1 kg).

Price: Model 1808A Dual Channel Vertical Amplifier, \$880; Model 1808A Option 003 Dual Channel Vertical Amplifier, \$800.

Accessories furnished: two 10:1 voltage divider probes.

Options

003: Model 1808A without probes, less \$80.

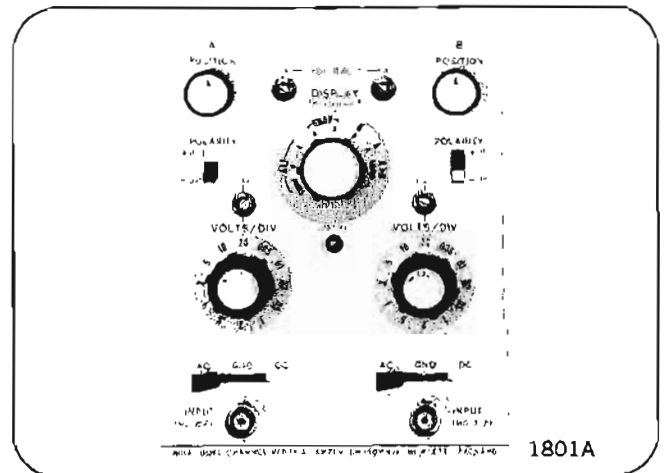

Description, 1801A

Model 1801A is a dual channel vertical amplifier plug-in for 180 system mainframes. Operating characteristics are: 5 mV/div to 20 V/div deflection factors; dc to 50 MHz bandwidth constant on all ranges; selectable display polarity; and selectable input coupling. The two channels can be operated singly, algebraically added, or in dual trace modes with alternate or chopped switching and selectable trigger source.

For added measurement versatility, Option 001 provides a X5 multiplier for 1 mV/div deflection factors. Option 001 also provides a Channel B output, which can be cascaded into Channel A for 500 $\mu\text{V}/\text{div}$ deflection factor.

Specifications, 1801A

Modes of operation: channel A; channel B; channels A and B displayed alternately on successive sweeps (ALT); channels A

35 MHz, LOW COST, 2 CHANNEL

10 mV/div, Easy-to-use
Model 1807A



OSCILLOSCOPES

and B displayed by switching between channels at approx 400 kHz rate (CHOP), with blanking during switching; channel A plus channel B (algebraic addition).

Each channel (2)

Bandwidth (measured with or without a Model 10004B probe, 3 dB down from 8 div reference signal from a terminated 50 ohm source. Lower limit is approx 0.8 Hz with 10004B probe when ac-coupled); dc-coupled, dc to 50 MHz; ac-coupled, approx 8 Hz to 50 MHz.

Rise time: <7 ns (measured with or without 10004B probe 10% to 90% of 8 div input step from a terminated 50 ohm source).

Deflection factor: 5 mV/div to 20 V/div (12 positions) in 1, 2, 5 sequence. $\pm 3\%$ attenuator accuracy. Vernier provides continuous adjustment between deflection factor settings and extends maximum deflection factor to at least 50 V/div.

Polarity: + up or - up, selectable.

Signal delay: input signals are delayed sufficiently to view leading edge of input pulse without advanced external trigger.

Input RC: 1 megohm $\pm 2\%$ shunted by approx 25 pF.

Input coupling: selectable, ac, dc, or ground. Ground position disconnects signal input and grounds amplifier input.

Maximum Input

DC-coupled: ± 350 V (dc + peak ac) at 10 kHz or less; ± 150 V (dc + peak ac) on 5 mV/div range at 10 kHz or less.

AC-coupled: ± 600 V dc.

A + B operation

Amplifier: bandwidth and deflection factors are unchanged; either channel may be inverted for $\pm A \pm B$ operation.

Differential Input (A-B) common mode: for frequencies from dc to 1 MHz, CMRR is at least 40 dB at 5 mV/div and at least 20 dB on other ranges for common mode signals of 24 div or less.

Triggering

Source: A, B, or composite ($A \mp B$). Modes, on the signal displayed; chop mode, on A or B signal; alternate mode, on A, B or successively (comp) from the displayed signal on each channel.

Frequency: dc to 50 MHz on signals causing 0.5 div or more vertical deflection in all display modes except dc to 100 kHz in chop mode.

General

Weight: net, 4 lbs (1.8 kg); shipping, 7 lbs (3.2 kg).

Environment: same as Model 180C/D mainframes.

Accessories furnished: two 10004B, 10:1 divider probes, approx 3 1/2 ft.

Price: Model 1801A Dual Channel Vertical Amplifier, \$680; Model 1801A Option 003 Dual Channel Vertical Amplifier, \$600.

Options (order by option number)

001: provides x5 magnifier and channel B vertical output. Contact your Hewlett-Packard field engineer for more information about this option.

003: Model 1801A without probes, less \$80.

090: 6 ft 10006B probes substituted for 10004B, 10:1 atten, no charge.

091: 10 ft 10005B probes substituted for 10004B, 10:1 atten, no charge.

Description, 1807A

Model 1807A is an economical, dual channel plug-in for applications involving logic timing measurements in circuits using MOS and TTL elements. A selection of standard, delay generators, or expanded sweep time bases, allow timing measurements to 5 ns/div in 180 mainframes or to 1 ns/div in 183 mainframes. The 181 variable persistence/storage mainframes provide bright, clear displays of low rep rate logic pulses when they are too slow for standard CRT displays.

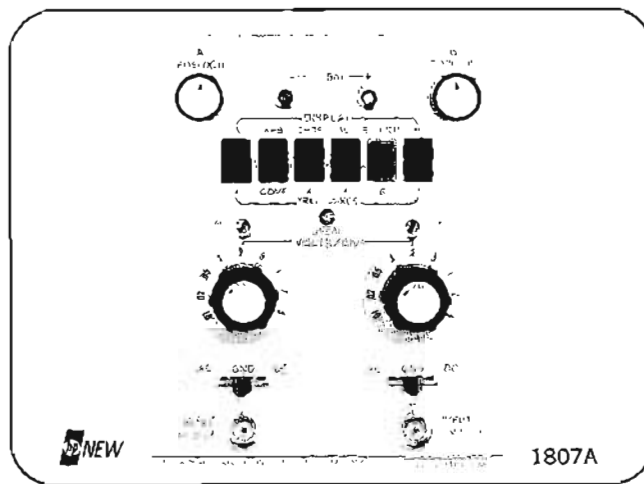

Specifications, 1807A

Modes of operation: channel A; channel B; channels A and B displayed alternately on successive sweeps (ALT); channels A and B displayed by switching between channels at approx 100 kHz rate (CHOP), with blanking during switching; and channel A plus channel B (algebraic addition).

Each channel (2)

Bandwidth: (measured with or without 10004B probe, 3 dB down from 8 div reference signal from a terminated 50 ohm. Lower limit is approx 0.8 Hz with 10004B probe when ac-coupled); dc-coupled, dc to 35 MHz; ac-coupled, approx 8 Hz to 35 MHz.

Rise time: <10 ns (measured with or without 10004B probe, 10% to 90% of 8 div input from a terminated 50 ohm source).

Deflection factor: 10 mV/div to 5 V/div (9 positions) in 1, 2, 5 sequence. $\pm 3\%$ attenuator accuracy. Vernier provides continuous adjustment between deflection factor settings and extends maximum deflection factor to 12.5 V/div.

Polarity: \pm UP or - UP, selectable on channel B.

Signal delay: input signals are delayed sufficiently to view leading edge of input pulse without advanced trigger.

Input RC: 1 megohm $\pm 2\%$ shunted by approx 27 pF.

Input coupling: selectable, ac, dc, or ground. Ground position disconnects input connector and grounds amplifier input.

Maximum input

DC-coupled: ± 350 V (dc + peak ac) at 10 kHz or less; ± 150 V (dc + peak ac) on 10 mV/div at 10 kHz or less.

AC-coupled: ± 600 V dc.

A + B operation

Amplifier: bandwidth and deflection factors are unchanged; channel B may be inverted for $\pm A \pm B$ operation.

Differential input (A-B) common mode: for frequencies from dc to 1 MHz, CMRR is at least 40 dB on 10 mV/div and at least 20 dB on other ranges for common mode signals of 24 div or less.

Triggering

Source: on channel A for channel A, chop and alternate modes, on channel B for channel B mode, on signal displayed for A + B mode.

Frequency: dc to 35 MHz on signals causing 0.5 div p-p or more vertical deflection in all display modes except dc to 100 kHz in chop mode.

General

Environment: same as 180C/D mainframe.

Weight: net, 4 lbs (1.8 kg); shipping, 8 lbs (3.6 kg).

Price: Model 1807A Dual Channel Vertical Amplifier, \$450.



DIFFERENTIAL/DC OFFSET

Calibrated V_0 to 600 V

Model 1803A

Description, 1803A

Model 1803A is a differential/dc offset amplifier plug-in for 180 system mainframes. Operating characteristics are: deflection factors of 1 mV/div to 2 V/div from dc to 30 MHz and from 5 mV/div to 20 V/div to 40 MHz; CMRR of 86 dB (20,000:1) on the 1 mV/div range with a 10 volt common mode signal; and calibrated offset voltage that provides differential comparison of pulse amplitude measurements with 0.5% accuracy.

Specifications, 1803A

Vertical deflection

Bandwidth: dc to 40 MHz (3 dB down) for deflection factors of 5 mV/div to 20 V/div; dc to 30 MHz (3 dB down) on 1 mV/div and 2 mV/div for V_0 range of 0 to 6 V, and 2 most sensitive volts/div settings on other V_0 ranges. Lower 3 dB limit is approximately 2 Hz with input ac coupled. (Measured with or without 10004B probe; 8 div reference signal from a terminated 50 ohm source. Lower limit is approximately 0.2 Hz with probe.)

Risetime: <10 ns for deflection factors of 5 mV/div to 20 V/div; <12 ns on 1 mV/div and 2 mV/div on V_0 range 0 to 6 V and on two most sensitive volts/div settings on other V_0 ranges. (Measured with or without 10004B probe; 10% to 90% of 8 div input step from a terminated 50 ohm source.)

Deflector factor

Ranges: from 0.001 V/div to 20 V/div (14 calibrated positions) in 1, 2, 5 sequence. $\pm 3\%$ attenuator accuracy.

Vernier: provides continuous adjustment between all deflection factor ranges; extends maximum deflection factor to at least 50 V/div. Uncalibrated light indicates when vernier is not in GAL position.

Input coupling: front panel selection ac, dc, ground or V_0 for both + and - inputs. Ground disconnects signal input and grounds amplifier input for reference.

Maximum input

V_0 Range	Deflection Factor	Maximum Input (dc + peak ac)
0 to 6 V	0.001 V/div to 0.02 V/div	± 15 V
0 to 6 V	0.05 V/div to 0.2 V/div	± 150 V
0 to 6 V	0.5 V/div to 20 V/div	± 600 V
0 to 60 V	0.01 V/div to 0.2 V/div	± 150 V
0 to 60 V	0.5 V/div to 20 V/div	± 600 V
0 to 600 V	0.1 V/div to 20 V/div	± 600 V

Overload recovery

6 V overload: within ± 10 mV of final signal value in $\leq 0.3 \mu\text{s}$ within ± 5 mV in $\leq 1 \mu\text{s}$, and within 1 mV in ≤ 1 ms.

60 V overload: within ± 100 mV of final signal value in $\leq 0.3 \mu\text{s}$, within ± 50 mV in $\leq 1 \mu\text{s}$, and within ± 10 mV in ≤ 1 ms.

600 V overload: within ± 1 V of final signal value in $\leq 0.3 \mu\text{s}$, within ± 0.5 V in $\leq 1 \mu\text{s}$, and within ± 100 mV in ≤ 1 ms.

Common mode rejection ratio: measured at 0.001 V/div. (CMRR decreases with increasing deflection factor.)

Frequency Range	CMRR	Common Mode Input Sinewave (Max p-p)
DC to 100 kHz	$\geq 20,000:1$ (≥ 86 dB)	10 V
100 kHz to 1 MHz	$\geq 10,000:1$ (≥ 80 dB)	10 V
1 MHz to 10 MHz	5,000:1	10 V
	Freq. in MHz	Freq. in MHz
20 MHz	$\geq 50:1$ (≥ 34 dB)	1 V
60 Hz	$\geq 2,000:1$ (≥ 66 dB)*	10 V

V_0 output: calibrated dc offset voltage available at front panel connector, continuously variable from 0 to ± 0.006 V, 0 to ± 0.06 V, 0 to ± 0.6 V, or 0 to ± 6 V. Accuracy of the ± 6 V range is

* AC coupled (all others dc-coupled).

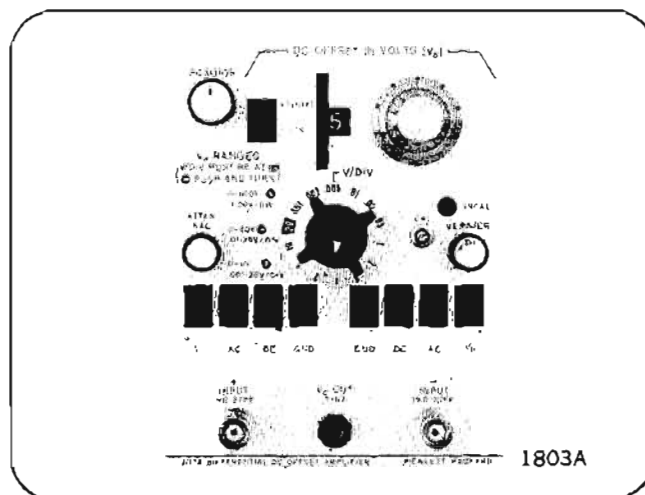

$\pm 0.15\%$ of reading ± 8 mV when driving a resistance of 10 megohms or higher.

DC offset

V_0 Range	Deflection Factor	Comparison Accuracy
0 to ± 6 V	0.001 V/div to 0.02 V/div	$\pm (0.15\% + 8 \text{ mV})$
	0.05 V/div to 0.2 V/div	$\pm (0.75\% + 8 \text{ mV})$
	0.5 V/div to 2 V/div	$\pm 1\%$
	5 V/div to 20 V/div	$\pm 3\%$
0 to ± 60 V	0.01 V/div to 0.2 V/div	$\pm (0.4\% + 80 \text{ mV})$
	0.5 V/div to 2 V/div	$\pm (0.75\% + 80 \text{ mV})$
	5 V/div to 20 V/div	$\pm 3\%$
0 to ± 600 V	0.1 V/div to 2 V/div	$\pm (0.65\% + 0.8 \text{ V})$
	5 V/div to 20 V/div	$\pm 3\%$

Triggering: dc to 40 MHz on signals causing 0.5 div or more vertical deflection.

General

Weight: net, 5 lbs (2,3 kg); shipping, 8 lbs (3,6 kg).

Environment: same as Model 180C/D mainframes.

Price: Model 1803A Differential DC Offset Amplifier, \$950.

Description, 1804A

Model 1804A is a four channel vertical amplifier plug-in for 180 system mainframes. Operating characteristics are: 20 mV/div to 10 V/div deflection factors; dc to 50 MHz bandwidth; and selectable input coupling. The four channels may be operated singly or in any combination of traces in alternate or chopped modes with selectable trigger source.

Specifications, 1804A

Modes of operation: channel A, B, C, or D or any combination displayed alternately on successive sweeps (ALT); channels A, B, C, or D or any combination displayed by switching between channels at approx 1 MHz rate (CHOP), with blanking during switching.

Each channel (4)

Bandwidth: (measured with or without 10004B probe 3 dB down from 8 div reference signal from a terminated 50 ohm source. Lower limit is approx 1 Hz with probe when ac-coupled.) DC-coupled, dc to 50 MHz, ac-coupled, 10 Hz to 50 MHz.

Risetime: <7 ns. (Measured with or without 10004B probe; 10% to 90% of 8 div input step from a terminated 50 ohm source.)

4 CHANNEL; HIGH GAIN

10 mV/div to 50 MHz; 100 μ V/div to 500 kHz
Models 1804A, 1806A



OSCILLOSCOPES

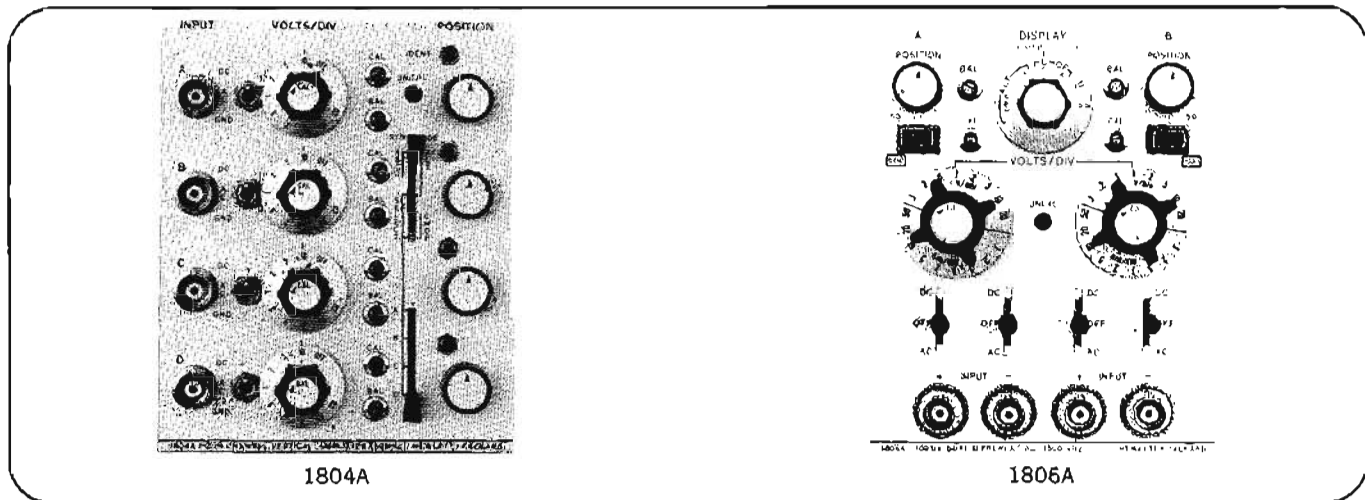

Deflection factor

Ranges: from 0.02 V/div to 10 V/div (9 calibrated positions) in 1, 2, 5 sequence. $\pm 3\%$ attenuator accuracy.

Vernier: provides continuous adjustment between all deflection factor ranges; extends maximum deflection factor to at least 25 V/div. Uncalibrated light indicates when vernier is not in CAL position.

Signal delay: input signals are delayed sufficiently to view leading edge of input pulse without advanced ext trigger.

Input RC: 1 megohm $\pm 2\%$ shunted by approx 25 pF.

Maximum input: dc-coupled, ± 350 V (dc + peak ac) at 10 kHz or less; ± 150 V (dc + peak ac) on 20 mV/div at 10 kHz or less; ac-coupled, ± 400 V dc.

Trace identification: pushbutton control displaces respective trace approx 0.5 div.

Triggering

Source: selectable on signal from any channel in either chop or alternate mode, or successively from the displayed signal on each channel in alternate mode.

Frequency: dc to 50 MHz on signals causing 0.5 div or more vertical deflection in all display modes except chop; dc to 200 kHz in chop mode.

General

Accessory supplied: Model 10412A extender card for ring counter board.

Weight: net, 5 lbs (2.3 kg); shipping, 8 lbs (3.6 kg).

Environment: same as Model 180C/D mainframes.

Price: Model 1804A Four Channel Vertical Amplifier, \$1050.

Options (order by option number)

090: four 10004B 10:1 Probes $\approx 3\frac{1}{2}$ ft long, add \$160.

091: four 10006B 10:1 Probes ≈ 6 ft long, add \$160.

092: four 10005B 10:1 Probes ≈ 10 ft long, add \$160.

Description, 1806A

Model 1806A is a dual channel, differential input amplifier for low level measurements in 180 system mainframes. Operating characteristics are: dc to 500 kHz bandwidth, 100 μ V/div to 20 V/div deflection factors, 100 dB CMRR from dc to 10 kHz with a ± 10 V common mode signal on the 100 μ V/div range, and less than 20 μ V of noise, measured tangentially at full bandwidth.

Specifications, 1806A

Modes of operation: channel A alone; channel B alone; channels A and B displayed alternately on successive sweeps (ALT);

channels A and B displayed by switching between channels at approx 100 kHz rate (CHOP) with blanking during switching.

Each channel (2)

Bandwidth (<3 dB down at 500 kHz): dc-coupled, dc to 500 kHz, ac-coupled, approx 2 Hz to 500 kHz; bandwidth limit switch, reduces upper bandwidth to approx 50 kHz.

Deflection factor

Ranges: from 100 μ V/div to 20 V/div (17 positions) in 1, 2, 5 sequence. $\pm 3\%$ attenuator accuracy.

Vernier: continuously variable between ranges; extends maximum deflection factor to at least 50 V/div. Uncalibrated light indicates when vernier is not in CAL position.

Noise: 20 μ V, measured tangentially at full bandwidth.

Input: differential or single-ended on all ranges, selectable.

Common mode

Frequency: dc to 10 kHz on all ranges.

Rejection ratio: ≥ 100 dB (100,000 to 1) with dc-coupled input on 100 μ V/div range, decreasing 20 dB per decade of deflection factor to ≥ 40 dB on the 200 mV/div range; CMRR is ≥ 30 dB on the 500 mV/div to 20 V/div ranges.

Maximum signal: ± 10 V (dc + peak ac) on 100 μ V/div to 200 mV/div ranges; ± 400 V (dc + peak ac) on all other ranges.

Input coupling: selectable AC, DC, or OFF for both + and - inputs. Off position disconnects signal input and grounds amplifier input for reference.

Input RC: 1 megohm shunted by approx 45 pF.

Maximum input: ± 400 V (dc + peak ac).

Input isolation: ≥ 80 dB between channels at 500 kHz with shielded connectors.

Triggering

Source: on channel A signal for A, Chop, or Alternate displays; on channel B signal for B, Chop, or Alternate; on composite A and B for alternate.

Frequency: dc to > 500 kHz on signals causing 0.5 div or more vertical deflection in all display modes except Chop. DC to 100 kHz in Chop.

General

Weight: net, 3 $\frac{1}{2}$ lbs (1.6 kg); shipping, 6 $\frac{1}{2}$ lbs (3.0 kg).

Environment: same as Model 180C/D mainframe.

Price: Model 1806A Dual Differential Vertical Amplifier, \$675.

Accessories furnished: two BNC to dual banana plug binding post adapters. HP Part No. 1250-1264.

Recommended probes (not supplied with Model 1806A): Models 10001A/B, 10002A/B, 10003A, 10007B; 10008B, and 10012B. Refer to oscilloscope accessories for more information.

OSCILLOSCOPES



100 MHz, DUAL CHANNEL 5 mV/div, High Z or 50 ohm inputs Model 1805A

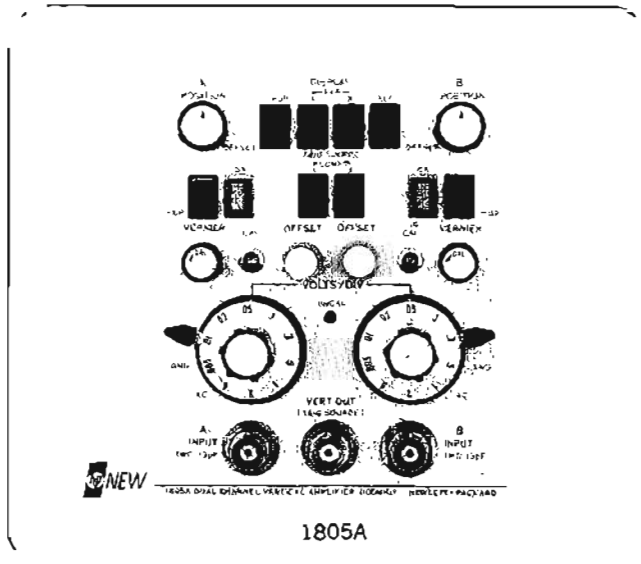

Description, 1805A

Model 1805A, 100 MHz vertical amplifier provides accurate measurements for both digital and analog design and troubleshooting. A selectable high impedance with low input capacitance or 50 ohm input provides accurate pulse and CW measurements. Other features that provide accurate, convenient measurements are: flexible triggering, 5 mV/div to 5 V/div deflection factors from dc to 100 MHz on all ranges, selectable display polarity on each channel, and up to ± 200 divisions of offset.

A new planar attenuator of thick film design now makes it possible to have both a low capacitance, high impedance input for probing and a precision 50 ohm input for transmission line measurements. In the high Z position (ac/dc) a 1 megohm input with only 13 pF shunt capacitance is established. This extremely low capacitance provides minimal loading in all probing applications, which can be reduced even further by using 10:1 divider probes. For precision 50 ohm measurements, a terminated 50 ohm input may be selected with a front panel switch. The internal termination is maintained at a high degree of quality by compensating for the normal scope input capacitance, which cannot be accomplished with an external termination. The internal termination also makes possible the high 10 volt maximum input capability.

Active probes are also available to reduce circuit loading while retaining the precision 50 ohm input measurement capability. Probe capacitance with the 1120A and its divider tips is less than 1 pF and with the 10020A passive resistive divider is less than 0.7 pF.

The dc offset capability of ± 200 div makes measurements easy with low level non-symmetrical logic. This dc offset allows dc offset on logic pulses to be restored while maintaining the low frequency pulse characteristics necessary in most logic measurements.

Timing measurements are fast and easy with the selection of trigger source from channel A or B or composite of A and B. This allows you to trigger on either channel while viewing the time relationship with the other channel or by selecting composite triggering each channel is individually triggered.

Specifications, 1805A

Modes of operation: channel A; channel B; channels A and B displayed alternately on successive sweeps (ALT); channels A and B displayed by switching between channels at approx 600 kHz rate (CHOP), with blanking during switching channel A plus channel B (algebraic addition).

Each channel (2)

Bandwidth: (3 dB down from 8 div reference signal from a terminated 50 ohm source).

DC-coupled: dc to 100 MHz.

AC-coupled: approx 10 Hz to 100 MHz.

Rise time: < 3.5 ns (measured from 10% to 90% points of 6 div input step from a terminated 50 ohm source).

Deflection factor

Ranges: 5 mV/div to 5 V/div (10 calibrated positions) in 1, 2, 5 sequence.

Attenuator accuracy: $\pm 2\%$.

Vernier: provides continuous adjustment between deflection factor settings and extends maximum deflection factor to at least 12.5 V/div. Uncalibrated light indicates when vernier is not in CAL position.

Dynamic range: 6 div at 100 MHz increasing to 16 div at ≤ 15 MHz.

Positioning range: 16 div.

Offset: ± 200 div; maximum offset on 2 volt range and above is limited by 300 volt maximum input voltage specification.

Polarity: + up or - up, selectable.

Signal delay: input signals are delayed sufficiently to view leading edge of input pulse without advanced trigger.

Input coupling: selectable, ac and dc (high impedance), 50 ohms, or ground. Ground position disconnects input connector and grounds amplifier input.

Input (selectable)

1 megohm: 1 megohm $\pm 1\%$ shunted by approx 13 pF.

50 ohm: 50 ohms $\pm 1\%$. VSWR, 1.35 at 100 MHz on 5 mV/div range and 1.1 at 100 MHz on all other ranges.

Maximum input

1 megohm: ± 300 V (dc + peak ac) at 1 kHz or less; ± 150 V (dc + peak ac) on 5 mV/div range at 1 kHz or less.

50 ohm: 10 V rms (dc-coupled input).

A + B operation

Amplifier: bandwidth and deflection factors are unchanged; either channel may be inverted for $\pm A \pm B$ operation.

Differential input (A-B) common mode: for frequencies from dc to 1 MHz, CMRR is > 40 dB for common mode signals up to 16 div and 20 dB from 1 MHz to 100 MHz for common mode signals up to 6 div.

Triggering

Source: selectable from channel A, channel B, or composite (A - B) signal in any display mode.

Frequency: dc to 75 MHz on signals causing 0.5 div p-p increasing to 1 div at 100 MHz or more vertical deflection in all display modes except dc to 100 kHz in chop mode.

Vertical signal output

Source: channel A, channel B, or channels A + B selected by Trigger Source.

Amplitude: approx 50 mV/div of display into 50 ohms for on screen signals not exceeding dynamic range specifications.

Bandwidth: dc to approx 80 MHz into 50 ohms.

General

Weight: net, 5 lbs (2.3 kg); shipping, 8 lbs (3.6 kg).

Environment: same as Models 180C/D.

Accessories furnished: two 10:1 voltage divider probes.

Price: Model 1805A Dual Channel Vertical Amplifier \$1400

250 to 600 MHz VERTICALS

10 mV/div to 250 MHz, large signal to >600 MHz
Models 1830A, 1831A, 1831B



OSCILLOSCOPES

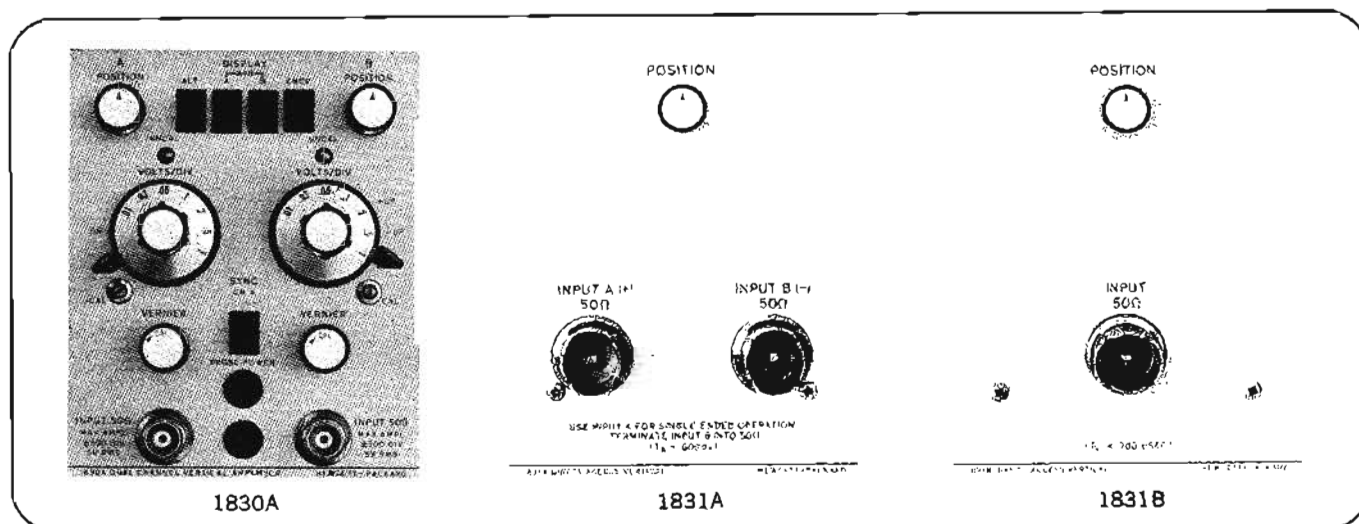

Specifications, 1830A

Modes of operation: channel A alone, channel B alone, channels A and B displayed alternately on successive sweeps (ALT), channels A and B displayed by switching (time shared) between channels, chop frequency of approx 250 kHz, channel A plus channel B, and by inverting channel B, channel A minus channel B.

Each channel (2)

Bandwidth: dc to 250 MHz, 3 dB down from 6 div reference signal at 10 MHz from a 50 ohm source.

Risetime: ≤ 1.5 ns, 10% to 90% with 6 div input step with a risetime of ≤ 200 ps from a 50 ohm source.

Pulse response: overshoot, ringing, flatness (combined), $< \pm 3\%$; preshoot, $< 0.5\%$.

Deflection factor

Ranges: from 0.01 V/div to 1 V/div (7 positions) in 1, 2, 5 sequence. $\pm 3\%$ attenuator accuracy (front panel Cal adjust).

Vernier: continuously variable between all ranges, extends maximum deflection factor to approx 2.5 V/div. Vernier UNCAL (uncalibrated) light indicates when vernier is not in the calibrated position.

Polarity: + up or - up selectable on channel B.

Signal delay: > 55 ns, which allows viewing the leading edge of a pulse without external delay or advanced trigger.

Drift: short term drift/min. and long term drift/hr, ≤ 0.05 div after $\frac{1}{2}$ hr from turn-on and at constant ambient temperature.

Input R: 50 ohms.

Maximum input: 5 V rms or ± 500 div peak, whichever is less.

VSWR: ≤ 1.30 on 10 mV/div and ≤ 1.20 from 20 mV/div to 1.0 V/div at 250 MHz.

Reflection coefficient: $\leq 10\%$ on 10 mV/div and $\leq 5\%$ from 20 mV/div to 1.0 V/div. Measured with 1 ns risetime TDR.

A + B operation: amplifier meets independent channel specifications for risetime and bandwidth. Channel B may be inverted for A minus B operation.

Triggering

Source: channel A or composite (on displayed signal) in all display modes.

Frequency: dc to > 250 MHz on signals causing 1 div or more vertical deflection in all modes (with Model 1840A and 1841A Time Bases).

General

Probe power: provides power for operating two Hewlett-Packard probes.

Weight: net, 5 lbs (2,3 kg); shipping, 8 lbs (3,6 kg).

Environment: same as 183 mainframe.

Price: Model 1830A, 250 MHz Vertical Amplifier \$900

Specifications, 1831A and 1831B

Note

These plug-ins require Option 035 to the 183 mainframes and the 1840A time base.

Vertical

Bandwidth: < 20 kHz to > 600 MHz (1831A), > 500 MHz (1831B).

Rise time: < 600 ps (1831A), < 700 ps (1831B).

Pulse response: $< 5\%$ overshoot; $< \pm 5\%$ perturbations with 350 ps rise time step input from a 50 ohm source; $< 6\%$ tilt for a 1 μ s wide pulse at 25°C and $< 10\%$ tilt from 0°C to 55°C.

Deflection factor: 5.75 V/div, $\pm 10\%$.

Input characteristics

Input R: 50 ohms, single-ended or differential (1831A); single-ended (1831B).

Maximum dc input: ± 100 V dc.

Maximum ac input: 2.0 watts, 4 div p-p CW.

VSWR: $< 1.3:1$ to 750 MHz.

Input reflections: $< \pm 10\%$, measured with 150 ps TDR.

Signal delay (1831B): approx 60 ns which allows viewing leading edge of a pulse without external delay.

Internal triggering (1831B): stable to 500 MHz with signals producing $\frac{1}{2}$ div or more vertical deflection.

General

Weight: 1831A net, 2 lbs (0,91 kg); shipping, 5 lbs (2,27 kg). 1831B net, 4 lbs (1,81 kg); shipping, 7 lbs (3,18 kg).

Environment: same as Model 183 mainframe.

Accessories furnished: one 50 ohm load, HP Part No. 0950-0090 (1831A only). Two mainframe termination resistors, HP Part No. 01831-61501.

Price

Model 1831A Direct Access Plug-in \$375
Model 1831B Direct Access Plug-in \$425

Options

001: 100 ohm input for 1831A. Specifications for model 1831A Option 001 are the same as Model 1831A except as follows:

Bandwidth: < 10 kHz to > 600 MHz.

Deflection factor: 5 V/div, $\pm 10\%$.

Input R: 100 ohms, single-ended or differential.

Tilt: $< 3\%$ for a 1 μ s wide pulse at 25°C; $< 5\%$ from 0°C to 55°C.

Maximum ac input: 2 watts, i.e. 8 div p-p CW.



2 CHANNEL/1 GHz SAMPLER

Easy-to-use, internal triggering

Model 1810A

Description, 1810A

Model 1810A is a 1 GHz, dual channel double-size sampling plug-in for use in all 180 series oscilloscope mainframes. Easy-to-use controls, operate and look like real-time plug-ins which reduces familiarization time and possible measurement errors. You can make accurate measurements of repetitive signals from dc to greater than 1 GHz with deflection factors of 2 mV/div to 200 mV/div without the problems encountered with previous, specialized sampling controls.

A unique sampling circuit maintains a sampling efficiency at 100% for all input signal levels, which eliminates time consuming external adjustments and false triggering. Other internal circuit improvements reduce internal adjustments to a minimum, and they are non-interacting, for fast calibration. Internal delay lines allow triggering on the displayed waveform without requiring an external pre-trigger. By adding 50 ohm impedance converter probes, 1120A, the 1810A can be used for general purpose probing with minimum circuit loading with very low probe shunt capacitance. Power for two Hewlett-Packard active probes is provided through the front panel power jacks or an 1122A probe power supply may be used for up to four probes.

Specifications, 1810A

Modes of operation: channel A; channel B; channels A and B displayed on alternate samples (ALT); channel A plus channel B (algebraic addition); and channel A versus channel B.

Vertical channels

Bandwidth: dc to 1 GHz.

Rise time: <350 ps.

Pulse response: <3% (overshoot and perturbations).

Deflection factor

Ranges: 2 mV/div to 200 mV/div (7 calibrated positions) in 1, 2, 5 sequence.

Accuracy: $\pm 3\%$.

Vernier: provides continuous adjustment between all deflection factor ranges; extends minimum deflection factor to <1 mV/div.

Polarity: + UP or - UP.

Dynamic range: >1.6 V.

Positioning range: $> \pm 1$ V on all deflection factors.

Input R: 50 ohms, $\pm 2\%$.

Maximum input: ± 5 V (dc + peak ac).

VSWR: <1.1:1 to 300 MHz, increasing to <1.5:1 at 1 GHz.

Reflection coefficient: <6%, measured with HP Model 1415A TDR.

Noise

Normal: <2 mV, observed from center 80% of dots.

Filtered: <1 mV.

Isolation between channels: ≥ 40 dB with 350 ps rise time input.

Time difference between channels: <100 ps.

A + B operation: bandwidth and deflection factors are unchanged; either channel may be inverted for $\pm A \pm B$ operation.

Vertical outputs: an uncalibrated, 1 V vertical output signal from each channel is provided at the rear panel of 180 system mainframes.

Time base

Ranges

Normal: 10 ns/div to 50 μ s/div (12 calibrated positions) in a 1, 2, 5 sequence. $\pm 3\%$ accuracy with vernier in calibrated position.

Expanded: direct reading expansion up to X100 in seven calibrated steps on all normal time scales, extends the range to 100 ps/div. Accuracy is $\pm 4\%$ (10 ps/div, $\pm 10\%$ using the mainframe magnifier).

Vernier: continuously variable between ranges; increases fastest sweep to <40 ps/div.

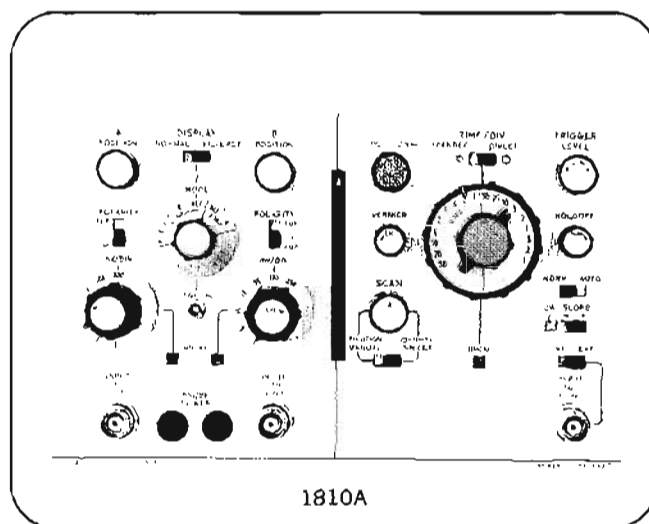

Triggering Mode

Normal: trigger level control can be adjusted to trigger on a wide variety of signals.

Automatic: triggers automatically on most signals with a minimum of adjustment of the level control. A baseline is displayed in the absence of an input signal.

Source: selectable; channel A triggers channel A or alternate; channel B triggers channel B, alternate, A + B, or A vs B.

Sine wave: 30 mV p-p for signals from 1 kHz to 200 MHz, 100 mV p-p for signals from 200 MHz to 1 GHz for jitter of <30 ps plus 1% of 1 period. Useful triggering can be obtained with 5 mV signals.

Pulse: 30 mV peak, 3 ns wide pulses for <30 ps jitter. Useful triggering can be obtained with 5 mV signals.

External

Sine wave: 30 mV p-p for signals from 1 kHz to 1 GHz for jitter of <30 ps plus 1% of 1 period. Useful triggering can be obtained with 5 mV signals.

Pulse: 30 mV peak, 3 ns wide pulses for <30 ps jitter. Useful triggering can be obtained with 5 mV signals.

Either internal or external

Auto: 50 mV p-p for CW signals from 10 kHz to 200 MHz for <30 ps jitter plus 2% of 1 period (may be used to 1 GHz with increased jitter). Pulse triggering requires 50 mV peak, 3 ns wide pulses for <30 ps jitter.

Level and slope: continuously variable from +800 mV to -800 mV on either slope of sync signal.

Coupling: ac coupling attenuates signals below approx 1 kHz.

Variable holdoff: variable over at least a 3:1 range in all sweep modes.

Marker position: intensified marker segment indicates point about which the sweep is to be expanded (automatically dimmed with increasing persistence in 181A and 181AR mainframes).

Scan

Internal: dot density, continuously variable from <100 to >1000 dots full screen or from approx 500 to >2000 dots in filtered mode.

Manual: scan is positioned manually by front panel control.

Horizontal output: an uncalibrated approx 0.75 V amplitude signal is provided at the rear panel of a 180 or 181 mainframe.

General

Probe power: supplies power to operate two Hewlett-Packard active probes.

Weight: net, 7 lbs (3,2 kg); shipping, 12 lbs (5,4 kg).

Environment: same as Model 181A/AR mainframes.

Price: Model 1810A 1 GHz Sampling, \$1650.

2 CHANNEL/18 GHz SAMPLER

Easy-to-use, 10 ps time scale

Model 1811A



OSCILLOSCOPES

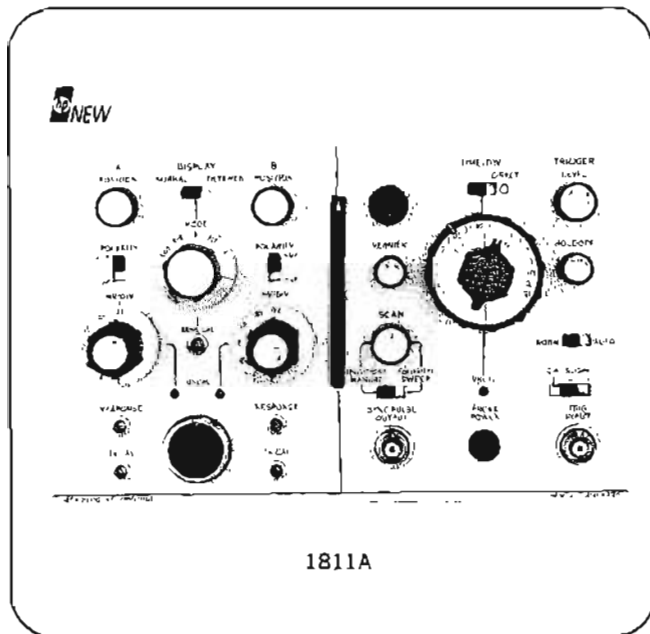

Description, 1811A

The Model 1811A sampling plug-in provides 18 GHz, dual-channel, feedthru sampling in the versatile 180 oscilloscope system. The logical arrangement of front panel controls reduces familiarization time and measurement errors and the feedthru remote sampling heads allow measurements of operating systems. Flexibility and economy is assured with this double-size plug-in since it will operate in all 180 series mainframes with a selection of standard CRTs (5-inch), large screen, variable persistence and storage, and the wideband 183 mainframes. A selection of remote sampling heads allows you to match a sampling system to a measurement problem at minimum cost.

The bridged method of extracting a signal used in this sampling system provides the optimum method of measurement since it extracts only a small amount of the waveform rather than terminating the signal in the measuring system. By using remote sampling heads connected in series with the system under test, the signal displayed is the signal that is passed through the sampler to the next stage of a system. Any problems are then displayed as they exist in the system.

The two sampling heads available are: 1430C, 1432A. Model 1432A provides 90 ps risetime capability while 18 GHz measurements are supplied by the 1430C which has a 20 ps risetime. Specifications for these sampling heads are on the following page.

18 GHz triggering with a displayed jitter of 10 ps or less is provided by a 1104A trigger countdown, 1106B tunnel diode, and 1109B high-pass filter. To allow viewing a signal without using a delay line, a trigger output is available as a signal source trigger which starts the sweep prior to display of the vertical signal.

Specifications, 1811A

Modes of operation: channel A; channel B, channels A and B displayed on alternate samples (ALT); channel A plus channel B (algebraic addition); and channel A versus channel B.

Vertical channels

Deflection factor

Ranges: 2 mV/div to 200 mV/div (6 calibrated positions) in 1, 2, 5 sequence.

Accuracy: $\pm 3\%$.

Vernier: provides continuous adjustment between all deflection factor ranges; extends min deflection factor to < 1 mV/div.

Polarity: + UP or - UP.

Positioning range: $> \pm 1$ V on all deflection factors.

Isolation between channels: ≥ 40 dB over bandwidth of the sampler.

Time difference between channels: < 100 ps.

A + B operation: bandwidth and deflection factors are unchanged; either channel may be inverted for $\pm A \pm B$ operation.

Vertical outputs: an uncalibrated, 1 V vertical output signal from each channel is provided at the rear panel of 180 system mainframes.

Time base

Ranges

Normal: 1 ns/div to 5 μ s/div (12 calibrated positions) in a 1, 2, 5 sequence. $\pm 3\%$ accuracy with vernier in calibrated position.

Expanded: direct reading expansion up to X100 in seven calibrated steps on all normal time scales, extends the range to 10 ps/div. Accuracy is $\pm 4\%$ (1 ps/div, $\pm 10\%$ using the mainframe magnifier).

Vernier: continuously variable between ranges; increases fastest sweep to < 4 ps/div.

Triggering

Mode

Normal: trigger level control can be adjusted to trigger on a wide variety of signals.

Automatic: triggers automatically on most signals with a minimum of adjustment of the level control. A baseline is displayed in the absence of an input signal.

Sine wave: 80 mV p-p for signals from 1 kHz to 1 GHz for jitter of < 10 ps plus 1% of 1 period. Useful triggering can be obtained with 5 mV signals. Triggering may be extended to 18 GHz with HP Models 1104A/1106B trigger countdown.

Pulse: 30 mV peak, 3 ns wide pulses for < 30 ps jitter. Useful triggering can be obtained with 5 mV signals.

Auto: 50 mV p-p for CW signals from 10 kHz to 200 MHz for < 30 ps jitter plus 2% of 1 period (may be used to 1 GHz with increased jitter). Pulse triggering requires 50 mV peak, 3 ns wide pulses for < 30 ps jitter.

Level and slope: continuously variable from +800 mV to -800 mV on either slope of sync signal.

Coupling: ac coupling attenuates signals below approx 1 kHz.

Variable holdoff: variable over at least a 3:1 range in all sweep modes.

Marker position: intensified marker segment indicates point about which the sweep is to be expanded (automatically dimmed with increasing persistence in 181A and 181AR mainframes).

Scan

Internal: dot density, continuously variable from < 100 to > 1000 dots full screen or from approx 500 to > 2000 dots in filtered mode.

Manual: scan is positioned manually by front panel control.

Horizontal output: an uncalibrated approx 0.75 V amplitude signal is provided at the rear panel of a 180 or 181 mainframe.

Trigger output: 1 ns, 1.5 V into 50 ohms.

General

Probe power: supplies power to operate one Hewlett-Packard active probe.

Environment: same as Models 180C/D mainframes.

Weight: net, 5 lbs (2.3 kg); shipping, 10 lbs (4.5 kg).

Price: Model 1811A Sampler, \$1700.



FEED THRU SAMPLING HEADS

4 or 18 GHz, Low reflection coefficients
Models 1430C, 1432A

Description, sampling heads

Models 1430C and 1432A provide accurate measurements of CW and fast rise pulses. The sampler is of feedthru design allowing measurements to be made using the system as a load rather than using an artificial internal termination. These remote samplers are connected to the scope by a five-foot cable which allows the head to be placed at the signal source to eliminate high frequency lossy lines.

Model 1430C provides 20 ps rise time with low overshoot for accurate measurements of fast rise pulses and CW signals to 18GHz. While the feedthru measurement technique allows measurements of an operating system, terminated measurements can also be made with the 50 ohm loads (Model 909A Option 012) that are supplied.

The 1432A provides 90 ps risetime (4 GHz) measurements for lower frequency measurements than the 1430C. Feedthru or terminated measurement may also be obtained with this sampler and the two 50 ohm loads that are supplied.

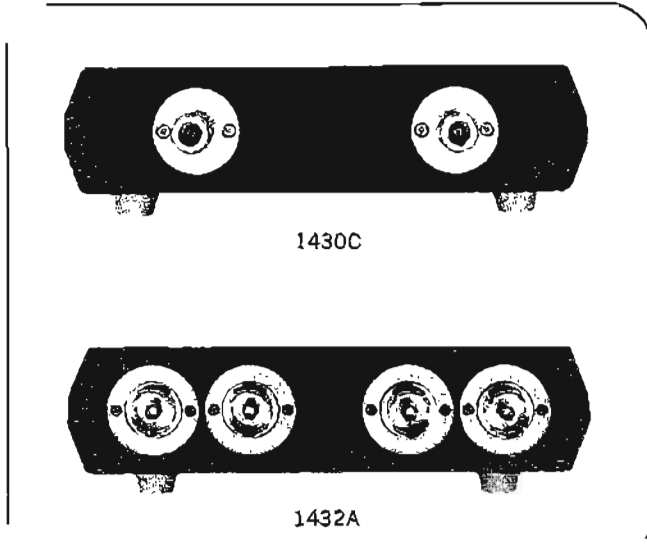

Specifications, 1430C

Rise time: approx 20 ps (<28 ps observed with 1105A/1106B pulse generator and 909A Option 012 50 ohm load).

Bandwidth: dc to 18 GHz.

Overshoot: <7.5%.

Noise: 10 mV unsmoothed; 2.5 mV smoothed. Both measured tangentially.

Dynamic range: ± 1 volt.

Low frequency distortion: < $\pm 5\%$.

Maximum safe input: ± 3 volts.

Input characteristics

Mechanical: type N connectors on input and output ports.

Electrical: 50 ohm feedthrough, dc-coupled. Reflection from sampler is approx 10%, measured with a 40 ps TDR system.

Pulses emitted from sampler input are approx 10 mV amplitude and 5 ns duration.

Time difference between channels: < 5 ps.

Connecting cable lengths: 5 ft.

General

Weight: net, 4 lbs (1.8 kg); shipping, 9 lbs (4.1 kg).

Accessories provided: two 50 ohm loads (HP Model 909A Option H12).

Price: Model 1430C Sampling Head, \$2800.

Specifications, 1432A

Rise time: <90 ps.

Bandwidth: dc to 4 GHz.

Overshoot: < $\pm 5\%$.

Noise: approx 8 mV observed noise on CRT excluding 10% of random dots. Noise decreases on automatically filtered ranges of 5 and 2 mV/div. Smoothed position of smoothing switch reduces noise and jitter approx 4:1. Response provides continuous adjustment between normal and filtered modes.

Dynamic range: 1 V p-p.

Low frequency distortion: <3%.

Maximum safe input: ± 5 V.

Input characteristics

Mechanical: GR type 874 connectors on input and output ports.

Electrical: 50 ohm feedthrough, dc-coupled. Reflection from sampler is approx 15% measured with a 90 ps TDR system.

Pulse emitted from sampler input are approx 50 mV in amplitude and 10 ns wide.

Time difference between channels: < 25 ps.

General

Weight: net, 4 lbs (1.8 kg); shipping, 9 lbs (4.1 kg).

Accessories provided: two 50 ohm loads with GR type 874 connectors.

Price: Model 1432A Sampling Head, \$1100.

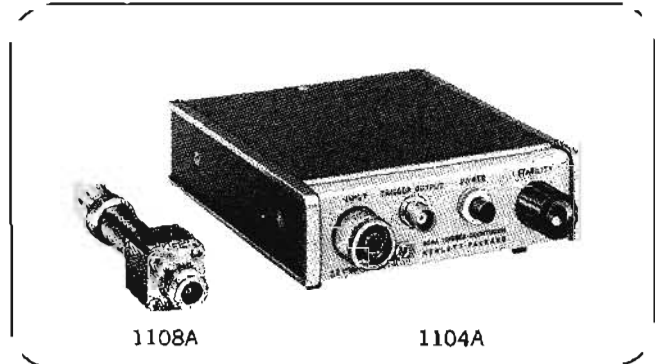

Specifications, 1104A/1106B/1108A

1104A/1106B/18 GHz Trigger Countdown

1104A/1108A/10 GHz Trigger Countdown

Input

Frequency range: (1106B) 1 GHz to 18 GHz. (1108A) 1 GHz to 10 GHz.

Sensitivity: (1106B) signals 100 mV or larger and up to 12.4 GHz, produce <20 ps of jitter (200 mV required to 18 GHz).

(1108A) signals up to 50 mV or larger and up to 10 GHz, produce <20 ps of jitter.

Maximum safe input: ± 1 V.

Input impedance: (1106B) 50-ohm Type N input connector.

(1108A) 50-ohm GR-874 input connector. Reflection from input connector is <10% using a 40 ps TDR system.

Signal appearing at input connector: approximately 250 mV.

Output

Center frequency: approximately 100 MHz.

Amplitude: typically 150 mV.

General

Weight

1104A: net, 2 lbs (0.9 kg); shipping, 4 lbs (1.8 kg).

1106B or 1108A: net, 1 lb (0.5 kg); shipping, 2 lbs (0.9 kg).

Price: HP Model 1104A, \$200. HP Model 1106B, \$550. HP Model 1108A, \$200.

Recommended accessory: HP Model 1109B/1129A High Pass Filter.

LOW COST TIME BASES

Single & delayed; 150 & 50 MHz triggering
Models 1820C, 1821A



OSCILLOSCOPES

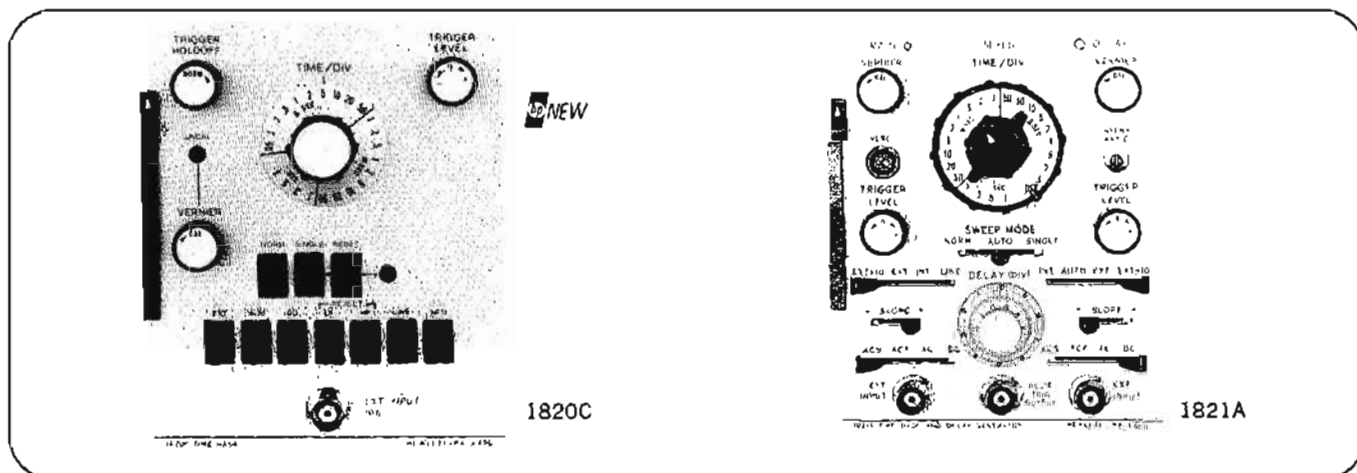

Specifications, 1820C Time base

Sweep

Ranges: 50 ns/div to 1 s/div (23 positions) in 1, 2, 5 sequence. $\pm 3\%$ accuracy with vernier in calibrated position.

Vernier: continuously variable between ranges, extends slowest sweep to at least 2.5 s/div. Uncalibrated light indicates when vernier is not in CAL position.

Magnifier: (on mainframe) expands fastest sweep to 5 ns/div.

Sweep mode

Normal: triggered by an int, ext or power line signal.

Automatic: bright baseline displayed in absence of trigger signal. Triggering is same as Normal except low frequency limit is 40 Hz.

Single: in Normal, sweep occurs once with same triggering as Normal; reset pushbutton arms sweep and lights indicator; in Auto, sweep occurs once each time reset pushbutton is pressed.

Triggering

Internal: refer to vertical amplifier plug-in specifications.

External: dc to 50 MHz on signals 50 mV p-p or more increasing to 150 mV at 150 MHz.

Line: power line frequency signal.

Level

Internal: at any point on the vertical waveform displayed.

External: continuously variable from +2 V to -2 V on either slope of trigger signal, from +20 V to -20 V $\div 10$ setting.

Slope: pushbutton selects + or - slope of trigger signal.

Coupling: front panel selection of AC, DC, HF Reject, or LF Reject. AC attenuates signals below approx 20 Hz, LF Reject attenuates signals below approx 15 kHz, HF Reject attenuates signals above approx 15 kHz.

Trigger holdoff: time between sweeps continuously variable, exceeding on full sweep on all ranges.

General

Environment: same as Models 180C/D mainframes.

Weight: net, 3 lbs (1,4 kg); shipping, 7 lbs (3,2 kg).

Price: Model 1820C Time Base, \$400.

Specifications, 1821A Delayed Time Base Main time base

Sweep

Ranges: 0.1 μ s/div to 1 s/div (22 positions) in 1, 2, 5 sequence. $\pm 3\%$ accuracy with vernier in CAL position.

Vernier: continuously variable between all ranges; extends slowest sweep to at least 2.5 s/div.

Magnifier: (on mainframe) expands fastest sweep to 10 ns/div.

Sweep mode

Normal: triggered by an int, ext, or power line signal.

Automatic: bright baseline displayed in absence of input signal.

Triggering same as normal except low frequency limit is 40 Hz for internal or external modes.

Single: sweep occurs once with same triggering as normal; reset pushbutton with armed indicator light.

Triggering

Internal: refer to vertical amplifier plug-in specifications.

External: from dc to 50 MHz on signals 0.5 V p-p or more, increasing to 1 V p-p at 100 MHz.

Line: power line frequency signal.

Level and slope: internal, at any point on the vertical waveform displayed; external, variable from +3 V to -3 V on either slope of the sync signal; from +30 V to -30 V in $\div 10$ setting.

Coupling: (AC, DC, ACF, or ACS). AC attenuates signals below ≈ 20 kHz, ACF (ac-fast) attenuates signals below ≈ 15 kHz, ACS (ac-slow) attenuates signals above ≈ 30 kHz.

Trace intensification: intensifies that part of Main time base to be expanded to full screen on Delayed time base. Rotating Delayed time base sweep switch from Off position activates intensified mode. Front panel screwdriver adjust sets relative intensity of brightened segment.

Delayed time base

Sweep

Ranges: 0.1 μ s/div to 50 ms/div (18 positions) in 1, 2, 5 sequence. $\pm 3\%$ accuracy with vernier in CAL position.

Vernier: continuously variable between all ranges; extends slowest sweep to at least 125 ms/div.

Triggering: applies to intensified Main, Delayed, and Mixed time base triggering.

Internal: refer to vertical amplifier plug-in specifications.

Automatic: triggers at end of set time delay.

External: same as main time base.

Level and slope: same as main time base.

Coupling: same as main time base.

Delay (before start of Delayed sweep)

Time: continuously variable from 0.1 μ s to 10 s.

Accuracy: $\pm 1\%$. Linearity. $\pm 0.2\%$. Time jitter, $< 0.005\%$ (1 part in 20,000) of maximum delay of each step.

Trigger output: (at end of Delay time) approx 1.5 V with < 50 ns risetime from 1000 ohm source resistance.

Mixed time base: dual time base in which Main time base drives first portion of sweep and delayed time base completes sweep at up to 1000 times faster. Also operates in single sweep mode.

General

Weight: net, 4 lbs (1,8 kg); shipping, 7 lbs (3,1 kg).

Environment: same as Model 180C/D mainframes.

Price: Model 1821A Time Base and Delay Generator, \$700.



TIME BASE & X100 EXPANDER

5 ns/div sweep, 150 MHz triggering

Model 1824A

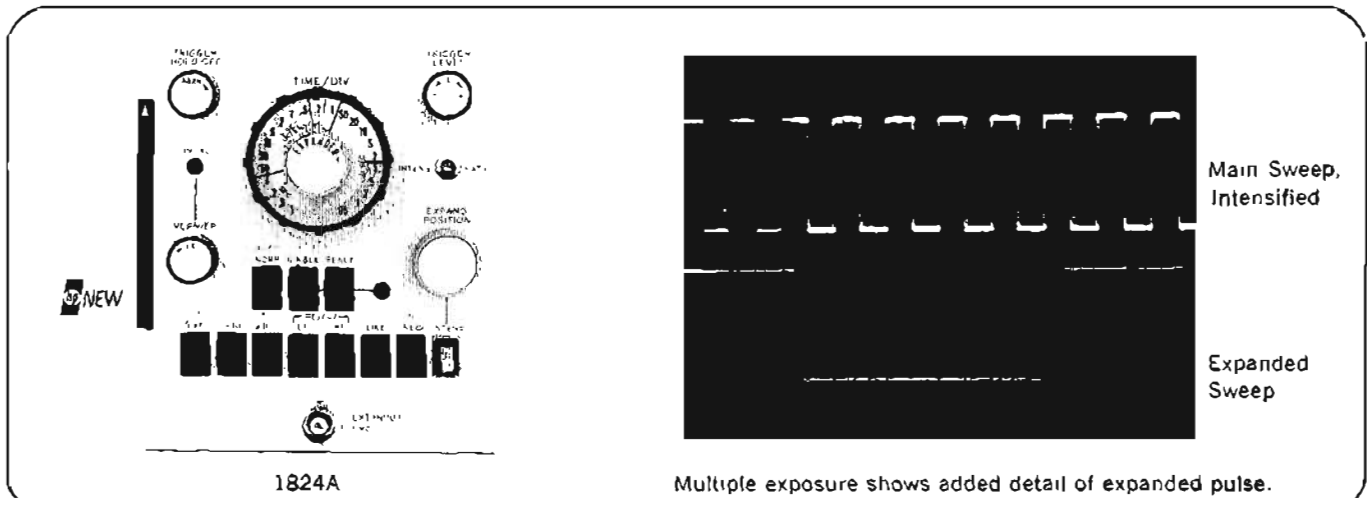

1824A

Multiple exposure shows added detail of expanded pulse.

Description, 1824A

Model 1824A time base and sweep expander plug-in is designed for use in all 180 series mainframes including the 183 wide band mainframes. This plug-in allows sweep expansions up to 100 times with 3% accuracy, 5 ns sweep speeds, and triggering to 150 MHz.

The expanded sweep feature allows detailed examination of selected portions of a display where time delay measurements are not of importance. This provides sweep expansion measurement capability without the expensive delay generator features for your applications. Expansions of 100 times are available and the time/div dial gives a direct readout of the expanded time/div, preventing many measurement errors. Convenient setup is provided by a trace intensification feature that selects the starting point of the portion of a sweep that will be expanded to full screen. Expanded sweep position is continuously variable over the center 9 divisions of the main sweep.

Pushbutton controls make operation easy with a minimum chance for error and an automatic trigger mode displays a baseline in absence of a trigger signal. A trigger hold off control provides for stable triggering on complex waveforms or a particular pulse in a digital word may be selected to trigger a display. Additional trigger flexibility is provided by complete selection of the trigger parameters which includes: ac or dc coupling, low or high frequency rejection, positive or negative slope, and a ± 10 mode that provides wider dynamic range of input signals. A trigger level control allows selection of the trigger signal at any point on the displayed signal or a ± 2 volt external signal.

An external trigger input sensitivity of 50 mV adds to the versatility of this plug-in by allowing 10:1 divider probe to be used with 0.5 V logic circuits. This allows standard probes to be used to reduce circuit loading at trigger pick-off points and reduces the possibility of circuit malfunction caused by the measuring instrument.

Specifications, 1824A

Time base

Sweep

Ranges: 50 ns/div to s/div (23 calibrated positions) in 1, 2, 5 sequence. $\pm 3\%$ accuracy with vernier in calibrated position.

Vernier: continuously variable between ranges, extends slowest sweep to at least 2.5 s/div. Uncalibrated light indicates when vernier is not in calibrated position.

Magnifier: (on mainframe) expands fastest sweep to 5 ns/div.

Expanded sweep

Expander: direct reading expander control provides up to 100 times sweep expansion, accuracy $\pm 3\%$. Expand position control selects part of basic time scale to be expanded, continuously variable from 0.5 div of sweep start to 9.5 div of basic time scale.

Trace intensification: front panel switch selects intensified mode for use in establishing start of expanded display. A front panel adjustment sets relative intensity of brightened segment.

Sweep mode

Normal: sweep is triggered by an internal, external, or power line signal.

Automatic: bright baseline displayed in absence of input signal. Triggering same as Normal except low frequency limit is 40 Hz.

Single: in normal, sweep occurs once with same triggering as Normal; reset pushbutton arms sweep and lights indicator; in Auto, sweep occurs once each time reset pushbutton is pressed.

Triggering

Internal: refer to vertical amplifier plug-in specifications.

External: dc to 50 MHz on signals of 50 mV p-p or more, increasing to 100 mV p-p at 100 MHz and 150 mV p-p at 150 MHz.

Line: power line frequency signal.

Level

Internal: at any point on the vertical waveform displayed.

External: continuously variable from +2 V to -2 V on either slope of trigger signal; from +20 V to -20 V in ± 10 setting.

Slope: pushbutton selects either positive or negative slope of trigger signal.

Coupling: front panel selection of AC, DC HF Reject or LF Reject.

AC: attenuates signals below approx 20 Hz.

LF Reject: attenuates signals below approx 15 kHz.

HF Reject: attenuates signals above approx 15 kHz.

Trigger holdoff: time between sweeps continuously variable. Exceeds one full sweep on all ranges.

General

Environment: same as Models 180C/D mainframes.

Price: Model 1824A Time Base and Sweep Expander, \$550.

DELAYED SWEEP GENERATOR

5 ns/div sweep, 150 MHz triggering
Model 1825A



OSCILLOSCOPES

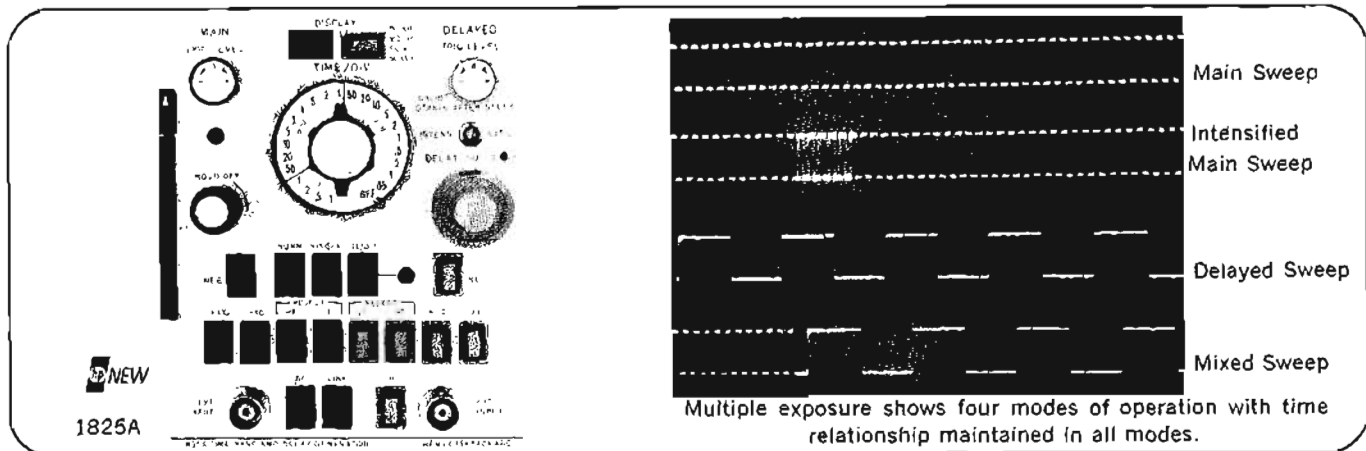

Description, 1825A

Model 1825A time base and delay generator provides sweep speeds ranging from 0.05 $\mu\text{s}/\text{div}$ to 1 s/div in 23 positions. Delay times are continuously variable from 50 ns to 10 s and are accurate to $\pm 1\%$ also a calibrated mixed sweep mode is provided. A mainframe X10 magnifier provides sweep-speeds to 5 ns/div with 5% accuracy.

One knob control makes stable triggering on signals easy in main, delayed, and mixed modes. Stable, accurate time displays are provided in main, delayed, and mixed modes with the highly sensitive 50 mV trigger capability at 50 MHz which increases to only 150 mV at 150 MHz. Trigger synchronization is maintained when switching between main, delayed, and mixed modes further simplifying use.

Front panel controls are logically arranged for quick familiarization and easy use. Pushbuttons eliminate front panel clutter and reduce the possibility of errors. Sweep mode pushbuttons make it easy to establish main, delayed, and mixed modes.

Trigger level controls on main and delayed sweeps allow selection on the desired portion of the signal for almost every measurement application. Also, the ± 10 function provides a wide dynamic range of triggering in both external and internal modes of operation.

External trigger sensitivity of 50 mV on both main and delayed sweeps allows a 10:1 divider probe to be used with 0.5 volt logic circuits. This allows probes to be used to reduce circuit loading at trigger pickoff points and reduces the possibility of circuit malfunction caused by the measuring instruments.

Specifications, 1825A

Main time base

Sweep

Ranges: 0.05 $\mu\text{s}/\text{div}$ to 1 s/div (23 positions) in 1, 2, 5 sequence. $\pm 3\%$ accuracy with vernier in calibrated position.

Vernier: continuously variable between ranges, extends slowest sweep to at least 2.5 s/div. Uncalibrated light indicates when vernier is not in CAL position.

Magnifier: (on mainframe) expands fastest sweep to 5 ns/div.

Sweep mode

Normal: sweep is triggered by an internal, external, or power line signal.

Automatic: bright baseline displayed in absence of trigger signal. Triggering is same as Normal except low frequency limit is 40 Hz.

Single: in Normal, sweep occurs once with same triggering as Normal; reset pushbutton arms sweep and lights indicator; in Auto, sweep occurs once each time reset pushbutton is pressed.

Delayed time base: delayed time base sweeps after a time delay set by Main time base and Delay controls. Delayed time base is triggered on first triggering pulse after set delay or automatically triggers after set delay when delayed level control is in detent position.

Sweep

Ranges: 0.05 $\mu\text{s}/\text{div}$ to 20 ms/div (18 positions) in 1, 2, 5 sequence. $\pm 3\%$ accuracy.

Magnifier: (on mainframe) expands fastest sweep to 5 ns/div.

Triggering: Main or Delayed time base.

Internal: refer to vertical amplifier plug-in specifications.

External: dc to 50 MHz on signals 50 mV p-p or more increasing to 100 mV p-p at 100 MHz and 150 mV p-p at 150 MHz.

Line: power line frequency signal. (Main only.)

Level

Internal: at any point on the vertical waveform displayed.

External: continuously variable from +2 V to -2 V on either slope of trigger signal, from ± 20 V to ∓ 20 V in ± 10 setting.

Slope: pushbutton selects either positive or negative slope of trigger signal.

Coupling: front panel selection of AC, DC, HF Reject, or LF Reject.

AC: attenuates signals below approx 20 Hz.

LF Reject: attenuates signals below approx 15 kHz.

HF Reject: attenuates signals above approx 15 kHz.

Trigger holdoff: time between sweeps continuously variable, exceeding one full sweep on all ranges. (Main only.)

Delay (before start of delayed sweep)

Time: continuously variable from 50 ns to 10 s.

Accuracy: $\pm 1\%$. Linearity: $\pm 0.2\%$.

Time jitter: 0.002% (1 part in 50,000) of maximum delay on each range.

Trace intensification: in Main sweep mode, intensifies that part of main time base to be expanded to full screen in delayed time base mode. In Mixed mode, intensifies that part of Main time base to be completed by Delayed time base. Rotating time base switch from OFF position activates intensified mode.

Calibrated mixed sweep: combines Main and Delayed sweeps into one display. Sweep is started by the Main time base and is completed by the faster Delayed time base. Delayed sweep start is aligned with start of intensified marker.

General

Weight: net, 4 lbs (1.8 kg); shipping, 7 lbs (3.1 kg).

Environment: same as Models 180C/D mainframes.

Price: Model 1825A Time Base and Delay Generator, \$800.



TIME BASE

1 ns/div sweep; 500 MHz triggering
Model 1840A

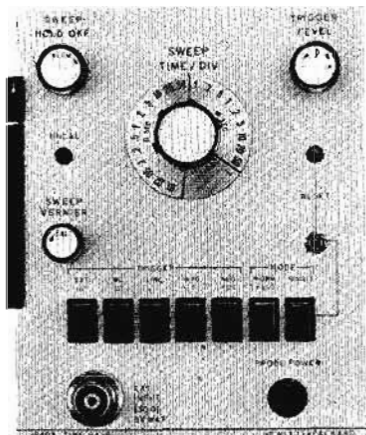

1840A

- 1 knob triggering to 500 MHz
- 50 mV trigger sensitivity
- 1 ns/div sweep speeds
- Simplified front panel controls

Description, 1840A

The 1840A Time Base provides stable one knob internal triggering from an 1830A to 250 MHz or from an 1831B to 500 MHz. External triggering to 250 MHz is provided with 20 mV input and increases to 500 MHz with 50 mV input signals. Trigger functions are controlled with convenient push-buttons which simplify panel layout and operation. A variable hold off control achieves a stable display of pulse groups by allowing triggering on a particular pulse in a group.

Sweep times are selectable from 10 ns/div to 0.1 sec/div and with the mainframe X10 magnifier a sweep speed of 1 ns/div is available. The single sweep mode of operation in

the 1840A is fully compatible with the 183 pulsed flood gun mode of operation which increases photographic writing speed. Fast single-shot events can be photographed and the film "post fogged" by synchronizing flood gun operation with the single sweep, which allows the camera shutter to be left open for the event.

Option 001 for the 1840A is available for applications involving high amplitude external trigger signals. This option provides selectable trigger levels of ± 5 volts or ± 25 volts and will withstand peak input pulses of 100 volts with 10 μ s duration.

Specifications, 1840A

Time base

Sweep

Ranges: from 10 ns/div to 0.1 s/div in 1, 2, 5 sequence. $\pm 3\%$ accuracy with vernier in calibrated position.

Vernier: continuously variable between all ranges, extends slowest sweep to at least 0.25 s/div.

Magnifier (on mainframe): extends fastest sweep to 1 ns/div with $\pm 5\%$ accuracy.

Sweep mode

Normal: sweep is triggered by an internal, external, or power line signal.

Automatic: bright baseline displayed in absence of trigger signal.

Single: sweep occurs once with Normal trigger conditions. Sweep may be reset with front panel pushbutton or electrically with rear panel input signal. Front panel light indicates when sweep is reset.

Triggering

Internal: refer to vertical amplifier plug-in specifications.

External: dc* to >250 MHz with signals of 20 mV p-p or more increasing to 50 mV, at 500 MHz. Input R, 50 ohms. $\div 10$ trigger attenuator allows wider dynamic range of Ext trigger input.

* (Automatic triggering is same as normal except low frequency limit is 5 Hz for internal and external triggering.)

Line: power line frequency trigger signal.

Level and slope

Internal: at any point on the displayed vertical waveform.

External: continuously variable from -100 mV to $+100$ mV in $\div 1$ and $+1.0$ V to -1.0 V in $\div 10$. Input R, 50 ohms nominal.

Coupling: front panel selection of ac or dc. AC attenuates signals below approx 5 kHz.

Sweep hold off: time between sweeps continuously variable exceeding one full sweep on all ranges.

General

Probe power: provides power for operating one Hewlett-Packard active probe.

Weight: net, 3 lbs (1,4 kg); shipping, 6 lbs (2,7 kg).

Environment: same as Model 183 mainframe.

Price: Model 1840A Time Base, \$650.

Options (order by option number)

001: contains attenuation and limiting circuits in the external trigger input which allows wider dynamic range of EXT trigger input levels. Specifications for the Model 1840A Option 001 are the same as Model 1840A except as follows:

External trigger input

$\div 1$ mode: 1 V p-p to 250 MHz, trigger level adjustable over ± 5 volt range.

$\div 5$ mode: 5 V p-p to 250 MHz, trigger level adjustable over ± 25 volt range.

Maximum input: 100 V peak with 10 μ s duration. Maximum continuous input, 5 V rms.

Price: Model 1840A Option 001, Time Base, add \$50.

035: eliminates sweep irregularities caused by high amplitude signals necessary for the 1831A and 1831B direct access plug-ins. This option is required for operation with 1831A or 1831B plug-ins and also requires a 183 mainframe with Option 035. No additional charge.

DELAYED SWEEP GENERATOR

1 ns/div sweeps; 500 MHz triggering
Model 1841A



OSCILLOSCOPES

- 1 knob triggering to 500 MHz
- 1 ns/div main and delayed sweeps
- Simplified front panel controls
- Indicator lights for sweep modes

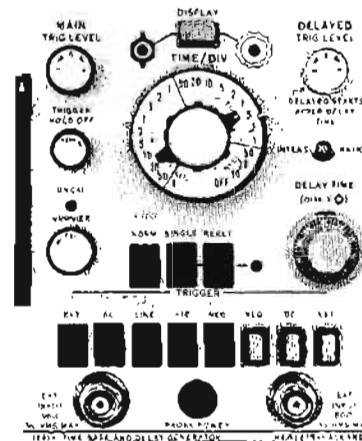

Description, 1841A

Mode 1841A Time Base and Delay Generator provides 21 sweep times ranging from 10 ns/div to 0.1 s/div. Delay times are selected by a calibrated 10-turn control across the time range set by the sweep time switch. A mainframe x10 magnifier provides 1 ns/div sweep times for both main and delayed sweeps to match the CRT writing speed.

One knob control makes triggering on rf carriers and signals even higher than the VHF range very easy. Both main and delayed sweep circuits trigger directly on 50 mV signals to 500 MHz without countdown procedures. Trigger synchroni-

zation is also maintained when switching from main to delayed or delayed to main sweeps.

Front panel controls are logically arranged for quick familiarization and easy use. Pushbutton controls for trigger functions eliminate front-panel clutter and reduce the chance for error. Sweep time controls are arranged to make it easy to read main and delayed sweep times at a glance and color coding on main and delayed controls clearly differentiate one sweep from the other. Also, front panel lights indicate the main or delayed mode of operation.

Specifications, 1841A

Main time base

Sweep

Ranges: from 10 ns/div to 0.1 s/div (22 positions) in 1, 2, 5 sequence. $\pm 3\%$ accuracy with vernier in calibrated position.

Vernier: continuously variable between all ranges, extends slowest sweep to at least 0.25 s/div.

Magnifier (on mainframe): extends fastest sweep to 1 ns/div, $\pm 5\%$.

Sweep mode

Normal: sweep is triggered by an internal, external, or power-line signal.

Automatic: bright baseline displayed in absence of a trigger signal.

Single: sweep occurs once with same triggering as normal; reset pushbutton with armed indicator light. Rear panel input (on mainframe) provides remote arming capability.

Triggering

Internal: refer to vertical amplifier plug-in specifications.

External: dc* to >250 MHz with signals of 20 mV p-p or more, increasing to 500 MHz with signals of 50 mV p-p or more. Input R, 50 ohms. Input in ± 10 , from ± 1 V to -1 V. *(Triggering in AUTO is same as normal except low frequency limit is 5 Hz.)

Line: power line frequency trigger signal.

Level and slope

Internal: at any point on the displayed vertical waveform.

External: continuously variable from -100 mV to $+100$ mV in ± 1 and 1.0 V to -1.0 V in ± 10 . Input R, 50 ohms nominal.

Trace intensification: used to set up delayed time base. Intensifies that part of main time base to be expanded to full screen on delayed time base. Moving delayed sweep switch from off position activates intensified mode. Front panel adjustment sets relative intensity of brightened segment.

Delayed time base: delayed time base sweeps after the time delay set by main time base and delay controls.

Sweep

Ranges: 10 ns/div to 1 ms/div in 1, 2, 5 sequence (16 positions). $\pm 3\%$ accuracy.

Triggering

Internal: refer to vertical amplifier plug-in specifications.

Automatic: delayed sweep is automatically triggered at end of set delay time.

External: dc to >250 MHz with signals of 20 mV p-p or more, increasing to 500 MHz on signals of 50 mV p-p or more. Input R, 50 ohms.

Coupling: front panel selection of ac or dc. AC attenuates signals below approx 5 kHz.

Delay (before start of delayed sweep)

Time: continuously variable from 50 ns to 1 s.

Accuracy: $\pm 1\%$ on 50 ms to 0.1 μ s, main sweep linearity $\pm 2\%$, time jitter is 0.005% (1 part in 20,000) of maximum delay of each step.

General

Probe power: supplies power to operate one Hewlett-Packard active probe.

Weight: net, 3.6 lbs (1.6 kg); shipping, 7 lbs (3.2 kg).

Environment: same as Model 183 mainframe.

Price: Model 1841A Time Base/Delay Generator, \$1150.



GENERAL PURPOSE TDR

Easy-to-use, economical, wide band TDR
Model 1818A

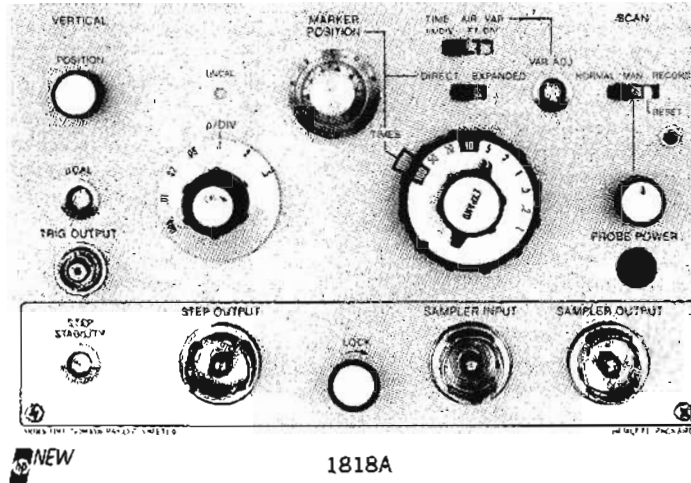

Description, 1818A

The 1818A TDR plug-in provides low cost, 150 ps TDR in the 180 oscilloscope system for the investigation of transmission systems, terminations, and components. The easy-to-use front panel controls provide quick, accurate displays with direct distance calibration of up to 500 feet and dielectric materials from $\epsilon = 1.0$ (air) to $\epsilon = 4.0$. This double-size plug-in provides a lightweight, wideband TDR system for checkout of shipboard, airborne, and remote communications equipment.

Using a "closed-loop radar" approach for investigation of a transmission system's fidelity, this system directly displays the location and magnitude of discontinuities in an analog or digital communication system. Information is lost when a signal encounters a discontinuity that causes energy to be reflected to the source. These reflections not only cause loss of amplitude in the received information but the re-reflection from discontinuities also appear as noise that is in the same format as the original signal which, if carried to extremes, could completely garble the information. This demonstrates the need for test equipment that can locate and display individual discontinuities in distance (time) and amplitude (Rho) for fast system setup or repair. While there are many instruments that can detect the presence of discontinuities, only TDR can quickly display them to allow a technician to repair them with minimum system downtime. TDR can also be used to determine the fidelity of a termination and can also be used, in the transmission mode, to determine the transmission quality of an amplifier or attenuator. In this mode of operation, the step generator signal source is applied to the device under test and the output is detected by the sampling portion of the plug-in. In the stimulus response mode, the 1818A uses the 50 ps step generator as a stimulus and the 120 ps sampling section displays the device response. This allows a waveform to be examined for risetime, delay, and pulse top aberrations. The 1818A TDR plug-in is designed for use in troubleshooting systems to provide quick, easy location of discontinuities that degrade system operation. When designing transmission systems, it is recommended that a 1815A TDR plug-in with an over-all system rise time of 35 ps be used for optimum fidelity.

Specifications, 1818A

System (in reflectometer configuration)

Rise time: <150 ps.
Overshoot: $\leq 5\%$ overshoot and ringing (down to $1/2\%$ in 2 nsec).
Internal reflections: <10% (does not limit resolution).
Reflectometer sensitivity: reflection coefficients as small as 0.002 can be observed.

Signal channel

Rise time: approx 120 ps.
Reflection coefficient: 0.5 div to 0.005/div in a 1, 2, 5 sequence.
Input: 50 ohms, feed-through type.
Noise and internal pickup, peak: 0.2% of step (terminated in 50 ohms).
Dynamic range: ± 0.5 volt.
External signal level: up to 1 V peak may be safely applied to the SAMPLER OUTPUT connector.
Attenuator accuracy: $\pm 3\%$.

Step generator

Amplitude: approx 0.25 V into 50 ohms (0.5 V into open circuit).
Rise time: approx 50 ps.
Output impedance: 50 ohms ± 1 ohm (dc-coupled).
Drop: <2% in 1 μ s.

Distance/time scale

Distance scale accuracy: $\pm 3\%$ \pm variation in air line ($\epsilon = 1$)
 1 m/div to 10 m/div.
Variable dielectric: ($\epsilon = 1$ to $\epsilon = 4$) 1 m/div to 10 m/div.
Time scale: 10 ns/div to 100 ns/div.
Magnification: X1 to X100 in a 1, 2, 5 sequence. Accuracy of the basic sweep is maintained at all magnifier settings.
Delay control: 0 to 10 div of unmagnified sweep, calibrated. Accuracy $\pm 3\%$.
Jitter: <20 ps.

General

Environment: same as Models 180C/D mainframes.
Weight: net, 3 lbs (1.4 kg); shipping, 7 lbs (3.2 kg).
Price: Model 1818A Time Domain Reflectometer, \$1200.
Accessories supplied: 2 GR elbows (HP Part No. 1250-0239).
 One 50 ohm load with GR connector (0950-0090).

HIGH RESOLUTION TDR

35 ps TDR system/12.4 GHz sampling
Models 1815A, 1815B, 1816A, 1817A



OSCILLOSCOPES

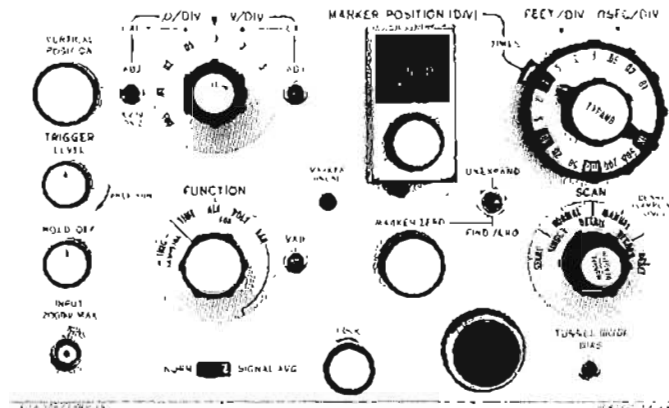

1815A

Descriptions, 1815A,B; 1816A; 1817A

Calibrated 35 ps risetime time domain reflectometry and 12.4 GHz (28 ps risetime) sampling capabilities are now available as part of the versatile 180 system oscilloscope.

The Model 1815A TDR/Sampler plug-in, a double-sized plug-in for the 180 system, can be combined with appropriate remote sampler head and tunnel diode mount to obtain a calibrated TDR system with a system risetime of 35 ps for high-resolution displays. Direct readout in feet along the line is obtained from the 1815A or in meters from the Model 1815B. Either an 1106A (20 ps) or 1108A (60 ps) tunnel diode mount is compatible for TDR with the plug-in and samplers.

The same plug-in and sampler heads used for TDR measurements also serve as either a 4 GHz or 12.4 GHz sampling system with a direct readout in time. For sampling use, there is direct triggering to 500 MHz and to 18 GHz with the Model 1104A/1106A trigger countdown.

Sampling heads, Model 1816A (90 ps risetime) and Model 1817A (28 ps risetime), are detachable, remote, single channel, feed-through samplers for convenient use in 50-ohm transmission systems. The plug-in and sampler heads provide the circuits for operating the tunnel diode pulse generators.

This calibrated TDR system allows analysis of coaxial microwave components, identifying discontinuities on the order of 0.25 inch apart. Typical components that can be analyzed are connectors, adapters, coaxial-to-circuit board transitions, loads, etc. Direct read-out in reflection coefficient, feet, or meters (optional) makes measurements faster and easier to interpret. Front panel calibration for air and polyethylene dielectrics is standard. In addition, the control allows variable calibration for different dielectrics from $\epsilon = 1$ to $\epsilon =$ approx 4.

Specifications, 1815A/B

Unless otherwise indicated, TDR and sampling performance specifications are the same. Where applicable, TDR specification is given first, followed by Sampler specification in parentheses. Model 1815A is calibrated in feet and 1815B is calibrated in meters.

Vertical

Scale: reflection coefficient ρ (volts) from 0.005/div to 0.5/div in 7 calibrated ranges; 1, 2, 5 sequence.

Accuracy: $\pm 3\%$; TDR only, $\pm 5\%$ on 0.01/div and 0.005/div in signal average mode.

Vernier: provides continuous adjustment between ranges; extends scale to >0.002 /div.

Signal average: reduces noise and jitter approx 2:1.

Horizontal

Scale: provides up to a 10,000 foot or meter display window with round-trip time or distance (time) in four calibrated decade ranges of 1/div, 10/div, 100/div, and 1000/div. Concentric expand control provides direct read-out in 28 calibrated steps in 1, 2, 5 sequence from 0.01 ns/div to 1000 ns/div or from 0.01 foot or meter/div to 1000 feet or meters/div (0.1 ns/div to 1000 ns/div).

Accuracy: time, $\pm 3\%$; distance, TDR only, $\pm 3\% \pm$ variations in propagation velocity.

Marker position: indicator, calibrated in divisions; provides direct read-out of round-trip time or distance (time), number of divisions \times decade range in units/div.

Marker zero: ten-turn control provides variable reference for marker position dial; allows direct read-out of round-trip time or distance (time) between two or more displayed events.

Zero finder: permits instant location of marker reference.

Dielectric, TDR only: calibrated for air, $\epsilon = 1$, and for polyethylene, $\epsilon = 2.25$. Also provides variable settings for dielectric constants $\epsilon = 1$ to $\epsilon =$ approx 4.

Triggering sampling only

Pulses: <50 mV for pulses 5 ns or wider for jitter <20 ps.

CW: signals from 500 kHz to 500 MHz require at least 80 mV for jitter $<2\%$ of signal period plus 10 ps; usable to 1 GHz. CW triggering may be extended to 18 GHz with HP Models 1104A/1106A trigger countdown.

General

Recorder outputs: approx 100 mV/div; vertical and horizontal outputs at BNC connectors on rear panel of mainframe.

Display modes: repetitive scan, normal or detail; single scan; manual scan; record.

Environment: same as Model 181A/AR mainframes.

Weight: net, 5 lbs (2.3 kg); shipping, 10 lbs (4.5 kg).

Price

Model 1815A TDR/Sampler (calibrated in feet) \$1250

Model 1815B TDR/Sampler (calibrated in meters) \$1250

OSCILLOSCOPES



NARROWBAND TDR

Test waveguide systems, compact, transportable
Model 1580A

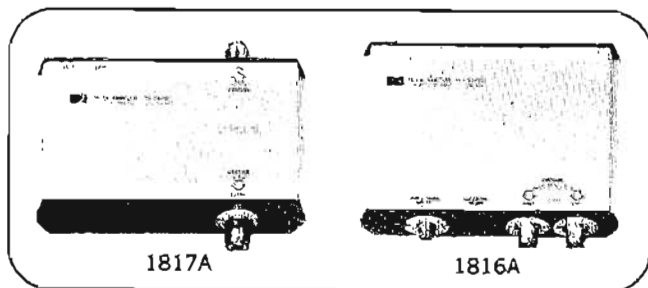

Specifications, 1817A and 1816A

Unless otherwise indicated, Model 1817A and Model 1816A specifications are the same. Where applicable, Model 1817A specifications (with Model 1106A tunnel diode mount) are given first, followed by Model 1816A specifications (in parentheses) with Model 1108A tunnel diode mount.

TDR system

System risetime: <35 ps (110 ps) incident as measured with Model 1106A (Model 1108A).

Overshoot: <±5%.

Internal reflections: <10% with 45 ps (145 ps) TDR; use reflected pulse from shorted output.

Jitter: <15 ps; with signal averaging, typically 5 ps.

Internal pickup: $\rho \leq 0.01$.

Noise: measured tangentially as a percentage of the incident pulse when terminated in 50 ohms and operated in signal averaging mode. <1% (0.5%) on 0.005/div to 0.02/div; <3% (1%) on 0.05/div to 0.5/div.

Low frequency distortion: $\leq \pm 3\%$.

Maximum safe input: 1 volt.

Sampler system

Risetime: <28 ps (90 ps).

Input: 50 ohm feedthrough.

Dynamic range: 1 V p-p.

Maximum safe input: 3 volts (5 volts).

Low frequency distortion: $\leq \pm 3\%$.

Noise

Normal: <8 mV (3 mV) tangential noise on 0.01 V/div to 0.5 V/div. Noise decreases automatically on 0.005 V/div.

Signal average: reduces noise and jitter approx 2:1.

Tunnel diode mount: direct connection for either Model 1106A or Model 1108A tunnel diode mount for TDR system.

Accessories supplied

Cable, plug-in to sampler: connects sampler (1816A or 1817A) to plug-in (1815A or B), HP Part No. 5060-0441; replacement price, \$75.

Cable, tunnel diode to sampler: connects tunnel diode (1106A or 1108A) to sampler, HP Part No. 01817-61603; replacement price, \$18.

Price

General

Model 1817A 28 ps Rise Time Sampling Head \$1500

Model 1816A 90 ps Rise Time Sampling Head \$ 850

Specifications, 1106A and 1108A

Tunnel diode mount connects directly to sampler and is required for a TDR system.

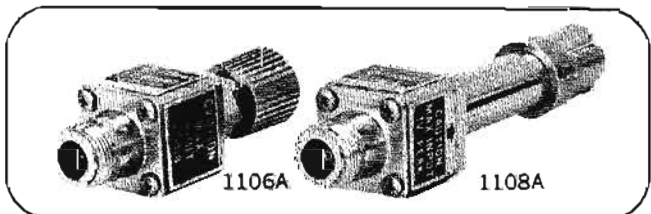

Amplitude (both): >200 mV into 50 ohms.

Risetime: Model 1106A, approx 20 ps; Model 1108A, <60 ps.

Output impedance: 50 ohms $\pm 2\%$.

Source reflection: Model 1106A, <10% with 45 ps TDR; Model 1108A, <10% with 154 ps TDR.

Weight (both): net, 1 lb (0.5 kg); shipping, 3 lbs (1.4 kg).

Price: Model 1106A, \$550; Model 1108A, \$200.

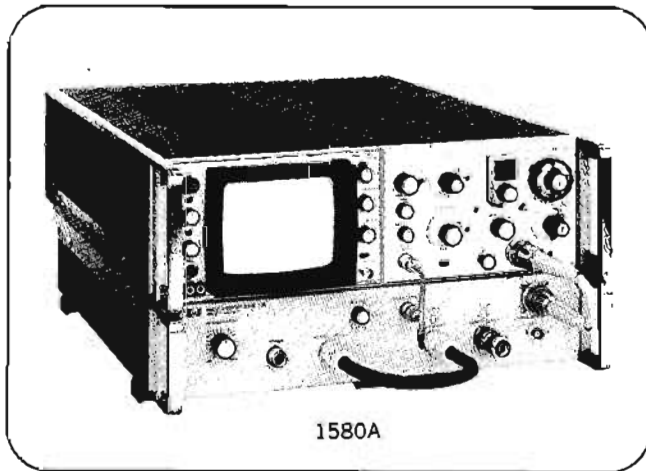

Description, 1580A

Model 1580A Narrow Band TDR System provides a quick, portable method of determining the location and magnitude of discontinuities in waveguide or bandpass coaxial transmission systems. Narrowband TDR clearly shows the magnitude of resistive or reactive discontinuities with the location directly calibrated in feet or meters from the source. This allows rapid system set-up or repair of faults caused by misaligned or corroded waveguide flanges and coaxial cable connectors, foreign objects inside waveguides, and crushed or bent waveguide or coaxial cable.

Narrowband TDR is similar in concept to radar, in that an rf pulse burst is transmitted down a system and, if a discontinuity exists, energy is reflected back to the source and is detected and displayed by the 1580A system. The use of an rf pulse burst allows the incident energy to be contained within the dominant mode of the waveguide or the passband of a narrowband system, which increases sensitivity and resolution of measurements when compared to a wideband TDR used for interrogation of a narrowband system.

Variable rf burst widths, from <5 to >100 ns, are provided by the 1580A which allows the incident rf burst bandwidth spectrum to be matched to the characteristics of a system being tested. Variable burst widths are useful when evaluating waveguide systems where the effects of dispersion, which causes a reflected rf burst to widen in time and lose amplitude, must be considered. The 1580A allows return losses of -40 dB and greater to be resolved when at least 70 mW of rf input power is available.

The Narrow Band TDR System consists of a standard 180AR rack model oscilloscope mainframe, a 1815A Option 001 TDR/Sampler Plug-in, and the 1580A Narrow Band TDR rf burst generator/sampler. The 1580A may also be purchased calibrated in meters at no additional cost by ordering Model 1580A Option 010.

For more information, contact your local Hewlett-Packard field engineer.

HIGH FREQUENCY ACCESSORIES

Time Domain Reflectometry and Sampling



OSCILLOSCOPES

TDR Accessories

Models 10452A-10456A Risetime Converters

Models 10452A through 10456A Risetime Converters slow down the step from the 1818A (or 1415A) in order to eliminate reflections caused by frequencies beyond the bandwidth of interest. Rise-times: (10-90% points as measured in 150 ps risetime system).

10452: 0.5 ns. 10453A: 1 ns. 10454A: 2 ns.
10455A: 5 ns. 10456A: 10 ns.

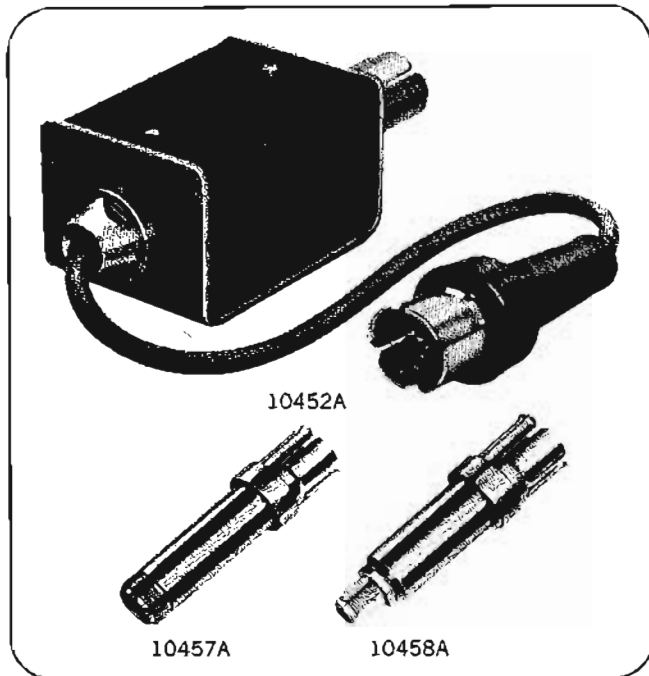

10452A

10457A

10458A

Specifications

Risetime accuracy: within $\pm 5\%$.
Overshoot: less than $\pm 3\%$.
Output impedance (dc): 50 ohms (accuracy determined by output impedance of generator).
Output mismatch: less than $\pm 5\%$ reflection to output risetime. Allowable input voltage: up to 50 volts, open circuit (from a 50-ohm source).
Connectors: GR Type 874.
Price: \$95.

Models 10457A-10458A 50 to 75 ohm Adapters

Adapters convert 1818A (or 1415A) 50 ohm output to 75 ohm systems.

Model 10457A: converts 50 ohm GR to 75 ohm Type N.

Price: \$45.

Model 10458A: converts 50 ohm GR to 75 ohm Type F (CATV).

Price: \$25.

Sampling Accessories

Specifications 1105A/1106B/1108A

1105A/1106B/20 ps Pulse Generator

1105A/1108A/60 ps Pulse Generator

Output

Risetime: approx 20 ps with 1106B, (< 60 ps with 1108A), < 28 ps observed with HP Model 1411A/1430C 28 ps Sampler and HP Model 909A Option 012 50 ohm termination.

Overshoot: $\pm 7.5\%$ as observed on 1411A/1430C with 909A Option 012.

Droop: less than 3% in first 100 ns.

Width: approximately 3 μ s.

Amplitude: greater than ± 200 mV into 50 ohms.

Output characteristics (1106B/1108A)

Mechanical: (1106B) Type N connector. (1108A) GR-874 connector.

Electrical: dc resistance; 50 ohm $\pm 2\%$. Source reflection; less than 10%, using a 40 ps TDR system. DC offset voltage; approximately 0.1 V.

Triggering

Amplitude: at least ± 0.5 V peak required.

Risetime: less than 20 ns required. Jitter less than 15 ps when triggered by 1 ns risetime sync pulse from 1424A or 1425A Sampling Time Base.

Width: greater than 2 ns.

Maximum safe input: 10 volts.

Input impedance: 200 ohms, ac-coupled through 20 pF.

Repetition rate: 0 to 100 kHz; free runs at 100 kHz.

Accessories provided (with Model 1105A): one 6-ft 50 ohm cable with Type N connectors, HP Model No. 10132A.

Weight

1106B or 1108A: net, 1 lb (0,5 kg); shipping, 2 lbs (0,9 kg).

1105A: net, 2 lbs (0,9 kg); shipping, 4 lbs (1,8 kg).

Price: HP Model 1105A, \$200. HP Model 1106B, \$550. HP Model 1108A, \$175.

1109B/1129A High-Pass Filters

The 1109B and 1129A High Pass Filters transmit only frequencies above 1 GHz. They are useful for blocking the 100 MHz "kickout" encountered when using a tunnel diode countdown to view high frequency signals on a sampling oscilloscope. The 1109B is designed for use with the Model 1104A/1106B Trigger Countdown, and the 1129A mates with the Model 1104A/1108A.

Specifications 1109B

Lower bandwidth limit: 3 dB down at 3 GHz, nominal.

Input characteristics

Mechanical: Type N connector.

Electrical (with output terminated in 50 ohms)

Reflection: less than 10% using 40 ps TDR system.

VSWR: typically 1.1:1 up to 10 GHz increasing to 2:1 at 15 GHz.

DC resistance: 50 ohms $\pm 2\%$ shunted across line.

Weight: net, 5 oz (0,14 kg).

Price: \$200.

Specifications 1129A

Lower bandwidth limit: 3 dB down at 3 GHz, nominal.

Input characteristics

Mechanical: GR-874 connector.

Electrical (with output terminated in 50 ohms)

Reflection: less than 3% using 150 ps TDR system.

DC resistance: 50 ohms $\pm 2\%$ shunted across line.

Weight: net, 4 oz (0,11 kg).

Price: \$100.

Other sampling accessories

50-ohm loads: Models 908A, \$45; and 909A Option 012, \$70.

50-ohm adapter: Model 11524A; has Type N female and APC-7 connectors. Price, \$70.

Air line extensions: Model 11566A; 10 cm, APC-7 connector. Model 11567A; 20 cm, APC-7 connector. Price, \$115 each.



1108A

1105A

OSCILLOSCOPES

PORTABLE 35, 75, and 150 MHz
AC, dc or battery operation
1700 Series

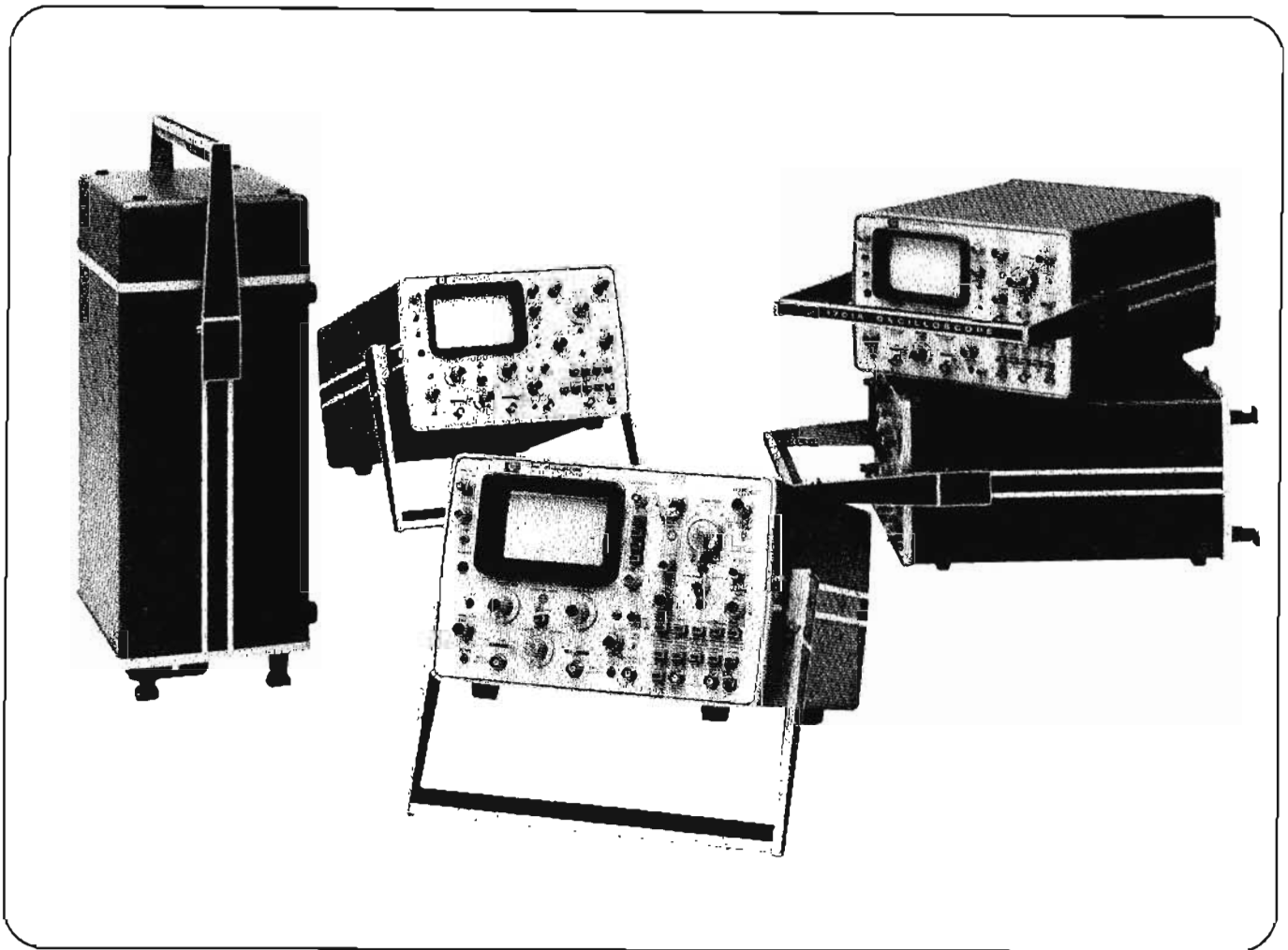

Introduction, 1700 Series

The Hewlett-Packard Series Oscilloscopes are light weight, battery operated, portable instruments designed for both lab and field service applications. All models are dual channel and range from 35 MHz to 150 MHz. You can choose models with a main time base only or with both main and delayed time bases. The 1700 series also includes two models with variable persistence and storage CRT's.

Operator convenience

All 1700 Series models have large CRT's and sharp traces for easy viewing and high resolution. Standard CRT's are 6 x 10 cm and variable persistence CRT's are slightly smaller.

Front panel controls are grouped according to function for fast familiarization and pushbuttons are used to further simplify operation. By releasing all pushbuttons you can easily locate the trace giving you a head start in viewing your waveform. Delayed sweep controls are grouped in a gray front panel strip for quick identification. Main and delayed sweep speeds are selected with separate controls allowing you to change the sweep speed on one time base without having to reset the other. An interlock is provided which prevents the

delayed time base from sweeping slower than the main time base.

Another convenience feature found on all standard models is scale illumination which aids in photographic work. A beam-finder allows quick location of the trace regardless of the INTENSITY, HORIZONTAL, or VERTICAL control positions. Warning lights are provided which indicate uncalibrated vertical deflection factors or sweep speeds. Additional conveniences provided are front panel adjustments for vertical deflection factors, dc balance, and 1 volt square wave calibrator for probe compensation.

Performance

The 1700 series—though light weight, rugged and portable—give you the performance ordinarily expected of laboratory oscilloscopes. Vertical bandwidths are specified over the full 6 divisions of vertical display. Maximum sensitivities are useable over the entire bandwidth; for example, the 1710A's deflection factor is 5 mV per div from dc to 150 MHz (3 dB point). In addition, display mode and trigger source flexibility assure you of the right trigger signal combination for your application.

Emphasis on performance is also provided in the 1700 Series horizontal system. Sweep linearity is specified over the full 10

PORTABLE 35, 75, and 150 MHz

10 ns/div sweep speeds
1700 Series



OSCILLOSCOPES

divisions of horizontal display for maximum usefulness and accuracy. In models with calibrated delay (Option 020), you can make differential timing measurements to approximately 1% accuracy by using a common reference graticule.

Internal trigger circuits have emitter coupled logic gates for greater reliability and stable operation over a wide temperature range. A trigger holdoff control is used to eliminate double triggering on complex digital waveforms while maintaining a full-screen, calibrated sweep.

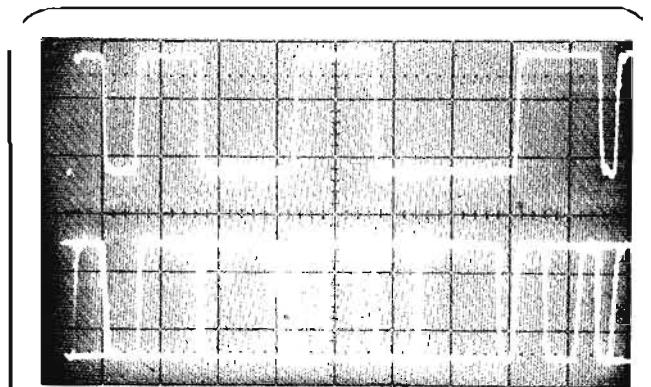

Though the performance of the 1700 Series is high quality, the price is kept low by offering just the features necessary for most applications. A laboratory package is available on all models which adds many features often used in a laboratory environment. This model flexibility assures you of the optimum price/performance ratio.

Battery Operation

1700 series models may be operated from a battery pack. The battery fits snugly inside all instruments with exception of the 1710A.

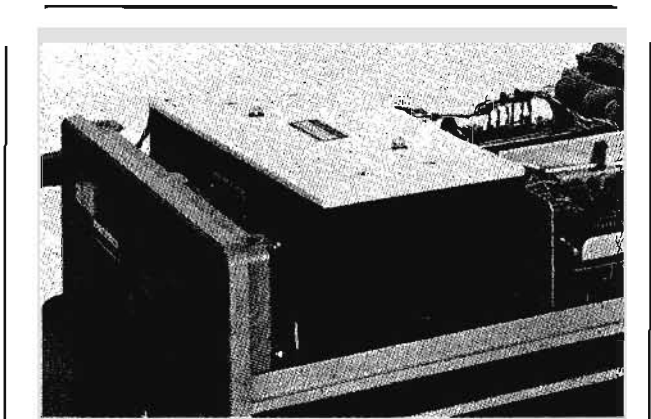

Many portable oscilloscope users are discovering the advantages of battery operation:

1. Convenience of working in an installation without having to turn off scope, move power cord, and reset and stabilize display;
2. isolation from ground loops and conducted RFI; and

3. freedom from errors due to power line fluctuations and supply variations.

The battery allows up to six hours of operation (1700A and 1701A) and is rechargeable over night. Other power modes are ac (110 V or 230 V $\pm 20\%$, 48 to 440 Hz) or external dc from 11.5 to 35 volts. This flexibility insures that power will be available in almost any possible situation.

Reliability

The 1700 series oscilloscopes have been designed for low power consumption which not only allows battery operation but increases reliability since most active components operate at only 10 to 20% of their power ratings. For example, the vertical output transistors do not require heat sinks. The low power consumption also means that the 1700 series scopes do not require ventilating holes or fans for cooling which reduces the amount of dust and dirt that can accumulate. Also the lack of ventilation holes reduces dc drift since the scope is less susceptible to short term temperature changes caused by drafts. Reliability is also enhanced in the trigger circuits by using emitter-coupled logic circuits instead of conventional tunnel diodes.

Serviceability

Ease of service is assured with the plug-in circuit boards and the low number of internal adjustments. For example, if all internal adjustments were misaligned, a technician (with a working knowledge of the scope) could completely recalibrate the 1700A in as little as one hour. This means real dollar savings over the lifetime of the instrument. Serviceability also extends to the probes supplied with the oscilloscopes. The 10006B Probe cables are supplied with spin-on/spin off connectors on both ends which reduces replacement time to just few minutes.

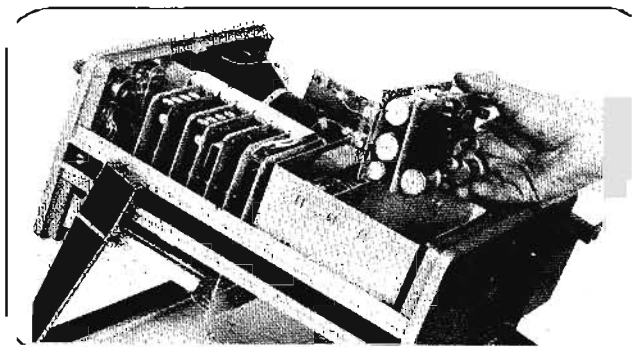

Storage cover

The Model 10101A Storage Cover, supplied with each oscilloscope, helps to protect the front panel during transportation and provides storage space for accessories. Accessories included with the 1700 oscilloscopes are two probes with probe accessories, power cord, dc plug, and spare fuses.

Field support

Video tapes are available which supply training and help you to become accustomed to 1700 series operation and applications. Ask your Hewlett-Packard field engineer for details.

OSCILLOSCOPES



PORTABLE, 35 MHz

Dual channel, 10 mV/div

Models 1700A, 1701A

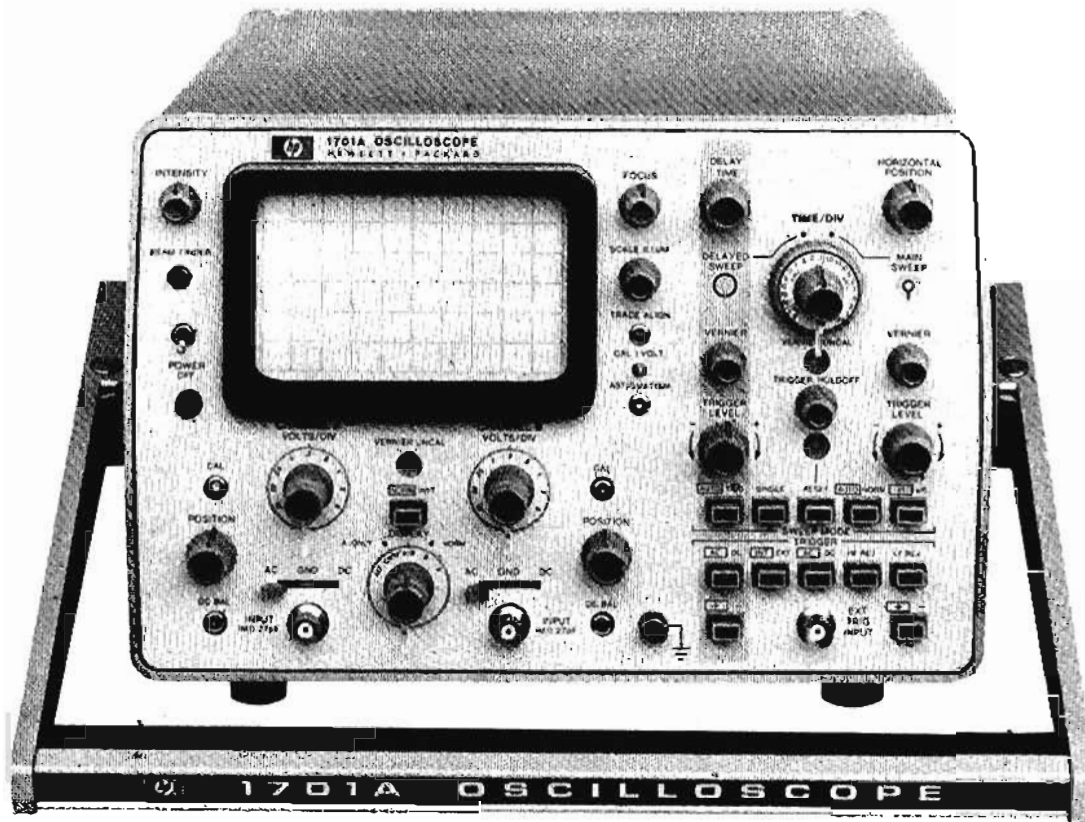

1701A

Description, 1700A/1701A

Models 1700A and 1701A are 35 MHz, dual channel, 10 mV/div deflection factor, portable oscilloscopes with 6 x 10 cm internal graticule cathode-ray tubes. The 35 MHz bandwidth and 10 ns/div expanded sweep speed provide accurate timing measurements in systems using MOS and TTL logic elements. Model 1700A is a non-delaying time base oscilloscope and the 1701A has a delaying time base.

Options are available to allow these oscilloscopes to be tailored to an application at minimum cost. For example, Option 020 for each oscilloscope provides additional features that are often required in laboratory situations.

More information about the 1700 series oscilloscopes is located at the beginning of this section.

Specifications, 1700A, 1701A

(Except as noted, specifications apply to 1700A and 1701A)

Vertical amplifiers

Modes of operation: channel A; channel B; channels A and B displayed alternately on successive sweeps (ALT); channels A and B displayed by switching between channels at approx 400 kHz rate with blanking during switching (Chop); channel A + channel B (algebraic addition).

Each channel (2)

Bandwidth: (direct or with Model 10006B probe, 3 dB down from 50 kHz, 6 div reference signals from 25 ohm source). DC-coupled, dc to 35 MHz; ac-coupled, 10 Hz to 35 MHz.

Risetime: <10 ns. Direct or with Model 10006B probe, 10% to 90% points with 6 div input step from 25 ohm source.

Deflection factor

Ranges: from 10 mV/div to 5 V/div (9 ranges) in 1, 2, 5 sequence. $\pm 3\%$ accuracy with vernier in calibrated position.

Vernier: continuously variable between all ranges, extends maximum deflection factor to at least 12.5 V/div.

Polarity: NORM or INV, selectable on channel B.

Signal delay: signals are delayed sufficiently to view leading edge of input signals without advanced external trigger.

Input RC: 1 megohm $\pm 2\%$, shunted by approx 27 pF.

Input coupling: ac, dc, or ground selectable. Ground position disconnects signal input and grounds amplifier input.

Maximum input

AC-coupled: ± 600 V (dc + peak ac); rms ac <350 V, 5 V/div to 20 mV/div; <150 V at 10 mV/div (10 kHz or less).

DC-coupled: <350 V (rms) 5 V/div to 20 mV/div; <150 V at 10 mV/div (10 kHz or less).

A + B operation

Amplifier: bandwidth and deflection factors are unchanged; channel B may be inverted for A-B operation.

Common mode (A-B): frequency, dc to 1 MHz; rejection ratio, at least 40 dB on 10 mV/div, at least 20 dB on all other ranges with verniers set for optimum rejection. Common mode signal amplitude equivalent to 30 div.

Trigger source (applies for all five modes of operation): Norm, on displayed signal; A only, on signal from Channel A.

Time base

Sweep

Ranges: from 0.1 μ s/div to 0.2 s/div (20 ranges) in 1, 2, 5 sequence. $\pm 3\%$ accuracy with vernier in calibrated position.

Vernier: continuously variable between all ranges, extends slowest

PORTABLE, 35 MHz

Dual channel, 10 mV/div

Models 1700A, 1701A



OSCILLOSCOPES

sweep to at least 0.5 s/div. Vernier uncalibrated light indicates when vernier is not in Cal position.

Magnifier: expands all sweeps by a factor of 10 and extends fastest sweep to 10 ns/div. Accuracy $\pm 5\%$ (including 3% accuracy of time base).

Sweep mode

Normal: sweep is triggered by an internal or external signal.

Automatic: bright baseline displayed in absence of input signal. Triggering is same as normal above 40 Hz.

Single: in Normal mode, sweep occurs once with same triggering as normal; reset pushbutton arms sweep and lights indicator; in Auto mode, sweep occurs once each time Reset pushbutton is pressed.

Triggering

Internal: dc to 35 MHz on signals causing 0.5 divisions or more vertical deflection increasing to 1.5 div deflection at 75 MHz in all display modes except chop; dc to 400 kHz in chop mode.

External: dc to 35 MHz on signals 50 mV p-p or more, increasing to 100 mV p-p at 75 MHz.

External input RC: approx 1 megohm, shunted by approx 27 pF.

Level and slope

Internal: at any point on the vertical waveform displayed.

External: continuously variable from +1.5 V to -1.5 V. (Model 1700A only, +15 V to -15 V in ± 10) on either slope of trigger signal. Maximum input, ± 100 V.

Coupling: AC, DC, LF REJ, or HF REJ.

AC: attenuates signals below approx 20 Hz.

LF REJ: attenuates signals below approx 15 kHz.

HF REJ: attenuates signals above approx 30 kHz.

Trigger holdoff: time between sweeps continuously variable, exceeding one full sweep at 20 ms/div and faster.

Model 1701A delayed time base

Sweep

Ranges: 0.1 μ s/div to 0.1 s/div (19 ranges) in 1, 2, 5 sequence. $\pm 3\%$ with vernier in calibrated position.

Vernier: continuously variable between all ranges, extends slowest sweep to 0.25 s/div.

Triggering

Internal: same as main time base.

Automatic: delayed sweep is automatically triggered at end of delay time.

Level and slope: at any point on the vertical waveform displayed.

Coupling: selectable, ac or dc. AC attenuates signals below approx 20 Hz.

Delay time: continuously variable from 0.1 μ s to 2 s.

Delay jitter: $< 0.005\%$ (1 part in 20,000) of maximum delay in each step.

Trace Intensification: intensifies that part of main time base to be expanded to full screen in delayed time base mode. Rotating time base switch from OFF position activates intensified mode.

Cathode-ray tube and controls

Type: post-accelerator, ≈ 22 kV accelerating potential; aluminumized P31 phosphor.

Graticule: 6 x 10 div internal graticule; 0.2 subdivisions on major horizontal and vertical major axes. 1 div = 1 cm. Front panel adjustment aligns trace with graticule.

Beam finder: returns trace to CRT screen regardless of setting of horizontal, vertical, or intensity controls.

Intensity modulation: $> +4$ V, dc to 1 MHz blanks trace of any intensity. Input R, 1000 ohms $\pm 10\%$. Maximum input, ± 10 V (dc \mp peak ac).

General

Calibrator: type, 1 kHz, $\pm 10\%$ squarewave; voltage, 1 V p-p $\pm 1\%$.

Power requirements

AC line: 115 or 230 V $\pm 20\%$, 48 to 440 Hz, 30 VA max.

DC line: 11.5 to 36 V, 18 watts max.

Battery (optional)

Operating time: up to 6 hours.

Recharge time: 14 hours maximum, with power switch off, if not operated after power indicator flashes.

Low battery Indicator: power light flashes to indicate that batteries are discharged.

Recharging: batteries are recharging whenever power mode switch is set to ac with power applied. With power switch off, full charge is applied. With power switch on, trickle charge is applied.

Weight

Without panel cover: net, 24 lbs (11 kg); shipping, 35 lbs (15.9 kg).

With panel cover and accessories: net, 27 lbs (12.3 kg); shipping, 38 lbs (17.2 kg).

With panel cover, accessories, and battery pack: net, 35 lbs (16 kg); shipping, 46 lbs (20.9 kg).

Dimensions: refer to outline drawing.

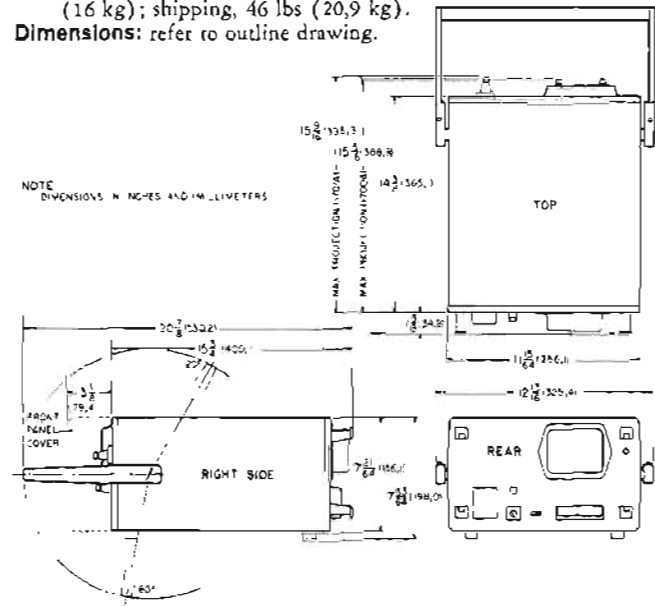

Environment: (oscilloscope operates within specifications over the following ranges); temperature, 0°C to +55°C; humidity, to 95% relative humidity to 40°C; altitude, to 15,000 ft; vibration, vibrated in three planes for 15 min. each with 0.010 inch excursion, 10 to 55 Hz.

Accessories furnished: mesh contrast filter, Model 10115A; front panel storage cover, Model 10101A; two Model 10006B probes; one dc power plug for assembling a dc power cord; one ac power cord with right angle plug; and one instruction manual.

Price (without battery pack)

Model 1700A Portable Oscilloscope\$1680

Model 1701A Delayed Sweep Portable Oscilloscope\$1800

Options (order by Option number)

012: Model 10103A battery pack installed, add \$200.

016: (Model 1701A): TV sync separator (may not be ordered with Option 020), add \$85.

020 (Model 1700A): external horizontal input; Channel A output which provides single channel, 1 mV/div deflection factor at reduced bandwidth when cascaded into Channel B. Add \$50.

020 (Model 1701A): mixed sweep; calibrated sweep delay; external trigger input for delayed sweep; external horizontal input; Channel A output which provides single channel, 1 mV/div deflection factor at reduced bandwidth when cascaded into Channel B. Add \$125.



PORTABLE, 35 MHz

Storage/variable persistence
Models 1702A, 1703A



1703A

Description

Model 1703A combines 1700 series features of dual channel, 10 mV/div deflection factor, and main and delayed time base sweep speeds to 10 ns/div, with variable persistence and storage. Model 1702A is identical to the 1703A but is without the delayed time base.

Variable persistence and storage

Hewlett-Packard's storage mesh CRT allows you to adjust the amount of time a trace is retained, from less than 1 second to over 1 hour. For example, when making timing adjustments between two low rep rate, narrow pulses, the persistence can be set so that the pulses are on screen for just one sweep. You can make your timing adjustments quickly and accurately, without the screen becoming cluttered with old traces.

Variable persistence is also very useful as a pseudo-normal write mode, when extra brilliance is required, or any time the sweep speed is low enough to cause flicker. In addition to variable persistence, the 1703A offers storage capability, for over 1 hour. This display capability is especially useful for single shot phenomena and other events with very infrequent occurrence. The armed trigger circuits will patiently wait for the event to happen, then capture the waveform when it occurs. All variable persistence and storage controls are conveniently grouped to the right of the CRT.

The 1703A's writing speed in the storage mode is 20 div/ms. And a mode called "Max Write" uses a fogging technique to increase writing speed to 1000 div/ms, with only a slight reduction in contrast between trace and background. (See Intro.)

Specifications, 1702A, 1703A

(Except as noted, specifications apply to 1702A and 1703A)

Vertical amplifiers

Modes of operation: channel A; channel B, channels A and B displayed alternately on successive sweeps (ALT); channels A and B displayed by switching between channels at approx 400 kHz rate with blanking during switching (CHOP); channel A + channel B (algebraic addition).

Each channel (2)

Bandwidth: (direct or with Model 10006B probe, 3 dB down from 50 kHz, 6 div reference signal from 25 ohm source). DC-coupled, dc to 35 MHz; ac-coupled, 10 Hz to 35 MHz.
Risetime: < 10 ns. Direct or with Model 10006B probe, 10% to 90% points with 6 div input step from 25 ohm source.

Deflection factor

Ranges: from 10 mV/div to 5 V/div (9 ranges) in 1, 2, 5 sequence. $\pm 3\%$ accuracy with vernier in calibrated position.
Vernier: continuously variable between all ranges, extends maximum deflection factor to at least 12.5 V/div.
Polarity: NORM or INV, selectable on channel B.
Signal delay: input signals are delayed sufficiently to view leading edge of input signals without advanced external trigger.

PORTABLE, 35 MHz

Delayed, non-delayed sweeps

Models 1702A, 1703A



OSCILLOSCOPES

Input RC: 1 megohm $\pm 2\%$, shunted by approx 27 pF.
Input coupling: ac, dc, or ground selectable. Ground position disconnects signal input and grounds amplifier input.

Maximum Input

AC-coupled: ± 600 V (dc + peak ac); rms ac < 350 V, 5 V/div to 20 mV/div; < 150 V at 10 mV/div (10 kHz or less).
DC-coupled: < 350 V (rms) 5 V/div to 20 mV/div; < 150 V at 10 mV/div (10 kHz or less).

A + B operation: same as Models 1700A and 1701A.

Trigger source: (applies for all five modes of operation) Norm, on displayed signal; A only, on signal from Channel A.

Time base

Sweep

Ranges: from 0.1 μ s/div to 0.2 s/div (20 ranges) in 1, 2, 5 sequence. $\pm 3\%$ accuracy with vernier in calibrated position.

Vernier: continuously variable between all ranges, extends slowest sweep to at least 0.5 s/div. Vernier uncalibrated light indicates when vernier is not in Cal position.

Magnifier: expands all sweeps by a factor of 10 and extends fastest sweep to 10 ns/div. Accuracy, $\pm 5\%$ (including 3% accuracy of time base).

Sweep mode

Normal: sweep is triggered by an internal or external signal.

Automatic: bright baseline displayed in absence of input signal. Triggering is same as normal above 40 Hz.

Single: in Normal mode, sweep occurs once with same triggering as normal; reset pushbutton arms sweep and lights indicator; in Auto mode, sweep occurs once each time Reset pushbutton is pressed.

Triggering

Internal: dc to 35 MHz on signals causing 0.5 divisions or more vertical deflection increasing to 1.5 div deflection at 75 MHz in all display modes except chop; dc to approx 400 kHz in chop mode.

External: dc to 35 MHz on signals 50 mV p-p or more, increasing to 100 mV p-p at 75 MHz.

External Input RC: approx 1 megohm shunted by approx 27 pF.

Level and slope

Internal: at any point on the vertical waveform displayed.

External: continuously variable from +1.5 V to -1.5 V (Model 1702A only, +15 V to -15 V in ± 10) on either slope of the trigger signal. Maximum input, ± 100 V.

Coupling: AC, DC, LF REJ, or HF REJ.

AC: attenuates signals below approx 20 Hz.

LF REJ: attenuates signals below approx 15 kHz.

HF REJ: attenuates signals above approx 30 kHz.

Trigger holdoff: time between sweeps continuously variable, exceeding one full sweep at 20 ms/div and faster.

Model 1703A delayed time base

Sweep

Ranges: 0.1 μ s/div to 0.1 s/div (19 ranges) in 1, 2, 5 sequence. $\pm 3\%$ with vernier in calibrated position.

Vernier: continuously variable between all ranges, extends slowest sweep to 0.25 s/div.

Triggering

Internal: same as main time base.

External: dc to 35 MHz on signals of 50 mV p-p or more, increasing to 100 mV p-p at 75 MHz.

Level and slope

Internal: at any point on the vertical waveform displayed.

Coupling: AC or dc. AC attenuates signals below approx 20 Hz.

Delay (before start of delayed sweep)

Time: continuously variable from 0.1 μ s to 2 s.

Linearity: $\pm 2\%$.

Jitter: 0.005% (1 part in 20,000) of maximum delay in each step.

Trace Intensification: intensifies that part of main time base to be expanded to full screen in delayed mode. Rotating time base switch from OFF position activates intensified mode.

Cathode-ray tube and controls

Type: post-accelerator, ≈ 8.5 kV accelerating potential; aluminized P31 phosphor

Graticule: 6 x 10 div internal graticule; 0.2 subdivisions on major horizontal and vertical major axes. 1 div = 0.85 cm. Front panel adjustment aligns trace with graticule.

Beam finder: returns trace to CRT screen regardless of setting of horizontal, vertical, or intensity controls.

Intensity modulation: $> +4$ V, dc to 1 MHz blanks trace of any intensity. Input R, 1000 ohms $\pm 10\%$. Maximum input, ± 10 V (dc + peak ac).

Persistence: Normal, natural persistence of P31 phosphor (approx 40 μ s); Variable, from < 0.2 s to > 1 min.

Storage writing speed: Write mode, > 20 div/ms; Maximum write mode, > 1000 div/ms.

Brightness: ≈ 100 foot lamberts.

Storage time: from Write mode to Store, traces may be stored at reduced intensity for > 1 hour. When switched to View mode, traces may be viewed at normal intensity for > 1 minute. From Max. Write mode to Store, traces may be stored at reduced intensity for > 5 minutes. When switched to View mode, traces may be viewed at normal intensity for > 15 seconds.

Erase: manual. pushbutton erasure takes approx 300 ms.

General

Calibrator

Type: 1 kHz, $\pm 10\%$ squarewave.

Voltage: 1 V p-p, $\pm 1\%$.

Power requirements

AC line: 115 or 230 V $\pm 20\%$, 48 to 440 Hz, 50 VA max.

DC line: 11.5 to 36 V, ≈ 25 watts max.

Battery (optional)

Operating time: up to 4 hours.

Recharge time: 14 hours maximum, with power switch off, if not operated after power indicator flashes.

Low battery indicator: power light flashes to indicate that batteries are discharged.

Weight

Without panel cover: net, 24 lbs (11 kg); shipping, 35 lbs (15.9 kg).

With panel cover and accessories: net, 27 lbs (12.3 kg); shipping, 38 lbs (17.2 kg).

With panel cover, accessories, and battery pack: net, 35 lbs (16 kg); shipping, 46 lbs (20.9 kg).

Dimensions: refer to 1700A/1701A outline drawing.

Environment: same as Models 1700A and 1701A.

Accessories furnished: mesh contrast filter; front panel storage cover, Model 10101A; two Model 10006B probes; one dc power plug for assembling a dc power cord; one ac power cord with right angle plug; and one instruction manual.

Price

Model 1702A Storage Oscilloscope\$2375

Model 1703A Delayed Sweep Storage Oscilloscope\$2575

Options (order by Option number)

012: Model 10103A battery pack installed, \$200.

020: (1702A only) external horizontal input; Channel A output which provides single channel, 1 mV/div deflection factor at reduced bandwidth when cascaded into Channel B, add \$75.

020: (1703A only) laboratory package. Mixed sweep; calibrated sweep delay; external trigger input for delayed sweep; external horizontal input; Channel A output which provides single channel, 1 mV/div deflection factor at reduced bandwidth when cascaded into Channel B, add \$150.



PORTABLE, 75 MHz

Dual channel, 10 mV/div
Models 1706A, 1707A



1707A

Description, 1706A/1707A

Models 1706A and 1707A are 75 MHz, dual channel, 10 mV/div deflection factor, portable oscilloscopes with 6 x 10 cm internal graticule cathode-ray tubes. The 75 MHz bandwidth and 10 ns/div expanded sweep speeds provide accurate measurements in systems using fast TTL and ECL logic measurements. Model 1706A has a non-delaying sweep time base and the 1707A has a delaying time base.

Options are available to allow these oscilloscopes to be tailored to an application at minimum cost. For example, Option 020 for each oscilloscope provides additional features that are often required in laboratory situations.

More information about the 1700 series oscilloscopes is located at the beginning of this section.

Specifications, 1706A, 1707A

(Except as noted, specifications apply to 1706A and 1707A.)

Vertical amplifiers

Modes of operation: channel A; channels A and B displayed alternately on successive sweeps (ALT); channels A and B displayed by switching between channels at approx 400 kHz rate with blanking during switching (Chop); channel A + channel B (algebraic addition).

Each channel (2)

Bandwidth: direct or with Model 10006B probe, 3 dB down from 50 kHz, 6 div reference signal from 25 ohm source.

DC-coupled: dc to 75 MHz.

AC-coupled: 10 Hz to 75 MHz

Risetime: < 4.7 ns. Direct or with Model 10006B probe, 10% to 90% points with 6 div input step from 25 ohm source.

PORTABLE, 75 MHz

Delayed, non-delayed sweeps

Models 1706A, 1707A



OSCILLOSCOPES

Deflection factor

Ranges: from 10 mV/div to 5 V/div (9 ranges) in 1, 2, 5 sequence. $\pm 3\%$ accuracy with vernier in calibrated position.

Vernier: continuously variable between all ranges, extends maximum deflection factor to at least 12.5 V/div.

Polarity: NORM or INV, selectable on channel B only.

Signal delay: Input signals are delayed sufficiently to view leading edge of input signals without advanced external trigger.

Input RC: 1 megohm $\pm 2\%$, shunted by approx 24 pF.

Input coupling: ac, dc, or ground selectable. Ground position disconnects signal input and grounds amplifier input.

Maximum Input

AC-coupled: ± 600 V (dc + peak ac); rms ac < 350 V, 5 V/div to 20 mV/div; < 150 V at 10 mV/div (10 kHz or less).

DC-coupled: < 350 V (rms) 5 V/div to 20 mV/div; < 150 V at 10 mV/div (10 kHz or less).

A + B operation

Amplifier: bandwidth and deflection factors are unchanged; channel B may be inverted for A-B operation.

Common mode (A-B)

Frequency: dc to 1 MHz.

Rejection ratio: at least 40 dB on 10 mV/div; at least 20 dB on all other ranges with verniers set for optimum rejection. Common mode signal amplitude equivalent to 30 div.

Triggering source: (applies for all five modes of operation) Norm, on displayed signal; A only, on signal from Channel A.

Time base

Sweep

Ranges: from 0.1 μ s/div to 0.2 s/div (20 ranges) in 1, 2, 5 sequence $\pm 3\%$ accuracy with vernier in calibrated position.

Vernier: continuously variable between all ranges, extends slowest sweep to at least 0.5 s/div. Vernier uncalibrated light indicates when vernier is not in Cal position.

Magnifier: expands all sweeps by a factor of 10 and extends fastest sweep to 10 ns/div. Accuracy $\pm 5\%$ (including 3% accuracy of time base).

Sweep mode

Normal: sweep is triggered by an internal or external signal.

Automatic: bright baseline displayed in absence of input signal. Triggering is same as normal above 40 Hz.

Single: in Normal mode, sweep occurs once with same triggering as normal; reset pushbutton arms sweep and lights indicator; in Auto mode, sweep occurs once each time Reset pushbutton is pressed.

Triggering

Internal: dc to 35 MHz on signals causing 0.5 divisions or more vertical deflection increasing to 1 div deflection at 75 MHz in all display modes except chop; dc to 400 kHz in chop mode.

External: dc to 35 MHz on signals 50 mV p-p or more, increasing to 100 mV p-p at 75 MHz.

External input RC: approx 1 megohm shunted by approx 27 pF.

Level and slope

Internal: at any point on the vertical waveform displayed.

External: continuously variable from $\div 1.5$ V to -1.5 V (Model 1706A only, ∓ 15 V to -15 V in $\div 10$) on either slope of the trigger signal. Maximum input, ± 100 V.

Coupling: AC, DC, LF REJ, or HF REJ.

AC: attenuates signals below approx 15 kHz.

LF REJ: attenuates signals below approx 15 kHz.

HF REJ: attenuates signals above approx 30 kHz.

Trigger holdoff: time between sweeps continuously variable, exceeding one full sweep at 20 ms/div and faster.

Model 1707A delayed time base

Sweep

Ranges: 0.1 μ s/div to 0.1 s/div (19 ranges) in 1, 2, 5 sequence. $\pm 3\%$ with vernier in calibrated position.

Vernier: continuously variable between all ranges, extends slowest sweep to 0.25 s/div.

Triggering

Internal: same as main time base.

Automatic: delayed sweep is automatically triggered at end of delay time.

Level and slope: at any point on the vertical waveform displayed.

Coupling: selectable, ac or dc. AC attenuates signals below approx 20 Hz.

Delay time: continuously variable from 0.1 μ s to 2 s.

Delay jitter: $< 0.005\%$ (1 part in 20,000) of maximum delay in each step.

Trace intensification: intensifies that part of main time base to be expanded to full screen in delayed time base mode. Rotating time base switch from OFF position activates intensified mode.

Cathode-ray tube and controls

Type: post-accelerator, ≈ 22 kV accelerating potential; aluminized P31 phosphor.

Graticule: 6 x 10 div internal graticule; 0.2 subdivisions on major horizontal and vertical major axes. 1 div = 1 cm, Front panel adjustment aligns trace with graticule.

Beam finder: returns trace to CRT screen regardless of setting of horizontal, vertical, or intensity controls.

Intensity modulation: $> +4$ V, dc to 1 MHz blanks trace of any intensity. Input R, 1000 ohms $\pm 10\%$. Maximum input, ± 10 V (dc + peak ac).

General

Calibrator

Type: 1 kHz, $\pm 10\%$ squarewave.

Voltage: 1 V p-p, $\pm 1\%$.

Power requirements

AC line: 115 or 230 V $\pm 20\%$, 48 to 440 Hz, 50 VA max.

DC line: 11.5 to 36 V, 25 watts max.

Battery (optional)

Operating time: up to 4.5 hours.

Recharge time: same as Models 1700A and 1701A.

Low battery indicator: same as Models 1700A and 1701A.

Weight: same as Models 1700A and 1701A.

Dimensions: refer to 1700A/1701A outline drawing.

Environment: same as Models 1700A and 1701A.

Accessories furnished: same as Models 1700A and 1701A.

Price (without battery pack)

Model 1706A Portable Oscilloscope\$1775

Model 1707A Delayed Sweep Portable Oscilloscope\$1925

Options (order by Option number)

012: Model 10103A battery pack installed, add \$200.

016 (Model 1707A): TV sync separator (may not be ordered with Option 020), add \$85.

020 (Model 1706A): same as Models 1700A and 1701A.

020 (Model 1707A): same as Models 1700A and 1701A.

OSCILLOSCOPES



PORTABLE, 150 MHz

Dual channel, 5 mV/div

Model 1710A

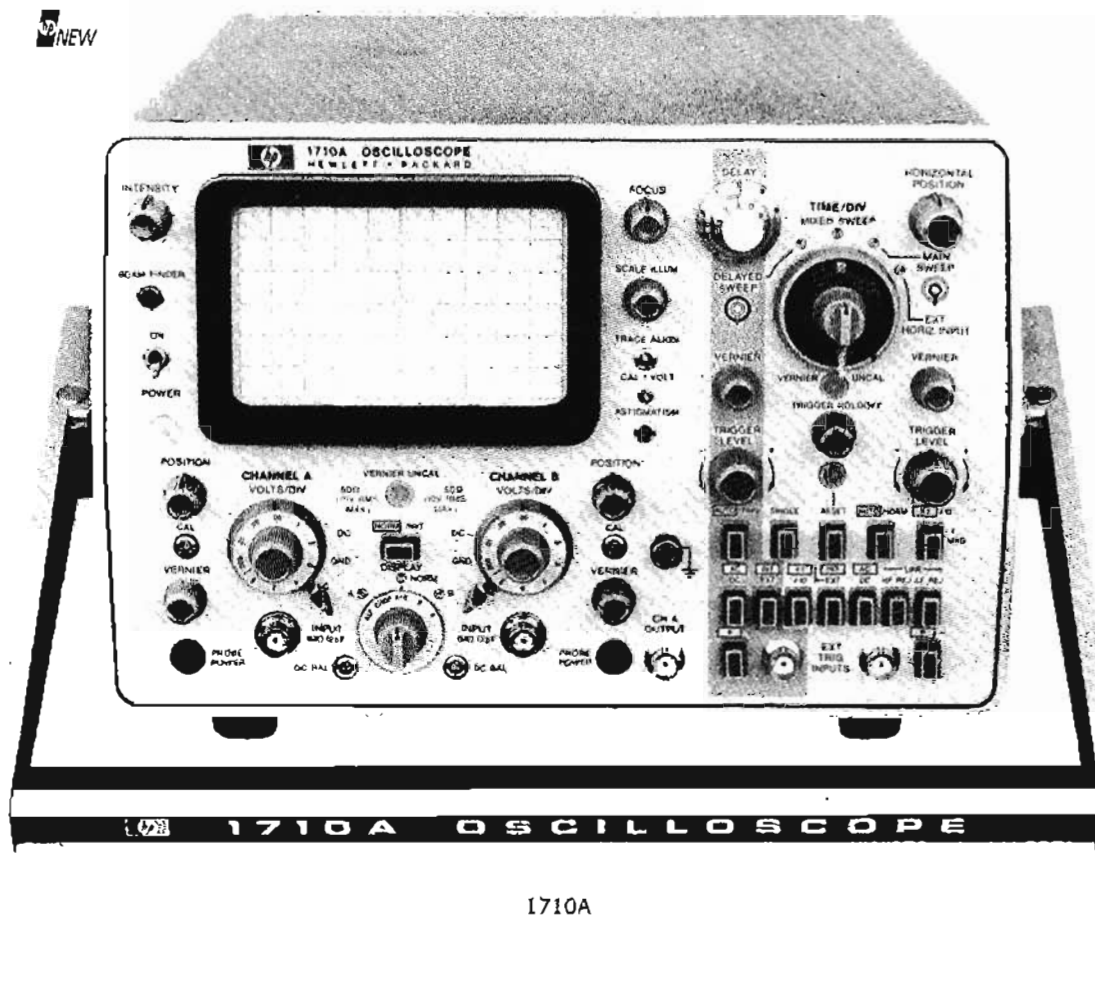

Description, 1710A

Model 1710A is a 150 MHz, dual channel, 5 mV/div deflection factor portable oscilloscope with a 6 x 10 cm internal graticule cathode-ray tube. The 150 MHz bandwidth and 2 ns/div expanded sweep speeds provide accurate measurements in logic and analog measurements. Laboratory performance in a portable package make this oscilloscope equally well suited for bench applications or field work, such as servicing high-speed computers or telemetry equipment.

The 1710A provides accurate measurements of high-frequency signals and fast rise time pulses with its 5 mV/div vertical deflection capability over the full 150 MHz bandwidth. The selectable input impedance of either 50 ohms or 1 megohm allows you to select the impedance that best fits your measurement application. If you are looking at a pulse from a 50 ohm source, you have an instant impedance match at the scope input with virtually no reflections to degrade the input signal or introduce phase shift. However, when probing high impedance circuits, the one megohm input is available with the flick of a switch. Its low shunt capacitance of 12 pF reduces phase shift and signal loss in pulse or CW measurements.

The 1710A's time base also adds to its laboratory quality performance. Its sweep linearity is specified over the full 10 centimeters of horizontal display. The calibrated delay dial provides magnification of any portion of the main sweep, and may also be used for accurate measurements of waveform time jitter and other precise time intervals. Enhancing the 1710A's accurate time base is its excellent trigger capability. Internal trigger sensitivity is less than 1 division over the entire bandwidth and <math><0.3</math> div up to 20 MHz. Externally, the scope will trigger on less than 200 mV p-p. The 1710A adds main sweep trigger flexibility with ext $\div 10$ and line sync functions not found on the other delayed sweep models.

Like other 1700 series models the 1710A is rugged and light-weight without sacrificing performance. Front panel controls are grouped by function for fast familiarization. The CRT presents a bright, sharp trace, especially valuable for viewing low rep-rate, fast rise pulses. The 1710A also comes with a storage cover, where probes and accessories can be conveniently stored.

More information about the 1700 series oscilloscopes is located at the beginning of this section.

PORTABLE, 150 MHz

Delayed sweeps to 2 ns/div

Model 1710A



OSCILLOSCOPES

Specifications, 1710A

Vertical amplifiers

Modes of operation: channel A; channel B; channels A and B displayed alternately on successive sweeps (ALT); channels A and B displayed by switching between channels at approx 1 MHz rate with blanking during switching (chop); channel A + channel B (algebraic addition).

Each channel (2)

Bandwidth: (3 dB down from 6 div reference signal from a 25 ohm source.)

DC-coupled: dc to 150 MHz.

AC-coupled: 10 Hz to 150 MHz.

Rise time: <2.4 ns (measured from 10% to 90% points of 6 div input step from a 25 ohm source).

Deflection factor

Ranges: 5 mV/div to 5 V/div (10 calibrated positions) in 1, 2, 5 sequence. $\pm 3\%$ with vernier in calibrated position.

Vernier: continuously variable between all ranges, extends maximum deflection factor to at least 12.5 V/div.

Polarity: NORM or INV, selectable on channel B.

Signal delay: input signals are delayed sufficiently to view leading edge of input signals without external trigger.

Input RC (selectable)

High Z: 1 meg ohm $\pm 1\%$ shunted by approx 12 pF.

50 ohm: 50 ohms $\pm 1\%$. VSWR, <1.3:1 on all ranges.

Input coupling: selectable, AC or DC (1 megohm), DC (50 ohms), or Ground. Ground position disconnects input connector and grounds amplifier input.

Maximum input

High Z: 150 V (dc + peak ac) at 1 kHz on 5 mV range increasing to 300 V (dc + peak ac) on all other ranges.

50 ohm: 10 V rms (dc-coupled input).

A + B operation: bandwidth and deflection factors are unchanged; channel B may be inverted for A-B operation.

Trigger source: selectable from channel A, or normal.

Channel A: all display modes triggered by channel A signal.

Normal: all display modes triggered by displayed signal except Chop. Chop triggered by Channel A signal.

Sweep modes: Main, Mixed, and Delayed

Main time base

Sweep

Ranges: from 20 ns/div to 0.2 s/div (22 ranges) in 1, 2, 5 sequence. $\pm 3\%$ accuracy over full scale with vernier in calibrated position.

Vernier: continuously variable between all ranges, extends slowest sweep to at least 0.5 s/div. Vernier uncalibrated light indicates when vernier is not in Cal position.

Magnifier: expands all sweeps by a factor of 10 and extends fastest sweep to 2 ns/div. Sweep accuracy is 5% (including 3% accuracy of the time base).

Sweep trigger mode

Normal: sweep is triggered by an internal or external signal.

Automatic: bright baseline displayed in absence of input signal. Triggering is same as normal above 40 Hz.

Single: in Normal mode, sweep occurs once with same triggering as normal, reset pushbutton arms sweep and lights indicator; in Auto mode, sweep occurs once each time Reset pushbutton is pressed.

Triggering

Internal: dc to 20 MHz on signals causing 0.3 divisions or more vertical deflection, increasing to 1 division deflection at 150 MHz in all display modes. Triggering on line frequency is also selectable.

External: dc to 20 MHz on signals of 50 mV p-p or more, increasing to 200 mV p-p at 150 MHz.

External input RC: approx 1 megohm shunted by approx 20 pF.

Level and slope

Internal: at any point on the vertical waveform displayed.

External: continuously variable from +1.5 V to -1.5 V on

either slope of the trigger signal. +15 V to -15 V in ± 10 on main time base only. Maximum input, ± 100 V.

Coupling: AC, DC, LF REJ, or HF REJ.

AC: attenuates signals below approx 10 Hz.

LF REJ: attenuates signals below approx 50 kHz.

HF REJ: attenuates signals above approx 50 kHz.

Trigger holdoff: time between sweeps continuously variable, exceeding one full sweep on all ranges.

Sweep Delayed time base

Ranges: 20 ns/div to 0.1 s/div (21 ranges) in 1, 2, 5 sequence. $\pm 3\%$ accuracy over full scale with vernier in calibrated position. Selected independently of main time base setting (must sweep faster than main time base).

Vernier: continuously variable between all ranges, extends slowest sweep to at least 0.25 s/div. Vernier uncalibrated light indicates when vernier is not in Cal position.

Magnifier: same as main time base.

Triggering

Internal: same as main time base.

Automatic: delayed sweep automatically starts at end of delay time.

Trigger: delayed sweep is armed at end of delay period.

Level and slope: at any point on the vertical waveform displayed when in triggered mode.

Coupling: selectable, AC or DC. AC attenuates signals below approx 10 Hz.

Delay time: continuously variable from 0.02 μ s to 2 s; accuracy $\pm 1\%$; linearity +0.2%.

Delay jitter: <0.005% (1 part in 20,000) of max. delay in each

Trace intensification: intensifies that part of main time base to be expanded to full screen in delayed time base mode. Rotating delayed time base switch from OFF position activates intensified mode.

Mixed time base: dual time base in which main time base drives first portion of sweep and delayed time base completes the sweep at up to 1000 times faster. Also operates in single sweep mode.

Cathode-ray tube and controls

Type: post-accelerator, ≈ 22 kV accelerating potential; aluminized P31 phosphor.

Graticule: 6 x 10 div internal graticule; 0.2 subdivisions on major horizontal and vertical major axes. 1 div = 1 cm. Front panel adjustment aligns trace with graticule.

Beam finder: returns trace to CRT screen regardless of setting of horizontal, vertical, or intensity controls.

Intensity modulation: >+6 V, dc to 1 MHz blanks trace of any intensity. Input R, 1000 ohms $\pm 10\%$. Maximum input, ± 10 V (dc + peak ac).

General

Calibrator

Type: 1 kHz, $\pm 10\%$ squarewave.

Voltage: 1 V p-p, $\pm 1\%$.

Current: 5 mA, $\pm 1\%$.

Power: 115 or 230 V $\pm 20\%$, 48 to 440 Hz, 75 VA max.

Weight

Without panel cover: net, 31 lbs (14.1 kg); shipping, 42 lbs (23.7 kg).

With panel cover and accessories: net, 34 lbs (15.4 kg); shipping, 46 lbs (25.4 kg).

Dimensions: refer to 1700A/1701A outline drawing, and add 1/8" to all chassis length measurements.

Environment: (Oscilloscope operates within specifications over the following ranges); temperature, 0°C to +55°C; humidity, to 95% relative humidity to 40°C, altitude, to 15,000 ft; vibration, vibrated in three planes for 15 min. each with 0.010 inch excursion, 10 to 55 Hz.

Accessories furnished: 10115A contrast filter, front panel storage cover, Model 10101A; two divider 10006C probes; one ac power cord with right angle plug; and one instruction manual.

Price: Model 1710A Oscilloscope \$3200.

Additional accessories: refer to 1700A/1701A accessories.



PLUG-IN OSCILLOSCOPE

One scope for many measurements

Model 140 System

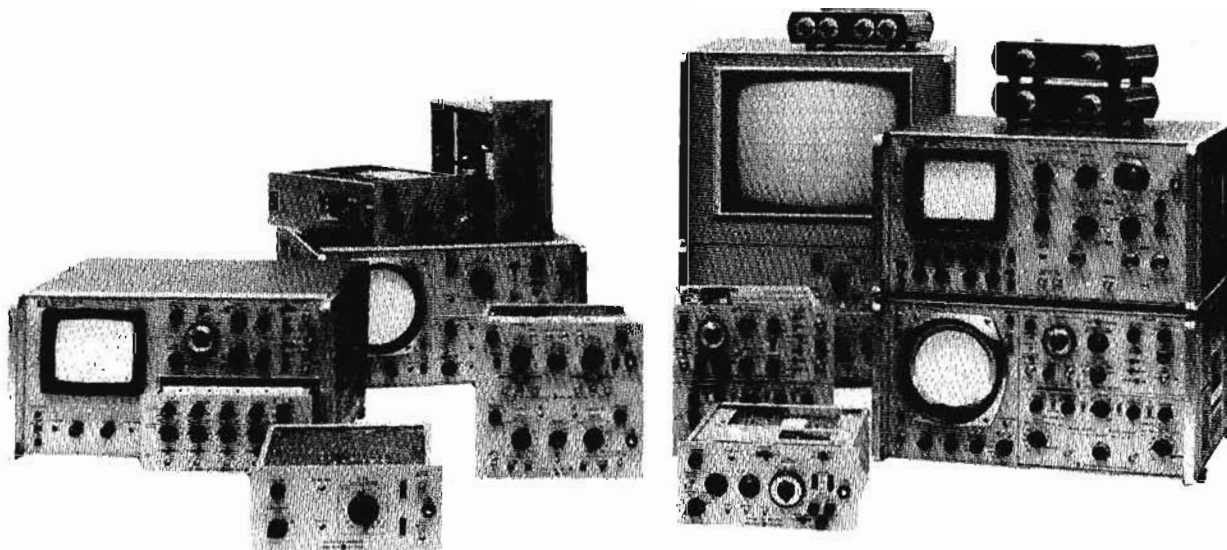

140 System

The Hewlett-Packard 140 Oscilloscope System provides the versatility you need for measurements over the entire oscilloscope spectrum. With many high performance vertical and horizontal plug-ins to choose from, you can head in any measurement direction; wide-band sampling, high-sensitivity, delayed sweep, or measurements such as time domain reflectometry, swept frequency, or spectrum analysis.

Hewlett-Packard's 140 oscilloscope system offers these capabilities:

- Sampling bandwidth to 18 GHz.
- Sampling delayed sweep time base.
- $50 \mu\text{V}/\text{div}$ deflection factors.
- Versatile single or double-size plug-in capability.
- Direct readout TDR.
- Swept frequency.
- Spectrum analyzer plug-ins.

In addition, the system offers standard CRT persistence in either the 140B, or 143A mainframes; or variable persistence and storage in the 141B mainframes. Select from these unique measurement capabilities or from the general purpose plug-ins available.

High-performance mainframes

The advanced 140B, 141B, and 143A mainframes give you a choice between conventional (fixed) CRT persistence, variable persistence and storage, and 8" x 10" CRT displays. As a result, the 140 system not only has an extensive plug-in capability, but also, the CRT versatility needed to meet the requirements of measurement problems today—six months from now—or in the distant future.

Because all deflection circuits are contained in the plug-ins, you get exclusive capabilities in mixing plug-ins. You can not only select the amplifier needed for the vertical axis, but also,

the particular time base generator needed for the horizontal axis.

Further, since the 140 system CRT's have identical horizontal and vertical deflection factors you can use two vertical amplifiers for an X-Y display . . . or one single-channel amplifier and one dual-channel amplifier to plot two variables against a third . . . or two identical dual-channel amplifiers for a pair of simultaneous X-Y displays.

Variable persistence and storage

The 141B mainframe gives you all the advantages of the 140B mainframe—plus the benefits of variable persistence and storage. At the twist of a knob, you can adjust trace persistence from 0.2 seconds to more than a minute. This variable persistence allows you to adjust the CRT persistence to match the changing characteristics of a signal—any necessary number of traces can be held for trend comparisons, or for flicker free displays.

The Hewlett-Packard mesh storage tube offers many advantages. With the 141B CRT a stored trace has the same high contrast and visual brightness of a conventional CRT. Intermediate trace values stand out clearly, you can easily distinguish between four or five separate trace intensities. Intensity of the CRT can be varied by a front panel control, or modulated externally for X-Y-Z presentations.

18 GHz sampling with delayed sweep

You can see through P band, observe CW signals to 18 GHz and beyond, and see fast pulses with 20 ps risetime capability. You can also use TDR measurements to resolve discontinuities down to less than 1 cm in the design of cables, coaxial components, connectors and strip lines. In addition, the delayed sweep can be used through the full bandwidth for displays of pulse segments that leave conventional sampling scopes blurred. You also get less than 20 ps jitter to ensure steady, clear displays.

MEASUREMENTS FROM DC TO 18 GHz

1, 2, or 4 channels, standard/delayed sweeps

Model 140 System



OSCILLOSCOPES

Two vertical amplifiers are available. Model 1411A provides dc to 18 GHz at 1 mV/div, dual-channel performance with remote samplers featuring feed-through inputs for minimum signal disturbance. The other sampling vertical amplifier, Model 1410A, gives performance to 1 GHz, with both high-Z probes and 50 ohm inputs—and internal triggering. Model 1425A Sampling Time Base plug-in provides delayed sweep, automatic triggering, and a movable intensified dot that makes it easy to set up the point of magnification.

50 μ V/div zero drift

The versatile HP 140 Scope System gives you six high-sensitivity plug-ins specifically designed for measurement of low-level signals. For example, the 1406A vertical plug-in offers 50 μ V/div deflection factors with no dc drift—plus precision calibrated dc offset for extreme magnification.

With the Hewlett-Packard calibrated offset feature, the 1406A gives you the advantages of a dc and ac voltmeter—four-digit readout, auto decimal placement, better than 0.5% measurement accuracy. As a dc voltmeter, the 1406A offers you the additional advantages of no drift in the measurement instrument, and the ability to observe and measure any ac riding on the dc voltage.

2-channel 20 MHz bandwidth, 4-channel displays to 15 MHz, and delayed sweep

If you need wideband real time performance, for example, you can use the dual-trace 1402A vertical amplifier and get dc to 20 MHz (15 MHz with Model 143A) at 5 mV/div,

algebraic addition, built-in delay line for viewing the leading edge of fast-rise pulses, full 6 div deflection and a wide dynamic range. An internal sync amplifier triggers on Channel A in dual trace mode of operation—gives stable traces and accurate time measurements without external triggering.

When you need to display four channels of information, you can use the 4-trace 1404A vertical amplifier and get dc to 15 MHz at 10 mV/div or 1 mV/div to 10 MHz, algebraic addition, and built-in delay line for viewing the leading edge of fast-rise pulses. Internal trigger circuits allow you to trigger on channel A, B, C, or D or select composite triggering, which triggers each channel individually.

For easy readability of complex waveforms and accurate time interval measurements, Model 1421A Time Base & Delay Generator provides calibrated time delays from 10 seconds to 0.5 μ s, calibrated sweep speeds from 0.2 μ s/div to 20 ns/div. The 1421A also offers mixed sweep which displays the first portion of a trace at normal sweep speeds, and expands the trailing portion of the trace at faster delayed sweep speeds to allow step-by-step magnified examination.

Spectrum analyzer plug-ins for measurements in the frequency domain

By a simple addition of Spectrum Analyzer plug-ins, you can convert your time-domain oscilloscope into a frequency-domain instrument. These spectrum analyzer plug-ins have absolute amplitude calibration, high sensitivity, low distortion, wide dynamic range, and flat frequency response.

140 Series Plug-in Selection Chart

Vertical Plug-in	REALTIME							SAMPLING			TDR	Swept Freq.
	1400B	1402A	1403A	1404A	1405A	1406A	1408A	1410A	1411A/1430C	1411A/1432A	1415A	1416A
Capabilities	1400B	1402A	1403A	1404A	1405A	1406A	1408A	1410A	1411A/1430C	1411A/1432A	1415A	1416A
Bandwidth	500 kHz	20 MHz	400 kHz	15 MHz	5 MHz	400 kHz	500 kHz	1 GHz	18 GHz	4 GHz		
Deflection Factor/div	100 μ V	5 mV	10 μ V	10 mV	5 mV	50 μ V	100 μ V	1 mV	1 mV	1 mV		
Channels	1	2	1	4	2	1	2	2	2	2		
X-Y	X	X	X	X	X	X	X	X	X	X		
Delayed Sweep			1421A for Realtime					1425A for Sampling				
No Drift						X						
Max. CMRR in dB	100	40	106	40	40	60	100					
Algebraic Add.		X		X	X		X	X	X	X		
TDR											X	
Wide Band TDR									X			
Swept Freq.												X
RECOMMENDED TIME BASES												
1421A	X	X	X	X	X	X	X					
1423A	X	X	X	X	X	X	X					
1424A								X	X	X		
1425A								X	X	X		
SPECTRUM ANALYZER SYSTEM PLUG-INS	Refer to Model Number Index for 8550 Series Plug-ins.											

OSCILLOSCOPES**SELECT FROM 3 MAINFRAMES**

Standard, storage, large screen CRTs
Model 140 System

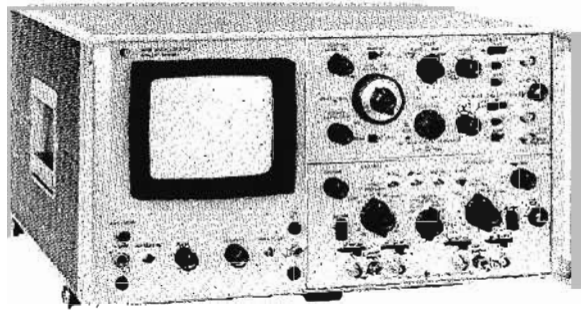

140B

- 8 x 10 div internal graticule
- Bright display
- Convenient beam finder
- Price: \$695 (less plug-ins)

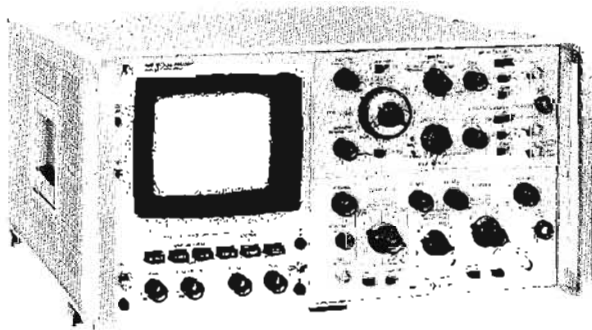

141B

- Variable persistence and storage
- Bright stored displays
- 8 x 10 div internal graticule
- Convenient beam finder
- Price: \$1500 (less plug-ins)

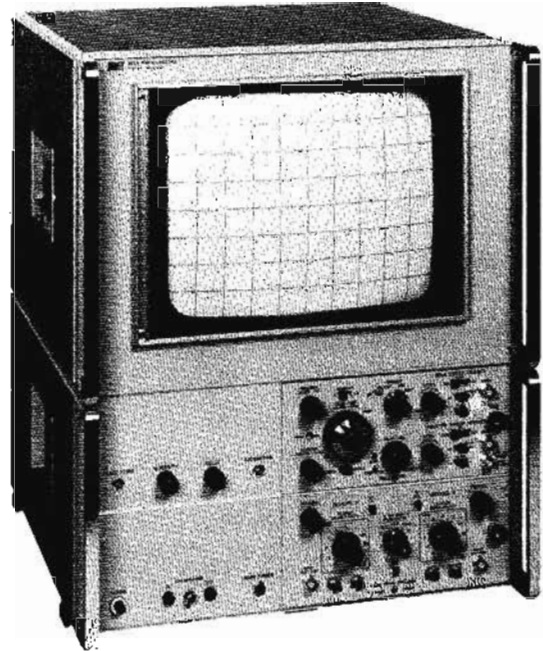

143A

- Large, 8 x 10 in. viewing area
- Bright, easy-to-see displays
- 8 x 10 div internal graticule
- Convenient beam finder
- Price: \$1500 (less plug-ins)

Description, 140 mainframes

The HP 140 Oscilloscope System provides the versatility you need for measurements over the entire oscilloscope spectrum. With many high-performance plug-ins to choose from, you can head in any measurement direction: wideband, sampling, high sensitivity, time domain reflectometry, swept frequency, and spectrum analysis.

The HP 140-system mainframes are designed to give you high-frequency and high-sensitivity performance. The mainframe contains a post-accelerator CRT with associated control circuits and power supplies and the power supplies for the plug-ins.

The 141B mainframe gives you all the advantages of the 140 mainframe plus the benefits of a mesh CRT with variable persistence and storage.

This variable persistence allows you to adjust CRT persistence to match the changing characteristics of a signal. Any

necessary number of traces can be held for trend comparisons or for flicker-free low-frequency displays.

With the mesh storage tube, a stored trace has the same high contrast as a conventional CRT and intermediate trace values are easily distinguished between four or five different trace intensities. Trace intensity can be controlled from the front panel or externally modulated for X-Y-Z presentations.

Another 140-System feature is the large screen, 8 x 10 inch viewing area, 143A mainframe, which is useful when the display is to be viewed from a distance or by many people at one time. The Model 143A provides high resolution displays throughout the oscilloscope spectrum with the same accuracy and linearity associated with conventional 5-inch displays.

For complete specifications about the 140 System, refer to the 140 System data sheet or contact your Hewlett-Packard field engineer.

For complete 140 System specifications, contact your Hewlett-Packard field engineer.

DC TO 20 MHz - REAL TIME

Single & Delayed Time Bases
Model 1400 series plug-ins



OSCILLOSCOPES

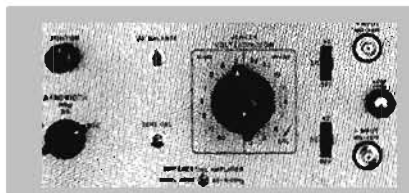

1400B

- 100 μ V/div
- dc to 500 kHz
- Differential on all ranges
- 100 dB CMRR
- Price: \$275.

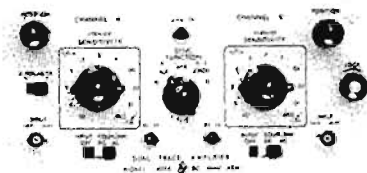

1402A

- 5 mV/div
- dc to 20 MHz-dual trace
- Signal delay for fast rise viewing
- Price: \$625

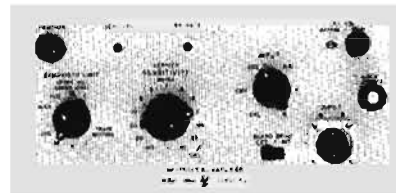

1403A

- 10 μ V/div
- 0.1 Hz to 400 kHz
- 106 dB CMRR
- Price: \$575

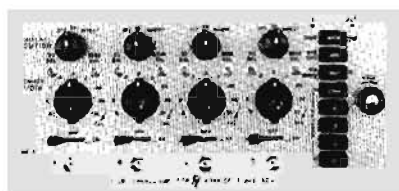

1404A

- 10 mV/div to 15 MHz
- 1 mV/div to 10 MHz
- Signal delay for fast rise viewing
- Selectable triggering
- Price: \$1025

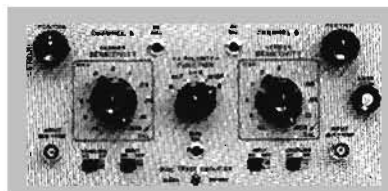

1405A

- 5 mV/div-dual trace
- dc to 5 MHz
- Algebraic addition
- Price: \$350

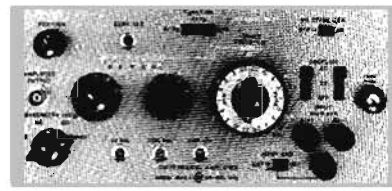

1406A

- 50 μ V/div-dc to 400 kHz
- No drift
- Calibrated offset for accurate ac an dc measurements
- Price: \$950

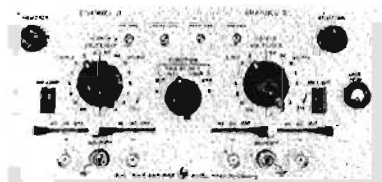

1408A

- 100 μ V/div-dual channel
- dc to 500 kHz
- 100 dB CMRR
- Alternate or chopped sweeps
- Price: \$575

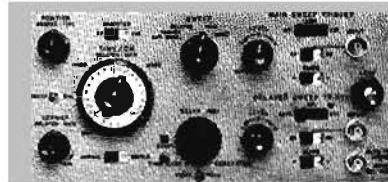

1421A

- 20 MHz triggering
- Delayed sweep
- Sweeps to 20 ns/div
- Price: \$725

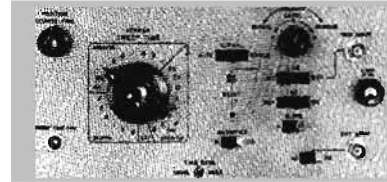

1423A

- 20 MHz triggering
- Sweeps to 20 ns/div
- Trigger hold-off
- Price: \$525

For complete 140 System specifications, contact your Hewlett-Packard field engineer.

OSCILLOSCOPES



DC TO 18 GHz SAMPLING TDR, SWEEPED FREQUENCY

Model 1400 series plug-ins

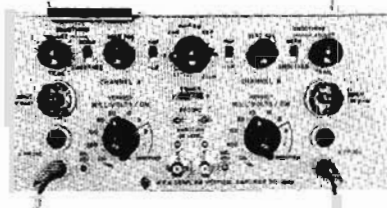

1410A

- 1 mV/div at 1 GHz dual trace
- Internal triggering
- High impedance probes and 50Ω inputs
- Price: \$1700

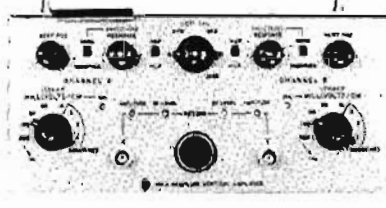

1411A

- 1 mV/div-dual trace
- Bandwidths to 18 GHz
- Remote samplers
- Price: \$850

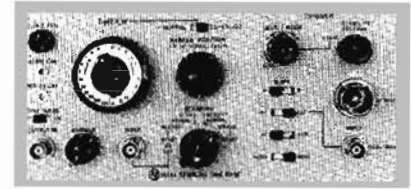

1424A

- Triggering to 5 GHz
- Sweeps to 10 ps/div
- Direct readout on all sweeps
- Price: \$1475

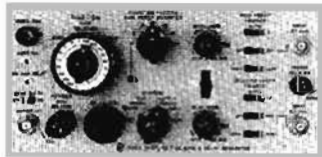

1425A

- Delayed sweep
- Sweeps to 10 ps/div
- Triggering to 1 GHz
- Price: \$2000



1430C

- 20 ps risetime
- Price: \$2800



1432A

- 90 ps risetime
- Price: \$1100

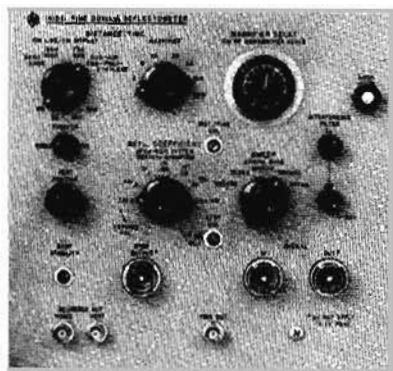

1415A

- Complete TDR system for testing cables, connectors, striplines
- Determines location, meaning, and nature of each discontinuity
- Resolves discontinuities—an inch apart
- Easy to operate
- Price: \$1200

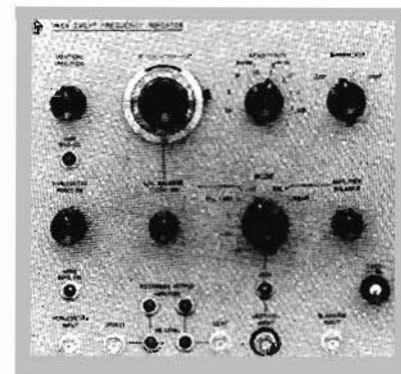

1416A

- Speeds and simplifies swept frequency measurements
- High resolution direct readout in dB
- Low drift
- X-Y recorder outputs
- Price: \$900

For complete 140 System specifications, contact your Hewlett-Packard field engineer.

500 kHz, 7 MHz BANDWIDTH
Solid State—Low drift
1200 Series



OSCILLOSCOPES



1200 Series

1200 Series Description

The 1200 series 500 kHz and 7 MHz oscilloscopes provide the most versatile, general purpose instruments for today's low frequency applications. These oscilloscopes are all solid-state, light-weight, reliable, stable, which makes them ideal for a variety of applications. The many features of these scopes provide accurate, versatile, easy-to-obtain and read displays. Logical arrangement of controls, a beam finder to locate off-screen displays, and automatic triggering make operation easy, which is important to persons in production line testing, system applications, and classroom or laboratory instruction.

The wide variety of instruments assure an oscilloscope that will match your measurement requirement. Basic choices for specialized or general purpose, low frequency measurement applications are: single or dual channel 500 kHz displays, 5 mV/div or 100 μ V/div deflection factors, standard or storage CRTs, and a 7 MHz, dual channel, 5 mV/div model—all available in cabinet or rack configurations. In addition, these lightweight instruments allow measurements in remote or difficult access areas such as: aircraft flight lines, communications field sites, or weapons test sites.

The 500 kHz models provide balanced inputs on all ranges and on each channel which is useful in low level audio applications. An additional feature on the dual channel models is an A vs. B mode, which displays channel A signal versus channel B signal through identical amplifiers with less than 1° phase shift up to 100 kHz.

Field effect transistors at the vertical amplifier input provide stable, low-drift operation virtually free of annoying trace

shifts caused by temperature changes, shock, and vibration. Long term stability also means less frequent calibration and lower periodic maintenance costs.

Rack versions (designated by a B, "1200B," following the model number) are only 5¼ inches high which saves valuable rack space and allows more instruments to be included in a rack for a more versatile system. Since these instruments are complete oscilloscopes, they offer the system user a read-out device and a convenient calibration and service tool.

In applications with displays that occur at slow rates, a storage/variable persistence CRT is available that will eliminate the annoying flicker or retain single occurrence traces. This longer persistence is useful when displaying slowly moving bio-medical phenomena and applications where the trace or display information must persist after the excitation is removed.

Single, normal, and free run modes of sweep operation are flexible enough for complex measurements, yet operation is simple and straight forward. The sweep time and magnifier controls provide a direct reading of a magnified sweep which reduces the chance of error and time for measurements.

Specification grouping

Due to the similarity of these oscilloscopes, the specifications have been grouped to reduce redundancy and increase usability. The layout is as follows: Cathode-Ray Tube (standard and storage); vertical amplifiers in sequence of 500 kHz, 100 μ V/div and 5 mV/div, and 7 MHz, 5 mV/div; Time Base, common to all 1200 oscilloscopes; followed by combined general information.



1200 Series Oscilloscope Selection Chart

Feature	1200A/B*	1201A/B*	1202A/B*	1206A/B*	1208A/B*	1217A/B*
Deflection Factor/div	0.1 mV to 20 V	0.1 mV to 20 V	0.1 mV to 20 V	5 mV to 20 V	5 mV to 20 V	5 mV to 20 V
Bandwidth	500 kHz	500 kHz	500 kHz	500 kHz	500 kHz	7 MHz
Number of Traces	2	2	1	2	1	2
Differential Input	all ranges	all ranges	all ranges	all ranges	all ranges	all ranges (B-A)
CMRR	100 dB	100 dB	100 dB	50 dB	50 dB	30 dB
Common-mode Signal Maximum	≈ 10 V	≈ 10 V	≈ 10 V	≈ 3 V	≈ 3 V	30 div
Phase Shift (A vs B)	1° to 100 kHz	1° to 100 kHz	—	1° to 100 kHz	—	—
Sweep Speeds/div	1 μ s to 5 s	1 μ s to 5 s	1 μ s to 5 s	1 μ s to 5 s	1 μ s to 5 s	1 μ s to 5 s
Ext. Horiz. Input	yes	yes	yes	yes	yes	yes
DC-coupled Z-axis	yes	yes	yes	yes	yes	yes
Variable Persistence and storage	no	yes	no	no	no	no
Price	\$1050	\$1900	\$790	\$895	\$715	\$1175

*"A" denotes standard bench model, e.g. 1200A. "B" denotes standard rack model, e.g. 1200B.

Specifications, 1200 Series

Cathode-ray tube and controls

Standard CRT

Type: mono-accelerator, 3000 V accelerating potential; P31 phosphor standard (refer to options for other phosphors).

Graticule: 8 x 10 div internal graticule, 0.2 subdivision markings on horizontal and vertical major axes. 1 div = 1 cm.

Beam finder: returns trace to CRT screen regardless of setting of horizontal, vertical, or intensity controls.

Intensity modulation: +2 V signal blanks trace of normal intensity; +8 V signal blanks any intensity trace, DC-coupled rear panel input; amplifier risetime, approx 200 ns; input R, 5 k ohms.

Variable persistence/storage CRT

1201A/B

Type: post-accelerator, variable persistence storage tube; 10.5 k V accelerating potential; aluminumized P31 phosphor.

Graticule: 8 x 10 div internal graticule, 0.2 subdivision markings on major axes. 1 div = 0.95 cm. Front panel recessed screw-driver adjustment aligns trace with graticule.

Intensity modulation: +2 volt signal blanks trace of normal intensity. +8 volt signal blanks trace of any intensity. DC-coupled input on rear panel; amplifier risetime approx 200 ns; input R is approx 5 k ohms.

Beam finder: returns trace to CRT screen regardless of horizontal or vertical control settings.

Persistence/storage characteristics

(Referenced to a centered 7 x 9 div area in STD mode and to a centered 6 x 8 div area in FAST mode.)

Persistence: conventional, natural persistence of P31 phosphor, approx 40 μ s. Variable, continuously variable from 0.2 s to >1 min. in STD mode; and from 0.2 s to 15 s in FAST mode.

Storage writing speed: STD mode, 20 div/ms; FAST mode, 0.5 div/ μ s.

Brightness: 100 foot-lamberts in write mode.

Storage time: STD writing speed, variable from approx 1 minute to >2 hours. Fast writing speed, variable from approx 15 s to >15 min.

Erase: pushbutton erasure takes approx 1.2 s. Write gun is blanked and sweep is reset until erasure is completed.

Vertical amplifiers

100 μ V, 500 kHz

1200A/B, 1201A/B, 1202A/B

Bandwidth: dc-coupled, dc to 500 kHz; ac-coupled, 2 Hz to 500 kHz.

Bandwidth limit switch: allows selection of upper bandwidth limit to approx 50 kHz or 500 kHz.

Risetime: 0.7 μ s max.

Deflection factor

Ranges: from 0.1 mV/div to 20 V/div (17 positions) in 1, 2, 5 sequence.

Attenuator accuracy: $\pm 3\%$ with vernier in calibrated position.

Vernier: continuously variable between all ranges; extends maximum deflection factor to at least 50 V/div.

Noise: <20 μ V measured tangentially at full bandwidth.

Input: differential or single-ended on all ranges, selectable.

Common mode

Frequency: dc to 10 kHz on all ranges.

Rejection ratio: 100 dB (100,000 to 1) with dc-coupled input on 0.1 mV/div range, decreasing by <20 dB per decade of deflection factor to at least 40 dB on the 0.2 V/div range; CMRR is at least 30 dB on the 0.5 V/div ranges.

Maximum signal: ± 10 V (dc + peak ac) on 0.1 mV/div to 0.2 V/div ranges; ± 400 V (dc + peak ac) on all other ranges.

Input coupling: selectable AC; DC, or OFF for both + and - inputs.

Input RC: 1 megohm shunted by approx 45 pF; constant on all ranges.

Maximum input: ± 400 V (dc + peak ac).

Remaining vertical amplifier specifications apply only to dual channel models

Modes of operation: Channel A alone; Channel B alone; Channels A and B (either Chop or Alternate); Channels A and B vs. horizontal input (Chop only); Channel A vs. B (A-vertical, B-horizontal). Chop frequency is approx 100 kHz.

Internal trigger source: on Channel A signal for A, Chop, and Alternate displays. On Channel B signal for B display.

Isolation: >80 dB between channels at 500 kHz, with shielded input connectors.

SOLID STATE, ECONOMICAL

7 MHz, 500 kHz, 5 mV/div
1200 Series



OSCILLOSCOPES

Phase shift: (Channel A vs. B) $< 1^\circ$ to 100 kHz with verniers in calibrated position.

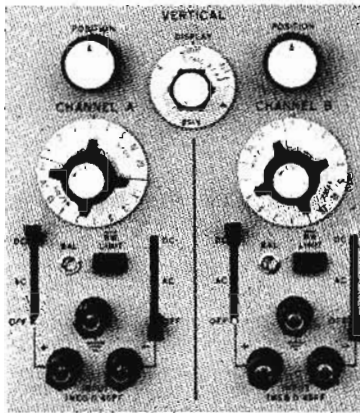

1201A/B
Vertical Amplifier

5 mV/div, 500 kHz

1205A/B, 1206A/B, 1207A/B

Bandwidth: dc-coupled, dc to 500 kHz; ac-coupled, 2 Hz to 500 kHz.

Risetime: 0.7 μ s max.

Deflection factor

Ranges: from 5 mV/div to 20 V/div (12 positions) in 1, 2, 5 sequence.

Attenuator accuracy: $\pm 3\%$ with vernier in calibrated position.

Vernier: continuously variable between all ranges; extends maximum deflection factor to at least 50 V/div.

Input: differential or single-ended on all ranges, selectable.

Common mode

Frequency: dc to 10 kHz on all ranges.

Rejection ratio: 50 dB with dc-coupled input on 5 mV/div to 0.2 V/div ranges; CMRR is at least 30 dB on the 0.5 V/div to 20 V/div ranges.

Maximum signal: ± 3 V (dc + peak ac) on 5 mV/div to 0.2 V/div ranges; ± 300 V (dc + peak ac) on all other ranges.

Input coupling: selectable AC, DC or OFF for both + and - inputs.

Input RC: 1 megohm shunted by approx 45 pF; constant on all ranges.

Maximum Input: ± 400 V (dc + peak ac).

Remaining vertical amplifier specifications apply only to dual channel models

Modes of operation: Channel A alone; Channel B alone; Channels A and B (either Chop or Alternate); Channels A and B vs. horizontal input (Chop only); Channels A vs. B (A-vertical, B-horizontal). Chop frequency is approx 100 kHz.

Internal trigger source: on Channel A signal for A, Chop, and Alternate displays. On Channel B signal for B display.

Isolation: > 80 dB between channels at 500 kHz, with shielded input connectors.

Phase shift: (Channel A vs. B) $< 1^\circ$ to 100 kHz with verniers in calibrated position.

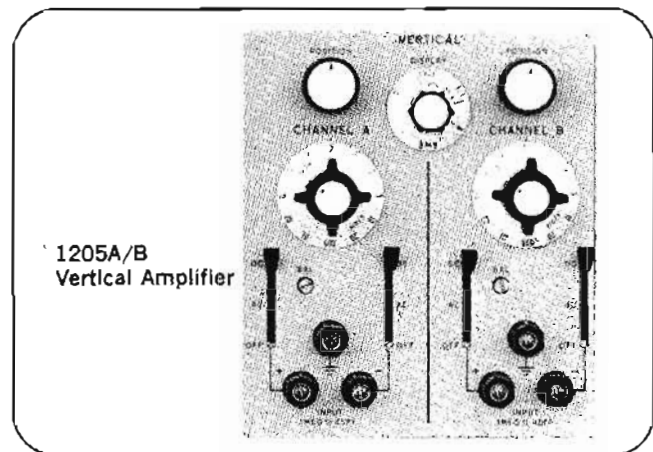

1205A/B
Vertical Amplifier

5 mV/div, 7 MHz

1217A/B

Bandwidth: dc-coupled, dc to 7 MHz; ac-coupled, 2 Hz to 7 MHz.

Risetime: 50 ns max.

Deflection factor

Ranges: from 5 mV/div to 20 V/div (12 positions) in 1, 2, 5 sequence.

Attenuator accuracy: $\pm 3\%$ with vernier in calibrated position.

Vernier: continuously variable between all ranges; extends maximum deflection factor to at least 50 V/div.

Input RC: 1 megohm shunted by approx 35 pF; constant on all ranges.

Input: single-ended on all ranges.

Input coupling: selectable AC, DC, or OFF.

Modes of operation: Channel A alone; Channel B alone; Channels A and B (either Chop or Alternate triggered by Channel A); Channels A + B (triggered by Channels A + B). Chop frequency is approx 100 kHz.

Differential Input: Channel A may be inverted for differential operation. Bandwidth and deflection factors remain unchanged.

Common mode

Frequency: dc to 100 kHz.

Rejection ratio: 30 dB on 5, 10, and 20 mV/div ranges and 20 dB on all other ranges.

Maximum signal: 30 div.

Internal trigger source: on Channel A signal for A, Chop, and Alternate displays; on Channel B signal for B display; on Channels A + B signal for Channel A + B display.

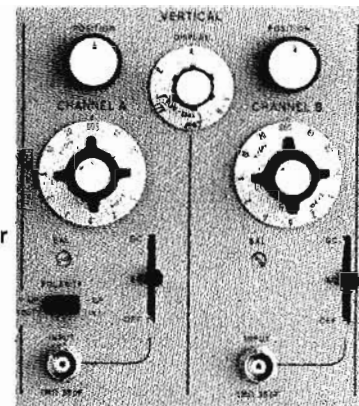

1217A/B
Vertical Amplifier

OSCILLOSCOPES



FLEXIBLE SWEEP & TRIGGER

Direct reading magnifier

1200 Series

Time Base

All models

Sweep

Ranges: from 1 μ s/div to 5 s/div (21 positions) in 1, 2, 5 sequence. $\pm 3\%$ accuracy with vernier in calibrated position.

Vernier: continuously variable between ranges; extends slowest sweep to at least 12.5 s/div.

Magnifier: direct reading x10 magnifier expands fastest sweep to 100 ns/div with $\pm 5\%$ accuracy.

Automatic triggering

Baseline is displayed in absence of an input signal.

Internal: 50 Hz to above 500 kHz (2 MHz in 1217A/B) on most signals causing 0.5 division or more vertical deflection, increasing to 1 div at 7 MHz in Models 1217A/B. Triggering on line frequency also selectable.

External: 50 Hz to above 1 MHz (2 MHz in 1217A/B) on most signals at least 0.2 V p-p, increasing to 0.5 V p-p at 7 MHz in Models 1217A/B.

Trigger slope: positive or negative slope on internal, external, or line trigger signals.

Amplitude selection triggering

Internal: dc to above 500 kHz on signals causing 0.5 division or more vertical deflection.

External: dc to 1 MHz on signals at least 0.2 V p-p. Input impedance is 1 megohm shunted by approx 20 pF.

Trigger level and slope: internal, at any point on vertical waveform displayed; or continuously variable from +100 V to -100 V on either slope of the external trigger signal.

Trigger coupling: dc or ac for external, line, or internal triggering. Lower ac cutoff is 2 Hz for external; 5 Hz for internal.

Internal low frequency triggering (1217A/B only): internal trigger signal is attenuated at approx 6 dB per octave for frequencies above 5 MHz.

Single sweep: selectable by front panel switch. Reset switch with armed indicator light.

Free run: selectable by front panel switch.

Maximum input: ± 350 V (dc + peak ac).

Horizontal amplifier

Bandwidth: dc-coupled, dc to 300 kHz; ac-coupled, 2 Hz to 300 kHz.

Deflection factor

Ranges: 0.1 V/div, 0.2 V/div, 0.5 V/div, and 1 V/div.

Vernier: continuously variable between ranges; extends maximum deflection factor to at least 2.5 V/div.

Maximum input: ± 350 V (dc + peak ac).

Input RC: 1 megohm shunted by approx 20 pF.

Input: single-ended on all ranges.

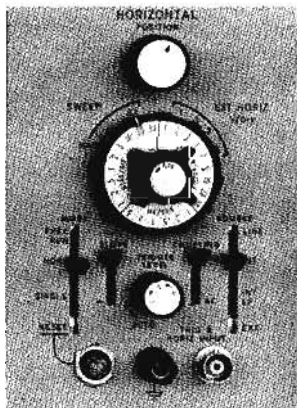

Typical Horizontal Time Base

General

Calibrator

Type: line frequency square wave.

Output: 1 V $\pm 1.5\%$.

Dimensions

Cabinet models (designated by A suffix). 8-5/16" wide x 11 3/4" high x 8-11/16" deep (211, 2 x 298, 5 x 474,7 mm).

Rack models (designated by B suffix): 19" wide x 5 1/4" high x 17 1/8" deep over-all (483 x 132, 5 x 435 mm), 15 3/8" (390,5 mm) behind front panel.

Power: 115 or 230 V $\pm 10\%$, 48 to 440 Hz, approximate watts 1200A/B, 50 W; 1201A/B, 60 W; 1202A/B, 40 W; 1205A/B, 45 W; 1206A/B, 40 W; 1217A/B, 75 W.

Weight

1200A: net, 25 lbs (11,4 kg); shipping, 34 1/2 lbs (15,7 kg).

1200B: net, 22 1/2 lbs (10,2 kg); shipping, 35 lbs (15,9 kg).

1201A: net, 30 lbs (13,6 kg); shipping, 39 1/2 lb (17,9 kg).

1201B: net, 27 1/2 lbs (12,5 kg); shipping, 40 lbs (18,2 kg).

1202A: net, 23 1/2 lbs (10,6 kg); shipping, 33 lbs (15,2 kg).

1202B: net, 21 lbs (9,5 kg); shipping, 33 1/2 lbs (15,2 kg).

1205A: net, 25 lbs (11,4 kg); shipping, 34 1/2 lbs (15,7 kg).

1205B: net, 22 1/2 lbs (10,2 kg); shipping, 35 lbs (15,9 kg).

1206A: net, 23 1/2 lbs (10,6 kg); shipping, 33 lbs (15,2 kg).

1206B: net, 21 lbs (9,5 kg); shipping, 33 1/2 lbs (15,2 kg).

1217A: net, 24 1/2 lbs (11,1 kg); shipping, 34 1/2 lbs (15,7 kg).

1217B: net, 23 lbs (10,4 kg); shipping, 35 lbs (15,9 kg).

Price

Model 1200A or 1200B Dual Channel, 100 μ V

Oscilloscope\$1050

Model 1201A or 1201B Dual Channel, 100 μ V

Storage Oscilloscope\$1900

Model 1202A or 1202B Single Channel, 100 μ V

Oscilloscope\$ 790

Model 1205A or 1205B Dual Channel, 5 mV Oscilloscope \$ 895

Model 1206A or 1206B Single Channel, 5 mV Oscilloscope \$ 715

Model 1217A or 1217B Dual Channel, 5 mV, 7 MHz

Oscilloscope\$1175

Options (order by Option number)

002 (standard CRT only): P2 phosphor in lieu of P31, no charge.

006 (rack models only): rear input terminals wired in parallel with front panel vertical and horizontal input terminals. Vertical input shunt capacitance is increased to approx 100 pF on 500 kHz models and to approx 85 pF on 7 MHz models. Horizontal input shunt capacitance is increased to approx 75 pF on 500 kHz and 7 MHz models.

Price: add \$35 for single channel models and \$55 for dual channel models.

007 (standard CRT only): P7 phosphor in lieu of P31, no charge.

009 (variable persistence/storage models only): remote erase through rear panel banana jack, shorting to ground provides erasure, add \$25.

011 (standard CRT only): P11 phosphor in lieu of P31, no charge.

Beamfinder does not intensify display on Option 011 Oscilloscopes.

015 (500 kHz models only): vertical channel signal outputs through rear panel connectors.

Vertical output signal specifications

Output: 0.3 V/div $\pm 10\%$, 0 V offset unaffected by position control setting.

Bandwidth: dc to 500 kHz.

Dynamic range: ± 3.5 V.

Maximum slewing rate: 12 V/ μ s with 300 pF load.

Minimum load RC: 10 k ohms shunted by approx 300 pF.

Source impedance: approx 300 ohms.

Price: single channel models, add \$70; dual channel models, add \$95.

SYSTEM & TV WAVEFORM

Low cost, easy-to-use
Models 120B, 130C, 191A



OSCILLOSCOPES

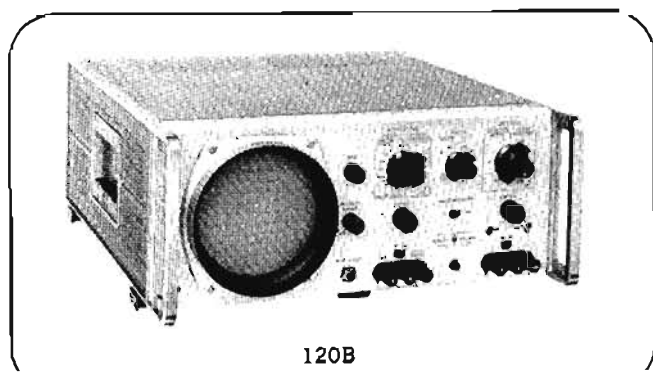

120B

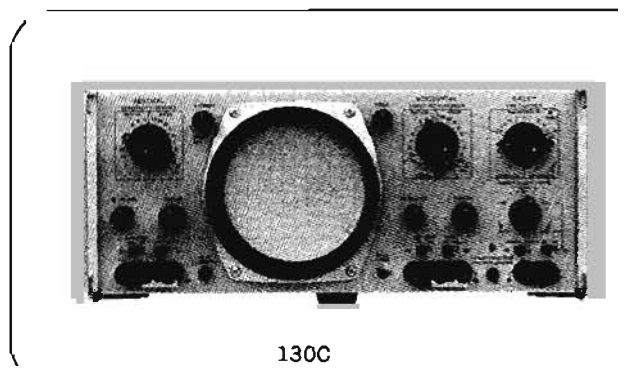

130C

Models 120B and 130C have applications in a few specialized systems and have abbreviated specifications. If complete specifications are required, contact your Hewlett-Packard Field Engineer.

Specifications, 120B

Time base

Range: 5 μ s/cm to 200 ms/cm \pm 5%. 1 μ s/cm in x5 \pm 10%.

Triggering

Automatic: internal, 50 Hz to 450 kHz for most signals of 1.0 cm vertical deflection; external, 50 to 450 kHz for signals 1.5 V p-p.

Amplitude selection: internal, 10 Hz to 450 kHz for signals $>$ 0.5 cm vertical deflection; external, 10 Hz to 450 kHz for signals 1.5 V p-p.

Trigger level and slope: from any point on the vertical waveform presented on CRT; or continuously variable from -7 to +7 volts on the negative slope of external sync signal.

Vertical amplifier

Bandwidth: dc to 450 kHz; lower limit 2 Hz when ac-coupled.

Deflection factor: 10 mV/cm to 10 V/cm in 4 steps, \pm 3%; vernier extends 10 V/cm step to at least 100 V/cm.

Maximum input: 50 V peak (dc + ac).

Balanced input: on 10 mV/cm range, common mode rejection is at least 40 dB; common mode signal \pm 3 V peak.

Phase shift: vertical to horizontal, \pm 2° to 100 kHz (with verniers in Cal).

Horizontal amplifier

Bandwidth: dc to 300 kHz; lower limit is 2 Hz when ac-coupled.

Deflection factor: 0.1 V/cm to 10 V/cm in 3 steps, \pm 5%; vernier extends 10 V/cm step to at least 100 V/cm.

General

Cathode-ray tube: 2700 V mono-accelerator, P31 phosphor.

Graticule: 10 cm x 10 cm internal graticule.

Beam finder: returns trace to CRT screen.

Intensity modulation: +20 V, pulse blanks normal intensity trace.

Dimensions: 16 $\frac{3}{4}$ " wide, 7 $\frac{1}{2}$ " high, 18 $\frac{3}{8}$ " deep overall (425 x 191 x 467 mm); hardware furnished for quick conversion to 7" x 19" (178 x 483 mm) rack mount.

Weight: net, 29 lbs (13 kg); shipping, 35 lbs (16.9 kg).

Power: 115 or 230 volts \pm 10%; 50 to 400 Hz; approx 90 W.

Price: HP Model 120B Oscilloscope \$625.

Specifications, 130C

Time base

Range: 1 μ s/cm to 5 s/cm, \pm 3%; vernier extends 5 s/cm step to at least 12.5 s/cm.

Magnifier: X2, X5, X10, X20, X50. \pm 5% for sweeps to 0.2 μ s/cm.

Automatic triggering: internal, 50 Hz to 500 kHz for signals $>$ 0.5 cm vertical deflection; external, 50 Hz to 500 kHz for signals $>$ 0.5 V p-p.

Amplitude selection triggering: internal, 10 Hz to 500 kHz for signals $>$ 0.5 cm vertical deflection; external, for signals $>$ 0.5 V p-p; dc to 500 kHz or 20 Hz to 500 kHz, ac-coupled.

Trigger level and slope: any point on the display or variable from -10 to +10 V on either slope of external sync signal.

Vertical and horizontal amplifiers

Bandwidth: dc to 500 kHz; lower limit is 2 Hz when ac-coupled.

Deflection factor: 0.2 mV/cm to 20 volts/cm, 1, 2, 5 sequence; accuracy \pm 3%; vernier extends 20 V/cm step to at least 50 V/cm.

Maximum input: 500 V peak (dc + peak ac).

Common mode rejection (dc to 50 kHz): 40 dB from 0.2 mV/cm to 0.1 V/cm 30 dB from 0.2 V/cm to 20 V/cm common mode signal max 4 V p-p on 0.2 V/cm range, 40 V p-p on 0.5 V/cm to 2 V/cm ranges, or 400 V p-p on 5 V/cm to 20 V/cm ranges.

Phase shift: \pm 1° to 100 kHz.

General

Calibrator: line frequency square wave, 500 mV \pm 2%.

Cathode-ray tube: 3 kV mono-accelerator.

Graticule: 10 cm x 10 cm internal graticule.

Beam finder: returns trace to CRT screen.

Intensity modulation: \pm 20 V pulse blanks normal intensity trace.

Dimensions: 16 $\frac{3}{4}$ " wide, 7 $\frac{1}{2}$ " high, 18 $\frac{3}{8}$ " deep over-all (426 x 191 x 467 mm); hardware furnished for quick conversion to 7" x 19" (178 x 843 mm) rack mount.

Weight: net, 31 lbs (15 kg); shipping, 38 lbs (18 kg).

Power: 115 or 230 volts \pm 10%; 50 to 400 Hz; approx 90 W.

Price: HP Model 130C Oscilloscope \$890.

191A TV Waveform Oscilloscope

The 191A is used for accurate displays of TV video waveforms and test signals. Its accuracy of 1% in signal amplitude measurements and positive field selection on noisy signals make this scope ideal for many video applications. Other conveniences features are: 20 kV CRT for bright, easy-to-read displays and RGB operation for color camera set-up.

Price: Model 191A TV Waveform Oscilloscope \$1775.

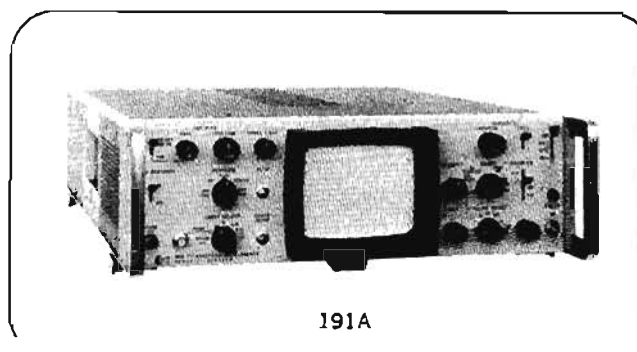

191A

OSCILLOSCOPES



GENERAL PURPOSE PROBES

Time mark generators and gain calibrator

Models 226A, 10411A, 10000 series



Model 226A is a high quality, time mark generator that provides 30 precision time intervals for calibrating oscilloscope time bases. Marker intervals are in a convenient 1, 2, 5 sequence to match sweep times on all common oscilloscopes. A single, easy-to-read front panel rotary switch provides usability without confusing nomenclature.

An optional feature provides TTL compatible programming for marker intervals. Marker range programming is accomplished with a six bit parallel TTL compatible, binary word to the rear panel program connector.

Specifications, 226A

Time mark

Ranges: from 2 ns to 10 s (30 ranges) in 1, 2, 5 sequence.

Output: +1 V p into 50 ohms on all ranges. 28 intervals from 10 ns to 10 s.

Accuracy: ±0.005%, 0°C to +55°C; ±0.002% at 25°C after 1/2 hour warmup.

Sine wave output: 2 ns and 5 ns sine wave, 1 V into 50 ohms.

Trigger frequency: same as time mark to 100 ns, 10 MHz for all ranges faster than 100 ns.

Programming (optional): all ranges are programmable, requires 6 parallel lines (6 bit word) and 2 timing lines. TTL compatible.

General

Dimensions: 4 1/2" high, 7 3/4" wide, 8" deep (114,3; 196,9; 203,2 mm).

Weight: net, 7 lbs (3,2 kg); shipping, 9 lbs (4,1 kg).

Power: 115 or 230 volts ±10%, 48 to 440 Hz, approx 25 watts.

Price: Model 226A Time Mark Generator\$670
Model 226A with Programming Option 003add \$150

Horizontal Gain Calibrator, 10411A

The Hewlett-Packard Model 10411A Horizontal Gain Calibrator is an instrument designed to calibrate the horizontal amplifier of 180, 181A/AR, and 182A oscilloscopes.

Specifications, 10411A

Current accuracy: ±1%.

Range: X1, 2.5 mA ±0.025 mA; X5, 0.5 mA ±0.005 mA; X10, 0.25 mA ±0.0025 mA.

Weight: net, 14 oz (0,4 kg); shipping, 2 lbs (0,9 kg).

Price: Model 10411A Horizontal Gain Calibrator \$65

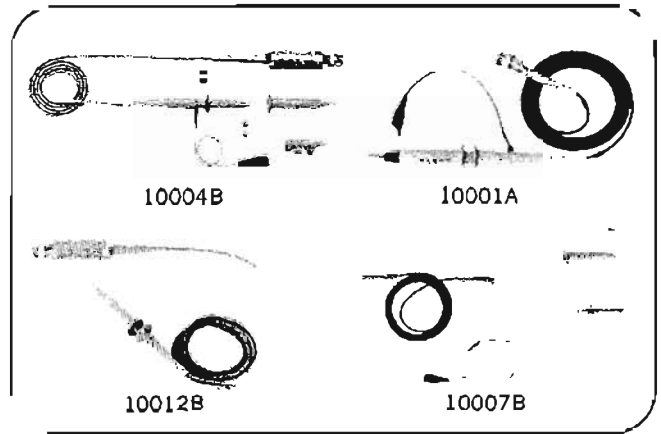

Voltage Divider Probe Specifications

Model No.	Division Ratio	Resistance MΩ	Shunt Capacitance	Compensates Scope Input Capacitance	Peak Volts	Division Accuracy	Over-all Length (approx. ft.)	Price
10001A	10:1	10	10 pF	15-55	600	2%	5	\$35
10001B	10:1	10	20 pF	15-45	600	2%	10	35
10002A	50:1	9	2.5 pF	15-55	1000	3%	5	40
10002B	50:1	9	5 pF	15-55	1000	3%	10	40
10003A	10:1	10	10 pF	15-55	600	2%	4	35
10004B	10:1	10	10 pF	17-30	500	3%	3.5	40
10004C	10:1	10	10 pF	8-28	500	2%	3.5	40
10005B	10:1	10	27 pF	17-30	500	3%	10	40
10006B	10:1	10	14 pF	17-30	500	3%	6	40
10006C	10:1	10	10 pF	5-15	500	2%	5.5	40
10007B	1:1	—	30 pF	—	600	—	3.5	22
10008B	1:1	—	60 pF	—	600	—	6	22
10012B	10:1	10	16 pF	30-55	500	3%	6	40
10014C	10:1	10	10 pF	5-15	500	2%	3.5	55
10016C	10:1	10	14 pF	5-15	500	2%	6	55

Probe/Instrument Compatibility

Scope/Plug-in	120B	130C	181A	1200 Series	1700A thru 1700A	1700A/1707A	1710A	1400B	1402A	1004A	1005A	1008A	1007A	1003A	1004A	1005A	1007A	1008A	1009A	1010A	1011A	1000A	
Probe																							
10001A	X	X	X				X	X	X	X	X									X			
10001B	X	X	X				X	X	X	X	X									X			
10002A	X	X	X				X	X	X	X	X									X			
10002B	X	X	X				X	X	X	X	X									X			
10003A	X	X	X				X	X	X	X	X									X			
10004B					X	X						X	X	X						X			
10004C																	X				X		
10005B					X	X						X	X	X						X			
10006B					X	X						X	X	X						X			
10006C																	X				X		
10007B	X	X	X	0	0	0	0	0	0	0	0	X	0	0	0	0	0	0	0	X	0	0	0
10008B	X	X	X	0	0	0	0	X	0	0	0	X	0	0	0	0	0	0	0	X	0	0	0
10009A			X																				
10012B	X	X	X				X	X	X	X	X									X			
10014A							X													X			
10016A							X													X			
10020A							X													X	X	0	0
1120A							X													X	0	0	X
1124A							0													0		X	0

PROBES FOR 50Ω SYSTEMS

100 and 500 MHz active, 700 MHz passive
Models 1120A, 1124A, 10020A, 1122A



OSCILLOSCOPES

500 MHz Active Probe with 1:1 Gain, 1120A

(Measured with output connected to a 50 ohm load.)

Bandwidth (measured from a terminated 50 ohm source): dc-coupled, dc to >500 MHz; ac-coupled, <1.5 kHz to >500 MHz.

Pulse response (measured from a terminated 50 ohm source) risetime, <0.75 ns; perturbations, <±6% measured with 1 GHz sampler.

Dynamic range: ±0.5 V with ±5 V dc offset.

Noise: approx 1.5 mV (measured tangentially).

Input RC: 100 k ohms, shunt capacitance approx 3 pF at 100 MHz; with 10:1 or 100:1 dividers, shunt capacitance is <1 pF at 100 MHz.

Maximum Input: ±100 V.

Weight: net, 4 lbs (1.8 kg); shipping, 7 lbs (3.2 kg).

Power: supplied by oscilloscope plug-ins with probe power jacks or a Model 1122A probe power supply.

Length: 4 ft over-all; with Option 001, 6 ft.

Accessories furnished

Model 10241A 10:1 divider: increases input R to approx 1 megohm shunted by <1 pF at 100 MHz.

Model 10243A 100:1 divider: increases input R to approx 1 megohm shunted by <1 pF at 100 MHz.

Model 10242A bandwidth limiter: reduces bandwidth to approx 27 MHz shunted by approx 6 pF and reduces gain <2%.

Also included: slip-on hook tip, 2.5" ground lead, spare probe tips, a slip-on BNC probe adapter, two red ID sleeves, and a probe divider adjustment tool (PN 5020-0570).

Price: Model 1120A, \$395. Model 1120A Option 001 approx 6 ft over-all length, add \$25.

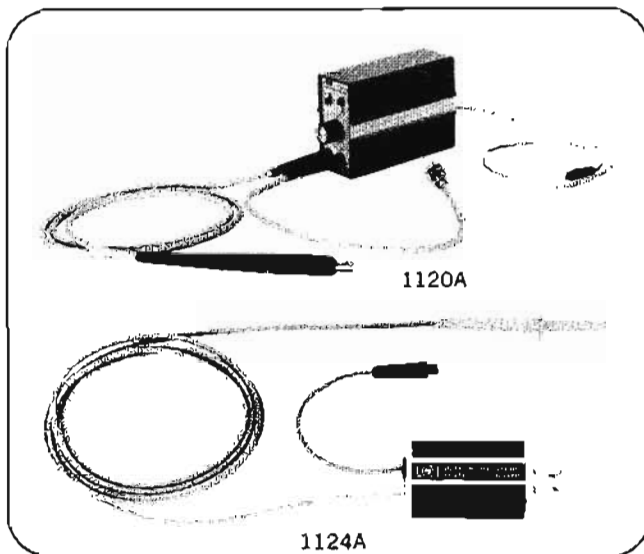

100 MHz Active Probe, 1124A

(Measured when connected to a 50 ohm load.)

Bandwidth (measured from a terminated 50 ohm source): dc-coupled, dc to 100 MHz; ac-coupled, 2 Hz to 100 MHz.

Pulse response (measured from a terminated 50 ohm source): risetime, <3.5 ns; perturbations, 5% p-p. Measured with pulse risetime of >2.5 ns.

Attenuation ratio: 10:1 ±5%; 100:1 ±5%.

Dynamic range: X10, ±10 V; X100, ±100 V.

Input RC: 10 megohms shunted by approx 10 pF.

Maximum safe input

DC-coupled: X10, ±300 V (dc + peak ac) ≤100 MHz; X100, ±500 V (dc + peak ac) ≤100 MHz.

AC-coupled: X10, ±300 V (dc + peak ac) ≤100 MHz. DC component must not exceed ±200 V; X100, ±500 V (dc + peak ac) ≤100 MHz. DC component must not exceed ±200 V.

Accessories supplied: one 8" ground lead, one retractable hook tip, and two probe tip insulating caps.

Power: supplied by 1800 series plug-ins with probe power jacks or Model 1122A probe power supply.

Weight: net, 7 oz (0.20 kg); shipping, 2 lbs (0.91 kg).

Length: approx 5 feet over-all.

Price: HP Model 1124A, \$125.

1122A Probe Power Supply

Probe driving capability: up to four Hewlett-Packard active probes. **Power output:** -12.6 and +15 V, ±3%.

Power Input: 115 V or 230 V ±10%, 48 to 440 Hz, 40 W (with four probes).

Weight: net, 5¼ lbs (2.4 kg); shipping, 8 lbs (3.63 kg).

Accessories supplied: four 10131B 36" extender cables.

Price: HP Model 1122A, \$225.

Resistive Dividers, 10020A

Division Ratio	Input R* (ohms)	Division Accuracy	Max V** (rms)	Input C (pF)
1:1	50	—	6	—
5:1	250	±3%	9	<0.7
10:1	500	±3%	12	<0.7
20:1	1000	±3%	15	<0.7
50:1	2500	±3%	25	<0.7
100:1	5000	±3%	35	<0.7

* When terminated in 50 ohms.

** Limited by power dissipation of resistive element.

Length (over-all): approx 4 ft.

Weight: net, 1 lb (0.45 kg); shipping, 3 lbs (1.36 kg).

Accessories supplied: blocking capacitor, BNC adapter tip, 6-32 adapter tip, alligator tip, boot extension, cable assy's 2" and 6" ground, spanner tip, insulating cap, colored sleeve.

Price: Model 10020A, \$100.

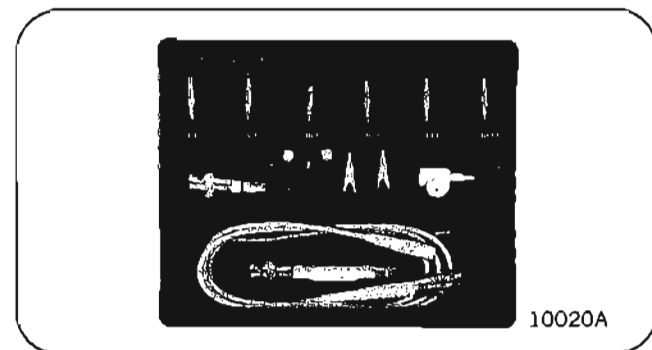

Probe Accessories

Probe tips

For probes 10001A-10003A: Model 10010C BNC adapter tip, \$10.

For probes 10004B-10006C and 100012B: Model 10011A BNC adapter tip.

Price: Model 10011A, \$8.

Terminations

Model 10100C, 50 ohm feed-through, \$15.

Model 10100B, 100 ohm (±2 ohm) feed-through for 1110A current probe.

Price: Model 10100B, \$18.



TERMINATIONS, ADAPTERS

Viewing, carrying, and mounting accessories

Models 10010, 10030, 10090, 10100, 10160, 10170 series

Attenuators: Models 10090A (2X, red), 10091A (5X, green), 10092A (10X, black) 50 ohm attenuators provide division accuracies of $\pm 3\%$ from dc to 1 GHz. Power dissipation is 2 watts average with a maximum peak of 3 kilowatts and maximum VSWR is 1.1:1 to 1 GHz.

Price: \$25 each.

Adapters

Model 10110A, Male BNC to dual female banana post. Price: \$7.

Model 10111A, female BNC to shielded banana post. Price: \$10.

BNC tip: 10011B for 10004B/C, 10005B, 10006B/C probes. \$8.

Probe tip kits

Probe tip kits, Models 10036A and 10037A, extend usefulness of 10004B/C, 10005B, 10006B/C, and 10012B probes. Model 10036A consists of an assortment including tips for the following: 0.08" jack; 0.025" and 0.045" square pin; 0.040-0.062" dia pin; and a long pin tip. Model 10037A contains six 0.025" square pin tips. Price: Model 10036A, \$20; Model 10037A, \$15. Probe tip kit, Model 10035A for 10001A-10003A probes contain pincer jaw, banana tip, pin tip, and spring tip. Price, \$5.

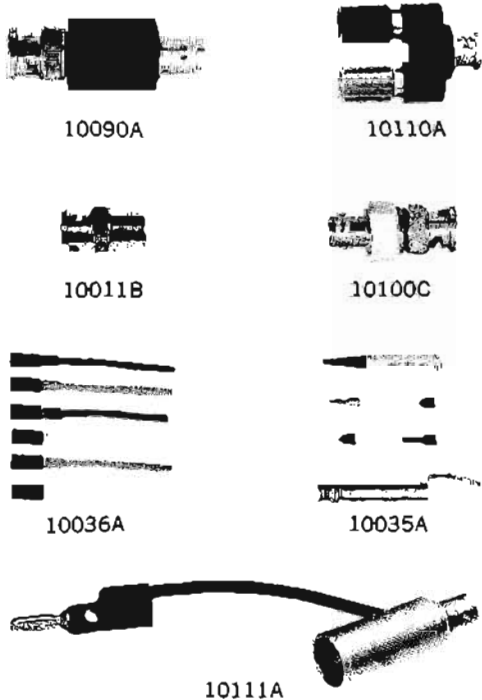

Viewing hoods

Model 10175A polarizer hood increases contrast and reduces glare when viewing dim traces under ambient light; price, \$15.

Model 10175B hood with removable vinyl face mask designed for use on Hewlett-Packard 5" round CRT bezels; price, \$20.

Model 10176A flexible viewing hood is for Hewlett-Packard 5" rectangular CRT bezels; price, \$10.



Slides and Slide Adapters

Both fixed and pivoted 22" slides are available for slide mounting Hewlett-Packard oscilloscopes. A slide adapter kit is required for either type slide.

120B through 140 series modular instruments

Slide adapter: HP Part Number 1490-0721, price, \$40.

Fixed slides: HP Part Number 1490-0714, price, \$32.50.

Pivot slides: HP Part Number 1490-0718, price, \$40.

180AR and 181AR slide adapter: HP PN 1490-0768, price, \$22.50.

180AR and 181AR pivot slides: HP PN 1490-0719, price, \$37.50.

180AR and 181AR fixed slides: HP PN 1490-0714, price, \$32.50.

Blank plug-ins: blank plug-ins are available for either 140 and 180 system vertical and horizontal mainframe compartments or a double-size is also available.

140-system blank plug-ins: vertical or horizontal, Model 10477A, price, \$25; double-size, Model 10478A, price, \$30.

180-system blank plug-ins

Vertical: Model 10408A, price, \$45.

Horizontal: Model 10409A, price, \$50.

Double size: Model 10410A, price, \$60.

Plug-in extenders

Plug-in extenders allow calibration and maintenance while a unit is operating.

140 system extender cable Model 10406A (one required for each plug-in), price, \$40.

180 system extender (metal frame extends both plug-ins) Model 10407A, price, \$75.

Panel covers

Models 10166A and 10169A panel covers provide front panel protection and space for probe and accessory storage for 180-series and 1200-series cabinet instruments.

180-system cabinet instruments, HP Model 10166A, price, \$30.

1200-system cabinet instruments, HP Model 10169A, price, \$35.

For 180-system and 191A TV waveform oscilloscope rack model instrument panel cover, order HP PN 5060-0437, \$39.50.

Flexible Covers for 180 Series

These flexible covers, made of durable vinyl-material, are designed to fit 180 series cabinet style mainframes. The covers provide protection during transportation or storage and each has a slot for access to the carrying handle.

Prices: Model 10167A for 180C and 181A, \$25; Model 10170A for 183A and 183C, \$25; Model 10172A for 182A, \$30.

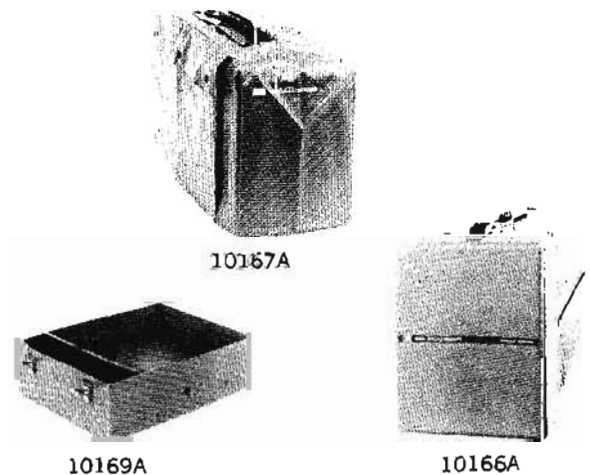

OSCILLOSCOPE CAMERAS

Low cost, easy-to-use, permanent records



OSCILLOSCOPES

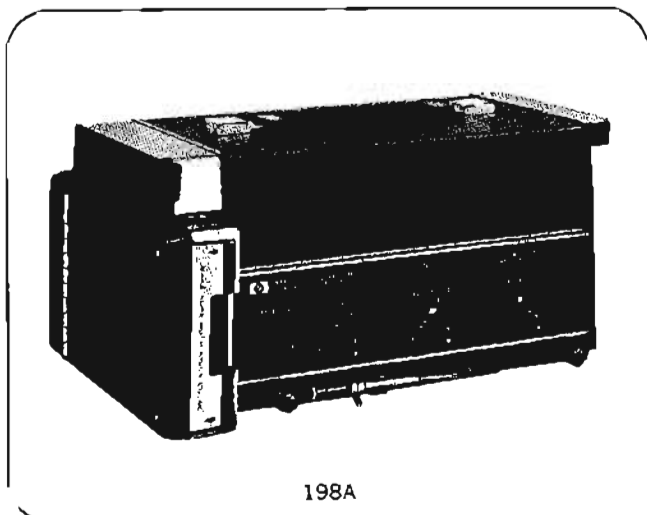

198A

Description, 198A

The HP Model 198A is an economical camera for general-purpose oscilloscope photography. In addition, this camera may be conveniently applied to normal photography of objects or surfaces which can be placed in the camera focal plane.

The camera features a Polaroid® back using the standard flat pack self-processing film, for rapid, on-the-spot results. Graticule (scale) illumination uses a simple pair of mirrors reflecting twin curtains of light onto the surface to be photographed. The mirror system is interlocked with lens focal distance and the mechanical focusing system. When the curtains of light just meet, the CRT graticule is evenly illuminated and the camera is focused.

Graticule illumination can be set continuously on, flashed by the shutter cable-release, or set off. When on or in flash, the illumination intensity is variable. Both focusing and graticule illumination may be seen through a viewing port at the rear of the camera.

Model 198A is easily and directly mounted on any 5-inch Hewlett-Packard oscilloscope by an adjustable clamp that locks the 198A securely in place. Bezel adapters are available for most other oscilloscopes.

Specifications, 198A

Film type: Polaroid® 107 Black and White ASA 3000 8-pack; Polaroid® 108 Color ASA 75 8-pack. (73 x 96 mm). Type 107 (black and white) development time: 15 seconds. Type 108 (color) development time: 60 seconds.

Object-to-image ratio: 1:0.85.

Lens: 75mm, f/3.5.

Shutter

Speeds: B, 1s, 1/2s, 1/4s, 1/8s, 1/15s, 1/30s, 1/60s. Cable release; cable has thumbscrew lock for time exposures.

Apertures: F/3.5, 4, 5.6, 8, 11, 16, 22.

Focus: directly adjustable with camera-back closed or open. Coincidence of vertical light patterns on CRT face indicates correct focus.

Graticule illumination: provided internally. Incandescent lamp and projector/mirror system, with variable intensity control, Off, FLASH, and ON.

Power required: 4 ea Type-C, 1.5 V dry cells (graticule illumination).

Synchronization: X-type contacts provided to trigger or synchronize other equipment with shutter release.

Compatibility

Direct: Hewlett-Packard 5-inch round and rectangular bezels (140, 180, 1200 series oscilloscopes; 8550 series spectrum analyzers, 780 series monitoring oscilloscopes, 8540, 8410 network analyzer, and all other Hewlett-Packard instrumentation having a 5-inch round CRT display.

Adapters for other oscilloscopes: refer to camera bezel adapters.

Dimensions: 7-9/16" x 12-3/16" x 5-13/16" (192 mm x 310 mm x 147 mm).

Weight: net, 6 1/2 lbs (2,95 kg); shipping, 11 lbs (4,99 kg).

Option 001: 1:0.7 object-to-image ratio, allows entire 5-inch round CRT to be photographed, add \$50.

Price: Model 198A Oscilloscope Camera, \$420.

"Polaroid"® by Polaroid Corp.

Description, 197A

Model 197A is a general purpose oscilloscope camera which can be used for most trace recording applications. All of the 197A controls are conveniently located outside of the camera. Control settings may be read at a glance and quickly changed if desired. Controls are also color-coded for optimum settings for most photos. The electronic shutter provides accurate exposure times from 1/30 to 4 seconds. All solid-state circuits insure reliable operation. The shutter may be operated remotely by providing a closure to ground, and a contact closure is provided when the shutter is open to allow synchronization of other equipment with the camera.

A simple screwdriver adjustment allows the reduction ratio (i.e., the object to image ratio) to be varied from 1:1 to 1:0.7. This allows an optimum amount of the graticule to be photographed, which is useful for making multiple exposures or for different sized CRT's. The camera can be quickly focused using the focus knob and split-image focus plate furnished with the camera.

A technique that enhances the quality of scope photos is available with the 197A camera. A low power ultraviolet (UV) light is used for exposing the black graticule lines in internal graticule CRT's. The UV light causes the CRT phosphor to glow uniformly over its entire surface. The white trace contrasts with the gray background and black graticule lines, making oscillograms taken with this camera easier to interpret.

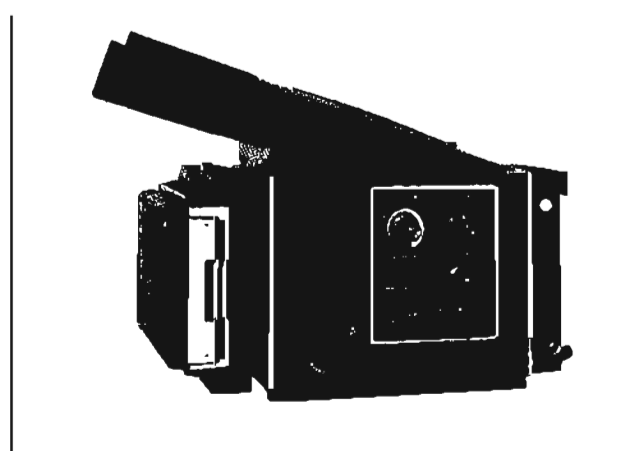

197A



OSCILLOSCOPE CAMERA

High speed, single shot trace photos

Specifications, 197A

Reduction ratio: continuously adjustable from 1:1 to 1:0.7. Reference scale provided on focus plate.

Lens: 75mm, f/1.9 high transmission lens; aperture ranges f/1.9 to f/16.

Shutter: electronically operated and timed shutter, with all solid-state circuits; shutter speeds are 1/30, 1/15, 1/8, 1/4, 1/2, 1, 2, 4 sec, Time, and Bulb; shutter has a sync contact closure output for triggering external equipment and input jack for remote operation.

Camera back: Polaroid® Land Camera using pack film Type 107 supplied; see options for other backs; backs may be interchanged without refocusing and may be rotated in 90-degree increments.

Mounting: quick lift on-off mounting with positive lock; swing away to left.

Viewing: low-angle, direct viewing flexible face mask.

Multiple exposure: back moves vertically through 11 detented positions at 1/2 cm per detent at 1:0.9 object-to-image ratio.

Focus: adjustable focusing with lock.

Dimensions: 14" long, 10 1/2" high, 7 3/8" wide (356 x 267 x 194 mm) with hood; 12" long, 6 1/2" high, 7 3/8" wide (305 x 165 x 194mm) without hood.

Weight: net, 10 lbs (4,5 kg); shipping, 14 lbs (6,4 kg).

Power: 115 V ±10%, 48 to 440 Hz, 6 watts.

Accessories furnished: combination split image focusing plate and reduction ratio scale.

Price: Model 197A Oscilloscope Camera, \$595.

Options

001: without ultraviolet light, deduct \$50.

003: Graflok® back in place of Polaroid back; no charge.

012: modified for 230 V operation; no charge.

004: Polaroid roll back in place of Polaroid back, no charge.

®Polaroid® by Polaroid Corp.

®Graflok® by Graflex, Inc.

Description, 195A

Model 195A is a high speed trace recording camera for photographing high-speed low repetition-rate waveforms. An 80mm, f/1.3 lens with a 2:1 reduction ratio provides high light transmission for high writing speeds.

The electronic shutter employed in the 195A provides accurate exposure times from 1/30 to 4 seconds. All solid-state circuits insure reliable operation. The shutter may be operated remotely by producing a closure to ground, and a contact closure is provided when the shutter is open to allow synchronization of other equipment with the camera.

An ultraviolet light option allows a two-fold increase in writing speed by "post-fogging" the film. Ordinarily, a single, faint trace may not expose the film sufficiently to bring the density level above the brightness threshold level. The gray background provided by the UV light, however, moves the trace's "zero" exposure level into the gray region, where a slight increase in exposure, caused by the trace, becomes visible.

The 195A mounts directly to Hewlett-Packard Oscilloscopes with 5-inch round, or rectangular CRTs without requiring a bezel adapter. The 195A will also swing away from the CRT face for easy viewing.

The camera back may be rotated from the normal horizontal position to a vertical position, allowing a 90° rotation of the film format. The back can also be moved through 11 detented

positions for multiple exposures. The camera back may also be removed and replaced with a 4 x 5 Graflok® back which allows use of cut or roll film, or a Polaroid® Pack Film back.

Specifications, 195A

Object-to-image ratio: 1:0.5.

Lens: 80mm, f/1.3 high transmission lens; aperture ranges from f/1.3 to f/11.

Shutter: electronically operated and timed shutter, with all solid-state circuits; shutter speeds are 1/30, 1/15, 1/8, 1/4, 1/2, 1, 2, 4 seconds, Time, and Bulb; shutter has a sync contact closure output for triggering external equipment and input jack for remote operation. Shutter-Open Light provides visual indication when shutter is open and shutter speed control is set to: T, B, and all other shutter speeds except 1/15 and 1/30 second.

Camera back: Polaroid® roll film holder standard; Polaroid® pack film holder or Graflok® backs available (see options); backs may be interchanged without refocusing and may be rotated in 90-degree increments.

Mounting: quick lift on-off mounting with positive lock; swing away to left.

Viewing: low-angle, direct viewing flexible face-mask.

Multiple exposure: back moves vertically through 11 detented positions.

Focus: adjustable focusing with lock.

Dimensions: 14 1/2" long, 9 3/4" wide, 10 1/2" high (368 x 248 x 172 mm) without hood.

Weight: net, 12 lbs (5,4 kg); shipping, 18 lbs (8,2 kg).

Power: 115 V ±10%, 48 to 440 Hz.

Accessories furnished: combination split image focusing plate and reduction ratio scale. HP Part No. 1000-0226.

Price: Model 195A Camera, \$975.

Options

001: with ultra violet light, add \$50.

002: Graflok® back instead of roll back, no charge.

003: Polaroid® pack back instead of roll back, no charge.

004: modified for 230 V operation, no charge.

®Polaroid® by Polaroid, Corp.

®Graflok® by Graflex, Inc.

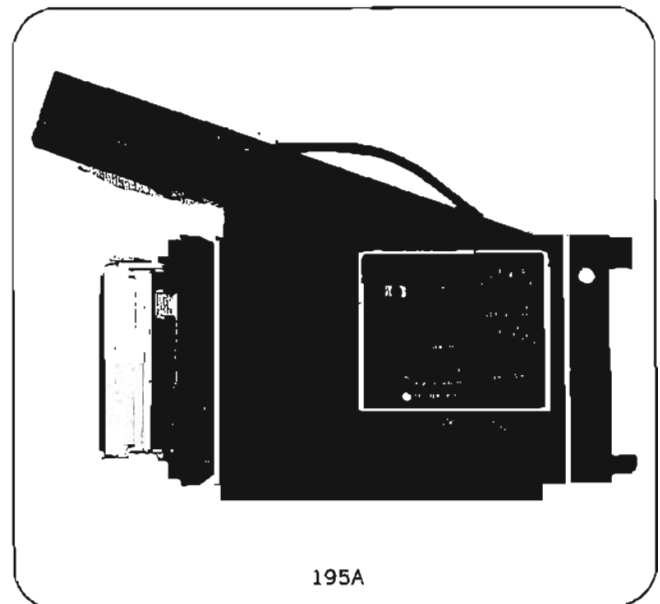

CAMERA ACCESSORIES



OSCILLOSCOPES

Camera backs



10353A

10365A

10352A

Model 195A is supplied with a Polaroid® Roll Film back and Model 197A is supplied with a Polaroid® Pack Film back. Either back may be ordered initially as options at no extra charge (refer to specifications), or the backs may be ordered separately. Polaroid® Pack Film back, Model 10353A, \$95. Polaroid® Roll Film back, Model 10365A, \$95. Graflex® back, Model 10352A, \$85.

Note: these backs will not fit on the HP Model 198A Camera.

Oscilloscope Bezel adapters

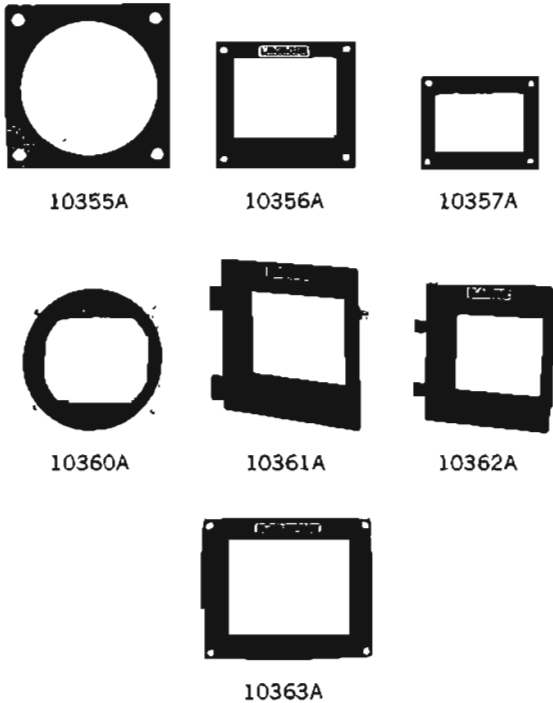

10355A

10356A

10357A

10360A

10361A

10362A

10363A

Models 195A, 197A, and 198A fit Hewlett-Packard 5-inch rectangular and round CRT oscilloscopes and can easily be fitted to other oscilloscopes by means of bezel adapters. Model 10355A adapts to Tektronix and Fairchild 5-inch round bezels, \$20. Model 10356A adapts to Tektronix 560 Series rectangular bezels, \$20. Model 10357A adapts to Tektronix 640 Series rectangular bezels, \$25. Model 10360A adapts Model 196A/B camera to the Hewlett-Packard rectangular bezel, \$20. Model 10361A adapts Tektronix C12 camera to Hewlett-Packard rectangular bezel, \$20. Model 10362A adapts Tektronix C27 camera to Hewlett-Packard rectangular bezel, \$20. Model 10363A adapts Tektronix C30 or C40 cameras to Hewlett-Packard rectangular bezel, \$20. Model 10106A (not shown) adapts the Tektronix C30A or C31 camera to 1700 series oscilloscopes, \$20.

®Polaroid® by Polaroid Corp.

Carrying case



10358B

The Model 10358B carrying case is constructed of fiberglass and aluminum with foam padding to protect the Model 195A, 197A, and 198A cameras to transit or storage. Price: \$80.

Other accessories

When the 4 x 5 Graflex back is used, various film packs and adapters may be used, some of which are shown below. Order these film packs from the manufacturer or your local camera dealer.



Model RH/50 70mm roll film holder

50 exposures without reloading.

Graflex catalog No. 1240.

Beattie-Coleman 70mm roll film holder available (type 45R).



Graphic film pack adapter

Daylight load-16-exposure film packs.

Graflex catalog No. 1234.



Polaroid Land 4 x 5 film holder No. 545

Makes both print and negative in 20 seconds—outside the dark room.

OSCILLOSCOPES



TESTMOBILES

Transport test equipment; save bench space
Models 1119A/B/C/D, 1117B

Description, Models 1119A/B

Models 1119A/B are designed for use with standard 16¾ inch wide Oscilloscopes. When used with scopes such as the 140 series, mounting hardware secures the instrument to the Testmobile. A Model 10479A Tilt-Table is available for the 180 and 1200 series. Typical oscilloscope tilt angle is ±40° in 10° increments.

Specifications, 1119A/B

- Oscilloscope compatibility:** 120, 130, 140 series direct; 180 and 1200 series with Model 10479A tilt tray; or 180 rack models with mounting plates (P/N 01119-69501).
- Tilt angle:** ±40° in 10° increments.
- Dimensions:** see outline drawing.
- Wheel size:** 4-inches (101,6 mm).
- Weight**
 - Model 1119A: net, 34 lb (15,4 kg); shipping, 47 lb (21,3 kg).
 - Model 1119B: net, 46 lb (20,9 kg); shipping, 63 lb (28,6 kg).
- Price**
 - Model 1119A: Testmobile\$110.
 - Model 1119B: Testmobile (with Model 10480A Storage Cabinet)\$145.
- Optional accessories**
 - Model 10480A: storage cabinet for 1119A provides additional storage space for accessories.
 - Weight: net, 20 lb (9,1 kg); shipping, 23 lb (10,4 kg).
 - Price: Model 10480A (supplied with 1119B)\$45.
 - Model 10479A tilt tray: allows oscilloscopes to be placed on Testmobile without direct mounting.
 - Weight: net, 12 lb (5,4 kg); shipping, 18 lb (8,2 kg).
 - Price: Model 10479A tilt tray\$35.
 - Mounting plates: (HP Part No. 01119-69501) adapts 180 series rack model oscilloscopes to Testmobile.
 - Weight: net, 1 lb (0,5 kg); shipping, 2 lb (0,9 kg).
 - Price: mounting plates (including detent wheel)\$27.

Description, 1119C/D

Models 1119C/D are for 180 and 1200 series cabinet style and 1700 series (with a 10105A Adapter) oscilloscopes. Instruments are secured to brace assembly with mounting knobs that mate with matching holes in the scope. Typical tilt angles are ±30° in 10° increments. A tilt-table shelf, Model 10479B allows small instruments to be mounted.

Specifications, 1119C/D

- Oscilloscope compatibility:** 180 and 1200 series cabinet models, direct, 1700 series with Model 10105A Adapter. When used with optional 104798B Tilt Tray, many other instruments may be placed on the Testmobile.
- Tilt angle:** ±30° in 10° increments.
- Dimensions:** see outline drawing.
- Wheel size:** 4 inches (101,6 mm).
- Weight**
 - Model 1119C: net, 32 lb (14,5 kg); shipping, 43 lb (19,5 kg).
 - Model 1119D: net, 43 lb (19,5 kg); shipping, 54 lb (24,5 kg).
- Price**
 - Model 1119C: Testmobile\$110.
 - Model 1119D: Testmobile (with Model 10480B Storage Cabinet)\$145.
- Optional accessories**
 - Model 10480B: storage cabinet for 1119C provides additional storage space for accessories.
 - Weight: net, 11 lb (5 kg); shipping, 16 lb (7,3 kg).
 - Price: Model 10480B (supplied with 1119D Testmobile).\$45.

- Model 10105A adapter plate:** adapts 1700 series oscilloscopes to 1119C and 1119D Testmobiles.
 - Weight: net, 1 lb (0,5 kg); shipping, 2 lb (0,9 kg).
 - Price: model 10105A adapter\$20.
- Model 10479B tilt tray:** allows oscilloscopes to be placed on Testmobile without direct mounting.
 - Weight: net, 8 lb (3,6 kg); shipping, 12 lb (5,4 kg).
 - Price: model 10479B tilt tray\$35.

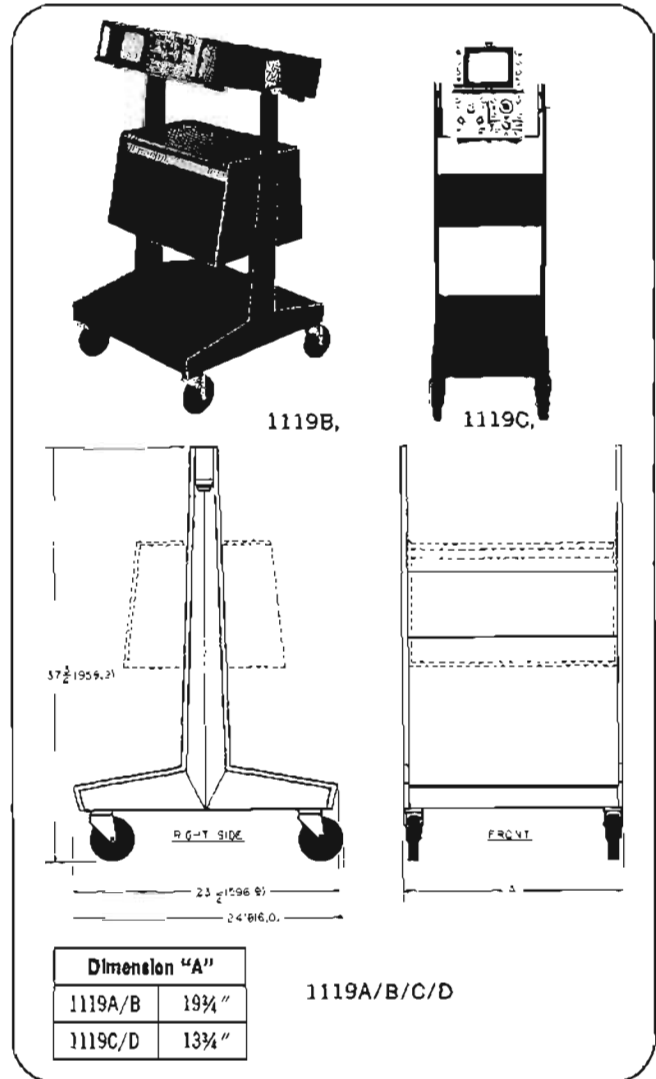

Description, 1117B

Model 1117B for cabinet and rack instruments provides tilt tray angles from -15° to +30° in 7½° increments. In addition, other instruments can be mounted in the standard relay racks of the lower compartment. Rack mounting depth is 23-inches and power distribution is supplied.

Optional accessory drawers 3" and 8" deep are available. The drawers may be installed in many vertical positions of the relay racks.

Specifications, 1117B

- Oscilloscope compatibility:** cabinet or 19-inch rack models.
- Tilt angle:** -15° to +30° in 7½° steps.

TESTMOBILES

Lightweight, compact, folds for transportation
Models 1118A, 1116A



OSCILLOSCOPES

Dimensions: see outline drawing.
Wheel size: 4-inch (101,6 mm).
Weight: net, 91 lb (41,3 kg); shipping, 109 lb (49,4 kg).
Instrument mounting hardware supplied: 8 screws (10-24 x 3/4) (HP Part No. 2680-0029), 8 Tinnerman nuts (HP Part No. 0590-0128).
Price (less drawers): model 1117B Testmobile\$225.
Optional accessories
Model 10475A 3-inch drawer
Weight: net, 9 lb (4,1 kg); shipping, 13 lb (5,9 kg).
Price: model 10475A, 3-inch accessory drawer\$40.
Model 10476A 8-inch drawer
Weight: net, 11 lb (5,4 kg); shipping, 18 lb (8,2 kg).
Price: model 10476A, 8-inch accessory drawer\$50.

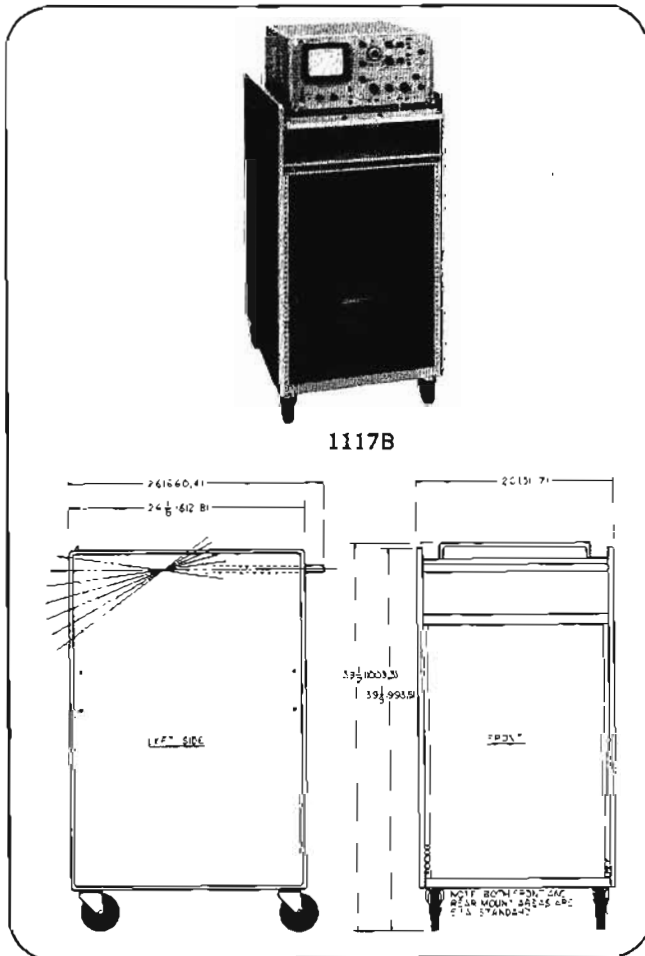

Description, 1118A

Model 1118A Testmobile is designed for 180 or 1200 series cabinet models, and (with a 10105A adapter) 1700 series oscilloscopes. Instruments can be tilted, rotated and vertically adjusted. This tripod testmobile also folds for easy transportation.

Specifications, 1118A

Oscilloscope compatibility: 180 and 1200 series cabinet models direct, 1700 series with 10150A Adapter Plate. (Use Model 119C or D Testmobile for 183 A or C Oscilloscopes.)
Tilt angle: ± 45°.
Horizontal rotation: 360°.

Vertical height: 33 to 43 inches (838,2 to 1117,6 mm).
Dimensions: see outline drawing.
Wheel size: 3-inches (76,2 mm) with locks on two wheels.
Weight: net, 13 lb (5,9 kg); shipping, 17 lb (7,7 kg).
Price: model 1118A, Testmobile\$120.
Optional accessory
Model 10105A adapter plate: adapts 1700 series oscilloscopes to 1118A Testmobiles.
Weight: net, 1 lb (0,5 kg); shipping, 2 lb (0,9 kg).
Price: model 10105A adapter\$20.

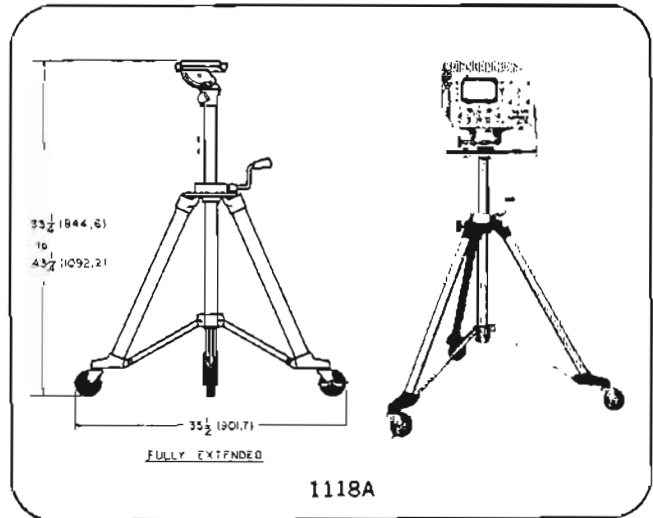

Description, 1116A

Model 1116A is a light weight Testmobile constructed of chrome-plated tubular steel and is well suited for holding general purpose instrumentation.

Specifications, 1116A

Oscilloscope compatibility: 140 series, 180 series rack models, 1200 series rack models, and other rack width instruments.
Tilt angle: horizontal to 30° in 7 1/2° steps.
Dimensions: see outline drawing.
Wheel size: 4 inches (101,6 mm).
Weight: net, 32 lb (15,5 kg); shipping, 49 lb (22,2 kg).
Price: model 1116A Testmobile\$95.

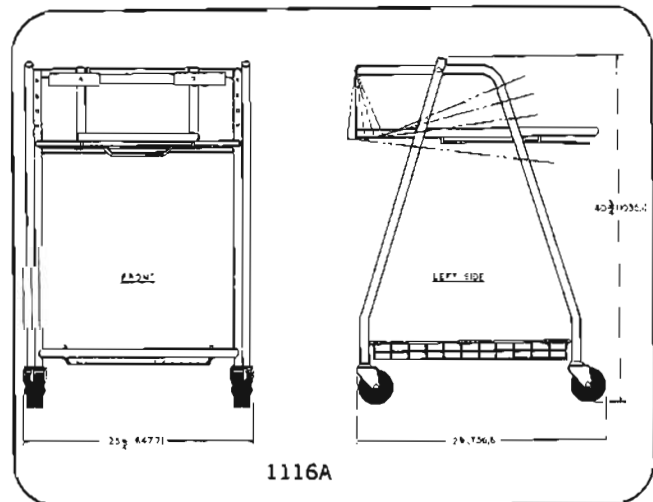



Power supplies, as described on the following pages, are defined as instruments which transform ac input power into regulated dc output power. This definition thus distinguishes power supplies from the more general category of electrical power sources which derive electrical power from other energy sources (e.g., batteries, solar cells, fuel cells), and excludes power supplies based on rotating machine principles or power supplies other than ac-to-dc types (e.g., ac-to-ac line regulators and frequency changers, dc-to-dc converters, and dc-to-ac inverters).

The power supply product information on the following pages is divided into two main sections: general purpose (pages 150 through 166), and special purpose (pages 167 through 171).

General Purpose Power Supplies

Within the general purpose section, the power supplies are organized in tabular form by output voltage in ascending order. Specifications for each model are presented in a single vertical column; each column is subdivided into four subsections: "Rating," "Performance," "Features," and "General."

Rating

Within the "Rating" subsection is the output voltage, output current, and model number. The following convention is observed in stating the output current rating: supplies with an adjustable current limit are listed as "O-XXXXA"; supplies with a fixed, factory-set current limit are listed as "XXXXA."

Performance

"Performance" information provided includes all the basic power supply specifications (load and line regulation, ripple and noise, temperature coefficient, stability, resolution, output accuracy, output impedance, and transient response). Definitions of all specifications are given in the left-hand portion of the table on page 152.

Generally speaking, Hewlett-Packard power supplies employ one of two basic circuit techniques, either (1) a transistor regulator, or (2) an SCR regulator. All low output power supplies use circuit technique (1) because it results in both lower cost and better performance. Medium output power supplies may use either of the two techniques, or alternatively, a combination of the two in which a transistor regulator is preceded by an SCR regulator. Power supplies of

very high output employ circuit technique (2) because of its greater efficiency.

These two circuit techniques result in distinctly different performance characteristics, particularly with regard to regulation, ripple, and transient response.

Typical specifications are as follows.

Specification	Transistor Regulated
Line & Load Regulation	0.001% to 0.05%
Ripple & Noise	50 μ V to 1 mV
Transient Response	Less than 50 μ s

Specification	SCR Regulated
Line & Load Regulation	0.05% to 1%
Ripple & Noise	0.1% to 3%
Transient Response	Less than 50-200 ms

Features

The "Features" subsection of the specifications table describes the specific characteristics of various extra-performance features available on most Hewlett-Packard power supplies. Included are:

Output Mode: DC power supplies can provide one of four basic modes of operation: (1) *Constant Voltage*, where the output voltage is maintained constant in spite of changes in load, line, or temperature; (2) *Constant Current*, where the output current is maintained constant in spite of changes in load, line, or temperature; (3) *Current Limit*, where the output current of a constant voltage power supply is limited to a predetermined maximum value (fixed or adjustable); and (4) *Voltage Limit*, where the output voltage of a constant current power supply is limited to a predetermined maximum value (fixed or adjustable).

Auto-Series, Auto-Parallel, and Auto-Tracking:

Auto-Series operation is a means of obtaining a higher output voltage than that available from a single supply. Similarly, Auto-Parallel operation is a means of obtaining a higher output current than that available from a single supply. Auto-Series and Auto-Parallel provide equal voltage and current sharing (respectively) under all load conditions; both allow the master supply alone to control the complete ensemble. Auto-Tracking operation is used when several different voltages referred to a common bus must vary in proportion to the setting of a particular supply; it permits simultaneous turn-on and turn-off of power supplies in the same system, thereby preventing application or re-

moval of main power sources without proper bias potentials being present.

Remote Sensing: Remote sensing, a feature provided on practically all Hewlett-Packard power supplies, is used to maintain good constant voltage load regulation at loads remotely located from the power supply output terminals.

Remote Programming: Most Hewlett-Packard power supplies permit control of the regulated output voltage or current by means of a remotely varied resistance or voltage. Programming coefficients (the change in programming voltage or current required for a unit change in the supply output voltage or current) and programming speeds are given in the specifications table for most remotely programmable supplies.

Overvoltage Protection Crowbar: A crowbar circuit, when connected across the output terminals of a constant voltage power supply, provides protection against any overvoltage condition which might occur due to operator error or failure of the power supply or load. The primary characteristics (trip voltage range, trip voltage margin, and price) of the crowbars available with Hewlett-Packard supplies are described in the specifications table.

In addition to the above features, dc output isolation and meter ranges are also given for each power supply.

General

Input power ratings and connections, temperature ratings and cooling method, dimensions, weight, price, and options available are all given in the "General" specifications subsection.

Photographs indicating front-panel control layout and package configuration of all power supplies listed in the general purpose (tabular) section are presented on pages 150 and 151. Note that the photographs are grouped by type of supply; these groupings are for convenience in locating the photograph of a given supply, and are not indicated in any manner in the specifications table.

Page 166 contains a listing of all options and accessories available with general purpose power supplies; the specific options available on a given power supply are indicated in the "General" subsection of the specifications table.

Special Purpose Power Supplies

The special purpose power supply section (pages 167 through 171) is organized by the particular type of supply,

each of which has its own special application areas.

Precision Constant Current Sources

Precision Constant Current Sources (page 167) are designed for applications requiring (1) more precise current regulation, (2) lower ripple and noise at low output current levels, and (3) higher output impedance and faster programming speed (better dynamic characteristics) than are available from a CV/CC supply operating in the constant current mode. Application Note AN-128, available at no charge from your local Hewlett-Packard sales office, provides detailed applications information on Hewlett-Packard Precision Constant Current Sources.

Power Supply/Amplifiers

Power Supply/Amplifiers (page 168) are multi-purpose laboratory instruments capable of operation either as DC Power Supplies, or as High Speed, Programmable, Bipolar, DC to 20 kHz Power Amplifiers. Application Note AN-82, available at no charge from your local Hewlett-Packard sales office, presents a comprehensive description of the features and applications of Hewlett-Packard Power Supply/Amplifiers.

Also on page 168 is the Model 712C, a multiple-output supply designed to provide plate, bias, and filament voltages for laboratory development of vacuum tube circuits.

Modular Slot Supplies

Modular Slot Supplies (Page 169) are intended for applications requiring a fixed, constant source of dc. The output of these supplies (nominally 6, 12, ± 15 , or 24 V) is adjustable over a $\pm 10\%$ band, hence the name "Slot."

Digital Voltage Sources

Digital Voltage Sources (pages 170 and 171) are designed for applications requiring a computer-controllable high-speed, bipolar, accurately settable source of dc or low frequency ac power. These power supplies are actually complete digital-to-analog subsystems, incorporating input/output isolation, internal digital data storage, flexible interfaces, programmable current latch, computer feedback signals, external analog input, and current monitoring terminals all in one compact package.

Also on page 171 is the 6933B Digital-to-Analog Converter; this instrument is similar to the Digital Voltage Sources except for its lower output power rating and the elimination of the programmable current latch.

Hewlett-Packard offers another means of achieving digitally programmable dc power: The 6940A/6941A Multiprogrammer (page 404), in combination with any of the general purpose power

supplies listed on pages 152-165 as being available with Option 40. This combination allows control of up to 240 power supplies via a single minicomputer I/O channel, with accuracy of 0.1% and programming speeds from 10 ms.

How to Select a Power Supply

(1) Determine whether your application requires a general purpose or special purpose power supply. If a special purpose supply is required, refer to the appropriate product page as previously described.

(2) If a general purpose supply is required, determine the desired mode of operation and proceed as follows:

For an application that primarily involves either *Constant Voltage/Constant Current* or *Constant Voltage/Current Limit* operation, enter the specifications table (page 152-165) at the desired voltage rating and select a supply that features "CV/CC" or "CV/CL," respectively, alongside the "Output Mode" heading.

In general, a power supply with an output voltage rating 10% higher than that required is recommended. This provides the necessary flexibility for testing and adjusting systems, or for performing "marginal checks" of a load circuit by varying the dc power feeding it. In addition, for optimum performance, the current rating of the selected power supply should equal or exceed the maximum instantaneous (not average) output current demanded by the load. Peak load demands in excess of the current rating of the supply will not damage the supply; instead, the output current will be limited to a preselected value and the output voltage will drop to a lower value.

If the desired voltage/current combination does not appear in the specifications table, consider series and parallel combinations of power supplies. For automatic operation, check the "Auto-Series, Auto-Parallel, and Auto-Tracking" entry in the "Features" subsection of the table.

For an application that primarily involves *Constant Current* operation, use the "Output Current Index" appearing on this page to locate a suitable power supply in the specifications table.

(3) Once a power supply has been selected to fit the particular application, refer to pages 150-151 and 166, respectively, for photographs and option/accessory descriptions.

(4) Finally, ask your local Hewlett-Packard sales office for a copy of the "DC Power Supply Handbook" (AN-90A). This 138-page book (available at no charge) is a comprehensive source of detailed information on the operation, performance, and connection of all Hewlett-Packard regulated dc power supplies.

Output Current Index
(General Purpose CV/CC Supplies Only)

Amps	Volts	Model	Page
0.05	4000	6525A	165
0.1	100	6212A	163
0.1	320	6209B	164
0.1	2000	6522A	165
0.2	50	6218A	161
0.2	160	6207B	164
0.2	1000	6521A	165
0.4	25	6216A	157
0.5, 1	50, 25	6220B	157
0.75	40	6202B	159
0.75, 1.5	40, 20	6200B	159
0.75	100	6299A	163
1	10	6214A	153
1	50	6228B	161
1	60	6294A	161
1.5	20	6201B	155
1.5	40	6255A	159
1.5	40	6289A	159
1.5	50	6226B	161
1.5	600	6448B	165
2	25	6227B	157
2.5	120	6443B	163
3	7.5	6203B	152
3	20	6253A	155
3	20	6284A	155
3	24	6224B	156
3	40	6265B	159
3	40	6290A	159
3	60	6296A	161
3	60	6271B	162
5	7.5	6281A	152
5	20	6285A	155
5	40	6266B	159
5	40	6291A	160
5	60	6438B	162
10	10	6282A	153
10	20	6263B	155
10	20	6286A	156
10	36	6433B	157
10	40	6267B	160
15	20	6427B	156
15	60	6439B	162
15	60	6274B	162
15, 20, 25	600, 500, 440	6483C	164
20	10	6256B	153
20	20	6264B	156
25	40	6434B	160
30	40	6268B	160
35	300	6479C	164
45	20	6428B	156
50	10	6259B	153
50	20	6261B	156
50	40	6269B	160
50	64	6459A	162
50	220	6477C	164
100	10	6260B	154
100	36	6456B	158
100	110	6475C	163
150	64	6472C	162
200	15	6453A	154
300	36	6469C	158
500, 600	18, 16	6466C	154
1000	8	6464C	153

POWER SUPPLIES



REGULATED DC POWER SUPPLIES

Laboratory and industrial types

Models 721A, 895A, 6101A-6116A, 6200B-6525A

**Low Cost
Laboratory Supplies**



6211A — 6218A

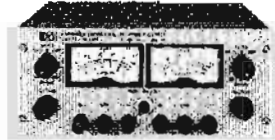

6205B



721A

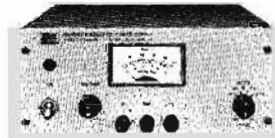

6200B, 6204B, 6206B

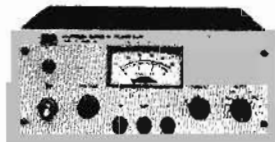

6201B — 6203B
6207B, 6209B

**General Purpose
Low Power (8-200 W)
Laboratory Supplies**

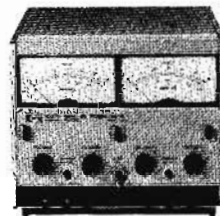

6227B, 6228B

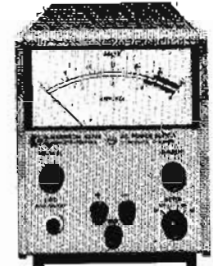

6220B — 6226B

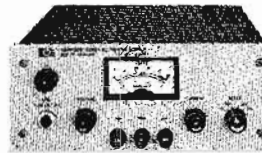

6281A, 6284A, 6289A,
6294A, 6299A

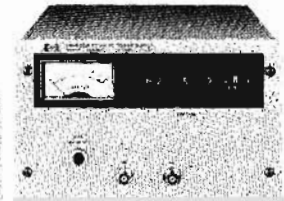

6516A

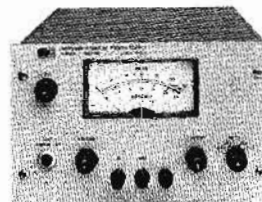

6282A, 6285A, 6286A,
6290A, 6291A, 6296A

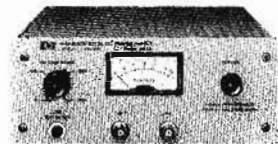

6515A

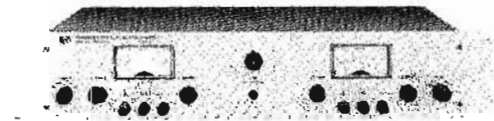

6253A, 6255A

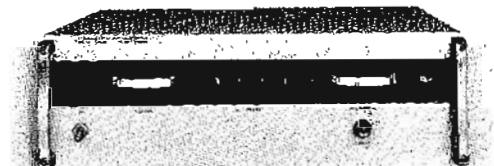

6521A — 6525A

**Special Purpose
Laboratory Supplies**

High stability/calibrator; integrated circuit supply



6101A — 6106A



6110A

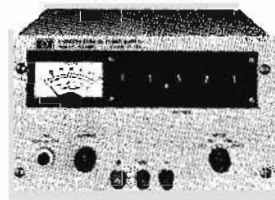

6111A — 6116A

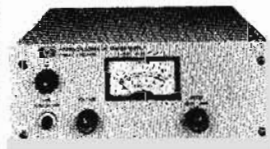

6384A

**General Purpose
Medium Power (120-2000 W)
Laboratory Supplies**

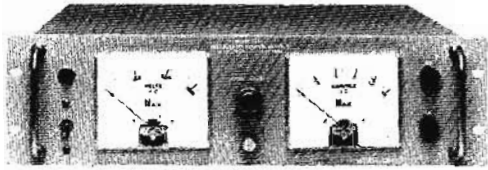

895A

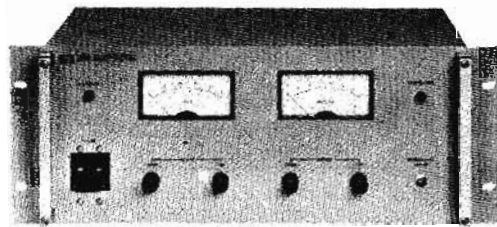

6259B, 6260B, 6261B, 6268B, 6269B

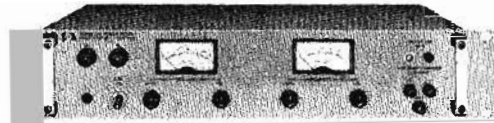

6263A, 6265B, 6266B, 6271B

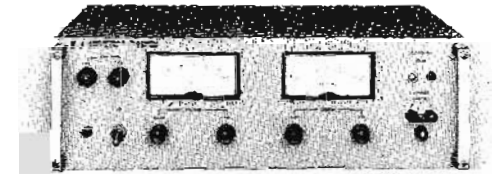

6256B, 6264B, 6267B

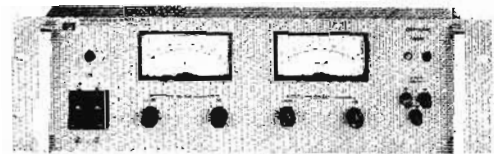

6274B

High Power (300-11,000 W) Industrial Supplies

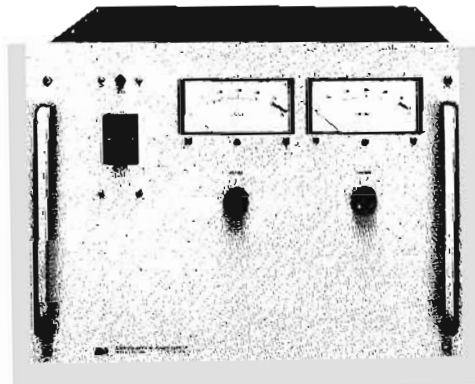

6453A — 6459A

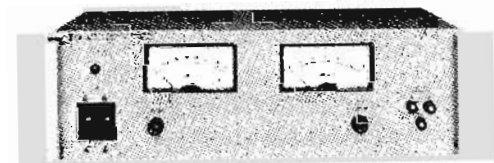

6448B

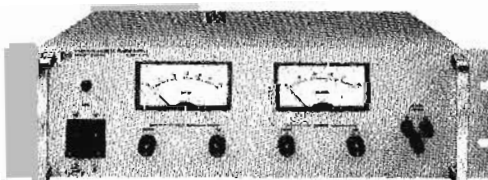

6428B, 6434B, 6439B

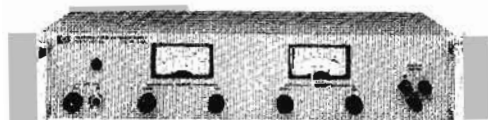

6427B, 6433B, 6438B, 6443B

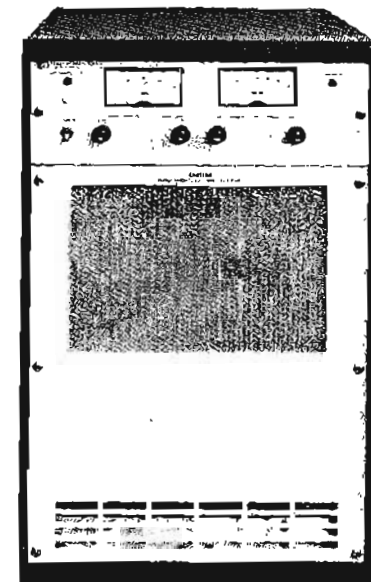

6464C - 6483C

POWER SUPPLIES *continued*

RATING	DC Output: Voltage and current spans indicate range over which output may be varied using front panel controls.				
	Volts	4-5.5V	0-7.5V	0-7.5V	
	Amps	8A	0-3A	0-5A	
	Model	6384A	6203B	6281A	
PERFORMANCE	Load Regulation: Voltage Load Regulation is given for a load current change equal to the current rating of the supply. Current Load Regulation is given for a load voltage change equal to the voltage rating of the supply.	Voltage	1mV	5mV	5mV
		Current	NA	0.03% plus 250µA	0.01% plus 250µA
	Line Regulation: For a change in line voltage between 103.5 and 126.5Vac or 207 and 253Vac at any output voltage and current within rating. Refer to Power (below) for appropriate line voltage.	Voltage	1mV	3mV	0.01% plus 2mV
		Current	NA	0.01% plus 250µA	0.01% plus 250µA
	Ripple and Noise: Rms/p-p (dc to 20MHz), at any line voltage and under any load condition within rating.	Voltage	1mV/5mV	200µV/1mV	200µV/1mV
		Current	NA	500µA	4mA rms
	Temperature Coefficient: Output change per degree Centigrade change in ambient following 30 minutes warm-up.	Voltage	3mV	0.02% plus 1mV	0.02% plus 500µV
		Current	NA	0.02% plus 2mA	0.02% plus 2.5mA
	Stability: Total drift in output over 8 hour interval under constant line, load, and ambient following 30 minutes warm-up.	Voltage	0.3% plus 10mV	0.1% plus 5mV	0.1% plus 2.5mV
		Current	NA	0.1% plus 10mA	0.1% plus 12.5mA
	Resolution: Minimum output voltage or current change that can be obtained using front panel controls.	Voltage	15mV	5mV	5mV
		Current	NA	2mA	2mA
Accuracy: Front Panel Meter (% of full scale)		±3%	±3%	±3%	
Output Voltage (thumbwheel-controlled supplies only).		NA	NA	NA	
Output Impedance (Typical): Represented by a resistance in series with an inductance.		0.001Ω, 1µH	2mΩ, 1µH	1mΩ, 1µH	
Load Transient Recovery: Time required for output voltage recovery to within the given level of the nominal output voltage following a change in output current equal to the current rating of the supply or 5 amps, whichever is smaller.	Time Level	50µs 10mV	50µs 10mV	50µs 15mV	
FEATURES	Output Mode: Constant Voltage/Constant Current, or Constant Voltage/Current Limited.	CV/CL	CV/CC	CV/CC	
	Auto-Series, Auto-Parallel, and Auto-Tracking.	No	Yes	Yes	
	Remote Sensing.	Yes	Yes	Yes	
	Remote Programming: Resistance Programming Coefficient	Voltage	NA	200Ω/V ±1%	200Ω/V ±1%
		Current	NA	500Ω/A ±10%	200Ω/A ±10%
	Voltage Programming Coefficient	Voltage	NA	1V/V ±1%	1V/V ±1%
		Current	NA	0.5V/A ±10%	0.2V/A ±10%
	Speed: Typical time required to non-repetitively program from zero to within 99.9% of the maximum rated output voltage, or from the maximum rated output voltage to within 0.1% of that voltage above zero.	Up Programming	No Load	NA	2ms
			Full Load	NA	4ms
		Down Programming	No Load	NA	10ms
			Full Load	NA	5ms
	Overvoltage Protection	Trip Voltage Range: (approximate)	4.5-5.6V	2.5-10V	2.5-10V
Crowbar:	Margin: Minimum setting above output voltage to prevent false tripping.	--	4% of output +2V	4% of output +2V	
	Price:	Standard	Option 11, \$50	Option 11, \$50	
DC Output Isolation: Supply may be floated at up to the given level above ground.		300V	300V	300V	
Meter Ranges: (Accuracy is specified as % of full scale)		6V, 10A ±3%	0.9V, 9V ±3% 0.4A, 4A ±3%	0.9V, 9V ±3% 0.6A, 6A ±3%	
GENERAL	Power:	115Vac ±10% 48-63Hz 1.4A, 120W	115Vac ±10% 48-440Hz 0.9A, 70W	115Vac ±10% 48-440Hz 1.3A, 118W	
		Connections	3-Wire, 5-Ft. Cord	3-Wire, 5-Ft. Cord	
	Temperature Ratings: Operating 0 to 55°C, Storage -40 to +75°C	Cooling	Convection	Convection	
	Dimensions (inches):		8½W x 3½H x 12½D	8½W x 3½H x 12½D	
	Weight:	Net	12 lbs, 5.4 kg	10 lbs, 4.5 kg	
		Ship	15 lbs, 6.8 kg	12 lbs, 5.4 kg	
	Price:		\$250	\$179	
	Options Available: (For complete description, refer to page 166)		28	7,8,9,11,13,14,28	

- (1) Published specifications apply only when (a) supply is delivering more than 5% of maximum rated output voltage (CV operation) or 5% of maximum rated output current (CC operation), and (b) load is drawing more than 100W. Restriction (b) is lifted when supply is delivering more than 30% of maximum rated output voltage (CV operation) or 30% of maximum rated output current (CC operation).
 (2) For operation with a 50Hz input (possible only with Option 05), output current is linearly derated from 100% at 40°C to 80% at 50°C.

◇ Operating temperature range for this supply is 0 to 50°C.

* Measured at rear terminals.



0-8V §	0-10V	0-10V	0-10V	0-10V	0-10V	0-10V
0-1000A §	1A	0-1A	0-2A	0-10A	0-20A	0-50A
6464C	6213A	8214A	8113A	6282A	6256B	6259B

0.05% plus 5mV	4mV	4mV	0.001% plus 100µV*	0.01% plus 1mV	0.01% plus 200µV	0.01% plus 200µV
0.1% plus 1A	NA	500µA	NA	0.05% plus 1mA	0.02% plus 500µA	0.02% plus 1mA
0.05% plus 5mV	4mV	4mV	0.001%	0.01% plus 1mV	0.01% plus 200µV	0.01% plus 200µV
0.1% plus 1A	NA	750µA	NA	0.05% plus 1mA	0.02% plus 500µA	0.02% plus 2mA
80mV/1V†	200µV/1mV	200µV/1mV	40µV/100µV	500µV/25mV	200µV/10mV	500µV/5mV
NA	NA	150µA/500µA	NA	5mA rms	5mA rms	25mA rms
0.03% plus 100µV	0.02% plus 1mV	0.02% plus 1mV	0.001% plus 10µV	0.02% plus 500µV	0.01% plus 200µV	0.01% plus 200µV
0.06% plus 0.25A	NA	6mA	NA	0.02% plus 5mA	0.01% plus 2mA	0.01% plus 4mA
0.3% plus 1mV	0.1% plus 5mV	0.1% plus 5mV	0.01% + 100µV	0.1% plus 2.5mV	0.03% plus 500µV	0.03% plus 2mV
0.6% plus 1A	NA	15mA	NA	0.1% plus 25mA	0.03% plus 6mA	0.03% plus 10mA
8mV	5mV	5mV	20µV	2mV	1mV	1mV
1A	NA	75µA	NA	3mA	20mA	50mA
±2%	±3%	±3%	±3%	±3%	±2%	±2%
NA	NA	NA	0.1% plus 1mV	NA	NA	NA
--	5mΩ, 1µH	5mΩ, 1µH	0.2mΩ, 1µH	0.001Ω, 1µH	100µΩ, 1µH	0.05mΩ, 1µH
50ms, 100ms †	50µs	50µs	NA	50µs	50µs	50µs
1.5V, 500mV †	15mV	15mV	NA	15mV	10mV	10mV

CV/CC	CV/CL	CV/CC	CV/CL	CV/CC	CV/CC	CV/CC
Yes	No	No	Yes	Yes	Yes	Yes
Yes	Na	No	Yes	Yes	Yes	Yes
200Ω/V ±2%	NA	NA	1kΩ/V ±0.1%	200Ω/V ±1%	200Ω/V ±1%	200Ω/V ±1%
1.0Ω/A ±2%	NA	NA	NA	100Ω/A ±10%	10Ω/A ±10%	4Ω/A ±10%
1.0V/V ±1%	NA	NA	1V/V ±0.1%	1V/V ±1%	1V/V ±1%	1V/V ±1%
6.2mV/A ±7%	NA	NA	NA	100mV/A ±10%	25mV/A ±10%	10mV/A ±10%
--	NA	NA	NA	70ms	60ms	70ms
--	NA	NA	NA	200ms	60ms	70ms
--	NA	NA	NA	9sec	5sec	200ms
--	NA	NA	NA	40ms	40ms	10ms
NA	NA	NA	3-13V	1-13V	2-12V	2-12V
NA	NA	NA	4% of output +2V	7% of output +1V	5% of output +1V	5% of output +2V
NA	NA	NA	Option 11, \$50	Option 11, \$55	Standard	Standard
100V	300V	300V	300V	300V	300V	300V
10V, 1200A ±2%	12V, 1.2A ±3%	12V, 1.2A ±3%	1.2V, 12V ±3% 250mA, 2.5A ±3%	1.2V, 12V ±3% 1.2A, 12A ±3%	12V, 24A ±2%	12V, 60A ±2%

Option 1,2,3,31,32 50A per phase @ 230V	115Vac ±10% 48-440Hz 0.29A, 28W	115Vac ±10% 48-440Hz 0.3A, 28W	115Vac ±10% 48-63Hz 0.5A, 52W	115Vac ±10% 57-63Hz 3.5A, 200W	115Vac ±10% 57-63Hz 5A, 375W	230Vac ±10% 57-63Hz 6A, 850W
4-Terminal Strip	3-Wire, 5-Ft. Cord	3-Wire, 5-Ft. Cord	3-Wire, 5-Ft. Cord	3-Wire, 5-Ft. Cord	3 Terminal Strip	3-Terminal Strip
Fan ◊	Convection	Convection	Convection	Convection	Convection	Fan
16¾W x 26¼H x 26¼D	5¼W x 3¼H x 8D	5¼W x 3¼H x 8D	8½W x 5¼H x 12½D	8½W x 5¼H x 16D	19W x 5¼H x 17½D	19W x 7H x 17½D
575 lbs, 260 kg	4.5 lbs, 2 kg	4.8 lbs, 2.2 kg	11 lbs, 5 kg	25 lbs, 11.3 kg	35 lbs, 15.8 kg	69 lbs, 31.3 kg
629 lbs, 285 kg	6.5 lbs, 2.9 kg	6.8 lbs, 3.1 kg	14 lbs, 6.3 kg	30 lbs, 13.6 kg	40 lbs, 18.1 kg	78 lbs, 35.3 kg
\$3500	\$95	\$120	\$375	\$350	\$495	\$695
1,2,3,5,23,31,32	28	28	11,28,40	5,7,8,9,11,13,14,18	5,7,8,9,10,13,14,20, 21,22,27,28,40	5,7,8,9,10,13,14, 20,21,22,26,27,40

† (1) Load transient recovery for this supply is defined as follows: Time required for output voltage recovery to within the given level of the nominal output voltage following a load change from full load to half load or half load to full load.
 (2) For operation with a 50Hz input (possible only with Option 05) the values given in the table are increased by 50%.
 -- indicates that information was not available at time of printing.
 NA indicates Not Applicable.

POWER SUPPLIES *continued*



Dual Range

2 Dual Range Outputs

R A T I N G	DC Output	Volts	0-10V	0-15V	* * 0-16V 0-18V§	0-20V	0-40V	0-20V	0-40V	0-20V
		Amps	0-100A	0-200A	0-600A 0-500A §	0.6A	0.3A	0.6A	0.3A	0-1A
	Model		6260B	6463A	6466C	6204B		6205B		6101A

P E R F O R M A N C E	Load Regulation	V	0.01% plus 200µV	0.2% plus 10mV comb. line and load	0.05% plus 5mV	0.01% plus 4mV	0.01% plus 4mV	0.001% plus 100µV*
		C	0.02% plus 2mA	1% or 2A combined line and load	0.1% plus 0.6A	NA	NA	NA
	Line Regulation	V	0.01% plus 200µV	0.2% plus 10mV comb. line and load	0.05% plus 5mV	0.01% plus 4mV	0.01% plus 4mV	0.001%
		C	0.02% plus 2mA	1% or 2A combined comb. line and load	0.1% plus 0.6A	NA	NA	NA
	Ripple and Noise (rms/p-p)	V	500µV/5mV	150mV rms†	180mV/1V†	200µV/1mV	200µV/1mV	40µV/100µV
		C	50mA rms	NA	NA	NA	NA	NA
	Temperature Coefficient	V	0.01% plus 200µV	0.05% plus 2mV	0.03% plus 200µV	0.02% plus 1mV	0.02% plus 1mV	0.005% plus 30µV
		C	0.01% plus 8mA	1.2A	0.06% plus 0.15A	NA	NA	NA
	Stability	V	0.03% plus 2mV	0.25% plus 10mV	0.2% plus 1mV	0.1% plus 5mV	0.1% plus 5mV	0.01% plus 300µV
		C	0.03% plus 20mA	6A	0.5% plus 0.8A	NA	NA	NA
	Resolution	V	1mV	---	18mV	10mV	10mV	0.002% plus 100µV
		C	100mA	---	0.5A	NA	NA	NA
	Accuracy	Meter	±2%	±2%	±2%	±3%	±3%	±3%
		Voltage	NA	NA	NA	NA	NA	NA
	Output Z		0.02mΩ, 1µH	---	---	25mΩ, 1µH	25mΩ, 1µH	0.5mΩ, 1µH
Transient Recovery	Time	50µs	50ms†	50ms, 100ms †	50µs	50µs	NA	
	Level	10mV	150mV†	1.5V, 500mV †	10mV	10mV	NA	

F E A T U R E S	Output Mode	CV/CC	CV/CC	CV/CC	CV/CL	CV/CL	CV/CL			
	Series, Par., Track.	Yes	Yes	Yes	Yes	Yes	Yes			
	Remote Sensing	Yes	Yes	Yes	Yes	Yes	Yes			
	R E M O T E	Res V	200Ω/V ±1%	200Ω/V	200Ω/V ±2%	200Ω/V ±1%	200Ω/V ±1%	1kΩ/V ±0.1%		
		Coef C	2Ω/A ±10%	1Ω/A	1.66Ω/A ±2%	NA	NA	NA		
		Volt V	1V/V ±1%	0.4V/V	1.0V/V ±1%	1V/V ±1%	1V/V ±1%	1V/V		
		Coef C	5mV/A ±10%	30mV/A	10.3mV/A ±7%	NA	NA	NA		
	P R O G R A M	Up Prog NL	70ms	---	---	2ms	8ms	2ms	8ms	150ms
		Speed FL	70ms	---	---	7.5ms	30ms	7.5ms	30ms	150ms
	D O W N	Prog NL	200ms	---	---	60ms	90ms	60ms	90ms	9sec
		Speed FL	5ms	---	---	20ms	80ms	20ms	80ms	200ms
	C R O W B A R	Range	2-12V	9-17V	8-20V	2.5-44V	2.5-44V	2.5-23V		
		Margin	5% of output +2V	5% of output +1V	10% of output V	4% of output +2V	4% of output +2V	4% of output +2V		
		Price	Standard	Option 6, \$350	Option 06, \$500	Option 11, \$50	Option 11, \$100 (2)	Option 11, \$50		
	Floating, up to:	300V	300V	100V	300V	300V	300V			
Meter Ranges	12V, 120A ±2%	20V, 200A ±2%	20V, 700A ±2%	5V, 50V ±3% 0.075A, 0.75A ±3%	5V, 50V ±3% 0.075A, 0.75A ±3%	2.4V, 24V ±3% 120mA, 1.2A ±3%				

G E N E R A L	Power	230Vac ±10% 57-63Hz 12A, 1600W	Option 1,2,3,31,32 14A per phase @ 230V	Option 1,2,3,31,32 50A per phase @ 230V	115Vac ±10% 48-440Hz 0.4A, 24W	115Vac ±10% 48-440Hz 0.5A, 50W	115Vac ±10% 48-63Hz 0.5A, 52W	
	Connections	3-Terminal Strip	4-Pin Plug & Jack	4-Terminal Strip	3-Wire, 5-Ft. Cord	3-Wire, 5-Ft. Cord	3-Wire, 5-Ft. Cord	
	Cooling	Fan	Fan	Fan ◊	Convection	Convection	Convection	
	Dimensions (inches)	19W x 7H x 17½D	19W x 14H x 18½D	16¾W x 26½H x 26½D	8½W x 3¾H x 12½D	8½W x 3¾H x 12½D	8½W x 3¾H x 12½D	
	Weight	Net	97 lbs, 43.9 kg	238 lbs, 108 kg	500 lbs, 226 kg	8 lbs, 3.6 kg	10 lbs, 4.5 kg	10 lbs, 4.5 kg
		Ship	106 lbs, 48 kg	299 lbs, 135 kg	555 lbs, 251 kg	10 lbs, 4.5 kg	12 lbs, 5.4 kg	12 lbs, 5.4 kg
	Price	\$895	\$1375	\$2800	\$159	\$255	\$265	
Options	5,7,8,9,10,13,14, 16,20,21,22,27,40	1,2,3,5,6,10,31,32	1,2,3,5,6,23,31,32	7,11,13,28	7,11,13,28	11,28,40		

§ (1) Published specifications apply only when (a) supply is delivering more than 5% of maximum rated output voltage (CV operation) or 5% of maximum rated output current (CC operation), and (b) load is drawing more than 100W. Restriction (b) is lifted when supply is delivering more than 30% of maximum rated output voltage (CV operation) or 30% of maximum rated output current (CC operation).
 (2) For operation with a 50Hz input (possible only with Option 05), output current is linearly derated from 100% at 40°C to 80% at 50°C.
 ◊ Operating temperature range for this supply is 0 to 50°C.
 ** The output capacity is up to 600A at 16V, but only 500A at 18V.

Dual Range Two Outputs

0-20V	0-20V	0-40V	0-20V	0-20V	0-20V	0-20V	0-20V
0-1A	0-1.5A	0-0.75A	0-1.5A	0-3A	0-3A	0-5A	0-10A
6111A	6200B		6201B	6253A	6284A	6285A	6263B

0.001% plus 100µV*	0.01% plus 4mV	0.01% plus 4mV	0.01% plus 4mV	0.01% plus 4mV	0.01% plus 1mV	0.01% plus 200µV
NA	0.03% plus 250µA	0.03% plus 250µA	0.01% plus 250µA	0.01% plus 250µA	0.05% plus 1mA	0.02% plus 500µA
0.001%	0.01% plus 4mV	0.01% plus 4mV	0.02% plus 2mV	0.01% plus 2mV	0.01% plus 1mV	0.01% plus 200µV
NA	0.01% plus 250µA	0.01% plus 250µA	0.01% plus 250µA	0.01% plus 250µA	0.05% plus 1mA	0.02% plus 500µA
40µV/100µV	200µV/1mV	200µV/1mV	200µV/1mV	200µV/1mV	500µV/25mV	200µV/10mV
NA	500µA rms	500µA	2mA rms	2mA rms	3mA rms	3mA rms
0.001% plus 10µV	0.02% plus 1mV	0.02% plus 1mV	0.02% plus 500µV	0.02% plus 500µV	0.02% plus 500µV	0.01% plus 200µV
NA	0.02% plus 1mA	0.02% plus 1mA	0.02% plus 1.5mA	0.02% plus 1.5mA	0.02% plus 2.5mA	0.01% plus 2mA
0.01% + 100µV	0.1% plus 5mV	0.1% plus 5mV	0.1% plus 2.5mV	0.1% plus 2.5mV	0.1% plus 2.5mV	0.03% plus 500µV
NA	0.1% plus 5mA	0.1% plus 5mA	0.1% plus 7.5mA	0.1% plus 7.5mA	0.1% plus 12.5mA	0.03% plus 6mA
200µV	10mV	5mV	5mV	5mV	3mV	2mV
NA	2mA	1mA	1mA	1mA	2mA	10mA
±3%	±3%	±3%	±3%	±3%	±3%	±2%
0.1% plus 1mV	NA	NA	NA	NA	NA	NA
0.5mΩ, 1µH	20mΩ, 1µH	20mΩ, 1µH	4mΩ, 1µH	4mΩ, 1µH	0.001Ω, 1µH	0.5mΩ, 1µH
NA	50µs	50µs	50µs	50µs	50µs	50µs
NA	10mV	10mV	15mV	15mV	15mV	10mV

CV/CL	CV/CC	CV/CC	CV/CC	CV/CC	CV/CC	CV/CC
Yes	Yes	Yes	Yes	Yes	Yes	Yes
Yes	Yes	Yes	Yes	Yes	Yes	Yes
1kΩ/V ±0.1%	200Ω/V ±1%	200Ω/V ±1%	200Ω/V ±1%	200Ω/V ±1%	200Ω/V ±1%	200Ω/V ±1%
NA	500Ω/A	1kΩ/A	1kΩ/A ±10%	500Ω/A ±10%	200Ω/A ±10%	100Ω/A ±10%
1V/V ±0.1%	1V/V ±1%	1V/V ±1%	1V/V ±1%	1V/V ±1%	1V/V ±1%	1V/V ±1%
NA	1V/A	2V/A	1V/A ±10%	0.33V/A ±10%	0.33V/A ±10%	200mV/A ±10%
NA	1mS	4ms	1ms	30ms	30ms	150ms
NA	3ms	12ms	3ms	80ms	80ms	150ms
NA	15ms	30ms	15ms	400ms	400ms	90ms
NA	4ms	10ms	4ms	100ms	400ms	90ms
2.5-23V	2.5-44V	2.5-23V	2.5-23V	2.5-23V	2-22V	2-23V
4% of output +2V	4% of output +2V	4% of output +2V	4% of output +2V	4% of output +2V	7% of output +1V	5% of output +1V
Option 11, \$50	Option 11, \$50	Option 11, \$50	Option 11, \$110	Option 11, \$50	Option 11, \$55	Standard
300V	300V	300V	300V	300V	300V	300V
2.4V, 24V ±3% 120mA, 1.2A ±3%	5V, 60V ±3% 0.18A, 1.8A ±3%	2.4V, 24V ±3% 0.18A, 1.8A ±3%	2.4V, 24V ±3% 4A, 0.4A ±3%	2.4V, 24V ±3% 0.4A, 4A ±3%	2.4V, 24V ±3% 0.6A, 6A ±3%	24V, 12A ±2%

115Vac ±10% 48-63Hz 0.5A, 52W	115Vac ±10% 48-440Hz 0.9A, 10W	115Vac ±10% 48-440Hz 0.8A, 66W	115Vac ±10% 48-440Hz 2.6A, 235W	115Vac ±10% 48-440Hz 1.5A, 128W	115Vac ±10% 57-63Hz 3.5A, 160W	115Vac ±10% 57-63Hz 4A, 350W
3-Wire, 5-Ft. Cord	3-Wire, 5-Ft. Cord	3-Wire, 5-Ft. Cord	3-Wire, 5-Ft. Cord	3-Wire, 5-Ft. Cord	3-Wire, 5-Ft. Cord	3-Wire, 5-Ft. Cord
Convection	Convection	Convection	Convection	Convection	Convection	Convection
8½W x 5¼H x 12½D	8½W x 3¾H x 12½D	8½W x 3¾H x 12½D	19W x 3¾H x 14½D	8½W x 3¾H x 14½D	8½W x 5¼H x 16D	19W x 3¾H x 17½D
11 lbs, 5 kg	10 lbs, 4.5 kg	10 lbs, 4.5 kg	28 lbs, 12.7 kg	14 lbs, 6.4 kg	22 lbs, 10 kg	34 lbs, 15.4 kg
14 lbs, 6.8 kg	12 lbs, 5.4 kg	12 lbs, 5.4 kg	39 lbs, 17.7 kg	16 lbs, 7.2 kg	24 lbs, 10.9 kg	41 lbs, 18.6 kg
\$375	\$199	\$179	\$479	\$239	\$359	\$489
11,28,40	7,8,9,11,13,14,28	7,8,9,11,13,14,28	7,8,9,10,11,13,14,28	7,8,9,11,13,14,28	5,7,8,9,11,13,14,18	5,7,8,9,10,13,14,20, 21,22,27,28,40

(1) Load transient recovery for this supply is defined as follows: Time required for output voltage recovery to within the given level of the nominal output voltage following a load change from full load to half load or half load to full load.
 (2) For operation with a 50Hz input (possible only with Option 05) the values given in the table are increased by 50%.

* Measured at rear terminals.
 — indicates that information was not available at time of printing.
 NA indicates Not Applicable.

POWER SUPPLIES *continued*

RATING	DC Output	Volts	0-20V	0-20V	0-20V	0-20V	0-20V	0-24V
		Amps	0-10A	0-15A	0-20A	0-45A	0-50A	0-3A
	Model		8286A	8427B	6264B	6428B	6281B	8224B

PERFORMANCE	Load Regulation	V	0.01% plus 1mV	20mV	0.01% plus 200µV	40mV	0.01% plus 200µV	0.01% plus 4mV
		C	0.05% plus 1mA	150mA	0.02% plus 500µA	450mA	0.02% plus 1mA	0.01% plus 250µA
	Line Regulation	V	0.01% plus 1mV	10mV	0.01% plus 200µV	20mV	0.01% plus 200µV	0.01% plus 2mV
		C	0.05% plus 1mA	150mA	0.02% plus 500µA	450mA	0.02% plus 1mA	0.01% plus 250µA
	Ripple and Noise (rms/p-p)	V	500µV/25mV	40mV/400mV†	200µV/10mV	40mV/500mV†	500µV/5mV	200µV/1mV
		C	5mA rms	NA	5mA rms	NA	25mA rms	200µA/1mA
	Temperature Coefficient	V	0.02% plus 500µV	0.03% plus 3mV	0.01% plus 200µV	0.03% plus 3mV	0.01% plus 200µV	0.02% plus 500µV
		C	0.02% plus 5mA	45mA	0.01% plus 2mA	135mA	0.01% plus 4mA	0.02% plus 1.5mA
	Stability	V	0.1% plus 2.5mV	0.1% plus 10mV	0.03% plus 500µV	0.1% plus 10mV	0.03% plus 2mV	0.1% plus 2.5mV
		C	0.1% plus 25mA	150mA	0.03% plus 8mA	450mA	0.03% plus 10mA	0.1% plus 7.5mA
	Resolution	V	3mV	10mV	2mV	10mV	2mV	20mV
		C	3mA	7.5mA	20mA	22.5mA	50mA	3mA
	Accuracy	Meter	±3%	±2%	±2%	±2%	±2%	±3%
		Voltage	NA	NA	NA	NA	NA	NA
	Output Z		0.001Ω, 1µH	10mΩ, 1µH	0.2mΩ, 1µH	2mΩ, 1µH	0.1mΩ, 1µH	5mΩ, 1µH
	Transient Recovery	Time	50µs	200ms†	50µs	200ms†	50µs	50µs
Level		15mV	200mV†	10mV	200mV†	10mV	10mV	

FEATURES	Output Mode		CV/CC	CV/CC	CV/CC	CV/CC	CV/CC	CV/CC	
	Series, Par., Track.	Yes	Yes	Yes	Yes	Yes	Yes	Yes	
	Remote Sensing	Yes	Yes	Yes	Yes	Yes	Yes	Yes	
	R	Res	V	200Ω/V ±1%	200Ω/V ±2%	200Ω/V ±1%	200Ω/V ±2%	200Ω/V ±1%	200Ω/V ±1%
		Coef	C	100Ω/A ±10%	20Ω/A ±20%	10Ω/A ±10%	6Ω/A ±20%	4Ω/A ±10%	500Ω/A ±10%
	O	Volt	V	1V/V ±1%	1V/V	1V/V ±1%	1V/V	1V/V ±1%	1V/V ±1%
		Coef	C	100mV/A ±10%	--	25mV/A ±10%	--	10mV/A ±10%	0.33V/A ±10%
	P	Up Prog	NL	150ms	--	140ms	--	150ms	4ms
		Speed	FL	150ms	--	140ms	--	150ms	10ms
	R	Down Prog	NL	9sec	--	10sec	--	250ms	50ms
		Speed	FL	70ms	--	80ms	--	25ms	15ms
	G.	Range		2-22V	NA	2.5-23V	NA	2-23V	NA
		Crowbar	Margin	7% of output +1V	NA	5% of output +1V	NA	5% of output +2V	NA
		Price		Option 11, \$55	NA	Standard	NA	Standard	NA
	Floating, up to:		300V	300V	300V	300V	300V	300V	
	Meter Ranges		2.4V, 24V ±3% 1.2A, 12A ±3%	24V, 18A ±2%	24V, 24A ±2%	24V, 50A ±2%	24V, 60A ±2%	3V, 30V ±3% 0.4A, 4A ±3%	

GENERAL	Power		115Vac ±10% 57-63Hz 6.5A, 320W	115Vac ±10% 57-63Hz 6.5A, 450W	115Vac ±10% 57-63Hz 8A, 600W	115Vac ±10% 57-63Hz 17A, 1200W	230Vac ±10% 57-63Hz 12A, 1500W	115Vac ±10% 48-63Hz 1.8A, 164W	
	Connections		3-Wire, 5-Ft. Cord	3-Wire, 5-Ft. Cord	3-Terminal Strip	3-Terminal Strip	3-Terminal Strip	3-Wire, 5-Ft. Cord	
	Cooling		Convection	Convection	Convection	Fan	Fan	Fan	
	Dimensions (inches)		8½W x 5¼H x 16D	19W x 3¼H x 17¼D	19W x 5¼H x 17¼D	19W x 5¼H x 16¾D	19W x 7H x 17¼D	51/8W x 6¼H x 11D	
	Weight	Net		26 lbs, 10.8 kg	36 lbs, 16.3 kg	47 lbs, 21.3 kg	67 lbs, 30.4 kg	78 lbs, 35.3 kg	16 lbs, 7.3 kg
		Ship		29 lbs, 13.1 kg	50 lbs, 22.7 kg	54 lbs, 24.5 kg	85 lbs, 38.5 kg	87 lbs, 39.4 kg	21 lbs, 9.5 kg
	Price		\$395	\$395	\$550	\$575	\$795	\$365	
	Options		5,7,8,9,11,13,14,18	5,10,17,18	5,7,8,9,10,13,14,20,21,22,27,28,40	5,10,17,18	5,7,8,9,10,13,14,20,21,22,26,27,40	13,14,28,40	

† (1) Load transient recovery for this supply is defined as follows: Time required for output voltage recovery to within the given level of the nominal output voltage following a load change from full load to half load or half load to full load.
 (2) For operation with a 50Hz input (possible only with Option 05) the values given in the table are increased by 50%.

Dual Range				Two Outputs		Dual Range		
0-25V	0-25V	0-25V	0-50V	0-25	0-30V	0-30V	0-60V	0-36V
400mA	0-400mA	0-1A	0-0.5A	0-2A	150mA	1A	0.5A	0-10A
6215A	6215A	6220B		6227B	721A	8206B		6433B

4mV	4mV	0.01% plus 2mV	0.01% plus 1mV	0.3% or 30mV	0.01% plus 4mV	36mV
NA	500µA	0.01% plus 250µA	0.01% plus 250µA	NA	NA	100mA
4mV	4mV	0.01% plus 2mV	1mV	0.3% or 15mV	0.01% plus 4mV	18mV
NA	500µA	0.01% plus 250µA	100µA	NA	NA	100mA
200µV/1mV	200µV/1mV	200µV/1mV	250µV/4mV	160µV rms	200µV/1mV	36mV/400mV†
NA	150µA/500µA	200µA/1mA	250µA/2mA	NA	NA	NA
0.02% plus 1mV	0.02% plus 1mV	0.02% plus 1mV	0.02% plus 200µV	---	0.02% plus 1mV	0.03% plus 6mV
NA	2mA	0.02% plus 1mA	0.02% plus 300µA	NA	NA	30mA
0.1% plus 5mV	0.1% plus 5mV	0.1% plus 5mV	0.2% plus 2mV	---	0.1% plus 5mV	0.1% plus 15mV
NA	5mA	0.1% plus 5mA	0.2% plus 3mA	NA	NA	100mA
5mV	5mV	40mV	5mV	---	10mV	9mV
NA	20µA	1mA	1mA	NA	NA	5mA
±3%	±3%	±3%	±2%	---	±3%	±2%
NA	NA	NA	NA	NA	NA	NA
20mΩ, 1µH	20mΩ, 1µH	20mΩ, 1µH	4mΩ, 2µH	0.2Ω, 30µH	40mΩ, 2µH	10mΩ, 1µH
50µs	50µs	50µs	50µs	---	50µs	200ms†
15mV	15mV	10mV	10mV	---	10mV	200mV†

CV/CL	CV/CC	CV/CC	CV/CC	CV/CL	CV/CL	CV/CC
No	No	Yes	Yes	No	Yes	Yes
No	No	Yes	Yes	No	Yes	Yes
NA	NA	200Ω/V ±1%	200Ω/V ±1%	NA	300Ω/V ±1%	200Ω/V ±2%
NA	NA	1kΩ/A	2kΩ/A	NA	NA	30Ω/A ±20%
NA	NA	1V/V ±1%	1V/V ±1%	NA	1V/V ±1%	1V/V
NA	NA	1V/A	2V/A	NA	NA	---
NA	NA	12ms	50ms	NA	12ms	50ms
NA	NA	30ms	120ms	NA	30ms	120ms
NA	NA	200ms	400ms	NA	360ms	600ms
NA	NA	30ms	120ms	NA	140ms	50ms
NA	NA	NA	5-28V	NA	2.5-66V	NA
NA	NA	NA	7% of output +1.5V	NA	4% of output +2V	NA
NA	NA	NA	Standard	NA	Option 11, \$50	NA
300V	300V	300V	300V	400V	300V	300V
30V, 500mA ±3%	30V, 500mA ±3%	6V, 60V ±3% 0.12A, 1.2A ±3%	30V, 2.4A ±2%	10V, 30V 10,300,100,300mA	7V, 70V ±3% 0.12A, 1.2A ±3%	40V, 12A ±2%

115Vac ±10% 48-440Hz 0.25A, 26W	115Vac ±10% 48-440Hz 0.25A, 26W	115Vac ±10% 48-440Hz 0.5A, 44W	115 or 230Vac ±10% switch, 48-63Hz 2.7A, 260W@115V	115 or 230Vac ±10% 48-63Hz 16W	115Vac ±10% 48-440Hz 1A, 66W	115Vac ±10% 57-63Hz 7A, 450W
3-Wire, 5-Ft. Cord	3-Wire, 5-Ft. Cord	3-Wire, 5-Ft. Cord	3-Wire, 5-Ft. Cord	3-Wire, 5-Ft. Cord	3-Wire, 5-Ft. Cord	3-Wire, 5-Ft. Cord
Convection	Convection	Convection	Convection	Convection	Convection	Convection
5¼W x 3¼H x 8D	5¼W x 3¼H x 8D	5½W x 6¼H x 11D	7¼W x 6¼H x 12¾D	7W x 4¾H x 5¼D	8¾W x 3¾H x 12¾D	19W x 3¾H x 17¾D
4.6 lbs, 2 kg	4.8 lbs, 2.2 kg	13 lbs, 5.9 kg	24 lbs, 11 kg	4 lbs, 1.8 kg	10 lbs, 4.5 kg	33 lbs, 14.9 kg
6.5 lbs, 2.9 kg	6.8 lbs, 3.1 kg	15 lbs, 6.8 kg	28 lbs, 12.9 kg	7 lbs, 3.2 kg	12 lbs, 5.4 kg	48 lbs, 21.7 kg
\$95	\$120	\$276	\$495	\$165	\$179	\$370
28	28	13,14,28,40	7,8,9,13,14	NA	7,11,13,28	5,10,17,18

--- indicates that information was not available at time of printing.
NA indicates Not Applicable.

POWER SUPPLIES *continued*



Dual Range

Two Dual Range Outputs

RATING	DC Output	Volts	0-36V	0-36V §	0-40V	0-20V	0-40V	0-20V	0-40V	0-40V
		Amps	0-100A	0-300A §	0.3A	0.6A	0.3A	0.6A	0-0.5A	0-0.5A
		Model	6456B	6469C	6204B		6205B		6102A	6112A

PERFORMANCE	Load Regulation	V	0.2% plus 10mV comb. line and load	0.05% plus 5mV	0.01% plus 4mV	0.01% plus 4mV	0.001% plus 100µV*	0.001% plus 100µV*
		C	1% or 1A comb. line and load	0.1% plus 0.3A	NA	NA	NA	NA
	Line Regulation	V	0.2% plus 10mV comb. line and load	0.05% plus 5mV	0.01% plus 4mV	0.01% plus 4mV	0.001%	0.001%
		C	1% or 1A comb. line and load	0.1% plus 0.3A	NA	NA	NA	NA
	Ripple and Noise (rms/p-p)	V	180mV (rms)	180mV/1V†	200µV/1mV	200µV/1mV	40µV/100µV	40µV/100µV
		C	NA	NA	NA	NA	NA	NA
	Temperature Coefficient	V	0.05% plus 2mV	0.03% plus 400µV	0.02% plus 1mV	0.02% plus 1mV	0.005% plus 50µV	0.001% plus 10µV
		C	0.6A	0.06% plus 0.1A	NA	NA	NA	NA
	Stability	V	0.25% plus 10mV	0.15% plus 1mV	0.1% plus 5mV	0.1% plus 5mV	0.01% plus 500µV	0.01% + 100µV
		C	3A	0.4% plus 0.4A	NA	NA	NA	NA
	Resolution	V	--	36mV	10mV	10mV	0.002% plus 100µV	200µV
		C	--	0.3A	NA	NA	NA	NA
	Accuracy	Meter	±2%	±2%	±3%	±3%	±3%	±3%
		Voltage	NA	NA	NA	NA	NA	0.1% plus 1mV
Output Z		--	--	25mΩ, 1µH	25mΩ, 1µH	2mΩ, 1µH	2mΩ, 1µH	
Transient Recovery	Time	50ms†	50ms, 100ms †	50µs	50µs	NA	NA	
	Level	300mV†	1.5V, 500mV †	10mV	10mV	NA	NA	

FEATURES	Output Mode	CV/CC	CV/CC	CV/CL	CV/CL	CV/CL	CV/CL	
	Series, Par., Track	Yes	Yes	Yes	Yes	Yes	Yes	
	Remote Sensing	Yes	Yes	Yes	Yes	Yes	Yes	
	R E M O T E	Res V	200Ω/V	200Ω/V ±2%	200Ω/V ±1%	200Ω/V ±1%	1kΩ/V ±0.1%	1kΩ/V ±0.1%
		Coef C	2Ω/A	3.33Ω/A ±2%	NA	NA	NA	NA
		Volt V	166mV/V	1.0V/V ±1%	1V/V ±1%	1V/V ±1%	1V/V ±0.1%	1V/V ±0.1%
		Coef C	60mV/A	20.6mV/A ±7%	NA	NA	NA	NA
	U P	Prog NL	--	--	8ms	2ms	8ms	2ms
		Speed FL	--	--	30ms	7.5ms	30ms	7.5ms
	D O W N	Prog NL	--	--	90ms	60ms	90ms	60ms
		Speed FL	--	--	80ms	20ms	80ms	20ms
	Range	22-41V	18-40V	2.5-44V	2.5-44V	2.5-44V	2.5-44V	
	Crowbar	Margin	5% of output +1V	10% of output V	4% of output +2V	4% of output +2V	4% of output +2V	4% of output +2V
		Price	Option 6, \$300	Option 06, \$450	Option 11, \$50	Option 11, \$100 (2)	Option 11, \$50	Option 11, \$50
Floating, up to:	300V	100V	300V	300V	300V	300V		
Meter Ranges		40V, 100A ±2%	40V, 350A ±2%	5V, 50V ±3%	5V, 50V ±3%	5V, 50V ±3%	5V, 50V ±3%	
				0.075A, 0.75A ±3%	0.075A, 0.75A ±3%	60mA, 600mA ±3%	60mA, 600mA ±3%	

GENERAL	Power	Option 1,2,3,31,32 14A per phase @ 230V	Option 1,2,3,31,32 50A per phase @ 230V	115Vac ±10% 48-440Hz 0.4A, 24W	115Vac ±10% 48-440Hz 0.5A, 50W	115Vac ±10% 48-63Hz 0.5A, 52W	115Vac ±10% 48-63Hz 0.5A, 52W	
	Connections	4-Pin Plug & Jack	4-Terminal Strip	3-Wire, 5-Ft. Cord	3-Wire, 5-Ft. Cord	3-Wire, 5-Ft. Cord	3-Wire, 5-Ft. Cord	
	Cooling	Fan	Fan ◊	Convection	Convection	Convection	Convection	
	Dimensions (inches)	19W x 14H x 18½D	16¾W x 26¾H x 26½D	8¾W x 3½H x 12½D	8¾W x 3½H x 12½D	8¾W x 3½H x 12½D	8¾W x 3½H x 12½D	
	Weight	Net	238 lbs, 108 kg	500 lbs, 226 kg	8 lbs, 3.6 kg	10 lbs, 4.5 kg	10 lbs, 4.5 kg	11 lbs, 5 kg
		Ship	299 lbs, 135 kg	555 lbs, 251 kg	10 lbs, 4.5 kg	12 lbs, 5.4 kg	12 lbs, 5.4 kg	14 lbs, 6.3 kg
	Price	\$1275	\$2500	\$150	\$255	\$265	\$375	
	Options	1,2,3,5,6,10,31,32	1,2,3,5,6,23,31,32	7,11,13,28	7,11,13,28	11,28,40	11,28,40	

§ (1) Published specifications apply only when (a) supply is delivering more than 5% of maximum rated output voltage (CV operation) or 5% of maximum rated output current (CC operation), and (b) load is drawing more than 100W. Restriction (b) is lifted when supply is delivering more than 30% of maximum rated output voltage (CV operation) or 30% of maximum rated output current (CC operation).
 (2) For operation with a 50Hz input (possible only with Option 05), output current is linearly derated from 100% at 40°C to 80% at 50°C.
 ◊ Operating temperature range for this supply is 0 to 50°C.
 * Measured at rear terminals.

Dual Range Two Outputs

0-40V	0-40V	0-20V	0-40V	0-40V	0-40V	0-40V	0-40V
0-0.75A	0-0.76A	0-1.6A	0-1.5A	0-1.5A	0-3A	0-3A	0-5A
6202B	6200B		6255A	6289A	6265B	6290A	6266B

0.01% plus 4mV	0.01% plus 4mV	0.01% plus 2mV	0.01% plus 2mV	0.01% plus 200µV	0.01% plus 1mV	0.01% plus 200µV
0.03% plus 250µA	0.03% plus 250µA	0.01% plus 250µA	0.01% plus 250µA	0.02% plus 500µA	0.05% plus 1mA	0.02% plus 500µA
0.01% plus 4mV	0.01% plus 4mV	0.01% plus 2mV	0.01% plus 2mV	0.01% plus 200µV	0.01% plus 1mV	0.01% plus 200µV
0.01% plus 250µA	0.01% plus 250µA	0.01% plus 250µA	0.01% plus 250µA	0.02% plus 500µA	0.05% plus 1mA	0.02% plus 500µA
200µV/1mV	200µV/1mV	200µV/1mV	200µV/1mV	200µV/10mV	500µV/25mV	200µV/10mV
500µA rms	500µA rms	500µA rms	500µA	3mA rms	3mA rms	3mA rms
0.02% plus 1mV	0.02% plus 1mV	0.02% plus 500µV	0.02% plus 500µV	0.01% plus 200µV	0.02% plus 500µV	0.01% plus 200µV
0.02% plus 0.5mA	0.02% plus 1mA	0.02% plus 0.8mA	0.02% plus 0.8mA	0.01% plus 1mA	0.02% plus 1.5mA	0.01% plus 1mA
0.1% plus 5mV	0.1% plus 5mV	0.1% plus 2.5mV	0.1% plus 2.5mV	0.03% plus 500µV	0.1% plus 2.5mV	0.03% plus 500µV
0.1% plus 2.5mA	0.1% plus 5mA	0.1% plus 4mA	0.1% plus 4mA	0.03% plus 3mA	0.1% plus 7.5mA	0.03% plus 3mA
10mV	10mV	10mV	10mV	5mV	8mV	5mV
1mA	2mA	2mA	2mA	3mA	1mA	5mA
±3%	±3%	±3%	±3%	±2%	±3%	±2%
NA	NA	NA	NA	NA	NA	NA
20mΩ, 1µH	20mΩ, 1µH	10mΩ, 1µH	10mΩ, 1µH	2mΩ, 1µH	3mΩ, 1µH	1mΩ, 1µH
50µs	50µs	50µs	50µs	50µs	50µs	50µs
10mV	10mV	15mV	15mV	10mV	15mV	10mV

CV/CC	CV/CC	CV/CC	CV/CC	CV/CC	CV/CC	CV/CC
Yes	Yes	Yes	Yes	Yes	Yes	Yes
Yes	Yes	Yes	Yes	Yes	Yes	Yes
200Ω/V ±1%	200Ω/V ±1%	200Ω/V ±1%	200Ω/V ±1%	200Ω/V ±1%	200Ω/V ±1%	200Ω/V ±1%
1kΩ/A ±10%	500Ω/A	1kΩ/A	500Ω/A ±10%	300Ω/A ±10%	500Ω/A ±10%	200Ω/A ±10%
1V/V ±1%	1V/V ±1%	1V/V ±1%	1V/V ±1%	1V/V ±1%	1V/V ±1%	1V/V ±1%
2V/A ±10%	1V/A	2V/A	0.66V/A ±10%	0.66V/A ±10%	167mV/A ±10%	333mV/A ±10%
4ms	4ms	1ms	15ms	15ms	275ms	275ms
12ms	12ms	3ms	45ms	45ms	275ms	275ms
30ms	30ms	15ms	200ms	200ms	12sec	6sec
30ms	10ms	4ms	40ms	40ms	400ms	150ms
2.5-44V	2.5-44V	2.5-44V	2.5-44V	2.5-45V	6-43V	2.5-45V
4% of output +2V	4% of output +2V	4% of output +2V	4% of output +2V	5% of output +1V	7% of output +1V	6% of output +1V
Option 11, \$50	Option 11, \$50	Option 11, \$110	Option 11, \$50	Standard	Option 11, \$55	Standard
300V	300V	300V	300V	300V	300V	300V
5V, 50V ±3% 0.09A, 0.9A ±3%	5V, 50V ±3% 0.18A, 1.8A ±3%	5V, 50V ±3% 0.18A, 1.8A ±3%	5V, 50V ±3% 0.18A, 1.8A ±3%	50V, 4A ±2%	5V, 50V ±3% 0.4A, 4A ±3%	50V, 6A ±2%

115Vac ±10% 48-440Hz 0.8A, 65W	115Vac ±10% 48-440Hz 0.9A, 70W	115Vac ±10% 48-440Hz 2.6A, 235W	115Vac ±10% 48-440Hz 1.3A, 110W	115Vac ±10% 57-63Hz 3A, 180W	115Vac ±10% 57-63Hz 3.5A, 170W	115Vac ±10% 57-63Hz 4A, 325W
3-Wire, 5-Ft. Cord	3-Wire, 5-Ft. Cord	3-Wire, 5-Ft. Cord	3-Wire, 5-Ft. Cord	3-Wire, 5-Ft. Cord	3-Wire, 5-Ft. Cord	3-Wire, 5-Ft. Cord
Convection	Convection	Convection	Convection	Convection	Convection	Convection
8½W x 3½H x 12½D	8½W x 3½H x 12½D	19W x 3½H x 14½D	8½W x 3½H x 14½D	19W x 3½H x 17½D	8½W x 5½H x 16D	19W x 3½H x 17½D
10 lbs, 4.5 kg	10 lbs, 4.5 kg	28 lbs, 12.7 kg	14 lbs, 6.4 kg	34 lbs, 15.4 kg	26 lbs, 11.8 kg	34 lbs, 15.4 kg
12 lbs, 5.4 kg	12 lbs, 5.4 kg	39 lbs, 17.7 kg	16 lbs, 7.2 kg	41 lbs, 18.6 kg	28 lbs, 12.7 kg	41 lbs, 18.6 kg
\$179	\$199	\$470	\$230	\$380	\$350	\$480
7,8,9,11,13,14,28	7,8,9,11,13,14,28	7,8,9,10,11,13,14,28	7,8,9,11,13,14,28	5,7,8,9,10,13,14,20 21,22,27,28,40	5,7,8,9,11,13,14,18	5,7,8,9,10,13,14,20 21,22,27,28,40

† (1) Load transient recovery for this supply is defined as follows: Time required for output voltage recovery to within the given level of the nominal output voltage following a load change from full load to half load or half load to full load.
 (2) For operation with a 50Hz input (possible only with Option 05) the values given in the table are increased by 50%.
 — indicates that information was not available at time of printing.
 NA Indicates Not Applicable.

POWER SUPPLIES *continued*

RATING	DC Output	Volts	0-40V	0-40V	0-40V	0-40V	0-40V	0-50V
	Amps		0-5A	0-10A	0-25A	0-30A	0-50A	0.2A
	Model		6291A	6267B	6434B	6268B	6269B	6217A
PERFORMANCE	Load Regulation	V	0.01% plus 1mV	0.01% plus 200 μ V	40mV	0.01% plus 200 μ V	0.01% plus 200 μ V	4mV
		C	0.05% plus 1mA	0.02% plus 500 μ A	200mA	0.02% plus 2mA	0.02% plus 2mA	NA
	Line Regulation	V	0.01% plus 1mV	0.01% plus 200 μ V	18mV	0.01% plus 200 μ V	0.01% plus 200 μ V	4mV
		C	0.05% plus 1mA	0.02% plus 500 μ A	200mA	0.02% plus 2mA	0.02% plus 2mA	NA
	Ripple and Noise (rms/p-p)	V	500 μ V/25mV	200 μ V/10mV	40mV/500mV†	1mV/5mV	1mV/5mV	200 μ V/1mV
		C	3mA	3mA	NA	20mA rms	25mA rms	NA
	Temperature Coefficient	V	0.02% plus 500 μ V	0.01% plus 200 μ V	0.03% plus 5mV	0.01% plus 200 μ V	0.01% plus 200 μ V	0.02% plus 1mV
		C	0.02% plus 2.5mA	0.01% plus 1mA	75mA	0.01% plus 2mA	0.01% plus 4mA	NA
	Stability	V	0.1% plus 2.5mV	0.03% plus 2mV	0.1% plus 20mV	0.03% plus 2mV	0.03% plus 2mV	0.1% plus 5mV
		C	0.1% plus 12.5mA	0.03% plus 3mA	250mA	0.03% plus 5mA	0.03% plus 10mA	NA
	Resolution	V	6mV	5mV	10mV	5mV	5mV	10mV
		C	2mA	10mA	12.5mA	30mA	50mA	NA
	Accuracy	Meter	\pm 3%	\pm 2%	\pm 2%	\pm 2%	\pm 2%	\pm 3%
		Voltage	NA	NA	NA	NA	NA	NA
Output Z		2m Ω , 1 μ H	0.5m Ω , 1 μ H	10m Ω , 1 μ H	0.2m Ω , 1 μ H	0.1m Ω , 1 μ H	40m Ω , 1 μ H	
Transient Recovery	Time	50 μ s	50 μ s	200ms†	50 μ s	50 μ s	50 μ s	
	Level	15mV	10mV	200mV†	10mV	10mV	15mV	
FEATURES	Output Mode		CV/CC	CV/CC	CV/CC	CV/CC	CV/CC	CV/CL
	Series, Par., Track.	Yes	Yes	Yes	Yes	Yes	Yes	No
	Remote Sensing	Yes	Yes	Yes	Yes	Yes	Yes	No
	R Res Coef	V	200 Ω /V \pm 1%	200 Ω /V \pm 1%	200 Ω /V \pm 2%	200 Ω /V \pm 1%	200 Ω /V \pm 1%	NA
		C	200 Ω /A \pm 10%	100 Ω /A \pm 10%	12 Ω /A \pm 20%	6 Ω /A \pm 10%	4 Ω /A \pm 10%	NA
	V Volt Coef	V	1V/V \pm 1%	1V/V \pm 1%	1V/V	1V/V \pm 1%	1V/V \pm 1%	NA
		C	200mV/A \pm 10%	50mV/A \pm 10%	--	16.7mV/A \pm 10%	10mV/A \pm 10%	NA
	Up Prog Speed	NL	275ms	275ms	--	300ms	350ms	NA
		FL	275ms	275ms	--	300ms	350ms	NA
	Down Prog Speed	NL	13sec	13sec	--	1sec	1sec	NA
		FL	275ms	140ms	--	30ms	20ms	NA
	Crowbar	Range	6-43V	2.5-45V	NA	4-45V	4-45V	NA
		Margin	7% of output +1V	5% of output +1V	NA	5% of output +1V	5% of output +1V	NA
	Price	Option 11, \$65	Standard	NA	Standard	Standard	Standard	NA
Floating, up to:	300V	300V	300V	300V	300V	300V	300V	
Meter Ranges	5V, 50V \pm 3% 0.6A, 6A \pm 3%	50V, 12A \pm 2%	50V, 30A \pm 2%	50V, 35A \pm 2%	50V, 60A \pm 2%	60V, 250mA \pm 3%		
GENERAL	Power	115Vac \pm 10% 57-63Hz 5.5A, 280W	115Vac \pm 10% 57-63Hz 8A, 550W	115Vac \pm 10% 57-63Hz 19A, 1300W	230Vac \pm 10% 57-63Hz 11A, 1600W	230Vac \pm 10% 57-63Hz 18A, 2500W	115Vac \pm 10% 48-440Hz 0.25A, 25W	
	Connections	3-Wire, 5-Ft. Cord	3-Terminal Strip	3-Terminal Strip	3-Terminal Strip	3-Terminal Strip	3-Wire, 5-Ft. Cord	
	Cooling	Convection	Convection	Fan	Fan	Fan	Convection	
	Dimensions (inches)	8 $\frac{1}{2}$ W x 5 $\frac{1}{4}$ H x 16D	19W x 5 $\frac{1}{4}$ H x 17 $\frac{1}{2}$ D	19W x 5 $\frac{1}{4}$ H x 16 $\frac{3}{4}$ D	19W x 7H x 17 $\frac{1}{2}$ D	19W x 7H x (17 $\frac{1}{2}$ D)	5 $\frac{1}{2}$ W x 3 $\frac{1}{4}$ H x 8D	
	Weight	Net	25 lbs, 11.3 kg	39 lbs, 17.7 kg	67 lbs, 30.4 kg	76 lbs, 34.4 kg	89 lbs, 40.3 kg	4.5 lbs, 2 kg
		Ship	28 lbs, 12.7 kg	46 lbs, 20.8 kg	82 lbs, 37.1 kg	84 lbs, 38.1 kg	98 lbs, 44 kg	6.5 lbs, 2.9 kg
	Price	\$395	\$650	\$550	\$726	\$875	\$95	
Options	5,7,8,9,11,13,14,18	5,7,8,9,10,13,14,20,21,22,27,28,40	5,10,17,18	5,7,8,9,10,13,14,20,21,22,26,27,40	5,7,8,9,10,13,14,20,21,22,27,40	28		

† (1) Load transient recovery for this supply is defined as follows: Time required for output voltage recovery to within the given level of the nominal output voltage following a load change from full load to half load or half load to full load.
 (2) For operation with a 50Hz input (possible only with Option 05) the values given in the table are increased by 50%.

Dual Range		Two Outputs		Dual Range		Dual Range		
0-50V	0-50V	0-25V	0-50V	0-50V	0-60V	0-30V	0-60V	0-60V
0-0.2A	0-0.5A	0-1A	0-1A	0-1.5A	0.5A	1A	0-1A	0-3A
6218A	8220B		6228B	6228B	6206B		6284A	6286A
4mV	0.01% plus 2mV	0.01% plus 1mV	0.01% plus 2mV	0.01% plus 2mV	0.01% plus 4mV	0.01% plus 2mV	0.01% plus 1mV	
500 μ A	0.01% plus 250 μ A	0.01% plus 250 μ A	0.01% plus 250 μ A	0.01% plus 250 μ A	NA	0.01% plus 250 μ A	0.05% plus 1mA	
4mV	0.01% plus 2mV	1mV	0.01% plus 2mV	0.01% plus 2mV	0.01% plus 4mV	0.01% plus 2mV	0.01% plus 1mV	
500 μ A	0.01% plus 250 μ A	100 μ A	0.01% plus 250 μ A	0.01% plus 250 μ A	NA	0.01% plus 250 μ A	0.05% plus 1mA	
200 μ V/1mV	200 μ V/1mV	250 μ V/4mV	200 μ V/1mV	200 μ V/1mV	200 μ V/1mV	200 μ V/1mV	500 μ V/25mV	
160 μ A/500 μ A	200 μ A/1mA	250 μ A/2mA	200 μ A/1mA	200 μ A/1mA	NA	500 μ A	3mA rms	
0.02% plus 1mV	0.02% plus 1mV	0.02% plus 200 μ V	0.02% plus 500 μ V	0.02% plus 500 μ V	0.02% plus 1mV	0.02% plus 500 μ V	0.02% plus 500 μ V	
1mA	0.02% plus 1mA	0.02% plus 150 μ A	0.02% plus 0.8mA	0.02% plus 0.8mA	NA	0.02% plus 0.5mA	0.02% plus 1.5mA	
0.1% plus 5mV	0.1% plus 5mV	0.2% plus 2mV	0.1% plus 2.5mV	0.1% plus 2.5mV	0.1% plus 5mV	0.1% plus 2.5mV	0.1% plus 2.5mV	
2.5mA	0.1% plus 5mA	0.2% plus 1.6mA	0.1% plus 4mA	0.1% plus 4mA	NA	0.1% plus 2.5mA	0.1% plus 7.5mA	
10mV	40mV	10mV	---	---	10mV	10mV	7mV	
10 μ A	1mA	0.5mA	---	---	NA	0.5mA	1mA	
$\pm 3\%$	$\pm 3\%$	$\pm 2\%$	$\pm 3\%$	$\pm 3\%$	$\pm 3\%$	$\pm 3\%$	$\pm 3\%$	
NA	NA	NA	NA	NA	NA	NA	NA	
40m Ω , 1 μ H	20m Ω , 1 μ H	10m Ω , 6 μ H	10m Ω , 1 μ H	10m Ω , 1 μ H	40m Ω , 2 μ H	15m Ω , 1 μ H	5m Ω , 1 μ H	
50 μ s	50 μ s	50 μ s	50 μ s	50 μ s	50 μ s	50 μ s	50 μ s	
15mV	10mV	10mV	10mV	10mV	10mV	15mV	15mV	
CV/CC	CV/CC	CV/CC	CV/CC	CV/CL	CV/CC	CV/CC	CV/CC	
No	Yes	Yes	Yes	Yes	Yes	Yes	Yes	
No	Yes	Yes	Yes	Yes	Yes	Yes	Yes	
NA	200 Ω /V $\pm 1\%$	200 Ω /V $\pm 1\%$	200 Ω /V $\pm 1\%$	300 Ω /V $\pm 1\%$	300 Ω /V $\pm 1\%$	300 Ω /V $\pm 1\%$	300 Ω /V $\pm 1\%$	
NA	2k Ω /A	1k Ω /A	1k Ω /A $\pm 10\%$	500 Ω /A $\pm 10\%$	NA	1k Ω /A $\pm 10\%$	500 Ω /A $\pm 10\%$	
NA	1V/V $\pm 1\%$	1V/V $\pm 1\%$	1V/V	1V/V $\pm 1\%$	1V/V $\pm 1\%$	1V/V $\pm 1\%$	1V/V $\pm 1\%$	
NA	2V/A	1V/A	1V/A $\pm 10\%$	1V/A	NA	1V/A $\pm 10\%$	333mV/A $\pm 10\%$	
NA	50ms	12ms	40ms	---	50ms	12ms	25ms	600ms
NA	120ms	30ms	100ms	2.4ms	120ms	30ms	80ms	600ms
NA	400ms	200ms	500ms	15ms	600ms	360ms	2sec	5sec
NA	120ms	30ms	100ms	---	50ms	140ms	175ms	200ms
NA	NA	5-55V	NA	2.5-65V	5-65V	5-65V	9-66V	
NA	NA	7% of output +1.6V	NA	4% of output +2V	4% of output +2V	4% of output +2V	7% of output +1V	
NA	NA	Standard	NA	Option 11, \$50	Option 11, \$50	Option 11, \$55	Option 11, \$55	
300V	300V	300V	300V	300V	300V	300V	300V	
60V, 250mA $\pm 3\%$	6V, 60V $\pm 3\%$ 0.12A, 1.2A $\pm 3\%$	60V, 1.2A $\pm 2\%$	6V, 60V $\pm 3\%$ 0.18A, 1.8A $\pm 3\%$	7V, 70V $\pm 3\%$ 0.12A, 1.2A $\pm 3\%$	7V, 70V $\pm 3\%$ 0.12A, 1.2A $\pm 3\%$	7V, 70V $\pm 3\%$ 0.12A, 1.2A $\pm 3\%$	7V, 70V $\pm 3\%$ 0.4A, 4A $\pm 3\%$	
115Vac $\pm 10\%$ 48-440Hz 0.25A, 26W	115Vac $\pm 10\%$ 48-440Hz 0.5A, 44W	115 or 230Vac $\pm 10\%$ switch, 48-63Hz 2.7A, 260W	115Vac $\pm 10\%$ 48-63Hz 1.8A, 164W	115Vac $\pm 10\%$ 48-440Hz 1A, 66W	115Vac $\pm 10\%$ 48-440Hz 1.3A, 114W	115Vac $\pm 10\%$ 48-440Hz 4.5A, 250W	115Vac $\pm 10\%$ 48-440Hz 4.5A, 250W	
3-Wire, 5-Ft. Cord	3-Wire, 5-Ft. Cord	3-Wire, 5-Ft. Cord	3-Wire, 5-Ft. Cord	3-Wire, 5-Ft. Cord	3-Wire, 5-Ft. Cord	3-Wire, 5-Ft. Cord	3-Wire, 5-Ft. Cord	
Convection	Convection	Convection	Fan	Convection	Convection	Convection	Convection	
5 $\frac{1}{4}$ W x 3 $\frac{3}{4}$ H x 8D	5 $\frac{1}{8}$ W x 6 $\frac{1}{4}$ H x 11D	7 $\frac{3}{4}$ W x 6 $\frac{1}{2}$ H x 12 $\frac{3}{4}$ D	5 $\frac{1}{8}$ W x 6 $\frac{1}{4}$ H x 11D	8 $\frac{1}{2}$ W x 3 $\frac{3}{4}$ H x 12 $\frac{3}{4}$ D	8 $\frac{1}{2}$ W x 3 $\frac{3}{4}$ H x 14 $\frac{3}{4}$ D	8 $\frac{1}{2}$ W x 5 $\frac{1}{4}$ H x 16D	8 $\frac{1}{2}$ W x 5 $\frac{1}{4}$ H x 16D	
4.8 lbs, 2.2 kg		24 lbs, 11 kg	16 lbs, 7.3 kg	10 lbs, 4.5 kg	13 lbs, 5.9 kg	25 lbs, 11.3 kg	25 lbs, 11.3 kg	
6.8 lbs, 3.1 kg	15 lbs, 6.8 kg	28 lbs, 12.9 kg	18 lbs, 8.2 kg	12 lbs, 5.4 kg	15 lbs, 6.8 kg	28 lbs, 12.7 kg	28 lbs, 12.7 kg	
\$120	\$275	\$495	\$355	\$179	\$230	\$385	\$385	
28	13,14,28,40	7,8,9,13,14	13,14,28,40	7,11,13,28	8,11,13,14,28	6,7,8,9,11,13,14,18	6,7,8,9,11,13,14,18	

--- indicates that information was not available at time of printing.
NA indicates Not Applicable.

POWER SUPPLIES *continued*



R A T I N G	DC Output	Volts	0-60V	0-60V	0-60V	0-60V	0-64V	0-64V §
	Amps		0-3A	0-5A	0-15A	0-15A	0-50A	0-150A §
	Model		6271B	6438B	6438B	6274B	6459A	6472C
P E R F O R M A N C E	Load Regulation	V	0.01% plus 200µV	60mV	120mV	0.01% plus 200µV	0.2% plus 10mV comb. line and load	0.05% plus 100mV
		C	0.02% plus 500µA	50mA	150mA	0.02% plus 500µA	1% or 0.5A comb. line and load	0.1% plus 0.15A
	Line Regulation	V	0.01% plus 200µV	30mV	80mV	0.01% plus 200µV	0.2% plus 10mV comb. line and load	0.05% plus 100mV
		C	0.02% plus 500µA	50mA	150mA	0.02% plus 500µA	1% or 0.5A comb. line and load	0.1% plus 0.15A
	Ripple and Noise (rms/p-p)	V	200µV/10mV	120mV/400mV †	60mV/500mV †	200µV/20mV	160mV rms †	160mV/1V †
		C	3mA rms	NA	NA	5mA rms	NA	NA
	Temperature Coefficient	V	0.01% plus 200µV	0.03% plus 10mV	0.03% plus 10mV	0.01% plus 200µV	0.05% plus 2mV	0.03% plus 4mV
		C	0.01% plus 1mA	15mA	45mA	0.01% plus 2mA	0.3A	0.08% plus 85mA
	Stability	V	0.03% plus 600µV	0.1% plus 30mV	0.1% plus 30mV	0.03% plus 2mV	0.25% plus 10mV	0.15% plus 16mV
		C	0.03% plus 3mA	50mA	150mA	0.03% plus 5mA	1.5A	0.3% plus 0.35A
	Resolution	V	10mV	9mV	9mV	10mV	--	64mV
		C	3mA	2.5mA	7.5mA	15mA	--	0.15A
	Accuracy	Meter	±2%	±2%	±2%	±2%	±2%	±2%
		Voltage	NA	NA	NA	NA	NA	NA
Output Z		5mΩ, 1µH	20mΩ, 1µH	10mΩ, 1µH	1mΩ, 1µH	--	--	
Transient Recovery	Time	50µs	200ms †	200ms †	50µs	50ms †	50ms, 100ms †	
	Level	10mV	300mV †	600mV †	10mV	600mV †	2V, 750mV †	
F E A T U R E S	Output Mode		CV/CC	CV/CC	CV/CC	CV/CC	CV/CC	CV/CC
	Series, Par., Track.	Yes	Yes	Yes	Yes	Yes	Yes	Yes
	Remote Sensing	Yes	Yes	Yes	Yes	Yes	Yes	Yes
	R Res	V	300Ω/V ±1%	300Ω/V ±2%	300Ω/V ±2%	300Ω/V ±1%	300Ω/V ±1%	300Ω/V ±2%
		Coef C	300Ω/A ±10%	80Ω/A ±20%	20Ω/A ±20%	67Ω/A ±10%	4Ω/A ±10%	6.7Ω/A ±2%
	O Volt	V	1V/V ±1%	1V/V	1V/V	1V/V ±1%	94mV/V	1V/V ±(1% ±1V)
		Coef C	167mV/A ±10%	--	--	33.3mV/A ±10%	120mV/A	41.2mV/A ±7%
	P Up Prog	NL	0.6sec	--	--	600ms	--	--
		Speed FL	600ms	--	--	600ms	--	--
	O Down Prog	NL	7sec	--	--	40sec	--	--
		Speed FL	0.2sec	--	--	40ms	--	--
	G. Range		6-66V	NA	NA	6-66V	38-73V	32-70V
		Crowbar Margin	5% of output +1V	NA	NA	5% of output +1V	5% of output +1V	10% of output V
	Price	Standard	NA	NA	Standard	Option 6, \$300	Option 06, \$400	
Floating, up to:	300V	300V	300V	300V	300V	100V		
Meter Ranges	70V, 4A ±2%	70V, 6A ±2%	70V, 18A ±2%	70V, 18A ±2%	80V, 50A ±2%	80V, 180A ±2%		
G E N E R A L	Power	115Vac ±10% 57-63Hz 4A, 300W	115Vac ±10% 57-63Hz 6.5A, 400W	115Vac ±10% 57-63Hz 17A, 1200W	115Vac ±10% 57-63Hz 15A, 1200W	Option 1,2,3,31,32 14A per phase @ 230V	Option 1,2,3,31,32 50A per phase @ 230V	
	Connections	3-Wire, 5-Ft. Cord	3-Wire, 5-Ft. Cord	3-Terminal Strip	3-Terminal Strip	4-Pin Plug & Jack	4-Terminal Strip	
	Cooling	Convection	Convection	Fan	Fan	Fan	Fan ◊	
	Dimensions (inches)	19W x 3½H x 17½D	19W x 3½H x 17½D	19W x 5½H x 16¾4D	19W x 5½H x 17½D	19W x 14H x 18½D	16¾W x 26¼H x 26¼D	
	Weight	Net	34 lbs, 15.4 kg	31 lbs, 14 kg	61 lbs, 27.6 kg	48 lbs, 21.7 kg	238 lbs, 108 kg	500 lbs, 226 kg
		Ship	41 lbs, 18.6 kg	50 lbs, 22.7 kg	80 lbs, 36.2 kg	54 lbs, 24.5 kg	299 lbs, 135 kg	555 lbs, 251 kg
	Price	\$460	\$370	\$550	\$696	\$1275	\$2800	
Options	5,7,8,9,10,13,14,20, 21,22,27,28,40	5,10,17,18	5,10,17,18	5,7,8,9,10,13,14,20, 21,22,27,28,40	1,2,3,5,6,10,31,32	1,2,3,5,6,23,31,32		

§ (1) Published specifications apply only when (a) supply is delivering more than 5% of maximum rated output voltage (CV operation) or 5% of maximum rated output current (CC operation), and (b) load is drawing more than 100W. Restriction (b) is lifted when supply is delivering more than 30% of maximum rated output voltage (CV operation) or 30% of maximum rated output current (CC operation).
 † (2) For operation with a 50Hz input (possible only with Option 05), output current is linearly derated from 100% at 40°C to 80% at 50°C.
 ◊ Operating temperature range for this supply is 0 to 50°C.
 • Measured at rear terminals.



0-100V	0-100V	0-100V	0-100V	0-100V	0-110V §	0-120V
0.1A	0-0.1A	0-200mA	0-200mA	0-750mA	0-100A §	0-2.5A
6211A	6212A	6106A	6116A	6299A	6475C	6443B

8mV	8mV	0.001% plus 100µV*	0.001% plus 100µV*	0.01% plus 2mV	0.05% plus 100mV	120mV
NA	500µA	NA	NA	0.01% plus 250µA	0.1% plus 0.1A	25mA
4mV	4mV	0.001%	0.001%	0.01% plus 2mV	0.05% plus 100mV	60mV
NA	500µA	NA	NA	0.01% plus 250µA	0.1% plus 0.1A	25mA
200µV/1mV	200µV/1mV	40µV/100µV	40µV/100µV	200µV/1mV	220mV/2V†	240mV/400mV†
NA	150µA/500µA	NA	NA	500µArms	NA	NA
0.02% plus 1mV	0.02% plus 1mV	0.005% plus 100µV	0.001% plus 10µV	0.02% plus 500µV	0.03% plus 5mV	0.03% plus 20mV
NA	0.5mA	NA	NA	0.02% plus 0.4mA	0.06% plus 75mA	8mA
0.1% plus 6mV	0.1% plus 5mV	0.01% plus 1mV	0.01% + 100µV	0.1% plus 2.5mV	0.15% plus 20mV	0.1% plus 60mV
NA	1.3mA	NA	NA	0.1% plus 2mA	0.3% plus 300mA	25mA
20mV	20mV	0.002% plus 100µV	200µV	20mV	22mV	30mV
NA	10µA	NA	NA	1mA	0.1A	1.3mA
±4%	±4%	±3%	±3%	±3%	±2%	±2%
NA	NA	NA	0.1% plus 1mV	NA	NA	NA
80mΩ, 6µH	80mΩ, 6µH	10mΩ, 1µH	10mΩ, 1µH	30mΩ, 1µH	--	0.1Ω, 2µH
50µs	50µs	NA	NA	50µs	50ms, 100ms †	200ms†
15mV	15mV	NA	NA	15mV	2.5V, 1V †	600mV†

CV/CL	CV/CC	CV/CL	CV/CL	CV/CC	CV/CC	CV/CC
No	No	Yes	Yes	Yes	Yes	Yes
No	No	Yes	Yes	Yes	Yes	Yes
NA	NA	1kΩ/V ±0.1%	1kΩ/V ±0.1%	300Ω/V ±1%	300Ω/V ±2%	300Ω/V ±2%
NA	NA	NA	NA	1kΩ/A ±10%	10Ω/A ±2%	120Ω/A ±20%
NA	NA	1V/V ±0.1%	1V/V ±0.1%	1V/V ±1%	1V/V ±(1% ±1V)	1V/V
NA	NA	NA	NA	1.3V/A ±10%	62mV/A ±7%	--
NA	NA	700ms	NA	25ms	--	--
NA	NA	700ms	NA	200ms	--	--
NA	NA	1sec	NA	1.5sec	--	--
NA	NA	700ms	NA	200ms	--	--
NA	NA	20-106V	20-106V	20-106V	55-120V	NA
NA	NA	4% of output +2V	4% of output +2V	4% of output +2V	10% of output V	NA
NA	NA	Option 11, \$50	Option 11, \$50	Option 11, \$50	Option 06, \$400	NA
300V	300V	300V	300V	300V	300V	300V
120V, 120mA ±4%	120V, 120mA ±4%	12V, 120V ±3% 25mA, 250mA ±3%	12V, 120V ±3% 25mA, 250mA ±3%	12V, 120V ±3% 0.1A, 1A ±3%	125V, 120A ±2%	150V, 3A ±2%

115Vac ±10% 48-440Hz 0.29A, 27W	115Vac ±10% 48-440Hz 0.29A, 28W	115Vac ±10% 48-63Hz 0.5A, 52W	115Vac ±10% 48-63Hz 0.5A, 52W	115Vac ±10% 48-440Hz 1.5A, 135W	Option 1,2,3,31,32 50A per phase @ 230V	115Vac ±10% 57-63Hz 6.5A, 400W
3-Wire, 5-Ft. Cord	3-Wire, 5-Ft. Cord	3-Wire, 5-Ft. Cord	3-Wire, 5-Ft. Cord	3-Wire, 5-Ft. Cord	4-Terminal Strip	3-Wire, 5-Ft. Cord
Convection	Convection	Convection	Convection	Convection	Fan ◊	Convection
5¼W x 3¼H x 8D	6¼W x 3¼H x 8D	8¼W x 3¼H x 12½D	8¼W x 5¼H x 12½D	8¼W x 3¼H x 14½D	16¼W x 26¼H x 26¼D	19W x 3¼H x 17½D
4.5 lbs, 2 kg	4.8 lbs, 2.2 kg	10 lbs, 4.5 kg	11 lbs, 5 kg	13 lbs, 5.9 kg	500 lbs, 226 kg	31 lbs, 14 kg
6.5 lbs, 2.9 kg	6.8 lbs, 3.1 kg	12 lbs, 5.4 kg	14 lbs, 6.3 kg	15 lbs, 6.8 kg	555 lbs, 251 kg	45 lbs, 20.4 kg
\$106	\$130	\$265	\$375	\$250	\$2800	\$360
28	28	11,28	11,28	8,11,13,14,28	1,2,3,5,6,23,31,32	5,10,17,18

† (1) Load transient recovery for this supply is defined as follows: Time required for output voltage recovery to within the given level of the nominal output voltage following a load change from full load to half load or half load to full load.
 (2) For operation with a 50Hz input (possible only with Option 06) the values given in the table are increased by 50%.
 -- indicates that information was not available at time of printing.
 NA indicates Not Applicable.

POWER SUPPLIES *continued*



RATING	DC Output	Volts	0-160V	0-220V §	0-300V §	0-320V	0-320V	0-440, 500, 600V §*
		Amps	0-0.2A	0-50A §	0-35A §	0-0.1A	1.5A	0-25, 20, 15A §
		Model	6207B	6477C	6479C	8209B	895A	6483C

PERFORMANCE	Load Regulation	V	0.02% plus 2mV	0.05% plus 100mV	0.05% plus 100mV	0.02% plus 2mV	0.007% or 10mV	0.05% plus 100mV
		C	200µA	0.1% plus 50mA	0.1% plus 35mA	200µA	NA	0.1% plus 35mA
	Line Regulation	V	0.02% plus 2mV	0.05% plus 100mV	0.05% plus 100mV	0.02% plus 2mV	0.007% or 10mV	0.05% plus 100mV
		C	200µA	0.1% plus 50mA	0.1% plus 35mA	200µA	NA	0.1% plus 35mA
	Ripple and Noise (rms/p-p)	V	500µV/40mV	330mV/2V†	330mV/3V†	1mV/40mV	1mV rms	600mV/5V†
		C	200µA rms	NA	NA	200µA	NA	NA
	Temperature Coefficient	V	0.02% plus 1mV	0.03% plus 8mV	0.03% plus 11mV	0.02% plus 1mV	0.03% plus 1.5mV	0.03% plus 20mV
		C	0.02% plus 150µA	0.06% plus 65mA	0.08% plus 60mA	0.02% plus 75µA	NA	0.06% plus 60mA
	Stability	V	0.1% plus 5mV	0.15% plus 35mV	0.15% plus 45mV	0.1% plus 5mV	0.1% plus 5mV	0.15% plus 80mV
		C	0.1% plus 750µA	0.3% plus 250mA	0.3% plus 250mA	0.1% plus 350µA	NA	0.3% plus 250mA
	Resolution	V	25mV	44mV	60mV	40mV	--	60mV
		C	500µA	50mA	35mA	200µA	--	25mA
	Accuracy	Meter	±3%	±2%	±2%	±3%	--	±2%
		Voltage	NA	NA	NA	NA	NA	NA
	Output Z		20mΩ, 1µH	--	--	20mΩ, 1µH	40mΩ, 0.16µH	--
Transient Recovery	Time	50µs	50ms, 100ms †	50ms, 100ms †	50µs	100µs	50ms, 100ms †	
	Level	10mV	5V, 2V †	7V, 3V †	10mV	20mV	12V, 5V †	

FEATURES	Output Mode		CV/CC	CV/CC	CV/CC	CV/CC	CV/CL	CV/CC
	Series, Par., Track.	Yes	Yes	Yes	Yes	No	Yes	Yes
	Remote Sensing	Yes	Yes	Yes	Yes	Yes	Yes	Yes
	R Res	V	300Ω/V ±1%	300Ω/V ±2%	300Ω/V ±2%	300Ω/V ±1%	300Ω/V	300Ω/V ±2%
		Coef	C	7.5kΩ/0.1A ±10%	20Ω/A ±2%	28.6Ω/A ±2%	15kΩ/0.1A ±10%	NA
	V Volt	V	1V/V ±1%	1V/V ±(1% ±1V)	1V/V ±(1% ±1V)	1V/V ±1%	--	1V/V ±(1% ±1V)
		Coef	C	0.75V/0.1A ±10%	124mV/A ±7%	177mV/A ±7%	1.5V/0.1A ±10%	NA
	Up Prog	NL	200ms	--	--	200ms	--	1.5 sec Δ
		Speed	FL	1.5sec	--	--	1.5sec	--
	Down Prog	NL	2.0sec	--	--	1.5sec	--	200 sec Δ
		Speed	FL	0.5sec	--	--	0.5sec	--
	Crowbar	Range	NA	110-240V	150-330V	NA	NA	300-660V
		Margin	NA	10% of output V	10% of output V	NA	NA	10% of output V
		Price	NA	Option 06, \$300	Option 06, \$300	NA	NA	Option 06, \$300
	Floating, up to:		300V	300V	300V	300V	300V	100V
Meter Ranges		20V, 200V ±3% 24mA, 240mA ±3%	250V, 60A ±2%	350V, 40A ±2%	40V, 400V ±3% 12mA, 120mA ±3%	320V, 1.5A	700V, 30A ±2%	

GENERAL	Power		115Vac ±10% 48-63Hz 1A, 60W	Option 1,2,3,31,32 50A per phase @ 230V	Option 1,2,3,31,32 50A per phase @ 230V	115Vac ±10% 48-63Hz 1A, 60W	115Vac ±10% 57-63Hz 8.7A, 585W	Option 1,2,3,31,32 50A per phase @ 230V	
	Connections		3-Wire, 5-Ft. Cord	4-Terminal Strip	4-Terminal Strip	3-Wire, 5-Ft. Cord	3-Wire, 5-Ft. Cord	4-Terminal Strip	
	Cooling		Convection	Fan ◊	Fan ◊	Convection	Convection	Fan ◊	
	Dimensions (inches)		8¼W x 3½H x 12¼D	16¾W x 26¼H x 26¼D	16¾W x 26¼H x 26¼D	8¼W x 3½H x 12¼D	19W x 5½H x 16¾D	16¾W x 26¼H x 26¼D	
	Weight	Net		10 lbs, 4.5 kg	500 lbs, 226 kg	500 lbs, 226 kg	10 lbs, 4.5 kg	50 lbs, 22.6 kg	500 lbs, 226 kg
		Ship		12 lbs, 5.4 kg	555 lbs, 251 kg	555 lbs, 251 kg	12 lbs, 5.4 kg	65 lbs, 29.4 kg	655 lbs, 251 kg
	Price		\$255	\$2800	\$2800	\$255	\$825	\$2800	
Options		8,13,14,28	1,2,3,5,6,23,31,32	1,2,3,5,6,23,31,32	8,13,14,28	NA	1,2,3,5,6,23,31,32		

◊ (1) Published specifications apply only when (a) supply is delivering more than 5% of maximum rated output voltage (CV operation) or 5% of maximum rated output current (CC operation), and (b) load is drawing more than 100W. Restriction (b) is lifted when supply is delivering more than 30% of maximum rated output voltage (CV operation) or 30% of maximum rated output current (CC operation).
 (2) For operation with a 50Hz input (possible only with Option 05), output current is linearly derated from 100% at 40°C to 80% at 50°C.
 ◊ Operating temperature range for this supply is 0 to 50°C.
 -- indicates that information was not available at time of printing.
 NA indicates Not Applicable.

1-600V	0-1000V	0-1600V	0-2000V	0-3000V	0-3000V	0-4000V
5mA-1.5A	0-200mA	5mA	0-100mA	6mA	6mA	0-50mA
54488	6521A	5515A	6522A	6110A	6516A	6525A

600mV	0.005% or 20mV	0.01% or 16mV	0.005% or 20mV	0.001% plus 100µV	0.01% or 16mV	0.005% or 20mV
15mA	2% or 1mA	NA	2% or 1mA	NA	NA	2% or 1mA
600mV	0.005% or 20mV	0.01% or 16mV	0.006% or 20mV	0.001%	0.01% or 16mV	0.005% or 20mV
15mA	1mA	NA	1mA	NA	NA	1mA
600mV/2V†	1mV rms	2mV/5mV	1mV rms	2mV/5mV	2mV/5mV	1mV rms
NA	2mA rms	NA	1mA rms	NA	NA	500µA rms
0.03% plus 100mV	0.012% plus 1mV	0.02% plus 2mV	0.012% plus 1mV	0.001% plus 50µV	0.02% plus 2mV	0.012% plus 1mV
5mA	0.2% plus 0.2mA	NA	0.2% plus 0.1mA	NA	NA	0.2% plus 0.05mA
0.1% plus 300mV	0.036% plus 3mV	0.05% plus 5mV	0.036% plus 3mV	0.01% plus 500µV	0.05% plus 5mV	0.036% plus 3mV
15mA	0.25% plus 0.5mA	NA	0.25% plus 0.25mA	NA	NA	0.25% plus 0.12mA
60mV	20mV	100mV	40mV	20mV	1V	80mV
0.75mA	--	NA	--	NA	NA	--
±2%	±2%	±2%	±2%	±3%	±2%	±2%
NA	1% of setting	NA	1% of setting	0.1% plus 100mV	NA	1% of setting
0.5Ω, 10µH	--	--	--	--	--	--
200ms†	50µs	100µs	50µs	NA	100µs	50µs
3V†	0.005% or 20mV	0.01% or 16mV	0.005% or 20mV	NA	0.01% or 16mV	0.005% or 20mV

CV/CC	CV/CC	CV/CL	CV/CC	CV/CL	CV/CL	CV/CC
Yes, except Auto-Ser.	No	No	No	No	No	No
Yes	No	No	No	No	No	No
300Ω/V ±2%	NA	NA	NA	NA	NA	NA
600Ω/A ±20%	NA	NA	NA	NA	NA	NA
1V/V	NA	NA	NA	NA	NA	NA
--	NA	NA	NA	NA	NA	NA
--	NA	NA	NA	NA	NA	NA
--	NA	NA	NA	NA	NA	NA
--	NA	NA	NA	NA	NA	NA
--	NA	NA	NA	NA	NA	NA
NA	NA	NA	NA	NA	NA	NA
NA	NA	NA	NA	NA	NA	NA
NA	NA	NA	NA	NA	NA	NA
300V	2000V	1000V	2000V	1000V	1000V	2000V
700V, 1.8A ±2%	1kV, 200mA ±2%	1800V ±2%	2kV, 100mA ±2%	3500V, 7mA ±3%	3500V ±2%	4kV, 50mA ±2%

115Vac ±10% 57-63Hz 16A, 1200W	115Vac ±10% 48-440Hz 4A, 270W	115Vac ±10% 60 ±0.3Hz 162mA, 19W	115Vac ±10% 48-440Hz 4A, 270W	115Vac ±10% 57-63Hz 1A, 50W	115Vac ±10% 57-63Hz 1A, 40W	115Vac ±10% 48-440Hz 4A, 270W
3-Terminal Strip	3-Wire, 5-Ft. Cord	3-Wire, 5-Ft. Cord	3-Wire, 5-Ft. Cord	3-Wire, 5-Ft. Cord	3-Wire, 5-Ft. Cord	3-Wire, 5-Ft. Cord
Fan	Convection	Convection	Convection	Convection	Convection	Convection
19W x 5¼H x 16¾4D	19W x 5¼H x 18D	8¾W x 3¼H x 11¾4D	19W x 5¼H x 18D	8¾W x 5¼H x 16D	8¾W x 5¼H x 16D	19W x 5¼H x 18D
61 lbs, 27.6 kg	42 lbs, 19 kg	9 lbs, 4.1 kg	42 lbs, 19 kg	19 lbs, 8.6 kg	17 lbs, 7.7 kg	42 lbs, 19 kg
72 lbs, 32.6 kg	63 lbs, 28.5 kg	11 lbs, 5.0 kg	63 lbs, 28.5 kg	23 lbs, 10.4 kg	21 lbs, 9.5 kg	63 lbs, 28.5 kg
\$695	\$795	\$235	\$785	\$520	\$315	\$795
5, 10, 17, 18	NA	13	NA	5, 18	5, 18	NA

† (1) Load transient recovery for this supply is defined as follows: Time required for output voltage recovery to within the given level of the nominal output voltage following a load change from full load to half load or half load to full load.
 (2) For operation with a 60Hz input (possible only with Option 05) the values given in the table are increased by 50%.

△ Programming speed for this supply is defined as follows: Typical time required to non-repetitively program from zero to within 99% of the maximum rated output voltage, or from the maximum rated output voltage to within 1% of that voltage above zero.

* The output capacity is up to 25A at 440V, up to 20A at 500V, and 15A at 600V.

POWER SUPPLIES *continued***Options and Accessories**

Options are customer-requested, factory-performed, mechanical and/or electrical modifications to standard instruments. A list of all options available on Hewlett-Packard dc power supplies is given below. To determine which options are available for a particular supply, refer to the appropriate product page.

OPTIONS

- 001:** 208 Vac $\pm 10\%$, 3-phase input, 57-63 Hz. No charge.
- 002:** 230 Vac $\pm 10\%$, 3-phase input, 57-63 Hz. No charge.
- 003:** 460 Vac $\pm 10\%$, 3-phase input, 57-63 Hz.
6464C, 6466C, 6469C, 6472C, 6475C, 6477C, 6479C, 6483C, \$200; all other models, no charge.
- 005:** 50 Hz ac input. Standard instrument is wired for nominal 60 Hz ac input. Option 005 includes realignment, and in some cases, internal rewiring.
6110A, 6516A, \$50.
6453A, 6456B, 6459A, \$25.
6464C, 6466C, 6469C, 6472C, 6475C, 6477C, 6479C, 6483C, no charge; all other models, \$10.
- 006:** internal overvoltage protection crowbar. Protects delicate loads against power supply failure or operator error. Monitors the output voltage and places a virtual short circuit (conducting SCR) across load within 10 μ s after preset trip voltage is exceeded. For complete specifications, refer to appropriate product page.
- 007:** ten-turn output voltage control. Replaces concentric coarse and fine voltage control.
6205B, 6227B, 6228B, 6253A, 6255A, \$50; all other models, \$25.
- 008:** ten-turn output current control. Replaces concentric coarse and fine current control.
6227B, 6228B, 6253A, 6255A, \$50; all other models, \$25.
- 009:** ten-turn output voltage and current controls. Consists of Options 007 and 008 on same instrument.
6227B, 6228B, 6253A, 6255A, \$90; all other models, \$45.
- 010:** chassis slides. Enables convenient access to power supply interior for maintenance. Chassis slides are attached to supply at factory.
6253A, 6255A, 6427B, 6428B, 6433B, 6434B, 6438B, 6439B, 6443B, 6448B, \$125.
6453A, 6456B, 6459A, \$195; all other models, \$50.
- 011:** internal overvoltage protection crowbar. Protects delicate loads against power supply failure or operator error. Monitors the output voltage and places a virtual short circuit (conducting SCR) across load within 10 μ s after preset trip voltage is exceeded. For complete specifications, refer to appropriate product page.
- 013:** three-digit graduated decadal voltage control. Includes single 10-turn control replacing coarse and fine voltage controls.
6205B, 6227B, 6228B, 6253A, 6255A, \$120.
6207B, 6209B, 6220B, 6224B, 6226B, 6294A, 6299A, 6515A, \$35; all other models, \$60.
- 014:** three-digit graduated decadal current control. Includes single 10-turn control replacing coarse and fine current controls.
6227B, 6228B, 6253A, 6255A, \$120.
6220B, 6224B, 6266B, \$35; all other models, \$60.
- 016:** 115 Vac $\pm 10\%$, single phase input. Factory modification

includes installation of a 115 V input power transformer to replace the standard 230 V transformer, \$75.

- 017:** 208 Vac $\pm 10\%$, single phase input. Factory modification includes installation of a 208 V input power transformer to replace the standard 115 or 230 V transformer, \$75.
- 018:** 230 Vac $\pm 10\%$, single phase input. Factory modification includes installation of a 230 V input power transformer to replace the standard 115 V transformer.
6110A, 6282A, 6285A, 6286A, 6290A, 6291A, 6296A, 6516A, \$50; all other models, \$75.
- 020:** voltage programming adjust. Allows the voltage programming coefficient and zero output voltage to be easily and accurately adjusted via an access hole in the rear panel, \$25.
- 021:** current programming adjust. Allows the current programming coefficient and zero output current to be easily and accurately adjusted via an access hole in the rear panel, \$25.
- 022:** voltage and current programming adjusts. Consists of Options 020 and 021 on same instrument, \$45.
- 023:** rack kit for mounting one 6464C-6483C supply in standard 19" rack, \$25.
- 026:** 115 Vac $\pm 10\%$, single phase input. Factory modification consists of reconnecting the multi-tap input power transformer (and other components where necessary) for 115 V operation, \$10.
- 027:** 208 Vac $\pm 10\%$, single phase input. Factory modification consists of reconnecting the multi-tap input power transformer (and other components where necessary) for 208 V operation.
6259B, 6260B, 6261B, 6268B, 6269B, \$15; all other models, \$10.
- 028:** 230 Vac $\pm 10\%$, single phase input. Factory modification consists of reconnecting the multi-tap input power transformer (and other components where necessary) for 230 V operation, \$10.
- 031:** 380 Vac $\pm 10\%$, 3-phase input, 57-63 Hz, \$275.
- 032:** 400 Vac $\pm 10\%$, 3-phase input, 57-63 Hz, \$275.
- 040:** interfacing for multiprogrammer operation. Prepares standard Hewlett-Packard power supplies for resistance programming by the 6940A Multiprogrammer or 6941A Multiprogrammer Extender.
6220B, 6224B, 6226B, 6256B, 6259B, 6260B, 6261B, 6263B, 6264B, 6265B, 6266B, 6267B, 6268B, 6269B, 6271B, 6274B, \$60.
6101A, 6102A, 6111A, 6112A, 6115A, \$30.

ACCESSORIES

- 14513A:** rack kit for mounting one 3½" high, half rack (8½" wide) supply, \$20.
- 14515A:** rack kit for mounting one 5¼" high, half rack (8½" wide) supply, \$23.
- 14525A:** rack kit for mounting two 5¼" high, half rack (8½" wide) supplies, \$12.
- 14523A:** rack kit for mounting two 3½" high, half rack (8½" wide) supplies, \$10.
- 14521A:** rack kit for mounting three 6211A-6218A supplies, \$25.
Option J01: rack kit for mounting two 6211A-6218A supplies (includes one filler panel), \$35.
Option J02: rack kit for mounting one 6211A-6218A supply (includes two filler panels), \$35.
- 6950A, Option J47:** filler panel for one 6211A-6218A supply. Used with rack kit 14521A, \$10.
- 14545A:** set of 4 snap-on casters for one 6464C-6483C supply, \$35.

CONSTANT CURRENT SOURCES

Precise regulation and resolution

Models 6177B, 6181B, 6186B



POWER SUPPLIES

Specifications

Load regulation: less than 25 ppm of output +5 ppm of range switch setting for a load change which causes the output voltage to vary from zero to maximum.

Line regulation: less than 25 ppm of output +5 ppm of range switch setting for change in the line voltage from 103.5 to 126.5 Vac (or 126.5 to 103.5 Vac) at any output current and voltage within rating.

Load transient recovery time: less than 200 μ s for output current recovery to within 1% of the nominal output current following a full load change in output voltage.

Temperature coefficient: output change per degree C is less than 75 ppm of output current +5 ppm of range switch setting.

Stability: less than 100 ppm of output current +25 ppm of range switch setting. Stability is measured for eight hours after one hour warm-up under conditions of constant line, load, temperature, and output setting.

Resolution: 0.02% of range switch setting.

Temperature rating: operating, 0 to 55°C; storage, -40 to +75°C.

Dimensions

6177B, 6181B: 7 $\frac{3}{4}$ " (19,7 cm) wide, 3-7/16" (8,8 cm) high, 12 $\frac{3}{8}$ " (30,87 cm) deep.

6186B: 7 $\frac{3}{4}$ " (19,7 cm) wide, 6-17/32" (15,67 cm) high, 12 $\frac{3}{8}$ " (30,87 cm) deep.

Weight

6177B, 6181B: 10 lbs (4,53 kg) net, 13 lbs (5,9 kg) shipping.

6186B: 13 lbs (5,9 kg) net, 17 lbs (7,7 kg) shipping.

Options

014: three digit graduated decadal current control, add \$35.

028: 230 Vac, single phase input (Models 6177B and 6181B only), add \$10.

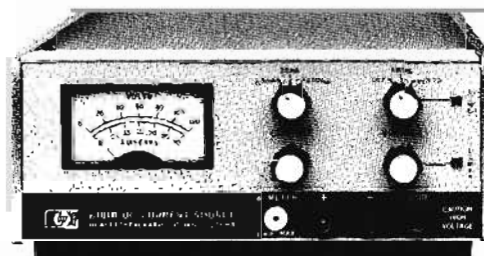

6177B, 6181B

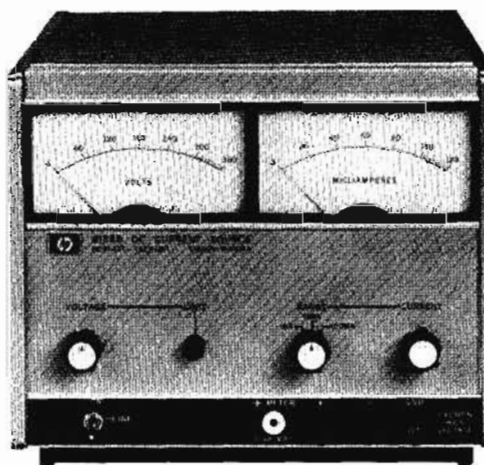

6186B

Model		6177B	6181B	6186B
Output Current		0-500 mA	0-250 ma	0-100 mA
Voltage Compliance		0-50 Vdc	0-100 Vdc	0-300 Vdc
Output Ranges	A	0-5 mA	0-2.5 mA	0-1 mA
	B	0-50 mA	0-25 mA	0-10 mA
	C	0-500 mA	0-250 mA	0-100 mA
AC Input		115 Vac \pm 10%, 48-63 Hz; 0.6 A, 55 W at 115 Vac For 230 Vac see Option 028	115 Vac \pm 10%, 48-63 Hz; 0.6 A, 55 W at 115 Vac For 230 Vac see Option 028	115/230 Vac, 48-63 Hz 0.9 A, 90 W at 115 Vac 115/230 Vac switch
Constant Current Remote Programming	Voltage Control (Accuracy: 0.5% of output current \pm .04% of range)	Range A	200 mV/mA	1 V/mA
		Range B	20 mV/mA	100 mV/mA
		Range C	2 mV/mA	10 mV/mA
Resistance Control (Accuracy: 1% of output control \pm .04% of range)	Range A	400 ohms/mA	2K ohms/mA	10K ohms/mA
	Range B	40 ohms/mA	200 ohms/mA	1K ohm/mA
	Range C	4 ohms/mA	20 ohms/mA	100 ohms/mA
Voltage Limit Remote Programming	Voltage Control (Accuracy: 20%)	Range A	1 V/V	1 V/V
		Resistance Control	870 ohms/V	440 ohms/V
		Accuracy	20%	20%
Output Impedance (R in parallel with C)*	Range A	R = 330 Meg, C = 500 pF	R = 1330 Meg, C = 10 pF	R = 10,000 Meg, C = 900 pF
	Range B	R = 33 Meg, C = 0.005 μ F	R = 133 Meg, C = 100 pF	R = 1,000 Meg, C = 700 pF
	Range C	R = 3.3 Meg, C = 0.05 μ F	R = 13.3 Meg, C = 1000 pF	R = 100 Meg, C = 1500 pF
Ripple and Noise: rms/p-p (dc to 20 MHz) Either output terminal can be grounded	Range A	0.40 μ A rms/5 μ A p-p	0.20 μ A rms/0.5 μ A p-p	50 nA rms/2 μ A p-p
	Range B	4.0 μ A rms/40 μ A p-p	2.0 μ A rms/7.5 μ A p-p	0.5 μ A rms/25 μ A p-p
	Range C	40 μ A rms/250 μ A p-p	20 μ A rms/100 μ A p-p	5 μ A rms/500 μ A p-p
Programming Speed: from 0 to 99% of range switch setting with a resistive load. *(Output Current Modulation)		500 μ s	500 μ s	1 ms
Meter Ranges (Accuracy 2% of full scale)		6, 60, 600 mA; 60 Vdc	3, 30, 300 mA; 120 Vdc	1.2, 12, 120 mA; 360 Vdc
Price		\$475	\$475	\$600

*This network is a simplified representation of a complex network. The formula $Z = RX_C / \sqrt{R^2 + X_C^2}$ is used for frequencies up to 1 MHz by substituting the values given for R and C. Above 1 MHz, the output impedance is greater than the formula would indicate—load transient overloads are less than 20% of range setting for a full load change with a 1 μ sec. rise time.

**Output current can be modulated 100% up to 100 Hz; percent modulation decreases linearly to 10% at 1000 Hz.

POWER SUPPLIES



DC POWER SUPPLY/AMPLIFIER

Bipolar output; frequency response to 20 kHz
Models 6823A, 6824A, 712C

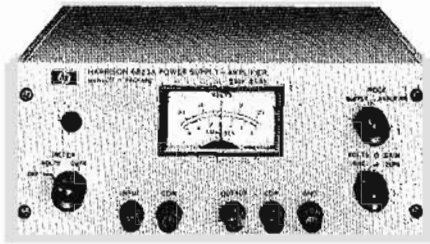

6823A

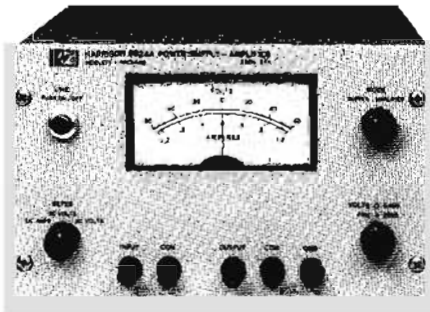

6824A

Models 6823A and 6824A are general-purpose laboratory instruments capable of a variety of operating modes. Two or more of these units can be connected in Auto-Series to obtain greater voltage capability. High speed constant current operation can be obtained by simply adding an external resistor in series with the load and making minor changes in the rear barrier strapping.

When used as a DC Power Supply, either model can be controlled from the front panel, or remotely programmed with resistance or voltage. As a power amplifier, each unit offers a signal-to-noise ratio of 80 dB at full output with low distortion, and 20 dB gain from dc to 20 kHz.

Specifications

POWER SUPPLY			
MODEL		6823A	6824A
OUTPUT:	DC Voltage	-20 to +20 Vdc	-50 to +50 Vdc
	DC Current	0-0.5A	0-1.0A
LOAD REGULATION:		0.02% plus 5 mV	
LINE REGULATION:		0.02% plus 5 mV	
RIPPLE & NOISE:		2 mV rms	10 mV rms
LOAD TRANSIENT RECOVERY TIME:		Less than 100 μ sec to within 5 mV +0.02% of the nominal output.	
POWER AMPLIFIER			
OUTPUT:	DC Voltage	40 V P-P	100 V P-P
	DC Current	0-0.5 A	0-1.0A
VOLTAGE GAIN:		Variable 0-10 (20 dB) output inverted	
FREQUENCY RESPONSE:		At full output = 3 dB from dc to 20 kHz.	
MAX. PHASE SHIFT:		dc - 180°, 100 Hz - 181°, 1 kHz - 183°, 10 kHz - 205°, 20 kHz - 225°	
DISTORTION:		<0.02% @ 1 kHz and full output	
INPUT IMPEDANCE:		2 k ohms approx.	
COMMON SPECIFICATIONS			
AC INPUT:		115 Vac \pm 10%, 1 phase, 48-440 Hz; 0.3 A, 24 W @ 115 Vac	115 Vac \pm 10%, 1 phase, 48-63 Hz; 1.3 A, 96 W @ 115 Vac
PRICE:		\$225	\$375
OPTIONS AVAILABLE*:		028 (\$10)	007 (\$35), 028 (\$10)
ACCESSORIES AVAILABLE*			

*See page 166.

MODEL 712C MULTIPLE-OUTPUT SUPPLY

Specifications

Output

DC main (CV/CC): 0 to 500 V at 0 to 200 mA.

DC fixed bias: -300 V at 0 to 50 mA.

DC variable bias: 0 to -150 V at 5 mA.

AC unregulated: 6.3 V CT at 10 A.

Input: 115 Vac \pm 10%, 57-63 Hz, 2 A at 115 Vac (230 Vac input not available).

CV Load Regulation: The constant voltage load regulation is given for a load current change equal to the current rating of the supply.
DC main: 0.01% +5 mV.

DC fixed bias: 50 mV.

DC variable bias is tied to fixed bias, hence source regulation is same for fixed bias. Internal impedance is 0 to 10,000 ohms, depending on bias control setting.

CC Load Regulation: The constant current load regulation is given for a load voltage change equal to the voltage rating of the supply.
DC main: 0.25 mA.

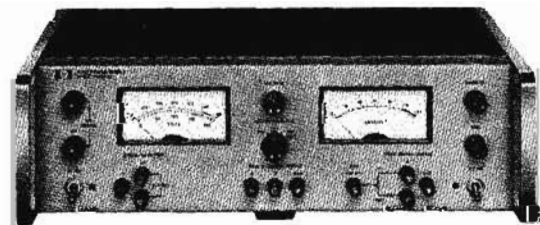

712C

Price: \$545.

Option 005: 50 Hz input, add \$25.

MODULAR SLOT SUPPLIES

Adjustable within $\pm 10\%$ band
Models 60063A-60246B, 60153D, 60155C



POWER SUPPLIES

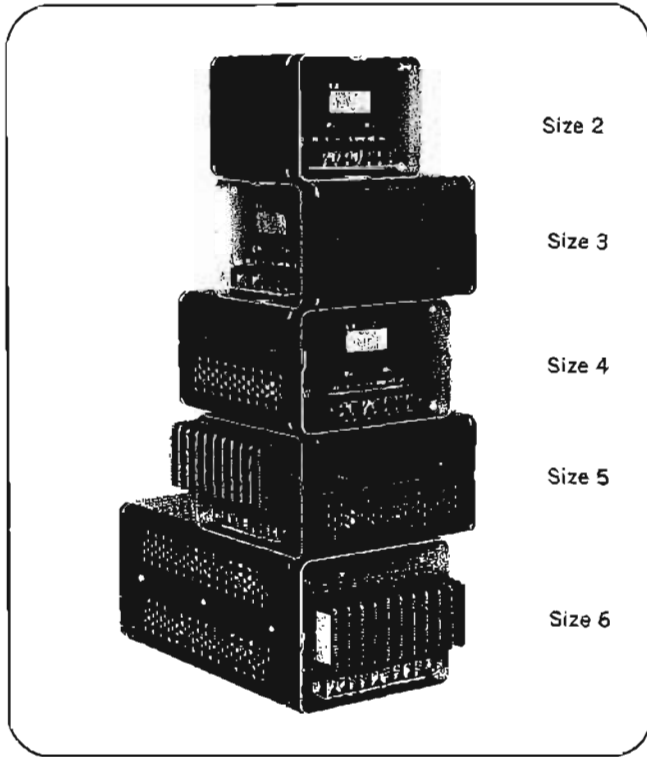

Size 2

Size 3

Size 4

Size 5

Size 6

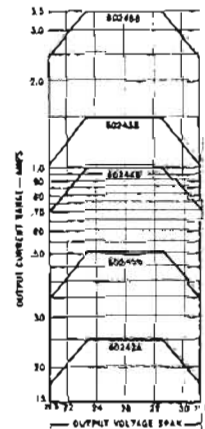
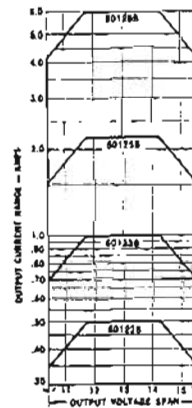
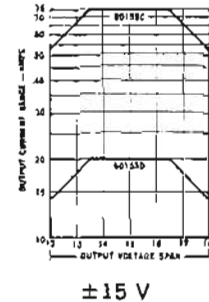
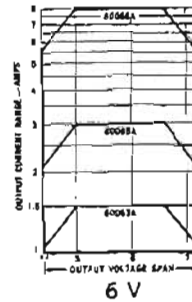

12 V Output Ratings 24V

These single and dual output modular supplies are intended for applications requiring a fixed constant voltage source of dc. The nominal output voltage is regulated to 0.05% and may be offset from the design center by up to 2 volts. The output voltage design center can be varied $\pm 10\%$ without derating the output current. Above $\pm 10\%$, the output current is derated as illustrated in the graphs. All supplies are short circuit proof and will not be damaged by overload. Since the output is floating, any supply can be used as either a positive or negative source.

Overall dimensions:

	Mounting face	Module length
Size 2:	3 3/8" (8,6 cm) x 4 1/4" (10,5 cm)	4 1/4" (10,5 cm)
Size 3:	3 3/8" (8,6 cm) x 4 1/4" (10,5 cm)	6" (15,2 cm)
Size 4:	3 3/8" (8,6 cm) x 5 1/8" (13 cm)	6" (15,2 cm)
Size 5:	3 3/8" (8,6 cm) x 5 1/8" (13 cm)	7-5/16" (18,6 cm)
Size 6:	4 1/4" (10,8 cm) x 5 1/8" (13 cm)	11" (27,9 cm)

MODEL	DC OUTPUT (Refer to Derating Charts)		AC INPUT			RIPPLE & NOISE		SIZE	*PRICE		
	NOMINAL VOLTS	AMPS	VOLTS	AMPS	WATTS	RMS	P-P (mV) dc to 20 MHz		1-9	10-19	20-49
60063A	6	1.5	115 V ac $\pm 10\%$, 48-440 Hz	0.3	26	1 mV or 0.006%, whichever is greater	3	3	\$ 87	\$ 85	\$ 81
60065A	6	3		0.75	63		3	5	\$110	\$107	\$103
60066A	6	8		1.5	150		6	6	\$197	\$191	\$186
60122B	12	0.5		0.16	15.7		3	2	\$ 72	\$ 70	\$ 68
60123B	12	1		0.3	26		3	3	\$ 79	\$ 77	\$ 74
60125B	12	2.2		0.75	62		4	5	\$100	\$ 97	\$ 94
60126B	12	6		1.75	153		6	6	\$179	\$174	\$169
60242B	24	0.25		1.5	15.5		3	2	\$ 72	\$ 70	\$ 68
60243B	24	0.5		0.3	26		3	3	\$ 79	\$ 77	\$ 74
60244B	24	1		0.5	45		3	4	\$ 88	\$ 85	\$ 83
60245B	24	1.5		0.75	65		9	5	\$100	\$ 97	\$ 94
60246B	24	3.5		2	160		12	6	\$179	\$174	\$169
60153D	DUAL ± 15	0-0.2	0.3	26	300 μ V	2	3	\$ 97	\$ 93	\$ 91	
60155C	DUAL ± 15	0-0.75	0.75	64	300 μ V	2	5	\$133	\$129	\$125	

* OEM pricing is available to original equipment manufacturers. Contact your local Hewlett-Packard sales office.

If chart does not include a SLOT supply to fill your needs, ask your HP Sales Engineer for the Custom SLOT Series data sheet.

POWER SUPPLIES



DIGITAL VOLTAGE SOURCES

Complete D/A subsystem in one package

Models 6129B, 6130B, 6131B

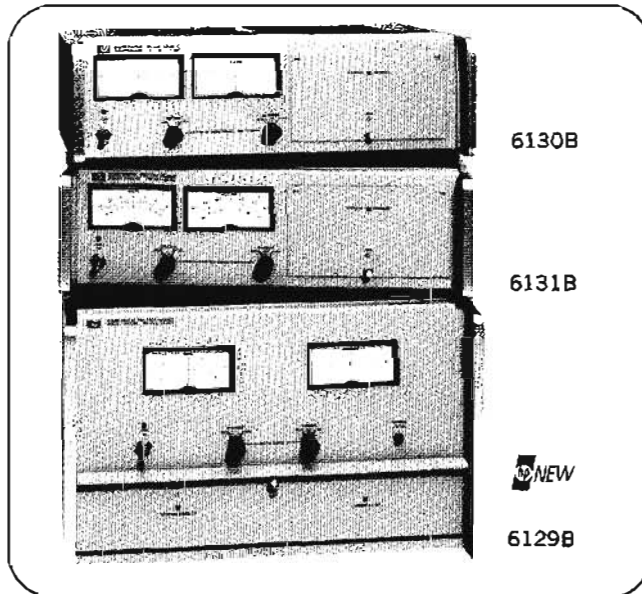

Description

Digitally Controlled Voltage Sources are complete digital-to-analog links between a computer (or other digital source) and any application requiring a fast, accurately settable source of dc or low frequency ac power. Initially, these applications may be thought of as requiring a digital-to-analog converter with augmented output power capability, a digitally controlled power supply, or a digitally controlled waveform synthesizer. However, such applications generally require more than a programmable power supply or the simple tandem combination of a D/A converter and an operational amplifier. Interface circuitry must be added to insure compatibility between the computer and the D/A converter, and isolation must be provided between input and output. Other functions required include reference and B+ sources, internal storage to increase computer operating efficiency and minimize programming overshoots, programmable current limiting protection for the output power amplifier and the load, and feedback signals to inform the computer of the voltage source status.

Specifications

	6129B	6130B	6131B
AC INPUT: Standard	115/230 Vac, 48-63 Hz 6.4A, 780 W @ 115 Vac 115/230 Vac switch-selected	115 Vac = 10%, 48 - 440 Hz, 1.2A, 100W	
Option 028		230 Vac = 10%, 48 - 440 Hz, 0.6A, 100 W	
DC OUTPUT: Binary Instruments (Option J20, Q62, or 064) X1 Range X10 Range	-16.384 to +16.3835 Vdc at 5A Source -50 to +50 Vdc to 5A Source	-16.384 to +16.3835 Vdc at 1A Source -50 to +50 Vdc at 1A Source	-16.384 to +16.3835 Vdc at 0.5A Source -100 to +100 Vdc at 0.5A Source
8421 BCD Instruments (Option 061 or 063) X1 Range X10 Range	-9.999 to +9.999 Vdc at 5A Source -50 to +50 Vdc at 5A Source	-9.999 to +9.999 Vdc at 1A Source -50 to +50 Vdc at 1A Source	-9.999 to +9.999 Vdc at 0.5A Source -99.99 to +99.99 Vdc at 0.5A Source
Sink Current Compliance The instrument will meet its specifications when an active load forces current into the more positive output terminal. The instrument can continuously absorb power from the load if the sink current is less than the maximum allowable value. The output voltage magnitude automatically increases to limit the sink current to the allowable level.	Sink current is limited to a value ranging linearly from 5.5A at 0 V to 2.5 A at 50 V. Externally applied terminal-to-terminal voltages in excess of 55 V will damage the instrument.	Sink current is limited to a value ranging linearly from 1.1A at 0 V to 0.25 A at 50 V. Externally applied terminal-to-terminal voltages in excess of 55 V will damage the instrument.	Sink current is limited to a value ranging linearly from 0.55A at 0 V to 0.25 A at 100V. Externally applied terminal-to-terminal voltages in excess of 110 V will damage the instrument.
ANALOG OUTPUT: All DCVS models will meet all specifications when the load operating point lies within the region bounded by the bold lines. The dotted lines shown the locus of the maximum voltage and current values allowed by the internal gross limit protective circuits.			
RESOLUTION: Change in output voltage for a change in the least significant digital input bit. Binary Instruments (Option J20, 062, or 064)		X1 Range: 0.5 mV X10 Range: 5 mV	
8421 BCD Instruments (Option 061 or 063)		X1 Range: 1 mV X10 Range: 10 mV	

	6129B	6130B	6131B
BASIC ACCURACY (90 DAYS): DC voltage accuracy at 23°C ± 3°C, 115 Vac input, no load, following 30 minutes warm-up	X1 Range: 1.5 mV X10 Range: 15 mV		X1 Range: 1 mV X10 Range: 10 mV
LINE REGULATION: Change in output voltage for any change in line voltage from 104 to 126 Vac (or 207 to 253 Vac for 230 Vac operation). Binary Instruments (Option J20, 062, or 064)	X1 Range: 250 μV X10 Range: 2.5 mV		X1 Range: 500 μV X10 Range: 5 mV
8421 BCD Instruments (Option 061 or 063)	X1 Range: 200 μV X10 Range: 2 mV		X1 Range: 400 μV X10 Range: 4 mV
LOAD REGULATION: Change in output voltage at the remote sensing terminals for any load current change within ratings.		X1 Range: 150 μV X10 Range: 500 μV	
TEMPERATURE COEFFICIENT: Change in output voltage per °C change in ambient temperature. Binary Instruments (Option J20, 062, or 064)		X1 Range: 160 μV/°C X10 Range: 800 μV/°C	X1 Range: 160 μV/°C X10 Range: 1.6 mV/°C
8421 BCD Instruments (Option 061 or 063)		X1 Range: 100 μV/°C X10 Range: 500 μV/°C	X1 Range: 100 μV/°C X10 Range: 1 mV/°C
PROGRAMMING TIME: Maximum time required for output voltage to settle within 0.1% of programmed voltage change after simultaneous receipt of data and gate signals with a resistive load connected across the output terminals: 300 μsec. Voltage range change requires 2 msec.			
STABILITY: DC output voltage drift under constant line, load, and ambient temperature for 8 hours after 30 minutes warm-up. Binary Instruments (Option J20, 062, or 064)		X1 Range: 500 μV X10 Range: 2.5 mV	X1 Range: 500 μV X10 Range: 5 mV
8421 BCD Instruments (Option 061 or 063)		X1 Range: 300 μV X10 Range: 1.5 mV	X1 Range: 300 μV X10 Range: 3mV
RIPPLE AND NOISE: RMS and peak-to-peak (dc to 50 MHz), at any line voltage and under any load condition within rating.	12 mV p-p 3 mV rms		7 mV p-p 3 mV rms
LOAD TRANSIENT RECOVERY TIME: Time required for the output voltage to recover within 0.1% of full range voltage following a full load current change: 150 μsec.			
METERS: The front panel includes a voltmeter and ammeter with the ranges indicated at right. Accuracy is 3% of full scale.	VOLTS -60 to +60 -10 to +10	AMPS -6.0 to +6.0 -1.5 to +1.5 -.60 to +.60	VOLTS -60 to +60 -10 to +10
			AMPS -1.2 to +1.2 -.3 to +.3 -.12 to +.12
			VOLTS -120 to +120 -20 to +20
			AMPS -.06 to +.06 -.15 to +.15 -.6 to +.6
ANALOG INPUT: DC GAIN: X1 Range X10 Range			1 = 0.2% 10 = 0.2%
BANDWIDTH TO -3 dB POINT:	Approximately 9.0 kHz		Approximately 25 kHz
STABILITY (8 HOURS): X1 Range X10 Range			Stability of input signal +500 μV Stability of input signal +5 mV
IMPEDANCE:			10 kΩ
MAXIMUM INPUT VOLTAGE: X1 Range X10 Range		± 20 V ± 5.0 V	± 20 V ± 10 V
CURRENT SENSING: COEFFICIENT:	.25 Volt/Amp		1 Volt/Amp
ACCURACY:	± 5%		± 2%
IMPEDANCE:	750Ω		800Ω

General

Dimensions:

6129B: 16¾" wide, 10½" high, 21¾" deep (42,55 x 26,67 x 54,3 cm).

6130B, 6131B: 16¾" wide, 5¼" high, 15¾" deep (42,55 x 13,34 x 39,69 cm).

Weight:

6129B: net 72 lbs (33 kg); shipping 78 lbs (35 kg).

6130B, 6131B: net 32 lbs (15 kg); shipping 48 lbs (22 kg).

Price: Model 6129B, \$2700. Models 6130B, 6131B, \$1800. Standard or special option must be specified.

Note: Isolation, storage, and current latch features may be deleted on special order. Prices for this version are \$2200 for the 6129B, and \$1300 for the 6130B and 6131B. Contact your HP field engineer for special ordering information.

Standard Options: (no additional charge, except for option 028).

028: transformer tap change for 230 Vac ± 10%, single phase input on 6130B and 6131B. Price \$10.

J20: Binary interface for 12661A DVS programmer.

061: BCD interface for NPN open collector circuits.

062: Binary interface for NPN open collector circuits.

063: BCD interface for microcircuit logic levels.

064: Binary interface for microcircuit logic levels.

Special Options: If none of the standard interface options meet your requirements, quotations for special options may be obtained from your HP field engineer.

Model 6933B D/A Converter

The Model 6933B Digital-Analog Converter is a complete D/A subsystem in one package. It is similar to the Models 6129B, 6130B, and 6131B Digitally Controlled Power Sources except for its lower output rating (±10 V at 0-10 mA) and the elimination of the programmable current limit feature.

Price: \$1500. Standard or special option must be specified.

Standard Options: Options J20, 061, 062, 063, and 064 are the same as described for Models 6129B, 6130B, and 6131B, and are available at no charge.

Special Options: Quotations for special options may be obtained from your HP field engineer.

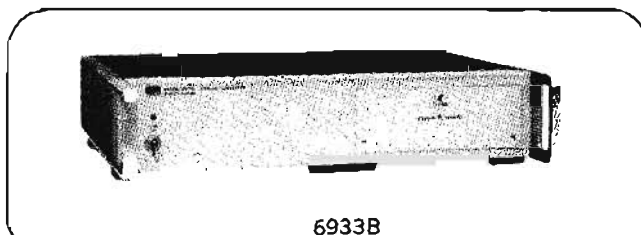

6933B

GRAPHIC RECORDERS



X-Y RECORDERS

The Cartesian coordinate graph is one of the most effective methods for presenting related data clearly. As a result, X-Y recorders have found wide application in areas from general purpose laboratory use to a specialized system read-out.

Applications

X-Y recorders are frequently used for the recording of spectra, since the sweeping device need not have a linear sweep as a function of time. Hewlett-Packard sweepers and spectrum analyzers—from audio through microwave—produce outputs directly compatible with Hewlett-Packard X-Y recorders. Sampling devices, such as fault locators, real-time spectrum analyzers, sampling oscilloscopes and time domain reflectometers benefit from the signal averaging caused by the null detection recording method used in all Hewlett-Packard X-Y recorders, reducing the effect of wideband noise. The final graph is significantly more accurate, precise and easier to reproduce than oscilloscope photos of the same event. An X-Y recorder is indispensable when permanent records are needed for such X vs Y data as semiconductor device curves, hysteresis charts, or records of physical variables such as pressure vs temperature.

Recorders are extremely effective where precise X-Y plots are needed, either to obtain accurate data or to allow rapid interpretation of data. An X-Y recorder automatically and conveniently plots the value of an independent variable versus a dependent variable, directly on conventional graph paper, working from readily derived electrical signals.

Basic Operation of X-Y Recorders

The precision needed for accurate X-Y graphs is accomplished in Hewlett-Packard recorders by the use of physically and electrically linear feedback elements (often called slidewires) coupled directly to the marking pen and the X-axis arm. Both X and Y axis slidewires are physically mounted along the travelling paths of the arm and pen carriage, avoiding any error-producing mechanical linkages.

The feedback generated from these slidewires is a voltage directly proportional to the position of the pen with respect to the "zero" position originally chosen. This voltage is balanced against the signal input by a differential amplifier. The output of the amplifier drives the pen motors, and the pen, until a null

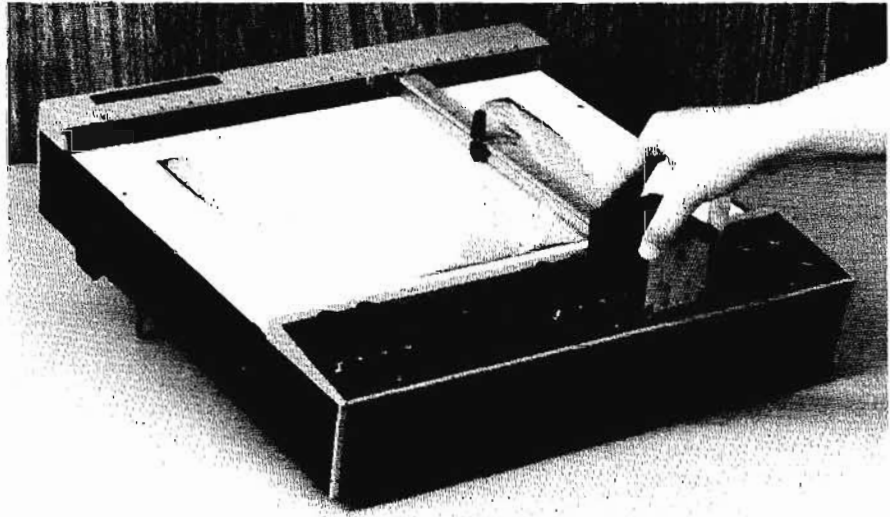

balance condition is reached. The accuracy of the final graph, then, is determined by the linearity of the slidewire and the ability of the servo system to drive the pen to the exact point desired (also called repeatability, deadband or resettability). Hewlett-Packard specifications include such potential errors in a single Accuracy specification.

X-Y recordings may also be made from computer-generated data or other digital devices by the 7591A Point Plotting System (page 177) or the 7200 series Graphic Plotters noted on page 402. The 7591A accepts analog inputs through a D/A converter or from analog outputs from systems such as Hewlett-Packard multichannel analyzers; the 7200 series receives data directly in digital form. Both plotters are directly compatible with HP 2100 series computers. X-Y plotters are also available for use with HP 9100 and 9800 series calculators.

Writing System

Most X-Y recorders use either a capillary or fiber pen/ink system and standard graph paper. Hewlett-Packard single-pen recorders utilize a self-contained disposable pen/ink system which allows quick, easy pen changes for renewal or color change. Red, blue, green and black colors are available, and interchangeable between recorders using disposable pens.

Autogrip Paper Holddown

Any graph paper may be used on Hewlett-Packard X-Y recorders, up to the 8½" x 11" or 11" x 17" maximum size of the recorder chosen. Paper is held

to the recording surface electrostatically with the Autogrip holddown system, which grips any paper tightly and silently without vacuum pumps or mechanical clips.

Hewlett-Packard graph paper is made to specification so that resetting of zero and full scale is unnecessary between successive recordings. Tolerances of margin and spacing are held to well within recorder specifications, as are perpendicularity and parallelism of graph lines and paper edges.

Selecting an X-Y Recorder

Hewlett-Packard X-Y recorders are available in 2 chart sizes: 8½" x 11" and 11" x 17". Since all 11" x 17" recorders also handle 8½" x 11" paper, this choice must be determined by instrument size requirement or cost. Laboratory general-purpose recorders are available in both paper sizes, in single or two pen versions, and with built-in or plug-in preamplifiers. All recorders are available with metric or English scaling.

Other selection considerations are sensitivity (up to 100 μ V/in. on the 7001A), speed and acceleration (the 7004B and 7034A are the fastest lab recorders), or the need for an automatic chart advance (available on the 2PA, 7001A and 7004B).

For OEM or other dedicated applications, the Models 7040A and 7041A provide the utmost in reliability and low cost. Both are designed so that customized systems can be made in a production environment, and are available with functional discounts to OEM purchasers.

GENERAL PURPOSE
Low Cost
Models 7005B and 7035B



X-Y RECORDERS

Models 7005B and 7035B are low cost, solid-state X-Y Recorders for general purpose applications. Each axis has an independent servo system with no interaction between channels. The recorders graph two related functions from two dc signals representing the functions. The ultra-compact design is convertible to rack mounting by addition of two wing brackets (supplied). Metric scaling and calibration are optional.

The input terminals accept either open wires or plug-type connectors. Five calibrated ranges from 1 mV/in. to 10 V/in. are provided in each axis. A variable range control permits scaling of signal for full scale deflection. Standard features include high input impedance (one megohm on all but the first two ranges), floated and guarded signal pair input, 0.2%

accuracy, Autogrip electric paper holddown, electric pen lift, adjustable zero set, lockable zero and variable range controls, and rear input connector. A plug-in time base (Model 17108A) operates on either axis to provide five sweep speeds from 0.5 to 50 s/in.

Each closed-loop servo system employs a high-gain solid-state servo amplifier, Hewlett-Packard servo motor, long-life balance potentiometer, photochopper, low pass filter, guarded inputs, precision attenuator and balance circuit. Both models are designed for easy maintenance with most components mounted on a printed circuit board and accessible by removing the rear cover. Both balance potentiometers are accessible for inspection or cleaning by removing a snap-on strip.

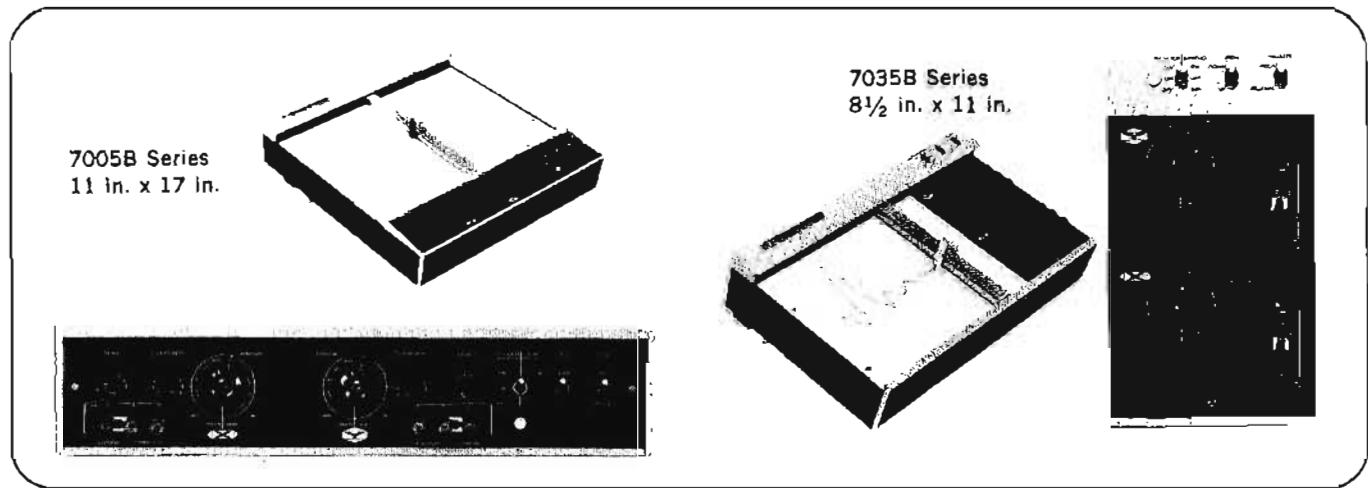

Specifications

Performance specifications

Input ranges: English: 1, 10, 100 mV/in.; 1 and 10 V/in.; Metric: 0.4, 4, 40, 400 mV/cm and 4 V/cm. Continuous vernier between ranges.

Type of inputs: floated and guarded signal pair; rear input connector.

Input resistance:

Range	Input resistance
1 mV/in (0.4 mV/cm)	Potentiometric (essentially infinite at null)
Variable	11 kΩ
10 mV/in (4 mV/cm)	100 kΩ
Variable	100 kΩ
100 mV/in (40 mV/cm)	1 MΩ
Variable	1 MΩ
1 mV/in (400 mV/cm)	1 MΩ
Variable	1 MΩ
10 V/in (4 V/cm)	1 MΩ
Variable	1 MΩ

Input filter: >30 dB at 60 Hz; 18 dB/octave above 60 Hz.

Maximum allowable source impedance: no restrictions except on fixed 1 mV/in. (0.4 mV/cm) range. Up to 20 kΩ source impedance will not alter recorder's performance.

Accuracy: ±0.2% of full scale.

Linearity: ±0.1% of full scale.

Resetability: ±0.1% of full scale.

Zero set: zero may be set up to one full scale in any direction from zero index. Lockable zero controls.

Slewing speed: 20 in./s, 50 cm/s nominal at 115 V.

Interference rejection: conditions for the following data is line frequency with up to 1 kΩ between the negative input and guard connection point.

Range		DC (CMR)	AC (CMR)
English	Metric		
1 mV/in	0.4 mV/cm	130 dB	100 dB
10 mV/in	4 mV/cm	110 dB	80 dB
100 mV/in	40 mV/cm	90 dB	60 dB
1 V/in	400 mV/cm	70 dB	40 dB
10 V/in	4 V/cm	50 dB	20 dB

General specifications

Paper holddown: Autogrip electric paper holddown grips any chart up to size of platen.

Pen lift: electric pen lift capable of being remotely controlled.

Dimensions: 7005B: 17½" high, 17½" wide, 4-5/16" deep (445 x 445 x 110 mm). 7035B: 10-15/32" high, 17½" wide, 4¾" deep (266 x 445 x 121 mm).

Weight: net, 18 lb (8 kg); shipping, 24 lb (10.9 kg).

Power: 115 or 230 V ±10%, 50- to 60 Hz, approximately 45 VA.

Time base accessory: Model 17108A self-contained external time base has five sweep speeds. Price \$ 175

Price:

Model 7005B—11 in. x 17 in. Chart Size \$1235

Model 7035B—8½ in. x 11 in. Chart Size \$ 985

Options:

- 01. Metric calibration N/C
- 03. Retransmitting potentiometer on X-axis \$ 75

X-Y RECORDERS



HIGH PERFORMANCE

Plug-in versatility and fast response
Models 7004B and 7034A

The 7004B and the 7034A are flexible to meet the constantly changing requirements of laboratory measurements. Plug-in modules and a variety of accessories form a versatile high-performance X-Y Recorder. Circuitry common to all plug-in modules (power supplies, interfaces, etc.) is located in the main frame. This allows the user to purchase additional low-cost plug-ins to expand the measurement capabilities of the system. The plug-in approach allows the user to purchase only the capabilities required.

With an acceleration of more than 1500 in./s², and slewing speed of 30 in./s, the 7004B and 7034A record more phenomena than earlier X-Y recorders.

These recorders use the most advanced technology available.

They use all-silicon integrated circuitry and the proven Autogrip electrostatic paper holddown.

Guarded input circuits are provided to utilize the superior performance fully. Guarding eliminates the effects of unwanted ac and dc common-mode voltages which can be troublesome in low level recording signals from thermocouples, strain gages and similar sources.

Plug-in modules provide a versatile X-Y Recorder for a variety of applications. If your application changes, the needed measurement capability is available by simply adding an inexpensive plug-in. In addition to these advantages, their high dynamic performance allows recorders to be used in practically any X-Y Recorder application.

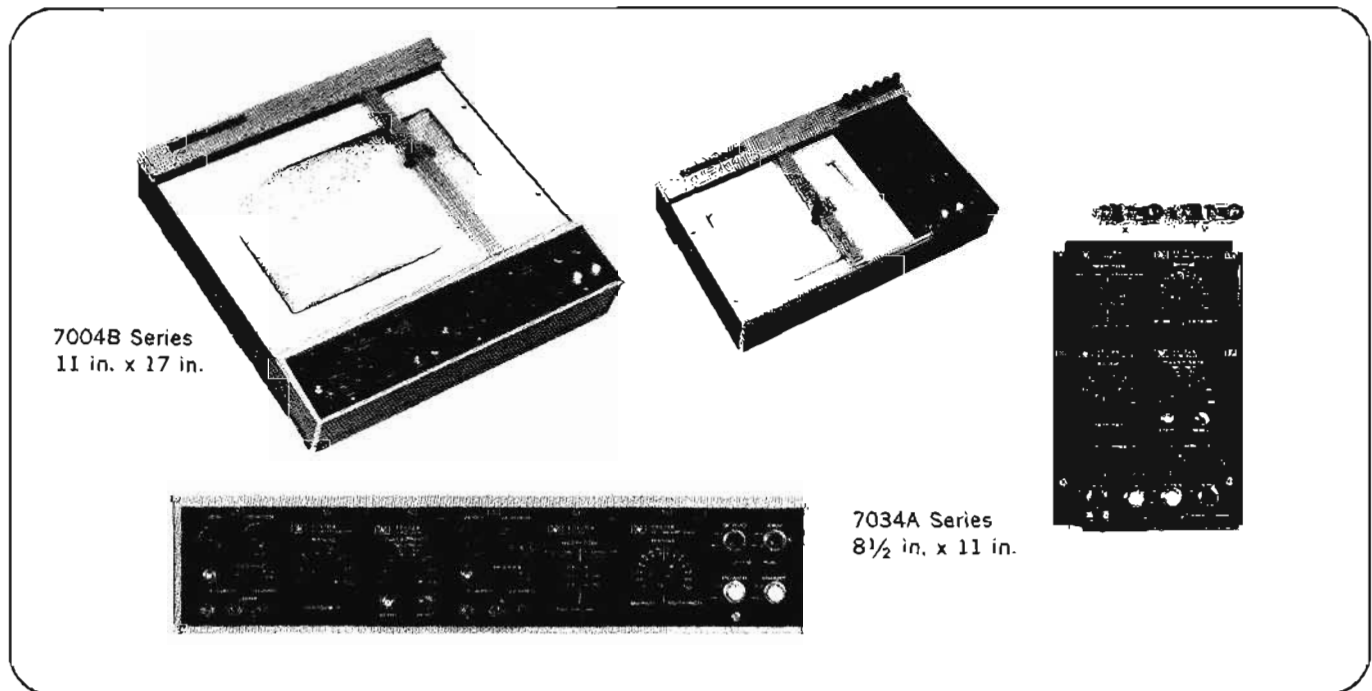

7004B Series
11 in. x 17 in.

7034A Series
8½ in. x 11 in.

Performance specifications

- Number of plug-ins:** frame will accept the equivalent of four single-width plug-ins, two per axis.
- Type of Input:** floating and guarded signal pair. Available at the front panel or at the rear connector.
- Zero set:** zero may be set ± 1 full scale from zero index.
- Zero check switches:** pushbutton zero check switch in each axis allows verification of recorder's zero position without removal or shorting of the input signal.
- Mainframe accuracy:** 0.2% of fs.
- Range vernier:** lockable, covers 2.5 times range setting.
- Slewing speed:** more than 30 in./s (75 cm/s) independent of line voltage and frequency.
- Acceleration:** more than 1500 in./s² (3800 cm/s²).
- Reference stability:** better than 0.003%/°C.
- Terminal based linearity:** $\pm 0.1\%$ of fs.
- Resettability:** $\pm 0.05\%$ of fs.

General specifications

- Paper holddown:** Autogrip paper holddown grips charts of any size up to size of platen.
- Pen lift:** local and remote control (contact closure or TTL).
- Dimensions:** 7004B: 17½" wide, 17½" high, 4¾" deep (445 x 445 x 121 mm). 7034A: 17½" wide, 10½" high, 4¾" deep (445 x 267 x 121 mm).
- Weight:** 7004B: net, 28 lbs (12.7 kg); shipping, 42 lbs (19.0 kg). 7034A: net, 16 lbs (7.3 kg); shipping, 31 lbs (14.1 kg).
- Power:** 115 or 230 volts ac $\pm 10\%$, 50 to 400 Hz, approximately 85 VA (depending on the plug-ins used).
- Price**

Model 7004B—11" x 17"	\$1445
Model 7034A—8½" x 11"	\$1295
- Options**

01 Metrically scaled and calibrated	N/C
02 X-axis retransmitting potentiometer, 5 k Ω $\pm 0.1\%$ linearity (7004B only)	\$ 75
04 Power supply for 17005-04 incremental chart advance (7004B only)	\$ 50

PLUG-IN MODULES

For recorder Models 7004B and 7034A



X-Y RECORDERS



DC Coupler
Model 17170A

The DC Coupler couples the input signal to the recorder main frame. The input signal range of 100 mV/in (50 mV/cm) may be adjusted to 250 mV/in (125 mV/cm) with a vernier control on the recorder front panel.



DC Amplifier
Model 17171A

The DC Pre-amplifier is a stable, low noise, dc amplifier. The 14 calibrated input ranges are supplemented by a vernier control on the recorder front panel to provide a continuously variable range from 0.5 mV/in. (0.25 mV/cm) to 25 V/in. (12.5 V/cm).



Time Base
Model 17172A

The Time Base plug-in makes X-T or Y-T recordings possible. It employs all-silicon solid-state construction including the latest integrated circuits. Standard features include eight speeds, automatic reset and pen lift at completion of sweep, and remote start control. A vernier control on the recorder front panel extends the sweep speed through 250 s/in. (125 s/cm).



Null Detector
Model 17173A

The Null Detector plug-in provides closed-loop plotting of data in point form, at up to 50 pps. Plotting is accomplished with the Model 17012B/C Point Plotter. The 17012B/C cable plugs into a jack on the 17173A panel and the plotting head is substituted for the recorder pen.

Upon receipt of a seek signal and after the recorder reaches balance, the Null Detector commands the 17012B/C Point Plotter to plot and initiates a plot-complete pulse.

17170A Specifications

Input range: a single fixed calibrated range of 100 mV/in. (50 mV/cm).

Input resistance: constant, 1 M Ω .

Common-mode rejection: 120 dB at dc and 70 dB at 50 Hz and above with 100 ohms between low side and guard connection point with source impedance 10 k Ω or less.

Price: Model 17170A

\$ 25

17171A Specifications

Input ranges: English: 0.5, 1, 2, 5, 10, 20, 50 mV/in., 0.1, 0.2, 0.5, 1, 2, 5, 10 V/in.; Metric: 0.25, 0.5, 1, 2.5, 5, 10, 25 mV/cm, 0.05, 0.1, 0.25, 0.5, 1, 2.5, 5 V/cm.

Input resistance: 1 M Ω .

Maximum allowable source resistance

Range	Max. Source Resistance
0.5 mV/in. (0.25 mV/cm)	10 k Ω
1 mV/in. (0.5 mV/cm)	20 k Ω
2 mV/in. (1.0 mV/cm)	40 k Ω
5 mV/in. (2.5 mV/cm)	100 k Ω
10 mV/in. (5.0 mV/cm)	200 k Ω
20 mV/in. (10.0 mV/cm)	400 k Ω
50 mV/in. (25 mV/cm) and up	1 M Ω

Common-mode rejection: 120 dB at dc and 100 dB at 50 Hz and above with 100 ohms between low side and guard connection point (at 0.5 mV/in. or 0.25 mV/cm). On other ranges CMR decreases 20 dB per decade step in attenuation.

System accuracy: $\pm 0.2\%$ of full scale.

Zero drift: $< 1 \mu\text{V}/^\circ\text{C}$ with a maximum of 25 μV from 0 to 55 $^\circ\text{C}$.

Price: Model 17171A

\$ 275

Option: 01 metrically scaled

N/C

17172A Specifications

Sweep speeds: English: 0.5, 1, 2, 5, 10, 20, 50, 100 s/in.; Metric: 0.25, 0.5, 1, 2.5, 5, 10, 25, 50 s/cm.

System accuracy: $\pm 1\%$ of full scale on the six fastest ranges, $\pm 2.5\%$ on the remaining two ranges.

Terminal based linearity: $\pm 0.5\%$ of full scale.

Price: Model 17172A

\$ 200

Option: 01 metrically scaled

N/C

17173A Specifications

Plot rate: up to 50 plots/s.

Enable-disable: required disable voltage +3 volts minimum to +20 volts maximum. Required enable voltage: 0 V dc or no connection. Other voltage combinations available on request.

Muting: local or remote.

Plotting accuracy: $\pm 0.25\%$ of full scale.

Input: all inputs, except analog inputs, are available through rear input connectors in the module. Analog inputs are applied to the input terminals of the main frame. Mating connector supplied.

Price: Model 17173A

\$ 225

Options

01. +3 to +20 V enable, 0 V disable	add \$ 25
02. -3 to -20 V disable, 0 V enable	add \$ 25
03. -5 to -20 V enable, 0 V disable	add \$ 25

X-Y RECORDERS



PLUG-IN MODULES

For recorder Models 7004B and 7034A



DC Offset
Model 17174B

The DC Offset plug-in provides the recorder with the capabilities of recording small signals superimposed on a steady-state dc voltage. The offset plug-in suppresses the steady-state dc voltage allowing recorder sensitivity to be increased.



Filter
Model 17175A

The Filter plug-in rejects ac input signal components. Insertion of the 17175A in front of any other signal conditioning input module will improve normal mode rejection.



Scanner
Model 17176A

The Scanner plug-in electrically scans between two inputs, similar to the chopped mode on an oscilloscope, and provides the capability of plotting two dependent variables vs. one independent variable. The Scanner plug-in, utilizing the Model 17012B/C high speed point plotter, can scan two selectable inputs (module or main frame) in two scan modes (multiplexing both inputs or singularly). The scan rate is adjustable from 0.1 s/scan to 4 s/scan.



DC Attenuator
Model 17178A

The DC Attenuator offers a stable, passive attenuator with eight ranges. A vernier control on the recorder control panel allows continuously variable settings between fixed ranges of the 17178A.

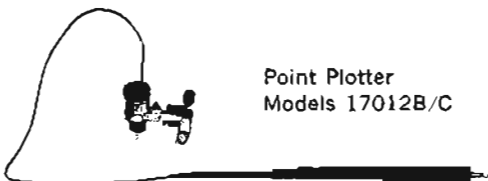

Point Plotter
Models 17012B/C

17174B Specifications

Offset: less than 1 mV to approximately 1 volt.

Controls: two lockable, ten-turn high resolution controls (less than 1 mV to approximately 10 mV and less than 1 mV to approximately 1 V). An offset polarity switch allows upscale or downscale zero offset.

Offset voltage stability: greater than 0.005%/°C.

Insertion loss: less than 0.05%.

Price: Model 17174B

\$ 100

17175A Specifications

Input voltage range: -5 to +50 V dc, 10 V ac maximum peak-to-peak.

Maximum source impedance: 1 k Ω , higher impedance decreases filter response.

Rejection: more than 55 dB at 50 Hz and higher ($\frac{1}{4}$ s rise time) or more than 70 dB at 50 Hz and higher (1 s rise time). Front panel selectable.

Insertion loss: 1%; filter may be switched out with no change in insertion loss.

Price: Model 17175A

\$ 75

17176A Specifications

Input: module input; front panel miniature binding posts isolated from ground (high and low only). Main frame input; utilizes existing input connectors on main frame.

Attenuator: fixed attenuator in decade steps from X1 to X0.001. Variable attenuator provides continuous coverage.

Input impedance: 100 k Ω .

Accuracy: 0.2% of full scale.

Scan rate: adjustable from 0.1 to 4 s/scan.

Price: Model 17176A

\$ 325

17178A Specifications

Input ranges: English: 0.1, 0.2, 0.5, 1, 2, 5, 10, 20 V/in.; Metric: 0.05, 0.1, 0.25, 0.5, 1, 2.5, 5, 10 V/cm.

Input resistance: 1 M Ω .

Common-mode rejection: 120 dB at dc and 70 dB at 50 Hz and above with 100 ohms between low side and point where the guard is connected (at 100 mV/in. or 50 mV/cm). On other ranges CMR decreases 20 dB per decade step in attenuation.

System accuracy: $\pm 0.2\%$ of full scale.

Price: Model 17178A

\$ 100

Option: 01 metrically scaled

N/C

17012B/C Specifications

The 7004B or 7034A, equipped with the 17012B or 17012C Point Plotter respectively, is capable of point plotting when used with the appropriate plug-in. The 17173A Null Detector plug-in allows rapid point plotting for applications such as a high speed readout for a multichannel pulse height analyzer. The 17176A Scanner plug-in allows plotting of two inputs on a single axis to form a X-Y₁, Y₂ or X₁, X₂-Y recorder.

Plotting rate is up to 50 points per second; power is supplied from the recorder.

Price: Model 17012B (fits Model 7004B)

\$ 95

Model 17012C (fits Model 7034A)

\$ 95

PLUG-IN MODULE; POINT PLOTTING SYSTEM



GRAPHIC RECORDERS

AC/DC CONVERTER/DC PREAMPLIFIER Model 17177A

The AC/DC Converter/DC Preamplifier plug-in combines a dc preamplifier with the ability to record ac signals in a single unit. Both ac and dc signals can be recorded over an input signal range from 5 mV/in. (2.5 mV/cm) to 20 V/in. (10 V/cm). The average-responding ac amplifier features an extremely flat frequency response, holding to within $\pm 0.5\%$ of full scale over the entire frequency range from 5 Hz to 100 kHz. Front panel, pushbutton switches select ac or dc operation, and the lower ac limit of 5 Hz or 50 Hz. The double-width module may be used in either axis.

Specifications

Input ranges: 5 mV/in. to 20 V/in. (2.5 mV/cm to 10 V/cm) in 1, 2, 5 steps.

Minimum usable input (ac only): $\pm 0.2\%$ of full scale.

Maximum allowable input: 300 V peak.

Type of input: floating and guarded signal pair. Rear inputs not available.

Input impedance: 1 M Ω shunted by less than 40 pF.

Maximum allowable source resistance: 10 k Ω .

Common-mode rejection: 80 dB at dc and 50 Hz and above with 100 Ω between low side and guard connection point and at 5 mV/in. (2.5 mV/cm). On other ranges CMR decreases 20 dB per decade step in attenuation.

Rise/fall time (ac only, 10-90%):

Fast response (50 Hz to 100 kHz): 0.5 s maximum.

Slow response (5 Hz to 100 kHz): 2.5 s maximum.

Calibration (ac only): responds to average value of input waveform; calibrated in rms value of sine wave.

Accuracy: dc $\pm 0.5\%$ of full scale; ac (expressed as percent of full scale).

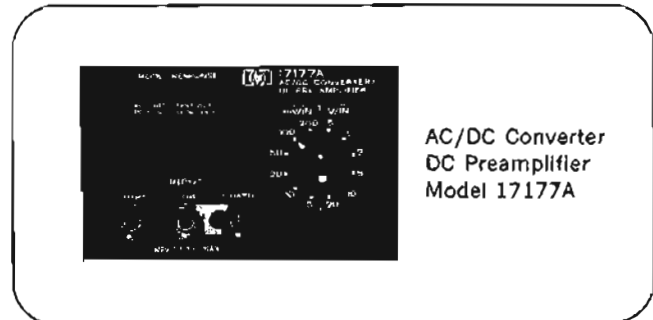

AC/DC Converter
DC Preamplifier
Model 17177A

Slow Response

50 Hz	150 Hz	50 kHz	100 kHz
$\pm 0.5\%$	$\pm 0.25\%$	$\pm 0.5\%$	

Fast Response

5 Hz	30 Hz	50 kHz	100 kHz
$\pm 0.5\%$	$\pm 0.25\%$	$\pm 0.5\%$	

Linearity: ac (expressed as percent of full scale, measured from 0.5% of full scale to full scale).

5 Hz	50 Hz	50 kHz	100 kHz
$\pm 0.35\%$	$\pm 0.25\%$	$\pm 0.35\%$	

Warm-up time: 3 minutes nominal.

Zero drift (referred to input): $\pm 30 \mu\text{V}/^\circ\text{C}$.

Offset: up to one full scale of offset by use of recorder's zero.

Size: double width, occupies both plug-in spaces in axis.

Price: HP 17177A, \$500.

Options

001: Metric scaled, no charge.

POINT PLOTTING SYSTEM Model 7591A

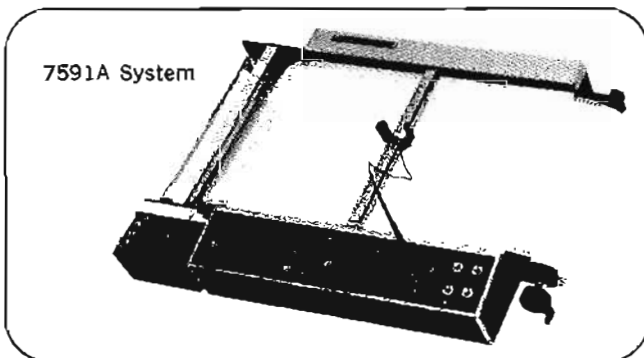

7591A System

The fastest and most economical way to point plot analog data from computers, pulse height analyzers, signal averagers, or multi-channel analyzers is to use the versatile HP 7591A Point Plotting System.

The 7591A was designed to accept plug-in accessories to meet high-speed point-plotting requirements and to plot on any size of flat sheet up to 11 in. x 17 in. on roll or fan-fold paper. The 17005A Incremental Chart Advance provides frame advance, incremental advance, time-base and major-division advance with a position accuracy of ± 0.005 inch; incremental advance is an ideal way to increase plot resolution. The 17173A Null Detector plug-in and the 17012B Point Plotter give you closed-loop plotting at rates up to 3000 plots/minute.

Specifications

Price

Model 7591A Point Plotting System, including 7004B (Option 04), 17173A, 17012B, and 17005A (Option 04)

\$2810

Options

001	Metrically scaled and calibrated	N/C
002	X-axis retransmitting potentiometer, 5 k Ω , $\pm 0.1\%$ linearity	add \$ 75
003	Fan fold adapter (used with 17005A)	add \$ 125
005	17173A with +3 to +20 V enable, 0 V disable	add \$ 25
006	17173A with -3 to -20 V disable, 0 V enable	add \$ 25
007	17173A with -3 to -20 V enable, 0 V disable	add \$ 25
008	7591A without 17005A (Option 04)	
	Incremental Chart Advance	less \$1045

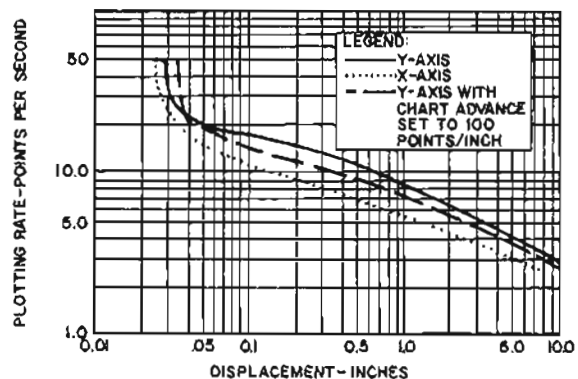

X-Y RECORDERS



TWO PEN X-Y₁, Y₂ Simultaneous plotting of three parameters Models 2FA and 136A

The 2FA and 136A are two-pen X-Y₁, Y₂ graphic recorders available with English or Metric scaling for bench or rack mounting. Features include a built-in time base on the X axis with 5 calibrated sweeps, 11 input voltage ranges with a continuous vernier that scales input voltages to fit the paper, a full-scale zero set and suppression, local and remote pen lift and potentiometric inputs. Two-pen capability makes these recorders extremely useful for plotting 3 parameters simultaneously.

The two pens traverse the full X axis with no more than 0.1 inch horizontal separation. The servo drives are independent and free of electrical ground. The servo amplifiers and power supplies are combined in a single compact modular unit. A simplified self-balancing system using linear slidewires and a continuous zener-controlled reference provides for non-interacting and accurate recording versatility. Autogrip electric paper holddown provides a positive grip on chart paper up to the size of the platen. Operation is silent and maintenance free.

2FA Series
11 in. x 17 in.

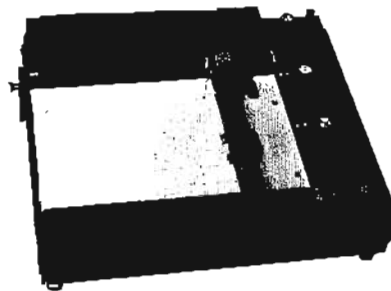
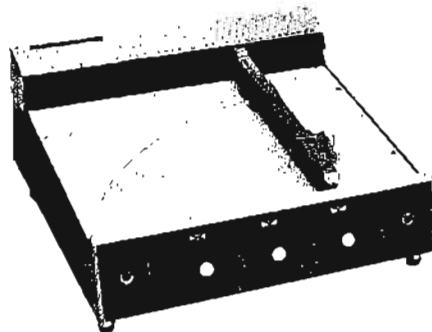

136A Series, 8½ in. x 11 in.



Specifications

Performance Specifications

Input ranges: 0.5, 1, 5, 10, 50 mV/in.; 0.1, 0.5, 1, 5, 10, 50 V/in.
Metric models: 0.2, 0.5, 2, 5, 20, 50 mV/cm; 0.2, 0.5, 2, 5, 20 V/cm. Variable range mode all positions.

Input resistance: one megohm at null on all fixed ranges. Variable range mode, 100,000 ohms on four most sensitive ranges and one megohm on all others. On the Model 2FA, potentiometric input is available on the four most sensitive ranges of each axis by removing an internal strap. On the Model 136A, potentiometric input is available on the four most sensitive ranges of the X-axis by removal of an internal strap and on both Y axes by a front panel switch.

Maximum allowable source impedance: up to 10 kΩ source impedance will not alter recorder's performance on the four lowest ranges. No source impedance restrictions on ranges above 10 mV/in.

Time Sweeps: (on X axis only) 0.5, 1, 5, 10, 50 s/in.; metric: 0.2, 0.5, 2, 5, 20 s/cm. Accuracy, 5% of full scale.

Accuracy: 0.2% of full scale.

Linearity: 0.1% of full scale.

Resetability: 0.1% of full scale on all ranges.

Reference stability: better than 0.002%/°C.

Slewing speed

2FA series: 60 Hz operation: 10 in./s (25 cm/s) on the X-axis; 20 in./s (50 cm/s) on Y₁ and Y₂ axes max. 50 Hz operation: 8 in./s (20 cm/s) on the X-axis; 16 in./s (40 cm/s) on Y₁ and Y₂ axes max.

136A/AM: 60 Hz operation: 20 in./s (50 cm/s) on the X-axis; 15 in./s (38 cm/s) on Y₁ and Y₂ axes max. 50 Hz operation: 16 in./s (40 cm/s) on the X-axis; 12 in./s (30 cm/s) on the Y₁ and Y₂ axes max.

General Specifications

Paper holddown: Autogrip paper holddown electronically grips charts of any size up to size of platen.

Pen lift: local and remote.

Power: 115 or 230 V, 50 or 60 Hz, 130 VA.

Dimensions: 2FA/2FAM (bench): 18¼" deep, 17½" wide, 8½" high (464 x 445 x 206 mm); 2FRA/2FRAM (rack): 8" deep, 19" wide, 19-7/32" high (203 x 483 x 488 mm); 136A/M (bench): 14" high, 17⅞" wide, 6-3/16" deep (355 x 454 x 157 mm); (rack) 14" high, 19" wide, 6-3/16" deep (355 x 483 x 157 mm).

Weight: 2FA series: net, 42 lb (18.9 kg); shipping, 55 lb (24.75 kg). 136A/AM: net, 34 lb (15.45 kg); shipping, 47 lb (21.3 kg).

Price: 2FA/2FRA (English), 2FAM/2FRAM (Metric) \$3450
136A/136AR (English), 136AM/136AMR (Metric) \$2750

Options

2FA Option Number	136A Option Number	Description	Price
01	02	Rear input connectors (supplied with mating connectors)	add \$15
02	-	Event marker	add \$100
-	03	5 kΩ retransmitting potentiometer-X axis	add \$100
03	04	Disposable pen tips	N/C

SPECIAL PURPOSE

For OEM and dedicated applications
Models 7040A, 7041A



X-Y RECORDERS

The 7040A and 7041A X-Y recorders are designed specifically for dedicated, single-purpose recording applications. The 7040A is a medium-speed unit for the majority of uses, while the 7041A is a high-speed unit featuring exceptionally fast acceleration for applications where recording time is critical or incoming data is at a high rate. Both units use the same rugged cast aluminum mainframe which forever eliminates the need for critical mechanical adjustments, the Autogrip holddown system which is silent and trouble-free with no moving parts, and a quick-change disposable pen.

Over 40 inexpensive options allow the recorder to be easily customized for nearly any specific task. Most can be easily and quickly installed or changed in the field should the recording requirement change. If some manual control is needed, a control panel (Option 038) may be added which provides the basic recorder functions such as zero set, servo, pen and chart handling. Other options include a time base, a plug-in X-axis event marker, TTL logic remote control and retransmitting potentiometers for both axes. The 7040 series option system avoids the cost and potential reliability problems associated with the extra, unused components when using a general-purpose recorder in a dedicated application.

A functional and quantity discount is available for both units when qualified for the OEM purchase agreement.

Specifications

Input ranges: single range from 0.5 mV/in. to 1 V/in. (0.2 to 500 mV/cm), specified by option choice.

Type of input: floating, 1 M Ω on all ranges, 200 V dc plus peak ac max; internal polarity switch; inputs through rear barrier strip or optional connector.

Common mode rejection: 100 dB dc; 80 dB at line frequency.

Slewing speed

7040A: 20 in./s (50 cm/s) min.

7041A: 30 in./s (75 cm/s) min.

Acceleration (peak)

7040A: Y axis 1000 in./s²; X axis 500 in./s².

7041A: Y axis 3000 in./s²; X axis 2000 in./s².

Accuracy: $\pm 0.2\%$ of full scale.

Sweep: optional, single range.

Zero set: external control provided by user; front panel controls available as Option 038.

Paper holddown: Autogrip electric paper holddown grips charts 11" x 17" and international A3 size or smaller.

Pen lift: electric pen lift controlled remotely by contact closure; TTL logic level provided by Option 039.

Dimensions: 14" high, 19" wide, 6½" deep (356 x 483 x 165 mm); rack mounting structure integral with unit.

Weight: net, 29 lbs (13.2 kg); shipping, 37 lbs (16.8 kg).

Power: 115 or 230 V $\pm 10\%$, 50 to 400 Hz, approx 130 VA.

Prices

Model 7040A \$ 890

Model 7041A \$1050

Note: OEM discounts available on both models.

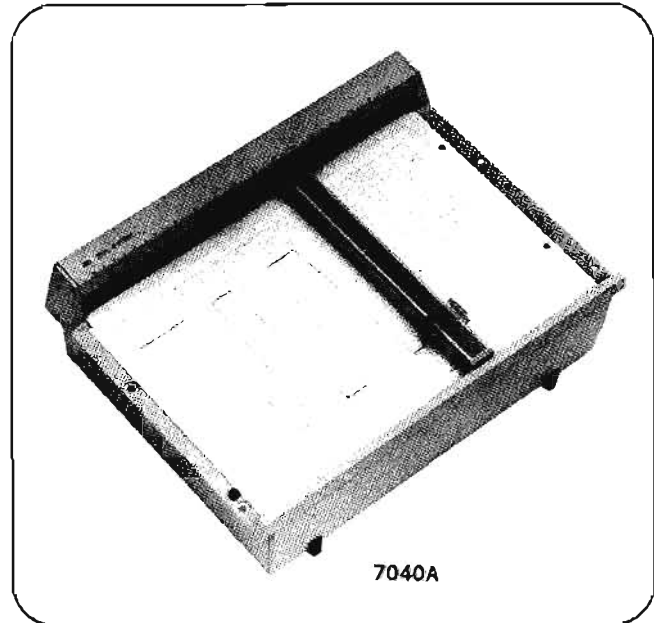

Options

Input range (specify one range option for each axis; must be both English or both metric).

X	Y	Range	Price	X	Y	Range	Price
001	007	0.5 mV/in.	\$ 30	013	019	0.2 mV/cm	\$ 30
002	008	1 mV/in.	\$ 30	014	020	0.5 mV/cm	\$ 30
003	009	10 mV/in.	\$ 30	015	021	5 mV/cm	\$ 30
004	010	100 mV/in.	N/C	016	022	50 mV/cm	N/C
005	011	500 mV/in.	N/C	017	023	100 mV/cm	N/C
006	012	1 V/in.	N/C	018	024	500 mV/cm	N/C

Note: other ranges available on special order.

Sweep range (specified by option choice, X axis only; accuracy $\pm 1\%$ of full scale $\pm 0.1\%/^{\circ}\text{C}$ max; TTL logic start and reset).

	Sweep	Price	Sweep	Price	
025	1 s/in.	\$125	030	0.5 s/cm	\$125
026	5 s/in.	\$125	031	1 s/cm	\$125
027	10 s/in.	\$125	032	5 s/cm	\$125
028	50 s/in.	\$125	033	10 s/cm	\$125
029	100 s/in.	\$125	034	50 s/cm	\$125

Note: other sweep ranges available on special order.

035	Event marker, upper margin of X axis	\$ 75
036	X axis retransmitting potentiometer (19.2 k Ω)	\$ 50
037	Y axis retransmitting potentiometer (13.1 k Ω)	\$ 50
038	Control panel; for line, pen lift, chart, servo standby, zero, and zero check; add 1¼" (44 mm) to height	\$125
039	TTL logic remote control; for pen lift and servo standby; also event marker if installed	\$ 50
040	Rear connector; X, Y input signals and retransmitting potentiometers, time base controls, Autogrip servo standby, pen lift, event marker and Option 039 control lines brought to a single locking connector	\$ 75
041	Side trim panels and dust cover (14", for standard unit)	\$ 15
042	Side trim panels and dust cover (15¼", for unit with Option 038 installed)	\$ 15

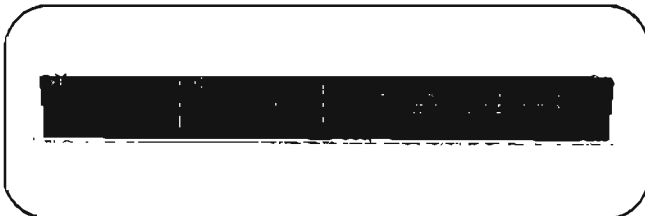

RECORDERS



HIGH GAIN RECORDER RECORDER ACCESSORIES

100 μ V/Inch Sensitivity — Model 7001A

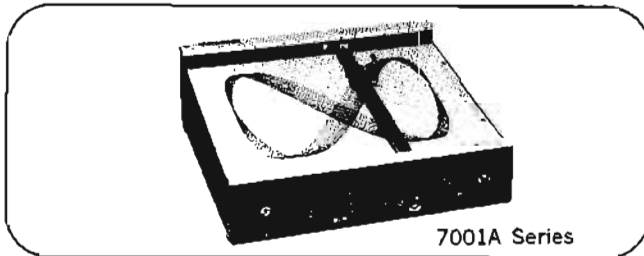

7001A Series

The 7001A X-Y recorder has high sensitivity, high common mode rejection and specially guarded and shielded circuitry. Units are available for bench (7001A) or rack mounting (7001AR), and with metric or English scaling.

Sweep features include automatic reset, adjustable sweep length and automatic recycling. The time base may be switched to operate on either axis. Zero offset for each axis may be preset in 5-inch calibrated steps up to 4 scale lengths on the Y axis and 3 scale lengths on X with continuous adjustability between steps. Zero check pushbutton switches are provided on each axis. Input impedance is 1 M Ω at null on all ranges, with potentiometric input possible on the 6 most sensitive ranges by internal strap or optional front panel switch.

Specifications

Input ranges: 19 ranges, 0.1 mV/in. to 20 V/in. in a 1, 2, 5

sequence (0.05 mV/cm to 10 V/cm in a 1, 2.5, 5 sequence).

Continuous vernier between ranges.

Type of input: floating and guarded signal pair.

Maximum allowable source impedance: 10 k Ω on first 6 ranges; no restrictions on ranges above 5 mV/in.

Interference rejection: dc CMR 140 dB on first 3 ranges; 120 dB at power line frequency on first 2 ranges.

Slewing speed: 20 in/s each axis at 60 Hz; 16 in/s at 50 Hz.

Accuracy: $\pm 0.2\%$ fs.

Reference stability: better than 0.005%/°C.

Time sweeps: 0.5, 1, 2, 5, 10, 20, 50, 100 s/in (0.25, 0.5, 1, 2.5, 5, 10, 25, 50 s/cm). Accuracy $\pm 2\%$.

Power: 115/230 V, 50 to 60 Hz, approximately 120 VA.

Dimensions: bench: 6 $\frac{1}{2}$ " high, 17 $\frac{1}{2}$ " wide, 17" deep (164 x 445 x 432 mm); rack: 17-7/16" high x 19" x 5 $\frac{3}{8}$ " (443 x 483 x 136 mm).

Weight: net, 35 lbs (15.9 kg); shipping, 46 lbs (20.9 kg).

Price: 7001A/AR (English), 7001 AM/AMR (metric) \$2175

Options

001	Potentiometric switch (first 6 ranges)	\$ 55
004	X axis retransmitting potentiometer (5 k Ω)	\$ 75
005	Rear input terminals	\$ 50
006	Y axis retransmitting potentiometer (5 k Ω)	\$ 75
007	Retransmitting potentiometers on both axis	\$ 150
009	Event marker (X axis)	\$ 100
010	Disposable pen tips	N/C

Recorder Accessories

17005A Incremental Chart Advance

The 17005A is a versatile accessory for 11" x 17" bench type X-Y recorders. In the frame advance mode, the chart advance permits successive X-Y plots to be made during unattended operation, indexing to within 0.005" of the original chart location. The major division advance mode allows successive X-Y plots to be made along the chart at 3" intervals. The time base mode converts the recorder from X-Y to strip chart recorder operation, while the incremental mode advances the chart in response to an external signal. Compatible Hewlett-Packard recorders are the 2FA, 7000A, 7001A, and 7004B-Opt. 04.

Specifications

Frame advance mode

Advance distance: 24 in. (60 cm); time: less than 20 s.

Accuracy: ± 0.005 in. (0,0125 cm) non-cumulative.

Major division advance mode

Advance distance: 3 in. (7,5 cm); time: less than 2.5 s.

Accuracy: ± 0.005 in. (0,0125 cm) non-cumulative.

Time base mode

Speeds: 1, 5, 10, 50, 100 s/in (0.4, 2, 4, 20, 40 s/cm).

Accuracy: $\pm 2\%$.

Incremental advance mode

Plot density: 200, 100, 50, 20, 10 plots/in. (80, 40, 20, 8, 4 plots/cm).

Max advance rate: 100, 90, 50, 20, 10 plots/s.

Accuracy: ± 0.002 in. (0,005 cm) non-cumulative.

Power: supplied by recorder.

Weight: net, 11 lbs (5 kg); shipping, 16 lbs (7,3 kg).

Price: Model 17005A \$995

Options

001	Fan fold adapter	\$125
002	Metric scale	N/C
004	Compatibility with 7004B-Opt. 04	N/C

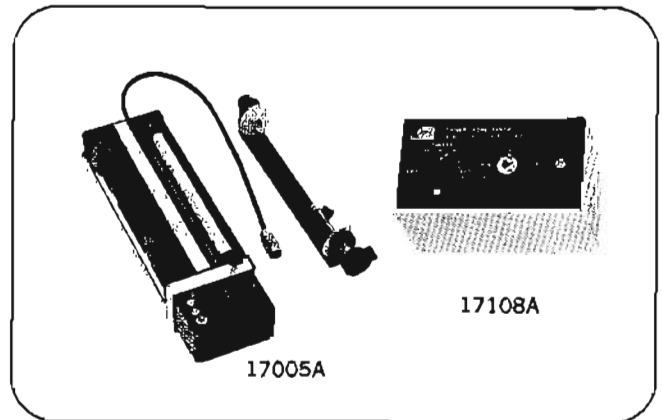

17108A Time Base

The 17108A is a self-contained external time base designed to plug directly into the input terminals of the 7035B and operate on either axis. An adapter supplied allows the use with a variety of Hewlett-Packard recorders. Any number of recorders may be driven simultaneously, provided the combined parallel input resistance is 20 k Ω or more.

Specifications

Sweep speeds: 0.5, 1, 5, 10, 50 s/in. (0.2, 0.4, 2, 4, 20 s/cm).

Accuracy: 5% of recorder full scale.

Linearity: 0.5% of full scale (20°C to 30°C).

Output voltage: 0 to 1.5 V.

Power: replaceable mercury battery (100 hr).

Price: 17108A \$175

17108AM (metric) \$175

STRIP CHART RECORDERS



GRAPHIC RECORDERS

Much of the instrumentation which extends, refines or supplements human perception produces information in the form of electrical analog signals. Records of such data are, of course, necessary. Electrical data acquired in serial fashion, comprising a chain of meaningful changes in a signal, record naturally on continuous instruments such as strip chart recorders. The character of the signal will determine the appropriate recording instrument. Permanent records of slowly changing analog values are conveniently made by Hewlett-Packard servo-driven strip chart recorders; oscillographic recorders can handle signals from dc to 150 Hz.

Parallel-input digital data may also be directly recorded using the Model 580A or 581A Digital to Analog converter. Outputs from most Hewlett-Packard counters, digital voltmeters and other digital measuring devices are converted to analog signals for recording on any strip chart recorder, and the galvanometer output feeds directly to the low-Z input of the 8809A signal coupler on plug-in oscillographic recorders.

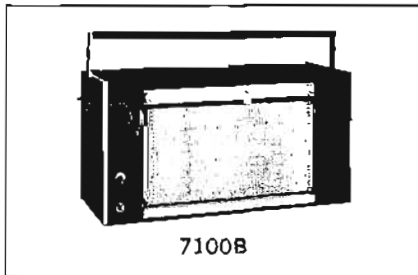

7100B

Strip Chart Recorders

Laboratory and industrial recorders are available that produce records in rectilinear coordinates with considerable accuracy—typically 0.2%. Two-pen models permit both channels to realize the full resolution of the chart width simultaneously, since the pens can overlap on the same chart without interference.

Selection of a servo-driven strip chart recorder depends upon the specific application. Highest sensitivity is offered by the 7100 series plug-in recorders (7100B, 7101B, 7127A, 7128A) with choices to 100 μ V full scale. Another plug-in measures temperature directly from a thermocouple input. The 7100B and 7101B offer 12 chart speeds, the 5" Model 680 eight speeds and the 7127A and 7128A four speeds.

For OEM or other dedicated applications, the 7123 and 7143 offer the ut-

most reliability at lowest cost. Both utilize a linear motor servo system with only one moving part, achieving reliability through simplicity. Many options are available to customize the recorder for a particular task. OEM discounts are available on all Hewlett-Packard servo-driven strip chart recorders.

Options are available on all units to match a particular application. Some of the most popular are:

Event markers—to register external events in time relationship to the chart recording.

Retransmitting potentiometers—additional slidewires which provide an electrical output proportional to the pen position for controlling external devices.

Limit switches—to provide control or alarm signals when the recorder pen reaches a pre-set limit.

Chart integrator—a second recording on the same chart which counts the integral of the main signal.

Types of Writing Systems

Hewlett-Packard strip chart recorders provide three types of writing systems: ink, electric and thermal writing. Thermal and ink writing are used on Hewlett-Packard oscillographic recorders.

Electric writing as well as ink is available on all Hewlett-Packard servo-driven strip chart recorders. With the elimination of ink refilling, long term unattended recording with maximum reliability is possible. Hewlett-Packard low voltage electric writing features crisp, clean, permanent records with the advantage of instant start-up. The record is not sensitive to light or pressure, thus eliminating special handling; it is permanent without processing.

Thermal Writing Oscillographic Recorders and Systems

A wide need exists in data recording for continuous, highly visible records of analog signals with maximum reliability and instant record availability. These requirements are well filled by Hewlett-Packard thermal writing oscillographic recorders, which use the heated stylus technique to produce truly rectilinear chart traces on heat sensitive Permapaper.®

Hewlett-Packard thermal recorders are available with 2, 4, 6, 8 and 16 channels and are compatible with standard Hewlett-Packard recording preamplifiers. All recorders and preamplifiers are available

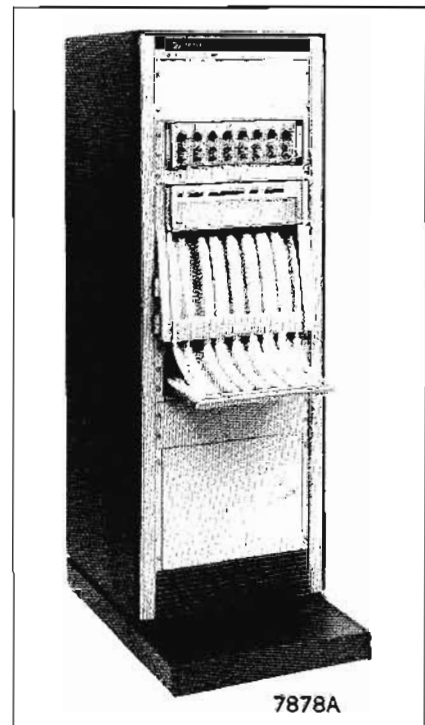

7878A

as systems in upright cabinets, less cabinet for mounting in standard RETMA equipment enclosures or in portable cases for field or laboratory use.

Sensitivities to 50 μ V full scale are available with recorder systems using plug-in preamps. Nine preamps are available to cover a wide variety of measuring tasks, including the use with carrier-excited transducers. On systems with six channels or more, multi-channel bank amplifiers are available for applications where the versatility of plug-ins is not needed.

Ink Writing Oscillographic Recorders and Systems

The ink writing oscillographic recorder used in the 7858B and 7878A systems is a compact, 8-channel recorder that produces rectilinear traces on Hewlett-Packard Z-fold or roll chart paper. The Z-fold chart paper permits instant access to any part of the recording. Roll and Z-fold paper may be used on either recorder interchangeably.

The 7858B uses any combination of the nine recorder preamps, while the 7878A is available with a choice of either medium gain or low gain bank amplifiers.

The recording fluid, a permanent ink that dries rapidly on contact with the paper, permits high resolution copying of recorded data.

STRIP CHART RECORDERS



10 in. PLUG-IN RECORDERS

Ink and electric writing

Models 7100B, 7101B, 7127A, 7128A

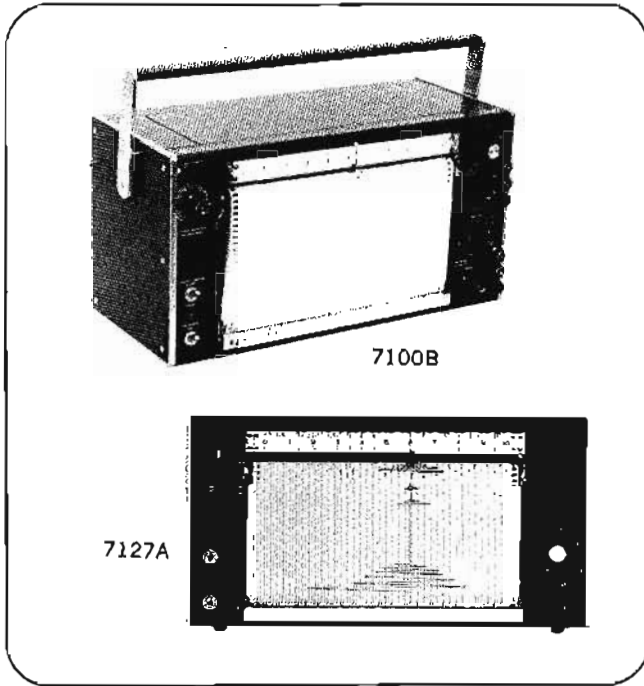

Ten-inch strip chart recorders are widely used in laboratory and industrial applications. Hewlett-Packard strip chart recorders feature high performance, low cost, and solid-state construction for reliability, compactness, and light weight. Models 7100B and 7128A have two servo pen drives and require two input modules. The 7101B and 7127A are single pen units and take one input module. Ordering information should specify basic frame and exact input modules required.

Each main frame is equipped with selectable chart speeds (4 for 7127A, 7128A; 12 for 7100B, 7101B) and a modular chart magazine. The chart magazine will swing out to a 10° or 30° angle for convenient note writing. An optional integrator that computes the area under the chart curve is available.

Specifications

Performance specifications

Recording mechanism

Ink: servo actuated ink pen drive.

Electric: a stylus with associated electronics and electro-sensitive paper are furnished.

Chart dimensions: (ink writing) 120' chart rolls, 11" wide with 10" (250 mm) calibrated writing width. (Electric writing) 100' chart rolls, 11" wide with 10" (250 mm) calibrated writing width.

Chart speeds: 7100B/7101B (English): 1, 2 in./hr; 0.1, 0.2, 0.5, 1, 2 in./min; 0.1, 0.2, 0.5, 1, 2 in./s. 7100BM/7101BM (Metric): 2.5, 5, 15, 30 cm/hr; 1.25, 2.5, 5, 15, 30 cm/min; 1.25, 2.5, 5 cm/s. 7127A/7128A (English): 1/4, 1/2, 1, 2 in./min.

Linearity: terminal based, 0.1% of full scale.

Resetability: 0.1% of full scale.

(Other specifications listed under plug-in modules.)

General specifications

Power: 115 or 230 V $\pm 10\%$, 60 Hz, 65 VA for 7100B and 7128A; 42 VA for Models 7101B and 7127A. 115 or 230 V, 50 Hz models available as option.

Dimensions: 7100B/7101B series (cabinet): 11-31/32" high, 17 1/2" wide, 8 1/4" deep (304 x 445 x 210 mm). 7100BR/7101BR (rack): 8-23/32" high, 19" wide, 8 1/4" deep (222 x 483 x 210 mm). 7127A/7128A series (cabinet): 9-3/32" high, 16 3/4" wide, 8 1/4" deep (231 x 425 x 210 mm). (rack; brackets supplied) 8-23/32" high, 19" wide, 8 1/4" deep (222 x 483 x 210 mm).

Weight: 7100B series: net, 28 lb (12,7 kg); shipping, 39 lb (17,7 kg). 7101B series: net, 28 lb (12,7 kg); shipping, 33 lb (17,3 kg). 7127A series: net, 25 lb (11,4 kg); shipping, 35 lb (15,9 kg). 7128A series: net, 28 lb (12,7 kg); shipping, 38 lb (17,3 kg).

Prices

Dual channel: 7100BR (English), 7100BM/BMR (metric) \$1500; 7128A (English only) \$1250.

Single channel: 7101B/BR (English), 7101 BM/BMR (metric) \$1000; 7127A (English only) \$850.

Options

7100B 7101B	7127A 7128A	Description	Additional price	
			7100B 7101B	7127A 7128A
04	14	5k Ω retransmitting potentiometer (channel 1)	50	\$50
05	01	High-low limit switches (channel 1)	50	50
06	08	Remote control of electric pen lift	50	50
07	02	Remote on-off chart control	25	25
10	03	50 Hz operation	N/C	N/C
11	13	Locking glass door	50	50
12	04	Event marker (ink) left side	35	35
14	06	Event marker (ink) both sides	70	70
15	07	Integrator (7127A, 7101B series or channel 2 of 7128A, 7100B series)	795	795
16	15	5k Ω retransmitting potentiometer (channel 2)	50	50
17	09	High-low limit switches (channel 2)	50	50
18	10	High-low limit switches (both channels)	100	100
19	17	Electric writing	75	75
20	20	Scale with "0" right side	N/C	N/C
22	22	Event marker (elec) left side	35	35
23	23	Event markers (elec) both sides	70	70
24	24	Disposable pen tips (servo pens only)	N/C	N/C
25	25	Soft zero right side	N/C	N/C
-	26	GC compatibility	-	N/C
-	11	Carrying handle	supplied	25
-	16	Retransmitting potentiometer (both channels)	-	100
-	H01	6, 12, 24, 48 in./hr.	-	N/C
-	H02	1 1/2, 3, 6, 12 in./hr.	-	N/C

Note: 7100B, 7101B: Option 15 is not compatible with options 14, 16, 19, 22, or 23. Options 15, 19, and 25 require special paper. 7127A, 7128A: Options 06, 15, 16, 17, 22, or 23 cannot be installed when instrument is equipped with Option 07. Options 07, 17, and 25 require special paper. Electric and ink writing systems are not compatible. Event markers must be of same type as the main writing system.

STRIP CHART RECORDERS

Plug-in Modules

For the Model 7100B, 7101B, 7127A, 7128A



GRAPHIC RECORDERS

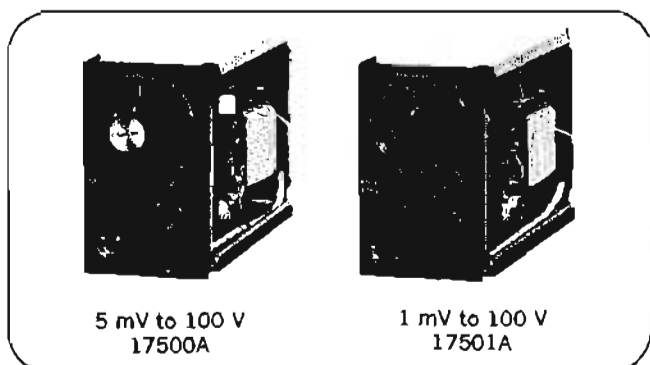

5 mV to 100 V
17500A

1 mV to 100 V
17501A

Multiple Input Span Modules

The Models 17500A (5 mV full scale) and 17501A (1 mV full scale) Multiple Span plug-ins offer high input resistance and a continuously variable span control. Common mode rejection is high and input impedance is one megohm at null on all calibrated spans.

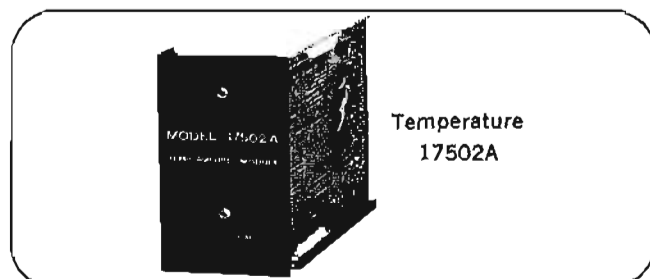

Temperature
17502A

Temperature Modules

The Model 17502A Temperature Measuring Input Module has a single span selectable to match almost any commonly used thermocouple. Corrections for changes in ambient temperature are made within the module, eliminating need for a remote compensation junction. Non-linear thermocouple output is converted in the module to a linear function of temperature permitting use of standard ruled graph paper.

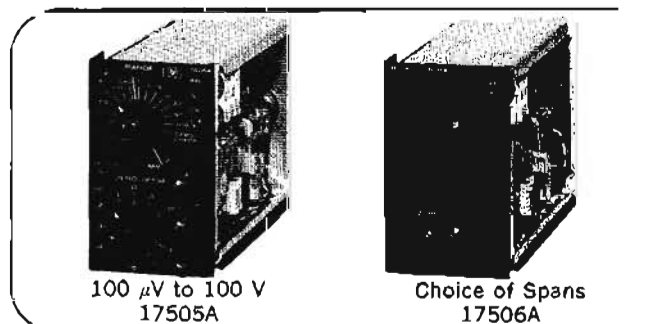

100 μ V to 100 V
17505A

Choice of Spans
17506A

High Sensitivity Modules

The 17505A High Sensitivity Input Module expands the sensitivity capability to 100 μ V full scale. Maximum sensitivity allows input signal variations smaller than 1 μ V to produce accurate measurable recordings. The 17506A plug-in may be ordered with any single span from 100 μ V to 100 V full scale. Both feature floating inputs up to 500 V dc.

17500A/17501A Specifications

Voltage spans: 17500A: 5, 10, 50, 100, 500 mV; 1, 5, 10, 50, 100 V full scale. 17501A: 1, 2, 5, 10, 20, 50, 100, 200 mV; 0.5, 1, 2, 5, 10, 20, 50, 100 V full scale.

Accuracy: $\pm 0.2\%$ of full scale.

Input resistance: 1 megohm at null on all fixed calibrated and variable spans except 100 k Ω in the variable mode on the four most sensitive spans on the 17500A only. Potentiometric operation is available on the 17500A on the four most sensitive spans and to the 17501A on the six most sensitive spans.

Interference rejection: dc common mode; 120 dB on the four most sensitive spans of the 17500A and the three most sensitive of the 17501A. Line frequency, 100 dB on the four most sensitive spans of 17500A and the three most sensitive of 17501A.

Zero-set: adj. full scale, plus one full scale of suppression. 5 scales of zero suppression available on the 17501A.

Maximum source impedance: up to 10 k Ω source impedance will not alter the recorder's performance on the four most sensitive spans of the 17500A and the six most sensitive of the 17501A. No source impedance restrictions on spans above 100 mV fs.

Reference stability: 0.005%/°C.

Weight: net, 2 lb (0.9 kg); shipping, 5 lb (2.2 kg).

Prices

Model 17500A	\$ 325	Model 17501A	\$ 375
--------------	--------	--------------	--------

Options

01 five-scale zero suppression (17501A only)	\$ 50
02 calibrated for use with integrator (8" span)	N/C

17502A Specifications

Voltage spans: single span to match cold-junction thermocouples of types J, K, R, S, and T at ranges as listed on the data sheet.

Accuracy: $\pm 0.5\%$ or $\pm 1^\circ\text{C}$, (whichever is greater); refer to NBS CIR 561, dated 1955.

Input resistance: potentiometric.

Interference rejection: dc common mode, 120 dB; line frequency, 100 dB.

Weight: net, 4 lb (1.8 kg); shipping, 7 lb (3.2 kg).

Price: Model 17502A \$ 400

17505A/17506A Specifications

Voltage spans: 17505A: .1, .2, .5, 1, 2, 5, 10, 20, 50, 100, 200, 500 mV; 1, 2, 5, 10, 20, 50, 100 V full scale. 17506A: any one of the above spans (specify).

Accuracy: $\pm 0.25\%$ of full scale.

Input resistance: 1 M Ω at null.

Interference rejection: dc CMR: 120 dB on most sensitive span. Line frequency CMR: 100 dB on most sensitive span. Line frequency normal mode: 17505A: switchable, 60 dB or 100 dB. 17506A: 100 dB.

Zero set: +2, -1.5 scales. Optional calibrated offset of +1 to -10 scales in one scale steps on 17505A.

Zero stability: $\pm 1 \mu\text{V}$ after one hour.

Maximum source impedance: 10 k Ω on nine most sensitive spans; no source impedance restrictions on spans above 100 mV fs.

Reference stability: 0.005%/°C.

Weight: net, 2 lbs (0.9 kg); shipping, 5 lbs (2.2 kg).

Price

Model 17505A	\$400
Model 17506A (specify voltage span)	\$250
Additional range cards for 17506A	\$ 25

Options

001 Calibrated offset: +1 to -10 scales in one scale steps. Accuracy $\pm 0.25\%$ per step. (17505A only.)	\$100
002 Calibrated for integrator use (8" span)	N/C
003 50 Hz operation	N/C

GRAPHIC RECORDERS



5 in. COMPACT RECORDER

Ink or electric writing

Model 680

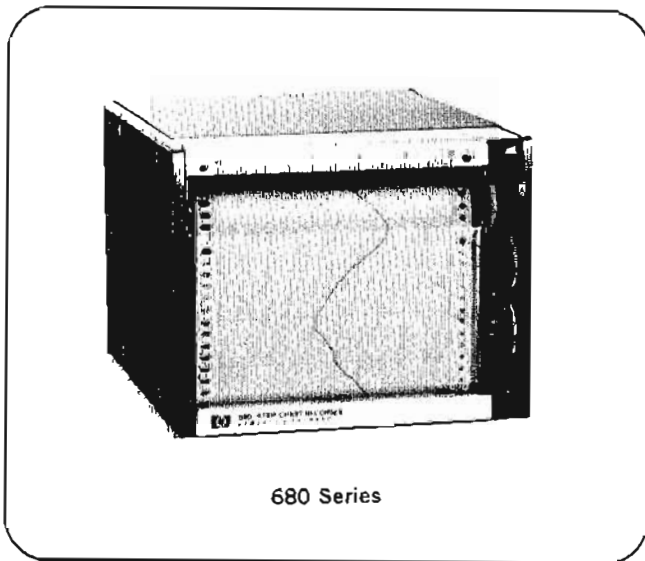

680 Series

The Models 680 and 680M 5-inch strip-chart recorders provide a wide range of performance for general or specialized use. The 680 is equipped with multi-range input, multi-speed chart transport, full-range zero set, and electric pen lift, features essential for general purpose applications. The instrument is available with standard (English) or metric scaling (680M). It is useful as a monitor for instrumentation with dc outputs and for digital devices utilizing D-A converters.

The recorder features modular construction with all-transistor circuitry, high accuracy, fast response, synchronous motor chart drive, and full-view tilting chart magazine. Standard features include instant chart speed transfer, local and remote pen lift control, tear-off or chart roll storage, and cartridge-fed ink pen. Optional electric writing provides crisp, clean, permanent records for long-term unattended recording.

Specifications

Performance specifications

Recording mechanism:

Ink: servo-actuated ink pen.

Electro sensitive: a stylus and associated electronics for electrosensitive paper are furnished in place of the ink pen.

Chart dimensions:

Ink: 6" by 100' roll charts, 5" (12 cm) writing width. Approximately 4" by 6" visible chart area during operation.

Electrosensitive: 6" by 65' roll charts, 5" (12 cm) writing width.

Response time: one-half second or less for full scale.

Chart speeds: eight synchronous-motor-controlled speeds at 1, 2, 4, 8 in./min; 1, 2, 4, 8 in./hr. Metric model: 2.5, 5, 10, 20 cm/min; 2.5, 5, 10, 20 cm/hr.

Spans: ten calibrated spans of 5, 10, 50, 100, and 500 mV; 1, 5, 10, 50, and 100 V full scale. Metric model has spans of 6, 12, 60, 120, and 600 mV; 1.2, 6, 12, 60, and 120 V. An extra span of 1 mV, full scale, is available at extra cost (1.2 mV on metric model).

Input: input resistance is 200,000 ohms per volt (166,666 ohms/volt on metric models), full scale, through 10 volt span; 2 megohms on all others. Potentiometric input on most sensitive span permits operation with essentially zero current drain at null. Constant 100 k Ω input resistance on all spans optionally available on both models.

Reference stability: $\pm 0.005\%/^{\circ}\text{C}$.

Zero set: continuously adjustable over full recorder span.

Accuracy: better than 0.2% of full scale.

Resettability: 0.1% of full scale.

Linearity: 0.1%.

Interference rejection: dc common mode rejection better than 100 dB on the most sensitive range.

General specifications

Pen lift: local and remote.

Power requirements: 115/230 V, 60 Hz, 22 VA. 50 Hz models available at no extra cost, (Option 10).

Dimensions: 6½" high, 8⅝" deep, 7¾" wide (165 x 219 x 197 mm). Rack mounting requires 7" (178 mm) of vertical space.

Weight: net, 11 lb (5 kg); shipping, 17 lb (7.6 kg).

Accessory kit supplied: spare pen, syringe, remote pen lift mating connector, pen cleaning wire, slidewire cleaner and lubricant, 8 ink cartridges (4 red and 4 blue), and one roll of chart paper.

Price: Model 680 (English) or 680M (Metric) \$900

Options:

01	With installed 5 k Ω , 0.1% linearity retransmitting potentiometer	add \$ 50
02	With ink event marker installed	add \$ 25
03	With installed high-low limit switches	add \$ 90
08	With 16/1 instead of 60/1 speed reducer	add \$ 25
09	With remote chart drive switch	add \$ 25
10	For 50 Hz operation	N/C
13	For operation with 7560A, 7561A	add \$ 25
14	Glass door with lock	add \$ 45
15	Electric writing (special paper required)	add \$ 75
16	Electric writing event marker	add \$ 35
18	Disposable pen tips	N/C
H01	1 mV span added (H01-680)	add \$ 50
	1.2 mV span added (H01-680M)	add \$ 50
H02	100 k Ω input resistance, all spans	add \$ 75

Note: ink and electric systems are not compatible. Event markers must be the same type as the main writing system. Options H01 and H02 not compatible.

DIGITAL TO ANALOG CONVERTERS

For high resolution recording
Models 580A, 581A



DIGITAL RECORDERS

Digital-to-Analog Converters make possible automatic, high-precision analog records from electronic counters, digital voltmeters and other devices providing the proper 4-line BCD output code. These converters operate directly with HP Quartz Thermometers, HP Nuclear Scalers and most HP solid-state counters; output kits are available for HP vacuum tube counters. Since the digital-to-analog converters tolerate a wide range of input voltages, they are suitable for use with other tube and solid-state devices.

Output signals for strip-chart or x-y recorders of both the potentiometer and galvanometer types are available, and controls for recorder calibration and zero adjustment are provided. A 50-pin connector accepts 4-line data from a maximum of nine decade counting units. This information is transferred to storage binary units upon receipt of a command pulse from the counting source. The stored data are then translated and weighted to provide the proper analog output voltage or current.

Specifications, 580A, 581A

Accuracy: 0.5% of full scale or better.

Potentiometer output: 100 mV full scale; minimum load resistance 20 K; calibrate control; dual banana plugs front and rear; typical 5 mV residual output at "000".

Galvanometer output: 1 mA full scale into 1500 ohms; zero and calibrate controls; phone jack front and rear.

Driving source: parallel entry 4-line BCD (9 digits maximum); "1" state +4 to +75 volts with reference to "0" state.

Reference voltages: reference voltages required for both the "0" and "1" state, reference voltages not to exceed ± 150 V to chassis.

Command pulse: positive or negative pulse, 20 μ s or greater in width, 6 to 20 volts amplitude.

Transfer time: 1 millisecond.

Power: 115 or 230 volts $\pm 10\%$, 50 to 1000 Hz, 11 W.

Options: please specify one of the following input code options (Option 001, 002, or 003):

001: 1-2-2-4 BCD code "1" state positive; "1" state +4 to +75 V with reference to "0" state. No additional cost.

002: 1-2-4-8 BCD code "1" state positive (voltages same as above). No additional cost.

003: 1-2-4-8 BCD code "1" state negative; "0" state +4 to

Any three successive digits (or the right-hand two) of the input may be chosen for analog output. By selecting the two or three least significant digits, analog records of high resolution and accuracy may be obtained with conventional strip chart and X-Y recorders. For example, recording the three right-hand digits of eight- or nine-column data can provide an analog record with resolution of 1 part in 10^3 .

Since the data in three successive columns can range only from 000 to 999, automatic zero-shifting is inherent in the output, keeping the record "on scale" at all times. As an example, consider successive readings of: 000, 120, 257, 496, 732, 998, 1024. Except for the last reading, the analog record would proceed up-scale to 998 (99.8% of full scale). Recording of the 1024 value would be made at 024 (2.4% of full scale). The quick transition of the pen from 998 to 024 would serve to indicate that the range has been shifted up by 1000. Down-scale shifts of zero are similarly indicated.

+75 V with reference to "1" state. No additional cost.

004: Special input cable 10513A for HP integrated circuit counters (e.g., 5221B, 5216A, 5331A/B, 5332A/B, 5325A) in lieu of 562A-16C input cable normally supplied. Add \$15.00.

Dimensions:

580A (rack mount): 16 $\frac{3}{4}$ " wide, 3-15/32" high, 11 $\frac{1}{4}$ " deep (425 x 88 x 286 mm).

581A: 7-25/32" wide, 6-3/32" high, 8" deep (198 x 155 x 203 mm).

Weight:

580A:

net: 13 lbs (6 kg)

shipping: 16 lbs (7.2 kg)

581A:

net: 8 lbs (3.5 kg)

shipping: 13 lbs (6 kg).

Accessory furnished: 562A-16C Cable, 6' (1830 mm) long with an Amphenol 57-30500 connector at each end. See also Option 004.

Price:

Model 580A, \$650.

Model 581A, \$675.

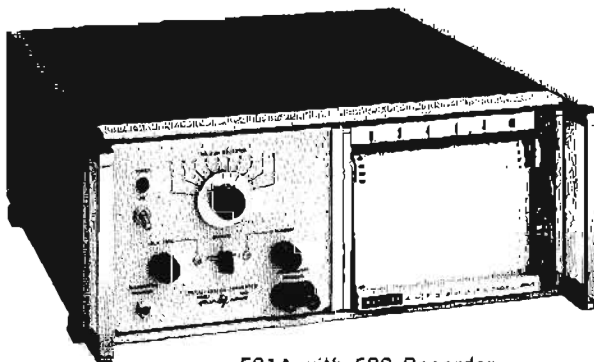

581A with 680 Recorder

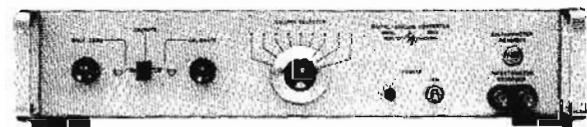

580A

RECORDERS

10 in. AND 5 in. RECORDERS

Linear motor drive—dedicated applications
Models 7123A/B and 7143A/B

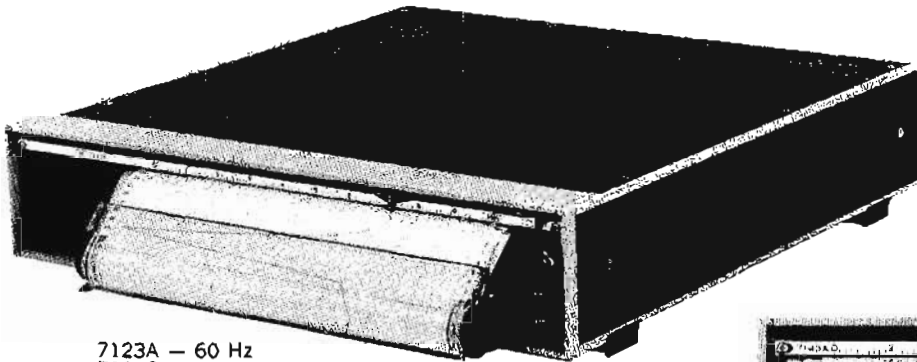

7123A — 60 Hz
7123B — 50 Hz

7143A — 60 Hz
7143B — 50 Hz

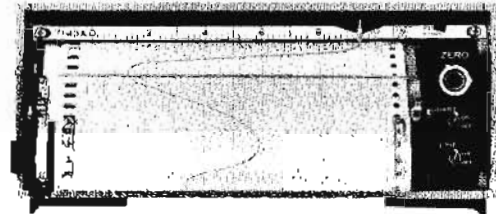

The 7123A/B and 7143A/B Strip Chart Recorders were developed specifically for dedicated recording applications. High reliability and exceptional performance plus a multitude of options allow custom tailoring to each application. These 3½ inch high recorders conserve rack space but still incorporate an effective chart drive and chart viewing system.

The 7123A/B uses chart paper with a 10 inch wide grid, the 7143A/B accommodates paper with a 5 inch grid. The suffix A denotes a recorder for use at 60 Hz line frequency; B denotes 50 Hz.

Reliability

Reliability is the keynote. Maximum reliability was achieved through the development of a unique linear servo motor. The motor enabled the design of a servo drive system with only one moving part—the motor slider/pen assembly. This single moving part replaces the many cables, pulleys, and gears found in a conventional servo system.

The entire radial field of the motor is produced by a permanent magnet, resulting in low power consumption and virtually no internal temperature rise. In addition, the motor can be driven continuously off scale with no audible noise and no possibility of damage to the recorder.

The traditional weak link of servo recorders has been eliminated. A conductive film potentiometer is used in place of the conventional wirewound slidewire. This conductive film potentiometer results in an order of magnitude increase in feed-back element life.

Electric writing

Electric writing (Option 036) is available to further enhance reliability and convenience. Using electrosensitive paper, the low voltage electric writing system provides a crisp, clear trace, eliminating the need for ink refilling and pen priming. The recorded trace is permanent, chemically stable, and insensitive to pressure and moisture. Totally unattended operation is achievable.

Precise response

The linear motor also provides extremely quick response, producing full scale response in less than ¼ second (1/3 second for 7123A/B). In addition, non-mechanical tachometer feedback is incorporated. The tachometer and the high gain solid state servo amplifier allow the units to faithfully reproduce the input signal and respond to step inputs with less than 1% overshoot.

Versatile chart drive

A unique chart drive and viewing system is incorporated. The system allows the paper to be rolled up, or to be fed out and conveniently torn off for inspection or filing. In addition, a slanted viewing/writing area is incorporated to facilitate both viewing and note making. Chart paper may be manually advanced at any time without gear changing or performance interruption.

Minimum panel height

The unique linear motor and chart drive/viewing system combine to make a recorder that requires only 3½ inches of rack height. This low silhouette provides the user with additional rack space without sacrificing recorder capability.

Low cost

The basic price is low. Additional savings are available when qualified for the OEM Purchase Agreement.

Flexibility with options

With almost 50 options available, the 7123A/B and 7143A/B can be "designed" to fit your exact requirements. Most options are modular and options such as span and chart speed can be changed in the field if the need arises.

Performance specifications

Input ranges: single span, 1 mV thru 100 V (specified by option).

Type of input: single ended, floating.

Input resistance: 1 M Ω constant on all spans.

Maximum allowable source resistance (R_s): 10 k Ω (unrestricted for spans below 1 V).

Normal mode rejection (at line frequency): >40 dB.

Common mode rejection: 100 dB at dc and 80 dB at line frequency with 1 k Ω between low and high side and common mode signal between low and ground.

Response time (R_s \leq 10 k Ω): 7143A/B: <1/4 s (<1/2 s for spans below 1 V). 7123A/B: <1/3 s (<1/2 s for spans below 1 V).

Overshoot: <1%.

Accuracy: $\pm 0.2\%$ full scale.

Zero drift: < $\pm 0.005\%/^{\circ}\text{C}$.

Linearity (terminal based): $\pm 0.1\%$ full scale.

Reference stability: $\pm 0.002\%/^{\circ}\text{C}$.

Chart speeds: speed determined by option choice.

Chart speed accuracy: synchronous with line frequency.

Zero set: left hand, adjustable ± 1 full scale (right hand optional).

Environmental (operating): 0 $^{\circ}\text{C}$ to 55 $^{\circ}\text{C}$, <95% RH (25 $^{\circ}$ to 40 $^{\circ}\text{C}$).

General specifications

Writing mechanism: servo actuated ink pen (electric writing optional).

Grid width: 7123A/B 10" or 25 cm. 7143A/B 5" or 12 cm.

Chart length: 100 ft or 30 meters (electric option 55 ft or 17 meters).

Pen lift: manual (electric optional).

Power: 7123A/7143A: 115/230 V $\pm 10\%$, 60 Hz, 30 VA. 7123B/7143B: 115/230 V $\pm 10\%$, 50 Hz, 30 VA.

Dimensions: 7123A/B: 3 1/2" high, 17" wide, 19 1/4" deep (89 x 432 x 489 mm). 7143A/B: 3 1/2" high, 8 1/2" wide, 19 1/4" deep (89 x 216 x 489 mm).

Weight: 7123A/B: net, 42 lb (19 kg); shipping, 51 lb (23 kg). 7143A/B: net, 25 lb (11.3 kg); shipping, 33 lb (15 kg).

Price: 7123A/B: \$750. 7143A/B: \$695.

Note: OEM discounts available.

Options

Span (specify one, front scale determined by choice of English or metric chart speed).

Span	Option	Price	Span	Option	Price
1 mV (1.2)*	001	\$150.	1 V (1.2)*	008	N/C
5 mV (6)*	002	\$150.	5 V (6)*	009	N/C
10 mV (12)*	003	\$100.	10 V (12)*	010	N/C
50 mV (60)*	004	\$100.	50 V (60)*	011	N/C
100 mV (120)*	005	\$100.	100 V (120)*	012	N/C
500 mV (600)*	006	\$100.			

*Metric 7143A/B

Note: additional spans are available on special order.

Speed	Option	Price	Option	Price	
6 in./min	016	N/C	15 cm/min	022	N/C
4 in./min	017	N/C	10 cm/min	023	N/C
1 in./min	018	N/C	5 cm/min	024	N/C
1/2 in./min	019	N/C	3 cm/min	025	N/C
1/4 in./min	020	N/C	15 cm/hr	026	N/C
1 in./hr.	021	N/C	3 cm/hr	027	N/C
2, 1, 1/2, 1/4 in./min				045**	\$155
5, 2.5, 1, 0.5 cm/min				048**	\$155

Note: additional speeds are available on special order.

Chart speed control

Description	Option	Price
60:1 speed reducer	028	\$20.
10:1 speed reducer	029	\$20.
4:1 speed reducer	030	\$20.

2:1 speed reducer	044	\$20.
Remote speed change*	031**	\$25.
Remote chart ON-OFF*	032**	\$25.
Remote pen lift*	033**	\$20.
Filter (adds 60 dB normal mode rejection)		
For spans 1 mV thru 5 mV,	007	\$45.
For spans 10 mV thru 100 V,	013	\$30.
Electronic chart integrator	035	\$750.
Electric writing	036**	\$35.
Event marker (RH)*		
Ink	034**	\$40.
Electric	037**	\$35.
Right hand zero		
Hard (scale, 10 to 0)	014	N/C
Soft (scale, 10 to +0.5)	015	N/C
Retransmitting pot		
5 k Ω $\pm 3\%$ linearity (10 V dc max)	039	\$50.
Limit switch		
SPDT contacts (2A @ 30 Vdc resistive).		
Front panel adjustable.	040**	\$120.
Rack slides		
(7123A/B only)	043	\$65.
Option power supply (required for options 031, 032, 033, 034, 036, 037, 040, 045, 048)	041	\$40.

* Actuated by contact closure to ground. Closed circuit current 1.5 mA (max), open circuit voltage +1.5 V (max).

** Requires Option Power Supply (Option 041).

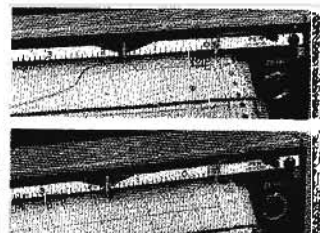

014 RH Hard Zero
015 RH Soft Zero

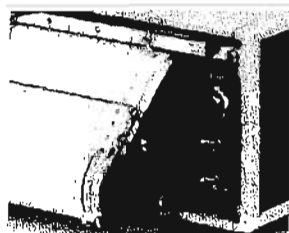

028, 029, 030
Speed Control

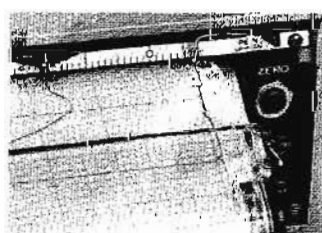

034 Ink
037 Electric

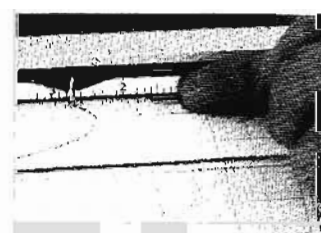

040 Limit Switch

OSCILLOGRAPHIC RECORDERS



PORTABLE RECORDERS

2-Channel

Models 320, 321, 322

Models 320, 321 and 322A are complete recording systems widely used in the field when two similar variables must be simultaneously analyzed and permanently recorded. They operate in any position, record signals on two 5 cm (50 div) channels, have electrical limiting to protect recorder styli and current feedback circuits to reduce drift. Model 320 has guarded and floating inputs designed for broad dc and ac

signals even with excess ground loop noise. Model 322A has two general purpose direct-coupled amplifier channels for single-ended or balanced inputs. Calibrated zero suppression is available as Option 02. Model 321, with built-in 2400 Hz carrier excitation source, is designed to measure signals from resistance bridges, variable reluctance devices, differential transformers and other ac transducers.

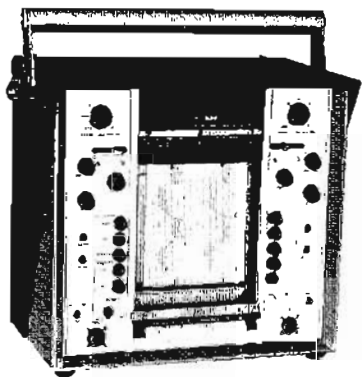

320

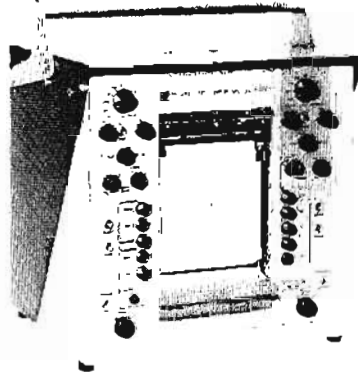

321

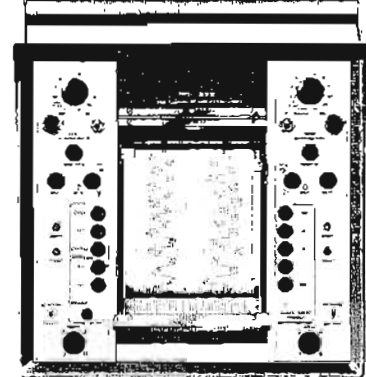

322

Specifications

Attenuation range

320: 0.5, 1, 2, 5, 10, 20 mV/div and V/10 div.

321: X1, 2, 5, 10, 20, 50, 100, 200 atten. factors.

322A: 10, 20, 50, 100, 200, 500 mV/div; 1, 2, 5, 10 V/div.

Attenuator accuracy: $\pm 2\%$ max.

Input circuit

320: floating and guarded signal pair; 0.5 M Ω on mV/div, 1 M Ω on V/10 div.

321: 6 k Ω min resistance, 13 k Ω min reactance, with full zero suppression and R&C balanced; 7 k Ω resistance with zero suppression out; transducer impedance 100 Ω min.

322A: balanced to ground; 5 M Ω each side.

Common mode rejection

320: 140 dB dc; 120 dB at 60 Hz with no input unbalance, 100 dB with 5 k Ω unbalance (± 500 V max).

321: quadrature rejection ratio greater than 100:1 (quadrature signal less than 50 div).

322A: 50:1 at 10 mV/div, 25:1 all other ranges. (Common mode signal 250 div or 500 V max).

Zero suppression: 5-step switch, center out, two positions each for positive and negative signals (standard on 321 only, optional on 322A).

Channel width: 5 cm (50 div).

Frequency response: dc to 125 Hz (-3 dB max at 10 div p-p); dc to 50 Hz (-3 dB max at full scale).

Response time: 5 ms (10 to 90% over center 10 div).

Electrical limiting: approx 115% of full scale.

Monitor output: approx 40 mV/div across 100 k Ω load.

Paper speeds: 1, 5, 20, and 100 mm/s (others optional).

Timer-marker: 1 s timer internal; optional event marker is operated by external contact closure.

General

Power requirements: 115 V $\pm 10\%$, 60 Hz, 100 VA.

Dimensions: portable cases: 13 $\frac{3}{4}$ " high, 14 $\frac{1}{2}$ " wide, 9 $\frac{1}{2}$ " deep (349 x 361 x 241 mm); rack mounts: 14" high, 19" wide, 16" deep (356 x 483 x 406 mm); paper take-up: 4 $\frac{3}{4}$ " high, 14 $\frac{1}{2}$ " wide, 9 $\frac{1}{2}$ " deep (121 x 370 x 241 mm); paper take-up rack mounted adds 5 $\frac{1}{4}$ " (133 mm) to recorder height.

Weight: net, 55 lbs (24 kg); shipping, 66 lbs (29.7 kg).

Optional accessory equipment: paper take-up 320-300 for portable cases, \$150; 320R-300 for rack mounted, \$175.

Prices

Model 320	\$2080
Model 321	\$2125
Model 322A	\$1850

Options

022	Zero suppression (322A only)	\$ 100
003	Rack mount	\$ 35
008	50 Hz operation, includes 115/230 V switch	\$ 50
012	(60 Hz) 2.5, 5, 25, 50 mm/s	\$ 25
013*	(50 Hz) 2.5, 5, 25, 50 mm/s	\$ 25
015	Extra event marker	\$ 76
018	(60 Hz) 0.5, 2.5, 10, 50 mm/s	\$ 175
019*	(50 Hz) 0.5, 2.5, 10, 50 mm/s	\$ 175
020	(60 Hz) 0.1, 0.5, 2, 10 mm/s	\$ 195
021*	(50 Hz) 0.1, 0.5, 2, 10 mm/s	\$ 195
022	(60 Hz) 1, 5, 20, 100 mm/min	\$ 175
023*	(50 Hz) 1, 5, 20, 100 mm/min	\$ 175

* Option 008 also required.

DUAL-CHANNEL RECORDER

Mount in cart, cabinet or portable case
Model 7702B



OSCILLOGRAPHIC RECORDERS

Model 7702B is a 2-channel thermal recorder using any pair of the eight versatile 8800 Preamplifiers as signal conditioners. The reliable heated stylus recording technique provides sharp, high resolution images that will not fade or smudge on plastic-coated Permapaper.[®]

The 7702B is designed to include many operator convenience features. Four pushbutton chart speeds are standard and four

additional speeds may be obtained by option. For accurate time correlation on the recording chart, a one-second marker is provided on standard units and a one-minute marker is added with the option. Remote marking is standard with a second marker optional and may be used for information coding. The recorded paper is collected on a front panel paper take up and is easily changed from the front of the instrument. Each recording channel is 5 cm wide (50 divisions).

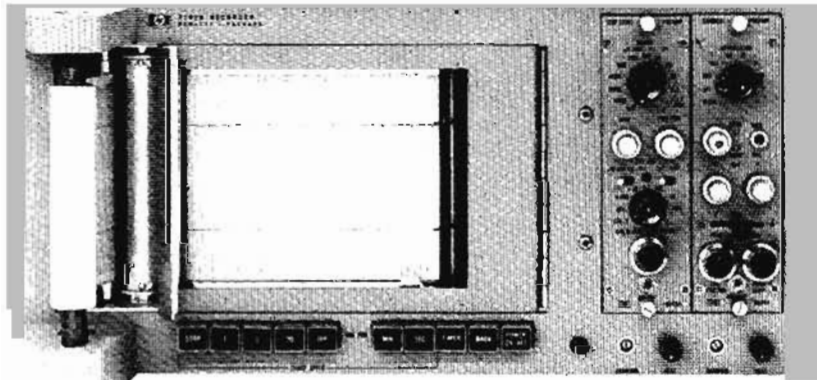

7702B

Specifications

(Full performance specifications determined by choice of 8800 Series Preamplifier, see following pages.)

Chart speeds: four speeds standard (1, 5, 20 and 100 mm/s) mechanically shifted and selected by front panel pushbuttons; other speed combinations available as options; provision is made for optional remote control of chart drive from suitable 115 V ac source.

Timer-off-marker: separate stylus marks edge of chart with 1 s pulses in TIME position or with line frequency pulses in MARK position; remote marking provision at rear connector by simple contact closure (115 V ac).

Front panel controls: individual stylus heat controls; push-buttons for power, timer, marker and speed selection; individual galvanometer damping adjustments (screwdriver adjust).

Paper: standard 200 ft rolls of 5 cm wide, 2-channel Permapaper[®] (651-52), easily loaded from the recorder front panel; 1-channel Permapaper[®] (651-51), may be used if only one channel is operated; orange, translucent Permapaper[®] (651-182), is available for making multiple copies of recording on contact copier (ozalid).

Paper take-up: automatic paper take-up standard equipment.

Power: 115/230 V $\pm 10\%$, 60 Hz, approx 200 VA; 115/230 V $\pm 10\%$, 50 Hz, available in Option 08.

Dimensions: rack mounted: 8 $\frac{3}{4}$ " high, 19" wide, 17" deep (222 x 483 x 432 mm); portable case (Option 02): 10-7/16" high, 20 $\frac{3}{8}$ " wide, 21-13/16" deep (265 x 530 x 576 mm);

mobile cart (Option 05): 39 $\frac{1}{4}$ " high, 26 $\frac{3}{4}$ " wide, 20 $\frac{1}{2}$ " deep (997 x 680 x 521 mm).

Weight (approx): typical with 2 preamplifiers, rack mounted: 60 lb (27,2 kg) net; 89 lb (40,4 kg) gross; portable case (Option 02): 89 lb (40,4 kg) net; 135 lb (60,8 kg) gross; mobile cart (Option 05): 130 lb (59 kg) net; 172 lb (77,4 kg) gross.

Price: two channel thermal recorder, 115/230 V switch, 60 Hz, for rack mounting, uses 8800 Series Preamplifiers, specify Portable Case or Mobile Cart by Option S2050

Options

02	Portable case	add \$ 195
03	One channel decrease	deduct \$ 50
05	Mobile cart (1062A)	add \$ 195
08	50 Hz operation	add \$ 50
09	Speeds, 2.5, 5, 25 and 50 mm/sec (50 Hz)	add \$ 75
10	Speeds, 2.5, 5, 25 and 50 mm/sec (60 Hz)	N/C
11	60:1 Speed Reduction (60 Hz) (includes one-minute marker)	add \$ 185
12	60:1 Speed Reduction (50 Hz)	add \$ 185
15	Extra Marker between channels	add \$ 76
18	60 Hz, 2:1 reduction, speeds of 0.5, 2.5, 10 and 50 mm/sec	add \$ 175
19	50 Hz, 2:1 reduction, speeds of 0.5, 2.5, 10 and 50 mm/sec	add \$ 175

Note 1: add price of preamplifiers to the above basic assembly prices for complete system cost; see following pages for specifications and prices.

OSCILLOGRAPHIC RECORDERS



4-CHANNEL THERMAL TIP Bench-top operation, plug-in preamps Model 7414A

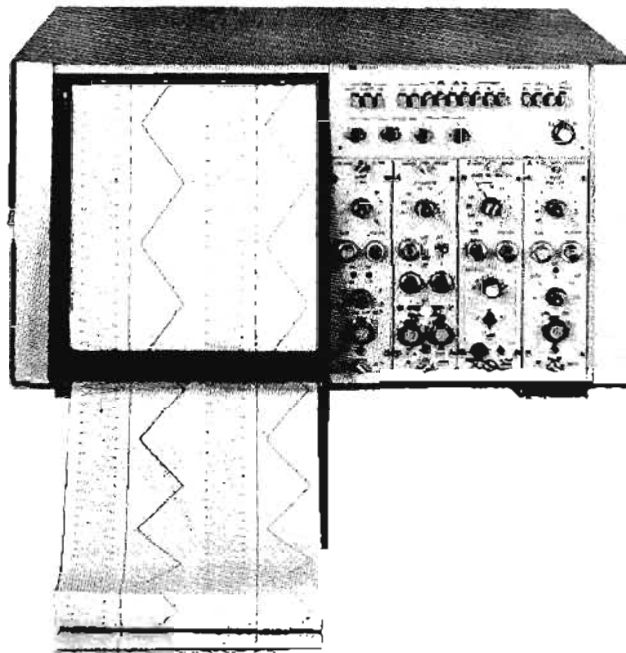

Contained in a single benchtop package, the 7414A represents a unique combination of convenience, high performance and flexibility. Incorporated are thermal writing and positive position feedback plus the capability to accept the entire complement of the 8800 series plug-in signal conditioners. In addition to the benchtop package, the 19-inch unit may be rack mounted or mounted in an optional mobile cart.

The thermal writing tip features high contrast writing, long stylus life, and rectilinear presentation. A closed-loop, contactless pen position feedback system results in 0.5% linearity. The system provides flat response (± 0.5 dB) to 50 Hz at full scale amplitude.

The 500 foot Z-fold pack loads in 30 seconds from the front with no threading. Z-fold allows for convenient data review and storage. Nine pushbutton chart speeds are provided ranging from 0.25 to 100 mm/s.

Specifications

Writing system: thermal with rectilinear presentation.

Chart speeds: 0.25, 0.5, 1, 2.5, 5, 10, 25, 50, 100 mm/s; electrically selected by front panel pushbuttons.

Chart accuracy: speed, synchronous with line $\pm 1\%$; weave, 0.5 mm.

Chart description: four channels, each 40 mm wide divided into 50 divisions, with time lines every 1 mm, Z-fold, heat-sensitive Permapaper®, packs of 500 sheets, each sheet 11.9" (30.1 cm) long and numbered on the right side for footage indication and indexing.

Limiting: factory set 1.5 mm outside grid. Settable, by internal screwdriver adjustment, from 2 mm outside to 8 mm inside grid.

Markers: one event marker and one combination event/timer marker in second and fourth margins. Third event marker is optional.

Remote operation: rear connector provides for remote operation of chart drive and event marker.

General

Power: 115/230 V $\pm 10\%$, 60 Hz, 350 VA (including signal conditioners). 50 Hz operation optional.

Weight: net, 112 lbs (50,5 kg); shipping, 132 lbs (59,5 kg).

Dimensions: cabinet: 11 $\frac{7}{8}$ " high, 20 $\frac{1}{8}$ " wide, 24" deep (302 x 511 x 604 mm); rack mount: 10 $\frac{1}{2}$ " x 19" x 24".

Price: Model 7414A (less preamplifiers) \$4500

Options

001	rack mount; includes slides and all mounting hardware. Deletes case	N/C
008	50 Hz operation	\$ 35
012	1 channel decrease; extreme right hand channel deleted, blank panel installed for plug-in. Not compatible with Option 015	deduct \$ 200
015	extra event marker, installed between channels 2 and 3. Not compatible with Option 012	\$ 35
054	installed in mobile cart. Includes paper take-up drawer	\$ 450

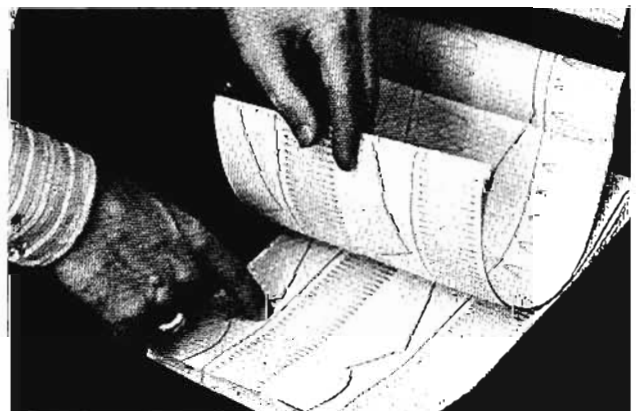

THERMAL WRITING SYSTEMS

6, 8, and 16 channels
7706B, 7708B, 7727A, 7729A, 7731A



OSCILLOGRAPHIC RECORDERS

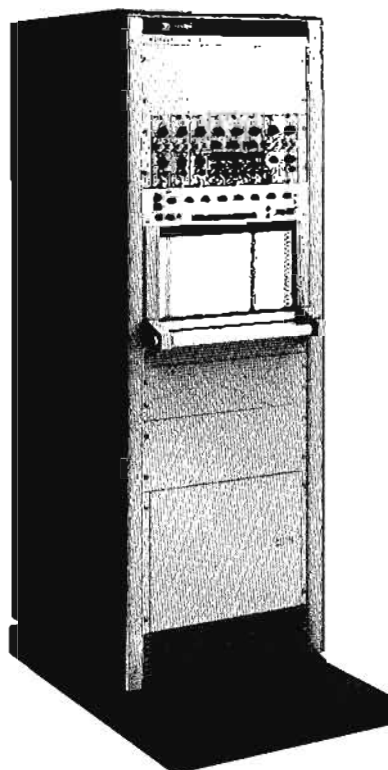

7708B

Multichannel thermal recording systems are available with either bank preamplifiers (all preamps of same type) or with individual 8800-series preamps for long-term system versatility.

Galvanometer power amplifiers incorporate damping circuits to ensure recorder accuracy, current feedback to reduce drift and adjustable electrical limiting to prevent overloading and to protect the styli.

Four and six channel paper may be used for economy when recording less than the maximum number of channels. Permapaper® in opaque or translucent forms is available.

Systems may be obtained in RETMA standard mobile cabinets, less cabinet for mounting in RETMA standard equipment racks, or in portable cases.

Specifications

(Overall system performance specifications are determined by choice of plug-in or bank amplifier. See page 193.)

Chart speeds: 0.25, 0.5, 1, 2.5, 5, 10, 25, 50, 100 mm/s, electrically shifted and selected by front panel pushbuttons; provision is made for remote operation of chart speeds and chart drive.

Event marker: right margin; built-in timer provides 1 s timing marks; manual or remote operation from contact closure. Optional event marker can be installed between channels.

Front panel controls: individual stylus heat controls; push-button speed selectors; motor starting switch; timer-off-marker switch.

Chart footage indicator: front panel indicator shows number of feet remaining on the supply roll.

Chart type: green or translucent Permapaper®, 200 ft long.

General

Power: 115 V \pm 10%, 60 Hz; approx 330 VA; 7731A requires approx 550 VA.

Dimensions: mobile cabinet mount: 72½" high, 24" wide, 36½" deep incl base (1842 x 610 x 927 mm); rack mount: 19" wide, 24½" deep, see height on page 193.

Prices

Model 7706B	\$ 5550
Model 7708B	\$ 5945
Model 7727A	\$ 4600
Model 7729A	\$ 5000
Model 7731A	\$10000

Options

001 less cabinet, for rack mounting	
7706B, 7708B	deduct \$ 395
7727A, 7729A, 7731A	deduct \$ 425
002 less cabinet, mounted in portable cases	
7706B, 7708B	add \$ 150
7727A, 7729A	deduct \$ 75
008 50 Hz operation	\$ 50
009 230 V operation	\$ 100
011 (60 Hz) 9 additional speeds (mm/min)	\$ 250
012* one channel decrease	deduct \$ 50
013* two channel decrease	deduct \$ 100
016 (60 Hz) 2:1 increase of standard speeds	\$ 75
017 (50 Hz) 2:1 increase of standard speeds	\$ 75
020 with 8820A amplifier	
6 channel (7727A)	\$ 1250
8 channel (7729A, 7731A)	\$ 1250
021 with 8821A amplifier	
6 channel (7727A)	\$ 2300
8 channel (7729A, 7731A)	\$ 2500
024* less 440 Hz card (do not order if using 8803A)	deduct \$ 50
025* less 2400 Hz card (do not order if using 8805A/B)	deduct \$ 50
027 (60 Hz) 2½:1 reduction of standard speeds	\$ 140
028 (50 Hz) 2½:1 reduction of standard speeds	\$ 140
029 (50 Hz) 9 additional speeds (mm/min)	\$ 250
031-037** extra marker between channels (31 between 1 and 2, 32 between 2 and 3, etc.)	\$ 70
040** dc marker amp (for use with Options 031-037)	\$ 110
041** with hidden paper take-up	\$ 475

* Applicable to 7706B, 7708 only.
** Not applicable to 7731A.

OSCILLOGRAPHIC RECORDER



INK WRITING SYSTEMS

Systems record on Z-fold paper or rolls
Models 7858B, 7878A

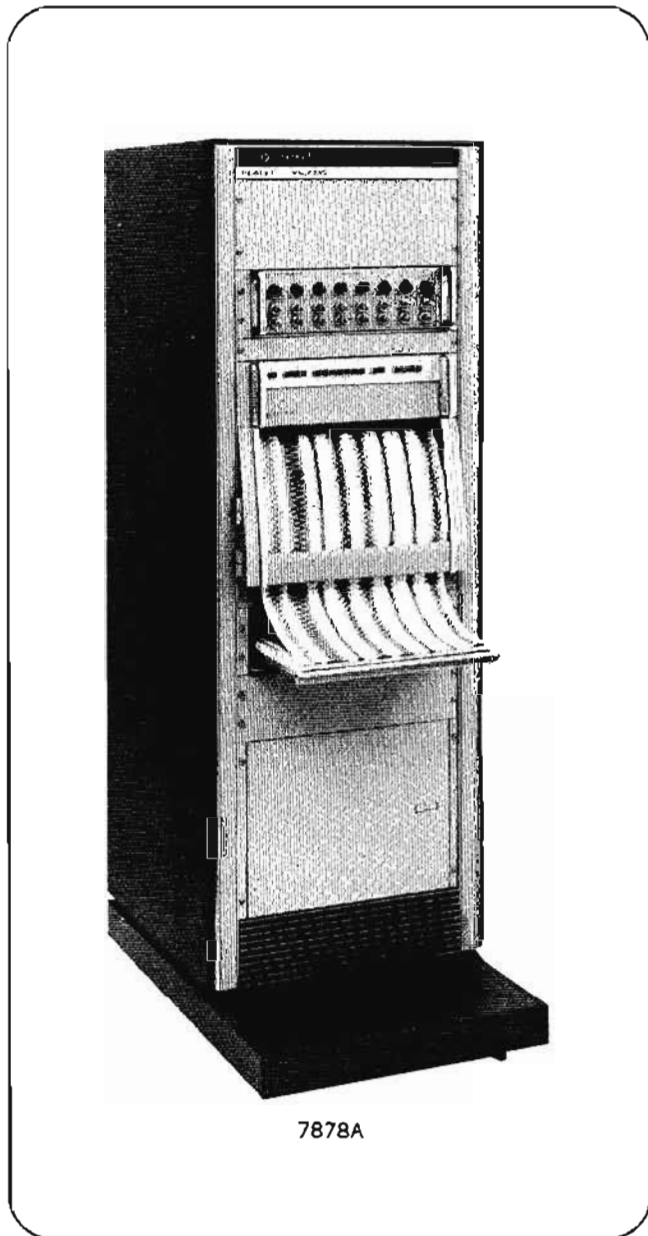

7878A

The models 7858B and 7878A are eight-channel, modulated pressure ink recording systems. The systems feature contactless position feedback from the pen tip, the convenience of Z-fold paper take-up, and the economy of ink-writing paper. All operating controls are front-panel accessible.

Fourteen chart speeds (0.025 to 200 mm/s) are standard, and conveniently selectable by front-panel pushbuttons. A left-hand edge marker pen provides 1 s or 1 min indications (also switch selected from front panel) for accurate time correlation. A right-hand marker pen permits event or time code monitoring. A front-panel warning light indicates when the ink supply is low and a new cartridge is required. An additional indicator can also be lighted at a remote location.

A remote connector on the recorder rear panel enables an operator to select the desired chart speed and to activate the

1 s or 1 min markers from a remote location. The functions are activated by simple contact closures.

Z-fold chart paper permits immediate access to any data without interrupting the recorder; it comes in 500-sheet packs, perforated so that individual sheets can be removed from the pack. Both roll and Z-fold paper are printed with eight 40 mm wide channels, 50 divisions/channel, with timing lines every millimeter. Rolls are 500 ft long, and Z-fold packs are 500 sheets x 30 cm (11.8") per sheet.

The low pressure ink system is modulated to match the recording pen velocity and chart speed, assuring sharp, constant width traces under all signal input conditions. The recording fluid is a permanent blue ink that dries rapidly on contact with the recording paper. The disposable ink cartridge can be replaced anytime—even while the system is operating—permitting uninterrupted tracings. One cartridge supplies over 1000 miles of recorder line.

Systems may be obtained in RETMA standard mobile cabinets, less cabinet for mounting in RETMA standard equipment racks, or in portable cases.

Specifications

(Overall system performance specifications are determined by choice of plug-in or bank amplifier. See page 193.)

Ink system: disposable, plug-in cartridge can be replaced while operating system; ½ hour reserve.

Chart speeds: 0.025, 0.05, 0.1, 0.25, 0.5, 1, 2, 2.5, 5, 10, 25, 50, 100, 200 mm/s, pushbutton selected.

Paper takeup: internal roll accessible by pivoting writing table; Z-fold takeup is below recorder; no modification required to change between roll and Z-fold paper.

Limiting: electrical, from ± 12 div (referenced from channel centerline) to beyond channel edge.

Remote operation: connector provided for remote operation of chart drive, chart speed selector and timer/marker. Provides a positive voltage to indicate remote readiness.

General

Power: 115 V $\pm 10\%$, 60 Hz, approx 600 VA. 50 Hz available as Option 008; 230 V operation as Option 009.

Weight: in cabinet with preamplifiers, approx 550 lbs (249 kg).

Dimensions: mobile cabinet mount: 72½" high, 24" wide, 36½" deep incl base (1842 x 610 x 927 mm); rack mount: 19" wide, 23" deep, see height on page 193.

Prices

Model 7858B (cabinet, less preamplifiers)	\$10350
Model 7878A (cabinet, less preamplifiers)	\$ 9500

Options

001 less cabinet, for rack mounting	deduct \$ 425
002 less cabinet, mounted in portable cases	N/C
008 50 Hz operation	\$ 50
009 230 V operation	\$ 100
012* one channel decrease	deduct \$ 200
013 two channel decrease	deduct \$ 400
020 with 8820A amplifier (7878A only)	\$ 1250
021 with 8821A amplifier (7878A only)	\$ 2500
024* less 440 Hz card (do not order if using 8803A)	deduct \$ 50
025* less 2400 Hz card (do not order if using 8805A/B)	deduct \$ 50

* Applicable to 7858B only.

RECORDER SYSTEMS

Operating specifications
7400, 7700, 7800 Series



OSCILLOGRAPHIC RECORDERS

Plug-in preamplifier systems

7702B, 7414A, 7706B, 7708B, 7858B

Maximum versatility from thermal or ink systems is achieved using the 8800 series plug-in preamplifiers. Signals as low as 1 μ V can be reliably recorded using the high gain dc preamplifier and frequencies to 100 kHz with either the ac/dc converter or logarithmic preamplifier.

For recording the outputs from transducers requiring ac excitation there are two carrier preamplifiers each with 10 μ V/div sensitivity, built-in excitation source and calibration in transducer load units. One unit, the 8805B, features automatic quadrature signal balance.

The Phase Sensitive Demodulator, 8806B, has a plug-in-within-a-plug-in permitting a change of reference frequencies from 50 Hz to 40 kHz.

All units have front-panel gain and zero controls, as well as a signal output jack. All may be used independently of the recorder as lab preamplifiers, when used with the bench-top power supply available as an option with each unit.

Bank amplifier systems

7727A, 7729A, 7731A, 7878A

Two bank amplifiers are available for general purpose applications where the versatility of plug-ins is not needed. Each model is available in 6 or 8 channel versions.

The 8820A Low Gain Amplifier provides 7 input ranges from 50 mV/div to 5 V/div in a 1, 2, 5 sequence. Each input is single ended, with 1 M Ω input resistance. All channels have lockable, front-panel gain vernier and zero position controls.

The 8821A has 12 input ranges from 1 mV/div to 50 mV/div and 0.1 V/div to 5 V/div. Input on the mV/div ranges is floating and guarded with 9 M Ω input resistance and 100 dB CMR at 60 Hz. On the V/div ranges the input is balanced to ground, with 4.5 M to ground on each side. CMR on these ranges is 66 dB at 60 Hz. Internal calibration of ± 20 mV, $\pm 1\%$ on the mV/div ranges and +2 V, $\pm 2\%$ on the V/div ranges is standard.

Ordered separately, prices are: Model 8820A 6-channel, \$1220; 8-channel, \$1250; Model 8821A, \$2300 and \$2500.

Oscillographic recorder system specifications

System	Number of channels, chart width	With amplifier model no.	Maximum sensitivity (mV/div)	Frequency response (-3 dB @ 10 div)	Rise time 10% to 90% (10 div)	Vertical rack space requirement
7702B	2 x 50 mm	8801A	5	125 Hz	5 ms	8 $\frac{1}{4}$ "
		8802A	1	125 Hz	5 ms	
		8803A	.001	90 Hz	7 ms	
7414A	4 x 50 mm	8801A	5	100 Hz	5 ms	10 $\frac{1}{2}$ "
		8802A	1	100 Hz	5 ms	
		8803A	.001	80 Hz	7 ms	
7706B	6 x 50 mm	8801A	5	125 Hz	5 ms	26 $\frac{1}{4}$ "
		8802A	1	125 Hz	5 ms	
		8803A	.001	90 Hz	7 ms	
7727A	6 x 50 mm	8820A	50	125 Hz	5 ms	24 $\frac{1}{2}$ "
		8821A	1	125 Hz	5 ms	
7708B	8 x 40 mm	8801A	5	150 Hz	4 ms	26 $\frac{1}{4}$ "
		8802A	1	150 Hz	4 ms	
		8803A	.001	100 Hz	6.4 ms	
7858B	8 x 40 mm	8801A	5	150 Hz	3 ms	31 $\frac{1}{2}$ "
		8802A	1	150 Hz	3 ms	
		8803A	.001	100 Hz	5.5 ms	
7729A	8 x 40 mm	8820A	50	150 Hz	4 ms	24 $\frac{1}{2}$ "
		8821A	1	150 Hz	4 ms	
7878A	8 x 40 mm	8820A	50	150 Hz	3 ms	29 $\frac{1}{4}$ "
		8821A	1	150 Hz	3 ms	
7731A	16 x 20 mm	8820A	100	125 Hz	4 ms	29 $\frac{1}{4}$ "
		8821A	2	125 Hz	4 ms	

OSCILLOGRAPHIC RECORDERS



PREAMPLIFIERS

Plug-in signal conditioners for recording
Models 8801A, 8802A, 8803A



8801A
5 mV/div



8802A
1 mV/div



8803A
1 μ V/div

DC Coupled Preamplifiers

The three dc-coupled preamplifiers on this page are the primary general-purpose devices used to couple external signals to the recorder. Each unit features a front-panel range switch and lockable gain vernier and zero position controls. Positive and negative zero offset is standard in all three units, with switchable ranges and a lockable, 10-turn potentiometer with calibrated dial face. A switch-selected, internal $\pm 1\%$ calibrator allows a quick check of system accuracy, and front-panel screwdriver-set calibration controls are available in all three units. Front-Panel dc balance controls are provided on the 8801A and 8802A, but are not needed on the 8803A because of the floating and guarded input circuit. Each unit features an output phone jack for the monitoring of the input signal by other devices without additional signal loading, or when the preamplifier is used separately from the recorder as a bench-top unit (Option 001 is the case and power supply for separate use, and includes the 440 Hz photochopper supply when ordered with the 8803A). All units may be operated directly from the output of Hewlett-Packard linear velocity and linear displacement transducers, or with other transducers utilizing dc excitation.

Specifications, Model 8801A

Input ranges: 5, 10, 20, 50, 100, 200 mV/div; 0.5, 1, 2, 5 V/div. Accuracy $\pm 1\%$.

Type of input: balanced to ground; 500 k Ω $\pm 1\%$ in parallel with approx 100 pF each side.

Common mode rejection: 48 dB min, dc to 140 Hz; ± 50 V max on 5, 10, 20 mV/div ranges; ± 500 V max all other ranges.

Frequency response and rise time: see chart on page 193.

Zero suppression: 0 to ± 10 and ± 100 V for single-ended or differential signals (± 50 V max on 5, 10, 20 mV/div ranges); calibrated 10-turn potentiometer with $\pm 0.1\%$ resolution; accuracy $\pm 0.5\%$ of suppression range, $\pm 1\%$ of reading.

Calibration: internal, $+100$ mV $\pm 1\%$.

Price: Model 8801A \$300

Option: 001 bench-top unit with power supply and portable case add \$415

Specifications, Model 8802A

Input ranges: 1, 2, 5, 10, 20, 50, 100, 200, 500, 1000 mV/div; accuracy $\pm 1\%$.

Type of input: balanced to ground; 180 k Ω $\pm 1\%$ in parallel with approx 100 pF each side.

Common mode rejection: 48 dB min, dc to 60 Hz on 1000 mV/div range, dc to 150 Hz all other ranges; ± 12.5 V max on 1, 2, 5 mV/div ranges; ± 125 V max on 10, 20, 50 mV/div ranges; ± 500 V max all other ranges.

Frequency response and rise time: see chart on page 193.

Zero suppression: 0 to ± 2 and ± 20 V for single-ended or differential signals (± 12.5 V max on 1, 2, 5 mV/div ranges); calibrated 10-turn potentiometer with $\pm 0.1\%$ resolution; accuracy $\pm 0.5\%$ of suppression range, $\pm 1\%$ of reading.

Calibration: internal, $+20$ mV $\pm 1\%$.

Price: Model 8802A \$325

Option: 001 bench-top unit with power supply and portable case add \$415

Specifications, Model 8803A

Input ranges: 1 to 5000 μ V/div and 10 to 5000 mV/div, 21 ranges in a 1, 2, 5 sequence. Accuracy $\pm 2\%$.

Type of input: floating and guarded signal pair; 1 M Ω on mV ranges.

Common mode rejection (dc): 160 dB min on μ V ranges, 100 dB min on mV ranges; 1 k Ω max source unbalance; ± 300 V max.

Common mode rejection (ac): 120 dB min on μ V ranges, 60 dB on mV ranges at 60 Hz; 500 k Ω max source unbalance; ± 10 V max, 1 μ V/div; ± 20 V max, 2 μ V/div; ± 50 V max, 5 μ V/div, 100 V max, 10 μ V/div and 10 mV/div; ± 220 V max all other ranges.

Frequency response and rise time: see chart on page 193.

Zero suppression: μ V ranges: 0 to ± 1 , 10, 100 mV; mV ranges: 0 to ± 1 , 10, 100 V; calibrated 10-turn potentiometer with $\pm 0.1\%$ resolution, accuracy $\pm 1\%$ of suppression range.

Calibration: internal, $+200$ μ V $\pm 1\%$ on μ V range, $+200$ mV $\pm 1\%$ on mV range.

Price: Model 8803A \$695

Option: 001 bench-top unit with power supply and portable case add \$415

PREAMPLIFIERS

Plug-in signal conditioners for recording
Models 8805A, 8805B, 8806B



OSCILLOGRAPHIC RECORDERS

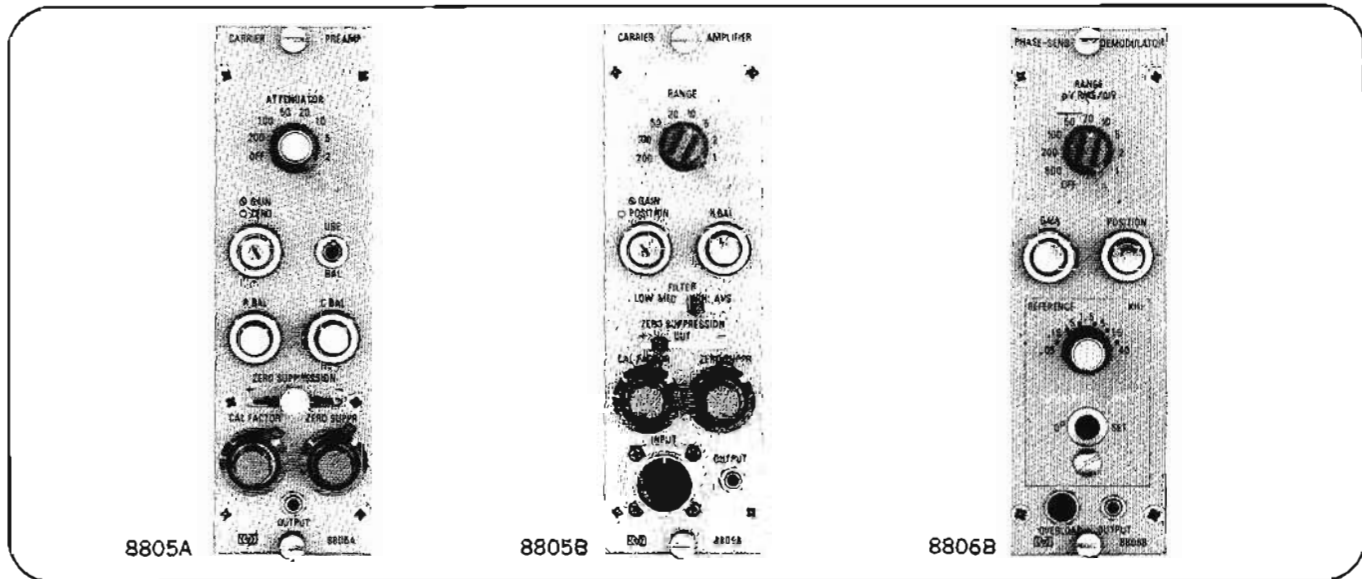

8805A, 8805B Carrier Preamplifiers

The carrier preamplifiers measure physical variables that can be coupled to suitable carrier excited transducers, such as strain gauge bridges, differential transformers, and resistance or reactance transducers. An internal oscillator provides an excitation voltage for the external transducer, eliminating the need for external excitation circuitry. A cal factor control allows attenuation and zero suppression to be calibrated in transducer load units. An internal switch is provided for full or half bridge use. The 8805B adds automatic quadrature signal balance, signal averaging capability, and selectable internal calibration for 2% to 100% of full scale.

Specifications, Models 8805A, 8805B

Sensitivity: 10 μ V/div.

Input attenuator: X1, 2, 5, 10, 20, 50, 100, 200; accuracy $\pm 2\%$.

Input impedance

8805A: approx 10 k Ω .

8805B: 1 M Ω $\pm 10\%$, single ended.

Transducer impedance: transducer load impedance connected to excitation terminals 100 ohms min; transducer impedance connected to signal input terminals 5 k Ω max.

Excitation: floating source 5 V nominal, 2400 Hz $\pm 2\%$; internal full bridge/half bridge switch grounds C.T. of excitation for use with half-bridge transducers.

Quadrature rejection: greater than 40 dB; quadrature signal less than 50 div; C bal control permits bucking of transducer quad unbalance up to ± 5 mV/V.

Zero suppression: 0 to 100% of transducer full load rating, for transducer cal factor up to 10 mV/V at full load; calibrated 10-turn potentiometer with 0.1% resolution; accuracy $\pm 0.5\%$ of suppression range; R bal control permits bucking of inphase unbalance to ± 3 mV/V regardless of cal factor.

Frequency response: dc to 110 Hz (-3 dB @ 10 div).

Rise time: approx 5 ms.

Calibration

8805A: 2% $\pm 0.02\%$ of transducer full scale output.

8805B: switchable, 2%, 10%, 50%, 100% $\pm 1\%$ of full scale.

Prices

Model 8805A

\$425

Model 8805B

\$675

Option: 001 (either model) bench-top unit with power supply and portable case

add \$485

8806B Phase Sensitive Demodulator

The 8806B provides a dc output proportional to the rms value of the input signal that is in phase or 180° out of phase with respect to a reference voltage. Plug-in modules provide various combinations of reference frequency ranges and phase shift capability.

Specifications, Model 8806B

Input ranges: 0.5, 1, 2, 5, 10, 20, 50, 100, 200, 500 mV rms/div; reference voltage 3-133 V rms in two overlapping ranges, internal range switch.

Type of input: signal input: transformer isolated, floating and guarded, approx 1 M Ω ; reference input: differential, transformer coupled, approx 500 k Ω each side to ground.

Common mode rejection: 40 dB min to 10 Hz, 500 V rms max; quadrature tolerance 50 div max.

Reference frequency range: 50 Hz to 40 kHz in six bands with variable frequency plug-in; fixed frequency calibrated plug-ins 60 Hz, 500 Hz, 5 kHz.

Frequency response and rise time

Ref frequency: 60 Hz: 12 Hz, 50 ms; 400 Hz: 65 Hz, 9 ms; 5 kHz: same as 8801A (see chart on page 193).

Phase shifter (plug-in)

Fixed frequency: 0°-90° dial; 2° graduations in four quadrants; accuracy $\pm 3\%$.

Variable frequency: continuous 0-360°.

Calibration: internal, 1 V rms at carrier ref frequency.

Price: Model 8806B

\$550

Options

001 bench-top unit with power supply and portable case

add \$415

002 variable frequency phase shifter plug-in, 50 Hz to 40 kHz

\$200

003 calibrated phase shifter plug-in, 60 Hz

\$150

004 calibrated phase shifter plug-in, 400 Hz

\$150

005 calibrated phase shifter plug-in, 5 kHz

\$150

OSCILLOGRAPHIC RECORDERS



PREAMPLIFIERS

Plug-in signal conditioners for recording
Models 8807A, 8808A, 8809A

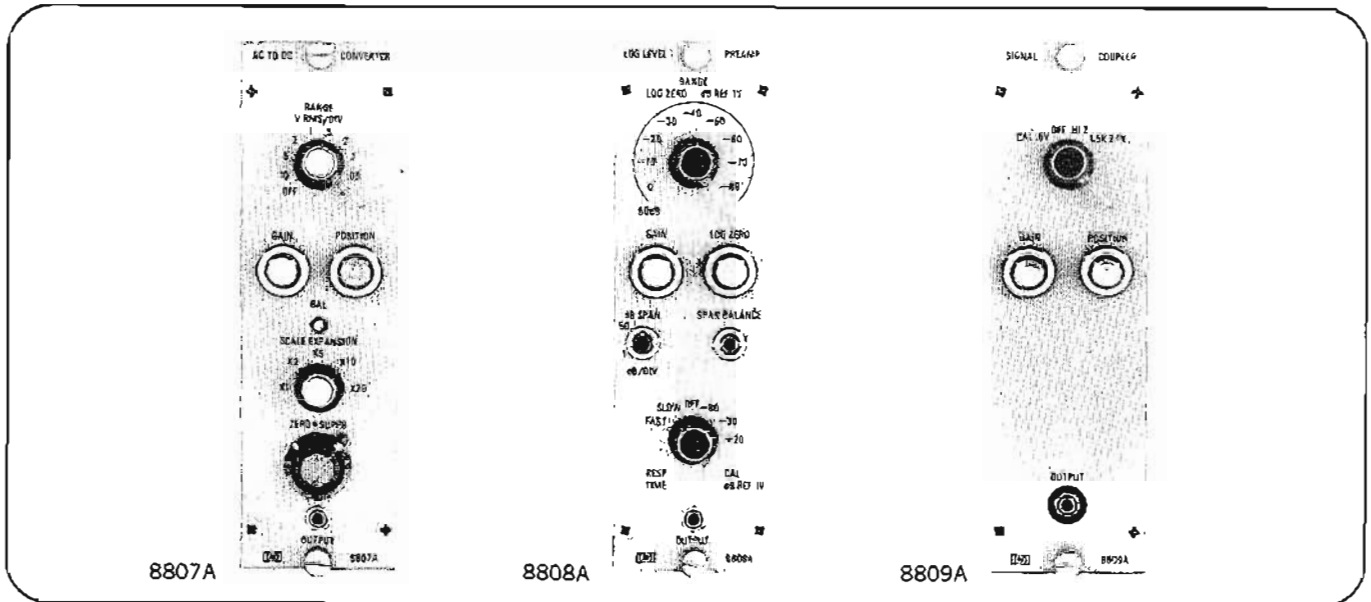

8807A AC-DC Converter

The 8807A provides a dc voltage output proportional to the average value of a full wave rectified ac input signal. Range sensitivity is calibrated in terms of rms for sinusoidal waveforms. The input circuit is transformer coupled, floating and guarded for high common mode rejection. Calibrated full-range zero suppression and variable scale expansion permit analysis of small excursions in large input signals. Option 001 extends the low frequency limit from 330 Hz to 50 Hz at the sacrifice of envelope rise time.

Specifications, Model 8807A

Input ranges: 0.02, 0.05, 0.1, 0.2, 0.5, 1, 2, 5, 10, V rms/div; accuracy $\pm 2\%$; scale expansion: X1, 2, 5, 10, 20 $\pm 2\%$.

Type of input: floating and guarded signal pair; approx 1 M Ω shunted by 10 pF and stray cable capacitance.

Input frequency range: standard model, 330 Hz to 100 kHz; Option 001, 50 Hz to 100 kHz.

Common mode rejection: 60 dB min at 60 Hz, 40 dB min at 400 Hz, with up to 10 k Ω source unbalance; ± 500 V max.

Zero suppression: 0 to 100% of full scale, any range; calibrated 10-turn potentiometer.

Frequency response and rise time

Standard model: 54 Hz, 11 ms.

Option 001: 9 Hz, 70 ms.

Calibration: internal, 1 V $\pm 1\%$; approx 500 Hz.

Price: Model 8807A

\$775

Options

001 50 Hz to 100 kHz signal filter	N/C
002 dc plug-in	N/C
003 bench-top unit with power supply and portable case	add \$415

8808A Logarithmic Preamplifier

The 8808A is an average detecting logarithmic converter. It is calibrated in decibels, where zero dB is taken as 1 V rms

at the input. The unit can operate over a 50 dB or 100 dB span allowing signals from 100 μ V to 1 V rms to be recorded without changing ranges.

Specifications, Model 8808A

Sensitivity ranges

50 dB span: bottom scale -80 to 0 dB below 1 V in 10 dB steps.

100 dB span: -80 to -50 dB below 1 V in 10 dB steps.

Type of input: single ended, 1 M Ω min.

Input frequency range: 5 Hz to 100 kHz slow response range; 500 Hz to 100 kHz fast range.

Rise time 10% to 90% (10 div): fast response, 20.5 ms (875 dB/s); slow response 2 s (9 dB/s).

Calibration: internal at approx 500 Hz: -80 , -30 , $+20$ dB referred to 1 V; accuracy of -30 dB position ± 0.25 dB.

Price: Model 8808A

\$625

Option: 001 bench-top unit with power supply and portable case

add \$415

8809A Signal Coupler

The 8809A inexpensively connects an external signal for recording. Available are front-panel output, lockable zero and gain controls, and switchable galvanometer (1.5 k Ω) or Hi Z (>100 k) input impedance.

Specifications, Model 8809A

Input range: adjustable from 20 to 50 mV/div.

Type of input: switch selected, 1.5 k Ω $\pm 2\%$ or 100 k Ω min, single ended.

Frequency response and rise time: same as 8801A (see chart on page 193).

Calibration: internal, 600 mV $\pm 2\%$.

Price: Model 8809A

\$125

Option: 001 bench-top unit with power supply and portable case

add \$415

INSTRUMENTATION RECORDERS

Intermediate and wide-band systems
3950 and 3955 Series



ANALOG TAPE RECORDERS

The HP 3955 and 3950 Series Magnetic Tape Recorders provide highly flexible, yet easy-to-operate systems to record and/or reproduce electrical signals. Both 7- and 14-channel capacity is available; plug-in electronics (Direct and FM) can be intermixed as desired. Maximum bandwidth of the 3955 at 60 ips is 300 kHz for Direct recording. Maximum bandwidth of the 3950 at 120 ips is 1.5 MHz for standard unit and 2.0 MHz for 3950 Option 011.

Each 3955/3950 System includes a high performance Tape transport and a number of interchangeable Record and Reproduce Amplifiers, offering an extremely wide latitude in determining the exact system configuration. Seven or fourteen track capability in either of two basic tape transports is available.

The smaller transport, which can handle tape reels up to 10½" in diameter, provides economy as well as performance. This transport is for applications requiring average recording times.

The larger transport accepts tape reels up to 15" in diameter to provide over 19 hours of recording time at a tape speed of 1⅞ ips.

Tape reels snap on and off specially designed hubs, and the open tape path allows quick, convenient tape threading.

All operating controls for the system are located on the transport chassis. Pushbuttons are utilized throughout to obtain the desired mode of operation. Rear connections are provided for remote control operation, accessories, and interconnecting cabling.

IRIG-compatible wide-band and intermediate band instrumentation recorders

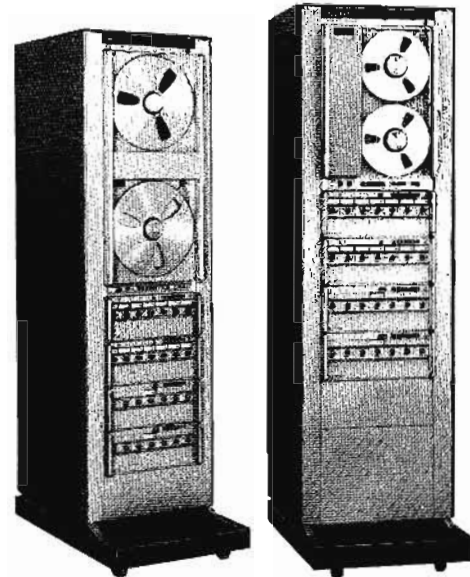

3950

3955

Specifications*

ANALOG INSTRUMENTATION RECORDER SYSTEM CAPABILITIES							
Model	Tape width	Number of tracks	Max. reel size	Number of speeds	Std. speed range (ips)	Direct passband	Typical system price
3950A-Opt 011	1"	14	15"	6	3¼-120	2.0 MHz	\$22,510
3950B-Opt 011	½"	7	15"	6	3¼-120	2.0 MHz	\$15,605
3950A	1"	14	15"	6	3¼-120	1.5 MHz	\$19,740
3950B	½"	7	15"	6	3¼-120	1.5 MHz	\$13,650
3955A	1"	14	15"	6	1⅞-60	300 kHz	\$14,390
3955B	½"	7	15"	6	1⅞-60	300 kHz	\$10,050
3955C	1"	14	10½"	6	1⅞-60	300 kHz	\$13,890
3955D	½"	7	10½"	6	1⅞-60	300 kHz	\$ 9,600

FM Electronics—3950 Series

Signal-to-noise ratio: low band at 120 ips: 50 dB S/N over dc-20 kHz passband. Intermediate Band at 120 ips: 48 dB S/N over dc-40 kHz passband. Wideband Group I at 120 ips: 47 dB S/N over dc-80 kHz passband. Wideband Group II at 120 ips: 36 dB S/N over dc-400 kHz passband.

FM Electronics—3955 Series

Signal-to-noise ratio: Low band at 60 ips: 50 dB S/N over dc-10 kHz passband. Intermediate Band at 60 ips: 48 dB S/N over dc-20 kHz passband. Wideband Group I at 60 ips: 47 dB S/N over dc-40 kHz passband.

General specifications

Voltage and frequency: 115 V ±10%, 60 Hz. (230 V, 50 Hz Opt).

Power consumption: from 350 to 700 watts.

Weight: depends on size of system; the following are typical: 675 lbs (306 kg) net, for in-cabinet 14-channel system. 575 lbs (261 kg) net, for in-cabinet 7-channel system.

Size: height: 78¼" (1990 mm) for cabinet with 70" (1780 mm) of vertical panel space, including casters. Width: 21" (533 mm). Depth: 37¾" (960 mm) overall.

Accessories: Refer to page 199.

*Detailed specifications (by model no.) are available on request.

ANALOG TAPE RECORDERS



PORTABLE TAPE RECORDER

Laboratory performance and accuracy
3960 Series

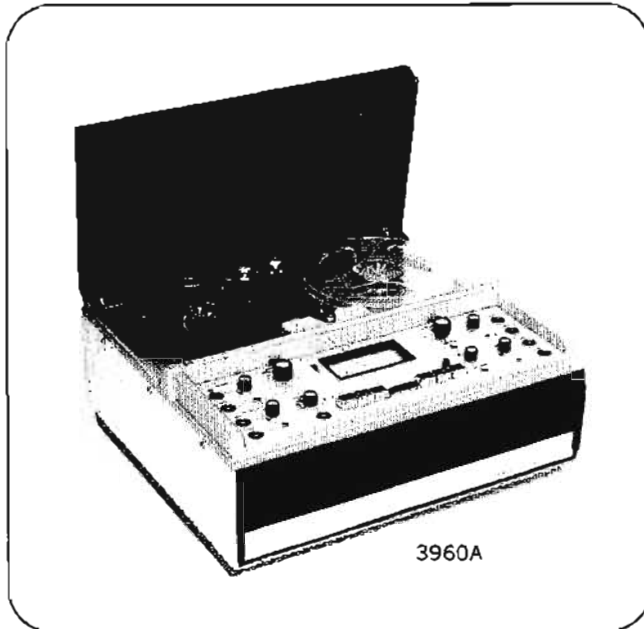

Laboratory performance and accuracy in a portable, 1/4-inch tape, instrumentation recorder are provided by the Hewlett-Packard Model 3960 Instrumentation Tape Recorder. The 3960 records and reproduces, at three electrically switched speeds, up to four channels simultaneously. Any of the four channels can be operated in either an FM or a Direct record/reproduce mode. And five standard (7 available) tape speeds and five FM/Direct channel combinations are available to meet the varying requirements of varied applications.

Standard Speeds (ips)	Channel Configuration				
	4 FM	2 FM 2 Dir	3 FM 1 Dir	1 FM 3 Dir	4 Dir
15, 3 3/4, 15/16	3960A	3960B	3960E	3960F	3960G
15, 3, 1.5	3960D	3960C	3960H	3960J	3960K

Note: Bias oscillator included in systems equipped with Direct electronics.

The advantages of portability and ruggedness allow you to take the 3960 to otherwise inaccessible or unrepeatable signal sources. Subsequently, tapes can be played back in the laboratory; if necessary, can be digitized by analog-to-digital converters; or can be repeatedly and variously analyzed by a diversity of sophisticated laboratory equipment.

Specifications*

FM Record/Reproduce

FM system conforms with IRIG Standard Intermediate Band.

Tape Speed (ips)	Carrier Center Frequency ⁽¹⁾ (kHz)	Passband ⁽²⁾ (Hz)	S/N Ratio ⁽³⁾ (rms/rms) (dB)	Distortion (%)
15	27	0 to 5000	48	1.5
7-1/2	13.5	0 to 2500	48	1.5
3-3/4	6.75	0 to 1250	48	1.5
3	5.40	0 to 1000	48	1.5
1-7/8	3.38	0 to 625	48	1.5
1.5	2.70	0 to 500	47	2.0
15/16	1.69	0 to 312	46	2.0

⁽¹⁾ Signal measured with carrier deviation = 40% at 10% of upper band-edge modulation frequency.

⁽²⁾ Frequency response over passband is = 1.0 dB referenced to 10% of upper band-edge frequency.

⁽³⁾ Without Flutter Compensation. Output filters of reproduce amplifiers selected for constant amplitude response. May also be selected for linear phase (transient) response.

Direct Record/Reproduce

Tape Speed (ips)	Passband (=3 dB)	Signal/Noise Ratio* (dB)
15	70 Hz-60 kHz	38
7-1/2	50 Hz-30 kHz	38
3-3/4	50 Hz-15 kHz	38
3	50 Hz-12 kHz	38
1-7/8	50 Hz-7.5 kHz	38
1.5	50 Hz-6 kHz	38
15/16	50 Hz-3.75 kHz	38

*Referenced to a 500 Hz sine wave with a maximum of 1% third harmonic distortion on tape. (Measured with 3M Type 951 instrumentation tape.) Using an 18 dB/octave bandpass filter, a 3 dB improvement can be obtained.

Flutter: measured in accordance with IRIG standards.

Tape Speed (ips)	Passband (Hz)	Flutter (%p-p)
15	0.2-2500	0.35
7 1/2	0.2-1250	0.35
3 3/4	0.2-625	0.40
3	0.2-500	0.45
1 7/8	0.2-312	0.50
1.5	0.2-250	0.55
15/16	0.2-156	0.70

General specifications

Configuration: supplied as a portable. Rack mounting kits available for standard 19-inch equipment racks.**

Power requirements: 115 or 230 V \pm 10%, 48 to 440 Hz. Consumption 80 watts. Also operates on 12 or 28 volt battery, using accessory DC to AC Inverters.

Size: 16 3/4" W, 15" H, 7 3/8" D (425 x 381 x 187 mm).

Weight: 50 pounds (22,7 kg).

Environment: temperature range is 0° to +55°C, operating; -40° to +75°C, nonoperating.

Altitude: 15,000 ft, operating; 25,000 ft, nonoperating.

Humidity: 10% to 95% (+25° to +40°C), noncondensing.

Shock: 30 g maximum (11 ms), nonoperating.

Price: the following prices are for typical systems:

3960A: 4 FM channels; 15, 3 3/4, 15/16 ips\$4585
3960G: 4 Dir channels; 15, 3 3/4, 15/16 ips\$4270

*For complete specifications, request 3960 Data Sheet.

**Refer to page 199 for complete list of accessories.

COMPLEMENTARY INSTRUMENTATION

Accessories and Options 3960 and 3950/3955 Series



ANALOG TAPE RECORDERS

3960 Series

All accessories for the 3960 Series Recorders can be field or factory installed. All options must be installed at the factory during manufacturing.

Accessory Kit, HP Model 13070A \$31.50
(Included at no charge with each 3960 Series Recorder.)

Includes: One 0.75-amp fuse for 230-volt operation, two jumper cables for FM alignment, four locking knobs for INPUT LEVEL controls, one extender board, one package of cotton swabs (to clean heads), one 24-contact system connector, one tuning wand, and one BNC-to-BNC cable.

Remote Start/Stop Switch, HP Model 13060A \$40.00
Includes 8-foot cable and mating connector.

Inverter (12 VDC to 115 VAC), HP Model 13061A \$190.00

Inverter (28 VDC to 115 VAC), HP Model 13061B \$190.00

Plug-in unit for battery operation. Includes power input cable, fuses, and mating connector.

Tape Loop Adapter, HP Model 13062A \$370.00
Holds a tape loop of from 5 to 30 feet.

Voice Channel, HP Model 13063A \$190.00
Voice record and reproduce amplifier card for all tape speeds. Includes microphone.

Rack Mount Kit, HP Model 13065A \$21.00
For stationary flush-mounting a 3960 in 19-inch racks.

Fiberglass Transit Case, HP Model 13066A \$375.00
Moisture and dust proof. Protects against excessive transportation shock and vibration.

Rack Slide Mounting Kit, HP Model 13068A/B \$165.00
For flush-mounting the 3960 in cabinets and racks. Allows 3960 to be pulled away from rack and rotated 90° for easy access to adjustments and replaceable parts. Model 13068A is for standard 19-inch racks; Model 13068B is for HP Series 2940 and 1073 cabinets.

Remote Control Option \$380.00
Allows electronic switching of all modes except tape speed and power on-off. Control lines select all other recorder functions with a momentary-contact closure. Status lines indicate the appropriate recorder condition.

Tape Speed Servo Option \$350.00
Provides the capability of controlling tape speed from a reference signal recorded on any of the four tracks. Minimum time base error is ± 4 usec at 15 ips and ± 25 usec at 15/16 ips. The control panel includes a switch for changing from tachometer mode to tape servo mode, and two indicator lights to indicate the mode in use.

3950/3955 Series

Automatic Tape Degausser, HP Model 3603A \$1,090

Degausses magnetic tape to 90 dB below saturated recorded level. Automatic operation; complete erasure every time. Designed for continuous operation. Accepts 3" to 15" diameter reels; 1/4" to 1"-wide tape. Use in rack or on table top. Digital Reel Hub Adapter Model 11572 \$17.00

Voice Channel, HP Model 3604A \$370

Records voice commentaries along with data. Provides for edge-track or multiplex recording. Multiplex operation combines voice with data for recording on any direct-record channel. Includes loudspeaker and retractable microphone.

AC Power Supply, HP Model 3680A \$1,150

Used to obtain crystal-controlled drive speed accuracy when system is operated from variable-frequency (47-63 Hz) power source. Eliminates minor tape speed changes resulting from abnormal frequency variations in the ac power line. Amplifier is driven from either an internal crystal or an external frequency source. Ideal for laboratory or field use, supplying up to 100 watts, 115 volts, at any frequency from 30 Hz to 1.5 kHz.

Tape Servo, HP Model 3681A \$1,450

Generates IRIG-specified speed-control signal for recording on tape with data. When the tape is replayed, the reproduced speed-control signal drives the 3680A AC Power Supply (above); it, in turn, controls the tape speed such that data signals are reproduced at exactly the same frequency as recorded.

Option 01 Amplitude Modulation 17 kHz \$1,280

Option 02 Constant Wavelength and AM, 17 kHz \$1,650

Remote Control Unit

Includes all functions for tape recorder operations from another location. With 25' cable. Rack mounting optional.

HP Model 3907-11A (for 10 1/2" reel systems) \$400

HP Model 3907-11A, Option 02 (for 15" reel systems) \$450

Reproduce Track Selector, HP Model 11539A \$360

Permits system economy by using less than a full complement of Reproduce Amplifiers. Each front-panel switch connects any of the 14 recorded data-tracks to the input of a single Reproduce Amplifier. With seven switches available, only one Reproduce Mainframe, and from 1 to 7 Reproduce Amplifiers may be used with a 14 channel system.

Pack Sensor HP Model 11553A \$370

Senses the remaining tape-pack on both supply and take-up reels. Permits system to be stopped before tape runs off end of reel; used for recycling tape, or turning on a second tape recording system before the first one runs out of tape. For 15" reel systems, only.

DIGITAL RECORDERS



DIGITAL RECORDER

20 lines/s; quiet; versatile
Model 5050B

Advantages

- Inexpensive mixed codes column by column
- Versatility of quick-change code discs
- few moving parts
- Quiet operation
- Data storage and digital clock optional

This recorder is compatible with Hewlett-Packard solid state and integrated circuit instruments and a wide variety of other equipment. It prints up to 18 columns of 4 line BCD data from one or two sources up to 20 lines/s.

The user can easily change code to 8421+, 8421-, or 4221+ by an inexpensive substitutable code disc, and can change print wheels to have a different code and/or character set in each column. Character suppression allows suppressing a character in each column (typically to suppress leading zeros).

A reduction in moving parts leads to reliable operation. Particular attention has been paid to ensuring quiet operation. Data storage options reduce data loading time from 50 ms to 0.1 ms and decrease input voltage requirements.

Specifications

Accuracy: identical to input device used.

Printing rate: 20 lines per second, maximum (asynchronous).

Column capacity: to 18 columns.

Print wheels: 16 positions, numerals 0 through 9, —, +, Z, V, Ω, *; other symbols available.

Input requirements—without data storage

Data input: parallel entry, BCD (8421, 4221), "1" state must differ from "0" state by >4.5 V but <75 V.

Input requirements—with data storage options

Data input: parallel entry, BCD, "1" state must differ from "0" state by >1.3 V but <35 V. Input drive ≥ 100 μ A. Data must be on lines when print command occurs and remain until release of hold-off (85 μ s after print command).

Transfer time: 50 ms without storage, 0.1 ms with.

Line spacing: adjustable, 3.5 to 4.5 lines/inch.

Inking: ink roller or pressure sensitive paper (use latter where 5050B is idling more than printing, or for temperature extremes).

Conversion: typically takes five minutes.

Operating temperature: -20°C to $+55^{\circ}\text{C}$ with pressure sensitive paper, $+10^{\circ}\text{C}$ to $+40^{\circ}\text{C}$ with ink roller.

Power: 115 or 230 V $\pm 10\%$, 50 to 60 Hz, approx 100 W idle, 190 W at 20 lines/sec. 50 Hz model with 20 prints/sec available.

Dimensions: cabinet: $16\frac{3}{4}$ " wide, $8\frac{1}{2}$ " high, $18\frac{3}{8}$ " deep (426 x 226 x 467 mm). Rack mount hardware supplied.

Weight: net, 40 lbs (18 kg); shipping, 53 lbs (24 kg).

Price: HP 5050B, \$1900. Column boards (one required for each two columns to be operated), \$125 each.

Options: 001 - 8421 "1" state positive code disc.

002 - 8421 "1" state negative code disc.

003 - 4221 "1" state positive code disc.

All three code discs are supplied with each 5050B at no charge. However, one of the above options must be specified so 5050B can be delivered with desired disc installed.

010 - 50 Hz operation, add \$15.

015 - Motor control, add \$75.

050 - Storage for 20 columns, add \$400.

051 - Storage for 10 columns, add \$200.

061 - Package for 5360A, add \$1490.

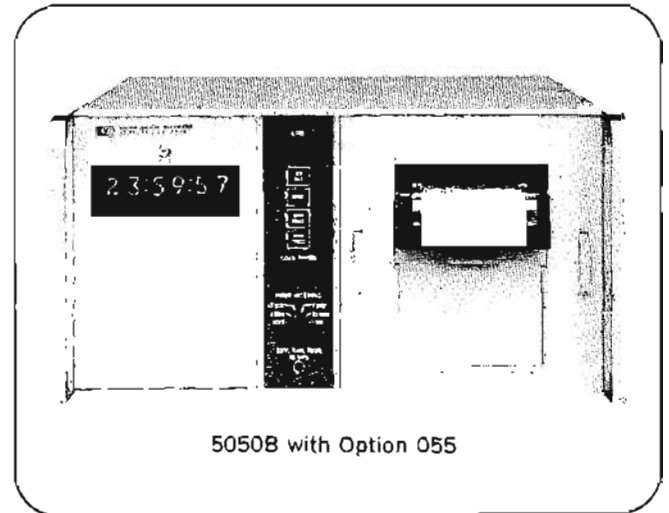

5050B with Option 055

Option 055 for 5050B recorder

Option 055 Clock, for use with the HP 5050B Digital Recorder, provides a convenient method for recording time while also serving as a programmer for the measuring-recording system. Integrated circuits and transistors perform all timing and logic functions. Column boards required for 5050B operation are built into the clock.

Easy-to-read display tubes indicate time to 23 hours, 59 minutes, 59 seconds. In the printout there is a seventh digit available for indicating tenths of a second. The BCD output code of the clock is selectable to be either $+8-4-2-1$ or $-8-4-2-1$, but information is easily adaptable to any other code used on the recorder.

As a programmer, the clock is extremely versatile. Print intervals of 1 second, 10 seconds, 1 minute, 10 minutes, or 1 hour are chosen by a front panel switch. Rates as high as 20 prints per second, determined by an external signal, are acceptable.

The clock is available in kit form for model 5050B or may be installed at the factory in new 5050B Recorders.

Specifications, Option 055

Time base: selectable to be 50 Hz, 60 Hz or external. External requires 10 pps negative pulse.

Print interval:

Internal: selectable to be 1 s, 10 s, 1 min., 10 min., or 1 hour between prints.

External: rates up to 20 prints per second.

Time-of-measurement accuracy: time recorded may be 0.1 s less than correct time \pm line accuracy.

Visual indication: 6 in-line digital display tubes indicate to 23 hours, 59 minutes, 59 seconds.

Printed output: seven digits indicate to 23 hours, 59 min, 59.9 s.

BCD output code: $+8-4-2-1$ or $-8-4-2-1$ selectable. Output adaptable to other recorder codes.

Print format: time printable in any recorder columns.

Clock set: 4 switches electronically set clock to desired initial time.

Power: 115 V or 230 V $\pm 10\%$. 50 Hz or 60 Hz.

Weight: net, 3 lbs (1.4 kg).

Price: HP Option 055 (factory installed), \$950.00. Price of kit for field installation available on request.

DIGITAL RECORDER

10 lines/s with economy and quality
Model 5055A



DIGITAL RECORDERS



Hewlett-Packard Model 5055A Digital Recorder provides a high-performance economical method of making permanent records of digital data. The unit is supplied with complete electronics for 10 columns of input data and will print at rates up to 10 lines per second. It accepts TTL integrated circuit logic levels in either a +8421 or -8421 code, the code being switch selectable on the rear panel.

Quiet, reliable operation is inherent in the design, resulting from the use of very few moving parts. The printer mechanism, manufactured by Hewlett-Packard, is a modified version of a mechanism whose reliability and serviceability has been demonstrated in other Hewlett-Packard recorders for years.

The 5055A prints in ink on regular paper or on pressure sensitive paper. For ink printing, the mechanism includes a continuously rotating ink roller—inherently a more reliable system than a start-stop ribbon mechanism. Paper loading is easy from the front, and when the paper supply runs out, an alarm lamp lights and recording stops automatically. An output signal is provided for inhibiting the data source.

Each column has an individual print wheel which can be changed independently if a different character set is desired in any column. Special wheels can be factory installed at nominal cost or may be field installed at a later date.

The recorder's cabinet is half-rack width and only six inches high. It can be used either on a bench or side by side with another instrument in a rack.

Specifications

Accuracy: identical to input device used.

Print cycle time: 100 ms.

Printing rate: 10 lines/sec maximum, asynchronous.

Print wheels: 16 positions, numerals 0 through 9, +, -, V, A, Ω , *; special wheels available at minimal cost.

Column capacity: supplied complete for 10-column operation.

Electrical

Data Input: parallel entry, BCD \pm 8421 (selected by rear panel switch).

Blanking: Hewlett-Packard counters with blanking will give insignificant zero suppression since blanked digit's output is (1111). May be defeated with rear panel switch.

Logic levels: high state $\geq +2.4$ V, +5 V maximum (open input line results in high state); low state $\leq +0.4$ V (1.6 mA max., low), 0 V minimum.

Print command: line 1-low to high transition causes print (nominal 1 k Ω input impedance); line 2-high to low transition causes print (nominal 400 Ω input impedance). Voltage levels are same as logic levels above, and a minimum pulse width of 0.5 μ s is required.

Inhibit voltage: (+) inhibit = transition from (≥ 0 , ≤ 0.4 V) to (≥ 2.4 V, ≤ 5.0 V) upon receipt of print command. Remains at high state until paper advance occurs, approximately 85 ms (< 5 mA in low state).

(-) inhibit = inverse of (+) inhibit.

Line spacing: fixed, 4 to 5 lines per inch.

Inking: ink roller or pressure sensitive paper. Pressure sensitive paper is recommended for operation under extreme temperatures.

Accessories furnished: one pad regular paper, one pad pressure sensitive paper, one ink roller, one paper deflector, one power cable.

Operating temperature: 0°C to +50°C with pressure sensitive paper, +10°C to +40°C with ink roller.

Input connector: amphenol 57-40500-375, HP Part No. 1251-0087, 50-pin female. Mating input cable connector: amphenol type 57-30500-375, HP Part No. 1251-0086, 50-pin male.

Front panel controls: power switch, power on indicator light, manual print pushbutton, manual paper advance pushbutton, out-of-paper light, standby/operate switch. (Paper loaded from front.)

Paper requirement: Hewlett-Packard folded tape. Approximately 15,000 lines per pad of regular paper, 18,000 lines per pad of pressure sensitive paper (pad fills 5055A twice and must be divided).

Power: 115 or 230 V \pm 10%, 60 or 50 Hz (two-speed motor pulley incorporated), approximately 25 W idle, 55 W at 10 lines/sec.

Dimensions: cabinet: 8" wide, 6-3/32" high, 16" deep (203 x 154 x 406 mm).

Weight: net, 18.5 lbs (10 kg) (approximately); shipping, 22 lbs (8.9 kg) (approximately).

Price: \$1150.

Accessories available: rack adapter frame 5060-0797, \$25.

Option 001: delivered set up for 50 Hz operation. No charge.

Option 002: input cable, 562A-16C. For use with 3450A*, 3480A/B, 5326A/B, 5500A*, 8443A, \$50.

Option 003: input cable, 10513A. For use with 5216A*, 5221B*, 5321B*, 5325A/B, 5330A/B, 5331A/B*, 5332A/B*, \$65.

Option 004: input cable, 10524A. For use with 5323A, \$65.

* Slight modification may be necessary.

Description	Part Number
Ink Roller (Black)	9260-0071
Standard Paper (Single Pad*)	9281-0386***
Standard Paper (Carton of 15 Pads*)	05050-8002***
Pressure Sensitive Paper (Single Pad**)	9281-0387***
Pressure Sensitive Paper (Carton of 15 Pads**)	05050-8003***
* One pad of standard paper is 250 feet long. ** One pad of pressure sensitive paper is 305 feet long. *** Each pad fills 5055A twice and must be divided.	

DIGITAL RECORDERS



DIGITAL RECORDER

Flexible data input with information storage
Model 562A

HP Model 562A Digital Recorder is a solid-state electro-mechanical device providing a printed record of digital data from any of a number of sources. Parallel data entry and low-inertia moving parts allow printing rates as high as 5 lines per second, each line containing up to 11 digits. Twelve-digit capacity is available on special order.

Data enter the unit through rear-mounted 50-pin connectors. Internal plug-in connectors route the information to any desired sequence of print wheels. A separate storage binary unit is associated with each individual print wheel for 4-line BCD input codes.

Model 562A may be equipped to translate 4-2-2-1 BCD, other 4-line codes or 10-line code by substituting plug-in column boards and input connector and cable assemblies.

Specifications

Accuracy: identical to input device used.

Printing rate: 5 lines per second, maximum.

Column capacity: to 11 columns (12 available on special order).

Print wheels: 12 positions, numerals 0 through 9, a minus sign and a blank; other symbols available.

Input requirements

Data input: parallel entry, BCD (4-2-2-1, 8-4-2-1, 2-4-2-1) or 10-line, see Options; "1" state must differ from "0" state by at least 4 Volts but by no more than 75 Volts.

Reference voltages: BCD codes require both "0" and "1" state references; 10-line codes require reference voltage for "0" state; reference voltages may not exceed ± 150 V to chassis; input impedance is approximately 270 k ohms.

Hold-off signals: both polarities are available simultaneously for BCD codes and are diode-coupled; 10 mA maximum load +15 V open circuit from 1 k source, -5 V open circuit from 2.2 k source (160 msec hold-off is provided for 10-line codes).

Print command: + or - pulse, 4.5 to 20 volts amplitude, 1 V/ μ s minimum rise time, 20 μ s or greater in width, ac coupled.

Analog output (optional): (from 4-2-2-1 or 8-4-2-1 boards) accuracy is $\pm 0.5\%$ of full scale or better; 100 mV for potentiometer recorder; 50 k ohm minimum load resistance; 1 mA into 1.5 k ohm maximum for galvanometer recorder.

Transfer time: 2 ms for BCD codes.

Paper required: HP folded paper tape (15,000 prints per packet with single spacing) HP Stock No. 560A-131A or standard 3-inch roll tape. 25 packet carton, \$21.00.

Line spacing: single or double.

Power: 115 or 230 V $\pm 10\%$, 50 to 60 Hz, approx. 130 W. (4 prints/s at 50 Hz; 50 Hz model with 5 prints/s available.)

Dimensions: cabinet: 20 $\frac{3}{4}$ " wide, 12 $\frac{1}{2}$ " high, 18 $\frac{1}{2}$ " deep (527 x 318 x 470 mm); rack mount: 19" wide, 10-15/32" high, 16 $\frac{1}{2}$ " deep (483 x 266 x 419 mm).

Weight: net 35 lbs (16 kg), shipping 80 lbs (36 kg) (cabinet); net 30 lbs (13 kg), shipping 63 lbs (31 kg) (rack mount).

Price: HP 562A, \$1185 (cabinet); HP 562A, Option 002, \$1160 (rack mount); basic unit with 11-column capacity: column

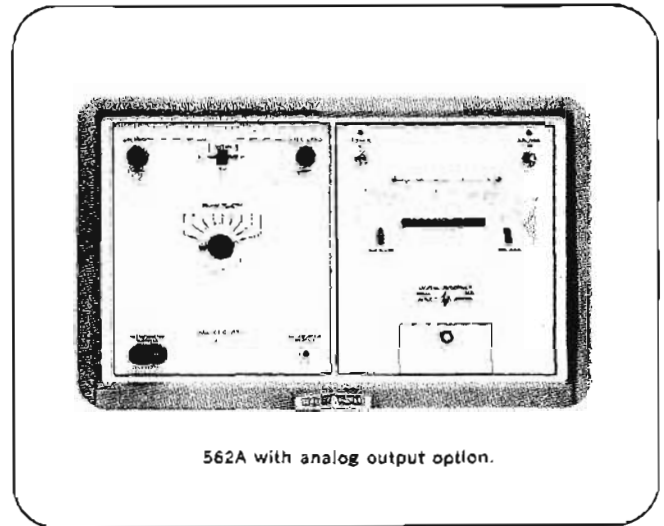

562A with analog output option.

boards, input connector assemblies and cables required for operation are not included, see Options.

Options, Group 1

(Completely equips 562A for operation with Hewlett-Packard instruments.)

Option 011. For 6-column operation from 4-2-2-1 "1" state positive code, add \$555.00.

Option 012. For 9-column operation from 4-2-2-1 "1" state positive code, add \$780.

Option 013. For 11-column operation from 4-2-2-1 "1" state positive code, add \$1023.

Option 014. For operation with 5245L; 10-column operation; prints measurement unit and indicates decimal position — e.g., 16942.496 kHz would be printed as 3 kHz 16942496; the first digit shows how far to move the decimal to the left; add \$880.

Options, Group 2, column boards

Option 021. 4-2-2-1 "1" state positive, \$75 each.

Option 022. 8-4-2-1 "1" state positive, \$75 each.

Option 023. 8-4-2-1 "1" state negative, \$75 each.

Option 024. 4-2-2-1 "1" state negative, \$75 each.

Option 025. 10-line "1" state positive (no storage), \$50 each.

Option 026. 10-line "1" state negative (no storage), \$50 each.

Option 027. 2-4-2-1 "1" state negative, \$75 each.

NOTE: Input connector assemblies and input cables (Group 3 options) are required for use with Group 2 column boards.

Options, Group 3, connector assemblies

Option 030. BCD input connector assembly for up to 9 columns, \$55.

Option 031. BCD input connector assembly for up to 6 columns, \$43.

Option 032. Input cable, for up to 10 BCD columns or three 10-line columns, \$50.

Option 033. 10-line input connector assembly for up to 3 columns, \$35.

Option 034. BCD input connector assembly for up to 10 columns, \$60.

Option 035. Input cable 10513A for IC counters, \$65.

NOTE: More than one input connector assembly and input cable are required for: 1. more than ten BCD columns; 2. operation from two sources; 3. more than three 10-line columns.

Options, Group 4

Option 041. Analog output (from 4-2-2-1 boards), \$175.

Option 042. Analog output (from 8-4-2-1 boards), \$175.

COUPLER/CONTROLLER

Programmable, bidirectional device interface
Models 2570A, 2575A



COUPLER/CONTROLLER SYSTEMS

The HP 2570A and HP 2575A Coupler/Controllers form the heart of inexpensive, programmable, and expandable systems, providing a bidirectional link that interfaces many Hewlett-Packard instruments (as well as non-Hewlett-Packard instruments) and peripherals to communicate with each other. Because of the many and varied system configurations possible, complete ordering information for coupler/controller systems is contained in a separate form, HP 2019A Systems Ordering Information, available from Hewlett-Packard field sales offices. Coupler/Controllers and their options should be ordered under their 2019A—(list option number here) classification, as shown in parentheses throughout the text. The discussion that follows is essentially a description of the coupler/controllers themselves, their associated plug-in cards, and brief specifications. More in-depth literature covering coupler/controllers, as mentioned throughout the following text, is available from Hewlett-Packard.

NOTE: The only electrical difference between the 2570A and 2575A is that the 2570A has eight input/output slots (channels to interface devices) and the 2575A has four input/output slots. Except as specifically noted in the following text, all mention of the 2570A applies equally to the 2575A.

Operating principles

Operation of the 2570A is based on the concept of providing a common communication code—ASCII (American Standard Code for Information Interchange). The simple system illustrated shows how a device such as a DVM, inputs its data to the coupler/controller which, in turn routes the data to an output device such as a paper tape printer. The sequence of operation is as shown. Note that the input data signal is converted from BCD to ASCII on the BCD input card; all data must be in ASCII when it reaches the 2570A backplane. Thus, a single 8-line ASCII bus on the backplane handles all data transfer between devices.

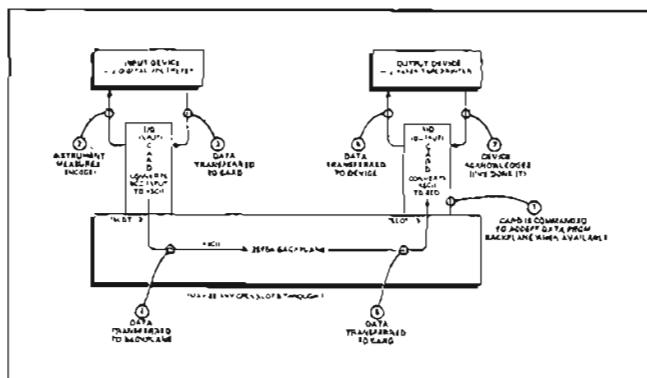

2570A Single-Source, Single Output System

The highly diversified operating capabilities of the coupler/controllers are all implemented under program control. All I/O operations can be programmed by either a self-contained pinboard programmer (up to 15 instructions) on the control card or by an external ASCII source, such as a teleprinter keyboard or tape reader.

Interface cards

Interface cards for many applications are available as kits specifically for the 2570A. The interface cards generate the necessary interface control signals, provide storage if required,

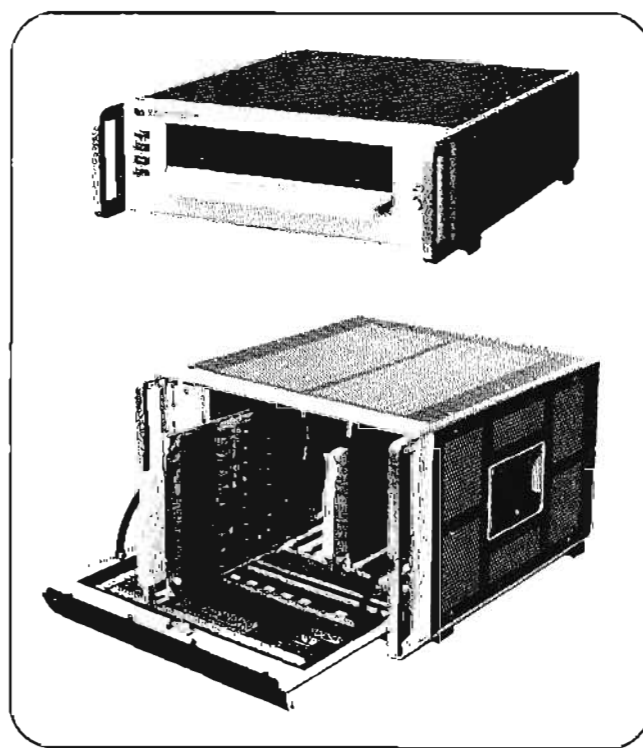

HP Coupler/Controllers with Front Panel Open. 2575A (top) Accepts up to Four I/O Devices. 2570A (bottom) Accepts up to Eight I/O Devices.

and provide the necessary control logic for I/O operations, e.g., proper timing conditions. The following is a brief description of interface cards available.

The HP 12797A (2019A Opt 100) BCD Input Card equips the 2570A to receive the digital output from a variety of instruments, including digital voltmeters, counters and quartz thermometers. The card translates up to 10 characters of 8421 BCD information from a digital source into ASCII and makes it available in serial form on the 2570A ASCII bus. Patch panel programming on the card permits format control of the input/output slot, and insertion of certain special characters. The HP 12797A BCD Input card interfaces the following Hewlett-Packard instruments to the 2570A: Counters: 5221A/B, 5245L/M, 5321A/B, 5323A, 5325A/B, 5326A/B, and 5330A/B; DVMs: 2401C, 2402A, 3450A, and 3480A/B; 2801A Quartz Thermometer; 4270A Capacitance Bridge.

The HP 12798B (2019A Opt 119) BCD Output Card provides a 10-digit parallel data output register as a means to interface the 2570A with parallel entry digital devices. The card can also be used as a general-purpose 40-bit output register. The HP 12798B BCD Output Card is compatible with the following Hewlett-Packard instruments: Digital Recorders: 562AR, 5050A/B, 5055A; 2759B Frequency Synthesizer Programmer; DVMs: 3450A, 3482A/3484A; Digital Voltage Sources: 6130B-J80, 6131B-J80. Counters: 5325B, 5326A/B; 6936A Multiprogrammer.

The HP 12799B (2019A Opt 140) 16-Bit Relay Register provides 16 programmable contact closures for control of external devices such as power supplies, solenoids, electrically activated control valves, or instruments requiring control voltage outside

of the normal logic ranges. The contact closures may be subdivided in any combination for controlling one or several devices. The voltages switched through the relay contacts can differ from each other and from the 2570A ground by as much as 100 volts peak. Contacts can be connected in series, parallel, or series-parallel, with or without diode isolation. Floating contact closure permits switching of diverse voltages and avoids ground loops.

The HP 12800A (2019A Opt 160) 8-Bit Duplex Register provides the 2570A with the capability to "talk" directly with 2100 series computers, the 2753A High Speed Tape Punch, and the 2748A/58A High Speed Punched Tape Reader. Commonly, the distance between the coupler/controller and other devices can be handled by the 12-foot cables available for this purpose. For separations up to 10,000 feet, order the HP 12770A (2019A Opt 380) Interface Kit (described below) to interface a coupler/controller to an Hewlett-Packard computer. Through this interface, the computer can provide on-line computational power. Software drivers are not supplied. Interconnect cables are available to allow the punch and reader to be operated independently or simultaneously (see 12800A (2019A Opt 160) specifications).

The HP 12801A (2019A Opt 180) Teleprinter Interface allows any Hewlett-Packard teleprinter to interface with the HP 2570A. Compatible Hewlett-Packard teleprinters, used mainly with computers and data acquisition systems, are the 2752A (modified ASR-33) and the 2754B (modified ASR-35); the 2749A (modified ASR-33) is used in Hewlett-Packard time-sharing systems. A system incorporating a 2570A can be manually controlled by entering instructions from the teleprinter keyboard. Alternatively, the system may be controlled by paper tape programs read from the teleprinter tape reader.

The HP 12802A (2019A Opt 200) Calculator Interface enables the 2570A and the HP 9100 Calculators to communicate directly with each other. Data can be input through the 2570A to the calculator x-register and conversely, processed data can be output from the x-register through the 2570A, to such devices as a teleprinter or tape punch. Additionally, the program storage capability of the 9100 can be used to exercise system control. Through the use of a two-key sequence of "FMT" and a number or letter, the calculator can take readings from DVMs, counters, etc., control scanners, program power supplies, and in essence, do any of the things that can be done through the normal pinboard program. Furthermore, the 9100 brings computational power and decision making capability to the system for minimal cost.

The HP 12803A (2019A Opt 220) Ten-Channel Reed Relay Scanner switches multiple analog input signals, in either numerical or random sequence, to a single measuring device such as a DVM or frequency counter. Reed relays switch up to 10 channels per plug-in card. With multiple scanners, up to sixty analog input channels can be switched to the DVM or counter with a single 2570A or up to 20 channels with a 2575A-based, stand alone digital data acquisition system. A two-digit channel identification is available for recording along with the data, or it may be suppressed, if desired.

The HP 12807A (2019A Opt 300) Pinboard Program Card provides 45 additional program steps for the 2570A. The steps are divided into five separate nine-step program segments, each of which can be treated as a separate subprogram that can be addressed directly and executed. A null step (no diodes in-

serted) determines the end of that subprogram. Program chaining is possible for programs longer than nine steps. More than one program card can be used at a time, greatly expanding programming capability.

The HP 12809B (2019A Opt 320) Time-Sharing Interface enables the 2570A to establish two-way communication with a time-shared computer. Any device interfaced to the 2570A also becomes interfaced to the computer, thereby enabling instruments and peripheral devices to communicate with each other and the computer. Thus, a computer program can control devices in a measurement system. The time-sharing interface (and an acoustical coupler, as described in the specifications) allows data to be transferred on-line to a time-shared computer for analysis without the need for manual data logging and the subsequent re-keying of information into a computer terminal. Logging is performed unattended and can be recorded, automatically. All the mass data storage and powerful processing power of the most sophisticated computers are readily available without the capital outlay for an in-house system. Other benefits include access to pre-written statistical routines, capability of accumulating large historical files, and storing sophisticated programs at a low cost; these files are available on instant recall, making it possible to get maximum usage from the computer.

The HP 12811A (2019A Opt 340) Clock/Timer/Pacer Card adds very flexible measurement timing capabilities to the 2570A (available on special order for the 2575A). The exact time of day can be recorded along with instrument data. Individual data points or complete measurement scans can be programmed (paced) through switches to begin at specified time intervals, at 0.1 sec increments from 0.1 sec to 99.9 sec (or 0.1 ms to 99.9 ms). Also, by means of the clock, intervals can be once every 0.1 sec, 1 sec, 10 sec, 1 min, 10 min, 1 hr, or only once every day. Clock intervals can be multiplied (jumper placement) by 2 or 3. Additionally, time delays may be inserted in the program in 0.1 sec increments from 0.1 sec to 99.9 sec (or 0.1 ms to 99.9 ms). The clock operates on 50/60 Hz or an optional 100 kHz crystal oscillator that mounts on the card. An emergency power option keeps the clock running in event of power failure.

The HP 12770A (2019A Opt 380) Serial Data Communications Interface allows an HP 2100 Series Computer to communicate with a 2570A Coupler/Controller at distances up to 10,000 feet, via two pairs of twisted shielded wire in a single cable. The 2570A can be operated either: (1) as a computer-controlled remote terminal accepting step-by-step instructions from a remote host computer to input and output data to instruments and operator interfaces, or (2) as a pre-programmed controller, using its own pinboard memory, to perform a specific function upon call from the remote host computer. Software drivers—Basic Control System (BCS) Real Time Executive (RTE)—are provided.

The HP 12817A (2019A Opt 052) Parity Generator Interface generates even or odd parity for data that has no parity, as a means to enable a computer interfaced to a 2570A to detect transmission errors. Since some computer systems can only accept data with parity, the parity generator then enables an instrumentation system interfaced to the 2570A to enter data into such computer systems. The parity generator is especially useful for introducing parity into punched tape during data acquisition, since such tapes cannot be edited later.

Specifications

(Most interface cards are supplied with a 48-pin PC connector kit, less cable, to allow the user to make his own device interconnecting cable; the kit is not supplied if one of the optional cables is ordered. The 10-channel scanner card is supplied with a 24-pin connector.)

**Mainframe: 2570A (2019A Opt. 001)
2575A (2019A Opt. 002)**

Input/output code: ASCII (8-bit parallel).
Programming: 15 I/O instructions or ASCII characters may be programmed using diode pins (64 furnished).
Power requirements: 2570A: 115 V ac (2.5 A) or 230 V ac (1.25 A), $\pm 10\%$, 48-440 Hz, 275 W. 2575A: 115 V ac (2.0 A) or 230 V ac (1.0 A), $\pm 10\%$, 48-66 Hz, 175 W.
Operating ambient: 0° to 50°C (32° to 122°F). Relative humidity: to 95% at 40°C (104°F).
Dimensions: 2570A: 10½" (267 mm) in 19" rack, 22" (559 mm) depth behind panel. 2575A: 5¼" (133 mm) in 19" rack, 20" (508 mm) depth behind panel.
Weight: 2570A: net, 42 lbs (19 kg); shipping, 60 lbs (27.2 kg). 2575A: net, 26 lbs (11.8 kg); shipping, 32 lbs (14.5 kg).
Price: (includes power cable and control card). 2570A: \$1875. 2575A: \$1275.

Mainframe options and accessories:

Option 001 (2019A Opt 051) Remote Start/Reset for 2570A
Price: \$300 (with initial order).
Option 001 (2019A Opt 050) Remote Start/Reset for 2575A
Price: \$200 (with initial order).
Field Installed Remote Start/Reset for 2575A: order HP 12818A (2019A Opt 053).
Price: \$415 (does not include installation).
Field Installed Remote Start/Reset for 2570A: Serial No. 1135A-00486 and above order HP 12819A (2019A Opt 055); Serial No. 1047A-00485 and lower order HP 12820A (2019A Opt 056).
Price: (does not include installation) HP 12819A (2019A Opt 055): \$415. HP 12820A (2019A Opt 056): \$415.
Program-Board Diode Pins: HP Part No. 5080-1620.
Price: \$2 each.
Diagnostic Control Panel: order HP 12804B (2019A Opt 240).
 Programming and service aid.
Price: \$400.
Option 001 (2019A Opt 241) Diagnostic Control Panel with Remote Start/Reset.
Price: \$600.
I/O Card Extender for 2570A/75A: order HP 12805A (2019A Opt 260).
Price: \$75.
Control Card Extender for 2570A: order HP 12806A (2019A Opt 280).
Price: \$75.
Control Card Extender for 2575A: order HP 12814A (2019A Opt 290).
Price: \$90.

12797A (2019A Opt 100) BCD Input Interface Card

Input capacity: 10 digits (+8421 BCD).
Serial Data Output to 2570A/75A Backplane Bus: up to 15 ASCII characters.
Price: 12797A (2019A Opt 100) BCD Input Interface Card, \$600.
Option 001 (2019A Opt 101) BCD Input Cable: HP Part No. 02547-6040. With Amphenol 57-30500 connector.
Price: \$50.
Option 002 (2019A Opt 102) BCD Input Cable: HP Part No. 02547-6063. With PC connector.
Price: \$50.

Option 003 (2019A Opt 103) BCD Input Cable: HP Part No. 12797-60002. For HP 5323A Counter.
Price: \$50.

12798B (2019A Opt 120) BCD Output Interface Card

Output capacity: 10 digits (+5 V positive true).
Price: 12798B (2019A Opt 120) BCD Output Interface Card, \$550.
Option 001 (2019A Opt 121) BCD Output Cable: HP Part No. 02547-6040. For HP 5050A/B and 562AR Digital Recorders.
Price: \$50.

Option 002 (2019A Opt 122) BCD Output for HP 2759B Frequency Synthesizer Programmer

Price: No charge.
Option 003 (2019A Opt 123) BCD Output Cable: HP Part No. 12798-60002. For HP 3450A/B Multi-Function Meter.
Price: \$50.

Option 004 (2019A Opt 124) BCD Output Cable: HP Part No. 12798-60003. For HP 3482A, 3484A, plug-ins for 3480A/B Digital Voltmeter.

Price: \$50.
Option 005 (2019A Opt 125) BCD Output Cable: HP Part No. 12798-60009. For HP 6130B-J80 and 6131B-J80 Digital Voltage Sources.
Price: \$50.

Option 007 (2019A Opt 127) BCD Output Cable: HP Part No. 12798-60005. For HP 5325B Universal Counter.
Price: \$50.

Option 008 (2019A Opt 128) BCD Output Cable: HP Part No. 12798-60006. For HP 5326A/B Counter/Timer/DVM.
Price: \$50.

Option 010 (2019A Opt 130) BCD Output Cable: HP Part No. 02547-6040. For HP 5055A Digital Recorder.
Price: \$50.

Option 011 (2019A Opt 131) BCD Output Cable: HP Part No. 12798-60013. For HP 6936A Multiprogrammer.
Price: \$50.

Option 020 (2019A Opt 139) BCD Output Interface +5 Volts Ground True: HP Part No. 12798-60011.
Price: \$550.

Option 021 (2019A Opt 119) BCD Output Interface +12 Volts Positive True: HP Part No. 12798-60012.
Price: \$550.

12799B (2019A Opt 140) 16-Bit Relay Register Interface Card

Maximum power: 10 W peak or continuous, per contact.
Maximum voltage: 100 V peak or continuous across open contacts, between output connector pins, and with respect to controller ground on the register card.

Maximum current: 500 mA per contact, peak or continuous.
Data output: 16 floating relay contacts, with ratings as specified above.

Price: 12799B (2019A Opt 140) 16-Bit Relay Register Interface Card, \$500.

Option 001 (2019A Opt 141) Relay Register Cable: HP Part No. 12799-60003. For HP 2402 DVM.
Price: \$50.

Option 002 (2019A Opt 142) Relay Register Cable: HP Part No. 12799-60002. For HP 2401C DVM.
Price: \$50.

Option 004 (2019A Opt 143) Relay Register Cable: HP Part No. 12799-60005. For HP 3460B/3462A DVM.
Price: \$100.

Option 005 (2019A Opt 144) Relay Register Cable: HP Part No. 12799-60004. For HP 3440A DVM.
Price: \$100.

Option 007 (2019A Opt 145) Relay Register Cable: HP Part No. 12799-60010. For HP 2801A Quartz Thermometer.
Price: \$100.

12800A (2019A Opt 160) 8-Bit Duplex Register Interface Card**Data:**

Output: high: 12 V \pm 10%, 10K source (jumper selectable) or 5 V \pm 5%, 10K source. Low: 0 to 0.5 V; sink 15 mA to ground.

Input: high: 3.0 V to 50 V. Low: 0 to 1 V; sink 5 mA to ground.

Price: 12800A (2019A Opt 160) 8-Bit Duplex Register Interface Card, \$550.

Option 001 (2019A Opt 161) Duplex Register Cable: HP Part No. 12597-6004. For HP 2748A Punched Tape Reader or HP 2758A Tape Reader Reroller.

Price: \$50.

Option 002 (2019A Opt 162) Duplex Register Cable: HP Part No. 12597-6005. For HP 2753A High-Speed Tape Punch (only).

Price: \$50.

Option 003 (2019A Opt 163) Duplex Register Cable: HP Part No. 12800-60002. Interconnects Duplex Register to HP 2748A (or 2758A) and HP 2753A by means of a Y-shaped cable.

Price: \$75.

Option 004 (2019A Opt 164) Duplex Register Cable: HP Part No. 12800-60003. For HP 2100 Series Computers. (No software drivers supplied.)

Price: \$50.

Option 005 (2019A Opt 165) Duplex Register Cable: (Europe only). For HP 8100A-004 Facit Punch.

Price: \$50.

Option 006 (2019A Opt 166) Duplex Register Cable: (Europe only). Interconnects Duplex Register to HP 2748A and HP 8100A-004.

Price: \$75.

12801A (2019A Opt 180) Teleprinter Interface Kit

Code: eight level, 11 unit ASCII code; 10 characters/second.

Compatibility: interfaces any of the following teleprinters with the 2570A/75A: HP 2752A, HP 2754B, HP 2749A.

Price: 12801A (2019A Opt 180) Teleprinter Interface Card, \$450.

12802A (2019A Opt 200) Calculator Interface

System speed: input: 20 readings/sec. Output: 20 readings/sec.

System programming: in addition to the 15 program steps in the 2570A/75A, the calculator interface includes 15 routines hard-wired on the interface card, plus 4 user-programmable routines.

Compatibility: interfaces with HP 9100 Series Calculators.

Price: HP 12802A (2019A Opt 200) Calculator Interface Card plus interconnecting cable, \$1775.

12803A (2019A Opt 220) Ten-Channel Reed Relay Scanner

Configuration: 10 ea. reed relays, 2 pole, form A. Common output bus, 2 line.

Input connector: 24-pins (2 wires per channel).

Absolute maximum ratings: open circuit switch voltage, absolute maximum (line to line or line to HP 2570A/75A ground): 120 V at 1 W (\pm 60 V mixed polarity). Short circuit switch current, absolute maximum: 75 mA at 2.5 W.

Signal path specifications

Differential thermal offset: $<$ 50 μ V.

Single-line thermal offset: $<$ 100 μ V.

Scanning speed (maximum permissible): (after receipt of scan advance command, scanner interrupts 2570A/75A program control for 2.8 \pm 0.5 ms, including relay switching time): 300 channels/sec.

Price: 12803A (2019A Opt 220) Ten-Channel Reed Relay Scanner, \$600.

Option 001 (2019A Opt 221) Cable: HP Part No. 12803-60003. Interconnects multiple scanner cards. Order one less than the total of scanner cards used.

Price: \$10.

12807A (2019A Opt 300) Pinboard Program Card

System programming: in addition to the 15 program steps in the 2570A/75A, the pinboard program card includes 45 program steps (5 subprograms with 9 steps each).

Program source: subprograms may be called from any ASCII source or program card in 2570A/75A.

Price: 12807A (2019A Opt 300) Pinboard Program Card including 200 diode pins, \$750. (Order additional diode pins under HP Part No. 5080-1620, \$2 each.)

12809B (2019A Opt 320) Time-Sharing Interface

Code: eight level, 11 unit ASCII code; 10 characters/second.

Compatibility: interfaces to the HP 2749A Teleprinter or any EIA compatible teleprinter.

Recommended acoustic coupler: the Anderson-Jacobson ADC 262 Acoustic Coupler, or equivalent, is recommended (EIA port necessary).

Price: HP 12809B (2019A Opt 320) EIA Teleprinter/Acoustic Coupler Interface Card plus interconnecting cables, \$1500.

12811A (2019A Opt 340) Clock/Timer/Pacer Card

Output: time in hr, min, sec in BCD for external display. Days optional.

Interval accuracy: \pm 0.1, $-$ 0 sec in second mode (50/60 Hz) \pm 0.1, $-$ 0 msec in millisecond mode (100 kHz crystal).

Timing override: coupler/controller reset or remote start will override programmed delays.

Price: HP 12811A (2019A Opt 340) Clock/Timer/Pacer Card, \$1250.

Option 001 (2019A Opt 341) Card with 100 kHz Crystal Oscillator time base.

Price: \$1560.

Option 002 (2019A Opt 342) 100 kHz Crystal Oscillator time base (field conversion of basic card).

Price: \$350.

12770 (2019A Opt 380) Serial Data Interface

Transmission mode: bit serial, asynchronous.

Error control: by parity checking. Correction is by retransmission.

Transfer rate: from 1,100 words/sec to 24,400 words/sec depending on line length.

12770A (2019A Opt 380) Interface Kit: includes both a 12813-60001 Coupler/Controller plug-in card and a 12665-60001 computer plug-in card, plus 12-foot interconnecting cables, and software drivers and diagnostics.

Option 003 (2019A Opt 381) 250-Foot Communications Cable with loose connectors.

Option 004 (2019A Opt 382) 250-Foot Communications Cable with assembled connectors.

Option 005 (2019A Opt 383) 500-Foot Communications Cable with loose connectors.

Option 006 (2019A Opt 384) 500-Foot Communications Cable with assembled connectors.

Option 007 (2019A Opt 385) 1000-Foot Communications Cable with loose connectors.

Option 008 (2019A Opt 386) 1000-Foot Communications Cable with assembled connectors.

12817A (2019A Opt 052) Parity Generator Interface Card

Inputs (from backplane): ASCII bits 1 through 7. Logic 1 = 0 (\pm 0.4) volt. Logic 0 = +3.4 (\pm 1.6) volts.

Output (to backplane): ASCII bit 8 (parity bit). Logic 1 = 0 (\pm 0.4) volt. Logic 0 = +3.4 (\pm 1.6) volts.

Price: HP 12817A (2019A Opt 052) Parity Generator Interface Card, \$150.

FREQUENCY AND TIME MEASURING INSTRUMENTATION



ELECTRONIC COUNTERS

Electronic counters have proven to be the most accurate, flexible, and convenient instruments available for making both frequency and time interval measurements. Since the introduction of the first high-speed counter (the 10 MHz HP Model 524A) more than 19 years ago, Hewlett-Packard has developed a broad range of counters to permit selecting the proper instrument for virtually any application.

Conventional counters

Data on these pages cover the basic concepts of the conventional frequency counter including operation, accuracy, input considerations and extended frequency response. The basics of measuring time interval are then considered and finally a new concept in frequency measurement, as provided by the Computing Counter System, is discussed. This general introduction is concluded with a counter selection chart introducing the broad range of electronic counters available from Hewlett-Packard.

Frequency measurements and the basic counter elements

The frequency of a continuous wave signal is the number of events or cycles that occur per unit time (one second). Most counters measure frequency by totalizing the number of cycles or events of the input signal for a precisely known period of time.

The basic elements of conventional counters (which excludes counters that use computation as part of their measuring process—e.g. HP 5360A Computing Counter) are: (1) the decade counting assemblies (DCA's) with numerical readouts to display the count; (2) the main gate, which controls the time over which the input signal is totalized; (3)

the time base, which supplies a reference of time for the main gate; (4) decade divider assemblies (DDA's) which divide the time base output to the desired increment of time for which the main gate will be open and (5) an input amplifier-Schmitt trigger to shape the input signal for the DCA's. The counter also contains logic control which interconnects the proper circuits for the desired measurement, selects the appropriate measurement units for display and initiates the measurement cycle.

Figure (1) shows the conventional counter for frequency measurement. The number of pulses derived from the input that are totalized during the "gate open" interval is a measure of the average input frequency for that interval. The count obtained is displayed and retained until a new sample is ready to be shown. The Sample Rate control determines the time between samples, resets the counter and initiates the next measurement cycle.

The time base selector switch selects the gating interval, positions the decimal point and selects the appropriate measurement units (e.g. Hz, kHz, MHz).

Period measurements

Period is the inverse of frequency ($P = 1/f$). Therefore, period measurements are made with the input and time base connections reversed. The unknown input signal controls the main gate time, and the time base frequency is counted in the DCA's. The input shaping circuit selects the zero axis crossing of successive cycles of the unknown as trigger points for opening and closing the gate.

Low frequencies may be determined more accurately by measuring period rather than frequency directly. This is true because the longer period of a low frequency allows more counts to accumu-

late in a period measurement; therefore, resolution and accuracy are both improved. For example, a frequency measurement of 100 Hz on the 8-digit 5248L Counter with a 10-second gate time will display as 0000.1000 kHz. A period measurement of 100 Hz on an HP 5248L with 100 MHz as the counted frequency, would display as 010000.00 μ s. Thus, resolution is increased by a factor of 10^3 and measurement time decreased by 100.

Multiple period averaging

Multiple period averaging reduces error and improves resolution in period measurements.

The number of periods of the unknown to be averaged is selectable. The HP 5326B can average up to 10^5 periods and several other HP counters can average up to 10^6 periods. In the example above, the counter would display 10000.000 μ s for a 10 period average. (The selector switch automatically shifts the decimal point in the display to show the correct reading for a single period.)

Totalizing

In the totalizing mode the main gate flip-flop is controlled remotely or by a manual start-stop switch. With the switch in Start (gate open), the decimal counter assemblies totalize input pulses until the main gate is closed. The counter display then represents the input pulses received during the interval between Start and Stop.

Ratio measurements

The ratio of two frequencies is determined by using the one signal for the gate control while the other signal is counted. With proper transducers, ratio measurements may be applied to any phenomenon which may be represented by pulses or sine waves. Gear ratios and clutch slippage as well as frequency divider or multiplier operation, are some of the measurements which can be made using this technique.

Accuracy is improved by the multiple period averaging technique by counting for 10^5 cycles of the gate control signal.

Rate measurements

With a preset counter, frequency measurements can be normalized automatically to rate measurements by appropriate selection of the gate time. The counter will then display a readout in the desired unit of measurement. For example: a gate time of 600 milliseconds causes the input from a 100-pulse-per-revolution

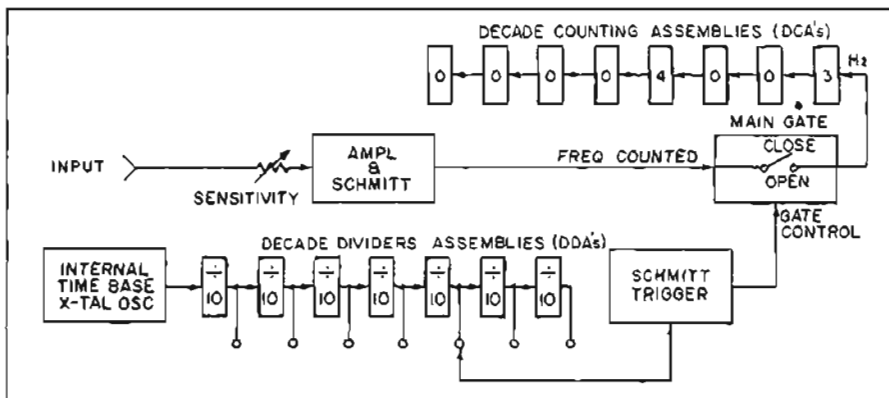

Figure 1. Function switch set to FREQUENCY and gate time selected by time base switch.

tachometer to be displayed directly in revolutions per minute.

Scaling

Several Hewlett-Packard counters can scale (divide) an input by powers of 10 up to 10^9 . The scaled output is available from the rear of the counter.

Measurement accuracy

There are three main sources of error in conventional counters:

± 1 count ambiguity. This is inherent in all conventional counters because input signal and time base are not synchronized, thus causing a one count ambiguity in the events totalized.

For low frequencies, where relatively few events can be totalized over practical gate times, this ambiguity contributes significant error. This is normally overcome by measuring period instead of frequency. The error is still there but can be made insignificant by selecting a high counted frequency and utilizing the period average mode.

Time base stability. Since frequency measurements are accomplished by comparing the unknown to the counter's internal oscillator or time base, any time base error translates directly into a measurement error. Error sources are:

Long term stability: The slow, but predictable, variation in average oscillator frequency with time due to the quartz crystal "aging". Aging is cumulative, so it is necessary to periodically calibrate the oscillator. See Application Note 52, available upon request.

A typical long term stability specification might read as $< 5 \times 10^{-10}/\text{day}$. With no calibration for 20 days, error could be 1×10^{-8} . Thus, with a 1-second gate, the error in 100 MHz measured on an 8-digit counter could be one count ($1 \times 10^{-8} \times 1 \times 10^8 = 1$ Hz).

Short term stability. More properly called "fractional frequency deviation", is a measure of the amount of noise or instability that the oscillator exhibits. (For measuring short term stability, see Application Notes 52 and 116, available upon request.)

Oscillator noise has components at many frequencies, so short term stability varies with measurement time, generally getting smaller the longer the gate time. Thus, a specification without a statement of averaging or measurement time is meaningless. Moreover, averaging times of 10 minutes or one hour are useless since such extreme measurement times are rare.

In general, Hewlett-Packard counters are specified for 1 s averaging times. In addition, however, the oscillators are selected so that their short term stabilities do not affect accuracy no matter what gate time is used.

Line voltage and temperature. Are self-explanatory specifications. The total inaccuracy due to the time base is the sum of long term, short term, line voltage and temperature errors.

Trigger error. Trigger error arises from noise on the gate-control signal that causes the gate to open and close at incorrect times. Since significant trigger error can occur only when an external signal controls the gate, this error occurs in period measurements.

For a 40 dB S/N signal, the trigger error in a period measurement is:

$$\frac{3 \times 10^{-3} \times e_s}{n \times e_{in}}$$

where n = number of periods averaged

e_s = counter sensitivity

e_{in} = input signal magnitude

This indicates that trigger error is only a factor for noisy, low frequency signals where n is small.

For frequency measurements the general accuracy statement is:

$$\pm 1 \text{ count} \pm \text{time base stability} \quad (1)$$

while for period measurements it is:

$$\pm 1 \text{ count} \quad (2) \pm \text{time base stability} \pm \text{trigger error.}$$

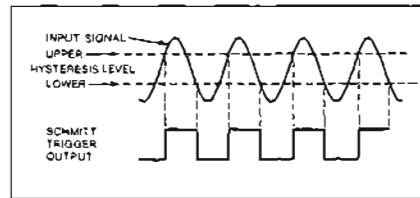

Figure 2. To be counted input signal must cross both hysteresis levels of the input Schmitt Trigger.

Input considerations

A counter's input circuit may be characterized by means of sensitivity, trigger level, ac/dc coupling, and input impedance.

Sensitivity means the minimum countable signal level. The amplifier-Schmitt trigger input circuit determines the sensitivity, since the signal applied to the Schmitt trigger must cross both its upper and lower hysteresis limits to produce an output. See Fig. (2).

The two hysteresis levels are usually located symmetrically about ground to conform to the usual situation of measuring a CW signal with no dc content. DC content is removed in the counter's ac coupling mode. If the input is a pulse train, however, the trigger level control must be used to shift the hysteresis levels out of the preset position to a position either above or below ground. see Fig. (3).

The input impedance of most Hewlett-Packard counters is either 50Ω or $1\text{ M}\Omega$. A $1\text{ M}\Omega$ input is provided for most direct

1. See under time base specifications for short term, long term, temperature and line voltage stability.

2. Refers to the frequency of the counted clock (i.e. the displayed count).

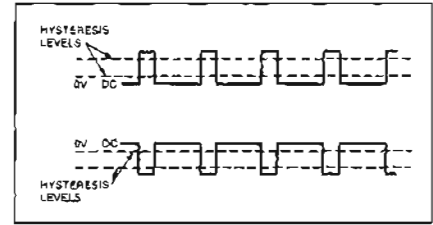

Figure 3. To enable a count on these waveforms the trigger level control must be out of PRESET to shift the hysteresis positive (upper waveform) or negative (lower waveform).

reading counters, since for frequencies up to 250 MHz this is the more versatile, avoiding loading the source connected to the counter. Above 250 MHz, however, the inherent shunt capacity of a $1\text{ M}\Omega$ input is severely limiting; then, a matched 50Ω input impedance is offered. Since most high frequency and microwave devices operate in a 50Ω environment, the prescaler and microwave plug-ins and counters (see below) provide a 50Ω input impedance.

Increasing the frequency range

The direct counting range of the conventional Hewlett-Packard counters described so far range from 10 MHz (5300A) to 150 MHz (5248L, M). Several techniques can increase this range:

Prescaling is accomplished by placing a divider between the Schmitt trigger of Figure (1) and the main gate. If the division factor is N , the gate time is extended by the same factor to ensure a correct readout. Hewlett-Packard manufactures a number of prescalers: the 50 MHz 5302A and 500 MHz 5303A plug-ons to the 5300A, the 350 MHz 5252A and 200 MHz 5258A prescaler plug-ins to the 5245 Series counters, and the 5327 line of counters where a 550 MHz prescaler is built into the mainframe.

Operating a prescaling counter is identical to a direct reading counter. The user is rarely aware that the signal is being prescaled; it just takes somewhat longer to obtain the same resolution as a direct counter.

Heterodyne conversion is the most accurate method of measuring high frequency or microwave signals. In a given measurement time it provides the same resolution of the conventional direct counting frequency counter.

Heterodyne converters simply down convert the unknown frequency f_x by mixing with an accurately known frequency f_a , such that the difference f_d is within the counter's range. See Fig. (4). The frequency f_a is selected by first multiplying the time base to a convenient frequency f_1 , (usually the maximum direct frequency of the counter), and then passing this signal through a harmonic generator. The appropriate harmonic $Nf_1 = f_a$ (N is an integer) is selected

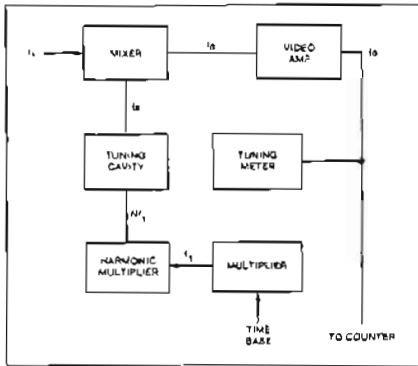

Figure 4. Basic operation of a heterodyne converter.

by the tuning cavity and passed to the mixer. The cavity is operated from a front panel control calibrated to read the frequency f_a directly. The difference frequency $(f_x - f_a) = f_d$ is amplified and measured by the counter. To the counter reading the operator adds the front panel control setting f_a to obtain the final answer f_x . The tuning meter of Figure (4) indicates when the unknown frequency has been located.

While the heterodyne converter is broad band, it is not as broad band as the transfer oscillator (see below). The band limiting culprit is the mechanical tuning cavity. The range from 150 MHz to 18 GHz is covered by Hewlett-Packard with three such heterodyne converters, the 150 MHz-3 GHz 5254C, the 3 GHz-12.4 GHz 5255A and the 8 GHz-18 GHz 5256A. In addition, the 50-500 MHz 5253B gives 500 MHz operation with the 5245L. All these converters are plug-ins to the high performance 5245 Series of counters.

Extremely broad band microwave frequency measurements can be made with the TRANSFER OSCILLATOR. Accuracy, however, cannot equal the heterodyne converter's.

The transfer oscillator principle is based on the property of harmonic mixing, that is; if f_x is the unknown input to a mixer and f_{LO} is the local oscillator, the mixer will produce an output $f_0 = f_x - Nf_{LO}$ where N is an integer. The mixer frequency response determines transfer oscillator frequency range and the extremely fast sampler in the HP 5257A Transfer Oscillator gives broad band measurements from 50 MHz to 18 GHz. The relative measurement accuracy is the same as that of the local oscillator which cannot match the heterodyne converter's crystal derived reference frequency.

The 5257A block diagram is in Figure (5). To operate, the user simply tunes the local oscillator for phase lock at zero beat (i.e. $f_x = Nf_{LO}$) as indicated by a front panel meter. The local oscillator frequency is then measured by the

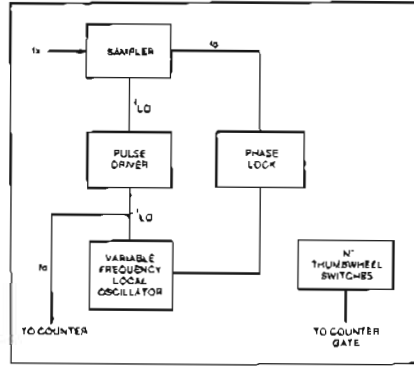

Figure 5. Basic operation of a transfer oscillator.

counter. To obtain a direct reading of the microwave frequency f_x , the 5257A is provided with thumbwheel switches, which extend the gate time of the counter by N . If f_x is completely unknown, so too is N ; however, a simple technique is described in the 5257A Operating Manual for determining N .

By opening the phase lock loop (via front panel switch), the 5257A Transfer Oscillator can also measure fm deviation and the frequency of a pulsed RF signal as described fully in the 5257A Operating Manual.

The 5257A is a plug-in to the 5245 Series of plug-in counters and contributes considerably to the measurement power and versatility of this line of mainframes.

5340A Microwave Frequency Counter is an extension of the manual transfer oscillator described. Just introduced, the 5340A is a state of the art product in every way. It is basically an automatic transfer oscillator that allows completely automatic frequency measurements from dc to 18 GHz via a single input. In addition, it has high sensitivity and a very short acquisition time. Full details on operation will be published in a 1972 issue of the Hewlett-Packard Journal.

Time interval

In addition to the measurement described earlier, the conventional counter lends itself to measuring time intervals. Applications are many and growing and include laser and radar ranging, integrated circuit rise, fall and delay time

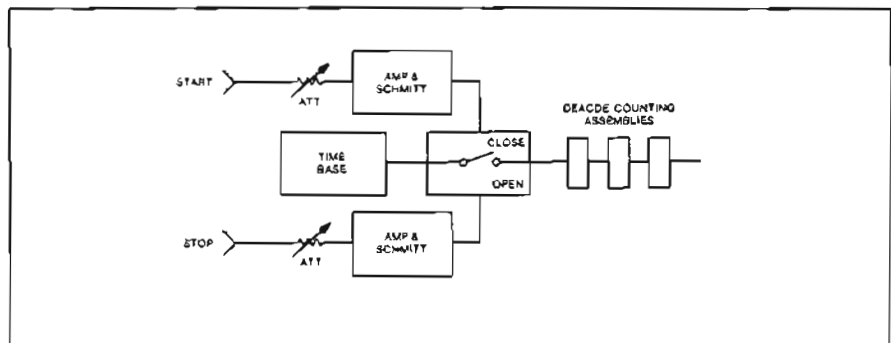

Figure 6. The basic elements of a time interval meter.

and nuclear time of flight measurements, to name but a few.

Hewlett-Packard manufactures a number of counters offering a wide range of time interval capability. Single shot (a single pulse) time interval resolution as good as 1 μ s to 100 ps can be obtained.

The basics of time interval measurements

Figure (6) illustrates the key elements of a time interval meter. The main gate is controlled by two independent inputs, the START input or channel and the STOP channel. When an external signal is applied to the start input, the main gate is opened and the DCA's accumulate clock pulses derived from the internal reference oscillator. When a stop signal occurs, the main gate closes and the accumulated count in the DCA's represents the time between the occurrence of start and stop signals.

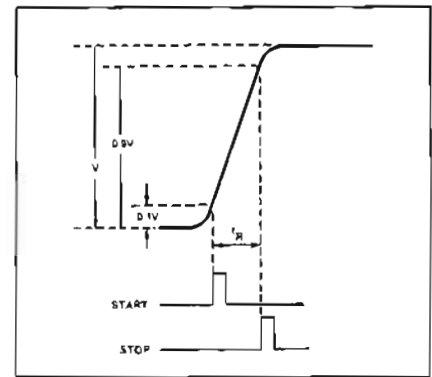

Figure 7. Measuring the rise time t_r by adjusting the trigger levels to the 10% and 90% points of the input amplitude.

The frequency of the counted clock determines measurement resolution, (e.g. a 10 MHz clock provides 100 nsec resolution). Obviously, the input amplifier/trigger and the main gate must operate at speeds consistent with the clock frequency, for otherwise the instrument's resolution would be meaningless. Present state of the art limits resolution to about 10 nsec; however, several Hewlett-Packard counters utilizing special techniques described below offer substantially better resolution than this.

Time interval—A two dimensional problem

The dimensionability of time interval may be described by the simple example in Fig. (7): measuring signal rise time. The time interval meter must generate a start signal at the 10% amplitude point of the input signal and generate a stop signal at the 90% point. Inherent in all time interval measurements therefore are two dimensions, one of amplitude, the other of time.

To take care of the amplitude problem most time interval meters include adjustable trigger level controls for both channels. With the trigger level set at a certain voltage V_1 , the channel produces an output pulse, which is applied to the main gate, when the input level reaches that voltage, V_1 . In addition each channel includes slope controls so that triggering can be obtained on either the positive or negative slope of the input signal.

Thus, the input circuits of a time interval meter must of necessity be more sophisticated than that of a frequency input to take care of the extra dimension added to the problem. The differences may be summarized as:

- (i) two independent input channels, one for start, the other for stop; that may be commoned right at the input so that measurements such as the rise time of a single input signal can be measured.
- (ii) trigger levels on each channel that can be adjusted over a wide amplitude range (dynamic ranges of 30:1 are typical).
- (iii) slope controls for each channel so that triggering can be effected at any point on the input signal within the dynamic range of the input.

Measuring trigger level

In days gone by when resolutions of less than 1 μ sec were all that was required, trigger level determination was satisfactorily accomplished by the oscilloscope intensification scheme. Signals derived from the start and stop channels were routed through the time interval meter to the Z axis modulation of an oscilloscope. With the input signal displayed on the oscilloscope, the points at which triggering occurred were evidenced by intensified dots. With today's resolutions of 10 nsec or better, the inherent delays of this method cause it to be useless.

The best way of determining trigger level is to actually measure the voltage at which the trigger is set. The HP 5360A/5379A, which can measure single shot events to 100 picoseconds, provide two jacks on the front panel of the 5379A from which the voltage settings of the two trigger levels can be monitored. The HP 5326B/5327B Universal Counters go even farther, providing an

internal DVM. The DVM also makes general purpose voltage measurements.

Measurement accuracy

The accuracy statement for time interval usually reads as: ± 1 count \pm trigger error \pm time base stability.

The same comments apply for time base stability in time interval and frequency measurements. Trigger error is rarely a factor since time interval measurements are usually made on relatively fast pulses. The ± 1 count (which refers to the clock frequency) is again the dominant factor.

Not included in the usual accuracy statement, but nevertheless extremely important, is trigger level settability. The importance of this is that errors in poorly set trigger levels can swamp any and all of the factors described above.

Increasing the resolution

Hewlett-Packard pioneered two ways of increasing the resolution of time interval measurement over and above that derived from the basic clock:

1. **Time Interval averaging:** This technique is based on the fact that if the ± 1 count error is truly random it can be reduced by averaging a number of measurements. The words "truly random" are significant. For time interval averaging to work the time interval must (i) be repetitive and (ii) have a repetition frequency which is asynchronous to the instrument's clock.

Under these conditions the resolution of the measurement is:

$$\frac{\pm 1 \text{ count}}{\sqrt{N}}$$

where $N =$ no. of time intervals averaged.

With averaging, resolution of a time interval measurement is limited only by the noise inherent in the instruments. The HP 5326/27 provide a resolution of better than 50 picoseconds utilizing this technique.

This is not the whole story, however, since the averaging described to date suffers one severe limitation; namely, the minimum measurable time interval remains at the period of the clock. This limitation is removed in the HP 5326/27

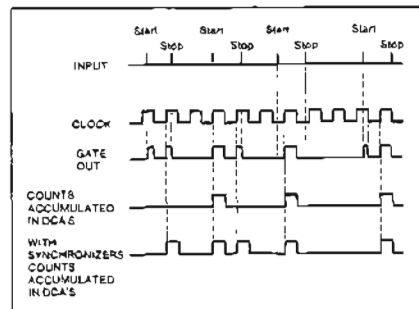

Figure 8. Synchronizer operation with time interval averaging.

Series of counters, by unique circuits known as synchronizers.

The Synchronizers (available only in HP 5326/27 counters at this time) operate as in Figure (8). The top wave-shape shows a repetitive time interval which is asynchronous to the square wave clock. When these signals are applied to the main gate, an output similar to the third waveform results. Note that much of this output results in transitions of shorter duration than the clock pulses. DCA's designed to count at the clock frequency dislike accepting pulses of shorter duration than the clock. The counts accumulated in the DCA's will therefore be those shown in the fourth trace. Since the time interval to be measured is slightly greater than the clock period, the fourth waveshape shows that the averaged answer will be in error, having been biased low because the DCA's require a full clock pulse to be counted.

This problem is alleviated by the synchronizers which are designed to detect leading edges of the clock pulses that occur while the gate is open. The wave-shape applied to the DCA's, when synchronizers are used, is shown by the fifth waveform. The leading edges are detected and reconstructed, such that the pulses applied to the DCA's are of the same duration as the clock.

Synchronizers are a necessary part of time interval averaging; without them the averaged answer is biased to a value less than the true average. In addition, it may easily be seen that with synchronizers involved, time intervals of much less than the period of the clock can be

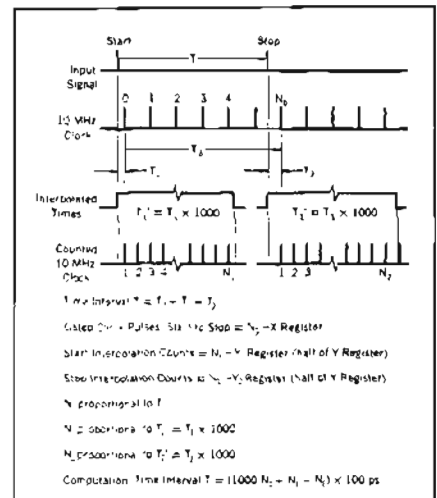

Figure 9. Time intervals measured by 5360A Computing Counter.

measured. The HP 5326/27 Counters utilize this technique to measure time intervals as small as 150 picoseconds when averaged, even though the clock period is 100 nsec.

2. **Interpolation:** In interpolation the inherent ± 1 count ambiguity is measured

and thereby removed. See Figure (9). The time interval T can be written as $T = T_0 + T_1 - T_2$ where T_0 is the time indicated by counting the basic clock frequency and T_1, T_2 are the inherent time ambiguities between the clock and the start and stop pulses respectively.

The start interpolator charges a capacitor for the time T_1 and then discharges it for a duration 1000 times longer. During the discharge time the clock is again counted resulting in N_1 counts. The stop interpolator performs in exactly the same manner, resulting in N_2 counts. Coincidentally, the time T_0 is measured in the conventional manner resulting in N_0 counts. It is easily seen that the time T is represented by the simple formula

$$T = 1000 N_0 + N_1 - N_2$$

The resolution of the measurement has been increased 1000 times by interpolation. The system behaves exactly as if the counted clock were 1000 times faster. There is no limitation on the input, and events which occur only once can readily be measured. Interpolation does require arithmetic capability in the instrument; however, this can be put to good use in many ways. One is that it allows zero time interval (coincidence) to be measured and even negative time interval. Thus, not only magnitude but sign or which event occurred first can be determined.

The HP 5360A Computing Counter System utilizes exactly this scheme. The counted clock is 10 MHz but the instrument behaves exactly as if it were 10 GHz, providing 100 pico second resolution.

Period counting

The measurement of the period of a signal rather than its frequency offers several distinct advantages. Until recently, however, the power of period counting could not be utilized because of one overriding disadvantage; the displayed answer is in terms of the period of the signal rather than its frequency. With the advent of the modern integrated circuit this disadvantage is removed, since it is now practical to compute and display the frequency from the period information contained after the measurement. The HP 5360A Computing Counter is a period measuring instrument, and with its full arithmetic capability all the advantages of period counting become a reality. These advantages are described below.

Accuracy

The frequency content of a sinusoidal signal is contained in just one cycle. In the frequency counting mode, one cycle results in one count. Conversely, with period counting, the number of counts depends solely on how high the fre-

quency of the counted clock is in relation to the input frequency. Therefore, in any given measurement time, period counting has greater resolving power than frequency counting provided the frequency measured is less than the counted clock. The preceding section showed that the HP 5360A has the resolving power equivalent to a 10 GHz clock. Interpolation provides an accuracy five times less than the resolution (2 GHz effective clock) yet this is easily sufficient to make the 5360A the most accurate frequency measuring device available. Moreover, as Figure (10) shows, this accuracy is inde-

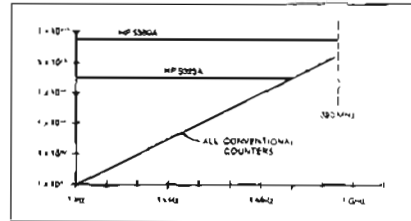

Figure 10. Comparing the measurement accuracy of the HP 5360A Computing Counter to all conventional counters.

pendent of frequency, in contrast to the conventional counter. A one second measurement of a 1 MHz signal, for example, provides an accuracy of 1 Hz with any conventional frequency counter, whereas the HP 5360A accuracy is 0.0005 Hz! The HP 5323A is a low frequency period counting instrument and its accuracy is also summarized on Figure (10).

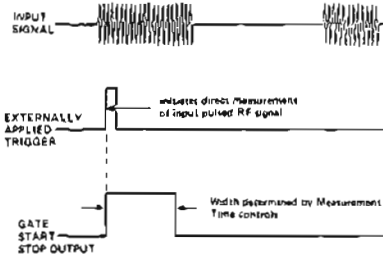

Figure 11. Direct measurement of pulsed RF by external triggering.

Triggered measurements

With period counting, the gate and input signal are synchronous, enabling triggered measurements on pulsed RF signals. See Figure (11). By triggering the HP 5360A on when a burst is present, a direct measurement of the pulsed signal can be made to counter accuracy.

This ability to trigger the beginning of a measurement at any point in real time implies a whole class of signals can now be measured. Using the 5245 Series heterodyne converters, the HP 5360A can measure pulsed RF signals from dc to 18 GHz. The ability to measure at any point in the burst enables the frequency profile of pulse compression, frequency agile and Doppler radar systems to be measured. In addition to these radar oriented signals, frequency shift keyed,

frequency modulated and transient signals can also be measured.

Most conventional counters do not provide this capability; the gate closure is a function of the time base. By presenting the DDA's to 9 (e.g. HP 5326/27), however, the gate can be closed via external control to enable burst measurements to be made. However, the resolving capability of such instruments limit their application in the areas mentioned above.

The computing counter system

The measurement capability of the HP 5360A described above requires of the instrument the arithmetic capability to add, subtract, multiply and divide. This arithmetic capability has been made available to the user via several programming accessories. This allows the user to program the system to solve equations, where measurements are the variables, in real time.

The arithmetic capability of the HP 5360A System makes it a computerized instrumentation system, where the instrument performs the measurements and the resultant raw data is reduced to a final form by the computer. Precision measurement plus computation is the key feature of the HP 5360A System, precise, total solutions to complex problems the resultant benefit. General application areas for the total system include data reduction, statistical analysis and process control. For additional details refer to the counter selection guide.

The table below shows arithmetic operations accessible by external programs and is an indication of the computing power of this unique instrument. Even greater computing power is expected to be available in accessories now under development.

Code	Name	Description	Register	After
14	8	2	2	1
X	Y	Z	Operation*	
0 0 0 0 0 1				X Y Z
0 0 0 0 1 0	MACRO	Call Macro Subprogram		
0 0 0 1 0 1	PLUG-IN	Call Plug-in Subprogram		
0 0 1 0 0 0	√X	Square-Root Subroutine		√
0 0 1 0 1 0	CHECK	Call Check Subprogram		
0 0 1 0 1 1	CAL	Call Calibrate Subprogram		
0 1 0 0 0 1	DISPLAY X	Display contents of X register	A	B C
0 1 0 0 1 0	10 X	Multiply X by 10	A B	C
0 1 0 0 1 1	ADD	Add X to Y	A B	C
0 1 0 1 0 1	SUBTRACT	Subtract X from Y	A B	C
0 1 1 0 0 0	1/X	Reciprocal of X	A	B C
0 1 1 0 0 1	LOAD	Enter New Number	A	B C
0 1 1 0 1 0	DIVIDE	Divide X by Y	A B	C
0 1 1 0 1 1	MULTIPLY	Multiply X by Y	A B	C
1 0 0 0 0 0	X←A	Interchange X and A	S	B C
1 0 0 0 0 1	X←B	Interchange X and B	S	B C
1 0 0 0 1 0	X←Y	Copy A into X and X into Y	S	B C
1 0 0 1 0 0	X X	Add X to X	A	B C
1 0 0 1 0 1	Y←X	Interchange X and Y	B	A C
1 0 0 1 1 0	CLEAR X	Reset X to Zero	0	B C
1 0 0 1 1 1	X←Y	Copy X into Y	B	A C
1 0 1 0 0 0	X←B	Interchange X and B	S	B C
1 0 1 0 0 1	B←X	Copy B into X and X into B	S	B C
1 0 1 0 1 0	X/10	Divide X by 10	A B	C
1 0 1 0 1 1	X←Z	Interchange X and Z	C	A B
1 0 1 1 0 0	CLEAR X Y Z	Reset X, Y and Z to Zero	0	A B C
1 0 1 1 0 1	Z←X	Copy Z into X and X into Z	C	A B

*Contents before operations: X = a, Y = b, Z = c
 *A is a storage register in the mainframe. Contents: S_A
 B is a storage register that can be provided in an external device. Contents: S_B

Counter Selection Guide

Classification	Description	Frequency	Functions*	Time Base	Price	Page
5300 Series Economic Portable	Plug-on versatility-select appropriate plug-on to meet your needs. Battery operation option for use where standard power outlets not available.	to 500 MHz	F, P, MPA, T.I., T. R.	3×10^{-7} /mo	from \$520	218
5326/27 Series Universal Counters	A family of six counters providing universal measurement versatility, includes sub nanosecond time interval measurements via averaging, a built-in integrating DVM and cw or burst frequency measurements.	to 550 MHz	F, P, MPA, T.I., T.I. average, T, R, V	optional up to 5×10^{-10} /day	from \$950	222
5245 Series High Performance Plug-in	A family of 5 mainframes and 12 plug-ins provide unmatched versatility. Plug-ins provide 18 GHz, 10 nsec time interval, voltage and preset capability.	to 150 MHz mainframe, 18 GHz with plug-ins	F, P, MPA, T.I., T, R, V	optional up to 5×10^{-10} /day	from \$2000	213
5340 Microwave Counter	Ultra broadband, high sensitivity microwave frequency counter. 1 Hz to 18 GHz via single input.	18 GHz	F	optional up to 5×10^{-10} /day	\$5300	228
5360 Computing Systems	Precision measurement plus computation. Most accurate frequency measuring device available. Time interval to 100 psec. Provides solutions that formerly required the use of a computerized instrumentation system.	320 MHz; to 18 GHz with 5245 plug-ins	F, P, MPA, T.I. and other functions derived from real time arithmetic capability	5×10^{-10} /day	from \$6500	230
Miscellaneous and Industrial	5210A, B 10 MHz Analog Frequency Meter and FM Discriminator 5323A Automatic High Resolution 20 MHz Frequency Counter 5332B 2 MHz Preset Controller/Counter 5330A/B Programmable Preset Time-Base and Preset Limit Counter				\$ 825 \$1595 \$1300 \$1250	234 234 233 233

*F = Frequency
P = Period
MPA = Multiple Period Average

T.I. = Time Interval
T = Totalize
R = Ratio
V = Voltage

HIGH PERFORMANCE COUNTERS

50 MHz and 150 MHz plug-in counters
5245 series



ELECTRONIC COUNTERS

- highest performance in general purpose counters
- wide selection of plug-ins provide unmatched versatility
- extremely high reliability proven from over forty million hours of field operation

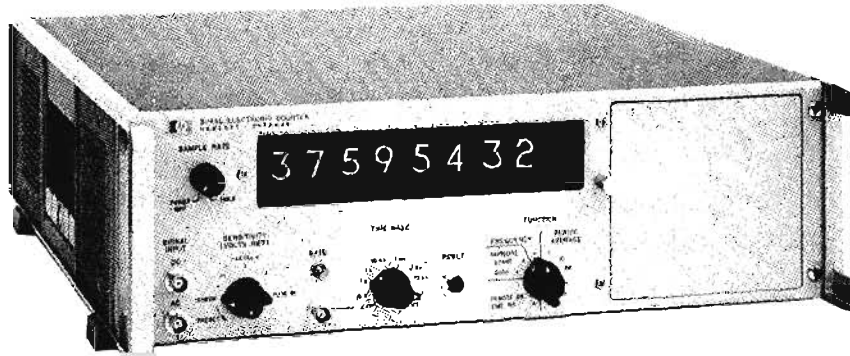

5245L

Hewlett-Packard 5245L plug-in counter the industry standard for high performance counters

The Hewlett-Packard 5245L is representative of the highest performance attainable in a general purpose counter. This instrument, which is the heart of the 5245 series, has become the industry standard . . . for instruments of its type, there are more 5245L counters in operation today than all the rest put together.

The 5245 series consists of a family of mainframes (described on P. 215) and a series of plug-ins (see Pages 216, 217). The plug-ins provide frequency measurement to 18 GHz, high sensitivity, time interval and preset capability. The wide choice of mainframes and plug-ins means that virtually any measurement task performable by counters can be accomplished by appropriate selection within this family.

The following is a description of the 5245L mainframe including salient specifications. The other mainframes in the family are similar to the 5245L and the differences are delineated on Page 215. Brief descriptions of the available plug-ins are given on Pages 216, 217. The reader is referred to the Frequency and Time Measuring Instrumentation tutorial on Page 208 for additional information on plug-in operation, and the 5245 series data sheet for complete details and specifications on all mainframes and plug-ins.

5245L Mainframe

The 5245L mainframe has the capability to measure frequency, period, multiple period average, ratio and multiple ratio. It can also be used to scale or divide a frequency in powers of 10 and to totalize random or periodic events. The basic counter offers a counting rate of 50 MHz with a 8 digit resolution.

Time Base: The internal time base of the 5245L is of sufficient accuracy and stability to serve as a secondary stan-

dard. Even so, a higher quality time base is offered (M type version). Specifications for all 5245 series time bases are given on Page 215.

Basic Operation: For frequency measurements gate times from 1 μ sec to 10 seconds may be selected via the front panel TIME BASE switch. The FUNCTION switch enables period and period average to 10^5 to be performed. This capability makes possible accurate frequency determination at low and intermediate frequencies.

Basic sensitivity is 100 mV rms but for higher level signals the attenuator (SENSITIVITY) can be used. A variable trigger level (LEVEL) is also provided to enable counting of positive or negative going pulses. In counting a sinusoidal signal, the LEVEL switch is put in the PRESET position. The input signal may be ac or dc coupled, the former being used to remove the dc content of a signal, the latter for counting pulses. The SAMPLE RATE control varies the rate at which measurements are taken from 5 per second to infinite in the HOLD position.

A four line binary-coded-decimal (BCD) digital output is provided from the rear of the counter. This can be used to obtain permanent printed records of measurements via digital recorders such as the HP 562A, 5050B, and 5055A. For providing strip chart plots of continuously varying phenomena, the HP 580A, 581A digital-analog converters can be used.

For use in systems, an Option (H65) is provided that allows complete remote control of all front panel controls.

The versatility of the mainframes and plug-ins notwithstanding, a number of options are offered on the mainframes. The reader is referred to the 5245 series data sheet for full descriptions.

Specifications 5245L

Frequency measurements

Range: dc coupled, 0 to 50 MHz; ac coupled, 25 Hz to 50 MHz.

Gate time: 1 μ s to 10 seconds in decade steps.

Accuracy: ± 1 count \pm time base accuracy.

Readout: kHz or MHz with positioned decimal point; units annunciator in line with digital display.

Shelf-check: counts 10 MHz for the gate time chosen.

Period average measurements

Range: Single Period 0 to 1 MHz
Multiple Period 0 to 300 kHz.

Periods averaged: 1 period to 10^5 periods in decade steps.

Accuracy: ± 1 count \pm time base accuracy \pm trigger error.

Readout: s, ms, or μ s, with positioned decimal point; units annunciator in line with digital display.

Self-check: checks operation from 1 period to 10^5 periods.

Ratio measurements

Displays: (f_1/f_2) times period multiplier; multiplier: $1 \cdot 10^5$.

Range: f_1 : 0 to 50 MHz. f_2 : 0 to 1 MHz in single ratio, 0 to 300 kHz in multiple ratio; ratios averaged 1 to 10^5 in decade steps.

Sensitivity: 0.1 V rms, each input (max).

Accuracy: ± 1 count of f_1 , \pm trigger error of f_2 . f_1 is applied to the decimal counters (enters "Ext." jack on front panel); f_2 is applied to decade dividers (enters Signal Input jack).

Readout: dimensionless; decimal point positioned for number of periods averaged.

Self-check: Period Average Shelf-check applies.

Scaling

Frequency range: 0 to 50 MHz.

Factor: by decades up to 10^9 , switch selected on rear panel.

Input: front panel, Signal Input jack.

Output: in place of time base output frequencies.

General

Display: 8 digits in-line; 99,999,999 maximum display.

Display storage: holds reading between samples; rear panel switch overrides storage.

Sample rate: time following a gate closing during which the gate may not be reopened is variable from < 0.2 s to 5 s in Frequency mode, independent of gate time; display can be held indefinitely.

Signal input

Sensitivity: 100 mV rms.

Coupling: ac or dc, separate BNC connectors.

Impedance: 1 M Ω in parallel with approx. 25 pF, all ranges.

Attenuation: step attenuator (SENSITIVITY switch) provides nominal sensitivities of 0.1, 1, and 10 V rms.

Trigger level adjustment: front panel control has ± 0.3 V trigger level range on 0.1 V position, ± 3 V range on 1 V position, ± 30 V range on 10 V position. A PRESET position automatically centers trigger level at 0 V.

Overload protection: diodes protect input circuit for up to 120 V rms (< 500 Hz) on 0.1 V range, 240 V rms on 1 V range, 500 V rms on 10 V range. Input resistance for overload conditions (input amplitude $>$ ten times SENSITIVITY) is 100 k Ω on 0.1 V range, and is approximately 1 M Ω on other ranges.

Pulse measurements: front panel TRIGGER LEVEL adjustment allows counting positive or negative pulses.

External input (selected by front panel Time Base switch):

Maximum sensitivity: 100 mV rms.

Impedance: 1 M Ω , approx. 20 pF, dc coupled.

Overload: diodes protect input circuit up to 120 V rms (< 500 Hz).

Digital output: 4-line BCD 4-2-2-1, "1" state positive; includes decimal point and measurement unit. "0" STATE LEVEL: -8 V. "1" STATE LEVEL: $+18$ V.

Impedance: 100 k Ω , each line.

BCD reference levels: approximately $+9.5$ V, 350 Ω source; approximately -1 V, 100 Ω source.

Print command: $+13$ V to 0 V step; dc coupled.

Hold-off requirement: $+15$ V min., $+25$ V max. from chassis group (1000 Ω source).

Cable connector: Amphenol 50-pin 57-30500-375, HP Part No. 1251-0086, 1 required.

Operating temperature range: -20°C to $+65^\circ\text{C}$.

Power supply: 115 or 230 volts $\pm 10\%$, 50 to 60 Hz; 95 watts.

Weight: net, 32 lbs (14,4 kg) with blank plug-in panel; shipping, 40 lbs (18,2 kg).

Connectors: BNC (except remote program and BCD out).

Accessories furnished: 10503A Cable, 4 ft (120 cm) long, male BNC connectors. Detachable power cord $7\frac{1}{2}$ ft (200 cm) long, NEMA plug. Circuit Board Extender, rack mount conversion parts.

Dimensions: $5\frac{1}{4}$ " high, $16\frac{3}{4}$ " side, $16\frac{3}{8}$ " deep (133 x 425 x 416 mm).



5245L/M

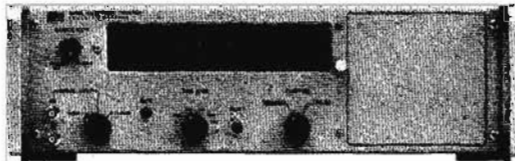

5246L

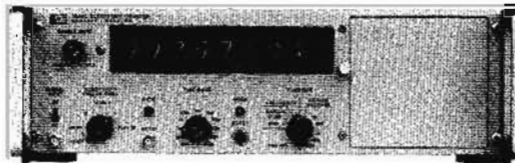

5248L/M

Frequency range: dc to 50 MHz.

Mainframe measurement functions: frequency, period, period average, ratio, scaling.

Compatible plug-ins: all, see pages 216-217.

L and M versions: differ only in time base specification. See below. General specifications are on page 214.

Frequency range: dc to 50 MHz.

Mainframe measurement functions: frequency only.

Compatible plug-ins: all except 5264A, see pages 216-217.

Display: 6 digits, optionally expandable to 8.

Price: \$2000.

Frequency range: dc to 150 MHz.

Mainframe measurement functions: frequency, period, period average, ratio, scaling.

Compatible plug-ins: all, see pages 216-217.

Price: 5248L, \$3050; 5248M, \$3775.

L & M versions differ only in time base specification, see below. Other than frequency range, specifications are essentially same as Model 5245L/M.

Time Base Specifications, 5245 Series

5245L, 5248L

Crystal frequency: 1 MHz.

Stability

Aging rate: < 3 parts in 10^9 per 24 hours after 72 hours.

Short term: < 2 parts in 10^{10} rms with measurement averaging time of one second under constant environmental and line voltage conditions.

Temperature: < 2 parts in 10^{10} per $^{\circ}\text{C}$ from -20°C to $+55^{\circ}\text{C}$.

Line voltage: $< \pm 5$ parts in 10^{10} for 10% change in line voltage from 115 V or 230 V rms.

Adjustment: fine frequency adjustment (range approximately 4×10^{-6}) and medium frequency adjustment (range approximately 1×10^{-6}) are available from the front panel through the plug-in hole. Coarse frequency adjustment (range approximately 1×10^{-4}) is available at the rear of the instrument.

Output frequencies

At rear panel: 0.1 Hz to 10 MHz in decade steps, selected by rear panel switch. Output is: 5 volts p-p rectangular wave with 1000 Ω source impedance.

At front panel: 0.1 Hz to 1 MHz in decade steps; available at "Ext." jack, selected by Time Base switch; stability same as internal time base; 1 V peak-to-peak.

External standard frequency: 1 MHz, 1 V rms into 1000 Ω . Can be substituted for internal time base via rear panel EXT. STD. FREQ. connector.

5246L

Frequency: 1 MHz.

Stability

Aging rate: $< 2 \times 10^{-7}$ /month.

Temperature: $< 2 \times 10^{-6}$ ($+10^{\circ}\text{C}$ to $+50^{\circ}\text{C}$).

Line voltage: $< 1 \times 10^{-7}$ 115 V, 230 V $\pm 10\%$.

Output frequency: 1 MHz. > 3 V p-p into 1 k Ω .

External input: 1 V rms into 500 Ω .

5245M, 5248M

Crystal frequency: 5 MHz

Stability

Aging rate: < 5 parts in 10^{10} per 24 hours after warm-up.

Short term (rms fractional frequency deviation): better than 5 parts in 10^{11} for 1 second averaging time.

Temperature: < 5 parts in $10^{11}/^{\circ}\text{C}$ from 0°C to 50°C (< 2.5 parts in 10^9 within the entire span of 0°C to 50°C).

Line voltage: $< \pm 1$ part in 10^{10} for 10% change in line voltage from 115 V or 230 V rms.

Load stability: typically $< \pm 2$ parts in 10^{11} for any of the following loads: open, short, 50 Ω resistive, 50 Ω inductive, 50 Ω capacitive.

Warm-up: for "off" periods up to approximately 24 hours: 1 hour typical to reach 5 parts in 10^9 of the frequency that existed when turned off. The 5 MHz crystal oscillator operates whenever the power cord is connected.

Adjustment: fine frequency adjustment, range approx. 5×10^{-8} , 16-turn control accessible through plug-in accessory compartment in front panel. Coarse frequency adjustment, range approx. 1×10^{-4} , 20-turn control at rear panel.

Output frequencies

At rear panel: 5 MHz sine wave, 1 V rms into 50 Ω . Available at all times whenever power line cord is energized, whether front panel power switch is ON or OFF.

At rear panel: 0.1 Hz to 10 MHz in decade steps; switch selected on rear panel; 5 V p-p rectangular wave with 1000 Ω source impedance at 1 MHz and lower; 1 V rms sine wave with 1000 Ω source impedance only at 10 MHz.

At front panel: 0.1 Hz to 1 MHz in decade steps; available at "Ext." jack selected by Time Base switch; stability same as internal time base; 1 V peak-to-peak.

External standard frequency: 5 or 10 MHz, 1 V rms, into 1000 Ω . Can be substituted for internal time base via rear panel EXT. STD. FREQ. connector.



PLUG-IN ACCESSORIES

Increase 5245 Series Counter versatility

Models 5253B, 5254C, 5255A, 5256A, 5257A, 5265A

5253B



5253B HETERODYNE CONVERTER

Frequency range: 50 MHz to 512 MHz.

Sensitivity: -13 dBm to +13 dBm.

Input impedance: 50Ω.

Price: \$650.

5254C

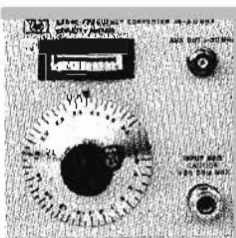

5254C HETERODYNE CONVERTER

Frequency range: 150 MHz to 3 GHz.

Sensitivity: -13 dBm to +13 dBm.

Input impedance: 50Ω.

Auxiliary output: 1 MHz—50 MHz.

Price: \$900.

5255A

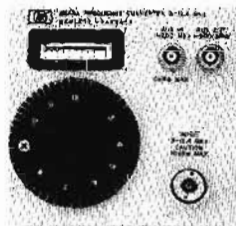

5255A HETERODYNE CONVERTER

Frequency range: 3 GHz to 12.4 GHz.

Sensitivity: -7 dBm to +10 dBm.

Input impedance: 50Ω.

Auxiliary input: 1 MHz—200 MHz at 5 mV sensitivity.

Auxiliary output: 1 MHz—200 MHz.

Price: \$2150.

5256A



5256A HETERODYNE CONVERTER

Sensitivity: -7 dBm to +10 dBm.

Input impedance: 50Ω.

Auxiliary input: 1 MHz—200 MHz at 5 mV sensitivity.

Auxiliary output: 1 MHz—200 MHz.

Price: \$2250.

5257A

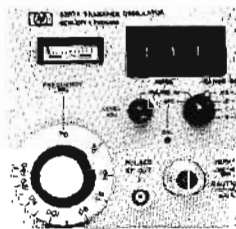

5257A TRANSFER OSCILLATOR

Frequency range: 50 MHz to 18 GHz.

Input signal: CW, pulsed RF or FM modulated.

Sensitivity: -7 dBm, 50 MHz to 15 GHz; -4 dBm, 15 GHz to 18 GHz.

Input impedance: 50Ω.

APC lock range: $\pm 0.2\%$ approx. of input frequency.

VFO stability: typically 1×10^{-7} per minute after 2 hours.

Price: \$2400.

5265A

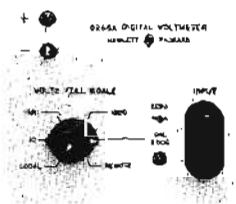

5265A DIGITAL VOLTMETER

Voltage ranges: 10 V, 100 V and 1000 V full scale.

Resolution: 100 μ V.

Accuracy: $\pm 0.1\%$ of reading, $\pm 0.01\%$ of full scale for readings $< 1/10$ of full scale.

Sample rate: 5 per second.

Input resistance: 10.2 MΩ on all ranges.

Noise rejection: 30 dB at 60 Hz, increasing at 12 dB per octave.

Price: \$800.

PLUG-IN ACCESSORIES

Increase 5245 Series Counter versatility
Models 5267A, 5262A, 5261A, 5258A, 5252A, 5264A



ELECTRONIC COUNTERS

5267A TIME INTERVAL UNIT

Range: 100 nsec to 10^8 sec with 5248L/M; 1 μ sec to 10^8 sec with 5245L/M; 1 μ sec to 10^6 sec with 5246L.

Resolution: 10 nsec with 5248L/M only; 0.1 μ sec otherwise.

Input sensitivity: 100 mV rms.

Input repetition rate: 5 MHz, max.

Input impedance: 1 M Ω /35 pF.

Markers: start, stop pulses available at rear of counter.

Price: \$475.

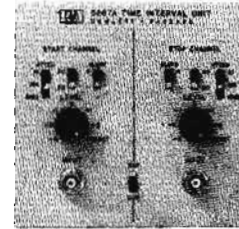

5267A

5262A TIME INTERVAL UNIT

Range: 1 μ sec to 10^8 sec (to 10^6 sec with 5246L).

Resolution: 0.1 μ sec.

Input sensitivity: 100 mV RMS.

Input repetition rate: better than 2 MHz.

Input impedance: from 10K/10 pF at x0.1 multiplier setting to 10 M Ω /20 pF at x100 setting.

Markers: start, stop pulses available at rear of counter.

Price: \$350.

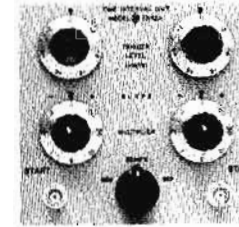

5262A

5261A VIDEO AMPLIFIER

Bandwidth: 10 Hz to 50 MHz.

Input sensitivity: 1 mV.

Input impedance: 1 M Ω /15 pF.

Auxiliary output: 40 dB gain max into 50 Ω . 300 mV rms max output undistorted into 50 Ω . Source impedance 50 Ω .

Price: \$500.

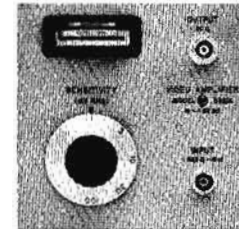

5261A

5258A SENSITIVE PRESCALER

Bandwidth: 1 MHz to 200 MHz.

Input sensitivity: 1 mV, 10 mV, 200 mV rms.

Input impedance: 50 Ω .

Scaling factor: 4.

Video amp output: 30 dB gain max at 1 mV sensitivity setting.

Price: \$1000.

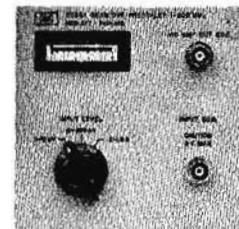

5258A

5252A PRESCALER

Bandwidth: dc to 350 MHz.

Input sensitivity: 100 mV rms.

Input impedance: 50 Ω .

Scaling factor: 2, 4 and 8.

Price: \$885.



5252A

5264A PRESET UNIT

Performs following basic functions:

- (i) $N \times$ frequency
 $N \times$ period
 $N \times$ ratio } measurements are made by mainframe
- (ii) Counts N events where input is applied to AUX INPUT of 5264A
- (iii) Divides a frequency input applied to AUX INPUT by N .

Divided output available at f/N OUTPUT

Frequency range aux Input: 20 Hz to 100 kHz.

N range: 1 to 99,999 in integral steps.

Price: \$825.

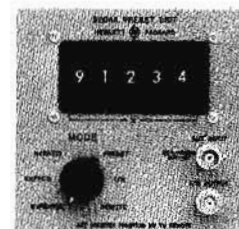

5264A



SNAP-TOGETHER COUNTER

Low cost portable counters to 500 MHz
Model 5300A Measuring System



Snap-together Modular Counter for Versatility and Non Obsolescence

5300A Plug-On Family

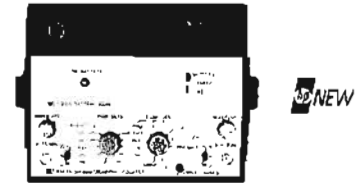

(with 5210A Battery Pack)



5301A



5302A



5303A



5304A

5300A Measuring System

With the 5300A Measuring System, low cost counters reach new performance and versatility levels.

Features

- 10 MHz, 50 MHz, or 500 MHz frequency range
- 100 ns time interval resolution
- Autoranging
- Unique time interval holdoff
- Expandable through interchangeable modules
- High accuracy
- Battery operation
- Compact and rugged
- High reliability MOS/LSI circuitry and LED display
- Designed for quick easy servicing
- BCD output

Large scale integration and solid state display technology have produced a uniquely versatile and capable counter at a surprisingly low cost. Quick and easy to use, this counter does what is important—solves your measurement problems while saving you money. Versatility comes from modular construction—take the counter mainframe and select the snap-on-module that you need now; expand the capability later with more modules if and when you need them. Hewlett-Packard is engaged in an ongoing program to develop new modules to expand the capability of the 5300A into other functional areas. An optional battery pack provides portable cord-free operation, eliminating power problems and ground loops. This is versatility that truly avoids obsolescence and optimizes your instrument dollars.

Unique benefits

The 5300A offers you a portable precision frequency counter which will measure frequencies to 500 MHz and time intervals with 100 ns resolution. The 5300A also has autoranging. Autoranging enhances ease of operation by automatically selecting the correct gate time to fill the display. Any frequency within range of the 5301A, 5302A, or 5304A may be applied and the counter will select the correct gate time up to 1 sec for maximum resolution without exceeding the display range. On the 5302A and 5304A, autoranging is also provided for the Period Average function to select the number of periods to be averaged.

A unique feature of the 5304A Timer/Counter module is the time interval holdoff. The time interval holdoff feature has been added so that a fixed delay may be added between the start of the measurement and the enabling of the stop channel. Thus electrical pulses which occur between the events that are to be measured can be ignored; e.g., a relay closure time may be measured using the time interval holdoff to prevent false triggering on the relay bounce. The delay itself can be digitally measured by the 5304A (see 5304A specifications).

The 5300A has been designed for easy servicing and minimum down time. The small number of components in the 5300A allows problems to be easily traced to a functional block. Troubleshooting is also simplified by the modular construction. The 5300A may be controlled through the connector which ties it to the modules, and a diagnostic routine will isolate problems for easy servicing. A service support package is available for this purpose (see accessories).

Features like these make the net cost of owning a 5300A Measurement System less than that of conventional counters.

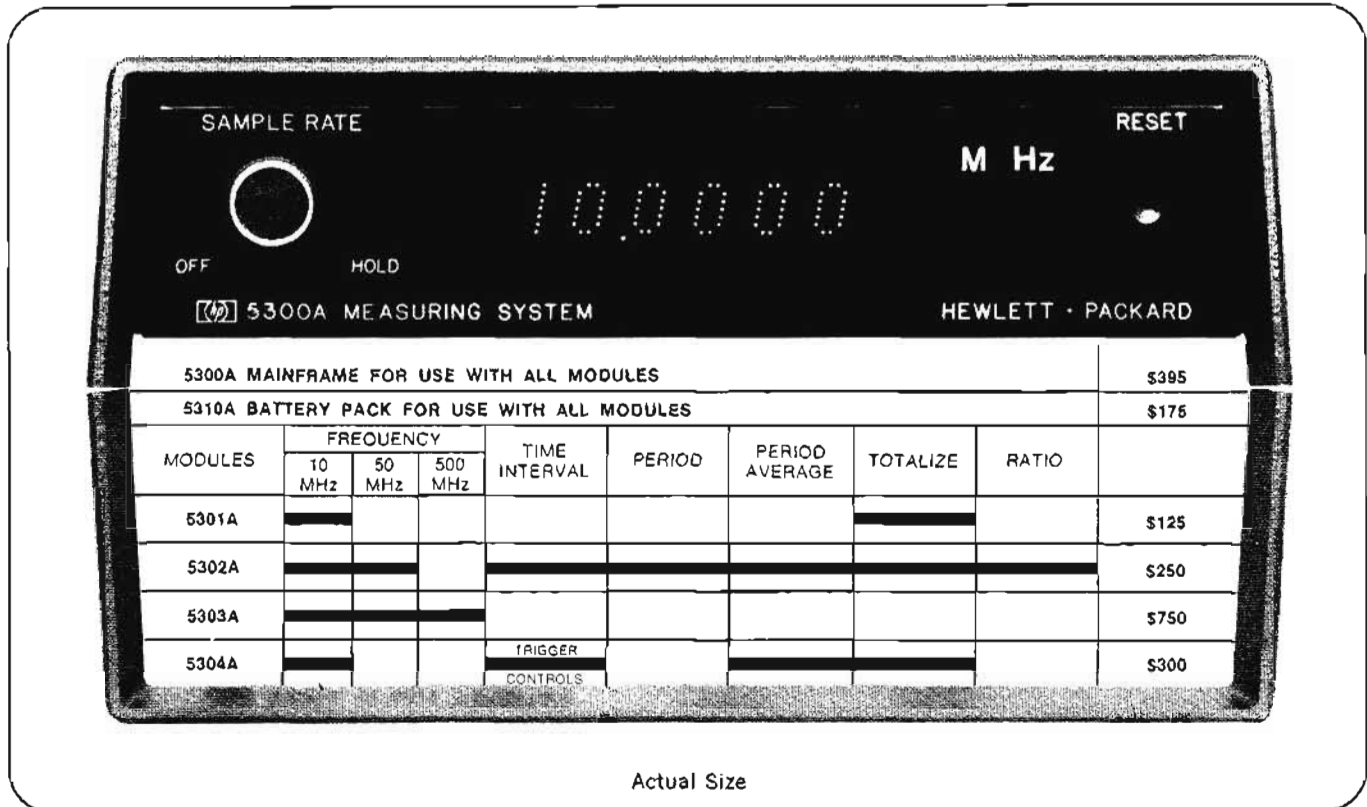

Actual Size

5300A Measurement System Mainframe Specifications

Mainframe unit provides system with power, reference frequency, display, counting logic and timing control.

Time base

Crystal frequency: 10 MHz.

Stability

Aging rate: < 3 parts in 10^7 /mo.

Temperature: < ± 5 parts in 10^6 , 0° to 50°C .

Typically: < ± 2 parts in 10^6 , 15° to 40°C .

Line voltage: < ± 1 part in 10^5 for 10% line variation.

Oscillator output: 10 MHz, approximately 1 V rms at rear panel BNC, 100 Ω source impedance.

External input: 1 MHz to 10 MHz, 1 V rms into 200 Ω .

General

Display: 6-digit solid state LED display (gallium arsenide phosphide light-emitting diodes) including decimal point and annunciator units. **OVERFLOW:** LED light indicates when display range is exceeded.

Display storage: holds reading between samples.

Sample rate: sample rate control adjusts the delay from the end of one measurement to the start of a new measurement. Variable from 50 ms to 5 seconds. **HOLD** position: display can be held indefinitely. **HOLD** input on rear panel connector also provides sample rate control or hold by contact closure to ground or TTL type low level.

Reset: front panel pushbutton switch resets all registers and initiates new measurement. Reset input by contact closure to ground or TTL type low level also available on rear panel connector.

Operating temperature: 0° to 50°C .

Power requirements: 115 or 230 volts $\pm 10\%$, 50 to 400 Hz, 25 VA maximum (depends on snap-on module). Mainframe power nominally 5 watts.

Battery operation: with 5310A rechargeable battery pack (see 5310A specifications).

Digital output: digital serial, 4-bit BCD parallel available at rear panel connector:

Code: 4-line 1-2-4-8 BCD, "1" state low, TTL type logic levels.

Decimal point: decimal point code (Binary "1111") automatically inserted at correct digit position.

Print command: positive step, TTL output.

Holdoff: contact closure to ground or TTL low level, inhibits start of new measurement cycle.

Connector: 20-pin PC connector. Mating connector Viking 2VH10/1JN or equivalent.

Parallel data output: available with printer interface, see 10533A specifications.

Weight: net, $5\frac{1}{2}$ lbs (1.5 kg); shipping, $5\frac{1}{2}$ lbs (2.5 kg).

Accessories available

Digital recorder interface: see 10533A specifications.

Service support package: contains an interface card and 4 diagnostic cards for easy troubleshooting of the 5300A, accessory 10548A. Price: \$90.

Rack mount kit: a rack mount is available, part number: 10573A single, 10574A double. Price: \$35.

Leather carrying case: holds 5300A, snap-on module, and the 5310A battery pack. Accessory 18019A. Price: \$25.

Dimensions (with snap-on module): height, $3\frac{1}{2}$ " (89 mm), width, $6\frac{1}{4}$ " (160 mm), depth, $9\frac{3}{4}$ " (248 mm).

Price: \$395.

Specifications, 10533A Recorder Interface

The 10533A accessory provides an interface between the 5300A measurement system mainframe and a standard parallel-input recorder such as the HP 5055A. The interface module provides conversion from the 5300A serial data output to a standard parallel format.

Output format: 10 parallel digits: 6 data, 1 decimal point, 1 overflow, 1 exponent and 1 exponent sign.

Code: 4-line 1-2-4-8 BCD, "1" state low, TTL levels.

Decimal point: floating decimal point automatically inserted at correct digit position. Coded "1111" ("*" on standard HP 5055A print wheels). Internal jumper wire removes decimal point from data format if desired.

Overflow: coded "1111" ("*") printed in first printer column when 5300A overflow light is on.

Exponent: ± 0 , ± 3 , ± 6 corresponding with 5300A measurement units.

Print command: negative step, TTL levels.

Inhibit input: +2.0 V or higher prevents the 5300A from recycling.

Power requirements: 100 mA at 5 volts, provided by 5300A mainframe.

Price: \$150.

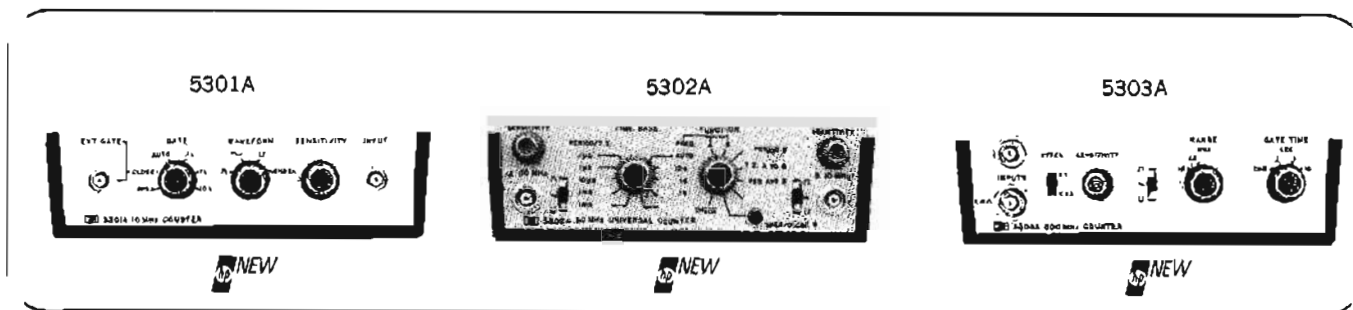

5301A 10 MHz Frequency Counter Module

Input channel

Range: 10 Hz to 10 MHz.

Sensitivity (min): 25 mV rms sine wave 50 Hz to 1 MHz. 50 mV rms sine wave 10 Hz to 10 MHz; 150 mV p-p pulse at minimum pulse width, 50 ns. Sensitivity variable to 2.5 V rms.

Impedance: 1 M Ω shunted by less than 30 pF.

Overload protection: 500 V (dc + peak ac). 250 V rms, dc to 400 Hz. 10 V rms at 10 MHz.

Trigger level: selectable positive, negative, or zero volts.

Frequency measurement

Range: 10 Hz to 10 MHz.

Gate times: manually selected 0.1, 1, or 10 seconds. AUTO position selects gate time to 1 second for maximum resolution.

Accuracy: ± 1 count \pm time base accuracy.

Open/close (totalizing)

Range: 10 MHz max.

External gate: gate signal by contact closure to ground or TTL low.

General

Check: counts internal 10 MHz reference frequency.

Operating temperature: 0° to 50°C.

Power requirements: including 5300A mainframe, nominally 8 watts.

Weight: net, 2 lbs (0.9 kg); shipping, 3¼ lbs (1.5 kg).

Dimensions: see 53004 Mainframe.

Price: \$125.

5302A 50 MHz Universal Counter Module

Input channels A and B

Range: channel A: 10 Hz to 50 MHz; channel B: 10 Hz to 10 MHz.

Sensitivity (min): 25 mV rms sine wave 50 Hz to 1 MHz. 50 mV rms sine wave 10 Hz to 10 MHz. 100 mV rms sine wave at 50 MHz. 150 mV p-p pulse at minimum pulse width, 50 ns. Sensitivity variable to 2.5 V rms.

Impedance: 1 M Ω shunted by less than 30 pF.

Overload protection: 500 V (dc + peak ac). 250 V rms, dc to 400 Hz. 10 V rms above 10 MHz.

Trigger level: selectable positive, negative, or zero volts.

Slope: automatically switched to trigger on positive slope for positive pulse and negative slope for negative pulse. Positive slope for sinusoidal inputs.

Marker outputs: rear panel BNC, TTL low level while gate is open.

Frequency

Range: channel A: 10 Hz to 50 MHz, prescaled by 10; channel B: 10 Hz to 10 MHz.

Gate times: manually selected 0.1, 1, or 10 seconds. AUTO position selects gate time to 1 second for maximum resolution.

Accuracy: ± 1 count \pm time base accuracy.

Time Interval

Range: 500 nsec to 1000 seconds.

Input: channels A and B.

Resolution: 100 ns to 1 ms in decade steps.

Accuracy: ± 1 count \pm time base accuracy \pm trigger error.*

Period

Range: 10 Hz to 1 MHz.

Input: channel B.

Resolution: 100 ns to 1 ms in decade steps.

Accuracy: ± 1 count \pm time base accuracy \pm trigger error.**

Period average

Range: 10 Hz to 1 MHz.

Input: channel B.

Periods averaged: 1 to 10³ automatically selected.

Frequency counted: 10 MHz.

Accuracy: ± 1 count \pm time base accuracy \pm trigger error.**

Ratio

Display: F_B/F_A times multiplier (N). N=10 to 10⁷, selectable in decade steps.

Range: channel A: 10 Hz to 1 MHz. Channel B: 10 Hz to 10 MHz.

Accuracy: ± 1 count of F_B \pm trigger error or F_A.*

Open/close (totalizing)

Range: 10 MHz max.

Function: opening and closing of gate initiated by front panel push-button switch.

General

Check: counts internal 10 MHz reference frequency.

Operating temperature: 0° to 50°C.

Power requirements: including 5300A mainframe, nominally 10 watts.

Weight: net, 2 lbs (0.9 kg); shipping, 3¼ lbs (1.5 kg).

Dimensions: see 5300A Mainframe.

Price: \$250.

5303A 500 MHz Frequency Counter Module

Range: dc to 500 MHz, prescaled by 100; dc to 50 MHz, prescaled by 10.

Sensitivity (min): 100 mV rms sine wave.

Impedance: 50 Ω .

Overload protection: 5 V rms.

Input channel B

Range: 10 Hz to 50 MHz, prescaled by 10; 10 Hz to 10 MHz, direct.

Sensitivity (min): 50 mV rms sine wave 20 Hz to 10 MHz. 100 mV rms sine wave 10 Hz to 50 MHz. 150 mV p-p pulse at minimum pulse width, 20 ns (70 ns on 10 MHz range). Sensitivity variable to 2.5 V x attenuator setting.

Attenuator: X1 or X25.

Impedance: 1M Ω shunted by less than 40 pF.

Overload protection: 250 V rms 10 Hz to 10 kHz. 10 V rms above 10 MHz.

Trigger level: selectable positive, negative, or zero volts.

Frequency measurement

Gate times: 0.1, 1, or 10 seconds.

Accuracy: ± 1 digit \pm time base accuracy.

General

Check: counts internal 10 MHz reference frequency.

Operating temperature: 0° to 50°C.

Power requirements: including 5300A mainframe, nominally 10 watts.

Weight: net, 2 lbs (0.9 kg); shipping, 3¼ lbs (1.5 kg).

Dimensions: see 5300A Mainframe.

Price: \$750.

* For any waveshape, trigger error is less than = $\frac{0.005 \mu s}{\text{Signal Slope (V/\mu s)}}$

** Trigger error is less than $\pm 0.3\%$ of one period + periods averaged for signals with 40 dB or better signal-to-noise ratio.

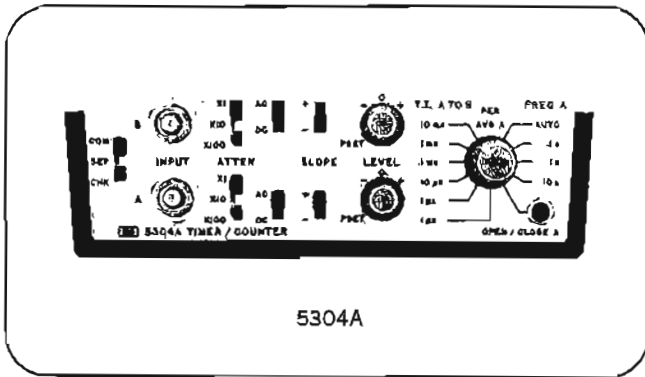

Specifications, 5304A Timer/Counter Module Input Channels A and B

Range: dc coupled; 0 to 10 MHz. AC coupled; 100 Hz to 10 MHz.
Sensitivity (min): 25 mV rms sine wave to 1 MHz. 50 mV rms sine wave to 10 MHz. 150 mV p-p pulse at minimum pulse width, 40 nsec. Sensitivity can be decreased by 10 or 100 times using ATTENUATOR switch.

Impedance: 1 MΩ shunted by less than 30 pF.

Overload protection: 250 V rms on X10 and X100 attenuator settings. On X1 attenuator setting 120 V rms up to 1 kHz, decreasing to 10 V rms at 10 MHz.

Trigger level: PRESET position centers triggering about 0 volts, or continuously variable over the range of -1 V to +1 V times attenuator setting.

Slope: independent selection of triggering on positive or negative slope.

Channel inputs: common or separate lines.

Gate output: rear panel BNC. TTL low level while gate is open.

Time interval

Range: 500 ns to 10⁴ sec.

Input: channels A and B; can be common or separate.

Resolution: 100 ns to 10 ms in decade steps.

Accuracy: ±1 count ± time base accuracy ± trigger error.*

Time interval holdoff: front panel concentric knob which inserts variable delay of approximately 100 μs to 100 ms between START (channel A) and enabling of STOP (channel B); may be disabled. Electrical inputs during delay time are ignored. Delay may be digitally measured in CHECK and TIME INTERVAL positions. Delay output: rear panel BNC. TTL low level during delay time.

Period average

Range: 10 Hz to 1 MHz.

Input: channel A.

Period averaged: 1 to 10³ automatically selected.

Frequency counted: 10 MHz.

Accuracy: ±1 count ± time base accuracy ± trigger error.**

Frequency

Range: 0 to 10 MHz.

Input: channel A.

Gate times: manually selected 0.1, 1, or 10 seconds. AUTO position selects gate time to 1 second for maximum resolution.

Accuracy: ±1 count ± time base accuracy.

Open/close (totalizing)

Range: 10 MHz max.

Input: channel A. Opening and closing of gate initiated by front panel pushbutton switch.

General

Check: inserts internal 10 MHz reference frequency into channels A and B.

Operating temperature: 0° to 50°C.

Power requirements: including 5300A mainframe, nominally 10 watts.

Dimensions: see 5300A mainframe.

Weight: net, 2 lbs (0.9 kg); shipping, 3¼ lbs (1.5 kg).

Price: \$300.

* For any waveshape, trigger error is less than = $\frac{0.005 \mu\text{s}}{\text{Signal Slope (V}/\mu\text{s})}$

** Trigger error is less than = 0.3% of one period ÷ periods averaged for signals with 40 dB or better signal-to-noise ratio.

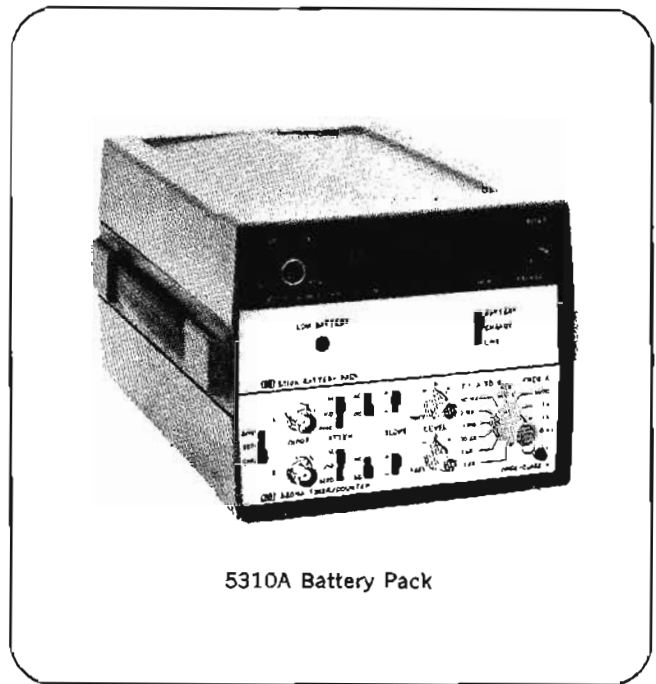

5310A Battery Pack

Specifications, 5310A Battery Pack Module

(Provides battery power from rechargeable nickel-cadmium cells.)

Battery capacity: 48 watt-hours, nominal. Typically more than 4 hours continuous operation at 25°C depending on snap-on module.

Recharging time: typically 18 hours.

Battery voltage: 12 V dc.

Low voltage indicator: light begins to glow at approximately 90% discharge.

Line failure protection: allows instrument to be operated in LINE position with automatic switch-over to battery power if line voltage fails. Batteries receive trickle charge in LINE position.

Operating temperature: operating: 0° to 50°C. Charging: 0° to 40°C, mainframe not operating.

Power requirements: charging power via 5300A mainframe, nominal 7.5 watts.

Weight: net, 5 lbs (2.3 kg); shipping, 6¼ lbs (2.9 kg).

Accessories furnished: shoulder carrying strap.

Dimensions: battery pack plugs between 5300A mainframe and snap-on module. Increases height of instrument by 1.5 in. (38.4 mm).

Price: \$175.

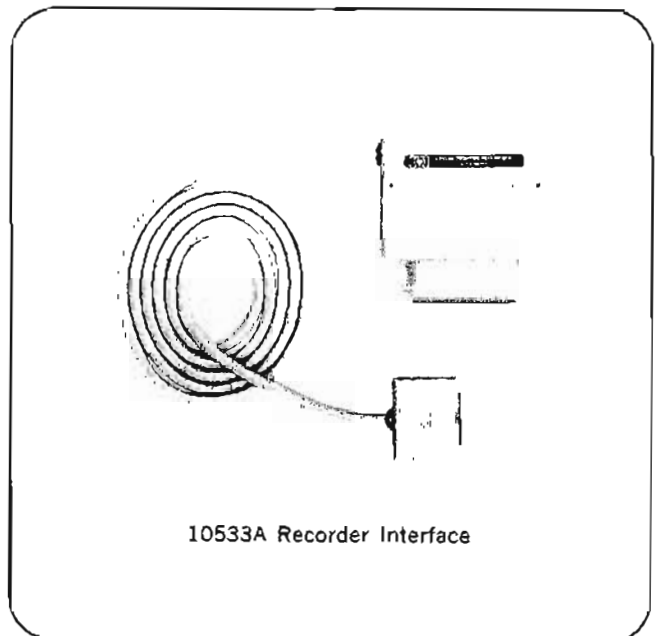

10533A Recorder Interface



UNIVERSAL COUNTERS

Unique Capabilities in 50 & 550 MHz Counters
5326/5327 Family

550 MHz Universal Timers/Counters/DVMs



5327A



5327B

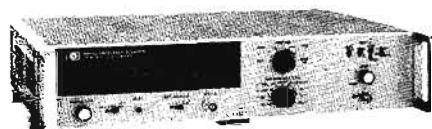

5327C

50 MHz Universal Timers/Counters/DVMs



5326A



5326B



5326C

Unique measurement benefits

The Hewlett-Packard 5326/5327 Universal Counters are both general-purpose lab instruments and fast, efficient systems instruments. Frequency measurements to 550 MHz, high resolution time interval measurements, and voltage measurements make the 5326/5327 family the most useful Timer/Counter/DVM's available. A single set of controls and one readout provide either frequency or voltage data which leads to easy manual operation. Systems interface is greatly simplified since a single programming connector and a single BCD connector serve both the counter and DVM sections.

New features

Many new features are offered with the 5326/5327 family which provide unique measurement benefits. The exclusive Hewlett-Packard feature of readout blanking suppresses unwanted zeros to the left of the most significant digit to improve clarity of the digital presentation. The new function of Time Interval Averaging (explained in Counters, Tutorial, see Index) provides the capability of high resolution (100 ps or better) averaged time interval measurements on repetitive input signals. 550 MHz frequency capability with low cost and good reliability is provided by new Hewlett-Packard high frequency monolithic integrated circuits. And, for those who need higher sensitivity in the 550 MHz area a 25 mV option is available (see General Specifications). An internal integrating DVM in the 5326B and 5327B allows, in addition to standard dc measurements, the ability to measure with digital precision the internal trigger levels of the A and B input channels. This feature adds a whole new dimension to Time Interval measurements. Full details on these new techniques are in April 1970 Hewlett-Packard Journal.

Hysteresis compensated slope selection has been added to the 5326/5327 family to further enhance its usefulness and ease of operation when making time interval measurements. Now, when switching from + to - slopes, the trigger level need not be readjusted, since the trigger points remain at the same value. The 5326/5327 also provides front panel trigger lamps which indicate when the attenuator and level controls are properly set to trigger on the applied input signal.

High stability time bases

The time base in the 5326/5327 family consists of a stable 10 MHz crystal oscillator. The standard room temperature crystal provides fast warm-up and high stability. Aging for the crystal is specified as less than 3 parts in 10^7 per month.

Two higher stability time bases (see High Stability Time Base Chart) are available as options. Both are housed in special proportional ovens to give an excellent temperature specification of less than 1 part in 10^8 over the range of -20° to $+65^\circ\text{C}$. And, their fast warm-up allows the oscillators to reach 5 parts in 10^9 in 15 min.

The two options, H49 and H50, have the aging rates of 3 parts in 10^9 per day and 5 parts in 10^{10} per day respectively. Their short term fluctuations are 1 part in 10^{10} rms for a one second average and 1 part in 10^{11} rms for a one second average respectively. (For a discussion of time base specifications, see Counters, Tutorial in Index.)

Measurements

The 5326 series measures frequencies from 0-50 MHz and the 5327 series extends this range to 550 MHz with either periodic or random signals. Each counter's gate time is selectable in decade steps from 0.1 μs through 10 s with the decimal point and units automatically displayed. The rear panel frequency input is front panel selectable for use with external scaling devices or for system applications.

The 5326A/B and 5327A/B will measure the period of a single input cycle with a selectable resolution of 0.1 μs to 10 s for frequencies from dc to 10 MHz. Periods are fully displayed with a 7 digit readout (8 digits optional); e.g., 999999.9 μs . If the count exceeds the number of digits in the readout, an overflow lamp lights on the front panel.

Period average measurements are provided with each member of the 5326/5327 family to reduce effect of trigger error and \pm one count ambiguity. Periods averaged are selectable from 1 to 10^8 ($10 \cdot 10^9$ when prescaling) in decade steps for input rates from 0 to 10 MHz. Period average measurements result in higher accuracy at low frequencies and faster measurements at high frequencies for equivalent resolution.

Time intervals of 0.1 μs to 10^5 s can be measured with the 5326A/B and 5327A/B using their standard time interval capability. However, the unique time interval

averaging capability offered in the 5326A/B and 5327A/B provides time interval measurements ranging from 0.15 ns to 10 s. Optimum resolution of these measurements made on repetitive signals is $100 \text{ ns}/\sqrt{\text{intervals averaged}}$. Since a measurement can be averaged over 10^8 intervals, maximum resolution can be in the 10 ps region.

The 5326B and 5327B offer dc voltage measurements in addition to the above described capability. DC ranges of 10, 100 and 1000 volts provide autopolarity with measurement times front panel selectable from 1 ms (2 digits) to 1 sec (5 digits). The highly linear and stable V-F Converter affords excellent accuracy.

Quantitative time interval

The 5326B and 5327B have two functions which make them absolutely unique among the universal counter/timers. The READ A and READ B functions allow the DVM to accurately measure the 2 internal input amplifier trigger points to within .05%, and display that value. Consequently, 50% point, 10%-90% rise time points, and others can be accurately set for time interval measurements by using the internal DVM functions. Coupling the Time Interval Averaging capability to the foregoing yields an extremely powerful measurement tool—quantitative time interval. This measurement accurately determines both relevant signal parameters—time between measure points and their respective levels.

Systems compatibility

Each member of the 5326/5327 family can be effectively used as a fast, efficient systems instrument.

Option 003 provides 4-line 1-2-4-8 BCD output with "1" state positive. This output is suitable for systems use or for output devices such as the HP Model 5050B or 5055A Digital Recorders.

Option 002 and Option 004 (5326A/B and 5327A/B only) provide remote programming capability via contact closure to ground or DTL drive. A rear panel connector provides access to all programmable circuits. With Option 002 all front panel controls are single line programmable except the FAST/NORM MODE, SEPARATE-COMMON switch (the CHECK position is programmable on the 5326A/B and 5327A/B only), input attenuators, and ac-dc input coupling switches. With Option 004 all front panel controls including all signal input conditioning are single line programmable except the FAST/NORM MODE. Both Options 002 and 004 provide programmable trigger level controls through single line analog signals.

In addition, the HP 10542A Remote Programming Interface provides two digital-to-analog converters to enable the 5326/5327 series with Option 004 to be completely programmed from a 40-bit digital output register.

5326/5327 Family Selection

Model	Description	Frequency Range	Period Average Totalize/Ratio Scaling	Time Interval Time Interval Averaging	DVM (DC Voltage)	Price
5326C	Multi-Function Counter	50 MHz	██████████			\$ 850
5326A	Universal Timer/Counter	50 MHz	██████████			1,250
5326B	Universal Timer/Counter/DVM	50 MHz	██████████			1,585
5327C	Multi-Function Counter	550 MHz	▨▨▨▨▨▨			1,495
5327A	Universal Timer/Counter	550 MHz	▨▨▨▨▨▨			1,795
5327B	Universal Timer/Counter/DVM	550 MHz	▨▨▨▨▨▨			2,150

General 5326/5327 Specifications

Display: 7 digits (8 optional).

Blanking: suppresses display of unwanted zeros left of the most significant digit.

Display storage: holds reading between samples. Rear panel switch overrides storage.

Sample rate: FAST and NORM ranges, and HOLD position.

Overflow: neon indicates when display range is exceeded.

Operating temperature: 0° to 50°C (see DVM Temp. Range).

Gate output: TTL level pulses, low while gate open, rear panel.

Power requirements: 115/230 V $\pm 10\%$, 50/60 Hz, 70 watts (max).

Weight: max: net, 16 lbs (7.4 kg); shipping, 18 lbs 16 oz (8.7 kg).

Dimensions: 3-15/32" high x 16 3/4" wide x 11 1/4" deep (88, 2 x 425 x 286 mm).

Accessories furnished: power cord, 7 1/2 ft and rack mount kit.

Accessories available

HP 10503A: 50 Ω BNC cable, 4 ft (122 cm). Price, \$7.

HP 10532A: extender board kit containing 2 each, 15-pin extender 5060-0049, 1 each, 18-pin extender 5060-2041, and 1 each amplifier extender, 10532-60001. Price, \$50.

HP 10542A: remote programming interface enables interfacing between the 5326/5327 series counters with Option 004 and a 40-bit output register. Includes two (2) 7 bit digital-to-analog converters for level controls and decoding for time base

and function selector. Price, \$400.

HP Cable 562A-16C: (6 ft, 183 cm) to connect 5326/5327 series with Option 003 to HP 5050B Digital Recorder. Price, \$50.

Option 001: 8-digit display. Price, \$75.

Option 002: remote programming.

Controls: all front panel controls are single line programmable except:

SEP-COM switch; CHECK is programmable (5326A/B, 5327A/B only).

FAST/NORM mode.

Input attenuators.

AC/DC input signal coupling.

Price: \$75.

Option 003: digital output (for numerals and polarity only).

Price: \$50.

Option 004: remote programming including all signal input conditions (includes attenuators and ac/dc switches).

Controls: all front panel controls are programmable except: FAST/NORM mode.

Price: \$200.

Option H60: higher sensitivity for the 550 MHz input channel on the 5327 series. 25 mV rms, 0 to 50°C; 10-15 mV rms typical at 25°C.

Price: \$125.

High Stability Time Base Options

Option	Aging Rate	Short Term Stability	Temperature Stability	Price
Standard	$< 3 \times 10^{-7}/\text{mo.}$	$< 5 \times 10^{-9}/1 \text{ sec rms (typ)}$	$< \pm 2.5 \times 10^{-6}, 0 \text{ to } 50^\circ\text{C}$	included
H49	$< 3 \times 10^{-9}/\text{day}$	$< 1 \times 10^{-10}/1 \text{ sec rms}$	$< 1 \times 10^{-6}, -20 \text{ to } +65^\circ\text{C}$	\$300.00
H50	$< 5 \times 10^{-10}/\text{day}$	$< 1 \times 10^{-11}/1 \text{ sec rms}$	$< 1 \times 10^{-6}, -20 \text{ to } +65^\circ\text{C}$	450.00

550 MHz Universal Timer/Counter/DVM

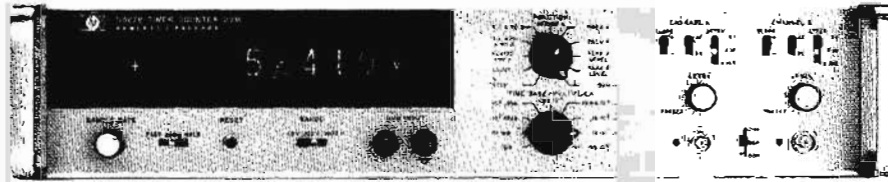

5327B

5326B and 5327B Specifications

Input Channels A and B

Range: dc-coupled: 0-50 MHz; ac-coupled: 20 Hz-50 MHz.

Sensitivity (min): 0.1 V rms sine wave; 0.3 V p-p pulse; 8 ns minimum pulse width. Sensitivity can be decreased by 10 or 100 times, using the ATTENUATOR switch.

Impedance: 1 M Ω shunted by less than 25 pF.

Dynamic input voltage range: 0.1 to 3 V rms ac times attenuator setting, ± 5 V dc times attenuator setting.

Trigger level: PRESET to center triggering about 0 V or variable over the range of -3 V to $+3$ V times attenuator setting. Trigger threshold band < 1.0 mV, referred to input at maximum frequency.

Overload protection: 250 V rms on all attenuator settings, except 25 V rms on X1 above 50 kHz.

Slope: independent selection of positive or negative slope.

Channel inputs: common or separate lines.

Marker outputs: rear panel BNC's. DTL pulse, low for approx 2 μ s after trigger point for A and B channels.

Input Channel C and C \div 10

Range: 5326B: Channel C: dc-coupled; 0-50 MHz. 5327B: Channel C: ac-coupled: 1 kHz-50 MHz; C \div 10 (prescale); 0-550 MHz.

Sensitivity: 5326B: Channel C: 5 mV rms. 5327B: Channel C: 5 mV rms; C \div 10 (prescale): 100 mV rms.

Impedance: 50 Ω nominal.

Maximum input: 5 volts rms; 7.5 volts peak.

Trigger level: 0 volts.

Location: rear panel.

Start

(Totalizing and Scaling)

Range: 0-10 MHz.

Factor: 1-10⁸ selectable in decade steps.

Output: rear panel TIME BASE BNC.

Display: Channel A input divided by scaling factor.

* ≈ 10 counts of input frequency. (≈ 1 count displayed.)

** For any wave shape, trigger error is less than $= \frac{0.0025}{\text{Signal Slope (V/\mu s)}} \mu\text{s}$

Frequency

Range: 5326B: 0-50 MHz. 5327B: 0-50 MHz (direct); 0-550 MHz (prescaled).

Input: 5326B: Channel A or Channel C (switchable). Channel A provides triggered frequency measurement. 5327B: Channel A; Channel C for direct and C \div 10 for prescaled (switchable). Channel A provides triggered frequency measurement.

Gate times: 0.1 μ s to 10 s in decade steps.

Accuracy: direct: ± 1 count \pm time base accuracy. Prescaled: ± 10 counts* \pm time base accuracy.

Display: MHz, kHz, or GHz with positioned decimal point.

Time interval

Range: 0.1 μ s to 10⁹ seconds.

Input: Channels A and B; can be common or separate.

Frequency counted: 10 MHz to 0.1 Hz in decade steps.

Accuracy: ± 1 count \pm time base accuracy \pm trigger error.**

Display: μ s, ms, seconds or 10's of seconds with positioned decimal point.

Time interval average

Range: 0.15 ns to 10 s.

Intervals averaged: 1-10⁸ selectable in decade steps.

Input: Channels A and B; can be common or separate.

Frequency counted: 10 MHz.

Accuracy: \pm time base accuracy ± 2 ns \pm
 $(\text{trigger error}^{**} \pm 100 \text{ ns})$
 $\sqrt{\text{intervals averaged}}$

Display: ns, μ s with positioned decimal point.

Period

Range: 0-10 MHz.

Input: Channel A.

Frequency counted: 10 MHz to 0.1 Hz in decade steps.

Accuracy: ± 1 count \pm time base accuracy \pm trigger error.***

Display: μ s, ms, seconds or 10's of seconds with positioned decimal point.

*** Trigger error is less than $\approx 0.3\%$ of one period \div periods averaged for signals with 40 dBm or better signal-to-noise ratio and 100 mV rms amplitude.

Period average

Range: 0-10 MHz.
Periods averaged: 1-10⁸ selectable in decade steps.
Input: Channel A.
Frequency counted: 10 MHz.
Accuracy: ±1 count ± time base accuracy ± trigger error.***
 (See footnote, page 224.)
Display: ns, μs with positioned decimal point.

Ratio

Display: any input function/F_{ext} times Multiplier (M). M = 1 to 10⁸ (10-10⁸ when prescaling) selectable in decade steps.
Range: any input function. See appropriate function section.
 F_{ext}: (External Oscillator Input) 100 Hz-10 MHz.
Mode: any input function.
Accuracy: accuracy of selected input function ± trigger error of F_{ext}.

Integrating Digital Voltmeter (5326B and 5327B only)

The unique combination of an integrating digital voltmeter and an electronic timer/counter produces an instrument which can do much more than can be done with a separate counter and a separate DVM. The mainframe DVM in the 5326B and 5327B easily measures ± dc levels in three programmable ranges from ±10 V to ±1000 V. Plus, the DVM can internally measure and set the start and stop time interval trigger point levels. This feature, together with hysteresis compensation, gives the 5326B and 5327B the easiest and most accurate trigger level setting system available with none of the drawbacks of oscilloscope marker techniques. The DVM measurement (integration) time is selectable from 1 ms to 10 sec to permit a trade-off of resolution vs. measurement time.

The heart of the integrating digital voltmeter in the 5326/5327 is the very stable voltage-to-frequency converter.

Using this converter, one obtains a very stable linear digital voltmeter with high resolution and excellent accuracy. This DVM can also measure high frequency ac voltages using the HP 11096 ac probe for voltages of 0.25 V to 30 V rms with ±5% accuracy and with 4 MΩ/2 pF input impedance. The frequency range is 100 kHz to 500 MHz. The combination of an integrating digital voltmeter with a timer/counter greatly expands the capabilities of both instruments. Thus the user of the 5326B or the 5327B Timer/Counter/DVM has a digital measurement system of unequalled capability at a moderate cost.

Technique: voltage-to-frequency conversion.
Voltage ranges: manual selection.

RANGE (V dc)	RESOLUTION (1 sec, Integration time)	INPUT IMPEDANCE
10	100 μV	10 MΩ
100	1 mV	10 MΩ
1000	10 mV	10 MΩ

Measurement time

- 1 msec 2 digits
- 10 msec 3 digits
- 100 msec 4 digits
- 1 sec 5 digits
- 10 sec 6 digits

Decimal points automatically displayed

Response time: <100 μs for full accuracy with a step function point.

AC noise rejection: infinite for multiples of (measurement time)⁻¹. See graph for Normal Mode Rejection.

Input: single ended.
Polarity: automatic polarity detection.
Overrange: 25% overrange on 10 V and 100 V ranges with full accuracy.
Overload protection: 1100 V dc all ranges.
Accuracy: after 10 minutes warm-up (within 90-day calibration period).

Range	Stability (% of Reading)	Linearity (% of Range)	Zero Drift (% of Range)	Counter
10 V	±0.04%	±0.01%	±0.01%	±1 count
100 V	±0.04%	±0.01%	±0.01%	±1 count
1000 V	±0.08%	±0.01%	±0.01%	±1 count

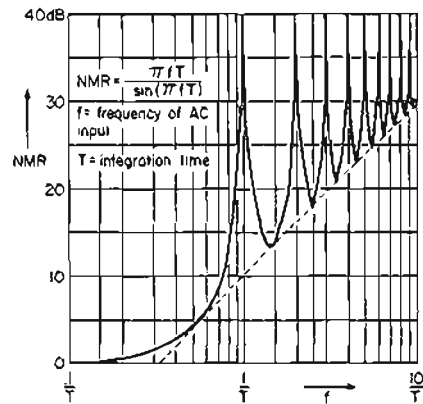

Operating temperature: 10°C to 40°C, <80% RH.

50 MHz Universal Timer/Counter/DVM

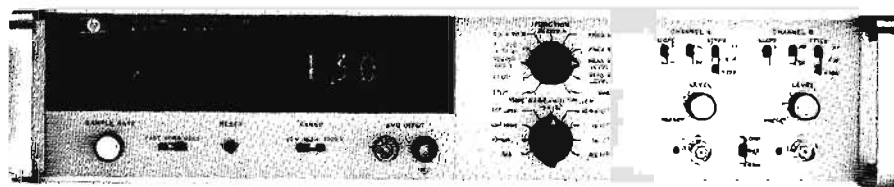

5326B

550 MHz Universal Timer/Counter

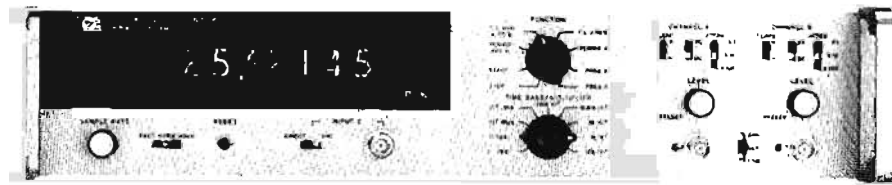

5327A

5326A And 5327A Specifications

Input Channels A and B

- Range:** dc-coupled: 0-50 MHz, ac-coupled: 20 Hz-50 MHz.
Sensitivity (min): 0.1 V rms sine wave, 0.3 V p-p pulse, 8 ns minimum pulse width.
 Sensitivity can be decreased by 10 or 100 times, using the ATTENUATOR switch.
Impedance: 1 M Ω shunted by less than 25 pF.
Dynamic input voltage range: 0.1 to 3 V rms ac times attenuator setting, ± 5 V dc times attenuator setting.
Trigger level: PRESET to center triggering about 0 V or variable over the range of -3 V to +3 V times attenuator setting. Trigger threshold band <1.0 mV, referred to input at maximum frequency.
Overload protection: 250 V rms on all attenuator settings, except 25 V rms on X1 above 50 kHz.
Slope: independent selection of positive or negative slope.
Channel inputs: common or separate lines.
Marker outputs: rear panel BNC's, DTL pulse, low for approx 2 μ s after trigger point for A and B channels.

Input Channel C and C \div 10

- Range:** 5326A, Channel C: dc-coupled: 0-50 MHz, 5327A: Channel C: ac-coupled; 1 kHz-50 MHz; C \div 10 (prescale); 0-550 MHz.
Sensitivity: 5326A: Channel C, 5 mV rms, 5327A: Channel C: 5 mV rms; C \div 10 (prescale): 100 mV rms.
Impedance: 50 Ω nominal.
Maximum input: 5 volts rms; 7.5 volts peak.
Trigger level: 0 volts.

Start

(Totalizing and Scaling)

- Range:** 0-10 MHz.
Factor: 1-10³ selectable in decade steps.
Output: rear panel TIME BASE BNC.
Display: Channel A input divided by scaling factor.

Frequency

- Range:** 5326A: 0-50 MHz, 5327A: 0-50 MHz (direct); 0-550 MHz (prescaled).
Input: 5326A: Channel A or Channel C (switchable). Channel A provides triggered frequency measurement. 5327A: Channel A; Channel C for direct and C \div 10 for prescaled (switchable).

- Channel A provides triggered frequency measurement.
Gate times: 0.1 μ s to 10 s in decade steps.
Accuracy: direct: ± 1 count \pm time base accuracy. Prescaled: ± 10 counts* \pm time base accuracy.
Display: MHz, kHz, or GHz with positioned decimal point.

Time interval

- Range:** 0.1 μ s to 10⁹ seconds.
Input: channels A and B; can be common or separate.
Frequency counted: 10 MHz to 0.1 Hz in decade steps.
Accuracy: ± 1 count \pm time base accuracy \pm trigger error.**
Display: μ s, ms, seconds or 10's of seconds with positioned decimal point.

Time interval average

- Range:** 0.15 ns to 10 s.
Intervals averaged: 1-10³ selectable in decade steps.
Input: channels A and B; can be common or separate.
Frequency counted: 10 MHz.
Accuracy: \pm time base accuracy ± 2 ns \pm (trigger error** ± 100 ns) $\sqrt{\text{intervals averaged}}$
Display: ns, μ s with positioned decimal point.

Period and Period average

- Range:** 0-10 MHz.
Input: Channel A.
Frequency counted: 10 MHz to 0.1 Hz in decade steps for period. 10 MHz for Period Average.
Periods averaged: 1-10³ selectable in decade steps.
Accuracy: ± 1 count \pm time base accuracy \pm trigger error.**
Display: ns, μ s, ms, seconds or 10's of seconds with positioned decimal point.

Ratio

- Display:** any input function/ F_{ext} times Multiplier (M). M = 1 to 10³ (10-10⁹ when prescaling) selectable in decade steps.
Range: any input function. See appropriate function section.
 F_{ext} : (External Oscillator Input) 100 Hz-10 MHz.
Mode: any input function.
Accuracy: accuracy of selected input function \pm trigger error of F_{ext} .

*, **, ***, ---see p. 227 for footnotes

50 MHz Universal Timer/Counter

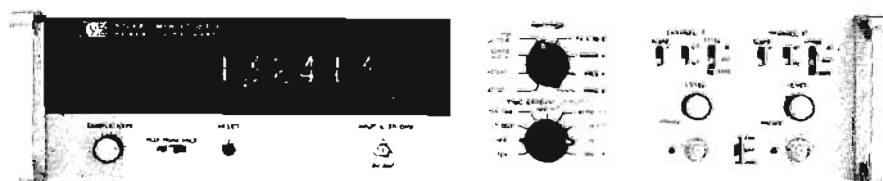

5326A

550 MHz Multi-Function Counter



5327C

5326C And 5327C Specifications

Input Channel A

Range: dc-coupled: 0-50 MHz; ac-coupled: 20 Hz-50 MHz.

Sensitivity (mln): 0.1 V rms sine wave; 0.3 V p-p pulse; 8 ns minimum pulse width.

Sensitivity can be decreased by 10 or 100 times, using the ATTENUATOR switch.

Impedance: 1 M Ω shunted by less than 25 pF.

Dynamic input voltage range: 0.1 to 3 V rms ac times attenuator setting. ± 5 V dc times attenuator setting.

Trigger level: PRESET to center triggering about 0 V or variable over the range of -3 V to +3 V times attenuator setting. Trigger threshold band <1.0 mV, referred to input at maximum frequency.

Overload protection: 250 V rms on all attenuator settings, except 25 V rms on X1 above 50 kHz.

Slope: independent selection of positive or negative slope.

Input Channel B and B \div 10
(5327C only)

Range: Channel B: ac-coupled, 1 kHz-50 MHz; B \div 10: dc-coupled, 0-550 MHz.

Sensitivity: Channel B: 5 mV rms; B \div 10 (prescaled): 100 mV rms.

Impedance: 50 Ω nominal.

Maximum Input: 5 volts rms, 7.5 volts peak.

Trigger level: 0 volts.

Start

(Totalizing and Scaling)

Range: 5326C: 0-10 MHz. 5327C: 0-10 MHz (direct); 0-100 MHz (prescaled).

Factor: 5326C: 1-10⁶ in decade steps. 5327C: Channel A or Channel B: 1-10⁶ in decade steps; B \div 10: 10-10⁹ (1-10⁹ on selector) in decade steps.

Output: rear panel TIME BASE BNC.

Display: Channel A, B, or B \div 10 input divided by scaling factor.

Frequency

Range: 5326C: 0-50 MHz. 5327C: 0-50 MHz (direct); 0-550 MHz (prescaled).

Input: 5326C: Channel A. Channel A provides triggered frequency measurement. 5327C: Channel A; Channel B for direct and B \div 10 for prescaled (switchable). Any channel provides triggered frequency measurement.

Gate times: 0.1 μ s to 10 s in decade steps.

Accuracy: direct: ± 1 count \pm time base accuracy. Prescaled: ± 10 counts* \pm time base accuracy.

Display: MHz, kHz or GHz with positioned decimal point.

Period average

Range: 5326C: 0-10 MHz. 5327C: 0-50 MHz (direct); 0-550 MHz (prescaled).

Periods averaged: 5326C: 1-10⁶ in decade steps. 5327C: Channel A or Channel B: 1-10⁶ in decade steps; B \div 10: 10-10⁹ (1-10⁹ on selector) in decade steps.

Frequency counted: 10 MHz.

Accuracy: direct: ± 1 count \pm time base accuracy \pm trigger error.*** Prescaled: ± 10 counts* \pm time base accuracy \pm trigger error.***

Display: ns, μ s with positioned decimal point.

Ratio

Display: any input function/ F_{EXT} times Multiplier (M). M = 1 to 10⁶ (10-10⁶ when prescaling) selectable in decade steps.

Range: any input function. See appropriate function section. F_{EXT} : (External Oscillator Input) 100 Hz-10 MHz.

Mode: any input function.

Accuracy: accuracy of selected input function \pm trigger error of F_{EXT} .

50 MHz Multi-Function Counter



5326C

* ± 10 counts of input frequency. (± 1 count displayed.)

** For any wave shape, trigger error is less than: $\frac{0.0025}{\text{Signal Slope (V/\mu s)}} \mu s$

*** Trigger error is less than $\pm 0.3\%$ of one period + periods averaged for signals with 40 dB or better signal-to-noise ratio and 100 mV rms amplitude.



MICROWAVE FREQ. COUNTER

Automatic, direct readout, 1 Hz to 18 GHz

Model 5340A

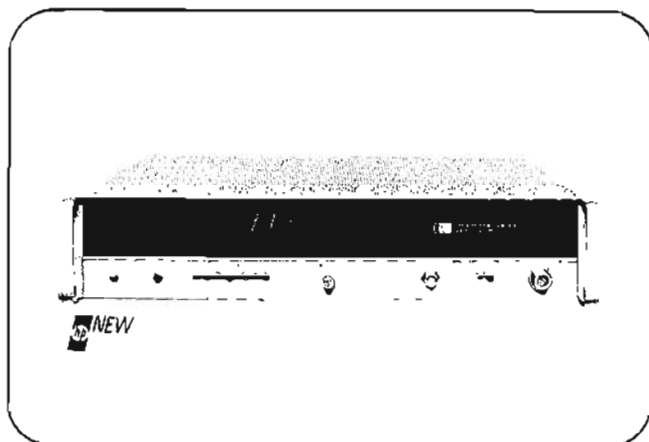

Single Input 1 Hz to 18 GHz • High Sensitivity, 35 dBm • Wide Dynamic Range • High Damage Level • Programmable • Fast • Auto Amplitude Discrimination • Superior AM & FM Characteristics.

The 5340A Automatic Microwave Frequency Counter provides a modern, easily used, more versatile, instrument for the direct measurement of frequencies from 1 Hz through 18 GHz. This instrument's single input, that covers the entire bandwidth, and high sensitivity result in an instrument suited to a wider variety of applications than ever before. Utilizing new microwave samplers incorporated in advanced phase lock loops, this new counter excels in virtually every microwave counter specification parameter.

Single Input & High Sensitivity

The single input simplifies the use of this instrument by allowing any unknown signal to be measured by connecting it to only this one input. In the past, several inputs have been utilized and had to be selected, complicating use and measurement. The high sensitivity enhances measurement in the microwave field where signals are low level and many times have to be connected via directional couplers or lossy devices. The sensitivity is such that in some cases signals can be measured directly with only the use of an antenna.

Superior AM Characteristics

The high sensitivity considerably improves measurement in the presence of audio modulation. As an example, measurement is easily achieved on a 0 dBm signal with 90% AM modulation.

High Impedance Input

A second high impedance input is provided covering the direct measurement range (10 Hz to 250 MHz) of the instrument. This input is useful in the measurement of JF frequencies or signals from higher impedance circuits. On a special basis the 5340A can be modified to subtract or add the frequency at the high impedance input from that at the 50Ω input. This modification is particularly useful when a direct measurement of carrier frequency is desired but is offset by an intermediate frequency.

No False Answers

Measurement and display are disabled until phase lock or direct measurement are determined; automatically preventing incorrect measurement or displays.

Automatic Amplitude Discrimination

Automatic amplitude discrimination allows the instrument to choose the largest signal in a spectrum and measure only that signal's frequency. The high sensitivity and wideband width of the 5340A make this feature necessary so that the counter will not lock and measure lower level or harmonically related signals present with the signal of interest.

Superior FM Characteristics

This microwave counter is designed to measure carrier frequencies in the presence of wide frequency deviations caused by frequency modulation, phase modulation, or high residual noise. FM tolerance characteristics are a function of modulation rate and carrier frequency and are fully described below.

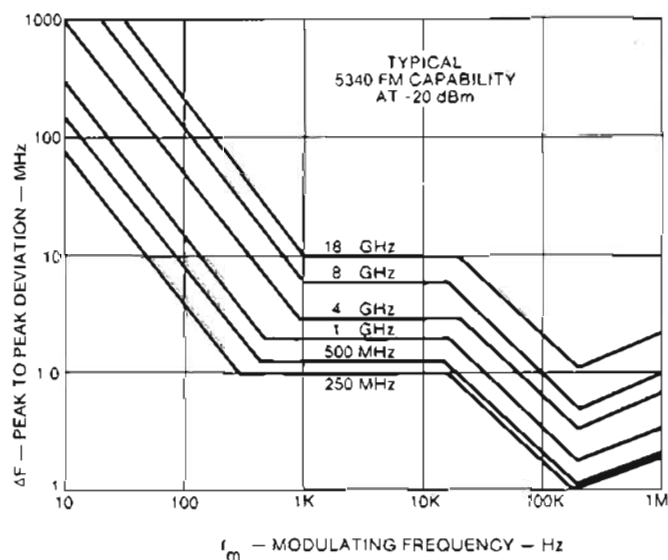

Figure 1. FM Characteristics.

Complete Programmability

All front panel controls and octave range programming of the phase lock loop are possible. The octave range programming allows selection of a single band for measurement reducing acquisition to typically less than 25 ms. These features combined with the digital output are programmable via a single input/output slot of most computers. Digital output is standard on all 5340A instruments and complete programmability may be achieved by specifying Option 003. Another valuable option available for systems use provides both front panel connectors on the rear of the instrument (Option 002).

Tentative specifications

Signal input

Input 1

Range: 1 Hz to 18 GHz.

Sensitivity: -35 dBm 1 Hz-12.4 GHz; -25 dBm 12.4-18 GHz.

Dynamic range: 42 dB (-35 dBm- $+7$ dBm). 1 Hz to 12.4 GHz; 32 dB 12.4 to 18 GHz.

Impedance: 50 Ω .

VSWR: $<2:1$ 1 Hz-12.5 GHz, $<3:1$ 12.4-18 GHz.

Connector: precision Type N.

Coupling: ac.

Lock-on time: <100 ms typical for any signal 1 Hz-18 GHz (under remote program control (optional) octave ranges may be selected reducing lock-on time to approximately 25 msec).

Input 2

Range: 10 Hz-250 MHz direct count.

Sensitivity: 50 mV rms.

Impedance: 1 M Ω shunted by <25 pF.

Connector: type BNC female.

Coupling: ac.

Shelf check: counts and displays 10 MHz for resolution chosen.

Automatic amplitude discrimination: the counter will automatically select the largest of all signals present (>250 to 18 GHz) providing that signal is 20 dB (10 dB typical) larger than any other.

Maximum am modulation: any amplitude modulation index as long as the minimum voltage of the signal is not less than the sensitivity specification. For example, with a -10 dBm input signal at 10 GHz, 94.5% modulation index will cause the signal to drop to -35 dBm (4 mV) at its lowest input amplitude and would be the limit of modulation possible. This is calculated as follows:

$$V_t = 4 \text{ mV where } V_t = \text{minimum amplitude, } V_p = 70 \text{ } (-10 \text{ dBm}) + 66 = 136 \text{ mV, and modulation index } m_1 = V_p - V_t / V_p + V_t = 94.5\%$$

FM modulation: Figure 1.

Time base

Crystal frequency: 10 MHz.

Stability

Aging rate: $<3 \times 10^{-7}$ per month.

Short term: $<5 \times 10^{-10}$ rms for 1 second averaging time.

Temperature: $<2 \times 10^{-8}$ over the range of -20°C to $+65^\circ\text{C}$.

Line variation: $<1 \times 10^{-7}$ for 10% line variation from 110 V or 230 V line.

Output frequency: 10 MHz ≥ 2.4 V square wave (TTL compatible) available from rear panel BNC.

External time base: requires 10 MHz approximately 1.5 V pp sinewave or squarewave into 1 k Ω via rear panel BNC. Switch selects either internal or external time base.

General

Resolution: front panel switch selects 1 MHz—100 kHz, 10 kHz—1 kHz—100 Hz—10 Hz—1 Hz.

Display: eight in line long life Nixie tubes with positioned decimal point and appropriate measurement units of kHz, MHz or GHz.

Accuracy: \pm count \pm time base error.

"DIR" lamp indicates measurement is direct.

"LOCK" lamp indicates phase lock has been achieved and measurement technique is indirect.

"GATE" lamp indicates measurement is in progress.

"REM'T" lamp indicates instrument is controlled via external or remote device.

"OFLO" indicates most significant digits will not be displayed. Digits displayed when "OFLO" is lighted are accurate ± 1 count \pm time base accuracy. "OFLO" is necessary for some high frequency measurements where resolution of 100 Hz or greater is required.

Sample rate: controls time between measurements. Continuously adjustable from approximately 200 ms to 10 secs. Hold position holds display indefinitely. Reset button resets display to zero and activates a new measurement.

Operating temperature: 0-50 $^\circ\text{C}$.

BCD output: connector 24 pin female Cinch #57-40340 HP #1251-0292. Mating connector Cinch #57-30240 HP #1251-0293. **Code:** bit parallel digit serial 8 level ASCII (TTL compatible).

Power: 115 V or 230 V $\pm 10\%$ 50-60 Hz 100 VA.

Weight: net, 25 lbs (11,4 kg); shipping, 30 lbs (13,6 kg).

Dimensions: dimensions in inches and (millimeters): width, 16 $\frac{3}{4}$ (425); depth, 13 $\frac{1}{4}$ (337); height, 3-15/32 (88,2).

Accessories furnished: power cord 7 $\frac{1}{2}$ ft (200 cm), NEMA plug.

Time base option 001

Option No.	Aging Rate	Short Term Stability	Temperature
001	$<5 \times 10^{10}$ /day	$<5 \times 10^{11}$ /1 sec RMS	$<1 \times 10^6$ /-20-+65 $^\circ\text{C}$
Standard	$<3 \times 10^7$ /mo.	$<5 \times 10^{10}$ /1 sec RMS	$<2 \times 10^6$ /-20-+65 $^\circ\text{C}$

Rear panel input connectors (Option 002): this option provides input connectors on the rear panel. Input specifications remain the same. Input 1 (Type N) is on the rear panel in place of installation on the front panel. Input 2 (BNC) is available on the front and rear panels. Input impedance is reduced to 50 Ω .

Remote programming, Option 003: connector 50 pin female Cinch #57-40500 HP #1251-0087. Mating connector male Cinch #57-30500 HP #1251-0086.

Price: 5340A; \$5300; Option 001, \$400; Option 002, \$100.



The Computing Counter System . . . Precise, Total Solutions to Complex Problems

The Computing Counter is a general purpose precision digital instrument with built-in arithmetic capability.

As a measuring device the Computing Counter provides unequalled precision. For example, it can measure the time between two events to a resolution of 100 picoseconds, about the time it takes light to travel one inch.

The Computing Counter's unique measurement technique employs extensive use of digital computation. Thus the main-frame contains an arithmetic unit which is an inherent, indispensable part of the measurement cycle.

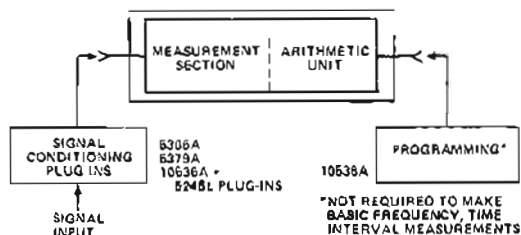

Basic Block Diagram of Computing Counter. The precision measurement technique employs digital computation as an inherent, indispensable part of the measurement cycle.

Measurement

Measurement versatility is enhanced by a wide range of plug-ins in addition to the input module. All measurements are made with speed and accuracy and in many respects, operation is easier than with the conventional instrument.

Computation

The arithmetic capability of the machine has been made available to the user via several programming devices.

This allows the system to be programmed to solve equations where measurements are the variables, in real time. This capability enormously increases the power of the Computing Counter System.

Note that the programming devices are not needed to obtain the measurement capabilities of the instrument. Inclusion of the appropriate programmer, however, enhances the capabilities of the Computing Counter system in providing precise, total solutions to complex problems at substantial cost saving and ease of operation.

The following two pages introduce the components of the Computing Counter System. Additional details are included in the tutorial (pp. 207-211). A full description of the system is given in the Computing Counter System data sheet. In addition, some of the many applications to which this versatile system can be put are described in the applications literature overpage. All literature is available on request.

Precision Frequency Measurements

5360A Computing Counter
5365A Input Module
5245 Series Plug-Ins

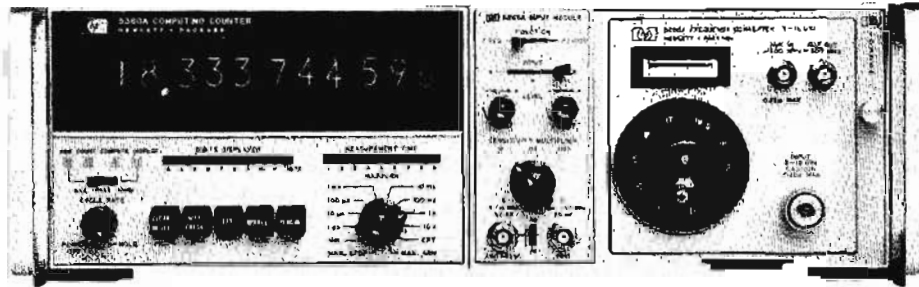

Features

- 320 MHz direct frequency range
- To 18 GHz with plug-ins
- Most accurate frequency measuring device available
- High speed . . . better than 300 measurements/sec
- External trigger capability enhances versatility
- Automatic display
- High stability time base
- Versatile measurement time controls
- High speed data gathering capability

Measure

- Pulse compression radar
 - CW and pulsed, Doppler radar
 - Frequency shift keyed (FSK)
 - Precision oscillators for fast calibration
 - PCM and fsk bit detection
 - FM and transient frequencies
 - Amplitude and pulse modulated signals
- Price: \$6500.

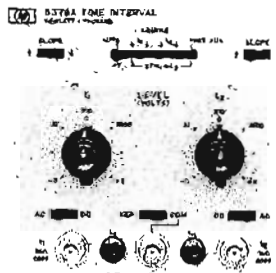

Precision time interval measurements
5379A Time Interval Plug-In

Features

- 100 picosecond displayed resolution
- ± 500 picosecond accuracy
- Zero seconds minimum measurable time interval
- Positive or negative time intervals
- High speed, better than 1000 measurements/sec
- Hysteresis compensation of trigger levels
- Versatile arming modes
- Absolute trigger level determination
- 5 picosecond resolution by averaging

Measure

- Laser and radar ranging
 - Delay line calibration
 - Integrated circuit characterization (rise, fall, delay times)
 - Computer checkout
 - Nuclear time of flight measurements
 - Coincidence detection
 - Instrument calibration
- Price: \$750.

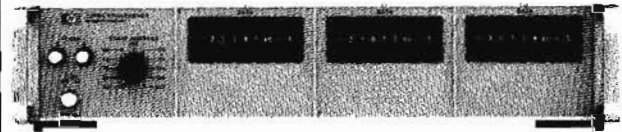

Computation
5376A Systems Programmer

- Automatic operation
- Simple programming
- Precision system measurement capability
- ROM program (easily reprogrammed)
- Digital I/O capability
- Programmable analog output
- Options maximize price/performance
- For systems, production, laboratory, maintenance, and test

The 5376A Systems Programmer is a programming device for the 5360A Computing Counter. The 5360A/5376A combination provides solutions to problems that formerly required the use of a computerized instrumentation system.

This versatile combination finds wide use in several general application areas. . . .

(i) data reduction, e.g.

crystal inductance
transducer linearization
equation solving
phase, accumulative phase, etc

(ii) statistical analysis, e.g. mean
 standard deviation
 fractional frequency deviation
 peak-peak fm deviation
 peak-peak time jitter
 maximum access time

(iii) process control provides stimulus
 measures response
 generates appropriate control signals
Price: prices start at \$1350. There are eight options available. See data sheet for details.

Computation

5375A Keyboard

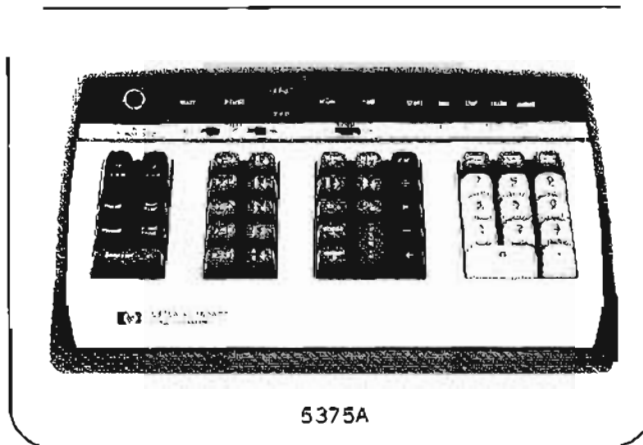

A laboratory tool for simultaneous data reduction or statistical analysis with measurements.

Similar to the Systems Programmer. The Keyboard is a programming device for the Computing Counter. The read-write memory enables programs to be entered or modified quickly and easily via the appropriate keystrokes. This makes it ideally suited for the laboratory environment.

Operations

Arithmetic: add, subtract, multiply, divide, square root, 10X and $\frac{1}{10}$. In addition, short algorithms are available to program for logarithm and exponential.

Measurement: MODULE A, MODULE B, PLUG-IN. Single keystrokes of any of these keys allow measurements to be made from the A input of the 5365A Input Module, the B input or the plug-in respectively.

Price: \$1350.

Applications literature

The Computing Counter System is a powerful tool that provides solutions to problems in many applications areas. In a continuing program, a substantial amount of applications literature is available, free of charge, on request.

Application sheets

Single page descriptions of specific problems and their solution with the Computing Counter System. This program covers a wide range of applications from hydrophone testing through crystal inductance measurements to Doppler range rate errors.

Application notes

More detailed treatment of general applications areas. Four are now available:

- AN 116 Precision Frequency Measurements
- AN 120 A New Technique for Pulsed RF Measurement
- AN 120-2 Measuring Phase with the 5360A
- AN 120-3 Non-Linear System Applications of the Computing Counter System

Programming manuals

Comprehensive manuals are available on programming the Computing Counter System from the 5375A Keyboard and the 5376A Systems Programmer. Titles are "Programming the 5375A Computing Counter Keyboard" and "5376A Systems Programmer User's Manual." This latter includes a comprehensive treatment of integrating the 5360A-5376A into an operational system.

Hewlett-Packard Journals

Four issues of this widely read publication deal with the Computing Counter System.

May 1969: 5360A/5365A Computing Counter and the 5379A Time Interval Plug-in.

March 1970: 5375A Keyboard.

December 1970: 5376A Systems Programmer.

November 1971: Frequency Stability Measurements.

Accessories

10536A Adapter: adapts following 5245 series plug-ins to the computing Counter: 5253B, 5254C, 5255A, 5256A, 5258A, 5252A, 5261A. 5257A also compatible except gate time extender does not work.

Price: \$175

5050B Opt. 061 Digital Recorder: This reliable 18 column recorder provides a printed record of 5360A measurements at rates up to 20 lines per second.

Price: \$3190.

K01-5360A Serial-Parallel Converter: converts serial bcd output from 5360A into a parallel form compatible with the conventional HP 5050B and 5055A Digital Recorders.

Price: \$995.

NORMALIZING COUNTERS

Most versatile preset counters available
Models, 5330A, 5330B, 5332B



FREQUENCY COUNTERS



5330B, Option 001

Hewlett-Packard Model 5330A features a preset (variable) time base for normalized measurements and Model 5330B combines this variable time capability with dual preset limits. Additionally, a presettable count offset is offered in either model as an option. These instruments were designed for physical measurements in laboratories, automatic control systems, and for digital measurement of all types in engineering and industry.

Models 5330A and 5330B measure in directly usable engineering units such as GPM, PSI, RPM in real time from rate or frequency type input signals. Preset digit switches are used to vary the length of counting time or to multiply or divide the number of input cycles, depending on which one of four operating modes are employed: rate (frequency); time (period); ratio; or F/MN (frequency division). While counting is in progress, a gate signal is issued from a rear panel jack and may be used as a control or timing signal.

The 5330B includes two separate 5-digit limit switches (L1 and L2) for limit control and testing applications. Three high-speed output signals associated with the L1 and L2 limits indicate when the measured value is below (LO), between (1N), or above (HI), these limits. The signals can be used to drive controllers or relays for speed control, for shutdown at predetermined totals, to actuate alarms at pre-shutdown totals, for precise timing of processes, etc.

Offset counting is possible via Option 001 which provides another 5-digit switch, designated "R". This switch may be set to any number from 0 to 99,999, which presets the counter such that counting of the input signal will start from this selected number and reset to this number each cycle. Both instruments are available with digital output and complete programmability. Further information and specifications are available in a detailed data sheet.

Price: 5330A, \$1250; 5330B, \$1650; Option 001, \$100.

Preset controller/counter Model 5332B



5332B

This preset controller/counter counts electrical events and issues output signals when preset count values are reached and also measures and limit-detect input rates or frequencies. This instrument provides all the features required in digital control and measurement applications: local and remote con-

trol, three versatile operating modes, wide frequency and voltage counting range, very fast recycling, high input impedance and sensitivity, lighted overflow indicator, and BCD output for recording or further digital processing. Applications include batching and precise control of weight, liquid level, length, rate, frequency, etc. The counter can also generate precise time intervals (or delays) and pulse trains, and can measure time intervals precisely. Use of integrated circuits provides compactness and maximum versatility coupled with economy, low power consumption, and low heat dissipation.

The 5332B has a crystal time base to permit limit-detecting frequencies (or rates) of random or periodic events from 0 to over 2 million pps at precise gate times of 0.01, 0.1, 1.0, and 10 seconds. Similarly frequencies up to 10 MHz can be measured. These instruments also measure and limit-detect single and multiple frequency ratios as well as time intervals from 10 μ s to 1.0 second.

Remote control and parallel BCD output are standard. For further details and specifications a technical data sheet is available.

Price: 5332B, \$1300.

FREQUENCY COUNTERS



FREQUENCY METER

Wideband, highly linear FM discriminator

Model 5210A

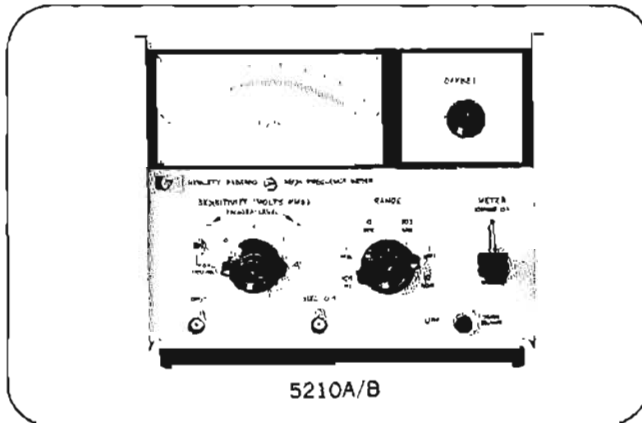

The Model 5210A Frequency Meter/FM Discriminator directly measures frequency or repetition rate of signals from 3 Hz to 10 MHz, independent of input voltage waveform. A sensitivity control allows for measurement of noisy signals. The special log linear scale offers an accuracy of 1% of reading from 10% of full scale up. With calibrated offset (Option 001) the accuracy is up to 0.2% of full scale.

The 5210A is also a wideband highly linear FM discriminator with a 3 dB output bandwidth of better than 1 MHz for

precise measurements on FM and PM signals. With output filters (HP 10531A) frequency deviation, modulation index, frequency response, distortion, incidental FM, and FM noise can be determined as well as "flutter" and "wow" to better than 100 dB below carrier frequency.

For more application details see the data sheet, Hewlett-Packard Journal, March, 1967, and Hewlett-Packard Application Note 87.

HP 10531A, Filter Kit

The HP 10531A Accessory Filter Kit provides a series of three plug-in low pass filters which can be adjusted to cover frequencies from 100 Hz to 1 MHz. These filters reject carrier and carrier harmonics while passing modulation components. Thus it is possible to measure demodulated signal components up to 20% of the carrier frequency using the Hewlett-Packard wave analyzers or similar narrow band voltmeters.

Option 001, calibrated offset

The calibrated offset provides for display of any of the 10 major divisions on a separate full meter scale (the EXPAND scale). This allows frequency measurements to be made with higher accuracy than is possible using the meter in the NORMAL mode.

Price: HP 5210A, \$825; Option 001, add \$125; HP 10531A, \$175.

5323A Automatic Counter

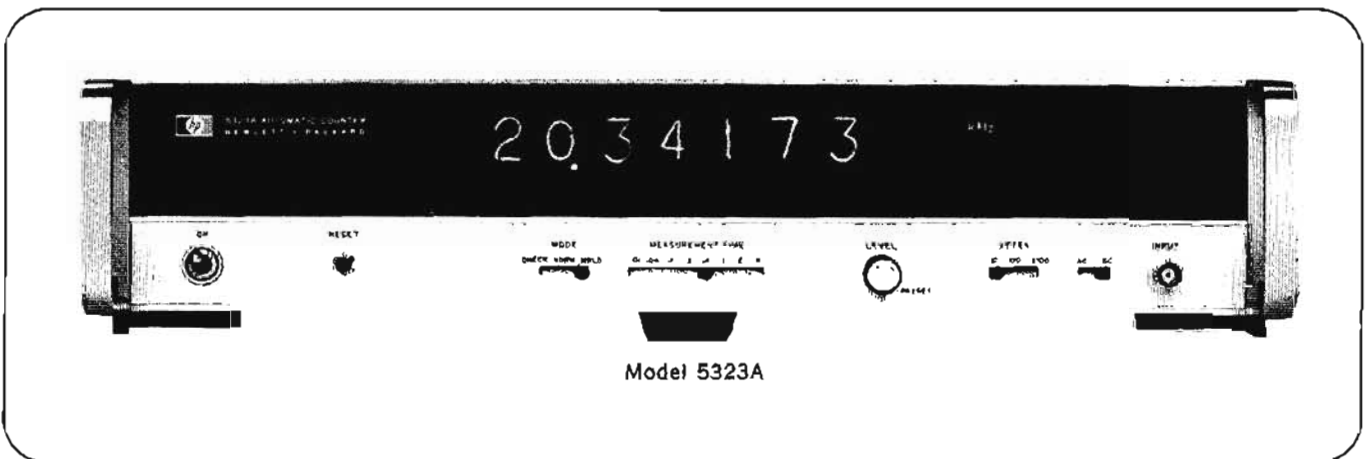

This direct reading electronic counter departs from traditional counter design to offer: much greater resolution and speed when measuring low frequencies (10^3 times greater resolution at 100 Hz); automatic operation; measurement over the entire frequency range using any gate time up to 4 s, including non-decade and unknown values; and direct measurement of pulsed signal carrier frequency. Since the counter automatically displays high resolution measurements from 0.125 Hz to 20 MHz without requiring gate time selection, ease of use and speed are increased both in visual readout and automatic systems applications. For tachometry applications, a rear panel X60 multiplier converts data from pulses per second to revolutions per minute to give a high resolution industrial measurement. Remote programming and digital output are also included.

The 5323A achieves its benefits of speed, resolution, and automaticity by measuring input signal period, then taking the reciprocal, which is frequency, using built-in computing circuits.

A wide selection of measurement times are provided: short times for high speed applications and long times for greater accuracy. Since the 5323A is not limited to either counting or gating in decade values only, additional speed may be achieved by using only the minimum measuring time necessary to obtain the accuracy required.

A full complement of the other features normally found in Hewlett-Packard's latest electronic counters is also provided. Detailed information in the technical data sheet is available upon request, or see Hewlett-Packard Journal, May 1969.

SELECTION GUIDE TO FREQUENCY AND TIME STANDARDS



FREQUENCY & TIME STANDARDS

Hewlett-Packard offers Frequency Standards & clocks which provide accurate frequency, time interval and time-keeping capabilities. Further, Hewlett-Packard standards provide means for comparing these quantities against national standards such as the National Bureau of Standards (NBS) and the U.S. Naval Observatory. Units of frequency or time cannot be kept in a vault for ready reference. They must be generated for each use, hence be regularly compared against recognized primary standards.

Frequency Standard & clock systems manufactured by Hewlett-Packard are used for control and calibration at observatories, national centers for measurement standards, physical research laboratories, missile and satellite tracking stations, radio navigation systems, manufacturing plants and radio monitoring and transmitting stations.

Types of frequency standards

At the present time, three types of frequency standards are in common use. These are:

1. The cesium atomic beam controlled oscillator.
2. The rubidium gas cell controlled oscillator, and
3. The quartz crystal oscillator.

Hewlett-Packard is the only manufacturer of all three types of frequency standards. Of these three standards, the first is referred to as a primary frequency standard and the last two as secondary frequency standards. The distinction between a primary standard and a secondary standard is that the primary standard does not require any other reference for calibration; whereas the secondary standard requires calibrations both during manufacturing and at certain intervals during use depending on the accuracy desired.

Cesium beam frequency standard

Cesium beam standards are in use wherever the goal is a very high accuracy primary frequency standard. In fact, the NBS frequency standard itself is of the cesium beam type. The cesium beam standard is an atomic resonance device which provides access to one of nature's invariant frequencies in accord with the principles of quantum mechanics. The cesium standard is a true primary standard and requires no other reference for calibration.

The HP Model 5061A is a portable cesium beam standard proved capable of

realizing the cesium transition frequency to the same levels of accuracy and long-term stability usually achieved by large-scale laboratory models. Its short term stability has now been improved to nearly match that of the Rubidium Frequency Standard.

periodic frequency checks are needed to maintain an accurate quartz crystal frequency standard.

Stability

Stability is specified in two ways, long-term and short-term. Long-term stability

TABLE 1
Comparison of Frequency Standards

Standard	Principal construction feature	Principal advantage
Cesium Atomic Beam Resonator Controlled Oscillator	Atomic beam interaction with fields-minimum disturbances of resonating atoms due to collisions and extraneous influences	High intrinsic reproducibility and long-term stability. Designated as primary standard for definition of time interval
Rubidium Gas Cell Resonator Controlled Oscillator	Gas buffered resonance cell with optically pumped state selection	Compact and light weight. High degree of short-term stability
Quartz Crystal Oscillator	Piezoelectrically active quartz crystal with electronic stabilization	Very compact, light and rugged. Inexpensive

Rubidium frequency standard

Rubidium frequency standards feature a high order of both short-term and long-term frequency stability. These are both important in certain fields such as deep-space communications, satellite ranging, and doppler radar. Also, rubidium standards are noted for being of small size.

Rubidium standards are similar to cesium beam standards in that an atomic resonant element prevents drift of a standard frequency quartz oscillator through a frequency lock loop. Yet the rubidium type is a secondary standard. Since the atomic resonant frequency of a rubidium gas cell is dependent upon gas mixture and gas pressure in the cell, it must be calibrated and then it is subject to a small degree of drift. The drift is typically 100 times less than the best quartz crystal standard.

Quartz crystal oscillators

Quartz oscillators are used in virtually every frequency control application. They are an integral part of atomic standards and are used extensively as independent frequency sources for the less demanding applications. The quartz oscillator designs have improved over the years to provide a relatively low cost, small size source of frequency.

However, an inherent characteristic of crystal oscillators is that their resonant frequency changes with time. After an initial aging period of a few days to a month, the rate of change of frequency or aging rate is almost constant. Over a long period the accumulated drift could amount to a serious error, and

refers to slow changes in the average frequency with time due to secular changes in the resonator and is usually expressed as a ratio, $\Delta f/f$ for a given period of time. For quartz oscillators this is often termed "aging rate" and specified in "parts per day." Rubidium standards being more invariant are specified in "parts per month." On the other hand, Cesium Beam Standards are primary units having little or no change or drift. Therefore, these primary standards are given a specified accuracy to within which the frequency is guaranteed.

Short-term stability refers to changes in frequency over a time sufficiently short so that change in frequency due to long term effects is negligible.

Short-term stability is usually specified as the rms average of a number of measurements each over a specified period of time and this averaging time should be given. The longer the averaging time used, the more any deviation is obscured since the average must approach the mean or nominal output frequency in the long run. Hewlett-Packard specifies the short-term stability of its standards in accordance with the definition developed by the National Bureau of Standards and others.* Measurements conforming to this definition can be easily made with available test equipment including the HP 5360A Computing Counter. Figure 1 is a comparison of the short term stability of various frequency standards.

* Statistics of Atomic standards D. Allen, Proceedings of IEEE, Feb. 1966, p. 221.

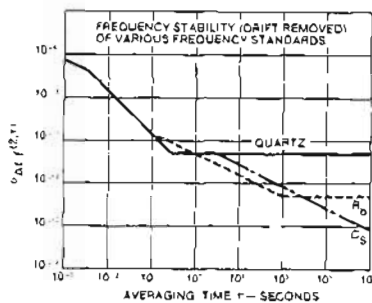

Figure 1. Short-term stability of various standards.

Spectral purity

Spectral purity is the degree to which a signal is coherent or, expressed in another way, a single frequency with a minimum of side band noise power. It is greatly desirable to have high spectral purity in a standard signal. This is especially important in applications where the standard frequency is multiplied to very high or microwave frequencies so that the frequency spectrum of the signal will be reasonably narrow.

The signal and its frequency spectrum are analogous to a frequency modulated wave where the total power is constant. If the frequency multiplying device is broadband, the ratio of the total sideband power to the signal power increases as the square of the multiplying factor. With frequency multiplication the signal-to-noise ratio will be degraded 6 dB per octave and 20 dB per decade.

Hewlett-Packard oscillators are designed to give exceptional spectral purity. One method of indicating spectral purity is with a phase noise plot. Figure 2 shows the performance of the HP 5061A, Opt. 04 Cesium Beam Atomic Frequency Standard. (See Hewlett-Packard Application Note 52, "Frequency and Time Standards," pages 3-4 and 5-1 for details of noise measurement).

Frequency standards and clocks

Frequency standards and clocks have no fundamental differences—they are based upon dual aspects of the same phenomenon. Time and frequency are intangible quantities which can be measured only with respect to some physical quantity. The basic unit of time, the second, is defined as the duration of 9,192,631,770 periods of transition within the cesium atom. Conversely an unknown frequency is determined by counting the

number of cycles over the period of a second.

The U.S. Naval Observatory (USNO) determines and keeps standard time for the United States. The Master Clock at the Observatory, one of the world's most accurate clocks, is made up of an ensemble of more than a dozen Hewlett-Packard cesium beam frequency standards. The USNO directly controls the distribution of precise time and time interval (frequency) from Naval radio stations, LORAN-C (operated by U.S. Coast Guard), Omega and Satellite Navigation Systems. Hewlett-Packard portable cesium standards, "flying clocks," are used to periodically check the synchronization between these stations and the Master Clock.

Hewlett-Packard cesium beam standards are widely used to drive precision clocks because of the extremely good long-term stability and reliability of this primary standard. If a quartz oscillator or other secondary standard is used, it must be evaluated for rate of drift and be kept carefully corrected.

Frequency comparison by VLF broadcast

One excellent way to keep a local system's frequency—hence, time interval—referenced against master time interval is by use of a LF or VLF standard broadcast such as those of the National Bureau of Standards and the Naval Observatory. A prime means for doing this with ease and convenience is the HP 117A Receiver which is designed to monitor the NBS 60 kHz broadcast from WWVB. This unit is a complete system in itself. The strip chart produced by the 117A records minute by minute the results of a precision phase comparison (resolution, 1 μ s) of the local signal against the received signal to show frequency offset or error of the local standard.

Time scale

The time interval of the atomic time scale is the International Second, defined in October 1967 by the Thirteenth General Conference of Weight and Measures. Starting in January 1972, Universal Time, Coordinated (UTC) will go to zero offset (standard frequency). This new UTC is broadcast from the NBS Station of WWVB (60 kHz). Therefore, the HP 117A VLF Receiver will provide direct comparison to the internationally agreed upon time (frequency) reference.

Standby power supplies

Minimum down-time, important for any system, is vital to a time standard. Its worth depends directly on continuity of operation. Noninterrupted operation is also important to ultraprecise quartz oscillators.

Hewlett-Packard standby power supplies ensure continued operation despite line interruptions, and operate over a range of ac line voltage to supply regulated dc to operate frequency standards and frequency dividers and clocks. The batteries in the supplies assume the full load immediately when ac power fails.

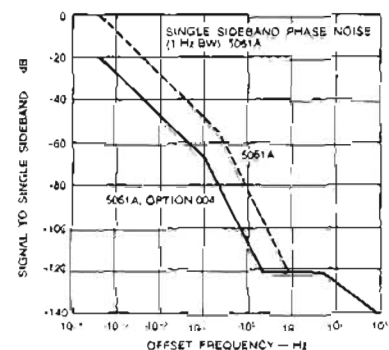

Figure 2. 5061A Opt. 004 Phase Noise.

Hewlett-Packard time and frequency standard

The Hewlett-Packard House Standard has as its basic reference the HP 5061A Cesium Beam Standard. The output is continually compared in phase with the U.S. National Bureau of Standards Frequency Standard (NBSFS) at Boulder, Colorado by reception of NBS standards stations WWVB and WWVL via HP 117A Receivers. The standard may also be compared to the U.S. Navy's VLF stations. Frequency is maintained in agreement with NBS/USNO coordinated time scale with an accuracy of parts in 10^{13} . Studies have shown this standard to rank among the world's most accurate.

Time is maintained relative to the Naval Observatory and the National Bureau of Standards' master clocks to an accuracy of better than ± 2.5 microseconds. This accuracy is verified with Flying Clock trips from the Naval Observatory to both Hewlett-Packard Santa Clara Division and Hewlett-Packard Geneva. Both locations have been designated U.S. Naval Observatory Time Reference Stations.

QUARTZ OSCILLATORS

State-of-the-art frequency stability
Models 105A/B



FREQUENCY & TIME STANDARDS

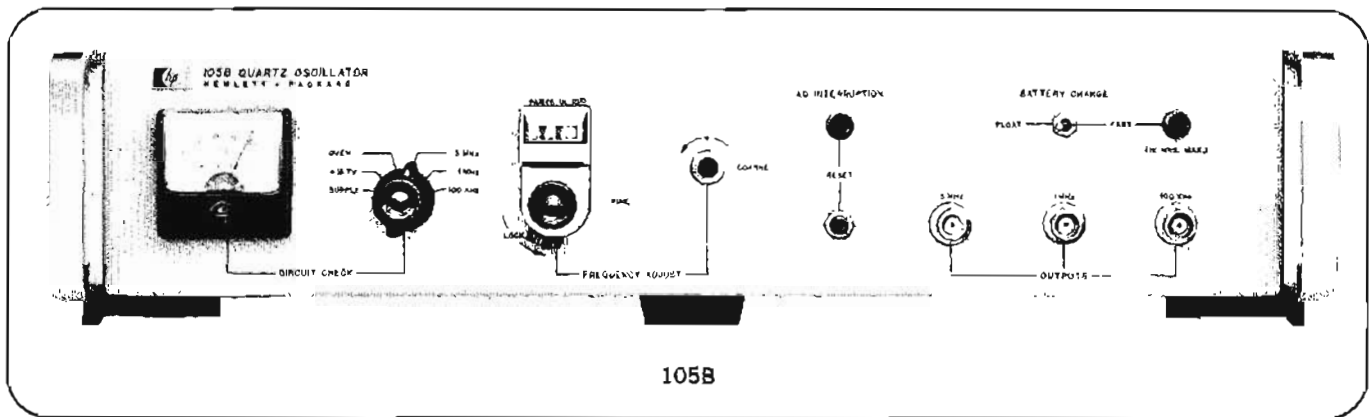

Advantages:

- High spectral purity
- Well-buffered outputs
- Aging $< 5 \times 10^{-10}$ per day

Uses:

- In-house frequency and time standards
- Microwave spectroscopy
- Advanced navigation, communication systems

Models 105A and B Quartz Oscillators provide state-of-the-art performance in precision frequency and time systems because of their excellent long and short term stability characteristics, spectrally pure outputs, unexcelled reliability, and ability to operate under a wide range of environmental conditions. They fill a need for a small and economical yet highly stable precision quartz oscillator for frequency and time standards. Both models can be operated from the ac line; the 105B has a built-in 8-hour standby battery for uninterrupted operation should line power fail. Both have 5 MHz, 1 MHz, and 100 kHz buffered sinusoidal outputs with excellent short term stability (5 parts in 10^{12} rms for 1 s averaging time) and aging rate (< 5 parts in 10^{10} per day).

The 105A/B features rapid warm-up. Typically, the oscillator will be within 1 part in 10^9 of the previous frequency in 20 minutes after an "off" period of 24 hours. The basis of these oscillators is an extremely stable 5 MHz, 5th overtone quartz crystal developed by Hewlett-Packard. New technologies in the crystal mounting and packaging have resulted in a cleaner crystal which in turn has a lower aging rate. The crystal, oscillator and AGC circuit are all enclosed in a proportional oven which reduces the temperature effects on these components and circuits.

The 2.7" x 2.7" x 5.4" package containing the oven enclosed crystal oscillator with AGC circuit and buffer amplifier are available separately as a component oscillator, the K07-105A, for use in equipment where a high quality 5 MHz source is required. Details are available from Hewlett-Packard sales offices.

Particular care was taken to provide a spectrally pure 5 MHz output which, when multiplied high into the microwave region, provides signals with spectra only a few cycles wide. Spectra less than 1 Hz wide can be obtained in X-band (8.2 to 12.4 GHz). The stability and purity of the 5 MHz output make it suitable for doppler measurements, microwave spectroscopy, and similar applications where the reference frequency must be multiplied by a large factor.

Specifications

Outputs: 5 MHz, 1 MHz, 100 kHz; 1 V rms into 50 Ω front and rear connectors.

Clock output: 1 MHz or 100 kHz; 0.5 V rms into 1 K Ω , rear connector. Normally supplied wired for 1 MHz output.

Frequency stability:

Aging rate: $< 5 \times 10^{-10}$ per 24 hours.

Short-term stability: for 5 MHz output only.

T (sec)	$\sigma_{\Delta f/f}(2, T)$	$\sigma_{\Delta t}(2, T)$
10^{-2}	1.5×10^{-10}	1.5×10^{-12}
10^{-1}	1.5×10^{-11}	1.5×10^{-12}
10^0	5×10^{-12}	5×10^{-12}

Temperature: $< 2.5 \times 10^{-9}$ total change 0°C to 50°C .

Load: $\pm 2 \times 10^{-11}$ open to short circuit, 50 Ω R, L or C load change.

Supply voltage: $\pm 5 \times 10^{-11}$ for 22-30 V dc from 26 V dc reference and for 115/230 V $\pm 10\%$.

Warm-up (at 25°C): to within 1×10^{-1} of previous frequency in 15 min., 1×10^{-3} in 20 min., 1×10^{-6} in 30 min.

Distortion (5 MHz, 1 MHz, 100 kHz) below rated output:

Harmonic: > 40 dB.

Nonharmonic: > 80 dB.

Signal-to-noise ratio: for 1 and 5 MHz, > 90 dB in a 30 kHz noise bw (5 MHz output filter bw is approximately 100 Hz).

Frequency adjustments:

Fine: 5×10^{-8} range with digital dial reading parts in 10^{10} .

Coarse: 1×10^{-6} front panel screwdriver control.

Phase locking: external ± 5 V to -5 V allows $> 2 \times 10^{-6}$ frequency control for locking to external source.

Environmental:

Temperature, operating: 0°C to $+50^\circ\text{C}$.

Temperature, storage: -40°C to $+75^\circ\text{C}$ ($+50^\circ$ for 105B).

Altitude: 50,000 ft.

Shock: MIL-T-21200 (30 G's).

Vibration: MIL-STD-167 and MIL-T-21200.

Electromagnetic compatibility (EMC): MIL-1-6181D.

Standby supply capacity: Model 105B only, 8 hours at 25°C ambient temperatures.

Power requirements: 115/230 V $\pm 10\%$, 50-400 Hz at 17 W (70 W warm-up) for 105A. For 105B add 1 W for float charge and 12 W for fast charge. 22-30 V dc at 6.4 W (10.3 W warm-up).

Dimensions: 3.15/32" high, 1.63/4" wide, 1.13/4" deep (88 x 425 x 286 mm).

Weight: 105A—net, 16 lbs (8 kg); shipping, 23 lbs 10.5 kg). 105B—net, 24 lbs (11 kg); shipping, 31 lbs (14 kg).

Price: Model 105A, \$1650; Model 105B, \$1950.



RUBIDIUM FREQUENCY STANDARD

Compact, lightweight atomic standard

Models 5065A, E21-5065A

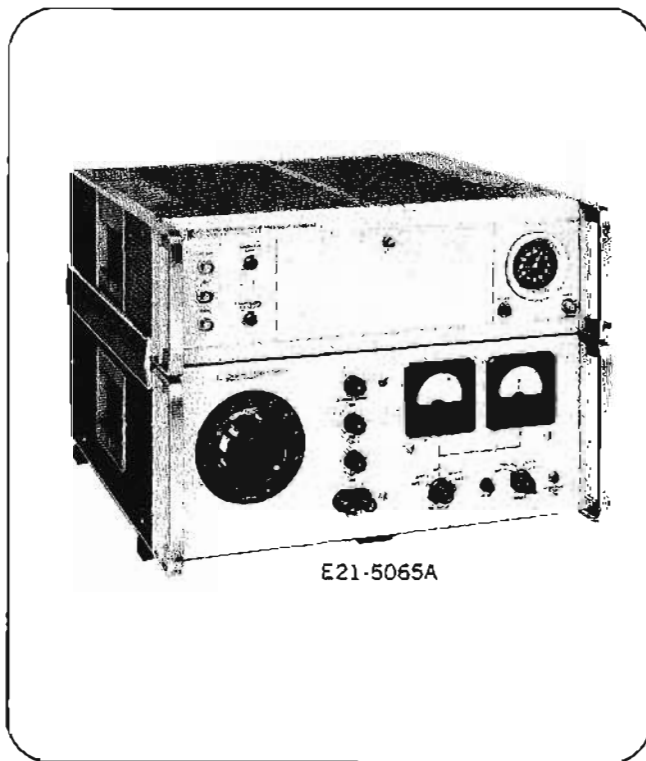

E21-5065A

Advantages:

- Low price atomic standard.
- Long term drift rate of $<1 \times 10^{-11}$ /mo.
- Short term stability of $<5 \times 10^{-13}$ for 100 s average.
- Calibrated fine frequency adjustment.
- Battery standby power guards against power failure (optional).
- Built in clock and digital divider (optional).
- Rubidium Vapor Frequency Reference warranted 3 years.

Uses:

- Precise frequency source for systems operating in the radio and TV spectrum.
- Precision timekeeping.
- House standards and calibration laboratories.
- Doppler radar.

The HP Model 5065A is an atomic-type secondary frequency standard which uses a rubidium vapor resonance cell as the stabilizing element. As a result, it has long term stability of better than 1×10^{-11} per month which exceeds that of high quality quartz oscillator frequency standards by 50 to 100 times. Furthermore, it has excellent short term stability. These features contribute to its desirability as a coherent signal source, as a master oscillator for radio and radar systems where special requirements for stability and/or narrow bandwidth must be met, as a precision timekeeper where the better performance of a cesium beam primary standard is not required, and as a house frequency standard for improved accuracy with fewer NBS calibrations compared to that required with quartz standards.

Front panel controls and circuit check meter of the 5065A are protected by a panel door. The magnetic field control provides fine frequency adjustment with which the frequency can

be set to a precision of better than 2×10^{-12} without reference to a chart. The 5 MHz low noise quartz oscillator is phase locked to the atomic frequency and provides the standard 5 MHz, 1 MHz, and 100 kHz outputs. The circuit check meter with selector switch monitors key voltages and currents for routine maintenance readings, calibration procedures, and fault finding.

The 5065A is designed for assured operation—to give the user confidence that the standard output signals are correct and locked to the atomic frequency. Logic within the unit maintains power to a "continuous operation" light on the front panel. If operation is interrupted, even momentarily, for any reason the light goes out and stays out until manually reset. An integrator limit light warns when the frequency correcting servo loop is approaching the limit of its dynamic range.

A time standard option generates 1 pulse per second available at a front panel BNC connector and drives a clock movement indicating hours, minutes and seconds. The clock pulse is adjustable over a range of 1 second in $1 \mu\text{s}$ increments to permit precise synchronization with another clock using a counter or oscilloscope. A screwdriver control allows continuous fine adjustment over any $1 \mu\text{s}$ range. The clock can also be automatically set to a $10 \pm 1 \mu\text{s}$ delay with respect to an external clock pulse.

An optional built in standby battery assures continuous operation of the HP 5065A in the event of brief power failures. The 5085A or K02-5060A Power Supplies will provide battery power for longer periods.

The HP Model 5065A is contained in a small sized package and is lightweight in comparison to a cesium beam standard. Additionally, the rubidium resonance cell is much more frequency stable than quartz oscillators while subjected to shock and vibration. Its environmental specifications include temperature, shock, vibration, EMC, humidity, and magnetic field effects.

The most significant module in the HP 5065A in terms of performance is the Rubidium Vapor Frequency Reference (RVFR). This temperature controlled, magnetically shielded unit which includes the Rb^{87} lamp, Rb^{85} filter cell, microwave cavity with Rb^{87} gas cell and a photo sensitive detector can be expensive to replace. It has been designed for maximum possible reliability. Field experience, including several million hours operation, have demonstrated this reliability and the module is now warranted for a period of three years. This increased warranty protects the owner in the event of a random failure.

E21-5065A

Portable Time Standard

E21-5065A Portable Time Standard is a complete system for precision timekeeping and for transporting time from one location to another. It consists of the 5065A Rubidium Standard with digital clock and divider (option 01) and the K02-5060A Power Supply with 6 or more hours standby capability. The K02-5060A is described in detail elsewhere in this catalog. The component units are held together by side bars, and the interconnecting cables are protected by a back cover.

Weight: 110 lb (50 kg).

Dimensions: $16\frac{3}{4}$ " (425 mm) wide, $12\text{-}13\frac{1}{16}$ " (326 mm) high, $19\frac{1}{2}$ " (495 mm) deep.

Price: \$12,225.

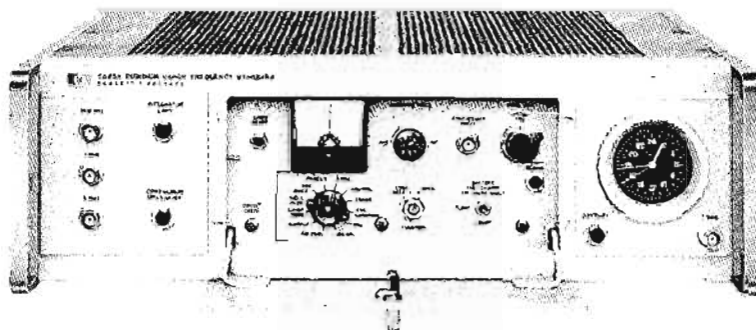

HP 5065A shown with Option 03 consisting of clock and standby battery

Specifications, 5065A

Frequency stability:

Long term: $\pm 1 \times 10^{-11}$ per month (maximum limit of drift rate).

Short term (5 MHz output):

$\frac{\Delta f}{f}$ (Std. Dev.)	Avg. Time
$< 7 \times 10^{-12}$	1 sec.
$< 2.2 \times 10^{-12}$	10 sec.
$< 7 \times 10^{-13}$	100 sec.

Calibration accuracy: set at factory to $\pm 1 \times 10^{-11}$.

Tunability:

Coarse frequency synthesizer adjustment:

Range: 10^{-7} . Resolution: $< 2 \times 10^{-9}$, thumbwheel adjustable.

Fine frequency magnetic field adjustment:

Range: 2×10^{-9} . Resolution: 2×10^{-12} .

Warm-up: within 1×10^{-10} in one hour and 5×10^{-11} in 4 hours after 24 hours "off" time at 25°C.

Outputs:

Frequencies: 5 MHz, 1 MHz, 100 kHz.

Voltage levels: > 1 V rms into 50 ohms.

Connectors: BNC front and rear.

Distortion (5 MHz, 1 MHz, 100 kHz) below rated output:

Harmonic: > 40 dB.

Nonharmonic: > 80 dB.

Signal-to-noise ratio: for 1 and 5 MHz, > 87 dB at rated output (in a 30 kHz noise bw). 5 MHz output filter bw is approx. 100 Hz.

Environmental:

Temperature, operating: 0° to 50°C . Frequency change is $< \pm 4 \times 10^{-11}$ from frequency reference at 25°C .

Temperature, nonoperating: -40° to $+75^\circ$. (With Options to 50°C .)

Production units have passed tests as follows:

Humidity: 0 to 95% relative humidity.

Vibration: MIL-STD-167 and MIL-E-5400, Curve 1, with isolators.

Shock: MIL-T-21200, and MIL-E-5400 (30 G's).

Electromagnetic compatibility (EMC): MIL-I-6181D and MIL-STD-461, Class A.

Altitude: frequency change is $< 5 \times 10^{-11}$ from 0 to 40,000 ft.

Frequency stability due to:

Magnetic fields: $< 5 \times 10^{-12}$ for 1 gauss dc change or 1 gauss peak ac, $60 \pm 10\%$ Hz and $400 \pm 10\%$ Hz.

Line voltage: $< 4 \times 10^{-12}$ over specified input range.

Power: 115 or 230 V ac $\pm 10\%$, 50 to 400 Hz; or 23 to 30 V dc.

Approx. power required:

	24 V dc	115 V ac
Without options:	35 W	49 W
Option 001	Add 8 W	9 W
Option 002	0 W	6 W
Option 003	Add 8 W	15 W

Accessories furnished: power cord, 6 ft (180 cm) detachable. Rack Mounting Kit, HP 5060-0775. Accessory Kit, HP 05065-

6066, includes Micon connector adapter male-male, mating connector HP 1251-0126 for EXT dc input. 3 circuit board extenders, test cable, and a special coil-tuning screwdriver.

Dimensions: $16\frac{3}{4}$ " (425 mm) wide, $5\text{-}7/32$ " (132.6 mm) high, $16\frac{3}{8}$ " (416 mm) deep.

Weight: net, 34 lbs (15.4 kg); shipping, 52 lbs (23.5 kg). Option 001 add 2 lbs (.9 kg); Option 002 add 3.5 lbs (1.6 kg).

Accessories available: EXT dc cable: connects 5065A to 5085A Standby Supply. HP 103A-16A, \$21.50.

Price: \$7,500.

Warranty: 1 year except 3 years for RVFR.

Option 001 time standard

Clock pulse:

Rate: 1 pulse per second.

Amplitude: $+10$ V peak $\pm 10\%$.

Width: 20 μs min.

Rise time: < 50 ns.

Fall time: < 1 μs .

Jitter: < 5 ns rms.

All specs are with 50 Ω load.

Output: front-panel BNC.

Synchronization: automatic to 10 ± 1 μs , delayed from reference input pulse (rear BNC). Manual adj. to ± 50 ns. Reference pulse must be $> +5$ V with a rise time < 50 ns and width > 0.5 μs .

Clock movement: 24-hour with sweep second hand.

Price: Option 001, add \$1,500.

Option 002 standby power supply

Capacity: 10-minute minimum at 25°C after full charge (incl. Option 01).

Charge control: front panel, Fast Charge-Float-Reset switch.

Indicator: a front-panel light flashes when ac power is interrupted and battery is being used. A continuous light indicates a fast charge condition.

Price: Option 002, add \$500.

Option 003

(Combines Options 001 and 002)

Price: Option 003, add \$1,800.

Performance of quartz oscillator only

(Rubidium Control Loop Open)

Aging rate: $\pm 5 \times 10^{-10}$ per 24 hours.

Frequency adjustments:

Fine adjustment: 5×10^{-11} range, with dial readings of parts in 10^{10} .

Coarse adjustment: 1 part in 10^5 , screwdriver adjustment at front panel.

Stability:

As a function of ambient temperature: frequency change is less than 2.5×10^{-9} total from 0° to $+50^\circ\text{C}$.

As a function of load: $\pm 2 \times 10^{-11}$ from open circuit to short, 50 Ω R, L, or C load change.

As a function of supply voltage: $\pm 5 \times 10^{-11}$ for 23 to 30 V dc from 26 V dc reference, or for 115/230 V ac $\pm 10\%$.

FREQUENCY & TIME STANDARDS



CESIUM BEAM FREQUENCY STANDARD

Compact primary standard, 7×10^{-12}

Models 5061A, E21-5061A

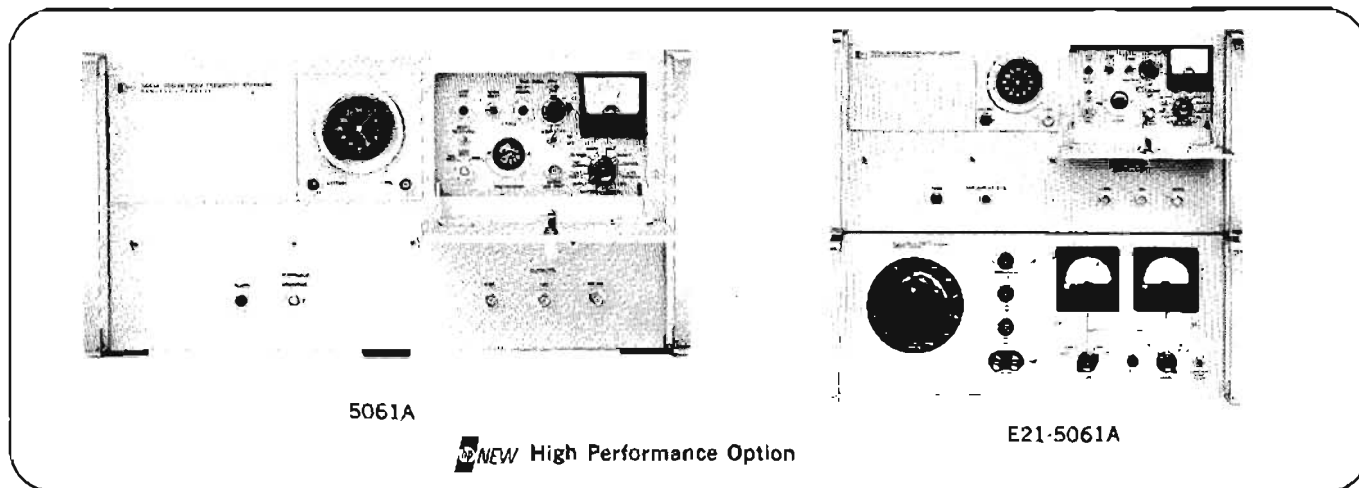

Advantages

- Accuracy of ± 7 parts in 10^{12}
- Settability of 1×10^{-12}
- Short term stability of 5×10^{-12} (1 s avg.)

The Hewlett-Packard Model 5061A is a compact, self-contained primary standard which has, since its introduction in 1967, become the standard of worldwide frequency and timekeeping. Its proven performance has made feasible many advanced systems requiring microsecond timing such as precision navigation (to hundred foot accuracy) and airborne collision avoidance.

Now, a new beam tube design concept including dual beam optics, improved magnetic shielding, and ruggedization has resulted in significant improvements in accuracy, short term stability, settability and environmental performance. This tube retains the unique cesium standard feature of virtually no long term instability or aging. This new beam tube is offered as Option 004 in new units and is also available as a retrofit kit for units already in use.

The intrinsic accuracy is improved to 7×10^{-12} (5×10^{-12} excluding environmental effects) which provides an excellent reference standard without need of calibration. If desired, such as in many timekeeping applications, two or more units may be set or calibrated to each other. The new settability specification of 1×10^{-12} means two calibrated units (clocks) would accumulate less than 10 nanoseconds per day time error (excluding environmental effects). A provision for degaussing the tube without adversely affecting the instrument operation allows removal of any residual magnetic field in the tube. This is important in achieving the new settability performance. The K24-5061A Degausser accessory unit is available for use with instruments using the new high performance tube.

The short term stability specification is improved by a factor of ten with the new tube. The 5×10^{-12} (1 sec avg.) performance compares very favorably with that of rubidium type standards which are noted for their excellent short term stability. An important advantage from the better short term stability is the capability to make measurements to a 1 sigma precision of 1×10^{-12} in about one minute compared to the two hours required previously.

Within the 5061A Primary Frequency Standard, the beam tube utilizes a quantum mechanical transition in the cesium 133 atom to stabilize a high quality quartz oscillator through a closed-loop, self-checking control circuit yielding exceptional accuracy. The 5061A has provision for an optional internal clock and digital divider and for a battery with $\frac{1}{2}$ hour standby power capacity and automatic charging.

The quartz crystal oscillator used in the 5061A has superior characteristics even without control by the atomic resonator. The quartz oscillator portion of this cesium beam standard is identical to the HP 105A.

The 5061A is compact and portable, no complex permanent installation is required.

Accuracy and intrinsic reproducibility

The data in figure 1 is based on over 250 independently aligned standard Model 5061A's. It demonstrates that the cesium beam tube frequency perturbations are so small that all units are within $\pm 5 \times 10^{-12}$ of each other and the National Bureau of Standards. The one sigma standard deviation is 1×10^{-12} between the standards. This performance is intrinsic to the 5061A primary frequency standard and is achieved without calibration.

Reliability and warranty

Over 10 million operational hours of history have proven the performance and reliability of Hewlett-Packard cesium beam standards in various worldwide applications. The units have provided dependable microsecond accuracy in aircraft, ship, and fixed environments.

A 3 year instrument warranty* is provided as a result of the 5061A's proved field reliability. This warranty includes the replacement of the cesium beam tube if it should fail within 3 years. Typically the beam tube life is in excess of 4 years.

Applications

Hewlett-Packard Cesium Beam Standards are used in critical applications such as Apollo timing and missile tracking where their inherent reliability and accuracy play an important role. They are also used in worldwide navigation stations (Loran C and Omega), various national observatories and scientific laboratories around the world, calibration labs, and in the field as very accurate, portable frequency and time standards for instrument and clock calibration. Other areas of application include precision mapping, long baseline interferometry, investigation of radio transmission phenomena, and aircraft collision avoidance systems. As indicated above, success of

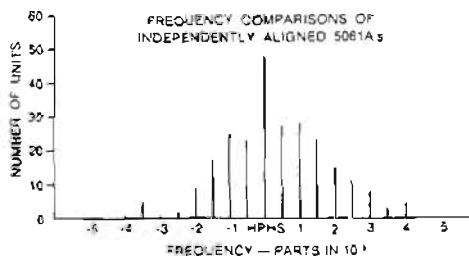

Figure 1.

NBS VIA VLF

* 1 year for battery and clock.

the cesium beam standard in each of these applications is dependent on its high reliability and accuracy.

The improved characteristics of the new high performance tube will make possible improvements in the performance of systems which depend on precise time and frequency.

E21-5061A Flying Clock

The E21-5061A consists of a 5061A Cesium Beam Standard and a K02-5060A Power Supply (page 244) joined together to make one portable unit. The power supply, which can be operated from 6 or 12 V dc, 24 to 30 V dc, or 115/230 V $\pm 10\%$, 50 to 400 Hz, will provide approximately 7 hours standby power (from sealed nickel-cadium batteries) for the 5061A Cesium Beam Standard.

5061A Cesium Beam Standard

Note: Specifications for the 5061A with the high performance, Option 004, Cesium beam tube are given first and enclosed in brackets [] where they differ from those of the standard instrument.

Accuracy: [7×10^{-12}], 1×10^{-11} ; maintained when subjected to temperatures from 0 to 50°C, magnetic fields up to 2 gauss or any combination thereof.

Reproducibility: [$\pm 3 \times 10^{-12}$], $\pm 5 \times 10^{-12}$.

Stability (frequency): [$\pm 1 \times 10^{-12}$ using K24-5061A degausser], $\pm 7 \times 10^{-12}$.

Long-term stability (for life of cesium tube): [$\pm 3 \times 10^{-12}$], $\pm 5 \times 10^{-12}$.

Short-term stability

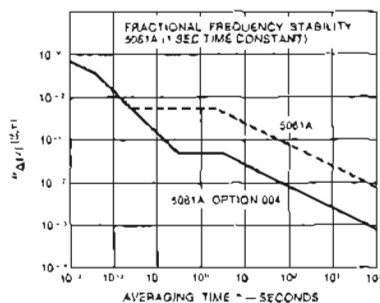

Time constant: adjustable slide switch for 1 and 60 seconds, recommend 1 s for normal operation. Use the longer time constant for improved short-term stability in controlled environments.

Warm-up time: [30] 45 minutes to fully operational from 25°C ambient temperature.

Outputs

Frequencies: 5 MHz, 1 MHz, 100 kHz.

Voltage levels: >1 V rms into 50 ohms at 5 MHz, 1 MHz, 100 kHz.

Connectors: BNC front and rear for 5 MHz, 1 MHz, 100 kHz.

Harmonic distortion: (5 MHz, 1 MHz, 100 kHz) down more than 40 dB from rated output.

Nonharmonically related output: (5 MHz, 1 MHz, 100 kHz) down more than 80 dB from rated output.

Signal-to-noise ratio: for 1 and 5 MHz, >87 dB at rated output (in a 30 kHz noise bandwidth, 5 MHz output filter bandwidth is approximately 100 Hz).

Quartz oscillator

The high quality internal oscillator may be used without turning on the cesium beam tube. See page 237 for specifications.

General

Warranty: 3 years, including the cesium beam tube. 1 year for optional battery and clock.

Environmental

Temperature: operating, 0 to 50°C. Stability, over full operating temperature range, $< \pm 5 \times 10^{-12}$ change from 25°C reference. Nonoperating, -40 to +75°C.

This wide range of operating power capabilities enables the E21-5061A to operate on local power in virtually any country in the world. Operation is approved aboard commercial aircraft. The seven hours of standby capability make it possible to travel where there is no power available and, of course, allow the E21-5061A to conveniently be transported between power sources and operated in almost any vehicle.

The improved settability and magnetic field (10 times better) performance of Option 004 significantly increases the accuracy of this portable standard. The E21-5061A Option 004 is a reliable truly portable primary frequency standard. And with Option 001 in the 5061A, it becomes a complete "flying clock" (see Hewlett-Packard Journal, August 1966 and December 1967).

Specifications

Production units have passed type testing as follows:

Humidity: 0 to 95% operating.

Altitude: $< 2 \times 10^{-12}$ change up to 40,000 ft operating.

Magnetic: dc field, [$\pm 1 \times 10^{-12}$ per gauss], $< \pm 2 \times 10^{-12}$ any orientation in 2 gauss field.

AC fields, $< \pm 2 \times 10^{-12}$ for 2 gauss peak for 50, 60 or 400 Hz ($\pm 10\%$).

Shock: MIL-T-21200, Class 1 and MIL-E-5400 (30 G's).

Vibration: MIL-T-21200 with isolators and MIL-STD-167.

EMC: MIL-STD-461A and MIL-I-6181D.

Power: 115 or 230 V ac $\pm 10\%$, 50 to 400 Hz, or 22 to 30 V dc. Approximate power required: 39 watts dc, 75 watts ac, with Option 003.

Net weight: 60 lbs Option 001, add 2 lbs Option 002, add 5 lbs. Option 004, add 8 lbs.

Accessories furnished: power cord, detachable. Rack mounting kit, two extender boards, test cables, maintenance tools, and a mating connector for Ext. dc input.

Accessories available: ext. dc cable, connects 5061A to 5085A standby supply, 103A-16A, \$21.50. K24-5061A Degausser required with Option 004 to achieve settability specification.

Price: HP Model 5061A, \$14,800.

Option 001 Time Standard

Clock pulse

Rate: 1 pulse per second.

Amplitude: +10 V $\pm 10\%$ peak.

Width: 20 μ s min.

Rise time: < 50 ns.

Fall time: < 1 μ s.

Jitter: < 5 ns rms pulse-to-pulse.

All specs are with 50 ohm load.

Synchronization (rear BNC): automatic, 10 μ s (± 1 μ s) delayed from reference input pulse. Manual adj. to $< \pm 50$ ns. Reference pulse must be $\geq +5$ V, with a rise time of < 50 ns.

Clock movement: 24-hour with sweep second hand.

Price: Option 001, add \$1500.

Option 002 Standby Power Supply

Capacity: 30 minutes minimum (1 hour typical) at 25°C at full charge. Includes Option 001.

Charge control: automatic when ac power is connected.

Indicator: a front panel light flashes when ac power is interrupted and battery is being used.

Price: Option 002, add \$600.

Option 003 (combines Option 001 and 002)

Price: Option 003, add \$2100.

Option 004 High Performance Cesium Beam Tube

Includes high performance tube and necessary circuit changes to give improved accuracy, reproducibility and stability performance shown above for Option 004. Options 001, 002 or 003 may be ordered with Option 004. (High performance retrofit kit available to replace the standard beam tube. Consult Hewlett-Packard field sales offices for details.)

Price: Option 004, add \$2000.



VLF COMPARATOR

Compares frequency against NBS standard
Model 117A

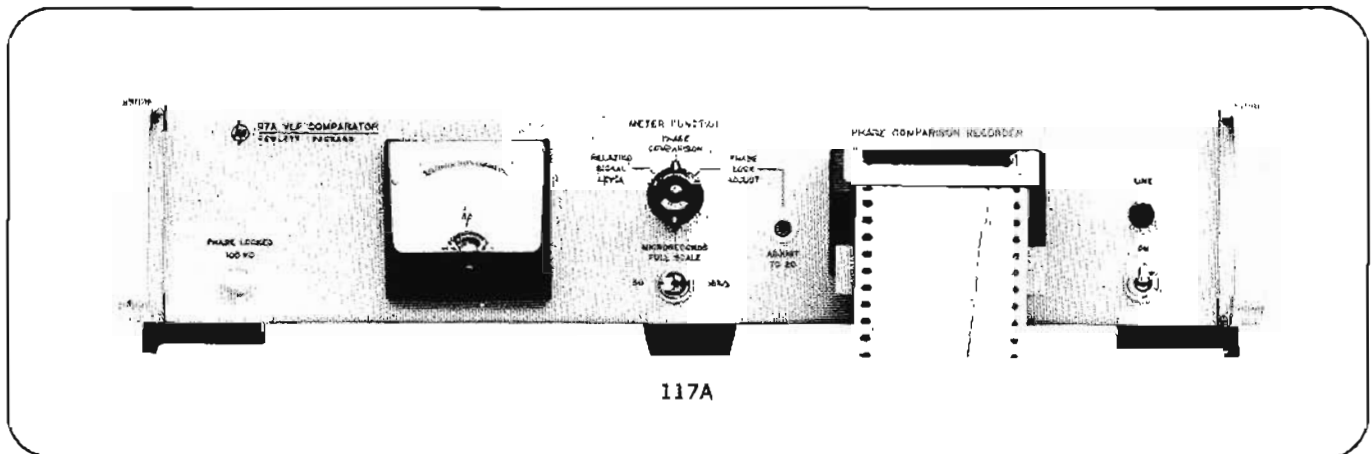

Advantages:

- Parts in 10^{11} accuracy possible over 24-hour period
- Provides traceability to NBS
- Plots minute-to-minute phase record
- Provides all equipment needed for frequency comparison

Uses:

- Offset and drift determinations for crystal oscillators
- Quick and easy checks of counter time-base accuracy
- Monitors atomic standards against NBS

The HP 117A VLF Comparator measures the frequency offset of a local standard frequency source against a standard radio frequency to an accuracy that can reach 2 parts in 10^{11} in a 24-hour period or parts in 10^{12} over longer periods. The HP 117A thus provides a link between house frequency standards and the Boulder, Colorado laboratories of the National Bureau of Standards (NBS) via station WWVB which broadcasts at 60 kHz with coverage of the entire continental United States. The modified H44-117A may be used to receive the 75 kHz broadcasts of HBG, Prangins, Switzerland.

The strip chart record of the HP 117A provides a precision phase comparison to show frequency offset of the local standard permitting its calibration to parts in 10^{10} in a few hours or long term monitoring to measure oscillator drift rate. A transparent template overlaid on the recording enables the operator to read at a glance the frequency offset of his local standard. A front panel meter shows relative level of the received signal, proper adjustment of the phase-locked oscillator and phase difference. Full-scale chart width and meter reading can be set for either a $50 \mu\text{s}$ or $16\text{-}2/3 \mu\text{s}$ phase difference.

Rear panel outputs provide for connection to external meters or recorders. An external recorder with a chart speed of several inches a minute can be used to record the amplitude modulated time code giving time of day and UT2 time corrections broadcast by WWVB.

Method of operation

The VLF Comparator is a complete system for comparison of a received standard broadcast signal with a local standard. It consists of a receiver, an electronic servo-controlled oscillator which functions as a narrow band tracking filter (and assures a continuous output signal despite noise and interference), a linear phase comparator and a strip chart recorder. A loop an-

tenna with a built-in preamplifier can be located up to 300 meters from the comparator. The cable carries power to the preamplifier.

Specifications

- Received standard frequency:** 60 kHz, NBS Station WWVB.
- Sensitivity:** $1 \mu\text{V}$ rms into 50Ω . Minimum field strength, $60 \mu\text{V}/\text{meter}$.
- Local standard input:** 100 kHz, 1 V rms into $1 \text{K}\Omega$ (divider to accept 1 MHz available as option).
- 100 kHz phase-locked output:** 5 V rectangular positive pulses into $5 \text{K}\Omega$ phase-locked to received signal.
- 60 kHz test output:** For self-checks of the 117A.
- Recorder outputs:** Phase comparison, 0-1 mA dc into 1400Ω . Relative signal strength, 100 mV dc from $2 \text{K}\Omega$.
- Overall phase stability:** $\pm 1 \mu\text{s}$, $0\text{-}50^\circ\text{C}$.
- Chart speed:** 1 in/hr (6 or 12 in/hr available at extra cost).
- Chart width:** $16\text{-}2/3 \mu\text{s}$ or $50 \mu\text{s}$ (selected by front panel switch).
- Meter readings:** Three switch positions: (1) relative signal level; (2) phase comparison; (3) phase-lock range to ensure negligible phase error.
- Adjustments:** A front panel control adjusts free-running frequency of voltage-controlled oscillator; three rear panel controls for full-scale adjustment for internal recorder, internal meter, and external recorder.
- Storage temperature:** -50°C to $+75^\circ\text{C}$.
- Operating temperature:** 0° to 50°C .
- Dimensions:** 16 $3/4$ " wide, 3 $15/32$ " high, 11 $1/4$ " deep (425 x 88 x 286 mm).
- Weight:** 117A: Net 20 lbs (9,1 kg), shipping 22 lbs (10 kg); antenna: net 12.5 lbs (5,7 kg), shipping 21 lbs (9,5 kg).
- Power:** 115 or 230 V $\pm 10\%$, 60 Hz, 40 watts.
- Accessories (Included):**
 - 10509A Loop Antenna:** Electrical height 1.6 cm, 43 in. (109 cm) in dia., mounts on 1-in. pipe thread. Operating temperature: -60° to $+80^\circ\text{C}$. Available separately (for use only with HP 117A), \$425 (incl. cable).
 - 10512A Coaxial Lead-in Cable:** 50Ω BNC-BNC connectors, 100 feet (30,5 m) long. Available separately at \$40 or in lengths to 300 m on special order.
 - 9281-0081 Recorder Chart Paper:** Box of six 30-ft. rolls, \$8.40. One roll shipped with 117A.
- Prices:** Model 117A including 10509A Antenna/Pre-amp and 10512A Lead-in Cable, \$1550.
- Option H44-117A:** 117A, modified for 75 kHz, with 10509A Antenna/Pre-amp and 10512A Lead-in Cable, 115/230 V, 50 Hz, \$2050.

DISTRIBUTION AMPLIFIER

Multiple high quality frequency std. outputs
Model 5087A



FREQUENCY & TIME STANDARDS

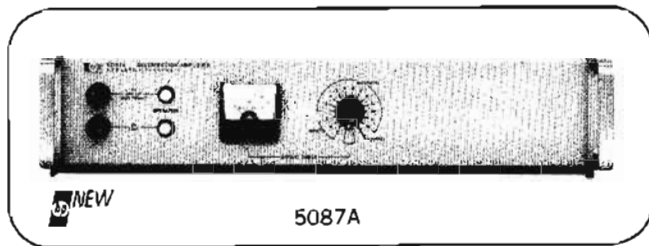

Features

12 outputs	Excellent isolation
3 input channels	High stability
Low noise	Versatile

This new distribution amplifier provides the isolation and flexibility required in various frequency distribution systems. Its low distortion and excellent isolation make it ideal for providing multiple outputs from high quality atomic and crystal frequency standards. The 3 input channels will accept 5 MHz, 1 MHz or 100 kHz in any combination with the number of outputs for each channel selectable up to a total of 12 outputs for the 3 channels. The output levels are individually adjustable from 0 to 3 V rms (1 V for 10 MHz). All outputs and input levels are monitored on a front panel meter.

Additional features are divider preamps that provide 1 MHz and 100 kHz from a single 5 MHz source and a multiplier-output amplifier that provides 10 MHz out from a 5 MHz input. The 10 MHz is convenient for driving the new generation counters which only accept 10 MHz as an external standard.

Advantages

Advantages include plug-in modular construction, meter monitored inputs and outputs, short circuit isolation, exceptional phase stability, low noise and crosstalk, and adjustable output levels.

The Model 5087A is designed for maximum versatility. The standard configuration is shown in Figure 1. Many combinations of inputs and outputs are possible. The unit has a mother board which provides the proper interconnections for many module combinations and eliminates wiring—increasing the instrument's reliability. The data sheet lists the module options and details concerning their selection for any configuration.

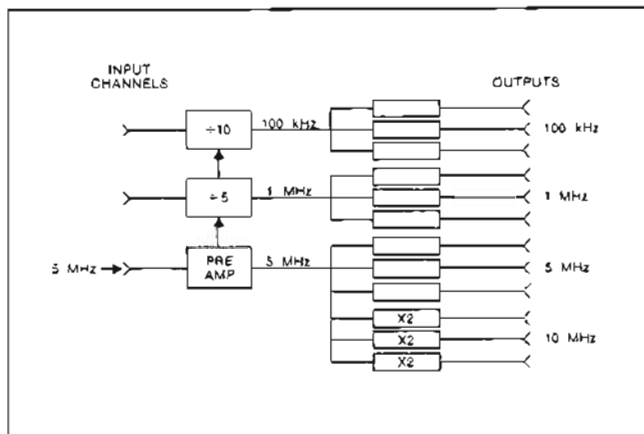

Figure 1. Standard configuration. Other configurations may be ordered.

Tentative Specifications, 5087A

Inputs

Frequencies: 3 each, any combination of 5.0 MHz, 1.0 MHz, or 100.0 kHz.

Level: 0.3 to 3.0 volts rms at 1 K ohm.

Outputs

Frequencies: up to 12, total of 5 MHz, 1 MHz, or 100 kHz.

Also 10 MHz suitable for counters (1 V at 50 ohm).

Level: 0 to 3 volts rms at 50 ohms.

Channels: 1 to 12.

Harmonic distortion: -40 dB.

Crosstalk: -60 dB.

Isolation

Amplitude change: 0.1%.

Phase change (open to short on any other channel): Less than 0.1 nanosecond.

Spurious: -80 dB.

SSB phase noise: -145 dB (1 Hz BW) for frequencies greater than 1 kHz from carrier.

Temperature

Operating: 0-50°C.

Nonoperating: -40 to +70°C.

Stability

Amplitude: ±½ dB, 0 to 50°C.

Phase: 0.1 nanosecond/°C, 5 MHz.

Power

AC input: 115/230 volts, 48 to 440 Hz, 20 volt amperes, max.

DC input: 22-30 volts dc, 600 milliamperes, max.

Weight: 16 lbs.

Size: 3½ x 19 x 11½.

Frequency and Time Reference Systems

The E10-5061A System pictured below is an example of custom reference systems which Hewlett-Packard can provide. Various types of frequency standards, comparators, distribution amplifiers, counters, etc. may be combined to meet specific requirements. Contact your Hewlett-Packard field engineer for details.

5087A
Distribution Amplifiers

Control Panel

Linear Phase Comparator

7825A Trend Recorder

680A Strip Chart Recorder

High Performance
Cesium Beam Standards
(5061A Option 004)

5085A
Standby Power Supplies



FREQUENCY & TIME STANDARDS



STANDBY POWER SUPPLIES

For frequency and time standards

Models 5085A, K02-5060A

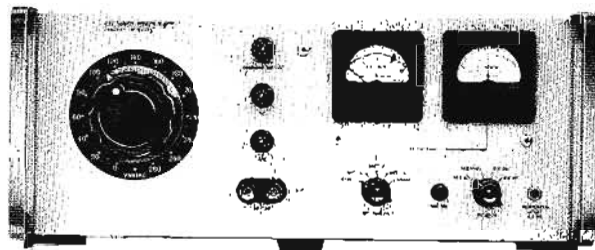

K02-5060A

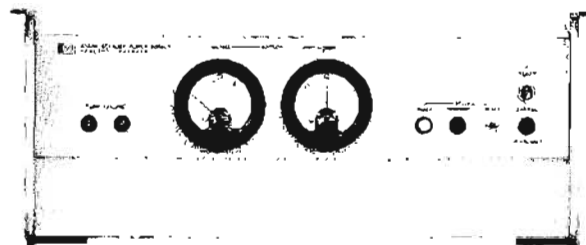

5085A

The HP Models 5085A and K02-5060A Standby Power Supplies furnish dc power to keep frequency or time standard systems operating during extended interruptions of ac line power. For applications where it is essential to maintain continuous operation and avoid loss of precise time, the use of a standby power supply is an absolute necessity. These units are designed for use with the Hewlett-Packard Cesium Beam Standards, Rubidium Vapor Standards, Quartz Oscillators and other equipment which will operate from 26 V dc. No switching is used in transferring power from line to battery operation and back again assuring uninterrupted operation.

HP K02-5060A

The K02-5060A is a very versatile unit which was designed specifically as a portable power supply for the 5061A and 5065A "Flying Clocks" where it is necessary to operate from a wide range of power sources along with the standby capability to maintain continuous operation where no external power is

Specifications, K02-5060A

Input and output voltages:

Input	Output
6 or 12 V dc	0-230 V, 60 Hz nominal
115 or 230 V ac, 50-400 Hz	0-230 V ac
24-30 V dc	24-30 V dc

Standby battery, 26 \pm 4 V dc available at all times.

AC and both dc inputs may be connected simultaneously.

Output current: 0.5 A ac, 2 A dc.

Standby capacity: 12 ampere-hours at 25°C, 7 hours standby when used in E21-5061A, 6 hours in E21-5065A.

Recharging: 1.6 hours recharging time required for each ampere hour of discharge.

Alarm indicator: external power failure.

Panel meters: voltmeter, ammeter indicating voltage and current of 4 internal batteries and load.

Battery: four paralleled rechargeable battery packs each containing 20 sealed nickel-cadmium cells. Packs may be removed individually without interfering with power supply operation.

Dimensions: 16 $\frac{3}{4}$ " wide, 6-31/32" high, 16 $\frac{3}{8}$ " deep (425 x 177 x 416 mm).

Weight: net, 67 lbs.

Accessories furnished: ac and dc input and output cables.

Price: \$2850.

available. A special inverter permits operation from a 6 or 12 V dc car battery in addition to the 115/230 V ac and 24-30 V dc capability. The 12 ampere-hour standby batteries are the sealed, nickel-cadmium type and thus spill-proof. Mounting hardware is available to attach the K02-5060A to either the 5061A or 5065A Standards to make a portable standard, the E21-5061A or E21-5065A.

HP 5085A

The HP 5085A is intended for installations where 115 or 230 V ac is available. Vented nickel-cadmium batteries with an 18 ampere-hour guaranteed capacity (derated from 25) are used. They provide about 10 hours of standby power for the 5061A Cesium Standard or 5065A Rubidium Standard (at average ambient temperature of 25°C).

Front panel lights indicate mode of operation, report fuse failure, and ac interrupt. A float-charge switch permits rapid recharge after an ac power failure.

Specifications, 5085A

Output voltage: 24 \pm 2 V dc at rated current.

Output current: 2 amperes (2.5 A for 30 min.).

Standby capacity: (at 25°C) 18 amp-hrs. after 48 hours charge.

Alarm indicators: panel lamps indicate: (1) FUSE FAILURE, (2) AC POWER, (3) AC INTERRUPT, (4) CHARGE.

Remote alarm provisions: SPDT relay contacts provided at rear terminals for operating remote alarm from separate power system.

Panel meters: battery voltage and charge/discharge current.

Power requirements: 115 or 230 \pm 10% V ac; 50 to 400 Hz (2.0 A max. at 115 V line).

Battery (supplied): vented nickel-cadmium 25 ampere-hour capacity derated to 18 ampere-hours. Periodic maintenance required.

Additional (external) battery provision: rear connector.

Dimensions: 16 $\frac{3}{4}$ " wide, 6-31/32" high, 16 $\frac{3}{8}$ " deep (425 x 177 x 416 mm).

Weight: net, 75 lbs (34.1 kg); shipping, 101 lbs (45.9 kg) including battery Option 01 (no batteries) is 50 lbs (22.8 kg) less.

Accessories furnished:

AC Power Line Power Cable, 6 ft long, DC Output Connector.

Instrument Extension Slides (for std. 24" deep rack).

Price: Model 5085A (complete with batteries), \$1700.

Options: Model 5085A without batteries, Option 001, is \$1060.

Hewlett-Packard frequency synthesizers translate the stable frequency of a precision frequency standard to any selected one of thousands, even billions of frequencies over a broad spectrum that extends from dc to 500 MHz. The selected frequency is known to quartz crystal oscillator accuracy; resolution is as fine as 0.01 Hz; and a new frequency can be switched upon electronic command in 20 μ s or from a keyboard as fast as the operator can push buttons. One synthesizer can do the work of a whole battery of oscillators and special-purpose signal generators and can do it better.

Synthesizers find application in many areas where the stability of a high-quality standard is required, including advanced communications, radio sounding, testing of frequency sensitive devices, and spectrum analysis.

Direct and indirect synthesis

Hewlett-Packard builds two types of frequency synthesizers, "direct" and "indirect." Direct synthesis simply performs a series of arithmetic operations on the signal from the frequency standard to achieve the desired output frequency. In indirect synthesizers of the type built by Hewlett-Packard, several internal oscillators are phase-locked to signals derived from the frequency standard. The outputs of these phase-locked oscillators are then combined to form the desired output frequency.

The direct synthesis approach has the advantage of faster switching time—microseconds as opposed to milliseconds—and somewhat finer frequency resolution—.01 Hz to .1 Hz as opposed to 1 Hz or 100 Hz for Hewlett-Packard indirect synthesizers.

Indirect synthesis, on the other hand, offers the advantage of lower cost for applications where microsecond switching time and frequency resolution finer than 1 Hz are not required.

Hewlett-Packard direct synthesizers are covered in this section. Indirect synthesizers are covered under the 3320A/B and 8660A/B model numbers.

Hewlett-Packard Synthesizers

Model No./ Type	Range	Minimum Step
5100B/5110B Direct	.01 Hz to 50 MHz	.01 Hz
5105A/5110B Direct	.1 Hz to 500 MHz	.1 Hz
3320A/B Indirect	.01 Hz to 13 MHz	.001 Hz*
8660A/B Indirect	.01 to 1300 MHz	1 Hz

* Optional

Direct Type Synthesizers

The 5100B/5110B and the 5105A/5110B Synthesizers are made up of two completely solid-state units: the synthesizer proper, and the driver.

The driver contains a frequency source, a spectrum generator, and appropriate selective networks. The source is a high quality crystal oscillator housed in an oven. It is well protected from line voltage variations, and has an aging rate of less than 3 parts in 10^6 per day.

The driver provides a series of fixed frequencies between 3 and 39 MHz which are fed to the synthesizer unit. The 5110B Driver provides outputs (optional) to drive up to four synthesizers simultaneously. This feature effectively reduces the cost per synthesizer in multiple output systems.

The synthesizer unit contains harmonic generators and suitable mixers, dividers, and amplifiers to derive the desired output frequency as a function of the fixed frequencies. The front-panel pushbuttons actuate a diode switching matrix.

All frequencies appearing at the inputs to this matrix are always present. This is the advantage of the direct synthesis method; it allows fast switching speeds.

High-speed switching

The oscillogram of Figure 1, page 247, shows the speed which is typical of Hewlett-Packard 5100B and 5105A Synthesizers when they change output frequency under electronic command. The upper waveform is synthesizer output; the lower is the externally applied switching voltage. Note the virtual absence of dead time and switching transients.

Synthesizer Programmer

The HP Model 2759B Synthesizer Programmer provides a means to interface a parallel BCD controller command (such as a computer) to the 10 line remote control input requirement of the synthesizers. The 2759B provides rapid and smooth transition between frequency changes.

Reliability

Since their introduction in 1963, Hewlett-Packard 5100 Series Synthesizers have found many applications.

The synthesizers have proven their high performance and reliability in many critical applications. Their continued use in deep space tracing systems, military satellite communication systems and radar applications attest to their performance and reliability. Actual operating field history has demonstrated a mean

time between failure (MTBF) in excess of 10,000 hours for the synthesizer system. You can be certain your synthesizer needs will be met with the proven performance and reliability of the Hewlett-Packard synthesizers.

Communications Applications

The high spectral purity of synthesizer output signals makes them ideal as local oscillators in receiver applications where frequency agility and/or narrow I.F. bandwidths are required of the receiver.

A surveillance receiver system which monitors multiple data channels by rapidly switching between channels is an ideal area of application for one of the Hewlett-Packard frequency synthesizers. With its rapid, highly repeatable switching capability, a synthesizer will serve as the local oscillator in this type of receiver, providing the proper local oscillator frequency for each channel under surveillance. A similar application arises in radio sounding applications.

Radar Applications

The 5100B/5110B is capable of switching between output frequencies in 0.01 Hz increments at a very fast rate; thus it is capable of making very good approximations of frequency versus time functions. This performance feature finds application in high performance "chirp" radar installations, which require an ultra linear sweep.

In doppler radar applications the Hewlett-Packard frequency synthesizer supplies all the necessary requirements for precise velocity measurements. The excellent stability of the synthesizer makes it ideal as the basic signal source in the transmitter, which requires stability capable of staying within a receiver bandwidth only a few cycles wide in the microwave region. A 5100B/5110B or another of the synthesizers also is well suited for use as the local oscillator in the doppler receiver, where the local oscillator must be capable of rapid change in order to keep the returning signal within the narrow receiver bandwidth.

NMR Applications

Nuclear magnetic resonance spectroscopy methods are used to determine the qualitative and quantitative structure of molecules. In NMR, the strength of an applied dc magnetic field and the frequency of simultaneously applied rf field uniquely determine the spin-interaction of nuclei. In this application the broad frequency range and precise 0.01 Hz increments of frequency are very valuable.

FREQUENCY SYNTHESIZERS

DC to 50 MHz or 100 kHz to 500 MHz

Models 5100B/5110B and 5105A/5110B

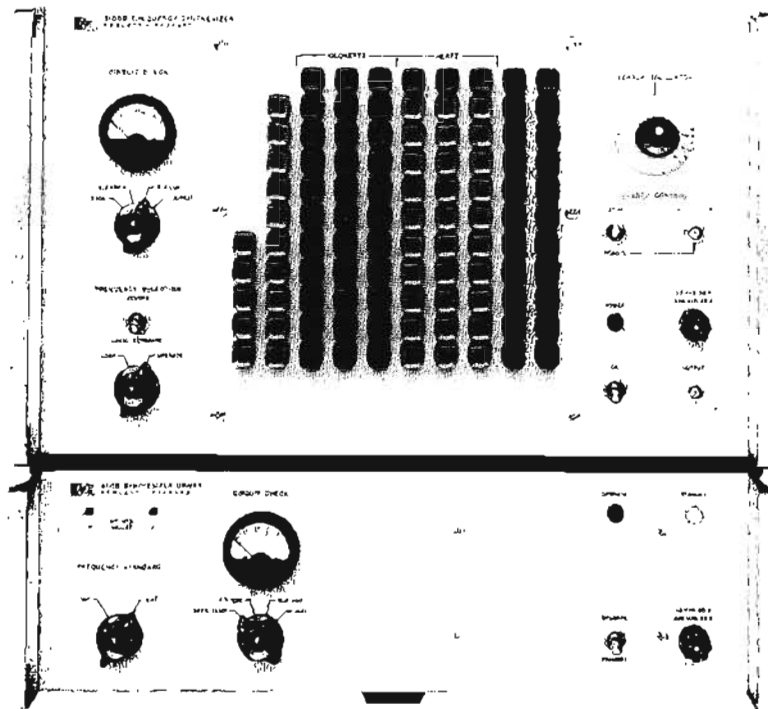

DC to 50 MHz in 0.01 Hz increments
Model 5100B/5110B

Advantages:

- Frequencies from dc to 500 MHz
- Remote programming
- Switching speed typically 20 μ s
- Proven reliability

Applications:

- Automatic testing of frequency-sensitivity devices
- Communications systems
- Doppler radar

The Models 5105A/5110B and 5100B/5110B together provide complete frequency coverage from dc to 500 MHz. The instruments both use direct synthesis to achieve their very fast switching speeds and high spectral purity. This technique translates the stability and spectral purity of a reference source to the selected output and in addition provides a fail-safe output. A precision high stability 1 MHz quartz oscillator is provided, or an external 1 MHz or 5 MHz standard may be used. Both units provide pushbutton or remote frequency selection and include a selectable search capability. The 5105A has 0.1 Hz steps from 100 kHz to 500 MHz in addition to a variable output level and phase modulation. The 5100B provides 0.01 Hz steps from dc to 50 MHz (dc to 100 kHz from separate connector). The 5110B Synthesizer Driver supplies 22 fixed frequencies required to input to the 5105A or 5100B. Both

units or any combination of them up to four may be driven by the 5110B.

Continuous tuning, sweep, FM

For both units a search oscillator provides continuously variable frequency selection over the range of any one column except the left-hand two. Operation of a front-panel control or application of an external dc voltage tunes the search oscillator over the complete frequency range of the selected digit (column). One of the advantages afforded by continuous control is the easy identification of an unknown frequency by beating it against the synthesizer output.

The search oscillator can be frequency modulated from an external source (sinewave) at a maximum rate of 1 kHz while retaining the voltage control calibration.

Remote operation

The 5105A/5110B and 5100B/5110B Synthesizers provide great control flexibility of a precision frequency source over a range greater than ever before available. Any frequency or search oscillator position available from the keyboard can be remotely selected and can be rapidly switched; in 20 μ s, typically.

Rear panel connectors on the 5105A/5100B provide pins corresponding to each front panel pushbutton, a ground connection, and a -12.6 volt line for use in remote programming. A combination of remote and local programming may be used, if so desired. For parallel BCD commands use HP 2759B Programmer.

No actual contact closure, such as a relay, is required. The —12.6 volts dc may be applied to the selected pin by electronic means.

Fast switching

The remarkably fast switching speed, valuable for such tasks as automatic digital frequency tracking, is one of the significant advantages of the direct synthesis method.

Figure 1 shows (upper trace) the 5105A/5110B output frequency switched between 399.8 MHz and 400.2 MHz with 400 MHz subtracted to display switching in greater detail. The sweep is 25 μ s/cm. The lower trace is that of the switching waveform applied to the synthesizer. The 5100B/5110B displays similar performance up to 50 MHz.

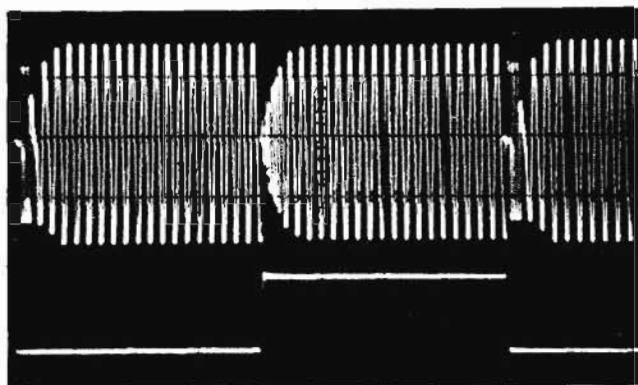

Figure 1. Synthesizer switching speed (25 μ s/cm).

Low noise performance

To achieve the excellent low-noise output specified for the Hewlett-Packard synthesizers over the full range requires the utmost care in design to identify and minimize noise sources followed by extensive testing at each stage of manufacture.

Figure 2 shows typical phase noise distribution for both synthesizers. The ratio of output signal to single-sideband phase noise (in a 1 Hz bandwidth) is plotted against frequency of offset from the signal.

The noise performance reflected in this plot is very good for instruments as complex and versatile as the 5105A and 5100B. It also demonstrates their suitability for applications where spectrum requirements are critical.

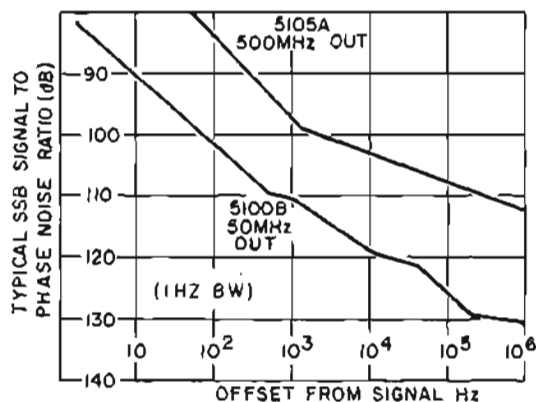

Figure 2. Composite phase noise plot for Hewlett-Packard synthesizers.

Spectral purity and stability

Particular care has been exercised in the design of the Hewlett-Packard synthesizers to insure a very clean output signal is provided over the entire frequency range of the instruments. A high order of spectral purity is essential for accurate doppler measurements, microwave spectroscopy, narrow band telemetry, communications and similar applications. The careful design and modular construction of the synthesizers make it possible to obtain output signals with spurious content at least 90 dB below the selected output in the case of the 5100B. The 5105A spurious signals are at least 70 dB below its output over the entire 500 MHz range.

Many applications require that a signal be multiplied into the microwave region. If the frequency multiplying device is broadband, the ratio of total sideband power to signal power increases as the square of the multiplying factor. Since the total power in a frequency modulated wave is constant, the increased sideband power must come from the carrier. The spectrum of the signal begins to "spread" since the increased sideband amplitude causes the intermodulation between sidebands to become appreciable. It is desirable, then, that the original signal have the highest possible signal to phase noise ratio.

The specified values in the table on the next page for rms Fractional Frequency Deviation at various averaging times and at various output frequencies represent the standard deviation of the short term frequency instability due to random noise. For example, the value given for one-second averaging at an output of 500 MHz is 1×10^{-11} . This corresponds to a standard frequency deviation of 0.0050 Hz. In other words, 68.3% of all observed frequency variations for measurement times of one second will differ from the carrier by less than plus or minus that amount. 99.7% of all frequency variations will differ from the carrier by less than ± 0.0150 Hz.

Modular construction

Modular construction has been used throughout the synthesizers and driver. The modular concept enables the system to meet stringent demands regarding spurious signals since the isolation that it affords minimizes spurious coupling. It also enhances serviceability and reliability. Careful design and quality control insure that all modules are interchangeable from one instrument to another.

Synthesizer driver, 5110B

The HP 5110B Synthesizer Driver supplies the HP 5100B and 5105A Synthesizers with 22 fixed, spectrally pure signals derived from a 1 MHz precision quartz oscillator.

The 1 MHz quartz oscillator which is the source for all output frequencies of the synthesizer driver is stable to 3 parts in 10^9 per 24 hours. To help maintain this excellent crystal stability, oven circuits are energized any time the instrument is connected to the power line. A circuit check meter allows verification of correct oven operation.

Where special requirements make it necessary that synthesized frequencies be derived from an external frequency standard, a rear panel connector on the 5110B accepts a 1 MHz or 5 MHz signal. The output spectral purity is partially dependent on the purity of the remote frequency standard.

Specifications

Specifications for the 5105A and 5100B Synthesizers and 5110B Synthesizer Driver are given on the following page.

Specifications
5100B/5110B and 5105A/5110B Synthesizers

Specifications	5105A/5110B	5100B/5110B																																			
Output frequency	100 kHz to 500 MHz	dc to 50 MHz																																			
Digital frequency selection	0.1 Hz through 100 MHz per step. Selection by front panel pushbutton or by remote switch closure. Any change in frequency may be accomplished in 20 μ s typically.	0.01 Hz through 10 MHz per step. Selection by front panel pushbutton or by remote switch closure. Any change in frequency may be accomplished in 20 μ s typically.																																			
Output voltage	Fixed: 0 dBm = 1 dBm into a 50 ohm resistive load. Variable: -6 dBm to +6 dBm into a 50 ohm resistive load.	1 volt rms = 1 dB from 100 kHz to 50 MHz. 1 volt rms +2 dB, -4 dB from 50 Hz to 100 kHz, into a 50 ohm resistive load. Nominal source impedance is 50 ohms. 15 mV rms minimum open circuit dc to 100 kHz, at separate rear connector, source impedance of 10 K ohms with shunt capacitance 70 pF.																																			
Search oscillator	Provides continuous variable frequency selection with a selectable incremental range of 1.0 Hz through 10 MHz. Manual or external voltage (-1 to -11 volts) control with linearity of \pm 5%. The search oscillator may be externally swept up to a 1 kHz sinewave rate.	Provides continuously variable frequency selection with an incremental range of 1.0 Hz through 1 MHz. Manual or external voltage (-1 to -11 volts) control with linearity of \pm 5%. The search oscillator may be externally swept up to a 1 kHz sinewave rate.																																			
Phase modulation	(rear panel input) = 3 radians maximum deviation; dc to 1 MHz rate.																																				
Signal-to-phase noise ratio*	Measured in a 30 kHz band centered on the signal (excluding a 1 Hz band centered on the signal) is greater than: <table border="1" style="margin-left: 20px;"> <tr> <td>Output frequency - MHz</td> <td>1</td> <td>50</td> <td>100</td> <td>500</td> </tr> <tr> <td>Ratio - dB</td> <td>48</td> <td>48</td> <td>48</td> <td>40</td> </tr> </table>	Output frequency - MHz	1	50	100	500	Ratio - dB	48	48	48	40	Greater than 54 dB in a 30 kHz band centered on the signal (excluding a 1 Hz band centered on the signal).																									
Output frequency - MHz	1	50	100	500																																	
Ratio - dB	48	48	48	40																																	
Signal-to-AM noise ratio	(Above 100 kHz): Greater than 74 dB in a 30 kHz band.																																				
RMS fractional frequency deviation (with a 30 kHz noise bandwidth) using 5110B internal oscillator*	<table border="1" style="margin-left: 20px;"> <thead> <tr> <th rowspan="2">Averaging time</th> <th colspan="4">Output Frequency</th> <th colspan="4">Output Frequency</th> </tr> <tr> <th>1 MHz</th> <th>50 MHz</th> <th>100 MHz</th> <th>500 MHz</th> <th>1 MHz</th> <th>5 MHz</th> <th>10 MHz</th> <th>50 MHz</th> </tr> </thead> <tbody> <tr> <td>10 ms</td> <td>1×10^{-7}</td> <td>2×10^{-9}</td> <td>1×10^{-9}</td> <td>6×10^{-10}</td> <td>3×10^{-8}</td> <td>6×10^{-9}</td> <td>3×10^{-9}</td> <td>6×10^{-10}</td> </tr> <tr> <td>1 s</td> <td>2×10^{-9}</td> <td>4×10^{-11}</td> <td>2×10^{-11}</td> <td>1×10^{-11}</td> <td>3×10^{-10}</td> <td>6×10^{-11}</td> <td>3×10^{-11}</td> <td>1×10^{-11}</td> </tr> </tbody> </table>	Averaging time	Output Frequency				Output Frequency				1 MHz	50 MHz	100 MHz	500 MHz	1 MHz	5 MHz	10 MHz	50 MHz	10 ms	1×10^{-7}	2×10^{-9}	1×10^{-9}	6×10^{-10}	3×10^{-8}	6×10^{-9}	3×10^{-9}	6×10^{-10}	1 s	2×10^{-9}	4×10^{-11}	2×10^{-11}	1×10^{-11}	3×10^{-10}	6×10^{-11}	3×10^{-11}	1×10^{-11}	
Averaging time	Output Frequency				Output Frequency																																
	1 MHz	50 MHz	100 MHz	500 MHz	1 MHz	5 MHz	10 MHz	50 MHz																													
10 ms	1×10^{-7}	2×10^{-9}	1×10^{-9}	6×10^{-10}	3×10^{-8}	6×10^{-9}	3×10^{-9}	6×10^{-10}																													
1 s	2×10^{-9}	4×10^{-11}	2×10^{-11}	1×10^{-11}	3×10^{-10}	6×10^{-11}	3×10^{-11}	1×10^{-11}																													
Spurious signals	Non-harmonically related signals are at least 70 dB below the selected frequency	Non-harmonically related signals are at least 90 dB below the selected frequency																																			
Harmonic signals	25 dB below the selected frequency. (applicable to fixed output when terminated in 50 ohms).	30 dB below the selected frequency (when terminated in 50 ohms).																																			
Dimensions	16 $\frac{3}{4}$ " wide, 16 $\frac{3}{8}$ " deep, 15-11/16" high (425 x 416 x 398 mm), incl. 5110B																																				
Price	model 5105A, \$10,250; model 5110B, \$4500	model 5100B, \$8150; model 5110B, \$4500																																			

* With the 5110B Driver internal frequency standard. When the 5110B Driver utilizes an external frequency standard, this will affect the stability and spectral purity of the output. Performance data stated above are based on the excellent internal frequency standard in the 5110B.

5110B Internal 1 MHz Quartz Oscillator

Aging rate: less than 3 parts in 10^9 per 24 hours.

Stability: as a function of ambient temperature: $\pm 2 \times 10^{-10}$ per $^{\circ}$ C from 0° C to $+55^{\circ}$ C. As a function of line voltage $\pm 5 \times 10^{-11}$ for a $\pm 10\%$ change in line voltage (rated at 115 or 230 volts rms line voltage).

Output, buffered: available at rear panel (1 V \pm 1.5 dB into 50 Ω resistive load).

Phase-locking capability: a voltage control feature allows 5 parts in 10^9 frequency control for -5 to +5 volts applied externally to the 5110B.

External frequency standard input requirements: 1 MHz or 5 MHz, 0.2 V rms minimum, 5 V maximum across 500 ohms.

General (5105A/5110B and 5100B/5110B)

Operating temperature range: 0 to $+55^{\circ}$ C.

Interference: complies with MIL-I-26600, Class 1 and 3, MIL-I-6181D.**

Susceptibility: complies with MIL-I-26600, Class 1 and 3, MIL-I-6181D.

Power: 115 or 230 V \pm 10%, 50 to 400 cycles, 35 W each synthesizer and driver (separate power supplies).

Optional features: the synthesizer drivers are capable of driving up to four frequency synthesizers:
Option 002, outputs for driving two synthesizers, \$125; Option 003, for three, \$235; Option 004, for four, \$345.
Any unused outputs must be terminated in 50 Ω BNC terminations, 10510A.

Note: small phase jumps may be experienced in additional synthesizer when first is switched in frequency.

Weight: 5105A and 5100B, net 85 lbs (38 kg); shipping, 96 lbs (42 kg) each. 5110B, net, 56 lbs (26 kg); shipping 62 lbs (28 kg).

Accessories furnished: 5100B and 5105A; Power Cable, Decade Test Cable, Connecting Cable to 5110B Driver (permits approx 2.5 ft vertical separation—longer cables available). 5110B: Power Cable.

** Interference compliance requires that the 5100B/5105A and 5110B are connected by a low inductance path such as adjacent rack mounting.

SIGNAL SOURCES

Oscillators, Function Generators and Precision Sources



SIGNAL SOURCES

Oscillators and function generators

Signal sources have been described by various names—oscillators, test oscillators, audio signal generators, etc. Different names are applied, depending on the design and intended use of the source. In the recently developed transistorized sources, the name "test oscillator" has been used to describe an oscillator having a calibrated attenuator and output monitor. The term "signal generator" is reserved for an oscillator with modulation capability.

A function generator is a signal generator that delivers a choice of different waveforms with frequencies adjustable over a wide range. The keynote of the modern function generator is versatility. Function generators now produce sine, triangle, square wave, sawtooth waves, and pulses with a provision to sweep or analog program frequency up to four decades. This is useful for automatic testing systems and sweeping audio amplifiers, filters, and servo systems. The function generator is also used extensively in medical research projects for nerve stimulation and electroanesthesia. Hewlett-Packard's function generators extend from a low frequency of 0.00005 Hz (HP 203A Option 002) up to a high frequency of 5 MHz (HP 3310A).

Basic requirements

In selecting an oscillator or function generator, the user will be most interested in its frequency coverage. The question to be answered here is, "Will the instrument supply both the lowest and highest frequencies of interest for anticipated tests?" As shown in Table 1, Hewlett-Packard manufactures a broad range of oscillators and function generators covering the frequency spectrum from 0.00005 Hz to 32 MHz.

The user's next concern will be with the available output power or voltage. Some tests require large amounts of power, while others merely require sufficient voltage output. For almost any application, there is a Hewlett-Packard oscillator capable of delivering the desired voltage output into a high-impedance load or of supplying the desired power into lower impedance loads.

Besides frequency range and power output, the user will be interested in the instrument stability, its dial resolution and the amount of harmonic distortion, hum and noise in the output signal.

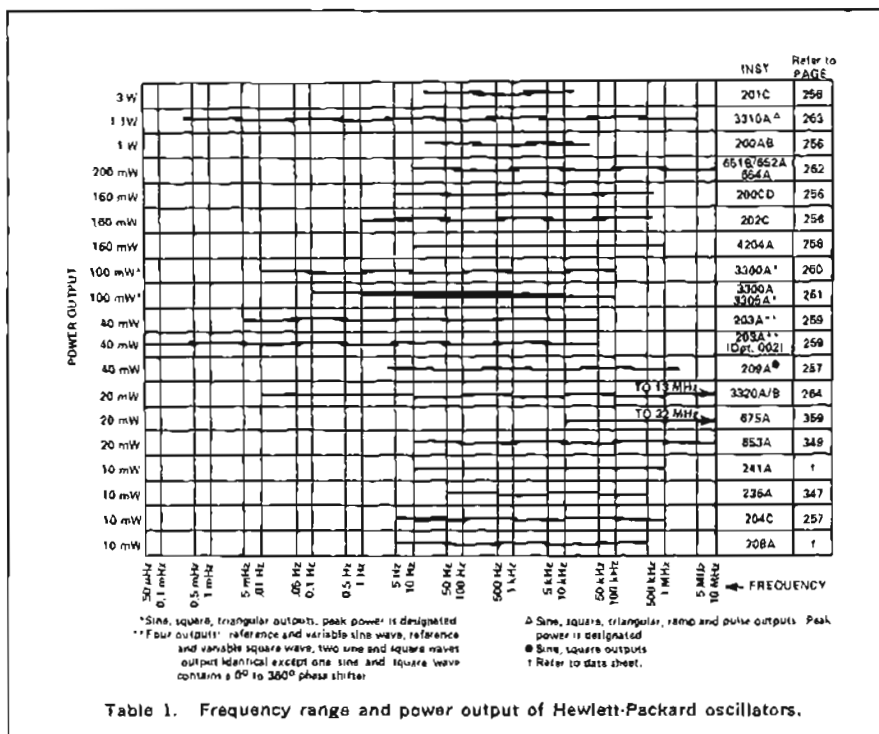

Table 1. Frequency range and power output of Hewlett-Packard oscillators.

In the ideal case, the user should be able to set the tuning dial of his oscillator to a particular frequency with assurance that the oscillator will deliver that frequency at all times. The dials may be precisely set by a vernier control, and the calibration marks may be easily read. The accuracy with which the frequency tracks the tuning dial enters into the overall accuracy figure.

Frequency stability

The frequency stability of the oscillator determines the ability of the instrument to maintain a selected frequency over a period of time. Component aging, power-supply variations and temperature changes all affect stability. Carefully chosen components, such as precision resistors and variable capacitors in the frequency-determining networks, contribute to long-term stability.

Amplitude stability

Amplitude stability is important in certain oscillator applications. Amplitude stability is inherent in the Hewlett-Packard RC oscillator circuit because of the large negative feedback factor and the amplitude stabilizing techniques. The "frequency response," or amplitude variation as the frequency is changed, is of special interest when the oscillator is used for response measurements throughout a wide range of frequencies.

Distortion

Distortion in the oscillator's output signal is an inverse measure of the purity of the oscillator's waveform. Distortion is undesirable in that a harmonic of the test signal may feed through the circuits under test, generating a false indication at the output. If the oscillator is used for distortion measurements, the amount of distortion that it contributes to the measurements should be far less than that contributed by the circuits under test.

Hum and noise

Hum and noise can be introduced at a variety of points in oscillator circuits; but when the circuit operates at a relatively high level, the amount of hum and noise introduced into the device under test is usually negligible. Hum and noise introduced by a power amplifier usually remain constant as the output signal amplitude is diminished. Hence, even though the hum and noise power may be quite small compared to the rated output, these spurious signals sometimes become a significant portion of low-level output signals. To overcome such a limitation, many Hewlett-Packard oscillators have their amplitude control on the output side of the power amplifier so that hum and noise are reduced proportionally with the signal when low-level signals are desired for test purposes.

Frequency synthesizer

The 3320A has the frequency accuracy and stability of synthesizers, and the spectral purity of oscillators at a very low price. The 3320B has all the features of the 3320A plus a precision leveling loop and a 100 dB attenuator (0.01 dB steps). Full (BCD) programmability of frequency is available on the 3320A. Frequency and amplitude are programmable (BCD or ASCII) with the 3320B. A complete interface kit and a low-cost mark-card programmer can be used with the 3320B. See page 264.

Precision sources

As industrial and military electronics become more sophisticated, measurements require greater precision in normal working environments. To help alleviate today's measurement demands, Hewlett-Packard offers a broad line of precision instruments. Refer to Hewlett-Packard Application Note 70, revised Oct. '69, for additional information.

Traceable to NBS

The absolute accuracy of Hewlett-Packard's precision instruments and calibrators is traceable to the National Bureau of Standards, as shown in the flow chart, Figure 1. Special care has been taken to develop instruments with state-of-the-art stability so that specified accuracy and traceability can be maintained for long periods of time.

AC calibrator

0.1 mV to 1100 V (10 Hz to 110 kHz)

The 745A AC Calibrator with the 746A High Voltage Amplifier now makes it possible to calibrate precision ac voltmeters from 0.1 millivolt to 1100 volts. The wide band frequency range, from 10 Hz to 110 kHz, has an accuracy up to 0.022% at midrange. Voltage long term stability is 0.01% over a calibration period of six months for frequencies from 50 Hz to 20 kHz. The ac calibrator has a six digit readout and the error of the instrument under test can be read directly in % of setting without time-consuming calculations.

The 746A is basically an X10 amplifier which supplies an additional 1000 volt range for the 745A AC Calibrator. The 746A contains logic circuits that insure proper operation and includes safety features that disconnect the high voltage if any operating condition is not normal.

DC precision sources

The long-term accuracy and stability of the Hewlett-Packard dc precision sources are dependent on selected Zener diodes. Three distinct steps are necessary to provide a reliable reference diode: 1) process control in its original fabrication, 2) design of a compatible circuit, and, 3) a 100% thorough test of the completed circuit.

To achieve the stability and accuracy

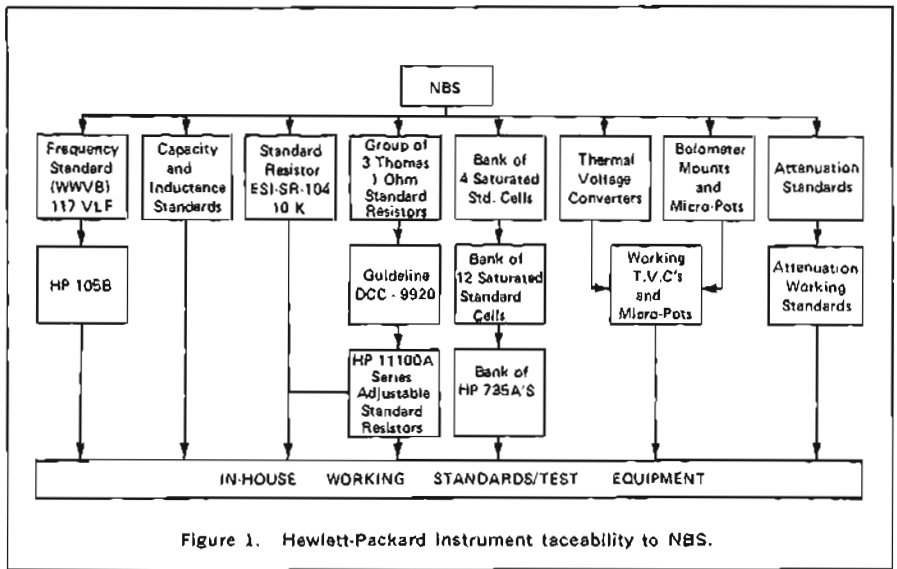

Figure 1. Hewlett-Packard Instrument traceability to NBS.

necessary for the Hewlett-Packard precision dc sources, a selected Zener diode and its associated circuitry is housed in a temperature-controlled oven. The inner-oven temperature is held nominally at $80^{\circ} \pm 0.01^{\circ}\text{C}$ during normal room variations.

The HP 735A Transfer Standard uses this reference supply to obtain accurate stable voltages of 1.000 volts, 1.018 to 1.020 volts, and 0 to 1000 μV . It is quickly calibrated by a front panel adjustment using a standard cell (or another 735A) and a null meter.

The HP 740B and 741B DC Standards use the oven reference supply for a reference voltage to generate the 0 to 1000 volt accurate, stable output. This reference voltage is applied to a precision resistive divider, which is the input to an amplifier chain, as shown in Figure 2.

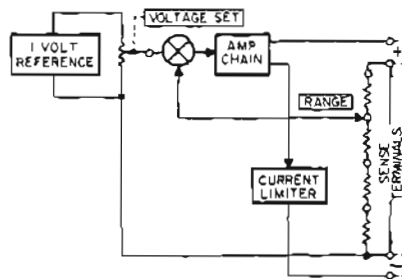

Figure 2. Simplified dc standards diagram.

The summing point compares the input of the amplifier to an attenuated sample of the output taken from the range voltage divider. The current limit control is nominally adjusted for the protection of the output load.

AC/DC meter calibration systems

The HP 738BR Option E02 Voltmeter Calibration System includes the Model 652A Test Oscillator and the Model 738BR Voltmeter Calibrator, mounted in a convenient cabinet. This system was designed specifically for calibrating high impedance voltmeters and oscilloscopes.

The 738BR provides a 400 Hz rms or peak-to-peak ac voltage and a dc voltage output from 300 μV to 300 volts. The accuracy is better than 0.1% dc and 0.2% ac. The 652A provides a frequency response, by using the expand position of the meter, from 10 Hz to 10 MHz with a flatness of $\pm 0.25\%$.

The HP Model 6920B Meter Calibrator is an easily portable, simple device used to calibrate ac and dc meters from 0.01 volt to 1 kV, and from 0.01 mA to 5 A. The output setting of voltage or current is adjusted by means of a three-digit, ten-turn readout on any volt, milli-ampere, or ampere range. The dc accuracy is 0.2%, and ac accuracy is 0.4% of output.

Model No	DC Ranges	AC Ranges	Frequency	Refer to Page
735A	0 to 1000 μV , 1.000 V, 1.018 V, 1.019 V		DC	251
740B	1 V to 1000 V, 4 ranges		DC	253
741	1 V to 1000 V, 4 ranges		DC	254
745A/746A		1 mV to 1000 V, 7 ranges	10 Hz to 110 kHz, 4 ranges	255
E02-738BR	300 μV to 300 V, 40 steps	300 μV to 300 V, 40 steps	DC and 400 Hz	251
6920B	.01 V to 1000 V, 4 ranges	.01 V to 1000 V, 4 ranges	DC and power line frequency	252

Table 2. Precision sources.

DC TRANSFER STANDARD

Portable instrument transfers std. voltages
Model 735A



SIGNAL SOURCES

The Hewlett-Packard 735A is a general purpose laboratory transfer standard. It may be used as a 1 V standard output with standard cell accuracy, a standard cell comparator with seven digits, or as a 0 to 1000 μV standard source for dc and potentiometric measurements.

Specifications

Standard outputs: 1.00000 V; $1.018 + \Delta^*$; $1.019 + \Delta^*$; 0 to 1000 μV Δ^* .

Transfer accuracy: (after 30 min. warmup) 2 ppm between saturated standard cells or unsaturated standard cells; 10 ppm standard cell to 1 V; 10 ppm saturated standard cell to unsaturated standard cells.

Stability: (after 30 min. warmup) better than 10 ppm/month.

Line regulation: $<1 \mu\text{V}$ for 10% line change.

Output impedance: 1 k Ω $\pm 1\%$.

Short circuit current: $<1.5 \text{ mA}$.

Temperature coefficient: $<1 \text{ ppm}/^\circ\text{C}$, 0° to $+50^\circ\text{C}$.

Variable output

Range: 0 to 1000 μV .

Accuracy: $\pm(0.1\% + 1.5 \mu\text{V})$.

Resolution: 1 μV .

Output impedance: $146\Omega \pm 1\%$.

Output noise: dc to 1 Hz $<1 \mu\text{V}$ p-p. 1 Hz to 1 MHz: $<100 \mu\text{V}$ rms.

Output: floating and guarded.

Power: 115 or 230 V $\pm 10\%$, 48 to 440 Hz, 20 VA max.

Output terminals: four 5-way binding posts. Positive, negative, circuit-guard shield, and chassis ground, positive and nega-



tive terminals are solid copper with gold flash. A maximum of 500 V dc may be connected between chassis ground and guard or circuit ground.

Dimensions: standard 1/3 module; $5\frac{1}{8}$ " wide, 3" high (without removable feet), 11" deep (130 x 76 x 279 mm).

Weight: net, $5\frac{1}{2}$ lbs (2.5 kg); shipping, 8 lbs (3.6 kg).

Price: HP 735A DC Transfer Standard, \$435.

* 3-digit reading 0 to 1000 μV offset voltage.

VOLTMETER CALIBRATOR

DC, rms and p-p volts; flatness 10 Hz-10 MHz
Model 738BR option E02 (738BR & 652A)

The 738BR Option E02 Voltmeter Calibration system combines the 652A Test Oscillator and the 738BR Voltmeter Calibrator. These instruments calibrate high impedance voltmeters and oscilloscopes for both frequency response and voltage accuracy. The system calibrates for ac* and dc voltage levels from 300 μV to 300 V in precise preselected steps and calibrates for frequency response from 10 Hz to 10 MHz.

Specifications

738BR opt. E02 voltmeter calibration system

738BR

Voltage range: 300 μV to 300 V, dc or ac (rms and p-p, 400 Hz).

Levels: calibration voltage 300 μV to 300 V in steps of 1, 3, 1.5 and 5; tracking voltages 0.1 to 1 V in 0.1 V steps and 0.05 to 0.5 V in 0.05 V steps.

Accuracy: 300 V working voltage into attenuator, accurate within 0.1% dc and 0.2% ac, after a 30-minute warmup.

Attenuator accuracy: within $\pm 0.1\%$ or $\pm 2.5 \mu\text{V}$, whichever is larger, open circuit.

Long-term stability: drift per week: $<0.1\%$ dc, $<0.2\%$ ac.

Power: 115 or (230 V must be specified) $\pm 10\%$ 50 to 60 Hz, 275 VA max.

Dimensions: 19" wide, 7" high, $15\frac{3}{4}$ " deep behind panel (483 x 178 x 400 mm).

Weight: net, 38 lbs (17 kg); shipping, 50 lbs (22.6 kg).

Price: HP 738BR, \$1100 (rack mount).

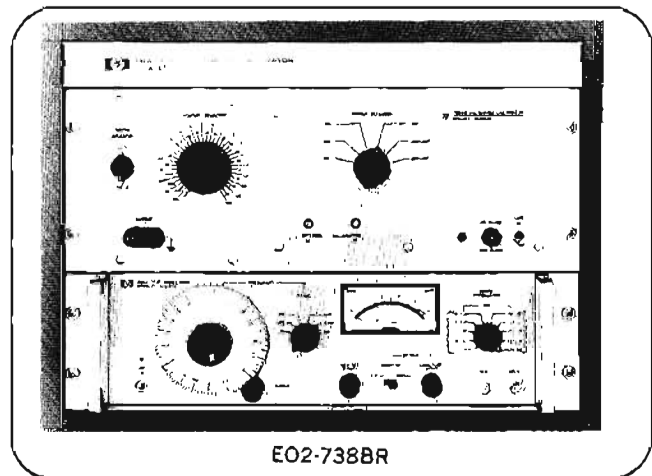

652A

Specifications are listed on page 262 of this catalog.

General (738BR opt. E02)

Dimensions: $20\frac{1}{2}$ " wide, $15\frac{5}{8}$ " high, $18\frac{1}{2}$ " deep (521 x 397 x 470 mm).

Weight: net, 75 lbs (33.8 kg); shipping, 110 lbs (49.8 kg).

Accessories furnished: cable HP part number 739A-16A, BNC to shielded 50 Ω terminated dual banana plug.

Price: HP 738BR option E02, \$2235.

* Refers to 400 Hz only; see data sheet.

PRECISION VOLTAGE SOURCES



AC/DC METER CALIBRATOR

Four calibrators in one case
Model 6920B



6920B

Can be used to check:

1. DC Voltmeters up to 1000 volts
2. Average reading AC Voltmeters up to 1000 volts
3. DC Ammeters up to 5 amps
4. Average reading AC Ammeters up to 5 amps

Description

Model 6920B is a versatile ac/dc meter calibrator, capable of both constant voltage and constant current output. Its absolute accuracy makes it suitable for laboratory or production testing of panel meters, multimeters, and other meters having accuracy of the order of 1.0% or higher. This calibrator has been designed for convenience, and combines in one instrument all the outputs needed to test the more commonly used meters. Model 6920B has been packaged in an HP cabinet module suitable for bench or rack use.

Output switch

An output switch selects the safest mode of operation for the particular type of meter being tested. A "lock" position leaves the testing parameters in operation to free both hands for attaching and disconnecting successive meters. A "test" position, springloaded so that the meter calibrator output is presented to the terminals only while finger pressure is applied, facilitates testing meters with several full-scale values and reduces the danger of burn-out.

AC Output waveshape

When the function switch is set on "AC", the output waveshape is sinusoidal (to a first approximation) and has the same frequency as the input line power applied to the instrument (except when an external ac reference is used). The feedback loop, which controls and regulates this ac, is actually monitoring the average value of the ac output, although the front panel controls are calibrated in terms of rms. Thus, this calibrator is suitable for use with average

reading ac voltmeters scaled in rms. In addition, the calibrator can be used with true rms meters, provided allowance is made for the total output distortions. This distortion is approximately equal to the line input waveshape distortion (or distortion of the external ac reference) plus 3%.

Specifications

Input: 115 V ac $\pm 10\%$, single phase, 58-62 Hz, 0.7 A, 65 W max.

Output voltage ranges:

- | | |
|-----------|-----------------------------|
| 0.01-1 V | current capability 0-5 A |
| 0.1-10 V | current capability 0-1 A |
| 1-100 V | current capability 0-100 mA |
| 10-1000 V | current capability 0-10 mA |

Above output voltage ranges and maximum current capabilities for each range apply in full for either dc or ac operation.

Output current ranges: (5 A maximum output)

- | | |
|---------------|---|
| 1-100 μ A | voltage capability 0-500 V (uncalibrated) |
| 0.01-1 mA | voltage capability 0-500 V |
| 0.1-10 mA | voltage capability 0-500 V |
| 1-100 mA | voltage capability 0-50 V |
| 0.01-1 A | voltage capability 0-5 V |
| 0.1-10 A | voltage capability 0-0.5 V |

Above output current ranges and maximum voltage capabilities for each range apply in full for either dc or 60 Hz operation.

Output accuracy: DC—0.2% of set value plus 1 digit. AC—0.4% of set value plus 1 digit (when used with average reading meters). Above accuracy applicable over a temperature range from 15°C to 35°C and over full input voltage range.

Controls:

FUNCTION SWITCH—This is a 3-position switch: "OFF", "AC", and "DC". In the "OFF" position the ac power input is disconnected from the unit. In the "AC" position the meter calibrator produces an ac output; similarly, in the "DC" position the calibrator produces a dc output.

RANGE SWITCH—10 positions, one for each voltage and current range.

CALIBRATED OUTPUT CONTROL—Digital potentiometer readout control (3 significant digits) determines exact value of output.

OUTPUT SWITCH—Switch described at left.

Output terminals: two front panel terminals are provided; these are the output terminals for both ac and dc operation. In voltage ranges, the negative terminal is grounded.

Ripple: in dc operation the output ripple is typically less than 1.0% rms/5% p-p of the output range switch setting.

Operating temperature range: 0-50°C.

Size: 6 $\frac{3}{4}$ " (172 mm) H x 7-13/16" (198 mm) W x 11" (279 mm) D.

Weight: 15 lbs (6,8 kg) net, 17 lbs (7,71 kg) shipping.

Price: \$750.

Option 005: 50 Hz ac input regulation realignment, add \$25.

Option 028: 230 V ac $\pm 10\%$, single phase input, add \$10.

DC STANDARD/ Δ VOLTMETER

Ultra stable, high resolution dc calibration source
Model 740B



SIGNAL SOURCES

Description

The Hewlett-Packard Model 740B is a precision multifunction instrument that operates as a dc standard voltage source, a dc differential voltmeter, a high impedance dc voltmeter and a dc power and voltage amplifier. The instrument is designed for use in both the standards laboratory and the field.

Specifications*

DC standard

Ranges

Output voltage: 0 to 1000† V in 4 decade ranges.

Performance

Accuracy (<70% RH, constant line, load and temperature $\pm 1^\circ\text{C}$. Calibrated at factory at 115 V and 23°C .) 30 day:
 $\pm(0.002\%$ of setting + 0.0004% of range). 90 day:
 $\pm(0.005\%$ of setting + 0.0004% of range).

Stability (<70% RH, constant line, load and temperature $\pm 1^\circ\text{C}$):

Period	Zero stability ppm of range	Voltage stability (excludes zero stability) setting + range
1 hr	± 1 ppm	$\pm(0$ ppm + 1 ppm)
24 hr	± 2 ppm	$\pm(5$ ppm + 1 ppm)

Temperature coefficient

10°C to 40°C: $< \pm 0.0002\%$ of setting/ $^\circ\text{C}$ or $\pm 0.0001\%$ of range/ $^\circ\text{C}$, whichever is greater.

Line regulation: $< \pm(0.0005\%$ of setting + 0.0001% of range) for 10% line voltage change.

Load regulation (no load to full load): $< (0.0005\%$ of setting + $10 \mu\text{V})$.

Output characteristics

Output current: maximum output current 50 mA at 1 V output, decreasing linearly to 20 mA at 1000 V output. Current limiter continuously adjustable from 10% to 100% of maximum output current.

Output resistance: $< (0.0002 + 0.0001 E_{\text{out}}) \Omega$.

Noise (rms value)

Range	0.01 Hz – 1 Hz	1 Hz – 1 MHz
1 V	$< 1 \mu\text{V}$	$< 100 \mu\text{V}$
10 V	$< 10 \mu\text{V}$	$< 100 \mu\text{V}$
100 V	$< 100 \mu\text{V}$	< 1 mV
1000 V	< 1 mV	< 10 mV

± 1

Period	Zero stability	Reading stability (excludes zero stability) reading + range
1 hr	$\pm(1$ ppm of range + $1 \mu\text{V})$	$\pm(0$ ppm + 1 ppm)
24 hr	$\pm(1$ ppm of range + $2 \mu\text{V})$	$\pm(5$ ppm + 1 ppm)

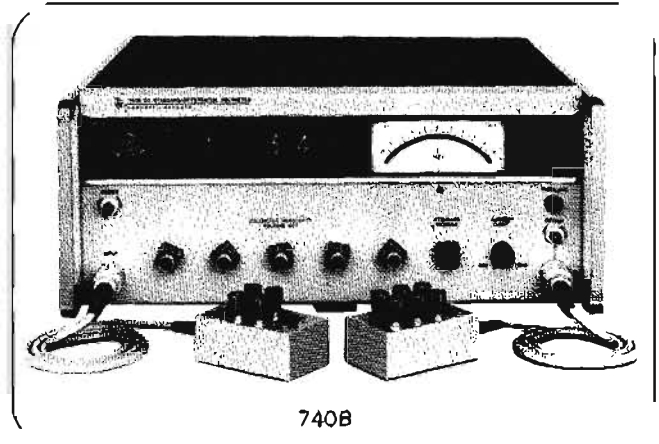

Temperature coefficient

10°C to 40°C: $< \pm(0.0002\%$ of reading + $1 \mu\text{V})/^\circ\text{C}$.
Line regulation: $< \pm(0.001\%$ of reading + $2 \mu\text{V})$ for 10% line voltage change.

Input characteristics

Input resistance: (independent of null).

100 mV to 1000 V ranges: $> 10^{10} \Omega$.

10 mV range: $> 10^9 \Omega$.

1 mV range: $> 10^8 \Omega$.

Effective common-mode rejection (ECMR): > 120 dB, at and above 60 Hz.

Normal-mode rejection (NMR): > 100 dB, at and above 60 Hz.

DC voltmeter

Voltage ranges: 1 μV to 1000 V† in 10 decade ranges.

Accuracy: $\pm(2\%$ of range + $0.1 \mu\text{V})$.

Input resistance: 100 mV to 1000 V range: $> 10^{10} \Omega$; 10 mV range: $> 10^9 \Omega$; 1 μV to 1 mV range: $10^8 \Omega$.

Zero drift: $< 2 \mu\text{V}$ per day; zero control limits: $> \pm 10 \mu\text{V}$.

Normal-mode rejection: same as dc differential voltmeter.

DC amplifier

Voltage gain: 1 mV range, 60 dB; 10 mV range, 40 dB; 100 mV range, 20 dB; 1 V to 1000 V ranges, 0 dB.

Gain accuracy: $\pm(0.01\%$ of input + 0.0005% of range + $2 \mu\text{V})$ referred to input.

Linearity: $\pm 0.002\%$ on any range.

Stability, temperature coefficient, line regulation, input resistance, ECMR, NMR: same as dc differential voltmeter.

Load regulation, output current, and output resistance: same as dc standard.

General

Operating temperature: 10°C to 40°C unless specified otherwise.

Storage temperature: -40°C to $+65^\circ\text{C}$.

RFI: meets MIL-I-6181D.

Power: 115 V or 230 V $\pm 10\%$, 48 Hz to 440 Hz, 100 VA max.

Dimensions: full module, $16\frac{3}{4}$ " wide, $6\frac{7}{8}$ " high, $18\frac{1}{4}$ " deep. (425 x 175 x 464).

Weight: net, 47.3 lbs (21.3 kg); shipping, 64 lbs (28.8 kg).

Accessories furnished

11054A input cable assembly; 11055B output cable assembly.

Price: HP 740B, \$2800.

† Maximum of -500 V dc with respect to line ground can be applied to or obtained from the HP 740B.
* Refer to data sheet for complete specifications.



AC-DC ΔVM/DC STANDARD

Multi-function calibration instrument

Model 741B

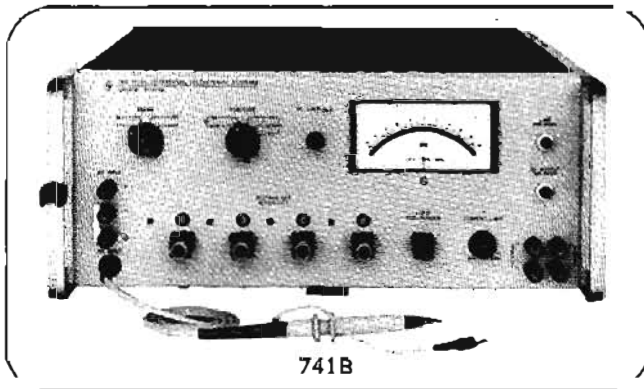

Description

The Hewlett-Packard Model 741B is a versatile and accurate instrument with six modes of operation: dc standard, dc differential voltmeter, dc voltmeter, ac differential voltmeter, ac voltmeter, and dc power amplifier.

The 741B is easy to use. The four most significant digits are digitally displayed; the meter displays the remaining resolution. The decimal point is placed automatically by the range switch. The voltage set switches are concentric with the sensitivity buttons; thus, there is no confusion about which switch to turn.

Specifications*

DC standard

Voltage ranges: 0 to 1000 V in 4 decade ranges.

Performance rating (after 1-hour warmup)

Accuracy:** <80% RH, constant line, load and temp $\pm 1^\circ\text{C}$.

90 day: $\pm 0.01\%$ of setting or $\pm 0.001\%$ of range, whichever is greater.

180 day: $\pm 0.015\%$ of setting or $\pm 0.0015\%$ of range, whichever is greater.

Stability: <80% RH, constant line, load and temp $\pm 1^\circ\text{C}$, after 8 hrs warmup, 100 V range and below.

1 hr: $< (0.0003\% \text{ of setting} + 0.0001\% \text{ of range})$.

24 hr: $< (0.001\% \text{ of setting} + 0.0001\% \text{ of range})$.

Temperature coefficient: $< (0.0003\% \text{ of setting} + 0.0001\% \text{ of range})$ per $^\circ\text{C}$.

Line regulation: $< (0.0001\% \text{ of setting} + 1 \mu\text{V})/1\%$ change.

Load regulation (no load to full load): $< (0.001\% \text{ of setting} + 10 \mu\text{V})$.

Output characteristics

Output current: current limiter continuously adjustable from $< 4 \text{ mA}$ to $> 20 \text{ mA}$, 0°C to 40°C . Reduced to 10 W maximum from 40°C to 50°C .

Output resistance: $< (0.0005\% + 0.0005 V_{\text{out}})\Omega$.

Noise (rms value)

Range	DC - 1 Hz	1 Hz - 1 MHz
1 V	$< 10 \mu\text{V}$	$< 200 \mu\text{V}$
10 V	$< 100 \mu\text{V}$	$< 200 \mu\text{V}$
100 V	$< 1 \text{ mV}$	$< 1 \text{ mV}$
1000 V	$< 10 \text{ mV}$	$< 10 \text{ mV}$

20 Hz-20 kHz, <500 V: 1 hr $< 0.003\%$ of range; 24 hr $< 0.005\%$ of range.

20 kHz-50 kHz, <500 V: $< 0.005\%$ per day.

20 kHz-100 kHz, <500 V: $< 0.02\%$ per day.

Accuracy (stability and temperature coefficient included): <80% RH, constant line, temperature $\pm 1^\circ\text{C}$, with 1 hr warmup.

20 Hz-20 kHz:

90 day.

Frequency	Voltage	Accuracy \pm (% of reading + % of range)
400 Hz - 5 kHz	50 mV - 100 V	$0.02\% + 0.01\%$ *
20 Hz - 30 Hz	50 mV - 500 V	$0.2\% + 0.01\%$
30 Hz - 50 Hz	50 mV - 500 V	$0.15\% + 0.01\%$
50 Hz - 100 Hz	50 mV - 500 V	$0.1\% + 0.01\%$
100 Hz - 20 kHz	50 mV - 500 V	$0.04\% + 0.01\%$
20 Hz - 20 kHz	1 mV - 50 mV	$0.4\% + 0.01\%$
50 Hz - 20 kHz	500 V - 1000 V	$1\% + 1\%$

Frequency	Voltage	Accuracy \pm (% of reading + % of range)
50 kHz - 100 kHz	50 mV - 500 V	$0.6\% + 0.01\%$
20 kHz - 50 kHz	1 mV - 50 mV	$0.4\% + 0.01\%$
20 kHz - 100 kHz	500 V - 1000 V	$1\% + 1\%$

Line regulation: $< 0.001\%$ of range per 1% line change.

Input characteristics

Input impedance: 1 M Ω shunted by $< 5 \text{ pF}$.

Overload protection: 1000 V can be applied on any range.

DC differential voltmeter

Voltage ranges: 1 V, 10 V, 100 V, 1000 V.

Performance rating (after 1-hour warmup).

Accuracy:** <80% RH, constant line and temp $\pm 1^\circ\text{C}$.

90 day: $\pm 0.02\%$ of reading or $\pm 0.004\%$ of range, whichever is greater.

180 day: $\pm 0.025\%$ of reading or $\pm 0.004\%$ of range, whichever is greater.

Stability: with 8-hour warmup, <80% RH, constant line and temp $\pm 1^\circ\text{C}$, 100 V range and below.

1 hr: $< (0.0003\% \text{ of reading} + 0.0001\% \text{ of range})$.

24 hr: $< (0.001\% \text{ of reading} + 0.0001\% \text{ of range})$.

Temperature coefficient: $< (0.0003\% \text{ of reading} + 0.0001\% \text{ of range})$ per $^\circ\text{C}$.

Line regulation: $< 0.0002\%$ of range per 1% line change.

Input resistance: $> 10^6\Omega$, independent of null.

Normal mode rejection (NMR): 50 Hz and above: $> 80 \text{ dB}$.

General

Power supply: 115 or 230 V $\pm 10\%$, 48 Hz to 440 Hz, 90 VA max.

Dimensions: 16 $\frac{3}{4}$ " wide, 6 $\frac{7}{8}$ " high, 18 $\frac{1}{4}$ " deep (425 x 175 x 464 mm).

Weight: net, 42 lbs (18.9 kg); shipping, 58 lbs (26.1 kg).

Accessories furnished: rack mounting kit for 19" rack.

Price: HP 741B, \$2145; HP 741B, Option 001**, \$2145.

* For complete specifications, refer to data sheet.

** Option 001: accuracies for DC ΔVM and DC Standard are interchanged.

AC CALIBRATION SYSTEM

Precision source; to 1100 V; 10 Hz to 110 kHz
Models 745A & 746A



SIGNAL SOURCES

Description

The 745A AC Calibrator combined with the 746A High Voltage Amplifier, is a compact, calibrated ac source with a continuously-adjustable frequency output from 10 Hz to 110 kHz. The output can be varied from 0.1 mV to 1099.999 V in steps of 1 ppm of range over the entire frequency band.

The Model 745A provides the first six voltage ranges, 0.1 mV to 109.9999 V, while the combination of the 745A and 746A permits the expansion to 1099.999 V as a seventh range.

745A/746A Combined Specifications

(Refer to data sheet for complete specifications)

Ranges

Output voltage ranges: 7 ranges with 10% overrange as follows:

Range	Settability and Resolution
1 mV	0.100000 mV to 1.099999 mV in 1 nV steps
10 mV	1.00000 mV to 10.99999 mV in 10 nV steps
100 mV	10.0000 mV to 109.9999 mV in 100 nV steps
1 V	0.100000 V to 1.099999 V in 1 μ V steps
10 V	1.00000 V to 10.99999 V in 10 μ V steps
100 V	10.0000 V to 109.9999 V in 100 μ V steps
1000 V	100.000 V to 1099.999 V in 1 mV steps

The output voltages from 100 μ V to 110 V are available from 745A output terminals; voltages from 100 V to 1100 V are available from the 746A output cable.

Output frequency range: continuously adjustable from 10 Hz to 110 kHz in 4 decade ranges with 10% overlap.

Error measurement: 2 ranges with zero center dial; $\pm 0.3\%$, $\pm 3\%$. A zero range is provided to switch out the effects of the error measurement system.

Performance rating

Accuracy: accuracy holds for a 90-day period and is met after a 1-hr warmup period at 25°C $\pm 5^\circ$ C with <95% RH. This applies only to the 745A. 746A warmup time required is approximately 30 s.

Voltage: specifications are absolute, traceable to the National Bureau of Standards.

1 mV to 100 V ranges:

Frequency	Accuracy
50 Hz to 20 kHz	$\pm (0.02\%$ of setting $+0.002\%$ of range $+10 \mu$ V)
20 Hz to 50 Hz	$\pm (0.05\%$ of setting $+0.005\%$ of range $+50 \mu$ V)
20 kHz to 110 kHz	
10 Hz to 20 Hz	$\pm (0.2\%$ of setting $+0.005\%$ of range $+50 \mu$ V)

1000 V range:

Frequency	Accuracy
50 Hz to 20 kHz	$\pm 0.04\%$ of setting
20 Hz to 50 Hz	$\pm 0.08\%$ of setting
20 kHz to 50 kHz	
50 kHz to 110 kHz	$\pm 0.15\%$ of setting
10 Hz to 20 Hz	$\pm (0.2\%$ of setting $+0.005\%$ of range)

Frequency: $\pm (2\%$ of setting $+0.2\%$ of end scale).

Error measurement: $\pm (0.5\%$ of setting $+0.5\%$ of range).

Temperature coefficient

Voltage: 1 mV to 100 V ranges: $\pm 0.0003\%$ of setting per $^\circ$ C, 0°C to 55°C. 1000 V range: $\pm 0.0005\%$ of setting per $^\circ$ C, 0°C to 55°C.

Frequency: $\pm 0.05\%$ of end scale per $^\circ$ C, 0°C to 55°C. Derate accuracy specifications by this temperature coefficient



745A/746A

for operation in temperature range of 0°C to 20°C and 30°C to 55°C.

Voltage stability: stability met after 1-hr warmup period at constant temperature with <95% RH.

1 mV to 100 V ranges

Long-term: $\pm 0.01\%$ of setting for 6 mo.

Short-term: $\pm 0.005\%$ of setting for 24 hr.

1000 V range

Long-term: 50 Hz to 20 kHz: $\pm 0.01\%$ of setting for 6 mo. 10 Hz to 50 Hz and 20 kHz to 110 kHz: $\pm 0.02\%$ of setting for 6 mo.

Short-term: $\pm 0.005\%$ of setting for 24 hr.

Output characteristics

Total distortion and noise: 0.05% of setting $+10 \mu$ V over 100 kHz bandwidth on all ranges.

Load capability

1000 pF or 50 mA on 1 mV to 100 V ranges (50 mA allows 800 pF at 100 V, 100 kHz).

1000 pF or 63 mA on 1000 V range (63 mA allows 100 pF at 1000 V, 100 kHz).

Line regulation: $\pm 0.001\%$ of setting change in output voltage for 10% change in line voltage (included in accuracy spec).

General

Operating temperature: 0°C to 55°C.

Power: 745A: 115 V or 230 V $\pm 10\%$, 48 Hz to 440 Hz, 115 VA max. 746A: 115 V or 230 V $\pm 10\%$, 50 Hz to 60 Hz, 1 kVA max. 746A aux power output rated at 120 VA max.

Dimensions: 745A: 16 $\frac{3}{4}$ " wide, 8 $\frac{3}{4}$ " high, 18 $\frac{1}{8}$ " deep (425 x 221 x 467 mm). 746A: 16 $\frac{3}{4}$ " wide, 7" high, 18 $\frac{1}{4}$ " deep (425 x 177 x 464 mm).

Weight: 745A: net, 65 lbs (29.3 kg); shipping, 81 lbs (36.5 kg). 746A: net, 75 lbs (34 kg); shipping, 93 lbs (41.9 kg).

Accessories furnished

745A: rack mount kit; HP Part No. 5060-0630, 22-pin printed circuit board extender; HP Part No. 5060-0043, 15-pin printed circuit board extender; HP Part No. 5060-0031, 10-pin printed circuit board extender; HP Part No. 1251-0084 remote programming mating plug.

746A: accessory kit; HP Part No. 00746-84401; HP Part No. 1251-0485, remote right angle connector; HP Part No. 1450-0356, incandescent lamp; HP Part No. 4040-0427, extractor; HP Part No. 5040-0404, probe holder; HP Part No. 5060-0216, joining kit bracket; HP Part No. 5060-0630, 22-pin printed circuit board extender; 7H rack mounting kit; HP Part No. 00746-02701, foam filter.

Price: HP 745A, \$4615; HP 746A, \$2050.

SIGNAL SOURCES



AUDIO OSCILLATORS

Exceptional value, highest quality
Models 200AB, 200CD, 201C, 202C

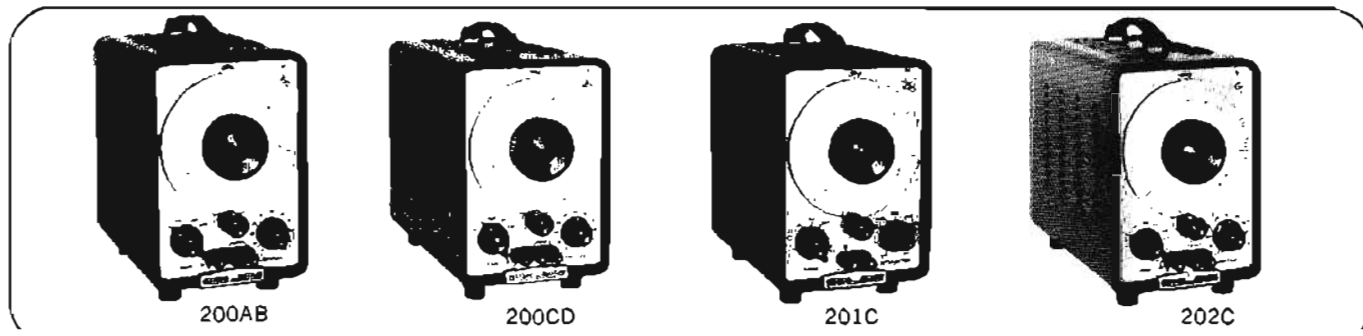

Description

The Hewlett-Packard series oscillators have high stability and accurate, easily resettable tuning circuits. Low-impedance operating levels together with superior insulation guarantee peak performance throughout years of trouble-free service. The instruments have a wide frequency range and long dial lengths and feature an improved vernier frequency control. Operation is simplified—just three controls are required. Instruments are compact, light in weight, and enclosed in a convenient, aluminum case with carrying handle. They occupy minimum bench space and are easily portable. Rack mounting is available on order.

The 200AB sinewave oscillator's frequency range of 20 Hz to 40 kHz is covered in four overlapping decade bands. The oscillator provides 1 W or 24.5 V into 600 Ω load. The output circuit is balanced and floating over the entire frequency range so that the instrument may be used to drive off-ground loads.

The 200CD covers the range of 5 Hz to 600 kHz in five overlapping decade bands. Accurate frequency is provided by 112 dial divisions and an effective scale length of 78 inches; a vernier drive allows precise adjustment. The 200CD gives a

maximum sinewave output of at least 10 V across its rated load of 600 Ω and at least 20 V open circuit. Its distortion rating is very low, <0.2% from 20 Hz to 200 kHz. A special feature of the 200CD is that its waveform purity does not depend on load.

Particularly designed for amplifier testing, transmission line measurements, loudspeaker testing, frequency comparison, and other high fidelity tests. The 201C meets every requirement for speed, simplicity and pure waveform. The frequency range, 20 Hz to 20 kHz, is covered in 3 bands; response is ± 1 dB full range. Output is 3 W or 42.5 V into 600 Ω ; an attenuator adjusts output 0 to 40 dB in 10 dB steps and provides either low impedance or constant 600 Ω impedance.

Model 202C brings to low-frequency oscillators the accuracy and stability associated with audio measurements. It provides excellent waveforms as low as 1 Hz.

The transformer-coupled, balanced output of the Model 202C enables it to meet the signal source requirements for tests of a wide variety of systems. The instrument provides an output of at least 10 V across its rated load of 600 Ω and at least 20 V open circuit.

Specifications

(Refer to data sheet for complete specifications)

HP Model	Frequency range	Calibration accuracy	Output to 600 ohms	Output impedance	Maximum distortion	Maximum hum and noise†	Input power	Weight—lb (kg)		Size—inches (mm)			Price
								net	ship	W	H	D	
200AB	20 Hz to 40 kHz (4 ranges)	$\pm 2\%$	1W (24.5V)	75 Ω (mid-freq)	1% 20 Hz to 20 kHz; 2% 20 kHz to 40 kHz	0.05%	75 VA	15	16	7 1/2	11 1/2	12	\$255
200CD	5 Hz to 600 kHz (5 ranges)	$\pm 2\%$	> 160mW (> 10 V)	600 Ω	0.2% 20 Hz to 200 kHz; 0.5% 5 Hz to 20 Hz and 200 kHz to 600 kHz	> 60dB below (< 0.1% of) rated output	90 VA	22	24	7 3/8	11 1/2	14 3/8	\$295
200CD Opt. H20			7.5 V										..
201C	20 Hz to 20 kHz (3 ranges)	$\pm 1\%$	3W (42.5V)	600 Ω	0.5%	0.03%	75 VA	16	19	7 1/2	11 1/2	12 1/2	\$315
202C	1 Hz to 100 kHz (5 ranges)	$\pm 2\%$	160mW (10 V)	600 Ω	0.5% above 5 Hz	0.1%	90 VA	25	28	7 1/2	11 1/2	14 1/2	\$350

* Output impedance: 600 Ω $\pm 10\%$, 20 dB, 30 dB and 40 dB setting; <600 Ω , 0 dB and 10 dB settings.

† Same as 200CD except: 0.06% 60 Hz to 50 kHz; 0.1% 20 Hz to 50 Hz and 50 kHz to 400 kHz; 0.5% 5 Hz to 20 Hz and 400 kHz to 600 kHz. Output: 7.5 V into 600 Ω load.

‡ Measured with respect to full rated output.

General

Frequency response: flat ± 1 dB over instrument range; reference level at 1 kHz.

Size and weight: maximum overall size and weights are given for cabinet models; 19" rack models also available.

Power: 115 or (230 V must be specified) $\pm 10\%$ at 48 to 440 Hz.

Accessories available: 11000A Cable Assembly, \$6; 11001A Cable Assembly, \$7; 11004A Line Matching Transformer, \$65; 11005A Line Matching Transformer, \$85.

SINE, SQUARE OSCILLATORS

Low distortion; wide range; balanced output
Models 209A, 204C, 204D



SIGNAL SOURCES

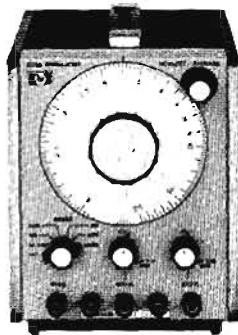

209A

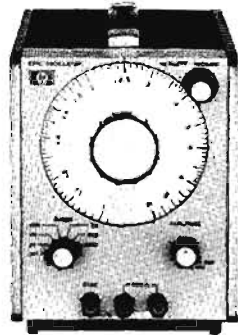

204C

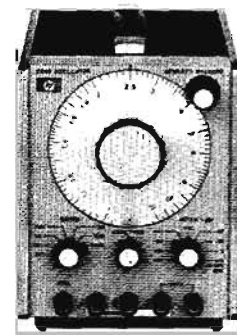

204D

The HP 209A is a small, lightweight, sine/square oscillator. Stable, accurate signals which can be synchronized with an external source are instantly available over a frequency range from 4 Hz to 2 MHz. Separately adjustable sine/square outputs are located on the front panel. Distortion and flatness can be minimized at low frequencies by a rear panel LOW DISTORTION MODE switch.

The HP 204C is a small, lightweight capacitive-tuned oscillator. Interchangeable power packs, line, rechargeable batteries or mercury batteries make this instrument ideal for both field and laboratory use. Internal heat generation and temperature coefficient is small, resulting in unusually low drift. Stable, accurate signals which can be synchronized with an external source are instantly available over a frequency range from 5 Hz to 1.2 MHz. Distortion can be minimized at low frequencies by a rear panel Low Distortion Mode switch; however, settling time with a rapid frequency change is increased.

The HP 204D Oscillator is identical to the 204C with the addition of an 80 dB attenuator and vernier. The attenuator with the vernier provides excellent output amplitude setability.

Specifications (209A)

Frequency: 4 Hz to 2 MHz in 6 ranges.
Dial accuracy: $\pm 3\%$ of frequency setting.
Flatness: at maximum output into 600 Ω load, 1 kHz reference.

Low distortion mode	$\pm 1\%$	$\pm 0.5\%$	$\pm 1\%$	$\pm 5\%$
Normal mode	+5%, -1%	$\pm 0.5\%$	$\pm 1\%$	$\pm 5\%$
	4	100	300k	1M 2M (Hz)

Distortion: 200 Hz to 200 kHz, 0.1% (-60 dB); 4 Hz to 200 Hz, $< 0.2\%$ (-54 dB); 200 kHz-2 MHz, $< 1\%$ (-40 dB).
Hum and noise: $< 0.01\%$ of input.

Output characteristics sine wave

Output voltage: 5 V rms (40 mW) into 600 Ω ; 10 V open circuit.
Output impedance: 600 Ω .
Output control: > 26 dB range continuously adjustable.
Output balance: > 40 dB below 20 kHz. Output can be floated up to ± 500 V p between output and chassis ground.

Output characteristics square wave

Output voltage: 20 V p-p open circuit symmetrical about 0 V. Output can be floated up to ± 500 V p.
Rise and fall time: < 50 ns into 600 Ω . Symmetry: $\pm 5\%$.
Output impedance: 600 Ω .

Synchronization

Sync output: sine wave in phase with output; 1.7 V rms open circuit (high end affected by capacitive loads); impedance 10 k Ω .
Sync input: same as 204C.
Price: HP 209A, \$355.

Specifications (204C)

Frequency: 5 Hz to 1.2 MHz in 6 overlapping ranges.
Dial accuracy: $\pm 3\%$ of frequency setting.
Flatness (at maximum output into 600 Ω load, 1 kHz reference)

Low distortion mode	$\pm 1\%$	$\pm 0.5\%$	$\pm 1\%$
Normal mode	+5%, -1%	$\pm 0.5\%$	$\pm 1\%$
	5	100	300k 1.2M (Hz)

Distortion: 30 Hz to 100 kHz, 0.1% (-60 dB); 5 Hz to 30 Hz, $< 0.6\%$ (-44 dB); 100 kHz-1.2 MHz, linearly derated to $< 1\%$.
Hum and noise: $< 0.01\%$ of output.

Output characteristics

Output voltage: > 2.5 V rms (10 mW or $+10$ dBm) into 600 Ω ; > 5 V rms open circuit.
Output impedance: 600 Ω .
Output control: > 40 dB range; continuously adjustable.
Output balance: > 40 dB below 20 kHz. Can be floated up to ± 500 V p between output and chassis ground.

Synchronization

Sync output: sine wave in phase with output; > 100 mV rms into < 100 pF over entire range; impedance 10 k Ω .
Sync input: oscillator can be synchronized to external signal. Sync range, the difference between sync frequency and set frequency, is a linear function of sync voltage. $\pm 1\%$ /V rms for sine wave with a maximum input of ± 7 V p (± 5 V rms).

Specifications (204D)

(Identical to 204C except "output control" is replaced by the following.)

Output attenuator

Range: 80 dB in 10 dB steps.
Overall accuracy: ± 0.3 dB, $+10$ dB through -60 dB ranges; ± 0.5 dB on -70 dB range.
Output vernier: > 10 dB range, continuously adjustable.

General

Operating temperature: specifications are met from 0 $^{\circ}$ C to 55 $^{\circ}$ C.
Power: standard: ac-line 115 V or 230 V $\pm 10\%$, 48 Hz to 440 Hz, < 7 VA max. Opt. 001: mercury batteries 300 hours operation. Opt. 002: line/rechargeable batteries 115 V or 230 V $\pm 10\%$, 48 Hz to 440 Hz, < 7 VA max. 35 hours operation per recharge.
Dimensions: 5 $\frac{1}{8}$ " wide, 6 $\frac{1}{4}$ " high (without removeable feet), 8" deep (130 x 159 x 203 mm).
Weight: net 6 lbs (2.7 kg); shipping 9 lbs (4 kg).
Accessories available: HP 11135A AC Power Pack for 204C, \$60. HP 11136A Mercury Power Pack for 204C, \$75. HP 11137A Rechargeable Battery/AC Power Pack for 204C, \$95. HP 11075A Instrument Case, \$60.
Price: HP 204C (ac line), \$260; HP 204D, \$335; HP 204C or 204D option 001 (mercury batteries), add \$15. HP 204C or 204D option 002 (rechargeable batteries, ac-line), add \$35.



DIGITAL OSCILLATOR

Four digit frequency resolution, 10 Hz to 1 MHz
Model 4204A



4204A

Simple, rapid 0.2% frequency selection
Flat frequency response, 10 Hz to 1 MHz
0.01% frequency repeatability
Excellent stability

Uses

Production line and repetitive testing
Standard source for calibrating ac to dc converters
Response testing of wide or narrow band devices
Filter checkout

Description

The Hewlett-Packard 4204A Digital Oscillator provides accurate, stable test signals for both laboratory and production

work. This one instrument does the jobs of an audio oscillator, and ac voltmeter, and an electronic counter, in applications requiring an accurate frequency source of known amplitude.

Any frequency between 10.0 Hz and 999.9 kHz can be digitally selected with an in-line rotary switch. As many as 36,900 discrete frequencies are available. Infinite resolution is provided by one vernier control, which also extends the upper frequency limit to 1 MHz. Frequency accuracy is better than $\pm 0.2\%$ and repeatability is typically better than $\pm 0.01\%$.

A built-in high impedance voltmeter measures the output. The meter is calibrated to read volts or dBm into a matched 600 ohm load. (0 dBm = 1 mW into 600 ohms.) The output attenuator has an 80 dB range, adjustable in 10 dB steps with a 20 dB vernier. Maximum output power can be increased to 10 volts into 600 ohms (+22 dBm).

Specifications

Frequency range: 10 Hz to 1 MHz, 4 ranges.
Frequency accuracy: $\pm 0.2\%$ or ± 0.1 Hz (at 25°C).
Frequency stability
±10% line voltage variation: $< \pm 0.01\%$.
Change of frequency with temperature: $< \pm 100$ ppm/°C.
Frequency response: flat within $\pm 3\%$.
Output: 10 V (22 dBm) into 600Ω, (160 mW). 20 V open circuit.
Output attenuators: 80 dB in 10 dB steps: $< \pm 0.5$ dB error.

Distortion: $< 0.3\%$, 30 Hz to 100 kHz. $< 1\%$, 10 Hz to 1 MHz.
Hum and noise: $< 0.05\%$ of output.
Dimensions: cabinet, 5¼" high, 16¼" wide, 11¼" deep (134 x 426 x 286 mm).
Power: 115 V/230 V switch, $\pm 10\%$, 11 VA max, 50 to 60 Hz.
Weight: net, 19 lbs (8.5 kg); shipping, 26 lbs (10.7 kg).
Price: HP 4204A, \$910.
Option 001: output monitor top scale calibrated in dBm/600Ω; bottom scale calibrated in volts, add \$10.

VARIABLE-PHASE GENERATOR

Sine- and square-waves 0.00005 Hz to 60 kHz
Model 203A



SIGNAL SOURCES

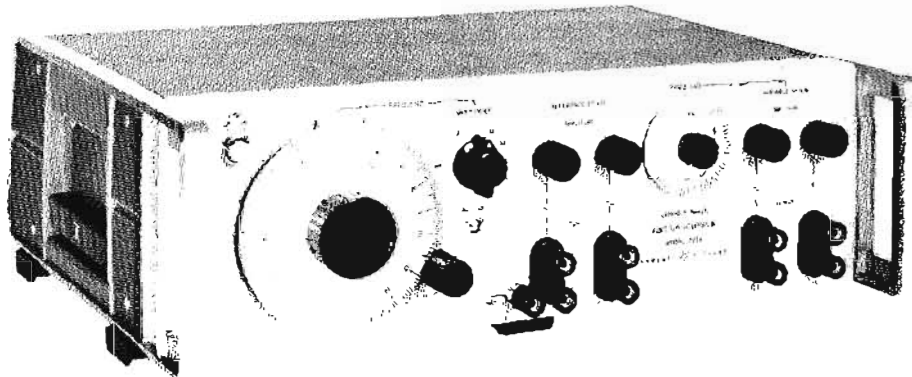

203A

The solid-state HP Model 203A Low-Frequency Function Generator provides two transient-free low-distortion square and sinusoidal test signals particularly useful for a wide variety of low-frequency applications. Field and laboratory testing of servo, geophysical, medical and high-quality audio equipment becomes practical when using the 203A.

The 203A frequency range of 0.005 Hz to 60 kHz is covered in 7 overlapping bands (2 additional ranges available on special order, offering frequency range to 0.00005 Hz). Accurate $\pm 1\%$ frequency setting is provided by 180 dial divisions. A vernier drive allows precise adjustment.

30 volt output

The 203A provides a maximum output voltage of 30 V peak-to-peak for all waveforms. The sinusoidal signals have a distortion that is less than 0.06% and provide virtually transient-free outputs when frequency and operating conditions are varied rapidly. The four output circuits of the 203A have individual 40 dB continuously variable attenuators.

Outputs consist of a reference sine and square wave, and a variable-phase sine and square wave. The two sine- and square-wave outputs are electrically identical except that one sine- and square-wave output contains a 0-to-360 degree phase-shifter. These four signals (two reference phase and two variable phase) are available simultaneously from the 203A. The output system is floating with respect to ground and may be used to supply an output voltage that is terminal grounded, or may be floated up to 500 volts dc above chassis ground. The output impedance is 600 ohms for all outputs.

Special features

A front-panel calibration provision permits the user to easily calibrate the oscillator frequency to the environment in which the instrument is used. The HP 203A features a unique method of mixing, filtering and dividing the frequency to maintain an exact decade relationship. Interchangeable decade modules provide greater reliability and ease of servicing.

Specifications, 203A

Frequency range: 0.005 Hz to 60 kHz in seven decade ranges.*

Dial accuracy: $\pm 1\%$ of reading.

Frequency stability: within $\pm 1\%$ including warmup drift and line voltage variations of $\pm 10\%$.

Output waveforms: sine and square waves are available simultaneously; all outputs have common chassis terminal.

Reference phase: sine wave, 0 to 30 V peak-to-peak; square wave, 0 to 30 V peak-to-peak (open circuit).

Variable phase: sine wave, 0 to 30 V peak-to-peak; square wave, 0 to 30 V peak-to-peak; continuously variable, 0 to 360°; phase dial accuracy, $\pm 5^\circ$ sine wave, $\pm 10^\circ$ square wave (open circuit).

Output impedance: 600 ohms.

Output power: 5 volts into 600 ohms (40 mW); 40 dB continuously variable attenuation on all outputs.

Distortion: total harmonic distortion hum and noise > 64 dB below fundamental ($< 0.06\%$) at full output.

Output system: direct-coupled output is isolated from ground and may be operated floating up to 500 V dc.

Frequency response: $\pm 1\%$ referenced to 1 kHz.

Square wave response: rise and fall time, < 200 ns; overshoot, $< 5\%$ at full output.

Power: 115 or 230 volts $\pm 10\%$, 48 to 440 Hz, 27.5 VA max.

Dimensions: cabinet: $5\frac{1}{4}$ " high, $16\frac{3}{4}$ " wide, $11\frac{1}{2}$ " deep (133 x 425 x 286 mm); rack mount kit (00203-84401) furnished with instrument.

Weight: net, 20 lbs (9.17 kg); shipping, 28 lbs (12.6 kg).

Price: HP 203A, \$1465; Option 001 (0.0005 Hz range), add \$50; Option 002 (0.00005 Hz range), add \$150.

*Two lower ranges of 0.0005 Hz (Option 001) and 0.00005 Hz (Option 002) are available on special order.



FUNCTION GENERATOR

Multiple outputs, plug-in versatility

Model 3300A & 3301A plug-in

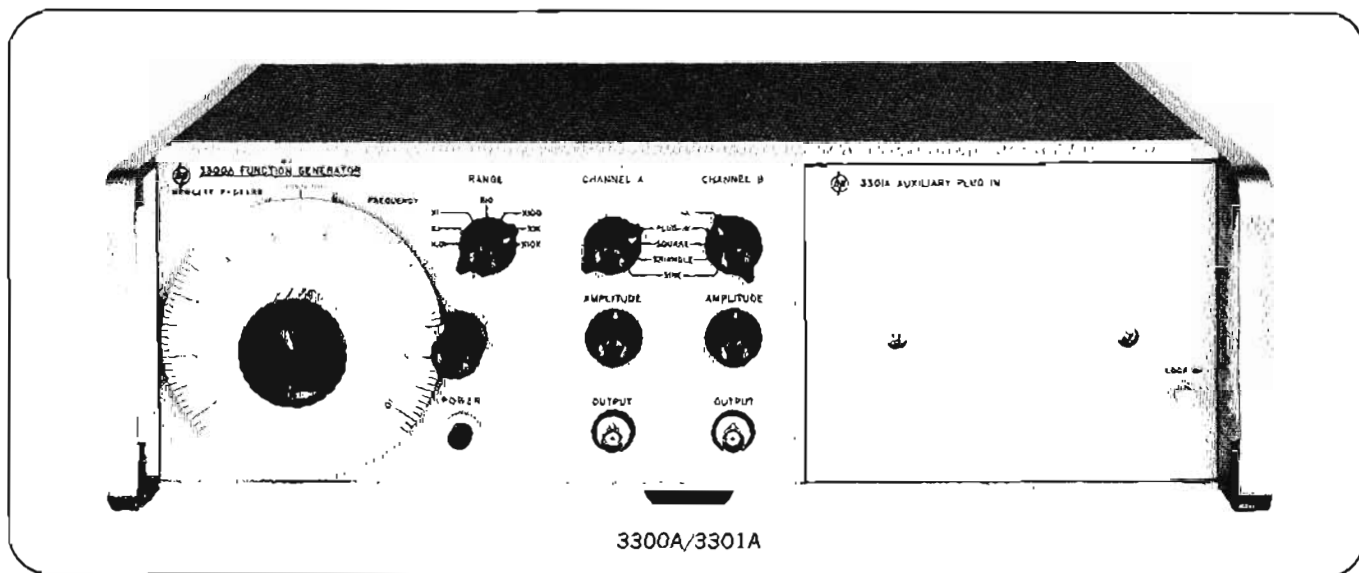

Description

Plug-ins and multiple outputs set the HP 3300A Function Generator apart from other function generators. Any two of three waveforms—sine, square or triangular—may be selected by a front-panel switch over the frequency range from 0.01 Hz to 100 kHz, continuously adjustable in seven decade ranges. This solid-state, multi-purpose source provides simultaneous signals of any two waveforms over the entire frequency range with independent variable amplitudes.

Plug-ins, which insert directly into the front panel, include the HP 3301A Auxiliary Plug-in to provide internal connections for basic unit operation. The 3302A plug-in provides single and multiple-cycle operation with adjustable start-stop phase. A phase-lock loop in the 3302A permits synchronizing the 3300A with an external signal and gives adjustable phase control. The HP 3304A Sweep/Offset Plug-in provides internal sweeping, dc offset, sawtooth waves and offset square waves. The 3305A Sweeper Plug-in supplies internal log sweep and manual sweep over four decades with calibrated variable start-stop frequency control within four decades. Sweep width is continuously-adjustable. It has manual or external triggering. Sweep can be analog-programmed with horizontal sweep available for driving scopes or recorders.

The frequency of the HP 3300A can be controlled by either the front-panel frequency dial or an external voltage applied to a rear-terminal connector. This feature is useful for sweeping filters, amplifiers and other frequency-dependent devices and for externally programming frequencies for production testing.

The output system of the HP 3300A is dc coupled and fully floating with respect to power-line ground. An internal shield reduces radiated interference and provides common-mode rejection with floating output. A balanced output can be obtained by using both output amplifiers. Each output amplifier will deliver 35 V p-p into an open circuit.

Specifications

Output waveforms: sinusoidal, square and triangular selected by panel switch (any two outputs available simultaneously).

Frequency range: 0.01 Hz to 100 kHz in 7 decade ranges.

Typical frequency stability

Short term: drift $< \pm 0.05\%$ of setting for 10 min.

Long term: drift $< \pm 0.25\%$ of setting for 24 hrs.

Frequency response: $\pm 1\%$, 0.01 Hz to 10 kHz; $\pm 3\%$, 10 kHz to 100 kHz on the X10 k range.

Dial accuracy: $\pm 1\%$ of maximum dial setting (1 minor division), 0.01 Hz to 10 kHz at $+25^\circ\text{C}$; $\pm 2\%$ of maximum dial setting (2 minor divisions), 10 kHz to 100 kHz on the X10 k range.

Maximum output per channel: > 35 V p-p open circuit; > 15 V p-p into 600 Ω ; > 2 V p-p into 50 Ω .

Output attenuators (both channels): 40 dB range.

Sine-wave distortion: $< 1\%$, 0.01 Hz to 10 kHz; $< 3\%$, 10 kHz to 100 kHz on the X10 k range.

Square-wave response: < 250 ns rise and fall time on all ranges; $< 1\%$ sag, $< 5\%$ overshoot at full output; $< 1\%$ symmetry error; < 500 ms rise and fall time (—A).

Triangle-linearity error: $< 1\%$, 0.01 Hz to 10 kHz; $< 2\%$, 10 kHz to 100 kHz at full output; $< 1\%$ symmetry error.

Sync-pulse output: > 10 V p-p open circuit. < 5 μs duration.

Output impedance (both channels): 600 Ω $\pm 20\%$.

DC stability: drift $< \pm 0.25\%$ of p-p amplitude over a period of 24 hours (after 30-min. warmup).

Remote frequency control: 0 to -10 V will linearly change frequency > 1 decade within a single range. Frequency re-settability with respect to voltage $\pm 1\%$ of maximum frequency on range selected.

Power: 115 or 230 V $\pm 10\%$, 48 to 440 Hz, 65 VA max.

Dimensions: standard Hewlett-Packard full module 16 $\frac{3}{4}$ " wide, 5-7/32" high, 11" deep (425 x 133 x 279 mm).

Weight: net, 20 lbs (9 kg); shipping, 25 lbs (11.3 kg).

Accessories furnished: rack mount kit for 19" rack.

Plug-ins available

HP 3301A Auxiliary Plug-in, \$30.

HP 3302A Trigger/Phase Lock Plug-in (see page 261).

HP 3304A Sweep/Offset Plug-in (see page 261).

HP 3305A Sweeper Plug-in (see page 261).

Price: HP 3300A Function Generator, \$725.

PLUG-INS FOR 3300A

Lin/log sweep, phase lock, dc offset
Models 3302A, 3304A, 3305A



SIGNAL SOURCES



3302A

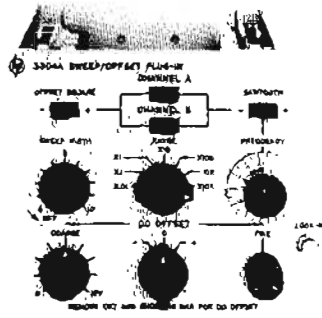

3304A

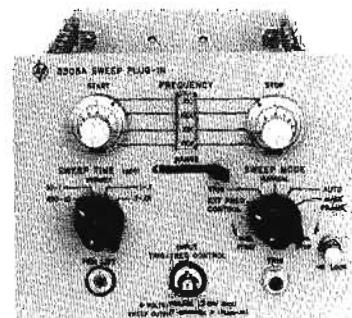

3305A

The HP 3302A Trigger/Phase Lock Plug-in provides single-cycle, multiple-cycle, and phase-lock operation. The instrument can be triggered over the entire frequency range, either manually or by applying an external voltage.

The HP 3304A Sweep/Offset Plug-in provides internal sweeping, dc offset, sawtooth waves, and offset square waves. Up to ± 16 V of dc offset is available for all signals generated in the main frame and plug-in. In addition, the independently frequency-controlled sawtooth wave may be switched internally to the frequency control circuit of the HP 3300A Function Generator to permit sweeping over a decade of frequency within a single range.

The HP 3305A Sweep Plug-in will sweep logarithmically, repetitively between any two frequencies within one of the three (4-decade) ranges: 0.1 Hz to 1 kHz, 1 Hz to 10 kHz, and 10 Hz to 100 kHz. Calibrated independent START-STOP controls greatly simplify setting desired sweep end points. Adjustable sweep time, from 0.01 to 100 seconds, provides sweep times slow enough for accurate response testing of low-frequency high-Q systems and fast enough for good visual displays of higher frequency responses.

Specifications, 3302A

Trigger requirements

Single cycle: manual or external, dc coupled. Requires at least 0.5 V to trigger externally. May be triggered with positive or negative input voltage which starts at or goes through 0 V (± 20 V p max.).

Multiple cycle: manual or external start/stop, dc coupled. Requires at least 0.5 V to start, 0 V to stop. May be triggered with either positive or negative (± 20 V p max.).

Phase lock: 10 Hz to 100 kHz (upper 4 ranges only), dc coupled. Requires + and -0.5 V p to lock, 10 V p-p for specified accuracy with sine wave input. The 3302A will lock on a fundamental or harmonic of the input signal.

Phase dial accuracy: $\pm 10^\circ$ from 10 Hz to 10 kHz; $\pm 20^\circ$ from 10 kHz to 100 kHz on X10 k range (fundamental).

Introduced distortion: $< 1\%$, 10 Hz to 10 kHz; $< 3\%$, 10 kHz to 100 kHz on X10 k range (fundamental).

Specifications, 3304A

DC offset

Voltage range: adjustable 0 to ± 16 V open circuit and ± 1 V vernier.

DC stability: ± 50 mV over 24-hr period (after 30-min. warm-up).

Offset square wave

Output polarity: positive or negative, from dc offset voltage or ground potential.

Amplitude: > 15 V p-p open circuit; continuously adjustable with 3300A amplitude control. Rise time: < 400 ns. Overshoot: $< 5\%$ at full output. Sag: $< 1\%$.

Sawtooth waveform

Frequency range: 0.01 Hz to 100 kHz, continuously adjustable over 7 decade ranges.

Dial accuracy: $< \pm 10\%$ full scale, 0.01 Hz to 1 Hz; $< \pm 5\%$ full scale, 1 Hz to 100 kHz.

Amplitude: > 15 V p-p open circuit; continuously adjustable over a 40 dB range with 3300A amplitude control.

Frequency response: $< 2\%$, 0.01 Hz to 10 kHz; $< 5\%$, 10 kHz to 100 kHz.

Output polarity: positive or negative, from dc offset voltage or ground potential.

Linearity: $< 1\%$, 0.01 Hz to 10 kHz; overshoot, $< 5\%$.
 $< 2\%$, 10 kHz to 100 kHz; overshoot, $< 5\%$.

Flyback time: $< 5\%$ +250 ns.

Internal sweep

Controls: start frequency set by 3300A frequency dial; sweep range set by sweep width control on plug-in.

Sweep rate: determined by sawtooth frequency setting.

Sweep width: adjustable from 0 to at least 1 decade on any one range.

Specifications, 3305A

Frequency range: 0.1 Hz to 100 kHz in 3 overlapping ranges.

Sweep width: limits adjustable 0 to 4 decades in any of 3 (4-decade) bands: 0.1 Hz to 1 kHz, 1 Hz to 10 kHz, 10 Hz to 100 kHz. Start-stop dial accuracy: $\pm 10\%$ of setting.

Sweep modes

Automatic: repetitive logarithmic sweep between start and stop frequency settings.

Manual: vernier adjustment of frequency between start and stop frequency settings.

Trigger: sweep between start and stop frequency settings and retrace with application of external trigger voltage or by depressing front-panel trigger button.

Trigger requirements: ac coupled, positive going at least 1 V p with > 2 V per ms rise rate. Max. input, ± 90 V p.

Sweep time: 0.01 s to 100 s in 4 decade steps, continuously adjustable vernier.

Retrace time: < 0.003 s for 0.1 to 0.01 s sweep times; < 0.03 s for 1 to 0.1 s sweep times; < 4 s for 100 to 1 s sweep times.

Blanking: oscillator disabled during retrace.

Pen lift: terminals shorted during sweep; open during retrace in auto and trigger modes for 100 to 1 s sweep times.

Sweep output: linear ramp at CHANNEL B OUTPUT (PLUG-IN); amplitude adjustable independently of sweep width; max. output > 15 V p-p into open circuit, > 7 V p-p into 600 Ω .

External frequency control

Sensitivity: 6 V/decade (refer: START setting), ± 24 V max.

V-to-F conversion accuracy: for each 6 V change in programming voltage, frequency changes 1 decade $\pm 5\%$ of end F.

Input impedance: 400 k Ω $\pm 5\%$. Max. rate: 100 Hz.

General

Dimensions: 6-1/16" wide, 4 3/4" high, 10 1/4" deep (154 x 121 x 260 mm).

Weight: net, 4 lbs 6 oz (2 kg); shipping 8 lbs (3.6 kg).

Price: HP 3302A, \$255; HP 3304A, \$295; HP 3305A, \$1015.

SIGNAL SOURCES



TEST OSCILLATORS

10 Hz to 10 MHz; 2%/mo amplitude stability
Models 651B, 652A, 654A

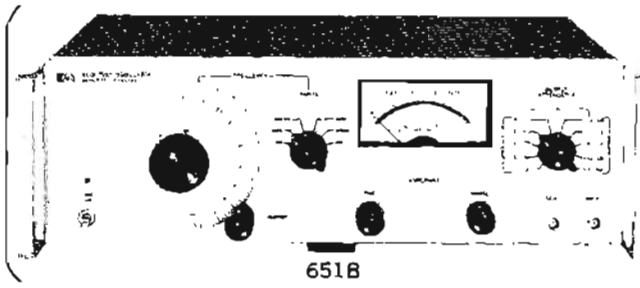

651B

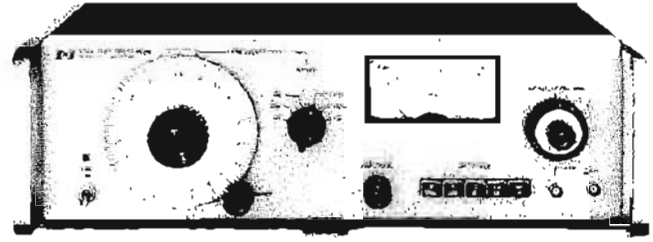

654A

Description

Amplitude and frequency stability of the 651B Test Oscillator provides test quality signals for laboratory or production measurements from 10 Hz to 10 MHz. Two output impedances are available from the front panel providing 200 mW into 50Ω or 16 mW into 600Ω.

The 652A is the same as the 651B with the addition of an expandable monitor for amplitude control to 0.25% across the band.

The 654A Test Oscillator is a lightweight, portable solid-state signal source. Its 10 Hz to 10 MHz frequency band, amplitude stability, accuracy, and level flatness make it an ideal general purpose test oscillator. The selective output impedances of 50Ω, 75Ω unbalanced, and 135Ω, 150Ω, 600Ω balanced make it useful in electronic research laboratories, in production testing, and for use as a commercial test instrument.

651B Specifications*

Frequency range: 10 Hz to 10 MHz, 6 band, dial calibration: 1 to 10.

Amplitude stability: ±2% per mo., 20°C - 30°C.

Dial accuracy (including warmup and ±10% line voltage variations): ±2%, 100 Hz to 1 MHz; ±3%, 10 Hz to 100 Hz and 1 MHz to 10 MHz.

Output (max): 3.16 into 50Ω or 600Ω; 6.32 open circuit.

Ranges: 0.1 mV to 3.16 V full scale, 10 steps in 1, 3, 10 sequence: -70 dBm to +23 dBm (50Ω output) full scale, 10 dBm per step; coarse and fine adjustable.

Flatness

Amplitude not readjusted to a reference on the output monitor: ±2%, 100 Hz to 1 MHz; ±3%, 10 Hz to 100 Hz; ±4%, 1 MHz to 10 MHz**.

Amplitude readjusted to a reference on the output monitor:

Range	Frequency			
	10 Hz	20 Hz	4 MHz	10 MHz
3 V and 1 V	2%	1%	2%	
.3V to .3 mV	2.5%	1.5%	2.5%	
.1 mV	3%	2%	3%	

Dimensions: 16¾" wide, 5-7/32" high, 13¼" deep (425 x 133 x 337 mm).

Weight: net, 17 lbs (7,7 kg); shipping, 22 lbs (9,9 kg).

Accessories furnished: rack mount kit for 19" rack.

Price: HP 651B, \$625.

Option 001: output monitor calibrated to read dBm for 600Ω, add \$25.

Option 002: outputs, 75Ω and 600Ω; calibrated in dBm/75Ω, add \$25.

Note: other output impedances above 50Ω are available.

652A Specifications*

(Same as Model 651B except as indicated below)

Expand scale: expands reference voltage of the normal scale from 0.9 to 1.0 or 2.8 to 3.2.

Flatness (amplitude readjusted using expanded scale on output monitor): ±0.25% 3 V and 1 V range; ±0.75% 0.3 V to 0.3 mV range; ±1.75% 0.1 mV range.

Accessories furnished: HP 11048B 50Ω feed-thru termination; rack mounting kit.

Price: HP 652A, \$755.

654A Specifications*

Frequency range: 10 Hz to 10 MHz in 6 bands.

Frequency accuracy: 100 Hz to 5 MHz, ±2%; 10 Hz to 100 Hz, ±3%; 5 MHz to 10 MHz, ±4%.

Level flatness (+10 dBm and 0 dBm): ±0.5% from 10 Hz to 10 MHz for unbalanced outputs, 10 Hz to 5 MHz for 135Ω and 150Ω outputs, and 10 Hz to 1 MHz for 600Ω output.

Output impedance: 50Ω unbalanced, 75Ω unbalanced, 135Ω balanced, 150Ω balanced, and 600Ω balanced.

Output level: +11 dBm to -90 dBm, 10 dB and 1 dB steps with adjustable ±1 dB meter range; calibrated for each impedance.

Attenuator

Range: 99 dB in 10 dB and 1 dB steps.

Accuracy: ±1.5% (0.15 dB) except ±10% (1 dB) at output levels below 60 dBm at frequencies >300 kHz.

Amplitude accuracy: ±1% for 90 days (1 kHz +10 dBm).

Meter tracking: ±0.05 dB.

Balance (on balanced impedances): >50 dB for frequencies from 10 Hz to 1 MHz, >40 dB to 5 MHz.

Distortion (THD): 10 Hz to 1 MHz, >40 dB below fundamental; 1 MHz to 10 MHz, >34 dB below fundamental.

Operating temperature: 0°C to +55°C (32°F to 130°F).

Power: 115 V or 230 V ±10%, 48 Hz to 440 Hz, 35 VA max.
Dimensions: 16¾" wide, 5-7/32" high, 11¼" deep (425 x 133 x 286 mm).

Weight: net, 21 lbs (9,5 kg); shipping, 23 lbs (10,4 kg).

Accessories furnished: rack mounting kit for 19" rack.

Price: HP 654A, \$910.

* Refer to data sheet for complete specifications.

** The response above 1 MHz at 600Ω output is affected by capacitive loads

FUNCTION GENERATORS

Compact, 7 functions, 10 decades of frequency
Model 3310A/B



SIGNAL SOURCES

Description

The 3310A Function Generator is a compact voltage-controlled generator with 10 decades of range. Ramp and pulse functions in addition to sine, square and triangle plus dc offset and external voltage control provide wide versatility. Also on the front panel is the fast rise time sync output, square wave in symmetrical functions and rectangular in pulse and ramp. Aspect ratio of non-symmetrical function is 15%/85%.

The 3310B has all the features of the standard 3310A plus single and multiple cycle output capability. With the start/stop phase knob in the detent position (max ccw) the instrument has the same specifications as the standard 3310A. When the start/stop phase knob is out of the detent, single or multiple cycle outputs can be obtained using either manual or external triggering.

Specifications (3310A)

Output waveforms: sinusoidal, square, triangle, positive pulse, negative pulse, positive ramp and negative ramp. Pulses and ramps have a 15% or 85% duty cycle.

Frequency range: 0.0005 Hz to 5 MHz in 10 decade ranges.

Sine wave frequency response

0.0005 Hz to 50 kHz: $\pm 1\%$; 50 kHz to 5 MHz: $\pm 4\%$.
Reference, 1 kHz at full amplitude into 50 Ω .

Dial accuracy

0.0005 Hz to 500 kHz all functions: $\pm (1\% \text{ of setting} + 1\% \text{ of full scale})$.

500 kHz to 5 MHz sine, square and triangle: $\pm (3\% \text{ of setting} + 3\% \text{ of full scale})$.

500 kHz to 5 MHz pulse and ramps: $\pm (10\% \text{ of setting} + 1\% \text{ of full scale})$.

Maximum output on HIGH: >30 V p-p open circuit; >15 V p-p into 50 Ω (except for pulses at frequency >2 MHz).

Pulse (frequency >2 MHz): >24 V p-p open circuit; >12 V p-p into 50 Ω .

Minimum output on LOW: <30 mV p-p open circuit; <15 mV p-p into 50 Ω .

Output level control: range >30 dB. HIGH and LOW outputs overlap for a total range of >60 dB; LOW output is 30 dB down from HIGH output.

Sine wave THD (below fundamental)

0.0005 Hz to 10 Hz: >40 dB (1%).

10 Hz to 50 kHz (on 1 k range): >46 dB (0.5%).

50 kHz to 500 kHz: >40 dB (1%).

500 kHz to 5 MHz: >30 dB (3%).

Square wave and pulse response: <30 ns rise and fall times at full output; <35 ns rise and fall times with AMPLITUDE control not fully CW; $<5\%$ total aberrations.

Triangle and ramp linearity: 0.0005 Hz to 50 kHz, $<1\%$.

Triangle symmetry: 0.0005 Hz to 20 Hz: $<1\%$; 20 Hz to 50 kHz: $<0.5\%$.

Impedance: 50 Ω .

Sync

Amplitude: >4 V p-p open circuit, >2 V p-p into 50 Ω .

Rise and fall times: <20 ns.

Waveform: square for symmetrical functions, rectangular for pulse and ramp.

Output impedance: 50 Ω .

Offset

Amplitude: ± 10 V open circuit, ± 5 V into 50 Ω , continuously adjustable.

Note: max V ac p + V dc offset is ± 15 V open circuit; ± 7.5 V into 50 Ω .

External frequency control range: 50:1 on any range.

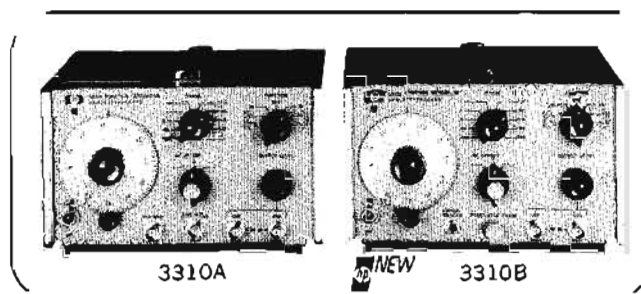

Input requirement: with dial set to low end mark, a linear positive ramp of 0 to $+10$ V ± 1 V will linearly increase frequency 50:1. With dial set at 50, a linear negative ramp of 0 to -10 V ± 1 V will linearly decrease frequency 50:1. An ac voltage will FM the frequency about a dial setting within the limits $(1 < f < 50) \times \text{range setting}$.

Linearity: ratio of output frequency to input voltage $\left(\frac{\Delta F}{\Delta V}\right)$ will be linear within 0.5%.

Sensitivity: approximately 100 mV/minor division.

Input impedance: 10 k Ω .

Note: specifications apply from 5 to 50 on the frequency dial.

General

Power: 115 V or 230 V $\pm 10\%$, 48 Hz to 440 Hz, 32 VA max.
Dimensions: $7\frac{3}{4}$ " wide, $4\frac{1}{2}$ " high (without removable feet) 8" deep (197 x 114 x 203 mm).

Weight: net, 6 lbs (2.7 kg); shipping, 10 lbs (4.5 kg).

Accessories available

HP Part No. 5060-0105 filler strip for use with HP 1051A combining case or HP 5060-0797 rack adapter frame.

Price: HP 3310A, \$595.

Specifications (3310B)

Specifications for 3310B are same as 3310A with the addition of the following:

Modes of operation: free run, single cycle, multiple cycle.

Frequency range: 0.0005 Hz to 50 kHz (usable to 5 MHz).

Single cycle:** EXT TRIGGER (ac coupled) requires a positive-going square wave or pulse from 1 V p-p to 10 V p-p of lower frequency than that set on the 3310B; the triggering signal can be dc offset, but $(V \text{ ac peak} + V \text{ dc}) \leq \pm 10$ V. EXT GATE (dc coupled) will trigger a single cycle on any positive waveform ≥ 1 V but ≤ 10 V which has period greater than the period of the 3310B output, and a duty cycle less than the period of the 3310B output. The gate signal cannot exceed 10 V.

Multiple cycle:** MANUAL TRIGGER will cause the 3310B to free run when depressed. When the trigger button is released, the waveform will stop on the same phase as it started. EXT GATE will cause the 3310B to free run when the gate is held at between +1 and +10 V. When the gate signal goes to zero, the 3310B will stop on the same phase as it started. For accurate gating, a square wave or square pulse is recommended.

Start-stop phase: The start-stop phase can be adjusted over a range of approximately $\pm 90^\circ$ using the front panel control.

Input impedance: EXT TRIGGER: 390 pF in series with 500 Ω .

EXT GATE: 500 Ω .

Price: HP Model 3310B, \$735.

** This specification applies on the X.0001 to X1 k range only.



FREQUENCY SYNTHESIZER

0.01 Hz to 13 MHz

Models 3320A, 3320B

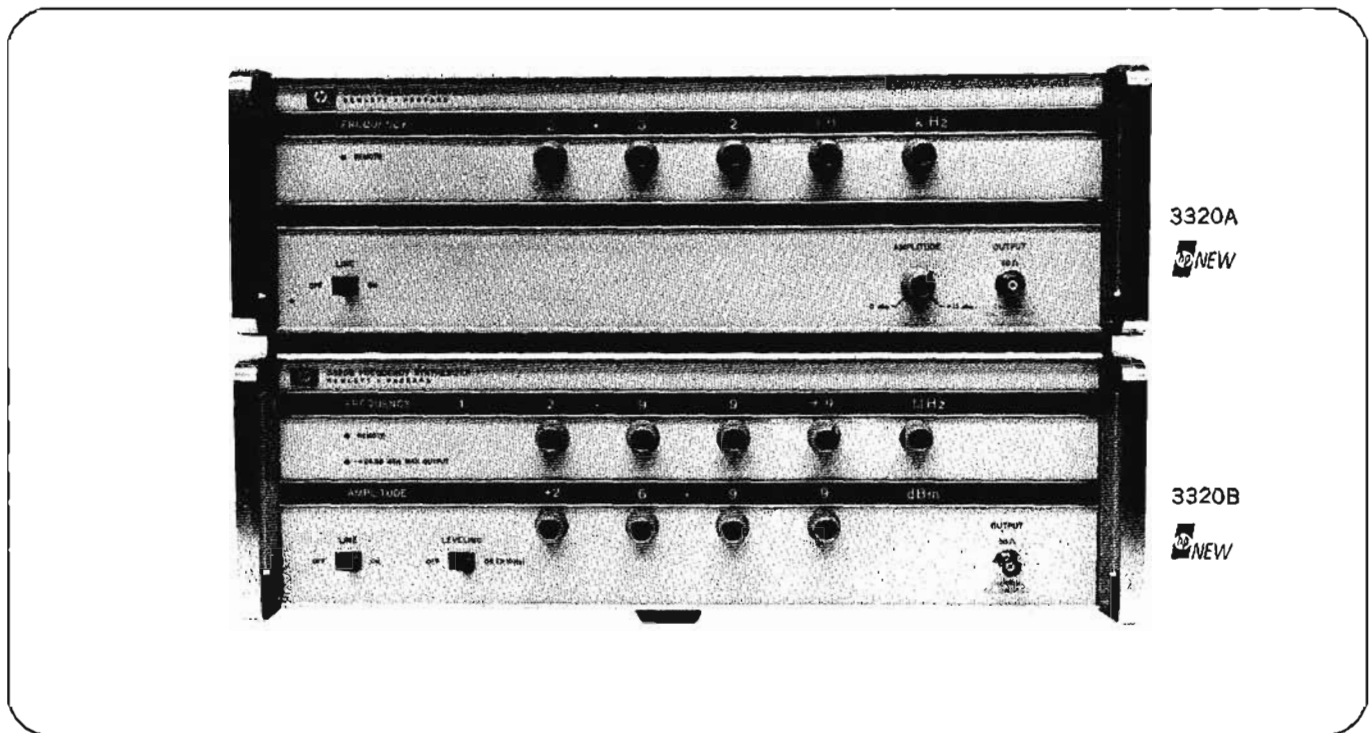

Description

The 3320A/B Frequency Synthesizer has the frequency accuracy, stability, and resolution demanded by many of today's exacting applications. The ease and flexibility of adding greater stability means the 3320A/B can be tailored to your needs as they emerge. Spectral purity and low signal-to-phase noise complement the frequency qualities of the 3320A/B.

The capability of the 3320A means you can add synthesizer quality to your design and production effort, yet the price allows you to avoid cutting deeply into your instrumentation budget.

The 3320B is more than a synthesizer. It offers precise level control, superior frequency response, low harmonic distortion and high power output which are features normally not found on frequency synthesizers. This makes the 3320B a precision bench signal source where neither frequency nor amplitude quality is sacrificed.

However, the 3320B is even more. It is a quality programmable signal source. Two choices of digital remote control afford great flexibility for today's system applications. High precision in both frequency and amplitude means that expensive system monitoring is unnecessary.

Features-frequency

The 3320A/B Frequency Synthesizer has a broad frequency range of 0.01 Hz to 13 MHz in seven frequency ranges (the two lower ranges, 100 Hz and 10 Hz, are optional).

Three digits plus a ten-turn two-digit continuous vernier plus 30% overrange capability gives the 3320A/B 1 part in 10^6 frequency resolution across its total frequency range. The standard instrument utilizes an ambient temperature crystal reference which reduces drift to less than ± 10 parts in 10^6 per

year. The ability to phase lock to an external frequency standard or to add an optional reference crystal oven provide a range of frequency stabilities covering most applications.

The 3320A/B is a synthesizer with ranges. This means the signal-to-phase noise is reduced as the instrument is down-ranged. The low spurious content of >60 dB down and low harmonic distortion, which ranges from -60 to -40 dB depending on frequency, contribute to a high quality spectral output.

Features-amplitude

The 3320A has a maximum 1 volt rms into 50 Ω output ($+13$ dBm) with a continuous $+13$ dBm to 0 dBm amplitude vernier. The 3320A is therefore recommended for applications where level control is not a critical parameter.

In applications where a high quality output amplitude is needed or it is desired to digitally control the output amplitude, the 3320B is recommended. The 3320B features a four-digit leveling loop with a 0.01 dB level resolution of a calibrated output from $+26.99$ dBm to -69.99 dBm (-73.00 dBm under remote control). This is a maximum of a full half watt of output power (5 volts rms into 50 ohms or 10 volts rms into an open circuit).

Frequency response of ± 0.05 dB over the range of 10 Hz to 13 MHz and level accuracy of ± 0.05 dBm absolute at 10 kHz complement the level capability of the 3320B.

Programmability/remote control

The 3320A/B is a programmable signal source. Digital remote control capability may be purchased installed in the instrument or may be added later if the need arises.

The 3320A with its Option 003 allows parallel BCD remote control of frequency only. The first digit of the frequency

vernier and the frequency range may be controlled digitally as well as the main frequency digits.

The 3320B has two remote control options. Both options allow full control of all functions except the last vernier digit and the line switch. Option 004 is parallel BCD remote control capability. Option 005 is a unique bit-parallel/word-serial ASCII programming option. This option is advantageous where several 3320B's need to be controlled since only one programming device is needed. The ASCII programming option has eight input lines thus allowing direct interface to the HP 3260A Marked Card Programmer, photo reader, or any other 8-bit controller. This buss line programming means a saving of computer interface slots and a simplification of software.

3320A/B Specifications

Frequency range: 0.01 Hz to 13 MHz in 7 ranges.

Frequency ranges: 10 MHz, 1000 kHz, 100 kHz, 10 kHz, 1000 Hz; 100 Hz and 10 Hz (optional). 30% overrange on all ranges.

Frequency resolution:

Range	Vernier Out (local or remote)	Vernier In (local)	Vernier In (remote)
10 MHz	10 kHz	10 Hz	1 kHz
1000 kHz	1 kHz	1 Hz	100 Hz
100 kHz	100 Hz	0.1 Hz	10 Hz
10 kHz	10 Hz	0.01 Hz	1 Hz
1000 Hz	1 Hz	1 mHz	0.1 Hz
100 Hz	0.1 Hz	0.1 mHz	0.01 Hz
10 Hz	0.01 Hz	0.01 mHz	0.001 Hz

Frequency accuracy

Vernier out: $\pm 0.001\%$ of setting for 6 mo, 0°C to 55°C.

Vernier in: $\pm 0.01\%$ of range for 6 mo, 0°C to 55°C.

Frequency stability

Long term: ± 10 parts in 10^6 of setting per year (vernier out) with ambient temperature reference. Optional high stability crystal reference oven available (Option 002).

Signal-to-phase noise (integrated): > 40 dB down in 30 kHz band, excluding ± 1 Hz, centered on carrier. 10 MHz range, vernier out. Improves on lower frequency ranges.

Harmonic distortion: with output frequencies $> 0.1\%$ of range at full output amplitude, any harmonically related signal will be less than the following specified levels.

- 60 dB with output from 5 Hz to 100 kHz.
- 50 dB with output from 100 kHz to 1 MHz.
- 40 dB with output from 1 MHz to 13 MHz.

Spurious: > 60 dB down.

Internal frequency standard: 20 MHz ambient temperature crystal. Optional 5 MHz reference crystal oven available Opt. 002.

Phase locking: the 3320A/B may be phase locked with a 200 mV to 2 V rms signal that is any subharmonic of 20 MHz from 1 MHz through 10 MHz (e.g., 1 MHz, 2 MHz, 2.5 MHz, 5 MHz, 10 MHz). BNC female connector.

Rear panel output: front or rear panel output is available. Can be easily changed by routing internal cable to front or rear female BNC connectors. No degradation of performance for rear panel output.

Auxiliary outputs

Tracking output: 20 MHz to 33 MHz offset signal. Tracks main output with 20 MHz offset. Rear panel female BNC, > 100 mV rms/50 Ω .

1 MHz reference output: sine wave, rear panel female BNC, 220 mV rms/50 Ω (> 0 dBm/50 Ω).

Low level output: same frequency as main output but remains between 50 mV rms and 158 mV rms (into 50 Ω) depending on main output level setting. May be used as counter output if wanted. Rear panel female BNC, sine wave.

3320A amplitude section

Amplitude: maximum 2 V rms $\pm 10\%$ open circuit.
maximum 1 V rms $\pm 10\%$ into 50 Ω .

Amplitude range: 0 dBm to +13 dBm range through $\frac{3}{4}$ turn front panel control (not programmable).

Frequency response: ± 2 dB over total range.

Output impedance: 50 Ω (75 Ω , Option 001).

3320B amplitude section

Amplitude range: +26.99 dBm ($\frac{1}{2}$ watt) to -69.99 dBm (-73.00 dBm under remote control) into 50 Ω . (+26.99 dBm = 5 V rms into 50 Ω).

Amplitude resolution: 0.01 dB.

Frequency response (10 kHz reference):

dc	10 Hz	13 MHz
± 0.5 dB	± 0.05 dB	+26.00 dBm
		-3.00 dBm
	± 0.1 dB	-23.00 dBm
± 0.25 dB	± 0.25 dB	-73.00 dBm

Amplitude accuracy (absolute): ± 0.05 dB at 10 kHz and +26.99 dBm (20°C to 30°C).

Output impedance: 50 Ω (75 Ω , Option 001).

Options

75 Ohm output impedance

Option 001 (3320A/B)

Attenuation and output referenced to 75 Ω .

Amplitude range (3320B only): +24.99 dBm to -69.99 dBm (-75.00 dBm under remote control) into 75 Ω .

Reference crystal oven*

Option 002 (3320A/B)

5 MHz crystal in temperature stabilized oven.

Long term stability: ± 1 part in 10^8 /day; ± 1 part in 10^7 /mo.

Frequency accuracy: ± 1 part in 10^7 of setting per mo. For field installation order accessory kit HP 11237A.

Parallel BCD remote control*

Option 003 (3320A only)

Allows digital remote control of frequency only on 3320A. Digital control of output level is not available on 3320A. The most significant digit of the vernier may be programmed thus giving four digits, plus 30% overrange, control of frequency in seven ranges (two are optional).

Frequency switching and settling time: $\pm 0.01\%$ of range, 15 ms; $\pm 0.001\%$ of range, 60 ms.

For field installation order accessory kit HP 11238A.

Parallel BCD remote control*

Option 004 (3320B only)

Allows full digital remote control of frequency and amplitude. **Four digits of frequency, overrange, frequency range, Vernier In/Out, four digits of amplitude, and leveling loop response times are all controlled digitally. All front panel controls, except line switch, are disabled in remote.

Frequency switching and settling time: $\pm 0.01\%$ of range, 15 ms; $\pm 0.001\%$ of range, 60 ms.

Amplitude switching and settling time: < 1.5 s to rated accuracy.

ASCII remote control Option 005* (3320B only)

Allows bit-parallel word-serial digital remote control of all functions. **A 3320B with this option will recognize an address and then accept instructions in a serial fashion. Instructions are in a 7-bit parallel ASCII code. Due to the addressing feature, up to ten 3320B's (with this option) may be programmed from one programmer. The HP 3260A Marked Card Programmer may be used as a programmer for this option.

This option requires 8 digital input lines for full control. **Seven of the eight are programming input lines and one is a data command line.

Full digital isolation is standard with this option.

Logic Level Requirements for All Digital Remote Control Options.

State	Requirements
"Low" (logical "1")	0 V to 0.4 V (5 mA max.) or contact closure to ground through <80 ohms.
"High" (logical "0")	+2.4 V to +5 V or removal of contact closure to ground.

100 Hz and 10 Hz ranges*

Option 006 (3320A/B)

Adds two lower frequency ranges, 100.0 Hz and 10.00 Hz, yielding greater resolution for low frequency outputs (see resolution section of specifications). These two ranges are fully programmable if digital remote options are installed.

For field installation order accessory kit HP 11240A.

General 3320A/B

Operating temperature: 0°C to 55°C.

Storage temperature: -40°C to +70°C.

Power requirements: 115 V or 230 V $\pm 10\%$, 48 Hz to 63 Hz, 110 VA max, (400 Hz operation on special basis).

Weight

3320A: 45 lbs (20,4 kg). Shipping: 59 lbs (26,7 kg).

3320B: 47 lbs (21,3 kg). Shipping: 61 lbs (27,5 kg).

Dimensions: 16 3/4" wide, 19 3/8" deep, 5 7/32" high (425 x 491,5 x 132,6 mm).

Accessories furnished: rack mounting kit.

Prices: 3320A, \$1900; Option 001, 75 Ω output, add \$25; Option 002, crystal oven, add \$290; Option 003, BCD remote control, add \$300; Option 006, 100 Hz/10 Hz ranges, add \$200. 3320B, \$2400; Option 001 75 Ω output, add \$25; Option 002, crystal oven, add \$290; Option 004, BCD remote control, add \$400; Option 005, ASCII remote control, add \$595; Option 006, 100 Hz/10 Hz ranges, add \$200.

Kit for interfacing to Hewlett-Packard 2100 Series computers. HP 11232A for interfacing 3320B Option 005.

Useful accessories

HP 11048C, 50 Ω feedthrough, \$15; HP 11094B, 75 Ω feedthrough, \$15; HP 3260A Marked Card Programmer allows the 3320B with ASCII remote to be easily programmed by a punched or marked card.

* Field installable.

** Except last vernier digit and line switch.

MARKED CARD PROGRAMMER

Reads marked & punched cards

Model 3260A

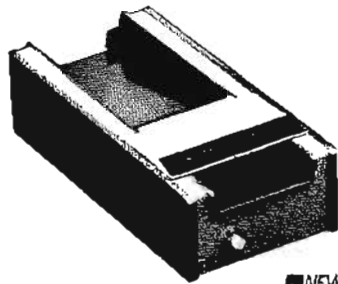

3260A

Description

The Hewlett-Packard Model 3260A is an eight channel optical mark sense card reader. The HP 3260A Marked Card Programmer detects pencil marks on hand-fed cards and gives a voltage output corresponding to the presence of marks in the eight columns. Punched holes are sensed the same as pencil marks. The TTL logic level output is "1" state low. The 3260A has its own internal power supply and card drive motor for maximum versatility. Cards are stacked in the output tray from the bottom so that the original card order is always retained.

Application

The 3260A offers a convenient and inexpensive method of programming devices or entering data into devices which accept eight-bit-parallel/word-serial instructions or data. Rapid and error free tests become easier to obtain since a 32 word card is typically read in 1.5 seconds and each test is performed exactly as the card instructs. This insures consistency for redundant tests by reducing operator errors. Extensive operator

training on complicated or delicate instrument controls becomes unnecessary when using the Marked Card Programmer.

General

Weight: net 6 lb (13,5 kg). Shipping 7.5 lb (16,5 kg).

Power: 120 V or 240 V +5% -10%, 48 Hz to 440 Hz, <8 VA when idle, <9 VA when reading a card.

Dimensions: 5 1/3" wide, 3 1/2" high, 11 1/4" deep (134,5 x 88,9 x 285,8 mm).

Temperature: operating range, 0° - 55°C.

Cable: 5 ft detachable cable supplied with 36 pin (2 x 18) connector. Connector is in stackable housing for parallel connection to multiple devices.

Cards

Furnished: 100 program cards (HP Part Number 9320-2886). Dimensions are 7 3/8" x 3 3/4" (187,2 x 82,6 mm).

Available: package of 2000, \$15; package of 10,000, \$60. Output tray extends for use with 11 inch cards.

Price: HP 3260A, \$750.

SIGNAL GENERATORS TO 40 GHz



SIGNAL SOURCES

Signal generators

Hewlett-Packard offers a complete line of easy-to-use HF, VHF, UHF, and SHF signal generators covering frequencies between 10 kHz and 40 GHz. Each Hewlett-Packard generator incorporates the following:

- 1) accurate, direct-reading, frequency calibration
- 2) variable output, accurately calibrated and direct reading
- 3) constant output impedance, well matched
- 4) varied modulation capabilities
- 5) low RF leakage
- 6) low harmonic content
- 7) freedom from spurious or incidental modulation.

This ensures the utmost convenience and accuracy for all kinds of measurements and signal simulations, including receiver sensitivity, selectivity or rejection, signal-to-noise ratio, gain bandwidth characteristics, conversion gain, antenna gain, transmission line characteristics, as well as power to drive bridges, slotted lines, filter networks, etc.

Synthesized signal generators

The 8660 Synthesized Signal Generator family is a new addition to the product line. These generators combine the signal stability and resolution of a frequency synthesizer with the modulation and output level calibration of a high quality signal generator. For maximum

versatility the 8660 family utilizes plug-in RF sections and modulation sections.

The Synthesized Signal Generator is a natural choice for applications requiring maximum signal stability and very fine frequency resolution. For example, with the AM/FM modulation plug-in installed, the 8660A or 8660B is ideally suited for high stability receiver testing. The digital sweep capability of the 8660B coupled with its 1 Hz frequency resolution and excellent spectral purity make it an excellent choice for designing and testing high-Q devices such as crystal filters.

The 8660 Synthesized Signal Generator is also completely TTL programmable, making it an ideal RF source for automatic systems.

Signal generator summary

Model	Frequency range	Characteristics	Page
8660A/B Synthesized Generator	.01 to 110 MHz 1 to 1300 MHz	1 Hz frequency resolution, 3×10^{-6} /day stability. Calibrated output from +13 to -146 dBm. Completely TTL programmable. Plug-ins determine frequency range and AM/FM capability	270
8651A Oscillator	22 kHz-70 MHz	1 mV to 3 V into 50 Ω load; 70 dB range, 20 ppm stability, solid state, portable; weight, 13.8 lbs	272
606A/B Signal Generator	50 kHz to 65 MHz 606B also has:	output 3 V to 0.1 μ V, mod. BW dc to 20 kHz, low drift and noise, low incidental FM, low distortion, auxiliary RF output, stabilized phase lock capability	274
8708A Synchronizer	50 kHz to 455 MHz	companion for 606B or 608F permitting $2/10^7$ continuous settability & stability, FM and phase modulation	274
8601A Generator Sweeper	100 kHz to 110 MHz	$\pm 1\%$ of frequency dial accuracy, cal output +20 to -110 dBm into 50 ohms, leveled to ± 0.25 dB, very low drift, residual FM and RFI leakage, 30% AM, 75 kHz dev FM, aux output, crystal cal	286
608E Signal Generator	10 to 480 MHz	output 1 V to 0.1 μ V, into 50-ohm load; AM, pulse modulation, direct calibration, leveled power output, aux RF output	275
608F Signal Generator	10 to 455 MHz	output 0.5 V to 0.1 μ V into 50 ohms, amplitude, pulse modulation, direct calibration, low incidental FM and drift, leveled output, aux RF output, stabilized phase lock capability	275
3200B Oscillator	10-500 MHz	1 V to 1 μ V output into 50 Ω , 120 dB attenuator range .002% stability, compact, portable; weight, 15 lbs	272
8654A Signal Generator	10-500 MHz	output 0 to -120 dBm into 50 Ω , direct calibration, leveled output, amplitude and frequency modulation, solid-state, compact, weight 16 lbs	273
612A Signal Generator	450 to 1230 MHz	output 0.5 V to 0.1 μ V into 50-ohm load; AM, pulse or square-wave modulation, direct calibration	277
614A Signal Generator	0.8 to 2.1 GHz	output at least 0.5 mW to -127 dBm (0.1 μ V) into 50 ohms, pulse or frequency modulation, direct calibration	279
8614A Signal Generator	0.8 to 2.4 GHz	output +10 to -127 dBm into 50 ohms, leveled below 0 dBm; internal square-wave; external pulse, AM and FM; auxiliary RF output	278
8614B Signal Source	0.8 to 2.4 GHz	output 15 mW; precision attenuator 130 dB range; internal square-wave, external pulse and FM; auxiliary RF output	278
616B Signal Generator	1.8 to 4.2 GHz	output 1 mW to -127 dBm (0.1 μ V) into 50-ohm load, pulse or frequency modulation, direct calibration	279
8616A Signal Generator	1.8 to 4.5 GHz	output +3 to -127 dBm into 50 ohms, leveled below 0 dBm; internal square-wave, external pulse, AM and FM; auxiliary RF output	278
8616B Signal Source	1.8 to 4.5 GHz	output 3 mW; precision attenuator 130 dB range; internal square-wave, external pulse and FM; auxiliary RF output	278
618C, 620B Signal Generators	3.8 to 7.6 GHz 7 to 11 GHz	output 1 mW to -127 dBm (0.1 μ V) into 50 ohms, pulse, frequency or square-wave modulation, direct calibration, ext FM and pulse modulation, auxiliary RF output	280
626A, 628A Signal Generators	10 to 15.5 GHz 15 to 21 GHz	output +10 dBm to -90 dBm; pulse, frequency or square-wave modulation, direct calibration	281
938A, 940A Frequency Doublers	18 to 26.5 GHz 26.5 to 40 GHz	driven by 9 to 13.25 GHz source, 13.25 to 20 GHz source, HP 626A, 628A, 8690 series sweepers or klystrons; 100 dB precision attenuator.	281

HF to UHF signal generators

These signal generators, HP 606A, 606B, 608E, 608F, and 612A, collectively cover frequencies from 50 kHz to 1.23 GHz and are characterized by extremely low drift and incidental frequency modulation. All may be amplitude (sine, square, pulse) modulated. A feedback loop in the 606A and 606B keeps their output and percent modulation constant as frequency is varied. The 608E and 608F also offer level power output resulting in significant time saving and convenience when the generator is being used to conduct tests at several frequencies. The 606B, 608E, and 608F offer an auxiliary, fixed-level, CW signal which can be applied to a counter for very accurate indication of carrier frequency.

The HP 606B and 608F contain voltage variable capacitors in their oscillator circuits enabling phase-locked operation with the HP Model 8708A RF Synchronizer. Frequency settability and stability of 2×10^{-7} can be obtained without compromise of the modulation or attenuation characteristics. This permits continuous frequency response examination of devices such as highly-selective, narrow-band filters, and adds phase and frequency modulation capability to the 606B and 608F Signal Generators.

Microcircuit technology at Hewlett-Packard has resulted in four compact, portable, signal generators and sources. The 8651A and 3200B Oscillators are versatile sources from 22 kHz to 70 MHz and 10 to 500 MHz respectively. The 8601A Generator/Sweeper, 100 kHz to 110 MHz, is a new general purpose instrument that sweeps as well as satisfies many specialized test and design applications.

The newest member of the portable solid-state family is the 8654A Signal Generator, 10-500 MHz, with calibrated output and a variety of modulation capabilities at reduced size and cost.

UHF to SHF signal generators and sources

This group of instruments, covering 800 MHz to 21 GHz, features extremely simple operation. The 614A, 616B, 618C, 620B, 626A and 628A Signal Generators provide large, direct-reading frequency and attenuator dials. They may be pulse, square-wave, and frequency modulated. Their versatility makes them useful for measuring signal-to-noise ratio, receiver sensitivity, SWR and transmission line characteristics.

Special purpose signal sources

Application	Frequency range	Modulation	Output	Model	Page
Test, calibrate FM receivers	54 to 216 MHz	FM, AM	0.2 V	202H	276
Test, calibrate FM receivers	195-270 MHz	FM, AM	0.2 V	202J	276
Down converter for 202H, 202J	100 kHz to 55 MHz	See specifications		207H	276
Telemetry tests	1430 to 1540 MHz 2150 to 2310 MHz	FM	-10 to -127 dBm	3205A	282
VOR/ILS tests	88 to 140 MHz	AM	0.2 V	211A	282
ILS/Glide Slope tests	329.3 to 335 MHz	AM	0.2 V	232A	282
DME/ATC tests	962 to 1213 MHz	Pulse	-10 dBm	8925A	282

The HP 8614A and 8616A Signal Generators are particularly easy to use. Frequency and attenuation are set on direct-reading, digital dials, and leveled output enables frequency response testing without time-consuming readjustment of the generator at each new frequency. Each unit contains a unique PIN diode modulator which permits such a wide range of amplitude modulation that remote control of output level or precise leveling with external equipment is possible.

Broadband frequency doublers, HP 938A and 940A, provide low-cost signal generator capability in the 18 to 40 GHz range. Designed to be driven by signal sources in the 9 to 20 GHz range, the frequency doublers preserve the versatility and stability of the driving source. Thus, the signals may be CW, pulsed or swept. An output monitor and precision attenuator provide a metered output, even though the input signal is uncalibrated.

Special signal generators

Hewlett-Packard's FM signal generators offer unusual modulation linearity and stability. The 202H FM-AM Signal Generator operates in the 54 to 216 MHz range and is designed to serve the broadcast FM, VHF-TV, and mobile communications markets. The 202J FM-AM Signal Generator is specifically designed for VHF telemetry and covers the 195 to 270 MHz frequency range. An accessory 207H Univerter provides additional coverage when used with either the 202H or 202J Signal Generators.

The 211A Signal Generator is specifically designed for the testing and calibration of aircraft VOR and ILS localizer receivers; an external modulator, such

as the Collins 479-F3, is required to provide simulated course and bearing. The 232A Glide Slope Signal Generator is specifically designed for the testing and calibration of ILS glide slope receivers. The 8925A DME/ATC Test Set is designed to provide complete facilities for the testing and calibration of aircraft DME radios and ATC transponders; suitable external modulators are required, such as the Collins 578D-1 and 578X-1, to simulate ground station operation.

Signal generator accessories

A variety of available accessories enhance the operation of Hewlett-Packard signal generators. HP 10511A Spectrum Generator and HP 10515A Frequency Doubler extend the usable frequency range of signal sources/generators up to 1 GHz. HP 11507A Output Termination provides three useful positions for matching 50Ω to other than 50Ω impedances. HP 11509A Fuseholder protects generator output attenuators against accidental burnout during transceiver testing. HP 10514A and 10534A Balanced Mixers offer varied mixing as well as AM, pulse and square-wave modulation applications.

The HP 8730 series of PIN modulators increases the modulation capability of microwave signal sources and at the same time virtually eliminates incidental FM. HP 8403A Modulator provides complete control of the 8730 series of PIN modulators, supplying the bias wave-shapes and levels for fast rise times, rated on-off ratios and amplitude modulation as well as providing pulse and square wave signals for direct application to signal sources.

SIGNAL GENERATOR ACCESSORIES

Additional capabilities for signal generation

Models 10511A, 10515A, 10514A, 10534A, 11507A-11509A



SIGNAL GENERATORS

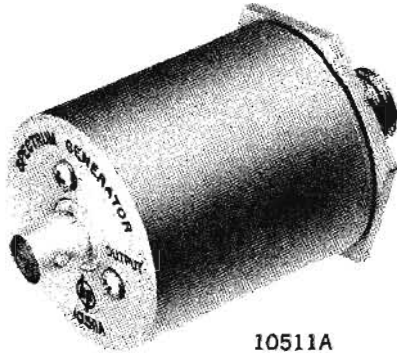

10511A

10511A Spectrum Generator

Extends the useful frequency range of signal generators, sources and frequency synthesizers by providing a spectrum of harmonics up to 1 GHz from sine-wave inputs between 10 and 75 MHz. A 50 Ω bandpass filter can then be cascaded with the 10511A to extract the desired harmonic. The harmonic power available is at least -19 dBm for harmonics 1 thru 10. **Input requirements:** 1 to 3 volts rms into 50 Ω , 10 to 75 MHz. **Price:** \$200; shipping weight: 1/2 lb (0,23 kg).

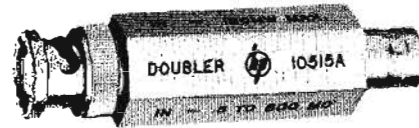

10515A

10515A Frequency Doubler

Extends the usable frequency range of signal generators, frequency synthesizers or other signal sources. Operating on input frequencies of 0.5 MHz to 500 MHz it provides a doubled output in the range of 1 MHz to 1 GHz. The frequency response of this 50 Ω device is very flat ($< \pm 2$ dB typically) over the entire frequency range and undesired harmonics are well suppressed.

Price: \$150; shipping weight: 1/2 lb (0,23 kg).

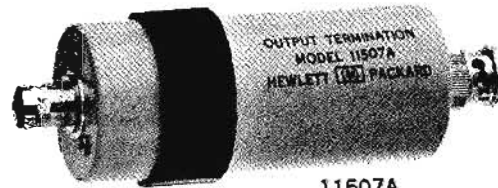

11507A

11507A Output Termination

A multi-purpose termination which enhances the usefulness of the 606A or 606B by providing the following:

1. A matched 50-ohm termination to permit use into high impedance circuits.
2. A 20-dB (10:1) terminated voltage divider which reduces the source impedance to 5 ohms.
3. A dummy antenna having the IEEE standard characteristics for receiver measurements (driven from 10:1 divider).

Frequency range: 50 kHz to 65 MHz on ω 0 to 20 dB positions, 540 kHz to 23 MHz on dummy antenna.

Price: \$70; shipping weight, 11 oz (311 g).

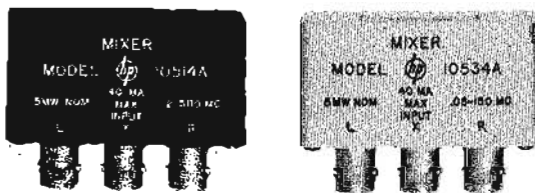

10514A

10534A

10514A, 10534A Double Balanced Mixers

Used with signal generators in a variety of mixing as well as AM, pulse and square-wave modulation applications. The careful balancing of the hot carrier diodes in the 10514 and 10534 Mixers provides excellent suppression of the local oscillator and input frequencies at the output port. Frequency range of the 10514 is 0.2-500 MHz and the 10534 is 0.5-150 MHz. Both feature low conversion loss, low internal interference and good balance. "A" models are equipped with BNC female connectors.

Shipping weight: 7 oz (198 g).

Price: HP 10514A, \$90; HP 10534A, \$70.

11508A Output Cable

Provides 50 Ω termination and standard binding posts at the end of a 24-inch (610 mm) length of cable. Allows direct connection of the signal generator to high impedance circuits.

Price: \$18; shipping weight: 1 lb (0,45 kg).



11509A

11509A Fuseholder

Prevents accidental burnout of attenuators in HP 606 and 608 Signal Generators during transceiver testing by introducing a fuse element between the signal generator and the transceiver. Several watts of RF power could otherwise be applied to the signal generator attenuator should the transceiver accidentally be switched to "Transmit." While the fuseholder provides protection, it in no way limits the usable output from the signal generators.

Accessories furnished: 10 extra fuses.

Price: \$40; shipping weight: 13 oz (370 g).

SIGNAL GENERATORS



SYNTHESIZED SIGNAL GENERATORS

Programmable, 10 kHz to 1300 MHz

Models 8660A, 8660B

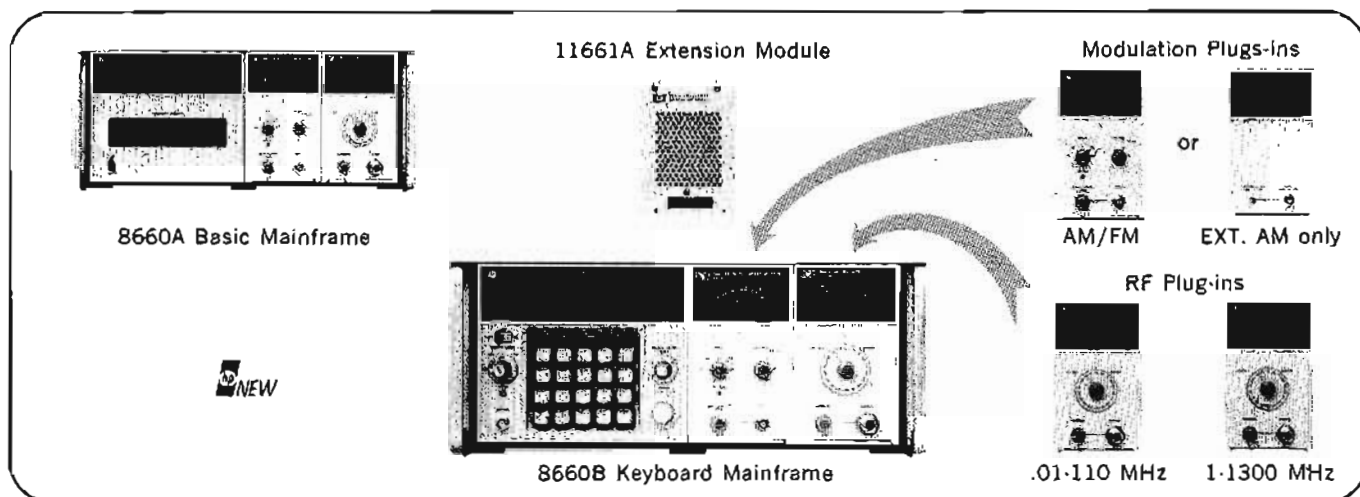

Features

- 1 Hz frequency resolution
- 80 dB spurious
- 3×10^{-8} /day stability
- Plug-in RF and modulation sections
- Completely TTL programmable

Applications

- Programmable RF source for automatic systems
- Precision receiver testing
- L.O. in high stability communication systems
- Laboratory frequency standard
- Swept testing of narrowband devices

The 8660A/B family is a modular plug-in system. Each complete system includes: 1) an all solid-state synthesized signal generator mainframe, 2) at least one RF section plug-in, and 3) either a modulation section or the 86631A Auxiliary Section Plug-in.

Mainframes

There are two different synthesized signal generator mainframes to choose from. Both feature complete TTL programming of frequency, output level, and modulation. Both mainframes can also be operated either from the internal 10 MHz crystal reference oscillator or an external frequency standard at 1 MHz, 2 MHz, 5 MHz, or 10 MHz.

The 8660A Mainframe uses front panel thumbwheel switches to select CW output frequency with a resolution of 1 Hz. An optional version of the mainframe with 100 Hz resolution is also available. With the 86601A Option 001 RF Section and 86631A Auxiliary Section plug-ins installed, the 8660A is an ideal programmable RF source for automatic systems. With the standard 86601A RF Section and the 86632A AM/FM Modulation Section installed, the 8660A becomes a complete Synthesized Signal Generator.

The 8660B keyboard mainframe combines all the capability of the 8660A with a keyboard control panel. Added capabilities of the 8660B include digital sweep, frequency stepping, synthesized search, and a ten digit numerical LED display.

Swept testing of very narrowband devices such as crystal filters is made possible by the 8660B's digital sweeping capability. The selected sweep width is divided into either 100 or 1000 discrete steps depending on the sweep speed selected, and

the RF output is synthesized at each step. The result is a very linear sweep with extremely low residual FM.

For receiver testing and similar applications which require frequency to be changed in uniform increments, a frequency stepping capability is provided on the 8660B. For example, if a receiver with 50 kHz channel spacing is being tested, 50 kHz can be entered on the keyboard. Then the step \uparrow or step \downarrow buttons will step the frequency to the next higher channel or lower channel respectively.

A unique synthesized search provides the dial tuning convenience of a signal generator while maintaining synthesizer signal quality. As the dial is rotated, the output frequency is tuned up or down in discrete synthesized steps which may be chosen as small as 1 Hz. When the 8660B is used as a local oscillator in a manual communication receiver, the synthesized search dial is very helpful in quickly locating unknown signals while maintaining the full-spectral purity of the synthesizer.

The ten-digit LED readout provides a continuous display of the selected CW or center frequency, with momentary contact pushbuttons to display sweep width, frequency step size, or a partially entered new command.

Plug-in RF sections

Two RF sections are presently available for 8660 Mainframes. The 86601A covers the 10 kHz to 110 MHz frequency range, and the 86602A used in conjunction with the 11661A Frequency Extension Module covers 1 MHz to 1300 MHz. Both RF sections have 1 Hz frequency resolution and 159 dB calibrated attenuators. In the remote mode, the output level can be programmed in 1 dB steps from +13 dBm to -146 dBm (1 V to .01 μ V).

Plug-in modulation sections

The 86632A Modulation Section provides AM and FM modulation capability. Internal modulation is provided at 400 Hz and 1 kHz. A switch selects ac or dc coupling of external modulation inputs. A modulation meter indicates AM percent or FM peak deviation. The 86632A is completely programmable through the 8660 Mainframe.

An 86631A Auxiliary Section must be installed in the mainframe if the AM/FM modulation section is not installed. The auxiliary section provides necessary interconnections for mainframe operation and provides external amplitude modulation capability. The 86631A is not programmable.

8660A/B Partial Specifications

(Refer to Technical Data Sheet for complete specifications)

8660A/B Synthesized Signal Generator Mainframes

Frequency accuracy and stability: CW frequency accuracy and long term stability are determined by reference oscillator in 8660A/B Mainframe ($3 \times 10^{-8}/24$ hours) or by external reference if used.

Reference oscillator

Internal: 10 MHz quartz oscillator. Aging rate less than ± 3 parts in 10^6 per 24 hours after 72-hour warmup. (± 3 parts in 10^6 per 24 hours optional, Option 001).

External: rear panel switch allows operation from any 1 MHz, 2 MHz, 2.5 MHz, 5 MHz, or 10 MHz signal at a level between 0.2 V and 2.0 V rms into 170 ohms.

Reference output: rear panel BNC connector provides output of reference signal selected at a level of at least 0.5 V rms into 170 ohms.

Remote programming

Functions

8660A: all front panel frequency, output level, and modulation functions are programmable.

8660B: CW frequency, frequency stepping (STEP Δ , STEP Ψ), output level, and modulation are programmable.

Switching time: less than 5 ms to be within 100 Hz of any new frequency selected. Less than 100 ms to be within 5 Hz of any new frequency selected.

Maximum stepping rate: 1 ms per step.

Programming input

Connector type: 36-pin Cinch Type 57 (mating connector supplied).

Logic: TTL compatible (negative true).

General

Operating temperature range: 0° to $+55^\circ\text{C}$.

Power: 115 or 230 V $\pm 10\%$, 50 to 60 Hz; approx 200 W.

Size: $16\frac{3}{4}$ " wide, 7" high, $21\frac{1}{2}$ " deep (426 x 178 x 547 mm).

Weight: net, 48 lbs (21,6 kg); shipping, 58 lbs (26,1 kg).

Price: Model 8660A, \$4900; Model 8660B, \$6000.

Options for 8660A and 8660B

Option 001: $\pm 3 \times 10^{-9}/24$ hrs; internal reference oscillator; add, \$300.

Option 002: no internal reference oscillator; less, \$350.

Option 003: operation from 50 to 400 Hz line; add, \$50.

Option 004: 100 Hz frequency resolution; less, \$500.

Option 009 (8660A only): LED Display indicates selected frequency in 1-2-4-8 BCD code; price: add, \$200.

86601A RF Section

Frequency range: 0.01 to 110 MHz; selectable in 1 Hz steps.

Output level: continuously calibrated from +13 to -146 dBm into 50 ohms; programmable in 1 dB steps.

Harmonics: < -40 dB.

Spurious: < -80 dB.

Amplitude modulation: (with 86631A or 86632A) 0 to 95% maximum rate, 50 kHz at output frequencies above 4 MHz.

Frequency modulation: (with 86632A) maximum rate, 1 MHz; maximum deviation, 1 MHz.

Weight: net, 11 lbs (5 kg); shipping, 15 lbs (6,8 kg).

Price: Model 86601A, \$1975.

Options: Option 001: no RF output attenuator; output level adjustable from +13 to 0 dBm; less, \$600.

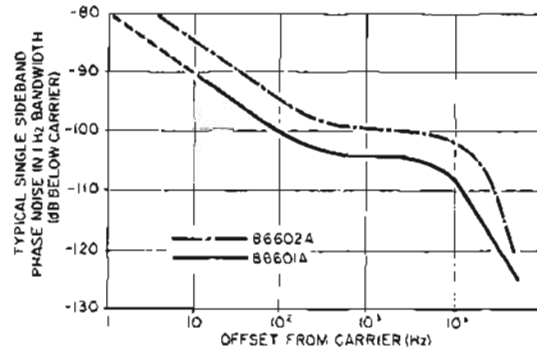

Typical Phase Noise Curves for 86601A and 86602A

86602A RF Section

Frequency range: 1 to 1300 MHz; selectable in 1 Hz steps.

Output level: continuously calibrated from +13 to -146 dBm into 50 ohms; programmable in 1 dB steps.

Harmonics: < -25 dB at output levels below +10 dBm.

Spurious

Non-line related: below 600 MHz -80 dB; above 600 MHz -80 dB within 45 MHz of carrier, -55 dB > 45 MHz from carrier.

Line related: -70 dB.

Amplitude modulation: (with 86631A or 86632A) 0 to 95% maximum rate, 50 kHz.

Frequency modulation: (with 86632A) maximum rate, 300 kHz; maximum deviation, 300 kHz.

Weight: net, approx 8 lbs (3,6 kg); shipping, 12 lbs (5,4 kg).

Options: same as 86601A.

Price: Model 86602A, \$2500.

11661A Extension Module

Must be installed in 8660A/B Mainframe to enable operation of 86602A RF Section.

Weight net, approx 4 lbs (1,8 kg); shipping, 8 lbs (3,6 kg).

Price: Model 11661A, \$2000.

86632A Modulation Section

Provides AM/FM capability as described above when used with 86601A or 86602A RF Section. Includes modulation meter and 400 Hz and 1 kHz internal oscillators; completely programmable.

Weight: net, 7 lbs (3,2 kg); shipping, 11 lbs (5 kg).

Price: Model 86632A, \$900.

86631A Auxiliary Section

The 86631A Auxiliary Section must be installed in an 8660A or 8660B Mainframe in place of the modulation section if a modulation section is not used. A jack is provided on the front panel to allow external AM through the 86631A as described above.

Weight: net, 2 lbs (0,9 kg); shipping, 6 lbs (2,8 kg).

Price: Model 86631A, \$90.



RF AND VHF OSCILLATORS

Portable, signal sources 22 kHz to 1 GHz
Models 8651A, 3200B

HP 8651A Oscillator

The HP 8651A RF Oscillator is a low-cost, portable, solid-state signal source covering the widely used frequency range of 22 kHz to 70 MHz. Its stability, accuracy, and level flatness provide versatile performance for production, field, or laboratory use. The output level of the 8651A is continuously adjustable over a 70 dB range from 3 volts to 1 millivolt into a 50-ohm load. Using the built-in meter, the actual output level in both dBm and rms volts can easily be determined.

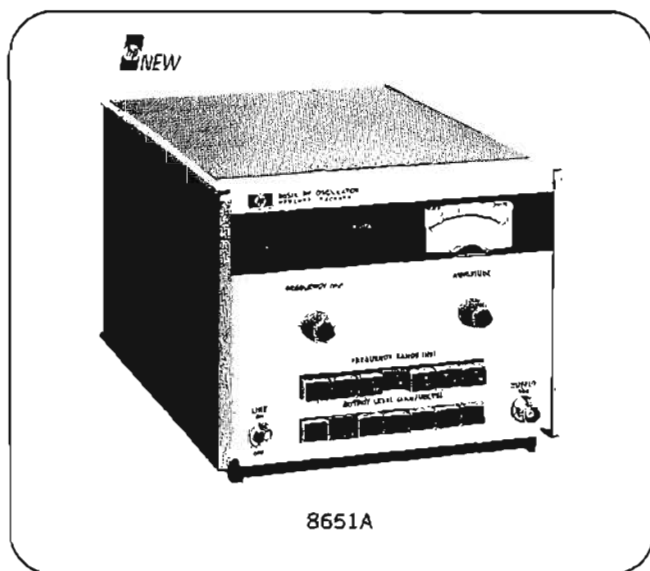

Specifications, 8651A

Frequency

Range: 22 kHz to 70 MHz in 7 bands.
Accuracy: $\pm 1.5\%$, 22 kHz to 22 MHz; $\pm 2\%$, 22 MHz to 70 MHz.
Stability (after 2-hr warmup): 20 ppm/min, 200 ppm/hr.

Output

Maximum: 3.0 V into 50 Ω ; 6.0 V open circuit.
Ranges 3 mV to 3 V full scale, 7 steps; -40 dBm to $+20$ dBm, 10 dB per step; continuously adjustable by AMPLITUDE control over 10 dB range.
Output monitor: voltmeter monitors level at input of attenuator in volts or dBm.
Flatness (at $+20$ dBm output): 3%, 22 kHz to 22 MHz; 5%, 22 MHz to 70 MHz.
Harmonic content (at $+20$ dBm output): 3%, 22 kHz to 22 MHz; 5%, 22 MHz to 70 MHz.
Impedance: 50 Ω with SWR typically 1.3.
Connector: BNC female.

General

Operating temperature: 0° to $+50^{\circ}\text{C}$ (32°F to 122°F).
Power: 115 V or 230 V $\pm 10\%$, 50-400 Hz, 15 W.
Weight: net, 13.8 lbs (6.2 kg); shipping, 16 lbs (7.2 kg).
Dimensions: 7-25/32" wide, 6-12/32" high, 11" deep (190 x 166 x 279 mm).
Price: \$765.

HP 3200B Oscillator

The HP 3200B VHF Oscillator is a stable, low-cost portable signal source with a frequency range from 10 to 500 MHz. Usable pulse modulation can be provided by a 2.5 volt sine wave input from standard audio oscillators. The 3200B can serve as a local oscillator for heterodyne detector systems and as a marker source for swept systems. Additional frequency coverage from 500 to 1000 MHz is available by using an optional accessory—the HP 13515A Frequency Doubler Probe.

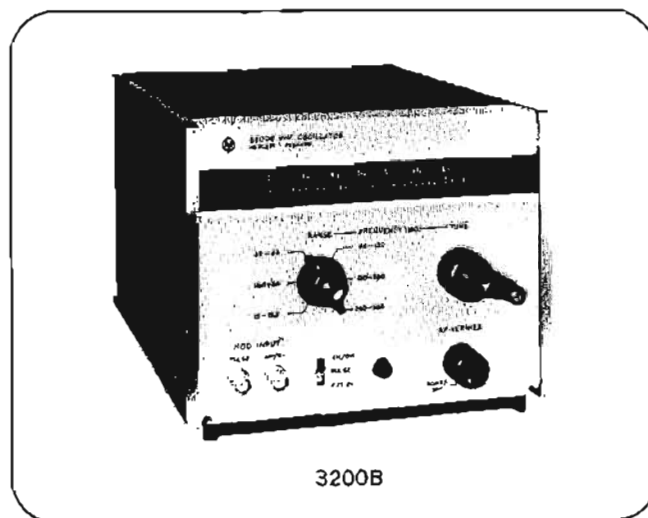

Specifications, 3200B

Frequency

Range: 10 to 500 MHz (to 1 GHz with HP 13515A Frequency Doubler Probe).
Accuracy: within $\pm 2\%$ after $\frac{1}{2}$ hr warmup.
Calibration: increments of less than 4%.
Stability (after 4-hr warmup under 0.2 mW load): short term (5 min) $\pm 0.002\%$; long term (1 hr) $\pm 0.02\%$; line voltage (5-volt change) $+0.001\%$.

Output

Maximum RF power (across 50-ohm external load): >200 mW (10 to 130 MHz); >150 mW (130 to 260 MHz); >25 mW (260 to 500 MHz). With doubler: >4 mW (.5 to 1 GHz).
Range: 0 to >120 dB attenuation from maximum output.
Load impedance: 50 ohms nominal.
Leakage: sufficiently low to permit measurements at 1 μV .
RFI: meets requirements of MIL-I-6181D.

Modulation

External AM: range, 0 to 30%; distortion, $<1\%$ at 30% AM; external requirements, approx 20 V rms into 600 Ω for 30% AM, 200 Hz to 100 kHz.
External pulse modulation requirements: -2.5 V pulse into 2000 Ω .

General

Power: 105 to 125 V or 210 to 250 V, 50 to 400 Hz, 30 W.
Dimensions: 7 $\frac{5}{8}$ " wide, 6 $\frac{1}{2}$ " high, 13 $\frac{1}{8}$ " deep (194 x 165 x 333 mm).
Weight: net, 15 lbs (6.8 kg); shipping, 17 lbs (8.6 kg).
Price: HP 3200B, \$595; HP 13515A, \$95.

VHF SIGNAL GENERATOR

Rugged solid-state generator 10-500 MHz
Model 8654A



SIGNAL GENERATORS

Features

- Calibrated output power
- Automatic power leveling
- AM, FM internal and external
- Rugged, lightweight, solid state
- Compact size and shape

Applications

- Receiver sensitivity, S/N ratio
- Antenna and filter characteristics
- Field maintenance and servicing
- Production and mobile test stations

The HP 8654A Signal Generator is a portable, low-cost, solid state generator providing calibrated output and versatile modulation capabilities over the 10 to 500 MHz frequency range. The 8654A provides stable RF signals for testing receivers, amplifiers, antennas and filter networks.

Its compactness and small size allow the 8654A to fit easily into production, mobile, airborne and shipboard test locations. Its rugged, lightweight construction is also suitable for field maintenance and service applications.

Internal oscillators provide both amplitude modulation and frequency modulation at 400 Hz and 1000 Hz or external modulation can be accomplished using standard audio oscillators. The front panel meter accurately indicates amplitude modulation percentage from 0-70% by using the AM meter mode switch.

Output power is automatically leveled to ± 1 dB over the entire frequency range at 0 dBm and below, and the power level is variable over more than a 120 dB dynamic range. The 10 dB-step attenuator and 13 dB vernier allow continuous

selection of power settings over the entire output range. The front panel meter displays the output power in dBm and volts and always indicates the calibrated level.

An auxiliary uncalibrated RF output is also available at the rear panel for use with a counter or other external equipment. Auxiliary output level is a minimum of -10 dBm.

The 8654A has a specified stability of 0.002% over a 5 minute operating period after a one-hour warmup. It will typically recover specified stability within 5 minutes following a frequency band change.

Effective RF shielding and output range permit receiver sensitivity measurements to be made down to power levels of $1.0 \mu\text{V}$.

Its compact size and shape combined with its stability and versatility make the HP 8654A a high-value VHF signal generator for economy-minded applications.



Specifications, 8654A

Frequency characteristics

Range: 10-500 MHz in 6 bands:

10-18.8 MHz	18.5-35 MHz	35-68 MHz
68-130 MHz	130-260 MHz	260-500 MHz

Accuracy: $\pm 2\%$ after 30 min warmup.

Stability: .002%/5 min after 1 hr warmup and 5 min after changing frequency bands; .002%/10% change in line voltage.

Residual FM: 5×10^{-7} peak.

Output characteristics

Maximum power (Into 50 Ω): > 0 dBm from 10 to 500 MHz; $> +5$ dBm from 50 to 350 MHz; $> +10$ dBm from 75 to 250 MHz.

Attenuator range: 10 dB steps and a 13 dB vernier provide continuous power settings from maximum power output to -120 dBm. Output is absolutely calibrated in volts and dBm and is monitored by the front panel output meter.

Level accuracy: ± 1.5 dB plus attenuator accuracy.

Attenuator accuracy: 10 to 50 dB, ± 0.5 dB; 60 to 120 dB ± 1.5 dB.

Level flatness: ± 1 dB from 10-500 MHz for output level 0 dBm and below.

Load impedance: 50 Ω nominal, VSWR: 1.2.

RF leakage: permits receiver sensitivity measurements down to at least $1.0 \mu\text{V}$. (Conducted and radiated leakage limits are below those specified in MIL-I-6181D.)

Modulation characteristics

(Specifications apply for carrier power level of -10 dBm and below and for the top 10 dB of the vernier range.)

Internal AM

Frequency: 400 Hz and 1 kHz $\pm 10\%$ available at front panel.

Modulation level: 0 to 80% AM continuously adjustable with the modulation "level" control.

Carrier envelope distortion: $< 4\%$ at 30% AM; $< 10\%$ at 70% AM.

External AM

Frequency: dc to 10 kHz for 30% AM; dc to 5 kHz for 70% AM.

Input level required: nominal 1 volt peak at external AM input yields full modulation. Carrier voltage can be varied from 0 to $\pm 90\%$ by an external dc input of 0 to ± 1 V nominal.

Carrier envelope distortion: $< 4\%$ at 30% AM; $< 10\%$ at 70% AM.

Modulation meter accuracy: $\pm 5\%$ of full scale for 0-70% AM.

Internal FM: 400 Hz and 1000 Hz internal oscillator; 0 to $> .1\%$ peak deviation.

External FM: 3 kHz bandwidth from 600 Ω source; 15 kHz bandwidth from 50 Ω source; 0 to $> .1\%$ peak deviation. Input level required: 5 volt peak for .1% deviation.

General

Power: 115 or 230 V $\pm 10\%$, 50 to 400 Hz, approximately 20 W.

Dimensions: 6 $\frac{1}{2}$ " x 10 $\frac{1}{2}$ " x 12" deep (165 x 266 x 321 mm).

Weight: 16 lbs.

Price: tentatively \$975.

SIGNAL GENERATORS



HF SIGNAL GENERATORS AND HF-VHF SYNCHRONIZER

Models 606A, 606B, 8708A

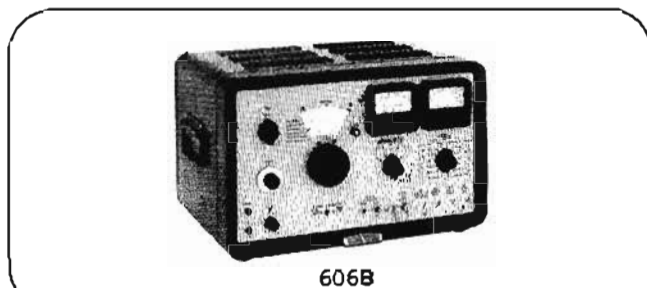

606B

The Hewlett-Packard 606B Signal Generator provides high quality operation in the 50 kHz to 65 MHz frequency range. Output signals are stable and accurately known. Output amplitude can be precisely established over a +23 to -120 dBm dynamic range with versatile modulation capabilities.

Specifications, 606B

Frequency and output characteristics

Range: 50 kHz to 65 MHz in 6 bands; accuracy: $\pm 1\%$.

Drift: (1 V output and below) less than 50 ppm (or 5 Hz, whichever is greater) per 10 min period after 2-hr warmup; less than 10 min to restabilize after changing frequency.

Stability when used with 8708A Synchronizer: 5×10^{-8} /min, 2×10^{-7} /10 min, 2×10^{-6} /day; $2 \times 10^{-7}/^{\circ}\text{C}$, 0° to 55°C ; $2 \times 10^{-7}/10\%$ line voltage change.

ΔF control: better than 10 ppm settability; range of ΔF control approx 0.1%.

Resetability: better than 0.15% after warmup.

Crystal calibrator: provides frequency checkpoints every 100 kHz and 1 MHz; jack provided for audio frequency output; crystal frequency accuracy better than 0.01% from 0° - 50°C .

Residual FM: less than ± 1 ppm or ± 20 Hz peak, whichever is greater.

Frequency control input: front panel input can be used with 8708A Synchronizer and external frequency control; limits: 0 to -50 V, 4 k Ω nominal input impedance.

Output level: continuously adjustable from 0.1 μV to 3 V into 50-ohm resistive load, calibrated in voltage and dBm.

Frequency response and output accuracy: at output below 1 V, output variation with frequency is less than 2 dB; output accuracy is better than ± 1 dB at any frequency.

Impedance: 50 ohms, SWR less than 1.2 on 0.3 V attenuator range and below.

RFI: meets all conditions specified in MIL-I-6181D; permits receiver sensitivity measurements down to at least 1.0 μV .

Harmonic output: at least 30 dB below the carrier.

Spurious AM: hum and noise sidebands are 70 dB below carrier down to thermal level of 50-ohm output system.

Auxiliary RF output: on front panel for use with HP 8708A Synchronizer or other external equipment. Minimum output: 100 mV rms into 50 ohms from 50 kHz to 19.2 MHz, 200 mV rms from 19 to 65 MHz.

Modulation characteristics

Internal AM:

Frequency: 400 and 1000 Hz, $\pm 5\%$.

Modulation level: 0 to 95% on 1 V attenuator range and below; 0 to at least 30% on 3 V range.

Incidental FM (attenuator on 1 V range and below, 30% modulation): less than 5×10^{-6} + 100 Hz peak.

Carrier envelope distortion: less than 1% at 30% AM, less

than 3% at 70% AM (attenuator on 1 V range and below).

External AM:

Frequency: dc to 20 kHz maximum, dependent on carrier frequency (f_c) and percent modulation as tabulated.

Maximum modulation frequency:

30% Mod:	70% Mod:	Squarewave Mod:
$0.06 f_c$	$0.02 f_c$	$0.003 f_c$ (3 kHz max.)

Modulation level: 0 to 95% on 1 V attenuator range and below, 0 to at least 30% on 3 V range.

Input required: 4.5 V peak produces 95% modulation (maximum input 50 V peak); input impedance 1000 ohms.

Carrier envelope distortion: same as for internal AM.

Modulation meter accuracy: $\pm 5\%$ of full scale, 0 to 90%, for modulation frequencies to 10 kHz, $\pm 10\%$ of full scale for frequencies from 10 kHz to 20 kHz.

Modulation level constancy (internal or external AM; attenuator on 1 V range and below): modulation level stays constant within $\pm 1/2$ dB regardless of carrier frequency and output level changes.

General

Power: 115 or 230 V $\pm 10\%$, 50 to 400 Hz, 135 W.

Dimensions: cabinet, 20 $\frac{3}{4}$ " wide, 12 $\frac{1}{2}$ " high, 14 $\frac{3}{4}$ " deep, (527 x 318 x 370 mm); rack, 19" wide, 10 $\frac{1}{2}$ " high, 14 $\frac{3}{8}$ " deep behind panel, (483 x 266 x 367).

Weight: cabinet, net, 55 lb (24.8 kg); shipping 65 lb (29.3 kg); rack, net, 50 lb (22.5 kg); shipping 63 lb (28.4 kg).

Accessories available (See Page 269):

11507A Output Termination, provides 3 positions: 50 ohms, 5 ohms and IEEE Standard Dummy Antenna.

11509A Fuseholder, protection for 606B transceiver tests.

10534A Mixer, for use as a nanosecond pulse modulator.

Price: HP 606B (cabinet), \$1730; HP 606BR (rack), \$1715.

Model 606A

The Model 606A covers the same frequency range as the 606B but does not include an auxiliary uncalibrated RF output or the frequency control feature with the 8708A. 606B specifications apply to the 606A except: harmonic output is less than 3%, output power level frequency response is ± 1 dB.

Price: HP 606A (cabinet), \$1630; HP 606AR (rack), \$1615.

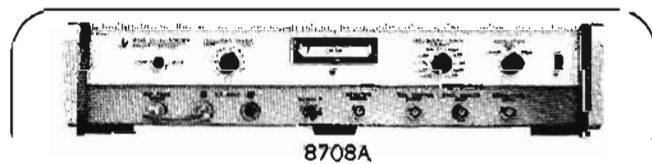

8708A

8708A Synchronizer

The 8708A Synchronizer is a phase-lock frequency stabilizer that provides crystal-oscillator frequency stability in the 606B (and 608F) signal generators to 430 MHz. The outstanding AM and output level control capabilities of the signal generators are retained. Phase-locking eliminates microphonics and drift, resulting in a frequency stability of 2×10^{-7} per 10 minutes, an increase by a factor of 250.

Specifications, 8708A

Frequency range: 50 kHz to 430 MHz; phase-locks 606B and 608F signal generator, with 2×10^{-7} settability.

Weight: net, 27 lb (12.2 kg); shipping 31 lb (14 kg).

Price: Model 8708A, \$1950.

VHF SIGNAL GENERATORS

Versatility and value, 10-480 MHz
Models 608E, 608F



SIGNAL SOURCES

Models 608E and 608F provide high-quality, versatile performance with distinctive ease of operation. The 608E provides an adjustable, calibrated output of 0.1 μV to 1 V rms from 10 to 480 MHz. The 608F is calibrated from 0.1 μV to 0.5 V rms over the 10-455 MHz frequency range and can be phase-locked with the 8708A Synchronizer for greater stability. An auxiliary RF output is available with both models.

Specifications, 608E and 608F

Frequency characteristics

Range: 608E: 10-480 MHz; 608F: 10-455 MHz in 5 bands.

Accuracy: 608E: $\pm 0.5\%$; 608F: $\pm 1\%$.

Drift: 608E/F: less than $50 \times 10^{-6}/10$ min after one hr warmup.

608F: stability when used with 8708A Synchronizer: $5 \times 10^{-8}/\text{min}$; $2 \times 10^{-7}/\text{min}$; $2 \times 10^{-6}/\text{day}$; $2 \times 10^{-7}/^{\circ}\text{C}$ (0° to 55°C); $2 \times 10^{-7}/10\%$ line voltage change.

Frequency control input (608F only): front panel input can be used with 8708A Synchronizer and external frequency control; limits 0 to -50 V, 4 K Ω nominal input impedance.

Resetability: better than $\pm 0.1\%$ after initial warmup; fine-frequency-adjust provides approx 25 kHz settability at 480 MHz (608E) or 455 MHz (608F).

Crystal calibrator: provides frequency check points every 1 MHz up to 270 MHz or every 5 MHz; jack provided for audio frequency output; crystal frequency accuracy better than 0.01% at room temperatures.

Residual FM: less than ± 5 parts in 10^7 peak.

Harmonic output: at least 35 dB below the carrier for harmonic frequencies below 500 MHz.

Output characteristics

Output level: continuously adjustable from 0.1 μV to 1.0 V (608E) and 0.1 μV to 0.5 V (608F) into a 50-ohm resistive load; output calibrated in volts and dBm.

Accuracy: within ± 1 dB of attenuator dial reading at any frequency when RF output meter indicates "ATTENUATOR CALIBRATED."

Impedance: 50 Ω with a maximum SWR of 1.2 for attenuator setting below -7 dBm.

RFI: meets all conditions specified in MIL-I-6181D; permits receiver sensitivity measurements down to at least 1.0 μV .

Auxiliary RF output: 608E: at least 180 mV rms into 50 Ω provided at front panel.

608F: front panel output for use with HP 8708A Synchronizer or other external equipment. Power levels into 50 Ω are: 10 to 215 MHz, -1.8 to $+7$ dBm; 215 to 400 MHz, $+2.0$ to $+6$ dBm; 400 to 430 MHz $+1.0$ to $+5$ dBm.

Modulation characteristics

Internal AM

Frequency: 400 and 1000 Hz, $\pm 10\%$.

Modulation level: 0 to 95% modulation at carrier levels 0.5 V and below (608E) and .224 V (1 mW) or below (608F).

Carrier envelope distortion: less than 2% at 30% AM, less than 5% at 70% AM.

External AM

Frequency: 20 Hz to 20 kHz.

Modulation level: 0 to 95% modulation at carrier levels of 0.5 V and below (608E) and at .244 V (1 mW) or below (608F); continuously adjustable with front panel MOD LEVEL control; input required, 1-10 V rms (1000 Ω input impedance).

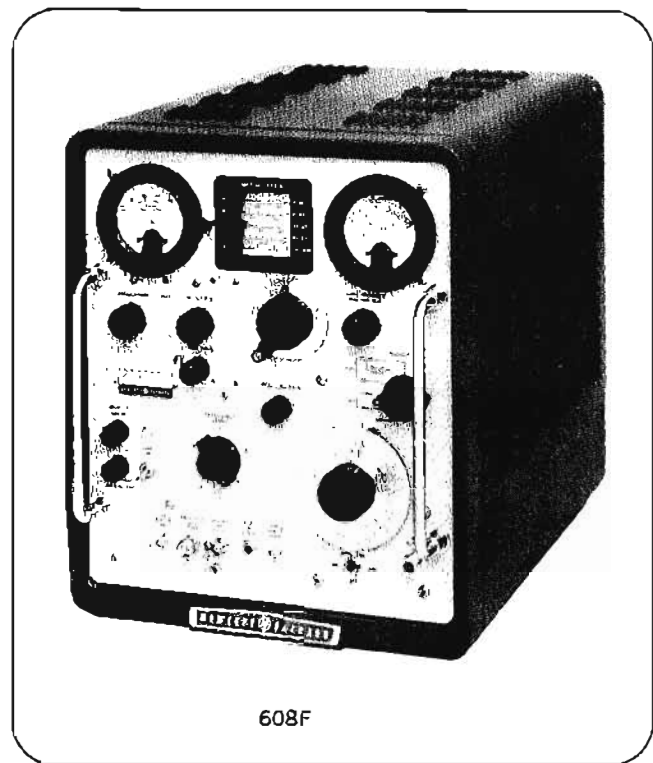

608F

Carrier envelope distortion: less than 2% at 30% AM, less than 5% at 70% AM, (modulation source distortion less than 0.5%).

Modulation meter accuracy: $\pm 5\%$ of full scale 0 to 80%, $\pm 10\%$ from 80% to 95% (for INT AM or 20 Hz to 20 kHz EXT AM).

Incidental FM (at 400 and 1000 Hz modulation): less than 1000 Hz peak at 50% AM for frequencies above 100 MHz; below 100 MHz, less than 0.001% at 30% AM.

External pulse modulation

Rise and decay time: from 40 MHz to 220 MHz, combined rise and decay time less than 4 μs ; above 220 MHz combined rise and decay time less than 2.5 μs .

On-off ratio: at least 20 dB for pulsed carrier levels of 0.5 V and above.

Input required: positive pulse, 10-50 V peak, input impedance 2000 Ω .

General

Power: 115 or 230 V $\pm 10\%$, 50 to 400 Hz; approx 220 W.

Dimensions: cabinet: 13 $\frac{1}{4}$ " wide, 16 $\frac{3}{8}$ " high, 21" deep (337 x 416 x 533 mm); rack mount: 19" wide, 13-31/32" high, 18 $\frac{3}{8}$ " deep behind panel (483 x 335 x 467 mm).

Weight: cabinet mount: net, 62 lbs (28 kg); shipping, 74 lbs (33.4 kg); rack mount: net, 62 lbs (28 kg); shipping, 83 lbs (37.4 kg).

Accessories available: (see page 269).

11508A Output Cable for high impedance circuits.

11509A Fuse Holder: protection for transceiver tests.

10514A Mixer for use as nanosecond pulse modulator.

Price: Model 608E (cabinet), \$1790; Model 608ER (rack mount), \$1830; Model 608F (cabinet), \$1940; Model 608FR (rack mount), \$1980.

SIGNAL GENERATORS



FM-AM SIGNAL GENERATORS

FM, AM, CW and pulse coverage, 54-270 MHz
Models 202H, 202J, 207H

202H, 202J

The HP 202H FM-AM Signal Generator covers the frequency range 54 to 216 MHz and is designed for the testing and calibration of FM receiving systems in the areas of broadcast FM, VHF, TV, mobile and general communications.

The HP 202J FM-AM Signal Generator covers the frequency range from 195 to 270 MHz and is designed for the testing and calibration of FM telemetering receiving systems in the 215 to 260 MHz band.

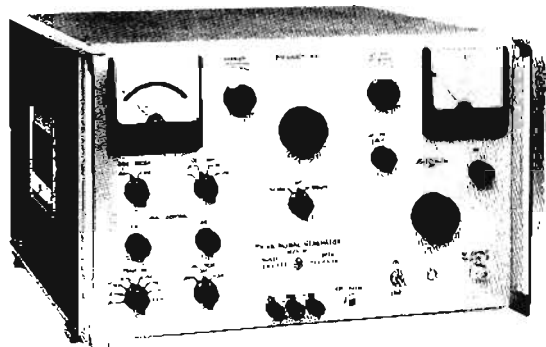

202H

Specifications, 202H, 202J

Radio frequency characteristics

RF range: 202H, 54 to 216 MHz; 202J 195-270 MHz.

RF accuracy (after 1 hr warm-up): main dial, $\pm 0.5\%$; electronic vernier, $\pm(10\% + 1 \text{ kHz})$.

RF stability: 202H: $< 0.01\%/hr$; 202J: $< 0.02\%/hr$, after 2-hour warm-up.

RF output: range 0.1 μV to 0.2 V (across external 50-ohm load at panel jack); accuracy: $\pm 10\%$, 0.1 μV to 50 mV; $\pm 20\%$, 50 mV to 0.2 V; auto level set; holds RF monitor meter to "red line" over band; impedance: 50 ohms; VSWR: < 1.2 ; spurious output: all spurious RF output voltages are at least 25 dB (202J) and 30 dB (202H) below desired frequency.

RF leakage: sufficiently low to permit measurements at 0.1 μV .

Amplitude modulation characteristics

AM range: internal, 0 to 50%; external, 0 to 100%.

AM accuracy: $\pm 10\%$ of reading at 400 Hz at 30% and 50%.

AM calibration: 30, 50, 100%.

AM distortion: $< 5\%$ at 30%, $< 8\%$ at 50%, $< 20\%$ at 90%.

AM fidelity: $\pm 1 \text{ dB}$, 30 Hz to 200 kHz.

Frequency modulation characteristics

FM deviation range: internal or external, 0 to 250 kHz in 4 ranges (202H); 0 to 300 kHz (202J).

FM deviation accuracy: $\pm 5\%$ of full-scale (for 400 Hz sine wave).

FM distortion (202H only): $< 0.5\%$ at 75 kHz (100 MHz), $< 1\%$ at 75 kHz (54 to 216 MHz), $< 10\%$ at 250 kHz (54 to 216 MHz); at 400 Hz modulation frequency.

FM non-linearity (202J only): $< 1.5\%$ at 150 Hz, $< 5\%$ at 300 kHz ("least squares" departure from straight line passing through origin).

FM fidelity 202H: $\pm 1 \text{ dB}$, 5 Hz to 200 kHz.

202J: $\pm 1 \text{ dB}$, 5 Hz to 500 kHz; $\pm 3 \text{ dB}$, 3 Hz to 1 MHz.

Pulse modulation characteristics

Source: external; rise time: 202H $\leq 0.6 \mu\text{s}$; 202J $< 0.25 \mu\text{s}$; fall time: $< 0.8 \mu\text{s}$.

Modulation oscillator characteristics

OSC frequency 202H: 50 Hz, 400 Hz, 1000 Hz, 3000 Hz, 7.5 kHz, 10 kHz, 15 kHz, 67 kHz; **202J:** 50 Hz, 400 Hz, 1700 Hz, 3900 Hz, 10.5 kHz, 30 kHz, 70 kHz, 100 kHz.

OSC accuracy: $\pm 5\%$.

OSC distortion: $< 0.5\%$, except $< 1.0\%$ at 67 kHz for 202H.

General

Dimensions: 16 $\frac{3}{4}$ " wide, 10 $\frac{1}{4}$ " high, 18 $\frac{3}{8}$ " deep (425 x 260 x 467 mm).

Weight: net, 47 lbs (20.3 kg); shipping, 66 lbs (29.7 kg) for 202H.

Power: 105 to 125 or 210 to 250 V, 50 to 400 Hz, 100 W.

Accessory furnished: 00502B patching cable.

Price: HP 202H, \$1595; HP 202J, \$1725; Option 001 Aux. RF output $> 50 \text{ mV}$, add \$150. (202J only.)

207H

The HP 207H Univerter is a frequency converter with unity gain designed for use with the HP 202H and 202J Signal Generators to provide additional frequency coverage from 100 kHz to 55 MHz. The 207H duplicates AM & FM of the 202H and 202J with no appreciable distortion for input levels less than 50 mV.

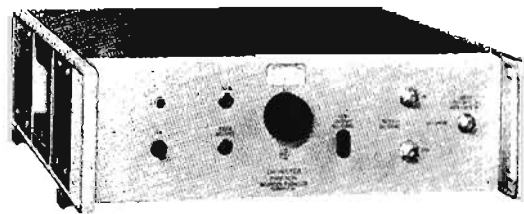

207H

Major Specifications, 207H

(When used with 202H and 202J Signal Generators.)

RF range: 100 kHz to 55 MHz (with 199.9 to 145 MHz input from 202H; 200.1 to 255 MHz input from 202J).

RF output: 1 μV to 0.1 V and 0.01 μV to 1 mV across external 50-ohm load at panel jack; $> 1 \text{ V}$ with 0.1 V input and 300-ohm output load.

Power: 105 to 125 V or 210 to 250 V, 50 to 400 Hz, 50 W.

Price: 207H, \$595.

UHF SIGNAL GENERATOR

All-purpose UHF signal generator, 450 to 1230 MHz
Model 612A



SIGNAL GENERATORS

Here is an all-purpose, precision signal generator particularly designed for utmost convenience and applicability throughout the important UHF-TV frequency band. It is ideally suited for measurements in UHF-television broadcasting, studio-transmitter links, citizen's radio and public service communications systems. The HP 612A also covers the important frequencies used in aircraft navigation aids such as DME, TACAN and airborne transponders. Accessory modulators, available from many of the manufacturers of these navigational aids, enable the 612A to provide the complex modulation patterns required for testing and aligning these systems. In the laboratory, the 612A is a convenient power source for driving bridges, slotted lines, antennas and filter networks. In addition, the HP 8731 PIN Modulators can be used with the 612A to obtain RF pulses with 30 ns rise time and 0.1 μ s minimum duration—with on-off ratios approaching 80 dB.

MOPA circuit

The master oscillator-power amplifier circuit in the HP 612A provides 0.5 volt into 50 ohms over the full frequency range of 450 to 1230 MHz. There is very low incidental FM (less than 0.002% at 30% AM) and excellent amplitude modulation capabilities by all frequencies from 20 Hz to 5 MHz. The degree of modulation is easily read from the large percent modulation meter. The instrument can be amplitude-modulated (either internally or externally), and provision is made for external pulse modulation as well. Pulse modulation can be applied to the amplifier or directly to the oscillator when high on-off signal ratios are required (signal may be completely cut off between pulses). Modulation can be up or down from a preset level to simulate TV modulation characteristics accurately.

Advanced design

The oscillator-amplifier circuit in the 612A employs high-frequency pencil triodes in a cavity-tuned circuit for precise

tracking over the entire band. Noncontacting cavity plungers are die-cast to precise tolerances, then injection-molded with a plastic filler for optimum Q. The frequency drive is a direct screw-operated mechanism, free from backlash. A waveguide-beyond-cutoff piston attenuator and crystal monitor circuit are used to ensure accurate, reliable output down to 0.1 μ V. The attenuator is calibrated over a range of 131 dB and has been carefully designed to provide a constant impedance-versus-frequency characteristic. The SWR of the 50-ohm output system is less than 1.2 over the complete frequency range.

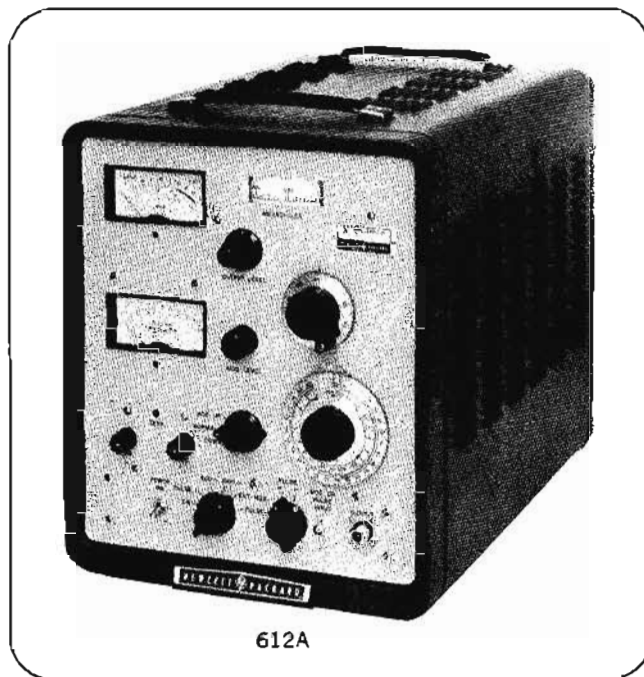

612A

Specifications

Frequency range: 450 to 1230 MHz in one band; scale length approximately 15" (381 mm).

Calibration accuracy: within $\pm 1\%$; resettability better than 5 MHz at high frequencies.

Output voltage: 0.1 μ V to 0.5 V into 50-ohm load; calibrated in V and dBm (0 dBm = 1 mW).

Output accuracy: ± 1 dB, 0 to -127 dBm over entire frequency range.

Internal impedance: 50 ohms; maximum reflection coefficient, 0.091 (1.2 SWR, 20.8 dB return loss) for attenuator settings of 0 dBm and below.

Amplitude modulation: above 470 MHz, 0 to 90% at audio frequencies, indicated by panel meter; accuracy $\pm 10\%$ of full scale, 30 to 90% modulation.

Incidental FM: less than 0.002% for 30% AM.

Internal modulation: 400 and 1000 Hz $\pm 10\%$; envelope distortion less than 3% at 30% modulation.

External modulation: 20 Hz to 5 MHz; above 470 MHz, 2 V rms produces 85% AM at modulating frequencies up to 500 kHz, at least 40% AM at 5 MHz; modulation may be up or down from the carrier level or symmetrical about the carrier level; positive or negative pulses may be applied to increase or decrease RF output from the carrier level.

Pulse modulation

Pulse 1 (pulse applied to amplifier): positive or negative pulses, 4 to 40 V peak produce an RF on-off ratio of at least 20 dB; minimum RF output pulse length, 1.0 μ s.

Pulse 2 (pulse applied to oscillator): positive or negative pulses, 4 to 40 V peak; no RF output during off time; minimum RF output pulse length, 1.0 μ s.

RFI: conducted and radiated leakage limits are below those specified in MIL-I-6181D; permits receiver sensitivity measurements down to 1 μ V.

Power: 115 or 230 volts $\pm 10\%$, 50 to 400 Hz, 215 watts.

Dimensions: cabinet: 13 $\frac{1}{2}$ " wide, 16 $\frac{1}{2}$ " high, 21 $\frac{1}{2}$ " deep (333 x 419 x 546 mm); rack mount: 19" wide, 13-31/32" high, 20 $\frac{1}{4}$ " deep behind panel (483 x 355 x 514 mm).

Weight: net, 56 lbs (25.2 kg); shipping, 68 lbs (30.6 kg) (cabinet); net, 56 lbs (25.2 kg); shipping, 77 lbs (34.6 kg) (rack mount).

Accessories available: 11500A RF Cable Assembly; 10503A Video Cable Assembly; 360B Low-Pass Filter (may be used where harmonic output must be reduced to a minimum, as in slotted line measurements).

Price: HP 612A, \$1850 (cabinet); HP 612AR, \$1890 (rack mount).

SIGNAL GENERATORS



SIGNAL GENERATORS, SOURCES

Stable, easy to use, 800 to 4500 MHz

Models 8614A, 8616A, 8614B, 8616B

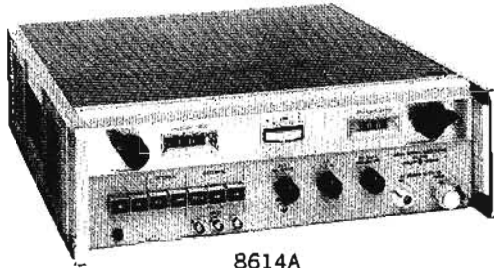

8614A

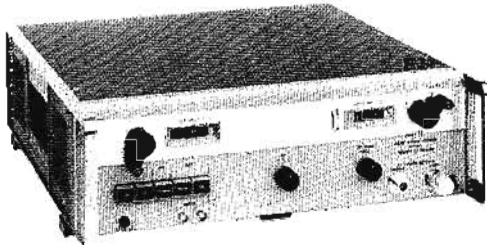

8614B

HP 8614A, 8616A Signal Generators

The HP 8614A and 8616A Signal Generators provide stable, accurate signals from 800 to 2400 MHz (8614) and from 1800 to 4500 MHz (8616A). Both frequency and attenuation are set on direct-reading digital dials, while selectable functions include CW, leveled output, square-wave modulation, and external AM, FM and pulse modulation. Modulation can be accomplished simultaneously with or without leveling.

Two RF power outputs are simultaneously available from separate front-panel connectors. One provides at least 10 mW (2 mW above 3000 MHz) or a leveled output from 0 to -127 dBm. The other is at least 0.5 mW across the band and is independent of attenuator setting. This signal can be used for phase-locking the signal generators for extreme stability, or it can be monitored with a frequency counter for extreme frequency resolution without adversely affecting the primary output.

A unique PIN diode modulator permits amplitude modulation from dc to 1 MHz or furnishes RF pulses with a 2 μ s rise time. This broad modulation bandwidth permits remote control of output level or precise leveling using external equipment. The internal leveling is also obtained by using a PIN modulator.

HP 8614B, 8616B Signal Sources

The HP 8614B and 8616B retain the convenience of the "A" models. Although the signal sources do not have power monitors or internal PIN diode modulation, relative power measurements can be made, using the precision attenuator. Modulation capabilities include internal square-wave modulation, plus external pulse and frequency modulation. A friction clutch arrangement permits setting the attenuator dial to any suitable reference while output power is held constant. Thus, the attenuator can be calibrated directly in dBm or insertion loss.

Specifications

Frequency range: 8614A and 8614B, 800 to 2400 MHz; 8616A and 8616B, 1800 to 4500 MHz.

Leveled output: constant within ± 0.75 dB (8614A) and ± 1.0 dB (8616A) across entire frequency range at any attenuator setting below 0 dB. Not available with 8614B and 8616B.

Frequency calibration accuracy: 8614A, ± 5 MHz; 8614B, ± 5 MHz or $\pm 0.5\%$, whichever is greater; 8616A, ± 10 MHz; 8616B, ± 10 MHz or $\pm 0.5\%$, whichever is greater.

Verrier: ΔF control has a minimum range of 1.5 MHz for fine tuning (1.0 MHz for 8614B, 8616B).

Frequency stability

With temperature: approximately 0.005%/°C change in ambient temperature.

With line voltage: less than 0.003% change for line voltage variation of $\pm 10\%$.

Residual FM: 8614A and 8616A, less than 2500 Hz peak; 8614B, less than 0.0003% peak; 8616B, less than 6 kHz peak.

RF output power

8614A: +10 dBm (10 mW) to -127 dBm (0.1 μ V) into a 50-ohm load; output attenuator dial directly calibrated in dBm from 0 to -127 dBm.

8614B: at least 15 mW max, controlled by attenuator.

8616A: +10 dBm to -127 dBm into a 50-ohm load, 1800 to 3000 MHz; +3 dBm to -127 dBm into a 50-ohm load, 3000 to 4500 MHz; output attenuator directly calibrated in dBm from 0 to -127 dBm.

8616B: at least 15 mW maximum, 1800 to 3000 MHz; at least 3 mW maximum, 3000 to 4500 MHz; controlled by attenuator.

Internal impedance: 50 ohms nominal.

Reflection coefficient

8614A, 8616A: less than 0.33.

8614B: less than 0.2.

8616B: less than 0.26.

Modulation

Internal square wave: 950 to 1050 Hz, can be synchronized with a +1 to +10 volt input signal.

External AM (8614A, 8616A only): dc to 1 MHz.

Incidental FM (8614A, 8616A only): negligible for power levels below -10 dBm.

External pulse

8614A and 8616A: 50 Hz to 50 kHz, 2 μ s rise time, +20 to +100 volts input.

8614B, 8616B (below 4000 MHz): 50 Hz to 500 kHz; +25 to +50 volts peak input; minimum RF pulse width, 300 ns; RF rise time, typically 200 ns.

External FM: (a) front-panel connector capacitively coupled to klystron repeller; input impedance, 220 k Ω shunted by approx 300 pF; (b) rear-panel connector is dc-coupled to the klystron repeller.

Power: 115 or 230 volts $\pm 10\%$, 50 to 60 Hz, approx 125 watts.

Dimensions: 16 $\frac{3}{4}$ " wide, 5 $\frac{1}{2}$ " high, 18 $\frac{3}{8}$ " deep (426 x 141 x 467 mm); hardware furnished for conversion to rack mount 19" wide, 5-7/32" high, 16 $\frac{3}{8}$ " deep behind panel (483 x 133 x 416 mm).

Weight: 8614A and 8616A: net, 44 lbs (19.8 kg); shipping, 48 lbs (22.0 kg); 8614B, 8616B: net, 38 lbs (17.1 kg); shipping, 44 lbs (19.4 kg).

Price: HP 8614A or 8616A, \$2490; HP 8614B or 8616B, \$1900.

Option 001: external modulation input connectors on rear panel in parallel with front-panel connectors; RF connectors on rear panel only, add \$25.

UHF SIGNAL GENERATORS

Direct-reading, direct control, 800 to 4200 MHz
Models 614A, 616B



SIGNAL GENERATORS

Ease of operation, direct-reading one dial frequency control, high stability and accuracy and broad frequency coverage are all advantages of these widely used signal generators.

The 614A covers frequencies from 800 to 2100 MHz, has constant internal impedance with less than 1.6 SWR, and output accuracy of ± 1.5 dB over the range of -10 dBm to -127 dBm. The 616B gives complete coverage of frequencies from 1.8 to 4.2 GHz, has constant internal impedance with less than 1.8 SWR, and output accuracy of ± 1.5 dB from -7 dBm to -127 dBm.

On both instruments, operation is extremely simple. Carrier frequency is set and read directly on the large tuning dial. No voltage adjustments are necessary during operation because of the coupling device which causes oscillator repeller voltage to track frequency changes automatically. Oscillator output is set and read directly on a simplified dial. Output may be continuous or pulsed, or frequency-modulated at power line frequency. Pulse modulation may be provided externally or internally. Internal pulsing may be synchronized with either positive or negative external pulses, or sine waves.

The oscillator portion of both the 614A and 616B consists of a reflex klystron in an external coaxial resonator. Frequency of oscillation is determined by a movable plunger which varies the resonant frequency of the resonator. Oscillator output is monitored by a temperature-compensated thermistor bridge circuit which is virtually unaffected by ambient temperature conditions. Voltage output is read directly. A logging scale on the frequency dial provides a resetability of 0.1%.

Specifications

Frequency range: 614A, 800 to 2100 MHz; 616B, 1.8 to 4.2 GHz.

Frequency accuracy: $\pm 1\%$.

Frequency stability: 0.005%/°C change in ambient temperature; line voltage changes of $\pm 10\%$ cause 0.01% frequency change.

Output power range (into 50-ohm load): 614A, 0.5 mW or 0.158 V to 0.1 μ V (-3 to -127 dBm) from 800 to 900 MHz, 1 mW or 0.224 V to 0.1 μ V (0 to -127 dBm) from 900 to 2100 MHz; 616B, 1 mW or 0.224 V to 0.1 μ V (0 to -127 dBm).

Power accuracy (at the end of 6-ft output cable, terminated in 50-ohm load): 614A, within ± 1.5 dB from -10 to -127 dBm; 616B, within ± 1.5 dB from -7 to -127 dBm.

Internal impedance: 614A, 50 ohms, reflection coefficient less than 0.23 (1.6 SWR, 12.7 dB return loss); 616B, 50 ohms, reflection coefficient less than 0.285 (1.8 SWR, 10.9 dB return loss).

Modulation: internal or external pulse or FM.

Internal pulse modulation: phase repetition rate variable from 40 to 4000 per sec; pulse length variable from 1 to 10

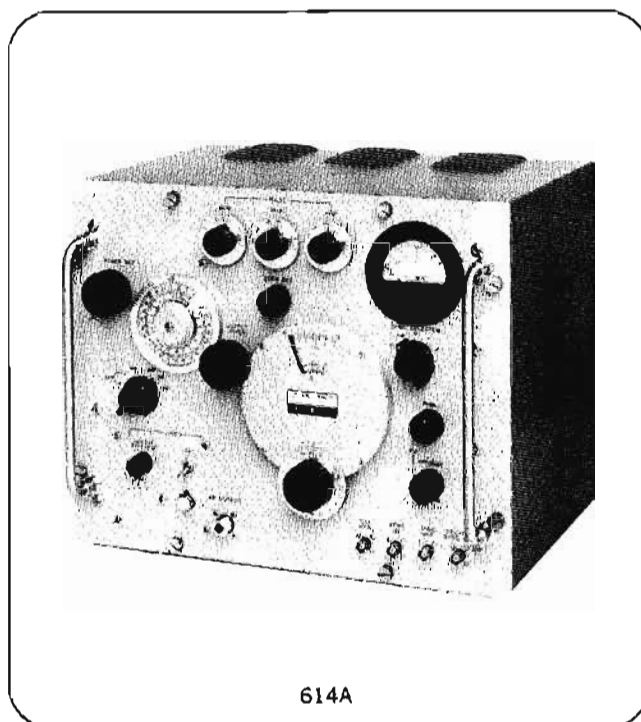

614A

μ s; delay variable from 3 to 300 μ s between synchronizing signal and RF pulse.

External pulse modulation: ext $-$: -40 to -70 V, 1 to 2500 μ s wide ext $+$: $+40$ to $+70$ V, 1 to 400 μ s wide, square wave: ± 40 to ± 70 V p-p, 40 to 4000 Hz.

Trigger pulses out: (1) simultaneous with RF pulse; (2) in advance of RF pulse, variable from 3 to 300 μ s (both approximately 1 μ s rise time, amplitude $+10$ to $+50$ volts).

External synchronization: pulses, ± 10 to ± 50 V, 1 to 20 μ s wide; may also be synchronized with sine waves.

Frequency modulation: oscillator sweeps at power line frequency; deviation and phase adjustable; maximum deviation approx 3 MHz p-p.

RFI: conducted and radiated leakage limits are below those specified in MIL-I-6181D.

Power: 115 or 230 V $\pm 10\%$, 50 to 400 Hz, approx 160 W.

Dimensions: cabinet: 17 $\frac{1}{4}$ " wide, 13 $\frac{5}{8}$ " high, 13 $\frac{1}{2}$ " deep (438 x 346 x 343 mm); rack mount: 19" wide, 13-31/32" high, 12 $\frac{1}{8}$ " deep behind panel (483 x 355 x 308 mm).

Weight: net, 58 lbs (26.4 kg); shipping, 66 lbs (30.0 kg).

Accessory furnished: 11500 A RF Cable Assembly.

Accessories available: 614A: 360C Low Pass Filter, $f_c = 2200$ MHz; 10503A Video Cable Assembly; 616B: S281A Waveguide-to-Coax Adapter, 2.6 to 3.95 GHz; G281A Waveguide-to-Coax Adapter, 3.95 to 5.85 GHz; 360D Low-Pass Filter, $f_c = 4.1$ GHz.

Price: HP 614A or HP 616B, \$2600 (cabinet); HP 614AR or 616BR, \$2640 (rack mount).

SIGNAL GENERATORS



SHF SIGNAL GENERATORS

Multiple-purpose instruments, 3.8 to 11 GHz
Models 618C, 620B

The Models 618C and 620B SHF Signal Generators provide versatility, accuracy, and stability in the range from 3.8 to 11 GHz. Frequency is set on a large, direct-reading

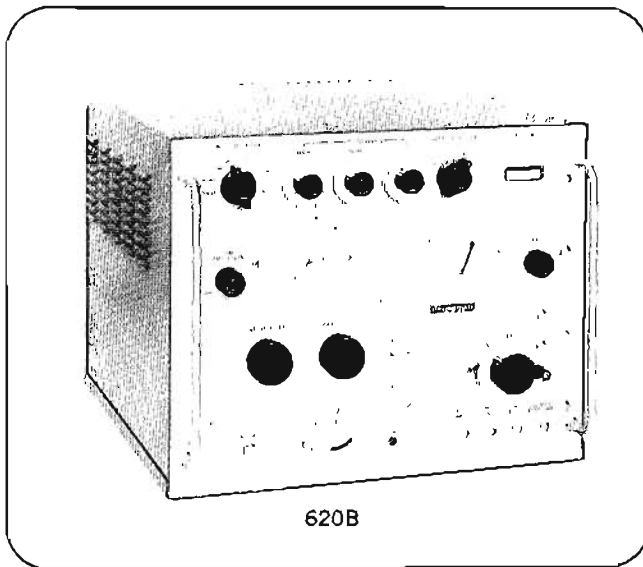

dial. A ΔF vernier control provides ultra-fine tuning capability. There is also a provision for remote fine tuning.

A calibrated output from 0 to -127 dBm (0.224 volts to 0.1 microvolt) is also set on a large, direct-reading dial. The dial is calibrated in both dBm and volts. An auxiliary output of at least 0.3 milliwatt is available and is independent of attenuator setting. Thus, it can be used for phase-locking the signal generator when crystal-oscillator stability is required, or it can be monitored with a frequency counter for extreme frequency resolution.

The 618C and 620B Generators both feature oscillators of the reflex klystron type, with external resonant cavity. Oscillator frequency is determined by a movable plunger which varies the length of the cavity. Oscillator output is monitored by a temperature-compensated detector circuit. This circuit operates virtually unaffected by ambient temperature conditions.

Modulation includes internal pulse, square wave, and frequency modulation plus external pulse and frequency modulation.

Specifications

Output

Frequency range: 618C: 3,800 to 7,600 MHz covered in a single band; 620B: 7 to 11 GHz covered in a single band; repeller voltage automatically tracked and proper mode automatically selected.

Calibration: direct reading; frequency calibration accuracy better than $\pm 1\%$.

Frequency stability: with temperature: less than 0.006%/°C change in ambient temperature; with line voltage less than 0.02% change for line voltage variation of $\pm 10\%$; residual FM: < 15 kHz peak.

Output range: 1 milliwatt or 0.224 volt to 0.1 microvolt (0 dBm to -127 dBm) into 50 ohms; directly calibrated in microvolts and dB; coaxial type N connector.

Output accuracy: within ± 2 dB from -7 to -127 dBm, within ± 3 dB from 0 to -7 dBm, terminated in 50-ohm load.

Source impedance: 50 ohms nominal; reflection coefficient less than 0.33.

Modulation

Modulation: internal or external pulse, FM, and square wave.

Internal pulse modulation: repetition rate variable from 40 to 4,000 pps, pulse width variable $1/2$ to 10 microseconds.

Sync out signals: simultaneous with RF pulse, positive; in advance of RF pulse, positive, variable 3 to 300 microseconds (better than 1 microsecond rise time and 25 to 100 volts amplitude into 1,000-ohm load).

External synchronization: sine wave: 40 to 4,000 Hz, 5 to 50 V rms; pulse: 40 to 4,000 pps, 20 to 70 V peak, positive or negative, 0.5 to 5 μ s wide, 0.1 to 1 μ s rise time.

Internal square-wave modulation: variable 40 to 4,000 Hz,

Internal FM: sawtooth sweep rate adjustable 40 to 4,000 Hz; frequency deviation to 5 MHz peak-to-peak over most of the frequency range.

External pulse modulation: pulse requirements: amplitude from 20 to 70 volts positive or negative, width 0.5 to 2,500 microseconds.

External FM: frequency deviation approximately 5 MHz peak-to-peak over most of the band; sensitivity approximately 20 V/MHz at front-panel connector, approximately 10 V/MHz at rear-panel connector (mating connector supplied); front-panel connector is capacitively coupled to klystron repeller; rear-panel connector is dc-coupled to klystron repeller and is suitable for phase-lock control input.

General

RFI: conducted and radiated leakage limits are below those specified in MIL-I-6181D.

Power source: 115 or 230 volts $\pm 10\%$, 50 to 60 Hz 230 W.

Dimensions: cabinet, 17 $1/2$ " wide, 13 $7/8$ " high, 20 $3/8$ " deep behind panel (445 x 353 x 518 mm); rack mount, 19" wide, 13-31/32" high, 19" deep behind panel (483 x 355 x 483 mm).

Weight: net, 67 lbs (30.4 kg); shipping, 75 lbs (34.1 kg).

Accessory furnished: 11500A Cable Assembly, 6 feet (1830 mm) of RG-214A/U 50-ohm coax, terminated on each end by type N male connectors.

Price: Model 618C or 620B (cabinet mount), \$2600. Model 618CR or 620BR (rack mount), \$2640.

SHF GENERATORS/DOUBLERS

Generate stable signals, 10 to 40 GHz

Models 626A, 628A, 938A, 940A



SIGNAL GENERATORS

626A, 628A

The 626A covers frequencies 10 to 15.5 GHz, and the 628A covers frequencies 15 to 21 GHz. In design and operation, the instruments are similar to Hewlett-Packard generators for lower frequency ranges. Carrier frequency is set and read directly on the large tuning dial. No voltage adjustment is necessary during tuning because repeller voltage is tracked with frequency changes automatically. Oscillator output also is set and read directly, and no frequency correction is necessary throughout operating range. A frequency logging scale permits frequency to be reset within 0.1%.

Both the 626A and 628A offer internal and external pulse, square-wave and frequency modulation. The pulse generators may be synchronized with an external sine wave and positive or negative pulse signals.

The high power output of these signal generators makes them ideally suited for driving HP 938A and 940A Frequency Doubler sets. These doubler sets retain the modulation and stability of the driving source and have accurate power monitors and attenuators.

Specifications, 626A, 628A

Frequency range: 626A, 10 to 15.5 GHz; 628A, 15 to 21 GHz.

Frequency calibration: dial direct-reading in GHz, accuracy better than $\pm 1\%$.

Output range: 10 mW to 1 pW (+10 dBm to -90 dBm, 0 dBm = 1 mW); attenuator dial calibrated in output dBm.

Source impedance: 50 ohms nominal; reflection coefficient: 626A, less than 0.43 at +10 dBm, 0.15 at 0 dBm and below. 628A, less than 0.43 at +10 dBm, 0.091 at 0 dBm and below.

Output monitor accuracy: better than ± 1 dB; temperature-compensated thermistor bridge circuit monitors RF oscillator power level.

Output connector: 626A: 0.850 x 0.475 inch waveguide, WR75, flat cover flange; 628A: 0.590 x 0.355 inch waveguide, WR51, flat cover flange.

Output attenuator accuracy: better than $\pm 2\%$ of attenuation in dB introduced by output attenuator.

Modulation: internal or external pulse, FM, or squarewave.

Internal pulse modulation: repetition rate variable from 40 to 4000 pps; pulse width variable 0.5 to 10 μ s.

Internal square-wave modulation: variable 40 to 4000 Hz controlled by "pulse rate" control.

Internal frequency modulation: power line frequency, deviation up to 10 MHz p-p.

External pulse modulation: pulse requirements: amplitude 15 to 70 volts peak positive or negative; width 1 to 2500 μ s.

External frequency modulation: provided by capacitive coupling to the klystron repeller; maximum deviation approx 10 MHz p-p.

Sync out signals: positive 20 to 50 V peak into 1000-ohm load; better than 1 μ s rise time; 1) simultaneous with RF pulse, positive; 2) in advance of RF pulse, positive, variable 3 to 300 μ s.

External synchronization: 1) sine wave, 40 to 4000 Hz, amplitude 5 to 50 V rms; 2) pulse signals 0 to 4000 pps, 5 to 50 V amplitude, positive or negative; pulse width 0.5 to 5 μ s; rise time 0.1 to 1 μ s.

Power: 115 or 230 volts $\pm 10\%$, 50 to 60 Hz, approx 200 watts.
Dimensions: cabinet: 17" wide, 14" high, 15" deep (432 x 356 x 381 mm); rack mount: 19" wide, 14" high, 12-13/16" deep behind panel (483 x 356 x 313 mm).

Weight: 626A, AR: net, 59 lbs (26.8 kg); shipping, 68 lbs (31.3 kg); 628A, AR: net, 56 lbs (25.4 kg); shipping, 65 lbs (29.5 kg).

Accessories furnished: 626A, MX 292B and MP 292B Waveguide Adapters; 628A, NP 292A and NK 292A Waveguide Adapters.

Accessories available: 10503A Video Cable Assembly for 626A M362A low-pass filter.

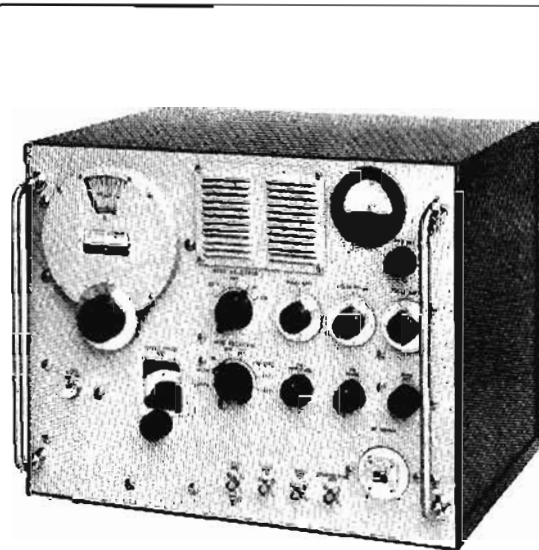

628A

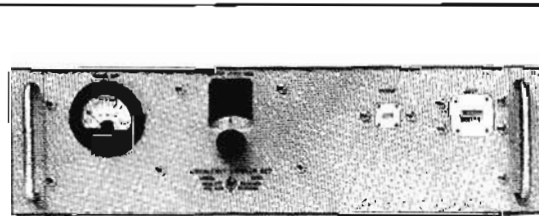

938A

Price: HP 626A or 628A, \$4400 (cabinet); HP 626AR or 628AR, \$4440 (rack mount).

Frequency doubler sets

Model 938A supplies power from 18 to 26.5 GHz and Model 940A from 26.5 to 40 GHz when driven by 9 to 13.25 GHz and 13.25 to 20 GHz sources respectively. For a swept output, use a swept-frequency source such as Model 8690B or Model 8620A/B series with appropriate RF units.

Specifications, 938A, 940A

Frequency range: 938A, 18 to 26.5 GHz; 940A, 26.5 to 40 GHz.
Conversion loss: less than 18 dB at 10 mW input.

Output power: approximately 0.5-1 mW when used with typical 626A, 628A signal generators; input power: 100 mW maximum.

Output attenuator: accuracy, $\pm 2\%$ of reading or ± 0.2 dB, whichever is greater; range, 100 dB.

Output reflection coefficient: approx 0.33 at full output; less than 0.2 with attenuator set to 10 dB or greater.

Input flange: 938A, M-band flat cover flange for WR-75 waveguide; 940A, N-band flat cover flange for WR-51 waveguide.

Output flange: 938A K-band flat cover flange for WR-42 waveguide; 940A R-band flat flange for WR-28 waveguide.

Dimensions: 19 1/2" wide, 5 3/8" high, 18" deep (489 x 137 x 457 mm).

Weight: net, 20 lbs (9 kg); shipping, 26 lbs (11.8 kg).

Price: HP 938A or HP 940A, \$2800.

SIGNAL GENERATORS**SPECIAL SIGNAL GENERATORS**

Avionics and telemetry test equipment
Models 3205A, 211A, 232A, 8925A

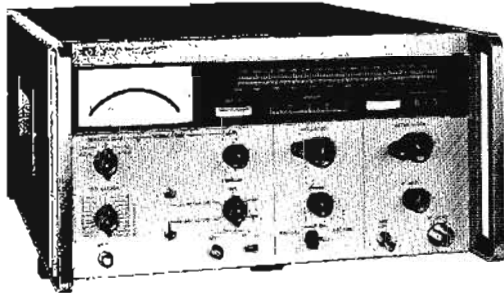
Telemetry Test Equipment

3205A

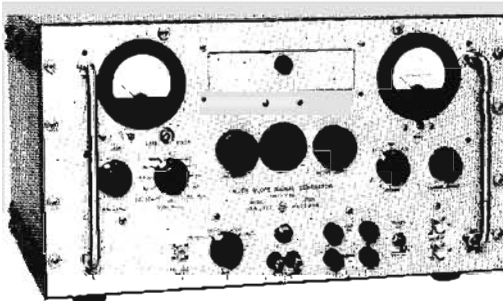
Avionics Test Equipment

232A

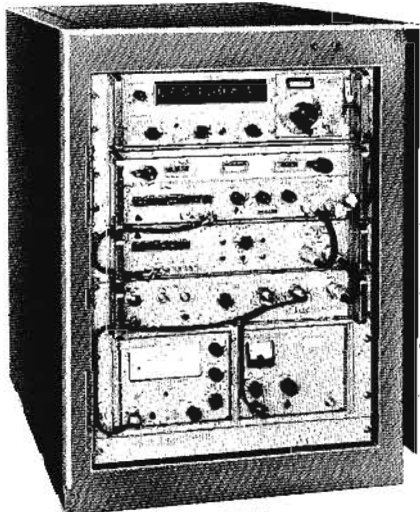

8925A

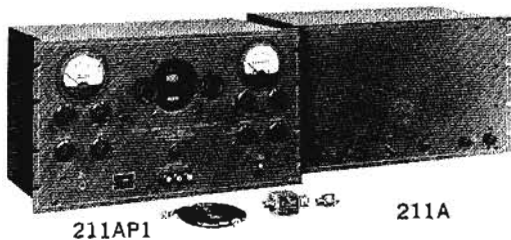

211AP1

211A

HP 3205A

The Model 3205A FM Signal Generator is a self-contained, completely solid-state instrument designed for use in the measurement and calibration of FM telemetry receivers in the 1435 to 1540 MHz and 2200 to 2300 MHz frequency bands. The generator has its own deviation meter calibration system that does not require external instrumentation. Calibrated RF output level, adjustable from -10 dBm to -127 dBm is also included. An internal modulation oscillator permits selection of channels 1 through 21 of the standard IRIG (Inter-range Instrumentation Group) subcarrier frequencies used for telemetry systems.

Frequency range: band 1, 1430 to 1540 MHz; band 2, 2150 to 2310 MHz.

Price: \$5750.

Option 001: all front panel connectors moved to rear panel, add \$50.

HP 232A

The FAA Instrument Landing System for aircraft includes a glide slope receiver for indicating the proper rate of descent. The HP 232A Glide Slope Signal Generator was designed for use in testing and calibrating these glide-slope receivers.

Frequency range: RF, 329.3 to 335 MHz in increments of 0.3 MHz; IF, 20.7 MHz; other frequencies between 15 and 30 MHz available on special order.

Price: HP 232A, \$3200.

HP 8925A

The HP 8925A DME/ATC Test Set is specifically designed for testing and calibrating DME (Distance Measuring Equipment) and ATC (Air Traffic Control) transponder aircraft equipment. When used with suitable modulators, the test set will also simulate some TACAN and IFF signals. Completely self-contained (except for video modulators), the system consists of a continuously tuneable signal generator (HP 8614A Option H01), direct-reading frequency counter (HP 5245L), solid-state modulator (HP 8403A Option H01), frequency converter (HP 5254A), wavemeter (HP 8905A), peak power measuring system (HP 8900B), and all necessary circuitry for interconnection to the radio set under test (HP 13505A).

Frequency range: 962 to 1213 MHz.

Price: HP 8925A, \$13,925.

Options: (specify by option number).

001: less 5245L/5254A Counter, \$10,350.

002: less cabinet, \$13,125.

003: dual power range (10 to 200/100 to 2000 W), add \$130.

004: HP 5246L Counter instead of HP 5245L, \$13,250.

HP 211A

The HP 211A Crystal-Monitored Signal Generator is specifically designed for the testing and calibrating of aircraft VOR and ILS localizer radio receiving equipment operating within the frequency range from 88 to 140 MHz. It also may be used for laboratory and development work where a precision-type amplitude-modulated RF signal source is required.

Frequency range: master oscillator: 88 to 140 MHz in one range; crystal oscillator: 110.1 and 114.9 MHz.

Price: HP 211A, 211AP1 Power Supply, \$2900.

PIN MODULATORS, MODULATORS

Versatile modulation
8730 Series, 8403A



SIGNAL GENERATORS

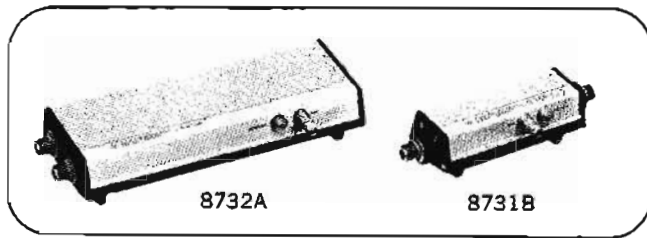

8730 PIN Modulators

With HP 8730 series PIN Modulators, signal sources, including klystrons, can be pulse-modulated, leveled or amplitude-modulated with sinusoidal and complex waveforms. Fast rise-times, low incidental FM and a nearly constant impedance match to source and load are typical of these absorption-type modulators.

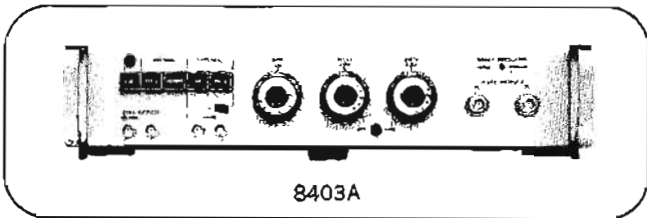

8403A Modulator

The Model 8403A provides complete control of the PIN modulators, supplying the appropriate modulation wave shapes and bias levels for fast rise times, rated on/off ratios and amplitude modulation. An internal square-wave and pulse modulator with PRF of 50 Hz to 50 kHz and adjustable pulse width and delay also provides square wave and pulses for general pulse applications. For applications requiring an absorption-type modulator plus controls in a single unit, a PIN modulator can be installed in the Model 8403A.

Specifications, 8403A

Output characteristics (available separately at front panel)
For driving 8730 PIN Modulators: AM and pulse output specially shaped for optimum RF rise and decay times.
For general pulse applications: positive dc-coupled pulse 25 to

30 volts in amplitude, approximately symmetrical about 0 volt; no AM signal.

Modulation

Internal square wave

Frequency: variable from 50 Hz to 50 kHz.

Symmetry: better than 45/55%.

Internal pulse

Repetition rate: variable from 50 Hz to 50 kHz.

Delay: variable from 0.1 μ s to 100 μ s, between sync out pulse and RF output pulse.

Width: variable from 0.1 μ s to 100 μ s.

External sync

Signal: 5 to 20 volts peak, + or -, pulse or sine wave.

Input impedance: approx 2000 ohms, dc-coupled.

Trigger out

Sync out: simultaneous with or 0.1 to 100 μ s in advance of RF pulse, as set by delay control.

Delayed sync out: simultaneous with output pulse.

Amplitude: approximately -2 volts.

Source impedance: approximately 330 ohms.

External pulse input

Amplitude and polarity: 5 volts to 20 volts peak, + or -.

Repetition rate: maximum average PRF, 500 kHz.

Input impedance: approximately 2000 ohms, dc-coupled.

Width: minimum 0.1 μ s; maximum $\frac{1}{\text{PRF}}$ -0.4 μ s.

Continuous amplitude modulation (with 8730 series)

Frequency response: dc to approximately 10 MHz (3 dB).

Sensitivity: approx 10 dB/volt with HP 8730A series; approx 20 dB/volt with HP 8730B series.

Input impedance: approximately 100 ohms.

General

Power: 115 or 230 volts \pm 10%, 50 to 400 Hz, approx 10 watts.

Dimensions: 16 $\frac{3}{4}$ " wide, 3 $\frac{3}{4}$ " high, 18 $\frac{3}{8}$ " deep (425 x 96 x 467 mm); hardware furnished for rack mount 19" wide, 3-15/32" high, 16 $\frac{3}{8}$ " deep behind panel (483 x 89 x 416 mm).

Weight: net, 17 lbs (7.7 kg); shipping 20 lbs (9.5 kg).

Price: HP 8403A, \$900.

Options: PIN Modulators installed

001 HP 8731A, add \$525 002 HP 8731B, add \$775

003 HP 8732A, add \$525 004 HP 8732B, add \$775

005 HP 8733A, add \$525 006 HP 8733B, add \$775

007 HP 8734A, add \$525 008 HP 8734B, add \$775

009 input and output connectors on rear panel, add \$25.

Specifications, 8730 Series

HP Model	8731A	8731B	8732A	8732B	8733A	8733B	8734A	8734B	8736A	8736B	MIL-8731B ¹
Frequency range (GHz)	0.8-2.4	0.8-2.4	1.8-4.5	1.8-4.5	3.7-8.3	3.7-8.3	7.0-12.4	7.0-12.4	8.2-12.4	8.2-12.4	0.4-0.9
Dynamic range (dB)	35	30	35	30	35	30	35	30	35	30	35
Max. residual atten. (dB) ¹	<1.5	<2.0	<2.0	<3.5 ²	<2.0	<3.0	<4.0	<5.0	<4.0	<5.0	<2.0
Typical rise time (ns) ³	40	30	40	30	30	30	30	30	30	30	40
Typical decay time (ns) ³	30	20	30	20	20	20	20	20	20	20	30
SWR, min. attenuation	1.5	1.6	1.5	1.6 ⁴	1.8	2.0	1.8	2.0	1.7	2.0	1.25 ⁵
SWR, max. attenuation	1.8	2.0	1.8	2.0	2.0	2.2	2.0	2.2	2.0	2.2	1.5 ⁵
Forward bias input resistance (ohms)	300	100	300	100	300	100	300	100	300	100	300
RF connector type	N	N	N	N	N	N	N	N	W/G ⁶	W/G ⁶	N
Weight, net lb (kg)	3 (1.4)	6 (2.7)	3 (1.4)	6 (2.7)	3 (1.4)	3 (1.4)	3 (1.4)	3 (1.4)	3 (1.4)	3 (1.4)	6 (2.7)
Shipping lb (kg)	4 (1.8)	9 (4.1)	4 (1.8)	9 (4.1)	4 (1.8)	5 (2.3)	4 (1.8)	5 (2.3)	4 (1.8)	5 (2.3)	9 (4.1)
Dimensions											
Length, in (mm)	11 $\frac{1}{2}$ (283)	11 $\frac{1}{2}$ (289)	11 $\frac{1}{2}$ (283)	11 $\frac{1}{2}$ (289)	8 $\frac{3}{4}$ (213)	12 $\frac{1}{4}$ (311)	8 $\frac{3}{4}$ (213)	12 $\frac{1}{4}$ (311)	6 $\frac{1}{2}$ (171)	10 $\frac{1}{2}$ (267)	11 $\frac{1}{2}$ (289)
Width, in (mm)	3 $\frac{1}{2}$ (83)	4 $\frac{1}{4}$ (124)	3 $\frac{1}{4}$ (83)	4 $\frac{1}{4}$ (124)	3 $\frac{1}{4}$ (83)	3 $\frac{1}{4}$ (83)	3 $\frac{1}{4}$ (83)	3 $\frac{1}{4}$ (83)	3 $\frac{1}{4}$ (83)	3 $\frac{1}{4}$ (83)	4 $\frac{1}{4}$ (124)
Height, in (mm)	2 $\frac{1}{4}$ (57)	2 $\frac{1}{4}$ (57)	2 $\frac{1}{4}$ (57)	2 $\frac{1}{4}$ (57)	2 $\frac{1}{4}$ (57)	2 $\frac{1}{4}$ (57)	2 $\frac{1}{4}$ (57)	2 $\frac{1}{4}$ (57)	2 $\frac{1}{4}$ (57)	2 $\frac{1}{4}$ (57)	2 $\frac{1}{4}$ (57)
Price	\$450	\$700	\$450	\$700	\$450	\$700	\$450	\$700	\$450	\$700	\$700

Maximum ratings: maximum input power, peak or CW: 1 W; bias limits: +20 V, -10 V.

Bias polarity: negative voltage increases attenuation.

RFI: radiated leakage limits are below those specified in MIL-8731B at input levels less than 1 mW; at all input levels radiated interference is sufficiently low to obtain rated attenuation.

¹With -5 V bias.

²4 dB, 4 to 4.5 GHz.

³Driven by HP 8403A Modulator.

⁴2.0 SWR, 4 to 4.5 GHz.

⁵Fits 1 x 1/2 in. (WR 90) waveguide.

⁶External high-pass filters required.

⁷Excluding high-pass filters.



Swept measurement

Swept frequency measurement is a method of characterizing magnitude and phase parameters as a function of frequency for an unknown device, component or system. A complete swept frequency measurement system has three basic elements: 1) a sweeper which is the signal source, 2) the unknown to be characterized and 3) the detector and display with which to interpret measurement results. Swept frequency measurements evolved as a fast, convenient and accurate method of phase and magnitude characterization replacing the laborious point by point measurement techniques.

The sweeper or signal source in a swept frequency system is a controlled oscillator which is made to vary in frequency between two limits in a prescribed manner, usually linear frequency change with time. The output power of the sweeper should be constant over the range of frequencies swept. Leveled power enables detection and displays to be presented accurately and directly without need for correction due to generator level change during sweep. Accurate frequency identifications depends on the sweeper's frequency accuracy, sweep width accuracy, sweep linearity and frequency stability with changes in temperature, load and line. Frequency accuracy is of prime importance in making narrow band measurements accurately and quickly using swept frequency techniques. Dynamic displays permit on-line adjustment and rapid testing of devices.

The output from the unknown must be detected and displayed in a manner which facilitates easy and accurate identification of sweep frequencies as well as magnitude and phase information. Several types of detectors-displays are available depending on application requirements. For fast, inexpensive magnitude-only measurement, a crystal detector and scope, or crystal detector and SWR meter (415E) with scope or X-Y recorder can be used. A bolometer or thermistor detector can also be used with an X-Y recorder for amplitude only measurement. When a wider dynamic range, more accuracy and phase information are needed, the more sophisticated tracking detector or network analyzer is used with CRT displays. Hewlett-Packard

CRT displays are available in two configurations: polar or magnitude-phase.

Sweep oscillators

The sweeper is a multipurpose test instrument used in the design, manufacture and maintenance of devices, components and systems. Hewlett-Packard sweepers cover the entire RF frequency spectrum from dc to 40 GHz in four broad instrument lines. These instruments feature solid state components to 18 GHz and plug-in versatility for a choice of band. Hewlett-Packard solid state and backward wave oscillator sweepers have superior frequency stability, high power output, external or internal modulation, analog and digital programming capability and systems compatibility.

Sweep oscillator features

Sweep range selection

The sweep frequency limits of the instrument may be set by selecting one of several different sweep modes. Start-Stop, Marker, Video, or Full sweep modes begin sweeping at one independently adjustable calibrated frequency and stop sweeping at a second independently adjustable calibrated frequency. With symmetrical or ΔF sweep, the center of the sweep range is first independently selected and then the calibrated sweep width is chosen. Manual sweep allows the sweeper to function with operator front panel control, a real convenience for calibration of display devices such as X-Y recorders.

Another valuable feature of today's solid state oscillators is self-contained, multiband capability in one compact instrument. This is the ability to select swept coverage from over six octave ranges. (i.e., from 100 MHz to 6.5 GHz) by simply pressing one band select lever, without expensive extraneous equipment.

Power output and leveling

Power out is adjustable at the front panel. To obtain constant power output and a good source match at microwave frequencies, an automatic leveling loop is employed. The basic external leveling configuration is shown in Figure 1 (internal leveling available as an option, if not standard, on all Hewlett-Packard sweep oscillators).

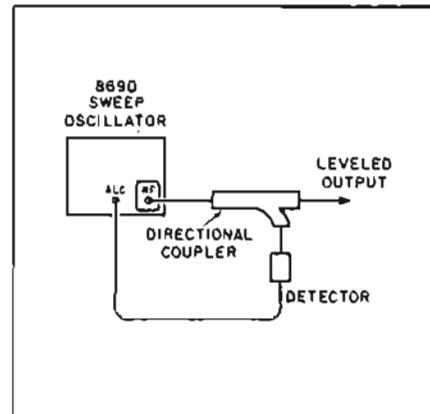

Figure 1. Basic closed-loop leveling system.

Leveling has two advantages: 1) leveled power output allows simplified detection and display and 2) the source match at the leveled output is markedly improved.

Modulation

Modulation capabilities further extend the sweepers usefulness both as a sweeper and as a signal generator for signal simulations. AM modulation is available both internally or externally on all Hewlett-Packard sweepers. AM modulation is useful for testing communication equipment and making microwave measurements (1 kHz modulation is required to drive the 415E SWR Meter). FM modulation allows remote analog programming of frequency (for example, for production testing) along with excellent FM signal simulation (for example, in communications).

Sweep control

Variable sweep rates are available from 0.01 to 100 seconds to match characteristic detector-display responses. Sweep may be initiated with automatic trigger, external trigger or manual trigger. Frequency changes linearly with sweep time until reaching the end sweep frequency. Blanking and pen lift signals are available at rear output connectors during flyback time when the RF is off.

Markers

Hewlett-Packard sweepers are sufficiently accurate to be used without markers but frequency identifications can be further improved with the use of markers or a counter with the sweeper in manual control.

Available outputs

The flexibility of a swept frequency instrument system depends on the sweeper being compatible and easily interfaced with other instruments or systems. Hewlett-Packard sweepers have all necessary outputs available for interconnection with Hewlett-Packard instrumentation systems.

Sweeper applications

Swept frequency systems are used to characterize an unknown's phase and magnitude characteristics as a function of frequency. Two basic types of measurements are made: transmission characteristics and reflection characteristics. For many transmission type measurements, it is only necessary to know amplitude response and establish that the phase response is linear, thereby causing no phase distortion. Reflection measurements are used to optimize device for impedance matching in order to obtain maximum power transfer. Swept frequency techniques can give complete sys-

tem characterization with S-parameter techniques for transistors, devices, components or systems.

For high power applications such as RFI-susceptibility test and high attenuation measurements, Hewlett-Packard offers TWT amplifiers which will provide better than 750 mW from 1-12.4 GHz. By phase-locking Hewlett-Packard's sweep oscillators, excellent microwave signal purity can be achieved for application such as microwave spectroscopy and high-Q swept frequency cavity measurements.

For achieving broadband sweep capability (more than one octave), Hewlett-Packard offers the HP 8707A RF Unit Holder and 8706A Control Unit. The 8706A Control Unit is placed in the sweeper and the RF plug-ins placed in the 8707A RF Unit Holder. Control of up to seven RF plug-ins is possible. With Hewlett-Packard's new solid state microwave sweepers, the 8620 series, this multiband capability is built-in and thus can operate as a value packed stand-alone instrument.

Complete amplitude and phase description of microwave devices is a powerful tool for component and systems design and test. Hewlett-Packard sweeper/network analyzer systems provide metered or CRT type (polar or magnitude and phase) real time display of this information. Active microwave components in a variety of packages, including can and stripline, can be accurately characterized and tested to 12.4 GHz.

Several Hewlett-Packard application notes such as the following describe numerous swept frequency measurements:

- AN65, "Swept Frequency Techniques"
- AN95, "S-Parameters . . . Circuit Analysis and Design"
- AN117-1 "Microwave Network Analysis Applications"
- AN117-2 "Stripline Component Measurements", etc.

All of these notes and others are available from your local Hewlett-Packard sales office.

Hewlett-Packard Sweep Oscillator—Summary Chart

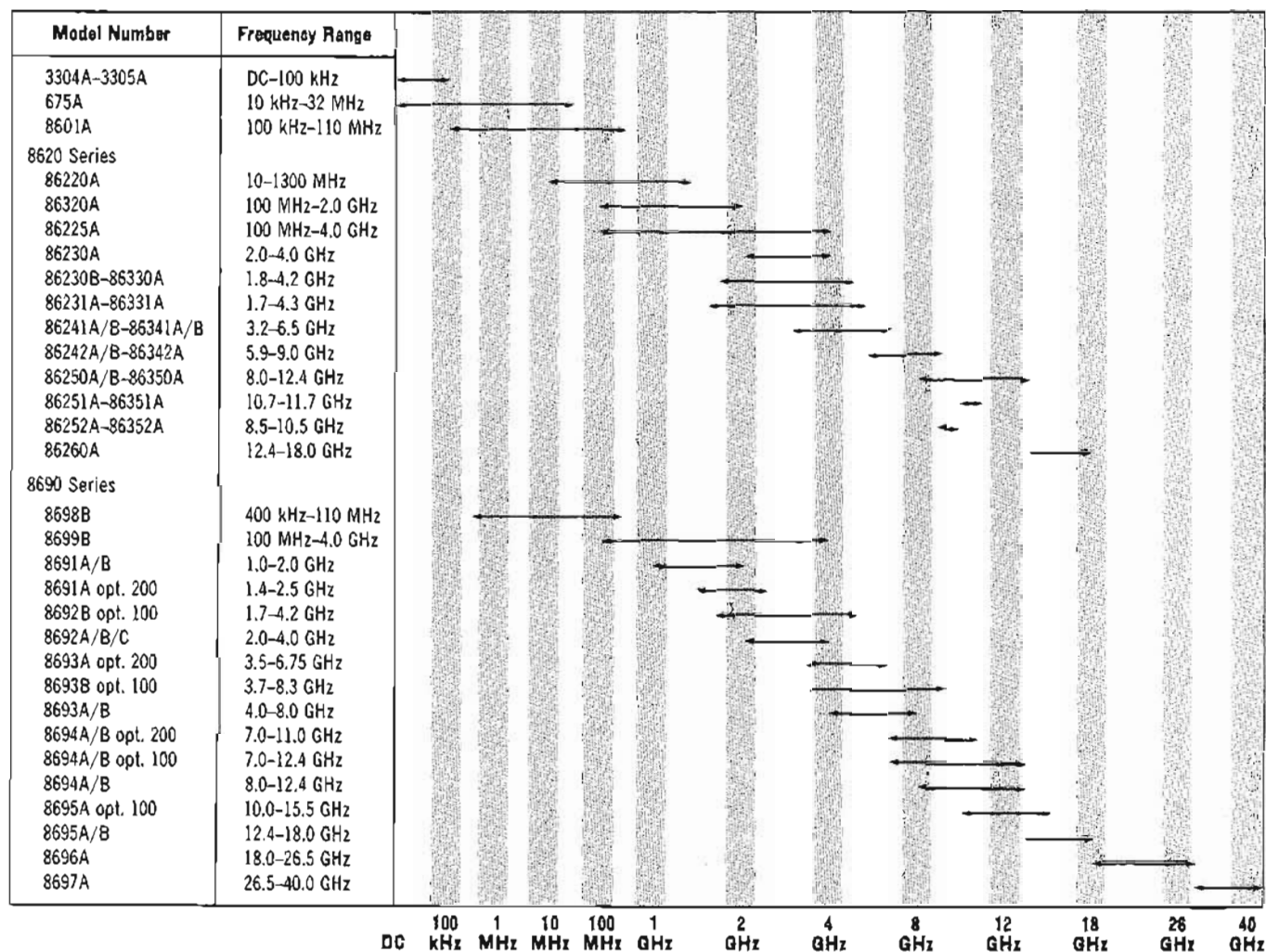

SWEEPERS



GENERATOR/SWEEPER

Digital marker

Model 8601A, 8600A



Covering 100 KHz to 110 MHz, the Model 8601A Generator/Sweeper combines the high linearity and flatness of a precision sweeper with a signal generator's frequency accuracy and wide range of calibrated power levels. Though it's small and lightweight, it does the work of two instruments easily and conveniently.

Specifications, 8601A

Frequency range: low range, 0.1-11 MHz; high range, 1-110 MHz.

Frequency accuracy: approximately $\pm 1\%$ of frequency.

Power output: +20 to -110 dBm; 10-dB steps and 13-dB

vernier provide continuous settings over entire range. Meter monitors output in dBm and rms volts into 50 Ω .

Power accuracy: ± 1 dB accuracy for any output level from +13 dBm to -110 dBm.

Flatness: ± 0.25 dB over full range, ± 0.1 dB over any 10 MHz portion (+10 dBm step or below).

Impedance: 50 Ω , SWR <1.2 on 0 dBm step and below.

Harmonics and spurious signals: (CW above 250 kHz, output levels below +10 dBm) harmonics at least 40 dB below carrier.

Residual FM: noise in a 10 kHz bandwidth including line related components (dominant component of residual FM is noise).

CW: less than 50 Hz rms, low range; 50 Hz rms high range.

SYM O, sweep: less than 100 Hz rms, low range; 1 kHz rms, high range.

Residual AM: AM noise modulation index (rms, 10 kHz bandwidth is <-50 dB; (typically -60 dB at 25°C).

Crystal calibrator: internal 5-MHz crystal allows frequency calibration to $\pm 10\%$ at any multiple of 5 MHz.

Sweep modes: full, video, and symmetrical.

Internal AM: fixed 30% $\pm 5\%$ at 1 kHz.

External AM: 0 to 50%, dc to 400 Hz; 0 to 30%, up to 1 kHz.

Internal FM: 1 kHz rate, fixed 75 kHz $\pm 5\%$ deviation, high range; 7.5 kHz $\pm 5\%$ deviation, low range.

External FM: sensitivity, 5 MHz per volt $\pm 5\%$, high range; 0.5 MHz per volt $\pm 5\%$, low range; negative polarity; FM rates to 10 kHz.

Weight: net, 21 lb (9.5 kg); shipping 27 lb (12.3 kg).

Dimensions: 7 25/32" wide, 6 3/32" high, 16 3/8" deep (190 x 155 x 416 mm).

Price: Model 8601A, \$2250.

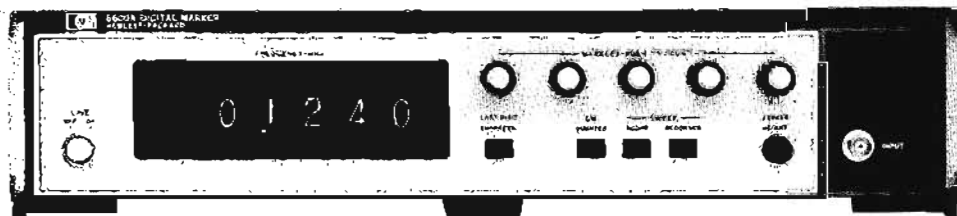

8600A

The Model 8600A Digital Marker provides five independent, continuously variable frequency markers over the range 0.1-110 MHz when used with the HP 8601A or 8690B/8698B Generator/Sweeper.

The high resolution controls and 6-digit readout permit 0.05% frequency settability. The frequency of any marker may be read while sweeping, simply by pushing a button within the marker control. The marker selected is brighter than the others and points in the opposite direction, ensuring positive marker identification.

Specifications, 8600A

Marker accuracy: any marker may be placed at a desired frequency \pm (0.05% of sweep width + 8601A sweeper stability).

Weight: net, 13 lbs (5.9 kg); shipping, 18 lbs (8.2 kg).

Dimensions: 3 7/8" high, 16 3/4" wide, 13 1/4" long (99 x 413 x 337 mm).

Price: Model 8600A, \$1100.

Option 001: includes modif. kit for 8690B/8698B; no additional charge.

VALUE FAMILY OF SWEEP OSCILLATORS

Models 8620A/B, 8621A, 86200 Series, 86300 Series



SWEEPERS

A Solid State Sweeper System with Outstanding Performance, Extreme Flexibility of Configurations, and Attractive Economies . . . All Made Possible by Modular Construction and Development of Superior Microelectronic Components.

The Mainframes:

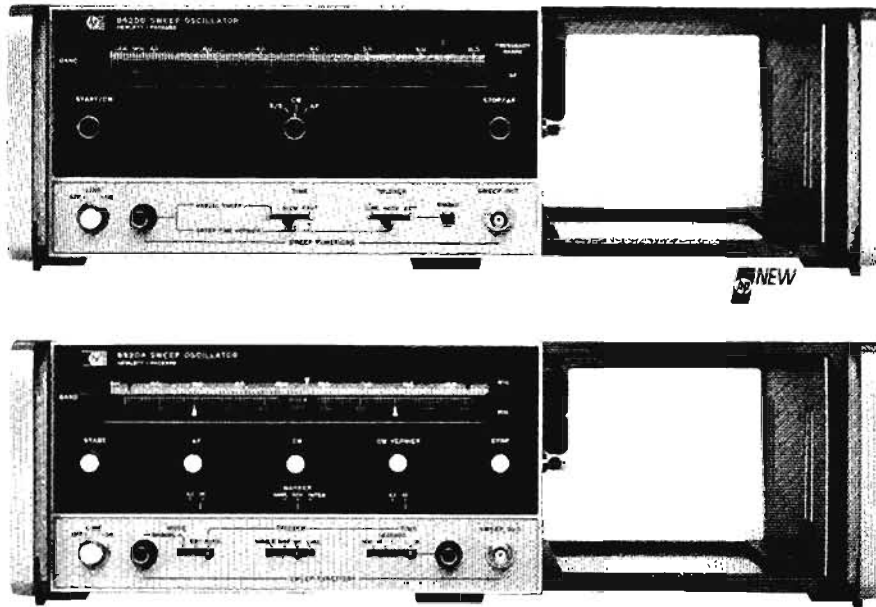

The RF Plug-ins:

Single-band

or

Multi-band



86200 Series
10 MHz to 18.0 GHz



8621A
RF Drawer



86300 Series
RF Modules
100 MHz to 12.4 GHz

SWEEPERS

A choice of two Solid State Mainframes
Models 8620B, 8620A

The 8620 family of sweep oscillators offers a choice of two solid state mainframes. Both are completely compatible with all RF plug-ins and offer as a standard feature multiband capability. The two mainframes differ in the number of operating modes and price.

Frequency band is selected by pressing a lever that rotates the frequency dial. This feature is standard on the 8620B as well as the 8620A mainframe.

One Simple Control allows setting of a CW frequency or Start-Stop sweep or ΔF sweep. This simplicity in the 8620B mainframe provides a high value sweeper at an extraordinarily low price.

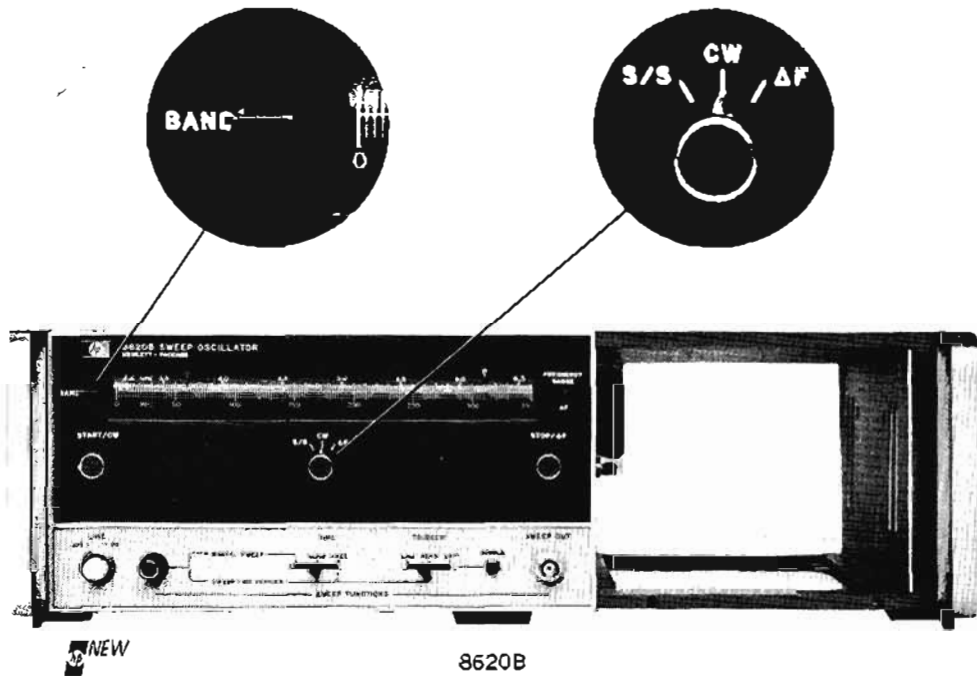

The 8620B is the more economical of the two mainframes but has all the features normally needed for swept-frequency measurements. It has highly linear sweeps, wide and narrow, and a stable CW. Yet it is priced much lower than any similar sweeper on the market.

Dimensions: 5 $\frac{1}{4}$ " (133 mm) high, 13 $\frac{1}{4}$ " (337 mm) deep, 16 $\frac{3}{4}$ " (425 mm) wide.

Weight: net, 24 lbs (11,1 kg); shipping, 30 lbs (13,4 kg).

Price: \$975.

ΔF Control sets a continuously calibrated sweep centered about the CW control setting. The expand switch allows frequency calibration from either 0 to 10% or 1% of full frequency band.

Independent CW Control serves as an amplitude or intensity marker when sweeping in the start-stop mode.

CW Vernier gives better frequency resolution than would be available on a 20-inch dial scale. This allows precise settings of CW frequencies or ΔF center frequencies.

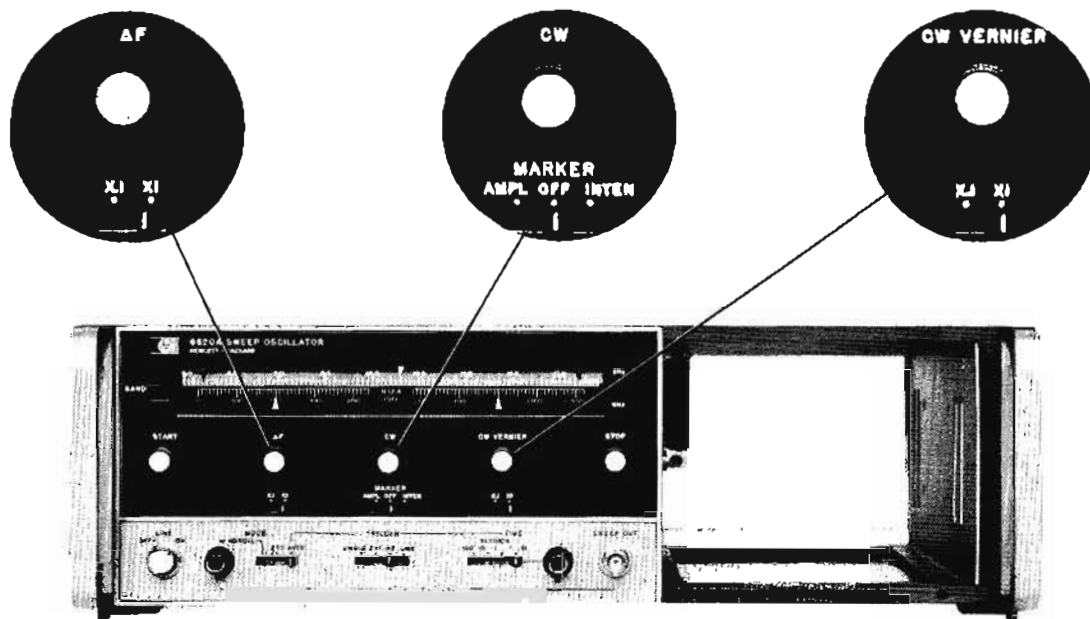

8620A

The 8620A offers all that the 8620B offers, and in addition has many other features that are highly useful in more stringent applications. Push-button convenience provides great latitude of control along with exceptional frequency resolution and settability. This mainframe can also be a completely programmable source (Option 001). Yet this mainframe is priced surprisingly low.

Dimensions: 5 $\frac{1}{4}$ " (133 mm) high, 13 $\frac{1}{4}$ " (337 mm) deep, 16 $\frac{3}{4}$ " (425 mm) wide.

Weight: net, 24 lbs (11,1 kg); shipping, 30 lbs (13,4 kg).

Price: \$1450.

Option 001: add \$500.

SWEEPERS

A choice of two types of RF Plug-ins

86200 Series, 86300 Series

SINGLE BAND Plug-ins

- High Performance
- Low Cost

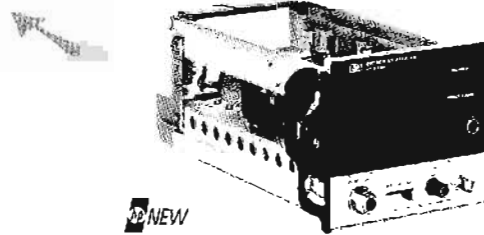
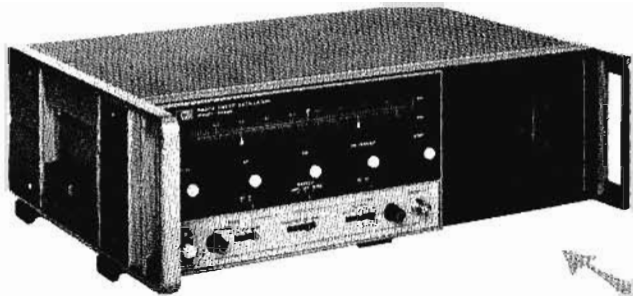

NEW

86200 Series

86200 Series RF Plug-ins

The 86200 series single-band plug-ins make extensive use of microelectronics for superior performance and high reliability at an extremely low price. Fundamental oscillators are either YIG-tuned transistor or bulk-effect circuits. YIG tuning results in exceptional tuning linearity and assures low noise and low spurious content. YIG tuning also provides low distortion frequency modulation capability at several MHz deviations and several MHz rates. Microcircuit PIN modulators in the plug-ins provide RF level control and amplitude modulation with virtually no frequency pulling.

The 86200 series plug-ins are completely compatible with either the 8620A or 8620B mainframe. Standard plug-ins are listed below. Special frequency bands and higher power outputs are available on request.

Frequency Range (GHz)	Maximum Leveled Pwr (dBm) ¹	Harmonic/Spurious (-dB)	Residual FM (kHz peak)	Price	Model Number
0.01-1.3	10	30/40	<5	1,775	86220A
0.1-4.0	(1-2) +13 (2-4) +10	30/30 20/60	<10 <7	3,750	86225A
2.0-4.0	7	16/60	<7	1,500	86230A
1.8-4.2	10	20/60	<7	1,900	86230B
1.7-4.3	9	20/60	<7	2,150	86231A
3.2-6.5	1	16/60	<7	1,500	86241A
3.2-6.5	10	20/60	<7	1,950	86241B
5.9-9.0	4	25/60	<15	1,675	86242A
5.9-9.0	10	30/60	<15	2,100	86242B
8.0-12.4	4	30/60	<10	1,675	86250A
8.0-12.4	10	30/60	<10	2,100	86250B
10.7-11.7	10	30/60	<10	1,700	86251A
8.5-10.5	13	30/60	<10	2,100	86252A
12.4-18.0	6	30/60	<30	2,850	86260A

86200 Series Options

- Option 010 or 020 must be ordered to specify proper dial scale.
- Option 010 includes 8620A dial scale, no charge.
- Option 020 includes 8620B dial scale, no charge.
- Option 001 internal leveling, add approximately \$350.
- Option 004 rear RF output, add \$75.

Dimensions: 5" (127 mm) high, 11⁵/₈" (295 mm) deep, 6" (152 mm) wide.

Weight: net, 5 lbs (2,3 kg); shipping, 7 lbs (3,2 kg).

MULTIBAND Plug-ins

- Modular Construction
- Self-contained

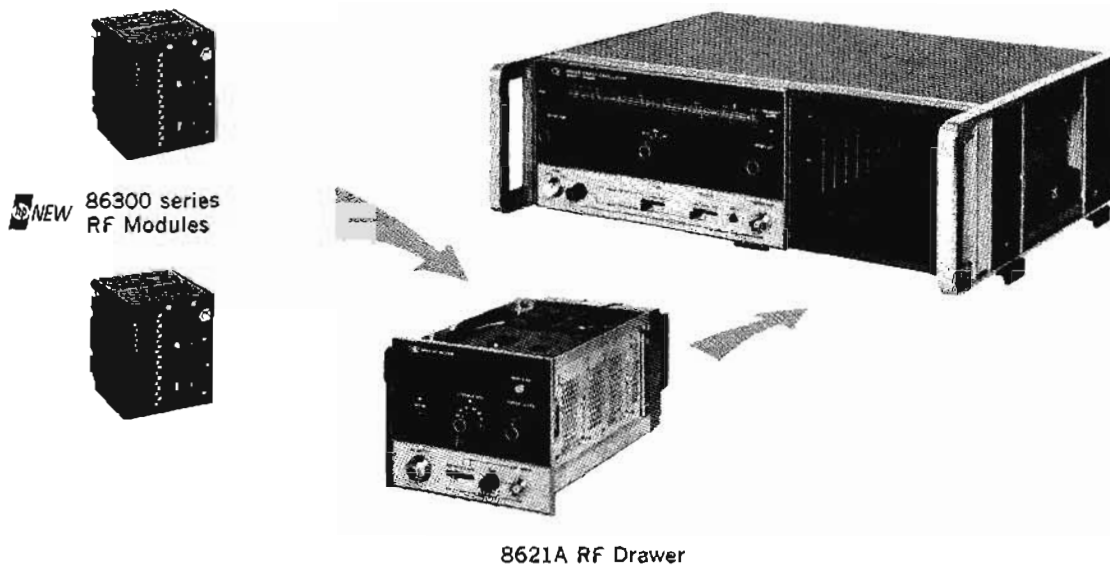

8621A RF Drawer

Frequency Range (GHz)	Maximum Leveled Pwr (dBm) ¹	Harmonio/Spurious (-dB)	Residual FM (kHz peak)	Price	Model Number
0.1-2*	+13	30/30	<10	\$1,750	86320A
1.8-4.2	+10	20/60	<7	1,850	86330A
1.7-4.3	+9	20/60	<7	2,100	86331A
3.2-6.5	+4	20/60	<7	1,650	86341A
3.2-6.5	+10	20/60	<7	1,800	86341B
5.9-9.0	+7	30/60	<15	1,950	86342B
8.0-12.4	+7	30/60	<10	1,950	86350A
10.7-11.7	+10	30/60	<10	1,650	86351A
8.5-10.5	+10	30/60	<10	1,850	86352A

*Order also 86330A or 86331A. 86320A cannot be used alone.

8621A RF Drawer, price: \$300.

Option 100—Multiband capability, add \$400.

Option 010—70 dB attenuator, add \$650.

Option 004—Rear RF output, add \$75.

Dimensions: 5" (127 mm) high, 11 $\frac{3}{8}$ " (295 mm) deep, 6" (152 mm) wide.

Weight: net, 3 lbs (1.4 kg); shipping, 5 lbs (2.5 kg).

86300 Series Options

Option 010, 020 or 030 must be ordered to specify proper dial scale.

Option 010 includes 8620A dial scale, no charge.

Option 020 includes 8620B dial scale, no charge.

Option 030 includes 8690B dial scale, no charge.

Option 001 internal leveling, add approximately \$250.

Dimensions: 4" (103 mm) high, 3 $\frac{3}{4}$ " (95 mm) deep, 3 $\frac{3}{8}$ " (92 mm) wide.

Weight: net, 3 lbs (1.4 kg); shipping, 4 lbs (1.8 kg).

With a multiband plug-in, changing frequency bands is as simple as pressing a front panel lever. Modular construction of a multiband plug-in allows a choice of any two fundamental RF modules and a heterodyne module. For example, 0.1 to 6.5 GHz can be covered in one self-contained plug-in. All switching necessary to multiplex the desired frequency band to a single output port is included in the plug-in.

The multiband plug-ins consist of two basic parts: the 86300 series RF Modules and the 8621A RF Drawer.

The 86300 series RF Modules contain all of the micro-electronic components that determine frequency range and power output. These microcircuits, in addition to giving the high performance and reliability that is normally expected of solid state components, are small enough so that a complete source module occupies only about four inch cube. These same modules can be used in conjunction with the 8700A RF Drawer to provide solid state plug-ins for the 8690A and 8690B mainframes.

The 8621A RF Drawer houses the 86300 series RF Modules. The standard drawer will accept one fundamental oscillator module. However, with the 1.8 to 4.2 GHz fundamental oscillator module, the standard drawer also accepts the 0.1 to 2 GHz heterodyne module to give 0.1 to 4.2 GHz coverage. The 8621A Option 100 will accept two fundamental oscillator modules and the heterodyne module. An optional 70 dB attenuator is also available along with a choice of either front or rear RF output.



SOLID STATE RF MODULES ... FOR 8690 SWEEPER SERIES

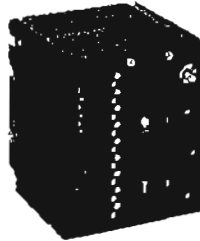

86300 Series RF Module. Same solid state modules as used in 8620 family of Sweep Oscillators.

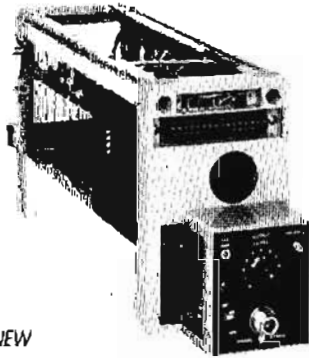

NEW

8700A RF Drawer

Dimensions: 4½" wide, 7¼" high, 17½" deep (115 mm x 185 mm x 445 mm).
Weight: net, 9 lbs (4,1 kg); shipping, 12 lbs (5,5 kg).
Price: \$425.

**8690B
Sweep
Oscillator
Mainframe**

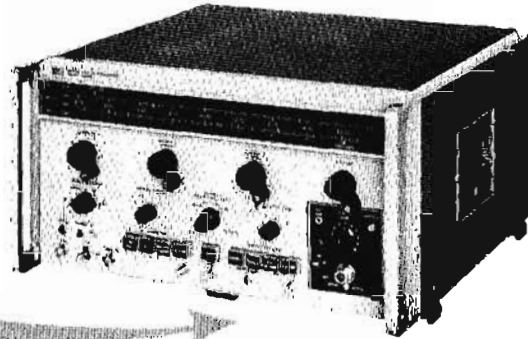

The 8690B Sweep Oscillator offers exceptional value in performance, operation and versatility. The 8690B mainframe provides complete flexibility with start/stop, ΔF , and marker sweep along with CW operation and AM and FM capability. The complete family of solid state and BWO plug-ins shown below, accent this value with coverage from 400 kHz to 40 GHz.
Dimensions: 8¾" (222 mm) high, 18⅝" (467 mm) deep, 16¾" (425 mm) wide.
Weight: net, 49 lbs (22,2 kg); shipping, 59 lbs (26,8 kg).
Price: \$1700.

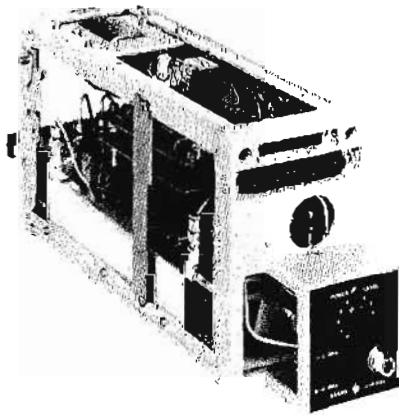

8699B RF Plug-in

PIN Leveled Solid State RF Plug-ins

Long life and high reliability are key features of all solid state oscillators. Through the extensive use of microelectronic circuitry such as absorptive PIN modulators, excellent performance is achieved in the areas of wide frequency coverage, low frequency pulling, low residual FM and good source match impedance.

Frequency Range (GHz)	Maximum Leveled Power	Harmonics/Spurious (-dB)	Residual FM (kHz peak)	Price	Model Number
400 kHz to 110 MHz	> 20 mW	20/40	< 5	\$1,625	8698B
0.1-4.0	> 6 mW	20/40	< 3	3,750	8699B
2.0-4.0	> 10 mW	20/40	< 3	2,075	8692C

BWO RF PLUG-INS

For high power and high frequency applications
8690 Series



SWEEPERS

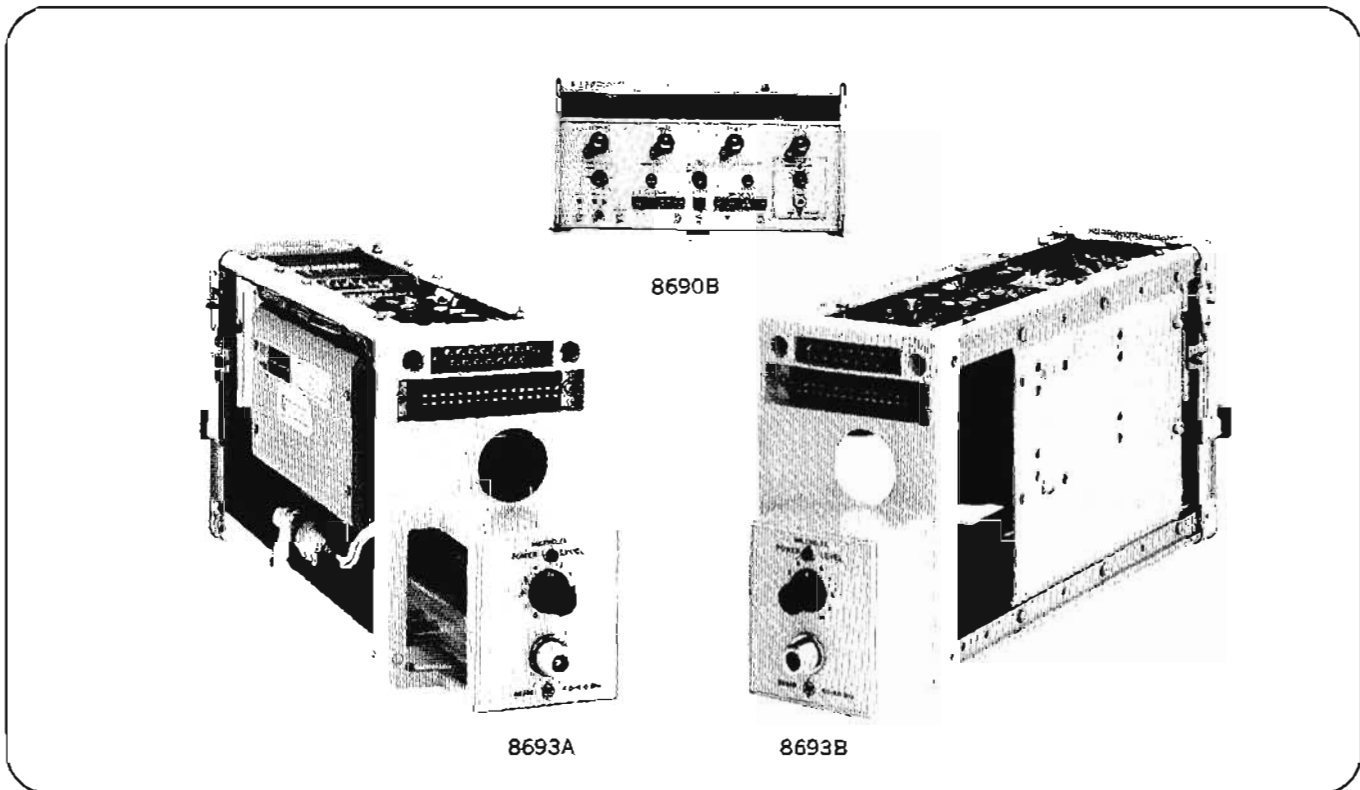

Grid Leveled BWO RF Plug-ins

Grid leveled BWO's achieve power and leveling control by changing bias on the grid of the BWO. Grid leveling provides the highest RF power plug-ins since no additional components such as PIN modulators are necessary for power control.

Frequency Range (GHz)	Maximum Leveled Power	Harmonics/Spurious (-dB)	Residual FM (kHz peak)	Price	Model Number
1.0-2.0	>100 mW	20/40	<30	\$2,125	8691A
1.4-2.5	>100 mW	20/40	<30	2,375	8691A/ Opt. 200
2.0-4.0	>70 mW	20/40	<30	1,950	8692A
3.5-6.75	>40 mW	20/40	<50	2,475	8693A/ Opt. 200
4.0-8.0	>25 mW	20/40	<50	1,850	8693A
7.0-11.0	>25 mW	20/40	<60	1,900	8694A/ Opt. 200
7.0-12.4	>25 mW	20/40	<60	2,150	8694A/ Opt. 100
8.0-12.4	>50 mW	20/40	<60	1,850	8694A
10.0-15.5	>25 mW	20/40	<150	2,975	8695A/ Opt. 100
12.4-18	>40 mW	20/40	<150	1,875	8695A
18-26.5	>10 mW	20/40	<200	2,750	8696A
26.5-40	>5 mW	20/40	<350	4,500	8697A

Option 001 internal leveling, add approximately \$450.

PIN Leveled BWO RF Plug-ins

PIN leveled BWO's achieve power and leveling control with a PIN modulator placed between the BWO and the front panel RF output. With constant bias and load impedance, the BWO provides a signal with low residual FM and frequency pulling with changes in power levels or load.

Frequency Range (GHz)	Maximum Leveled Power	Harmonics/Spurious (-dB)	Residual FM (kHz peak)	Price	Model Number
1.0-2.0	>70 mW	20/40	<10	\$2,475	8691B
1.7-4.2	>15 mW	20/40	<20	2,625	8692B/ Opt. 100
2.0-4.0	>40 mW	20/40	<15	2,275	8692B
3.7-8.3	>5 mW	20/40	<20	2,550	8693B/ Opt. 100
4.0-8.0	>15 mW	20/40	<15	2,225	8693B
7.0-11.0	>15 mW	20/40	<20	2,300	8694B/ Opt. 200
7.0-12.4	>15 mW	20/40	<20	2,550	8694B/ Opt. 100
8.0-12.4	>30 mW	20/40	<15	2,250	8694B
12.4-18	>15 mW	20/40	<25	2,375	8695B

Option 001 internal leveling, add approximately \$450.

SWEEPERS



ACCESSORIES

Applications and systems
8690B Series

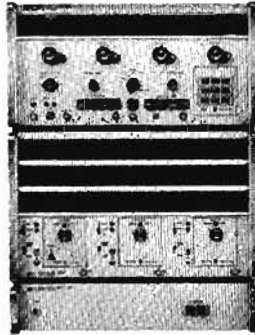

8690B with 8706A
Control Unit

8707A RF Unit Holder
with 8690B RF Units

8705A Signal Multiplexer

Multiband systems

Broadband sweep capability, 400 kHz to 40 GHz, with pushbutton control of frequency range is available with the 8706A Control Unit and the 8707A RF Unit Holder. The 8706A Control Unit plugs into the 8690B in place of the normal 8690B RF plug-in and the 8707A RF Unit Holder accepts the 8690B RF plug-ins which are to be controlled. It is possible to have pushbutton control of from two to seven 8690B RF plug-ins with an 8706A Control Unit and from one to three 8707A Unit Holders.

The 8705A Signal Multiplexer switches RF signals up to 12.4 GHz from three 8690B-series RF units to either of two RF ports. To provide leveled power at the 8705A RF output ports, a detector operating from a wideband coupler in the 8705A provides an ALC signal for the 8690B Sweep Oscillator leveling circuits.

Specifications, 8705A

Frequency range: dc to 12.4 GHz. Output port reflection coefficient ≤ 0.25 (VSWR ≤ 1.67). Input port reflection coefficient ≤ 0.15 (VSWR ≤ 1.35).

Insertion loss: 3 dB.

Weight: net, 17 lbs (7,8 kg); shipping, 22 lbs (10 kg).

Price: Model 8705A, \$2075.

Specifications, 8706A

Compatibility: the 8706A controls up to three 8707A RF Unit Holders; Option H26 for remote band switching of 8699B.

Weight: net, 16 lbs (7,3 kg); shipping, 25 lbs (11,4 kg).

Price: Model 8706A, \$650.

Specifications, 8707A

Capability: accepts up to three 8690B RF units.

Frequency range: 400 kHz to 40 GHz.

Sweep functions

Normal: permits all 8690B sweep functions.

Preset: provides start-stop sweep determined by preset adjustments on the 8707A. Sweep end points can be set independently for each RF unit.

Weight: net, 30 lbs (13,6 kg); shipping, 37 lbs (16,8 kg).

Price: Model 8707A, \$1525.

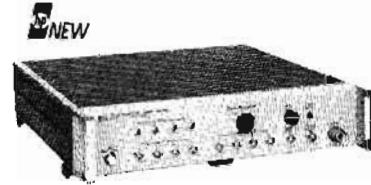

8701A



8404A

8701A Sequential Sweep Control

The 8701A Sequential Sweep Control makes possible wideband sweeping by sequentially triggering and controlling two, three, or four 8690A/B or 690C/D Sweeper Mainframes.

When the sweepers are connected to the 8701A, they maintain all of their sweep functions (i.e., START/STOP, ΔF , and MARKER SWEEP) and capabilities (sweep time and band tuning). Thus, a set of sweeper mainframes can operate in the START/STOP function to provide wideband sweeping, or one or more sweepers can operate in ΔF or MARKER SWEEP function to provide narrowband sweeping. Switching from wideband to narrowband sweeping is accomplished with the ease of pushing a button. Furthermore, by setting band ends for each sweeper mainframe independently, one can sweep any special band of interest such as communications and ECM bands which are not normally available in one RF plug-in oscillator.

Specifications, 8701A

Frequency coverage: 1-12.4 GHz; 1-18 GHz (8701A Option 001).

Leveling: $< \pm 1.5$ dB (1-2 GHz); $< \pm 1.25$ dB (2-12.4 GHz); $< \pm 2$ dB (12.4-18 GHz).

Weight: net, 16 lbs (7,3 kg); shipping, 20 lbs (9,1 kg).

Dimensions: 16 $\frac{3}{4}$ " wide, 3-25/32" high, 18 $\frac{3}{8}$ " deep (425 x 96 x 467 mm).

Price: 8701A, \$3850; Option 001, add \$200.

8404A Power Meter Leveling Amplifier

The 8404A Leveling Amplifier is used to level the 8690B Sweeper when a power meter is used as the RF detector. When the recorder output of the power meter (431B/C or 432A/B/C) is connected to the 8404A Leveling Amplifier and the output of the 8404A connected to the external AM input of the 8690B, ± 0.05 dB or less variation in leveled output can be expected.

Price: Model 8404A, \$395.

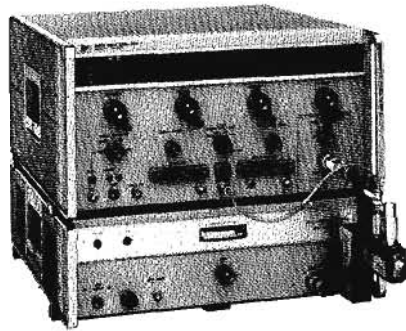

Leveled
High-power
Sweep
Oscillator
Systems

Leveled High-Power Sweep Oscillators

The 8322A/B Series leveled high-power sweep oscillator systems provide 750 mW broadband or 1 watt narrow band in four bands from 1 GHz to 12.4 GHz. Flatness is ± 0.3 dB from 1.0 to 8.0 GHz and ± 1.0 dB from 8.0 to 12.4 GHz. These systems are complete with solid state or BWO sweeper, Hewlett-Packard traveling wave amplifier, band-pass filter (8430A Series), directional detector (780 Series) and needed cables.

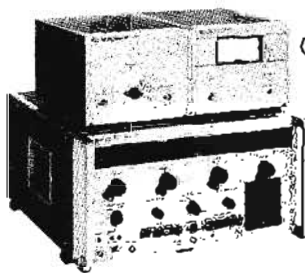

(8709A Synchronizer)

8320A Stabilized Source

8320A, 8321A, and 8324A Stabilized Sweep Oscillator Systems

Stabilized Sweep Oscillator Systems are phase-locked systems which increase the frequency stability of the microwave sweeper for more sophisticated microwave applications such as narrow-band receiver or filter tests, parametric amplifier pumps or Doppler system sources. Other applications include reflectometers, microwave spectroscopy and radio astronomy. CW stabilized systems are available from .1 to 40 GHz.

Complete specifications or data on these systems is available on request from Hewlett-Packard. Stabilized swept systems are available on special order.

Selected Specifications

Stabilized mode: CW only.

Frequency range: 0.5-12.4 GHz (8320A); 12.4-40 GHz Waveguide (8321A); 0.5-4 GHz (8324A).

Stability: $\leq 5 \times 10^{-7}$ /sec, $\leq 1 \times 10^{-5}$ /hr.

Residual FM: $\leq 5 \times 10^{-7}$ rms.

Dimensions: 15" high, 19" wide, 18" deep (approximately).

Price: \$7,500 to \$16,000 depending on band.

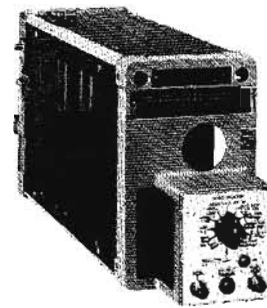

11531A

11531A Test Unit

The Model 11531A Test Unit facilitates 8690B Sweep Oscillator calibration. The unit plugs into the 8690B like an RF unit. Calibration voltages for sweep range amplitude and end points (all sweep modes) as well as marker calibration, BWO calibration, Blanking and Pen lift are sampled and made available at the Model 11531A front panel output for fast, accurate calibration.

Price: Model 11531A, \$350.

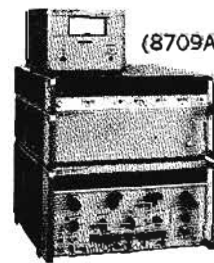

(8709A Synchronizer)

8457A
Microwave
Synthesizer
Signal Source

8457A Microwave Synthesizer, 8-40 GHz

The 8457A Programmable Microwave Synthesizer System offers today's user the utmost in frequency stability, operating simplicity and systems compatibility. Typical areas of application include automatic test systems, CW/Doppler radar, telecommunications, secure communications, narrow-band filter and receiver testing, anechoic chamber evaluations, radio and radar astronomy, MRR and EPR analytical spectroscopy. Complete specifications and options available on request.

Price: Model 8457A, \$21,000 to \$26,000 depending on frequency range and options ordered.

8709A Synchronizer

The 8709A Synchronizer features automatic synchronization and side-band cancellation; the lock points are spaced by the reference oscillator frequency (240-400 MHz). This eliminates ambiguities in achieving phase-lock and identifying harmonic lock numbers.

Specifications, 8709A

Input frequency: 20 MHz.

Sensitivity: -65 dBm.

Minimum output voltage

High level: +12.0 to -12.0 V dc.

Low level: +0.8 to -0.8 V dc.

Weight: net, 12 lbs (5.4 kg); shipping, 15 lbs (6.8 kg).

Price: HP 8709A, \$995.



Pulse and square wave generators are most often used with an oscilloscope as the measuring device. Waveform shapes as seen by the oscilloscope, either at the output or at pertinent points within a system under test provide both qualitative and quantitative evaluations of system or device performance.

Square waves or pulses

The fundamental difference between pulse and square wave generators concerns the signal duty cycle. Square wave generators have equal "on" and "off" periods, this equality being retained as the repetition rate is varied. The duration of a pulse generator "on" period, on the other hand, is independent of pulse repetition rate. The duty cycle of a pulse generator can be made quite low so that these instruments are generally able to supply more power during the "on" period than square wave generators. The HP Model 214A, for instance, supplies up to 200 watts in its output pulse.

Short pulses reduce power dissipation in the component or system under test. For example, measurements of transistor gain are made with pulses short enough to prevent junction heating and the consequent effect of heat on transistor gain.

Square wave generators are used where the low-frequency characteristics of a system are important, such as in the testing of audio systems. Square waves also are preferable to short pulses if the transient response of a system requires some time to settle down.

Pulse generators

In the selection of a pulse generator, the quality of the output pulse is of primary importance. High-quality test pulses insure that degradation of the displayed pulse may be attributed to the test circuit alone.



Figure 1. Carefully controlled pulse shapes insure accurate measurements.

The pertinent characteristics of a test pulse, shown in Figure 2, are controlled and specified accurately in Hewlett-Packard pulse generators. Rise and fall times should be significantly faster than the circuits or systems to be tested. Variable rise time and fall time, available in HP 1900 pulse system, HP Models 8002A, 8007A, 8012A, and 8005A, are useful for testing over a wide range of operating conditions.

Any overshoot, ringing, and sag in the test pulse should be known, so as not to be confused with similar phenomena caused by the test circuit.

The range of pulse width control should be broad enough to fully explore the range of operation of a circuit. Narrow pulse widths are useful in determining the minimum trigger energy required by some circuits.

Maximum pulse amplitude is of prime concern if appreciable input power is required by the tested circuit, such as a magnetic core memory. At the same time, the attenuation range should be broad enough to prevent overdriving the test circuits, as well as to simulate actual circuit operating conditions.

The range of pulse repetition rates is of concern if the tested circuits can operate only within a certain range of pulse rates, or if a variation in the rate is needed.

Triggering

The trigger requirements for synchronizing a pulse generator should be evaluated in light of the triggers available in anticipated measurement set-ups. Most Hewlett-Packard pulse generators have versatile trigger circuits similar to oscilloscopes. These circuits synchronize on most waveforms of more than 1 V amplitude.

Hewlett-Packard pulse generators also supply fast rise output triggers for operation of external equipment. The output triggers may be timed to occur either before or after the main output pulse.

Source impedance

Generator source impedance is an important consideration in fast pulse systems. This is because a generator which has a source impedance matched to the connecting cable will absorb reflections resulting from impedance mismatches in the external system. Without this match, reflections would be re-reflected by the generator, resulting in spurious pulses or perturbations on the main pulse.

DC coupling of the output circuit is necessary when retention of dc bias levels in the test circuit is desired in spite of variations in pulse width, pulse amplitude, or repetition rate.

Applications of pulse and square wave generators

Pulse generators with fast risetimes are widely used in the development of digital circuits. Teamed with a fast oscilloscope, these generators enable evaluation of transistor and diode switching times. Very fast rise time pulse generators used with fast oscilloscopes also can measure the stray inductances and capacitance of components.

Variable rise and fall time pulses are invaluable for testing devices whose output changes with rise and fall times, such as magnetic memories. Variable transition time pulses are useful in checking logic circuits where the input signal characteristics must be carefully specified.

Pulse generators are used as modulators for klystrons and other rf sources to obtain high peak power while maintaining low average power.

Pulse generators also are used for impulse testing. A very short pulse is rich in harmonic frequency components, so that impulse testing amounts to simultaneous frequency response testing of components or systems.

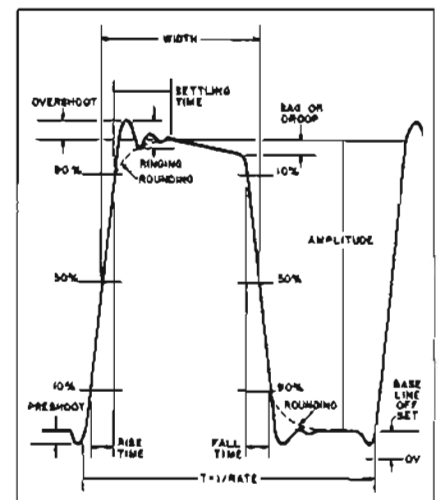

Figure 2. Test pulse description in terms of primary characteristics.

Test of linear systems with pulse or square wave generators and oscilloscopes are dynamic tests which quickly analyze system performance.

Hewlett-Packard designs pulse generators with fast rise times (fixed or variable), matched source impedance, flexible

pulse width and amplitude control, and versatile triggering capabilities required by a wide range of measurements. Particular attention has been paid to the quality of the output pulse, with all aspects of pulse shape carefully controlled and specified in detail.

Plug-in pulse generator

The 1900 system provides the optimum in performance at minimum cost by allowing you to select a pulse generator that will control only the pulse parameters required for a particular application. The completely specified high-quality test pulses provide accurate, dependable tests of circuits and components. Another feature is built-in shielding that reduces electro-magnetic radiation and conduction.

Flexibility and compatibility are achieved by having all pulse generator module circuits contained in a plug-in. Mainframes only contain the power supplies and, if desired, optional programming wiring. Plug-in design also provides the equivalent of two or more pulse generators, in laboratory applications, by simply changing plug-ins in a mainframe. In system applications, plug-ins can be selected to fit the exact test requirements and in the event of a malfunction, system downtime is reduced by changing plug-ins instead of the complete pulse generator. This flexibility is illustrated by the block diagram in figure 3.

Optional programming

All major functions in the 1900 system are designed for remote analog or digital

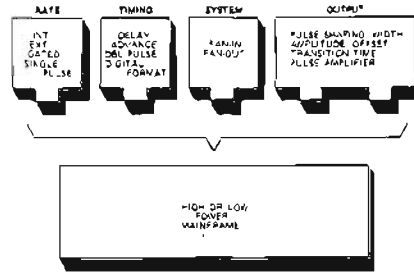

Figure 3. 1900 System Block Diagram.

programming, Analog programming provides semi-automatic testing of components or equipment that require several different repeatable pulse waveforms. Digital programming is provided by the 6936S multiprogrammer which allows control of a large number of pulse parameters with a single, 16 bit parallel computer word. This provides complete control of pulse parameters in a fully automatic test system at minimum cost.

Dedicated pulse generators

The versatile 8000 series pulse generators provide a wide selection of pulse parameter control and repetition rates to meet your testing requirements at the lowest possible cost. These pulse generators offer fixed or variable transition times, maximum rep rates of 10, 50, 100, and 200 MHz, fixed and variable delays, and many other features.

For digital applications, the 8006A word generator provides two 16-bit words or a single 32-bit word. With this versatility in output formats, digital

equipment can be fully exercised during design or checkout.

The range of repetition rates in the variable rise-and-fall-time models enable testing of circuits and components under actual operating conditions rather than conditions limited by the pulse generator. Also, rise and fall times can be adjusted to simulate a function generator, providing triangular, sawtooth, and trapezoidal shapes as well as pulses and square waves.

Fixed transition time pulsers are also available for checking fast switching speeds. Long pulse durations (some to 3 seconds) in these pulse generators make them ideal for checking analog devices such as wideband amplifiers, filters, and other linear devices.

For complex waveforms, the 8010A dual-channel pulse generator provides two separate pulse trains with independent control of all pulse parameters except rep rate. The two channels may also be combined without loss of amplitude to form pulses of almost any shape.

Models 8007A (100 MHz) and 8008A (200 MHz) will fill a design engineer's requirements in developing and testing high-speed digital circuits for computers, communications, telemetry, and many other applications. To further increase the usefulness of these pulse generators, they can be operated as a pulse shaper for RZ or NRZ formats which will make them compatible with technology for years to come.

Pulse Generator Selection Chart

TYPE	SQUARE WAVE		PULSE GENERATORS													DIGITAL	
	Model No.	211B	221A	214A	8002A	8003A	8004A	8005A	8007A	8008A	8010A	8012A	8013A	1900*	1900*	8006A	1900*
Max. Rep Rate (MHz)	10/1	10	1	10	10	10	10	100	200	10	50	50	25	125	10	50	
Gated Output			●	●	●	●	●	●	●	●	●	●	●	●			
Ext Trigger			●	●	●	●	●	●	●	●	●	●	●	●	●	●	
Delay	Fixed		Var	Fixed	Fixed	Var	Var	Var	Var	Var	Var	Var	Var	Var		Var	
Output V into 50Ω	-5/-30	+5	±100	±5	5	±5	5	±5	4	5	±5	5	±50	±5	5		
Simultaneous Output	-5				+5		+5		+,-	+,-		+,-					
Rise Time (ns)	5/70	10	15	10-2s	5	1	10 μs to 2s	2.5 to 250 μs	<1	10 to 1s	5 to 0.5s	3.5	7 to 1ms	<2	10		
Double Pulse			●			●	●	●	●	●			●	●			
Offset (V into 50Ω)						±2	±2	±2.5	±2	±2	±2.5	-5, +1 +5, -1	±3	±5			
Digital Formatting															two 16- or one 32-bit word	16-bit word 40Gen	
RZ/NRZ Formats (external input, word, PRBS, or bit error detection)								●	●		●	●	●	●	●	●	
Price	\$450	\$225	\$975	\$730	\$490	\$825	\$1100	\$1600	on req.	\$1925	\$875	\$625	*	*	\$1200	*	

*Plug-in pulse/digital system. output, risetime, price, and many other parameters vary with plug-ins. Refer to 1900 System selection chart for more details.



WORD GENERATOR

Two channel binary waveform generator
Model 8006A

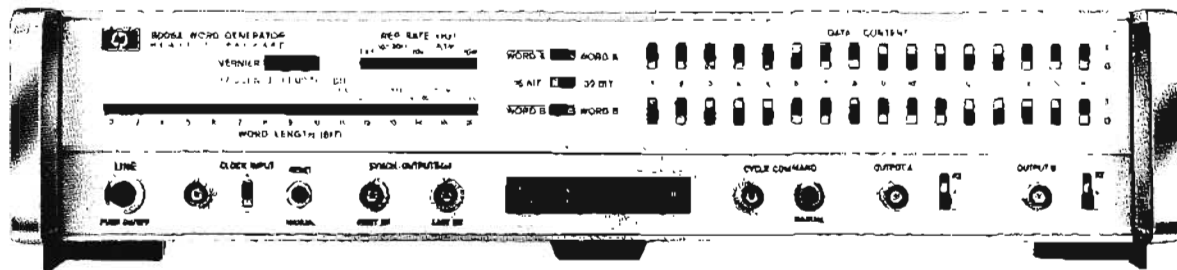

8006A

The 8006A generates serial digital words of variable length at clock rates up to 10 MHz. An easy selection of two 16 bit words is available. A single action puts the two 16 bit words in series to provide a 32 bit word at each output. Selectable operating modes include positive return-to-zero (RZ) format, positive and negative non-return-to-zero (NRZ) format, manual or automatic word cycling, complementary output signals, and remote programming of the data content. The remote programming feature allows conversion of parallel words to serial words. Two outputs provide trigger pulses coincident with the first and the last bit.

Additionally, a pseudo-random binary sequence variable from 7 to 65535 bits can be obtained from channel A output, with the inverted sequence available at channel B.

Specifications

Word generation: one 4 to 32 bit word (only even number of bits) or two 2 to 16 bit words.

Word content: independently set for both words by front panel switches or remote programming (parallel data input). Complement of each word selectable by front panel switches, WORD A - WORD A, WORD B - WORD B.

Word cycling: continuous or by cycle command (external trigger or manual).

Bit rate: internal, 10 Hz to 10 MHz, four ranges, continuous adjustment within ranges. Manual or external clock 0 to 10 MHz.

Reset: manual reset of word outputs to bit 1 in AUTO CYCLE mode and to word pause in SINGLE CYCLE mode.

Word format: +RZ/+NRZ/-NRZ selectable for each word output. Positive outputs have current sink capability to drive integrated circuits (TTL/DTL).

Synch outputs: trigger pulses corresponding to the first bit (leading edge) and last bit (trailing edge).

Pseudo-random sequence generation PRN: provides a linear shift register sequence at channel A output and the inverted sequence at channel B output. Maximum bit rate is 9 MHz.

Sequence length: variable from 7 to 65535 bits.

Trigger pulse: selectable for each bit in sequence.

Interface:

Clock input:

Repetition rate: 0 to 10 MHz. Amplitude: $> \pm 2$ V, $< \pm 10$ V.

Width: > 15 ns at ± 1 V. Input impedance: $> 500\Omega$.

Cycle command input:

Minimum period: word length plus 100 ns. Amplitude $> +2$ V, $< +10$ V.

Width: > 15 ns, at 1 V. Input impedance: $> 500\Omega$.

External data inputs: no storage capability for programmed data.

Low state: contact closure, saturated DTL or voltage source (TTL) > 0 V, $< +0.8$ V.

High state: open, off DTL or voltage source (TTL) $> +2.4$ V, $< +5$ V.

Synch outputs:

Amplitude: $> +2$ V across 50Ω .

Width: approx. 40 ns. Output impedance: 50Ω .

Word outputs:

Positive NRZ, RZ: high: $+2.5$ V across 50Ω , source impedance 50Ω . Low: ≥ -0.3 V, $\leq +0.3$ V, source impedance approx. 0Ω . Current sink capability 80 mA maximum.

RZ pulse width: approx. 45 ns.

Negative NRZ: high: 0 V. low: -5 V across 50Ω , source impedance 50Ω .

Transition times: < 10 ns.

General

Operating temperature: 0° to 50°C .

Power: 115 V or 230 V $\pm 10\%$ / -15% , 48 Hz to 440 Hz, 59 W.

Weight: net, $13\frac{1}{4}$ lbs (6 kg).

Dimensions: $16\frac{3}{4}$ " wide, $3\text{-}15/32$ " high, $13\frac{1}{4}$ " deep (425.5 x 88.2 x 337 mm).

Price: Model 8006A, \$1200

Option 001: rear panel clock output. Amplitude approx. 2 V across 50Ω . Source impedance approx. 50Ω . Pulse width approx. 30 ns. Price: add \$30.

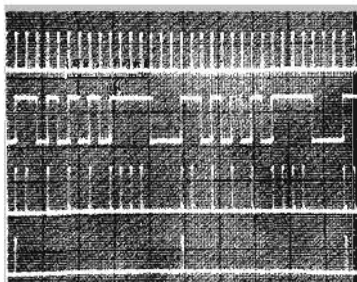

1. External clock
2. NRZ Output (16 bit continuous word recycling)
3. RZ Output signal
4. First bit synch pulse

PULSE GENERATORS

Maximum repetition rate 10 MHz
Models 8002A, 8003A, 8004A



SIGNAL SOURCES



8002A



8003A

The Hewlett-Packard 8002A generates pulses with variable transition times. All pulse parameters are variable over extremely wide ranges. Indeed, the 8002A is a function generator capable of delivering triangular, sawtooth and trapezoidal shapes as well as pulses and square waves.

Either positive or negative output signals can be selected, the source impedance is a constant 50Ω. Output amplitude is continuously adjustable from 0.02 to 5 volts and can be doubled by switching off the internal 50Ω load. The output is protected against damage from a short circuit.

The generator can be triggered externally with sine waves or pulses of either polarity. A trigger output signal is also available.

The 8003A is a highly flexible dual output general-purpose pulse generator, with fixed transition times of 5 ns; its characteristics are similar to those of the 8002A.

Remote programming of repetition rate, pulse width, and amplitude is offered as an option for the 8003A, making it suitable for use in automatic and semi-automatic test systems.

Specifications

Source impedance: 8002A: 50Ω ±10%. 8003A: 50Ω ±3% shunted by typ. 20 pF.

Pulse characteristics (50Ω source and load impedance):

Transition times:

8002A: 10 ns to 2 s, 6 ranges, ranges are common for both transition times, two verniers allow independent control of leading and trailing edge.

8003A: <5 ns.

Preshoot, overshoot, ringing: <5% of pulse amplitude.

Linearity: 8002A: for transition times >20 ns, maximum amplitude deviation from a straight line between the 10 and 90% points is less than 4% of pulse amplitude.

Amplitude: 5 V max. (10 V across an open circuit). Output circuit protected, cannot be damaged by shorting. Seven-step attenuator reduces output voltage to 0.05 V (positive and negative output independent on 8003A).

Polarity: 8002A: + or - selectable. 8003A: + and - simultaneously within 5 ns.

Pulse width: 30 ns to 3 s in 5 ranges.

Maximum duty cycle: >90% from 0.3 Hz - 1 MHz. >50% from 1 MHz - 10 MHz.

Delay: 8002A: 180 ns or 35 ns fixed delay between trigger and pulse. 8003A: 15 ns or 10 ns delay between Trigger Output and both Pulse Outputs.

Repetition rate and trigger:

Free running: 0.3 Hz to 10 MHz, 5 ranges.

Manual: pushbutton for single pulse.

Trigger input: sine waves 2 V_{p-p} or pulses of either polarity, >1 V up to 10 MHz.

Input impedance: approximately 1 KΩ, dc coupled.

External trigger delay: approximately 35 ns between leading edge of external input pulse and the leading edge of trigger output pulse.

Trigger output pulse (suitable for triggering another Model 8002A or 8003A): >+2 V across 50Ω, width 15 ns ±5 ns.

Synchronous gating: gating signal turns generator "on", last pulse is completed even if gate ends during the pulse.

Gate input: -2 V to -20 V enabling.

Input impedance: approximately 1 kΩ, dc coupled.

General

Power: 115 or 230 V ±10%, -15%. 50 Hz - 400 Hz, 40 W (8002A), 30 W (8003A).

Dimensions: 6-17/32" high, 7-25/32" wide, 11" deep (166 x 190 x 279 mm).

Weight: net, 9 lbs (4 kg); shipping, 11 lbs (5 kg).

Price: Model 8002A: \$730. Model 8003A: \$490.

Option 001 (8003A only): remote programming. Ranges: rep. rate, width by contact closure to ground. All verniers: by value of external resistor. Add \$70.

SIGNAL SOURCES *continued***Pulse Generators**

Models 8004A, 8010A

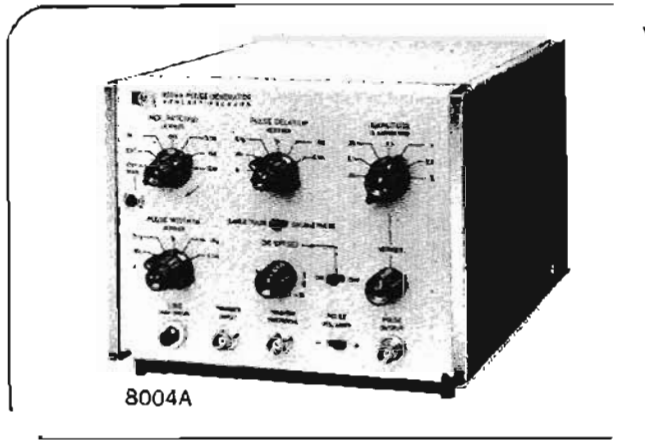
**8004A pulse generator**

The 8004A generates pulses with extremely fast transition times. Pulse width is variable over a wide range. The variable pulse delay can be reduced to zero. A double pulse mode provides convenient test signals for logic and memory circuits. DC offset permits the pulse baseline level to be set up to ± 2 V off ground independent of the setting of the pulse amplitude controls.

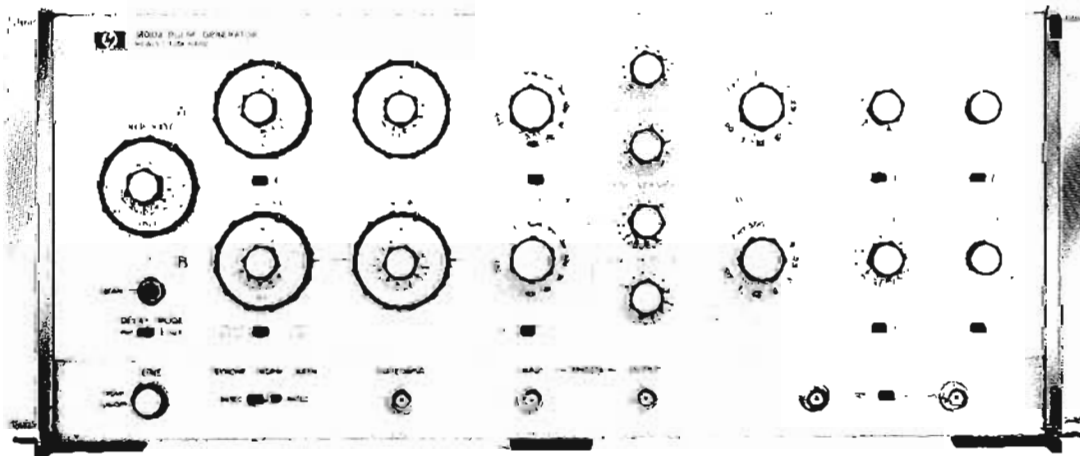
Specifications**Pulse characteristics (50 Ω source and load impedance):**Transition times: < 1.5 ns.**Preshoot, overshoot, ringing:** $< 5\%$ of pulse amplitude.**Amplitude:** 5 V max. seven-step attenuator reduces output to 0.05 V; continuous adjustment between steps reduces output to < 0.02 V. Output shortcircuit proof.**Polarity:** + or - selectable.**Source impedance:** 50 Ω shunted by typ. 10 pF.**DC offset:** ± 2 V across 50 Ω load; independent of attenuator and vernier settings; can be switched off.**Pulse width:** 0 to 1 ms in six ranges, Vernier provides continuous adjustment within ranges.**Maximum duty cycle:** $> 50\%$ from 100 Hz to 1 MHz; $> 25\%$ from 1 to 10 MHz.**Width jitter:** $< 0.1\%$ on any width setting, plus 50 ps.**Pulse delay (with respect to trigger output):** 0 to 1 ms in 5 ranges; continuous adjustment within ranges.**Delay jitter:** $< 0.1\%$ on any delay setting.**Repetition rate and trigger:** same as 8005A except:**Free running:** repetition rate: 100 Hz to 10 MHz, five ranges. Vernier provides continuous adjustment.**External triggering:** delay, approx. 125 ns between trigger input and trigger output. May be reduced to approx. 35 ns (slide switch on board).**Trigger output width:** 15 ns \pm 10 ns.**Gating:** same as 8005A except no A/B gate.**General****Power:** 115 or 230 V, $\pm 10\%$, -15% , 50 to 400 Hz, 35 W.**Weight:** net 7 lb (3.5 kg); shipping 9 lb (4.5 kg).**Dimensions:** 7 $\frac{3}{4}$ " wide, 6 $\frac{1}{2}$ " high, 11" deep (197 x 165 x 279).**Price:** \$825.**8010A pulse generator****8010A**

PULSE GENERATORS

Two channels for complex waveforms
Models 8010A, 8005A



SIGNAL SOURCES

8010A pulse generator

The Model 8010A Pulse Generator offers all the advantages of the 8005A plus additional features. The 8010A comprises two completely separate channels with only the repetition rate common to both. Pulse delay, width, transition times, amplitude, and DC-offset controls are indepen-

dent for each channel. Most front panel controls are calibrated.

The polarity of each output can be selected individually. Complex wave shapes, of the order shown in Figure 1 are generated by Channels A and B together with the 8010A's combining capabilities. Both channels can also be operated in a square wave mode.

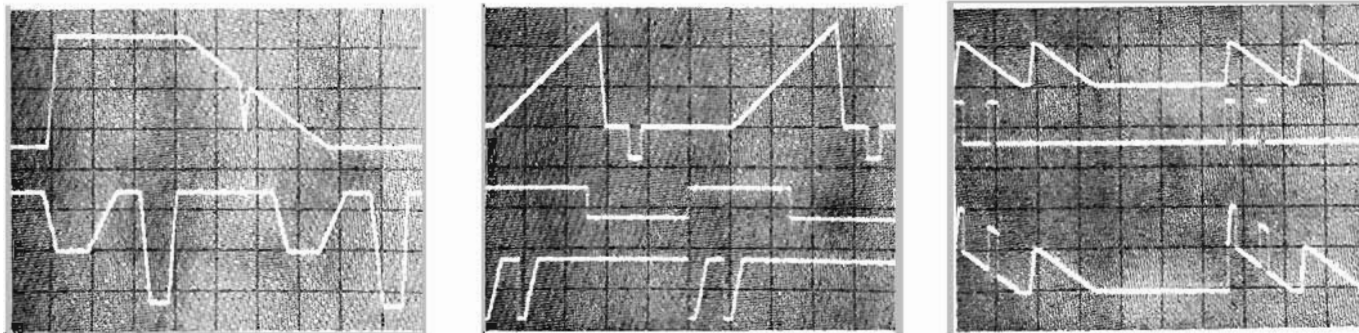

Figure 1. A selection of waveforms showing single and combined outputs.

Specifications

Pulse characteristics (with 50 Ω load impedance):

Transition times: sep. outputs: <10 ns to 1 s, eight ranges; ranges are common for leading and trailing edge. Independent verniers provide separate control of leading and trailing edge within each range up to a max. ratio of 1:10.

Common outputs: <12 ns to 1 s.

Accuracy: $\pm 10\%$ of setting $\pm 2\%$ of full scale ± 4 ns.

Linearity: for transition time >30 ns maximum amplitude deviation from a straight line between the 10% and 90% points is less than 4% of pulse amplitudes.

Overshoot and ringing: <5% of pulse amplitude.

Pulse width (A and B): <20 ns to 1 s eight ranges, continuous adjustment within ranges.

Accuracy: $\pm 10\%$ of setting $\pm 2\%$ of full scale ± 4 ns.

Maximum duty cycle: >90% for repetition rates from 1 Hz to 1 MHz. >50% from 1 to 10 MHz.

Width jitter: <0.1% on any width setting.

Maximum output: 5 V sep. Combined outputs: 10 V channel B (channel A no output).

Attenuator: seven-step attenuator reduces output to 0.05 V, continuous adjustment between steps reduces minimum output to 0.02 V.

Pulse polarity: A and B independently selectable.

Source impedance: 50 Ω $\pm 10\%$ shunted by typ. 20 pF.

DC-offset: ± 2 V across 50 Ω load. Independent of attenuator and vernier setting; can be switched off.

Pulse delay: (A and B) 50 ns to 1 s delay with respect to trigger output. Eight ranges; continuous adjustment within ranges.

Accuracy: $\pm 15\%$ of setting.

Delay jitter: <0.1% on any delay setting.

Repetition rate and trigger:

Free running: 1 Hz - 10 MHz, seven ranges, continuous adjustment within ranges.

Accuracy: $\pm 10\%$ of setting $\pm 2\%$ of full scale.

Period jitter: <0.1%.

Square wave: 1 Hz - 10 MHz output symmetrical to ground.

Double pulse: channel A and B independently selectable.

External triggering:

Rep. rate: 0 to 10 MHz. (For square wave output frequency divided by a factor of 2).

Trigger input: sine waves 1 V p-p. Pulses 0.5 V, >20 ns.

Input impedance: 1.0 k Ω .

Delay: approximately 30 ns between trigger input and trigger output.

Manual: pushbutton for single pulse.

Sep. triggering for both channels: +2 V, >50 ns. Input impedance 50 Ω (inputs on rear panel).

Trigger output:

Amplitude: > +2 V across 50 Ω . 15 ns ± 10 ns.

Impedance: 50 Ω .

Synchronous gating: gating signal turns rate generator "on".

Asynchronous gating: gating signal turns the output pulse "on". Trigger output always available.

Gate inputs: -2 V to -10 V enabling.

General

Power: 115 or 230 V + 10%, -15%, 50 to 400 Hz 200 W.

Dimensions: 16 $\frac{3}{4}$ " wide, 7 $\frac{1}{4}$ " high, 18 $\frac{3}{8}$ " deep (425 x 184 x 466 mm).

Price: \$1925



PULSE GENERATORS

Two channels for complex waveforms
Models 8010A, 8005A

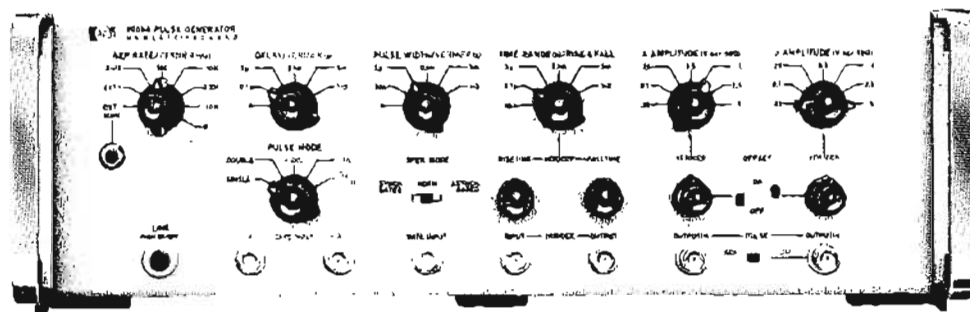

8005A

8005A pulse generator

With adjustable rise and fall times, variable width and delay features, simultaneous positive and negative outputs that can be combined into a single complex signal, the Model 8005A gives complete control of the output waveform. Both output amplitudes are separately adjustable and dc-offset controls allow independent setting of the baseline. Versatile gating possibilities further enhance the utility of the 8005A. Signals of great complexity can be generated using the A/B delay mode, as illustrated in Figure 1.

Specifications

Pulse characteristics (50 Ω source and load impedance):

Transition times: separate outputs: <10 ns to 2 s, six ranges (common for both transition times), independent verniers for leading and trailing edge.

Common outputs: <12 ns to 2 s.

Linearity: for transition times >30 ns, maximum amplitude deviation from a straight line between 10 and 90% points is $\leq 4\%$ of pulse amplitude.

Preshoot, overshoot, ringing: <5% of pulse amplitude.

Pulse width: 30 ns to 3 s in five ranges; continuous adjustment within ranges.

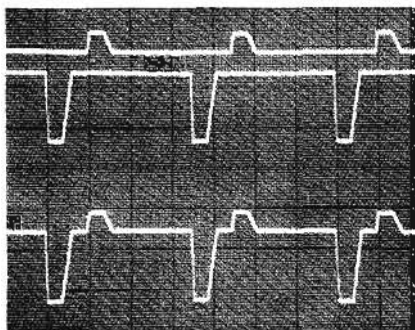

Figure 1. Separate and combined non-simultaneous outputs.

Maximum duty cycle: >90% for repetition rates from 0.3 Hz to 1 MHz; >50% from 1 to 10 MHz.

Width jitter: <0.1% on any width setting.

Amplitude: 5 V maximum (10 V across an open circuit); seven-step attenuator reduces output to 0.05 V; continuous adjustment; minimum output 0.02 V.

Output mode: Sep: + and - pulses available simultaneously or delayed with respect to each other. Delay is variable.

Source impedance: 50 $\Omega \pm 10\%$ shunted by 20 pF.

DC-offset: ± 2 V across 50 Ω load; can be switched off.

Pulse delay: 100 ns to 3 s with respect to trigger output; five ranges; continuous adjustment within ranges. Delay jitter: <0.1% on any setting.

Repetition rate and trigger:

Free running: 0.3 Hz to 10 MHz, five ranges; continuous adjustment within ranges. Period jitter: <0.1%.

Double pulse: increases max. rate to 20 MHz.

External triggering: 0 to 10 MHz.

Sensitivity: sine waves 2 V p-p; pulses 1 V peak, >15 ns; maximum input ± 10 V. Delay: approx. 35 ns between trigger input and trigger output. Input impedance: approx. 1 k Ω , dc-coupled.

Manual: pushbutton for single pulse.

Trigger output: amplitude >+2 V across 50 Ω , 15 ns ± 5 ns wide.

Gating:

Synchronous gating: gating signal turns generator "on". Last pulse is completed even if gate ends during pulse.

Asynchronous gating: gating signal turns output pulse "on". Trigger output always available; last pulse ends with gate.

Gate A/B: independent gating signal for each output.

Gate input: -2 V to -20 V enabling.

Input impedance: approx. 1 k Ω , dc-coupled.

General

Power: 115 or 230 V, $\pm 10\%$, -15%, 50 to 400 Hz, 68 W.

Weight: net 16 lb (7 kg); shipping 20 lb (9 kg).

Dimensions: 16 $\frac{3}{4}$ " wide, 5 $\frac{1}{2}$ " high, 13 $\frac{3}{4}$ " deep (425 x 140 x 336 mm).

Price: \$1100.

PULSE GENERATOR

Repetition rate up to 100 MHz
Model 8007A



SIGNAL SOURCES

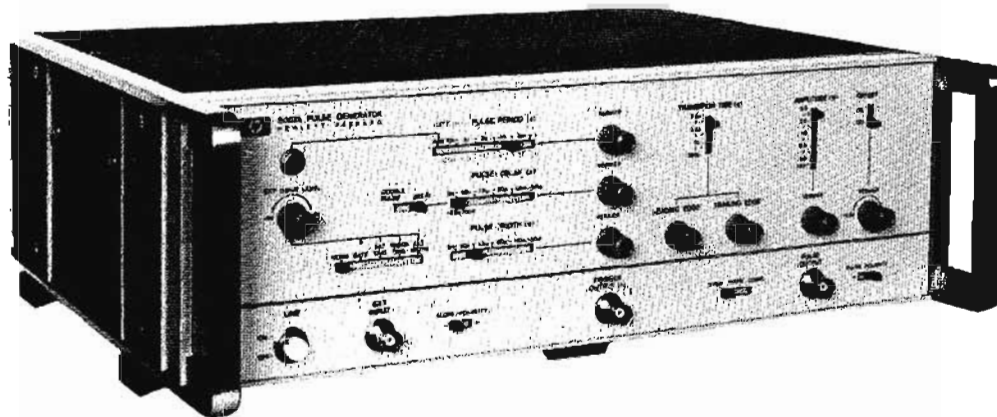

8007A

The 8007A is a versatile pulse generator with very fast variable transition times of 2.5 ns min.

The output can be set to positive or negative polarity, complement or symmetrical to ground, square waves can be simulated by adjusting pulse width and transition time. Variable DC-offset of ± 2.5 V is also available.

In "External Width" mode drive input and output pulse have equal width. Transition times and amplitude of the output pulse can be set by the front panel controls. This

mode is useful for shaping NRZ signals, as the width information is passed on to the output pulse unchanged.

The "Width Trigger" mode is suitable for shaping RZ signals. Delay, width, transition times and amplitude are determined by the front panel controls.

External triggering and synchronous gating are provided. The trigger level is adjustable for all externally controlled modes with the slope polarity selectable. This is very useful to avoid malfunction caused by noise and ringing on the external trigger signal.

Specifications

Pulse characteristics (50 Ω source and load impedance):

Transition times: <2.5 ns to 250 μ s, three ranges (common for both transition times). Independent verniers for adjusting leading and trailing edge within each range up to maximum ratios of 1:50 or 50:1.

Linearity: for transition times >20 ns; maximum amplitude deviation from a straight line between 10% and 90% points $\leq 5\%$ of pulse amplitude.

Preshoot, overshoot, ringing: <5% of pulse amplitude.

Pulse width: <5 ns to 50 ms in five ranges. Vernier provides continuous adjustment within ranges.

Width jitter: <0.1% on any width setting.

Maximum duty cycle: normal >50%; complementary approx. 100%.

Amplitude: 5 V max. (10 V across an open circuit); four-step attenuator reduces output voltage to 0.5 V. Vernier provides continuous adjustment between steps and reduces output to 0.2 V. Pulse can be switched off for offset adjustment.

Pulse output: + or - polarity selectable; normal, complement, or symmetrical to ground.

Source impedance: 50 Ω \pm 4 Ω shunted by typ. 10 pF.

DC-offset: ± 2.5 V across 50 Ω load. Independent of amplitude setting, can be switched off.

Pulse delay: <30 ns to 50 ms with respect to trigger output.

Five ranges, with continuous adjustment within ranges.

Delay jitter: <0.1% on any delay setting.

Repetition rate and trigger: 10 Hz to 100 MHz in five ranges. Continuous adjustment within ranges.

Period jitter: <0.1%.

Double pulse: available only up to pulse rate setting of 50 MHz, representing an output pulse rate of 100 MHz.

Trigger output: > +1 V across 50 Ω . 4 ns \pm 2 ns wide.

External triggering: 0 to 100 MHz.

Delay: approximately 15 ns between trigger input and trigger output.

Manual: front panel pushbutton for single pulse.

External width and Width trigger:

External width: output pulse width determined by width of drive input.

Width trigger: external drive input switched to the width generator. Pulse width determined by front panel width setting.

Rate generator: provides trigger pulses independent of drive input.

Synchronous gating: gating signal turns generator "on". Last pulse is completed even if gate ends during pulse.

External input: impedance: 50 Ω , DC-coupled. Max. input: ± 5 V.

Level: adjustable from +1 V to -1 V. Polarity: + or -.

Sensitivity: sine waves 1 V; pulses ± 0.5 V.

General

Operating temperature range: 0°C to +55°C.

Power requirements: 115 or 230 V $\pm 10\%$, -15%, 48 to 440 Hz, 100 VA (maximum).

Weight: net 17.6 lb (8 kg), shipping 19.8 lb (9 kg).

Dimensions: 16 $\frac{3}{4}$ " wide, 5 $\frac{1}{2}$ " high, 13 $\frac{1}{4}$ " deep (425 x 140 x 344 mm).

Price: \$1600.

SIGNAL SOURCES



PULSE GENERATORS

Repetition rate up to 50 MHz, high flexibility
Models 8012A, 8013A

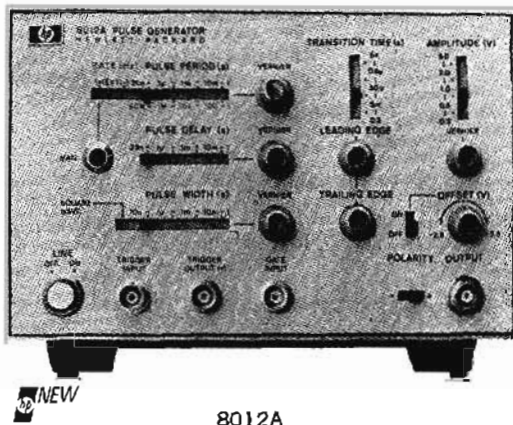

8012A

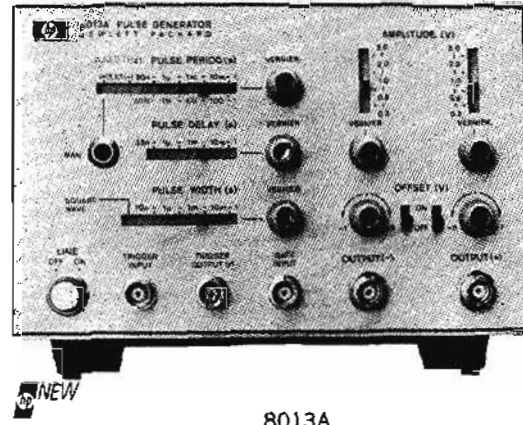

8013A

The 8012A and the 8013A are extremely flexible pulse generators with repetition rate, delay, width, amplitude and DC offset variable over very wide ranges.

The 8012A has one output and offers independently variable transition times, ranging from 5 ns to 0.5 s.

The 8013A has two outputs, providing simultaneous pulses of opposite polarity. Transition times are fixed at 3.5 ns.

Both instruments feature external triggering, synchronous gating, square wave mode and pulse shaping capability for RZ and NRZ signals.

Specifications

Pulse characteristics (50 Ω source and load impedance):

Transition times: 8012A: 5 ns–0.5 s in four ranges. Ranges common for both transition times, verniers provide separate control of leading and trailing edge within each range up to maximum ratios of 100:1 or 1:100. 8013A: 3.5 ns fixed.

Linearity: (8012A) for transition times >30 ns maximum deviation from a straight line between the 10% and 90% points is 5% of pulse amplitude.

Preshoot, overshoot, ringing: <5% of pulse amplitude.

Pulse width: <10 ns to 1 s in four ranges. Vernier provides continuous adjustment within ranges.

Width jitter: <0.1%–50 ps on any width setting.

Maximum duty cycle: >75% from 1 Hz to 10 MHz, decreasing to >40% at 50 MHz.

Maximum output: 5 V across 50 Ω . (10 V across open circuit). Output circuit protected, cannot be damaged by shorting. 8013A: internal 50 Ω load may be disconnected, providing 10 V across 50 Ω .

Attenuator: four-step attenuator reduces output voltage to 0.5 V. Vernier provides continuous adjustment between steps. Minimum output 0.2 V.

Polarity: 8012A: positive or negative selectable. 8013A: two outputs, positive and negative.

Source impedance: 8012A: 50 Ω \pm 10% shunted by typ. 20 pF. 8013A: 50 Ω \pm 3% shunted by typ. 20 pF.

DC offset: (across 50 Ω load) 8012A: \pm 2.5 V. 8013A: positive output: +1 V to –5 V, negative output: –1 V to –5 V. Independent of amplitude control settings, may be switched off.

Pulse delay: <35 ns to 1 s (with respect to trigger output), four ranges; continuous adjustment within ranges.

Delay jitter: <0.1% +50 ps on any delay setting.

Repetition rate and trigger: 1 Hz to 50 MHz in four ranges, continuous adjustment within ranges.

Period jitter: <0.1% +50 ps on any rate setting.

Square wave: 0.5 Hz to 25 MHz in four ranges. Duty cycle 50% \pm 5% up to 1 MHz, tolerance increases to \pm 15% at 25 MHz.

Trigger output: >+1 V across 50 Ω , 16 ns \pm 10 ns wide. Suitable for triggering another 8012A.

External triggering: 0 to 50 MHz. For square wave output, frequency divided by factor 2.

Trigger input: sine waves 1.5 Vp-p (about zero), pulses 0.8 V, either polarity, >7 ns. Maximum input \pm 7 V.

Impedance: 50 Ω \pm 10%, dc coupled.

Delay: 25 ns \pm 8 ns between leading edge of trigger input and trigger output signals.

Manual: pushbutton for single pulse.

Gating:

Synchronous gating: gating signal turns generator "on". Last pulse is completed even if the gate ends during pulse.

Gate input: dc-coupled; voltage at open connector approx. +1.8 V. Shorting current \leq 12 mA. Input impedance approx. 160 Ω .

Gate input signal: voltage >+1.5 V or resistor >300 Ω to ground enables rep. rate generator. Voltage <+0.8 V or resistor <150 Ω disables rep. rate generator. Gate input TTL compatible.

Maximum input signal: = 5 V.

External width and RZ:

External width: output pulse width determined by width of drive input signal. Amplitude, transition times selectable.

RZ mode: external drive input switched to delay generator. Period determined by period of drive input signal. Delay, amplitude width, transition times selectable.

Rep. rate generator: provides trigger output independent of external width input signal.

Input signal: >+1 V, >7 ns wide. Maximum \pm 5 V. Impedance 50 Ω , dc coupled.

General

Operating temperature range: 0°C to +55°C.

Power: 115 or 230 V +10%, –15%, 48 to 440 Hz, 70 VA max.

Weight: net, 9 lbs (4 kg); shipping, 14.6 lbs (6.5 kg).

Dimensions: 7.9" wide, 5.6" high, 13" deep (200 x 142 x 30 mm).

Price: 8012A \$875.

8013A \$625.

PULSE GENERATOR

Repetition rate up to 200 MHz, two outputs
Model 8008A



SIGNAL SOURCES

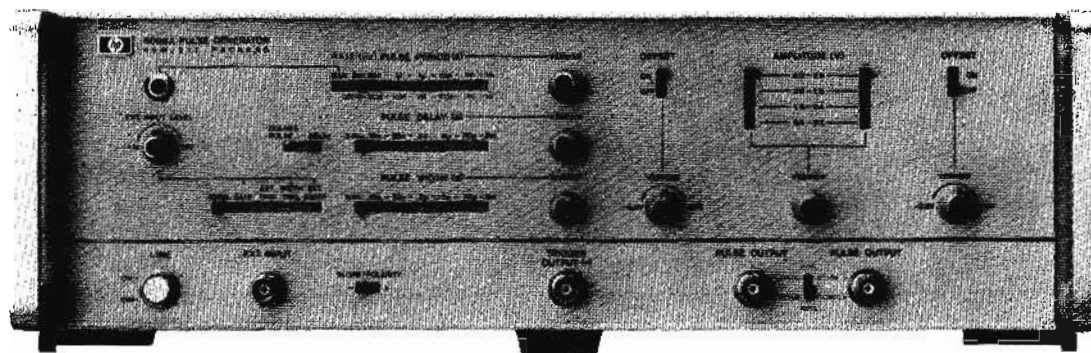

8008A

The Model 8008A is an extremely fast pulse generator with repetition rate variable from 10 Hz to 200 MHz and fixed transition times < 1 ns.

The two outputs make pulse and complement available simultaneously, with selectable polarity. The maximum output amplitude of 4 V, together with the DC-offset of ± 2 V ensures compatibility with the fastest logic integrated circuits available.

This model can also be operated as pulse shaper in the same way as the 8007A pulse generator. External gating and triggering are possible; the trigger level for any external input signal can be adjusted between +1 V and -1 V.

Specifications

Pulse characteristics (50 Ω source and load impedance):

Transition times: < 1 ns fixed.

Preshoot, overshoot, ringing: $< 5\%$ of pulse amplitude.

Pulse outputs: normal and complement simultaneously, polarity common for both outputs, + or - selectable.

Source impedance: 50 Ω $\pm 5\%$ shunted by typ. 10 pF.

Amplitude: 4 V max, four-step attenuator reduces output to 0.5 V separately for each channel. Vernier common for both outputs: continuous adjustment between steps, minimum output less than 0.2 V.

DC-offset: ± 2.0 V across 50 Ω load. Separately adjustable for each channel. Independent of amplitude setting; can be switched off.

Pulse delay: < 25 ns to 0.5 ms with respect to trigger output. Six ranges, continuous adjustment within ranges.

Delay jitter: $< 0.1\%$ on any delay setting.

Pulse width: 2.5 ns to 0.5 ms, six ranges, continuous adjustment within ranges.

Width jitter: $< 0.1\%$ on any width setting.

Maximum duty cycle: $> 50\%$.

Repetition rate and trigger: 10 Hz to 200 MHz, six ranges, continuous adjustment within ranges.

Double pulse: to 100 MHz (simulates 200 MHz).

Period jitter: $< 0.1\%$ on any period setting.

Trigger output: $> +1$ V across 50 Ω , 3 ns ± 1 ns wide.

External triggering: 0 to 200 MHz, sine waves 1 Vp-p, pulses 0.5 V, > 2.5 ns wide, either polarity.

Delay: approximately 10 ns between trigger input and trigger output.

Manual: pushbutton for single pulse.

Width trigger and external width

Width trigger: external drive input switched to delay generator.

External width: output pulse width determined by drive input.

Rate generator: provides trigger pulses independent of drive input.

Synchronous gating: gating signal turns generator "on". Last pulse is completed even if gate ends during the pulse.

External input: impedance: 50 Ω , dc coupled. Maximum input: ± 10 V.

Trigger level: adjustable from +1 V to -1 V. Slope polarity + or - selectable.

Sensitivity: at least 0.5 V.

General

Power: 115 V or 230 V $+10\%$ -15% . Maximum 70 VA.

Weight: net, 17 lbs (8 kg); shipping, 20 lbs (9 kg).

Dimensions: 16 $\frac{3}{4}$ " wide, 5 $\frac{1}{2}$ " high, 13 $\frac{1}{4}$ " deep (425 x 140 x 336 mm).



PLUG-IN PULSE GENERATOR

Pulse generation with digital formatting

Model 1900 system

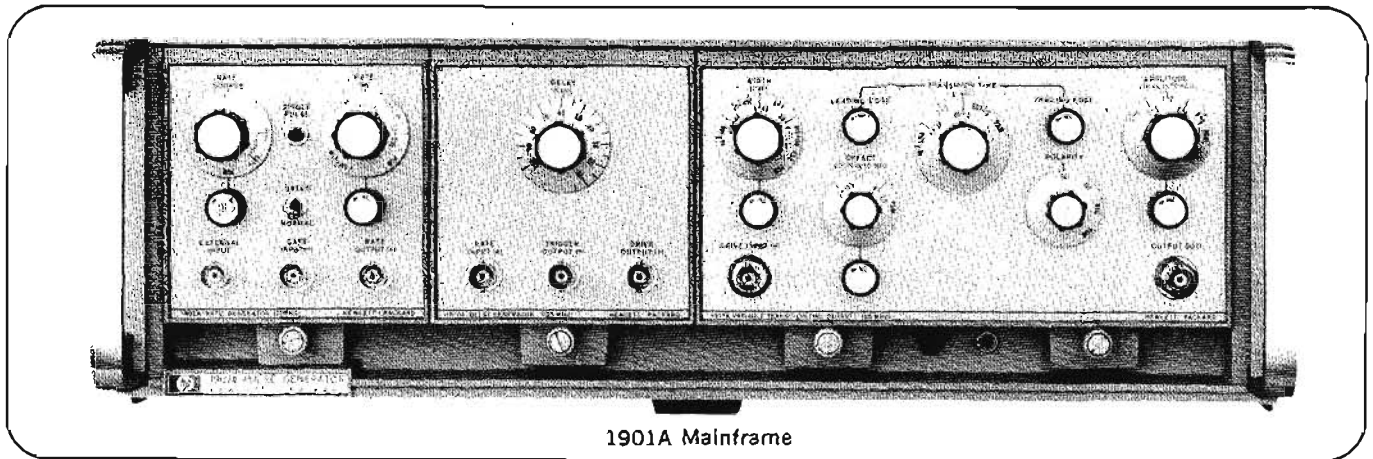

1901A Mainframe

Introduction, 1900 Series

The 1900 series provides you with the optimum in performance at minimum cost by allowing you to select a pulse generator that will control only the pulse parameters you are interested in. The completely specified high-quality test pulses from the 1900 series provide accurate, dependable tests of your circuits. Another feature is built-in shielding to reduce electromagnetic radiation and conduction, which reduces interference with other instrumentation.

Model 1900 series plug-in/mainframe compatibility not only lets you select a pulse generator to fit a specific requirement but also allows you to assemble a standard or a programmable pulse system for complex pulse-digital testing or circuit design work. This flexibility and compatibility is achieved by having all pulse generator module circuits contained in the plug-in. Mainframes only contain the power supplies and, if desired, optional programming wiring. This plug-in flexibility allows easy updating or expansion at a later date if your requirements change.

1900 Pulse/Digital System Plug-In Selection Chart

	Rate		Delay		Digital Formatting					Output Pulse Shaping				
	1905A	1906A	1908A	1910A	1925A	1927A	1928A	1930A	1934A	1915A	1917A	1920A	1921A	1922A
Max Rep Rate (MHz)	25	125	25	125	50	125	125	40	25	25	25	25	125	125
Gated Output	•	•												
Ext Trigger Input	•	•												
Delay Control			Var	5 ns steps					•					
Advance/Double Pulse			•											
Output V into 50Ω					>2	>2	>2	>2	>2	±50	±10	±5	+5	-5
Risetime	5 ns	3 ns	5 ns	3 ns	4 ns	4 ns	4 ns	4 ns	4 ns	7 ns-1 ms	7 ns-500 μs	<350 ps	<2 ns	<2 ns
Width	10 ns	5 ns	10 ns	5 ns	RZ/NRZ	NRZ	NRZ	RZ/NRZ	RZ/NRZ	15 ns-40 ms	15 ns-40 ms	0-10 μs	4 ns-1 ms	4 ns-1 ms
Constant Risetime with Amplitude Changes										•	•	•	•	•
Offset (V into 50 ohms)										±1.5	±2.5	±2	±5	±5
Digital Formatting					2-16 Bit word	1-8 Fan-In	1-8 Fan-Out	PRBS/Bit Error Detection	2-4 Phase					
RZ/NRZ					•	NRZ	NRZ	•	•	RZ/NRZ	RZ/NRZ	RZ	RZ/NRZ	RZ/NRZ
Programmable**	Opt.	Opt.	Opt.	No	Std.	No	No	Std.	Std.	Opt.	Opt.	Opt.	Opt.	Opt.
Price	\$200	\$275	\$200	\$200	\$850	\$150	\$225	\$1200	\$775	\$1700	\$575	\$1925	\$950	\$950

* Mainframes are required for plug-in operation. The two available are: Model 1900A for high power (1915A plug-in) pulse testing and digital systems. Price, \$850. Model 1901A for general purpose pulse testing and digital systems. Price, \$490.

** Programming requires Option 001 mainframes. Two versions are available: Option 001 plug-ins, for semi-automatic operation and Option 005 plug-ins to interface with computer controlled 6936S multi-programmer.

RATE GENERATORS

25 MHz and 125 MHz rep rates
Models 1900A, 1901A, 1905A, 1906A



SIGNAL SOURCES

Mainframe Specifications, 1900A and 1901A

Plug-in compatibility

Mechanical: mainframe compartments accept up to four quarter-size plug-ins, two half-size plug-ins, or combinations of quarter- and half-size plug-ins. Blank plug-ins are required to fill unused plug-in compartments for proper plug-in cooling and reduce RFI.

Electrical: provides power for quarter- and half-size plug-ins in many combinations with the following limitations.

1900A: number of plug-ins not to exceed one, 1915A; one, 1920A, two, 1921A; two, 1922A; one each 1921A and 1922A; two, 1925A; two, 1930A; or one each 1925A and 1930A.

1901A: number of plug-ins not to exceed three 1921A, three 1922A, or combinations of 1921A and 1922A not to exceed three. Model 1915A will not operate in a 1901A mainframe.

Internal interconnection of plug-ins: mainframe contains cables to provide connections between plug-ins. Cable connections may be changed for any combination of plug-in interconnection. Internal or external plug-in interconnection is selected by switches in plug-ins.

General

Dimensions: 16 $\frac{3}{4}$ " wide, 5 $\frac{1}{4}$ " high, 21 $\frac{3}{8}$ " deep over-all (425 x 133 x 543 mm); 19 $\frac{3}{8}$ " (492 mm) behind rack mount.

Weight: 1900A, net 35 lbs (16 kg); shipping, 46 lbs (21 kg); 1901A, net 28 lbs (12.7 kg); shipping, 39 lbs (17.6 kg).

Specifications, 1905A and 1906A

(Except as noted, specifications apply to both rate generators.)

Frequency

Internal: 1905A, 25 Hz to 25 MHz in 6 ranges; 1906A, 10 Hz to 125 MHz in 8 ranges. 10:1 vernier allows continuous adjustment over selected range.

External: 1905A, 0 to 25 MHz; 1906A, 0 to 125 MHz.

Period jitter: <0.1% of selected period.

External trigger

Amplitude: 1905A, 0.5 V p-p min., 5 V p-p max.; 1906A, 0 to 50 MHz, 0.5 V p-p min; 50 to 125 MHz 1.5 V p-p min. Maximum input, 5 V p-p.

Slope: positive or negative (selectable).

Trigger level: selectable on input waveform from 0 to ± 3 V.

Delay: 1905A, approx 27 ns between external input and rate output; 1906A, approx 12 ns between external input and rate output.

Input impedance: approx 50 ohms, dc-coupled.

Synchronous gating

Amplitude: 1905A, -2 V gates generator on, -5 V max; 1906A, +1 V gates generator on, +5 V max.

Input impedance: approx 50 ohms, dc-coupled.

Output pulse

Impedance: approx 50 ohms, dc-coupled.

Power: 115 or 230 V $\pm 10\%$, 48 to 66 Hz, 300 watts max. in 1900A and 250 watts max. in 1901A (varies with plug-ins).

Accessories furnished: rack mounting tabs and power cord.

Price

1900A: high power mainframe\$850

1901A: general purpose mainframe\$490

Options

001: provides internal cabling and connectors from plug-ins to rear panel for digital or analog programming. Price, add \$175.

002: non-pivoting chassis slides with adjustable length of 20 to 22 inches. Price, add \$90.

Accessories

Analog programming kit: provides field installation of Option 001. Price, analog programming kit (HP P/N 01900-69502), \$175.

Chassis slide kit: allows installation of non-pivoting slides with an adjustable length of 20 to 22 inches. Price, chassis slide kit (HP P/N 01900-69501), \$90.

Blank plug-ins: blank plug-ins fill unused plug-in compartments to provide proper plug-in cooling and reduce RFI. Price: Model 10481A, quarter-size blank plug-in, \$25; Model 10482A, half-size blank plug-in, \$30.

Plug-in extender: provides access to components when servicing and calibrating an operating plug-in. Extender accommodates both quarter- and half-size plug-ins. Price: Model 10484A plug-in extender, \$135.

Amplitude: >1.5 V into 50 ohms (drives two 1900 series plug-ins).

Rise time: 1905A, <5 ns; 1906A, <3 ns.

Width: 1905A, <10 ns; 1906A, <5 ns.

General

Weight: net, 1 $\frac{1}{4}$ lbs (0.6 kg); shipping, 6 lbs (2.7 kg).

Price

1905A: 25 MHz Rate Generator\$200

1906A: 125 MHz Rate Generator\$275

Options

001: analog programming. Provides connector and circuit card for control of Rate Source (INT, EXT, +, -) and pulse Rate. A programming kit (HP P/N 01905-69501) is also available for field installation of Option 001. Kit price is \$100. Price: 1905A or 1906A Option 001, add \$100.

005: (1905A only) digital programming. Provides digital control of Rate Source and Pulse Rate. Refer to 6936S/6937S description or contact your Hewlett-Packard Field Engineer for more information. Price: 1905A Option 005, add \$300.

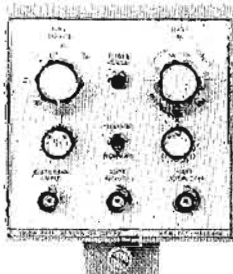

1905A

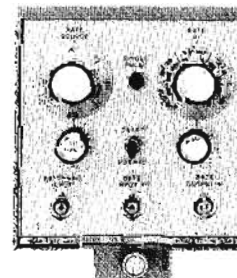

1906A



DELAY GENERATORS

25 MHz variable and 125 MHz incremental delay
Models 1908A, 1910A

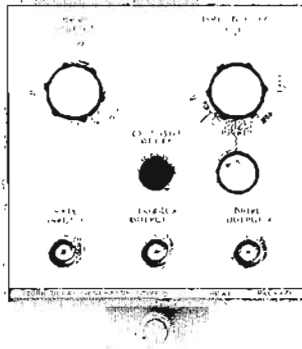

1908A

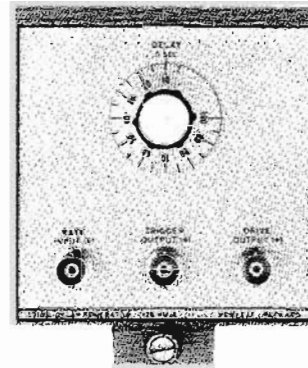

1910A

- 0 to 25 MHz Rep Rate
- Advance or Delay from 15 ns to 10 ms
- Double Pulse

Specifications, 1908A

Time interval (between Trigger and Drive Outputs)

Range: 15 ns to 10 ms in 6 ranges. 10:1 vernier provides continuous adjustment in any range.

Jitter: <0.1% of selected time interval.

Excessive delay light: indicates that selected delay time exceeds pulse period.

Rate Input

Repetition rate: 0 to 25 MHz.

Amplitude: >1.5 V peak min., 5 V peak max.

Maximum delay after rate input (with delay control set to (minimum)

Trigger output: approx 14 ns in delay mode; approx 29 ns in advance mode.

Drive output: approx 29 ns in delay mode; approx 14 ns in advance mode.

Input impedance: approx 50 ohms, dc-coupled.

Trigger and drive outputs

Output impedance: approx 50 ohms.

Amplitude: >1.5 V into 25 ohms (drives two 1900 series plug-ins).

Risetime: <5 ns.

Width: <10 ns.

General

Weight: net, 1¼ lbs (0,6 kg); shipping, 6 lbs (2,7 kg).

Price: Model 1908A, Delay Generator, \$200.

Options

001: analog programming. Provides connector and circuits for control of Drive Output (Delay, Double Pulse) and Time Interval. Drive Output modes and Time Interval ranges are selected by contact closure to ground. Time interval vernier is controlled by analog current. Price:

- 0 to 125 MHz Rep Rate
- 5 ns to 100 ns Delay
- Delay Longer than a Pulse Period
- <10 ns Jitter

Option 001, add \$100.

005: digital programming. Provides digital control of Drive Output (Delay, Double Pulse) and Time Interval. Refer to 6936S/6937S description or contact your Hewlett-Packard Field Engineer for more information. Price: 1908A Option 005, add \$500.

Accessories

Programming kit: provides field installation of Option 001.

Price: HP Part No. 01908-69501, \$100.

Specifications, 1910A

Time interval (from Trigger Output to Drive Output)

Range: 5 ns to 100 ns in 5 ns increments.

Jitter: <10 ps.

Rate input

Repetition rate: 0 to 125 MHz.

Amplitude: 0 to 25 MHz: 1 V peak min., 5 V peak max.
25 MHz to 125 MHz: 1.5 V peak min., 5 V peak max.

Maximum delay after rate input (with delay control set to min.).

Trigger output: approx 5 ns.

Drive output: approx 10 ns.

Input impedance: approx 50 ohms dc-coupled.

Trigger and drive outputs

Output impedance: approx 50 ohms

Amplitude: >1.5 V into 25 ohms.

Risetime: <3 ns.

Width: <5 ns.

General

Weight: net, 2½ lbs (1,13 kg); shipping, 4¾ lbs (2,2 kg)

Price: Model 1910A, Delay Generator, \$200.

OUTPUT PULSE SHAPING

High power and fast rise time
Models 1915A, 1920A



SIGNAL SOURCES

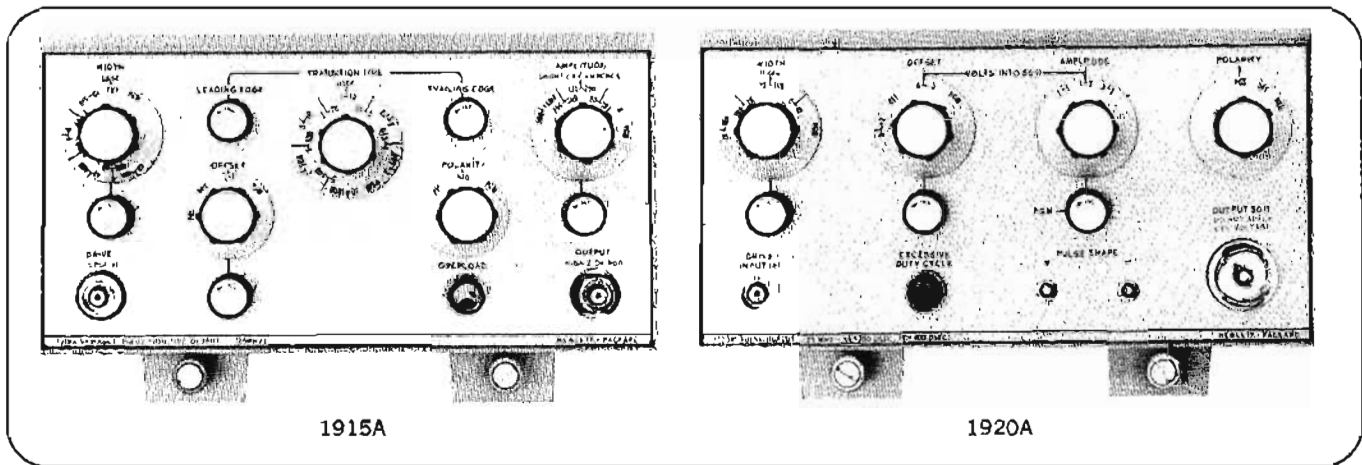

Specifications, 1915A

Output pulse

Source impedance: 50 ohm or high impedance; self-contained 50 ohm termination may be connected or disconnected.

High impedance output: approx 4 k ohms shunted by <45 pF.

50 ohm output: approx 50 ohms shunted by <45 pF.

Amplitude (Short Circuit Current): 50 mA to 1 A in 4 ranges; 2.5:1 vernier allows continuous adjustment over each range. Voltage into external 50 ohms is ± 2.5 V to ± 50 V with high Z source; ± 1.25 V to ± 25 V with 50 ohm source. Maximum amplitude (including offset) is ± 50 V.

Pulse shape

Pulse top variations: 50 ohm source and 50 ohm load, $\pm 5\%$ for transition times 7 ns to 20 ns, $\pm 2\%$ for transition times >20 ns; high impedance source and 50 ohm load, $\pm 5\%$ for all transition times.

Transition times: 7 ns (10 ns with high Z source) to 1 ms in 11 ranges (1, 2, 5 sequence); two 100:1 verniers provide independent control of rise- and fall-times. Transition time variations over entire amplitude range (± 0.2 to ± 25 volts); $\pm 15\%$, ≥ 100 ns; $\pm 40\%$, 7 to 100 ns.

Polarity: plus or minus, selectable.

Baseline offset: ± 60 mA, maximum offset into external 50 ohms is ± 1.5 V with 50 ohm source; ± 3 V with high Z source.

Width

Internal: ranges, 10 ns to 40 ms in 7 decade ranges (except for first range which is 10 to 40 ns); 10:1 vernier provides continuous adjustment over each range; width jitter, $<0.5\%$ of selected pulse width.

External: provides pulse amplifier operation; output pulse width determined by width of drive input.

Duty cycle: 0 to $>90\%$, internal width mode; 0 to 100%, external width mode.

Overload

Overload lamp lights to indicate when power detector protection circuits are turning off the output current to limit output power and prevent output transistor damage. The power detector is energized for single pulse or $<0.2\%$ duty cycle operation for pulse widths >1 μ s. If single pulse or low duty cycle operation is desired, Option H15 may be ordered.

Drive Input

Repetition rate: 0 to 25 MHz.

Amplitude: 1 V peak min., 5 V peak max.

Input impedance: 50 ohms, dc-coupled.

Maximum delay: (after drive input) <45 ns.

General

Weight: net, 5 $\frac{1}{2}$ lbs (2.5 kg); shipping, 9 lbs (4.1 kg).

Price: Model 1915A Variable Transition Time Output, \$1700.

Options

001: analog programming. Provides connector and circuits to control width, transition time, amplitude, polarity, and offset. Price: Option 001, add \$275.

002: positive output. Provides positive-only pulse output and positive-only offset. Price: Option 002, deduct \$225.

003: negative output. Provides negative-only pulse output and negative-only offset. Price: Option 003, deduct \$225.

004: voltage calibration. Calibration of pulse amplitude in voltage. Price: Option 004, add \$25.

Accessories

Programming kit: provides field installation of Option 001.

Price: HP Part No. 01915-69501, add \$275.

Specifications, 1920A

Output pulse

Source resistance: 50 ohms $\pm 5\%$.

Amplitude: 0.5 to 5 V into 50 ohms in three ranges; 1, 2, 5 sequence. 2.5:1 vernier provides continuous adjustment over each range. Output circuit cannot be damaged by shorting.

Pulse shape (measured at 5 V into 50 ohms)

Leading edge: risetime, <350 ps; preshoot, $<1\%$; overshoot and ringing, $<10\%$ p-p; time to settle to within 3% of flat top, <5 ns; rounding, $<5\%$.

Trailing edge: falltime, <400 ps; preshoot, $<1\%$ for pulse width >5 ns; overshoot and ringing, $<10\%$ p-p; time to settle to within 3% of baseline, <5 ns except for perturbation 10-20 ns after trailing edge $\leq \pm 4\%$; rounding, $<5\%$.

Polarity: plus or minus, selectable.

Baseline offset: plus, minus, or off; selectable. 0-2 V into 50 ohms.

Width: 0 to 10 μ s in four ranges. 10:1 vernier provides continuous adjustment between ranges.

Width jitter: <20 ps or 0.1% whichever is greater.

Duty cycle: 0 to $>25\%$ (0 to 20 MHz rep rate); 0 to 10% (>20 MHz rep rate).

Drive Input

Repetition rate: 0 to 25 MHz.

Amplitude: 1 V peak min., 5 V peak max.

Maximum delay after rate input: approx 60 ns.

Input impedance: 50 ohms, dc-coupled.

General

Weight: net, 4 lb (1.8 kg); shipping, 10 lb (4.5 kg).

Price: Model 1920A, 350 ps Rise Time Output, \$1925.

Options

001: analog programming. Provides connector and circuits to control width range and vernier, offset range and vernier, and amplitude vernier. Price: Option 001, add \$150.



OUTPUT PULSE SHAPING

General purpose 25 MHz and 125 MHz
Models 1917A, 1921A, 1922A

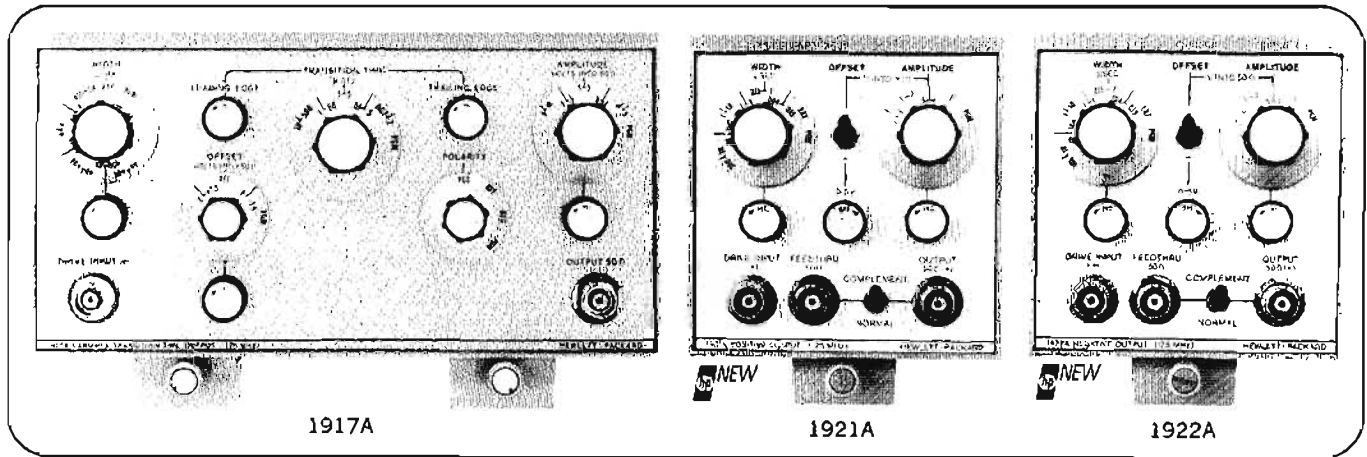

Specifications, 1917A

Output pulse

Source impedance: 50 ohms or high Z; selected with internal switch. High impedance output, approx 3 k ohms shunted by 45 pF; 50 ohm output, approx 50 ohms shunted by 45 pF.

Amplitude: (volts into 50 ohms) 0.2 to 10 V with 50 ohms source; 0 to 14 V (8 to 400 mA) with 3000 ohm source; 2.5:1 vernier provides continuous adjustment over each range.

Pulse shape

Pulse top variations: $\pm 5\%$ for transition times > 7 ns.

Transition times: 7 ns to 500 μ s in 5 ranges; two 50:1 verniers provide independent control of rise- and fall-times.

Transition time variations over entire amplitude range (± 0.2 to $+10$ volts): $\pm 15\%$, ≥ 100 ns; $\pm 40\%$, 7 to 100 ns.

Polarity: plus or minus, selectable.

Baseline offset: ± 2.5 V into external 50 ohms with 50 ohm source; ± 100 mA with 3000 ohm source.

Width

Internal: ranges, 10 ns to 40 ms in 7 ranges; 10:1 vernier provides continuous adjustment over each range; width jitter, $< 0.25\%$ of selected pulse width.

External: provides pulse amplifier operation; output pulse width determined by width of drive input.

Duty cycle: internal width mode, 65% except for 15 to 40 ns width range. 50% on 15 to 50 ns width range; external width mode, up to 100%; limited by output pulse transition times.

Drive Input

Repetition rate: 0 to 25 MHz.

Input impedance: 50 ohms, dc-coupled.

Amplitude: 1 V peak min., 5 V peak max.

Maximum delay after drive input: approx 35 ns.

General

Weight: net, 2½ lbs (1,13 kg); shipping, 6¼ lbs (2,8 kg).

Price: Model 1917A, Variable Transition Time Output, \$575.

Options

001: analog programming. Provides connector and circuits to control Width, Transition Time, Amplitude, Polarity, and Offset. Price: Option 001, add \$275.

005: digital programming. Provides digital control of Width, Transition Time, amplitude, Polarity, and Offset. Refer to 6936S/6937S description or contact your Hewlett-Packard Field Engineer for more information.

Price: 1917A Option 005, add \$2000.

Accessories

Programming kit: provides field installation of Option 001.

Price: HP Part No. 01917-69501, \$275.

Specifications, 1921A/1922A

Output pulse

Source impedance: approx 50 ohms shunted by 9 pF. Reflection coefficient is typically < 0.15 for incident pulses with rise times > 1.5 ns.

Pulse amplitude: (volts into 50 ohms) 0.5 to 5 V; 2.5:1 vernier provides continuous adjustment over each range.

Polarity: 1921A, positive; 1922A, negative. Opposite pulses can be obtained from each unit by adjusting offset, amplitude, and complement controls.

Duty cycle: $> 50\%$ in internal; up to 100% with complement; external width mode, up to 100%.

Feedthru mode: allows output pulses to be added on a 50 ohm transmission line for bipolar applications.

Complement: selects normal pulse or its logic complement. Transition time shift: normal to complement, typically $< \pm 1$ ns.

Pulse shape

Pulse top variations: $< \pm 5\%$ for amplitudes from 1 to 5 V and $< \pm 7\%$ for amplitudes of < 1 V.

Base line offset: 0 to ± 5 V into 50 ohms.

Transition times: < 2 ns.

Width

Internal: ranges, 4 ns to 1 ms in 6 ranges (10:1 vernier provides continuous adjustment over each range); jitter, < 25 ps $+ 0.1\%$ of pulse width; time intersymbol interference, width change with rep rate < 1.5 ns $+ 2\%$ of pulse width.

External: provides pulse amplifier operation; output pulse width is determined by width of drive input. Pulse width tracking is within approx ± 1 ns with input pulse width measured at 0.6 V. Time intersymbol interference: transition shift with rep rate, < 1 ns.

Drive input

Repetition rate: 0 to 125 MHz.

Input impedance: 50 ohms, dc-coupled.

Pulse shape: amplitude, > 1.5 V; width, > 3 ns; slope, > 0.25 V/ns in internal width, > 0.15 V/ns in external width (smaller slopes may cause degradation of performance).

Maximum input: ± 5 V.

Propagation delay: internal width mode, approx 18 ns; external width mode, approx 15 ns; feedthru mode, approx 4 ns.

General

Weight: net, 3 lbs (1,4 kg); shipping, 6 lbs (2,7 kg).

Price:

Model 1921A Positive Output \$950

Model 1922A Negative Output \$950

Options (order by Option number)

001: analog programming. Provides connector and circuits to control width, amplitude, complement, and offset.

Price: Option 001 for 1921A or 1922A, add \$150.

DIGITAL FORMATTING

Bit error detection, cryptography, PRBS
Model 1930A



SIGNAL SOURCES

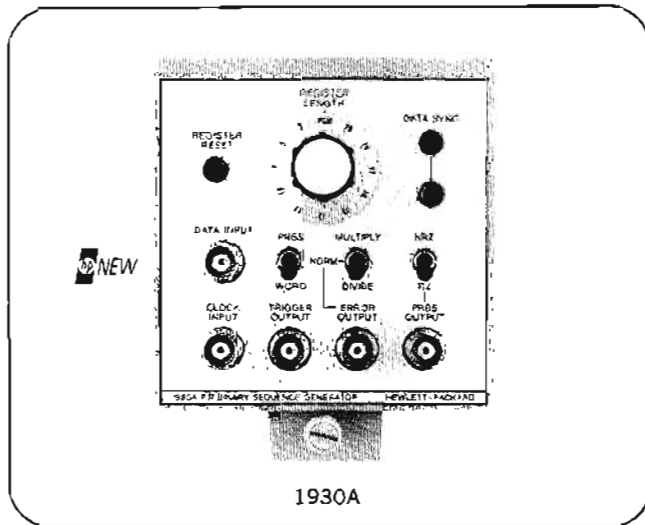

Description, 1930A

Model 1930A is a quarter-size, digital formatting plug-in that provides bit error detection, random signal simulation, and coding and decoding functions for the 9000 pulse system. This versatile plug-in will operate in RZ or NRZ formats at rates up to 40 MHz. Models 1905A or 1906A rate generator plug-ins provide clock rates of either 25 or >50 MHz rates and the output pulses can be shaped by any of the 9000 system output stages. Model 1917A provides control of TTL levels. ECL and bipolar pulses can be generated with Model 1921A and 1922A output stages.

Bit error detection

One of the main reasons for testing digital processing equipment is to determine how accurately the transmitted signal is received and to find the effect of noise in the transmission system. The measure of a digital system's quality is Bit Error Rate (BER). The 1930A can detect these errors and they can be counted on a counter to display the bit error rate.

Bit error detection in digital transmission systems is simplified by the ability of 1930A to rapidly synchronize to a data stream (either words or pseudorandom sequences) and do a bit by bit comparison of the incoming data. For example: one 1930A generates a signal that is transmitted over a digital communications link and a second 1930A would then synchronize to the incoming signal from the digital link. Each time the received signal is different from the stored replica an error pulse is produced at the error output, which can be counted with a counter to provide a bit error rate measurement.

Random signal simulation

The primary signal requirement for design and test of digital equipment is a known repeatable digital pattern—a word which can be provided by a 1925A word generator plug-in. However, if the equipment is processing digital signals, a more thorough test is required that covers all possible words in a random order. The 1930A provides these pseudo-random binary sequences that cover all possible combinations of an n-bit word, with the exception of the all-zeros state.

Random signal simulation allows a device that processes digital information to be completely exercised while providing the stationary characteristics of a repetitive signal. In pattern

sensitive devices, pseudorandom binary sequences provide a fast, easy, complete method to generate all possible combinations of up to 20 bits during design and checkout.

Cryptography

Coding in digital applications is accomplished by dividing the incoming data stream by the characteristic equation of the generator. The pseudorandom binary sequence completely scrambles the original data in both time and frequency domains. Eleven different scrambling patterns can be selected with a front panel register length switch and feedback taps inside the plug-in allow over 73,000 different pseudorandom patterns. Scrambling patterns may also be set by remote, electronic program signals through the rear panel of an Option 001 mainframe. To decode the information, another 1930A set to the same sequence multiplies the scrambled signal by the same equation to regain the original data.

Specifications, 1930A

Clock Input

Repetition rate: 0 to 40 MHz (typically to 50 MHz in most sequences).

Input R: 50 ohms, dc-coupled.

Amplitude: +1 V min.

Width: >4 ns and <15 ns.

Propagation delay: 40 ns max. (Clock input to transition of output data).

Maximum input: ± 5 V.

Data input

Repetition rate: 0 to 40 MHz (typically to 50 MHz).

Input R: 50 ohms, dc-coupled.

Amplitude

One level: +1 V min.

Zero level: 0 V.

Maximum input: ± 5 V.

Trigger output

Amplitude: 1 V (open circuit).

Width: approx 1 clock period.

Source R: 50 ohms.

Error output

Amplitude: 45 \pm 5 mA current source or >2 V into 50 ohms.

Width: >10 ns, <50% of period in RZ mode.

Source R: unterminated current source.

Self generated error rate: $<1 \times 10^{-12}$.

PRBS output

Amplitude: 45 \pm 5 mA or >2 V into 50 ohms.

Rise and fall times: <4 ns.

Width:

RZ: >9 ns, <50% of period.

Source R: unterminated current source.

Programming inputs (Requires Option 001 1900A or 1901A Mainframes)

False: contact closure to <0.6 V.

True: open or >3.0 V.

Response: <300 ns.

Threshold: approx 2.2 V or 5.5 k ohms.

General

Weight: net, 2¼ lb (1,02 kg); shipping, 4½ lb (2,04 kg).

Price: Model 1930A, PR Binary Sequence Generator \$1200



DIGITAL FORMATTING

Word and multiphase clock generators
Models 1925A, 1934A

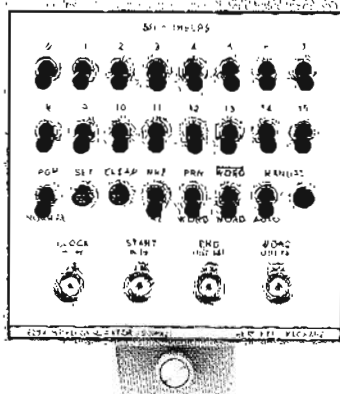

1925A

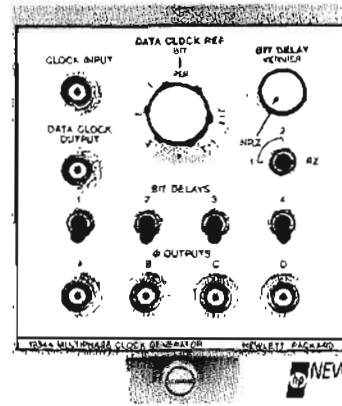

1934A

- 0 to 50 MHz Clock
- 2 to 16 Bit Words
- RZ/NRZ Formats
- Word/Word Complement

- Selectable Phase Pattern
- 2 Phase, 25 MHz
- 4 Phase, 12.5 MHz
- RZ/NRZ Formats

Specifications, 1925A

Clock input

Repetition rate: 0 to 50 MHz (15 to 35°C), 0 to 45 MHz (0 to 50°C).

Input impedance: 50 ohms, dc-coupled.

Amplitude: +1 V min, +5 V max.

Width: >4 ns, <18 ns at +0.6 V.

Propagation delay: 35 ns max., leading edge of transition of output data.

Transition time jitter: (between clock or END and WORD-OUT) 100 ps.

Start input

Period: > (word length plus 30 ns).

Input impedance: 50 ohms, dc-coupled.

Amplitude: +1 V min, +5 V max.

Width: >5 ns.

Programming inputs (requires 1900A Option 001 or 1901A Option 001 mainframe).

True: contact closure, saturated DTL, or voltage source (TTL) <+0.2 V.

False: open, off DTL, or voltage source (TTL) >2.5 V, <4.0 V.

Noise immunity: >0.7 V p-p. When true <0.2 V, when false >3.5 V.

Noise bandwidth: <15 MHz.

Word and End output

True: 45 ± 5 mA current source or >1 V into 25 ohms.

False: <1 mA.

Risetime and falltime: <4 ns.

Perturbations: <15%.

Source impedance: unterminated current source.

Word length: 2 to 16 bits, set by internal switches.

Word content: set by front panel switches or programmed.

General

Weight: net, 2¼ lbs (1.02 kg); shipping, 4½ lbs (2.04 kg).

Price: Model 1925A, Word Generator\$850

Specifications, 1934A

Clock input

Repetition rate: dc to >50 MHz.

Width: >4 ns and <½ clock period.

Input R: 50 ohms, dc-coupled.

Amplitude: ≥ +1 V or <+3 V.

Maximum input: ±5 V.

Data clock output

Repetition rate: two phase, ½ input rate; four phase, ¼ input rate.

Width: <15 ns.

Transition times: <4 ns.

Source impedance: emitter follower voltage source.

Amplitude: >2 V into 50 ohms.

Position with respect to matrix bit: >15 ns advance.

Phase outputs

Amplitude: 45 mA ± 5 mA or >2 V into 50 ohms.

Repetition rate: two phase, dc to >25 MHz; four phase, dc to >12.5 MHz.

Width: NRZ, one input clock period; RZ, <10 ns.

Source impedance: unterminated current source.

Transition time: <4 ns.

Bit delay

Range 1: 7 to 35 ns.

Range 2: 35 to 500 ns.

Vernier: provides variable delay between trailing edge of preceding bit and leading edge of selected bit and must not exceed ½ input clock period delay time.

Programming inputs (requires 1900A Option 001 or 1901A Option 001 mainframe).

Functions

False: contact closure to <0.6 V.

True: open or >3 V.

Settling time: <300 ns.

Threshold: approx 2.1 V or 5700 ohms.

Vernier

Sustaining voltage: -4.7 V.

Current: -0.7 mA to -10 mA.

General

Weight: net, 2¼ lbs (1.02 kg); shipping, 4½ lbs (2.04 kg).

Price: Model 1934A, Multiphase Clock Generator\$775

DIGITAL PROGRAMMING

Complete Pulse Generator Control

Models 6936S, 6937S



SIGNAL SOURCES

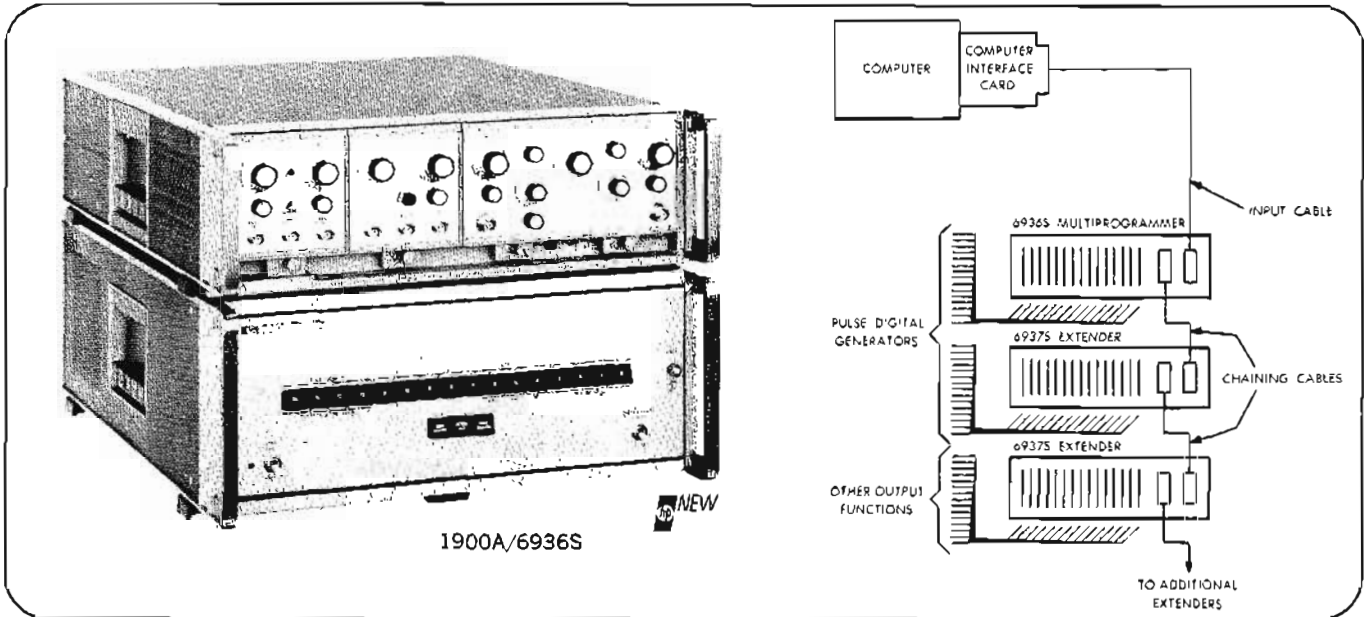

Description, 1900/6936S

The 1900/6936S is a digitally programmable pulse generator system that provides complete, computer control of pulse parameters for fast, accurate test signals in a fully automated system. Consisting of the plug-in 1900 pulse system and a 6936S Multiprogrammer, it allows reliable, efficient control of a large number of pulse parameters through a minicomputer using a single, 16-bit parallel computer word.

If the output function requirements expand, up to fifteen 6937S Extenders may be added to provide up to 240 separate, individually addressable output channels from only one computer I/O slot. This allows a system to be expanded with no changes in computer hardware. Also, with the appropriate computer interface cards, the 6936S can be utilized for programming devices other than the 1900 Pulse System.

The plug-in pulse generator concept allows you to select

only the plug-in functions required for a particular test system. And the flexibility of this plug-in system allows future expansion or modification at minimum cost. Programming capability is designed into the 1900 series which allows you to order only the programming capability required for a test application. Also, if the test requirements change at a later date, the programming option can be added without modification to plug-ins or Multiprogrammer or Extender mainframes.

Software and interface engineering are built into each Option 005 plug-in, which eliminates expensive installation or programming costs. The flexibility and expandability of this digital pulse system makes it ideal for use in automatic checkout systems.

For complete information about the programmable pulse generator system, contact your HP Field Engineer.

Specifications, 1927A/1928A

(Except as noted, specifications apply to both fan-in and fan-out amplifiers.)

Input

- Threshold:** continuously variable from +0.5 V to +3 V. In 1927A, one adjustment sets all eight inputs to the same level.
- Repetition rate:** 0 to 125 MHz.
- Amplitude:** 1 V min., 4 V max.
- Width:** >4 ns.
- Propagation delay:** 1927A, <8 ns; 1928A, <10 ns.
- Input impedance:** 50 ohms, dc-coupled.

Output

- Source impedance:** unterminated current source.
- Logic one:** 45 mA, ±5 mA current source; >2 V into 50 ohms.
- Transition times:** <3 ns.
- Pulse stretching:** increase in pulse width is <3 ns.
- 1928A Differential delay between output ports:** <3 ns.

General

Weight: net 1¼ lb (0,6 kg); shipping, 6 lb (2,7 kg).

Price

- 1927A Fan-In Amplifier\$150.
- 1928A Fan-Out Amplifier\$225.

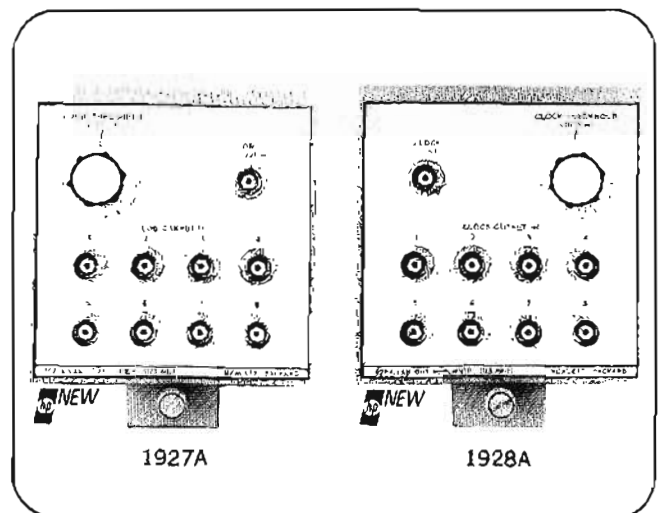

SIGNAL SOURCES



PULSE GENERATORS

200 watt pulses/general purpose testing
Models 214A, 211B, 221A

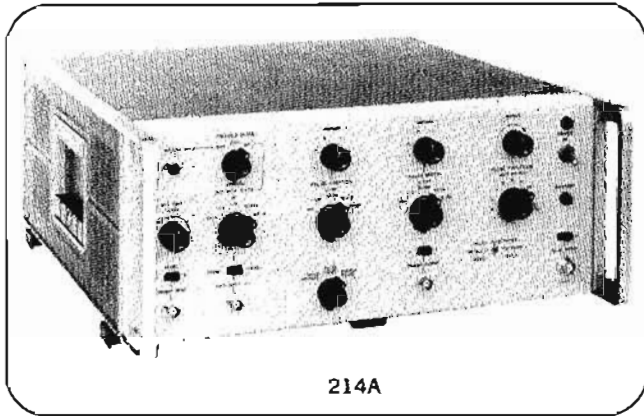

214A

Description, 214A

The high 200 watts of pulse power (2 amp peak \pm 100 volts into 50 ohms) and fast risetime of 15 ns are particularly suited for testing current-driven devices such as magnetic cores, as well as high-power modulators. Source impedance is 50 ohms on all but the highest (100-volt) range, to minimize errors caused by re-reflections when operating into unmatched loads. At lower output levels, the risetime is less than 13 ns (typically less than 10 ns). Carefully controlled pulse shape, pulse rate and width, and minimum pulse jitter insure accurate and dependable test results. All characteristics of the pulse waveform including overshoot, preshoot, pulse droop, and pulse top variations, are completely specified, and pulse irregularities are kept to a minimum.

Specifications, 214A

Output pulse

Source resistance: 50 ohms on 50 V and lower ranges; approx 1500 ohms on the 100 V range.

Rise and fall time: <13 ns on 20 V and lower ranges and the -50 V range, <15 ns on the +50 V range; typically <10 ns with the vernier set for maximum attenuation and typically 15 ns on 100 V range.

Pulse amplitude: 100 V into 50 ohms. Attenuator provides 0.2 to 100 V in 1, 2, 5, 10 sequence (9 ranges); vernier reduces output of 0.2 V setting to 80 mV and provides continuous adjustment between ranges.

Polarity: positive or negative.

Overshoot: <5%, both leading and trailing edges (measured on a 50 MHz oscilloscope).

Pulse top variation: <5%.

Droop: <6%.

Preshoot: <2%.

Pulse widths: 50 ns to 10 ns in 5 decade ranges; continuously adjustable vernier.

Width jitter: <0.05% of pulse width +1 ns.

Maximum duty cycle: 10% on 100 and 50 V ranges; 25% on 20 V range; 50% on 10 V and lower ranges.

Internal repetition rate: 10 Hz to 1 MHz (5 ranges), continuously adjustable vernier.

General

Power: 115 or 230 V \pm 10%, 48 to 66 Hz, approx 325 W.

Dimensions: 16 $\frac{3}{4}$ " wide, 7 $\frac{1}{4}$ " high, 18 $\frac{3}{8}$ " deep (425 x 184 x 467 mm).

Weight: net, 35 lbs (16.8 kg); shipping, 41 lbs (19.7 kg).

Price: Model 214 Pulse Generator, \$975.

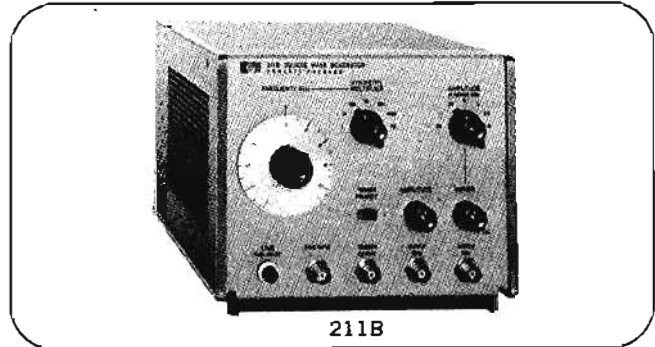

211B

Description, 211B

The Hewlett-Packard Model 211B is a compact, fully transistorized Square Wave Generator designed for general purpose laboratory and production line applications. It provides frequency coverage from 1 Hz to 10 MHz in seven decade ranges with a linearly calibrated dial for continuous adjustment on all positions. The symmetry control varies the "on" time from 25% to 75% of the period.

Two negative-going output pulses are available simultaneously, one from a 50-ohm source having a 5 ns rise and fall time and the other from 600 ohms with a rise and fall time of 70 ns (140 ns open circuit). The two pulses have a time phase difference of 180°. The outstandingly clean pulse shape, with less than 5% distortion, enables many pulse testing applications to be performed that usually appertain to expensive equipment costing more than \$450.

Description, 221A

Model 221A is a small, lightweight square wave generator with all solid-state circuits. High quality and reliability combined with a low price of \$225 results in a truly general-purpose laboratory instrument.

Clean waveshapes are assured by the 50-ohm source impedance, even when driving other than 50-ohm loads. Amplitudes from 0 to +5 V into 50 ohms are available at repetition rates from 1 Hz to 10 MHz.

Frequency programming capability is standard and it may be operated as a voltage-controlled oscillator (VCO) by supplying a dc voltage to a rear panel connector. This allows the frequency vernier to be swept over the full 10:1 range selected. The output may also be gated on and off by applying a pulse to the rear panel connector.

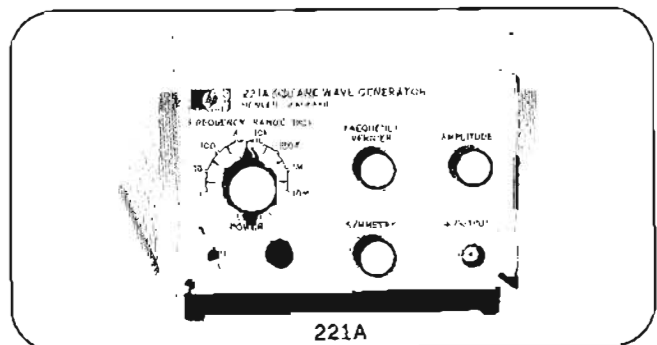

221A

For complete specifications contact your Hewlett-Packard field engineer.

POWER MEASUREMENTS



POWER METERS

Power measurements

Power measurements are basic at microwave frequencies. Unlike voltage and current levels along a transmission line, microwave power remains constant with position of measurement in a lossless line and can easily be related to circuit performance.

Bolometric power meters

Below 10 milliwatts, power is usually measured with bolometers (temperature-sensitive resistive elements) in conjunction with a balanced bridge. There are two general types of bolometers: thermistors, whose resistance decreases with temperature (negative temperature coefficient), and barretters, which have a positive temperature coefficient. Thermistors are most commonly used because they are more rugged, both physically and electrically, than barretters.

Automatic bolometer bridges

The Hewlett-Packard Model 432 Power Meter is a temperature-compensated, automatically balanced thermistor bridge. The 432 automatically maintains bridge balance and reads substituted bias power to a basic accuracy of $\pm 1\%$ of full scale.

Since all bolometer elements are temperature-sensing devices, they are unable to distinguish between applied power level changes and environmental temperature changes. Temperature variations can unbalance the bridge. This results, if uncompensated, in "zero drift" of the power meter and erroneous power measurements.

A dual bridge arrangement is used in the 432 to compensate for variations in temperature at the thermistor mount. The thermistor mounts used with the 432 have two thermistor elements. The two are in close thermal proximity and are affected equally by changes in ambient temperature. This arrangement compensates for temperature changes, thus reducing zero drift in the 432 by a factor of 100 over uncompensated meters. Another advantage of the 432 design is that when zeroed on the most sensitive range, the meter may be switched to any other power range without rezeroing (zero-carryover is within 0.5% on all ranges).

Compensated thermistor mounts available for the 432 include the 478A (10 MHz to 10 GHz) and the 8478B (10 MHz to 18 GHz) coaxial mounts. The 486A waveguide series collectively cover

the waveguide bands from 2.6 to 40 GHz. All mounts have low SWR over their frequency ranges without tuning.

Non-temperature-compensated bridges

The HP Model 430C Power Meter operates with a number of non-temperature-compensated barretter or thermistor mounts such as the HP 477B coaxial and 487 waveguide series. The 478A, 8478B, and 486A thermistor mounts also can be operated in a non-temperature-compensated mode with the 430C using the 11528A adapter. This permits utilization of the 430C power meter in waveguide bands not covered by the 487 series of mounts. Accuracy of the 430C in measuring substituted power is $\pm 5\%$ of full scale.

Calorimetric power meters

Calorimetric power meters dissipate the unknown power in a resistive termination that is matched to the transmission line or source impedance. The temperature rise caused by the power dissipation is then measured by a temperature sensor which is calibrated against known amounts of dc power.

Fluid calorimeters such as the HP 434A utilize a moving stream of oil to transfer heat quickly to the sensing element. An amplifier-feedback arrangement, in conjunction with the series oil flow system reduces measurement time in the 434A to less than 5 seconds for full-scale response. The HP 434A covers the important range of 10 mW to 10 watts.

Peak power measurement

A frequent requirement in microwave work is the measurement of peak power in a periodic pulse.

Hewlett-Packard produces a versatile instrument that conveniently measures peak power directly in the 50 MHz to 2 GHz region. This instrument (the 8900B) utilizes a video comparator technique to bring a known impedance to a level which is equal to the pulse being measured. This allows simple measurements of peak pulse power with a basic accuracy of 1.5 dB even when the waveform is not rectangular. A custom calibration chart increases accuracy to 0.6 dB for critical applications.

Application Note 64

Complete information on the theory and operation of bolometers and bridges

along with other types of power meters, is included in a comprehensive application note available from Hewlett-Packard. Application Note 64 contains up-to-date information on virtually all aspects of microwave power measurement, including detailed descriptions and illustrations of instruments, techniques, error analysis and applications.

Steps toward better accuracy

Tuners: Certainly one of the most important steps for higher accuracy is the elimination of mismatch loss with a tuner. Hewlett-Packard bolometer mounts and calorimeter input systems are designed and tested for good broadband impedance match (low SWR) to common microwave transmission lines. However, source SWR must also be considered in any power measurement, and the combination of source and load SWR can produce serious mismatch errors. To eliminate mismatch error, HP 870A waveguide series or 872A coaxial slide-screw tuners may be used ahead of the bolometer or calorimeter input.

Effective efficiency and calibration factor: A bolometric power meter can only measure power that is absorbed by the bolometer element, not that which is dissipated elsewhere in the mount or reflected by the mount (SWR). Furthermore, the spatial distribution of current and resistance within the element is slightly different for microwave frequencies and the dc (or low-frequency ac) which is actually measured by the meter. The effects of these sources of error are measured at certain frequencies during the manufacture of the Models 478A and 486A mounts and presented on their nameplates as Calibration Factor and Effective Efficiency. Calibration Factor is the ratio of substituted bias power in the power meter to the microwave power incident on the mount. Effective Efficiency is the ratio of substituted bias power in the power meter to the microwave power absorbed by the mount.

Instrumentation: HP 432 power meters provide a basic accuracy of $\pm 1\%$ in substituted power to the thermistor. The DVM output of the HP 432 allows connection of a digital voltmeter (such as the HP 3480A) for high resolution readout of power. Rear panel connectors also allow direct measurement of voltages in the bridges; the computed substituted dc power reduces instrumentation error to less than $\pm 0.2\% \pm 0.5 \mu\text{W}$.

POWER METERS



POWER METERS

Automatic zero, high accuracy

Models 432A, B, C

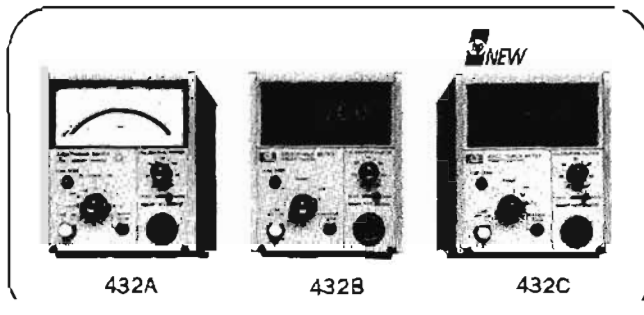

Automatic zeroing: Depress a front panel toggle switch and the 432 Power Meter automatically resets to zero in a fraction of a second.

DC bridge circuit: Using dc instead of the conventional 10 kHz bias current results in three benefits: 1) No signal emission from the mount to disturb sensitive circuits 2) meter zeroing is independent of the impedance connected to the RF input of the thermistor mount 3) the instrument is not affected by capacitance changes caused by movement of the thermistor mount cable.

High accuracy—no thermoelectric error: High accuracy over a wide temperature range is featured on the 432 Power Meters. By measuring the output voltage of the thermistor bridges, and computing the corresponding power, even higher accuracy of $\pm 0.2\% \pm 0.5 \mu\text{W}$ can be obtained.

Accuracy is maintained on even the most sensitive range because the error due to thermoelectric effect is reduced to a negligible level.

Recorder outputs—analogue and digital: A rear panel connector provides an analog voltage proportional to the meter reading on all 432 Power Meters. In addition, the 432B and 432C Digital Power Meters feature BCD output of power reading—standard.

Long cable options: Thermistor mount cables up to 10 feet long can be used without special matching of the bridge circuit. Optional cables up to 200 feet long may be used if the cable is matched to the bridge circuit.

Calibrated mounts: Each thermistor mount is furnished with data stating the Calibration Factor* and Effective Efficiency* at various frequencies across the operating range. For easy and accurate power measurements, the front panel of the 432 contains a calibration factor control, calibrated in 1% steps from 88% to 100%, that compensates for losses in the mount and eliminates the need for calculation.

Convenient calibration: Verification of full-scale calibration on all ranges is provided by the 8477A Power Meter Calibrator described on page 317.

Specifications

Instrument type: automatic, self-balancing power meter for use with temperature-compensated thermistor mount.

Power range

432A: seven ranges with full scale readings of 10, 30, 100, and 300 μW , 1, 3, and 10 mW; also calibrated in dBm from -20 dBm to $+10$ dBm full scale in 5 dB steps.

432B, 432C: four ranges with full scale readings of 10 and 100 μW , and 1 and 10 mW.

* "Calibration Factor" and "Effective Efficiency" are figures of merit expressing the ratio of the substituted signal measured by the power meter to the microwave power incident on and absorbed by the mount, respectively.

Noise: less than 0.25% of full scale peak.

Response time: at recorder output, 35 ms times constant (typical).

Fine zero: automatic, operated by front panel switch. Remote fine zero may be accomplished with 432C.

Zero carryover: less than 0.50% of full scale when zeroed on most sensitive range.

RFI: meets all conditions specified in MIL-I-6181D.

Meter

432A: taut-band suspension, individually computed calibrated, mirror-backed scales. Milliwatt scale more than $4\frac{1}{4}$ " (108 mm) long.

432B, 432C: three digits with one digit overrange. 20% overrange capability on all ranges.

Calibration factor control: 13-position switch normalizes meter reading to account for thermistor mount calibration factor. Range 100% to 88% in 1% steps.

Thermistor mount: external temperature-compensated thermistor mounts required for operation (HP 478, 8478B, and 486 Series; mount resistance 100 or 200 ohms).

Recorder output: proportional to indicated power with 1 volt corresponding to full-scale. 1 k Ω output impedance.

BCD output: 8, 4, 2, 1 code: "1" positive. TTL compatible logic. Operates with HP 5055A Digital Recorder. "Print" and "Inhibit" lines available. (432B and 432C only.)

Bridge outputs (V_{RF} and V_{COMP}): direct connections to the thermistor bridges; used in instrument calibration and precision power measurements.

Model 432C control lines: (note: instrument is referenced to $+5$ V, "Logical 0" is equivalent to 0 V).

Outputs

BCD output as described above.

Overrange: single bit indicates meter overrange.

Underrange: single bit indicates meter underrange.

Range: two-bit code indicates range selected.

Print: single bit indicates data is ready.

Inputs

Remote enable: single bit establishes control of instrument ranging and fine zero controls for remote programming. Remote fine zero may be accomplished in remote or local modes of operation.

Remote range: two-bit code selects instrument range.

Auto zero: contact closure to ground or TTL "0" zeros meter.

Inhibit: single bit holds data and stops A/D converter.

External trigger: when in inhibit mode, single bit starts new data conversion. Data ready in 10 msec.

Inputs and outputs: compatible with 5055A Digital Recorder and 12566A-M2 interface card for 2100 Series computers.

Power

432A: 115 or 230 V ac $\pm 10\%$, 50 to 400 Hz, 2 $\frac{1}{2}$ watts. Optional rechargeable battery provides up to 24 hours continuous operation. Automatic battery recharge.

432B: 115 or 230 V ac $\pm 10\%$, 50 to 400 Hz, 10 watts.

432C: 115 or 230 V ac $\pm 10\%$, 50 to 400 Hz, 16 watts.

Weight

432A: net, 6 lbs 14 oz (3.1 kg); shipping, 10 lbs 5 oz (4.7 kg).

432B: net, 6 lbs 14 oz (3.1 kg); shipping, 10 lbs 5 oz (4.7 kg).

432C: net, 7 lbs (3.2 kg); shipping, 10 lbs 7 oz (4.8 kg).

THERMISTOR MOUNTS, CALIBRATOR

Broad Frequency coverage
Models 478A, 8478B, 486 Series, 8477A



POWER METERS

Dimensions: 5 1/8" wide, 6-3/32" high, 11" deep (130 x 155 x 279 mm).

Accessories furnished: 5 ft (1.52 m) cable for Hewlett-Packard temperature-compensated thermistor mounts; 7 1/2 ft (2.29 m) power cable. Main plugs shipped to match destination requirements.

Options

001: rechargeable battery installed, provides up to 24 hours continuous operation, add \$100 (432A only).

002: input connector placed on rear panel in parallel with front, add \$25.

003: input connector on rear panel only, add \$10.

(Note: thermistor mount cable impedance is part of the 432 input bridge circuit. For cables over 10 feet long, the bridge is matched to specific cable options, so the various cables should not be interchanged.)

009: 10 ft (3.05 m) cable for 100-ohm or 200-ohm mount, add \$30.

010: 20 ft (6.10 m) cable for 100-ohm or 200-ohm mount, add \$50.

011: 50 ft (15.24 m) cable for 100-ohm or 200-ohm mount, add \$100.

012: 100 ft (30.48 m) cable for 100-ohm or 200-ohm mount, add \$150.

013: 200 ft (60.96 m) cable for 100-ohm or 200-ohm mount, add \$250.

Price: Model 432A, \$575; Model 432B, \$975; Model 432C, \$1375.

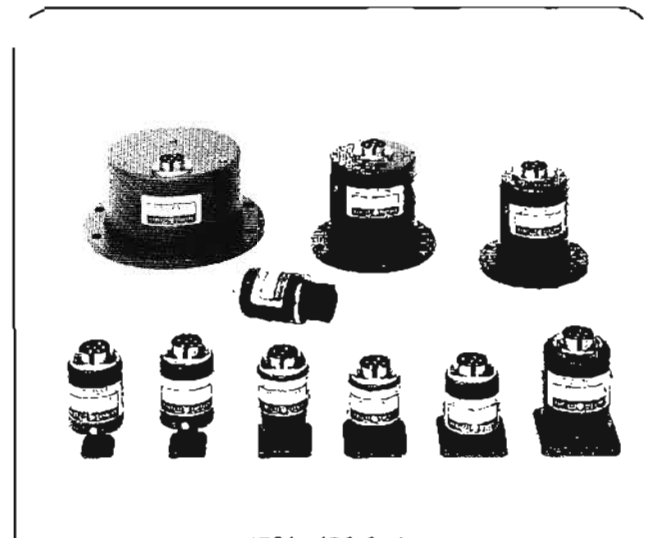

478A, 486 Series

Temperature-compensated Thermistor Mounts

High efficiency and good RF match are characteristic of the HP 478A and 8478B Coaxial and 486A-Series Waveguide Thermistor mounts which, in conjunction with the 432 Power Meter, provide you with high accuracy even in routine power measurements. These thermistor mounts are temperature-compensated for low drift, even in the presence of thermal shocks, permitting measurement of microwave power as low as one microwatt. Each mount contains data showing Calibration Factor and Effective Efficiency at six frequencies, directly traceable to the National Bureau of Standards at those frequencies where NBS provides calibration service.

Specifications

HP Model	Frequency range, GHz	Maximum SWR	Operating resistance (ohms)	Price
478A	10 MHz to 10 GHz	1.75, 10 to 25 MHz 1.3, 25 MHz to 7 GHz 1.5, 7 to 10 GHz	200	\$195
8478B ²	10 MHz to 18 GHz	1.75, 10 to 30 MHz 1.35, 30 to 100 MHz 1.1, 0.1 to 1 GHz 1.35, 1 to 12.4 GHz 1.5, 12.4 to 18 GHz	200	\$325 ⁴
S486A	2.60 to 3.95	1.35	100	\$390
G486A	3.95 to 5.85	1.5	100	\$275
J486A	5.30 to 8.20	1.5	100	\$275
H486A	7.05 to 10.0	1.5	100	\$275
X486A	8.20 to 12.4	1.5	100	\$190
M486A	10.0 to 15.0	1.5	100	\$335
P486A	12.4 to 18.0	1.5	100	\$240
K486A ³	18.0 to 26.5	2.0	200	\$350
R486A ³	26.5 to 40.0	2.0	200	\$395

¹ 11528A Adapter adapts mount to 430 Series Power Meter (thermistor circuit unbalanced, no temperature compensation), \$10.

² 11527A Adapter adapts 8478B to 431A/B Power Meters (thermistor circuit unbalanced), \$25.

³ Circular flange adapters: K-band (UG-425/U) HP 11515A, \$60 each; R-band UG-381/U) HP 11516A, \$50 each.

⁴ Option 011, furnished with APC-7 RF connector, add \$25.

8477A Power Meter Calibrator

The 8477A Calibrator is specifically designed for use with the 432 Power Meter. It allows you to verify full-scale meter readings on all ranges, and meter tracking. Simply connect three cables between the power meter and calibrator; no charts or additional instruments are required.

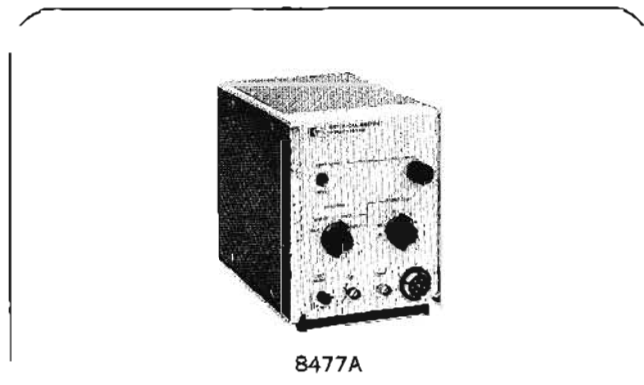

8477A

Specifications, 8477A

Calibration points: outputs corresponding to meter readings of: 0.01, 0.03, 0.1, 0.3, 1.0, 2.0, 3.0, and 10 mW (for mount resistance switch settings of both 100 and 200 ohms).

Calibration uncertainty: ±0.2% on the top five ranges, and ±0.5% on the 0.01 and 0.03 mW ranges from +20° to +30°C.

RFI: meets all conditions specified in MIL-I-6181D.

Power: 115 or 230 V ±10%, 50-400 Hz, approximately 2 W.

Weight: net, 4 1/2 lbs (2.0 kg); shipping, 6 1/4 lbs (2.9 kg).

Dimensions: 6-3/32" high, 5 1/8" wide, 8" deep (155 x 130 x 203 mm).

Price: Model 8477A, \$495.

POWER METERS



POWER METER

Works with positive or negative bolometers

Models 430C, 477B, 487 thermistor mounts

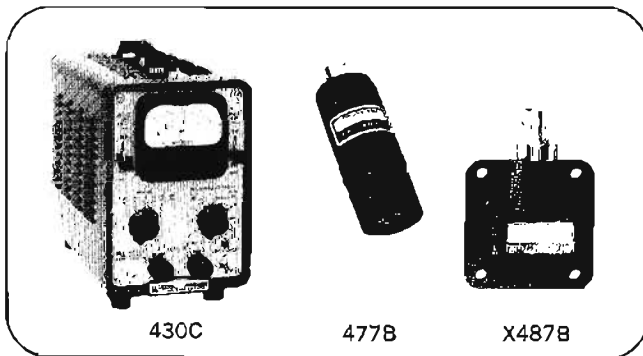

The HP 430C reads RF power directly in dBm or mW. The instrument may be used with either positive or negative bolometer mounts at any frequency for which there is a mount available.

The Model 477B thermistor mount allows measurements from 10 MHz to 10 GHz, and the 487-series waveguide mounts cover the 8.2-18.0 GHz frequency range. Hewlett-Packard barretter mounts may be used as can the 478A, 8478B, and 486-series thermistor mounts with the 11528A adapter.

Specifications, 430C

Power range: 5 ranges, front-panel selector; full-scale readings of 0.1, 0.3, 1, 3, and 10 mW; also calibrated in dB from -20 to +10 dBm.

External bolometer: frequency range depends on bolometer mount; bolometers can operate at resistance levels of 100 or 200 ohms and can have positive or negative temperature coefficients; any dc bias current up to 16 mA is available for biasing bolometers.

Accuracy: $\pm 5\%$ of full scale.

Power: 115 or 230 V $\pm 10\%$, 50 to 400 Hz, approximately 90 W.

Dimensions: cabinet, 7½" wide, 11½" high, 14¼" deep (191 x 292 x 362 mm); rack mount, 19" wide, 7" high, 13½" deep behind panel (483 x 178 x 333 mm).

Weight: net, 14 lbs (6,3 kg); shipping, 16 lbs (7,2 kg) (cabinet); net, 18 lbs (8,1 kg); shipping, 27 lbs (12,2 kg) (rack mount).

Accessory available: 11528A adapter, adapts HP 478A, 486A, 8478B thermistor mounts for use with 430C, \$10.

Price: HP 430C, \$490 (cabinet); HP 430CR, \$500 (rack mount).

Specifications, 477B thermistor mount

Frequency range: 10 MHz to 10 GHz.

Reflection coefficient: full range, < 0.2 (1.5 SWR, 14 dB return loss); 50 MHz to 7 GHz, < 0.13 (1.3 SWR, 17.7 dB return loss).

Power range: 0.01 to 10 mW (with HP 430C) 10 mW maximum average power; 1 W maximum peak power.

Element: 200-ohm, negative temperature coefficient thermistor included; approximately 13 mA bias required.

RF connector: Type N male.

Price: HP 477B, \$135.

Specifications, 487 thermistor mounts

HP Model	Maximum SWR	Frequency range* GHz	Price
X487B	1.5	8.2 - 12.4	\$150
P487B	1.5	12.4 - 18.0	\$175

*HP 486A Waveguide Thermistor Mounts are available in S- through R-band (2.8 to 40 GHz); 11528A Adapter required.

Peak Power Calibrator Model 8900B

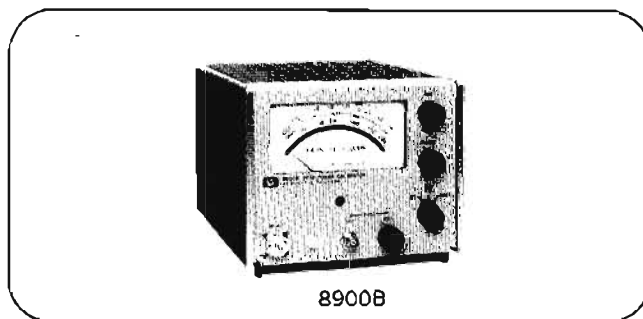

Features:

- Measures true peak power ± 0.6 dB absolute
- Measurement completely independent of repetition rate and pulse width ($> 0.25 \mu\text{sec}$)
- Readily standardized against external bolometer or calorimeter.
- Incorporates wide-band (7 MHz) detector output for pulse monitoring

The HP 8900B peak power calibrator provides a convenient means for measuring the peak RF power of pulses in the range from 50 to 2000 MHz. The power level is read out directly on the panel meter and is completely independent of repetition rate and pulse width ($> 0.25 \mu\text{sec}$).

Specifications

Radio frequency measurement characteristics

RF range: 50 to 2000 MHz.

RF power range: 200 mW peak full scale (may be readily increased through use of external attenuators or directional couplers).

RF power accuracy: ± 1.5 dB (± 0.6 dB with custom calibration curve furnished with instrument).

RF power precision: 0.1 dB.

RF pulse width: $> 0.25 \mu\text{s}$.

RF repetition rate: 1.5 MHz maximum.

RF impedance: 50 ohms.

RF VSWR: < 1.25 .

Monitor output

Level: > 0.2 volt for 20 mW input (nominal).

Impedance: 150 ohms nominal.

Bandwidth: > 7 MHz.

Physical characteristics

Dimensions: 7¼" wide, 6⅞" high, 11" deep (197 x 156 x 279 mm).

Weight: net, 10 lbs (4,5 kg); shipping, 13 lbs (5,9 kg).

Power: 105 to 125 or 210 to 250 volts, 50 to 60 Hz.

Price: HP 8900B, \$725 (includes calibration curve).

CALORIMETRIC POWER METER

Just connect, read power 10 mW to 10 watts

Model 434A



POWER METERS

With the 434A, measurement is literally as simple as connecting to a 50-ohm Type N front-panel terminal and reading power directly. The instrument has only two simple front-panel controls and is ideal for use by nontechnical personnel.

Model 434A fills the important range between microwave power meters such as the HP 432 Series, and conventional calorimeters whose lower range is approximately 10 watts. But, unlike previous cumbersome and costly equipment suggested for this range, the HP 434A is completely self-contained and requires no external detectors. In addition, the wider frequency response permits the unit to be conveniently calibrated by the application of a known dc power.

Rapid response time

Model 434A employs a self-balancing bridge and a high-efficiency heat transfer system to and from an oil stream to provide a full-scale response time of 5 seconds or less. This fast reaction, a fraction of the response time needed by ordinary calorimeters, means the 434A quickly follows small power changes, such as may be encountered in tuning.

Basically, the Model 434A consists of a self-balancing bridge which has identical temperature-sensitive resistors (gauges) in

two legs, an indicating meter and two load resistors, one for the unknown input power and one for the comparison power. The input load resistor and one gauge are in close thermal proximity so that heat generated in the input load resistor heats the gauge and unbalances the bridge. The unbalance signal is amplified and applied to the comparison load resistor which is in close thermal proximity to the other gauge so that the heat generated in the comparison load resistor is transferred to its gauge and nearly rebalances the bridge.

The meter measures the power supplied to the comparison load to rebalance the bridge. The characteristics of the gauges are the same, and the heat transfer characteristics from each load are the same, so the power dissipated in each load is the same, and the meter may be calibrated directly in input power.

The power measurement is accurate because the flow rates through the two heads are the same and the oil enters the heads at nearly the same temperature. To ensure constant temperature and to bring the streams to nearly the same temperature, they are passed through a parallel-flow heat exchanger just before entering the heads. Identical flow rates are obtained by placing all elements of the oil system in series.

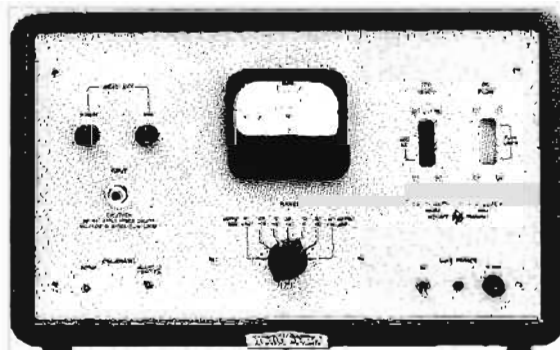

434A

Specifications

Input power range: seven meter ranges; full-scale readings of 0.01, 0.03, 0.1, 0.3, 1, 3 and 10 watts; meter scale also calibrated from -10 to 0 dBW, providing continuous readings from -30 to $+10$ dBW; power range can be extended upward with attenuators or directional couplers.

Maximum input power: 1 kW peak; 10 watts average.

Frequency range: dc to 12.4 GHz.

Accuracy: within $\pm 5\%$ of full scale; includes dc calibration and RF termination efficiency but not mismatch loss; greater accuracy can be achieved through appropriate techniques.

Estimated attainable accuracy

	Upper ranges	Two lowest ranges
DC	0.5%	2%
0 to 1 GHz	1%	3%
1 to 4 GHz	2%	4%
4 to 10 GHz	3%	5%
10 to 12.4 GHz	4%	5%

DC input impedance: 50 ± 5 ohms at Type N input jack.

Reflection coefficient: dc to 5 GHz, < 0.13 (1.3 SWR, 17.7 dB return loss); 5 to 11 GHz, < 0.2 (1.5 SWR, 14 dB return loss); 11 to 12.4 GHz, < 0.26 (1.7 SWR, 11.7 dB return loss).

Meter response time: less than 5 seconds for full-scale deflection.

Internal callibrator: 100 mW dc $\pm 1\%$ into 45 to 55 ohms.

Power: 115 or 230 volts (specify) $\pm 10\%$, 50 to 60 Hz approximately 180 watts with no input, 200 watts with 10 watts input.

Dimensions: cabinet: $20\frac{3}{4}$ " wide, $12\frac{3}{4}$ " high, 14" deep (527 x 324 x 356 mm); rack mount: 19" wide, 10-15/32" high, $13\frac{1}{2}$ " deep behind panel (483 x 266 x 343 mm).

Weight: net 49 lb (22,2 kg), shipping 59 lb (26,8 kg) (cabinet); net 43 lb (19,4 kg), shipping 56 lb (25,2 kg) (rack mount).

Accessories available: 281A,B Waveguide-to-Coax Adapters; 11550A (formerly K02-434A) DC Test Set (for more accurate power measurements), \$2000.

Price: HP 434A, \$2100 (cabiner); HP 434AR, \$2085 (rack mount).



NOISE FIGURE METERS; SOURCES

Automatic noise figure measurements to 18 GHz
Models 340B, 342A; 343A, 345B, 347A, 349A

In microwave communications, radar, etc., the weakest signal that can be detected is usually determined by the amount of noise added by the receiving system. Thus, any decrease in the amount of noise generated in the receiving system will produce an increase in the output signal-to-noise ratio equivalent to a corresponding increase in received signal. From a performance standpoint, an increase in the signal-to-noise ratio by reducing the amount of noise in the receiver is more economical than increasing the power of the transmitter.

The quality of a receiver or amplifier is expressed in a figure of merit, or noise figure. Noise figure is the ratio, expressed in dB, of the actual output noise power of the device to the noise power which would be available if the device were perfect and merely amplified the thermal noise of the input termination

rather than contributing any noise of its own.

The Hewlett-Packard system of automatic noise figure measurement depends upon the periodic insertion of a known excess noise power at the input of the device under test. Subsequent detection of noise power results in a pulse train

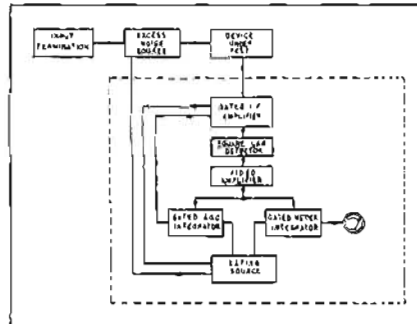

Figure 1. Automatic noise figure measurement system.

of two power levels. The power ratio of these two levels contains the desired noise figure information. Hewlett-Packard noise figure meters automatically measure and present this ratio directly in dB of noise figure.

Noise figure is discussed in detail in Hewlett-Packard Application Note 57, which is available from your local Hewlett-Packard field office upon request. Application Note 57, "Noise Figure Primer," derives noise figure formulas, describes general noise figure measurements and discusses accuracy considerations. One of the measurement systems discussed in Application Note 57 is shown in Figure 1. The portion of the diagram within the dashed box is a simplified block diagram of the HP 340B and 342A Noise Figure Meters, and the excess noise source could be any of the noise sources described on these pages.

Advantages:

- Reads noise figure directly in dB
- Completely automatic measurement
- Easily used by nontechnical personnel
- No periodic recalibration needed
- Fast response; ideal for recorder operation

Uses:

- Measure noise figure in microwave or radar receivers, RF and IF amplifiers
- Compare unknown noise sources against known noise levels
- Adjust parametric amplifiers for optimum noise figure

HP noise figure meters and noise sources offer time-saving and cost-reducing advantages. Their ease of operation and continuous, automatic metering of noise figure reduce the time required for alignment and adjustment and simplify measurements so that they can be done by nontechnical personnel. No periodic recalibration of the meters is needed, and accurate alignment is easy, so high-level, on-line performance is assured.

In operation, a noise source is connected to the input of the device under test. The IF output of the device is connected to the 340B or 342A. The noise figure meter gates the noise source on and off. When the noise source is on, the noise level is that of the device plus the noise source. When the noise source is off, the noise level is that of the

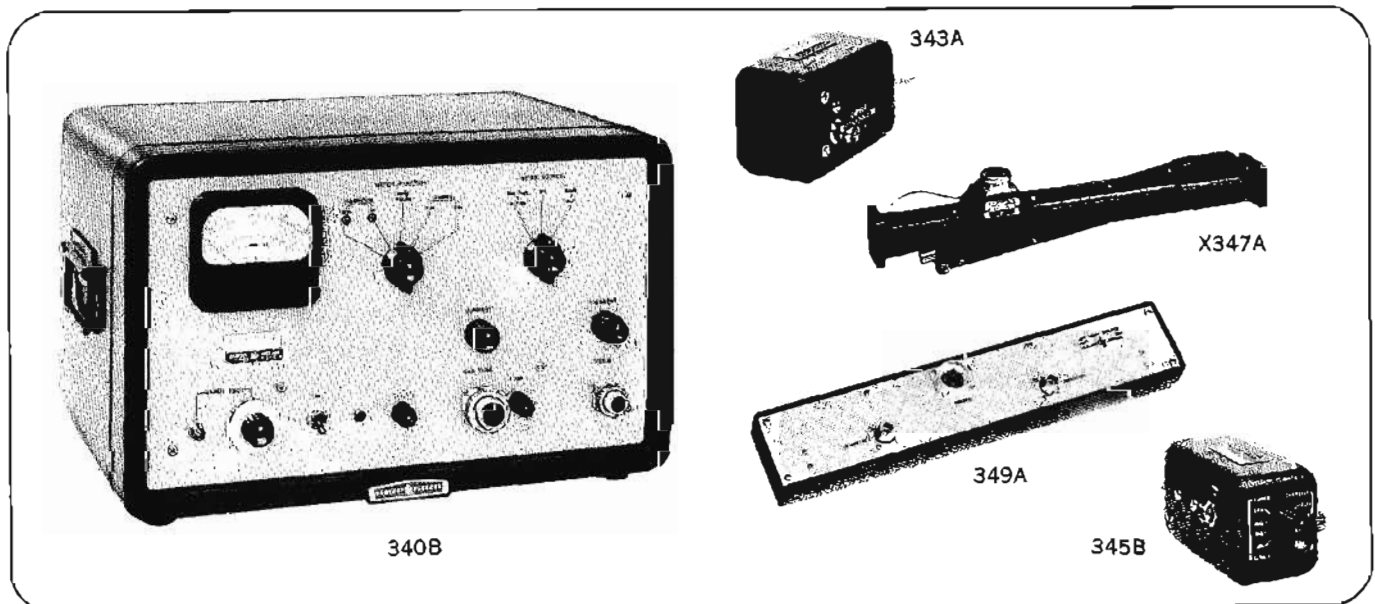

device and its termination. The noise figure meter automatically compares the two conditions and displays noise figure directly in dB. Power to operate the noise source is supplied by the noise figure meter. Simply connect the noise source, adjust drive current using the controls and meter on the 340B or 342A, and the noise source is ready for operation.

Noise figure meters

Model 340B Noise Figure Meter, when used with an HP noise source, automatically measures and continuously displays noise figure for frequencies of 30 and 60 MHz. On special order up to four custom frequencies between 10 and 70 MHz, and some frequencies outside this range, can be supplied.

Model 342A is similar to Model 340B, except that it operates on five frequencies: 60, 70, 105, 200, and the basic tuned-amplifier frequency of 30 MHz. Up to six custom frequencies between 10 and 200 MHz, including 21.4 MHz, are available on special order.

Noise sources

Hewlett-Packard 343A VHF Noise Source: Specifically for IF and RF amplifier noise measurement, a temperature-limited diode source with broadband noise output from 10 to 600 MHz with 50-ohm source impedance and low SWR.

Hewlett-Packard 345B IF Noise Source: Operates at either 30 or 60 MHz, as selected by a switch; another selector permits matching 50-, 100-, 200-, and 400-ohm impedances.

Hewlett-Packard 347A Waveguide Noise Source: Argon gas discharge tubes mounted in waveguide sections; for waveguide bands 3.95 through 18 GHz, they provide uniform noise throughout the range; maximum SWR is 1.2.

Hewlett-Packard 349A UHF Noise Source: Argon gas discharge tubes in Type N coaxial configuration for automatic noise figure readings, 400 to 4000 MHz.

Specifications, 340B and 342A

Noise figure range: 5.2 dB noise source, 0 to 15 dB, indication to infinity; 15.2 dB noise source, 3 to 30 dB, indication to infinity.

Accuracy (excluding source accuracy): noise diode scale: ± 0.5 dB, 0 to 15 dB; gas tube scale: ± 0.5 dB, 10 to 25 dB; ± 1 dB, 3 to 10 dB and 25 to 30 dB.

Input frequency: 340B: 30 or 60 MHz, selected by switch; 342A: 30, 60, 70, 105, and 200 MHz, selected by switch. Other frequencies available; prices and details on request.

Bandwidth: 1 MHz minimum.

Input requirements: -60 to -10 dBm (noise source on); corresponds to gain between noise source and input of approximately 50 to 100 dB for 5.2 dB noise source and 40 to 90 dB for 15.2 dB noise source.

Input impedance: 50 ohms nominal.

AGC output: nominal 0 to -6 V from rear binding posts.

Recorder output: 1 mA maximum into 2000 ohms maximum.

Power input: 115 or 230 volts $\pm 10\%$, 50 to 60 Hz, 185 to 435 watts, depending on noise source and line voltage.

Power output: sufficient to operate 343A, 345B, 347A or 349A Noise Sources.

Dimensions: cabinet: $20\frac{3}{4}$ " wide, $12\frac{3}{4}$ " high, $14\frac{1}{2}$ " deep (527 x 324 x 368 mm); rack mount: 19" wide, 10-15/32" high, $13\frac{7}{8}$ " deep behind panel (483 x 266 x 353 mm).

Weight: net 44 lb (19.8 kg), shipping 55 lb (24.8 kg) (cabinet); net 37 lb (16.7 kg), shipping 51 lb (22.9 kg) (rack mount).

Accessories furnished: one 340A-16A Cable Assembly, connects noise figure meter to 347A or 349A Noise Source.

Price: HP 340A, \$1000 (cabinet); HP 340BR \$985 (rack mount); HP 342A, \$1100 (cabinet); HP 342AR, \$1085 (rack mount); not available in all countries.

Specifications, 343A

Frequency range: 10 to 600 MHz.

Excess noise ratio¹: 10 to 30 MHz, 5.20 dB ± 0.20 dB; 100 MHz, 5.50 dB ± 0.25 dB; 200 MHz, 5.80 dB ± 0.30 dB; 300 MHz, 6.05 dB ± 0.30 dB; 400 MHz, 6.30 dB ± 0.50 dB; 500 MHz, 6.50 dB ± 0.50 dB; 600 MHz, 6.60 dB ± 0.50 dB.

Source impedance: 50 ohms.

Reflection coefficient: < 0.091 (1.2 SWR), 10 to 400 MHz; < 0.13 (1.3 SWR), 400 to 600 MHz.

Noise generator: temperature-limited diode.

Dimensions: $2\frac{3}{4}$ " wide, $2\frac{1}{2}$ " high, 5" deep (70 x 63 x 127 mm).

Weight: net $\frac{3}{4}$ lb (0.34 kg); shipping 2 lbs (0.9 kg).

Price: HP 343A, \$150.

Option 001: spare noise diode(s) calibrated and supplied with instrument, add \$40 each.

Specifications, 345B

(same weight and dimensions as 343A)

Spectrum center: 30 or 60 MHz, selected by switch.

Excess noise ratio¹: 5.2 dB.

Source impedance: 50, 100, 200 or 400 ohms, $\pm 4\%$, as selected by switch; less than 1 pF shunt capacitance.

Noise generator: temperature-limited diode.

Price: HP 345B, \$200 (operation at any two frequencies between 10 and 60 MHz in lieu of 30 and 60 MHz available on special order).

Specifications, 347A

HP Model	Range (GHz)	Excess noise ratio ^{1,2}	Approx. length		Price
			(in.)	(mm)	
G347A	3.95—5.85	15.2 ± 0.5	19	483	\$450
J347A	5.30—8.20	15.2 ± 0.5	19	483	\$450
H347A	7.05—10.0	15.6 ± 0.5	16	406	\$425
X347A	8.20—12.4	15.7 ± 0.4	14 $\frac{3}{4}$	375	\$375
P347A	12.4—18.0	15.8 ± 0.5	14 $\frac{1}{4}$	375	\$400

Reflection coefficient for all models, fired or unfired, 0.091 (SWR 1.2) max. (source terminated in well-matched load).

Specifications, 349A

Frequency range: 400 to 4000 MHz, wider with correction.

Excess noise ratio¹: 15.6 dB ± 0.6 dB,² 400 to 1000 MHz; 15.7 dB ± 0.5 dB,² 1000 to 4000 MHz.

SWR: < 1.35 (fired), < 1.55 (unfired) up to 2600 MHz; < 1.55 (fired or unfired), 2600 to 3000 MHz; < 2.0 (fired), < 3.0 (unfired) 3000 to 4000 MHz.

Dimensions: 3" wide, 2" high, 15" long (76 x 51 x 381 mm).

Weight: net $3\frac{1}{4}$ lb (1.4 kg); shipping 6 lb (2.7 kg).

Price: HP 349A, \$325.

$$^1 \text{ ENR (dB)} = 10 \log \frac{k(T - T_0)B}{kT_0B}$$

where kTB = available noise power, and kT_0B = available noise power with noise source at 290° K.

² Includes factor for insertion loss.

MICROWAVE TEST EQUIPMENT



BASIC INSTRUMENTS FOR MICROWAVE MEASUREMENTS

Frequency, impedance, attenuation

Hewlett-Packard offers a complete line of microwave test equipment from which systems can be assembled for making accurate reflection, transmission and frequency measurements. Measurement techniques and equipment functions are discussed briefly in the following paragraphs. More detailed information is available in Application Notes 64, 65, and 84, complimentary copies of which are available from Hewlett-Packard sales offices.

Frequency measurements

There are two general classes of frequency measuring devices—active and passive types. Electronic counters, transfer oscillators, and frequency converters are examples of active types. These instruments measure frequency well into the microwave region with accuracies of a few parts in 10^8 . More information about active frequency-measuring instruments is contained in the frequency counter section of this catalog.

Where the accuracy of active devices is not required, passive devices offer direct readout at a considerable saving in cost. Passive transmission-type frequency meters, such as the HP 532, 536A, and 537A, are two-port devices that absorb part of the input power in a tunable cavity. When the cavity is tuned to resonance, a dip occurs in the transmitted power level. This dip can be observed on a meter or oscilloscope display of the detected RF voltage. Frequency is then read from a calibrated dial driven by the cavity tuning mechanism.

The accuracy of cavity frequency meters depends upon the cavity Q, dial calibration, backlash, and effects of temperature and humidity variations. The Hewlett-Packard waveguide and coaxial passive frequency meters achieve accuracies of a few parts in 10^1 .

Impedance measurements

Impedance-matching a load to its source is one of the most important considerations in microwave transmission systems. If the load and source are mismatched, part of the power is reflected back along the transmission line toward the source. This reflection not only prevents maximum power transfer, but also can be responsible for erroneous measurements of other parameters or even cause circuit damage in high-power applications.

The power reflected from the load interferes with the incident (forward)

power, causing standing waves of voltage and current along the line. SWR which is the ratio of standing-wave maxima to minima is directly related to the impedance mismatch of the load. The standing-wave ratio (SWR), therefore, provides a valuable means of determining impedance and mismatch.

There are two methods for measuring SWR; slotted line technique (single and swept frequency) and reflectometer techniques.

Slotted line techniques— single frequency

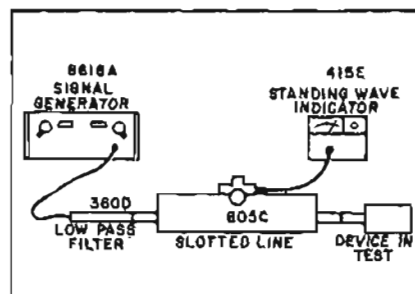

Figure 1. Typical setup for SWR and impedance measurements in coax using HP 805C Slotted Line

Standing-wave ratio can be measured directly with a slotted line in a setup like the one shown in Figure 1. The slotted line is placed immediately ahead of the load in test, and the source is adjustable for 1-kHz amplitude modulation at the desired microwave frequency. The slotted line probe is loosely coupled to the RF field in the line, thus sensing relative amplitudes of the standing-wave pattern as the probe is moved along the line. The ratio of maxima to minima (SWR) is displayed directly on the SWR meter.

While this method works well for single-frequency testing, it is time-consuming for broadband applications.

The swept slotted line

A measuring system which combines the speed and convenience of swept-frequency measurements and the inherent accuracy of the slotted line can be built around the 817A Slotted Line System. The 817A consists of an 816A Coaxial Slotted Line, 809C Carriage and 448A Slotted Line Sweep Adapter and can be used throughout the range from 1.8 to 18 GHz. The signal source is a sweep oscillator and the readout device is an oscilloscope.

The measurement technique is much the same as for fixed-frequency measurements. However, instead of the plot being a single vertical line, which would be the case in a fixed-frequency measurement, it is a smear or envelope as shown in Figure 2. At any given frequency, the ratio of the maximum and minimum amplitude of the envelope is the SWR.



Figure 2. Multi-sweep slotted-line measurement. Vertical scale 0.5 dB/cm (SWR = 1.12/cm).

A storage oscilloscope such as the HP 141A is ideal for these measurements. A plot of SWR can be generated in a few seconds and retained on the CRT for evaluation or photography. Accuracy of slotted-line measurements is limited primarily by the residual SWR of the line itself, 1.01 in waveguide and 1.02 to 1.06 in coax depending upon the frequency and type of connector. However, there are other considerations. Penetration of the detector probe into the line should be kept to a minimum to prevent standing waves due to the probe itself. Elimination of harmonics from the signal source is also important. HP 360, 362, and 8430 filters are excellent for this purpose.

Reflectometer techniques

The reflection coefficient (ρ) of a device or system is another useful term in establishing the impedance match of microwave devices. The following relationships of ρ and SWR are frequently used in impedance work:

$$|\rho| = \frac{E_{\text{reflected}}}{E_{\text{incident}}} = \frac{\text{SWR} - 1}{\text{SWR} + 1}$$

The amplitude of reflected voltage with respect to the incident voltage is given in terms of dB return loss by the expression: $\text{dB} = -20 \log_{10} |\rho|$. For example, if the reflected signal from a test is 26 dB below the incident signal level, the reflection coefficient of the device is calculated as 0.05.

The reflection coefficient of a load can be measured by separating the incident and reflected waves propagated in the transmission line connecting the source and load. The reflectometer uses directional couplers to accomplish this separation in both waveguide and coaxial systems. Reflectometers permit continuous oscilloscope displays or permanent X-Y recordings of reflection coefficient across complete operating bands.

Incident power in the improved reflectometer is held constant by leveling. With incident power held constant, only the relative amplitude of the reflected wave need be measured to determine reflection coefficient. This technique permits better accuracy than older systems, and fast sweep speeds enable the use of oscilloscope displays. See Figure 3.

To calibrate the reflectometer, a short circuit is placed at the output port, thus reflecting all of the incident power. The detector in the reverse-arm coupler samples the reflected power and provides a proportional dc voltage for readout. By placing a calibrated attenuator ahead of the detector, specific amounts of return loss may be pre-inserted for calibration of the oscilloscope or recorder gain. The attenuator is then returned to zero, the short removed and the test device connected and measured on the pre-calibrated display.

Calibration also is possible without the pre-insertion attenuator if the detector law is known and the vertical response of the readout device is constant. Calibration levels with this technique are established with the RF turned off (corresponding to no reflection), then with all of the power reflected by a sliding short. A more complete discussion and error analysis of reflectometer systems is included in Hewlett-Packard Application Note 65, "Swept Frequency Techniques."

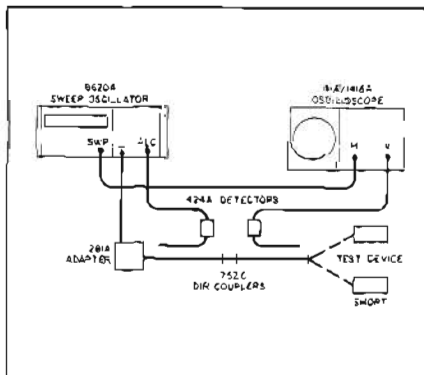

Figure 3. Typical Waveguide Reflectometer.

Attenuation measurements

Attenuation is defined as the decrease in power (at the load) caused by inserting a device between a Z_0 source and load. Under this condition, the measured value is a property of the device alone so that this is the "ideal system" in which to make measurements. The term Z_0 is used to describe a unity SWR condition where the load and source impedances equal the transmission line impedance.

There are three common methods for measuring RF attenuation: 1) square-law detection with audio substitution, 2) linear detection with IF substitution, and 3) direct RF substitution using attenuators calibrated by either of the first two methods. Accurate square-law measurements and RF substitution are possible using modern crystal detectors such as the HP 423A coaxial, and 424A waveguide series.

Square-law detection technique

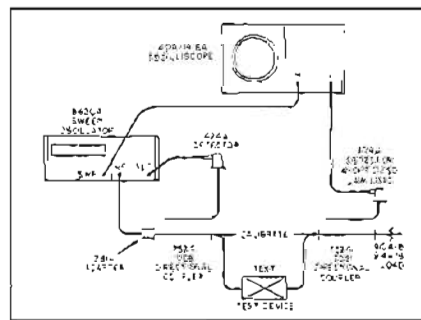

Figure 4. Swept attenuation system for measurements up to 40 dB with oscilloscope.

Figure 4 shows a waveguide system for swept attenuation measurements of 30 to 40 dB. Source power is leveled using a single 752-series 10-dB directional coupler in the ALC loop. Coupling variation versus frequency in the leveling loop causes leveled power variation of about 1 dB at the point of test device insertion. This power variation is nearly equal to, but opposite, the coupling variation of the readout coupler.

With the 8620A sweeping the frequency range of interest, a zero-dB reference level is established on the oscilloscope without the test device in the system. The device is then inserted as indicated in Figure 4 and its attenuation versus frequency determined by the amplitude decrease from the CRT reference level previously established.

IF substitution technique

The IF substitution technique of attenuation measurement involves conversion of the microwave frequency to a constant, much lower frequency for which very accurately calibrated attenuators are available. These are the principles used in the HP 8405A Vector Voltmeter and HP 8410A Network Analyzer. For information about these instruments see the Network Analyzer section of this catalog.

RF substitution technique

Swept attenuation measurements up to 45 or 50 dB can be made using the RF pre-insertion, X-Y recorder system shown in Figure 5. Coupler tracking and detector errors are eliminated by plotting a calibration grid on the X-Y recorder prior to the actual measurement. In addition to being leveled, the sweeper is internally amplitude-modulated at 1 kHz to drive the 415E SWR Meter. The 415E, after amplifying the 1-kHz signal, feeds a proportional dc voltage to the recorder Y-input. The dc sweep voltage from the 8620A drives the recorder X-input directly.

Calibration lines are plotted by setting in specific values of attenuation on the 382A near the anticipated test device attenuation and triggering single 30-second sweeps. The 382A is then set to 0 dB and the test device inserted as shown in Figure 5. A final sweep is triggered and attenuation of the test device plotted over the calibration grid.

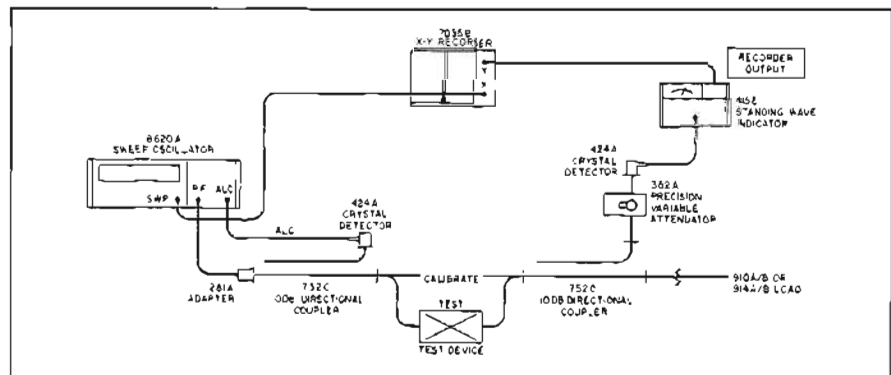

Figure 5. RF pre-insertion technique for swept attenuation measurements.

MICROWAVE TEST EQUIPMENT



WAVEGUIDE INSTRUMENTATION

For waveguide systems operating 2.60-40 GHz

Instrument Name	Uses	Family Model Number	Frequency coverage by band - GHz								
			S 2.6- 3.95	G 3.95- 5.85	J 5.30- 8.20	H 7.05- 10.0	X 8.20- 12.4	M 10.0- 16.0	P 12.4- 18.0	K 18.0- 26.5	R 26.5- 40.0
Adapters	Interconnect coaxial-waveguide systems	281A	X	X	X	X	X				
	Interconnect two different waveguide systems	281B 292A 292B					X X X	X	X X	X	
Low-pass filters	Output filters for signal sources to eliminate harmonics	362A					X	X	X	X	X
Variable attenuators	Measurement of reflection coefficient, insertion loss, transfer characteristics by RF substitution; reduction of power levels; reduction of source mismatch	382A 375A	X		X	X	X X		X X	X	X
Crystal Detectors	RF detection; reflection coefficient, attenuation measurements	424A 422A	X	X	X	X	X	X	X	X	X
Detector mount	Tunable detector mount for accurate matching of waveguide sections to crystal or bolometer	485B					X				
Thermistor mount	Power measurements with 432 series (486A), and 430C (487B).	486A 487B	X	X	X	X	X X	X	X X	X	X
Frequency meters	Frequency measurements	532A 532B			X	X	X		X	X	X
Directional couplers	Power measurements; power leveling; reflection measurements; isolation	752A 752C 752D			X X X	X X X	X X X		X X X	X X X	X X X
Slotted line systems	Measurement of SWR, wavelength, impedance; fixed and swept-frequency slotted line measurements	810B 815B			X	X	X		X	X	X
PIN modulators	Sinusoidal and complex AM and RF pulsing of microwave sources without incidental FM	8735A 8735B					X X				
Fixed and sliding loads	Fixed loads for terminating waveguide systems. Sliding loads for separating load reflections from other system reflections	910A 910B 914A 914B			X X	X X	X X		X X	X	X
Fixed and sliding shorts	Establish measurement planes, reflection phase and magnitude references	920A 920B 923A 930A			X	X	X X		X	X	X
Mixers	Harmonic Mixer	932A							X		
Slide screw tuners Phase shifters	Correct discontinuities in waveguide Provide phase control	870A 885A			X		X X		X X		

¹Instrument model number consists of family model number prefixed by letter of waveguide band, E.G., X281B specifies X-band waveguide to coax adapter.

COAXIAL ATTENUATORS

High performance, low cost, dc to 18 GHz
Models 8491A, B; 8492A; 8493A, B



MICROWAVE TEST EQUIPMENT



8491A



8492A



8493A



11582A

8491A/B, 8492A, 8493A/B Fixed Attenuators

Hewlett-Packard fixed coaxial attenuators provide precision attenuation, flat frequency response, and low VSWR over broad frequency ranges at low prices. Attenuators are available in nominal attenuations of 3-dB, 6-dB and 10-dB increments from 10 dB to 60 dB. These attenuators are swept-frequency tested to insure meeting specifications at all frequencies.

11581A, 11582A, 11583A Attenuator Sets

A set of four Hewlett-Packard attenuators, 3, 6, 10 and 20 dB are furnished in a handsome walnut accessory case. In addition to the calibration stamping on the bodies of the attenuators, the set includes a calibration report. The calibration report is certified traceable to the National Bureau of Standards. The calibration report also includes accuracy of both the attenuation and the reflection coefficients at selected frequencies.

11581A (8491A's): includes 3, 6, 10, 20 dB. Price: \$250

11582A (8491B's): includes 3, 6, 10, 20 dB. Price: \$310

11583A (8492A's): includes 3, 6, 10, 20 dB. Price: \$575

Specifications 8491A/B, 8492A, 8493A/B

	8491A		8491B			8492A			8493A		8493B		
Attenuation ¹ (dB)	Option : 3, 6, 10, 20, 30, 40, 50, 60		Option : 3, 6, 10, 20, 30, 40, 50, 60			Option : 3, 6, 10, 20, 30, 40, 50, 60			Option : 3, 6, 10, 20, 30		Option : 3, 6, 10, 20, 30		
Frequency	DC - 12.4 GHz		DC - 18 GHz			DC - 18 GHz			DC - 12.4 GHz		DC - 18 GHz		
SWR ²	DC-8 GHz 1.2	8-12.4 1.3	DC-8 GHz 1.2	8-12.4 GHz 1.3	12.4-18 GHz 1.5	DC-8 GHz 1.16	8-12.4 GHz 1.25	12.4-18 GHz 1.35	DC-8 GHz 1.2	8-12.4 GHz 1.3	DC-8 GHz 1.2	8-12.4 GHz 1.3	12.4-18 GHz 1.5
Attenuation Accuracy													
3 dB	±0.3 dB		±0.3 dB			±0.3 dB			±0.3		±0.3 dB		
6 dB	±0.3 dB		±0.3 dB ³			±0.3 dB ³			±0.3 dB		±0.3 dB ³		
10 dB	±0.5 dB		±0.5 dB			±0.5 dB			±0.5 dB		±0.5 dB		
20 dB	±0.5 dB		±0.5 dB ⁴			±0.5 dB ⁴			±0.5 dB		±0.5 dB		
30 dB	±1 dB		±1 dB			±1 dB			±1 dB		±1 dB		
40 dB	±1.5 dB		±1.5 dB			±1.5 dB			-		-		
50 dB	±1.5 dB		±1.5 dB			±1.5 dB			-		-		
60 dB	±2 dB		±2 dB			±2 dB			-		-		
Connector	N		N			APC-7			SMA		SMA		
Dimensions	2-7/16 x 13/16 inches		2-7/16 x 13/16 inches			2 3/4 x 13/16 inches			1-9/16 x 1/2 inches		1-9/16 x 1/2 inches		
Shipping Wt.	6 oz.		6 oz.			7 oz.			4 oz.		4 oz.		
Price (Qty. 1-4)	3-30 dB, \$60 Ea 40-60 dB, \$85		3-30 dB, \$75 Ea 40-60 dB, \$110			3-30 dB, \$140 Ea 40-60 dB, \$175			\$65 Ea -		\$80 Ea -		

1. Option numbers same as attenuator values; e.g., Option 003 for 3 dB, Option 006 for 6 dB, Option 010 for 10 dB etc.

2. Check data sheet for SWR slight variation of options 003 and 006 with frequency bands.

3. 6 dB option accuracy is ±0.4 dB, 12.4 - 18 GHz.

4. 20 dB option accuracy is ±1 dB, 12.4 - 18 GHz.

MICROWAVE TEST EQUIPMENT



COAXIAL ATTENUATORS

Variable attenuators to 12.4 GHz

Models 354A, 355C-F, 393A, 394A, 33300 Series

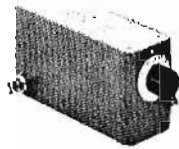

355D



355E

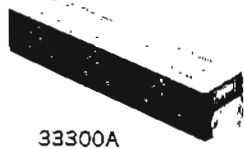

33300A

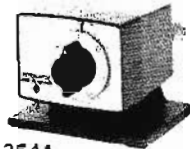

354A



394A

With loads A and B in place the instrument is an attenuator.
With load A only, the instrument is a variable directional coupler.

354A step attenuator, dc to 12.4 GHz

The Model 354A is a turret-type coaxial attenuator which provides 0 to 60 dB of attenuation in 10-dB steps over the frequency range from dc to 12.4 GHz. Attenuation changes are made with a simple knob rotation; no pull-turn-push sequence is required. For bench use the attenuator is supplied with a base; however, the base is removable for easy conversion to rack mount.

355C, D, E, F manual and programmable attenuators, dc to 1 GHz

These are precision attenuators from dc-1 GHz. The 355C and D are manual while the 355E and F are programmable. 0-12 dB in 1-dB steps are provided by the 355C and E; 0-120 dB in 10 dB steps are provided by the 355D and F. Attenuator sections are inserted and removed by cam-driven microswitches. The programmable version uses a 7-pin connector which allows remote control by BCD signals.

393A, 394A attenuators, 500 MHz to 1 GHz and 1 GHz to 2 GHz

Each of these coaxial variable attenuators uses the principle of a directional coupler to achieve a wide range of attenuation over a full octave. The HP 393A covers 5 to 120 dB from 500 to 1000 MHz; HP 394A covers 6 to 120 dB from 1 to 2 GHz. With special high-power terminations they handle up to 200 watts average. Since these instruments are variable directional couplers, they are particularly useful for mixing signals while maintaining isolation.

33300/01/04/05 programmable step attenuators, dc to 18 GHz

These step attenuators provide a fast and precise means for electrically controlling the level of signal attenuation in automatic test systems. They are available in four basic configurations: 0-70 dB in 10-dB steps (33300), 0-42 dB in 6-dB steps (33301), 0-11 dB in 1-dB steps (33304) and 0-110 dB in 10-dB steps (33305). Magnetic latching solenoids (12 and 24 volts) are used to switch individual attenuation elements into and out of contact with a 50 ohm transmission line, A and B are "no contacts" and C and D are "with contacts." Specifications in the table below are for the 33300 only. Refer to data sheet for specifications of the 33301/04/05, whose prices range from \$650-\$950.

Specifications	354A	355C/E	355D/F	393A	394A	33300A, B, C, D,
Mode of Operation:	Manual	355C: Manual 355E: Programmable	355D: Manual 355F: Programmable	Manual	Manual	Programmable
Attenuation:	0-60 in 10 dB steps	12 dB in 1-dB steps	120 dB in 10-dB steps	5-120 dB, variable	6-120 dB variable	0-70 dB in 10 dB steps
Frequency range:	dc-12.4 GHz	dc-1 GHz	dc-1 GHz	.5-1 GHz	1-2 GHz	dc-18 GHz
Accuracy:	±2 dB	±0.1 dB at 1000 Hz; ±0.25 dB dc to 500 MHz; ±0.5 dB to 1 GHz	±0.3 dB to 120 dB at 1000 Hz; ±1.5 dB to 90 dB below 1 GHz; ±3 dB to 120 dB below 1 GHz.	±1.25 dB or ±1.75% whichever is greater	±1.25 dB or ±2.5% whichever is greater	3%, dc to 12.4 GHz 4% 12.4 to 18 GHz
Impedance:	50 ohms	50 ohms		50 ohms		50 ohms
Power dissipation:	2 watts ave., 100 peak	0.5 watt average, 350 volts peak		Approximately 200 watt, max. rating of termination must be observed		2 watt ave., 500 watts peak
Maximum SWR:	1.5, dc - 8 GHz 1.75, 8-12.4 GHz	1.2 below 250 MHz; 1.3 below 500 MHz; 1.5 below 1 GHz		2.5, 5 to 15 dB 1.5, 15 to 30 dB 1.4, 30 to 120 dB	2.5, 6 to 10 dB 1.8, 10 to 15 dB 1.6, 15 to 120 dB	refer to data sheet
Maximum Insertion Loss:	<1.5 dB	0.25 dB at 100 MHz; 0.75 dB to 500 MHz; 1.5 dB to 1 GHz		-	-	0.8 dB, dc-8 GHz 1.2 dB, 8-12.4 GHz 1.8 dB, 12.4-18 GHz
Dimensions (in.):	4 long, 4½ wide, 3½ in. high	6 long, 2¾ wide, 2½ high (152 x 70 x 67 mm)		5½ wide, 12 long, 2¾ deep, (140 x 305 x 70)		7 x 1.5 x 1.25 (178 x 38 x 32)
Weight:	net 2 lb. (1.2 kg), shipping 4 lb. (1.8 kg)	net 2 lb. (0.9 kg); shipping 3 lb. (1.4 kg)		net 6 lb. (2.7 kg), shipping 9 lb. (4.1 kg)		net 2 lb. (0.9 kg), shipping 3 lb. (1.4 kg)
Price:	354A - \$390	355C: \$160 Manual 355E: \$275 Programmable	355D: \$160 Manual 355F: \$275 Programmable	393: \$725	394A: \$725	33000A: \$665 33000B: \$665 33000C: \$690 33000D: \$690

WAVEGUIDE ATTENUATORS

Frequency coverage to 40 GHz
Models 382A, C and 375A



**MICROWAVE
TEST EQUIPMENT**

Precision Variable Attenuators

Operation of these direct-reading, precision attenuators depends on a mathematical law, rather than on the resistivity of the attenuating material. Accurate attenuation from 0 to 50 dB (0 to 60 dB for S382C) is assured regardless of temperature and humidity. The

instruments can handle considerable power and feature large, easily read dials. In addition, the S382C achieves both long electrical length and short physical dimensions through dielectric loading. The result is an S-band attenuator which is only 25¼ inches long and yet is more accurate than previously available units.

HP Model	S382C	J382A	H382A	X382A	P382A	K382A ¹	R382A ¹
Frequency range (GHz):	2.6-3.95	5.3 - 8.2	7.05 - 10.0	8.2 - 12.4	12.4 - 18.0	18.0 - 26.5	26.5 - 40.0
Waveguide size (in.): (EIA):	3 x 1½ WR284	1½ x ¾ WR137	1¼ x ⅝ WR112	1 x ½ WR90	.702 x .391 WR62	½ x ¼ WR42	.360 x .220 WR28
Power handling capacity, watts, average continuous duty:	10	10	10	10	5	2	1
Size length, in. (mm): height, in. (mm): depth, in. (mm):	25¼ (641) 6 (152) 8 (203)	25 (635) 7⅞ (200) 6-3/16 (157)	20 (508) 7-15/16 (202) 6½ (165)	15¾ (397) 7⅞ (194) 4-11/16 (119)	12½ (318) 7¾ (197) 4¾ (121)	7⅞ (194) 6⅞ (156) 4¾ (121)	6⅞ (162) 6⅞ (156) 4¾ (121)
Weight net, lb (kg): shipping, lb (kg):	18 (8,1) 22 (9,9)	13 (5,9) 17 (7,7)	11 (5,0) 15 (6,8)	6 (2,7) 8 (3,6)	5 (2,3) 8 (3,6)	3 (1,4) 6 (2,7)	3 (1,4) 6 (2,7)
Price:	\$1800	\$700	\$675	\$425	\$500	\$725	\$800

For all 382A Models

Incremental attenuation range: 0 to 50 dB.

Residual attenuation: less than 1 dB.

Reflection coefficient: less than 0.07 (1.15 SWR, 23.1 dB return loss).

Accuracy: ±2% of reading in dB, or 0.1 dB, whichever is greater. Includes calibration and frequency error.

For Model S382C

Calibrated attenuation range: 0 to 60 dB (above residual attenuation).

Residual attenuation: less than 1 dB.

Accuracy: ±1% of reading in dB, or 0.1 dB, whichever is greater, from 0 to 50 dB; ±2% of reading above 50 dB; includes calibration and frequency error.

Reflection coefficient: less than 0.091 (1.2 SWR, 20.8 dB return loss), 2.6 to 3 GHz; less than 0.07 (1.15 SWR, 23.1 dB return loss), 3 to 3.95 GHz.

Degree dial: 0 to 90°; calibrated in 0.01° increments.

¹ Circular flange adapters: K-band (UG-425/U) 11515A, \$60 each; R-band (UG-381/U) 11516A, \$50 each.

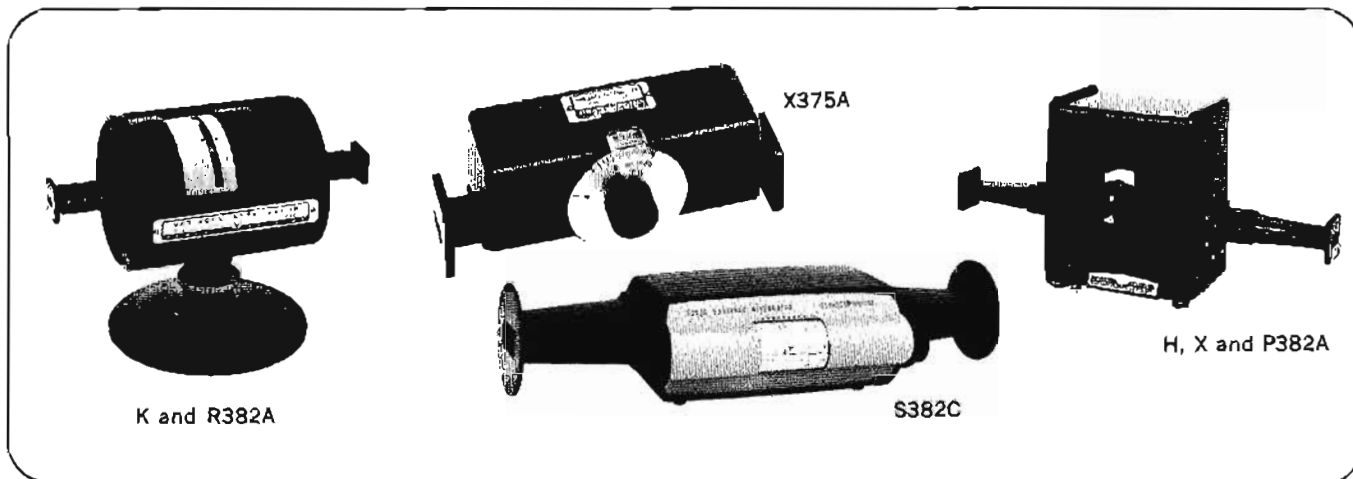

K and R382A

X375A

S382C

H, X and P382A

General-Purpose Attenuators

Variable flap attenuators provide a simple, convenient means of adjusting waveguide power level or isolating source and load. They consist of a slotted section in which a matched resistive strip is inserted. The degree of strip penetration determines attenuation. A dial shows average reading over the frequency band, and a shielded dust cover reduces external radiation and eliminates hand capacity effects. Attenuation is variable from 0 to 20 dB. Dial calibration is accurate within ±1 dB from 0 to 10 dB, ±2 dB from 10 to 20

dB. Maximum reflection coefficient is 0.07 (1.15 SWR, 23.1 dB return loss).

Specifications, 375A

HP Model	Frequency (GHz)	Power dissipation (watts)	Length		Fits waveguide size (in.)	Price
			(in.)	(mm)		
X375A	8.2 - 12.4	2.0	7-4/5	198	1 x ½	\$225
P375A	12.4 - 18.0	1.0	7¼	184	.702 x .391	\$250

BROADBAND COAX COUPLERS

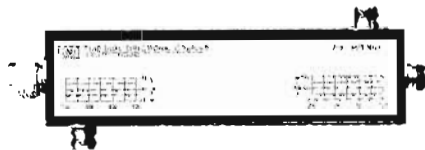
 Multi-Octave coverage with high directivity
 774D-778D

774D

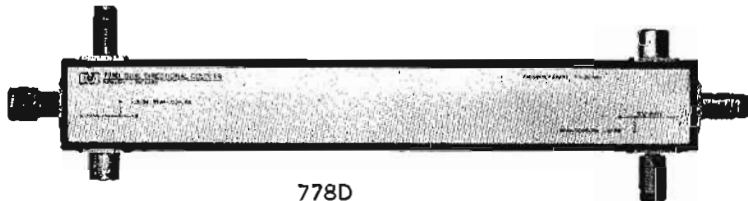

778D

774D-777D Dual Directional Couplers

The economical 774D-777D couplers cover frequency spreads of more than two-to-one, each centered on one of the important VHF/UHF bands. With their high directivity, these couplers are ideal for reflectometer applications. Furthermore, the close tracking of the auxiliary arms makes these couplers particularly useful for reflectometers driven by externally-leveled sweep oscillators such as HP8690B and 8620A/B. The forward signal is detected and used to level the output of the sweep oscillator while the reflected signal, after detection is applied to a display device. Changes in the leveled power due to the coupling variation in the forward arm are virtually cancelled by a similar coupling variation in the reverse arm.

778D Dual Directional Coupler

The HP778D is a 20-dB dual directional coupler with a frequency range of 100 MHz to 2 GHz. High directivity

and close tracking (typically 0.7 dB and 4°) of the auxiliary arms make it ideal for reflectometer measurements of complex reflection coefficient. Maximum errors in such measurements are:

Freq. Range (GHz)	Maximum Magnitude Error $\Delta\Gamma_L$	
	Swept Frequency	Fixed Frequency
0.1-1	$\pm(0.015 + 0.02 \Gamma_L + 0.05 \Gamma_L ^2)$	$\pm(0.015 + 0.05 \Gamma_L ^2)$
1-2	$\pm(0.025 + 0.02 \Gamma_L + 0.05 \Gamma_L ^2)$	$\pm(0.025 + 0.05 \Gamma_L ^2)$

Maximum phase error $= \pm \sin^{-1}(\Delta\Gamma_L/\Gamma_L)$.

$|\Gamma_L|$ = reflection coefficient of unknown.

Errors include directivity, source match, and tracking, but do not include any detection errors.

The 778D is provided with type "N" connectors. APC-7 is available as an option, and adapters to other connectors are available on request.

Specifications 774D, 775D, 776D, 777D, 778D

HP Model	Frequency Range	Coupling Attenuation	Coupling Variation	Directivity	SWR	Max Input	Connector	Length In (mm)	Price
774D	215-450 MHz	20 dB	± 1 dB	40 dB	1.15 pri 1.2 aux	50 W avg, 500 W pk,	pri: type N, one male, one female aux: type N, female	9-1/16 (230)	\$300
775D	450-940 MHz	20 dB	± 1 dB	40 dB	1.15 pri 1.12 aux	0.1 sec duty cycle		9-1/16 (230)	\$325
776D	940-1900 MHz	20 dB	± 1 dB ¹	40 dB	1.15 pri 1.2 aux			6-5/16 (161)	\$325
777D	1900-4000 MHz	20 dB	± 0.4 ¹	30 dB	1.2 pri 1.3 aux	8 7/8 (225)		\$350	
778D	100-2000 MHz	20 dB nominal	± 1 dB ²	Inc. port: 36 dB, 0.1-1 GHz, 32 dB, 1-2 GHz Ref. port: 30 dB, 0.1-2 GHz	1.1 all	50 W avg, 10 kW pk	Pri line ³ N-male input, N-female output Aux arms: N-female	16 1/4 (425)	\$450 Opt 011: add \$25 Opt 012 no extra charge

¹ Aux arm tracking: <0.3 dB for 776D, <0.5 dB for 777D.

² Auxiliary outputs typically track within 0.7 dB and 4°.

³ Option 011: APC-7 output, N-female input.

Option 012: N-male output, N-female input.

DIRECTIONAL COUPLERS

High directivity, low SWR
779D, 790 Series, 780 Series



**MICROWAVE
TEST EQUIPMENT**

779D directional coupler

Representing the latest achievement in broadband coaxial couplers, the HP 779D spans more than two octaves from 1.7 to 12.4 GHz with excellent directivity. With increased coupling factor (typically 24 dB), the 779D is useful down to 500 MHz. Upper frequency usefulness extends to 18 GHz with directivity reduced to about 15 dB.

The 779D is normally supplied with type N connectors on all ports. On special order, a precision APC-7 connector can be supplied on any, or all, ports.

790 directional couplers

The 790 directional couplers are ultra-flat, high directivity couplers which are ideal for power-monitoring applications in coaxial systems. Output coupling (ratio of output power from main and auxiliary arms) is specified rather than coupling factor. Thus, no correction factor is required to account for insertion losses in the main arm.

780 directional detectors

The 780 series directional detectors are directional couplers with built-in crystal detectors. The couplers have flat frequency

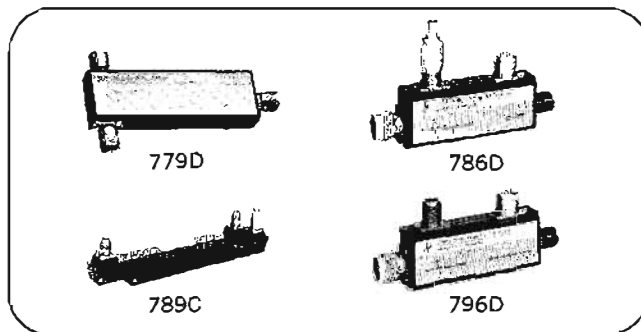

response and good directivity, while the detectors have good frequency response plus high sensitivity. The configuration of the directional detector reduces the number of ambiguities over the standard system of separate coupler and detector and makes possible tighter correlation between main-arm power and detected signal.

The directional detector is well suited for sweep oscillator leveling and can also be used to monitor power with a voltmeter or oscilloscope.

Specifications, 779D, 790 Series

HP Model	Frequency range (GHz)	Mean output coupling (dB) ¹	Output coupling variation (dB) ²	Directivity (dB) ²	Equly. source match ^{2,3}	Max. primary line SWR	Max. aux. arm SWR	Max. Input (W)	Max. insertion loss (dB) ⁴	Length		Shipping weight		Price
										(in)	(mm)	(lb)	(kg)	
779D	1.7 to 12.4	20 ±0.5	≤0.75	30, 1.7-4 GHz, 26, 4-12.4GHz	1.2	1.2	1.2	50	0.5	7 $\frac{1}{4}$	196	3	1.4	\$550
796D	0.96 to 2.11	20 ±0.5	≈0.2	30	1.13	1.15 ²	1.20 ²	50	0.4	6	152	2	0.9	\$275
797D	1.9 to 4.1	20 ±0.5	≈0.2	26	1.16	1.15 ²	1.25 ²	50	0.5	4 $\frac{3}{8}$	124	2	0.9	\$300
798C	3.7 to 8.3	10 ±0.3	≈0.3	20	1.25	1.20	1.20	10	0.8	4 $\frac{3}{8}$	124	2	0.9	\$325

For all models: RF connectors: primary line: type N, one male (input), one female; auxiliary arm: type N female.⁵

¹Difference in dB between power out of primary line and auxiliary arm.

²Sweep-frequency tested.

³The apparent SWR at the output port of a directional coupler when it is used in a closed-loop leveling system.

⁴Includes loss due to coupling.

⁵Type N connectors mate compatibly with connectors whose dimensions conform to MIL-C-39012 or MIL-C-71.

Specifications, 780 Series

HP Model	Frequency range (GHz)	Freq. resp. (dB) ¹	Low-level sens. ($\mu\text{V}/\mu\text{W}$)	Directivity (dB)	Equly. source SWR ²	Max. SWR	Max. Input (W, peak or avg.)	Max. insertion loss (dB)	Length		Shipping weight		Price
									(in)	(mm)	(lb)	(kg)	
786D	0.96 to 2.11	≈0.2	>4	30	1.13	1.15	10	0.4	6	152	2	0.9	\$300
787D	1.9 to 4.1	≈0.2	>4	26	1.16	1.15	10	0.5	4 $\frac{3}{8}$	124	2	0.9	\$300
788C	3.7 to 8.3	≈0.3	>40	20	1.25	1.20	1	0.8	4 $\frac{3}{8}$	124	2	0.9	\$325
789C	8.0 to 12.4	≈0.5	>20	17	1.25	1.40	1	1.2	11 $\frac{1}{8}$	295	3	1.4	\$550

¹ Includes coupler and detector variation with frequency as read on a meter calibrated for square-law detectors (e.g., HP 415E SWR Meter).

² The apparent reflection coefficient at the output of an RF generating system, using a directional detector in a closed-loop leveling system.

³ Type N connectors mate compatibly with connectors whose dimensions conform to MIL-C-39012 or MIL-C-71.

For all models

Detector output impedance: 15 k Ω max. shunted by approx. 10 pF.

Detector element: supplied.

Noise: <200 μV peak-to-peak with CW power applied to produce 100 mV output.

Detector output polarity: negative.

Detector output connector: BNC female.

RF connectors:³ Type N, one male (input), one female (789C: both female).

Options

002. Furnished with load resistor for optimum square law characteristics at 24°C (75°F), $\leq \pm 0.5$ dB variation from square law over a range of at least 30 dB from low level up to 50 mV peak output (working into external load >75 k Ω); sensitivity typically one-fourth of unloaded sensitivity; add \$20.

003. Positive polarity detector output; no additional charge.

MICROWAVE TEST EQUIPMENT



DIRECTIONAL COUPLERS

Easy-to-use, precision instruments

Model 752A,C,D

The HP 752 Directional Couplers are important tools in waveguide measurements. They can be used to monitor power, measure reflections, mix signals, or isolate signal sources or wavemeters.

Each coupler has an overall directivity of better than 40 dB (including reflection from built-in termination and flange) over its entire range. Performance characteristics are unaffected by humidity, temperature or time, thus making these units especially useful in microwave "standards" measurements. Coupling factors are 3, 10 and 20 dB; mean coupling accuracy is ± 0.4 dB (± 0.7 dB for K- and R-bands); and coupling variation vs frequency is ± 0.5 dB (± 0.6 dB for R752D).

Used together and connected back to back, two couplers are most useful with the HP 8620A Sweep Oscillator (see Signal Sources) in broadband reflection and SWR measurements. One directional coupler samples power traveling toward the load, and the detected sample can be used to

maintain a constant forward power. The output of the auxiliary arm of the second coupler, which samples power reflected from the load, is then a direct indication of reflection coefficient and swr. After detection, this signal can be viewed on an oscilloscope or permanently recorded on an x-y recorder. The HP 424A Series Crystal Detectors are ideal for use with the 752 couplers.

In the system described above, the variation in coupling with frequency of the two couplers tends to cancel. This cancellation effectively improves the leveling of the signal source and increases the accuracy of the measurement. For applications in which the actual variations in source output must be minimized, matched pairs of couplers for the leveling loop are available on special order. The pair comprises a 3- and 10- or 20-dB coupler. The 3-dB coupler is connected to the auxiliary arm of the 10- or 20-dB coupler, reducing coupling variation to less than ± 0.2 dB. Swept-frequency techniques are described in detail in Application Note 65, available from any HP field office.

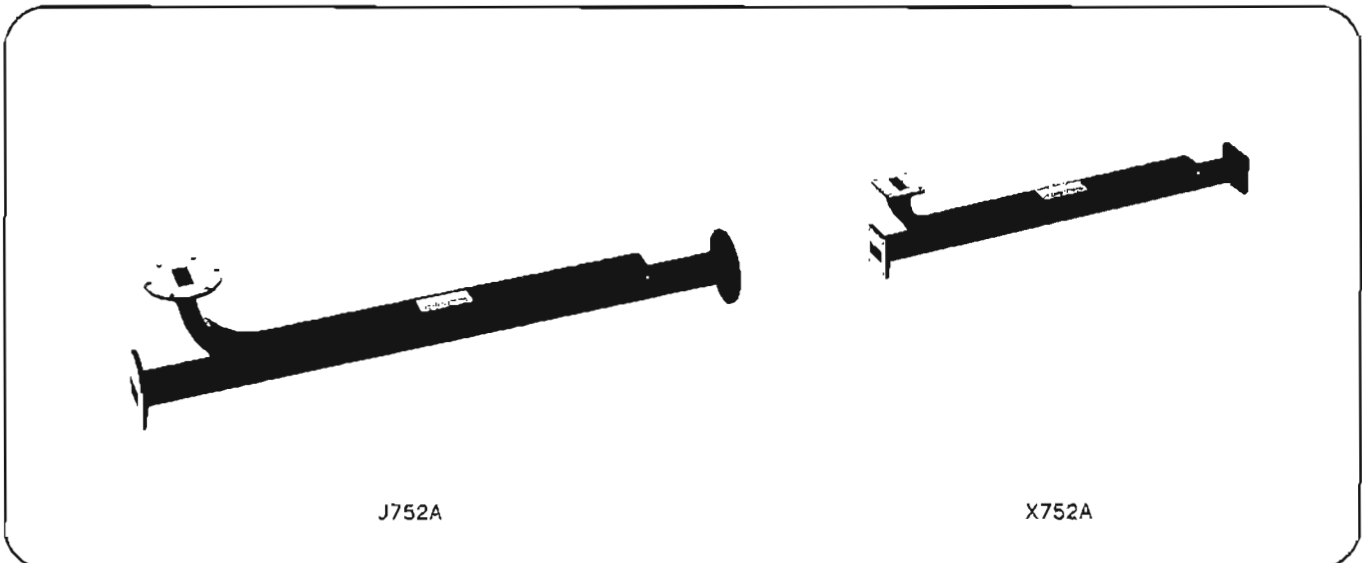

Specifications, 752 Series

Band ^{1,2} (prefix)	Frequency (GHz)	Fits waveguide size (in)	Mean coupling accuracy (dB) ^{3,4}	SWR ^{5,6} main guide		Average power aux. guide load (W)	Length (in)			Shipping weight		Price
				752A	752C,D		A	C	D	(lbs)	(kg)	
J*	5.85-8.2	1½ x ¾	±0.4	1.1	1.05	1	26½	25-9/16	25-9/16	8	3.6	\$300
H	7.05-10	1½ x ¾	±0.4	1.1	1.05	1	18¾	17½	17½	4	1.8	\$400
X	8.2-12.4	1 x ½	±0.4	1.1	1.05	1	16-11/16	15-11/16	15-11/16	3	1.4	\$200
P	12.4-18	702 x 391	±0.4	1.1	1.05	1	13¾	12¾	12¾	2	0.9	\$225
K†	18-26.5	½ x ¼	±0.7	1.1	1.05	½	10¾	9-15/16	9-15/16	2	0.90	\$275
R†	26.5-40	360 x 220	±0.7	1.1	1.05	½	11¾	8¾	8-23/32	2	0.90	\$300

¹When ordering, specify suffix letter to indicate nominal coupling: A for 3 dB, C for 10 dB, D for 20 dB (example: X-band, 3 dB coupling, Model X752A).

²Directivity is at least 40 dB; swept-frequency tested.

³Mean coupling is the average of the maximum and minimum coupling values in the rated frequency range.

⁴Coupling variation over rated frequency range is not more than ± 0.5 dB about mean coupling (± 0.6 dB for R752D).

⁵Auxiliary arm swr is 1.15 (1.2 for P-, K- and R-band units).

⁶Swept-frequency tested.

[†]J752 Couplers operate to 5.3 GHz with reduced performance.

†Circular flange adapters: K-band (UG-425/U), HP 11515A, \$60 each; R-band (UG-381/U), HP 11516A, \$50 each.

CRYSTAL DETECTORS

Flat response, high sensitivity, low SWR

Models 8470A, 8471A, 8472A, 423A, 424A, 420A/B, 422A



MICROWAVE
TEST EQUIPMENT

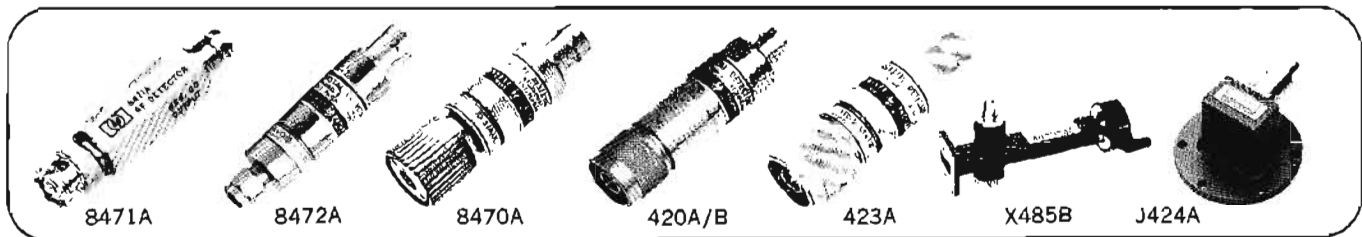

The HP 8470A and 8472A extend the frequency range of coaxial crystal detectors to 18 GHz. Like the 423A and 424A Crystal Detectors, the 8470A and 8472A combine extremely flat frequency response with high sensitivity and low SWR, making them extremely useful as the detecting element in closed-loop leveling systems. Matched pairs are available for applications requiring the utmost in detector tracking, and all but the 8472A can be supplied with video loads for optimum conformance to square law over a range of at least 30 dB.

The 422A Crystal Detectors are convenient waveguide detectors which cover K- and R-bands. They have a dynamic range of 40 dB or more, making them suitable for reflectometer as well as general-purpose applications.

The 420A is a low-cost crystal detector which covers the coaxial range from 10 MHz to 12.4 GHz, making it ideal for general-purpose video detection. The 420B is essentially the same unit as the 420A with the addition of a selected video

load for optimum square-law characteristics in the 1 to 4 GHz range.

X485B Detector Mount

The X485B Detector Mount permits the accurate matching of waveguide sections to a bolometer element. The mount is tuned by a variable short, can be used with a barretter or, where SWR is not critical, with a silicon crystal.

Specifications, X485B¹

HP Model	Frequency range (GHz)	Maximum SWR ²	Fits waveguide size		Length		Price
			(in.)	(EIA)	(in.)	(mm)	
X485B ³	8.2 - 12.4	1.25	1 x 1/2	WR90	6-7/16	163	\$150

¹Detector elements are not supplied

²With Weinschel 1180P-B barretter

³May use 1N21 or 1N23 crystal for maximum detection sensitivity where SWR is not critical

Specifications

HP Model	Frequency Range GHz	Frequency Resp. (dB)	Low-Level Sensitivity (mV/μW)	Maximum SWR	RF Input	Matched Pair Available	Square-Law Load Available	Length		Shipping Weight		Price
								(in.)	(mm)	(lb.)	(kg)	
8471A	100 KHz-1.2 GHz	±0.6; typ ±0.1/100 MHz	>0.35	Typically 1.3	BNC Male	No	No	2 3/4	70	1	0.5	\$ 50
423A	0.01-12.4	±0.2/octave to 8 GHz; ±0.5 overall	>0.4	1.2 to 4.5 GHz; 1.35, 4.5-7 GHz 1.5, 7-12.4 GHz	Type N Male	Yes ¹	Yes ²	2-15/32	63	0.5	0.2	150
420A	.01-12.4	±3.5 dB	>0.1	3.0	Type N Male	No	No	3	76	0.5	0.2	65
420B	1-4 GHz with load	±3	>0.05	3.0	Type N Male	Yes ¹	Yes ²	3	76	0.5	0.2	95
8470A	0.01-18	±0.2/octave to 8 GHz; ±0.5 to 12.4 GHz ±1 Overall	>0.4	1.2 to 4.5 GHz; 1.35 to 7 GHz; 1.5 to 12.4 GHz; 1.7 to 18 GHz	APC-7	Yes ¹	Yes	2 1/2	64	1	0.5	190
8472A	0.01-18	Same as 8470A	>0.4	Same as 8470A	SMA Male	Yes ¹	No	2 1/2	64	0.2	0.1	175
8472A Opt. 100	.01-18	Same as 8470A	>0.4	Same as 8470A	OSM Male	Yes ¹	No	2-1/16	53	0.2	0.1	190
S424A	2.60-3.95	±0.2	>0.4	1.35		Yes ³	Yes ²	2-7/16	62	2	0.9	210
G424A	3.95-5.85	±0.2	>0.4	1.35		Yes ³	Yes ²	2-1/16	52	2	0.9	200
J424A	5.30-8.20	±0.2	>0.4	1.35		Yes ³	Yes ²	1 1/2	48	1	0.5	200
H424A	7.05-10.0	±0.2	>0.4	1.35	Wave-Guide	Yes ³	Yes ²	1-9/16	40	0.6	0.3	190
X424A	8.20-12.4	±0.3	>0.4	1.35	Cover	Yes ²	Yes ²	1 1/2	35	0.5	0.2	170
M424A	10.0-15.0	±0.5	>0.3	1.5	Flange	Yes ²	Yes ²	1	25	0.5	0.2	290
P424A	12.4-18.0	±0.5	>0.3	1.5		Yes ³	Yes ²	15/16	24	0.4	0.2	210
K422A ⁴	18.0-26.6	±2	±0.3	2.5		Yes ⁴	Yes ²	2	51	0.6	0.3	350
R422A ⁵	26.5-40.0	±2	±0.3	3		Yes ⁴	Yes ²	2	51	0.6	0.3	350

For all models—Maximum Input: 100 mW peak or average, 8471A: 3 V rms, 4.2 V pk. Detector element: supplied. Output polarity: negative (positive output available: for 423A, 8470A, 424A specify Option 003—no additional charge; for 8471A specify Option 004—no additional charge; for 8472A by special order only). Output connector: BNC female (for OSSM on 8472A, specify Option H01 and add \$15/unit).

¹Frequency response characteristics (excluding basic sensitivity) track within ±0.2 dB per octave from 10 MHz to 8 GHz, ±0.3 dB from 8 to 12.4 GHz, and (8470A and 8472A) ±0.6 dB from 12.4 to 18 GHz; specify Option 001, add \$20 per unit (\$40 per pair). (8472A, available on special order.)
²±0.5 dB variation from square law up to 50 mV peak output into >75 kΩ; sensitivity typically >0.1 mV/μW; specify Option 002; add \$20.
³Frequency response characteristics (excluding basic sensitivity) track within ±0.2 dB for S-, G-, J- and H-band units, ±0.3 dB for X-band units, and ±0.5 dB for M- and P-band units; specify Option 001; add \$20 per unit (\$40 per pair).
⁴Matched pair of units fitted with square-law loads. Frequency response characteristics (excluding basic sensitivity) track within ±1 dB for power levels less than approx. 0.05 mW; specify Option 001; add \$40 per unit (\$80 per pair).
⁵Circular flange adapters: 11515A (UG-425/U) for K-band, \$60 each; 11516A (UG-381/U) for R-band, \$50 each.

SLOTTED LINES

Precision tools for measurements to 40 GHz
Models 805C, 809C, 810B, 816A, 817A, 444A, 447B

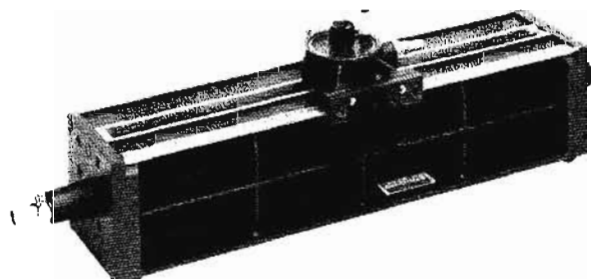

805C

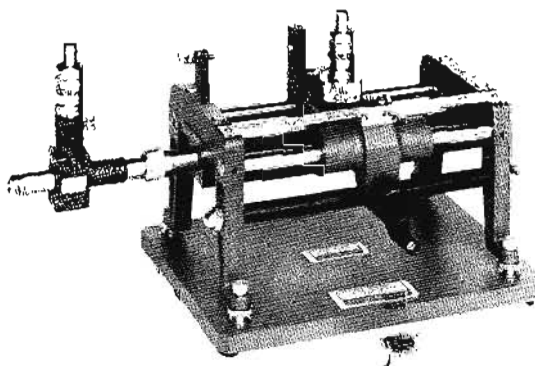

817A

Slotted Lines, Detectors

Hewlett-Packard offers a complete line of slotted lines, detectors and carriages covering the frequency range of .5-40 GHz. A summary of this product group is presented on the following three pages.

805C Coaxial Slotted Line, 0.5-4 GHz

Model 805C is a coaxial slotted line with an integral probe circuit tunable from 500 to 4,000 MHz. The slotted line consists of two parallel planes and a rigid center conductor. This configuration results in negligible slot radiation, minimum sensitivity to variation in probe depth or centering, and greater structural stability.

Specifications, 805C

Frequency range: 500 to 4,000 MHz.

Impedance: 50Ω.

Residual SWR: less than 1.04:1.

Connectors: type N, one male/female.

Calibration: metric, cm and mm; vernier reads to 0.1 mm.

Detector probe: tunable; detector may be 1N21B crystal (supplied) or 821 series barretter or selected 1/100-amp instrument fuse.

Accessories furnished: 11511A shorting jack; 11512A shorting plug.

Accessory available: 11510A carrying case, \$100.

Price: HP 805C, \$1000.

817A Coaxial Swept Slotted Line System, 1.8-18 GHz

The 817A is a fully tested, complete swept slotted line system that enables you to make accurate swept-frequency SWR measurements in coax from 1.8 to 18 GHz. The 817A system consists of an 816A Coaxial Slotted Line, an 809C Carriage with baseplate, and a 448A Slotted Line Sweep Adapter.

Specifications, 817A

Frequency range: 1.8 to 18 GHz.

Impedance: 50Ω ±0.2Ω.

Output connector: APC-7 or type N female, depending upon which end of the 816A is connected to the load.

Residual SWR:

APC-7 connector: 1.02-1.04 depending on frequency coverage.

Type N connector: 1.04-1.06 depending on frequency coverage.

Accessories furnished: 11512A N male short, 11565A APC-7 short.

Dimensions (maximum envelope): 13½" long, 7" wide, 7" high (343 x 178 x 178 mm).

Weight: net, 15 lbs (6,5 kg); shipping 20 lbs (9,0 kg).

Price: Model 817A, \$1100.

Option 022: type N male connector in lieu of APC-7, less \$15.

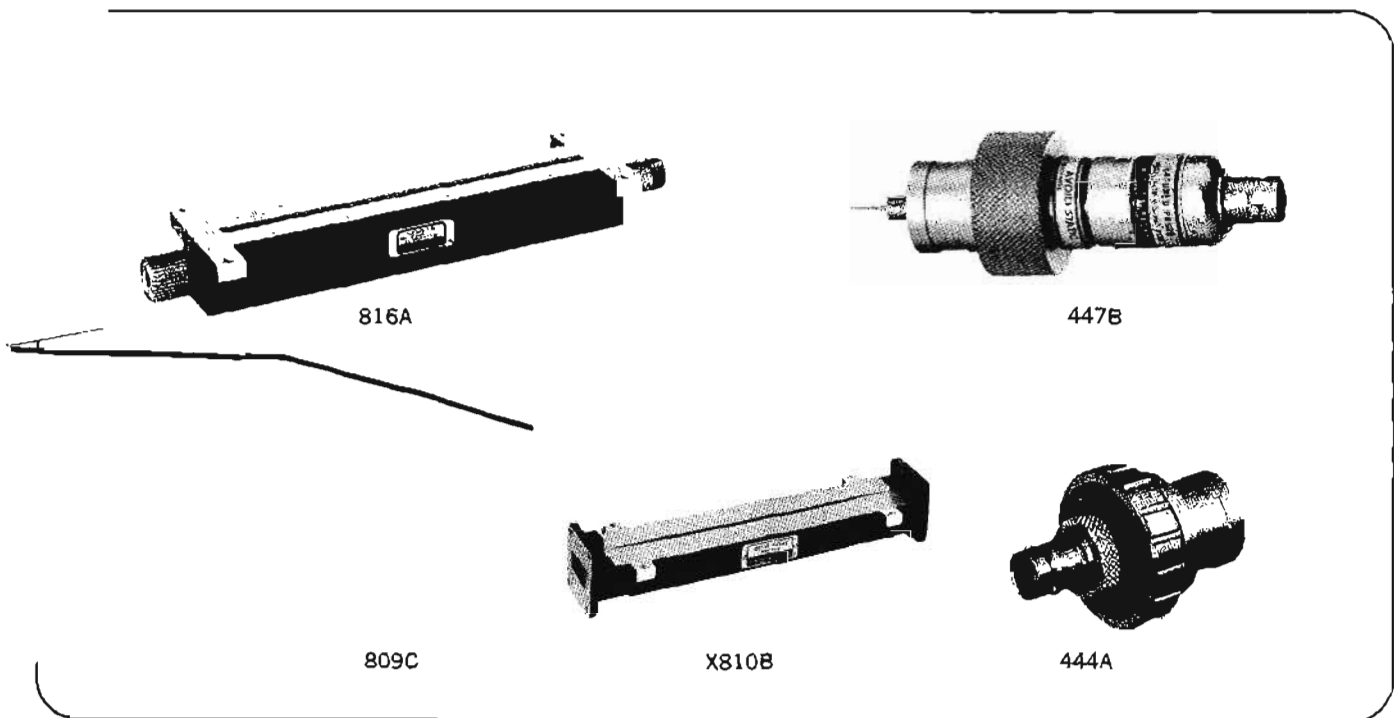

809C Carriage

The 809C Carriage operates with the 816A Coaxial Slotted Section and four 810B Waveguide Slotted Sections. Four detectors can be used with the 809C: the 442, 444A, 447B, and 448A. The carriage has a centimeter scale with a vernier reading to 0.1 mm, and provision is made also for mounting a dial gauge if more accurate probe position reading is required.

Price: 809C, \$300.

816A Coaxial Slotted Section, 1.8-18 GHz

(Used with 809C Carriages and 447B or 448A Detector Probes)

The 816A consists of two parallel planes and a rigid center conductor. This configuration virtually eliminates radiation and minimizes the effect of variation in probe penetration and centering. It is fitted with one APC-7 and one type N female connector.

Specifications, 816A

Frequency: 1.8-18 GHz.

Residual VSWR:

APC-7 1.02-1.04 depending on frequency coverage.

type N 1.04-1.06 depending on frequency coverage.

Length: 9 $\frac{3}{4}$ inches (248 mm).

Weight: net, 1 $\frac{1}{2}$ lbs (0.68 kg); shipping 3 lbs (1.4 kg).

Accessories furnished: 11512A type N male short; 11565A

APC-7 short.

Price: HP 816A, \$350.

Option 011: both connectors APC-7, add \$25.

810B Slotted Sections, 5.3-18 GHz

(Used with 809C Carriage and 442B/444A Detector)

Waveguide slotted line measurements in the frequency

range 5.3-18 GHz are made using the 810B Slotted Section, the 809C Carriage and 444A Probe or 440A plus 442B Probe combination.

Specifications, 810B

HP Model	Frequency range (GHz)	Fits Waveguide size EIA	Equivalent	Price
J810B	5.30-8.20	WR137	UG441/U	\$275
H810B	7.05-10.0	WR112	UG138/U	215
X810B	8.20-12.4	WR90	UG135/U	205
P810B	12.4-18.0	WR62	UG419/U	225

444A Untuned Probe, 2.6-18 GHz

The 444A Untuned Probe, for use with HP 810B Waveguide Slotted Sections, consists of a crystal, plus a small antenna in convenient housing. The probe is held in position by friction or may be fixed by a locking ring. No tuning is required and sensitivity equals or exceeds many elaborate single and double-tuned probes. The 444A fits the 809C Carriage or other carriages with a $\frac{3}{4}$ inch (19 mm) mounting hole. Frequency range is 2.6 to 18 GHz.

Accessory furnished: 11506A Probe Extension Kit.

Price: HP 444A, \$65.

447B Detector

Model 447B consists of a crystal diode detector plus a small antenna probe for sampling energy in HP 816A Coaxial Slotted Lines. The untuned probe is extremely sensitive over its frequency range of 1.8 to 18 GHz. Such performance is achieved through the use of a unique, easily replaced diode package developed by Hewlett-Packard. The 447B fits HP 809C Carriage or other carriages with a $\frac{3}{4}$ " (19 mm) mounting hole.

Price: HP 447B, \$125.



SLOTTED LINES

Precision tools for measurement to 40 GHz

Models 440A, 442B, 446B, 448A, 814B, K815B

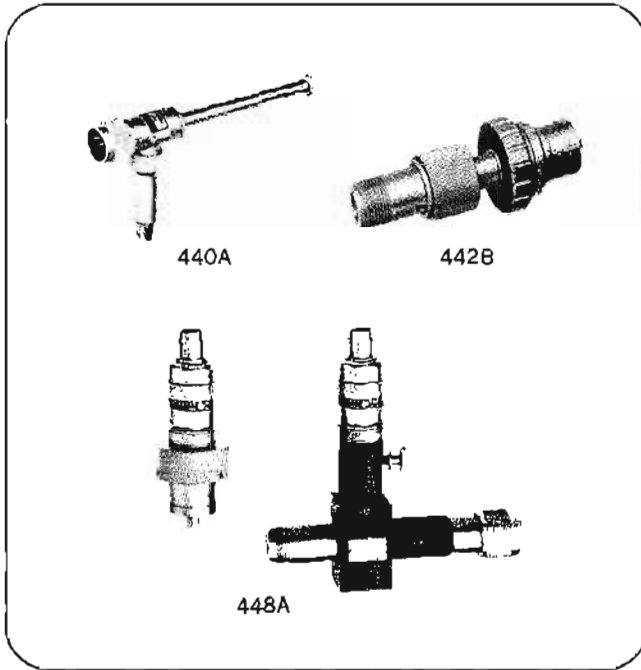

440A Detector Mount

The 440A is a tunable mount used for detecting RF energy in coaxial systems or in conjunction with the HP 442B in waveguide or coaxial slotted sections. Detector (not supplied) can be a 1N21 or 1N23 Crystal or 821 Series Barretter.

Price: 440A, \$125.

442B Broadband Probe, 2.6-12.4 GHz

Model 442B is a probe whose depth of penetration into a slotted section is variable. Held in position by friction, it may be fixed in place by a locking ring. Sampled RF appears at a type N jack. It can be connected to a 440A Detector Mount to form a sensitive and convenient tuned RF detector for HP 810B Waveguide Slotted Sections. The 442B fits the 809C Carriage. Frequency range is 2.6 to 12.4 GHz.

Price: HP 442B, \$60.

448A Slotted Line Sweep Adapter, (detector probe) 1.8-18 GHz

The 448A consists of a short slotted line and two matched detectors with adjustable probes. One detector levels the signal source, the other monitors the standing waves in the 816A.

Specifications, 448A

Frequency range: 1.8-18 GHz.

Connectors: type N, one male/female.

Weight: net, 7 oz (0.20 kg); shipping, 14 oz (0.40 kg).

Price: 448A, \$400.

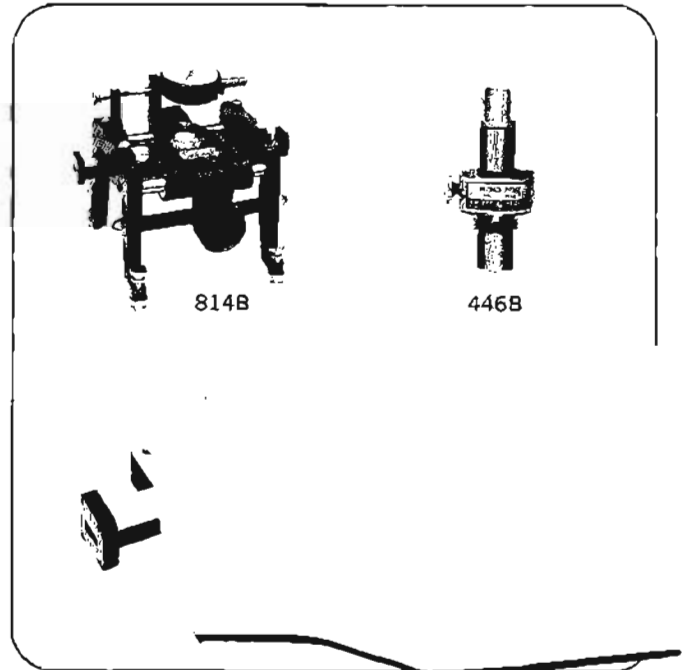

815B Slotted Section, 18-40 GHz

(Used with 814B Carriage and 446B Detector)

The 815B Waveguide Slotted Sections are designed to fit the 814B Carriage. Like the lower-frequency slotted sections, each 815B is precision-manufactured, broached and checked with precision gauges for careful control of guide wavelength. The slot is tapered to insure a low SWR.

Specifications, 815B

	K815B	R815B
Frequency range (GHz):	18 to 26.5	26.5 to 40
Residual SWR:	1.01	1.01
Overall length:	7-9/16" (192 mm)	7-9/16" (192 mm)
Price:	\$675	\$700

* Circular flange adapters: K-band (UG425/U) 11515A, \$60 each, R-band (UG381/U) 11516A, \$50 each.

814B Carriage

The HP 814B Carriage is designed for use with the HP K815B (18 to 26.5 GHz) and R815B (26.5 to 40 GHz) Waveguide Slotted Sections and HP 446B Untuned Probe. The carriage is equipped with a dial indicator for accurate reading. Slotted sections are easily interchanged.

Price: HP 814B, \$660.

446B Broadband Detector

The HP 446B is a broadband detector and probe which consists of a modified 1N53 silicon diode in a carefully designed shielded housing. No tuning is required, and probe penetration may be varied quickly and easily. Designed for use with the 814B Carriage, the 446B has a frequency range of 18 to 40 GHz.

Price: HP 446B, \$275.

TERMINATIONS

Loads and shorts for measurements to 40 GHz
Models 905; 907-911; 914; 920; 923; 930



MICROWAVE TEST EQUIPMENT



905A

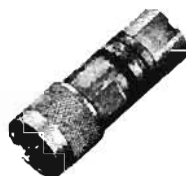

908A



11512A

905A, 907A, 911 Sliding Loads

The 905A, 907A and 911A are movable 50Ω, low reflection loads for precision measurements. The 905A and 907A are supplied with three interchangeable connectors, N-male, N-female and APC-7. The 911A is supplied with SMA male and female.

HP Model	Frequency range	Load SWR	Power rating	Length in. (mm)	Shipping weight	Price
905A	1.8-18 GHz	1.05	1W avg. 5kW pk	1 1/2 (440)	3 lb (1.4 kg)	\$300
907A	1-18 GHz	1.1, 1-1.5 GHz; 1.05, 1.5-18 GHz	1W avg. 5kW pk	30% (778)	9 lb (4.1 kg)	\$450
911A	2-18 GHz	1.1, 2-4 GHz; 1.05, 4-18 GHz	1W avg. 5kW pk	14% (380)	3 lb (1.4 kg)	\$250

908A, 909A Terminations

The 908A and 909A Terminations are low-reflection loads for terminating 50Ω coaxial systems in their characteristic impedance:

908A 909A Specifications

Model	Frequency coverage	Connector	Price
908A	dc - 4 GHz	N-female	1-4, \$45 ea
909A	dc - 18 GHz	APC-7	1-4, \$85 ea
909A (Opt. 012)	dc - 18 GHz	N-male	1-4, \$85 ea Less \$15 ea
909A (Opt. 013)	dc - 18 GHz	N-female	1-4, \$85 ea Less \$15 ea

11511A, 11512A, 11565A Shorts

These shorts are used for establishing measurement planes and known reflection phase and magnitude in 50Ω coaxial systems.

Price: 11511A N-female \$10, 11512A N-male \$10, 11515A APC-7 \$25.



X930A



X910B

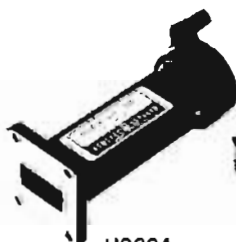

H920A



X914B



X923A

910A-B, 914A Waveguide Terminations

The 910A-B are fixed termination for waveguide systems. The 914A-B are similar to the 910A-B, except that its absorptive element is movable and a lockable plunger controls the position of the element.

910A/B, 914A/B Specifications

Model	Frequency Range (GHz)	SWR	Power Ratings	Type	Waveguide Size (EIA)	Price
J910A	5.3-8.2	1.02	1 watt	fixed	WR137	\$ 95
H910A	7.05-10.0	1.02	1 watt	fixed	WR112	80
X910B	8.2-12.4	1.015	1 watt	fixed	WR90	55
P910A	12.4-18	1.02	1 watt	fixed	WR62	50
J914A	5.3-8.2	1.01	2	sliding	WR137	225
H914A	7.05-10.0	1.01	1	sliding	WR112	200
X914B	8.2-12.4	1.01	1	sliding	WR90	95
P914A	12.4-18	1.01	1/2	sliding	WR62	175
K914B	18-26.5	1.01	1/2	sliding	WR42	350
R914B	26.5-40	1.01	1/2	sliding	WR28	400

920A-B, X923A, X930A Shorts

The 920A-B are movable shorts, adjustable through at least half a wavelength at the low end of the band. The X923A is also a movable short, but is adjustable through about two wavelengths at 8.2 GHz. The X930A is a removable short. SWR is less than 1.02 in "open", greater than 125 in "short".

920A-B, X923A Specifications

Model	Frequency Range (GHz)	Waveguide Size EIA	Price
J920A	5.3-8.2	WR137	\$200
H920A	7.05-10.0	WR112	165
X923A	8.2-12.4	WR90	150
P920B	12.4-18	WR62	190
K920B	18.0-26.5	WR42	325
R920B	26.5-40.0	WR28	350
X930A	8.2-12.4	WR90	300

MICROWAVE TEST EQUIPMENT



LOW-PASS; BANDPASS FILTERS

Effective elimination of undesirable signals

Models 360A-D; 362A; 8430A-8436A

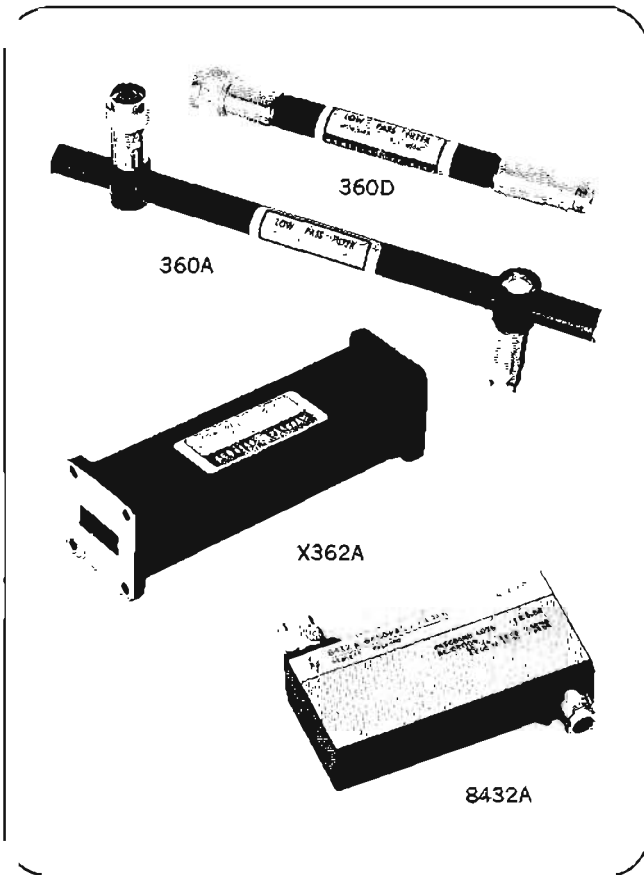

These Hewlett-Packard low-pass and bandpass filters facilitate microwave measurements by eliminating undesirable signals (such as harmonics) from the measurement system. Suppression of such signals is particularly important in applications such as slotted-line measurements, where harmonics generated by the signal source could otherwise impair measurement accuracy. These filters also can be used as preselectors for the HP 8555A Spectrum Analyzer. As such, they permit the maximum utilization of the analyzer's broad spectrum-width capability while ensuring virtually spurious-free displays.

Specifications, 360 Series

HP Model	360A	360B	360C	360D
Cut-off frequency	700 MHz	1200 MHz	2200 MHz	4100 MHz
Insertion loss	≤1 dB below 0.9 times cut-off frequency			
Rejection	≥50 dB at 1.25 times cut-off frequency			
Impedance	50 ohms through pass band; should be matched for optimum performance			
SWR	<1.6 to within 100 MHz of cut-off	<1.6 to within 200 MHz of cut-off	<1.6 to within 300 MHz of cut-off	<1.6 to within 300 MHz of cut-off
Connectors	Type N, one male, one female			
Overall length (in.) (mm)	10 ³ / ₈ (276)	7-7/32 (183)	10-25/32 (274)	7 ³ / ₈ (187)
Center line (in.) to male end (mm)	2 ¹ / ₈ (54)	2 ¹ / ₈ (54)	—	—
Center line (in.) to female end (mm)	2 ¹ / ₄ (57)	2 ¹ / ₄ (57)	—	—
Shipping weight (lb) (kg)	2 (0.9)	2 (0.9)	2 (0.9)	1 (0.45)
Price	\$115	\$105	\$95	\$90

Specifications, 362A Series

HP Model	X362A	M362A	P362A	K362A*	R362A*
Passband (GHz)	8.2-12.4	10.0-15.5	12.4-18.0	18.0-26.5	26.5-40.0
Stop band (GHz)	16-37.5	19-47	23-54	31-80	47-120
Passband insertion loss	less than 1 dB	less than 1 dB	less than 1 dB	less than 1 dB	less than 2 dB
Stopband rejection	at least 40 dB	at least 40 dB	at least 40 dB	at least 40 dB	at least 35 dB
SWR	1.5	1.5	1.5	1.5	1.8
Waveguide size, in. (EIA)	1 x 1/2 (WR 90)	0.850 x 0.475 (WR 75)	0.702 x 0.391 (WR 62)	1/2 x 1/4 (WR 42)	0.360 x 0.220 (WR 28)
Length, in. (mm)	5-11/32(136)	4-15/32(114)	3-11/16(94)	2 1/2(64)	1-21/32(42)
Shipping weight, lb (kg)	2(0.9)	2(0.9)	13/16(0.37)	1/2(0.15)	1/4(0.11)
Price	\$450	\$350	\$375	\$385	\$420

*Circular flange adapters: K-band (UG425/U), HP 11515A, \$60 each; R-band (UG381/U), HP 11516A, \$50 each.

Specifications, 8430 Series

HP Model	Passband frequency (GHz)	Max. passband insertion loss	Rejection band attenuation				Dimensions		Shipping weight		Price
			Below passband		Above passband		(in.)	(mm)	(lb)	(kg)	
			Frequency (GHz)	Attenuation	Frequency (GHz)	Attenuation					
8430A	1 to 2	2 dB	≤0.8	≥50 dB	2.2 to 20	≥45 dB	5 1/2 x 4 3/4 x 1	140 x 121 x 25	3	1.4	\$335
8431A	2 to 4	2 dB	≤1.6	≥50 dB	4.4 to 20	≥45 dB	5 1/2 x 3 x 1	140 x 76 x 25	3	1.4	\$335
8432A	4 to 6	2 dB	≤3.5	≥50 dB	6.5 to 20	≥45 dB	4 1/2 x 2 x 1	114 x 51 x 25	2	0.9	\$335
8433A	6 to 8	2 dB	≤5.5	≥50 dB	8.5 to 20	≥45 dB	4 x 1 1/2 x 1	102 x 38 x 25	2	0.9	\$335
8434A	8 to 10	2 dB	≤7.5	≥50 dB	10.5 to 17	≥45 dB	4 3/8 x 1 x 1	118 x 25 x 25	2	0.9	\$335
8435A	4 to 8	2 dB	≤3.2	≥50 dB	8.8 to 20	≥45 dB	3 3/8 x 1 3/4 x 1	92 x 45 x 25	2	0.9	\$335
8436A	8 to 12.4	2 dB	≤6.9	≥50 dB	13.5 to 17	≥45 dB	2 7/8 x 1 x 1	73 x 25 x 25	1	0.45	\$335

Connectors: Type N, one male, one female.

FREQUENCY METERS

For general-purpose or lab use

Models 532A/B, 536A, 537A



MICROWAVE TEST EQUIPMENT

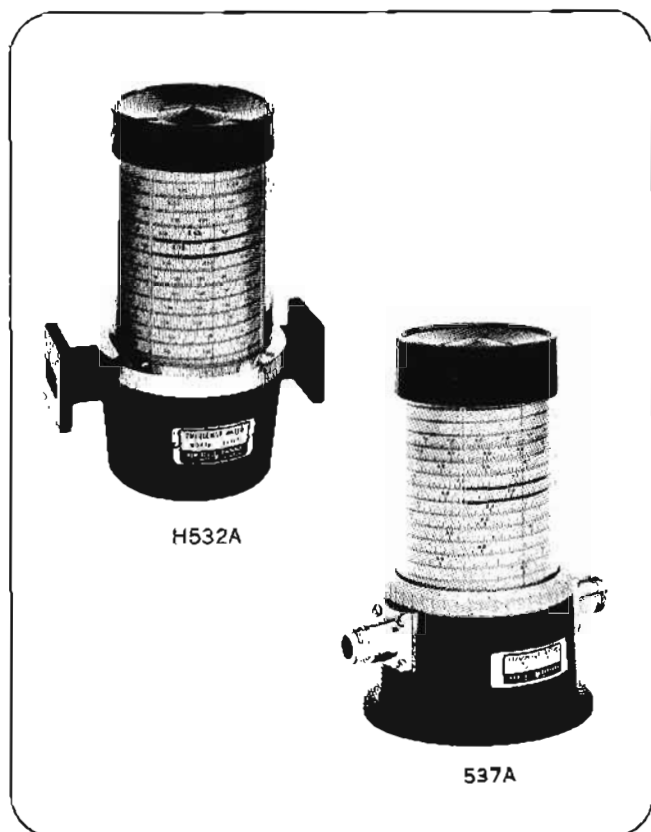

Advantages

- High resolution, easy-to-read dial
- Direct reading
- Broadband
- Accuracy specified over 20°C and 0 to 100% relative humidity

These direct-reading frequency meters allow you to measure frequencies from 5.30 to 40 GHz in waveguide and from 960 MHz to 12.4 GHz in coax quickly and accurately. Their long scale length and numerous calibration marks provide a high resolution which is particularly useful when measuring frequency differences or small frequency changes. Frequency is read directly in GHz so no interpolation or charts are required.

The instruments comprise a special transmission section with a high-Q resonant cavity which is tuned by a choke plunger. A 1-dB or greater dip in output indicates resonance; virtually full power is transmitted off resonance. Tuning is by a precision lead screw, spring-loaded to eliminate backlash. Resolution is enhanced by a long, spiral scale calibrated in small frequency increments. For example, Model X532B has an effective scale length of 77 inches (1956 mm) and is calibrated in 5-MHz increments. Resettability is extremely good, and all frequency calibrations are visible so you can tell at a glance the specific portion of the band you are measuring. Except for the J532A, there are no spurious modes or resonances. (See note 4 below.)

Specifications, 532A Series, 536A and 537A

Model	Frequency Range (GHz)	Dial Accuracy (%)	Overall Accuracy ¹ (%)	Dip at Resonance	Calibration Increment (MHz)	Fits Waveguide		Equivalent Flange	Size In. (mm)			Weight lb (kg)		Price
						Nom. OD (in)	EIA		Length	Height	Depth	Net	Shipping	
536A	0.96-4.20	0.10 ²	0.17 ³	Note 6	2				6 (152)	9 1/8 (232)	6 (152)	10 (4,5)	13 (5,9)	\$600
537A	3.7-12.4	0.10	0.17	1 dB min	10				4 3/8 (118)	5 1/4 (146)	3 1/2 (89)	4 (1,8)	5 (2,3)	\$525
J532A	5.30-8.20 ⁴	0.033	0.065	1 dB min	2	1 1/2 x 3/4	WR137	UG-441/U	6 1/4 (159)	9 1/8 (232)	4 1/2 (114)	8 (3,6)	11 (5,0)	\$550
H532A	7.05-10.0	0.040	0.075	1 dB min	2	1 1/4 x 5/8	WR112	UG-138/U	6 1/4 (159)	8 (203)	4 3/8 (111)	6 (2,7)	9 (4,1)	\$650
X532B	8.20-12.4	0.050	0.08	1 dB min	5	1 x 1/2	WR90	UG-39/U	4 1/2 (114)	6 1/8 (156)	2 3/8 (73)	3 (1,4)	4 (1,8)	\$325
P532A	12.4-18.0	0.068	0.10	1 dB min	5	0.702 x 0.391	WR62	UG-419/U	4 1/2 (114)	6 1/4 (159)	2 3/4 (70)	3 (1,4)	4 (1,8)	\$350
K532A	18.0-26.5	0.077	0.11	1 dB min	10	1/2 x 1/4	WR42	UG-595/U	4 1/2 (114)	5 3/8 (137)	2 3/8 (73)	2 (0,9)	3 (1,8)	\$525
R532A	26.5-40.0	0.083	0.12	1 dB min	10	0.360 x 0.220	WR28	UG-599/U	4 1/2 (114)	5 1/2 (140)	2 3/4 (70)	2 (0,9)	3 (1,8)	\$525

¹ Includes allowance for 0 to 100% relative humidity, temperature variation from 13 to 33°C, and backlash.

² 0.15, 0.96 to 1 GHz.

³ 0.22, 0.96 to 1 GHz.

⁴ Because of the wide frequency range of the J532A, frequencies from 7.6 to 8.2 GHz can excite the TE₁₁₂ mode when the dial is set between 5.3 and 5.6 GHz.

⁵ Circular flange adapters: K-band (UG-425/U) 11515A, \$60 each; R-band (UG-381/U) 11516A, \$50 each.

⁶ 1 dB min., 1-4 GHz; 0.6 dB min., 0.96-1 GHz and 4-4.2 GHz.

MICROWAVE TEST EQUIPMENT



TUNERS, PHASE SHIFTERS

Precision instruments for lab or general use
Models 870A, 885A

885A Waveguide Phase Shifters

HP 885A Phase Shifters provide accurate, controllable phase variation in the J-, X-, and P-band frequency ranges. They are particularly useful in microwave bridge circuits where phase and amplitude must be adjusted independently. They also are used in the study of phased arrays.

The instruments are differential phase devices; that is, they add or subtract a known phase shift from the total phase

shift which a wave undergoes in traveling through the device.

The instruments have high accuracy over their entire phase range, -360 to $+360$ electrical degrees, have low power absorption, are simple to operate, and require no charts or interpolation. They are sturdily built, comprising two rectangular-to-circular waveguide transitions with a dial-driven circular waveguide mid-section. These waveguide phase shifters are housed in cast aluminum containers for extreme rigidity and durability.

Specifications, 885A

Model	Frequency Range (GHz)	Differential Phase Angle Range ¹	Accuracy ² (The smaller of)	Insertion Loss ³	SWR (max.)	Power Rating (Watts)	Waveguide		Weight				Price
							Size (EIA)	Flange	Net lb	Net kg	Shipping lb	Shipping kg	
J885A	5.3-8.2	-360° to $+360^\circ$	$\approx 3^\circ$ or $0.1 \Delta\phi$	< 2 dB	1.35	10	WR137	UG-344/U	14	6.3	18	8.2	\$950
X885A	8.2-12.4	-360° to $+360^\circ$	$\approx 2^\circ$ ($\approx 3^\circ$, 10-12.4 GHz) or $0.1 \Delta\phi$	< 1 dB, 8.2-10 GHz; < 2 dB, 10-12.4 GHz	1.35	10	WR90	UG-39/U	8	3.6	11	5.0	\$725
P885A	12.4-18	-360° to $+360^\circ$	$\approx 4^\circ$ or $0.1 \Delta\phi$	< 3 dB	1.35	5	WR62	UG-419/U	6	2.7	8	3.6	\$900

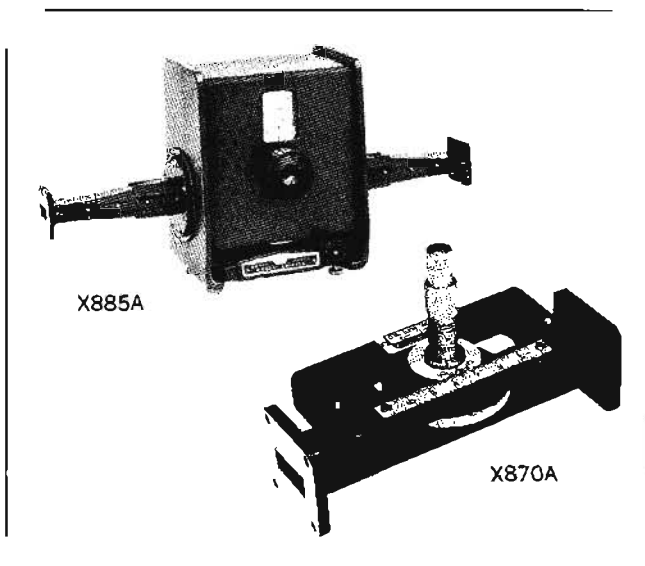

870A Slide-Screw Tuners

Waveguide slide-screw tuners are used primarily for correcting discontinuities or for "flattening" waveguide systems. They are also used to match loads, terminations, bolometer mounts, or antennas to the characteristic admittance of the waveguide. They are particularly valuable in determining experimentally the position and magnitude of matching structures required in waveguide systems.

HP 870A tuners consist of a waveguide slotted section with a precision-built carriage on which is mounted an adjustable probe. The position and penetration of the probe is adjusted to set up a reflection which is used to cancel out an existing reflection in a system.

Probe penetration into the guide is varied by a micrometer drive. Position of the probe along the guide is adjusted by a thumb-operated wheel, and position can be read to 0.1 mm on a vernier scale. An SWR of 20 can be corrected to 1.02, and small SWR's can be corrected exactly.

Model	Freq. Range (GHz)	Fits Waveguide Size Nom. OD (in.) (EIA)	Equivalent Flange Type	Length		Net Weight		Shipping Weight		Price	
				(in.)	(mm)	(lbs.)	(kg)	(lbs.)	(kg)		
P870A	12.40-18.00	0.702 x 0.391	WR62	UG-419/U	5	127	1/2	0.23	2	0.9	\$275
X870A	8.20-12.40	1 x 1/2	WR90	UG-39/U	5 1/2	140	3/4	0.34	2	0.9	\$250

MIXERS, COAXIAL SWITCHES

Broadband mixers and switches

Models 934A, P932A, 8761A/B



**MICROWAVE
TEST EQUIPMENT**

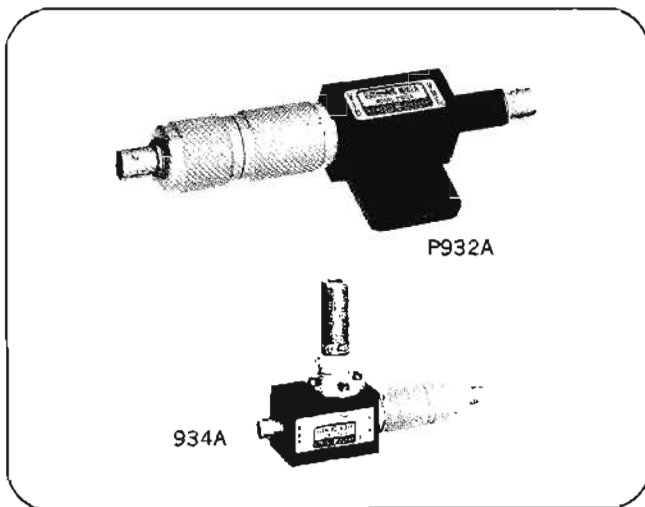

934A, P932A Harmonic Mixers

HP 934A, P932A simplify frequency measurements from 2 to 18 GHz. They are also excellent as RF mixers in phase-stabilized signal sources. Both feature high sensitivity, yet require no tuning.

Specifications 934A, P932A					
Model	Frequency Range (GHz)	Maximum Input	Typical Sensitivity	Min. video output*	Price
934A	2 to 12.4	100 mW	-48 dBm at 3.5 GHz -25 dBm at 10 GHz	1.4 mV p-p	\$150
P932A	12.4 to 18	100 mW	-10 dBm	0.4 mV p-p	\$350

*With 0 dBm input signal.

8761A/B Coaxial Switch

The HP 8761 is a single-pole, double-throw coaxial switch with low standing-wave ratio, low insertion loss, and good isolation from dc to 18 GHz. Mechanically, the switch is a break-before-make type controlled by a latching solenoid. Solenoids are available in 12- and 26-volt ratings and can be operated by dc or pulsed signals. Any of seven coaxial connectors, or a 50-ohm termination, may be specified for each port.

Specifications, 8761A/B

Characteristic impedance: 50 ohms.

Frequency range: dc to 18 GHz.

Standing-wave ratio: looking into one of the connected ports with 50 ohms (or built-in termination) on the other, third port open.

Frequency	Connector type		
	7-mm	N	3-mm (SMA)
dc-12.4 GHz	<1.15 (1.20)	<1.20 (1.25)	<1.25 (1.30)
dc-18 GHz	<1.20 (1.25)	<1.25 (1.30)	<1.30 (1.35)

SWR in parenthesis applies to switch with built-in termination.

These specifications apply when connected ports are of the same connector type; for mixed connector types, the larger of the two VSWR's applies. N-connector VSWR specifications apply to Option 4 connectors.

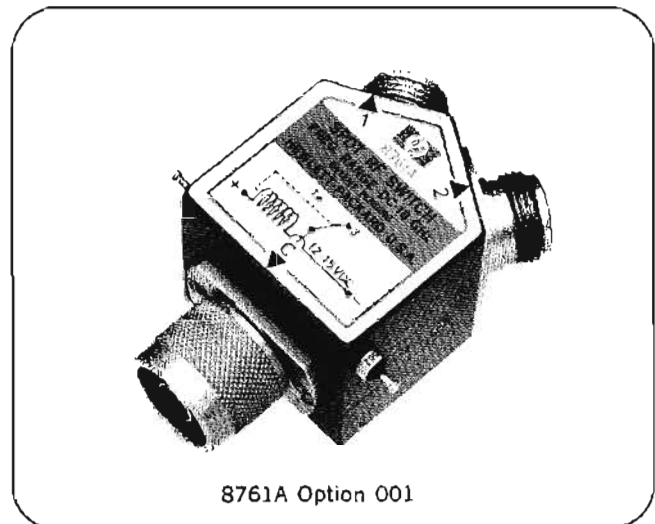

Insertion loss: <0.5 dB, dc-12.4 GHz; <0.8 dB, dc-18 GHz.

Isolation: >50 dB, dc-12.4 GHz; >45 dB, dc-18 GHz.

Power: safely handles 10 W average, 5 kW peak, without built-in termination; built-in termination rated at 2 W average, 100 W peak.

Switching energy: 1.5 W for 20 ms (permanent magnet latching).

Solenoid voltages (dc or pulsed): 12-15 V, 8761A; 24-30 V, 8761B.

Switching speed: 35-50 ms (includes settling time).

Life: >1,000,000 switchings.

Dimensions: 1.6 x 1.5 x 1.5 in. (41 x 38 x 38 mm), excluding connectors and solenoid terminals.

Weight: net, 5-8 oz (140-220 gm); shipping, 8-11 oz (220-300 gm).

Price: Model 8761, \$150 each, 1-9; \$140 each, 10-24. Add \$35 for built-in termination.

Ordering information, 8761A/B

Specify solenoid voltage and connectors (including built-in 50Ω termination) by the alphabetic suffix on the switch model number and the appropriate three-digit option number.

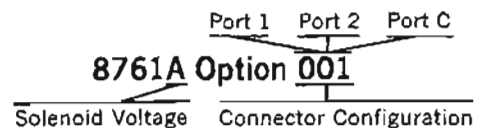

A: 12 - 15 V; B: 24 - 30 V

Option Code	Connector Type	Option Code	Connector Type
0	N Jack	4	7-mm for UT-250 Coax
1	N Plug	5	3-mm Jack
2	7-mm Jack	6	3-mm Plug
3	7-mm Plug	7	50Ω Termination

"Jack" identifies the connector with fixed threads; "plug" identifies the connector with the coupling nut.

MICROWAVE TEST EQUIPMENT



MISCELLANEOUS EQUIPMENT

Increase flexibility of microwave measurements

Models 281A-B, 292A-B, 11524A/25A, 11588A, 11606A

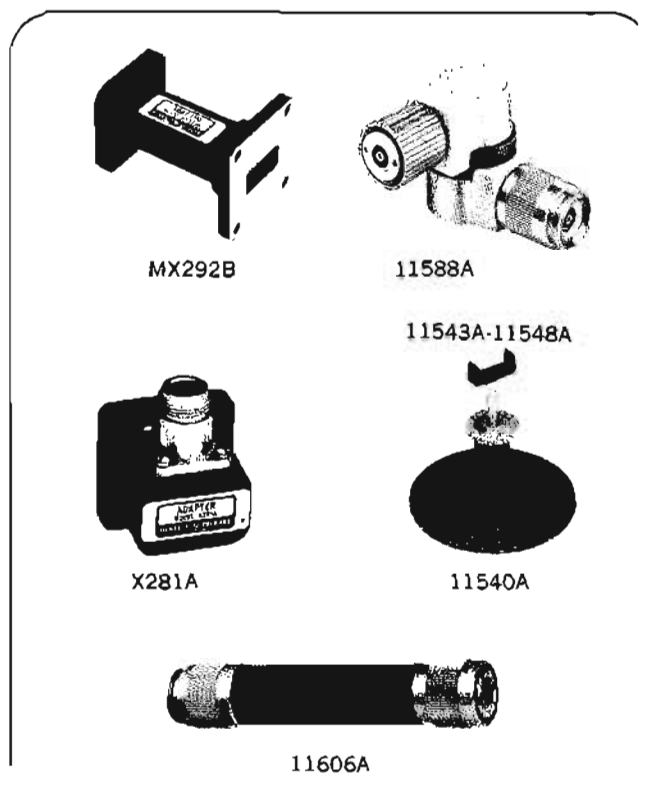

281A-B Coax to Waveguide Adapters

HP 281A-B adapters transform waveguide impedance into 50-ohm coaxial impedance. Power can be transmitted in either direction, and each adapter covers the full frequency range of its waveguide band with SWR less than 1.25.

Specifications 281A,B

HP Model	SWR	Frequency Range (GHz)	Waveguide Size EIA	Coaxial Connector	Length		Qty 1-4 Price
					(in.)	(mm)	
S281A	1.25	2.60-3.95	WR284	N Female	2½	64	\$75
G281A	1.25	3.95-5.85	WR187	N Female	2½	54	\$60
J281A	1.25*	5.30-8.20	WR137	N Female	2	51	\$55
H281A	1.25	7.05-10.0	WR112	N Female	1¾	41	\$50
X281A	1.25	8.20-12.4	WR90	N Female	1¾	35	\$45
X281B	1.25	8.20-12.4	WR90	APC-7**	1¾	35	\$90
P281B	1.25	12.4-18	WR62	APC-7**	15/16	24	\$95

*1.3 from 5.3 to 5.5 GHz.

**Option 013. Furnished with stainless steel N-female connector, less \$15.

Waveguide to Waveguide Adapters

Models 292A-B waveguide-to-waveguide adapters connect two different waveguide sizes with overlapping frequency ranges. The 292A consists of a short tapered section of waveguide. The 292B is broached waveguide with a step transition between waveguide sizes.

Specifications 292A,B

HP Model	SWR	Length		Frequency range (GHz)	Price
		(in.)	(mm)		
HX292B	1.05	1½	38	8.20 to 10.0	\$60
MX292B	1.05	2¾	60	10.0 to 12.4	\$70
MP292B	1.05	2¾	60	12.4 to 15.0	\$80
NP292A	1.05	2¾	60	15.0 to 18.0	\$60
NK292A	1.05	2¾	60	18.0 to 22.0	\$60

11524A, 11525A, 11533A, 11534A Coax to Coax Adapters

These coaxial adapters, not pictured here, permit easy interconnection of 50-ohm precision 7-mm (APC-7) connectors and 50-ohm Type N or SMA (3-mm type) connectors.

HP Model	Description	Shipping Weight	Price
11524A	APC-7 to N female	4 oz (110 gm)	\$70
11525A	APC-7 to N male	5 oz (140 gm)	\$70
11533A	APC-7 to SMA male	5 oz (140 gm)	\$115
11534A	APC-7 to SMA female	5 oz (140 gm)	\$115

11588A Swivel Adapter, 11606A Rotary Air Line

The 11606A rotary air line and the 11588A swivel adapter are capable of a full 360° of rotation. A combination of the air line and the adapter permits rigid coax movement in three dimensions. Even the most awkwardly shaped devices can be easily connected or disconnected in a coax system with the aid of these components.

Specifications, 11588A and 11606A

Frequency range: dc to 12.4 GHz.

Reflection coefficient (SWR): 0.048 (1.1). Ambiguity due to rotation 0.003 (-50 dB).

Insertion loss: 0.5 dB.

Connectors: 11588A, one precision 7-mm jack and one APC-7; 11606A, one 7-mm plug and one 7-mm jack. Combinations of APC-7, Type N, and 3-mm type SMA available; prices on request.

Dimensions: 11588A, 1 5/8" x 2 5/16" x 1 3/16" (42 x 59 x 30 mm); 11606A, 3 15/16" x 3/4" x 3/4" (100 x 19 x 19 mm).

Weights: 11588A, net, 8 oz (220 gm), shipping, 11 oz (310 gm); 11606A, net, 6 oz (170 gm), shipping, 11 oz (310 gm).

Prices: Model 11588A, \$200; Model 11606A, \$150.

Waveguide Stand, Waveguide Clamps

The 11540A waveguide stand locks HP waveguide clamp at any height from 2¾" to 5¼" (70 to 133 mm). The stand is 2½" (64 mm) high, and the base measures 4¾" (121 mm) in diameter. Price: 11540A, \$10. The waveguide clamps are offered in six sizes to hold waveguide covering frequencies from 5.30 to 40 GHz. They consist of a molded plastic cradle with a center rod. Price: 11543A-11548A, \$5 each.

SWR METER

Reduced noise for greater usable range
Model 415E



MICROWAVE
TEST EQUIPMENT

The Hewlett-Packard Model 415E SWR Meter is a low-noise tuned amplifier-voltmeter calibrated in dB and SWR for use with square-law detectors. It is an extremely useful and versatile instrument, measuring SWR, attenuation, gain, or any other parameter determined by the ratio of two signal levels. The standard tuned frequency is 1000 Hz and is adjustable over a range of about 7% for exact matching to the source modulation frequency. Amplifier bandwidth is also adjustable, from 15 to 130 Hz. The narrow bandwidth facilitates single-frequency measurements by reducing noise, while the widest setting accommodates a sweep rate fast enough for oscilloscope presentation.

The 415E has a very low noise figure, less than 4 dB. This represents a 6 to 10 dB improvement over other SWR meters. Equally significant is the fact that the noise figure has been optimized for source impedances presented by detectors most often used with SWR meters. As a result the 415E has greater measurement range because the reduction in noise permits the measurement of lower-level signals for a given signal-to-noise ratio.

A precision 60-dB attenuator with an accuracy of 0.05 dB/10 dB assures high accuracy in attenuation measurements. In addition, an expand-offset feature allows any 2-dB range to be expanded to full scale for maximum resolution. Linearity on the expanded ranges is ± 0.02 dB, permitting full utilization of the increased resolution; high accuracy is possible on the normal scales as well, for linearity is limited only by meter resolution. The meter itself has individually calibrated, mirror-backed scales plus a rugged taut-band movement for full realization of the inherently high accuracy, resolution, and linearity of the instrument.

The Model 415E operates with either crystal or bolometer detectors. Both high- and low-impedance inputs are available for crystal detectors (see page 333), optimum crystal source impedances being 50 to 200 and 2500 to 10,000 ohms respectively. For operation with bolometers, the 415E provides precise bias currents of 4.5 and 8.7 mA into 200 ohms, as selected at the front panel. This bias is peak-limited for positive bolometer protection.

Both ac and dc outputs are provided for use of the 415E as a high-gain tuned amplifier and with recorders. The solid-state 415E can be operated with an internally mounted battery pack (optional extra) for completely portable use or to eliminate ground loops.

Specifications

Sensitivity: 0.15 μ V rms for full-scale deflection at maximum bandwidth (1 μ V rms on high impedance crystal input).

Noise: at least 7.5 dB below full scale at rated sensitivity and 130 Hz bandwidth with input terminated in 100 or 5000 Ω ; noise figure less than 4 dB.

Range: 70 dB in 10- and 2-dB steps.

Accuracy: ± 0.05 dB/10-dB step; maximum cumulative error between any two 10-dB steps, ± 0.10 dB; maximum cumulative error between any two 2-dB steps, ± 0.05 dB; linearity, ± 0.02 dB on expand scales, determined by inherent meter resolution on normal scales.

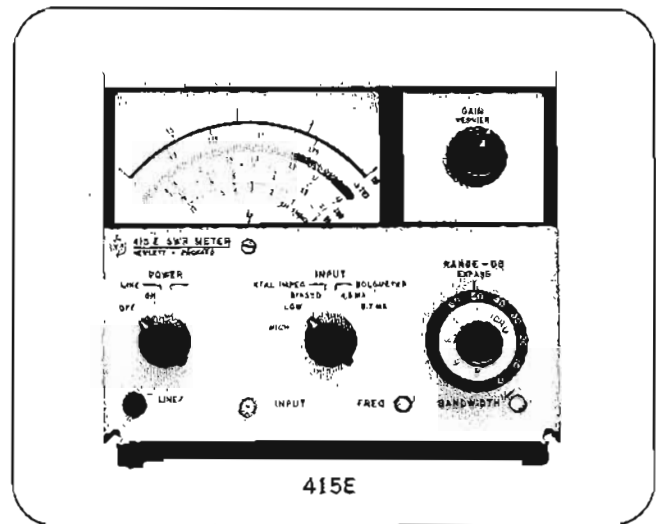

Input: unbiased low and high impedance crystal (50-200 and 2500-10,000 Ω optimum source impedance respectively for low noise); biased crystal (1 V into 1 k Ω); low and high current bolometer (4.5 and 8.7 mA $\pm 3\%$ into 200 Ω), positive bolometer protection; input connector, BNC female.

Input frequency: 1000 Hz adjustable 7%; other frequencies between 400 and 2500 Hz available on special order.

Bandwidth: variable, 15-130 Hz; typically less than 0.5 dB change in gain from minimum to maximum bandwidth.

Recorder output: 0-1 V dc into an open circuit from 1000 Ω source impedance for ungrounded recorders; output connector, BNC female.

Amplifier output: 0-0.3 V rms (Norm), 0-0.8 V rms (Expand) into at least 10,000 Ω for ungrounded equipment; output connector, dual banana jacks.

Meter scales: calibrated for square-law detectors; SWR: 1-4, 3.2-10 (Norm); 1-1.25 (Expand). dB: 0-10 (Norm); 0-2.0 (Expand); battery: charge state.

Meter movement: taut-band suspension, individually calibrated mirror-backed scales; expanded dB and SWR scales greater than 4 $\frac{1}{4}$ in. (108 mm) long.

RFI: conducted and radiated leakage limits are below those specified in MIL-I-6181D.

Power: 115-230 V $\pm 10\%$, 50-400 Hz, 1 W; optional rechargeable battery provides up to 36 hr continuous operation.

Dimensions: 7 $\frac{5}{32}$ in. wide, 6 $\frac{3}{32}$ in. high, 11 in. deep from panel (190 x 155 x 279 mm).

Weight: net, 10 lb (4.5 kg)
shipping, 13 lb (6.3 kg)

Accessory available: 11057A Handle, fits across top of instrument for carrying convenience.

Combining cases: 1051A, 11 $\frac{1}{4}$ in. (286 mm) deep. 1052A, 16 $\frac{3}{8}$ in. (416 mm) deep.

Price: HP Model 415E, \$425.

Options: 001. rechargeable battery installed, add \$100; 002. rear-panel input connector in parallel with front-panel connector, add \$25.

MICROWAVE TEST EQUIPMENT



SWR AND RATIO METERS

For convenient SWR measurements

Models 415B, 416B

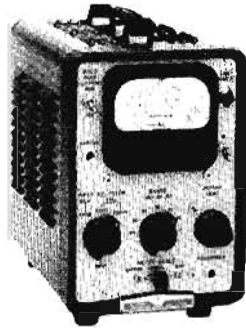

415B

415B Standing Wave Indicator

Similar to the 415E, this meter is a tuned voltmeter for SWR measurements with Hewlett-Packard slotted lines and detector mounts. It has an input selector for both bolometers and crystals. A special 5 dB attenuator is incorporated to increase resolution through use of the upper portion of the logarithmic meter scale.

Specifications, 415B

Input: "bolo" (200 ohms), bias provided for 8.7 or 4.3 mA bolometer or 1/100 amp fuse; "Crystal" (200 ohms) for crystal rectifier; "Crystal" (200 k Ω) high impedance for crystal rectifier as null detector; BNC connector.

Sensitivity: 0.1 μ V at 200 ohms for full-scale deflection.

Noise: at least 5 dB below full scale when operated from 200-ohm resistor at room temperature.

Frequency: 1000 Hz \pm 2%; other frequencies, 315 to 2020 Hz, available on special order; should not be harmonically related to power line frequency.

Bandwidth: 30 Hz (nominal).

Range: 70 dB; input attenuator provides 60 dB in 10-dB steps; accuracy, \pm 0.1 dB per 10-dB steps.

Calibration: square law; meter reads SWR, dB.

Scale selector: "Normal," "Expand" and " -5 dB."

Power: 115 or 230 volts \pm 10%, 50 to 60 Hz, 55 watts.

Dimensions: cabinet: 7 $\frac{1}{2}$ " wide, 11 $\frac{3}{4}$ " high, 12 $\frac{1}{2}$ " deep (191 x 299 x 318 mm).

Weight: net, 14 lbs (6.3 kg); shipping, 15 lbs (6.8 kg) (cabinet); net, 17 lbs (7.7); shipping, 27 lbs (12.2) (rack mount).

Price: HP 415B, \$500 (cabinet); HP 415BR, \$510 (rack mount).

416B

The HP 416B is designed for use with unlevelled signal sources in the measurement of reflection coefficient. The ratio meter provides valid results independent of incident power variations as high as 20:1. Either swept- or fixed-frequency measurements can be made using the Model 416B.

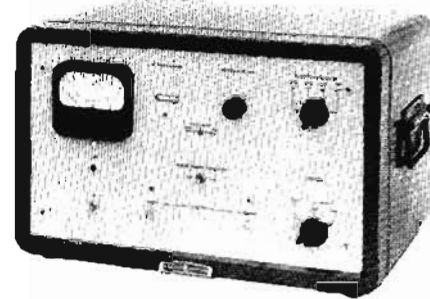

416B

A high-impedance output on the rear of the instrument permits swept-frequency measurements to be presented on an oscilloscope or preserved on a graphic recorder. The 416B operates with either crystals or bolometers.

	Crystal	Bolometer
Incident channel	3 to 100 mV rms	0.3 to 10 mV rms
Reflected channel	3 μ V to 100 mV rms	0.3 μ V to 10 mV rms



Balanced/symmetrical measurements

The world of telecommunications is characterized by the extensive use of balanced or symmetrical circuitry. The basic reasoning behind this is that the extremely large number of circuits in close physical proximity to each other and to 50/60 Hz power lines must have some protection against pickup of spurious and unwanted signals. Shielding is usually not practical, since most of the coupling is electromagnetic due to the relatively low impedance of the circuits. This kind of coupling requires expensive magnetic shielding to be effective. The solution, then, is to operate the circuits balanced or symmetrical. Provided the two sides of the circuit receive relatively equal exposure to the source of interference, the coupling will be in the form of a longitudinal or common-mode voltage; i.e., equal amplitude and phase on both sides of the circuit. The balanced input of various amplifiers in the telephone multiplex equipment will ignore spurious signals by virtue of their common-mode rejection capability.

DB readings are typically used in the communications industry rather than voltage readings as power is generally of more interest. DB readings compress the extremely wide range of voltages and powers in a communications system and offer the ability to compute gain and loss.

Hewlett-Packard dedicated communications instruments properly indicate dB, dBm or dBm regardless of the input impedance chosen. Wide frequency ranges allow measurements to be made on voice frequency circuits or carrier systems up to 3600 channels. Narrow bandwidth filters are available to make highly selective measurements in voice frequency telegraph systems using frequency shift keying techniques. Wider bandwidths are available to allow a complete 3.1 kHz voice channel to be measured. Sweep and wide dynamic range plotting capability makes possible highly accurate measure-

ments of group filters, channel bank filters and voice frequency telegraph filters. Hewlett-Packard selective voltmeters and tracking detectors may be used as a team to allow the entire baseband spectrum, or a portion thereof, of a carrier system to be displayed on an oscilloscope. They may be used to determine the frequency response of active or passive transmission devices. Hewlett-Packard selective voltmeters make highly accurate and wide range measurements practical in most complex communications systems.

Modern telephone communications has expanded and developed to the point where a high quality connection can be established across the country as readily as across town. High quality long-haul communications would be impossible if it were not for the telephone carrier system. A carrier system combines a large number of communications channels having a normal 4 kHz bandwidth into a single baseband, which may be many MHz in bandwidth and which can be used to modulate a microwave radio system or transmitted direct over a coaxial cable system. Each voice channel is given a definite frequency assignment and by modulation techniques (usually single sideband suppressed carrier) elevated to an assigned slot. The resulting frequency spectrum looks something like Figure 1.

The channel assignment shown in Figure 1 represents the baseband signal. An individual channel may occupy a different frequency slot from those shown at different stages in a carrier system, but the channel will still be a nominal 4 kHz wide. In order to synchronize the receive demodulators with the send modulators (since the carrier is suppressed) and to provide level regulation, several pilot tones are inserted in spaces between channels. Hence a carrier system produces a signal having a very complex spectrum. Since this baseband signal represents the capability of transmitting 3600 revenue-producing toll circuits, down time is out of the question and main-

tenance must be performed on an "in-service" basis. This is where the selective voltmeter finds one of its most practical applications. It can be used to examine the entire baseband, signal by signal, without interfering with or interference from the other signals.

Noise measurements

The theory of message-circuit noise measurement is based on a relative interfering effect of the noise on the subscriber's hearing. Because of the frequency response of the telephone subset and the fact that the human ear responds differently to noise of various frequencies, a weighting function is assigned to each frequency in proportion to its contribution to the interfering effect. The weighting curve currently accepted as a U.S. Standard is the Bell System C-message weighting. The unit used to define noise measured in this manner is dBRNC, meaning decibels above Reference Noise, C-message weighted. The CCITT recommendation is psophometric weighting, which has a slightly different curve and is referenced to 800 Hz. The measuring units for this weighting are picowatts psophometric, pWp.

Radio link test equipment

The Microwave Link Analyzer (Model 3702B/3710A) system measures and identifies the principle forms of distortion occurring in radio relay communications systems. Measurements can be made on an end-to-end or loopback basis. Overall performance can be assessed in a baseband to baseband or IF to IF mode and combinations thereof. Individual sections can be checked in a similar fashion. Measurement capability includes envelope delay distortion, FM linearity, power, gain/attenuation, IF amplitude response, IF return loss and modulator/demodulator sensitivity. See Pages 354 and 355. Model 8605A Communications Sweep Oscillator is an all solid state CW and swept source which offers 47 to 100 MHz IF coverage and multiband RF coverage. See Page 353.

Meeting the requirements of the telecommunications industry is one of the chief activities of Hewlett-Packard, as evidenced by the instruments briefly described in this dedicated communications section of the catalog. Many of these instruments were developed specifically at the request of the industry.

See Pages 249-314 (Oscillators) and 33-83 (Voltmeters) for your general purpose instruments needs.

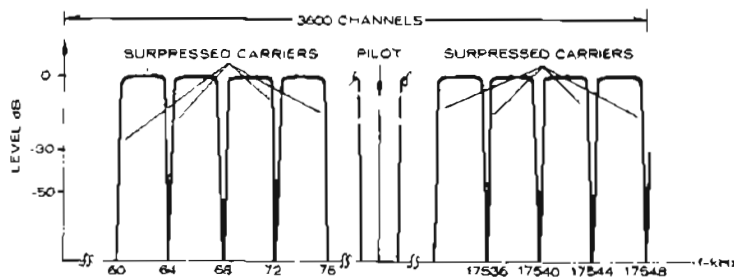

(Figure 1. L-4 carrier frequency allotment.)

COMMUNICATIONS TEST EQUIPMENT



TRANSMISSION & NOISE MEASURING SET

Psophometer

Model 3555B/3556A

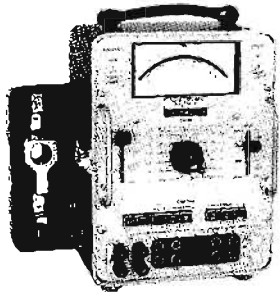

3555B

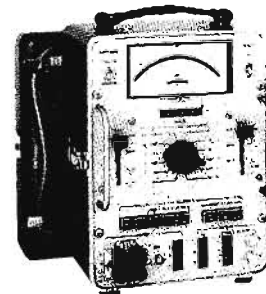

3556A

The HP 3555B Transmission & Noise Measuring Set and HP Psophometer are designed especially for telephone plant maintenance. Both instruments measure transmission gain, loss, cross-talk coupling and noise. The weighting curves of the 3555B complies with the Bell System C-message weighting standard. Besides the built-in C-message, program, 3 kHz and 15 kHz filters are also included.

The 3556A has built-in telephone program filters weighted

according to 1960 CCITT recommendations. Also included are 3 kHz and 15 kHz filters. Operating instructions printed in the protective cover are available in different languages at no extra charge. Refer to data sheet.

Complementary equipment for the 3555B is the HP 236A Telephone Test Oscillator (236A Opt. H10 for the 3556A). When used together, they make a complete transmission test set for accurate, convenient voice and carrier measurements.

Specifications*

	3555B (Bell Standards)	3556A (CCITT STANDARDS)
VOICE FREQUENCY LEVEL MEASUREMENTS:		
dB/volt range	-91 dBm to +31 dBm	-78 dBm to +32 dBm/0.1 mV to 30 V F.S.
Level accuracy	±0.5 dB; ±0.2 dB, 40 Hz to 15 kHz, level > 60 dBm	±0.5 dB, ±0.2 dB, 100 Hz to 5 kHz
Input	Terminated or bridged 600Ω or 900Ω balanced. Bridging loss: < 0.3 dB at 1 kHz. Balance: > 80 dB at 60 Hz, > 70 dB at 6 kHz, > 60 dB to 20 kHz.	Terminated: 600Ω symmetrical. Nonterminated: 10 kΩ symmetrical. Nonterminated error: < 0.4 dB at 800 Hz. Symmetry: > 80 dB at 50 Hz, > 70 dB at 6 kHz, > 50 dB to 20 kHz.
Return loss	30 dB min (50 Hz to 20 kHz)	30 dB min (50 Hz to 20 kHz)
Holding circuit	700Ω dc resistance, 60 mA max. loop line current at 300 Hz. With holding circuit in, above specs apply from 300 Hz to 4 kHz.	
NOISE MEASUREMENTS:		
dB/volt range	-1 dBm to +121 dBm	-78 dBm to +32 dBm/0.1 mV to 30 V F.S.
Weighting filters	3 kHz, 15 kHz, C-message, and program. (EEI, Bell System)	3 kHz, 15 kHz, telephone and program, (P53, CCITT)
Input	Same as for voice frequency measurements.	
CARRIER FREQUENCY LEVEL MEASUREMENTS:		
dB/volt range	-61 dBm to +11 dBm	-48 dBm to +12 dBm/3 mV to 3 V F.S.
Level accuracy	600Ω balanced (symmetrical): 1 kHz to 150 kHz, ±0.5 dB; 10 kHz to 100 kHz, ±0.2 dB. 135Ω balanced (for 150Ω balanced)†: 1 kHz to 600 kHz, ±0.5 dB; 10 kHz to 300 kHz, ±0.2 dB. 75Ω unbalanced (asymmetrical): 100 Hz to 600 kHz, ±0.2 dB; 30 Hz to 1 MHz, ±0.5 dB; 1 MHz to 3 MHz, ±0.5 dB ±10% of meter reading.	
Input	Terminated or bridged 135Ω† or 600Ω balanced (symmetrical) and 75Ω unbalanced (asymmetrical).	
Return loss	600Ω: 26 dB min., 3 kHz to 150 kHz; 135Ω†: 26 dB min. 1 kHz to 600 kHz; 75Ω: 30 dB min to 3 MHz.	
Bal/symmetry	> 70 dB to 10 kHz, > 60 dB to 100 kHz, > 40 dB to 600 kHz.	
GENERAL:		
Meter	Linear dB scale	Linear dBm scale
External battery	24 V or 48 V office battery, < 15 mA.	
Internal battery	Single NEDA 202, 45 V "B" battery.	4 rechargeable batteries (25 V total) or power line from 90 V to 250 V ac, 48 Hz to 440 Hz, < 10 VA. Option 001 uses same battery as 3555B.
AC:	115 or 230 V (specify for 3555B) (switch for 3556A) 48 Hz to 440 Hz, < 10 VA.	
Dimensions	7½ in. wide x 11½ in. high x 8 1/8 in. deep.	197 mm wide, 299 mm high, 207 mm deep.
Weight	Net: 15 lb (6.8 kg) shipping: 17 lb (7.5 kg)	
Jacks	Will accept Western Electric 241, 309, 310, 358, 289 and 347 plugs; 1011B hand-set or 52 type head-set.	Will accept Siemens 9 REL KL1-6A, 4 mm diameter banana plugs or 3-prong Siemens 9 REL STP-6AC connector.
Price	HP 3555B \$625	HP 3556A \$800

*Refer to data sheet for complete specifications.

†150Ω for 3556A.

TELEPHONE OSCILLATOR

Wide range telephone test oscillator
Model 236A and Options



COMMUNICATIONS
TEST EQUIPMENT

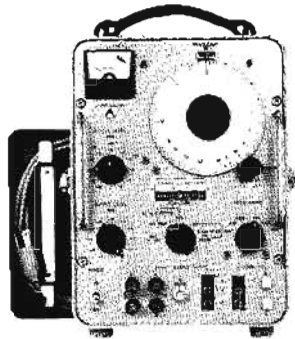

236A

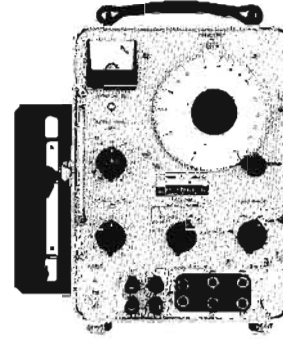

236A Opt H10

General

The solid-state Hewlett-Packard 236A and 236A Option H10/H20 Telephone Test Oscillators are designed specifically to deliver transmission test signals. They are particularly useful for lineup and maintenance of telephone voice and carrier systems.

Description

The HP 236A is the perfect companion to the HP 3555B Transmission/Noise Measuring Set for accurate, convenient voice and carrier measurements meeting Bell standards. Like-

wise, CCITT recommendations are met when the HP 236A Option H10 and HP 3556A Psophometer are used together. Refer to the opposite page for specifications and details.

Complementary equipment for the 236A is the HP 3555B Transmission and Noise Measuring Set (3556A Psophometer for the 236A Option H10). When used together, they make a complete transmission test set for accurate, convenient voice, carrier and noise measurements. Operating instructions printed in the protective cover are available in different languages (236A Option H10 and H20 only) at no extra charge. Refer to data sheet.

Specifications*

	236A (Bell)	236A Option H10 (CCITT)
Frequency range	50 Hz to 560 kHz	
Frequency dial accuracy	±3% of setting	
Frequency response		
600 Ω output	±0.3 dB from 50 Hz to 20 kHz	
900 Ω output	±0.3 dB from 50 Hz to 20 kHz	
136 Ω output	±0.3 dB from 5 kHz to 560 kHz	
150 & 75 Ω outputs	±0.3 dB from 5 kHz to 560 kHz	
Output level/accuracy	-31 to +10 dBm in 0.1 dBm step/±0.2 dBm from -31 to +10 dBm (1 kHz ref., Opt. H10.800 Hz ref.)	
Noise	At least 65 dB below total output or -90 dBm - whichever noise is greater.	
Distortion	At least 40 dB below fundamental output.	
Output circuit	Balanced (symmetrical) and floating. Can be operated up to ±500 V dc above (earth) ground.	
Output impedance	600 and 900 Ω ±5% 136 Ω ±10%	600 and 150 Ω symmetrical 75 Ω asymmetrical
Output balance (output symmetry)	600 and 900 Ω outputs: 70 dB at 100 Hz, 55 dB at 3 kHz 136 and 150 Ω outputs: 50 dB at 5 kHz, 30 dB at 560 kHz	
Output jacks	Accepts Western Electric 241, 309, and 310 plugs. Binding posts accept banana plugs, spade lugs, phone tips or bare wires. Removable shorting bar between sleeve and ground binding posts.	Accepts 3-prong Siemens 9 REL, STP 6 AC or 4mm diameter banana plugs.
Dial jacks	Accepts Western Electric 309 and 310 plugs. Clip posts accept Western Electric 1011B lineman's handset clips.	Accepts 3-prong Siemens 9 REL, STP 6 AC or 4 mm diameter plugs. Clip posts accept lineman's handset clips as alligator clips.
DC holding coil	600 and 900 Ω outputs only. 700 Ω ±10% dc resistance; 60 mA maximum loop current at 100 Hz.	
Power requirements	Line: 115 or 230 V (switch) ±10% ac, 48 Hz to 440 Hz, < 2 VA. Internal battery: single NEDA 202 45 V "B" battery. 236A Option H20: (same as 236A Option H10 except) five 6.25 V rechargeable batteries; 90 V - 250 V ac, 48 Hz - 440 Hz, < 10 VA during battery charge.	
Weight	Net: 13.5 lbs (6.1 kg); shipping 17 lbs (7.7 kg)	
Complementary equipment	HP 3555B Transmission and Noise Measuring Set	HP 3556A Psophometer
Price	HP 236A \$600	HP 236A Option H10 (ac line and dry battery) \$700 HP 236A Option H20 (ac line and rechargeable batteries) \$750

*Refer to data sheet for complete specifications.

COMMUNICATIONS TEST EQUIPMENT



PORTABLE TEST SET

Measures transmission line characteristics
Model 3550B

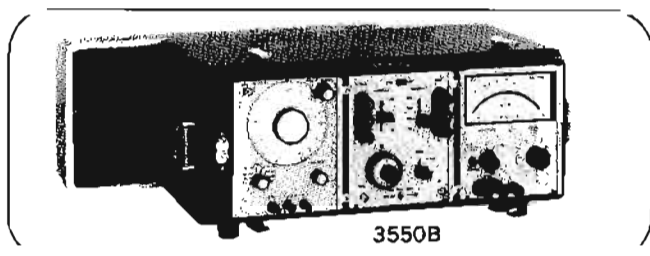

Description

The Hewlett-Packard Model 3550B Portable Test Set is designed specifically to measure transmission line and system characteristics such as attenuation, frequency response, or gain. It is particularly useful for lineup and maintenance of multi-channel communication systems. Model 3550B contains a wide range oscillator, a voltmeter, and a patch panel to match both the oscillator and the voltmeter to 135, 600, and 900 ohm lines. These instruments are mounted in a combining case that is equipped with a splash-proof cover. In addition, the oscillator, voltmeter, and patch panel may be used separately whether they are in or removed from the combining case.

Both the oscillator and voltmeter are transistorized and operate from their internal rechargeable batteries or from the ac line. The batteries provide 40 hours of operation between charges and are recharged automatically during operation from the ac line.

Specifications*

Oscillator 204C Opt. H20

Frequency range: 5 Hz to 1.2 MHz in 6 ranges. Vernier.
Dial accuracy: $\pm 3\%$ of setting.
Frequency response: $+5\%$ -1% 5 Hz to 100 Hz. $\pm 0.5\%$ 100 Hz to 300 kHz. $\pm 1\%$ 300 kHz to 1.2 MHz (normal).
Output impedance: 600 Ω .
Output: >2.5 V rms (10 mW or $+10$ dBm) into 600 Ω ; >5 V rms open circuit. Can be floated up to ± 500 V peak between output and chassis ground.
Output control: >40 dB ranges continuously adjustable.
Output balance: >40 dB below 20 kHz.
Distortion: $<1\%$ 5 Hz to 30 Hz and 100 kHz to 1.2 MHz; $<0.1\%$ 30 Hz to 100 kHz (Low Dist. Mode).
Hum and noise: $<0.01\%$ of output.
Operating temperature: (for specifications): 0°C to 55°C .

Voltmeter 403B Opt. 001

Range: 0.001 to 300 V rms full scale (12 ranges).
Frequency range: 5 Hz to 2 MHz.
Accuracy: within ± 0.2 dB of full scale from 10 Hz to 1 MHz; within ± 0.4 dB of full scale from 5 Hz to 10 Hz and 1 MHz to 2 MHz, except ± 0.8 dB 1 to 2 MHz on the 300 V range (0°C to $+50^{\circ}\text{C}$).
Meter: individually calibrated, raut band. Responds to average value of input waveform and is calibrated in the rms value of a sine wave.
Nominal input impedance: 2 M Ω ; shunted by <60 pF on 0.001 V to 0.03 V ranges, <30 pF on 0.1 V to 300 V ranges.
DC isolation: signal ground may be ± 500 V dc from chassis ground.

Patch panel, 353A

(specifications with oscillator and voltmeter)

Input (receiver)

Frequency range: 50 Hz to 560 kHz.
Frequency response: ± 0.5 dB, 50 Hz to 560 kHz.

Balance: better than 70 dB at 60 Hz for 600 Ω and 900 Ω ; better than 60 dB at 1 kHz for 600 and 900 Ω ; better than 40 dB over entire frequency range for 135, 600 and 900 Ω .
Impedance: 135, 600, 900 Ω and bridging (10 k Ω); center-tapped.

Insertion loss: <0.75 dB at 1 kHz.

Maximum level: $+22$ dBm (10 V rms at 600 Ω).

Output (source) includes all receiver specifications and attenuation: 110 dB in 1 dB steps.

Accuracy: 10 dB section $<\pm 0.25$ dB per step. 100 dB section, $<\pm 0.5$ dB per step.

Available telephone patch panels

Patch panel 353A opt. H02 (same as Model 353A except as indicated).

Attenuator: 23 dB ± 0.5 dB (1-step slide switch).

Hold circuit (send terminals)

Frequency response: 300 Hz to 3 kHz, ± 0.5 dB, 1 kHz reference.

DC resistance: 240 Ω NOMINAL.

Maximum dc current: 100 mA.

Maximum dc voltage: 150 V.

Connectors: special telephone jacks to accept Western Electric No. 309 and 310 plugs. Sleeve jack is connected to sleeve of jacks 309 and 310.

Patch panel 353A opt. H03 (same as Model 353A except as indicated).

Hold circuit (receive terminals)

Frequency response: 300 Hz to 3 kHz, ± 0.5 dB, 1 kHz reference.

DC resistance: 240 Ω NOMINAL.

Maximum dc current: 100 mA.

Maximum dc voltage: 150 V.

Attenuation: 23 dB ± 0.5 dB (1-step slide switch).

Hold circuit (send terminals)

Frequency response: 300 Hz to 3 kHz ± 0.5 dB, 1 kHz reference.

DC resistance: 240 Ω NOMINAL.

Maximum dc current: 100 mA.

Maximum dc voltage: 150 V.

Connectors: special telephone jacks to accept Western Electric No. 309, 310 and 241 at send and rec terminals. Sleeve jack is connected to sleeve of jacks 309 and 310.

General

Power: specifications for both voltmeter and oscillator (patch panel has no power connector). 4 rechargeable batteries (furnished); 40 hr operation per recharge, up to 500 recharging cycles; recharging circuit is self-contained and functions automatically when instrument is operated from ac line (115 or 230 V $\pm 10\%$, 48 to 448 Hz, total of 7 VA max).

Dimensions: 8 $\frac{3}{8}$ " high, 19 $\frac{1}{4}$ " wide, 13 $\frac{1}{4}$ " deep (with cover installed) (213 x 489 x 336 mm).

Weight: net, 30 lbs (13.5 kg); shipping, 41 lbs (18.5 kg).

Accessories furnished: detachable power cord; two 11035A Cables (1 foot long, dual banana-plug to BNC); the three instruments are enclosed in a 11046A Combining Case with a splash-proof cover.

Price: HP 3550B (204C opt. H20, 353A and 403B opt. 001), \$1255. HP 3550B opt. H02 (204C opt. H20, 353A opt. H02 and 403 opt. 001), \$1375. HP 3550B opt. H03 (204C opt. H20, 353A opt. H03 and 403B opt. 001), \$1375.

* For complete specifications refer to data sheet.

VIDEO TEST OSCILLATOR

Balanced, unbalanced, auto leveled outputs
Models 653A, 653A Option H01



**COMMUNICATIONS
TEST EQUIPMENT**

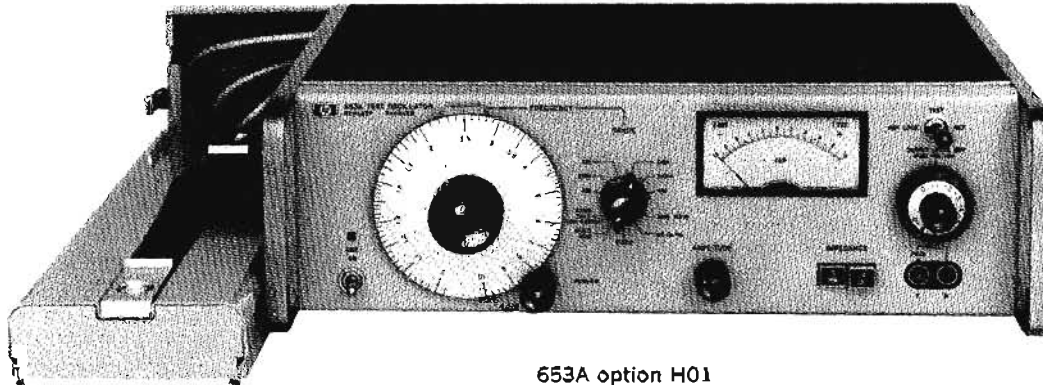

653A option H01

The 653A Test Oscillator is a lightweight, portable, solid-state signal source primarily used in the adjustment of transmission characteristics of television video loops. For this adjustment, the HP 653A Test Oscillator replaces the Western Electric 61C Signal Generator, HP 200CD Reference Oscillator, Western Electric 70B Power Meter at the sending end, and the Western Electric 1AP or 38A Transmission Comparing Set and associated cabling.

Adjustable test frequencies from 10 Hz to 10 MHz cover the complete video frequency range. The internal 300 kHz reference oscillator, conveniently selected by a front-panel switch for comparison measurements, eliminates the need for a separate reference oscillator. Amplitude stability, accuracy, and frequency response, good for 90 days from calibration, eliminate the need for the power meter at the sending end.

Front and rear covers provide protection and convenient cable storage space during transportation and periods when the instrument is not in use. The test set can be operated vertically on the floor or ground.

In addition to the features of the standard, the 653A option H01 includes a 60 Hz square wave, a simulated video signal, a modulated video signal, and a separate sync-only pulse. The simulated video signal, useful for qualitative monitoring, contains a blanking pulse, sync pulse, and white window. For video measurements and adjustments, the 653A option H01 can replace the Western Electric 61C Signal Generator, 70B Power Meter, 1AP or 38A Transmission Comparing Set, HP 200CD Reference Oscillator, and much associated cabling.

The 654A Test Oscillator is similar to the 653A except it is a general purpose test oscillator. The internal 300 kHz reference oscillator is deleted. It has BNC output connectors, and the meter is calibrated in dBm. Output impedances of 50 and 75 ohms unbalanced and 135, 150, and 600 ohms balanced are selected by a pushbutton switch.

Specifications, 653A

Frequency range: 10 Hz to 10 MHz in 6 bands.
Test frequency accuracy: $\pm 1\%$ at 4.5 MHz \ddagger ; $\pm 2\%$, 100 Hz to 5 MHz (on X100 range); $\pm 3\%$, 10 Hz to 5 MHz; $\pm 4\%$, 10 Hz to 10 MHz.
Reference accuracy (0 dBV): frequency, 300 kHz $\pm 2\%$; level, ± 0.1 dB for 90 days.
Output impedance: 75 Ω unbalanced, 124 Ω balanced.
Return loss (on 0 dB range and below): > 40 dB to 5 MHz;

> 30 dB, 5 MHz to 10 MHz.

Output level: +11 dBV max to -90 dBV, 10 dB and 1 dB steps with adjustable ± 1 dB vernier into 75 Ω unbalanced or 124 Ω balanced.

Overall attenuator accuracy: ± 0.15 dB (± 1 dB at output levels below -60 dB at frequencies > 300 kHz).

Meter range: ± 1 dBV full scale.

Meter resolution: 0.02 dB.

Meter tracking accuracy: ± 0.05 dB.

Frequency response (0 dBV, with meter centered, at end of recommended 6-ft cables): ± 0.05 dB, 10 Hz to 10 MHz.

Balance: > 50 dB, 10 Hz to 1 MHz; > 40 dB, 1 MHz to 10 MHz.

Distortion (THD): > 40 dB below fundamental, 10 Hz to 5 MHz; > 34 dB, 5 MHz to 10 MHz.

Hum and noise: > 70 dB below full output.

Output jacks: accepts WE 358A and 408A plugs; max dc voltage which can be applied to the output jacks, $< \pm 3$ V p.

Counter output: > 0.1 V rms into 50 Ω , BNC connector.

Specifications, 653A option H01

(in addition to the 653A specifications)

Functions*

Sine wave (standard operation).

60 Hz square wave, 0 dBV = 1 V p-p, risetime $2T$ ($T = 125$ ns).

Simulated video signal with sync pulse, blanking pulse and white window, 0 dBV = 1 V p-p, risetime 150 ns.

Video signal modulated by 60 Hz square wave, 0 dBV = 1 V p-p, risetime 150 ns.

Sync pulse only, 0 dBV = 0.25 V p-p, width 12.7 μ s, risetime 150 ns.

Output amplitude accuracy: $\pm 5\%$ all signals except sine wave.

General

Operating temperature: 32°F to 130°F.

Power: 115 V or 230 V $\pm 10\%$, 48 Hz to 440 Hz, 35 VA max.

Dimensions (covers installed): 16 $\frac{3}{4}$ " wide, 5" high, 16" deep (425 x 127 x 406 mm).

Weight: net, 21 lbs (9.5 kg); shipping, 31 lbs (14 kg).

Accessories furnished: rack mount kit, front cover, rear cover, 7.5-ft yellow power cord.

Price: HP 653A, \$1030.

*Waveforms conform to EIA Spec. RS170.

\ddagger Accuracy for temperatures from 20°C to 30°C.



SELECTIVE VM; OSCILLATOR

Signal analysis to 22 MHz; tracking oscillator
Models 312A, 313A

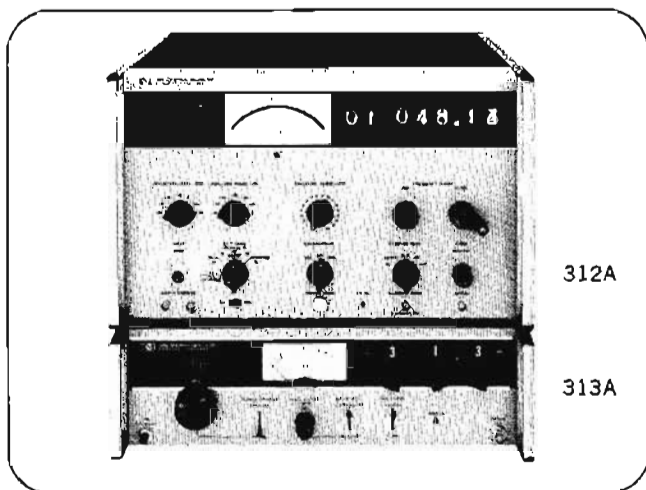

Description

The Hewlett-Packard Model 312A/313A is a frequency selective voltmeter/tracking oscillator set operating in the frequency range of 1 kHz to 18 MHz (22 MHz for 312A Option H01) that covers the range of all commercially available carrier and radio systems including the Western Electric L4 system. The set is capable of making transmission and noise measurements with an unparalleled speed and accuracy resulting in a substantial time savings even when operated by inexperienced craftsmen.

Many accurate measurements can be made using the automatic features of the 312A. The digital frequency readout and AFC eliminate any guesswork on the part of the craftsman as to the signal being measured. The high level of stability and many operating features of the 312A eliminate the need for corrections and external accessories, making even the most difficult measuring task simple. The 312A performs level, noise and transmission measurements, all in one convenient, easy-to-use package.

Pilot level measurement

The frequency accuracy and tuning ease of the 312A allow a quick, unambiguous measurement of pilot levels. The craftsman needs only to determine the frequency of the pilot from the system frequency chart and then set the digital frequency dial of the 312A to this frequency.

No guesswork is required to determine if the correct pilot is being measured. Pilot frequency can be checked by tuning the 312A to a small wavemeter dip in the exact center of the set's passband. When tuned to this dip, the digital counter indicates the incoming frequency to the nearest 10 Hz.

Measurement of other tones

The 312A can easily measure and discriminate between other signals such as suppressed carriers, test tones, signalling tones, fault alarm tones, intermodulation products and any other signals present in the system. The digital frequency readout allows exact measurement of the tones and eliminates the time-consuming procedure of bumping these tones to determine if the proper one is being measured. All that is needed is a system frequency chart. The selection of input impedances allows measurement at group, supergroup, baseband and entrance link test points without any external matching pads or transformers.

Noise measurement

One of the problems in measuring channel noise in working systems is that conventional 3 kHz bandwidth selective volt-

meters measure the carrier leak in addition to the noise. This has been avoided by making the measurement at a narrower bandwidth to eliminate the carrier leak and then converting to an equivalent 3 kHz bandwidth. The 312A Option 001 is equipped with carrier rejection filters that measure the noise in a 3 kHz bandwidth and filter out the carrier leak. In this measurement, noise is measured directly in dBmC without the need for error-prone conversions and calculations.

Frequency response measurement

The 312A/313A combination can measure frequency response, because the output frequency of the tracking oscillator is slaved to the selective voltmeter tuning. Back-to-back or loop-around measurements can be made with one set. End-to-end measurements can be easily made with a set at each end. The 313A is an inexpensive (\$1400) addition to the 312A Selective Voltmeter for this application. The accuracy of the digital frequency tuning insures that signals will not inadvertently be placed in active channels or near pilots. In addition, response of repeaters and the various system filters may be readily and accurately measured. Equalizer adjustments of cable systems and entrance links are rapidly made with this tracking setup.

Specifications, 312A

Tuning characteristics

Frequency range: 1 kHz to 18 MHz in 18 overlapping bands, 200 kHz overlap between bands. (Options H01, H05, and H10, 1 kHz to 22 MHz in 22 overlapping bands.)

Frequency accuracy: $\pm(10 \text{ Hz} + \text{time-base accuracy})$. Frequency indicated on in-line digital readout with $\pm 10 \text{ Hz}$ resolution.

Time-base stability

Aging rate: $\pm 2 \text{ ppm}$ per week; as a function of ambient temperature: $+15^\circ$ to $+35^\circ\text{C}$, $\pm 20 \text{ ppm}$; 0° to $+55^\circ\text{C}$, $\pm 100 \text{ ppm}$; as a function of line voltage: $\pm 0.1 \text{ ppm}$ for changes of $\pm 10\%$.

Selectivity

Rejection	200 Hz bandwidth	1000 Hz bandwidth	3100 Hz bandwidth
3 dB	200 Hz $\pm 10\%$	1 kHz $\pm 10\%$	3.1 kHz $\pm 10\%$
60 dB	<470 Hz	<2350 Hz	<6680 Hz

(Midpoint of the band is marked by rejection notch 3 Hz wide)

Automatic frequency control

Dynamic hold-in range: $\pm 3 \text{ kHz}$ at 3.1 kHz bandwidth.

Tracking speed: 100 Hz/s; locks on to signals as low as 60 dB below zero reference. Zero reference level set with amplitude range switch set to 0 dB.

Amplitude characteristics

Amplitude range (full scale): 50 to 150 Ω , -97 dBm to $+23 \text{ dBm}$; 600 Ω , -107 to $+13 \text{ dBm}$.

Voltage: 3 μV to 3 V full scale (50 Ω reference).

Amplitude accuracy

Amplitude range attenuator: $\pm 0.1 \text{ dB}$ (1% of reading).

Reference level attenuator: at 1 MHz, $\pm 0.2 \text{ dB}$.

Frequency response (bridging input with external termination of 50 Ω $\pm 1\%$): 1 kHz to 10 kHz, $\pm 0.5 \text{ dB}$ (5% of reading); 10 kHz to 10 MHz, $\pm 0.2 \text{ dB}$ (2% of reading); 10 MHz to 18 MHz, $\pm 0.5 \text{ dB}$ (5% of reading).

Meter tracking: $\pm 0.1 \text{ dB}$ to -10 dB (1% of reading).

	312A Option H01	312A Option H10	312A Option H05
FREQ. RGE.	1 kHz to 22 MHz in 22 overlapping bands		
AMP. ACC.	75 Ω \pm 0.2 dB		50 Ω \pm 0.2 dB
METER CALIB.	dBm/75 Ω		V and dBm/50 Ω
INPUT Z	75 Ω or bridging (10 k Ω / <35 pF)		50 Ω or bridging (10 k Ω / 35 pF)
OUTPUT/INPUT	WE-477B/WE-289B	BNC/WE-477B	BNC/BNC
PRICE	ON REQUEST		

Internal calibrator output

Frequency: 1 MHz square wave (derived from time base).
Amplitude: -40 dBm into 75 Ω termination.
Amplitude stability: \pm 0.1 dB.
Output connector: BNC female.

Matching impedance: 50, 60, 75, 124, 135, 150 or 600 Ω , balanced or unbalanced.

Bridging impedance: 20 k Ω \pm 3% shunted by <30 pF (balanced); 10 k Ω \pm 3% shunted by <60 pF, reference level attenuator at -40 dB (unbalanced). Refer to data sheet for complete specs.

Common-mode rejection (balanced input): 1 kHz to 5 MHz, >40 dB; 5 MHz to 18 MHz, >30 dB.

Input connector: BNC female (2).

Harmonic distortion: 1 kHz to 1 MHz, >55 dB below zero reference. 1 MHz to 18 MHz, >65 dB below zero reference in any position; residual responses: 72 dB below zero reference; noise level, referred to input: 50 to 150 Ω , -120 dBm; 600 Ω , -130 dBm (200 Hz bandwidth at 0).

Receiver characteristics

Receiver mode outputs

AM and AM/AFC: diode-demodulated audio.

Beat: beat frequency audio center at f_o .

LSB: product-demodulated audio, carrier reinserted at f_o + 1.8 kHz.

USB: product-demodulated audio, carrier reinserted at f_o - 1.8 kHz.

Audio output level: >0.5 V rms into 10 k Ω with full scale meter deflection.

Recorder output level: 1 V \pm 0.1 V with full-scale meter deflection across open circuit. Output connector, BNC female. Tracking accuracy, better than \pm 0.1 dB to 20 dB below full-scale reference on 0 dB position of amplitude range switch; better than \pm 0.2 dB to 30 dB below full-scale reference. Output resistance, 1 k Ω .

Auxiliary outputs

1 MHz: 1 V p-p sine wave into 1 k Ω ; output connector, BNC female.

30 MHz: 40 mV to 70 mV rms into 50 Ω ; output connector, BNC female.

Local oscillator (30 to 48 MHz): 60 mV to 90 mV rms into 50 Ω ; output connector, BNC female.

Power: 115 or 230 V \pm 10%, 48 to 440 Hz, 100 VA max.

Dimensions: 16 $\frac{3}{4}$ " wide, 10 $\frac{3}{4}$ " high, 18 $\frac{3}{8}$ " deep (426 x 274 x 467 mm); hardware furnished for conversion to rack mount 19" wide, 10-15/32" high, 16 $\frac{3}{8}$ " deep behind panel (483 x 266 x 416 mm).

Weight: net, 46 lbs (20.7 kg); shipping, 62 lbs (27.9 kg).

Price: HP 312A, \$4275. HP 312 Option H01, 312A Option H05, 312A Option H10, price on request. HP 312A Option C01 (furnished with input connector equivalent to WE-465C and internal calibrator output connector equivalent to WE-477B), price on request.

Specifications for 312A, Option 001

(Same as Standard Model 312A with following exceptions)

Bandpass: 3100 Hz with carrier rejection notched at \pm 2 kHz from the center of passband.

Rejection notches: down >55 dB at 2 kHz above and below center of passband; down >45 dB at \pm 7.5 Hz from center of rejection notch.

Price: 312A Option 001, add \$100.

Specifications, 313A

Frequency range

As tracking oscillator: same as 312A (18 MHz) or (22 MHz).

As signal source: 1 kHz to 22 MHz in one band, continuous tuning.

Frequency accuracy

As tracking oscillator: 35 Hz \pm 4 Hz above 312A tuning.

As signal source: \pm 1% of maximum dial setting from 10 kHz to 2 MHz; \pm 3% of maximum dial setting from 2 to 8 MHz; \pm 5% of maximum dial setting from 8 to 22 MHz.

Frequency stability

As tracking oscillator: same as 312A time base \pm 100 Hz/ $^{\circ}$ C.

As signal source: short term (5 min) drift <1 kHz in stable environment after warmup.

Frequency response: \pm 0.1 dB, 10 kHz to 22 MHz.

Amplitude stability: \pm 0.1 dB for 90 days (0 to +55 $^{\circ}$ C).

Meter mode

312A expand: meter expands any 2 dB range of 312A meter indication from -7 to +3 dB using 312A recorder output. Meter range, -1 to +1 dB; tracking error, \pm 0.05 dB over full 2 dB range (operates with any 1 V, 1 k Ω recorder output).

Output monitor: meters voltage at the input of the attenuator and can be calibrated from the front panel.

Maximum output: 0 or +10 dBm \pm 0.1 dB, selectable at front panel.

Output attenuator: 3-section attenuator provides 0 to 99.9 dB attenuation in 0.1 dB steps.

Attenuator accuracy: 0.9 dB section (0.1 dB steps), \pm 0.02 dB; 9 dB section (1 dB steps), \pm 0.1 dB; 90 dB section (10 dB steps), \pm 0.1 dB to 50 dB, \pm 0.2 dB to 90 dB.

Output impedance: 75 Ω unbalanced (50 Ω optional, see Option 001 below).

Output connector: BNC female.

Harmonic distortion: >34 dB below fundamental.

Non-harmonic distortion

As tracking oscillator: >40 dB below fundamental.

As signal source: >50 dB below fundamental.

Recorder output: \pm 0.3 V for full-scale deflection. Output impedance 1 k Ω , BNC female connector.

Power: 115 or 230 V \pm 10%, 48 to 440 Hz, 35 VA maximum.

Dimensions: 16 $\frac{3}{4}$ " wide, 5 $\frac{1}{2}$ " high, 18 $\frac{3}{8}$ " deep (426 x 141 x 467 mm).

Weight: net, 25 lbs (11.3 kg); shipping, 30 lbs (13.5 kg).

Accessories furnished: 11086A interconnecting cables for use with HP 312A, each cable 2 ft (610 mm) long with BNC male connectors (3).

Price: HP 313A, \$1400. HP 313A Option C01 (furnished with output connector equivalent to WE-477B), price on request.

Option 001: output impedance 50 Ω unbalanced; no additional charge.

PLUG-IN SELECTIVE VOLTMETER

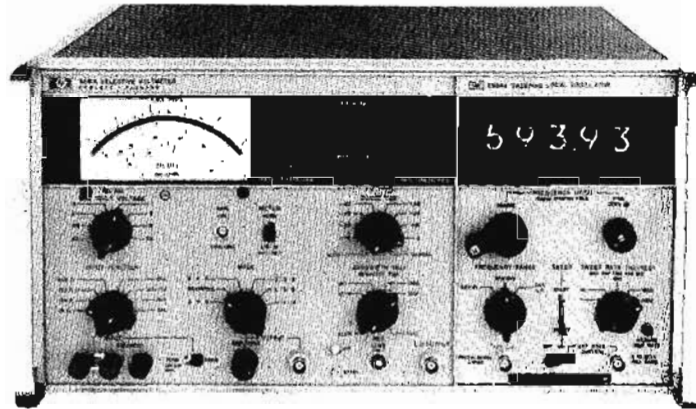
 Balanced/symmetrical inputs
 Models 3591A/3594A

3591A/3594A

Description

The 3591A is a general purpose 20 Hz to 620 kHz frequency selective voltmeter having balanced/symmetrical input with selectable impedances. With the balanced input circuitry, the 3591A is particularly useful for communications applications in the lab, field, or production line. Other than input differences, the 3591A is essentially identical to the 3590A, (see page 376), having all the virtues of automatic ranging, wide dynamic range, and log and linear X and Y recorder outputs.

Because of the input amplifier arrangement, differential signals can be measured by the 3591A in the presence of longitudinal (common mode) voltage. Compatibility is thus obtained with balanced/symmetrical systems which can only be monitored by balanced/symmetrical input devices such as the 3591A. Applications include measurement of transmission lines, equalizers, filters, and multiplex carrier systems up to 120 channels.

Specifications^{1,2}

Frequency range: 20 Hz to 620 kHz.

Amplitude ranges: 3 μ V to 30 V full scale in 15 ranges.

Amplitude accuracy with input terminated

Meter switch in normal position

Overall accuracy: ± 0.43 dB to ± 0.67 dB or $\pm 5\%$ to $\pm 8\%$ of reading depending on frequency, including the following:

Frequency response flatness, total deviation: 600 Ω termination: 20 Hz to 100 Hz ± 0.53 dB ($\pm 5\%$); 100 Hz to 620 kHz ± 0.26 dB ($\pm 3\%$). All other terminations: 5 kHz to 620 kHz ± 0.26 dB ($\pm 3\%$); meter tracking: ± 0.1 dB or $\pm 1\%$ of reading, 0 dB to -10 dB indication. Meter switch in linear dB position: overall accuracy: ± 1 dB.

Amplitude accuracy with input bridged: same as 3590A specification.

Amplitude ranges (DBM): 75 Ω : -90 dBm to $+50$ dBm full scale in 10 dBm steps; 135 Ω , 150 Ω and 600 Ω , -100 dBm to $+40$ dBm full scale in 10 dB steps; (Voltage): 3 μ V to 30 V full scale in 3, 10 sequence.

Noise level

Bandwidths	Input Noise Level (600 Source Impedance)
10 Hz and 100 Hz	< -125 dBm (< 0.44 μ V) or at least 85 dB below zero dB reference
1 kHz and 3.1 kHz	< -115 dBm (< 1.38 μ V) or at least 85 dB below zero dB reference

Input mode: single-ended or balanced about ground (not floatable) terminated or bridged.

Functions DBM: level calibrated in dBm for input impedance selected; ABS VM: level calibrated in volts for input impedance selected; REL: variable amplitude reference adjustment, 10 dB range; CAL: internal level calibrator.

Impedances, resistances:* 100 k Ω bridged and balanced; 50 k Ω bridged and single-ended; 600 Ω , 150 Ω , 135 Ω , 75 Ω terminated; capacitance (each channel to ground): 10 mV and 30 mV ranges: < 55 pF; 100 mV to 30 V ranges: < 40 pF; return loss: 100 Hz to 620 kHz: 600 Ω , > 30 dB; 5 kHz to 620 kHz: 150 Ω , 135 Ω , 75 Ω : > 35 dB; longitudinal voltage (common-mode) rejection: 20 Hz to 620 kHz: > 40 dB.

Maximum input level

Terminated: 75 Ω : 4.3 V rms ($+24$ dBm); 135 Ω : 5.8 V rms ($+24$ dBm); 150 Ω : 6.1 V rms ($+24$ dBm); 600 Ω : 12.3 V rms ($+24$ dBm).

Bridged: 10 mV and 30 mV input ranges: 14 V rms; 100 mV to 30 V input ranges: 75 V rms; max longitudinal (common-mode) voltage not to exceed max input voltage range setting.

Power: 115 V or 230 V $\pm 10\%$, 48 Hz to 440 Hz, 115 VA max.

Dimensions: 16 $\frac{3}{4}$ " wide, 8 $\frac{3}{4}$ " high, 16 $\frac{3}{8}$ " deep (425 x 221 x 416 mm).

Weight: net, 38 lbs (17.2 kg); shipping, 56 lbs (25 kg).

Accessories furnished: rack mounting kit for 19" rack. (Refer to page 376 for plug-in information. The 3591A must have a plug-in to operate).

Price: HP 3591A, \$3435.

Plug-ins: HP 3592A, \$80; HP 3593A, \$1130; HP 3594A, \$1640.

* Other terminations available on special order.

** For complete specifications refer to data sheet. See page 376-377.

COMMUNICATIONS SWEEP OSCILLATOR AND ACCESSORIES

Model 8605A



COMMUNICATIONS TEST EQUIPMENT

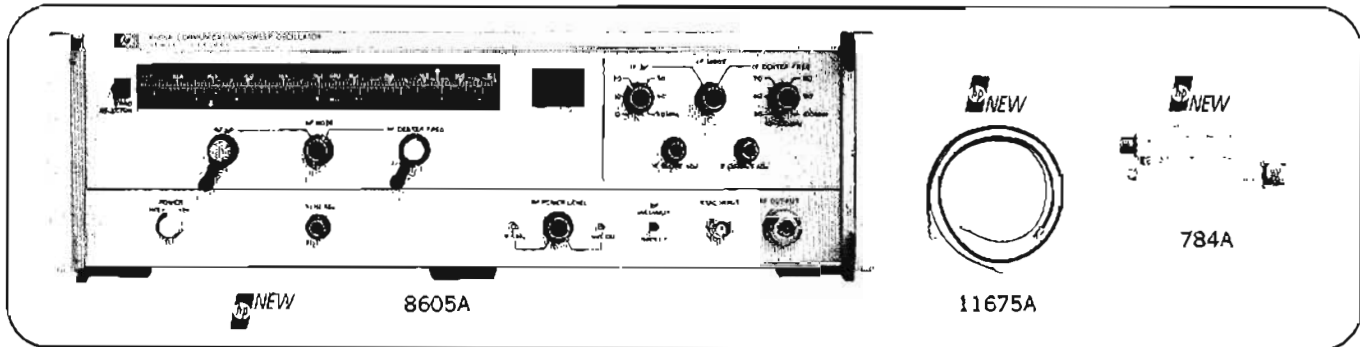

Description

The Hewlett-Packard Model 8605A Communications Sweep Oscillator is an all solid state CW and swept source which offers 47 to 100 MHz IF coverage and multiband RF coverage. Multiband RF coverage is available anywhere in the microwave region, 1.7 to 13.25 GHz. While 4, 6 and 11 GHz bands are standard options almost any other band or bands are available upon request.

The instrument is easy to use and features excellent frequency accuracy and extremely flat power output characteristics (0.01 dB). The 70 MHz IF sweep generator controls are on the right of the mainframe, the multiband RF (microwave) controls are separate and on the left of the mainframe. The multiband RF section features a band switching lever for convenient control of RF frequency range and a highly adaptive multiband, modular design that enables Hewlett-Packard to offer self-contained multiband capacity anywhere in the 1.7 to 13.25 GHz region.

General instrument specifications

Sweep frequency: adjustable from 20 to 40 sweeps per second.
Sweep output: direct-coupled sawtooth, zero to approx. +10 V.
Blanking output: 0 V during trace, +15 V during retrace.
Furnished: 7½' (2290 mm) power cable with NEMA plug, rack-mounting kit, and accessory kit.
Power: 115 or 230 V $\pm 10\%$, 50 to 400 Hz; approx 150 watts.
Dimensions: 5¼" (133,4 mm) high, 16¾" (416,0 mm) deep, 16¾" (425,5 mm) wide.
Weight: (including RF section) 33 lbs (15,0 kg); shipping, 48 lbs (21,8 kg).

70 MHz IF Section Specifications

Frequency range: 47 to 100 MHz.
 ΔF sweep width range: 0 to 53 MHz.
Frequency accuracy (25°C): CW mode; ± 2 MHz; Cardinal markings every 5 MHz; rear panel BNC counter monitor jack provided.
Residual FM-CW mode: < 1 kHz peak.
Linearity: ΔF sweep mode, $\pm 2.5\%$, as a % of sweep width.
Maximum leveled power output: $> +10$ dBm; internally leveled.
Power output variation (internally leveled): 55 to 85 MHz: < 0.01 dB peak to peak; 47 to 100 MHz: < 0.025 dB peak to peak.
Power output slope adjustment range: ± 0.1 dB slope control.
Spurious signals: (down from fundamental output at +10 dBm); harmonics, more than 40 dB; non-harmonics, more than 50 dB.
IF output: 75 ohm WECO 567A jack; other connectors available.

Ordering information

Model 8605A Communications Sweep Oscillator: price includes 70 MHz IF section and RF bands specified optionally below.

Optional RF bands (order only one option)

Option	Price:
4 GHz band, Option 001;	\$3875
6 GHz band, Option 002;	\$4450
11 GHz band, Option 003;	\$4650
4 & 6 GHz bands, Option 004;	\$5075
4 & 11 GHz bands, Option 005;	\$5225
6 & 11 GHz bands, Option 006;	\$6425
4, 6 & 11 GHz bands, Option 007;	\$6775
Other bands, Request: Hewlett-Packard quotation	

Connector and modulation options

Option 050: 75-ohm BNC in place of WECO-567A for IF output; **Price:** no charge.
Option 070: external FM input for use as up-converter: rate, dc to 8 MHz; **Price:** add \$250.

Model 11675A Leveling Cable Assembly; Price: \$50.

Model 784A Directional Detector; Price: \$625.

Multi-band, RF (Microwave) Section Specifications

Band	Frequency Range	Frequency Accuracy CW-Mode	Linearity % of Sweep Width	Max. Leveled Power Incl. 11675A & 784A	Power Variation		Spurious Signals down from fundamental		External FM-Option 070: Rate
					Over 30 MHz Channel	Over specified Band	Harmonic	Non-Harmonic	
4 GHz	3.65 to 4.25 GHz	± 5 MHz	$\pm 1.0\%$	$> +11$ dBm (> 12.5 mw)	≤ 0.01 dB	≤ 0.15 dB	> -40 dB	> -60 dB	DC to 8 MHz
6 GHz	5.9 to 6.5 GHz	± 8 MHz	$\pm 1.0\%$	$> +11$ dBm (> 12.5 mw)	≤ 0.01 dB	≤ 0.15 dB	> -40 dB	> -60 dB	DC to 8 MHz
11 GHz	10.7 to 11.7 GHz	± 10 MHz	$\pm 2.0\%$	$> +5$ dBm (> 3.1 mw)	≤ 0.01 dB	≤ 0.2 dB	> -40 dB	> -60 dB	DC to 8 MHz
Other	Portion of 1.7-13.25 GHz	$\pm 0.5\%$ of band width	$\pm 1.0\%$ to $\pm 2.0\%$	$> +11$ dBm to $> +5$ dBm	≤ 0.01 dB	depends on band	depends on band	> -40 dB typically	DC to 8 MHz



MICROWAVE LINK ANALYZER

Checks terrestrial and satellite radio links

Models 3710A, 3715A, 3716A, 3702B, 3703B, 3705A

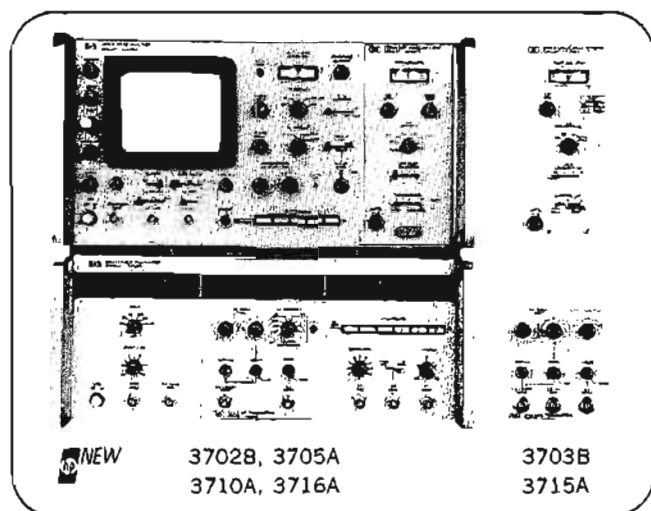

Description

The Microwave Link Analyzer is a combined baseband (BB) and Intermediate Frequency (IF) analyzer. Designed to satisfy international measurement requirements, the MLA permits rapid tuning and equalization of satellite and terrestrial radio relay links for realization of their full traffic potential.

The MLA allows the various forms of distortion occurring in a link to be identified, measured and localized to BB and IF devices and BB/IF combination devices (eg, modulators and/or demodulators). From these measurements, it is also possible to deduce the radio frequency (RF) performance of the link. RF measurements however can be made directly with the aid of the Model 3730A Down Converter.

Inclusion of high frequency BB test signals corresponding to the upper BB frequency of the link, permits the detection of amplitude to phase modulation conversion effects. Optimization of the link differential gain and phase performance using these frequencies will generally give the best overall system performance as determined by white noise loading tests.

Features

Combined IF and BB test set covering the IF (45 to 95 MHz) and BB (83.3 kHz to 8.2 MHz) frequency spectrum of 1800 Channel and Color TV Radio Relay links. Demodulation of BB frequencies up to 5.6 MHz.

Sweep width automatically compensated by chosen BB frequency to give constant sideband excursion.

AM facility 10%, 60 kHz to 10 MHz, with low incidental PM (0.15°/10%) enables AM to PM conversion and AM suppression measurements to be made on limiters.

IF amplitude flatness ± 0.05 dB from 45 to 95 MHz using a PIN diode levelling circuit. IF frequency stability of ± 100 kHz via a pulse count discriminator circuit. IF frequency markers of 70 MHz, 2 MHz 'comb' and sliding symmetrical pair.

Easy to use—distinctive front panel layout with 'slide rule scales' which give 'at a glance' test signal settings—no need to switch a meter sequentially. Front-panel cross checking facilities between the Transmitter and Receiver rapidly locate measurement problems.

BB frequencies switch selectable—no need to change a module when changing BB frequency.

Receiver can be remote from Transmitter for between station measurements. 'Slave' facility for local display of remote measurements.

Inbuilt CRT display for ease of use, minimizing interconnections and more importantly eliminating ground loop problems which may be present in terminal stations. Dual display of interdependent link parameters. Constant X-axis CRT deflection independent of sweep width changes.

Comsat/Intelsat requirements met by optionally available sweep frequency and measurement bandwidth, appropriate to satellite link signal-to-noise conditions.

Western Electric compatibility with optional connectors, sweep and BB frequencies.

Measurements

Measurements can be either one way or loop. When one way measurements are made, the measurements at the receive end can be 'slaved' back for display at the transmit end with negligible additional distortion contributed by the return path of the microwave link. The measurements performed by the MLA are:

- | | | |
|---|----------|---|
| 1 | BB to BB | } Using internal BB frequencies
83.3 kHz to 8.2 MHz. |
| 2 | IF to BB | |
| 3 | BB to IF | } Using internal BB frequencies
83.3 kHz to 5.6 MHz. Above 5.6 MHz
an external demodulator can be used. |
| 4 | IF to IF | |

GROUP DELAY/
LINEARITY

Modulators and demodulators separately or in combinations; IF and BB devices and through-link tests (loop or one way).

DIFFERENTIAL PHASE/
GAIN

As for GROUP DELAY but using the higher BB frequencies including TV color subcarrier.

AM TO PM CONVERSION

Limiters.

AM SUPPRESSION

Limiters.

IF AMPLITUDE RESPONSE

Modulators, IF devices and through-link tests.

SENSITIVITY

Modulators and demodulators.

IF RETURN LOSS

IF input ports.

BB RETURN LOSS

BB input ports.

FREQUENCY SPECTRUM

IF signals.

POWER, GAIN.

IF and BB devices.

ATTENUATION

Transmitter

The Transmitter part of the MLA generates the signals required for testing and setting-up the IF, BB, IF/BB and BB/IF sections of a radio relay link. The Transmitter consists of a 3710A IF/BB Transmitter mainframe, which embraces sweep and IF sections and a 3715A BB Transmitter or a 3716A BB Transmitter plug-in, which contains the BB and BB + sweep sections.

The 3715A BB Transmitter offers BB frequencies of 83.3, 250 and 500 kHz and the 3716A BB Transmitter offers, in addition to the 3715A frequencies, the higher BB frequencies of 2.4, 4.43, 5.6 and 8.2 MHz. Also incorporated in the 3716A are the facilities of Auto Sweep Reduction and of Reduce BB Frequency indication, both relevant at the higher BB frequencies.

Receiver

The Receiver analyses signals from radio-relay-link IF, BB, IF/BB and BB/IF sections. Frequency demodulation, power/linearity and dual trace CRT display circuits are contained in the 3702B IF/BB Receiver mainframe and the phase detection circuitry is in the 3703B Group Delay Detector or 3705A Differential Phase Detector plug-in.

The 3703B Group Delay Detector provides group delay measurements at BB frequencies of 83.3, 250 and 500 kHz and the 3705A Differential Phase Detector additionally gives differential phase measurements at BB frequencies of 2.4, 4.43, 5.6 and 8.2 MHz.

MLA System Price \$9,000 to \$11,000 dependent upon system configuration and options.

Down Converter, Attenuator and Accessory Kit

RF tests on radio links, 75 Ω accessories

Models 3730A, 3731A, 3732A, 3733A, 3750A, 15550A

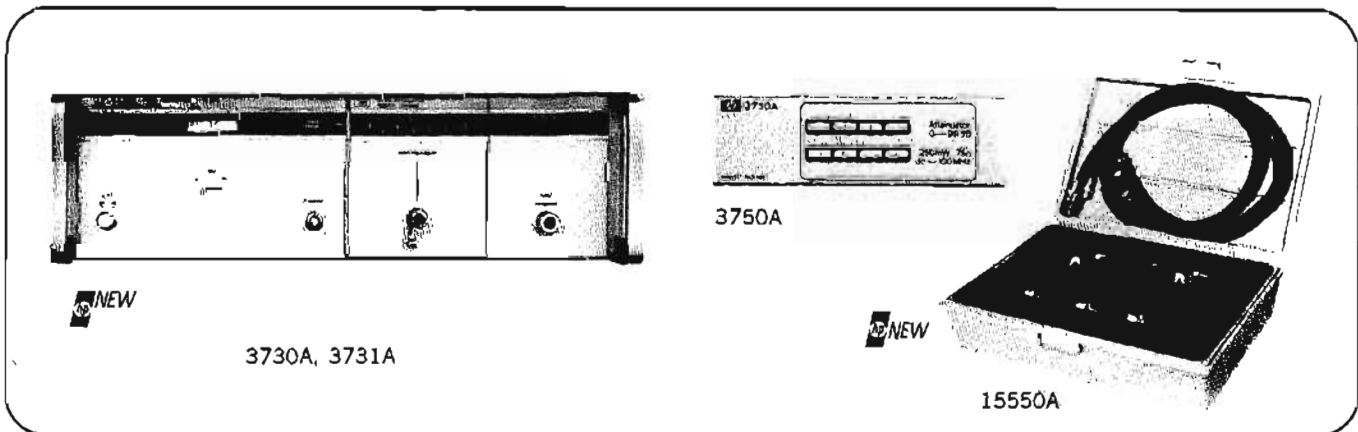

Model 3730A Down Converter

The Model 3730A Down Converter, equipped with one of three Oscillator plug-ins, forms a versatile RF to IF Converter for use in the design, testing, commissioning and maintenance of radio relay links. The Oscillator Plug-ins are Model 3731A, 5.925 to 6.525 GHz; Model 3732A, 6.42 to 6.92 GHz; and Model 3733A, 6.87 to 7.27 GHz.

The Converter is a valuable extension to the MLA, adding the capability to make measurements from BB to RF, IF to RF, and, by using a suitably modulated generator, RF to RF. The Converter with the MLA thus allows rapid measurement and adjustment of individual RF sections and components by simultaneously displaying their amplitude response and group delay characteristics. This enhanced measurement capability ensures more rapid and direct fault localization and permits equalization at RF for better equipment bandwidth utilization.

3730A Price: \$2640.

3731A/3732A/3733A Price: \$1305 each.

Model 3750A Attenuator

The Model 3750A Attenuator is designed for use in a frequency range from 0 (dc) to 100 MHz. Attenuation of 0 to 99 dB, 75 Ω impedance, is provided in 1 dB steps by the operation of pushbutton switches. Cumulative accuracy ± 0.5 dB, BNC connectors, SWR < 1.08, maximum power 250 mW (+ 24 dBm). Usable to 400 MHz with reduced specification.

3750A Price: \$150.

Model 15550A Accessory Kit

The Model 15550A Accessory Kit furnished with the MLA and also available separately contains: a BB hybrid, an IF hybrid, interconnecting cables, terminations, and a 17 dB standard mismatch. The hybrids while primarily intended for use in making return loss measurements can also be used as general purpose directional bridges and power splitters.

15550A Price: \$220.

NETWORK ANALYZERS



COMPLETE CHARACTERIZATION OF LINEAR NETWORKS

Network analysis

A fundamental problem facing engineers is to predict the behavior of a network that is stimulated by an arbitrary signal and connected to other arbitrary networks. A way to solve this problem is to completely describe the network's behavior in the frequency domain. Network analysis accomplishes this for passive and active linear networks by measuring parameters at the network's ports. Network analysis creates thus a data model representing the actual network behavior as a function of frequency. (For description of the behavior of nonlinear devices see sections about Spectrum Analyzers and Wave Analyzers).

The engineer designing multicomponent networks tries to predict the performance of the final circuit from a knowledge of the parameters of individual components. The production engineer responsible for the manufacture of each component must know the tolerances allowable on the components to ensure a finished product within specifications. Network analysis helps these engineers to narrow the limits of uncertainty about network behavior.

Network behavior

It is possible, to a certain extent, to predict circuit performance by calculation. However, theoretical calculations often disagree with actual measured values since a "perfect" network does not exist and since the electrical characteristics of a circuit may vary in a complicated way with frequency.

At frequencies above approximately 1 MHz, a single lumped element becomes a "circuit" consisting of the basic element plus a number of parasitics like stray capacitance, lead inductance and unaccountable absorptive losses. The magnitudes of these parasitics depend largely upon the construction of the device and are difficult or impossible to predict.

At frequencies above 1 GHz, the geometry of the components used in a circuit becomes comparable to the wavelength used. Lower frequency techniques and lumped-element theory are almost impossible to use for complete network characterization. To analyze the behavior of networks at microwave frequencies, distributed-element theory, that is transmission-line theory, has to be applied.

A device or "black box" may behave like a resistor at very low frequencies, like an L-C circuit at RF frequencies, and like a transmission line at microwave frequencies. This circuit behavior is difficult

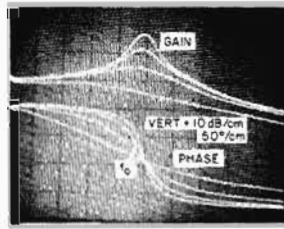

Phase and amplitude responses of an L-C network are traced on an oscilloscope readout. The display shows changes in values of the damping ratio parameter in real-time, resulting in a considerable speedup of design work. The measurement setup includes the 676A Tracking Detector.



Magnitude and phase of the complex impedance of a resonant circuit are measured with the 8407A Network Analyzer using the 11655A Impedance Probe. The calculated parallel resonance is 5.2 MHz. The unexpected series resonance at 60 MHz caused by circuit parasitics can be important information for circuit design.

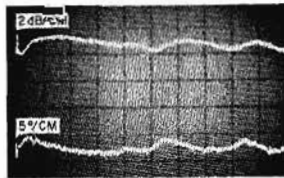

The insertion loss and "nonlinear" portion of the phase shift of a PIN modulator are traced on the 8412A Phase Magnitude Display. The electrical length of the PIN modulator has been compensated by the line stretcher of the "transducer" used for transmission measurements with the 8410A.

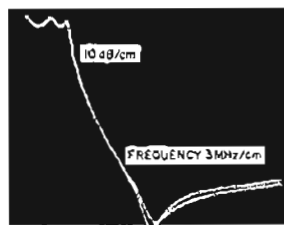

The amplitude responses of two nearly identical filters are compared using the dual-channel capability of the 676A Tracking Detector and a dual-channel oscilloscope. The 676A can also measure and display the amplitude and phase difference between the two channels, a useful capability for production testing.

and impractical to predict by calculations. Network analysis enables the engineer to accurately measure circuit behavior in a speedy and convenient way.

Network parameters

At lower frequencies, currents and voltages can readily be measured. Current and voltage transfer functions and impedance, the ratio of voltage to current, are widely used circuit parameters. In circuit design, h , y or z parameters are used. At microwave frequencies, however, these parameters cannot be accurately measured because it is extremely difficult to establish the required short and open circuit measurement conditions. Also, voltage and current vary along the transmission line causing measurements to become arbitrary. Consequently, microwave phenomena are more commonly expressed in terms of power which is invariant along a lossless transmission line.

Parameters which describe the energy flow within a network are the scattering parameters or S-parameters. They are used at microwave frequencies because they are much easier to measure and design with than other kinds of parameters at these frequencies.

S-parameters describe the ratios of reflected and transmitted signals within a network.

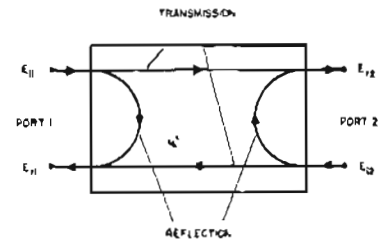

S_{11} is the reflection coefficient at port 1, E_{r1}/E_{i1} , if $E_{i2} = 0$ (port 2 is terminated in its characteristic impedance). S_{21} is the transmission coefficient E_{t2}/E_{i1} , if $E_{i2} = 0$. By reversing the ports, S_{22} and S_{12} can be defined. It is important to note that the network is always terminated in its characteristic impedance thus avoiding oscillation by active devices and other unwanted parasitic effects caused by open or short circuit terminations during measurements.

S-parameters completely characterize transistors, solid state devices and other active and passive linear networks. They are useful in the design of amplifiers, transistor circuits, and in flow graph analysis of multicomponent circuits.

Hewlett-Packard has developed a set of tutorials for measurement of and design with S-parameters: Application Notes 95, 117-1, 117-2; videotapes "Basic Microwave Review—Part 1" #800586, "S-parameter Measurements" #800504, "High Frequency Amplifier Design Using S-parameters" #800600; calculator programs "Microwave Circuit Design PAC, Vol. 1"; seminars on design techniques with S-parameters are also being offered.

With the increased use of microwave frequencies in communication systems and other new applications, S-parameter measurements become more and more important and are more generally used in design work. The accuracy and ease of S-parameter measurements are also available at RF frequencies. Since S-parameters completely characterize linear networks, they can mathematically be converted into any desired parameter set such as h, y and z parameters or return loss, impedance and transfer functions.

Hewlett-Packard helps the RF engineer with these parameter conversions, where desirable, by offering a variety of displays, display overlays, a reflectometer calculator and software for Hewlett-Packard programmable calculators.

Network analyzers

Hewlett-Packard offers a complete line of network analyzers throughout the frequency range 10 kHz to 40 GHz. Compared to other instrumentation that can be used for network characterization such as broadband voltmeters, log amplifiers, oscilloscopes, crystal detectors and slotted lines, network analyzers offer the following advantages.

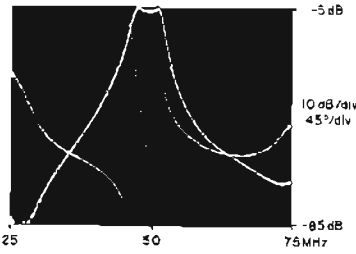

The insertion loss and phase shift of a tunable 50 MHz bandpass filter are traced on the 8412A Phase-Magnitude Display used with the 8407A Network Analyzer. The swept frequency display allows rapid adjustments for linear phase shift through the passband. Group delay can be computed from the phase information displayed.

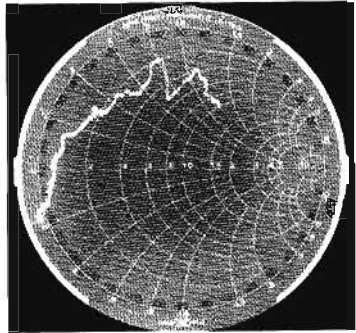

The reflection coefficient S_{11} of a transistor is measured over the frequency range 300 MHz to 700 MHz. The measurements setup includes the 8410A Network Analyzer using the 8414A Polar Display. The Smith Chart overlay permits direct readings of complex impedance values.

Versatility of measurements

Hewlett-Packard network analyzers are capable of measuring or testing a large variety of parameters of numerous networks—passive, active and networks

with various characteristic impedances. A broad frequency coverage and the design of the network analyzers achieve this measurement versatility. As ratio-meters, their performance is virtually independent of the power level used to stimulate the device under test. Their dual-channel capability enables measurement of various parameters through the use of "transducers"; besides S-parameters, the ratio of voltage to current (impedance) or voltage and current transfer functions can be measured. Comparison measurements become possible. The variety of "transducers" allows the user also to update his "mainframe" as measurement/test requirements change.

Accuracy of measurements

Hewlett-Packard network analyzers are built either as tracking receivers which convert the swept RF signal to a narrow-band constant IF signal or they use harmonic frequency conversion for obtaining a constant IF signal. In both cases, sensitive, low noise detection of the IF signal becomes possible. Furthermore, precision attenuators allow high resolution, accurate IF substitution measurements.

Speed of measurements

Hewlett-Packard network analyzers are capable of real-time swept displays (except for 8405A Vector Voltmeter and 4815A RF Impedance Meter). Swept measurements entail a substantial increase in speed of measurements compared to CW measurements. Also, they prevent oversights due to point-by-point techniques and make measurement results easier to interpret.

Network Analyzer Summary

Model	Frequency Range	Source	Measurement Capabilities
675A Tracking Detector	10 kHz-32 MHz	675A Sweeping Signal Generator	<ul style="list-style-type: none"> • Transfer Functions, Impedance in 50Ω, 75Ω systems • Comparison Measurements of two networks in 50Ω, 75Ω systems • Complex Impedance, 0.3Ω-3kΩ
8407A Network Analyzer	100 kHz-110 MHz	8601A Generator/Sweeper 8690B/8698B Sweep Oscillator	<ul style="list-style-type: none"> • Transfer Functions, Impedance in 50Ω, 75Ω systems • Complex Impedance 0.1Ω to >10kΩ • High Impedance In-Circuit Probing • High Resolution Comparison Measurements in 50Ω, 75Ω systems • S-parameters in 50Ω, 75Ω systems
4815A Vector Impedance Meter	500 kHz-108 MHz (CW)	Internal (external possible)	<ul style="list-style-type: none"> • Complex Impedance, 1Ω to >100 kΩ
8405A Vector Voltmeter	1 MHz-1 GHz (CW)	608E, F Signal Generator, VHF 612A Signal Generator, UHF 3200B Oscillator, VHF 8654A Signal Generator, UHF	<ul style="list-style-type: none"> • Voltmeter • Transfer Functions, Impedance in 50Ω systems • Group Delay, Amplitude Modulation Index • S-parameters in 50Ω systems
8410A Network Analyzer	110 MHz-40 GHz	8620-Series Sweep Oscillator 8690-Series Sweep Oscillator	<ul style="list-style-type: none"> • Transmission/Reflection Characteristics in 50Ω systems • S-parameters in 50Ω systems

676A

The 676A Tracking Detector tracks the 675A Sweeping Signal Generator from 10 kHz to 32 MHz. The dual-channel 676A used with an oscilloscope or X-Y recorder, will display log amplitude (80 dB dynamic range) and phase (360°) response of test devices. Comparison measurements of two devices are possible as well as absolute measurements of transfer functions (gain, insertion loss and phase shift). Complex impedance measurements over a 0.3Ω to 3 kΩ range can be made when using the 11138A Impedance Adapter.

Applications are detailed in Application Notes 112-1 and 112-2, including techniques for getting extremely high resolution and Bode plots. Also, a videotape is available "Network Analysis" #800338.

8407A

The 8407A Network Analyzer tracks the 8601A Generator/Sweeper (or 8690B/8698B Sweeper) from 100 kHz to 110 MHz. The 8407A achieves great versatility of measurements through a set of six different "transducers." Measurement capabilities include:

- 1) Transmission (gain, loss, phase shift) in 50Ω and 75Ω systems. Reflection (return loss, impedance) in 50Ω and 75Ω systems.

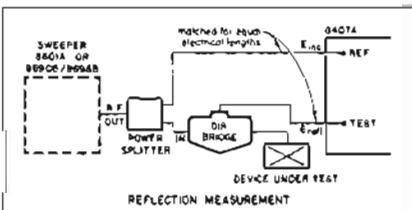
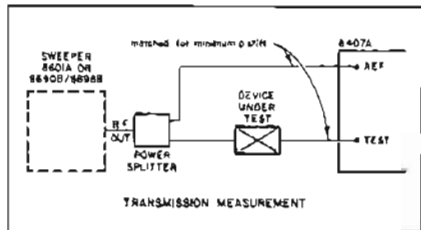

- 2) Complex impedance $|Z|$, θ or $R \pm jX$ over the wide impedance range 0.1Ω to >10 kΩ.
- 3) Voltage and current transfer functions (voltage or current gain, loss; phase shift).
- 4) High impedance in-circuit probing.
- 5) Visual comparison measurements with 0.01 dB, 0.2° resolution in 50Ω and 75Ω systems.
- 6) S-parameter measurements of active and passive linear networks (transistors) in 50Ω systems (also 75Ω systems for passive devices).

A rectangular and polar display and various CRT overlays permit direct readings of parameter values of interest. Applications are detailed in Application Notes 121-1, 121-2. Also, a videotape

"8407 Network Analyzer System" #800475 is available.

4815A

To design a circuit for maximum power transfer and/or with desired frequency characteristics, engineers must know the impedance of the components they use. The 4815A RF Vector Impedance Meter provides direct readout of complex impedance values $|Z|$ and θ on adjacent meters thus greatly simplifying the measurement of impedance compared to conventional methods. Operating range of the 4815A is 1Ω to 100 KΩ and 0° to 360° over the frequency range 500 kHz to 108 MHz.

These operating characteristics are very similar to the 8407A/11655A impedance measuring system. The 8407A/11655A combination is superior to the 4815A with regard to accuracy (reactive probe parasitics of 11655A can be cancelled out), and also speed (real-time swept displays). However, the 4815A is lower priced.

8405A

The 8405A Vector Voltmeter is a dual-channel RF millivoltmeter and phase-meter. It reads the absolute voltages on either of two channels and simultaneously determines the phase relationship between them. CW measurements are made over the frequency range 1 MHz to 1 GHz.

Besides its use as a voltmeter, applications of the 8405A include:

- 1) Transmission measurements (gain, loss, phase-shift) in 50Ω impedance systems. Reflection measurements (impedance, return loss) in 50Ω systems.

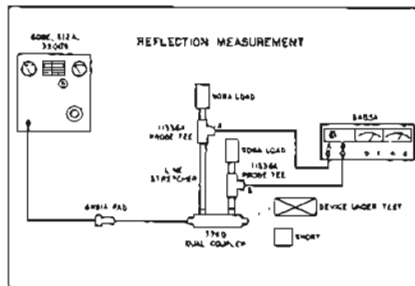
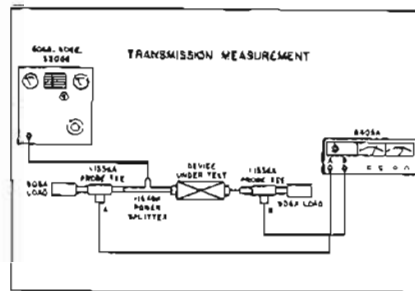

- 2) Group Delay, Amplitude Modulation Index
- 3) In-circuit probing
- 4) S-parameters in 50Ω systems

For detailed applications, Application Notes 77-1, 77-3, 77-4 and 91 are available.

8410A

The 8410A Network Analyzer System measures the transmission and reflection characteristics (S-parameters) of linear networks in the form of gain, attenuation, phase shift, reflection coefficient, normalized impedance in the frequency range 110 MHz to 40 GHz.

Harmonic frequency conversion from RF to a constant IF is accomplished by the 8411A Harmonic Frequency Converter operating from 110 MHz to 12.4 GHz; the 8411A Option H10 operates up to 18 GHz. In the frequency ranges 18-26.5 GHz (K-band) and 26.5-40 GHz (R-band), the K8747A and R8747A Reflection/Transmission Test Units use crystal mixers and a local oscillator to heterodyne the signals down into the range of the 8410A/8411A. In this manner, waveguide components can be characterized for S-parameters from 18 to 40 GHz.

The 8410A is a ratiometer, like the 8407A Network Analyzer, using both a reference and a test signal input. Consequently, the power from the sweeper must be split into two channels. This is accomplished by a "Test Set" whose other major function can be to provide the switching required for making transmission and reflection measurements with minimum or no changes in the measurement setup. Hewlett-Packard offers a total of twelve different test sets covering various frequency ranges and switching functions.

Another major instrument required in the 8410 measurement system is a unit for amplitude and phase detection and display. Hewlett-Packard offers three plug-ins for this purpose: a phase-gain indicator with a meter readout for CW measurements, a phase-gain display for displaying log amplitude and phase versus frequency, and a polar display displaying amplitude and phase in polar coordinates.

The 8410A is capable of sweeping octave bands through 18 GHz. Between 18 GHz and 40 GHz, 2 GHz frequency windows can be viewed. Measurements of more than 60 dB of attenuation and 40 dB of gain are possible. Another important facility is a line stretcher in the reference channel of the test sets, making possible equalization of electrical lengths in both channels for accurate differential phase measurements.

The variety of test sets, displays and accessories for measuring active devices makes the 8410A Network Analyzer adaptable to almost any measurement with regard to linear networks. For more detailed information, the videotape "8410 Network Analyzer System" #800475 is available.

NETWORK ANALYZER

80 dB amplitude response/360° phase
Models 675A/676A



NETWORK ANALYZERS

Network Analyzer, 675A & 676A

This network analyzer provides swept phase and amplitude information over the 10 kHz to 32 MHz frequency range. Both laboratory and production oriented, the 675A Sweeping Signal Generator and 676A Phase/Amplitude Tracking Detector system provides an amplitude response with 80 dB dynamic range, accompanied by 360° (or multiples of) phase measurement capability.

Frequency

The 675A frequency can be manually positioned, automatically swept between two preset limits, or swept about a center frequency in calibrated increments. A bypass marker system superimposes markers on all phase and amplitude channels for easy frequency identification and calibration. 100 kHz and 1 MHz comb markers and up to five individual single frequency markers are available in the 100 kHz to 32 MHz range.

When used with a low frequency oscilloscope or X-Y recorder, the network analyzer presents displays that can be calibrated in frequency, phase, and amplitude. Along with the low residual FM (<70 Hz peak), low spurious response and low noise (-85 dB), these capabilities permit accurate measurements of devices with steep responses.

Amplitude and phase

The 676A is a dual channel detector synchronously tuned to the sweep frequency. Four scope outputs (A, B, A-B, PHASE A-B) are located on the front panel of the detector. A and B provide 80 dB of log amplitude dynamic range (50 mV/dB) for each channel, and A-B is the log difference between the two channels. All three present information in linear dB. PHASE A-B is a dc voltage that is linearly proportional (10 mV/degree) to the phase difference between channels from 0° to 360°.

To make using an oscilloscope or recorder more convenient, a "CAL" is provided for the scope outputs to allow fine adjustment of the display. Phase is also conveniently calibrated using the 5° to 100° "PHASE CAL CHECK" buttons. Either push-button supplies a calibrated dc offset to the vertical input of the oscilloscope allowing a quick check of phase and calibration of the display.

Specifications, (675A and 676A)*

Frequency range: 10 kHz to 32 MHz in one range with Start-Stop, Manual, Center Frequency Sweep, and CW control. Digital drum readout, 1 kHz settability, 20 kHz resolution.

RF output (Channels A and B): two equal-amplitude, in-phase outputs derived from 675A output through resistive power divider.

Level (676A only): +2 dBm (0.28 V rms) into 50Ω with 675A set to +13 dBm. Adjustable with 675A attenuator.

Impedance: 50Ω (75Ω on request). NOTE: impedance independent of 675A. Impedance of 675A must match impedance of 676A.

Output Isolation: 16 dB between channels.

RF input (Channels A and B): identical inputs synchronously tuned to 675A output frequency.

Level: +2 dBm max (not to exceed +13 dBm or 1 V rms).
Impedance: same as RF output.

Crosstalk: >84 dB between channels.

Amplitude functions

Range: 0 to -80 dBm.

Accuracy

Using Channel A or B: output proportional to log of input ± 1.5 dB over 80 dB dynamic range.

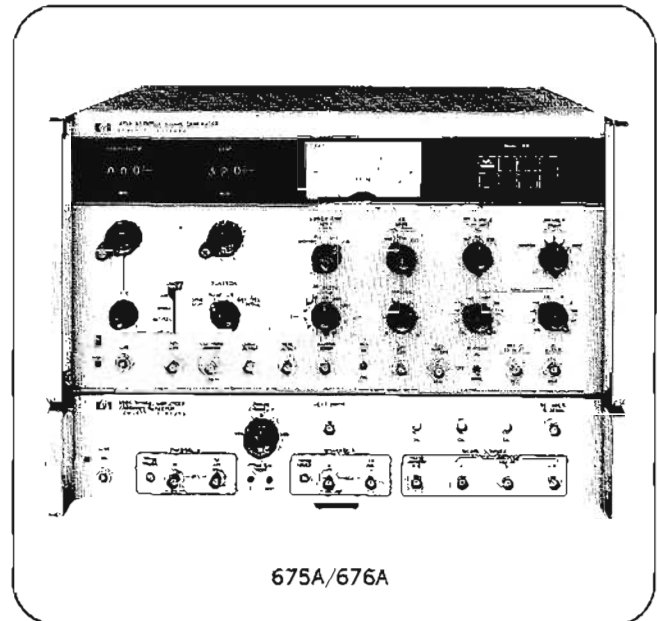

675A/676A

System flatness

Using Channel A or B: ± 0.8 dB, 10 kHz to 200 kHz, 675A unlevelled; ± 0.8 dB, 200 kHz to 32 MHz, 675A internally levelled.

Noise: < -85 dB (50Ω source impedance).

Spurious responses: < -85 dB (50Ω source impedance).

Channel A and B scope output: 50 mV/dB (+4.2 V dc for +2 dBm input level) adjustable with CAL control.

Phase function

Range: 0° to 360°. Display recycles every 360°, internal phase shifter allows 0° to 360° continuous phase offset.

Accuracy

As a function of frequency: 100 kHz to 32 MHz, $\pm 1^\circ$; 10 kHz to 100 kHz, $\pm 2^\circ$.

As a function of amplitude: $\pm 5^\circ$ over entire 80 dB dynamic range.

Calibrator accuracy: 100° $\pm 1.0^\circ$, 5° $\pm 0.2^\circ$.

Phase scope output: 10 mV/° (1.80 V dc ± 1.80 V dc for 180° with phase control set to 0°). Adjustable with CAL control.

General

Operating temperature: 0°C to 50°C.

Power: 115 V or 230 V $\pm 10\%$, 48 Hz to 440 Hz.

Dimensions (675A): 16 $\frac{3}{4}$ " wide, 8 $\frac{3}{4}$ " high, 18 $\frac{3}{8}$ " deep (425 x 221 x 467 mm); (676A): 16 $\frac{3}{4}$ " wide, 3-15/32" high, 18 $\frac{3}{8}$ " deep (425 x 88 x 467 mm).

Total system weight: net, 59 lbs (26.3 kg); shipping, 83 lbs (37.4 kg).

Total system power: 185 VA max.

Price (must order 676A and 675A for network analyzer system): HP 676A, \$1450; HP 675A, \$2400.

HP 675A Option 001 (includes 1 MHz harmonic comb marker), add \$75.

HP 675A Option 002 (includes 100 kHz harmonic comb marker), add \$75.

HP 675A Option 003 (includes 1 MHz and 100 kHz harmonic comb markers), add \$125.

* Refer to data sheet for complete specifications.



RF VECTOR IMPEDANCE METER

Quickly, easily measure Z & θ , .5 to 108 MHz

Model 4815A

Advantages:

- Direct reading of impedance and phase
- Convenient probe for in-circuit measurements
- Self calibration check provides measurement confidence
- Analog outputs for data recording
- Low-level test signal minimizes circuit disturbance

The HP 4815A RF Vector Impedance Meter provides all of the convenience of "probe and read" measurements. In use, the probe is connected directly into the circuit to be evaluated, frequency is selected, and complex impedance is read. This type measurement allows a straightforward adaptation to various jigs and fixtures for special measurements. Where only component values are to be determined, a quick-mount adapter is provided to allow rapid measurements. For critical component applications, the unit to be evaluated may be mounted directly in its working circuit and its value determined in its actual environment, at the frequency of interest.

Specifications

Frequency

Range: 500 kHz to 108 MHz in five bands: 500 kHz to 1.5 MHz, 1.5 to 4.5 MHz, 4.5 to 14 MHz, 14 to 35 MHz, 35 to 108 MHz.

Accuracy: $\pm 2\%$ of reading, $\pm 1\%$ of reading at 1.592 and 15.92 MHz.

RF monitor output: 150 mV minimum into 50 ohms.

Impedance magnitude measurement

Range: 1 ohm to 100 k ohms; full-scale ranges: 10, 30, 100, 300, 1 k, 3 k, 10 k, 30 k, 100 k ohms.

Accuracy: $\pm 4\%$ of full scale $\pm \left(\frac{f}{30 \text{ MHz}} + \frac{Z}{25 \text{ k ohms}} \right)$

% of reading, where f = frequency in MHz and Z is in ohms; reading includes probe residual impedance.

Calibration: linear meter scale with increments 2% of full scale.

Phase angle measurement

Range: 0 to 360° in two ranges: $0 \pm 90^\circ$, $180^\circ \pm 90^\circ$.

Accuracy: $\pm \left(3 + \frac{f}{30 \text{ MHz}} + \frac{Z}{50 \text{ k ohms}} \right)$ degrees;

where f = frequency in MHz and Z is in ohms.

Calibration: increments of 2°.

Adjustments: front panel screwdriver adjustments for Magnitude and Phase Zero.

Recorder outputs

Frequency: 0 to 1 volt from 0 to 1 k ohm source, proportional to dial rotation.

Impedance magnitude: 0 to 1 volt from 1 k ohm source.

Phase angle: 0 ± 0.9 volt from 1 k ohm source.

Dimensions: 16 $\frac{3}{4}$ " wide, 7 $\frac{1}{4}$ " high, 18 $\frac{3}{4}$ " deep (426 x 185 x 476 mm).

Weight: net 39 lbs (17,6 kg), shipping 55 lbs (24,8 kg).

Power: 105 to 125 V or 210 to 250 V, 50 to 400 Hz, 50 W.

Accessories furnished:

1. 00600A Probe Accessory Kit: contains BNC Type "N" adapter, Probe Socket, 00601A Component Mounting Adapter, 2 probe center pins, probe ground assembly.
2. Rack Mount Kit.

Price: HP 4815A, \$2650.

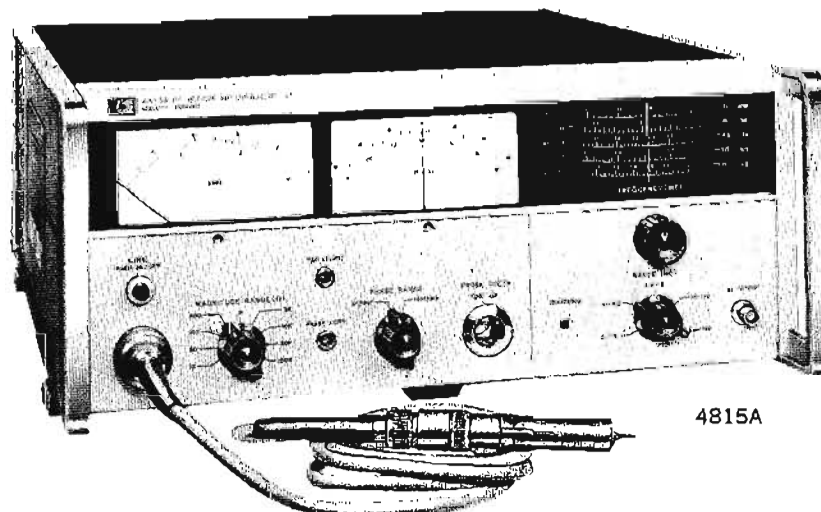

VECTOR VOLTMETER
 Accurate voltage, phase measurements, 1-1000 MHz
 Model 8405A



NETWORK ANALYZERS

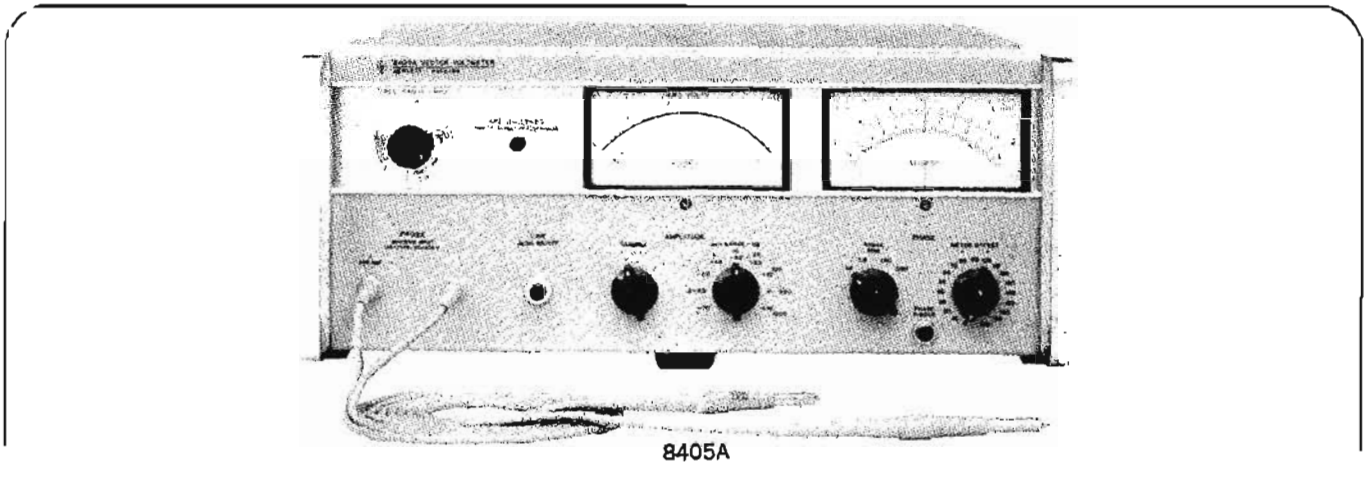

Description

The 8405A Vector Voltmeter measures voltage vectors described by both magnitude and phase. This capability makes the 8405A a unique instrument for about any design and test application in the frequency range 1 to 1000 MHz.

In addition to absolute voltage measurements, capabilities include insertion loss and group delay of passband-filters and other transmission devices, gain and phase margin of amplifiers, complex impedance of mixers, antennas, matching the electrical lengths of cables, s-parameters of transistors, amplitude modulation index, RF distortion measurements, and in-circuit probing.

The 8405A achieves this measurement versatility through its two-channel capability enabling voltage magnitude measurements in either channel, thus allowing ratio measurements, and phase difference measurements between the two channels. Gain or loss in excess of 90 dB and phase measurements with 0.1° resolution over a 360° phase range are possible.

Accuracy is achieved through the 1 kHz bandwidth entailing response only to the fundamental frequency of the input signal. Also, phase-locked coherent sampling to translate 1 to 1000 MHz RF signals to 20 kHz IF signals enables accurate detection of voltage magnitude and phase. Automatic phase-locked tuning makes it possible to select the one of 21 overlapping octave ranges which contains the input signal frequency by simply rotating a switch.

Specifications

Frequency range: 1 MHz to 1 GHz in 21 overlapping octave bands; tuning automatic within each band.

Isolation between channels: 1 to 300 MHz, >100 dB; 300 to 1,000 MHz, >80 dB.

Maximum input: ac, 2 V peak; dc, ±50 V.

Voltage range (rms):

Channel	1 - 10 MHz	10 - 500 MHz	500 - 1000 MHz
A	1.5 mV - 1.0 V	300 μV - 1.0 V	500 μV - 1.0 V
B	<20 μV - 1.0 V	<20 μV - 1.0 V	<20 μV - 1.0 V

Specifications

Frequency range: 1 MHz to 1 GHz in 21 overlapping octave bands; tuning automatic within each band.

11536A 50 Ω Tee, with Type N RF fittings, for monitoring signals in 50 Ω transmission line without terminating the line. \$75

11549A Power Splitter, all connectors Type N female (UG-28A/U). \$85

908A Termination, for terminating 50 Ω coaxial systems in their characteristic impedance.

11512A Shorting Plug, Type N male.

11570A Accessory Kit for measurements in 50 Ω systems. \$340



RF NETWORK ANALYZER

Swept complete network characterization
8407 Family

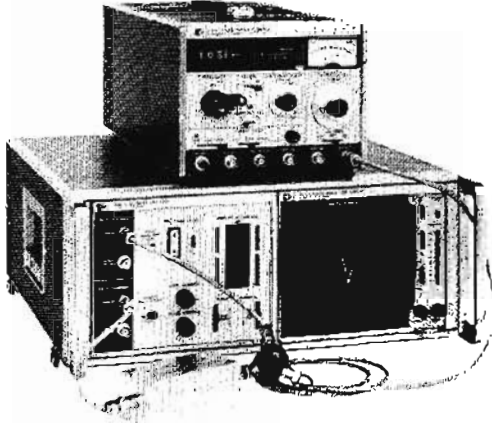

8407 system

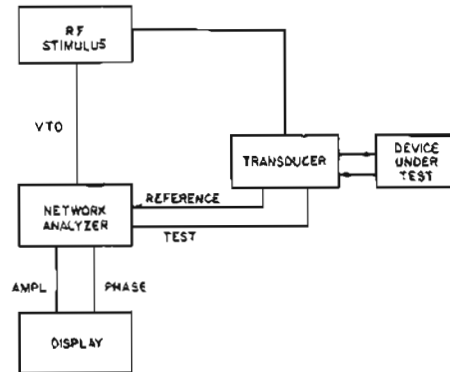

8407 block diagram

System Description

The 8407A Network Analyzer System is a versatile measuring system for engineering and testing in the frequency range 100 kHz to 110 MHz; the system is capable of accurate swept measurements of numerous magnitude and phase properties of attenuators, detectors, filters, cables, antennas, recording heads, amplifiers and many other passive and active linear networks.

Measurements include: gain, loss, phase shift (compute group delay), return loss, complex reflection coefficient of networks with 50 or 75-ohm characteristic impedance. Swept complex impedance, $|Z|$, θ over the 0.1Ω to $>10\text{ k}\Omega$ range and swept voltage and current transfer functions, also in-circuit, can be measured with speed and accuracy. The system can also be used for high resolution visual comparison measurements and for making transistor s-parameter measurements with push-button ease. This measurement versatility is achieved through the modular construction of the system.

Basic instruments are: the HP 8601A Generator/Sweeper providing the RF stimulus for the device under test and the VTO output required by the network analyzer; the HP 8407A Network Analyzer which is a ratio meter using both a TEST and a REFERENCE channel input; the HP 8412A Phase-Magnitude display or the 8414A Polar Display for detecting and displaying amplitude and phase as a function of frequency. These instruments have to be combined with the one of six different "transducers" that corresponds to the measurement of network parameters desired.

This modular construction makes the system easily adaptable to new measurement/test requirements—addable at small incremental costs. Thus, system utilization is optimized and obsolescence avoided. Accuracy, speed and flexibility of measurements combine to make the 8407 Network Analyzer System an extremely useful tool for design and development work as well as in production testing.

Instrument Description

RF Stimulus

The HP 8601A Generator/Sweeper is the signal source that provides the RF stimulus to the device under test and the VTO for the local oscillator of the 8407A Network Analyzers. The 8601A is a 0.1 to 110 MHz CW or swept source. Sweep is in two ranges from 0.1 to 11 MHz and 1 to 110 MHz.

The HP 8690B/8698B Sweep Oscillator is the other signal source that can be used with the 8407A Network Analyzer. Sweep is in two ranges from 0.4 to 11 MHz and from 4 to 110 MHz. The 8690B also accepts plug-ins from 100 MHz to 40 GHz.

The HP 8600A Digital Marker is an optional complement to the 8601A or 8690B/8698B signal sources. The 8600A provides five independent, continuously variable markers which may be placed on a display while making swept mea-

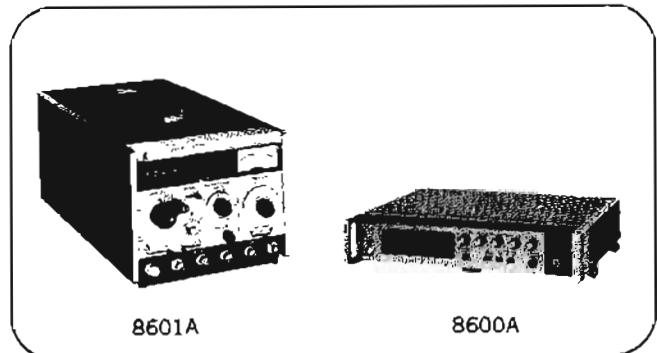

8601A

8600A

surements. A marker displayed on a counter readout, while sweeping, is useful for very accurately determining frequency values of interest.

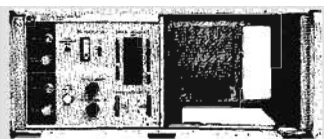

8407A

Network Analyzer

The 8407A Network Analyzer is a ratio meter using both a TEST and a REFERENCE channel input. The 8407A forms the magnitude ratio and phase difference between these two input signals after their conversion to a constant intermediate frequency. The resultant signals are routed to a display for detection and display. Dynamic range is 80 dB with the 8412A Phase-Magnitude Display, measurement range is from +90 dB to -100 dB. Input power to the device under test can be from -10 dBm to -85 dBm. Display REFERENCE attenuators provide 89 dB of accurate test channel offset permitting high resolution measurements by using IF substitution techniques. Residual magnitude and phase responses versus frequency are typically less than ± 0.1 dB and $\pm 2^\circ$ from 1 to 110 MHz.



8412A

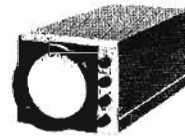

8414A

Displays

The 8412A Phase-Magnitude Display is an accurate oscilloscope readout displaying amplitude and phase versus frequency either separately or simultaneously. It has 80 dB and $\pm 180^\circ$ display range. Measurements with 0.05 dB and 0.2° resolution are possible.

The 8414A Polar Display has a measurement range of 30 dB and 360° . For reflection measurements, the 8414A displays reflection coefficient as a function of frequency. Smith Chart overlays permit readings of normalized complex impedance values. A rectangular overlay permits readings of $R \pm jX$ for impedance measurements over the range 0.1Ω to $>10\text{ k}\Omega$.



11652A



11654A

NEW



8728A

NEW



85404B



11655A



1121A

NEW



85426A



85428A

Transducers

The 11652A Reflection/Transmission Kit contains a power splitter and two phase-matched low leakage cables permitting accurate swept measurements of gain, loss and phase shift. It also contains a directional bridge (8721A) with >40 dB directivity, a calibration short and a precision termination for measurements of return loss and reflection coefficient (complex impedance) in 50 or 75-ohm systems.

The 11655A Impedance Probe makes possible swept accurate complex impedance measurements over the wide impedance range 0.1Ω to $>10\text{ k}\Omega$. The 11655A's design allows effective elimination of all reactive parasitics of the probe so that open circuit impedance appears simply as a $10\text{ k}\Omega$ resistor. This feature and a built-in 100Ω , 0° calibrator make it possible to measure true values of unknown impedance.

The 11654A Passive Probe Kit includes two each of probe cables and current probe tips and a wide variety of accessories for grounding and getting at those "difficult to measure" circuits. Voltage or current transfer functions can be measured with a pair of voltage or current probes. By using one voltage probe and one current probe, complex impedance or admittance can accurately be measured at frequencies below 11 MHz.

The 1121A AC Probe is an active probe biased through the PROBE PWR jacks on the front panel of the 8407A. The probe has a $100\text{ k}\Omega$, 3 pF input impedance. Voltage transfer functions can thus be measured in low level signal circuits with minimum circuit disturbance or in circuits whose characteristic impedance is radically different from 50 ohms.

The 8728A Network Comparator adds the capability for making swept visual comparison measurements with the 8407A. The transmission characteristics of a test network and of a known standard are traced separately on a highly sensitive large-screen oscilloscope for visual comparison. Level differences of 0.01 dB, 0.2° are easily discernable. The 8728A provides the switching required to accomplish the substitution comparison between the two networks.

The 85404B S-Parameter Test Set provides all the switching necessary for measuring with push-button ease the four s-parameters of passive and active linear networks with 50 or 75-ohm characteristic impedance (HP 85428A Min Loss Pads for 75-ohm systems). Transistors can easily be measured by using, in conjunction with the test set, the HP 8717B Transistor Bias Supply and the HP 11600B or 11602B Transistor Fixture which plugs into the HP 85426A Bias Insertion Network (2 each required).

Mainframe, display plug-ins, transducers

Specifications

8407A

Frequency range: 0.1 to 110 MHz.
Measurement range: gain +90 dB, loss -100 dB.
Impedance: 50 Ω , Option 008: 75 Ω . **VSWR** <1.08.
Amplitude accuracy:
Frequency response (may be calibrated out): ± 0.2 dB, 0.1 to 110 MHz; ± 0.05 dB over any 10 MHz portion.
Display reference: <0.05 dB/1 dB step, total error <0.1 dB; <0.1 dB/10 dB step, total error <0.25 dB.
Phase accuracy:
Frequency response (may be calibrated out): $\pm 5^\circ$, 0.1 to 110 MHz; $\pm 2^\circ$ over any 10 MHz portion.
Display reference: <0.5 $^\circ$ /10 dB step, total error <3 $^\circ$.
Power: 65 watts, 50-60 Hz, 115/230V $\pm 10\%$.
Weight: net, 32 lb (14.6 kg); shipping 39 lb (17.8 kg).
Dimensions: 7 $\frac{1}{4}$ " high, 18 $\frac{3}{8}$ " deep, 16 $\frac{3}{4}$ " wide.
Price: 8407A, \$2950; Option 008, 75 Ω , add \$110.

11658A

General: 50 to 75-ohm matching resistor for 8407A.
Insertion loss: 3.5 dB. **Return loss:** >40 dB.
Weight: net, 1 oz. **Price:** \$30.

8412A

General: plug-in CRT display for 8407A.
Amplitude accuracy: display, 0.08 dB/dB from midscreen.
Phase accuracy:
Display: 0.065 $^\circ$ /degree from midscreen.
Phase offset: 0.3 $^\circ$ /20 degree step, not to exceed total error of 3 $^\circ$ for 360 $^\circ$ of change, positive or negative direction.
Vs. displayed amplitude: <1 $^\circ$ /10 dB, total error for 80 dB <6 $^\circ$.
Power: 23 watts, supplied by 8407A.
Weight: net, 17 lb (7.8 kg); shipping 22 lb (10 kg).
Price: 8412A, \$1,575.

8414A

General: plug-in normalized polar coordinate display for 8407A: magnitude calibration is in 0.2 of full scale graduations, full scale determined by DISPLAY REFERENCE setting on 8407A. Phase calibration is in 10 $^\circ$ increments over a 360 $^\circ$ range.
Accuracy: all errors in amplitude and phase due to the display are contained within a circle of 3 mm about the measurement point.
Power: 35 watts, supplied by 8407A.
Weight: net, 13 lb (5.9 kg); shipping 17 $\frac{1}{2}$ lb (7.8 kg).
Price: 8414A, \$1,300.

11652A

General: reflection-transmission kit contains power splitter, 8721A directional bridge, a precision 50 Ω termination, calibrating short, BNC adapters and matched, low-leakage cables.
Directional bridge: 8721A: 6 dB coupling in main and auxiliary arm. Frequency response is ± 0.5 dB, 0.1 to 110 MHz. Directivity is >40 dB, 1 to 110 MHz. Return loss at LOAD port is >30 dB. **Price:** 8721A, \$150; Option 008, 75 Ω , add \$10.
Power splitter: 6 dB loss through each arm.
50 Ω termination: return loss is >43 dB.
Weight: net, 1.5 lb (0.7 kg); shipping 2.5 lb (1.2 kg).
Price: 11652A, \$325; Option 008, 75 Ω , add \$50.

11654A

General: passive probe kit contains a pair each of six resistive divider probes (1:1, 5:1, 10:1, 20:1, 50:1, 100:1) current probes, and variety of adapters.
Weight: net, 2 lb (0.9 kg); shipping 3 lb (1.4 kg).
Price: 11654A, \$400.

11655A

General: impedance probe, mounts directly onto 8407A. Contains a component mounting adapter, a probe to BNC adapter, a probe to type N adapter and various ground assemblies.
Frequency range: 0.5 to 110 MHz.
Measurement range: amplitude, 0.1 Ω to >10 k Ω ; phase, 0 $^\circ$ $\pm 90^\circ$.
Internal calibrator: amplitude 100 Ω $\pm 0.5\%$; phase 0 $^\circ$ $\pm 2^\circ$.
CW accuracy: amplitude $\pm 5\%$; phase $\pm 5^\circ$ for $|Z| > 3.16\Omega$.
Swept frequency accuracy: typically $\pm 5\%$ in amplitude, $\pm 5^\circ$ in phase from 3-110 MHz; accuracy is decreasing below 3 MHz.
Weight: net, 5.63 lb.
Price: 11655A, \$750.

1121A

General: 1:1 active probe furnished with 10:1 and 100:1 divider and BNC adapter.
Frequency response: 1 kHz to 100 MHz, ± 0.5 dB, $\pm 2^\circ$.
Input impedance: 100 k Ω , shunt capacitance 3 pF at 100 MHz; with 10:1 or 100:1 divider, 1 M Ω , shunt capacitance 1 pF at 100 MHz.
Output impedance: 50 Ω nominal.
Power: supplied by 8407A through PROBE PWR jacks.
Weight: net, 1.5 lb (0.7 kg); shipping 2.5 lb (1.2 kg).
Dimensions: 3" high, 8" deep, 10 $\frac{1}{2}$ " wide.
Price: \$395.

8728A

Frequency range: DC to 250 MHz.
Repeatability: 0.003 dB at 3 sigma. **VSWR:** <1.05.
Channel isolation: >90 dB.
Dimensions: 16 $\frac{3}{4}$ " wide, 7 $\frac{1}{4}$ " high, 21 $\frac{1}{4}$ " deep.
Power: 20 watts, 50-60 Hz, 115/230 V $\pm 10\%$.
Weight: net, 30 lb.
Price: 8728A, \$2950; Option 006, 75 Ω WECO connectors, add \$850; Option 008, 75 Ω BNC connectors, add \$800.

85404B

Frequency range: 0.1 to 110 MHz.
Repeatability: <0.001 dB. **VSWR:** <1.2.
Connectors: 50 Ω APC-7; min loss pads (85428A) for 75 Ω .
Power: 85 watts, 50-60 Hz, 115/230 V $\pm 10\%$.
Dimensions: 7" high, 19 $\frac{3}{8}$ " deep, 16 $\frac{3}{4}$ " wide.
Weight: 58 lbs. **Price:** \$5000.

85426A

General: bias insertion network for 85404B.
Frequency range: 0.1 to 500 MHz.
Insertion loss: <0.2 dB. **Return loss:** >30 dB.
Max bias current: 750 mA, max bias voltage: 30 V.
Connectors: BNC for biasing; APC-7 for RF.
Price: \$300.

85428A

General: min loss pad (75 Ω) for 85404B.
Insertion loss: 5.7 dB. **VSWR:** <1.05.
Price: 85428A (50 Ω SMA, 75 Ω BNC), \$200; Option 001 (50 Ω APC-7, 75 Ω GR900), add \$150.

MICROWAVE NETWORK ANALYZERS

110 MHz to 12.4 GHz
Model 8410S



NETWORK ANALYZERS

All 8410S Systems measure transmission and reflection parameters of coaxial and waveguide components in the form of gain, attenuation, phase, reflection coefficient or impedance. Each option has been configured either for making general measurements within a frequency range or for push-button S-parameter measurements on semiconductor devices in a variety of package styles. In addition to selected transducer and accessory items, each option contains the 8410 Network Analyzer, 8411A Harmonic Frequency Converter, two plug-in displays (the 8412 Phase Magnitude Display and 8414A Polar Display), and the 11609 Cable Kit. All systems come complete with necessary accessories and interconnecting cables. Overall system accuracy is specified for easier error analysis. Individual instruments which make up the system can also be ordered separately for updating existing network analyzer equipment.

Sweeps over octave bands

Swept displays for efficient real time testing over full-band. Rapid sweep for dynamic CRT display—make adjustments to devices while viewing overall effects.

Wide dynamic range—high resolution

60-dB amplitude and 360° phase displays: use precise offset controls to read amplitude and phase to 0.1 dB and 0.1 degree resolution. No phase ambiguity—meter indicates phase sense directly.

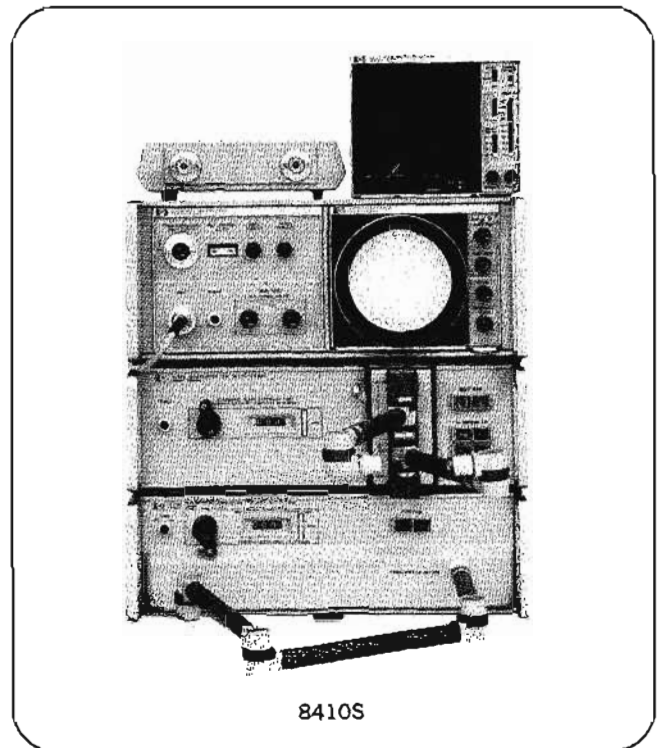

8410S

8410S Network Analyzer Systems

Frequency range	8410S ¹ Option No.	TRANSDUCER UNITS			Transistor Bias Supply	Transistor Fixture	Transistor Fixture	Universal Extension	Flexible Arm	Accessory Kit	Price	Use
		8743A 2-12.4 GHz	8745A/11599A .11-2 GHz	8746E/11608A .5-12.4 GHz								
110 MHz-2 GHz	110*		■								\$12,760	General purpose—low frequency
110 MHz-2 GHz	400		■		■	■					13,170	Characterize semiconductors with TO-18 or TO-72 packages
110 MHz-2 GHz	401		■		■		■				13,170	Characterize semiconductors with TO-5 or TO-12 packages
2-12.4 GHz	210*	■							■	■	11,970	General purpose—high frequency
.5-12.4 GHz	500			■	■						14,670	Characterize stripline semiconductors with T1-Line packages
.5-12.4 GHz	501			■	■						14,670	Characterize stripline semiconductors with K-disk packages
110 MHz-12.4 GHz	310*	■	■				■		■	■	16,235	General purpose—complete frequency coverage

*Options 100, 200, and 300 are identical to 110, 210, and 310 respectively except for the 8412A which is replaced by the 8413A.

¹The 8410A network analyzer, 8411A harmonic frequency converter, 8412A phase magnitude display, 8414A polar display, and 11609A cable kit are included in each of the above options.



8410S Specifications

Function: All systems measure transmission and reflection parameters on either a swept-frequency or CW basis in the form of attenuation, gain, phase shift, reflection coefficient, return loss, or impedance depending on readout display.

Display units: Choice of 8412A phase magnitude display, 8413 phase-gain indicator, or 8414A polar display. 8412A and 8414A accept intensity marker and blanking signals from Hewlett-Packard sweep oscillators.

Measurement range: full 60 dB dynamic range.

RF input: 20 dB range between -21 dBm and +7 dBm between .11-2 GHz or -14 dBm and +14 dBm between 2-12.4 GHz. 20-dB variation causes less than 1.5 dB and 4° change amplitude and phase readings.

Transmission measurement accuracy: Accuracy curves below show overall system uncertainty when measuring amplitude and phase. Sources of error included are IF gain control, meter accuracy, phase offset, system noise, and crosstalk. System frequency response is specified separately and is not included in accuracy curves.

Frequency response

Transmission: typically $< +0.35$ dB amplitude and $< \pm 3^\circ$ phase for .11 to 2 GHz. $< \pm 0.5$ dB amplitude and $< \pm 5^\circ$ phase for 2 to 12.4 GHz.

Reflection: magnitude typically $< \pm 0.06$; phase $< \pm 5^\circ$.11 to 2 GHz, and $< \pm 7^\circ$ 2 to 12.4 GHz; as read on the 8414A with a short on the unknown port.

Transmission reflection selection: manual by front panel lighted pushbuttons; remote by contact closure or saturated transistors through 36-pin connector contacts.

Reflection measurement accuracy: Accuracy curves show overall system uncertainty when measuring reflection coefficient. Sources of error included are directivity, source match, and polar display accuracy. System frequency response is specified separately and is not included in the accuracy curves.

Transmission amplitude uncertainty.

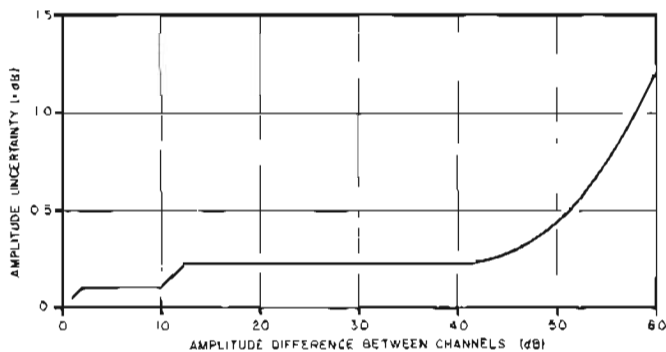

Transmission phase uncertainty.

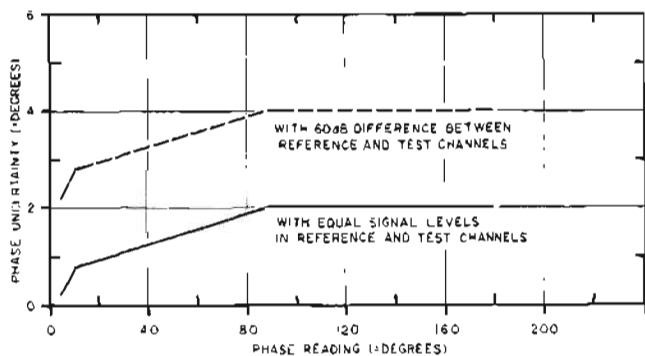

Reflection coefficient uncertainty.

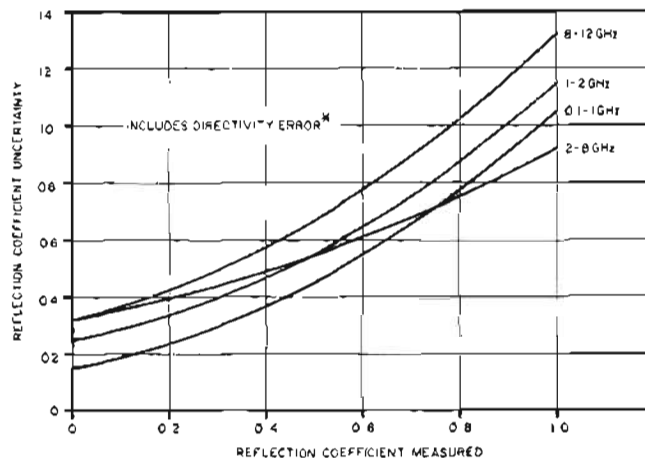

Reflection phase uncertainty.

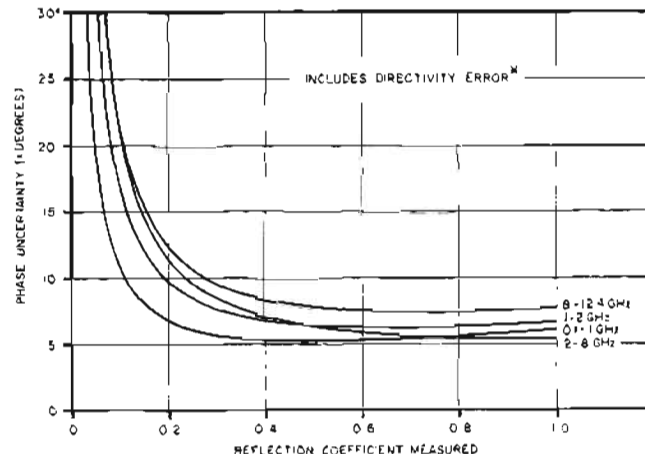

**Accuracy can be improved by using a sliding load to cancel coupler directivity errors. This will reduce the reflection coefficient uncertainty .015 from .11-1 GHz, .025 from 1-2 GHz, and .032 from 2-12.4 GHz; Phase uncertainty is reduced to a maximum of $\pm 5^\circ$.

TRANSISTOR S-PARAMETERS

100 MHz to 12.4 GHz



NETWORK ANALYZERS



Transistor S-Parameter Measurements

100 MHz to 2 GHz

The 8745A S-parameter test set combined with the 11600B or 11602B Transistor Fixtures make accurate transistor characterization as easy as pushing a button. Transistors are conveniently biased with the new 8717B Transistor Bias Supply by a simple cable connection to a rear panel connector of the 8745A. The 8745A, 8717B, 11600B and 11602B are capable of making useful S-parameter measurements from 40 MHz to 2 GHz and can be used with either the 8405A Vector Voltmeter, 8407A Network Analyzer, or 8410A Network Analyzer.

Models 11600B and 11602B Transistor Fixtures

Function: used with or without the 8745A to measure transistors and other semiconductor devices. Mounts directly on the 8745A. A Calibration short and thru are included with the fixtures.

Model 11600B: for TO-18/TO-72 or similar transistor packages. It has four snap-on dials, two for bipolars and two for FET's.

Model 11602B: for TO-5/TO-12 or similar transistor packages. It has two snap-on dials for bipolars.

Frequency: dc to 2 GHz.

Lead lengths: accepts leads up to 1.5 inches long.

Lead diameters: 0.016 to 0.019 inch.

Impedance: $50\Omega \pm 2\Omega$.

Connectors: APC-7 precision connectors.

Option 001: precision type N connectors.

Dimensions: $4\frac{5}{8}'' \times 6'' \times 1\frac{1}{2}''$ (119 x 152 x 38 mm).

Weight: 38 oz, (1.1 kg).

Price: 11600B, \$600; 11602B, \$600.

Option 010: includes 50-ohm calibration load, add \$50.

500 MHz to 12.4 GHz

The 8746B S-parameter Test Set combined with the 11608A Transistor Fixture permit complete characterization of TO-51 and K-disc packaged stripline transistors. The 8717B Transistor Bias Supply conveniently attaches to the 8746B Bias Networks with a rear panel connector cable. With the 8717B it is possible to make frequency swept measurements of all four S-parameters as a function of load current and voltage with pushbutton ease. The 8746B, 11608A, and 8717B can be used with either the 8405A Vector Voltmeter or 8410 Network Analyzer.

Model 11608A Transistor Fixtures

Function: used with the 8746B for completely characterizing stripline transistors. Mounts directly on 8746B. A calibration short and a through are included with Options 002 and 003.

Frequency range: DC to 12.4 GHz.

VSWR: (measured with thru-line calibration unit inserted and one end of the fixture terminated in a 50-ohm load).

< 1.10 to 4 GHz.

< 1.15, 4 GHz to 8 GHz.

< 1.25, 8 GHz to 12.4 GHz.

Striplines: 0.031" thick (P.P.O.); 0.080" wide.

Impedance: 50 Ω .

Dimensions: $5\frac{5}{8}'' \times 3\frac{1}{2}'' \times 1''$ (143 x 89 x 25 mm).

Weight: 16 oz (.45 kg).

Prices: Model 11608A—APC-7 Hybrid Connectors

Option 001: machinable for custom packages, \$375.

Option 002: TO-51 (0.250 inch diameter), \$400.

Option 003: K-disc (0.205 inch diameter), \$400.

With type N (female) connectors, Opt. 100, less \$30.

8717B Transistor Bias Supply

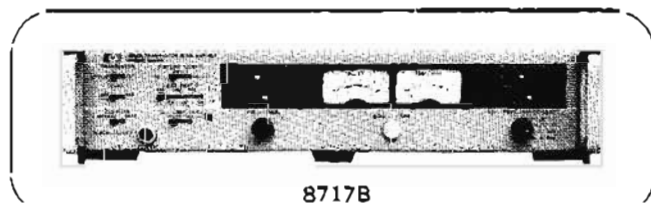

8717B

The 8717B Transistor Bias Supply is an ideal power supply for manual or programmable transistor testing. It is particularly useful with the 11600B, 11602B, and 11608A Transistor Fixtures. The 8717B has two meters for independently monitoring current and voltage on any of the three leads of a transistor under test. Bias connections are conveniently selected for all transistor configurations (EBC,

BEC, BCE) with a front panel switch. Special circuitry protects sensitive (expensive) devices from excessive current transients which commonly occur in less sophisticated supplies during accidental loss of line power or when applying or removing bias.

Specifications, 8717B

Voltage ranges: 1, 3, 10, 30, 100 V.

Current ranges: 0.1, 0.3, 1, 3, 10, 30, 100, 300, 1000 mA.

Accuracy: 4% of meter full scale for both current and voltage.

Dimensions: $16\frac{3}{4}'' \times 3\frac{3}{8}'' \times 13\frac{1}{2}''$ (425 x 86 x 336 mm).

Weight: net, 20 lbs (9.0 kg); shipping, 25 lbs (11.0 kg).

Price: 8717B, \$1600.

Option 001: programmable D/A converter, \$550.



MICROWAVE NETWORK ANALYZERS

Individual instruments

8410 Family

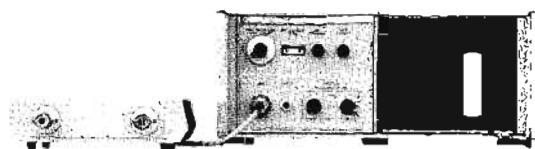

8411A

8410A



8412A



8413A



8414A

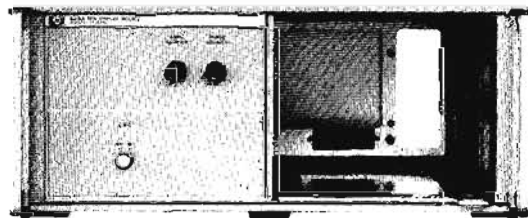

8418A



11587A

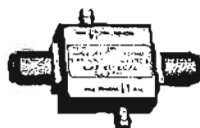

11589A

Network analyzer

8410A Network Analyzer, 8411A Frequency Converter

Function: 8411A Harmonic Frequency Converter converts RF signals to IF signals for processing in 8410A Mainframe. 8410A is the mainframe for display plug-in units. Mainframe includes tuning circuits, IF amplifiers, and precision IF attenuator.

Price: Model 8410A, \$2100; Option 005 (compatible with 8418A), add \$100; Model 8411A, \$2600.

Display units

8412A Phase-Magnitude Display

Function: plug-in CRT display unit for 8410A or 8407A. Displays relative amplitude in dB and/or relative phase in degrees between reference and test channel inputs versus frequency.

Price: Model 8412A, \$1575.

8413A Phase-Gain Indicator

Function: plug-in meter display unit for 8410A or 8407A.

Displays relative amplitude in dB between reference and test channel inputs or relative phase in degrees. Pushbutton selection of meter function and range.

Price: Model 8413A, \$1300.

8414A Polar Display

Function: plug-in CRT display unit for 8410A or 8407A.

Displays amplitude and phase data in polar coordinates on 5" cathode ray tube.

Price: Model 8414A, \$1300.

8418A Auxiliary Power Supply

Function: provides power for operation of the 8412A Phase-Magnitude Display, the 8413A Phase-Gain Indicator or the 8414A Polar Display Unit. Used in conjunction with the Option 005 8410A Network Analyzer, it provides the capability of viewing amplitude and phase readout in both rectangular and polar coordinates simultaneously.

Price: Model 8418A, \$800.

Accessories

11587A, 11650A Accessory Kits

Function: 11650A contains accessories normally used for transmission and reflection tests with the 8745A and 8743A. 11587A contains accessories normally used for transmission and reflection measurements with the 8740A, 8741A and 8742A.

Weight: net, 4 lbs (1.34 kg); shipping, 5 lbs (2.2 kg).

Price: 11587A, \$975; 11650A, \$775.

11589A and 11590A Bias Networks

Function: provides dc bias and bias sensing on 50Ω systems. **Frequency range:** 11589A; .10-3 GHz. 11590A; 1-12.4 GHz. **VSWR:** < 1.2.

Insertion loss: < 0.8 dB.

Connectors: Type N.

Price: Models 11589A, \$275 or 11590A, \$325.

Option 001: APC-7 connectors, add \$30.

Transducers

8740A Transmission Test Unit

Function: RF power splitter and calibrated line stretcher for transmission measurement with network analyzer.

Frequency range: dc-12.4 GHz.

Price: Model 8740A, \$1600.

8741A and 8742A Reflection Test Units

Function: wideband reflectometer, phase-balanced for swept or single frequency impedance tests with 8410A. Calibrated adjustable reference plane.

Frequency range: 0.11-2.0 GHz (8741A); 2.0-12.4 GHz (8742A).

Price: Model 8741A, \$1700; Model 8742A, \$1800.

8745A S-Parameter Test Set

Function: wideband RF power splitter and reflectometer with calibrated line stretcher. Pushbutton operated for either transmission or reflection measurements with network analyzer.

Frequency range: 0.1-2 GHz.

Price: Model 8745A, \$3300; Option 001 (type N female connectors on outputs to 8411A), no additional charge.

11599A Quick Connect Adapter

Function: quickly connects and disconnects the 8745A and the transistor fixtures or 11604A Universal Extension.

Dimensions: 3" x 5" x 4 1/4" (76 x 127 x 108 mm).

Weight: net, 14 oz (397 gm); shipping, 2 lbs (652 gm).

Price: Model 11599A, \$90.

11604A Universal Extension

Function: mounts on front of 8745A; connects to device under test. Rotary air lines and rotary joints connect to any two-port geometry.

Weight: net, 4 lbs (1,9 kg); shipping, 6 lbs (2,5 kg).

Dimensions: 10 1/2" x 5" x 1 1/4" (267 x 127 x 31,6 mm).

Price: Model 11604A, \$925.

11607A Small Signal Adapter

Function: used with the Hewlett-Packard Model 8745A S-Parameter Test Set. It permits measurements with Model 8410A Network Analyzer with incident signal levels to the test device in the -20 to -40 dBm range.

Frequency range: 0.11-2.0 GHz.

Price: \$600.

8743A Reflection/Transmission Test Units

Function: wideband RF power splitter and reflectometer with calibrated line stretcher. Pushbutton operated for either transmission or reflection measurements with network analyzer.

Frequency range: 2-12.4 GHz.

Price: Model 8743A, \$2675.

11605A Flexible Arm

Function: mounts on front of 8743A; connects to device under test. Rotary air lines and rotary joints connect any two-port geometry.

Weight: net, 4 lbs (1,8 kg); shipping, 6 lbs (2,7 kg).

Length: 10.1" (256,3 mm) closed, 25.5" (647,7 mm) extended.

Price: Model 11605A, \$800.

8746B S-Parameter Test Set

Function: wideband RF power divider and reflectometer with calibrated line stretcher and a selectable 0-70 dB incident signal attenuator. Pushbutton operated for either transmission or reflection measurements with network analyzer.

Frequency range: 0.5 to 12.4 GHz.

Price: \$5000.

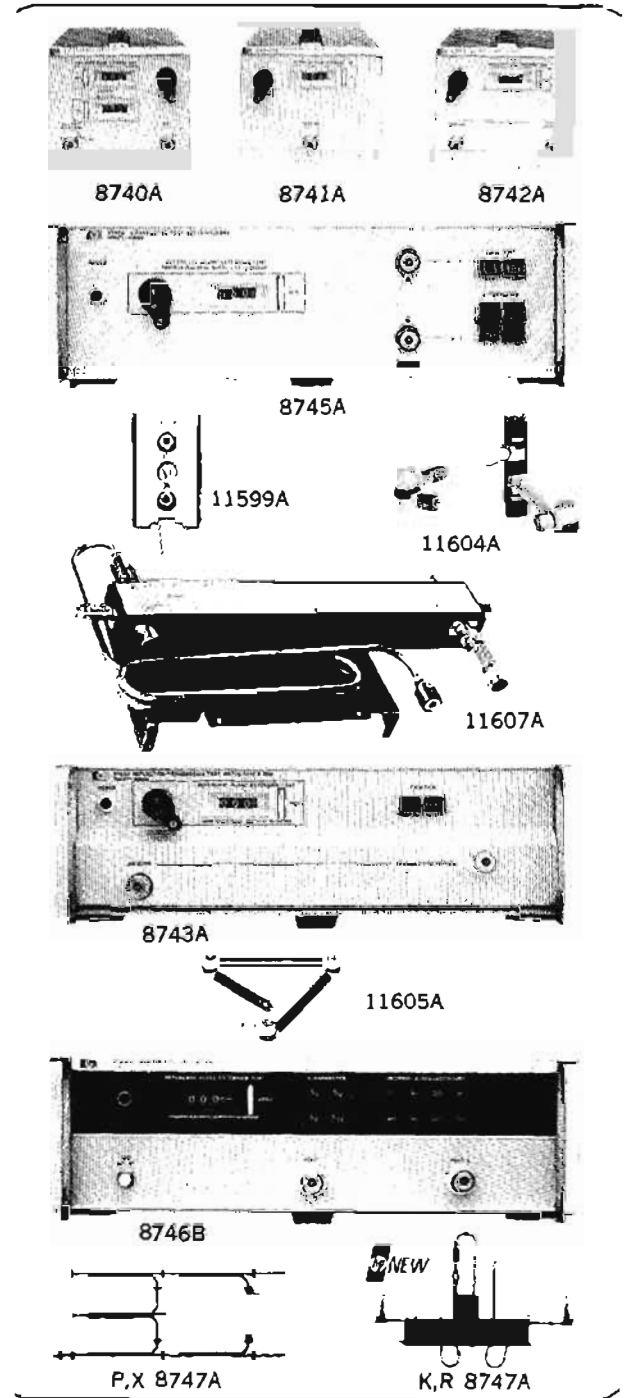

P,X 8747A Reflection/Transmission Test Units

Function: waveguide setup for measuring reflection and transmission parameters of waveguide devices with the network analyzer.

Frequency range: X8747A: 8.2-12.4 GHz; P8747A: 12.4-18 GHz.

Price: Model X8747A, \$1950; P8747A, \$1950.

K,R 8747A Reflection/Transmission Test Units

Function: waveguide setup for measuring reflection and transmission parameters of waveguide devices with the network analyzer; down-converts with built-in mixers to the frequency range of the 8411A.

Frequency range: K8747A: 18-26.5 GHz; P8747A: 26.5-40 GHz.

Price: Model K8747A, \$5650; R8747A, \$6300.



AUTOMATIC NETWORK ANALYZER

Production test, calibration metrology and design
8540 Series



Typical 8540 Series
Automatic Network Analyzer
with interactive graphic
console.

Hewlett-Packard Automatic Network Analyzers combine the amplitude and phase measurement capability of the network analyzer with the control and computational capability of a small computer to produce a series of versatile measurement systems tailored to applications in production testing, calibration metrology and design.

A feature of all such systems is the ability to measure and store a set of complex error coefficients which effectively define the measurement errors introduced by the system. During each measurement, these error terms are automatically applied to the network analyzer readings to greatly increase the final accuracy.

The combination of complete amplitude and phase characterization and mathematical capability allows the error corrected readings to be converted directly to more meaningful forms such as VSWR, return loss, impedance, gain or loss, group delay and h , y , z or S -parameters. Similarly, measured data may be entered directly into programs for Computer Aided Design or statistical analysis.

Since the measurement process is digitally controlled, data collection and interpretation are more rapid than with manual methods and production test personnel can perform complex tests which would otherwise be infeasible or non-cost effective.

Automated systems are available to cover the frequency range from 100 kHz to 18.0 GHz and are designed to be modular in both hardware and software. The cost of an initial purchase may be optimized to satisfy a current measurement problem or capital cost restriction with the flexibility to expand the capability at some future date.

Systems are available to attach to a timeshare terminal thus minimizing the investment in computer hardware while giving access to large computing power.

Systems are fully supported by modular applications software using a version of BASIC, which provides an interpretive language for program generation and modification. FORTRAN routines are also supplied to suit some applications.

Flexible operator interaction and data output formats are provided by options for standard computer peripherals such as the teleprinter, X-Y recorder, and lineprinter, while high speed data and program storage are provided by a magnetic tape cassette input/output unit.

For on-line graphic and alpha-numeric display, the System Console provides a solid-state keyboard, 30 character per second printer and large screen CRT together with the hardware and software required to produce sophisticated interactive graphics. For production test applications, the System Console can rapidly present instructions to the operator or display concise graphical and alpha-numeric data for decision making.

In the design laboratory, the combination of network analysis, computation and interactive graphic display provides an exceptionally powerful tool for analysis, optimization and design.

To satisfy the need for production tests which require measurements other than those based on amplitude and phase, optional hardware and software modules may be integrated into a system to measure such parameters as power, frequency and voltage or to provide additional stimuli, such as DC voltage, for biasing active devices.

On-going customer support for automated systems is provided by Systems Analysts operating in the field, while service support and service contracts are available from worldwide field service centers.

For more detailed information and application assistance, contact your local Hewlett-Packard Systems Field Engineer.



An electrical signal is a voltage or current representing a time-varying phenomenon. It may be the output of a transducer measuring a parameter of the environment, or it may be used to carry information, effect or other intelligence in communications. The output of a radio transmitter, of an electrode implanted in the human skull, or of an accelerometer mounted on the axle of an automobile are examples of useful signals.

Any instrument which takes an electrical signal and measures some function of that signal is a signal analyzer. A simple example is a voltmeter, which measures one parameter of a signal. To extract more information from a signal, further analysis may be required. For example, an oscilloscope may be used to display the variation of amplitude with time.

The signal analyzers described on this and the following pages are those which *transform* the signal in certain ways to extract information from it. Some filter the input signal and measure the results. Others sample the signal, digitize it, and perform computations on the resulting data. Included are wave analyzers, distortion analyzers, spectrum analyzers, signal averagers, correlators, and powerful computer-based Fourier analyzers.

Frequency-domain Analysis

Time-varying signals can often be represented as the sum of a number of frequency components. These components are sinusoids of different frequencies having appropriate amplitude and phase relationships. It's possible, therefore, and often quite useful, to describe signals in the frequency domain, with the horizontal axis representing frequency and the vertical axis representing amplitude. Wave and spectrum analyzers produce this kind of representation by filtering the signal.

Wave Analyzers

If a voltmeter is preceded by a band-pass filter, the meter reading will correspond to the voltage of the signal passing through the filter. If the filter center frequency is tuned and the meter reading recorded at each filter frequency, the result is a frequency spectrum, showing signal amplitude as a function of frequency. As the filter bandwidth gets narrower, the voltmeter responds to a smaller portion of the frequency spectrum and thus can resolve frequencies

which are closer together. This tuned-voltmeter concept is the basis of the wave analyzer. Modern wave analyzers offer features such as automatic sweeping, extremely high resolution, large dynamic range, high sensitivity, and automatic frequency control. They are widely used for measuring harmonic distortion and intermodulation products especially when signal density is high.

Distortion Analyzers

Distortion analyzers are the inverse of wave analyzers. They remove only the fundamental frequency component and measure everything else in the signal. They are used for fast quantitative measurements of total harmonic distortion and noise.

Spectrum Analyzers

A spectrum analyzer, like a wave analyzer, is basically a swept filter or receiver. However, it has a CRT display which shows at a glance how the energy in a signal is distributed as a function of frequency. Spectrum analyzers start at audio frequencies and are the primary tools for signal analysis at RF and microwave frequencies. Latest models have absolute amplitude calibration, 70 dB display range, high sensitivity, ease of operation, and great versatility. Their many uses include spectrum monitoring and measurements of distortion, spectral purity, and modulation index. Used with a tracking generator, a spectrum analyzer can characterize the frequency response of filters or other networks.

Real-time Audio Spectrum Analyzer

Acoustic or vibration signals, such as machine noise, are usually analyzed in the frequency domain. Swept frequency analysis, however, is limited at very low frequencies by the time needed to sweep a filter across the selected frequency range. The real-time audio spectrum analyzer resolves this problem by dividing the spectrum between 2 Hz and 40 kHz into 24, 30, or 36 discrete 1/3-octave bands, each having its own filter. The outputs of these filters are displayed on a CRT which shows the distribution of signal energy in all the frequency bands simultaneously.

Computers and Spectrum Analyzers

Spectrum analyzers and real-time audio spectrum analyzers can be interfaced to a computer for additional signal analysis. These systems are especially useful for automatic spectrum and noise monitoring.

Digital Analysis

There are many applications where signals can be analyzed most efficiently or completely if fed directly to a digital processor. Digital analyzers accept analog signals and have internal analog-to-digital converters and digital processors to perform mathematical operations. For example, they can compute the spectrum of a signal, determine the crosscorrelation between two signals, analyze the statistics of random signals, and perform many other operations which are difficult if not impossible with analog instruments. Hewlett-Packard's expanding line of digital analyzers consists of a computer-based Fourier analyzer, Fourier analysis peripherals for Hewlett-Packard and other computers, a special-purpose correlator with spectrum display, and a hardwired signal averager. These can be used to analyze very-low-frequency signals or signals which are random or obscured by noise. Application areas include neurophysiology, structural vibrations, aerodynamics, servomechanism analysis, underwater acoustics, and many others.

Fourier Analyzers

The Fourier analyzer is a powerful keyboard-controlled instrument which uses a minicomputer to perform fast transforms and other computations on input signals or data. Because it's a digital system it can do spectrum analysis to dc. It can do averaging, compute magnitude and phase, compute transfer functions, and do all kinds of statistical analysis. There's a calibrated CRT display. The built-in minicomputer can be used separately as a general-purpose computer.

Signal Averager

The signal averager is a special-purpose digital analyzer. It computes a time average of noisy repetitive signals to improve signal-to-noise ratio by as much as 60 dB. Computer interface and correlator plug-in are options.

Correlator

The correlator is also a special-purpose digital analyzer. It computes autocorrelation and crosscorrelation functions and, with a new spectrum display, converts them to frequency spectra. It also has some averaging capability.

For More Information

Detailed descriptions and specifications on this complete line of signal analyzers are on the pages that follow.

SIGNAL ANALYZERS



DISTORTION ANALYZERS

Distortion analyzers

The goal of audio and communications equipment is to reproduce input signals faithfully at the output. System non-linearity distorts the waveshape of the signals. Poor reproduction brought about by distortion will appear to the user of audio equipment as a change in the quality or as noise; to the user of communications gear, it appears as channel crosstalk.

Distortion in amplifiers, created by nonlinear circuits, consists of components present in the output that are not contained in the input signal. An ac signal that appears to be a pure sine wave as viewed on an oscilloscope (Figure 1) may have some harmonic distortion. The total of these frequency components present in the signal, in addition to the fundamental frequency, can be measured quickly and easily with Hewlett-Packard distortion analyzers.

One type of distortion analyzer contains a narrow band rejection filter which, when properly tuned, removes the fundamental frequency so that the amplitude of the remaining components can be measured simultaneously. Hewlett-Packard distortion analyzers are used for fast quantitative measurements of total harmonic distortion and noise.

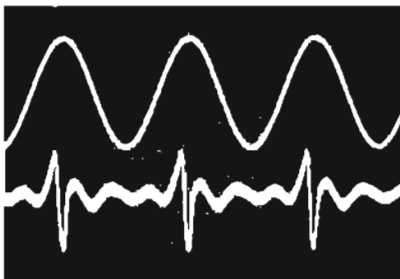

Total harmonic distortion analysis

This measurement technique compares the amplitude of the harmonics to that of the original signal at the output where the original signal becomes the fundamental frequency of the harmonics. The defining equation is:

$$(1) \text{ total harmonic distortion} = \frac{\sqrt{\sum(\text{harmonics})^2}}{\text{fundamental}}$$

A frequency-selective voltmeter is needed to measure the fundamental, and either a selective voltmeter with a wide dynamic range or a frequency rejection circuit with a true rms detector is needed to measure the harmonics. The frequency

rejection circuit nulls the fundamental and passes its harmonics to the detector with no attenuation so that the ratio between the fundamental and harmonics can be determined.

A less expensive way to measure the total harmonic distortion, however, is to use a rejection filter and a broadband detector. Since the fundamental is not directly measured, the equation becomes

$$(2) \text{ THD} = \frac{\sqrt{\sum(\text{harmonics})^2}}{\sqrt{(\text{fundamental})^2 + (\text{harmonics})^2}}$$

If the distortion is less than 10%, the denominator of equation 2 will be within 1/2% of the denominator in equation 1, which is as accurate as any frequency selective voltmeter.

There are two difficulties in making total harmonic distortion measurements. First, to get a measurement within the desired accuracy, the harmonic content of the test signal must not be more than a third of the distortion expected to be caused by the system. Second, the chore of nulling the fundamental can be time-consuming. Oscillators that meet the distortion requirements and nulling equipment, which has recently become available, can overcome the difficulties.

Automatic null

Since the nulling of the fundamental is normally the time-consuming portion of total harmonic distortion measurement, great savings can be realized, especially in production line testing with an analyzer which automatically rejects the fundamental. The time saved is as much as 25 seconds of a 30-second measurement. With automatic nulling, the accuracy of the null achieved is no longer a function of operator training, manual dexterity, or signal source frequency drift.

The analyzer will maintain a null even though there is a slow drift in the input frequency. This ability to "pull" the null has opened the door to a number of ap-

plications where the total harmonic distortion measurements were not readily applied in the past. Among them are:

1. Single-frequency production line testing of such components as integrated-circuit amplifiers or transformers. As long as the long term drift of the signal source is less than +1%, a good null will be achieved.

2. Optimizing the performance of an oscillator. Here, any variation in the parameters causes the frequency to shift slightly. The automatic nulling of the analyzer allows the oscillator performance to be improved on a continuous basis rather than by relying on a point-to-point check which may or may not find the optimum point.

3. Correcting distortion in signal generators which produce sine waves by mixing or by nonlinear shaping. The small frequency shifts would cause the loss of the null if it were not for the automatic null feature.

Selecting an analyzer

Distortion analyzers may be regarded as the inverse of wave analyzers. Distortion analyzers remove any signal component to which they are tuned, having the rest of the signal for measurement. In practice, distortion analyzers are tuned to the fundamental frequency and, by measuring the amplitude of the remaining harmonic components all at once, they provide an indication of percentage total harmonic distortion. Distortion analyzers do not provide information about individual distortion products—wave analyzers (see page 374) and spectrum analyzers (see page 379) do this job, but they do not provide fast readings of the signal's total departure from sine wave purity.

Table 1 describes the models and features of Hewlett-Packard distortion analyzers.

Option 001, for each model, features VU meter characteristics conforming to FCC requirements.

Model No.	Auto Nulling	Hi-Pass Filter	Lo-Pass Filter	AM Detector	Gear Reduction Tuning
331A					X
332A				X	X
332A Opt. H05			X	X	X
333A	X	X			
334A	X	X		X	
334A Opt. H05	X		X	X	

Optional, for each model, features VU meter characteristics conforming to FCC requirements.

DISTORTION ANALYZER

Manual or auto tuned; FCC approved
Models 331A, 332A, 333A, 334A



SIGNAL ANALYZERS

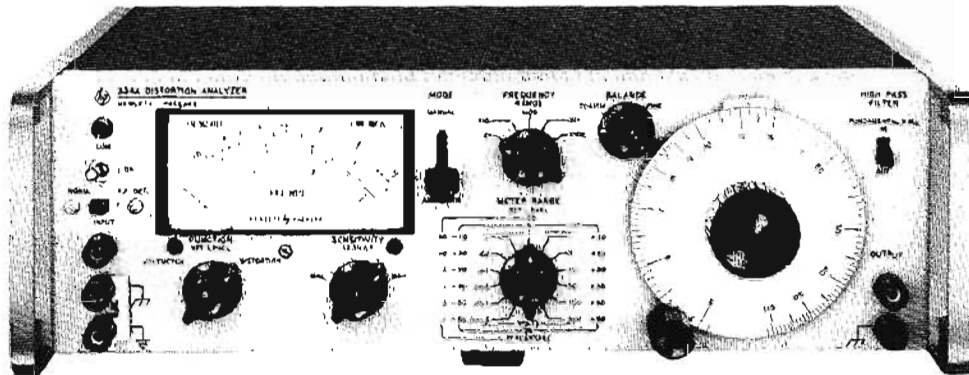

334A

Specifications (All Models)*

Distortion measurement range: any fundamental frequency, 5 Hz to 600 kHz. Distortion levels of 0.1%-100% are measured full scale in 7 ranges.

Harmonic distortion measurement accuracy (full scale):
Fundamental Input Less Than 30 V

Range	±3%	±6%	±12%
100%-0.3%	10 Hz-1 MHz	10 Hz-3 MHz	
0.1%	30 Hz-300 kHz	20 Hz-500 kHz	10 Hz-1.2 MHz

Fundamental Input Greater Than 30 V

Range	±3%	±6%	±12%
100%-0.3%	10 Hz-300 kHz	10 Hz-500 kHz	10 Hz-3 MHz
0.1%	30 Hz-300 kHz	20 Hz-500 kHz	10 Hz-1.2 MHz

Elimination characteristics

Fundamental rejection: >80 dB.

Second harmonic accuracy for fundamentals of 5 Hz to 600 Hz; better than -3 to +1 dB depending upon frequency range.

Distortion Introduced by instrument: <0.03% from 5 Hz to 200 kHz; <0.06% from 200 kHz to 600 kHz. Meter indication is proportional to the average value of a sine wave.

Frequency calibration accuracy

Better than ±5% from 5 Hz to 300 kHz.

Better than ±10% from 300 kHz to 600 kHz.

Input impedance: distortion mode, 1 MΩ ±5% shunted by <70 pF (10 MΩ shunted by <10 pF with HP 10001A 10:1 Divider Probe); voltmeter mode: 1 MΩ ±5% shunted by <35 pF 1 to 300 V rms; 1 MΩ ±5% shunted by <70 pF, 300 μV to 0.3 V rms.

Input level for distortion measurements: 0.3 V rms for 100% set level or 0.245 V for 0 dB set level (up to 300 V may be attenuated to set-level reference).

DC isolation: signal ground may be ±400 V dc from external chassis.

Voltmeter range: 300 μV to 300 V rms full scale (13 ranges) 10 dB per range.

Voltmeter accuracy: (using front panel input terminals) ±2% and ±5% depending upon frequency and input range).

Output: 0.1 ±0.01 V rms open circuit and 0.05 ±0.005 V rms into 2 kΩ for full scale meter deflection.

Output impedance: 2 kΩ.

AM detector (Models 332A and 334A only): high impedance dc restoring peak detector with semiconductor diode operates from 550 kHz to >65 MHz. Broadband input, no tuning is required; maximum input: 40 V p-p ac or 40 V peak transient; distortion introduced by detector: carrier frequency: 550 kHz-1.6 MHz: <50 dB (0.3%) for 3-8 V rms carriers modulated 30%.

Automatic nulling mode (Models 333A and 334A only)

Set level: at least 0.2 V rms.

Frequency ranges: X1, manual null tuned to <3% of set level; total frequency hold-in ±0.5% about true manual null. X10 through X10 k, manual null tuned to <10% of set level; total frequency hold-in ±1% about true manual null; automatic null accuracy: 5 Hz to 100 Hz; meter reading within 0 to +3 dB of manual null. 100 Hz to 600 kHz; meter reading within 0 to +1.5 dB of manual null.

High-pass filter (Models 333A and 334A only)

3 dB point at 400 Hz with 18 dB per octave roll off, 60 Hz rejection >40 dB. Normally used only with fundamental frequencies >1 kHz.

Low-pass filter: 332A Option H05 and 334A Option H05 (4 pole, 3 dB down at 30 kHz).

General

Weight: net 17¼ lbs (8 kg); shipping 25 lbs (11,3 kg).

Dimensions: 16¾" wide, 5" high (without removable feet), 13¼" deep (426 x 126 x 337 mm).

Accessories furnished: rack mounting kit for 19" rack.

Power supply: 115 or 230 V ±10%, 48 to 440 Hz; 331A and 332A 6 VA max., 333A and 334A 13 VA max. Terminals are provided for external battery supply. Positive and negative voltages between 30 V and 50 V are required. Current drain from each supply is 40 mA. (80 mA for models 333A and 334A).

Price: HP 331A, \$680; HP 332A, \$710; HP 333A, \$920; HP 334A, \$950. 332A option H05, add \$110; 334A option H05, add \$85; option 001, indicating meter has VU characteristics conforming to FCC requirements for AM/FM and TV broadcasting; add \$15 for 331A and 332A; add \$20 for 333A and 334A.

* Refer to data sheet for complete specifications.



What is a wave analyzer?

Wave Analyzer, Frequency Selective Voltmeter, Carrier Frequency Voltmeter, Tuned Voltmeter . . . they're all the same thing, just different names.

A wave analyzer can be thought of as a finite bandwidth window filter which can be tuned throughout a particular frequency range.

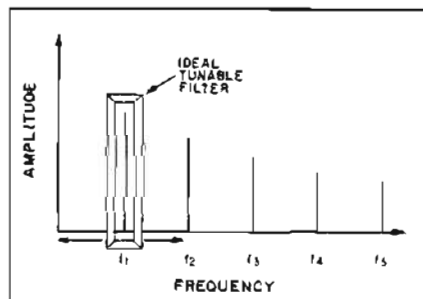

Figure 1. Wave Analyzer Tunable Filter.

Signals located on the frequency spectrum will be selectively measured as they are framed by the window. Thus, for a particular signal, the wave analyzer can indicate its frequency (window position) and amplitude. Amplitude is read on an analog meter; frequency is read on either a mechanical or electronic readout. It has the advantage of accuracy, resolution, ease of operation and low cost.

The uses of wave analyzers can be categorized into three broad areas: 1) Amplitude measurement of a single component of a complex frequency spectrum, 2) Amplitude measurement in the presence of noise and interfering signals and, 3) Measurement of signal energy appearing in a specified, well defined bandwidth.

The selection checklist provides a guide for comparing features and choosing an instrument suitable for the task at hand.

Wave analyzer considerations

Frequency characteristics

Range: should be selected with the future in mind as well as present requirements.

Accuracy and resolution: should be consistent with available bandwidths. Narrow bandwidths require frequency dial accuracy to place the narrow window in the proper position for measurement. Accuracy of instruments with selectable bandwidths is determined by the basic center-frequency accuracy of the IF bandwidth filters in addition to the local oscillator frequency accuracy. Accuracy is usually specified as a fixed frequency error at any point on the dial meaning

poorer percentage accuracy at the low frequency settings.

Readout: usually a frequency dial but newer instruments use a frequency counter as a dial. Although digital readout is more expensive, its accuracy and ease of use outweigh the increased cost.

Stability: frequency stability is important when using narrow bandwidths and for long term signal monitoring. Stability is achieved by phase locking and frequency counters but the best stability is with automatic frequency control. (AFC). AFC locks the local oscillator to the incoming signal and eliminates any relative drift between the two. It serves as a tuning aid to pull the signal to within the passband eliminating peaking the frequency control. The AFC always tunes to the same spot in the passband improving accuracy on repetitive measurements.

Sweep: some instruments are equipped with a sweep arrangement to allow use as a spectrum analyzer. Readout is a CRT or X-Y recorder. Some instruments sweep the local oscillator while others use an external spectrum analyzer to sweep a broadband IF.

Amplitude characteristics

Range: the amplitude range is determined by the input attenuator and the internal noise of the instrument. Sensitivity is defined as the lowest measurable signal level equal to the noise level for a unity signal-to-noise ratio (often called tangential sensitivity). Sensitivity will vary with bandwidth and input impedance.

Dynamic range: defined as the dB ratio of the largest and smallest signals that can be simultaneously accommodated without causing an error in the measurement of the smaller.

Attenuators: the amplitude range switch is an attenuator in the input and IF stages. Instruments are available with a single control which switches input and IF range in predetermined steps or with two switches for independent control of input and IF range. Intermodulation distortion is lowest when the input amplifier has the minimum signal applied and the IF gain is greatest. Conversely the internal noise, important when making sensitive measurements, is lowest with maximum input signal and lowest IF gain. The two attenuator instruments allow this transfer of gain between input and IF to be accomplished easily.

Accuracy: amplitude accuracy is a

function of frequency, input attenuator response, IF attenuator performance, calibration oscillator stability and accuracy, and meter tracking. Often specifications are broken up to separately describe each contributor.

Readout: amplitude readout is usually a meter calibrated in dB and/or volts. Linear voltage meters are used to allow the user to see down into the noise at the bottom of the scale. Digital readouts are not used because of their slow response and lack of directional and positional information. This is important since the readout is used as a tuning indicator to show presence of a signal in the passband and when it has reached a peak. Expanded scale meters allowing expansion of any 1 or 2 dB portion of the scale into a full scale presentation allow resolution of input level changes of a few hundredths of a dB. This is useful when the wave analyzer is used as a sensitive indicator in bridge or comparison measurements. The expanded scale meter is included in some instruments and is an external accessory on others.

Input characteristics

Impedance: may be high impedance bridging input or terminating impedance to match standard transmission lines. High frequency measurements require matched systems to avoid error-producing standing waves on interconnecting cables. The measure of impedance accuracy is usually return loss or reflection coefficient ($RL = 20 \log p$). In lower frequency instruments, percent accuracy is used. High input impedance instruments are usually poorer in frequency and noise performance and are usually low frequency instruments. High impedance at high frequencies is accomplished by using a bridging probe to place the impedance at the point of measurement. The probe may be active with unity gain or passive with 20-30 dB insertion loss.

Input arrangement: input may be balanced-to-ground or unbalanced. Communications system usage typically requires balanced input. Standard 600 and 135/150Ω balanced inputs are limited in frequency to less than 1 MHz and 12-Ω balanced to less than 10 MHz in most instruments. The impedance may be balanced to ground with the center point grounded or may be completely isolated from ground. Unbalanced inputs do not have frequency range limitations.

Miscellaneous characteristics

IF bandwidths: this determines the basic bandwidth and selectivity of the instrument. Shape factor, defined as the ratio of the 60 to 3 or 6 dB attenuation bandwidths of the bandpass curve, is important as it determines how well close-together signals can be resolved. A low numerical ratio implies a more selective bandpass.

Demodulation: many instruments are provided with circuits to perform AM envelope and single-sideband demodulation of signals. Single-sideband suppressed-carrier signals require that the instrument reinsert the carrier. This also requires that the instrument be tuned above or below the carrier frequency. Frequency accuracy and resolution are important here. A bandwidth of at least 3 kHz is required for understandable voice signal demodulation.

Physical characteristics: occasional field

use requires portability and battery operation which is usually limited to the lower frequency instruments. Instruments with narrow bandwidth crystal filters are somewhat susceptible to vibration and shock. Active filters eliminate this problem.

Tracking generator: tracking generators whose frequency is slaved to the wave analyzer's tuning are useful for frequency response measurements. For higher frequency instruments, the generator is usually a separate instrument which can be slave tuned or separately tuned. Separate tuning with the same accuracy and resolution as the wave analyzer meter is necessary when making harmonic analysis or measuring systems with frequency translation. Lower frequency instruments typically have a built-in generator referred to as a BFO output. This output is slave tuned only.

Outputs: DC output proportional to

meter indication is useful for recording. This type of output is usually limited in dynamic range to 20-40 dB. AC output at the IF frequency for external recorders and indicators will operate over the complete dynamic range. One recent model uses a unique log converter technique to place the entire dynamic range on the meter and its dc output. AC output for earphone monitoring of demodulated input signals is usually provided. Most instruments in the lower frequency range are equipped with a BFO and restored output. BFO output is a constant amplitude, levelled output whose frequency is the same as that to which the instrument is tuned. Restored output is an amplified, filtered replica of the input signal. Its frequency is the same as the input signal and it is band-limited or filtered by the instrument's bandwidth. Local oscillator inputs and outputs are occasionally provided for slaving instruments together.

Table 1. HP wave analyzers.

HP wave analyzers	Frequency range	Selective bandpasses	Dynamic range Absolute	Relative	Freq readouts	Type of inputs	Type of outputs	Modes of operation
302A (p. 378)	20 Hz to 50 kHz	6 Hz	30 μ V-300 V full scale	> 75 dB	dial	banana jacks	rec: 1 mA dc into 1000 Ω full scale BFO: 2 V open circuit, meter at full scale	AFC, normal, BFO
3590A/ 3594A (p. 376)	20 Hz to 620 kHz	10 Hz 100 Hz 1000 Hz 3100 Hz	3 μ V-30 V full scale	> 85 dB	5-place digital	BNC un- balanced	rec: X and Y axes log and linear. BFO: to 1 V rms. L.O.: (1.28 MHz-1.9 MHz) 0.65 V rms.	AFC, restored, BFO, USB, LSB, AM sweep
310A (p. 378)	1 kHz to 1.5 MHz	200 Hz 1000 Hz 3000 Hz	10 μ V-100 V full scale	> 75 dB	dial	banana jacks	rec: 1 mA dc into 1500 Ω full scale BFO: 0.5 V into 135 Ω meter at full scale output impedance 135 Ω	AFC, normal BFO, USB, LSB AM
312A/ 313* (p. 350)	1 kHz to 18 MHz 18 ranges	200 Hz 1000 Hz 3100 Hz	3 μ V-3 V full scale or -97 to +23 dBm -107 to +13 dBm (600 Ω only)	> 72 dB	7-place decade counter	BNC & probe 11530A bridged/ terminated balanced or unbalanced	rec: 1 V dc full scale 1 k Ω source aux: 1 MHz (1 V p-p) 30 MHz (40-70 mV) rms L.O. (30-48 MHz) 60 to 90 mV rms audio: > 0.5 V into 10 k Ω 313A: Track or tuned 75 Ω unbalanced, -99.9 to +10 dBm	AFC, AM, beat LSB, USB
3591A/3594A (p. 352)	Same as 3590A/3594A except input bridged/terminated bal. or unbal. and modified input circuitry.							
312A/313A Op. H01 (p. 350)	Same as 312A except 1 kHz to 22 MHz and WE-477B input unbalanced.							
312A/313A Op. H05	Same as 312A Option H01 except 50 Ω unbalanced input with BNC connector.							

*313A option 001, 50 Ω unbalanced output.

SIGNAL ANALYZERS



PLUG-IN WAVE ANALYZER

85 dB dynamic range; electronic sweeping
Models 3590A, 3592A, 3593A, 3594A, 3595A

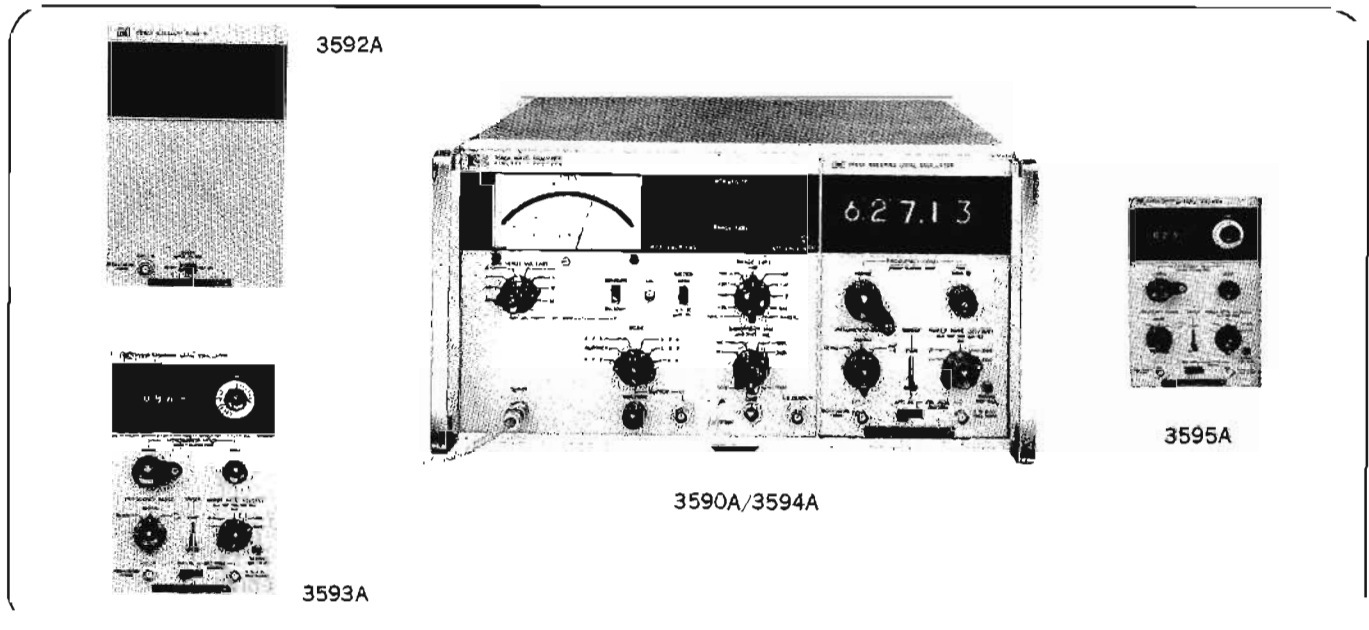

Description

The Hewlett-Packard Model 3590A Wave Analyzer offers automatic, state-of-the-art detection of signal amplitude and frequency information. Over a frequency range of 20 Hz to 620 kHz, the analyzer can separate frequency components of an input signal to locate the fundamental, harmonics, inter-modulation products, or any other signals present in the spectrum. Selectable bandwidths of 10, 100, 1000 and 3100 Hz permit easy location of signals and separation of closely spaced components. Operation has been greatly simplified by automatic amplitude ranging and electronic sweeping. X-Y recorder outputs permit frequency spectrum recordings to be made covering the entire frequency range with a linear dB amplitude display of 90 dB.

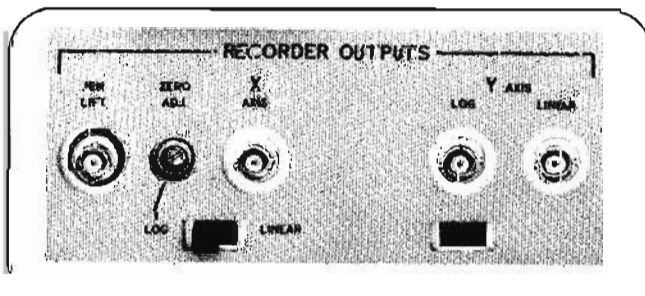

Recorder outputs

Both X and Y recorder outputs are available at the rear panel of the 3590A. These outputs produce either logarithmically or linear varying dc voltages. Any combination of X and Y log or linear outputs (Lin-lin, lin-log, log-lin, or log-log) can be chosen to provide maximum flexibility. Recordings can also be made on standard semi-log graph paper to produce direct plots.

Y-axis log and linear outputs occur simultaneously, but the X-axis output is switched to choose the output function. When the switch is in LINEAR (RAMP ONLY), the dc offset produced by the start frequency location is blocked out. This

permits wide expansion of a narrow sweep segment without having to buck out the offset voltage.

A contact closure drops the pen during the sweep. During retrace and standby, the pen is lifted.

Plug-ins

3592A Auxiliary Plug-in

The 3592A is made for the situation where two or more main frames are slave tuned. This situation occurs when two signals are to be analyzed simultaneously. An example of this is reading X and Y axis sensors in a vibration test. The other plug-ins can also be slave tuned.

3593A/4A/5A Sweeping Local Oscillator

The 3593A was designed for fast sweeping for short periods of time. It represents a price savings over the other sweeping plug-ins.

The 3594A has a nixie tube readout for accurate setting of start frequencies and readout of frequencies during sweep. The 5-digit readout represents an order of magnitude improvement in resolution over the mechanical readouts of the other plug-ins.

The 3595A was designed to fulfill the requirement of slow sweeping for long periods of time. Using the 2 Hz/s sweep speed the 3595A can sweep the entire audio spectrum (20 Hz-20,000 Hz) with a 10 Hz bandwidth. It is also possible to sweep a baseband signal from 312 kHz to 552 kHz with a 1000 Hz bandwidth. These longtime sweeps can be made automatically with no resetting or manual ranging.

Specifications

3590A Wave Analyzer

Frequency range: 20 Hz to 620 kHz.

Frequency accuracy: refer to plug-in specs.

Amplitude ranges: 3 μ V to 30 V full scale in 16 ranges.

Amplitude accuracy (meter switch in normal position)

Overall accuracy: ± 0.5 dB or $\pm 5\%$ of reading, including the following: frequency response flatness: ± 0.2 dB or $\pm 2\%$ total deviation; meter tracking: ± 0.1 dB or $\pm 1\%$ of reading, 0 dB to -10 dB indication.

Amplitude accuracy (meter switch in linear dB position)

Overall accuracy: ± 1 dB; internal calibrator: frequency: 100 kHz ± 10 Hz; amplitude: full scale on 0 dB range in CAL mode; amplitude accuracy: ± 0.1 dB ($\pm 1\%$) with 90 day calibration cycle.

Dynamic range (IM and harmonic distortion products)

>85 dB below zero dB reference level when ABSOLUTE measurements are being made (>70 dB for 20 Hz to 50 Hz).
>80 dB below zero dB reference level when RELATIVE adjustment is used (>70 dB for 20 Hz to 50 Hz); (residual responses): >80 dB below zero reference (>70 dB for 20 Hz to 50 Hz).

Noise level (on .01V max input voltage range at 20 kHz)

Bandwidths	Input Noise Level (500 Ω Source Impedance)
10 Hz and 100 Hz	< 0.3 μ V or at least 90 dB below 0 dB reference
1 kHz and 3.1 kHz	< 1.0 μ V or at least 80 dB below 0 dB reference

Selectivity (shape factor)

Rejection	Bandwidths			
	10 Hz	100 Hz	1 kHz	3.1 kHz
-3 dB Point	10 Hz	100 Hz	1 kHz	3.1 kHz
-60 dB Point	35 Hz	320 Hz	3.1 kHz	9.6 kHz

(Frequency accuracy at -3 dB and -60 $\pm 10\%$)

Automatic frequency control: capture threshold: 75 dB below 0 dB reference, AFC will lock on trace signal; dynamic hold-in range: >3 bandwidths. Tracking rate proportional to bandwidth.

Input impedance

Resistance: 100 k Ω all ranges.

Capacitance: <50 pF for 10 mV, 30 mV ranges <30 pF for 100 mV to 30 V ranges.

Automatic ranging: 8 ranges, 0 dB to -70 dB. Ranging rate proportional to bandwidth.

Mode outputs: amplitude: adjustable 0 to 1 V rms open cir-

cuit; BFO frequency flatness: ± 0.2 dB or $\pm 2\%$; resistance: 600 Ω , BFO frequency is equal to tuned frequency.

L.O. output

Frequency: 1.28 MHz to 1.90 MHz (1.28 MHz + tuned frequency); amplitude: 0.65 V rms $\pm 20\%$ open circuit; resistance: 250 Ω .

Recorder outputs

X-Axis (3593A/3594A only)	Plug-in Frequency Ranges	
	62 kHz	620 kHz
X-axis linear output: (1 k Ω source resistance)	0 to -12.4 V (200 mV/kHz $\pm 5\%$)	0 to -12.4 V (20 mV/kHz $\pm 5\%$)
X-axis log output: (1 k Ω source resistance)	5 V/decade $\pm 5\%$ (20 Hz - 62 Hz)	5 V/decade $\pm 5\%$ (600Hz - 620kHz)

Y-axis: linear Y axis output: +5 V dc $\pm 4\%$ for full scale meter indication, 2.5 k Ω source resistance; log Y axis output: +1 V to +10 V dc, ± 0.1 V proportional to linear dB meter indication (-90 to 0 dB, 0.1 V/dB) 1 k Ω source resistance.

Pen lift: contact closure during sweep, open during reset (3593A/3594A only).

Power: 115 V or 230 V $\pm 10\%$, 48 Hz to 440 Hz, 115 VA (includes plug-in).

Dimensions: 16 $\frac{3}{4}$ " wide, 8 $\frac{3}{4}$ " high, 16 $\frac{3}{8}$ " deep (425 x 221 x 416 mm).

Weight: net 38 lbs (17,2 kg); shipping, 55 lbs (24,9 kg).

Accessories furnished: rack mounting kit for 19" rack.

Price: HP 3590A, \$3280.

Specifications**Model 3592A Auxiliary Plug-in**

External L.O. Input: 0.65 V ± 0.2 V rms, 1.28 to 1.90 MHz (1.28 MHz + tuned frequency).

Weight: net, 2 lbs (.9 kg); shipping, 6 lbs (2,7 kg).

Dimensions: 8" high, 4.5" wide, 11" deep (20 x 11 x 28 cm).

Price: HP 3592A, \$80.

	MODELS 3593A and 3594A		MODEL 3595A	
	20 Hz to 62 kHz	500 Hz to 620 kHz	20 Hz to 62 kHz	500 Hz to 620 kHz
Frequency Accuracy:	3593A: $\pm (1\% + 20$ Hz) of dial setting 3594A: $\pm (1$ Hz + time base accuracy)	3593A: $\pm (1\% + 200$ Hz) of dial setting 3594A: $\pm (10$ Hz + time base accuracy)	$\pm (1\% + 20$ Hz) of dial setting	$\pm (1\% + 200$ Hz) of dial setting
Frequency Resolution:	3593A: 10Hz/minor div. 3594A: 1Hz/minor div.	3593A: 100Hz/minor div. 3594A: 10Hz/minor div.	10 Hz/minor div.	100 Hz/minor div.
Ext. Freq. Control:	0 to 15.5 V (250 mV/kHz $\pm 5\%$)	0 to 15.5 V (25 mV/kHz $\pm 5\%$)	0 to 15.5 V (250 mV/kHz $\pm 5\%$)	0 to 15.5 V (25 mV/kHz $\pm 5\%$)
Bandwidth Specified:	10, 100, 1000 3100 Hz	100, 1000, 3100 Hz	10, 100, 1000 3100 Hz	100, 1000, 3100 Hz
X-axis Recorder Output:	Linear output: 0 to -12.4 V		Same as 3593A/94A	
	200 mV/kHz $\pm 5\%$	20 mV/kHz $\pm 5\%$		
	Log output: 5 V/decade $\pm 5\%$			
	50 Hz calib. point	500 Hz calib. point	20 Hz calib. point	200 Hz calib. point
Y-axis:	Refer to main frame specifications			
Sweep Rates:	1, 10, 100, 1000, 3100 Hz/s.		1, 2, 10, 100, 1000 Hz/s.	
Sweep Ramp Linearity:	$\pm 1\%$ of final value		$\pm 2.5\%$ of final value for first 10,000 s.	
Max Sweep Time:	620 s $\pm 15\%$		60,000 s.	
Start Freq:	determined by frequency setting			
Pen Lift:	contact closure during sweep, open during reset.			
External L.O. Input:	0.65 V ± 0.2 V rms, 1.28 to 1.90 MHz (1.28 MHz + tuned frequency).			
Dimensions:	8" high, 4.5" wide, 11" deep (20 x 11 x 28 cm).		net 9.5 lbs (4,3 kg); shipping 14 lbs (6,3 kg)	
Weight:	net 7.5 lbs (3,4 kg); shipping 12 lbs (5,5 kg).			
Price:	HP 3593A, \$1130; HP 3594A, \$1640.		HP 3595A, \$1250	

SIGNAL ANALYZERS



WAVE ANALYZER, SWEEP DRIVE

Measure harmonics, intermodulation products

Models 302A, 310A

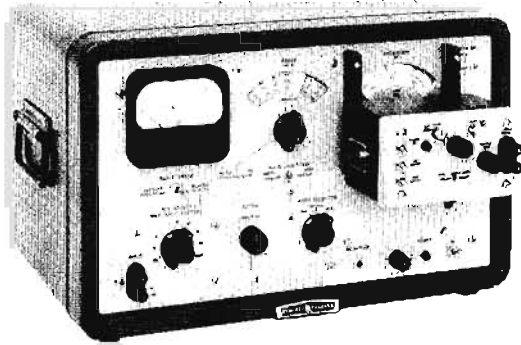

302A with 297A Accessory

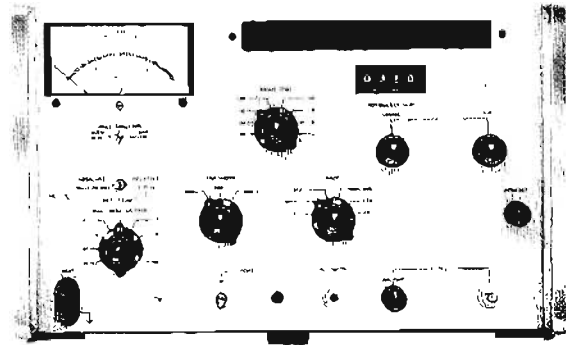

310A

	*Specifications, 302A	*Specifications 310A				
Frequency range:	20 Hz to 50 kHz.	1 kHz to 1.5 MHz (200 Hz bandwidth); 5 kHz to 1.5 MHz (1000 Hz bandwidth); 10 kHz to 1.5 MHz (3000 Hz bandwidth).				
Frequency accuracy:	+(1% + 5 Hz) of dial setting	+(1% + 300 Hz).				
Frequency resolution:	10 Hz per division.	200 Hz per division (linear graduation)				
Amplitude ranges:	30 μ V to 300 V full scale in 15 ranges.	10 μ V to 100 V full scale 16 ranges.				
Amplitude accuracy:	\pm 5% of full scale.	+6% of full scale.				
Dynamic range:	> 75 dB	> 75 dB				
Selectivity:	Rejection	Bandwidth	Rejection	Bandwidth 200Hz	1000 Hz	3000 Hz
	0.1 dB	> 2 Hz	\geq 3 dB	$f_0 \pm 108$	$f_0 \pm 540$	$f_0 \pm 1550$
	3 dB	6 Hz \pm 10%	\geq 50 dB	$f_0 \pm 500$	$f_0 \pm 2400$	$f_0 \pm 7000$
	60 dB	60 Hz \pm 10%	\geq 75 dB	$f_0 \pm 1000$	$f_0 \pm 5000$	$f_0 \pm 17000$
	80 dB	< 140 Hz				
Input impedance:	30mV to 1 V (input ranges: 100 k Ω 3 V to 300 V input ranges: 1 M Ω 30 mV to 1 V input ranges: < 100 pF. 3 V to 300 V input ranges: < 30 pF.		10 k Ω on most sensitive range, 30 k Ω on next range, 100 k Ω on other ranges; shunt capacitance < 100 pF on three most sensitive ranges, < 50 pF on other ranges.			
AFC:	0 to 2 V rms open circuit proportional to meter deflection. Frequency is exactly the same as the measured component's frequency. AFC hold-in range: \pm 100 Hz.		Dynamic hold-in range is \pm 3 kHz minimum at 100 kHz; tracking speed is approximately 100 Hz/s; locks on signal as low as 70 dB below a full-scale reference set on the 0 dB position of the Range switch.			
Restored-frequency output:		Restored signal frequency maximum output is at least 0.25 V (meter at full scale) across 135 Ω , with approximately 30 dB of level control provided; output impedance approximately 135 Ω				
BFO output:	Constant-level amplitude, adjustable 0 to 2 V rms open circuit.	0.5 V across 135 Ω with approx. 30 dB of level control provided; output impedance approx. 135 Ω				
Recorder output:	1 V dc open circuit; source resistance, 1 k Ω	1 V dc open circuit; source resistance, 1 k Ω				
Power:	115 or 230 V +10%, 48 to 440 Hz, ext. batt. range, 28 V to 18 V, 10 VA max.	115 or 230 V +10%, 48 to 440 Hz; 25 VA max.				
Dimensions:	Cabinet 20 $\frac{1}{2}$ " wide, 12 $\frac{1}{2}$ " high, 14 $\frac{1}{2}$ " deep behind panel (527 x 318 x 368 mm). Rack: 19 in. wide, 10 15/32 in. high, 13 in. deep (483 x 266 x 330 mm).	16 $\frac{1}{2}$ " wide, 10 $\frac{1}{2}$ " high, 18-3/8" deep (426 x 274 x 467 mm); hardware furnished for conversion to rack mount 19" wide, 10-15/32" high, 16-3/8" deep behind panel (483 x 266 x 416 mm).				
Weight:	Cabinet net 43 lbs (19.5 kg), shipping 51 lbs (23 kg); rack mount net 35 lbs (16 kg), shipping 51 lbs (23 kg).	Net 44 lbs (20 kg); shipping 51 lbs (23 kg).				
Accessories:	297A Sweep Drive: sweep speed with 302A: 170 and 17 Hz/s. Sweep limits: any interval from 64 revolutions to 10 $^\circ$. Sweep voltage output: at least 12 V maximum; full output is obtained with either 2.1 or 50 rpm of the shaft. Price: HP 297A, \$445.					
Price:	HP 302A (cabinet), \$2085; HP 302AR (rack), \$2070.	HP 310A \$2695. Option 001 with internal Xtal calib., add \$105. Option 002 dB scale upper-				

FREQUENCY DOMAIN MEASUREMENT



SPECTRUM ANALYZERS

Spectrum Analyzers

Basically a spectrum analyzer is a swept receiver that provides a CRT display of amplitude versus frequency. It shows how energy is distributed as a function of frequency, displaying the Fourier components of a given waveform. With it you can measure frequency response; characterize mixers, doublers, and other frequency conversion devices. You can measure signal purity or see directly the bandwidth needed to pass a given signal.

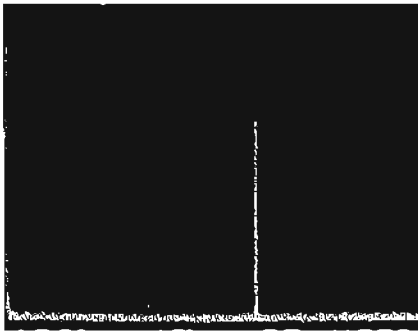

CW Signal. This is a calibrated display of a -30 dBm CW signal at 60 MHz. The zero frequency indicator appears at the far left of the display; the horizontal scan is 10 MHz/div. The log reference level (top graticule line of the display) is 0 dBm.

Oscillators

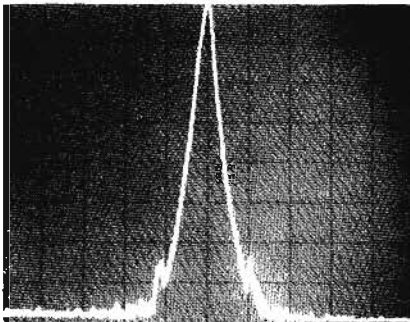

Oscillator spectral purity. The spectrum analyzer may be used to measure the spectral purity of oscillators. Above, a 70 MHz carrier has line related sidebands (60 Hz) which are 65 dB down. These sidebands may be the result of ripple on the power supply. The spectrum analyzer scan is 50 Hz per division, and a 10 Hz bandwidth was used to allow resolution of the close in sidebands.

Frequency converters

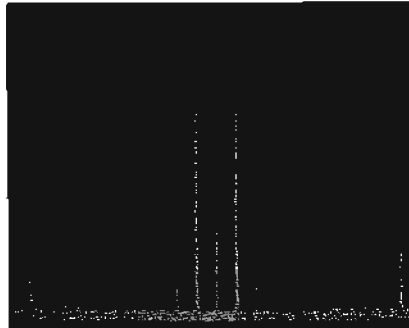

Mixer. Driving a double-balanced mixer with an L.O. of 50 MHz at 0 dBm and with a 5 MHz, -30 dBm signal, results in the output shown. The log reference level is -10 dBm and the frequency scan is 10 MHz/division centered at 50 MHz. The two sidebands at 45 MHz and 55 MHz have a conversion loss of 6 dB (6 dB below the -30 dBm graticule line). The local oscillator (50 MHz signal) has 50 dB isolation. 5 MHz signal leak-through is at -71 dBm, i.e., 41 dB isolation. Second order distortion products at 40 and 60 MHz are 40 dB down.

Modulators

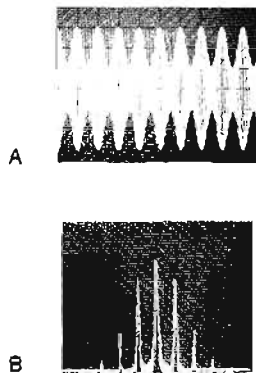

50 percent AM. Figure A shows a time domain photograph of an amplitude modulated carrier. The percent modulation is: $M = \frac{(6 - 2)}{(6 + 2)} = \frac{4}{8} = 50\%$. (Scope calibration 0.1 msec/division, 50 mV/division.) The same waveform is measured in the frequency domain in "B" since the carrier and sidebands differ by 12 dB, $M = 50\%$. Frequency scan is 10 kHz/div centered at 60 MHz, and the log reference level is +10 dBm. You can also measure the 2nd and 3rd harmonic distortion on this waveform. 2nd harmonic sidebands at $f_c \pm 2 f_m$ are 28 dB down.

Amplifiers

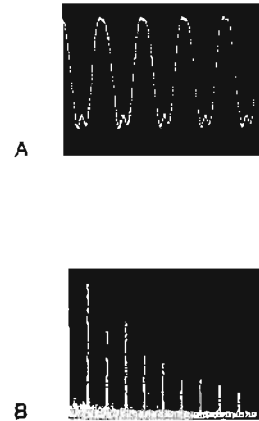

Harmonic distortion. Overdriving an amplifier results in a severely distorted waveform easily observed with the oscilloscope; however, quantitative measurements of distortion levels are difficult to obtain. The scope calibration is 0.05 volt/division vertical, 0.1 μ sec/division horizontal. The spectrum analyzer easily gives quantitative information about the distortion of the two signals. The frequency scale is 5 MHz/division centered at 25 MHz, and the log reference level is 0 dBm.

Filters

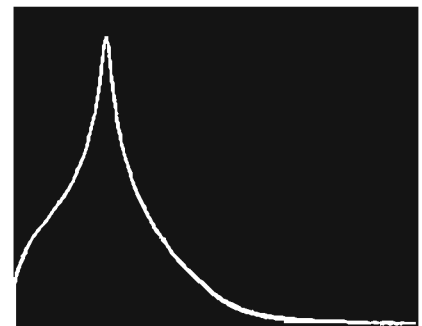

Filter frequency response. Using a tracking signal source and a spectrum analyzer, filter frequency response is easily measured and recorded. In this case, an audio filter used in a communications system is being measured. The spectrum analyzer scan is 0 to 10 kHz. The log reference level is -10 dBV, and the input to the filter was at -13 dBV. Therefore, the insertion loss at 2.4 kHz is 4 dB. Extremely high-Q devices can be measured with this system.

Spectrum Analyzer Capabilities

To be useful in making measurements in the frequency domain, the analyzer must be capable of making quantitative measurements. To make quantitative measurements, an analyzer must:

- 1) make absolute frequency measurements
- 2) make absolute amplitude measurements
- 3) operate over a large dynamic range
- 4) have frequency and amplitude high resolution capability
- 5) have high sensitivity
- 6) provide means of observing signals at the slow sweep rate high resolution scans i.e. variable persistence.

Hewlett-Packard spectrum analyzers excel in these six measures of performance.

Let us consider each of these performance standards in greater detail.

Absolute frequency measurements

There are two ways to measure absolute frequency with an Hewlett-Packard spectrum analyzer. The absolute frequency can be read off the slide-rule type of frequency dial. Accuracy in this case is approximately 1% of full scale. It is also possible to use a counter and tracking generator to measure the frequency of signals on the CRT to much better accuracy.

The tracking generator is a source that tracks the spectrum analyzer tuning response. Hence, the tracking generator frequency is equal to the frequency the spectrum analyzer is tuned to. Counting the tracking generator frequency results in precision frequency measurements.

Absolute amplitude measurements

All Hewlett-Packard spectrum analyzers are absolutely calibrated for amplitude measurements. This means the spectrum analyzer indicates to the user what the log ref level or linear sensitivity is regardless of control settings. In addition, a warning light is available to signal any combination of control settings that leads to an uncalibrated condition. This makes operation of the analyzer easy and foolproof.

Dynamic range

The dynamic range of a spectrum analyzer is defined as the difference between the input signal level and the average noise level or distortion products whichever is greater. Hence, dynamic range

can be either distortion limited or noise limited.

Frequency and amplitude resolution

Frequency resolution is the ability of the analyzer to separate signals closely spaced in frequency. The frequency resolution of an analyzer is a function of three factors:

- 1) minimum IF bandwidth
- 2) IF filter factor
- 3) spectrum analyzer stability

The minimum IF bandwidth ranges from 10 Hz to 300 Hz on Hewlett-Packard spectrum analyzers.

IF filter factor is the ratio of 3 dB bandwidth to 60 dB bandwidth. Filter factor specifies the selectivity of the IF filter. Hewlett-Packard spectrum analyzers have IF filter factors as low as 11:1.

Analyzer frequency stability also limits resolution. The residual FM (short term stability) should be less than the narrowest IF bandwidth. If not, the signal would drift in and out of the IF pass band. Hewlett-Packard analyzers have excellent stability. The residual FM ranges from <1 Hz at low frequency, to <100 Hz at microwave frequencies. The stabilization circuitry is completely automatic and foolproof. No signal recentering, phase-lock loop manual search, or checking is required.

Amplitude resolution is a function of the vertical scale calibration. Hewlett-Packard analyzers offer both log calibration for observing large amplitude variations (10 dB/div and 2 dB/div) and linear calibration for observing small amplitude variations.

Sensitivity

Sensitivity is a measure of an analyzer's ability to detect small signals, and is often defined as the point where the signal level is equal to the noise level. Since noise level decreases as the bandwidth is decreased, sensitivity is a function of bandwidth. The maximum attainable sensitivity ranges from -140 dBm to -125 dBm with Hewlett-Packard analyzers.

Variable persistence

High resolution and sensitivity both require narrow bandwidths and consequently slow sweep rates. Because of these slow sweeps, variable persistence is virtually indispensable in providing a bright, steady, flicker-free trace. (In effect, variable persistence allows one to

vary the length of time a trace remains on the CRT.)

Tracking preselector

Spurious responses are generated when the analyzer is over-driven. In addition if an analyzer utilizes harmonic mixing, multiple and image responses can occur.

The only way to simultaneously avoid spurious, multiple, harmonic and image responses, is to filter the RF signal through a tracking preselector. This is an electronically tuned bandpass filter that automatically tracks the analyzer's tuning. A preselector improves the dynamic range of the analyzer from 70 dB to 100 dB.

Tracking generator

A tracking generator is a tracking signal source which tracks the tuning response of a spectrum analyzer. The tracking generator expands the measurement capability of the spectrum analyzer.

A tracking generator/spectrum analyzer is ideal for frequency response and return loss measurements. Inserting a test device between the tracking generator and analyzer results in a display of the insertion loss versus frequency or frequency response of the device. Return loss measurements versus frequency are also possible with a directional coupler or hybrid. The tracking generator also makes precision frequency measurements possible as described in "Absolute Frequency Measurements" above. In addition, the tracking generator is an excellent stable sweeping signal generator. The residual FM ranges from ± 1 Hz for low frequency tracking generators to ± 400 Hz for microwave tracking generators.

Wave analyzers

Wave analyzers offer another method of measuring both the amplitude and frequency of an input signal's component. A wave analyzer is similar to a spectrum analyzer. However, the characteristics of a wave analyzer are optimized for low frequency narrow band measurements.

The electronic sweeping and amplitude autoranging of the new HP 3590A wave analyzer permit X-Y and strip chart plots of amplitude versus frequency over a frequency range of 20 Hz to 620 kHz and a dynamic range of more than 85 dB.

A BFO output is available with Hewlett-Packard wave analyzers. This output corresponds to a tracking generator output in a spectrum analyzer. With a BFO output swept frequency response measurements are possible.

AUTOMATIC SPECTRUM ANALYZERS

Surveillance, stimulus/response testing to 18 GHz
Model 8580A Series



SPECTRUM ANALYZERS

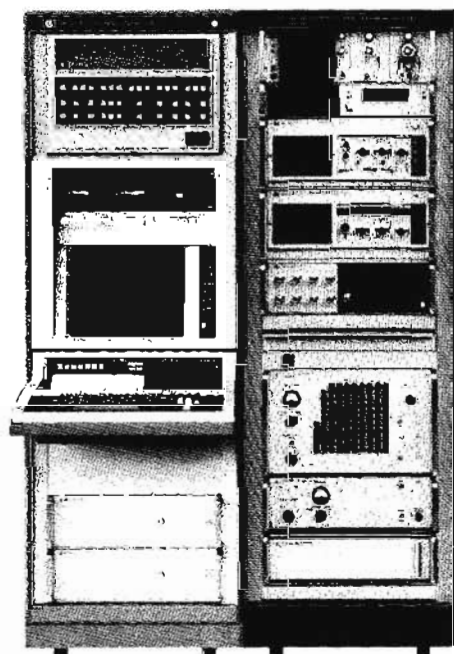

Representative
8580A System
Tailored for High
Speed Surveillance
of VHF, UHF Bands
.01-500 MHz

Description

The 8580A Automatic Spectrum Analyzers are flexible measurement systems for applications in surveillance and network characterization from 10 kHz to 18 GHz. These systems consist of a variety of programmable instruments that are controlled from a small instrumentation computer. The measurement heart is a calibrated receiver with programmable tuning and bandwidth. This receiver can be tuned from 10 kHz to 18 GHz by simple one line statements in BASIC or FORTRAN measurement programs. Receiver bandwidth is selectable from 10 Hz to 300 kHz. Other programmable system functions include input selection (up to 8 ports) and sensitivity (down to -130 dBm).

Optional signal sources expand the capability of the 8580 systems. Precision RF sources, with programmable level and frequency, supply signals required to excite test devices for network analysis measurements. Programmable dc power supplies are available for bias or to control ports of test devices.

Applications

The 8580A Automatic Spectrum Analyzers are valuable tools for gathering spectral density data on signals present in complex electronic equipment or in a geographic region. RFI testing, for example, is enhanced by the automatic system's ability to correct for sensor transfer functions and compare measured data against specification limits. Performance

of a complex communication network can be continually monitored to report network performance on a regular basis. Similarly, radiation in a particular locale can be surveyed to gather statistics on available spectrum or unauthorized transmissions. These applications emphasize an important feature of the Automatic Spectrum Analyzer; totally unattended operation. The 8580 may be programmed to measure, analyze, and record results, and hence run without human intervention, for long periods. This makes comprehensive monitoring a practical tool for spectrum management.

Network characterization is also greatly advanced through use of an Automatic Spectrum Analyzer. An 8580 can measure the magnitude of reflection and transmission coefficients of linear networks, as well as the distortion parameters (harmonic, intermodulation, cross-modulation) of non-linear devices such as amplifiers. Frequency translators such as mixers, modulators, and frequency multipliers are also readily characterized. Additionally, oscillators can be evaluated for output level, distortion, and spurious output signals.

For both surveillance and network characterization applications, the 8580's absolute calibration (frequency and power), broad frequency coverage, high frequency accuracy, wide measurement range, speed, and ease of programming, combined with the flexible hardware option list, offer a measurement system that can be tailored to your application. Contact your local Hewlett-Packard office for complete technical information.

SPECTRUM ANALYZERS



QUANTITATIVE SPECTRUM ANALYSIS 20 Hz to 40 GHz

The high value Spectrum Analyzer Family . . .

- Cover 20 Hz to 40 GHz with just a change of tuning section.
- Add measurement capability to your system as it is needed.
- Select a system from a wide choice of configurations.
- Enjoy the advantages of a fully calibrated solid state system.

Your Choice of . . .

tuning sections . . .

and companion instruments.

three display sections . . .

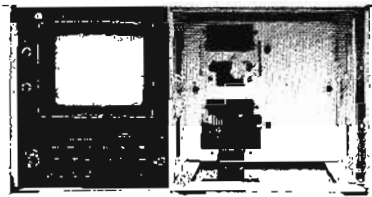

141T
Variable Persistence
Display

two IF sections . . .

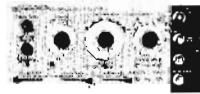

8552B
High Resolution IF

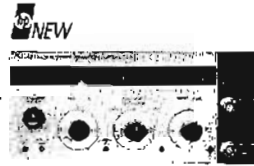

8556A
20 Hz-300 kHz



8553B
1 kHz-110 MHz



8554L
500 kHz-1250 MHz

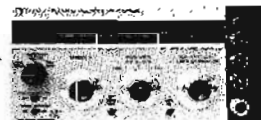

8555A
10 MHz-40 GHz



Built into 8556A
Tracking Generator
20 Hz-300 kHz



8443A/B
Tracking Generator
100 kHz-110 MHz



8444A
Tracking Generator
500 kHz-1250 MHz



8445A
Automatic Preselector
10 MHz-18 GHz



The Family Features . . .

AUTOMATIC TUNING STABILIZATION for narrow scans means operating ease.

DIGITAL FREQUENCY READ-OUT with counter accuracy is available with the 8443A. Counter outputs are supplied with the other tracking generators.

INTERNAL GRATICULE: Eliminates parallax reading errors which can contribute as much as 2 dB error to the signal amplitude reading.

A FREQUENCY MARKER helps the user select and identify the signal of interest. The **FREQUENCY** control positions the marker.

VARIABLE PERSISTENCE: Allows flicker-free slow scans. Slower scans are necessary when using the high resolution capability of today's analyzer.

MANUAL SCAN: Allows the setting up of accessories such as X-Y recorders, adjusting signals on screen during slow scans, and measuring frequency with a counter.

THE CALIBRATION WARNING LIGHT maintains absolute amplitude calibration by assuring the operator that the selected scan rate is not too fast for the bandwidth and video filtering chosen.

THREE CALIBRATED SCAN MODES—Preset, Per Division, and Zero Scan. The analyzer can scan over its full frequency range, a given scan width, or operate as a fixed tuned receiver.

SWEPT FREQUENCY RESPONSE MEASUREMENTS over 120 dB dynamic range of filters, amplifiers, networks, etc., are possible with a tracking generator.

A very stable **INTERNAL CALIBRATION STANDARD** for initial calibration of the spectrum analyzer.

A FULL SET OF RECORDER OUTPUTS for full recorder compatibility.

ABSOLUTE AMPLITUDE CALIBRATION: Means the calibration of the CRT, i.e., log ref level or linear sensitivity, is always indicated by the analyzer regardless of control settings.

Versatility of **THREE DISPLAY MODES**—linear, 10 dB/div, and 2 dB/div. The 2 dB/div is particularly useful for frequency response measurements.

VIDEO FILTERING: Allows easier observation of weak signals, and makes wide band noise and EMI measurements easier.

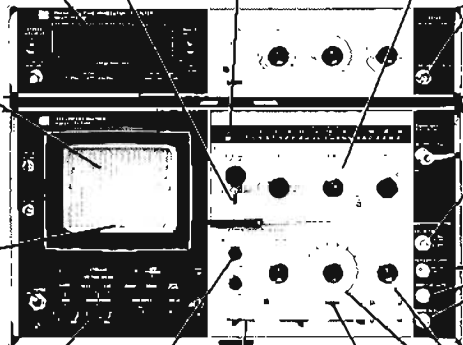

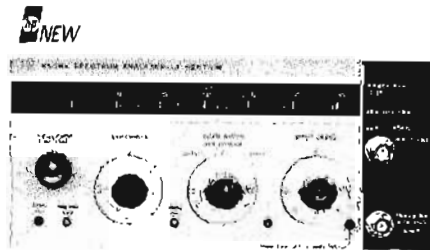
SPECTRUM ANALYZERS *continued***Tuning Section, IF Sections and Display Sections****The Tuning Sections . . .****8556A—20 Hz to 300 kHz**

- Absolute Amplitude Accuracy to ± 0.6 dB.
- 20 Nanovolt Sensitivity (-142 dBm 50Ω).
- High Resolution 10 Hz Bandwidth < 1 Hz Residual FM (with 8552B).
- Selectable Scan Widths—Preset from 0 or Symmetrical About Center Frequency.
- Built-in 0.01% Crystal Markers for Frequency Accuracy.
- Two Frequency Scales Selectable (0-30 kHz, 0-300 kHz).
- Fully Isolated High Impedance Input Useful with Compensated Oscilloscope Probes.
- Built-in Tracking Generator for Swept Frequency Response Measurements Over 120 dB Range.
- Counter Output for Precision Frequency Measurements.
- Price: \$1,690.

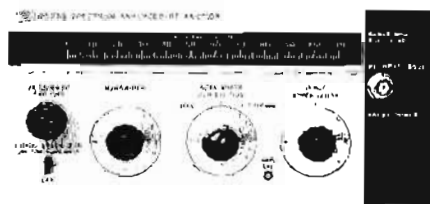
**8553B—1 kHz to 110 MHz**

- Absolute Amplitude Accuracy to ± 0.8 dB.
- Maximum Sensitivity -140 dBm (10 Hz Bandwidth).
- 10 Hz Resolution to See 60 Hz Sidebands 60 dB Down (with 8552B).
- Scan Widths from 200 Hz to 100 MHz.
- Frequency Accuracy ± 10 Hz with Tracking Generator.
- Two Frequency Scales Selectable (0-11 MHz, 0-110 MHz).
- Probe Power Provided for Use with High Impedance Active Probes.
- All Distortion Products 70 dB Down with -40 dBm to Mixer.
- Price: \$2,200.

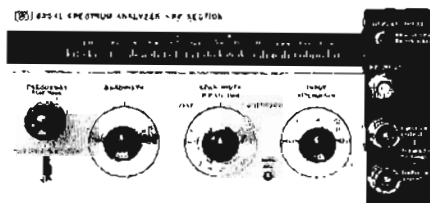
**8554L—500 kHz to 1250 MHz**

- Absolute Amplitude Accuracy to ± 1.6 dB.
- Sensitivity to -117 dBm (300 Hz Bandwidth).
- Residual FM Less Than 300 Hz.
- Scan Widths from 20 kHz to 1250 MHz.
- Frequency Accuracy ± 10 MHz.
- All Distortion Products 65 dB Down with -40 dBm to Mixer.
- Price: \$3,500.

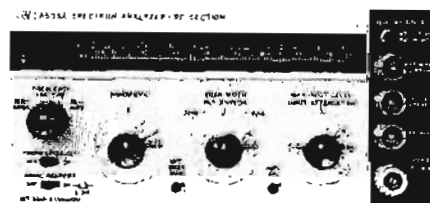
**8555A—10 MHz to 40 GHz**

- Absolute Amplitude Accuracy to ± 1.6 dB.
- Direct Coax Input to 18 GHz.
- Maximum Sensitivity -125 dBm (Fundamental Mixing, 100 Hz Bandwidth).
- High Resolution 100 Hz Bandwidth (30 Hz First LO Residual FM).
- Full Scans of 2, 4, 6, and 8 GHz Free of Unwanted Responses with Preselection.
- Frequency Accuracy ± 15 MHz (Fundamental Mixing).
- Price: \$5,975.

The IF Sections

8552B—High Resolution

- 11:1 IF Filter Factor (5-Stage Crystal Filter).
- 10 Hz Minimum Bandwidth.
- 10 dB/Div Log, 2 dB/Div Log, and Linear Displays.
- Video Filter 10 kHz, 100 Hz, and 10 Hz Positions.
- Calibrated Logarithmic and Linear Display Sensitivity Controls.
- Base Line Clipper for Better Viewing of Display.
- Price: \$2,900.

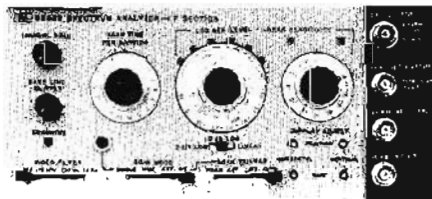

8552A—Economy

- 25:1 IF Filter Factor.
- 50 Hz Minimum Bandwidth.
- Log and Linear Displays (Log is 10 dB/Div).
- Video Filter 10 kHz and 100 Hz Positions.
- Calibrated Logarithmic and Linear Display Sensitivity Controls.
- Base Line Clipper for Better Viewing of Display.
- Price: \$2,200.

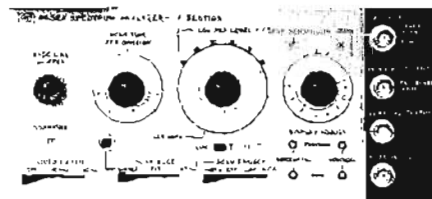

The Display Sections

141T—Variable Persistence

- Variable Persistence for Those High Resolution Slow Scans.
- Storage for Signal Comparison and Study.
- Conventional Standard Persistence Operation Available.
- Internal Graticule to Eliminate Parallax Reading Errors.
- Accepts Time Domain Oscilloscope Plug-ins as Well as Any Spectrum Analyzer Frequency Domain Tuning or IF Section.
- 8-Division Linear Display and 70 dB Logarithmic Display.
- Price: \$1,800.

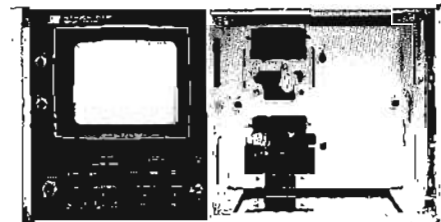

140T—Standard Persistence

- Standard Persistence P-7 Phosphor.
- Internal Graticule to Eliminate Parallax Reading Errors.
- Accepts Time Domain Oscilloscope Plug-ins as Well as Any Spectrum Analyzer Frequency Domain Tuning or IF Section.
- 8-Division Linear Display and 70 dB Logarithmic Display.
- Price: \$950.

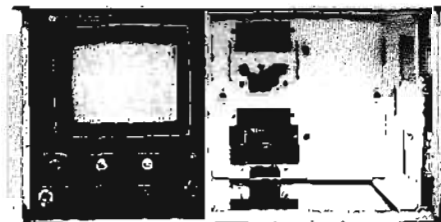

143S—Large Screen

- Large Screen Viewing for Demonstration, Lectures, Etc.
- Internal Graticule to Eliminate Parallax Reading Errors.
- Accepts Time Domain Oscilloscope Plug-ins as Well as Any Spectrum Analyzer Frequency Domain Tuning or IF Section.
- 8-Division Linear Display and 70 dB Logarithmic Display.
- Price: \$1,700.

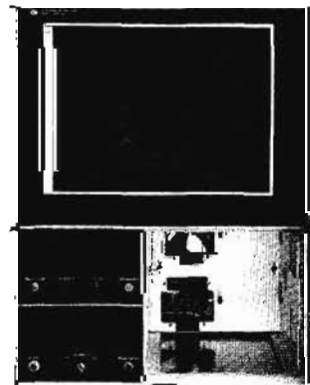



COMPANION INSTRUMENTS

Expand analyzer performance
100 kHz to 18 GHz

Tracking Generators

100 kHz-110 MHz

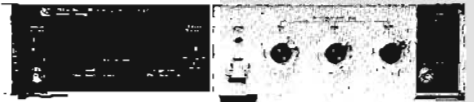

8443A

Price: \$3,500



8443B

Price: \$1,975

500 kHz-1300 MHz



8444A

Price: \$2,950

With the 8443, the 8553B system becomes a:

- SWEPT FREQUENCY RESPONSE MEASUREMENT SYSTEM
 - Frequency Resolution < 10 Hz
 - Amplitude Resolution 0.1 dB
 - Dynamic Range > 120 dB
- SWEEP GENERATOR
 - Residual FM < 1 Hz peak-to-peak
 - Calibrated Output -120 dBm to +10 dBm
 - Output Flatness ± 0.5 dB (8443A only)
 - Frequency Accuracy 10 Hz
- SELECTIVE FREQUENCY COUNTER (8443A ONLY)
 - Sensitivity 25 nV (-140 dBm)
 - Selectivity 10 Hz
 - Resolution 10 Hz

With the 8444A (use with 8554L or 8555A), the spectrum analyzer system becomes a:

- SWEPT FREQUENCY RESPONSE MEASUREMENT SYSTEM
 - Frequency Resolution 1 kHz
 - Amplitude Resolution 0.1 dB
 - Dynamic Range > 90 dB
- SWEEP GENERATOR
 - Residual FM 400 Hz peak-to-peak (8554L)
200 Hz (8555A)
 - Calibrated output 0 dBm to -10 dBm
 - Flatness ± 0.75 dB

Perform precision frequency measurements:

- EXTERNAL COUNTER OUTPUT
 - Unknown signals ± 10 kHz accuracy
 - Frequency response ± 400 Hz

Automatic Preselectors

8445A
10 MHz-18 GHz, Standard
1.8 GHz-18 GHz, Opt. 010



Price: Standard, \$2,000; Opt. 010, \$1,400

8445A
10 MHz-18 GHz, Opt. 020
1.8 GHz-18 GHz, Opt. 030



Price: Opt. 020, \$2,200; Opt. 030, \$1,600

With the 8555A tuning section, the 8445A preselector:

- ELIMINATES ALL UNWANTED RESPONSES.
- IMPROVES DYNAMIC RANGE by Eliminating Harmonic Distortion Products.
- IMPROVES ANALYZER INTERMODULATION DISTORTION Characteristics for Signals Spaced Down to 50 MHz.
- Prevents Analyzer LO Power from Interfering with Sensitive Circuitry.
- Allows Use of 2, 4, 6, AND 8 GHz SCANS for Signal Measurement Not Just Observation.
- Completely AUTOMATIC OPERATION Leaves User Free to Concentrate on Measurement Itself.
- DISCONNECTS FROM ANALYZER for Critical Measurements So That Maximum Analyzer Sensitivity and Best Frequency Response Are Available.

ACCESSORIES

Models 1121A; 8406A; 8430 Series; 8447 Series;
8721A; 10020A; 11517A



SPECTRUM ANALYZERS

High Impedance Probes

For making signal measurements without disturbing circuitry. (See Pages 363 and 140.)



1121A

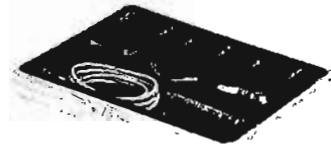

10020A

Passive Filters

To improve the performance of the analyzer by eliminating unwanted responses. (See Page 338.)



8430 Series

External Mixer

To extend the frequency range of the analyzer to 40 GHz. Taper sections for 12.4-18 GHz (11518A), 18-26.5 GHz (11519A) or 26.5-40 GHz (11520A) bands are required.

Price: \$200 (Mixer only).

\$125 (Taper sections each).



11517A

Directional Bridge

For making return loss measurements from 100 kHz to 110 MHz. (See Page 364.)

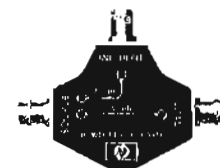

8721A

Preamplifiers

Improve noise figures of 8553B, 8554L and 8555A by 16 dB and more. (See Page 31.)

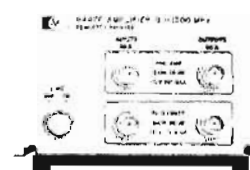

8447 Series

Comb Generator

For precision frequency measurements to .01% accuracy. Usable up to 5 GHz.

Price: \$675.

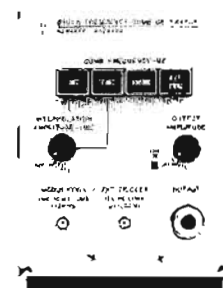

8406A

DIGITAL SIGNAL ANALYZERS



POWERFUL TECHNIQUES FOR LOW FREQUENCY ANALYSIS

- Analyze frequencies down to dc.
- Completely characterize random signals.
- Perform statistical analysis on-line.
- Get accurate results, using digital techniques.

These are some of the unique characteristics of the Hewlett-Packard line of Digital Signal Analyzers. These instruments are finding extensive use in situations where low frequency signals (below about 250 kHz) need to be analyzed in detail, on line, at a reasonable cost. The Digital Signal Analyzers are described on the following pages, 389-394.

What is DSA?

The signal analyzers described on the preceding pages are ideally suited to characterizing coherent or relatively noise-free signals. There are certain measurement problems, however, which they cannot solve. "Traditional" instrumentation typically is incapable of:

Analyzing random signals or signals obscured by noise.

Measuring the joint properties of two or more signals.

Computing complex statistical functions of a signal.

Analyzing very low frequency signals (below about 20 Hz).

In the past, these problems could be tackled only by a general purpose digital computer which was usually off-line and expensive, and required special training to operate. The DSA line offers the advantages of digital computation without these drawbacks, at considerably less cost than custom-built systems.

Figure 1 shows the basic functional components of a Digital Signal Analyzer. One or more inputs are sampled at regular intervals, Δt . A number of sampled amplitude values are converted to digital form and fed to the memory. The desired function is computed in the arithmetic unit using a series of input samples, and the result is again stored in memory. The contents of the memory can be read out to a display, allowing observation of the results during analysis. The whole operation is overseen by a controller.

Advantages

The use of digital techniques gives these analyzers several advantages over analog instruments. They are able to

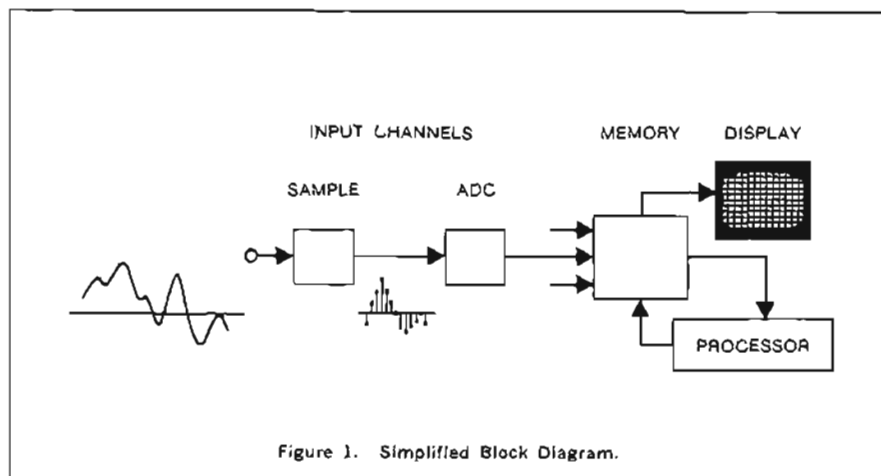

Figure 1. Simplified Block Diagram.

analyze very low frequency signals, down to dc, with high accuracy and stability. They are also flexible, being able to compute many different statistical functions with a wide variety of averaging times.

Equally important, digital signal analyzers are easy to use. They can be operated without special programming, and they have built-in, calibrated CRT displays for easy interpretation of results. Outputs to X-Y recorders for hard copy are standard, and each analyzer can be easily interfaced to a computer for further analysis of data.

These advantages have opened up several new applications for signal analysis, many of them in fields which are not traditional users of electronic instrumentation.

Applications

Here are just a few applications in which the benefits of digital signal analysis are particularly significant.

Bearing fault detection: Local vibrations of a bearing are detected using an accelerometer mounted on the bearing housing. The output of the accelerometer is fed to a Fourier Analyzer which can identify spectral "signatures" of the vibration signal. Such quantities as roughness, out of round, or lack of centering can modify the signature of a good bearing. Interpreting these signatures may require complex manipulation of the spectra; this is greatly simplified by use of the Fourier Analyzer's computer.

Certain localized faults, such as cracks or pits in the bearing surface, emit "clicks" each time they pass the point of contact. These are best detected by time averaging, which separates vibrations which are synchronous with shaft rota-

tion from those which are not. This averaging can be performed best by the 5480S Signal Analyzer which is a special purpose signal averager. The user therefore has a choice between the low cost unit for this specific operation, or the general purpose Fourier Analyzer, which can perform more complex analysis in addition to signal averaging.

Study of aerodynamic turbulence: Researchers in this area are very familiar with the advantages of statistical analysis for extracting information from low frequency random signals. In particular, the cross-correlation function between the outputs of two transducers down stream from a model in a wind tunnel can measure the way in which turbulence decays as it progresses down the stream. Model 3721A Correlator can measure this correlation function much more rapidly and conveniently than an off-line computer.

Measurement of dynamic system response: New techniques of testing such systems as aircraft servos, process control systems, and voice communication channels involve the use of noise as a test signal. The advantages of noise are that it contains all frequencies in the band of interest, and it simulates the kind of signals which perturb these systems during normal operation. Measurement of the cross-correlation, transfer, and coherence functions between the noise input and the output of these systems can characterize them very rapidly even during normal operation, in the presence of other signals.

There are many other areas in which DSA is proving a useful measurement tool. Further information is available in the form of application notes for each instrument in the line.

FOURIER ANALYZERS

Modular design for flexibility
Models 5451A, 5470A, 5471A



SIGNAL ANALYZERS

Application areas:

- Vibrations
- Underwater sound
- Communications
- Biomedicine
- Many others

Features:

- DC to 25 kHz frequency range
- 80 dB dynamic range
- Real time analysis—three speeds to choose from
- Relocatable software
- Keyboard control—no software knowledge needed

Description

The 5451A Fourier Analyzer can provide the complete answer to low frequency signal analysis problems. The latest in a highly successful line of Fourier analyzers, the 5451A employs powerful mathematical techniques such as the Fourier Transform and statistical averaging to obtain information from even the most obscure, noisy signals. Completely digital operation assures maximum accuracy with system flexibility. Real time analysis is a standard feature. The optional 5470A Fast Fourier Processor and 5471A FFT Arithmetic Unit give the system three processing speeds. A controlling, measurement oriented keyboard controls all operations. Complete measurement routines are available at the touch of a button. Incoming signals and results of all computations are displayed on the integrated CRT and display plug-in. The dual channel analog-to-digital converter completes the system and provides simultaneous sampling

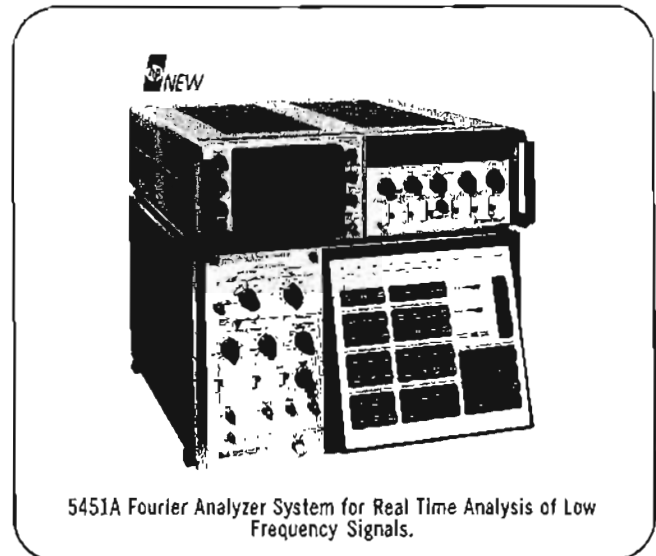

5451A Fourier Analyzer System for Real Time Analysis of Low Frequency Signals.

of two or more signals for calculation of transfer and coherence functions, cross correlation, etc.

For complete information on pricing, options and technical performance consult your local Hewlett-Packard sales office.

System prices start at about \$35,000.

5471A Arithmetic Unit

Low cost, hardwired fourier transform arithmetic unit

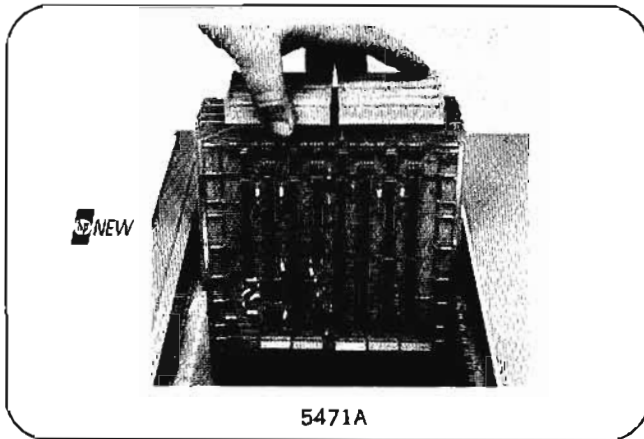

5471A

Features:

- Fourier Transform (1024 point) in 160 msec*
- Low cost
- 4 to 2048 point transforms
- In place averaging

Description

The 5471A Fast Fourier Transform Arithmetic Unit acts as an expanded EAU to increase processing speeds of the 5451A by a factor of six. In addition, this arithmetic unit may be plugged into any HP 2100 Series Computer to give hardwired Fourier Transform capability. The 5471A is supplied with an Assembly or Fortran callable driver for stand alone use and is integrated into the 5451A software for system use. In addition to Fourier transforms of 4 to 2048 points, the 5471A performs block multiplication, addition, conjugate multiplication, scaling and HANNING. Double precision is selectable on some operations.

Price: \$4500.

* With 2100A

5470A Fast Fourier Processor

High speed signal analysis at an attractive cost

Features:

- Fourier Transform (1024 points) in 15.2 msec
- Internal 4K memory, 8K optional
- Parallel processing with host computer
- Two may be paralleled for super-fast processing

Description

The 5470A Fast Fourier Processor is a high speed processor designed to increase processing speeds of a 5451A System or any HP 2100 Series Computer. Its internal memory allows parallel processing with the host computer. Operations include 64 to 2048 point Fourier transforms (4096 optional), block multiplication, addition, conjugate multiplication, block scaling and HANNING. Double precision is selectable on some operations. The 5470A interfaces through two I/O slots and may be used with any Hewlett-Packard computer with its Assembly or Fortran callable driver. Prices start at \$25,000.

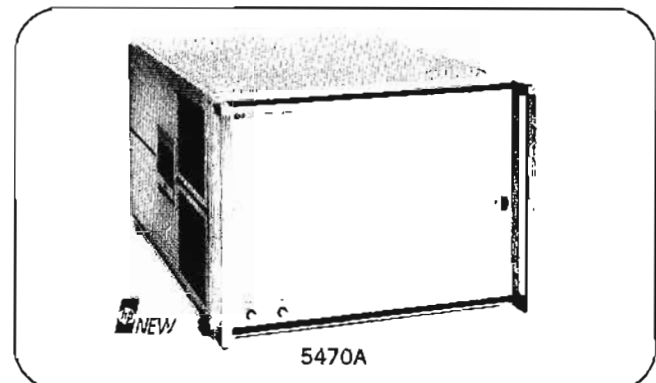

5470A

SIGNAL ANALYZERS



SIGNAL ANALYZER

Signal averaging and statistical analysis

Models 5480S, 5481A, 5494A

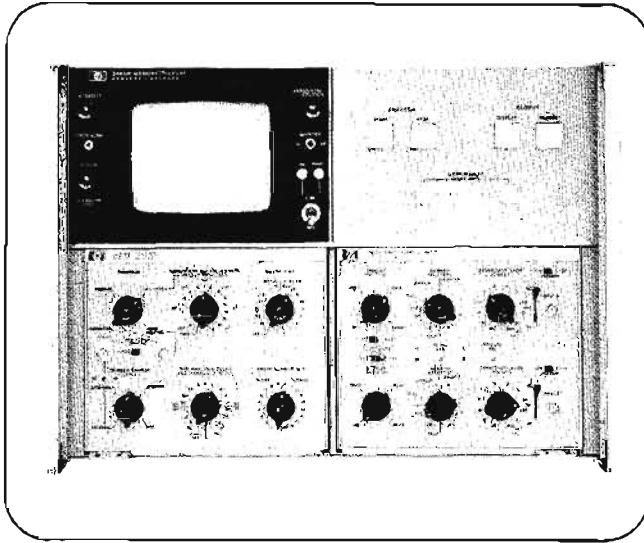

5480S Signal Analyzer

Signal averaging provides an unparalleled method of recovering a signal buried in background noise. Featuring true and weighted averaging, real time variance, and the ability to measure correlation functions and histograms, the 5480S brings a new dimension to the analysis of noisy signals.

True averaging: Display always represents true average calibrated in volts per centimeter; the display does not "grow" as in conventional summation but remains stable as the noise disappears.

Flicker free: Continuous display for all sweep speeds allows viewing the accumulated data while acquisition takes place.

Variance: The statistical variance is a measure of the variability of a signal. The 5480S gives you, point by point, real time variance which allows you to spot variations in your signal or tells you exactly when the display represents the true average.

Weighted averaging: A time varying signal may be observed in this mode which exponentially de-emphasizes old information in favor of new.

Multiple inputs, correlation: The 5485A Two Channel Input and the 5487A Four Channel Input plug-ins offer multiple channel capability. The 5488A Correlation/Average Input permits auto and cross-correlation of signals as well as two input channels for averaging.

Input filtering: Each 5480S System includes the 5489A Two Channel Input Filter; in addition to removing high frequency noise to reduce averaging time, the X10 gain provided by the 5489A increases resolution (page 393).

Histograms: The 5480S provides frequency and time interval histograms, and multichannel scaling. This capability can be extended with the H15-5326B, to include trend analysis, such as post stimulus histograms, and dwell and latency histograms.

H15-5326B Counter: A modified 5326B (catalog page 222), this unit can set precise threshold levels for dwell and latency histograms, and provides a gated output for time interval trend analysis.

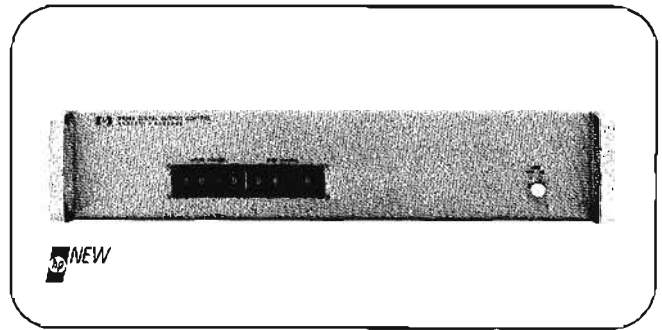

5494A Digital Output Control

The 5494A interfaces the 5480S to a HP 5050B or 5055A Digital Recorder, for print-out. The 5494A converts binary data from the analyzer into Binary Coded Decimal (BCD), and controls "handshaking" between the instruments. Any number of points may be selected for output, the amplitude (in cm) of each selected point being printed together with the point's address for identification.

The 5494A output is also compatible with the BCD input card of the 2570A/2575A couplers. Through the coupler, data can be transferred directly to, for example, a desk top calculator, (Model 9100A/B), for on-line data manipulation.

5481A Signal Analyzer System

Combining the 5480S with the HP 2100A Digital Computer, the 5481A Signal Analyzer System permits extensive on-line analysis of gathered data. Fourier transforms, power spectra, curve integration, smoothing, and differentiation, and many other data manipulating functions are possible. Or the 5481A System may be used for automating your other instrumentation providing you with multiplexed analog to digital conversion, display output on built-in 5480 oscilloscope, a 1000 word buffer memory, and controlling software.

Prices

All 5480S Signal Analyzer Systems include the 1024 word, 24 bit Memory/Display mainframe, the 5486B Control Plug-in, and the 5489A Two Channel Low-Pass Filter/Amplifier; the digitizing plug-in is chosen by option.

5480S Signal Analyzer	\$9950
Opt 01 5485A Two Channel Input	N.C.
Opt 02 5487A Four Channel Input	+ \$ 375
Opt 03 5488A Correlation/Average Input	+ \$ 475
5489A Low-Pass Filter	\$ 425
5494A Digital Output Control	\$1750

The basic 5481A Signal Analyzer System includes the 5480S, the 2100A Digital Computer, the 2752A Teleprinter, and the 10625A Interface with complete software.

5481A Signal Analyzer System \$26,200

Complete specifications available on the 5480B Technical Data Sheet. Consult ordering information guide for pricing details.

CORRELATOR, SPECTRUM DISPLAY

Real-time statistical signal analysis system
Models 3721A, 3720A



SIGNAL ANALYZERS

3721A Correlator

The Model 3721A Correlator is a digital statistical signal analyzer covering the range dc to 250 kHz. It computes autocorrelation, crosscorrelation, and amplitude probability functions. In addition, a signal recovery facility uses signal averaging to improve the signal-to-noise ratio of a repetitive signal buried in noise. The resultant functions are displayed on a built-in CRT.

The versatile analysis and averaging capabilities combined with portability, automatic calibration, built-in CRT and real-time operation make the 3721A an ideal analyzer for both laboratory and field use.

Major Specifications

Input signal bandwidth: dc to 250 kHz.

Input range: 40 mV rms to 4 V rms.

Functions: Autocorrelation, Crosscorrelation, Probability (Density and Integral), Signal Recovery.

Number of points: 100 points computed and displayed for each function.

Sampling interval: 1 s to 1 μ s (1 Hz to 1 MHz sampling rates). External clock facility allows any interval $\geq 1 \mu$ s to be selected. In Correlation and Signal Recovery the time between displayed points is equal to the sampling interval.

Averaging: two modes are provided:

Summation: computation automatically stopped after a fixed number of samples has been taken. Number of samples selectable from 128 to 128×1024 .

Exponential: continuous averaging with time constant selectable from 36 ms to over 10^7 seconds.

Calibration: vertical calibration is automatically displayed on an illuminated panel (except Probability).

Outputs:

All computed functions are displayed on the built-in CRT. Analog outputs are provided for use with an X-Y recorder and external oscilloscope.

Digital outputs allow the transfer of computed data to any hp digital computer or hp paper tape punch (2753A, 2895A or 8100A). Extra plug-in assemblies are required, type depending on the peripheral used.

Price: Model 3721A \$7,600.

3720A Spectrum Display

The 3720A Spectrum Display is a unique add-on unit for the Correlator, to complement and extend its capability by Fourier transforming any time display on the 3721A and presenting its equivalent frequency function on a built-in display.

The 3720A performs the Real and/or Complex transformation of autocorrelation and crosscorrelation functions to produce the Power and Cross Spectral Density functions respectively, and converts signal recovered data into frequency information.

Together the 3721A Correlator and 3720A Spectrum Display, each with its own CRT display, form an analysis system giving both time and frequency information simultaneously.

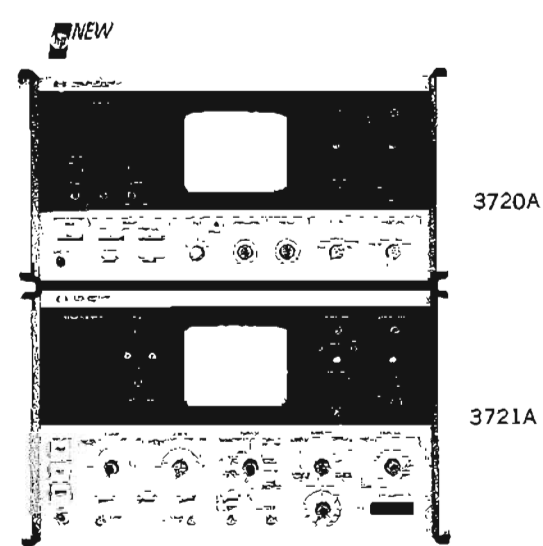

Major Specifications

Input data: digital data is transferred from the Correlator and held in either of two stores, labelled 1 and 2.

Computed transforms: either the Real or Complex transform can be computed of the contents of the store 1, the contents of store 2, or the contents of stores 1 and 2 together.

Frequency range: 0.005 Hz to 250 kHz using internal 3721A clock. Extendable down to dc with external clock.

Displayed frequency range: two decades of frequency are displayed, the highest frequency being $\frac{1}{2} \Delta t$ Hz (Δt is the 3721A Timescale setting).

Dynamic range: ratio of full scale signal to noise level, for fixed integrator gain, is better than 50 dB. Variable over a 40 dB range by integrator gain control.

Integrator gain: continuously variable over a 2 decade range in seven discrete steps, with intermediate vernier.

Windows: two choices are available:

OFF—natural window, nominal bandwidth $1/200 \Delta t$.

ON—triangular window, nominal bandwidth $1/100 \Delta t$.

Interpolation: two modes available:

MANUAL—computes and displays 100 frequency points.

Frequencies of all 100 points can be simultaneously and equally varied over a frequency interval, $1/200 \Delta t$.

AUTO—automates the manual interpolation, calculating 10 equispaced points across each frequency interval.

Transform presentation: all combinations of the following axes are available for display.

Vertical axis—Phase, Log Mod, Modulus, Imaginary, Real.

Horizontal axis—Frequency, Log Freq, Real, Phase.

CRT display: built-in variable persistence CRT with storage facility.

X-Y recorder: separate horizontal and vertical analog outputs corresponding to the CRT display.

Price: to be announced.



NOISE GENERATOR; FILTER

Calibrated noise; low pass filter/amplifier

Models 3722A; 5489A



3722A

The Model 3722A Noise Generator uses digital techniques to synthesize binary and Gaussian noise patterns. These 'pseudo-random' patterns, which are of known content and duration, are repeated over and over without interruption. Since one pattern is identical with the next, each pattern has the same effect on the system under test: for this reason, pseudo-random noise signals cause no statistical variance in test results. The Model 3722A also generates truly random binary and Gaussian noise.

The basis of the Model 3722A is a binary waveform generator—a shift register which operates under the control of either a feedback mechanism (pseudo-random mode) or a random noise source (random mode). The shift register is clock triggered, with the result that transitions between output levels of the binary waveform can occur only in time with beats of the clock—although whether or not a transition occurs on a given beat is determined by the feedback mechanism or random noise source. The binary output has a $(\sin x/x)^2$ shaped spectrum and the Gaussian output, which is derived from the binary signal by precision low-pass filtering, has an almost rectangular spectrum. Both binary and Gaussian outputs are controllable in bandwidth, but the output power remains constant regardless of selected bandwidth—a particularly useful feature, of importance in applications where usable noise power must be made available in a very restricted frequency band. The frequency of the first null in the binary spectrum is selectable from 0.003 Hz to 1 MHz, and the bandwidth (at -3 dB point) of the Gaussian noise is selectable from 0.00015 Hz to 50 kHz.

Outputs from the Model 3722A are available at fixed amplitudes of ± 10 V (binary) and 3.16 V rms (Gaussian), and a precision amplitude control provides a variable output of either signal ranging from 0.1 V rms up to the level of the fixed outputs.

Specifications

Binary output (fixed amplitude)

Amplitude: ± 10 V.

Output impedance: $< 10\Omega$.

Load impedance: 1 k Ω minimum.

Rise time: < 100 ns.

Power density: approximately equal to (clock period \times 200) V²/Hz at low frequency end of spectrum.

Power spectrum: $(\sin x/x)^2$ form: first null occurs at clock frequency, and -3 dB point occurs at $0.45 \times$ clock frequency.

Gaussian output (fixed amplitude)

Amplitude: 3.16 V rms.

Output impedance: $< 1\Omega$.

Load impedance: 600 Ω minimum.

Zero drift: < 5 mV change in zero level in any 10°C range from 0° to +55°C.

Power density: approximately equal to (clock period \times 200) V²/Hz at low frequency end of spectrum.

Power spectrum: rectangular, low-pass: nominal upper frequency f_0 (-3 dB point) equal to $1/20$ th of clock frequency. Spectrum is flat within ± 0.3 dB up to $1/2 f_0$, and more than 25 dB down at $2 f_0$.

Crest factor: up to 3.75, dependent on sequence length.

Variable output (Binary or Gaussian)

Amplitude (open circuit)

Binary: 4 ranges: ± 1 V, ± 3 V, ± 3.16 V and ± 10 V, with ten steps in each range, from $\times 0.1$ to $\times 1.0$.

Gaussian: 3 ranges: 1 V rms, 3 V rms and 3.16 V rms, with ten steps in each range, from $\times 0.1$ to $\times 1.0$.

Output impedance: 600 $\Omega \pm 1\%$.

Main controls

Sequence length switch: first 17 positions select different pseudo-random sequence lengths: final position selects random mode of operation (INFINITE sequence length). Sequence length (N) is number of clock periods in sequence: possible values of N are 15, 31, 63, 127, 255, 511, 1023, 2047, 4095, 8191, 16383, 32767, 65535, 131071, 262143, 524287, 1048575.

$N = 2^n - 1$, where n is the range 4 through 20.

Clock period switch: selects 18 frequencies from internal clock:

Clock period	Clock frequency	Gaussian noise bandwidth
333 s	0.003 Hz	0.00015 Hz
100 s	0.01 Hz	0.0005 Hz
33.3 s	0.03 Hz	0.0015 Hz
10 s	0.1 Hz	0.005 Hz
3.33 μ s	300 kHz	15 kHz
1 μ s	1 MHz	50 kHz

Internal clock

Crystal frequency: 3 MHz nominal.

Frequency stability: ≤ 25 ppm over ambient temperature range 0° to +55°C.

Output: +12.5 V rectangular wave, period as selected by CLOCK PERIOD switch.

External clock

Input frequency: usable BINARY output (pseudo-random only) with external clock frequencies up to 1 MHz.

Input level: negative-going signal from +5 V to +3 V initiates clock pulse.

Maximum input: ± 20 V.

Secondary outputs

Sync: negative-going pulse (+12 V to +1.5 V) occurring once per pseudo-random sequence; duration of pulse equal to selected clock period.

Gate: gate signal indicates start and completion of selected number of pseudo-random sequences (1, 2, 4 or 8, selected by front panel control). Two outputs are provided:

1. Logic signal: output normally +12.5 V, falls to +1 V at start of gate interval and returns to +12.5 V at end of interval.
2. Relay changeover contacts: gate relay switching is synchronous with logic signal.

Binary relay: relay changeover contacts operate in sync with binary output signal.

Remote control

Control inputs: remote control inputs for RUN, HOLD, RESET and GATE RESET functions are connected to 36-way receptacle on rear panel.

Sequence length indication: 18 pins plus one common pin on the 36-way receptacle are used for remote signalling of selected sequence length (contact closure between common pin and any one of the 18 pins).

General

Dimensions: 16 3/4 in. wide, 5 7/32 in. high, 16 3/8 in. deep (425 x 132.6 x 416 mm).

Weight: net 23 lbs (10.5 kg); shipping, 30 lbs (13.5 kg).

Price: Model 3722A, \$2,755.

Option 001

Zero moment option: shifts relative position of sync pulse and pseudo-random binary sequence such that first time moment of sequence, taken with respect to sync pulse, is zero (sequence shift mechanism is operative only when selected sequence length is ≤ 1023); option 001 also provides facility for inverting binary output signal. ADD \$58.

Model 3722A Option H01

Model 3722A Option H01 is a standard Model 3722A Noise Generator modified to provide a second binary output which can be delayed by a selectable number of clock periods with respect to the main binary output. The delayed binary output is available only when the instrument is in the pseudo-random mode, that is, generating repeated noise patterns.

The delay introduced between the two binary outputs is selected by three decade switches on the front panel. These switches, which are set according to a conversion table supplied with the instrument, provide almost all possible delays ranging from zero to the number of bits (N) in the sequence in use.

Specifications**Delayed binary output**

Typical performance figures for the delayed output are:

Amplitude: switches between +1.5 V and +12 V.

Maximum sink current at 1.5 V level: 10 mA.

Rise time: < 50 ns.

Fall time: < 20 ns.

Price: Model 3722A Option H01, \$3,015.

5489A Low Pass Filter/Amplifier

The model 5489A is a high quality two channel filter of remarkably small size and low cost. It is intended for general purpose use, and is recommended for use with all the analyzers described in this section of the catalog.

Variable bandwidth and gain

The 5489A has a low pass Butterworth response, having an attenuation slope of 12 dB/octave above the cut-off frequency. The bandwidth of each channel is selectable from DC-1 Hz to DC-30 KHz in 10 steps. In addition, the gain of each channel may be set to either X1 or X10, allowing simultaneous amplification and filtering. Both channels may be cascaded to increase the gain to X100 and steepen the attenuation slope to 24 dB/octave.

Specifications**General:**

Cutoff Frequency (3 dB attenuation): 1 Hz to 30,000 Hz. Selectable in 1, 3, 10 steps and OUT (by-pass). Frequency accuracy $\pm 10\%$ except 30,000 Hz setting.

Maximum Attenuation: 80 dB.

Passband Gain: X1 (0 dB) $\pm 1\%$ or X10 (20 dB) $\pm 3\%$.

Noise and Hum (Referred to input, with 1 K Ω source impedance): 100 μ V rms in 50 kHz band. 250 μ V rms in 500 kHz band.

DC Offset Drift (Referred to input with 1 K Ω source impedance): 100 μ V/ $^{\circ}$ C.

Input:

Range: ± 10 Volt P-P on X1 gain, ± 1 Volt P-P on X10 gain.

Protection: Protected to ± 30 Volts.

Impedance: 1 megohm shunted by 75 pF, Single-ended.

Output:

Level: ± 10 Volts, maximum, at ± 5 mA, DC through 10 kHz.

Slew Rate: 0.6 V/ μ s, maximum.

Protection: May be shorted to ground indefinitely.

Overload Recovery: 50 μ s for 100% overload.

Output Impedance: 50 ohms, nominal, single-ended.

Physical:

Environmental: Operating Range, 0 to 55 $^{\circ}$ C.

Power: 115/230 V ac, 50-400 Hz, 10 Watts.

Weight: Net 2 lbs, 4 oz. (1.1 kg).

Size: 11 1/2" high x 5 1/8" wide x 6" long (3.8 x 1.3 x 15.2 cm).

Price: 5489A\$425

SPECTRUM ANALYZERS



REAL-TIME AUDIO ANALYZER

60 dB display dynamic range/computer compatible
Model 8064A/8065A

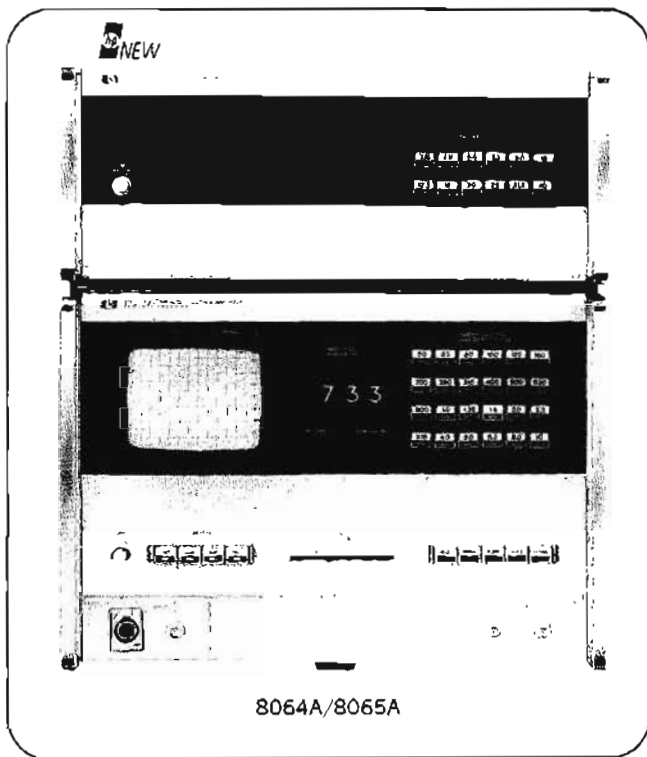

The 8064A Real Time Audio Spectrum Analyzer measures low frequency (under 50 kHz) phenomena continuously as they occur: real-time.

In a real-time measurement, data must be presented in usable form at essentially the same time the event occurs, and the delay in presenting the data must be small enough to allow a corrective action to be taken if required. An advantage of measuring in real time is that the effects of external adjustments or changes in measurement parameter can be seen immediately and acted upon if necessary. Measurements that previously took many hours to complete can now be performed in a few seconds with the Hewlett-Packard 8064A.

Electrical signals from a suitable transducer or other source are input to the analyzer where they are fed via a preamplifier to a parallel bank of active filters. These filters divide the spectrum into 24 channels each one-third octave wide. Up to 12 additional channels are available in the 8065A Real Time Analyzer Module giving a total of 36 parallel channels. These filter channels can be chosen within the frequency band of 2 Hz to 40 kHz. Each filter feeds an RMS detector which provides a choice of two time constants within 50 ms to 10 sec range to suit the kind of measurement to be made. The intensities at the detector outputs are sampled in turn, converted into signals which are displayed altogether on a CRT. The signals displayed can be read directly in dB with the aid of a scaling bar projected on the CRT screen. The scaling bar shifts as the user shifts the 60 dB display within the total 140 dB measurement range. An

overload light flashes to warn of signals that overload the preamplifier or the filter inputs.

In addition to providing a choice of time-constants, there is a storage facility behind the detectors so that the display can be held at any instant, or indicate the maximum value obtained during a series of measurements. The level of any desired channel can be displayed digitally, with a resolution of 0.1 dB while the selected channel will be intensified on the CRT. The CRT display also can be recorded on an X-Y recorder. The analyzer can be operated as a self-contained instrument or as a part of a data acquisition recording or processing system. For system operation the following facilities are provided: a) Two digital outputs with scanning rate of 1 ms per channel (independent of the CRT display). This scan can be controlled by computer or other remote device. The digital outputs comprise channel identification and indication of overload and overrange or underrange, and whether there is a pre-weighting network switched in. Thus, it is possible to operate two separate peripherals at the same time, e.g. computer and digital printer or other digital peripheral. It is possible to operate a tape punch via interface card which can be plugged into the 8064A. b) Remote control of range, time constants, display mode and scanning mode by computer or other programming device.

Applications

The 8064A's broad application areas are mainly measurement sounds that affect the human ear in some way. Channels with a one-third octave bandwidth have been shown through scientific research to be optimum for this kind of measurement: a finer resolution does not yield any additional useful data. These broad application areas involve:

- a) Product noise control. Evaluation and quality control of noisy products, for example, tire noise analysis or diesel engine production control.
- b) Noise abatement. Questions like how to build a quieter building or how to make a quieter car.
- c) Acoustic research, for example, in anechoic chambers.

Supplementary equipment

The following output devices can be connected directly to the HP 8064A:

- 5055A Digital Printer
- 7035B X-Y Recorder
- 1300A X-Y Display
- 680M Strip Chart Recorder
- 8100A Tape Punch + 15197A Interface

15189A Computer Interface Kit for 2100 series computer, allows computer controlled data acquisition and remote programming of the 8064A.

AIRCRAFT NOISE MONITORING SYSTEM

Fully automatic, computerized, expandable
Model 80500A



SIGNAL ANALYZERS

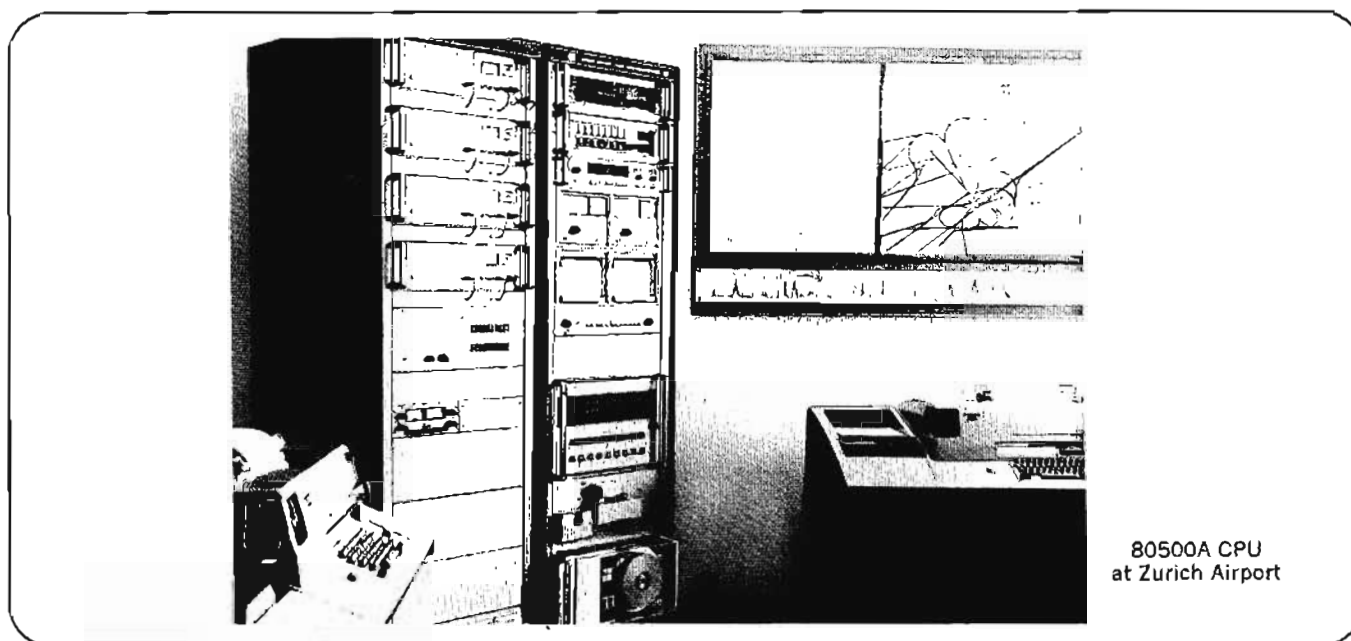

80500A CPU
at Zurich Airport

The Hewlett-Packard 80500A Aircraft Noise Monitoring System monitors sound at a number of locations (terminals) in or around an airport. The sound levels detected at the various noise monitoring terminals are transmitted to a central processing unit which stores sound level data, makes audible and visible signals in response to "excessive" noise levels, provides immediate printed violation reports and prints statistical data either periodically or on request.

In the event of a noise level violation, the immediate availability of data enables authorities to identify the offending aircraft while still in the vicinity of the airport. Thus corrective action such as instructing the pilot to alter his flight route or scheduling an inspection of the aircraft can be initiated at the time of violation.

The 80500A Aircraft Noise Monitoring System, in addition to detecting excessively noisy aircraft, provides a record of noise events which is essential in airport noise abatement studies.

Measurements originating from each terminal are processed in the computer. Flexible software enables the sound level to be averaged on an energy basis over short or long periods of time. Weighting factors which take the time of day or night into consideration can easily be included. Other methods of evaluation based on the dB (A) or dB (D) sound level data are possible: Noise Number Index, Community Noise Exposure Level, Total Noise Exposure Level, etc.

Under control of a standard Hewlett-Packard program the system constantly monitors sound levels in the range of 70 to 120 dB (A). Events exceeding 80 dB are reported on a teleprinter, and if the sound level at one of the monitoring terminals exceeds a limit (set individually by the operator for each terminal), the system gives a visual and audible alarm.

The system consists of the following two basic sub-systems: a central processing unit (CPU) and a noise monitoring terminal (NMT). The CPU consists of: A computer for real time data acquisition and off-line compilation of statistics.

A data acquisition sub-system to scan telephone lines under computer control and to convert frequency modulated signals from NMT's into digital data for further processing.

An analog recording sub-system (optional) to record sound level of manually selected NMT's on a strip chart recorder.

A tape reader for program loading and data input.

A tape punch for data storage.

Teleprinters for printed reports and typing in program parameters.

The noise monitoring terminals (four of them may be enough for a small airport, 24 may be appropriate for a larger airport) consists basically of:

An outdoor microphone to convert sound pressure into analog signal.

A sound level detector that provides a linear volts per decibel signal.

An analog-to-frequency converter to provide signals that can be sent to the CPU via telephone lines.

Miscellaneous—power supply, telephone line matching transformer, control unit for remote calibrating and testing.

The whole system, even the outdoor microphones, meets the requirement of ICAO recommendations $\frac{1}{2}$, $\frac{1}{3}$, and $\frac{1}{4}$ as well as IEC recommendation 179.

For complete system information or a quotation on an 80500A Aircraft Noise Monitoring System designed to meet the special requirements at your airport, call your local Hewlett-Packard field engineer. System prices vary with the number of Noise Monitoring Terminals, optional instrumentation, and computer peripheral equipment options.

SPECTRUM ANALYZERS



NOISE GEN/MISC. ACCESS.

Precise signals/transducers & accessories

Models 8057A, 8056A, 15118A, 15105A,
15170A, 15114, 15127A, 15117A

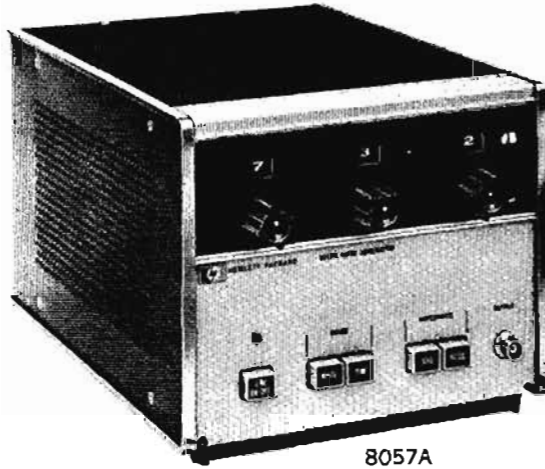

8057A

Model 8057A Precision Noise Generator

The Hewlett-Packard 8057A Precision Noise Generator is an audio frequency noise generator producing pseudo-random signals, available at binary and Gaussian distribution outputs. These signals are repeated noise patterns of known content and duration. Both white and pink noise with an equal rms value can be selected by pushbuttons. By producing a defined rms value, the high stability of the output level allows the use of a directly calibrated attenuator with 0.1 dB resolution. This makes the 8057A a highly accurate noise source. The frequency spectrum goes from dc to 26 kHz. White and pink noise is pushbutton selectable as well as output impedance 50 Ω or 600 Ω .

8056A Filter Set

The HP Model 8056A Filter Set comprises twenty-four $\frac{1}{3}$ octave wide filters with center frequencies in the range 2 Hz to 40 kHz (the standard version covers the range from 50 Hz to 10 kHz). Octave filters and broadband weighting networks A, B, C, D are available on special order. The unit has front panel controls for continuously adjustable spectrum shaping of ± 20 dB in each channel. Parallel and summing outputs are built in.

Transducers, Accessories

High quality pick-ups for sound and vibration

Model 15119C $\frac{1}{2}$ -inch Condenser Microphone, consisting of cartridge, preamplifier, and 10-foot cable is the stan-

dard tool for making acoustical measurements. The 15119D $\frac{1}{2}$ -inch Condenser Microphone offers high precision measurements with closer tolerances than with the 15119C. Both versions have a smooth, slender, cylindrical construction to ensure a virtually negligible disturbance of the sound field by the microphone itself.

Hewlett-Packard also offers a 1-inch Condenser Microphone Model 15109B for measuring extremely low sound levels. The 15109B is 10 dB more sensitive than the $\frac{1}{2}$ -inch microphones.

15118A and 15108A Preamplifiers

The 15118A and 15108A preamplifiers are microphone assemblies without cartridge. The built-in preamplifiers are all solid state with source-follower FET input stages: input impedance greater than 1000 M Ω in parallel with 2 pF. With essentially unity gain, the preamplifiers make excellent impedance converters for vibration pick-ups (accelerometers).

15114A Microphone Power Supply

The 15114A Power Supply permits the use of Hewlett-Packard Microphone Assemblies and Preamplifiers with instruments which do not provide the necessary voltage or connector. The 15114A can be operated for at least eight hours from four standard 1.5 volt cells.

15127A Cable Amplifier

The 15127A Cable Amplifier permits Hewlett-Packard Microphones and Preamplifiers to be operated at a distance of up to 330 feet (100 meters). The unity gain may be changed to 10 dB by a simple wiring change.

15117A Sound Level Calibrator

The 15117A is a precision acoustic signal source for field calibration of acoustic instrumentation which uses Hewlett-Packard 1-inch or $\frac{1}{2}$ -inch microphones. The calibrator produces a 1 kHz sound at sound levels selectable between 94 dB and 124 dB, as well as a 1 V rms, 1 kHz electrical sine-wave signal.

Direct calibration of sound-measuring equipment without using a microphone is also possible with the 15117A, since the 1000 Hz electrical signal is available from a telephone jack in the side of the instrument. This source provides 1 volt rms (120 dB above 1 μ V) into an open circuit, with an accuracy of ± 0.1 dB, independent of the acoustic signal level setting.

MULTICHANNEL ANALYZER

8192 channel, 200 MHz clock rate ADC
Model 5401B



SPECTRUM ANALYZERS

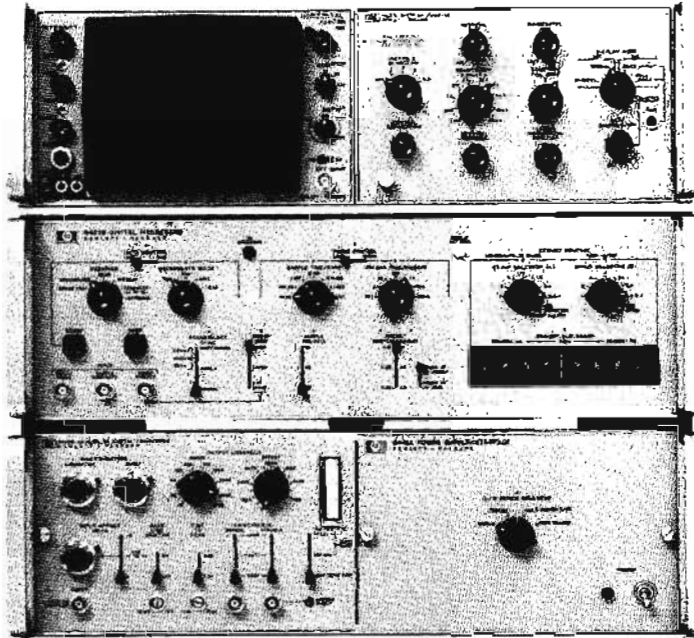

H51-180A Oscilloscope with
5431B Display Plug-in

5422B Digital Processor

5416B Analog-to-Digital
Converter in 5410A Power
Supply/Interface

5401B Multichannel Analyzer

5401B Multichannel Analyzer

- Performs Pulse Height Analysis, Sampled Voltage Analysis, and Multichannel Scaling.
- 8192 Channel Analog-to-Digital Converter, 200 MHz Clock.
- ADC has precision upper and lower discriminators, dc input offset capability, base line monitor, coincidence and anti-coincidence gating, dead time and count rate meter, various output channel and digital offset ranges.
- Standard memory sizes of 1024, 4096, and 8192 channels available.
- 10 MHz Up/Up and Up/Down Multichannel Scaling.
- Interfaces to Various Peripherals, including Parallel Printer, Teletype, Tape Punch, Tape Reader, Incremental Magnetic Tape, HP 9100A/B Calculator, 2575A Coupler/Controller, HP 2100 Computers.
- 5586A Spectrum Stabilizer available to compensate for gain and baseline drifts.
- Application Note 138 available which describes applications of Multichannel Analyzers.

Other nuclear products

5586A Spectrum Stabilizer—to compensate for gain and baseline drifts of nuclear systems. Application Note 139 describes how the spectrum stabilizer is used. Price: \$2400.

5554A Preamplifier—charge-sensitive preamplifier with selectable sensitivity and voltage gain, is combination preamp and amplifier. Price: \$360.

5580B NIM Power Supply—provides the output voltages required by the AEC-NBS Standards (TID-20893). Price: \$1150.

5582A Linear Amplifier—amplifier with variable pulse shaping capability and suitable for scintillation and gas-flow nuclear detectors, NIM unit. Price: \$750.

5583A Single Channel Analyzer—operates in Single Channel Analyzer Mode or Dual Integral Mode, NIM unit. Price: \$650.

5584A Dual Timing Pickoff—has two independent channels which produce timing pulses based on leading edge or zero crossing of input pulses. Price: \$900.

5585A Fast Coincidence Module—accepts up to four input signals, three inputs are for coincidence signals, one for anti-coincidence, NIM unit. Price: \$900.

5590A Scaler-Timer Module—contains two separate registers for scaling and timing, has six digital readout tubes, NIM unit. Price: \$1875.

5201L Scaler-Timer—combines a single channel analyzer with a preset pulse counter, 19-inch rack-mountable unit. Price: \$2095.

For complete data sheets, prices, etc., please consult your local Hewlett-Packard office.

SIGNAL ANALYZERS**NUCLEAR ANALYZER SYSTEMS**

Calculator and Computer-Controlled

Models 5402A, 5403A, 5406B

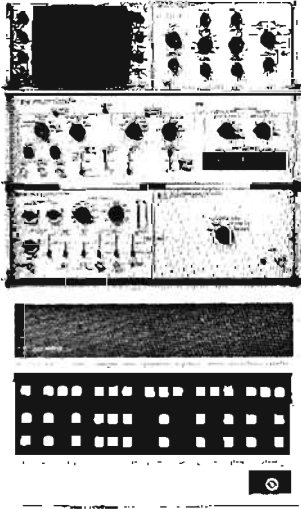

5402A

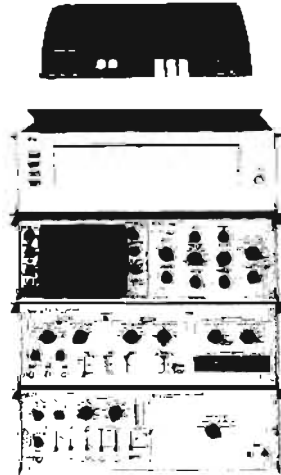

5403A

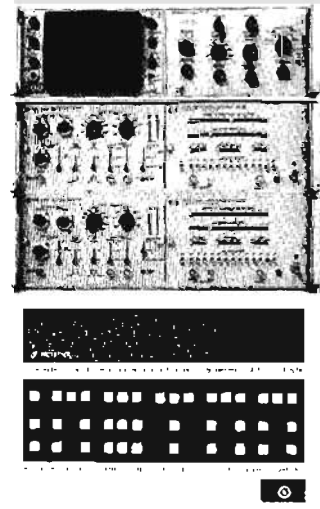

5406B

5402A MCA/BASIC System

A Multichannel Analyzer (MCA) System with control and data reduction by 8K 16-bit HP 2100A Computer. Operates in Hewlett-Packard's BASIC, a computer language that's powerful yet very easy to learn. The versatile general purpose computer can be used alone for other tasks too.

Programmable operations:

Erase, Accumulate, Display, Parallel Output, Serial Output, Serial Input, Transfer (Region A to Region B), Start, Stop, MCA/Computer Data Transfer, MCA Status Check, Computer Paper Tape Input/Output, Teleprinter Input/Output, Computer Magnetic Tape Input/Output.

This system is ideal for the investigator who has a unique data reduction job to do and who wishes to have the computer system output formatted reports, without requiring the services of a professional programmer. Hewlett-Packard provides a starter set of BASIC-language applications programs, including peak analysis, radioassay, spectrum smoothing, peak search, spectrum stripping, log conversion.

5403A MCA/Calculator System

Performs computer-type functions without computer-type costs. Automates data accumulation and reduction with programs you can learn to write in an afternoon (or use ours). The Multichannel Analyzer (MCA) and highly versatile Hewlett-Packard calculator can be used independently. Includes 5401B MCA, 2575A Coupler/Controller, 9100A Calculator (9100B optional), 10622A Interface.

5406B Nuclear Analyzer System

- Computer-Based Nuclear System
- Single Parameter, Multiplex Single Parameter, and Multiparameter Analyzer
- Multiparameter Analyzer Operations Include Digital Gating, List (Address) Recording with Magnetic Tape, and Delayed-Time Totalizing
- Analog-to-Digital Converter and Display Subsystem Connect Directly to 2100A Computer
- DMI, DMA, and Program Control ADC-to-Memory Data Transfer Modes
- Up to 32,000 16-Bit Words of Memory Available in 2100A Computer
- Data Channel Size Can Be 16, 20, 24, or 32 Bits
- Wide Range of Peripheral Devices
- Complete Operating System
- Executive Software that Controls:
 - Analyzer Functions
 - Programmed Automatic Operations
 - Foreground, Background, and Interrupt Operations
 - Data Reduction
- Modular Hardware and Software Design
- Data display in slice, isometric, and contour modes
- Single Parameter Peak Analysis, Spectrum Stripping, Background Subtraction, Spectrum Smoothing, and Two Parameter Peak Analysis Subroutines Available with the Standard 5406B System
- Extremely Easy to Incorporate User-Written Subroutines into 5406B

For complete data sheets, prices, etc., please consult your local Hewlett-Packard office.

MINICOMPUTER

General-purpose digital computer
Model 2100A



COMPUTERS & PERIPHERALS

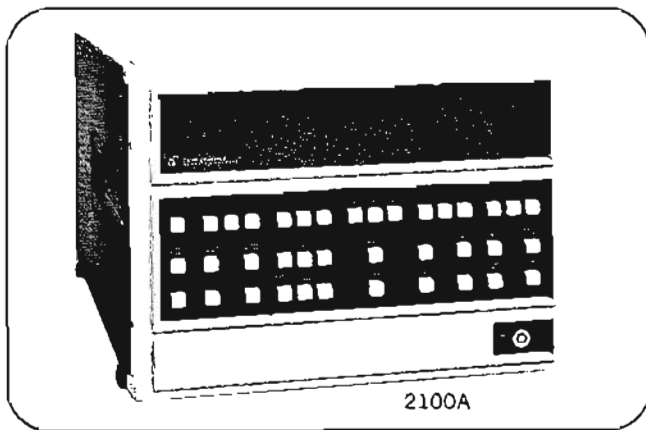

The Thoroughly Modern Mini

The Hewlett-Packard 2100A is a general-purpose digital computer designed for a wide range of small computer applications.

Features built into the 2100A include extended arithmetic instructions, power fail interrupt with automatic restart, memory parity check with interrupt and memory protect. Besides the standard built-in features, dual-channel Direct Memory Access (DMA) and Floating Point Hardware is also available. Under DMA control, data can be transferred to or from computer memory at rates greater than one million 16-bit words per second. Floating Point Hardware provides a typical ten-fold speed increase for scientific, compute bound algorithms.

A minimum 2100A provides 4096 words of core memory, self-contained power supply and 14 input/output channels.

You can select a wide range of memory sizes up to 32K words, all in mainframe. By including an HP 2155A Extender, you add another 31 input/output channels and power supply.

The 2100A automatically inherits a comprehensive range of proven software packages, including assemblers, compilers, operating systems and subroutines. A complete line of standard computer peripherals and I/O interface kits are also available, permitting complete systems to be tailored around the 2100A. Added to these capabilities, you can also depend on the Hewlett-Packard reputation for high quality and worldwide customer support. The result is a cost-effective computer that can meet your data processing problems today and continue meeting them as your needs expand.

Memory

Type: folded planar core.

Word size: 16 bit with 17th parity bit.

Page size: 1024 words.

Direct addressing: 2 pages.

Indirect addressing: all pages.

Modular sizes: 4K and 8K word memory modules provide 4, 8, 12, 16, 24 and 32K configurations all in the 2100A mainframe without additional power supply or cabinetry.

Cycle time: 980 nsec.

Loader protection: switch protects last 64 words.

Registers

Accumulators: two (A and B), 16 bits each. Directly addressable.

Memory control: three (T, P, M), 16 bits each.

Supplementary: two (Overflow and Extend), one bit each.

Manual data: one 16-bit switch register.

Floating Point Hardware Execution Times (Optional)

	Minimum	Maximum
Add:	23.5 μ sec	59.8 μ sec
Subtract:	24.5 μ sec	60.8 μ sec
Multiply:	33.3 μ sec	41.1 μ sec
Divide:	51.9 μ sec	55.9 μ sec
Fix:	5.9 μ sec	8.8 μ sec
Float:	9.8 μ sec	24.5 μ sec

Input/Output

Multilevel automatic priority interrupt: determined by interface location.

I/O channels in 2100A Computer: 14.

I/O channels in 2100A Computer plus 2155A Extender: 45.

I/O compatibility: HP 2114/2115/2116.

Memory Parity Check With Interrupt (Standard)

Priority: second highest priority interrupt (shared with Memory protect).

Operation: monitors all words read from Memory.

Interrupt: to trap cell for user written routine when parity error is detected.

Violation register: contains memory address where error occurred.

Memory Protect (Standard)

Priority: second highest priority interrupt (shared with Memory Parity).

Operation: initiated under program control; protects any amount of memory.

Fence register: set under program control; memory below fence is protected.

Violation register: contains memory address of violating instruction.

Physical*

Dimensions

Width: 16 $\frac{3}{4}$ " with adaptors for mounting in 19" rack.

Height: 12 $\frac{1}{4}$ " (rack mounted).

Depth: 2100A—26" (23" behind rack mounting ears);
2155A—23 $\frac{1}{2}$ " (23" behind rack mounting ears).

Weight

Minimum: 91 lbs (41 kg).

Maximum: 111 lbs (50 kg).

Electrical*

Power requirements: 115 V/230 V \pm 10%, 47.5 to 66 Hz, 800 watts maximum.

Current available to I/O:

	2100A Mainframe	2155A Extender
\pm 4.85 V	16.8A	45.8A
-2 V	7A	19.5A
\pm 12 V	3A	5A
-12 V	3A	5A

Environmental*

Operating temperature: 0° to 55°C (+32° to +131°F).

Relative humidity: to 95% at 40°C (104°F).

Ventilation

Intake: rear panel.

Exhaust: sides of front panel and cabinet.

Heat dissipation: 2700 BTU/hr. maximum.

* Except as noted, applies to both the 2100A Computer and the 2155A I/O Extender.



DISC DRIVE

Moving-head dual-disc 7900A



7900A with Disc Cartridges

The Model 7900A Disc Drive is a random-access moving-head dual-disc memory device, compactly designed for use as a peripheral unit in small and medium sized computer systems. It uses a permanent disc and a removable disc cartridge, both with a packing density of 2200 bits/inch. Each disc surface contains 203 tracks, divided into 24 sectors, and each sector is capable of storing approximately 6,000 data bytes. With four disc surfaces, data capacity totals approximately 5 million bytes. And using removable cartridges provides an unlimited amount of shelf storage.

A photo-optical positioning system, working in conjunction with a velocity transducer and a powerful voice-coil-driven actuator, provides exceptionally fast and precise head positioning. In fact, the actuator moves the head-carriage assembly from track to track in less than 10 milliseconds, and completely across all the tracks on the disc in less than 55 milliseconds. Average access time is less than 35 milliseconds.

The fixed-removable configuration, plus very rapid cartridge changing and a fast data transfer rate, provides a capability for making a backup copy of an on-line data base or system. The large on-line capacity allows storing and maintaining large data or program files.

The accuracy of positioning allows collecting or producing files on a disc cartridge on one 7900A Disc Drive and then reading these files on any other 7900A, even if it is operating in a totally different environment.

Other significant standard features of the 7900A Disc Drive include Write Protection on either disc and use of up to four drives per controller. It also has an absolute air filtration system that minimizes environmental contamination and maintains positive pressure in the drive enclosure during cartridge changing.

Operating power for the 7900A is supplied by the Model 13215A Disc Power Supply. It provides three regulated, constant dc voltages; two unregulated dc voltages; and the ac voltage to operate the disc drive ac motors.

To rapidly check out the 7900A during servicing, the Model 13219A Disc Service Unit (DSU) was developed. It is a small, portable, attache-case enclosed unit designed as an aid to on-site troubleshooting of the 7900A. Through a single connector, the DSU applies simulated controller signals to the disc drive and processes the drive responses for display.

For use with HP computers

Interface equipment and cabling are available to install the 7900A in a Hewlett-Packard computer system. A moving-head disc operating system (DOS-M), complete with disc drive, magnetic tape unit, computer, and all peripheral devices, is shown on page 407.

For the OEM

OEM configurations and quantity discounts are available. Contact your local Hewlett-Packard sales and service office.

Specifications

Access times

Head positioning (includes settling):

Track-to-track: <10 milliseconds.

Average move (67 tracks): <35 milliseconds.

Maximum move (203 tracks): <55 milliseconds.

Rotational delay

Average ($\frac{1}{2}$ revolution): 12.5 milliseconds.

Maximum (1 revolution): 25.0 milliseconds.

Data transfer rate: 2.5 million bits/second (312,000 8-bit byte second).

General specifications

Power requirements: see HP 13215A Power Supply, below.

Dimensions: 10 $\frac{1}{2}$ " H, 19" W, 25 $\frac{5}{8}$ " D (267 x 483 x 651 mm).

Depth from mounting surface: 22-15/16" (583 mm).

Weight: 117 pounds (53.1 kg).

Environment: operates within specifications over the following ranges:

Temperature: operating: +50° to +104°F (+10° to +40°C); nonoperating: -4° to +149°F (-20° to +65°C).

Humidity: up to 95%, noncondensing.

Vibration: 10 to 50 Hz at 0.01" peak-to-peak excursion.

Attitude (pitch and roll): accuracy of positioning is not affected by the attitude of the drive.

Air filtration: absolute air filter; volume is 65 CFM.

HP 13215A Power Supply

Power requirements (all single phase):

110/120 V \pm 10%, 60 Hz \pm 2%, 3.4A (4.1A @ 50 Hz \pm 2%).

220/240 V \pm 10%, 60 Hz \pm 2%, 1.7A (2.0A @ 50 Hz \pm 2%).

Dimensions: 7" H, 16 $\frac{3}{4}$ " W, 19 $\frac{3}{4}$ " D (178 x 425 x 502 mm).

Weight: 55 pounds (25 kg).

Accessories available: 9164-0045 Disc Cartridge; 13211A Rack Mounting Kit; 13219A Disc Service Unit.

Price: \$9975, including 13215A Power Supply and 9164-0045 Disc Cartridge. (OEM discounts available.)

DIGITAL TAPE RECORDER

OEM, On-Line, and Off-Line Applications
7970 Series



COMPUTERS &
PERIPHERALS

The 7970 Series Digital Magnetic Tape Units provide 800, 556, or 200 cpi NRZI and 1600 cpi phase-encoded electronics with the same superior operational and reliability characteristics usually associated with higher priced and more complex digital recorders. The 7970 was especially designed as a modular unit to enhance serviceability and reliability. All major transport assemblies are easily accessible for service and/or replacement, when required. The complete data electronics assembly is made up of plug-in type cards, neatly packaged in card cages within the 24-inch transport.

For the OEM

Model 7970B/C option configuration table (NRZI only)

Speed	9 Track			7 Track			7/9 Track R/R
	RAW	R/O	BASE	RAW	R/O	BASE	
10-20.1 ips	121	122	123	130	131	132	139
21-37.5 ips	Std	125	126	133	134	135	140
37.6-45 ips	127	128	129	136	137	138	141

Model 7970E option configuration table

Speed (ips)	9 Track						7/9 Track	
	PE Only			PE/NRZI			PE/NRZI	
	RAW Slave	RAW Master	R/O Slave	R/O Master	R/O Slave	R/O Master	R/O Slave	R/O Master
12.5 or 18	142	143	144	145	154	155	156	157
25 or 37.5	146	Std	148	149	158	159	160	161
45	150	151	152	153	162	163	164	165

ips = Inches per second cpi = characters per inch
 NRZI = 800, 556, or 200 cpi PE = 1600 cpi
 RAW = Read After Write R/O = Read Only R/R = Read/Read
 Master = Initial PE unit Slave = additional PE unit
 Base = transport, less data electronics

For use with HP computers

For Hewlett-Packard computer users, the 7970 with interface kit and software kit may be used as a peripheral to configure a magnetic tape operating system. Systems available are listed below. (See also page 407.)

NRZI (800-CPI 9-Track; 800, 556, 200 CPI 7-Track)

- 7970B-200: 9-Track RAW, 25 or 37.5 ips
- 202: 9-Track RAW, 45 ips
- 204: 7-Track RAW, 25 or 37.5 ips
- 206: 7-Track RAW, 45 ips

Phase-Encode (1600 CPI)

- 7970E-204: 9-Track RAW Master, 25 or 37.5 ips
- 206: 9-Track RAW Master, 45 ips
- 208: 9-Track RAW Slave, 25 or 37.5 ips
- 210: 9-Track RAW Slave, 45 ips

Interface Kits (require 2 computer I/O slots)

- 13181A: 9-Track RAW, 37.5 ips, NRZI
- 13182A: 7-Track RAW, 37.5 ips, NRZI
- 13183A: 9-Track RAW, 37.5 ips, PE

The following apply to any of the above Interface Kits:

- Opt 001: 9-Track RAW, 25 ips, NRZI
- Opt 002: 9-Track RAW, 45 ips, NRZI

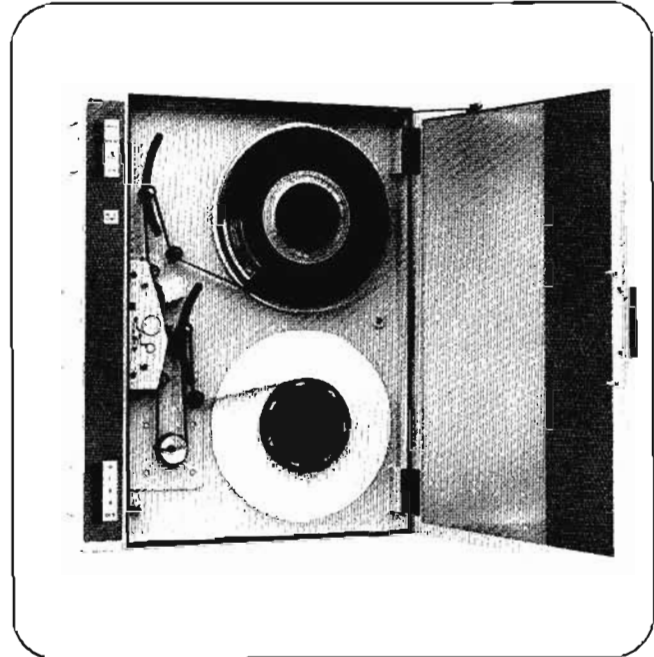

Software Kits (for Add-Ons)

- 13200A: 9-Track NRZI (800 CPI), 8K, Non-EAU
- 13202A: 7-Track NRZI (800/556/200 CPI), 8K, Non-EAU
- 13203A: 9-Track Phase-Encoded (1600 CPI), 8K, Non-EAU

The following apply to any of the above Software Kits:

- Opt 001: 8K, EAU Software
- Opt 002: 16K, Non-EAU Software
- Opt 003: 16K, EAU Software

Specifications*

- Tape speed range:** 10 to 45 ips.
- Reel diameter:** up to 10½" (26.7 cm).
- Tape:** computer grade. **Width:** 0.5". **Thickness:** 1.5 mils.
- Tape tension:** 8.5 ounces, nominal.
- Tape format:** IBM/ANSI compatible.
- Rewind speed:** 160 ips.
- Start/stop travel:** Read-After-Write: 0.187" ±0.020".

General specifications

- Power requirements:** 115 or 230 (±10%) VAC, 48 to 440 Hz single phase. 400 VA, maximum (on high line).
- Size:** 24" H, 19" W, 15¾" D (610 x 483 x 400 mm). Depth from mounting surface: 12" (305 mm).
- Weight:** 140 lbs, maximum (63.5 kg).
- Operating environment (hardware)**
 - Ambient temperature:** +32° to +131°F (0° to +55°C).
 - Relative humidity:** 20% to 80%, noncondensing.
 - Altitude:** 10,000 feet (3048 meters).
- Price:**** Model 7970B-Std, \$4600. Model 7970E-Std, \$8100.
 Model 7970B-200/13181A, \$9700.
 Model 7970B-204/13182A, \$10,400.
 Model 7970E-204/13183A, \$13,200.

* For complete specifications and a list of accessories, request technical Data Sheet (7970B/C or 7970E).

** OEM configurations and discounts are available.



7200 Series Graphic Plotters

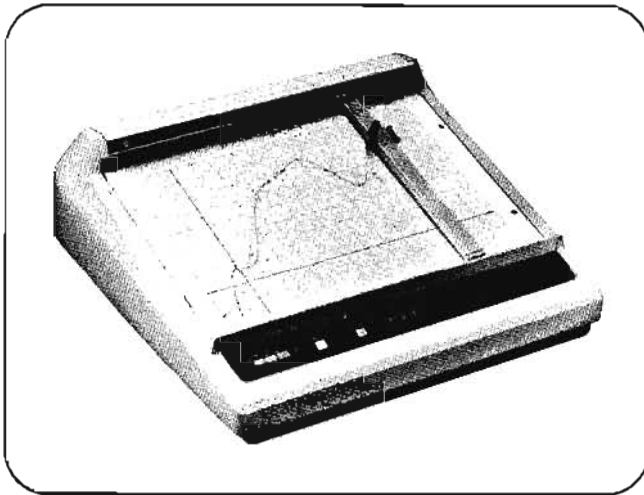

Hewlett-Packard Graphic Plotters offer the user an opportunity to produce graphs of computer-generated data. They operate with terminals which communicate with a computer directly or in a time sharing environment. Simple alphanumeric commands, which can be generated by any computer in any language, are used to feed data and control the plotter.

The plotters connect directly to most communications terminals, and any of the newer terminals operating up to 30 characters/sec which utilize the EIA interface. Each feature the same ease of use, paper and pen system as Hewlett-Packard analog recorders (see page 172), using standard graph paper up to 11" x 17". Metric and English paper can be handled interchangeably.

Data is supplied in pairs of four-digit X and Y coordinates, so each new data point is totally defined and not dependent upon previous points. True vector plotters, the 7200 series systems interpolate straight lines between data points, eliminating the need for the computer to generate intermediate points.

The plotters may be used on-line with a computer, or off-line with input directly from a paper or magnetic tape reader, a card reader such as the Model 2761B shown below, or even from the terminal keyboard. They operate in parallel with most terminals, and have the capability to silence the terminal as the plotter data is being received.

Graphic plotters are particularly useful for the graphing of functions, curve fitting, regression analysis, transfer functions, probability distribution, shear and moment diagrams, checking of numerical control machine programs, or anything else that can be graphed. BASIC routines for curve and alphanumeric generation are available to be used on major time-sharing systems.

Models are available for 10 char/s ASCII code, for 14.9 char/s Correspondence, BCD or EBCD code, and a switchable speed unit accepts up to 30 char/s from terminals using EIA interface and ASCII code. The type of terminal must be specified on order; ask your local Hewlett-Packard Data Products Sales Office for complete specifications.

Prices

Model 7200A (for teletypes, others at 10 char/s)	\$3300
Model 7201A (for IBM 2741, A-J 841 or Datel 30)	\$3300
Model 7202A (10, 15, 30 char/s switchable, EIA, ASCII)	\$3575

Note: rentals begin at \$200/mo; 2-year leases from \$159 mo. OEM discounts available on purchases.

2761A, 2761B Optical Mark/Sense Card Readers

The 2761 series Optical Mark Readers are low cost, desk-top remote data-transmission terminals which read punched and marked tabulating cards. They are designed for use with standard telephone data sets in communication networks where limited information must be gathered from many sources, or where it is desirable to use the original document as direct input to the system, rather than paper tape, magnetic tape or manual entry from a keyboard. Each unit provides the convenience of automatic card feed for up to 300 cards.

The input is a standard tabulating card, coded by marking lines through pre-printed boxes with a regular soft lead pencil. Up to 80 columns of alpha-numeric information may be marked or punched on a single card. Marking and punching may be intermixed on the same card.

Since the tab cards can be hand marked, and are read directly as marked, keypunch operations are bypassed. Cards can be pre-punched or pre-printed with identifiers and routine information for turn-around applications, reducing the amount of hand-entered data, and assuring correct identification of the turn-around document. Immediate data transmission can speed the input of orders, payroll charges, inventory entries, shipments, billings and similar operating data to a central processor. The Optical Mark Reader is easy to use, and operation requires no special skills or training.

The 2761A is designed to read data directly into a computer or other data acquisition system in 12-bit parallel form at rates

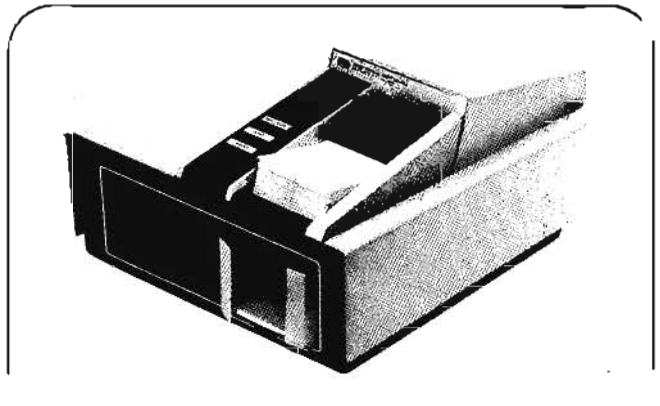

up to 250 cards/min. The 2761B generates a bit-serial ASCII code output from either the Hollerith punch format or the Hewlett-Packard Dial Code format. Data rates of 10, 30 or 105 char/s are available by option. Ask your local Hewlett-Packard Data Products Sales Office for complete specifications.

Prices

Model 2761A (12-bit parallel output)	\$2750
Model 2761B (64-character Hollerith code)	\$3100
Model 2761B (64-character Dial code)	\$3150

Note: OEM discounts available.

DATA LOGGER

Portable data acquisition system
Model 2070A



COMPUTERS &
PERIPHERALS

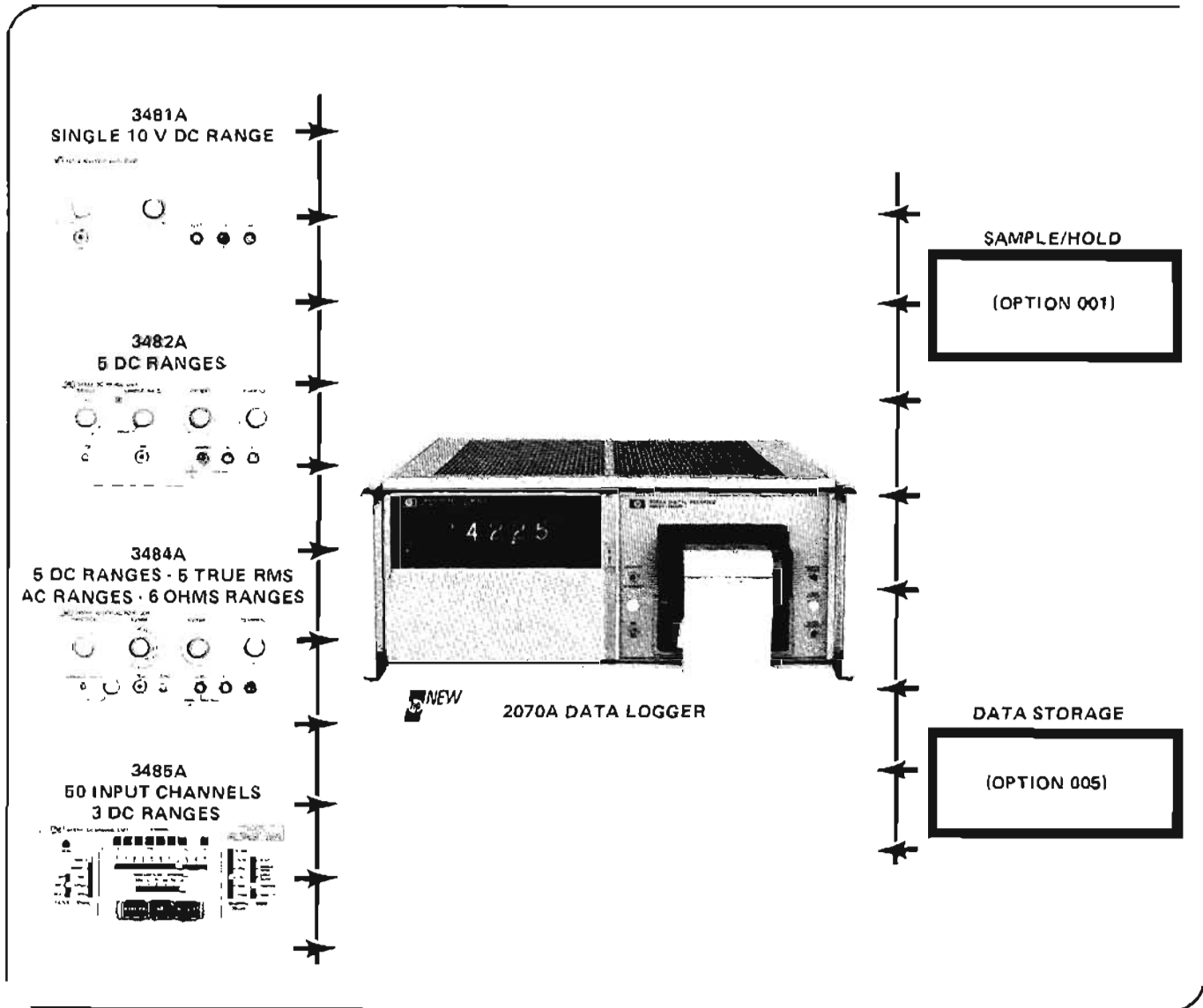

Description

The 2070A Data Logger is designed for a wide range of portable data acquisition applications. The basic 2070A consists of a 3480A Digital Voltmeter and a 5055A Digital Recorder. The 2070A will accept any of 4 plug-in units including two units with dc only, an AC/DC/ Ω unit and one with up to 50 2-wire input channels. The 2070A has two unique options: Data Storage and Sample-and-Hold. Data Storage allows the 2070A to be used at its maximum speed of 1000 readings/s with output on the self-contained printer at 10 lines/s. Up to 50 complete readings may be stored. Sample-and-Hold allows the 2070A to digitize changing input voltages with the elimination of digitization errors.

Applications for the 2070A include taking peak readings on repetitive wave forms. This application uses Sample-and-Hold's analog output which shows where on the wave shape the sample is taking place. Data Storage may be added to digitize

low frequency wave shapes at trigger rates up to 1000/s. Data Storage frees the DVM from printer. Up to 1000 measurements may be made per second, yet the output may be at 10 lines/s. Data Storage and Sample-and-Hold may be used for transient analysis. Preset trigger lines allow the previous 10 or 20 readings to be printed, plus the next 40 or 30 readings (for a total of 50 readings.) Data leading up to a transient may then be observed, plus the transient itself.

The 2070A was designed as a "turn-key" system. Switches and connectors are accessible on the rear panel to simplify the control of both Data Storage and Sample-and-Hold options. The interconnecting cable between the DVM and the printer rearranges the printed columns into an easy to read format. Each reading is identified with a 2-digit number. The printer or the DVM may be used separately for other applications. Prices begin at \$3025 and go to \$6275. Please refer to the data sheets for complete information.



MULTIPROGRAMMER

Convenient and flexible systems interface
Models 6940A, 6941A

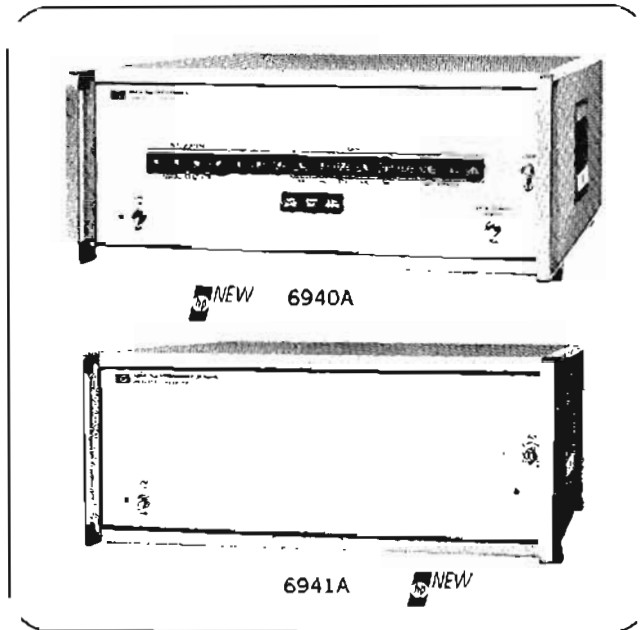

Description

The 6940A/6941A Multiprogrammer is an inexpensive device that, depending on the particular application, can function as a bidirectional data distributor, converter, coupler, programmer, or multiplexer. It allows a single, parallel, 16-bit computer I/O channel to control up to 240 individually addressable and programmable, 12-bit I/O channels. A Multiprogrammer system is composed of one master mainframe (6940A) and from zero to 15 extender mainframes (6941A). Each mainframe will accept up to 15 plug-in input or output cards, in any combination (16 units x 15 cards = 240 channels).

The programmable outputs available include resistance, voltage, current, contact closures, and logic levels. Input functions available are contact closures and logic levels.

Applications

Applications for the Multiprogrammer exist wherever one to several thousand devices must be independently controlled or monitored from a single computer I/O channel or other single source of digital data. One common application area is automatic testing, where the Multiprogrammer can be used both to provide stimuli for a device under test and to collect responses from the device. For example, the Multiprogrammer's programmable output functions can control power amplifiers, pulse generators, power supplies, and a wide variety of other programmable instrumentation, while also acting as direct stimuli to the device under test. At the same time, the Multiprogrammer can monitor the responses (up to 2,880 contact closures or logic levels) from the device under test, and input them to the computer through only one I/O channel.

Other applications result from the Multiprogrammer's ability to act as a low-cost, bidirectional interface between a computer and a wide range of devices such as strip chart recorders, electrically controlled valves, setpoint controllers, digital panel meters, alarms, CRT displays, operator console switches and pushbuttons, lamp display panels, analog computers, ac power switches, and X-Y recorders.

Common Specifications

Input/Output card positions: maximum of 15 per mainframe.
Data transfer rate: 100 k word/sec. guaranteed minimum.
Maximum data resolution: 12 bits.
Dimensions: 16.75" W, 6.78" H, 21.25" D.
Power: 115 or 230 V ac $\pm 10\%$, 48 to 440 Hz, approx 2 A.

Multiprogrammer, Model 6940A

Interfacing: 6940A mainframe is designed to interface with binary sources employing TTL or DTL logic.
Weight: 35 lbs (15.9 kg) net, 43 lbs (19.5 kg) shipping.
Price: \$1500.

Extender, Model 6941A

Weight: 33.5 lbs (15.2 kg) net, 40.3 lbs (18.3 kg) shipping.
Price: \$900.

Programmable Output Cards

Series Element Output Card, Model 69300A: allows customer to select and load own series-adding elements. Price, \$300.
Parallel Element Output Card, Model 69360A: allows customer to select and load own parallel-adding elements. Price, \$300.
Resistance Output Cards, Models 69301A-69313A: Supplies variable resistance for programming voltage and current output of power supplies equipped with Option 40. Price, \$345.
Low Speed D/A Converter Card, Model 69320A: -10.24 to $+10.23$ V dc at 0.5 mA output, 6 ms prog. speed. Price, \$385.
High Speed D/A Converter Card, Model 69321A: -10.240 to $+10.235$ V dc at 0.5 mA output, 50 μ s prog. speed. Price, \$420.
Current D/A Converter Card, Model 69370A: 0 to $+20.470$ mA at 0-11 V dc output, 100 μ s programming speed. Price, \$425.
Relay Register Card, Model 69330A: provides 12, independent, SPST, normally open contact pairs. Price, \$370.
Relay Output/Readback Card, Model 69433A: similar to 69330A, except has data verifications capability. Price, \$430.
TTL Output Card, Model 69331A: supplies 12 bits with TTL/DTL compatible logic levels. Price, \$200.
Breadboard Output Card, Model 69380A: allows customer to design own analog or digital output circuit. Price, \$75.

Input Cards

Digital Input Card, Model 69431A: monitors 12 lines of TTL, DTL, RTL, or contact closure logic. All lines have same common (ac earth ground). Price, \$200.
Isolated Digital Input Card, Model 69430A: monitors 12, independent, 12 V inputs. All input lines are isolated. Price, \$370.
Telephone Relay Monitor Card, Model 69432A: designed specifically for monitoring status of 12 telephone relays. Price, \$215.
Breadboard Input Card, Model 69480A: allows customer to design own analog or digital input circuit. Price, \$75.

Accessories

Custom Interface Card, Model 69340A: allows interfacing the 6940A with programming sources having non-standard logic level, logic sense, or termination specifications. Price, \$125.
6940A Interface Kit, Model 14543A: contains hardware and software for interfacing the 6940A with any Hewlett-Packard computer. Price, \$1250.
Pocket Programmer, Model 14533B: permits manual programming of all data and control functions. Price, \$97.
Main Input Cable Assembly, Model 14540A: connects the 6940A to the 12566A Microcircuit Interface I/O Card. Price, \$150.
Chaining Cable Assembly, Model 14541A: connects 6940A to 6941A, and 6941A's to other 6941A's. Price, \$150.
Pocket Programmer Extension Cable Assembly, Model 14534A: used with the Pocket Programmer for maximum convenience. Price, \$50.
Voltage Regulator Card, Model 69351A: required in every 6940A or 6941A mainframe containing High Speed D/A Converter or Current D/A Converter Cards. Price, \$125.

COMPUTER SYSTEMS

For automatic testing
9500 Series



COMPUTERS & PERIPHERALS

HP 28035A Digital Test Subsystem now allows digital testing or a combination of digital and analog testing with the 9500 Series.

NEW

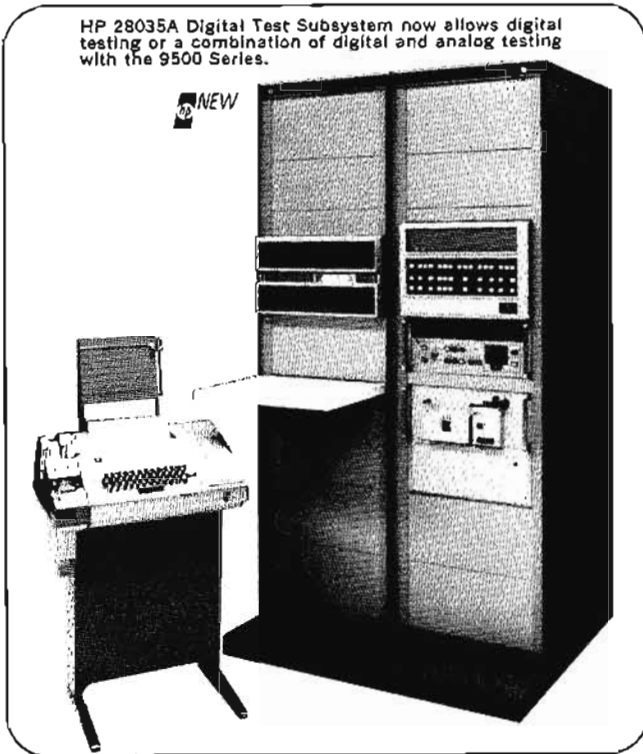

One of the Many Configurations of an HP 9500 Series Automatic Test System

The HP 9500 Series Automatic Test Systems offer a highly cost-effective solution to the testing requirements of modern electronic equipment. Hewlett-Packard automatic test systems encompass a wide range of testing capability, from individual circuit modules and sub-assemblies to highly complex avionic systems.

The major system elements are a controller, plus stimulus, switching, and measurement subsystems. Individual instruments comprising these systems are determined by the specific testing requirements. The overall concept further includes plug-in hardware interfacing plus an easily-learned software operating system that is able to handle present-day programmable instruments plus those anticipated in the future.

Instead of the disc controller system shown (block diagram), other standardized controller systems available are: punched tape and magnetic cassette tape systems. Off-the-shelf commercially available instruments are used wherever possible in the subsystems.

Easily Learned Programming

One of the most important factors in selecting an automatic test system is availability of an easily-learned and powerful software system. The requirement is essential since these systems are operated by engineers and technicians, who know testing rather than computer programming. HP ATS BASIC software very adequately satisfies the requirements. Because there are only a few rules to remember, it can be learned in a few hours, and be used effectively to write test programs within two or three days. Programs are typed directly into the com-

puter via the system keyboard. Each program statement is checked for errors as it is entered into the system. If an error is made, the system types out an error message, after which the statement can be immediately retyped correctly. Thus, considerable time is saved in writing programs as compared with non-interpretive compilers which require that the entire program be recompiled.

The compiler can call instrument driver subroutines (programs supplied with each computer-controlled instrument) to communicate with the stimulus, measurement, and switching subsystems. For example, to program digital voltage source (DVS) number 1 to supply 12.34 volts at 70 mA, merely type the statement:

```
20 DVS (1,12.34,70)
```

where 20 is the program statement number. To change the voltage to say 12.83 volts, type:

```
20 DVS (1,12.83,70)
```

This same ease of programming applies to all aspects of the Hewlett-Packard ATS BASIC software, which offers all the computational capabilities needed for automatic testing, along with instrument control and timing statements.

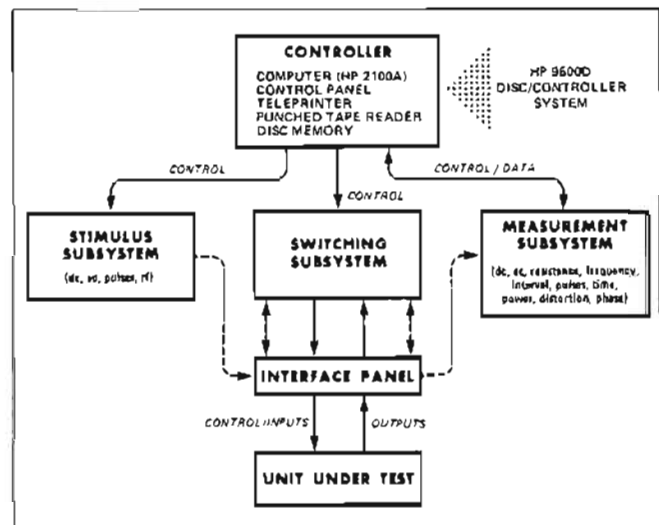

HP 9500 Series Automatic Test Systems Overall Concept

Programs are always executed from computer memory. In addition to keyboard entry, programs can be entered from punched paper tape, or called from storage on disc or cassette magnetic tape.

Special Capabilities

The inherent flexibility and modular construction of the 9500 Series makes the overall system easily expandable to handle very large testing requirements encompassing many types of stimuli and measurements. Hewlett-Packard welcomes the opportunity to offer expert engineering assistance to solve your testing needs. Contact Hewlett-Packard Automatic Measurement Division (ATS) for a solution to your problem.

A comprehensive set of literature, including an easy-to-follow selection guide, describing the 9500 Series is available from Hewlett-Packard field sales offices.



Hewlett-Packard has for many years been an industry leader in the development, manufacture, and supply of automatic digital data acquisition systems. For several years now this has also been true for Hewlett-Packard computer-automated data acquisition and control systems.

Hewlett-Packard employs a modular concept in configuring the wide range of data acquisition and control capability offered. Modularity in the systems starts with the computer (HP 2100A) memory capacity, which is plug-in expandable from 4,096 words to 32,768 words. Input/output capacity of the system computer is expandable from the basic 14 channels in the mainframe to 45 channels with the addition of an I/O extender. Modularity goes beyond the computer to encompass a selection of 8 different data acquisition (analog-to-digital) subsystems, 15 peripheral devices, 8 different general purpose interfaces, a choice of 3 different software operating systems, and 3 different computer programming languages. These subsystems and peripherals are fully hardware and software compatible, so they are readily assembled into a system that satisfies present measuring needs, and yet can be easily expanded to suit future requirements.

Applications of computerized systems

In research, development, and production applications, for example, a Hewlett-Packard computerized system: (a) coordinates the stimulus and measurement actions of the instruments involved in various experiments, (b) acquires and converts analog data from physical sensors to digital form, (c) corrects the data for non-linearity and offsets, and multiplies it by known factors to convert it to meaningful scientific units, (d) calculates consequent results, (e) performs statistical analyses, and (f) logs or displays results.

Systems involving remote test sites are easily handled by tying the sites into one unified distributed system by means of Hewlett-Packard data communications interfaces. Here a small computer system at each remote site performs most of the data acquisition and control functions and concentrates the data prior to transmission to a central computer, up to nearly two miles distant over simple hardware lines. Data phone interfaces can be used for greater distances.

System concept

Major system functions of a Hewlett-Packard system for data acquisition and control are shown in the diagram. Central element of the system is an HP 2100A Digital Computer. For multiplexing and digitizing analog input signals, a choice of standard subsystems provides high-resolution (dc) measurements at rates to 40 channels/second and high-speed measurements at rates to 100,000 samples/second. Other instruments are available for ac voltage measurements, high frequency counting, dc stimulus output, etc.

Interfacing with users' equipment

Many versions of bi-directional registers are available to interface digital-type user-furnished equipment to the system computer. Also available are hard-contact relay output registers for controlling external circuits and digital-to-analog converters for controlling analog-type devices. These interface registers and converters are contained on single cards which plug into the Hewlett-Packard computer. The computer's large input/output capacity allows many external devices to be monitored and controlled, over and above the measuring instruments and peripherals comprising the basic system.

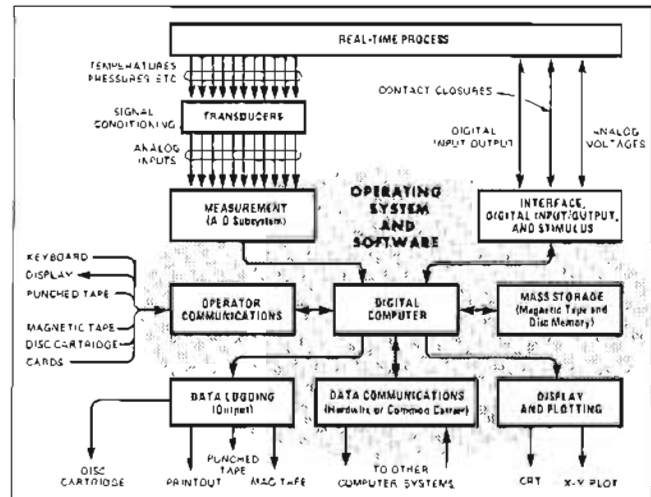

System software

Hewlett-Packard computerized data acquisition and control systems are supported by a very comprehensive catalog of software. Three software operating systems—Basic Control System (BCS), Data Acquisition and Control Executive (DACE), and Real Time Executive (RTE)—provide an operational framework for data acquisition and control in real-time. The systems are programmed in Hewlett-Packard Assembly language, FORTRAN, or ALGOL.

The BCS provides relocation and linking services, thus simplifying preparation of user-programs and their configuration into the overall system. BCS is an interrupt-driven system that allows measurements, processing, and logging of results to take place concurrently.

The DACE is a clock-driven system designed for applications in which operation of the data acquisition system must be scheduled in real-time. Data acquisition and control programs are subdivided into "tasks" such as measurements, calculations, limit checking, logging of data, and updating of control commands. The DACE enables cueing (or deleting) of tasks at desired elapsed times. Task constants and parameters can be examined and modified without recompiling. Within a task, transducer readings can be converted to engineering units and linearized; sampling rates can be related to actual values measured and changed as a signal strays beyond limits; other tasks can be initiated, depending on results obtained in the current task.

The RTE is a clock-and-interrupt-driven system providing multiprogramming, foreground-background operation with priority scheduling, interrupt handling, and program load-and-go capabilities. Under RTE control several real-time foreground programs, e.g., multiple test stations, can run concurrently with general-purpose background programs. (Foreground and background refer to areas of core.) While data are being taken on demand, processed, and output in the foreground, the time not needed for real-time processing may be used for program development in background without interrupting the running programs.

Additional information on the 9600 Series systems is provided in a brochure, "Computer Systems for Data Acquisition and Control." The brochure, plus an easy-to-understand Selection Guide are available from Hewlett-Packard Field Sales Offices.

DISC OPERATING SYSTEM

A small computing system with a lot of punch
Model 2120A



COMPUTER SYSTEMS



2120A

Description

The HP 2120 minisystem offers you maximum performance for your computing dollar. It gets its power from the marriage of hardware and software. It combines Hewlett-Packard's versatile 2100A minicomputer, the fast 7900 five megabyte disc, a teletype console, paper tape reader, and its unique disc operating system that makes the whole system tick. Best of all, it won't hurt your pocketbook either. 2120 minisystems start at less than \$33,000.

The *2100A Digital Computer* is the heart of the 2120 minisystem. It has a submicrosecond memory, uses the latest in MSI/LSI technology, and is controlled by a microprogrammed read only memory. The system uses a basic 8K of memory and can be expanded to 32K. Standard features are direct memory access, hardware multiply/divide, memory protect, and memory parity check. A floating point processor can be optionally added to give the system more computational power.

The *7900 Moving Head Disc* has five million bytes of on-line storage. It can be used to store operating systems, compilers, programs, and program data. The systems' storage can be expanded to 47 million bytes—large enough for the most demanding applications.

The 2748 Paper Tape Reader and 2752 Teletype offer an economical way to access the 2120's capabilities. Other peripherals such as magnetic tape, card readers, line printers, and punches are optional.

The 2120 Disc Operating System was designed to give the small computer user the conveniences of a large system without a high overhead penalty. There are many features which you can choose to make more efficient use of your computer.

Easy System Generation

A user can configure his 2120 system to meet a given I/O configuration. This configuration can be changed by loading memory with another executive from disc or changing the cartridge and loading it.

Mixed Job Stream

In batch mode, multiple job decks can be stacked upon one another, and executed in a load and go environment without manual intervention. FORTRAN, ALGOL, and Assembly Language programs can be intermixed in the same chain of programs. System directives, source code, and data can be integrated into a single job deck.

Disc and Core Memory Hardware Protection

System integrity is assured through hardware memory protection.

System Accounting

The 2120 Disc Operating System can be equipped with a system clock which will tell the operator how long a particular job has taken. The system clock can be also accessed by a program.

Logical I/O Unit Designation

I/O programming is device independent. Programs written in FORTRAN, ALGOL, and Assembly Language specify a logical unit number. Logical unit numbers are assigned to appropriate devices at system generation time, but can be changed by the operator prior to the execution of a program.

Automatic System Disc Management

The system operator can add, change, and delete files from the system disc. All references to files are by name because the 2120 File Management System keeps track of all physical locations. After any file deletion, or edit, the system automatically repacks the disc to eliminate any wasted space.

Extended File Manager

User data files can be written under the command of an extended file manager. Files and record sizes are specified by the user at program execution time. All input/output is buffered to reduce the number of physical disc reads or writes records can be accessed on a direct or sequential basis.

Large Disc Capacity

The 2120 Basic System has 5 million bytes of storage and it can expand to 47 million bytes of on-line storage. In addition, data, source statements, and programs can be stored on removable cartridges providing unlimited capacity.

Program Segmentation

User programs may be structured into a main program with subservient segments. The segments can be stored on the disc and called into memory by the main program when they are needed. The program can use a common area of core for its data.

Utilities

Editing, debugging, and file maintenance utilities are available on the system disc, and they can be called in when needed.

The 2120 is designed to work in a variety of applications. It's a cost-effective system for today and an expandable one for tomorrow.

CALCULATORS



COMPUTING CALCULATOR Series 9800

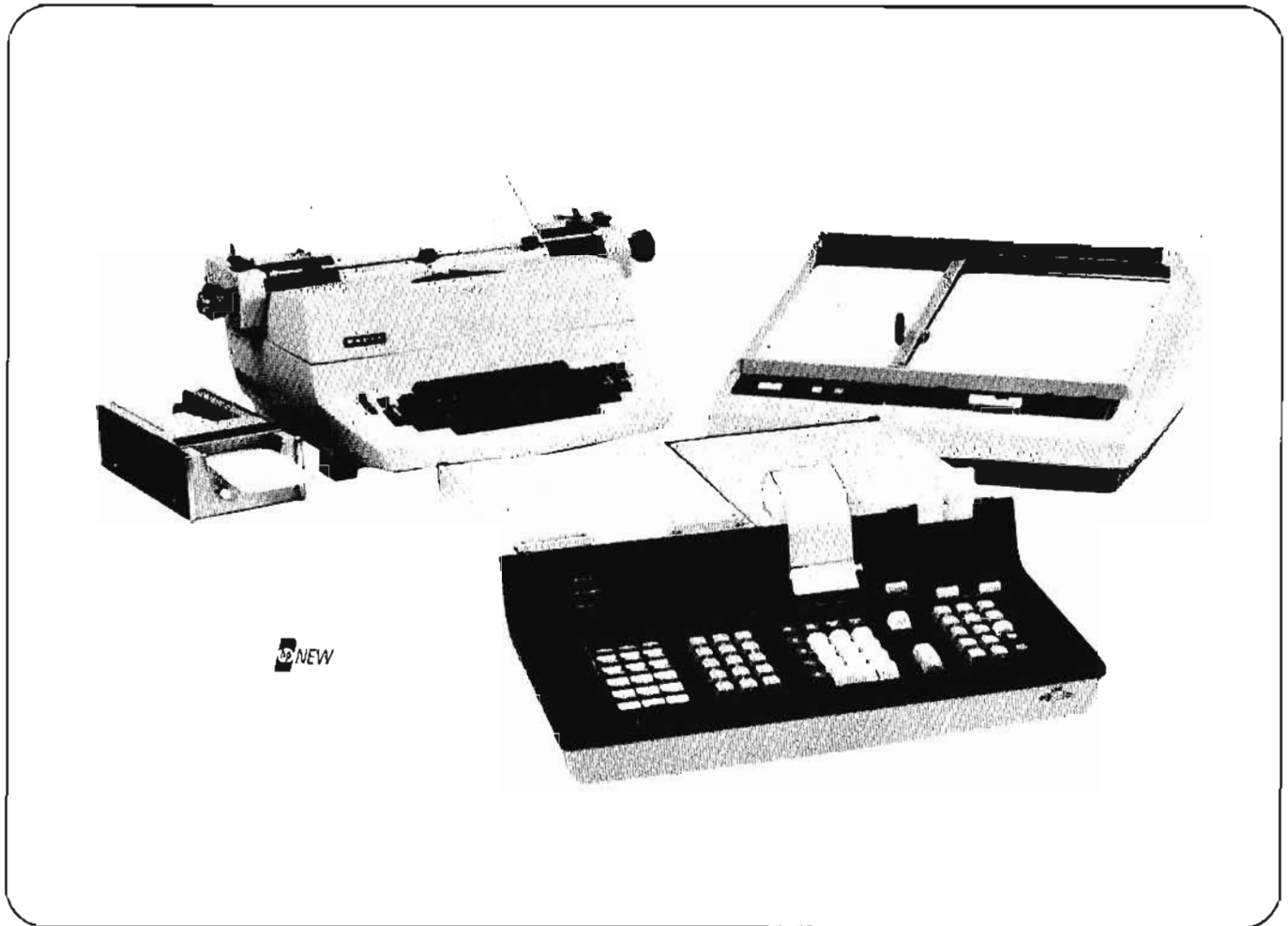

Computing calculator

Whatever your discipline, from physicist to financier, engineer to biochemist, there is a Hewlett-Packard Series 9800 Programmable Calculator that's right for you. The Series 9800 is the only computing calculator on the market that incorporates all the special features you'd specify, if you were designing a calculator for yourself. In fact, that's exactly what happens. The modular structure allows you to help design the calculator that best suits your needs! From keyboard to memory, peripherals to program packages, you can configure the Series 9800 to satisfy any situation—including a tight budget.

Simplicity of operation

Only Hewlett-Packard allows you to "design" your own problem-solving system. With the unique modular/plug-in architecture of the Series 9800, you specify—and pay for—only the capability you need. And if your needs change? No problem. You can expand the memory, add peripherals, or change the keyboard of your existing calculator, at any time, without costly modifications.

Custom keyboards

Only the Series 9800 gives you the opportunity to select from special keyboard plug-in blocks, so you can personalize

its problem solving capabilities to your discipline. This unique Hewlett-Packard feature vastly extends your computing power, simplifies programming, and reduces your computing time.

You have a choice of Statistics or Mathematics functions under single keystroke command. These function blocks include separate (ROM) memories so they do not draw on the main calculator memories, leaving them fully available for further problem-solving power. A third keyboard plug-in option, the User-Definable Function block, allows you to customize individual keys for operations uniquely important to you and your discipline.

When the user plugs in the Mathematics block, he can solve all the log, trig, and transcendental functions normally found on an engineering slide rule. He has 28 functions available. Included is a "DO LOOP," a feature found only on large computers, which allows the user to cycle through a subroutine or function a specified number of times. Other functions include converting a number to the log to the base 10 and back, changing degrees, minutes and seconds to decimal degrees and back, and specifies angles in degrees, radians or grads. (A grad is 1/100 of a right angle—a common unit—of measurement of angle, used mainly in Europe.) A user-definable key is included. It can be programmed to perform any function or it can define one program which can call other programs.

The Statistics block is for the typical calculations used in statistical data reduction. Its primary function is to carry out the summations of variables, sum of cross products, and sums of squares needed as fundamental quantities in a variety of commonly used statistical analyses. A VARIABLES key defines the number of variables to be treated, from 1 to 5. A key is used to accumulate the summations of variables, cross products and squares. A MEAN key computes (from the collected summations) the arithmetic mean of up to three variables. Other keys include VARIANCE, REGRESSION (least squares curve fitting), MAX/MIN to collect maximum and minimum values of variables, a key to compute a statistic, chi-squared and log keys, both natural logs and logs to the base 10. A RANDOM key generates a sequence of pseudo-random numbers. Data can be deleted from a statistical analysis with a new CORRECT key.

If neither the Mathematics block nor the Statistics block fulfill the specific needs of the user, he may select the new User Definable block. He may, for example, program a single key to calculate amortization. Or a Bessel function could be computed with a single keystroke. Any subroutine or function may be keyed in, then executed. Provision is made for protecting entered functions. A DELETE key is used when functions must be changed. New editing features are included in the User Definable block. Single program steps may be located, inserted, or deleted using the FIND, INSERT and DELETE keys.

Other function blocks allow the user to gain more peripheral control. For instance, with the plotter (ROM) blocks, the user has complete alphanumeric plotter output, axis generation, automatic function scaling, and special symbol point plotting. Titled, scaled and labeled plots can now be produced.

Printer

Exceptionally quiet, the Hewlett-Packard designed thermal printer is an option. It prints a 16 character line; each of the 16 characters is formed by a 5 by 7 dot matrix. Inexpensive heat-sensitive paper is used and loading is simple. The roll is simply dropped in; the paper threads itself automatically.

Alphanumeric printing

Labeling computer data as it is printed out is an obvious advantage. It is not necessary to interpret code numbers or abbreviated symbols. Medical data, payroll data and statistical data of all kinds can be labeled while printed out so that anyone can read the results from the tape with no danger of misinterpretation. The printout may be used directly as a report of results.

User instructions in a program may also be printed out to eliminate the need to refer to instruction manuals.

Alphanumeric characters may be printed directly from the keyboard, or automatically via programmed request. Alpha capability greatly simplifies programming and program editing. A list of keystrokes may be printed as the keys are depressed using the new KEY LOG key. Or a list of program steps may be printed out by pressing the LIST key. With the Alpha block in place, each step is listed by its mnemonic symbol such as CLR for CLEAR key. Errors are thus easy to spot and correct.

Easy-to-use language

All operations and logic are performed in standard mathematical notation; there's no unwieldy computer language to learn. From simple 10-key adding machine arithmetic to powerful logic propositions, the Series 9800 is designed so you and your staff can be solving problems after only a few moments of instruction and orientation.

Magnetic card reader

You can store long programs or large amounts of data on handy magnetic cards for instant entry into your calculator. The "feed-through" feature of the magnetic card reader speeds program and data entry. For particularly long programs, cards may be linked for automatic feed, on command by the calculator.

Performance

Expandable memory

Memories are expandable (at any time) with plug-in memory modules. In basic configuration the Series 9800 can perform a complete regression analysis or solve a system of 10 simultaneous equations. If more memory is needed, more can be added.

Powerful programming aids

Indirect addressing and indirect arithmetic are powerful features included in the Series 9800. With the INDIRECT key, the calculator user has an automatic way of incrementing registers. He saves hours of work in cases where he wants to perform mathematical operations on a whole series of numbers.

Register arithmetic enables the user to operate on registers without recalling their contents to the X or Y working registers. Adding indirect to register arithmetic enables the user to program the machine to calculate a register number, then go to that register and operate on its contents. It might have applications, for example, where it is necessary to (1) find a tax table, then (2) get the tax from that table. The ability to use indirect addressing and indirect arithmetic results in shorter programs and faster computation.

Peripherals

Often the means of getting data acceptable for computation or putting the final figures into an acceptable form takes as much or more time than the calculation itself. Hewlett-Packard offers a full-range of Series 9800 peripherals. The user can choose a Marked Card Reader, Paper Tape Reader, Digitizer, Typewriter, or X-Y Plotter.

Hewlett-Packard calculators are also included in other instrumentation systems such as multi-channel analyzer systems or data acquisition systems.

Cost

The basic Series 9800 Calculator starts at \$2975. Lease rates are also available. A basic calculator includes a lot of computing power.

There's enough memory to solve 10 simultaneous equations; a bright, LED display; full programming capability, including looping and branching, subroutines, indirect arithmetic, and symbolic addressing; built-in magnetic card reader; and a full input/output structure that allows the user to plug into Series 9800 peripherals.



Transistors, diodes, hybrid thin film circuits, Solid state displays and optoelectronics

Low cost components, now available from Hewlett-Packard, offer exceptional performance in consumer, industrial, and other OEM equipment. With sophisticated semiconductor processing equipment, and the industry's most extensive hybrid thin-film microcircuit manufacturing facilities, Hewlett-Packard applies newly developed technologies to component manufacturing, offering high performance diodes, transistors, and complete circuits—and also solid state numeric and alphanumeric readouts plus LEDs and other optoelectronic devices—in quantity at economically attractive prices.

Transistors

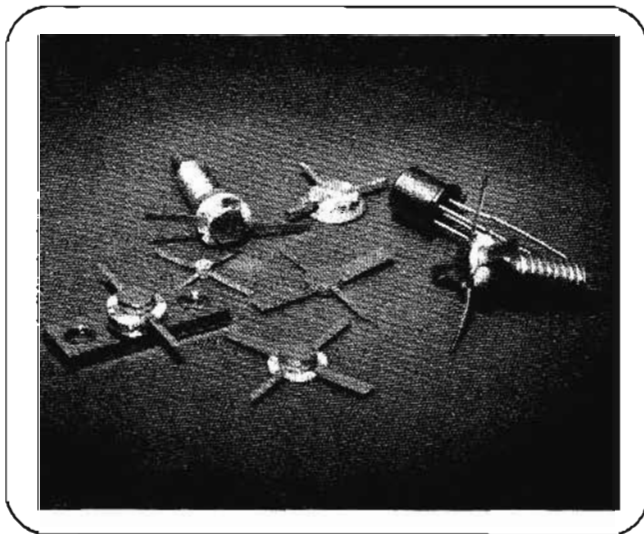

For RF and microwave amplifiers and oscillators, Hewlett-Packard sets the price and performance standards of the transistor industry. For example, consider this: an NPN silicon transistor with typical f_{max} of 12 GHz at \$19 (in stripline package). This transistor (HP 21 Series) puts out 100 mW at 4 GHz with gain typically 7.5 dB, achieved by improved processes that didn't call for reduction in geometries, hence no compromise in power. Then there is the HP 21A: noise figure guaranteed <3.0 dB at 2 GHz and <4.5 dB at 4 GHz (\$60). Or consider the \$19 HP 11: it generates over 600 mW at 2 GHz with 8 dB gain using a new design geometry that equalizes power distribution.

Hewlett-Packard transistors fill all requirements for multi-stage VHF-UHF amplifiers: low-noise input stage, high-gain intermediate stages, and power output stage. Complete data sheet characterization and excellent processing uniformity make it possible to design your circuit by calculation instead of by trial-and-error.

Hewlett-Packard transistors are supplied in chip form, or in several stripline packages in either common-base or common-emitter configurations. The chips have unique moly-gold contact pads that don't deteriorate under high bonding temperatures, improving yields of thin-film hybrid microcircuits.

Look to Hewlett-Packard for further advancements in microwave transistor performance and pricing.

Diodes

Four types of high technology silicon diodes are offered:

Schottky barrier (hot carrier) diodes are unexcelled for fast digital switches, clamps, and samplers, and high frequency mixers and detectors, both high level and low level. Fast recovery (<100 ps), low turn-on voltage (as low as 3-40 mV at 1 mA), high breakdown (as high as 70 V), give sub-nanosecond switching, high rectification efficiency and low noise at prices that go to less than 20¢ in 100,000 quantities. Excellent diode-to-diode uniformity simplifies applications requiring closely matched diodes.

PIN diodes are advantageous as current-controlled resistors for RF switching, leveling, electrically-controlled attenuation, and AGC circuits. Long carrier lifetime in some types gives low distortion at signal frequencies as low as 1 MHz; short carrier lifetime in others permits fast RF switching (<5 ns).

Step recovery diodes are ideal for harmonic multipliers and fast-rise pulse generators. Abrupt termination of reverse recovery current can, depending on type, generate voltage steps up to tens of volts with transition times appreciably shorter than 1 ns. Frequency multiplication from X2 to as high as X100 can produce useful harmonics to 18 GHz.

IMPATT diodes are state-of-the-art devices for generating microwave power—as much as 1 W at 14 GHz with 7% efficiency from a single diode. One IMPATT plus a resonator plus a dc power supply equals one simple, inexpensive, solid-state microwave source.

These diodes are available in traditional glass packages, and in special packages for waveguide, coaxial, and stripline mounting. Also available: chips and beam lead packages for hybrid IC mounting.

Hybrid Thin-Film Circuits

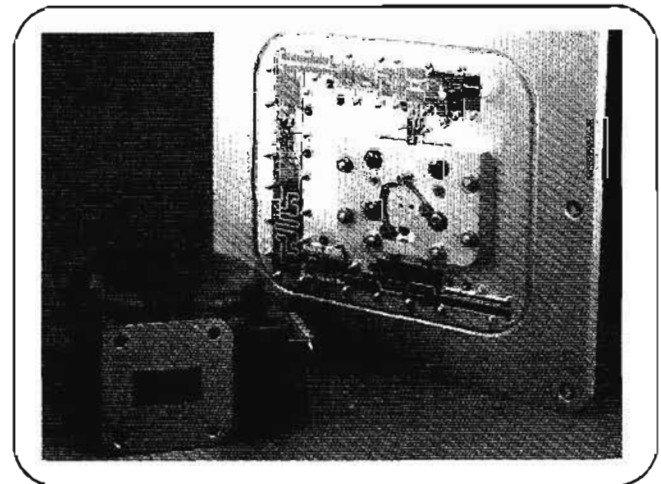

Combining Hewlett-Packard transistors and diodes with thin-film circuits has resulted in components ideally suited to the telecommunications field, with performance/price capabilities far beyond that thought possible just a few years ago. The hybrid thin-film technology couples Hewlett-Packard's experience with passive microwave components design and exotic

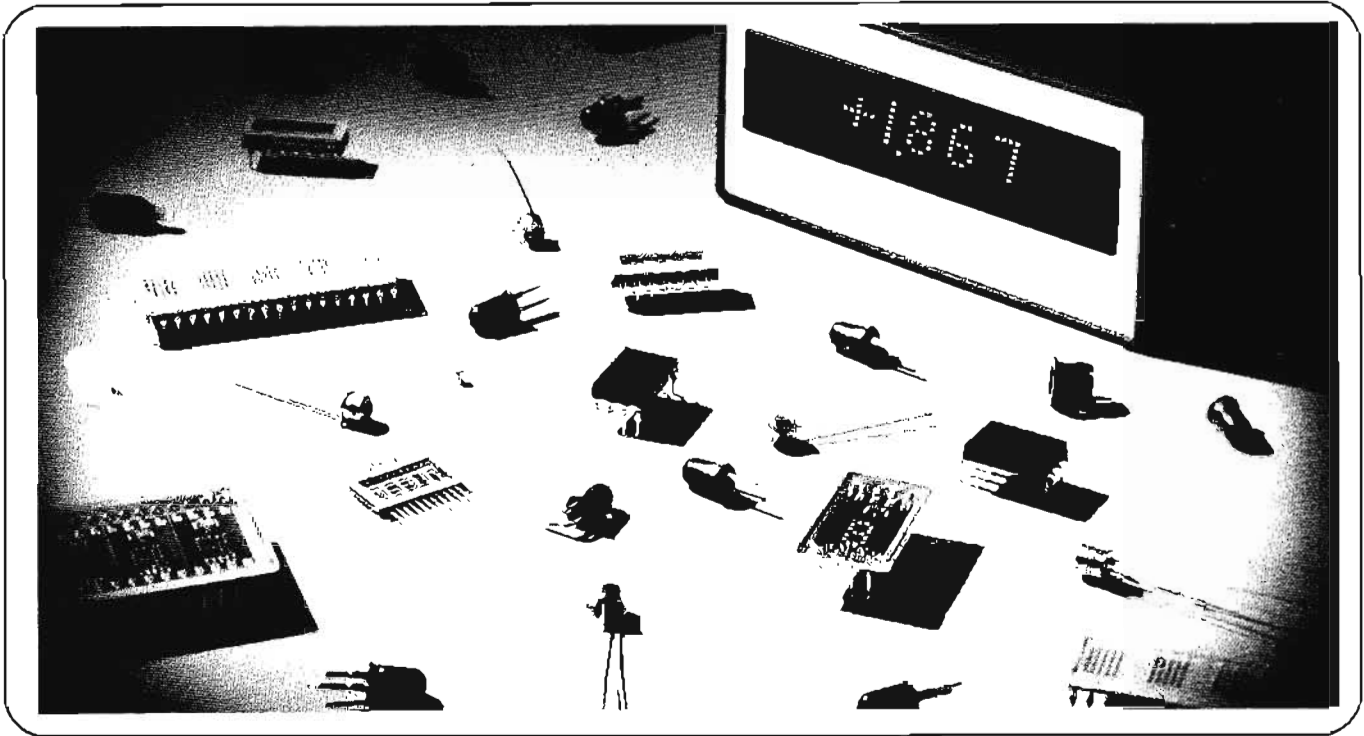

semiconductor devices to form products such as the recently developed 12 GHz receiver front end, all on a single 5" x 5" ground plane. A Gunn oscillator, 2 GHz IF amplifiers and a unique packaging configuration give the receiver top performance with high reliability and low cost. S-band repeaters and X-band transmitter power amplifiers for use in common carrier and data communications systems have also been developed offering the same advantages.

Producing a greater quantity of RF and microwave hybrid thin film circuits than any other manufacturer, Hewlett-Packard is well equipped to supply modules in large quantities for reliable and economic OEM systems.

Solid State Displays and Optoelectronics

Hewlett-Packard offers a complete line of GaAsP discrete light emitting diodes (LEDs) and numeric and alphanumeric displays. These components provide solid state reliability to visible data transmission. As status indicators and solid state displays, these compact light emitting diodes are electrically compatible with monolithic integrated circuits (typically 10 mA at 1.5 V), with a useful life greater than 100,000 hours. The visible emitters generate a brilliant red color (655 nm) at levels in the range of 100-200 fL.

Low-cost numeric displays are packaged single or clustered, with or without on-board decoder/driver electronics. The alphanumeric displays are constructed using X-Y addressing techniques, providing minimum power dissipation and maximum flexibility in application at a low unit cost. Small character

displays for portable instruments and calculator application are also available.

Solid state displays are offered in plastic encapsulation or hermetic packages. Designed with several unique features, these displays are ideal for conventional indicator requirements as well as allowing many new applications in the display of information.

Discrete LED indicator lamps are designed for easy panel mounting with clips or direct PC board application. Both plastic and hermetic packages offer high brightness over a wide viewing angle with low power requirements. Hewlett-Packard offers a wide selection of lead, lens, brightness, and package combinations.

Hewlett-Packard PIN photodiodes are excellent light detectors with their exceptionally fast response (1 ns), wide spectral response (from near infra-red to violet), and wide range linearity (constant efficiency over 6 decades of amplitude). Low dark current (as low as 150 pA at 10 V) make these detectors especially well-suited for operation at low light levels.

Emitters and detectors are packaged in photon-coupled isolators that give high isolation (100 megohms, 2 pF) between input (emitter) and output (detector). Signals with frequency components from dc to 3.5 MHz can be coupled through these devices.

Write for more information

Complete detailed product literature, application information, and prices are as near as your phone. Call any Hewlett-Packard sales office.



QUARTZ THERMOMETER

0.0001°C or °F resolution, direct measurement
Models 2801A, 2831A, 2833B, 2850A/B/C

Description

The method of temperature sensing employed in the 2801A Quartz Thermometers is based on the sensitivity of the resonant frequency of a quartz crystal to temperature change.

Temperature range of the 2801A Quartz Thermometer is -80 to $+250^{\circ}\text{C}$ (-112 to $+482^{\circ}\text{F}$). The quartz thermometer is considerably more linear than a platinum resistance thermometer: $\pm .05\%$ of span from -40 to $+250^{\circ}\text{C}$ compared with a typical figure of $\pm .55\%$ for the same range for platinum thermometers. Linearity of the quartz thermometer is superior to that of thermocouples and thermistors, which have an exponential characteristic. The excellent sensing characteristics of the quartz thermometer are supplemented by the advantages of direct digital readout (no bridge balancing, or reference to resistance or voltage-temperature tables or curves), immunity to noise and cable resistance effects, no reference junction, and good interchangeability between sensing probes.

The 2801A is equipped with two sensing probes for measuring temperature at either probe or the difference between the two. A 6-digit visual readout and recording output with a choice of push-button-controlled sample times provides resolution of 0.01, 0.001 or 0.0001°C or F. With Option 010 (100 second sample period) resolutions of 0.001, 0.0001 or 0.00001°C or °F can be obtained. Signal polarity indication is provided. The 2801A includes the capability for operation as a 300 kHz electronic counter.

Temperature sensing probes

Various standard probe configurations are available for the 2801A Quartz Thermometer. Probes from the 2850 series are furnished with the quartz thermometer.

Remote operation of probes

Each temperature sensing probe has a quartz-crystal which is resonant at a frequency dependent upon temperature, and is driven by a 2830A Sensor Oscillator. The oscillators are transistorized devices enclosed in small die-cast aluminum housings. They are normally installed in the 2801A flush-mounted in a front panel recess. A 12-foot cable connects each probe to its associated sensor oscillator; this cable forms part of the tuned circuit and cannot be altered in length. However, the sensor oscillators may be unplugged from the instrument and connected to it by standard 75-ohm coaxial cable up to 500 feet in length, with no loss in measurement accuracy. For greater distances, one or two 2831A Amplifiers may be used for a maximum of 4500 feet.

Oceanographic temperature sensor

The Model 2833B Oceanographic Temperature Sensor Assembly for the 2801A Quartz Thermometer is especially designed for use in rugged environments such as oceans, rivers, harbors and industrial fluids at pressures up to 10,000 psi. It meets all requirements for oceanographic investigations, for temperature profile and thermal pollution studies in rivers and harbors, for well-logging, factory effluent studies and other difficult industrial environments.

The 2833B combines the functions of a quartz crystal sensor and oscillator which are housed in a stainless steel pressure case approximately $5\frac{3}{8}$ inch long, with a maximum diameter of $\frac{7}{8}$ inch. A single coaxial cable transmits the temperature signal to, and the dc operating power from the 2801A.

The 2833B connects directly to the 2801A through the cable provided and gives a direct digital readout in °C or °F. Operating range of the 2833B is -40 to 120°C (-112 to $+248^{\circ}\text{F}$) when used with the 2801A Quartz Thermometer. It may be used with as much as 3000 feet of cable with no loss of accuracy or sensitivity.

Specifications, 2801A

Temperature range: -80 to $+250^{\circ}\text{C}$ (-112 to $+482^{\circ}\text{F}$ with Option 001).

Calibration accuracy: thermometer-probe combination calibrated at factory to within $.02^{\circ}\text{C}$ ($.04^{\circ}\text{F}$) absolute, traceable to NBS.

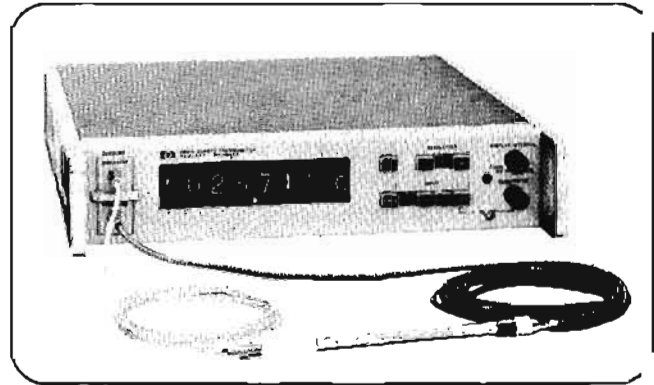

Linearity: -40 to $+250^{\circ}\text{C}$: better than $.15^{\circ}\text{C}$ ($.27^{\circ}\text{F}$) referred to best fit straight line through 0°C ; -80 to -40°C : better than 0.7°C (1.25°F) referred to same line as above; 0 to $+100^{\circ}\text{C}$: better than $.05^{\circ}\text{C}$ ($.09^{\circ}\text{F}$) referred to best fit straight line through 0°C .

Stability

Short term: better than $\pm .0001^{\circ}$.

Long term: zero drift less than $\pm .01^{\circ}\text{C}$ ($.018^{\circ}\text{F}$) at constant probe temperature for 30 days.

Ambient temperature effect: less than $.002^{\circ}\text{C}$ per $^{\circ}\text{C}$ change.

Display: 2801A: 6-digit in-line readout in $^{\circ}\text{C}$, or $^{\circ}\text{F}$. Decimal point, $^{\circ}\text{C}$ ($^{\circ}\text{F}$), and polarity indication included. Readout and units indication in kHz in counter mode of operation. Storage feature holds display between readings.

Digital recorder output: BCD, 4-2-2-1, positive-true, for each digit, decimal point (exponent), polarity, and operating mode. 8-4-2-1 positive true optionally available.

External programming: selected by contact closures or transistor circuit closures to ground. Measurement initiation, probe selection (T1, T2, or T1-T2), and resolution (.01, .001, or .0001 $^{\circ}$) programmable.

Counter operation: Frequency Range: 2 Hz to 300 kHz; Resolution: 10, 1, and 0.1 Hz; Sensitivity: 0.5 to 10 V rms; Input Impedance: 1M, 50 pF shunt; Gate Time: 0.1, 1 and 10 sec.

Power required: 115/230 V $\pm 10\%$, 50 to 60 Hz, 85 W.

Instrument environment: ambient temperatures from 0 to $+55^{\circ}\text{C}$ ($+32$ to $+130^{\circ}\text{F}$), at relative humidity to 95% at 40°C .

Weight: net, 22.5 lbs (10.1 kg); shipping, 35 lbs (15.9 kg).

Dimensions: $3-15/32$ " x $16-5/16$ " x $16\frac{3}{4}$ " (88 x 414 x 425 mm).
Price: 2801A Quartz Thermometer, including two 2830A Sensor Oscillators and two (matched) 2850 series Temperature Sensors, \$3250.

Specifications, HP 2831A Amplifier

Operating frequency: 28 to 29 MHz approx.

Gain: 40 dB approx.

Power required: $+12$ to $+20$ V dc, at 8 mA approx. (Normally supplied by HP 2801A.)

Connectors: coaxial output connector mates with HP 2801A Quartz Thermometer.

Operating conditions: same as HP 2830A Sensor Oscillator.

Dimensions, weight, finish: same as HP 2830A Sensor Oscillator.

Price: 2831A Amplifier, \$100.

Specifications 2833B Oceanographic Sensor

Temperature range: -40 to $+120^{\circ}\text{C}$ (-112 to $+248^{\circ}\text{F}$).

Response time (step change): 63.2% of final value in 3 sec; 99.0% in 16 sec; 99.9% in 24 sec (flow at 2 fps).

Price: \$900; opt. 001 (50 ft. long waterproof cable): N/C; opt. 002 (armored 50 ft. long waterproof cable with load-bearing termination): add \$255 plus \$1.50/ft. above 50 ft.

ACCESSORIES

Cable assemblies

For general purpose use



MEASURING DEVICES

10501A Cable Assembly

44" of 50Ω coaxial cable terminated on one end only with UG-88C/U BNC male connector; HP 10501A, \$8 each.

10502A Cable Assembly

9" of 50Ω coaxial cable terminated on both ends with UG-88C/U BNC male connectors; HP 10502A, \$12 each.

11086A Cable Assembly

24" of 50Ω coaxial cable terminated on both ends with UG-88C/U BNC male connectors; HP 11086A, \$7 each.

10503A Cable Assembly

4' of 50Ω coaxial cable terminated on both ends with UG-88C/U BNC male connectors; HP 10503A, \$13 each.

11000A Cable Assembly

Dual banana plugs terminate a section of 50Ω cable, 44" over-all; plugs for binding posts spaced $\frac{3}{4}$ "; HP 11000A, \$6 each.

11001A Cable Assembly

Identical with 11000A except dual banana plug on one end and UG-88C/U BNC male on the other; HP 11001A, \$7 each.

11002A Test Leads

Dual banana plug to alligator clips, 5'; HP 11002A, \$8 each.

11003A Test Leads

Dual banana plug to probe and alligator clip, 5'; HP 11003A, \$10 each.

11035A Cable Assembly

12" 50Ω coaxial cable terminated on one end with a dual banana plug and on the other end with a UG-88C/U BNC male connector; HP 11035A, \$7 each.

11500A Cable Assembly

6' of 50Ω coaxial cable terminated on both ends with UG-21D/U Type N male connectors; HP 11500A, \$20 each.

11501A Cable Assembly

6' of 50Ω coaxial cable terminated with UG-21D/U Type N male and UG-23D/U Type N female; HP 11501A, \$20 each.

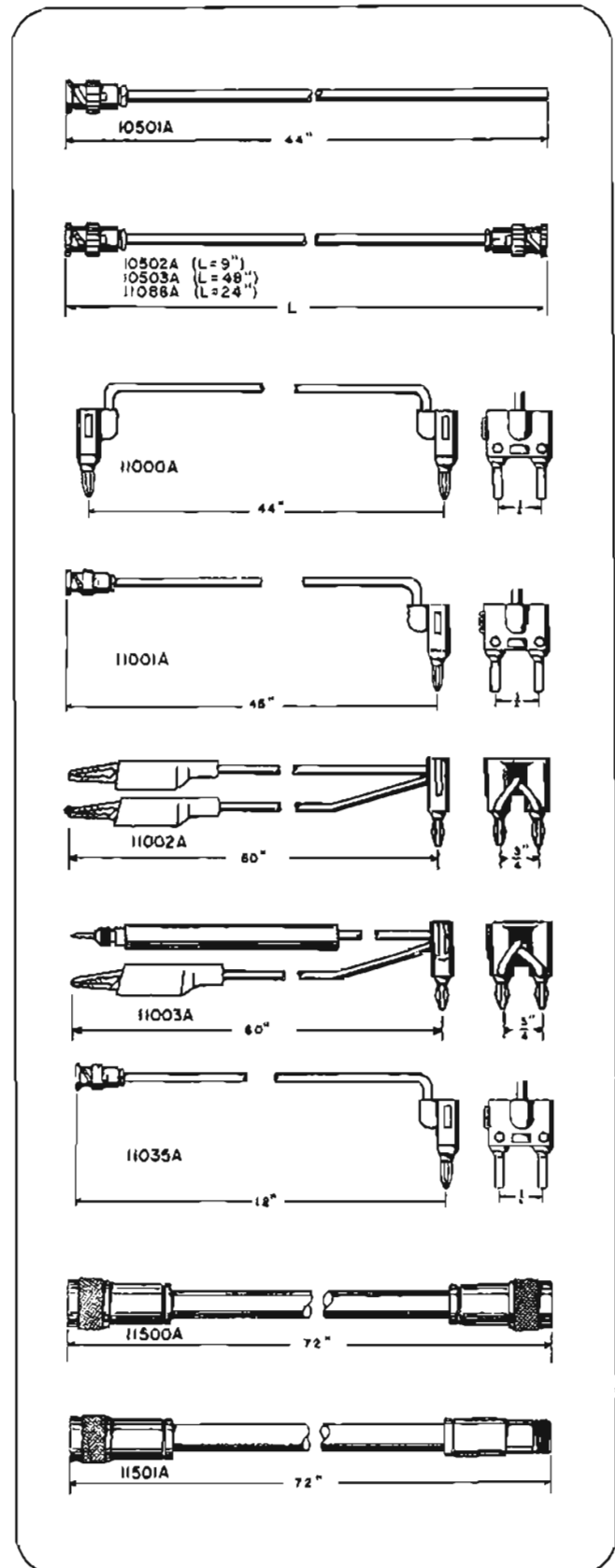

CABINETS



CABINETS

Rugged, durable, and ready-to-use
2940 Series

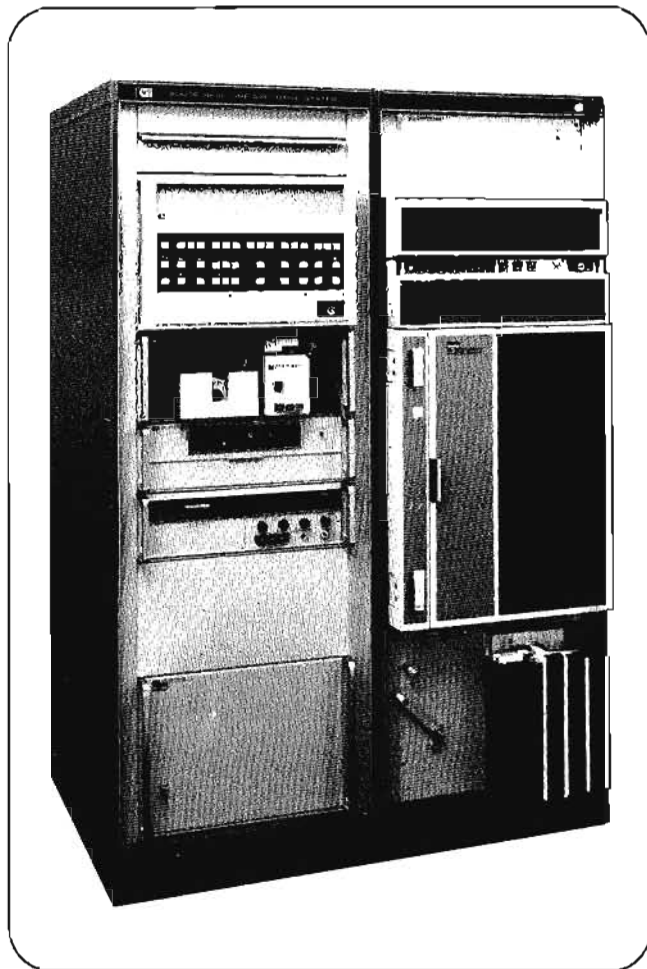

Typical Instrumentation Racking in a 2940 Series Cabinet

The model number 2940 identifies a series of exceptionally rugged, yet lightweight Hewlett-Packard enclosures, all of which have been carefully designed to present a clean professional appearance wherever they are used. Choices include one-, two-, and three-bay cabinets with 35-, 56-, and 70-inch panel openings. (35-inch panel opening is available on one-bay cabinet only.) Usable depth of the cabinets, 27 inches, is compatible with all Hewlett-Packard computers and instruments. Optionally, solid or transparent doors can be fitted to any cabinet bay for protection of equipment. Solid doors are available in either wood-grained or enamel finish. Cabinets are equipped with eyebolts having a combined load capacity of 5600 pounds for easy handling, and also come with casters for mobility at the operating site. An efficient ventilation system holds the temperature rise inside of the cabinet to less than 15°C with respect to outside ambient.

All 2940 Series Cabinets are supplied fully wired in accordance with IEC electrical specifications for the power option specified at time of order. Cabinets ordered with a system are shipped with the instruments rack mounted, in-

strument support rails in place, and blank panels installed to cover unoccupied panel space. When cabinets are ordered separately (not with a system), blank panels must be ordered separately and instrument support rails are furnished as follows: 4 pairs per 35-inch bay, 5 pairs per 56-inch bay, 6 pairs per 70-inch bay.

Cabinet ordering information

BAYS	HEIGHT		Max Pwr Per Bay for Temp Rise 15°C	Power Outlets Per Bay	POWER CONNec- TION TO MAINS	WEIGHT		Order 2940A/B Option	Price \$
	Panel	Overall				Net	Ship		
One Bay	35 (889)	43.25 1098	500W	6	HP-supplied power cable and plug rated 15A at 115 VAC.	128 (58.1)	230 (104.8)	135	825
	56 (1422)	64.25 (1632)	2000W	9	HP-supplied power cable and plug rated 20A at 115 VAC.	161 (73.1)	280 (127.1)	156	1,000
	70 (1778)	78.25 (1988)	2000W	11	HP-supplied power cable and plug rated 20A at 115 VAC.	181 (82.2)	332 (150.7)	170	1,050
Two Bays	2x56 (2x1422)	64.25 (1632)	2000W	9	HP-supplied power cable and user- furnished plug.	294 (133.5)	471 (213.8)	256	1,650
	2x70 (2x1778)	78.25 (1988)	2000W	11	HP-supplied power cable and user- furnished plug.	333 (151.2)	554 (253.8)	270	1,850
Three Bays	3x56 (3x1422)	64.25 (1632)	2000W	9	Through user- furnished cable or conduit.	434 (197.0)	672 (305.1)	356	2,300
	3x70 (3x1778)	78.25 (1988)	2000W	11	Through user- furnished cable or conduit.	494 (224.3)	796 (361.4)	370	2,500

NOTES:

- ① Inside of cabinet with respect to ambient temperature outside of cabinet. 500W in 35-inch bay includes 17W for power box and fan. 2000W in 56- or 70-inch bay includes 53W for power box and fan.
- ② Additional outlets are available as follows: Option 060: 6 additional outlets for 35-inch cabinet, add \$40; Option 061: 9 additional outlets for 56-inch cabinet, add \$45; Option 062: 11 additional outlets for 70-inch cabinet, add \$50.
- ③ Price includes complete electrical system. (Order by option number from POWER OPTIONS table.)
- ④ Dimensions in inches and (millimeters)
- ⑤ Usable depth 27 1/4 inches (702 mm). Overall depth 30 inches (762 mm), 37.75 inches (959 mm) with base extension.
- ⑥ Overall height includes casters but not eyebolts
- ⑦ Weight in pounds and (kilograms)
- ⑧ Panel opening is 19 inches (483 mm) wide; behind-panel opening is 17.75 inches (451 mm) wide

Specifying color scheme

Cabinets and cabinet accessories which have an A/B suffix after the model number are available in a choice of two color schemes. Suffix A models (2940A, 12674A, etc.) are textured blue with Hewlett-Packard grey trim for compatibility with most existing Hewlett-Packard instruments. Suffix B models (2940B, 12674B, etc.) are moss grey with mint green trim for compatibility with the colors of the newest Hewlett-Packard instruments.

Specifying power

Specify electrical power desired by ordering from the POWER OPTIONS table below. For example, for 35-inch cabinet with 115 V ac electrical system, specify a 2940A (or B) Cabinet with Options 135 and 051.

Power options

2940A Option No.	PRIMARY POWER INPUT (50-80 Hz)			
	115 Vac Option No.	230 Vac (Europe) Option No.	230 Vac (U.S.A.) Option No.	120/208 Vac 3 phase Option No.
135	051	050	①	Not available
156	052	055	②	Not available
170	052	055	③	Not available
256	053	056	058	④
270	053	056	058	④
356	054	057	⑤	059
370	054	057	⑥	059

① Internal power strips wired for 115 Vac
 ② Internal power strips wired for 230 Vac
 ③ Internal power strips wired for 115 Vac (center tapped input)
 ④ Internal power strips wired for 120 Vac
 ⑤ Available on special order. Consult HP Field Sales Office.

Specifying front doors

Cabinet front doors, listed in the table below, provide 2.56 inches (65 mm) from front of rack mounted instrument to inside of door to allow for knobs and other protrusions; this adds 2 inches (50,8 mm) to cabinet depth. All doors include a key-lock. Order by Accessory No. Specify right or left opening.

Cabinet front doors

Transparent (Grey Tint) Panel			
Height In (mm)	Accessory No.	Net Weight Lb (kg)	Price \$
12.25 (311)	12696B	6 (2,7)	180
31.5 (800)	12693B	12 (5,4)	190
56 (1422)	12677B	18.5 (8,2)	200
70 (1778)	12687B	22.5 (10)	210
HP Grey or Mint Grey Panel			
12.25 (311)	12697A/B	5.5 (2,4)	160
31.5 (800)	12694A/B	10 (4,5)	170
56 (1422)	12678A/B	16 (7,2)	180
70 (1778)	12688A/B	19.5 (8,8)	190
Wood Grained Panel			
12.25 (311)	12698B	6 (2,7)	160
31.5 (800)	12695B	12 (5,4)	170
56 (1422)	12686B	18.5 (8,2)	180
70 (1778)	12689B	22.5 (10)	190

Front door option: (specify front door Accessory No. plus Option No).

Option 003: extra-deep door for 56- or 70-inch cabinet. Allows 5.56 inches (141 mm) from instrument front panel to inside of door. Adds 5 inches (127 mm) to cabinet depth.

Price: add \$20.

Specifying base extensions

A base extension is required to prevent tip-over of cabinet with a computer, magnetic tape unit, or other heavy instruments that swing out for servicing. Order by Option No.

Option 016: base extension for one-bay cabinet, \$50.

Option 026: base extension for two-bay cabinet, \$80.

Option 036: base extension for three-bay cabinet, \$120.

Cabinet accessories

Equipment slides: 150 lbs (68 kg) load capacity. Order by Accessory No.

Accessory No. 12692B: slide for mounting non-Hewlett-Packard instruments. Price: \$60.

Accessory No. 12692B-002: brackets for mounting 3.5 inch (88,9 mm) high Hewlett-Packard instruments. Price: \$85.

Accessory No. 12692B-003: brackets for mounting Hewlett-Packard instruments over 3.5 inches (88,9 mm) high with handle recess. Price: \$85.

Storage drawers: 75 lbs (34 kg) load capacity; installed at bottom of cabinet if no other location is specified. Order by Accessory No.

Height		Depth		Accessory No.	Price
In.	mm	In.	mm		
3.5	89	16	406	12672A/B	\$90
5.25	133	16	406	12673A/B	

Instrument support rails: one pair with attaching hardware. Order Accessory No. 12679B. Price: \$10.

Writing surfaces: topped with white Formica. Fixed shelves are removed for shipping. Slideout shelf is installed if ordered with cabinet. Order by Accessory No.

Type of shelf	Usable area In. (mm)	Panel height	Accessory No.	Price
1-Bay Slide-out	16 x 16.5 (406 x 419)	3.5 (89)	12674A	\$140
1-Bay Fixed	15 x 20 (381 x 508)	1.75 (44)	12675A	\$100
2-Bay Fixed	15 x 41 (381 x 1041)	1.75 (44)	12676A	\$150

Blank panels: Hewlett-Packard grey or mint grey with attaching screws. Order by Accessory No.

Height In. (mm)	Accessory No.	Price	Height In. (mm)	Accessory No.	Price
1.75 (115)	12680A/B	\$10	7 (178)	12683A/B	\$10
3.5 (89)	12681A/B		8.75 (222)	12684A/B	
5.25 (133)	12682A/B		10.5 (267)	12685A/B	

Modular enclosure systems

The Hewlett-Packard modular enclosure system provides a complete solution to instrument packaging and mounting problems. The system is in accord with EIA standard rack and panel dimensions, yet each enclosure is equally well suited to bench or field use.

Two types of instruments

Basically, instruments enclosed in the modular system fall into two classes: (1) instruments which require full EIA

ACCESSORIES



rack width. These instruments mount directly in racks by means of brackets and filler strips included with the instruments. Feet and tilt stand are provided for bench use. Instruments can be stacked for maximum utilization of available space. (2) instruments which require only one-third or one-half the full module width. Adapter frames are available for mounting in standard EIA racks. Combining cases and rack adapter frames use blank panels to fill areas not used by instruments and provide convenient storage of leads, cords, etc. Model 1052A Combining Case accepts cooling kits to maintain proper ambient temperature.

Specifications Combining cases

11046A accepts third-module instruments.

Dimensions: 19¼" wide, 8⅜" high, 13¼" deep (489 x 213 x 367 mm), \$150.

1051A accepts third- or half-module instruments up to 11¼" (286 mm) deep.

Dimensions: 16¾" wide, 7¼" high, 13¼" deep (425 x 185 x 337 mm); hardware furnished for conversion to rack mount 19" wide, 6-31/32" high, 11¼" deep behind panel (483 x 177 x 286 mm).

Weight: net 11 lbs (5 kg); shipping 15 lbs (6,8 kg).

Price: HP 1051A, \$135.

1052A accepts third- or half-module instruments up to 16⅜" (416 mm) deep.

Dimensions: 16¾" wide, 7¼" high, 18⅜" deep (425 x 185 x 467 mm); hardware furnished for conversion to rack mount 19" wide, 6-31/32" high, 16⅜" deep behind panel (483 x 177 x 416 mm).

Weight: net 13 lbs (5,9 kg); shipping 18 lbs (8 kg).

Price: HP 1052A, \$150.

Rack adapter frame

5060-0797 Adapter rack mounts third- and/or half-module instruments up to 6-3/32" high (155 mm), \$25.

5060-0808 Adapter rack mounts third- and/or half-module instruments up to 3" high (75 mm), \$25.

Control panel covers

These covers quickly convert full-width cabinets to easily carried portable units.

Control panel covers

Part No.	EIA Panel Height		Price
	(in.)	(mm)	
5060-0826	3-15/32	88	\$22.50
5060-0827	5-7/32	133	\$25.00
5060-0828*	6-31/32	177	\$27.50
5060-0829	8-23/32	222	\$28.50
5060-0830	10-15/32	266	\$30.00
5060-0831	12-7/32	310	\$32.50

*Also fits HP 1051A and 1052A.

Joining brackets

5060-0215 Joining Bracket Kit for semi-permanently joining any two full-module instruments 11¼" (286 mm) deep behind the front panel, \$20.

5060-0216 Joining Bracket Kit for semi-permanently joining any two full-module instruments 16⅜" (416 mm) deep behind the front panel, \$25.

Instrument cases

11075A accepts third-module instrument 6½" high 8" deep.
Weight: net 3 lbs (1,4 kg); shipping 5 lbs (2,3 kg).

Price: HP 11075A, \$45.

11076A accepts third-module instrument 6½" high, 11" deep.
Weight: net 3 lbs (1,4 kg); shipping 6 lbs (2,7 kg).

Price: HP 11076A, \$45.

Field cases

The Hewlett-Packard field cases are rugged protective outer shells for use when instruments must be frequently transported and used away from laboratory conditions. They are molded of strong fiberglass-reinforced plastic and sealed tightly, making them rainproof under the test conditions of MIL-STD-108. Cases meeting MIL-C-4510 are available. Carrying handles fold flat when not in use. Two basic case styles are available: transit and operating. Cases are available to accommodate nearly any instrument and combination of accessories. Special size cases can also be ordered. A technical data sheet is available.

Transit cases

Transit cases are typically provided with foam cushions custom-formed to fit the standard Hewlett-Packard modular cabinets. This arrangement provides maximum protection against damage from handling, dropping, or crushing. Prices: \$70-\$220.*

Operating cases

Operating cases are equipped internally with shock-mounted frames that accept combinations of any standard 19-inch rack-mounting instruments up to the maximum height of the frames. This arrangement offers the convenience of operation without removing the instrument from its carrying case. At the same time, environmental protection is afforded. Drawers and casters are available. Prices: \$460-\$685.*

* Quantity discounts available.