

HP Archive

This vintage Hewlett Packard document was preserved
and distributed by

[www. hparchive.com](http://www.hparchive.com)

Please visit us on the web !

On-line curator: Glenn Robb

HEWLETT  PACKARD

MEASUREMENT/COMPUTATION



1977.

*ELECTRONIC
INSTRUMENTS
AND SYSTEMS*



PRODUCT EXCELLENCE, LASTING VALUE

Your assurance of lasting value accompanies every Hewlett-Packard product. We intend to continue our long-standing practice of offering you excellent products, supported by a wide variety of useful services both before and after the sale.

HP design technology

Our responsibility to you begins with product designs which apply advanced technologies, often pioneered at HP through our extensive ongoing research. Many of today's commonly-accepted measurement standards and practices began with the design of innovative HP products.

Advanced technology is not the only design consideration, however. An HP product's "manufacturability" and (especially important after you purchase that product) its "serviceability" also contribute to its lasting value.

HP manufacturing

HP product designers understand the practical aspects of product manufacture. This emphasis on modern manufacturing technology, coupled with superior workmanship and high productivity, ultimately delivers high-value HP products to you at competitive prices. In addition, HP manufacturing facilities contribute to the ultimate serviceability of the products you purchase by furnishing clear and well-written operating and service instructions.

Today, Hewlett-Packard has more than 30 product-responsible divisions located in California, Colorado, Idaho, New Jersey, Oregon, Pennsylvania and Massachusetts in the U.S.—as well as in Scotland, the German Federal Republic, France, Japan, Singapore, Malaysia and Brazil.

HP product serviceability

Serviceability can mean many things. In the broadest sense, it means getting full utilization and value from your purchase, and this is one of HP's principle objectives in serving you.

In other ways, it can mean having a product that is easy to understand and operate—as well as one that works under a variety of adverse conditions and can be depended upon to perform as expected for years to come. As a practical matter, it also means having a product backed by a reputable firm so that subsequent maintenance, repairs and parts are readily available. Hewlett-Packard's world-wide service organization helps you receive full and continuing value from your HP purchase.

HP SALES AND SERVICE: NEARBY . . . AND WORLDWIDE

Product excellence and value are only part of the total HP story. Equally important is the ready availability of local sales and service support.

To be responsive to your needs and those of other customers, Hewlett-Packard has over 3,000 sales and service engineers and other technical personnel located in more than 172 offices in 65 countries. This means that a significantly high percentage (more than 10%) of our world-wide total number of employees are *specifically and directly available to you and other HP customers for pre-and-post sale technical support.*

To locate the HP Sales and Service Office nearest you, please see the listing inside the back cover of this catalog.



Identifies products having the Hewlett-Packard Interface Bus (HP-IB) capability. HP-IB is our implementation of the IEEE Standard 488 and the identical ANSI Standard MCI.1, "Digital interface for programmable instrumentation." For the complete story, see pages 20-29.



Identifies newly introduced products or capabilities. New products are also indicated by bold-face listings in the Model Number Index.

ALPHABETICAL INDEX	1
MODEL NUMBER INDEX	10

CATALOG SECTIONS:

After-Sale Service	572	Microwave Test Equipment.....	380
Amplifiers	30	Network Analyzers	408
Analog Voltmeters	33	Ordering Information	571
Cabinets & Measurement Accessories	474	Oscillators & Function Generators.....	305
Calculators & Peripherals.....	520	Oscilloscopes	112
Calibrators	320	Physical & Optical Measurements.....	556
Chemical Analysis, Instruments for	566	Power & Noise Figure Meters	370
Civil Engineering/Surveying Equipment	563	Power Supplies	178
Component Test	72	Pulse & Word Generators	278
Computers: Components & Systems	535	Recorders & Printers	204
Digital Circuit Testers & Analyzers	94	Signal Analyzers	434
Digital Voltmeters	44	Signal Generators	326
Displays	166	Sweep Oscillators	351
Electronic Counters	235	Solid State Components & Circuits	564
Frequency Synthesizers	314	Telecommunications Test Equipment	488
Frequency & Time Standards	266	Training/Video Tapes	573
Hewlett-Packard Interface Bus (HP-IB)	20	Transceiver Test Equipment	486
Medical Instrumentation	568	X-Ray Systems, Scientific & Industrial	570
Application Notes — a selected listing	575		
Sales/Service Offices			inside back cover
Information Request Card			back of catalog

CATALOG CONTENT

This catalog is designed primarily to serve the needs of engineers, scientists and technicians who are concerned or work with electrical/electronic phenomena. It deals with the broad area of *measurement* (plus generation and recording), as well as related *computation*.

HP has many additional capabilities not detailed in this catalog, which are instead summarized on the last few pages. In the event your work is related to any of these other HP capabilities, we will be pleased to send you specific product information on request.

- A**
- AC**
- Calibrator 321
 - Current Probe 483
 - Digital Voltmeter 48, 50, 54, 58, 62, 66
 - Divider Probe 47, 482
 - Probes 47, 482
 - RF 38, 42, 47
 - True RMS 41, 58, 62
 - Voltmeters 37-42, 48, 50, 52, 54, 58, 62, 66
- Access System 548
- Accessories**
- Base Band Sweeper 512
 - Cables/Connectors 480
 - Cameras 161
 - Carrying Cases 47
 - Connectors, Adapters 481
 - Modular Power Supplies 199
 - Oscilloscope 156-165
 - Signal Generators 350
 - Spectrum Analyzer 467
 - Voltmeter 47, 482
- AC/DC**
- Converter Plug-In Module 207, 228
 - Meter Calibrator 321
- Active Probes** 157, 425
- Adapters**
- 50 — 75Ω 421, 425, 467
 - Cables/Connectors 480
 - Coaxial and Waveguide 402
 - Slotted Line Sweep 396
- Air Line Extensions** 402
- Alphanumeric LED Displays** 564
- Alphanumeric Printer** 232
- AM/FM Signal Generators** 328, 335, 340
- Amplifiers**
- AC Calibrator/High Voltage 322
 - AC Carrier Preamplifier 223
 - Broadband Preamp 30, 265
 - Digitally Programmable 532
 - Frequency Standard Distribution 276
 - General Purpose 30
 - IF 512
 - Leveling 369
 - Logarithmic 40, 43
 - Plug-Ins for Oscillographic Recorders 227-229
 - Power 32
 - Power Supply 197
 - Pulse 30
 - RF/Microwave 31
- Amplitude/Delay Distortion Analyzer** 492
- Analog-to-Digital Converter** 60, 62, 66, 532
- Analog Voltmeters General Information** 33
- Analytical Instrumentation** 566
- Analyzers**
- Automatic Network 422, 555
 - Automatic Spectrum 447, 555
 - Audio Spectrum 450, 458, 470
 - Correlation 472
 - Digital Signal 470
 - Distortion 441, 442
 - Fourier 470
 - Frequency Stability 468
 - Gain-Phase 416
 - Logic 94
 - Logic State, 16/32-bit Parallel 96
 - Low Frequency Spectrum 447, 450, 470
 - Mechanical Impedance 470
 - Network 408-433
 - Noise 470
 - Power Spectrum 470
 - Spectrum 149, 434-473
 - Telephone Line 492
 - Transfer Function 470
 - Vibration 450, 470
 - Wave 446, 506, 508
- APC-3.5 Precision Microwave Connectors** 380
- APC-7 Series Adapters** 402, 481
- Asynchronous Communications Interface** 522, 538
- Asynchronous Data Set Interface** 538
- Asynchronous Multiplexer** 538
- Atomic Clock** 268-273
- Attenuators**
- 75 ohm General Purpose 510
 - Coaxial 385
 - Coaxial, Microwave, OEM 388
 - Decade 89
 - Resistive 89
 - Coaxial Step 386
 - Waveguide 389
- Automatic Capacitance Bridge** 79, 81, 83, 84
- Automated Measurement & Control Syst.** 532
- Automated Test Systems** 70, 71, 422, 532-555
- Automatic Data Acquisition System** 71
- Automatic Dialer Interface** 522, 538
- Automatic Receiver System** 555
- Automatic Synthesizer** 316, 318
- Avionics Signal Generator** 338
- B**
- Balancing Transformers 483
 - Bandpass Filters 399
 - Battery Operated**
 - Counters 252, 260
 - DVM 48, 50, 52, 54
 - Hand-Held Calculators 523, 529
 - Microwave Power Meter 373, 376
 - Multifunction Meter 50, 52
 - Oscilloscopes 128
 - Voltmeter 48, 50, 52, 54
- BB Sweeper Accessory** 512
- Bridge, Directional** 406, 425
- Broadband Detectors** 394

ALPHABETICAL INDEX

- Broadband Sampling Voltmeter 42
 Buffered Asynchronous Communications Interface 522, 538
C
 Cables/Connectors 480
 Cabinet X-Ray Systems 570
 Cabinets 484-490
 Cabinets, System II 474-479
 Cable Assemblies 480
 Calculators & Peripherals 520
 8-bit Parallel Interface 531
 16-bit Duplex Interface 531
 BCD Input Interface 531
 Binary Synchronous ROM 531
 Card Reader 530, 545
 CRT Subsystem 531
 Data Communications Interface and ROM 531
 Character Impact Printer 527
 Desktop Programmable 527-529
 Digitizer 530
 Flexible Disk Drive 528
 General Interface 531
 HP-IB Interface 28, 531
 Hand-Held Business 524
 Hand-Held Financial 526
 Hand-Held Programmable 522, 525
 Hand-Held Scientific 523, 524
 High-Speed Tape Reader Subsystem 530
 Hopper Card Reader 530
 I/O Expander 530
 Interactive ROM 531
 Line Printer Subsystem 531
 Mass Memory Subsystem 529
 Paper Tape Reader 530
 Serial Interface 531
 RS-232-C Serial Interface 531
 Tape Cassette 530
 Tape Punch Subsystem 530
 Thermal Printer 531
 X-Y Plotter 531
 Calculator Based Network Analyzer 413, 422
 Calculator Based Spectrum Analyzer 447
 Calculator Controlled Instrument Systems 486, 532
 Calibrators
 AC 321, 322
 For 432 Series 377
 For 435A 373
 Peak Power 377
 Cameras
 Adapters 162
 Oscilloscope 161
 Oscilloscope Camera Adapter Table 163
 Capacitance Bridges; Meters 83-87
 Capacitive Voltage Divider 482
 Capacitors, Decade 89
 Card Readers 530, 545
 Card Reader for 1600A Logic State Analyzer 99
 Carriage, Slotted Section 396
 Carrier Preamplifiers 227
 Carrier Testing 503
 Cases, Combining 484
 Cavity Frequency Meters 393
 Cesium Beam Frequency Standard 268-270
 Chromatographic Data Systems 566
 Clips, Logic 106
 Clip, IC Test 159
 Clip-on, DC Milliammeter 36
 Clip-on, AC Current Probe 483
 Clock, Atomic 268-273
 Coaxial Instrumentation
 Accessories 402, 480
 Attenuators 385, 386, 388
 Crystal Detectors 394
 Directional Bridge 406, 425
 Directional Couplers 390
 Directional Detectors 391
 Dual Directional Coupler 390
 Fixed Attenuators 385
 Frequency Meters 393
 Harmonic Mixer 400
 Instrumentation Table 382
 Low-Pass Filters 399, 406
 Pad, Attenuators 385
 Power Splitter 406, 420, 426
 Sliding Load 398
 Slotted Line 396
 Slotted Section 396
 Step Attenuators 386
 Swept Slotted Line Systems 396
 Switch 401
 Termination 398
 Thermistor Mount 377
 Thermocouple Mount 374
 Waveguide Adapters 402
 Comb Generator 467
 Combining Cases 484
 Communications, General Information 488, 503, 509, 515
 Communication Test Equipment 79, 83, 490
 Communications, Data 489
 Communications Test Set 489
 Components, Microwave, OEM 388, 394, 401
 Component Test 72
 Auxiliary Capacitor 88
 Digital IC Tester 91-93
 General Information 72
 Reference Inductors 88
 Series Loss Test Adapter 88
 Test Fixture 74
 Computers
 Display Terminals, CRT 541

HP 1000 Systems 546
 HP 2000 547
 HP 3000 548
 21 MX Computers 536
 21 MX DISComputers 537
 21 MX E-Series Processors 536
 21 MX K-Series Component Products 537
 Connector Adapters 382, 402, 481
 Connectors, Microwave Precision 380, 402
 Constant Current Sources 196, 202
 Controller, Vibration 196-202
 Controllers for HP-IB 28
 Converters
 A-to-D 26, 60, 62, 66, 532
 D-to-A 26, 202, 532
 DC to DC Converters 201
 HP-IB Programmable 26
 Modular DC to DC Converters 201
 Serial to Parallel 28
 Correlator 472
 Common Carrier Interface 26
 Counters, Electronic 235-265
 Auto. Freq. Conv. 241
 Auto. Ranging 254
 Computing 243
 Counter/Timer 238, 246, 251, 256, 532
 Digital Multimeter/Counter 246, 251, 257
 DVM 248, 251, 257
 Heterodyne Converter Plug-Ins 241, 244, 245
 Low Cost 261
 Microwave 241, 244, 245, 262, 263
 Plug-In Adapters 241, 243
 Portable, Battery Operated 252, 260
 Programmable 238, 243, 246, 251, 264, 532
 Reciprocal 238, 243, 258, 532
 Time Interval 238, 243-246, 255, 258, 532
 Time Interval Probes 264
 Transfer Oscillator Plug-In 243
 Universal 238, 246, 255, 258
 Video Amplifier Plug-In 244
 Couplers, Directional (Coax and Waveguide) 390, 392
 CRT Terminals 541
 Crystal Detector 394
 Crystal Oscillators 274
 Current
 Divider 47
 Sources 202, 321, 532
 Current Tracer, Logic 105
D
 D/A Converter 259, 532
 Data
 Acquisition Systems 71, 532
 Base Management Software Image/2000 548
 Centers, Mini 548
 Communications 488

Communications Interfaces 537, 538
 Error Analyzer 490
 Generator 304, 516
 Logger 70
 Source Interface 538
 Station 541
 Transmission Test Set 490, 496
 Voice Channel Test Set 490, 500
 Data Source Interface 538
DC
 Amplifier 197
 Amplifier Plug-In Module 207
 Attenuator Plug-In Module 207
 Bank Amplifier 229
 Bridge Preamplifier 223
 Coupler Plug-In Module 207
 Differential Voltmeter 324
 Digital Voltmeter 48, 50, 52, 54, 57, 62, 66
 Milliammeter 36, 54
 Nullmeter 35, 324
 Offset Plug-In Module 207
 Preamplifier Plug-In Module 207
 Standard 324
 Voltage Divider 47, 482
 Voltmeters 34, 35, 37, 48, 50, 52, 54, 57, 62, 66
 DC-to-DC Converters 201
DC Power Supplies 178-203
 Amplifier/Power Supply 30, 197
 Condensed Listing 180
 Constant Current Sources 196
 Digitally Controlled 202
 Dual Tracking 192
 General Information 178
 General Purpose: 25 – 200 W Output 184, 191
 General Purpose: 100 – 2000 W Output 186
 General Purpose: 300 – 11,000 W Output 188, 190
 General Purpose: 0 – 320 V 186
 High Voltage 193
 HP-IB Programmable 180, 191
 Low Cost Lab 182
 Modular, DC-to-DC Converters 201
 Modular, Single Output, Series Regulated 199
 Modular, Dual Output, Series Regulated 199
 Modular, 200 – 600 W, Switching Regulated 199
 Modular, 110 W Switching Regulated 199
 Modular, Triple-Output Switching 199
 Options 198
 Precision Voltage Sources 194
 Programmable 191, 202
 Specifications Definitions 179
 Decade Capacitors and Attenuators 89
 Delay Generator/Frequency Divider 280
 Delay and Rate Plug-ins 296

- Detectors
 Coaxial, Microwave, OEM394
 Crystal, Coaxial and Waveguide394
 Directional391
 Error516, 518
 Slotted Line396
- Digital
 AC Voltmeters48, 50, 52, 54, 58, 62, 66
 Capacitance Meter81, 83-87
 Circuit Test532
 DC Voltmeters48, 50, 52, 54, 60, 62, 66
 IC Tester91
 Interface (HP-IB, IEEE, ANSI)20
 I/O Sub-system532
 LCR Meter79, 81
 Multimeter48, 50, 52, 54, 62, 66
 Ohmmeter48, 50, 52, 54, 62, 66, 75, 76
 Oscillator308, 316, 318
 Power Meters (RF/Microwave)372, 376
 Pressure Gauge557
 Printer232
 Programmable Power Supplies532
 Magnetic Tape Units540
 Signal Analyzers446, 450, 470
 Spectrum Analyzers447, 450, 470
 Tape Systems540
 Test Systems553
 Thermometer57
 Vibration Controller471
 Voltmeters48, 50, 52, 54, 58, 62, 66
- Digital-to-Analog Converters259, 538
- Digitizer530
- Dimensional Measurement562, 558
- Diodes564
- Directional Bridge406, 425
- Directional Couplers
 Coaxial390
 Waveguide392
- Directional Detectors391
- Disc Sub-Systems539
 Sub-system, Cartridge539
- DISComputers522
- Display Terminal Interface538
- Displays166-177
 Cathode-ray Tube166
 High Resolution/Medical168
 High Resolution/Storage168
 Large Screen 32 cm (13 in.)176
 Large Screen 35.6 cm (14 in.)173
 Large Screen 43.2 cm (17 in.)173
 Large Screen 48.2 cm (19 in.)173
 Large Screen 53.3 cm (21 in.)173
 Numeric and Alphanumeric565
- Distortion Analyzers441
- Distributed Systems547
- Distribution Amplifier276
- Divider Probe482
- Double Balanced Mixers350
- Down Converter Generator, 0.5 to 550 kHz339
- Down Converter: RF to JF510
- Dual Tracking, Power Supply192
- Duplex Registers538
- E
 EIA Registered Visible Light Emitting
 Diodes565
- Emulation Subsystem547
- Error Measuring Set (1 Kb/s × 50 Mb/s)518
- Error Rate **Measurement**516
- Error Rate **Measurement** System516
- Expander, I/O530, 532
- F
 Fast Fortran Processor537
- Faxitron™ X-Ray Systems570
- Filters
 Bandpass399, 464
 Coaxial and Waveguide399
 High Pass406
 Low Pass399, 406
 Low Pass Plug-In Module207
- Fourier Analyzer470
- FM Signal Generators328, 332, 335, 340
- Frequency
 Counters235, 532
 Doubler Probe348
 Doublers347, 350
 Meters, Coaxial and Waveguide393
 Response Test Sets404
 Stability Analyzer468
- Frequency Standards
 Cesium268-270
 Distribution Amplifier276
 General Information266
 Quartz274, 275
 Rubidium271
 Standby Power Supplies277
- Frequency and Time Standards266-275
- Frequency Selective Voltmeter and Tracking
 Oscillator506
- Frequency Synthesizers316, 328, 332
- Function Generators310
- Fuseholder, RF350
- G
 Gas Chromatographs566
- General Purpose Interfaces20, 531, 538
- General Purpose Interface Bus Controllers28
- Generators
 Data304, 516
 Noise378, 473
 Pattern518
 Pulse278
 Signal328-349
 Spectrum350

Square Wave 293
 Sweep 351-369
 Tracking 454, 458, 460-465
 Word 278
 Graphic Plotters 204, 214
 Graphic Plotters Terminal 214
 Group Delay (Network Analyzer) 418
 Group Delay Network Computer 215
 Guarded Digital Multimeter 62, 66
H
 Hardwired Serial Interface 522, 538
 Harmonic Analyzer 446
 Harmonic Mixer (Coaxial and Waveguide) 400
 Hewlett-Packard Interface Bus (HP-IB) 20-29, 531
 Hexadecimal Display with Electronics 565
 High Gain Preamplifier 227
 High Resistance Meter 76
 Hi-Rel Numeric Displays 227
I
 IC Tester, Digital 91
 IMAGE/1000 Software 552
 IMAGE/2000 Software 547
 IMAGE/3000 Software 548
 Impatt Diodes 564
 Impedance Meter 90
 Impedance Meter, RF Vector 90
 Impedance Probe 425
 Impedance Transformers (50 - 75Ω) 425, 467
 Input/Output Computer Cards 532
 Inspection Systems, X-Ray 570
 Instrument Accessories 482
 Insulation Resistance Meter 76
 Insulation Test 76
 Intelligent Terminals 54
 Interface, Digital (HP-IB, IEEE, ANSI) 20
 Interface Bus Card 28
 Interface Cover for 1645A 490
 Interface Kit, Digitally Controlled Power
 Supply 202
 Interface Kit, Multiprogrammer 532
 Integrating DVM 48, 50, 52, 54, 62, 66
 Intermodulation Analyzer 447
L
 Laboratory Kit, Microwave 380
 Laboratory, Strip Chart Recorders 204, 216-222
 Laboratory, X-Y Recorders 204, 206-213
 Laser Measurement 559
 Laser Transducer 558
 LCR Meter 74, 79
 Level Generator 508
 Light Emitting Diodes 564
 Limiter 467
 Line Printers, 200 LPM 540
 Liquid Chromatographs 566
 Loads/Termination, Coaxial and Waveguide 398
 Logarithmic Preamplifier 227, 228

Logarithmic Voltmeter 40, 43
 Logic
 Analyzer 101
 Clip 104
 Current Tracer 105
 Comparator 105
 Lub 108
 Probes 102
 Pulser 104
 State Analyzers 96-99
 Tracer, Current 105
 Troubleshooting Kits 108
 Low Distortion Generator 316, 318
 Low Frequency Spectrum
 Analyzer 447, 450, 458, 470
 Low Gain Preamplifier 223, 227
 Low Resistance Meter 62, 75
M
 Machinery Analyzer 470
 Magnetic Tape Recorders, Analog 230
 Magnetic Tape Subsystem, Digital 540
 Magnetic Tape Units, Digital 540
 Mark Reader, Optical 530, 545
 Marker Generator 354
 Mass Spectrometers 566
 Mechanical Impedance Analyzer 470
 Medical Applications 570
 Medium Gain Preamplifier 223, 227
 Memory Systems 522
 Meters
 AC 37-42, 48, 50, 52, 54, 58, 62, 66
 AC/DC 37, 38, 48, 50, 52, 54, 58, 62, 66
 Capacitance 83-85
 Differential 324
 Digital Multimeter 48, 50, 52, 54, 58, 62, 66
 Gain Phase 416
 High Capacitance 86
 Impedance 77, 78, 90
 LCR 74, 79
 Logarithmic Voltmeters 40, 43
 Milliammeter, AC 483
 Milliammeter, DC 36, 50, 54
 Milliohmmeter 54, 75
 Multifunction 37, 38, 48, 50, 52, 54, 58, 62, 66
 Noise Figure 378
 Ohmmeter 37, 38, 48, 50, 52, 54, 58, 62, 66
 Power (RF/Microwave) 372, 376
 Selective VM 506, 508
 Standing-Wave-Ratio (SWR) 403
 True RMS 41, 58, 62
 Microcircuit Interface 538
 Microprogrammable Processors 522
 Microwave
 Catalog 380
 Counters 241, 244, 245, 262, 263
 Laboratory Kit 380

Link Analyzers	510, 513	Quartz	274
Power Measuring Equipment	372, 376	Quartz Component	275
Radio Testing	509	RF	348
Signal Generators	332, 345-347	Sweep	316, 318, 351-369
Synthesizer	332, 334	Telephone Test	499
Test Equipment	380-407, 509-511	Test	309
Millimeter-wave Coaxial Equipment	382	Wide Range	316, 318
Millimeter-wave Waveguide Equipment	384	Oscillographic Recorders	204, 223-229
Milliohmeter	54, 62, 75	Oscilloscopes	112-165
Mini Data Centers	510-513	Accessories	156-165
MIS Chip Capacitors	564	Cameras	161
Mixers, Coaxial and Waveguide	400, 467	Contrast Filters	160
Mixer/Detector	564	100 MHz Third-Channel Trigger View	122
Modal Analysis	470	100 MHz Variable Persistence/Storage, Third-Channel Trigger View	122
Modular Power Supplies	199-201	200 MHz Delayed Sweep	120
Modulators, PIN Diode	349	200 MHz Dual Delayed Sweep	120
Motor Controller, Programmable	532	275 MHz Delayed Sweep	116
MPE/3000 Software	547	275 MHz Dual-Delayed Sweep with Microprocessor	116
Multi-meter	37, 38, 48, 50, 52, 54, 58, 62, 66	General Information	112-115
Multiple Span Plug-In Module	217	High Writing Speed Mainframe	136
Multiplexer, General Purpose	532	Large Screen Mainframe	135
Multiprogrammer	532	Light Shields	160
N		Low Frequency	150
Network Analysis, General Information	408-412	Plug-In, 180 series	137
Network Analyzers	408-433	Portable	128
Automatic	422	Rack Mount Slides and Adapters	160
Solutions to Problems	413-415	Ruggedized Portable, 50 MHz	129
Networks, Computer	547	Sampling	144-147
Noise		Spectrum Analyzer Plug-In	149, 452, 454
Analyzer, Acoustic	470	Testmobiles	164
Figure Meter	378	Variable Persistence/Storage	122, 128, 133, 150
Generator	378, 473	Viewing Hoods	160
Source (IF) (UHF) (VHF) and Waveguide	378	Output Voltage Divider	350
Null Detector Plug-In Module	207	Output Amplifiers (8080 System)	280
Null Meter	35	Output Plug-ins (1900 System)	296
Numeric LED Displays	565	P	
O		Pad, Coaxial Attenuator	385
OEM		Pattern Analyzer	100
Computers	536	Pattern Generator/Error Detector	518
Displays	166	PCM Testing	515
Microwave Attenuators	388	Peak Power Meter, Analog	377
Microwave Detectors	394	Phase Lock Synchronizer	369
Microwave Switches	401	Phase Meters	413, 416, 418, 424, 426, 427
Modular Power Supplies	199-201	Phase Modulation, Signal Generator	331
Strip Chart Recorders	204, 216-222	Phase Sensitive Demodulator Preamplifiers	227, 228
Switches, Coaxial, Microwave	401	Phase Shifters, Waveguide	400
X-Y Recorders	204, 206-213	PIN Diodes	564
Ohmmeters	37, 38, 48, 50, 52, 54, 58, 62, 66	PIN Modulators, Microwave	349
Optical Mark Reader	530, 545	PIN Photodiodes	565
Optically Coupled Isolators	565	Plotter, X-Y	531
Optoelectronics	565	Plug-In Counters	238-245
Oscillators		Plug-In Extender	532
Audio	306-309	Plug-In Oscilloscopes	130-148
Function Generator	310	Plug-In Pulse Generator System	296
General Information	305		
Low Frequency	311		



Point Plotter Plug-In Modules 207

Portable

- Calculators 520-529
- Counters 252, 261
- Data Acquisition Systems 70
- Instrumentation Tape Recorders 204, 230
- Oscilloscopes 128
- Storage Oscilloscopes 122, 128, 150
- Strip Chart Recorders 204, 216-222
- Test Set 502
- Voltmeter 48, 50, 52
- X-Ray Systems 570

Power Meters, RF & Microwave 372, 376

Power Sensors 374, 377

Power Meter Calibrators 373, 377

Power Splitter 406, 420, 426

Power Supplies 182-204

- Amplifier/Power Supplies 197
- Atomic Clock 268-273
- Condensed Listing 180
- Constant Current Sources 196
- Digitally Controlled 202
- Dual Tracking 192
- Frequency Standards 268-275, 322
- General Purpose: 25 - 200 W Output 184, 191
- General Purpose: 100 - 2000 W Output 186
- General Purpose: 300 - 11,000 W Output 188, 190
- General Purpose: 0 - 320 V 192
- High Voltage 193
- Low Cost Lab 182-185
- Modular, DC to DC Converters 201
- Modular, Single Output, Series Regulated 199
- Modular, Dual Output Series Regulated 199
- Modular, 200 - 600 W, Switching 199
- Modular, 110 W, Switching 199
- Modular, Triple-Output Switching 199
- Oscilloscope Probe 158
- Precision Voltage Sources 194
- Programmable 202, 532
- Specifications Definitions 181
- Standby Counter 241

Power Supply/Amplifier 30, 197

Preamplifiers 31, 265

Precision Coaxial Connectors 380

Precision DC Amplifier 323

Precision Frequency Source 266-275, 316, 318, 322

Precision Oscillator 266-275, 316, 318

Precision Voltage Sources 194, 322

Preselector 464

Preset Capacitance Meter 83

Pressure Gauge 557

Printers, Instrumentation 232-234

Printer, Line 530

Probes

- Accessories 47, 159, 482

- Active 157, 425
- Current 36, 105, 158, 483
- Digital Multimeter 48
- Frequency Doubler 348
- High Frequency 47, 348, 482
- Impedance 425
- Logic 102
- Miniature 156
- Slotted Line 397
- Trigger (TTL, MOS, ECL) 102
- Time Interval 264
- Voltage Divider 47, 156, 482

Process Control Interface 532

Processors 522

Programmable

- Counters 238, 243, 246, 251, 264, 532
- Programmable Data Logger 70
- Programming, 1900 System 296
- Pseudorandom Noise Generator 473
- Pulse Amplifiers 30
- Pulse and Word Generators 278
- Pulse Generators 278, 532
- Pulse Pattern Generator Plug-ins (1900 System) 296
- Pulse/Word Generator System, 300 MHz/1 GHz 280
- Pulse Modulators, Microwave 349
- Pulsers, Logic 104

Q

- Q-Meter 88
- Quartz Component Oscillator 275
- Quartz Frequency Standard 274

R

- Random Noise Generator 473
- Range Calibrator (for 435A) 373
- Ratio Meter 66
- Readers, Card 530, 545
- Receiver Test System 486
- Reciprocal Counters 238, 243, 258, 532

Recorders

- Oscillographic 204, 223-229
- Portable Instrumentation Tape 204, 230
- Strip Chart 204, 216-222
- X-Y 204, 206-213

Reflection/Transmission Test

- Sets 404, 420, 425, 431-433

Reflectometer Bridge 406

Relay Output Cards 532

Relay Register 532

Repetition Rate Generators (8080 System) 280

Resistance Meter 48, 50, 52, 54, 62, 66, 75, 76

RMS Voltmeter 41, 58, 62

Rotary Air Line, Coaxial 402

Rotary Joint, Coaxial 402

Rotary Vane Attenuators, Waveguide 389

Rotating Machinery Analysis 470

- RTE-B Real Time System 552
 RTE-C Real Time System 552
 RTE-II Real Time System 552
 RTE-III Real Time System 552
 Rubidium Frequency Standard 271
 RX Meter 90
- S**
 S-Parameter Test Sets 420, 431, 432
 Sampling Oscilloscopes 144-147
 Sampling & TDR Accessories 139
 Scanner 69, 532
 Scanner Plug-In Module 207, 532
 Schottky Diodes 564
 Scientific & Industrial X-Ray Systems 570
 Selective Level Measuring Set 504
 Selective Level Voltmeters 494, 506, 508
 Selective Voltmeter 494, 506, 508
 Self-Test Digital Multimeter 62, 66
 Sensors, Microwave Power 374
 Serial-to-Parallel Converter 100
 Shorts, Coaxial and Waveguide 398
 Signal Analyzers 434-473
 Digital 470
 General Information 434-440
 Random Vibration Controller 471
 Shock Vibration Controller 471
 Sine Vibration Controller 471
 Spectrum Analyzers 149, 447-470
 Signal Coupler Preamplifier 227, 228
 Signal Generators
 Accessories 350
 Down Converter, 0.5 to 500 kHz 339
 General Information 326
 HF, VHF, UHF 338
 Microwave 328
 Synthesized 328, 332
 Signal Sources 306-309, 316, 318
 Signature Analysis 450, 470
 Sinewave Generators 306-309, 316, 318
 Sinewave Oscillator 306-309, 316, 318
 Single Span Plug-In Module 217
 Sliding Load (Coaxial and Waveguide) 398
 Software, Computer 522
 Solid State Displays 565
 Solid State Lamps 565
 Spectrometers 566
 Spectrum Analyzers, General Information 434-440
 Spectrum Analyzers 149, 447, 450, 452-467, 470
 Spectrum Analyzer Preselector 464
 Spectrum Display 472
 Square Wave Generators 293
 Stability Analyzer, Frequency 468
 Standards: Frequency and Time 266-274
 Standing Wave Ratio (SWR) Meter 403
 Step Attenuators, Coaxial 386
 Step Recovery Diodes 564
 Stepping Motor Control 532
 Storage Control Unit 539
 Strip Chart Recorder 204, 216-222
 Structural Dynamics 470
 Sweep Oscillators, General Information 351-353
 Sweep Oscillators 316, 318, 351-369
 Sweeping Slotted Line 396
 Switches 532, 564
 Switches, Coaxial 401
 Switches, Coaxial, Microwave OEM 401
 Swivel Adapter 402
 Synchronizer Counter 340
 Synchronizer, Phase Lock 369
 Synchronous Communications Interface 522, 547
 Synchronous Data Set Interface 538
 Synthesizer, Automatic 316, 318, 328, 332
 Synthesizer, Frequency 316, 318, 328, 332, 334
 Synthesized Signal Generators 328, 332
 Synthesizers — General Information 314, 326
 Synthesizers, Spectrum 470
 System Digital Voltmeter 60, 62, 66
- T**
 Tape Cassette, Punch, Reader Sub-systems 530
 Tape Degausser 230
 Tape Recorders, Analog Magnetic 230
 Telecommunications Test Equipment
 Amplifier — IF 512
 Amplitude/Delay Distortion Analyzer 492
 Attenuator — 75 Ω General Purpose 511
 Carrier Testing 503
 Microwave Link Analyzer at BB, IF
 (70 MHz) 510
 Microwave Link Analyzer: 140 MHz IF 513
 Microwave Radio Testing 509
 PCM Testing 515
 Telephone Line Analyzer 492
 Transmission Impairment Measuring Set 500
 Voice Data Testing 488
 Telephone Test Oscillators 499
 Teleprinter Interfaces 547
 Temperature Plug-In Module 217
 Terminal, CRT 54
 Terminated Output Cable 350
 Terminations, Coaxial and Waveguide 148, 398
 Test Leads 47, 480
 Testmobiles, Oscilloscope 164
 Test Oscillators 309
 Test Set, Voice Band 541
 Test Sets, Transmission 541
 Thermal Printer 232, 531
 Thermistor Mounts, Coaxial and Waveguide 377
 Thermocouple Power Sensors 374
 Thermometer 560-562
 Time Base External Module 208
 Time Base Plug-In Module 207
 Time Domain Reflectometers 146

Time Interval
 Counters 238, 243-246, 251-258, 264, 532

Time Mark Generator 160

Time Standard 266-274

TIMS 500, 501

Touch-Hold Probe 47

Tracer, Current 105

Tracking Generators 454, 458, 460-465, 506, 508

Training/Video Tapes 574-576

Transceiver Test System 486

Transfer Function Analyzer 470

Transistors, Siliconbipolar 564

Transmission Impairment Measuring Set 500

Transmission Line Test Equipment, Coaxial 382

Transmission & Noise Meter Psophmeter 496, 498

Transmission Parameter Analyzer 541

Transmission Test Set 502

Transistor Bias Supply 432

Transistor Test Fixtures 431

Transistors 564

Transponder 541

Triangle Wave Generator 310

Trigger Countdown 148

True RMS Voltmeter 41, 58, 62

Tuners, Microwave 400

Tuning Varactors 564

TWT Amplifiers 32

Type N Short 398

U

Universal Bridge 77

Universal Carriage (Slotted Section) 396

Universal Counters 238, 243, 246, 255, 258

Universal Interface 538

V

Variable Phase Function Generator 310

Vector Impedance Meter 90

Vector Voltmeter 426

VHF Oscillator 348

Vibration Analyzer 450, 470

Vibration Controller 471

Video Tapes 573

Voice Band Analyzer 541

Voice Data Testing 488

Voltmeters 37-42, 48, 50, 52, 54, 58, 62, 66

Voltmeter, Vector 426

W

Wave Analyzer 446

Wave Analyzer 446, 506, 508

Wave and Distortion Analyzers 441, 442, 446, 508

Waveform Analyzer, Fourier 470, 541

Waveguide

Attenuators 389

Coaxial Adaptors 402

Crystal Detectors 395

Directional Couplers 392

Frequency Meters 393

Harmonic Mixer 400

Holder 402

Instrumentation and Accessories 384

Instrumentation vs Frequency Bands 384

Low-Pass Filters 399

Millimeter Counter 251

Movable Shorts 398

Phase Shifters 400

Precision Attenuators 89, 389

Shorting Switch 398

Slide Screw Tuners 400

Sliding Loads 398

Sliding Short 398

Slotted Section 397

Stand 402

Terminations 398

Thermistor Mounts 377

Variable Attenuators 89, 389

Waveguide-Waveguide Adapters 402

Word Generators 278

X

X-Ray Systems, Scientific & Industrial 570

X-Y Displays 166-177

X-Y Plotters 204, 214, 531

X-Y Recorders 204, 206-213

MODEL NUMBER INDEX

New product listings are printed in bold face type

HP-21 Scientific Pocket Calculator	522	345B IF Noise Source	378
21 MX Computers	536	347A series Noise Sources	378
21 MX E-Series Computers 2109A, 2113A		349A Noise Source	378
Processors	536	350D Attenuator Set	89
21 MX K-Series 2108K Board	537	355 series Coaxial Step Attenuators	386
HP-22 Business Management Pocket		360 series Coaxial Low-pass Filters	399
Calculator	523	362A series Waveguide Low-pass Filters	399
HP-25 Scientific Programmable Pocket		375 series Waveguide Variable Attenuators	389
Calculator	522	382 series Waveguide Precision Variable	
HP-25C Scientific Pocket Calculator	522	Attenuators	389
HP-27 Scientific/Plus Pocket Calculator	523	393A Coaxial Variable Attenuator	388
HP-35, 45 see HP-21, 25		394A Coaxial Variable Attenuator	388
MX/55 DISComputer	537		
HP-67 Fully Programmable Pocket Calculator	525	400	
MX/65 DISComputer	537	ARS-400 Automatic Receiver System	555
DTS-70 Digital Test Systems	553	400E & EL AC Voltmeters	40
HP-70 see HP-22		400F & FL AC Voltmeter	40
HP-80 Business Pocket Calculator	523	400GL AC Voltmeter	40
HP-91 Scientific Printing Calculator	526	403B AC Voltmeter	39
HP-97 Fully Programmable Printing		410C Voltmeter	38
Calculator	525	415E SWR Meter	403
		419A DC Null Voltmeter	35
100		422A series Waveguide Crystal Detectors	395
105A & B Quartz Frequency Standards	274	423A Coaxial Crystal Detector	394
123A Oscilloscope Camera	161	423B Coaxial Crystal Detectors	394
124A Oscilloscope Camera	162	424A series Waveguide Crystal Detectors	395
140T Spectrum Analyzer Mainframe	457	427A Voltmeter	37
141T system Spectrum Analyzers	456	428B Clip-on DC Milliammeter	36
141T Spectrum Analyzer Mainframe	457	432 series Power Meters	376
180 series Plug-in Oscilloscopes	130	435A Power Meter	373
180C, D & TR High Writing Speed		436A Power Meter	372
Oscilloscope Mainframes	136, 453, 455	440A Detector Mount	397
181A, AR, T & TR Variable Persistence/		442B Slotted Line RF Probe	397
Storage Mainframes	133, 453, 455	444A Slotted Line Detector	397
182C & T Large Screen Oscilloscope		446B Slotted Line Detector	397
Mainframe	135, 453, 455	447B Slotted Line Detector	396
184A High Speed Oscilloscope Mainframe	134	448A & B Slotted Line Sweep Adapters	396
197A Oscilloscope Camera	161	456A Current Probe for voltmeters	483
		461A Amplifier	30
200		462A Amplifier	30
200CD Wide Range Oscillator	306	465A Amplifier	30
201C Audio Oscillator	306	467A Power Amplifier	30
203A Variable Phase Function Generator	310, 400	478A Coaxial Thermistor Mount	377
204C Oscillator	307	485B Waveguide Detector	395
204D Oscillator	307	486A series Waveguide Thermistor Mounts	377
209A Oscillator	307	489A TWT Amplifier	32
211B Square Wave Generator	293	491C TWT Amplifier	32
214A Pulse Generator	295	493A TWT Amplifier	32
226A Time Mark Generator	160	495A TWT Amplifier	32
236A Telephone Test Oscillator	499		
250B RX Meter	90	500	
281 series Coaxial-Waveguide Adapters	402	532 series Waveguide Frequency Meters	393
292 series Waveguide-Waveguide Adapters	402	536A Coaxial Frequency Meter	393
		537A Coaxial Frequency Meter	393
300		545A Logic Probe	103
312B & 313A Frequency Selective Voltmeter		546A Logic Pulser	104
and Tracking Oscillator	444	547A Current Tracer	105
312D Selective Levelmeter & Generator	506	548A Logic Clip	106
331A Distortion Analyzer	442		
332A Distortion Analyzer	442	600	
333A Distortion Analyzer	442	606B Signal Generator	342
334A Distortion Analyzer	442	608E Signal Generator	343
340B Noise Figure Meter	378	612A Signal Generator	344
342A Noise Figure Meter	378	618C Signal Generator	346
343A VHF Noise Source	378	620B Signal Generator	346

626A Signal Generator 347
 628A Signal Generator 347
 651B Test Oscillator 309
 652A Test Oscillator 309
 654A Test Oscillator 309
 680 Strip Chart Recorder 219

700
 740B DC/Differential Standard Voltmeter 324
 745A AC Calibrator 322
 746A Hi Voltage Amplifier 322
 752 series Waveguide Directional Couplers 392
 774D Coaxial Dual Directional Coupler 390
 775D Coaxial Dual Directional Coupler 390
 776D Coaxial Dual Directional Coupler 390
 777D Coaxial Dual Directional Coupler 390
 778D Coaxial Dual Directional Coupler 390
 779D Coaxial Directional Coupler 391
 786D Coaxial Directional Detector 391
 787D Coaxial Directional Detector 391
 788C Coaxial Directional Detector 391
 789C Coaxial Directional Detector 391
 796D Coaxial Directional Coupler 391
 797D Coaxial Directional Coupler 391
 798C Coaxial Directional Coupler 391

800
 805C Coaxial Slotted Line 396
 809C Universal Carriage 396
 810B series Waveguide Slotted Sections 397
 814B Slotted Section Carriage 397
 815B series Waveguide Slotted Sections 397
 816A Slotted Coaxial Section 396
 817A & B Coaxial Swept Slotted Line Systems 396
 870A series Waveguide Slide Screw Tuners 400
 885A series Waveguide Phase Shifters 400
 895A DC Power Supply 186

900
 905A Coaxial Sliding Load 398
 907A Coaxial Sliding Load 398
 908A Coaxial 50-Ohm Termination 148, 398
 909A Coaxial Termination 148, 398
909A Option 012 50-Ohm Termination 148
 910 series Waveguide Terminations 398
 911A Coaxial Sliding Load 398
 914 series Waveguide Sliding Loads 398
 920 series Waveguide Moving Shorts 398
 923A Waveguide Sliding Short 398
 930A Waveguide Shorting Switch 398
 932A Waveguide Harmonic Mixer 400
 934A Coaxial Harmonic Mixer 400
 938A Frequency Doubler Set 347
 940A Frequency Doubler Set 347
 970A Probe Digital Multimeter 48

1000
HP 1000 Systems/Models 30, 31, 80, 81 546
 1001A Testmobile 164
 1001B Testmobile 164
 1002A Testmobile 164
 1002B Testmobile 164
 1003A Testmobile 164
 1004A Testmobile 164
 1026A Microwave Laboratory Kit 380

1051A & 1052A Combining Cases 484
1080 High Performance Liquid Chromatograph Systems 566
 1104A/1106B Opt 001 18 GHz Trigger Countdown 147
 1104A/1108A 10 GHz Trigger Countdown 147
 1105A/1106B 20 ps Pulse Generator 148
 1105A/1108A 60 ps Pulse Generator 148
 1109B High Pass Filter (type N) 148
 1110A Current Probe 158
 1111A AC Current Amplifier 158
 1114A Testmobile, Oscilloscope 164
 1117B Testmobile, Oscilloscope 164
 1120A 500 MHz Active Probe 157
 1121A AC Probe 425
 1122A Probe Power Supply 159
 1124A 100 MHz Active Probe 157
 1125A 250 MHz Impedance Converter Probe 158
 1200A & B Dual Channel Oscilloscopes, 100 μ V/div 154
 1201A & B Dual Channel Storage Oscilloscopes, 100 μ V/div 154
 1205B Dual Channel Oscilloscopes, 5 mV/div 154
 1220A Dual Channel Oscilloscope, 15 MHz 152
 1221A Single Channel Oscilloscope, 15 MHz 152
 1222A Dual Channel, Delay Line Oscilloscope, 15 MHz 152
1223A Dual Channel, Variable Persistence/Storage Oscilloscope, 15 MHz 150
 1230A Logic Trigger 102
1304A 32 cm. (13 in.) Display 176
 1310A 48.3 cm (19 in.) Display 173
 1311A 35.6 cm (14 in.) Display 173
 1317A 43.2 cm (17 in.) Display 173
 1321A 53.3 cm (21 in.) Display 173
 1332A High Resolution Display 168
1333A High Resolution Medical Display 168
 1335A High Resolution Storage Display 168
 1430C Sampling Head, 18 GHz for 1811A 144
 1600A 16 Bit Logic State Analyzer 96
 1600S Logic State Analyzer System 96
 1607A 16 Bit Logic State Analyzer 96
 1620A Pattern Analyzer 100
 1645A Data Error Analyzer 490
 1645S Data Transmission Test Set 490
 1700 series Oscilloscopes 116
 1703A Portable Storage Oscilloscope, Delayed Sweep 128
 1707B Portable Delayed Sweep Oscilloscope, 75 MHz 128
 1707B Option 300, 50 MHz 129
 1710B Dual Channel Oscilloscope, 200 MHz 120
 1712A Dual-Delayed Sweep Oscilloscope, 200 MHz 120
 1720A Oscilloscope, 275 MHz 116
 1722A 275 MHz Oscilloscope, Direct Readout of volts and time 116
 1740A 100 MHz Oscilloscope, Trigger View 122
1741A 100MHz Oscilloscope, Variable Persistence/Storage, Third-Channel Trigger View 122
 1801A Dual Channel Vertical Amplifier, 50 MHz 138



MODEL NUMBER INDEX

New product listings are printed in bold face type

1803A Differential DC Offset Amplifier	138	3040A Network Analyzer	413
1804 Four Channel Vertical Amplifier, 50 MHz	140	3042A Network Analyzer	414
1805A Dual Channel Vertical Amplifier, 100 MHz	137	3044A Automatic Spectrum Analyzer	447
1806A 100 μ V Dual Channel Differential Amplifier	138	3045A Automatic Spectrum Analyzer	448
1807A Dual Channel Vertical Amplifier, 35 MHz	138	3051A Programmable Data Logger	70
1808A Dual Channel Vertical Amplifier, 75 MHz	137	3052A Automatic Data Acquisition System	71
1809A Four Channel Vertical Amplifier, 100 MHz	140	3200B VHF Oscillator	348
1810A 1 GHz Dual Channel Sampler	144	3310A Function Generator	313, 403
1811A 18 GHz Sampler	144	3310B Function Generator	313, 403
1815A & B TDR/Samplers	146	3311A Function Generator	311, 401
1816A Sampling Head, 4 GHz	146	3312A Function Generator	312, 402
1817A Sampling Head 12.4 GHz	146	3320A Frequency Synthesizer	316
1818A Time Domain Reflectometer, 170 ps tr	146	3320B Frequency Synthesizer	317
1820C Time Base	142	3320C Level Generator	506
1821A Time Base/Delay Generator	142	3330B Automatic Synthesizer	318
1825A Time Base and Delay Generator	143	3350A Laboratory Automation Systems	566
1900A Pulse Generator Mainframe	296	3352A Laboratory Data System (see 3350A)	566
1905A Rate Generator Plug-in	299	3380A Reporting Integrator	570
1906A Rate Generator Plug-in	299	3400A RMS Voltmeter	41
1908A Delay Generator Plug-in	299	3403C True RMS Voltmeter	58
1909A Delay/Gate Generator Plug-in	299	3406A Broadband Sampling Voltmeter	42
1915A Variable Transition Time Output Plug-in	297	3435A Digital Voltmeter	52
1916A Variable Transition Time Output Plug-in	297	3437A System Digital Voltmeter	60
1917A Variable Transition Time Output Plug-in	297	3450B Multi-Function Meter	62
1920A Pulse Output Plug-in	297	3455A Digital Voltmeter	62
1925A Word Generator Plug-in	298	3465A Digital Multimeter	54
1930A PRBS Binary Sequence Generator Plug-in	298	3465B Digital Voltmeter	54
2000		3470A Digital Multimeter	56
2000 Multi-Terminal/RJE Computer System	547	3476A/B Digital Voltmeter	50
2102A Memory System for 21MX Computers	537	3490A Multimeter	66
2108K Board for 21 MX K-Series	537	3495A Scanner	69
2109A, 2113A Processors for 21 MX E-Series Computer	536	3550B Communications Test Set	502
2123A, 2124B, 2125A DISComputer	537	3551A Transmission Test Set	496
2300B RTE-B Real Time BASIC Software	552	3552A Transmission Test Set	497
2300C RTE-C Memory Based Real Time Operating System Software	552	3555B Transmission & Noise Measuring Set	498
2607A Line Printer	547	3556A Psophometer	498
2460A (see 2640B)		3575A Gain/Phase Meter	416
2640B Interactive Display Terminal	541	3580A Spectrum Analyzer	450
2640C Cyrillic Display Terminal	543	3581A Wave Analyzer	446
2640N Danish/Norwegian Display Terminal	543	3581C Selective Voltmeter	494
2640S Swedish/Finnish Display Terminal	543	3590A Wave Analyzer	508
2641A APL Display Terminal	543	3591A Selective Voltmeter	508
2645A Display Station	542	3594A Sweeping Local Oscillator Plug-in	508
2801A Quartz Thermometer	560	3702B IF/BB Receiver (70 MHz IF)	510
2802A Digital Thermometer	57, 562	3710A IF/BB Transmitter (70 MHz IF)	510
2811B Quartz Pressure Gauge	557	3720A Spectrum Display	472
2850 Quartz Temperature Probes	560	3721A Correlator	472
3000		3722A Noise Generator	473
3000CX Mini Datacenters see HP 3000 Series II Systems	548	3730A Down Converter: RF to IF	510
HP 3000 Series II Systems	548	3743A IF Amplifier	512
		3744A BB Sweeper Accessory	512
		3745A Selective Level Measuring Set (CCITT)	504
		3745B Selective Level Measuring Set (BELL)	504
		3750A Attenuator: 75 Ω	510
		3760A Data Generator	304, 516
		3761A Error Detector	516
		3770A Amplitude/Delay Distortion Analyzer	492
		3770B Telephone Line Analyzer	492
		3780A Pattern Generator/Error Detector	518
		3790A IF/BB Transmitter (140 MHz IF)	513
		3792A IF/BB Receiver (140 MHz IF)	513
		3964A Instrumentation Tape Recorder	230
		3968A Instrumentation Tape Recorder	230

4000		
4204A Oscillator	308	
4260A Universal Bridge	77	
4261A Digital LCR Meter	79	
4265B Universal Bridge	78	
4270A Automatic Capacitance Bridge	86	
4271A Digital LCR Meter	81	
4272A 1 MHz Preset Capacitance Meter	83	
4282A Digital High Capacitance Meter	84	
4328A Milliohmmeter	75	
4329A High Resistance Meter	76	
4332A LCR Meter	74	
4333A Distortion Analyzer	441	
4342A Q Meter	88	
4350A & B High Capacitance Meters	87	
4436A Attenuator	89	
4437A Attenuator	89	
4440B Decade Capacitor	89	
4800A Vector Impedance Meter	90	
4815A Vector Impedance Meter	90	
4940A Transmission Impairment Measuring Set	500	
4942A Transmission Impairment Measuring Set	500	
5000		
5000A Logic Analyzer	101	
5011T Logic Troubleshooting Kit	108	
5015T Logic Troubleshooting Kit	108	
5021A Logic Troubleshooting Kit	108	
5022A Logic Troubleshooting Kit	108	
5023A Logic Troubleshooting Kit	108	
5035A Basic Logic Lab	110	
5035T Logic Lab	111	
5045A Digital IC Tester	91	
5050B Digital Recorder	234	
5055A Digital Recorder	233	
5060-series Rack Frames and Adapters	485	
K02-5060A Standby Power Supply	277	
5061A Cesium Beam Frequency Standard	268	
5061A with Option 004 Tube	269	
E21-5061A Flying Clock (Cesium)	269	
5062C Cesium Beam Frequency Reference	268, 270	
5065A Rubidium Frequency Standard	268, 271	
E21-5065A Portable Rubidium Time Standard	271	
5085A Standby Power Supply	277	
5087A Distribution Amplifier	276	
5150A Thermal Printer	232	
5245L Electronic Counter	242	
5248L Electronic Counter	242	
5253B Frequency Converter Plug-in	244	
5254C Frequency Converter Plug-in	244	
5255A Frequency Converter Plug-in	244	
5256A Frequency Converter Plug-in	244	
5257A Transfer Oscillator Plug-in	244	
5261A Video Amplifier Plug-in	245	
5262A Time Interval Plug-in	244	
5265A Digital Voltmeter Plug-in	245	
5267A Time Interval Plug-in	245	
5300A Counter Mainframe	252	
5300B Counter Mainframe	252	
5301A 10 MHz Counter Module	255	
5302A 50 MHz Universal Counter Module	255	
5303B 500 MHz Counter Module	256	
5304A Timer/Counter Module	256	
5305A 1100 MHz Counter Module (see 5305B)		
5305B 1300 MHz Counter Module	257	
5306A Digital Multimeter/Counter	257	
5307A Frequency Counter Module	258	
5308A Timer Counter Module	258	
5310A Battery Pack Module	260	
5311B Digital-to-Analog Converter	259	
5312A ASCII Converter	259	
5326A Universal Counter	251	
5326B Universal Counter/Digital Voltmeter	251	
5327A Universal Counter	251	
5327B Universal Counter/Digital Voltmeter	251	
5328A Universal Counter	246	
5340A Microwave Frequency Counter	262	
5341A Microwave Frequency Counter	263	
5345A Electronic Counter	238	
5353A Channel C: Plug-in for 5345A	241	
5354A 4 GHz Frequency Converter	241	
5360A Computing Counter	243	
5363A Time Interval Probes	264	
5375A Computing Counter Keyboard	243	
5379A Time Interval Plug-in	243	
5381A Frequency Counter	261	
5382A Frequency Counter	261	
5383A Frequency Counter	261	
5390A Frequency Stability Analyzer	468	
5425A Digital Vibration Test Control System	471	
5451B Fourier Analyzer	470	
5451B Option 350 Vibration Control System	471	
5501A Laser Transducer	558	
5526A Laser Interferometer	559	
5700A Laboratory Gas Chromatographs	566	
5831A-9C Dual Flame Detector	566	
5840A Reporting Gas Chromatographs	566	
5950B FSCA Spectrometer	566	
5980A GC/Mass Spectrometers	566	
5981 EI Mass Spectrometer (see 5980A)	566	
8000		
6002A DC Power Supply	191	
6101A DC Power Supply	194	
6102A DC Power Supply	194	
6104A DC Power Supply	194	
6105A DC Power Supply	194	
6106A DC Power Supply	194	
6110A-6116A DC Power Supplies	194	
6128C-6131B Digitally Controlled Voltage Sources	202	
6140A Digital Current Source	202	
6177C DC Power Supply	196	
6181C DC Power Supply	196	
6186C DC Power Supply	196	
6200B-6209B Power Supplies	183	
6211A-6218A DC Power Supplies	182	
6220B DC Power Supply	184	
6224B DC Power Supply	184	
6226B DC Power Supply	184	
6227B DC Power Supply	192	
6228B DC Power Supply	192	
6236A DC Power Supply	182	
6237A DC Power Supply	182	
6253A DC Power Supply	184	
6255A DC Power Supply	184	
6256B DC Power Supply	186	

MODEL NUMBER INDEX

New product listings are printed in bold face type

6259B DC Power Supply	186	7040A X-Y Recorder	210
6260B DC Power Supply	186	7041A X-Y Recorder	210
6261B DC Power Supply	186	7044A X-Y Recorder	212
6263B DC Power Supply	186	7045A X-Y Recorder	212
6264B DC Power Supply	186	7046A X-Y Recorder	211
6265B DC Power Supply	186	7047A X-Y Recorder	213
6266B DC Power Supply	186	7100B Strip Chart Recorder, 2 Pen	216
6267B DC Power Supply	186	7101B Strip Chart Recorder, 1 Pen	216
6268B DC Power Supply	186	7123A Strip Chart Recorder	218
6269B DC Power Supply	186	7127A Strip Chart Recorder, 1 Pen	216
6271B DC Power Supply	186	7128A Strip Chart Recorder, 2 Pen	216
6274B DC Power Supply	186	7130A Strip Chart Recorder, 2 Pen	220
6281A DC Power Supply	184	7131A Strip Chart Recorder, 1 Pen	220
6282A DC Power Supply	184	7132A Strip Chart Recorder, 2 Pen	221
6284A DC Power Supply	184	7133A Strip Chart Recorder, 1 Pen	221
6285A DC Power Supply	184	7143A Strip Chart Recorder	218
6286A DC Power Supply	184	7155B Portable Strip Chart Recorder	222
6289A DC Power Supply	184	7202A Graphic Plotter	214
6290A DC Power Supply	184	7203A Graphic Plotter	214
6291A DC Power Supply	184	7210A Digital Plotter	215
6294A DC Power Supply	184	7260A Optical Mark Reader	545
6296A DC Power Supply	184	7261A Optical Mark Reader	545
6299A DC Power Supply	184	7402A 2-Channel Oscillographic Recorder	223
6384A DC Power Supply	183	7404A 4-Channel Oscillographic Recorder	224
6427B DC Power Supply	188	7414A 4-Channel Oscillographic Recorder	226
6428B DC Power Supply	188	7418A 6 to 8 Channel Oscillographic Recorder	226
6433B DC Power Supply	188	7562A Log Voltmeter/Converter	43
6434B DC Power Supply	188	7563A Log Voltmeter/Amplifier	43
6438B DC Power Supply	188	7670A Automatic Sampler	566
6439B DC Power Supply	188	7702B 2-Channel Oscillographic Recorder	226
6443B DC Power Supply	188	7900A Disc Drive	539
6448B DC Power Supply	188	7905A Disc Drive	539
6452A DC Power Supply	190	7970 series Digital Magnetic Tape Subsystem	540
6453A DC Power Supply	188	7970 B/E Magnetic Tape Units	540
6456B DC Power Supply	188		
6459A DC Power Supply	188	8000	
6464C DC Power Supply	188	8002A Pulse Generator	293
6466C DC Power Supply	188	8004A Pulse Generator	293
6469C DC Power Supply	188	8005B Pulse Generator	292
6472C DC Power Supply	188	8006A Pulse Generator	301
6475C DC Power Supply	188	8007B Pulse Generator	291
6477C DC Power Supply	188	8008A, see 8082A	
6479C DC Power Supply	188	8010A Pulse Generator	294
6483C DC Power Supply	188	8011A Pulse Generator	286
6515A DC Power Supply	193	8012B Pulse Generator	287
6516A DC Power Supply	193	8013B Pulse Generator	287
6521A DC Power Supply	193	8015A Pulse Generator	288
6522A DC Power Supply	193	8016A Pulse Generator	302
6525A DC Power Supply	193	8080A Mainframe	281
6823A DC Power Supply/Amplifier	197	8081A Repetition Rate Generator, 300 MHz	285
6824A DC Power Supply/Amplifier	197	8082A Pulse Generator	290
6825A DC Power Supply/Amplifier	197	8083A Output Amplifier, 300 MHz	282
6826A DC Power Supply/Amplifier	197	8084A Word Generator, 300 MHz	283
6827A DC Power Supply/Amplifier	197	8091A Repetition Rate Generator, 1 GHz	285
6920B AC/DC Meter Calibration	321	8092A Delay Generator/Freq. Divider	284
6940B Multi-Programmer	532	8093A Output Amplifier, 1 GHz	282
6941B Multi-Programmer Extender	532	8403A Modulator	349
		8404A Leveling Amplifier	369
7000		8405A Vector Voltmeter	426
7004B X-Y Recorder	206	8406A Comb Generator	467
7010A X-Y Recorder	209	8407A Network Analyzer	424
7015A X-Y Recorder	209	8410B Network Analyzer Mainframe	430
7034A X-Y Recorder	206	8410S series Network Analyzers	427
7035B X-Y Recorder	208	8411A Harmonic Frequency Converter	430

8412A Phase-Magnitude Display	424, 430	8690B Sweep Oscillator	366
8413A Phase Gain Indicator	430	8691B-8695B RF Units (PIN leveled BWO)	
8414A Polar Display	424, 430	for 8690B	367
8418A Auxiliary Power Supply	430	8691A-8697A RF Units (Grid Leveled BWO)	
8430A series Bandpass Filters	399	for 8690B	367
8443A Tracking Generator	460	8698B, 8699B Solid State RF Units for 8690B	367
8444A Tracking Generator	462, 465	8705A Signal Multiplexer for 8690B	369
8444A Option 058 Tracking Generator	454	8706A Control Unit for 8690B	369
8445B Automatic Presclector	464	8707A RF Unit Holder for 8690B	369
8447 series Amplifiers	31, 467	8709A Phase-lock Synchronizer	369
8470A Coaxial Crystal Detector	394	8717B Transistor Bias Supply	432
8470B Coaxial Crystal Detector	394	8721A Coaxial Directional Bridge	425
8471A Coaxial Crystal Detector	394	8731-8735 series PIN Modulators	349
8472A Coaxial Crystal Detector	394	8740A Transmission Test Unit	432
8472B Coaxial Crystal Detector	394	8741A Reflection Test Unit	432
8477A Power Meter Calibrator	377	8742A Reflection Test Unit	432
8478B Coaxial Thermistor Mount	377	8743A Reflection/Transmission Test Unit	431
8481A Power Sensor	374	8745A S-Parameter Test Set	431
8481H Power Sensor	374	8746B S-Parameter Test Set	432
8482A Power Sensor	374	K & R 8747A Waveguide	
8482H Power Sensor	375	Reflection/Transmission Test Units	433
8483A Power Sensor	375	X & P 8747A Waveguide	
8484A Power Sensor	375	Reflection/Transmission Test Units	433
8491 series Coaxial Fixed Attenuators	385	8755 Frequency Response Test Sets	404
8492A Coaxial Fixed Attenuator	385	8761A & B Coaxial Switches	401
8493 series Coaxial Fixed Attenuators	385	8801A Low Gain Preamplifier	227
8494 series Coaxial Step Attenuators	386	8802A Medium Gain Preamplifier	227
8495 series Coaxial Step Attenuators	386	8803A High Gain Preamplifier	227
8496 series Coaxial Step Attenuators	386	8805A Carrier Preamplifier	227
8502A & B Reflection Transmission Bridges	420	8805B Carrier Preamplifier	227
8503A & B S-Parameter Test Sets	420	8806B Phase Sensitive Demodulator	228
8505A Network Analyzer	418	8807A AC/DC Converter	228
8507A Automatic Network Analyzer	422	8808A Logarithmic Preamplifier	228
8542B 18 GHz Automatic Network Analyzer	555	8809A Signal Coupler	228
8552A Spectrum Analyzer—IF Section	457	8820A DC Bank Amplifier	229
8552B Spectrum Analyzer—IF Section	457	8821A DC Bank Amplifier	229
8553B Spectrum Analyzer, Tuning Section	460	8900B Peak Power Calibrator	377
8554B Spectrum Analyzer, Tuning Section	462	8950A Automatic Transceiver Test System	486
8555A Spectrum Analyzer, Tuning Section	464		
8556A Spectrum Analyzer, Tuning Section	458	9000	
8557A Spectrum Analyzer	149, 452	9500 series Automatic Test Systems	554
8558B Spectrum Analyzer	149, 454	9510D Automatic Test System	554
8580B Automatic Spectrum Analyzer	555	9571A Digital Test Station	553
8600A Digital Marker	354, 425	9600 Measurement and Control Systems	549
8601A Generator/Sweeper	354, 425	9602A Automatic Measurement & Control	
8614A Signal Generator	345	System	549
8616A Signal Generator	345	9603A Automatic Measurement & Control	
8620 system Sweep Oscillators	355	System	549
8620C Sweeper Mainframe	356	9603R Remote Measurement & Control	
8621B Multiband Sweeper Drawer	364	Systems	549
8640A AM/FM Signal Generator	335	9604A Automatic Measurement & Control	
8640B AM/FM Signal Generator	335	System	549
8640A & B Option 002, AM/FM Signal		9611A Industrial Measurement & Control	
Generators	335	System	549
8640B Option 004, Avionics Signal Generator	338	9611R Remote Measurement & Control	
8640M Signal Generator	339	Systems	549
8654A Signal Generator	340	9640 Automatic Measurement & Control	
8654B Signal Generator	340	System	550
8655A Synchronizer/Counter	340	9700A Distributed Systems Central	551
8660A Synthesized Signal Generator	328	9815A Programmable Calculator	527
8660C Synthesized Signal Generator	328	9825A Programmable Calculator	528
8671A Microwave Frequency Synthesizer	334	9830A Programmable Calculator	529
8672A Synthesized Signal Generator	332	9830B Programmable Calculator	529



MODEL NUMBER INDEX

New product listings are printed in bold face type

9862A X-Y Plotter	531	10251A MOS Trigger Probe	102
9863A Tape Reader	530	10252A ECL Trigger Probe	102
9864A Digitizer	530	10253A Card Reader for 1600A Logic State Analyzer	99
9865A Tape Cassette	530	10254A Serial-to-Parallel Converter	100
9866A Thermal Printer	531	10352B Graflok Back	162
9866B Thermal Printer	531	10353A Pack Film Back	162
9868A I/O Expander	530	10355A Camera Bezel Adapter	162
9869A Hopper Card Reader	530	10356A Camera Bezel Adapter	162
9870A Card Reader	530	10358B Camera Carrying Case	163
9871A Character Impact Printer	527	10360A Camera Bezel Adapter	162
9878A I/O Expander	530	10361A Camera Bezel Adapter	162
9880B Mass Memory	529	10362A Camera Bezel Adapter	162
9881A Line Printer Subsystem	531	10363A Camera Bezel Adapter	162
9882A CRT Subsystem	531	10366B Camera Bezel Adapter	162
9883A High Speed Tape Reader Subsystem	530	10367A Camera Bezel Adapter	162
9884A Tape Punch Subsystem	530	10369A Camera Bezel Adapter	162
9885M/S Flexible Disk Drive	528	10370A Camera Bezel Adapter	162
10000			
10001A 10:1 Divider Probe	156	10371A Camera Bezel Adapter	162
10001B 10:1 Divider Probe	156	10372A Camera Bezel Adapter	162
10002A 50:1 Divider Probe	156	10374A Camera Carrying Case	163
10002B 50:1 Divider Probe	156	10375A Camera Bezel Adapter	162
10003A 10:1 Divider Probe	156	10376A Camera Bezel Adapter	162
10004D 10:1 Divider Probe	156	10387A Interface, Type 303 Modems (1645A)	490
10005D 10:1 Divider Probe	156	10388A Interface, CCITT V35 (1645A)	490
10006D 10:1 Divider Probe	156	10389A Interface, Breakout Box (RS-232C) (1645A)	490
10007B 1:1 Probe	47, 156	10407B Plug-in Extender (180 system)	160
10008B 1:1 Probe	47, 156	10475A 3 in. Drawer for 1117B	165
10011B BNC Adapter Tip	156	10476A 8 in. Drawer for 1117B	165
10013A 10:1 Divider Probe	156	10491B Rack Mount Adapter, 1700 series, 1600A	160
10014A 10:1 Divider Probe	156	10501A Cable	40, 480
10015A 10:1 Divider Probe	156	10502A Cable	40, 480
10016B 10:1 Divider Probe	156	10503A Cable	40, 480
10017A Miniature Divider Probe	156	10511A Spectrum Generator	350
10020A Resistance Divider	157	10514A Double Balanced Mixer	350
10021A Miniature 1:1 Probe	156	10519A Accessory	40, 480
10022A Miniature 1:1 Probe	156	10525-60012 Tip Kits	103
10024A IC Test Clip	159	10525T, 10525H & 10525E Logic Probes	103
10034A Probe Ground Lead Kit	159	10526T Logic Pulser	104
10035A Probe Tip Kit	159	10528A Logic Clip	106
10036A Probe Tip Kit	159	10529A Logic Comparator	107
10037A Probe Tip Kit	159	10533A Printer Interface	252
10100B 100 ohm Feedthrough Termination	159	10534A Double Balanced Mixer	350
10100C 50 ohm Feedthrough Termination	159	10536A Plug-in Adapter for 5360A	243
10102A RFI Screen, 1703A, 1707B	160	10541A Reference Boards	103
10104A Viewing Hood, 1703A-1722A	160	K01-10541A Preprogrammed Reference Boards	103
10106A Camera Bezel Adapter	162	10544A Component Oscillator	275
10110A BNC Male to Dual Banana Post	381	10548A Service Kit for 5300 series	252
10111A Shielded Banana Plug to BNC Female	381	10590A Plug-in Adapter for 5345A	241
10113A Triple Banana Plug to Dual BNC Female	381	10631A, B & C HP-1B Cables	25
10115A Blue Contrast Filter (1703A-1722A)	160	10638A Degausser (Cesium Std.)	269
10116A Light Shield (1220A, 1221A, 1222A)	160	10653A, B & C High Performance Cesium Beam Tube Retrofit Kits	269
10117A Panel Cover (1220A, 1221A, 1222A)	153	10810A & B LED Clock Kits	269
10119A Rack Mount Kit (1220A, 1221A, 1222A)	153	10855A Preamp	265
10140A Viewing Hood (1740A, 1741A)	160	11000	
10176A Viewing Hood	160	11000A Cable	480
10178A Mesh Contrast/RFI Filter	160	11001A Cable	480
10190A Light Shield (182)	160	11002A Test Lead	480
10233A Cable, 1645A to 5055A or 5150A	491	11003A Test Lead	480
10235A Interface Cover for 1645A	490		
10250A TTL Trigger Probe	102		

11021A Probe Accessories	482	11608A Transistor Fixture	432
11035A Cable	480	11609A Cable Kit for 8410S	433
11036A AC Probe for 410C	482	11650A Accessory Kit for 8410S	433
11040A Probe Accessory	482	11652A Reflection/Transmission Kit for 8407A	425
11042A Probe Accessory	482	11654A Passive Probe Kit for 8407A	425
11044A Probe Accessory	482	11655A Impedance Probe for 8407A	425
11045A DC Voltage Divider for 410C	482	11658A Matching Resistor for 8407A	425
11046A Carrying Case	485	11661B Extension Module for 8660A & C	330
11047A Probe Accessory	482	11664A Detector for 8755	407
11067A Test Lead Kit	47	11665B Modulator for 8755	407
11068A Soft Carrying Case	51	11666A Reflectometer Bridge for 8755	406
11070 A/B/C Cable Assembly	480	11667A DC-18 GHz Power Splitter	406
11075A & 11076A Instrument Cases	485	11668A 50 MHz High Pass Filter for 8755	406
11086A Cable	480	11678A Low Pass Filter Kit	406
11096B High Frequency Probe	37	11683A Range Calibrator	373
11143A BNC to Clip Leads	480	11687A Adapter, 50 to 75Ω	350
11202A 8-bit Parallel I/O Interface Card	531	11690A Frequency Doubler	350
11203A BCD Input Interface Card	531	11691D Coaxial Directional Coupler	391
11205A Serial Interface Card	531	11692D Coaxial Dual Directional Coupler	390
11285A Data Communication Interface and ROM	531	11693A Limiter	467
11297B Binary Synchronous ROM	531	11694A Matching Transformer, 50-75Ω	467
11298B Interactive ROM	531	11697A, B & C Band-pass Filters	350
11456A Test Card for 3470 series	56	11708A 50 MHz Reference Attenuator	374
11457A Rack Kit for 3470 series	56	11710A Down Converter	339
11458A Strap for 3470 series	56	11850A & B Power Splitters	420
11473A-11476A Current Probe Balancing Transformers	483	11851A RF Cable Kit for 8505A	421
11500A Cable	480	11852A 50Ω/75Ω Minimum Loss Pad	421
11501A Cable	480	11853A 50Ω Type N Accessory Kit	421
11507A Output Termination	350	11854A 50Ω BNC Accessory Kit	421
11508A Terminated Output Cable	350	11855A 75Ω Type N Accessory Kit	421
11509A Fuscholder	350	11857A Test Port Extension Cables for 8503A	421
11511A Type N Short	398	11858A Rigid Interconnect Adapter	421
11512A Type N Short	398		
11515A Waveguide Adapter	402	12000	
11516A Waveguide Adapter	402	12531C Teleprinter Interface	538
11517A Mixer	467	12531D Terminal Interface	538
11518A-11520A Waveguide Taper Sections	467	12551B 16-Bit Relay Register	538
11524A APC7 to N Adapter	402, 481	12554A 16-Bit Duplex Register	538
11525A APC7 to N Adapter	402, 481	12555B Digital to Analog Converter	538
11531A Test Plug-in for 8690B	369	12565A Microcircuit Interface	538
11533A APC7 to SMA Adapter	402, 481	12587B Asynchronous Communications Interface	538
11534A APC7 to SMA Adapter	402, 481	12589A Automatic Dater Interface	538
11536A Probe Tee for 8405A	426	12597A 8-Bit Duplex Register	538
11540A Waveguide Stand	402	12604B Data Source Interface	538
11542A-11548A Waveguide Clamps	402	12618A Synchronous Communications Interface	538
11549A Power Splitter for 8405A	426	12859A Direct Memory Access	538
11565A APC-7 Short	398	12880A Display Terminal Interface	538
11566A Air Line Extension	402	12889A Hardwired Serial Interface	538
11567A Air Line Extension	402	12920B Asynchronous Multiplexer	538
11570A Accessory Kit for 8405A	426	12930A Universal Interface	538
11581A Attenuator Set	385	12966A Buffered Asynchronous Communication Interface	538
11582A Attenuator Set	385	12967A Synchronous Communications Interface	538
11583A Attenuator Set	385	12968A Asynchronous Communications Interface	538
11587A Accessory Kit for 8410 series	433	12970A Magnetic Tape Subsystem	540
11588A Swivel Adapter	402	12971A Magnetic Tape Subsystem	539, 540
11589A & 11590A Bias Networks	433	12972A Magnetic Tape Subsystem	540
11599A Quick-Connect Adapter for 8745A	433	12977A Fast FORTRAN Processor	537
11600B Transistor Fixture	431	12978A Writable Control Store	537
11602B Transistor Fixture	431		
11604A Universal Extension for 8745A	431		
11605A Flexible Arm for 8743A	431		
11606A Rotary Air Line	402		
11607A Small Signal Adapter for 8745A	433		



MODEL NUMBER INDEX

New product listings are printed in bold face type

13000			
13037A	Storage Control Unit	539	
13064A	Tape Degausser	230	
13187A	16K Memory Module	536	
13215 A	Power Supply	539	
13231A	Display Enhancements	544	
13238A	Terminal Duplex Register	544	
13245A	Character Set Generation Kit	544	
13250B	Serial Printer Interface	544	
13254A	Video Output Interface	544	
13390A	DISCU/15	539	
13515A	Frequency Doubler Probe	348	
14000			
14513A	Rack Kit 3 1/2"H	198	
14515A	Rack Kit 5 1/4"H	198	
14521A	Rack Kit, Bench Series	198	
14523A	Rack Kit 3 1/2"H	198	
14525A	Rack Kit 5 1/4"H	198	
14533B	Pocket Programmer	203	
14534A	Pocket Programmer	203	
14535A	DCPS Interface Kit	203	
14536A	DCPS Chaining Cable	203	
14539A	DCPS to 21MX Cable	203	
14544A	DCPS to PDP-8/I Cable	203	
14545A	Casters	198	
16000			
16005A	Probes	75	
16006A	Probe	75	
16007A	Test Leads	75	
16008A	Resistivity Cell	76	
16014A	Series Loss Test Adapter	88	
16019A	Test Fixture	74	
16022A	Test Fixture	83	
16029A	Test Fixture	78	
16033A	Test Lead	83	
16035A	Test Leads	87	
16036A	Test Leads	87	
16037A	Test Fixture	85	
16038A	Test Fixture	87	
16138A	Test Leads	74	
16413A	HP-IB Interface Kit	85	
16462A	Auxillary Capacitor	88	
16470A	Reference Inductors	88	
16491A	Camera Bezel Adapter	162	
17000			
17005A	Chart Advance for 7004B Recorder	207	
17012B	Point Plotter	207	
17012C	Point Plotter	207	
17108A	Time Base	208	
17170A	DC Coupler	207	
17171A	DC Amplifier	207	
17172A	Time Base	207	
17173A	Null Detector	207	
17174B	DC Offset	207	
17175A	Filter	207	
17176A	Scanner	207	
17177A	AC/DC Converter DC Preamplifier	207	
17178A	DC Attenuator	207	
17400A	High Gain Preamplifier	223	
17401A	Medium Gain Preamplifier	223	
17402A	Low Gain Preamplifier	223	
17403A	AC Carrier Preamplifier	223	
17404A	DC Bridge Amplifier	223	
17500A	Multiple Span	217	
17501A	Multiple Span	217	
17502A	Temperature Module	217	
17503A	Single Span	217	
17504A	Single Span	217	
17505A	High Sensitivity	217	
17506A	Single Span	217	
18000			
18019A	Carrying Case	540	
18641A	PRT Temperature Probes	57	
18642A	PRT Temperature Probes	57	
18643A	PRT Temperature Probes	57	
18644A	PRT Temperature Probes	57	
20000			
20854A	Timeshare BASIC "F" Software	537	
20855A	BASIC Control System Software	537	
20856A	Timeshare Basic "E" Software	537	
24307B	DOS-III Software	537	
24337A	Basic Analysis and Mapping Program Software	537	
24342B	Terminal Control System Software	537	
24376B	Image/2100 Software	537	
24380A	HP Remote Job Entry Software Package for BCS	537	
24383A	Course Writing Facility	537	
24383B	Course Writing Curriculum Conversion	537	
30000			
30130B	2780/3780 Emulation Subsystem for 3000 CX	547	
33300 series	Step Attenuators	388	
33311B/C	Coaxial Switches	401	
33320 series	Coaxial Step Attenuators	388	
33321 series	Coaxial Step Attenuators	388	
33322 series	Coaxial Step Attenuators	388	
33330B/C	Coaxial Crystal Detectors	394	
34110A	Carrying Case	47	
34111A	High Voltage Probe	47	
34112A	Touch-Hold Probe	47	
34702A	Multimeter	56	
34740A	Display	56	
34750A	Display	56	
40000			
43501B	X-Ray System	570	
43804	X-Ray System	568	
43805	X-Ray System	568	
43807	X-Ray System	588	
50000			
59301A	ASCII—Parallel Converter	26	
59303A	Digital-to-Analog Converter	26	
59304A	Numeric Display	26	
59306A	HP-IB Relay Actuator	26	
59307A	HP-IB VHF Switch	26	
59308A	HP-IB Timing Generator	26	
59309A	HP-IB Digital Clock	26	
59310B	HP-IB Computer Interface	28	
59313A	Analog-to-Digital Converter	26	
59401A	Bus System Analyzer	25	
59403A	HP-IB Common Carrier Interface	26	
59405A	HP-IB Calculator Interface	28	
59500A	Multiprogrammer HP-IB Interface	532	
59501A	HP-IB Power Supply Programmer	26	

60000	
61000 Modular Power Supplies (OEM)	201
61005C DC-to-DC Converter (single output)	201
61315D DC-to-DC Converter (triple output)	201
62000 & 63000 Modular Power Supplies (OEM)	200
62005A-62048G Modular Power Supplies	199
62212A-62215G Dual Output Modular Supplies	199
62605M-62628J 200-600W Switching Power Supplies	199
63005C 110 W Switching Power Supply	199
63312F Triple-output Switching Power Supply	199
63315D Triple-output Switching Power Supply	199
69321B Multiprogrammer D/A Voltage Converter	534
69325A-69328A Amplifier Control Cards	534
69330A Relay Output Card	534
69331A Digital Output Card	534
69332A Open Collector Output Card	534
69335A Stepping Motor Control Card	534
69351B Voltage Regulator Card	533
69370A D/A Current Converter Card	534
69380A Breadboard Output Card	534
69421A Voltage Monitor Card	534
69430A Isolated Digital Input Card	534
69431A Digital Input Card	534
69433A Relay Output With Readback Card	534
69434A Event Sense Card	534
69435A Pulse Counter Card	534
69436A Process Interrupt Card	534
69480A Breadboard Input Card	534
69500A Unloaded Resistance Output Card	534
69501A-69513A Power Supply Control Cards	534
69600B Programmable Timer Card	534
69601B Frequency Reference Card	534

80000	
85030A Applications Pac for 85030-9830A/B	423
85031A APC-7 Calibration and Verification Kit for 8507A	423
85032A Type-N Calibration Kit for 8507A	423
85033A SMA Calibration Kit for 8507A	423
85426A Bias Insertion Network	425
85428B Minimum Loss Pad	425
86200 series Sweeper Plug-ins for 8620C	362
86222A & B Sweep Oscillator Plug-ins for 8620C	360
86290A Broadband Sweeper Plug-in for 8620C	358
86300 series Sweeper Modules for 8620C	364
86601A RF Section for 8660A,C	330
86602B RF Section for 8660A,C	330
86603A RF Section for 8660A,C	330
86631B Auxiliary Section for 8660A,C	330
86632B AM/FM Section for 8660A,C	330
86633B AM/FM Section for 8660A,C	330
86634A Phase Modulation Section for 8660A,C	330
86635A Φ M, FM Section for 8660A,C	330

90000	
91007A Distributed System Kit for 8505B Systems	551
91008A Distributed Systems Kit for 8542B Systems	551

91075B TESTAID-III Test Generation Software	553
91214A Remote Data Base Access Package	547
91703A-91705A Distributed Systems Kits for 9600 Systems	551
91707A-91708A Distributed Systems Kits for 9500 Systems	551
91780A Remote Data Transmission Subsystem	551
92001A RTE-II Disc Based Real Time Operating System Software	552
92002A Batch Spool Monitor Software	552
92060A RTE-III Real Time Operating System Software	552
92063A IMAGE/1000 Data Base Management	552
97001A Rechargeable Battery Pack for 970A	48
97002A AC/DC Current Shunt/Bench Cradle for 970A	48
97003A RF Adapter for 970A	48
97004A Accessory Kit for 970A	48
97010A Battery Charger for 970A	48
98032A 16-bit Duplex Interface	531
98033A BCD Input Interface	531
98034A HP-IB Interface	531
98133A BCD Interface	531
98134A General Interface	531
98135A HP-IB Interface	531
98136A RS-232-C Serial Interface	531
08441-6012 Cable Assembly	480

0950-0090 GR-874 to 50 Ω Termination	481
1250-0076 90° BNC Male-Female	481
1250-0077 Type N Female to BNC Male	481
1250-0080 BNC Female to Female	481
1250-0082 Type N Male to BNC Male	481
1250-0176 Type N Male to Type N Female 90°	481
1250-0216 BNC Male to Male	481
1250-0239 GR-874 90° Elbow	481
1250-0240 GR-874 to Type N Female	481
1250-0559 Type N Tee, 1 Male, 2 Female	481
1250-0777 Type N Female to Type N Female	481
1250-0778 Type N Male to Male	481
1250-0780 Type N Male to BNC Female	481
1250-0781 BNC Tee 1 Male, 2 Female	481
1250-0846 Type N Tee, 3 Female	481
1250-0847 GR-874 to Type N Male	481
1250-0849 GR-874 to BNC Male	481
1250-0850 GR-874 to BNC Female	481
1250-1158 SMA Female to Female	481
1250-1159 SMA Male to Male	481
1250-1206 GR-874 to Type C Male	481
1250-1207 GR-874 to Type HN Female	481
1250-1208 GR-874 to Type C Female	481
1250-1209 GR-874 to TNC Female	481
1250-1210 GR-874 to TNC Male	481
1250-1211 GR-874 to Type HN Male	481
1250-1263 BNC Male to Single Banana Post	481
1250-1264 BNC Male to Dual Banana Post	481
1250-1454 BNC Adapter Tip for HP Miniature Probes	159
1251-2277 Dual Banana plug to BNC Female	481
1251-2816 Dual Banana plug (for cable)	481



HEWLETT-PACKARD INTERFACE BUS

Versatile interconnect system for instruments and controllers

HP-IB

- HP's implementation of IEEE Standard 488 and identical ANSI Standard MC 1.1
- Useful over wide range of problems, from simple to very complex—add capabilities as your system requirements grow
- Very broad selection of HP-IB instruments and accessory devices—available now
- Wide choice of computing controllers for the reduction, analysis, storage and management of measurement data



Make accurate, problem-oriented measurements, controlled by calculator or computer.

There are many measurement applications where interactive instruments coupled with a controller can provide superior, error-free results as compared with conventional manual methods. Such instrumentation systems have usually been beyond the practical reach of all but large-scale or high-volume users because of previous interfacing complexities and the associated high costs.

Now, three things combine to reduce significantly the engineering costs of putting a system together. These are: (1) the Hewlett-Packard Interface Bus, also known simply as "HP-IB"; (2) the recent development and growing number of "smart" instruments having internal processor capability; and (3) the advent of a broad choice of computing controllers, ranging from individual "friendly" keyboard units through those capable of multistation measurements and sophisticated data management.

Before further discussing the merits of instrumentation systems, it is important to note that substantial numbers of measurements will continue to be made manually. HP intends to continue to provide individual state-of-the-art instruments for making specific manual bench measurements. We do, however, see a clear trend toward these same instruments being utilized in instrumentation systems and interconnected via the HP Interface Bus.

Benefits of a systems approach

The decision to use a "system" instead of conventional manual methods must be based on an engineering evaluation of benefits vs. costs. Among the many benefits associated with a systems approach:

- More consistent results in repeated measurements — a system is not subject to operator fatigue.
- Greater throughput because systems are generally faster.
- More thorough testing because system speed allows more parameters to be measured in a shorter time.
- Results expressed in engineering or scientific units since many systems controllers are capable of on-line data manipulation.
- Greater accuracy because system errors can be measured automatically, stored, and accounted for in the results.
- "Adaptive" data acquisition wherein a system can be programmed to branch to other measurements to help pinpoint the problem when it senses an abnormal condition.

Relationship of HP-IB to present and proposed interface standards

Hewlett-Packard is committed to the overall advancement of measurement technology, and has for quite some time been working on the problems of simplifying and standardizing instrument interconnection.

Concurrent with the considerable practical experience HP has gained (with both HP-IB and interface techniques in general) over recent years has been the growing international interest in establishing a suitable standard for programmable measuring apparatus — a standard that will allow instrument systems to be configured from the products made by different manufacturers. European organizations, particularly in Germany, have been instrumental in initiating an international standardization effort.

In mid-1972, HP began to participate in various national and international standardization bodies. The U.S. Advisory Committee, composed of diverse interests represented by both users and manufacturers, first established initial goals — and then adopted the interface concept utilized by the HP Interface Bus as an appropriate starting point. A draft document was subsequently written and evaluated by members of the Committee, and then submitted as the U.S. proposal to an IEC (International Electrotechnical Commission) Working Group in the autumn of 1972. Since then, the interface definition has undergone a number of minor changes to accommodate various needs at the international level.

In September 1974, the parent technical committee, IEC TC66, approved the main interface draft document for a formal ballot among the member nations of the IEC. Balloting took place in 1976, and it is anticipated that an IEC document will be available for publication in 1977. *The present definition of the HP-IB is compatible with the main IEC draft document.*

Meanwhile, the IEEE Standards Board has approved IEEE Standard 488-1975 "Digital Interface for Programmable Instrumentation", as published in April 1975.¹ The IEEE standard is based on work initiated by the IEC, and follows the general concepts of the document now under consideration by IEC member nations. *The HP Interface Bus is Hewlett-Packard's implementation of IEEE Standard 488.* (NOTE: In January 1976, the American National Standards Institute adapted the above and published it as ANSI Standard MC 1.1).

Why the HP Interface Bus name?

Over the past several years, HP has developed and sold instruments that are interfaceable via the basic digital techniques now adopted as the IEEE Standard (and contained in the final IEC draft document).

As the list of HP products available with the "new digital interface" has grown, our customers have in the past sought a convenient way to identify those products having

¹To purchase a copy of the 20-page IEEE Standard 488-1975, contact: The Institute of Electrical and Electronics Engineers, 345 East 47th Street, New York, N.Y. 10017.

the interface capability. In response, we in 1974 adopted the name "Hewlett-Packard Interface Bus" (commonly shortened to "HP Interface Bus" or simply "HP-IB"). We will continue to use the identifying name and this symbol:



Both will be used with appropriate HP products so that their interface capabilities may be readily identified.

As additional instrumentation interface standards become approved, HP will clearly indicate the relationship of the Hewlett-Packard Interface Bus to those standards — just as we have done with IEEE Standard 488-1975 (and identical ANSI Standard MC 1.1).

It should be pointed out that as a practical matter, device-dependent *operational* characteristics have been *excluded* from the IEEE and proposed IEC Standards definitions. In this way, users retain maximum flexibility in selecting instruments from different manufacturers and in utilizing each instrument's particular capabilities to best advantage.

The implications of this are put in perspective by the "Forward" message printed in IEEE Standard 488-1975: "... a system configurator must have sufficient awareness of the options included in each of the devices in a system in order to ensure that the correct communication techniques are used."

Relative to the great progress made in standardizing three of the four interface system elements (*mechanical, electrical, functional*), understanding the remaining device-dependent *operational* parameters referred to in the IEEE document is a relatively small but essential ingredient necessary to ensure complete operational systems.

It would be presumptuous for Hewlett-Packard to speak for other manufacturers; however, it is our objective to reduce as much as practical any device-related ambiguities associated with HP products operating per the IEEE Standard (and proposed IEC Standard). We expect to do this through product design considerations; through new message concepts, as well as further code and format guidelines; and through various printed materials and training activities.

How the HP Interface Bus operates

All active interface circuitry is contained within the various HP-IB devices, and the interconnecting cable (containing 16 signal lines) is entirely passive. The cable's role is limited to that of interconnecting all devices together in parallel, whereby any one device may transfer data to one or more other participating devices.

Every participating device (instrument, controller, accessory module) must be able to perform at least one of the roles of *TALKER*, *LISTENER* or *CONTROLLER*. A *TALKER* can transmit data to other devices via the bus, and a *LISTENER* can receive data from other devices via the bus. Some devices can perform both roles (e.g. a programmable instrument can *LISTEN* to receive its control instructions and *TALK* to send its measurement).

A *CONTROLLER* manages the operation of the bus system primarily by designating which devices are to send and receive data, and it may also command specific actions within other devices.

A minimum HP-IB system configuration consists of one *TALKER* and one *LISTENER*, but without a *CONTROLLER*. In this configuration, data transfer is limited to direct transfer between one device manually set to "talk only" and one or more devices manually set to "listen only" (e.g. a measuring instrument talking to a printer, for semi-automatic data logging).

The full flexibility and power of the HP-IB become more apparent, however, when one device which can serve as *CONTROLLER/TALKER/LISTENER* (e.g. calculator or computer) is interconnected with other devices which may be either *TALKERS* or *LISTENERS*, or both (e.g. frequency synthesizers, counters, power meters, relay actuators, displays, printers, etc.), depending on the application. An HP-IB *computing controller* participates in the measurement by scheduling measurement tasks, setting up individual devices so that they can perform these tasks, monitoring the progress of the measurement as it proceeds, and interpreting the results of the measurement. (See page 28 for additional details about HP-IB computing controllers.)

HP-IB connections and structure

The 16 signal lines within the interconnecting HP-IB cable are grouped into three sets, according to their function.

Eight *DATA* lines carry coded messages in bit-parallel, byte-serial form to and from devices, with each byte being transferred from one *TALKER* to one or more *LISTENERS*. Data flow is bidirectional in that the same lines are used both to input program data and to output measurement data from an individual device. Data is exchanged asynchronously, enabling compatibility among a wide variety of devices. All interface messages (to set up, maintain, and terminate an orderly flow of device-dependent messages) are 7-bit coded. Device-dependent messages may be from 1 to 8 bits; however, the codes containing printable characters of the ASCII (American Standard Code for Information Interchange) code set are most commonly used, and messages containing numbers are typically presented in scientific notation (FORTRAN-type) format.

Three *DATA BYTE TRANSFER CONTROL* (handshake) lines are used to effect the transfer of each byte of coded data on the eight *DATA* lines.

The five remaining *GENERAL INTERFACE MANAGEMENT* lines ensure an orderly flow of information within the HP-IB system. One of these is called the "ATTENTION" line.

The controller dictates the role of each of the other devices by setting the *ATTENTION* line low (true) and sending talk or listen addresses on the *DATA* lines. (Addresses are manually set into each device at the time of system configuration, either by switches built into the device as shown above, or by jumpers on a PC board.) When the *ATTENTION* line is low, all devices must listen to the

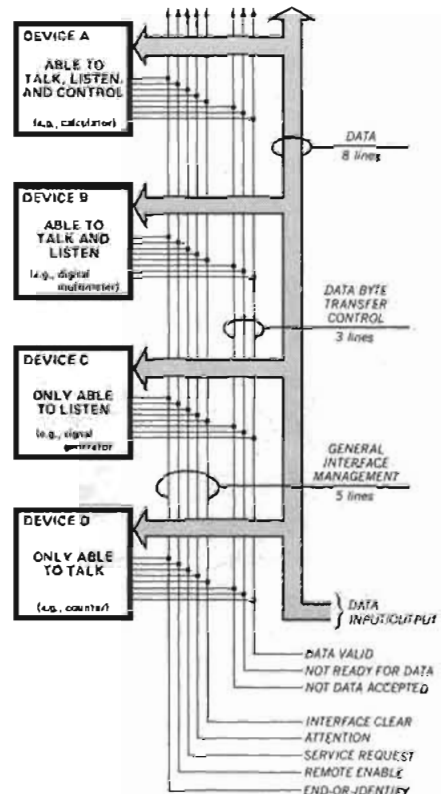

Interface connections and bus structure



Rear panel switches are set so Instrument will either be addressable by controller in a multi-device system, or will simply "talk only" to another device such as a printer.

DATA lines. When the *ATTENTION* line is high (false), only those devices that have been addressed will actively send or receive data, while all others ignore the *DATA* lines.

Several listeners can be active simultaneously, but only one talker can be active at a time. Whenever a talk address is put on the *DATA* lines (while *ATTENTION* is low), all other talkers are automatically unaddressed.

It is not possible in this limited space to go into detail on each signal line's role. But you should note that every HP-IB device need not be able to respond to all the lines. As a practical and cost-effective matter, each HP-IB device will usually be designed to respond only to those lines that are pertinent to its typical function on the bus. (Details appear in each device's operating manual.)

HEWLETT-PACKARD INTERFACE BUS

Versatile interconnect system for instruments and controllers

HP-IB

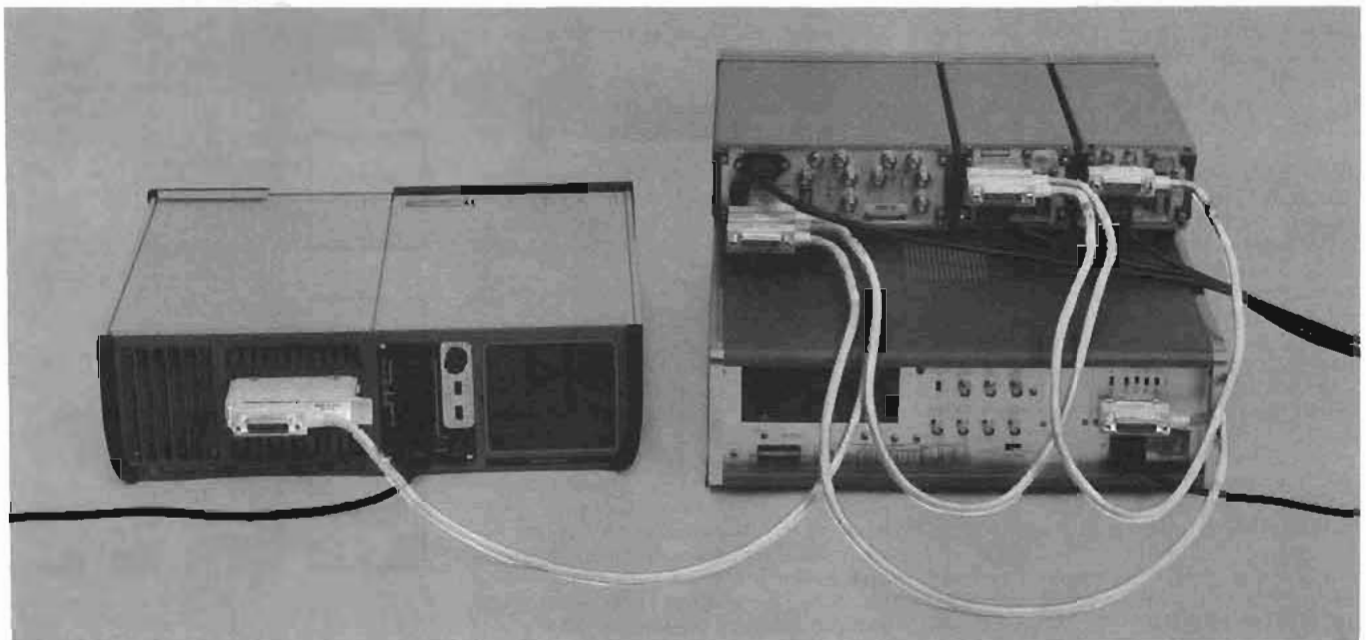

Rear view of an assembled 5-device HP-IB bench system. Note both single and stacked connections.

HP-IB specification summary

Interconnected devices: Up to 15 maximum on one contiguous bus.

Interconnection path: Star or linear bus network; total transmission path length 2 metres times number of devices or 20 metres, whichever is less (see HP 59403A for extending operating distance).

Message transfer scheme: Byte-serial, bit-parallel asynchronous data transfer using interlocked 3-wire handshake technique.

Data rate: One megabyte per second maximum over limited distances; 250–500 kilobytes per second typical over full transmission path (depends on device).

Address capability: Primary addresses, *31 TALK* and *31 LISTEN*; secondary (2-byte) addresses, *961 TALK* and *961 LISTEN*. Maximum of 1 *TALKER* and up to 14 *LISTENERS* at a time.

Control shift: In systems with more than one controller, only one can be active at a time. A currently active controller can pass control to another, but only designated system controller can assume control over others.

Interface circuits: Driver and receiver circuits are TTL-compatible.

Special notice to early purchasers of HP-IB products

Hewlett-Packard fully supports IEEE Standard 488, including the provision that ISO metric threads be used on the bus connector lock screw and corresponding stud mount. This means that present HP-IB products are coming to you already equipped with the proper metric thread connector hardware.

If you are among the many present users of HP-IB products purchased over the past few years, please note that the connector locking

threads on early products are *non-metric* — and they are therefore not compatible with metric threaded connectors now being produced per the IEEE Standard.

Two different metal finishes are being used by HP to help you tell the difference between metric and non-metric connectors. Whereas the older non-metric parts have a shiny nickel finish, all *metric-threaded* lock screws and stud mounts have a *black* finish and the letter "M" stamped on them.

A special HP-IB Metric Conversion Kit has been set up by Hewlett-Packard to assist customers in converting the connectors on their older HP-IB products (instruments, cables, controller interfaces) to be compatible with the new standard metric-threaded connector. This conversion kit is available at modest cost, and is identified as Part Number 5060-0138. Please contact your HP field engineer or service representative for details.

Instruments and computing controllers for "do-it-yourself" HP-IB system solutions

Hewlett-Packard has an extremely broad range of HP-IB instruments and computing controller capabilities, as indicated on the following page — capabilities you can use in assembling a wide variety of system solutions, via HP-IB. We are committed to the HP-IB concept, and you may be assured that we will continue to add to this list of interfaceable products.

Each bench instrument is, by itself, an exceptional performer in terms of providing signals, making measurements, or recording results. Each has the additional capability which allows its use in HP-IB instrumentation systems — either in "do-it-yourself" systems configured and assembled by users

themselves, or in some of the standard systems which are designed, preassembled and supported by HP. While the HP-IB interface is optional in many instruments, it is increasingly becoming "standard" in some of the newer products.

Most principle functions on the instruments are HP-IB programmable. For specific details, please consult the appropriate catalog page, or the technical data sheet which is available for each product.

Just as with the instruments, HP's computing controllers which are available for use with HP-IB are all proven performers. Regardless of your need for reducing, analyzing, storing or managing measurement data, HP has a computing controller that should be right for your application.

Warranty considerations

Every HP-IB device (instrument or computing controller) carries the standard Hewlett-Packard warranty appropriate to that individual product — regardless of whether it is purchased separately as a stand-alone item for use in customer-assembled HP-IB systems, or furnished as part of a standard HP-IB system assembled by Hewlett-Packard.

HP additionally takes responsibility for standard HP-IB systems (designed and assembled by Hewlett-Packard — see page 24) performing as specified. However, software or interfacing which has not been provided by Hewlett-Packard as part of the standard system delivered by HP are not covered by this warranty.

In all cases, overall operational responsibility for those HP-IB systems assembled by a customer from individual HP-IB devices shall rest with the customer.

Individual Hewlett-Packard products available with HP-IB (IEEE 488) capability

Products related to:	Model	Product name/characteristics	See Page
Stimulus	3320B Option 007	Frequency Synthesizer: 0.01 Hz to 13 MHz	316
	3330B	Automatic Synthesizer/Sweeper: 0.1 Hz to 13 MHz	318
	6002A Option 001	DC Power Supply: 200 W extended range	191
	8016A Option 001	Word Generator: 9 × 32 bit	302
	8620C Option 011	Sweep Oscillator: 10 MHz to 18 GHz	355
	8660A Option 005	Synthesized Signal Generator: 10 kHz to 2.6 GHz	328
	8660C Option 005	Synthesized Signal Generator: 10 kHz to 2.6 GHz	328
	8671A	Microwave Frequency Synthesizer: 2 to 6.2 GHz	334
	8672A	Synthesized Signal Generator: 2 to 18 GHz	332
	59308A	Timing Generator	26
59501A	Power Supply Programmer: Isolated D-to-A converter	26	
Measurement	436A Option 022	Power Meter: -70 dBm to +35 dBm, up to 18 GHz	372
	3437A	System Digital Voltmeter: high speed, 3½ digits	60
	3455A	Digital Voltmeter: 5½ or 6½ digits, auto calibration	62
	3490A Option 030	Digital Voltmeter: 5 digits, self test	68
	3495A	Scanner: up to 40 channels, low thermal & relay	69
	3745A	Selective Level Measuring Set: CCITT FDM systems	504
	3745B	Selective Level Measuring Set: Bell FDM systems	504
	4261A Option 101	Digital LCR Meter: auto range and auto balance	79
	4270A Option 101	Automatic Capacitance Bridge	86
	4271A Option 101	1 MHz Digital LCR Meter	81
	4272A Option 101	1 MHz Preset C Meter	83
	4282A Option 101	Digital High Capacitance Meter	84
	4942A Option 010	Transmission Impairment Measurement System (TIMS)	500
	5312A	HP-IB Interface (Talker) for 5300B System	259
	5328A Option 011	Universal Counter: to 512 MHz, 10 ns time interval	246
	5340A Option 011	Automatic Microwave Counter: 10 Hz to 18 GHz	262
	5341A Option 011	Automatic Microwave Counter: high speed, to 4.5 GHz	263
	5345A Option 011	General Purpose Plug-In Counter	238
	5363A	Time Interval Probes	264
	5501A Option 251	Laser Transducer: for accurate positioning	558
	8503A Option 001	S-Parameter Test Set: 50 or 75 Ohm, for 8505A	420
	8505A Option 001	RF Network Analyzer: 500 kHz to 1.3 GHz	418
	59303A	Digital-to-Analog Converter	26
59306A	Relay Actuator: for programmable switches, attenuators	28	
59307A	VHF Switch: two 50 Ohm, bidirectional, dc to 500 MHz	26	
59309A	Digital Clock: month, day, hour, minute, second	26	
59313A	Analog-to-Digital Converter	26	
59500A	Multiprogrammer Interface Kit: for 6940B/6941B	532	
Display	5150A Option 001	Alphanumeric Thermal Printer: 20 columns	232
	59304A	Numeric Display: 12 LED characters, decimal point <i>See also calculators, computers and peripherals</i>	26
Storage	3964A Option 007	Instrumentation Tape Recorder: 4 channel	230
	3968A Option 007	Instrumentation Tape Recorder: 8 channel <i>See also calculators, computers and peripherals</i>	230
Translation	69301A	ASCII-to-Parallel Converter: string up to 16 characters	26
	59403A	HP-IB/Common Carrier Interface: RS232C or CCITT V24	26
Control and Computation	59310B	Interface for 21MX & 2100 Computers (see also p. 536)	28
	59405A Option 020	Interface for 9820A Calculator	28
	59405A Option 021	Interface for 9821A Calculator	28
	59405A Option 030	Interface for 9830A/B Calculators (see also p. 529)	28
	98034A	Interface for 9825A Calculator (see also p. 528)	28
	98135A	Interface for 9815A Calculator (see also p. 527) <i>For HP-IB data management, see also HP 1000 and HP 9840A, p. 546</i>	28

HEWLETT-PACKARD INTERFACE BUS

Versatile interconnect system for instruments and controllers

HP-IB



A preassembled HP-IB system solution — the 8950A Automatic Transceiver Test System.

HP-IB applications information

Several application notes have been published, describing how selected HP instruments and computing controllers can be interconnected via HP-IB for solving a wide variety of measurement problems.

AN 164-2 provides basic information on using a Model 8660 synthesized signal generator with Model 9820/21/30 calculators.

All notes in the *AN 174* series describe how to use a Model 5345A electronic counter with Model 9820/21/30 calculators for many different measurements, as indicated by the following titles:

AN 174-1: measuring the transfer characteristic of a voltage controlled oscillator.

AN 174-2: measuring differential nonlinearity of a voltage controlled oscillator.

AN 174-3: measuring integral nonlinearity of a voltage controlled oscillator.

AN 174-4: measuring dual voltage controlled oscillator tracking error.

AN 174-5: determining probability densities (histograms).

AN 174-6: measuring the stability of a frequency source.

AN 174-7: measuring fractional frequency standard deviation (sigma) vs. averaging time (tau).

AN 174-8: measuring FM peak-to-peak deviation.

AN 174-9: making automatic phase measurements with the 5345A Electronic Counter.

AN 174-10: measuring electrical length (delay) of cables.

AN 174-11: measuring warm-up characteristics and aging rates of oscillators.

AN 174-12: measuring frequency sweep linearity of sweep generators.

AN 174-13: measuring the tuning step transient response of VCO's to 18 GHz.

AN 181-1: describes using Model 5340A frequency counter with Model 9820/21/30 calculators in 3 system configurations.

AN 181-2: describes a data acquisition system based on Model 5300B measuring system and Model 9820/21 calculators.

AN 187-2: describes configuration of a 2-18 GHz synthesized frequency source using Model 8620C sweep oscillator and 9820/21/30 calculators.

AN 187-3: describes three configured systems for making microwave scalar measurements, using the Model 8620C sweep oscillator.

AN 187-5: describes the Model 8620C's programmable capabilities with the Model 9820/21/30 calculators.

AN 196: describes several HP-IB systems using Model 436A power meter.

AN 201-1: describes a computer-controlled HP-IB system for the automatic Quality Assurance evaluation of precision resistors.

AN 201-2: measuring differential nonlinearity of a voltage controlled oscillator, via computer-controlled HP-IB system.

In addition to the above printed application notes, Hewlett-Packard has video tapes dealing with the use of computing controllers for HP-IB.

Preassembled HP-IB system solutions . . . integrated and supported by HP

Many applications can be satisfied with standard HP-IB measurement systems. These systems are not only assembled and checked out at the factory — they are also fully integrated and documented, and HP assumes full responsibility for overall specified system performance. HP's standard HP-IB system warranty applies, and installation and maintenance agreements are available.

Several families of preassembled HP-IB systems are currently available, with more to come. The following systems offer maximum flexibility in terms of data manipulation and analysis, and in available accessories and peripherals, as used with computing controllers.

Data logging and data acquisition

Model 3051A Programmable Data Logger (page 70): economical data collection and analysis, interactive test capabilities.

Model 3052A Automatic Data Acquisition System (page 71): fast and precise low level measurements, powerful computation.

Network analysis

Model 3040A Network Analyzer (page 413): complete amplitude and phase characterization (also group delay, optionally), 50 Hz to 13 MHz.

Model 3042A Automatic Network Analyzer (page 414): identical to 3040A above, and includes HP 9825A computing controller.

Model 8507A Automatic RF Network Analyzer (page 418): measures complex impedance, transfer functions, group delay; 500 kHz to 1.3 GHz.

Spectrum analysis

Model 3044A Spectrum Analyzer (page 447): precise amplitude and frequency measurements, 10 Hz to 13 MHz.

Model 3045A Automatic Spectrum Analyzer (page 447): identical to 3044A above, and includes HP 9825A computing controller.

Frequency stability analysis

Model 5390A Frequency Stability Analyzer (page 468): short and long term characterization of precision frequency sources, 500 kHz to 18 GHz.

Transceiver testing

Model 8950A Automatic Transceiver Test System (page 486): for AM and FM transceivers, 2 to 1000 MHz, transmitting up to 100 W.

Digital circuit board testing

Model DTS-70 Digital Test System (page 553): for fast and accurate fault location on loaded digital printed circuit boards.

HEWLETT-PACKARD INTERFACE BUS



Versatile interconnect system for instruments and controllers

Bus system analyzer, cables & accessory modules

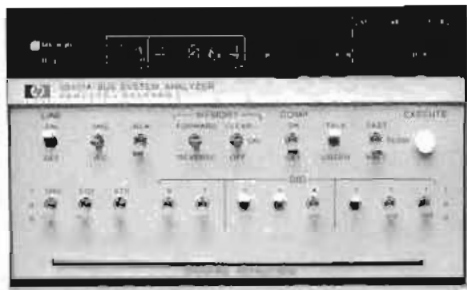

59401A



10631A/B/C

59401A Bus system analyzer

The HP-IB (IEEE 488) concept has greatly simplified many of those things which have in the past made instrument interfacing a burdensome task. Even so, software errors can occur if the system designer does not completely understand the bus system or the capabilities of the instruments and other devices being interfaced. And hardware problems can occur if the instruments/devices are not functioning properly, or if they are not completely compatible with the bus standard.

The 59401A Bus System Analyzer is especially useful in design and service work. It simplifies and speeds up the diagnosis of software and hardware problems by allowing the user to see the status of all bus lines, including the actual characters on the bus data lines. Because the 59401A can also drive all bus lines, it can completely exercise another Talker, Listener or Controller — which is especially useful in verifying compatibility of new or user-designed products with the HP-IB.

There are several choices of analyzer operating speed. It may be operated at one character at a time (useful for software debugging), at 2 characters per second, or at regular bus speed. It may also be operated at a variable rate as determined by the external clock input.

The analyzer's 32 character memory can be used to store bus characters in the Listen mode, or to output characters to the bus in the Talk mode. When the analyzer is in the Compare mode, a stream of bus traffic may be stopped on a pre-selected character — and at that time, a trigger pulse is available, which is very useful when analyzing transient or timing problems related to the bus.

59401A Specifications

Display: monitors all bus lines. Represents data lines, any memory location, or DIO front panel switch settings; in octal code and ASCII character.

Listen mode: stores up to 32 characters of bus traffic in memory for real time and repetitive testing. In compare mode, halts bus traffic when a selected character is present, and user can display any one of the previous 31 characters stored in memory.

Timing: accept <750 ns; ready <750 ns.

Talk mode: bus lines can be driven directly from front panel switches; memory can be loaded from front panel switches for driving bus with a 32 character sequence.

Timing: (1) data changed >500 ns before DAV pulled low; (2) ATN driven low >1 μ s before DAV pulled low; (3) DAV driven high <700 ns after NDAC is false; (4) DAV driven low <700 ns after NRFD is false, if conditions 1 and 2 are met.

Operating speeds: one character at a time, 2 characters per second, regular bus speed, or variable rate determined by external clock input; in either Listen or Talk mode.

External clock input: 1 standard power TTL gate input; ≤ 10 MHz repetition rate.

Compare output: provides 1 standard power TTL gate output (LOW TRUE) sync pulse when bus character is same as front panel switches.

HP-IB load: 1 bus load (capable of driving 14 other bus devices).

General

Temperature ranges: operating, 0 to 50°C; storage, -40 to +75°C.

Humidity: 95% relative, 0 to 40°C.

Power requirements: 100, 120, 220 or 240 V +5%, -10%; 48 to 66 Hz; ≤ 42 VA.

Dimensions: 205.1 mm W, 145.5 mm H, 495.3 mm D (8.075" X 5.730" X 19.500")

Weight: net, 5.64 kg (12.44 lb).

Options and accessories

5061-0089, front handle kit

10631B 2 m (6.6 ft) bus cable, furnished

59401A Bus System Analyzer

Price

\$15

N/C

\$2500

HP-IB Interconnection cables

Three different length HP-IB cables are available. Both ends of each cable have a double-sided male/female connector, so that multiple cables may be conveniently stacked for parallel connection.

Metric threads are now standard on HP cable connector lock screws (and matching stud mounts on instruments), and indicated by a black finish and stamped letter "M". *Note that early HP-IB products were equipped with connectors having non-metric threads, and are therefore not compatible with the metric connectors.* Contact your nearby HP Sales and Service Office for an HP-IB Metric Conversion Kit, 5060-0138, available at nominal cost.

Model number and cable length

10631A HP-IB Cable, 1 m (3.3 ft)

10631B HP-IB Cable, 2 m (6.6 ft)

10631C HP-IB Cable, 4 m (13.2 ft)

Price

\$60

\$65

\$70

HP-IB Accessory modules

Modules in the HP 59300, 59400 and 59500-series are ideal building blocks for use with instruments to extend measurement capabilities. All of the modules listed here can be interconnected via the HP-IB to HP measuring instruments, signal sources and recording devices capable of operating directly on the HP-IB (see rapidly expanding list on previous pages). In addition, these modules frequently serve as useful ways to interconnect with devices which are not themselves capable of direct HP-IB operation.

Instrument requirements differ. Some only output or accept data on the HP-IB. Others can be remotely programmed by ASCII characters sent along the HP-IB. These modules can work with instruments on any of these levels with or without a controller. Each module having controls can be operated stand-alone from its front panel, or it can be placed in automatic operation under program control.

Module provision for stand-alone, local operation also has important system benefits. The operator can set up and check out the system under manual control, avoiding otherwise complex and time consuming error tracing. Each module has status indicator lights that make it easy to monitor operation.

These modules are housed in cabinets which are part of HP's new "System II" program (see page 474). This extremely flexible enclosure system makes it easy to lock products together horizontally or vertically, for bench or rack use.

HEWLETT-PACKARD INTERFACE BUS

Versatile interconnect system for instruments and controllers

HP-IB

Accessory modules



59301A



59303A

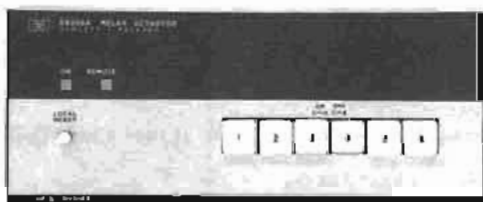

59306A



59304A

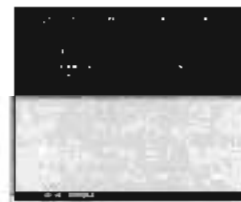

59309A

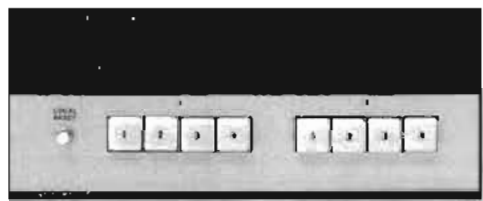

59307A

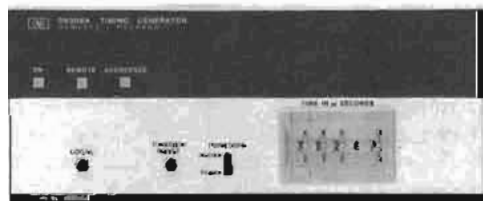

59308A

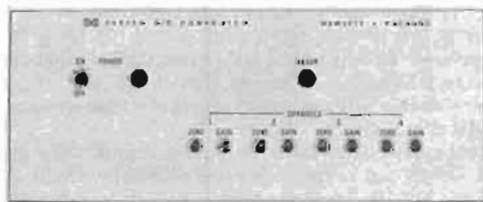

59313A



59501A

59301A ASCII-parallel converter

The 59301A accepts byte-serial ASCII characters on the HP Interface Bus and converts them to parallel output. A string of up to 16 characters terminated by linfeed is converted and placed upon the output lines; the linfeed character signals execution of a print command (strobe). With the 59301A, instruments with the HP-IB interface can be operated with HP 3050B/5055A Printers and their accessories; a switch selects output to be formatted as print format or hexadecimal format; requires two output cables, HP 562-16C (not furnished).

The 59301A can additionally be used with HP 6128C thru 6145A (Option J99) digitally-controlled power supplies, for HP-IB programmable voltage and current.

59303A digital-to-analog converter

Accepts an ASCII string and converts any three consecutive digits to analog voltage accurate to 0.1% in 30 μ s. Fully programmable via the HP-IB or operates stand-alone from the front panel. Offers three output modes for conversion: normal, offset, or plus-minus (9.99 volts to -9.99 volts) to make it convenient for operating strip chart recorders.

A primary application for the HP 59303A is to present on a logging device the data points being taken during a measurement, such as with the HP 5345A Counter. No controller is required for operation. Compatible logging devices include strip chart recorders, X-Y plotters, and displays.

59304A numeric display

Presents a highly visible readout of up to 12 characters and decimal point. Operates as an HP-IB monitor displaying Bus traffic, or it can be addressed to display such things as frequency readout or intermediate calculator results.

59306A relay actuator

This module has six Form-C relays that provide for control of external devices either manually from front panel pushbuttons or remotely from the HP-IB. Relay contacts are specified to handle 0.5 amp. Use the 59306A with HP 8761A/B SPDT switches for HP-IB programmable microwave switching dc-18 GHz; use it with HP 8494 thru 8496G/H attenuators for HP-IB programmable attenuation dc-18 GHz.





59403A

59307A dual VHF switch

This module offers a pair of single throw 4-pole switches (dc to 500 MHz, 50 ohm) optimized for fast risetime (1 ns) pulse waveforms. Switches are independent and bidirectional, and can be operated either from front panel pushbuttons or remotely from the HP-IB.

59308A timing generator, 59309A digital clock

This HP-IB programmable timing family offers time-of-day and precision timed intervals over a wide range from sub-seconds to days. The clock and generator are independent of each other and can operate under program control or stand-alone. The 59309A HP-IB Digital Clock displays month, day, hour, minute, and second; and upon command outputs time via the Interface Bus to logging devices. Time can be updated by remote command. The clock accepts a small internal battery to provide glitch-free power and more than a day's standby; alternatively, the clock operates up to a year on standby supplied by ordinary D-size batteries. The 59308A Timing Generator provides pacing and timing signals output for remote use via the Interface Bus or on rear panel BNC's. Timed intervals can be selected by thumbwheels or can be programmed to have precise lengths from microseconds to minutes to more than a day. Accepts trigger inputs from front panel pushbutton, from rear panel connectors, or remotely via the Bus.

Rear panel BNC's output TTL and FCL levels with switch selection of square wave or pulse and of positive-going or negative-going edge. Output pulses are 500 ns ± 100 ns wide, rise time 50 ns.

59313A analog-to-digital converter

This medium-speed 4-channel unit can accept a full scale input of ± 10 V dc on each channel, individually selectable in four ranges. It also has a program-controlled reverse channel for driving small signal lamps, relays, or TTL circuits. An HP-IB controller can command this unit to perform a single conversion, or initiate a series of internally-paced conversions at one of six selectable rates (up to 200/s if one channel; up to 50/s on each of four channels). Sampling can also be initiated externally by TTL transition or contact closure to ground.

59403A HP-IB/common carrier interface

This module provides a way to extend the separation of component parts in an HP-IB system by more than the 20 metre maximum trans-



The distance between HP-IB devices may be extended by up to 1000 metres, using two 59403A's; even further with modems.

mission path length specified in various interface Standards, and it is especially useful for production or remote site applications. Distances up to 1000 metres are possible by using two 59403A modules (one at each location) interconnected by a dedicated and shielded two-twisted-pair cable. And even longer distances can be achieved by using a telephone line (with appropriate modems) instead of the dedicated cable.

Each 59403A module converts HP-IB data and control lines to a serial bit stream of digital information for transmission over the dedicated or telephone lines, and vice versa in the reverse direction. In both cases, operation is full duplex, so that (for example) one HP-IB device at a remote location can request service from the controller at the same time the controller is sending data to another HP-IB device at the remote location.

The recommended dedicated cable is available from HP as Part Number 8120-1197 (Belden type 8723). The 59403A is designed to operate with 110, 300 and 1200 baud asynchronous or synchronous full duplex modems which are EIA RS232C or CCITT V24 compatible. In the U.S., Bell 103A modems with "soft carrier turn-off" are recommended for use on the direct dial (DDD) network. (Check with your local telephone authorities regarding data communication regulations.)

59501A power supply programmer (Isolated DAC)

This single-channel digital-to-analog converter can control a wide range of power supplies (output voltage, or current), as well as other analog programmable devices. It may also be used as a low level signal source, depending on the speed of the controller. It has two output ranges (0-1 and 0-10 V dc in unipolar mode; -1 to +1 and -10 to +10 V dc in bipolar mode), as well as photo-isolators which electrically separate HP-IB control and data lines from power supply circuitry by up to 600 V dc.

General

Operating environment: operating temperature, 0 to 50°C; relative humidity, to 95% at 40°C.

Power: HP 59300-series: 115 or 230 V (±10%); 50-400 Hz; 15 VA max. (HP 59313A, 18 VA max.). HP 59403A and HP 59501A: 110, 120, 220, or 240 V (+5%, -10%); 48-63 Hz; 60 VA max.

Accessories supplied: each 59403A is provided with one dedicated line connector HP Part Number 1251-3764 (Switchcraft 2504M). Note that 10631-series HP-IB interconnection cables must be purchased separately.

HP-IB accessory modules

Model	Description	Dimensions -- max. height ¹ × width × depth mm (inches)	Net Weight kg (lb)	Shipping Weight kg (lb)	Price
59301A	ASCII-to-parallel Converter	101.6 × 212.9 × 294.6 (4 × 8.38 × 11.6)	1.70 (3.78)	2.32 (5.16)	\$575
59303A	Digital-to-analog Converter	101.6 × 105.9 × 294.6 (4 × 4.17 × 11.6)	2.61 (5.80)	3.17 (7.04)	\$850
59304A	Numeric Display	101.6 × 105.9 × 294.6 (4 × 4.17 × 11.6)	1.23 (2.73)	1.58 (3.51)	\$700
59306A	Relay Actuator	101.6 × 212.9 × 294.6 (4 × 8.38 × 11.6)	2.64 (5.87)	3.23 (7.18)	\$700
59307A	VHF Switch	101.6 × 212.9 × 294.6 (4 × 8.38 × 11.6)	2.64 (5.87)	3.23 (7.18)	\$750
59308A	Timing Generator	101.6 × 212.9 × 294.6 (4 × 8.38 × 11.6)	2.10 (4.67)	3.83 (8.51)	\$1025
59309A	HP-IB Digital Clock	101.6 × 105.9 × 294.6 (4 × 4.17 × 11.6)	1.70 (3.78)	2.84 (6.31)	\$1025
59313A	Analog-to-digital Converter	101.6 × 212.9 × 345.4 (4 × 8.38 × 13.6)	5.45 (12.0)	6.36 (14.0)	\$1500
59403A	HP-IB/Common Carrier Interface	101.6 × 212.9 × 430.0 (4 × 8.38 × 16.9)	4.50 (10.0)	6.10 (13.5)	\$1300
59501A	Power Supply Programmer	101.6 × 212.9 × 294.6 (4 × 8.38 × 11.6)	2.61 (5.80)	3.17 (7.04)	\$500

¹ Height above sockets only, with feet removed height is 388.3 mm (15.27 inches).

HEWLETT-PACKARD INTERFACE BUS

Versatile interconnect system for instruments and controllers

Computing controllers/interfaces



HP 9815A computing controller (HP 98135A Interface)



HP 9825A computing controller (HP 98034A Interface)



HP 9830A/B computing controller (HP 59405A Interface)

A separate controller is not required for simple HP-IB configurations (e.g. data logging). However, the full flexibility and potential of the Hewlett-Packard Interface Bus are more obvious when used with HP computing controllers.

Role of a computing controller

In addition to managing the flow of information over the bus, the computing controller in an operating measurement system actively participates by scheduling measurement tasks, by setting up individual devices so they can perform the tasks, by monitoring the progress of the measurement as it proceeds, and by interpreting the results of the measurement.

HP computing controllers serve another important function by providing access to a large number of display, input/output and data storage peripherals. These include plotters, line printers, floppy disks, tape cassettes, etc. Additionally, HP computing controllers can perform the job of interfacing with other instrument subsystems or computer systems using serial communication links—thereby gaining access to common data bases, sharing results, etc.

Finally, a computing controller can provide the tools for program development. These will normally include an editor that can be used in generating source programs, debug aids that can be used in analyzing and modifying program flow, and a means of storing and recalling programs and/or results.

Wide choice of HP computing controllers

Hewlett-Packard has a continuum of HP-IB (IEEE 488) computing controllers from which to select. If your interfaced-system application is of the "lab bench" variety (as in engineering design or metrology), you may prefer to use one of the desk-top keyboard units such as the 9815A, 9825A or 9830A/B. On the other hand, if your application calls for complex or high volume production testing at multiple locations, simultaneously, and in several programming languages, your choice will probably be one of the solutions offered by the HP 1000 (incorporating a 21MX computer).

Regardless of which HP computing controller you choose initially, the universality of the HP-IB interface means you have great flexibility in changing or expanding the control portion of your interfaced measurement system, as your needs change or grow.

HP-IB interfaces for each of our computing controllers are described below. For more comprehensive details on the computing controllers themselves, please consult pages 527-529, 536 and 546.

98135A HP-IB Interface for 9815A

HP's most economical computing controller is the 9815A desk-top unit, for handling the less complex tasks associated with small systems. If you are familiar with HP's hand-held personal calculators, you'll feel at home with the 9815A's Reverse Polish Notation (RPN) language. The keyboard has a 10-key numeric pad, 15 special function keys, program language and control keys, editing keys, and 28 scientific function keys including trigonometric functions. The 9815A has a built-in 16-character numeric display as well as a thermal printer having alphanumeric capability. It also contains a high-speed bidirectional magnetic tape data cartridge system.

For HP-IB applications, the 9815A can accept one Model 98135A Interface, which plugs into one of the two I/O slots on the 9815A. The interface has a 1.8 metre cable terminated in an HP-IB connector with metric fasteners, and it allows the 9815A to communicate with up to a maximum of 14 HP-IB instruments or peripheral devices. If your application requires an interrupt capability, please see other HP computing controllers, since interrupt is not available with the 9815A/98135A.

98034A HP-IB Interface for 9825A

The 9825A desk-top computing controller is an extremely flexible performer. It uses HPL, a high-level, formula-oriented programming language which offers power and efficiency for handling equations, data manipulation, and input/output operations. HPL provides for subroutine nesting and flags, and allows 26 simple variables and 26 multidimensional array variables, limited only by the size of the 9825A's memory. Also, HPL has a language compatibility with the HP 9820A and HP 9821A, permitting programs for these earlier models to be converted for use with the 9825A.

Significant capabilities of the 9825A include two-level priority interrupt (for controlling several instruments or peripherals requiring attention at unpredictable rates or times), live keyboard, direct memory access, multidimensional arrays, automatic memory record and load, and an extended range of internal computation. The 9825A has a typewriter-like keyboard with upper/lower case, a numeric pad, and 12 special function keys (shiftable to 24). It has a built-in 32-character alphanumeric display and a 16-



HP 1000 computer system (utilizing a 21MX controller and one or more HP 59310B Interfaces)

character printer (both upper/lower case), as well as a high-performance data cartridge system. There are three I/O slots and four ROM slots.

The *Model 98034A Interface* is required for operating the 9825A in HP-IB applications. A 9825A equipped with a "General I/O" ROM can handle fundamental HP-IB input/output operations; with an "Extended I/O" ROM, the 9825A is capable of complete HP-IB control. Each 98034A Interface has a 4 metre cable terminated in an HP-IB connector with metric fasteners, and can control up to 14 HP-IB devices, in conjunction with the 9825A. Up to three of the interfaces may be plugged directly into the 9825A I/O slots—and as many as 14 Interfaces (up to 14 devices each) can be connected to one 9825A, through the use of a *Model 9878A I/O Expander*.

59405A HP-IB Interface for 9830A/B

The familiar and easy-to-use BASIC language is used with 9830A/B desk-top computing controllers. BASIC is a formal, interactive language which appeals to beginners as well as experienced programmers. An additional benefit is that BASIC is a standard computer language; programs you develop initially for 9830A/B HP-IB systems can be later adapted with minimum effort for use with a 21MX computing controller—if your HP-IB system requirements expand to require full computer capabilities available via the 21MX.

User-available read/write memory within mainframe ranges from a minimum of 3520 (8-bit) bytes in the standard HP 9830A, up to a maximum of 30,144 bytes in the HP 9830B with option 001. An external mass memory subsystem is available for allowing 9830A/B computing controllers to handle up to 4.8 million bytes of information. Standard 9830A/B's have a 32-character alphanumeric display, built-in tape cassette, and keyboard which includes special function keys. There are 4 I/O slots, and many peripherals are optionally available.

A 9830A or 9830B can control up to 14 HP-IB devices via a *Model 59405A Option 030 Interface*, plugged into one I/O slot—and an appropriate ROM (provided with the interface) also plugged into the computing controller. Included with the interface is a 4 metre cable terminated with HP-IB connector with metric fasteners, as well as a *User's Guide (59300-90002)*.

59405A HP-IB Interface for 9820A and 9821A

The HP 59405A interface described above is also available for earlier computing controllers. For the HP 9820A, order *Model 59405A Option 020 Interface*, which includes the appropriate ROM and *User Guide (59300-90001)*. For the HP 9821A, order *Model 59405A Option 021 (same User Guide)*.

59310B HP-IB Interface for HP 1000 (& 21MX-series)

The HP 1000 computing controller is especially well suited for broad measurement and data management requirements such as those found in quality assurance, production testing, etc. This is because the HP 1000

(combining a 21MX computer and Real Time Executive Software) is capable of concurrently controlling multiple clusters of HP-IB test and measuring equipment which may be organized into separate physical or functional groupings, each of which may have up to 14 HP-IB devices per cluster. The HP 1000 also: (1) makes it possible to develop new programs while existing programs are actively controlling and communicating with the bus-interfaced devices; (2) can be programmed in HP Real Time BASIC, QUERY, FORTRAN, and HP Assembly language; and (3) can be linked to distributed computer networks to achieve centralized test record maintenance, yield analysis, and work order scheduling and tracing.

Each separate bus cluster (of up to 14 HP-IB devices) connected to the HP 1000 requires one *Model 59310B Interface*. Two variations of this interface are also available for OEM or "do-it-yourself" end user assembly of HP-IB/21MX systems. The *Model 59310B Option 422* provides the broadest range of capabilities—and includes a driver, utility software and a manual supporting operation in HP's disc-based RTE-II and RTE-III Real Time Executive systems. For very simple applications, *Model 59310B Option 423* includes a driver, utility software and a manual that support operation in HP's memory-based Basic Control Systems (BCS). A diagnostic routine for quickly confirming correct operation is included in both versions, and each interface has a 4 metre cable terminated in an HP-IB connector with metric fasteners.

Compatibilities between various HP computers and operating systems are indicated below. The 21MX-series computers include the HP 2105A, HP 2108A, HP 2112A and HP 1000; note that the 59310B interface may also be used with earlier models HP 2100A/S.

	HP 1000	HP 2105A	HP 2108/12A	HP 2100A/S
RTE-II:	Yes	No	Yes	Yes
RTE-III:	Yes	No	Yes	No
BCS:	No	Yes	Yes	Yes

For preconfigured/assembled 21MX/HP-IB computing controller systems, please also see the HP 9640A.

HP-IB interface model number	Price
59310B: interface, RTE-II/UI for HP 1000	\$1000
59310B Option 422: RTE for 21MX and 2100A/S	\$1000
59310B Option 423: BCS for 21MX and 2100A/S	\$1000
59405A Option 020: interface for 9820A	\$1300
59405A Option 021: interface for 9821A	\$1300
59405A Option 030: interface for 9830A/B	\$1300
98034A: interface for 9825A	\$ 400
98135A: interface for 9815A	\$ 600

AMPLIFIERS

General purpose amplifiers

Model 461A, 462A, 465A, 467A



461A



465A



467A

461A, 462A Description

These general purpose amplifiers can be used as preamplifiers to raise the level of a signal or as a buffer.

Solid-state HP amplifiers, Models 461A and 462A, provide stable 20 and 40 dB gain over a wide frequency range with fast rise time

461A Specifications

Frequency response: ± 1 dB, 1 kHz to 150 MHz when operating into a 50 Ω resistive load (500 kHz reference).

Gain at 500 kHz: 40 dB ± 0.5 dB or 20 dB ± 1.0 dB, selected by front-panel switch (inverting).

Input impedance: nominal 50 Ω .

Maximum input: 1 V rms or 2 V p-p pulse.

Maximum dc input: ± 2 V.

Maximum output: 0.5 V rms into 50 Ω resistive load.

Equivalent wide-band input noise level: $< 40 \mu\text{V}$ in 40 dB position when loaded with 50 Ω .

Distortion: $< 5\%$ at maximum output and rated load.

Overload recovery: $< 1 \mu\text{s}$ for 10 times overload.

Dimensions: 130 mm wide \times 76 mm high \times 279 mm deep ($5\frac{1}{8} \times 3 \times 11$ ").

Weight: net, 1.8 kg (4 lb). Shipping, 2.7 kg (6 lb).

462A Specifications

Pulse response: leading edge and trailing edge: rise time, < 4 ns; overshoot, $< 5\%$.

Pulse overload recovery: $< 1 \mu\text{s}$ for 10 times overload.

Pulse duration for 10% droop: 30 μs .

Pulse delay: nominally 12 to 14 ns.

Equivalent input noise level: $< 40 \mu\text{V}$ in 40 dB position (50 Ω load).

Input impedance: nominal 50 Ω .

Maximum input: 1 V rms or 2 V p-p pulse.

Maximum dc input: ± 2 V.

Gain: 20 or 40 dB selected by front panel switch (inverting).

Output: 1 V p-p into 50 Ω resistive load.

Dimensions: 130 mm wide \times 76 mm high \times 279 mm deep ($5\frac{1}{8} \times 3 \times 11$ ").

Weight: net, 1.8 kg (4 lb). Shipping, 2.7 kg (6 lb).

465A Description

HP's 465A amplifier provides 20 dB or 40 dB gain (X10 or X100) with flat frequency response from 5 Hz to 1 MHz with floating inputs.

465A Specifications

Voltage gain: 20 dB (X10) or 40 dB (X100), open circuit.

Gain accuracy: ± 0.1 dB ($\pm 1\%$) at 1 kHz.

Frequency response: ± 0.1 dB, 100 Hz to 50 kHz; < 2 dB down at 5 Hz and 1 MHz.

Output: > 10 V rms open circuit; > 5 V rms into 50 Ω (0.5 W).

Distortion: $< 1\%$, 10 Hz to 100 kHz; $< 2\%$, 5 Hz to 10 Hz and 100 kHz to 1 MHz.

Input impedance: 10 M Ω shunted by < 20 pF.

Output impedance: 50 Ω .

Noise: $< 25 \mu\text{V}$ rms referred to input (with 1 M Ω source resistance).

Dimensions: 130 mm wide \times 76 mm high \times 279 mm deep ($5\frac{1}{8} \times 3 \times 11$ ").

Weight: net, 1.8 kg (4 lb). Shipping, 3.2 kg (7 lb).

467A Description

HP's 467A Power Amplifier/Supply is a 10 watt peak power amplifier and -20 V (to $+20$ V) dc power supply. The wide band width offers low dc drift from dc to 1 MHz and 0.3% gain. With continuously variable gain and floating inputs, HP's 467A can also be used as a power supply.

467A Specifications

Power amplifier

Voltage gain (non-inverting): fixed steps: X1, X2, X5, X10. Variable: 0-10, resolution is better than 0.1% of full output.

Accuracy: $\pm 0.3\%$ from dc to 10 kHz; $\pm 1.0\%$ from 10 kHz to 100 kHz; $\pm 10\%$ from 100 kHz to 1 MHz with load of $> 40\Omega$.

Output: ± 20 V p at 0.5 A p.

Distortion: $< 0.01\%$ at 1 kHz; $< 1\%$ at 100 kHz; $< 3\%$ at 1 MHz.

Input impedance: 50 k Ω shunted by 100 pF.

DC power supply

Voltage range: $> \pm 20$ V, ± 10 V, ± 4 V, ± 2 V, ± 1 V with adjustable vernier. Resolution: better than 0.1% of full output.

Current: ± 0.5 A p.

Load regulation: (front panel) < 10 mV, no load to full load.

Line regulation: < 10 mV for a $\pm 10\%$ change in line voltage.

General

Output impedance: (front panel): 5 m Ω in series with 1 μH .

Current limit: < 800 mA.

Dimensions: 130 mm wide \times 159 mm high \times 279 mm deep ($5\frac{1}{8} \times 6\frac{1}{8} \times 11$ ").

Weight: net, 4.5 kg (10 lb). Shipping, 6.8 kg (15 lb).

Model number and name

Model number and name	Price
HP 461A Amplifier	\$470
HP 462A Amplifier	\$470
HP 465A Amplifier	\$345
HP 467A Power Amplifier/Supply	\$875

AMPLIFIERS

Wide band amplifiers

Models 8447A/B/C/D/E/F

- Wide Band
- Flat Response
- Low Noise



The HP 8447 series of general purpose amplifiers combines high reliability and convenience.

High performance

The performance of these amplifiers qualifies them for a number of

uses: to improve the sensitivity of counters, spectrum analyzers, RF voltmeters, EMI meters, power meters and other devices without distortion or degradation of amplitude accuracy; to increase the maximum power available from a signal generator or sweeper.

Broadband frequency coverage

The 8447 series offers an amplifier for nearly every application in the 100 kHz to 1.3 GHz frequency range. The wide bandwidths are compatible with other wideband instruments and accommodate wide-band spectra.

Options

A variety of options are available: a 75Ω impedance model (Option 002) for applications such as television/FM broadcasting and CATV; two dual channel versions (Option 001—BNC connectors and Option 011—Type N connectors) which operate with dual channel systems such as oscilloscopes or network analyzers (or the channels may be cascaded for increased gain); Type N connectors rather than the standard BNC connectors (Option 010).

General

Weight: net, 1.56 kg (3 pounds, 7 ounces). Shipping, 2.30 kg (5 pounds, 1 ounce).

Dimensions: 130 mm wide, 85.8 mm high, 216 mm deep (5 1/8" × 3 3/8" × 8 1/2").

Power requirements: 110 or 230 V ac ± 10%, 48-440 Hz, 15 watts.

Model number and name

Model number and name	Price
8447A Preamp	\$650
8447B Preamp	\$725
8447C Power Amp	\$550
8447D Preamp	\$725
8447E Power Amp	\$775
8447F Preamp-Power Amp	\$1300

Specifications

	8447A Preamp	8447B Preamp	8447C Power Amp	8447D Preamp	8447E Power Amp	8447F Preamp- Power Amp
Frequency Range	0.1 — 400 MHz	0.4 — 1.3 GHz	30 — 300 MHz	100 kHz — 1.3 GHz	100 kHz — 1.3 GHz	100 kHz — 1.3 GHz
Typical 3 dB Bandwidth	50 kHz — 700 MHz	0.35 — 1.35 GHz	10 — 400 MHz	50 kHz — 1.4 GHz	50 kHz — 1.4 GHz	50 kHz — 1.4 GHz
Gain (Mean)	20 dB ±0.5 dB at 10 MHz	>20 dB 22 dB typical	30 dB ±1 dB	26 dB ±1.5 dB (20° — 30°C)	22 dB ±1.5 dB (20° — 30°C)	
Gain Flatness Across Full Frequency Range	±0.5 dB	±1.5 dB	±1 dB	±1.5 dB	±1.5 dB	
Noise Figure	<5 dB	<5 dB 0.4 — 1.0 GHz <6 dB 1.0 — 1.3 GHz	<11 dB	<8.5 dB	<11 dB typical	
Output Power for 1 dB Gain Compression	> +6 dBm	> -3 dBm	> +17 dBm	> +7 dBm typical	> +15 dBm	
Harmonic Distortion	-32 dB for 0 dBm output	-30 dB for -15 dBm output	-35 dB for +10 dBm output	-30 dB for 0 dBm output (typical)	-30 dB for +10 dBm output	
Typical Output for <-60 dB Harmonic Distortion	-25 dBm	-45 dBm	-15 dBm	-30 dBm	-20 dBm	
VSWR	<1.7	<2.0 input <2.2 output	<2.0	<2.0 input <2.2 output 1 — 1300 MHz	<2.2 1 — 1300 MHz	
Impedance	50Ω	50Ω	50Ω	50Ω	50Ω	
Reverse Isolation	>30 dB	>40 dB	>35 dB	>40 dB	>40 dB	
Maximum DC Voltage Input	±10 V	±10 V	±10 V	±10 V	±10 V	
Options Available	001	001, 010, 011	002	001, 010, 011	010	010

← 8447D AND 8447E COMBINED IN A SINGLE PACKAGE →

AMPLIFIERS

Microwave power amplifiers

Models 489A, 491C, 493A & 495A

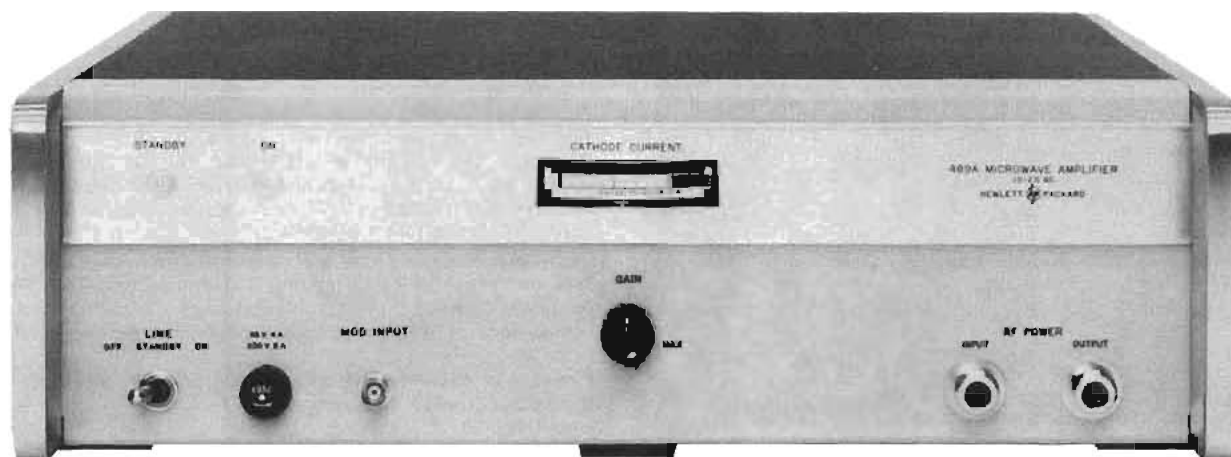

Microwave TWT amplifiers

Amplification of frequencies from 1 to 12.4 GHz is accomplished in four ranges by the Hewlett-Packard medium-power, microwave amplifiers. Each delivers at least 1 watt for a 1-milliwatt input — a gain of at least 30 dB.

All four TWT amplifiers have provision for amplitude modulation, and since the internal modulation amplifier is dc-coupled, remote programming and power leveling are possible. Sensitivity is high for large output power changes from relatively small modulation signals, obviating the need for an external modulation amplifier.

The dc amplifier has a gain of 20 dB and exhibits a passband from dc to 500 kHz when modulation index is in the neighborhood of 1 dB, as might be encountered in RF leveling. When the modulating levels are high, in the region of 20 volts, the passband will be a minimum of 100 kHz; a 20-volt change at the MOD INPUT produces a minimum of 20 dB off/on ratio.

Cathode current in the TWT is monitored by a front panel meter and can be conveniently controlled by the GAIN adjustment for rated power output, or for reducing tube current to extend tube life when full output power is not required. And helix, collector, and anode current can be measured at an easily accessible test point board. Combined with the 8620 or 8690 sweep oscillator they make an excellent high power swept source.

Advantages

DC coupled modulation circuitry allows power leveling and remote programming.

Periodic-permanent-magnet focusing means fewer alignment problems.

Applications

Antenna efficiency and pattern measurements.

Extends attenuation measuring systems capability by at least 30 dB.

RFI susceptibility tests.

489A-495A Specifications

Output power: 1 watt for an input of ≤ 1 mW.

Gain: 30 dB at rated output.

Input/output: impedance, 50 Ω ; connectors, type N female.

Noise figure: ≤ 30 dB.

Amplitude modulation:

Sensitivity: modulation input of > -20 V peak reduces RF output by ≥ 20 dB from dc to 500 kHz.

Frequency response: dc to 500 kHz (3 dB).

Pulse response: < 1 μ s rise and fall times.

Dimensions: 426 mm wide, 140 mm high, 467 mm deep (16 $\frac{1}{4}$ " \times 5 $\frac{1}{2}$ " \times 18 $\frac{3}{8}$ ").

Weight: net, 14.9 kg (33 lb). Shipping, 18.0 kg (40 lb).

	489A	491C	493A	495A
Frequency range (GHz)	1-2	2-4	4-8	7-12.4
Gain variation with freq. at rated output small signal across any 10% of band	≤ 6 dB	≤ 6 dB	≤ 6 dB	≤ 6 dB
across full band	≤ 12 dB	≤ 12 dB	≤ 12 dB	≤ 10 dB (for 300 MHz)

Options

\$68: Rack Flange Kit

Model number and name

489A, 1 to 2 GHz TWT amplifier

491C, 2 to 4 GHz TWT amplifier

493A, 4 to 8 GHz TWT amplifier

495A, 7 to 12.4 GHz TWT amplifier

Information on 12.4 to 18 GHz TWT on request

Price

add \$10

\$2900

\$2900

\$3300

\$3300

Meter movements

Voltage, current and resistance measurements can be easy, fast, and accurate with electronic instruments using meter movements.

The meter movement readout continues to be popular since it is economical and suitable for many jobs. It also lends itself well to special, nonlinear scales such as dB.

dB scale and, therefore, a nonlinear voltage scale. Several different types of meter faces are illustrated in Figure 1.

Analog meters (Figure 2) usually have nonlinearities and/or offsets present in the attenuators and amplifiers. The meter movement itself can have nonlinearities — even with individually calibrated meter scales. Nonlinearities cause percent of reading errors, and

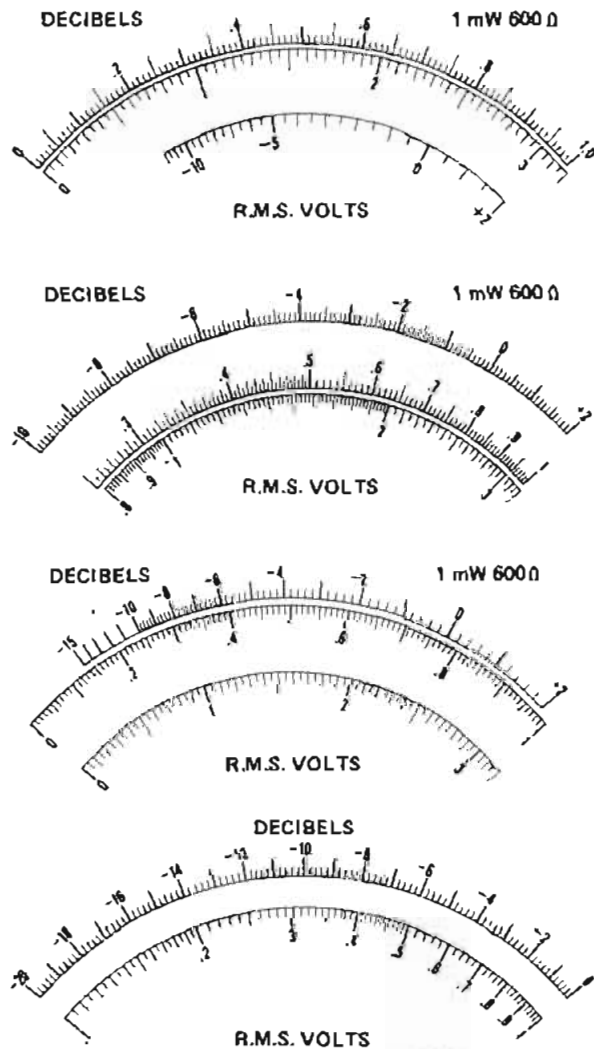

Figure 1. Four different types of meter scales available. (a) Linear 0–3 V and 0–10 V scales plus a dB scale. (b) Linear dB scale plus non-linear (logarithmic) voltage scales. (c) dB scale placed on larger arc for greater resolution. (d) Linear –20 to 0 dB scale useful for acoustical and communications applications.

Voltmeter considerations

Accuracy — Before we can discuss meter accuracy, we must have a familiarity with the various meter scales available. Many instruments have meter scales marked in both volts and decibel (dB) units. It should be noted that dB and voltage are complements of each other. That is, if a voltage scale is made linear, the dB scale on the same meter face will be logarithmic or nonlinear. Likewise, if the dB scale is made linear, the voltage scale becomes nonlinear. The term "linear-log scale" is applied to an instrument that has a linear

offsets cause percent of full scale errors. Percent of reading errors are constant no matter where the meter pointer is. Percent of full-scale error increases as the pointer goes further down scale.

Looking at instrument specification sheets, accuracy specifications are usually expressed in one of three ways: 1. percent of the full-scale value, 2. percent of the reading is, 3. (percent of reading + percent of full-scale). The first is probably the most commonly used accuracy specification. The second (percent of reading) is more commonly applied to meters

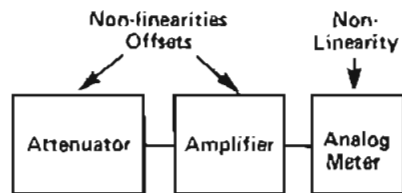

Figure 2. Non-linearities cause % of reading errors. Offsets cause % of full scale errors.

having a logarithmic scale. The last method has been used more recently to obtain a tighter accuracy specification on a linear-scale instrument.

Hewlett-Packard uses the two-part accuracy specification to take advantage of the upper-scale accuracy and yet maintain a reasonable specification for the lower portion of the scale.

For a thorough evaluation of accuracy, the following should be considered: Does it apply at all input-voltage levels up to maximum overrange point? (Linearity specifications may be added to qualify this point.) Does it apply to all frequencies throughout its specified bandwidth? Does it apply on all ranges? Does it apply over a useful temperature range for the application? If not, is temperature coefficient specified?

Selecting an analog voltmeter

Basic specs for Hewlett-Packard analog meters are in Table 1. Guidelines are restated below.

1. For measurements involving dc applications, select the instrument with the broadest capability meeting your requirements.
2. For ac measurements involving sine waves with only modest amounts of distortion (<10%), the average-responding voltmeter can perform over a bandwidth extending to several megahertz.
3. For high-frequency measurements (>10 MHz), the peak-responding voltmeter with the diode-probe input is the most economical choice. Peak-responding circuits are acceptable if inaccuracies caused by distortion in the input waveform can be tolerated.
4. For measurements where it is important to determine the effective power of waveforms that depart from a true sinusoidal form, the true rms-responding voltmeter is the appropriate choice. In general, true-rms meters reveal only the rms value of an ac signal. Because they are ac coupled, most voltmeters have a frequency cut-off around 20 Hz. This restriction keeps the true-rms voltmeter from accounting for any low frequencies or dc components in a signal.

The 3403C RMS Digital Voltmeter measures dc plus ac from 2 Hz to 100 MHz. See page 59.

For very wide bandwidths (up to 1 GHz) and high-sensitivity measurements of sinusoidal or nonsinusoidal waveforms, the HP 3406A is the proper choice. Although the 3406A is average-responding, it has a sample hold output which makes analysis of waveforms possible.

ANALOG VOLTMETERS

General information (cont.)

Table 1. HP analog instruments

DC VOLTMETERS	Voltage Range	Frequency Range Accuracy at FS*	Input Impedance	Model	See Page
DC NULL VOLTMETER	$\pm 3 \mu\text{V}$ — $\pm 1 \text{ kV}$ end scale 0.1 μV resolution (18 ranges)	dc $\pm 2\% + 1 \mu\text{V}$	100 k — 100 M Ω depending on range (infinite when nullified)	419A	34
DC VOLT-AMMETER	DC: $\pm 1 \text{ mV}$, $\pm 300 \text{ V}$ (12 ranges) $\pm 1 \text{ nA}$, $\pm 300 \mu\text{A}$ (12 ranges)	$\pm 3\%$ dc	10 M Ω all ranges	4304B	See Data Sheet
DC DIFFERENTIAL VOLTMETER	1 mV — 1 kV (7 ranges)	dc $\pm (0.005\% \text{ reading} + 0.0004\% \text{ range})$	$> 10^{10}$	740B	324
AC VOLTMETERS	Voltage Range	Frequency Range Typical Accuracy	Response Input Impedance	Model	See Page
RECHARGEABLE BATTERY AC VOLTMETER	1 mV — 300 V (12 ranges)	5 Hz — 2 MHz $\pm 2\% - \pm 5\%$	Average 2 M Ω / $< 30 - < 60 \text{ pF}$	403B	39
FAST-RESPONSE AC VOLTMETER 100 kHz low-pass filter ac amplifier	100 μV — 300 V — 90 dB — +52 dB	20 Hz — 4 MHz — $\pm 1\% - \pm 4\%$	Average 10 M Ω / $10 - 25 \text{ pF}$	400F 400FL	40
HIGH ACCURACY dB VOLTMETER 20 dB log scale (0 dB = 1 V)	-100 dB — +60 dB (8 ranges)	20 Hz — 4 MHz — $\pm 0.2 \text{ dB} - 0.4 \text{ dB}$	Average 10 M Ω / $< 15 - < 30 \text{ pF}$	400GL	40
HIGH ACCURACY AC VOLTMETER has dc output ($\pm 0.5\%$) for driving recorder	1 mV — 300 V — 70 dB — +52 dB	10 Hz — 10 MHz $\pm 1\% - \pm 5\%$	Average 10 M Ω / $< 12 - < 25 \text{ pF}$	400E 400EL	40
RMS VOLTMETER provides rms readings of complex signals. Has dc output for driving DVM's or recorders	1 mV — 300 V (12 ranges)	10 Hz — 10 MHz $\pm 1\% - \pm 5\%$	10 M Ω / $15 - 40 \text{ pF}$	3400A	41
SAMPLING RF VOLTMETER provides true rms measurements when used with 3400A. Many accessories	1 mV — 3 V (8 ranges)	10 kHz to $> 1.2 \text{ GHz}$ $\pm 3\% - \pm 13\%$	Statistical Average: Input Z depends on probe tip used	3406A	42
VECTOR VOLTMETER phase and amplitude measurements	100 μV — 10 V (9 ranges)	1 MHz — 1 GHz $\pm 0.5 \text{ dB} - \pm 1 \text{ dB}$	Average 0.1 M Ω / 2.5 pF	8405A	426
MILLIOHMETER: two probes used when making 4 terminal measurements	0.001 to 100 Ω FS (11 ranges)	1 kHz (fixed) $\pm 2\%$ FS	Max. output Voltage: 20 mV	4328A	75
HIGH RESISTANCE METER and picoammeter	0.5 M Ω to $2 \times 10^{16} \Omega$ FS (7 ranges) 0.05 pA — 20 μA	Voltage: $\pm 10\%$ Current: $\pm 5\%$	Max. output Voltage: 1 kV	4329A	76
MULTIFUNCTION METERS	Voltage Range (Accuracy)	Current Range (Accuracy)	Resistance Range (Accuracy)	Model	See Page
BATTERY-OPERATED MULTIFUNCTION METER has 10 M Ω dc input impedance and 10 M Ω /20 pF ac input impedance	DC: $\pm 100 \text{ mV}$ to 1000 V ($\pm 2\%$) 9 ranges AC: 10 mV — 300 V 10 Hz — 1 MHz ($\pm 2\%$) 10 ranges		10 Ω — 10 M Ω mid-scale $\pm 5\%$; from 0.3 to 3 on the meter scale (7 ranges)	427A	37
VERSATILE VOLTMETER has 100 M Ω dc input impedance and 10 M Ω /1.5 pF ac impedance	DC: $\pm 15 \text{ mV}$ to $\pm 1500 \text{ V}$ ($\pm 2\%$) 11 ranges AC: 0.5 V — 300 V 20 Hz — $> 700 \text{ MHz}$ ($\pm 3\%$ at 400 Hz) 7 ranges	DC: $\pm 1.5 \mu\text{A}$ to $\pm 150 \text{ mA}$ ($\pm 3\%$) 11 ranges	10 Ω — 10 M Ω (center scale) 0 to midscale: $\pm 5\%$ or $\pm 2\%$ of midscale (whichever is greater) 7 ranges	410C	38
CURRENT METERS	Current Range	Accuracy	Frequency Range	Model	See Page
DC MILLIAMMETER with clip-on probe eliminates direct connection	1 mA — 10 A FS (9 ranges)	$\pm 3\%$	dc — 400 Hz	428B	36

* For exact accuracy refer to page designated.

ANALOG VOLTMETERS

DC null volt-ammeter

Model 419A



Description

Eighteen voltage ranges with $0.1 \mu\text{V}$ resolution on the lowest range. Accuracy of this rechargeable battery-operated instrument is $\pm 2\%$ of end scale $\pm 0.1 \mu\text{V}$ on all ranges. Noise is less than $0.3 \mu\text{V}$ p-p, and drift is less than $0.5 \mu\text{V}/\text{day}$.

An internal nulling voltage allows input voltages up to 300 mV to be nulled giving an infinite input impedance. Input impedance above 300 mV range is 100 megohms .

Seven pushbuttons allow rapid function selection. This dc null voltmeter operates from ac line or from internal rechargeable batteries. During operation from ac line, batteries are trickle-charged. A fast-charge pushbutton is provided to increase the charging rate, recharging batteries in approximately 16 hours. Battery voltage may be checked with the battery-test pushbutton. The zero pushbutton allows compensation for any internal offsets before measurement. When this pushbutton is depressed, the positive leg of the voltmeter is disconnected from the positive input terminal.

When the voltmeter pushbutton is depressed, HP 419A functions as a zero-center scale $3 \mu\text{V}$ to 1000 V dc voltmeter.

When the AM pushbutton is depressed, HP 419A functions as a zero-center scale 30 pA to 30 nA ammeter.

Specifications

DC null voltmeter

Ranges: $\pm 3 \mu\text{V}$ to $\pm 1000 \text{ V}$ dc in 18 zero-center ranges.

Accuracy: $\pm (2\% \text{ of range} \pm 0.1 \mu\text{V})$.

Zero control range: $> \pm 15 \mu\text{V}$.

Zero drift: $< 0.5 \mu\text{V}/\text{day}$ after 30 min warm-up.

Zero temperature coefficient: $< 0.05 \mu\text{V}/^\circ\text{C}$.

Response time: 3 s to within 95% of final reading on $3 \mu\text{V}$ range; 1 s to within 95% of final reading on $10 \mu\text{V}$ to 1000 V ranges.

Noise: $< 0.3 \mu\text{V}$ p-p, input shorted. Noise amplitude approximates Gaussian distribution. RMS value (standard deviation) is $< 0.075 \mu\text{V}$, p-p noise value is $< 0.3 \mu\text{V}$ 95% of the time.

Input characteristics

At null: infinite resistance on $3 \mu\text{V}$ through 300 mV ranges in set null mode. Negative input terminal can be floated to $\pm 500 \text{ V}$ dc from power line ground.

Off null:

Voltage range	Input resistance
$3 \mu\text{V} - 3 \text{ mV}$	$100 \text{ k}\Omega$
$10 \text{ mV} - 30 \text{ mV}$	$1 \text{ M}\Omega$
$100 \text{ mV} - 300 \text{ mV}$	$10 \text{ M}\Omega$
$1 \text{ V} - 1000 \text{ V}$	$100 \text{ M}\Omega$

Negative input terminal can be floated up to $\pm 500 \text{ V}$ dc from power-line ground.

AC normal mode rejection: ac voltages 50 Hz and above and 80 dB greater than end scale affect reading $< 2\%$. Peak ac voltage not to exceed maximum overload voltage.

DC ammeter

Ranges: $\pm 30 \text{ pA}$ to $\pm 30 \text{ nA}$ in 7 zero-center ranges.

Accuracy: $\pm (3\% \text{ of range} + 1 \text{ pA})$.

Zero control range: $> \pm 150 \text{ pA}$.

Zero drift: $< 5 \text{ pA}/\text{day}$ after 30 min warm-up.

Zero temperature coefficient: $< 0.5 \text{ pA}/^\circ\text{C}$.

Noise: $< 3 \text{ pA}$ p-p, input shorted.

Input resistance: $100 \text{ k}\Omega$ on all ranges.

Amplifier

Gain: 110 dB on $3 \mu\text{V}$ range, decreases 10 dB per range.

Output: 0 to $\pm 1 \text{ V}$ at 1 mA maximum for end-scale reading. Output level adjustable for convenience when used with recorders.

Output resistance: depends on setting of output level control. $< 35 \Omega$ when output control is set to maximum.

Noise: 0.01 Hz to 5 Hz : same as voltmeter (referred to input). $> 5 \text{ Hz}$: $< 10 \text{ mV}$ rms (referred to output).

General

Overload protection: the following voltages can be applied without damage to instrument.

1 V to 1000 V range: 1200 V dc.

10 mV to 300 mV range: 500 V dc.

$3 \mu\text{V}$ to 300 mV range: 50 V dc.

Operating temperature: instrument will operate within specifications from 0°C to 50°C .

Operating humidity: $< 70\% \text{ R.H.}$

Storage temperature: -20°C to $+50^\circ\text{C}$.

Power: 115 V or $230 \text{ V} \pm 10\%$, 48 Hz to 440 Hz , 2 VA max. or 4 internal rechargeable batteries (furnished). 30-hr operation per recharge. Operation from ac line permissible during recharge.

Dimensions: 197 mm wide, 156 mm high (without removable feet), 203 mm deep ($7\frac{3}{4}'' \times 6\frac{1}{4}'' \times 8''$).

Weight: net, 3.7 kg (8.3 lb). Shipping, 5.4 kg (12 lb).

419A DC Null Volt-Ammeter

\$830

ANALOG VOLTMETERS

1 mA to 10 A clip-on dc milliammeter

Model 428B

- No circuit interruption
- No circuit loading



Description

Direct current from 1 milliamperes to 10 amperes full scale can be measured without interrupting your measured circuit or producing loading errors. With the HP Model 428B Clip-on Milliammeter, cutting wires for insertion of current meters and calculating current from voltage and resistance readings are eliminated. All that is required for fast, accurate readings is to clip around the wire and select the proper current range.

The 428B measures current by utilizing a clip-on transducer that converts the magnetic field around the conductor to an ac voltage proportional to dc current. This voltage is detected and displayed as direct current on the 428B's meter. Since there is no direct contact with the circuit being measured, complete dc isolation is assured.

The meter responds to dc current only and is therefore not susceptible to common mode currents. However, low frequency currents up to 400 Hz can be measured by connecting an oscilloscope or voltmeter to the convenient front panel output; or this output can be used to drive a strip chart recorder for permanent long term records.

For even greater sensitivity, several loops of the measured conductor can be put through the probe, increasing sensitivity by the same factor as the number of turns used. Sum or difference measurements of currents in separate wires can also be made. By placing the wires through the probe with currents flowing in the same direction, their sum is indicated; currents flowing in opposite directions will give a difference indication. In this way, balancing currents is easily accomplished by making any difference equal to zero.

To decrease sensitivity on circuits carrying more than 10 amps, it is only necessary to shunt a section of the circuit with two or more wires of the same resistance. A current divider is thereby constructed and the probe can be used to measure the current in one leg. Total current in the circuit is measured by multiplying the 428B reading by the number of legs in the divider.

Specifications

DC current range: 1 mA to 10 A full scale, nine ranges.

Accuracy: $\pm 3\%$ of full scale ± 0.15 mA, from 0°C to 55°C (when instrument is calibrated to probe).

Probe inductance: $< 0.5 \mu\text{H}$.

Probe inducted voltage: < 15 mV p (worst case at 20 kHz and harmonics).

Output: variable linear output level with switch position for calibrated 1 V into open circuit (corresponds to full scale deflection), 1.5 V max. into open circuit in uncalibrated position, 0.73 ± 0.01 V into 1 k Ω in calibrated position.

Noise: 1 mA range, < 15 mV rms across 1 k Ω ; 3 mA range, < 5 mV rms across 1 k Ω ; 10 mA through 10 A ranges, < 2 mV rms across 1 k Ω .

Frequency range: dc to 400 Hz (3 dB point).

AC rejection: signals above 5 Hz with p value $<$ full scale affect meter accuracy $< 2\%$ (except at 40 kHz carrier frequency and its harmonics). On the 10 A range, ac p value is limited to 4 A.

Power: 115 or 230 V $\pm 10\%$, 50 to 60 Hz, approx. 75 VA max.

Operating temperature range: -20°C to $+55^\circ\text{C}$.

Storage temperature: -40°C to $+65^\circ\text{C}$.

Probe insulation: 300 V maximum.

Probe tip size: approximately $\frac{1}{2}$ " by $\frac{3}{16}$ " aperture diameter $\frac{1}{32}$ ".

Dimensions: cabinet: 191 mm wide, 292 mm high, 368 mm deep ($7\frac{1}{2}$ " \times $11\frac{1}{2}$ " \times $14\frac{1}{2}$ "); rack mount: 483 mm wide, 177 mm high, 330 mm deep (19 " \times $6\frac{1}{2}$ " \times 13 ").

Weight: net, 8.6 kg (19 lb). Shipping, 10.9 kg (24 lb) (cabinet); net, 10.8 kg (24 lb). Shipping, 14.4 kg (32 lb) (rack mount).

428B Analog Milliammeter (cabinet)

\$920

ANALOG VOLTMETERS

Low-cost multi-function meter

Model 427A



427A

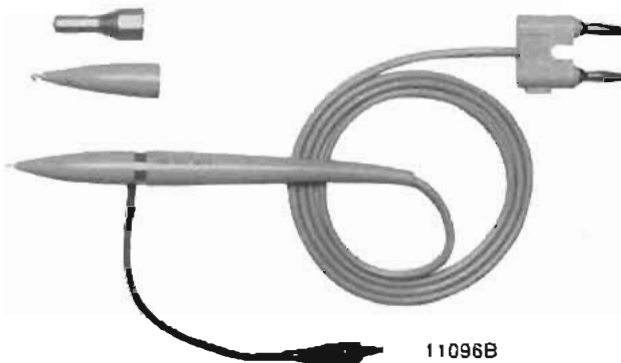

11096B

Description

Hewlett-Packard's Model 427A is a portable, versatile, low cost multi-function meter which is valuable in any laboratory, production line, service department, or in the field. It is capable of measuring dc voltages from 100 mV to 1 kV full scale; ac voltage from 10 mV to 300 V full scale at frequencies up to 1 MHz (>500 MHz with the 11096B High Frequency Probe); and resistance from 10 Ω to 10 M Ω center scale.

The 427A will operate continuously for more than 300 hours on its internal 22.5 V dry cell battery. AC line and battery operation is available with option 001.

Specifications

DC voltmeter

Ranges: ± 100 mV to ± 1000 V in 9 ranges in 10 dB steps.

Accuracy: $\pm 2\%$ of range.

Input resistance: 10 M Ω .

AC normal mode rejection (ACNMR): ACNMR is the ratio of the normal mode signal to the resultant error in readout. 50 Hz and above: >80 dB.

Overload protection: 1200 V dc.

AC voltmeter

Ranges: 10 mV to 300 V in 10 ranges in 10 dB steps.

Frequency range: 10 Hz to 1 MHz.

Response: responds to average value, calibrated in rms.

Accuracy:

Frequency	Range	
		0.01 V to 30 V
10 Hz to 100 kHz	2% of range	
100 kHz to 1 MHz		

Input impedance: 10 mV to 1 V range, 10 M Ω shunted by <40 pF; 1 V to 300 V range, 10 M Ω shunted by <20 pF.

Overload protection: 300 V rms momentarily, 1 V range and below; 425 V rms max above 1 V range.

Ohmmeter

Ranges: 10 Ω to 10 M Ω center scale in 7 decade ranges. Accuracy (from 0.3 to 3 on scale): $\pm 5\%$ of reading.

Source current (ohms terminal positive):

Range	Open circuit Voltage	Short circuit Current
X 10	0.1 V	10 mA
X 100	0.1 V	1 mA
X 1 k	1 V	1 mA
X 10 k	1 V	100 μ A
X 100 k	1 V	10 μ A
X 1 M	1 V	1 μ A
X 10 M	1 V	0.1 μ A

General

Input: may be floated up to ± 500 V dc above chassis ground. Ohms input open in any function except ohms. Volts input open when instrument is off.

Operating temperature: 0°C to 50°C.

Power: >300 hr operation per battery.

HP 427A: 22.5 V dry cell battery, Eveready No. 763 or RCA VS102.

HP 427A Option 001: battery operation or ac line operation, selectable on rear panel. 115 V or 230 V $\pm 20\%$, 48 Hz to 440 Hz, 2 VA max.

Dimensions: (standard $\frac{1}{2}$ module): 130 mm wide, 159 mm high (without removable feet), 203 mm deep ($5\frac{1}{8}$ " \times $6\frac{1}{4}$ " \times 8").

Weight: net, 2.4 kg (5.3 lb). Shipping, 3.6 kg (8 lb).

Accessories available

HP 11096A High Frequency AC Probe extends range to >500 MHz.

With the 11096A, you can measure 0.25 to 30 V rms signals out to 500 MHz with better than ± 1 dB accuracy. Usable relative measurements can be made up to 1 GHz (3 dB point at 700 MHz). The 11096A is a peak-responding detector calibrated to produce a dc output proportional to the rms value of a sine wave input. Input impedance is 4 M Ω shunted by 2 pF.

Options and accessories

11075A High Impact Case. A rugged case for carrying, storing and operating the 427A

11096B High Frequency AC probe

11001A 45" test lead, dual banana plug to male BNC

11002A 60" test lead, dual banana plug to alligator clips

11003A 60" test lead, dual banana plug to pencil probe and alligator clip

10111A BNC female to dual banana adapter

11067A Test lead kit

Model number and name

427A Multi-function Meter (includes batteries)

427A Option 001 AC power supply & battery

Price

\$115

\$87

\$17

\$12

\$12

\$17

\$5

\$475

Add \$30

ANALOG VOLTMETERS

General purpose multi-function voltmeter

Model 410C



410C with 11036A

Description

HP's Model 410C is a versatile general purpose instrument for use anywhere electrical measurements are made. This instrument measures dc voltages from 15 mV to 1500 V, direct current from 1.5 μ A to 150 mA full scale, and resistance from 0.2 Ω to 500 M Ω . With a standard plug-in probe, ac voltages at 20 Hz to 700 MHz from 50 mV to 300 V and comparative indications to 3 GHz are attainable.

Specifications

DC voltmeter

Voltage ranges: ± 15 mV to ± 1500 V full scale in 15, 50 sequence (11 ranges).

Accuracy: $\pm 2\%$ of full scale on any range.

Input resistance: 100 M Ω $\pm 1\%$ on 500 mV range and above, 10 M Ω $\pm 3\%$ on 150 mV range and below.

AC voltmeter

Voltage ranges: 0.5 V to 300 V full scale in 0.5, 1.5, 5 sequence (7 ranges).

Frequency range: 20 Hz to 700 MHz.

Accuracy: $\pm 3\%$ of full scale at 400 Hz for sinusoidal voltages from 0.5 V to 300 V rms. The ac probe responds to the positive peak-above-average value of the applied signal. The meter is calibrated in rms.

Frequency response: $\pm 2\%$ from 100 Hz to 50 MHz (400 Hz ref.); 0 to -4% from 50 MHz to 100 MHz; $\pm 10\%$ from 20 Hz to 100 Hz and ± 1.5 dB from 100 MHz to 700 MHz.

Input impedance: input capacitance 1.5 pF, input resistance > 10 M Ω at low frequencies. At high frequencies, impedance drops off due to dielectric loss.

Safety: the probe body is grounded to chassis at all times for safety. All ac measurements are referenced to chassis ground.

DC ammeter

Current ranges: ± 1.5 μ A to ± 150 mA full scale in 1.5, 5 sequence (11 ranges).

Accuracy: $\pm 3\%$ of full scale on any range.

Input resistance: decreasing from 9 k Ω on 1.5 μ A range to approximately 0.3 Ω on the 150 mA range.

Special current ranges: ± 1.5 , ± 5 and ± 15 nA may be measured on the 15, 50 and 150 mV ranges using the dc voltmeter probe, with $\pm 5\%$ accuracy and 10 M Ω input resistance.

Ohmmeter

Resistance range: resistance from 10 Ω to 10 M Ω center scale (7 ranges).

Accuracy: zero to midscale: $\pm 5\%$ of reading or $\pm 2\%$ of midscale, whichever is greater; $\pm 7\%$ from midscale to scale value of 2; $\pm 8\%$ from scale value of 2 to 3; $\pm 9\%$ from scale value of 3 to 5; $\pm 10\%$ from scale value of 5 to 10.

Amplifier

Voltage gain: 100 maximum.

AC rejection: 3 dB at 0.5 Hz; approximately 66 dB at 50 Hz and higher frequencies for signals < 1600 V p or 30 times full scale, whichever is smaller.

Isolation: impedance between common and chassis is > 10 M Ω in parallel with 0.1 μ F. Common may be floated up to 400 V dc above chassis for dc and resistance measurements.

Output: proportional to meter indication; 1.5 V dc at full scale, maximum current, 1 mA.

Output impedance: $< 3\Omega$ at dc.

Noise: $< 0.5\%$ of full scale on any range (p-p).

DC drift: $< 0.5\%$ of full scale/yr at constant temperature. $< 0.02\%$ of full scale/ $^{\circ}$ C.

Overload recovery: recovers from 100:1 overload in < 3 s.

General

Maximum Input: (see overload recovery). DC: 100 V on 15, 50 and 150 mV ranges, 500 V on 0.5 to 15 V ranges, 1600 V on higher ranges. AC: 100 times full scale or 450 V p whichever is less.

Power: 115 V or 230 V $\pm 10\%$, 48 Hz to 440 Hz, 13 VA (20 VA with 11036A AC Probe).

Dimensions: 130.2 mm wide, 165 mm high (without removable feet), 320.7 mm deep (5 1/8" \times 6 1/2" \times 11" behind panel).

Weight: net, 4 kg (8 lb). Shipping, 5.44 kg (12 lb).

Accessories furnished: detachable power cord, NEMA plug, 11036A AC Probe.

Accessories available: see Pages 480-485.

Model number and name

410C Option 002 (less AC probe)

HP 410C with HP 11036A Detachable AC Probe

Price
less \$44
\$820

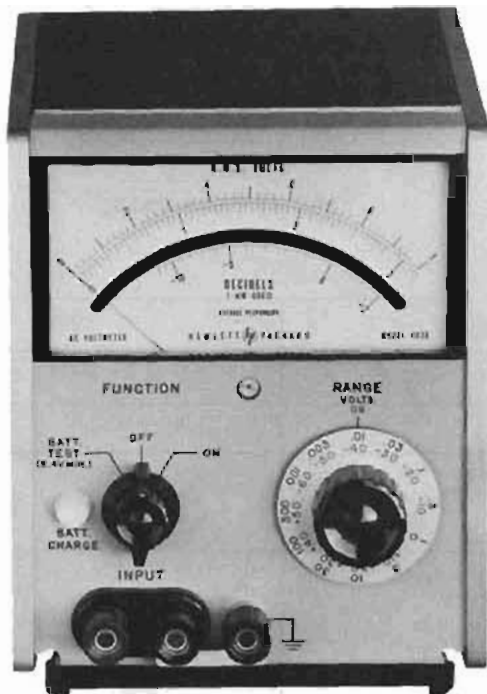

Description

The Hewlett-Packard 403B AC Voltmeter is a versatile, general purpose instrument for laboratory and production work yet is ideal for use in the field since it is solid-state, battery-operated, and portable.

It measures from 100 microvolts to 300 volts, covering 5 Hz to 2 MHz. It operates from internal batteries and thus may be completely isolated from the power line and external grounds, permitting accurate measurements at power line frequency and its harmonics without concern for beat effects. Isolation from external ground also permits use where ground loops are troublesome. Turnover effect and waveform errors are minimized because the meter responds to the average value of the input signal.

The 403B operates from an ac line as well as from the internal battery pack, and batteries recharge during ac operation. Battery charge may be easily checked with a front-panel switch to assure reliable measurements. Normally, about 60 hours of ac operation recharges the batteries, but an internal adjustment is provided which nearly doubles the charging rate. The Model 403B can be used while its batteries charge. A sturdy taut-band meter eliminates friction and provides greater precision and repeatability.

For improved resolution in dB measurements, the 403B Option 001 is available. This version spreads out the dB scale by making it the top scale of the meter.

Specifications

HP Model	403B	403B Option 001
Range	0.001 to 300 V rms full scale, 12 ranges, in a 1, 3, 10 sequence. -60 dB to +50 dB in 12 ranges with 10 dB steps.	
Meter	Responds to average value of input waveform, calibrated in the rms value of a sine wave.	
Frequency Range	5 Hz to 2 MHz	5 Hz to 2 MHz
Accuracy	within $\pm 2\%$ of full scale from 10 Hz to 1 MHz; within $\pm 5\%$ of full scale from 5 to 10 Hz and 1 to 2 MHz, except $\pm 10\%$ 1 to 2 MHz on the 300 V range (0 to 50° C).*	within ± 0.20 dB of full scale from 10 Hz to 1 MHz; within ± 0.4 dB of full scale from 5 to 10 Hz and 1 to 2 MHz, except ± 0.8 dB 1 to 2 MHz on the 3000 V range (0 to 50° C).*
Input Impedance	2 M Ω ; shunted by <60 pF; 0.001 to 0.03 V ranges; <30 pF, 0.1 to 300 V ranges.	same as 403B
Maximum Input	Fuse protected (signal ground can be ± 500 V dc from chassis).	same as 403B
Power	4 rechargeable batteries, 40 hr. operation per recharge, up to 500 recharging cycles; self-contained recharging circuit functions during operation from ac line.	same as 403B
Dimensions	130 mm wide, 159 mm high (without removable feet), 203 mm deep (5 1/4" x 6 1/4" x 8").	same as 403B
Weight	net, 2.9 kg (6 1/2 lb). Shipping, 3.6 kg (8 lb).	same as 403B
Price	\$480	add \$30

* Use 10001A 10:1 Divider and 10111A Adapter to retain $\pm 5\%$ (± 0.4 dB) accuracy while measuring up to 425 V rms at 1 to 2 MHz.

ANALOG VOLTMETERS

AC voltmeter, 10 Hz to 10 MHz

Models 400E, EL, F, FL, GL

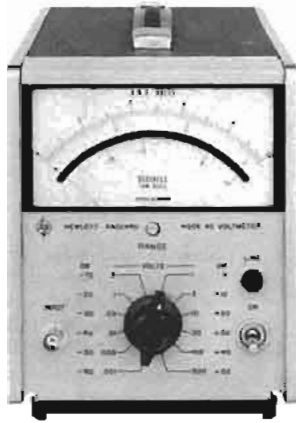

Specifications

	400E/EL*	400F/FL*	400GL
Voltage range:	1 mV to 300 V F.S. 12 ranges	100 μ V to 300 V F.S. 14 ranges	-80 dB to +60 dB F.S. 8 ranges
Frequency range:	10 Hz to 10 MHz	20 Hz-4 MHz	20 Hz-4 MHz
Input impedance:	10 M Ω on all ranges <25 pF to <12 pF depending on ranges	10 M Ω on all ranges <25 pF to <10 pF depending on ranges	10 M Ω on all ranges <300 pF to <15 pF depending on ranges
Accuracy:*	\pm (% reading + % range) 3 mV-300 V ranges 10 Hz-40 Hz: \pm (2.5+2.5) 40 Hz-2 MHz: \pm (1+0) 2 MHz-4 MHz: \pm (1.5+1.5) 4 MHz-10 MHz: \pm (2.5+2.5) 1 mV range 10 Hz-40 Hz: \pm (2.5+2.5) 40 Hz-500 kHz: \pm (1+0) 500 kHz-4 MHz: \pm (2.5+2.5)	\pm (% reading + % range) 300 μ V-300 V ranges 20 Hz-40 Hz: \pm (2+2) 40 Hz-100 Hz: \pm (1+1) 100 Hz-1 MHz: \pm ($\frac{1}{2}$ + $\frac{1}{2}$) 1 MHz-2 MHz: \pm (1+1) 2 MHz-4 MHz: \pm (2+2) 100 μ V range 30 Hz-60 Hz: \pm (2+2) 60 Hz-100 kHz: \pm (1+1) 100 kHz-500 kHz: \pm (1+0-7)	+60 dB range 20 Hz-40 kHz: \pm 0.4 dB 40 Hz-100 kHz: \pm 0.2 dB -60 dB thru +40 dB ranges 20 Hz-40 Hz: \pm 0.4 dB 40 Hz-500 kHz: \pm 0.2 dB 500 kHz-2 MHz: \pm 0.4 dB 2 MHz-4 MHz: +0.2 -0.8 dB -80 dB range 30 Hz-60 Hz: \pm 0.4 dB 60 Hz-100 kHz: \pm 0.2 dB 100 kHz-500 kHz: +0.2 -0.8 dB
Recovery	<2 s for 80 dB overload		
Overload	*500 V rms ac, 300 V dc		*1200 V rms max. input, 1000 V dc max. input
Calibration:	Scale -10 to +2 dB, 10 dB between ranges, 100 divisions on 0 to 1 scale. The dB scale reads -10 to +2 dB; 10 dB between ranges.		Linear dB scale, 100 divisions from -20 to 0 dB. Log voltage scale 0 dB = 1 V.
Weight:	Net. 2.7 kg (6 lb). Shipping, 4.1 kg (9 lb)		
Dimensions:	130 mm wide, 159 mm high (without removable feet), 279 mm deep (5 $\frac{1}{8}$ " \times 6 $\frac{1}{8}$ " \times 11")		
Power:	AC: 115 or 230 V \pm 10%, 48 to 440 Hz, 6 VA max. DC: External batteries: + and - voltages between 35 V and 55 V		
Price:	400E, \$450; 400EL, \$465	400F, \$450; 400FL, \$465	400GL, \$465

*NOTE: 400EL same as 400E, and 400FL same as 400F, except for calibration: linear dB scale -10 dB to +2 dB; 10 dB between ranges. Log voltage scales 0.3 to 1 and 0.8 to 3, 120 divisions from -10 to +2 dB, 40 dB.

Accuracy is % of reading in dB only.

*Ac overload voltage increases with increasing frequency.

ANALOG VOLTMETERS

10 Hz to 10 MHz true RMS voltmeter

Model 3400A

- 10 MHz bandwidth
- High crest factor for accurate pulse measurements
- Stable, linear dc output

- 1 mV full-scale sensitivity
- 10 M Ω input impedance
- Taut-band individually calibrated meter

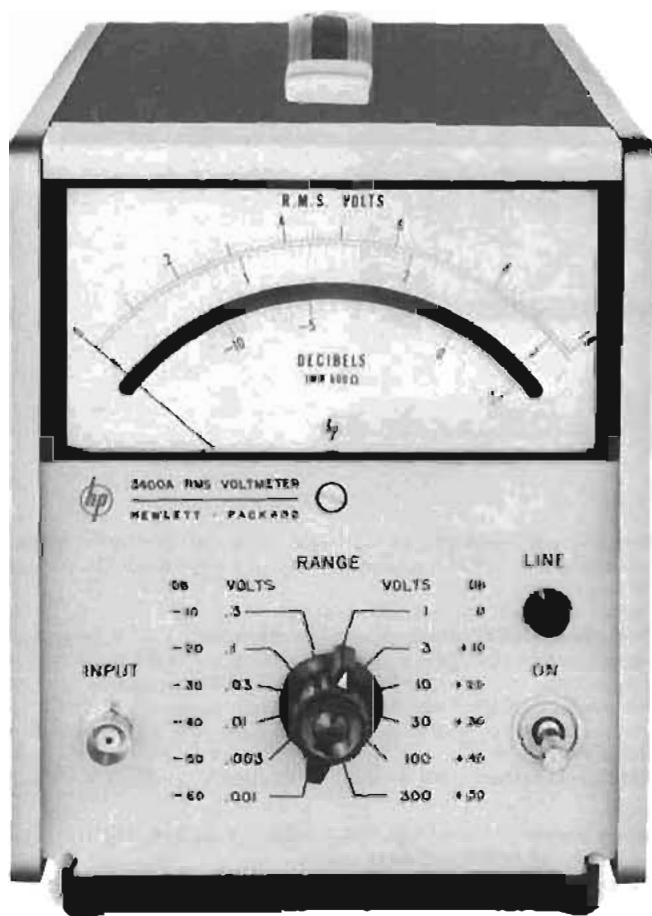

Description

The Hewlett-Packard Model 3400A is a true root-mean-square (rms) voltmeter, providing a meter indication proportional to the dc heating power of the input waveform.

Six-decade frequency coverage makes the 3400A extremely flexible for all audio and most rf measurements and permits the measurement of broadband noise and fast-rise pulses.

Pulses or other non-sinusoids with crest factors (ratio of peak to rms) up to 10:1 can be measured full scale. Crest factor is inversely proportional to meter deflection, permitting up to 100:1 crest factor at 10% of full scale.

Permanent plots of measured data and higher resolution measurements can be obtained by connecting an X-Y plotter, strip chart recorder or digital voltmeter to the convenient rear-panel dc output. The dc output provides a linear 0 to 1 volt drive proportional to meter deflection.

RMS current

True rms current measurements can be made conveniently by using the HP Model 456A Current Probe with the Model 3400A. See page 476.

Specifications

Voltage range: 1 mV to 300 V full scale, 12 ranges.

dB range: -72 to +52 dBm (0 dBm = 1 mW into 600 Ω).

Frequency range: 10 Hz to 10 MHz.

Response: responds to rms value (heating value) of the input signal for all waveforms.

Meter accuracy: % of full scale (20°C to 30°C)*

10Hz	50Hz	1MHz	2MHz	3MHz	10MHz
±5%	±1%	±2%	±3%	±3%	±5%

Ac-to-dc converter accuracy: % of full scale (20°C to 30°C)*

10Hz	50Hz	1MHz	2MHz	3MHz	10MHz
±5%	±0.75%	±2%	±3%	±3%	±5%

Crest factor: (ratio of peak to rms amplitude of input signal): 10 to 1 at full scale (except where limited by maximum input) inversely proportional to meter deflection, (e.g., 20 to 1) at half-scale, 100 to 1 at tenth scale).

Maximum continuous input voltage: 500 V ac peak at 1 kHz on all ranges; 600 V dc on all ranges.

Input impedance: from 0.001 V to 0.3 V range: 10 M Ω shunted by <50 pF. From 1.0 V to 300 V range: 10 M Ω shunted by <20 pF ac-coupled input.

Response time: for a step function, <5 s to final value.

AC overload: 30 dB above full scale or 800 V p, whichever is less, on each range.

Output: negative 1 V dc into open circuit at full-scale deflection, proportional to meter deflection from 10-100% of full scale. 1 mA maximum; nominal source impedance is 1000 Ω . Output noise <1 mV rms.

Power: 115 or 230 V \pm 10%, 48 to 66 Hz, 15 VA max.

Dimensions: 130 mm wide, 159 mm high (without removable feet), 279 mm deep (5 1/2" \times 6 1/2" \times 11"); 1/2 module.

Weight: net, 3.3 kg (7 1/4 lb). Shipping, 4.5 kg (10 lb).

Accessories furnished: 10110A Adapter, BNC to dual banana jack.

Accessories available:

	Price
11001A Cable, 45 in. long, male BNC to dual banana plug	\$17
10503A Cable, 4 ft. long, male BNC connectors	\$15
11002A Test Lead, dual banana plug to alligator clips	\$12
11003A Test Leads, dual banana plug to probe and alligator clip	\$12
11076A Carrying Case	\$135

Model number and name

3400A option 001 spreads out the dB scale by making it the top scale of the meter

add \$30

Rear terminals in parallel with front panel terminals and linear log scale uppermost on the meter face are available on special order.

3400A RMS voltmeter

\$800

*TC: \pm 0.3% from 0°C to 20°C and 30°C to 55°C.

ANALOG VOLTMETERS

10 kHz to 1.2 GHz RF voltmeter

Model 3406A



Description

High frequency voltages can be measured easily with HP's 3406A Sampling Voltmeter. Employing sampling techniques, the HP 3406A has extremely wide bandwidth (10 kHz to 1.2 GHz) with high input impedance. Signals as small as 50 μ V can be resolved on the sampling voltmeter's linear scale. Full scale sensitivity from 1 mV to 3 V is selected in eight 10 dB steps and may be read directly from -62 dBm to +23 dBm for power measurements. Accessory probe tips make the HP 3406A suitable for voltage measurements in many applications such as receivers, amplifiers and coaxial transmission lines.

Measurement indications can be retained on the 3406A meter by depressing a pushbutton located on the pen-type probe. This feature is useful when measurements are made in awkward positions where the operator cannot observe the meter indication and probe placements at the same time.

Specifications

Voltage range: 1 mV to 3 V full scale in 8 ranges; decibels from -50 to +20 dBm (0 dBm = 1 mW into 50 Ω); average-responding instrument calibrated to rms value of sine wave.

Frequency range: 10 kHz to 1.2 GHz; useful sensitivity from 1 kHz to beyond 2 GHz.

Full-scale accuracy (%) with appropriate accessory (after probe is properly calibrated)

10 kHz	20 kHz	25 kHz	100 kHz	100 MHz	700 MHz	1 GHz	1.2 GHz
± 13	± 8	± 5	± 3	± 5	± 8	± 13	

Input impedance: input capacity and resistance will depend upon accessory tip used. 100,000 Ω shunted by <2.1 pF at 100 kHz with bare probe; <10 pF with 11072A isolator tip supplied.

Sample hold output

Provides ac signal whose unclamped portion has statistics that are

narrowly distributed about the statistics of the input, inverted in sign (operating into >200 k Ω load with <1000 pF). Output is 0.316 V at f.s. on any range.

Noise: <175 μ V rms referred to input.

Accuracy (after probe is properly calibrated): 0.01 V range and above: same as full scale accuracy of instrument. 0.001 V to 0.003 V range: value of input signal can be computed by taking into account the residual noise of the instrument. Jitter: meter indicates within $\pm 2\%$ p of reading 95% of time (as measured with HP 3400A True RMS Voltmeter).

RMS crest factor: 0.001 V to 0.3 V, 20 dB; 1 V, 13 dB; 3 V, 3 dB.

Meter

Meter scales: linear voltage, 0 to 1 and 0 to 3; decibel, -12 to +3. Individually calibrated taut-band meter.

Response time: indicates within specified accuracy in <3 s. Jitter: $\pm 1\%$ peak (of reading).

General

DC recorder output: adjustable from 0 to 1.2 mA into 1000 ohms at full scale, proportional to meter deflection.

Overload recovery time: meter indicates within specified accuracy in <5 s (30 V p-p max.).

Maximum input: ± 100 V dc, 30 V p-p.

RFI: conducted and radiated leakage limits are below those specified in MIL-6181D and MIL-1-16910C except for pulses emitted from probe. Spectral intensity of these pulses are nominally 50 nV/ $\sqrt{\text{Hz}}$; spectrum extends beyond 2 GHz.

Temperature range: instrument, 0°C to +55°C; probe, +10°C to +40°C.

Power: 115 or 230 V $\pm 10\%$, 48 Hz to 66 Hz, 25 VA max.

Dimensions: 197 mm wide, 159 mm high (without removable feet), 279 mm deep (7 $\frac{1}{4}$ " \times 6 $\frac{1}{4}$ " \times 11"); $\frac{1}{2}$ module.

Weight: net, 5.4 kg (12 lb). Shipping, 6.8 kg (15 lb).

Accessories: refer to data sheet.

ANALOG VOLTMETERS

Logarithmic voltmeters, ac or dc log scaling

Models 7562A and 7563A



7562A



7563A

Description

Hewlett-Packard Model 7562A is a wide range (80 db), single channel logarithmic voltmeter/converter designed to produce dc output voltages in a logarithmic relationship to dc input voltages or the true RMS value of an ac input voltage. It contains a true RMS detector which is not dependent on pure sinusoidal signals to achieve measurement accuracy. A self-contained meter calibrated in volts and dB results in an accurate voltmeter. A constant amplitude oscilloscope output makes the converter compatible with a variety of oscilloscope readout and phase meter applications.

The Model 7563A Logarithmic Voltmeter/Amplifier is a low cost, single channel, dc logarithmic amplifier with a very high dynamic range (110 dB) designed to produce a logarithmic-related dc output voltage for a very wide range of dc input voltages. A single input range of 316 μ V to 100 V is coupled with an input polarity switch for ease and versatility of operation. A high input impedance (100 k Ω) and a low output impedance (less than 5 Ω) allows the 7563A to be used in systems or on the bench. A front panel meter calibrated in dB and mV provides instantaneous visual indication of operating levels. Applications include log scaling of recorder axes, pulse height analyzers, scope displays, and almost any circumstances where log compression of dc voltage ranges is required. Dual or single rack mounting capability is afforded by a field installable rack mounting adapter, utilizing a minimum of rack space.

7562A Specifications

Performance specifications

AC and DC modes

Input:

Dynamic range: 80 dB.

Voltage range: 1 mV to 10 V or 10 mV to 100 V selectable by front panel switch. Accepts either ac or positive signals.

Output:

Voltage: 0 to 800 mV dc corresponding to 10 mV/dB.

Output impedance: 100 ohms.

DC mode

Accuracy: ± 0.25 dB at 25°C.

Input impedance: 100 k Ω , shunted by less than 100 pF; single ended.

Temperature coefficient: ± 0.02 dB/°C maximum.

Zero stability: ± 0.25 dB.

AC mode

Input impedance: 1 M Ω , shunted by less than 100 pF; single ended.

Accuracy and frequency response: (at 25°C).

Range Setting	0.5 Hz	2	5	20	50	200 Hz	50 kHz (<10 V)	100 kHz (>10 V)
0.5 Hz	± 1 db	± 0.5 db					± 1 db	+1 -3 db
5 Hz			± 1 db	± 0.5 db			± 1 db	+1 -3 db
50 Hz					± 1 db	± 0.5 db	± 1 db	+1 -3 db

Temperature coefficient: ± 0.04 dB/°C maximum.

Slewing speed:

Range setting	Minimum slewing speed
0.5 Hz	1 dB/s
5 Hz	10 dB/s
50 Hz	60 dB/s

Oscilloscope output: approx. 0.5 V rms regardless of input.

Crest factor: 5:1 unless limited by max. input voltage.

Maximum peak input voltage: ± 25 V on 1 mV to 10 V range; ± 250 V on 10 mV to 100 V range.

General specifications

Operating temperature: 10°C to 40°C.

Warm-up time: 20 minutes nominal.

Connectors: front and rear input and output BNC connectors.

Power requirements: 115/230 Vac, 50 to 400 Hz, 40 VA

Dimensions: 88 mm high, 197 mm wide, 292 mm deep (3 1/8" \times 7 7/8" \times 11 1/2").

Weight: Net, 3.6 kg (8 lb). Shipping 5.4 kg (12 lb).

7563A Specifications

Performance specifications

Input

Dynamic range: 110 dB.

Voltage range: 316 μ V to 100 V. Accepts either positive or negative signals, selectable by front panel switch.

Output

Voltage: 0 to 1.1 V dc corresponding to 10 mV/dB. Rear terminals: adjustable 1 to 10 mV/dB.

Output impedance: less than 5 Ω front panel, 300 Ω rear.

Meter accuracy: reading accurate to ± 1.5 dB, referred to output.

Input impedance: 100 k Ω , shunted by less than 100 pF, single ended.

Accuracy: (at 25°C).

316 μ V	1 mV	10 V	31.6 V	100 V
± 0.5 dB	± 0.25 dB	± 1.0 dB	± 1.5 dB	

Temperature coefficient: ± 0.02 dB/°C maximum and ± 3 μ V/°C referred to input.

Zero stability: ± 0.25 dB at constant temperature.

Rise Time:

Maximum Rise Time	
Signal Level	1 mV-10 V Range
316 μ V - 1 mV	2000 μ s
1 mV - 10 mV	400 μ s
10 mV - 100 mV	40 μ s
100 mV - 1 V	4 μ s
1 V - 100 V	2 μ s

General specifications

Operating temperature: 10°C to 40°C.

Warm-up time: 20 minutes nominal.

Connectors: front and rear input and output BNC connectors.

Power requirements: 115/230 V ac, 50 to 400 Hz, 40 VA.

Dimensions: 88 mm high, 197 mm wide, 292 mm deep (3 1/8" \times 7 7/8" \times 11 1/2").

Weight: net, 3.6 kg (8 lb). Shipping, 5.4 kg (12 lb)

Model number and name

7562A Logarithmic Voltmeter/Converter

7563A Logarithmic Voltmeter/Amplifier

Price

\$1600

\$1200



Digital voltmeters

Digital voltmeters (DVM's) offer many advantages over other types of voltmeters. Among the advantages of DVM's are greater speed, increased accuracy and resolution, reduction of operator errors and the ability to provide automatic measurements in systems applications.

Digital voltmeters display measurement results as discrete numerals rather than as a pointer deflection on a continuous scale, which is commonly used in analog devices. Human error and tedium are reduced by direct numerical readout, and operator training is minimized by automatic polarity and range-changing features of some DVM's.

Digital voltmeters are available to measure ac and dc voltages, current, resistance and ratio. Appropriate transducers can be used to measure other parameters such as strain or temperature. An increasingly popular use of DVM's is in automatic measurement systems. Such a system can be as simple as connecting the DVM digital output to a digital printer or as powerful as a calculator or computer controlled DVM system that provides automatic data reduction and unattended operation.

Building blocks

Digital voltmeters convert an analog signal to an equivalent digital value. To do this, the input signal (ac/dc voltage or current, or resistor value) must pass through the basic building blocks shown in Figure 1.

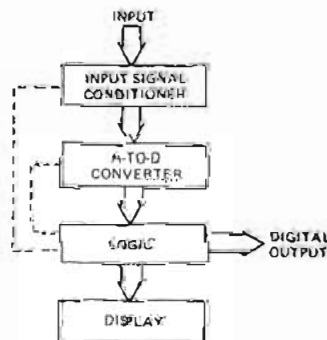

Figure 1 — Basic building blocks of a DVM

Digital voltmeters that have current measuring capability use internal shunt resistors to convert unknown current to an ac or dc voltage. This voltage is then digitized and

scaled (by shunt value) to provide a reading of the current.

The signal to be measured first passes through an input signal conditioner. This converts ac signals, dc signals, or resistances to a proportional dc voltage that is within the range of operation of the analog-to-digital (A-to-D) converter.

The A-to-D converter generates numerical values that correspond to the dc voltage out of the signal conditioner. The logic block controls the order of internal information flow and manages the communication of digital information with external devices. A visual result of measurement is provided by the display block.

Signal conditioners

Of all the parts of a DVM, the signal conditioning and conversion part has the greatest influence on the instrument's characteristics.

A dc input often must be amplified or attenuated to be within the range of the A-to-D converter. For example, if full scale input of the A-to-D unit is 10 V, the dc input amplifier/attenuator would amplify the signal on the 100 mV and 1 V ranges and attenuate the signal on 100 V and 1000 V ranges.

There are two types of ac converters in common use today: average responding and true rms responding. The average responding converter is relatively inexpensive and is intended primarily for measurement of sine waves having little or no distortion. This type of converter measures average value of the rectified sine wave which is then multiplied by a scale factor ($rms = 1.11 \text{ ave.}$) to provide the rms value. Errors may result from this technique when the input signal is not a distortionless sine wave.

The true rms responding converter typically has wider bandwidth and thus has the ability to measure nonsinusoids and is insensitive to distortion. True rms converters measure equivalent heating power of the waveform using a thermocouple or thermopile. The resulting dc voltage is equivalent to heating power, or true rms, of the ac signal. Some Hewlett-Packard true rms converters measure not only ac signal, but also dc components which, in turn, improves low frequency performance. The composite equals $\sqrt{(dc)^2 + (ac \text{ rms})^2}$.

Ohms converters measure value of resistors by supplying a known constant dc current to the unknown resistor and then measuring the resulting voltage drop across it. There are three popular techniques for supplying dc current to the unknown resistor: two-wire, three-wire, and four-wire.

The two-wire technique is most common and most economical for applications where test leads are short. Since the same input terminals are used to supply dc current and measure voltage drops, this technique is affected by lead resistance.

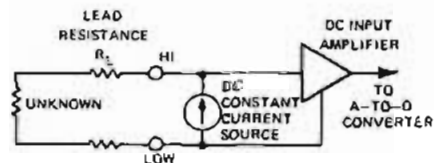

Figure 2 — Simple two-wire ohms converter

A dc current source that is totally isolated from the measuring circuits (Figure 3) is used by the four-wire technique to overcome sensitivities to lead resistance. This scheme offers the ultimate in performance for ohms measurements, particularly for remote measurements, while the two-wire method is more suited to bench use where leads are short.

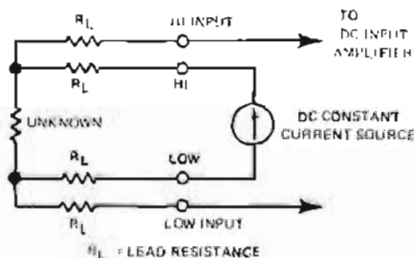

Figure 3 — Simplified 4-wire ohms converter

Like the two-wire converter, the three-wire converter is sensitive to lead resistance, especially on the low side of the input, but it may be possible to null out error caused by lead resistance with an internal adjustment.

A-to-D converters

Analogue-to-digital converters change dc signals from signal conditioners and converters to discrete numerical values. The conversion technique used determines speed, resolution and noise rejection characteristics of the DVM. For a detailed discussion refer to Hewlett-Packard Application Note 158.

Noise rejection

Source and type of noise are important in determining the type of noise rejection needed. There are two types of noise which may affect accuracy and sensitivity of a DVM: normal mode and common mode.

Normal mode noise enters the DVM with the signal and is superimposed on it. Filtering is the simplest way to cut down on noise but it slows measurement speed. Integration "calculates" noise out of the measurement by looking at the input signal over a period of

time equal to the period of expected noise. Filtering is advantageous for rejecting broadband noise, while integration is better for rejecting line related noise. Figure 4 shows typical noise rejection for filtering and integrating methods.

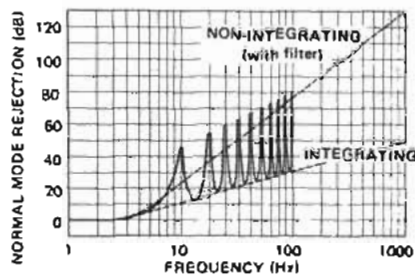

Figure 4 — Normal mode noise rejection for two DVM's, one using filtering and the other using integration

Common mode noise appears between the DVM's input terminals and ground. It is usually caused by grounding differences between the DVM and the device being measured.

Errors caused by common mode noise may be reduced by a passive technique called "guarding." Guarding shunts the noise to ground and away from input terminals. By proper connection of the guard (Figure 5), a remarkable improvement can be seen in a DVM's ability to reject common mode noise.

"Effective" common mode rejection is the specification that usually appears in data sheets. Effective refers to the final reading. Effective CMR is the combined result of "pure" CMR due to guarding plus normal mode rejection of the instrument.

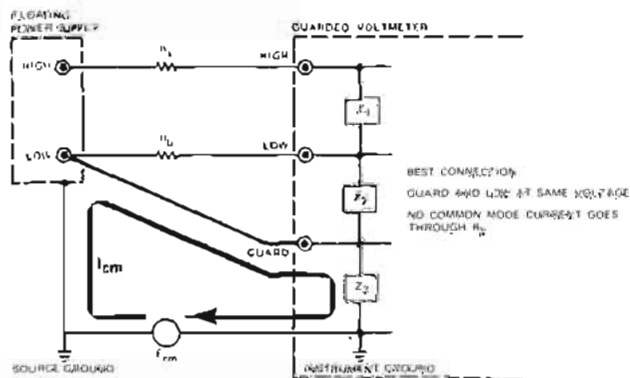

Figure 5 — Best connection—guard connected to low at source

Specifications

Resolution and sensitivity

DVM's are classified according to the number of full digits. An overrange digit is an extra digit added to allow the user to read beyond full scale. This overrange digit is often called a "one-half" or a "partial" digit since it cannot display all numbers through 9. Overranging greatly extends a DVM's usefulness by maintaining resolution up to, and beyond, full scale. For example, if a signal changes from 9.999 V to 10.012 V, a four-digit DVM without overranging could measure the first voltage as "9.999 V," but would require a range change to make the second measurement with a resulting reading of "10.01 V." The 0.002 V change would not be seen. With overranging, the second measurement could be made as "10.012 V" with no loss of resolution.

Overrange can be expressed as either a percentage of full scale or as part of the range itself. A four-digit DVM with 100% overrange would have a maximum display of "19999." Alternatively, the range can be described as 2 V, 20 V, etc., with no overrange specification. The maximum display remains "19999." A specification of 20% overranging would have a maximum reading of "1999." This can also be expressed as a 1.2 V, 12 V, etc., range with no overrange.

Resolution is the ratio of the maximum number of counts that can be displayed to the least number of counts. Full-scale resolution of a five-digit DVM is 100,000 to 1, or 0.001%. Overranging is generally ignored in resolution.

Sensitivity refers to the smallest incremental voltage change that the DVM is able to detect. Mathematically, it is the lowest full-scale range multiplied by the resolution of the DVM. Sensitivity of a five-digit DVM with

resolution of 0.001% and a 100 mV lowest full-scale range is $0.001\% \times 100 \text{ mV} = 1 \mu\text{V}$.

Accuracy

Accuracy is the exactness to which a voltage can be determined, relative to the Legal Volt maintained by the U.S. National Bureau of Standards. Accuracy specification equals errors involved in traceability to N.B.S., as well as errors made by the instrument.

To be meaningful, accuracy must be stated along with the conditions under which it will hold. These conditions should include time, temperature, line variations and humidity. Conditions specified should be realistic relative to intended use. For example, a DVM specified with a temperature range of $25^\circ\text{C} \pm 1^\circ\text{C}$ would require a highly controlled environment, whereas $\pm 5^\circ\text{C}$ would cover the majority of environments.

The period of time over which accuracy holds is especially important since it indicates the DVM's stability and how often it will have to be calibrated.

Accuracy is usually expressed as a percent of the reading plus a percent of the range (or full scale). Figure 6 shows that accuracy is always better at or above full scale.

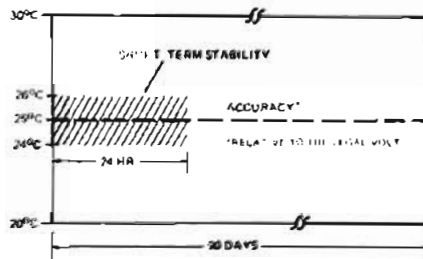

Figure 6 — Typical four-digit DVM accuracy

Reading rate

Most DVM's have their own internal trigger source which may be adjustable or fixed. Quite often, trigger rate is independent of response time of the analog circuits. For example, a DVM may have a fixed sample rate of five readings per second, which is fine for dc measurements, but the ac converter may take two seconds to respond. This means that the user must wait for several samples before obtaining a steady reading. Thus, as Figure 7 shows, the DVM's speed is determined by settling time of its input circuitry, plus time required to digitize the signal.

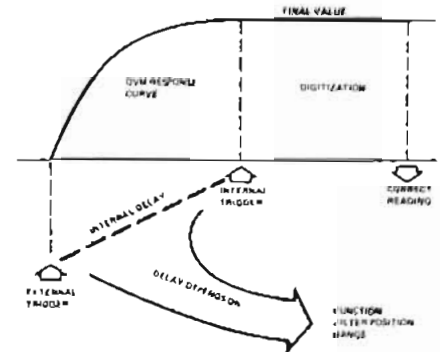

Figure 7 — DVM speed depends upon response time and reading period

When a DVM is used in an automatic system, its internal trigger is seldom used. External triggers are issued by the system incorporating the appropriate delay to allow for settling.

Additional information

For more information on DVM operation and selection, refer to Hewlett-Packard Application Note 158.

DVM SELECTION GUIDE

DIGITS	dc	ac	Ohms	Current	Special Features	HP Model No.	Page
3	•	•	•	Opt	Probe	970A	48
3	•	•			True rms ac, dB display	3403C	58
3	•	•	•	•	High performance, autoranging	3435A	52
3	•				High speed and HP-IB	3437A	60
3	•	•	•	•	Low cost, autoranging	3476 A/B	50
4	•	•	•	•	1 μV sensitivity	3465A	54
4/5	•	Opt	•	Opt	Snap-on flexibility	3470A Series	56
5	•	•	•		Self test and HP-IB	3490A	66
5/6	•	•	•		High resolution and HP-IB	3455A	62
6 or 8	•	•	•		Counter	5306A	257

DIGITAL VOLTMETERS

Voltmeter accessories
Probes, dividers, carrying cases

10007B Straight-thru probe

10007B



11067A Test lead kit



34110A Soft vinyl carrying case



11096B High frequency probe

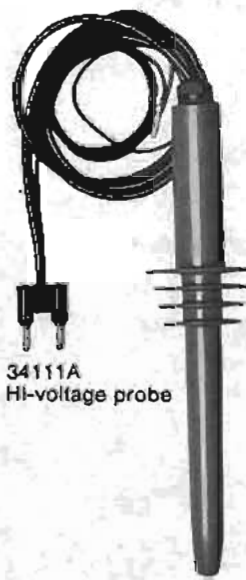

34111A Hi-voltage probe



34112A Touch-hold probe



10007B, 10008B Probe

The 10007B and 10008B are straight-thru BNC probes with a retractable hook tip and 20 cm (8 in.) ground lead with alligator tip.

	Peak Voltage	Shunt Capacitance	Length
10007B	600 V	40 pF	1.1 m (3.5 ft.)
10008B	600 V	60 pF	1.8 m (6 ft.)

11067A Test lead kit

Includes two leads with many interchangeable tips to accommodate various applications.

11068A

Soft carrying case for 3476A and B DMM. Has shoulder strap and zippered opening for instrument and accessory pouch.

11096B High frequency probe

Converts dc voltmeter with 10 MΩ input to high-frequency ac voltmeter. Works with any dc voltmeter with 10 MΩ input impedance.

11096B Specifications

Voltage range: 0.25 to 30 V rms
Transfer accuracy (when used with 10 MΩ ±10% dc voltmeter):

	100 kHz	100 MHz	500 MHz
+10°C to +30°C	±0.5 dB	±1.2 dB	

Down 3 dB at 10 kHz and 700 MHz.

Response: peak responding. Calibrated to read rms value of sine wave.

Input impedance: 4 MΩ shunted by 2 pF.

Max. Input: 30 V rms ac; 200 V dc.

Cable length: 4' long (1219 mm).

Accessories furnished: High-Frequency Adapter; Straight Tip; Hook Tip; Ground Lead.

Accessories available: HP 10218A BNC Adapter; HP 10219A Type 874 Adapter; HP 10220A Microdot Adapter; HP 11063A 50Ω Tee.

34110A

Carrying case for 1/2 rack size instruments. Inside dimensions of 25.4 cm X 22.9 cm X 10.2 cm or 10" deep X 9" wide X 4" thick. Zipper top lid and zippered accessory pouch. Has shoulder carrying strap.

34111A DC Hi-voltage probe

1000:1 divider will accept up to 48 kV. Input Z = 10⁹Ω, divider accuracy. Meets specifications when connected to 10 MΩ input resistance instrument.

0-20 kV	} <4%	Divider has interchangeable hook and pointed tip.
30-40 kV		
20-30 kV		

34112A Touch-hold probe

Allows user to hold DMM display by depressing button on probe body. Both AC and DC voltage up to 1200 V max. DC or AC RMS may be measured and held. Usable on the 3435A and 3465A and B.

Model number and name	Price
10007B Divider Probe	\$27
10008B Divider Probe	\$27
11067A Test Lead Kit	\$5
11068A Soft Carrying Case for 3476A and B DMM	\$20
11096B High Frequency Probe	\$87
34110A Carrying Case for 1/2 Rack Size Instruments	\$25
34111A DC Hi-Voltage Probe	\$75
34112A Touch-Hold Probe	\$40

DIGITAL VOLTMETERS

Digital multimeter

Model 970A

- Puts a complete DMM in the palm of your hand
- Autoranging, autozero, autopolarity

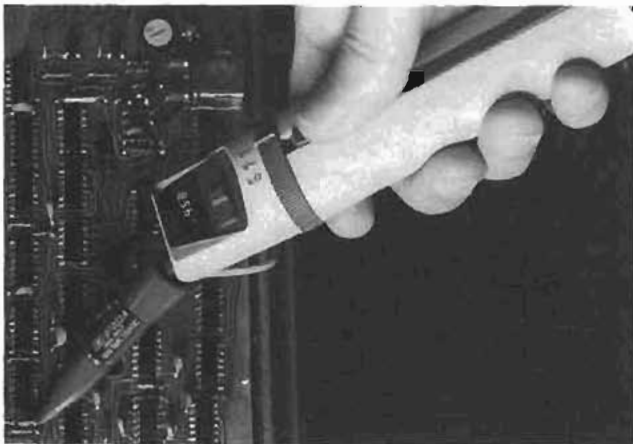
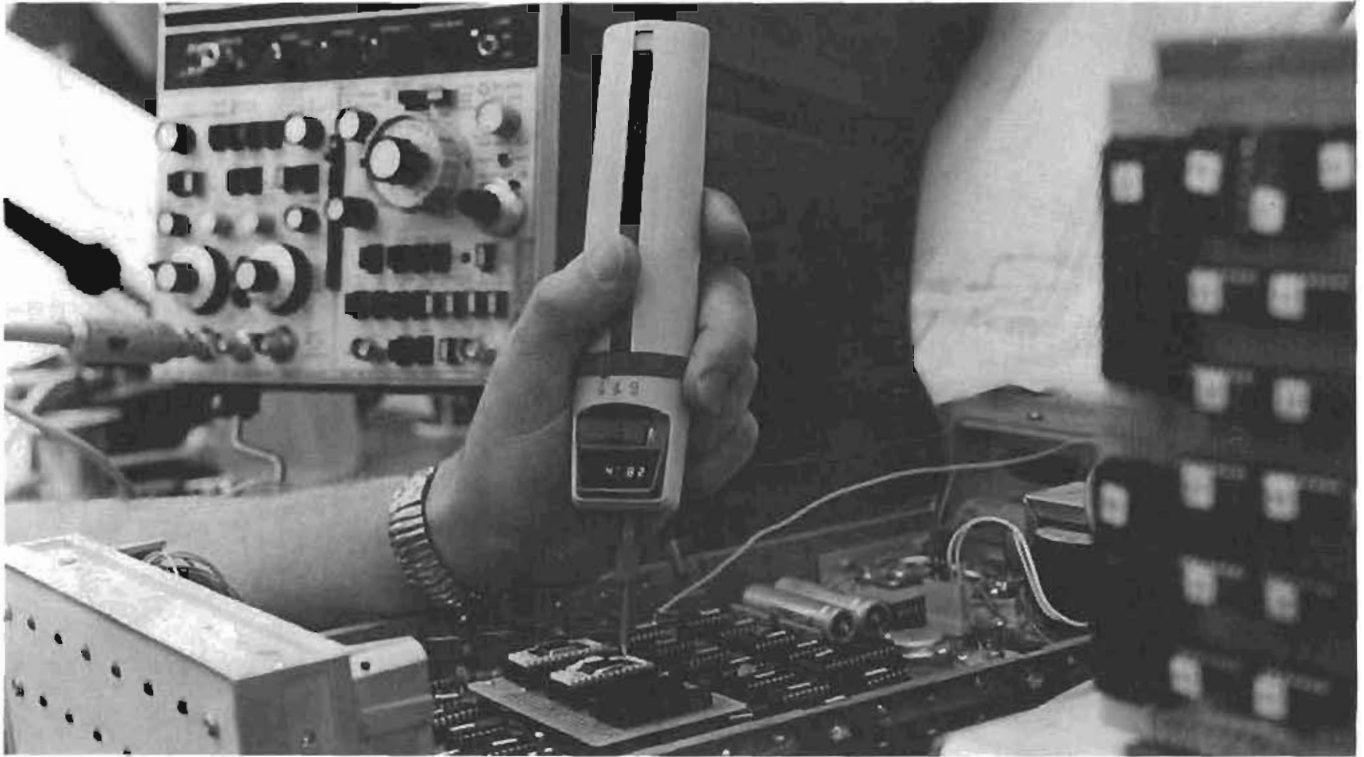

Description

Hewlett-Packard's 970A Probe Digital Multimeter is completely self-contained and autoranges through five ranges of ac and dc volts and ohms.

The pocket-sized multimeter is ideal for field, lab, or bench application. All electronics, including display and batteries, are in one seven-ounce package.

HP's Model 970A automatically selects the right range, making it easy to use by technicians, repairmen, telephone craftsmen and engineers. This probe was the first hand-held DMM incorporating solid-state autoranging technology. All solid-state switching is in its one MOS circuit.

A five-digit LED (Light Emitting Diode) cluster is used in this 3½-digit DMM. There are no scales to misinterpret. All voltage readings are in volts, and resistance readings in kilohms.

Automatic decimal placement and automatic polarity indication save you time. Set the function selector (acV, dcV or kΩ). Connect the ground clip, touch the probe tip to a test point, press the Push-to-Read bar, and the readout displays the correct reading and polarity. When measuring ohms or dc volts, it takes typically less than two seconds to range and settle to the final reading.

Since the display is close to point of measurement, the readout can be seen at a glance without interrupting your trouble-shooting. Also, the display can be electronically inverted to avoid reading errors.

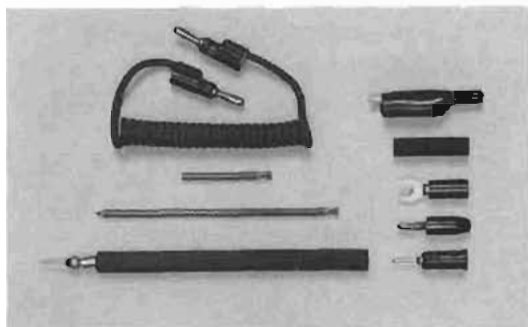

Accessory Kit

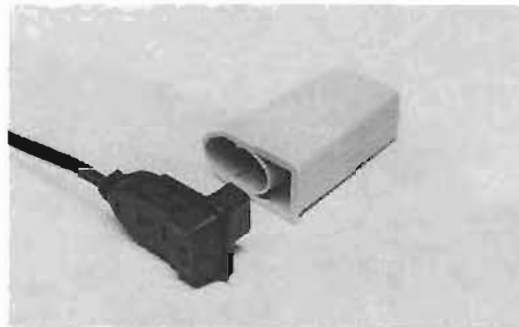

Battery Charger

HP's 970A Probe Digital Multimeter can be converted into a five-function bench instrument with optional 97002A Current Shunt/Bench Cradle. A six-position manual switch selects five ranges of ac and dc volts and ohms. Two general purpose binding posts accept wraparound, screw-down, clip-on or banana plug terminations.

The HP 97003A RF Adapter measures ac voltage over a frequency range of 100 kHz to 500 MHz from 0.25 V to 30 V. A broad line of tips, adapters and tees are also available.

Specifications, Model 970A

DC voltmeter

Ranges: 0.1 V, 1 V, 10 V, 100 V, 1000 V (500 V max input).

Accuracy (20°C to 30°C): ±(0.7% of reading + 2 digits).

Input resistance: 10 MΩ, ±5%.

Input protection: ≤750 V peak.

Temperature coefficient: ±(0.05% of reading + 2 digits)/°C.

AC voltmeter

Ranges: 0.1 V, 1 V, 10 V, 100 V, 1000 V (500 V rms sine wave max input).

Accuracy (20°C to 30°C):

Range	45 Hz to 1 kHz	1 kHz to 3.5 kHz
1 V to 1000 V	±(2% of reading 5 digits)	±(3% of reading 5 digits)
0.1 V (>3 mV)	±(2% of reading 5 digits)	±(5% of reading 5 digits)

Input resistance: 10 MΩ, ±5%.

Input capacitance: <30 pF.

Input protection: ≤750 V peak.

Temperature coefficient: ±(0.05% of reading + 0.5 digits)/°C.

Ohmmeter

Ranges: 1 kΩ, 10 kΩ, 100 kΩ, 1000 kΩ, 10,000 kΩ.

Accuracy (20°C to 30°C): ±(1.5% of reading + 2 digits).

Input voltage protection (resistor fused — clip mounted): ≤115 V rms for up to 1 minute. ≤250 V rms for up to 10 seconds.

Temperature coefficient: ±(0.05% of reading + 0.2 digits)/°C.

General

Ranging: automatic.

Sample rate: 3/second.

Overrange: 10%.

Calibration cycle: 1 year.

Operating environmental conditions: Temperature range, 0°C to 40°C.

Humidity: ≤95% RH.

Power: rechargeable batteries.

Typical operating time using fully charged battery: 2 hours continuous at 25°C.

Typical battery charging time: 14 hours at 25°C. (Indefinite charging will not damage battery).

Weight (with battery pack): net, 200 g (7 oz). Shipping, 1.8 kg (4 lb).

Dimensions: 165 mm long × 45 mm wide × 30 mm deep (6½" × 1¾" × 1¼").

97002A Specifications

DC ammeter

Ranges: 0.1 mA, 1 mA, 10 mA, 0.1 A, 1 A FS.

Accuracy (20°C to 30°C): ±(2.5% of reading + 2 digits).

AC ammeter

Ranges: 0.1 mA, 1 mA, 10 mA, 0.1 A, 1 A FS.

Accuracy (20°C to 30°C, >3% of range): 45 Hz to 1 kHz; ±(4% of reading + 5 digits). 1 kHz to 3.5 kHz; ±(7% of reading + 5 digits).

DC V, ac V, ohms: same as 970A specifications.

General

Full range insertion voltage: <0.25 V.

Input protection: 2 amp fast acting fuse.

Weight: net, 170 g (6 oz). Shipping, 1.8 kg (4 lb).

Dimensions: 95 mm long, 95 mm wide, 51 mm deep (3¾" × 3¾" × 2").

97003A Specifications

Response: the 97003A is a peak responding detector and is calibrated to read rms value of a sine wave.

Voltage range: 0.25 V to 30 V rms.

Max input: 30 V rms ac; 200 V dc.

AC to dc transfer accuracy when operating into HP 970A:

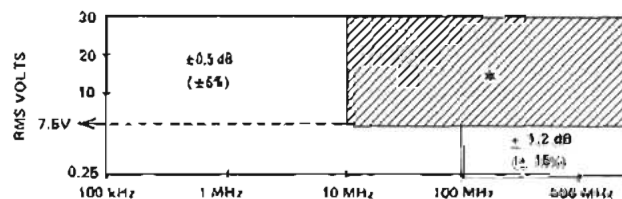

*HP's 97003A is usable from 10 MHz to 500 MHz and 7.5 V rms to 30 V rms. It is not traceable to the United States National Bureau of Standards over that range.

Input impedance: input resistance: >25 kΩ.

Shunt capacitance: <3 pF for plastic tips. <4 pF for metal high frequency adapter tip.

General

Accessories supplied: ground lead, straight tip, battery charger, soft carrying case.

Accessories available: 11063A, 50-ohm tee; 11536A, 50-ohm tee; 10218A, BNC Adapter; 10219A, Type 874 Adapter; 10220A, Micro-dot Adapter. See data sheet for information on ordering chargers.

Model number and name	Price
97001A extra rechargeable battery pack	\$27
97002A ac/dc current shunt/bench cradle	\$49
97003A RF adapter	\$88
97004A accessory kit	\$36
970A Digital Multimeter (includes soft carrying case, battery and charger)	\$335

DIGITAL VOLTMETERS

Low-cost autoranging 3½ digit DMM

Model 3476A/B



Description

If you measure current, voltage or resistance, you can use the 3476A/B to make these measurements faster and with fewer reading errors. This versatile new instrument incorporates autorange to let you concentrate on your measurement, not the range or range multiplier. With autorange, readings always have the same multiplier: voltage always in volts, current in amps, and resistance in kilohms. In addition to autorange the 3476A/B has auto-zero and auto-polarity. Auto-zero eliminates the need to zero the instrument prior to a test, and auto-polarity lets you measure both positive and negative voltages without the inconvenience of reversing test leads.

The 3476A/B saves you time by combining the five most common measurements in one instrument. It measures AC voltage, DC voltage, AC current, DC current and resistance. In addition to these five basic measurements, the 3476A/B has additional features to save you time and effort. For example, there are two units to choose from. The lower cost 3476A operates on AC for your bench measurements. The 3476B will operate on either AC or nickel-cadmium batteries. Under battery operation you can break ground loops resulting in quieter readings or make measurements in remote locations. The 3476B will give you eight hours of continuous service before a recharge is required. Keep it plugged in and it will charge overnight and be ready for your next trip.

Convenience

An instrument designed to make your most common measurements should be convenient to use. The 3476A/B was designed to be convenient. An example is the replacement of the input protection fuses. Replacement is easy—no disassembly or re-calibration is necessary—simply slide back the input terminal cover plate to expose the defective fuse. Convenience means attention to design detail. A multi-position bail allows convenient positioning. There is even a vertical detent for viewing from above. Another convenient detail is the shape of the case. Small instruments with pushbuttons have trouble staying put when the buttons are pressed. The 3476A/B solves this problem with a finger grip ridge allowing one-handed operation.

3476A/B specifications

Ranges: ±0.1100 V	Maximum Display: ±0.1098 V
±1.100 V	±1.098 V
±11.00 V	±10.98 V
±110.0 V	±109.8 V
±1100 V	±1098 V

Maximum Input: 1000 V (DC + Peak AC)

Accuracy: (20°C to 30°C)*

Range	Accuracy*
0.1100 V	±(0.3% of reading + 2 digits)
1.100 V 11.00 V	±(0.3% of reading + 1 digit)
110.0 V 1100 V	±(0.4% of reading + 1 digit)

Common mode rejection: (1 kΩ unbalance) > 100 dB @ 50 Hz, 60 Hz.

Input resistance: 10 MΩ ±5%.

Input protection: < 1100 V peak.

Temperature coefficient: ±(0.05% of reading + 0.2 digit)/°C.

AC Voltmeter

Ranges: 0.1100 V	Maximum Display: 0.1098 V
1.100 V	1.098 V
11.00 V	10.98 V
110.0 V	109.8 V
1100 V	1098 V

Maximum Input: 700 V rms

Accuracy: converter is average responding calibrated in rms (20°C to 30°C)*

Ranges**	45 Hz to 2 kHz	2 kHz to 5 kHz	5 kHz to 10 kHz
1.100 V to 1100 V	±(1.5% of reading + 4 digits)	±(3% of reading + 6 digits)	±(8% of reading + 10 digits)
0.1100 V	±(2% of reading + 6 digits)	±(5% of reading + 6 digits)	±(18% of reading + 10 digits)

** Ranges usable from 0.03 of range to full scale

Common mode rejection: (1 kΩ unbalance) >80 dB @ 50 Hz, 60 Hz.
Input resistance: 10 MΩ ±5%.
Input capacitance: <30 pF.
Input protection: <1100 V peak.
Temperature coefficient: ±(0.05% of reading +0.5 digit)/°C.

DC ammeter

Ranges: ±0.1100 A **Max. display:** ±0.1098 A
 ±1.100 A ±1.098 A

Accuracy: (20°C to 30°C) ±(0.8% of reading +2 digits)
Impedance: 1-1.5 ohm constant
Current protected: 1.5 A fuse
Temperature coefficient: ±(0.05% of reading +0.2 digit)/°C

AC ammeter

Ranges: 0.1100 A **Maximum display:** 0.1098 A
 1.100 A 1.098 A

Accuracy: (20°C to 30°C)*

Ranges**	45 Hz to 2 kHz	2 kHz to 5 kHz
1.100 A	±(2% of reading + 4 digits)	±(3.5% of reading + 6 digits)
0.1100 A	±(2.5% of reading + 6 digits)	±(5.5% of reading + 6 digits)

** Ranges usable from 0.03 of range to full range.

Impedance: 1-1.5 ohm constant
Current protected: 1.5 A fuse
Temperature coefficient: ±(0.05% of reading +0.5 digit)/°C.

Ohmmeter

Ranges: 1.100 kΩ **Maximum display:** 1.098 kΩ
 11.00 kΩ 10.98 kΩ
 110.0 kΩ 109.8 kΩ
 1100 kΩ 1098 kΩ
 11000 kΩ 10980 kΩ

Accuracy: (20°C to 30°C)

Ranges	Accuracy*
110.0 kΩ, 1100 kΩ	±(0.3% of reading + 1 digit)
11000 kΩ, 1.100 kΩ, 1100 kΩ	±(0.5% of reading + 1 digit)

Open circuit voltage: <4 V
Input voltage protection: <30 V rms continuous, fuse protected from 30 V to 250 V rms.
Temperature coefficient: ±(0.05% of reading + 0.2 digit)/°C.

* 90 day cal. cycle. Add (0.2% of reading to all functions + 1 digit for AC V and ACI) for one year cal. cycle

General

Ranging: Automatic, Range Hold.
Common to ground: <500 V (Peak).
Sample rate: ≈ 3/second.
Overload indication: horizontal bars.
Operating environmental conditions
Temperature range: 0°C to 40°C.
Humidity: <95% RH.

Power: 3476A AC line, 3476B AC line and batteries, <6 VA.

- Standard, 104-127 V ac; 54-66 Hz;
- Option 001, 86-106 V ac; 54-66 Hz;
- Option 002, 86-106 V ac; 48-54 Hz;
- Option 003, 190-230 V ac; 48-54 Hz;
- Option 004, 208-250 V ac; 48-54 Hz.

Note: No charge for options 001 through 004. Power options may be changed in field by rearranging jumpers. See manual for details.

Batteries: 4 rechargeable Nickel Cadmium Sub C size. Typical continuous operating time using fully charged batteries: 8 hours at 25°C. Typical battery charging time: 14 hours at 25°C with instrument turned off. Trickle charge with instrument on.

Weight: 3476A — net, 0.77 kg (1 lb 11 oz); shipping, 1.68 kg (3 lb 11 oz). 3476B — net, 0.97 kg (2 lb, 2 oz); shipping, 1.88 kg (4 lb 2 oz).
Dimensions: 3476A/B: 5.8 cm (2.3") high, 16.8 cm (6.6") wide, 20.6 cm (8.1") deep.



3476A



11068A

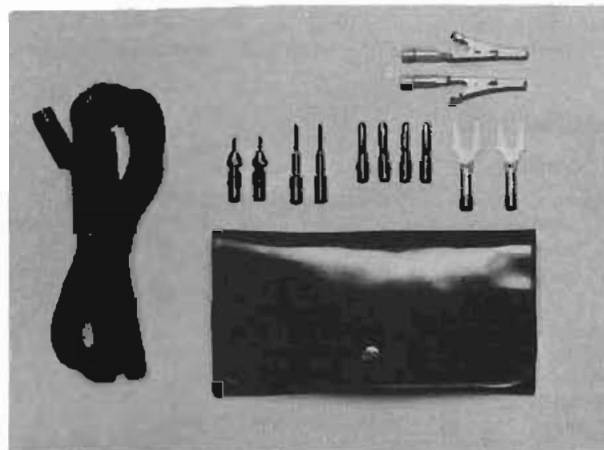

11067A

Accessories:***

- 11096A RF probe 10 kHz to 700 MHz (with adaptors) \$87
- 11067A Test Lead Kit \$5
- 11068A Soft Carrying Case \$20
- Option 910 Extra Manual add \$2
- Option 005 3476A/B, Test Lead Kit, and Soft Carrying Case add \$25

Model number***

- 3476A \$225
- 3476B \$275

*** Domestic U.S. prices only. Data subject to change.

Price



DIGITAL VOLTMETERS

3½ Digit, high accuracy DMM

Model 3435A



Description

The 3435A is a 3½ digit multimeter providing five functions of ACV, DCV, ACI, DCI and Ω . It is available with rechargeable batteries or AC line power only. The 34112A Touch-Hold probe provides "eyes-on" probing of AC and DC voltages by holding the 3435A display using a button on the probe. The 3435A case is rugged with a detent position carrying handle which is used also as a tilt stand.

Specifications

DC voltmeter

Ranges:	Maximum display:
± 200 mV	± 199.9 mV
± 2 V	± 1.999 V
± 20 V	± 19.99 V
± 200 V	± 199.9 V
± 1200 V	± 1199 V

Maximum input: 1200 V (DC + Peak AC)

Ranging: automatic or manual

Sensitivity: 100 μ V on 200 mV range

Polarity: automatically sensed and displayed

Accuracy: 1 year, 15 to 30°C @ 95% RH

Range	Specifications
200 mV	$\pm(0.1\%$ of reading + 2 digits)
2 V to 1200 V	$\pm(0.1\%$ of reading + 2 digits)

Temperature coefficient: (0 to 15°C and 30 to 55°C) $\pm(0.18\%$ of reading to +0.1 digit)/°C

Input resistance: 10 M Ω $\pm 1\%$

Input type: floating, 500 V maximum, com. to ground

Normal mode rejection: 40 dB at 50 Hz/60 Hz $\pm 0.1\%$

Response time: <0.7 second to within 1 digit of final value on one range. Add 1 second for each range change.

Effective common mode rejection: (1 k Ω unbalance) >120 dB at 50/60 Hz $\pm 0.1\%$

DC Current

Ranges:	Maximum display:
± 200 μ A	± 199.9 μ A
± 2 mA	± 1.999 mA
± 20 mA	± 19.99 mA
± 200 mA	± 199.9 mA
± 2000 mA	± 1999 mA

Maximum input: current: 2 amp (fuse protected), Voltage: 250 V

Ranging: manual only

Sensitivity: 100 nA on 200 μ A range

Polarity: automatically sensed and displayed

Accuracy: 1 year, 15 to 30°C 95% RH

Range	Specifications
200 μ A to 20 mA	$\pm(0.3\%$ of reading + 2 digits)
2000 mA	$\pm(0.6\%$ of reading + 2 digits)

Temperature coefficient: (0 to 15°C and 30 to 55°C) $\pm(0.28\%$ of reading + 0.1 digit)/°C

Voltage burden:

Range	Maximum Burden at Full Scale
200 μ A to 20 mA	<220 mV
200 mA	<240 mV
2000 mA	<400 mV

Response time: 0.7 second on any range to within 1 digit of final value.

AC voltmeter

AC converter: avg. responding rms calibrated.

Ranges:	Maximum display:
200 mV	199.9 mV
2 V	1.999 V
20 V	19.99 V
200 V	199.9 V
1200 V	1199 V

Maximum input: 1700 V (DC + Peak AC), 10⁷ volt-Hz max.
Ranging: automatic or manual
Sensitivity: 100 μV on 200 mV range
Accuracy: (with display of ≥ 20 digits) 1 year, 15 to 30°C @ 95% RH

Range	Specifications
30 Hz - 50 Hz	±(1.5% of reading + 3 digits)
50 Hz - 20 kHz	±(0.3% of reading + 3 digits)
20 kHz - 100 kHz	±(1.5% of reading + 10 digits)

Temperature coefficient: (0 to 15°C and 30 to 55°C) ±(0.04% of reading + 0.2 digit)/°C

Input impedance: resistance: 5 MΩ. Shunt capacitance: <50 pF
Response time: 1.6 seconds to within 3 digits of final value on one range. Add 1.2 seconds for each range change.
Input type: floating, 500 V maximum com. to ground.

AC current	Maximum display:
Ranges: 200 μA	199.9 μA
2 mA	1.999 mA
20 mA	19.99 mA
200 mA	199.9 mA
2000 mA	1999 mA

Maximum input: current: 2 amp (fuse protected). Voltage: 250 V
Ranging: manual only
Sensitivity: 100 nA on 200 μA range
Accuracy: (with display of ≥ 20 digits) — 1 year, 15 to 30°C @ 95% RH.

Current Range	30 Hz		50 Hz		10 kHz
	±(2% of reading + 4 digits)	±(1.2% of reading + 4 digits)	±(1.7% of reading + 4 digits)	±(0.9% of reading + 4 digits)	
2000 mA					
200 mA					
200 μA					

Temperature coefficient: (0 to 15°C and 30 to 55°C) ±(0.05% of reading + 0.2 digit)/°C
Voltage burden:

Range	Maximum Burden at Full Scale
200 μA to 20 mA	<220 mV rms
200 mA range	<240 mV rms
2000 mA range	<400 mV rms

Response time: 1.6 seconds on any range to within 3 digits of final value.
Input type: floating, 500 V maximum com. to ground

Ohmmeter

Ranges:	Maximum display:
20Ω	19.99Ω
200Ω	199.9Ω
2 kΩ	1.999 kΩ
20 kΩ	19.99 kΩ
200 kΩ	199.9 kΩ
2 MΩ	1.999 MΩ
20 MΩ	19.99 MΩ

Input protection: 250 V rms
Ranging: automatic or manual
Sensitivity: 10 milliohm on 20Ω range
Accuracy: 1 year, 15 to 30°C @ 95% RH

Range	Specifications
20Ω	±(0.5% of reading + 10 digits)
200Ω - 2 MΩ	±(0.2% of reading + 2 digits)
20 MΩ	±(0.8% of reading + 2 digits)

Temperature coefficient: (0 to 15°C and 30 to 55°C)

Range	Specifications
20Ω - 2 MΩ	±(0.04% of reading + 0.2 digit)/°C
20 MΩ	±(0.18% of reading + 0.2 digit)/°C

Configuration: 2 wire
Open circuit voltage: <5 V
Current through unknown
 Range: 20Ω 200Ω 2 kΩ 20 kΩ 200 kΩ 2 MΩ 20 MΩ
 Current: 5 mA 50 mA 500 μA 50 μA 5 μA 500 nA 50 nA
Response time: 0.8 second to within 1 digit. Add 0.8 second for each range change.

General
Calibration: data sheet specifications guaranteed for 1 year
Display: 7 segment red 0.3 inch high LED's. Function and range announcement
Reading rate: 2.4 - 4.7/s depending on input level.
A-D conversion: Dual slope
Integration time: 100 ms.
Ranging: automatic or manual on ACV, DCV and ohms. Manual only on AC & DC current.
Storage temperature: AC line power only, -40 to +75°C; with batteries, -40 to +65°C

Operating temperature: (0 to 55)°C
Humidity: 95% RH, +15 to +40°C
Power: AC line: 48-440 Hz; 86-250 V, (see configuration) Battery: rechargeable lead-acid 10 hours minimum continuous operation with full charge. Recharge time: 16 hours operating, 12 hours nonoperating. Batteries and charger available separately; consult operating manual. Total instrument power dissipated: AC only; 3 watts; with charger; 8 watts.
Dimensions:

3435A	3435A Option 002
23.81 cm (9 3/8") wide	20.96 cm (8 1/4") wide
9.84 cm (3 7/8") high	8.57 cm (3 3/8") high
27.62 cm (10 7/8") long	26.67 cm (10 1/2") long

Weights: 3435A 2.41 kg (5 lb 5 oz)
 3435A Opt. 001 1.84 kg (4 lb 1 oz)
 3435A Opt. 002 1.81 kg (4 lb)

Configuration:
 3435A, streamlined portable case with handle, AC line power, Batteries and charger included. \$400
 3435A Opt. 001, streamlined portable case, AC line power only. less \$65
 3435A Opt. 002, Rack and Stack case, AC line power only. (Rack mount kit not included.) less \$35
 All orders must include one of the power options: 86-106 V Opt. 100; 190-233 V Opt. 210; 104-127 V Opt. 115; 208-250 V Opt. 230. N/C

***Accessories:**
 11000A Test leads, dual banana both ends. \$17
 11002A Test leads, dual banana to dual alligator. \$12
 11003A Test leads, dual banana to probe and alligator. \$12
 11096B RF Probe, 10 kHz to 700 MHz. \$87
 34110A Soft vinyl carrying/operating case. \$25
 34111A High-voltage probe 48 kV DC. \$75
 34112A Touch-Hold Probe. \$40
 11067A Test lead kit. \$5
 5061-0054 1/2 Module rack mount kit. \$15

Model number and name	Price
3435A	\$400
3435A Opt. 001	less \$65
3435A Opt. 002	less \$35

* Domestic U.S. prices only.

DIGITAL VOLTMETERS

1 μV Sensitivity, 4½-digit, 5-function multimeter

Models 3465A and B



3465A



3465B

Description

The 3465A and B are 4½ digit multimeters providing five functions of ACV, DCV, ACI, DCI and Ω . They feature both portability and bench applications by offering a choice of line and battery power options. The 3465A is offered in the half-module rack and stack case. The 3465B is offered in the rugged streamlined synthetic case with a carrying handle. Both units accept the 34112A touch-hold probe for "eyes-on" measurements of AC and DC voltage.

Specifications

DC Voltmeter

Voltage ranges: $\pm 20,000$ mV
 ± 200.00 mV
 ± 2.0000 V
 ± 20.000 V
 ± 200.00 V
 ± 1000.0 V

Maximum input: 1000 VDC and peak AC.

Sensitivity: 1 microvolt on lowest range.

Polarity: automatically sensed and displayed.

Accuracy: (1 year + 23°C $\pm 5^\circ\text{C}$)

Range	Specifications
20 mV	$\pm 0.03\%$ of reading ± 2 digits
200 mV thru 200 V	$\pm 0.02\%$ of reading ± 1 digit
1000 V	$\pm 0.025\%$ of reading ± 1 digit

Temperature coefficient: (0°C to 50°C): $\pm 0.003\%$ of reading/ $^\circ\text{C}$.

Input resistance:

Range	Specifications
20 mV thru 2 V	$\geq 10^{10}\Omega$
20 V thru 1000 V	10 M Ω $\pm 1\%$

Normal mode rejection: > 60 dB at 50/60 Hz $\pm 0.1\%$

Effective common mode rejection: (1 k Ω unbalance) AC: > 120 dB at 50/60 Hz $\pm 0.1\%$

DC current

Current ranges: ± 200.00 μA
 ± 2.0000 mA
 ± 20.000 mA
 ± 200.00 mA
 ± 2000.0 mA

Maximum input: 2A from <250 V source (fuse protected).

Sensitivity: 10 nA on lowest range.

Polarity: automatically sensed and displayed.

Accuracy: (1 year + 23°C $\pm 5^\circ\text{C}$)

Range	Specifications
200 μA , 2 mA	$\pm 0.07\%$ of reading ± 1 digit
20 mA	$\pm 0.11\%$ of reading ± 1 digit
200 mA 2000 mA	$\pm 0.6\%$ of reading ± 1 digit

Temperature coefficient: (0°C to 50°C)

Range	Specifications
200 μA	$\pm 0.006\%$ of reading/ $^\circ\text{C}$
2 mA, 20 mA	$\pm 0.004\%$ of reading/ $^\circ\text{C}$
200 mA 2000 mA	$\pm 0.01\%$ of reading/ $^\circ\text{C}$

Voltage burden:

Highest range: < 700 mV FS

All other ranges: < 250 mV FS

Ohmmeter

Ohms ranges: 200.00 Ω

2.0000 k Ω

20.000 k Ω

200.00 k Ω

2000.0 k Ω

20 000 M Ω

Protection: 350 V (DC + peak AC); 250 V rms

Sensitivity: 10 milliohm on lowest range.

Accuracy: (1 year + 23°C $\pm 5^\circ\text{C}$)

Range	Specifications
200 Ω	$\pm 0.02\%$ of reading ± 2 digits
2 k Ω thru 2 M Ω	$\pm 0.02\%$ of reading ± 1 digit
20 M Ω	$\pm 0.1\%$ of reading ± 1 digit

Temperature coefficient: (0°C to 50°C)

Range	Specifications
200 Ω thru 2 M Ω	$\pm 0.0015\%$ of reading/ $^\circ\text{C}$
20 M Ω	$\pm 0.004\%$ of reading/ $^\circ\text{C}$

Configuration: 2 wire

Open circuit voltage: <math> < 5 \text{ V max.}</math>
 Current through unknown:

Range	I
200Ω	1 mA
2 kΩ	1 mA
20 kΩ	10 μA
200 kΩ	10 μA
2000 kΩ	1 μA
20 mΩ	0.1 μA

AC voltmeter

Voltage range: 200.00 mV
 2.0000 V
 20.000 V
 200.00 V
 500 V

Maximum input: full scale to 10 kHz decreasing linearly to 50% of full scale at 20 kHz; except on 500 V range, see overload protection.

Overload protection: 600 V DC max.
 500 V AC rms
 800 V peak

Sensitivity: 10 μV on lowest range.

Accuracy: converter is average responding calibrated to rms (1 year + 23°C ± 5°C)

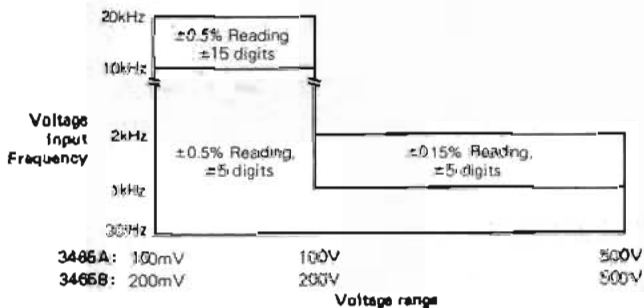

Temperature coefficient: (0°C to 50°C): ±0.005% of reading + 0.2 digit.

Input impedance: resistance: 1 MΩ, <math> < 100 \text{ pF shunt}</math>

AC current

Current range: 200.00 μA
 2.0000 mA
 20.000 mA
 200.00 mA
 2000.0 mA

Maximum input: full scale to 10 kHz decreasing linearly to 50% of full scale at 20 kHz.

Maximum input: 2 A from <math> < 250 \text{ V source}</math> (fuse protected).

Sensitivity: 10 nA on lowest range.

Accuracy: (1 year + 23°C ± 5°C)

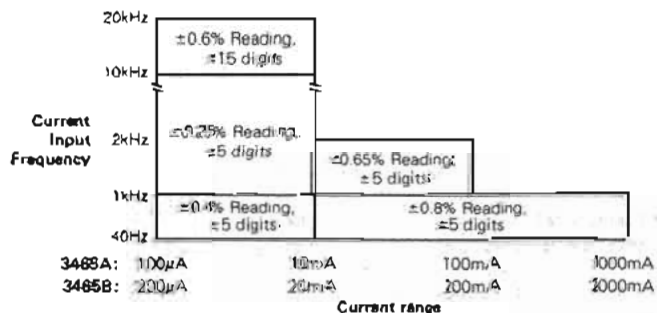

Temperature coefficient: (0°C to 50°C): ±0.01% of reading/°C

Voltage burden:

1A range: <math> < 700 \text{ mV FS}</math>

All other ranges: <math> < 250 \text{ mV FS}</math>

General

Integration time: 100 ms.

Reading rate: 2½ readings per second.

Display: light-emitting diodes.

Overload indication: display blanks.

Humidity range: 95% @ 40°C.

Operating temperature: 0°C to +55°C. (Nickel Cadmium Batteries 0°C to +40°C).

Storage temperature: -40°C to +75°C. (Nickel Cadmium Batteries, -40°C to +40°C).

Dimensions:

3465B: 101.6 mm H × 212.7 mm W × 279.4 mm D (4" × 8½" × 11")

3465B: 97 mm H × 228 mm W × 276 mm D (3.82" × 8.92" × 10.86")

Weights: net, 2 kg (4.5 lbs). Shipping, 4.5 kg (10 lbs).

Power (see Options):

3465A: batteries or AC line; built-in battery charger.

AC line: 86 to 127 V or 176 to 254 V, 48 to 440 Hz.

Batteries: 2 rechargeable Nickel Cadmium battery packs (HP 8200) A's, provide 6 hours continuous use when fully charged. 14 hours to recharge batteries fully (instrument off).

3465B: batteries or AC line; built-in battery charger, batteries when fully charged provide 6 hours continuous operation. 8 hours to recharge batteries fully (instrument off). Must order one power line option.

Options, accessories & parts

3465A:

Opt 001: AC operation only (no battery packs supplied; battery charger built-in)

Opt 002: 4 type D alkaline dry cells, in lieu of 82001A's, provide 60 hours continuous use at 23°C; has receptacle for HP 82002A battery eliminator, 82002A not included

82001A battery pack (uses 2 packs)

82002A Battery eliminator (hand-held calculator charger)

1420-0224 Type D Alkaline cell (equal to U-2); 4 required

Price

3465A:

less \$20

less \$105

\$10 ea.

\$20

\$1 ea.

3465B options (must specify one)

Opt 100: 86 to 106 VAC line; 48 to 440H

N/C

Opt 115: 104 to 127 VAC line; 48 to 440H

N/C

Opt 210: 190 to 230 VAC line; 48 to 440H

N/C

Opt 230: 208 to 250 VAC line; 48 to 440H

N/C

Model number and name

HP 3465A DMM with two 82001A's & charger

Price

\$530

HP 3465B DMM with batteries and charger*

\$500

* Must order one power line option

DIGITAL VOLTMETERS

DVM Interchangeable displays

Model 3470 system



Description

Hewlett-Packard's 3470 is a low cost line of DVM's using a flexible snap-together package. Two display sections provide a choice of four or five digits, both with 100% overranging and LED display. These displays lock onto an ac/dc/Ω multimeter. In addition, a temperature module is available for use with the four-digit display section.

34740A Display

This 4½-digit display locks onto the 34702A voltmeter module to form a complete DVM using a clear, LED display with four full digits plus 100% overranging.

34750 Display

This 5½-digit display offers five-digit resolution with any 34702A voltmeter module. As with the 34740, it uses a LED display with 100% overranging.

34702A Multimeter

This plug-on provides four ranges of both ac and dc plus six ranges of ohms. AC function covers 45 Hz to 100 kHz. Ohms ranges are 100Ω to 10 MΩ full scale.

2802A Thermometer

This unit includes a thermomodule (lower unit) which contains temperature measuring circuits, probe connections and operating controls; HP's 34740A 4½-digit display is included. Option 001 deletes the display for those that want to use their own 4½-digit display.

34702A Specifications

DC voltage

Range: ±1 V to ±1000 V full scale in four decade ranges.

Display: 4-digit (34740A) or 5-digit (34750A).

Full range display:

Range	4-digit display	5-digit display
±1 V	±1.0000 V	±1.00000 V
±10 V	±10.000 V	±10.0000 V
±100 V	±100.00 V	±100.000 V
±1000 V	±1000.0 V	±1000.00 V

Overrange: 100% except 20% on 1000 V range.

Range selection: manual pushbuttons.

Accuracy (30 days, +23°C ± 5°C, ≤96% R.H.)

4-digit display: ± (0.03% rdg + 0.01% rng).

5-digit display: ± (0.02% rdg + 0.005% rng).

Temperature coefficient (0°C to +50°C)

4-digit display: ± (0.0035% rdg + 0.001% rng)/°C.

5-digit display: ± (0.0025% rdg + 0.0002% rng)/°C.

Stability (24 hours, +23°C ± 1°C)

4-digit display: ± 0.01% rdg + 0.005% rng).

5-digit display: ± (0.008 rdg + 0.004% rng).

Reading rate:

Display option	4-digit display	5-digit display
Opt 060 (60 Hz rejection)	5/s	5/s
Opt 050 (50 Hz rejection)	8/s	4/s

Input terminals: floating pair.

Input resistance: 11.11 MΩ ± 0.2% on 1 V and 10 V ranges; 10.1 MΩ ± 0.2% on 100 V range; 10 MΩ ± 0.2% on 1 kV range.

Effective CMR: 1 kΩ unbalance; >80 dB at dc.

Normal mode rejection: >60 dB at 50 Hz ± 0.1% (Opt 050) or at 60 Hz ± 0.1% (Opt 060).

Maximum input voltage: ±1200 V, high to low; ±500 V low to chassis.

AC Voltage

Voltage range: 1 V ac to 1000 V ac full scale in four decade ranges.
Full range display:

Range	4-digit display	5-digit display
1 V	1.0000 V	1.00000 V
10 V	10.000 V	10.0000 V
100 V	100.00 V	100.000 V
1000 V	1000.0 V	1000.00 V

1. Because the internal temperature differs on line and battery operation, references must be adjusted to retain this specification when type of power source is changed.

Detector: average-responding.

Scale: rms for a sine wave.

Frequency range: 45 Hz to 100 kHz.

Accuracy (30 days, 23°C ±5°C, ≤95% RH):

Display	45 Hz to 20 kHz	20 kHz to 100 kHz
4-digit	±(0.25% rdg + 0.05% rng)	±(0.75% rdg + 0.05% rng)
5-digit	±(0.25% rdg + 0.05% rng)	±(0.75% rdg + 0.05% rng)

Temperature coefficient (0°C to +50°C): ±(0.03% rdg + 0.001% rng)/°C.

Stability (24 hours, +23°C ±1°C):

45 Hz to 20 kHz: ±(0.15% rdg + 0.05% rng).

20 kHz to 100 kHz: ±(0.4% rdg + 0.05% rng).

Response time: <2 s to within +0.3% of final value or 20 counts, whichever is greater.

Input impedance: 11.11 MΩ ±0.2%, 80 pF shunt on 1 V and 10 V ranges; 10.1 MΩ ±0.2%, 80 pF shunt on 100 V range; 10 MΩ ±0.2%, 80 pF shunt on 1000 V range.

Input terminals: floating pair.

Maximum input voltage: 1200 V rms high to low, except 2.5 × 10⁶ V Hz limit on 1 V range with minimum protection of 300 V rms and maximum of 1200 V p; ±500 V p, dc to 440 Hz low to chassis.

Resistance

Range: 100Ω to 10 MΩ full scale in 6 decade ranges.

Full range display:

Range	4-digit display	5-digit display
100Ω	100.00Ω	100.000Ω
1 kΩ	1.000 kΩ	1.0000 kΩ
10 kΩ	10.000 kΩ	10.0000 kΩ
100 kΩ	100.00 kΩ	100.000 kΩ
1 MΩ	1.0000 MΩ	1.00000 MΩ
10 MΩ	10.000 MΩ	10.0000 MΩ

Overrange: 100% on all ranges.

Accuracy (30 days, +23°C ±5°C, ≤95% RH):

Range	4-digit display	5-digit display
10 MΩ	±(0.25% rdg + 0.02% rng)	±(0.25% rdg + 0.015% rng)
Others	±(0.05% rdg + 0.02% rng)	±(0.045% rdg + 0.015% rng)

Temperature coefficient (0° to +50°C):

10 MΩ range: ±(0.035% rdg + 0.001% rng)/°C.

Other ranges: ±(0.006% rdg + 0.001% rng)/°C.

Stability (24 hours, +23°C):

10 MΩ range: ±(0.1% rdg + 0.01% rng).

Other ranges: ±(0.02% rdg + 0.02% rng).

Input terminals: floating pair (different from voltage input terminals).

Current through unknown: 10 mA on 100Ω range decreasing one decade per successively higher range.

Overload protection: ±350 V p (248 V sine wave).

2802A Specifications

2802A Digital Thermometer is complete with 4½-digit HP 34740A display, less probes. Option 050 for 50 Hz or Option 060 for 60 Hz operation must be specified.

These specifications are "total system specifications" meaning they apply to both the instrument and the probe working together (not just the best electronic specifications for the instrument by itself). HP 2802A Thermometer specifications relate directly to system performance under actual working conditions.

Ranges: -200° to +600°C and -100° to +200°C.

Resolution: 0.1°C on -200°C to +600°C range, 0.01°C on -100° to +200°C range.

Accuracy: ±(0.5°C ±0.25% of reading) on both ranges.

Display: 4½ digits LED on HP 34740A module.

Stability: ±0.2°C for seven days (23°C ±5°C ambient).

Linear analog output: 1 mV/°C on -200° to +600°C range (-0.2 V to +0.6 V FS), 10 mV/°C on -100 to +200°C range (-1.0 V to +2.0 V FS). Voltage accuracy equal to that of digital display. Output impedance 1 kΩ on both ranges.

Environmental standard: HP 2802A Thermometer operates within these specifications in environments of 0° to 50°C and up to 95% relative humidity over most of this temperature range. After calibration in some arbitrary ambient temperature, instrument calibration remains valid with ambient temperature changes up to 10°C.

For the following probes, time constant is determined using water flowing at 1 m per second.

18641A Probe contains the sensor in the tip of a 13 cm (5 in.) stainless steel sheath, 6.4 mm (¼ in.) diameter, with armored cable 1.8 m (6 ft.) long. It operates from -200 to +500°C, to +600°C short term. Cable movement must be prevented above 250°C. Time constant is five seconds.

18642A Probe is the same as the 18641A except that it has a Teflon-insulated cable 1.8 m long. This cable must be kept below 250°C.

18643A Probe contains the sensor in the tip of a 13 cm stainless steel sheath. For fast response, the last 5.1 cm (2 in.) of the sheath tip is reduced to 0.32 cm (0.13 in.) diameter. This probe operates from -200° to +500°C, to +600°C short term. It has a 1.8 m Teflon-insulated cable. This cable must be kept below 250°C. Time constant is 1.8 seconds.

18644A Probe Kit includes platinum sensor cartridge, 1.3 cm × 0.25 cm diameter, having two nickel leads, 1 cm × 0.03 cm diameter, cable connector, wiring diagram for four-wire hook-up. Time constant 0.5 sec.

For all models

Operating temperature: 0°C to 50°C.

Storage temperature: -40°C to 74°C.

Power: ≤8.7 VA at 100 V, 120 V, 220 V, +5%, -10% switchable; 48 Hz to 440 Hz.

Weight	Net	Shipping
34740A 4-digit display or 34750A 5-digit display	1.36 kg (3 lb)	1.92 kg (4 lb 4 oz)
2802A Thermomodule + display	2.27 kg (5 lb)	3.39 kg (7 lb 8 oz)

Dimensions

Display + meter: 247.7 mm deep × 158.8 mm wide × 98.4 mm high (9¾" × 6¼" × 3¾").

Accessories available: 11098A High Frequency Probe, measures to 700 MHz. Accepts 0.25 V to 30 V signals with input impedance of 4 MΩ shunted by 2 pF; 11456A Read Out Test Card for testing and troubleshooting either display. 18641A Probe; 18642A Probe; 18643A Probe; 18644A Probe Kit.

Options and accessories

	Price
2802A Opt. 001 bottom module only (less display)	less \$420
Opt. 050, 50 Hz rejection	N/C
Opt. 060, 60 Hz rejection	N/C
11096B High Frequency Probe	\$87
11456A Read Out Test Card	\$64
56A-16C Cable for operating 5055A Digital Recorder	\$60
18641A Temperature Probe	\$165
18642A Temperature Probe	\$150
18643A Temperature Probe	\$180
18644A Temperature Probe Kit	\$105

Model number and name

2802A Digital Thermometer (includes 4½-digit display)	\$795
34702A Multimeter	\$325
34740A 4-digit display	\$450
34750A 5-digit display	\$720

DIGITAL VOLTMETERS

True RMS voltmeter

Model 3403C

- DC and 2 Hz To 100 MHz
- 3½ digit



Description

The Model 3403C is usable from dc to 100 MHz. True rms is especially valuable for measurements of noise, multiplexed signals, modulated waves and signals with high harmonic content.

dB display

The dB display option provides readings directly in dB, a major convenience to ac users. The dB reference to which the measurement is made is conveniently adjustable from the front panel to provide referenced dB measurements, or to provide a convenient means to offset the reading by as much as 13 dB for unreferenced measurements.

Specifications

Ranges

Full range display: 10.00 mV (ac only); 100.0 mV; 1.000 V; 10.00 V; 100.0 V; 1000 V.

Overrange: >90% on all ranges except as limited by max input voltage.

Ranging information: front panel annunciators indicate overrange (approximately 190% of full range), or underrange (approximately 17% of full range) conditions.

Performance

AC frequency range

Slow response: 2 Hz to 100 MHz.

Fast response: 25 Hz to 100 MHz.

Response time

Fast response: 1 s.

Slow response: 10 s.

Instrument reads final reading $\pm 0.1\%$ of input change in stated response time.

Display rate

Fast response: 4 readings per s.

Slow response: 2 readings per s.

READING ACCURACY = $\pm\%$ OF RANGE $\pm \pm\%$ OF READING **

RANGE	VOLTS			FREQUENCY (Hz)						
	DC	DC-AC	AC	DC	2	25	100K	1M	10M	100M
1000V	.3	.3	.3	.2	.4	.2				
100V	.2	.2	.2	.2	.4	.2	1			
10V	.2	.2	.2	.2	.4	.2	.5	1		
1V	.2	.2	.2	.2	.4	.2	.5	1	2.5	10
100mV	.6	.6	.2	.2	.4	.2	.5	2	2.5	10
10mV			.2			.3	1.2	3		

CAUTION: frequencies and ranges in this area may result in invalid readings without ranging indication.

* DC + AC function and slow response time only

** % of reading specification is representative of typical flatness.

Functions

DC: responds to dc component of input signal.
AC: responds to true rms value of ac coupled input signal.
AC + DC: responds to true rms value of dc and ac input signal; reading is $\sqrt{(dc)^2 + (ac\ rms)^2}$.
Temperature coefficient: $\pm 0.1 \times$ reading accuracy*/°C outside the 25°C $\pm 5^\circ$ C temperature range.
Accuracy: 90 days (25°C + 5°C, <95% RH, 17% of range to 190% of range).

Input characteristics

Input impedance: <10 MHz.
1 V to 1000 V range: 10 M Ω $\pm 10\%$ shunted by 19 pF $\pm 10\%$.
10 mV and 100 mV range: 20 M Ω $\pm 10\%$ shunted by 16 pF $\pm 10\%$.
10 MHz to 100 MHz: the following table gives maximum loading due to input shunt impedance across a terminated source.

System impedance (source and load)	Frequency	
	10 MHz	100 MHz
50 Ω	1%	10%
75 Ω	2%	20%

Crest factor:

2 Hz to 25 Hz	2:1 at full range input.
>25 Hz	10:1 at full range input.

Maximum input voltage

High to low: 1000 V rms, 1500 peak or 10³ V-Hz on any range. Maximum dc voltage in ac mode: 500 V dc.
Low to chassis: ± 500 V dc, when floated with special banana to BNC adapter.

Options

Autoranging (3403C option 001)
Automatic ranging: uprange at approximately 190% of full range; downranges at approximately 17% of full range.
Autorange time: fast response: 1 s per range change. Slow response: 10 s per range change.
Remote control + digital output + autoranging (3403C option 003)
 Provides remote control of all front panel functions, ranges, digital output and autoranging.
dB display (3403C option 006)
Measurement range: 108 dB (-48 dBV to +60 dBV).
Calibrated dB reference: 0 dB = 1.000 V; reference level may be set for 0 dBm (600 Ω) by adjusting front panel dB calibration adjustment.
Variable dB reference: reference level may be shifted downward from calibrated position >13 dB.
 *data from accuracy charts.

dB recorder output: output voltage: 200 mV for 20 dB. Output resistance: 1 k Ω $\pm 500 \Omega$.
Accuracy: 90 days (25°C + 5°C, <95% RH).

READING = (\pm dB) + (\pm dB)**

RANGE	dB		FREQUENCY (Hz)										
	AC	DC + AC	DC	25	100K	1M	10M	100M					
1000V	.15	.15	.02	.04*	.02	[Cross-hatched area]							
100V	.15	.15	.02	.04*	.02					.1			
10V	.15	.15	.02	.04*	.02					.05	.1		
1V	.15	.15	.02	.04*	.02					.05	.1	.25	.1
100mV	.15	.15	.02	.04*	.02					.05	.2	.25	.1
10mV	.15				.03					.12	.3		

 CAUTION: frequencies and ranges in this area may result in invalid readings without ranging indication.

- * DC + AC function and slow response time only
- ** specification is representative of typical flatness.

General

Operating conditions

Temperature range: 0°C to 50°C.
Humidity: <95% RH.

Recorder output

Output voltage: 1 V dc open circuit for full range input.
Output resistance: 1 k Ω $\pm 10\%$.
Power: 115 V or 230 V $\pm 10\%$, 48 Hz to 440 Hz, 35 VA max. (including all options).

Input terminals: BNC front panel connector standard for low to high terminals; rear panel connector available by internally reversing position of ac converter module.

Weight: including all options: Net, 5 kg (11 lb). Shipping, including all options: Net, 7.2 kg (16 lb).

Dimensions: 234.9 mm wide \times 127 mm high \times 196.8 mm deep (9 1/4" \times 5" \times 7 1/4").

Accessories furnished: floating adapter-banana to BNC.

Model number and name

Option 001 autoranging	Price add \$156
*Option 003 remote control + digital output + autoranging	add \$355
*Option 006 dB display	add \$315
3403C True RMS voltmeter	\$2375

*Options 003 and 006 are available only as factory installed options.

DIGITAL VOLTMETERS

High speed 3½ digit system voltmeter

Model 3437A



Description

The Hewlett-Packard 3437A System Voltmeter has been designed to be used in systems. It is a 3½ digit high speed dc voltmeter with sample and hold. The standard unit measures DC volts, provides trigger delay, burst reading capability and Hewlett-Packard Interface Bus (HP-IB).

There are three DC floating input ranges: 0.1 V, 1.0 V and 10.0 V full scale with a maximum display of "1999". Sample and Hold allows the 3437A to be an instantaneous reading voltmeter. The trigger delay can be set from 0.1 μS to 1.0 second and the number of readings can be set from 0 to 9999 readings.

Typical operation

Example: set Delay to 1 mS and Number of Readings is set to 1000. The 3437A will now take 1000 readings spaced 1 mS apart upon receiving one trigger.

Data output

All front panel switches are programmable from the HP-IB. Two data output formats are available: (1) ASCII output (Serial ASCII characters) and (2) Packed output (two 8-bit bytes on the HP-IB to send the complete reading).

High speed

The Packed output mode allows more data to be stored in the calculator or computer as well as increasing the maximum reading rate from 3000 readings/second to greater than 5000 readings/second.

Systems capability

The user may select the mode for which the voltmeter requests service from the controller (calculator or computer). Request Service can be programmed manually or automatically to request service for: (1) Data Ready, (2) Trigger Ignore, or (3) Invalid Program. Any combination of these three can be selected.

Applications

Waveform analysis—The 3437A can be used to analyze a wide variety of waveforms. The delay and burst reading capability allows frequency, positive or negative peak values, RMS value and harmonic distortion to be measured. The accuracy of these measurements is comparable to more traditional measurement techniques.

Transient signals analysis—The 3437A is capable of measuring transient signals because of the wide bandwidth input (> 1 MHz), high measuring speed and sample-and-hold.

Fast AC measurements—Sinusoidal signals of known frequency can be measured in less than one cycle of the signal. Very low frequency measurements can be made more quickly than with conventional techniques.

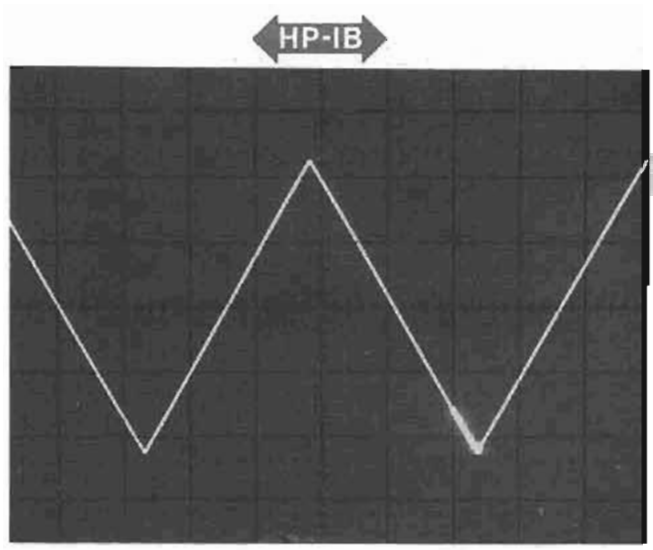

Figure 1 shows a signal to be measured by both an oscilloscope and the 3437A. The oscilloscope delayed sweep is used to intensify the point of interest. The delayed gate output is used to trigger the 3437A at the same point in time as indicated on the oscilloscope display. The voltage at the point of interest is now known to the accuracy of the 3437A.

High speed scanning—Multiple input measurement applications can be satisfied with the 3437A and the HP 3495A Scanner. Reading rates of greater than 100 channels/second can be attained.

Bench measurements—In addition to systems applications, the 3437A can be used to improve oscilloscope amplitude and measurement accuracy.

Data-sheeted systems

The 3437A is part of the 3052A Data Acquisition System. (Refer to Page 71. The 3052A includes the 3437A, 3455 5½/6½ digit DVM, 3495A Scanner and 9825A Calculator. The combination of the 3437A and 3455A voltmeters provides systems versatility such as high speed, system timing and high sensitivity measurements. The delay generator in the 3437A is used to provide timing triggers for the 3455A DVM. The 3455A provides 1 µV sensitivity and high speed DC measurements with greater than 60 dB normal mode noise rejection.

Specifications

DC Volts

Ranges	Max. Display	Overload Reading
10 V	±19.98	±99.99
1 V	±1.998	±9.999
0.1 V	±.1998	±.9999

Ranging: Manual or Remote

Performance

- Static accuracy (90 days, 23°C ± 5°C):**
 - 10 V Range: ±0.05% of reading ±1.6 digits
 - 1 V Range: ±0.03% of reading ±1.6 digits
 - 0.1 V Range: ±0.06% of reading ±1.8 digits
- Static accuracy (1 year, 23°C ± 5°C):**
 - 10 V Range: ±0.05% of reading ±2 digits
 - 1 V Range: ±0.03% of reading ±2 digits
 - 0.1 V Range: ±0.06% of reading ±2.2 digits

Static accuracy temperature coefficient (0°C–50°C): ±0.002% reading/°C ±0.05 digits/°C

Input characteristics

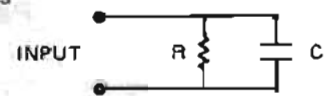

- 10 V Range: R = 1 MΩ ±20%; C <75 pF
- 1 V Range: R >10⁸Ω; C <75 pF
- 0.1 V Range: R >10⁸Ω; C <75 pF

Maximum input voltage high to low on all ranges: <±30 V Peak

Maximum voltage low to chassis: ±42 V Peak

Number of Readings (N Readings)*

N Readings: 0** to 9,999

* Readings are not internally stored.
** For N = 0 the 3437 operates in delay mode only

Maximum reading rate (Remote, N Rdgs. > 1, and a zero delay listener*)

- ASCII: 3600 Readings/s
- Packed: 5700 Readings/s

* Actual Reading Rate is given by

$$\text{ASCII: } \frac{3600 (\text{listen rate}^{\dagger})}{3600 + \text{listen rate}^{\dagger}}$$

$$\text{PACKED: } \frac{5700 (\text{listen rate}^{\dagger})}{5700 + \text{listen rate}^{\dagger}}$$

† Listen rate is maximum speed that listener can accept data bytes

Delay

N Rdgs. = 0 or 1:

DELAY (setting): 0 to 0.999 999 9 s in 0.1 µs steps

N Rdgs. > 1 (Remote and a zero delay listener*)

- ASCII: 0.0002778 s ≤ DELAY ≤ 0.9999999 s
- PACKED: 0.0001754 s ≤ DELAY ≤ 0.9999999 s

* Minimum delay is a function of listener delay related by

- ASCII: 277.8 µs + listener delay
- PACKED: 175.4 µs + listener delay

Accuracy (EXT. TRIG to DELAY OUT, 0°C to 50°C)

- Delay offset:** 100 ns ± 25 ns
- Delay accuracy:** ±0.008% DELAY + Delay offset
- Delay repeatability (Jitter):** for N Rdgs = 0 or 1:
 - DELAY of 0 or 0.1 µs: ±2 ns
 - DELAY of 0.2 µs to 50 ms: ±10 ns + 0.0002% DELAY setting
 - DELAY of >50 ms: ±110 ns

Input bandwidth (3 dB)

- 10 V Range: 1.0 MHz
- 1 V Range: 1.1 MHz
- 0.1 V Range: 40 kHz

Setting time

- 10 V Range:** A 10 V step to within 20 mV of final value t = 7.5 µs; a 10 V step to within 200 mV of final value t = 700 ns
- 1 V Range:** A 1 V step to within 2 mV of final value t = 1.5 µs; a 1 V step to within 20 mV of final value in 700 ns
- 0.1 V Range:** A 0.1 V step to within 200 µV of final value t = 25 µs; a 0.1 V step to within 2 mV of final value in 700 ns

General

- Operating temperature:** 0 to 55°C
- Storage temperature:** -40°C to 75°C
- Humidity range:** >95% R.H., 0°C to 40°C
- Power:** 100 V, 120 V, 220V, 240 V ±5%, -10%, 48 Hz to 400 Hz line operation. <60 VA with all options
- Dimensions:** 212.7 mm wide × 88.9 mm high × 527.3 mm deep (8 3/4" × 3 1/2" × 20 3/4")
- Weight:** net, 5.6 kg (12 lb 4 oz); Shipping, 7.6 kg (16 lb 12 oz)

3437A System Voltmeter

\$1900

DIGITAL VOLTMETERS

5½/6½-digit DVM with Auto Cal

Model 3455A

- AutoCal
- Self test
- Bench/system

- AD/DC/OHMS
- High speed
- Removable reference

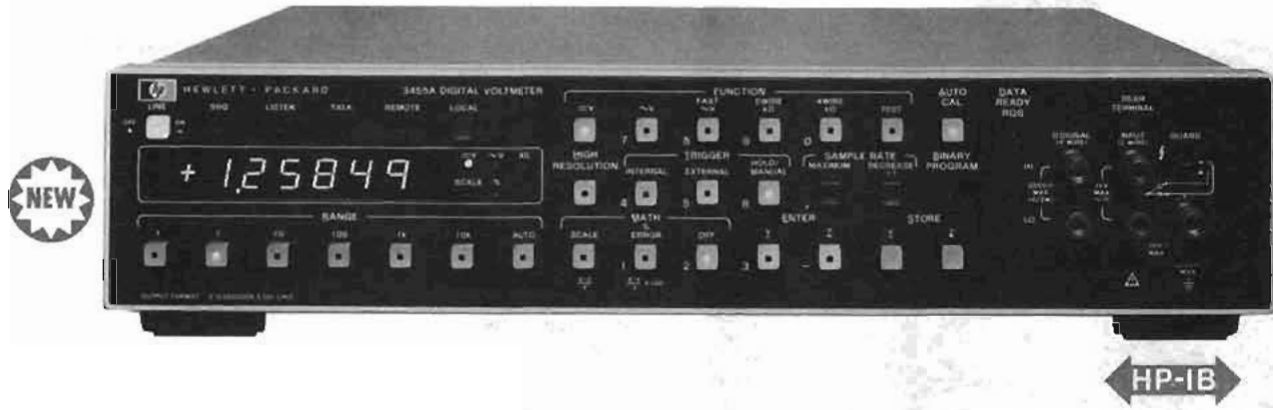

Description

Hewlett-Packard's 3455A Digital Voltmeter is a microprocessor controlled 5½- or 6½-digit integrating voltmeter for bench or systems applications. The standard instrument measures DC volts, AC volts, and resistance. HP-IB I/O for systems applications is also standard.

Measuring speed

The 3455A is fully guarded and has greater than 60 db normal mode noise rejection at reading rates of up to 24 readings per second on all DC ranges. Ohms reading rates are up to 12 readings/second and an AC fast mode gives reading rates of up to 13 readings/second at frequencies above 300 Hz.

Performance

DC measurements can be made with up to 1 μ V sensitivity. Ohms measurements are made with either a 2-wire or 4-wire mode. The High Resolution (6½-digit) mode gives DC and Ohms measurements with greater than 1 part per million resolution. AC voltage measurements can be made from 30 Hz to 250 kHz with the optional average responding converter.

True rms

The standard true rms converter gives AC measurements from 30 Hz to 1 MHz. Complex signals with crest factors of up to 7:1 at full scale can be measured.

Math

The math functions provide the user with unique computational capability. The Scale mode ($\frac{\Delta}{\nabla}$) allows the user to offset, take ratios, or scale readings to give readouts in physical units. The % Error mode ($\frac{\Delta}{\nabla} \times 100$) converts readings into percentage change from Y which is entered as a reference. For the math functions X is the present reading, Y and Z are previously entered readings or numbers entered from the front panel or by remote program.

Auto Cal

The auto cal feature gives the user high accuracy DC volts and ohms measurements and simplifies calibration of these functions. The DC and ohms operating circuits are checked against internal references and any errors are corrected digitally. All dc and ohms adjustments are in a removable reference assembly.

Serviceability

The self-test feature is used to aid in troubleshooting as well as verifying operation of the 3455A. Test verifies proper operation of the DC measuring circuits by comparing their parameters against predetermined limits. If a problem is found, the display is used to assist in finding the problem area by indicating which parameter is in error. Detailed troubleshooting can then be used to quickly isolate the problem.

Routine maintenance and calibration has been simplified with the removable reference assembly. Calibration of DC and ohms functions can be done by replacing the reference assembly with a recently calibrated one. Extra reference assemblies are available as HP accessory number 11177A. A spare assembly is ideal for one or more 3455A's. Calibrate DC and ohms in a 3455A without removing it from the bench or system. Just return the extra reference assembly to the cal lab or HP for calibration and have it back in time to calibrate the 3455 next time.

Data-sheeted systems

The 3455A is included as part of two data-sheeted systems. The 3051A and 3052A are fully integrated, tested, verified and specified as systems and come with complete systems software and documentation. These systems provide complete solutions to many of your measurement problems.

3051A Programmable Data Logger

The 3051A Programmable Data Logger has been specifically designed to solve your dedicated, long term data logging problems.

The 3051A consists of:

- 3455A DVM
- 3495A Scanner
- 9815A Calculator
- Special Data Logger ROM

Your data logging problems can be simplified with such features as:

- Thermocouple linearization
- Cold junction reference
- Data analysis and processing
- Decision making and control capabilities
- Data formatting and storage
- Power fail-restart

Typical application areas are:

- Plant monitoring
- Process monitoring
- Parameter testing

3052A Automatic data acquisition system

The 3052A Automatic Data Acquisition System has been designed to solve your data acquisition, control and automatic testing problems.

The 3052A consists of:

- 3455A DVM
- 3437A System Voltmeter
- 3495A Scanner
- 9815A Calculator & ROMs

These 3052A features give you a wide range of problem solutions:

- Signal digitizing (>5000 readings/second)
- High speed scanning (>100 channels/second)
- System timing
- Vectored interrupt system for simultaneous control and processing of multiple tasks
- High speed data access and storage
- Alphanumeric display for easy interaction with the operator

Typical application areas are:

- R & D
- Production testing & QA

For further information on either of these two systems refer to pages 70 and 71 or contact your local HP field engineer.

HP Technology

HP has developed an instrument oriented microprocessor to provide the high performance of the 3455A. The microprocessor has a parallel architecture to give the high speed necessary to control the measurement processes of a bench/systems voltmeter. Two microprocessors are used: one for control of the measurement and the second for interface to the HI-IB and computation of the math functions.

Auto cal is a process by which the 3455A internally checks its DC and ohms operating circuits against internal references and corrects for errors. The benefits of auto cal are high accuracy and simplified calibration. Only four adjustments for calibration of DC and ohms are required and these are in the removable reference assembly. The microprocessor is also used to control the auto cal process and compute the correction factors.

The HP-developed fineline tantalum nitride resistor technology used in several HP digital voltmeters is also used in the 3455A. This technology provides accurate temperature tracking resistors that result in excellent long term DC accuracy.

Specifications

DC Voltage

Ranges		Maximum Display	
High Resolution Off	High Resolution On	High Resolution Off	High Resolution On
0.1	—	±0.149999 V	—
1	1	±1.49999 V	±1.499999 V
10	10	±14.9999 V	±14.99999 V
100	100	±149.999 V	±149.9999 V
1000	1000	±1000.00 V	±1000.000 V

Range selection: Manual, Automatic or Remote

Performance

High Resolution Off

Accuracy:

24 hours: 23°C ±1°C

- 10 V range: ±(0.002% of reading + 1 digit)
- 1 V range: ±(0.003% of reading + 1 digit)
- 0.1 V range: ±(0.004% of reading + 4 digits)
- 100 & 1000 V range: ±(0.004% of reading + 1 digit)

90 days: 23°C ±5°C

- 10 V range: ±(0.005% of reading + 1 digit)
- 1 V range: ±(0.006% of reading + 1 digit)
- 0.1 V range: ±(0.007% of reading + 4 digits)
- 100 & 1000 V range: ±(0.007% of reading + 1 digit)

6 months: 23°C ±5°C

- 10 V range: ±(0.008% of reading + 1 digit)
- 1 V range: ±(0.009% of reading + 1 digit)
- 0.1 V range: ±(0.010% of reading + 5 digits)
- 100 & 1000 V range: ±(0.010% of reading + 1 digit)

1 year: 23°C ±5°C

- 10 V range: ±(0.013% of reading + 1 digit)
- 1 V range: ±(0.014% of reading + 1 digit)
- 0.1 V range: ±(0.015% of reading + 6 digits)
- 100 & 1000 V range: ±(0.015% of reading + 1 digit)

High Resolution On

24 hours: 23°C ±1°C

- 10 V range: ±(0.002% of reading + 3 digits)
- 100 & 1000 V range: ±(0.004% of reading + 3 digits)
- 1 V range: ±(0.003% of reading + 4 digits)

90 days: 23°C ±5°C

- 10 V range: ±(0.005% of reading + 3 digits)
- 100 & 1000 V range: ±(0.007% of reading + 3 digits)
- 1 V range: ±(0.006% of reading + 4 digits)

6 months: 23°C ±5°C

- 10 V range: ±(0.008% of reading + 3 digits)
- 100 & 1000 V range: ±(0.010% of reading + 3 digits)
- 1 V range: ±(0.009% of reading + 5 digits)

1 year: 23°C ±5°C

- 10 V range: ±(0.013% of reading + 3 digits)
- 100 & 1000 V range: ±0.015% of reading + 3 digits)
- 1 V range: ±(0.014% of reading + 6 digits)

Input characteristics

Input resistance: 0.1 V through 10 V range: >10¹⁰ ohms. 100 V and 1000 V range: 10 megohm ±0.1%

Maximum input voltage

- High to low input terminals: ±1000 V peak
- Guard to chassis: ±500 V peak
- Guard to low terminal: ±200 V peak

Normal mode rejection (NMR): NMR is the ratio of the peak normal-mode voltage to the peak error voltage in the reading.

NMR at 50 or 60 Hz ±0.1%: >60 dB

Effective common mode rejection (ECMR): ECMR is the ratio of the peak common-mode voltage to the resultant peak error voltage in the reading.

ECMR with 1 kΩ unbalance in low lead at

- DC: >140 db
- 50 Hz or 60 Hz ±0.1%: >160 db

Maximum reading rate:

	60 Hz Gate Length		50 Hz Gate Length	
	High Resolution Off	High Resolution On	High Resolution Off	High Resolution On
Local	5 rdg/s	3 rdg/s	3.5 rdg/s	2.5 rdg/s
Remote	24 rdg/s	6 rdg/s	22 rdg/s	5 rdg/s



DIGITAL VOLTMETERS

5 1/2/6 1/2-digit DVM with Auto Cal

Model 3455A (cont.)

AC Voltage (rms converter) (High Resolution On or Off)

Ranges: 1.00000 V	Maximum Display: 1.49999 V
10.0000 V	14.9999 V
100.000 V	149.999 V
1000.00 V	1000.00 V

Range selection: Manual, Automatic or Remote
Function selection: ACV or Fast ACV

Input characteristics Input impedance

Front terminals: 2 M Ω \pm 1% shunted by less than 90 pF.
Rear terminals: 2 M Ω \pm 1% shunted by less than 65 pF.

Maximum input voltage

High to low terminals: \pm 1414 volts peak***
Guard to chassis: \pm 500 V peak
Guard to low terminal: \pm 200 V peak

*** Subject to a 10⁴ volts-Hz limitation.

Maximum reading rate:

	60 Hz Gate Length		50 Hz Gate Length	
	ACV	FAST ACV	ACV	FAST ACV
Local	1.3 rdg/s	4.5 rdg/s	1.1 rdg/s	3.5 rdg/s
Remote	1.3 rdg/s	13 rdg/s	1.1 rdg/s	12 rdg/s

Response time

ACV and FAST ACV

First reading to <0.1% of step size when triggered coincident with step change when on correct range (for AC signals with no DC component).

AC voltage (average converter) Opt. 001 (High Resolution On or Off)

Ranges: 1 V	Maximum Display: 1.49999 V
10 V	14.9999 V
100 V	149.999 V
1000 V	1000.00 V

Range selection: Manual, Automatic or Remote
Function selection: ACV or Fast ACV

Performance (rms converter)

Accuracy: \pm (% of reading + digits)*

	FAST ACV	AC coupling: 300 Hz–20 kHz	20 kHz–100 kHz	100 kHz–250 kHz**	250 kHz–500 kHz**	500 kHz–1 MHz**
	ACV	30 Hz–20 kHz				
24 hrs: 23°C \pm 1°C	0.04% + 40 digits	0.4% + 80 digits	1.8% + 200 digits	4% + 400 digits	5% + 1500 digits	
90 days: 23°C \pm 5°C	0.05% + 50 digits	0.5% + 100 digits	2.0% + 250 digits	5% + 500 digits	6% + 2000 digits	
6 mos: 23°C \pm 5°C	0.06% + 60 digits	0.6% + 130 digits	2.1% + 300 digits	5.1% + 600 digits	6.3% + 2400 digits	
1 year: 23°C \pm 5°C	0.07% + 70 digits	0.7% + 160 digits	2.2% + 350 digits	5.3% + 700 digits	6.6% + 2800 digits	

* Guard must be connected to Low. On the 1000 V range, add 0.01 ppm/volt-kHz.

** Frequencies greater than 100 kHz specified on 1 and 30 V ranges only.

Input characteristics

Input impedance: Front Terminals — 2 M Ω \pm 1% shunted by less than 90 pF. Rear Terminals — 2 M Ω \pm 1% shunted by less than 65 pF.

Maximum input voltage

High to low terminals: \pm 1414 volts peak***
Guard to chassis: \pm 500 V peak
Guard to low terminal: \pm 200 V peak

*** Subject to a 10⁴ volts-Hz limitation.

Maximum reading rate:

	60 Hz Gate Length		50 Hz Gate Length	
	ACV	FAST ACV	ACV	FAST ACV
Local	1.3 rdg/s	4.5 rdg/s	1.1 rdg/s	3.5 rdg/s
Remote	1.3 rdg/s	13 rdg/s	1.1 rdg/s	12 rdg/s

Ohms:

	Ranges		Maximum Display	
	High Resolution Off	High Resolution On	High Resolution Off	High Resolution On
0.100000 k Ω	—	0.149999 k Ω	—	
1.000000 k Ω	1.000000 k Ω	1.499999 k Ω	1.499999 k Ω	
10.000000 k Ω	10.000000 k Ω	14.999999 k Ω	14.999999 k Ω	
100.000000 k Ω	100.000000 k Ω	149.999999 k Ω	149.999999 k Ω	
1000.000000 k Ω	1000.000000 k Ω	1499.999999 k Ω	1499.999999 k Ω	
10000.000000 k Ω	10000.000000 k Ω	14999.999999 k Ω	14999.999999 k Ω	

Range selection: Manual, Automatic, or Remote
Function selection: 2-wire k Ω or 4-wire k Ω

Performance

High Resolution Off

Accuracy: 4-wire k Ω

24 hours: 23°C \pm 1°C

0.1 k Ω range: \pm (0.003% of reading + 4 digits)

1 k Ω range: \pm (0.003% of reading + 1 digit)

10 k Ω range: \pm (0.005% of reading + 2 digits)

100 k Ω range: \pm (0.002% of reading + 2 digits)

1000 k Ω range: \pm (0.012% of reading + 5 digits)

10,000 k Ω range: \pm (0.1% of reading + 5 digits)

90 days: 23°C \pm 1°C

0.1 k Ω range: \pm (0.005% of reading + 5 digits)

1 k Ω range: \pm (0.005% of reading + 1 digit)

10 k Ω range: \pm (0.007% of reading + 2 digits)

100 k Ω range: \pm (0.004% of reading + 2 digits)

1000 k Ω range: \pm (0.014% of reading + 5 digits)

10,000 k Ω range: \pm (0.100% of reading + 5 digits)

Performance (average converter)

Accuracy: \pm (% of reading + digits)*

	FAST ACV	300 Hz–500 Hz	500 Hz–1 kHz	1 kHz–100 kHz	100 kHz–250 kHz**
	ACV	30 Hz–50 Hz	50 Hz–100 Hz	100 Hz–100 kHz	100 kHz–250 kHz**
24 hrs: 23°C \pm 1°C	0.47% + 70 digits	0.32% + 50 digits	0.09% + 25 digits	0.70% + 60 digits	
90 days: 23°C \pm 5°C	0.50% + 70 digits	0.35% + 50 digits	0.1% + 25 digits	0.75% + 60 digits	
6 mos: 23°C \pm 5°C	0.50% + 70 digits	0.40% + 60 digits	0.1% + 30 digits	0.75% + 60 digits	
1 yr: 23°C \pm 5°C	0.50% + 70 digits	0.40% + 70 digits	0.12% + 35 digits	0.75% + 80 digits	

* Guard must be connected to Low. On the 1000 V range, add 0.01 ppm/volt-kHz. Specifications are for input levels above 1/10th of range.

** Frequencies greater than 100 kHz specified on 1 and 10 V ranges only.

6 months, 23°C ±5°C

- 0.1 kΩ range: ±(0.005% of reading + 6 digits)
- 1 kΩ range: ±(0.005% of reading + 1 digit)
- 10 kΩ range: ±(0.007% of reading + 2 digits)
- 100 kΩ range: ±(0.004% of reading + 3 digits)
- 1000 kΩ range: ±(0.014% of reading + 5 digits)
- 10,000 kΩ range: ±(0.100% of reading + 5 digits)

1 year: 23°C ±5°C

- 0.1 kΩ range: ±(0.006% of reading + 7 digits)
- 1 kΩ range: ±(0.006% of reading + 2 digits)
- 10 kΩ range: ±(0.008% of reading + 3 digits)
- 100 kΩ range: ±(0.005% of reading + 4 digits)
- 1000 kΩ range: ±(0.015% of reading + 6 digits)
- 10,000 kΩ range: ±(0.100% of reading + 6 digits)

4-wire kΩ

High Resolution On

24 hours: 23°C ±1°C

- 1 kΩ range: ±(0.0025% of reading + 4 digits)
- 10 kΩ range: ±(0.0045% of reading + 4 digits)
- 100 kΩ range: ±(0.0020% of reading + 5 digits)
- 1000 kΩ range: ±(0.0120% of reading + 4 digits)
- 10,000 kΩ range: ±(0.1000% of reading + 4 digits)

90 days: 23°C ±5°C

- 1 kΩ range: ±(0.0035% of reading + 5 digits)
- 10 kΩ range: ±(0.0060% of reading + 5 digits)
- 100 kΩ range: ±(0.0035% of reading + 6 digits)
- 1000 kΩ range: ±(0.0135% of reading + 5 digits)
- 10,000 kΩ range: ±(0.1000% of reading + 5 digits)

6 months: 23°C ±5°C

- 1 kΩ range: ±(0.0040% of reading + 6 digits)
- 10 kΩ range: ±(0.0065% of reading + 6 digits)
- 100 kΩ range: ±(0.0040% of reading + 7 digits)
- 1000 kΩ range: ±(0.0140% of reading + 6 digits)
- 10,000 kΩ range: ±(0.1000% of reading + 6 digits)

1 year: 23°C ±5°C

- 1 kΩ range: ±(0.0045% of reading + 7 digits)
- 10 kΩ range: ±(0.0070% of reading + 7 digits)
- 100 kΩ range: ±(0.0045% of reading + 8 digits)
- 1000 kΩ range: ±(0.0145% of reading + 7 digits)
- 10,000 kΩ range: ±(0.1000% of reading + 7 digits)

2-wire kΩ: all accuracy specifications are the same as 4-wire kΩ except add 0.0004 kΩ to all readings.

Input characteristics

Maximum voltage generated across unknown: <5 volts for open circuit; <4.7 volts for valid reading.

Signal source driving unknown (nominal): 0.1 kΩ, 1 kΩ & 10 kΩ ranges.

Overload protection

Non-Destruction — ±350 V peak

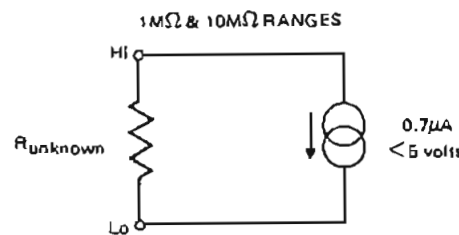
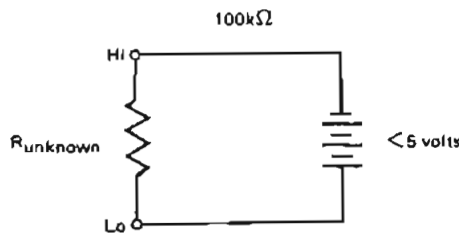
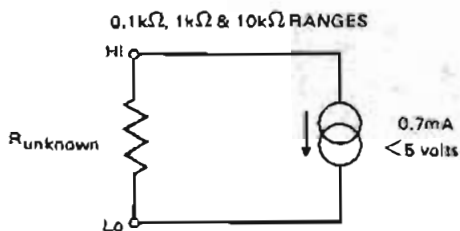

Maximum reading rate:

	60 Hz Gate Length		50 Hz Gate Length	
	High Resolution Off	High Resolution On	High Resolution Off	High Resolution On
Local	4.5 rdg/s	2 rdg/s	4 rdg/s	1.8 rdg/s
Remote	12 rdg/s	3 rdg/s	11 rdg/s	2.5 rdg/s

Math

Scale (X-Y-Z): X is present reading. Y and Z are previously entered readings, or numbers entered from the front panel or by external program.

Maximum number (entered or displayed): ±199,999.9

Accuracy: ±(Accuracy of X reading ± 1 digit of displayed answer)

% Error ((Z-Y/X) × 100%): X is present reading. Y is a previously entered reading, or number entered from the front panel or by external program.

Maximum number (entered or displayed): ±199,999.9

Accuracy: ±(Accuracy of X reading ± 1 digit of displayed answer)

How to enter numbers in "Y" or "Z"

From a current displayed reading: press STORE "Y" or "Z"

From front panel: press ENTER "Y" or "Z". The front panel is now set for numerical entry. These numbers are in blue next to the keys. Enter number and press STORE "Y" or "Z".

By remote program: send program codes for equivalent front panel operations.

General

Power: 100 V, 120 V, 240 V +5%–10%, 48 Hz to 440 Hz line operation; ≤60 VA with all options.

Dimensions: 425.4 mm wide, 85.7 mm high, 520.7 mm deep (16 3/4" × 3 3/8" × 20 3/4")

Weight: net, 9.38 kg (20 lb 11 oz). Shipping, 11.79 kg (26 lb)

Options

00): Average converter

3455A: Digital Voltmeter

Price
less \$200
\$3200

DIGITAL VOLTMETERS

Five-digit digital multimeter with self-test

Model 3490A



Description

Hewlett-Packard's Model 3490A Multimeter is a five-digit integrating digital voltmeter. The basic instrument measures dc voltages, ac voltages, and resistances. Additional measurement capability is achieved by the addition of low cost options.

HP's 3490A uses a dual slope integrating technique and is fully guarded, providing excellent noise immunity at five readings per second on all dc ranges. Ranging is automatic over all ranges on all functions. DC measurements can be made with $1 \mu\text{V}$ resolution on the 100 mV range. AC voltage measurements can be made from 20 Hz to 250 kHz in four ranges. The 1 V range provides $10 \mu\text{V}$ of ac voltage resolution. Ohms measurements can be made, utilizing the four-wire conversion technique which eliminates errors due to test lead resistances. Six ranges of ohms, including a 100 Ω range, are provided. All functions and ranges include 20% overranging except the 1000 V range.

Display

The 3490A uses Hewlett-Packard's light emitting diodes (LED's). These display digits are the seven segment type. The extremely high reliability of this LED display assures maximum life.

Self-test

At the flip of a switch, Hewlett-Packard's 3490A Digital Multimeter sequences itself through 10 tests that check timing signals and autoranging circuits, validate the performance of most logic-circuit IC's and check the six-digit LED display. These tests, and six others provided by six additional front-panel switches, cut calibration costs and ensure the DMM is ready to make accurate measurements.



DC functions

The standard 3490A includes five ranges of dc measurement capability from 100 mV to 1000 V. Measurements are made from the front panel at a precise five readings/s, and at slower rates, using digitally controlled sample rate selector. High input resistance, $>10^{10}\Omega$ on 100 mV, 1 V, and 10 V range, assures accurate measurement of high impedance sources.

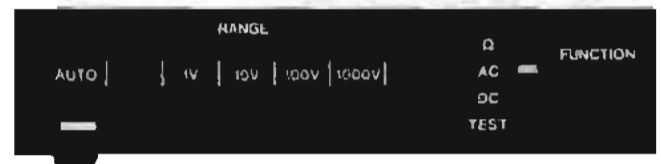

AC functions

Four ranges of ac measurements are provided. The average ac value is accurately detected, and the rms value is displayed with five digits of resolution. Full autoranging, wide frequency response, and 20% over-ranging are designed-in features to permit easy operation.

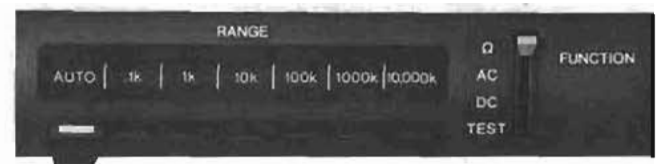

Ohms

Six ohms ranges are standard, and all ranges provide true four-wire ohms measurement capability. Maximum current through the unknown is approximately 1 mA. Over-voltage protection for ohms sensing terminals insures maximum protection against inadvertent application of a high voltage to ohms terminals. Over-voltage protection is provided to 250 V and fuse protection to 1000 V.

Serviceability

HP's 3490A has been "designed for serviceability." Inside, the 3490's low parts density provides easy access for servicing. Test points and jumpers are keyed to detailed diagnostics.

Several diagnostic aids are available to further minimize 3490A repair time. A service video tape, Accessory No. 11128A, will demonstrate use of self-test and front panel symptoms to isolate failures. The 11126A accessory provides a set of IC reference boards with most of the 3490A logic IC's for use with HP 10529A Logic Comparator. Using these boards with the Logic Comparator, a faulty IC can be isolated in seconds without removing it from the circuit. Also, a spare parts set, Accessory No. 11127A, containing most critical components of the 3490A, will be available.

Options

Systems applications

Model 3490A offers built-in flexibility for systems applications. HP's 3490A offers both HP-IB interface and a bit parallel (BCD coded) interface. This combination provides the necessary versatility to configure the lowest cost instrument system.

Ratio, opt 080

DC/DC and AC/DC three-wire ratio measurements can be conveniently added to the 3490A. This capability offers both auto-polarity and a selection of two reference ranges. The 1 V and 10 V ranges are specified from 10% to 120% of selected range. Ratio function is not programmable.

50 Hz operation, opt 050

60 Hz operation, opt 060

Maximum noise immunity is achieved when power line frequency is harmonically related to the sample period of the integrating DMM. Option 050 will maximize normal and common mode rejection for 50 Hz power line frequency, and Option 060 will provide this rejection for 60 Hz.

Sample/hold, option 040 and 045

Sample/hold provides HP's 3490A with extra and unique measurement capability.

The Sample/hold option has two modes of operation to solve difficult measurement problems.

Track and hold: In this mode, input voltage is held instantly upon receiving an external command. This mode is useful in digitization of repetitive or transient waveforms.

Acquire and hold: In this mode, a known delay is inserted to permit the input amplifier to settle to a specified accuracy. This is useful in measuring pulse height or any similar step input.

Digital output, opt 021 and remote control, opt 022

These options provide digital control and data output in the parallel BCD code of 8-4-2-1, either negative or positive true logic. Selection is accomplished by positioning an internal switch. The remote control option provides complete control of all functions, ranges, and external trigger commands. The digital output option provides nine columns of information which includes function, polarity, data, and range. These options may be purchased separately to meet specific application requirements. Either of these options require Option 020 Systems Expand.

BCD/remote

Both Option 021 and 022 require Option 020, BCD/Remote Expand. This option provides the required internal and external connectors to permit user installation of Digital Output, Opt 021 and/or Remote Control, Opt 022 and should be ordered as an initial option on HP's 3490A. This option includes rear terminals in parallel (switchable front/rear terminals are available as a special - H19).

HP-IB data input/output, opt 030

The HP-IB option permits HP Model 3490A to operate on a single data/control bus with up to 14 other instruments. This serial code is an eight-bit byte typically using an ASCII-type coding. A unique "talker/listener" address structure makes the system's hardware more economical and associated software much simpler. The HP-IB is compatible with Hewlett-Packard Models 9815A, 9820A, 9821A, 9825A and 9830A calculators as well as Hewlett-Packard computers.

Specifications

DC voltage ranges

Full range display: ± 1.00000 V, ± 10.0000 V, ± 100.0000 V, ± 1000.00 V.

Overrange: 20% on all ranges except 1000 V range.

Range selection: manual, automatic, or remote (optional).

DC voltage performance

Accuracy: $\pm(\%$ of reading + % of range).

		0.1 V Range		1 V to 1000 V Range	
		% rdg.	% rng.	% rdg.	% rng.
24 hrs	(23°C \pm 1°C)	$\pm(0.005 + 0.001)$		$\pm(0.004 + 0.001)$	
30 days	(23°C \pm 5°C)	$\pm(0.01 + 0.005)$		$\pm(0.008 + 0.002)$	
90 days	(23°C \pm 5°C)	$\pm(0.01 + 0.005)$		$\pm(0.01 + 0.002)$	
6 months	(23°C \pm 5°C)	$\pm(0.013 + 0.005)$		$\pm(0.013 + 0.002)$	
1 year	(23°C \pm 5°C)	$\pm(0.015 + 0.005)$		$\pm(0.015 + 0.002)$	

DC voltage input characteristics: fully guarded with 140 dB ECMR at dc and 60 Hz $\pm 0.1\%$ with 1 k Ω imbalance between guard and low.

Maximum input voltage:

0.1 V to 1000 V ranges: ± 1500 V peak.

Guard to chassis: ± 500 V peak.

Guard to low: ± 200 V peak.

Input resistance:

0.1 V to 10 V ranges: $> 2 \times 10^9 \Omega$. (<70% R.H.).

100 V and 1000 V ranges: 10 M Ω $\pm 0.15\%$.

Maximum reading rate: 5 readings/s.

Normal mode rejection ratio: 50 Hz $\pm 0.1\%$; 60 Hz $\pm 0.1\%$; > 50 dB.

Notes:

1. On the 1000 V range, add 0.04 ppm/volt to the % of reading specification.

2. Thermal EMF's generated external to the DVM may be compensated to achieve the % of range accuracy specified by utilizing the rear panel zero adjust provided in the 3490A.

AC voltage ranges

Full range display: 1.00000 V, 10.0000 V, 100.000 V, 1000.00 V.

Overrange: 20% on all ranges except 1000 V range.

Range selection: manual, automatic, or remote (optional).

DIGITAL VOLTMETERS

Five-digit digital multimeter with self-test

Model 3490A (cont.)

AC voltage performance

Accuracy: \pm (% of reading + % of range):

		20 Hz - 50 Hz	50 Hz - 100 kHz	100 kHz - 250 kHz
24 hrs	(23°C \pm 1°C)	\pm (0.32 + 0.05)	\pm (0.09 + 0.025)	\pm (0.7 + 0.06)
30 days	(23°C \pm 5°C)	\pm (0.35 + 0.05)	\pm (0.1 + 0.025)	\pm (0.75 + 0.06)
90 days	(23°C \pm 5°C)	\pm (0.35 + 0.05)	\pm (0.1 + 0.025)	\pm (0.75 + 0.06)
6 months	(23°C \pm 5°C)	\pm (0.40 + 0.06)	\pm (0.1 + 0.03)	\pm (0.75 + 0.07)
1 year	(23°C \pm 5°C)	\pm (0.45 + 0.07)	\pm (0.12 + 0.035)	\pm (0.75 + 0.08)

AC voltage input impedance

Without rear terminals: 2 M Ω \pm 1% shunted by <65 pF.With rear terminals: 2 M Ω \pm 1% shunted by <90 pF.

AC voltage maximum reading rate: 1 reading/s.

AC voltage response time: <1 s to within rated accuracy for a step input applied coincident with encode trigger.

AC maximum input voltage: 1000 V rms; \pm 1500 V peak.

Notes:

- Guard must be connected to low.
- On the 1000 V range, add 0.01 ppm/(volt-kHz).
- Frequencies > 100 kHz specified on 1 V and 10 V ranges only.
- Specifications are for input levels above 1/100th of full scale.

Ohms ranges

Full range display: .100000 k Ω , 1.00000 k Ω , 10.0000 k Ω , 100.000 k Ω , 1000.00 k Ω , 10000.0 k Ω .

Overrange: 20% on all ranges.

Range selection: manual, automatic, or remote (optional).

Ohms performance

Accuracy: \pm (% of reading + % of range).

Note: Thermal EMFs generated external to the DVM may be compensated to achieve the % of range accuracy specified by utilizing the rear panel zero adjust provided in HP's 3490A.

		0.1 k Ω		1 k Ω - 100 k Ω		1000 k Ω		10,000 k Ω	
		% rdg.	% rng.	% rdg.	% rng.	% rdg.	% rng.	% rdg.	% rng.
24 hrs	(23°C \pm 1°C)	\pm (0.006 + 0.001)		\pm (0.005 + 0.001)		\pm (0.007 + 0.001)		\pm (0.025 + 0.001)	
30 days	(23°C \pm 5°C)	\pm (0.012 + 0.005)		\pm (0.010 + 0.002)		\pm (0.012 + 0.002)		\pm (0.035 + 0.002)	
90 days	(23°C \pm 5°C)	\pm (0.012 + 0.005)		\pm (0.012 + 0.002)		\pm (0.015 + 0.002)		\pm (0.035 + 0.002)	
6 months	(23°C \pm 5°C)	\pm (0.015 + 0.005)		\pm (0.015 + 0.002)		\pm (0.020 + 0.002)		\pm (0.040 + 0.002)	
1 year	(23°C \pm 5°C)	\pm (0.018 + 0.005)		\pm (0.018 + 0.002)		\pm (0.025 + 0.002)		\pm (0.050 + 0.002)	

Ohms terminal characteristics

Maximum voltage generated across unknown: 20 V for overload; 13 V for valid reading.

Ohms current thru unknown:

0.1 k Ω to 10 k Ω range: 1 mA.100 k Ω to 1000 k Ω range: 10 μ A.10,000 k Ω range: 1 μ A.

Ohms overload protection:

Nondestructive: 250 V rms.

Fuse destructive: \pm 1000 V peak.

Ohms maximum reading rate:

0.1 k Ω to 100 k Ω range: 5 readings/s.1000 k Ω range: 4 readings/s.10,000 k Ω range: 2 readings/s.

General

Data output (BCD), option 021

Data output is 1-2-4-8 TTL output which is compatible with HP 562A, 5050B, and 5055A Digital Recorders. Either high true or low true logic code can be selected with an internal switch.

Storage temperature: -40°C to +75°C.

Remote control, option 022

The remote control option uses a low true logic (BCD type) code. Required voltage levels for input signal and output signal levels are listed below.

BCD and remote terminals:

	High Level	Low Level
DVM Inputs	+3.9 V \pm 1.5 V, 100 μ A max	+0.3 V \pm 0.3 V, 2 mA max
DVM Outputs	+3.9 V \pm 1.5 V, 400 μ A max	+0.3 V \pm 0.3 V, 15 mA max

Operating temperature: 0°C to 50°C.

Warm-up time: one hour warm-up required to meet all specifications on the 0.1 V range and the 0.1 k Ω range. Thirty minutes warm-up required to meet all other specifications.

Humidity range: <95% R.H., 0°C to 40°C.

Power: 100 V, 120 V, 220 V, 240 V \pm 5%, -10%, 48 Hz to 400 Hz line operation \leq 60 VA with all options.Dimensions: 425.4 mm wide, 85.7 mm high, 466.7 mm deep (16 1/4" \times 3 3/8" \times 18 3/8").

Weight: net, 9.38 kg (20 lb 11 oz). Shipping, 11.79 kg (26 lb).

Options

020: BCD/remote expand, includes rear terminals in parallel

021: BCD* — full parallel, 1-2-4-8 code

022: Remote* — full parallel, 1-2-4-8 code

030: HP-1B remote control and data output

040: Sample-and-hold*

045: Sample-and-hold (without Opt. 020 or 030)

050 or 060: 50 Hz or 60 Hz operation

080: Three-wire ratio

Rack mounting kit furnished.

3490A Digital Multimeter (includes ac, dc, & ohms)

Opt 050 Noise Rejection for 50 Hz

Opt 060 Noise Rejection for 60 Hz

Price

\$236

\$295

\$202

\$1045

\$525

\$550

N/C

\$236

\$1985

N/C

N/C

*These options require BCD/Remote Expand Option 020 or HP-1B Opt 030.
Note: Rack mounting requires support in rear of instrument.

Scanner Model 3495A

- Low level switching
- Multichannel closure

- Switched guard
- Relay actuation

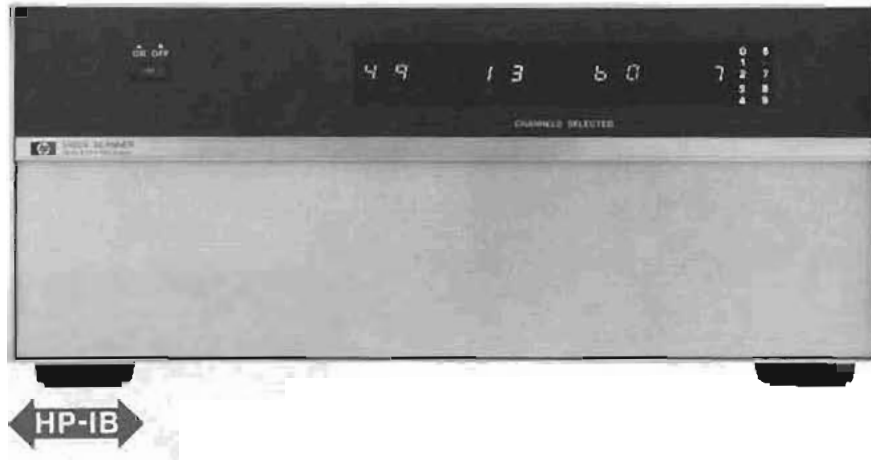

Description

General

The 3495A Scanner is a versatile instrument programmable via the Hewlett-Packard Interface Bus (HP-IB) which will scan or provide contact closure control for up to 40 channels. Two types of relay assemblies are available: a Low Thermal Scanner for connection to low level sources such as thermocouples and strain gauges, and a Relay Actuator assembly for controlling higher current relays and distributing low current dc or ac voltages. Each assembly contains 10 channels and the 3495A can hold up to four of these assemblies for a maximum of 40 channels. Multiple 3495's may be used on the HP-IB to provide more than 40 channels.

Low thermal assembly

The Low Thermal Assembly has a three-wire 10 to 1 multiplexer for connection to low level sources such as thermocouples and strain gauges. The signal switching relays for each channel are low thermal dry reed relays constructed in such a way as to minimize temperature gradients between high and low inputs. An uncertainty of $<2 \mu\text{V}$ thermal EMF is maintained through the Low Thermal Assembly. Each channel has a separate guard relay to minimize the effect of common mode voltage on low level measurements.

The Low Thermal Assembly has a break-before-make feature which assures that only one channel is closed at a time to prevent the possibility of connecting two inputs. However, the 3495A has a flexible addressing scheme between relay assemblies which permits multiple wire scanning for applications such as four-wire ohms measurements.

Applications: low level dc measurements; dc volts, ac volts, and resistance scanning.

Transducer sensing: thermocouples, thermistors, strain gauges, pH meters.

Relay actuator assembly

The relay actuator assembly provides 10 independently programmable two-wire closures for controlling higher current relays, distributing low current dc or ac voltages, or external control functions. Each channel contains a two-pole armature type relay capable of switching up to two amps rms. This relay is more suited to higher current, lower voltage applications than the low thermal assembly.

Two normally open contacts for each relay are available on the channel terminal connector. Any combination of channels on this assembly may be closed or opened simultaneously.

Applications: process control, actuate visual or audio indicators, control higher current relays, 8×10 Matrix switching.

Specifications, 3495A scanner

Low-thermal channels, option 001

Number: 10 to 40 fully guarded, multiplexed channels available in each scanner. Additional scanners can be used for more channels.*

Type: three-pole, low-thermal dry reed relays. Third pole switches guard and is not low-thermal.

Actuator channels, option 002

CAUTION: for use in circuits fused at two amperes or less.

Number: 10 to 40 noncommon channels available in each scanner. Additional scanners can be used for more channels.*

Type: two-pole armature relay; four terminals per channel. Single unswitched guard for 10 channels. Ten independently controlled relays permit any number of channels to be closed simultaneously.

*Up to 15 HP-IB programmable devices may be connected at one time including an HP-IB controller, 3495A Scanners, measuring instruments, and other peripherals.

Option	001	002
Maximum contact ratings		
Voltage	230 V peak	100 V rms
Current	200 ma (non-inductive)	2 A rms
Power	2 VA	200 VA
Isolation	$> 10^{10} \Omega$	(no spec)
Maximum input voltage		
Between any two terminals	230 V peak	230 V peak
Guard to chassis	200 V peak	200 V peak
Guard to low	200 V peak	200 V peak
Uncertainty (differential EMF)	$< 2 \mu\text{V}$	$< 30 \mu\text{V}$
Switching time	$< 10 \text{ ms}$	$< 40 \text{ ms}$

General

Operating temperature: 0°C to $+55^\circ\text{C}$

Humidity range: $< 95\%$ R.H., 0°C to $+40^\circ\text{C}$

AC power: 100, 120, 220, or 240 volts ($\pm 5\%$ – 10%) 100 VA max. 48 to 66 Hz

Dimensions

Height: 190.5 mm (7.5 in.), including feet. Width: 428.6 (16.875 in.).

Depth: 520.7 mm (20.5 in.).

Weight: 3495A: net, 17.5 kg (38.5 lb). Shipping, 21.1 kg (46.5 lb).

Options

Order one or more Option 001 or 002 to obtain desired number of low thermal or actuator channels. Option 001 and 002 may be used in any combination up to a total of four relay assemblies for each 3495A.

001: ten channel low thermal relay assembly

002: ten channel relay actuator assembly

907: Front Handle Kit

908: Rack Flange Kit

909: Rack Flange & Front Handle Combination Kit

Price

add \$600

add \$400

add \$15

add \$10

add \$20

3495A Scanner

\$1250

DIGITAL VOLTMETER

Programmable data logger

Model 3051A

- Data collection
- Data analysis
- Decision making
- Thermocouple linearization
- File compiler



General description

A programmable data logger is a system which can collect and analyze data, make decisions based on the data and interact with the test, process, experiment, instrument or system which generates the data.

The 3051A Programmable Data Logger consists of:

- 3495A Input Multiplexer
- 3455A High Accuracy/Resolution DVM
- 9815A Calculator with 2008 Step Memory
- System ROM

The 3051A is designed to provide a cost effective solution to:

- Your plant monitoring requirements for energy conservation, environmental impact and security.
- Your production process monitoring requirements for environmental impact, independent process evaluation and safety.
- Your dedicated parameter testing requirements for component test, subassembly test and data collection.
- Your quality assurance requirements for component test subassembly test, equipment environmental test and data collection.

In the above applications the information may be about pressure, temperature, level, flow, facts about the environment, equipment status or equipment performance. The information can be processed providing that it exists or can be made to exist as an electrical signal. Several devices are available to translate the information into electrical signals (i.e. transducer outputs, sensor outputs, equipment output or instrument output). The electrical signals need to be measured in a time sequence, analyzed, recorded and limit decisions made. The signals may be either local or scattered over the length of a plant. The 3051A combines the features of a data logger and a programmable calculator into a low cost solution to these requirements.

Hardware description

The hardware is fully integrated, specified, documented and tested as a system. The system is capable of measuring dc from 1 μ volt to 200 volts, ac from 10 μ volts to 200 volts, and ohms from 1 milliohm to 10 Megohms. It can measure 1 μ volt dc signals at a six channels per second rate in the presence of noise. The system's greater than 120 db effective common mode rejection and greater than 60 db normal mode rejection effectively cancel out unwanted offsets or superimposed noise signals. The 1 μ volt sensitivity in conjunction with the system's ROM allows temperature resolution to better than 0.1°C. The system can measure thermocouples and perform reference junction compensation at a rate of three channels per second. The less than 3 μ volt dif-

ferential thermal e.m.f. of the low thermal ten channel scanner card provides reliable measurements with minimum thermal uncertainty. A ten channel relay actuator card provides alarm and multiple switching functions. The system can scan from 1 to 80 channels of analog data. The number of data channels decreases by 10 for each relay actuator card used. The high speed data cartridge provides high speed file access and storage. Up to 10 000 six digit readings can be stored on the data cartridge. The user can communicate with the system via an alphanumeric keyboard. The system can communicate with the user by a numeric display and an alphanumeric thermal strip printer. This conversational interaction capability allows the system to be operated by personnel with no formal knowledge of programming or data logging. The auto restart capability allows the system to operate unattended. The auto restart and the optional 59403A Common Carrier Interface allows remote distributed system configurations.

Firmware description

The system ROM contains J, K and T thermocouple linearization tables, a general linearization routine, four types of split precision data storage and string manipulation. The ROM allows the system to easily make thermocouple temperature measurements, linearize transducer data, store the data in an efficient manner and format alpha messages for output.

Software

The file compiler allows easy application program generation by automatically combining programs and subroutines from separate tape files. For example, the data logger can be programmed without writing software. The user selects set-up routines (scan sequence, scan interval, channel range and function and scan mode), operating routines (check limits, convert to meaningful units, record). Then the user calls the file compiler which assembles the routines into an application program. Instrument verification software provides for easy system checkout and proof that the instruments are properly functioning. The calculator has built-in program editing, syntax checking and error message generation.

A report generator is supplied to format the data for the optional HP 9871A Plotter Printer.

For more information contact your local HP field engineer or nearest HP Sales Office for complete details about this low cost solution to measurement, analysis and decision making problems.

3051A Programmable data logger

from \$9550

DIGITAL VOLTMETERS

Automatic data acquisition system

Model 3052A



- Improve productivity in research and manufacturing.
- Increase throughput and lower the cost in Q.A. testing.
- Conserve plant energy through electric load monitoring/control.
- Monitor pilot and production processes.
- Perform on-line data analysis and processing.
- Measure DC, AC, and Ohms.



Description

The 3052A Automatic Data Acquisition System combines speed, precision and repeatability in low level measurements with powerful computation and analysis capabilities. This system provides a highly capable yet economical solution to parameter testing, stimulus response and signal analysis applications in production test, laboratory and process monitoring/control areas.

System configuration

The 3052A consists of the following:

- 3455A High Accuracy/High Resolution DVM
- 3437A High Speed Sampling DVM
- 3495A Input Multiplexer
- 9825A High Performance Calculator and ROMS
- Optional 9871A Printer/Plotter

Two digital voltmeters in the 3052A provide a unique combination of high speed and high accuracy measurements.

Measurement

DC measurement rates up to 20 channels/second are possible with 1 μ V resolution on the 100 mV range. This sensitivity and dynamic range are required for example in thermocouple measurements with a 0.5°C or better resolution.

Excellent noise rejection and very low thermal uncertainty make the 3052A particularly suited for accurate, repeatable, low-level measurements even in the presence of noise. The > 120 dB effective common-mode rejection of the 3455A/3495A effectively cancels out unwanted offsets or superimposed noise signals.

AC measurements can be made up to 1 MHz with the standard AC True RMS converter or up to 250 kHz with the optional average converter. A programmable Fast AC mode provides an AC measurement rate of up to 10 channels/second for inputs above 300 Hz.

Repetitive waveforms up to 1 MHz or low frequency transients (below 1 kHz) can be digitized by the 3437A High Speed Sampling DVM. With this DVM and the 9825A Calculator, up to 5000 readings/second on a single high speed channel can be stored for further analysis.

By multiplexing the 3437A input with the Scanner, up to 125 channels/second can be measured with 100 μ V resolution and 3 1/2 digits. The sample-and-hold measuring technique of the 3437A makes it more suited for high quality inputs with minimum noise and common mode signals.

Resistance measurements can be made with either easy to connect 2-wire technique or the more accurate 4-wire method. Multiplexed high

resistance measurements up to 15 megohms can be made with the full accuracy of the 3455A.

Data analysis

The 9825A Calculator can be programmed to perform any mathematical calculation required, from transducer linearization to statistical analysis. A new feature of the 9825A, multi-dimensional arrays, allows logical data organization and storage for complicated testing and a high speed bi-directional data cartridge provides bulk data storage.

Output and control

A High degree of operator interaction with the system and its program is provided by the 32 character alpha-numeric display and the 16 character thermal printer. Program inputs, intermediate test conditions, or final results can be displayed or printed for more efficient testing.

The optional 9871A Character Impact Printer is ideally suited for producing finished test reports, completely documented problem solutions or typing on pre-printed forms, all under automatic control of the calculator. Simple charts and graphs can also be plotted with the bi-directional motions of the platen and print mechanism.

The system can assume an active role in the application process by performing control, alarm, and multiple switching functions with the relay actuator cards in the 3495A. Each of these cards provides ten double-pole single-throw contact closures for connection to external devices.

Software

In most systems, application software is expensive and time consuming to develop. With the 3052A, however, programming is greatly simplified and the system can be operational in a much shorter time.

The easy to learn programming language of the 9825A and the supplied instrument control routines allow the user without a sophisticated programming background to develop his own test software. For easy system installation and verification, the 3052A documentation and software package provides step-by-step instructions. In addition detailed operating instructions and modular example programs enable fast system start-up and easy operation. The 3052A is fully integrated, tested, verified, and specified as a system with complete software and documentation supplied to ensure that the system is ready to perform your specific task.

For more information, contact your local HP Field Engineer or nearest HP Sales Office.

3052A Automatic data acquisition system

from \$16,000

COMPONENT TEST

General information

C, R, L, D, Q, Z, θ and IC's



Component Test Selection Guide

Instrument	Frequency				Q or $\frac{1}{D}$		C in farads, L in henries or R in ohms						Basic Accuracy			See Page		
	DC	1 Hz	1 kHz	1 MHz	1 GHz	10^0	10^3	10^{-12}	10^{-9}	10^{-6}	10^{-3}	10^0	10^3	10^6	.1%		1%	10%
RX Meter 250B				—		—		— C —		— L —			— R —				•	90
Universal Bridge 4260A	•		•			—		—	— C —		—		— R —				•	77
Digital LCR Meter 4261A			•			—		—	— C —		—		— R —				•	79
Universal Bridge 4265B			•			—		—	— C —		— L —		— R —				•	78
Auto C-Bridge 4270A			•	•	•	—		—	— C —		—						•	86
1 MHz LCR Meter 4271A				•		—		—	— C —		— L —		— R —				•	81
1 MHz Preset C Meter 4272A				•		—		—	— C —								•	83
Digital High Capacitance Meter 4282A		•	•	•		—		—		— C —							•	84
Milliohm Meter 4328A			•										— R —				•	75
High Resistance Meter 4329A	•								10^6				— R —				•	76
LCR Meter 4332A			•	•		—		—	— C —		— L —		— R —				•	74
Q Meter 4342A				—		—		—	— C —		— L —						•	88
High C Meter 4350A		•				—		—		— C —							•	87
Vector /Z/ Meter 4800A		—	—			—		—	— C —		— L —						•	90
Digital IC Tester 5045A	Many Digital IC families and ROMS with printed data																	92

Impedance/Z/θ, C, R, L, D & Q

Hewlett-Packard's family of impedance measurement instruments combine the familiar null measurement techniques with digital logic and feedback circuits to achieve simple and rapid operation without a sacrifice in precision. The basic specifications for Hewlett-Packard's impedance family is summarized on the opposite page. Frequency, Q, capacitance, inductance, resistance and basic accuracy can be traded off to select the most suitable instrument. For some instruments, capacitance and inductance are not the principal parameters but are secondary to the primary readout.

Impedance considerations

There are two basic types of impedance measuring instruments: bridges and meters. In general, bridge type instruments have the best accuracy specifications. This type of instrument has found wide application and is the basis for the HP 4260A/4265B Universal Bridge, 4270A Automatic Capacitance Bridge, and 250B RX Meter.

In the past, bridge instruments have required considerable operator skill to obtain consistent results. However, the Universal Bridge was specifically designed to achieve rapid and consistent audio frequency measurements.

The evolution of bridge measurements has created the need for completely automatic instruments to rapidly characterize multi-conductor cables, variable capacitor diodes, and discrete capacitors. To satisfy these customer requirements, the 4270A Automatic Capacitance Bridge was developed. This instrument is completely programmable and displays capacitance and dissipation factor/conductance in digital form. BCD outputs are available for remote processing.

Impedance meters, in general, utilize constant current/voltage sources to excite the unknown impedance. Amplitude and phase sensitive voltmeters detect the real and reactive voltage/current components of the unknown. The display for most impedance meters is an analog meter. Although impedance meters do not have the accuracy of bridge instruments, they are less expensive and easy to use. The 4350A High Capacitance Meter, 4800A Vector Impedance Meter, and the 4332A LCR Meter utilize this principal. Impedance meters have analog outputs proportional to the displayed function.

The HP 4261A Digital LCR Meter, 4271A LCR Meter and 4272A Preset C Meter all utilize the combination of a bridge and digital voltmeter techniques. The wide measurement ranges of the 4261A enable easy measurements on various kinds of components.

The 4271A is particularly useful for measuring microcircuit parameters. The 4272A, with its built-in limit comparator, is especially convenient when measuring small capacitances.

Integration into HP-IB system

Adding the HP-IB option to a component test instrument enables the instrument to be systemized into an HP-IB system. This permits high speed measurement of many components along with arithmetic processing of the data.

The HP-IB option (OPT. 101) for LCR measuring instruments is available for HP models 4271A, 4270A, 4261A, 4272A and 4282A. Two functions are provided: talker (measured data transfer) and listener (measurement remote control). System controller may be an HP model 9821A, 9830A with bus interface kit (HP 59405A OPT. 021, 030), or an HP model 9825A with HP-IB card (HP 98034A). If other system components such as a plotter, printer, scanner or measurement instrument are added to the system, the integrated system reaches a high level of usefulness. For example, it would provide a component manufacturer with inspection/reliability test capabilities in the quality control or in-process test/inspection departments. In semiconductor device measurements, the combination can process the especially needed complex arithmetic manipulation of the measured data for the various device characteristics.

Figure 1 is the block diagram of a semiconductor device characteristic measurement system using the 4271A option 101. This calculator controlled system graphically shows the relationships between either bias voltage (measured with digital multimeter) and capacitance (measured with the 4271A), or between impurity density and depletion layer width, on a graphic plotter. Bias is automatically applied to the device and its ca-

pacitance measured as directed by the calculator.

Summary

To help you select an impedance meter suitable to your needs the following guidelines may be used:

- (1) For a desired accuracy and cost range, select the instrument with the broadest capability in C, L, R & D or Q.
- (2) Bridge instruments will provide the best accuracies (0.1% to 1%). However, only the higher priced bridges offer the speed and convenience in measurement available in meter type instruments.
- (3) To obtain meaningful results, a parts user should make measurements at the same frequency and voltage level specified by the manufacturer.

For additional information on component measurements, Hewlett-Packard offers for sale a tutorial RCL video tape. The tape has three parts:

Part 1 — Resistance (7 min.) — explains basic resistance measurements.

Part 2 — Capacitance (11 min.) — format similar to Part 1 — explains capacitance measurements.

Part 3 — Inductance (11 min.) — develops the theory of inductors and their functions in circuits.

You may preview this video tape at your nearest HP Sales Office. Please call for an appointment. The tape (ID #90249C/D) is available in 1/2" EIAJ format (C) or 3/4" video cassette (D).

Hewlett-Packard's impedance instruments have been used in numerous diverse applications, from the measurement of the dielectric constant of liquids, to the wing to fuselage continuity of aircraft. If you have an unusual application or need assistance, contact your nearest Hewlett-Packard sales office for application information.

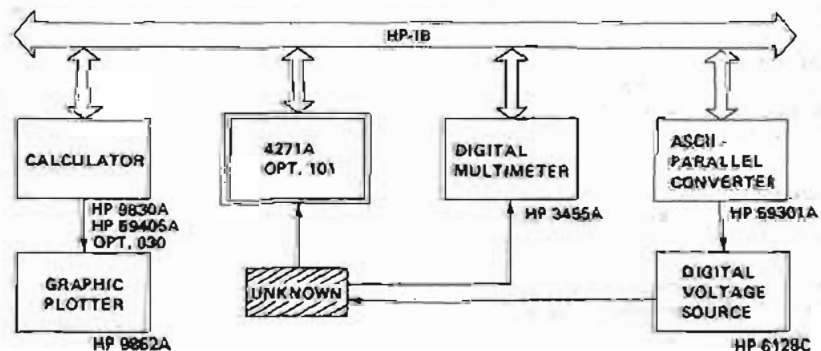

Figure 1. Measuring Semiconductor Characteristics (Typical System)

COMPONENT TEST

LCR meter

Model 4332A

- Touch and read operation
- Wide range
- Low test voltage
- Guarded measurement

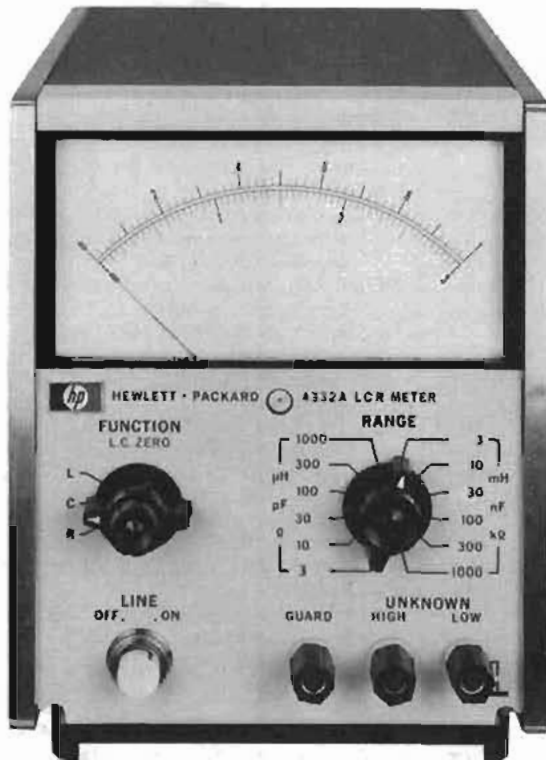

4332A

Description

Hewlett-Packard's Model 4332A LCR Meter measures inductance, capacitance, and resistance with speed and accuracy. The instrument provides direct-readings of L, C, and R with linear meter scales. The 4332A is extremely useful for measurements of both linear and non-linear components such as semiconductor capacitor values, inductance of coils with ferrite core.

Specifications

Inductance measurement

Measurement equivalent circuit: series.

Range: 3 μ H to 1 H full scale, 12 ranges.

Measuring frequency

3 μ H to 1000 μ H ranges: 100 kHz \pm 5%.

3 mH to 1000 mH ranges: 1 kHz \pm 5%.

Voltage across sample: <1.5 mV rms.

Accuracy (at 25°C): \pm [1% reading + (1.5 + 3/Q) % of full scale + 0.03 μ H].

Capacitance measurement

Measurement equivalent circuit: parallel.

Range: 3 pF to 1 μ F full scale, 12 ranges.

Measuring frequency

3 pF to 1000 pF ranges: 100 kHz \pm 5%.

3 nF to 1000 nF ranges: 1 kHz \pm 5%.

Voltage across sample: approximately 70 mV rms.

Accuracy (at 25°C): \pm [1% reading + (1.5 + 3/Q) % of full scale + 0.03 pF].

Resistance measurement

Range: 3 Ω to 1 M Ω full scale, 12 ranges.

Measuring frequency: 1 kHz \pm 5%.

Voltage across sample: <1 mV rms.

Accuracy (at 25°C)

3 Ω to 30 k Ω ranges: \pm (0.5% reading + 2% full scale + 0.03 Ω).

100 k Ω to 1000 k Ω ranges: \pm (1% reading + 2% full scale).

Analog outputs: 1.0 V dc full scale, independent of range in use and 1.0 V or 0.3 V dc full scale, corresponding to the range in use.

Output impedance: approximately 500 Ω .

Accuracy: better than meter reading accuracy by 0.5% full scale.

Overrange: 110% of full scale.

General

Response time: typically 0.25 s for analog outputs. Typically 1.0 s for meter.

Operating temperature: 0°C to 50°C.

Temperature coefficient: \pm 0.05% of full scale/°C (0°C to 50°C).

DC bias: 100 V dc maximum can be applied from external source.

Power: 115 V/230 V \pm 10%, 48 Hz to 66 Hz, 8 VA.

Dimensions: 130 mm \times 155 mm \times 279 mm (5 $\frac{1}{8}$ " \times 6 $\frac{1}{8}$ " \times 11").

Weight: net, 3.5 kg (7 lb 11 oz).

Accessories furnished: 16138A Test Leads, Power Cord 8120-1348.

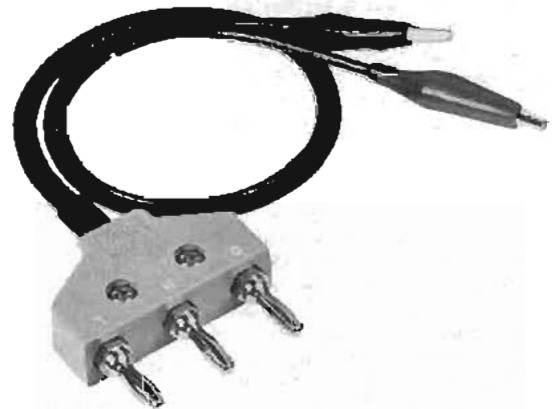

16138A



16019A

Accessories available: 16019 Test Fixture.

16019A Test Fixture

4332A LCR Meter

S55

S1175

COMPONENT TEST

Milliohmmeter

Model 4328A

- 20 $\mu\Omega$ resolution on 1 m Ω range
- Four terminal measurement
- Low test voltage (20 mV)



4328A (with 16005A Probes included)



16006A Probe (2 each included)

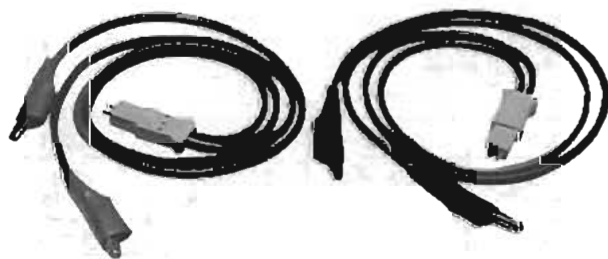

16007A/B Test leads (1 each included)

Description

HP's 4328A Milliohmmeter is a portable instrument for measurement of low resistances. It uses a Kelvin Bridge method to obtain its high sensitivity but has incorporated both the current and voltage drives into one probe, so that only two probes are needed in actual measurement.

The range of the 4328A extends from 100 ohms to one milliohm full scale. Maximum sensitivity is 20 microhms, making it ideal for measuring contact resistance of switches, relays, and connectors.

A unique phase discriminator in the meter circuit permits accurate resistive measurements on samples with a series reactance up to twice full scale resistance.

The milliohmmeter is internally driven by a one kilohertz signal. With an ac drive signal, dc bias up to 150 volts can be superimposed without affecting accuracy of measurement. Hence, HP's 4328A can make dynamic resistance measurements in forward-biased diodes.

Maximum voltage across any sample with proper range selection is less than 200 microvolts peak. In case of incorrect range setting, a maximum voltage of 20 millivolts peak will never be exceeded, so that explosive devices such as fuses and squibs can be safely checked.

The basic 4328A is line operated. With Option 001, it can be operated from four rechargeable batteries for 15 continuous hours. A recorder output provides an output proportional to meter deflection.

Specifications

Range: 0.001 to 100 ohms full scale in a 1, 3, 10 sequence.

Accuracy: $\pm 2\%$ of full scale. No additional error is caused by series reactance of samples up to two times full scale.

Measuring frequency: 1000 Hz ± 100 Hz.

Voltage across sample: 200 μ V peak at full scale.

Maximum voltage across sample: 20 mV peak in any case.

Superimposed dc: 150 V dc maximum may be superimposed on samples from an external source.

Recorder output: 0.1 V dc output at full scale meter deflection.

Range (ohms)	Applied Current (mA)	Maximum Dissipation in Samples (μ W)
0.001	150	23
0.003	50	8
0.01	15	2.3
0.03	5	0.8
0.1	1.5	0.23
0.3	0.5	0.08
1	0.15	0.023
3	0.05	0.008
10	0.015	0.0023
30	0.005	0.0008
100	0.0015	0.00023

General

Power requirements: 115/230 V switch $\pm 10\%$, 50 to 60 Hz, 1.5 VA.

Weight: 3.2 kg (7 lb).

Dimensions: 155.1 mm high \times 130 mm wide \times 279 mm wide (6 $\frac{1}{8}$ " \times 5 $\frac{1}{8}$ " \times 11").

Accessories furnished: Model 16005A Probe, 16006A Probe and 16007A/B Test Leads, 16143A Probe Cable, Detachable Power Cord.

Model number and name

Option 001, Rechargeable battery operation
4328A Milliohmmeter

Price

add \$48
\$975

COMPONENT TEST

High resistance meter

Model 4329A

- Wide range: 500 k Ω to $2 \times 10^{16}\Omega$



Description

The HP 4329A is a solid-state insulation resistance meter designed for easy, accurate and direct readings of the very high resistance values typically found in synthetic resins, porcelain, insulating oils and similar materials. It is also useful for measurements in electrical components like capacitors, transformers, switches and cables. Seven fully regulated dc test voltages (between 10 and 1000 V) are provided as test sources.

Selected scales are identified by illuminated indicators on the meter face. Selected resistance or current multiplying factors are also illuminated for rapid, error-free measurement. Three resistance scales and one current scale are provided. The HP 4329A is instantly convertible from ungrounded-to-grounded-sample operation via a simple relocation of the front panel ground strap from "guard" to "+" position. The instrument cabinet itself is always at ground potential. Test voltage shorts or sample breakdown currents will not damage instrument circuitry.

The HP 4329A also has a current measurement capability. Minute currents as low as 0.05 pA can be readily measured. The standard instrument package includes HP 16117A Low Noise Test Leads; these are used in most types of measurement.

4329A Specifications

Resistance measurement

Range: 500 k Ω to $2 \times 10^{16}\Omega$

Accuracy: total accuracy is determined by test voltage and range used. At low resistance end of each scale, accuracy is $\pm 3\%$, near center scale $\pm 5\%$, and near the specified upper limit on the meter scale (see table below), accuracy is $\pm 10\%$. Accuracy is not specified above these limits. On all voltage ranges, if multiplier is set to Rmax., an additional $\pm 3\%$ is included.

Test voltage*	10 V	25 V	50 V	100 V	250 V	500 V	1000 V
Available resistance readings	$5 \times 10^5\Omega$ to $2 \times 10^{14}\Omega$	$1.25 \times 10^6\Omega$ to $5 \times 10^{14}\Omega$	$2.5 \times 10^6\Omega$ to $1 \times 10^{15}\Omega$	$5 \times 10^6\Omega$ to $2 \times 10^{15}\Omega$	$1.25 \times 10^7\Omega$ to $5 \times 10^{15}\Omega$	$2.5 \times 10^7\Omega$ to $1 \times 10^{16}\Omega$	$5 \times 10^7\Omega$ to $2 \times 10^{16}\Omega$
Meter scale	.5 to 20	.13 to 5	.25 to 10	.5 to 20	.13 to 5	.25 to 10	5 to 20
Upper limit	5	1.25	2.5	5	1.25	2.5	5

*Accuracy of test voltage, 1% \pm 3%

- Selectable test voltages: 10 V to 1000 V

Current measurement

Range: 5×10^{-14} to 2×10^{-11} A in 8 ranges.

Meter scale: 0 to 20 in 40 linear divisions.

Input resistance: 10^4 to $10^{11}\Omega$ $\pm 1\%$, depending on range.

Accuracy: $\pm 5\%$ of full scale deflection (there can be an additional $\pm 3\%$ error at the top decade). Using current source of infinite z. For finite sources, input resistance must be taken into consideration.

General

Recorder output: 0 to 100 mV dc, proportional to meter deflection; 1k Ω output resistance.

Power: 115/230 V $\pm 10\%$, 50-60 Hz, approximately 3 VA.

Dimensions: 166 mm high, 198 mm wide, 223 mm deep ($6\frac{1}{2}$ " \times $7\frac{3}{4}$ " \times $8\frac{3}{4}$ ").

Weight: 3.5 kg (7.7 lb).

Accessory furnished: HP 16117A Low Noise Test Leads.

Accessory available: Model 16008A Resistivity Cell.



16008A Description

The HP 16008A can safely, rapidly and conveniently measure the volume and surface resistivity of sheet insulation materials. Conversion from volume to surface resistivity measurement requires operation of one switch only; no lead interchange or disconnection is necessary. Designed for use with the HP 4329A Resistance Meter (other voltage supplies and picoammeters may be used), the complete system allows direct measurement of volume resistivity up to approximately $4 \times 10^{16}\Omega$ (on samples 0.1 cm thick)—and surface resistivity up to approximately $4 \times 10^{11}\Omega$. Test voltages up to 1000 V may be used.

16008A Specifications

Inner electrode: 50 mm diam.

Guard electrode: 70 mm diam.

Auxiliary electrode: 100 mm \times 120 mm.

Maximum sample size: 125 mm \times 125 mm \times 7 mm.

Maximum test voltage: 1000 V dc.

Dimensions: 49 mm high, 198 mm wide, 156 mm deep (2 " \times $7\frac{1}{2}$ " \times $6\frac{1}{4}$ ").

Weight: 1.4 kg (3 lb).

Model number and name

16008A Resistivity cell

4329A High resistance meter

Price

\$430

\$1335

- Electronic autobalance — single control null
- Digital readout for C, R, L
- Direction indicators for fast range selection and balance



Description

Measurements of C, R, L, D (dissipation factor of capacitors), and Q are easily made with Hewlett-Packard's Model 4260A Universal Impedance Bridge.

Readout for C, R, and L is digital with the decimal point automatically positioned. Units of measurement and equivalent circuit automatically appear with a twist of the function switch. There are no multipliers or confusing nonlinear dials which need interpolation.

Operation is simple. Set the function knob for the parameter to be measured, adjust range switch for an on-scale indication, and obtain a null with CRL control. There are no interacting controls to adjust and readjust, nor any false nulls. A unique electronic autobalance circuit solves all these problems. Components with low Q or high Q are as easy to measure as those without less.

For D or Q measurements, switch out of auto and turn DQ control until another null is obtained. Only one adjustment is needed for each measurement.

Five bridge circuits are incorporated in HP's 4260A; each is composed of stable, high-quality components for good accuracy and linearity. An internal 1 kHz drives the bridge.

Nulling is easy. Illuminated pointers (<CRL>) automatically tell whether a null is up- or down-scale. Both range and CRL controls can be set watching these pointers.

Components may be biased by connecting a battery to rear terminals. An external oscillator and detector can be used for measurements in the 20 Hz - 20 kHz range.

Specifications

Capacitance measurement

Range: 1000 pF to 1000 μF, in 7 full scale ranges.
Accuracy: ±(1% + 1 digit), from 1 nF to 100 μF. ±(2% + 1 digit), from 1 pF to 1 nF and 100 μF to 1000 μF.

Dissipation factor

Range
Low D — (of series C): 0.001 to 0.12.
High D — (of parallel C): 0.05 to 50.
Accuracy: for C > 100 pF.

$$\text{Low D} \dots \dots \dots + \frac{2}{\sqrt{D \text{ of reading}}} \%.$$

$$\text{High D} \dots \dots \dots + (10 D \text{ of reading} + 4) \%.$$

$$\dots \dots \dots - (10 \sqrt{D \text{ of reading}} + 2) \%.$$

Add ±1 dial division for frequencies other than 1 kHz.

Inductance measurement

Range: 1000 μH to 1000 H, in 7 full scale ranges.
Accuracy: ±(1% + 1 digit), from 1 mH to 100 H. ±(2% + 1 digit), from 1 μH to 1 mH and 100 H to 1000 H.

Quality factor

Range
Low Q — (of series L): 0.02 to 20.
High Q — (of parallel L): 8 to 1000.
Accuracy: for L > 100 μH.

$$\text{Low Q} \dots \dots \dots + \left(\frac{10}{Q \text{ of reading}} + 4 \right) \%.$$

$$\dots \dots \dots - \left(\frac{10}{\sqrt{Q \text{ of reading}}} + 2 \right) \%.$$

High Q ± 2 √Q of reading %.

Add ±1 dial division for frequencies other than 1 kHz.

Auto-balance

Eliminates need for DQ adjustments in parallel C and series L measurements at 1 kHz.

Accuracy: for D < 1 and Q > 1 add ±0.5% to C and L accuracy specifications.

Resistance measurement

Range: 10Ω to 10 MΩ, in 7 full scale ranges.
Accuracy: 10 mΩ to 10Ω ±(2% + 1 digit), 10Ω to 1 MΩ ±(1% + 1 digit), 1 MΩ to 10 MΩ ±(2% + 1 digit).

Oscillator and detector

Internal oscillator: 1 kHz ±2%, 100 mV rms ±20%.
Internal detector: tuned amplifier at 1 kHz; functions as a broadband amplifier for measurements with external oscillator.

General

Power: 115 or 230 volts ±10%, 50-60 Hz, approx. 7 VA.
Dimensions: 198 mm wide × 166 mm high × 279 mm deep (7⁷/₁₆" × 6⁵/₁₆" × 11").
Weight: net, 5 kg (11 lb). Shipping, 6.8 kg (15 lb).

Optional

204C Opt. 001 for measurements 20 Hz-20 kHz
 4260A Universal Bridge

Price

\$455
\$1065

COMPONENT TEST

Universal bridge

Model 4265B

- High accuracy: 0.2%
- Wide range
 - C: 0.1 pF to 1111 μ F
 - L: 0.1 μ H to 1111 H
 - R: 0.1 m Ω to 1 M Ω

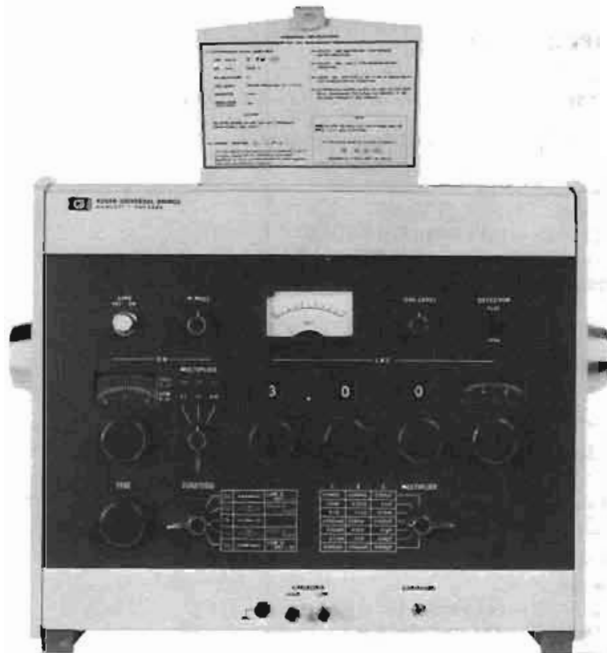

Description

Hewlett-Packard's Model 4265B Universal Bridge provides an economical way to make high precision measurements of L, C, or R and D or Q. Components can be measured in ranges of 0.1 μ H to 1111 H in inductance, 0.1 pF to 1111 μ F in capacitance and 0.1 m Ω to 1.111 M Ω in resistance. L and C measurements are performed over a wide range of loss with either series or parallel equivalent circuits selected by the function switch. Basic measurement accuracy is 0.2% of reading for L, C, and R.

Measurement frequency range is 50 Hz to 10 kHz with an external oscillator, and 1 kHz with internal oscillator. A dc measurement for resistance is also available with external dc power supply and null detector.

The front panel design provides appropriate space and convenient positioning of knobs for easy balancing. The rugged handle is used as the tilt stand at angles of 0, 40, or 60 degrees.

Specifications

Resistance measurement

Full scale range: 1000.0 m Ω to 1.0000 M Ω , 7 ranges.

Overrange: 11.1%.

Minimum resolution: 0.1 m Ω .

****Accuracy (at 1 kHz):** $\pm(0.2\%$ of reading + 0.01% of F.S.), $\pm(0.4\%$ of reading + 0.01% F.S.) for 1000.0 m Ω range.

Residual resistance: 1 m Ω .

Inductance measurement

Full scale range: 1000.0 μ H to 1000.0 H, 7 ranges.

Overrange: 11.1%.

Minimum resolution: 0.1 μ H.

****Accuracy (at 1 kHz):** $\pm(0.2\%$ of reading + 0.01% of F.S.), $\pm(0.4\%$ of reading + 0.01% F.S.) for 1000.0 μ H range.

Residual inductance: 0.04 μ H (in series with 1 m Ω).

Loss factor range: (at 1 kHz).

Q of series L: 0.001 to 10, accuracy $\pm(5\%$ of reading + 2 minor divisions).

Q of parallel L: 1 to 1000, accuracy $\pm(5\%$ of reading + 2 minor divisions) for 1/Q.

Capacitance measurement

Full scale range: 1000.0 pF to 1000.0 μ F, 7 ranges.

Overrange: 11.1%.

Minimum resolution: 0.1 pF.

****Accuracy (at 1 kHz):** $\pm(0.2\%$ of reading + 0.01% of F.S.), $\pm(0.4\%$ of reading + 0.01% F.S.) for 1000.0 μ F range.

Residual capacitance: 0.4 pF.

Loss factor range: (at 1 kHz).

D of series C: 0.001 to 1, accuracy $\pm(5\%$ of reading + 2 minor divisions).

D of parallel C: 0.1 to 1000, accuracy $\pm(5\%$ of reading + 2 minor divisions) for 1/D.

****For temperature of 25°C \pm 10°C.**

General

Internal oscillator:

Frequency: 1 kHz \pm 15 Hz.

Output: continuously variable with front panel control. Maximum voltage is 0.4 V rms.

External oscillator:

Frequency range: 50 Hz to 10 kHz or dc for resistance measurement.

Internal detector: tuned amplifier at 1 kHz. In 1 kHz position, maximum sensitivity of 10 μ V, selectivity better than 26 dB. In "Flat," operates as a broad band detector from 50 Hz to 10 kHz.

External dc bias: capacitance measurements in Cs mode, maximum bias voltage of 250 V dc. Inductance measurements in Lp mode.

Operating temperature: 0° to 55°C.

Power: 100/120/200/240 V \pm 10%; 48 to 440 Hz, 5 VA.

Dimensions: 376 mm high, 115 mm deep, 393 mm wide (14 $\frac{1}{2}$ " \times 4 $\frac{1}{2}$ " \times 15 $\frac{3}{4}$ ").

Weight: net, 5.5 kg (12.1 lb). Shipping, 7.1 kg (15.7 lb).

Accessories furnished: power cord, 230 cm (7 $\frac{1}{2}$ ft). Crystal earphone.

Accessories available: model 16029A Test Fixture.



Model name and number

16029A Test Fixture

4265B Universal Bridge

Price:

\$55

\$1010

COMPONENT TEST

Digital LCR Meter

Model 4261A

- Fully automatic—autoranging
- Wide range C = 0.1 pF to 19 mF, L = 0.1 μ H to 1900 H, R = 1 m Ω to 19 M Ω
- Low cost with high performance
- Versatile accessories/options
- High reliability



Description

The Model 4261A Digital LCR Meter is a new, fully automatic instrument that satisfies many of today's user requirements in the LCR measurement field.

The 4261A features high speed, accurate measurements. The devices under test need only be connected and the function L, C, or R selected. The instrument automatically displays the desired parameter. Tedious balancing operations typically used in conventional manual bridges are completely eliminated. Measurement circuit mode (series or parallel) is also automatically selected.

Complementing its wide LCR measurement range, HP's 4261A has other features such as high accuracy (basically 0.2% of reading), high speed measurement (typically 4 per second), 120 Hz or 1 kHz measurement frequencies, 1 V or 50 mV test signal levels, internal bias sources and parallel or series equivalent circuit modes.

Measurements are taken using the five-terminal method, which easily converts to four, three or two terminals to meet most LCR measurement applications. For example, the four-terminal input could be used to measure the capacitance of an electrolytic capacitor, the inductance of transformer or the internal resistance of a dry cell. The

three-terminal input is appropriate for semiconductor junction capacitance or cable capacitance measurements. To fit these needs, three kinds of optional test leads and fixtures are available. The 4261A can easily measure parameters of pulse transformers, filter coils and electrolytes in addition to ordinary LCR components.

Expanded use features of this highly reliable instrument include optionally available digital output, remote control, and HP-IB options which enable a wide range of applications from the research laboratory to the production line.

Specifications

Parameter measured: C-D (Capacitance & Dissipation Factor), L-D (Inductance & Dissipation Factor), and R (Resistance).

Display: 3½ digits, max. display 1900.

Circuit mode: Auto, Parallel and Series.

Measuring circuit: five-terminal method.

Range mode: Auto or Range Hold

Measurement frequencies: 120 Hz \pm 3% or 1 kHz \pm 3%.

Trigger: Internal, Manual or External.

Measurement ranges, measurement accuracies & test signal levels: see tables on next page for C-D, L-D, and R measurements. Accuracy applies over a temperature range of 23°C \pm 5°C (at 0°C to 55°C, error doubles).

DC Bias

Internal source: 1.5 V, 2.2 V, 6 V (selectable on front panel).

Accuracy: \pm 5%.

External source: provision for external DC bias voltage of +30 V maximum at binding posts on rear panel.

General

Measuring time: typically approx. 1000 counts on fixed range for low loss measurements. Specific data follows:

1 kHz: C/L 220–260 ms, R 120–160 ms

120 Hz: C/L 900 ms, R 700 ms

When auto range is selected, a range selection time of 180 ms at 1 kHz and a range step time 670 ms at 120 Hz is added to the above typical times.

Reading rate: internal trigger—approx. 30 ms between end of measurement and start of next cycle; External trigger—measurement cycle is initiated by remote trigger input.

Data format: +1-2-4-8 BCD, TTL logic level, "1" (high level).

Operating temperature: 0°C to 55°C.

Humidity: to 95% RH at 40°C.

Voltage requirements: 100/120/220/240 V \pm 10%, 48 to 66 Hz.

Power consumption: \leq 25 VA with any option.

Altitude: 50 000 ft.

Dimensions: 213 mm W \times 134 mm H \times 422 mm D (8½" \times 5¼" \times 16½")

Weight: approx. 7.5 kg (16.5 lb)

R Measurement

RANGE	120 Hz or 1 kHz	1000 m Ω	10.00 Ω	100.0 Ω	1000 Ω	10.00 k Ω	100.0 k Ω	1000 k Ω	10.00 M Ω
Test Signal Level *1.		1 V							
		70 mA	10 mA	1 mA	100 μ A	10 μ A			
	AUTO	Same as Mode				Same as Mode			
R Accuracy *2.		0.3% + 2 counts							
		0.2% + 2 counts							
	AUTO	Same as Mode				Same as Mode			

*1. Typical data, varies with number of counts.

*2. \pm (% of reading + counts).

C-D Measurement

RANGE	C	120 Hz 1 kHz	1000 pF 100.0 pF	10.00 nF 1000 pF	100.0 nF 10.00 nF	1000 nF 100.0 nF	10.00 μ F 1000 nF	100.0 μ F 10.00 μ F	1000 μ F 100.0 μ F	10.00 mF 1000 μ F	
	D	0.001 to 1.900, common to all C ranges.									
Test Signal Level *1.		1 V or 50 mV									
		10 μ A	100 μ A	1 mA	10 mA	70 mA					
	AUTO	Same as Mode				Same as Mode					
C Accuracy *2.		0.2% + 1 count + 0.2 pF					(Test signal level; 1 V)				
		0.5% + 3 counts	0.3% + 2 counts				(Test signal level; 50 mV)				
	AUTO	Same as Mode				0.3% + 2 counts		0.5% + 2 counts	1% + *3 2 counts		
D Accuracy *2.		0.2% + (2 + 200/Cx) counts					(Test signal level; 1 V)				
		0.3% + (2 + 1000/Cx) counts					(Test signal level; 50 mV)				
	AUTO	Same as Mode				0.3% + (2 + Cx/500) counts		1% (5 + Cx/500) counts			

*1. Typical data, varies with value of D and number of counts.

*2. \pm (% of reading + counts + n). Cx is capacitance readout in counts.

*3. (5% + 2 counts) at 1 kHz

L-D Measurement

RANGE	L	120 Hz 1 kHz	1000 μ H 100.0 μ H	10.00 mH 1000 μ H	100.0 mH 10.00 mH	1000 mH 100.0 mH	10.00 H 1000 mH	100.0 H 10.00 H	1000 H 100.0 H	
	D	0.001 to 1.900, common to all L ranges.								
Test Signal Level *1.		1 V								
		70 mA	10 mA	1 mA	100 μ A	10 μ A				
	AUTO	Same as Mode				Same as Mode				
L Accuracy *2.		0.3% + 2 counts					1% + 2 counts			
		0.2% + 2 counts + 0.2 μ H								
	AUTO	Same as Mode				Same as Mode				
D Accuracy *2.		0.3% + (3 + Lx/500) counts					1% + 2 counts			
		0.2% + (3 + 200/Lx) counts								
	AUTO	Same as Mode				Same as Mode				

*1. Typical data, varies with value of D and number of counts.

*2. \pm (% of reading + counts + n). Lx is inductance readout in counts.

Accessories available:

16061A: test fixture (direct coupled type), 5-terminal.

16062A: Test Leads with alligator clips, 4-terminal (for low impedance measurements).

16063A: Test Leads with alligator clips, 3-terminal (for high impedance measurements).

16414A: HP-IB Interface Kit

Options available

Option 001: BCD Output of C/L/R and D (simultaneous).

Option 002: BCD Output of C/D, L/D and R (alternately).

Option 003: BCD Remote Control (except for DC bias function).

Option 101: HP-IB Remote Control and Data Output.

Model number and name:

16061A Test Fixture

16062A Test Leads

16063A Test Leads

16414A HP-IB Interface Kit

Option 001 BCD Output (Simultaneous)

Option 002 BCD Output (Alternately)

Option 003 BCD Remote Control

Option 101 HP-IB Data Output and Remote Control

4261A Digital LCR Meter

Price

\$100

\$55

\$55

\$1855

\$145

\$130

\$65

\$2065

\$1740

COMPONENT TEST

1 MHz digital LCR meter

Model 4271A



- Precision measurement of low value components
- High speed

- Convenient options for data processing
- C = 0.001 pF to 19 nF; L = 0.1 nH to 1.9 mH; R = 0.001Ω to 19 kΩ



Description

The HP 4271A features automatic high speed measurements of low value L, C and R components at 1MHz. Dissipation factor or conductance is also measured. The 4271A has a basic measurement accuracy of 0.1%–1.2% with minimum resolution of 0.1nH, 0.001pF or 1mΩ for L, C and R respectively. The four-terminal pair measurement technique has the advantage of reducing errors due to electro magnetic coupling of leads as well as reducing residual inductance or

stray capacitance. The 4271A includes a zero adjustment capability for C, G, L and R measurement by offset controls that cancel the residuals existing in the measurement fixtures. Many available accessories and options expand the usefulness of the 4271A.

Typical applications for the 4271A are microcircuit measurements using a microprobe, capacitance — voltage characteristic measurements on variable capacitance diodes, passive component tests on devices such as ceramic/mica capacitors, reed relays and pulse transformers.

Specifications

Full scale ranges:

	Range	Capacitance	Conductance	Inductance	Resistance	Dissipation Factor*
Full scale display	1	10.000 pF	100.00 μS	1000.0 nH	10.000 Ω	1.0000
	2	100.00 pF	10000.0 μS	10.000 μH	100.00 Ω	
	3	1000.0 pF	10.000 mS	100.00 μH	1000.0 Ω	
	4	10.000 nF	100.00 mS	1000.0 μH	10.000 kΩ	
Over-ranging	1–4	90%	90%	90%	90%	60%

*When reading of L or C is more than 1000 counts

Capacitance:

Range	Test sig level—high ±(% of reading + counts)	Test sig level—low ±(% of reading + counts)
1	0.1 + 7	0.2 + 8
2	0.1 + 3	0.2 + 4
3	0.1 + 3	0.2 + 3
4**	0.4 + 3	0.4 + 3

Accuracy

(When conductance reading is less than 100 counts and resistance reading is less than 1000 counts.) Accuracy listed in the following table applies over a temperature range of 23°C ± 5°C. (At 0°C to 50°C, accuracy is doubled.)

Warm-up time: one hour required to meet all specifications.

Conductance:

Range	Test sig level—high ±(% of reading + counts)	Test sig level—low ±(% of reading + counts)
1	$0.2 + \left(7 + \frac{N_c}{1000}\right)$	$0.3 + \left(7 + \frac{2N_c}{1000}\right)$
2	$0.2 + \left(3 + \frac{N_c}{1000}\right)$	$0.3 + \left(3 + \frac{2N_c}{1000}\right)$
3, 4**	$1.2 + \left(2 + \frac{2N_c}{1000}\right)$	$1.2 + \left(2 + \frac{2N_c}{1000}\right)$

Where N_c is capacitance readout in counts.

Dissipation factor:

Range	Test sig level—high ±(% of reading + counts)	Test sig level—low ±(% of reading + counts)
1	$1.0 + \left(10 + \frac{20,000}{N_c}\right)$	$1.0 + \left(15 + \frac{30,000}{N_c}\right)$
2, 3	$1.0 + \left(10 + \frac{10,000}{N_c}\right)$	$1.0 + \left(15 + \frac{20,000}{N_c}\right)$
4**	$1.0 + \left(15 + \frac{30,000}{N_c}\right)$	$1.0 + \left(15 + \frac{30,000}{N_c}\right)$

**On Range 4, Test sig level is low only. N_c is capacitance readout in counts.

Inductance measurement accuracy**Inductance:**

Range	Test sig level—high ±(% of reading + counts)	Test sig level—low ±(% of reading + counts)
1**	1.0 + 15	1.0 + 15
2	0.6 + 4	0.6 + 6
3, 4	0.2 + 4	0.3 + 6

Resistance:

Range	Test sig level—high ±(% of reading + counts)	Test sig level—low ±(% of reading + counts)
1**	$1.2 + \left(8 + \frac{2N_L}{1000}\right)$	$1.2 + \left(8 + \frac{2N_L}{1000}\right)$
2	$1.2 + \left(2 + \frac{2N_L}{1000}\right)$	$1.2 + \left(2 + \frac{2N_L}{1000}\right)$
3, 4	$0.2 + \left(2 + \frac{2N_L}{1000}\right)$	$0.3 + \left(2 + \frac{2N_L}{1000}\right)$

Where N_L is inductance readout in counts.**Dispersion factor:**

Range	Test sig level—high ±(% of reading + counts)	Test sig level—low ±(% of reading + counts)
1**	$1.0 + \left(20 + \frac{30,000}{N_L}\right)$	$1.0 + \left(20 + \frac{30,000}{N_L}\right)$
2, 3	$1.0 + \left(15 + \frac{10,000}{N_L}\right)$	$1.0 + \left(20 + \frac{20,000}{N_L}\right)$
4	$1.0 + \left(15 + \frac{20,000}{N_L}\right)$	$1.0 + \left(15 + \frac{30,000}{N_L}\right)$

At Range 1, test sig level is low only where N_L is inductance readout in counts.Conductance, resistance measurement accuracy****Accuracy:** when capacitance or inductance is less than 1,000 counts.**Conductance:**

Range	Test sig level—high ±(% of reading + counts)	Test sig level—low ±(% of reading + counts)
1	0.2 + 8	0.3 + 9
2	0.2 + 4	0.3 + 5
3, 4***	1.2 + 4	1.2 + 4

***On Range 4, test sig level is low only.

Resistance:

Range	Test sig level—high ±(% of reading + counts)	Test sig level—low ±(% of reading + counts)
1	1.2 + 10	1.2 + 10
2	1.2 + 4	1.2 + 4
3, 4	0.2 + 4	0.3 + 4

Test signal:

Test Level	mV rms; tolerance (%) capacitance		μ A rms; tolerance (%) inductance	
	Level-High	Level-Low	Level-High	Level-Low
1	500 ± 10	20 ± 10	2000 ± 20	2000 ± 20
2	500 ± 10	20 ± 10	500 ± 10	200 ± 10
3	500 ± 10	20 ± 10	500 ± 10	20 ± 10
4	20 ± 20	20 ± 10	50 ± 10	2 ± 10

Frequency: 1 MHz ± 0.01%.

Offset adjustment: offset adj. compensates for (a) stray capacitance or residual conductance of test fixture; variable ranges are 1 pF and 1 μ S, or (b) residual inductance or residual resistance of test fixture. Variable ranges are 100 nH and 100 m Ω .

DC bias (optional)

Internal source: DC bias is available as a plug-in board, Option 001, which has following specifications:

Range: 00.0 V to 39.9 V, variable in steps of 0.1 V.

Accuracy: ±0.2% of setting ±5 mV at 23°C ±5°C. Warm-up time is >60 min.

Output resistance: 1.5 k Ω ± 10%.

Short circuit current: less than 6 mA.

Control: HP Model 16023A DC Bias Controller (available extra) or HP Model 9810/9820A Calculator when Option 005 is installed.

Control input connector: HP P/N 1251-0143, 14-pin receptacle. (Amphenol 57-40140).

Mating connector: HP Part No. 1251-0142. (Amphenol 57-30140).

External source: ±200 V maximum to BNC connector (ext input) on rear panel. Max bias current 20 mA. Input resistance 10.5 k Ω ± 10%.

Monitor output: bias voltage monitoring BNC connector monitor on rear panel. Output resistance 480 Ω ± 10% to H CUR terminal.

General**Measuring speed**

Fixed range: 100 ms to 250 ms in C-G and L-R measurements, 160 ms to 400 ms in C-D and L-D measurements.

Autorange: 100 ms/range step added to above values.

Power: 100 V, 120 V, 220 V, 240 V ± 10%, 48-66 Hz, 80 VA.

Dimensions: 88.1 mm high × 425.5 mm wide × 496.9 mm deep (3 $\frac{1}{2}$ " × 16 $\frac{3}{4}$ " × 19 $\frac{3}{16}$ ").

Weight: 10 kg (22 lb).

Accessories available:

16023A DC Bias Voltage Controller, used with Option 001.

16032A Test Leads with BNC connectors.

16033A Test Leads with miniature coaxial connectors.

16038A Test Fixture.

16039A Test Fixture for "D" offset.

Options available:

Option 001 DC Bias supply, 0.0 V to 39.9 V.

Option 002 C/L BCD output. May be used with Option 003 for simultaneous outputs +8241 Code.

Option 003 G/R/D BCD Output. +8421 Code. (See Option 002).

Option 004 Parameter Serial BCD Output. Allows selection of: 1. (C or L) Data only; 2. (D or G or R) Data only; or 3. (C or L) and (D or G or R) Data — 8421 Code.

Option 005 Calculator Interface. HP 9810A or 9820A or 9830A. Utilizes HP 11202A I/O Card and Cable. Available extra.

Option 010 1 MHz Digital LCR Meter, less 16022A Test Fixture. Specify 16032A, 16033A.

Option 101 HP-IB System Compatible

Model number and name

Model number and name	Price
16023A DC Bias Controller	\$410
16032A Test Leads (BNC)	\$156
16033A Test Leads	\$178
16038A Test Fixture	\$165
16039A Test Fixture for "D" offset	\$190
Option 001 DC Bias Supply	add \$235
Option 002 C/L BCD output	add \$125
Option 003 G/R/D BCD output	add \$125
Option 004 Parameter Serial BCD output	add \$215
Option 005 Calculator Interface	add \$370
Option 010 4721A Less Test Fixture	less \$350
Option 101 HP-IB System Compatible	add \$2330
4721A 1 MHz Digital LCR Meter	\$4760

COMPONENT TEST

1 MHz Preset C Meter

Model 4272A



- Simultaneous go/no go check on production line
- High accuracy—basically 0.1% of reading
- High speed measurements—8 per second



Description

The 4272A 1 MHz preset C meter is a unique instrument in which a 5 digit "in-house" comparator is combined with 1 MHz capacitance measurement capability. Capacitance can be measured from 10 pF full scale (resolution 0.001 pF) to 1000 pF full scale (maximum display 1900 pF).

In addition to the comparator capability, the instrument can be set to high and low limits with the built-in thumbwheel switch. Limit indications include panel lamp display, relay contact and TTL output for HI, IN and LO comparisons.

The combination of measurement and comparator capability makes this instrument very applicable for production line GO/NO GO checking. When relatively small capacitors such as ceramic or mica are checked for quality in the production process, there is no necessity to read the digital display.

A GO/NO GO check requires only a glance at the HI-IN-LO lamp display. Decision type outputs can be utilized in an automatic selection system.

BCD data output for data processing of variable is optionally available.

Specifications

Parameter measured: capacitance—equivalent parallel circuit by four terminal pair method.

Test signal

Frequency: 1 MHz $\pm 0.01\%$

Level: 1 V rms $\pm 10\%$

Measurement range and accuracy: 0.001 pF–1900.0 pF in 3 decade range, manually selected. Remote ranging is optionally available.

Range	Full Scale Display	Overrange	Accuracy*
10 pF	10.000 pF	90%	0.1 + 7
100 pF	100.00 pF	at	0.1 + 3
1000 pF	1000.0 pF	each range	0.1 + 2

* $\pm(\% \text{ of reading} + \text{counts})$

Accuracy applies over a temperature range of $23^\circ\text{C} \pm 5^\circ\text{C}$ at dissipation factors $D < 0.1$ (At 0°C – 50°C , error doubles). Warm-up time is >60 min.

Offset adjustment: offset adjustment compensates for stray capacitances of 0 to 1 pF and residual inductances of 0 to 100 nH existing at test fixture.

Function: compares measured value with HI and LOW LIMIT setting and provides HI, IN and LO comparison outputs.

HI and LOW LIMIT SETTING RANGE: 00000–19999 at each limit switch.

Comparison output: visual, relay contacts and TTL level.

Visual: 3 LED's indicate HI, IN or LO.

Relay contacts: 3 SPST contacts to circuit common for HI, IN or LO output.

TTL level: 3 open collector circuits to HI level (open) for HI, IN or LO output (Fanout max 30 mA).

Measuring time: < 120 mS

Reading rate

Internal: < 400 mS

Between end of measurement and start of next cycle.

External: a new cycle may be started by pushing manual trigger button or by remote trigger input to remote trigger connector.

Remote trigger input: a measurement cycle may be initiated at remote trigger connector by changing logic level state from "0" (zero volts or connection to ground though less than 25Ω) to "1" (TTL high level or open), pulse width $> 1 \mu\text{s}$.

General

Operating temperature & humidity: 0°C to 50°C , relative humidity to 95% at 40°C .

Power requirements: 100/120/220/240 V $\pm 10\%$, 48–66 Hz.

Power consumption: ≤ 60 VA with any option.

Dimensions: 426 \times 99 \times 467 mm (W \times H \times D).

Weight: approximately 10 kg.

Accessories furnished: 16033A Test Leads with BNC Connectors



Accessories available

16022A: Test Fixture, General Purpose

16033A: Test Leads with Miniature Coaxial Connectors

16038A: Test Fixture

Note: The above accessories are the same as for the 4271A.

Options available

Option 002 BCD and Decision Outputs

Option 005 ASCII Code Input/Outputs for Calculator Interface Utilizes HP 11202A I/O Card (Not Included)

Option 006 BCD Remote Control

Option 101 HPIB Data Output and Remote Control

Model number and name

16022A Test Fixture

16033A Test Lead

16038A Test Fixture

Option 002 BCD Output

Option 005 Calculator Interface

Option 006 Remote Control

Option 101 HPIB Data Output and Remote Control

4272A 1 MHz Preset C Meter

Price

\$380

\$178

\$165

\$85

\$320

\$85

\$2150

\$4760

COMPONENT TEST

Digital high capacitance meter

Model 4282A

- Wide range—10 nF to 1 F full scale
- Dissipation factor or ohm-farad measurements
- Internal bias supply
- Digital and analog outputs for recording



16035A



16036A

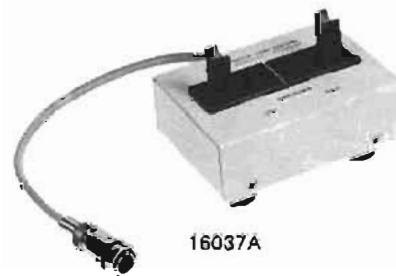

16037A

Description

Hewlett-Packard's Model 4282A Digital High Capacitance Meter can make precision measurements on high value tantalum or aluminum electrolytic capacitors. Applications include both capacitor design measurements and production testing — either in incoming or outgoing inspection.

Two types of leads are supplied with the HP 4282A. One is the standard four-wire alligator clip style, and the other, comprises two specially designed clips that maintain the Kelvin four-wire measurement.

Two unique features of the HP 4282A are: alternating mode (alternately displays either capacitance and dissipation factor, C-D, or capacitance and the product of ohms and farads, C- Ω F) and the capability to double as a three-digit DVM.

Both digital and analog outputs are available for making permanent recordings.

The standard model has four measuring frequencies: 50, 60, 100, 120 Hz. These represent power line frequencies and their second harmonics. Most large value capacitors are used as filters in power supplies and are operated at these frequencies. If your application requires tests at other frequencies, please refer to Models 4260A, 4261A, 4265A, 4270A and 4271A on the adjoining pages.

Specifications

Measuring functions: capacitance, dissipation factor, *ohm-farad

and dc voltage. Selectable by function switch.

***Ohm-farad:** the product of the capacitance and equivalent series resistance of the capacitor.

Function switch setting	Function and display
C	Capacitance measurement.
D	Dissipation factor measurement.
Ω F	Ohm-farad measurement
C-D	Capacitance and dissipation factor measurements (alternately).
C- Ω F	Capacitance and ohm-farad measurements (alternately).
V	DC bias voltage or external voltage measurements.
	Note All measurements are continuously repeated as long as unknown is connected.

Measuring ranges:

Function	Full-scale display	Over ranging
C (capacitance)	10.000 nF to 1.0000 F, four full digits, 9 ranges in decade steps, manual selection.	18%
D (dissipation factor)	1.000 to 10.000, three full digits, 2 ranges, auto selection.	18%
ΩF (ohm-farad)	1.000 Ω mF to 10.000 mF three full digits, 2 ranges, auto selection.	18%
V (dc voltage)	10.00 V to 1.000 kV, three full digits, 3 ranges, in decade steps, manual selection (maximum voltage is 600 V).	18%

Measuring circuit: series equivalent circuit using four-terminal method.

Measuring frequencies: 50 Hz, 60 Hz, 100 Hz and 120 Hz (50 Hz and 60 Hz synchronized by line frequency). Accuracy: $\pm 1.5\%$.

Measuring voltages

10 nF to 10 mF ranges: < 1 V rms.

100 mF range: < 0.1 V rms.

1 F range: < 10 mV rms.

Accuracy: (+23°C $\pm 5^\circ C$ after half hour warm up): \pm (% of reading + % of full-scale).

Capacitance:

C Range	% of reading	% of full-scale
10 nF	1.0 + 0.5 · Drdg	0.2
100 nF	0.5 + 0.5 · Drdg	0.1
1 μF to 1 mF	0.4 + 0.5 · Drdg	0.05
10 mF	1.0 + 0.5 · Drdg	0.05
100 mF	1.5 + 0.5 · Drdg	0.5
1 F	2.5 + 0.5 · Drdg	1.0

Dissipation factor:

C Range	% of reading	% of full-scale
10 nF	1.5 + 0.5 · Drdg	0.2 · Cfs/Crdg + 0.3
100 nF to 1 mF	1.5 + 0.2 · Drdg	0.2 · Cfs/Crdg + 0.3
10 mF	1.5 + 0.2 · Drdg	0.2 · Cfs/Crdg + 0.5
100 mF, 1 F	2.5 + 0.2 · Drdg	0.2 · Cfs/Crdg + 3

Ohm-farad:

C Range	% of reading	% of full-scale
10 mF	1.0 + 0.5 · Ω Frdg	0.2 · Cfs/Crdg + 0.3
100 nF to 1 mF	1.0 + 0.2 · Ω Frdg	0.2 · Cfs/Crdg + 0.3
10 mF	1.0 + 0.2 · Ω Frdg	0.2 · Cfs/Crdg + 0.5
100 nF, 1 F	1.0 + 0.2 · Ω Frdg	0.2 · Cfs/Crdg + 3

Drdg: reading of dissipation factor.

Ω Frdg: reading of ohm-farad.

Crdg: reading of capacitance.

Cfs: full-scale of C range setting.

DC voltage measurement accuracy

10 V range: \pm (0.05% of reading + 0.1% of full-scale).

100 V and 1 kV ranges: \pm (0.2% of reading + 0.1% of full-scale).

Temperature coefficient:

(referred to +23°C, and temperature range: of 0°C to 50°C)

Function	Temperature coefficient
C	$\pm 0.02\%$ of reading/ $^\circ C$
D, ΩF	$\pm 0.03\%$ of reading/ $^\circ C$
V	$\pm 0.01\%$ of reading/ $^\circ C$

Option 001 Leakage Current Measurement adds following capabilities to standard model:

Leakage current measurement: (1.)

Range: 1.000 μA to 10.000 mA, 5 ranges, three full digits.

Overranging: 18%.

Accuracy: 1 μA range: \pm (2% of reading + 2.0% of full-scale). 10 μA to 10 mA ranges: \pm (2% of reading + 0.3% of full-scale).

Bias voltages: internal source: 0 to 10 V, 0 to 100 V, 2 ranges, continuously variable over each range. Maximum current is 100 mA for 10 V range and 60 mA (for 1 minute) for 100 V range.

External source: usable up to 600 V dc across ext bias terminals on rear panel.

Protective resistor: 1 k Ω for 100 V range and for external bias, 1 Ω for 10 V range.

General

DC bias voltage: 0 to 10 V, continuously adjustable with DC bias control. Maximum charging current is 100 mA.

Balancing time: normally one second (when measuring on C ranges of 10 nF through 10 mF, capacitance value near full-scale, dissipation factor less than one and without dc bias).

Reading rate: continuously variable from 0.3 to 2 seconds with rate control.

Reset: initiates one reading by depressing Reset Int pushbutton or contact closure to ground or TTL low level at reset ext line. Mating plug for reset test jack: HP part No. 1251-0918.

Digital output: output signals: BCD + 1-2-4-8, data parallel, decimal point, function and unit, overload and unbalance, and polarity.

Level:

State	Level	Characteristics
Low	0.3 V \pm 0.3 V	Max sink current 15 mA
High	3.9 V \pm 1.5 V	Max load current 300 μA

Print command output: negative going TTL pulse of approx. 1 ms.

Printer hold input: TTL low level or contact closure to ground.

Connector: mating, HP P/N 1251-0084; Amphenol 57-30360-375 (36-pin blue ribbon).

Remote programming: programmable functions, C-range, I_L range (option 001) and reset by TTL low level of contact closure to ground.

Connector: mating, HP P/N 1251-0084; Amphenol 57-30360-375 (36-pin blue ribbon).

Analog output: DC output of 1 V full-scale in proportion to displayed value.

Accuracy: add $\pm 0.5\%$ of reading to accuracy specification.

Operating environment: 0°C to +50°C, $\leq 90\%$ RH.

Power requirements: 100 V, 120 V, 220 V or 240 V $\pm 10\%$, 50 Hz or 60 Hz, approx. 70 VA.

Dimensions: 425 mm wide \times 88 mm high \times 467 mm deep (16 1/2" \times 3 1/2" \times 18 1/2").

Weight: net, 8.8 kg (4 lb). Shipping, 12.9 kg (5.86 lb).

Accessories furnished

16035A test leads: four alligator clips.

16036A test leads: two alligator-jaw clips. Power cord: 230 cm (7 1/2 ft), HP Part No. 8120-1378.

Accessories available

Accessories available	Price
16037A Test Fixture	\$195
16037A, Option 001 (vertical lead devices)	\$195
16413A HP-IB Interface Kit	\$1980

Options

Option 101 HP-IB System Compatible	\$1980
Option 908 Rack Flange: Kit	add \$10

Model number and name:

4282A with option 001 (leakage current)	\$3790
4282A Digital High Capacitance Meter	\$3500

COMPONENT TEST

Capacitance bridge

Model 4270A

- Fully automatic
- 1 kHz to 1 MHz
- Measure from 18,000 pF to 1,2000 μ F Full Scale



Description

A unique instrument from Hewlett-Packard, the 4270A Automatic Capacitance Bridge provides a wide variety of high speed measurements of both active and passive capacity values. Five-digit readout of capacitance from full-scale ranges of 18,000 pF to 1,2000 μ F is complemented by .001 pF resolution and measurement speed of 0.5 seconds. In addition, a second in-line 4-digit Nixie display of capacitor loss is given simultaneously in terms of parallel conductance (G) or dissipation factor (D). In the laboratory, HP's 4270A will be extremely useful for examination of semiconductor junction capacities, input capacitances of amplifiers and other active devices, as well as analysis of stray capacity values, cables and simple capacitors. DC biasing, four frequencies from 1 kHz to 1 MHz and a fully guarded measurement will add to laboratory flexibility.

Specifications

Measuring circuit

Float: guarded terminals of unknown are floated from ground. L-ground: one side of known terminals is grounded, guard is retained.

Parameters measured: capacitance, equivalent parallel conductance and dissipation factor.

Measuring frequency: 1 kHz, 10 kHz, 100 kHz and 1 MHz \pm 1%.

Range modes

Auto: range selection and balance performed automatically.

Hold: range is held on fixed position, balance begins with most significant digit. Range determined by previous auto or track range selected or by manually stepping range step.

Track: range held on fixed position, balance begins with last digit.

Balancing time: typically 0.5 s.

Measuring rate: measurement cycle equals balance time plus display time. Balance time typically 0.5 s; display times selected by meas rate are 70 ms, 2 secs, 5 secs, and manual.

Test voltage across unknown

Normal: 1 V rms constant in pF or nF at 1 kHz, 0.1 V rms constant, in μ F at 1 kHz, 0.5 V rms constant at 10 kHz, 100 kHz and 1 MHz.

Low: $\frac{1}{3}$ of normal.

Repeatability: \pm 2 digits at normal test voltage, \pm 10 digits at low test voltage.

DC bias: Internal or external to \pm 200 V, in hold and track mode.

Internal bias at float measurement

Voltage: 0 to 20 V dc; 0 to 200 V dc; continuously variable on front panel, monitored on rear panel.

Dial accuracy: \pm 5% of full scale.

Source resistance: 100 k Ω .

Polarity: low unknown terminal (-), high unknown terminal (+) in float position of meas ctrl control.

Remote: programmable by resistor with 250 Ω /V rate at 20 V range, 25 Ω /V rate at 200 V range.

Remote accuracy: \pm 2% of full scale.

Internal bias at L-ground: an additional connection using a blocking capacitor and a coaxial cable is necessary for internal source.

Available full scale ranges:

Capacitance				Conductance	Dissipation Factor
1 kHz	10 kHz	100 kHz	1 MHz		
180.00 pF	18,000 pF			899.9n Ω	8999
1800.0 pF*	180.00 pF	18,000 pF		8.999 μ Ω	
18,000 nF	1800.0 pF	180.00 pF	18,000 pF	89.99 μ Ω	
180.00 nF	18,000 nF	1800.0 pF	180.00 pF	899.9 μ Ω	
1,2000 μ F	180.00 nF	18,000 nF	1200.0 pF	8.999m Ω	

NOTE: heavy line encloses available full-scale ranges in L-GROUND full display of D/G is obtained at TRACK MODE, and is limited by AUTO RESET of L.S. sec at AUTO/HOLD MODE.

*Accuracy at L-GROUND is not specified on this range.

Basic accuracy: \pm % of reading; \pm number of digits

	Frequency	1 kHz & 10 kHz	100 kHz	1 MHz
C	D < 0.1	\pm 0.1% \pm 1 digit \pm 0.01 pF	\pm 0.3% \pm 1 digit \pm 0.01 pF	\pm 1% \pm 1 digit \pm 0.02 pF
	Basic Accuracy	\pm 0.2% \pm 1 digit	\pm 0.5% \pm 1 digit	\pm 2% \pm 1 digit
	0.1 < D < 0.899	\pm 0.01 pF	\pm 0.01 pF	\pm 0.01 pF
G	Basic Accuracy	\pm 1% \pm 10 digits		\pm 3% \pm 10 digits
D	Basic Accuracy	\pm 1% \pm (10 + Cs/Cx) digits		\pm 3% \pm (10 + Cs/Cx) digits

NOTE: Cs: external standard capacitor

Cx: capacitance measured

Outputs: 4 line BCD.

Inputs

Trigger hold off level: level must be between 10 V and 15 V.

Remote programming: eight front-panel functions can be remotely controlled by external contact closure to ground with impedance less than 400 Ω . Programmable functions are reset, frequency, range mode, test voltage, loss meas, range step, dc bias, bias vernier.

Operating temperature: 0°C to 50°C.

Power requirements: 115 or 230 V ac \pm 10%, 50 to 60 Hz (approximately 110 W).

Weight: net, 15.5 kg (34 lb). Shipping, 21.6 kg (48 lb).

Accessories available:

Accessories for HP's 4270A Automatic Capacitance Bridge

The following adapters convert BNC Connectors on HP's 4270A to allow direct insertion of components. 16011A converts from BNC to binding posts. 16012A converts from BNC to test axial lead devices. It has a centrally located guard plane to reduce errors due to stray capacitance. 16013A converts from BNC to test vertical lead devices. It has a guard plane similar to 16012A. 11143A converts from BNC to clip leads. 44" overall length with third lead to preserve guard terminal.

Options and accessories

101: HP-1B Compatible	\$1980
16011A BNC Connector	\$58
16012A BNC Connector	\$68
16013A BNC Connector	\$68
16411A HP-1B Interface Kit	\$1980
11143A BNC Cable	\$39

4270A Automatic Capacitance Bridge

\$6825

COMPONENT TEST

High capacitance meters

Model 4350A

- Wide range . . . 0.02 μF to 300 mF
- Capacitance, $\tan \delta$, and leakage current measurements

- Recorder output
- High speed measurement



4350A

Description

Hewlett-Packard Model 4350A High Capacitance Meter measures high capacitances from 0.02 μF to 300 mF and simultaneously measures dissipation factor. Leakage current can be measured with the 4350A. HP's 4350A provides analog output proportional to meter deflection.

4350A Specifications

Capacitance measurement

Capacitance

Range: 1 μF to 300 mF full scale in 12 ranges.

Accuracy (% of full scale):

Tan δ range	Capacitance Range Full Scale	
	1 μF to 100 mF	300 mF
0 to 1	$\pm 3\%$	$\pm 4\%$
1 to 5	$\pm 4\%$	$\pm 5\%$

Tan δ :

Range: 0.5 or 5 full scale in 2 ranges.

Absolute accuracy:

0.5 full scale: ± 0.025

$$5 \text{ full scale: } \begin{aligned} &+ [0.06 + \frac{(\text{reading})^2}{20}] \\ &- [0.06 + \frac{(\text{reading})^2}{25}] \end{aligned}$$

Internal test signal

Frequency: 120 Hz \pm 5 Hz.

Internal dc bias

Voltage range: 0 to 6 V dc, continuously adjustable.

Response time (C and $\tan \delta$): typically 1 s.

Tan δ uncal: indicates the reading of $\tan \delta$ is uncalibrated when the deflection of capacitance meter is below 10% or above 130% of full scale.

Leakage current measurement

Current

Range: 1 μA to 10 mA full scale in 9 ranges.

Accuracy: $\pm 3\%$ of full scale.

DC bias voltage

Internal: up to 100 V dc in 2 ranges.

External: 600 V dc max.

Warning lamp: indicates "danger" when dc voltage across an unknown is higher than 1.5 V dc.

Analog outputs

Capacitance

1 V dc all ranges: for use with analog comparator.

1 V dc or 0.3 V dc full scale: for use with DVM.

Overrange: 25% of full scale.

Accuracy: (% of full scale)

Tan δ	Capacitance Range Full Scale	
	1 μF to 100 mF	300 mF
0 to 1	± 2	± 3
1 to 5	± 3	± 4

Loss angle (δ):

Tan δ vs. analog output voltage: 0.1 V/degree.

Tan δ	δ	Output Voltage
0 to 0.5	0° to 26.6°	(0 to 2.66 V dc) ± 0.13 V dc
0.5 to 5	26.6° to 78.7°	(2.66 to 7.87 V dc) ± 0.3 V dc

Residual noise: 40 mV p-p max.

General

Temperature range: 0°C to 50°C.

Power: 115 V or 230 V $\pm 10\%$, 48 Hz to 440 Hz, 38.5 VA max.

Dimensions: 198 mm wide \times 166 mm high \times 305 mm deep (7 $\frac{1}{2}$ " \times 6 $\frac{1}{2}$ " \times 12").

Weight: net, 4.8 kg (11 lb). Shipping, 6.8 kg (15 lb).



16035A Test cable (furnished)

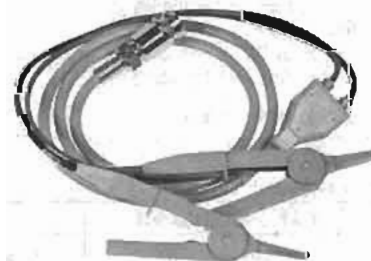

16036A Test cable (furnished)

Accessories furnished: 16035A Test Cable with four alligator clips; 16036A Test Cable with two alligator clips.

Accessories available: 16037A test fixture for axial lead components; 16037A Option 001 test fixture for vertical lead components.

Model number and name

4350A High Capacitance Meter

16037A Test Fixture

Option 001

Price

\$1375

\$195

N/C

COMPONENT TEST

Q Meter

Model 4342A

- Frequency range: 22 kHz to 70 MHz
- Q range: 5 to 1000



Description

The direct-reading expanded scale of the 4342A permits measurement of Q from 5 to 1000 and readings of very small changes in Q resulting from variation in test parameters. The 4342A is solid state with the elimination of specially matched, fragile thermocouple components.

The 4342A will measure dissipation factor and dielectric constant of insulating materials. The Q meter can measure coefficient of coupling, mutual inductance, and frequency response of transformers. RF resistance, reactance, and Q of resistors and capacitors can also be determined.

Push button operation of frequency range and Q/ Δ Q range selection provides straightforward measurement. Automatic indication of meter scales, frequency dials and frequency multipliers are featured, adding to simplicity and reading speed.

Specifications

RF characteristics

RF range: 22 kHz to 70 MHz in 7 bands: 22 to 70 kHz, 70 to 220 kHz, 220 to 700 kHz, 700 to 2200 kHz, 2.2 to 7 MHz, 7 to 22 MHz, 22 to 70 MHz.

4342A Option 001: 10 kHz to 32 MHz in 7 bands: 10 to 32 kHz, 32 to 100 kHz, 100 to 320 kHz, 320 to 1000 kHz, 1 to 3.2 MHz, 3.2 to 10 MHz, 10 to 32 MHz.

RF accuracy: $\pm 1.5\%$ from 22 kHz to 22 MHz; $\pm 2\%$ from 22 MHz to 70 MHz; $\pm 1\%$ at "L" point on frequency dial.

4342A Option 001: $\pm 1.5\%$ from 10 kHz to 10 MHz; $\pm 2\%$ from 10 MHz to 32 MHz; $\pm 1\%$ at "L" point on frequency dial.

RF increments: approximately 1% resolution.

Q measurement characteristics

Q range: 5 to 1000 in 4 ranges: 5 to 30, 20 to 100, 50 to 300, 200 to 1000.

Q accuracy: % of indicated value: (at 25°C).

Q	4342A & 4342A Opt. 001		4342A
	22 kHz - 30 MHz		30 MHz - 70 MHz
5 - 300	± 7		± 10
300 - 600	± 10		± 15
600 - 1000	± 15		± 20

Q increments: upper scale: 1 from 20 to 100; lower scale: 0.5 from 5 to 30.

Δ Q range: 0 to 100 in 4 ranges: 0 to 3, 0 to 10, 0 to 30, 0 to 100.

Δ Q accuracy: $\pm 10\%$ of full scale.

Δ Q increments: upper scale: 0.1 from 0 to 10; lower scale: 0.05 from 0 to 3.

Inductance measurement characteristics

L range: 0.09 μ H to 1.2 H, direct reading at 7 specific frequencies.

L accuracy: $\pm 3\%$ after substitution of residuals (approx. 10 nH).

Resonating capacitor characteristics

Capacitor range: main dial: 25 to 470 pF; vernier dial -5 to +5 pF.

Capacitor accuracy: main dial: $\pm 1\%$ or 1 pF, whichever is greater; vernier dial ± 0.1 pF.

Capacitor increments: main dial: 1 pF from 25 to 30 pF; 2 pF from 30 to 200 pF; 5 pF from 200 to 470 pF; vernier dial: 0.1 pF.

General

Rear panel outputs

Frequency monitor: 170 mV rms min. into 50 Ω .

Q analog output: 0 to 1 V ± 50 mV dc after 15 minutes warmup, proportional to meter deflection. Output impedance approximately 1 k Ω .

Over limit signal output: contact closure at the rear panel. Relay contact capacity 0.5 A/15 VA.

Over limit display time: selectable, 1 s or continuously on, after limit exceeded.

Temperature range: 0°C to 50°C.

Power: 115 or 230 V $\pm 10\%$, 50-400 Hz, 25 VA max.

Dimensions: 425 mm wide \times 138 mm high \times 414 mm deep (16 $\frac{1}{4}$ " \times 5 $\frac{1}{2}$ " \times 16 $\frac{1}{2}$ ").

Weight: net, 14 kg (31 lb). Shipping, 18.45 kg (41 lb).

Accessories available:

HP 16014A: Series Loss Test Adaptor is designed for measuring low impedance components, low-value inductors and resistors, and also high-value capacitors. Using the adaptor adds convenience in connecting components in series with the test circuit of the 4342A Q Meter. This adaptor consists of a teflon printed-circuit base on which are mounted binding posts, to accept the Reference Inductors, and a pair of low-inductance series terminals for the unknown.

HP 16462A: Auxiliary Capacitor is designed to extend the Q and L measurement capability of the 4342A Q Meter. It is especially useful for measuring small inductors at low frequencies.

HP 16470A reference inductors: A range of 20 inductors, any of which can be supplied separately, is available for use with the 4342A Q Meter for measuring the RF characteristics of capacitors, resistors, and insulating materials. These inductors have three terminals. One terminal is connected to the case to stabilize measurements.

Options & Accessories

Option 001 Frequency Range

16014A, Series Loss Test Adaptor

16462A, Auxiliary Capacitor

16470A, Reference Inductors, set of 20

Price
add \$163
\$55
\$265
\$790
or \$39 ea.
\$2275

4342A Q Meter

COMPONENT TEST

Decade capacitors and attenuators

Models 4440B, 4436A, 4437A, 350D

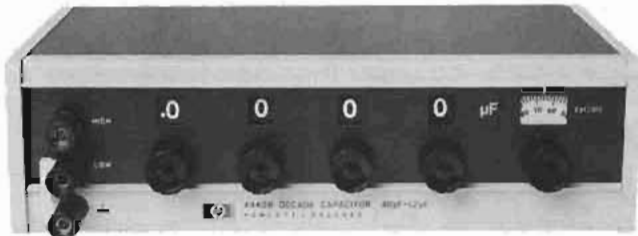

4440B



4437A

4440B Description

The Hewlett-Packard 4440B Decade Capacitor is a high accuracy instrument providing usable capacitances from 40 pF to 1.2 μF. Its 0.25% accuracy makes it an ideal aid for circuit design or as a working standard.

Use of silvered-mica capacitors in four decades of 100 pF provides higher accuracy, low dissipation factors and good temperature coefficient. An air capacitor vernier provides 100 pF (from 40 pF to 140 pF) with resolution of 1 pF. Capacitors are housed in a double shield in such a way that increased capacitance from two terminals to three terminals is held to 1 pF.

4440B Specifications

Capacitance: 40 pF to 1.2 μF in steps of 100 pF with a 40 pF to 140 pF variable air capacitor providing continuous adjustment to better than 2 pF between steps.

Direct reading accuracy: ±(0.25% + 3 pF) at 1 kHz for three-terminal connection.

Resonant frequency: typical values of the resonant frequency are 450 kHz at 1 μF, 4 MHz at 0.01 μF and 40 MHz at 100 pF.

Dissipation factor: for C > 1040 pF, 0.001 MAX at 1 kHz.
for C < 1040 pF, 0.005 MAX at 1 kHz.

Temperature coefficient: < +70 ppm/°C.

Insulation resistance: 5 GΩ minimum, after 5 minutes at 500 V dc.

Maximum voltage: 42 V dc or 30 V rms.

Weight: net, 2.5 kg (5½ lb); shipping 3.6 kg (8 lb).

Dimensions: 264 mm wide × 152 mm deep × 76 mm high (11" × 6" × 3").

4436A/4437A Description

The Hewlett-Packard Models 4436A/4437A Attenuators provide accurate steps of attenuation with 0.1 dB resolution for power-level measurements, communication system tests, and gain or loss measurements on filters and amplifiers, and similar equipment.

4436A Specifications

Maximum attenuation: 119.9 dB.

Attenuation increments: 0.1 dB.

Input/output impedance: 600Ω, balanced.

Frequency range: dc to 1.5 MHz (0 to 110 dB); dc to 1 MHz (0 to 119.9 dB).

Accuracy

Attenuation	100 kHz	1 MHz	1.5 MHz*
0 ~ 60 dB	±0.1 dB	±0.2 dB	±0.2 dB
60 ~ 90 dB	±0.1 dB	±0.3 dB	±0.3 dB
90 ~ 110 dB	±0.2 dB	±0.5 dB	±0.5 dB
110 ~ 119.9 dB	±0.3 dB	±0.1 dB	

*Typical value

Maximum input power: +30 dBm.

DC isolation: signal ground may be ±300 V dc from external chassis.

Dimensions: 198 mm wide × 76 mm high × 177 mm deep (7¾" × 3" × 6¾").

Weight: net, 1.7 kg (3.8 lb). Shipping, 2.9 kg (6.5 lbs).

4437A Specifications

The Model 4437A is a 600 ohms unbalanced type, and its specifications are identical to the 4436A.

350D Description

Two attenuator sections make up the Hewlett-Packard 350D Attenuator. One section is a 100 dB attenuator, adjustable in 10 dB steps. The other is a 10 dB attenuator, adjustable in 1 dB steps.

350D Specifications

Attenuation: 0 to 110 dB, 1 dB and 10 dB steps.

Power capacity: 600Ω unbalanced; 5 W (55 V dc or rms) max, continuous duty.

DC isolation: signal ground may be ±500 V dc from chassis.

Accuracy

10 dB section:

	0 dB	10 dB
dc to 100 kHz		< ±0.125 dB/step
100 kHz to 1 MHz		< ±0.25 dB/step

100 dB section:

	0 dB	70 dB	100 dB
dc to 100 kHz	< ±0.25 dB		< ±0.5 dB/step
100 kHz to 1 MHz	< ±0.5 dB		< ±0.75 dB/step

Dimensions: standard Hewlett-Packard ½ module (30 mm wide × 159 mm high × 203 mm deep (5¼" × 6¼" × 8").

Weight: net, 1.8 kg (4 lb). Shipping, 2.7 kg (6 lb).

Model number and name

4440B Decade Capacitor

4436A Attenuator

4437A Attenuator

350D Attenuator

Price

\$530

\$815

\$530

\$214

COMPONENT TEST

Vector impedance meters, RX meter

Models 4800A, 4815A, and 250B

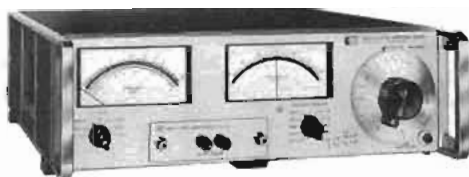

4800A



4815A

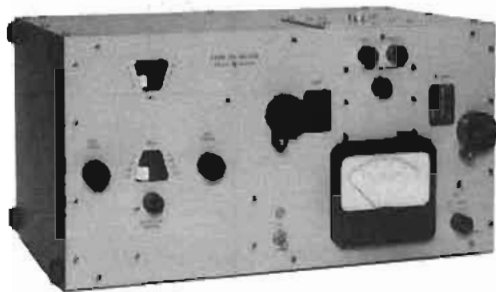

250B

Model 4800A

HP's 4800A measures the vector impedance of components, complex networks, and other two-terminal devices. Besides measuring vector impedance, the 4800A measures component values. At frequencies that are decade multiples of $\frac{1}{2}\pi$, as marked on the frequency dial, L and 1/C are read directly if the phase is approximately $\pm 90^\circ$, respectively. R is equal to the impedance magnitude at frequencies where the phase is approximately 0° . The vector impedance meter also yields Q and inductor values by using either $f_0/\Delta f$, R_p/wL or the wL/R_s technique.

Specifications

Frequency characteristics

Range: 5 Hz to 500 kHz in five bands; 5 to 50 Hz, 50 to 500 Hz, etc.
Accuracy: $\pm 2\%$, 50 Hz to 500 kHz; $\pm 4\%$, 5 to 50 Hz; $\pm 1\%$ at 15.92 on frequency dial from 159.2 Hz to 159.2 kHz; $\pm 2\%$ at 15.92 Hz.

Impedance measurement characteristics: 1 ohm to 10 megohms in seven decade ranges from X1 to X10 M. Accuracy is $\pm 5\%$ of reading.

Phase angle measurement characteristics: 0° to $\pm 90^\circ$ in 5° increments. Accuracy is $\pm 6^\circ$.

Direct capacitance measurement capabilities: 0.1 pF to 10 000 μ F direct reading at decade multiples of 15.92 Hz. Accuracy is $\pm 7\%$ of reading for D less than 0.1 at 159.2 Hz to 159.2 kHz.

Direct inductance measurement capabilities: 1 μ H to 100 000 H direct reading at decade multiples of 15.92 Hz. Accuracy is $\pm 7\%$ of reading for Q greater than 10 from 159.2 Hz to 159.2 kHz.

Measuring terminal characteristics: both terminals above ground, neither may be grounded. Calibration resistor and shield provided.

Dimensions: 426 mm W \times 133 mm H \times 467 mm D ($16\frac{1}{2}'' \times 5\frac{1}{4}'' \times 18\frac{3}{8}''$).

Weight: net, 10.8 kg (24 lb). Shipping, 13.5 kg (30 lb).

Power: 115 or 230 V $\pm 10\%$, 48 to 440 Hz, 29.7 VA.

Model 4815A

The HP 4815A RF Vector Impedance Meter provides all of the convenience of "probe and read" measurements. In use, the probe is connected directly into the circuit to be evaluated, frequency is selected, and complex impedance is read. This type measurement allows a straightforward adaptation to various jigs and fixtures for special measurements. Where only component values are to be determined, a quick-mount adapter is provided to allow rapid measurements. For critical component applications, the unit to be evaluated may be mounted directly in its working circuit and its value determined in its actual environment, at the frequency of interest.

Specifications

Frequency

Range: 500 kHz to 108 MHz in five bands.

Accuracy: $\pm 2\%$ of reading; $\pm 1\%$ of reading at 1.592 and 15.92 MHz.

RF monitor output: 150 mV minimum into 50 ohms.

Impedance magnitude measurement

Range: 1 ohm to 100 k Ω ; full-scale ranges: 10, 30, 100, 300, 1 k, 3 k, 10 k, 30 k, 100 k Ω .

Accuracy: $\pm 4\%$ of full scale $\pm (f/30 \text{ MHz} + Z/25 \text{ k}\Omega)\%$ of reading, where f = frequency in MHz and Z is in ohms.

Calibration: linear meter scale with increments 2% of full scale.

Phase angle measurement

Range: 0 to 360° in two ranges: $0 \pm 90^\circ$, $180^\circ \pm 90^\circ$.

Accuracy: $\pm (3 + f/30 \text{ MHz} + Z/50 \text{ k}\Omega)$ degrees where f = frequency in MHz and Z is in ohms. Calibrated in 2° increments.

Dimensions: 426 mm W, 185 mm H, 476 mm D ($16\frac{1}{2}'' \times 7\frac{1}{4}'' \times 18\frac{3}{8}''$).

Weight: net, 17.6 kg (39 lb). Shipping 24.8 kg (55 lb).

Power: 105 to 125 V or 210 to 250 V, 50 to 400 Hz, 50 W.

Model 250B

The 250B RX Meter measures two-terminal RF impedance in terms of equivalent parallel resistance and capacitance. The self-contained instrument includes a continuously tuned 0.5 to 250 MHz oscillator, high-frequency bridge, amplifier-detector, and null indicating meter. Connections may be conveniently made to the bridge terminals which are arranged for almost zero lead length.

Specifications

RF range: 500 kHz to 250 MHz in eight bands, $\pm 2\%$ accuracy, scale increments of approximately 1%.

Measurement characteristics

Resistance: range from 15 to 100 000 ohms.

Accuracy is $\pm \left[2 + \frac{F}{200} + \frac{R}{5000} + \frac{Q}{20} \right] \pm 0.2$ ohms

F = frequency in MHz, R = RX Meter R_p reading in ohms, $Q = \omega CR \times 10^{-12}$, where C = RX Meter C_p reading in pF; Resistance calibration increments of approximately 3%.

Capacitance: range 0 to 20 pF (may be extended through use of auxiliary coils); Accuracy is $\pm (0.5 \text{ pF} + 0.5 F^2 C \times 10^{-3}) \pm 0.15 \text{ pF}$, F = frequency in MHz, C = RX Meter C reading in pF; Calibration in 0.1 pF increments.

Inductance: range, 0.001 μ H to 100 mH (actual range depends on frequency; auxiliary resistors employed). Accuracy is same as capacitance accuracy given above.

RF measurement voltage: approximately 50 to 750 mV, depending on frequency.

Weight: net, 18 kg (40 lb). Shipping, 22.5 kg (50 lb).

Power: 105 to 125 volts or 210 to 250 volts, 50 to 400 Hz, 66 VA.

Accessories available: 00515A Coax Adapter Kit (Type N).

Options

908: Rack Flange Kit

Model number and name

4815A RF vector impedance meter

4800A Vector impedance meter

250B RX Meter

00515A Coax Adapter Kit

Price

add \$10

\$3375

\$2100

\$3900

\$95

COMPONENT TEST**Digital IC tester****Model 5045A**

- Simple fool-proof operation
- Complete test set-up by inexpensive magnetic cards
- Tests CMOS, ECL, TTL, DTL

- Permanent printed record of IC failures
- Tests IC's up to 16 pins — 24 pins optional
- Includes self-check

**Description**

The HP Model 5045A is a microprogrammed digital IC tester simple enough to be used by an unskilled operator yet it includes capabilities often found only in large, computer-based test systems. To test a device, all that's required is a preprogrammed magnetic card — insert the card into the front panel slot, and the Tester is ready to fully test one of the many devices listed in our comprehensive program catalog. You don't need special PC boards, extra power supplies or any special fixtures — just load the magnetic card and start testing. An operator can be trained in just a few minutes — the 5045A is just that simple to use.

To provide a permanent record of individual IC failures as the test is being made, the quiet HP thermal printer has been included in the 5045A to record detailed failure information for every bad IC. Your operator just keeps on testing — the record is automatically kept and can be reviewed later or returned with the bad IC's to the manufacturer.

**Tests all these families
ECL, CMOS, TTL, HTL, DTL**

The universal pin electronics in the 5045A let each pin act as either driver, receiver, clock, power supply, input, or output. This provides the great flexibility and capability needed to test circuits all the way from basic gates to arithmetic logic units and ROM's. Devices with power supply voltages up to 15 volts or both positive and negative voltages up to 7.5 volts may be tested. Any number of the pins in the 5045A may be used as inputs or outputs if required by the device-under-test.

**Tests all these devices
GATES, FLIP-FLOPS, ONE-SHOTS, COUNTERS, SHIFT
REGISTERS, ALU'S, ADDERS, STATIC RAMS*, ROMS* ...
AND MANY MORE**

As your testing requirements expand to new devices, your 5045A can be easily and inexpensively updated by adding new program cards. The nominal cost of these cards means that you don't have to be satisfied with testing a small fraction of your circuit types. You can keep your program library complete — and still stay within your budget.

* If the supply voltages are compatible with those available in the 5045A (see specifications).

DC parametric and functional tests

The 5045A thoroughly tests devices both functionally and parametrically to ensure that those expensive failures don't get loaded into your PC boards. Functional tests check the ability of the device to correctly operate according to its truth table as the appropriate input stimulus is applied. DC parametric tests check the voltages and currents on device inputs and outputs under various conditions specified by the manufacturer. These tests eliminate almost all defective devices and avoid the expense of finding and replacing bad circuits once they have been soldered into PC boards and perhaps become part of a complex system.

Flexible tests

Both parametric and functional tests are controlled by software. The flexibility of this technique makes possible parametric tests in which the voltages and currents can be individually set for each pin of the device and may be changed many times during a single test. In the functional tests, software generated test patterns are used for device input stimulus. These test patterns may be uniquely tailored to test those devices with special requirements.

Unique test technique

To provide the accuracy of direct comparison testing without expensive performance or reference boards, the 5045A uses a unique IC simulation technique. The correct functional operation of the device under test is simulated and this simulation is used as a reference. As both the device under test and simulator are driven with the same inputs, their outputs are compared on a step-by-step basis. If a failure occurs, the 5045A can indicate exactly where it happened by printed message or can stop on the failure so the fault can be investigated in more detail.

Economical ROM testing

To test the many different truth tables which may be programmed in ROM's of the same generic type, it is not necessary to buy a card for each one. A single card containing stimulus information for the generic ROM type is loaded into the 5045A and the unique truth table of a known good ROM is "memorized" by the 5045A. The complete program is then recorded on a blank card for future use. Duplicates of any card may be made from the original by programming the 5045A, pressing "write", and then inserting a blank card.

COMPONENT TEST

Digital IC Tester



Test head mounts directly on automatic handlers for trouble-free testing.

Automatic IC handlers

Since automatic IC handling is a necessity for high volume testing, the 5045A was designed with this in mind. The special circuits used to generate the fast rise and fall times necessary in testing digital circuits are contained in the removable test deck. This test deck can be placed within inches of the IC being tested. Problems associated with long cables between handler and tester—ringing, oscillation, slow rise/fall times—are eliminated.

Hewlett-Packard, in cooperation with major automatic handler manufacturers, has designed custom interface kits for popular handlers. This kit reduces the task of interfacing the 5045A and a handler to nothing more than plugging the two together.

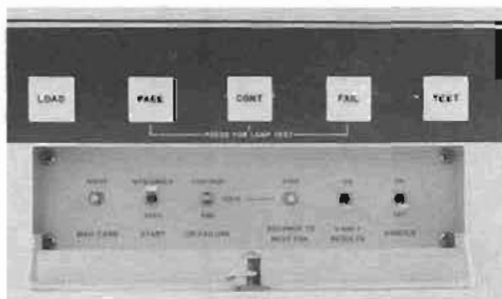

Behind the protective front panel door are controls which can configure the operation of the 5045A just the way you want it.

Automatic testing

For automatic testing of IC's with a handler, select START:MAN/HANDLER where the start signal from the handler initiates the test sequence and select END ON FAILURE so the Tester doesn't waste time completing the test sequence once the circuit is known to be bad. The printer may be turned either on or off when an automatic handler is used.

Manual testing

For manual testing of IC's select START:AUTO to make the test sequence repeat automatically, and END OF FAILURE to make the test sequence end when the first failure is encountered. Next, turn the printer off to prevent error printout when no IC is in the socket. Then just insert the IC . . . if the PASS light goes on, the circuit is good. From then on, it is not necessary to touch a single switch or control. Just insert another IC and continue to test. If a printed failure diagnosis is desired, turn the printer on and select START:MAN/HANDLER; then, for each test press the TEST button.

Printer gives permanent copy of test results

The thermal printer provides information regarding the test results and conveys special instructions to the user in certain cases. When a circuit fails, the reasons for failure are printed along with an indication of the pins that failed. The printer also shows the number of IC's that have passed and failed since the card was entered.

Number of devices which failed	TEST:	CONTINUITY	Number of devices which passed
	FAIL	PASS	28
Failed pin numbers	FAIL PIN: 1 2 3		
	4 5 8 9 10		
	11 12 13 14		

If a more detailed failure analysis is desired, the printer provides a special voltage/current print-out . . . a digital multimeter PLUS! Each pin of the device has a programmed test limit for both voltage and current (for any given part of a test). When a failure occurs (with the printer turned on), the record produced gives these limits for all pins that did not fail. For pins that did fail, the voltage and current at the failure are recorded; then, the driving parameter (voltage for inputs, current for outputs) is reduced until the test passes and the voltage and current are again recorded. With these two independent measurements on each failed pin, you can determine not only what failed and to what degree it failed, but also determine the conditions under which the device would pass.

TEST:	FAIL	4PASS	0
1	2LV	0.04LMA	
2	2LV	0.04LMA	
3	0.4LV	3 MA	
3	1.855 V	16LMA	
4	0.8LV	-1.6LMA	
5	0.8LV	-1.6LMA	
6	2.4LV	-0.4LMA	
7	0LV	-200LMA	
8	0.4LV	2.105 MA	
8	2.41 V	16LMA	
9	2LV	0.04LMA	
10	2LV	0.04LMA	
11	2.4LV	-0.4LMA	
12	0.8LV	-1.6LMA	
13	0.8LV	-1.6LMA	
14	4.75LV	200LMA	
CORRECT LOGIC STATE OF EACH PIN			
CORRECT 1001110			
PIN STATE 01100010			
FAIL PIN: 3 8			

Self test feature

In an incoming inspection or production environment it is especially important to know your equipment is operating as it should. The Tester has self-test cards to automatically exercise all major circuitry (the drivers and receivers for all pins, the central processor, the memory, and associated circuits). This way, you know every day that the Tester is functioning correctly—and that none of those bad IC's are getting into your production runs, and cutting into your company's profits. Also included are a set of calibration cards.

COMPONENT TEST

Digital IC Tester

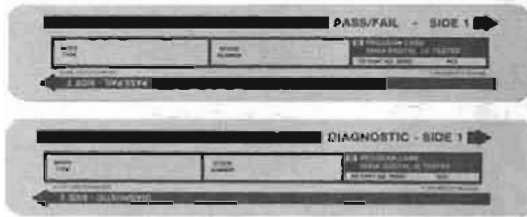

Two test cards and duplicates are provided with each program.

Ordering the pre-programmed magnetic cards

The 5045A is programmed by pre-recorded magnetic cards which are purchased from Hewlett-Packard to cover your unique requirements. These cards, covering most common device types, are listed in the IC PROGRAM CATALOG (P/N 5952-7383). This catalog contains a wide variety of logic families and functions and includes the majority of common device types. It is constantly being expanded by new programs. The programs may be ordered with the 5045A or later. When additional programs are needed after the original purchase, they may be ordered through your local Hewlett-Packard sales office or by mail with a prepaid coupon.

Each IC program ordered comes complete with both a PASS/FAIL test card and a DIAGNOSTIC test card and includes duplicates of each. The PASS/FAIL test will be used for the majority of your testing needs since it is both complete and fast (typical test time for MSI sequential devices is 300 ms). The DIAGNOSTIC test provides extra information about a circuit failure by supplementing the PASS/FAIL test with additional test steps or by providing a more detailed print-out of the test contained on the PASS/FAIL card. A data sheet containing verbal test descriptions and all parameters is included for both PASS/FAIL and DIAGNOSTIC cards.

Condensed specifications

Test set-up method

Preprogrammed magnetic card. All test conditions including parametric information, input stimuli, and corresponding outputs are contained on the card. The program is verified each time it is loaded.

Test structure

Functional tests: truth table is verified by direct comparison between the output of a software generated IC simulator (or stored truth table for certain circuits) and the output of the device under test.

Parametric tests: DC parameters (voltages and currents) are tested to the manufacturers' data sheet specifications except where limited by the specifications of the Tester. Test limits are indicated in the information accompanying each magnetic card.

Continuity test: verifies pin contact by checking for the presence of current flow into or out of all active pins (failure of this test is shown on the "CONT" indicator).

Test pattern generation

Test Patterns are derived through algorithmic techniques or from stored truth tables and are individually tailored to each IC.

Universal pin drivers

Note: The same circuit is used for driving and monitoring a pin whether that pin is an input, output, power supply, or clock. All voltages and currents can be set individually and uniquely on each pin. External test fixtures are not required.

Voltage applied to the device under test: (Supply Voltage, Input Voltage, and Output Voltage)

Range (15 Volts)	Accuracy
$-7.5 \text{ V} \leq \text{to} < -1.875 \text{ V}$	$\pm 25 \text{ mV}$
$-1.875 \text{ V} \leq \text{to} \leq +1.875 \text{ V}$	$\pm 15 \text{ mV}$
$+1.875 \text{ V} < \text{to} \leq +7.5 \text{ V}$	$\pm 25 \text{ mV}$

Current applied to the device under test: (Supply Current, Input Current, and Output Current)

Range	Accuracy
$-200 \text{ mA} \leq \text{to} < -2.5 \text{ mA}$	$\pm 0.4 \text{ mA}$ or $\pm 6\%^{**}$
$-2.5 \text{ mA} \leq \text{to} \leq +2.5 \text{ mA}$	$\pm 10 \mu\text{A}$ or $\pm 6\%^{**}$
$+2.5 \text{ mA} < \text{to} \leq 200 \text{ mA}$	$\pm 0.4 \text{ mA}$ or $\pm 6\%^{**}$

Slew rate: 30 ns/volt

Rear panel outputs

Automatic handler interface: 14 pin Amphenol connector provides "End of Test", "Pass", "Fail" and "Fail Continuity" signals and accepts "Start Test". All signals are negative true TTL levels.

General

Power: 100/120/200/240 V (+5%, -10%), 48-66 Hz, 240 VA.

Dimensions: 19 cm high, 42.5 cm wide, 58 cm deep (7.5 in. X 16.7 in. X 22.8 in.).

Shipping weight: 27.7 kg (61 lb).

Operating temperature: 0°C to 50°C

Relative humidity: 80%

Options and accessories

5045A Digital IC tester

Option 004†: Interface package for IPT Model 800 Automatic IC Handler \$1000

Option 005†: Interface package for Sym-Tek Model 7191ND Automatic IC Handler and other related models \$1000

Option 006†: Interface package for Daymare 952/3 Automatic IC Handler \$1000

Option 007†: Interface package for Siemens (MCT) Model 2608 Automatic IC Handler \$1000

Option 024: expands the capability of the 5045A to 24 pins \$2000

Option 908: Rack flange kit \$10

Option 910: set of additional product manuals \$30

9164-0071: blank magnetic program card (Pass/Fail) \$2

9164-0072: blank magnetic program card (Diagnostic) \$2

9281-0401: 250 foot roll of thermal print paper (minimum order six rolls) \$2.20 ea.

10845A: preprogrammed magnetic card for any device listed in the IC PROGRAM CATALOG. The specific cards required are designated on the program card order sheet. 1-9, \$30 ea. 10-500, \$25 ea.

10846A: coupon book containing ten coupons each redeemable in one IC program which is listed in the IC PROGRAM CATALOG. The coupons are mailed directly to the factory and the appropriate program cards are returned by airmail. The coupons expire two years from the date of receipt. \$250

** Whichever is greater.

† All interface packages include a test head extender cable, an interface board unique to the particular handler, and a cable to supply the control signals to the handler.

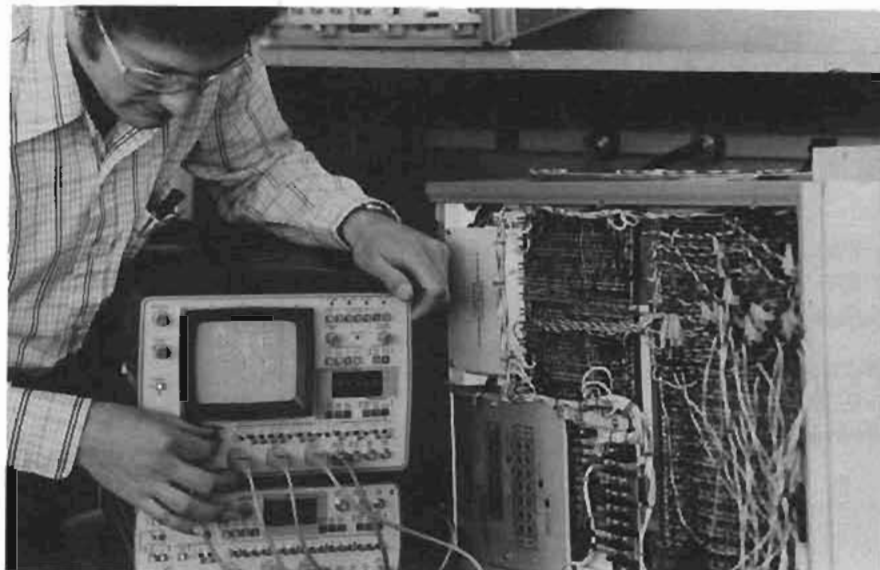

Introduction

The increasing use of digital circuits in new products has created a concurrent need for new equipment to pinpoint and troubleshoot defects. Because more and more of these new products manipulate data, they operate in the data domain, rather than the time or frequency domains that are characteristic of analog circuitry. Instruments that analyze circuits in the time and frequency domains simply cannot cope with digital data manipulations.

Data-domain instruments—generally classified as Logic State Analyzers—are useful for monitoring bits, words, addresses, and instructions as a function of time or sequence rather than voltage as a function of time or frequency. Whether the instrument is monitoring 32 or 16 bit words or a single node, as with a logic probe, the signal display is in binary form—either 1's or 0's on a cathode-ray tube or the on and off states of a lamp. Analysis of circuit operation is direct because you see logic states and word flow at a glance, without interpretation of waveforms.

Electrical vs. functional analysis

Electrical and functional analysis are not separable but each is used to complement the other. For example, only when word flow is incorrect as determined with a functional display need a technician be concerned with the voltage conditions that created the words. Even when word-flow errors require electrical analysis, the number of signal nodes in the vicinity of the error complicates the use of oscilloscopes. Thus, it is helpful to define scope functions of probing, triggering, and display in terms of words versus event or sequence, or words versus time rather than in volts versus time.

Electrical analysis

The traditional analog picture of absolute voltage versus sweep time allows careful analysis of electrical parameters. This is true because the important information—amplitude versus time—is the information that the waveform carries. This method can help de-

cipher noise, ringing, spikes, constant dc levels, voltage swings, and so forth. Further, it is the analysis domain in which typical users are most experienced and have the most confidence.

Functional analysis

Digital information is often nonrepetitive. Extremely long (and fast) data sequences are common. Also, parameters which are significant for analog analysis are less important in a digital measurement, e.g. amplitude is usually important only in that voltage must be above or below threshold values (logic HIGH, or logic LOW). Also time is often not important in an absolute sense, but becomes critical when related to the clock rate of a system in operation. Thus a functional measurement consists of an observation of digital information (logic HIGH or LOW) versus system time (CLOCK).

We can use this definition of functional measurement to construct a hierarchy of logic state troubleshooting levels. Each level supplies only the information necessary for that level of digital troubleshooting.

Logic analyzers

To effectively troubleshoot digital circuits the logic state analyzer must meet several basic requirements:

1. Data must be read and presented in binary form for easy reading with no interpretation.
2. There should be enough inputs so that the entire data word can be monitored at once.
3. A trigger point is required that is related to a unique data word within a sequence.
4. Digital delay is needed to position the display window to the desired point in time from the reference (trigger word).
5. Digital storage is needed to retain single-shot events along with negative time (data leading up to a desired trigger point).

Digital signals are almost invariably multitone and are difficult to interpret from a volts vs. time display when you are only interested in logic state vs. system time. The HP 1600A and 1607A solve this problem by displaying digital words 32 or 16 bits wide ver-

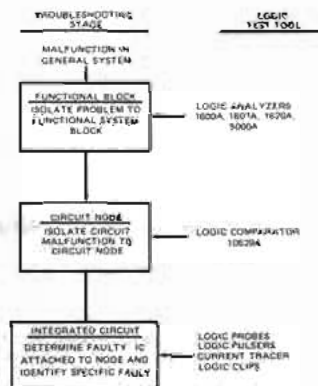

Figure 1. Digital troubleshooting is fast and efficient using the HP family of troubleshooting tools. Each instrument provides a functional indication of logic state activity, whether the problem is at the system level or isolated to an individual IC.

sus system clock in a table display which is very easy to use when examining functional relationships. The 32 bit wide word is achieved using a 1600A and 1607A in parallel or these may be used in a dual clock mode for monitoring data across I/O ports, for instance.

The table displays are in terms of logic HIGH's (ones) and logic LOW's (zeroes) versus a clock signal. Triggering is accomplished by using trigger word switches which allow selection of a unique trigger point. Further, the display may be moved in system time from the trigger point using digital delay in either a positive or negative direction. Two additional inputs on the 1600A and 1607A called qualifiers permit even more selectivity of displayed data.

The 1600A offers a new display called Mapping which is a display of 2^{16} dots instead of a table of 1's and 0's. Each dot location represents one possible combination of the 16 input lines so that each input word is represented by a dot. Dots are interconnected by vectors so that the sequence of data transactions can be observed. The map mode is ideal when you are turning-on a digital system because it is a display of data words that shows overall machine operation. The upper left corner of the display represents word 00,00 and the lower right is FF,FF in hexadecimal. By knowing where the system should be in its program, you can quickly determine if the machine is operating properly. Additionally, the word that is represented by any dot can be determined by positioning a trigger word cursor (circle) over a particular dot with the proper combination of trigger word switch settings.

Negative digital delay is possible due to the inherent storage features of logic analyzers which allow the instrument to display a number of events leading up to a selected trigger event. The Model 5000A Logic Analyzer, for example, can display up to 64 bits (in Serial A mode), of data that occur before the trigger point.

Positive delay allows movement of the display downstream from the trigger. For instance, in a disc memory the start of a sector may be the only available unique trigger point, yet the data to be analyzed may be thousands of bits downstream from the trigger. An analyzer with digital delay can position the display window precisely at the exact location of the character or signal to be examined.

In digital systems very low repetition rate or single-shot events are encountered that require storage to permit analysis. For example, "once per keystroke" calculator sequences fall into this category. Logic State Analyzers contain sufficient memory to capture and store such events, thus are highly useful in single-shot applications.

Digital triggering and delay are necessary for functional analysis, but are also of great value when "aiming" or positioning electrical analysis windows on oscilloscopes. These capabilities are needed for both serial and parallel data stream analyses, because they allow a user to "window" in on events that occur as part of very long data sequences.

Logic state analyzer accessories
Serial-to-parallel converter

For functional analysis of serial data, the Hp 10254A permits display of serial data in up to 16 bytes on the 1600A Logic State Analyzer, with the same windowing capabilities as for parallel data.

Card reader

When performing repetitive tests on digital components or systems, the HP 10253A provides a low cost method of performing simple or complete system checks. With a test procedure on cards, special operator training on the system under test is not needed—just insert a card in the card reader and look for intensified ones on the 1600A.

Triggering
Serial data

In serial data analysis, the problem of data pattern recognition can be solved if the data or instruction portions of a serial word are known. It then becomes possible to generate a unique trigger from a known serial event. If a pattern set on the Model 1620A Pattern Analyzer, for example, matches the bits contained in the instruction portion of a serial word, a trigger is generated. Thus, a unique trigger is defined to allow analysis of serial data streams. Added to this is the capability of digital delay which allows further indexing from the user-selected trigger point.

Parallel data

For parallel data analysis, it is often necessary to trigger on the simultaneous occurrence of several events. For example, if one or more channels of data go high at the same point in time that the CLOCK signal goes high, a trigger could be generated at this point. Additionally, the selected trigger events could be either high or low polarity signals.

Triggering need not be clock-related, but instead can be asynchronous. This allows the user to initiate the display sequence on a signal that might not be present when the clock samples the inputs to the analyzer. Signals such as spikes, or other random events can

therefore be detected or used as trigger events.

Trigger probes

The HP model 10250 series Trigger Probes feature TTL, MOS, and ECL compatibility, a 4-bit AND gate trigger and selectable bit levels (HI, LO, OFF). The circuit-powered probes provide 4-bit pattern recognition triggering for digital signal analysis and may be used for both functional and electrical analysis.

The HP Model 1230A trigger probe offers 8-bit parallel triggering capability with the addition of digital delay capability of 9998 clocks and synchronous or asynchronous operation. This provides versatile triggering capabilities for oscilloscope windowing to digital problem areas.

The IC troubleshooters

Once a fault has been isolated down to a board or circuit area, a group of hand-held low-cost instruments are used to troubleshoot specific nodes and IC's. These products are designed to test digital IC's in-circuit, and they are extremely valuable in their ability to isolate logic faults.

Logic comparison

The time-proven technique of logic comparison is used to locate specific faulty nodes by testing IC's dynamically within a circuit. This allows IC's to be tested without removal from boards, or signal sources. Products such as the Model 10529A Logic Comparator test the response of circuit-installed IC's against known-good IC's plugged into the Comparator. This method is not affected by faulty signals in the system or by incorrectly operating feedback loops because the Comparator looks for expected outputs based on given inputs to two like devices. The Comparator LED display provides a direct indication of which IC pins are operating incorrectly, thus identifying a bad node.

Nodal analysis

Once a bad circuit node (see Figure 2) has been isolated, there is the problem of determining which IC connected to the node is faulty. To help with this, HP manufactures several logic state stimulus-response, in-circuit logic testers.

Logic probes

The Logic Probe detects levels or pulses anywhere in a circuit, and displays them by a band of light around the probe tip. Circuits

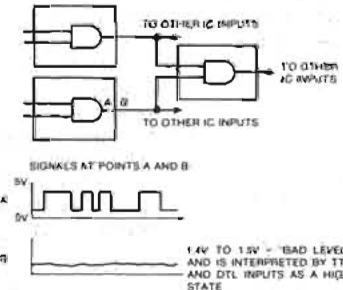

Figure 2. A typical IC failure, an open output bond, allows all inputs normally driven by that output to float to a "bad" level. This is usually interpreted as a logic high by the inputs, thus inputs driven by an open bond respond as though a static high signal is applied.

that are normally low and are then pulsed high are indicated by the light turning on periodically. Logic highs that are pulsed low are displayed by having a solidly lit band that turns off momentarily. The probe also detects either very fast, or high frequency pulse activity, and "stretches" them to provide a display at a 10 Hz rate.

Logic clip

A multi-pin logic state indicator, the Logic Clip indicates the states of either 14- or 16-pin DIP packages. Each pin is displayed by an individual LED, which allows a user to easily follow input versus output relationships. When a circuit's clock rate is slowed down or stopped, the Clip provides a very useful in-circuit test of a device's truth table.

Logic pulser

The Logic Pulser provides a unique capability: the ability to inject digital pulses between gates. The Pulser automatically injects the correct polarity, pulse has sufficient capability to drive a low node high or a high node low.

Current tracer

Often a bad node is identified but the specific device causing the fault can only be identified by cutting traces, or replacing circuit elements. The 547A Current Tracer eliminates just such "shotgun" techniques by showing exactly where digital current pulses are flowing in the circuit. Use of current tracing techniques solves the most vexing troubleshooting problems: stuck data busses, solder-bridges, stuck nodes containing many circuit elements, and the wired-AND.

Stimulus-response testing

The Pulser/Probe or Pulser/Clip combination helps the user to identify the faulty circuits causing a system malfunction. The logic test instruments mentioned here permit arbitrary signal injection and readouts between gates. Thus, an added capability is provided the digital troubleshooter: the ability to stimulate a circuit and monitor it for an output response.

Education

The need for education has also grown stride for stride with the huge growth of IC usage. Both needs (troubleshooting and training) are commonly based, because well trained logic personnel are by their nature good IC troubleshooters. The 5035T Logic Lab combines these concepts by providing an HP-quality learning experience—even for those users who already know part of the digital story.

HP also provides additional learning tools such as application notes and videotapes. Application notes include 163-1, Techniques of Digital Troubleshooting, and 167 Data Domain Measurement series. Also available is a four part videotape series, "The Data Domain, Its Analysis and Measurements", designed to provide instruction in logic state analysis measurement techniques and the debugging of processor-based systems. Measurements shown in these tapes include: paging, loops and map techniques, asynchronous measurements, lost program, I/O data transfer, memory access time, software programmable I/O ports and interrupts. Contact your local HP Sales Office for additional information on these training aids.

DIGITAL CIRCUIT TESTERS & ANALYZERS

16/32 Bit parallel logic state analyzers

Models 1600A, 1607A & 1600S

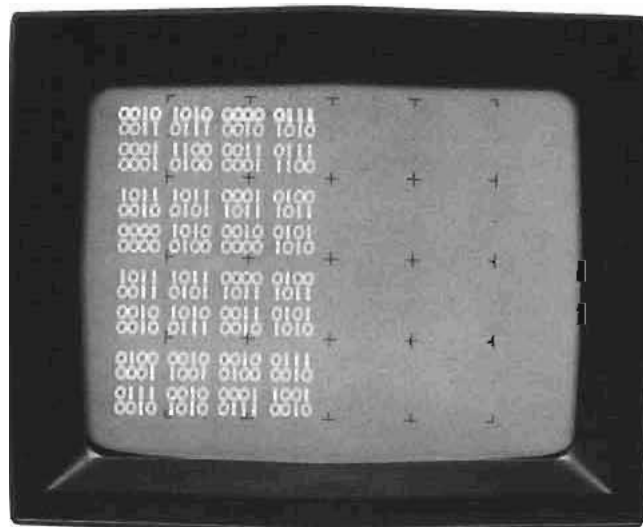
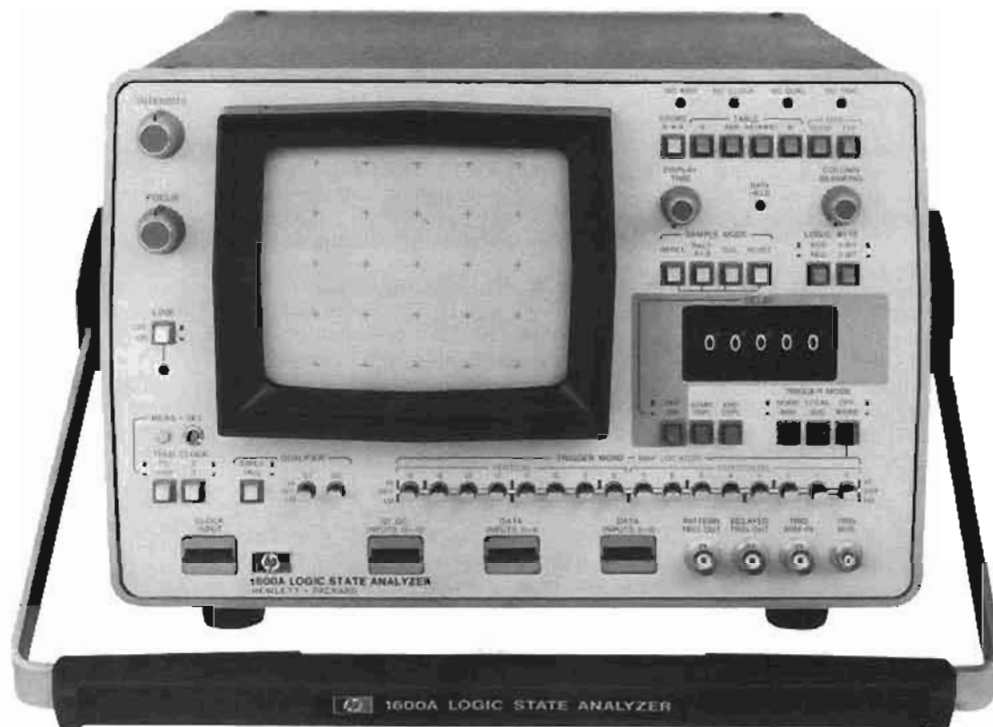

Start display triggering allows you to page through a system while following an algorithm to trace data flow or determine any malfunctions that may occur.

Introduction

Models 1600A and 1607A Logic State Analyzers offer digital data measurement capabilities in an easy-to-read format that ideally suits the Data Domain. Sixteen parallel data inputs in either analyzer, or 32 parallel bits with two analyzers bused together at clock speeds to 20 MHz furnish fast functional measurements of digital data flow. You save time in digital design and troubleshooting with the measurement that shows data the same way the components see it. The functional display is in word format and is triggered on data words to permit analysis of data, or state sequences, such as program addresses, instructions, and data. Repetitive testing or debugging and checking of digital components and systems is faster and easier with the 10253A Card Reader and the 1600A Analyzer which compares active to fixed data.

These Logic State Analyzers are Data Domain instruments specifically designed to debug, test, and troubleshoot digital processes by capturing and displaying program execution or data transfer as it occurs in systems operating at clock rates to 20 MHz. Data capture may either be started or stopped when the incoming data matches the pattern set on a 16-bit trigger word switch register. Digital delay allows the capture of data to be started or stopped up to 99 999 clock cycles after the trigger pattern. Data is displayed as a conventional data table with the first word at the top of the screen and the last word at the bottom.

Model 1600A is a self-contained Analyzer with its own display. The 1607A does not have a display, but provides both analog and digital outputs. The 1607A analog outputs are used to convert most oscilloscopes with de-coupled X, Y, and Z inputs into a logic state analyzer. The 1607A digital outputs are used to expand the 1600A to either a 32-bit wide machine or dual-clock capability.

Start display triggering

In the Start Display mode, the Analyzer triggers on a unique word established by the trigger word switches and displays that trigger word along with the 15 following words as they are clocked through a machine at operating speeds up to 20 MHz. This mode is valuable for paging through a system while following an algorithm to trace data flow.

End display triggering

The Analyzer's digital memory in this mode captures events leading up to and including the trigger word providing a "negative time" display. This negative time mode is extremely valuable for troubleshooting, since you can trigger on an unallowed state or a fault and see how the machine arrived at the malfunction rather than just the results of the error. In addition, delay may be combined with the End Display trigger to permit capture of both positive and negative time data. This allows positioning the trigger word so you can see events before and after the trigger word to reduce analysis time.

Delay

When the data you want to see does not immediately follow the desired trigger word, delay can be used to position the 16 word "window" an exact number of clock pulses (0 to 99 999) from the trigger word. Digital delay is useful for moving the display window past loops and measuring lengths of subroutines while maintaining a desired pattern trigger point. A "Delay ON-OFF" switch allows quick reference back to the trigger word if it has been moved off-screen by the delay.



The digital memory may be used to capture events leading up to and including the trigger word (displays negative time). By also using delay mode, the end display trigger word may be positioned mid screen to display both negative and positive time data.



1607A

Bus trigger

The Bus Trigger capability allows the 1600A and 1607A trigger words to be bused together to form a 32 bit wide trigger for use in machines with long words. In this mode, the analyzers can be used in single or dual clock modes. In the single clock mode, both analyzer clock inputs are connected to the same clock. In the dual clock mode, independent clocks can show interaction between two machines at their interface. If the digital interface between the 1600A and 1607A is also used, the 1600A displays all 32 bits of data.

1600A logic state analyzer

Model 1600A is capable of displaying 32 channels of information in standard digital format. That is, the most significant bit on the left and the least significant bit on the right with the first word at the top and each succeeding word under the previous word. The data sequence table is also made easier to read with the ability to group the columns of data into blocks of three for reading in octal code or blocks of four for reading in hexadecimal or BCD codes.

When used with the 1607A, the 1600A can display two independent tables or one table 32 bits wide for fast analysis of complex machine operation. When the 1600A is used alone, you can display an active and a stored table of 16 bits each for comparison. The store "A" into "B" mode (A → B) duplicates the data in the A memory in the B memory which then acts as a "save" register. By storing this reference data, you can make comparisons between the A and B tables for quick troubleshooting.

An exclusive OR (A ⊕ B) capability displays the A memory data and reduces the B memory to a display of logic differences on a bit-by-bit basis between the A and B memories. This permits fast, at-a-glance comparison of complex sequences, even one bit differences are quickly identified. For easier recognition, the ones (differences) in the A ⊕ B field are intensified.

A Halt when A does not equal B mode (A ≠ B) automatically halts and stores the data in the A table when the data in the A-memory does not equal the data in the B memory. This frees you from the tedious waiting and watching chore with infrequent or intermittent malfunctions.

Map display

The map display provides an overall view of machine operation in a repetitive loop and after familiarization permits identification of machine activity without the need to read tabular listings. This speeds analysis with a pattern display that the eye can easily recognize. In the map mode, the display is an array of 2¹⁶ dots where each dot represents one possible combination of the 16 bit lines so that every input word is represented by an illuminated dot. The sixteen bit word is divided in half with the eight least significant bits driving (through an A-to-D converter) the horizontal deflection plates and the eight most significant bits driving the vertical deflection plates. The map display presents three types of information — each dot represents a specific address or state the machine goes to, the relative frequency of occurrence of that state (brightness), and the line between dots is a vector where the brighter end of the vector is the "goes to" address.

A map cursor, which is positioned with the trigger word switches, shows the trigger word or address of any desired dot in the map display. In the map expand mode, the cursor identifies the sector of the map to be expanded to full screen for increased resolution. Return to table mode is accomplished with the push of a button with the trigger word selected by the cursor position.

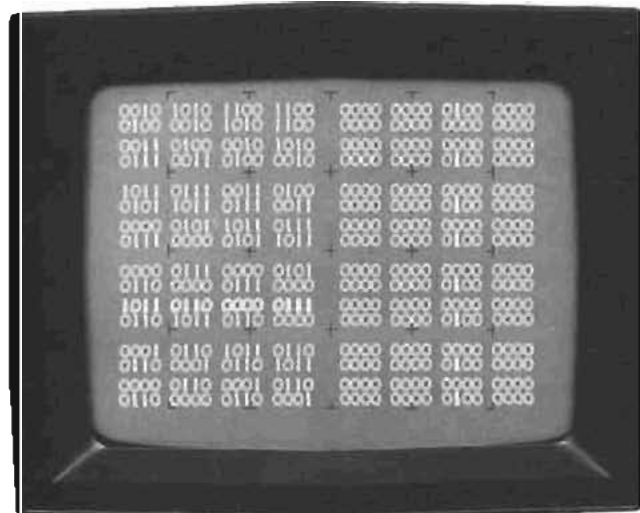

In the exclusive OR mode (A ⊕ B), A memory data is displayed on the left while the table on the right displays logic differences between A and B memories. This provides very fast "at-a-glance" comparisons.

loops and measuring lengths of subroutines while maintaining a desired pattern trigger point. A "Delay ON-OFF" switch allows quick reference back to the trigger word if it has been moved off-screen by the delay.

Trigger word off

With the Trigger Word pushbutton in the OFF position, the Analyzer's display is independent of the Trigger Word switch settings. With the Trigger Word Off you can trigger a display in the Qualifier Trigger or Trigger Bus modes, or with these modes off the display free runs.

The free run mode aids in troubleshooting by displaying active (superimposed ones and zeros) and inactive (either a one or a zero) data lines. Another use of this mode is determining in which loop a machine may be stuck. In this free run application, use the single sample mode to capture an arbitrary 16 word group. After selecting a trigger word from that group, End, Start, or Delay mode can be used to page through the loop to determine what is forcing the machine to remain in the loop.

DIGITAL CIRCUIT TESTERS & ANALYZERS

Models 1600A, 1607A & 1600S (cont.)

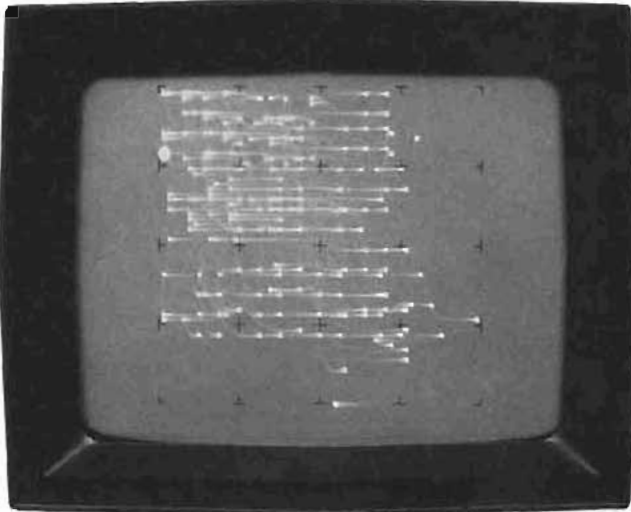

The map display offers an overall view of machine operation with each dot representing one input word. After some familiarization, these patterns become easily recognized by the operator, offering fast overview analysis of a system.

1607A logic state analyzer

The 1607A can be systemized with a 1600A to provide a 32 bit wide logic state analyzer for large machine applications, or a dual 16 bit analyzer for I/O measurements or other dual clock applications, or it may be used to convert an oscilloscope into a logic state analyzer. Rear panel X, Y, and Z outputs will drive almost all modern displays or oscilloscopes (not recommended for storage displays or oscilloscopes) with dc-coupled inputs on all three channels. A Z-axis disable (ON-OFF) switch eliminates the need to disconnect the Z-axis input cable when conventional scope operation is desired. Size and position adjustments on the 1607A offer sufficient range of adjustment to provide the best state display on the CRT display or oscilloscope being used. This reduces the amount of readjusting of controls needed to switch between state and electrical analysis. All of the functions described in the introduction section apply to the 1607A and oscilloscope combination which form a complete Logic State Analyzer test system for the digital design engineer.

1600A and 1607A common features

Qualifier inputs

Two additional channels (Q_0 , Q_1) increase flexibility in both triggering and data collection. When used to qualify the trigger word, the qualifier inputs expand the trigger word to 18 channels, however the qualifier signals are not displayed.

Selective store

In the display (clock) qualification mode, the two qualifier channels must be true at the time of the clock edge so that the analyzer only displays "qualified" data. This is particularly useful when monitoring multi-use buses with time multiplexed addresses, instructions, and data. With display qualification, only the desired information is stored in memory, eliminating the need to display the other data.

Trigger outputs

The trigger outputs extend troubleshooting capabilities in digital circuit analysis by windowing oscilloscopes to the proper digital point in time for electrical analysis of circuit operation. The Pattern Trigger Output and Delayed Trigger Output are independent of the display both when the word pattern, selected by the trigger switches is met and when the digital delay counts down. This allows the highest possible repetition rate of trigger outputs to synchronize an oscilloscope for the brightest possible display. The Pattern Trigger Output may also be used as a "clock stopper" when desired.

Indicators

When a display is not present, the NO ARM, NO CLOCK, NO QUALIFIER and NO TRIGGER indicators quickly pinpoint the problem to show you what is preventing a display. There is a hierarchy to these indicators which is essentially the most significant difficulty to the left on the 1600A and from the top on the 1607A. For example, if clock qualification is selected and the qualifier and trigger word are not satisfied, then the no qualifier indicator will light until it is satisfied, then the no trigger light will light until it is satisfied.

Sequential triggering

Both Analyzers may be sequentially triggered by using trigger outputs from other instruments as arming inputs. For example, this permits a prior event determined with a 1607A to enable a 1600A to look for a particular event after qualification. This digital arming capability can be supplied by a Model 1620A Pattern Analyzer, any of the 10250 series 4-bit data probes, or other external signals that define the desired time frame.

Additional features

Clock threshold can be selected for fixed TTL levels or variable and adjusted to the desired threshold level. Unused channels may be blanked to remove unneeded channels from the display from left to right. A logic positive or negative switch permits the displayed pattern to match either positive or negative true logic systems. This does not change the data logic, but changes only the display to match the system under test. Since the Analyzer samples 16 words of information when the trigger word matches the system data, the display may change too rapidly for analysis — when this happens a display time control allows adjustments of the time a display is held on screen. A BYTE pushbutton allows the display to be arranged in blocks of 4 bits or blocks of 3 bits for easier reading of BCD, Hexadecimal or octal codes.

1600S

The 1600S is a system which includes the 1600A and 1607A plus the 10236A Trigger Bus Cable and the 10237A Data Cable. The combined system provides additional capability for logic analysis of complex systems, e.g., 32 channels of data may be acquired and displayed; two systems may be analyzed simultaneously while running at different clock rates; or two separate 16×16 data fields may be acquired forming 32 consecutive words after a trigger or 16 words before and after a trigger.

Specifications

Clock and data inputs

Repetition rate: 0 to 20 MHz.

Input RC: 40 k Ω \pm 3 k Ω shunted by ≤ 14 pF (at the probe tip).

Input bias current: ≤ 30 μ A.

Input threshold: TTL, fixed at approx. +1.5 V; variable, ± 10 V dc.

Maximum input

Level: -15 to +15 V dc.

Swing: 15 V peak from threshold.

Minimum input

Swing: 0.5 V + 5% of p-p threshold voltage.

Clock pulse width: 20 ns at threshold.

Data pulse width: 25 ns at threshold.

Data setup time: time data must be present prior to clock transition, 20 ns.

Hold time: time data must be present after clock transition, 0 ns.

Pattern and delayed trigger outputs

High: ≥ 2 V into 50 Ω (line driver interface).

Low: < 0.4 V into 50 Ω (line driver interface).

Pulse duration

Delayed trigger: approx. 25 ns (RZ format) at 1 V level.

Pattern trigger: approx. 25 ns in RZ format at 1 V level with delay set to zero or off. With delay on and not set to zero, pattern trigger output starts on receipt of a pattern trigger signal and ends when the delay ends.

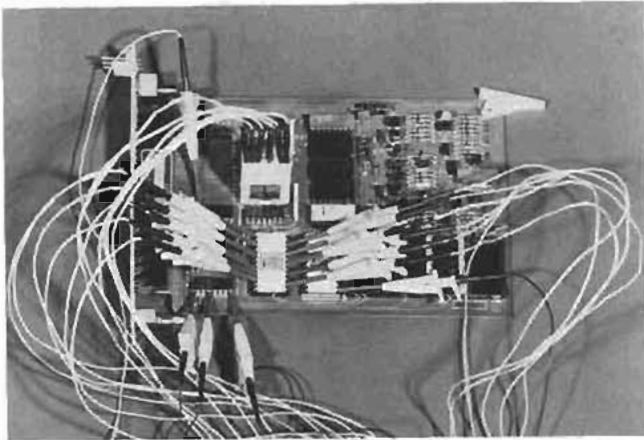

Digital probes permit direct connection to dual in-line packages, even on adjacent heads.

Trigger arm input

Impedance: 50Ω

Level: low state, 0 V to <0.4 V; high state, 2 V to <5 V.

Pulse width: 15 ns minimum at 1.5 V level.

Arming conditions: if the arming pulse positive edge occurs <45 ns after a clock, triggering occurs on the same clock cycle that it is armed. If the arming pulse positive edge occurs >75 ns after a clock, triggering occurs on the next clock cycle.

1607A X-, Y-, and Z-axis outputs

X-axis: <0.6 V to >6 V p-p, ±8 V max into ≥100 kΩ.

Y-axis: <0.6 V to >6 V p-p, ±8 V max into ≥100 kΩ.

Z-axis: 0 to 10 V p-p into ≥1 kΩ.

Display interface requirements: the 1607A interfaces with oscilloscope or display with the following input parameters. (Not recommended for storage oscilloscopes or displays).

X and Y inputs: 0.1 to 1 V/div deflection factors; dc coupled input; and >500 kHz bandwidth.

Z-axis input: dc coupled with positive blanking; full blanking must occur with 10 V input at 10 mA.

General

Display rate: variable from <200 ms to >5 s (1600A), <50 ms to >5 s (1607A).

Power: 100, 120, 220, 240 V ac; -10%, +5%; 48 to 440 Hz; 120 VA max.

Logic probe power: rear panel BNC connector, +5 V, 0.1 A.

Dimensions

1600A: 335 mm (13 1/8 in.) wide; 197 mm (7 3/4 in.) high; 540 mm (21 1/4 in.) length with handle; 460 mm (18 1/2 in.) length without handle.

1607A: 284 mm (11 1/8 in.) wide; 121 mm (4 3/4 in.) high; 460 mm (18 1/2 in.) deep.

Operating environment: temperature, 0 to 55°C (+32° to +130°F); humidity to 95% relative humidity at 40°C (104°F); altitude to 4600 m (15 000 ft); vibrated in three planes for 15 minutes each with 0.254 mm (0.010 in.) excursion, 10 to 55 Hz.

Weight

Model 1600A: net, 12.7 kg (28 lb), Shipping, 15.9 kg (35 lb).

Model 1607A: net, 6.4 kg (14 lb), Shipping, 8.2 kg (18 lb).

Model 1600S: net, 19.1 kg (42 lb), Shipping, 22.7 kg (50 lb).

Accessories supplied: three 10231B data probes and one 10230B clock probe; one 230 V fuse package, one 2.3 m (7.5 ft) power cord; and one accessory case.



10253A Card Reader and 1600A Logic State Analyzer provide convenient methods of comparing fixed stored data (cards) with active data.

Accessories

Card reader: Model 10253A Card Reader plugs directly into the 1600A and provides a convenient method of performing repetitive tests on digital components or systems. Cards provide a low cost method of storing fixed data that may represent a complete system test procedure or a simple QC test. Applications include incoming inspections, production testing, service and maintenance, engineering, and environmental testing.

Cards: special printed cards are in format required for loading data into the 1600A Logic State Analyzer Table B memory. 187mm (7 3/8 in.) length cards are loaded into Table B in <2 s.

Power: supplied by 1600A.

Weight: net, 1 kg (2.1 lb), Shipping, 1.8 kg (4 lb).

Operating environment: same as 1600A except: temperature, +10°C to +40°C (+50°F to 104°F); humidity, to 80% relative humidity at +40°C (104°F).

Accessories supplied: one drum card, HP P/N 10253-90001; one exercizer card, HP P/N 10253-90002; 100 data cards, HP P/N 9320-3324; one interface box mounting bracket, HP P/N 01120-64701; and one Operating Note.

Serial-to-parallel converter: Model 10254A Serial-to-parallel Converter acts as the interface between a serial data system and a 1600A or 1607A, converting the serial data into parallel format for full utilization of these logic state analyzers in serial data stream analysis.

Trigger bus cable: Model 10236A Trigger Bus Cable interconnects the 1600A and 1607A to provide 32-bit word capability (supplied with the Model 1600S).

Weight: net, 0.2 kg (6 oz), Shipping, 0.5 kg (1 lb).

Data cable: Model 10237A Data Cable interconnects the 1607A and 1600A to provide the 32-bit data display (supplied with the Model 1600S).

Weight: net, 0.23 kg (8 oz), Shipping, 0.5 kg (1 lb).

Rack mount adapter: Model 10491B Rack Mount Adapter, 222 mm (8 3/4 in.) high and 540 mm (21 1/4 in.) deep; adapts the 1600A to a standard 483 mm (19 in.) rack.

Model number and name

Model number and name	Price
1600A Logic State Analyzer	\$4200
1607A Logic State Analyzer	\$2900
1600S includes a 1600A and 1607A	\$7100
10236A Trigger Bus Cable (supplied with 1600S)	\$20
10237A Data Cable (supplied with 1600S)	\$60
10253A Card Reader	\$800
10254A Serial-to-parallel Converter	\$975
10491B Rack Mount Adapter	\$100

DIGITAL CIRCUIT TESTERS AND ANALYZERS

16 Bit serial/parallel digital triggering & display

Models 10254A & 1620A

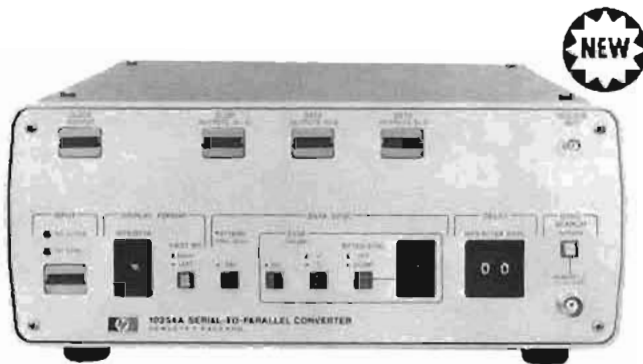

10254A Serial-to-parallel converter

Model 10254A Serial-to-parallel Converter is an accessory to the 1600A and 1607A Logic State Analyzers that extends their use to measurements in serial data streams. The 10254A acts as the interface between the system under test and the logic state analyzer, converting serial data into parallel format for full utilization of the analyzer capabilities. The 10254A permits selective display of up to 16 bytes of data per sync signal, with up to 16 bits per byte. One line on the analyzer's display represents one byte of serial data. Synchronization of the data may be either by a sync pulse through the input probe or by a unique pattern set on the analyzer trigger word switches. In Pattern sync, the search for a sync in the serial data flow is initiated by pushbutton or by a remote input pulse edge.

Probe inputs

Repetition rate: 10 MHz max in Edge Sync, 7 MHz max in Pattern Sync.

Input RC: 40 k Ω \pm 3 k Ω shunted by \leq 14 pF (at the probe tip).

Input threshold: TTL, fixed at 1.5 V dc; variable \pm 10 V dc.

Maximum input: level, \pm 15 V dc; swing, 15 V peak from threshold.

Pulse width: 40 ns min at threshold.

Setup time: time data must be present prior to clock transition, 50 ns.

Hold time: time data must be present after clock transition, zero ns.

Operating modes

Display format

Bits/byte: 1 to 16 bits per byte selectable.

First bit, left/right: configures output byte for most significant bit left or right to correspond to input data convention.

Data sync

Pattern: when selected, 10254A synchronizes on a unique pattern in the serial data stream, determined by logic state analyzer Trigger Word switch settings.

Edge Sync: when selected, 10254A synchronizes on input probe sync signal, positive or negative edge selectable.

Bytes/sync: in Count, 10254A acquires only number of bytes selected (1-16) for display between sync pulses.

Delay: number of clock pulses after sync and before data acquisition is selectable, 0 to 99.

General

Weight: net, 3.2 kg (7 lb). Shipping, 5 kg (11 lb).

Power: +5 V dc, +12 V dc and -12 V dc, supplied by the 1600A or 1607A Logic State Analyzer.

Dimensions: 28.4 cm (11 $\frac{1}{8}$ ") wide, 12.1 cm (4 $\frac{1}{2}$ ") high, 41.4 cm (16 $\frac{1}{8}$ ") deep.

Accessories supplied: one Model 10236A Trigger Bus Cable, four interface cables (HP P/N 10254-61601), and one Operating Note.

Equipment required: 1600A or 1607A plus a 10231C data probe from the 1600A, 1607A or ordered separately, for use as the 10254A input data probe (labels supplied with 10254A).

Model number and name

10254A Serial-to-parallel Converter

10231C Six Bit Data Probe (see equipment required)

Price

\$975

\$205

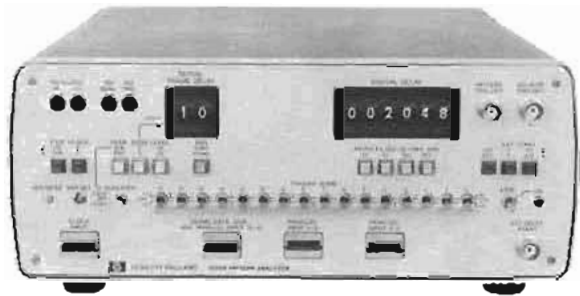

1620A Pattern analyzer

Model 1620A Pattern Analyzer generates a trigger from serial or parallel digital pattern recognition and/or digital delay for oscilloscopes or other externally triggered instruments. Pattern recognition is selectable up to 16 bits in either serial or parallel mode, with digital delay selection up to 999 999 bits.

A separate qualifier line is provided for use in the serial mode, enabling you to look for bit patterns at a discrete time or during time intervals. A serial frame delay gives you window selection in the bit stream, relative to the qualifier starting edge.

In the parallel recognition mode the Analyzer is capable of either synchronous or asynchronous operation. In the parallel asynchronous mode a selectable pulse width filter reduces the possibility of false triggering caused by glitches resulting from skew in the data stream entering the Analyzer.

Digital delay can be started by pattern recognition or by an external trigger input (Ext Delay Start). This allows moving the measurement window a selectable number of clock cycles downstream from a trigger point defined by the Analyzer or the trigger input.

Serial operation only

Clock, serial data and qualifier inputs are provided on the rear panel through BNC connectors for use with conventional X10 attenuation probes. For serial applications, front panel probes are not required. Option 003 deletes probes normally supplied with the 1620A.

Clock and data probe inputs

Repetition rate: 20 MHz max

Input RC: 40 k Ω \pm 3 k Ω shunted by <14 pF (at the probe tip).

Input bias current (input grounded): <10 μ A.

Input threshold: TTL, fixed at 1.5 \pm 0.1 V dc. Variable, to \pm 10 V.

Maximum input: level, \pm 15 V dc; swing, 15 V peak from threshold.

Minimum input swing: 0.5 V \pm 5% of threshold voltage p-p.

Clock pulse width: 20 ns min.

Setup time: 20 ns min (normally 10 ns).

Hold time: zero ns (normally -5 ns).

BNC inputs: ext delay start, Rear panel; serial data, qualifier, and clock.

Ext delay start Input RC: 1 M Ω \pm 5% shunted by <25 pF in X1 or X10.

Pattern and delayed trigger outputs

Level: high, \geq 2 V; low, \leq 0.5 V (both into 50 ohms).

Width: approx 25 ns in sync modes.

General

Weight: net, 4.5 kg (10 lb). Shipping, 6.4 kg (14 lb).

Power: 100, 120, 220, or 240 Vac \pm 5%, -10%; 48 Hz to 440 Hz, max power 58 VA (nominal 43 VA).

Dimensions: 28.4 cm (11 $\frac{1}{8}$ ") wide, 11.9 cm (4 $\frac{1}{8}$ ") high, 40.6 cm (16") deep.

Accessories furnished: one Model 10230B clock probe, three Model 10231B data probes, one 2.3 m (7.5 ft) power cord, one Operating and Service Manual.

Option 003: 1620A without probes for serial use less \$450

Individual probes:

10230C clock probe

\$145

10231C data probe

\$205

1620A Pattern Analyzer (including probes)

\$1750

- Logic state vs system time display
- Synchronous or asynchronous triggering
- 15 ns spike detection

- Negative time display
- Precision digital delay
- Compatible with all logic families



The 5000A Logic Analyzer is an analyzer with features that make it especially attractive for serial data applications. Its flexible triggering circuits make possible a stable display whether the trigger event is an asynchronous spike or a combination of synchronous signals. The trigger point may even be positioned in the middle of the display for simultaneous viewing of data before and after the trigger. For serial data organized into words, the display can be delayed from the trigger not only in terms of clock cycles, but also in terms of your word sync pulses. The display consists of sixty-four LED indicators for displaying two channels of thirty-two bits each or one channel of sixty-four bits.

Digital triggering

The 5000A Logic Analyzer utilizes a digital triggering format which allows indexing to any position within a data sequence by selecting a signal at either the A or B input, the External Trigger input, or logical AND combinations of two or three of these inputs or their complements. If more than three data inputs are required to define a unique starting point within a sequence, the parallel triggering capability of the Logic Analyzer may be greatly expanded by use of the 10250 series of trigger probes.

Another unique mode of triggering offered exclusively by the Logic Analyzer is "asynchronous triggering." This triggering technique allows a display sequence to be initiated on a signal that is not present when the inputs are sampled by the clock (not accessible to synchronous triggering).

Digital delay

If the desired data display is not present immediately following the trigger, the variable digital delay of the Analyzer allows repositioning of the display to any point within the data sequence. The 32-bit "display window" can be moved with digital preciseness an exact number of clock pulses relative to the fixed trigger point. Data occurring far downstream in a bit sequence becomes conveniently visible just by dialing the appropriate delay number into the front-panel thumb-wheel delay register.

The Logic Analyzer also offers a look-ahead or "negative delay" feature. The Analyzer always has access to the last 64-bits of data prior to the occurrence of the trigger and has the ability to display this data if desired. Thus, not only can a failure mode be observed, but the sequence of events which lead to the failure can now be displayed for analysis.

Spike detection

One of the Logic Analyzer's special troubleshooting capabilities consists of being able to detect spikes as narrow as 15 ns between clock pulses in a data stream. When placed in the "SPIKE A" mode, the

Analyzer ignores synchronous data and only indicates the location of spikes. These spikes may be caused by race conditions, ringing, noise, or design and are defined as more than one transition of the data on the A channel between clock cycles.

Annunciators

Analyzer operation is always made apparent by its front panel LED annunciators. An LED for each of the five signal inputs functions as a logic probe to dynamically indicate logic states and pulse trains. If a probe isn't making contact or an input isn't receiving pulses, you know it immediately. Two other LED's light to indicate the occurrence of the arming and triggering processes. You never waste time trying to see signals that aren't there.

5000A Condensed specifications

Inputs

Input impedance: 1 M Ω shunted by 35 pF.

Input threshold voltage: continuously variable over ± 1.4 V. (± 14 V with 10:1 divide probes). Compatible with TTL, ECL, MOS, RTL, HTL and CMOS logic families.

Maximum input voltage: ± 200 V continuous, ± 400 V transient.

Data and trigger inputs (channel A.B. external trigger)

Minimum setup time: 15 ns

Minimum hold time: 0 ns.

Clock input

Maximum pulse repetition rate: 10 MHz.

Minimum pulse width: 15 ns.

Input modes

A,B: two-channel operation.

Serial A: A and B display registers cascaded into a single 64-bit display loaded from Channel A input.

Spike A: detects multiple transitions at A input during a clock period.

Minimum spike width: 15 ns.

Trigger controls

Minimum sweep rearming time: 60 ms after last clock pulse of sweep.

Hold off control: increases rearming time to 4 sec.

Triggering modes

Clocked mode: analyzer triggers on first clock pulse after all input conditions defined by slope control switches are met. Trigger condition must remain until clock pulse occurs.

Asynchronous mode: analyzer triggers when trigger conditions are met. Conditions need not remain until clock pulse occurs.

Minimum pulse width: 40 ns.

Minimum setup time: 60 ns.

Digital delay

Post-trigger delay range: display begins 0 to 999 999 clock periods after trigger event.

Pre-trigger (negative) delay range: display begins 0 to 32 clock periods (64 in Serial A mode) before trigger event.

Word delay: permits two levels of digital delay.

General

Power: 115 or 230 V $\pm 10\%$, 48 to 440 Hz, approx. 35 watts.

Dimensions: 213 mm wide \times 178 mm high \times 366 mm deep (8.4" \times 7" \times 14.4").

Temperature: 0 to 55°C.

Options and accessories

10013A: 10:1 Voltage Divider Probe

10250A: TTL Trigger Probe

Option 908: Rack Flange Kit

Option 910: one additional product manual

5000A Logic Analyzer

Price

\$39

\$95

\$10

\$37

\$2500

DIGITAL CIRCUIT TESTERS & ANALYZERS

4 & 8 Bit parallel trigger probes

Models 10250A, 10251A, 10252A & 1230A

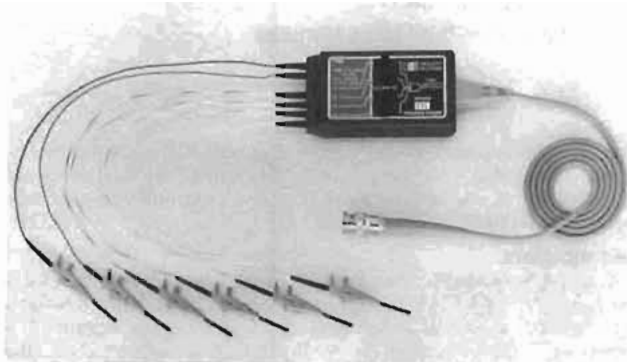

10250A

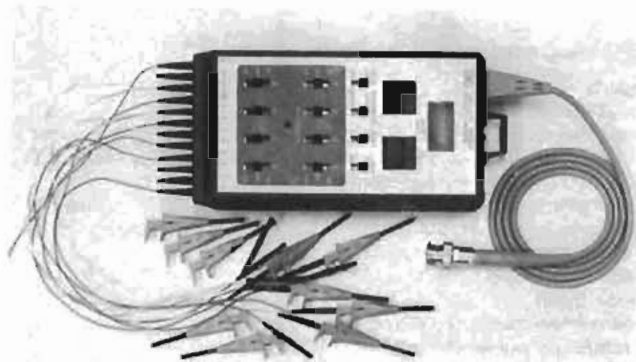

1230A

4 Bit trigger probes

Model 10250A (TTL), 10251A (MOS), and 10252A (ECL) Trigger Probes are useful service, production, and design troubleshooting tools that offer digital pattern triggering to enhance the use of oscilloscopes, logic analyzers, and other test equipment. With the 4 bit trigger probe, you trigger on four parallel events. The four inputs may be switched to HI, LO, or OFF (don't care) for convenient selection of the trigger point. No separate power supply is needed because probe power is obtained from the circuit under test.

10250A specifications

Input

Low level: 0.8 V (-0.6 V min); -0.8 mA max at 0.4 V (0.5 standard TTL load).

High level: 2 V (5.0 V max); 100 μ A max at 2 V.

Output

Swing: 0.5 V to 4.5 V min into 1 megohm.

Transition time: 7 ns max from 0.6 V to 1 V; 50 ns min to 4 V with 1 megohm, 20 pF load.

Delay

Propagation: 30 ns max from any input to trigger output.

Difference: 10 ns max between any two inputs.

Power (supplied by circuit under test)

Voltage: +5 V \pm 5%; -0.4 V to +7 V max.

Current: 30 mA max; normal operation, 17 mA.

Overall length: approx. 168 cm (66 in.).

Weight: net, 227 g (8 oz); Shipping, 907 g (2 lb).

Accessories included: six miniature probe tips, one Operating Note, and one vinyl carrying case.

10251A specifications

Input

Threshold: $(V+ \text{ plus } V-) \div 2, \pm 20\%$ of $(V+ \text{ minus } V-)$.

Output

Swing: $V- \text{ plus } 20\%$ of $(V+ \text{ minus } V-)$ to $V+$ minus 20% of $(V+ \text{ minus } V-)$ min into 1 megohm.

Delay (with specified threshold voltages)

Propagation: 350 ns max at 5 V, 210 ns max at 10 V; from any input to trigger output.

Difference: 70 ns max at 5 V, 35 ns max at 10 V; between any two inputs.

Power (supplied by circuit under test)

Voltage: between +3 V and +15 V ($V+$ minus $V-$).

Current: 5 mA max.

Overall length, weight, and accessories: same as 10250A.

10252A specifications

Input

Low level: approx. -1.6 V ($V_{cc} = 0$; $V_{ee} = 5.2$ V).

High level: approx. -0.9 V ($V_{cc} = 0$; $V_{ee} = 5.2$ V).

Output

Swing: 0.5 V p-p.

Transition time: 12 ns max with 1 megohm, 20 pF load.

Delay

Propagation: 20 ns max from any input to trigger output

Difference: 5 ns max between any two inputs.

Power (supplied by circuit under test)

Voltage: 5.2 V \pm 10%; \pm 7 V max.

Current: 70 mA max.

Overall length, weight, and accessories: same as 10250A.

Model 1230A

8 Bit trigger probe with delay

The compact Model 1230A Logic Trigger unit generates a trigger output pulse (TTL compatible) from parallel digital pattern recognition with digital delay capability for oscilloscopes, logic analyzers, or other externally triggered test equipment. Pattern recognition is selectable to 8 bits with the trigger word switches and digital delay is selectable to 9998 clocks, with a choice of synchronous or asynchronous operation.

1230A specifications

Input

Frequency: 15 MHz max.

Logic levels: logic '0': 0 V to 0.8 V; logic '1': 2 V to 15 V.

Current: -360 μ A for logic '0' input (-400 μ A for GATE input); 100 μ A for logic '1' input.

Maximum input voltage range: -1 V to +15 V.

Output (negative-going edge true)

Logic '0': 0.5 V max (60 mA current sinking capability)

Logic '1': 2 V min into 50 Ω (40 mA source current).

Operating modes

Word recognition

Synchronous pattern recognition: trigger word input recognition only during positive or negative edge (selectable) of CLOCK input signal.

Minimum set-up time: 20 ns.

Minimum hold-time: zero ns.

Asynchronous pattern recognition: independent of CLOCK input.

Maximum propagation delay after word recognition: 45 ns.

Minimum input pulse width: 25 ns.

GATE Input: for strobing or expanding word recognizer. GATE switch set to LO, GATE input pulse must be 20 ns longer than 'word-true' time. Set to HI, GATE input pulse must be 10 ns longer than 'word-true' time.

Events delay

Delay range: 1-9998 events start counting on positive edge or negative edge (selectable) of CLOCK input signal after word recognition.

General

Power requirements: 300 mA at 5 V.

Voltage on Power inputs: +4.75 V to +15 V max dc. Protected against reverse polarity.

Weight: net, 454 g (1 lb); Shipping, 907 g (2 lb).

Model number and name

10250A, 10251A, or 10252A Trigger Probe

1230A Logic Trigger

Price

\$95

\$495

DIGITAL CIRCUIT TESTERS & ANALYZERS



Logic probes

Models 545A, 10525T, & 10525E

- Dynamic multi-family logic indicators
- Pulse stretching for narrow pulses
- Bad level/open circuit detection

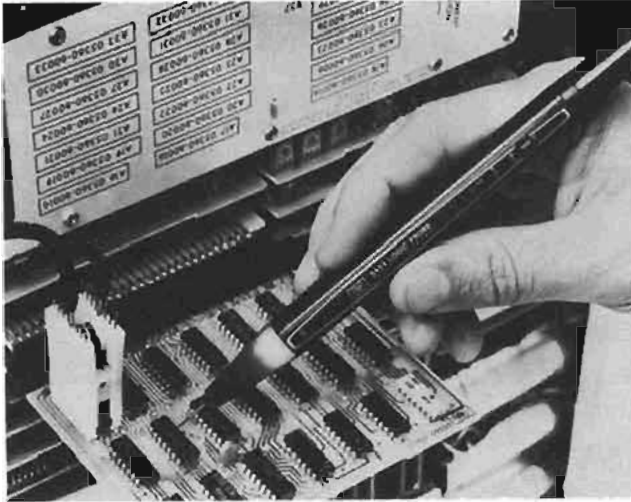

Logic probes

Logic Probes greatly simplify tracing logic levels and pulses through IC circuitry to find nodes stuck HIGH or LOW, intermittent pulse activity, and normal pulse activity. That's because they instantly show whether the node probed is high, low, bad level, open circuited, or pulsing.

Logic probes require a simple connection to the circuit under test's power supply, and they're ready to use. The strain-relieved power cord, and line-voltage protected tip insure long life and durability. High input impedance protects against circuit loading, not just in the HIGH state, but for logic LOW's as well.

545A TTL/CMOS Logic probe

The all-new HP Model 545A Logic Probe contains all the features built into previous HP probes, plus switch-selectable, multi-family operation and built-in pulse memory. Employing the same straightforward one-lamp display as our other probes, the 545A operates from 4 to 18 volts in CMOS applications, or from 4.5 to 15 V dc supplies in the TTL mode while maintaining standard TTL thresholds.

The probe's independent, built-in pulse memory and LED display help you capture hard to see, intermittent pulses. Just connect the probe tip to a circuit point, reset the memory, and wait for the probe to catch those hard to find glitches. The memory captures and retains a random pulse until reset.

The hand-held 545A is light, rugged, overload protected, and very fast: 80 MHz in TTL, 40 MHz in CMOS. It also employs unique new power supply connectors that enable you to power the probe using several different methods.

545A Specifications

Input current: $\leq 15 \mu\text{A}$ (source or sink)

Input capacitance: $\leq 15 \text{ pF}$

Logic thresholds

*TTL: Logic one 2.0 + 0.4, -0.2 V dc. Logic zero 0.8 + 0.2, -0.4 V dc

CMOS: 3 — 10 V dc supply

Logic one: $0.7 \times V_{\text{supply}} \pm 0.5 \text{ V dc}$

Logic zero: $0.3 \times V_{\text{supply}} \pm 1.0 \text{ V dc}$

CMOS: ≥ 10 — 18 V dc supply

Logic ONE: $0.7 \times V_{\text{supply}} \pm 1.0 \text{ V dc}$

Logic ZERO: $0.3 \times V_{\text{supply}} \pm 1.0 \text{ V dc}$

Input minimum pulse width: 10 ns with ground lead (typically 20 ns without ground lead)

- One lamp, finger-tip display
- Pulse memory capability
- Overload protected

Input maximum pulse repetition

Frequency: TTL, 80 MHz. CMOS, 40 MHz

Input overload protection: $\pm 120 \text{ V}$ continuous (dc to 1 kHz); ± 250 for 15 seconds (dc to 1 kHz)

Pulse memory: indicates first entry into valid logic level; also indicates return to initial valid level from bad level for pulse $\geq 1 \mu\text{s}$ wide.

Power requirements

TTL: 4.5 to 15 V dc •

CMOS: 3 to 18 V dc

Maximum current: 70 mA

Overload protection: $\pm 25 \text{ V}$ dc for one minute

Temperature: 0° to 55°C

Accessory Included: Ground Clip

HP Part No. 00545-60105

* $\pm 5 \pm 10\%$ V dc power supply; usable to +15 V dc with slightly increased logic low threshold.

10525T Logic probe

The model 10525T Logic Probe provides TTL/DTL troubleshooting at low cost. Ideally suited to 5 volt logic applications, the 10525T has high input impedance, overload protection, and 50 MHz data rate capability. Available with accessory pulse memory and tip kit.

10525T Specifications

Input impedance: $> 25 \text{ k}\Omega$ in both the high and low state (< 1 low power TTL load).

Logic one threshold: 2.0 V $\pm 0.2 \text{ V}$.

Logic zero threshold: 0.8 V $\pm 0.2 \text{ V}$, -0.4 V.

Input minimum pulse width: 10 ns.

Input maximum pulse repetition frequency: $> 50 \text{ MHz}$.

Input overload protection: ± 70 volts continuous, ± 200 volts intermittent, 120 V ac for 30 seconds, 240 V ac for 10 seconds.

Power requirements: 5 V $\pm 10\%$ at 60 mA, internal overload protection for voltages from +7 to -15 volts. Includes power lead reversal protection.

Temperature: 0° to 55° C.

Accessories included: BNC to alligator clips, ground clip.

ECL logic probe

The HP Model 10525E Logic Probe extends the time-proven, cost-saving logic probe troubleshooting technique to high-speed ECL logic.

Operation of the ECL probe is analogous to that of the 10525T except the 10525E's high speed circuitry stretches single shot phenomena so that single pulses as narrow as 1 nanoseconds may be observed.

The 10525E may be powered directly from any -5.2 volt source and its high input impedance minimizes circuit loading.

10525E Specifications

Input impedance: 12 k Ω in both the high and low state.

Logic one threshold: -1.1 V $\pm 0.1 \text{ V}$.

Logic zero threshold: -1.5 V $\pm 0.1 \text{ V}$.

Input minimum pulse width: 5 nsec.

Input maximum pulse repetition frequency: 50 MHz (typically 100 MHz at 50% duty cycle.)

Input overload protection: ± 70 volts continuous, 200 volts intermittent, 120 V ac for 30 seconds.

Power requirements: -5.2 V $\pm 10\%$ at 80 mA; supply overload protection for voltages from -7 to +400 volts.

Accessories included: BNC to alligator clips, ground clip.

Accessories available:

00545-60104 Tip Kit for 545A Probe

10525-60012 Tip Kit for 10525T Probe, 10526T Pulser

10525-60015 Pulse Memory for 10525T Probe

Price

\$30⁰

\$40⁰

\$80⁰

Model number and name

545A Logic Probe

10525T Logic Probe

10525E Logic Probe

Price

\$125

\$85

\$150



DIGITAL CIRCUIT TESTERS & ANALYZERS

Logic pulsers

Models 546A & 10526T

- In-circuit stimulation without unsoldering
- Automatic injection of proper polarity pulse
- Greatly simplifies digital troubleshooting

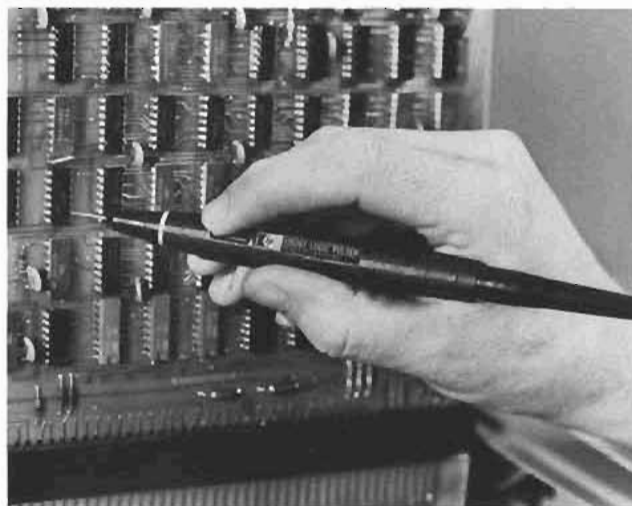
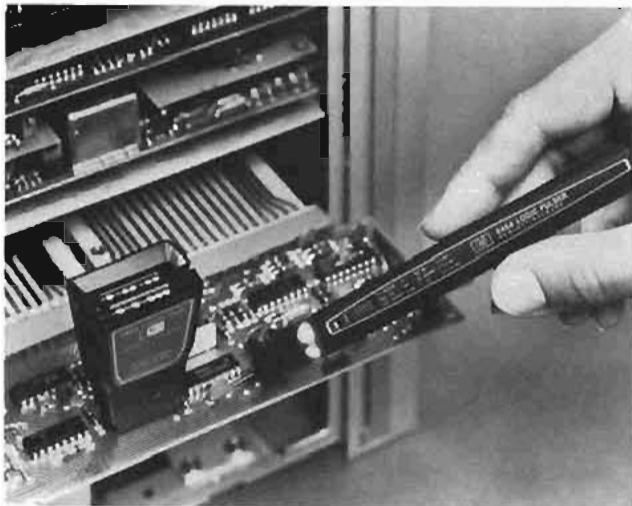

Logic pulser

The Logic Pulser solves the old problem of pulsing IC's on digital logic boards for designers and troubleshooters. Merely touch the Pulser to the circuit under test, press the pulse button and all circuits connected to the node (outputs as well as inputs) are briefly driven to their opposite state. No unsoldering of IC outputs is required. Pulse injection is automatic so the user need not concern himself whether the test node is in the high or low state; high nodes are pulsed low and low nodes, high, each time the button is pressed.

The Pulser is essentially a pulse generator with high output current capability packed in a convenient, easy-to-use probe. Ability to source or sink up to 0.65 Amperes insures sufficient current to override IC outputs in either the high or low state. Output pulse width is limited so the amount of energy delivered to the device under test is never excessive. Additionally, the Pulser output is three-state so that the circuit under test is unaffected until the Pulser is activated.

Combining in-circuit pulse injection with the unique detection capabilities of Logic Probes, Logic Clips, and the 547A Current Tracer focuses new power on solving the problems of fault isolation. Pulser/Probe, Pulser/Clip, and Pulser/Tracer combinations enable the digital designer or troubleshooter to hold complete stimulus-response capability at his finger tips.

Gate operation is tested with the Pulser driving the input and the probe monitoring transmitted pulses at the output. When pulses are not received, place the Pulser and Probe on the same pin to detect if the failure is due to a short to ground or V_{cc} .

Testing sequential circuits is the domain of the Logic Clip and Logic Pulser. The Clip simultaneously monitors all output states while the Pulser applies clock and reset pulses to the device. Improper operation, if present, is immediately obvious since the IC will not go through its prescribed sequence of states.

Finally, when Pulsers are used with the 547A Current Tracer, the Pulser acts as a current pulse source to enable exact location of faulty gates on a node, solder bridges, or stuck devices on bus structures.

546A Logic Pulser

Automatic polarity pulse output, pulse width, and amplitude control make for easy multi-family operation when you use the 546A Logic Pulser. But, the real surprise comes when you consider one of its six ROM-programmable output patterns (single pulses; pulse streams of either 1, 10, or 100 Hz; or bursts of 10 or 100 pulses). This feature allows you to continually pulse a circuit when necessary, and it also provides an easy means to put an exact number of pulses into counters and shift registers. Used with our new family of IC Troubleshooters, the 546A acts as both a voltage and current source in digital troubleshooting applications.

546A Specifications

Output:

			Typical Output Voltage	
Family	Output Current	Pulse Width	HIGH	LOW
TTL/DTL	≤ 650 mA	≥ 0.5 μ s	≥ 3 V dc	≤ 0.8 V dc
CMOS	≤ 100 mA	≥ 5.0 μ s	$V(\text{supply}) - 1$ V dc	≤ 0.5 V dc

Power supply requirements: TTL — 4.5 to 5.5 V dc at 35 mA, CMOS — 3 to 18 V dc at 35 mA, protected to 25 V dc

10526T Logic pulser

The economical 10526T provides dependable single-shot operation in TTL/DTL applications. Just press the pulse button, and the pulser delivers a single powerful pulse of the correct pulse width, polarity and amplitude.

10526T Specifications

Output high pulse voltage: > 2 V at 0.65 A (1 A typical at $V_{ps} = 5$ V, 25°C)

Output low pulse voltage: < 0.8 V at 0.65 A (1 A typical at $V_{ps} = 5$ V, 25°C)

Output impedance, active state: < 2 ohms

Output impedance, off state: > 1 Megohm

Pulse width: 0.3 μ s nominal

Input overload protection: ± 50 volts continuous

Power supply input protection: ± 7 volts (includes power lead reversal protection)

Power requirements: 5 V $\pm 10\%$ at 25 mA

Temperature: 0°C to 55°C

Accessories included: BNC to alligator clips, ground clip

Accessories Available

00545-60104: Tip Kit for 546A Pulser	\$30
10525-60012: Tip Kit for 10526T Pulser	\$40
10526-60002: Multi-Pin Stimulus Kit	\$25

Price

Model number and name

546A Logic Pulser	\$150
10526T Logic Pulser	\$115

- Solves the "Wired-AND" Problem
- Displays in-circuit Digital Current flow
- All Family: 1 mA to 1 A
- Finger-tip indicator

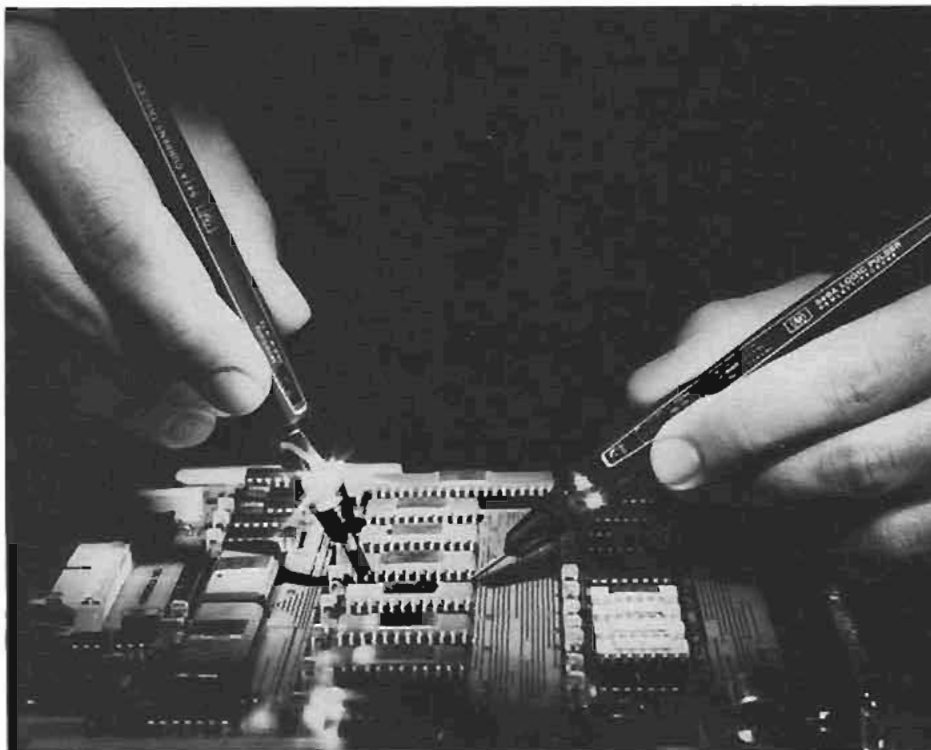

The all-new 547A Current Tracer precisely locates low-impedance faults in digital circuits by locating current sources or sinks. On a shorted node, all points are stuck in one state by the short. Many similar troubleshooting problems, such as shorted wired-AND/OR configurations, result in wasted time and excessive costs: several IC's have to be removed before finding the bad one, and in the process the circuit board may be damaged. Now, the 547A exactly pinpoints the one faulty point on a node, even on multilayer boards. In addition, the Tracer locates hairline solder bridges that manage to pass unnoticed until a circuit is operated for the first time.

Constructed as a hand-held probe, the Tracer is a sophisticated instrument designed to troubleshoot circuits carrying fast rise-time current pulses. The Tracer senses the magnetic field generated by these signals in the circuit (or, provided by a Logic Pulser), and displays transitions, single pulses, and pulse trains using a simple one-light indicator. Because it is not voltage sensitive, the Tracer operates on all logic families having current pulses exceeding 1 mA, and the repetition rates less than 10 MHz, including CMOS, where even lightly loaded outputs can have up to 2 to 3 mA typical current pulses.

Prior to introduction of the 547A, logic state indicators were limited to displaying voltage information. A node was HIGH, LOW, open, or pulsing. When a node is stuck, however, it may be trying to change state but isn't able to cross threshold levels. Use of the Current Tracer adds the final bit of information necessary to pinpoint just such logic faults on bad nodes. For example, on a bad node the Tracer can veri-

fy that the driver is functioning and also show where the problem is by tracing current flow to the source or sink causing the node to be stuck.

To use the Tracer, simply align the dot on its tip at a reference point, usually the output of a node driver. Set the sensitivity control to indicate the presence of AC current activity. Then, trace the circuit to see where current is flowing. As you probe from point to point or follow traces, the lamp will change intensity, and when you find the fault the Tracer will indicate the same brightness found at the reference point.

547A Specifications

Input

Sensitivity: 1 mA to 1 A

Frequency response: light indicates: Single-step current transitions; single pulses ≥ 50 ns in width; pulse trains to 10 MHz (typically 20 MHz for current pulses ≥ 10 mA).

Risetime: light indicates current transitions with risetime ≤ 200 ns at 1 mA.

Power supply requirements

Voltage: 4.5 to 18 Vdc

Input current: ≤ 75 mA

Maximum ripple: ± 500 mV above 5 V dc

Overvoltage protection: ± 25 Vdc for one minute

Temperature: 0° to 55°C

547A Digital Current Tracer

\$350

DIGITAL CIRCUIT TESTERS & ANALYZERS

Logic clips

Modela 548A & 10528A

- Displays IC logic states at a glance
- Self-powered, self-contained
- No adjustments required

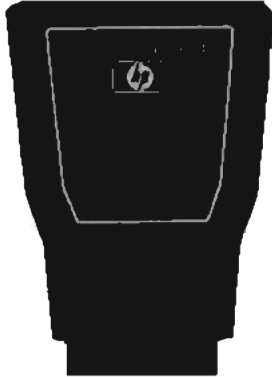

Logic clips

The Logic Clip is an extremely handy service and design tool which clips onto dual-in-line-package (DIP) IC's, instantly displaying the states of all 14 or 16 pins. Each of the clip's 16 LED's independently follows level changes at it's associated pin. Lit diodes are logic High, extinguished diodes are Low.

The Logic Clip's real value is in its ease of use. It has no controls to be set, needs no power connections, and requires practically no explanation as to how it is used. The clip has its own gating logic for locating the ground and V_{cc} pins and its buffered inputs reduce circuit loading.

The Logic Clip is much easier to use than either an oscilloscope or a voltmeter when a logic designer or service engineer is interested in whether a circuit is in the high or low state, rather than its actual voltage. The Clip, in effect, is 16 binary voltmeters, and the user does not have to shift his eyes away from his circuit to make the readings.

The intuitive relationship of the input to the output — lighted diodes corresponding to high logic states — greatly simplifies the troubleshooting procedure. The user is free to concentrate his attention on his circuits, rather than on measurement techniques. Also, timing relationships become especially apparent when clock rates can be slowed to about 1 pulse per second.

When used in conjunction with the logic pulsers, the Logic Clip offers unparalleled analysis capability for troubleshooting sequential circuits. The Clip first attaches to the IC to be tested; the Pulser is then brought into action to inject pulses between gates allowing it to supply signals to the IC under test absolutely independent of gates connected to the IC. All outputs may then be observed simultaneously on the Logic Clip. Deviations from expected results are immediately apparent as the Pulser steps the IC through its output states.

548 Multi-family logic clip

Fully automatic, protected to 30 V dc, and employing bright new LED's in it's display, the 548A brings multi-family operation to the HP line of IC troubleshooters. The Clip can be externally powered, if desired, using a simple power connector.

548A Specifications

Input threshold: $\geq(0.4 \times \text{Supply Voltage}) = \text{Logic High}$

Input impedance: 1 CMOS load

Input protection: 30 V dc for 1 minute

Supply voltage: 4-18 V dc across any two pins

Auxiliary supply input: 4.5 to 18 V dc applied via connector. Supply must be ≥ 1.5 V dc more positive than any pin of IC under test.

Supply current: < 50 mA

10528A Logic clip

Protection to +7 V dc, automatic operation, and low circuit loading in TTL/DTL applications helps make the 10528A a valuable replacement for more expensive test equipment like Scopes and voltmeters. The clip is, in effect, like 16 binary voltmeters, allowing the user to look at the circuit rather than having to shift his attention toward test equipment.

10528A Specifications

Input threshold: 1.4 ± 0.6 V; TTL or DTL compatible (except gates with expander inputs).

Input impedance: one TTL load (-1.2 mA typical) per input).

Input protection: voltages < -1 V or > 7 V must be current limited to 10 mA.

Supply voltage: $5 \text{ V} \pm 10\%$ across any two or more inputs.

Maximum current consumption: 130 mA.

Temperature: 0 to 55°C .

Dimensions: $55 \times 40 \times 25$ cm (2.15 in. high, 1.5 in. wide, 1 in. deep) maximum.

Weight: net, 45 gm (1.5 oz). Shipping, 120 gm (4 oz).

Model number and name

548A Logic clip

10528A Logic clip

Price

\$105

\$85

Logic comparator Model 10529A

- Finds faulty nodes
- Dramatically cuts troubleshooting time
- Performs in-circuit IC testing with no unsoldering

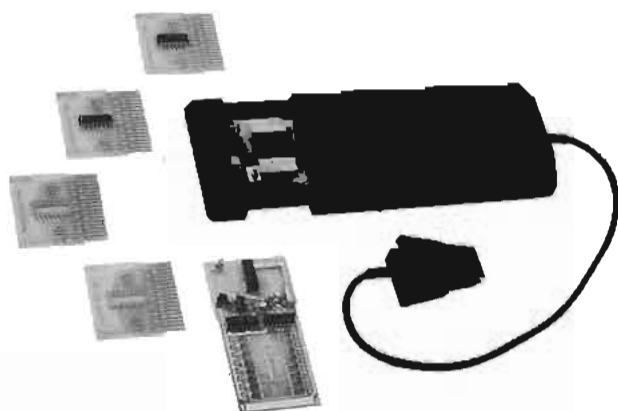

The Model 10529A Logic Comparator checks the operation of dozens of IC's in less than a minute per IC. The Comparator clips onto powered TTL or DTL IC's and detects functional failures by comparing the in-circuit test IC with a known good reference IC inserted in the Comparator. Any logic state difference between the test IC and the reference IC is identified to the specific pin(s) on 14- or 16-pin dual in-line packages on the Comparator's display. A lighted LED corresponds to logic difference. The Logic Comparator can save considerable time in locating a faulty IC. There are no controls to be set and no power connections.

The procedure is very simple. First the IC to be tested is identified. An IC of the same type is placed in the Comparator's IC socket, or a reference board with an IC of the same type is inserted in the Comparator. The Comparator is clipped onto the test IC, and an immediate indication is given if the test IC operates differently from the reference IC. Even very brief dynamic errors are detected, stretched, and displayed.

The 10529A operates by connecting the test and reference IC inputs in parallel; thus the reference IC is exercised by input signals identical to those of the test IC. The outputs of the two IC's are compared; any differences in outputs are detected, and LED's corresponding to the particular pins are lit on the Comparator's display. Intermittent errors as short as 200 nanoseconds (using the socket board) are detected, and the error indication on the Comparator's display is stretched for a visual indication. A failure on an input pin, such as an internal short, will appear as a failure on the IC driving the failed IC; thus a failure indication actually pinpoints a malfunctioning node.

Programming for the specific IC is easily accomplished by two different methods. First, the socket board included with the Comparator is inserted in the Comparator drawer. Outputs of the particular IC to be tested are selected via 16 miniature switches which tell the Comparator which pins of the reference IC are to be allowed to respond freely. The reference IC is then inserted into the socket and locked into place. IC may be set up in seconds. Alternatively, if specific IC types are to be tested repeatedly, the reference IC may be soldered into one

of the 10 reference boards provided with the Comparator. The reference board is programmed by opening the connections between the test and reference IC's outputs and solder-bridging V_{cc} and ground.

When troubleshooting you want to know that the tester is operating properly. A test board is supplied with the Logic Comparator for this purpose. When inserted in the comparator the test board exercises all of the circuitry, test leads, and display elements to verify proper operation.

The Logic Comparator's ease of use and small size make it an invaluable addition to the troubleshooter's test gear either in the field or in the factory. With TTL and DTL failures that are functionally related, the Comparator can find bad nodes up to ten times faster than conventional signal tracing techniques. At its low price, the Logic Comparator can pay for itself in days.

10541A: twenty additional blank reference boards; identical to the 10 boards provided with the Logic Comparator they allow additional IC's to be programmed for Comparator testing.

K01-10541A: twenty preprogrammed reference boards; 20 of the most common TTL IC's already programmed and ready for use with the Logic Comparator. The K01-10541A includes the following IC's: 7400 Quad 2-input NAND; 7402 Quad 2-input NOR; 7404 Hex inverter; 7408 Quad 2-input AND; 7410 Triple 3-input NAND; 7420 Dual 4-input NAND; 7430 8-input NAND; 7440 Dual 4-input NAND buffer; 7451 Dual 2-wide, 2-input AND-OR-INVERT; 7454 4-wide, 2-input AND-OR-INVERT; 7473 Dual J-K master-slave flip-flop; 7474 Dual D flip-flop; 7475 Quad bistable D latch; 7476 Dual J-K flip-flop with preset and clear; 7483 4-bit binary full adder; 7486 Quad 2-input exclusive-OR; 7490 Decade counter; 7493 4-bit binary counter; 74121 Monostable multivibrator; 9601 Monostable multivibrator, retriggerable.

10529A Specifications

Input threshold: 1.4 V nominal (1.8 V nominal with socket board), TTL or DTL compatible.

Test IC loading: outputs driving Test IC inputs are loaded by 5 low-power TTL loads plus input of Reference IC. Test IC outputs are loaded by 2 low-power TTL loads.

Input protection: voltages < -1 V or > 7 V must be current limited to 10 mA.

Supply voltage: 5 V $\pm 10\%$, at 300 mA.

Supply protection: supply voltage must be limited to 7 V.

Maximum current consumption: 300 mA.

Sensitivity

Error sensitivity: 200 ns with reference board or 300 ns with socket board. Errors greater than this are detected and stretched to at least 0.1 seconds.

Delay variation immunity: 50 ns. Errors shorter than this value are considered spurious and ignored.

Frequency range: maximum operational frequency varies with duty cycle. An error existing for a full clock cycle will be detected if the cycle rate is less than 3 MHz.

Accessories included: 1 test board; 10 blank reference boards; 1 programmable socket board; 1 carrying case.

Accessories available

10541A: Twenty Blank Reference Boards for the Logic Comparator

Price

\$95

K01-10541A: Twenty Pre-programmed Boards for the Logic Comparator

\$175

10529A Logic Comparator

\$525

DIGITAL CIRCUIT TESTERS & ANALYZERS

Multi-family logic troubleshooting kits

Model 5021A, 5022A, 5023A

- Complete CMOS/TTL troubleshooting kits
- Stimulus-response capability
- In-circuit fault finding



- In-circuit analysis
- Dynamic and static testing
- Multi-pin testing

Multi-family logic

5021A Troubleshooting kit

The 5021A Kit combines multi-family Probe, Pulser and Clip into one handy kit for stimulus-response testing in lab, field and factory applications. Useful in dynamic or static circuits such as gates, flip-flops, and micro processors, the 5021A kit instruments operate in TTL, CMOS, or most any other positive voltage logic families.

5021A Specifications

5021A contains

545A Logic Probe

546A Logic Pulser

548A Logic Clip

Dimensions: 29 L × 14.6 W × 6.4 H cm (11.75 × 5.75 × 2.5 in.)

Weight: net, 0.6 kg (13 oz). Shipping, 0.72 kg (16 oz).

5022A Multi-family logic troubleshooting kit

The 5022A Kit brings the advantages of stimulus-response testing to both voltage and current domains in digital circuits. Now, for the first time, you can stimulate a circuit and exactly pinpoint logic faults as never before possible.

Start by locating a stuck node with the Pulser-Probe combination. Then, pulse the node and follow digital current pulse flow to the faulty circuit element using the 547A Current Tracer. This valuable addition to the IC Troubleshooter line exactly locates the low impedance point to troubleshoot stuck data busses, solder bridges, and three-state devices.

5022A Specifications

5022A contains

545A Logic Probe

546A Logic Pulser

547A Current Tracer

548A Logic Clip

Dimensions: 29 L × 14.6 W × 6.4 H cm (11.75 × 5.75 × 2.5 in.)

Weight: net, 0.43 kg (15 oz). Shipping, 0.51 kg (1 lb 2 oz).

5023A Multi-family logic troubleshooting kit

The 5023A Kit includes all of our Multi-family troubleshooters, plus the TTL/DTL Logic Comparator in one complete lab, field, or factory troubleshooting kit. The comparator adds the ability to "map" and locate faulty logic responses by identifying incorrect static and dynamic logic state responses on 14 or 16-pin digital IC's.

Once bad nodes have been mapped using the Comparator, the Probe, Pulser, Current Tracer and Clip exactly locate logic faults in digital circuits.

5023A Specifications

5023A contains

545A Logic Probe

546A Logic Pulser

547A Current Tracer

548A Logic Clip

10529A Logic Comparator

Dimensions: 33.7 L × 20 W × 22.5 H cm (13.25 × 7.875 × 8.875 in.)

Weight: net, 1.64 kg (3 lb 10 oz). Shipping, 2.12 kg (4 lb 12 oz).

Accessories available

00545-60104, Tip Kit for 545A Probe, and 546A Pulser

Price

\$30

10526-60002, Multi-Pin Stimulus Kit for 546A Pulser

\$25

10529-60006, External Reference Kit for 10529A Com-

\$125

parator

10541A: Twenty blank reference boards for 10529A

\$95

Comparator

K01-10541A: Twenty pre-programmed reference

\$175

boards for 10529A Comparator

Model number and name

5021A Troubleshooting Kit

\$375

5022A Multi-family Logic Troubleshooting Kit

\$700

5023A Multi-family Logic Troubleshooting Kit

\$1200

DIGITAL CIRCUIT TESTERS & ANALYZERS

Economical TTL/DTL Troubleshooting Kits
Models 5011T, 5015T & Accessories



5011T

5011T Logic troubleshooting kit

The HP 5011T Logic Troubleshooting Kit combines all the troubleshooting capability of four instruments, the 10529A Logic Comparator, the 10526T Logic Pulser, the 10525T Logic Probe, and the 10528A Logic Clip. The Logic Comparator attaches to 14- and 16-pin dual in-line TTL and DTL circuits. Both sequential and combinatorial logic are testable. The IC under test is allowed to operate normally while its outputs are compared against a reference IC of the same type inserted in the Comparator. Should the circuit under test operate improperly, the failure is detected and displayed on the hand held Comparator's panel. Sixteen LED's exactly pinpoint the failed node.

5011T Specifications

Includes

- 10525T Logic Probe
- 10526T Logic Pulser
- 10528A Logic Clip
- 10529A Logic Comparator

Dimensions: 13.2 cm × 20.3 cm × 8.25 cm (12.25 in. × 8.0 in. × 3.25 in.)

Weight: net, 1.36 kg (3 lb). Shipping, 2.27 kg (5 lb).



5015T

5015T Logic troubleshooting mini kit

The HP 5015T Logic Troubleshooting Mini Kit combines the unique logic analysis capability of the 10525T Logic Probe, the 10526T Logic Pulser, and the 10528A Logic Clip into a single, handy kit. These three instruments provide stimulus/response capability for dynamic and static testing of in-circuit integrated circuits.

5015T Specifications

5015T Includes

- Model 10525T Logic Probe
- Model 10526T Logic Pulser
- Model 10528A Logic Clip

Dimensions: 28.6 cm × 13.3 cm × 6.4 cm (11.25 in. × 5.25 in. × 2.5 in.)

Weight: net, 0.63 kg (1 lb 6 oz). Shipping, 0.74 kg (1 lb 10 oz).



10526-60012

10526-60002

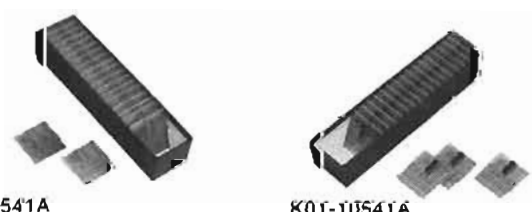

10541A

K01-10541A

Accessories available

	Price
10526-60012: Tip Kit	\$40
10526-60002: Multi-pin Stimulus Kit	\$25
10541A: Twenty Blank Comparator Reference Boards	\$95
K01-10541A: Twenty Pre-programmed Comparator Reference Boards	\$175

Model number and name

5011T Logic Troubleshooting Kit	\$725
5015T Logic Troubleshooting Mini Kit	\$250

DIGITAL CIRCUIT TESTERS & ANALYZERS

Logic Lab
Model 5035A

- Flexible circuit breadboard aid
- Use standard IC's, components, and interconnecting wires
- Removable breadboard for circuit expansion
- Completely self-contained

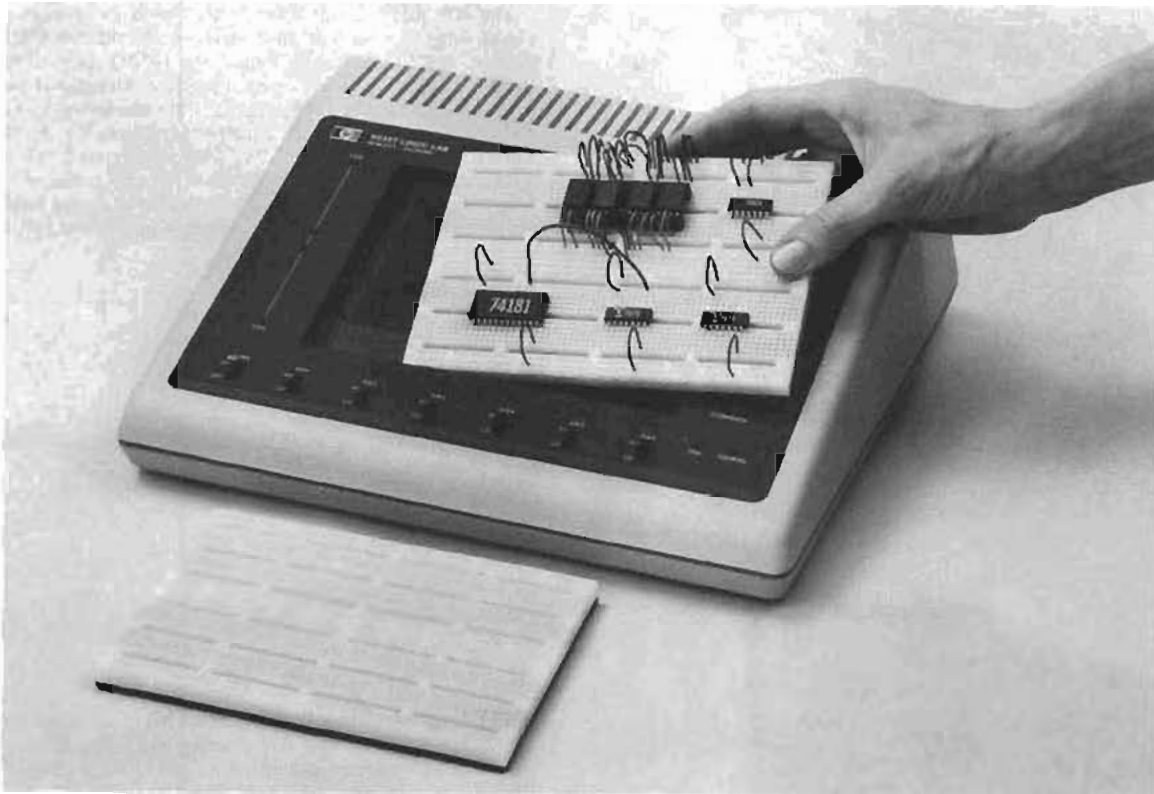

The 5035A Logic Lab brings convenience, simplicity, and flexibility to the task of breadboarding new designs or trying out alternative circuit configurations in R&D, production engineering, and product support. Fully self-contained, this rugged design partner helps you check out ideas quickly without chasing after equipment or soldering components or connections. One of the Logic Lab's key features is the uniquely removable breadboard assembly which acts like a giant socket allowing you to plug in components of all varieties and types and interconnect them with standard 24-gauge hookup wire without soldering. Each component pin for, say, dual-inline IC packages has four common tie points for fan in and fan out. Additional buses allow for signal routing or junctions. Since the breadboard holds up to 16 DIPs, a large circuit under design can be partitioned into subsections and each one checked out individually. Since the breadboard is removable, the circuits do not need to be disassembled after check out. The 1-amp capability of the Logic Lab mainframe could allow several breadboards to be powered simultaneously and interconnected by solderless hookup wire.

In addition to the 5 volt-1 amp laboratory power supply built in the Logic Lab mainframe, 6 data switches can be used to provide HIGH/LOW signals to the circuit under test. These switches are completely "debounced" so that each transition is a single edge. Thus various parts of your circuit may effectively have different "clocks" by using the data switches. Also they may be used as pulse sources since an up-down or down-up operation provides only a single pulse. Four LED indicators allow monitoring of various circuit points with HIGH/LOW indications. Two generators in the mainframe provide squarewave 1 Hz and 100 kHz signals that can be routed to your circuit.

The Logic Lab mainframe also has two 5 volt output connectors on its rear panel for powering the 10525T Logic Probe and the 10526T Logic Pulser. Available separately, these powerful troubleshooting tools provide a valuable complement to the 5035A Logic Lab. For

years the Probe and Pulser have provided circuit designers and digital troubleshooters the in-circuit stimulus/response capability optimized for IC work. The 10528A Logic Clip also is very handy to monitor all pins of 14- and 16-pin DIP's simultaneously. The 10528A clips directly to IC's mounted on the Logic Lab breadboard. Each of the three instruments is available individually or they may be obtained together as the 5015T Logic Kit.

5035A Specifications

Power supply: 5 volts $\pm 5\%$, over 0-1 Amp range; 10 mV rms ripple maximum. Continuous short circuit protection.

Data switches: 6 bounceless slide switches for TTL high/low outputs.

LED indicators: 4 high/low indicators.

Clocks: 2 independent: 1 Hz and 100 kHz.

Breadboard assembly (MP part number 1258-0121): removable.

Interconnections: all power supply, data switch, LED indicator, and component contact points may be interconnected by standard 24-gauge hook-up wire.

Power requirements: 100/120/220/240 V ac $\pm 5\%$, -10% 50 or 60 Hz line frequency; 30 watts max; $0^\circ - 55^\circ\text{C}$.

Dimensions: mainframe: 89 x 311 x 267 mm (12 1/4 in. wide, 3 1/2 in. high [max], 10 1/2 in. deep).

Breadboard assembly: 165 x 114 x 13 mm (6 1/2 in. x 4 1/2 in. x 1/2 in. thick).

Weight: net, 5.9 kg (13 lb). Shipping, 6.9 kg (15.13 lb).

Accessories Available:

1258-0121: Additional breadboard assembly

1540-0258: Heavy duty, padded vinyl carrying case

05035-60006: Wire interconnect kit (285 prestripped, assorted length and color, 24-gauge hook-up wires)

5035A Logic Lab

Price

\$45

\$25

\$15

\$425

DIGITAL CIRCUIT TESTERS AND ANALYZERS

Logic Lab
Model 5035T

- Complete digital training program
- Digital text and laboratory workbook

- Digital test instrumentation
- All required components and interconnections



The 5035T Logic Lab is a combination of all the essential elements needed for a successful introductory course in practical digital electronics. This unique program is structured to aid the digital trainee in the *rapid* understanding of theory and the practical aspects of digital circuits.

Each 5035T Logic Lab includes: A completely self-contained mainframe with a removable breadboard assembly, a tutorial text on digital electronics complete with laboratory workbook, and all the components and interconnecting wires needed for the laboratory experiments. Also included with the Logic Lab are three industrially proven digital test instruments: the 10525T Logic Probe, the 10526T Logic Pulser, and the 10528A Logic Clip.

Mainframe

The 5035T Logic Lab mainframe features rugged industrial quality construction with a 5 volt one ampere short-circuit protected power supply. This feature allows the Logic Lab to withstand many years of rough student usage. Also 6 TTL compatible bounceless data switches, 2 independent signal sources of 1 Hz and 100 kHz, and 4 LED logic state indicators make the Logic Lab an extremely versatile training and circuit breadboarding tool.

Removable breadboard assembly

One of the Logic Labs key features is the uniquely removable breadboard assembly which acts like a giant socket allowing insertion of all varieties and types of components. After insertion the busing structure of the breadboard permits circuit interconnections to be easily made without soldering using *standard* 24 gauge wire. The unique structure of the breadboard makes circuit build-up and modification both fast and easy saving hours of valuable assembly time.

The removability of the breadboard allows several individuals to construct circuits simultaneously on separate breadboards, then test their circuits in a common mainframe. This reduces the incremental cost-per-student and allows individual training to proceed at a pace consistent with ability.

When system expansion becomes necessary several breadboard assemblies may be built and checked independently for correct circuit operation then combined and operated simultaneously from a single mainframe.

Text and laboratory workbook

The text and laboratory workbook combine to form the heart of the Logic Lab digital training program. The practical concise text provides the necessary background, while circuit skill and practical hands-on experience are developed by the 26 experiments in the functional laboratory workbook. The program is arranged in modules of complexity so that learning can be tailored to the student's background and end objectives. In addition, its modular nature allows the use of self-paced and individualized study techniques. The text and workbook sections are written to increase the student's knowledge of digital electronics, to provide practical experience with actual circuit elements and to provide some exposure to the basics of digital circuit design.

Components supplied

Each 5035T Logic Lab includes thirty-two state-of-the-art TTL, SSI, and MSI integrated circuits, including gates, flip-flops, counters, decoders, and an arithmetic logic unit (A.L.U.). Also included are four LED matrix digital displays with built-in BCD to decimal decoders and 285 prestripped, 24 gauge hookup wires of various lengths and colors.

Digital test instrumentation

The increased use of digital integrated circuits has brought new demands for a digital type of test instrumentation. Hewlett-Packard's in-circuit digital troubleshooters, the Logic Probe, Logic Pulser, and Logic Clip have been used in industry for years by technicians and engineers alike. These industrial instruments also make ideal training tools because of their straightforward indication and operation.

Logic probe

The 10525T Logic Probe is a dynamic logic state indicator. It identifies logic highs, lows, open circuits with fingertip display (lit and extinguished band of light), detects single pulses as narrow as 10 nanoseconds and pulse trains to 50 M bits/second. The Logic Probe will provide the student with a unique digital analysis capability unavailable using any other measurement technique.

Logic pulser

The 10526T Logic Pulser provides the student with the equivalent of a hand held digital pulse generator. It injects a pulse *anywhere in-circuit*; no disconnections are necessary. The Pulser overrides momentarily, the existing state of the node, and it selects the proper polarity pulse automatically. High nodes are pulsed low and lows pulsed high with a single depression of the pulse button.

Logic clip

The 10528A Logic Clip is particularly useful in understanding the functional nature of IC gates. The Clip attaches directly to dual-inline packages, and with no wires or connection displays the logic states at the IC pins simultaneously via 16 LEDs—one per pin. An LED lit indicates a logic high and extinguished, a logic low.

5035T Specifications

Includes

Model 5035A Logic Lab; "Practical Digital Electronics—An Introductory Course" Text and Workbook; Logic Probe; Logic Pulser; Logic Clip; Component and Wire Kit; Carrying Case.

Accessories available:

1258-0121: Additional Breadboard Assembly	Price: \$45
10656A: Set of 10 "Practical Digital Electronics—An Introductory Course" Text and Lab Workbook	: \$150
10657A: Additional Component and Wire Kits	: \$150

5035T Logic Lab

\$750

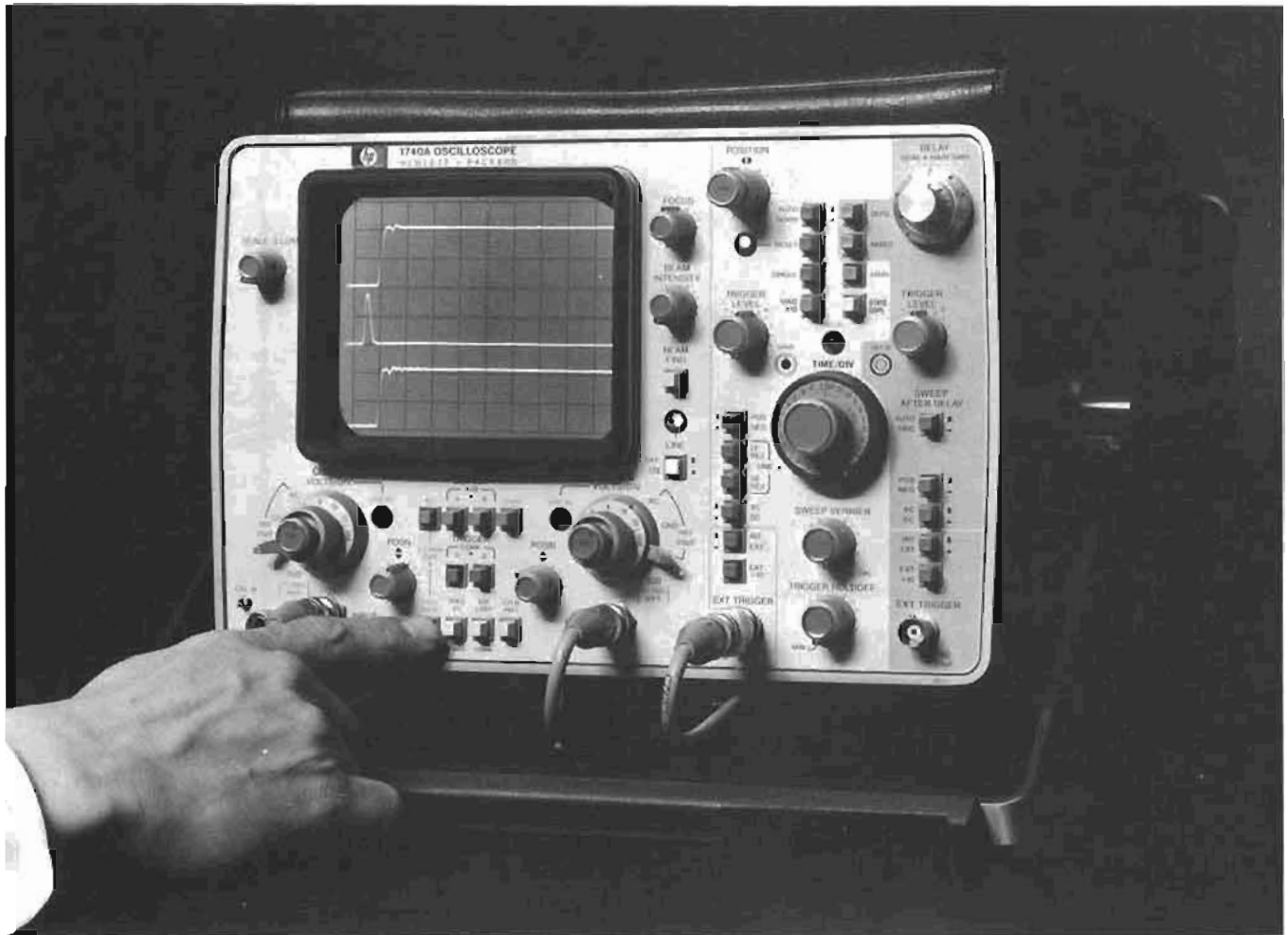

The oscilloscope—the most general purpose and basic tool of the electrical designer—has evolved into a very accurate and versatile measurement tool. With the rapid growth, in the past few years, of technology in integrated circuits, the measuring capabilities have increased tremendously. Bandwidth has increased, sweep speeds are faster and more linear, displays are larger and brighter, and controls are easier to operate. In general, the most versatile test instrument has become even more accurate and more flexible.

Hewlett-Packard pioneered many of the measurement capabilities that are now taken for granted in oscilloscopes. A few of these are internal graticule CRT, beam finder, expansion mesh CRT, trigger holdoff, mixed sweep, general purpose sampling to 18 GHz, time domain reflectometry, and rugged variable persistence/storage.

Selecting an oscilloscope

Today's selection of an oscilloscope is not as easy as it was in previous years. The recent technological changes have considerably improved the price performance ratios that are

available. In addition, measurement requirements have also changed and expanded.

To make the best selection, use your immediate measurement application as a starting point. Then look at your past and future requirements. After examining all of the possible measurement requirements, you will have an idea of the type of oscilloscope needed in your application. In a somewhat broad sense oscilloscopes can be classified in two categories, mainframes with plug-ins and nonplug-ins.

Plug-in oscilloscopes

The plug-in oscilloscope (figure 1) offers maximum flexibility by permitting general purpose measurements as well as retaining the capability to make specialty measurements. By carefully selecting a mainframe, you will be able to change the measurement capability by using different plug-ins rather than having another infrequently used special purpose oscilloscope on hand. Plug-in oscilloscopes are usually called General Purpose Laboratory instruments because of the broad measurement capabilities.

General purpose lab scopes are used in basic circuit design for almost every electronic product and are most often configured as a 2 channel, wide band, delayed sweep instrument. As the general purpose measurement needs expand, the plug-in flexibility allows you to reconfigure your instrument to fit other applications.

In addition to general purpose dual channel plug-ins with bandwidths from 25 to 100 MHz, many specialty plug-ins are also available — high sensitivity, differential mode, four channels; standard, delayed, expanded, or mixed sweep operation; sampling bandwidths to 18 GHz; time domain reflectometry; spectrum analysis to 1500 MHz, and swept frequency testing from 100 MHz to 18 GHz. The flexibility of the plug-in system is considerable — it makes one instrument do many jobs.

Nonplug-in oscilloscopes

Nonplug-in oscilloscopes (figure 2) are sometimes referred to as "dedicated" instruments because of their nonplug-in form. Although they are dedicated in form they are truly general purpose in measurement capa-



Figure 1. Representative plug-in oscilloscopes from Hewlett-Packard's 180 series.

bility with full laboratory accuracy and quality. These oscilloscopes are usually dual channel, delayed sweep instruments with a wide variety of measurement capabilities. If the applications do not require plug-in flexibility for changing requirements, then the lower cost nonplug-in oscilloscope is a useful choice for a general purpose laboratory instrument.

High speed

Hewlett-Packard has two 275 MHz oscilloscopes that are ideal for use in the design, manufacturing, and testing of high speed computers and peripherals with fast interface logic, high speed digital communications and instrumentation, as well as high frequency rf applications. Model 1720A has conventional volts-versus-time measurements and is particularly well suited for timing measurements with its delayed sweep and 1 ns/div sweep speeds.

Model 1722A with its microprocessor and LED display eliminates the time-consuming counting of divisions, interpolating between graticule lines, and multiplying by the appropriate scale factor. With microprocessor calculated results and direct LED readout, measurements are made without manual computation which saves time and reduces the possibility of human error. Measurements of dc voltage, instantaneous voltage, pulse width, pulse period and frequency, propagation delay, rise time, and relative amplitude expressed in percent, are all made in a convenient, repeatable, unambiguous manner. In addition to providing digital readout of a measurement, the microprocessor gives considerably more repeatable measurements than previously possible in real time oscilloscopes. Dual-delayed sweep improves accuracy of time interval measurements because the CRT is used as a nulling device which eliminates nonlinearity errors. The dual-delayed sweep measurement technique, developed by Hewlett-Packard, simplifies rise time, propagation delay, clock phasing and other high-speed timing measurements. Two separate markers are used to enable the operator to see both start and stop points of the time interval simultaneously. These two markers also reduce the possibility of setting a measurement to the wrong event. In the delayed sweep mode, the start and stop mode are overlapped to obtain maximum accuracy

with the improved resolution of optical nulling.

For time interval measurements at 200 MHz, Model 1712A includes Dual-Delayed sweep with a scaled dc voltage output for direct readout on an external DVM. For traditional measurements in the 200 MHz range, Model 1710B is available with standard delayed sweep.

100 MHz

Model 1740A is a 100 MHz oscilloscope with a third channel trigger view for accurate general purpose measurements. This oscilloscope with its large 8 x 10 cm CRT offers delayed sweep measurements to 100 MHz at 5 mV/cm deflection factors. A X5 magnifier increases sensitivity to 1 mV/cm on both channels to 40 MHz without the need to cascade channels. As a further aid to measurement flexibility Option 101 to the 1740A (figure 3) provides rear panel inputs and switching circuits for interfacing with the Model 1607A Logic State Analyzer. This option permits single pushbutton switching between data domain table displays and time domain measurements. The functional 16 bit wide displays provided by the 1607A permit fast analysis of digital systems when you only need logic flow information. And, with the digital triggering capability of the 1607A coupled to the 1740A external trigger you have the ability to "window" the time domain display to the digital problem area for electrical analysis.

Model 1741A offers the same conventional operating features as the 1740A plus variable persistence/storage for a truly versatile general purpose oscilloscope. For viewing low rep rate fast rise time signals, the variable persistence mode allows you to adjust the trace for an optimum display. The 1741A storage CRT provides a bright, crisp stored trace with a writing speed of 100 cm/us which is ideal for capturing single-shot and low rep rate signals common in today's digital circuits.

35 MHz and 75 MHz

For applications in the 35 MHz and 75 MHz area, there are two scopes with battery, dc, or ac line power capability for field and lab applications. The 35 MHz oscilloscope offers storage and variable persistence operation with a rugged burn resistant CRT

which makes it ideal for general use.

The low power requirements of Hewlett-Packard portable oscilloscopes has permitted development of the ruggedized 1707B Option 300 which meets environmental requirements described in MIL-O-83225 (USAF), designated AN/USM 338. In fact, a few modifications allowed the oscilloscope to surpass the drip-proof test and operate under water. Meeting these rugged requirements did not reduce the laboratory accuracy of the instruments and it incorporates the same basic proven circuits as the standard 1707B oscilloscope.

15 MHz

In the dc to 15 MHz range there are four models available. 1223A variable persistence/storage, 1220A and 1222A dual channel, and 1221A single channel, that are designed for industrial and educational applications, and production line testing. Logical front panel layout, large 8 x 10 division internal graticule, and automatic triggering reduce familiarization time and assure maximum efficiency in production and student environments.

500 kHz

Low frequency scopes which have about 500 kHz bandwidth are used in educational, medical, system monitors, engineering, production, and in some cases field service. These scopes could be classified as the "workhorses" of the electronics industry since they are most commonly found in system applications. The 1200 series scopes easily fill these requirements with their 100 uV and 5 mV sensitivity, solid-state and lightweight construction, and reliable and stable operation. Also available are storage and variable persistence models which eliminate annoying flicker and retain single-shot traces that are common in bio-medical or electro-mechanical applications.

Oscilloscope basics

Because the oscilloscope can display electrical signals which vary with time, it has become today's most widely used electronic measuring instrument. It produces a visual display of any physical quantity which can be represented as a voltage. This permits precise measurement and analysis of the phenomenon represented by the voltage.



Figure 2. Representative Hewlett-Packard nonplug-in oscilloscopes.

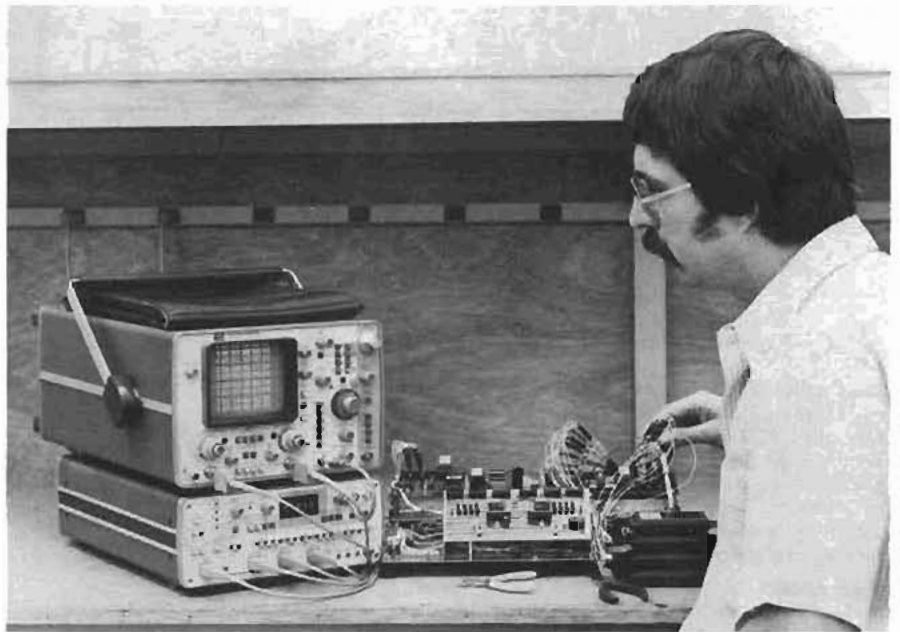

Figure 3. Option 101 to 1740A offers one button switching between Logic State Analysis and volts vs. time measurements.

The cathode-ray tube

A CRT produces an electron beam whose movement is controlled by the vertical and horizontal amplifiers and by the power supplies which form, shape, and accelerate it. This electron beam strikes a phosphor screen and a visible glow results as the beam is moved.

Since the beam deflection can be calibrated against a grid (graticule) on the CRT face, amplitude and time measurements can be made. All Hewlett-Packard graticules are internal and in the same plane as the phosphor, eliminating parallax.

Hewlett-Packard manufactures all its own CRT's—technological leadership has accompanied this.

An expansion mesh, used first by Hewlett-Packard in 1962, with a voltage on it produces an electrostatic field which bends the beam after its initial deflection at the electron gun structure. By controlling mesh radius, Hewlett-Packard CRT designers have produced increasingly larger display areas while simultaneously reducing the overall length of the tube.

Storage scopes are available with rugged variable persistence (the time it takes for the trace to fade to 10% of its original brightness). This is made possible by use of a storage mesh immediately behind the phosphor. Control circuits then determine the rate at which a display fades away after being stored as a charged pattern on the mesh.

Vertical deflection system

Since the CRT is limited as to the range of deflection voltages which can be applied, a

vertical amplifier and attenuator are used. These are accurately calibrated to provide a deflection factor related to the graticule (e.g., 5 mV/division).

Horizontal deflection system

To deflect the electron beam horizontally, an amplifier and sweep generator are used. A sawtooth waveform generator sweeps the beam at a selectable uniform rate. With such a linear rate of sweep, calibration to the graticule is possible (e.g., 1 ms/division).

For meaningful displays, the horizontal deflection system must provide synchronizing circuits to start the sweep at a specific instant with respect to the measured waveform. Automatic triggering on Hewlett-Packard scopes makes starting of the sweep a quick, easy step.

Power supplies

Scopes contain low and high voltage power supplies and determine, with the CRT, the maximum capability of a scope, especially of a mainframe.

Low voltage power supplies give operating power to scope circuits such as the vertical and horizontal amplifiers. The high voltage power supply forms and controls the CRT electron beam.

Hewlett-Packard has made contributions in power supplies, too, and two examples will show their significance:

1. The 1703A and 1707B portable scopes have an advanced design LVPS. It is highly efficient and has a newly designed dc-to-dc converter. The result is a scope which consumes approximately 25 watts and operates from ac line, dc line, or optional battery.



Figure 4. Power supply module can be operated outside the mainframe to facilitate maintenance.

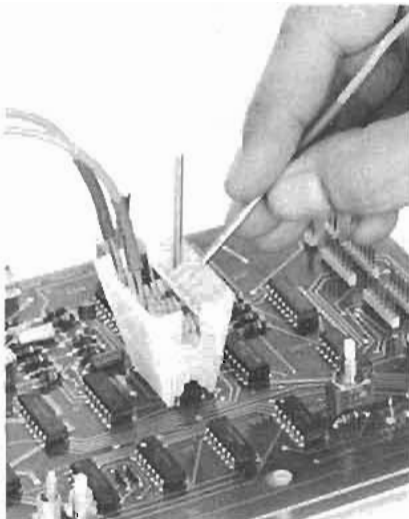

Figure 5. New HP miniature probes and IC Test Clip permit easy probing of dual-in-line packages with minimum probe loading.

The effects of resistive loading have been recognized for some time. High input impedances have been used to reduce the voltage division between circuit and measuring device. This technique will cause minimal error if measurements are at low frequencies and the circuit test point has a low impedance.

When these probing requirements are not met, inaccuracies result for one big reason: CAPACITANCE. And the effects of capacitance in the probe or scope input change drastically because of frequency.

Hewlett-Packard has pioneered in helping solve the capacitance problem in high frequency measurements by providing selectable input impedance — 50 ohms or a high Z with low capacitance. This measurement convenience is available because of Hewlett-Packard's innovative design, illustrated in figure 5, that uses thick-film attenuators.

Sampling oscilloscopes

Sampling oscilloscopes use a technique which is similar in principle to use of a stroboscope for study of periodic or varying motion.

Samples are taken on successive recurrences of a waveform. As each amplitude sample is taken later in time on the waveform, the CRT beam is deflected to the corresponding point where a visible dot is then displayed. The rate at which sampling occurs is very fast; thus the dots are displayed as a coherent-appearing waveform on the CRT.

Samples are obtained when a pulse "turns on" the sampling circuit for an extremely short time. During this interval the input waveform amplitude is measured, the samples are then effectively "stretched" in time, and amplified at relatively low bandwidths.

Thanks to fast-switching diodes developed by Hewlett-Packard—some even for use in other types of instrumentation—sampling scope bandwidths have progressed to the 18 GHz point.

Oscilloscope selection

1700 Series Oscilloscopes

Dual channel with selection of 275 MHz, 200 MHz, 100 MHz, 75 MHz or 35 MHz. 275 MHz or 200 MHz dual-delayed sweep for laboratory, production and field use in digital and high frequency rf applications. 100 MHz storage/variable persistence or non-storage with 3rd channel trigger view; and 35 MHz storage with variable persistence. See page 116.

180 System high frequency plug-in scope

The one plug-in instrument to solve nearly any general-purpose laboratory or production line measurement problem. Bandwidths of 500 kHz, 35 MHz, 50 MHz, 75 MHz or 100 MHz. Standard, storage/variable persistence, >400 cm/μs storage writing speed or big-screen. Sampling to 18 GHz. TDR, spectrum analysis and swept frequency analysis. See Page 130.

1220 Series 15 MHz bandwidth

Single and dual channel, and dual channel storage/variable persistence oscilloscopes for production line testing, educational, and industrial applications. See Page 150.

1200 Series Low Frequency Scopes

Low frequency, nonplug-in scopes of proven, all-solid-state circuit design. Many operating features normally found only on much wider bandwidth, more expensive scopes. 500 kHz bandwidths in standard or storage/variable persistence. Deflection factors as low as 100 μV/div. See Page 154.

Oscilloscope accessories

Supporting accessories to get the most out of your scope investment. Cameras and adapters, testmodules, active and passive probes, and adapters to meet most any need. See Page 156.

2. Mainframes in the 180 System have a reliable LVPS which, when repair may be required, can be removed from the instrument in a fully operating status; refer to figure 4. Repair or calibration time is greatly reduced.

Input probes

Proper selection of well-designed probes will minimize circuit loading effects and provide the most accurate and useful waveform information. Improper matching of probe to circuit measurement point or of probe to scope will cause rise time errors in pulse measurements and cause both amplitude and phase errors in CW measurements.

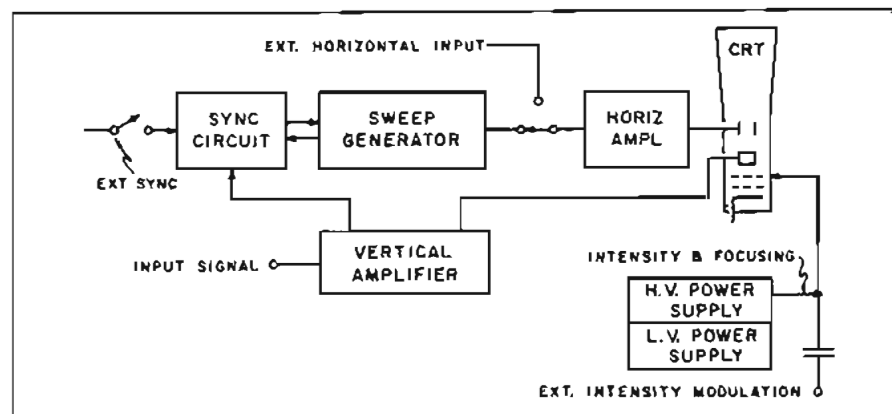

Figure 6. Typical oscilloscope block diagram.

OSCILLOSCOPES

275 MHz, dual-delayed sweep

Models 1720A & 1722A



1722A, 1720A Description

Models 1720A and 1722A are precision, wideband, high performance oscilloscopes in all traditional vertical, horizontal, and triggering operations. Vertical deflection factors of 10 mV/div to 5 V/div with 2% attenuator accuracy cover most oscilloscope measurement requirements. The full bandwidth of 275 MHz is maintained in all calibrated and uncalibrated modes as well as over the full 0°C to +55°C temperature range. Rise time measurement accuracy is maintained over the entire 6 cm display.

For maximum measurement flexibility, there are switch-selectable 50 Ω or 1 M Ω inputs with the full bandwidth available in either mode. The HP 10017A miniature probe with an input of 1 M Ω shunted by less than 8 pF is ideal for use with the 1 M Ω /11 pF inputs of these oscilloscopes. The small size of the 10017A allows probing in compact circuits where conventional probes are difficult or impossible to use. For convenient probing of dual-in-line packages, the 10017A may be inserted into a 10024A IC test clip which eliminates the problem of holding the probe tip on an IC pin or possible shorting between pins. The IC test clip also provides built-in probe grounding which eliminates the problems associated with separate probe ground leads, and reduces capacitive loading.

A crisp, bright trace over the full 6 \times 10 cm display area offers easier, more accurate measurements. Beam intensity is automatically regulated for convenient viewing and increased CRT life. However, maximum intensity is maintained when viewing low rep rate, fast transition pulses. An automatic focus circuit reduces the need for focus re-adjustment with intensity level changes normally encountered in probing applications while retaining a front panel control for fine adjustments when desired.

Internal triggering is stable in excess of 275 MHz and requires only 1 cm of vertical deflection (0.5 cm to 50 MHz). The internal trigger sync takeoff is immediately after the attenuator for a stable display regardless of changes in position, vernier, or polarity controls. For external triggering applications, you only need 100 nV p-p to trigger in excess of 275 MHz and only 50 mV p-p to 100 MHz.

Improved accuracy and convenience of the 1722A

Time Interval measurements

The Hewlett-Packard developed dual-delayed sweep, coupled with microprocessor calculated results, LED readout, and exceptional time base accuracy makes measurements of very short time intervals accurate and convenient. Measurements such as rise time, pulse width, period, and propagation delay can be made between two events on channel A, two events on channel B, or between an event beginning on channel A and ending on channel B. Time interval is measured by using the Hewlett-Packard developed Dual-Delayed Sweep technique to display the start and stop points of the time interval as intensified markers. Measurements are made in the Main Intensified mode by first adjusting marker width with the Delay Time/Division control. Then the first marker is set to t_1 with the Delay dial. The second marker is positioned by using the DEC \leftrightarrow INC controls (Coarse, Medium, or Fine) which causes the microprocessor to develop the voltage to position the marker. While developing the voltage ($t_2 - t_1$) to separate the markers, the microprocessor automatically converts the voltage, scaled to the time base setting, and displays the result. The time interval is displayed in units of seconds (exponent-0), milliseconds (exponent-3), microseconds (exponent-6), or nanoseconds (exponent-9).

Once the markers are positioned, increased accuracy can be obtained by switching to the Delayed Sweep mode where the two markers are expanded to full screen and displayed alternately. Maximum accuracy is obtained by overlapping the two delayed sweeps using the DEC \leftrightarrow INC controls.

Frequency measurements (1/Time)

The 1/Time mode eliminates the need for calculations when setting clock frequencies or measuring the frequency or repetition rate of a waveform. The frequency measurement is made in the same manner as the time interval measurement and has the same accuracy capabilities. The microprocessor simply computes the reciprocal of the period and displays the results in units of Hz (exponent 0), kHz (exponent 3), or MHz (exponent 6).



DC voltage measurements

When the Input DC Volts pushbutton is pressed, the digital readout displays the average value of the input to channel A. The 1722A then functions as a 3-1/2-digit voltmeter with full scale ranges from 95 mV to 47 V. When using a 10:1 divider probe, a front panel switch compensates the LED readout for direct readings from 0.95 V to 470 V. Measurements are made by pressing the REF SET button to store a reading as a reference; the LED display then shows the difference between the reference and a new voltage at the channel A input.

Point-to-point voltage measurements

When in the POSN (position) mode, the DVM circuits read the level of the position control voltage which allows measurements of voltage on any part of a waveform through dc substitution. This measurement is made by selecting the desired point on the waveform and positioning it on a convenient graticule line. The REF SET button is pressed to establish the graticule line as the zero level, then the position control is adjusted to bring the point to be measured to the same graticule line. You then have a direct digital readout of the voltage level between the measurement points.

Percent measurement

The percent mode offers fast, convenient, direct reading, amplitude measurements of pulse overshoot, ringing, preshoot, and amplitude modulation on an rf carrier. Percentage measurements are made in the Position mode with the vernier out of CAL position. The vernier is then adjusted to establish a five-division separation between the desired zero and 100% point of the waveform on the CRT graticule. Next, the zero percent level is positioned to a horizontal graticule line, and the REF SET button is pressed. Positioning any other part of the waveform to the reference graticule line gives a direct reading of that waveform level in percent. This measurement technique permits you to show exactly where the 50% level is on a pulse for consistent pulse width measurements, or it can determine the 10% and 90% levels for rise time measurements.

Digital circuit analysis

The HP 1607A Logic State Analyzer and Option 101 on the 1720A and 1722A offer a convenient method of debugging and troubleshooting digital circuits. State Display Option 101 adds rear-panel inputs and internal switching circuits for switching between logic state display and analog display (voltage vs time). The ability to quickly switch between state and analog displays is very useful when word-flow errors require analysis of electrical parameters to determine corrective measures.

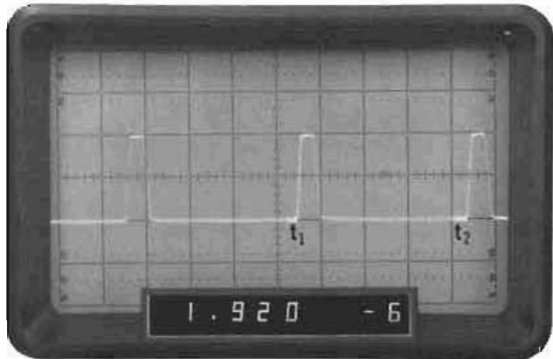

Two intensified markers are positioned to cover the start and stop points of the desired interval. The LED readout automatically and continuously displays the time between the two markers (1.92 μ s).

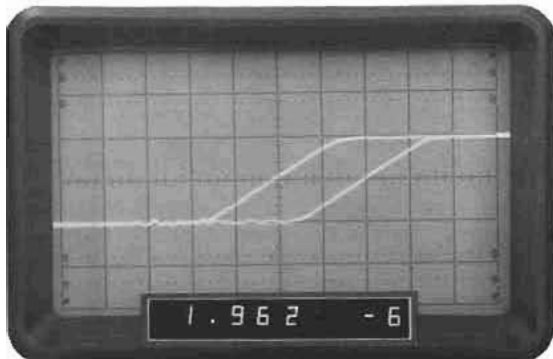

For increased accuracy, the scope is placed in the Delayed Sweep mode to display the two intensified traces alternately. When the two traces are made to coincide using the DEC—INC controls, maximum accuracy is achieved (1.962 μ s, $\pm 0.63\%$).

Models 1720A & 1722A (cont.)

1720A and 1722A Specifications

Vertical display modes

Channel A; channel B; channels A and B displayed alternately on successive sweeps (ALT); channels A and B displayed by switching between channels at approx. 1 MHz rate with blanking during switching (CHOP); channel A plus channel B (algebraic addition); X-Y (channel A vs. channel B).

Vertical amplifiers (2)

Bandwidth: (≤ 3 dB down from a 6 div reference signal.)

DC-coupled: dc to 275 MHz in both 50 ohm and high impedance input modes.

AC-coupled: approx. 10 Hz to 275 MHz.

Bandwidth limit: limits upper bandwidth to approx. 20 MHz.

Rise time: ≤ 1.3 ns (measured from 10% to 90% points of a 6 div input step).

Deflection factor

Ranges: 10 mV/div to 5 V/div (9 calibrated positions) in 1, 2, 5 sequence. $\pm 2\%$ attenuator accuracy.

Vernier: continuously variable between all ranges; extends maximum deflection factor to at least 12.5 V/div. Front panel light indicates when vernier is not in CAL position.

Polarity: channel B may be inverted, front panel pushbutton.

Signal delay: input signals are delayed sufficiently to view leading edge of input pulse without external trigger.

Input coupling: selectable, AC or DC, 50 ohm (dc), or ground. Ground position disconnects input connector and grounds amplifier input.

Input RC (selectable)

AC and DC: 1 megohm $\pm 2\%$ shunted by approx. 11 pF.

50 ohm: 50 ohms $\pm 2\%$; SWR, ≤ 1.3 on 10, 20, and 50 mV ranges and ≤ 1.15 on all other ranges.

Maximum input

AC and DC: ± 250 V (dc + peak ac) at 1 kHz or less.

50 ohm: 5 V rms or ± 250 V peak whichever is less.

A + B operation

Amplifier: bandwidth and deflection factors are unchanged; channel B may be inverted for A - B operation.

Differential (A - B) common mode: CMRR is at least 40 dB from dc to 5 MHz decreasing to 26 dB at 50 MHz. Common mode signal amplitude equivalent to 12 cm with one vernier adjusted for optimum rejection.

Trigger source

Selectable from channel A, channel B, or composite.

Channel A: all display modes triggered by channel A signal.

Channel B: all display modes triggered by channel B signal.

Composite: all display modes triggered by displayed signal.

Channel A Input - dc volts (1722A)

Display: light emitting diodes (LED).

Number of digits: 3 $\frac{1}{2}$.

Display units: 0 exponent indicates volts; -3 exponent indicates millivolts.

X1 range: 95 mV to 47 V full scale vertical deflection (10 mV/div to 5 V/div).

X10 range: 0.95 V to 470 V full scale vertical deflection (100 mV/div to 50 V/div with X10 probe).

Accuracy: $\pm 0.5\%$ reading $\pm 0.5\%$ full scale (full scale = 10 cm), $+20^\circ\text{C}$ to $+30^\circ\text{C}$.

Stability: temperature coefficient, $< \pm 0.02\%/^\circ\text{C}$.

Input impedance: X1 range, 1 megohm shunted by approx. 11 pF; X10 range (with X10 probe) 10 megohms shunted by approx. 10 pF.

Sample rate: approx. 2/s.

Response time: ≤ 1 s.

Reference set: meter may be zeroed permitting dc voltage measurements with respect to any voltage within selected range. Drift may be eliminated by the REF SET control.

Overrange: flashing display indicates overrange condition.

Channel A position - volts (channel A vernier in CAL detent) (1722A)

With the following exceptions, specifications are the same as Channel A Input - DC volts.

Measurement: dc substitution method using channel A position control to determine voltage of any point on displayed waveform using any graticule line as reference.

Bandwidth: dc to 275 MHz (≤ 3 dB down from a 6 div reference signal).

Dynamic range: ± 6 cm from ground referenced to center screen.

Reference set: meter may be zeroed, permits instantaneous voltage measurements with respect to any voltage within selected range.

Accuracy: $\pm 1\%$ reading $\pm 0.5\%$ of full scale (10X the volts/div range) measured at dc.

Channel A position - % (channel A vernier out of CAL detent) (1722A)

Measurement: dc substitution method using channel A position control to determine percent of any waveform point with respect to user defined 0 and 100% points.

Range: 0 to $\pm 140\%$ (calibrated with vernier so that 100% equals 5 div).

Accuracy: $\pm 1\%$.

Zero reference: meter may be zeroed to permit percent measurements with respect to any waveform point.

Vertical output

Amplitude: one division of vertical deflection produces approx. 100 mV output (dc to 50 MHz).

Cascaded deflection factor: 1 mV/div with both vertical channels set to 10 mV/div.

Cascaded bandwidth: dc to 5 MHz with bandwidth limit engaged.

Source reactance: approx. 100 ohms.

Source selection: trigger source set to channel A selects channel A output; trigger source set to channel B selects channel B output.

Horizontal display modes

Main, main intensified, mixed, delayed, mag X10, and X-Y.

Main time base

Sweep:

Ranges: 10 ns/div to 0.5 s/div (24 ranges) 1, 2, 5 sequence.

Accuracy

Main sweep time/div	Accuracy (0°C to $+55^\circ\text{C}$)	
	X1	X10
10 ns to 50 ns	$\pm 3\%$	$\pm 5\%$
100 ns to 20 ms	$\pm 2\%$	$\pm 3\%$
50 ms to 0.5 s	$\pm 3\%$	$\pm 3\%$

Vernier: continuously variable between all ranges; extends slowest sweep speed to at least 1.25 s/div. Vernier uncalibrated light indicates when vernier is not in CAL position.

Magnifier: expands all sweeps by a factor of 10; extends fastest sweep to 1 ns/div.

Sweep mode

Normal: sweep is triggered by internal or external signal.

Automatic: bright baseline displayed in absence of input signal from 10 ns/div to 20 ms/div. Triggering is same as normal above 40 Hz. Normal triggering is generally required for sweep speeds from 50 ms/div to 0.5 s/div.

Single: in Normal mode, sweep occurs once with same triggering as normal, reset pushbutton arms sweep and lights indicator; in Auto mode, sweep occurs once each time Reset pushbutton is pressed.

Triggering

Internal: dc to 50 MHz on signals causing 0.5 division or more vertical deflection, increasing to 1 division of vertical deflection at 300 MHz in all display modes. Triggering on line frequency is also selectable.

External: dc to 100 MHz on signals of 50 mV p-p or more increasing to 100 mV p-p at 300 MHz.

External input RC: approx. 1 megohm shunted by approx. 15 pF.

Maximum external input: ± 250 V (dc + peak ac) at 1 kHz or less.

Trigger level and slope

Internal: at any point on the vertical waveform displayed.
External: continuously variable from +1.0 V to -1.0 V on either slope of the trigger signal; +10 V to -10 V in divide by 10 mode ($\div 10$).

Coupling: AC, DC, LF REJ, or HF REJ.

AC: attenuates signals below approx. 10 Hz.
LF REJ: attenuates signals below approx. 7 kHz.
HF REJ: attenuates signals above approx. 7 kHz.

Trigger holdoff: time between sweeps continuously variable exceeding one full sweep from 10 ns/div to 50 ms/div.

Main intensified

Intensifies that part of main time base to be expanded to full screen in delayed time base mode. Delay control (1720A) and time interval controls (1722A) adjust position of intensified portion of sweep. Rear panel intensity ratio control sets relative intensity of brightened segment.

Delayed time base

Sweep

Ranges: 10 ns/div to 20 ms/div (20 ranges) in 1, 2, 5 sequence.
Accuracy (0 to +55°C): same as main time base.
Magnifier (0 to +55°C): same as main time base.

Triggering

Internal: same as main time base except there is no Line Frequency triggering.
Starts after delay: delayed sweep automatically starts at end of delay period.
Trigger: with delayed trigger level control out of detent (starts after delay) delayed sweep is triggerable at end of delay period.
External: dc to 100 MHz on signals of 50 mV p-p or more, increasing to 100 mV p-p at 300 MHz.
External input RC: approx. 1 megohm shunted by approx. 15 pF.
Maximum external input: ± 250 V (dc + peak ac) at 1 kHz or less.

Trigger level and slope: same as main time base.

Coupling: same as main time base.

Delay time range: 0.5 to 10X Main Time/Div settings of 20 ns to 0.5 s (minimum delay, 50 ns).

Differential time measurement accuracy (1720A)

Main time base setting	Accuracy (+15°C to +35°C)
50 ns/div to 20 ms/div	$\pm(0.5\% + 0.1\%$ of full scale)
20 ns/div	$\pm(1\% + 0.2\%$ of full scale)
50 ms/div to 0.5 s/div	$\pm 3\%$

Delay jitter (1720A): $< 0.005\%$ (1 part in 20 000) of max delay in each step.

Time Interval (1722A)

Delay time: continuously variable from 10 ns to 5 s.
Delay jitter: refer to Time Interval Measurements, Stability.

Time Interval measurements, 1722A (time)

Function: measures time interval between two events on channel A (channel A display); between two events on channel B (channel B display); or between two events starting from an event on channel A and ending with an event on channel B (Alternate display).
Display units: 0 (s); -3 (ms); -6 (μ s); or -9 (ns).

Accuracy

Main time base setting	Accuracy (+20°C to +30°C)
100 ns/div to 20 ms/div	$\pm 0.5\%$ of measurement $\pm 0.02\%$ of full scale (for measurements < 1 cm). For measurements > 1 cm, $\pm 0.5\%$ of measurement $\pm 0.05\%$ of full scale.
50 ns/div*	$\pm 0.5\%$ of measurement $\pm 0.06\%$ of full scale.
20 ns/div*	$\pm 0.5\%$ of measurement $\pm 1.2\%$ of full scale.
50 ms/div to 0.5 s/div.	$\pm 3\%$

*Starting after 60 ns of sweep.

Resolution: intervals < 1 cm, $> 0.01\%$ of full scale; intervals > 1 cm, $> 0.1\%$ of full scale; maximum display resolution, 20 ps.

Stability (0 to +55°C): short term, $< 0.01\%$. Temperature, $\pm 0.03\%/^{\circ}\text{C}$ deviation from calibration temperature range.

Reciprocal of time Interval measurements, 1722A (1/time)

Function: calculates and displays the reciprocal of the measured time interval.

Display units: 0 (Hz); 3 (kHz); 6 (MHz).

Accuracy: same as Time Interval Measurements.

Resolution: same as Time Interval Measurements.

Stability: same as Time Interval Measurements.

Mixed time base

Dual time base in which the main time base drives the first portion of sweep and the delayed time base completes the sweep at the faster delayed sweep. Also operates in single sweep mode.

X-Y operation

Bandwidth

Y-axis (channel A): same as channel A.

X-axis (channel B): dc to > 3 MHz.

Deflection factor: 10 mV/div to 5 V/div (9 calibrated positions) in 1, 2, 5 sequence.

Phase difference between channels: $< 3^{\circ}$, dc to 3 MHz.

Cathode-ray tube and controls

Type: post accelerator, approx. 20.5 kV accelerating potential, aluminum P31 phosphor.

Graticule: 6×10 div internal graticule, 0.2 subdivision markings on major axes. 1 div = 1 cm. Rear panel adjustment aligns trace with graticule. Internal flood gun graticule illumination.

Beam finder: returns trace to CRT screen regardless of setting of horizontal, vertical, or intensity controls.

Intensity modulation: +8 V, ≥ 50 ns width pulse blanks trace of any intensity, useable to 20 MHz for normal intensities. Input R, 1 k Ω $\pm 10\%$. Maximum input, +10 V (dc + peak ac).

Auto-focus: automatically maintains beam focus with variations of intensity.

Intensity limit: automatically limits CRT beam current to decrease possible CRT damage. Circuit response time ensures full writing speed for viewing low duty cycle, fast rise time pulses.

Rear panel controls: astigmatism, pattern, main/delayed intensity ratio, and trace align.

General

Rear panel outputs: main and delayed gates, -0.7 V to +1.3 V capable of supplying approx. 3 mA.

Calibrator: 1 kHz $\pm 10\%$ square wave; 3 V p-p $\pm 1\%$; < 0.1 μ s rise time.

Power: 100, 120, 220, 240 V, -10%, +5%; 48 to 440 Hz; 110 VA max.

Weight: (1722A) net, 13.6 kg (30 lb). Shipping, 19.5 kg (43 lb). (1720A) net, 13.2 kg (29 lb). Shipping, 18.1 kg (40 lb).

Operating environment: temperature, 0 to +55°C (+32°F to +130°F); humidity, to 95% relative humidity at +40°C (+104°F); altitude, to 4600 m (15 000 ft); vibration, vibrated in three planes for 15 min. each with 0.254 mm (0.010 in.) excursion, 10 to 55 Hz.

Dimensions: 335 mm wide (13 $\frac{1}{16}$ in.); 197 mm high (7 $\frac{7}{8}$ in.); 570 mm length with handle (22 $\frac{1}{16}$ in.), 518 mm length without handle (20 $\frac{3}{8}$ in.).

Accessories furnished: one Model 101 15A blue light filter; one front panel cover; one vinyl storage pouch; one 2.3 m (7.5 ft) power cord; two 10017A 10:1 divider probes; one Operating and Service Manual.

Recommended probes

Divider probes for 1 megohm inputs: models 10014A and 10016B, 10017A.

Divider probe for 50 ohm inputs: model 10020A, resistive divider.

Active probes for 50 ohm inputs: models 1120A, and 1125A.

Options

001: U.S. fixed line cord

Price
add \$15

003: probe power supply with two rear panel jacks for use with HP active probes. Provides power to operate two 1120A, 1124A, or 1125A active probes

add \$50

101: logic state display interface for operation with Model 1607A Logic State Analyzer

add \$150

Model number and name

1720A 275 MHz Oscilloscope

\$3750

1722A 275 MHz Oscilloscope with Microprocessor

\$4900

OSCILLOSCOPES

200 MHz dual-delayed sweep

Models 1710B & 1712A

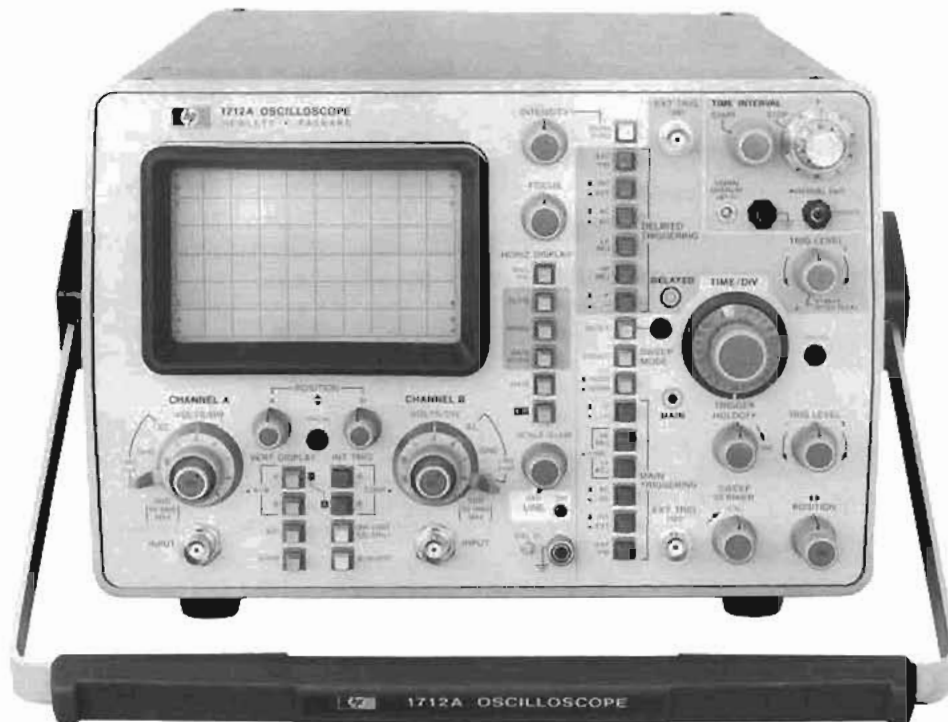

1710B, 1712A Specifications

Vertical display modes

Channel A; channel B; channels A and B displayed alternately on successive sweeps (ALT); channels A and B displayed by switching between channels at approx. 1 MHz rate with blanking during switching (CHOP); channel A plus channel B (algebraic addition); X-Y (channel A vs. channel B).

Vertical amplifiers (2)

Bandwidth: (3 dB down from a 6 div reference signal.)

DC-coupled: dc to 200 MHz in both 50 ohm and high impedance input modes 10 mV/div to 5 V/div, to 150 MHz at 5 mV/div.

AC-coupled: lower limit is approx. 10 Hz.

Bandwidth limit: limits upper bandwidth to approx. 20 MHz.

Rise time: <1.75 ns 10 mV/div to 5 V/div, <2.3 ns at 5 mV/div (measured from 10% to 90% points of 6 div input step).

Deflection factor

Ranges: 5 mV/div to 5 V/div (10 calibrated positions) in 1, 2, 5 sequence, $\pm 2\%$ attenuator accuracy.

Vernier: continuously variable between all ranges; extends maximum deflection factor to at least 12.5 V/div. Front panel light indicates when vernier is not in CAL position.

Polarity: channel B may be inverted. front panel pushbutton.

Signal delay: input signals are delayed sufficiently to view leading edge of input pulse without advanced trigger

Input coupling: selectable, AC or DC, 50 ohms (dc) or ground. Ground position disconnects input connector and grounds amplifier input.

Input RC (selectable)

AC and DC: 1 megohm $\pm 2\%$ shunted by approx. 11 pF.

50 ohm: 50 ohms $\pm 2\%$; SWR <1.3 on 5, 10, 20, and 50 mV ranges and <1.15 on all other ranges.

Maximum input

AC and DC: ± 250 V (dc + peak ac) at 1 kHz or less

50 ohm: 5 V rms or ± 250 V peak, whichever is less.

A + B operation

Amplifier: bandwidth and deflection factors are unchanged; channel B may be inverted for A-B operation.

Differential (A - B) common mode: CMRR is at least 40 dB from dc to 5 MHz decreasing to 26 dB at 50 MHz. Common mode signal amplitude equivalent to 12 cm with one vernier adjusted for optimum rejection.

Trigger source

Selectable from channel A, channel B, or Composite.

Channel A: all display modes triggered by channel A signal.

Channel B: all display modes triggered by channel B signal.

Composite: all display modes triggered by displayed signal.

Vertical output

Amplitude: one division of vertical deflection produces approx 100 mV output (dc to 25 MHz).

Cascaded deflection factor: 1 mV/div with both vertical channels set to 10 mV/div.

Cascaded bandwidth: dc to 5 MHz with bandwidth limit engaged.

Source resistance: approx. 100 ohms.

Source selection: trigger source set to channel A selects channel A output, to channel B selects channel B output.

Horizontal display modes

Main, main intensified, delayed, mixed, mag. X10, X-Y.

Main time base

Sweep

Ranges: 10 ns/div to 0.5 s/div (24 ranges) 1, 2, 5 sequence.

Accuracy

Main Sweep Time/Div	Accuracy (0°C to +55°C)	
	X1	X10
10 ns to 50 ns	$\pm 3\%$	$\pm 5\%$
100 ns to 20 ms	$\pm 2\%$	$\pm 3\%$
50 ms to 0.5 s	$\pm 3\%$	$\pm 3\%$

Vernier: continuously variable between all ranges; extends slowest sweep to at least 1.25 s/div. Vernier uncalibrated light indicates when vernier is not in CAL position.

Magnifier: expands all sweeps by a factor of 10; extends fastest sweep to 1 ns/div.

Sweep mode

Normal: sweep is triggered by internal or external signal.

Automatic: bright baseline displayed in absence of input signal from 10 ns/div to 20 ms/div. Triggering is same as normal above 40 Hz. Normal triggering is generally required for sweep speeds from 50 ms/div to 0.5 s/div.

Single: in Normal mode, sweep occurs once with same triggering as normal, reset pushbutton arms sweep and lights indicator; in Auto mode, sweep occurs once each time Reset pushbutton is pressed.

Triggering

Internal: dc to 100 MHz on signals causing 0.5 div. or more vertical deflection, increasing to 1 div. of vertical deflection at 200 MHz in all display modes. Triggering on line frequency is also selectable.
External: dc to 100 MHz on signals of 50 mV p-p or more increasing to 100 mV p-p at 200 MHz. Maximum input, ± 250 V (dc + peak ac) at 1 kHz or less.
External input RC: approx. 1 megohm shunted by approx. 15 pF.

Trigger level and slope

Internal: at any point on the vertical waveform displayed.
External: continuously variable from +1.0 V to -1.0 V on either slope of trigger signal, +10 V to -10 V in divide by 10 mode ($\div 10$).
Coupling: AC, DC, LF REJ, or HF REJ.
AC: attenuates signals below approx. 10 Hz.
LF REJ: attenuates signals below approx. 7 kHz.
HF REJ: attenuates signals above approx. 7 kHz.

Trigger holdoff: time between sweeps continuously variable, exceeding one full sweep from 10 ns/div to 50 ms/div.

Main intensified (1710B)

Intensifies that part of main time base to be expanded to full screen in delayed time base mode. Delay control adjusts position of intensified portion of sweep. Rear panel intensity ratio control sets relative intensity of brightened segment.

Main intensified (1712A)

Intensifies two parts of main time base to be expanded to full screen in delayed time base mode. "START" control positions the first intensified portion of the sweep; "STOP" control positions the second intensified portion of the sweep. Rear panel intensity control sets relative intensity of brightened segments.

Delayed time base

Sweep

Ranges: 10 ns/div to 20 ms/div (20 ranges) in 1, 2, 5 sequence.
Accuracy (0 to +55°C): same as main time base.
Magnifier (0 to +55°C): same as main time base.

Triggering

Internal: same as main time base except there is no Line Frequency triggering.
Starts after delay: delayed sweep automatically starts at end of delay period.
Trigger: with delayed trigger level control out of detent (starts after delay) delayed sweep is triggerable at end of delay period.
External: dc to 100 MHz on signals of 50 mV p-p or more, increasing to 100 mV p-p at 200 MHz. Maximum input, ± 250 V (dc + peak ac) at 1 kHz or less.
External input RC: approx. 1 megohm shunted by approx. 15 pF.

Trigger level and slope

Internal: at any point on the vertical waveform displayed when in triggered mode.
External: continuously variable from +1.0 V to -1.0 V on either slope of trigger signal, +10 V to -10 V in divide by 10 mode ($\div 10$).
Coupling: AC, DC, LF REJ, or HF REJ.
AC: attenuates signals below approx. 10 Hz.
LF REJ: attenuates signals below approx. 7 kHz.
HF REJ: attenuates signals above approx. 7 kHz.

Delay time range: 0.5 to 10X Main Time/Div settings of 20 ns to 0.5 s (minimum delay 50 ns).

Differential time measurement accuracy (1710B)

Main time base setting	Accuracy (+15°C to +35°C)
50 ns/div to 20 ms/div	$\pm(0.5\% \pm 0.1\% \text{ of full scale})$
20 ns/div	$\pm(1\% \pm 0.2\% \text{ of full scale})$
50 ms/div to 0.5 s/div	$\pm 3\%$

Delay jitter (1710B): <0.005% (1 part in 20 000) of maximum delay in each step.

Time interval (1712A)

Function: measures time interval between two events on channel A (channel A display); between two events on channel B (channel B display); or between two events starting from an event on channel A and ending with an event on channel B (alternate display).

Accuracy

Main Time Base Setting	Accuracy (+20°C to +30°C)
100 ns/div to 20 ms/div	$\pm 0.5\% \text{ of measurement} \pm 0.05\% \text{ of fs}$
50 ns/div*	$\pm 0.5\% \text{ of measurement} \pm 0.1\% \text{ of fs}$
20 ns/div*	$\pm 0.5\% \text{ of measurement} \pm 0.2\% \text{ of fs}$
50 ms/div to 0.5 s/div	$\pm 3\%$

*Starting after 50 ns of sweep

Measurement accuracy is the Time Interval Accuracy plus the external DVM accuracy.

Stability (0 to +55°C): short-term 0.005%. Temperature, $\pm 0.03\%$ C deviation from calibration temperature range.

Time interval output voltage: varies from 10 V to 20 mV full scale. Full scale output voltage can be determined by multiplying the number on the TIME/DIV dial by 10 V (e.g. 0.05 s, 0.05 ms, or 0.05 μ s per div gives 0.5 V output full-scale).

Mixed time base

Dual time base in which the main time base drives the first portion of sweep and the delayed time base completes the sweep at the faster delayed sweep. Also operates in single sweep mode.

X-Y operation

Bandwidth

Y-axis (channel A): same as channel A.

X-axis (channel B): dc to >1 MHz.

Deflection factor: 5 mV/div to 5 V/div (10 calibrated positions) in 1, 2, 5 sequence.

Phase difference between channels: <3°, dc to 1 MHz.

Cathode-ray tube and controls

Type: post accelerator, approx. 20.5 kV accelerating potential, aluminum P31 phosphor.

Graticule: 6 X 10 div internal graticule, 0.2 subdivision markings on major horizontal and vertical axes. 1 div = 1 cm. Rear panel adjustment aligns trace with graticule. Internal flood gun graticule illumination.

Beam finder: returns trace to CRT screen regardless of setting of horizontal, vertical, or intensity controls.

Intensity modulation (Z-axis): +5 V, ≥ 50 ns width pulse blanks trace of any intensity, useable to 20 MHz for normal intensities. Input R, 1 k Ω $\pm 10\%$. Maximum input, ± 10 V (dc + peak ac).

Auto-focus: automatically maintains beam focus with variations of intensity.

Intensity limit: automatically limits beam current to decrease possible CRT damage. Circuit response time ensures full writing speed for viewing low duty cycle, fast rise time pulses.

Rear panel controls: astigmatism, pattern, main/delayed intensity ratio, and trace align.

General

Rear panel outputs: main and delayed gates, -0.7 V to +1.3 V capable of supplying approx. 3 mA.

Calibrator: type, 1 kHz $\pm 15\%$ square wave: 3 V p-p $\pm 1\%$; <0.1 μ s rise time.

Power: 100, 120, 220, 240, -10%, +5%; 48 to 440 Hz; 110 VA max.

Weight: net, 13.2 kg (29 lb). Shipping, 18.1 kg (40 lb).

Operating environment: temperature, 0 to +55°C (+32°F to +130°F); humidity, to 95% relative humidity at 40°C (104°F); altitude, to 4600 m (15 000 ft); vibration, vibrated in three planes for 15 min, each with 0.254 mm (0.010 in.) excursion, 10 to 55 Hz.

Dimensions: 335 mm wide (13 1/8 in.), 197 mm high (7 7/8 in.), 570 mm length with handle (22 7/8 in.), 518 mm length without handle (20 3/8 in.).

Accessories furnished: one 10115A blue light filter; one front panel cover; two 10014A 10:1 divider probes; one 2.3 m (7.5 ft) power cord; one vinyl storage pouch; one Operating and Service Manual.

Options

001: U.S.A. fixed line power cord Price add \$15

003: probe power supply with two rear panel jacks for use with HP active probes. Provides power to operate two 1120A, 1124A, or 1125A Active Probes add \$50

091: two 10016B 10:1 voltage divider probes substituted for two 10014A probes N/C

101: logic state display interface for operation with Model 1607A Logic State Analyzer \$450

Model number and name

1710B 200 MHz Oscilloscope \$3000

1712A Dual-Delayed Sweep Oscilloscope \$3600

OSCILLOSCOPES

100 MHz, dual channel, variable persistence/storage

Models 1740A & 1741A

- Dual channel, 5 mV/div to 100 MHz
- 3rd Channel trigger view
- Selectable input impedance
- 100 cm/ μ s storage writing speed (1741A)
- Single shot auto-store (1741A)
- Auto-erase (1741A)

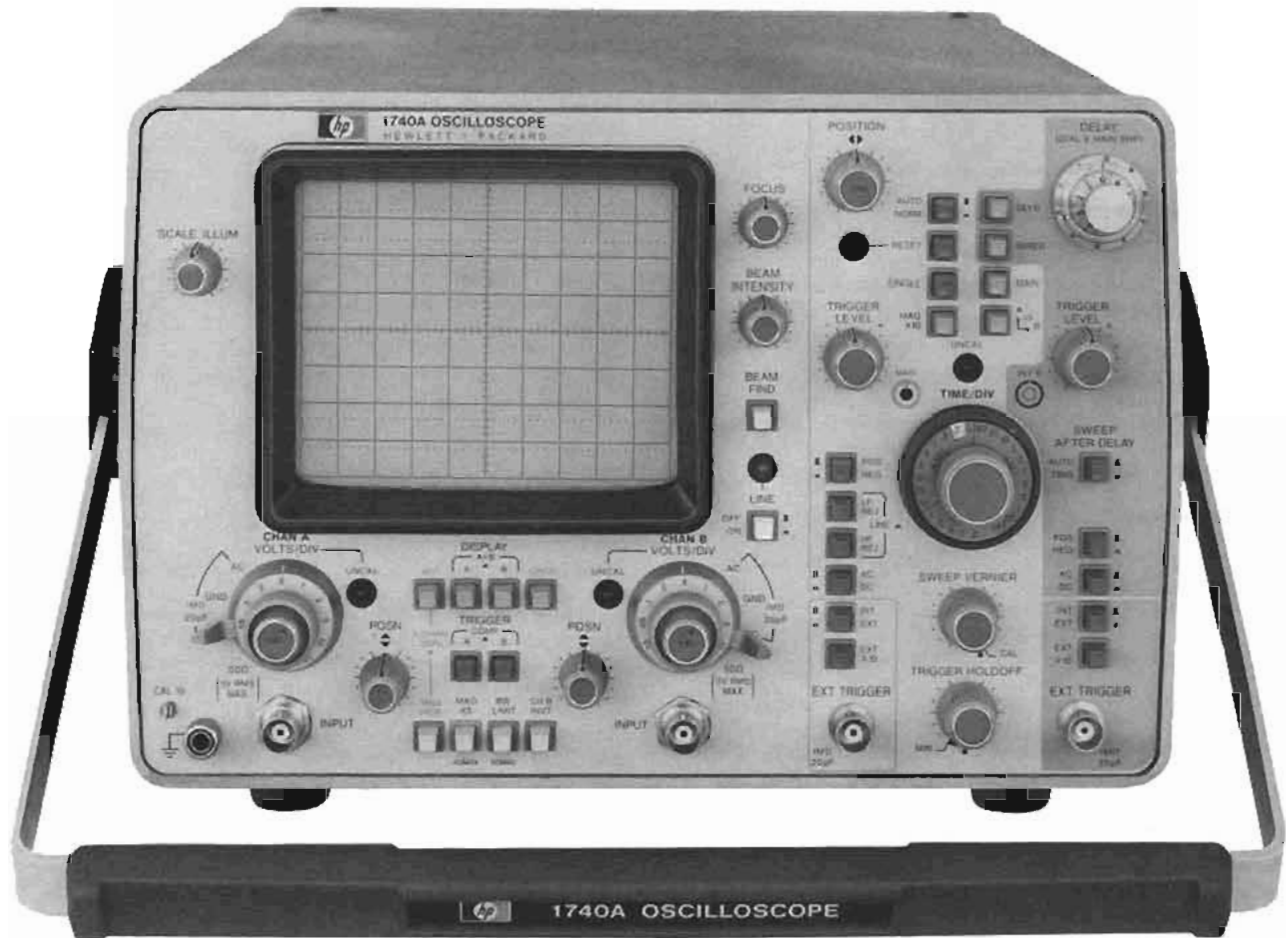

1740A, 1741A (new) Description

Introduction

The Hewlett-Packard Model 1740A and 1741A 100 MHz, 5 mV/div, dual-channel oscilloscopes offer the high performance necessary to meet the demanding requirements of both laboratory and field applications. The 1740A/1741A have the performance and features to make accurate measurements with ease. The carefully designed front panel includes a large, high-resolution CRT with logically arranged controls which reduce operator learning time and make repetitive measurements easier. Several features that make these oscilloscopes more versatile than the average 100 MHz portable oscilloscope include a third channel trigger view for viewing the external trigger signal with both vertical channels; an X5 vertical magnifier for 1 mV/div deflection factors on both channels; selectable input impedance (1 M Ω /50 Ω) for general purpose probing and precise rise time measurement; and in the 1740A a Logic State Display option for convenient switching between logic state and electrical analysis.

1740A 8 x 10 cm CRT

The CRT has a crisp, bright trace over the fully specified 8 x 10 cm display area. An accelerating potential of 15 kV makes the display

compatible with the 5 ns/cm sweep speeds for easier viewing of low rep rate, fast transition time signals. The small spot size of the lab quality CRT along with the no parallax internal graticule makes critical and difficult timing measurements easier to perform. An internal floodgun uniformly illuminates the CRT phosphor for high quality trace photos with a sharp well defined internal graticule.

1741A Storage CRT

The Hewlett-Packard storage and variable persistence CRT offers a well defined trace with a storage writing speed of greater than 100 cm/ μ s and a burn resistant storage surface which is ideal for digital and general purpose applications. Storage operation is extremely easy with indicators that clearly show the mode of operation. A press of the store pushbutton automatically switches the 1741A to a deep store mode, with no screen illumination, for maximum storage time. Another press of the store pushbutton displays the stored trace.

For viewing low rep rate fast rise time signals, the variable persistence mode allows you to adjust the trace for an optimum display. By adjusting the persistence to match the rep rate you can integrate a trace to provide a sharp, clear display for accurate measurements of low duty-cycle pulse trains such as those from disc, tape, or drum peripheral units.

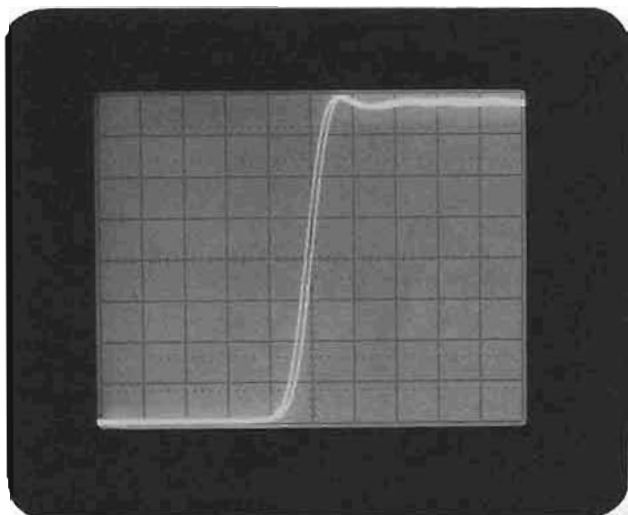

Exceptionally fine trace in the variable persistence mode permits high resolution timing measurements as shown with this dual trace, alternate sweep display at a sweep speed of 5 ns/div.

For maximum convenience in single-shot applications, an auto-store mode which operates in the single-shot mode, makes it easy to capture random events. To prevent the possibility of recording the wrong event, the 1741A automatically switches to the Normal triggering mode when single-shot mode of operation is selected. When your event occurs, the 1741A triggers and automatically switches from the Write mode to the Store mode which is shown by the indicators. To view the signal, a press of the Store/Display pushbutton displays your trace. For convenience, a push of the Erase pushbutton erases the CRT and resets the time base.

An auto-erase mode allows the 1741A to operate as if it is in a repetitive, single-shot mode even when a continuous signal is available. When in the auto-erase mode, the 1741A automatically switches to maximum persistence which provides maximum trace retention between erasures. This mode is convenient for setup of single-shot events by making it easier to obtain the optimum focus and intensity for a particular signal. Additionally, if you are displaying more than one trace, such as two or three channels, the 1741A will wait for the required number of sweeps to be displayed before automatically erasing the display.

3rd channel trigger view

In many applications, especially in digital circuits, it is necessary to use external trigger sources to maintain proper timing relationships and to know the time relationship of the trigger signal to the displayed events. By pressing the Trigger View pushbutton while in al-

Model 1740A (cont.)

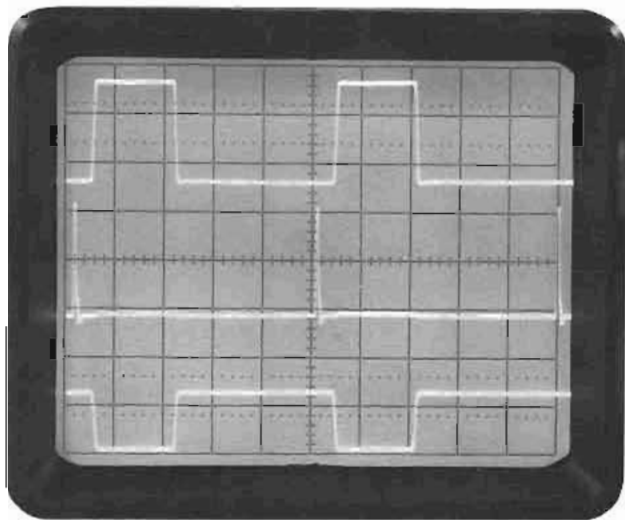

Third channel trigger view of the external trigger signal offers measurement convenience with the center screen threshold. The 2.5 ns fixed delay between the external trigger input and the displayed signal permits easier timing measurements.

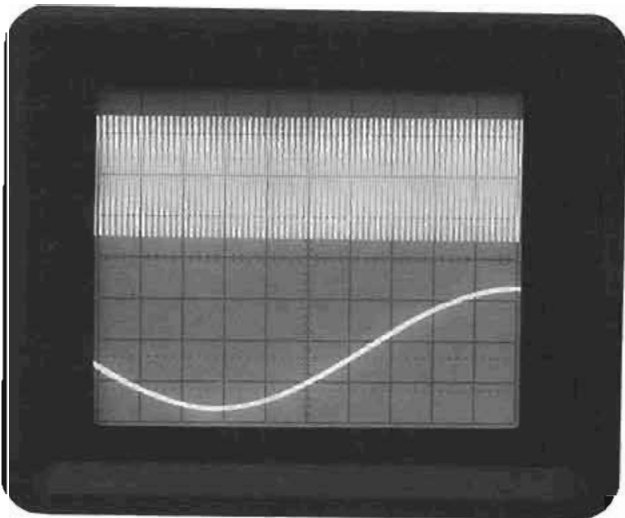

Triggering ability on two signals widely separated in frequency is clearly shown with these signals which have a ratio of 1000 to 1 while triggering in the composite mode.

In chop mode, the external trigger signal is displayed as a third channel with the trigger threshold at center screen. By adjusting the trigger level control, you can see which portion of the trigger signal is initiating the sweep. With the External Trigger input in the L1 mode, the deflection factor is 100 mV/div which is compatible with ECL levels and in the $\div 10$ mode is 1 V/div which is compatible with TTL levels.

Stable flexible triggering

Stable internal triggering to greater than 100 MHz requires only 1 div of vertical deflection. To prevent annoying trace shift, the internal trigger sync take-off is immediately after the attenuator which maintains a stable display regardless of changes in position, vernier, or polarity controls. A full complement of easy-to-use pushbutton trigger controls assures you of the desired trigger signal conditioning for your measurement. In the external mode, triggering to 100 MHz only requires 100 mV and 50 mV to 50 MHz.

Selectable Input Impedance

For maximum measurement flexibility, these scopes have switch-selectable 1 megohm or 50 ohm inputs. This permits a high input impedance for general purpose probing with 10:1 divider probes for minimum circuit loading. The 50 ohm input with internal compensation and low reflections provides faithful pulse reproduction for accurate transition time measurements in circuits where low capacitive loading is required.

Vertical amplifiers

Vertical deflection factors are 5 mV/div to 20 V/div over the full 100 MHz bandwidth, full temperature range, and 8×10 div display area with 3% attenuator accuracy. For two channel low level measurements requiring 1 mV/div and 2 mV/div deflection factors to 30 MHz (40 MHz in the 1740A), a X5 magnifier is included which eliminates the need for cascading. This low level capability permits measurements on tape and disc heads or power supply ripple with a convenient front panel pushbutton. The 20 V/div setting allows you to make convenient measurements of power line signals while using standard 10:1 divider probes.

Serviceability

Access to the uncluttered interior for calibration and servicing is fast with the easy to remove covers. Innovations in circuit design along with custom integrated hybrid circuits reduce calibration time because of a minimum of adjustments. Wire harnesses and interconnection cables between boards are reduced with an interface board which connects the main boards together. This interface board helps to reduce service time and reassembly errors normally encountered with instruments containing many cables. The 1740A and 1741A do not require a fan or ventilating holes for convection cooling which reduces the amount of dust and dirt that can accumulate inside the scope.

Digital circuit analysis

1740A/1607A

With the increasing use and complexity of digital circuits in new products, the debugging and troubleshooting of a digital system can be very difficult. The Hewlett-Packard 1740S, consisting of a 1740A Option 101 and a 1607A Logic State Analyzer, offers a solution to digital troubleshooting with the combination of logic state and electrical analysis. The 1740A Logic State Display option adds rear-panel inputs with internal switching circuits for single pushbutton switching between the standard front panel inputs and the rear panel state display inputs without changing cables. This single pushbutton switch-

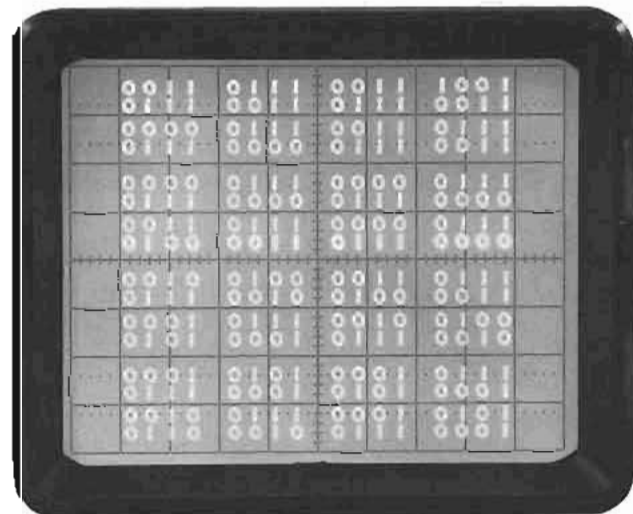

Word triggering with the Analyzer's digital memory and digital delay permits viewing events leading up to and following the trigger word for faster troubleshooting.

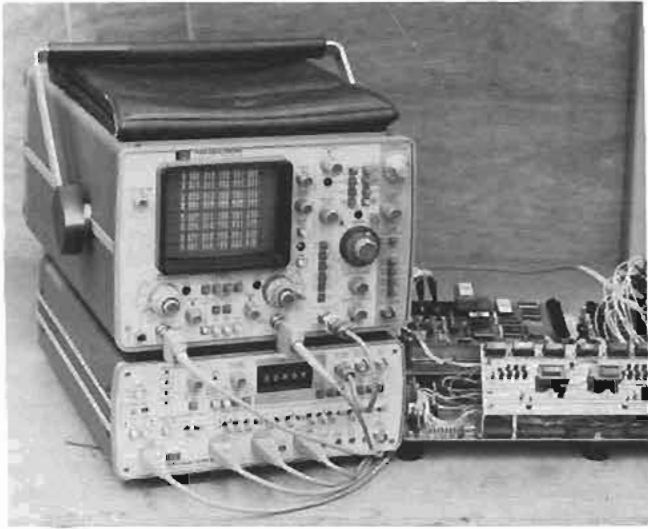

Model 1740A Option 101 offers convenient one button switching between logic state and electrical analysis without changing probe or cable connections.

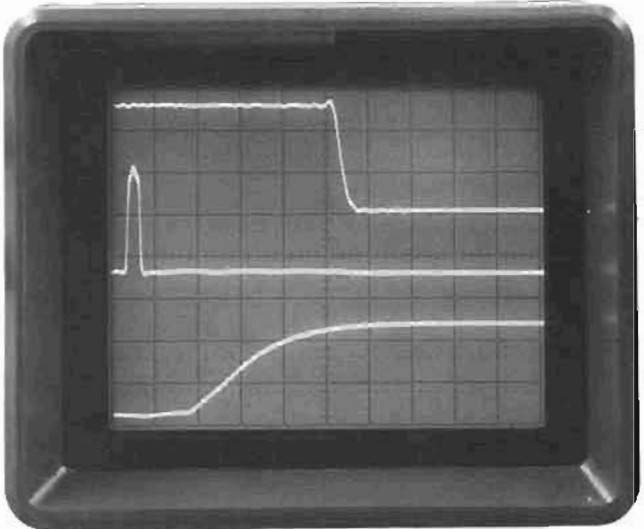

Time relationship of two very low rap rate signals is clearly shown with the variable persistence capability of the 1741A. The stable triggers required for this alternate sweep display to maintain time relationship were generated by the 1600A Logic State Analyzer.

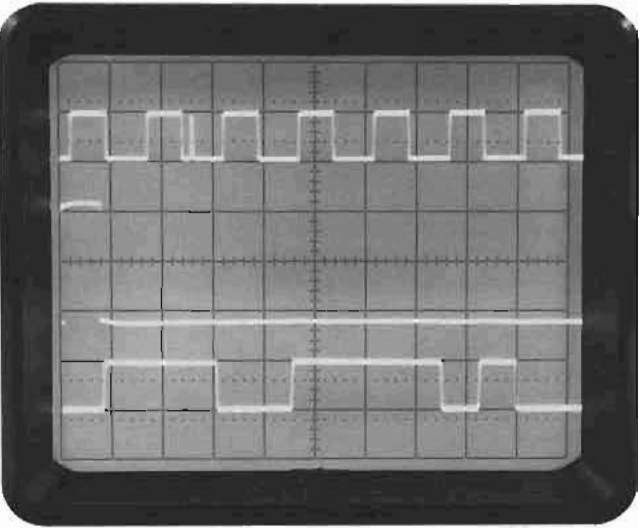

Analog display of digital data shows race condition pulse (top trace) which is defined in time by the 3rd channel trigger view. With the trigger signal defined by a 16-bit word you know when the problem occurs to reduce troubleshooting time.

ing capability is very useful when digital word-flow errors require analysis of electrical parameters to determine corrective measures.

The 1607A's digital Delay mode makes it possible to position the 16 word oscilloscope display window a desired number of clock pulses from the trigger word. The Delay mode coupled with the End Display mode allows you to monitor the events that lead up to and follow a fault. By comparing the algorithm with the data display, erroneous operation is quickly identified.

Switching to the electrical analysis mode permits probing of the cir-

cuit nodes to determine if an electrical problem exists that could be causing the machine to improperly execute an instruction. This internal switching between state and electrical analysis requires no resetting of controls or changing of cables.

1741A/1600A

Combining the variable persistence and storage capabilities of the 1741A with the 1600A Logic State Analyzer's real time analysis of data flow provides the ideal instruments for both design and troubleshooting applications in digital environments. A pattern trigger and/or digital delay output from the 1600A allows synchronization of the word-format display with the 1741A's display of the digital signal's electrical characteristics. In addition, the 1600A offers a map mode of operation that provides an overall view of machine operation and aids in locating lost programs.

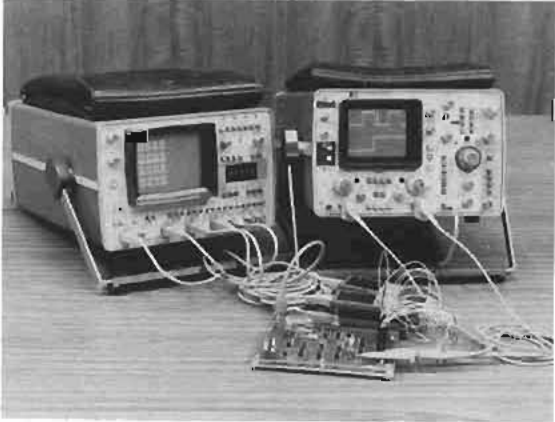

Using the 1600A Logic State Analyzer in conjunction with the 1741A permits simultaneous monitoring of digital data flow and electrical analysis to determine improper circuit operation.

1740A and 1741A Specifications

Vertical display modes

Channel A; channel B; channels A and B displayed alternately on successive sweeps (ALT); channels A and B displayed by switching between channels at an approximate 250 kHz rate with blanking during switching (CHOP); channel A plus channel B (algebraic addition); and trigger view.

Vertical amplifiers (2)

Bandwidth and Rise Time at all deflection factors from 0°C to +55°C.

Bandwidth: (1740A) 3 dB down from 8 div reference signal; (1741A) 3 dB down from 6 div reference signal.

DC-coupled: dc to 100 MHz in both 50Ω and 1 MΩ input modes.

AC-coupled: approx. 10 Hz to 100 MHz, 1 Hz with 10:1 divider probes.

Bandwidth limit: limits upper bandwidth to approx. 20 MHz.

Rise Time: ≤3.5 ns measured from 10% to 90% points of a 6 div input step.

Deflection factor

Ranges: 5 mV/div to 20 V/div (12 calibrated positions) in 1, 2, 5 sequence, accurate within 3%.

Vernier: continuously variable between all ranges, extends maximum deflection factor to at least 50 V/div. UNCAL light indicates when vernier is not in the CAL position.

Polarity: channel B may be inverted, front panel pushbutton.

Delay line: input signals are delayed sufficiently to view leading edge of input pulse without advanced trigger.

Input coupling: selectable AC or DC, 50Ω (dc), or ground. Ground position disconnects input connector and grounds amplifier input.

Input RC (selectable)

AC or DC: 1 MΩ ±2% shunted by approx. 20 pF.

50 ohm: 50Ω ±3%.

Maximum input

AC or DC: 250 V (dc + peak ac) or 500 V p-p at 1 kHz or less.

50 ohms: 5 V rms.

A+B operation

Amplifier: bandwidth and deflection factors are unchanged; channel B may be inverted for A-B operation.

Differential (A-B) common mode: CMRR is at least 20 dB from dc to 20 MHz. Common mode signal amplitude equivalent to 8 divisions with one vernier adjusted for optimum rejection.

Vertical magnification (X5)

Bandwidth: 3 dB down from 8 div reference signal.

DC-coupled: (1740A) dc to approx. 40 MHz; (1741A) dc to approx. 30 MHz.

AC-coupled: (1740A) approx. 10 Hz to 40 MHz; (1741A) approx. 10 Hz to 30 MHz.

Rise time: (1740A) ≤9 ns, (1741A) ≤12 ns (measured from 10% to 90% points of 8 div input step).

Deflection factor: increases sensitivity of the 5 and 10 mV/div deflection factor settings by a factor of 5 for a maximum sensitivity of 1 mV on channels A and B.

Trigger source

Selectable from channel A, channel B, composite, or line frequency.

Channel A: all display modes triggered by channel A signal.

Channel B: all display modes triggered by channel B signal.

Composite: all display modes triggered by displayed signal except in Chop. In Chop mode trigger signal is derived from channel A.

Line frequency: trigger signal is derived from power line frequency.

Trigger view

Displays internal or external trigger signal. In Alternate or Chop mode, channel A, channel B, and the trigger signals are displayed. In channel A or B mode, Trigger View overrides that channel. Internal trigger signal amplitude approximates vertical signal amplitude. External trigger signal deflection factor is approx. 100 mV/div or 1 V/div in EXT ×10. Triggering point is approx. center screen. With identically timed signals to a vertical input and the Ext trigger input, trigger signal delay is 2.5 ns ±1 ns.

Horizontal display modes

Main, main intensified, mixed, delayed, mag X10, and A vs. B.

Main and delayed time bases

Ranges

Main: 50 ns/div to 2 s/div (24 ranges) in 1, 2, 5 sequence.

Delayed: 50 ns/div to 20 ns/div (18 ranges) in 1, 2, 5 sequence.

Accuracy

Sweep Time/Div	*Accuracy		Temp Range
	X1	X10	
50 ns to 20 ms	±3%	±4%	0°C to +15°C +15°C to +35°C +35°C to +55°C
	±2%	±3%	
	+3%	+4%	

*Add 1% for 50 ms to 2 s ranges.

Main sweep vernier: continuously variable between all ranges, extends slowest sweep to at least 5 s/div. UNCAL light indicates when vernier is not in CAL position.

Magnifier (X10): expands all sweeps by a factor of 10, extends fastest sweep to 5 ns/div.

Calibrated sweep delay

Delay time range: 0.5 to 10 × Main Time/Div settings of 100 ns to 2 s (minimum delay 150 ns).

Differential time measurement accuracy

Main Time Base Setting	*Accuracy (+15°C to +35°C)
100 ns/div to 20 ms/div	±(0.5% + 0.1% of full scale)
50 ns/div to 2 s/div	±(1% + 0.1% of full scale)

*Add 1% for temperatures from 0°C to +15°C and +35°C to +55°C.

Delay jitter: <0.002% (1 part in 50 000) of maximum delay in each step from +15°C to +35°C; <0.005% (1 part in 20 000) from 0°C to +15°C and +35°C to +55°C.

Triggering

Main sweep

Normal: sweep is triggered by internal or external signal.

Automatic: bright baseline displayed in absence of input signal. Above 40 Hz, triggering is same as normal. For stable triggering at approx. 40 Hz and below, use Normal triggering.

Single: automatically switches triggering to Normal and the sweep occurs once with same triggering as Normal, reset pushbutton arms sweep and lights indicator. (1741A) Single sweep is also initiated with Erase pushbutton, sweep is armed after the erase cycle.

Delayed sweep (sweep after delay)

Auto: delayed sweep automatically starts at end of delay.

Trig: delayed sweep is armed and triggerable at end of delay period.

Internal: dc to 25 MHz on signals causing 0.3 divisions or more vertical deflection increasing to 1 division of vertical deflection at 100 MHz in all display modes (required signal level is increased by 2 when in

Chop mode and by 5 when X5 vertical magnifier is used). Triggering on Line frequency is also selectable.

External: dc to 50 MHz on signals of 50 mV p-p or more increasing to 100 mV p-p at 100 MHz (required signal level is increased by 2 when in Chop mode).

External input RC: approx. 1 mΩ shunted by approx. 20 pF.

Maximum external input: 250 V (dc + peak ac) or 500 V p-p at 1 kHz or less.

Level and slope

Internal: at any point on the positive or negative slope of the displayed waveform.

External: continuously variable from +1 V to -1 V on either slope of the trigger signal, +10 V to -10 V in divide by 10 mode (÷10).

Coupling: AC, DC, LF REJ, or HF REJ.

AC: attenuates signals below approx. 20 Hz.

LF Reject (Main Sweep): attenuates signals below approx. 4 kHz.

HF Reject (Main Sweep): attenuates signals above approx. 4 kHz.

Trigger holdoff (main sweep): increases sweep holdoff time in all ranges.

Calibrated mixed time base

Dual time base in which the main time base drives the first portion of sweep and the delayed time base completes the sweep at the faster delayed sweep. Also operates in single sweep mode. Accuracy, add 2% to main time base accuracy.

A vs. B operation

Bandwidth

Channel A (Y-axis): same as channel A.

Channel B (X-axis): dc to 5 MHz.

Deflection factor: 5 mV/div to 20 V/div (12 calibrated positions) in 1, 2, 5 sequence.

Phase difference between channels: <3°, dc to 100 kHz.

Cathode-ray tube and controls (1740A)

Type: Hewlett-Packard, 12.7 cm (5 in.) rectangular CRT, post accelerator, approx. 15 kV accelerating potential, aluminized P31 phosphor.

Graticule: 8 × 10 div (1 div = 1 cm) internal non-parallax graticule, 0.2 subdivision markings on major horizontal and vertical axes and markings for rise time measurements. Internal floodgun graticule illumination.

Beam finder: returns trace to CRT screen regardless of setting of horizontal, vertical, or intensity controls.

Z-axis input (Intensity modulation): +4 V, ≥50 ns width pulse blanks trace of any intensity, usable to ≤10 MHz for normal intensity. Input R, 1 kΩ ±10%. Maximum input ±20 V (dc + peak ac).

Rear panel controls: astigmatism and trace align.

Cathode-ray tube and controls (1741A)

Type: Hewlett-Packard, 12.7 cm (5 in.) rectangular CRT, post accelerator, approx. 7.5 kV accelerating potential, aluminized P31 phosphor.

Graticule: 8 × 10 div (1 div = 0.85 cm) internal, non-parallax graticule, 0.2 subdivision markings on major horizontal and vertical axes, with markings for rise time measurements. Graticule illumination is achieved with Persistence control set to minimum.

Beam finder: returns trace to CRT screen regardless of setting of horizontal and vertical controls.

Z-axis input (Intensity modulation): +4 V, ≥50 ns width pulse blanks trace of any intensity, usable to ≤10 MHz for normal intensity. Input R, 1 kΩ ±10%. Maximum input ±20 V (dc + peak ac).

Operating modes: write, store, display, auto-store, auto-erase, and conventional (rear panel control).

Persistence (with brightness control full ccw)

Variable: approx., 100 ms to 1 min.

Conventional: natural persistence of P31 phosphor (approx. 40 μs).

Storage writing speed: ≥100 cm/μs (118 div/μs) over center 7 × 9 div (with viewing hood).

Storage time

Display mode: at least 10s at 22°C.

Store mode: at least 30s at 22°C.

Brightness: approx. 170 cd/m² (50 ftl).

Erase time: approx 300 ms.

Rear panel controls: astigmatism, trace align, conventional pushbutton and view time.

General

Rear panel outputs: main and delayed gates, 0.8 V to >+2.5 V capable of supplying approx. 5 mA.

Amplitude calibrator (0°C to +55°C)

Output voltage	1 V p-p into >1 MΩ 0.1 V p-p into 50Ω	±1%
Rise time	≤0.1 μs	
Frequency	approx. 1.4 kHz	

Power: 100, 120, 220, 240 V ac ±10%; 48 to 440 Hz; 100 VA max.

Weight: (1740A) net, 13 kg (28.6 lb). Shipping, 17.7 kg (39 lb.); (1741A) net 13.8 kg (30.5 lb). Shipping 17.7 kg (39 lb).

Operating environment: temperature 0°C to +55°C; humidity to 95% relative humidity at +40°C; altitude, to 4600 m (15 000 ft); vibration, vibrated in three planes for 15 min. each with 0.254 mm (0.010 in.) excursion, 10 to 55 Hz.

Dimensions: 335 mm (13 3/8 in.) wide, 197 mm (7 3/4 in.) high, 1740A 597 mm (23 1/2 in.) long with handle, 492 mm (19 3/8 in.) long without handle, 1741A 616 mm (24 1/4 in.) long with handle, 552 mm (21 3/4 in.) long without handle.

Accessories furnished: one blue light filter HP P/N 01740-02701, one front panel cover, one 2.3 m (7.5 ft) power cord, one vinyl accessory storage pouch, one Operators Guide and one Service Manual, two Model 10006D 10:1 divider probes approx. 1.8 m (6 ft.) long. The 1741A also includes one Model 10173A RFI filter and contrast screen, and one Model 10140A viewing hood.

Options

001: fixed power cord (U.S. only) in lieu of detachable power cord

101 (1740A): Logic State Display single pushbutton (Gold Button) interface Option for operation with the HP Model 1607A Logic State Analyzer. Permits single pushbutton switching between functional 16 channel logic state analysis and electrical analysis of digital data. Option 101 removes the A vs. B mode and replaces it with the State Display pushbutton and adds interface circuits for switching between front panel inputs and rear panel logic state inputs.

Price

add \$15

add \$105

Logic state analysis equipment required for Option 101 (1740A)

Model 1607A: Model 1607A 16-Bit Logic State Analyzer includes three data probes and one clock probe.

\$2900

Four Model 10502A: 23 cm (9 in.) cables. Three for X, Y, and Z interconnections and one for pattern triggering connection to the oscilloscope.

\$15 ea.

1740S: Model 1740S includes 1740A 100 MHz oscilloscope with Option 101, Model 1607A Logic State Analyzer, four 10502A 23 cm (9 in.) BNC interconnecting cables with a bracket and strap (HP P/N 5061-1213) for combining into a single package.

\$5175

Model number and name

1740A 100 MHz Oscilloscope

\$2095

1741A 100 MHz Storage Oscilloscope

\$3950

OSCILLOSCOPES

35 MHz storage, 75 MHz, battery powered

Models 1703A & 1707B



1703A and 1707B Specifications

Modes of operation

Channel A; channel B; channels A and B displayed alternately on successive sweeps (ALT); channels A and B displayed by switching between channels at approx. 400 kHz rate with blanking during switching (CHOP); channel A plus channel B (algebraic addition).

Each channel (2)

Bandwidth: (direct or with Model 10006D probe, 3 dB down from 50 kHz, 6 div reference signal from a terminated 50 ohm source.)

DC-coupled: dc to 35 MHz in 1703A, dc to 75 MHz in 1707B.

AC-coupled: lower limit is approx. 10 Hz.

Rise time: < 10 ns in 1703A, < 4.7 ns in 1707B. Direct or with Model 10006D probe, 10% to 90% points with 6 div input step from a terminated 50 ohm source.

Deflection factor

Ranges: 10 mV/div to 5 V/div (9 ranges) in 1, 2, 5 sequence, $\pm 3\%$ attenuator accuracy with vernier in CAL position.

Vernier: continuously variable between all ranges, extends max deflection factor to at least 12.5 V/div. Vernier uncal light indicates when vernier is not in CAL position.

Polarity: NORM or INV, selectable on channel B.

Signal delay: input signals are delayed sufficiently to view leading edge of input signals without advanced external trigger.

Input RC: 1 megohm $\pm 1\%$, shunted by approx. 27 pF in 1703A, approx. 24 pF in 1707B.

Input coupling: AC, DC, or Ground. Ground position disconnects signal input and grounds amplifier input.

Maximum input

AC-coupled: ± 600 V (dc + peak ac); rms ac < 350 V, 5 V/div to 20

mV/div, < 150 V at 10 mV/div (10 kHz or less).

DC-coupled: < 350 V (rms) 5 V/div to 20 mV/div, < 150 V at 10 mV/div (10 kHz or less).

A + B operation

Amplifier: bandwidth and deflection factors are unchanged; channel B may be inverted for A - B operation.

Common mode (A - B): frequency, dc to 1 MHz; rejection ratio, at least 40 dB on 10 mV/div, at least 20 dB on all other ranges with verniers set for optimum rejection. Common mode signal amplitude equivalent to 30 div.

Trigger source

Applies for all five modes of operation.

Norm: on displayed signal

A only: on signal from channel A.

Channel A output (1703A, 1707B Opt 015)

Amplitude: open circuit output voltage approx. 100 mV per div of display.

Cascaded deflection factor: 1 mV/div with both vertical channels set to 10 mV/div.

Cascaded bandwidth: dc to 3 MHz (using HP Model 10121A 20 cm, 8-inch, BNC cable to connect channel A output to channel B).

Coupling: dc.

DC level: approx. 0 V.

Source resistance: approx. 200 ohms.

Main time base

Sweep

Ranges: from 0.1 μ s/div to 2 s/div (23 ranges) in 1, 2, 5 sequence, $\pm 3\%$ accuracy with vernier in CAL position.

Vernier: continuously variable between all ranges, extends slowest sweep to at least 5 s/div. Vernier uncal light indicates when vernier is not in CAL position.

Magnifier: expands all sweeps by a factor of 10 and extends fastest sweep to 10 ns/div. Accuracy $\pm 5\%$ (including 3% accuracy of time base).

Sweep mode

Normal: sweep triggered by an int or ext signal.

Automatic: bright baseline displayed in absence of input signal. Triggering is same as normal above 40 Hz.

Single: in Normal mode, sweep occurs once with same triggering as normal; reset pushbutton arms sweep and lights indicator; in Auto mode, sweep occurs once each time reset pushbutton is pressed.

Triggering

Internal: dc to 35 MHz on signals causing 0.5 div or more vertical deflection increasing to 1 div at 75 MHz for 1707B in all display modes except chop; dc to 400 kHz in chop mode. Triggering on line frequency is also selectable.

External: dc to 35 MHz on signals 50 mV/p-p or more, increasing to 100 mV/p-p at 75 MHz in the 1707B.

External input RC: approx. 1 megohm shunted by approx. 27 pF.

Level and slope: internal, at any point on the vertical waveform displayed; external, continuously variable from +1.2 V to -1.2 V on either slope of the trigger signal. Max input, ± 100 V.

Coupling: AC, DC, LF REJ, or HF REJ; AC, attenuates signals below approx. 20 Hz; LF REJ, attenuates signals below approx. 15 kHz; HF REJ, attenuates signals above approx. 30 kHz.

Trigger holdoff: time between sweeps continuously variable.

Delayed time base

Trace intensification: intensifies that part of main time base to be expanded to full screen in delayed time base mode. Rotating time base switch from OFF position activates intensified mode.

Sweep

Ranges: 0.1 μ s/div to 0.2 s/div (20 ranges) in 1, 2, 5 sequence. $\pm 3\%$ accuracy with vernier in calibrated position.

Vernier: continuously variable between all ranges, extends slowest sweep to 0.5 s/div.

Magnifier: expands all sweeps by a factor of 10 and extends fastest sweep to 10 ns/div. Accuracy is $\pm 5\%$ (including 3% accuracy of time base).

Sweep mode

Trigger: delayed sweep is armed at end of delay period.

Auto: delayed sweep is automatically triggered at end of delay period.

Triggering

Internal: same as main time base.

External: same as main time base. Input RC is approx. 1 megohm shunted by approx. 27 pF.

Level and slope: same as main time base.

Coupling: selectable, AC or DC. AC attenuates signals below approx. 20 Hz.

Delay (before start of delayed sweep)

Time: continuously variable from 0.1 μ s to 2 s.

Time jitter: $<0.005\%$ (1 part in 20 000) of max delay in each sweep speed.

Calibrated delay accuracy: $\pm 1\%$ linearity, $\pm 0.2\%$.

Mixed sweep

Combines main and delayed sweeps into one display. Sweep is started by the main time base and is completed by the faster delayed time base. Also operates in single sweep mode.

External horizontal input

Bandwidth: dc to 1 MHz when driven directly from a terminated 50 ohm source. DC coupled.

Deflection factor (with beam positioned at left edge of CRT): X1, 1 V/div; X10, 0.1 V/div.

Vernier: 10:1 vernier extends deflection factor to at least 10 V/div (X1) or 1 V/div (X10).

Dynamic range: beam may be positioned at left edge of CRT with 0 V to -5 V input.

Maximum input: ± 100 V.

Input RC: approx. 1 megohm shunted by approx. 10 pF.

Cathode-ray tube and controls (1703A)

Type: post-accelerator, approx. 8.3 kV accelerating potential; aluminum P31 phosphor.

Graticule: 6 \times 10 div internal graticule; 0.2 subdivisions on major horizontal and vertical axes. 1 div = 0.85 cm. Rear panel adjustments for trace alignment and astigmatism.

Beam finder: returns trace to CRT screen regardless of setting of horizontal or vertical controls.

Intensity modulation: $>+4$ V, dc to 1 MHz blanks trace of any intensity. Input R, 1000 ohms $\pm 10\%$. Max input, ± 10 V (dc + peak ac).

Persistence

Normal: natural persistence of P31 phosphor (approx. 40 μ s).

Variable: from <0.2 s to >1 min. (standard mode).

Storage writing speed

Standard mode: >20 div/ms over central 5 \times 9 divisions.

Fast write mode: >1000 div/ms over central 5 \times 9 divisions.

Brightness: approx. 340 cd/m² (100 f).

Storage time: from standard to Store, traces may be stored with STORE TIME full cw for >1 hr. With STORE TIME full cw, traces may be viewed at normal intensity for >1 min. From Fast mode to Store, traces may be stored with STORE TIME full cw for >5 min. With STORE TIME full cw, traces may be viewed at normal intensity for >15 s.

Erase: manual, pushbutton erasure takes approx. 500 ms.

Erase: manual, pushbutton erasure takes approx. 500 ms.

Erase: manual, pushbutton erasure takes approx. 500 ms.

Cathode-ray tube and controls (1707B)

Type: post-accelerator, approx. 22 kV accelerating potential, aluminum P31 phosphor.

Graticule: 6 \times 10 div internal graticule; 0.2 subdivisions on major horizontal and vertical axes. 1 div = 1 cm. Front panel adjustments for trace alignment and astigmatism.

Beam finder: returns trace to CRT screen regardless of setting of horizontal, vertical, or intensity controls.

Intensity modulation: $>+4$ V, dc to 1 MHz blanks trace of any intensity. Input R, 1000 ohms $\pm 10\%$. Max. input, ± 10 V (dc + peak ac).

General

Calibrator: 1 kHz, $\pm 10\%$ square wave; 1 V p-p, $\pm 1\%$.

Operating environment: temperature, 0 to $+55^\circ\text{C}$; humidity, to 95% relative humidity at $+40^\circ\text{C}$; altitude, to 4600 m (15 000 ft); vibration, vibrated in three planes for 15 min, each with 0.254 mm (0.010 in.) excursion, 10 to 55 Hz.

Dimensions: 325 mm (12 7/8 in.) wide; 198 mm (7 7/8 in.) high; 1703A is 578 mm (22 3/4 in.) long with handle, 448 mm (17 5/8 in.) long without handle; 1707B is 530 mm (20 7/8 in.) long with handle, 400 mm (15 7/8 in.) long without handle.

Weight

With panel cover and accessories: (1703A) net, 13.6 kg (30 lb). Shipping, 17.7 kg (39 lb). (1707B) net, 12.3 kg (27 lb). Shipping, 16.8 kg (37 lb).

With panel cover, accessories, and battery pack: (1703A) net, 17.7 kg (39 lb). Shipping, 20.9 kg (46 lb). (1707B) net, 15.9 kg (35 lb). Shipping, 19.5 kg (43 lb).

Power

AC line: 115 or 230 V $\pm 20\%$, 48 to 440 Hz, 40 VA max.

DC line: 11.5 to 36 V; 40 VA max.

Battery (optional): operating time, up to 4 hours; recharge time, 14 hours max, with power switch off, if not operated after power indicator flashes; low battery indicator, power light flashes to indicate that batteries are discharged and further operation may damage battery; recharging, batteries are recharging whenever power mode switch is set to AC with power applied. With power switch off, full charge is applied. With power switch on, trickle charge is applied.

Accessories supplied: one Model 10115A blue light filter, one front panel cover (HP P/N 01720-64101), one vinyl storage pouch (HP P/N 1540-0292); two Model 10006D, 10:1 divider probes, 1.8 m (6 ft) long; one 2.3 m (7.5 ft) power cord with right angle plug (HP P/N 8120-1521); three fuses, one 2A (HP P/N 2110-0002), one 0.5A slow blow (HP P/N 2110-0008), one 0.25A slow blow (HP P/N 2110-0018); and one Operating and Service manual.

Options

Option 012: Model 10103B Battery Pack installed

Option 015 (1707B): adds channel A output

Option 300 (1707B): ruggedized 50 mHz dual channel oscilloscope, meets all environmental requirements described in MIL-O-83225 (USAF), designated AN/USM-338

Price

add \$300

add \$50

add \$1365

Model number and name

1703A 35 MHz Delayed Sweep Storage Oscilloscope

\$3500

1707B 75 MHz Delayed Sweep Oscilloscope

\$2600

OSCILLOSCOPES

General purpose plug-in scopes, to 18 GHz

Model 180 series

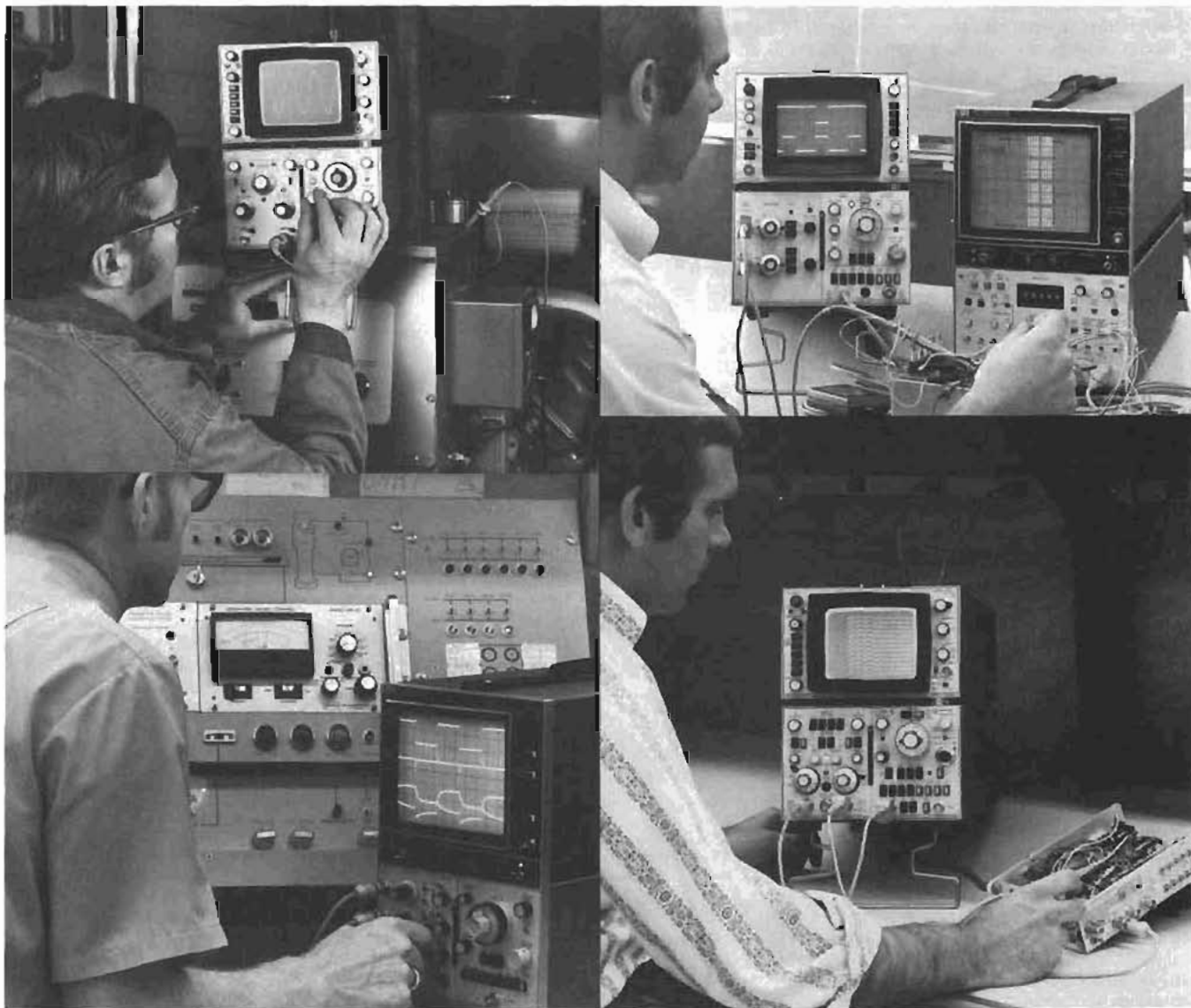

Introduction

The 180 plug-in oscilloscope combines high performance, plug-in versatility, and operating ease to give you a flexible operating system with laboratory quality throughout. Whether you require four channel real time measurements to 100 MHz, sampling to 18 GHz, 170 ps rise time Time Domain Reflectometry, High Resolution Spectrum Analysis, or precision Swept Frequency testing, each of these and more are available in a compact package with a large CRT display.

The focal point for performance is the mainframe with a high quality CRT for accurate measurements. Four mainframes are available, two in cabinet or rack configuration and two in cabinet configuration. A selection of plug-ins for these mainframes allows you to configure an oscilloscope for general purpose use through 100 MHz, 18 GHz sampling, Time Domain Reflectometry, Spectrum Analysis, and Network Analysis. You can meet your present measurement needs, selecting only those plug-ins to meet present requirements at minimum cost, yet keep the full capability of the mainframe for future requirements.

Models 180C, 180D, and 182C mainframes have bright, easy to see displays for maximum resolution and measurement accuracy. Models 180C and 180D each have a CRT display with a full 8×10 cm internal graticule and a writing speed of $1500 \text{ cm}/\mu\text{s}$. For multi-trace view-

ing and easy-to-see displays, the 182C CRT display has a large 8×10 division (one division equals 1.29 cm) internal graticule.

Storage/variable persistence mainframes give you the widest selection of general purpose and high speed storage applications. Advances in processing and target material have resulted in a very rugged storage surface as well as extremely high writing speeds. This storage surface is so burn resistant that special operating procedures are not required, extending the versatility of storage measurements to general purpose applications.

Storage writing speeds of $100 \text{ cm}/\mu\text{s}$ or $400 \text{ cm}/\mu\text{s}$ are available in the 184A and 184A Option 005, which allows you to capture those elusive transients that were too fast for other storage scopes to record. With these fast writing speeds you can easily make pulse timing adjustments, locate noise pulses and missing bits from low duty-cycle digital signals. Low duty-cycle pulse trains from disc, tape, or drum peripheral units can also be viewed through repetitive sweeps by using variable persistence to build up the intensity of dim traces.

For medium speed storage and variable persistence applications, Models 181A/AR mainframes are available. Variable persistence mode, in both models, allows you to adjust display retention time to match the speed of slowly changing signals for maximum viewing ease. This allows direct viewing of complete waveforms without clutter in electromechanical, biomedical, chemical, geological, oceanographical, and many other areas with slowly changing signals.



vided by four channel 100 MHz, and 50 MHz plug-ins and a differential/dc offset plug-in with 40 MHz bandwidth.

A selection of time base plug-ins gives you a choice of single, expanded, and delayed sweeps with magnified sweep speeds to 5 ns/div in 180 mainframes. Models 1820C, 1824A, and 1825A have triggering capabilities to 150 MHz and the 1821A triggers in excess of 50 MHz. Models 1821A and 1825A have calibrated delayed and mixed sweeps for accurate timing measurements and detailed examination of selected portions of waveforms.

Sampling

Models 1810A and 1811A sampling plug-ins provide fast, easy low level, high frequency measurements. The 1810A looks and operates like a real time plug-in which reduces familiarization time for accurate, low-level measurements to 1 GHz. Measurements to 18 GHz are available with the 1811A and the 1430C remote feedthrough sampling head. The remote sampling head reduces measurement errors at high frequencies by eliminating long high frequency interconnecting cables. The feedthrough method of measurement in the sampling head increases accuracy by allowing measurements to be made while the system is operating with its own loads.

Time domain reflectometry

Time Domain Reflectometry is a fast, convenient technique for measuring the electrical characteristics of transmission systems. This measurement technique provides a display of the impedance profile of a system showing magnitude, nature, and distance of discontinuities. Model 1818A is an easy-to-use 170 ps rise time TDR plug-in for design and installation evaluation of transmission or interconnecting systems. For critical design work or system installations, the 1815A/B with its remote sampling heads will display discontinuities as close as 6.4 mm (0.25 inch) with a system rise time of 35 ps.

Logic state analysis

The 1607A Logic State Analyzer combined with a 180 or 182 oscilloscope provides a complete logic analyzer system for functional measurements of digital systems at speeds to 20 MHz. The 1607A analog outputs connect to the 180 or 182 scope dc-coupled X (Ext Horiz)-, Y-, and Z-axis inputs to provide a 16 x 16 bit data field display of 1's and 0's. The 180 or 182 scopes may also be triggered by the 1607A to display waveforms related to the logic flow at a preselected point. In the data domain the analyzer scope combination displays the logic states so you can pinpoint a problem. Then, in the time domain, the 1607A triggers the scope where the problem occurs for electrical analysis.

Spectrum analysis

The 8557A (350 MHz) and 8558B (1500 MHz) Spectrum Analyzer plug-ins display the absolute amplitude of the frequency components of an input signal. Applications include: distortion and modulation measurements, mixer characterization, filter measurements and absolute power measurements.

Operation of both analyzers is extremely simple; only three controls are needed for most measurements. Two controls set the frequency scale, and one is used for the amplitude scale. Measurements can be made from +30 dBm (7 volts) to -117 dBm (320 nV) on a 70 dB distortion-free display. The 8557A features a full span of 350 MHz; the 8558B as wide as 1000 MHz, and for more detailed analysis, both can scan a range as narrow as 50 kHz.

Sweep frequency testing

Hewlett-Packard's Model 8755 series Frequency Response Test Sets are precision detection and display systems for making the basic microwave measurements of insertion gain/loss and return loss (SWR) from 15 MHz to 18 GHz. The 8755L is cabinet mounted with a large screen display for bench applications; the 8755M occupies a minimum of space when rack mounted.

The 8755 system has been specifically designed to achieve a full 60 dB dynamic range when used with solid state sweepers (HP 8620 series) which typically have an output level in excess of +10 dBm. The 60 dB dynamic range from +10 to -50 dBm means it is possible to view a full 40 dB of return loss with couplers having a 20 dB auxiliary arm coupling factor.

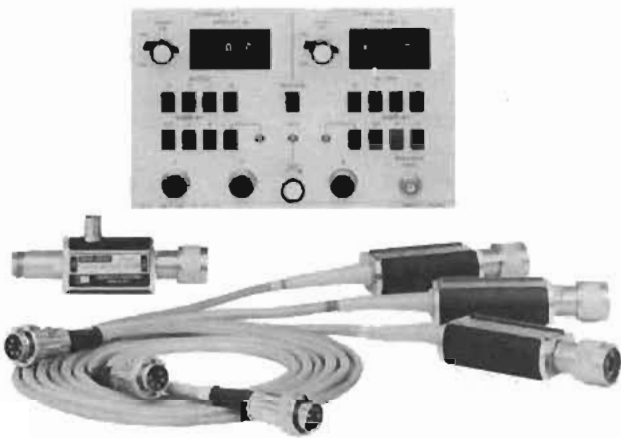

Real time measurements

A selection of eight, high performance, vertical real time plug-ins assures the right plug-in for almost any measurement application. Real time, dual channel plug-ins are available in 500 kHz, 35 MHz, 50 MHz, 75 MHz, and 100 MHz bandwidths with deflection factors of 100 μ V, 10 mV, and 5 mV. Additional measurement capability is pro-



OSCILLOSCOPES

General purpose plug-in scopes, to 18 GHz

180 SYSTEM SELECTION CHARTS

MAINFRAMES		
Model No.	Description	Page
180C/D	High speed, 8 × 10 cm internal graticule (180D rack style)	136
181A/AR	5 cm/μs storage writing speed/variable persistence (181AR rack style)	133
182C	Large screen, 8 × 10 div internal graticule (10.3 × 12.9 cm)	135
184A	100 cm/μs storage writing speed/variable persistence	134
184A Opt 005	400 cm/μs storage writing speed/variable persistence	134

Model No.	VERTICAL PLUG-INS								SAMPLING (Vertical Section)		
	1801A	1803A	1804A	1805A	1806A	1807A	1808A	1809A	¹ 1810A	^{1,2} 1815A/B	^{1,2} 1811A
Bandwidth MHz	50	40 (30)	50	100	0.5	35	75	100	1 GHz	4 or 12.4 GHz	4 or 18 GHz
Min. deflection factor/div	5 mV (500 μV Opt 001 cascaded)	10 mV (1 mV cascaded)	20 mV	5 mV	100 μV	10 mV	5 mV	10 mV	2 mV	5 mV	2 mV
Channels	2 (Opt 001, 1 cascaded)	1 diff	4	2 (1 cascaded)	2 (both diff)	2	2	4	2	1	2
Input RC	1 MΩ/ 25 pF	1 MΩ/ 27 pF	1 MΩ/ 25 pF	1 MΩ/ 13 pF or 50Ω	1 MΩ/ 45 pF	1 MΩ/ 27 pF	1 MΩ/ 12 pF or 50Ω	1 MΩ/ 12 pF or 50Ω	50Ω	50Ω	50Ω
Differential input	yes	yes (with dc offset)	no	yes	yes	yes	yes	yes	yes	no	yes
Page	138	138	140	137	138	138	137	140	144	146	144

Model No.	TIME BASE PLUG-INS						SAMPLING (Time Base Section)			TDR		FREQUENCY-DOMAIN PLUG-INS		
	1820C	1821A ³	1825A	¹ 1810A	^{1,2} 1815A/B	^{1,2} 1811A	¹ 1818A	^{1,2,3} 1815A/B	8557A	8558B	8755A ⁴			
Ext Trig Freq (MHz)	150	100	150	>1 GHz	18 GHz with trigger countdown	18 GHz with trigger countdown	<170 ps rise time TDR system	<35 ps rise time TDR	Spectrum Analyzer 0.1–350 MHz. Measurements from -117 dBm to +20 dBm.	Spectrum Analyzer plug-in. 0.1–1500 MHz. Measurements from -117 dBm to +30 dBm.	Swept Amplitude Analyzer plug-in measures insertion gain/loss and return loss from 15 MHz to 18 GHz.			
Int Trig Freq.	Determined by Vert. Amp. Plug-in.			1 GHz			Calibrated in feet and metres	1815A calibrated in feet 1815B calibrated in metres						
Sweep Speeds/div ⁴	5 ns 1 s	10 ns 1 s	5 ns 1 s	100 ps (expanded) -50 μs	10 ps -1 μs	10 ps -1 μs								
Delayed and mixed sweep	No	Yes	Yes	No	No	No								
Page	142	142	143	144	146	144	146	146	149	149	404			

Mainframe	MAINFRAME / VERTICAL / TIME BASE COMPATIBILITY CHART																		
	VERTICAL PLUG-INS								TIME BASE PLUG-INS				TDR/SAMPLING, FREQ. DOMAIN						
	1801A/Opt 001	1803A	1804A	1805A	1806A	1807A	1808A	1809A	1820C	1821A ³	1824A	1825A	1810A	1811A	1815A/B	1818A	8557A	8558B	8755A
180C/D	X	X	X	X	X	X	X	X	X	X	X	X	X	X	X	X	X	X	X
181A/AR	X	X	X	X	X	X	X	X	X	X	X	X	X	X	X	X	X	X	X
182C	X	X	X	X	X	X	X	X	X	X	X	X	X	X	X	X	X	X	X
184A	X	X	X	X	X	X	X	X	X	X	X	X	X	X	X	X	X	X	X

NOTES

1. Double width plug-ins.
2. Requires remote sampling heads.
3. Requires Remote Pulse Generator.
4. Includes X10 mainframe magnification.
5. For vertical plug-ins up to 50 MHz.
6. Requires remote modulator and detectors.

OSCILLOSCOPES

180 Mainframes: storage, 5 cm/ μ s writing speed

Models 181A/AR

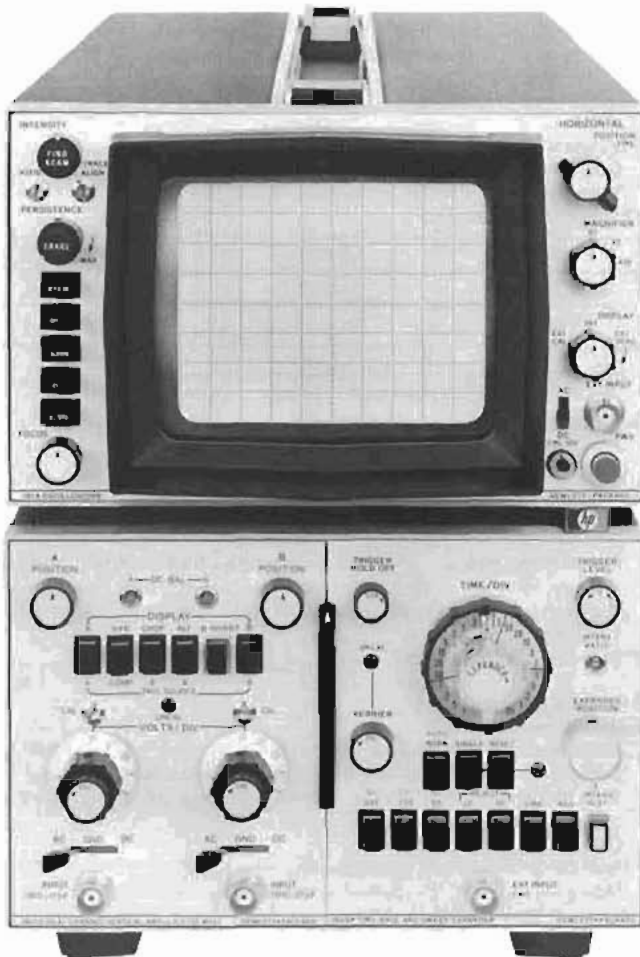

181A/AR specifications

Cathode ray tube and controls

Type: post-accelerator storage; approx. 8.5 kV accelerating potential; aluminized P31 phosphor.

Graticule: 8 X 10 div internal graticule, 0.2 subdivision markings on major horizontal and vertical axes. 1 div = 0.95 cm. Front panel adjustment aligns trace with graticule.

Beam finder: returns trace to CRT screen regardless of horizontal or vertical control setting.

Intensity modulation (external input)

Input: approx. +2 V, ≥ 50 ns pulse width (≤ 10 MHz sine wave) will blank trace of normal intensity.

Input R: approx. 5 k Ω .

Maximum input: ± 20 V (dc + peak ac).

Persistence

Normal: natural persistence of P31 phosphor (approx. 40 μ s).

Variable: from <0.2 s to >1 min.

Storage writing speed

Write mode: >20 cm/ms

Max write mode: >5 cm/ μ s.

Brightness: >342.6 cd/m² (100 f).

Storage time: from Write mode to Store, trace may be stored at reduced intensity for >1 hour; to View mode, traces may be viewed at normal intensity for >1 minute. From Max Write mode to Store, traces may be stored at reduced intensity for >5 minutes; to View mode, traces may be viewed at normal intensity for >15 seconds.

Erase: manual, pushbutton erasure takes approx. 300 ms

Horizontal amplifier

External input

Bandwidth: dc-coupled, dc to 5 MHz; ac-coupled, 5 Hz to 5 MHz.

Deflection Factor: 1 V/div in X1; 0.2 V/div in X5; 0.1 V/div in X10.

Vernier: provides continuous adjustment between ranges.

Dynamic range: ± 20 V.

Maximum input: 600 V dc (ac-coupled input).

Input RC: approx 1 megohm shunted by approx 30 pF.

Sweep magnifier: X5, X10; accuracy, $\pm 5\%$ with 3% accuracy time base.

Outputs

Four rear panel emitter follower outputs for main and delayed gates, main and delayed sweeps or vertical and horizontal outputs when used with TDR/sampling plug-ins. Will drive impedances ≥ 1000 ohms without distortion.

General

Calibrator: approx 1 kHz square wave, 3 μ s rise time; 10 V p-p into ≥ 1 megohm; accuracy, $\pm 1\%$.

Operating environment: temperature, 0 to $+55^\circ\text{C}$ ($+32^\circ\text{F}$ to $+130^\circ\text{F}$); humidity, to 95% relative humidity at 40°C (104°F); altitude, to 4600 m (15 000 ft); vibration, vibrated in three planes for 15 min, each with 0.254 mm (0.010 in.) excursion, 10 to 55 Hz.

Dimensions

Cabinet Model, 181A: 200 mm wide, 289 mm high, 540 mm deep behind panel (7 $\frac{7}{8}$, 11 $\frac{3}{8}$, 21 $\frac{1}{2}$ in.).

Rack Model, 181AR: 425 mm wide, 132.6 mm high, 543 mm deep overall (16 $\frac{3}{4}$, 5 $\frac{1}{8}$, 21 $\frac{1}{2}$ in.); 493 mm (19 $\frac{3}{8}$ in.) deep behind rack mount tabs.

Weight (without plug-ins)

Model 181A (cabinet): net, 10.9 kg (24 lb). Shipping, 15.4 kg (34 lb).

Model 181AR (rack): net, 11.8 kg (26 lb). Shipping, 17.2 kg (38 lb).

Power: 115 or 230 V $\pm 10\%$, 48 to 440 Hz; 115 watts at normal line with plug-ins; max mainframe power, 225 VA.

Accessories supplied: 2.3 m (7 $\frac{1}{2}$ ft) power cord, Model 10178A mesh contrast filter, blue plastic light filter (HP P/N 5060-0548), 230 V fuse package (HP P/N 5080-9672), one Operating and Service Manual. A rack mount kit (HP P/N 5060-0552) and 2 clip-on probe holders (HP P/N 5040-0464) are supplied with the 181AR rack model.

181T/TR

181T cabinet and 181TR rack model mainframes are related to 8557A and 8558B plug-ins; with non-buffered rear panel auxiliary outputs. For detailed information refer to an 8557A or 8558B data sheet.

Options

H49: Model 181A with remote programming capability for Write, Max Write, Normal, Store, View, and Erase functions. Programming is accomplished with contact closure, DTL, or TTL logic sources.

Option H49 Programming (181A)

Price

add \$515

Model number and name

Model 181A Storage Oscilloscope, Cabinet Style

\$2350

Model 181AR Storage Oscilloscope, Rack Style

\$2450

OSCILLOSCOPES

180 Mainframe: storage, 100 cm/ μ s writing speed

Model 184A

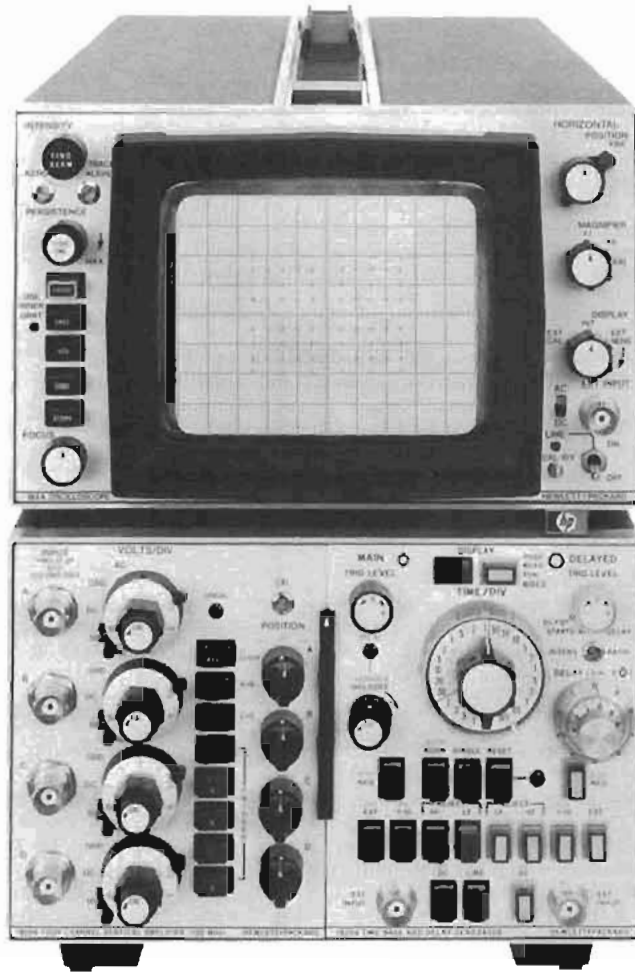

184A Mainframes Description

The Model 184A cabinet style variable persistence and storage mainframe provides writing speeds of 100 cm/ μ s or with Option 005, 400 cm/ μ s (with viewing hood). These writing speeds are fast enough that traces you previously had to photograph to see can now be viewed directly in normal ambient light. A FAST mode optimizes writing speed by switching the CRT display to reduced scan while maintaining calibration and resolution. A second graticule, for the FAST mode, is superimposed in the center of the screen and a front panel light indicates when the scope is in the FAST mode.

184A Specifications

Cathode-ray tube and controls

Type: post-accelerator storage tube; aluminumized P31 phosphor.

Graticule: 8 \times 10 div internal graticule, 0.2 div subdivisions on major axes, 1 div = 0.95 cm, 8 \times 10 div internal graticule superimposed in center of normal scope graticule (for fast writing speed mode), 1 div = 0.475 cm. Front panel adjustment aligns trace with graticule.

Beam finder: returns trace to CRT screen regardless of setting of horizontal or vertical control setting.

Intensity modulation (external input)

Input: approx. +2 V, \geq 50 ns pulse width (\leq 10 MHz sine wave) will blank trace of normal intensity.

Input R: approx. 5 k Ω .

Maximum input: \pm 20 V (dc + peak ac).

Writing modes: conventional (non-storage), standard, and fast (variable persistence and storage). Pressing STORE and either STD or FAST provides maximum persistence with floodguns off for a ready-to-write state. The CRT will remain primed and ready-to-write for the storage time of $>$ 10 min, in STD/STORE and $>$ 30 s in FAST/STORE.

Persistence

Conventional: natural persistence of P31 phosphor (approx. 40 μ s).

Variable: from $<$ 50 ms to $>$ 1 min.

Storage writing speed

Model No.	Standard*	Fast**
184A	$>$ 0.2 cm/ μ s	$>$ 100 cm/ μ s
184A Opt 005	$>$ 0.2 cm/ μ s	$>$ 400 cm/ μ s

*Adjustable writing speeds to approx. 10 cm/ μ s are available with rear panel controls.

**Calibrated 3.8 \times 4.75 cm reduced scan area.

Brightness

Standard: $>$ 342.6 cd/m² (100 ft).

Fast: $>$ 173.3 cd/m² (50 ft).

Storage time

Standard writing speed: variable from $>$ 1 min. at normal intensity to $>$ 10 min. at reduced brightness.

Fast writing speed: variable from $>$ 10 s (8 s for Opt 005) at normal intensity to $>$ 30 s at reduced brightness. Storage time may vary with wide temperature changes. Specifications are for normal room temperature (\pm 22°C).

Erase: manual, pushbutton erasure takes approx. 300 ms.

Horizontal amplifier

External input

Bandwidth: dc-coupled, dc to 5 MHz, ac-coupled, 5 Hz to 5 MHz.

Deflection factor: 1 V/div in X1; 0.2 V/div in X5; 0.1 V/div in X10; accuracy, \pm 5%. Vernier provides continuous adjustment between ranges.

Dynamic range: \pm 20 V.

Maximum input: 600 V dc (ac-coupled input).

Input RC: approx. 1 megohm shunted by approx. 30 pF.

Sweep magnifier: X5, X10; accuracy, \pm 5% (with 3% accuracy time base).

Calibrator

Type: approx. 1 kHz square wave, 3 μ s rise time.

Voltage: 10 V p-p into \geq 1 megohm; accuracy, \pm 1%.

Outputs

Four rear panel emitter follower outputs for main and delayed gates, main and delayed sweeps, or vertical and horizontal outputs when used with TDR/Sampling plug-ins. Maximum current available, \pm 3 mA. Will drive impedances \geq 1000 ohms without distortion.

General

Operating environment: temperature, 0 to +55°C (+31°F to +130°F); humidity, to 95% relative humidity at 40°C (104°F); altitude, to 4600 m (15000 ft); vibration, vibrated in three planes for 15 min, each with 0.254 mm (0.010 in.) excursion, 10 to 55 Hz.

Dimensions: 200 mm wide, 289 mm high, 540 mm deep behind panel (7 $\frac{1}{2}$, 11 $\frac{1}{2}$, 21 $\frac{1}{2}$ inches).

Weight: (without plug-ins) net, 10.9 kg (24 lb). Shipping, 15 kg (33 lb).

Power: 115 or 230 V \pm 10%, 48 to 440 Hz, 115 watts at normal line with plug-ins. Max mainframe power, 225 VA.

Accessories supplied: 2.3 m (7 $\frac{1}{2}$ ft) power cord, Model 10178A mesh contrast filter, blue plastic light filter (HP P/N 5080-0548), 250 V fuse package (HP P/N 5080-9681), one Operating and Service Manual.

Model number and name

184A Cabinet Storage Mainframe

184A Option 005 Fast Storage CRT

Price

\$2750

add \$500

OSCILLOSCOPES

180 Mainframe: large screen

Model 182C

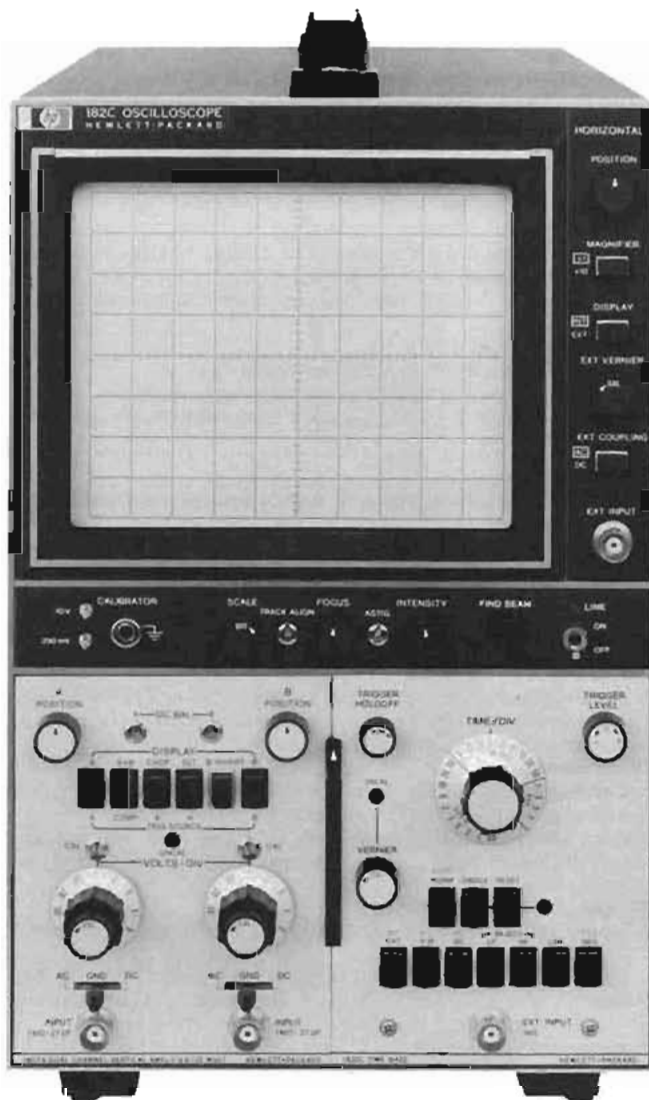

182C Description

Model 182C mainframe provides large, easy-to-read displays on a 16.5 cm (6½ in.) CRT with 100 MHz capability. A parallax free, internal graticule allows accurate readings from any angle or from a distance which is extremely useful in systems testing. The large display also improves measurement accuracy of displays such as four channel, differential/dc offset, sampling, and time domain reflectometer measurements.

The cathode-ray tube has 21 kV accelerating potential for bright displays of low repetition rate signals. Particular attention to electron optics in the CRT assures that the large display size does not cause degradation of the trace. Internal flood guns provide graticule illumination which allows adjustment of background illumination for optimum contrast of graticule and trace for easy-to-read three-shade pho-

tographs. A find beam control reduces set-up time by returning the beam to the display area regardless of vertical, time base, or intensity control settings.

182C Specifications

Cathode-ray tube and controls

Type: post accelerator, 21 kV accelerating potential; aluminized P31 phosphor.

Graticule: 8 × 10 div internal graticule, 0.2 div sub-divisions on major axes, 1 div = 1.29 cm. Front panel adjustment aligns trace with graticule. Scale control illuminates CRT phosphor for viewing with hood or taking photographs.

Beam finder: returns trace to CRT screen regardless of setting of horizontal, vertical, or intensity controls.

Intensity modulation (external input)

Input: approx. +2 V, ≥ 50 ns pulse width (≤ 10 MHz sine wave) will blank trace of normal intensity. Input R approx. 5 kΩ.

Maximum input: ±20 V (dc + peak ac).

Horizontal amplifier

External input

Bandwidth: dc to 5 MHz; ac-coupled, 5 Hz to 5 MHz.

Deflection factor: 1 V/div, X1; 0.1 V/div, X10; accuracy, ±5%.

Vernier provides continuous adjustment between ranges.

Dynamic range: ±20 V.

Maximum input: ±300 V (dc + peak ac).

Input RC: 1 megohm shunted by approx. 30 pF.

Sweep magnifier: X10; accuracy, ±5% (with 3% accuracy time base).

Calibrator: approx. 1 kHz square wave, < 3 μs rise time; 250 mV p-p and 10 V p-p into ≥ 1 megohm, ±1%.

Outputs

Four rear panel emitter follower outputs for main and delayed gates, main and delayed sweeps or vertical and horizontal outputs when used with TDR/Sampling plug-ins. Maximum current available, ±3 mA. Will drive impedance ≥ 1000 ohms without distortion.

General

Operating environment: temperature, 0 to 55°C (+32°F to +130°F); humidity, to 95% relative humidity at 40°C (104°F); altitude, to 4600 m (15000 ft); vibration, vibrated in three planes for 15 min, each with 0.254 mm (0.010 in.) excursion, 10 to 35 Hz.

Dimensions: 201.6 mm wide, 338.1 mm high, 498.5 mm deep overall (7¾, 13¼, 19¾ inches).

Weight: (without plug-ins) net, 12.2 kg (27 lb). Shipping, 15.4 kg (34 lb).

Power: 115 or 230 V ±10%, 48 to 440 Hz, < 110 watts with plug-ins at normal line. Max. mainframe power, 200 VA.

Accessories supplied: 2.3 m (7½ ft) power cord, blue plastic light filter (HP P/N 5060-0547), 230 V fusepackage (HP P/N 5080-9672), one Operating and Service Manual.

182T

Cabinet model mainframe related to 8557A, 8558B, and 8755A plug-ins; non-buffered rear panel auxiliary outputs; and P39 medium-persistence CRT phosphor. For detailed information refer to an 8557A, 8558B or 8755A data sheet.

Options

010: mainframe without rear panel main and delayed sweep and gate outputs

Price

less \$100

Model number and name

Model 182C Oscilloscope Mainframe

\$1500

Model 182C Option 010 Oscilloscope Mainframe

\$1400

OSCILLOSCOPES

180 Mainframes: high writing speed

Models 180C/D

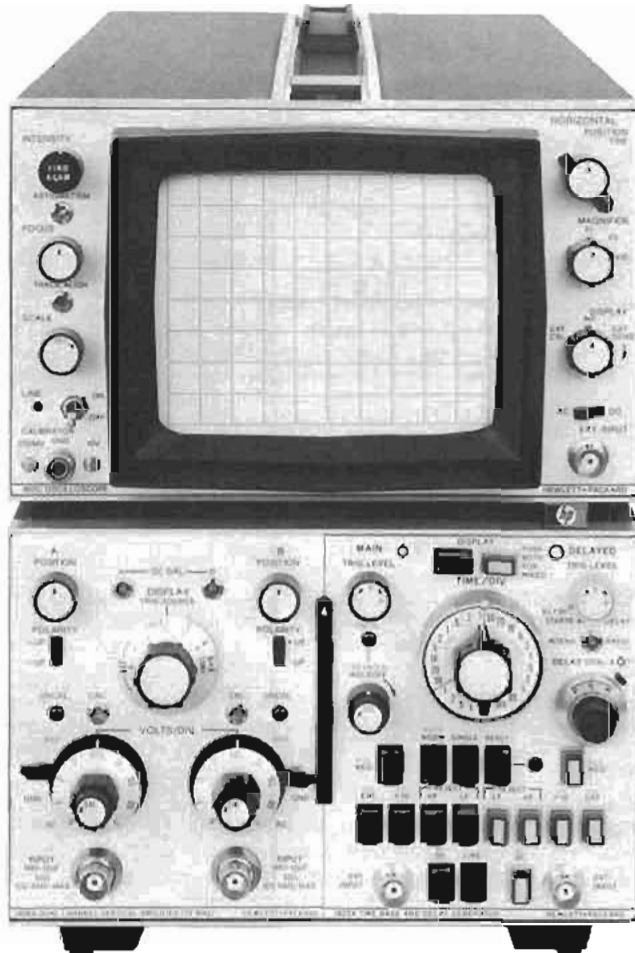

180C/D Specifications

Cathode-ray tube and controls

Type: post accelerator, approx. 15 kV accelerating potential, aluminized P31 phosphor.

Graticule: 8 × 10 div internal graticule, 1 div = 1 cm, 0.2 div subdivisions on major axes. Front panel recessed screwdriver adjustment aligns trace with graticule. Scale control illuminates CRT phosphor when viewing with hood or taking photographs.

Beam finder: returns trace to CRT screen regardless of setting of horizontal, vertical, or intensity controls.

Intensity modulation (external input)

Input: approx. +2 V, ≥ 50 ns pulse width (≤ 10 MHz sine wave) will blank trace of normal intensity.

Input R: approx. 5 kΩ.

Maximum input: ± 20 V (dc + peak ac).

Photographic writing speed: 1500 cm/μs. Measured using P31 phosphor, 10 000 ASA film without film fogging and HP Model 195A camera (1.3 lens, 1:0.5 object-to-image ratio). Writing speed may be increased substantially by using film fogging techniques, P11 phosphor, and faster camera lenses.

Horizontal amplifier

External input

Bandwidth: dc to 5 MHz dc-coupled; 5 Hz to 5 MHz ac-coupled.

Deflection Factor: 1 V/div, X1; 0.2 V/div, X5; 0.1 V/div, X10; accuracy ± 5%. Vernier provides continuous adjustment between ranges.

Dynamic range: ± 20 V.

Maximum input: 600 V dc (ac-coupled input).

Input RC: approx. 1 megohm shunted by approx. 30 pF.

Sweep magnifier: X5, X10, accuracy ± 5% (with 3% accuracy time base).

Outputs

Four rear panel, emitter follower outputs provide main and delayed sweeps, or vertical and horizontal outputs when used with TDR/Sampling plug-ins. Maximum current available, ± 3 mA. Outputs will drive impedances of ≥ 1000 ohms without distortion.

General

Calibrator: approx. 1 kHz square wave, < 3 μs rise time; 250 mV p-p and 10 V p-p into ≥ 1 megohm; accuracy, ± 1%.

Operating environment: temperature, 0 to +55°C (+32°F to +130°F); humidity, to 95% relative humidity at 40°C (104°F); altitude, to 4.6 km (15 000 ft); vibration, vibrated in three planes for 15 min. each with 0.254 mm (0.010 in.) excursion, 10 to 55 Hz.

Dimensions

Cabinet model, 180C: 200 mm wide, 289 mm high, 540 mm deep behind panel (7 7/8, 11 3/8, 21 1/4 inches).

Rack model, 180D: 425 mm wide, 132.6 mm high, 543 mm deep overall (16 3/4, 5 1/8, 21 3/8 inches); 493 mm (19 3/8 in.) deep behind rack mount tabs.

Weight (without plug-ins)

Model 180C (cabinet): net, 10.4 kg (23 lb). Shipping, 15.4 kg (34 lb).

Model 180D (rack): net, 11.8 kg (26 lb). Shipping, 17.2 kg (38 lb).

Power: 115 or 230 V, ± 10%; 48 to 440 Hz; normally < 110 watts with plug-ins at normal line. Max mainframe power, 200 VA.

Accessories supplied: 2.3 m (7 1/2 ft) power cord, blue plastic light filter (HP P/N 5060-0548), 230 V fuse package (HP P/N 5080-9672), one Operating and Service Manual. A rack mount kit (HP P/N 5060-0552) and 2 clip-on probe holders (HP P/N 5040-0464) are supplied with the 180D rack model.

180TR

Rack model mainframe related to 8557A, 8558B, and 8755A plug-ins; non-buffered rear panel auxiliary outputs; and P39 medium-persistence CRT phosphor. For detailed information refer to an 8557A, 8558B or 8755A data sheet.

Options

010: deletes rear panel outputs for main and delayed gates and main and delayed sweeps

Price

less \$100

Model number and name

180C Cabinet Style Mainframe

180C Option 010 (see Options)

180D Rack Style Mainframe

180D Option 010 (see Options)

\$1450

\$1350

\$1550

\$1450

OSCILLOSCOPES



180 Verticals: 2 channel, 100 MHz & 75 MHz
Models 1805A & 1808A

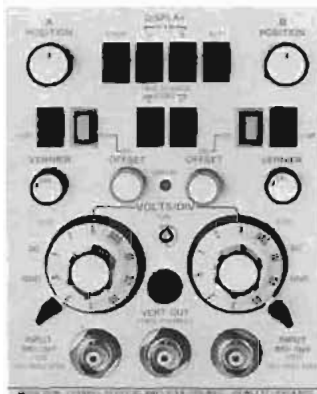

1805A

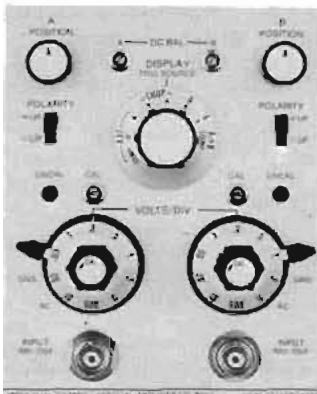

1808A

1805A, 1808A Specifications

Modes of operation

Channel A; channel B; channels A and B displayed alternately on successive sweeps (ALT); channel A and B displayed by switching between channels at approx. 400 kHz rate (CHOP) with blanking during switching; channel A plus channel B (algebraic addition).

Each channel (2)

Bandwidth: (measured with or without 10014A probe, 3 dB down from 8 div reference signal from a terminated 50 ohm source.)

DC-coupled: dc to 100 MHz (1805A), dc to 75 MHz (1808A).

AC-coupled: (1805A) approx. 10 Hz to 100 MHz (lower limit is approx. 1 Hz with 10014A probe), (1808A) approx. 8 Hz to 75 MHz (lower limit is approx. 0.8 Hz with 10014A probe).

Rise time: (1805A) < 3.5 ns, (1808A) < 4.7 ns (both measured with or without 10014A probes, 10% to 90% points of 6 div input step from a terminated 50 ohm source).

Deflection factor

Ranges: 5 m/div to 5 V/div (10 calibrated positions) in 1, 2, 5 sequence; $\pm 2\%$ attenuator accuracy.

Vernier: provides continuous adjustment between deflection factor settings and extends maximum deflection factor to at least 12.5 V/div. Front panel light indicates when vernier is not in CAL position.

Polarity: + up or - up, selectable.

Signal delay: input signals are delayed sufficiently to view leading edge of input pulse without advanced trigger.

Input coupling: AC, DC, 50 ohms (dc), or ground. Ground position disconnects input connector and grounds amplifier input.

Input RC

AC and DC: 1 megohm $\pm 1\%$ shunted by approx. 13 pF (1805A), 12 pF (1808A). Constant on all ranges.

50 ohm: 50 ohms $\pm 2\%$, SWR < 1.2 at 100 MHz (1805A), π 75 MHz (1808A), on all ranges.

Maximum input

AC and DC: ± 300 V (dc + peak ac) at 1 kHz or less, ± 150 V (dc + peak ac) on 5 m/div range at 1 kHz or less.

50 ohm: 10 V rms (de-coupled input).

Dynamic range: (1805A) 6 div at 100 MHz increasing to 16 div at ≤ 15 MHz.

Positioning range: (1805A) 16 div.

Drift (1808A): < 100 μ V/ $^{\circ}$ C.

A + B operation

Amplifier: bandwidth and deflection factors are unchanged; either channel may be inverted for $\pm A \pm B$ operation.

Differential input (A - B) common mode: (1805A) CMRR is at least 40 dB from dc to 1 MHz for common mode signals of 16 div or less; CMRR is at least 20 dB at 50 MHz for common mode signals of 6 div or less. (1808A) CMRR is at least 40 dB on 5 mV/div and at least 20 dB on other ranges for frequencies between dc and 2 MHz and common mode signal of 24 div or less.

Triggering (1805A)

Source: selectable from channel A, channel B, or a composite (Comp) signal from A and B in any display mode. Composite is channels A and B signals switched for Alt and Chop modes and added for A and B mode. Vernier and position controls do not affect A, B, or composite trigger signals. A and B signals are independent of polarity selection.

Frequency

Time Base Plug-in	Trigger Frequency*	Required Vertical Deflection
1820C, 1824A ₁	dc - 50 MHz	1/2 div
1825A	dc - 100 MHz	1 div
1821A	dc - 50 MHz	1 div

*all display modes except Chop, dc to 100 kHz in Chop.

Triggering (1808A)

Source: A, B, or A+B on the individual or composite signal displayed; chop mode selectable from A or B; alternate mode A, B, or composite (A+B switched).

Frequency: dc to 75 MHz on signals causing 0.5 div p-p or more vertical deflection in all display modes (1821A requires 1 div p-p), except dc to 100 kHz in chop mode.

Offset (1805A)

$\pm 2(X)$ div of offset. Allows offset of dc or ac signals up to the dynamic range and maximum input.

Vertical signal output (1805A)

(selected by trigger source switch)

Bandwidth: > 50 MHz into 50 ohms.

Amplitude: > 50 mV for each division of display into 50 ohms with usable amplitudes up to 500 mV p-p.

Source impedance: approx. 50 ohms.

General

Operating environment: same as 180 C/D mainframes.

Weight: net, 2.3 kg (5 lb); shipping, 3.6 kg (8 lb).

Accessories supplied: two 10014A 10:1 voltage divider probes approx. 1.1 m (3 1/2 ft) long, one Operating and Service Manual.

Recommended probes

10014A, 10016B passive probes, 10020A resistive divider probe kit, and the 1120A and 1125A active probes maintain full performance of the 1805A and 1808A.

Model number and name

1805A Dual Channel Vertical Amplifier

1808A Dual Channel Vertical Amplifier

Option 003: without probes

Price

\$1550

\$1100

less \$120

OSCILLOSCOPES

180 Verticals: 0.5 MHz, 35 MHz, 50 MHz and dc offset

Models 1801A, 1806A, 1807A & 1803A

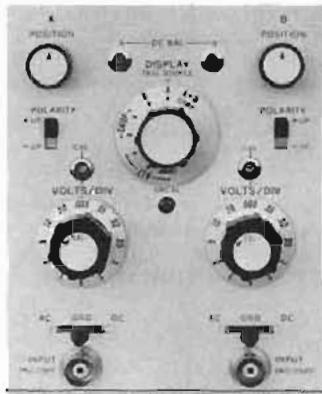

1801A

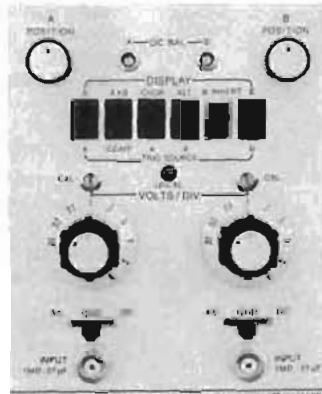

1807A

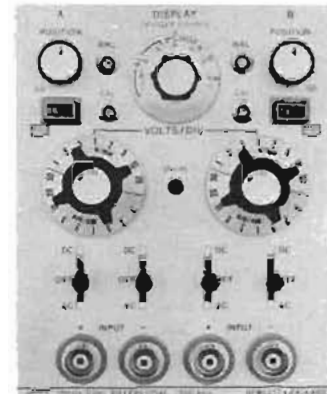

1806A

1801A, 1806A, 1807A Specifications

Modes of operation

Channel A; channel B; channels A and B displayed alternately on successive sweeps (ALT); channels A and B displayed by switching between channels at approx. 400 kHz rate (1801A), 100 kHz (1806A, 1807A), in CHOP mode with blanking during switching; channel A plus channel B, algebraic addition (1801A, 1807A).

Each channel (2)

Bandwidth: (measured with or without a Model 10004D probe (1801A, 1807A), Model 10001A/B probe (1806A), 3 dB down from 8 div reference signal from a terminated 50 ohm source.)

DC-coupled: (1801A) dc to 50 MHz, (1807A) dc to 35 MHz, (1806A) dc to 500 kHz.

AC-coupled: (1801A) approx. 8 Hz to 50 MHz, (1807A) approx. 8 Hz to 35 MHz, (1806A) approx. 2 Hz to 500 kHz. Lower limit (1801A, 1807A) is approx. 0.8 Hz with 10004D probe, (1806A) approx. 0.2 Hz with 10001A/B probe.

Bandwidth limit switch (1806A): limits bandwidth to approx. 50 kHz.

Rise time: (1801A) <7 ns, (1807A) <10 ns (measured with or without 10004D probe, 10% to 90% of 8 div input step from a terminated 50 ohm source).

Deflection factor

Ranges: (1801A) 5 mV/div to 20 V/div (12 positions) in 1, 2, 5 sequence; (1807A) 10 mV/div to 5 V/div (9 positions) in 1, 2, 5 sequence; (1806A) 100 μ V/div to 20 V/div (17 positions) in 1, 2, 5 sequence; $\pm 3\%$ attenuator accuracy.

Vernier: provides continuous adjustment between deflection factor settings and extends maximum deflection factor to at least 50 V/div (1801A, 1806A), 12.5 V/div (1807A). Front panel light indicates when vernier is not in CAL position.

Polarity: (1801A) +up or -up, selectable, (1807A) + up or - up selectable on channel B.

Signal delay: (1801A, 1807A) input signals are delayed sufficiently to view leading edge of input pulse without advanced trigger.

Input: (1806A) differential or single-ended on all ranges, selectable.

Input coupling: (1801A, 1807A) selectable, AC, DC, or Ground; ground position disconnects signal input and grounds amplifier input. (1806A) selectable AC, DC, or OFF for both + and - inputs; OFF position disconnects signal input and grounds amplifier input for reference.

Input RC: (1801A) approx. 1 megohm shunted by approx. 25 pF; (1807A) 1 megohm $\pm 2\%$ shunted by approx. 27 pF; (1806A) approx. 1 megohm shunted by approx. 45 pF; constant on all ranges.

Maximum Input (1801A, 1807A)

DC-coupled: ± 350 V (dc + peak ac) at 10 kHz or less, ± 150 V (dc + peak ac) on 5 mV/div range (1801A), 10 mV/div (1807A), at 10 kHz or less.

AC-coupled: ± 600 V dc.

Maximum Input (1806A): ± 400 V (dc + peak ac).

A + B operation (1801A, 1807A)

Amplifier: bandwidth and deflection factors are unchanged; (1801A) either channel may be inverted for $\pm A \pm B$ operation; (1807A) channel B may be inverted for $-A \pm B$ operation.

Differential Input (A - B) common mode: CMRR is at least 40 dB at 5 mV/div (1801A), 10 mV/div (1807A), and at least 20 dB on other ranges for frequencies between dc and 1 MHz and for common mode signals of 24 div or less.

Input Isolation (1806A): ≥ 80 dB between channels at 500 kHz with shielded connectors.

Noise (1806A): < 20 μ V, measured tangentially at full bandwidth.

Common mode (1806A)

Frequency: dc to 10 kHz on all ranges.

Rejection ratio: ≥ 100 dB (100 000 to 1) with dc-coupled input on 100 μ V/div range, decreasing 20 dB per decade of deflection factor to ≥ 40 dB on the 200 mV/div range; CMRR is ≥ 30 dB on the 500 mV/div to 20 V/div ranges.

Maximum signal: ± 10 V (dc + peak ac) on 100 μ V/div to 200 mV/div ranges; ± 400 V (dc + peak ac) on all other ranges.

Triggering (1801A)

Source: for channel A, B, or A+B, on the signal displayed; Chop is selectable from channel A or B; Alt is selectable from channel A, B, or Comp (channels A and B switched).

Frequency: dc to 50 MHz on signals causing 0.5 div or more vertical deflection in all display modes except Chop; dc to 100 kHz in Chop mode.

Triggering (1807A)

Source: on channel A for channel A, Chop, and Alt modes; on channel B for channel B mode; on composite signal displayed for A+B mode.

Frequency: dc to 35 MHz on signals causing 0.5 div or more vertical deflection in all display modes except Chop; dc to 100 kHz in Chop mode.

Triggering (1806A)

Source: for channel A or B, on the signal displayed; Chop is selectable from channel A or B; Alt is selectable from channel A, B, or Comp (channels A and B switched).

Frequency: dc to >500 kHz on signals causing 0.5 div or more vertical deflection in all display modes except Chop; dc to 100 kHz in Chop.

General

Operating environment: same as 180C/D mainframe.

Weight: net, 1.8 kg (4 lb). Shipping, 3.6 kg (8 lb).

Accessories supplied: (1801A) two 10004D, 10 I divider probes, approx. 1.1 m (3 1/2 ft), one Operating and Service manual; (1807A) one Operating and Service Manual; (1806A) two BNC to dual banana plug binding post adapters (HP P/N 1250-1264), one Operating and Service Manual.

Recommended probes: the 10004D, 10005D, and 10006D passive divider probes maintain full performance of the 1801A or 1807A; the 10001A/B, 10002A/B, 10003A passive divider probes maintain full performance of the 1806A.



1803A

1803A Specifications

Vertical deflection

Bandwidth: (measured with or without 10004D probe, 3 dB down from 8 div reference signal from a terminated 50 ohm source.)

DC-coupled: dc to 40 MHz from 0.005 V/div to 20 V/div; dc to 30 MHz on 0.001 V/div and 0.002 V/div or when using V_0 range of 0 to 6 V or two most sensitive volts/div settings for other V_0 ranges.

AC-coupled: lower bandwidth is approx. 2 Hz, upper bandwidth is the same as dc-coupling. Lower bandwidth is approx. 0.2 Hz with 10004D probe.

Rise time: <10 ns for deflection factors of 0.005 V/div to 20 V/div; <12 ns on 0.001 V/div and 0.002 V/div, on V_0 range of 0 to 6 V and on the most sensitive volts/div settings for other V_0 ranges. Measured with or without 10004D probe; 10% to 90% of 8 div input step from terminated 50 ohm source.

Deflection factor

Ranges: from 0.001 V/div to 20 V/div (14 calibrated positions) in 1, 2, 5 sequence; attenuator accuracy $\pm 3\%$.

Vernier: provides continuous adjustment between deflection factor settings and extends maximum deflection factor to at least 50 V/div. Front panel light indicates when vernier is not in CAL position.

Input coupling: AC, DC, Ground, or V_0 for both + and - inputs. Ground disconnects signal input and grounds amplifier input.

Input RC: approx. 1 megohm shunted by approx. 27 pF, constant on all ranges.

Maximum Input

V_0 Range	Deflection Factor	Maximum Input (dc + peak ac)
0 to 6 V	0.001 V/div to 0.02 V/div	± 15 V
0 to 6 V	0.05 V/div to 0.2 V/div	± 150 V
0 to 6 V	0.5 V/div to 20 V/div	± 600 V
0 to 60 V	0.01 V/div to 0.2 V/div	± 150 V
0 to 60 V	0.5 V/div to 20 V/div	± 600 V
0 to 600 V	0.1 V/div to 0 V/div	± 600 V

Overload recovery

6 V overload: within ± 10 mV of final signal value in 0.3 μ s or less, within ± 5 mV in 1 μ s or less, and within 1 mV in 1 ms or less.

60 V overload: within ± 100 mV of final signal value in 0.3 μ s or less, within ± 50 mV in 1 μ s or less, and within ± 10 mV in 1 ms or less.

600 V overload: within ± 1 V of final signal value in 0.3 μ s or less, within ± 0.5 V in 1 μ s or less, and within ± 100 mV in 1 ms or less.
Common mode rejection ratio: measured at a deflection factor of 0.001 V/div. (CMRR decreases with increasing deflection settings.)

Frequency Range	CMRR	Common Mode Input Sinewave (max p-p)
dc to <100 kHz	$\geq 20\,000:1$ (≥ 86 dB)	10 V
100 kHz to <1 MHz	$\geq 10\,000:1$ (≥ 80 dB)	10 V
1 MHz to <10 MHz	$\geq \frac{5\,000:1}{\text{Freq in MHz}}$	$\frac{10\text{ V}}{\text{Freq in MHz}}$
20 MHz	$\geq 50:1$ (≥ 34 dB)	1 V
60 Hz	$\geq 2\,000:1$ (≥ 66 dB)*	10 V

*AC-coupled (all others dc-coupled).

DC offset

V_0 Range	Deflection Factor	Comparison Accuracy
0 to ± 6 V	0.001 V/div to 0.02 V/div	$\pm(0.15\% + 8\text{ mV})$
	0.05 V/div to 0.2 V/div	$\pm(0.75\% + 8\text{ mV})$
	0.5 V/div to 2 V/div	$\pm 1\%$
	5 V/div to 20 V/div	$\pm 3\%$
0 to ± 60 V	0.01 V/div to 0.2 V/div	$\pm(0.4\% + 8\text{ mV})$
	0.5 V/div to 2 V/div	$\pm(0.75\% + 8\text{ mV})$
	5 V/div to 20 V/div	$\pm 3\%$
0 to ± 600 V	0.1 V/div to 2 V/div	$\pm(0.65\% + 0.8\text{ V})$
	5 V/div to 20 V/div	$\pm 3\%$

V_0 output: calibrated dc offset voltage available at front panel connector, continuously variable from 0 to ± 0.006 V, 0 to ± 0.06 V, 0 to ± 0.6 V or 0 to ± 6 V. Accuracy of the 6 V range is $\pm 0.15\%$ of reading ± 8 mV, when driving a resistance of 10 megohms or higher.

Triggering

DC to 40 MHz on signals causing 0.5 div or more vertical deflection.

General

Operating environment: same as 180C/D mainframe.

Weight: net, 2.3 kg (5 lb). Shipping, 4.5 kg (10 lb).

Accessories supplied: one Operating and Service Manual.

Recommended probes

Models 10004D, 10005D, and 10006D passive probes maintain full performance of the 1803A.

Model number and name

Model number and name	Price
1801A Dual Channel Vertical Amplifier	\$1000
Option 001: channel B output and X5 magnifier	add \$155
Option 003: without probes	less \$110
Option 090: 1.8 m (6 ft) 10006D probes in lieu of 10004D	N/C
Option 091: 3 m (10 ft) 10005D probes in lieu of 10004D	N/C
1806A Dual Channel Vertical Amplifier	\$850
1807A Dual Channel Vertical Amplifier	\$750
1803A Dual Channel Vertical Amplifier	\$1500

OSCILLOSCOPES

180 Time bases: single & delayed

Models 1820C & 1821A

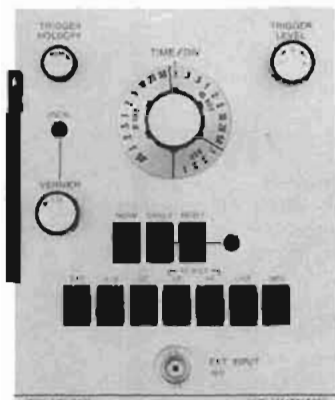

1820C



1821A

1820C Specifications

Time base

Sweep

Ranges: 0.05 μ s/div to 1 s/div (23 positions) in 1, 2, 5 sequence; $\pm 3\%$ accuracy with vernier in CAL position.

Vernier: continuously variable between ranges, extends slowest sweep to at least 2.5 s/div. Front panel light indicates when vernier is not in CAL position.

Magnifier: (mainframe) expands fastest sweep to 5 ns/div.

Sweep mode

Normal: triggered by an int, ext, or power line signal.

Automatic: bright baseline displayed in absence of trigger signal. Triggering is same as Normal except low frequency limit is 40 Hz.

Single: in Normal, sweep occurs once with same triggering as Normal (reset pushbutton arms and lights indicator); in Auto, sweep occurs once each time reset pushbutton is pressed.

Triggering

Internal: refer to vertical plug-in specifications.

External: dc to 50 MHz on signals 50 mV p-p or more increasing to 100 mV at 100 MHz and 150 mV at 150 MHz.

Line: power line frequency signal.

Level

Internal: at any point on the vertical waveform displayed.

External: continuously variable from +2 V to -2 V on either slope of trigger signal, from +20 V to -20 V in ± 10 setting.

Slope: pushbutton selection of + or - slope of trigger signal.

Coupling: front panel selection of AC, DC, HF Reject or LF Reject. AC attenuates signals below approx. 20 Hz. LF reject attenuates signals below approx. 15 kHz. HF reject attenuates signals above approx. 15 kHz.

Trigger holdoff: (time between sweeps continuously variable, exceeding one full sweep on all ranges.

General

Operating environment: same as 180C/D mainframe.

Weight: net, 1.4 kg (3 lb). Shipping, 3.2 kg (7 lb).

1821A Specifications

Main time base

Sweep

Ranges: from 0.1 μ s/div to 1 s/div (22 positions) in 1, 2, 5 sequence; $\pm 3\%$ accuracy with vernier in CAL position.

Vernier: continuously variable between all ranges; extends slowest sweep to at least 2.5 s/div.

Magnifier: (mainframe) expands fastest sweep to 10 ns/div.

Sweep mode

Normal: triggered by an int, ext, or power line signal.

Automatic: bright baseline displayed in absence of input signal. Triggering same as normal except low frequency limit is 40 Hz for internal or external modes.

Single: sweep occurs once with same triggering as normal; reset pushbutton with indicator light.

Delayed time base

Delayed time base sweeps after a time delay set by Main time base and Delay controls.

Sweep

Ranges: from 0.1 μ s/div to 50 ms/div (18 positions) in 1, 2, 5 sequence; $\pm 3\%$ accuracy with Vernier in CAL position.

Vernier: continuously variable between all ranges; extends slowest sweep to at least 125 ms/div.

Magnifier: (mainframe) expands fastest sweep to 10 ns/div.

Triggering

Main and delayed time base

Internal: refer to vertical plug-in specifications.

External: from dc to 50 MHz on signals 0.5 V p-p or more, increasing to 100 MHz on signals 1 V p-p or more.

Line: power line frequency signal.

Level and slope: internal, at any point on the vertical waveform displayed; external, continuously variable from +3 V to -3 V on either slope of the sync signal, from +30 V to -30 V in ± 10 .

Automatic (delayed only): triggered at end of set time delay.

Coupling: front panel selection of AC, DC, ACF, or ACS. AC attenuates signals below approx. 20 Hz. ACF (ac-fast) attenuates signals below approx. 15 kHz. ACS (ac-slow) attenuates signals above approx. 30 kHz.

Trace intensification: intensifies that part of Main time base to be expanded to full screen on Delayed time base. Rotating Delayed time base sweep switch from Off position activates intensified mode. Front panel screwdriver adjust sets relative intensity of brightened segment.

Delay (before start of Delayed sweep)

Time: continuously variable from 0.1 μ s to 10 s.

Accuracy: $\pm 1\%$. Linearity, $\pm 0.2\%$. Time jitter is $< 0.005\%$ (1 part in 20 000) of maximum delay of each step.

Trigger output: (at end of Delay time) approx. 1.5 V with < 50 ns rise time from 1000 ohm source resistance.

Mixed time base: dual time base in which Main time base drives first portion of sweep and delayed time base completes sweep at up to 1000 times faster. Also operates in single sweep mode.

General

Operating environment: same as 180 C/D mainframes.

Weight: net, 1.8 kg (4 lb). Shipping, 3.6 kg (8 lb).

Model number and name

1821A Time Base and Delay Generator

1820C Time Base

Price

\$875

\$525

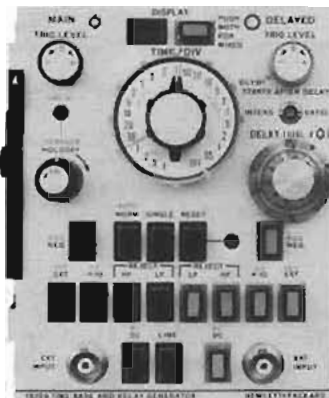

1825A

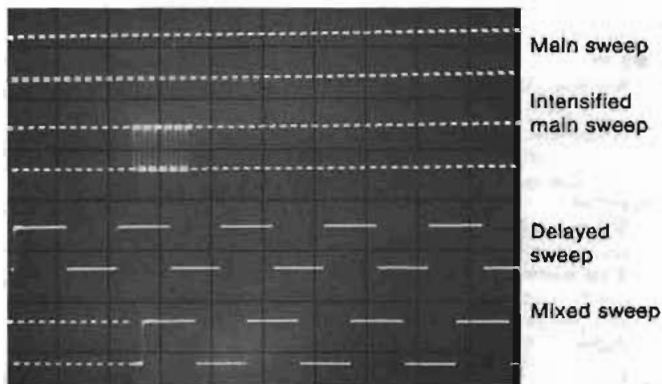

Multiple exposure shows four modes of operation for 1825A, with time relationship maintained in all modes.

1825A Description

Model 1825A time base and delay generator provides sweep speeds ranging from $0.05 \mu\text{s}/\text{div}$ to $1 \text{ s}/\text{div}$ in 23 positions. Delay times are continuously variable from 50 ns to 10 s and are accurate to 0.75% with extremely low jitter of 1 part in 50,000. Also, a calibrated mixed sweep mode is provided. A mainframe X10 magnifier increases sweep-speed capability to $5 \text{ ns}/\text{div}$ with 5% accuracy.

One knob control makes triggering easy in main, delayed, and mixed modes. Stable, accurate time displays are provided in main, delayed, and mixed modes with the highly sensitive 50 mV external trigger capability at 50 MHz which increases to only 150 mV at 150 MHz. Trigger synchronization is maintained when switching between main, delayed, and mixed modes, further simplifying use.

Front panel controls are logically arranged for quick familiarization and easy use. Pushbuttons eliminate front panel clutter and reduce the possibility of errors. Easy-to-operate pushbuttons establish main, delayed, and mixed modes of operation.

Trigger level controls on main and delayed sweeps allow selection of the triggering point on the desired portion of the signal for almost every measurement application. Also, the $\div 10$ function provides a wide dynamic range of triggering in both external and internal modes of operation.

External trigger sensitivity of 50 mV on both main and delayed sweeps allows a 10:1 divider probe to be used to reduce circuit loading at trigger pick-off points and reduces the possibility of circuit malfunction caused by the measuring instrument.

1825A Specifications

Main time base

Sweep

Ranges: $0.05 \mu\text{s}/\text{div}$ to $1 \text{ s}/\text{div}$ (23 positions) in 1, 2, 5 sequence; $\pm 3\%$ accuracy with vernier in CAL position.

Vernier: continuously variable between ranges, extends slowest sweep to at least $2.5 \text{ s}/\text{div}$. Front panel light indicates when vernier is not in CAL position.

Magnifier: (on mainframe) expands fastest sweep to $5 \text{ ns}/\text{div}$, accuracy $\pm 5\%$.

Sweep mode

Normal: sweep is triggered by an internal, external, or power line signal.

Automatic: bright baseline displayed in absence of trigger signal. Triggering is same as Normal except low frequency limit is 40 Hz.

Single: in Normal, sweep occurs once with same triggering as Normal; reset pushbutton arms sweep and lights indicator; in Auto, sweep occurs once each time reset pushbutton is pressed.

Delayed time base

Delayed time base sweeps after a time delay set by Main time base and Delay controls. Delayed time base is triggered on first trigger pulse after set delay or automatically triggers after set delay when delayed level control is in detent position.

Sweep

Ranges: $0.05 \mu\text{s}/\text{div}$ to $20 \text{ ms}/\text{div}$ (18 positions) in 1, 2, 5 sequence; $\pm 3\%$ accuracy.

Magnifier: (on mainframe) expands fastest sweep to $5 \text{ ns}/\text{div}$, accuracy $\pm 5\%$.

Triggering

Internal: refer to vertical amplifier plug-in specifications.

External: dc to 50 MHz on signals 50 mV p-p or more increasing to 100 mV p-p at 100 MHz and 150 mV p-p at 150 MHz.

Line: power line frequency signal. (Main only.)

Level

Internal: at any point on the vertical waveform displayed.

External: continuously variable from +2 V to -2 V on either slope of trigger signal, from +20 V to -20 V in $\div 10$ setting.

Slope: pushbutton selects either positive or negative slope of trigger signal.

Coupling: front panel selection of AC, DC, HF Reject, or LF Reject.

AC: attenuates signals below approx. 20 Hz.

LF reject: attenuates signals below approx. 15 kHz.

HF reject: attenuates signals above approx. 15 kHz.

Trigger holdoff: time between sweeps continuously variable, exceeding one full sweep on all ranges. (Main only.)

Delay (before start of delayed sweep)

Time: continuously variable from 50 ns to 10 s.

Accuracy: $\pm 0.75\%$ of differential delay ± 2 minor divisions of delay dial.

Time jitter: 0.002% (1 part in 50 000) of maximum delay on each range.

Trace intensification

In Main sweep mode, intensifies that part of main time base to be expanded to full screen in delayed time base mode. Rotating time base switch from OFF position activates intensified mode.

Calibrated mixed sweep

Combines Main and Delayed sweeps into one display. Sweep is started by the Main time base and is completed by the faster Delayed time base. Delayed sweep start is aligned with start of intensified marker.

General

Operating environment: same as 180C/D mainframes.

Weight: net, 1.8 kg (4 lb). Shipping, 2.7 kg (6 lb).

Accessories supplied: one Operating and Service Manual.

1825A Time Base and Delay Generator

\$875

OSCILLOSCOPES

180 Samplers: 1 GHz & 18 GHz

Models 1810A, 1811A & 1430C

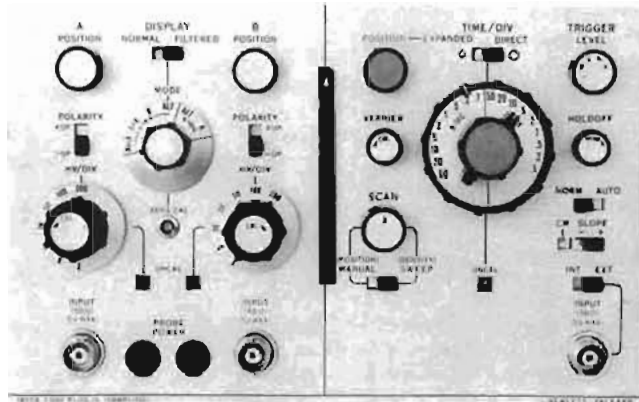

1810A

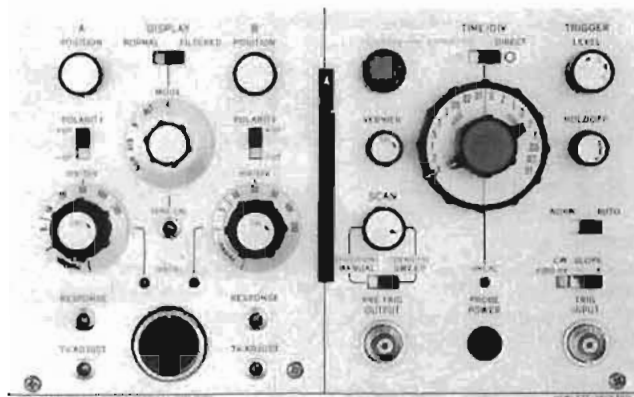

1811A

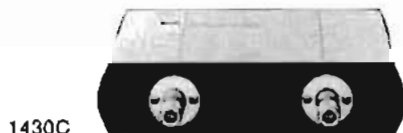

1430C

1810A Specifications

Modes of operation

Channel A; channel B; channels A and B displayed on alternate samples (ALT); channel A plus channel B (algebraic addition); and channel A versus channel B.

Vertical channels

Bandwidth: dc to 1 GHz.

Rise time: <350 ps.

Pulse response: $\leq \pm 5\%$ or 3 mV p-p (overshoot and perturbations) in normal display mode.

Deflection factor

Ranges: 2 mV/div to 200 mV/div (7 calibrated positions) in 1, 2, 5 sequence; $\pm 3\%$ accuracy.

Vernier: provides continuous adjustment between all deflection factor ranges; extends minimum deflection factor to <1 mV/div. Front panel light indicates when vernier is not in CAL position.

Polarity: + up or - up.

Dynamic range: > 1.6 V.

Positioning range: $> \pm 1$ V on all deflection factors.

Input R: 50 ohms, $\pm 2\%$.

Maximum input: ± 5 V (dc + peak ac).

SWR: <1.1 to 300 MHz, increasing to <1.5 at 1 GHz.

Reflection coefficient: <6%, measured with HP Model 1415A TDR.

Random noise

Normal: <2 mV, observed from center 80% of dots.

Filtered: reduces noise at least 2 to 1.

Isolation between channels: ≥ 40 dB with 350 ps rise time input.

Time difference between channels: <100 ps.

A + B operation: bandwidth and deflection factors are unchanged; either channel may be inverted for $\pm A \pm B$ operation.

Time base

Ranges

Normal: 10 ns/div to 50 μ s/div (12 calibrated positions) in a 1, 2, 5 sequence. $\pm 3\%$ accuracy with vernier in calibrated position.

Expanded: direct reading expansion up to X100 in seven calibrated steps on all normal time scales, extends the range to 100 ps/div. Accuracy is $\pm 4\%$ (10 ps/div, $\pm 10\%$ using the mainframe magnifier).

Vernier: continuously variable between ranges; increases fastest sweep to <40 ps/div. Front panel light indicates when vernier is not in CAL position.

Triggering

Mode

Normal: trigger level control can be adjusted to trigger on a wide variety of signals.

Automatic: triggers automatically on most signals with a minimum of adjustment of the level control. A baseline is displayed in the absence of an input signal.

Internal

Source: selectable; channel A triggers channel A or alternate; channel B triggers channel B, alternate, A + B, or A vs B.

Sine wave: 30 mV p-p for signals from 1 kHz to 200 MHz, 100 mV p-p for signals from 200 MHz to 1 GHz for jitter of <30 ps plus 1% of 1 period. Useful triggering can be obtained with 5 mV signals.

Pulse: 30 mV peak, 3 ns wide pulses for <30 ps jitter. Useful triggering can be obtained with 5 mV signals.

External

Sine wave: 30 mV p-p for signals from 1 kHz to 1 GHz for jitter of <30 ps plus 1% of 1 period. Useful triggering can be obtained with 5 mV signals.

Pulse: 30 mV peak, 3 ns wide pulses for <30 ps jitter. Useful triggering can be obtained with 5 mV signals.

Either internal or external

Auto: 50 mV p-p for CW signals from 10 kHz to 200 MHz for <30 ps jitter plus 2% of 1 period (may be used to 1 GHz with increased jitter). Pulse triggering requires 50 mV peak, 3 ns wide pulses for <30 ps jitter.

Level and slope: level control minimizes jitter and is variable over ± 800 mV range on either slope of sync signal.

Coupling: ac coupling attenuates signals below approx. 1 kHz.

Variable holdoff: variable over at least a 3:1 range in all sweep modes.

Marker position: intensified marker segment indicates point about which the sweep is to be expanded (automatically dimmed with increasing persistence in 181 and 184 mainframes).

Scan

Internal: dot density, continuously variable from <100 to >1000 dots full screen or from approx. 500 to 2000 dots in filtered mode.

Manual: scan is positioned manually by front panel control

General

Probe power: supplies power to operate two HP active probes.

Recorder outputs

Vertical: an uncalibrated 1 V vertical output from each channel is provided at the rear panel of 180 system mainframes.

Horizontal: an uncalibrated 0.75 V amplitude signal is provided at the rear panel of 180, 181, 182, and 184 mainframes.

Operating environment: same as 180C/D mainframes.

Weight: net, 3.2 kg (7 lb). Shipping, 5 kg (11 lb).

Accessories supplied: one Operating and Service Manual.

1811A Specifications

Modes of operation

Channel A; channel B; channels A and B displayed on alternate samples (ALT); channel A plus channel B (algebraic addition); and channel A versus channel B.

Vertical channels

Deflection factor

Ranges: 2 mV/div to 200 mV/div (6 calibrated positions) in 1, 2, 5 sequence; accuracy $\pm 3\%$.

Vernier: provides continuous adjustment between all deflection factor ranges; extends minimum deflection factor to < 1 mV/div. Front panel light indicates when vernier is not in CAL position.

Polarity: + up or - up.

Positioning range: $> \pm 1$ V on all deflection factors.

A + B operation: bandwidth and deflection factors are unchanged; either channel may be inverted for $\pm A \pm B$ operation.

Time base

Ranges

Normal: 1 ns/div to 5 μ s/div (12 calibrated positions) in a 1, 2, 5 sequence. $\pm 3\%$ accuracy with vernier in calibrated position.

Expanded: direct reading expansion up to X100 in seven calibrated steps on all normal time scales, extends the range to 10 ps/div. Accuracy is $\pm 4\%$ (1 ps/div, $\pm 10\%$ using the mainframe magnifier).

Vernier: continuously variable between ranges; increases fastest sweep to < 4 ps/div.

Triggering

Auto: triggers automatically on most signals with a minimum of level control adjustment. A baseline is displayed in the absence of an input signal.

Normal: trigger level control may be adjusted to trigger on a wide variety of signals.

CW: 80 mV p-p for sine wave signals from 1 kHz to 1 GHz for jitter of < 10 ps plus 1% of 1 period of trigger signal. Useful displays can be obtained with trigger signals as low as 5 mV. Triggering may be extended to 18 GHz with HP Model 1104A/1106B trigger countdown.

\pm Slope: triggers on 50 mV/peak, 3 ns wide pulses, for < 30 ps jitter.

Level and slope: continuously variable from +800 mV to -800 mV on either side of sync signal.

Coupling: ac coupling attenuates signals below approx. 1 kHz.

Variable holdoff: variable over at least a 3:1 range in all sweep modes.

Marker position: intensified marker segment indicates point about which the sweep is to be expanded (automatically dimmed with increasing persistence in 181 and 184 variable persistence/storage mainframes).

Scan

Internal: dot density, continuously variable from < 100 to > 1000 dots full screen or from approx. 500 to > 2000 dots in filtered mode.

Manual: scan is positioned manually by front panel control.

Trigger output: 1 ns, 1.5 V into 50 ohms.

General

Probe power: supplies power to operate HP active probe.

Recorder outputs

Vertical: an uncalibrated 1 V vertical output signal from each channel is provided at the rear panel of 180 series mainframes.

Horizontal: an uncalibrated 0.75 V amplitude signal is provided at the rear panel of 180, 181, 182, or 184 mainframes.

Operating environment: same as 180C/D mainframes.

Weight: net, 2.3 kg (5 lb). Shipping, 5 kg (11 lb).

Accessories supplied: one Operating and Service Manual.

1430C Specifications

Sampling head

Rise time: approx. 20 ps (< 28 ps observed with 1105A/1106B pulse generator and 909A Option 012, 50 ohm load).

Bandwidth: dc to > 18 GHz.

Overshoot: $< 7.5\%$.

Noise: approx. 10 mV observed noise on CRT excluding 10% of random dots. Noise decreases to approx. 2.5 mV on the automatically filtered 2 mV/div and 5 mV/div ranges and all other ranges when display switch (on 1811A) is set to filtered position.

Dynamic range: 1 V p-p.

Low frequency distortion: $< \pm 5\%$.

Maximum safe input: ± 3 volts.

Input characteristics

Mechanical: type N female connectors on input and output ports.

Electrical: 50 ohm feedthrough, dc-coupled. Reflection from sampler is approx. 10%, measured with a 40 ps TDR system. Pulses emitted from sampler input are approx. 10 mV amplitude and 5 ns duration.

Time difference between channels: < 5 ps.

Isolation between channels: ≥ 40 dB over sampler bandwidth.

Connecting cable length: 1.5 m (5 ft).

General

Weight: net, 1.8 kg (4 lb). Shipping, 4.1 kg (9 lb).

Accessories supplied: two 50 ohm loads with type N male connectors (HP Model 909A Option 012), one 1.5 m (5 ft) sampling head to 1811A interconnecting cable (HP P/N 5060-0540), and one Operating and Service Manual.

*Components required for sampling systems

1811A Sampling plug-in
Sampling to 18 GHz with 1430C Sampling Head (Type N Female input/output connectors)
Trigger Accessories
< 1 GHz: Cable 11500A Type N Male to Type N Male 1.8 m (6 ft), Adapter 1250-0077 Type N Female to BNC Male.
1 GHz to 10 GHz: 1104A Trigger Countdown, 1108A Tunnel Diode, Adapter 1250-0847 GR Type 874 to Type N Male, 1109B High Pass Filter, 10503A Male BNC to Male BNC Trigger Cable 1.2 m (4 ft).
1 GHz to 18 GHz: 1104A Trigger Countdown, 1106B Tunnel Diode, 1109B High Pass Filter, 10503A Male BNC to Male BNC Trigger Cable 1.2 m (4 ft).
TDR with 1430C Sampling Head
1105A Pulse Generator, 1106B Tunnel Diode 20 ps tr, 10503A Male BNC to Male BNC Trigger Cable 1.2 m (4 ft).
1105A Pulse Generator, 1108A Tunnel Diode 60 ps tr, Adapter 1250-0847 GR 874 to Type N Male, 10503A 1.2 m (4 ft) Male BNC to Male BNC Trigger Cable.

*Use any 180 series mainframe

Model number and name	Price
1810A Sampler	\$2350
1811A Sampler	\$2100
1430C Sampling Head, 18 GHz	\$3250
1104A Trigger Countdown	\$270
1105A Pulse Generator	\$320
1106B (Type N Connector)	\$650
1106B Opt. 001 (APC-7 connector)	\$700
1108A (GR-874 Connector)	\$290
Recommended Accessory: HP Model 1109B High Pass Filter	\$230

OSCILLOSCOPES

180 TDR: 35 & 170 ps rise time

Models 1815A/B, 1816A, 1817A & 1818A

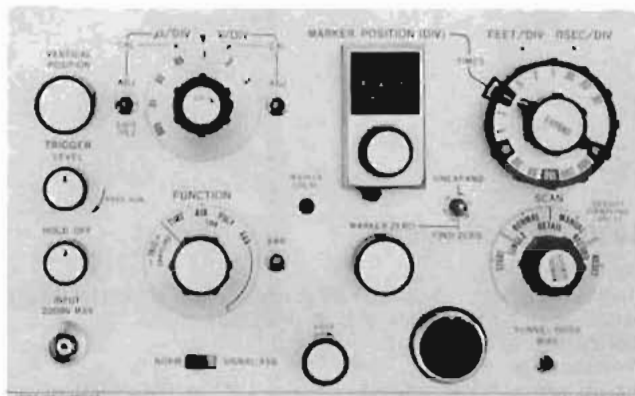

1815A



1817A



1816A

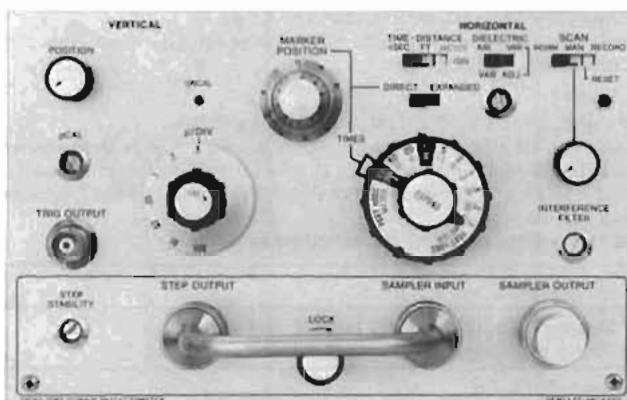

1818A

1815A/B Description

Models 1815A and 1815B provide calibrated 35 ps system rise time, time domain reflectometry and 12.4 GHz (28 ps rise time) sampling capability with remote feedthrough sampling heads for extremely accurate measurements. This TDR system can locate impedance discontinuities in transmission systems up to 10 000 metres or feet long and also allows measurement of discontinuities spaced only a few millimetres apart. As a single channel, general purpose sampling oscilloscope, you have deflection factors to 2 mV/div and sweep times to 10 ps/div.

1815A/B Specifications

Unless indicated otherwise, TDR and sampling performance specifications are the same. Where applicable, TDR specification is given first, followed by Sampler specification in parentheses. Model 1815A is calibrated in feet and Model 1815B is calibrated in metres.

Vertical

Scale: reflection coefficient ρ (volts) from 0.005/div to 0.5/div in 7 calibrated ranges; 1, 2, 5 sequence.

Accuracy: $\pm 3\%$; TDR only, $\pm 5\%$ on 0.01/div and 0.005/div in signal average mode.

Vernier: provides continuous adjustment between ranges; extends scale to >0.002 /div.

Signal average: reduces noise and jitter approx. 2:1.

Horizontal

Scale: provides up to a 10 000 metre or foot display window with round-trip time or distance (time) in four calibrated decade ranges of 1/div, 10/div, 100/div, and 1000/div. Concentric expand control provides direct read-out in 28 calibrated steps in 1, 2, 5 sequence from 0.01 ns/div to 1000 ns/div or from 0.01 metre or foot/div to 1000 metres or feet/div.

Accuracy: time, $\pm 3\%$; distance (TDR only) $\pm 3\%$, \pm variations in propagation velocity.

Marker position: indicator, calibrated in divisions, provides direct read-out of round-trip time or distance (time), number of divisions \times decade range in units/div. Front panel light indicates when vernier is not in CAL position.

Marker zero: ten-turn control provides variable reference for marker position dial, allows direct read-out of round-trip or distance (time) between two or more displayed events.

Zero finder: permits instant location of marker reference.

Dielectric, TDR only: calibrated for air, $\epsilon = 1$ and for polyethylene, $\epsilon = 2.25$. Also provides settings for dielectric constants $\epsilon = 1$ to $\epsilon =$ approx. 4.

Triggering, sampling only

Pulses: <50 mV for pulses 5 ns or wider for jitter <20 ps.

CW: signals from 500 kHz to 500 MHz require at least 80 mV for jitter $<2\%$ of signal period plus 10 ps; usable to 1 GHz. CW triggering may be extended to 18 GHz with HP models 1104A/1106B trigger countdown.

Recorder outputs

Approx. 100 mV/div; vertical and horizontal outputs at BNC connectors on rear panel of mainframe.

Display modes

Repetitive scan, normal or detail; single scan; manual scan; record.

General

Operating environment: temperature, 0 to $+55^\circ\text{C}$ ($+32^\circ\text{F}$ to $+130^\circ\text{F}$); humidity, to 95% relative humidity at 40°C (104°F); altitude, to 4600 m (15 000 ft); vibration, vibrated in three planes for 15 min. each with 0.254 mm (0.010 in.) excursion, 10 to 55 Hz.

Weight: net, 2.3 kg (5 lb). Shipping, 4.5 kg (10 lb).

1817A (28 ps Tr)/1816A (90 ps Tr) samplers specifications

Unless indicated otherwise, Model 1817A and Model 1816A specifications are the same. Where applicable, Model 1817A specification used with Model 1106B Opt 001 tunnel diode mount is given first, followed by Model 1816A specification (in parentheses) used with Model 1108A tunnel diode mount.

TDR system (requires 1106B Opt 001 or 1108A)

System rise time: <35 ps (110 ps) incident as measured with Model 1106B Opt 001 (Model 1108A).

Overshoot: $<\pm 5\%$.

Internal reflections: $<10\%$ with 45 ps (145 ps) TDR; use reflected pulse from shorted output.

Jitter: <15 ps; with signal averaging, typically 5 ps. Internal pickup: $\rho \leq 0.01$.

Noise: measured tangentially as a percentage of the incident pulse when terminated in 50 ohms and operated in signal averaging mode. $<1\%$ (0.5%) on 0.005/div to 0.02/div; $<3\%$ (1%) on 0.05/div to 0.5/div.

Low frequency distortion: $\leq \pm 3\%$.

Maximum safe input: 1 volt.

Tunnel diode mount: direct connection of 1106B Opt 001 to 1817A or 1108A to 1816A.

Sampler system

Rise time: <28 ps (90 ps).

Input: 50 ohm feedthrough.

Dynamic range: 1 V p-p.

Maximum safe input: 3 volts (5 volts).

Low frequency distortion: $\leq \pm 3\%$.

Noise

Normal: <8 mV (3 mV) tangential noise on 0.01 V/div to 0.5 V/div

Noise decreases automatically on 0.005 V/div range.

Signal average: reduces noise and jitter approx. 2:1



General

Weight

1817A: net, 1.4 kg (3 lb). Shipping, 5 kg (11 lb).

1818A: net, 1.4 kg (3 lb). Shipping, 4.5 kg (10 lb).

Accessories supplied

Cable, Plug-in to sampler: connects sampler (1816A or 1817A) to plug-ins (1815A or B). HP P/N 5060-0441.

Cable, tunnel diode to sampler: connects tunnel diode (1106B Opt 001 or 1108A) to sampler, type N male connectors on each end. HP P/N 01817-61603.

Recommended accessories

Trigger source: external trigger source is required for triggering above 500 MHz. 10 GHz source is provided by the 1104A Trigger Countdown with the 1108A Tunnel Diode Mount. 18 GHz source is provided by the 1104A Trigger Countdown with the 1106B Opt 001 Tunnel Diode Mount.

1106B Opt 001 (20 ps Tr)/1108A (60 ps Tr) tunnel diode mounts specifications

Tunnel diode is required for a TDR system. Refer to sampling head specifications for mounting requirements.

Amplitude (both): >200 mV into 50 ohms.

Rise time: 1106B Opt 001 approx. 20 ps; 1108A, <60 ps.

Output impedance: 50 ohms, $\pm 2\%$.

Source reflections: 1106B Option 001, <10% with 45 ps TDR; 1108A, <10% with 145 ps TDR.

Weight (both): net, 0.5 kg (1 lb). Shipping, 1.4 kg (3 lb).

*Components required for TDR/sampling systems

1815A/B TDR/SAMPLING PLUG-IN	
1817A Sampling Head (APC-7 Input/Output Connectors)	1816A Sampling Head (GR Type 874 Input/Output Connectors)
TDR 35 ps Tr 1106B Opt 001 Tunnel Diode	TDR 110 ps Tr 1108A Tunnel Diode
Sampling up to 12.4 GHz Termination, 50 ohm Model 909A, APC-7 connector.	Sampling 4 GHz Termination, 50 ohm with GR Type 874 connector, HP P/N 0950-0090.
Trigger Accessories <500 MHz Adapter, 1250-0750 APC-7 to Type N Female, 11500A Cable Type N Male to Type N Male, 1.8 m (6 ft), Adapter 1250-0077 Type N Female to BNC Male.	Trigger Accessories <500 MHz Adapter 1250-1211 GR Type 874 to Type N Female, 11500A Cable Type N Male to Type N Male 1.8 m (6 ft), Adapter 1250- 0077 Type N Female to BNC Male.
500 MHz to 10 GHz 1104A Trigger Countdown. 1108A Tunnel Diode. Adapter 1250-0847 GR Type 874 to Type N Male. 1109B High Pass Filter. Adapter 1250-0750 APC-7 to Type N Female. 10503A Male BNC to Male BNC Trigger Cable 1.2 m (4 ft).	500 MHz to 10 GHz 1104A Trigger Countdown. 1108A Tunnel Diode. Adapter 1250-0847 GR Type 874 to Type N Male. 1109B High Pass Filter. Adapter 1250-0240 GR Type 874 to Type N Male. 10503A Male BNC to Male BNC Trigger Cable 1.2 m (4 ft).
500 MHz to 18 GHz 1104A Trigger Countdown. 1106B Opt 001 Tunnel Diode. Adapter 1250-0749 APC-7 to Type N Male. 1109B High Pass Filter. Adapter 1250-0750 APC-7 to Type N Female. 10503A Male BNC to Male BNC Trigger Cable 1.2 m (4 ft).	

*Use any 180 series mainframe.

1818A Description

The 1818A Time Domain Reflectometer plug-in with a 180 series mainframe gives you a completely integrated wide band system for testing of transmission lines, strip lines, cables, connectors, and many other devices in high frequency systems. The easy-to-use controls provide accurate direct distance calibrated displays of up to 300 metres or 1000 feet with dielectric materials from $\epsilon = 1.0$ (air) to $\epsilon = 4.0$. This allows you to quickly determine the magnitude and nature of each resistive or reactive discontinuity in coaxial components such as attenuators, cables, connectors, and delay lines in microwave or pulse circuits. You can also locate and identify faults such as shorts, opens, loose connectors, defective tap offs, splices, and mismatches with measurement resolution as close as 2.54 cm.

1818A Specifications

System (in reflectometer configuration)

Rise time: <170 ps.

Overshoot: $\leq 5\%$ overshoot and ringing (down to $\frac{1}{2}\%$ in 3 ns).

Internal reflections: <10% (does not limit resolution).

Reflectometer sensitivity: reflection coefficients as small as 0.001 can be observed.

Signal channel

Rise time: approx. 150 ps.

Reflection coefficient: 0.5/div to 0.005/div in a 1, 2, 5 sequence.

Input: 50 ohms, feedthrough type.

Noise and internal pickup, peak: 0.1% of step (terminated in 50 ohms).

Dynamic range: ± 0.5 volt.

External signal level: up to 1 V peak may be safely applied to the Sampler output connector.

Attenuator accuracy: $\pm 3\%$.

Step generator

Amplitude: approx. 0.25 V into 50 ohms (0.5 V into open circuit).

Rise time: approx. 50 ps.

Output impedance: 50 ohms ± 1 ohm (dc-coupled).

Drop: <1% in 1 μ s.

Distance/time

Distance scale: 3 metres/div and 30 metres/div; 10 ft/div and 100 ft/div. Accuracy, $\pm 3\%$.

Variable dielectric: $\epsilon = 1$ to $\epsilon = 4$.

Time scale: 10 ns/div and 100 ns/div. Accuracy, $\pm 3\%$.

Magnification: X1 to X100 in a 1, 2, 5 sequence provides time scales down to 0.1 ns/div and distance scales to 0.03 metres/div or 0.1 ft/div. Accuracy of the basic sweep is maintained at all magnifier settings.

Delay control: 0 to 10 div of unmagnified sweep. Accuracy, $\pm 3\%$.

Jitter: <20 ps.

General

Recorder outputs

Vertical: approx. 1 V vertical output signal is provided at the rear panel of 180 series mainframes.

Horizontal: approx. 1 V horizontal output signal is provided at the rear panel of a 180, 181, 182, or 184 mainframe.

Operating environment: temperature, 0 to +35°C (35°C to 55°C with small increase in system rise time); humidity, to 95% relative humidity at 40°C (104°F); altitude, to 4600 m (15 000 ft); vibration, vibrated in three planes for 15 min, each with 0.254 mm (0.010 in.) excursion, 10 to 55 Hz.

Weight: net, 2.3 kg (5 lb). Shipping, 5 kg (11 lb).

Accessories supplied: type N connector assembly. One 50 ohm load with Type N male connector. One Operating and Service Manual.

Model number and name

Model number and name	Price
1815A TDR/Sampler (calibrated in feet)	\$1750
1815B TDR/Sampler (calibrated in metres)	\$1750
1817A 28 ps Rise Time Sampling Head	\$2050
1816A 90 ps Rise Time Sampling Head	\$1500
1104A Trigger Countdown	\$270
1106B Opt 001 20 ps Tunnel Diode Mount	\$700
1108A 60 ps Tunnel Diode Mount	\$290
1818A Time Domain Reflectometer	\$1315

OSCILLOSCOPES

180 Sampling & TDR accessories

Models 1104A, 1105A, 1106B, 1108A & 1109B



1104A

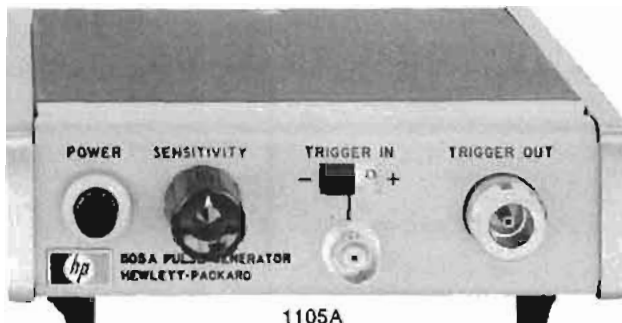

1105A



1106B



1108A



1109B



908A

1104A/1106B/1108A Specifications

1104A/1106B 18 GHz trigger countdown

1104A/1108A 10 GHz trigger countdown

Input

Frequency range: (1106B) 1 GHz to 18 GHz. (1108A) 1 GHz to 10 GHz.

Sensitivity: (1106B) signals 100 mV or larger up to 12.4 GHz, produce <20 ps of jitter (200 mV required to 18 GHz). (1108A) signals up to 50 mV or larger up to 10 GHz produce <20 ps jitter.

Maximum safe input: ± 1 V.

Input impedance: dc resistance approx 50 ohms. Reflection from input connector is <10% using a 40 ps TDR system.

Signal appearing at input connector: approx. 250 mV.

Output

Center frequency: approx. 100 MHz.

Amplitude: typically 150 mV.

Connectors

1104A: input, type N male; trigger output, BNC female.

1106B: input, type N male; output, type N female.

1108B Opt 001: input, APC-7; output, type N female.

1108A: input, GR Type 874; output type N female.

Weight

1104A: net, 0.9 kg (2 lb). Shipping, 1.8 kg (4 lb).

1106B or 1108A: net, 0.5 kg (1 lb). Shipping, 0.9 kg (2 lb).

1105A/1106B/1108A Specifications

1105A/1106B/20 ps pulse generator

1105A/1108A/60 ps pulse generator

Output

Rise time: approx. 20 ps with 1106B. (<60 ps with 1108A). <28 ps observed with HP Model 1411A/1430C 28 ps Sampler and 50 ohm termination HP Model 909A Option 012.

Overshoot: $\pm 7.5\%$ as observed on 1411A/1430C with 909A Option 012.

Droop: <3% in first 100 ns.

Width: approx. 3 μ s.

Amplitude: > +200 mV into 50 ohms.

Output characteristics (1106B/1108A)

Mechanical: (1106B) Male Type N input connector, Female Type N output connector; (1108A) GR-874 input connector, Female Type N output connector.

Electrical: dc resistance, 50 ohms $\pm 2\%$. Source reflection, <10%, using a 40 ps TDR system. DC offset V, approx. 0.1 V.

Triggering

Amplitude: at least ± 0.5 V peak required.

Rise time: <20 ns required. Jitter <15 ps when triggered by 1 ns rise time sync pulse.

Width: >2 ns.

Maximum safe input: 1 volt.

Input impedance: 200 ohms, ac-coupled through 20 pF.

Repetition rate: 0 to 100 kHz; free runs at 100 kHz.

Accessories supplied (with Model 1105A): one 1.8 m (6 ft) 50 ohm cable with Type N Male connectors on each end, HP Model 10132A

Weight

1106B or 1108A: net, 0.5 kg (1 lb). Shipping, 0.9 kg (2 lb).

1105A: net, 0.9 kg (2 lb). Shipping, 1.4 kg (3 lb).

1109B High-pass filter

The 1109B High-Pass Filter transmits only frequencies above 1 GHz. It is useful for blocking the 100 MHz "kickout" encountered when using a tunnel diode countdown to view high frequency signals on a sampling oscilloscope. The 1109B is designed for use with the Model 1104A/1106B Trigger Countdown.

1109B Specifications

Lower bandwidth limit: 3 dB down at 3 GHz, nominal.

Input characteristics

Mechanical: male type N input connector; Female Type N output connector.

Electrical (with output terminated in 50 ohms)

Reflection: <10% using 40 ps TDR system.

SWR: typically 1.1 up to 10 GHz increasing to 2 at 15 GHz.

DC Resistance: 50 ohms $\pm 2\%$ shunted across line.

Weight: net, 0.14 kg (5 oz). Shipping, 0.45 kg (2 lb).

Other sampling accessories

50 ohm loads: Models 908A with Type N male connector (4 GHz) and 909A Option 012 with Type N male connector (18 GHz).

50 ohm adapters: Model 11524A has Type N Female and APC-7 connectors; Model 11525A has Type N Male and APC-7 connectors.

Air line extensions: Model 11566A, 10 cm, APC-7 connector. Model 11567A, 20 cm, APC-7 connector.

Model number and name

Model number and name	Price
1104A Trigger Countdown	\$270
1105A Pulse Generator	\$320
1106B 20 ps Tunnel Diode Mount	\$650
1108A 60 ps Tunnel Diode Mount	\$290
1109B High Pass Filter	\$230
908A 50 ohm Termination	\$50
909A Opt 012 50 ohm Termination	\$80
11524A 50 ohm Adapter	\$85
11525A 50 ohm Adapter	\$85
11566A Air Line Extension	\$150
11567A Air Line Extension	\$170

OSCILLOSCOPES

180 Spectrum analyzers

Models 8557A & 8558B



- Economic spectrum analysis 0.01 to 1500 MHz
- Simple, 3 knob operation
- Direct signal power display in dBm

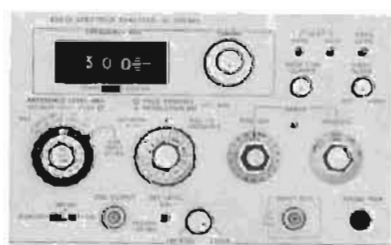
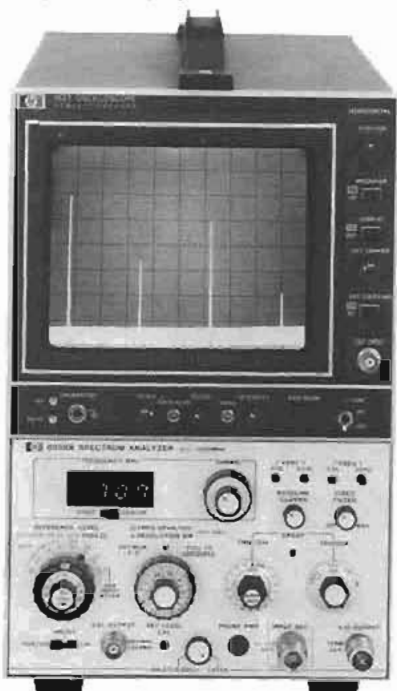

8557A

8558B and 8557A spectrum analyzer

The 8557A/8558B spectrum analyzers plug into any 180 series oscilloscope mainframe to provide low cost 0.01 to 350 MHz or 0.1 to 1500 MHz performance with high amplitude and frequency accuracy, and they're easy to use.

Simple three knob operation

For most measurements only three controls are required; one for amplitude calibration and two for frequency calibration. The center or start frequency of the display is shown on a digital readout, and the analyzer automatically selects the resolution bandwidth and proper scan time to provide calibrated measurements with any desired frequency scan.

Absolute amplitude calibration

Signal levels can be read directly from the CRT display in dBm (or dBmV for option 002) without the use of external standards or calculations. The signal level represented by the top CRT graticule line is always indicated by the reference level control, and scale factors of 10 dB/div, 1 dB/div, and linear can be selected.

Optional 75 ohm input impedance

Two options are available which allow measurements in 75 ohm systems: Option 001 has 75 ohm impedance and retains the dBm power calibration; Option 002 has 75 ohm impedance with the amplitude calibrated in dBmV for measurements in systems such as CATV.

Companion tracking generator

The 8444A Option 058 tracking generator provides a calibrated RF

- Resolution bandwidths from 1 kHz to 3 MHz
- Optional 75Ω input impedance
- Companion tracking generator (for 8558B only)

signal matching exactly the 8558B analyzer tuned frequency. This makes swept frequency tests, such as insertion loss and return loss measurement, possible over 0.5 to 1300 MHz frequency range. The 8444A Option 058 is specified on page 454.

Suggested displays

The 8557A/8558B spectrum analyzers will function with any 180-series display. However, the following are suggested: for low cost, large screen display, the Model 182T is ideal; the Model 181T offers variable persistence and storage; and the Model 180TR offers a rack mount configuration. Each of these displays provides a long persistence P39 phosphor (except variable persistence displays) and four non-buffered rear panel outputs compatible with most X-Y recorders. 100 volt operation available as option 003.

8557A and 8558B Specifications

Frequency specifications

Frequency range: 10 kHz to 350 MHz (8557A), 100 kHz to 1500 MHz (8558B).

Frequency display span (on a 10-division CRT horizontal axis):

8557A: F (full span, 0.01–350 MHz), 12 calibrated spans from 20 MHz/div to 5 kHz/div in a 1, 2, 5 sequence; **8558B:** 14 calibrated spans from 100 MHz/div to 5 kHz/div. In 0 kHz/div both analyzers become fixed-tuned receivers.

Digital frequency readout: Indicates center frequency or start frequency of the frequency display scan.

Stability

Residual FM: less than 1 kHz peak-to-peak for time ≤ 0.1 sec.

Noise sidebands: more than 75 dB (8557A), 65 dB (8558B) below CW signal, 50 kHz or more away from signal with a 1 kHz resolution bandwidth and full video filter.

Resolution

Bandwidth ranges: 3 dB resolution bandwidths of 1 kHz to 3 MHz in a 1, 3, 10 sequence.

Resolution bandwidth selectivity: 60 dB/3 dB resolution bandwidth ratio $< 15:1$.

Video filter: post-detection filter used to average displayed noise.

Amplitude specifications

Absolute amplitude calibration range

Log calibration range: from -117 dBm to $+20$ dBm (8557A), $+30$ dBm (8558B) in 10 dB steps. Reference level vernier, 0 to -12 dB continuously.

Log display ranges: 10 dB/div on a 70 dB display, and 1 dB/div on an 8 dB display.

Linear display: from 2.2 microvolts (-100 dBm) full scale to 2.24 volts ($+20$ dBm) 8557A, 7.1 volts ($+30$ dBm) 8558B full-scale in 10 dB steps.

Dynamic range

Average noise level: < -107 dBm with 10 kHz resolution bandwidth (0 dB input attenuation).

Spurious responses: For input signal level \leq Optimum Input Level setting, all image and out-of-band mixing responses, harmonic and intermodulation distortion products are more than 70 dB below input signal level, 1 MHz to 350 MHz (8557A), 5 MHz to 1500 MHz (8558B); 60 dB below, 20 kHz to 1 MHz (8557A), 100 kHz to 5 MHz (8558B).

Residual responses (no signal present at input): < -100 dBm with 0 dB input attenuation.

Calibrator

Amplitude: -30 dBm ± 1.0 dB.

Frequency: 250 MHz (8557A), 280 MHz (8558B) ± 50 kHz, crystal controlled.

Input specifications

Input impedance: 50Ω nominal.

Typical reflection coefficient < 0.27 (1.74 SWR) 8557A, < 0.20 (1.5 SWR) 8558B for all Optimum Input Level settings except -40 dBm (0 dB Input Attenuation).

Input connector: BNC female (8557A), type N female (8558B).

Input attenuator: 50 dB range (8557A), 70 dB range (8558B).

Price and further information: see pages 452 & 454.

OSCILLOSCOPES

15 MHz, dual channel, variable persistence/storage

Model 1223A

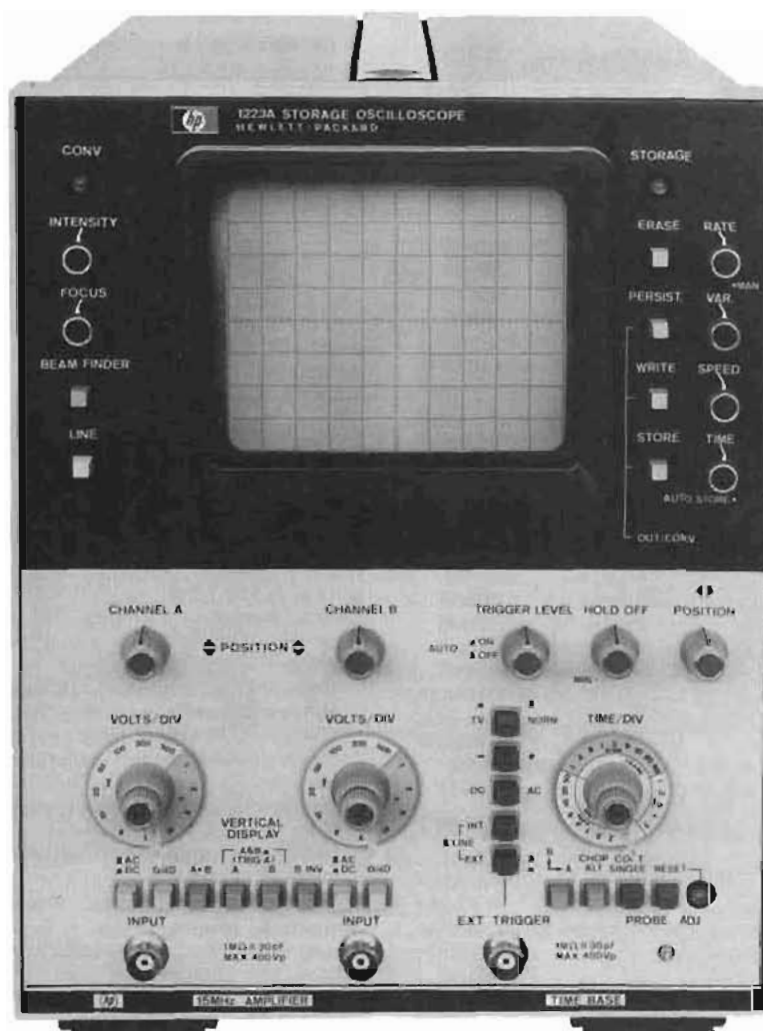

1223A

1223A Description (new)

Hewlett-Packard Model 1223A dual channel 15 MHz oscilloscope incorporates a rugged, performance proven CRT that gives you a choice of conventional, variable persistence, or storage operation. Features include: an 8 X 10 division internal graticule for parallax-free measurements, 3% vertical accuracy, 4% horizontal accuracy, calibrated sweep speeds from 2 s/div to 0.1 μ s/div, automatic triggering, pushbutton beam finder, X-Y display capability, TV sync separator, variable trigger holdoff, dc-coupled external trigger, selectable Chop or Alternate sweep mode, and single-shot capability. Storage features include: variable erase rate, variable writing speed, auto-store mode, remote erase and remote setting of erase rate. The 1223A cabinet utilizes Hewlett-Packard's "System II" enclosure system for a strong light-weight package that attenuates RFI and provides easy accessibility for servicing, and versatility in bench/rack configuration.

Triggering

The operator can select the source of the sweep trigger (internal, line, external ac, dc, or TV) as well as trigger on either the positive or negative going transitions of the signal. Further flexibility is added by the ability to preset the signal amplitude required to trigger the sweep, assuring that perturbations below the desired amplitude do not trigger the oscilloscope. A trigger holdoff control eliminates double triggering on complex digital waveforms and maintains a full-screen, calibrated sweep.

Automatic triggering assures that a base-line is present even in the absence of a signal or if the trigger level control is set beyond the range of the trigger signal. With automatically triggered sweep, displays are stable because the observed signal itself determines when a sweep should start.

Storage/variable persistence CRT

The 8 X 10 division Hewlett-Packard post-accelerator storage CRT, with 1.5 kV accelerating potential, aluminized P31 phosphor, and mesh storage, offers a bright, crisp trace in both conventional and storage modes. For maximum convenience in single-shot applications, an auto-store mode which operates in the single-shot mode, makes it easy to capture random events.

For viewing low rep rate fast rise time signals, the variable persistence mode allows you to adjust the trace for an optimum display. By adjusting the persistence to match the rep rate you can integrate a trace to provide a sharp, clear display for accurate measurements of low duty-cycle pulse trains such as those from disc, tape, or drum peripheral units.

For convenience and flexibility other storage features include: variable erase rate, variable writing speed, an auto-store mode for capturing and storing single events, and remote erase and remote setting of erase rate.

X-Y inputs

Phase shift measurements through the vertical amplifiers permit maximum measurement flexibility with the wide selection of deflection factors.

TV sync

The built-in TV sync separator assures stable, automatic triggering on frame or line for convenient TV troubleshooting. With the instrument's times-ten magnifier, signals can be pulled out easily. The calibrated time base makes it easy to identify timing problems in vertical or horizontal TV circuits. The external horizontal input allows vector presentations of color CRT drive signals. Dual channels make it easy to set color demodulator circuits.

Optional accessories

General purpose probing is provided with the Model 10013A 10:1 divider probe with 10 megohms input shunted by only 13 pF. It extends input range to 100 V/div and multiplies input impedance without degrading frequency response. A standard (corporate) rack mounting adapter kit is available.

1223A Specifications

Modes of operation

Channel A; channel B; channels A and B displayed alternately on successive sweeps (ALT); channels A and B displayed by switching between channels at approx. 200 kHz rate with blanking during switching (CHOP); channel A plus channel B (algebraic addition).

Vertical amplifiers (2)

Bandwidth: (3 dB down from 50 kHz, 6 div reference signal from a terminated 50 ohm source)

DC-coupled: dc to 15 MHz.

AC-coupled: lower limit is approx. 2 Hz.

Rise time: approx. 23 ns (measured from 10% to 90% points of 6 div input step from a terminated 50 ohm source).

Deflection factor

Ranges: 2 mV/div to 10 V/div (12 calibrated positions) in 1, 2, 5 sequence. $\pm 3\%$ accuracy with vernier in calibrated position on 10 mV/div to 10 V/div ranges, $\pm 5\%$ accuracy on 2 mV/div and 5 mV/div ranges.

Vernier: continuously variable between all ranges; extends maximum deflection factor to at least 25 V/div.

Polarity: channel B may be inverted, front panel pushbutton.

Signal Delay: input signals are delayed sufficiently to view leading edge of input signal without advanced external trigger.

Input RC: AC or DC, approx. 1 megohm shunted by approx. 30 pF.

Input coupling: AC, DC, or GND. GND position disconnects input connector and grounds amplifier input.

Maximum Input: ± 400 V (dc + peak ac).

A+B operation

Amplifier: bandwidth and deflection factors are unchanged; channel B may be inverted for A-B operation.

Differential (A-B) common mode: CMRR is at least 30 dB from dc to 1 MHz.

Time base

Trigger source

Channel A: display modes A, A and B, A and B INV triggered by channel A signal.

Channel B: display modes B, B INV triggered by channel B signal.

A plus B (composite signal): display modes A + B, A-B triggered by displayed signal.

Sweep

Ranges: from 100 ns/div to 2 s/div (22 ranges) in 1, 2, 5 sequence. $\pm 4\%$ accuracy over full scale, with Magnifier in calibrated position.

Magnifier: continuously expands sweep at least 10 times. Extends fastest sweep to 10 ns/div.

Sweep trigger modes

Normal: sweep is triggered by internal or external signal or line.

Automatic: bright baseline displayed in absence of input signal. Triggering is same as Normal above 20 Hz.

Single: in Normal mode, sweep occurs once with same triggering as normal, reset pushbutton arms sweep and lights indicator; in Auto mode, sweep occurs once each time Reset pushbutton is pressed.

Trigger holdoff: time between sweeps continuously variable up to 10

times. Allows triggering on complex signals without loss of time base calibration.

Triggering

Internal: dc to 15 MHz on signals causing 1 div or more vertical deflection.

External: dc to 15 MHz on signals of 0.1 V p-p or more.

External Input RC: approx. 1 megohm shunted by approx. 20 pF.

Line: triggers on line frequency.

Trigger coupling: AC, DC, TV

AC: attenuates signals below 10 Hz.

TV sync: separator for + or - video, requires 1 div of video signal to trigger, automatic frame (2 s/div to 100 μ s/div) and line select (50 μ s/div to 0.1 μ s/div). Usable also as a low pass filter.

Level and slope

Internal: at any point on the positive or negative slope of the displayed waveform.

External: continuously variable from +1 V to -1 V on either slope of the trigger signal.

Calibrated X-Y operation

Operation is via channel A (X-axis) and channel B (Y-axis).

Bandwidth: X-axis dc to 1 MHz, otherwise see Vertical Amplifiers Bandwidth specifications.

Accuracy: see Vertical Amplifiers Deflection Factor specifications. X-Y phase shift less than 3° at 100 kHz.

Cathode-ray tube and controls

Type: post accelerator storage tube, 8.5 kV total accelerating potential, aluminumized P-31 phosphor.

Graticule: 8 X 10 div (1 div = 0.94 cm) internal graticule. 0.2 subdivision markings on major horizontal and vertical axes. 10% and 90% lines for 6 and 8 division reference.

Intensity modulation (Z-axis): grounding a signal, dc to 1 MHz, blanks trace of any intensity; positive TTL voltage or greater unblanks trace; input voltage limits -1 V peak to +15 V peak, from source capable of sinking 2 mA.

Beam finder: returns trace to CRT screen regardless of settings of horizontal and vertical controls.

Persistence

Conventional: natural persistence of P31 phosphor (approx. 40 μ s).

Variable: from <0.1 s to >1 min.

Storage time

Store mode: at minimum writing speed (20 div/ms) and minimum setting of Store Time control, storage time is a minimum of one minute at minimum brightness. At higher writing speeds minimum storage time decreases to 10 s at 1000 div/ms writing speed.

Auto store mode: cumulative time to capture and store a single event is ≥ 2 hours.

Storage writing speed: continuously variable from 20 div/ms (8 X 10 div) to ≥ 100 div/ms (6 X 8 div).

Erase

Manual: pushbutton for overriding automatic or remote erasure cycle.

Automatic: time between erasure cycles variable from 1 s to 1 min. Erase cycle resets and arms sweep in 800 ms or less.

Remote: contact with ground activates a single erasure cycle. Max voltage to Remote input is +15 V peak.

General

Probe adjust: approx. 0.5 V p-p, 1 kHz square wave for adjusting probe compensation.

Power: 100, 120, 220, 240, +5%-10%, 48-440 Hz, 88 VA max.

Weight: net, 11.9 kg (26 1/2 lb). Shipping, 15 kg (33 lb).

Dimensions: 213 mm (8 3/8 in.) wide, 279 mm (11 in.) high, 476 mm (18 3/4 in.) deep overall.

Accessories furnished: one blue light filter, one power cord, fuses for 100 V, 120 V operation and 220, 240 V operation and one Operating and Service Manual.

Operating environment: temperature, (nonoperating) -40°C to +75°C (-40°F to 167°F), (operating) 0°C to +55°C (32°F to 130°F); humidity, to 95% relative at +40°C (+104°F); altitude, to 4600 m (15 000 ft.); vibration, vibrated in three planes for 15 min, each with 0.254 mm (0.01 in.) excursion, 10 to 55 Hz.

1223A Storage, Variable Persistence Oscilloscope \$2250

OSCILLOSCOPES

15 MHz dual/single channel, general purpose
Models 1220A, 1221A & 1222A

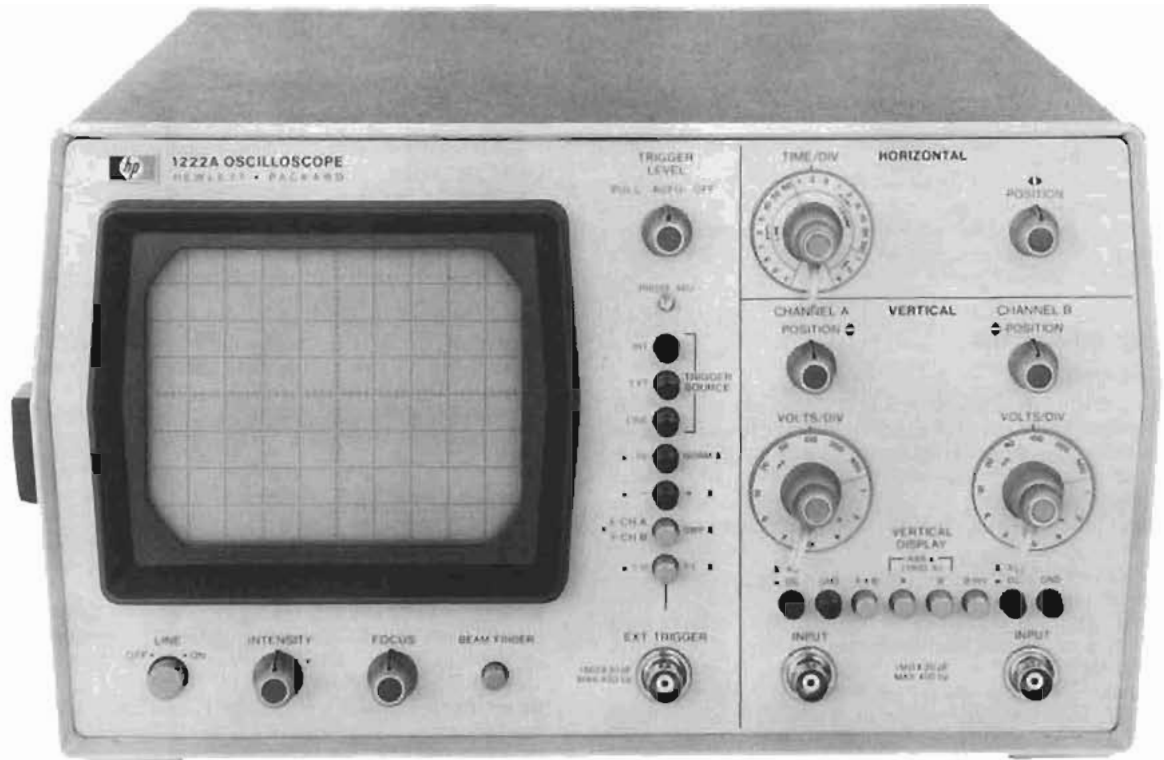

1220A, 1221A, 1222A Description

Hewlett-Packard Models 1220A/1222A (dual channel) and 1221A (single channel) 15 MHz oscilloscopes are high quality instruments with features ordinarily found only in laboratory models. These oscilloscopes have the performance necessary for a wide variety of applications. Features include a large 8 × 10 cm internal graticule for no-parallax measurements, 3% vertical attenuator accuracy, 4% horizontal accuracy, calibrated sweep times from 0.5 s/div to 0.1 μs/div, dc coupling, automatic triggering, a sweep magnifier to expand the display up to ten times for detailed analysis, a pushbutton beam finder, X-Y display capability, TV sync separator, and in the 1222A delay lines permit the leading edges of pulses to be viewed.

Easy operation

The human engineered front panel with functionally grouped controls and color-coded pushbuttons makes measurements easier and faster. Inputs are protected to 400 V, reducing chances of accidental electrical damage. Automatic triggering assures that a base-line is present even in the absence of a signal or if the trigger level control is set beyond the range of the trigger signal. And, although the dual channel Models 1220A and 1222A operate in either a chopped or alternate mode, the operator need not concern himself with making a choice since the Time/Div switch automatically selects the best display mode.

The basic stability of the solid-state circuits and components used throughout is such that internal adjustments have been reduced to a

minimum. This decreases calibration requirements and provides real savings over the oscilloscope's lifetime. Recalibration, when necessary, is simple and straightforward compared to most other oscilloscopes.

Triggering

Even though the instruments are easy to operate, these oscilloscopes have the flexibility for multi-purpose use. The operator can select the source of sweep trigger (internal, external, ac line, TV) and he can select the trigger slope, adding to the oscilloscope's versatility by allowing triggering on either the positive or negative going transitions of the signal. Further flexibility is added by the ability to preset the signal amplitude required to trigger the sweep, assuring that perturbations below the desired amplitude will not trigger the oscilloscope.

With automatically triggered sweep, displays are stable because the observed signal itself determines when a sweep should start. Automatic triggering produces a free running trace in the absence of a signal for fast setup. It locks onto any input signal of the proper polarity and amplitude.

CRT

The internal 8 × 10 cm CRT graticule eliminates parallax errors that occur when the graticule is external to the CRT. The 3% vertical accuracy combined with the no-parallax graticule enables the oscilloscope to be used as a voltmeter as well as for waveform display. CRT beam intensity can be modulated through a rear panel Z-axis input.

X-Y Inputs

Phase shift measurements through the vertical amplifiers in the 1222A permit maximum measurement flexibility with the wide selection of deflection factors. In Models 1220A and 1221A, external signals can be applied to the horizontal deflection amplifiers. This X-Y capability permits X-Y plots or Lissajous figures with a phase shift of less than 3° to 100 kHz.

TV Sync

The built-in TV sync separator assures stable, automatic triggering on frame or line for convenient TV troubleshooting. With the instruments times-ten magnifier, signals can be pulled out easily. The calibrated time base makes it easy to identify timing problems in vertical or horizontal TV circuits. The external horizontal input allows vector presentations of color CRT drive signals. Dual channels make it easy to set color demodulator circuits.

Rugged lightweight design

These oscilloscopes are, except for the CRT, entirely of solid-state design, resulting in low power consumption. The consequent low heat has made possible a rugged, lightweight, closed cabinet with a vinyl-clad aluminum cover that is resistant to shock, dust, and moisture. A convenient side-panel handle and stabilizing feet on the opposite side make handling easy. This allows these oscilloscopes to be used in areas where ruggedness is a necessity. These areas include production lines, numerically controlled machinery, process control equipment, automotive, aircraft and marine electronics, and communications.

Optional accessories

An optional front panel cover, Model 10117A, is available to protect the instrument during transportation and gives storage space for probes and other accessories. General purpose probing is provided with the Model 10013A 10 to 1 divider probe with 10 megohms input shunted by only 13 pF. It extends input range to 100 V/cm and multiplies input impedance without degrading frequency response. With a rack mount kit, Model 10119A, the oscilloscopes can be mounted to occupy only 22.2 cm (8 7/8 inches) of vertical space. Also available is the lightweight, handheld Model 124A Oscilloscope Camera which only requires pressing the shutter release to obtain trace photos. This rugged, easy-to-use camera is ideal for use in educational, production, and field applications because there are no controls to be damaged or misadjusted. Refer to the Oscilloscope Cameras section for more information.

1220A/1221A/1222A Specifications

Modes of operation (1220A/1222A)

Channel A; channel B; channel B inverted (1222A); channel A ± B (1222A); channels A and B displayed alternately on successive sweeps (Alt); triggering by A channel; channels A and B displayed by switching between channels at approx. 200 kHz rate with blanking during switching (Chop); automatic selection of alternate or chop mode. Chop, at sweep speeds from 0.5 s/cm to 1 ms/cm; Alt, 0.5 ms/cm to 0.1 μs/cm.

Vertical amplifiers (2 in 1220A/1222A, 1 in 1221A)

Bandwidth: (3 dB down from 50 kHz, 6 div reference signal from a terminated 50 ohm source.)

DC-coupled: dc to 15 MHz.

AC-coupled: lower limit is approx. 2 Hz.

Rise time: approx. 23 ns.

Deflection factor

Ranges: from 2 mV/cm to 10 V/cm (12 ranges) in 1, 2, 5 sequence. ±3% accuracy with vernier in calibrated position on 20 mV/cm to 10 V/cm ranges, ±5% accuracy on 2 mV/cm, 5 mV/cm, and 10 mV/cm ranges.

Vernier: continuously variable between all ranges, extends maximum deflection factor to at least 25 V/cm.

Input RC: approx. 1 megohm shunted by approx. 30 pF.

Input coupling: AC, DC, or GND selectable. GND position disconnects signal input and grounds amplifier input.

Maximum input: ±400 V (dc + peak ac).

Differential (A - B) CMRR (1222A): CMRR is at least 30 dB from dc to 1 MHz.

Time base

Sweep

Ranges: from 0.1 μs/cm to 0.5 s/cm (21 ranges) in 1, 2, 5 sequence. ±4% accuracy with Expander in calibrated position.

Expander: continuously expands sweeps at least 10 times. Maximum usable sweep speed is approx. 20 ns/cm.

Sweep mode: sweep is triggered by internal or external signal. Bright baseline displayed in absence of input signal when Auto is selected.

Triggering

Internal: approx. 10 Hz to 15 MHz on signals causing 1 cm or more vertical deflection.

External: approx. 10 Hz to 15 MHz on signals 0.1 V p-p or more.

External input RC: approx. 1 megohm shunted by approx. 30 pF.

Line: triggers on line frequency.

TV sync: separator for + or - video, requires 1 cm of video signal to trigger, automatic frame (0.5 s/cm to 100 μs/cm) and line select (50 μs/cm to 0.1 μs/cm). Usable also as a low-pass filter.

Level and slope

Internal: at any point on the positive or negative slope of the displayed waveform.

External: continuously variable from +0.5 V to -0.5 V on either slope of the trigger waveform. +10 extends trigger range to +5 V to -5 V.

Calibrated X-Y operation (1222A)

Operation is via channel A (X-axis) and channel B (Y-axis).

Bandwidth: X-axis dc to 1 MHz, otherwise see Vertical Amplifiers Bandwidth specifications.

Sensitivity: see Vertical Amplifiers Deflection Factors specifications.

Cathode-ray tube and controls

Type: mono-accelerator, approx. 2 kV accelerating potential, P31 phosphor.

Graticule: 8 × 10 cm internal graticule; 0.2 cm subdivisions on major horizontal and vertical axes.

Beam finder: returns trace to CRT screen regardless of setting of horizontal and vertical controls.

Intensity modulation: +5 V (TTL compatible) 1 Hz to 1 MHz blanks trace of any intensity. Input R approx. 1 kΩ. Maximum input, 7 V rms.

External horizontal input (1220A/1221A)

Bandwidth: dc to 1 MHz.

Coupling: dc.

Expander	X Mode Attenuator	Deflection Factor
Cal.	1:1	1 V/cm
Cal.	1:10	10 V/cm
cw	1:1	100 mV/cm

Continuous adjustment between ranges by Expander.

Input RC: approx. 1 megohm shunted by approx. 30 pF.

X-Y Phase shift: <3° at 100 kHz.

General

Probe adjust: approx. 0.5 V p-p, 2 kHz square wave for compensating probe.

Power: 100, 120, 220, 240 V, +5, -10%, 48 to 66 Hz, 60 VA max.

Weight

1220A/1222A: net, 7.3 kg (16 lb). Shipping, 9.5 kg (21 lb).

1221A: net, 7.0 kg (15 1/2 lb). Shipping, 9.3 kg (20 1/2 lb).

Dimensions: 311.2 mm (12 1/4 in.) wide, 181 mm (7 1/8 in.) high, 412.8 mm (16 1/4 in.) deep overall.

Accessories furnished: one blue light filter, one power cord, fuses for 100, 120 V operation and 220, 240 V operation and one Operating and Service Manual.

Operating environment: temperature, 0 to +45°C (+32°F to +113°F), storage/transit -40°C to +75°C (-40°F to +167°F); humidity, to 95% relative humidity at +40°C (+104°F); altitude, to 4600 m (15 000 ft); vibration, vibrated in three planes for 15 min each with 0.254 mm (0.010 in.) excursion, 10 to 55 Hz.

Note: probes are not supplied with these oscilloscopes; Model 10013A probes are recommended.

Model number and name

Model number and name	Price
1220A Dual Channel Oscilloscope	\$795
1221A Single Channel Oscilloscope	\$695
1222A Dual Channel Oscilloscope	\$895
10117A Front Panel Cover	\$28
10119A Rack Mount Kit	\$80

OSCILLOSCOPES

500 kHz general purpose

1200 Series

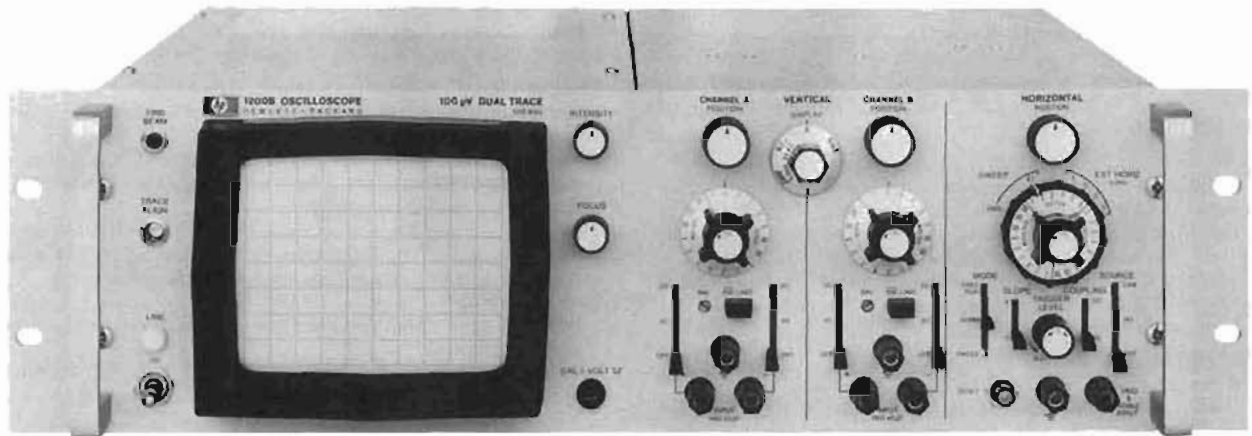

1200B

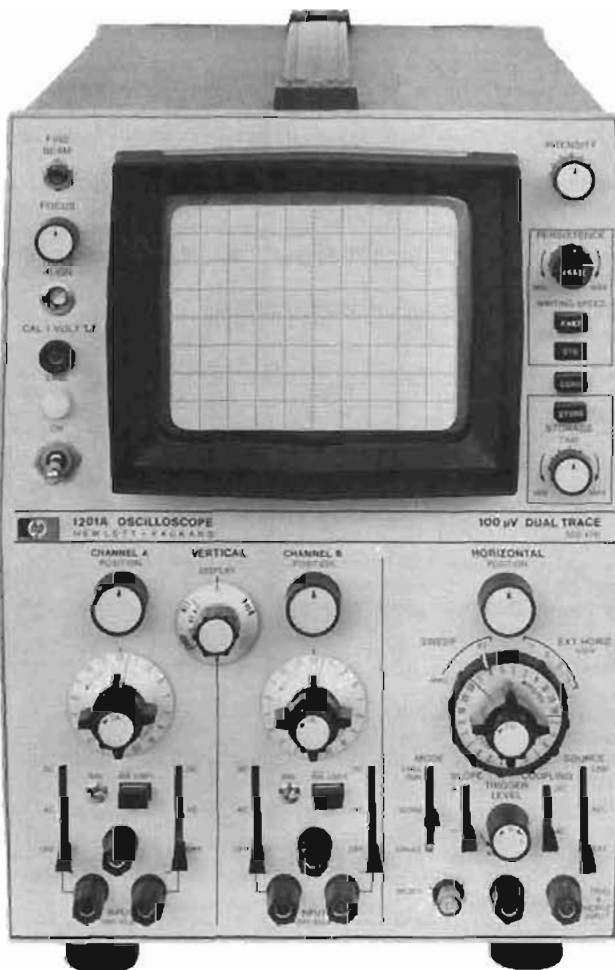

1201A

Vertical amplifiers specifications

Modes of operation: channel A; channel B; channels A and B (either Chop or Alternate triggered by channel A). Chop frequency is approx. 100 kHz; channel A vs B (A-vertical, B-horizontal).

Bandwidth: dc-coupled, dc to 500 kHz; ac-coupled, 2 Hz to 500 kHz. A bandwidth limit switch (1200 and 1201) selects upper bandwidth limit to approx. 50 kHz or 500 kHz.

Rise time: 0.7 μ s max.

Deflection factor

Ranges (1200 and 1201): from 0.1 mV/div to 20 V/div (17 positions) in 1, 2, 5 sequence.

Ranges (1205): from 5 mV/div to 20 V/div (12 positions) in 1, 2, 5 sequence.

Attenuator accuracy: $\pm 3\%$ with vernier in calibrated position.

Vernier: continuously variable between all ranges; extends maximum deflection factor to at least 50 V/div.

Noise (1200 and 1201): $< 20 \mu$ V measured tangentially at full bandwidth.

Input: differential or single-ended on all ranges.

Common mode

Frequency: dc to 10 kHz.

Rejection ratio

1200 and 1201: 100 dB (100 000 to 1) with dc-coupled input on 0.1 mV/div range, decreasing by < 20 dB per decade of deflection factor to at least 40 dB on the 0.2 V/div range; CMMR is at least 30 dB on 0.5 V/div to 20 V/div ranges. Maximum signal is ± 10 V (dc + peak ac) on 0.1 mV/div to 0.2 V/div ranges; ± 400 V (dc + peak ac) on all other ranges.

1205: 50 dB with dc-coupled input on 5 mV/div to 0.2 V/div ranges; CMMR is at least 30 dB on the 0.5 V/div to 20 V/div ranges. Maximum signal is ± 3 V (dc + peak ac) on 5 mV/div to 0.2 V/div ranges; ± 300 V (dc + peak ac) on all other ranges.

Input coupling: selectable AC, DC, or OFF for both + and - inputs.

Input RC: approx. 1 M Ω shunted by approx. 45 pF.

Maximum input: ± 400 V (dc + peak ac).

Internal trigger source: on channel A signal for A, Chop, and Alternate displays, on channel B signal for B display.

Isolation: > 80 dB between channels at 500 kHz, with shielded input connectors.

Phase shift: A vs B mode, $< 1^\circ$ to 100 kHz with verniers in calibrated position.

Time base specifications

Sweep

Ranges: from 1 μ s/div to 5 s/div (21 positions) in 1, 2, 5 sequence. $\pm 3\%$ accuracy with vernier in calibrated position.

Vernier: continuously variable between ranges; extends slowest sweep to at least 12.5 s/div.

Magnifier: direct reading X10 magnifier expands fastest sweep to 100 ns/div with $\pm 5\%$ accuracy

Automatic triggering

Baseline is displayed in absence of an input signal.

Internal: 50 Hz to above 500 kHz on most signals causing 0.5 division or more vertical deflection. Triggering on line frequency also selectable.

External: 50 Hz to above 1 MHz on most signals at least 0.2 V p-p.

Trigger slope: positive or negative slope on internal, external, or line trigger signals.

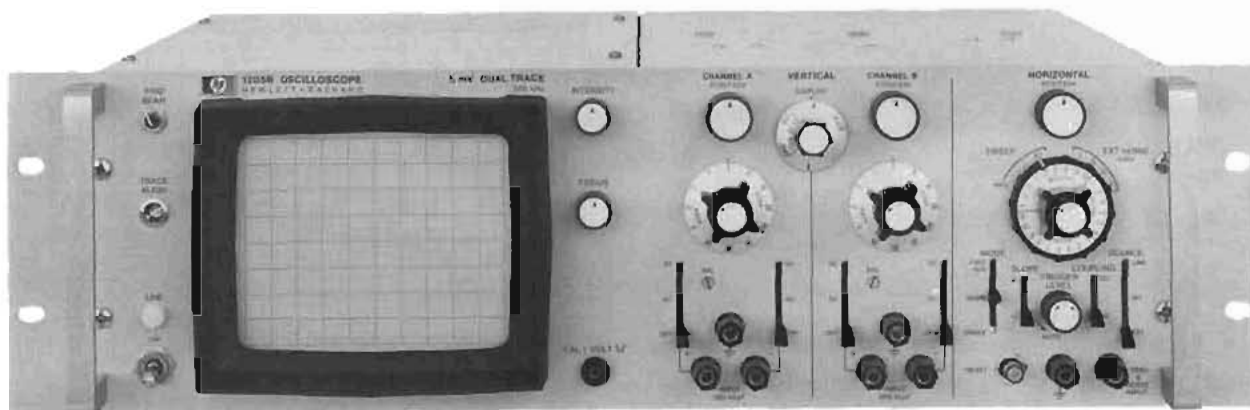

1205B

Amplitude selection triggering

Internal: dc to above 500 kHz on signals causing 0.5 division or more vertical deflection.

External: dc to 1 MHz on signals at least 0.2 V p-p. Input impedance is approx. 1 MΩ shunted by approx. 20 pF.

Trigger level and slope: internal, at any point on vertical waveform displayed; or continuously variable from +100 V to -100 V on either slope of the external trigger signal.

Trigger coupling: dc or ac for external, line, or internal triggering. Lower ac cutoff is 2 Hz for external; 5 Hz for internal.

Single sweep: selectable by front panel switch. Reset switch with armed indicator light.

Free run: selectable by front panel switch.

Maximum input: ±350 V (dc + peak ac).

Horizontal amplifier

Bandwidth: dc-coupled, dc to 300 kHz; ac-coupled, 2 Hz to 300 kHz.

Deflection factor: ranges, 0.1 V/div, 0.2 V/div, 0.5 V/div, and 1 V/div. Vernier, continuously variable between ranges; extends maximum deflection factor to at least 2.5 V/div.

Maximum input: ±350 V (dc + peak ac).

Input RC: approx. 1 MΩ shunted by approx. 20 pF.

Input: single-ended on all ranges.

Cathode-ray tube and controls specifications

Beam finder: returns trace to CRT screen regardless of setting of horizontal, vertical, or intensity controls.

Intensity modulation: +2 V signal blanks trace of normal intensity. +8 V signal blanks any intensity trace. DC-coupled rear panel input; amplifier rise time, approx. 200 ns; input R approx. 5 kΩ.

Standard CRT, 1200, 1205

Type: mono-accelerator, approx. 3000 V accelerating potential, P-31 phosphor standard.

Graticule: 8 × 10 div internal graticule, 0.2 subdivision markings on horizontal and vertical major axes; 1 div = 1 cm. Front panel recessed screwdriver adjustment aligns trace with graticule.

Variable persistence/storage CRT, 1201

Type: post-accelerator, variable persistence storage tube; approx. 10.5 kV accelerating potential; aluminum P-31 phosphor.

Graticule: 8 × 10 div internal graticule, 0.2 subdivision markings on major axes; 1 div = 0.95 cm. Front panel recessed screwdriver adjustment aligns trace with graticule.

Persistence storage characteristics

(Referenced to a centered 7 × 9 div area in STD mode and to a centered 6 × 8 div area in FAST mode.)

Persistence: conventional, natural persistence of P-31 phosphor, approx. 40 μs; variable, continuously variable from 0.2 s to >1 min. in STD mode; and from 0.2 s to 15 s in FAST mode.

Storage writing speed: STD mode, 20 div/ms; FAST mode, 0.5 div/μs.

Brightness: 343 cd/m² (100 ft) in write mode.

Storage time: STD writing speed variable from approx. 1 min. to >2 hours. Fast writing speed, variable from approx. 15 s to >15 min.

Erase: pushbutton erasure takes approx. 1.2 s. Write gun is blanked and sweep is reset until erasure is completed.

General specifications

Callibrator: 1 V ±1.5% line frequency square wave.

Dimensions

Cabinet models (designated by A suffix): 211 mm (8¹/₁₆ in.) wide × 298 mm (11¹/₂ in.) high × 475 mm (18¹/₁₆ in.) deep.

Rack models (designated by B suffix): 483 mm (19 in.) wide × 133 mm (5¹/₂ in.) high, 466 mm (18¹/₁₆ in.) deep overall; 423 mm (16¹/₂ in.) behind front panel.

Power requirements: 115, 230 V ±10%, 48 to 440 Hz, 150 VA max.

Weight

1200A: net, 11.4 kg (25 lb). Shipping, 15.7 kg (34¹/₂ lb)

1200B, 1205B: net, 10.2 kg (22¹/₂ lb). Shipping, 15.9 kg (35 lb).

1201A: net, 13.6 kg (30 lb). Shipping, 17.9 kg (39¹/₂ lb).

1201B: net, 12.5 kg (27¹/₂ lb). Shipping, 18.2 kg (40 lb).

Vertical output signals specifications (Opt 015)

Output: 0.3 V/div ±10%, 0 V offset unaffected by position control setting.

Bandwidth: dc to 500 kHz.

Dynamic range: ±3.5 V.

Maximum slewing rate: 12 V/μs with 300 pF load.

Minimum load RC: 10 kΩ shunted by approx. 300 pF.

Source impedance: approx. 300 ohms.

Options

006: rack models only, rear input terminals wired in parallel with front panel vertical and horizontal input terminals. Vertical input shunt capacitance is increased to approx. 100 pF. Horizontal input shunt capacitance is increased to approx. 75 pF.

009: variable persistence/storage models only, remote erase through rear panel banana jack, shorting to ground provides erasure (not compatible with Opt. 006).

015: vertical channel signal outputs through rear panel connectors

Model number and name

1200A or 1200B Dual Channel, 100 μV Oscilloscope \$1500

1201A or 1201B Dual Channel, 100 μV Storage Oscilloscope \$2400

1205B Dual Channel, 5 mV Oscilloscope \$1400

Price

add \$60

add \$25

add \$125

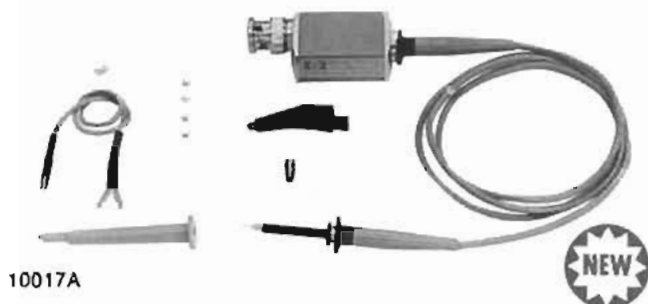

10017A

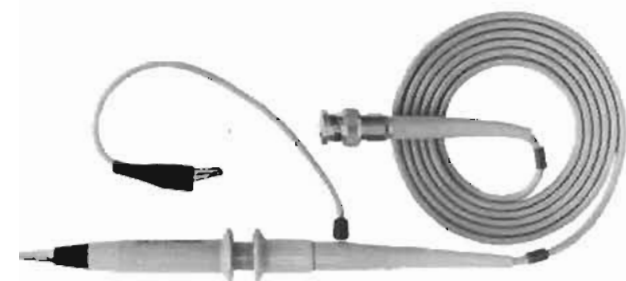

10001 - 10003A

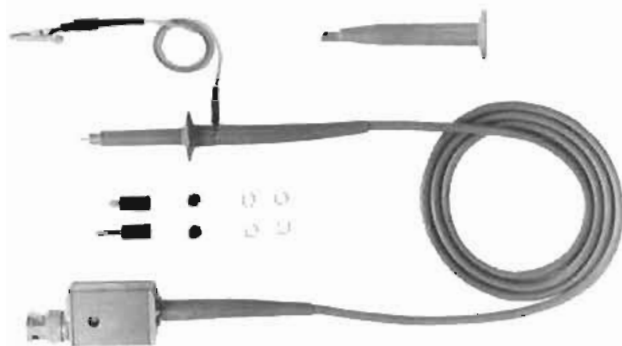

10004D - 10006D, 10014A, 10015A, 10016B

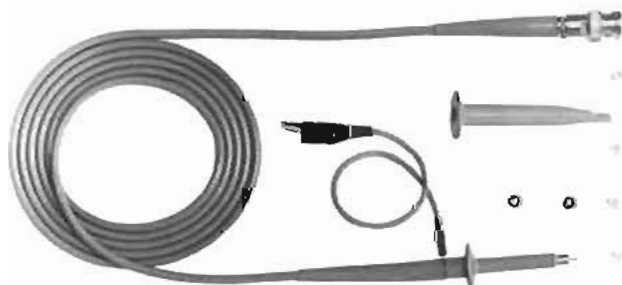

10007B, 10008B

Probe/instrument compatibility

Scope/ Plug-in	1200 Series	1270 Series	1703A	1707B	1710B/1712A	1720A/1722A	1740A, 1741A	1402A	1801 thru 1804A	1805A	1806A	1807A	1808A	1809A	1810A	1811A	1815A-B
Probe																	
10001A	X	X	L	L			L	X	L		X	L					
10001B	X	X	L	L			L	X	L		X	L					
10002A	X	X	L	L			L	X	L		X	L					
10002B	X	X	L	L			L	X	L		X	L					
10003A	X	X	L	L			L	X	L		X	L					
10004D	X	X	X	X			X	X	X		X						
10005D	X	L	L				L	X	X		X						
10006D	X	L	L				X	X	X		X						
10007B	X	X	L	L	L	L	L	L	L	L	X	L	L	L	L		
10008B	X	L	L	L	L	L	L	L	L	L	X	L	L	L	L		
10013A	X	X	L	L				X	L		X	L					
10014A					X	X				X			X	X			
10015A					X	X				X			X	X			
10016B					X	X				X			X	X			
10017A					X	X				X			X	X			
10020A					X	X	X		X		X	X	L	L	L		
10021A	X	X	L	L	L	L	L	L	L	L	X	L	L	L			
10022A	X	L	L	L	L	L	L	L	L	L	X	L	L	L			
1120A					X	X	X		X		X	X	L	L	L		
1124A					L	L	L		L		L	L	L	L	L		
1125A					X	L	X		X		X	X	L	L	L		

Notes:

X Indicates that probe will maintain the bandwidth of the instrument.
L Indicates that probe may limit the bandwidth of the instrument.

Voltage divider probe specifications

Model No.	Division Ratio	Resistance (M Ω)	Shunt Capacitance	Compensates Scope Input Capacities	Max DC Volts	Overall Length m (ft)	Price
10001A	10:1	10	10 pF	15-55	600	1.5 (5)	\$60
10001B	10:1	10	20 pF	15-45	600	3.0 (10)	\$60
10002A	50:1	9	2.5 pF	15-55	1000	1.5 (5)	\$60
10002B	50:1	9	5 pF	15-55	1000	3.0 (10)	\$60
10003A	10:1	10	10 pF	15-55	600	1.3 (4)	\$60
10004D	10:1	10	10 pF	20-30	500	1.1 (3.5)	\$65
10005D	10:1	10	17 pF	20-30	500	3.0 (10)	\$65
10006D	10:1	10	14 pF	20-30	500	1.8 (6)	\$65
10007B	1:1	-	40 pF	-	600	1.1 (3.5)	\$32
10008B	1:1	-	60 pF	-	600	1.8 (6)	\$32
10013A	10:1	10	13 pF	24-45	500	1.8 (6)	\$35
10014A	10:1	10	10 pF	9-13	500	1.1 (3.5)	\$65
10015A	10:1	10	14 pF	9-13	500	2.7 (9)	\$65
10016B	10:1	10	14 pF	9-13	500	1.8 (6)	\$75
10017A*	10:1	1	8 pF	9-14	300	1(3.3)	\$90
10021A*	1:1	-	30 pF	-	300	1(3.3)	\$35
10022A*	1:1	-	60 pF	-	300	2(6.6)	\$35

* Miniature probes

10017A Miniature voltage divider probe (new)

Model 10017A Miniature Voltage Divider Probe is a 300 MHz 10:1 divider probe with an input RC of 1 M Ω and shunt capacitance of less than 8 pF, weighing only 44 grams (1.55 oz.). This extremely lightweight probe is for use with oscilloscopes that have a bandwidth of 300 MHz or less and an input impedance of approximately 1 M Ω shunted by 9 to 14 pF.

Length of the probe body is only 45 mm (1.78 in.) with an outside diameter of 2.5 mm (0.10 in.). Even with the insulation sleeve installed, the probe body is only 75 mm (2.95 in.) long with an outside diameter of 3.3 mm (0.13 in.). The small size of the 10017A allows probing in compact circuits where conventional probes are difficult or impossible to use. And, though small in size, the probe is as easy to handle as a pencil.

The 10017A probe also provides a solution to the problem of convenient probing of dual-in-line packages. Use of conventional probe pincers presents difficulty in attaching and dislodging the pincer tip from the IC pins, often resulting in shorting between pins. If the pincer tip is not used, the probe tip requires attention and may easily slide off the pin and short to adjacent pins. These problems are almost to-

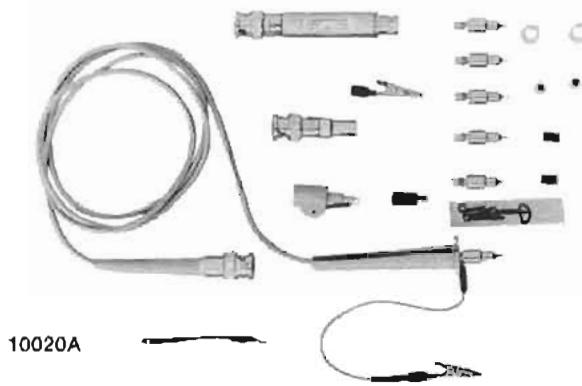

10020A



1120A

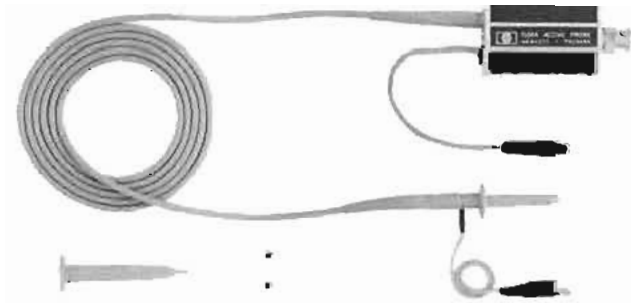

1124A

ally eliminated by use of the 10017A and the Model 10024A IC Test Clip. The 10024A (see page 159) connects to dual-in-line packages and provides built-in probe grounding which eliminates most problems associated with separate probe ground leads, and reduces probe loading without degradation of bandwidth. Grounding of the 10024A is accomplished by simply inserting the supplied grounding pin in the hole corresponding to the IC ground pin. The 10017A miniature probe tip can then be inserted into the desired test clip hole for a firm grip without the problem of holding the probe tip on an IC pin or possible shorting between pins.

10020A Resistive divider kit

Probe length (overall): approx. 121.9 cm (4 ft).
Weight: net, 0.45 kg (1 lb). Shipping, 1.36 kg (3 lb).
Accessories supplied: blocking capacitor, BNC adapter tip, 6-32 adapter tip, alligator tip, bent extension, cable ass'y's 5.1 cm (2 in.) and 15.2 cm (6 in.) ground, splitter tip, insulating cap, colored sleeve.

10020A Resistive dividers

Division Ratio	Input R° (ohms)	Division Accuracy	Max V** (rms)	Input C (pF)
1:1	50	—	6	—
5:1	250	±3%	9	<0.7
10:1	500	±3%	12	<0.7
20:1	1000	±3%	15	<0.7
50:1	2500	±3%	25	<0.7
100:1	5000	±3%	35	<0.7

*When terminated in 50 ohms.
 **Limited by power dissipation of resistive element.

1120A 500 MHz active probe

(Measured with output connected to a 50 ohm load.)
Bandwidth: (measured from a terminated 50 ohm source) dc-coupled, dc to >500 MHz; ac-coupled, <1.5 kHz to >500 MHz.
Pulse response: (measured from a terminated 50 ohm source) rise time, <0.75 ns; perturbations, <±10% measured with 1 GHz sampler.
Dynamic range: ±0.5 V with ±5 V dc offset.
Noise: approx. 2.5 mV (measured tangentially).
Input RC: 100 kΩ, shunt capacitance approx. 3 pF at 100 MHz; with 10:1 or 100:1 dividers, shunt capacitance is <1 pF at 100 MHz.
Maximum input: ±80 V.
Weight: net, 1.8 kg (4 lb). Shipping, 3.2 kg (7 lb).
Power: supplied by oscilloscopes with probe power jacks or a Model 1122A probe power supply.
Length: 1.2 m (4 ft) overall; with Option 001, 1.8 m (6 ft).

Accessories furnished

Model 10241A 10:1 divider: increases input R to approx. 1 megohm shunted by <1 pF at 100 MHz.
Model 10243A 100:1 divider: increases input R to approx. 1 megohm shunted by <1 pF at 100 MHz.
Model 10242A bandwidth limiter: reduces bandwidth to approx. 27 MHz shunted by approx. 6 pF and reduces gain <2%.
Also included: slip-on hook tip, 6.4 cm (2.5 in.) ground lead, spare probe tips, a slip-on BNC probe adapter, two red ID sleeves, and a probe divider adjustment tool (PN 5020-0570).

1124A 100 MHz active probe

(Measured when connected to a 50 ohm load.)
Bandwidth: (measured from a terminated 50 ohm source) dc-coupled, dc to 100 MHz; ac-coupled, 2 Hz to 100 MHz.
Pulse response: (measured from a terminated 50 ohm source) rise time, <3.5 ns; perturbations, 5% p-p. Measured with pulse rise time of >2.5 ns.
Attenuation ratio: 10:1 ±5%; 100:1 ±5%.
Dynamic range: X10, ±10 V; X100, ±100 V.
Input RC: 10 megohms shunted by approx. 10 pF.
Maximum safe input
DC-coupled: X10, ±300 V (dc + peak ac) ≤100 MHz; X100 ±500 V (dc + peak ac) ≤100 MHz.
AC-coupled: X10, ±300 V (dc + peak ac) ≤100 MHz. DC component must not exceed ±200 V; X100, ±500 V (dc + peak ac) ≤100 MHz. DC component must not exceed ±200 V.

Accessories supplied: one 20.3 cm (8 in.) ground lead, one retractable hook tip, and two probe tip insulating caps.
Power: supplied by instruments with probe power jacks or Model 1122A probe power supply.
Weight: net, 0.2 kg (6 oz). Shipping, 0.91 kg (2 lb).
Length: approx. 1.5 m (5 ft) overall.
Available accessory: 10131B 91.4 cm (36 in.) extender cable (refer to 1122A Probe Power Supply). Required for use with 1700 oscilloscopes with probe power option.

Model number and name

10020A Resistive divider probe kit	\$140
1120A 500 MHz Active Probe	\$595
1120A Opt 001, 1.8 m (6 ft) length	add \$35
1124A 100 MHz Active Probe	\$170

Probes, other accessories (cont.)

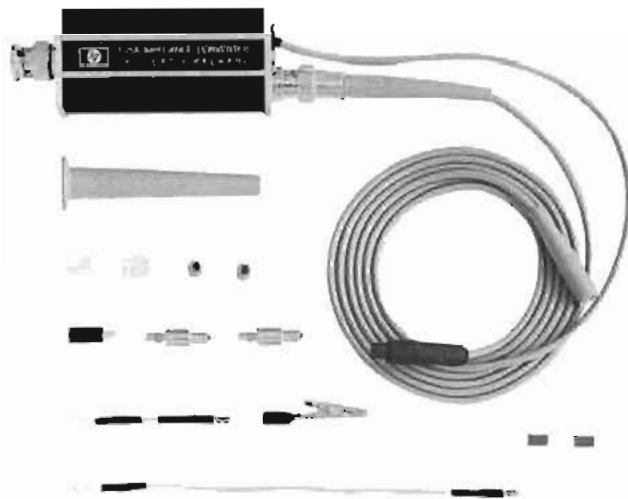

1125A



1111A



1110A

1125A Impedance converter probe

Model 1125A Active Divider Probe provides high impedance input (approximately 100 k Ω) at less than 50 Hz which decreases as frequency increases. Input impedance remains a constant 5 k Ω to 50 MHz with the X100 tip and 500 ohms with the X10 tip to greater than 250 MHz. The low probe tip shunt capacitance of <0.7 pF provides minimum capacitive loading at high frequencies. Power is supplied by instruments with probe power jacks or the 1122A probe power supply.

1125A Specifications

Attenuation ratio: (oscilloscope gain may be adjusted for 10:1 and 100:1 division ratio) 10.5:1 and 105:1, $\pm 5\%$.

Dynamic range at probe tip: X10, ± 4 V; X100, ± 40 V.

Input impedance at probe tip

High frequency: approx. 500 ohms (X10) or 5 k Ω (X100) shunted by 0.7 pF (in X10 or X100 modes).

Low frequency: approx. 100 k Ω (dc-coupled).

Maximum Input

All modes: ± 300 V (dc + peak ac) with ± 200 V max dc component.

X10: dc to 500 Hz, 200 V rms; decreasing 6 dB per octave to 12 V rms at 10 kHz. ≥ 10 kHz, 12 V rms is max allowable continuous input.

X100: dc to 1.5 kHz, 200 V rms; decreasing 6 dB per octave to 35 V rms at 10 kHz. ≥ 10 kHz, 35 V rms is max allowable continuous input.

Bandwidth: (with X10 or X100 tip and supplied 1.3 m (4 ft) cable).

DC-coupled: dc to 250 MHz.

AC-coupled: 20 Hz to 250 MHz.

Pulse response in X10 or X100: $\leq \pm 5\%$ perturbations measured from a terminated 50 ohm source.

Accessories supplied: one 1.2 m (4 ft) 50 ohm cable, one X10 divider tip, one X100 divider tip, one probe handle, two red color coding sleeves, two clear plastic insulating caps, two jade gray insulating caps, one 5.1 cm (2 in.) 6-32 ground lead, one 15.2 cm (6 in.) 6-32 ground lead, one 6-32 adapter tip and one 6-32 alligator tip.

Power: supplied by instruments with probe power jacks or a Model 1122A probe power supply.

Length: approx. overall length, 147.3 cm (58 in.).

Weight: net, 0.2 kg (6 oz). Shipping, 0.9 kg (2 lb).

1111A AC current amplifier

Deflection factor: (with a 50 mV/div oscilloscope deflection factor) in X1, 1 mA/div to 50 mA/div; in X100, 100 mA/div to 5 A/div; 1, 2, 5 sequence in X1 or X100.

Accuracy: in X1, $\pm 3\%$; in X100, $\pm 4\%$.

Rise time: 18 ns.

Noise: <100 μ A p-p, referenced to input signal.

Maximum ac current: above 700 Hz, 50 A p-p; below 700 Hz, decreases at 1.4 A/20 Hz.

Output impedance: 50 ohms.

Dimensions: 38.1 mm high, 130.2 mm wide, 152.4 mm deep (1 1/2" \times 5 1/8" \times 6 in.).

Weight: net, approx. 0.91 kg (2 lb). Shipping, 1.36 kg (3 lb).

Power: 115 or 230 V $\pm 10\%$, 50 to 440 Hz, 1.5 watts.

1110A Current probe

Sensitivity: without 100 ohm termination, 1 mV/mA; with 100 ohm termination, 0.5 mV/mA.

Accuracy: $\pm 3\%$.

Bandwidth

Lower -3 dB point: without 100 ohm termination, approx. 1700 Hz; with 100 ohm termination, approx. 850 Hz.

Upper -3 dB point: with 4 pF capacitive load, approx. 45 MHz; with 30 pF capacitive load, approx. 35 MHz.

Rise time: with 4 pF capacitive load, approx. 7 ns; with 30 pF capacitive load, approx. 9 ns.

Insertion impedance: approx. 0.01 ohm shunted by 1 μ H; capacitance to ground <3 pF.

Maximum dc current: 0.5 A.

Maximum ac current: 15 A p-p above 4 kHz; decreasing below 4 kHz at 3.8 A/kHz rate.

Weight: net, 0.45 kg (1 lb). Shipping, 0.91 kg (2 lb).

Dimensions: probe aperture, 3.9 mm (5/32 in.) diameter; overall length, 1.5 m (5 ft).

Model number and name

1125A Impedance Converter Probe
1111A Current Amplifier
1110A Current Probe

Price

\$200
\$370
\$150



1122A

1122A Probe power supply

Probe driving capability: up to four Hewlett-Packard active probes.

Power output: -12.6 and +15 V, $\pm 3\%$.

Power input: 115 V or 230 V $\pm 10\%$, 48 to 440 Hz, 40 W (with four probes).

Weight: net, 2.7 kg (6 lb). Shipping, 3.63 kg (8 lb).

Accessories supplied: four Model 10131B 91.4 cm (36 in.) extender cables.

Digital trigger probes

Models 10250A (TTL), 10251A (MOS), and 10252A (ECL) Trigger Probes are useful service, production, and design trouble-shooting tools that offer digital pattern triggering to enhance the use of oscilloscopes, logic analyzers, and other test equipment. With the 4-bit trigger probe, you trigger on four parallel events. The four inputs may be switched to HI, LO, or OFF (don't care) for convenient selection of the trigger point. No separate power supply is needed because probe power is obtained from the circuit under test.

The compact Model 1230A Logic Trigger unit generates a trigger output pulse (TTL compatible) from parallel digital pattern recognition with digital delay capability for oscilloscopes, logic analyzers, or other externally triggered test equipment. Pattern recognition is selectable to 8 bits with the trigger word switches and digital delay is selectable to 9998 clocks with a choice of synchronous or asynchronous operation.

For 4 and 8 bit parallel trigger probe specifications and prices refer to the Digital Circuit Testers and Analyzers section.

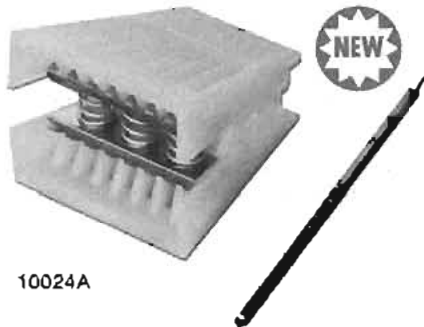

10024A

Probe accessories

Terminations

Model 10100C: 50 ohm feedthrough.

Model 10100B: 100 ohm (± 2 ohm) feedthrough for 1110A current probe.

IC test clip (new)

Model 10024A: for use with 10017A, 10021A, 10022A miniature probes in probing dual-in-line packages. Reduces probe loading and shorting between IC pins.



10100C

10011B

Probe tips

Model 10011B BNC adapter tip: for probes 10004D-10006D, 10007B, 10008B, 10013A, 10014A, 10016B, and 1124A.

HP P/N 1250-1454 BNC adapter tip: for 10017A, 10021A, 10022A miniature probes.

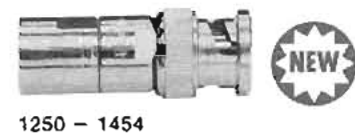

1250 - 1454

Probe tip kits

Probe tip kits, Models 10036A and 10037A, extend usefulness of 10004D, 10005D, 10006D, 10007B, 10008B, 10013A, 10014A, 10015A, 10016B, and 1124A probes. Model 10036A consists of an assortment including tips for the following: 2.0 mm (0.08 in.) jack; 0.6 mm (0.025 in.) and 1.4 mm (0.045 in.) square pin; 1.0 mm-1.6 mm (0.040-0.062 in.) dia pin; and a long pin tip. Model 10037A contains six 0.6 mm (0.025 in.) square pin tips. Probe tip kit Model 10035A for 10001A-10003A probes contains pincer jaw, banana tip, pin tip, and spring tip.

Model 10034A probe adapter kit consists of an assortment of 6-32 screw-on tips, and two ground lead cables which allow many methods of connecting the ground leads in a circuit. A 6-32 to slip-on adapter allows these tips to be used on 10004D-10006D, 10007B, 10008B, 10013A, 10014A, 10016B, and 1124A probes. The kit consists of one 15.2 cm (6 in.) and one 30.5 cm (12 in.) ground lead, one hook tip, one alligator tip, one pin tip, one tip for 0.6 mm (0.025 in.) square pins, one banana tip, and one slip-on to 6-32 adapter.

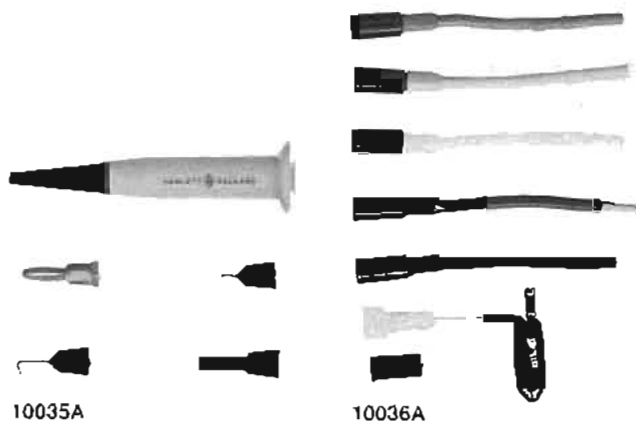

10035A

10036A

Model number and name

Model number and name	Price
1122A Probe Power Supply	\$425
10024A IC Test Clip	\$15
10100C 50 ohm Feedthrough Termination	\$22
10100B 100 ohm Feedthrough Termination	\$26
10011B BNC Adapter Tip	\$12
1250-1454 BNC Adapter Tip	\$8.25
10034A Probe Tip Kit	\$30
10035A Probe Tip Kit	\$9
10036A Probe Tip Kit	\$35
10037A Probe Tip Kit	\$25

Probes, other accessories (cont.)



226A



10116A



10176A



10491B

Calibration and service accessories

Plug-in extender

Model 10407B: 180 system extender (metal frame extends both plug-ins). Allows calibration and maintenance while a unit is operating.

226A Time mark generator

Model 226A is a high quality, time mark generator that provides 30 precision time intervals for calibrating oscilloscope time bases. Marker intervals are in a convenient 1, 2, 5 sequence that matches the sweep time settings on oscilloscopes. A single, easy-to-read front panel rotary switch provides easy use without confusing nomenclature.

Ranges: from 2 ns to 10 s (30 ranges) in 1, 2, 5 sequence.

Output: +1 V peak into 50 ohms. 28 intervals from 10 ns to 10 s. Sine wave output on 2 and 5 ns ranges provides 1 V into 50 ohms.

Accuracy: $\pm 0.005\%$, 0°C to $+55^\circ\text{C}$; $\pm 0.002\%$ at 25°C after $\frac{1}{2}$ hour warmup.

Trigger frequency: same as time mark to 100 ns, 10 MHz for all ranges faster than 100 ns.

Programming (optional): all ranges are programmable, requires 6 parallel lines (6 bit word) and 2 timing lines, TTL compatible.

Dimensions: 114.3 mm high, 196.9 mm wide, 203.2 mm deep (4.5 x 7.75 x 8 in.).

Weight: net, 3.2 kg (7 lb). Shipping, 4.5 kg (10 lb).

Power: 115 or 230 V $\pm 10\%$, 48 to 440 Hz; approx. 25 watts.

Viewing accessories

Viewing hoods

10176A: viewing hood for 12.7 cm (5 in.) rectangular CRT bezels.

10104A: collapsible viewing hood for 1700 series oscilloscopes.

10116A: collapsible light shield for 1220 series oscilloscopes.

10190A: light shield for large screen 182 oscilloscopes.

10140A: collapsible viewing hood for 1740A, 1741A oscilloscopes.

Light filters

10102A: metal mesh screen for 1703A, 1707B oscilloscopes improves display contrast and serves as RFI filter. The screen's metal frame is grounded through four metal tabs to provide RFI filtering.

10173A: RFI filter and contrast screen for 1740A, 1741A.

10178A: metal mesh for 181, 184 oscilloscopes.

10115A: blue light filter for 1703A-1722A series oscilloscopes.

Amber plastic filter: HP P/N 5020-0530, for 12.7 cm (5 in.) rectangular CRT.

Blue light filter: HP P/N 01740-02701 for 1740A, 1741A

Blue plastic filter: HP P/N 5060-0548, for 12.7 cm (5 in.) rectangular CRT.

Smoke gray plastic filter: HP P/N 5020-0567, for 12.7 cm (5 in.) rectangular CRT.

Model number and name

Model number and name	Price
10407B Plug-in Extender	\$140.00
226A Time Mark Generator	\$800.00
226A Option 003, TTL compatible programming	add \$155.00
10173A RFI Filter and Contrast screen for 1740A, 1741A	\$10.00
10176A Viewing Hood for 12.7 cm (5 in.) rect. CRT	\$19.00
10104A Viewing Hood for 1703-1722A oscilloscopes	\$15.00
10140A Viewing Hood for 1740A, 1741A oscilloscopes, supplied with 1741A	\$15.00
10116A Light Shield for 1220 series oscilloscopes	\$13.00
10190A Light Shield for 182 oscilloscopes	\$17.00
10102A RFI Screen for 1703A, 1707B oscilloscopes	\$15.00
10178A Filter, mesh contrast/RFI for 181, 184 main-frames	\$22.00
10115A Filter, blue contrast for 1703-1722A oscilloscopes	\$3.00
Amber plastic filter (HP P/N 5020-0530) for 12.7 cm (5 in.) rect. CRT	\$4.00
Blue plastic filter (HP P/N 5060-0548) for 12.7 cm (5 in.) rect. CRT	\$5.00
Blue light filter (HP P/N 01740-02701) for 1740A, 1741A	\$2.50
Smoke gray plastic filter (HP P/N 5020-0567) for 12.7 cm (5 in.) rect. CRT	\$10.50

Rack mount slides and adapters

1700 series oscilloscopes, 1600A Logic State Analyzer

10491B Rack Mount Adapter: adapts to standard 483 mm (19 in.) rack, 222 mm (8 7/8 in.) high, 540 mm (21 1/4 in.) deep. \$100.00

180, and 181 rack style oscilloscopes

A slide adapter is required to secure an oscilloscope to the slides.

Fixed slides, 22-in: HP P/N 1490-0714 \$75.00

Pivot slides, 22-in: HP P/N 1490-0719 \$105.00

Slide adapter: HP P/N 1490-0768 \$80.00

Front panel cover

HP P/N 5040-0516: provides front panel protection for 1700 series oscilloscopes, 1600A Logic State Analyzer \$9.00

OSCILLOSCOPES

Cameras for display recording

Models 123A & 197A



123A



197A

123A Description

Model 123A is a lightweight compact camera which fits directly on HP 1700 series oscilloscopes with 6×10 div CRT's. The camera does not require external power and only weighs 1.6 kg (3½ lb) making it ideal for use in field applications. The 123A has a range finder for easy focusing using a split image technique. This range finder also serves as a viewing port so that you can make minor CRT intensity and graticule illumination adjustments with the camera in place. For convenience in setting up the display the camera has a swing-away feature allowing full visibility of the CRT screen. Controls are color coded for optimum settings and are located outside of the camera for easy reading and fast adjustment to reduce initial setup time.

The 123A mounts directly or with adapters to the oscilloscopes as listed in the oscilloscope/camera adapter table.

123A Specifications

Reduction ratio: continuously adjustable from 1:1 to 1:0.65.

Lens: 56 mm, f/3.5 lens; aperture ranges f/3.5, f/4, f/5.6, f/8, f/11, f/16, and f/22.

Shutter speeds: 1/60, 1/30, 1/15, 1/8, 1/4, 1/2, and 1 second, and Bulb. Cable has thumbscrew lock for time exposures. X-type contacts provided to trigger or synchronize other equipment with shutter release.

Graticule illumination: supplied by the oscilloscope.

Camera back: 83 mm \times 108 mm (3¼ in. \times 4¼ in.) Polaroid® pack back.

Mounting: lift on/off mounting with positive lock. Mounts directly on HP 1700 series oscilloscopes with 6×10 div CRT's. Adapters are available to fit other scopes, see Camera Accessories.

Range finder: viewing port provides split image of the CRT to allow setting of the focus.

Viewing: range finder viewing port allows viewing the CRT with camera in position. Camera swings away for wide angle viewing.

Focus: adjustable with camera back closed or open; split image focusing plate provided for use when object-to-image ratio is changed.

Dimensions: 220 mm long, 122 mm high, 192 mm wide (8½ in., 4¾ in., 7½ in.).

Weight: net, 1.6 kg (3½ lb). Shipping, 2.3 kg (5 lb).

Accessories furnished: combination split image focusing plate and reduction ratio scale, and instruction manual.

“Polaroid”® by Polaroid Corp.

197A Description

Model 197A is a versatile, general purpose oscilloscope camera that can be used for many trace recording applications. All controls are located outside of the camera for easy reading and fast adjustment during setup. The controls are also color coded for optimum settings for most photos which reduces initial setup time.

An electronically-controlled shutter, with all solid-state circuits for reliable operation, provides accurate exposure times from 1/30 to 4 seconds. The shutter may be operated remotely by providing a closure to ground and a contact closure is provided when the shutter is open to allow synchronization of other equipment.

The reduction ratio (i.e., object-to-image ratio) may be varied from 1:1 to 1:0.7 with a screwdriver adjustment. This allows the optimum amount of a graticule to be photographed, which is useful when making multiple exposures or when used on different size graticules. The camera can be quickly focused to match the reduction ratio with the split-image focus plate supplied with the camera.

The 197A camera is supplied with an 83 mm \times 108 mm (3¼ in. \times 4¼ in.) Polaroid pack back. The back may be rotated 90° from the normal horizontal position to a vertical position and can be moved through 11 detented positions for multiple exposures. The back may also be replaced with a Graflok® back which allows use of sheet or roll film.

“Graflok”® by Graflex, Inc.

197A Specifications

Reduction ratio: continuously adjustable from 1:1 to 1:0.7. Reference scale provided on focus plate.

Lens: 75 mm, f/1.9 high transmission lens; aperture ranges f/1.9 to f/16.

Shutter speeds: 1/60, 1/30, 1/15, 1/8, 1/4, 1/2, 1, 2, 4 seconds, Time and Bulb; shutter has a sync contact closure output for triggering external equipment and an input jack for remote operation.

Graticule illumination: supplied by oscilloscope. Refer to Options for internal graticule illumination.

Camera back: 83 mm \times 108 mm (3¼ in. \times 4¼ in.) Polaroid pack back (another back is available, see Options); backs may be interchanged without refocusing and may be rotated in 90-degree increments.

Mounting: lift on/off mounting with positive lock, swing-away hinging to left. Mounts directly on most HP oscilloscopes with 12.7 cm (5 in.) round or rectangular CRTs. Adapters are available to fit other scopes and displays, see Camera Accessories.

Viewing: low-angle, direct viewing through a flexible facemask.

Multiple exposure: back can be moved through 11 detented positions (1/2 cm per detent at 1:0.9 object-to-image ratio).

Focus: adjustable focusing with lock; split image focusing plate provided.

Dimensions: 356 mm long, 267 mm high, 194 mm wide (14, 10½, 7¾ in.).

Weight: net, 4.5 kg (10 lb). Shipping, 7.3 kg (16 lb).

Power: 115 V \pm 10%, 48 to 440 Hz, 6 watts.

Accessories furnished: combination split image focusing plate and reduction ratio scale, 2.3 m (7.5 ft) power cord and instruction manual.

Options

Options	Price
003: Graflok back in place of pack back (on initial order).	N/C
006: replaces standard 197A adapter with 10375A adapter to directly fit 1332A, 1333A, and 1335A displays	add \$25
007: meets UL listing requirements for medical and dental electronic equipment (minimum order 10)	add \$25
008: replaces standard 197A adapter with 10376A adapter to directly fit 1740A, 1741A oscilloscopes	add \$50
012: factory wired for 230 V operation.	N/C
H02: provides internal graticule illumination using ultraviolet light with an OFF, ON switch. Not required for oscilloscopes with graticule illumination.	\$125

Model number and name

123A Oscilloscope Camera	\$615
197A Oscilloscope Camera	\$870

OSCILLOSCOPES

Cameras (cont.) and camera accessories

Model 124A

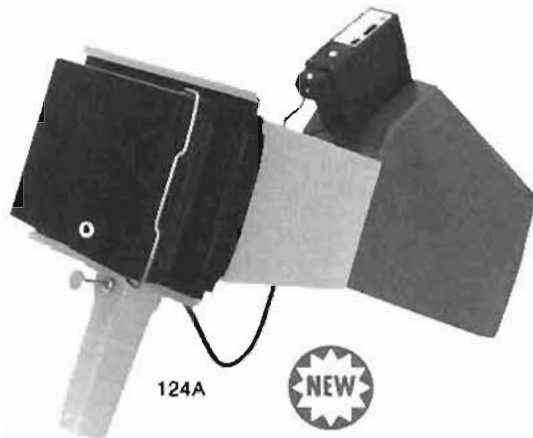

124A Description (new)

The Model 124A is a very easy-to-use, economical camera for oscilloscope display photography. This rugged, lightweight camera is designed for general purpose trace recording requirements in education, industry, and field service applications.

The 124A is prefocused — just place the hood over the instrument bezel and press the cable release. The camera is focused and the picture is framed without requiring any other adjustments. The f-stop is fixed as is the shutter speed to reduce the adjustment problems normally encountered in general purpose applications. An electronic flash which is powered by two AA batteries, provides graticule illumination on scopes without built-in illumination. Lens aperture, shutter speed, and flash output are matched to provide the correct illumination of internal or external graticules. For oscilloscopes with internal graticule illumination, the flash unit may be switched off and the oscilloscope controls set for the desired graticule and trace contrast.

Operation is very easy; if the trace is overexposed, adjust the oscilloscope's intensity control; if the trace is too faint, press the shutter release several times to integrate the trace. Multiple operation of the shutter release does not overexpose the graticule because the electronic flash requires approximately ten seconds to recharge the internal high voltage capacitor after its initial firing.

The 1 to 0.88 reduction ratio permits the entire 8 × 10 cm graticule format to be recorded on Polaroid Type 107 film. The flash output, lens f-stop, and shutter speed are calculated for proper exposure of Type 107 (ASA 3000) film.

The 124A may also be used to copy printed material or its own photos, or to photograph printed circuit boards, small assemblies, etc.

124A Specifications

Reduction ratio: 1:0.88.

Lens: 90 mm; 3 element coated glass, f-stop is factory adjusted between approx. f/5.6 and f/8.

Shutter speed: fixed to approx. 1/60 s.

Graticule illumination: preset, electronic flash mounted on camera hood.

Camera back: Polaroid 83 mm (3¼ in.) × 108 mm (4¼ in.) pack. Recommended film is Polaroid Type 107, ASA 3000.

Mounting: hood is placed over the CRT bezel and is held in position during exposure.

Focus: fixed, depth of field permits focusing on phosphor and graticule (internal or external) when the hood can be held against the front panel.

Compatibility: 140B, 141B, 180A thru D, 181A/AR, 183A/B/C, D, 184A/B, 1200 Series, 1220 Series, 1600A, 1740A*, 1741A*. Also compatible with other HP instruments (such as Spectrum Analyzers) with an 8 × 10 cm graticule CRT and having bezels like the 180C.

Dimensions (overall): length, 394 mm (15½ in.); height, 344 mm (13½ in.); width, 171 mm (6¾ in.).

Weight: net, 1.2 kg (2½ lb). Shipping, 1.7 kg (3½ lb).

Power: 2 each size AA batteries. Alkaline or rechargeable NICAD type recommended. Batteries not supplied.

*Some shadowing appears at the top of the CRT screen when used with the camera's flash.

124A Oscilloscope Camera

\$250



10353A



10352B

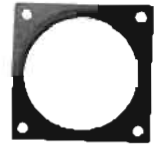

10355A

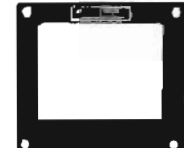

10356A



10360A



10361A



10362A



10363A



10106A



10366B



10367A



10369A



10370A



10371A



10372A



10375A



10376A



16491A

Film backs for 197A camera

Model 197A has the Polaroid Pack Film Back as standard equipment. The Graflok Back may be ordered initially as an option at no extra charge.

10353A Pack film back: uses Polaroid Land Film, 83 mm × 108 mm (3¼ in. × 4¼ in.), with eight exposures.

10352B Graflok back: requires a film holder available from local camera stores. The back accepts Polaroid Land 102 mm × 127 mm (4 in. × 5 in.) film holder, standard cut-film holders, film-pack adapters, and roll film holders. For additional information about film holders that will fit the Graflok back, contact your local camera store.

Camera bezel adapters

The following Hewlett-Packard adapters provide mounting of Hewlett-Packard, Tektronix, and Dumont cameras to Hewlett-Packard as well as Tektronix and Dumont oscilloscopes. Refer to the oscilloscope/camera adapter table for a cross-reference of these adapter/camera/oscilloscope combinations. No adapters are available for the 124A because it is hand-held against the instrument front panel (see 124A specifications for compatibility).

10355A: adapts 195A, 197A, & 198A cameras to Tektronix and Fairchild/Dumont 127 mm (5 in.) round bezels.



10358B



10374A

10366A: adapts 195A, 197A, & 198A cameras to Tektronix 560 Series rectangular bezels.
10360A: adapts 196A/B camera to HP 127 mm (5 in.) rectangular CRT (180C style bezels).
10361A: adapts Tektronix C12 camera to HP 127 mm (5 in.) rectangular CRT (180C style bezels).
10362A: adapts Tektronix C27 camera to HP 127 mm (5 in.) rectangular CRT (180C style bezels).
10363A: adapts Tektronix C30A, C31, C32, or C40 cameras to HP 127 mm (5 in.) rectangular CRT (180C style bezels).
10106A: adapts Tektronix C30A, C31, C32, or C40 cameras to HP 1700 series scopes with 6 x 10 div CRTs.
10366B: adapts 195A, 197A, & 198A cameras to HP display models 1330A/1331A (serial prefix 1110A & above) & 1331C (serial prefix 1116A & above). For lower serial prefix numbers contact your Hewlett-Packard Field Engineer.

10367A: adapts 195A & 197A cameras to HP 182 scope.
10369A: adapts 123A camera to HP 127 mm (5 in.) rectangular CRT (180C style) & HP 127 mm (5 in.) round CRT.
10370A: adapts 123A camera to HP 182 large screen CRT.
10371A: adapts 123A camera to Tektronix 422/453/454/485 scopes.
10372A: adapts 123A camera to Tektronix 464/465/466/475.
***10375A:** adapts 197A, 195A cameras to 1332A, 1333A, & 1335A displays. Tektronix 600, 5100, & 7000 series scopes.
***10376A:** adapts 195A & 197A cameras to 1740A, 1741A scopes.
16491A: adapts 123A camera to HP 1740A, 1741A scopes.

Carrying cases

10358B: constructed of fiberglass and aluminum with padding for protection during transit. The carrying case will accommodate the 195A, 197A, & 198A cameras.
10374A: carrying case for 123A camera with storage space for 1 pack of film.

* See 197A Options 006 & 008 before ordering these adapters for 197A.

Model number and name	Price
10353A Pack Film Back	\$130
10352B Graflok Back	\$165
10355A Camera Adapter	\$27
10356A Camera Adapter	\$27
10360A Camera Adapter	\$27
10361A Camera Adapter	\$27
10362A Camera Adapter	\$27
10363A Camera Adapter	\$40
10106A Camera Adapter	\$25
10366B Camera Adapter	\$20
10367A Camera Adapter	\$34
10369A Camera Adapter	\$50
10370A Camera Adapter	\$28
10371A Camera Adapter	\$28
10372A Camera Adapter	\$30
10375A Camera Adapter	\$75
10376A Camera Adapter	\$100
16491A Camera Adapter	\$130
10358B Carrying Case	\$120
10374A Carrying Case	\$30

OSCILLOSCOPE	CAMERA												
	HEWLETT-PACKARD ¹⁰					TEKTRONIX INC.				DUMONT			
	123A	*195A	*196A/B	197A	*198A	C12	C27	C30A/31/32/40	C50 Series	450A-1	453A-1	450A-7B	321A
5-in. Round CRT	10369A	Direct	Direct	Direct	Direct	--	--	--	--	Direct	Direct	Direct	Direct
5-in. Rectangular CRT ¹¹	10369A	Direct	*10360A	Direct	Direct	³ 10361A	³ 10362A	10363A	9	*10360A	*10360A	*10360A	*10360A
182	10370A	10367A	--	10367A	--	--	--	--	--	--	--	--	--
1330/1331 ²	10369A & 10366B	² 10366B	--	² 10366B	² 10366B	--	--	10363A	--	--	--	--	--
1332A/1333A/1335A	8	10375A	--	⁷ 10375A	--	6	6	6	Direct	--	--	--	--
1700 Series (6 x 10 div CRT's)	Direct	--	--	--	--	--	--	10106A	--	--	--	--	--
1740A, 1741A	16491A	10376A	--	³ 10376A	--								
TEKTRONIX INC.													
5-in. Round 549	10369A & 10355A	10355A	10355A	10355A	10355A								
5-in. Recl. & 560 Series	--	10356A	--	10356A	10356A								
529 Series	10369A & 10356A	10356A	--	10356A	10356A								
464/465/466/475	10372A	--	--	--	--								
422/453/454/485/323/324	10371A	--	--	--	--								
600, 5100 & 7000 series	--	10375A	--	⁷ 10375A	--								
DUMONT													
5-in. Round CRT	10369A & 10355A	10355A	Direct	10355A	10355A								

Notes

- This chart only includes HP adapter and camera compatibility, for other combinations contact your Field Engineer.
- 1330A/1331A serial prefixes 1110A and above and 1331C serial prefix 1116A and above require 10366B adapter. For lower serial prefixes contact your HP Field Engineer. These instruments are no longer in production.
- The 10361A and 10362A adapter hinge mounts interfere with the Find Beam pushbutton on 180 mainframes.
- Model 195A, 196A/B and 198A cameras are no longer in production.
- 197A Option 008 includes the 10367A which directly fits 1740A, 1741A scopes.
- Tektronix Inc. cameras with adapters for 7000 series scopes can be used with HP 1332A, 1333A, & 1335A Displays.
- 197A Option 006 includes the 10375A which fits HP 1332A, 1333A, & 1335A displays, Tektronix 600, 5100 & 7000 series oscilloscopes directly.
- Adapter available on special order; contact your HP Field Engineer.
- Requires HP adapter 10360A and Tektronix adapter for 5 in. round bezels.
- For compatibility of 124A camera, see 124A specifications.
- 5 in. rectangular CRT's with 180C type bezels, e.g. 1600A.

OSCILLOSCOPES

Testmobiles: save bench space, easily moved

Models 1114A, 1117A & 1000 series



1114A

1002B

1117B

Testmobile/instrument compatibility

Testmobile Model Number	Instruments
1001A without Storage Cabinet and 1002A with Storage Cabinet	1700 series, 1220 series, 1600A, 3580A
1001B without Storage Cabinet and 1002B with Storage Cabinet	180 thru 184 cabinet style, 1601L
1003A without Storage Cabinet and 1004A with Storage Cabinet	140, 141, and 180 thru 184 rack style, 1645A
1114A	180 thru 184 and 1200 cabinet style, 1220 and 1700 series, 1600A, 1601L, 3580A
1117B	All instruments listed above plus 1200 series, 143, 1600S.

1000 Series description

The 1000 series testmobiles are of sturdy lightweight aluminum construction with high quality casters set 48.3 cm (19 in.) apart to provide a stable platform. Large 10.2 cm (4 in.) mar resistant rubber tires provide quiet, smooth movement, even over uneven floor surfaces. The top mounting trays on these testmobiles are convenient table-top height and can be tilted with one hand to any desired viewing angle between 30° above and 20° below horizontal. The mount locks in position with a twist of the handle. Mounting trays vary in size and thickness and are designed for specific HP instruments as shown in the Testmobile/Instrument Compatibility chart. A sturdy molded shelf near the base provides space for additional equipment or you can order models with a convenient cabinet which includes a molded top shelf, an 11.4 cm (4½ in.) drawer, and two internal shelves for maximum storage space.

1000 Series specifications

Compatibility: see Testmobile/Instrument Compatibility chart.

Tilt angle: continuous within 50° range (30° above, 20° below horizontal).

Load limits: mounting tray, 27 kg (60 lb); lower molded shelf (1001A/B, 1003A), 34 kg (75 lb); 54 kg (120 lb) combined load with an instrument on the mounting tray and a load on the lower shelf.

Safety: testmobiles are designed to hold one instrument only on the mounting tray, with no provisions for stacking; and are designed to be pushed with the mounting tray handle, especially over uneven floor surfaces.

Dimensions: see outline drawings.

Wheel size: 102 mm (4 in.) diameter.

Weight

1001A/B, 1003A: net, 11.4 kg (25 lb), Shipping, 17.3 kg (38 lb).

1002A/B, 1004A: net, 17.3 kg (38 lb), Shipping, 24 kg (53 lb).

1114A Description

Model 1114A is a general purpose testmobile designed for 180 and 1200 cabinet style, and 1220 and 1700 series oscilloscopes, without special adapters. A channel in the tilt tray positions the front feet of the oscilloscope and a nylon tie-down strap securely holds the instrument in place. The combination tilt tray handle/release lever allows one-hand adjustment of viewing angle, from 15° below horizontal to 60° above. A base tray provides space for other instruments/accessories. Large rear wheels allow easy pushing over carpeted or rough floor surfaces, and locking front casters hold the testmobile in position.

Introduction

Hewlett-Packard testmobiles provide convenient portability for your oscilloscopes and other test equipment; they also save your bench space while requiring little floor space. The top tray on each testmobile can be tilted for easy viewing. You can select from models designed for specific HP instruments or from general purpose testmobiles that hold most HP oscilloscopes and also many other standard size instruments. Refer to the Testmobile/Instrument Compatibility chart for assistance in selecting the best testmobile for your requirements.

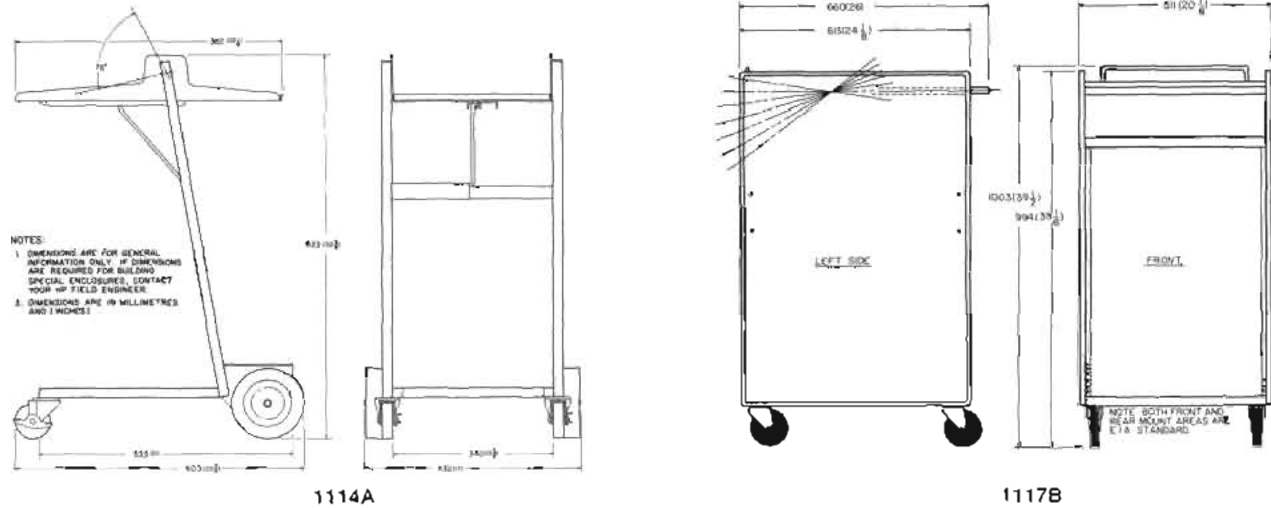
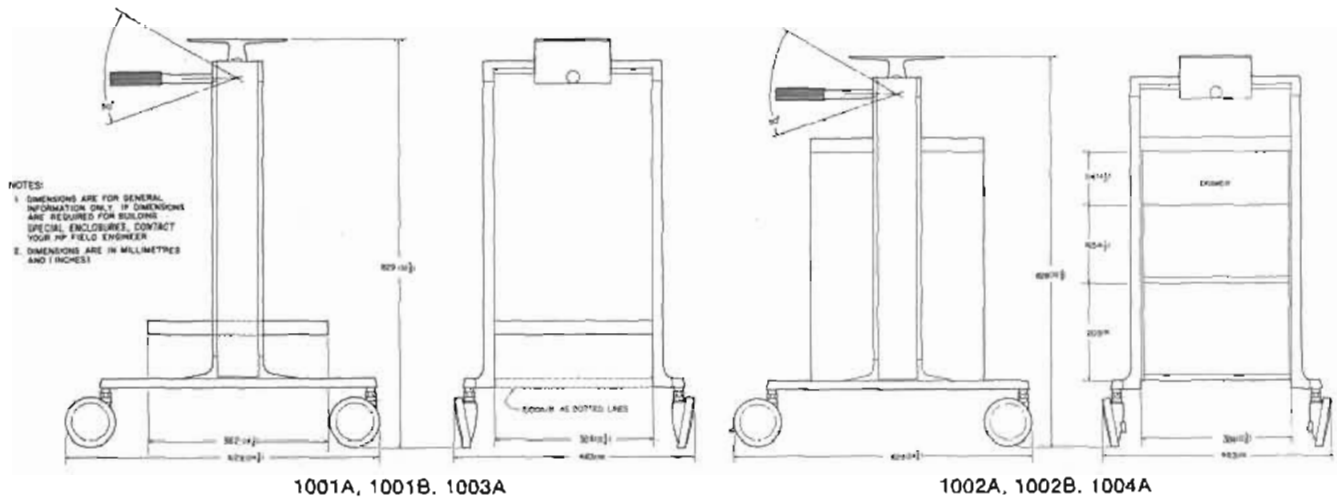

1114A Specifications

Compatibility: 180 and 1200 cabinet style, and 1220 and 1700 series oscilloscopes. See Testmobile/Instrument Compatibility chart.
Tilt angle: 75° range in 12 steps (60° above, 15° below horizontal).
Load limits: tilt tray, 18.2 kg (40 lb); 36.4 kg (80 lb) combined load with an instrument on the tilt tray and a load on the base tray.
Safety: testmobiles are designed to hold one instrument only on the tilt tray, with no provisions for stacking; and are designed to be pushed with the tilt tray handle, especially over uneven floor surfaces.
Dimensions: see outline drawing.
Wheel size: 76 mm (3 in.) diameter, locking caster (front); 152 mm (6 in.) diameter (rear).
Weight: net, 12.7 kg (28 lb). Shipping, 15 kg (33 lb).

1117B Description

Model 1117B for cabinet and rack model instruments provides tilt tray angles from -15° to +30° in 7½° increments for easy viewing. In addition, other instruments can be mounted in the standard EIA racks of the lower compartment. Rack mounting depth is 58.4 cm (23 in.) and power distribution is supplied. Optional accessory drawers 7.6 cm (3 in.) and 20.3 cm (8 in.) deep are available to provide convenient storage space. The drawers may be installed in many vertical positions of the lower compartment, allowing room for other rack mounted equipment.

1117B Specifications

Compatibility: cabinet or 48.3 cm (19 in.) rack model oscilloscopes.

See Testmobile/Instrument Compatibility chart.

Tilt angle: -15° to +30° in 7½° steps.

Dimensions: see outline drawing.

Wheel size: 102 mm (4 in.) diameter.

Weight: net, 41.3 kg (91 lb). Shipping, 49.4 kg (109 lb).

Instrument mounting hardware supplied: 8 screws for rack mounting instruments (HP P/N 2731-0002); 8 cup washers (HP P/N 3050-0007); 8 nylon washers (HP P/N 3050-0248); 8 Tinnerman nuts (HP P/N 0590-0172).

Optional accessories

Model 10475A: 7.6 cm (3 in.) drawer.

Weight: net, 4.1 kg (9 lb). Shipping, 5.9 kg (13 lb).

Model 10476A: 20.3 cm (8 in.) drawer.

Weight: net, 5.4 kg (11 lb). Shipping, 8.2 kg (18 lb).

Model number and name

Model number and name	Price
Model 1001A with molded lower shelf	\$225
Model 1001B with molded lower shelf	\$240
Model 1003A with molded lower shelf	\$240
Model 1002A with storage cabinet	\$310
Model 1002B with storage cabinet	\$310
Model 1004A with storage cabinet	\$300
Model 1114A Testmobile	\$140
Model 1117B Testmobile less drawers	\$375
Model 10475A 7.6 cm (3 in.) drawer	\$60
Model 10476A 20.3 cm (8 in.) drawer	\$90

CATHODE-RAY TUBE DISPLAYS

Displays for OEM applications

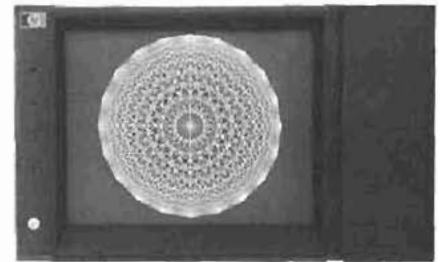
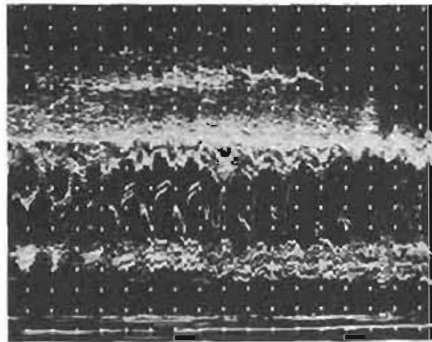

Hewlett-Packard's cathode-ray tube displays offer OEM's and end users top performance, versatility, and reliability for all types of systems—from spectrum, network, and chemical analyzers, and automatic test systems to computer graphics and radar. These displays are complete units which include the cathode-ray tube, vertical and horizontal deflection amplifiers, a video (Z-Axis) amplifier, and high and low voltage power supplies.

Performance features include high resolution, high writing speed, constant light output, bright easy-to-read displays, and reduced power requirements. Versatility is assured with a variety of standard options that allow you to tailor a display to your system's needs. Reliability and serviceability are built into these displays with well-designed interior layout, plug-in board construction, and other features made possible by Hewlett-Packard's highly developed CRT technology.

The yokeless electrostatic deflection used in HP displays increases writing speed, reduces power requirements, and simplifies operation when compared to magnetic deflection displays. The most important advantage is that characters and vectors can be written about ten times faster than with magnetic displays.

Half-rack displays

Model 1332A is a high resolution, high brightness display with a 158.8 mm (6 1/4 inch) diagonal CRT which is only 133.4 mm (5 1/4 in.) high. The 1332A is designed to meet the stringent requirements of medical diagnostic and instrumentation system applications. The major features in the 1332A include a small crisp spot size that varies by no more than 10% over the quality area; multiple gray levels with focus independent of intensity setting; high stability of position, gain, and brightness; regulated CRT filament voltage to eliminate light output variations with changes in line voltage; large 113 cm² display area; bright 22.5 kV CRT; and Underwriters Laboratories Listing.

One application of the 1332A is in Medical Thermography which requires stable light output for long scan periods. In this diagnostic technique, a very sensitive infrared detector scans the body to detect skin temperature. Similar to other applications, the stable light output and focus permits time exposure photographs to accurately map a profile of skin temperature.

5 MHz bandwidth, large display area, and excellent picture quality make the 1332A ideal for use in instrumentation systems. System applications include display monitors,

nuclear spectrometers, swept frequency measurements, frequency ratios, spectrum analysis, Fourier analysis, spectrophotometry, chemical analysis, and nuclear magnetic resonance.

The 1333A is a high resolution 8 × 10 cm display especially designed to permit diagnostic-quality photographs from state-of-the-art nuclear, ultrasonic, thermographic, and X-ray scanning systems. The small 0.02 mm spot size, wide range of gray scales, good contrast, and stable light output provide exceptional image quality, a necessity in medical diagnostic systems and applications requiring precisely controlled image parameters. Image quality combined with high luminous power density and speed make the 1333A ideal for recording rapid sequence dynamic studies in nuclear medicine and for capturing transient displays in ultrasound work.

Half-rack storage displays

Model 1335A high resolution, storage CRT display offers medical and instrumentation OEM users a variable persistence, storage, and non-storage CRT display with excellent performance. Outstanding picture quality and amplifier performance with a frame designed for OEM use make the 1335A

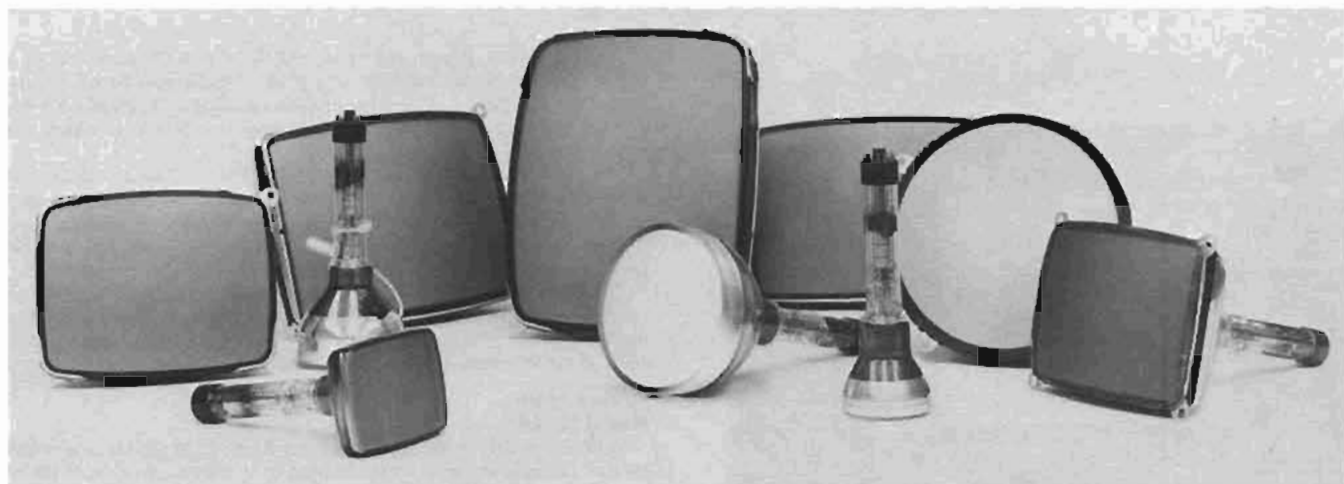
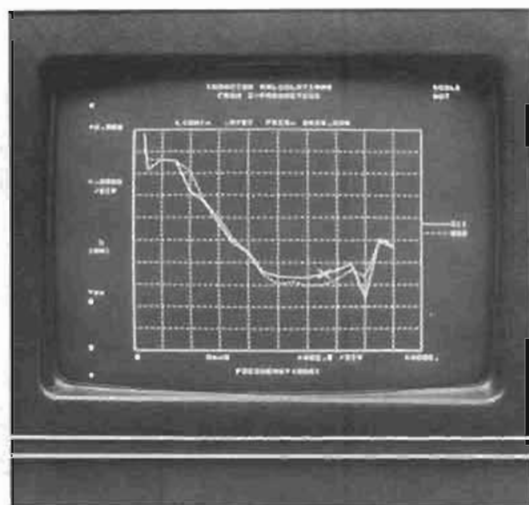

a significant advancement in storage displays.

A non-storage resolution of approximately 40 lines per cm (100 lines per in.) with a spot size that is relatively independent of intensity setting or Z-axis input signals enhances the CRT image in applications requiring focusing over a wide range of intensity levels. Variable persistence allows the elimination of flicker in some presentations with the ability to increase the persistence to match the refresh rate.

The 1335A CRT is a totally new design which is optimized for information display and offers a high resolution image with excellent contrast and uniformity in medical diagnostic applications. Fine image detail and a well focused spot at all intensity levels and positions make the 1335A ideal for use in Specrum, Fourier, Network, and Chemical analysis as well as automatic test systems.

In system applications, the 1335A offers flexibility in selecting Erase, Store, Write, Conventional and Variable Persistence modes. These operating modes can be selected with the manual front panel controls, remote program inputs, or a combination of both.

Large screen displays

Five large screen graphic displays are available for OEM computer graphic and instrumentation applications. Linear writing speed, in these displays, is an unmatched $25.5 \text{ cm}/\mu\text{s}$ (10 in./ μs) for visible writing and is capable of slew rates in excess of $255 \text{ cm}/\mu\text{s}$ (100 in./ μs) when the spot does not have to be seen. These speeds are attained with a yokeless, electrostatic deflection system which consumes much less power than the multi-winding coils of magnetic deflection systems. Maximum power consumption of these displays is a low 110 watts compared to 500 or more for others. Additionally, the much faster response of electrostatic deflection permits as much as 10 times the amount of information to be displayed in a given period as that of magnetic displays.

Fast amplifier response (5 MHz bandwidth) and electrostatic CRT deflection also simplifies system programming since vectors and characters can be written randomly from anywhere in the display area in less time than the sequential programming necessary for raster scan magnetic displays. Since coils are not used for deflection, no delay line is needed to properly synchronize Z-axis blanking with spot movement thus eliminating the possibility of display smearing and also mak-

ing the display easier to interface with a system.

Model 1321A has a 533 mm (21 inch) diagonal display with excellent geometry and linearity and a small 0.51 mm (0.020 inch) spot size. The large $305 \times 305 \text{ mm}$ (12 X 12 inch) quality area is ideal for presenting complex graphic information while using the additional viewing area for character writing.

Model 1317A is a 432 mm (17 inch) diagonal display which is the largest X-Y display presently made that mounts directly in a 483 mm (19 inch) rack with its long CRT axis horizontal. This large, high resolution display is ideal for the readout in computer graphic and instrumentation systems, since it mounts directly in standard 483 mm (19 inch) EIA racks.

Models 1310A (483 mm, 19 inch, diagonal) and 1311A (356 mm, 14 inch, diagonal) displays are housed in optional attractive plastic covers which when ordered with a tilt stand, make them ideal for table top applications.

Model 1304A has a 20 cm (7.9 in.) X 25 cm (9.8 in.) display area. The cabinet is fully compatible with the Hewlett-Packard System-11 modular enclosure system for more versatility in OEM applications and better access for servicing.

CATHODE-RAY TUBE DISPLAYS

High resolution; storage

Models 1332A, 1333A & 1335A



1332A



1333A



1335A

1332A, 1335A, and new 1333A Description

Models 1332A, 1333A, and 1335A are high-quality cathode-ray tube displays designed to satisfy a wide range of OEM medical and electronic instrument display needs to 5 MHz. The major differences between these displays are their CRT's which are optionally available with or without internal, parallax free grati- cules.

Model 1332A has a large 9.6 X 11.9 cm display area with the resolution and picture quality required for medical diagnostic systems plus a bright display for differentiating between many gray shades, or for viewing in brightly lighted areas.

Model 1333A has a high resolution CRT with an 8 X 10 cm viewing area specifically optimized for photographic applications such as gamma camera systems. The 1333A's combination of high resolution, luminous power density, and speed permits crisp easy-to-read, diagnostic-quality photographs to be obtained from state-of-the-art nuclear, ultrasonic, thermographic, and X-ray scanning systems.

Model 1335A's high resolution 8 X 10 cm storage display offers medical and instrumentation OEM users a variable persistence, storage, and non-storage CRT display with excellent performance. Outstanding picture quality and amplifier performance combine to make the 1335A a significant advancement in storage displays.

The 1332A, 1333A, and 1335A have Post Deflection Accelerator CRT's to assure a bright, crisp trace. An opaque aluminum layer behind the phosphor enhances trace brightness while blocking stray light from the CRT filaments that could reach photographic film during time exposures.

Regulated, low power write gun and flood gun filaments assure a constant light output under varying line conditions. More importantly, the low power filament operation significantly extends CRT life and eliminates grid and other stray emissions common to older, less efficient designs.

Models 1332A, 1333A, and 1335A (Opt 330) are listed with Underwriters Laboratories in accordance with the UL 544 Medical Safety Standard which defines detailed patient protection requirements. Regular inspection of our production facility by UL assures you that this patient protection is built into the display that you purchase.

The three models are 13.3 cm (5 1/4 in.) high, half rack width, 49.5 cm (19 1/2 in.) long packages that can be combined with identical empty modules to form an attractive full width horizontal or vertically stacked OEM instrument.

Picture clarity

Model 1332A

Spot size is only 0.305 mm (0.012 in.) diameter at high intensity levels and remains extremely well focused over the entire range of intensity levels. This resolution makes the 1332A well suited for applications requiring sharp focusing on multiple gray shades or varying writing speeds with frequent video drive level changes. Spot resolution, within the quality area, varies by less than 10% making the display especially useful in applications where sharp focus is required throughout the quality area. An example of this is where alphanumeric characters are mixed with traces, curves, or graphs.

The large 9.6 cm X 11.9 cm viewing area and bright display make the 1332A ideal for the OEM with both visual and some photographic requirements. Display brightness lets you view the display in high ambient light conditions while maintaining resolution and gray shades for photographic work. Whenever uniform photographic recording of the display becomes critical, the 1333A should be used.

Model 1333A

Model 1333A is specifically designed for photographic recording where display uniformity and high resolution images are essential. Spot size is a crisp 0.20 mm (0.008 in.) diameter everywhere on its 8 X 10 cm display, which allows resolution of 193 354 picture elements. The spot remains round and sharply focused in all areas of the screen and at varying intensity levels, eliminating the need to readjust focus or astigmatism controls. No compromises are needed for optimizing overall image sharpness in applications where all areas of the screen contain critical information and the Z-axis drive level varies widely. For displays that do not require the entire screen, sharply focused alphanumeric messages such as patient identification or operator instructions can be inserted along the extreme edges and corners for maximum use of the display area.

Light output uniformity is fully specified, both overall and for small increments, which assures you that the information content of the display is an accurate representation of the input signals. Additionally, light output drift is specified, including all effects of the Z-axis amplifier, high voltage supply, and CRT. A regulated dc CRT filament volt-

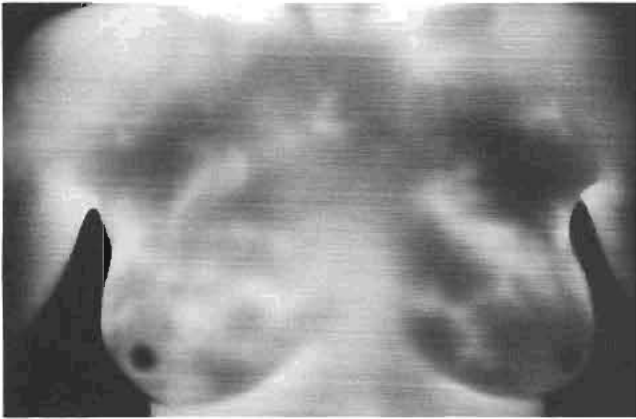

Stable light output of 1332A for long scan periods permits time exposure photograph to paint a picture of body temperature versus location in a Medical Thermography application.

age is also used to assure constant light output independent of line voltage fluctuations. The regulated dc filament voltage also reduces the possibility of interference patterns resulting from correlation between input signal frequencies and the high voltage oscillator or power line frequencies.

Model 1335A

The CRT can be operated in non-storage, storage, or variable persistence modes. In the non-storage mode (called CONVENTIONAL), the CRT operates similar to a mono-accelerator conventional CRT with an exceptionally small spot that focuses uniformly over the entire quality area. Resolution is approximately 40 lines per cm (100 lines per in.). In addition, spot size is relatively independent of intensity settings or Z-axis input signals, eliminating the need to refocus at each intensity setting. This characteristic enhances the CRT image in applications requiring the CRT to focus on a wide range of intensity levels. Applications include those where markers intensify areas of interest, where characters or vectors are written, and anywhere that the writing speed or drive levels of the beam vary. The light output remains extremely stable because of regulated CRT filament voltages and an exceptionally stable Z-axis amplifier.

The same excellent CRT performance is maintained in the Variable Persistence operating mode. Persistence is continuously adjustable with a front panel control, from approximately 0.20 s to full storage. This mode allows you to eliminate flicker on some presentations by increasing the persistence to match the refresh rate. The variable persistence mode is selected by pressing the WRITE pushbutton.

The storage CRT is preset to store dots having a Z-axis width of 1 μ s or greater for up to 30 minutes. The storage mode offers the greatest contrast because the background is completely dark. An internal adjustment allows an increase of writing speed to capture faster signals with reduced storage time and trace to background contrast. Another adjustment may be used to enhance either the storage time of the trace or the stored brightness of the stored images. Stored resolution is over 20 lines per cm (50 lines per in.) and stored traces retain sharp details.

Programmability (1335A)

The Model 1335A offers users great flexibility in selecting ERASE, STORE, WRITE, CONVENTIONAL, and VARIABLE PERSISTENCE modes. These modes can be selected with the manual front panel controls, remote program inputs, or a combination of both.

In manual operation, the front panel controls select the operational mode. In program mode, a single program line inhibits the manual controls and prevents operator intervention. Additional control lines can be used to selectively enable the front panel ERASE and VARIABLE PERSISTENCE controls during remote operation to provide interactive capability. Provisions have been made so that any programmable functions can be hard wired to operate through the front panel controls during remote operation.

Electronics

The X and Y amplifiers have 70 ns rise time (bandwidth is 5 MHz) and the Z-axis blanking amplifier has a 25 ns rise time. When faster X



The 1333A is optimized for photographic image quality with a wide range of gray scales, high image contrast, and excellent uniformity as shown in this high resolution gamma camera full body bone scan photograph.

and Y amplifier response is required, Model 1332A has an Option available to obtain 25 ns rise times. All amplifiers are full differential and operate at exceptionally low power levels for stable, drift-free performance over wide ranges of operating temperatures.

The time required to make any size movement on the CRT, including the response time for the amplifiers to settle within one spot diameter of final position, is less than 300 ns. This means that many thousands of vectors and characters can be written on the display without flicker or annoying distortions.

OEM frame

The 1332A, 1333A, and 1335A displays are built around a comprehensive, modular mechanical frame which allows OEM's to develop many integrated package combinations to fit their applications. The basic package is 13.3 cm (5 1/4 in.) high, and half a standard rack width. The frame consists of four castings which provide a strong package and does not require additional support from the system it is installed in. These half module frames are fully compatible with Hewlett-Packard's System-II modular enclosure system; refer to Cabinets, System-II.

Empty modules of equal size allow the frame to be combined into either a full width module suitable for rack mounting or bench use or in a vertically stacked configuration. Your custom-designed circuits can easily be installed in these empty modules. Combining covers are also available to give the combined frames an integrated, single-unit appearance. Additional hardware is also available for rack mounting, mounting on slides, and to dress up the basic frame.

CATHODE-RAY TUBE DISPLAYS

Models 1332A, 1333A & 1335A (cont.)

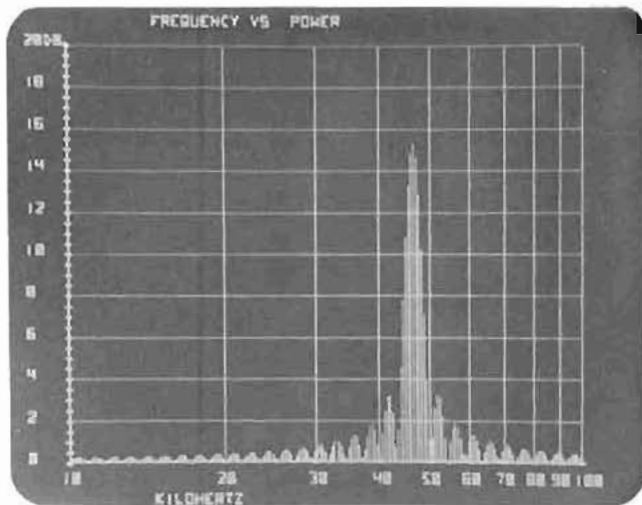

Fine image detail and a well-focused spot at all intensity levels make the 1335A ideal for use in Spectrum, Fourier, Network, and Chemical analysis as well as automatic test systems.



Empty half-width frame, available as an accessory, provides an attractive full-width or double-height package with an integrated appearance with space for your special circuits.

Considerable effort has been taken in developing the structural, thermal, RFI, and modular characteristics of this mechanical frame to provide you with the best possible display for your OEM system.

All frequently used controls are adjustable from the front panel for maximum accessibility when the display is mounted in a rack, cabinet, or system. The most frequently used controls, such as intensity, focus, and position have knobs while infrequently used controls such as astigmatism, trace align, and X and Y gain are screwdriver adjustments. A front panel door covers the controls for a more pleasant appearance and reduces the chance of misadjustment by untrained personnel. The ac line switch is mounted on the rear panel to prevent inadvertent turn-off and allows the display to be powered through the common system power bus.

Serviceability

Construction of these displays is modular, rugged, and extremely serviceable. Printed circuit boards are plug-in type with interconnections through edge connectors and multiconductor wire strips that connect to sockets on the boards. Serviceability also extends to CRT replacement which, with a knowledgeable technician, can be accomplished in approximately ten minutes. Calibration time is kept to a minimum with easily accessed and independent adjustments.

Options and accessories

A wide range of options are available to permit you to tailor the display to your specific requirements; refer to Specifications for a complete listing. Accessories available include rack mounting kits, OEM half module frames and rack slides, and BNC shorting caps for use with certain Options. For convenient system interconnection, Model 10488A 3.6 m (12 ft) Display Cable is available as an accessory. Model 197A Opt 006 camera is adapted for direct recording of 1332A, 1333A, and 1335A displays. Refer to the individual display data sheets for a complete description of accessories.

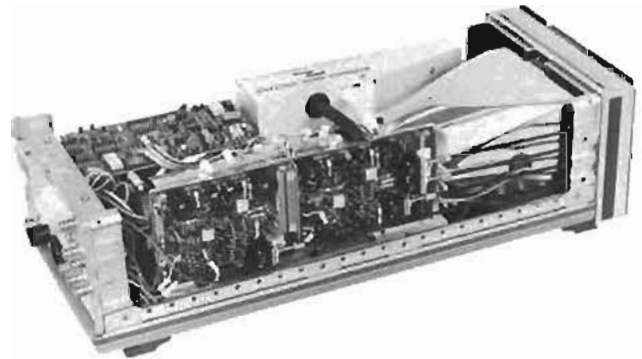

The well-designed interior layout and use of plug-in boards, multiconductor cables, and multi-pin connectors make the 1332A, 1333A, and 1335A very serviceable.

1332A, 1333A, and 1335A Specifications

Vertical and horizontal amplifiers

Response

Rise time: ≥ 70 ns (10% to 90% points) for full screen deflection or less.

Bandwidth: dc to approx. 5 MHz for 7.6 cm (3 in.) deflection (1332A), 5.1 cm (2 in.) deflection (1333A, 1335A).

Phase shift (1332A, 1335A): $< 1^\circ$ dc to 1 MHz (measured with X and Y gain set to max).

Deflection factor

Horizontal: 100 mV/div (1 V p-p for 10 div deflection). Front panel adjustable from approx. 80 mV/div to 200 mV/div. 1 div = 1.2 cm (0.47 in.), 1332A. 1 div = 1.0 cm (0.39 in.), 1333A. 1 div = 0.95 cm (0.37 in.), 1335A.

Vertical: 100 mV/div (0.8 V p-p for 8 div deflection). Front panel adjustable from approx. 80 mV/div to 200 mV/div. 1 div = 1.2 cm (0.47 in.), 1332A. 1 div = 1.0 cm (0.39 in.), 1333A. 1 div = 0.95 cm (0.37 in.), 1335A.

Settling time: signal settles to within one spot diameter of final value in < 300 ns for any large or small movement. Off screen deflection not to exceed specified dynamic range.

Linear writing speed: 25.4 cm/ μ s (10 in./ μ s).

Inputs: rear panel BNC connectors with shield grounded. Full differential inputs available, see Options.

Input RC: approx. 1 megohm shunted by < 60 pF.

Maximum input: ± 50 V (dc + peak ac).

Polarity: positive vertical input moves beam up; positive horizontal input moves beam right.

Position: front panel controls adjust zero input to an off-screen position in any direction from anywhere within the viewing area. Beam position with both inputs shorted (0 V into X and Y amplifiers) and the position control electrically centered is in the geometric center of display area.

Dynamic range: beam may be deflected off-screen up to $\frac{1}{2}$ screen diameter in any direction provided that the zero input position is on screen, without degradation of specifications.

Crosstalk: < 0.254 mm (0.010 in.) with one input terminated in 50 ohms and the other driven by a 1 V, 500 kHz signal. < 0.38 mm (0.015 in.) at 5 MHz when driven from a 50 ohm source.

Drift

Position: ≤ 0.5 mm/hr (0.020 in./hr) and ≤ 1.02 mm (0.040 in.) in 24 hr with covers installed after 15 min. warmup.

Gain: $< 1.0\%$ under all combinations of specified line voltage with covers installed after 15 min. warmup and temperature between $+20^\circ\text{C}$ and $+55^\circ\text{C}$.

Common mode rejection ratio: at least 40 dB (100:1) up to 10 kHz for 1 V (full screen) inputs; at least 25 dB (18:1) at 1 MHz for 1 V (full screen) inputs.

Z-axis amplifier

Rise time: ≤ 25 ns; CW bandwidth approx. 5 MHz.
Blanking range: a 1 V change in input Z voltage causes a full scale change in brightness. The cutoff level can be set from +0.2 V dc to -1 V dc with the intensity control. With intensity control full cw, brightness is limited to a safe level for any Z-axis input voltage.
Blanking polarity: a positive-going input Z-axis voltage increases brightness.
Input: rear panel BNC connector with shield grounded. Full differential input available, see Options.

Input RC: approx. 1 megohm shunted by < 60 pF.
Maximum input: ± 50 V (dc + peak ac).
Gain: internally adjustable over 2.5:1 attenuation ratio.
Light output stability (drift): spot photometer measurements of light output made at one hour intervals will not vary more than 10% from previous measurement for any location within the useable display area, under all specified conditions of line voltage and temperature with intensity set to $> 5\%$ of peak brightness.

Cathode-ray tube (1332A)

Type: post deflection accelerator, approx. 22.5 kV accelerating potential, aluminized P31 phosphor (see Options for other types of phosphor), electrostatic focus and deflection.
Viewing area: 114 cm² (17.67 in.²) approx. 9.6 cm vertically by 11.9 cm horizontally (3.8 in. \times 4.7 in.).
Quality area: center 9 div horizontally and center 7 div vertically.
Graticule: 8 \times 10 div internal graticule. 1 div = 1.2 cm (0.47 in.).

Resolution
Spot size: ≤ 0.3 mm (0.012 in.) at center screen. Does not vary by more than 10% over entire quality area with intensity held constant. Measured using shrinking raster method. Line resolution is approx. 3.15 lines/cm (80 lines/in.).

Light output
Line brightness: at least 170 cd/m² (50 f) at a writing speed of 0.254 cm/ μ s (0.1 in./ μ s), 60 Hz refresh rate, P31 phosphor, 0.3 mm (0.012 in.) spot size.
Uniformity: light output of spots located anywhere in the quality area does not vary by more than 40%.

Geometry: $< 3\%$ pincushion and barrel distortion over usable display area.
Linearity: $< 3\%$ of full scale along major axes.
Contrast ratio: 4:1 or greater. Measured by photometrically summing the trace brightness and background, then dividing by the background brightness.

Cathode-ray tube (1333A)

Type: post deflection accelerator, approx. 12 kV accelerating potential, aluminized P31 phosphor, electrostatic focus and deflection.
Viewing area: 80 cm² (12.4 in.²), 8 cm vertically by 10 cm horizontally (3.1 \times 3.9 in.).
Quality area: 8 cm vertically by 10 cm horizontally (3.1 \times 3.9 in.).
Graticule: none; see Options.

Persistence: approx. 40 μ s for P31 phosphor.
Spot size: 0.20 mm (0.008 in.) over entire quality area. Measured using shrinking raster method, line resolution is approx. 49 lines/cm (125 lines/in.).

Light output
Line brightness: 34.3 cd/m² (10 f) at a writing speed of 0.254 cm/ μ s (0.1 in./ μ s), 60 Hz refresh rate, P31 phosphor, 0.02 mm (0.008 in.) spot size.
Uniformity: with a 1:1 photograph of the CRT display using Polaroid Type 107-084 film, input signals adjusted for uniform stimulation of the entire CRT screen area and exposure parameters adjusted for an average reflection density of 0.3 to 0.6 in the resultant print, the difference between any two points on the photograph in a centered 7 \times 9 cm rectangular area is less than one step on a Kodak 12-step gray scale.

Linearity: $< 3\%$ of full scale along major axes.
Contrast ratio: 4:1 or greater. Measured by photometrically summing the trace brightness and background, then dividing by the background brightness.

Stray emission: no stray emissions from the CRT will be visible on Polaroid Type 107 ASA 3000 film after a 30 minute time exposure with the camera lens set to f/1.9.

Cathode-ray tube (1335A)

Type: post deflection accelerator, approx. 8.5 kV accelerating potential, aluminized P31 phosphor, electrostatic focus and deflection.
Viewing area: 72.2 cm² (11.2 in.²), approx. 8 cm vertically by 10 cm horizontally (3.1 \times 3.9 in.).
Quality area: center 9 div horizontally and center 7 div vertically.
Graticule: 8 \times 10 div internal graticule, 1 div. = 0.95 cm (0.37 in.).
Geometry: $< 3\%$ pincushion and barrel distortion over usable display area.

Linearity: $< 3\%$ of full scale along major axes.
Contrast ratio: 4:1 or greater. Measured by photometrically summing the trace brightness and background, then dividing by the background brightness.

Conventional (non-store) parameters

Spot size: 0.254 mm (0.010 in.) over entire quality area. Measured using shrinking raster method. Non-stored line resolution is approx. 39 lines/cm (100 lines/in.).
Line brightness: 68 cd/m² (20 f) at a writing speed of 0.254 cm/ μ s (0.1 in./ μ s), 60 Hz refresh rate, P31 phosphor, 0.0254 mm (0.010 in.) spot size.
Persistence: approx. 40 μ s for P31 phosphor.

Storage parameters

Stored spot resolution: approx. 20 lines/cm (51 lines/in.).
Brightness: > 680 cd/m² (> 200 f) in WRITE mode.
Erase time: < 500 ms.
Storage time: > 1 min. at full brightness in WRITE mode, extending to > 30 min. in STORE mode at lower brightness.
NOTE: storage time (brightness) in STORE mode is continuously adjustable from 1 min. (full brightness) to > 30 min. (minimum brightness) with an internal adjustment.
Variable persistence: continuously adjustable from 0.2 s to full storage (one minute).
Information storage rate: 750 000 dots per second.
Dot writing time: will store a dot anywhere inside the quality area having an unblanking time of 1 μ s.
Writing speed: > 50 cm/ms.

Remote programming (1355A)

(TTL compatible-except VARIABLE PERSISTENCE)
Remotely programmable functions: ERASE, WRITE, STORE, CONVENTIONAL and VARIABLE PERSISTENCE.
Remote selection: a single TTL control line disables the front panel ERASE, WRITE, STORE, CONVENTIONAL, and VARIABLE PERSISTENCE functions and transfers control to the remote inputs.
Control enable: separate TTL inputs to enable front panel ERASE and/or VARIABLE PERSISTENCE controls during remote operation.
Variable persistence: an external dc voltage between 0 and +10 V sets the persistence. Or, a pot can be connected through the Remote Input connector to control persistence if 10 V dc is not available.
Erase verify: a TTL HIGH output during ERASE (will drive ten low power gates).

Safety protection

Implosion: transparent safety panel between CRT and bezel protects viewer.
High voltage shock: anode lead is securely attached to CRT.
X-ray emission: < 0.05 mr/hr. Not measurable with Victoreen Model 440 RF/C in background noise.
UL listing: meets Underwriter's Laboratories listing for Medical and Dental Equipment (Option 330).

NOTICE TO USER: These instruments are designed and manufactured primarily for OEM systems applications. Therefore, without Option 315 or Option 330, the top and bottom protective covers are not provided and internal wiring connections of HAZARDOUS VOLTAGES ARE EXPOSED. Operator protection from these hazardous voltages must be provided by the purchaser and/or user of the instruments. If in doubt, ORDER OPTION 315 or OPTION 330. OPTION 330 meets UL listing for Medical and Dental Equipment.

CATHODE-RAY TUBE DISPLAY

Models 1332A, 1333A & 1335A (cont.)

General

Input connectors: rear panel BNC for X, Y, and Z-inputs with shields grounded.

Front panel controls

Knobs: POSITION X, POSITION Y, FOCUS, INTENSITY, PERSISTENCE, 1335A only.

Pushbuttons (1335A): ERASE, WRITE, STORE, and CONVENTIONAL.

Screwdriver adjustments: TRACE ALIGN, ASTIGMATISM, GAIN X, GAIN Y.

Line indicator: front panel lamp.

Operating environment: temperature, 0 to +55°C, non-operating -40°C to +70°C; humidity, up to 95% relative humidity at 40°C; altitude, up to 4600 m (15 000 ft), non-operating up to 7000 m (25 000 ft); shock, 30 g level with 11 ms duration and 1/2 sine wave shape; vibration, vibrated in three planes for 15 min, each with 0.254 mm (0.010 in.) excursion, 10 to 55 Hz.

Power: selectable 100, 120, 220, or 240 V ac, +5%, -10% (-20%, 1333A); 48 Hz to 440 Hz*, max power (1332A) 50 VA (approx. 40 W), max power (1335A) 65 VA (approx. 55 W). Average power dissipation at 60 Hz and 120 V without any options is approx. 24 watts (1332A), approx. 35 watts (1335A). *Systems requiring UL Medical and Dental listing must operate from 48 Hz to 66 Hz only.

Dimensions: 213 mm (8 1/2 in.) wide, 146 mm (5 3/4 in.) high including feet, 524 mm (20 1/2 in.) deep.

Weight: net, 8.6 kg (19 lb) with covers and feet. Shipping, 10.5 kg (23 lb). Covers, feet, tilt stand, and trim are not supplied with standard 1332A, 1333A, 1335A.

Accessories supplied: one blue contrast filter, one Operating and Service manual, one 0.375 A fuse (1332A) or one 0.5 A fuse (1333A, 1335A) for 220, 240 V ac operation, one 2.3 m (7.5 ft) line cord (90° IEC to NEMA 5-15P, 3 conductor) for use in Canada, Mexico, Japan, and U.S., and one remote program connector (1335A only).

Options

Price

X and Y amplifiers

Deflection factor

100: 500 mV/div, 5 V p-p for full-screen deflection add \$20

101: 1 V/div, 10 V p-p full screen deflection add \$20

Polarity

105: negative X and Y inputs move beam up and right (BNC connectors) N/C

106: full differential inputs, shield grounded (BNC connectors) add \$20

Input impedance

110: 50 ohms add \$10

Rise time

120 (1332A): 25 ns rise time add \$200

Z-axis input (video amplifier)

Blanking range

200: 0 to 5 V add \$10

201: 0 to 10 V add \$10

Polarity

205: negative input unblanks trace, BNC shield grounded N/C

206: full differential input, BNC shield grounded add \$10

Input impedance

210: 50 ohms add \$10

Gain characteristics

215: light output varies linearly ($\pm 20\%$) with a linear change in Z-axis input voltage (gamma correction) add \$50

Digital input

218: TTL blanking level. High state (+2.5 V to +5 V) blanks any analog Z-input signal. Low state (0.0 V to 0.8 V) returns blanking to analog Z-axis input. Inputs through both BNC connector and Remote Program Input (1335A) add \$50

Cathode-ray tube

Graticule/phosphor type

011 (1332A, 1333A): P11, aluminized, with 8 x 10 div internal graticule add \$30

031 (1333A): P31, aluminized, with 8 x 10 div internal graticule N/C

039 (1332A): P39, aluminized, with 8 x 10 div internal graticule add \$30

631 (1332A, 1335A): P31, aluminized, no graticule N/C

611 (1332A, 1333A): P11, aluminized, no graticule add \$30

639 (1332A): P39, aluminized, no graticule add \$30

Magnetic shield

550 (1332A): full magnetic shield on CRT add \$95

Contrast filters

NOTE: the plastic filter serves as integral implosion protection for the viewer, therefore the display cannot be ordered without the standard or an optional filter.

561: clear, CRT implosion shield replaces standard blue filter, display recognized by UL as system component. N/C

562 (1332A, 1335A): clear, RFI coated surface also includes metallized front panel add \$150

General

AC line cord

300: 2.3 m (7.5 ft) removable, 240 V max, 3 conductor 90° IEC to Great Britain, Singapore N/C

301: 2.3 m (7.5 ft) removable, 240 V max, 3 conductor IEC to Australia, New Zealand N/C

302: 2.3 m (7.5 ft) removable, 240 V max, 3 conductor 90° IEC to East and West Europe N/C

303: 2.3 m (7.5 ft) removable, 240 V max, 3 conductor IEC to NEMA 5-15P (USA, Canada, Japan, Mexico) N/C

304: 77.2 cm (30 in.) coiled, extends to 1.8 m (6 ft) removable, 120 V max, 3 conductor IEC to NEMA 5-15P (USA, Canada, Japan, Mexico) (not available with Option 315 or 330) add \$5

AC line voltage tolerance

310 (1332A, 1335A): +5%, -20% tolerance at 100, 120, 220, or 240 V ac setting. Increases power dissipation to 50 watts (1332A), 60 watts (1335A). add \$50

Front panel controls

322 (1333A, 1335A): 10 turn intensity control potentiometer with counting dial add \$50

323: screwdriver adjustments on left side of front panel changed to internal adjustments add \$10

324 (1332A, 1333A): adds 25 pin connector to rear panel. X, Y, and Z-signal inputs wired to the positive signal inputs (note: input capacitance increases to approx. 120 pF) add \$25

325 (1332A): scale illumination. Illuminates phosphor background for photographing the internal graticule (available with standard phosphor and phosphor Options 011 and 039 only) add \$60

326: controls on right side of front panel changed to screwdriver adjustments. These include INTENSITY, FOCUS, POSITION X, and POSITION Y (also includes scale illumination when Option 325 is ordered for 1332A). When Option 332 is specified with Option 326, the intensity control is as described in Option 322 and the FOCUS, POSITION X, and POSITION Y become screwdriver adjustments. add \$25

Consumer safety

315: includes covers, feet, trim, and tilt stand add \$70

330: meets UL listing 544 for Medical and Dental Electronic Equipment. Includes special three-conductor ac line cord, specially marked covers, feet, tilt stand, trim, clear CRT implosion shield, and UL label add \$75

Model number and name

1332A High Resolution Display \$1300

1333A High Resolution Medical Display \$1550

1335A High Resolution Storage Display \$1900

CATHODE-RAY TUBE DISPLAYS

Large-screen instrumentation & computer graphic displays

Models 1310A, 1311A, 1317A & 1321A

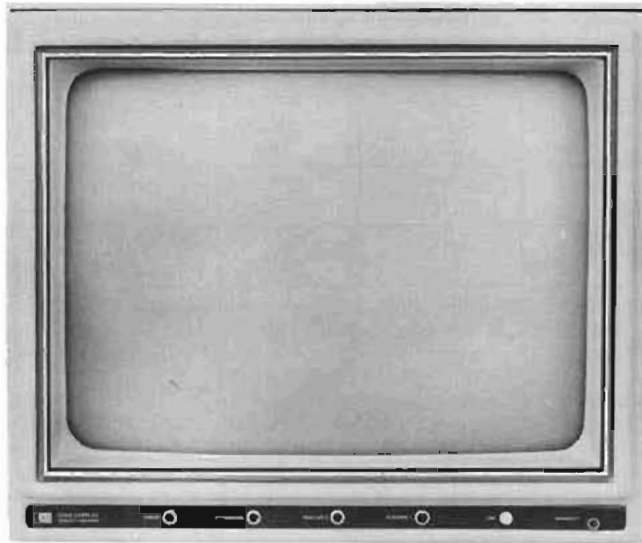

1310A

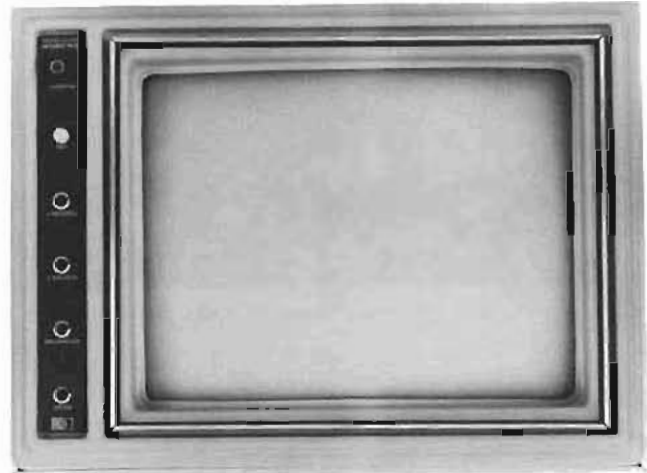

1311A

1310A, 1311A, 1317A, 1321A Description

Models 1310A, 1311A, 1317A, and 1321A large screen displays' high speed performance is the answer to many OEM display requirements. These high resolution displays are ideal as the readout in computer graphic and instrumentation systems because of their high slewing speeds and low power operation.

1310A, 1311A, 1317A, 1321A Specifications

Vertical and horizontal amplifiers

Rise time: ≤ 75 ns, 10% to 90% points, for full screen deflection or less.

Bandwidth: dc to 5 MHz (3 dB down) for 8.9 cm (3.5 in.) deflection or less in 1311A, 10.2 cm (4 in.) in 1317A, 12.7 cm (3.5 in.) in 1310A or 1321A.

Phase shift: $< 0.1^\circ$ to 50 kHz and $< 1^\circ$ to 250 kHz for full screen signal inputs.

Deflection factor (1317A, 1321A): continuously variable with front panel control.

1317A: from approx. 39 mV/cm (100 mV/in.) to 69 mV/cm (175 mV/in.)

1321A: from approx. 33 mV/cm (83 mV/in.) to 58 mV/cm (147 mV/in.)

Deflection factor (1310A, 1311A): continuously variable with front panel adjustment through the range indicated.

	Vertical	Horizontal
1310A	from approx. 35.8 mV/cm (90 mV/in.) to 60.9 mV/cm (153 mV/in.)	from approx. 26.2 mV/cm (67 mV/in.) to 45.9 mV/cm (117 mV/in.)
1311A	from approx. 46.3 mV/cm (118 mV/in.) to 81 mV/cm (207 mV/in.)	from approx. 35.8 mV/cm (90 mV/in.) to 60.9 mV/cm (153 mV/in.)

Linear writing time: < 40 ns/cm (< 100 ns/in.).

Linear writing speed: > 25 cm/ μ s (> 10 in./ μ s).

Diagonal settling time: within 1 spot diameter of final value in < 500 ns (1310A, 1311A, 1321A), $< 1 \mu$ s (1317A), for any on or off screen movement. Off screen deflection not to exceed one screen diameter.

Repeatability: $< 0.15\%$ error (full screen) for re-addressing a point from any on or off screen direction. Off screen deflection not to exceed one screen diameter.

Sequential point plotting time: signal settles to within 0.25 mm (0.010 in.) of final value in < 200 ns for any 2.5 mm (0.10 in.) step.

Crosstalk: < 0.38 mm (< 0.015 in.) with one input terminated in 50 Ω and the other input excited by a 1 V, 500 kHz signal.

Spot jitter and motion: (1310A, 1311A, 1321A) < 0.13 mm (< 0.015 in.); (1317A) < 0.25 mm (< 0.010 in.).

Inputs: (1310A, 1311A) BNC connectors with floating shield; (1317A, 1321A) BNC connectors with grounded shield. Separate differential inputs (shield grounded) available for 1317A, 1321A, see Options.

Input RC: center conductor 10 k Ω shunted by approx. 40 pF. Shield input (1310A, 1311A only) is 47 Ω to ground and can be replaced with 10 k Ω for full differential input. A switchable 50 Ω termination between shield and ground is also provided.

Maximum input: ± 50 V (dc + peak ac) with 10 k Ω internal termination, ± 5 V (dc + peak ac) with 50 Ω internal termination.

Polarity: positive vertical input moves beam up; positive horizontal input moves beam right. Polarity can be reversed by changing internal lead connections.

Position: front panel controls allow zero input to be set off screen in any direction from anywhere within viewing area.

Dynamic range: at least ± 1.5 screen diameters from center screen.

Linearity: (1310A, 1311A, 1321A) 1% of full scale display along major axes within quality area; (1317A) $< 3\%$ of full scale display along major axes within quality area.

Drift: 1.3 mm/hr. (0.05 in./hr.) and 2.5 mm (0.10 in.) in 24 hours with covers installed.

Z-axis amplifier

Rise time: < 20 ns (cw bandwidth is approx. 15 MHz).

Blanking range: a 1 V change in input Z voltage causes a full scale change in brightness. The cutoff level can be set from 0 V dc to -1 V dc with the intensity control.

Blanking polarity: positive input unblanks CRT, internally reversible for negative unblanking.

Input: BNC connector (shield grounded). Differential input available on 1317A, 1321A; see Options.

Input RC: approx. 10 k Ω shunted by approx. 60 pF. 50 Ω termination may be selected with internal switch.

Maximum input: ± 50 V (dc + peak ac) with 10 k Ω internal termination, ± 5 V (dc + peak ac) with 50 Ω internal termination.

Offset (1317A, 1321A): internal adjustment provides ± 1 V offset (continuous) to blanking range.

Gain adjust: extends blanking range by over 2.5:1 (continuous).

CATHODE-RAY TUBE DISPLAYS

Models 1310A, 1311A, 1317A & 1321A (cont.)



1317A with standard rack mount ears fits in 48.3 cm (19 in.) rack.

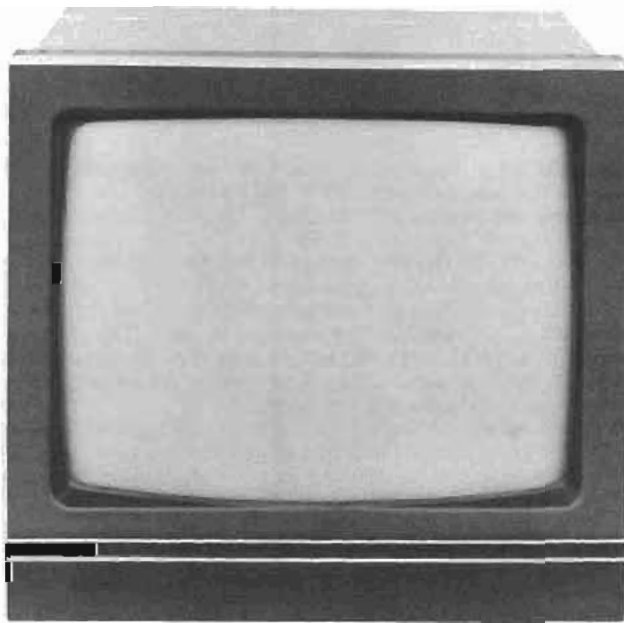

1321A

Cathode-ray tube

Type: post deflection accelerator, approx. 28.5 kV accelerating potential; P31 aluminized phosphor standard (refer to Options for other phosphors); electrostatic focus and deflection.

Viewing area

1310A: 48 cm (19 in.) diagonal; approx. 28 cm (11 in.) by 38 cm (15 in.).

1311A: 36 cm (14 in.) diagonal; approx. 22 cm (8 7/8 in.) by 28 cm (11 in.).

1317A: 43 cm (17 in.) diagonal; approx. 34 cm (13 3/8 in.) by 26 cm (10 1/4 in.).

1321A: 53 cm (21 in.) diagonal; approx. 35 cm (14 in.) by 30 cm (12 in.).

Resolution

Spot size (1310A, 1311A)

Model	Inside Quality Area	Quality Area
1310A	0.51 mm (0.020 in.)	27.9 × 27.9 cm (11 × 11 in.)
1311A	0.38 mm (0.015 in.)	21.6 × 21.6 cm (8 5/8 × 8 5/8 in.)

Spot size (1317A, 1321A)

Model	Inside Quality Area	Outside Quality Area	Quality Area
1317A	0.51 mm (0.020 in.)	<0.76 mm (0.030 in.)	25.4 × 25.4 cm (10 × 10 in.)
1321A	0.51 mm (0.020 in.)	1.02 mm (0.40 in.)	30.5 × 30.5 cm (12 × 12 in.)

Lines: (1310A, 1317A, 1321A) approx. 20 lines/cm (50 lines/in.) measured with shrinking raster method, inside quality area; (1311A) approx. 27 lines/cm (60 lines/in.) measured with shrinking raster method, inside quality area.

Light output: line brightness is approx. 170 cd/m² (50 ft) at a writing speed of 0.25 cm/μs (0.10 in./μs), 60 Hz refresh rate, P31 phosphor. 0.51 mm (0.020 in.) spot size on 1310A, 1317A, and 1321A, 0.38 mm (0.015 in.) on 1311A.

Geometry: <3% (1317A), <2% (1321A) pincushion and barrel distortion within quality area.

Phosphor protection: circuit automatically detects absence of beam deflection and limits beam current to a safe but viewable level.

Dynamic focus: automatically corrects spot geometry for position on screen and beam intensity (video drive level).

Contrast ratio: 4:1 or greater with 340 cd/m² (100 ft) ambient light and CRT face in a vertical plane. Measured by photometrically summing the trace and background brightness and then dividing by background brightness.

Trace align: rotates X-axis into geometric alignment with CRT viewing area.

Orthogonality: separately aligns Y-axis perpendicular to X-axis.

Focus uniformity (1321A only): spot size does not vary more than 10% anywhere within the quality area when referenced to center screen at a fixed video drive level.

Safety protection

Implosion: (1317A, 1321A) meets safety requirements of UL 478 for EDP units and systems which exceeds IEC 348 (IEC 65) safety requirements; (1310A, 1311A) rim and tension banding prevents implosive deactivation. With Option 068 (all models), meets requirements of UL 544 for medical and dental equipment.

High voltage: anode lead is permanently bonded to CRT.

X-ray emission (1317A, 1321A): <0.1 mR/hr measured with Victoreen Model 440 RF/C. The displays are fitted with Underwriters Laboratories for Electronic Data Products, thereby meeting OSHA (Subpart S) approval.

X-ray emission (1310A, 1311A): <0.05 mR/hr (not measurable in background noise with Victoreen Model 440 RF/C).

General

X, Y, and Z inputs: rear panel BNC female connectors. (1310A, 1311A) X and Y inputs have a floating shield and the Z input has a grounded shield. (1317A, 1321A) All BNC connectors have grounded shield.

Front panel controls (1317A, 1321A): Intensity, Position X, Gain X, Position Y, Gain Y, Trace Align, Orthogonality, Focus, and Astigmatism located below the CRT behind a hinged door.

Line indicator: (1310A, 1311A) lamp mounted behind front panel; (1317A, 1321A) lamp mounted behind front panel door.

Power: (1310A, 1311A) 115 V ac ±10% or 230 V ac ±10%, 48 Hz to 440 Hz; maximum power 115 VA (approx. 100 watts); (1317A, 1321A) selectable 100, 120, 220, or 240 V ac ±5% or ±10%, 48 Hz to 440 Hz; maximum power in 1317A, 115 VA (approx. 100 watts), in 1321A, 135 VA (approx. 110 watts).

Dimensions

1317A: 426 mm (16 3/4 in.) wide, 410 mm (16 1/8 in.) high including feet, 567 mm (22 3/8 in.) deep.

1321A: 527 mm (20 7/8 in.) wide, 483 mm (19 in.) high with feet, 632 mm (24 7/8 in.) deep.

1310A, 1311A: (approx. overall dimensions without rack mount adapters or tilt stand) 1310A, 497 mm (19 7/16 in.) wide, 513 mm (16 1/8 in.) high, 660 mm (26 in.) deep; 1311A, 426 mm (16 3/4 in.) wide, 319 mm (12 5/8 in.) high, 578 mm (22 3/4 in.) deep. Contact your local HP Field Engineer for a data sheet with dimensional drawings.

Weight

1310A: net, 24 kg (53 lb); with covers 26.8 kg (59 lb). Shipping, 32.2 kg (92 lb).

1311A: net, 18.1 kg (40 lb); with covers 20.4 kg (45 lb). Shipping, 28.1 kg (53 lb).

1317A: net, 26.3 kg (58 lb). Shipping, 33.4 kg (75 lb).

1321A: net, 36.3 kg (80 lb). Shipping, 43.1 kg (95 lb).

Operating environment: temperature, 0 to +55°C (+32°F to +131°F) — non-operating, -40°C to +70°C (-40°F to 158°F); humidity, to 95% relative humidity at +40°C (+104°F); altitude, to 4600 m (15 000 ft) — non-operating, to 7600 m (25 000 ft); vibration, vibrated in three planes for 15 min, each with 0.25 mm (0.010 in.) excursion, 10 to 55 Hz.

Accessories supplied

1310A, 1311A: rack mount adapter, front panel cover, one 0.75A slow blow fuse for 230 V ac operation, one power cord, and one Operating and Service Manual.

NOTICE TO USERS: the 1310A and 1311A are designed and manufactured primarily for OEM systems applications. Therefore, without OPTION 003, the Top and Bottom Protective Covers are not provided and internal wiring connections of HAZARDOUS VOLTAGES ARE EXPOSED. Operator protection from these hazardous voltages must be provided by the purchaser and/or user of the instruments. If in doubt, ORDER OPTION 003.

1317A, 1321A: 0.75A slow blow fuse for 220 and 240 V ac operation, one 2.3 m (7.5 ft) power cord, and one Operating and Service Manual.

Options*

003: (1310A, 1311A) top and bottom covers with tilt stand (rack mount adapter not supplied with Option 003 instruments).

005: form fitting green contrast filter with anti-glare surface.

008: form fitting blue contrast filter with anti-glare surface.

008: UL listed for Medical and Dental equipment; includes covers for 1310A and 1311A.

009: (1310A, 1311A) tilt stand for use with Option 008 instruments.

050: (1317A, 1321A) TTL blanking input. High state, +2.5 V to +5 V blanks any analog Z-input. Low state, 0.0 V to 0.8 V returns blanking to analog Z-axis input.

051: (1317A, 1321A) differential inputs to X, Y, and Z amplifiers. Inputs for each axis through separate BNC connectors (shield grounded).

052: (1317A, 1321A) four bit binary Z-axis input provides 16 levels of gray shades (TTL compatible). Settling time ≤ 300 ns.

053: (1317A, 1321A) linear light output (±20%) with respect to Z-axis drive change (gamma correction).

054: (1317A, 1321A) TTL blanking input. Low state, 0.0 V to 0.8 V blanks any analog Z-axis input. High state, +2.5 V to +5 V returns blanking to analog Z-axis input.

055: (1317A) fixed slides for EIA standard rack, 48.3 cm (19 in.).

604: aluminized P4 phosphor in lieu of P31.

607: aluminized P7 phosphor in lieu of P31, includes amber contrast filter with anti-glare surface.

639: aluminized P39 phosphor in lieu of P31.

* Special displays, such as round CRTs and different size CRTs, are available. Contact your local HP Field Engineer for information.

Accessories

Cover kits: (1310A, 1311A) top and bottom cover for field installation. For desk top operation, a tilt stand is required since the covers are not designed to support an instrument. Cover kit for 1310A is HP P/N 01310-68710, for 1311A HP P/N 01311-68709.

Tilt stand kits: (1310A, 1311A) provide field installation of tilt stand for stand alone operation. Kit for 1310A is HP P/N 01310-68702, for 1311A HP P/N 01311-68702.

Rack mounting kits: (1310A, 1311A) rack mounting adapters are supplied with standard instruments on initial order or may be ordered later as a kit. Rack mounting kit for the 1310A is HP P/N 01310-68701, for the 1311A HP P/N 01311-68701.

Slide kits: (1310A, 1311A) fixed slide kits are available for mounting the 1310A and 1311A Displays in a standard 48.3 cm (19 in.) rack. A pivoting slide kit is also available for the 1311A. Fixed slide kit for 1310A is HP P/N 01310-68704, for 1311A HP P/N 01311-68704. The pivoting slide kit for the 1311A is HP P/N 01311-68705.

Display cable, Model 10488A: provides one convenient interconnection cable between the display and the system. The cable contains three color-coded coaxial cables with three male BNC connectors.

Options and accessories

	Price
1310A and 1311A	
Option 003: top and bottom covers/tilt stand	\$225
Option 005: green contrast filter for 1310A	\$45
green contrast filter for 1311A	\$30
Option 006: blue contrast filter for 1310A	\$45
blue contrast filter for 1311A	\$30
Option 008: adds covers, warning labels. UL 544 listing for medical, dental use.	\$155
Option 009: tilt stand for use with Opt 008	\$175
Option 604: aluminized P4 phosphor	\$30
Option 607: aluminized P7 phosphor	\$80
Option 639: aluminized P39 phosphor	\$30
1310A Cover Kit HP P/N 01310-68710	\$146
1311A Cover Kit HP P/N 01311-68709	\$160
1310A Tilt-Stand Kit HP P/N 01310-68702	\$111
1311A Tilt-Stand Kit HP P/N 01311-68702	\$280
1310A Rack Mount Kit HP P/N 01310-68701	\$20
1311A Rack Mount Kit HP P/N 01311-68701	\$22
1310A Fixed Slide Kit HP P/N 01310-68704	\$160
1311A Fixed Slide Kit HP P/N 01311-68704	\$195
1311A Pivoting Slide Kit HP P/N 01311-68705	\$130
1317A and 1321A	
Option 005: green contrast filter for 1317A	\$50
green contrast filter for 1321A	\$60
Option 006: blue contrast filter for 1317A	\$50
blue contrast filter for 1321A	\$60
Option 008: UL 544 listing for medical, dental use	\$25
Option 050: TTL blanking input (see Options)	\$25
Option 051: Differential inputs to X, Y, and Z-axes	\$25
Option 052: four bit binary Z-axis input provides 16 levels gray shades (TTL compatible).	\$100
Option 053: gamma correction (see Options)	\$50
Option 054: TTL blanking input (see Options)	\$25
Option 055: (1317A) fixed slides for EIA std. rack	\$100
Option 604: aluminized P4 phosphor	\$30
Option 607: aluminized P7 phosphor	\$100
Option 639: aluminized P39 phosphor	\$30

Model number and name

(OEM discounts are available.)

1310A 48 cm (19 in.) Display	\$3600
1311A 36 cm (14 in.) Display	\$3300
1317A Large Screen Display	\$3350
1321A Large Screen Display	\$3800
10488A Display Cable	\$55

CATHODE-RAY TUBE DISPLAYS

Large screen display

Model 1304A



1304A Description

The Model 1304A 20 cm × 25 cm (7.9 in. × 9.8 in.) display offers the high writing speed, fast settling time, low power consumption and reliability inherent in Hewlett-Packard electrostatic directed beam displays in a cost-effective package that makes it ideal for applications such as Fourier or Spectrum Analyzers, physiological monitoring, or calculator-based graphic systems. The 0.5 mm (0.02 in.) spot size permits up to 2000 characters or a 400-line raster to be presented clearly on the screen, with sufficient brightness for viewing in brightly lighted indoor environments. Dynamic focus circuits keep the spot sharply focused at all intensity levels, essential to image quality in graphic systems employing Z-axis drive compensation for writing speed, or where cursors or other regions of unequal brightness are needed.

The 1304A utilizes the HP System-II modular enclosure system (refer to Cabinets, System-II), allowing it to accept a wide range of mounting hardware, interlocking hardware, handles, and slides which are available for this enclosure system. The modular construction, with interconnections through multipin connectors and multiconductor cables, makes servicing the 1304A easy. Low power circuits, low component count, and a minimum of soldered connections provide reliability in a low cost package.

A wide selection of options permit the 1304A to be tailored to specific requirements; refer to Specifications for a listing.

1304A specifications

Vertical and horizontal amplifiers

Risetime: ≤ 70 ns, 10% to 90% points, for full screen deflection or less.
Bandwidth: dc to 5 MHz (3 dB down) for 10 cm (3.9 in.) deflection or less.

Phase shift: < 1° to 250 kHz for full screen signal inputs.

Deflection factor: 80 mV/div (1 V p-p for 25 cm, 9.8 in., deflection). Front panel adjustable from 40 to 120 mV/div. 1 div = 2.0 cm (0.79 in.)

Linear writing time: < 40 ns/cm (< 100 ns/in.)

Linear writing speed: > 25 cm/μs (> 9.8 in./μs).

Settling time: (large and small step) signal settles to within one spot diameter of final value in < 300 ns for any on-screen movement. Off-screen deflection must not exceed specified dynamic range.

Repeatability: < 0.15% error (full screen) for readdressing a point from any on or off screen location within the specified dynamic range.

Inputs: fully differential BNC connectors with shield grounded.

Input RC: ≥ 100Ω shunted by ≤ 60 pF. Can be set to 50Ω internally. 50Ω X and Y inputs available, see Options.

Maximum input: ± 50 V (dc + peak ac) for high impedance input termination; ± 5 V (dc + peak ac) for 50Ω input termination.

Polarity: a positive signal input to the (+) input moves beam up or to the right. A negative signal input to the (-) input moves the beam up or to the right.

Position: front panel controls allow undeflected spot to be set off screen from anywhere within the viewing area. Spot position with both inputs shorted and position pots electrically centered is at the geometric center of the viewing area.

Dynamic range: at least ± 1.5 screen diameters from the geometric center of the viewing area.

Drift

Position: 1.0 mm/hr (0.04 in./hr.) and a max of 2.5 mm (0.1 in.) in 24 hrs. with covers installed after 15 min. warmup.

Gain: < 1% under all conditions of specified line voltage with covers installed after 15 min. warmup and temperature between +20°C and +55°C (+68°F and +131°F).

Crosstalk: < 0.25 mm (0.01 in.) with one input terminated in 50Ω and the other axis excited by a 1 V, 500 kHz signal. (< 0.5 mm at 5 MHz).

Z-axis amplifier

Risetime: < 25 ns (cw bandwidth is approx. 5 MHz).

Blanking range: a 1 V change in input Z voltage causes a full scale change in brightness. The cutoff level can be set from +0.2 V dc to -1 V dc with the intensity control. With intensity control full ccw, brightness is limited to a safe level for any Z-axis input voltage.

Blanking polarity: fully differential. A positive or negative going input voltage into the positive or negative inputs, respectively, increases brightness.

Input: fully differential BNC connectors with shields grounded to chassis.

Input RC: approx. ≥ 100 kΩ shunted by < 60 pF. Can be set to 50Ω internally. 50Ω Z-axis input available, see Options.

Maximum input: ± 50 V (dc + peak ac) with high impedance input termination; ± 5 V (dc + peak ac) for 50Ω input termination.

Gain: internally adjustable over 2.5:1 attenuation range.

Focus correction: amplifier automatically corrects focus voltage for changes in grid to cathode voltage.

Cathode-ray tube

Type: post deflection accelerator, approx. 27 kV accelerating potential. Aluminized P43 phosphor, electrostatic focus and deflection.

Viewing area: 500 cm² (77.4 in.²) 20 cm (7.9 in.) vertically by 25 cm (9.8 in.) horizontally.

Quality area: 20 cm (7.9 in.) vertically by 25 cm (9.8 in.) horizontally.

Graticule: none (see Options).

Spot size: < 0.5 mm (0.02 in.) at center screen; ≤ 0.64 mm (0.025 in.) over entire quality area measured using shrinking raster method. Line resolution is approx. 20 lines/cm (50 lines/in.).

Linearity: < 3% of full scale along major axes.

Geometry: < 3% pincushion or barrel distortion within quality area.

Trace align: rotates X-axis into geometric alignment with CRT viewing area.

Orthogonality: separately aligns Y-axis perpendicular to X-axis.

Safety protection

Implosion: meets safety requirements of UL 478 for EDP units and systems which exceed IEC 348 (IEC 65) safety requirements.

High voltage: anode lead is permanently bonded to CRT.

X-ray emission: < 0.5 mR/hr measured with Victoreen Model 440 RF-C

General

Signal input connectors: two rear panel BNC female connectors for each axis.

Front panel controls: all located behind door on front panel.

Knobs: Intensity, Focus, X Position, Y Position.

Screwdriver adjustments: Trace Align, X Gain, Y Gain, Astigmatism.

Line indicator: green LED mounted on front panel.
Dimensions: 425 mm (16 3/4") wide, 324 mm (12 3/4") high, 524 mm (20 3/4") deep overall.
Operating environment: temperature: 0°C to +55°C (+32°F to +131°F), — non-operating, -40°C to +70°C (-40°F to +158°F); humidity, 5% to 95% relative humidity at +40°C (+104°F); altitude, to 4600 m (25 000 ft); non-operating to 15 300 m (50 197 ft); shock, 30 g level shock, 11 ms duration, and 1/2 sine wave shape; vibration, vibrated in three planes for 15 min. each with 0.38 mm (0.01 in.) excursion, 5 Hz to 55 Hz, 1 min. per octave, 10 min. each resonance.
Line power: 100, 120, 220, or 240 V ac selectable on rear panel, +5% to -20%; 48 Hz to 66 Hz; max power 100 VA (approx. 85 W). Average power dissipation at 60 Hz and 120 V ac is approx. 60 W.
Weight: net, 20 kg, (44 lbs). Shipping, 28.2 kg, (62 lbs).
Accessories supplied: one contrast filter, one Operating and Service Manual, one 2.3 m (7.55 ft.) line cord (90 IEC to NEMA 5-15 P, 3 conductor) for use in Canada, Mexico, Japan, and the United States. See options for other available line cords.

Options	Price
X and Y amplifiers	
Deflection factor	
100: 500 mV/div, 5 V p-p for full screen deflection	add \$25
101: 1 V/div, 10 V p-p for full screen deflection	add \$25
Input impedance	
110: 50Ω	add \$15
Z-Axis input (video amplifier)	
Blanking range	
200: 0 to 5 V	add \$25
201: 0 to 10 V	add \$25
Input impedance	
210: 50Ω	add \$15
Gain characteristics	
215: light output varies linearly (±20%) with a linear change in Z-axis input voltage (gamma correction)	add \$50
Digital input	
216: TTL blanking level. High state (+2.5 V to +5 V) blanks any analog Z-input signal. Low state (0.0 V to 0.8 V) returns blanking to analog Z-axis input. Input through rear panel BNC connector	add \$50
217: same as 216, except polarity reversed	add \$50
218: 4-bit binary input. Allows binary selection of 16 levels of gray, TTL levels. Settling time ≤300 ns. Levels linear within ±20%. Includes 25 pin program connector mounted to rear panel. When Option 218 is ordered with Option 216 or 217, TTL blanking input is provided through both a BNC connector and the 25 pin remote connector	add \$100
Cathode-ray tube	
Graticule/phosphor type	
004: P4 aluminized phosphor with 10 × 12 div internal graticule (1 div = 2.0 cm, 0.79 in.)	add \$30
043: P43 aluminized phosphor with 10 × 12 div internal graticule (1 div = 2.0 cm, 0.79 in.)	N/C
039: P39 aluminized phosphor with 10 × 12 div internal graticule (1 div = 2.0 cm, 0.79 in.)	add \$30
604: P4 aluminized phosphor in lieu of P43	add \$30
639: P39 aluminized phosphor in lieu of P43	add \$30
561: clear filter replaces standard neutral density contrast filter	N/C
563: blue filter replaces standard neutral density contrast filter	N/C

General

AC line cord	
300: 2.3 m (7.5 ft.) removable, 240 V max, 3 conductor 90° IEC to Great Britain, Singapore	N/C
301: 2.3 m (7.5 ft.) removable, 240 V max, 3 conductor IEC to Australia, New Zealand	N/C
302: 2.3 m (7.5 ft.) removable, 240 V max, 3 conductor 90° IEC to East and West Europe	N/C
303: 2.3 m (7.5 ft.) removable, 240 V max, 3 conductor IEC to NEMA 5-15 P (USA, Canada, Japan, Mexico)	N/C
304: 77.2 cm (30 in.) coiled, extends to 1.8 m (6 ft.) removable, 120 V max, 3 conductor IEC to NEMA 5-15 P (USA, Canada, Japan, Mexico) (not available with Option 330)	add \$5

Front panel control

322: 10 turn intensity control potentiometer with counting dial	add \$50
---	----------

Rear panel connector

324: add 25 pin connector to rear panel. X, Y, and Z-signal inputs wired to the positive signal inputs (note: input capacitance increases to approx. 120 pF)	add \$25
--	----------

Consumer safety

330: meets UL listing 544 for Medical and Dental Electronic Equipment. Includes special three conductor ac line cord, specially marked covers, and UL label	add \$50
---	----------

Accessories

Rack flange kit: the rack flange kit provides rack mounting of the 1304A in a standard width EIA relay rack. Kit includes two flush rack ears without handles that fit on each side of the 310 mm (12 1/4 in.) high front panel frame, and attaching hardware. HP P/N 5061-0081	\$15
Rack flange kit with handles: the rack flange and front handle combination kit provides rack mounting for the 1304A in a standard width EIA relay rack. Kit includes rack flanges and front handles that fit on each side of the 310 mm (12 1/4 in.) high front panel frame and attaching hardware. HP P/N 5061-0087	\$25
Standard slide kit: allows 1304A to be mounted on slides for use in a standard EIA relay rack (also order bracket kit, HP P/N 1494-0023). Includes slides and all hardware necessary for attaching slides to 1304A and rack. HP P/N 1494-0017	\$40
Standard tilt slide kit: allows 1304A to be mounted on pivoting slide for use in a standard EIA relay rack (also order bracket kit, HP P/N 1494-0023). Includes slides and all hardware necessary for attaching slides to 1304A and rack. HP P/N 1494-0026	\$85
Bracket kit: required with standard slide kit or tilt slide kit for mounting 1304A in EIA relay rack. HP P/N 1494-0023	\$10
Input signal cable: Model 10488A Input Signal Cable provides convenient connection between the display and signal source. The cable has three color-coded 50Ω coaxial cables with three male BNC connectors on each end for the X, Y, and Z-inputs. Approx. length is 3.6 m (12 ft.)	\$55
1304A Large screen display	\$2400

OEM discounts are available



Introduction

Hewlett-Packard power supplies are available in many types, sizes, and ratings. There are laboratory supplies used in circuit development, modular supplies to power systems, high power supplies for industrial processes, and many special purpose supplies ranging from constant-current sources to bipolar power supply amplifiers.

The true value of a power supply

The best power supply for the job must first satisfy all the physical criteria: voltage and current ratings, performance specifications, size, and features. But equally important are the less tangible aspects that affect the real cost of ownership. Such factors as the experience and expertise of the manufacturer's engineering staff should be considered. Are his designs conservative—does he use quality components—does he have established QA procedures?

If you have a problem or need application assistance, are the manufacturers' reps accessible, responsive, and knowledgeable? Are spare parts and service available on a worldwide scale?

These factors do not show up on a spec sheet, but are closely related to a company's capability and responsibility towards its customers. When you purchase a power supply from Hewlett-Packard, you receive guaranteed product performance plus all the intangibles that add up to long-term value—and it usually costs no more.

Regulation techniques

HP power supplies are designed using one of four proven stabilization techniques: series, switching, SCR, and SCR pre-regulator/series regulator.

Series regulation: this technique uses a feedback loop to control the voltage drop across a series-pass transistor located between the rectified dc input and the output terminals of the power supply. The feedback network senses changes in the output voltage and develops an error signal which adjusts the drop across the series transistor such that it maintains the output terminal voltage at the desired level. Good regulation (0.001% to 0.05%), low ripple and noise (50 μ V to 1 mV), and fast transient response (<50 μ s) characterize this type of regulator.

With all its attributes of excellent performance and circuit simplicity, the series regulator has one drawback: it is relatively inefficient (typically 30 to 40%). Heat sinks are employed to dissipate the heat generated by the series transistors and this necessarily increases the size and weight of the supply.

All linear OEM modular and low power lab supplies use this technique.

Extended range series regulation: this technique uses a pair of triac switches with appropriate control logic to automatically select different transformer secondary taps depending on the output voltage and current demand placed on the supply, and the AC input voltage and frequency. Several voltage-current combinations can thereby be supplied from the input rectifier to the following se-

ries regulator. This extends the range of voltage (or current) output available within the power rating of the supply beyond that obtained from a simple series regulator. Model 6002A uses this technique.

Switching regulation: this technique regulates the output voltage by essentially switching a series transistor on and off at a rapid rate (about 20 kHz) and delivering this "chopped" current to an output filter. A feedback network senses changes in the output and feeds back a correction signal which adjusts the transistors on-off duty cycle to maintain a constant output voltage. Since a transistor dissipates very little power when it's fully on or off, the regulator has excellent efficiency (typically 65-80%).

Besides low power dissipation, another advantage of this technique is that the high pulse repetition rates make possible the use of transformers, inductors, and filter capacitors that are much smaller than those required for operation at power line frequencies.

Stabilization performance of the switching regulator is somewhat lower than the series regulator (typically 0.2% regulation; 20 mV rms, 40 mV p-p ripple and noise) but well suited for the majority of OEM system applications.

SCR regulation: in many high power applications, the tight regulation and low ripple and noise characteristics of the series regulator can be beneficially traded for economy, efficiency, and compact size. This is where the SCR regulator is most valuable. Typical performance specifications for SCR supplies are 0.05 to 1% regulation, 50 mV rms, 500 mV p-p ripple and noise, 50-200 ms transient response, and 70% efficiency. Regulation is accomplished by sensing both the AC input and DC output of the supply and generating a firing pulse for SCR's located in two legs of a bridge rectifier. If the output voltage tries to decrease, the control circuit generates the firing pulse earlier in the input half cycle. More voltage is then passed through the SCR to the output filter to raise the output voltage to the correct level.

SCR pre-regulator/series regulator: this technique incorporates the best of both worlds, and is used in most medium to high power, high performance power supplies. In these supplies, the SCR pre-regulator changes the rectifier output in coordination with the output voltage of the supply so that only a small voltage drop is maintained across the series pass transistor. This reduces the power dissipation in the series elements and greatly improves the efficiency (up to 70%). Typical performance specifications are similar to series regulated supplies except for slower transient response.

Selecting power supplies

By model number: if you know the model number, you can find the power supply description page from the numerical index in the front of this catalog

By voltage rating: the condensed listing on the following two pages lists power supplies in order of output voltage rating. The reference catalog page covers detailed specifications.

POWER SUPPLIES

Specification definitions and power supply terms

Specification definitions

The following definitions expand on the terms used in the individual power supply specification tables.

Load effect (load regulation): voltage load effect is given for a load current change equal to the current rating of the supply. Current load effect is given for a load voltage change equal to the voltage rating of the supply. In general, where a supply has both front and rear output terminals, load effect is specified for the rear terminals only.

Source effect (line regulation): given for any change in line voltage within the specified range at any output voltage and current within rating.

PARD (ripple and noise): measured within 20 Hz to 20 MHz bandwidth at any line voltage and under any load condition within rating. For the high voltage supplies, models 6515A-6525A, the measurement bandwidth is 1 Hz to 20 MHz.

Temperature coefficient: output change per degree Celsius change in ambient following 30-minute warm-up.

Drift (stability): change in output (dc to 20 Hz) over 8-hour interval under constant line, load, and ambient following 30-minute warm-up.

Resolution: minimum output voltage or current change that can be obtained using front panel controls.

Output impedance: typical values, approximated by a resistance in series with an inductance.

Load effect transient recovery (load transient recovery): time required for output voltage recovery to within the specified level of the nominal output following a change in output current equal to the current rating of the supply or 5 amps, whichever is smaller.

Remote programming speed: typical time required to non-repetitively change from zero to within 99.9% of the maximum rated output voltage, or from the maximum rated output voltage to within 0.1% of that voltage above zero (99% and 1% for high power models 6427B-6483C and precision models 6101A-6116A).

Remote sensing: a means by which the power supply monitors a stabilized output quantity directly at the load using extra "sensing" leads.

Stabilized power supply:

(1) **Constant Voltage Power Supply (CV):** a power supply that stabilizes output voltage with respect to changes of influence quantities.

(2) **Constant Current Power Supply (CC):** a power supply that stabilizes output current with respect to changes of influence quantities.

(3) **Constant-Voltage/Constant-Current Power Supply (CV/CC):** a power supply that operates as a constant-voltage power supply or constant-current power supply, depending on load conditions.

Terms related to static operation

Constant-voltage/constant-current cross-over: the behavior of a power supply that automatically converts the mode of operation from voltage stabilization to current stabilization when the output current reaches a preset value and vice versa.

Discontinuous control resolution (resolution): in the case of discontinuous control (e.g., by means of switches, wire-wound adjustable resistors), the maximum increment in the value of a stabilized output quantity arising from the smallest reproducible control element step.

Drift: the maximum change of an output quantity during a specified period of time following the warm-up time, with all influence and control quantities maintained constant during the warm-up time and the period of drift measurement. Drift includes both periodic and random deviations over the bandwidth from zero frequency (dc) to a specified upper frequency limit. This specified upper frequency limit for drift must coincide with the lower frequency limit for PARD so that all deviations under constant operating conditions are covered by specifying one or the other.

Warm-Up Time: the time interval after switching on the power supply until it complies with all performance specifications.

Terms related to dynamic operation

Output Impedance: the complex ratio of a sinusoidal voltage and a sinusoidal current at the output terminals, the one being caused by the other and being of external origin.

Transient recovery time: the time interval between a step change in one of the influence quantities or control quantities and the instant when the stabilized output quantity returns to and stays within the transient recovery band.

Turn-on (turn-off) overshoot: the overshoot resulting from the application (removal) of the source power or from the power supply source switch being turned on (turned off).

Remote control terms

Remote programming: a product feature whereby the output voltage or current may be controlled by means of an externally applied analog resistance, voltage, or current. The remote control device may range from a simple external resistor, or voltage source, to isolated D/A converters specifically designed for use with power supplies. The 6940B/6941B Multiprogrammer (pg. 532) and the 59501A Isolated D/A Converter (pg. 26) are designed for interfacing power supplies identified in the Condensed Listing (pg. 180-181) with calculators or computers.

Digitally controlled power supplies: are programmable in binary or 8421 BCD, and incorporate isolation, data storage, and other system-oriented features. See page 202 for details.

HP-IB: the Hewlett-Packard Interface Bus is HP's implementation of IEEE Standard 488-1975, and provides a versatile interconnect system for instruments and controllers. See page 20 for HP-IB system details.

Terms related to physical and environmental aspects

Ambient temperature: the temperature of the medium in which the power supply is immersed, usually the temperature of the air surrounding the power supply.

Isolation voltage: in the case of a floating output, input, or control input, the maximum voltage that may be permanently maintained between specified terminals.

Protection terms

Crowbar protection circuit: a protection circuit which rapidly places a low resistance shunt across the output terminals of the power supply, thereby initiating action to reduce output voltage to a low value.

Current limiting: the action of limiting the output current of a constant-voltage supply to some predetermined maximum value (fixed or adjustable) and automatically restoring the output voltage to its normal value when the overload or short circuit is removed. There are three types of current limiting.

(1) By constant-voltage/constant-current crossover.

(2) By decreasing output voltage as current increases (otherwise known as automatic current limiting.)

(3) By decreasing both voltage and current as load resistance decreases (otherwise known as foldback or outback current limiting).

Overcurrent protection: protection of the power supply and/or connected equipment against excessive output current, including the short-circuit current.

Overtemperature protection: protection of the power supply or parts of it against temperatures exceeding specified values.

Reverse voltage protection: protection of the power supply against reverse voltage applied at the output terminals.

Short-circuit current: the steady-state current delivered by a constant voltage power supply when its output terminals are short-circuited.

Thermal disconnect: a device which prevents the maintenance of excessively high temperature in certain parts of the apparatus by disconnecting those parts from their supply.

Voltage limiting: the action of limiting the output voltage of a constant-current supply to some predetermined maximum value (fixed or adjustable) and automatically restoring the output current to its normal value when the load conditions are restored to normal. There are two types of voltage limiting:

(1) By constant-voltage/constant-current crossover.

(2) By decreasing output current as voltage increases (otherwise known as automatic voltage limiting.)

Open-circuit voltage: the voltage at the terminals of a constant-current power supply when there is no load connected.

DC Volts	DC Amps (Max.)	Type	Model	Page
4-5.5	8	Low Cost Lab	6384A †	183
0 ± 5 & ± 20 Dual Range	1	BPSA*	6825A †	197
0 ± 5 & ± 50 Dual Range	1	BPSA*	6826A †	197
5 ± 0.50	2	Modular	62005A †	199
5 ± 0.50	4	Modular	62005C †	199
5 ± 0.50	8	Modular	62005E †	199
5 ± 0.50	16	Modular	62005G †	199
5, & ± 12 to 15, ± 0.25 max	18 & 2A	Modular	63315D †	199
5 ± 0.25	22	DC-to-DC	61005C	201
5 ± 0.25	22	Modular	63005C †	199
5 & 12 to 15 ± 0.25 max	18 & 2A	DC-to-DC	61315D	201
5 & ± 12 to 15 ± 0.25 max	40 & 10A	Modular	63312F	199
5 ± 0.50	40	Modular	62605J †	199
5 ± 0.25	60	Modular	62605L †	199
5 ± 0.25	100	Modular	62605M †	199
0-6, 0 ± 20, Dual Tracking	2.5 & 0.5	Low Cost Lab	6236A †	182
0-7.5	3	Low Cost Lab	6203B †	183
0-7.5	5	Gen. Purpose	6281A †	184
0-8	1000	High Pwr.	6454C †	188
0-10	1	Low Cost Lab	6213A †	182
0-10	1	Low Cost Lab	6214A †	182
0-10	2	Prec. Volt.	6113A †	194
0-10	10	Gen. Purpose	6282A †	184
0-10	70	Gen. Purpose	6256B †	186
0-10	50	Gen. Purpose	6259B †	186
0-10	100	Gen. Purpose	6260B †	186
0 ± 10 & 0 ± 100 Dual Range	0.5	BPSA*	6827A †	197
12 ± 0.60	1.5	Modular	62012A	199
12 ± 0.60	3	Modular	62012C †	199
12 ± 0.60	6	Modular	62012E †	199
12 ± 0.60	12	Modular	62012G †	199
12 ± 0.60	23	Modular	62612J †	199
± 12 ± 0.60 Dual	1.4	Modular	62212A †	199
± 12 to ± 15, & 5 ± 0.25 max	2 & 18A	Modular	63315D †	199
± 12 ± 0.60 Dual	3.3	Modular	62212E †	199
± 12 ± 0.60 Dual	6	Modular	62212G †	199
0-15	200	High Pwr.	6453A †	188
15 ± 0.75	1.25	Modular	62015A †	199
15 ± 0.75	2.5	Modular	62015C †	199
15 ± 0.75	5	Modular	62015E †	199
15 ± 0.75	10	Modular	62015G †	199
15 ± 0.75	20	Modular	62615J †	199
± 15 ± 0.75 Dual	1.25	Modular	62215A †	199
± 15, & 5 ± 0.25	2 & 18 max	Modular	63315D †	199
± 15 ± 0.75 Dual	3	Modular	62215E †	199
± 15 ± 0.75 Dual	5.2	Modular	62215G †	199
0-16 or 0-18	600 or 500	High Pwr.	6466C †	188
0 ± 16	12.5	Dig. Prog. Volt.	6128C †	202
0-18 & 0-± 20 Dual Tracking	1 & 0.5	Low Cost Lab	6237A †	182

DC Volts	DC Amps (Max.)	Type	Model	Page
18 ± 0.90	1	Modular	62018A †	199
18 ± 0.90	2.25	Modular	62018C †	199
18 ± 0.90	4.5	Modular	62018C †	199
18 ± 0.90	9	Modular	62018G †	199
18 ± 0.90	16.7	Modular	62618J †	202
0 ± 20, 0-6 Dual Tracking	0.5 & 2.5	Low Cost Lab	6236A †	182
0 ± 20, 0-18 Dual Tracking	0.5 & 1	Low Cost Lab	6237A †	182
0-20 & 0-40 Dual Range	0.6 & 0.3	Low Cost Lab	6204B †	183
0-20 & 0-40 Two Dual Range	0.6 & 0.3	Low Cost Lab	6205B †	183
0-20	1	Prec. Volt.	6101A †	194
0-20	1	Prec. Volt.	6111A †	194
0-20	1.5	Low Cost Lab	6201B †	183
0-20 & 0-40 Dual Range	1.5 & 0.75	Low Cost Lab	6200B †	183
0-20 & 20-40 Dual Range	2 & 1	Prec. Volt.	6104A †	194
0-20	2 & 1	Prec. Volt.	6114A †	194
0-20	3	Gen. Purpose	6284A †	184
0-20 & 0-20 Two Outputs	3 & 3	Gen. Purpose	6253A †	184
0-20	5	Gen. Purpose	6285A †	184
0-20	10	Gen. Purpose	6263B †	186
0-20	10	Gen. Purpose	6286A †	184
0-20	15	High Pwr.	6427B †	188
0-20	20	Gen. Purpose	6264B †	186
0-20	45	High Pwr.	6428B †	188
0-20	50	Gen. Purpose	6261B †	186
0 ± 20	0.5	BPSA*	6823A †	197
20-40 & 0-20 Dual Range	1 & 2	Prec. Volt.	6104A †	194
20-40 & 0-20 Dual Range	1 & 2	Prec. Volt.	6114A †	194
0-24	3	Gen. Purpose	6224B †	184
24 ± 1.20	1.75	Modular	62024C †	199
24 ± 1.20	3.75	Modular	62024E †	199
24 ± 1.20	7.5	Modular	62024G †	199
24 ± 1.20	12.5	Modular	62624J †	199
0-25	0.4	Low Cost Lab	6215A †	182
0-25	0.4	Low Cost Lab	6216A †	182
0-25 & 0-50 Dual Range	1 & 0.5	Gen. Purpose	6220B †	184
0-25 & 0-25 Two-Tracking	2	Gen. Purpose	6227B †	192
28 ± 1.40	0.7	Modular	62028A †	199
28 ± 1.40	1.5	Modular	62028C †	199
28 ± 1.40	3.25	Modular	62028E †	199
28 ± 1.40	6.5	Modular	62028G †	199
28 ± 1.40	10.7	Modular	62628J †	199
0-30 & 0-60 Dual Range	1 & 0.5	Low Cost Lab	6206B †	183
0-36	10	High Pwr.	6433B †	188
0-36	100	High Pwr.	6456B †	188
0-36	300	High Pwr.	6469C †	188
0-40 & 0-20 Dual Range	0.3 & 0.6	Low Cost Lab	6204B †	183

† Available on GSA Contract Number GS-00S-27455.

● May be used with the 59501A HP-1B Isolated D/A Converter/Power Supply Programmer.

* May be used with the 6940B Multiprogrammer when equipped with Option 040.

* BPSA = Bipolar Power Supply/Amplifier.

† Available on GSA Contract Number GS-00S-27455.

● May be used with the 59501A HP-1B Isolated D/A Converter/Power Supply Programmer.

* May be used with the 6940B Multiprogrammer when equipped with Option 040.

* BPSA = Bipolar Power Supply/Amplifier.

DC Volts	DC Amps (Max.)	Type	Model	Page
0-40 & 0-20 Dual Range	0.3 & 0.6	Low Cost Lab	6205B †	183
0-40	0.5	Prec. Volt.	6102A †	194
0-40	0.5	Prec. Volt.	6112A †	194
0-40	0.75	Low Cost Lab	6202B †	183
0-40 & 0-20 Dual Range	0.75 & 1.5	Low Cost Lab	6200B †	183
0-40 & 0-40 Two Outputs	1.5 & 1.5	Gen. Purpose	6255A †	184
0-40	1.5	Gen. Purpose	6289A †	184
0-40	3	Gen. Purpose	6265B †	186
0-40	3	Gen. Purpose	6290A †	184
0-40	5	Gen. Purpose	6266B †	186
0-40	5	Gen. Purpose	6291A †	184
0-40	10	Gen. Purpose	6267B †	186
0-40	25	High Pwr.	6434B †	188
0-40	30	Gen. Purpose	6268B †	186
0-40	50	Gen. Purpose	6269B †	186
48 ± 2.40	0.45	Modular	62048A †	199
48 ± 2.40	1	Modular	62048C †	199
48 ± 2.40	2	Modular	62048E †	199
48 ± 2.40	4	Modular	62048G †	199
0-48	120	High Pwr.	6452A †	190
0-50	0.2	Low Cost Lab	6217A †	182
0-50	0.2	Low Cost Lab	6218A †	182
0-50 (Compliance)	0-0.5	Prec. Cur.	6177C †	196
0-50 & 0-25	0.5 & 1	Gen. Purpose	6220B †	184
0-50 & 50-100 Dual Range	0.8 & 0.4	Prec. Volt.	6105A †	194
0-50 & 50-100 Dual Range	0.8 & 0.4	Prec. Volt.	6115A †	194
0-50 & 0-50 Two-Tracking	1	Gen. Purpose	6228B †	192
0-50	1.5	Gen. Purpose	6226B †	184
50-100 & 0-50 Dual Range	0.4 & 0.8	Prec. Volt.	6115A †	194
50-100 & 0-50 Dual Range	0.4 & 0.8	Prec. Volt.	6105A †	194
0-50	10-4	Gen. Purpose	6002A †	191
0 ± 50	5	Dig. Prog. Volt.	6129C †	202
0 ± 50	1	Dig. Prog. Volt.	6130C †	202
0 ± 50	1	BPSA*	6824A †	197
0-60 & 0-30 Dual Range	0.5 & 1	Low Cost Lab	6206B †	183
0-60	1	Gen. Purpose	6294A †	184
0-60	3	Gen. Purpose	6296A †	184
0-60	3	Gen. Purpose	6271B †	186
0-60	5	High Pwr.	6438B †	188
0-60	15	Gen. Purpose	6274B †	186
0-60	15	High Pwr.	6439B †	188
0-64	50	High Pwr.	6459A †	188
0-64	150	High Pwr.	6472C †	188
0-100 (Compliance)	± 0.016	Dig. Prog. Cur.	6140A †	202
0-100	0.1	Low Cost Lab	6211A †	182
0-100	0.1	Low Cost Lab	6212A †	182

DC Volts	DC Amps (Max.)	Type	Model	Page
0-100	0.2	Prec. Volt.	6106A †	194
0-100	0.2	Prec. Volt.	6116A †	194
0-100 (Compliance)	0.25	Prec. Cur.	6181C †	196
0-100	0.75	Gen. Purpose	6299A †	184
0 ± 100	0.5	Dig. Prog. Volt.	6131C †	202
0-110	100	High Pwr.	6475C †	188
0-120	2.5	High Pwr.	6443B †	188
0-160	0.2	Low Cost Lab	6207B †	183
0-220	50	High Pwr.	6477C †	188
0-300 (Compliance)	0.1	Prec. Cur.	6186C †	196
0-300	35	High Pwr.	6479C †	188
0-320	0.1	Low Cost Lab	6209B †	183
0-320	1.5	Gen. Purpose	895A †	186
0-440 or 0-500 or 0-600	25 or 20 or 15	High Pwr.	6483C †	188
1-600	1.5	High Pwr.	6448B †	188
0-1000	0.2	High Volt.	6521A †	193
0-1600	0.005	High Volt.	6515A †	193
0-2000	0.1	High Volt.	6522A †	193
0-3000	0.006	Prec. Volt.	6110A †	194
0-3000	0.006	High Volt.	6516A †	193
0-4000	0.05	High Volt.	6525A †	193

† Available on GSA Contract Number GS-00S-27455
 ● May be used with the 59501A HP-IB Isolated D/A Converter/Power Supply Programmer
 ★ May be used with the 6940B Multiprogrammer when equipped with Option 040.
 * BPSA = Bipolar Power Supply/Amplifier.

Power Supply Digital Programming Interfaces		
Description	Model	Page
HP-IB Isolated D/A Converter/Power Supply Programmer: one channel, two programmable ranges. Provides HP-IB interface for programming either output voltage, or current (where current programming is available as described in specifications for individual power supply model) of power supplies designated with a ● symbol in the above condensed listing "model" column. Interfacing details are covered in publication number 5952-3990	69501A	26
Multiprogrammer: a highly versatile I/O expander and converter that can control up to 240 power supplies from one HP-IB port or one 16-bit duplex I/O channel. It will control output voltage and current of power supplies designated with a ★ symbol in the above condensed listing "model" column when they are equipped with Option 040. Additional Multiprogrammer capabilities include digital I/O for monitoring crowbars, relays for output switching, A/D converters for measuring power supply output, timers for automatic power supply sequencing, etc. Ask your HP field engineer for the 48-page Multiprogrammer Data Sheet, publication number 5952-3982, for complete details.	6940B	532

† Available on GSA Contract Number GS-00S-27455
 ● May be used with the 59501A HP-IB Isolated D/A Converter/Power Supply Programmer.
 ★ May be used with the 6940B Multiprogrammer when equipped with Option 040.
 * BPSA = Bipolar Power Supply/Amplifier.



POWER SUPPLIES

Low cost lab: compact, single and triple outputs

Models 6211A-6218A, 6236A and 6237A

- 10W output . . . Low ripple and noise
- Compact, Impact-resistant stackable case
- Short-circuit proof



6211A, 6218A

- 0 to 6 V & 0 to ± 20 V, Model 6236A
- 0 to 18 V & 0 to ± 20 V, Model 6237A
- No turn-on/turn-off overshoot



6236A, 6237A

Description

These popular low-cost bench supplies are designed for general laboratory use and are equipped with front-panel mounted voltage controls, a combination volt/ammeter, and output binding posts. Output voltage is continuously variable, via coarse and fine controls from 0 V to 15% above the maximum rated output. A switch selects either output voltage or current for display on the panel meter.

Load connections are made via three binding posts. Either the + or the - post may be grounded through an adjacent GND terminal or the supply may be operated floating at up to 300 volts above ground.

The Constant Voltage/Constant Current Models have concentric coarse and fine current controls which allow setting the current-limit point to any value within the current rating. Using these controls, the CV/CC supplies can also be operated as constant current sources with 500 μ A load regulation. All CV/CC models can be connected in series or parallel.

The Constant Voltage/Current Limiting (CV/CL) Model supplies are short-circuit protected by a fixed current limiting circuit which is activated at approximately 120% of rated load current. The CV/CL models can be connected in series only.

Ratings

Volts	Amps	Model	Load Effect	Source Effect	PARD Rms/p-p	Mode
0-10	1	6213A	4 mV	4 mV	200 μ A/1 mV	CV/CL
0-10	0-1	6214A	4 mV	4 mV	200 μ A/1 mV	CV/CC
0-25	0.4	6215A	4 mV	4 mV	200 μ A/1 mV	CV/CL
0-25	0-0.4	6216A	4 mV	4 mV	200 μ A/1 mV	CV/CC
0-50	0.2	6217A	4 mV	4 mV	200 μ A/1 mV	CV/CL
0-50	0-0.2	6218A	4 mV	4 mV	200 μ A/1 mV	CV/CC
0-100	0.1	6211A	8 mV	4 mV	200 μ A/1 mV	CV/CL
0-100	0-0.1	6212A	8 mV	4 mV	200 μ A/1 mV	CV/CC

AC Power Requirements: 115 V $\pm 10\%$, 1 ϕ 48-440 Hz, (for 230 V operation, order option 028)

Dimensions: 133 \times 83 \times 368 mm, (3 $\frac{1}{4}$ "H \times 5 $\frac{1}{4}$ "W \times 8"D).

Accessories and options

14521A Rack kit for one, two, or three supplies.
Option 028 230 V ac single phase input

Price

\$45
N/C

Model number and name

6213A, 6215A, 6217A CV/CL Low Cost Lab Supplies \$130
6211A CV/CL Low Cost Lab Supply \$160
6214A, 6216A, 6218A CV/CC Low Cost Lab Supplies \$155
6212A CV/CC Low Cost Lab Supply \$185

Description

Small size, ease of operation and application-related performance make the 6236A and new 6237A valued additions to any lab where digital or linear integrated circuits are used.

Measuring only 3 $\frac{1}{2}$ in. H \times 8 $\frac{1}{2}$ in. W \times 12 $\frac{1}{2}$ in. D, the 6236A and 6237A take up a minimum of bench space, and weighing 9 $\frac{1}{2}$ lb, can be handled with ease. In addition to being compact and portable, these supplies are easy to operate. Control of single and dual outputs is provided by separate single-turn potentiometers. A three-position meter switch selects the desired output for display of voltage and current on dual panel meters. The 0 to +20 V and 0 to -20 V outputs track one another within 1% to supply the symmetrical voltages needed by operational amplifiers and similar balanced voltage source devices.

These supplies are protected from overloads by fixed current limiting circuits. The +20 V and -20 V outputs are limited to 0.50 A for all overload conditions. The 0 to 18 V single output of the 6237A is similarly limited to 1.0 A. A foldback current limiting circuit in the 6236A reduces the available output from 2.5 A at the 6 V setting to 1 A at the 0 V setting (and under short circuit conditions). This foldback characteristic permits more available output current at the most commonly used output of 5-6 V than would normally be the case.

Specifications (both models, unless otherwise indicated.)

DC Output

6236A: 0 to 6 V (2.5 A at 6 V reducing to 1 A at 0 V); and 0 to +20 V and -20 V at 0.5 A, dual tracking.

6237A: 0 to 18 V at 1 A; and 0 to +20 V and -20 V at 0.5 A, dual tracking.

AC Input: 120 V ac nominal, 104 V to 127 V, 47-63 Hz, 112 W, 1.2 A

Load effect (load regulation): 0.01% + 2 mV (all outputs)

Source effect (line regulation): 0.04% + 2 mV (all outputs)

PARD (ripple & noise): 0.35 mV rms, 1.5 mV p-p (20 Hz to 20 MHz).

Resolution: 15 mV for 6 V output, 70 mV for other outputs.

Drift (stability): following 30-minute warm-up is 0.1% + 5 mV.

Output voltage overshoot: no overshoot

Temperature coefficient: 0.02% + 1 mV output change per degree C.

Temperature ratings Operating: 0 to 40°C Storage: -50 to +75°C.

Dimensions: 89 mm H \times 216 mm W \times 319 mm D. (3 $\frac{1}{2}$ " H \times 8 $\frac{1}{2}$ " W \times 12 $\frac{1}{2}$ " D).

Weight: 4.3 kg (9.5 lb) **Color:** olive gray

Options and accessories

Option 100: 87-106 V, 47-63 Hz input

Option 220: 191-233 V, 47-63 Hz input

Option 240: 208-250 V, 47-63 Hz input

14513A Rack Kit for one supply

14523A Rack Kit for two supplies

Price

N/C

N/C

N/C

\$15

\$25

Model number and name

6236A Triple Output Power Supply

\$335

6237A Triple Output Power Supply

\$335

POWER SUPPLIES

Low cost lab: general bench applications

Models 6200B-6209B, and 6384A

- Short-circuit proof
- Floating output (up to 300 V above ground) — can be used as a positive or negative source
- Remote sensing

- Bench or rack mounting
- Multi-function meter



6200B-6203B
6207B, 6209B
CV/CC



6204B, 6206B CV/CL



6205B CV/CL
Two, Dual Range Outputs



6384A CV/CL

Description

Models 6200B-6209B

This series of low-cost bench supplies includes nine models covering an output voltage range from 0-7.5 V to 0-320 V. All models are equipped with coarse and fine output voltage controls (except Models 6207B and 6209B, which have 10-turn voltage controls), volt/ampere meter, meter function/range switch, and front and rear output terminals. In addition, on the dual-range models (6204B-6205B), an output range switch permits the selection of either a high or a low output voltage range.

Model 6205B combines the versatility of a dual power supply with the flexibility of auto-parallel and auto-series operation to extend the output ratings of this supply to 20 V/1.2 A, 40 V/0.6 A, and 80 V/0.3 A. In addition, using the supply's auto-tracking capability, opposite polarity voltages (± 20 V, ± 40 V) can conveniently be obtained from this one supply.

The Constant Voltage/Current Limiting supplies (6204B-6205B), are short-circuit protected by a fixed current limiting circuit which is activated at approximately 110% of rated load current. The current-limit point can be reduced by changing the value of a single internal resistor. For the Constant Voltage/Constant Current supplies, concentric coarse and fine current controls allow the current-limit point to be set to any value within the current rating. Using these controls, the CV/CC supplies can also be operated as constant current sources.

Units may be bench operated or rack mounted individually or in pairs using accessory rack mounting hardware.

Model 6384A

This low-cost bench supply is designed specifically for use with digital-logic integrated circuits. Its output ratings and superior performance, combined with the protection of built-in overvoltage crowbar and current limiting circuits, make it an excellent IC supply for both laboratory and systems use.

Drift: 0.1% +5 mV (6384A, 0.3% +10 mV) per 8 hours after 30 minute warm-up.

Temperature coefficient, per °C: 0.02% +1 mV (6384A, 3 mV/°C).

Load effect transient recovery: 50 μ s to recover within 10 mV of nominal output voltage. (50 μ s and 40 mV for 6384A).

Overvoltage protection crowbar (optional on 6200B-6206B)

Option 011 on 6200B-6206B: adjustment range from 2.5 V to 104% of maximum rated output of supply, plus 2 V. Minimum operating setting (margin) is 104% of nominal output, plus 2 V.

Standard feature on 6384A: trip voltage factory set at 5.25 V; field adjustable down to 5 V.

Temperature ratings: operating, 0 to 50°C. Storage, -40 to +75°C. These supplies are convection cooled.

Rear panel terminals

DC output: 6200B-6209B have front and rear output terminals; model 6384A has only rear output terminals.

Remote sensing: terminals are provided to correct for load lead voltage drop.

Auto-series, auto-parallel, and auto-tracking operation: Models 6200B-6209B have terminals for multiple supply operation.

Dimensions: 216 mm W \times 89 mm H \times 317 mm D (8 1/2" \times 3 1/2" \times 12 1/2").

Weight: net, 4.5 kg (10 lb). Shipping, 5.4 kg (12 lb).

Specifications

RATINGS		PERFORMANCE							GENERAL	
DC Output		Model	Load Effect	Source Effect	PARO rms/p-p	Control Mode and resolution	Remote Control coefficients	Power* 115 V ac \pm 10%	Options*	Price
Volts	Amps									
4.4-5.5	0-5	6384A	2mV	2mV	0mV/5mV	CV/CL 15 mV/NA	NA	48-63 Hz 1.4 A, 120 W	2B	\$350
0-7.5	0-3	6203B	5 mV	5 mV	200 μ V/1 mV	CV/CC 5 mV/2 mA	200 Ω /V \pm 1% 500 Ω /A \pm 10%	48-440 Hz 0.9 A, 70 W	9, 11, 15, 2B	\$270
0-20	0-1.5	6201B	0.01% +4 mV	0.01% +4 mV	100 μ V/1 mV	CV/CC 5 mV/1 mA	300 Ω /V \pm 1% 1 k Ω /A \pm 10%	48-440 Hz 0.8 A, 66 W	9, 11, 15, 2B	\$245
Dual range 0-20 or 0-40	0-0.6 or 0-0.3	6204B	0.01% +4 mV	0.01% +4 mV	200 μ V/1 mV	CV/CL 10 mV/2V	200 Ω /V \pm 5% NA	48-440 Hz 0.6 A, 24 W	9, 11, 15, 2B	\$230
Dual range 0-20 or 0-40	0-1.5 or 0-0.75	6200B	0.01% +4 mV	0.01% +4 mV	200 μ V/1 mV	CV/CC 10 mV/2 mA	200 Ω /V \pm 1% 0.5 k Ω /A \pm 10% or 1 k Ω /A \pm 10%	48-440 Hz 0.5 A, 20 W	9, 11, 15, 2B	\$275
Two dual ranges 0-20/0-40 and 0-20/0-40	0-0.6/0.3 or 0-0.6/0.3	6205B	0.01% +4 mV	0.01% +4 mV	200 μ V/1 mV	CV/CC 10 mV/2 mA	200 Ω /V \pm 1% N/A	48-440 Hz 0.5 A, 50 W	9, 11, 15, 2B 4B	\$325
Dual range 0-30 or 0-60	0-1 or 0-0.5	6206B	0.01% +4 mV	0.01% +4 mV	200 μ V/1 mV	CV/CL 10 mV/NA	200 Ω /V \pm 1% N/A	48-440 Hz 1 A, 60 W	9, 11, 15, 2B	\$240
0-40	0-0.75	6202B	0.01% +4 mV	0.01% +4 mV	300 μ V/1 mV	CV/CC 10 mV/1 mA	200 Ω /V \pm 1% 1 k Ω /A \pm 10%	48-440 Hz 0.8 A, 66 W	9, 11, 15, 2B	\$240
0-160	0.32	6207B	0.02% +2 mV	0.02% +2 mV	500 μ V/40 mV	CV/CC 25 mV/500 μ A	300 Ω /V \pm 1% 75 k Ω /A \pm 10%	48-62 Hz 1 A, 60 W	9, 15, 2B	\$305
0-320	0-0.1	6209B	0.02% +2 mV	0.02% +2 mV	1 mV/40 mV	CV/CC 40 mV/500 μ A	300 Ω /V \pm 1% 150 k Ω /A \pm 10%	48-63 Hz 1 A, 60 W	9, 15, 2B	\$320

* For 230 V ac \pm 10% operation, order option 02E. See page 198 for complete option descriptions.

POWER SUPPLIES

General purpose: 25–200 W output

Models 6220B–6299A

- Constant voltage/constant current operation
- Remote sensing and programming
- Auto-series, -parallel, & -tracking operation

- Front and rear output terminals
- Floating output — use as positive or negative source
- Bench or rack mounting



6281A, 6284A, 6289A,
6294A, 6299A



6220B, 6224B, 6226B



6282A, 6285A, 6286A,
6290A, 6291A, 6296A

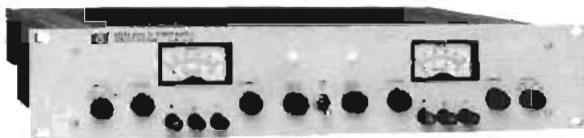

6253A, 6255A

Description

6281A–6299A

This series of medium-power Constant Voltage/Constant Current power supplies is available in two power ranges: 37–75 watts (packaged in 3½-inch high half-rack cases), and 100–200 watts (packaged in 5¼-inch high half-rack cases). All models except 6294A and 6299A have separate coarse and fine voltage and current controls that allow the voltage and current outputs to be varied from zero to the maximum rated values. The latter two models have ten-turn voltage controls. Crossover from constant voltage to constant current operation occurs automatically when the load current exceeds the value established by the current control settings. A four-position meter function switch selects either of two output voltage or output current ranges (X1, X0.1) for display on the panel meter.

The 37–75 watt models are of the series-regulated type. They have excellent regulation and ripple characteristics and include a special output-capacitor discharge circuit for improved programming speed. The 100–200 watt models employ a series-regulator/SCR-preregulator configuration to achieve the high efficiency necessary for a convection-cooled package of this size. They also have excellent regulation, low ripple and noise, and moderate programming speeds.

6253A and 6255A

These versatile dual-output models each contain two identical, independently-adjustable 60-watt power supplies in a full-rack width case. The regulator, voltage and current control, and metering circuits of each section of the supply are electrically identical to those of the individual 37–75 watt models described above.

Specifications

RATINGS			PERFORMANCE							
DC Output			Load Effect		Source Effect		PAR (rms/p-p)		Drift (stability)	
Volts	Amps	Model	Voltage	Current	Voltage	Current	Voltage	Current	Voltage	Current
0–7.5	0–5	6281A	5 mV	0.01% +250 μ A	0.01% +2 mV	0.01% +250 μ A	200 μ V/1 mV	4 mA rms	0.1% +2.5 mV	0.1% +12.5 mA
0–10	0–10	6282A	0.01% +1 mV	0.05% +1 mA	0.01% +1 mV	0.05% +1 mA	500 μ V/25 mV	5 mA rms	0.1% +2.5 mV	0.1% +25 mA
0–20	0–3	6253A*	0.01% +4 mV	0.01% +250 μ A	0.02% +2 mV	0.01% +250 μ A	200 μ V/1 mV	2 mA rms	0.1% +2.5 mV	0.1% +7.5 mA
0–20	0–3	6284A	0.01% +4 mV	0.01% +250 μ A	0.01% +2 mV	0.01% +250 μ A	200 μ V/1 mV	2 mA rms	0.1% +2.5 mV	0.1% +7.5 mA
0–20	0–5	6285A	0.01% +1 mV	0.05% +1 mA	0.01% +1 mV	0.01% +1 mA	500 μ V/25 mV	3 mA rms	0.1% +2.5 mV	0.1% +12.5 mA
0–20	0–10	6286A	0.01% +1 mV	0.05% +1 mA	0.01% +1 mV	0.01% +1 mA	500 μ V/25 mV	5 mA rms	0.1% +2.5 mV	0.1% +25 mA
0–24	0–3	6224B	0.02% +4 mV	0.01% +250 μ A	0.01% +2 mV	0.01% +250 μ A	200 μ V/1 mV	200 μ A/1 mA	0.1% +2.5 mV	0.1% +7.5 mA
0–25	0–1	6220B**	0.01% +2 mV	0.01% +250 μ A	0.01% +2 mV	0.01% +250 μ A	200 μ V/2 mV	200 μ A/1 mA	0.1% +5 mV	0.1% +5 mA
0–40	0–1.5	6255A*	0.01% +2 mV	0.01% +250 μ A	0.01% +2 mV	0.01% +250 μ A	200 μ V/1 mV	500 μ A rms	0.1% +2.5 mV	0.1% +4 mA
0–40	0–1.5	6289A	0.01% +2 mV	0.01% +250 μ A	0.01% +2 mV	0.01% +250 μ A	200 μ V/1 mV	500 μ A rms	0.1% +2.5 mV	0.1% +4 mA
0–40	0–3	6290A	0.01% +1 mV	0.05% +1 mA	0.01% +1 mV	0.05% +1 mA	500 μ V/25 mV	3 mA rms	0.1% +2.5 mV	0.1% +7.5 mA
0–40	0–5	6291A	0.01% +1 mV	0.05% +1 mA	0.01% +1 mV	0.05% +1 mA	500 μ V/25 mV	3 mA	0.1% +2.5 mV	0.1% +12.5 mA
0–50	0–1.5	6226B	0.01% +2 mV	0.01% +250 μ A	0.01% +2 mV	0.01% +250 μ A	200 μ V/1 mV	200 μ A/1 mA	0.1% +2.5 mV	0.1% +4 mA
0–60	0–1	6294A	0.01% +2 mV	0.01% +250 μ A	0.01% +2 mV	0.01% +250 μ A	200 μ V/1 mV	500 μ A rms	0.1% +2.5 mV	0.1% +2.5 mA
0–60	0–3	6296A	0.01% +1 mV	0.05% +1 mA	0.01% +1 mV	0.05% +1 mA	500 μ V/25 mV	3 mA rms	0.1% +2.5 mV	0.1% +7.5 mA
0–100	0–0.75	6299A	0.01% +2 mV	0.01% +250 μ A	0.01% +2 mV	0.01% +250 μ A	200 μ V/1 mV	500 μ A rms	0.1% +2.5 mV	0.1% +2 mA

* Models 6253A and 6255A contain two identical, independently-adjustable power supplies.

** Model 6220B has a single, dual range output with ratings of 0–25 V at 0–1 A or 0–50 V at 0–0.5 A.

By combining the versatility of a dual power supply with the flexibility of auto-series and auto-parallel operation, twice the maximum rated output voltage or current of each section can be obtained from the one supply. In addition, using the supply's auto-tracking capability, opposite-polarity voltages (± 20 V for Model 6253A or ± 40 V for Model 6255A) are possible.

6220B, 6224B, and 6226B

These Constant Voltage/Constant Current supplies are designed for general laboratory use. All have excellent regulation, low ripple and noise, and high speed programming characteristics. Large easy-to-read meter scales, 10-turn voltage and current controls, and front and rear output terminals, enhance ease of operation. Model 6220B is a dual-range instrument with output ratings of 0-25 V at 0-1 A or 0-50 V at 0-0.5 A. It is the only model of the three employing convection cooling. Model 6224B and 6226B have single outputs of 0-24 V at 0-3 A and 0-50 V at 0-1.5 A, respectively.

Accessories and options

The accessories and options available for use with Models 6220B-6299A are listed on page 198.

Specifications — general

Load effect transient recovery: time, 50 μ s. Level, 15 mV.

Meter accuracy: 3% of full scale.

Power: standard input voltage is 115 V ac $\pm 10\%$. Order option 028 for 230 V ac $\pm 10\%$ operation. Input power frequency, maximum input current, maximum power consumption are: 6220B, 48-440 Hz, 0.5 A, 44 W; 6224B, 48-63 Hz, 1.8 A, 164 W; 6226B, 48-63 Hz, 1.8 A, 164 W; 6253A, 48-440 Hz, 2.6 A, 235 W; 6255A, 48-440 Hz, 2.6 A, 235 W; 6281A, 48-440 Hz, 1.3 A, 118 W; 6282A, 57-63 Hz, 3.5 A, 200 W; 6284A, 48-440 Hz, 1.5 A, 128 W; 6285A, 57-63 Hz, 3.5 A, 160 W; 6286A, 57-63 Hz, 5.5 A, 320 W; 6289A, 48-440 Hz, 1.3 A, 110 W; 6290A, 57-63 Hz, 3.5 A, 170 W; 6291A, 57-63 Hz, 5.5 A, 280 W; 6294A, 48-440 Hz, 1.3 A, 114 W; 6296A, 57-63 Hz, 4.5 A, 250 W; 6299A, 48-440 Hz, 1.5 A, 135 W.

Dimensions: 6220B, 6224B, & 6226B: 130 mm W \times 166 mm H \times 294 mm D (5 $\frac{1}{8}$ " \times 6 $\frac{5}{8}$ " \times 11 $\frac{7}{16}$ "). 6253A, 6255A: 426 mm W \times 87 mm H \times 403 mm D (16 $\frac{3}{4}$ " \times 3 $\frac{3}{16}$ " \times 15 $\frac{3}{8}$ "). 6281A, 6284A, 6289A, 6294A, 6299A: 209 mm W \times 87 mm H \times 398 mm D (8 $\frac{3}{4}$ " \times 3 $\frac{3}{16}$ " \times 15 $\frac{3}{8}$ "). 6282A, 6285A, 6286A, 6290A, 6291A, 6296A: 210 mm W \times 131 mm H \times 435 mm D (8 $\frac{1}{4}$ " \times 5 $\frac{1}{8}$ " \times 17 $\frac{1}{4}$ ").

Temperature: operating, 0 to 55°C; storage, -40 to 75°C.

REMOTE CONTROL FEATURES								GENERAL						
Resistance Coefficient		Voltage Coefficient		Speed, UP*		Speed, DOWN*		Overvoltage		Weight			Options A	Price
Voltage	Current	Voltage	Current	NL	FL	NL	FL	Range	Margin	Net	Shipping			
200 Ω /V $\pm 1\%$	200 Ω /A $\pm 10\%$	1 V/V $\pm 1\%$	0.2 V/A $\pm 10\%$	1 ms	2 ms	10 ms	6 ms	2.5-10 V	4% +2 V	6.4 kg/14 lb	7.2 kg/16 lb	9, 11, 15, 28, 40	\$360	
200 Ω /V $\pm 1\%$	100 Ω /A $\pm 10\%$	1 V/V $\pm 1\%$	100 mV/A $\pm 10\%$	70 ms	200 ms	9 s	100 ms	1-13 V	7% +1 V	11.3 kg/25 lb	13.6 kg/30 lb	5, 9, 11, 15, 28, 40	\$485	
200 Ω /V $\pm 1\%$	500 Ω /A $\pm 10\%$	1 V/V $\pm 1\%$	0.33 V/A $\pm 10\%$	30 ms	80 ms	400 ms	100 ms	2.5-23 V	4% +2 V	12.7 kg/28 lb	17.7 kg/39 lb	9, 10, 11, 15, 28, 40	\$565	
200 Ω /V $\pm 1\%$	500 Ω /A $\pm 10\%$	1 V/V $\pm 1\%$	0.33 V/A $\pm 10\%$	30 ms	80 ms	400 ms	400 ms	2.5-23 V	4% +2 V	6.4 kg/14 lb	7.2 kg/16 lb	9, 11, 15, 28, 40	\$290	
200 Ω /V $\pm 1\%$	200 Ω /A $\pm 10\%$	1 V/V $\pm 1\%$	200 mV/A $\pm 10\%$	150 ms	150 ms	9 s	450 ms	2-22 V	7% +1 V	10 kg/22 lb	10.9 kg/24 lb	5, 9, 11, 15, 28	\$480	
200 Ω /V $\pm 1\%$	100 Ω /A $\pm 10\%$	1 V/V $\pm 1\%$	100 mV/A $\pm 10\%$	150 ms	150 ms	9 s	250 ms	2-22 V	7% +1 V	10.8 kg/26 lb	13.1 kg/29 lb	5, 9, 11, 15, 28	\$480	
200 Ω /V $\pm 1\%$	500 Ω /A $\pm 10\%$	1 V/V $\pm 1\%$	0.33 V/A $\pm 10\%$	4 ms	10 ms	50 ms	15 ms	NA	NA	7.3 kg/16 lb	9.5 kg/21 lb	15, 28, 40	\$440	
200 Ω /V $\pm 1\%$	1 k Ω /A $\pm 10\%$ 2 A/A $\pm 10\%$	1 V/V $\pm 1\%$	1 V/A $\pm 10\%$ 2 V/A $\pm 10\%$	12 ms	30 ms	200 ms	30 ms	NA	NA	5.9 kg/13 lb	6.8 kg/15 lb	15, 28, 40	\$400	
200 Ω /V $\pm 1\%$	500 Ω /A $\pm 10\%$	1 V/V $\pm 1\%$	0.66 V/A $\pm 10\%$	15 ms	45 ms	200 ms	40 ms	2.5-44 V	4% +2 V	12.7 kg/28 lb	17.7 kg/39 lb	9, 10, 11, 15, 28, 40	\$565	
200 Ω /V $\pm 1\%$	500 Ω /A $\pm 10\%$	1 V/V $\pm 1\%$	0.66 V/A $\pm 10\%$	15 ms	45 ms	200 ms	40 ms	2.5-44 V	4% +2 V	6.4 kg/14 lb	7.2 kg/16 lb	9, 11, 15, 28, 40	\$290	
200 Ω /V $\pm 1\%$	500 Ω /A $\pm 10\%$	1 V/V $\pm 1\%$	333 mV/A $\pm 10\%$	275 ms	275 ms	6 s	1.2 s	6-43 V	7% 1 V	11.8 kg/26 lb	12.7 kg/28 lb	5, 9, 11, 15, 28	\$480	
200 Ω /V $\pm 1\%$	200 Ω /A $\pm 10\%$	1 V/V $\pm 1\%$	200 mV/A $\pm 10\%$	275 ms	275 ms	13 s	1.8 s	6-43 V	7% +1 V	11.3 kg/25 lb	12.7 kg/28 lb	5, 9, 11, 15, 28	\$480	
200 Ω /V $\pm 1\%$	500 Ω /A $\pm 10\%$	1 V/V	1 V/A	20 ms	65 ms	200 ms	250 ms	NA	NA	7.3 kg/16 lb	8.2 kg/18 lb	25, 28, 40	\$440	
300 Ω /V $\pm 1\%$	1 k Ω /A $\pm 10\%$	1 V/V $\pm 1\%$	1 V/A $\pm 10\%$	25 ms	80 ms	2 s	175 ms	5-65 V	4% +2 V	5.9 kg/13 lb	6.8 kg/15 lb	9, 11, 15, 28, 40	\$320	
300 Ω /V $\pm 1\%$	500 Ω /A $\pm 10\%$	1 V/V $\pm 1\%$	333 mV/A $\pm 10\%$	600 ms	600 ms	5 s	1.1 s	9-86 V	7% +1 V	11.3 kg/25 lb	12.7 kg/28 lb	5, 9, 11, 15, 28	\$480	
300 Ω /V $\pm 1\%$	1 k Ω /A $\pm 10\%$	1 V/V $\pm 1\%$	1.33 V/A $\pm 10\%$	25 ms	200 ms	1.5 s	200 ms	20-106 V	4% +2 V	5.9 kg/13 lb	6.8 kg/15 lb	11, 15, 28, 40	\$335	

▲ See page 198 for complete option and accessory descriptions.
 * U₀ = increasing output voltage. NR = No output load current. FL = Full rated output load current.

POWER SUPPLIES

General purpose: 120–2000 W output

Models 6256B–6274B & 895A

- Built-in overvoltage protection*
- Constant voltage/constant current operation
- Remote programming and sensing

- Remote sensing
- Auto-series, -parallel, and -tracking operation
- $\leq 50 \mu\text{sec}$ load transient recovery

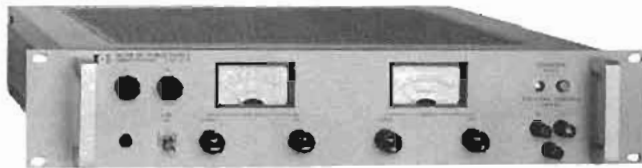

6263B, 6265B, 6266B, 6271B

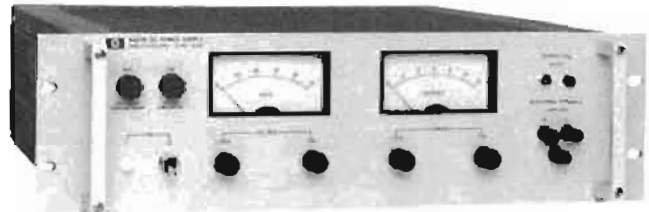

6256B, 6264B, 6267B

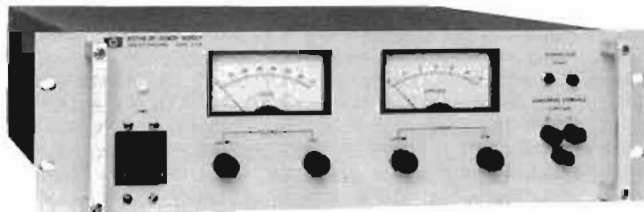

6274B



895A

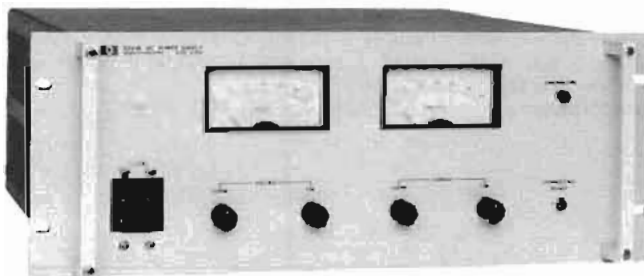

6259B, 6260B, 6261B, 6268B, 6269B

Models 6256B–6274B

This series of high-performance Constant Voltage/Constant Current supplies includes thirteen models with output ratings from 10 to 60 V. All models employ a transistor series-regulator/triac-preregulator circuit to achieve high efficiency, excellent regulation, low ripple and noise, and moderate programming speeds in a compact full-rack width package.

Separate coarse and fine voltage and current controls allow the voltage and current outputs to be varied from zero to the maximum rated value. Crossover from constant voltage to constant current operation occurs automatically when the load current exceeds the value established by the current control settings.

* These six features apply to 6256B–6274B only.

Specifications†

RATINGS		PERFORMANCE								
DC Output		Model	Load Effect		Source Effect		PAR (rms/p-p)		Drift (stability)	
Volts	Amps		Voltage	Current	Voltage	Current	Voltage	Current	Voltage	Current
0–10	0–20	6256B	0.01%+200 mV	0.02%+500 μA	0.01%+200 μV	0.02%+500 μA	200 $\mu\text{V}/10 \text{ mV}$	5 mA rms	0.03%+500 μV	0.03%+6 mA
0–10	0–50	6259B	0.01%+200 μV	0.02%+1 mA	0.01%+200 μV	0.02%+1 mA	500 $\mu\text{V}/5 \text{ mV}$	25 mA rms	0.03%+2 mV	0.03%+10 mA
0–10	0–100	6260B	0.01%+200 μV	0.02%+2 mA	0.01%+200 μV	0.02%+2 mA	500 $\mu\text{V}/5 \text{ mV}$	50 mA rms	0.03%+2 mV	0.03%+20 mA
0–20	0–10	6263B	0.01%+200 μV	0.02%+500 μA	0.01%+200 μV	0.02%+500 μA	200 $\mu\text{V}/10 \text{ mV}$	3 mA rms	0.03%+500 μV	0.03%+6 mA
0–20	0–20	6264B	0.01%+200 μV	0.02%+500 μA	0.01%+200 μV	0.02%+500 μA	200 $\mu\text{V}/10 \text{ mV}$	5 mA rms	0.03%+500 μV	0.03%+6 mA
0–20	0–50	6261B	0.01%+200 μV	0.02%+1 mA	0.01%+200 μV	0.02%+1 mA	500 $\mu\text{V}/5 \text{ mV}$	25 mA rms	0.03%+2 mV	0.03%+10 mA
0–40	0–3	6265B	0.01%+200 μV	0.02%+500 μA	0.01%+200 μV	0.02%+500 μA	200 $\mu\text{V}/10 \text{ mV}$	3 mA rms	0.03%+500 μV	0.03%+3 mA
0–40	0–5	6266B	0.01%+200 μV	0.02%+500 μA	0.01%+200 μV	0.02%+500 μA	200 $\mu\text{V}/10 \text{ mV}$	3 mA rms	0.03%+500 μV	0.03%+3 mA
0–40	0–10	6267B	0.01%+200 μV	0.02%+500 μA	0.01%+200 μV	0.02%+500 μA	200 $\mu\text{V}/10 \text{ mV}$	3 mA rms	0.03%+2 mV	0.03%+3 mA
0–40	0–30	6268B	0.01%+200 μV	0.02%+2 mA	0.01%+200 μV	0.02%+2 mA	1 mV/5 mV	20 mA rms	0.03%+2 mV	0.02%+5 mA
0–40	0–50	6269B	0.01%+200 μV	0.02%+2 mA	0.01%+200 μV	0.02%+2 mA	1 mV/5 mV	25 mA rms	0.03%+2 mV	0.03%+10 mA
0–60	0–3	6271B	0.01%+200 μV	0.02%+500 μA	0.01%+200 μV	0.02%+500 μA	200 $\mu\text{V}/10 \text{ mV}$	3 mA rms	0.03%+500 μV	0.03%+3 mA
0–60	0–15	6274B	0.01%+200 μV	0.02%+500 μA	0.01%+200 μV	0.02%+500 μA	200 $\mu\text{V}/2 \text{ mV}$	5 mA rms	0.03%+2 mV	0.03%+5 mA
0–320	0–1.5	895A	0.007% or 10 mV	—	0.007% or 10 mV	—	1 mV rms	—	0.1%+5 mV	—

† Refer to page 179 for complete specification definitions.

Additional features include built-in overvoltage crowbar protection; remote error sensing; and auto-series, auto-parallel, and auto-tracking operation. The crowbar trip point adjustment and associated overvoltage indicator are conveniently located on the front panel.

Auto-series, auto-parallel, and auto-tracking connections should ordinarily include no more than three supplies. If a specific application requires the use of more than three supplies in any of the three connections, consult your local HP Field Engineer for additional information.

All dc output, ac input, sensing, control, and programming connections are made to rear-panel terminals. Either the positive or negative output terminal may be grounded or the supplies may be operated floating at up to 300 volts above ground. Models 6256B, 6263B, 6264B, 6265B, 6266B, 6267B, and 6271B are convection cooled. All other models in this series employ cooling fans.

Model 895A

Model 895A is a general purpose Constant Voltage/Current Limit supply. Output voltage is adjustable from 0 – 320 V via a front panel 10-turn potentiometer with concentric knoblock and a single-turn fine control. Separate voltage and current meters provide continuous indication of power supply outputs. High performance specifications include 0.007% line and load regulation and 1 mV rms ripple and noise. Remote sensing and programming are standard features.

Accessories and options

The accessories and options available for use with Models 6256B–6274B, 895A are listed on page 198.

Specifications – general

- Load effect transient recovery:** time — 50 μ sec. Level — 10 mV.
- Resolution:** voltage control — less than 0.02%. Current control — less than 0.15%.
- Temperature coefficient per °C:** 0.01% of output plus 200 μ V (895A — 0.03% + 1.5 mV).

Temperature ratings: operating, 0 to 55°C; Storage, –40 to 75°C.
Remote control programming: these power supplies are capable of being programmed in constant voltage and constant current operation by using an external resistance or DC voltage with coefficients as shown in the table below.

Rear terminal wiring configurations for remote control operation are specified in the operating and service manual supplied with the power supply. For remote control programming procedures and timing considerations, contact your local HP field engineer.

Power: input voltage is 115 VAC or 230 VAC \pm 10%, 57–63 Hz. For other input voltage and frequency options available, see option listing below and page 198. Standard input voltage, maximum input current, and maximum power are: 6256B, 115 V ac, 5 A, 375 W†; 6259B, 230 V ac, 6 A, 850 W†; 6260B, 230 V ac, 12 A, 1600 W†; 6261B, 230 V ac, 12 A, 1500 W†; 6263B, 115 V ac, 4.5 A, 350 W*; 6264B, 115 V ac, 8 A, 600 W†; 6265B, 115 V ac, 3 A, 180 W*; 6266B, 115 V ac, 4 A, 325 W*; 6267B, 115 V ac, 8 A, 550 W†; 6268B, 230 V ac, 12 A, 1600 W†; 6269B, 230 V ac, 18 A, 2500 W†; 6271B, 115 V ac, 4 A, 300 W*; 6274B, 115 V ac, 18 A, 1200 W†; 895A, 115 V ac, 8.7 A, 585 W†.

* Three-wire, five-foot AC power cord included with power supply.
 † Three-terminal barrier strip provided on power supply for AC power connections.

Dimensions: 6263B, 6265B, 6266B, 6271B: 425.5 mm W \times 83.7 mm H \times 479.4 mm L (16.75" \times 3.296" \times 18.875"). 6256B, 6264B, 6267B, 6274B: 425.5 mm W \times 127 mm H \times 479.4 mm L (16.75" \times 5.00" \times 18.875"). 6259B, 6260B, 6261B, 6268B, 6269B: 425.5 mm W \times 173 mm H \times 479.4 mm L; (16.75" \times 6.812" \times 18.875"). 895A: 435 mm W \times 128.6 mm H \times 463.6 mm L (17.125" \times 5.062" \times 18.25").

Typical output impedance: approximated by a resistance in series with an inductance: 6256B, 100 μ Ω , 1 μ H; 6259B, 50 μ Ω , 1 μ H; 6260B, 20 μ Ω , 1 μ H; 6261B, 100 μ Ω , 1 μ H; 6263B, 500 μ Ω , 1 μ H; 6264B, 200 μ Ω , 1 μ H; 6265B, 2 m Ω , 1 μ H; 6266B, 1 m Ω , 1 μ H; 6267B, 500 μ Ω , 1 μ H; 6268B, 200 μ Ω , 1 μ H; 6269B, 100 μ Ω , 1 μ H; 6271B, 5 m Ω , 1 μ H; 6274B, 1 m Ω , 1 μ H; 895A, 40 m Ω , 16 μ H.

REMOTE CONTROL FEATURES								GENERAL					
Resistance Coeff.		Voltage Coeff.		Up*		Down*		Overvoltage		Weight		Options [†]	Price
Voltage	Current	Voltage	Current	NL	FL	NL	FL	Range	Margin	Net	Shipping		
200 Ω /V \pm 1%	10 Ω /A \pm 10%	1 V/V \pm 1%	25 mV/A \pm 10%	60 ms	60 ms	5 sec	100 ms	2–12 V	5% + 1 V	15.8 kg/35 lb	18.1 kg/40 lb	5, 9, 10, 15, 22, 27, 28, 40	\$670
200 Ω /V \pm 1%	4 Ω /A \pm 10%	1 V/V \pm 1%	10 mV/A \pm 10%	70 ms	70 ms	700 ms	100 ms	2–12 V	5% + 2 V	31.3 kg/69 lb	35.3 kg/78 lb	5, 9, 10, 15, 22, 26, 27, 40	\$1090
200 Ω /V \pm 1%	2 Ω /A \pm 10%	1 V/V \pm 1%	5 mV/A \pm 10%	10 ms	10 ms	200 ms	75 ms	2–12 V	5% + 2 V	43.9 kg/97 lb	48 kg/106 lb	5, 9, 10, 15, 22, 27, 40	\$1160
200 Ω /V \pm 1%	100 Ω /A \pm 10%	1 V/V \pm 1%	50 mV/A \pm 10%	150 ms	150 ms	7 sec	350 ms	2–23 V	5% + 1 V	15.4 kg/34 lb	18.6 kg/41 lb	5, 9, 10, 15, 22, 27, 28, 40	\$635
200 Ω /V \pm 1%	80 Ω /A \pm 10%	1 V/V \pm 1%	25 mV/A \pm 10%	140 ms	140 ms	10 sec	150 ms	2.5–23 V	5% + 3 V	21.2 kg/47 lb	24.5 kg/54 lb	5, 9, 10, 15, 22, 27, 28, 40	\$720
200 Ω /V \pm 1%	4 Ω /A \pm 10%	1 V/V \pm 1%	10 mV/A \pm 10%	150 ms	150 ms	250 ms	250 ms	2–23 V	5% + 2 V	35.3 kg/78 lb	39.4 kg/87 lb	5, 9, 10, 15, 22, 26, 27, 40	\$1080
200 Ω /V \pm 1%	300 Ω /A \pm 10%	1 V/V \pm 1%	167 mV/A \pm 10%	275 ms	275 ms	12 sec	1.5 sec	2.5–45 V	5% + 1 V	15.4 kg/34 lb	18.6 kg/41 lb	5, 9, 10, 15, 22, 27, 28, 40	\$560
200 Ω /V \pm 1%	200 Ω /A \pm 10%	1 V/V \pm 1%	100 mV/A \pm 10%	275 ms	275 ms	13 sec	1.5 sec	2.5–45 V	5% + 1 V	15.4 kg/34 lb	18.6 kg/41 lb	5, 9, 10, 15, 22, 27, 28, 40	\$600
200 Ω /V \pm 1%	100 Ω /A \pm 10%	1 V/V \pm 1%	50 mV/A \pm 10%	275 ms	275 ms	13 sec	750 ms	2.5–45 V	5% – 1 V	17.7 kg/39 lb	20.8 kg/46 lb	5, 9, 10, 15, 22, 27, 28, 40	\$720
200 Ω /V \pm 1%	6 Ω /A \pm 10%	1 V/V \pm 1%	16.7 mV/A \pm 10%	300 ms	300 ms	1 sec	650 ms	4–45 V	5% + 1 V	34.4 kg/76 lb	38.1 kg/84 lb	5, 9, 10, 15, 22, 26, 27, 40	\$1060
200 Ω /V \pm 1%	4 Ω /A \pm 10%	1 V/V \pm 1%	10 mV/A \pm 10%	350 ms	350 ms	1 sec	600 ms	4–45 V	5% + 1 V	40.3 kg/89 lb	44 kg/98 lb	5, 9, 10, 15, 22, 27, 40	\$1130
300 Ω /V \pm 1%	300 Ω /A \pm 10%	1 V/V \pm 1%	167 mV/A \pm 10%	600 ms	600 ms	7 sec	2 sec	6–66 V	5% + 1 V	15.4 kg/34 lb	18.6 kg/41 lb	5, 9, 10, 15, 22, 27, 28, 40	\$590
300 Ω /V \pm 1%	67 Ω /A \pm 10%	1 V/V \pm 1%	33.3 mV/A \pm 10%	600 ms	600 ms	40 sec	800 ms	6–66 V	5% + 1 V	21.7 kg/48 lb	24.5 kg/54 lb	5, 9, 10, 15, 22, 27, 28, 40	\$840
300 Ω /V	—	—	—	—	—	—	—	NA	NA	22.6 kg/50 lb	29.4 kg/65 lb	—	\$795

* Up = increasing output voltage. NL = No output load current. FL = Full rated output load current.
 † See page 198 for complete option and accessory descriptions.

POWER SUPPLIES

General purpose: 300–11,000 W output

Models 6427B–6483C

- Outstanding value—low cost/watt
- Up to 75% efficiency at full output
- Constant voltage/current operation

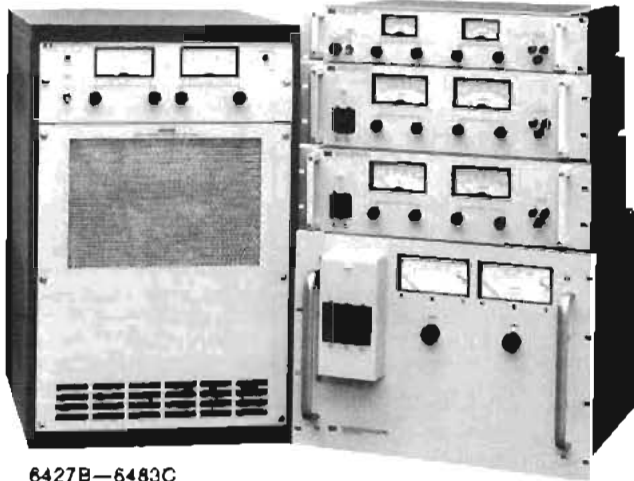

6427B–6483C

Description

This series of SCR-regulated power supplies is designed for high-power applications requiring a fixed variable DC source with moderate regulation and ripple. For supplies with better regulation, faster response time, and lower ripple, see models 6256B-6274B and 895A, on page 186.

Operating features

All supplies in this series are of the Constant Voltage/Constant Current type. Large easy-to-read panel meters continuously monitor output voltage and current.

Input and output power, remote sensing, remote programming, and auto-series, -parallel, and -tracking connections are made to bus bars and terminal blocks on the rear panel.

Specifications†

RATINGS			PERFORMANCE						
DC Output		Model	Load Effect		Source Effect		PARD Δ p-p/rms	Temperature Coefficient	Drift
Volts \S	Amps \S		Voltage	Current	Voltage	Current			
0–8	0–1000	6464C	0.05% +5 mV	0.1% +1 A	0.05% +5 mV	0.1% +1 A	80 mV/1V	0.03% +100 μ V	0.3% +1 mV
0–15	0–200	6453A	0.2% +10 mV††	1% or 2 A††	0.2% +10 mV††	1% or 2 A††	150 mV rms	0.05% +2 mV	0.25% +10 mV
0–15 or 18	0–600 or 500*	6466C	0.05% +5 mV	0.1% +0.6 A	0.05% +5 mV	0.1% +0.6 A	180 mV/1 V	0.03% +200 μ V	0.2% +1 mV
0–20	0–15	6427B	20 mV	150 mA	10 mV	150 mA	40 mV/400 mV	0.03% +3 mV	0.1% +10 mV
0–20	0–45	6428B	40 mV	450 mA	20 mV	450 mA	40 mV/500 mV	0.03% +3 mV	0.1% +10 mV
0–36	0–10	6433B	36 mV	100 mA	18 mV	100 mA	36 mV/400 mV	0.03% +5 mV	0.1% +15 mV
0–36	0–100	6456B	0.2% +10 mV††	1% or 1 A††	0.2% +10 mV††	1% or 1 A††	180 mV rms	0.05% +2 mV	0.25% +10 mV
0–36	0–300	6469C	0.05% +5 mV	0.1% +0.3 A	0.05% +5 mV	0.1% +0.3 A	180 mV/1V	0.03% +400 μ V	0.15% +1 mV
0–40	0–25	6434B	40 mV	200 mA	18 mV	200 mA	40 mV/500 mV	0.03% +5 mV	0.1% +20 mV
0–60	0–5	6438B	60 mV	50 mA	30 mV	50 mA	120 mV/400 mV	0.03% +10 mV	0.1% +30 mV
0–60	0–15	6439B	120 mV	150 mA	60 mV	150 mA	60 mV/500 mV	0.03% +10 mV	0.1% +30 mV
0–64	0–50	6459A	0.2% +10 mV††	1% or 0.5 A††	0.2% +10 mV††	1% or 0.5 A††	160 mV rms	0.05% +2 mV	0.25% +10 mV
0–64	0–150	6479C	0.05% +100 mV	0.1% +0.15 A	0.05% +100 mV	0.1% +0.15 A	160 mV/2 V	0.03% +4 mV	0.15% +16 mV
0–110	0–100	6475C	0.05% +100 mV	0.1% +0.1 A	0.05% +100 mV	0.1% +0.1 A	220 mV/2 V	0.03% +5 mV	0.15% +20 mV
0–120	0–2.5	6443B	120 mV	25 mA	60 mV	25 mA	240 mV/480 mV	0.03% +20 mV	0.1% +60 mV
0–220	0–50	6477C	0.05% +100 mV	0.1% +50 mA	0.05% +100 mV	0.1% +50 mA	330 mV/2 V	0.03% +8 mV	0.15% +35 mV
0–300	0–35	6479C	0.05% +100 mV	0.1% +35 mA	0.05% +100 mV	0.1% +35 mA	330 mV/3 V	0.03% +11 mV	0.15% +45 mV
0–440, 500 or 600	0–25, 20, 15*	6483C	0.05% +100 mV	0.1% +35 mA	0.05% +100 mV	0.1% +35 mA	600 mV/5 V	0.03% +20 mV	0.15% +80 mV
1–600	5 mA–1.5 A	6448B	1% +400 mV	2% +10 mA	600 mV	15 mA	600 mV/2 V	0.03% +100 mV	0.1% +300 mV

† Refer to page 179 for complete specification definitions.

†† Specified for combined line and load regulation.

Δ For operation with a 50 Hz input (possible only with Option 05), the rms ripple and transient response specifications are increased by 50%.

* The output current rating is given in the same order corresponding with the voltage rating.

Protective features

In addition to the overload protection inherent in Constant Voltage/Constant Current operation, there are many other built-in protective features included in these supplies. The features vary within the three model classifications as follows:

6427B–6448B: (1) Reverse voltage protection. (2) Fused AC input.
6453A, 6456B, 6459A: (1) AC line loss protection circuit monitors 3-phase input and cuts off SCR's and opens output bus if a phase drops out; operation resumes when AC input returns to normal. (2) 3-phase input circuit breaker. (3) Optional internal crowbar (Option 006) protects load from overvoltage condition.

6464C–6483C: (1) High-temperature protection thermostat opens input to power transformer and lights front panel indicator if supply overheats. (2) Prolonged overload protection circuit is activated and lights front panel indicator if output current exceeds approximately 115% of maximum rating. (3) Optional internal crowbar (except on 6464C) protects load from overvoltage condition. (4) Turn-on circuit limits peak line current during start-up into low impedance loads. (5) Phase-balance circuit permits operation with line-to-line input voltage imbalance up to 8%. (6) Overcurrent and over-voltage circuits of master and slave supplies used in auto-series, -parallel, or -tracking operation can be interlocked.

Auto-series, -parallel, -tracking operation

Supplies may be connected in auto-series, or auto-tracking. (Except 6448B and 6483C which cannot be connected in auto-series.)

Up to three lower power models (6427B–6448B) may be connected in any of the above configurations. Higher-power model (6453A–6483C) interconnection should ordinarily include no more than two supplies.

Remote sensing

Remote sensing permits regulation at the load connection, rather than at the output terminals of the power supply. In all cases, there are limits to the permissible load-lead voltage drops, as follows:

Models 6427B–6448B: 2 volts in negative output lead.

Models 6453A, 6456B, 6459A: 1 volt in negative output lead.

Models 6464C–6483C: 3 volts in negative output lead.

\S Under light loading conditions, power supply may not meet all published specifications. The graph on page 189 defines the permissible operating regions for CV and CC modes of operation. For operation with a 50 Hz input (possible only with Option 05), output current is linearly derated from 100% at 40°C to 80% at 50°C.

POWER SUPPLY OUTPUT RESTRICTIONS AS A FUNCTION OF LOADING

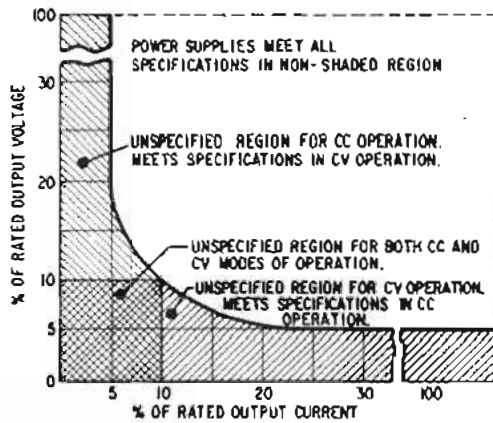

Remote programming

The voltage and current outputs of the supplies can be programmed by a remote resistance, or, for most models, a voltage source. Programming speeds and coefficients are detailed in the specifications table.

AC power requirements

The AC power requirements vary with the three model classifications (see option listings). When powered from a 50 Hz source (possible with Option 005), the rms ripple and transient response specifications increase by 50%. The p-p ripple specification is unchanged by line frequency.

Dimensions

Models 6427B, 6433B, 6438B and 6443B: 483 mm W × 89 mm H × 445 mm D. (19" × 3½" × 17½")

Models 6428B, 6434B, 6439B, & 6448B: 483 mm W × 133 mm H × 426 mm D; (19" × 5¼" × 16¾")

Models 6453A, 6456B, & 6459A: 483 mm W × 356 mm H × 464 mm D (19" × 14" × 18¼").

Models 6464C, 6466C, 6469C, 6472C, 6475C, 6477C, 6479C, & 6483C: 426 mm W × 667 mm H × 664 mm D (16¾" × 26¼" × 26½").

Options

AC, input power
6427B-6448B

Std: 115 V ac, ±10%, single phase, 57-63 Hz.

027: 208 V ac, ±10%, single phase, 57-63 Hz.

028: 230 V ac, ±10%, single phase, 57-63 Hz.

005: Realignment for 50 Hz operation.

6453A, 6456B, 6459A: AC input may be delta or wye with isolated neutral. AC input connections are by means of Hubbell No. 7413G connector at rear of unit. A matching connector is furnished.

001: 208 V ac, ±10%, 3-phase, 15.5 A/phase, 57-63 Hz.

002: 230 V ac, ±10%, 3-phase, 14 A/phase, 57-63 Hz.

031: 380 V ac, ±10%, 3-phase, 8.5 A/phase, 57-63 Hz.

032: 400 V ac, ±10%, 3-phase, 8.0 A/phase, 57-63 Hz.

003: 460 V ac, ±10%, 3-phase, 7 A/phase, 57-63 Hz.

005: realignment for 50 Hz operation.

6464C-6483C: AC input may be delta or wye with isolated neutral. AC input connections are by means of enclosed 4-wire terminal block.

001: 208 V ac, ±10%, 3-phase, 55 A/phase, 57-63 Hz.

002: 230 V ac, ±10%, 3-phase, 50 A/phase, 57-63 Hz.

031: 380 V ac, ±10%, 3-phase, 30 A/phase, 57-63 Hz.

032: 400 V ac, ±10%, 3-phase, 28.5 A/phase, 57-63 Hz.

003: 460 V ac, ±10%, 3-phase, 25 A/phase, 57-63 Hz.

005: Realignment for 50 Hz operation.

006: internal overvoltage protection crowbar.

6459A, 6477C, 6479C, 6483C

6453A, 6456B

6472C, 6475C

6469C

6466C

Price

N/C
N/C
N/C

N/C
N/C
\$55
\$55
N/C
N/C

N/C
N/C
\$200
\$200
\$210
N/C

\$345
\$395
\$460
\$510
\$570

Resolution		REMOTE CONTROL										GENERAL			
		Load Transient Recovery Δ		Resistance Coefficient		Voltage Coefficient		Up		Down		Net Weight		Options A	Price
		V	C	Voltage	Current	Voltage	Current	HL	FL	HL	FL	Kg	lb		
8 mV	1 A	100 ms, 500 mV	200Ω/V ±2%	1Ω/A ±2%	1 V/V ±1%	6.2 mV/A ±7%	1.6 s	0.6 s	6 s	0.1 s	235	518	1, 2, 3, 5, 23, 31, 32	\$4330	
85 mV	1 A	50 ms, 150 mV	200Ω/V ±2%	1Ω/A	0.8 V/V	30 mV/A	1 s	0.5 s	20 s	0.2 s	108	238	1, 2, 3, 5, 6, 10, 31, 32	\$1960	
18 mV	0.5 A	100 ms, 500 mV	200Ω/V ±2%	1.66Ω/A ±2%	1 V/V ±1%	10.3 mV/A ±7%	1.6 s	0.6 s	15 s	0.2 s	226	500	1, 2, 3, 5, 6, 23, 31, 32	\$3910	
10 mV	7.5 mA	200 ms, 200 mV	200Ω/V ±2%	20Ω/A ±20%	1 V/V	NA	0.3 s	1.4 s	100 s	1.4 s	16.3	36	5, 10, 27, 28	\$540	
10 mV	22.5 mA	200 ms, 200 mV	200Ω/V ±2%	6Ω/A ±20%	1 V/V	NA	0.16 s	0.72 s	65 s	0.72 s	30.4	67	5, 10, 27, 28	\$780	
9 mV	5 mA	200 ms, 200 mV	200Ω/V ±2%	30Ω/A ±20%	1 V/V	NA	0.3 s	1.4 s	110 s	1.4 s	14.9	33	5, 10, 27, 28	\$535	
30 mV	0.5 mA	50 ms, 300 mV	200Ω/V ±2%	2Ω/A	166 mV/V	60 mV/A	1 s	0.5 s	60 s	0.5 s	108	238	1, 2, 3, 5, 6, 10, 31, 32	\$1850	
36 mV	0.3 A	100 ms, 500 mV	200Ω/V ±2%	3.33Ω/A ±2%	1 V/V	20.6 mV/A ±7%	1.6 s	0.5 s	20 s	0.5 s	226	500	1, 2, 3, 5, 6, 23, 31, 32	\$3660	
10 mV	12.5 mA	200 ms, 200 mV	200Ω/V ±2%	12Ω/A	1 V/V	NA	0.26 s	1.2 s	75 s	1.2 s	30.4	67	5, 10, 27, 28	\$745	
9 mV	2.5 mA	200 ms, 300 mV	200Ω/V ±2%	60Ω/A	1 V/V	NA	0.52 s	2.5 s	205 s	2.5 s	14	31	5, 10, 27, 28	\$540	
3 mV	7.5 mA	200 ms, 600 mV	300Ω/V ±2%	20Ω/A	1 V/V	NA	0.26 s	1.3 s	76 s	1.3 s	27.6	61	5, 10, 27, 28	\$690	
110 mV	0.25 mA	50 ms, 600 mV	300Ω/V ±2%	4Ω/A	94 mV/V	120 mV/A	1 s	0.7 s	45 s	0.7 s	108	238	1, 2, 3, 5, 6, 10, 31, 32	\$1850	
64 mV	0.15 mA	100 ms, 750 mV	300Ω/V ±2%	6.7Ω/A ±2%	1 V/V ±3%	41.2 mV/A ±7%	1.4 s	0.7 s	55 s	0.7 s	226	500	1, 2, 3, 5, 6, 23, 31, 32	\$3660	
22 mV	0.1 A	100 ms, 1 V	300Ω/V ±2%	10Ω/A ±2%	1 V/V ±3%	62 mV/A ±7%	1.5 s	0.7 s	80 s	0.7 s	226	500	1, 2, 3, 5, 6, 23, 31, 32	\$3550	
30 mV	1.3 mA	200 ms, 600 mV	300Ω/V ±2%	120Ω/A	1 V/V	NA	0.5 s	2 s	210 s	2 s	14	31	5, 10, 27, 28	\$500	
44 mV	56 mA	100 ms, 2 V	300Ω/V ±2%	20Ω/A ±2%	1 V/V ±3%	124 mV/A ±7%	1.5 s	1 s	95 s	1 s	226	500	1, 2, 3, 5, 6, 23, 31, 32	\$3450	
90 mV	35 mA	100 ms, 3 V	300Ω/V ±2%	28.5Ω/A ±2%	1 V/V ±3%	177 mV/A ±7%	1.5 s	1.6 s	75 s	1.6 s	226	500	1, 2, 3, 5, 6, 23, 31, 32	\$3550	
60 mV	25 mA	100 ms, 5 V	300Ω/V ±2%	40Ω/A ±2%	1 V/V ±3%	0.25 V/A ±7%	1.5 s	2 s	120 s	2 s	226	500	1, 2, 3, 5, 6, 23, 31, 32	\$3910	
90 mV	0.75 mA	200 ms, 3 V	300Ω/V ±2%	600Ω/A	1 V/V	NA	0.2 s	1 s	46 s	1 s	27.6	61	5, 10, 27, 28	\$720	

Δ For operation with a 50 Hz input (possible only with Option 005), the rms ripple and transient response specifications are increased by 50%.

▲ See page 198 for complete option and accessory descriptions.

POWER SUPPLIES

General purpose: 1800–2800 W output
Model 6452A

- Excellent regulation
- High efficiency, light weight, small size
- Fast programming and transient response
- Wide-range output ratings
- Stabilized for highly reactive loads
- Single or three-phase ac input



6452A

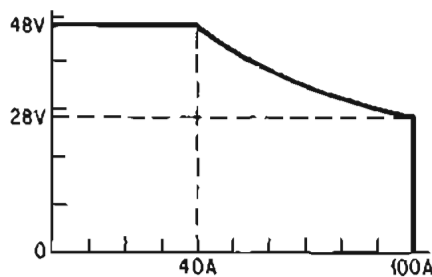

Figure 1.

Description

The 6452A DC power supply is the first of a series which offers a new level of performance in high power direct current applications. New and unique circuit design combines the benefits of 20 kHz switching and SCR control technology to offer high efficiency, light weight, and small size while improving upon the performance specifications generally available at the 2 to 3 kilowatt power level. Output voltages and currents available range from 48 V/40 A to 28 V/100 A (see figure 1). This extended output range provides the user with the higher current often required for low voltage applications while still maintaining the flexibility for higher voltages when required. Typical applications for this power supply are semiconductor burn-in operations, DC magnet power, battery charging or replacement, and large automatic testing systems.

The 6452A offers constant voltage/constant current operating modes. Front panel light emitting diode (LED) indicators display the mode in which the power supply is operating. Additional front panel LED indicators provide visual information on overtemperature, overvoltage, and overrange conditions. The overrange indicator activates when changes in the load or output voltage/current settings cause the power supply to exceed the maximum power available (Figure 1). The overvoltage indicator activates simultaneously with the firing of the internal overvoltage protection circuit. This overvoltage circuit is front panel adjustable from 10% to 110% of rated output voltage.

In addition to the power supply circuitry described above, the 6452A incorporates several new features. An auxiliary, patented, control circuit enables the power supply to maintain its specifications with highly reactive loads. Internal AC input wiring enables the power supply to accept either single or three-phase 230 Volt AC power.

Other models with similar power ratings in this series will provide output voltages up to 600 V and output currents up to 300 A.

Specifications

DC output: 0–48 V, 0–100 A, see Figure 1 for maximum power ratings.

Source effect (line regulation): 0.05% +25 mV in constant voltage operation and 0.1% +100 mA in constant current over the specified AC voltage input range.

Load effect (load regulation): 0.05% +25 mV in constant voltage over the specified load current range.

PARD (ripple and noise): 25 mV rms/250 mV p-p (DC to 20 MHz).

Temperature coefficient, per °C: 0.05% of output plus 400 μ V.

Stability: 0.3% of output voltage over an eight-hour period, following a 30-minute warm-up.

Load transient recovery: 6 ms is required for output voltage to recover within 1% of output voltage setting following a change in output current from 50 A to 100 A.

Remote control programming

Voltage control coefficients: Constant voltage, 85 mV/V \pm 2%; Constant current: 50 mV/A \pm 2%.

Resistance control coefficients: Constant voltage 45 ohms/V \pm 2%; Constant current: 2 ohms/A \pm 3%.

Programming speed: the time required to non-repetitively change from 0 to 99% of maximum rated output voltage under full load current conditions is 20 ms.

Overvoltage protection: a standard feature is an overvoltage protection circuit fully adjustable via front panel control over a range from 5 to 53 volts.

AC power: the 6452A operates from a single phase, or three phase source (phase-to-phase voltage) over a range of 208–250 V ac, 50, 60 Hz. A rear panel switch enables the unit to operate down to 190 V ac with a 15% output power derating. Maximum rms current required is 30 amps single phase or 20 amps three-phase.

Temperature: operating: 0 to 40°C; output power must be derated for operation from 40°C to 55°C; storage: –40 to +75°C.

Weight: net, 34 kg (75 lb). Shipping, 38.6 kg (85 lb).

Dimensions: 190.5 mm H \times 425.5 mm W \times 609.6 mm D (7.5" \times 16.75" \times 24").

POWER SUPPLIES

General Purpose: 200 watt, extended range

Model 6002A

- 200-watt extended range
- Constant voltage/constant current operation
- HP-IB programming option

- Built-in overvoltage protection crowbar
- CV/CC operating status indicators
- Remote analog programming and sensing



Description

The model 6002A offers a new level of performance and usefulness in laboratory power supplies. It employs a unique regulation control concept that automatically yields a continuous span of voltage-current ratings within the basic 200-watt power rating boundary. This is beneficial in that more current is available at lower voltages, and higher voltage is available for a given current level than can be obtained from conventional 200-watt supplies.

Conventional 200-watt power supplies, rated for 50 volts or 20 volts could only operate within the two shaded regions shown in Figure 1. The 6002A not only provides the outputs of the two conventional supplies, but also delivers the extra output capability shown between 20 and 50 volts.

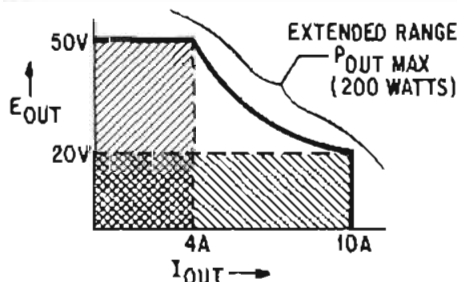

Figure 1.

This "extended range" capability of the 6002A provides the user with a single power supply that can cover a wide variety of applications in the lab or as a system component, without having to overspecify both the output voltage and current.

System features/remote control

Analog programming of output voltage and current can be accomplished through the use of remotely controlled resistance or voltage applied to rear panel terminals. Additional control terminals are provided for remote load voltage sensing, auto-series or parallel operation, and for remotely activating the "crowbar" circuit. A pulse output from the crowbar terminal indicates the overvoltage circuit has been self-activated. A voltage step change appearing on another terminal indicates change-over to or from constant current operation.

HP-IB option

Digital programming via option 001 permits control of output voltage or current by the Hewlett-Packard Interface Bus (HP-IB). Two programmable ranges allow better resolution between 0-10 volts or 0-2 amps. The selection of HP-IB control of either voltage or current is done by rear panel switches.

Specifications

DC output: voltage and current output can be adjusted over the ranges indicated by front panel controls, analog programming, or optional HP-IB interface.

Voltage: 0-50 V **Current:** 0-10 A

Maximum 200 Watts output from 20 V to 50 V.

Load effect: Constant voltage, 0.01% +1 mV. Constant Current, 0.01% +1 mA.

Source effect: CV, 0.01% +1 mV. CC, 0.01% +1 mA.

PARD (ripple and noise): rms/p-p, 20 Hz to 20 MHz; CV, 1 mV/10 mV/CC, 5 mA rms.

Temperature coefficient: CV, 0.02% +200 μ V/ $^{\circ}$ C. CC, 0.02% +5 mA/ $^{\circ}$ C.

Drift: CV, 0.05% +1 mV/8 hrs. CC, 0.05% +5 mA/8 hrs.

Resolution: front panel controls: CV, 10 mV, CC, 10 mA.

Output impedance: approximately 0.5 Ω in series with 1 μ H.

Load transient recovery: 100 μ s for output voltage to recover within 15 mV of nominal voltage setting following a load current change of 50% to 100% or 100% to 50% of full load current.

Remote control coefficients: resistance programming: CV, 1 k Ω /V \pm 7%. CC, 100 Ω /A \pm 7%. Voltage programming: CV 1V/V \pm 20 mV, CC, 50 mV/A \pm 10%.

Response time: maximum time for output voltage to change between 0 to 99.9% or 100% to 0.1% of maximum rated output voltage. UP Programming: no load, 100 ms; full load, 100 ms. DOWN Programming: no load, 400 ms; full load, 200 ms.

Overvoltage protection: trip voltage adjustable from 2.5 V to 60 V.

DC output isolation: 150 V dc.

Power: 100, 120, 220, or 240 V ac (-13% , $+6\%$), 48-63 Hz.

Temperature rating: 0 to 55 $^{\circ}$ C operating, -40 to +75 $^{\circ}$ C storage. Supply is cooled by built-in fan.

Dimensions: 212 mm W \times 180 mm H \times 422 mm D (8.36" \times 6.97" \times 16.6").

Weight: net, 14.5 kg (32 lb). Shipping, 15.9 kg (35 lb).

HP-IB Option

Programmable ranges: High (0-50 V or 0-10 A), Low (0-10 V or 0-2 A).

Programming speed: same as response time.

Accuracy: Hi range: CV, 0.2% +25 mV; CC, 0.5% +25 mA.

Lo range: CV, 0.2% +10 mV; CC, 0.2% +25 mA.

Resolution: Hi range: CV, 50 mV; CC, 10 mA.

Lo range: CV, 10 mV; CC, 2 mA.

Isolation: 250 Volts DC from Bus data lines to power supply.

Options

001: HP-IB Interface

6002A Extended Range DC Power Supply

Price

\$150

\$800

POWER SUPPLIES

General Purpose: dual-tracking outputs

Models 6227B & 6228B

- Two 50-watt power supplies for independent or tracking operation
- Built-in overvoltage protection crowbars



6227B



6228B

Description

These versatile lab supplies each house two identical 50 W regulated power supplies. A convenient front panel switch selects either independent or tracking operation. In the tracking mode, the right supply tracks the left within $0.2\% \pm 2$ mV. The tracking mode is especially useful for powering operational amplifiers, push-pull stages, deflection systems, or any application where plus and minus voltages must track with insignificant error. The independent mode permits operation of the two supplies individually, in auto-parallel or in auto-series.

Each side of the dual supply can be operated as a constant voltage or constant current source, and each has its own crowbar for overvoltage protection. In the tracking mode, an overvoltage condition in either supply trips both crowbars. The power supply outputs are isolated up to 300 V from output to chassis or output to output.

Specifications

DC output: 6227B, 0-25 V @ 0-2 A; 6228B, 0-50 V @ 0-1 A.

AC input: 115 or 230 V ac $\pm 10\%$, 48-63 Hz, 260 W. Selected by rear panel switch.

CV load effect (load regulation): for a load current change equal to the current rating of the supply; $0.01\% \pm 1$ mV.

CC load effect: for a load voltage change equal to the voltage rating of the supply; $0.01\% \pm 250$ μ V.

Source effect (line regulation): for a change in line voltage between 103.5 and 126.5 V ac or 207 and 253 V ac at any output voltage and current within rating; CV, 1 mV; CC, 100 μ A.

PARD (ripple and noise): at any line voltage and under any load condition within rating (20 Hz to 20 MHz); CV, 250 μ V rms/4 mV p-p; CC, 250 μ A rms/2 mA p-p.

Temperature coefficient: output change per degree Centigrade change in ambient following 30 minutes warm-up; CV, $0.02\% \pm 200$ μ V; CC, $0.02\% \pm 300$ μ A.

Drift (stability): total drift in output (dc to 20 Hz) over 8-hour interval under constant line, load, and ambient following 30 minutes warm up; CV, $0.2\% \pm 2$ mV; CC, $0.2\% \pm 3$ mA.

Remote resistance programming: CV, $200\Omega/V \pm 1\%$; CC, $500\Omega/A \pm 10\%$ (6227B); $1\text{ k}\Omega/A \pm 10\%$ (6228B).

Remote voltage programming: CV, $1\text{ V/V} \pm 1\%$; CC, $0.5\text{ V/A} \pm 10\%$ (6227B); $1\text{ V/A} \pm 10\%$ (6228B).

Programming Speed (CV): 60 ms to within 25 mV of zero or maximum rated value.

Output impedance (typical): approximated by a resistance in series with an inductance; 6227B, $2\text{ m}\Omega/2\text{ }\mu\text{H}$; 6228B, $1\text{ m}\Omega/6\text{ }\mu\text{H}$.

Resolution (fine control): voltage, 5 mV (6227B), 10 mV (6228B); current, 1 mA (6227B), 0.5 mA (6228B).

Internal overvoltage crowbars: during independent operation, each

- Auto-parallel and auto-series capability
- Constant current in addition to constant voltage outputs

supply is protected by its own crowbar. In the tracking mode, an overvoltage in either supply results in firing both crowbars.

Trip voltage margin: the minimum trip voltage above the operating output voltage of the supply to prevent false crowbar tripping: 7% of the output voltage + 1.5 V.

Trip voltage range: 6227B, 5-28 V dc; 6228B, 5-55 V dc.

Tracking error: in tracking mode, the slave supply is matched to $0.2\% \pm 2$ mV of the master.

Transient recovery time: in constant voltage, the output will recover in 50 μ sec to within 10 mV of its nominal value for a resistive load change demanding an output current change equal to the current rating of the supply. The nominal output voltage is defined as the mean between the no load and full load voltages.

Temperature ratings: operating: 0 to 55°C; Storage: -40 to +75°C.

Cooling: natural convection cooling.

Weight (net/shipping): 11/12.9 kg (24/28 lb).

Dimensions: 197 mm W \times 155 mm H \times 310 mm D (7 $\frac{7}{8}$ in. W \times 6 $\frac{1}{8}$ in. H \times 12 $\frac{1}{2}$ in. D).

Finish: mint gray panel with olive gray case.

Options

007: two ten-turn output voltage controls replace both sets of concentric coarse and fine voltage controls

Price:

add \$60

008: two ten-turn output current controls replace both sets of concentric coarse and fine current controls

add \$60

009: four ten-turn output voltage and current controls replace all four concentric coarse and fine voltage and current controls

add \$110

013: three digit graduated decadal voltage control includes graduated ten-turn control replacing standard coarse and fine voltage controls

add \$150

014: three digit graduated decadal current control includes graduated ten-turn control replacing standard coarse and fine current controls

add \$150

040: interfacing for Multiprogrammer operation Prepares standard HP power supplies for resistance programming by the 6940B Multiprogrammer or 6941B Multiprogrammer Extender

add \$135

Accessories Available

5060-8762 — Rack kit for mounting one or two dual supplies

\$55

5060-8760 — Filler panel to block unused half of rack when mounting only one dual supply

\$11

Model number and name

6227B Dual Tracking Power Supply

\$695

6228B Dual Tracking Power Supply

\$695

POWER SUPPLIES

General purpose: high voltage output

Models 6515A - 6525A

- Short circuit proof
- Precise voltage control — four-decade thumbwheel or switch-and vernier
- Convection cooling

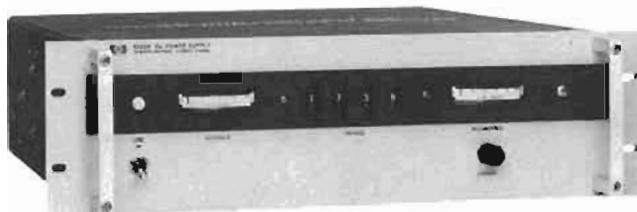

6521A, 6522A, 6525A



6515A



6516A

Description

6521A, 6522A, 6525A

This series of high performance power supplies has broad application both in the laboratory and in the system. They have sufficient output current to power devices such as TWT's, klystrons, magnetrons, backward-wave oscillators, high-power gas lasers, electron-beam welding devices, etc. Output voltage is set easily and precisely by a three-decade thumbwheel switch plus a thumbwheel vernier providing 0.002% resolution. In constant voltage operation, a single-turn current control allows the current-limit point to be set to any value within the current rating. In constant-current operation, the current control varies the output current while the voltage controls (thumbwheels) provide an adjustable voltage limit. The supplies are protected against reverse voltage that could be generated by an active load. Protection from reverse current requires pre-loading the supply with a dummy load to ensure that the supply outputs current through the entire operating cycle of the load. Either the positive or negative terminal may be grounded or the supply may be operated floating at up to 2000 V above ground.

6515A and 6516A

These high-voltage power supplies are lower in cost and output power than the 6521A-6526A supplies. Their small size, low price, and short-circuit-proof operation make them excellent high-voltage laboratory supplies, or high-voltage system supplies where current requirements are no more than 6 mA.

Model 6515A employs a sixteen-position rotary switch and a ten-turn vernier control to adjust the output voltage. The rotary switch selects output voltage increments from 0 to 1500 V in 100-volt steps; the vernier control permits fine adjustment (100 mV resolution) over any 100-volt span. Model 6516A uses a three-decade thumbwheel switch

- Floating output — can be used as a positive or negative source
- Front-panel meters
- Bench or rack mounting

plus a thumbwheel vernier for convenient and precise (0.1 V resolution) output voltage control.

Non-adjustable current-limit protection is provided on both models. On Model 6516A, the current-limit point is fixed at approximately 8 mA. On Model 6515A, the current limit value varies with the selected output voltage range as follows (voltage range/current limit): 0-300 V/7.5 mA, 400-700 V/65 mA, 800-1100 V/32 mA, 1200-1500 V/25 mA. Both supplies are protected against reverse voltages that could be generated by an active load. Pre-loading is necessary to protect the supplies from reverse currents. Either the positive or negative terminal may be grounded or the supply may be operated floating at up to 1000 V above ground. Units are packaged in half-rack width cases. They may be bench operated or mounted individually or in pairs using accessory rack-mounting kits.

Specifications

6521A, 6522A, 6525A

Accuracy: 1% of thumbwheel switch setting.

Temperature rating: operating, 0 to 55°C; storage, -40 to +75°C.

Temperature coefficient, per °C: voltage, 0.012% + 1 mV. Current: 6521A, 0.2% + 0.2 mA; 6522A, 0.2% + 0.1 mA; 6525A, 0.2% + 0.05 mA.

Output impedance, typical: 0.1 ohm in series with 1 μ H.

Load effect transient recovery: 50 μ s to recover within 0.005% or 20 mV, whichever is greater.

Output modes: automatic cross-over constant voltage/constant current.

Meters: 2% of full scale accuracy. Scales: 6521A: 0-1 kV & 0-200 mA; 6522A: 0-2 kV & 0-100 mA; 6525A: 0-4 kV & 0-50 mA.

Power: 115 V ac \pm 10%, 48-440 Hz, 4 A, 270 W.

Weight: net, 19 kg (42 lb). Shipping, 28.5 kg (63 lb).

Dimensions: 483 mm W \times 133 mm H \times 457 mm D, (19" \times 5 1/4" \times 18").

6515A and 6516A

Accuracy: 6516A, 1% of thumbwheel switch setting.

Temperature rating: operating, 0 to 55°C; storage, -40 to +75°C.

Temperature coefficient, per °C: voltage, 0.02% + 2 mV

Load effect transient recovery: 100 μ s to recover within 0.01% or 16 mV, whichever is greater.

Output modes: constant voltage with fixed current limit.

Meters: 2% of full scale accuracy. Scales: 6515A: 1.8 kV; 6516A: 3.5 kV.

Power: 6515A: 115 V ac \pm 10%, 60 \pm 0.3 Hz, 0.16 A, 19 W.

6516A: 115 V ac \pm 10%, 57-63 Hz, 1 A, 40 W.

Weight: 6515A: net, 4.1 kg (9 lb). Shipping, 5.0 kg (11 lb). 6516A: net, 7.7 kg (17 lb). Shipping, 9.5 kg (21 lb).

Dimensions: 6515A, 216 mm W \times 89 mm H \times 299 mm D (8 1/2" \times 3 1/2" \times 11 3/4"). 6516A, 216 mm W \times 133 mm H \times 406 mm D (8 1/2" \times 5 1/4" \times 16").

RATINGS			PERFORMANCE										GENERAL	
DC Output		Model	Load Effect		Source Effect		PRRD (rms/p-p)		Drift		Resolution		Options [▲]	Price
Volts	mA		Voltage	Current	Voltage	Current	Voltage	Current	Voltage	Current	V	C		
0-1000	0-200	6521A	0.005% or 20 mV*	2% or 1 mA*	0.005% or 20 mV*	1 mA	1 mV/500 mV	2 mA rms	0.036% +3 mV	0.25% +0.5 mA	20 mV	0.6 mA	None	\$1140
0-1500	5	6515A	0.01% or 16 mV*	NA	0.01% or 16 mV*	NA	2 mV/5 mV	NA	0.05% +5 mV	NA	100 mV	NA	15, 19	\$340
0-2000	0-100	6522A	0.005% or 20 mV*	2% or 1 mA*	0.005% or 20 mV*	1 mA	1 mV/500 mV	1 mA rms	0.036% +3 mV	0.25% +0.25 mA	40 mV	0.3 mA	None	\$1140
0-3000	6	6516A	0.01% or 16 mV*	NA	0.01% or 16 mV*	NA	1 mV/15 mV	NA	0.05% +5 mV	NA	1 V	NA	5, 18	\$480
0-4000	0-50	6525A	0.005% or 20 mV*	2% or 1 mA*	0.005% or 20 mV*	1 mA	1 mV/500 mV	500 μ A rms	0.036% +3 mV	0.25% +0.12 mA	80 mV	0.15 mA	None	\$1140

*whichever is larger

▲See page 198 for complete option and accessory descriptions.

POWER SUPPLIES

Special purpose: precision sources

Models 6101A-6116A

- 0.025% output voltage accuracy
- 5-minute warm-up
- Built-in overvoltage crowbar

- Constant voltage/current operation
- Thumbwheel or ten-turn voltage controls
- 0.1% output voltage accuracy



6110A



6101A, 6102A, 6106A



6111A, 6112A, 6113A, 6116A



6104A, 6105A



6114A, 6115A

Description

6104A, 6105A, 6114A, and 6115A

These four 40-watt precision power supplies are ideal for applications where an accurate, highly stable, and easy-to-use source of dc voltage is required. All four models feature automatic dual range operation. For example, Models 6104A and 6114A can supply 0-20 V at 0-2 A, and 20-40 V at 0-1 A, without manual range switching. Automatic output current range crossover occurs when the supply is providing greater than one-half of the maximum rated output voltage.

Specifications†

RATINGS			PERFORMANCE								
DC Output		Model	Load Effect		Source Effect		PRRD (rms/p-p)		Temperature coefficient	Drift (Stability)	
Volts	Amps		Voltage	Current	Voltage	Current	Voltage	Current		8-hour	90 day
0-10	0-2	6113A	0.001% + 100 μ V	NA	0.001%	NA	40 μ V/100 μ V	NA	0.001% + 10 μ V	0.01% + 100 μ V	—
0-20	0-1	6101A	0.001% + 100 μ V	NA	0.001%	NA	40 μ V/100 μ V	NA	0.005% + 30 μ V	0.01% + 300 μ V	—
0-20	0-1	6111A	0.001% + 100 μ V	NA	0.001%	NA	40 μ V/100 μ V	NA	0.001% + 10 μ V	0.01% + 100 μ V	—
0-20, 20-40	0-2, 0-1	6104A	0.0005% + 100 μ V	0.01% + 500 μ A	0.0005% + 40 μ V	0.005% + 40 μ A	40 μ V/200 μ V*	200 μ A/1 mA	0.005% + 25 μ V	0.005% + 50 μ V*	0.01% + 100 μ V*
0-20, 20-40	0-2, 0-1	6114A	0.0005% + 100 μ V	0.01% + 500 μ A	0.0005% + 40 μ V	0.005% + 40 μ A	40 μ V/200 μ V*	200 μ A/1 mA	0.001% + 15 μ V	0.005% + 15 μ V**	0.0075% + 30 μ V**
0-40	0-0.5	6102A	0.001% + 100 μ V	NA	0.001%	NA	40 μ V/100 μ V	NA	0.005% + 50 μ V	0.01% + 500 μ V	—
0-40	0-0.5	6112A	0.001% + 100 μ V	NA	0.001%	NA	40 μ V/100 μ V	NA	0.001% + 10 μ V	0.01% + 100 μ V	—
0-50, 50-100	0-0.8, 0-0.4	6105A	0.0005% + 50 μ V	0.01% + 500 μ A	0.0005% + 100 μ V	0.005% + 20 μ A	40 μ V/200 μ V*	200 μ A/1 mA	0.005% + 50 μ V	0.005% + 50 μ V*	0.01% + 100 μ V*
0-50, 50-100	0-0.8, 0-0.4	6115A	0.0005% + 50 μ V	0.01% + 500 μ A	0.0005% + 100 μ V	0.005% + 20 μ A	40 μ V/200 μ V*	20 μ A/1 mA	0.001% + 15 μ V**	0.005% + 15 μ V	0.0075% + 30 μ V**
0-100	0-200 mA	6106A	0.001% + 100 μ V	NA	0.001%	NA	40 μ V/100 μ V	NA	0.005% + 100 μ V	0.01% + 1 μ V	—
0-100	0-200 mA	6116A	0.001% + 100 μ V	NA	0.001%	NA	40 μ V/100 μ V	NA	0.001% + 10 μ V	0.01% + 1 μ V	—
0-3000	0-6 mA	6110A	0.001% + 100 μ V	NA	0.001%	NA	2 mV/5 mV	NA	0.001% + 50 μ V	0.01% + 500 μ V	—

† Refer to page 179 for complete specification definitions and page 198 for option descriptions.

* Pot wiper jump effect may add 5 mV (6104A) or 10 mV (6105A). When remote programmed, drift is 0.001% + 15 μ V (8 hour) or 0.0075% + 30 μ V (90-day) plus stability of remote programming device.

** Specified with final decade pot set to zero. If pot is set to value other than zero, pot wiper jump effect may cause drift of 0.0015% + 200 μ V (90-day).

* 200 μ V p-p noise is typical with a maximum 400 μ V p-p spike of less than 1 μ sec duration occurring repetition rate of twice power line frequency under worst case conditions of high line, full output voltage. When operated at 400 Hz input, peak-to-peak ripple is less than 10 mV.

Output voltage controls

Pushbutton voltage controls on Models 6114A and 6115A allow the output voltage to be set rapidly and accurately. The setting is displayed on large, easy-to-read numerals. A fifth digit, set via a thumbwheel on the switch assembly, provides output voltage resolution of 200 μ V.

Models 6104A and 6105A are intended for applications where the supply is to be primarily remote programmed. The output voltage control on these units is a ten-turn potentiometer; an optional three-digit Decadial is available for improved resettability (Option 015).

Output current controls

A front-panel current control allows the output current to be set to any desired value within the maximum rating. Using this control, the supplies can be operated as constant current sources with 0.01% current regulation. A current mode indicator (a light-emitting diode) immediately lights when either the supply is operated in the gross current limit region, or the output current level established by the setting of the front panel control is reached.

Remote programming

All four of these supplies can be remote programmed by means of an external voltage or resistance; when remote resistance programmed, output voltage accuracy is 0.01% plus the accuracy of the remote programming resistor, and output current accuracy is 0.25% plus the accuracy of the remote programming resistor.

For computer controlled applications, these supplies are designed to be digitally programmed with the HP Model 6940B Multiprogrammer or 6941B Multiprogrammer Extender.

Overvoltage protection

A circuit technique used in these supplies permits the output voltage to drop completely to zero once the overvoltage protection circuit has been triggered, rather than to only 1-3 V as is typical with other SCR crowbars. This same circuit technique also permits the trip threshold to be set as low as 0.5 V, thus providing load protection at very low output voltage levels.

6101A, 6102A and 6106A

Although these 20-watt precision power supplies do not provide quite the level of performance and flexibility of Models 6104A, 6105A, 6114A, and 6115A, they are lower in cost and are suitable for many precision power applications. Output voltage is adjusted by separate coarse (10-turn) and fine (single-turn) controls; resolution is 0.002% + 100 μ V of the output voltage. A single-turn current control allows full-range adjustment of the current-limit point. Additional features include a volt/ampere meter and associated meter function switch. The four-position function switch selects either of two output voltage or output current ranges (X1, X0.1) for display on the panel meter.

The d-c output of these supplies is floating, allowing the supplies to be used as either positive or negative sources. Terminals for +OUT, -OUT, and GND are provided on both the front and rear of the supply. The rear terminal strip also includes terminals for remote resistance programming, remote sensing, and auto-series, auto-tracking operation.

Units are packaged in 3 1/2-inch high, half-rack cases which may be bench operated or rack mounted using accessory rack mounting hardware.

6111A, 6112A, 6113A and 6116A

This series of precision power supplies has essentially the same features and characteristics as models 6101A-6106A described above, but also includes a five-decade thumbwheel voltage programmer for convenient and precise (100 μ V resolution) adjustment of output voltage. Units are packaged in 5 1/4-inch high, half-rack cases which are suitable for bench or rack installation.

6110A

Model 6110A is designed for applications requiring a precise and stable source of high-voltage dc power. Output voltage is set easily and precisely by a five-digit thumbwheel programmer providing 2 mV resolution. A non-adjustable current-limit circuit protects the supply from all overload conditions regardless of degree or duration. Plus and minus output connectors (Type UG-931/U) are provided on the front panel. Mating connectors (Type UG-932/U) are supplied with each unit. Either the positive or the negative terminal may be grounded, or the supply may be operated floating at up to 1,000 volts above ground. Units are packaged in 5 1/4-inch high, half-rack cases which are suitable for bench or rack installation.

General specifications — (see table also)

Temperature rating: all precision models; operating 0° to 50°C. Storage, -40° to +75°C.

DC output isolation: output terminals of precision models may be floated up to 300 V above ground. High voltage precision model 6110A may be floated to 1000 V.

Remote sensing: provided on all precision models except 6110A.

6104A, 6105A, 6114A, and 6115A

Power: 104-127 or 208-244 V ac selected by switch, 48-440 Hz, 150 VA maximum.

Dimensions: 197 mm W \times 166 mm H \times 336 mm D (7 3/4" \times 6 1/2" \times 13 1/4")

Weight: net, 7.7 kg (17 lb). Shipping, 9.5 kg (21 lb).

6101A, 6102A, and 6106A

Power: 115 V ac \pm 10%, 48-63 Hz, 0.5 A, 52 W (for 230 V, order Optn. 028).

Dimensions: 216 mm W \times 89 mm H \times 318 mm D (8 1/2" \times 3 1/2" \times 12 1/2")

Weight: net, 4.5 kg (10 lb). Shipping, 5.4 kg (12 lb).

6111A, 6112A, 6113A and 6116A

Power: 115 V ac \pm 10%, 48-63 Hz, 0.5 A, 52 W (for 230 V, order Optn. 028).

Dimensions: 216 mm W \times 133 mm H \times 318 mm D (8 1/2" \times 5 1/4" \times 12 1/2")

Weight: net, 5 kg (11 lb). Shipping, 6.8 kg (14 lb).

6110A

Power: 115 V ac \pm 10%, 57-63 Hz, 1 A, 50 W (for 50 Hz, order Optn. 005; for 230 V, order Option 018).

Dimensions: 216 mm W \times 133 mm H \times 406 mm D (8 1/2" \times 5 1/4" \times 16")

Weight: net, 8.6 kg (19 lb). Shipping, 10.4 kg (23 lb).

Accuracy	Resolution	Output Z (Typical)	Load Transient Recovery	Output Mode	REMOTE CONTROL								GENERAL			
					Resistance Coefficient ¹		Voltage Coefficient		UP \blacktriangleright		ODWN \blacktriangleleft		Overvoltage Protection	Options A ²	Price	
					Voltage	Current	Voltage	Current	NL	FL	NL	FL				
0.1% + 1 mV	20 μ V	0.2 m Ω + 1 μ H	NA	CV/CL	1 k Ω /V \pm 0.1%	NA	1 V/V \pm 0.1%	NA	NA	NA	NA	NA	NA	Opt 11, 3-23 V	11, 28, 40	\$480
NA	0.002% + 100 μ V	0.5 m Ω + 1 μ H	NA	CV/CL	1 k Ω /V \pm 0.1%	NA	1 V/V \pm 0.1%	NA	150 ms	250 ms	3 s	200 ms	Opt 11, 2.5-23 V	11, 28, 40	\$350	
0.1% + 1 mV	500 μ V	0.5 m Ω + 3 μ H	NA	CV/CL	1 k Ω /V \pm 0.1%	NA	1 V/V \pm 0.1%	NA	NA	NA	NA	NA	Opt 11, 2.5-23 V	11, 28, 40	\$480	
NA	8 mV	0.05 m Ω + 3 μ H	<50 μ s, 50 mV	CV/CC	2 k Ω /V \pm 0.01%	500 Ω /A \pm 0.25%	1 V/V ³	0.5 V/A \pm 1%	1.75 s	1.75 s	250 ms	160 ms	Std, 0.5-45 V	9, 15	\$580	
0.025% + 1 mV	200 μ V	0.05 m Ω + 3 μ H	<50 μ s, 50 mV	CV/CC	2 k Ω /V \pm 0.01%	500 Ω /A \pm 0.25%	1 V/V ³	0.5 V/A \pm 1%	1.75 s	1.75 s	250 ms	160 ms	Std, 0.5-45 V	9, 15	\$740	
NA	0.002% + 100 μ V	2 m Ω + 1 μ H	NA	CV/CL	1 k Ω /V \pm 0.1%	NA	1 V/V \pm 0.1%	NA	300 ms	300 ms	3 s	200 ms	Opt 11, 2.5-44 V	11, 28, 40	\$350	
0.1% + 1 mV	200 μ V	2 m Ω + 3 μ H	NA	CV/CL	1 k Ω /V \pm 0.1%	NA	1 V/V \pm 0.1%	NA	NA	NA	NA	NA	Opt 11, 2.5-44 V	11, 28, 40	\$480	
NA	15 mV	0.05 m Ω + 3 μ H	<50 μ s, 50 mV	CV/CC	2 k Ω /V \pm 0.01%	1 k Ω /A \pm 0.25%	1 V/V ³	1 V/A \pm 1%	4.46 s	4.46 s	500 ms	175 ms	Std, 0.5-110 V	9, 15	\$600	
0.025% + 1 mV	200 μ V	0.05 m Ω + 3 μ H	<50 μ s, 50 mV	CV/CC	2 k Ω /V \pm 0.01%	1 k Ω /A \pm 0.25%	1 V/V ³	1 V/A \pm 1%	4.46 s	4.46 s	500 ms	175 ms	Std, 0.5-110 V	9, 15	\$740	
NA	0.002% + 100 μ V	10 m Ω + 1 μ H	NA	CV/CL	1 k Ω /V \pm 0.1%	NA	1 V/V \pm 0.01%	NA	700 ms	700 ms	1 s	760 ms	Opt 11, 20-105 V	11, 28	\$350	
0.01% + 1 mV	200 μ V	10 m Ω + 1 μ H	NA	CV/CL	1 k Ω /V \pm 0.1%	NA	1 V/V \pm 0.1%	NA	NA	NA	NA	NA	Opt 11, 20-105 V	11, 28	\$480	
0.1% + 100 mV	20 mV	-	NA	CV/CL	NA	NA	NA	NA	NA	NA	NA	NA	NA	5, 18	\$730	

¹See page 198 for complete option and accessory descriptions.

²UP = increasing output voltage, NL = No output load current, FL = Full rated output load current

³Accuracy is equal to accuracy of remote programming device \pm 200 μ V.

POWER SUPPLIES

Special purpose: constant current sources

Models 6177C, 6181C & 6186C

- Continuously variable voltage limit
- Output useful to micro-ampere region



6177C, 6181C

6186C

Description

These solid-state constant-current sources are ideal for semiconductor circuit development, component testing, and precision electroplating applications.

Their high-speed remote programming characteristics make these supplies useful in testing and sorting semiconductors, resistors, relays, meters, etc. The ability to superimpose ac modulation on the dc output permits the supplies to be used for measurement of dynamic or incremental impedance of circuit components.

Specifications

Load effect (load regulation): Less than 25 ppm of output ± 5 ppm of range switch setting for a load change which causes the output voltage to vary from zero to maximum.

- High output impedance—no output capacitor

Source effect (line regulation): Less than 25 ppm of output ± 5 ppm of range switch setting for a change in the line voltage from 104 to 127 V ac (or 127 to 104 V ac) at any output current and voltage within rating.

Load effect transient recovery: Less than 800 μ s for recovery to within 1% of nominal output current following a full load change in output voltage. (On 6186C, recovery time for 100 mA/10 mA/1 mA ranges is 800 μ s/1.6 ms/4 ms, respectively.)

Temperature coefficient: Output change per degree C is less than 75 ppm of output current ± 5 ppm of range switch setting.

Drift (stability): Less than 100 ppm of output current ± 25 ppm of range switch setting. Stability is measured for eight hours after one hour warm-up under conditions of constant line, load, temperature, and output setting.

Resolution: 0.02% of range switch setting.

Temperature rating: Operating 0 to 55°C. Storage -40 to +75°C.

Accessories available

5060-8764: rack adapter for rack mounting one or two 6177C or 6181C supplies.

5060-8762: rack adapter for rack mounting one or two 6186C supplies.

5060-8530: filler panel for Models 6177C, 6181C

5060-8760: filler panel for Model 6186C

Options

014: three digit graduated decadal current control. Includes calibrated 10-turn control replacing front panel current knob. The dial is calibrated from 0 to 99.9 with minor divisions equal to 0.1.

028: 230 V ac $\pm 10\%$, single phase input. Models 6177C and 6181C only

Model number and name

6177C, 6181C Constant Current Source

6186C Constant Current Source

Price

\$50

\$55

\$11

\$11

\$45

N/C

\$645

\$879

Model		6177C	6181C	6186C	
Output Current**		0-500 mA	0-250 mA	0-100 mA	
Voltage Compliance Δ		0-50 V dc	0-100 V dc	0-300 V dc	
Output Ranges		A 0-5 mA	0-2.5 mA	0-1 mA	
		B 0-50 mA	0-25 mA	0-10 mA	
		C 0-500 mA	0-250 mA	0-100 mA	
AC Input		115 V ac $\pm 10\%$, 48-63 Hz, 0.6 A, 55 W at 115 V ac For 230 V ac see Option 028	115 V ac $\pm 10\%$, 48-63 Hz, 0.9 A, 90 W at 115 V ac For 230 V ac see Option 028	115/230 V ac, 48-63 Hz, 0.9 A, 90 W at 115 V ac 115/230 V ac switch	
Constant Current Remote Programming:	Voltage Control (Accuracy: $\pm 5\%$ at output current $\pm 0.4\%$ of range)	Range A 200 mV/mA	1 V/mA	10 V/mA	
		Range B 20 mV/mA	100 mV/mA	2 V/mA	
		Range C 2 mV/mA	10 mV/mA	100 mV/mA	
	Resistance Control (Accuracy: 1% of output control $\pm 0.04\%$ of range)	Range A 400 ohms/mA	2 k Ω /mA	10 k Ω /mA	
		Range B 40 ohms/mA	200 ohms/mA	1 k Ω /mA	
		Range C 4 ohms/mA	20 ohms/mA	100 ohms/mA	
Voltage Limit Remote Programming	Voltage Control (Accuracy: 2%)	1 V/V	5 V/V	1 V/V	
		Resistance Control	820 ohms/V	440 ohms/V	820 ohms/V
		Accuracy	2%	20%	15%
Typical Output Impedance (R in parallel with C)*		Range A R = 330 Meg, C = 500 pF	R = 130 Meg, C = 10 pF	R = 10,000 Meg, C = 900 pF	
		Range B R = 33 Meg, C = 0.605 μ F	R = 133 Meg, C = 100 pF	R = 1,000 Meg, C = 700 pF	
		Range C R = 3.3 Meg, C = 0.05 μ F	R = 13.3 Meg, C = 1000 pF	R = 100 Meg, C = 1500 pF	
PARD (Ripple and Noise) rms/p-p (dc to 20 MHz) with xkber output terminal grounded.		Range A 1.8 μ A rms/40 μ A p-p	0.8 μ A rms/20 μ A p-p	2.0 μ A rms/5 μ A p-p	
		Range B 1.6 μ A rms/200 μ A p-p	2 μ A rms/100 μ A p-p	2 μ A rms/50 μ A p-p	
		Range C 1.60 μ A rms/2 mA p-p	28 μ A rms/500 μ A p-p	20 μ A rms/500 μ A p-p	
Programming Speed: from 0 to 99% of range switch setting with a resistive load.		6 msec	8 msec	10 msec	
** (Output Current Modulation)					
Dimensions		7 $\frac{1}{2}$ " (W) \times 3 $\frac{1}{2}$ " (H) \times 12 $\frac{1}{2}$ " (D) 193 mm (W) \times 88 mm (H) \times 315 mm (D)	7 $\frac{1}{2}$ " (W) \times 3 $\frac{1}{2}$ " (H) \times 12 $\frac{1}{2}$ " (D) 193 mm (W) \times 88 mm (H) \times 315 mm (D)	7 $\frac{1}{2}$ " (W) \times 6 $\frac{1}{2}$ " (H) \times 12 $\frac{1}{2}$ " (D) 193 mm (W) \times 158 mm (H) \times 315 mm (D)	
Weight (Net/Shipping)		4.53 kg (10 lb)/5.9 kg (13 lb)	4.53 kg (10 lb)/5.9 kg (13 lb)	5.9 kg (13 lb)/7.7 kg (17 lb)	
<p>* This network is a simplified representation of a complex network. The formula $Z = R\omega C / \sqrt{R^2 + 1/\omega^2 C^2}$ is used for frequencies up to 1 MHz by substituting the values given for R and C. Above 1 MHz, the output impedance is greater than the formula would indicate.</p> <p>** Output current can be modulated 100% up to 50 Hz; percent modulation decreases linearly to 10% at 500 Hz.</p> <p>Δ Maximum voltage obtainable with voltage limit control is 0.5 V.</p>					

- High-speed remote programming
- Overload protection
- Wide-band response



6825A-6827A



6823A



6824A

Description

The Power Supply/Amplifier is a general-purpose instrument useful in any laboratory engaged in research and development of electronic systems, circuitry, or components. The unit can be operated in one of two basic operating modes: power supply or amplifier. Terminals at the rear permit access to various internal control points to further expand the operational capabilities of the instrument. The resulting flexibility lends the Power Supply/Amplifier to an almost unlimited number of applications.

Models 6825A through 6827A

These models feature dual-range output, Constant Voltage/Constant Current operation, and metering of the ac and dc output voltage and current. Output voltage and current as a dc supply, or gain as a power amplifier, are remotely controllable and are compatible with Hewlett-Packard Multiprogrammer Systems.

As a dc power supply, the unit can furnish a bipolar, Constant Voltage or Constant Current output. It can be remotely programmed with a resistance, voltage, or current and its high speed programming characteristics adapt it to a wide variety of laboratory and production testing applications. The supply can sink, as well as source, current permitting it to serve as a variable load device.

As a direct-coupled power amplifier, each unit offers a signal-to-noise ratio of approximately 80 dB at full output with low distortion, and a frequency response up to 40 KHz in the fixed gain mode.

Models 6823A and 6824A

Although these models do not provide quite the level of performance and flexibility of Models 6825A through 6827A, they are lower in cost and are suitable for many applications.

As power supplies, these units offer Constant Voltage/Current Limiting operation, remote programming, and Auto-Series, Auto-Parallel operation.

As power amplifiers, the units exhibit a high signal-to-noise ratio with a 20 dB gain from dc to 10 KHz. They are useful in servo systems, as pulse or oscillator amplifiers, for motor control, and a variety of other applications.

General specifications

Temperature: operating, 0 to 55°C, storage, -40 to +75°C.

Power: 6823A & 6824A, standard input voltage is 104-127 V ac, 48-440 Hz, 0.3 A, 6224A, 1.3 A. Order option 028 for 230 V \pm 10% operation. 6824A, 6825A, & 6826A, 100, 120, 220, or 240 V ac, -13% + 6%, switchable 48-63 Hz, 150 W.

Dimensions: 6823A, 209 mm W \times 88 mm H \times 319 mm D (8 $\frac{1}{8}$ " \times 3 $\frac{1}{2}$ " \times 12 $\frac{3}{16}$ "). 6824A, 209 mm W \times 131 mm H \times 303 mm D (8 $\frac{1}{8}$ " \times 5 $\frac{1}{12}$ " \times 11 $\frac{1}{16}$ "). 6825A, 6826A & 6827A, 198 mm W \times 155 mm H \times 316 mm D (7 $\frac{7}{8}$ " \times 6 $\frac{1}{8}$ " \times 12 $\frac{3}{16}$ ").

Weight: 6823A, 7.26 kg (16 lb). 6824A, 7.7 kg (17 lb). 6825A, 6826A & 6827A, 8.2 kg (18 lb).

Power supply specifications†

RATINGS			PERFORMANCE												
DC Output		Model	Load Effect		Source Effect		Par δ (rms/p-p)		Transient Recovery		Resolution		Output Z (Typical)	Options	Price
Volts	Amps		Voltage	Current	Voltage	Current	Voltage	Current	Time	Level	Voltage	Current			
-5 V to +5 V -20 V to +20 V	0-2.0 A Both Ranges	6825A	0.01% + 1 mV	0.02% + 400 μ A	0.01% + 2 mV	0.01% + 250 μ A	5/15 mV	3/10 mA	100 μ s	20 mV	40 mV	8 mA	0.5 m Ω , 1.5 μ H	9	\$825
-5 V to +5 V/ -50 V to +50 V	0-1.0 A Both Ranges	6826A	0.01% + 1 mV	0.01% + 250 μ A	0.01% + 5 mV	0.01% + 250 μ A	6/35 mV	0.8/5 mA	100 μ s	50 mV	100 mV	3 mA	1 m Ω , 1.5 μ H	9	\$825
-10 V to +10 V/ -100 V to +100 V	0-0.5 A Both Ranges	6827A	0.01% + 1 mV	0.01% + 250 μ A	0.01% + 10 mV	0.01% + 250 μ A	10/30 mV	0.4/5 mA	100 μ s	100 mV	200 mV	1.5 mA	2 m Ω , 4 μ H	9	\$825
-20 V to +20 V	0-0.5 A	6823A	0.02% + 5 mV	—	0.02% + 5 mV	—	2 mV rms	—	100 μ s	0.02% + 5 mV	—	—	—	2*	\$290
-50 V to +50 V	0-1.0 A	6824A	0.02% + 5 mV	—	0.02% + 5 mV	—	10 mV rms	—	100 μ s	0.02% + 5 mV	—	—	—	9, 28	\$460

† Refer to page 119 for complete specification definitions.

* See page 198 for complete option and accessory descriptions.

Power amplifier specifications

RATINGS			PERFORMANCE									
Output		Model	Voltage Gain		Frequency Response, +1, -3 dB		Distortion at full output		Input Z (Typical)	Programming Coefficients		
Volts	Amps		Fixed	Variable	Fixed Gain	Variable Gain	100 Hz	10 kHz		Gain*	Voltage	Current
10 V p-p or 40 V p-p	2 A pk	6825A	0K 4K	0-2X 0-8X	dc - 20 kHz	dc - 1% kHz	0.1% THD	0.5%	10 k Ω	R1/10.24 k Ω 4 R1/10.24 k Ω	1 V/V 4 V/V	1 A/V
10 V p-p or 100 V p-p	1 A pk	6826A	1X 10X	0-2X 0-20X	dc - 40 kHz	dc - 1% kHz	0.1% THD	0.3%	10 k Ω	R1/10.24 k Ω 10 R1/10.24 k Ω	1 V/V 10 V/V	1 A/V
20 V p-p or 200 V p-p	0.5 A pk	6827A	2X 20X	0-4X 0-40X	dc - 30 kHz	dc - 1% kHz	0.1% THD	1%	10 k Ω	2 R1/10.24 k Ω 20 R1/10.24 k Ω	2 V/V 20 V/V	1 A/V
40 V p-p	0.5 A pk	6823A	—	0-10X	—	dc - 10 kHz	0.1% THD	—	2 k Ω	—	1 V/V	—
100 V p-p	1 A pk	6824A	—	0-10X	—	dc - 10 kHz	0.1% THD	—	2 k Ω	—	1 V/V	—

* 5 Ω is the test programming resistance.

POWER SUPPLIES

Options and accessories

For low cost lab, general, and special purpose models

A wide range of options are available to modify standard models to meet the requirements of a particular application. Various low cost lab, general purpose and special purpose power supply descriptions are found on pages 182 through 197. To determine which options are available for a particular power supply, refer to the appropriate product page. Always check the AC input voltage, current, and frequency requirements for the standard model and the AC power available in the area or country where the power supply will be used. If options are required, they must be specified with the order.

Option number and description

005: 50 Hz ac input; optimizes power supplies that require adjustment/modification for 50 Hz operation. Order only when listed as required in specifications for a particular model.

009: ten-turn output controls. Replaces single-turn output voltage and current controls (where applicable and available). 6104A, 6105A, 6114A, 6115A, 6204B, 6206B, 6209B, 6294A, 6299A and 6824A-6827A
6200B-6203B, 6205B, 6256B-6291A, and 6296A
6227B, 6228B, 6253A, and 6255A

010: chassis slides. For access to rack mounted power supplies. 6256B, & 6263B-6267B

6253A, 6255A, 6259B-6261B, 6268B, 6269B, & 6427B-6448B

6453A, 6456B & 6459A

011: internal overvoltage protection crowbar. Protects delicate loads against power supply failure or operator error. Dual output models have dual crowbars.

Single output models, where available

Dual output models, 6205B, 6253A, & 6255A

015: three-digit graduated turns-counting dial and ten-turn controls for output voltage and current (where applicable and available). Improves resetability of power supply output.

6177C, 6181C, 6186C, and 6515A

6114A, 6115A, 6204B, 6206B, & 6200B-6226B

6104A, 6105A, 6207B, 6209B, 6294A & 6299A

6200B-6203B, 6205B, 6256B-6291A, & 6296A

6227B, 6228B, 6253A, & 6255A

016: 115 V ac $\pm 10\%$ single phase input. Consists of replacing power transformer and circuit breaker, and reconnecting bias transformer, RFI choke and fans. For model 6260B only.

019: 230 V ac $\pm 10\%$, 50 ± 0.3 Hz, single phase input. Consists of replacing input transformer, line cord and fuse. Option 019 applies only to models 6110A, 6515A, & 6516A.

022: voltage and current programming adjust. Allows the V and I programming coefficients and zero output to be conveniently adjusted to 0.1% accuracy via access holes in the rear panel. Consists of four potentiometers and resistors located inside the rear panel. Option 022 applies only to models 6256B-6274B.

023: rack mounting attachments. Factory installed for mounting model 6464C-6483C in a standard 19" rack.

026: 115 V ac $\pm 10\%$, single phase input. Consists of replacing the input circuit breaker and reconnecting the power transformer, bias transformer, RFI choke, and fans. Option 026 applies only to models 6259B, 6261B, and 6268B.

027: 208 V ac, $\pm 10\%$, single phase input. Consists of reconnecting power transformer taps, and other components where necessary. Order only when listed in the specifications for a particular model.

028: 230 V ac $\pm 10\%$, single phase input. Consists of reconnecting power transformer taps, and other components where necessary. Order only when listed in the specifications for a particular model.

040: multiprogrammer interface. Prepares standard HP power supplies for resistance programming by the 6940B Multiprogrammer or 6941B Multiprogrammer Extender. This option includes option 022, special calibration, and protection check-out procedures (where required).

Price

N/C

\$30

\$60

\$100

\$85

\$160

\$250

\$70

\$130

\$50

\$75

\$100

\$125

\$250

\$80

\$50

\$60

\$30

N/C

N/C

N/C

6101A, 6102A, 6106A, and 6111A-6113A \$40

6205B, 6220B, 6224B, 6226B, 6256B-6274B, & 6281A-

6299A \$75

6464C, 6466C, 6469C, & 6472C \$100

6227B, 6228B, 6253A & 6255A \$150

100: 87-106 V ac, 47-63 Hz, single phase input N/C

220: 191-233 V ac, 47-63 Hz, single phase input N/C

240: 208-250 V ac, 47-63 Hz, single phase input N/C

(Note: options 100, 220, and 240 are for models 6236A and 6237A only, and consist of setting an internal AC voltage selection switch and selecting appropriate line fuse.)



14513A Rack Kit for one 3 1/2" high supply

14515A Rack Kit for one 5 1/4" high supply



14523A Rack Kit for two 3 1/2" high supplies

14525A Rack Kit for two 5 1/4" high supplies

Accessories

Rack Mounting Hardware

14513A: 3 1/2" High rack kit for one supply \$25

14513A and 14523A rack kits apply to the following models: 6106A, 6102A, 6106A, 6200B-6209B, 6236A, 6237A, 6281A, 6284A, 6289A, 6294A, 6299A, 6515A, 6823A.

14523A: 3 1/2" high rack kit for two supplies \$15

14515A: 5 1/4" high rack kit for one supply \$30

14525A: 5 1/4" high rack kit for two supplies \$20

14515A and 14525A rack kits apply to the following models: 6110A-6113A, 6116A, 6282A, 6285A, 6286A, 6290A, 6291A, 6296A, 6516A, 6824A.

14521A: rack kit for one, two or three supplies \$45

Includes two filler panels. 14521A rack kit applies to the following models: 6211A-6218A.

5060-8762: adapter frame for rack mounting one or two 1/2 rack width units or one, two or three 1/3 rack width units \$55

This frame applies to the following models: 6104A, 6105A, 6114A, 6115A, 6186C, 6220B, 6224B-6228B, 6825A, 6826A, 6827A.

5060-8764: adapter frame for rack mounting one or two 1/3 rack width units \$50

This frame applies to the following models: 6177C, 6181C.

5060-8759: Blank Filler Panel. \$10

This 1/2 rack width panel applies to the following models: 6220B, 6224B, 6226B.

5060-8760: Blank Filler Panel \$11

This 1/3 rack width panel applies to the following models: 6104A, 6105A, 6114A, 6115A, 6186C, 6227B, 6228B, 6825A, 6826A, 6827A.

5060-8530: Blank Filler Panel \$11

This 1/3 rack width panel applies to the following models: 6177C, 6181C.

14545A: casters — set of four \$50

Snap-on casters for one 6464C-6483C power supply. (For rack mounting information on these supplies, see option 023.)

POWER SUPPLIES









OEM Modular: single and multiple outputs

Model series 62000-63000

- 20 kHz switching and linear regulated
- UL Recognized (UL 478 #E51529)
- Overcurrent and overtemperature protected

- Quantity and OEM discounts available
- Special output ratings available up to 48 volts and up to 600 Watts



Single Output

	LINEAR REGULATED				20 kHz SWITCHING			
								
	128 mm (5.03") high and 292 mm (11.5") deep {except 63000, 126 mm (4.96") H and 262 mm (10.3") D}							
	Width 48 mm (1.91")	100 mm (3.94")	100 mm (3.94")	207 mm (8.14")	87 mm (3.44")	207 mm (8.14")	207 mm (8.14")	207 mm (8.14")
5 V	62005A 2.0 A	62005C 4.0 A	62005E 8.0 A	62005G 16.0 A	63005C 22.0 A	62605J 40.0 A	62605L 60.0 A	62605M 100.0 A
12 V	62012A 1.5 A	62012C 3.0 A	62012E 6.0 A	62012G 12.0 A	10.0 A ²	62612J 23.0 A	30.0 A ¹	50.0 A ¹
15 V	62015A 1.25 A	62015C 2.5 A	62015E 5.0 A	62015G 10.0 A	8.0 A ²	62615J 20.0 A	24.0 A ¹	62615M 40.0 A
24 V	62024A 0.75 A	62024C 1.75 A	62024E 3.75 A	62024G 7.5 A	—	62624J 12.5 A	15.0 A ²	24.0 A ²
28 V	62028A 0.7 A	62028C 1.5 A	62028E 3.25 A	62028G 6.5 A	—	62628J 10.7 A	12.9 A ²	21.4 A ²
48 V	62048A 0.45 A	62048C 1.0 A	62048E 2.0 A	62048G 4.0 A	—	—	7.5 A ²	12.5 A ²
List Price*	\$140	\$195	\$225	\$310	\$375	\$540	\$580	\$650

Dual Output

±12 V	62212A 1.4 A	—	62212E 3.3 A	62212G 6.0 A	—	—	15.0 A ²	25.0 A ²
±15 V	62215A 1.25 A	—	62215E 3.0 A	62215G 5.2 A	—	—	12.0 A ²	20.0 A ²
±24 V	—	—	—	—	—	—	7.5 A ²	12.5 A ²
List Price	\$200	—	\$255	\$375	—	—	—	—

Triple Output, 20 kHz Switching

	5 V	+12 V	-12 V	+15 V	-15 V	Output Power		Dimensions			List Price*
					H			W	D		
63315D	18 A	2 A	2 A	—	—	110 W max.		126 mm (4.96")	121 mm (4.76")	262 mm (10.3")	\$495
63315D	18 A	—	—	2 A	2 A	300 W, max. Output Power		126 mm (4.96")	207 mm (8.14")	330 mm (13.0")	\$750
63312F	40 A	7.5 A	7.5 A	—	—						
63312F ¹	40 A	—	—	7.5 A	7.5 A						

Quad Output, 20 kHz Switching

	5 V	+12 V	-12 V	+15 V	-15 V	Output Power	User may specify a fixed voltage from 1 V to 50 V. Up to 4 A and up to 30 watts is available from this output. Please inform your HP Field Sales Engineer as to your exact requirements, and request price & delivery.
63312F ²	40 A	7.5 A	7.5 A	—	—		
63312F ²	40 A	—	—	7.5 A	7.5 A		

* Quantity and OEM discounts are available.

¹: Special ratings available on special order basis at no additional cost.

²: Special ratings available on special order basis at additional cost.

POWER SUPPLIES

OEM Modular: single and multiple outputs

Model series 62000 – 63000 & accessories

- 20 kHz Switching and linear regulation
- Overvoltage, overcurrent & overtemperature protection

- UL Recognized component (UL478 #E51529)
- Conforms to IEC 435 Safety of Data Processing Equipment



Description

Switching regulated power supplies operate at efficiencies in the 65–70% range and consequently generate less heat and consume less power than comparable linear regulated designs. 20 kHz switching permits a significant reduction in size of transformers, filters, and other components. These factors result in a power supply that is smaller and runs cooler than an equivalent series regulated power supply.

The HP family of fixed voltage switching regulated modular power supplies offer a convenient off-the-shelf solution for many OEM requirements. Available in single and multiple outputs, they are UL Recognized Components, conform to IEC 435 Safety Specifications, and have many built-in power system protective features. The remote voltage sensing feature is protected from accidentally opened leads, and the supply output is protected from overvoltage, overcurrent, and reverse voltage. An auto-reset thermal cutout protects the supply from overtemperature. The dielectric withstand test voltage is 1500 V rms from primary to case, and from primary to output, and 500 V dc from output to case. Minimum insulation resistance is 10 megohms.

20 kHz Switching regulated – condensed specifications

	C, D, & F Series	J Series	L & M Series
Load effect	0.1%	0.1%	0.05%
Source effect	0.02%	0.1%	0.05%
PAR, rms/p-p	5 mV/50 mV	20 mV/40 mV*	15 mV/50 mV
Load transient recovery	1 ms*	3 ms*	0.75 ms*
Efficiency, minimum	65%*	65%*	70%*
Carryover time	> 20 ms*	> 30 ms*	> 15 ms*
Operating temperature	0–40°C	0–50°C	0–40°C
Cooling	convection	convection	fan
AC input voltage	87–127/ 180–250	104–127	104–127
Optional input, VAC	—	190–233 or 208–254	187–256

* Data is for 5 unit models. Efficiency improves as voltage-string increases.

Linear regulated

Description

Single and dual output modular power supplies are offered in this series of linear regulated models. Packaged in modules which are 1/8, 1/4, and 3/8-width fractions of the standard 19-inch rack system, and with uniform height and depth, they provide design flexibility. Modular combinations mounted in the HP 62410A tray develop power systems for rack installations, or the modules may be mounted individually in equipment.

Protection from overcurrent, overtemperature, reverse voltage, and open remote voltage sensing terminals is standard on all models. A built-in overvoltage protection circuit is optional. Output voltage tracking accuracy is within $\pm 3\%$ on the dual output models.

Linear regulated condensed specifications

Load effect: 0.01%

Source effect: 0.001%

PAR, rms/p-p: Single output, 1 mV/2 mV. Dual output, 1 mV/5 mV.

Load transient recovery time: 50 μ s for output voltage to recover within 15 mV of nominal for 50% to 100% or 100% to 50% load current change.

Temperature ratings: single output models 0–50°C. Dual output, 0–40°C. Derating to 70°C on all models.

AC input voltage: single output models, 104–127 V AC, 48–63 Hz, 220 V, 240 V or field changeable 120/240 V input is available as an option. Dual output models, 104–127 Vac, 57–63 Hz, 220 V or 240 V, 48–63 Hz input is available as an option.

62000 Series modular power supply accessories

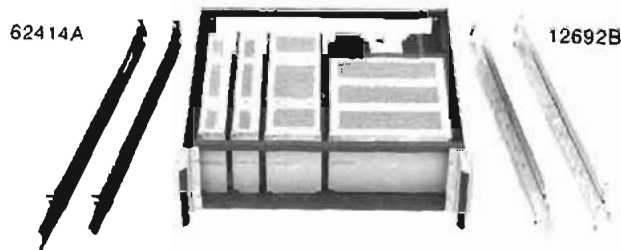

62410A



62411A

62412A



62415A

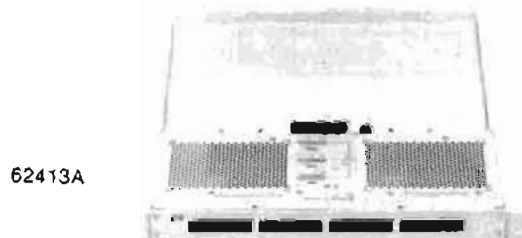

62413A

62000 Series accessories

62410A: accommodates any combination of 62000 Series modular supplies totaling a full rack width or less. Attaches to a 19" equipment rack, via front mounting ears.

62411A: rack tray front panel. Has a 2 1/4" clearance behind panel for meters, controls, etc.

62412A: mounts on rear of rack mounting tray. A 2 1/4" clearance behind the panel permits addition of connectors, terminal blocks, etc.

62413A: occupies only 1 3/8" of rack space, yet provides over 20 l/s (45 CFM) of cooling air to modular supplies installed in rack tray.

62414A: A 20" slide kit for use with standard 19" wide equipment racks of 20" depth. Does not fit HP 29400A or B enclosures.

62415A: mounts on rear of rack tray for convenient access to power connections to supplies.

12692B: slides for HP 29400A/B series cabinets.

Price

\$70

\$15

\$15

\$215

\$55

\$30

\$70

POWER SUPPLIES

OEM Modular: DC/DC Converters

Model series 61000

- DC to DC converter — 20 kHz switching regulated
- 48 volt DC input for communications systems
- 110 watts, single and triple output voltages



61005C single output

61315D triple output

Description

These modular dc-dc converters offer a convenient solution to the problem of obtaining commonly used circuit operating voltages for digital and analog devices from a 48 volt dc source. They are designed for use as components in telephone equipment, communications systems, and related applications where operation from 48 volt battery power systems is required. They perform the functions of voltage conversion, regulation, isolation, load protection, and control. Operating features include output voltage and current limit adjustments, remote load voltage sensing, and output on/off remote control. The input and output are protected from overvoltage, reverse voltage, and overcurrent as a standard feature. The converter is also protected from over-temperature operation by an auto-resetting thermal cutout.

An advanced 20 kHz switching technique is used resulting in a compact modular design with quiet, efficient operation. The 5 volt output is controlled by the switching regulator. The switching regulator is also the source for the ± 12 to ± 15 volt outputs in the 61315D which are independently series regulated.

Specifications

Maximum load currents cannot be obtained simultaneously from Model 61315D. See drawing below for load sharing tradeoff. (See attached for illustration #2).

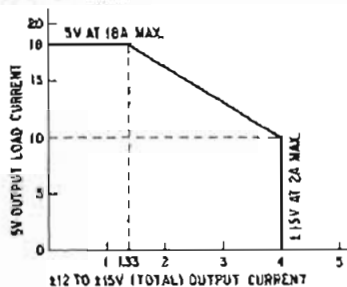

Output ratings:

61005C (single output)	61315D (triple output)
4.75 to 5.25 V, 22 A	4.75 to 5.25 V 18 A
	+11.4 to +15.75 V 2 A
	-11.4 to -15.75 V 2 A

Dual output tracking accuracy, Model 61315D: 2%.

Output effects

Temperature effect: 0.015%/°C

Source effect: 0.1% over entire input voltage range.

Load effect: 0.1% 0-100% load change

PARD (ripple and noise): all outputs, 5 mV rms, 40 mV p-p, 20 Hz to 20 MHz bandwidth, 0.1 mV psophometric, 600 ohms using "C" filter.

Load effect transient recovery: output voltage returns to within 1% of nominal in less than 1ms (5 V output), or 25 μ s (± 12 to ± 15 V output) following a load change from 100% to 50% or 50% to 100%.

Remote sensing: terminals are provided. Will correct for load lead voltage drop of up to 5% while maintaining nominal voltage at the

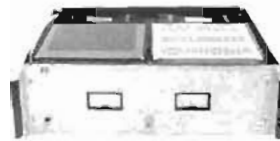

Custom power systems



OEM Modular Power Supplies

load. Load is protected if sensing leads are inadvertently opened.

Output overcurrent protection: foldback current limit. Adjustable from 50% to 130% of rating.

Output reverse voltage protection: protected against reverse polarity voltage applied across output terminals. Maximum continuous reverse current is 15 A for 5 V output and 1 A for ± 12 to ± 15 outputs.

Output overvoltage protection: standard, non-adjustable. Trip level on 5 V output is 6-7 V, on ± 12 to ± 15 V output is 16-18 V.

Remote shutdown: via barrier strip terminal, with TTL input or contact closure. Low (closed) = output off, High (open) = output on.

Input: 48 V dc nominal. Range, 42 to 46 V dc continuous.

Current, 5 A maximum.

Input reverse polarity protection: shunt diode blows fuse; no damage to power supply.

Under-voltage protection: input voltage from 0 to 56 V dc will not damage power supply.

Input transient protection: 60 V dc, surge for 5 sec. Normal operation.

Input overvoltage protection: inputs above 60 V will shut down converter to prevent damage. Maximum surge voltage is 75 V for 5 seconds.

Input overcurrent protection: 6 A, 250 V fuse is accessible at terminal end of power supply, fuse is in (-) input lead.

Turn-on surge current: 80 A maximum input transient.

Operating temperature range: 0 to 40°C, full rated output. Derate linearly by 1.7%/°C from 40°C to 70°C.

Cooling: convection cooled; may be conduction cooled through surface at end of case. Finned heat sink removable.

Over-temperature protection: thermal cutout, auto-reset.

Conducted EMI: dc input and output leads comply with VDE 0875/7.71 level N (150 kHz-30 MHz).

Dielectric withstand voltage: input to output & input to case, 1000 V dc for 1 minute. Output to case, 500 V dc for 1 minute.

Isolation: input to output & input to case, 100 M Ω , min. (500 V dc). output to case, 100 M Ω , min.

Safety: IEC 435 (Safety of Data Processing Equipment). Designed to comply with UL 478 (subject to approval).

Custom power systems

Custom power systems based on the OEM Modular Power supplies and accessories in this catalog, plus AC & DC wiring, metering, indicators, test points, etc. can be assembled and tested by Hewlett-Packard to meet your specific needs.

Contact your local HP Field Engineer for price and delivery information.

Additional information

A 20-page catalog, titled "OEM Modular Power Supplies" (publication 3952-3979) contains comprehensive information for the OEM designer including complete specifications, outline drawings, ordering information for modified switching and linear-regulated supplies, reliability test results, construction details, and equipment cooling guidelines. To receive a copy, use the card at the back of this catalog, or contact your local HP Field Engineer.

Model number and name

61005C Single output dc to dc converter
61315D Triple output dc to dc converter
(quantity and OEM discounts are available).

Price

\$400
\$525

POWER SUPPLIES

Digitally controlled: binary or BCD

Models 6128C – 6131C & 6140A

- Digitally programmable in binary or BCD
- HP-IB compatible option J99 & 59301A
- Fast, accurate, bipolar output
- Digital inputs isolated from analog output
- Internal storage of digital data
- Digitally programmable current latch (on DVS models) or voltage limit (on DCS model)

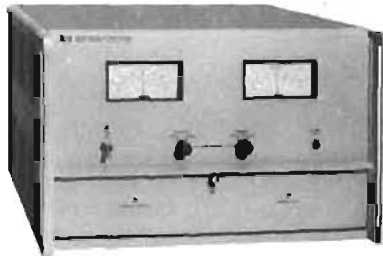

6128C, 6129C

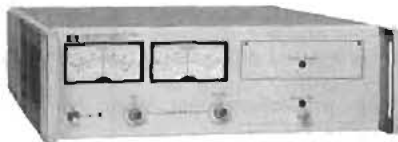

6140A

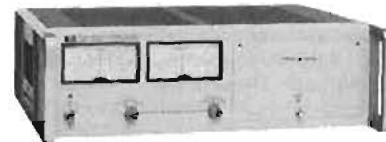

6130C, 6131C

Digital voltage sources

HP's family of digital voltage sources (DVS's) include models 6128C, 6129C, 6130C, and 6131C. All models are programmable in binary or 8421 BCD and have many system-oriented features that enhance their use in automatic testing and control environments. Among these features are: isolation between the digital input and analog output lines, digital storage of programmed inputs, programmable current latch, analog input, and current monitoring terminals.

Isolation

All digital lines of the DVS's are isolated from the analog output. This feature is essential in automatic test systems to avoid forming ground loops that could impair system operation and damage the computer and instruments.

Nearly all computer manufacturers ground the power supplies for the digital I/O logic to the mainframe of the computer, which is connected to the ac power line ground. If a DVS did not have isolation, one of its analog output terminals would be connected to the digital input common line.

Internal storage

The DVS's internally store the computer's output magnitude (voltage setting), polarity, range, and output latch/limit digital inputs when the computer's gate command is received. When the DVS has finished processing the digital input, it notifies the computer by transmitting its flag. Since the DVS stores the digital data, the computer does not have to continually refresh the DVS; it is free to carry out other important tasks. The DVS maintains its programmed output indefinitely, changing the output only when the computer changes the digital input data and sends another gate command.

In addition to eliminating the need for redundant programming by the computer, internal storage also facilitates the control of multiple DVS's from a single computer I/O channel. The number of DVS's that can be controlled from a single I/O channel depends on the capabilities of the computer's I/O data bus drivers. Most computers can easily drive up to eight DVS's.

Programmable current latch

Overcurrent protection is provided by a current latch circuit which can be externally programmed to one of eight values between 2% and 100% (six values for the 6131C) of the unit's rated output current. When activated, the current latch circuit turns off the output power amplifier reducing the output current to less than 20 mA. The reaction time of the current latch circuit (time between the start of a current overload and turn off of the power amplifier) can be adjusted by adding an external capacitor at the rear terminals. The upper current limit is safeguarded by a separate fixed current limit circuit that prevents the output current from exceeding 110% of the current rating. The computer is continuously informed of possible current overload or current latch conditions by status outputs which are fed back to the programming source.

Analog input

In automatic test systems, it is often desirable to inject an ac "wiggles" on top of a programmable dc level to measure impedance at various voltage levels, to simulate worst case power supply conditions for a module under test, or measure component parameters such as dynamic gain or transconductance. Many automatic control systems require this feature to provide "dither" for the system. All DVS's provide an analog input to fulfill this need.

Current monitoring terminals

The output current of all DVS's can be measured without upsetting voltage accuracy by connecting a voltmeter across the current monitoring terminals on the rear barrier strip.

Digital current sources

The Digital Current Source, Model 6140A is ideally suited for system applications requiring a rapidly programmable, high-precision source of current.

The isolation, internal storage, and analog input features described for the DVS's also apply to the DCS's. In addition, the DCS's have programmable voltage limiting and voltage monitoring terminals.

Models 6128C-6131C, & 6140A (cont.)

Common specifications**AC power input**

6128C, 6129C: 115/230 V ac, 48-63 Hz; 6.4 A, 780 W @ 115 V ac; 115/230 V ac switch-selected.

6130C, 6131C: 115 V ac $\pm 10\%$, 48-440 Hz; 1.2 A, 100 W.

6140A: 115/230 V ac, 48-63 Hz; 1.2 A, 100 W @ 115 V ac; 115/230 V ac switch-selected.

Dimensions

6128C, 6129C: 425.5 mm W \times 266.7 mm H \times 542.9 mm D (16 $\frac{1}{4}$ " W \times 10 $\frac{5}{8}$ " H \times 21 $\frac{1}{8}$ " D).

6130C, 6131C: 425.5 mm W \times 133.4 mm H \times 396.9 mm D (16 $\frac{1}{4}$ " W \times 5 $\frac{1}{8}$ " H \times 15 $\frac{5}{8}$ " D).

6140A: 425.5 mm W \times 133.4 mm H \times 542.9 mm D (16 $\frac{1}{4}$ " W \times 5 $\frac{1}{8}$ " H \times 21 $\frac{1}{8}$ " D).

Weight

6128C, 6129C: net, 35 kg (78 lb). Shipping, 39 kg (85 lb).

6130C, 6131C: net, 15 kg (32 lb). Shipping, 18 kg (40 lb).

6140A: net, 17 kg (38 lb). Shipping, 20 kg (44 lb).

Cooling

6130C, 6131C: are convection cooled.

6128C, 6129C, 6140A: are forced air cooled.

Programming time: less than 300 μ sec (350 μ sec on 6128C) for output to settle time within 0.1% of programmed change. Range change requires 2 μ sec.

	Binary Instruments Option J20 & 064		BCD Instruments Option J99 & 063	
	X1 Range	X10 Range	X1 Range	X10 Range
6128C				
Output	± 16.384 V, 12.5 A	—	± 9.999 V, 12.5 A	—
Accuracy	1.5 mV	—	1.5 mV	—
Resolution	0.5 mV	—	1 mV	—
6129C				
Output	± 16.384 V, 5 A	± 50.00 V, 5 A	± 9.999 V, 5 A	± 50.00 V, 5 A
Accuracy	1.5 mV	15 mV	1.5 mV	15 mV
Resolution	0.5 mV	5 mV	1 mV	10 mV
6130C				
Output	± 16.384 V, 1 A	± 50.00 V, 1 A	± 9.999 V, 1 A	± 50.00 V, 1 A
Accuracy	1 mV	10 mV	1 mV	10 mV
Resolution	0.5 mV	5 mV	1 mV	10 mV
6131C				
Output	± 16.384 V, 0.5 A	± 100.00 V, 0.5 A	± 9.999 V, 0.5 A	± 99.99 V, 0.5 A
Accuracy	1 mV	10 mV	1 mV	10 mV
Resolution	0.5 mV	5 mV	1 mV	10 mV
6140A				
Output	± 16.384 mA, 100 V	± 163.84 mA, 100 V	± 9.999 mA, 100 V	± 99.99 mA, 100 V
Accuracy	1 μ A $\pm 0.01\%$	10 μ A $\pm 0.01\%$	1 μ A $\pm 0.01\%$	10 μ A $\pm 0.01\%$
Resolution	0.5 μ A	5 μ A	1 μ A	10 μ A

Accessories furnished:

1251-0086 50-contact rear plug.

5060-7948 Plug-in extender board for DVS models.

5060-7948/5060-7982 Two plug-in extender boards for DCS.

Software for HP computers

Drivers in the form of punched paper tape with accompanying operating manuals are available for Hewlett-Packard BCS, DOS, RTE, and BASIC software operating systems. Contact your HP Field Engineer for prices and ordering information.

AC power option

028: transformer tap change for 230 V ac $\pm 10\%$, single phase input on 6130C and 6131C.

Standard interface options

J20: binary interface for 12661A I/O programmer card for Hewlett-Packard computers.

J99: interfacing DCPS's with calculator-based test/control systems. All DCPS's may be modified to be compatible with ASCII-to-Parallel Converter, Model 595301A in calculator-based systems. In addition to DCPS modification, two items are supplied as part of Option J99: (1) a 1.83 m cable to connect DCPS to Model 59301A; (2) J99 Interface Note, containing Installation Instructions, Software Listings, Operating Instructions, and Diagnostics.

063: BCD interface for microcircuit logic levels.

064: binary interface for microcircuit logic levels.

Special options

If none of the standard interface options meet your requirements, quotations for special options may be obtained from your Hewlett-Packard field engineer.

Accessories available

14533B Pocket programmer permits manual programming of all input functions by switch closure

14534A Pocket programmer extension cable (18")

14535A HP computer interface kit includes 12661A computer I/O card, 14539A cable, verification software and BCS Driver. Up to eight DCPS's may be controlled from one 14535A

14539A cable connects the first DCPS in a chain of up to eight instruments to the 12661A DVS programming card for Hewlett-Packard computers

14536A chaining cable connects an additional DCPS to the existing chain of DCPS's

14544A Cable connects a DCPS with option J95 (no charge) to a DEC PDP-8/I computer. Includes instructions for constructing the interface from DEC logic modules

Model number and name

6128C, 6129C Digital Voltage Source

Option 908: Rack Flange Kit

6130C, 6131C Digital Voltage Source

6140A Digital Current Source

Option 908: Rack Flange Kit

Price

N/C

N/C

\$170

N/C

N/C

\$150

\$75

\$1700

\$170

\$170

\$155

\$3150

add \$15

\$1900

\$2575

add \$10

RECORDERS & PRINTERS

General information



Introduction

Hewlett-Packard offers a wide selection of recorders and plotters that record and display data accurately, quickly, and reliably. Some application areas are manufacturing, education, laboratories, R & D, and hospitals. The recorders can also be utilized by the original equipment manufacturer (OEM) to fulfill the need for recording and displaying data from the OEM's equipment. Models may be chosen from X-Y, strip chart, oscillographic, and instrumentation tape recorders, as well as graphic plotters for computer, timeshare, and calculator users.

X-Y recorders

These recorders are designed to plot Cartesian coordinate graphs from dc electrical information. They may be selected in two basic chart sizes and from three basic levels of performance depending upon measurement needs. Certain models have high sensitivity and high common mode rejection. Models are available with and without time sweep capability. Metric and English instruments may also be selected. Additionally, two-pen models capable of simultaneously plotting two curves may also be chosen. Finally, whether the application be in Bio-Medical, Chemical, Material Testing, etc., a wide variety of X-Y Recorders is available to fit the requirement.

Plug-in modules

To expand the versatility and application of one group of X-Y Recorders, plug-in modules are provided. If an application changes, the needed measurement capability is attainable by simply adding an inexpensive plug-in. Recorders utilizing the modules are the 7004B and 7034A. Modules include Amplifiers, Time Bases, DC Offset, Filters, Null Detectors, and Scanners. The flexibility inherent in the plug-in concept will allow the user to meet the constantly changing requirements of laboratory measurement.

Digital graphic plotters

HP Graphic Plotters bring complete graphic capability to your mini-computer or terminal with a minimum of programming effort and software. Simple commands and data formats which can be generated by almost any computer in any language, are used to control the plotter.

The plotters provide pictorial display of numerical data in almost all areas of Engineering and Science. Typical applications include curve fitting, regression analysis, transfer functions, electromechanical system simulation, probability distribution, shear and moment diagrams, verifying numerical control machine programs — almost anything which is represented by columns of numbers. A few simple program steps are often all that is needed to add graphic capability to any application program.

Strip chart recorders

HP Strip Chart Recorders produce accurate records in rectilinear coordinates. All two-pen models permit both channels to realize the full resolution of the chart width simultaneously, since the pens can overlap on the same chart without interference.

Selection of a servo-driven strip chart recorder depends upon the specific application. The 7100 Series and 7130A Series models offer one-pen and two-pen servo drive systems. The 7123A and 7143A offer single-pen only and utilize the linear motors with only one moving part. The 7155B battery-operated unit is useful in field applications as well as laboratory uses.

Oscillographic recorders

Time correlation of multiple channels of data, instantaneous read-out, and the capability to use calibrated units of the customer's choice are just some of the advantages of using the direct writing Oscillographic Recorders. Permanent and easily reproduced records of signals from dc to 150 Hz can be made. From two to eight channels of recording are available, depending upon the recorder model selected.

With appropriate plug-in signal conditioners, the recorders can record electrical signals from microvolts to volts. Add transducers and they can make records of all types of physical measurements, such as force, position, strain, stress, acceleration, and temperature.

Plug-in preamplifiers

A wide line of preamplifiers is available for pressurized ink system recorders which provide unmatched flexibility.

Portable tape recorders

The 3964A and 3968A are new instrumentation tape recorders that provide significant benefits by recording on 1/2-inch tape as compared to recording on 1/4-inch tape. The units are designed to meet the demands of the individual and OEM users. Versatility, portability, and durability are additional characteristics of these units.

Many standard features are also supplied. They include E-to-E mode for FM recording, Tape/Tape servo, Equalization, Remote Control, AC/DC calibrator, Flutter compensation, Voice capability, Unipolar operation (FM only), and Reversing (Dubbing).

Recorder consumables kit

Use of Hewlett-Packard consumable products insures optimum performance from X-Y Strip Chart, Oscillographic, Graphic Plotter, or Instrument Tape Recorders.

Recorder Consumables starter kits are available to allow a working quantity of applicable consumables (pens, paper, ink, etc.) to be purchased with the recorder. These kits appear as model numbers along with the appropriate instrument in this catalog.

A complete list of all consumables available for HP recorders is located in the *Consumables Catalog* which is available on request.

X-Y RECORDERS

Model	Description	Chart Size DIN (Inches)	No. of Pens	Time Base	Max. Sensitivity		Standard Writing Method	Plug-Ins
					mV/cm	mV/in.		
7010A	OEM	A4 (8½ × 11)	1	Option	10	10	Disposable Pen	No
7015A	Lab — General Purpose	A4 (8½ × 11)	1	Option	10	10	Disposable Pen	No
7034A	Fast Response, AC Capability	22 cm × 28 cm (8½ × 11)	1	Plug-In	0.25	0.5	Disposable Pen	Yes
7035B	General Purpose	22 cm × 28 cm (8½ × 11)	1	17108A Plug-On	0.4	1.0	Disposable Pen	No
7004B	Fast Response, AC Capability	28 cm × 42 cm (11 × 17)	1	Plug-In	0.25	0.5	Disposable Pen	Yes
7040A	OEM	A3 (11 × 17)	1	Option	0.2	0.5	Disposable Pen	No
7041A	OEM Fast Response	A3 (11 × 17)	1	Option	0.2	0.5	Disposable Pen	No
7044A	General Purpose	A3 (11 × 17)	1	Option	0.25	0.5	Disposable Pen	No
7045A	Fast Response	A3 (11 × 17)	1	Option	0.25	0.5	Disposable Pen	No
7046A	Fast Response	A3 (11 × 17)	2	Option	0.25	0.5	Disposable Pen	No
7047A	Fast Response	A3 (11 × 17)	1	Standard	0.02	0.05	Disposable Pen	No

PLOTTERS

Model	Description	Code	Interface	Data Transmission Rate	Max Plotting Speed Vec/Min	Plot Accuracy	Reliability	Plotter Commands	Numerical Resolution
7202A	Terminal Plotter. Connects between Computer Terminal & MODEM	Serial ASCII	EIA RS232C (CCITT V24) or 20 mA TTY	10, 15, or 30 Char/s Asynchronous	105	Within 0.076 mm	>0.18 mm	Mnemonic	1 in 10,000 or 0.01%
7203A	High Speed Terminal Plotter. Connects between Computer Terminal & MODEM	Serial ASCII	EIA RS232C (CCITT V24) only	10 or 30 Char/s Asynchronous	450 Dependent on Vector slope & Length	Within 0.1 mm	>0.18 mm	Single ASCII Character	1 in 2500 or 0.04%
7210A	Computer Plotter, Connects to Computer Mainframe	Parallel BCD (8421) or Binary	Binary Option 001 includes HP 2100/21MX Interface	Synchronous by Handshake	1200 Dependent on Vector slope & Length	Within 0.1 mm	>0.18 mm	Determ. by status of bits in first data pass	1 in 10,000 or 0.01%

STRIP CHARTS

Model	Description	Chart Width		No. of Channels	Standard No. Chart Speeds	Chart Speed Range				Standard Writing Method	Maximum Sensitivity mV (metric) Full Scale	Signal Input Sensitivity
		Cm	In.			Min Cm/Hr	Max Cm/Min	Min In./Hr	Max In./Min			
680	Lab-OEM	12	5	1	8	2.5	20	1	8	Capry ink pen w/replace cart	5 (5)	10 Spans
7143A	OEM	12	5	1	Deter. by Opt.	3	15	1	6	Disp. Ink Pen	1 (1.2)	Single Span
7155B	Lab-OEM	12	5	1	7	1	12			Disp. Ink Pen	1 (1.2)	16 Spans
7100B	Lab-OEM	25	10	2	12	2.5	5 cm/sec	1	2 in./sec	Capry ink pen w/replace cart	0.1 (0.1)	Plug-In
7101B	Gen Purpose-OEM	25	10	1	12	2.5	5 cm/sec	1	2 in./sec	Capry ink pen w/replace cart	0.1 (0.1)	Plug-In
7123A	OEM	25	10	1	Deter. by Opt.	3	15	1	6	Disp. Ink Pen	1 (1)	Single Span
7127A	Lab-OEM	25	10	1	4	N/A	N/A	0.25 in./min	2	Capry ink pen w/replace cart	0.1 (N/A)	Plug-In
7128A	Lab-OEM	25	10	2	4	N/A	N/A	0.25 in./min	2	Capry ink pen w/replace cart	0.1 (N/A)	Plug-In
7130A	OEM	25	10	2	Deter. by Opt.	3	15	1	6	Disp. Ink Pen, Therm Opt	1 (1)	Single Span
7131A	OEM	25	10	1	Deter. by Opt.	3	15	1	6	Disp. Ink Pen, Therm Opt	1 (1)	Single Span
7132A	Lab	25	10	2	8	2.5	15	1	6	Disp. Ink Pen, Therm Opt	1 (1)	11 Spans
7133A	Lab	25	10	1	8	2.5	15	1	6	Disp. Ink Pen, Therm Opt	1 (1)	11 Spans

OSCILLOGRAPHIC RECORDERS

System	No. of Channels × Chart Width (mm)	Writing Method	With Amp Model No.	Maximum Sensitivity mV/Div	Vertical Rack Space Requirement	
					(mm)	Inches
7402A	2 × 50	Pressurized Ink	17400A thru 17404A	0.001 1 20	267	10½
7404A	4 × 40	Pressurized Ink	17400A thru 17404A	0.001 1 20	267	10½
7414A	4 × 40	Thermal	8800 Series Preamps	0.001	267	10½
7418A	6 × 40 8 × 40	Thermal	8800 Series Preamps	0.001	451 406	17½ 16.0

RECORDERS & PRINTERS

Fast response X-Y recorder, plug-in-modules

Models 7004B, 7034A, & 17170 series plug-ins

- High performance

- Plug-in versatility

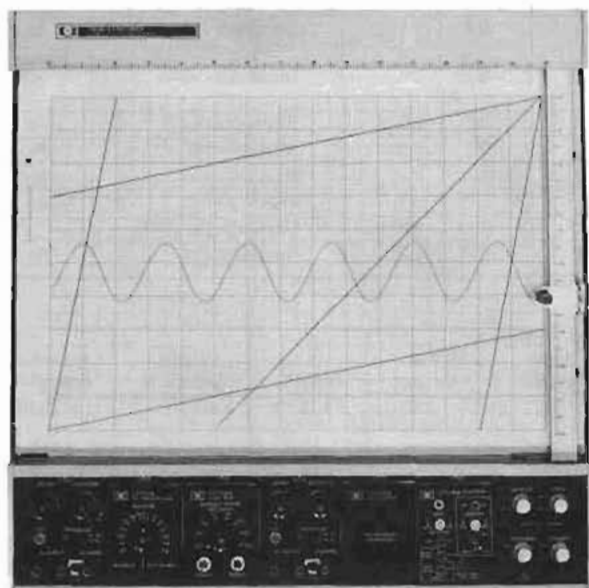

7004B

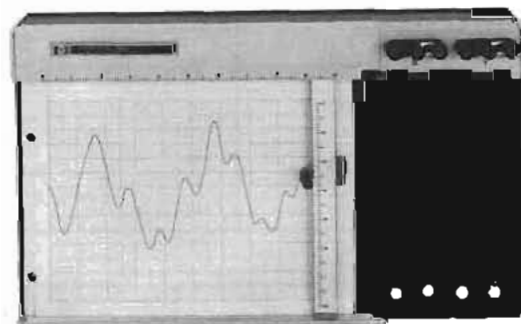

7034A



17170A



17171A



17172A

The Hewlett-Packard Models 7004B and 7034A provide acceleration of more than 3800 cm/s^2 (1500 in./s^2) and slewing speed of 76 cm/s (30 in./s). The high acceleration allows the pen to follow small, quick input changes. Front and rear guard terminals are available for signal inputs. Guarding helps eliminate the common mode voltage effects that are troublesome when recording from low-level sources such as thermocouples, strain gauges and similar sources. Additional features include the proven Autogrip electrostatic paper hold-down, the disposable ink pen, a RECORD/SETUP switch, knob locks, five-way binding posts, tilt stand, to name a few.

Selection of the plug-ins is dependent upon the type of X-Y recorder, as well as purpose. Two plug-ins per axis are placed in the mainframe. Each may be used individually or in series by setting the front panel switch.

7004B, 7034A, 17170 Series plug-ins specifications

7004B and 7034A Performance specifications

Plug-ins: accept 4 single-width; 2 per axis.

Type of input: floating & guarded signal pair. Avail. thru front panel or rear connector.

Zero set: may be set ± 1 fs from zero index.

Zero check switches: pushbutton in each axis allows verification of recorder's zero position without removal or shorting of input signal.

Mainframe accuracy: $\pm 0.2\%$ of full scale.

Range vernier: lockable, covers 2.5 times range setting.

Slewing speed: more than 75 cm/s (30 in./s) independent of line voltage & frequency.

Acceleration: more than 3800 cm/s^2 (1500 in./s^2).

Reference stability: better than $0.003\%/^{\circ}\text{C}$.

Terminal based linearity: $\pm 0.1\%$ of full scale.

Resetability: $\pm 0.05\%$ of full scale.

7004B and 7034A General specifications

Paper holddown: autogrip grips charts up to size of platen.

Pen lift: local and remote control (contact closure or TTL).

Dimensions: 7004B - 445 mm wide, 267 mm high, 121 mm deep ($17\frac{1}{2}'' \times 17\frac{1}{2}'' \times 4\frac{1}{4}''$). 7034A - 445 mm wide, 267 mm high, 121 mm deep ($17\frac{1}{2}'' \times 10\frac{1}{2}'' \times 4\frac{1}{4}''$).

Weight: 7004 B - net 12.7 kg (28 lb). Shipping 14.1 kg (42 lb). 7034A - net 7.3 kg (16 lb). Shipping 14.1 kg (31 lb).

Power: 115 or 230 V ac $\pm 10\%$, 50 to 400 Hz , approx. 85 VA (dependent on plug-in).

17170A DC Coupler specifications

Input range: single, fixed calib range of 50 mV/cm (100 mV/in.).

Input resistance: $1 \text{ M}\Omega$ constant.

Common mode rejection: 120 dB at dc & 70 dB at 50 Hz & above with 100Ω between low side & guard connect point with source impd. $10 \text{ k}\Omega$ or less.

17171A DC Amplifier specifications

Input ranges: $0.25, 0.5, 1, 2.5, 5, 10, 25 \text{ mV/cm}$, $0.05, 0.1, 0.25, 0.5, 1, 2.5, 5 \text{ V/cm}$ ($0.5, 1, 2, 5, 10, 20, 50 \text{ mV/in.}, 0.1, 0.2, 0.5, 1, 2, 5, 10 \text{ V/in.}$).

Input resistance: $1 \text{ M}\Omega$.

Common mode rejection: 120 dB at dc & 100 dB at 50 Hz & above with 100Ω between low side & guard connect point at 0.25 mV/cm (0.5 mV/in.). CMR on others decreases 20 dB/decade step in attenuation.

System accuracy: $\pm 0.2\%$ full scale.

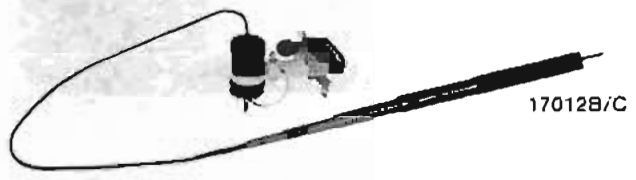
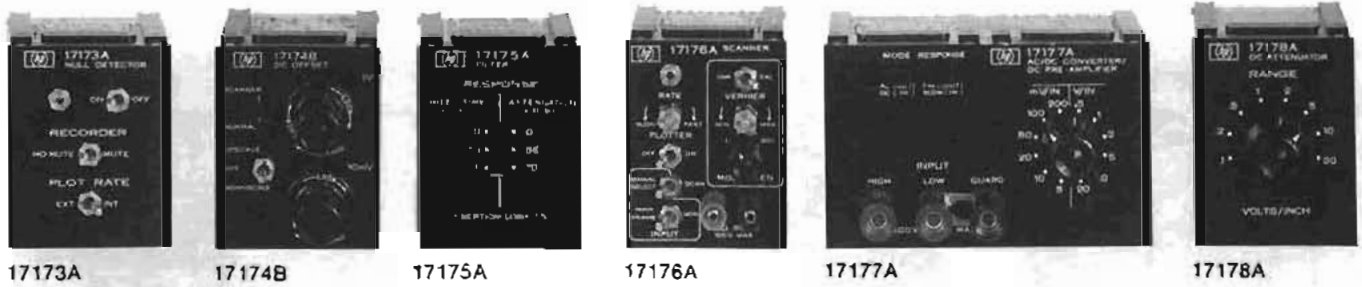

17172A Time base specifications
Sweep speeds: 0.25, 0.5, 1, 2.5, 5, 10, 25, 50 s/cm (0.5, 1, 2, 5, 10, 20, 50, 100 s/in.).
System accuracy: ±1% of fs on 6 fastest ranges; ±2.5% on remaining 2.

17173A Null detector specifications
Plot rate: Up to 50 plots/s.
Enable/disable: Required disable voltage +3 V min. to +20 V max. Required enable voltage — 0 V dc or no connect. Other voltage combinations available on request.
Muting: local or remote.
Plotting accuracy: ±0.25% of full scale.

17174B DC Offset specifications
Offset: <1 mV to approx. 1 V.
Controls: 2 lockable, 10-T high resolution controls (<1 mV to approx. 10 mV & <1 mV to approx. 1 V). An offset polarity switch allows upscale or downscale zero offset.
Offset voltage stability: >0.005%/°C.

17175A Filter specifications
Input ranges: —5 to +45 V dc, 10 V ac max p-p.
Maximum source impedance: 1 kΩ; higher impedance decreases filter response.
Rejection: >55 dB at 50 Hz & higher (½ s rise time) or >70 dB at 50 Hz & higher (1 s rise time). Front panel selection.

17176A Scanner specifications
Input: front panel miniature binding posts isolated from ground (high & low only). Mainframe input — utilizes existing input connectors.
Attenuator: fixed attenuator in decade steps from X1 to X0.001. Variable attenuator provides continuous coverage.
Input impedance: 100 kΩ.
Accuracy: 0.2% of full scale.
Scan rate: adjust. from 0.1 to 4 s/scan.

17177A AC/DC Converter DC preamplifier specifications
Input ranges: 2.5 mV/cm to 10 V/cm (5 mV/in. to 20 V/in.) in 1, 2, 5 steps.
Minimum usable input (ac only): ±0.2% of full scale.
Maximum allowable input: 300 V peak.
Type of input: floating & guarded sig. pair. No rear inputs.
Input impedance: 1 MΩ shunted by less than 40 pF.
Maximum allowable source resistance: 10kΩ.
Common mode rejection: 80 dB at dc & 50 Hz & above with 100Ω between low side & gurd connect point & at 2.5 mV/cm (5 mV/in.). CMR on other ranges, decreases 20 dB/decade step in attenuation.
Rise/fall time (ac only, 10-90%): Slow response (5 Hz to 100 kHz) 2.5 s max; fast response (50 Hz to 100 kHz) 0.5 s max.

Calibration (ac only): responds to average value of input waveform; calib in rms value of sinewave.
Accuracy (% of fs): DC — ±0.5%; AC (fast response) — ±0.25% from 150 Hz to 50 kHz, ±0.5% from 50 Hz to 150 Hz & 50 kHz to 100 kHz; AC (slow response) — ±0.25% from 30 Hz to 50 kHz from 5 Hz to 30 Hz & 50 kHz to 100 kHz.
Linearity (ac): expressed as % of fs, measuring from 0.5% of fs.

5 Hz	50 Hz	50 kHz	100 kHz
±0.35%	±0.25%	±0.35%	

Warmup time: 3 minutes nom.
Zero drift (referred to input): ±30 μV/°C.
Offset: up to 1 fs of offset using recorder's zero.
Size: double width occupies both plug-in spaces in axis.

17178A DC Attenuator specifications
Input ranges: 0.05, 0.1, 0.25, 0.5, 1, 2.5, 5, 10 V/cm (0.1, 0.2, 0.5, 1, 2, 5, 10, 20 V/in.).
Input resistance: 1 MΩ.
Common mode rejection: 120 dB at dc & 70 dB at 50 Hz & above with 100Ω between low side & point where guard is connected (at 50 mV/cm or 100 mV/in.). Other ranges CMR decreases 20 dB/decade step in attenuation.
System accuracy: ±0.2% of full scale.

Options	Price
001: Metrically scaled & calibrated (7004B/7034A)	N/C
002: X-axis retrans pot. 5 kΩ ±0.1% linearity (7004B)	\$90
003: Tank type pens (7004B)	N/C
004: Power supply for 17005-04 increment chart adv. (7004B)	\$55
001: Metrically scaled (17170A/17171A/17172A/17177A/17178A)	N/C
001: +3 to 20 V enable, 0 V disable (17173A)	\$25
001: Symbol plotting capability (6) (17012B/C)	\$30
002: -3 to -20 V disable, 0 V enable (17173A)	\$25
003: -3 to -20 V enable, 0 V disable (17173A)	\$25
908: Rack mount kit	add \$20
910: Extra manual	add \$15
17024A Consumable starter kit — English (7034A)	\$41
17025A Consumable starter kit — Metric (7034A)	\$43
17026A Consumable starter kit — English (7004B)	\$49
17027A Consumable starter kit — Metric (7004B)	\$55
Model number and name	
7004B X-Y Recorder (28.26 cm × 43.18 cm) (11" × 17")	\$2010
7034A X-Y Recorder (21.59 cm × 28.26 cm) (8½" × 11")	\$1980
17005A Chart Advance (7004B only)	\$1450
17170A DC Coupler Plug-in	\$55
17171A DC Amplifier Plug-in	\$395
17172A Time Base Plug-in	\$290
17173A Null Detector	\$370
17174B DC Offset Plug-in	\$185
17175A Filter Plug-in	\$160
17176A Scanner Plug-in	\$530
17177A AC/DC Converter Plug-in	\$730
17178A DC Attenuator Plug-in	\$210
17012B/C Point Plotter	\$160

RECORDERS & PRINTERS

General performance X-Y recorder, time base

Models 7035B & 17108A

- Floating Guarded inputs

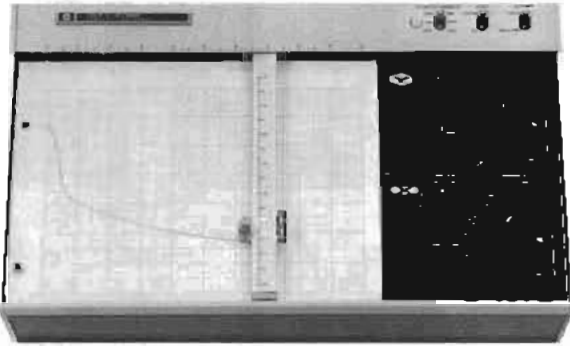

7035B

The 7035B is a high-quality, low cost instrument designed for use in general purpose applications. Each axis has an independent servo system with no interaction between channels. The 7035B plots two graphs from two dc signals representing the function being measured.

Input terminals accept either open wires or plug-type connectors. Five calibrated ranges from 0.4 mV/cm (1 mV/in.) to 4 V/cm (10 V/in.) are provided in each axis. A variable range control permits scaling of signal for full scale deflection. High input impedance (1 megohm on all but the first two ranges), floated and guarded input, and 0.2% accuracy is provided.

Each closed-loop servo system uses a high-gain, solid-state servo amplifier, servo motor, long-life balance potentiometers, photochopper, low pass filter, guarded inputs, and attenuator and balance circuit.

A plug-in time base, Model 17108A, operates on either axis to provide five sweep speeds from 0.2 to 20 s/cm. The unit is self-contained, external, and designed to directly plug into the 7035B input terminals. Any number of recorders may be driven simultaneously, provided the combined parallel input resistance is 20 k Ω or more.

7035B Specifications

Performance specifications

Input ranges:

Metric: 0.4, 4, 40, 400 mV/cm and 4 V/cm;

English: 1, 10, 100 mV/in.; 1 and 10 V/in. Continuous vernier between ranges.

Types of inputs: floated and guarded signal pair; rear input connector.

Input resistance:

Range	Input resistance
0.4 mV/cm (1 mV/in.)	Potentiometric (essentially infinite at null)
Variable	11 k Ω
4 mV/cm (10 mV/in.)	100 k Ω
Variable	100 k Ω
40 mV/cm (100 mV/in.)	1 M Ω
Variable	1 M Ω
400 mV/cm (1 V/in.)	1 M Ω
Variable	1 M Ω
4 V/cm (10 V/in.)	1 M Ω
Variable	1 M Ω

Normal mode rejection: >30 dB at 60 Hz; 18 dB/octave above 60 Hz.

Maximum allowable source impedance: no restrictions except on

- Disposable pens

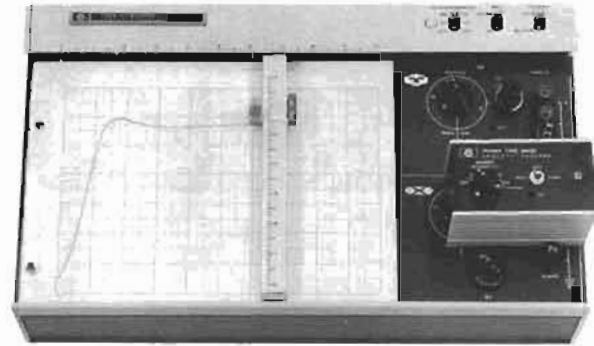

7035B with 17108A

fixed 0.4 mV/cm (1 mV/in.) range. Up to 20 k Ω source impedance will not alter recorder's performance.

Accuracy: $\pm 0.2\%$ of full scale.

Linearity: $\pm 0.1\%$ of full scale.

Resettability: $\pm 0.1\%$ of full scale.

Zero set: zero may be set up to one full scale in any direction from zero index. Lockable zero controls.

Stewing speed: 50 cm/s, (20 in./s) nominal at 115 V.

Common mode rejection: conditions for the following data are line frequency with up to 1 k Ω between the positive input and guard connection point. Max. dc common mode voltage is 500 V.

Range		DC (CMR)	AC (CMR)
Metric	English		
0.4 mV/cm	1 mV/in.	130 dB	100 dB
4 mV/cm	10 mV/in.	110 dB	80 dB
40 mV/cm	100 mV/in.	90 dB	60 dB
400 mV/cm	1 V/in.	70 dB	40 dB
4 V/cm	10 V/in.	50 dB	20 dB

General specifications

Paper holddown: autogrip electric paper holddown grips 216 mm \times 279 mm (8 1/2 in. \times 11 in.) charts or smaller. Special paper not required.

Pen lift: electric pen lift capable of being remotely controlled.

Dimensions: 265 mm high, 445 mm wide, 121 mm deep (10 3/8" \times 17 1/2" \times 4 3/4" deep).

Weight: net, 8 kg (18 lb). Shipping, 10.9 kg (24 lb).

Power: 115 or 230 V $\pm 10\%$, 50 to 60 Hz, approximately 45 VA.

17108A Specifications

Sweep speeds: 0.2, 0.4, 2, 4, 20 s/cm (0.5, 1, 5, 10, 50 s/in.)

Accuracy: 5% of recorder full scale.

Linearity: 0.5% of full scale (20°C to 30°C).

Output voltage: 0 to 1.5 V.

Power: replaceable mercury battery (100 hr).

Options and accessories

Opt 001 — Metric calibration

Opt 003 — Retransmitting potentiometer on X-axis 5 k Ω $\pm 3\%$

Opt 020 — Modification for use with models 3580A and 3581A/C

Opt 908 — Rack mount kit

Opt 910 — Extra manual

17108A Time Base Plug-In

17108AM Time Base Plug-In (metric)

17024A Consumables starter kit — English

17025A Consumables starter kit — Metric

7035B General Purpose X-Y recorder

Price
N/C

add \$90

add \$295

add \$15

add \$10

\$235

\$235

\$41

\$43

\$1295

RECORDERS & PRINTERS

Low cost OEM, lab X-Y recorders

Models 7010A & 7015A

- Low cost

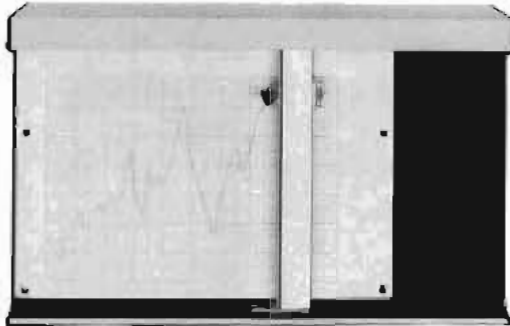

7010A

The Hewlett-Packard Models 7010A and 7015A X-Y Recorders are low cost, one-pen, DIN A4 (8½ × 11 in.) instruments that feature maximum electrical and mechanical flexibility to fit many and varied applications. The 7010A is specifically designed for the OEM user who is concerned with cost and space. Optional voltage spans from 0.01 V/div to 1 V/div, as well as time base sweep options, control panel, metric calibration, electrical pen lift, and carrying case are available. The 7015A is for the laboratory user such as schools and other institutions where cost is the primary consideration without sacrificing reliability or dependability. A control panel supplied with power on/off, standby, and range switches (three spans from 10 mV/cm to 1 V/cm), as well as vernier and zero controls is provided with the standard recorder. Options available include metric calibration, time base, electric pen lift, and carrying case. Standard equipment supplied on both units includes the electrostatic paper holddown, rear connector and a universal pen holder (located in the standard Accessory Kit) that will hold most fiber tip pens.

7010A and 7015A Specifications

Performance specifications

Input ranges: 7010A — single range, 0.1 V/div.; 7015A — three ranges 0.01 V/cm, 0.1 V/cm, 1 V/cm (0.01 V/in., 0.1 V/in., 1 V/in.). Vernier adjustment overlapping all ranges.

Type of inputs: floating, constant 1 MΩ impedance.

Impedance to ground: 10 MΩ from either terminal to ground.

Common mode rejection: 100 dB (dc), 90 dB (ac) from +10°C to +40°C, 0–80%RH. Degrades 20 dB/decade step in attenuator (both ac and dc).

Connection: 7010A — via circuit board pins or standard rear connector. 7015A — front panel binding posts or standard rear connector.

Accuracy: ±0.3% of full scale at 25°C on 0.1 V/div. (includes linearity and deadband). Temperature coefficient ±0.02%/°C.

Range accuracy: ±0.3% of full scale ±0.2% of deflection (includes linearity and deadband) at 25°C. Temperature coefficient 0.02%/°C.

Deadband: 0.2% of full scale.

Overshoot: 2% full scale maximum.

Slowing speed: 50 cm/s, (20 in./sec) minimum.

Peak acceleration: X-axis — 1270 cm/sec² (500 in./sec²) min, Y-axis — 2540 cm/sec² (1000 in./sec²) minimum.

Zero conditions:

Control ranges: pen positioned at any location on chart using 10 T pot +1 full scale zero suppression.

Resolution: pen positioned within +0.005 in. of any point on chart.

Zero drift: pen will not move more than 2.5 mm/day (0.1 in./day) independent of temperature.

General specifications

Paper holddown: autogrip electric paper holddown grips DIN A4 or 8½ × 11 in. charts.

- Universal pen holder

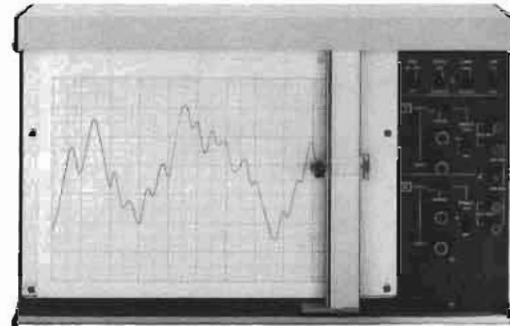

7015A

Front panel controls:

7010A: optional

7015A: power on/off, servo standby, range switches, vernier, zero controls and chart hold. Pen lift switches optional.

Writing system: disposable pens, and universal pen holder to hold most fiber tip pens.

Platen size: holds DIN A4 or 8½ × 11 in. size chart paper.

Dimensions: 267 mm high, 432 mm wide, 135 mm deep (10½ × 17 × 5 inches). Provisions provided for rack mounting in DIN or 19" size rack.

Power: switch selectable for 100, 115, 200, 230 V ac, 47.5–440 Hz, 70 VA maximum.

Weight: net, 7.2 kg (16 lb); shipping, 10 kg (22 lb).

Time base: (optional)

Sweep rates: 7010A: single rate — 1 sec/cm, 10 sec/cm. 7015A: six from 0.1 sec/cm to 50 sec/cm (0.5 sec/in. to 100 sec/in.).

Accuracy: 1.5% @ 25°C, temperature coefficient ±0.1% per °C over temperature range of +10°C to +40°C.

Controls: start, reset, actuated by remote contact closure or TTL. 7015A also from control panel.

Options and accessories

7010A:

Options and accessories	Price
7010A:	
001: Metric calibration	N/C
002: Control panel — provides power on/off servo standby, chart hold switch, zero controls, and, if ordered, electric pen lift	\$50
003: Electric pen lift	\$50
004: Deletes recorder case	les. \$50
005: Single span — 10 mV/div — X-axis	N/C
006: Single span — 1 V/div — X-axis	N/C
007: Single span — 10 mV/div — Y-axis	N/C
008: Single span — 1 V/div — Y-axis	N/C
009: Sweep rate — 1 sec/div — X-axis (includes elect. pen lift)	\$150
010: Sweep rate — 10 sec/div — X-axis (includes elect. pen lift)	\$150
011: Case, carrying (not to be used for shipping)	\$75
908: Rack mount kit	\$15
910: Extra manual	\$10
17024A Consumable Starter Kit — English	\$41
17025A Consumable Starter Kit — Metric	\$43

7015A:

001: Metric calibration — 10 mV/cm, 100 mV/cm, 1 V/cm	N/C
002: Time base (includes electric pen lift)	\$200
003: Electric pen lift	\$50
004: Case, carrying (not to be used for shipping)	\$75
908: Rack mount kit	\$15
910: Extra manual	\$10
17024A Consumable Starter Kit — English	\$41
17025A Consumable Starter Kit — Metric	\$43

Model number and name

7010A OEM X-Y Recorder	\$980
7015A Lab X-Y Recorder	\$1025

RECORDERS & PRINTERS

OEM, Dedicated applications X-Y recorders

Models 7040A & 7041A

- Rugged one-piece casting
- Over 40 options

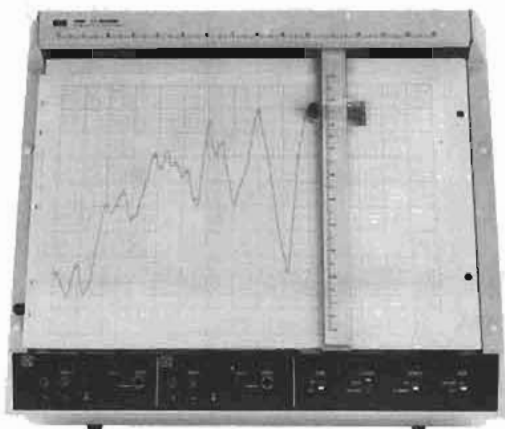

7040A-038

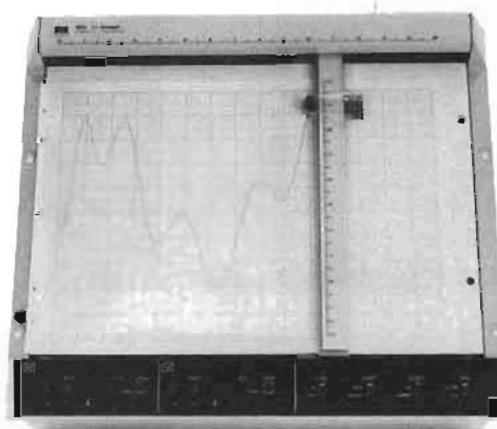

7041A-038

The 7040A and 7041A X-Y recorders are specifically designed for dedicated, single-purpose recording applications. The 7040A is a medium-speed unit while the 7041A is a high-speed unit featuring fast acceleration for applications where recording time is critical or incoming data is at a high rate.

Both models use a one-piece aluminum casting mainframe which eliminates the need for critical mechanical adjustments. They are also equipped with the Autogrip paper holddown system and the quick-change disposable pen.

Additionally, over 40 options give these recorders the ability to be customized for the needed application. Most of the options can be easily and quickly installed or changed in the field. This includes a control panel (Option 038) which would provide the basic recorder functions such as zero set, servo, pen, and chart operation. Other options include a time base, a plug-in X-axis event marker, TTL logic remote control, plus a variety of input ranges.

A functional and quantity discount is available for both units when qualified for the OEM purchase agreement.

7040A & 7041A Specifications

Input ranges: single range from 0.2 to 500 mV/cm (0.5 mV/in. to 1 V/in.), specified by option choice.

Type of input: floating, 200 V dc or peak ac max; internal polarity switch; inputs through rear barrier strip or optional connector.

Input resistance: 1 M Ω constant.

Common mode rejection: 100 dB dc; 80 dB at line frequency.

Stewing speed:

7040A: 50 cm/s (20 in./s) min.

7041A: 76 cm/s (30 in./s) min.

Acceleration (peak)

7040A: Y axis 2540 cm/s² (1000 in./s²); X axis 1270 cm/s² (500 in./s²).

7041A: Y axis 7620 cm/s² (3000 in./s²); X axis 5080 cm/s² (2000 in./s²).

Accuracy: $\pm 0.2\%$ of full scale.

Sweep: optional, single range.

Zero set: external control provided by user; front panel controls available as Option 038.

Paper holddown: autogrip electric paper holddown grips DIN A3 or 11 in. \times 17 in. charts or smaller.

Pen lift: electric pen lift controlled remotely by contact closure; TTL logic level provided by Option 039.

Dimensions: 356 mm high, 483 mm wide, 165 mm deep (14 \times 19 \times 6 $\frac{1}{2}$ "); rack mounting structure integral with unit.

Weight: net, 13.2 kg (29 lb). Shipping, 16.8 kg (37 lb).

Power: 115 or 230 V $\pm 10\%$; 50 to 400 Hz; approx. 130 VA.

Options

Input range: specify one range option for each axis; must be both English or both metric

X	Y	Range	Price	X	Y	Range	Price
001	007	0.5 mV/in.	\$100	013	019	0.2 mV/cm	\$100
002	008	1 mV/in.	\$100	014	020	0.5 mV/cm	\$100
003	009	10 mV/in.	\$100	015	021	5 mV/cm	\$100
004	010	100 mV/in.	N/C	016	022	50 mV/cm	N/C
005	011	500 mV/in.	N/C	017	023	100 mV/cm	N/C
006	012	1 V/in.	N/C	018	024	500 mV/cm	N/C

Note: other ranges available on special order.

Sweep range: specified by option, X axis only; accuracy $\pm 1\%$ of full scale $\pm 0.1\%/^{\circ}\text{C}$ max; TTL logic start and reset

	Sweep	Price		Sweep	Price
025	1 s/in.	\$150	030	0.5 s/cm	\$150
026	5 s/in.	\$150	031	1 s/cm	\$150
027	10 s/in.	\$150	032	5 s/cm	\$150
028	50 s/in.	\$150	033	10 s/cm	\$150
029	100 s/in.	\$150	034	50 s/cm	\$150

Note: other sweep ranges available on special order.

035: event marker, upper margin of X axis add \$100

036: X axis retransmitting potentiometer (19.2 k Ω) add \$60

037: Y axis retransmitting potentiometer (13.1 k Ω) add \$60

038: control panel; for line, pen lift, chart, servo standby, zero, and zero check; add 44 mm (1 $\frac{3}{4}$ ") to height add \$140

039: TTL logic remote control; for pen lift and servo standby; also event marker if installed add \$60

040: rear connector; X, Y input signals and retransmitting potentiometers, time base controls, Autogrip servo standby, pen lift, event marker and Option 039 control lines brought to a single locking connector add \$90

041: side trim panels and dust cover (356 mm, [14"]) for standard unit add \$20

042: side trim panels and dust cover (400 mm, [15 $\frac{1}{2}$ "]) for unit with Option 038 installed add \$20

910: Extra manual add \$10

17026A Consumable Starter Kit — English \$49

17027A Consumable Starter Kit — Metric \$55

Model number and name

7040A Medium speed X-Y recorder \$1200

7041A High speed X-Y recorder \$1440

Note: OEM discounts available on both models.

RECORDERS & PRINTERS



Two-pen, three parameter X-Y/Y recorder

Model 7046A

- Small pen separation

- Virtually no overshoot

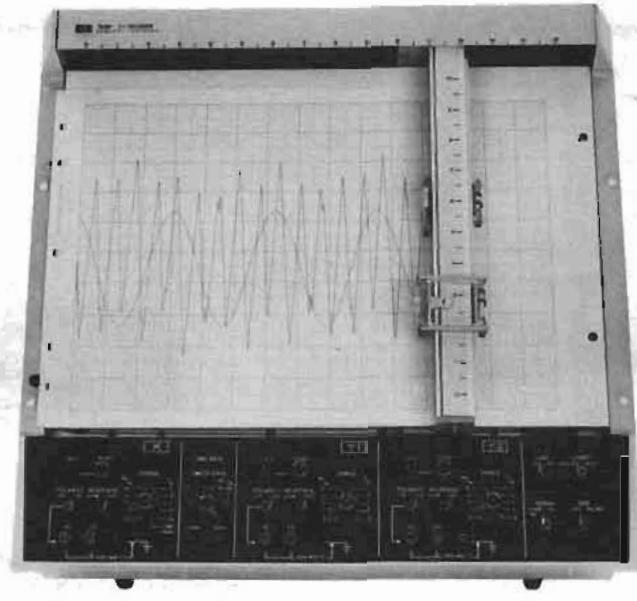

The Model 7046A is a general-purpose 2-pen laboratory X-Y recorder designed to assure high quality recordings without sacrificing ruggedness, reliability and high performance so necessary for a laboratory recorder. The unit has dynamic performance that surpasses most 2-pen recorders by offering Y-axis acceleration exceeding 6350 cm/s² (2500 in./sec²). This high acceleration plus very little overshoot results in the 7046A reproducing a wide range of fast changing input signals.

A front panel polarity switch that switches pen direction, and the response switch which reduces the speed of the unit, are also available. The Autogrip paper holddown system which holds DIN A3, up to 27.9 cm x 43.2 cm (11 x 17 in.) size paper is also standard.

7046A Specifications

Performance specifications

Input ranges: metric calibration available in 0.25, 0.5, 2.5, 5, 25 mV/cm; 0.05, 0.25, 0.5, 2.5, 5 V/cm (0.5, 1, 5, 10, 50 mV/in.; 0.1, 0.5, 1, 5, 10 V/in.). Continuous vernier between ranges.

Type of input: floating and guarded, 500 V dc or peak ac maximum. Polarity reversal switch located on front panel, guard internally connected. Inputs through front panel binding posts or rear connector.

Input resistance: 1 megohm constant on all ranges.

Common mode: 110 dB dc and 90 dB at 50 Hz and above (exceeds 130 dB dc and 110 dB ac under normal lab environmental conditions) with 1 kΩ between HI and LO terminals, CMV applied between ground and LO, and attenuator on most sensitive range. On other ranges, CMR decreases 20 dB per decade step in attenuation.

Slewing speed: Fast Response, 76 cm/s (30 in./s) minimum; Slow Response, 36 cm/s (15 in./s) typical.

Acceleration (peak, fast response only): Y-axis 6350 cm/s² (2500 in./s²), X-axis 3800 cm/s² (1500 in./s²).

Accuracy: ±0.2% of full scale (includes linearity and deadband) at 25°C. Temp Coefficient ±0.01% per °C.

Range accuracy: ±0.2% of full scale ±0.2% of deflection (includes linearity and deadband) at 25°C. Temp Coefficient ±0.01% per °C.

Deadband: 0.1% of full scale.

Overshoot: 1% of full scale (maximum).

Zero set: zero may be placed anywhere on the writing area or electrically off scale up to one full scale from zero index.

Environmental (operating): 0 to 55°C and <95% relative humidity (40°C).

General specifications

Writing mechanism: servo actuated ink pens.

Writing area: 25 cm x 38 cm (10" x 15").

Paper holddown: autogrip electric paper holddown grips DIN A3 or 11 in. x 17 in. Special paper not required.

Pen lift: electric (remote, via contact closure or TTL level).

Dimensions: 441 mm high, 483 mm wide, 173 mm deep (17½" x 19" x 6¾"); rack mounting structure integral with unit.

Power: 115 or 230 volts ac ±10%, 48 to 400 Hz, 175 VA.

Weight: net, 16 kg (35 lb). Shipping, 21.4 kg (47 lb).

Options and accessories

007: Metric Calibration

001: Time Base

Sweep rates: Metric calibration is 0.25, 0.5, 2.5, 5, 25, 50 s/cm (0.5, 1, 5, 10, 50, 100 s/in.).

Accuracy: 1% at 25°C (Temp. Coeff. ±0.1%/°C max).

General: switchable to X-axis. Start and reset by front panel control, remote by momentary contact closure to ground or TTL levels. Automatic reset at full scale, recycle accomplished by continuous start signal.

002: Event Marker

Writes in upper margin, aligned with X-axis position of Y pen, approximately 0.12 cm (0.05 in.) excursion completed 50 ms after application of signal. Controlled remotely by contact closure to ground or by TTL levels. Contact resistance: 4 kΩ (maximum).

910: Extra manual

17026A Consumable Starter Kit — English

17027A Consumable Starter Kit — Metric

7046A 2-pen, X-Y/Y, recorder

Price
N/C
add \$225

add \$100

add \$10
\$49
\$55
\$3175

RECORDERS & PRINTERS

High performance X-Y recorders

Models 7044A, 7045A, & 7047A

- High dynamic response

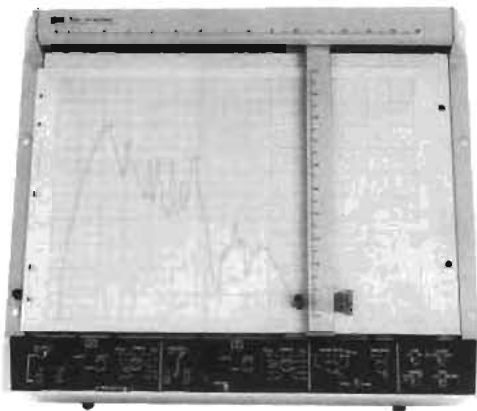

7044A

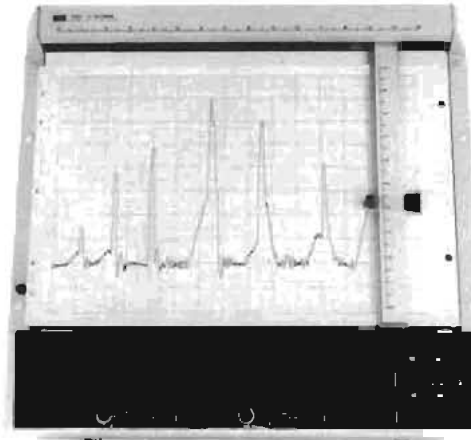

7047A

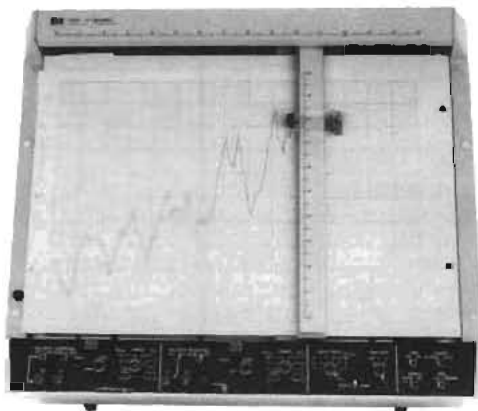

7045A

- Performs laboratory measurements

The Models 7044A, 7045A, and the 7047A are general purpose X-Y recorders specifically designed to offer the needed requirements to perform laboratory measurements. This allows for a wide range of quick-changing signals to be reproduced accurately and dependably. The 7044A is a medium-speed recorder designed for most general-purpose applications. The 7045A and 7047A offer higher speed and Y-axis acceleration exceeding 7620 cm/sec^2 (3000 in./sec^2).

Other outstanding features found on the recorders include 10 calibrated dc input ranges on each axis of the 7044A and 7045A from 0.25 mV/cm to 5 V/cm (0.5 mV/in. to 20 V/in.) and 12 calibrated dc input ranges on each axis of the 7047A from 0.02 mV/cm to 5 V/cm (0.05 mV/in. to 10 V/in.). In between, a 1-5-10 sequence is used (except for the 0.02 mV/cm, most sensitive range setting of the metric option on the 7047A.) On all three, arbitrary full scale voltage ranges may be established with the vernier control in conjunction with the calibrated dc ranges.

Additionally, these recorders are equipped with front panel polarity switches which reverse pen direction, eliminating the need for reversing the input leads. The 7045A and 7047A are provided with a RESPONSE switch which allows the user to slow the response of the recorder for easier setup. The 7047A preamplifiers for the X and Y axes are contained in two specially designed aluminum enclosures. These contain chopper dc amplifiers and have the unique serviceability feature of being removable and operational outside of the mainframe, using the cable extender included in the Accessory Kit.

Also available on all models is the continuous duty, aluminum framed dc servo motor; the X-axis of the 7045A and 7047A contain the larger, faster motor. This reduces overheating and wear if the pen is driven offscale for an indefinite time. The trouble-free Autogrip electrostatic holddown platen capable of holding chart paper of the European size A3 and 11 in. \times 17 in. size is included, as well as a disposable pen with four color choices, and plastic coated wirewound balance potentiometer. Latest circuitry design and assembly techniques have also been incorporated, thereby reducing failure and maintenance time.

Options include the Time Base (standard on the 7047A) Event Marker and Metric Scaling. TTL Remote Control and Rear Connector are standard on all models.

7044A, 7045A Specifications

Performance specifications

input ranges: 0.25, 0.5, 2.5, 5, 25 mV/cm; 0.05, 0.25, 0.5, 2.5, 5 V/cm (English calibration available in 0.5, 1, 5, 10, 50 mV/in.; 0.1, 0.5, 1, 5, 10 V/in.). Continuous vernier between ranges.

Type of input: floating and guarded, 500 V dc or peak ac maximum. Polarity reversal switch located on front panel, guard internally connected. Inputs through front panel 5-way binding posts or rear connector.

Input resistance: 1 megohm constant on all ranges.

Common mode: 110 dB dc and 90 dB at 50 Hz and above (exceeds 130 dB dc and 110 dB ac under normal lab environmental conditions) with 1 kΩ between HI and LO terminals, CMV applied between ground and LO, and attenuator on most sensitive range. CMR decreases 20 dB per decade step in attenuation.

Slewing speed

7044A: 50 cm/sec (20 in./sec) minimum.

7045A: Fast Response, 76 cm/sec (30 in./sec) minimum. Slow Response, 36 cm/sec (15 in./sec) typical.

Acceleration (peak)

7044A: Y-axis 2540 cm/sec² (1000 in./sec²), X-axis 1270 cm/sec² (500 in./sec²).

7045A: (Fast Response only) Y-axis 7620 cm/sec² (3000 in./sec²), X-axis 5080 cm/sec² (2000 in./sec²).

Accuracy: ±0.2% of full scale (includes linearity and deadband) at 25°C. Temp Coefficient ±0.01% per °C.

Range Accuracy: ±0.2% of full scale ±0.2% of deflection (includes linearity and deadband) at 25°C. Temp Coefficient ±0.01% per °C.

Deadband: 0.1% of full scale.

Overshoot: 7044A — 2% of full scale (maximum), 7045A — 1% of full scale (maximum).

Zero set: zero may be placed anywhere on the writing area or electrically off scale up to one full scale from zero index.

Environmental (operating): 0° to 55°C and <95% relative humidity (40°C).

General specifications

Writing mechanism: servo actuated ink pen.

Writing area: 25 cm × 38 cm (10" × 15").

Paper holddown: autogrip electric paper holddown grips DIN A3 or 11 in. × 17 in. charts or smaller. Special paper not required.

Pen lift: electric. (Remote via TTL.)

Dimensions: 400 mm high, 483 mm wide, 165 mm deep (15 3/4" × 19" × 6 1/2"); rack mounting structure integral with unit.

Power: 115 or 230 V ac ±10%, 48 to 400 Hz; 7044A, 135 VA; 7045A, 175 VA.

Weight: net, 13.7 kg (30 lb). Shipping, 19.1 kg (42 lb).

7044A & 7045A Options

006: Metric Calibration

001: Time Base

Sweep rates: 0.25, 0.5, 2.5, 5, 25, 50 sec/cm (0.5, 1, 5, 10, 50, 100 sec/in.).

Time Base Accuracy: 1.0% at 25°C.

Temp Coefficient ±0.1% per °C.

General: Switchable to either X or Y axis. Start and reset by front panel control, remote by momentary contact closure to ground or TTL levels. Automatic reset at full scale, recycle accomplished by continuous start signal.

002: Event Marker: Writes in upper margin, aligned with X-axis position, approximately 0.13 cm (0.05 in.) excursion completed 50 msec after application of signal. Controlled remotely by contact closure to ground or by TTL levels.

Price
N/C
\$225

\$100

7047A Specifications

Performance specifications

Input ranges: 0.02, 0.05, 0.1, 0.5, 1, 5 mV/cm; 0.01, 0.05, 0.1, 0.5, 1, 5

V/cm (0.05, 0.1, 0.5, 1, 5, 10 mV/in.; 0.05, 0.1, 0.5, 1, 5, 10 V/in.). Continuous vernier between ranges.

Type of input: floating and guarded (front input only). Employs a unique common mode driver circuit that eliminates the need for connecting CMV to the recorder if CMV is less than or equal to 10 V pk.

Input resistance: 1 megohm constant on all ranges.

Accuracy: ±0.2% of full scale (includes linearity and deadband) at 25°C. Temp Coefficient ±0.01% per °C.

Range accuracy: ±0.2% of full scale ±0.2% of deflection (includes linearity and deadband) at 25°C. Temp Coefficient ±0.01% per °C.

Deadband: 0.1% of full scale.

Common mode rejection: 140 dB dc and 130 dB ac with 1 kΩ imbalance in either the high or low terminal (exceeds 150 dB under normal laboratory conditions.) CMR decreases 20 dB per decade step in attenuation.

Normal mode rejection: 30 dB minimum at line frequency with FILTER IN. (50 dB typical at 60 Hz and 40 dB typical at 50 Hz).

Slewing speed: 76 cm/second (30 in./sec) minimum. 97 cm/sec (38 in./sec) typical under normal lab conditions.

Acceleration (peak): Y-axis 7620 cm/sec² (3000 in./sec²)
X-axis 5080 cm/sec² (2000 in./sec²)

Overshoot: 1% of full scale maximum.

Calibrated zero offset: provides eleven scales of calibrated zero offset in both axes. Switchable in steps of one full scale from +1 to -10 scales.

Offset accuracy: at 25°C, ±0.1% of full scale times N where N = number of scales of offset.

Temperature coefficient: ±0.004% of full scale times N per °C.

Time base: speeds of 0.1, 0.5, 1, 5, 10, 50 sec/cm (0.5, 1, 5, 10, 50, 100 seconds/in.). Switchable into X or Y axis.

Time base accuracy: 1.0% at 25°C. Temp Coefficient ±0.1% per °C.

General specifications

Writing mechanism: servo actuated ink pen.

Writing area: 25 cm × 38 cm (10 in. × 15 in.).

Paper holddown: autogrip electric paper holddown grips DIN A3 or 11 in. × 17 in. charts or smaller. Special paper not required.

Pen lift: electric (remote via TTL level).

Dimensions: 441 mm H × 483 mm W × 173 mm D (17 1/4" × 19" × 6 3/4"); rack mounting structure integral with unit.

Power: 115 or 230 V ac ±10%, 48 to 66 Hz, 180 VA maximum.

Weight: net, 18.6 kg (41 lb). Shipping, 24 kg (53 lb).

7047A Options

001: Metric calibration.

Ranges are 0.02, 0.05, 0.10, 0.50, 1, 5 mV/cm; 0.01, 0.05, 0.1, 0.5, 1, 5 V/cm.

002: Event marker

Marking area: in margin at same X coordinate as recorder pen.

Excursion: approximately 0.050 inch.

Actuation time: stroke complete 50 ms after application of signal.

Ink capacity: 0.45 cc cartridge, cartridge reloading type. Writing distance 500 ft minimum.

Price

N/C

add \$100

Options and accessories (all models)

910: Extra manual

add \$15

17026A Consumable starter kit — English

\$49

17027A Consumable starter kit — metric

\$55

Model number and name

7044A Medium speed X-Y recorder

\$1820

7045A High speed X-Y recorder

\$2190

7047A High sensitivity X-Y recorder

\$3040

RECORDERS & PRINTERS

Digital input graphic plotters for terminal applications

Models 7202A & 7203A



7202A



7203A

The 7202A Graphic Plotter brings complete graphic capability to the computer terminal with a minimum of programming effort and software overhead. ASCII characters are utilized in a brief and concise format to represent the high resolution absolute position coordinates. Simple mnemonic commands control the plotting modes — Plotter off, plot lines, or plot points. Only a few program statements are needed to bring full graphic display to the terminal. Scale the data with a simple formula and add a single print statement to cause the four-digit integer X and Y coordinates to be printed on a line and plotted. The result is the final graph.

A 7203A brings high-speed graphic display to the computer terminal. Serial ASCII characters transmitted by the computer system are interpreted as binary position data. Pen and position maneuvers are independent, single character commands to provide increased flexibility and control. Data scaling and conversion into the proper ASCII character representation is easily handled by a program subroutine. Four ASCII characters representing X and Y coordinates are transmitted by the system for each data print. Moves of any length up to the maximum plot dimension can be made at any angle. Plotter control subroutines are available for most Hewlett-Packard timeshare systems (i.e., Option 006 for HP 2000/ACCESS systems) to handle all scaling, binary code conversion and timing considerations. Merely define the range of the data and the speed of the terminal.

Convenient front panel scaling controls of the Plotters permit selection of any plot size or position on any style paper up to 11 × 17 inches. The paper is held secure by an electrostatic holddown system. Clean, convenient disposable pens are available in four colors.

7202A and 7203A Specifications

7202A performance specifications

Plotting surface: 12.7 × 12.7 cm to 25.4 × 38.1 cm (5 × 5 in. to 10 × 15 in.).

Plotting maneuvers: plots lines or points.

Speed: up to 105 vector/min.

Numerical code: ASCII: X and Y represented by four-digit integers (separated by at least one space).

Numerical resolution: 1/10,000 (0.01%).

Plot accuracy: better than 0.076 mm (0.03 in.).

Resetability: 0.18 mm (0.007 in.) maximum.

Data rate: 110, 150, or 300 baud, switchable.

Controls: power, chart hold, terminal mute, line/local, pen down, graph limits, characters/sec.

Indicators: power, plot, improper format.

Interface: EIA RS232C or 20 mA current loop, select configuration option desired. Other interface configurations available. Contact factory.

Move length: 76.2 mm (3 in.) max. with pen down; 254 mm (10 in.) max. with pen up.

Power requirements: 115/230 V ac, 48 to 400 Hz, 100 VA

7203A performance specifications

Plotting surface: front panel scalable up to 25.4 × 38.1 cm (10 × 15 in.).

Plotting maneuvers: pen or position. Pen and position maneuvers are independent commands.

Speed: up to 450 vectors per minute.

Numerical code: binary; X and Y represented by ASCII character pairs.

Numerical resolution: 1/2500 (0.04%).

Plot accuracy: better than 0.10 mm (0.04 in.).

Resetability: 0.18 mm (0.007 in.) maximum.

Controls: power, chart hold, mute, line/local, pen up, pen down, graph limits, character/sec.

Indicators: power, error, plot.

Data rate: 110 or 300 baud, switchable.

Interface: EIA RS232C.

Move length: any length at any angle with appropriate software subroutine.

Power requirements: 100, 115, 200, or 230 V ±10%, 48 to 66 Hz, 100 VA maximum.

7202A and 7203A general specifications

Paper size: any size up to 29.9 × 43.2 cm (11 × 17 in.).

Plotting mode: absolute coordinates.

Writing method: ink, disposable pens.

Height: 216 mm (8½ in.).

Width: 508 mm (20 in.).

Depth: 511 mm (20¼ in.).

Weight: 18.1 kg (40 lb); shipping 23.6 kg (52 lb).

Options

For 7202A: (must order option 001, 003, or 004)

001: EIA RS232 MODEM interface

003: EIA RS232 terminal interface

004: ASR33

908: Extra manual

For 7203A: (must order option 001 or 002)

001: EIA RS232 MODEM interface

002: EIA RS232 terminal interface

005: Software SUBROUTINE for HP 2000C/F

006: Software SUBROUTINE for HP 2000 ACCESS

and HP 3000

910: Extra manual

Accessories

17026A Consumable starter kit — English

17027A Consumable starter kit — Metric

Model number and name

7202A Graphic Plotter

7203A Graphic Plotter

Price

N/C

N/C

N/C

add \$13.50

N/C

N/C

add \$20

add \$20

add \$20

add \$24

add \$24

\$49

\$53

\$4100

\$4100

RECORDERS & PRINTERS

Graphic plotter for computer applications

Model 7210A

- High speed, high resolution graphics
- Built-in vector generator
- Absolute or relative coordinates

- Versatile "handshake" interface
- Accepts binary or BCD codes

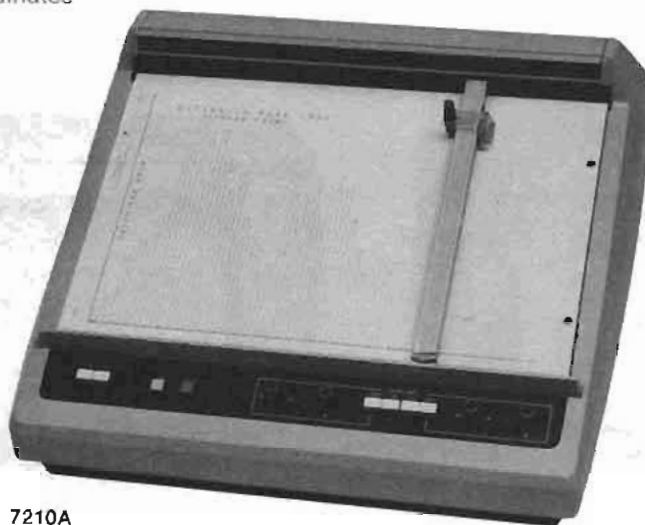

7210A

The Hewlett-Packard Model 7210A Digital Plotter is an output peripheral designed for use with computers and computer systems. The exceptional speed, resolution, and accuracy are available at the low cost normally associated with analog plotters, yet the 7210A does not require the higher system overhead of incremental plotters.

It can be added easily to either your computer or terminal. Accepting either Binary or BCD codes under full program control, the pen can make up to 20 moves per second at any angle. The internal microprocessor allows typical operation with less than 250 16-bit words of computer memory.

Any sheet type graph paper, up to 27.9 × 43.2 cm (11 × 17 inches), with or without preprinted grids, may be used. The Autogrip paper hold-down system solidly grips the paper. Four colors of ink are available in clean, disposable pens that can be changed quickly and easily.

7210A Specifications

Plotting surface: 25.4 × 38.1 cm (10 × 15 in.).

Plotting area: front panel scalable up to 25.4 × 38.1 cm (0 × 0 to 10 × 15 in.).

Plotting maneuvers: pen or position. Pen and position maneuvers are independent commands.

Vector generation: automatic. A command to perform a position maneuver will cause the Plotter to traverse a straight line path to any specified point on the platen.

Vector length: limited only by the plotting surface.

Vector speed: up to 30.5 cm/sec (12 in./second). The speed is dependent upon the slope of the line. Plotter will process up to 20 vectors/second.

Numerical code: position data is received in BCD (8421) or Binary.

Plotting modes: absolute coordinates and relative coordinates.

Numerical resolution: 1/10 000 (0.01%).

Plot accuracy: better than 0.10 cm (0.04 inch) in 38.1 cm (15 inches).

Resettability: 0.18 mm (0.007 inch) max.

Writing method: ink, disposable pens. Four colors available.

Paper size: any size up to 27.9 × 43.2 cm (11 × 17 in.).

Power: 100 V, 115 V, 200 V, or 230 V ±10% (choice of 4 positions at rear panel), 48 to 66 Hz, 100 watts maximum.

Weight: net, 18.1 kg (40 lb). Shipping 23.6 kg (52 lb).

Accessories supplied

Accessories supplied	HP Part Number
1. Accessory Kit	07210-80010
1 Pkg Disposable Pens, Red (5)	5081-1190
1 Pkg Disposable Pens, Blue (5)	5081-1191
1 Pkg Disposable Pens, Black (5)	5081-1192
1 Slidewire Cleaner	5080-3605
1 Fuse (for 230 V operation)	2110-0080

2. Operating Manual	07210-90000
3. Interface Manual	07210-90002
4. Mating Connector	
1 50 Pin Connector	1251-2771
1 Hood	1251-2769
2 Jackscrews	1251-2770
5. Dust Cover	4040-0477
6. Graph Paper, 20 sheets (English)	9270-1004
7. Graph Paper, 20 sheets (Metric)	9270-1024
8. Power Cord 2.3 m (7.5 ft)	8120-1348

Supplies available

Supplies available	HP Part Number
Disposable Pens (package of 5)	
Red	5081-1190
Blue	5081-1191
Green	5081-1192
Black	5081-1193

Graph Paper (box of 100 sheets)

Graph Paper (box of 100 sheets)	Plot Area	HP Part Number
Linear	25 cm × 38 cm	9270-1024
Linear	10 in. × 15 in.	9270-1004
Linear	18 cm × 25 cm	9270-1023
Linear	7 in. × 10 in.	9270-1006
Semi-Log	10 in. × 2 cycle	9280-0159
Semi-Log	10 in. × 3 cycle	9280-0160
Semi-Log	2 cycle × 15 in.	9280-0169
Semi-Log	3 cycle × 15 in.	9280-0168
Log-Log	2 cycle × 3 cycle	9280-0167
Log-Log	3 cycle × 2 cycle	9280-0165
Log-Log	3 cycle × 4 cycle	9280-0171
Blank (with scaling points)	10 in. × 15 in.	9280-0180

Accessories available

Accessories available	Price
17260A plotter stand (includes mounting plate)	\$110
17261A mounting plate	\$20
17026A Consumable starter kit — English	\$49
17027A Consumable starter kit — Metric	\$55
Carrying/transit case (p/n 9211-1377)	\$226

Options

001: interface to HP 2100 and 21MX Series Computer. Includes all hardware and software. add \$860

910: Extra manual add \$27

7210A Digital Plotter \$3750

DEN discounts available

RECORDERS & PRINTERS

Lab strip chart recorders, plug-in modules

Models 7100B, 7101B, 7127A, 7128A, 17500A thru 17506A

- One and two pen mainframes
- Seven plug-in modules

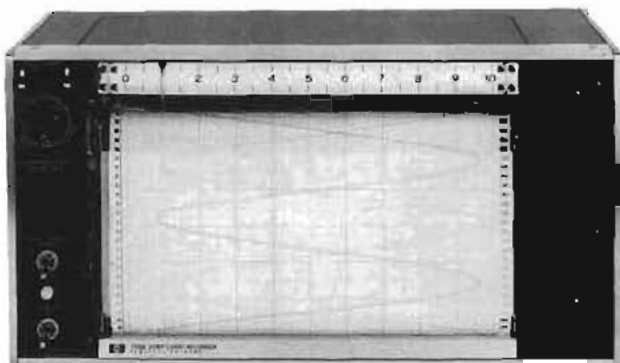

7100B

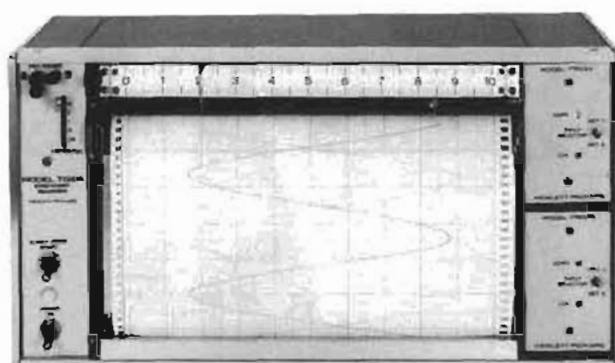

7128A



17500A



17501A



17502A



17505A



17506A

The Hewlett-Packard Models 7100B/7101B and 7127A/7128A Strip Chart Recorders are basic recorder frames containing all the mechanical and electrical elements for strip chart recording. A wide line of interchangeable plug-ins complete their recording ability. Models 7100B and Models 7128A have two independent pens and require two input modules; Model 7101B and Model 7127A are single pen recorders and require one input module.

7100 Series specifications

Performance specifications

Response Time: <0.5 s (50 Hz), <0.6 s

Linearity (terminal based): $\pm 0.1\%$ full scale.

Resetability: $\pm 0.1\%$ full scale.

Chart Speeds:

7100BM/7101BM: 2.5, 5, 15, 30 cm/h; 1.25, 2.5, 5, 15, 30 cm/min; 1.25, 2.5, 5 cm/s.

7100B/7101B: 1, 2, in./h; 0.1, 0.2, 0.5, 1, 2 in./min; 0.1, 0.2, 0.5, 1, 2 in./s

7127A/7128A: 1/4, 1/2, 1, 2 in./min.

Option H01: 6, 12, 24, 48 in./hr.

Option H02: 1 1/2, 3, 6, 12 in./hr.

Chart speed accuracy: synchronous with line frequency.

General specifications

Writing system: servo actuated ink pen (electric writing optional)

Grid width: 25 cm or 10 in.

Chart length: 36 m or 120 ft.

Pen lift: manual (remote optional).

Power: 115/230 V $\pm 10\%$, 60 Hz (50 Hz optional)

7100B/7128A: 65 VA

7101B/7127A: 42 VA

Weight:

7100B/7128A: net, 11.8 kg (26 lb). Shipping, 18.2 kg (40 lb).

7101B/7127A: net, 10.9 kg (24 lb). Shipping, 17.3 kg (38 lb).

Dimensions:

7100B/7101B series (cabinet): 304 mm high, 445 mm wide, 210 mm deep (12" \times 17 1/2" \times 8 1/4").

7100B/7101B (rack): 222 mm high, 483 mm wide, 210 mm deep (8 3/8" \times 19" \times 8 1/4").

7127A/7128A series (cabinet): 231 mm high, 425 mm wide, 210 mm deep (9 1/8" \times 16 1/4" \times 8 1/4"). (Rack: brackets supplied) 222 mm high, 483 mm wide, 210 mm deep (8 3/4" \times 19" \times 8 1/4").

17500A/17501A Specifications

Voltage spans:

17500A: 5, 10, 50, 100, 500 mV; 1, 5, 10, 50, 100 V full scale.

17501A: 1, 2, 5, 10, 20, 50, 100, 200 mV; 0.5, 1, 2, 5, 10, 20, 50, 100 V full scale.

Accuracy: $\pm 0.2\%$ of full scale.

Input resistance: 1 megohm at null on all fixed calibrated and variable spans except 100 k Ω in the variable mode on the four most sensitive spans on the 17500A only.

Interference rejection: dc common mode; 120 dB on the four most sensitive spans of the 17500A and the three most sensitive of the 17501A. Line frequency; 100 dB on the four most sensitive spans of 17500A and the three most sensitive of 17501A.

Zero-set: adj. full scale, plus one full scale of suppression. 5 scales of zero suppression available on the 17501A.

Maximum source impedance: up to 10 k Ω source impedance will not alter the recorder's performance on the four most sensitive spans

of the 17500A and the six most sensitive of the 17501A. No source impedance restrictions on spans above 100 mV fs.

Reference stability: 0.005%/°C.

Weight: net, 0.9 kg (2 lb). Shipping, 2.2 kg (5 lb).

17502A Specifications

Voltage spans: single span to match cold-junction thermocouples of types J, K, R, S, and T.

Accuracy: ±0.5% or ±1°C, (whichever is greater): refer to NBS CIR 561, dated 1955.

Input resistance: potentiometric.

Interference rejection: dc common mode, 120 dB; line frequency, 100 dB.

Weight: net, 1.8 kg (4 lb). Shipping, 3.2 kg (7 lb).

17503A Specifications

Voltage span: 1 mV.

Type of input: floating (500 V dc max) rear input only.

Input resistance: potentiometric.

Maximum allowable source resistance: 5 kΩ

Normal mode rejection: >60 dB at 60 Hz.

Common mode rejection: 120 dB (dc) and 100 dB (60 Hz).

Accuracy: ±0.2% full scale.

Reference stability: 0.005%/°C.

Zero set: ±1 scale.

Weight: net, 0.9 kg (2 lb). Shipping, 2.2 kg (5 lb).

17504A Specifications

Voltage spans: 5 mV thru 100 V, determined by range card, no vernier

Type of input: floating (500 V dc max) rear input only.

Input resistance: 1 MΩ at null on all spans.

Maximum allowable source resistance: 10 kΩ.

Normal mode rejection: >60 dB at 60 Hz.

Common mode rejection: 120 dB (dc) and 90 dB (60 Hz) four most sensitive range cards.

Accuracy: ±0.2% full scale.

Reference stability: 0.005%/°C.

Zero set: ±1 scale, screwdriver adjust.

Weight: net, 0.9 kg (2 lb). Shipping, 2.2 kg (5 lb).

17505A/17506A Specifications

Voltage spans:

17505A: .1, .2, .5, 1, 2, 5, 10, 20, 50, 100, 200, 500 mV; 1, 2, 5, 10, 20, 50, 100 V full scale.

17506A: any one of the above spans (specify).

Accuracy: ±0.25% of full scale.

Input resistance: 1 MΩ at null.

Interference rejection: dc CMR: 120 dB on most sensitive span. Line frequency CMR: 100 dB on most sensitive span. Line frequency normal mode: 17505A: switchable, 60 dB or 100 dB. 17506A: 100 dB.

Zero set: +2, -1.5 scales. Optional calibrated offset of +1 to -10 scales in one scale steps on 17505A.

Zero stability: ±1 μV after one hour.

Maximum source impedance: 10 kΩ on nine most sensitive spans; no source impedance restrictions on spans above 100 mV fs.

Reference stability: 0.005%/°C.

Weight: net, 0.9 kg (2 lb). Shipping, 2.2 kg (5 lb).

7100 Series options

		7100B 7101B	7127A 7128A	Price \$
Retransmitting 5 kΩ Potentiometer	Channel 1	004	014	55
	Channel 2	016	015	55
High-Low Limit Switches (Each limit SPDT with 0.5 A, 30 V dc contacts)	Channel 1	005	001	55
	Channel 2	017	009	55
	Both Channels	018	010	115
Electric writing		019	017	90
Event Marker	Left side: ink	012	004	40
	electric	022	022	40
	Both sides: ink	014	006	80
	electric	023	023	80

Remote Control	Pen Lift Chart ON-OFF	006 007	008 002	55 25
Right Hand Zero	Hard (scale, 10 to 0) Soft (scale, 10 to -0.5) ¹	020 025	020 025	N/C N/C
50 Hz Operation		010	003	N/C
Locking Glass Door		011	013	150
Integrator (Integrates Channel 2 if 2 pen unit) ^{1,2}		015	007	970
Disposable Pen Tips		024	024	N/C
Carrying Handle		Std	011	25
Mint Gray Control Panel		029	029	N/C
Rack mount		908	908	20
Extra manual		910	910	10

1. Not compatible with event marker (right hand), retransmitting potentiometer (Channel 2), or metric calibration.
2. Requires special Hewlett-Packard chart paper.

Plug-in options

17500A/17501A/17502A:

001: 5 scale zero suppression (17501A)

002: calibrated for use with Integrator (8 in. span) (17500A/17501A)

029: mint gray control panel

910: extra manual

17503A:

001: detector Selector Switch

002: 50 Hz

003: calibrated for use with Integrator (8 in. span)

029: mint gray control panel

910: extra manual

17504A:

001: 50 Hz

002: calibrated for use with Integrator (8 in. span)

010-019: range cards (specify opt)

Additional range cards (order by part number)

17505A:

001: +1 to -10 scales of calibrated offset in one scale steps. Accuracy ±0.25% per step

002: calibrated for use with Integrator (8 in. span)

003: 50 Hz

029: mint gray control panel

910: extra manual

17506A:

002: calibrated for use with Integrator (8 in. span)

003: 50 Hz

005-023: spans (specify one)

029: mint gray control panel

910: extra manual

Consumables starter kit

17029A — English — 7100 series

17030A — Metric — 7100BM/7101BM

Price

add \$55

N/C

N/C

add \$5

N/C

N/C

N/C

N/C

add \$5

N/C

N/C

N/C

add \$25 ea.

add \$115

N/C

N/C

N/C

add \$5

N/C

N/C

N/C

N/C

add \$5

\$43

\$46

Model number and name

Single Channel:

7101B, 7101BM Strip chart recorder

7127A Strip chart recorder (English)

Dual Channel:

7100B, 7100BM Strip chart recorder

7128A Strip chart recorder (English)

17500A Multiple span plug-in

17501A Multiple span plug-in

17502A Temperature plug-in

17503A Single span plug-in

17504A Single span plug-in

17505A High sensitivity plug-in

17506A (specify voltage span)

\$1300

\$1130

\$1850

\$1730

\$380

\$435

\$465

\$345

\$320

\$485

\$325



RECORDERS & PRINTERS

Linear motor strip chart recorders

Models 7123A & 7143A

- Low silhouette

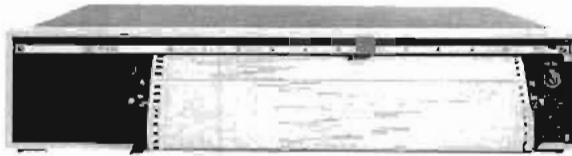

7123A.045,015

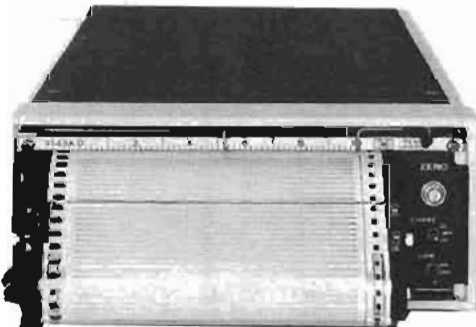

7143A

The Hewlett-Packard Models 7123A and 7143A Strip Chart Recorders are designed specifically for dedicated recording applications. High reliability, excellent performance, plus a large assortment of options allow custom tailoring to each application. These 3½-inch high recorders conserve rack space without sacrificing chart capabilities.

7123A and 7143A Specifications

Performance specifications

Input ranges: single span, 1 mV thru 100 V (specified by option).

Type of input: single ended, floating.

Input resistance: 1 MΩ constant on all spans.

Normal mode rejection (at line frequency): >6 dB (>66 dB with optional filter).

Common mode rejection: >100 dB at dc; >80 dB at line frequency.

Response time: < 1/3 s (< 1/2 s for spans below 1 V) with less than 10 kΩ source impedance.

Overshoot: <1% of full scale.

Accuracy (Including linearity and deadband): 7123A ±0.25% of full scale at 25°C. Temp Coeff 0.01%/°C; 7143A ±0.4% of full scale at 25°C. Temp Coeff 0.01%/°C.

Deadband: 7123A — 0.1% of full scale; 7143A — 0.2% of full scale.

Zero drift: < ±0.2 μV/°C ±0.03% full scale/°C for 7143A; ±0.015% full scale/°C for 7123A.

Reference stability: ±0.002%/°C.

Chart speeds: speed determined by option choice.

Chart speed accuracy: synchronous with line frequency.

Zero set: left hand, adjustable ±1 full scale (right hand optional).

Environmental (operating): 0° to 55°C; 95% relative humidity (40°C).

General specifications

Writing mechanism: disposable ink pen.

Grid width: 7123A — 25 cm (10 in.); 7143A — 12 cm (5 in.).

Chart length: 28.5 metres (95 ft).

Pen lift: manual (remote optional on 7123A).

Dimensions: 7123 — 81 mm × 432 mm × 495 mm (3½" × 17" × 19½"); 7143 — 81 mm × 216 mm × 495 mm (3½" × 8½" × 19½").

Power: 115/230 V ±10%. Option 060 — 60 Hz, 60 VA; Option 050 — 50 Hz, 60 VA.

Weight: 7123A — net, 19 kg (42 lb). Shipping, 23 kg (51 lb). 7143A — net, 11.3 kg (25 lb). Shipping, 15 kg (33 lb).

- Modular design

Options

Span: Must specify one. Front scale determined by Metric or English chart speed.

7123A,7143A	Span	Price	7123A,7143A	Span	Price
001	1 mV	\$165	008	1 V	N/C
002	5 mV	\$165	009	5 V	N/C
003	10 mV	\$115	010	10 V	N/C
004	50 mV	\$115	011	50 V	N/C
005	100 mV	\$115	012	100 V	N/C
006	500 mV	\$115			

Chart speeds: Must specify one basic speed or one basic chart speed and one reducer or one multiple speed.

7123A,7143A	Speed	Price	7123A,7143A	Speed	Price
016	6 in./min	N/C	022	15 cm/min	N/C
017	4 in./min	N/C	023	10 cm/min	N/C
018	1 in./min	N/C	024	5 cm/min	N/C
019	½ in./min	N/C	025	3 cm/min	N/C
020	¼ in./min	N/C	026	15 cm/hr	N/C
021	1 in./hr	N/C	027	3 cm/hr	N/C

Variable speed options: dual speed via speed reducer (not compatible with Options 045, 048, 092).

Options

028: 60:1 Speed reducer*

029: 10:1 Speed reducer*

030: 4:1 Speed reducer*

044: 2:1 Speed reducer*

*The slowest speed must not be less than 2.54 cm (1 in./hr).

Options requiring power supply

041: Option power supply

031: Remote speed change

032: Remote chart on-off (not compatible with Options 045 & 048)

033: Remote pen lift (7123A Only)

040: Limit switches

036: Electric wiring

034: Event marker (right hand) ink

037: Event marker (right hand) electric

Multiple speeds (7123A only)

045: 4 speeds; ¼, ½, 1, 2 in./min plus external input

048: 4 speeds; 0.5, 1, 2.5, 5 cm/min plus external input

Other options and accessories

038: Retransmitting potentiometer (5 kΩ, ±0.5% linearity, 10 V dc max).

007: Input filter, 1 mV thru 5 mV spans

013: Input filter, 10 mV thru 100 V spans

014: RH Zero hard right (scale, 10 to 0)

015: RH Zero soft (scale, 10 to -0.5, 7123 only)

043: Rack slides (7123 only)

035: Chart integrator (7123 only)

Analytical option combinations. (7123A only). The following three options are for analytical applications such as chromatography and include 1 mV span, input filter for added line frequency rejection (60 dB), right hand zero, mint-gray control panels, and chart speeds as indicated.

090: ½ and ¼ in./min

091: 1 and ½ in./min

092: ¼, ½, 1, 2 in./min plus external input (not compatible with Options 028, 029, 030, 031, 032, 044)

908: Rack mount kit (7123 only)

910: Extra manual

17033A Consumable Starter Kit (7123A) — English

17034A Consumable Starter Kit (7123A) — Metric

17035A Consumable Starter Kit (7123A) — English (right hand soft zero)

17048A Consumable Starter Kit (7143A) — English

17049A Consumable Starter Kit (7143A) — Metric

Model number and name

7123A Strip Chart Recorder (25 cm or 10 in.)

7143A Strip Chart Recorder (12 cm or 5 in.)

Price

\$40

\$40

\$40

\$40

\$45

\$25

\$25

\$40

\$135

\$40

\$45

\$40

\$170

\$170

\$55

\$50

\$30

N/C

N/C

\$75

\$830

\$265

\$265

\$455

\$15

\$15

\$46

\$46

\$44

\$36

\$41

\$1025

\$980

RECORDERS & PRINTERS

Compact strip chart recorder

Model 680

- Multi-range—Compact

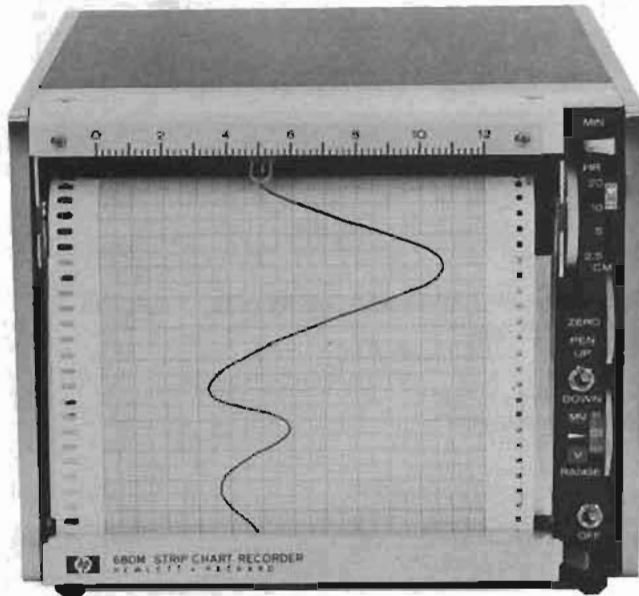

680M

The Hewlett-Packard Model 680 12 cm (5 in.) strip chart recorders provide high accuracy and fast response for a wide range of performance for general or specialized use. The 680 is equipped with multi-range spans, multispeed chart transport, full range zero set, and electric pen lift. The instrument is useful as a monitor for instrumentation with dc outputs and for digital devices utilizing digital to analog converters.

Features include modular construction with all-transistor circuitry, synchronous motor chart drive, and full-view tilting chart magazine.

680 Specifications

Performance specifications

Spans: ten calibrated spans; Metric — 6, 12, 60, 120, 600 mV; 1.2, 6, 12, 60, 120 V (English — 5, 10, 50, 100, 500 mV; 1, 5, 10, 50, 100 V).

Type of input: input floating with respect to ground.

Maximum dc common mode voltage: 500 V.

Input resistance: 200 k Ω /V (166 k Ω /V, metric models) full scale, through 10 V span; 2 M Ω on all others. Constant 100 k Ω input resistance on all spans, Option H02.

Common mode rejection: dc 100 dB on most sensitive range. Decreases 20 dB per decade step in attenuation.

Accuracy: $\pm 0.2\%$ of full scale.

Response time: maximum, 0.5 s full scale.

Repeatability: 0.1% of full scale.

Chart speed: synchronous motor driver; Metric — 2.5, 5, 10, 20 cm/min; 2.5, 5, 10, 20 cm/hr (English — 1, 2, 4, 8 in./min; 1, 2, 4, 8 in./hr). Option 008, gear ratio 16/1 instead of 60/1 speeds — $\frac{1}{16}$, $\frac{1}{8}$, $\frac{1}{4}$, $\frac{1}{2}$, 1, 2, 4, 8 in./min.

Zero set: adjustable over full span.

General specifications

Writing mechanism: ink. (Electric writing optional.)

Pen lift: electric, controlled by local switch or remote contact closure.

Power: 115/230 V, 60 Hz, 22 VA.

- High accuracy, fast response

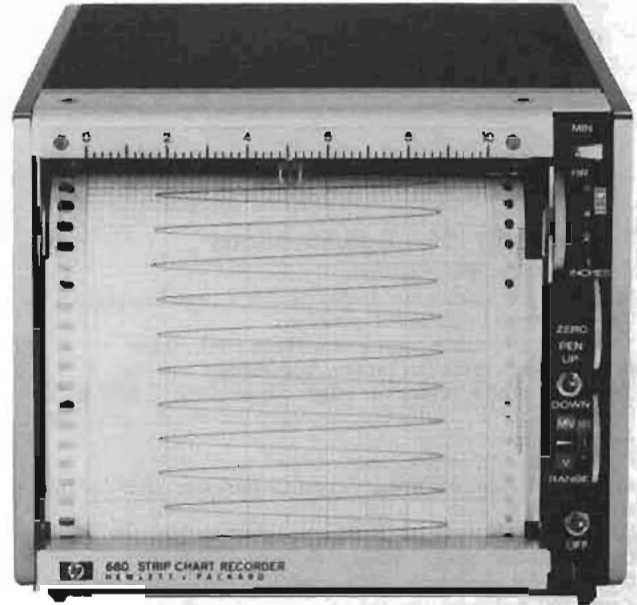

680

Weight: nct, 5 kg (11 lb); shipping 7.6 kg (17 lb).

Dimensions: 165 mm H \times 197 mm W \times 219 mm D ($6\frac{1}{2}$ " \times $7\frac{1}{4}$ " \times 8 $\frac{3}{4}$ ").

Accessory kit supplied with each instrument—Ink Writing:

1. Slidewire cleaner, slidewire lubricant, remote pen lift connector, spare pen, pen cleaning wire, four cartridges each of red ink and blue ink.
2. One roll of graph paper.
3. Power Cord 2.1 m (7 ft).
4. Fuse, $\frac{1}{4}$ Amp 125 V SB
5. Instruction Manual.

Options and accessories

001: With installed 5 k Ω , 0.1% linearity retransmitting potentiometer

Price

add \$75

002: With ink event marker installed

add \$65

003: With installed high-low limit switches

add \$105

008: With 16/1 instead of 60/1 speed reducer

add \$25

009: With remote chart drive switch

add \$25

010: For 50 Hz operation

N/C

014: Glass door with lock

add \$125

015: Electric writing

add \$100

018: Event marker, electric writing

add \$45

018: Disposable pen tips

N/C

H01: 1 mV span added (H01-680)

add \$55

1.2 mV span added (H01-680M)

add \$55

H02: 100 k Ω input resistance, all spans

add \$90

Note: Options H01 and H02 not compatible.

17046A Consumable starter kit — English

\$33

17047A Consumable starter kit — Metric

\$38

Model number and name

680M Strip chart recorder (metric)

\$1175

680 Strip chart recorder (English)

\$1175

OEM discounts available.

RECORDERS & PRINTERS

OEM 10-inch strip chart recorders

Models 7130A & 7131A

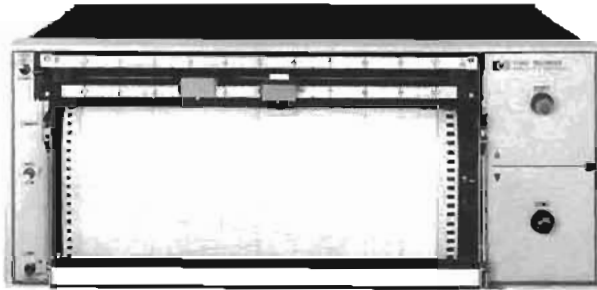

7130A

The Model 7130A is a 10-inch, two-pen recorder; the 7131A is a 10-inch, one-pen recorder. Spans and chart speeds are selected by options.

7130A and 7131A Specifications

Performance specifications

Input ranges: single span, 1 mV thru 100 V (specified option).

Type of input: single ended, floating.

Maximum allowable source resistance (R_s): 10 kΩ.

Normal mode rejection (at line frequency): >40 dB

Common mode rejection: >120 dB at dc & >100 dB at line frequency.

Response time: <1/2 sec

Overshoot: <2% of full scale

Accuracy (including linearity and deadband): ±0.2% of full scale at 25°C.

Deadband: ±0.1% of full scale.

Chart speeds: speed determined by option choice.

Chart speed accuracy: ±0.08% plus line frequency accuracy

Zero set: left hand, adjustable ±1 full scale (right hand optional).

Environmental (operation): 0°C to 55°C, 95% RH (40°C).

General specifications

Writing mechanism: disposable ink pens (thermal writing option).

Grid width: 25 cm or 10 in.

Chart length: 24 metres or 80 ft.

Pen lift: manual (electric or independent optional).

Dimensions: 178 mm high, 432 mm wide, 340 mm deep (7" × 17" × 13 1/2").

Power: 7130A, 7131A: 115/230 V ±10%, 60 Hz, 120 VA.

7130B, 7131B: 115/230 V ±10%, 50 Hz, 120 VA.

Weight: net, 12.3 kg (27 lb), Shipping, 17.4 kg (38 lb).

Accessory kits: two-channel (7130A), 07130-60055; one-channel (7131A), 07131-60109; thermal writing (7130A/7131A), 07130-60068.

Span: must specify one for each channel; spans may be different. The front scale is determined by choice of English or metric chart speed. The 500 series options are for the lower channel of the 7130A only.

Option				Option			
Span	Upr Chnl	Lwr Chnl	Price	Span	Upr Chnl	Lwr Chnl	Price
1 mV	001	501	\$165	1 V	008	508	N/C
5 mV	002	502	165	5 V	009	509	N/C
10 mV	003	503	115	10 V	010	510	N/C
50 mV	004	504	115	50 V	011	511	N/C
100 mV	005	505	115	100 V	012	512	N/C
500 mV	006	506	115				

Chart speeds: must specify one basic speed.

Speed	Option	Price	Speed	Option	Price
6 in./min	016	N/C	15 cm/min	022	N/C
4 in./min	017	N/C	10 cm/min	023	N/C
1 in./min	018	N/C	5 cm/min	024	N/C
1/2 in./min	019	N/C	3 cm/min	025	N/C
1/4 in./min	020	N/C	15 cm/hr	026	N/C
1 in./hr	021	N/C	3 cm/hr	027	N/C

Speed reducers:

Option	Price	Option	Price
60:1 Speed Reducer*	028 \$45	4:1 Speed Reducer*	030 \$45
10:1 Speed Reducer*	029 \$45	2:1 Speed Reducer*	031 \$45

*The slowest speed resulting from the addition of a speed reducer must not be less than 2.54 cm/hr (1 in./hr)

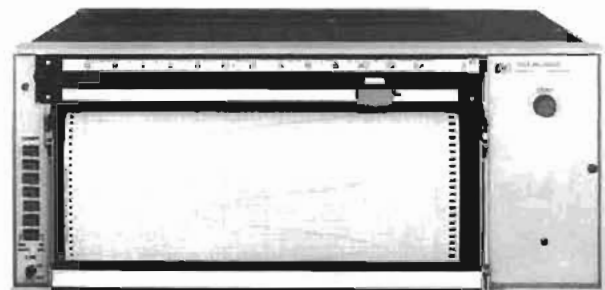

7131A

Multiple speeds

4 speed: 1/4, 1/2, 1, 2 in./min, plus extern input

4 speed: 0.625, 1.25, 2.5, 5 cm/min plus external input

Option Price

046 \$165

049 \$165

Options requiring option power supply

Option Power Supply

Option

041 \$60

8 chrt spds: 1, 2, 4, 6 in./min & hr + ext inpt

045 \$195

8 chrt spds: 2.5, 5, 10, 15 cm/min & hr + ext inpt

048 \$195

Remote Speed Change*

032 \$20

Remote Chart On-Off*

033 \$50

Remote Pen Lift*

036 \$45

Right Hand Event Marker

(not compatible with option 054)

037 \$70

Right Hand Event Marker Thermal

(must order option 054)

038 \$100

Left Hand Event Marker*

537 \$70

*Actuated by contact closure to ground or TTL levels. Closed circuit current 15 mA (maximum), open circuit voltage +1.5 V minimum.

Other Options:

	Upr Chnl	Lwr Chnl	
Retransmitting Potentiometers	040	540	\$75
Limit Switches*	044	544	\$150
Input Filter (1-500 mV)	007	507	\$50
Right Hand Zero Hard, Scale 10 to 0		014	N/C
Right Hand Zero Soft, Scale 10 to -0.5		015	N/C
Independent Mech. Pen Lift (7130 only)		034	N/C
Rack Slides		042	\$75
Capillary Ink Pen & Cartridge		053	N/C
Thermal Writing: Model 7130A**		054	\$200
Model 7131A**		054	\$140
Rear Control Connector		056	\$50
50 Hz & 60 Hz Operation		050, 060	N/C
Rack Mounting Brackets		908	\$15
Extra Manual		910	\$10

*Contact rating 1 amp at 1.5 V, 0.5 amp at 250 V non-inductive

**Recommended for pen speeds below 5 inches per second.

Analytical option combinations: the following options are for analytical applications such as chromatography and include 1 mV span each channel, right hand soft zero, front panel detector switch on the 7131A, and two chart speeds as indicated.

	Option	7130	7131
2 speeds: (1/2 and 1/4 in./min)	090	\$475	\$295
2 speeds: (1 and 1/4 in./min)	091	\$475	\$295
4 speeds: (2, 1, 1/2, 1/4 in./min)	092	\$595	\$380

Accessories

17036A Consumable starter kit — English	\$51
17037A Consumable starter kit — Metric	\$51
17038A Consumable starter kit — English-Thermal	\$47
17039A Consumable starter kit — Metric-Thermal	\$47
17040A Consumable starter kit — English-R.H. soft zero	\$51

Model number and name

7130A OEM Two-Pen Recorder	\$1600
7131A OEM One-Pen Recorder	\$1150

RECORDERS & PRINTERS

Laboratory 10-inch strip chart recorder

Models 7132A & 7133A



- Multi-range attenuators

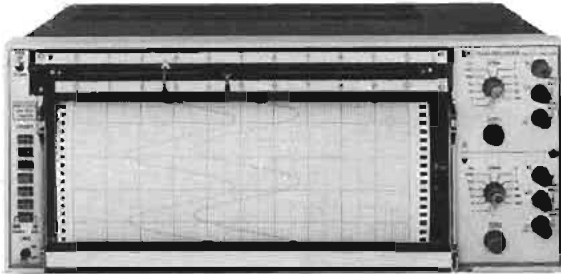

7132A

The Hewlett-Packard Models 7132A two-pen and 7133A one-pen Strip Chart Recorders are laboratory instruments equipped with standard features that qualify them to accommodate your laboratory or scientific application needs.

The 7132A and 7133A are equipped with multi-range attenuators providing eleven input ranges from 1 mV to 100 V full scale in a 1-5-10 sequence. Both models have eight chart speeds of 2.5, 5, 10, 15 cm/minute and 2.5, 5, 10, 15 cm/hour (1, 2, 4, 6 inches per minute and 1, 2, 4, 6 inches per hour). Disposable ink pens are standard. These pens provide a clear, continuous trace, and are easily replaced.

Modular construction facilitates easy removal of the servo module for inspection or maintenance of the drive system, slidewire, or pen lift. The elimination of slip clutches in the servo module contributes to quiet, reliable operation. In addition, should the pen go off scale, the amplifier gain is automatically reduced, preventing noise or damage to the equipment. A stepper motor chart drive eliminates mechanical shifting of gears.

The chart magazine may be adjusted to any of three angles to provide a comfortable writing surface. Chart paper may be automatically rolled up or fed out of the recorder. A convenient front panel indicator lets you know when the paper supply is low.

In addition to multi-range capability, the Models 7132A and 7133A offer as standard features: Eight Chart Speeds, Disposable Pens, Remote Pen Lift, and Remote Chart On/Off.

Options include: Metric Calibration, Right Hand Zero (Hard), Right Hand Event Marker, and 50 or 60 Hz Operation.

7132A and 7133A Specifications

Performance specifications

Input ranges: eleven ranges from 1 mV to 100 V full scale in 1-5-10 sequence with overlapping vernier.

Type of input: single ended, floating.

Input resistance: 1 megohm on all ranges.

Maximum source resistance: 10 k Ω (to within rated response).

Normal mode rejection (at line frequency): greater than 40 dB.

Common mode rejection: greater than 120 dB dc and 100 dB ac.

Accuracy: $\pm 0.2\%$ of full scale (includes linearity and deadband) at 25°C. Temp Coefficient $\pm 0.01\%$ per °C.

Range accuracy: $\pm 0.2\%$ of full scale $\pm 0.2\%$ of deflection (includes linearity and deadband) at 25°C. Temp Coefficient $\pm 0.01\%$ per °C.

Deadband: 0.1% of full scale.

Response time: less than 0.5 second.

Overshoot: less than 2% of full scale.

Chart speeds: 2.5, 5, 10, 15 cm/min, and 2.5, 5, 10, 15 cm/hour (1, 2, 4, 6 inches/minute, and 1, 2, 4, 6 inches/hour).

Chart speed accuracy: $\pm 0.08\%$ plus line frequency accuracy.

Zero set: provides three full scales of offset.

Environmental (operating): 0 to 55°C, less than 95% relative humidity (40°C).

- Disposable pens

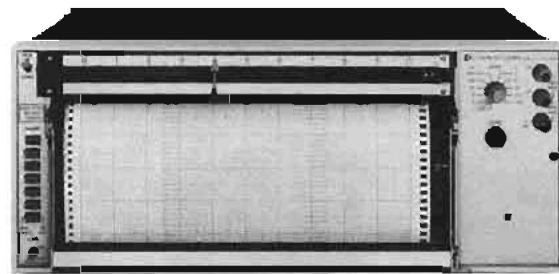

7133A

General specifications

Writing mechanism: disposable ink pens (thermal writing option).

Grid width: 25 cm (10 inches).

Chart length: 30 meters (100 ft).

Pen lift: solenoid operated with remote capabilities.

Power: 115/230 V $\pm 10\%$, 50 or 60 Hz, 120 VA.

Dimensions: 178 mm high, 432 mm wide, 340 mm deep (7" \times 17" \times 13 $\frac{3}{8}$ ").

Weight: net, 12.3 kg (27 lb). Shipping, 17.4 kg (38 lb).

Supplies furnished with each instrument:

1. Accessory kit:	
Disposable Pens — Blue (Package of 3)	07130-62500
Disposable Pens — Red (Package of 3)	07130-62510
Fuse, .75 amp, 250 V, Slow Blow	2110-0379
Plastic Kit Box	1540-0149
Slidewire Cleaner	5080-3605
Flexible Tubing, 0.032 ID, 0.4 ft	0890-0340
Pen Cleaning Assembly	17999-15126
Syringe for Pen Cleaning	17999-09423
2. Operating and Service Manual	07132-90000
3. One roll of Chart Paper	
Chart Paper, English	9280-0444
Chart Paper, Metric	9380-0445
Chart Paper, Thermal — English	9280-0288
Chart Paper, Thermal — Metric	9280-0289
4. Power Cord (2.1 meters or 7 ft)	8120-1378
5. Ink Cartridge, Black (for Event Marker)	07130-60002

Options & accessories

	Price
001: metric calibration. Provides chart speeds of 2.5, 5, 10, and 15 cm per minute, and 2.5, 5, 10, and 15 cm per hour.	N/C
014: Right Hand Zero (Hard) Positive voltage input causes pen to deflect from right to left.	N/C
037: Right Hand Event Marker (not compatible with Opt 054).	\$70
038: Thermal Event Marker (Opt 054 required).	\$100
537: 7132A Only. Left Hand Event Marker (Not Available with Thermal Writing, Option 054).	\$70
050: 50 Hz Line Power	N/C
060: 60 Hz Line Power	N/C
054: Thermal Writing, Model 7132A (recommended for pen speed below 5"/s).	\$200
054: Thermal Writing, Model 7133A	\$140
908: Rack mount brackets	\$15
910: Extra manual	\$10
17037A Consumable starter kit — Metric	\$51
17038A Consumable starter kit — English — Thermal	\$47
17039A Consumable starter kit — Metric — Thermal	\$47
17040A Consumable starter kit — English	\$51

Model number and name

7132A Laboratory Two-Pen Recorder	\$2160
7133A Laboratory One-Pen Recorder	\$1600

RECORDERS & PRINTERS

Portable, battery power strip chart recorder

Model 7155B

- Under 30 pounds with internal battery
- 12 centimeter chart width
- Operates at -28°C to $+65^{\circ}\text{C}$

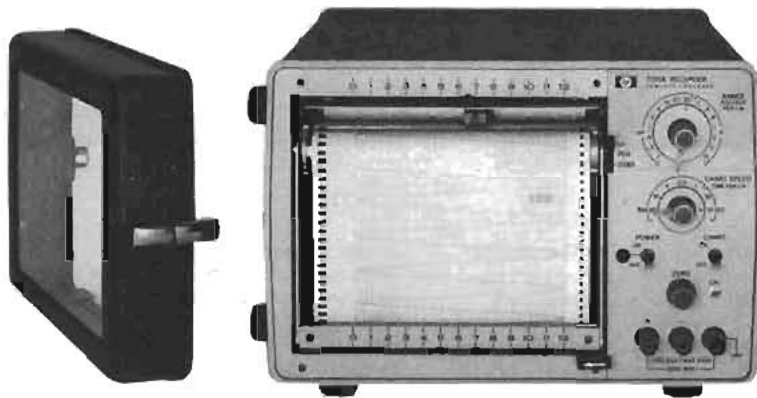

7155B

The Hewlett-Packard 7155B is a 12 cm portable strip chart recorder designed especially for field applications while maintaining laboratory specifications. It is a rugged, light-weight instrument weighing under 30 pounds with the rechargeable battery installed. The standard unit operates on external dc or ac from 48 to 440 Hz. The optional internal battery, which operates for nine hours on a single charge, may be selected. The instrument operates within HP Class A temperature range (-28°C to $+65^{\circ}\text{C}$); a first in the strip chart recording field.

This unit is provided with 16 calibrated spans, seven chart speeds, the totally-electronic transmission that eliminates the need for mechanically shifting the gears, and a sealed jelled electrolyte battery that allows operation in any orientation. Additional standard items include the disposable pen, front plexiglass cover, three chart magazine tilt angles, and easy access to PC boards for serviceability.

7155B Specifications

Performance specifications

Input ranges: 0.1 mV/cm thru 10 V/cm in a 1, 2, 5 sequence with overlapping vernier (12 cm full scale).

Type of Input: single ended, floating.

Input resistance: 1 megohm.

Maximum allowable source resistance: 5 k Ω for rated response.

Common mode rejection: 100 dB dc and 80 dB ac.

Full scale response time: 0.6 sec to within rated accuracy.

Overshoot: 1% of full scale maximum.

Accuracy: $\pm 0.4\%$ of full scale (includes linearity and deadband) at 25°C . Temp Coefficient $\pm 0.01\%$ per $^{\circ}\text{C}$.

Range accuracy: $\pm 0.4\%$ of full scale $\pm 0.2\%$ of deflection (includes linearity and deadband) at 25°C . Temp Coefficient $\pm 0.01\%$ per $^{\circ}\text{C}$.

Chart speeds: 30, 10, 5, 2.5, 1 minute/cm; 30 and 10 sec/cm.

Chart speed accuracy: $\pm 1\%$.

Environmental (operating): -28°C to $+65^{\circ}\text{C}$ <95% relative humidity (40°C).

General specifications

Writing mechanism: disposable ink pens.

Grid width: 12 cm.

Chart length: 21 metres (70 ft).

Pen lift: mechanical.

Weight: net 14 kg (30 lb) with battery option installed.

Power: external ac (48 to 440 Hz, 85 V to 130 V or 172 V to 260 V).
External dc (10.5 to 36 V, 0.5 amp typical 0.9 amp maximum independent of voltage).

Supplies furnished

Part Number	Description
07155-90001	operating and service manual
9280-0278	chart paper, 21.3 m (70 ft)
8120-1538	power cord, 2.3 m (7.5 ft)
07155-80090	accessory kit, includes:
1251-2614	DC connector
2110-0012	0.5 A SLBL fuse
5080-3635	slidewire lubricant
5080-3605	slidewire cleaner
07155-80014	3 red disposable pens
07155-80015	3 red event marker pens (if ordered)

Options and accessories

005: right hand zero
(Positive voltage input causes pen to deflect from right to left).

006: event marker

Contact closure on rear panel causes approximately 0.06 cm (0.025 inch) deflection of event pen. Marking occurs along left hand edge of paper.

008: internal battery

The jelled electrolyte battery operates nine hours on a single charge (at 25°C). Recharging is from external AC only and requires approximately 14 hours to full charge. Instrument may be operated while charging.

910: extra manual

17051A Consumable starter kit

7155B Portable strip chart recorder

Price
N/C

\$120

\$300

\$10

\$54

\$1400

RECORDERS & PRINTERS

Two and four-channel oscillographic recorders

Models 7402A, 7404A, & 17400A series preamps

- Instant drying ink

- Interchangeable plug-ins

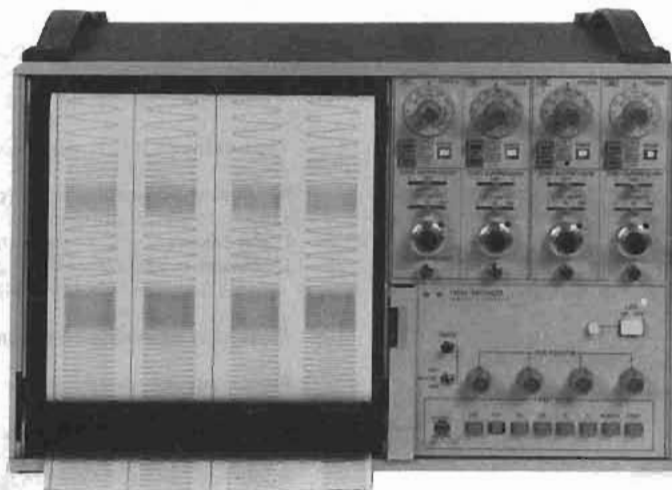

7404A



7402A

The Hewlett-Packard Models 7402A and 7404A are rectilinear, low pressure ink writing oscillographic recorders, which, when used with interchangeable 17400A Series Preamplifiers, measure and record one to four input signals against time. The 7402A Recorder is portable and records on either two 50 mm channels or a single 100 mm channel. The 7404A is a four channel recorder, but will also record on two 80 mm channels.

Clear traces that dry immediately on contact with the paper are produced by the pressurized ink system of these units. The pen is constructed with stainless steel with a tough carbide tip. Pens will last the life of the instrument. Four chart speeds are provided on the 7402A, while 12 are available on the 7404A. Remote control of the chart speed is either by contact closure or TTL.

The 7402A may be equipped with a Left Hand Event Marker (Option 001), Right Hand Event Marker/Timer (Option 002), or Left and Right Hand Event Marker/Timer (Option 003). It may be actuated by a front panel pushbutton labeled MARK or by remote contact closure or TTL through the rear terminal strip. On Option 003, a 1 SEC toggle switch provides one second timing sequences; Option 002 provides marks in second or minute sequences. The 7404A records event marks in Channel 1 (Left Edge) and provides automatic mark-per-second or mark-per-minute sequences when the front panel sec-mark-min

toggle switch is set to SEC or MIN position. A mark may be recorded when the MARKER/TIMER pushbutton is pressed. Additionally, it can be actuated by a remote marker command through a rear panel connector or by remote contact closure or TTL. Event markers for channels 2, 3, and 4 are available as Options 013, 014, and 015, respectively.

Oscillographic recorders with plug-ins can be used to measure parameters such as voltage, pressure, flow, force, displacement, and temperature with respect to time. These recorders can be used in applications such as line production, troubleshooting, or physical measurements.

17400A High gain

This plug-in is equipped to handle all normally encountered dc signal sources. A unique error indicator is included to signal overdriven inputs. It provides 1 μ V/div sensitivity, 1 megohm input resistance, guarded and floated inputs, and calibrated zero suppression.

17401A Medium gain

Stable and solid, this de-coupled preamplifier provides the basic signal conditioning required to cover the majority of applications. The optional calibrated zero suppression supports 1 mV/div maximum sensitivity balance-to-ground inputs.

17402A Low gain

As an economical unit, no compromises are made in basic performance. The single-ended input is available through a conventional rear connector as well as convenient front panel binding posts. Eight calibrated ranges are provided from 20 mV/div to 5 V/div.

17403A AC Carrier

The 17403A supplies excitation of 5 v at 2.4 kHz to the passive transducer and receives the returning transducer output. The 17403A operator with full or half-bridge transducers including transformer, strain gage, and potentiometer types. Front panel selection of nine different input sensitivity ranges from 0.1m V/V full scale is provided. When used, a 2.4 kHz Carrier Frequency Oscillator must be ordered for the mainframe.

17404A DC Bridge

This plug-in supplies dc excitation voltage to the transducer and receives the returning transducer output. Front panel selection of seven input sensitivity ranges from 0.1 mV/div to 10 mV/div are provided.

7402A, 7404A, 17400A Series plug-ins specifications

7402A General specifications

Number of channels: two analog channels. One event marker/timer (optional); one event marker (optional).



17400A



17403A



17402A



17401A

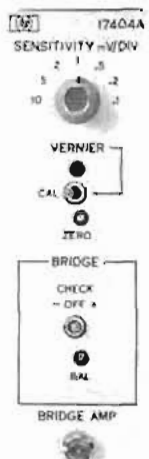

17404A

Chart description: 50 mm wide channels with 50 div full scale. Time lines every 1 mm. Chart length 84 m (275 ft).

Chart speeds: 1, 5, 25, 125 mm/s controlled by front panel, rear panel TTL or contact closure.

Chart speed accuracy (at 25°C): $\pm 0.5\%$ plus power line frequency variation. Temp coeff 0.01%/°C.

Chart weave: ± 0.25 mm maximum.

Zero: adjustable to ± 36 div either side of grid center.

Writing system: blue-black ink with rectilinear presentation; 55 cc replaceable with throw-away cartridge.

Environmental (operating): 0°C to 55°C and up to 95% relative humidity from 25°C to 40°C for mm/s speeds (80% relative humidity for mm/min.)

Power: 115/230 V ac $\pm 10\%$ 60 Hz, 140 VA.

Weight: net, 18.2 kg (40 lb) with 2 17400A's & paper. Shipping, 26.9 kg (59 lb).

Dimensions: 284 mm H, 253 mm W, 384 mm D (11 $\frac{1}{8}$ " \times 9 $\frac{3}{4}$ " \times 15 $\frac{1}{4}$ ").

7404A General specifications

Number of channels: four analog channels. Left hand event marker/timer.

Chart description: 40 mm wide channels with 50 div full scale. Time lines every 1 mm. Chart length 84 m (275 ft).

Chart speeds: 5, 10, 25, 50, 100, 200 mm/s and mm/min controlled by front panel, rear panel TTL or contact closure.

Chart speed accuracy (at 25°C): same as 7402A.

Chart weave: same as 7402A.

Zero: same as 7402A.

Writing system: same as 7402A.

Environmental (operating): same as 7402A.

Power: 100/115/200/230 V ac $\pm 10\%$ 60 Hz, 300 VA.

Weight: net, 31.4 kg (69 lb). Shipping, 43.2 kg (95 lb).

Dimensions: 290 mm H, 438 mm W, 384 mm D (11 $\frac{1}{8}$ " \times 17 $\frac{1}{4}$ " \times 15 $\frac{1}{8}$ ").

17400A with 7402A and 7404A

Input ranges: 1, 2, 5, 10, 20, 50, 100, 200, 500 μ V/div; 1, 2, 5, 10, 20, 50, 100, 200, 500 mV/div; 1, 2, 5 V/div. Continuous vernier between ranges.

Type of Input: differential, floated and guarded. Inputs thru rear connector.

Maximum allowable input (continuous): 500 V dc on 10 mV/div range and above; other ranges 120 V dc or 120 V ac rms.

Input resistance: 1 Megohm (min.)

Common mode rejection: 150 dB dc and 140 dB at line frequency with 1 k Ω source imbalance. 90 dB dc and 80 dB at 60 Hz on 10 mV/div range and above.

Maximum allowable common mode voltage: ± 200 V dc max voltage.

Frequency response: for 10 divisions deflection -3 dB at 110 Hz on 10 μ V/div range and above.

Rise time (typical, 10 to 90% of full scale deflection): 7.5 ns.

Overshoot: less than 2% of full scale.

Accuracy (on calibrated range, at 25°C, includes linearity): $\pm 1\%$ of full scale. Temp Coeff 0.06%/°C. Allows for ability to interchange unit without recalibration.

Range accuracy (at 25°C, includes linearity): $\pm 1\%$ of full scale $\pm 0.2\%$ of reading. Temp Coeff 0.06%/°C. Allows for ability to interchange unit without recalibration.

Zero suppression: 1, 10, 100 V on 10 mV/div range and above; other ranges 1, 10, 100 mV. Continuous calibrated vernier between suppression steps.

Zero suppression accuracy: $\pm 0.5\%$ of suppression $\pm 0.5\%$ of full scale. $\pm 0.02\%$ /°C.

17401A with 7402A and 7404A

Input ranges: 1, 2, 5, 10, 20, 50, 100, 200, 500 mV/div; 1, 2, 5 V/div. Continuous vernier between ranges.

Type of Input: balanced to ground. Inputs thru rear connector.

Maximum allowable input (continuous): 230 V rms on 500 mV/div range and above; other ranges 120 V rms.

Input resistance: 1 Megohm (min.)

Common mode rejection: greater than 50 dB dc to line frequency with 100 ohm source imbalance.

Maximum allowable common mode voltage: 250 V dc or peak ac on 500 mV/div and above; other ranges 15 V dc or peak ac.

Frequency response: 7402A — For 10 div deflection -3 dB at 140 Hz; 7404A — For 10 div deflection -3 dB at 150 Hz.

Rise time (typical, 10 to 90% of full scale deflection): 7 ns.

Overshoot: less than 2% of full scale.

Accuracy (on calibrated range, at 25°C, includes linearity): $\pm 1\%$ of full scale. Temp Coeff 0.06%/°C. Allows for ability to interchange unit without recalibration.

Range accuracy (at 25°C, includes linearity): $\pm 1\%$ of full scale $\pm 0.2\%$ of reading. Temp Coeff 0.06%/°C. Allows for ability to interchange unit without recalibration.

Zero suppression: (optional) 0.2, 2, 20 V. Continuous calibrated vernier between suppression steps.

Zero suppression accuracy: $\pm 0.5\%$ of suppression $\pm 0.5\%$ of full scale. $\pm 0.02\%$ /°C.

17402A with 7402A and 7404A

Input ranges: 20, 50, 100, 200, 500 mV/div; 1, 2, 5 V/div. Continuous vernier between ranges.

Type of Input: single ended. Inputs thru front or rear connector.

Maximum allowable input (continuous): 230 V rms on 200 mV/div range and above; other ranges 120 V rms.

Input resistance: 1 Megohm (min.)

Frequency response: 7402A — For 10 div deflection -3 dB at 140 Hz; 7404A — For 10 div deflection -3 dB at 150 Hz.

Rise time (typical, 10 to 90% of full scale deflection): 7 ns.

Overshoot: less than 2% of full scale.

Accuracy (on calibrated range, at 25°C, includes linearity): $\pm 1\%$ of full scale. Temp Coeff 0.06%/°C. Allows for ability to interchange unit without recalibration.



Range accuracy (at 25°C, includes linearity): $\pm 1\%$ of full scale $\pm 0.2\%$ of reading. Temp Coeff $0.06\%/^{\circ}\text{C}$. Allows for ability to interchange unit without recalibration.

17403A with 7402A and 7404A

Input ranges: 0.1, 0.2, 0.5, 1, 2, 5, 10, 20, 50 mV/V full scale. Continuous vernier between ranges. Also provides division of above sensitivities by 100.

Type of input: differential, floating.

Maximum allowable input (continuous): 50 V rms at 2.4 kHz.

Input resistance: 100 k at 2.4 kHz.

Common mode rejection: 120 dB dc to line frequency with 1 k Ω source imbalance.

Maximum allowable common mode voltage: ± 200 V dc or peak ac.

Frequency response: 7402A — For 10 div deflection -3 dB at 140 Hz; 7404A — For 10 div deflection -3 dB at 150 Hz. For Preamp only — output available on rear of recorder. Filter switch to 50 -3 dB at 50 Hz; rolloff 40 dB/decade. Filter switch to 200 -3 dB at 200 Hz; rolloff 40 dB/decade. Filter switch to AVG — Time constant 1.0 s $\pm 10\%$ dc to 0.16 Hz; rolloff 20 dB/decade.

Rise time (typical, 10 to 90% of full scale deflection): preamp filter switch to 50 or 200; 7.5 rms. Preamp filter switch to AVG; 1 s.

Overshoot: less than 2% of full scale.

Accuracy (on calibrated range, at 25°C, includes linearity): $\pm 0.6\%$ of full scale at 25°C. Temp Coeff $0.06\%/^{\circ}\text{C}$.

Range accuracy (at 25°C, includes linearity): $\pm 0.6\%$ of full scale $\pm 0.2\%$ of reading. Temp coeff $0.06\%/^{\circ}\text{C}$.

Zero suppression: ten turn control from 0 to 100% of full scale.

Zero suppression accuracy: 0.5% of setting $\pm 0.5\%$ of full scale.

Drift (zero line referenced to input): ± 0.2 $\mu\text{V}/\text{V}/\text{week}$ (includes excitation drift).

Source resistance: compensated by front panel adjustment.

Balance controls: R Balance ± 5 mV/V. Temp Coeff. ± 0.3 mV/V $^{\circ}\text{C}$. C Balance ± 7 mV/V. Temp Coeff ± 1.8 $\mu\text{V}/\text{V}/^{\circ}\text{C}$.

Quadrature rejection: 40 dB at 2.4. Quadrature tolerance: 2:1.

Transducer excitation: full Bridge — 5.0 V rms $\pm 5\%$, 2.4 kHz $\pm 3\%$. Half Bridge — One half full bridge excitation.

Excitation load resistance: 100 ohms min. (Unlimited output short circuit duration.)

17404A with 7402A and 7404A

Input ranges: 0.1, 0.2, 0.5, 1, 2, 5, 10 mV/div with overlapping vernier between ranges.

Type of input: differential, floating and guarded.

Maximum allowable input (continuous): 17 V dc or peak ac.

Input resistance: 100 k (min).

Common mode rejection: 100 dB dc and 80 dB at line frequency with 1 k source imbalance.

Maximum allowable common mode voltage: ± 165 V dc or peak ac.

Frequency response: 7402A — For 10 div deflection -3 dB at 140 Hz; 7404A — For 10 div deflection -3 dB at 150 Hz. Amplifier only (output available on rear of recorder). -3 dB at 3 kHz.

Rise time (typical, 10 to 90% of full scale deflection): 7 ms.

Overshoot: less than 2% of full scale.

Accuracy (on calibrated range, at 25°C, includes linearity): $\pm 1.0\%$ of full scale at 25°C (excludes excitation supply errors). Temp Coeff. $0.06\%/^{\circ}\text{C}$.

Range accuracy (at 25°C, includes linearity): $\pm 1.0\%$ of full scale at 25°C (excludes excitation supply errors). Temp Coeff $0.06\%/^{\circ}\text{C}$.

Drift (zero line referenced to input): ± 0.2 $\mu\text{V}/\text{V}/\text{week}$ (includes excitation drift).

Source resistance: 1 k Ω max.

Balance controls: unloaded bridge completion board. Front panel balance and cal controls (balance up to 5 V).

Transducer excitation: 5 V dc $\pm 1.0\%$.

Excitation load resistance: 50 ohms min. (Unlimited output short circuit duration.)

Accessories supplied

Description	HP Part Number
1. Operating and Service Manual (Model 7402A)	07402-90001
Operating and Service Manual (Model 7404A)	07404-90000

2. Chart Paper (One 275 ft (84 m) roll) — 7402A	9280-0258
Chart Paper (One 275 ft (84 m) roll) — 7404A	9280-0293
3. Ink Cartridge (55 cc, installed)	
For Model 7402A without Option 009	07402-60008
For 7404A or 7402A with Option 009	07402-60066
4. Rear Plug-in Connectors (2 each 7402A, 4 each 7404A)	1251-1895
5. Power Cord (7.5 ft (2.3 m))	8120-1378
6. Miscellaneous Fuses (spares for internal supplies)	
7. Pen Cleaning Wires	17999-15126
8. Ink Line Plugs, 3 each	07402-20048
9. 4 oz. (118 cc) Bottle of Ink Cleaner	07402-60040

Supplies/accessories available

Description	HP Part Number
7402A Paper: 275 ft (84 m) roll, two 50 mm channels	9280-0258
7402A Paper: 275 ft (84 m) roll, one 100 mm channel	9280-0276
7404A Paper: 275 ft (84 m) roll, four 50 div channels	9280-0293
7404A Paper: 275 ft (84 m) roll, two 100 div channels	9280-0294
Ink Cartridge (55 cc) for 7402A without Option 009	07402-60008
Ink Cartridge (55 cc) for 7404A & 7402A with Option 009	07402-60066
Mobile cart for 7404A	1064A-018
Input Adapter Plug	17133A

Field Installation Kits as follows:

Rack Mounting Kit for 7402A	07402-60023
Rack Mounting Kit for 7404A	07404-60074
Rack Mounting Kit for 7404A in 1064A-018 Cart	07404-60082
Paper Take-up Kit for 7402A	07402-60022
Paper Take-up Kit for 7404A	07404-60076
Hard Cover Kit for 7402A	07402-60062
Hard Cover Kit for 7404A	07404-60072
Option 011 Circuit Board for Models 7402A/7404A	07402-60252

7402A Options

001: Event marker (left hand)	add \$100
003: Event marker (left hand) and event marker/timer (right hand) for 1 s intervals.	add \$200
004: 50 Hz power line operation	N/C
005: Paper take-up (external)	add \$150
008: Event marker/timer (right hand) for minutes and seconds (not compatible with Options 001 or 003)	add \$175
009: 60:1 speed reducer	add \$225
010: Hard cover (not compatible with Option 005 or 908)	add \$50
011: 2.4 kHz oscillator for use with 17403A	add \$50
908: Rack mount adapter	add \$120

7404A Options

004: 50 Hz power line operation	N/C
005: Paper take-up (external)	add \$200
010: Hard cover (not compatible with Option 005, 012 or 908)	add \$75
011: 2.4 kHz oscillator for use with 17403A AC Carrier	add \$50
012: Rack mount adapter for use with 1064A mobile cart	add \$75
013: Channel 2 event marker	add \$65
014: Channel 3 event marker	add \$65
015: Channel 4 event marker	add \$65
908: Rack mount adapter	add \$150

Model number and name

7402A Mainframe (less plug-ins)	\$2275
7404A Mainframe (less plug-ins)	\$4160
17400A High Gain Preamplifier	\$785
17401A Medium Gain Preamplifier	\$275
17401A-Option 001 (Zero suppression)	add \$140
17402A Low Gain Preamplifier	\$170
17403A AC Carrier Preamplifier	\$730
17404A DC Bridge Amplifier	\$530
17052A Consumables Starter Kit — 7402A	\$45
17053A Consumables Starter Kit — 7404A	\$54

RECORDERS & PRINTERS

Two, four and eight-channel oscillographic recorders

Models 7702B, 7414A, 7418A & 8800 series signal conditioners

- Versatile configurations
- Thermal writing

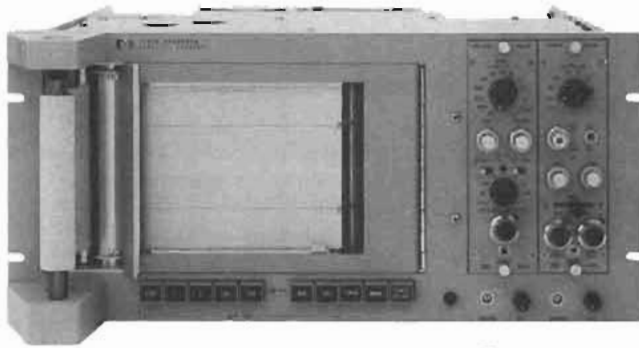

7702B

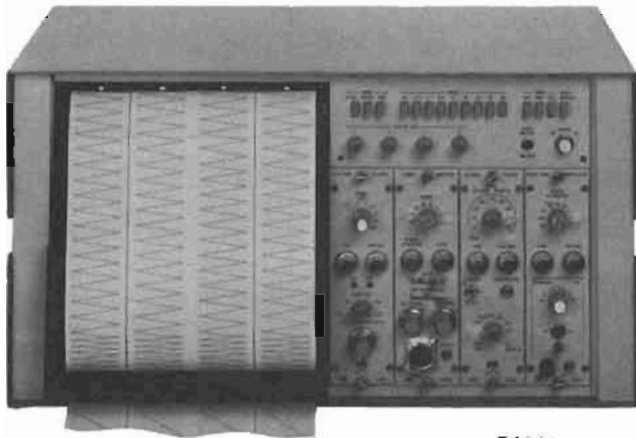

7414A

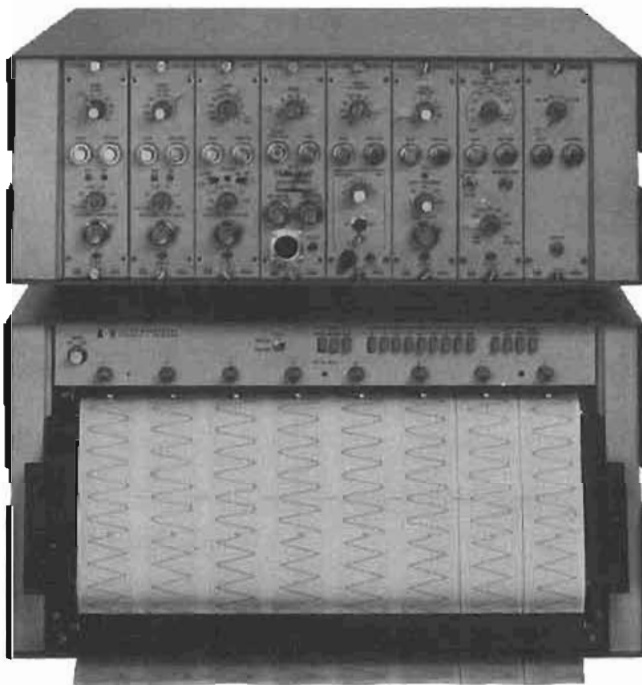

7418A

The Hewlett-Packard Models 7702B 2-channel, 7414A 4-channel, and 7418A 6- and 8-channel Oscillographic Recorders provide permanent reproducible records of multichannel, real-time, low frequency data. They can be contained in a single benchtop package, a mobile cart, or in an upright cabinet. The unit selected, depending upon channel needs, represent a unique combination of reliability, high performance, and flexibility. A complement of the 8800 Series Plug-In Signal Conditioners result in a system capable of meeting many measurement requirements.

Thermal writing tips in Models 7414A and 7418A, featuring long stylus life and rectilinear presentations, are provided. A 500-sheet, Z-fold chart paper pack loads easily, allows for convenient data review, and storage capability. Two event markers are supplied. One is activated by either a one-second or one-minute front panel timer button, the other by the event button. Both markers can be activated remotely.

7702B, 7414A, 7418A, 8800 Series plug-in specifications

7702B General specifications

Chart speeds: 1, 5, 20, and 100 mm/sec; plus eight optional.

Markers: event-right side marker standard, center marker optional.

Chart paper: two 50 mm wide channels each with 50 div; time lines every 1 mm; roll type Permapaper®.

Paper loading and takeup: front panel loading and paper take-up.

Power: 115/230 V ac $\pm 10\%$, 60 Hz, 230 VA (includes plug-ins), 50 Hz optional.

Dimensions: height, 22.2 cm (8.75 in.); width 48.3 cm (19 in.); depth 43.8 cm (17.25 in.) for standard rack. For Portable Case — height, 23.5 cm (9.25 in.), width 49.8 cm (19.6 in.), depth 54.6 cm (21.5 in.). For Mobile Cart, height, 99.7 cm (39.25 in.), width 68 cm (26.75 in.), depth 52.1 cm (20.50 in.).

Weight: 27.2 kg (60 lb) for rack mount; 40.4 kg (89 lb) in Portable Case; 59 kg (130 lb) in Mobile Cart.

7414A General specifications

Chart speeds: 0.25, 0.5, 1.0, 2.5, 10, 25, 50, 100 mm/s. Speed regulation $\pm 1\%$. Paper weave less than 0.5 mm. Speed selected via front panel pushbuttons.

Limiting: electrical limiting keeps stylus within a range of 1.5 mm beyond edge of channel.

Markers: event — local or remote control (monopolar), located on right side, between channels 3 and 4. Timed — 1 min or 1 sec interval (monopolar), located on left side, between channels 1 and 2.

Chart paper: four 40 mm wide channels each with 50 div; time lines every 1 mm; heat sensitivity Z-fold Permapaper® with green grid lines available in packs of 500 sheets, each 30 cm (12 in.).

Paper loading: no threading required.

Remote operation: rear panel connector provides for chart drive and event marker.

Power: 115/230 V ac $\pm 10\%$, 60 Hz, 350 VA (includes plug-ins), 50 Hz optional.

Dimensions: height, 29 cm (11 in.); width, 48 cm (19 in.) for standard rack. Depth, 57 cm (23 in.). Projection, 6 cm (3 in.) from rack front.

Weight: net, 50.5 kg (112 lb). Shipping, 59.5 kg (132 lb).

7418A General specifications

Chart speeds: 0.5, 1, 2.5, 5, 10, 25, 50, 100, 200 mm/sec. Speed regulation $\pm 1\%$. Paper weave less than 0.5 mm. Speed selected via front panel pushbuttons.

Remote operation: rear panel connector provides for chart drive and event marker, optional extra markers. Remote connector supplies — 20 V.

Power: 115/230 V ac $\pm 10\%$, 60 Hz. Recorder only 575 VA; system plug-ins 695 VA.

Dimensions: height, 29 cm (11 in.); width, 48 cm (19 in.) for standard RETMA equip rack. Depth 57 cm (23 in.). Projection 6 cm (3 in.) from front of rack.

Weight: 50 kg (110 lb) including driver amplifiers.



8801A



8802A



8803A



8805A

8801A with 7701B, 7414A and 7418A

Input ranges: 5, 10, 20, 50, 100, 200, 500, 1000 mV/div; accuracy $\pm 1\%$.
Max calibrated sensitivity and max fs Input: 5 mV/div (gain 20) 250 V.
Input circuit & input frequency range: resist. 500 k Ω $\pm 1\%$ each side bal to gnd; parallel with approx. 100 pF.
Rise time (10 div, 10-90%, 4% overshoot): 5 ms.
Calibration (referred to input): 100 mV, $\pm 1\%$, internal.
Output frequency response (-0.5 dB at 50 div): 50 Hz.
Zero suppression: ± 10 and ± 100 V for single-ended or diff. signals. 10-T pot sets precise values of zero suppression voltages; ± 50 V max suppress on 5, 10, 20, mV/div ranges; max error of suppression $\pm 0.5\%$ of suppression range, and 1% of indicated suppression.
Output noise, max (less trace width): 0.2 div, p-p.
Zero drift, 20° to 40°C, 103 to 127 V (less trace width): temp — 1.25 div/10°C, 0.5 div/hr, constant ambient. Line voltage — 0.15 div.
Common mode rejection and tolerance: 48 dB min, dc to 150 Hz; ± 50 V max on other ranges for $< 1\%$ change in differential sensitivity.
Output linearity (less trace width): 0.25 div, after calibration for zero error to center scale $+20$ div.

8802A with 7702B, 7414A and 7418A

Input ranges: 1, 2, 5, 10, 20, 50, 100, 200, 500, 1000 mV/div; accuracy $\pm 1\%$.
Maximum calibrated sensitivity and max fs Input: 1 mV/div (gain 100) 50 V.
Input circuit and input frequency range: resist 180 k Ω $\pm 1\%$, each side bal to gnd, parallel with approx. 100 pF.
Rise time (10 div, 10-90%, 4% overshoot): 5 ms.
Calibration (referred to input): 20 mV, $\pm 1\%$, internal.
Output frequency response (-0.5 dB at 50 div): 50 Hz.
Zero suppression: ± 2 V and 20 V for single-ended or differential signals; 10-T pot sets precise values of zero suppression voltages; ± 12.5 max suppression on -1, 2, 5 mV/div ranges; max error of suppression $\pm 0.5\%$ of suppression range and 1% of indicated suppression.
Output noise, max (less trace width): 0.2 div, p-p.
Zero drift, 20° to 40°C, 103 to 127 V (less trace width): same as 8801A.
Common mode rejection and tolerance: 48 dB min, dc to 60 Hz, 1000 mV/div range; 48 dB min, dc to 150 Hz other ranges ± 12.5 V on 1, 2, 5 mV/div ranges; ± 125 V on 10, 20, 50 mV/div ranges; ± 500 V max other ranges for less than 1% change in differential sensitivity.
Output linearity (less trace width): same as 8801A.

8803A with 7702B, 7414A and 7418A

Input ranges: 1, 2, 5, 10, 20, 50, 100, 200, 500, 1000, 2000, 5000 μ V/div; 10, 20, 50, 100, 200, 500, 1000, 2000, 5000 mV/div; accuracy $\pm 1\%$ on 5000 μ V/div to 20 μ V/div ranges, $\pm 2\%$ on 10 μ V/div to 1 μ V/div; accuracy of $\times 1000$ attenuator $\pm 1\%$.
Maximum calibrated sensitivity and max fs Input: 1 μ V/div (gain 100,000) 250 V.
Input circuit and input frequency range: 1 M Ω min on μ V range,

independent of gain; 5 M Ω on mV range; floating and guarded.
Rise time (10 div, 10-90%, 4% overshoot): 5 ms, 6% overshoot.
Calibration (referred to input): 200 μ V $\pm 1\%$ internal on μ V/div range; 200 mV $\pm 1\%$ internal on mV/div range.
Output frequency response (-0.5 dB at 50 div): 50 Hz.
Zero suppression: μ V ranges ± 1 , ± 10 , ± 100 mV; mV ranges ± 1 , ± 10 , ± 100 V, 10-T pot sets precise values of zero suppression voltages; accuracy $\pm 1\%$ suppression range.
Output noise, max (less trace width): 1.5 mm p-p at 1 μ V/div; 0.1 div, p-p min gain.
Zero drift, 20% to 40%, 103 to 127 V (less trace width): temp — μ V range 1 μ V/10°C referred to input, ± 0.26 div/10°C for 0 output & ± 0.65 div/10°C for fs output. mV range, 1 mV/10°C referred to input, ± 0.26 div/10°C for 0 output. Line voltage 0-0.07 div; fs 0.35 div.
Common mode rejection and tolerance: μ V range, max source unbal of 1 k Ω ; 160 dB min at dc, 120 dB min at 60 Hz; mV range, max source unbal of 500 k Ω ; 100 dB min at dc, 60 dB min at 60 Hz dc. 300 V pk; 60 Hz. 1 μ V/div, 10 V rms; 2 μ V/div, 20 V rms; 5 μ V/div, 50 V rms; 10 μ V/div and 10 mV/div, 100 V rms; 20 μ V to 5000 μ V/div and 20 mV to 5000 mV/div, 200 V rms.
Output linearity (less trace width): 1 mV range 0.35 div, others 0.25 div after calibrating for zero error at center scale and $+20$ div.

8805A/B with 7702B, 7414A and 7418A

Input ranges: $\times 1$, 2, 5, 10, 20, 50, 100, 200; accuracy $\pm 2\%$.
Maximum calibrated sensitivity and max fs Input: 10 μ V rms/div (gain 10,000 rms ac to dc); 100 mV rms.
Input circuit and input frequency range: input impedance — 8805A approx. 10 k Ω ; 8805A 1 μ l $\pm 10\%$; single-ended. Min load resistance across excitation 100 Ω . Max impedance in series with input (transducer output impedance) \leq k Ω . Excitation — floating source 5 V rms nominal at 2400 Hz $\pm 2\%$. Internal full bridge — half bridge switch grounds C.T. of excitation for use with half bridge transducer.
Rise time (10 div, 10-90%, 4% overshoot): 5.6 ms.
Calibration (referred to input): 2% $\pm 0.02\%$ of transducer fs output. Adjust by Cal Factor control; accuracy ± 55 μ V/V out of 10 mV/V. 8805B switchable Cal voltage to 2%, 10%, 50%, or 100% $\pm 1\%$ of fs.
Output frequency response (-0.5 dB at 50 div): 50 Hz.
Zero suppression: 0—100% of transducer full load rating, for transducers having Cal Factor up to 10 mV/V at full load, 10-T pot with calibration dial; accuracy — 1 dial div $\pm 0.5\%$ of suppress range. Zero Supp Polarity switch, Separate R Bal control allows bucking of in-phase unbal to ± 3 mV/V regardless of Cal Factor.
Output noise, max (less trace width): approx. 0.2 div, p-p.
Zero drift, 20% to 40%, 103 to 127 V (less trace width): temp — 0.45 div/10°C; Line voltage — 0.25 div.
Common mode rejection and tolerance: quadrature rejection and tolerance: > 40 dB. Tolerance error: $< \pm 2\%$ fs when quadrature voltage equal to twice in-phase signal required for center to edge deflection on chart. C Balance control permits bucking of transducer's quad unbalance of up to ± 5 mV/V.
Output linearity (less trace width): 0.4 div after calibrating for zero error at center scale and $+20$ div.

RECORDERS & PRINTERS

Two, four and eight-channel oscillographic recorders



8806B



8807A



8808A



8809A

8806B with 7702B, 7414A and 7418A

Input ranges: sig input — 0.5, 1, 2.5, 10, 20, 50, 100, 200, 500 mV/div; $\pm 1\%$, 50 Hz to 10 kHz; $\pm 2\%$, 10 kHz to 20 kHz; $\pm 3\%$, 20 kHz to 40 kHz. Ref voltage — 3 to 20 V rms, 20 to 133 V rms.

Maximum calibrated sensitivity and max fs input: 0.5 mV rms/div (gain 200 rms ac to dc) 25 V rms.

Input circuit and input frequency range: signal input — transformer isolated, floating point and guarded; resistance approx. 1 M Ω . Reference input, differential, transformer coupled; resistance approx. 500 k Ω each side to ground, may be used single ended. 50 Hz to 40 kHz in 6 bauds with variable frequency plug-in; 60 Hz, 400 Hz and 5 kHz fixed frequency phase shifter plug-in; special order phase shifter plus-ins 50 Hz to 40 kHz.

Rise time (10 div, 10-90%, 4% overshoot): 5 ms (5 kHz ref).

Calibration (referred to input): 1 V rms internal at carrier reference frequency: $\pm 1\%$ 50 Hz to 10 kHz; $\pm 2\%$ 10 kHz to 20 kHz; $\pm 3\%$ 20 kHz to 40 kHz.

Zero suppression: none. Phase shifter plug-ins allow control of reference phase over 360°. Fixed frequency: 0° to 90° dial; 2° graduations; any of 4 quadrants by panel switches; dial accuracy within $\pm 3^\circ$. Variable frequency: adjust thru 360°.

Output noise, max (less trace width): 7 μ V \times sq root of frequency response, referred to input.

Zero drift, 20° to 40°C, 103 to 127 V (less trace width): temp: 0.5 div/10°C; Line voltage: 0.25 div.

Common mode rejection and tolerance: CM: >40 dB up to 10 kHz 500 V rms, max. Quadrature tolerance: equal to amplitude of a fs, in-phase signal.

Output linearity (less trace width): 0.4 div after calibrating for zero error at center scale and +20 div.

8807B with 7702B, 7414A and 7418A

Input ranges: 0.02, 0.05, 0.1, 0.2, 0.5, 1, 2, 5, 10 V rms/div, $\pm 2\%$ (midband). Scale expansion: X1, 2, 5, 10, 20, $\pm 2\%$.

Maximum calibrated sensitivity and max fs input: 1 mV rms/div (gain 100 rms ac to dc), 20 mV rms/div with X1 scale expansion 500 V rms.

Input circuit and input frequency range: approx. 1 M Ω resistive in parallel with 10 pF and stray cable capacitance; floating and guarded. Standard model: 330 Hz to 100 kHz; Opt 001: 50 Hz to 100 kHz.

Rise time (10 div, 10-90%, 4% overshoot): 11.2 ms. Opt 001: 70 ms, approx. 10% overshoot.

Calibration (referred to input): 1 V internal $\pm 1\%$; approx. 500 Hz.

Output frequency response (-0.5 dB at 50 div): 54 Hz (3 dB at 10 div), Opt 001 — 9 Hz.

Zero suppression: up to 100% of fs on any range can be suppressed; 10-T pot with calibrating dial. Scale expansion: 5, 10, 20, or 50% of fs can be expanded to cover full chart.

Output noise, max (less trace width): baseline offset/noise: 2 mV rms referred to input +0.025 div \times scale expansion.

Zero drift, 20° to 40°C, 103 to 127 V (less trace width): temp 0.03 div/10°C \times scale expansion +0.35 div/10°C; at constant ambient 0.005 div/hr \times scale expansion. Line voltage 0.005 div \times scale expansion +0.1 div.

Common mode rejection and tolerance: 60 dB min at 60 Hz; 40 dB min at 400 Hz with up to 10 k source unbalance: ± 500 V pk.

Output linearity (less trace width): 0.55 div +0.05 div \times scale

expansion, 330 Hz to 5 kHz; Opt 001: 60 Hz to 5 kHz, after calibration for zero error at lower and upper ends of printed coordinates.

8808A with 7702B, 7414A and 7418A

Input ranges: 50 dB span: bottom scale -80, -70, -60, -50, -40, -20, -10, and 0 dB below 1 V (i.e., 100 μ V, 320 μ V, 1, 3.2, 10, 32, 100, 320 mV and 1 V). 100 dB span: bottom scale -80, -70, -60, and -50 dB below 1 V.

Maximum calibrated sensitivity and max fs input: 100 μ V rms sine wave corresponds to bottom scale output, -80 dB below 1 V 320 V rms.

Input circuit and input frequency range: single ended, resistance 1 M Ω min. 5 Hz to 100 kHz for <3 dB down from midband level on "Slow" response range; 500 Hz to 100 kHz on "Fast" response range.

Rise time (10 div, 10-90%, 4% overshoot): fast: 20.5 ms (875 dB/s). Slow: 2 s (9 dB/s).

Calibration (referred to input): internal from oscillator at approx. 500 Hz. -80, -30, and +20 dBV = dB ref. to 1 V (100 μ V, 32 mV and 10 V) -80 +20 dBV internally adjustable: -30 dBV accuracy ± 0.25 dB (at 115 V line at 25°C).

Output noise, max (less trace width): 50 dB range: 0.8 div, p-p. 100 dB range: 0.4 div, p-p (max noise at bottom of recording chart).

Output linearity (less trace width): departure from log characteristic 50 dB: 1.25 div, 100 dB: 1 div, after calibrating for zero error at lower and upper ends of printed coordinates.

8809A with 7702B, 7414A and 7418A

Input ranges: continuously adjustable from 20 to 50 mV/div.

Maximum calibrated sensitivity and max fs input: 30 mV/div (gain 3.33), 0 to +2.5 V or 0 to -2.5 V.

Input circuit and input frequency range: switch selected: 1500 Ω $\pm 2\%$ or 100 k Ω min, incremental; single ended.

Rise time (10 div, 10-90%, 4% overshoot): 5 ms.

Calibration (referred to input): 600 mV $\pm 2\%$, internal.

Output frequency response (-0.5 dB at 50 div): 50 Hz.

Output noise, max (less trace width): 0.1 div, p-p.

Zero drift, 20° to 40°C, 103 to 127 V (less trace width): temp: 0.4 div/10°C at 30 mV sensitivity. Line voltage: 0.3 div.

Common mode rejection and tolerance: 50,000: 1 at dc.

Output linearity (less trace width): 0.4 div after calibrating for zero error at center scale and +20 div.

8820A with 7418A

Sensitivity: 0.05 V/div (Amplifier Gain 2).

Maximum fs input: 250 V (edge to edge).

Input ranges (attenuation): 0.05, 0.1, 0.2, 0.5, 1, 2, 5 V/div. Attenuator accuracy $\pm 2\%$.

Input circuit: single ended, 1 M Ω min.

Frequency response: dc to <0.5 dB down at 50 Hz (50 div, p-p). dc to <3 dB down at 100 Hz (10 div p-p).

Rise time (10 div, 10-90%, 4% overshoot): <6 ms.

Output linearity (less trace width): linear within ± 0.25 div after setting mechanical zero of stylus to within ± 1 div of chart center and calibrating for zero error at center scale and ± 20 div.

Drift, 20° - 40°C, 115 V $\pm 10\%$, 60 Hz (less trace width): temp. <0.5%/10°C. Line voltage: ± 0.2 div.

Calibration: 1 V $\pm 1\%$ calibration voltage in each channel, plus 1 common 1 V $\pm 1\%$ calibration voltage for all channels.

Temp rating: operating: 0° to +35°C; storage: -40° to 75°C.

8821A with 7418A

Sensitivity: 0.001 V/div (Amplifier Gain 100).

Maximum fs input: 250 V (edge to edge).

Input ranges (attenuation): 0.001, 0.002, 0.005, 0.010, 0.020, 0.050, 0.1, 0.2, 0.5, 1, 2, 5 V/div. Attenuator accuracy (dc) 1/2% on 0.001 to 0.050 V/div ranges; 1% on 0.1 to 5 V/div ranges.

Input circuit: balanced, floating and guarded, 9 M Ω constant for all gain settings (0.001 to 0.050 V/div); 4.5 M Ω each side to ground (0.1 to 5 V/div).

Common mode rejection: 100 dB at 60 Hz, 0.001 V/div sensitivity, 1 k Ω source unbalance, decreases to 66 dB at 0.05 V/div, 66 dB at 60 Hz, 0.01 to 5 V/div sensitivity, 1 k Ω source unbalance.

Common mode tolerance: ± 20 V on 0.001 to 0.05 V/div ranges (6 most sensitive); ± 250 V on 0.1 to 5 V/div ranges (6 least sensitive).

Frequency response: dc to <0.5 dB down at 50 Hz (50 div p-p), dc to <3 dB down at 100 Hz (10 div p-p).



8821A



8820A

Rise time (10 div, 10-90%, 4% overshoot): <6 ms.
Output linearity (less trace width): same as 8820A.
Drift, 20° to 40°C, 115 V ±10%, 60 Hz (less trace width): same as 8820A.
Calibration: +0.02 V ±1% on 6 most sensitive ranges. Simulates +2 V ±2% at input on 6 least sensitive ranges.
Temperature rating: same as 8820A.

7702B Options

002: Portable Case and Cover	Price
003: One-Channel Decrease	\$225
005: Mobile Cart (1062A)	less \$55
008: 50 Hz Operation	\$350
009: Speeds 2.5, 5, 25, and 50 mm/sec (50 Hz)	\$55
010: Speeds 2.5, 5, 25, and 50 mm/sec (60 Hz only)	\$90
011: 60:1 Speed Reduction (60 Hz)	N/C
012: 60:1 Speed Reduction (50 Hz)	\$205
015: Extra Event Marker installed between channels	\$205
018: 60 Hz Speed Kit 2:1 Reduction. Speeds of 0.5, 2.5, 10, 50 mm/sec. (Not compatible with Opt. 10,11)	\$90
019: 50 Hz Speed Kit 2:1 Reduction. Speeds of 0.5, 2.5, 10, and 50 mm/sec. (Not compatible with Opt. 009 and 012)	\$190
	\$190

Note: Option 008 required when ordering Option 009, 012, or 019.

7414A Options

001: Rack mount (include slides, mounting hardware; delete case)	N/C
008: 50 Hz operation	N/C
009: 230 V ac operation	N/C
012: 1 channel decrease; extreme RH channel deleted, blank panel instal; not compatible with Opt 015	less \$225
015: Extra Event Marker, installed between channel 2 and 3; not compatible with Opt 012	\$40
025: 50 Hz speed reduction, 60:1 (opt 008 required)	\$320
026: 60 Hz speed reduction, 60:1	\$320
054: Installed in mobile cart. Includes paper takeup drawer	\$575

7418A Options

001: 6 channel Hot-Tip Therm Recorder only* (includes takeup tray) (*For plug-in preamp. Opt 003 Power Supply required to operate 8800 Plug-In Preamps. For Bank Amps, select 1 of options 031-034).	less \$620
002: Rack mount kit	\$205
003: Bench top configuration	\$260
004: 63-in. Cabinet (includes 7-in. drawer)	\$1350
005: 42-in. Cabinet (includes 7-in. drawer)	\$1350
006: 28-in. Portable cart (includes opt 002)	\$950
008: 50 Hz operation	N/C
009: 230 V ac operation	N/C
014: Extra Event Marker between Channels 4 & 5	\$90
015: Extra Event Marker between Channels 5 & 6	\$90
025: 50 Hz speed reduction 60:1 (opt 008 required)	\$310
026: 60 Hz speed reduction 60:1	\$310
030: 8848A plug-in preamp power supply (required for operation of 8800 Preamps)	\$1170

031: 8820A 8-channel bank amp (not compatible with opt 001) when ordering separately, order 8820A for 6 channels, see opt 033	\$1650
032: 8821A 8-channel bank amp (not compatible with opt 001) when ordering separately, order 8821A for 6 channels, see opt 034	\$2780
033: 8820A 6-channel bank amp (not compatible with 7418A 8-channel) when ordering separately, order 8820A opt 002	\$1650
034: 8821A 6-channel bank amp (not compatible with 7418A 8-channel) when ordering separately, order 8821A opt 002	\$2575

8801A, 8802A, 8803A & 8809A Options

001: Bench top unit with power supply & portable case	\$460
--	-------

8803A Options

001: Bench top unit with power supply & portable case	\$555
--	-------

8805A & 8805B Options

001: Bench top unit with power supply & portable case	\$535
002: Harmonic filter kit (required when 267, 268, 270, or 12808 transducers are used)	\$30

8806B Options

001: Bench top unit with power supply & portable case	\$490
002: Variable frequency phase shifter plug-in, 50 Hz to 40 kHz	\$260
003: Calibrated phase shifter plug-in, 60 Hz	\$205
004: Calibrated phase shifter plug-in, 400 Hz	\$165
005: Calibrated phase shifter plug-in, 5 kHz	\$165

8807A Options

001: 50 Hz to 100 kHz signal filter	N/C
002: Dc plug-in	N/C
003: Bench top unit with power supply & portable case	\$460

8808A Options

001: Bench top unit with power supply & portable case	\$460
--	-------

8820A Options

002: 2-channel reductions	N/C
----------------------------------	-----

8821A Options

002: 6 channel bank amp	less \$205
--------------------------------	------------

Model number and name

7702 B 2-channel oscillographic recorder	\$2990
7414A 4-channel oscillographic recorder	\$5300
7418A 6 to 8-channel oscillographic recorder	\$7000
8801 A Low gain preamplifier	\$385
8802 A Medium gain preamplifier	\$385
8803 A High gain preamplifier	\$805
8805A Carrier preamplifier	\$515
8805B Carrier preamplifier	\$825
8806B Phase sense demodulator preamplifier	\$620
8807A Ac/dc converter preamplifier	\$855
8808A Logarithmic preamplifier	\$690
8809A Signal coupler preamplifier	\$140
8820A Dc bank amplifier	\$1650
8821A Dc bank amplifier	\$2780

RECORDERS & PRINTERS

Instrumentation tape recorders, tape degausser

Models 3964A, 3968A, and 13064A

- 1/4-inch magnetic tape benefit
- Selectable FM/Direct electronics



3964A

HP-IB



13064A



Two new instrumentation tape recorders, the 3964A, 4-channel and 3968A, 8-channel, utilizing a 1/4-inch format are designed to meet the demands of the individual and OEM users. Versatility, portability, and durability are three important characteristics of these new and exciting recorders. Excellent performance is assured in both the laboratory and the field.

These reasonably priced units are equipped with many standard features usually found only on more expensive recorders.

The 13064A Tape Degausser completely erases all previous magnetic recordings from an entire reel of tape by saturating the tape alternately in both polarities with a large AC magnetic field.

3964A/3968A standard features

"E-to-E" mode for FM recording: input signal is automatically transferred to the output when in fast forward, rewind, or stop. Simplifies recorder setup and calibration.

Tape/Tach servo: in the reproduce mode the capstan servo can be controlled either by the internal tach frequency or for maximum time base accuracy from a pre-recorded signal on one of the data channels.

Equalization: direct data cards can be easily equalized for a wide variety of tapes.

Remote control: multi-pin connector located at rear of instrument provides remote control and status (TTL or contact closure) for all tape speeds and operational modes.

AC/DC calibrator: provides internal AC/DC voltage source for setting up input and output levels for each of the data channels. Voltage levels and channel monitoring selected with pushbutton ease.

Flutter compensation: available with the flip of a switch. Flutter modulation introduced during the record mode is eliminated providing an improvement in FM signal-to-noise ratio by up to 12 dB.

Voice capability: recorded data can be voice annotated on Channel 4 of 3964A or Channel 8 of 3968A with press-to-talk microphone.

Unipolar operation for FM recording: when a signal has a positive only or negative only deviation, the FM input reference level can be offset to plus or minus full deviation to permit full utilization of the channel's dynamic range.

- Eight channels or four channels
- Laboratory or field applications



3968A

HP-IB

Re-recording (dubbing): FM data cards can be set up for dubbing, allowing duplicate recordings to be made with minimum degradation to signal-to-noise.

3964A and 3968A specifications

Transport specifications

Tape width: 1/4 inch (6.3 mm).

Reel size: standard 7-inch (18 mm) plastic reel; totally enclosed by reel cover.

Heads: 3964A — one four-track record and one four-track reproduce using in-line track configuration. 3968A — one eight-track record and one eight-track reproduce. Interlaced odd-even track configuration.

Tape speeds: 15 ips (3.81 cm/s), 7 1/2 ips (2.38 cm/s), 3 3/4 ips (4.75 cm/s), 1 3/4 ips (9.52 cm/s), 7/8 ips (19.05 cm/s), 15 ips (38.10 cm/s).

Capstan drive: DC motor with phaslock servo.

Tape speed accuracy: ±0.2% (tach servo).

Time base error (tape servo):

Tape speeds	15	7 1/2	3 3/4	1 3/4	1 1/4	3/4
TBE (microsec)	±4	±5	±7.5	±15	±25	±50

Flutter:

Tape Speed (ips)	Pass Band (Hz)	Flutter (% p-p)	Tape Speed (ips)	Pass Band (Hz)	Flutter % p-p)
15	0.2-2500	0.35	1 3/4	0.2-312	0.50
7 1/2	0.2-1250	0.35	1 1/4	0.2-156	0.70
3 3/4	0.2-625	0.40	3/4	0.2-78	1.50

Tape motion controls: forward, reverse record; forward, reverse play; fast forward; fast rewind; stop; pushbutton selectable.

Start and stop times (typical):

Tape speeds	15	7 1/2	3 3/4	1 3/4	1 1/4	3/4
Start (sec)	3	1.50	0.90	0.50	0.50	0.50
Stop (sec)	0.30	0.30	0.30	0.30	0.30	0.30

Rewind time (typical): 1800 foot (549 m) reel in 100 seconds; 2300 foot (701 m) reel in 145 seconds.

Braking: fail-safe mechanical differential brakes.

End-of-tape sensing: tape drive stops automatically at the end of tape.

Reel revolution counter: 4-digit revolution counter with pushbutton reset.

FM record/reproduce specifications (using 3M-888 Tape or equivalent)

Tape Speed	Carrier Center Frequency	Passband ¹ (Hz)	Signal-to-Noise Ratio	
			3964A	3968A
15	27	DC - 5000	48	46
7½	13.50	DC - 2500	48	46
3¾	6.75	DC - 1250	48	46
1¾	3.38	DC - 625	46	46
15/16	1.69	DC - 312	44	44
15/32	0.85	DC - 156	40	40

1. Frequency response over passband is ±1.0 dB referenced to 10% of upper bandedge frequency.
 2. Signal measured with carrier deviation ±40% of upper passband without flutter compensation. Output filters of reproduce amplifiers selected for constant amplitude response. May also be selected for linear phase (transient) response.

Flutter compensation: can improve signal-to-noise by up to 4 dB under static conditions and as much as 12 dB under conditions of vibration. Selected by rear panel switch.
Distortion: total harmonic distortion <1.2% @ 15 to 1½ ips, <2% @ 1½ to 15/32 ips.
Linearity: ±1% of peak-to-peak output for best straight line through zero at ±40% deviation.
DC Drift: ±0.1% (max) of full scale output per °C.
Input level: 1 V to 30 V (peak-to-peak); continuously adjustable.
Input impedance: 100 kΩ nominal, shunted by <100 pF single-ended.
Output level: 1 to 5 V (peak-to-peak); continuously adjustable.
Output impedance: 50 ohms nominal, single-ended.
Non-bias recording: available by internal jumper selection.
Direct record/reproduce specifications (using 3M-888 Tape or equivalent)

Tape Speed (ips)	Passband (±3 dB) ¹		S/N Ratio (dB) ²	
	3964A	3968A	3964A	3968A
15	70 - 64 000 Hz	500 - 64 000 Hz	38	36
7½	50 - 32 000 Hz	250 - 32 000 Hz	38	36
3¾	50 - 16 000 Hz	100 - 16 000 Hz	38	36
1¾	50 - 8000 Hz	100 - 8000 Hz	38	36
15/16	50 - 4000 Hz	100 - 4000 Hz	38	36
15/32	50 - 2000 Hz	100 - 2000 Hz	37	35

1. Reference to 10% of upper bandedge.
 2. Referenced to a 500 Hz sine wave with a maximum of 1% third harmonic distortion when reproduced at 3¾ ips.

Input level: 1 V to 30 V (p-p); continuously adjustable.
Input impedance: 100 kΩ nominal, single-ended.
Output level: 0.5 to 5 V (p-p); continuously adjustable.
Output impedance: 50 ohms nominal, single-ended.

Signal monitoring

Meter modes: peak AC or DC (selected by front panel switch).
Meter accuracy (peak AC mode): better than ±½ dB for signals with duty cycle of 20% or greater.
Selector: front panel pushbuttons select metered channels.

Calibrator

Signal source: pushbutton selectable internal or external signal source.
Internal signal source: peak AC and ± DC levels of 0, 1.0, 1.414, 2.5, 5.0, and 10.0 volts.
Level of accuracy: ±2% of selected voltage.
AC frequency: 500 Hz ±5% <0.25% second or third harmonic distortion.

Voice annotation

Modes of operation: data only, voice only, or data interrupted by voice.
Microphone: dynamic, hand-held, with press to talk switch.
Record level: automatic leveling.
Monitoring: built-in speaker, headphone jack.

General specifications

Size: 3964A — 400 mm (15.7") H × 427 mm (16.8") W × 256 mm (10.1") D. 3968A — 445 mm (17.5") H × 427 mm (16.8") W × 256 mm (10.1") D.
Weight: 3964A — 29.5 kg (65 lb), 3968A — 31.3 kg (69 lb).
Power requirements: 100, 120, 220, or 240 V, +5%, -10%, 48-440 Hz, 110 W average.
Temperature: storage, -40°C to 75°C; operating, 0°C to 55°C; tape limit, 10°C to 40°C.
Altitude: storage, 15 240 m (50 000 ft.); operating, 4500 m (15 000 ft.).
Humidity: the system, excluding tape limitations, will operate from 10% to 95% RH (25°C to 40°C), non-condensing.
Shock: 30 g maximum (11 ms) non-operating.
Mounting: supplied with rack mounting kit for standard 19-inch equipment racks.

13064A Specifications

Tape size: ¼-inch (6.33 mm) tape on reels up to 10½ inch (266 mm) in diameter.
Erase: 60 dB minimum.
Duty cycle: one minute ON — three minutes OFF.
Dimensions: 133 mm W × 184 mm D × 76.2 mm H (5¼" × 7¼" × 3").
Weight: net, 4.3 kg (9½ lb). Shipping, 4.5 kg (10 lb).
Power requirements: 115 V ac ±10%, 50-60 Hz (Option 001), 230 V ac ±10%, 50-60 Hz (Option 002).

Options 3964A/3968A

- 001:** FM Record/Reproduce. Provides one FM data card. Specify number of FM channels required with ordering. add \$350
- 002:** direct Record/Reproduce. Provides one Direct data card. Specify number of Direct channels required when ordering. add \$315
- 003:** rear Input/Output Connectors. A rear panel with BNC input and output connectors for each channel and in parallel with front cover panel connectors. Recommended for rack mounted units only. add \$65
- 004:** Locking Knobs. Factory installed, screwdriver adjustable locking knobs ensure input level setting on a given channel(s) is not accidentally changed (four on 3964A, eight on 3968A). add \$35
- 005:** metric speed designations. Provides metric speed designations of 38,10, 19,05, 9,52, 4,75, 2,38, and 1.19 cm/s on front panel speed selector pushbuttons. N/C
- 007:** HP-IB Remote Control. HP-IB compatible remote control of all tape speeds and operational modes. add \$325
- 024:** loop adapter. Simplifies data analysis application requiring continual replay of significant data. A tape loop from 5 to 30 feet can be accommodated by this option. add \$425
- 026 and 027:** rack mounting/rack slides. Rack slides, which provide 90° instrumentation rotation.
 - Option 026, Rack Slides for 19" racks add \$90
 - Option 027, Rack Slides for HP cabinets add \$135
- 041:** IRIG servo reference frequency. Changes standard servo reference from 27 kHz to 25 kHz at 15 ips. add \$100
- 070:** overlap. With two 3964A or 3968A units, option provides automatic play/record commands for second recorder when first unit electronically senses tape is low. add \$200
- 010:** extra manual add \$30
- Transit case:** Moisture and dustproof; vibration and shock proof.
 - 3964A part no. 13107A \$250
 - 3968A part no. 13106A \$250

Model number and name

- 3964A 4-channel Instrumentation Tape Recorder Mainframe \$4600
- 3968A 8-channel Instrumentation Tape Recorder Mainframe \$6000
- 13064A Tape Degausser (specify Opt 001 or 002) \$100

RECORDERS & PRINTERS

Alphanumeric, 20 column thermal printer

Model 5150A

- Silent operation
- Optional scanner and clock
- Alphanumeric

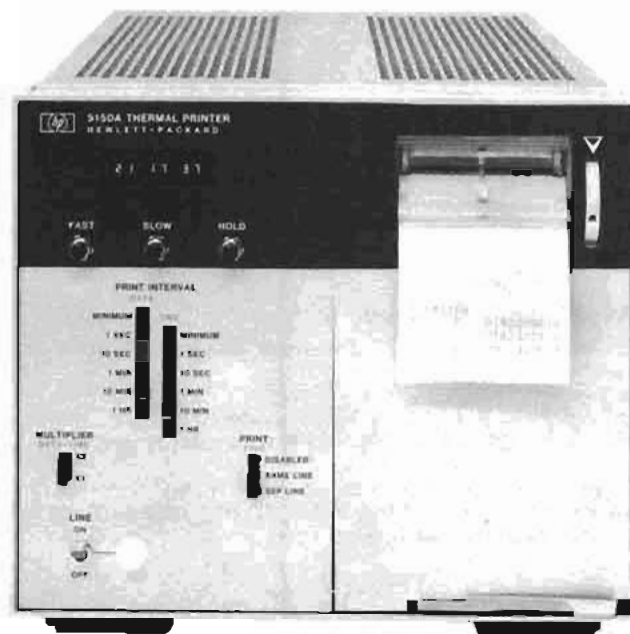

HP-IB 5150A, option 004

General

The 5150A Thermal Printer is a versatile instrumentation printer designed to accept and record up to 20 columns of data from most HP digital instruments. Because it uses a thermal printing technique, it is extraordinarily quiet while in operation. Two input interfaces are available (one must be specified with the order) to allow data input from the HP Interface Bus (use Option 001) or from BCD-coded sources (use Option 002). Other options which add to the flexibility of this printer are the Option 003 Scanner, which can sequentially address and interrogate up to 13 instruments on the HP-IB, and the Option 004 Clock, which can be used with either the HP-IB or BCD Interfaces.

Option 001 HP-IB interface

With Option 001 installed, the printer can accept up to 20 ASCII characters per line via the HP-IB. Inputs are interpreted according to the 64 member upper-case ASCII character set. With this interface, the printer can also serve as an "addressable listener" in a controller-based HP-IB system.

Option 002 BCD interface

With Option 002 installed, the printer will accept 10 columns of TTL-level BCD data. Two Option 002's may be installed for 20-column print-out from one or two sources. The standard 16-member character set consists of 0 through 9, +, -, V, A, R, and [blank]. Special character sets which draw from the 64-character upper-case ASCII set may also be specified.

Option 003 scanner

With both Options 001 and 003 installed, the printer can log data from up to 13 instruments on the HP-IB. Operation is asynchronous; that is, the printer will address the lowest address instrument, wait for data, print, then go to the next instrument.

Option 004 clock

Used with either the HP-IB Interface or BCD Interface, this option gives the printer two additional capabilities: it can control the elapsed time between successive data printouts, and it can print the time of day immediately following each data printout. When used with the Option 003 Scanner, the clock controls the elapsed time between the initiation of successive scans.

Specifications

Character Print: 5 × 7 dot matrix

Printing rate: 3 lines per second

Line Spacing: approximately 6 lines per inch (2.5 lines per cm)

Paper advance mechanism: direct drive, stepping motor

Paper: thermal sensitive, in rolls or fan-folded (one roll supplied)

Operating environment: 0°C to 50°C temperature; 95% relative humidity (85% RH with fan-folded paper)

Power: 100, 120, 220, or 240 volts. 48 to 440 Hz (50 or 60 Hz only for Option 004), 100 VA

Dimensions: half-rack module, 216 mm W × 178 mm H × 356 mm D (8½" × 7" × 14¼")

Weight: approximately 7 kg (16 lb) (5150A + 1 option)

HP-IB interface (Option 001)

Columns: 20

Printed character set: 64 ASCII characters (columns 2, 3, 4, and 5 of ANSI X3.4-1968, except "↑" in column 5, row 14)

Input Logic Levels: TTL (low <0.4 V, High >2.5 V)

Data format: byte-serial with storage, compatible with HP-IB.

Inhibit (output): holds NRFD line of HP Interface Bus low following receipt of either CR or LF (selectable) until print is completed. This interval is approximately 250 ms minimum, or the duration of Option 004 Clock data print interval with clock in Hold mode.

BCD Interface (Option 002)

Columns: 10 (20 columns with two Option 002's installed)

Character set: 0 through 9, +, -, V, A, R, and [blank].

Input Logic Levels: TTL (low <0.4 V, High >2.5 V)

Data format: parallel BCD (8421); switch selects + or ~true logic

Print command: pos. or neg. TTL transition; 2 kΩ input impedance. **Inhibit (output):** + or -, same levels as above; remains at true level until print is completed (approximately 250 ms minimum) or during Option 004 Clock data print interval with clock in Hold mode.

Scanner (Option 003)

Instruments scanned: 1 to 13

Cycle time of scan: limited by the slowest of (a) response of instruments scanned, (b) 3 samples per second, or (c) Data Print Interval setting on Option 004 Clock.

Compatibility: HP Interface Bus (utilizes ASCII code)

Identifier: labels data line of each instrument with letters A-M.

Protect feature: bypasses non-responding instrument after 3 sec.

Clock (Option 004)

Data print interval: selectable by front panel switches: minimum, 1 s, 2 s, 10 s, 20 s, 1 min, 2 min, 10 min, 20 min, 1 hr, 2 hrs. Print interval will be that of input device if it is slower than the selected interval.

Time print interval: selectable by front panel switch, same intervals as above (intervals shorter than data interval prevented).

Time print format: selectable by front panel switch: Disabled, same as data, or separate line from data.

Display: six-digit, seven-segment LED display of hours, minutes, seconds (00:00:00 to 23:59:59); settable via front panel switches.

Time base: line frequency (50 or 60 Hz, selectable by jumper)

Operating supplies/accessories

	Price
562A-16C General purpose BCD Interface Cable	\$85
9281-0401 Roll of paper, 76 metres (box of six)	\$2.20
9270-0431 Fan-fold paper, 76 metre pad	\$3.80
05150-60002 HP-IB Interface Kit	\$220
05150-60005 BCD Interface Kit	\$135
05150-60008 Scanner Kit	\$275
10533A BCD Interface Cable for 5300A	\$225
10631A Interface Bus Cable, 1 metre	\$60
10631B Interface Bus Cable, 2 metres	\$65
10631C Interface Bus Cable, 4 metres	\$75

Options

001: HP-IB Interface	add \$200
002: BCD Interface	add \$125
003: Scanner	add \$250
004: Clock	add \$350
005: BCD Interface Cable (562A-16C)	add \$85
910: Extra manual	add \$15

5150A Thermal Printer

\$875

RECORDERS & PRINTERS

10-column BCD digital printer

Model 5055A

- 10 lines/sec.
- 10 columns of data
- 4-line \pm 8421 BCD

- TTL Logic Levels
- Ink or pressure sensitive printing

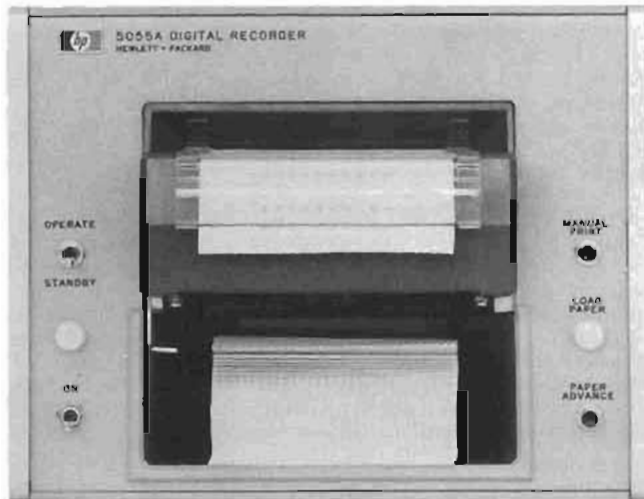

Description

General

The Hewlett-Packard Model 5055A Digital Recorder provides a high-performance economical method of making permanent records of digital data. It prints up to 10 columns of data from 4-line BCD data sources at rates up to 10 lines/sec. Printing is asynchronous; i.e. the print cycle starts the instant the external print command is received and requires only 100 ms under any condition. The eight inch cabinet width allows for either bench use or side-by-side rack mounting, using the HP Adapter Frame, 5060-0797. The codes offered are \pm 8421, selectable by a rear panel switch. Each column has an individual print wheel with 16 characters—10 numeric and 6 non-numeric. Special wheels can be ordered at minimal cost. The 5055A is supplied complete for 10 columns of printed data and accepts TTL compatible integrated circuit logic levels. Leading zeros are suppressed when the printer is used with HP instruments which have blanking.

Reliability

Reliability is enhanced by design simplicity; i.e. there are an unusually small number of moving parts in the printer. The printer mechanism, manufactured by Hewlett-Packard, is a modified version of a mechanism whose reliability and serviceability has been demonstrated in other H-P printers for many years.

Ink or pressure sensitive printing

The 5055A prints in ink on regular paper or on pressure sensitive paper. For ink printing, the mechanism includes a continuously rotating ink roller—inherently more reliable than a start-stop ribbon mechanism. Paper loading is easy from the front, and when the paper runs out an alarm lamp lights and recording stops automatically. An output signal is provided for inhibiting the data source.

Versatile

Each column has an individual print wheel which can be changed independently of the other 9 wheels if a different character set is desired. This can apply to as many columns as desired. Special print wheels can be factory installed or may be field installed at a later date. Both can be done at a nominal cost.

Specifications

Printing

Accuracy: identical to input device used

Print cycle time: 100 ms.

Printing rate: 10 lines/sec maximum, asynchronous

Line spacing: fixed, 4 to 5 lines per inch.

Printing: ink roller or pressure sensitive paper. Pressure sensitive paper is recommended for operation under extreme temperature.

Print wheels: 16 positions, numerals 0 to 9, +, -, V, A, Ω , *; special wheels available.

Column capacity: supplied complete for 10-column operation.

Electrical

Data input: parallel entry, BCD \pm 8421 (selected by rear panel switch)

Blanking: Hewlett-Packard counters with blanking will give insignificant zero suppression when blanked digits output is (1111). May be defeated with rear panel switch.

Logic levels: high state $\geq +2.4$ V, +5 V maximum (open input line results in high state); low state $\leq +0.4$ V (1.6 mA max., low), 0 V minimum.

Print command: line 1-low to high transition causes print (nominal 1k Ω input impedance); line 2-high to low transition causes print (nominal 400 Ω input impedance). Voltage levels are same as logic levels above, and a minimum pulse width of 0.5 μ s is required.

Inhibit voltage: (+) inhibit = transition from (≥ 0 , ≤ 0.4 V) to (≥ 2.4 V, ≤ 5.0 V) upon receipt of print command. Remains at high state until paper advance occurs, approximately 85 ms ($<$ mA in low state). (-) inhibit = inverse of (+) inhibit.

General

Operating temperature: 0°C to +50°C with pressure sensitive paper, +10°C to +40°C with ink roller.

Input connector: amphenol 57-40500-375, HP Part No. 1251-0087, 50-pin female. Mating input cable connector: amphenol type 57-30500-375, HP Part No. 1251-0086, 50-pin male.

Front panel controls: power switch, power on indicator light, manual print pushbutton, manual paper advance pushbutton, out-of-paper light, standby/operate switch. (Paper loaded from front.)

Power: 115 or 230 V \pm 10%, 60 or 50 Hz (two-speed motor pulley incorporated), approximately 25 W idle, 55 W at 10 lines/sec.

Dimensions: cabinet: 203 mm \times 154 mm \times 406 mm (8" wide, 6 $\frac{1}{2}$ " high, 16" deep)

Weight: net, 10 kg (18.5 lb) (approximately). Shipping, 8.9 kg (22 lb) (approximately).

Operating supplies/accessories:

	Price
9260-0071 Ink roller (black)	\$16.50
9281-0386 Standard paper (250' pad)	\$2.50
9281-0387 Pressure sensitive paper (305' pad)	\$4.50
5060-0797 Rack adapter frame	\$55.00
10533A Interface Cable for 5300A	\$225.00

Options

001: 50 Hz line operation no charge

002: 562A-16C input cable interconnects with 3450B, 3480C/D, 5326A/B/C, and 8443A \$85

5055A Digital Recorder

Supplied with Ink roller (9260-0071), one pad standard paper (9281-0386) and one pad pressure sensitive paper (9281-0387). Each pad provides two loadings of recorder.

\$1750



RECORDERS & PRINTERS

Versatile 18-column BCD digital printer

Model 5050B

- 20 lines/sec.
- Up to 18 columns of data
- 4-line \pm 8421, + 4221 BCD



Description

Compatible

This recorder is compatible with a wide range of Hewlett-Packard solid state and integrated circuit instruments and a wide variety of other equipment. It prints up to 18 columns of 4 line BCD data from one or two sources up to 20 lines/sec.

Versatile

The user can easily change code to +8421, -8421, or +4221 by an inexpensive substitutable code disc, and can change print wheels to have a different code and/or character set in each column. Character suppression allows suppressing a character in each column.

Storage

An optional data storage feature is available at extra cost to reduce the time required to transfer data to the recorder. This means that the data source is inhibited for only about 0.1 ms out of a print cycle of 50 ms duration, compared to being inhibited during the complete print cycle without storage.

Specifications

Printing

Accuracy: identical to input device used.

Print cycle time: 50 ms.

Printing rate: 20 lines/second, max. (asynchronous)

Line spacing: adjustable, 3.5 to 4.5 lines/inch

Printing: ink roller or pressure sensitive paper. Pressure sensitive paper is recommended for operation under extreme temperatures.

Print wheels: 16 positions, numerals 0 through 9, -, +, Z, V, Ω , *; special wheels available at minimal cost.

Electrical

Input requirements without data storage: parallel entry, BCD (\pm 8421, +4221), "1" state must differ from "0" state by >4.5 V but <75 V.

Input requirements with data storage: parallel entry, BCD, "1" state must differ from "0" state by >1.3 V but <35 V. Input drive ≥ 100 μ A. Data must be on lines when print command occurs and remain until release of holdoff (85 μ s after print command).

Transfer time: 50 ms without storage, 0.1 ms with storage.

- Storage option
- Ink or pressure sensitive printing

General

Operating temperature: -20°C to $+55^{\circ}\text{C}$ with pressure sensitive paper, $+10^{\circ}\text{C}$ to $+40^{\circ}\text{C}$ with ink roller.

Power: 115 or 230 V $\pm 10\%$, 50 to 60 Hz, about 100 W idle, 190 W at 20 lines/sec. 50 Hz model with 20 prints/second also available.

Dimensions: cabinet: 426 mm \times 226 mm \times 467 mm (16 $\frac{1}{4}$ " wide, 8 $\frac{1}{2}$ " high, 18 $\frac{1}{2}$ " deep).

Weight: net, 18 kg (40 lb). Shipping, 24 kg (53 lb).

Option 055 clock for 5050B printer

General: the Option 005 Clock provides a compact, convenient and versatile method for recording time—with 0.1 second resolution—along with other data measurements being recorded by the 5050B Printer. In addition Option 055 serves as an automatic measuring-recording system programmer by allowing printing at preselected time intervals.

High resolution: easy to read display tubes indicate time to 23 hours, 59 minutes, 59 seconds. In the printout there is a seventh digit available for indicating tenths of a second.

Specifications

Time base: selectable to be 50 Hz, 60 Hz or external. External requires 10 pps negative pulse.

Print Interval

Internal: selectable to be 1s, 10s, 1 min., 10 min., or 1 hour between prints.

External: rates up to 20 prints per second.

Time of measurement accuracy: time recorded may be 0.1s less than correct time \pm line accuracy.

Visual indication: 6 in-line digital display tubes indicate to 23 hours, 59 minutes, 59 seconds.

Printed output: seven digits indicate to 23 hours, 59 min., 59.9s.

BCD output code: +8421 or -8421 selectable. Output adaptable to other recorder codes.

Print format: time printable in any recorder column.

Clock set: 4 switches electronically set clock to desired initial time.

Power: 115 V or 230 V $\pm 10\%$, 50 Hz or 60 Hz.

Weight: net, 1.4 kg (3 lb)

Operating supplies:

9281-0386 Standard paper (1 pad)

9281-0387 Pressure sensitive paper (1 pad)

Price

\$2.50

\$4.50

Options

001: 8421 "1" state positive code disc

no charge

002: 8421 "1" state negative code disc

no charge

003: 4221 "1" state positive code disc

no charge

All three code discs are supplied with each 5050B at no charge. However, one of the above options must be specified so the 5050B can be delivered with the desired disc installed.

010: 50 Hz operation

add \$25

015: Motor Control

add \$125

020: Column Boards (one required, in addition to basic instrument, for each two columns to be operated)

add \$185 ea.

032: Input cable, one per data source

add \$85 ea.

050: Storage for 20 columns

\$575

051: Storage for 10 columns

add \$300

055: Clock (factory installed)

add \$1350

(Price of kit for field installation available on request.)

061: Package for 5360A

add \$2250

908: Rack Flange kit

add \$35

910: Extra manual

add \$5

5050B Digital Recorder

\$2950



Introduction

The digital electronic frequency counter has come a long way since the first versions appeared over two decades ago. Once the luxury of large metrology labs and some crystal manufacturers, the frequency counter is now common-place in laboratories, on production lines, as a service tool and in automatic instrumentation systems. Moreover, counters have become increasingly more versatile and more powerful in the measurements they perform, thereby finding much wider applications. When Hewlett-Packard introduced the 524A in 1952 it was considered a milestone; the counter could measure frequencies up to 10 MHz, or the time between two electrical events to a resolution of one ten billionth of a second, 100 ns. Twenty years later, HP's product line features counters that can measure the frequency of a 10 mV signal at 18 GHz completely automatically, or can resolve time to one billionth of a second (100 psec), the same time it takes light to travel one inch!

Basic counter measurements

The basic measurements which counters are capable of performing are described in this section.

Frequency

This fundamental measurement is performed by totalizing the number of input cycles or events for a precisely known period of time. The total count that results is proportional to the unknown frequency, and logic circuits internal to the counter position the

decimal point such that the display directly indicates the input frequency. The time reference is usually derived from a precision quartz oscillator internal to the counter.

Using this basic technique allows measurements to 500 MHz to be made. Several methods are available, however, to extend this frequency range to 18 GHz and more. These are described in more detail below.

Period

The inverse of frequency, this capability is sometimes offered to provide the user with high resolution, low frequency measurements. In digital systems a period measurement represents the average bit to bit time of the input signal.

Totalize

This measurement is similar to frequency except that the user now controls the time over which the measurement takes place. With digital systems becoming more prevalent, this fundamental measurement assumes considerable importance. The HP 5345A, with its ability to totalize at a 500 megabit rate, represents the state of the art at this time.

Ratio

The ratio between two input frequencies is a measurement that is also offered by some counters. The major application for ratio is measurement of harmonically related signals.

Scaling

Some counters offer the capability of providing a digital output signal whose fre-

quency is a scaled or divided version of the input frequency.

Time interval

The measurement of the time between two events or the time between two points on a common event, commonly referred to as time interval, is of major importance and is used in a wide variety of applications.

The 2 nanosecond single shot measurement resolution of the HP 5345A represents today's state of the art. Utilizing an analog interpolation scheme, however, allows the HP 5360A Computing Counter to obtain a 100 picosecond resolution. HP also pioneered the concept of time interval averaging, whereby for repetitive inputs substantial improvement in resolution over the single shot measurement can be obtained.

Time interval averaging is offered in five HP counters (5345A; 5328A; 5327A/B; 5326A/B and 5308A). Also available for precision time interval measurements is the new 5363A Time Interval Probes box usable with any time interval counter. The 5363A has a ± 10 volt dynamic range as well as a built in calibration feature and digitally set trigger voltages to eliminate the major uncertainties associated with TI measurements. The 5363A is fully programmable via the HP Interface Bus for systems applications.

All manner of time interval measurements are discussed in detail in Application Note AN 191 "Time Interval Measurement With an Electronic Counter" available on request from any Hewlett-Packard sales office.

ELECTRONIC COUNTERS

General information

Application Note 172: The Fundamentals of Electronic Frequency Counters

This forty-four page application note describes in detail the measurements mentioned above. In addition, the key considerations in making frequency and time measurements, plus the major characteristics required of a counter for certain applications are also described. For those readers who require more than the brief resumé above, this application note is available on request at any Hewlett-Packard sales office.

The contents of application note 172 are as follows:

- Introduction
- Fundamentals of Electronic Counters
- More About the Basic Frequency Counter
 - Input Considerations
 - Oscillator Characteristics
 - Sources of Measurement Error
 - Prescaling — Increasing the Frequency Response
- Normalizing and Preset Counters
- Period Measuring Frequency Counters (Time Interval)
 - Input Considerations
 - Trigger Level
 - Measurement Accuracy
 - Increasing Accuracy and Resolution
- Microwave Frequency Measurements
 - Heterodyne Conversion
 - Transfer Oscillator
- Some Examples of Component Technology

The major types of electronic counters

While counters can potentially offer all the measurement capabilities described above, they essentially fall into four classes: frequency counters; universal counters; microwave counters and reciprocal counters. These are described below.

Frequency counters

These counters offer the basic capability of frequency measurement and in addition sometimes provide some or all of the other measurements described above except time interval. HP has a wide range of counters that fall into this class including: a) the 5380 low cost bench series, a family of three counters featuring 80 MHz—7 digit, 225 MHz—8 digit

Table 1. Frequency counters summary

Model No.	Frequency Range	Number of Digits	Time Base	Other Functions*
5300A/5301A	10 MHz	6	3×10^{-2}	1
5381A	80 MHz	7	3×10^{-2}	
5382A	225 MHz	8	3×10^{-2}	
5383A	520 MHz	9	3×10^{-2}	
5300B/5303B	525 MHz	8	3×10^{-2}	
5300B/5305B	1300 MHz	8	3×10^{-2}	
5341A, Op. 003	1500 MHz	10	1×10^{-2}	
5341A	4500 MHz	10	1×10^{-2}	
5340A	18000 MHz	8	3×10^{-2}	

*See legend on Page 237

Table 2. Universal counter summary

Model No.	Frequency Range	Time Interval Resolution		Time Base	Other Functions*
		Single Shot	Averaging		
5300A/5304A	10 MHz	100 nsec	—	3×10^{-7} per Month	P, MPA, T, R
5300A/5302A	50 MHz	100 nsec	—	3×10^{-7} per Month	MPA, T, R
5326A/5326B	50 MHz	100 nsec	50 psec	3×10^{-7} per Month	P, MPA, T, R, V
5300A/5308A	75 MHz	100 nsec	100 psec	3×10^{-7} per Month	P, MPA, T, R
5328A	100 MHz	100 nsec or 10 nsec	10 psec	3×10^{-7} per Month	P, MPA, T, R, E, V**
5345A	500 MHz	2 nsec	2 psec	5×10^{-10} per Day	P, MPA, T, R
5328A Opt 030	512 MHz	100 nsec or 10 nsec	10 psec	3×10^{-7} per Month	P, MPA, T, R, E, V**
5327A/5327B	550 MHz	100 nsec	50 psec	3×10^{-7} per Month	P, MPA, T, R, V
5328A Opt 031	1300 MHz	100 nsec or 10 nsec	10 psec	3×10^{-7} per Month	P, MPA, T, R, E, V**

*See legend on Page 237

**Optional function

and 520 MHz—9 digit instruments; b) the 5300 portable, battery operated snap-on series with the 5303B snap-on covering 525 MHz and the 5305B 1300 MHz counter.

Universal counters

These instruments provide time interval capability in addition to the other measurements provided by the frequency counter. The 5302A snap-on is a perfect example of such an instrument featuring 50 MHz frequency, 100 nsec time interval plus period, ratio and totalize. Another member of the same family, the 5308A is ideally suited as a general purpose bench instrument, for in addition to the 5302A capabilities the 5308A offers time interval averaging, totalizing (with electronic start, and stop) and frequency to 75 MHz. The 5304A snap-on is especially oriented towards time interval featuring adjustable hold off. The 5326A/B (50 MHz) and 5327A/B (550 MHz) are rack-mounted programmable instruments with useable time interval resolutions to 50 psec via averaging. The 5328A (100 MHz) and 5328A Option 031 (1300 MHz) are high performance rack mount instruments programmable (Option 011) via the HP Interface Bus. Time interval averaging gives resolution to 10 psec on repetitive signals and Option 040 also has 10 nsec one shot resolution. Finally, the 5345A offers a 500 MHz bandwidth, with totalizing, ratio and period capability to this speed

(50 psec), plus 2 nsec single shot time interval and 2 psec time interval averaging! This extremely powerful instrument features plug-in flexibility (see page 238), and a reciprocal frequency measurement mode (see below).

Microwave counters

As Application Note 172 describes, the two techniques of microwave measurement, heterodyne and transfer, each offer their own advantages; with the former having higher resolution per unit measurement time and better FM tolerance, and the latter having a wider frequency range and better sensitivity. The 5354A 4 GHz heterodyne converter is a plug-in to the 5345A and features extremely high resolution, wideband FM tolerance and the ability to measure pulsed RF for pulse widths down to 50 nsec. Application Note 173 discusses automatic pulsed RF measurement in detail. The 5341A is also a heterodyne type microwave counter with 4.5 GHz frequency range. Conversely the 5340A is a transfer oscillator/type counter that can measure frequency from 10 Hz to 18 GHz via a single input at -35 dBm sensitivity! In fact the H10-5340A is guaranteed to 23 GHz at -15 dBm sensitivity. Application Note AN 190 discusses making frequency measurements to 40 GHz with counter accuracy using a 4 GHz Microwave Counter together with readily available microwave generators and mixers.

Table 3. Microwave counter summary

Model No.	Frequency Range	Technique	Time Base	Sensitivity	Number of Digits
5354A*	4 GHz	Auto Heterodyne	5×10^{-10} per Day	-10 dBm	11
5341A	4.5 GHz	Auto Heterodyne	1×10^{-7} per Month	-20 dBm	10
5254C/5255A/5256A**	to 18 GHz	Manual Heterodyne	3×10^{-9} per Day	-13 dBm	8
5257A**	18 GHz	Manual Transfer Osc	3×10^{-9} per Day	-7 dBm	8
5340A	18 GHz	Auto Transfer Osc	3×10^{-7} per Month	-35 dBm	8

*Plug-in to 5345A Counter

**Plug In to 5245 Series Counters or 5345A with adapter

Reciprocal counters

A special class of frequency counters, referred to as reciprocal counters, are also available from Hewlett-Packard. The distinction between these and conventional counters is that the latter provides 1 Hz resolution in one second, whereas the resolution of the reciprocal counter is proportional to the frequency of the internal counted clock. The four instruments available are summarized in Table 4 below. Note that both the 5360A and 5345A are plug-in instruments and hence the high mainframe resolving power offered by both apply to any of the compatible plug-ins. These two instruments also have pulsed RF measurement capability via an external gate mode. In addition the 5345A includes a unique frequency averaging mode that allows high resolution measurements on repetitive pulses even if pulse width is 50 nsecs.

HP Interface bus

The more recently introduced counters (and other HP digital instruments) have a digital input/output structure which is compatible with the interface bus which is Hewlett-Packard's implementation of the IEEE Digital Interface Standard 488-1975. HP Desktop Calculators in the 9820/21A/30A Series and Minicomputers in the HP 2100/21MX Series are also compatible with the interface bus, making it possible to expand the capabilities of the individual instruments

even into areas of real time data reduction and control. Interfacing is available for interconnecting up to 14 compatible devices on one I/O slot. The HP 59310A Computer Interface serves for minicomputers and the HP 59405A HP-IB Calculator Interface interconnects up to 14 devices using one I/O slot and one ROM. At this time, compatible instruments are the 5345A, 5340A, 5341A, 5328A, and 5312A (for 5300B system). Accessories in the 59300A Series and the 5150A Thermal Printer are also compatible.

Table 4. Reciprocal frequency counters

Model No.	Frequency Range	Measurement Resolution	Number of Digits	Time Base	Sensitivity
5300A/5307A	2 MHz	3×10^{-5}	6	3×10^{-7} per Month	10 mV rms
5323A	20 MHz	1×10^{-7}	7	3×10^{-7} per Month	100 mV rms
5360A/5365A	320 MHz	5×10^{-10}	12	5×10^{-10} per Day	20 mV rms
5345A	500 MHz	2×10^{-9}	11	5×10^{-10} per Day	20 mV rms

Table 5. Counter selection guide

Classification	Description	Frequency	Functions*	Time Base	Price	Page
5381A, 5382A & 5383A Low Cost	Traditional HP quality and reliability at new low prices.	To 520 MHz	F	3×10^{-5} /Mo. Optional 1×10^{-7} /Mo.	From \$295	261
5300 Series Economic Portable	Select from 8 plug-ons to meet present needs. Move up in functions or frequency range when needed. Battery pack, D to A converter and HP Interface Bus output module extend versatility.	To 1300 MHz	F, P, MPA, TI, TI AVG, T, R, V, E	3×10^{-7} /Mo. Optional 1×10^{-7} /Mo.	From \$685	252
5326/27 Series Universal Counters	A family of four universal counters that can include sub nanosecond time interval averaging, a built in DVM, burst frequency measurements and systems options.	To 550 MHz	F, P, MPA, TI, TI AVG, T, R, V	3×10^{-7} /Mo. Optional to 1.5×10^{-8} /Mo.	From \$2000	251
5328A Universal Counter	A new high performance universal counter with sub nanosecond time interval averaging capability that can include high frequency measurement, DVM or HP Interface Bus options.	To 1300 MHz	F, P, MPA, TI, TI AVG, T, R, V, E	3×10^{-7} /Mo. Optional to 1.5×10^{-8} /Mo.	From \$1300	246
5245 Series General Purpose Plug-in Counters	Two mainframes and 9 plug-ins provide unmatched versatility. Plug-ins provide up to 18 GHz frequency, 10 nsec time interval and voltage capabilities	To 18 GHz	F, P, MPA, TI, T, R, V	1×10^{-7} /Mo. ($< 3 \times 10^{-9}$ /Day)	From \$4250	242
5345 Series High Performance Plug-in Counters	A new series of high performance mainframe and plug-ins, providing 500 MHz direct count, 2 nsec time interval, and 4 GHz automatic pulsed RF measurements.	To 18 GHz	F, P, MPA, TI, TI AVG, T, R, E	1.5×10^{-8} /Mo. ($< 5 \times 10^{-10}$ /Day)	From \$4250	238
5340 & 5341 Automatic Counters	Broad band, high sensitivity, microwave frequency measurements 10 Hz - 1.5 GHz, 10 Hz - 4.5 GHz and 10 Hz - 23 GHz.	To 23 GHz	F	Optional to 1.5×10^{-8} /Mo. ($< 5 \times 10^{-10}$ /Day)	From \$2975	262
5360 Computing Systems	Most accurate frequency measurements available plus time interval measurements to 100 psecs	To 18 GHz	F, P, MPA, TI	1.5×10^{-8} /Mo. ($< 5 \times 10^{-10}$ /Day)	From \$9000	263

***Legend for Functions**

- | | |
|-------------------------------|--|
| F = Frequency | TI AVG = Time Interval Average |
| P = Period | T = Totalize |
| MPA = Multiple Period Average | R = Ratio |
| TI = Time Interval | V = Voltage |
| | E = Electronically Controlled Totalize |

ELECTRONIC COUNTERS

500 MHz plug-in counter

Model 5345A

- 500 MHz Direct Counting
- 20 mV Sensitivity DC to 500 MHz
- 2 nsec Single Shot T.I. Resolution

- Averaging to 2 psec resolution
- Pulsed RF and Microwave Measurements
- Programmable for systems applications via HP-IB

HP-IB



The 5345A Electronic Counter represents the most advanced general purpose instrument in the Hewlett-Packard Counter Product line. Utilizing state of the art monolithic bipolar integrated circuit technology especially designed and manufactured at Hewlett-Packard, this instrument provides unsurpassed power, versatility and flexibility in frequency and time measurements.

Major mainframe features

Frequency: direct from DC to 500 MHz — Reciprocal technique provides high measurement resolution.

Time interval: resolution of 2 nsec single shot.

Averaging: new modulated clock technique gives true averages under all conditions. T.I. resolution extended to 2 psec. Frequency averaging improves RF pulse measurements similarly.

Totalize: to 500 megabit rate on both A and B inputs. A ± B functions also available.

Ratio: from DC to 500 MHz on both inputs.

Fully programmable: provides great flexibility when used with calculators and computers.

Plug-in versatility: two plug-ins presently available (see page 12.7) with an on-going R&D program to extend this number. In addition the 10590A plug-in adapter allows all the existing 5245 plug-ins to be used.

Signal input circuits

Signal conditioning: fully optimized front end includes switchable

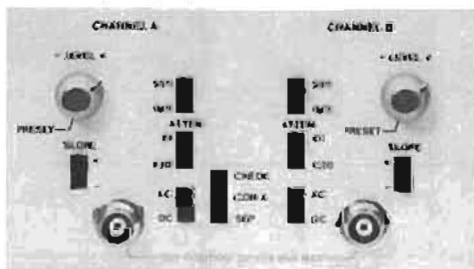

Figure (1) Input Switches

500/1MΩ input impedances, DC/AC coupling, and slope selection that assures triggering on any waveform.

Sensitivity, dynamic range: highly sensitive wideband amplifiers as-

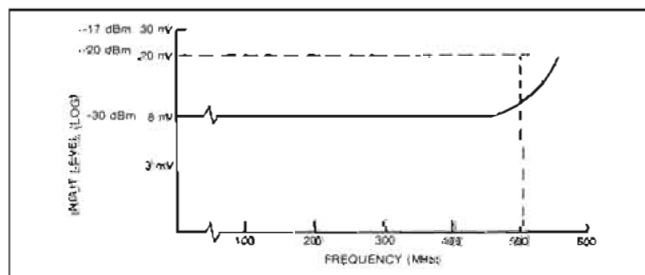

Figure (2) Typical Amplifier Sensitivity

sure measurements on even the lowest level sinusoidal and digital signals. The inputs also feature an extremely wide linear dynamic range of -2 to +0.5 V that greatly increases measurement versatility, especially on digital input signals.

Frequency measurements

Reciprocal capability: one of the advantages of measuring period

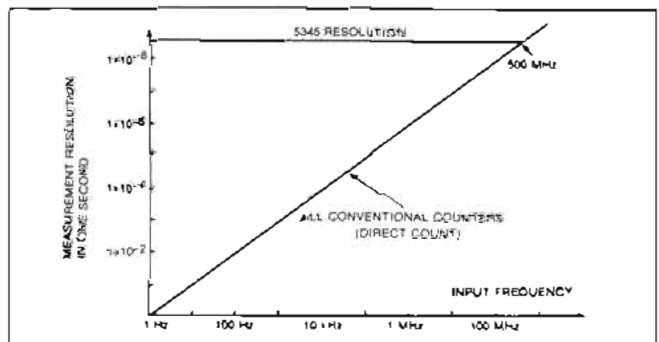

Figure (3) Measurement Resolution

and computing the frequency is that measurement resolution is independent of input frequency and at the maximum to which the instrument is capable of resolving. Thus for example, a 1 MHz input can be resolved to 2×10^{-6} (≈ 0.002 Hz) in one second, whereas the conventional counter provides 1 Hz resolution, some 500 times less.

Measurement speed

Mode of Operation	Readings per Second
Normal Operation (Max sample rate)	10
Externally armed	500
Externally gated	500
Computer dump	9,000

The extremely high resolution obtained in one second can be traded for measurement speed. For example a 100 μsec gate time provides a resolution of 2×10^{-5} yet the measurements can now be made 5000 times a second, thus making the 5345A an invaluable tool in high speed data acquisition systems.

Ext. gated capability: via the rear panel gate control input; this capability allows the operator to determine at what point in real time and for how long the measurement is to be made. This capability essentially replaces the front panel "sample rate" and "gate time" controls.

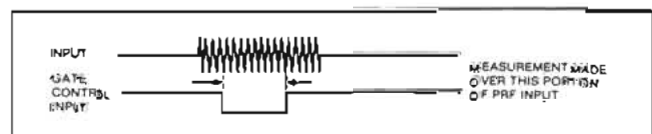

Figure (4) External Gate Control

The major application is in the measurement of pulsed RF signals.

Frequency averaging: the minimum pulse width for which the input frequency can be measured is 20 ns. The single shot measurement resolution is 2×10^{-9} divided by the GATE TIME. This resolution can be improved up to 1000 times by a unique mode of operation known as frequency averaging that is built into the mainframe. The only requirement for this mode is that the signal is repetitive.

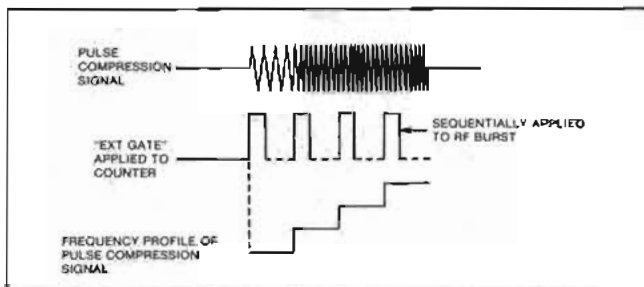

Figure (5) Frequency Averaging to Increase Resolution

In addition to greatly enhancing narrow pulse measurement capability, the frequency averaging mode also allows higher resolution on pulse profile measurements.

Time interval

Precision measurement: the single shot time interval measurement resolution of the 5345A is 2 nsecs, which is the time it takes light to travel approximately 2 feet—the 5345A is an extremely high resolving time measuring device.

Trigger level: quantitative high speed time interval measurements are provided by the 5345A since the user can simply determine where triggering occurs even on complex waveforms. The method of determination involves measuring the DC levels at which triggering occurs. These DC levels are available at rear panel BNC's.

The ability to determine trigger level, together with the high sensitivity and wide dynamic range of the inputs greatly enhances the versatility and power of the 5345A in time interval measurements.

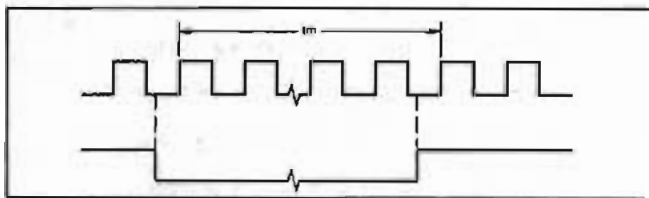

Figure (6) Using EXT GATE to Measure TM

Ext. gate capability: external gating adds even more versatility to the time interval measurements of the 5345A, as measurements such as that shown in figure (6) indicate.

Time interval averaging: for repetitive inputs a successive number of measurements may be automatically averaged by the 5345A, obtaining up to 1000 times improvement in resolution (2 psecs). This averaging mode may be used irrespective of whether the instrument is in the conventional or ext. gate mode of operation.

Totalize

High speed: the 5345A has the ability to totalize to a 500 megabit

rate through either or both A and B inputs. Coupled with the high sensitivity and full signal conditioning of both channels, this capability enables measurements to be made on most modern digital systems.

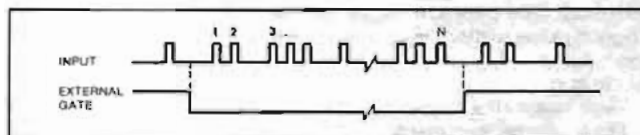

Figure (7) Selecting a Portion of a Pulse Train

Ext. gate capability: using the external gated mode allows the user to select only the desired portion of the input pulse train for measurement.

A ± B Modes

The A - B mode is used for comparison tests between high speed reference and test signals applied to the two mainframe inputs.

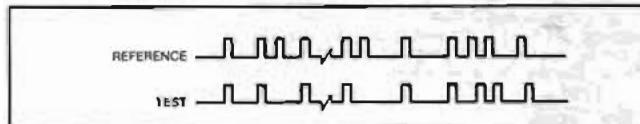

Figure (8) Comparison Measurements

Any difference between the total number of events accumulated in each channel is indicated by the 5345A display after the measurement is completed.

The primary application for the A + B mode is in the measurement of NRZ signals. By setting the "A" trigger slope to "+" and the B slope to "-" allows all transitions and hence bits of the NRZ signal to be counted. Thus 1 gigabit NRZ waveforms can be measured.

This mode of operation does not introduce any limitations—maximum input rate is 500 megabits on either channel and external gating may be used.

Ratio

This measurement represents the ratio of the number of events occurring through channel B divided by the number occurring through channel A. The major features are: a) that the measurement or comparison between the two signals occurs during the same real time duration (similar to the A ± B totalize modes); and, b) the frequency or bit rate of either channel can vary from DC to 500 MHz. These features allow this measurement to be extremely useful in digital systems and synthesizer check out.

Digital I/O

Option 011 provides complete digital input-output capability (except slope and level control) to the 5345A. Digital output is a bit parallel, byte serial ASCII coded format and the I/O structure conforms to the Hewlett-Packard Interface Bus (HP-IB) standard. This option is particularly recommended for a bench top calculator controlled environment.

Option 012 is similar to Option 011, but includes programmable control of slope and level. Option 012 is recommended for a computer controlled environment.

The model 59310A Interface Kit provides a complete operational package for use with the HP 2100 Series Computers. Similarly, other interface kits allow the user to interface the 5345A Option 011 or 012 and other HP-IB compatible devices to the 9820, 9825 and 9830 Series HP Calculators. This powerful calculator counter combination is described in more detail on pages 28 and 29.

Model 5345 (cont.)

5345A Condensed specifications**Frequency/period measurements****Range:** 0.00005 Hz to 500 MHz**Accuracy:** $\pm 2 \times 10^{-9}$ gate time \pm trigger error* \pm time base error**Gate time:** 1000 seconds to 100 nanoseconds in decade steps; <50 ns in MIN position.**Time interval/time interval average****Range:** 10 nsec to 20,000 sec**Minimum time between trigger points:** 10 nsec**Trigger pulse width:** 1 nsec minimum width input at minimum voltage input**Accuracy:****Time Interval:** \pm trigger error** \pm 2 ns \pm time base error**Time interval averaging:** $\pm \frac{\text{trigger error}^{**} \pm 2 \text{ nsec}}{\sqrt{\text{intervals averaged}}} \pm 0.7 \text{ nsec} \pm$ time base accuracy

not affected by harmonics of clock frequency.

Resolution:**Time Interval:** 2 nsec**Time interval average:** $\pm \frac{2 \text{ nsec}}{\sqrt{\text{intervals averaged}}} \pm 2 \text{ picoseconds}$ *Trigger error for sinewaves of 40 dB signal-to-noise amplitude ratio is $<[\pm 0.3\%$ of one period \div number of periods averaged]. If peak noise amplitude is greater than 10 mV(rms), additional miscounting may occur (this situation can arise when measuring high-level outputs of broadband synthesized signal sources).

**For any wave shape, trigger error is less than

 $\pm \frac{0.0025 \mu\text{s}}{\text{Signal Slope (V}/\mu\text{s})}$ **Ratio B/A****Range:** both channels accept dc to 500 MHz**Accuracy:** \pm L.S.D. \pm trigger error***Start/stop****Range:** both inputs dc to 500 MHz**Modes:** A, A \pm B determined by rear panel switch**Scaling****Range:** dc to 500 MHz**Scaling factor:** selectable by GATE TIME setting. Scaling factor equals GATE TIME setting/ 10^{-9} seconds.**Input:** input signal through channel A**Output:** output frequency equals input frequency divided by scaling factor. Rear panel BNC supplies 50% duty cycle TTL compatible pulses.**Input channels A and B****Range:** 0 to 500 MHz dc coupled 50 Ω and 1 M Ω ; 4 MHz to 500 MHz ac coupled, 50 Ω ; 200 Hz to 500 MHz ac coupled, 1 M Ω **Impedance:** selectable, 1 M Ω shunted by less than 30 pF or 50 Ω (nominal).**Sensitivity:** X1, 20 mV rms sine wave and 60 mV peak-to-peak pulse. X20, 300 mV rms sine wave and 1.2 V peak-to-peak pulse**Trigger level:** continuously adjustable to more than cover the DYNAMIC RANGE**Output:** rear panel BNC connectors bring out CHAN A TRIG LEVEL and CHAN B TRIG LEVEL for convenient DVM monitoring. Accurate to ± 15 mV**Common input**

In this mode the signal is applied to channel A

Range: ac coupled 50 Ω , 4 MHz to 400 MHz; ac coupled 1 M Ω , 300 Hz to 400 MHz**Impedance:** 50 Ω remains 50 Ω ; 1 M Ω becomes 500 k Ω shunted by 60 pF**Sensitivity:** 50 Ω : 40 mV rms, 1 M Ω : No change**Dynamic range:** 50 Ω \pm 800 mV(X1); \pm 5.0 V(X20) 1 M Ω : No change.**General****Display:** 11 digit LED display and sign. Annunciator displays ksec to nsec, k to n, μ Hz to GHz. Decimal point is positioned with DISPLAY POSITION control or positioned after the first, second or third most significant digit if DISPLAY POSITION is in AUTO. Leading zeros are suppressed.**Overflow:** asterisk is illuminated when display is overflowed**Sample rate:** continuously variable from <0.1 sec to >5 sec with front panel control. In HOLD position the last reading is maintained until the counter is reset.**External arm input:** counter can be armed by a -1.0 V signal applied to the rear panel 50 Ω input.**External gate input:** same conditions as for EXT ARM**Gate Output:** >1 volt into 50 Ω **Time base****Standard high stability time base:** Crystal Frequency, 10 MHz (10544A)**Stability****Aging rate:** $< 5 \times 10^{-10}$ per day**Short term:** $< 1 \times 10^{-11}$ for 1 sec average**Temperature:** $< 7 \times 10^{-9}$, 0 $^{\circ}$ C to 55 $^{\circ}$ C**Option 001:** Crystal Frequency, 10 MHz**Stability:****Aging rate:** $< 3 \times 10^{-7}$ per month**Short term:** $< 2 \times 10^{-9}$ rms for 1 sec**Temperature:** $< 2 \times 10^{-6}$, 25 $^{\circ}$ C to 35 $^{\circ}$ C $< 5 \times 10^{-6}$, 0 $^{\circ}$ C to 55 $^{\circ}$ C**Line voltage:** $< 1 \times 10^{-4}$, $\pm 10\%$ from nominal**Self test:** a 100 MHz signal is internally applied**External frequency standard input:** input voltage > 1.0 V rms into 1 k Ω required from source of 1, 2, 2.5, 5, or 10 MHz $\pm 5.0 \times 10^{-3}$ ($\pm 5 \times 10^{-6}$ for opt. 01). Input can be sine or square wave.**Frequency Standard Output:** > 1 V rms into 50 Ω at 10.0 MHz sine wave.**Operating temperature:** 0 $^{\circ}$ C to 55 $^{\circ}$ C**Power requirements:** 100/120/220/240 V rms $\pm 5\%$ -10% 48 to 66 Hz, maximum power 250 VA.**Weight:** 17 kg (37 lb)**Options and Accessories****Option 001:** Room Temperature Time Base**Option 010:** Digital output only. HP Interface Bus format, talk only. Useful with 59301A ASCII-to-Parallel Converter and 5050B or 5055A Digital Printers.**Option 011:** Digital Input/Output same as Option 010. Compatible with HP Interface Bus and allows 5345A to be remotely programmed.**Option 012:** Digital I/O similar to Option 011. Includes slope and level control.**Option 908:** Rack flange kit**K13-59992A:** includes state machine tester as an aid for trouble-shooting the arithmetic processor.**10595A Board extender kit:** useful for troubleshooting plug-in boards while in operation.**10590A Plug-in adapter:** adapts 5245 series plug-ins to 5345. See next page**K15-59992A Standby power unit:** plug-in to maintain oscillator operation for prolonged periods without line voltage.**Reference literature available:**

HP Journal, Vol. 25-10, June 1-74

AN 173 Recent Advances in Pulsed Microwave Measurements

AN 174A Series of Application Notes on Counter/Calculator Applications

5345A Data sheet

I.D. #90337D Color Video Tape. Applications and demonstrations

5345A Plug-In Counter**Price**
less \$400

add \$250

add \$800

\$1450

add \$10

\$2250

\$475

\$600

\$1200

\$4250

- Fully automatic to 4 GHz
- Pulse measurements
- Frequency averaging



5354A

- Count a group of events between A and B
- Frequency sum and difference measurements

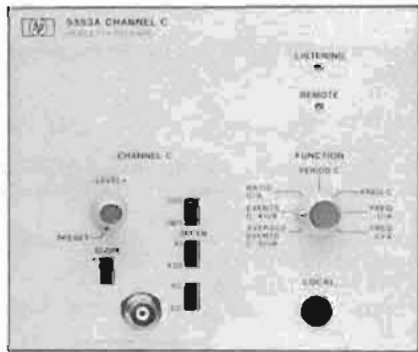

5353A



10590A

5354A Automatic frequency converter

The 5354A translates not only the microwave signal but all its modulation directly to the 500 MHz window of the counter (via the heterodyne technique). It allows signals with a large amount of FM to be easily characterized.

Perhaps even more powerful is its ability to take direct measurements on the carriers of very narrow microwave pulses. Pulse measurements can be easily automated.

Range: 15 MHz to 4 GHz

Sensitivity: -10 dBm (70 mV rms) auto mode, -20 dBm typical (22 mV rms) Manual/Pulse mode to +20 dBm (2.2 V rms)

Input signal capability: CW signals, Pulsed microwave signals, Signals with very high FM content.

RF Pulse width: determined by counter GATE TIME setting

FM Sensitivity: overlap at band edges ± 10 MHz

Maximum deviation at band center

± 250 MHz, above 1 GHz and below 500 MHz

± 125 MHz, between 500 MHz and 1 GHz

Operating modes: Automatic and Manual

Automatic: measures lowest frequency signal of sufficient amplitude to trigger counter.

Manual: measures signal within selected band. Signals of sufficient amplitude between 15 MHz and 525 MHz will also be counted.

Acquisition time:

Automatic mode: CONT. WAVE, < 2 ms; PULSED R.F., < 1s.

Manual mode: when proper band has been selected CONT. WAVE < 5 μ sec; PULSED R.F. < 20 nsec.

Option 011: remote control via HP Interface Bus and L.O. \pm I.F.

add \$200

5354A Automatic Frequency Converter

\$3250

5353A Channel C plug-in

The 5353A Channel C Plug-In consists of a third input to the 5345A Counter. When the plug-in counting capability is combined with the mainframe gating capability it becomes quite easy to make frequency sum and frequency difference measurements.

For high speed digital applications, the greatest benefit the plug-in offers is the ability to count a specific group of events while ignoring others. This measurement is required in many applications such as computer peripheral testing and digital communications systems. It is accomplished in the events C between A and B mode by applying a start signal to CHAN A and a stop signal to CHAN B while applying the data to be counted to CHAN C.

Range: de coupled: 0 to 500 MHz; ac coupled: 10 MHz to 500 MHz

Impedance: 50 Ω (nominal), or 1 M Ω shunted by less than 30 pF

Sensitivity: variable to 20 nV rms sine wave and 60 mV peak-to-peak pulse. Attenuator settings are X1 and X20.

Modes of operation: Frequency C & A; Frequency C \sim A; Period C; Frequency C: Ratio C/A; Average Events C, A to B; Events C, A to B.

Events accuracy: Plus or minus one event worst case

Option 011: Digital Input. Full compatibility with HP Interface Bus. Provides for digital control over all functions excluding an amplifier.

add \$250

5353A Channel C plug-in

\$1025

10590A Plug-in adapter

The 10590A allows the user to interface any of the 5245 series of plug-ins (except the 5264A) to the 5345A (see page 254 for details on these plug-ins). The major application is to extend the frequency range to 18 GHz via the 5255A, 5256A and 5257A plug-ins. In addition the adapter is "intelligent" in that it detects the plug-in being used and automatically adjusts the 5345 accordingly.

10590A Plug-in adapter

\$600

ELECTRONIC COUNTERS

General purpose plug-in counters

Models 5245L & 5248L

- Highest performance in general purpose counters
- Wide selection of plug-ins provide unmatched versatility
- Extremely high reliability proven from over forty million hours of field operation



5245L

The 5245L has gained unprecedented popularity due to its high performance, flexibility and years of proven stability. Even though its performance has been recently upstaged by the 5345A, the 5245L is still considered the standard of the industry for instruments of this type with more 5245L counters in operation today than all other plug-in counters combined.

The 5245 series consists of a family of mainframes and a series of plug-ins. The plug-ins provide frequency measurement to 18 GHz, high sensitivity, time interval and preset capability. The wide choice of mainframes and plug-ins means that virtually any measurement task performable by counters can be accomplished by appropriate selection within this family.

The 5245 series of counters are not only leaders in terms of performance and versatility, they are unsurpassed in the industry for ruggedness, wide operating temperature range, and field-proven reliability.

The following is a description of the 5245L mainframe. The other mainframes are similar to the 5245L. The main differences are delineated in these condensed specifications. Refer to the 5245 series data sheet for complete details and specifications on all mainframes and plug-ins.

Specifications

5245L

Frequency measurements

Range: dc to 50 MHz

Gate time: 1 μ s to 10 seconds in decade steps

Accuracy: ± 1 count \pm time base accuracy

Period average measurements

Range: dc to 1 MHz for single period; dc to 300 KHz for multiple period

Periods averaged: 1 period to 10⁵ periods in decade steps

Accuracy: ± 1 count \pm time base accuracy \pm trigger error*

Mainframe measurement functions: frequency, period, period average, ratio, scaling

Signal Input

Sensitivity: 100 mV rms

Coupling: AC and DC

Impedance: 1 M Ω in parallel with approx. 25 pF all ranges

Attenuation: step attenuator provides nominal sensitivities of 0.1, 1, and 10 V rms (SENSITIVITY switch)

Trigger Level: continuously adjustable over ± 3 V multiplied by the setting of the SENSITIVITY switch

Compatible 5245 series plug-ins: all

Time Base: 1 MHz oscillator, aging rate $< 3 \times 10^{-9}$ /day

Display: 8 digits

Operating temperature range: -20°C to $+65^{\circ}\text{C}$

Weight: net, 14.4 kg (32 lb) with blank plug-in panel

Dimensions: 133 mm high, 425 mm wide, 416 mm deep (5 $\frac{1}{4}$ " 16 $\frac{1}{2}$ " 16 $\frac{1}{2}$ "*)

5248L

Frequency range: dc to 150 MHz

Mainframe measurement functions: frequency, period, period average, ratio, scaling

Compatible 5245 series plug-ins: all

Time Base: 1 MHz oscillator, aging rate $< 3 \times 10^{-9}$ /day

Options

908: Rack Flange Kit

Price
add \$35

Model number and name

5245L 50 MHz Electronic Counter

\$4250

5248L 150 MHz Electronic Counter

\$5000

* Trigger error is $< (\pm 3\%$ of one period \div number periods averaged) for signals with 40 dB signal-to-noise ratio and 100 mV rms amplitude; error decreases as signal to noise ratio increases.

ELECTRONIC COUNTERS

Computing counter system

Models 5360A & 5375A - 5379A



5360A

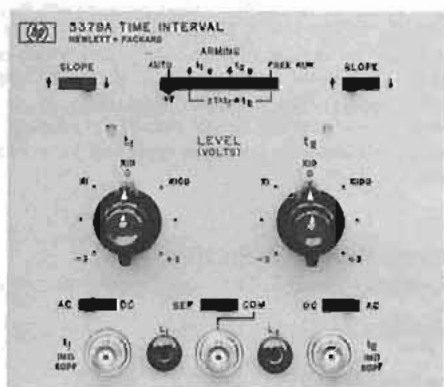

5379A



5375A

The Computing Counter is a general purpose precision digital instrument with built-in arithmetic capability. As a measuring device the Computing Counter provides unequalled precision. For example, it can measure the time between two events to a resolution of 100 picoseconds, about the time it takes light to travel one inch.

The Computing Counter's unique measurement technique employs extensive use of digital computation. Thus the mainframe contains an arithmetic unit which is an inherent, indispensable part of the measurement cycle. The arithmetic capability of the machine has been made available to the user via several programming devices. This allows the system to be programmed to solve equations where measurements are the variables, in real time. This capability enormously increases the power of the Computing Counter System.

Key specifications include a dc to 320 MHz direct count frequency range, measurement resolution of 1 part in 10^{10} per second of gate time, and ± 100 psec single shot time interval resolution using the 5379A Time Interval plug-in. A detailed description of the Computing Counter System and complete specifications are contained in the Computing Counter data sheet, available upon request.

5379A Time Interval plug-in

With the 5379A Time Interval Plug-In, the Computing Counter becomes a high precision and versatile time interval meter. Measurements can be made down to zero and even "negative" times by virtue of a unique arming scheme. Single shot events can be measured with ± 100 psec resolution and an accuracy of ± 1 nsec. By programming the Computing Counter from any of a number of programming devices (such as the 5375A Keyboard), the average of a number of measurements can be displayed to resolutions better than 5 psec.

5375A Keyboard

The 5375A provides the Computing Counter with the capability to add, subtract, multiply, divide and perform square root, logarithm and exponential functions. Decision capability and branching are possible also. Electrical outputs are made available for limit testing and peak to peak measurements.

10536A Plug-In Adapter

The 10536A Adapter is a versatile accessory which allows nine of the 5245 series plug-ins to be used in the Computing Counter. Frequency range can be extended to 18 GHz with these plug-ins.

Model number and name

5360A Computing Counter
Option 908: Rack Flange Kit
5379A Time Interval Plug-In
5375A Keyboard
10536A Plug-In Adapter

Price

\$9000
add \$10
\$1350
\$1800
\$550

ELECTRONIC COUNTERS

Plug-Ins for 5245L/M, 5246L, 5248L/M & 5345A

Models 5252A-5267A



5253B

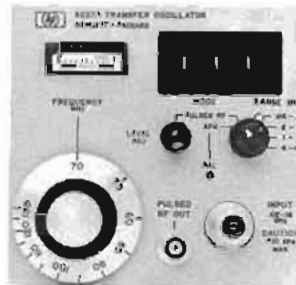

5257A

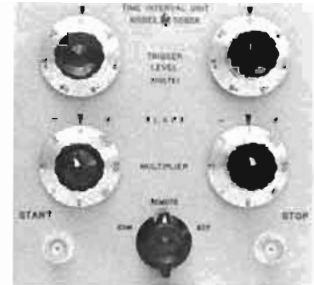

5262A



5254C



5255A



5256A

The 5245 series of plug-ins adds greatly to the versatility of the 5245 series of plug-in counters. In addition, these plug-ins enhance the measurement capability of the 5345A Electronic Counter and the 5360A Computing Counter by the use of plug-in adapters which provide an interface between the plug-in and the 5345A and 5360A mainframes. A compatibility summary for presently available plug-ins is shown below, followed by brief descriptions of the individual plug-ins. Refer to the 5245 series data sheet for complete details and specifications for all the plug-ins.

Plug-in compatibility summary

5345A compatibility (using 10590A plug-in adapter): all except the 5264A

5360A compatibility (using 10536A plug-in adapter): all except the 5265A, 5267A, 5262A, 5264A

5245L/M compatibility: all

5248L/M compatibility: all

5246L compatibility: all except the 5264A

Specifications

Price

5253B Heterodyne converter

\$1050

Frequency range: 50 MHz to 512 MHz

Sensitivity: -13 dBm to +13 dBm

Mixing frequencies: 50 to 500 MHz in 10 MHz steps

Input coupling: ac

Accuracy: maintains counter accuracy

Input impedance: 50Ω

5254C Heterodyne converter

\$1550

Frequency range: 150 MHz to 3 GHz

Sensitivity: -13 dBm to +13 dBm

Mixing frequencies: 0.15 to 3 GHz in 50 MHz steps

Input coupling: ac

Accuracy: maintains counter accuracy

Input impedance: 50Ω

Auxiliary output: 1 MHz - 50 MHz



5267A



5265A

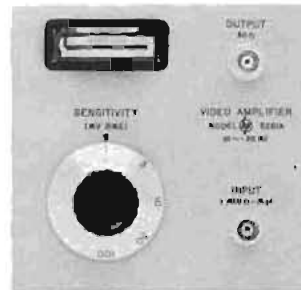

5261A

5255A Heterodyne converter

\$2500

Frequency range: 3 GHz to 12.4 GHz
Sensitivity: -7 dBm to +10 dBm
Mixing frequencies: 2.8 to 12.4 GHz in 200 MHz steps
Input coupling: dc
Accuracy: maintains counter accuracy
Input impedance: 50Ω
Auxiliary input: 1 MHz - 200 MHz at 5 mV sensitivity
Auxiliary output: 1 MHz - 200 MHz

5256A Heterodyne converter

\$2925

Frequency range: 8 GHz to 18 GHz
Sensitivity: -7 dBm to +10 dBm
Mixing frequencies: 8 to 18 GHz in 200 MHz steps
Input coupling: dc
Accuracy: maintains counter accuracy
Input impedance: 50Ω
Auxiliary input: 1 MHz - 200 MHz at 5 mV sensitivity
Auxiliary output: 1 MHz - 200 MHz

5257A Transfer oscillator

\$2975

Frequency range: 50 MHz to 18 GHz
Input signal: CW, pulsed RF or FM modulated
Sensitivity: -7 dBm, 50 MHz to 15 GHz; -4 dBm, 15 GHz to 18 GHz
APC lock range: approximately ±0.2% of input frequency
Pulse carrier frequency measurements: minimum pulse width: 0.5 μsec. Minimum repetition rate: 10 pulses per second
Input impedance: 50Ω
VFO stability: typically 1 × 10⁻⁷ per minute after 2 hours

5262A Time interval unit

\$580

Range: 1 μsec to 10³ sec (to 10⁶ sec with 5246L)
Resolution: 0.1 μsec
Input sensitivity: 100 mV rms
Start-Stop: independent or common channels
Trigger slope: positive or negative on Start and Stop channels, independently selected
Trigger amplitude: both channels adjustable from -250 to +250 V peak
Input repetition rate: better than 2 MHz
Input impedance: from 10k/10 pF at X0.1 multiplier setting to 10 MΩ/20 pF at X100 setting

5267A Time interval unit

\$580

Range: 100 nsec to 10⁸ sec with 5248L/M; 1 μsec to 10⁸ sec with 5245L/M; 1 μsec to 10⁶ sec with 5246L
Resolution: 10 nsec with 5248L/M only; 0.1 μsec otherwise
Input sensitivity: 100 mV rms
Start-Stop: independent or common channels
Trigger slope: positive or negative on Start and Stop channels, independently selected
Trigger amplitude: both channels adjustable from -300 to +300 V peak
Input repetition rate: 5 MHz, max
Input impedance: 1 MΩ/35 pF

5265A Digital voltmeter

\$1090

Voltage ranges: 10 V, 100 V and 1000 V full scale
Resolution: 100 μV
Accuracy: ±0.1% of reading, ±0.01% of full scale for readings < 1/10 of full scale
Sample rate: 5 per second
Input resistance: 10.2 MΩ on all ranges
Range selection: manual
Noise rejection: 30 dB at 60 Hz, increasing at 12 dB per octave

5261A Video amplifier

\$595

Bandwidth: 10 Hz to 50 MHz
Input sensitivity: 1 mV
Input impedance: 1 MΩ/15 pF
Auxiliary output: 40 dB gain max into 50Ω; 300 mV rms max output undistorted into 50Ω; source impedance 50Ω



ELECTRONIC COUNTERS

100 MHz Universal counter

Model 5328A

- 100 MHz, 512 MHz and 1300 MHz
- 100 ns or 10 ns time interval
- T.I. averaging to 10 ps resolution
- "armed" measurements
- DVM options
- HP-IB interface option

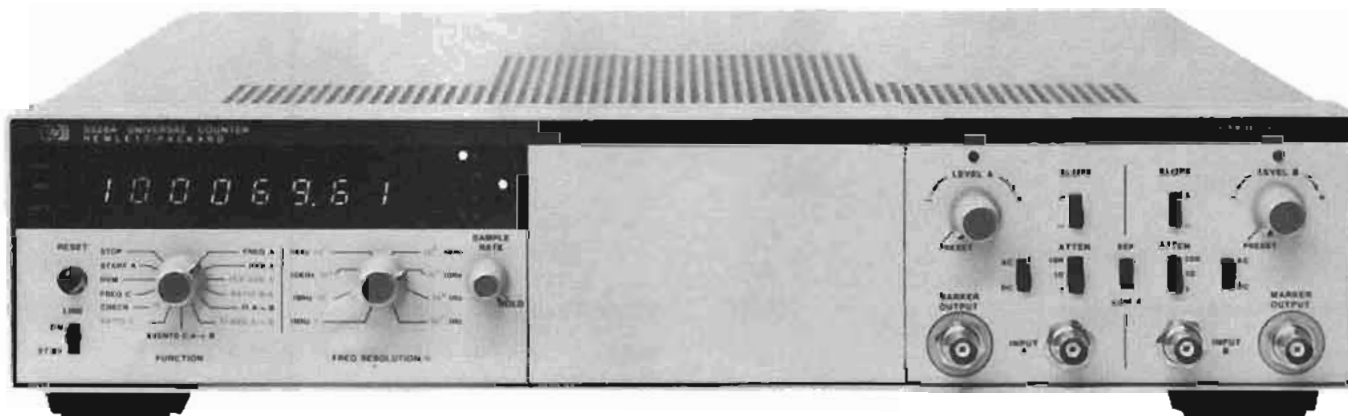

HP-IB

Model 5328A

Description

The 5328A, thru the use of the latest technology (such as a ROM controlled measurement cycle) and a modular design, provides you with the optimum in universal counter price/performance. Optional modules allow you to tailor the performance of the 5328A to meet your particular measurement needs. In many instances, however, the standard 5328A offers all the capability you're ever likely to need:

Burst and CW measurements to 100 MHz: special gating circuits start a measurement only when the input signal is present, allowing burst frequencies to be made as easily as CW measurements. The option 030 channel C extends this capability to 512 MHz; option 031, to 1300 MHz.

Single shot time interval measurements: the standard universal module's 100 ns single shot resolution meets or exceeds the requirements for a wide range of applications such as mechanical and electromechanical device timing (relays), time of flight measurements (ballistics), sonar ranging, radio ranging and navigation.

Time interval averaging: resolution better than 10 ps (10^{-11} seconds) for repetitive time intervals as short as 100 ps.

Period, period average, ratio, totalize, scale: extra problem solving power for your special requirements.

Armed measurements: versatile arming modes (controlled by a rear panel switch) allow the real time control over when a measurement begins. Useful for measurements such as frequency burst profile and frequency sweep linearity.

Trigger lights: trigger light blinks when channel is triggering; light is ON when input is above trigger level; OFF when input is below trigger level. Simplifies trigger level adjustments.

High performance marker outputs: marker outputs (operational to 100 MHz) indicate where channel is triggering in real time for oscilloscope monitoring applications. Provides measurement feedback to the operator for greatly simplified measurement set-ups.

These features and capabilities make the 5328A an excellent choice for general purpose lab use, electronic service, and production test. For more demanding applications, a variety of options offer extended performance at a modest increase in price.

Summary of characteristics

Model No.	Description	Features
5328A	Universal Counter	Frequency to 100 MHz; 100 ns single shot T.I.; T.I. averaging; Period; Period Avg; ratio; totalize Oven oscillator with aging rate $< 5 \times 10^{-10}$ /day
Opt. 010	High Stability Time Base	
Opt. 011	HP-IB Interface	Allows 5328A to output data and be controlled via the HP Interface Bus.
Opt. 020	DVM	Single ended DVM for trigger level and external voltage measurements.
Opt. 021	High Performance DVM	Floating DVM for trigger level and high accuracy external voltage measurements.
Opt. 030	512 MHz Channel C	Frequency measurements to 512 MHz; 9 digit display.
Opt. 031	1300 MHz Channel C	Frequency measurements to 1300 MHz; 9 digit display.
Opt. 040	High Performance Universal Module	Same as standard 5328A but with 10 ns single shot T.I.; improved T.I. averaging; improved T.I. accuracy; measurements with delay; T.I. A-B marker; hysteresis compensation; switchable input impedance (1 M Ω /50 Ω).
Opt. 041	Programmable Input Module	Full remote programming of all universal module controls thru opt. 011; 10 ns single shot T.I.; switchable 1 M Ω /50 Ω input impedance.

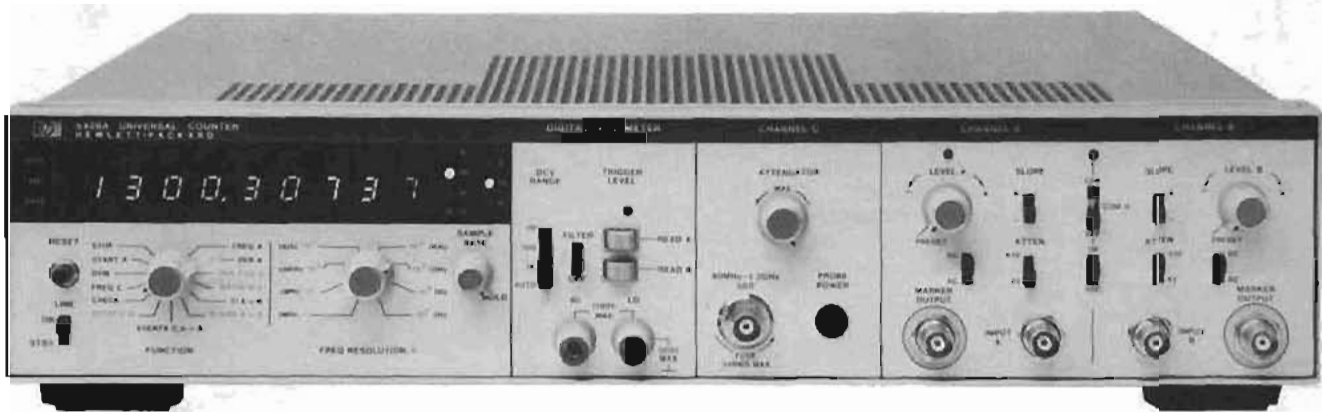

5328A with options 021, 031, 041

5328A Option descriptions

High stability time base (Opt. 010)

The standard time base for the 5328A is a room temperature 10 MHz crystal providing a long term aging rate of less than 3 parts in 10⁷ per month. The option 010 oven oscillator offers excellent short term and temperature stability which can contribute to higher measurement accuracy. The low aging rate of <5 X 10⁻¹⁰/day permits reduced intervals between time base calibrations.

HP Interface bus for systems use (Opt. 011)

The option 011 HP-IB Interface brings the full capability and power of the HP Interface Bus. The 5328A can accept program code words over the HP-IB which remotely program various front and rear panel controls. In addition, measurement results may be output over the bus to HP-IB compatible instruments, calculators, or computers.

Remotely programmable controls include FUNCTION selection, RESOLUTION selection, ARMING, SAMPLE RATE (max. or manual), RESET, measurement modes, output modes, and display modes. Option 041 adds programming of channel A and B input signal conditioning controls.

Digital voltmeters (Opt. 020, 021)

The unique combination of an integrating digital voltmeter with a universal counter produces a superb general purpose measuring instrument. By using a voltage to frequency conversion technique, the incremental cost of adding DVM capability to the 5328A is very low.

Two DVM options are available: the option 020 DVM with single-ended input and the option 021 High Performance DVM with floating input. You can use these DVM's to measure channel A and B trigger levels and external voltages. Since a built-in DVM greatly simplifies time interval measurement set-ups, it is highly recommended that one of the DVM options be selected, particularly if time interval measurements are one of your major applications.

High frequency channel C (Opt. 030, 031)

With a high frequency channel C module the 5328A is ideally suited for use in a wide variety of communications measurements. Option 030 gives direct count measurements to 512 MHz with 15 mV rms sensitivity; option 031 counts to a full 1300 MHz with 20 mV rms sensitivity. Typical applications include servicing, maintaining, calibrating,

and monitoring communications transmitters and receivers such as found in two-way radio, radio and television broadcasting, mobile radio, and common carrier multiplexing and transmission.

Extended capability universal modules (Opt. 040, 041)

Options 040 and 041 give extended performance for time interval measurements. Option 040 is designed for bench use and includes "delay" capability for increased measurement versatility. Option 041 adds full programming of the input signal conditioning controls.

Both of these options generate a 100 MHz clock to give 10 ns single shot resolution for time interval measurements. This resolution is useful in applications such as computer/peripheral timing measurements, logic timing measurements, RADAR ranging, and optical ranging.

For improved time interval averaging performance, the options have input channels adjusted for delay matching to better than 2 ns. Additionally, options 040 and 041 use a jittered clock in T.I. AVG. function to give averaging even for those cases when the input repetition rate is asynchronous with the counter's internal timebase.

Selectable input impedance adapts the counter to the measurement environment: 50Ω for fast signals in a 50Ω environment, 1 MΩ to reduce circuit loading or to use with scope probes.

The "delay" feature of option 040 allows you to disable the inputs from triggering for selected periods of time (20 μs to 20 ms). Delay is useful for ignoring high amplitude noise such as from chattering relays or ignoring stop pulses in multiple stop T.I. measurements.

Option 041 allows remote programming of input trigger level, slope, coupling, and attenuator setting. Under remote control, the input impedance is independently selectable on the A and B channels. Also, a remote "Invert" function switches the A and B channel signals internally. "Invert" gives exceptional flexibility for two channel time interval measurements.

Retrofit kits

Retrofit kits, available for all options, allow you to upgrade the performance of your 5328A in response to your changing measurement requirements.

The condensed specifications on the following pages highlight some of the important performance characteristics of the 5328A and its options. Complete specifications and detailed applications information are available in the 5328A data sheet.

ELECTRONIC COUNTERS

Model 5328A (cont.)

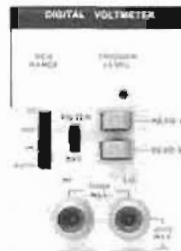
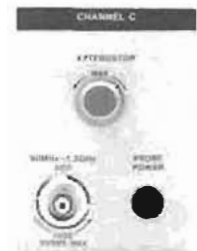
Opt 020
DVMOpt 021
High Performance DVWOpt 030
512 MHz
Channel COpt 031 1300 MHz
Channel C

Digital voltmeter modules

Digital voltmeter measurements†

DVM (option 020 and 021): trigger levels of input channels A and B and external voltages may be measured.



10855A Preamp

	Opt. 020	Opt. 021
Maximum sensitivity:		
Meas. time:		
10 s (N = 10 ²)	1 mV	10 μ V
1 s (N = 10 ⁴)	1 mV	100 μ V
0.1 s (N = 10 ⁵)	2 mV	1 mV
10 ms (N = 10 ⁶)	20 mV	10 mV
1 ms (N = 10 ⁷)	200 mV	100 mV
Range:	0 to \pm 125 V dc	\pm 10, \pm 100, \pm 1000 V dc, and A utorange
Accuracy: (20 min. warm-up)	\pm 0.5% reading \pm 4 mV	\pm 0.03% reading \pm 0.004% range; for 1000 V range, \pm 0.087% reading \pm 0.004% range
Input terminals:	Single ended	Floating pair
Input impedance:	10 M Ω	10 M Ω
Normal mode:	> 60 dB at 60 Hz	> 80 dB at 50 Hz or greater with filter on
Rejection ratio:	(50 Hz) \pm 0.1%	DC: > 120 dB
Effective common-mode rejection ratio:		AC: > 120 dB for multiples of 60 Hz (50 Hz) with filter on
Maximum input:	\pm 500 V	H1 to LO: \pm 1100 V all ranges; LO to chassis ground: \pm 500 V
Trigger level:	2 mV display resolution	1 mV display resolution; trigger level reading automatically multiplied by setting of attenuator switch if using option 040 or 041 universal module

†Performance: 60 days at 23°C \pm 5°C and RH < 50%

Channel C modules

	Opt. 030	Opt. 031
Input characteristics		
Sensitivity:	15 mV rms	20 mV rms
Coupling:	dc	ac
Trigger level:	0 V, fixed	0 V, fixed
Impedance:	50 Ω	50 Ω
Maximum input:	5 V rms	5 V rms, \pm 5 V dc
Input protection:	fused	fused
Attenuator:	No	Variable for optimum noise suppression on signals to 5 V rms
Frequency C measurement		
Range:	5-512 MHz (direct count)	90-1300 MHz (prescaled, \div 4)
Resolution:	1 MHz to 0.1 Hz in decade steps	1 MHz to 0.1 Hz in decade steps
Accuracy:	\pm 1 count \pm timebase error	\pm 1 count \pm timebase error
Ratio C/A measurement		
Range: A:	0-10 MHz	0-10 MHz
C:	5-512 MHz	90-1300 MHz
General		
Probe power:	No	Power to operate 10855A Preamp or HP active probe

Events C, A to B (with option 030 only)

The number of events at the C input are totaled during the synchronized time interval defined by inputs to channels A and B. The synchronized time interval is a multiple of 100 ns with the standard universal module; a multiple of 10 ns with option 040 or 041 universal modules.

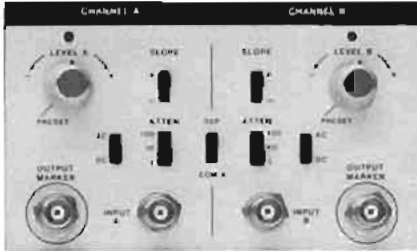

Standard Universal Module

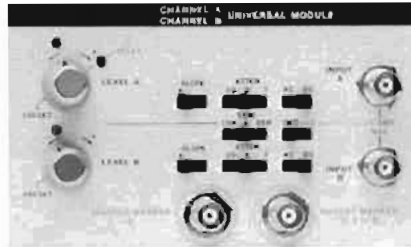

Opt. 040 High Performance Universal Module

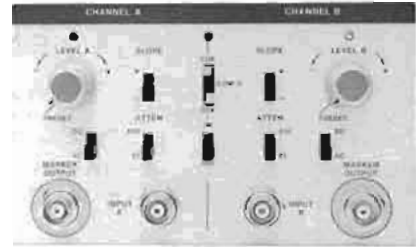

Opt. 041 Programmable Input Universal Module

Accessories

10B65A Preamp (for use with option 031): gives >22 dB gain with ±1 dB flatness over the entire frequency range of the option 031 1300 MHz Channel C. (See page 12.31 for more details.)

Universal modules, channels A and B

	Standard	Option 040 Option 041
Input characteristics		
Sensitivity		
0-40 MHz (ac coupled):	25 mV rms	
20 Hz-40 MHz (dc coupled):	25 mV rms	
40-100 MHz:	50 mV rms	
Min pulse width:	5 ns, 140 mV p-p	
Coupling:	ac or dc, switchable	
Impedance:	1 MΩ 40 pF	1 MΩ or 50Ω, switchable
Trigger level:	variable ±2.5 V times atten. setting	
Trigger slope:	independent selection of + or - slope	
Attenuators:	X1, X10, X100	Opt. 040: X1, X2, X20 Opt. 041: X1, X10
Dynamic range:	25 mV to 1 V rms times attenuator setting for 0-40 MHz; 50 mV to 500 mV times attenuator setting for 40-100 MHz	
Channel input:	Separate or Common A	Separate, Common A, or Check
Delay:	No	Opt. 040 only: 20 μs to 20 ms
Programmable Controls	No	Opt. 041 only: level, slope, coupling, atten, impedance, SEP-COM-CHK
Frequency A measurement		
Range:	0-100 MHz, direct count	
Resolution:	1 MHz to 0.1 MHz in decade steps	
Accuracy:	±1 count, ±1 timebase error	
Period A measurement		
Range:	0-10 MHz	
Resolution:	100 ns to 1 s in decade steps	10 ns to 0.1 s in decade steps
Accuracy:	±1 count ± timebase error ± trigger error*	

Period Average A measurement		
Range:	0-10 MHz	
Resolution:	100 ns to 0.01 ps in decade steps	10 ns to 0.001 ps in decade steps
Accuracy:	±1 count displayed ± timebase error ± trigger error* N	
Time interval A to B measurements		
Range:	100 ns to 10 ⁶ s	10 ns to 10 ³ s
Resolutions:	100 ns to 1 s in decade steps	10 ns to 0.1 s in decade steps
Accuracy:	±1 count ± timebase error ± trigger error*	
Time Interval average A to B		
Range:	0.1 ns to 10 s	0.1 ns to 1 s
Resolution:	±100ns ± trigger error* √N ±10 ps	±10ns ± trigger error* √N ±10 ps
Accuracy:	± resolution ±4 ns ± timebase error	± resolution ±2 ns ± timebase error
Min. pulse width:	25 ns	10 ns
Min. dead time: (from each stop event to next start event)	150 ns	40 ns
Ratio B/A measurements		
Range: A:	0-10 MHz	
Range: B:	0-100 MHz	
Totalizing and scaling, Start A		
The number of counts at the A input are totalized for N=1 on the resolution switch. For N>1, A/N is totalized and the scaled output (A/N) is available at the Timebase Out rear panel connector.		
Range: N=1	0-100 MHz	
Range: N>1	0-10 MHz	

*Trigger error is <0.3% of one period for sinewaves at 40 dB S/N or better and amplitude equal to sensitivity of counter. For any waveshape, trigger error is less than

$$\frac{\pm 2 \times \text{peak noise voltage}}{\text{signal slope}}$$

(or $\frac{\pm 0.0025 \mu\text{s}}{\text{signal slope in V}/\mu\text{s}}$ for 40 dB S/N.)

Model 5328A (cont.)

Measurements with delay (option 040)

Delay mode is activated by the inner concentric knob on Level A control of option 040 Universal Module. A red LED indicates delay is activated. In delay mode, Channel A triggers and is then disabled from triggering again until the delay times out (disabled state occurs within 1 μ s after triggering). Channel B is continuously disabled until the delay times out. After the delay, both A and B are enabled. The delay time may be measured by placing the counter in T.I. A—B and the Universal Module in check (CHK).

Delay range: 20 μ s to 20 ms continuously adjustable

Minimum dead time: 1 μ s between stop and next start (T.I. average measurements only)

General

Display: 9 digit LED display. Ninth digit used only with channel C functions (FREQ, C, Ratio C/A, Events C, A—B).

Blanking: suppresses display of unwanted zeros to left of most significant digit.

Storage: holds reading between samples; can be overridden by rear panel switch.

Sample rate: variable from less than 2 ms between measurements to HOLD which holds display indefinitely.

Gate output: rear panel output, TTL levels, high when counter gate open.

Timebase output: rear panel output; TTL levels.

Check signal: with function switch in CHECK, counter should display 10 MHz \pm 1 count. With options 040 and 041, place function switch in FREQ A and universal module in CHECK (CHK). Counter should display 100 MHz \pm 1 count.

Trigger lights: light is ON when input is above trigger level; OFF when input is below trigger level; BLINKING when channel is triggering. Operate over full frequency range of 0—100 MHz.

Marker outputs: indicate actual change of state of input Schmidt trigger for channels A and B with <20 ns delay. Output levels into 50 Ω are 0 to -100 mV for the standard universal module, 0 to -50 mV for option 040, and 0 to +1 V for option 041. Outputs are protected from inadvertently applied voltage to \pm 5 V dc.

Arm: rear panel switch turns arming ON or OFF. With arming ON the measurement is armed by an input other than the input involved in the measurement. The following are armed by an event at B: Freq A, Period A, Period Avg A, Freq C, DVM, Ratio C/A; the following are armed by an event at C: T.I. A—B, Events C, A—B, Ratio B/A.

Operating temperature: 0° to 50°C

Power requirements: 100/120/220/240 V rms, +5%, -10% (switch selectable), 48-66 Hz; 150 VA max.

Timebase oscillators**Standard crystal oscillator**

Frequency: 10 MHz

Aging rate: $< 3 \times 10^{-7}$ /month

Temperature: $< 2.5 \times 10^{-6}$, 0° to 50°C

Line voltage: $< 1 \times 10^{-3}$ for 10% change

Option 010 oven oscillator

Frequency: 10 MHz

Aging rate: $< 5 \times 10^{-10}$ /day after 24-hour warm-up

Short term: $< 1 \times 10^{-10}$ rms/s

Temperature: $< 7 \times 10^{-6}$, 0° to 50°C

Line voltage: $< \pm 5 \times 10^{-3}$ for 10% variation

Warm-up: within 5×10^{-9} of final value in 20 min.

Ext. freq. std. input: 30 kHz to 10 MHz signal of amplitude > 1.0 V rms into 1 k Ω . Maximum input: 5 V p-p. Correct reading obtained only with 10 MHz input. Other inputs give scaled readings. With options 040 and 041 the following constraints apply: ext. freq. std. must be 10 MHz for Period Avg., T.I. Avg., Period (N=1), and T.I. (N=1).

HP-IB Interface (Option 011)

Option 011 provides digital output of measurement data ("talker") as well as input for remote program control ("listener").

Programmable features: function, resolution, sample rate (max or manual control), arming, display modes, measurement cycle modes, output modes, and reset commands. Option 041 adds control of channel A and B trigger level, slope, attenuator, coupling, input impedance, and SEP-COM-CHECK selection.

HP-IB commands: responds to the following bus commands (see HP-IB Users Guides for definitions): Unlisten, Untalk, Local Lockout, Device Clear, Serial Poll Enable, Serial Poll Disable, Go to Local, Selected Device Clear, and Group Execute Trigger.

Service request (SRQ): if enabled, indicates end of measurement.

Maximum data output rate: 500 readings/sec.

Accessories

5363A Time Interval Probes solve many of the "hidden" problems of precision time interval measurements. The 5363A Time Interval Probes minimize circuit loading, give calibrated trigger level settings, increase input dynamic range, and allow differential channel delay calibration. See page 264 for more details.

Options and accessories

	Price
Opt. 010: High Stability Timebase	\$525
Opt. 011: HP-IB Interface	\$350
Opt. 020: DVM	\$200
Opt. 021: High Performance DVM	\$500
Opt. 030: 512 MHz Channel C	\$400
Opt. 031: 1300 MHz Channel C	\$600
Opt. 040: High Performance Universal Module	\$350
Opt. 041: Programmable Input Controls Module	\$950
Opt. 907: Front Handle Kit	\$15
Opt. 908: Rack Flange Kit	\$10
Opt. 909: Rack Flange and Front Handle Combination Kit	\$20
10855A Preamp	\$225
5363A Time Interval Probes	\$1900
5328A Universal Counter	\$1300

ELECTRONIC COUNTERS

50 MHz and 550 MHz universal counters

5326/5327 Family



5327B

Description

The four models of the Hewlett-Packard 5326/5327 family offer versatile, high precision counters to measure frequency, time intervals, or voltage. The 5326 series covers the frequency range to 50 MHz; the 5327 series measures to 550 MHz. In addition, the 5326/5327 family offers the following features to make your measurements simpler, easier to set up, and more accurate:

8 digit display: 8 digits standard to give high resolution measurements without overflow.

Burst and CW measurement: special gating circuits start a count only when your input signal is present. You can measure a frequency burst as easily as a CW signal.

One shot time interval measurements: from 0.1 μ sec to 10^8 sec.

Time interval averaging: resolution better than 100 ps for intervals as short as 150 ps with repetitive signals.

Built-in DVM: set trigger levels with ease, plus measure external DC voltages.

Period, ratio, totalize and scale measurements: extra problem solving capability for your special requirements.

High sensitivity input channels: for measuring the frequency of low level signals down to 5 mV to 50 MHz and 25 mV to 550 MHz.

Fused input protection: for 550 MHz channels to prevent expensive damage for accidental overloads.

Systems compatibility: BCD output standard, plus a choice of two remote programming options to suit your application.

Oven oscillator option: aging rate $< 5 \times 10^{-10}$ /day for precision applications.

Front panel trigger lights: to show when the counter is triggering properly on the input signal.

The built-in DVM

Both the 5326B and the 5327B include a built-in DVM. With the built-in DVM, you can actually set trigger levels with digital accuracy. The functions READ A and READ B monitor the internal trigger level settings for the A and B channels. The values are shown directly on the display. Of course, the integrating DVM can also make accurate external voltage measurements. Thus a single instrument can do the job of two. For systems applications, this means there is only one instrument to program and a single set of outputs for all measurements.

Systems compatibility

Each member of the 5326/5327 family can be effectively used as a fast efficient systems instrument. BCD output is included as a standard feature. Options 002 and 004 provide remote programming of the counter controls. The 10542A Remote Programming Interface joins option 004 to a standard 40 bit output register for the HP 2100 series computers.

Model number and name:

Model number and name:	Price
5326A Timer/Counter	\$2000
5326B Timer/Counter/DVM	\$2400
5327A Timer/Counter	\$2550
5327B Timer/Counter/DVM	\$2950

Options

002: Remote Programming	add \$80
004: Full Remote Prog. (5326A/B, 5327A/B only)	add \$325
011: High Stability Oven Oscillator	add \$450
908: Rack Flange Kit	add \$10

Accessories:

10542A Remote Programming Interface	\$700
-------------------------------------	-------

5326/5327 Family selection guide

Model	Description	Frequency Range	Period Average Totalize/Ratio Scaling	Time Interval Time Interval Averaging	DVM (DC Voltage)
5326A	Universal Timer/Counter	50 MHz	—————	—————	—————
5326B	Universal Timer/Counter/DVM	50 MHz	—————	—————	—————
5327A	Universal Timer/Counter	550 MHz	—————	—————	—————
5327B	Universal Timer/Counter/DVM	550 MHz	—————	—————	—————

ELECTRONIC COUNTERS

Plug-on modular/portable counter system

Model 5300 A/B system & 5301A-5312A



5300 Measuring system

The 5300 measuring system marks a new era of high performance and versatility for low cost counters.

Features include

- 10 MHz, 50 MHz, 525 MHz and 1.3 GHz
- 100 ns Time interval resolution and time interval averaging
- Up to 8 digits
- Auto ranging
- Unique time interval hold off
- Expandable with interchangeable modules
- Optional FCC type approved TCXO time base
- Portable-battery operation with all modules
- Compact and rugged
- High reliability MOS/LSI circuitry and LED display
- Designed for quick & easy owner-servicing
- Output via BCD, HP Interface Bus (HP-IB), or D to A converters

Description

Large scale integration and solid state display technology have helped to produce a uniquely versatile and capable counter at a surprisingly low cost. Easy to use and reliable, this counter does what is important—solves your measurement problems while saving your money. Versatility and antiobsolescence come from modular construction. Take your choice from two mainframes and select the snap on module that you need now. Expand the capability later with more modules, if and when you need them. You can expand the capability of your 5300 Measuring system to match your expanding needs and budget. Hewlett-Packard is engaged in an on-going program to develop expanded capabilities for the 5300 as shown by the "new modules" just added in this catalog. An optional battery pack provides portable cord-free operation of any of the modules, eliminating power problems and ground loops. The new plug-between digital to analog converter gives you an analog output that can drive a strip chart recorder, providing hard copy of any of the 5300 System's measurements. You can now easily obtain hard copy recordings of frequency drifts, time interval shifts, ratio changes, ohms variations, and even totalized levels from the 5300 system and its plug-between D to A converter. The BCD output and HP-IB module lets you interface digitally with other instruments and systems. This is versatility that truly avoids obsolescence and optimizes your instrument dollars.

Unique benefits

Snap-together modularity allows you to match the display/mainframe capabilities with the functional module of your choice to match your present needs. Additional modules can be added as your measurement needs and budget expand, including the selection of three center modules which allows you to add a battery, a D to A Converter, or an HP-IB output to your system when and if you need them. Frequencies up to 1.3 GHz can be measured with this portable precision frequency counter. Single time intervals can be measured with 100 ns resolution. Time interval averaging up to 10⁸ intervals allows you much greater resolution than ever available before in a counter of this price range.

Auto ranging

Auto ranging is included in many of the functions, enhancing the ease of operation by automatically selecting a correct gate time to fill the display. Any frequency within the range of the 5301A, 5302A, 5304A, 5307A and 5308A may be counted with the counter's logic circuits automatically selecting the correct gate time up to 1 second for maximum resolution without exceeding the display range. In the 5302A and 5304A auto ranging is also provided for the Period Average function to select the number of periods to be averaged. The high performance 5308A Universal Counter provides autoranging in the Frequency, Period Average, Ratio, and Time Interval average modes, a first for counters in any price range.

Time interval holdoff

Time interval holdoff is a unique feature of the 5304A Time/Counter module. This feature allows you to add a fixed delay between the start of a time interval measurement and the enabling of the stop channel. Thus any electrical pulses or irregularities in a waveshape that occur between the desired trigger points can be ignored. Even the delay itself can be measured with the 5304A.

5300A 6 DIGIT MAINFRAME	\$500 pg 254
5300B 8 DIGIT MAINFRAME	\$460 pg 254
5310A BATTERY PACK	\$275 pg 260
5311B DIGITAL TO ANALOG CONVERTER	\$395 pg 259
5312A ASCII INTERFACE	\$350 pg 259

Model	Frequency MHz	Period	Period Average	Time Interval	Time Interval Average	Totalize	Ratio	Multimeter ACV, DCV, Ω	High Resolution Reciprocal	
5301A	10									\$225 pg 255
5302A	50									\$325 pg 255
5303B	525									\$825 pg 256
5304A	10									\$385 pg 256
5305B	1300									\$900 pg 257
5306A	10									\$550 pg 257
5307A	2									\$395 pg 258
5308A	75									\$450 pg 258

Typical Configurations



Frequency Measurement System For Mobile Communications
Go Anywhere Portability

5300B, 5310A, 5305B



Trend Recording System For Voltage, Resistance, and Frequency
Graphic Copy For Visual Analysis

5300A, 5311B, 5306A



Data Acquisition System For Measurement And Recording Of Data
Reduction Of All Measurements

5300B, 5312A, 5308A

High resolution

High resolution at low frequencies is provided by the 5307A counter module. This easy to use counter makes a period average measurement, inverts it and displays the result as a frequency, thereby providing the high resolution of a period measurement and the ease of use of a frequency measurement automatically.

Digital and analog output

Digital output is available in BCD format (standard in 5300A mainframe) or ASCII format via the HP Interface Bus (to be used with 5300B mainframe) to provide interfacing with digital printers or with desktop calculators and other data processing equipment. Analog output for long term monitoring with strip chart recorders is provided by a digital to analog converter. This provides the capability to generate hard copy results of any of the measurements made by any of the 5300 modules.

Battery pack

A snap between battery pack provides a truly portable, light weight, go-anywhere measuring system for any of the 5300 Systems.

Serviceability

Reliability and easy servicing have been major design criteria for all of the 5300 modules. The small number of components and the use of modular design techniques allows problems to be easily traced to functional blocks. A check function is built into most of the functional modules to allow immediate checking of the basic counter circuits from the front panel. A user oriented service support package is available that provides plug-in cards with automatic diagnostic routines that allow the 5300 mainframes to troubleshoot themselves.

Features like these make the net cost of owning either a 5300A or 5300B Measuring System less than that of conventional counters.

5300 A/B systems (cont.)



5300A



5300B

HP-IB

5300A and 5300B measurement system mainframe

The mainframe units provide the system with power, reference frequency, display, counting logic and timing control.

The 5300A has a six digit, dot matrix display, standard time base, external time base input and BCD output as a standard rear panel output. The 5300B has an 8-digit 7-segment display, standard time base or optional TCXO time base, external time base input and no digital output from the mainframe. See mainframe/plug-on display chart below for number of display digits with a particular mainframe and plug-on combination.

Time-base

Standard crystal frequency: 10 MHz

Stability

Aging rate: <3 Parts in 10⁷/mo

Temperature: <±5 Parts in 10⁶, 0° to 50°C

Typically: <±2 Parts in 10⁶, 15° to 40°C

Line voltage: <±1 Part in 10⁷ for 10% Line Variation

Oscillator output: 10 MHz, Approximately 1 V rms at rear panel BNC, 100Ω source impedance

External input: 1 MHz to 10 MHz, 1 V rms into 200Ω

Option 001: High stability time base (5300B Only)

Frequency: 10 MHz

Stability

Aging rate: <1.2 part in 10⁶/year

Temperature: <±5 parts in 10⁷, 0° to 50°C

Line voltage: <±5 parts in 10⁸ for 10% line variation

Oscillator output: 10 MHz, approximately 1 V rms at rear panel BNC, 200Ω source impedance

External input: 1 to 10 MHz, 1 V rms into 500Ω

General

Display: 6 Digit, Dot Matrix (5300A) or 8 Digit, 7 Segment Matrix (5300B)

Solid state LED display (Gallium Arsenide Phosphide Light Emitting Diodes) including decimal point and annunciator units.

Overflow: LED Light indicates when display range is exceeded.

Display storage: Holds reading between samples

Sample rate: Sample rate control adjusts the delay from the end of one measurement to the start of a new measurement. Continuously variable from less than 50 msec to greater than 5 seconds. HOLD position: display can be held indefinitely. Reset: Front panel pushbutton switch resets all registers and initiates new measurement. Reset input by contact closure to ground or TTL type low level also available on rear panel connector (5300A only).

Operating temperature: 0° to 50°C

Power requirements: 115 or 230 volts ±10%, 50 to 400 Hz, 25 VA maximum (depends on plug-on module). Mainframe power without

plug-on nominally 5 watts. Battery operation: with 5310A rechargeable battery pack (see 5310A specifications).

Digital output (5300A only)

Digital serial, 4-bit BCD parallel available at rear panel connector.

Code: 4-line 1-2-4-8 BCD, "1" state low, TTL type logic levels.

Decimal point: decimal point code (Binary "1111") automatically inserted at correct digit position.

Print command: positive step, TTL output

Holdoff: contact closure to ground or TTL low level, inhibits start of new measurement cycle.

Connector: 20-pin PC connector. Mating connector Viking 2VH10/1JN or equivalent.

Parallel data output: available from Printer Interface. See 10533A specification

Note: digital output for 5300B Mainframe is provided by 5312A HP-IB Interface module.

Weight: net, 1.5 kg (3½ lb). Shipping, 2.5 kg (5½ lb)

Dimensions (with snap-on module): Height, 89 mm (3½"). Width, 160 mm (6¼"). Depth, 248 mm (9½")

Mainframe/plug-on compatibility

Plug-on	Display Digits	
	with 5300A	with 5300B
5301A	6	7
5302A	6	7
5303B	6	8
5304A	6	7
5305B	6	8
5306A (Frequency)	6	7
(ACV, DCV, OHMS)	5	5
5307A	6	6
5308A	N/A	8

Accessories

Digital Recorder Interface: (for use with 5300A, BCD output) See 10533A Specifications, Page 255

10548A Service support package: Contains an interface card and 4 diagnostic cards for easy trouble shooting of 5300A or 5300B, Page 260

18019A Leather carrying case: Holds 5300A or 5300B, snap-on module and 5310A battery pack plus accessories

Rack mount kits:

10851A Single

10852A Double

10853A Single/with plug-between

10854A Double/with plug-between

Model number and name

5300A 6 digit mainframe

5300B 8 digit mainframe

OPT 001 TCXO (5300B only)

Price

\$95

\$35

\$40

\$40

\$40

\$40

\$500

\$460

add \$180

- 10 MHz
- Auto ranging
- External gate

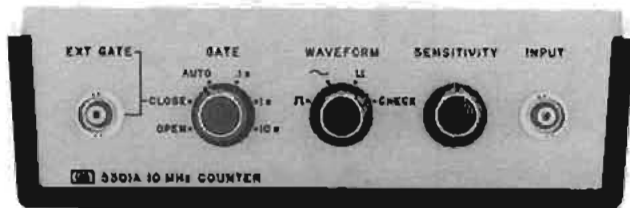

5301A 10 MHz frequency counter module

Input
Range: 10 Hz to 10 MHz
Sensitivity (min): 25 mV rms sine wave 50 Hz to 1 MHz. 50 mV rms sine wave 10 Hz to 10 MHz; 150 mV p-p pulse at minimum pulse width, 50 ns. Sensitivity variable to 2.5 V rms.
Impedance: 1 MΩ shunted by less than 30 pF.
Overload Protection: 500 V (dc + peak ac), 250 V rms, dc to 400 Hz, 10 V rms at 10 MHz.
Trigger Level: selectable positive, negative, or zero volts

Frequency measurement
Range: 10 Hz to 10 MHz
Gate times: manually selected 0.1, 1, or 10 seconds AUTO position selects gate time to 1 second for maximum resolution.
Accuracy: ±1 count ± time base accuracy

Open/close (totalizing)
Range: 10 MHz max count rate.
External gate: gate signal by contact closure to ground or TTL low.

General
Check: counts internal 10 MHz reference frequency.
Operating temperature: 0° to 50°C.
Power requirements: including mainframe, nominally 8 watts.
Weight: net, 0.9 kg (2 lb). Shipping, 1.5 kg (3¼ lb)
Dimensions: see Mainframe

Price: \$225

10533A Recorder interface specifications

The 10533A accessory provides an interface between the 5300A measurement system mainframe and a standard parallel-input recorder such as the HP 5055A. The interface module provides conversion from the 5300A serial data output to a standard parallel format.
Output format: 10 parallel digits; 6 data, 1 decimal point, 1 overflow, 1 exponent and 1 exponent sign.
Code: 4-line 1-2-4-8 BCD; "1" state low, TTL levels.
Decimal point: floating decimal point automatically inserted at correct digit position. Coded "1111" ("*" on standard HP 5055A print wheels). Internal jumper wire removes decimal point from data format if desired.
Overflow: coded "1111" ("*") printed in first printer column when 5300A overflow light is on.
Exponent: ±0, ±3, ±6 corresponding with 5300A measurement units.
Print command: negative step, TTL levels.
Inhibit input: +2.0 V or higher prevents the 5300A from recycling.
Power requirements: 100 mA at 5 volts, provided by 5300A mainframe.

Price: \$225

*For any wave shape, trigger error (μs) is less than

$$\pm \frac{0.005 \mu s}{\text{Signal Slope (V/}\mu\text{s)}}$$

For period average this is less than ±0.3% of one period + period average for signals with 40 dB or better signal-to-noise ratio.

- 50 MHz universal counter.
- Automatic or manual gate selection.
- 100 nsec time interval resolution.

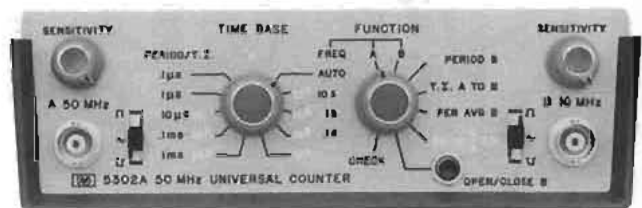

5302A 50 MHz universal counter module

Input channels A and B
Range: channel A: 10 Hz to 50 MHz, Channel B: 10 Hz to 10 MHz
Sensitivity (min): 25 mV rms sine wave 50 Hz to 1 MHz. 50 mV rms sine wave 10 Hz to 10 MHz. 100 mV rms sine wave at 50 MHz. 150 mV p-p pulse at minimum pulse width, 50 ns. Sensitivity variable to 2.5 V rms.
Impedance: 1 MΩ shunted by less than 30 pF.
Overload protection: 500 V (dc + peak ac), 250 V rms, dc to 400 Hz, 10 V rms above 10 MHz.
Trigger level: selectable positive, negative, or zero volts.

Slope: automatically switched to trigger on positive slope for positive pulse and negative slope for negative pulse. Positive slope for sinusoidal inputs.
Marker outputs: rear panel BNC, TTL low level while gate is open.

Frequency
Range: channel A: 10 Hz to 50 MHz, prescaled by 10; channel B: 10 Hz to 10 MHz
Gate times: manually selected 0.1, 1, or 10 seconds. AUTO position selects gate time to 1 second for maximum resolution.
Accuracy: ±1 count ± time base accuracy

Time interval
Range: 500 nsec to 1000 seconds
Input: channels A and B
Resolution: 100 ns to 1 ms in decade steps
Accuracy: ±1 count ± time base accuracy ± trigger error*

Period
Range: 10 Hz to 1 MHz
Input: channel B
Resolution: 100 ns to 1 ms in decade steps
Accuracy: ±1 count ± time base accuracy ± trigger error*

Period average
Range: 10 Hz to 1 MHz
Input: channel B
Periods averaged: 1 to 10³ automatically selected.
Frequency counted: 10 MHz
Accuracy: ±1 count ± time base accuracy ± trigger error*

Ratio
Display: F_A/F_B times multiplier (N), N = 10 to 10³, selectable in decade steps
Range: channel A: 10 Hz to 1 MHz, Channel B: 10 Hz to 10 MHz
Accuracy: ± count of F_B ± trigger error of F_A *

Open/close (totalizing)
Range: 10 MHz max
Input: channel B opening and closing of gate initiated by front panel pushbutton switch.

General
Check: counts internal 10 MHz reference frequency.
Operating temperature: 0° to 50°C
Power requirements: including mainframe, nominally 10 watts
Weight: net, 0.9 kg (2 lb). Shipping, 1.5 kg (3¼ lb)
Dimensions: see Mainframe

Price: \$325



ELECTRONIC COUNTERS

5300A/B System (cont.)

- CW or burst to 525 MHz
- Automatic gain control and fused input
- FCC type approved

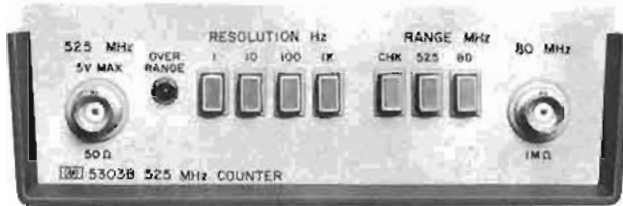

5303B Frequency counter module

This counter module was especially designed for servicing and calibrating mobile communications equipment and AM & FM broadcast equipment. An automatic gain control (AGC) amplifier has been provided on the 80 MHz channel. This provides ease of use by compensating for input level variations and rejecting noise up to 50% of the peak-to-peak level of the input signal. The front end circuitry of the 525 MHz channel is fuse protected against high input signal levels that would normally cause expensive frontend damage. The addition of the battery pack makes this an ideal portable instrument for the lab or the field.

Input channel A (CW or burst)

Range: DC to 525 MHz, preselected by 8

Sensitivity (fixed):

100 mV rms sine wave, dc to 500 MHz

125 mV rms sine wave, 500 MHz to 525 MHz

Signal must pass through zero.

Impedance: 50 Ω

Overload protection: 5 V rms (input circuitry fuse protected)

Input channel B (CW or burst)

Range: 50 Hz to 80 MHz, direct

Sensitivity (automatic):

25 mV rms sine wave, 100 Hz to 50 MHz

50 mV rms sine wave, 50 Hz to 100 Hz and 50 MHz to 80 MHz

Sensitivity is adjusted automatically by AGC (automatic gain control).

Effective up to input clipping level of 10 V p-p.

Impedance: 1 M Ω shunted by less than 40 pF

Overload protection: 250 V rms, 50 Hz to 10 KHz declining to 10 V rms above 10 MHz

Frequency measurement

Resolution: (selectable), 1, 10, 100, 1000 Hz

Accuracy: ± 1 digit \pm time base accuracy

General

Check: counts internal 10 MHz reference frequency.

Overflow: light indicates display exceeded.

Operating temperature: 0° to 50°C

Power requirements: including mainframe, nominally 10 watts

Weight: net, 0.9 kg (2 lb). Shipping, 1.5 kg (3 1/4 lb)

Dimensions: see mainframe.

Price:

\$825

Option 001: High stability time base (for use with 5300A)

Frequency: 10 MHz

Stability

Aging rate: <1.2 part in 10⁶/year

Temperature: < ± 5 parts in 10⁷, 0° to 50°C

Line voltage: < ± 5 parts in 10⁴ for 10% line variation

Oscillator output: 10 MHz, approximately 1 V rms at rear panel BNC, 200 Ω source impedance

External input: 1 to 10 MHz, 1 V rms into 500 Ω

5303B 525 MHz Counter

\$180

*For any waveshape, trigger error is less than

$$\pm \frac{0.05 \text{ at}}{\text{Signal Slope (V/}\mu\text{s)}}$$

**Trigger error is less than $\pm 0.3\%$ of one period \Rightarrow period averaged for 40 dB or better signal-to-noise ratio

- Matched input amplifiers
- Time interval hold-off
- 100 nsec time interval resolution

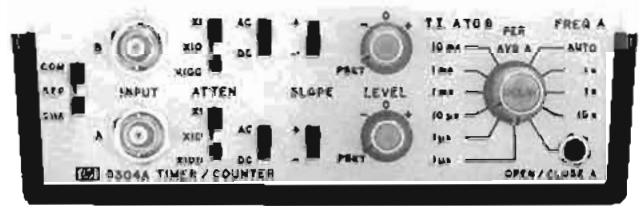

5304A Timer/counter module

Input channels A and B

Range: DC coupled; 0 to 10 MHz, AC coupled; 100 Hz to 10 MHz
Sensitivity (min): 25 mV rms sine wave to 1 MHz, 50 mV rms sine wave to 10 MHz, 150 mV p-p pulse at minimum pulse width, 40 nsec. Sensitivity can be decreased by 10 or 100 times using ATTENUATOR switch.

Impedance: 1 M Ω shunted by less than 30 pF.

Overload protection: 250 V rms on X10 and X100 attenuator settings. On X1 attenuator setting 120 V rms up to 1 kHz, decreasing to 10 V rms at 10 MHz.

Trigger level: PRESET position centers triggering about 0 volts, or continuously variable over the range of -1 V to +1 V times attenuator setting.

Slope: independent selection of triggering on positive or negative slope.

Channel Inputs: common or separate lines.

Gate output: rear panel BNC. TTL low level while gate is open.

Time interval

Range: 500 ns to 10⁴ sec

Input: channels A and B, can be common or separate

Resolution: 100 ns to 10 ms in decade steps.

Accuracy: ± 1 count \pm time base accuracy \pm trigger error*

Time interval holdoff: front panel concentric knob which inserts variable delay of approximately 100 μ s to 100 ms between START (channel A) and enabling of STOP (channel B); may be disabled. Electrical inputs during delay time are ignored. Delay may be digitally measured in CHECK and TIME INTERVAL positions. Delay output: rear panel BNC. TTL low level during delay time.

Period average

Range: 10 Hz to 1 MHz

Input: channel A

Period averaged: 1 to 10³ automatically selected.

Frequency counted: 10 MHz

Accuracy: ± 1 count \pm time base accuracy \pm trigger error**

Frequency

Range: 0 to 10 MHz

Input: channel A

Gate times: manually selected 0.1, 1, or 10 seconds, AUTO position selects gate time to 1 second for maximum resolution.

Accuracy: ± 1 count \pm time base accuracy

Open/close (totalizing)

Range: 10 MHz max

Input: channel A Opening and closing of gate initiated by front panel pushbutton switch.

General

Check: inserts internal 10 MHz reference frequency into channels A and B.

Operating temperature: 0° to 50°C

Power requirements: including mainframe, nominally 10 watts.

Weight: net, 0.9 kg (2 lb). Shipping, 1.5 kg (3 1/4 lb).

Dimensions: see mainframe

5304A Timer/counter module

\$385

- 1300 MHz
- Preamp Power
- Fast high resolution tone measurements



5305B 1300 MHz frequency counter module

Input Channel A (CW OR BURST)
Range: 90 MHz to 1300 MHz, prescaled by 16
Sensitivity: 20 mV rms
Impedance: 50Ω

Attenuator: continuously variable to give optimum noise suppression for signals up to 3.5 V rms.
Overload protection: 5 V rms, maximum. Input circuitry is fuse protected: Fuse is located in BNC connector and is accessible from the front panel.
Operating dynamic range: >47 dB

Input Channel B (Normal and High Resolution Mode)
Range: 50 Hz to 100 MHz, direct count in normal mode. 50 Hz to 10 kHz in high resolution mode. In the high resolution mode the 5305B uses a phase-locked multiplier to increase resolution X1000 over normal measurement resolution.

Sensitivity: 20 mV rms
Impedance: 1 MΩ shunted by less than 40 pF.
Overload protection: 250 V rms from 50 Hz to 10 kHz, declining to 10 V rms above 10 MHz.
Automatic hold: in high resolution mode, the last valid reading is held in display when input is terminated.

Frequency Measurement

Resolution (selectable)
Normal mode (50 Hz to 1300 MHz): 0.1 Hz to 10 000 Hz in decade steps corresponding to gate times of 10 s to 0.0001 s in decade steps on channel B and to gate times of 160 s to 0.0016 s in decade steps on channel A.
High resolution mode (50 Hz to 10 kHz): 0.0001, 0.001, 0.01, 0.1, 1, 10 Hz corresponding to 10, 1, 0.1, 0.01, 0.001, 0.0001 second gate times on channel B.
Accuracy: ±1 digit displayed ± time base accuracy.
Display: Hz, kHz, MHz with positioned decimal point.

General

Check: counts internal 10 MHz reference frequency to check counting circuits.
Operating temperature: 0°C to 50°C.
Power requirements: nominally 12 watts including mainframe.
Weight: net, 1.0 kg (2¼ lb). Shipping, 1.8 kg (4 lb).
Dimensions: with mainframe, 89 mm H (3½") X 160 mm W (6¼") X 248 mm L (9¾").
Compatible mainframes: 5300A (6 digits) or 5300B (8 digits). 5300B is recommended.

Accessories:

10855A Preamp: 22 dB gain with ±1 dB flatness from 2 MHz to 1300 MHz.

Model number and name
 5305B 1300 MHz counter
 10855A Preamp

Price
 \$900
 \$225

- DC volts, AC volts, ohms and frequency

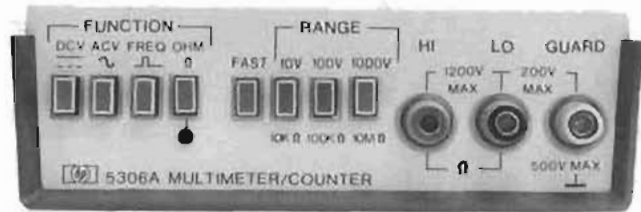

5306A Digital multimeter/counter module

DC voltage

Range	Accuracy (60 days, 23°C ±5°C, <80% RH)	Sensitivity
10 V	±(0.03% of reading + 0.003% of range)	100 µV
100 V	±(0.03% of reading + 0.003% of range)	1 mV
1000 V	±(0.097% of reading + 0.03% of range)	10 mV

Temperature coefficient: ±(0.002% of reading/°C + 0.0002% of range/°C)

Sample times: normal, 0.5 sec; Fast, 0.05 sec
Input: floating pair, 10 MΩ resistance, all ranges
Effective common mode rejection (1 kΩ imbalance): DC: >80 dB; 50 Hz or 60 Hz ±0.1%: >80 dB
Normal mode rejection: 50 Hz or 60 Hz ±0.1%: >50 dB
Maximum input high to Low: 1100 V dc all ranges
Low to Guard: ±200 V dc or peak ac
Guard to Ground: ±500 V dc or 240 V rms at 50 or 60 Hz

AC voltage

Range	Frequency	Accuracy (60 days, 23°C ±5°C, <80% RH)
10 V	40 Hz to 10 kHz	±(0.98% of reading + 0.02% of range)
	10 kHz to 100 kHz	±(0.98% of reading + 0.10% of range)
100 V	40 Hz to 500 Hz	±(1.5% of reading + 0.05% of range)
	1000 V	40 Hz to 500 Hz

Temperature coefficient

10V and 100V range: ±(0.05% of reading + 0.003% of range/°C)
1000V range: ±(0.5% of reading + 0.003% of range/°C)
Input impedance: 10 MΩ shunted by <75 pF maximum
Maximum input voltage: (see DC voltage specification)
Effective common mode rejection (1 kΩ imbalance): DC: >80 dB; 50 Hz or 60 Hz ± 0.1%: >50 dB (10 V range)

Ohms

Range	Accuracy (60 days, 23°C, ±5°C, <80% RH)	Sensitivity
10 kΩ	±(0.5% of reading + 0.003% of range)	0.1 Ω
100 kΩ	±(0.5% of reading + 0.003% of range)	1 Ω
10 MΩ	±(0.75% of reading + 0.003% of range)	100 Ω

Temperature coefficient: ±(0.0002% of range/°C)
Current through unknown: 1 mA on 10 kΩ range; 100 µA on 100 kΩ range; 1 µA on 10 MΩ range
Overload protection: 10 kΩ range: 240 V rms for 1 min. 140 V rms continuous (warning lamp indicates overvoltage) 100 kΩ, 10 MΩ ranges: 240 V rms continuous

Frequency

Range: 40 Hz to 10 MHz
Sensitivity (min): 50 mV rms to 1 MHz; 125 mV rms to 10 MHz
Trigger level: automatically adjusts to 40% of peak-level of input
Overload protection: 1000 V rms. On 10 V range: 240 V rms from 40 Hz to 400 kHz, 10⁴ V Hz from 400 kHz to 10 MHz
Gate times: normal: 1 sec, Fast: 0.1 sec
Accuracy: ±1 count ± time base accuracy
Power requirements: including mainframe, nominally 12 watts
Weight: net, 1.1 kg (2.3 lb). Shipping, 1.7 kg (3.6 lb)

5306A Digital Multimeter/Counter

\$550

5300A/B System (cont.)

- High resolution at low frequencies
- 10 mV rms sensitivity
- 100 Hz and 10 kHz low pass filters

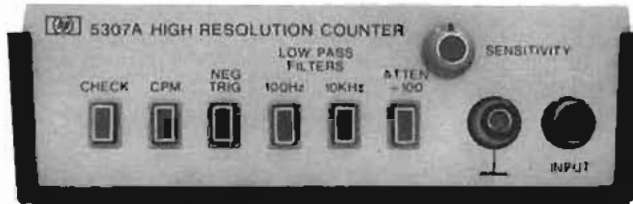

5307A High resolution counter module

5307A is a period average measuring, frequency indicating (reciprocal) counter, that provides very high resolution measurements in a minimum of time: (i.e. 60,000 Hz in $< 1/2$ second). The CPM mode converts Hz to counts/minute.

Input

Range: Hz mode: 5 Hz to 2 MHz. CPM mode: 50 to 10 M counts/minute (0.8333 Hz to 166 kHz).

Sensitivity (Min.):

10 mV rms	5 Hz – 1.2 MHz	120 CPM – 10 MCPM
25 mV rms	1.2 MHz – 2.0 MHz	50 CPM – 120 CPM

Pulses:

For low-duty cycle pulses ($< 15\%$).
15 mV peak for 250 nsec pulses.
100 mV peak for 100 nsec pulses.

Basic sensitivity can be varied continuously up to 2.5 V rms by adjusting sensitivity control.

Attenuator: $\div 1$ or $\div 100$ effectively raises basic input sensitivity by a factor of 100 (10 mV \rightarrow 2.5 V to 1 V \rightarrow 250 V).

Low pass filters: (3 dB Point)

	100 Hz	10 kHz
Max. Attenuation	60 dB	40 dB
Roll-off	20 dB per Decade	

Impedance:

No filters	1 M Ω shunted by < 50 pF	
100 Hz filters	1 M Ω shunted by series of 100 k Ω and 0.015 μ F	
10 kHz filter	1 M Ω shunted by series of 100 k Ω and 150 pF	

Coupling: AC coupled amplifier.

Overload protection: 200 V rms below 10 kHz; 2×10^6 V Hz rms to 0.4 MHz; 5 V rms above 0.4 MHz; 300 V rms with $\div 100$ attenuator

Trigger level: selected positive or negative for optimum triggering from sinusoidal inputs or \pm pulses.

Frequency measurement

Periods averaged: automatically selected for maximum resolution. Two periods are averaged for signals up to 100 Hz. Periods averaged increase decade for decade up to 200,000 periods averaged above 1 MHz.

Measurement time: varies from 312 msec for a display of 170000 to 815 msec for a display of 999000. Hold-off adjustable from .35 μ sec to 3.5 μ sec and 1 msec to 10 msec.

Accuracy: $\pm 3 \times 10^{-5} \pm$ trigger error** \pm time base error.

Display: Hz mode: Hz and MHz with automatic decimal point.

CPM mode: M with automatic decimal point.

General

Check: measures internal reference frequency. Displays 1.00000 MHz in Hz mode, 100 000 M in CPM mode.

Operating temperature: 0° to 50°C

Power requirements: including Mainframe, nominally 10 watts.

Weight: net, 0.9 kg (2 lb). Shipping, 1.5 kg (3 1/2 lb).

5307A High resolution counter

\$395

* $\pm 3 \times 10^{-5}$ is due to reciprocation scheme and is worst case.

** For any wave shape, trigger error (μ s) is less than

$$\frac{0.005 \mu\text{s}}{\text{Signal Slope (V/\mu s)}}$$

For period average this is less than $\pm 0.3\%$ of one period \div periods averaged for signals with 40 dB or better signal-to-noise ratio.

- 75 MHz
- Time interval averaging
- Auto ranging or manual operation



5308A Universal counter/timer module

Input (channels A and B)

Range: DC coupled; 0 to 75 MHz, AC coupled; 20 to 75 MHz
Sensitivity: (min) 25 mV rms to 10 MHz, 50 mV rms to 75 MHz 150 mV p-p pulse at pulse width of 10 nsec.

Impedance: 1 M Ω shunted by less than 50 pF

Overload protection: X1: 125 V rms to 400 kHz declining to 10 V rms at 75 MHz. X10: 250 V rms to 4 MHz declining to 13 V rms at 75 MHz.

Trigger level: variable over the range of ± 2.0 V and ± 20 V.

Slope: independent selection of triggering on + or - slope.

Rear outputs: gate, trigger levels and time base/scaling.

Frequency

Range: 0 to 75 MHz, Channel A or Channel B

Gate times: 8 selectable times from 1 μ s to 10 S

Accuracy: ± 1 count \pm time base accuracy

Frequency ratio

Display: Fa/Fb, 1 to 10^8 periods selectable manual or auto.

Range: channel A: 0 to 75 MHz, Channel B: 0 to 5 MHz

Accuracy: ± 1 count of Fa \pm trigger error of Fb.**

Period

Range: 0 Hz to 5 MHz, Channel B

Resolution: 100 nsec to 10 sec

Accuracy: ± 1 count \pm time base accuracy \pm trigger error**

Display: μ s, ms or s with positioned decimal point.

Period average

Range: 0.1–5 MHz; (200 nsec to 10 sec), Channel B

Periods averaged: 1 – 10^8 selectable manual or automatic

Accuracy: ± 1 count \pm time base accuracy \pm trigger error**

Time interval

Range: 200 nsec to 10^9 sec, 25 ns minimum pulse width

Inputs: separate A and B or Common B

Resolution: 100 nsec to 10 sec

Accuracy: ± 1 count \pm time base accuracy \pm trigger error**

Display: μ s, ks or s with positioned decimal point

Time interval average

Range: 1 ns to 10 s, dead time between intervals 200 ns

Inputs: channels A and B separate or common B

Intervals averaged: 1 to 10^8 , selectable manual or automatic

Accuracy: \pm time base accuracy ± 5 ns

$$\pm \frac{[\text{Trigger Error}^{**} \pm 100 \text{ ns}]}{\sqrt{\text{Intervals Averaged}}}$$

Totalize

totalizes Channel A while Channel B is low.

totalizes Channel A between pulses on Channel B.

Range: 75 MHz in X1 Position, 5 MHz in X10ⁿ positions.

Accuracy: ± 1 count \pm trigger error** on Channel B

General

Auto position: automatically sets time base to give maximum resolution within 1.1 second measurement time for Frequency, Frequency Ratio, Period Average, and Time Interval Average.

Operating temperature: 0° to 50°C

Power requirements: including 5300B, nominally 15 watts.

Weight: net, 0.9 kg (2 lb). Shipping, 1.5 kg (3 1/2 lb)

Note: compatible with 5300B only.

5308A 75 MHz Timer/counter

\$450

- Three modes of operation
- Battery compatible
- Column selective

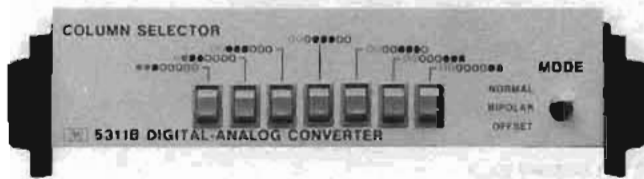

5311B Digital to analog converter module

The 5311B Digital to Analog Converter conveniently snaps in-between the mainframe and plug-on module of any 5300 system. It provides high resolution, expanded scale analog output of any of the 5300 system measurements. With the 5311B you can select any three consecutive digits, or the right-hand two of the mainframe display for conversion to analog output. This makes it possible to focus on just that part of the display that contains the important information. Now your stripchart recorder can give you a permanent record of any functional measurement made by any 5300 measurement system. Easy to use, just snap it in place. The 5311B can also be used with the 5310A battery pack to provide a rugged, portable, go-anywhere monitoring system. Three modes of output makes it possible to tailor the output to the application.

Operating modes

Three modes selectable by switch on front panel.

Normal mode: analog output is directly proportional to digital input. Digital 000 produces zero output; 999 produces full scale output.

Plus/minus mode: digital 000 produces center scale output; -999 produces zero output; 999 produces full scale output.

Offset mode: 500 produces zero output; 000 produces midscale output; 499 produces full scale output. This mode effectively adds 500 to digital input to acquire half scale offset. Compatible with all mainframes and plug-on modules.

Mode	Output		
	0 to 50% of Scale	50% of Scale	50% to 100% of Scale
Normal	0 to 499	500	501 to 999
Plus/Minus	-999 to -001	000	001 to 999
Offset	500 to 999	600	001 to 499

Output selection

Manual pushbuttons to select any three consecutive digits or the last two digits of the Mainframe display.

Output ranges

Potentiometric Recorder Output: 0.1 V, 1.0 V, or 10 V full scale into >20 kΩ. Dual banana plugs.

Galvanometer Recorder Output: 1 mA full scale into <1.5 kΩ phone jack.

General

Accuracy: ±0.25% of range ±50 μV/°C on potentiometric output, ±20 nA/°C on galvanometer output after calibration for appropriate range.

Calibration: zero and full scale calibration switch and adjustments on rear panel.

Transfer time: <5 ms

Operating temperature: 0° to 50°C

Power requirements: nominally 1 watt

Weight: net, 0.8 kg (1.7 lb). Shipping, 1.4 kg (3.0 lb)

Dimensions: Digital-to-Analog Converter plugs between Mainframe and plug-on module. Increases height of instrument by 38.4 mm (1.5 in.).

5311B Digital-Analog Converter

\$395

- Expanded digital output
- ASCII format

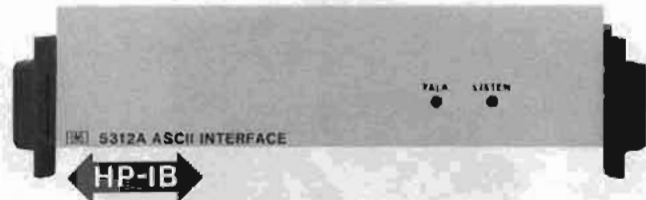

5312A ASCII (HP-IB) interface module

The ASCII Interface Module snaps in between the 5300B and any plug-on module. It provides digital Output capability via the HP Interface Bus. This is an easy to implement method of interfacing any 5300 system that utilizes the 8-digit 5300B mainframe with any HP-IB compatible printer.

The 5312A outputs fifteen bits of information in the following format.

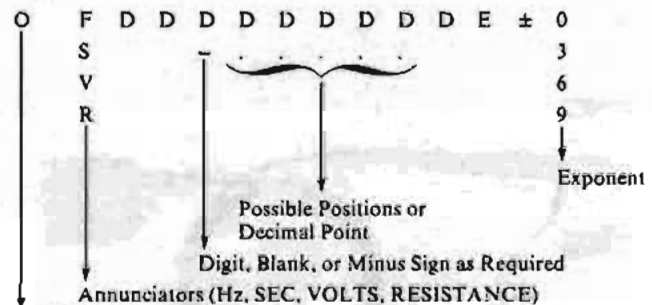

Overflow indicator

General

Sample rate: controlled by mainframe front panel control or by setting rate of reset command (when in listening mode, counter can be reset by sending "initialize" command).

Transfer time: 20 Milliseconds

Transfer rate: maximum of 40 reading/Sec depending on capabilities of plug-on.

Indicator lights: indicates if instrument is in Talk or Listen Modes.

Self test mode: checks functioning of basic interface.

```

OF  0171135E+0
F   10171.92E+3
F   10173.10E+3
F   10173.38E+3

R   2.3175E+3
R   2.3409E+3
R   2.3759E+3

OV  0.0000E+0
V   -2.1655E+0
V   -2.1654E+0

F   1076268E+0
    
```

Samples of digital output from 5300 measuring system utilizing the 5312A HP-IB converter and the 5150A thermal printer. Note the indication of function, decimal position, exponent and overflow when required.

Programmability: front panel controls are not programmable

Note: the 5312A is not compatible with the 5300A mainframe which contains its own BCD Digital Output.

5312A ASCII Interface

\$350

5300A/B System (cont.)

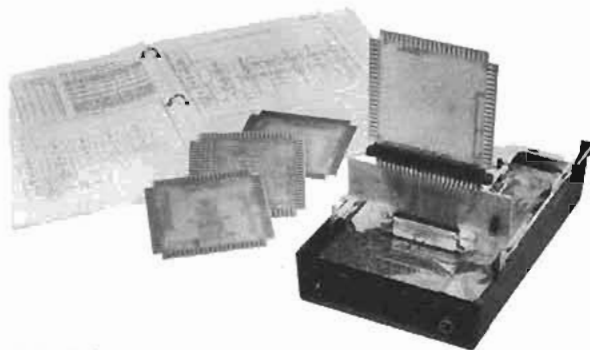

10548A Service support package

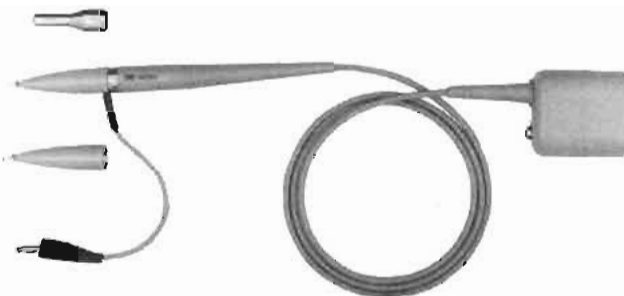

11096A High frequency probe

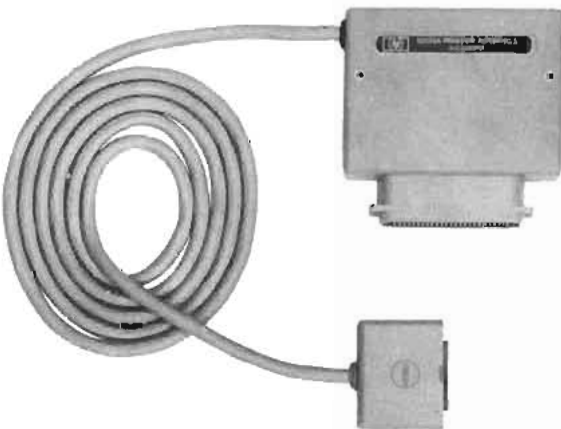

10533A BCD Serial to parallel interface

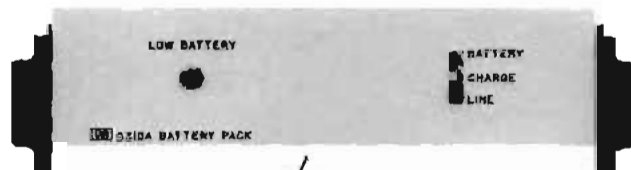

5310A Battery pack

5310A Battery pack module

Provides battery power to 5300A mainframe and snap on modules from rechargeable nickel-cadmium cells.

The 5310A Battery Pack is easily inserted between the 5300A or 5300B mainframe and any functional module, providing a truly portable measurement system. Low voltage strobbled solid state displays and the MOS/LSI IC design of the mainframes make efficient battery operation possible. The front panel warning light indicates a low battery condition. Any 5300 system with the battery inserted will automatically switch over to battery operation in the event of power failure, providing extra reliability for unattended operation. Floating operation is also possible with the 5310A Battery Pack, thus avoiding ground loops.

Battery capacity: 48 watt-hours, nominal. Minimum 3, typically 5 hours of continuous operation at charging and operating temperature (20° to 30°C).

Recharging time: 18 hours from minimum level (indicated by Low Voltage Indicator) to full charge.

Battery voltage: 12 Vdc

Low voltage indicator: solid state warning light begins to glow at approximately 90% discharge.

Line failure protection: allows instrument to be operated in LINE position with automatic switch-over to battery power if line voltage fails. Batteries receive trickle charge in LINE position to maintain charge.

Operating temperature: operating: 0° to 50°C. Charging: 0° to 40°C, mainframe not operating.

Power requirements: charging power via mainframe, nominal 7.5 watts

Weight: net, 2.3 kg (5 lb). Shipping, 2.9 kg (6 1/4 lb).

Accessories furnished: shoulder carrying strap

Dimensions: battery pack plugs between 5300A or 5300B mainframes and any plug-on module. Increase height of instrument by 38.4 mm (1.5 in.)

Price:

\$275

10548A Service support package

The unique HP 10548A Service Kit provides an easy and efficient means of trouble shooting the 5300A or 5300B mainframes. The four diagnostic cards, shown in use above, contain 16 self running tests that locate problems to the component level. Complete diagnostic flow charts in the manuals provide further step by step procedures. When failures are diagnosed, repair is simple. All components are easily accessible by merely removing a single screw and snapping out the main PC board.

Price:

\$95

11096A High frequency probe

Allows the 5306A to make high frequency ac voltage measurements. This probe is used for ac voltage measurements of 0.25 volt to 30 volts over a frequency range of 100 kHz to 500 MHz with an accuracy of $\pm 5\%$ from 100 kHz to 100 MHz and $\pm 7\%$ to 500 MHz over 10° to 30°C. Three probe tip accessories are supplied to extend the probe's versatility.

Price:

\$275



ELECTRONIC COUNTERS

Low cost counters for frequency measurements
Models 5381A, 5382A & 5383A



5381A



5382A



5383A

Description

General

The 5381A, 5382A and 5383A are a logical result of H-P's long-standing leadership in frequency counter development. Leadership in quality, technology and efficient production procedures allows H-P to offer a price/performance combination in these three precision instruments unequalled in their product category. These counters are designed to deliver reliable, high quality operation in such diverse areas as: Production Line Testing, Service and Calibration (2-Way Radio and test equipment), Frequency Monitoring, Education and Training.

Resolution

The 5381A, 5382A and 5383A employ the direct counting technique and with 7, 8 and 9 digits respectively offer resolution of 10 Hz in 0.1 sec, 1 Hz in 1 sec and 0.1 Hz in 10 seconds.

Specifications

5381A

Frequency range: 10 Hz to 80 MHz
Sensitivity: 25 mV rms — 30 Hz to 20 MHz, 50 mV rms — 10 Hz to 80 MHz
Input impedance: 1 M Ω , <50 pF
Input attenuation: X1, X10, X100
Accuracy: ± 1 count \pm timebase error
Resolution: direct count: 1 Hz in 1 second
Gate times: 0.1 second, 1 second, 10 seconds
Display: 7 LED Digits
Rear panel input: sensitivity: TTL levels or 2.5 V rms
Ratio: Rear Panel Input, 10 kHz to 2 MHz
External frequency standard: Rear Panel Input, 1 MHz
Timebase
Frequency: 1 MHz
Aging: <0.3 ppm/month
Temperature: ± 10 ppm 0°C to 40°C
Line voltage: ± 1 ppm for 10% line change

5382A

Frequency range: 10 Hz to 225 MHz
Sensitivity: 25 mV rms — 30 Hz to 10 MHz, 50 mV rms — 10 Hz to 225 MHz
Input impedance: 1 M Ω , <40 pF
Input attenuation: X1, X10, X100
Accuracy: ± 1 count \pm timebase error
Resolution: direct count: 1 Hz in 1 second
Gate Time: 0.1 second, 1 second, 10 seconds
Display: 8 LED Digits, nonsignificant zero blanking
Rear panel input: sensitivity: 250 mV rms
Ratio: Rear Panel Input, 100 kHz to 10 MHz
External frequency standard: Rear Panel Input, 10 MHz
Timebase
Frequency: 10 MHz
Aging: <0.3 ppm/month
Temperature: ± 2.5 ppm 0°C to 40°C
Line voltage: ± 0.5 ppm for 10% line change

5383A

Frequency range: 10 Hz to 520 MHz
Sensitivity
 1 M Ω 25 mV rms — 20 Hz to 10 MHz
 50 mV rms — 10 Hz to 50 MHz
 50 Ω 25 mV rms — 20 Hz to 100 MHz
 50 mV rms — 20 Hz to 520 MHz
Input impedance: selectable: 1 M Ω , <40 pF or 50 Ω
Input attenuation: 1 M Ω \times 1, \times 10; 50 Ω \times 1 — fuse protected
Accuracy: ± 1 count \pm timebase error
Resolution: direct count: 1 Hz in 1 second
Gate time: 0.1 second, 1 second, 10 seconds
Display: 9 LED Digits, nonsignificant zero blanking
Display test: RESET function (activated with GATE TIME switch) illuminates all segments of all digits.
Rear panel input: sensitivity: 250 mV rms
Ratio: Rear Panel Input, 100 kHz to 10 MHz
External frequency standard: Rear Panel Input, 10 MHz
Timebase output
Frequency: 10 MHz timebase
Voltage: 300 mV p-p into 50 Ω load
Control: active with Rear Panel Internal/External switch in internal position.
Timebase
Frequency: 10 MHz
Aging: <0.3 ppm/month
Temperature: ± 2.5 ppm 0°C to 40°C
Line voltage: ± 0.5 ppm for $\pm 10\%$ line change

TCXO Option

Option 001 (available for all models)
 Temperature Compensated Crystal Oscillator Timebase
Frequency: 10 MHz
Aging: <0.1 ppm/month
Temperature: <1 ppm 0°C to 40°C
Line voltage: ± 0.1 ppm for $\pm 10\%$ line change
Note: Timebase output available for both 5382A and 5383A with Option 001. Rear panel input not available.

5380 Family general data

Overflow: LED lamp indicator when most significant digit overflows
Reset: manual selection of reset occurs when GATE TIME switch is between three normal positions.
Package: rugged, high strength metal case
Operating temperature: 0°C to 40°C
Power requirements: 100, 120, 220, 240 V rms ($\pm 5\%$, -10%) 48–440 Hz; 20 VA maximum
Weight: net, 2.2 kg (4.75 lb). Shipping, 2.8 kg (6 lb).
Dimensions: 98 mm H \times 160 mm W \times 248 mm D (3.5" \times 6.25" \times 9.75")

Model number and name

Model number and name	Price
5381A Frequency Counter	\$295
5382A Frequency Counter	\$495
5383A Frequency Counter	\$795
Option 001 TCXO (all models)	add \$100

ELECTRONIC COUNTERS

Automatic microwave counters

Models 5340A & 5341A

- Single input 10 Hz to 18 GHz
- Automatic amplitude discrimination
- High sensitivity, -35 dBm
- Optional extension to 23 GHz
- Superior AM and FM tolerance
- Exceptional reliability



HP-IB 5340A

The 5340A Frequency Counter provides a modern, easily used, more versatile instrument for the direct measurement of frequencies from 10 Hz through 18 GHz via a single input connector. Utilizing new microwave samplers incorporated in advanced phase-lock loops, this counter excels in virtually every specification parameter. It is therefore suited to a wider range of applications than ever before possible for a fully automatic microwave counter.

The exceptional sensitivity of this instrument enhances measurement in the microwave field, where signals are commonly low level and many times are connected via directional couplers or lossy devices. Wide tolerance of AM, FM, and residual noise insure accurate measurement of microwave carrier frequencies despite the presence of these deviations. Automatic amplitude discrimination allows the 5340A to choose the largest signal in a spectrum (250 MHz to 18 GHz) and measure only that signal's frequency, ignoring all others.

Access to the HP Interface Bus via Option 011 provides a particularly flexible systems interface. The ability to program octave range via this input allows reduction of acquisition time to typically less than 25 msec. Application Note 181-1 describes the use of a calculator-controlled measurement system built around the HP Interface Bus for microwave component testing.

5340A Specifications

Signal input

Input 1

Range: 10 Hz to 18 GHz

Symmetry: sinewave or squarewave input (40% duty factor, worst case)

Sensitivity: -30 dBm, 10 Hz to 500 MHz; -35 dBm, 250 MHz to 10 GHz; -25 dBm, 10 to 18 GHz

Dynamic range: 37 dB, 10 Hz to 500 MHz; 42 dB, 500 MHz to 10 GHz; 32 dB, 10 GHz to 18 GHz

Impedance: 50Ω

VSWR: <2:1, 10 Hz-12.4 GHz; <3:1, 12.4-18 GHz

Connector: Precision Type N

Coupling: dc to load, ac to instrument

Damage level: +30 dBm ± 7 V dc (total power not to exceed 1 watt)

Acquisition time: <150 ms mean typical

Input 2

Range: 10 Hz-250 MHz direct count

Sensitivity: 50 mV rms, 150 mV p-p pulses to 0.1% duty factor; minimum pulse width 2 ns

Impedance: 1 MΩ shunted by <25 pF

Connector: type BNC female

Coupling: ac

Maximum input: 200 V rms, 10 Hz to 100 Hz; 20 V rms, 100 Hz to 100 kHz; 2 V rms, 100 kHz to 250 MHz

Automatic amplitude discrimination: Automatically selects the

strongest of all signals present (within 250 MHz to 18 GHz phase-lock range), providing signal level is: 6 dB above any signal within 200 MHz; 10 dB above any signal within 500 MHz; 20 dB above any signal, 250 MHz-18 GHz.

Maximum AM modulation: Any modulation index as long as the minimum voltage of the signal is not less than the sensitivity specification.

Time Base

Crystal frequency: 10 MHz

Stability

Aging rate: <±3 × 10⁻⁷ per month

Short term: <5 × 10⁻¹⁰ rms for 1 second averaging time

Temperature: <±2 × 10⁻⁴ over the range of 0° to 50°C

Line variation: <±1 × 10⁻⁷ for 10% line variation from nominal

Output frequency: 10 MHz, ≥2.4 V square wave (TTL compatible) available from rear panel BNC.

External time base: requires 10 MHz approximately 1.5 V p-p sine wave or square wave into 1 kΩ via rear panel BNC. Switch selects either internal or external time base.

Optional time base (Option 001) aging rate: <5 × 10⁻¹⁰ per day after 24 hour warm-up for less than 24 hour off-time.

General

Accuracy: ±1 count ± time base error

Resolution: front panel switch selects 1 MHz, 100 kHz, 10 kHz, 1 kHz, 100 Hz, 10 Hz, or 1 Hz.

Display: eight in-line long life display tubes with positioned decimal point and appropriate measurement units of kHz, MHz, or GHz.

Self check: counts and displays 10 MHz for resolution chosen.

Sample rate: controls time between measurements. Continuously adjustable from 50 msec typical to 5 seconds. HOLD position holds display indefinitely. RESET button resets display to zero and activates a new measurement.

Operating temperature: 0° to 50°C

Power: 115 V or 230 V ±10%, 48-66 Hz, 100 VA

Weight

Net: 11.3 kg (25 lb)

Shipping: 14.1 kg (31 lb)

Dimensions: 425 mm W × 467 mm D × 88.2 mm H (16 1/4" × 13 1/4" × 3 1/2")

Options

001: High Stability Time Base

002: Rear Panel Connectors

011: Remote Programming-Digital Output (HP-IB)

H10: Frequency Extension to 23 GHz

908: Rack Flange Kit

Price

add \$500

add \$105

add \$390

add \$150

add \$10

5340A Frequency Counter

\$6200

- Automatic or manual band-selection
- Wide FM tolerance
- Optional 1.5 GHz range

- Fast acquisition time
- High sensitivity
- Fully automatic diagnostics



HP-IB 5341A

The new 5341A Frequency Counter performs exceptionally fast measurements of frequency up to 4.5 GHz. Using a unique HP-designed microwave switchable filter, its automatic heterodyne measurement technique insures high tolerance of FM on the measured signal. In the normal mode of operation, the 5341A will automatically measure and display the lowest CW signal within its sensitivity; in the manual mode, the operator can choose to search within any of ten frequency bands which cover the counter's full range. Also at the operator's command, a convenient routine provides "qualifiers" in the display for complete diagnostic information concerning both the measured signal and the counter's internal operation.

The high sensitivity (-15 dBm in automatic mode, -20 dBm in manual) of the 5341A makes it ideal for measurement of low-level signals in the testing of UHF and microwave components and equipment. An extremely fast acquisition time (100 μ sec in manual mode) makes this counter the optimum choice for systems applications.

Option 003 limits the frequency range of the 5341A to 1.5 GHz, at a considerably reduced cost. Option 011 connects the 5341A to the high-speed HP Interface Bus for data output and complete programmability, including the ability to remotely select the manual search bands.

5341A Specifications

Signal input

Input 1

Range: 50 MHz to 4.5 GHz

Impedance: 50 Ω nominal

Connector: precision Type N

Sensitivity: -15 dBm (AUTO operating mode); -20 dBm (MANUAL operating mode)

Maximum input: +20 dBm

Damage level: +30 dBm

Operating modes: AUTO: counter automatically selects and displays lowest frequency within its sensitivity range; MANUAL: Measurement band is selected manually, and counter measures within a 525 MHz range above displayed band number (in the 500 MHz and 750 MHz bands, counter measures within a 250 MHz range).

Measurement time: acquisition time + gate time

Acquisition time: 600 μ s (AUTO operating mode); 100 μ s (MANUAL operating mode)

FM tolerance: 30 MHz peak-to-peak worst case. Tolerates 500 MHz peak-to-peak (0-500 MHz and 1.0-4.5 GHz) and 250 MHz peak-to-peak (500 MHz to 1.0 GHz) in center of bands.

Input 2

Range: 10 Hz to 80 MHz

Impedance: 1 M Ω , shunted by 50 pF

Connector: type BNC female

Coupling: ac

Sensitivity: 10 millivolts

Maximum input: 5 volts peak-to-peak

Damage level: 400 volts dc; 250 volts rms ac, 10 Hz to 100 kHz, decreasing 6 dB per octave to 80 MHz.

Time base

Crystal frequency: 10 MHz

Stability

Aging rate: $< 1 \times 10^{-7}$ per month

Temperature: $< \pm 1 \times 10^{-6}$ over the range 0°C to 50°C

Line variation: $< \pm 1 \times 10^{-5}$, $\pm 10\%$ from nominal

Output frequency: 10 MHz, ≥ 2.4 V square wave (TTL compatible) available from rear panel BNC.

External time base: requires 10 MHz approximately 1.5 V p-p sine wave or square wave into 1 k Ω via rear panel BNC. Switch selects either internal or external time base.

Optional time base (Option 001) aging rate: $< 5 \times 10^{-10}$ per day after 24 hour warm-up for less than 24 hour off-time.

General

Accuracy: \pm count \pm time base error

Resolution: front panel switch selects 1 MHz, 100 kHz, 10 kHz, 1 kHz, 100 Hz, 10 Hz, or 1 Hz.

Display: ten-digit sectionalized LED display and appropriate measurement units of kHz, MHz, or GHz.

Self check: counts and displays 1 GHz for resolution chosen.

Sample rate: continuously adjustable from 40 msec to 10 seconds and HOLD.

Operating temperature: 0°C to 50°C

Power: 115 or 230 volts, with +5% to -10% tolerance, 48 to 66 Hz, 104 VA

Remote programming and digital output: optional (Option 011) via 24-pin, series 57 Microribbon connector. Program and output information are 7-bit ASCII code. Compatible with HP Interface Bus.

Weight

Net: 10.5 kg (23 lb)

Shipping: 13.2 kg (29 lb)

Dimensions: 425 mm W \times 467 mm D \times 88.2 mm H (16 $\frac{1}{2}$ " \times 18 $\frac{3}{4}$ " \times 3 $\frac{1}{2}$ "¹)

Options

001: High Stability Time Base

002: Rear Panel Connectors

003: 1.5 GHz Frequency Range

011: Remote Programming-Digital Output (HP-IB)

900: Rack Flange Kit

Price

add \$500

add \$105

less \$1000

add \$390

add \$10

5341A Frequency Counter

\$3975

ELECTRONIC COUNTERS

Time interval probes

Model 5363A

- Solves major T.I. problems
- Precisely defines trigger points
- Greatly improves dynamic range



HP-IB programmable Time Interval Probes

Repeatable measurements

The 5363A provides the necessary input signal conditioning to allow a precision time interval counter to make highly accurate and repeatable measurements on time varying waveforms. No longer are count-

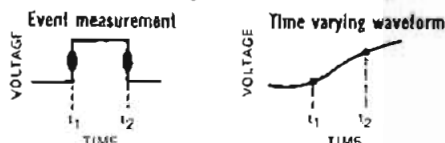

ers restricted to "event" type measurements. Counters such as the 5345A, 5328A and 5360A can now be adapted to make measurements such as rise time, fall time, slew rate, propagation delay and phase jitter analysis.

Trigger point calibration

A unique scheme of Trigger Point Calibration is used instead of hysteresis compensation to assure that the value selected on the digital dials or via the HP-IB is the actual triggering point rather than some unspecified "best estimate" of the trigger point or the center of the hysteresis window.

20 V dynamic range with 10 mV resolution

Greatly improved dynamic range allows the trigger point to be selected in 10 mV increments from -9.99 V to +9.99 V covering the range of most commonly used logic circuits. The use of attenuators on traditional T.I. counters to extend their range increases the effective hysteresis window by the same attenuation amount. This prevents trigger points close to the top or bottom (i.e. 10% or 20% points) of the waveform from being selected and sometimes creates "holes" where certain trigger points cannot be selected at all. The wide dynamic range of the 5363A overcomes these problems.

Minimized circuit loading

Active high impedance, low capacitance probes minimize circuit loading and pulse distortion while permitting test points to be monitored without the need for built-in pulse transformers or impedance matching devices. Each probe contains both a start and a stop channel so that a rise time into a device can be measured with one probe, the rise time out of the device with the other and the propagation delay thru the device can be measured between the probes.

Systematic timing errors eliminated

Delays through probes, cables and the inherent differential delays inside the counters timing channels (i.e., <700 ps in 5345A) limit the absolute accuracy of the time interval measurement to some un-

- Equalizes system timing errors
- Active probes minimize circuit loading
- Measures to zero time interval

known but fixed amount.

The 5363A calibration procedure equalizes out such system delays and allows the counter and probes to be set for 0.0 ns. When a counter with a minimum T.I. range is used (such as HP 5345A or 5328A) a fixed offset of 10.0 ns can be switched in allowing the counter to measure down to zero time interval.

Automated operation

Under calculator control the standard HP-IB capability allows the probes and a counter to perform a wide variety of automated waveform analysis. In the lab or production line complex measurements or go-no-go decisions can be made with push button simplicity. For further details refer to the 5363A Technical Data Sheet and AN 191 on Time Interval Measurements.

Specifications

Dynamic range: +9.99 V to -9.99 V

Voltage resolution: 10 mV

Time resolution: depends on counter used (typ. 10 ps with 5345A T.I. Avg).

Impedance: 1 MΩ shunted by <15 pF

Effective bandwidth: 350 MHz (or 1 ns rise time)

Minimum pulse width: input signal must remain below and above trigger point for at least 5 ns (i.e., max repetition rate of square wave = 100 MHz)

Absolute accuracy:

$$\pm 1 \text{ ns} \pm \frac{\text{START trigger level accuracy}}{\text{START signal slew rate at trigger point}} \pm \frac{\text{STOP trigger level accuracy}}{\text{STOP signal slew rate at trigger point}}$$

Trigger level accuracy (A&B)*: = $\pm 8 \text{ mV} \pm 0.2 \text{ mV}/^\circ\text{C} \pm 0.15\%$ of trigger point

Differential trigger level accuracy (A&B)*: used when A&B are set to the same voltage, same slope, and identical wave forms: $\pm 3 \text{ mV} \pm 0.3\%$ of trigger point

Max input voltage: 30 V peak

Linear operating range: $\pm 10 \text{ V}$

Output to counter: separate start and stop channels, -0.5 to +0.5 V into 50Ω, <2 ns rise time

Trigger level outputs: trigger point setting $\pm 75 \text{ mV}$

Delay compensation range: 2 ns adjustable about 0.0 ns or 10.0 ns

Power: 100, 120, 220 or 240 V ac (+5 -10%); 48 to 440 Hz; 30 VA max

Weight: 16.2 kg (7 lb, 6 oz.)

Dimensions: rack height 88.9 mm (3.5 in.); half rack width module 212 mm (8.38 in.); depth 248 mm (11.6 in.) Probe length 122 cm (4 ft.)

Environmental: operating temperature 0°C to 55°C

Systems Interface: HP-IB programming of all functions except delay adjust vernier (which can be measured in a system).

* After calibration and within the range between 100 mV or 8% (whichever is greater) from the top or bottom of input signal.

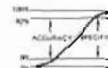

Recommended counters

Counter Model	Price
5345A Electronic Counter; 2 ns single shot T.I., True T.I. averaging	\$4250
5328A Opt. 040 Universal Counter; 10 ns single shot T.I., True T.I. Averaging	\$1650
5360A/5379A Computing Counter; 1 ns T.I. accuracy, 0.1 ns resolution for single shot events	\$9850

Accessories

10229A Hook Tip	\$5
10218A BNC to Probe Adapter	\$11
1250-0655 BNC Tee to Probe Adapter	\$15
10100C 50Ω Feedthru termination for non-50Ω T.I. counter	\$22
10821A Accessory Kit with 2 each of above plus adapters	\$125

5363A Time Interval Probes

\$1900

ELECTRONIC COUNTERS

Broadband preamp

Model 10855A

- 2 MHz to 1300 MHz
- ≥ 22 dB gain

- 50 Ω input and output impedance
- Fuse protected input



10855A Preamp

Description

The 10855A Preamp gives a minimum of 22 dB gain to enhance measurements of very low-level signals. The 10855A operates conveniently with a variety of HP measuring instruments having probe power outlets, or will work with a separate power supply. The 10855A Preamp includes several major features to aid your measurements:

- **≥ 22 dB gain** from 2 MHz to 1300 MHz boosts broadband signals;
- **± 1 dB flat response** reduces distortion in non-sinusoidal waveforms;
- **50 Ω input and output impedances** match high frequency environments;
- **Fuse protected input** prevents costly damage.
- **Excellent reverse isolation**, >45 dB.

The 10855A Preamp is especially useful where the source signal is at a very low level. It also helps where divider probes are used to reduce circuit loading. The 10855A Preamp can operate from the HP 1122A Probe Power Supply for use with instruments that do not have a probe power outlet.

Compatible Hewlett-Packard products

These products presently have probe power outlets that will drive the 10855A Preamp.

5305B	1300 MHz Frequency Counter
5328A/031	1300 MHz Universal Counter
8505A	Network Analyzer
8553B	Spectrum Analyzer RF Section
8557A	Spectrum Analyzer
8558B	Spectrum Analyzer
1810A	1 GHz Scope Plug-in (Sampling)
1811A	Sampling Time Base and Vertical Amplifier
1841A	Time Base and Delay Generator
1122A	Probe Power Supply



10855A with 5300B/5305B counter

Specifications

- Frequency range:** 2 MHz-1300 MHz
- 3 dB Bandwidth:** 1 MHz-1400 MHz, typical
- Gain (minimum):** 22 dB; 24 dB typical
- Gain flatness across full frequency range:** ± 1 dB
- Noise figure:** < 8.5 dB typical
- Output power for 1 dB gain compression:** 0 dBm
- Harmonic distortion:** -30 dB for -15 dBm output, typical
- Output for < -60 dB harmonic distortion:** -25 dBm, typical
- VSWR:** input and output, < 2.2
- Impedance:** 50 Ω nominal
- Reverse isolation:** > 45 dB
- Maximum input:** 3.5 V rms ($+24$ dBm), fuse protected

General

Current required at +15 V supply: 40 mA (mating connector included)

Weight: net, 0.03 kg (1 oz.); Shipping, 0.1 kg (7 oz.)

Dimensions: 80 mm long (3 $\frac{1}{8}$ "), 25 mm high (1"), 15 mm wide ($\frac{5}{8}$ ")

10855A Preamp

\$225

Hewlett-Packard offers Frequency Standards and clocks which provide accurate frequency, time interval and timekeeping capabilities. Further, Hewlett-Packard standards provide means for comparing these quantities against national standards such as the National Bureau of Standards (NBS) and the U.S. Naval Observatory. Units of frequency or time cannot be kept in a vault for ready reference. They must be generated for each use, hence be regularly compared against recognized primary standards.

Frequency Standard and clock systems manufactured by Hewlett-Packard are used for control and calibration at observatories, national centers for measurement standards, physical research laboratories, missile and satellite tracking stations, communication systems, radio navigation systems, manufacturing plants and radio monitoring and transmitting stations.

Types of frequency standards

At the present time, three types of frequency standards are in common use. These are:

1. The cesium atomic beam controlled oscillator.
2. The rubidium gas cell controlled oscillator, and
3. The quartz crystal oscillator.

Hewlett-Packard is the only manufacturer of all three types of frequency standards. Of these three standards, the first is a primary frequency standard and the last two are secondary frequency standards. The distinction between a primary standard and a secondary standard is that the primary standard does not require any other reference for calibration; whereas the secondary standard requires calibrations both during manufacturing and at intervals during use depending on the accuracy desired.

Cesium beam frequency standard

Cesium beam standards are in use wherever the goal is a very high accuracy primary frequency standard. In fact, the NBS frequency standard itself is of the cesium beam type. The cesium beam standard is an atomic resonance device which provides access to one of nature's invariant frequencies in accord with the principles of quantum mechanics. The cesium standard is a true primary standard and requires no other reference for calibration.

The HP Model 5061A and the new 5062C are portable cesium beam standards proved capable of realizing the cesium transition frequency approaching levels of accuracy and long term stability achieved by large-scale laboratory models. Recent beam tube improvements have made the short-term stabil-

TABLE 1 Comparison of Frequency Standards

Standard	Principal construction feature	Principal advantage
Cesium Atomic Beam Resonator Controlled Oscillator.	Atomic beam interaction with fields-minimum disturbances of resonating atoms due to collisions and extraneous influences.	High intrinsic reproducibility and long-term stability. Designated as primary standard for definition of time interval.
Rubidium Gas Cell Resonator Controlled Oscillator.	Gas buffered resonance cell with optically pumped state selection.	Compact and light weight. High degree of short-term stability.
Quartz Crystal Oscillator.	Piezoelectrically active quartz crystal with electronic stabilization.	Very compact, light and rugged. Inexpensive

ity comparable to that of the Rubidium Frequency Standard. With this improved performance cesium standards now have the capability of rapid measurement to high precision along with the excellent long term stability necessary for timekeeping.

Rubidium frequency standard

Rubidium frequency standards feature a high order of both short-term and long-term frequency stability. These are both important in certain fields such as deep-space communications, satellite ranging, and doppler radar.

Rubidium standards are similar to cesium beam standards in that an atomic resonant element prevents drift of a quartz oscillator through a frequency lock loop. Yet the rubidium gas cell is dependent upon gas mixture and gas pressure in the cell. It must be calibrated and then it is subject to a small degree of drift. The drift is typically 100 times less than the best quartz crystal standard.

Quartz crystal oscillators

Quartz oscillators are used in virtually every frequency control application including atomic standards. The excellent short-term stability and spectral purity of the quartz oscillators used in Hewlett-Packard atomic standards contribute to the high quality of the output signal of these standards. For less demanding applications where some long-term drift can be tolerated, quartz oscillators are used as independent frequency sources. The quartz oscillator designs have improved over the years to provide a relatively low cost, small-size source of frequency.

However, an inherent characteristic of crystal oscillators is that their resonant frequency changes with time. After an initial aging period of a few days to a month, the

rate-of-change of frequency or aging rate is almost constant. Over a long period the accumulated drift could amount to a serious error, and periodic frequency checks are needed to maintain an accurate quartz crystal frequency standard.

Stability

Stability is specified in two ways. Long term stability refers to slow changes in the average frequency with time due to secular changes in the resonator and is usually expressed as a ratio, $\Delta f/f$ for a given period of time. For quartz oscillators this is often termed "aging rate" and specified in "parts per day." Rubidium standards being more stable are specified in "parts per month." On the other hand, Cesium Beam Standards are primary units with no systematic drift. Therefore, the frequency of these primary standards is guaranteed to a specified accuracy.

Short term stability refers to changes in frequency over a time sufficiently short so that change in frequency due to long term effects is negligible.

Short-term stability is usually specified as the rms average of a number of measurements each over a specified period of time. The longer the averaging time used, the more any deviation is obscured since the average must approach the mean or nominal output frequency in the long run. Hewlett-Packard specifies the short-term stability of its standards in accordance with the definition developed by the National Bureau of Standards and others.* Measurements conforming to this definition can be easily made with available test equipment including the HP 5360A Computing Counter. Figure 1 is a comparison of the short-term stability of various frequency standards.

*Statistics of Atomic Standards, D. Allan, Proceedings of IEEE, Feb 1966, page 737.

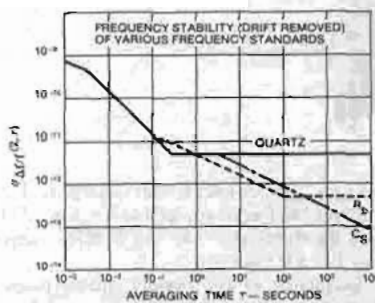

Figure 1. Short term stability of various standards.

Spectral purity

Spectral purity is the degree to which a signal is coherent, or, expressed in another way, a single frequency with a minimum of sideband noise power. It is very desirable to have high spectral purity in a standard signal. This is especially important in applications where the standard frequency is multiplied to very high or microwave frequencies so that the frequency spectrum of the signal will be reasonably narrow.

The signal and its frequency spectrum are analogous to a frequency modulated wave where the total power is constant. If the frequency multiplying device is broadband, the ratio of the total sideband power to the signal power increases as the square of the multiplying factor. With frequency multiplication the signal-to-noise ratio will be degraded 6 dB per octave and 20 dB per decade.

Hewlett-Packard oscillators are designed to give exceptional spectral purity. One method of indicating spectral purity is with a phase noise plot. Figure 2 shows the performance of the HP 5061A, Opt. 004 Cesium Beam Atomic Frequency Standard.

Frequency standards and clocks

Frequency standards and clocks have no fundamental differences — they are based upon dual aspects of the same phenomenon. Time and frequency are intangible quantities which can be measured only with respect to some physical quantity. The basic unit of time, the second, is defined as the duration of 9,192,631,770 periods of transition within the cesium atom. Conversely an unknown fre-

quency is determined by counting the number of cycles over the period of a second. The Master Clock at the U.S. Naval Observatory, one of the world's most accurate clocks, is made up of an ensemble of more than a dozen Hewlett-Packard cesium beam frequency standards. The USNO directly controls the distribution of precise time and time interval (frequency) from Naval radio stations, LORAN-C (operated by U.S. Coast Guard), Omega and Satellite Navigation Systems. Hewlett-Packard portable cesium standards, "flying clocks," are used to periodically check the synchronization between these stations and the Master Clock.

Hewlett-Packard cesium beam standards are widely used to drive precision clocks because of the extremely good long-term stability and reliability of this primary standard. If a quartz oscillator or other secondary standard is used, it must be evaluated for rate of drift and be corrected periodically.

Time scale

The time interval of the atomic time scale is the International Second, defined in October 1967 by the Thirteenth General Conference of Weight and Measures. Since January 1972 the frequency offset between UTC and Atomic Time has been zero and the UTC time scale is kept in synchronism with the rotation of the earth to within ± 0.9 second by step-time adjustments of exactly 1 second, when needed.

The U.S. National Bureau of Standards (NBS) and USNO provide the official basis for Standard Times for the United States. The UTC signal is broadcast from the NBS stations WWV and WWVB and by several other stations throughout the world. (See Hewlett-Packard Application Note S2-1, Fundamentals of Time and Frequency Standards, for a list of stations broadcasting time signals).

Standby power supplies

Minimum down-time, important for any system, is vital to a time standard. Its worth depends directly on continuity of operation. Noninterrupted operation is also important to ultra-precise quartz oscillators.

Hewlett-Packard standby power supplies ensure continued operation despite line interruptions, and operate over a range of ac line voltage to supply regulated dc to operate

frequency standards and frequency dividers and clocks. The batteries in the supplies assume the full load immediately when ac power fails.

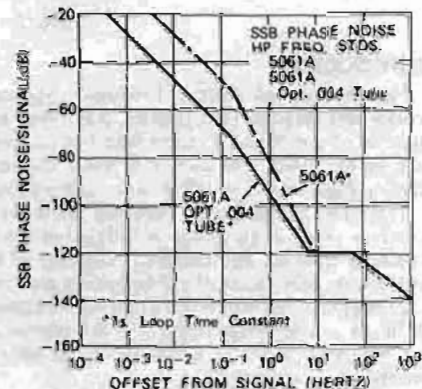

Figure 2. 5061A Phase Noise

Hewlett-Packard time and frequency standard

The Hewlett-Packard House Standard at the Santa Cruz Division consists of an ensemble of four Hewlett-Packard Cesium Beam Standards each with the Option 004 High Performance Tube.

The standard is compared to the U.S. Naval Observatory Master Clock in Washington, D.C. by means of Loran D and TV Line 10 measurements through the USASTRATCOM satellite system. It is also compared with the U.S. National Bureau of Standards Frequency Standard (NBS FS) at Boulder, Colorado by means of LORAN-C through the Naval Observatory. The frequency uncertainty of the standard is within a few parts in 10^{13} with respect to the standards maintained by the NBS and the USNO.

Time is maintained relative to the Naval Observatory and the National Bureau of Standards master clocks to an accuracy of better than ± 2.5 microseconds. This accuracy is verified with Flying Clock trips from the Naval Observatory to both Hewlett-Packard Santa Clara Division and Hewlett-Packard Geneva. Both locations have been designated U.S. Naval Observatory Time Reference Stations.

FREQUENCY & TIME STANDARDS

Atomic frequency standards

Models 5061A, 5062C, 5065A

- 5061A:
 - Primary standard, $\pm 1 \times 10^{-11}$ accuracy
 - Proven reliability
 - World-wide usage

- 5061A, option 004
 - Accuracy $\pm 7 \times 10^{-12}$
 - Settability $\pm 1 \times 10^{-13}$
 - Short term 5×10^{-12} (1 sec avg)



5061A

Introduction

Hewlett-Packard Atomic Frequency Standards have become the world-wide standards for frequency and time keeping since the introduction of the 5060A Cesium Standard in 1964. With the introduction of the 5062C the user now has a choice of four different frequency standards to satisfy a wide variety of applications:

1) 5061A Cesium Beam Frequency Standard. This standard with an accuracy of $\pm 1 \times 10^{-11}$ was introduced in 1967 to replace the 5060A. The high accuracy and excellent reliability of these units have gained world-wide acceptance of HP frequency standards.

2) 5061A with Option 004 High Performance Cesium Beam Tube. With the unique design features in this improved Cesium Beam Tube, the 5061A accuracy is $\pm 7 \times 10^{-12}$ and short term stability is improved by a factor of 10.

3) 5062C Cesium Beam Frequency Reference. This new unit with its small cesium beam tube is designed for on-line system applications where a rugged primary standard is required.

4) 5065A Rubidium Frequency Standard. This instrument features excellent long and short term stability performance at approximately one-half the cost of a cesium standard.

These units are described in detail on the following pages and the specifications are combined in a table to facilitate the comparison and selection of the best unit to suit the user's application.

Principles of operation

The basic block diagram of both cesium and rubidium standards is the same (see Figure 1). The output of the 5 MHz Crystal Oscillator is

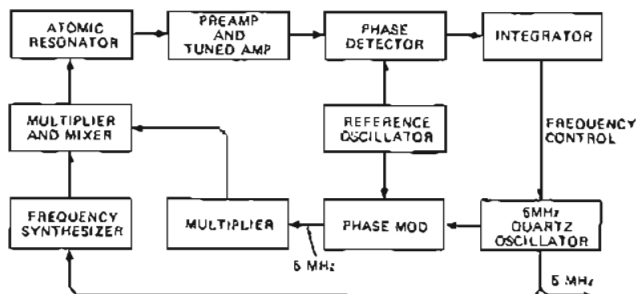

Figure 1. Block diagram of atomic frequency standards.

multiplied and synthesized to the atomic resonance frequency (6834+ MHz for rubidium and 9192+ MHz for Cesium). This signal is frequency modulated to sweep through the atomic resonance frequency causing the beam intensity in the cesium tube or transmitted light

through the rubidium cell to vary. The output signal is amplified and through a phase detector controls the frequency of a low noise 5 MHz quartz crystal oscillator. This oscillator provides the 5 MHz output. Dividers produce 1 MHz and 100 kHz outputs.

The invariant resonance frequency of the cesium atoms passing through the microwave cavity maintain the output frequency of the cesium standard constant to extremely high accuracy. The accuracy is in part a function of the microwave cavity length and is highest in the 5061A with the long cavity of the high performance beam tube.

In the rubidium standard a buffer gas is required to reduce collisions between the rubidium atoms in the gas cell and the resonant frequency varies slightly with pressure of the buffer gas. As a result, the rubidium standard has to be calibrated and the frequency drifts slowly with time because of small changes in gas pressure and other effects within the rubidium cell and lamp. Offsetting this disadvantage are: 1) high signal-to-noise ratio of the rubidium cell output which results in excellent short term stability and; 2) a lower cost standard because of the simpler rubidium cell and associated electronics.

Each of the instruments has front panel controls, a circuit check switch and meter for monitoring performance. These and other controls are protected by a panel door. Front panel lights indicate any interruption of continuous operation and that the crystal oscillator is locked to the atomic resonance.

Applications: Starting with their initial usage as reference standards in national laboratories the applications of HP atomic standards have expanded to include use in operational systems such as the LORAN C and OMEGA navigation transmitters, satellite tracking and guidance stations, very long base line interferometers, navigation receivers based on direct distance measurement (LORAN Rho-Rho), geophysical survey positioning systems and communications systems. Precise timing for frequency control is required for some secure communication systems and to improve efficiency of PCM and spread spectrum systems.

Cesium standard accuracy: The cesium beam standard is a primary frequency standard. A cesium beam tube carefully constructed along with the required supporting electronics will, when independently aligned, put out the correct frequency within very narrow limits. The frequency spread of the output for over 250 independently aligned 5061A standards with the standard beam tube is shown in Figure 2. It can be seen from this data that the frequency perturbations in the standard beam tube are so small that all the units are within $\pm 5 \times 10^{-12}$ of each other and of the NBS frequency. The one sigma standard deviation is 1×10^{-12} between units. This performance is intrinsic to the 5061A and is achieved without calibration. The absolute accuracy, intrinsic reproducibility and absence of any perceptible long-term drift or aging are important advantages of cesium standards and assure that the output frequency of a cesium standard is always within the specified accuracy.



E21-5061A

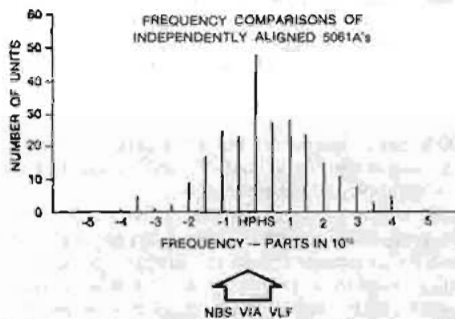

Figure 2. Frequency of independently aligned 5061A Cesium Beam Standards with standard beam tube.

5061A Cesium beam standard

The first Hewlett-Packard Cesium Beam Standard, the 5060A, was introduced in 1964. This was followed in 1967 with the improved 5061A and in 1973 with the high performance beam tube option for the 5061A. Over this 11 year period the accuracy and reliability of Hewlett-Packard cesium standards has been demonstrated and these standards have become the world-wide standard for frequency and time keeping. The 5061A has provision for an optional digital divider and reliable, easy-to-read LED clock (Option 001) and for a battery with ½ hour standby power capacity with automatic charging (Option 002).

Reliability and Warranty: over 25 million operational hours have proven the performance and reliability of Hewlett-Packard cesium beam standards in various world-wide applications. The units have provided dependable microsecond accuracy in aircraft, ship and fixed environments.

A three-year warranty on the 5061A and the standard cesium beam tube is provided as a result of proven field reliability over an extended period. This warranty includes replacement of the cesium beam tube if it should fail within the warranty period. Typically, beam tube life has been in excess of four years.

5061A with Option 004, high performance cesium beam tube

The Hewlett-Packard Model 5061A primary frequency standard with the Option 004 cesium beam tube offers increased stability and accuracy in the instrument which has become the worldwide standard of frequency and time keeping since its introduction in 1967. Improvements in magnetic shielding, ruggedization and environmental

performance permit improved performance and expansion of navigation and communication systems that have been made practical by the 5061A.

The design concept of the high performance beam tube includes unique HP designed dual beam optics with higher beam intensity to accomplish better short term stability and greater immunity to effects of shock and vibration. A 50 percent increase in resonance cavity length without change in the overall beam tube size contributes to better accuracy and settability because of the high Q of the narrower resonant line width. This tube retains the unique cesium standard feature of virtually no long term instability or aging.

The intrinsic accuracy is improved to $\pm 7 \times 10^{-12}$ which provides an excellent reference standard without need of calibration. If desired, as in many timekeeping applications, two or more units may be calibrated to determine the difference in rate or may be adjusted to the same frequency. With the improved settability specification of 1×10^{-13} small changes in frequency are accomplished rapidly and accurately. A provision for degaussing the tube without adversely affecting the instrument operation allows removal of any residual magnetic field in the tube. This is important in achieving the settability performance.

The short term stability specification is improved by a factor of ten with the new tube. The 5×10^{-12} (1 sec avg.) performance compares very favorably with that of rubidium type standards which are noted for their excellent short term stability. An important advantage from the better short term stability is the capability to make measurements to 1 sigma precision of 1×10^{-12} in about one minute compared to the two hours required previously. The 5061A with the Option 004 High Performance Tube has the same high reliability as the 5061A with the standard tube. The new high performance tube is warranted for 14 months (10 000 hours) and is designed to have the same long life as the standard tube.

10653A/B/C Retrofit kit

The high performance beam tube may be installed in place of the standard tube in existing HP 5060A or 5061A Cesium Standards. The 10653A/B/C Kit includes the new tube and the parts necessary for installation. Further information on the 10653A/B/C Retrofit Kit is available from HP Sales Offices.

10638A Degausser

The Model 10638A Degausser is designed for use with the Option 004 High Performance Beam Tube to achieve settability of $\pm 1 \times 10^{-13}$ and reproducibility of $\pm 3 \times 10^{-12}$. The degausser removes residual magnetic fields in the beam tube which slowly decay and cause a small frequency change. The degausser should be used when initially setting up the 5061A with Option 004 or after the instrument has been moved or adjusted.

10810A/B LED clock kit

The LED Clock readout is available as a retrofit kit to replace the mechanical clock used in earlier models of the 5061A and in the 5065A Rubidium Standard.

E21-5061A Flying clock

The E21-5061A consists of a 5061A Cesium Beam Standard with Option 001 LED Clock and a K02-5060A Power Supply joined together to make one portable unit. The power supply, which can be operated from 6 or 12 V dc, 24 to 30 V dc, or 115/230 V $\pm 10\%$, 50 to 400 Hz, will provide approximately 7 hours standby power (from sealed nickel-cadmium batteries) for the 5061A Cesium Beam Standard.

This wide range of operating power capabilities enables the E21-5061A to operate on local power in virtually any country in the world. Operation is approved aboard commercial aircraft. The seven hours of standby capability make it possible to travel where there is no power available and, of course, allow the E21-5061A to conveniently be transported between power sources and operated in almost any air or surface vehicle as a "flying clock" (see Hewlett-Packard Journal, August 1966 and December 1967).

The Option 004 tube, because of the improved shielding, offers a significant increase in accuracy under the varying earth's magnetic field conditions experienced by flying clocks and is a desirable addition to the E21-5061A. In addition, the better short term stability permits more accurate and rapid comparison of standards. The Option 002 Battery may also be added to increase standby capability.

FREQUENCY & TIME STANDARDS

Atomic frequency standards

Models 5061A, 5062C, 5065A (cont.)

- Primary frequency/time reference
- Fast warm-up
- Rugged, reliable

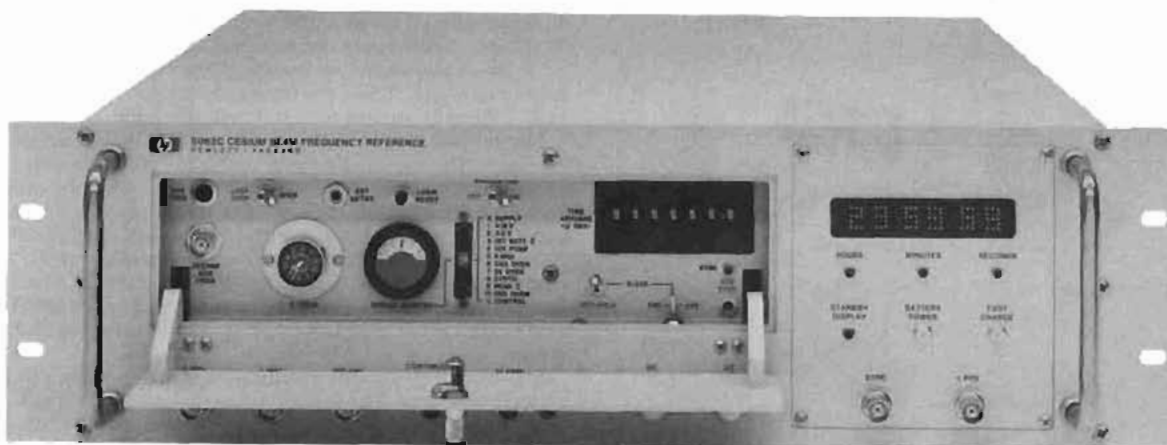

5062C

5062C Cesium beam frequency reference

The Model 5062C Cesium Beam Frequency Reference is a rugged and compact precision oscillator designed for use in surface and airborne systems such as shipboard navigation systems and air transport communications systems. It combines the precision of a laboratory primary standard with the rugged, compact features required for on-line system operations in the extreme environments sometimes encountered in ships and aircraft.

Features important for system operation are the expanded operating temperature range (-28°C to $+65^{\circ}\text{C}$), 20 minute warm-up, frequency accuracy of within ± 3 parts in 10^{11} (including temperature and magnetic field effects) with negligible long-term drift and no need for calibration.

The basic design of the Model 5062C is patterned after that of the Hewlett-Packard Model 5060A and the 5061A Cesium Beam Clocks, but this rugged unit is 25% smaller in size. Yet, space is provided for an optional clock and standby batteries. Other features such as special output frequencies or a time code generator may be added. The key to the smaller size is a newly developed, small, rugged cesium beam tube. This tube, approximately six inches long and four inches diameter, includes all the features of the sixteen inch tube used in the HP 5061A to insure high accuracy and stability plus long life. In addition, multiple cesium beams assure accuracy under the shock, vibration and acceleration encountered in operating systems.

New, compact electronics compliment the small beam tube in accomplishing the 5062C design. Plug-in keyed printed circuit cards assure ease of maintenance. Particular attention has been given to both the electronics and mechanical design to the temperature, shock and vibration encountered in system applications. The resulting rugged design assures stable operation under extreme environmental conditions. The 5062C meets many of the requirements of MIL-E-16400 specification for ship and shore equipment. These include the wide operating temperature range, the 400 pound hammer blow specified by MIL-S-901 and the Type I shipboard vibration of MIL-STD-167-1 (4-50 Hz).

With minor circuit additions the rugged, commercial, design of the 5062C meets the operating requirements of military specification MIL-F-28811 (EC). The nomenclature, 0-1695/U has been assigned to this version of the instrument which is identified as the 5062C, Option 010. The added features are described below.

Reliability: the unit incorporates conservatively designed circuits to insure reliability. Similar designs in the 5061A Cesium Beam Standard have demonstrated mean time between failures (MTBF) in ex-

cess of 40,000 hours in laboratory environments.

Extensive testing of the 5062C under vibration and temperature extremes assures reliability of the instrument

Ease of maintenance was included along with reliability and ruggedness as design goals of the 5062C. The front panel circuit monitoring switch and meter permit checks for proper operation and monitoring of critical functions. In the event of a malfunction, troubleshooting is simplified by well marked test points on the circuit cards and mother boards. Board extenders permit access to individual boards while operating. The circuit boards are keyed to assure that they are properly located. The few board adjustments are readily accessible when the instrument covers are removed. The 5062C is supplied with pivot slides for easy access when the unit is rack mounted. All these features simplify troubleshooting and minimize mean time to repair (MTTR) in the event of failure.

Options: the 5062C is designed to include clock and battery options and space is available to add other features required to meet system requirements. Special output frequencies, time code generators, and additional buffered outputs may be added. The following standard options are available:

Option 001 Digital clock: this option adds a front panel LED display of hours, minutes and seconds. A digital divider generates one pulse-per-second from 5 MHz. This master pulse may be synchronized to a reference pulse. The digital clock and the clock 1 PPS are adjustable in phase with respect to the master pulse in 0.1 microsecond steps.

Option 002 Standby battery: the sealed gelled-electrolyte battery provides a minimum of one hour standby at 25°C after full charge. The battery is automatically recharged after use. When external power fails, the standby battery assures continuous output without interruption.

Option 003 Digital clock and standby battery: this option combines Option 001 and 002.

Option 010 Time-code generator: this option includes the Option 001 Digital Clock and Option 002 Standby Battery along with other special features required to meet the operating requirements of the 0-1695/U Frequency Standard, Cesium Beam in accordance with Military Specification MIL-F-28811(EC). These include a time code generator, four one-pulse-per-minute outputs, additional 5 MHz outputs, added RFI shielding and special rear panel and mating connectors. The rugged design of the 5062C meets the environmental requirements of the military specification.

REGULATORY & TIME STANDARDS
Hewlett-Packard Company
15151 E. Armstrong Avenue
Chandler, Arizona 85226

- Compact, low-price atomic standard
- Long term drift rate $<1 \times 10^{-11}$ /mo
- Short term stability $<5 \times 10^{-12}$ (100 sec avg)



5065A Rubidium frequency standard

The HP Model 5065A is an atomic-type secondary frequency standard which uses a rubidium vapor resonance cell as the stabilizing element. As a result, it has long term stability of better than 1×10^{-11} per month which exceeds that of high quality quartz oscillator frequency standards by 50 to 100 times. Furthermore, it has excellent short term stability. These features contribute to its desirability as a coherent signal source, as a master oscillator for radio and radar systems where special requirements for stability and/or narrow bandwidth must be met, as a precision time keeper where the better performance of a cesium beam primary standard is not required, and as a house frequency standard for improved accuracy with fewer NBS calibrations compared to that required with quartz standards.

Front panel controls and circuit check meter of the 5065A are protected by a panel door. The magnetic field control provides fine frequency adjustment with which the frequency can be set to a precision of better than 2×10^{-12} without reference to a chart. The 5 MHz low noise quartz oscillator is phase locked to the atomic frequency and provides the standard 5 MHz, 1 MHz, and 100 kHz outputs. The circuit check meter with selector switch monitors key voltages and currents for routine maintenance readings, calibration procedures, and fault finding.

The 5065A is designed for assured operation — to give the user confidence that the standard output signals are correct and locked to the atomic frequency. Logic within the unit maintains power to a "continuous operation" light on the front panel. If operation is interrupted, even momentarily, for any reason the light goes out and stays out until manually reset. An integrator limit light warns when the frequency correcting servo loop is approaching the limit of its dynamic range.

The HP Model 5065A is contained in a small sized package and is lightweight in comparison to a cesium beam standard. Additionally the rubidium resonance cell is much more frequency stable than quartz oscillators while subjected to shock and vibration. Its environmental specifications include temperature, shock, vibration, EMC, humidity, and magnetic field effects.

Reliability and warranty: the most significant module in the HP 5065A in terms of performance is the Rubidium Vapor Frequency Reference (RVFR). This temperature controlled, magnetically shielded unit includes the Rb gas cell and a photo sensitive detector designed for maximum possible reliability. Field experience, including

several million hours of operation, have demonstrated this reliability and the module is now warranted for a period of three years. This increased warranty protects the owner in the event of random failure.

The Option 001 Digital Clock has an easy to read LED time-of-day display. The olive black upper panel provides a dark background around the readout for excellent contrast and readability. Initial clock setting is accomplished by means of pushbuttons easily accessible by removing the top cover. The LED display offers high reliability, freedom from errors due to mechanical shock, and performance over the full environmental range of the 5065A. A sync button on the digital divider permits automatic synchronization of this 1 PPS pulse to an external pulse. The clock 1 PPS is adjustable in decade steps from 1 μ s to 1 s, with respect to the synchronized reference, with 6 thumbwheel switches. A screwdriver adjustment allows fine continuous adjustment over a range of 1 μ sec.

To conserve battery power, the display is not illuminated when ac power is not available. A STANDBY READ pushbutton below the display is used for readout when operating on the internal battery or external dc.

The LED clock readout is available as a retrofit kit, HP Model 10810A/B, to replace the mechanical clock in earlier models of the 5065A. Contact your Hewlett-Packard sales office for full details.

The Option 002 Standby Battery provides the 5065A with a minimum of 10 minutes standby power at 25°C. Switchover from line to battery is automatic so there is no interruption of operation if ac line power should fail. A front panel ac interruption light warns when ac power has failed or has been disconnected. Fast or float charging rates may be selected when ac power is available.

The Option 003 combines the Option 001 Clock and Option 002 Battery and should be specified if both Options 001 and 002 are required.

E21-5065A Portable time standard

E21-5065A Portable Time Standard is a complete system for precision timekeeping and for transporting time from one location to another. It consists of the 5065A Rubidium Standard with digital clock and divider (Option 001) and the K02-5060A Power Supply with 6 or more hours standby capability. The component units are held together by side bars, and the interconnecting cables are protected by a back cover.

FREQUENCY & TIME STANDARDS

Atomic frequency standards

Models 5061A, 5062C, 5065A (cont.)

Specifications

Instrument:	5061A Option 004	5061A	5062C	5065A
Type of Standard:	Cesium	Cesium	Cesium	Rubidium
Accuracy: maintained in magnetic field to 2 gauss and over temperature range of:	$\pm 7 \times 10^{-12}$ 0 to 50°C	$\pm 1 \times 10^{-11}$ 0 to 50°C	$\pm 3 \times 10^{-11}$ -28°C to +65°C	
Stability: Long Term: Short Term 5 MHz ⁽²⁾ : Averaging time: 0.01 sec 1 sec 10 sec 100 sec	$\pm 3 \times 10^{-12}$ ⁽¹⁾ 1.5×10^{-10} 5×10^{-12} 2.7×10^{-12} 8.5×10^{-13}	$\pm 5 \times 10^{-12}$ ⁽¹⁾ 1.5×10^{-10} 5.6×10^{-11} 2.5×10^{-11} 8×10^{-12}	$\pm 1 \times 10^{-11}$ ⁽¹⁾ 4×10^{-10} 7×10^{-11} 2.2×10^{-11} 7×10^{-12}	$\pm 1 \times 10^{-11}$ /month 1.5×10^{-10} 5×10^{-12} 1.6×10^{-12} 5×10^{-13}
SSB Phase Noise Signal (1 Hz BW) Offset from signal: Hz: 10 ⁻³ 10 ⁻² 10 ⁻¹ 0 10 ¹ 10 ² 10 ³	-28 dB -48 dB -68 dB -96 dB -120 dB -125 dB -140 dB	-8 dB -28 dB -48 dB -82 dB -120 dB -125 dB -140 dB	-6 dB -26 dB -46 dB -74 dB -114 dB -134 dB -144 dB	-25 dB -52 dB -72 dB -93 dB -120 dB -126 dB -140 dB
Reproducibility	$\pm 3 \times 10^{-12}$ ⁽³⁾	$\pm 5 \times 10^{-12}$	$\pm 1 \times 10^{-11}$	
Settability (frequency):	$\pm 1 \times 10^{-13}$ ⁽³⁾	$\pm 7 \times 10^{-13}$	$\pm 2 \times 10^{-12}$	$\pm 2 \times 10^{-12}$
DC Magnetic Field Stability:	$\pm 2 \times 10^{-13}$ 2 Gauss Field	$\pm 2 \times 10^{-12}$ 2 Gauss Field	$< 2 \times 10^{-12}$ 2 Gauss Field	$< 5 \times 10^{-12}$ 1 Gauss Field
Warm-up:	At 25°C 30 Min.	At 25°C 45 Min.	At -28°C 20 Min.	At 25°C 1×10^{-10} 1 hr. 5×10^{-11} 4 hrs.
Sinusoidal Outputs: Output Voltage:	5 MHz, 1 MHz, 100 kHz, Front & Rear BNC 1 V into 50 ohms			
Harmonic Distortion: (below rated output) Non-Harmonic related output: (below rated output) Under vibration or AC Mag Field: Signal-to-Phase Noise Ratio in 30 kHz noise BW (1 and 5 MHz):	>40 dB >80 dB >60 dB >87 dB	>40 dB >80 dB >60 dB >87 dB	>40 dB >80 dB >60 dB >87 dB	>40 dB >80 dB >60 dB >87 dB
Environmental				
Temperature, operating with Option 001, 002 or 010 ⁽⁴⁾ Freq. change from 25°C:	0 to 50°C $< 5 \times 10^{-12}$	0 to 50°C $< 5 \times 10^{-12}$	-28° to +65°C $< 2 \times 10^{-11}$	0 to 50°C $< 4 \times 10^{-11}$
Temperature, non-operating without options: with Option 001: with Option 002 or 010 ⁽⁴⁾	-40° to 75°C -40° to 75°C -40° to 50°C	-40° to 75°C -40° to 75°C -40° to 50°C	-62° to 75°C -40° to 75°C -40° to 60°C	-40° to 75°C -40° to 75°C -40° to 50°C
Humidity, operating: 95% up to	40°C	40°C	50°C	40°C
Altitude, operating: Max. frequency change:	40,000 Ft. 2×10^{-12}	40,000 Ft. 2×10^{-12}	50,000 Ft. 5×10^{-12}	40,000 Ft. 5×10^{-11}
NOTES: (1) For life of beam tube. (2) Short-term stability for the 5061A with both standard and high performance tubes is given for the normal loop time constant; for improved short-term stability in controlled environments the long time constant may be used. (3) With 10638A Degausser. (4) 5062C only.				

FREQUENCY & TIME STANDARDS

Atomic frequency standards

Models 5061A, 5062C, 5065A (cont.)



Instrument:	5061A Option 004	5061A	5062C	5065A
AC Magnetic Field: 50, 60 and 400 Hz $\pm 10\%$	$<2 \times 10^{-12}$ for 2 Gauss peak	$<2 \times 10^{-12}$ for 2 Gauss peak	$<2 \times 10^{-12}$ for 2 Gauss peak	$<5 \times 10^{-12}$ 1 Gauss peak
Vibration: with isolators:	MIL-STD-167-1 MIL-T-21200	MIL-STD-167-1 MIL-T-21200	MIL-STD-167-1	MIL-STD-167-1
Shock:	MIL-E-5400, Class 1 (30 G)			
	1MIL-T-21200, C.1		MIL-E-16400	MIL-T-21200, C.1
EMC:	MIL-STD-461, Notice 3, Class A			
General				
Power: AC:	50, 60 or 400 Hz $\pm 10\%$, 115/230 V $\pm 10\%$			
DC:	43 W 22 to 30 V 27 W	43 W 22 to 30 V 27 W	48 W 22 to 30 V 33 W	49 W 23 to 30 V 35 W
Option 001: Add (AC/DC)	10/7.5 W	10/7.5 W	12/7 W	10/7.5 W
002: Add (AC/DC)	22/4.5 W	22/4.5 W	25/3 W	6/0 W
010: Add (AC/DC)			62/15 W	
Dimensions (H x W x D): Inches: mm:	8 1/4 x 16 1/2 x 16 1/2 221 x 425 x 416	8 1/4 x 16 1/2 x 16 1/2 221 x 425 x 416	5 1/4 x 19 x 21 133 x 482 x 533	5 1/4 x 16 1/2 x 16 1/2 133 x 425 x 416
Weight: (lb./kg.)	70/31.8	67/30.5	50/22.7	34/15.4
Option 001: Add (lb./kg.)	2/0.9	2/0.9	5/2.3	2/0.9
002: Add (lb./kg.)	5/2.3	5/2.3	15/6.8	3.5/1.6
Option 001, Clock				
1 PPS Outputs: Master: Clock:	Front & Rear BNC	Front & Rear BNC	Rear BNC Front & Rear BNC	Front & Rear BNC
	10 V peak into 50 Ω load			
Amplitude:				
Width:	20 μ s min	20 μ s min	20 μ s $\pm 5\%$	20 μ s min
Rise Time:	<50 ns	<50 ns	<20 ns	<50 ns
Fall Time:	<2 μ s	<2 μ s	<1 μ s	<2 μ s
Jitter, pulse-to-pulse:	<5 ns, rms	<5 ns, rms	<5 ns, rms	<5 ns, rms
Synchronization:	Automatic, 10 ± 1 μ s delay	Automatic, 10 ± 1 μ s delay	Auto. to within ± 500 ns	Auto., 10 ± 1 μ s delay
Clock pulse adjustment range:	1 μ s to 1 s	1 μ s to 1 s	0.1 μ s to 1 s	1 μ s to 1 s
Clock display:	Solid State Digital			
Option 002, Standby Power Supply Capacity at 25°C with Option 001 Clock:	30 Minutes	30 Minutes	One Hour	10 Minutes
Recharge, Fast/Float:	Automatic, fast charge			Switch

Model number and name

5061A Cesium Beam Frequency Standard

Option 001 Clock	\$19,950
Option 002 Standby Power Supply	add \$2075
Option 003 Clock and Standby Power Supply	add \$1000
Option 004 High Performance Beam Tube	add \$3075
Option 908 Rack Flange Kit	add \$3250
	add \$15
E21-5061A Flying Clock	\$26,225

Consists of: 5061A with Option 001 and K02-5060A Standby Power Supply.

Weight: 64 kg (141 lb).

Dimensions: 425 mm x 405 mm x 546 mm (16 1/4" x 15 1/8" x 21 1/2") (includes handles).

10638A Degausser

	\$850
Weight: 1.2 kg (3 lb)	
Dimensions: 130 mm x 77 mm x 279 mm (5 1/8" x 3 1/2" x 11")	

5062C Cesium Beam Frequency Reference

Option 001 Clock	\$17,950
Option 002 Standby Power Supply	add \$2100
Option 003 Clock and Standby Power Supply	add \$1000
Option 010 Clock, Battery, Time-Code Generator	add \$3100
Option 010 Clock, Battery, Time-Code Generator	add \$5100
5065A Rubidium Frequency Standard	\$8950
Option 001 Clock	add \$2075
Option 002 Standby Power Supply	add \$495
Option 003 Clock and Standby Power Supply	add \$2570
Option 908 Rack Flange Kit	add \$10
E21-5065A Portable Time Standard	\$15,225

Consists of: 5065A with Option 001 and K02-5060A Standby Power Supply.

Weight: 50 kg (110 lb)

Dimensions: 425 mm x 314 mm x 546 mm (16 1/2" x 12 1/2" x 21 1/2") (includes handles).

FREQUENCY & TIME STANDARDS

Quartz frequency standards

Models 105A/B

- High spectral purity
- Well-buffered outputs
- Aging $<5 \times 10^{-10}$ per day

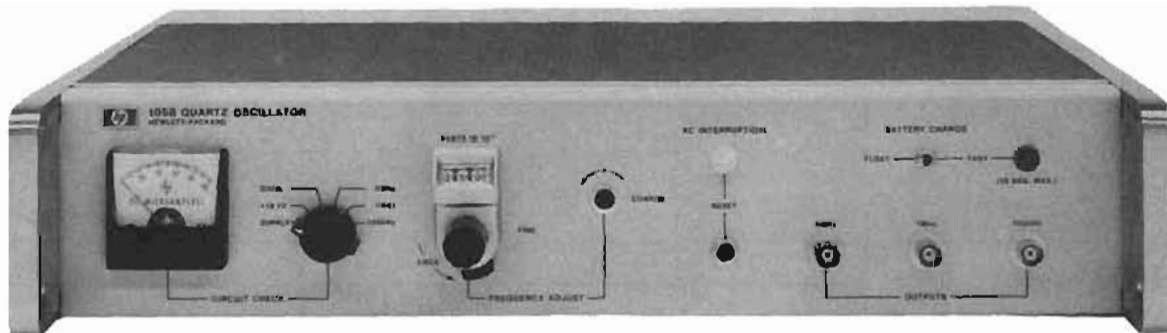

105B

Models 105A and B Quartz Oscillators provide state-of-the-art performance in precision frequency and time systems because of their excellent long and short term stability characteristics, spectrally pure outputs, unexcelled reliability, and ability to operate under a wide range of environmental conditions. They fill a need for a small and economical yet highly stable precision quartz oscillator for frequency and time standards. Both models can be operated from the ac line; the 105B has a built-in 8-hour standby battery for uninterrupted operation should line power fail. Both have 5 MHz, 1 MHz and 100 kHz buffered sinusoidal outputs with excellent short term stability (5 parts in 10^{12} rms for 1 s averaging time) and aging rate (<5 parts in 10^{10} per day).

The 105A/B features rapid warm-up. Typically, the oscillator will be within 1 part in 10^9 of the previous frequency in 30 minutes after an "off" period of 24 hours. The basis of these oscillators is an extremely stable 5 MHz, 5th overtone quartz crystal developed by Hewlett-Packard. New technologies in the crystal mounting and packaging have resulted in a cleaner crystal which in turn has a lower aging rate. The crystal, oscillator and AGC circuit are all enclosed in a proportional oven which reduces the temperature effects on these components and circuits.

The 68 mm \times 68 mm \times 137 mm (2.7" \times 2.7" \times 5.4") package containing the oven enclosed crystal oscillator with AGC circuit and buffer amplifier are available separately as a component oscillator, the K07-105A, for use in equipment where a high quality 5 MHz source is required. Details are available from Hewlett-Packard sales offices.

Particular care was taken to provide a spectrally pure 5 MHz output which, when multiplied high into the microwave region, provides signals with spectra only a few cycles wide. Spectra less than 1 Hz wide can be obtained in X-band (8.2 to 12.4 GHz). The stability and purity of the 5 MHz output make it suitable for doppler measurements, microwave spectroscopy, and similar applications where the reference frequency must be multiplied by a large factor.

Specifications

Outputs: 5 MHz, 1 MHz, 100 kHz; 1 V rms into 50 Ω front and rear connectors.

Clock output: 1 MHz or 100 kHz; 0.5 V rms into 1 k Ω , rear connector. Normally supplied wired for 1 MHz output.

Frequency stability

Aging rate: $<5 \times 10^{-10}$ per 24 hours.

Short-term stability: for 5 MHz output only.

τ (sec)	$\sigma \Delta f/f$ (2, τ)	$\sigma \Delta f$ (2, τ)sec
10^{-2}	1.5×10^{-10}	1.5×10^{-12}
10^{-1}	1.5×10^{-11}	1.5×10^{-12}
10^0	5×10^{-12}	5×10^{-12}

Temperature: $<2.5 \times 10^{-9}$ total change 0°C to 50°C.

Load: $\pm 2 \times 10^{-11}$ open to short circuit, 50 Ω R, L or C load change.

Supply voltage: $\pm 5 \times 10^{-11}$ for 22-30 V dc from 26 V dc reference and for 115/230 V $\pm 10\%$.

Warm-up (at 25°C): to within 1×10^{-1} of previous frequency in 15 min., 1×10^{-8} in 20 min., 1×10^{-9} in 30 min.

Distortion (5 MHz, 1 MHz, 100 kHz) below rated output:

Harmonic: >40 dB.

Non-harmonic: >80 dB.

Signal-to-noise ratio: for 1 and 5 MHz, >90 dB in a 30 kHz noise BW (5 MHz output filter BW is approximately 100 Hz).

Frequency adjustments

Fine: 5×10^{-8} range with digital dial reading parts in 10^{10} .

Coarse: 1×10^{-8} front panel screwdriver control.

Phase locking: external +5 V to -5 V allows $>2 \times 10^{-8}$ frequency control for locking to external source.

Environmental:

Temperature, operating: 0°C to +50°C.

Temperature, storage: -40°C to +75°C (+50° for 105B).

Altitude: 15.24 km (50 000 ft.)

Shock: MIL-T-21200 (30 Gs).

Vibration: MIL-STD-167 and MIL-T-21200.

Electromagnetic compatibility (EMC): MIL-I-6181D.

Standby supply capacity: model 105B only, 8 hours at 25°C ambient temperatures.

Power requirements: 115/230 V $\pm 10\%$, 50-400 Hz at 17 W (70 W warm-up) for 105A. For 105B add 1 W for float charge and 12 W for fast charge. 22-30 V dc at 6.4 W (10.3 W warm-up).

Dimensions: 88 mm high \times 425 mm wide \times 286 mm deep (3 1/2" \times 16 3/4" \times 11 1/4").

Weight: 105A — net, 8 kg (16 lb), Shipping, 10.5 kg (23 lb), 105B — net, 11 kg (24 lb), Shipping, 14 kg (31 lb).

Options

Option 908: Rack Flange Kit

Option 910: Extra manual

Price

add \$10

add \$10.50

Model number and name

105A Quartz Oscillators

105B Quartz Oscillators

\$2500

\$2950

- Excellent spectral purity
- Low power
- Fast warm-up

- High reliability
- Rugged
- Compact

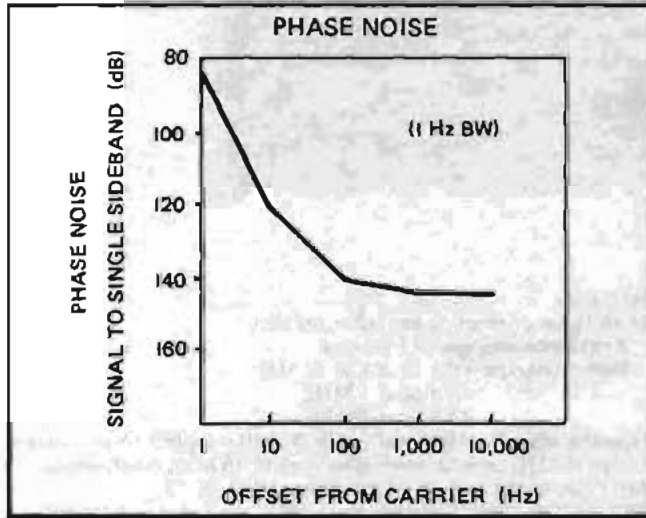

The 10544A Quartz Crystal Oscillator was developed by Hewlett-Packard to meet the needs for compact, high stability oscillators for use in test equipment and systems. Its excellent short-term stability and high spectral purity is especially desirable in applications where multiplication and synthesis are used to generate microwave frequencies. Rugged construction and high quality components assure high reliability and optimum performance. With the extremely low aging rate of this oscillator a significant cost savings can be realized by the end user because of the reduced frequency of calibration needed to stay within FCC accuracy requirements.

The crystal for the oscillator is supported in a new rugged mounting in a cold-welded, high bake out enclosure. The housing around the crystal enclosure is massive with high thermal conductivity which contributes both to rapid warmup and excellent temperature stability. The oscillator, AGC amplifier and oven control circuits are all inside a thermally insulated oven. Rigid plastic foam with extremely low thermal conductivity is used to provide thermal insulation and firm mechanical support for the oven enclosure.

Low priced and compact, the 10544A uses an efficient thermistor control of the heater current duty cycle to maintain the oven temperature. The oven heater may be operated over the range of 55 to 30 V while the oscillator and oven controller require a regulated 11.0 to 13.5 V source. A simple external IC regulator may be used if the necessary voltage is not available.

The 10544A is ideally suited for use in communication and navigation systems, synthesizers, time-code generators, counters and spectrum analyzers. The 10 MHz output frequency is a convenient starting point since it is easily divided or multiplied.

A screwdriver adjustment through the top of the oven enclosure permits frequency adjustment over a range of 2×10^{-6} (20 Hz), yet the control is sensitive enough to allow adjustment to better than 1×10^{-9} (0.01 Hz). Frequency can also be controlled electronically over a 1 Hz range with an externally applied voltage.

Specifications

Output: 10 MHz¹, 1 V rms $\pm 20\%$.

Impedance: 1000 ohms

Frequency stability:

Aging rate: $< 5 \times 10^{-11}/\text{day}^2$; $< 1 \times 10^{-7}/\text{year}^2$

Short term stability:

Averaging time	Δ/f	Averaging time	Δ/f
1 ms	5×10^{-9}	1 s	1×10^{-11}
10 ms	5×10^{-10}	10 s	1×10^{-12}
100 ms	5×10^{-11}	100 s	2×10^{-13}

Temperature: $< 7 \times 10^{-9}$ (0 to 71°C); $< 1.5 \times 10^{-8}$ (-55 to +71°C)

Load: $< 5 \times 10^{-10}$ ($\pm 25\%$ load change)

Warmup²: $< 5 \times 10^{-9}$ of final value in 20 min. (25°C, at 20 V dc)

Oven voltage³: $< 1 \times 10^{-10}$ ($\pm 10\%$ change)

Circuit voltages: $< 5 \times 10^{-10}$ ($\pm 1\%$ change)

SSB phase noise ratio (1 Hz bw)⁴

Offset from carrier:	Ratio:
1 Hz	83 dB
10 Hz	120 dB
100 Hz	140 dB
1 kHz	145 dB
10 kHz	145 dB

Distortion below rated output, harmonic >25 dB;

Nonharmonic >80 dB

Frequency adjustment

coarse (18-turn control): $> 2 \times 10^{-6}$

fine (EFC): $> 1 \times 10^{-7}$

Connector: 15 pin PC Board

Voltages required: oven, 20-30 V dc, -55 to +71°C; 15-30 V dc, 10 to +71°C, 3 watts at 25°C. Circuits, 11.0-13.5 V regulated dc, 40 mA.

Case size: 72 x 52 x 62 mm (2.8" x 2" x 2.4")

Weight: 0.31 kg (11 oz.)

Quantity

1 to 4

5 to 9

10 to 24

25 to 49

Larger quantity discounts available.

Price

\$625 each

\$600 each

\$575 each

\$525 each

(1) Frequencies from 4.5 to 62 MHz available on special order.

(2) After 24-hour warm-up and oscillator off-time less than 24 hours.

(3) Final value is defined as frequency 24 hours after turn on. With 15 V dc oven input, warm-up time is 60 minutes.

(4) A 10% voltage change will cause a frequency change of $< 1 \times 10^{-9}$ for < 2 min.

(5) For continuous operation.

FREQUENCY & TIME STANDARDS

Distribution amplifier

Model 5087A

- Versatile with 3 input and 12 output channels
- Low noise, high stability, and isolation

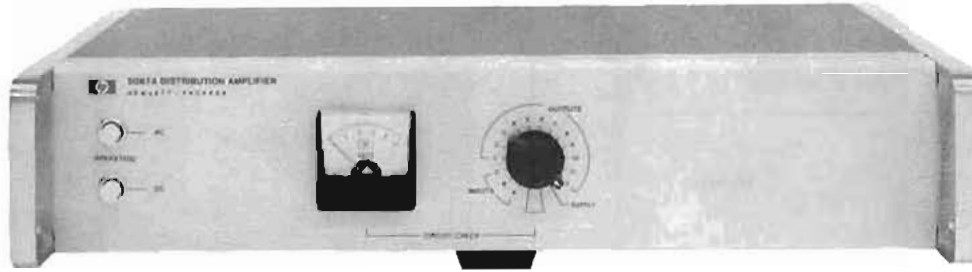

The Hewlett-Packard Model 5087A Distribution Amplifier provides the isolation and flexibility required for distribution of the output of high quality frequency standards. Low distortion and excellent isolation make it ideal for providing multiple outputs from atomic or crystal frequency standards. The 3 input channels will accept 10 MHz, 5 MHz, 1 MHz or 100 kHz in any combination. The number of outputs for each channel is selectable up to a total of 12 outputs. The output levels are individually adjustable from 0 to 3 V rms. All input and output levels are monitored on a front panel meter.

The Distribution Amplifier features plug-in modular construction, short circuit isolation, exceptional phase stability, low noise and crosstalk, and uninterrupted switchover to standby dc in event of ac power failure.

The shielding around each input and output plug-in amplifier assures minimum noise and crosstalk. The tuned output amplifiers provide clean signals and high channel-to-channel isolation.

The instrument is designed for maximum versatility and can be supplied to meet a wide variety of special requirements. The standard configuration of input and output amplifiers is shown in Figure 1.

Several other commonly used configurations are also available and special combinations of the various input and output modules can be supplied. Input and output amplifiers can be added or the configuration easily changed at any time.

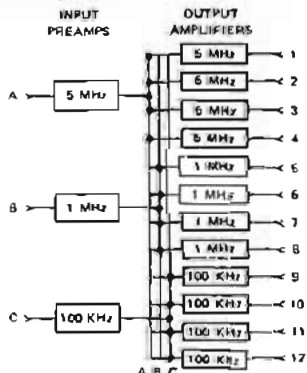

Figure 1. 5087A Distribution Amplifier with Option 031. Standard Configuration Input and output amplifiers.

Specifications

Inputs

(up to three, rear panel BNC)

Frequencies: 10 MHz, 5 MHz, 1 MHz or 100 kHz.

Level: 0.3 to 3.0 V rms, 50 ohms.

Outputs

(up to 12, rear panel BNC)

Frequencies: 10 MHz, 5 MHz, 1 MHz or 100 kHz.

Level: 0-3 V into 50 ohms (screwdriver adjustment).

Harmonic distortion: >40 dB below rated output.

Non-harmonic distortion: >80 dB below rated output.

isolation

Load (open or short on any other channel)

Amplitude change: 0.1 percent

Phase change: <0.1 ns at 5 or 10 MHz

<0.5 ns at 1 MHz

<5.0 ns at 100 kHz

Injected signal: 1 V signal up to 50 MHz applied to any output except 10 MHz, will be down more than 60 dB in all other outputs; 10 MHz output channel will be down more than 50 dB.

SSB phase noise (5 MHz): >145 dB below signal in 1 Hz BW for frequencies >1 kHz from carrier.

Short term stability degradation (5 MHz): <1 × 10⁻¹² in 10 kHz band. (1 s average).

Environmental

Temperature: MIL-E-16400, Class 4

Operating: 0-50°C; storage: -62° to +75°C.

Stability

Amplitude: ±0.5 dB, 0° to 50°C.

Phase: <0.1 ns/°C., 5 and 10 MHz.

EMC: MIL-STD-461A.

Humidity: 95% at 40°C.

Vibration: MIL-STD-167.

Altitude: Up to 30,000 ft.

Shock: MIL-T-21200, Class I and MIL-E-5400 (30 Gs).

General

Power: 115 or 230 V ±10%, 48 to 440 Hz, 20 VA, max, or 22-30 V dc, 500 milliamperes, max.

Dimensions: 88 × 425 × 286 mm (3 1/2" × 16 1/2" × 11 1/4").

Weight: typical, Option 031 - Net 7 kg (15 lb).

Options

Normal configurations (input and output amplifiers)

Option 031: 5, 1 and 0.1 MHz inputs and 4 outputs at

each frequency

Option 032: Single 5 MHz input and 12 outputs

Option 033: Single 10 MHz input and 12 outputs

Option 034: Single 5 MHz input, 4 each outputs at 5, 1

and 0.1 MHz

Price

add \$1050

add \$1000

add \$1000

add \$1150

Special configurations

Input preamplifiers (up to 3 total):

Option 004: Input Preamplifier (0.1 to 10 MHz)

Option 005: 5 to 1 MHz Input Divider

Option 006: 1 to 0.1 MHz Input Divider

Option 011: 5 to 10 MHz Input Doubler

Option 013: 10 to 5 MHz Input Divider

Option 014: 10 to 1 MHz Input Divider

Output amplifiers (up to 12 total):

Option 001: 5 MHz Output Amplifier

Option 002: 1 MHz Output Amplifier

Option 003: 0.1 MHz Output Amplifier

Option 012: 10 MHz Output Amplifier

Option 908: Rack Flange Kit

add \$35

add \$85

add \$85

add \$85

add \$85

add \$85

add \$85

add \$85

add \$85

add \$85

add \$10

5087A: Distribution Amplifier Mainframe

\$990

FREQUENCY & TIME STANDARDS



Standby power supplies
Models 5085A & K02-5060A

- 12 Amp-hr capacity
- Sealed nickel-cadmium cells
- Used in "flying clocks"



K02-5060A

The HP Models 5085A and K02-5060A Standby Power Supplies furnish dc power to keep frequency or time standard systems operating during extended interruptions of ac line power. For applications where it is essential to maintain continuous operation and avoid loss of precise time, the use of a standby power supply is an absolute necessity. These units are designed for use with the Hewlett-Packard Cesium Beam Standards, Rubidium Vapor Standards, Quartz Oscillators and other equipment which will operate from 22 to 30 V dc. No switching is used in transferring power from line to battery operation and back again thus assuring uninterrupted operation.

HP K02-5060A

The K02-5060A is a very versatile unit which was designed specifically as a portable power supply for the 5061A and 5065A "Flying Clocks" where it is necessary to operate from a wide range of power sources along with the standby capability to maintain continuous operation where no external power is available. A special inverter permits operation from a 6 or 12 V dc car battery in addition to the 115/230 V ac and 24-30 V dc capability. The 12 ampere-hour standby batteries are the sealed, nickel-cadmium type and thus spill-proof. Mounting hardware is available to attach the K02-5060A to either the 5061A or 5065A Standards to make a portable standard, the E21-5061A or E21-5065A.

HP 5085A

The HP 5085A is intended for installations where 115 or 230 V ac is available. Vented nickel-cadmium batteries with an 18 ampere-hour guaranteed capacity (derated from 25) are used. They provide about 10 hours of standby power for the 5061A Cesium Standard or 5065A Rubidium Standard (at average ambient temperature of 25°C).

Front panel lights indicate mode of operation, report fuse failure, and ac interrupt. A float-charge switch permits rapid recharge after an ac power failure.

K02-5060A Specifications

Input and output voltages:

Input	Output
6 or 12 V dc	0-230 V, 60 Hz nominal
115 or 230 V ac, 50-400 Hz	0-230 V ac
24-30 V dc	24-30 V dc

Standby battery, 26 ±4 V dc available at all times.

AC and both dc inputs may be connected simultaneously.

Output current: 0.5 A ac, 2 A dc.

Standby capacity: 12 ampere-hours at 25°C, 7 hours standby when used in E21-5061A, 6 hours in E21-5065A.

- 18 Amp-hr capacity
- Vented nickel-cadmium cells

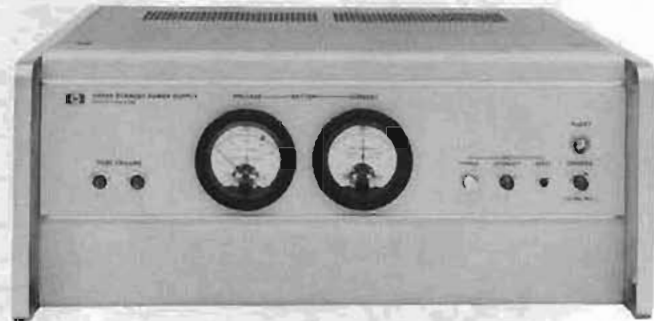

5085A

Recharging: 1.6 hours recharging time required for each ampere hour of discharge.

Alarm indicator: external power failure.

Panel meters: voltmeter, ammeter indicating voltage and current of 4 internal batteries and load.

Battery: four paralleled rechargeable battery packs each containing 20 sealed nickel-cadmium cells. Packs may be removed individually without interfering with power supply operation.

Temperature

Operating: 0 to 50°C.

Storage: -40 to 60°C.

Dimensions: 425 mm wide × 177 mm high × 416 mm deep (16½" × 6¾" × 16¼").

Weight: net, 30.5 kg (67 lb)

Accessories furnished: ac and dc input and output cables.

5085A Specifications

Output voltage: 24 ±2 V dc at rated current.

Output current: 2 amperes (2.5 A for 30 min.).

Standby capacity: (at 25°C) 18 amp-hrs. after 48 hours charge.

Alarm indicators: panel lamps indicate: (1) FUSE FAILURE, (2) AC POWER, (3) AC INTERRUPT, (4) CHARGE.

Remote alarm provisions: SPDT relay contacts provided at rear terminals for operating remote alarm from separate power system.

Panel meters: battery voltage and charge/discharge current.

Power requirements: 115 or 230 ±10% V ac; 50 to 400 Hz (2.0 A max. at 115 V line).

Battery (supplied): vented nickel-cadmium 25 ampere-hour capacity derated to 18 ampere-hours. Periodic maintenance required.

Additional (external) battery provision: rear connector.

Temperature

Operating: 0 to 50°C.

Storage: -40 to 75°C.

Dimensions: 425 mm wide × 177 mm high × 416 mm deep (16½" × 6¾" × 16¼").

Weight: net, 34.1 kg (75 lb). Shipping, 45.9 kg (101 lb) including battery. Option 001 (no batteries) is 22.8 kg (50 lb) less.

Accessories furnished:

AC Power Line Power Cable, 6 ft. long, DC Output Connector, Instrument Extension Slides (for std. 24" deep rack).

Model number

5085A (complete with batteries)

Option 001, without batteries

K02-5060A

Price

\$2300

less \$640

\$3700

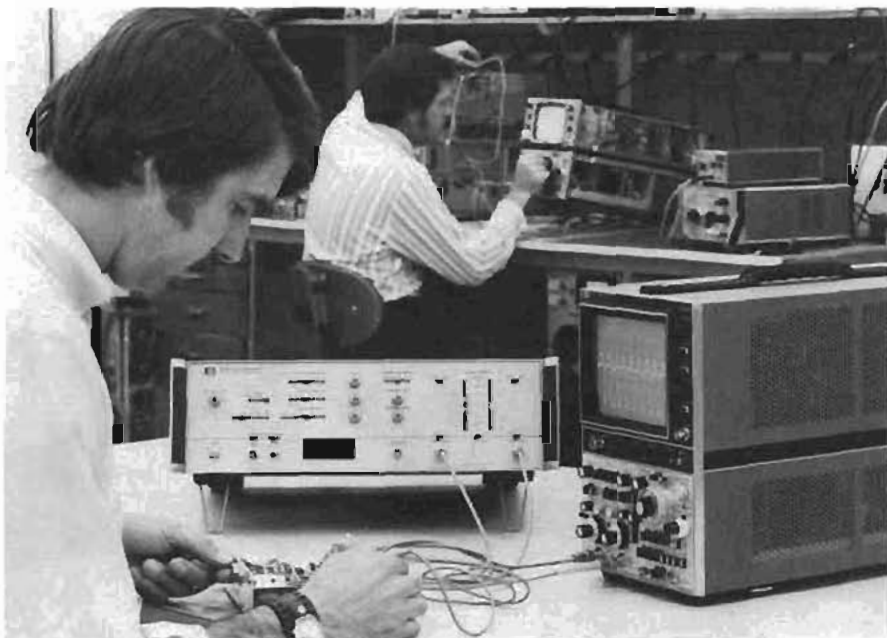

The wide range of quality pulse and word generators available from Hewlett-Packard includes a cost effective solution for most pulse testing applications. Instruments range from inexpensive units ideal for clocking simple logic circuits to high performance models offering precise control of all pulse parameters which are ideal for detailed parametric analysis. Units are available with maximum frequencies from 1 MHz to 1000 MHz and with output voltages ranging from a few volts to 100 V. This wide range of instrument capabilities lets you choose a pulse generator exactly tailored to your testing needs.

In addition to technical performance, important design emphasis is always placed on the ruggedness, reliability, and serviceability of every Hewlett-Packard pulse generator. This means, for example, that all outputs are fully protected against open and short circuit conditions and that only the highest quality components are used. The result is that each of these instruments, from the simplest to the most advanced, is a high value generator that should provide you excellent service.

Pulse generator functional blocks

The repetition rate generator is an oscillator that determines the period of the pulse train: the time from the start of one pulse to the beginning of the next one.

The output of the repetition rate generator drives the delay generator and is supplied to

the front panel trigger output as a reference and synchronizing signal.

The delay generator enables shifting the pulse in time by delaying it a variable length of time with respect to the trigger output. It also furnishes the double pulse mode of operation, in which the first pulse is directed straight to the width generator with zero delay and a second pulse is produced after the delay interval.

The width generator provides adjustment of the duration of the output pulse. The selected pulse width is independent of frequency, remaining constant as the frequency is varied. The slope generator enables setting the rise and fall times of the output signal to simulate desired test conditions.

The output amplifier block amplifies and conditions the pulse for clean transmission to an external 50 ohm environment and also includes attenuator and offset circuitry. The attenuator provides adjustment of the amplitude of the output pulse; offset controls permit a DC shift of the entire pulse either above or below ground. Most amplifiers also include a pulse complementing function to allow pulse duty cycles to approach 100%, and provide selectable positive and negative-going pulses as well.

The external input provides a means of controlling or synchronizing the generator with external signals. It functions in a number of different operating modes. In External

Trigger mode the repetition rate generator is disabled and one output pulse is produced for each pulse received at the external input. Manual triggering of single pulses is also afforded. In Gate mode the repetition rate generator is synchronously switched on as long as the External Input is held high. A pulse burst is thus produced whose frequency is determined by the internal rate generator and whose length is determined by the width of the externally applied signal.

In External Width mode the external signal is applied to the input of the slope generator. Rise and fall times as well as amplitude and offset are determined by the pulse generator; the period and duration of the input signal are unchanged.

50 ohm source impedance

All Hewlett-Packard pulse and word generators have constant 50 ohm source impedance, a feature very important in producing clean output pulses. Signal reflections from the circuit under test are effectively absorbed by the 50 ohm source thus avoiding re-reflection to the tested circuit. The internal 50 ohm source also enables back-terminated operation in which high impedance loads may be driven without an external terminating resistor.

Many HP generators provide, in addition, a switch selectable 50 ohm source. The pulse generator output stage is a current source which produces its maximum voltage when its total available current is concentrated in a single 50 ohm load. Thus to achieve maximum output voltage, only one 50 ohm termination may be used, located either at the source or at the load. With a switch selectable source impedance you can choose the best termination configuration for your application. Highly capacitive loads, for example, are best driven from a 50 ohm source without a terminating resistor at the load. Low capacitance loads are best driven from a high impedance source with the 50 ohm termination placed at the load.

Independent parameters

All variable pulse parameters on Hewlett-Packard pulse generators can be adjusted completely independently of one another. This means, for example, if pulse offset is varied, the amplitude is not affected, and if pulse frequency is adjusted, transition times and width remain constant. A further feature is complete specification of all pulse parameters including thorough specification of pulse perturbations and jitter. Thus you always know what pulses to expect from your generator.

Human engineering

Careful attention to human engineering as well as extensive experience in the design of instrument front panels has enabled Hewlett-Packard to produce pulse and word generators with logical front panel layout and controls that are easy to operate. On many Hewlett-Packard pulse generators timing parameters are adjusted by horizontally oriented controls and amplitude parameters by vertically oriented controls, exactly as these tim-

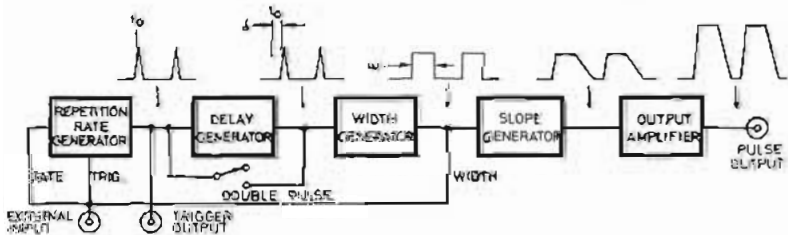

PULSE GENERATOR BLOCK DIAGRAM

ing and amplitude parameters are displayed on an oscilloscope. In addition the physical relationship of pulse period, delay, and width controls minimizes the risk of incompatible control settings. Reduced operator familiarization time and faster setup of the desired pulse are direct benefits.

Digital integrated circuit applications

Digital circuit development, covering such logic families as TTL, ECL, and CMOS is a very important pulse generator applications area.

MOS/CMOS: MOS, and particularly CMOS, is a popular logic family due to its very low power dissipation, high packing density, and high noise immunity. The 8015A and 8011A pulse generators are ideal for MOS and CMOS applications, providing the high amplitude, 16 volt test pulses that these circuits require. The 8015A even produces 30 volt pulses when both its output channels are combined. A further feature of both generators is the pulse burst option which enables a preset number of pulses to be produced. This is useful, for example, when testing counters and shift registers. The 1915A and 1917A output stages for the 1900 system are also suited to MOS/CMOS application.

ECL: Emitter coupled logic features multi-hundred megahertz toggle rates and propagation delays ranging into the subnanosecond region. Hewlett-Packard's 8080 pulse/word generator system, with 1 GHz repetition rates and 300 ps transition times offers performance more than sufficient for testing the fastest ECL circuits. General purpose ECL applications are covered by model 8082A with a 250 MHz repetition rate and

transition times variable down to 1 ns.

TTL: Transistor-transistor logic is the most popular logic family. A wide range of Hewlett-Packard generators, including the 8005B, 8011A, 8012B, and 8007B, are well suited to testing these devices. The 250 MHz 8082A with its 5 volt amplitude is also well suited here, and provides frequency coverage for future faster applications.

High voltage applications

Radar and power semiconductor testing as well as materials and other forms of basic research often require very high power output pulses. Model 214A offering 100 V/2 A performance and model 1915A with 50 V/1 A are ideal for these applications.

Word generators

In contrast to a pulse generator, which normally provides continuous streams of pulses, a word generator produces digital waveforms with bit content programmed by the user. Digital information is normally encoded such that a high level or pulse represents a logical one and a low level or lack of a pulse represents a logical zero. Thus the user may determine his digital word to be 11100110 and program his word generator to produce 3 pulses followed by 2 spaces, then 2 pulses and finally a single space.

Word generators are used to produce the complex waveforms necessary for integrated circuit testing, telecommunications system development, and for interface simulation. Word generation may be serial, in which data is produced on only a single channel, or parallel,

in which many channels of information are simultaneously produced. A repetition rate generator (clock generator) and output amplifier are normally also included to produce a self-contained unit fully capable of delivering data to a device under test.

Word generator applications

The 8016A is a 50 MHz, 8 channel word generator which can supply all of the signals necessary for testing complex MSI and LSI integrated circuits. Adjustable pulse width and interchannel delays enhance the usefulness of the 8016A enabling full parametric as well as functional testing. An HP-IB interface provides rapid loading of the instrument's memory.

Another important word generator applications area is in testing of telecommunications systems. The word generator is used to insert a known digital pattern into the system. The model 8084A word generator module for the 8080 system can supply 64-bit data patterns with repetition rates up to 300 M bits per second in either RZ or NRZ formats. Pseudorandom binary sequences (PRBS) and variable content digital words useful in communications testing applications are also produced by the 8006A, 1925A, 1930A, and 3760A.

The 3760A has been specifically designed for communications applications and provides variable length PRBS and WORD patterns at repetition rates to 150 M bits per second. A second data output delayed 8 bits with respect to the main output is optionally available. The 3760A may be used with the 3761A Error Detector to make bit-by-bit error rate measurements.

Pulse Generators

Model No.	214A	211B	8002A	8004A	8010A	8005B	8011A	8012B	8013B	8015A	8007B	8082A	1900 System
Max. rep. rate (MHz)	1	10	10	10	10	20	20	50	50	50	100	250	25/125
Output V into 50Ω	±100	-5/-30	±5	±5	±5/±10	±5/±10	±8/±16	±5/±10	±5/±10	±8/±16/±30	±5	±5, ECL	±5 to ±50
Number of outputs	1	2	1	1	2 indep.	3(+,-, TTL)	1	1	2	2 indep.	1	2	1, - and COMP
Min. trans. times	12 ns	5 ns	10 ns var.	1.5 ns	10 ns var.	10 ns var.	10 ns	3 ns var.	3.5 ns	5 ns var.	2 ns var.	4 ns var.	350 ps (var.)
Width	50 ns to 30 ms		30 ns to 3 s	0 to 1 ms	20 ns to 1 s	25 ns to 3 s	25 ns to 100 ms	10 ns to 1 s	20 ns to 1 s	10 ns to 1 s	5 ns to 50 ms	2 ns to 0.5 ms	0 to 40 ms
Delay	•	•	•	•	•	•	•	•	•	•	•	•	•
Offset V into 50Ω				±2	±2	±2		±2.5	±2.5	±7/±14/±14	±4	±2	±1.5 to ±5
External input	•	•	•	•	•	•	•	•	•	•	•	•	•
Double pulse mode	•			•	•	•			•		•	•	
Selectable Zs			•			•	•	•	•	•			•
Counted burst							Option			Option			Word/PRBS

Word Generators

Model No.	8006A	8016A	3760A
Max. rep. rate (MHz)	10	50	150
No. of channels	2	8	1
Bits per channel	16/32	32/64/128/256	3 to 10
Output V into 50Ω	+2.5/-5	ECL/TTL (var.)	3.7
Width/delay control	•	•	•
RZ/NRZ formats	•	•	•
PRBS	•	•	•
Programmable	•	•	•

8080 Subnanosecond Pulse/Word Generator System

Model No.	Rep. rate gen.			Word generator	Output amplifiers	
	8081A	8081A	8082A		8083A	8083A
Max. rep. rate (MHz)	500	1,000	1,000	300	300	300
Output V into 50Ω	500 mV _{pp}	500 mV _{pp}	600 mV _{pp}	1 channel	±2/ECL	±1.2/ECL
Outputs	1 (int)	1 (int)	2 (int)	16, 32, 64 bits/chann.	2 (NORM/COMP)	3
Min. trans. times	1.2 ns	0.5 ns	0.5 ns	Clock output	160 ps	200 ps
Delay/Advance			5.9 ns	First/last bit trig		
Offset V into 50Ω				RZ/NRZ	±1	±1.2
Ext. trig/gate	•	•	[Freq +2]	•		

PULSE GENERATORS

8080 System—general information

1 GHz/ 300 MHz pulse/word generator system

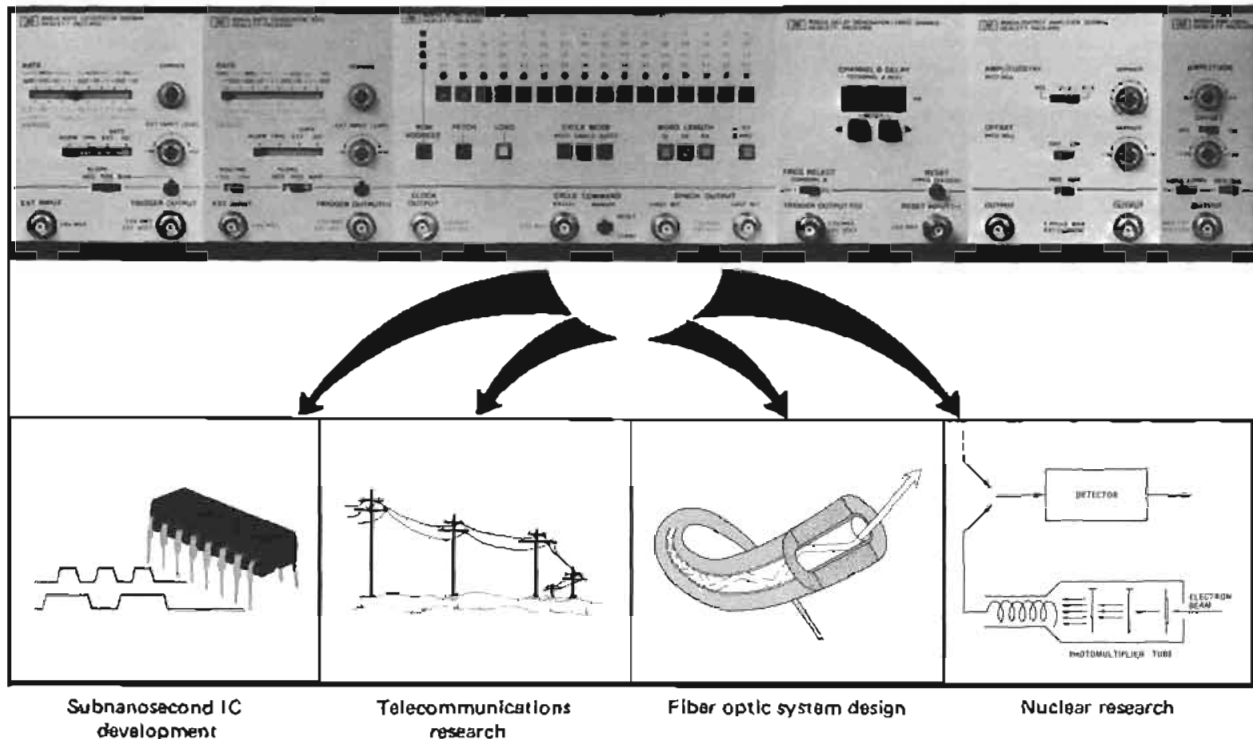

Subnanosecond IC development

Telecommunications research

Fiber optic system design

Nuclear research

General introduction

The Hewlett-Packard 8080 Pulse/Word Generator System is a powerful new tool in the design of subnanosecond logic and communications systems. The 8080 system combines the waveform generation techniques necessary for testing today's high speed circuits with the modularity for future system upgrading and expansion.

Flexibility built into the system gives you a choice of components from two fully compatible module families. Building blocks are available for either 300 MHz or 1 GHz operation. You can incorporate valuable test capabilities such as pulse advance and delay, interchannel delay, word generation and multichannel operation in your system. The result is a high performance, precision pulse generator tailored to fit your application at minimum cost.

System description

Each of the 8080 system modules is a typical pulse or word generator functional block. Repetition rate generators and output amplifiers are available for either 300 MHz or 1 GHz operation. The 64-bit serial word generator module brings high speed data stream capability to the system, and a 1 GHz delay generator/frequency divider provides interchannel delay in 100 ps increments, as well as half-frequency operation. The full-rack-width mainframe houses and powers the modules.

Using these modules you can configure systems with capabilities covering a broad spectrum of stimulus applications. A basic square wave signal source, for example, consisting of repetition rate generator and output amplifier can provide clocking signals for assemblies of logic circuits. More complex systems, even multi mainframe, can produce single or multichannel data streams optimized for subnanosecond PCM research or IC testing.

The combination of pulse and word generation capability in an integrated system makes possible economical, easy-to-use testing solutions. Modular flexibility eliminates the redundancies inherent in less convenient combinations of separate instruments and ensures easy expansion at a later date should test requirements change.

The two systems described as follows are typical of the wide range of systems that can be configured using the fully compatible 8080 modules.

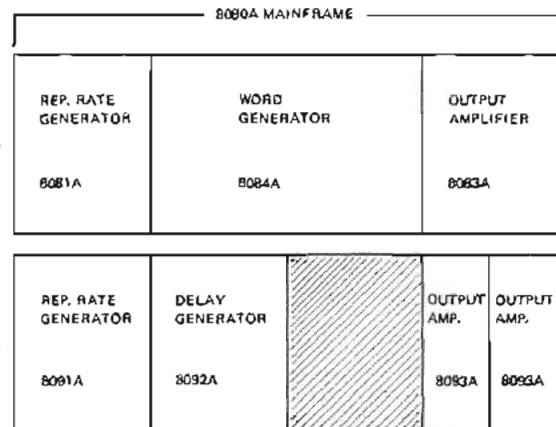

Typical systems showing full range of modules available

1 GHz pulse generator system

Models 8091A repetition rate generator, 8092A delay generator/frequency divider, and two 8093A output amplifiers form a versatile 1 GHz pulse generator system. The system includes two output stages with fully independent level controls and the capability to offset the outputs timewise from one another. This system configuration and the waveforms it generates are ideal for testing the fastest integrated and discrete digital circuits and optical components. Major features of this system include:

- 1 GHz repetition rate
- ≤ 300 ps transition times
- ± 1.2 V output amplitude (into 50 ohms)
- interchannel pulse advance and delay
- selectable half-frequency operation on one channel

Model 8092A delay generator/frequency divider module provides the system with two innovative measurement capabilities very useful, for example, in dynamic testing of high speed clocked devices. The first of these is interchannel delay. Delay is produced from one channel with respect to the other. Secondly, the repetition rate of one of the channels can be set to half of the frequency of the other. The two output waveforms thus provide the clock and data signals necessary for flip-flop and shift register testing.

PULSE GENERATORS

8080 System: general information/mainframe

Model 8080A

- Powers all 8080 series modules
- Full RFI shielding

The full frequency output drives the tested device's clock input, and the half frequency waveform supplies the data input. Setup and hold times are easily determined by adjusting the interchannel delay. With counter circuits, the same technique can be applied to measure the setup time required between count enable and clock inputs.

Output
Waveforms



The full and half frequency outputs of the generator contain each of the four digital combinations of two bits. Thus all types of dual input gates can also be tested. Possibilities include determination of proper functional operation, propagation delay, and sensitivity to race-induced signal overlaps.

Formerly two separate, synchronized pulse generators have been required to perform the above measurements. The 8080 system provides all the necessary capabilities in a single, integrated solution, and with the testing precision afforded by 300 ps rise and fall time test pulses.

300 MHz Word generator system

Combining the Model 8084A word generator module with a repetition rate generator and an output amplifier produces a high performance 300 MHz serial data generator. The variable content digital bit stream and synchronizing clock of such a system provide the waveforms necessary for test and development of integrated circuits and telecommunications systems components such as shift registers, modulators and multiplexers.

The Model 8081A repetition rate generator supplies the system clock. It drives the word generator module at rates from 10 Hz to 300 MHz. The Model 8083A output amplifier applies amplitude, rise-time and pulse shape parameters to the word generator output signal and conditions it to provide clean waveforms to an external 50 ohm environment. Major features of the system include:

- selectable word length — 16, 32 or 64 bits
- 300 MHz clock rate
- ≤ 800 ps transition times
- ± 2 V output amplitude into 50 ohms

Data
Formats

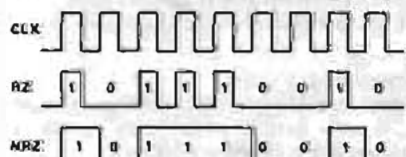

With a single switch you can rapidly select preset ECL-compatible signal levels. When different or more precise levels are required, output pulse amplitude and offset are also separately adjustable. The word generator module gives you a choice of RZ or NRZ data format and provides word framing signals to trigger an oscilloscope. Simultaneous data and data signals, supplied by the complementary output amplifier, are particularly useful for testing balanced transmission line systems and line receivers or for simulating dual-ended IC outputs.

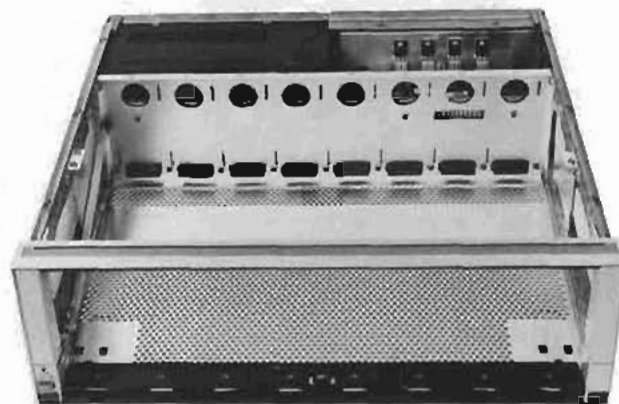

8080A Mainframe (with top cover removed)

8080A Description

The Model 8080A Mainframe provides housing and DC power supplies for the 8080 system modules. The modules are built in $\frac{1}{8}$, $\frac{1}{4}$ and $\frac{1}{2}$ mainframe widths and can be accommodated in the mainframe in any position and combination.

Systems can be reconfigured very easily; the modules are slid into the required position in the mainframe and secured with screws. The high frequency signal connections between modules are then made internally using 50 ohm coaxial cable with SMC connectors.

The ease with which modules can be exchanged greatly improves serviceability because a defective module can be isolated rapidly and repaired or exchanged. Ease of maintenance is further enhanced by the free access provided to all circuits and assemblies in the system.

The entire system is RFI shielded including a power line filter and sealing gaskets on the modules.

8080A Specifications

Compatibility

Electrical: provides power for all modules in any combination of $\frac{1}{8}$, $\frac{1}{4}$ or $\frac{1}{2}$ -size modules.

Mechanical: mainframe compartments accept up to two $\frac{1}{2}$ -size, four $\frac{1}{4}$ -size or eight $\frac{1}{8}$ -size modules in any combination.

General

Operating temperature range: 0°C to 55°C.

Power: 115 V or 230 V, +10%, -22%. Frequency 48 Hz to 66 Hz single phase. Up to 200 VA. Power available for modules 70 watts.

Weight: net, 5 kg (11 lbs).

Dimensions: 145 mm H \times 426 mm W \times 450 mm D (16 $\frac{1}{4}$ \times 5 $\frac{1}{16}$ \times 17 $\frac{1}{8}$ in.)

Options and accessories

907: front handle kit	add \$15
908: rack flange kit	add \$10
909: rack flange/front handle kit	add \$20
910: additional instrument manual (includes binder and system description)	add \$15
15400A: blank panel, quarter mainframe width	\$30
15401A: blank panel, eighth mainframe width	\$20
15402A: Feedthru panel (6 \times BNC) eighth mainframe width	\$25
8080A Mainframe	\$820

PULSE GENERATORS

8080 System: 300 MHz/1 GHz output amplifiers

Models 8083A & 8093A

- 800 or 300 ps transition times
- 8083A — 2 V amplitude, ± 1 V offset
- 8093A — 1.2 V amplitude, ± 1.2 V offset

- Norm/compl, pos./neg. outputs available
- Selectable, preset ECL outputs
- Low reactance 50 ohm source impedance

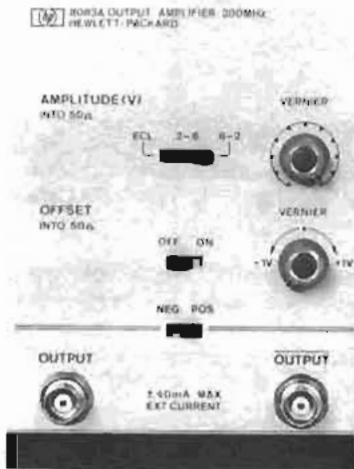

8083A



8093A

8083A and 8093A Descriptions

Models 8083A and 8093A are the output amplifiers of the 8080 series. They apply amplitude and output format parameters to the generated signals, and supply precision fast risetime pulses to the tested device or system.

Model 8083A is a quarter-width module that covers repetition rates up to 300 MHz with fixed transition times of less than 800 ps. Pulse amplitude is variable up to 2 V, can be set to positive or negative polarity, and can be offset from ground by ± 1 V. Simultaneous normal and complement outputs simplify tests of balanced input devices and systems.

Model 8093A is an eighth-width module that extends performance to 1 GHz repetition rate. The 300 ps pulse transition times provided by this module enable parametric testing of even the fastest logic families. Other applications include bandwidth determination, switching transistor and circuit evaluation, and driving high speed data multiplexers and modulators. The amplifier delivers positive or negative pulses with up to 1.2 V amplitude and ± 1.2 V offset. The output format can be set to deliver normal or complementary pulses.

An additional amplitude setting on both modules provides fixed ECL-compatible output levels. Levels can be adjusted internally if required.

Connection to the circuit or system under test is simplified by the low-reactance 50 ohm source impedances of the two modules. These outputs will deliver clean pulses into 50 ohm systems and preserve pulse shapes by absorbing reflections from external loads.

8083A Specifications

Output channels

Simultaneous normal and complement outputs provided.

Source impedance: 50 ohms $\pm 5\%$.

Polarity: neg./pos. selectable.

Output pulse

Amplitude (Into 50 ohm load): 0.2 V to 2 V in two ranges continuously adjustable, plus ECL range (-0.8 V to -1.6 V adjustable).

Maximum levels: ± 4 V.

Offset (Into 50 ohm load): ± 1 V common to both channels.

Transition time (10% to 90%): ≤ 800 ps.

Duty cycle (with drive input duty cycle of 50%): 50% $\pm 10\%$.

Prehoot, overshoot and ringing: $\leq 10\%$.

Output protection: max applied ext. voltage ± 2 V in pos. mode and 0 V to -4 V in neg. mode, or max ext current ± 40 mA.

Drive input

Input frequency: 300 MHz.

Transition time (10% to 90%): ≤ 3 ns.

Input impedance: 50 ohms typical.

Input signal: ≥ 500 mV p-p amplitude, 0 V ± 200 mV high level.

Max input voltage: ± 1 V.

Size

Quarter mainframe width.

8093A Specifications

Output channel

Format: normal or complement selectable.

Source impedance: 50 ohms $\pm 5\%$.

Polarity: neg./pos. selectable.

Output pulse

Amplitude (Into 50 ohm load): ≤ 0.6 V to 1.2 V continuously adjustable, plus ECL range (-0.8 V to -1.6 V adjustable).

Maximum levels: ± 4 V.

Offset (Into 50 ohm load): ± 1.2 V

Transition time (10% to 90%): ≤ 300 ps.

Duty cycle (with drive input duty cycle of 50%): 50% $\pm 10\%$.

Prehoot, overshoot and ringing: $\leq 10\%$.

Output protection: max applied ext. voltage: ± 2 V.

Drive input

Input frequency: 1 GHz.

Transition time (10%–90%): ≤ 600 ps. A second input allows input transition times up to 10 ns for repetition rates up to 300 MHz.

Input impedance: 50 ohms typical.

Input signal: ≥ 500 mV p-p amplitude, 0 V ± 200 mV high level.

Max input voltage: ± 1 V.

Size

Eighth mainframe width.

8083A and 8093A Option

910: additional operating and service manual

Model number and name

8083A 300 MHz Output Amplifier module

8093A 1 GHz Output Amplifier module

Price
add \$9

\$795
\$1525

PULSE GENERATORS

8080 System: word generator

Model 8084A

- 300 bit word generation
- 16, 32 or 64 bit word lengths
- RZ/NRZ formats
- Selectable auto/single/gated cycle mode

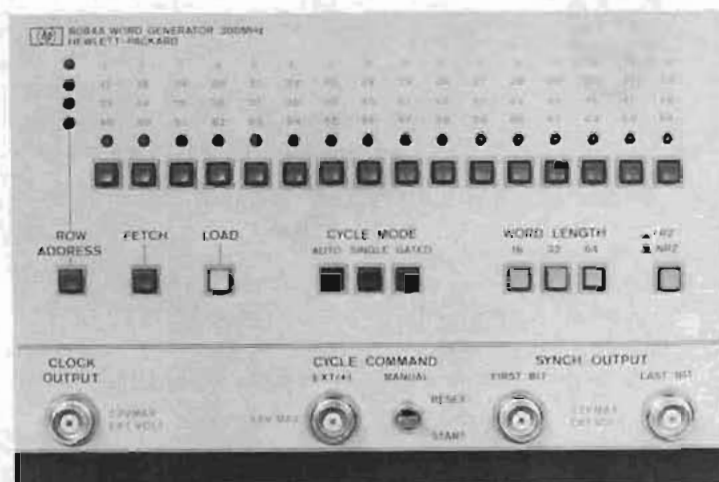

8084A

8084A Description

The Model 8084A word generator module provides high speed data streams for testing integrated circuits, memories, and data transmission lines and systems.

The 8084A with complementary rate generator and output amplifier modules, forms a serial data generator system with pulse parameters tailored to your measurement requirements.

The 8084A module generates a serial digital word in RZ or NRZ mode at repetition rates up to 300 MHz. Word length of 16, 32 or 64 bits is selectable via front panel pushbuttons. Data is fetched from and loaded into the 64-bit memory in 16-bit segments using the Fetch and Load pushbuttons. The 16-bit segments are selected using a Row Address pushbutton with four LED indicators, and the data content is loaded and displayed using a row of 16 data pushbuttons and adjacent LEDs.

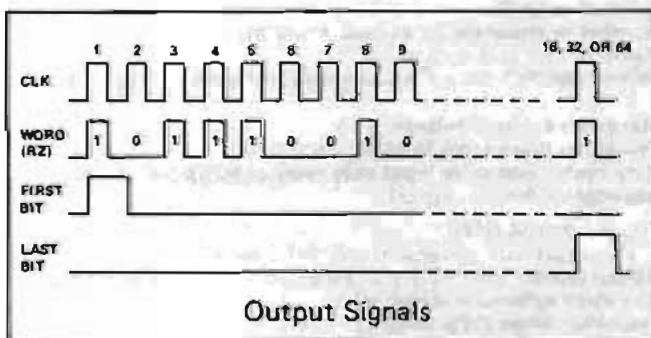

The 8084A operates in Auto, Single or Gated cycle modes. In Auto mode the output is continuous and the word is recycled automatically. In Single cycle mode one word is produced for each cycle command pulse. In Gated cycle mode data is continuously generated as long as the cycle command input is held high, and the last word is always completed.

Synchronizing the 8084A to test instruments or circuits is achieved using the First and Last Bit framing outputs and the Clock output.

8084A option 001 replaces the internal Clock input and Gate and Word outputs with front panel BNC connectors, and should be ordered only when parallel connecting 8084A modules in separate mainframes.

Specifications

Data capacity

Number of data channels: 1 × 16, 32 or 64 bits selectable

Internal outputs (Word, Word, Clock, Cycle Command)

Cycle command function: gates rep. rate generator.

Word, Word format: RZ, NRZ switch selectable.

Clock: inverted output simultaneous with CLOCK output.

Source impedances: 50 ohms ±5%. Will drive one 8080 system module.

Output signal into 50Ω: > 500 mV p-p amplitude, 0 V ± 100 mV high level.

Transition times (10% to 90%): word ≤ 1.2 ns, gate ≤ 1.5 ns.

RZ duty cycle (with 50% duty cycle drive input): Word (Auto mode) 50% ± 5%, Word (Gated, Single Cycle mode) 50% ± 10%, Word and Clock 50% ± 10%.

External outputs (clock, first bit, last bit)

Clock: delivers one pulse per bit. RZ format.

First Bit (FB): coincident with first bit of word. NRZ format.

Last Bit (LB): coincident with last bit of word. NRZ format.

Source impedances: 50 ohms ±5%. Max external voltage: ±2 V.

Output signals into 50Ω: > 500 mV p-p amplitude, 0 V ± 100 mV high level or > 500 mV p-p amplitude, 0 V ± 100 mV low level (switch selectable).

Transition times (10% to 90%): FB and LB ≤ 1.5 ns, Clock ≤ 1.2 ns.

RZ duty cycle (with 50% duty cycle drive input): 50% ± 10%.

Cycle modes

Auto mode: data recycled continuously.

Single cycle: one word for every cycle command input pulse.

Gated cycle: words are generated as long as cycle command is active. Last word always completed.

Cycle command input

Input impedance: 50 ohms ± 10% or 600 ohms ± 10% selectable.

Amplitude: ≥ +0.8 V. Max input: ±6 V.

Width: ≥ 3 ns.

Manual: by switch on front panel.

Size

Half mainframe width.

Options

001: replaces internal clock input, cycle command and word outputs with front panel BNC's. Only in multi-mainframe systems.

910: additional operating and service manual.

8084A 300 MHz word generator module.

Price

add \$65

add \$12

\$2510

PULSE GENERATORS

8080 System: 1 GHz delay generator/freq. divider

Model 8092A

- 9.9 ns channel separation
- Digital delay/advance in 100 ps steps
- LED display of delay or advance interval
- Selectable half frequency operation



8092A

8092A Description

The Model 8092A is a delay generator/frequency divider for use in functional and parametric testing of subnanosecond digital logic circuits. The 8092A has two output channels which can be delayed or advanced with respect to each other in 100 ps steps over ± 9.9 ns range. The selected delay is digitally displayed on numeric LEDs.

The 8092A delay is obtained by delay lines, which offers jitter free delay, that can be set to greater than one clock period. An added advantage of the delay line is that you can easily repeat delay settings if required in a later test.

Another feature of the 8092A is the capability of dividing the channel B frequency by 2. In this operating mode, the two 8092A output channels carry f and $f/2$ with variable interchannel delay.

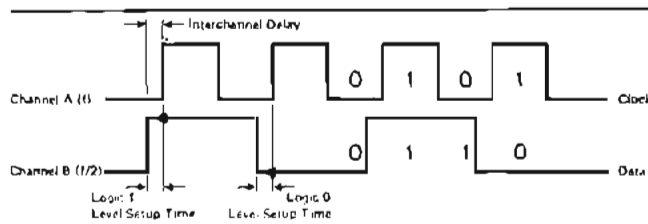

Frequency Division for FLIP-FLOP and Gate Testing

These waveforms are ideal for high speed flip-flop testing. The full frequency signal drives the clock input and the half frequency signal the data input. You can then use the channel separation to check device setup and hold times. The f and $f/2$ waveforms also contain all of the four combinations of two bits (00, 01, 10 and 11) so that you can test dual input gates. Both of these tests normally require two pulse generators to perform them.

The advance and delay pushbuttons have a built-in rapid count facility. If you hold down either pushbutton for more than one second, the channel separation increments at a greatly increased rate. This enables you to step through large time intervals very quickly. If you press both pushbuttons together, the delay immediately resets to zero.

A half-frequency trigger output is provided for triggering test equipment when the frequency divider is used. A reset control is also provided to enable you to reset the frequency divider flip-flop to the logic 0 state before the start of a pulse burst in gated mode. You can reset the flip-flop either electrically or with a pushbutton.

8092A Specifications

Channel B delay/advance (channel A reference)

- Range: ± 9.9 ns.
- Step size: 100 ps.
- Step accuracy: ± 50 ps.

Frequency division

Channel B output frequency is selectable by front panel switch. Frequencies available: f (channel A) or $f/2$.

Internal outputs

- Number of channels: 2 (channels A and B)
- Fan-out: 1 for each output
- Output signal: > 500 mV p-p amplitude, $0\text{ V} \pm 100$ mV high level.

Maximum external voltage: ± 2 V.

Transition times (10% to 90%): < 600 ns.

Duty cycle (with drive input duty cycle of 50%): $50\% \pm 10\%$.

Impedance: 50 ohms typical.

Trigger output ($f/2$)

The trigger output is present only in $f/2$ mode.

Output signal: > 400 mV p-p amplitude, $0\text{ V} \pm 100$ mV high level.

Maximum external voltage: ± 2 V.

Transition times (10% to 90%): < 1 ns.

Output impedance: 50 ohms typical.

Reset input

Negative-going transition resets ch. B to low level in $f/2$ mode.

Input frequency: 0 to 5 MHz

Reset time: ≥ 100 ns

Input levels: high $0\text{ V} \pm 50$ mV, low $-0.6\text{ V} \pm 50$ mV.

Maximum external voltage: ± 6 V.

Transition times (10% to 90%): ≤ 5 ns.

Input impedance: 1 k Ω typical

Size

Quarter mainframe width.

Option

910: additional operating and service manual

8092A Delay generator/frequency divider module.

Price

add \$10

\$280.00

PULSE GENERATORS

8080 System: repetition rate generators

Models 8081A & 8091A

- 300 MHz/1 GHz repetition rate
- High resolution rate controls

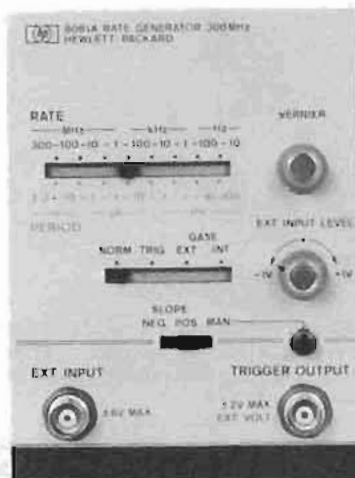

8081A

8081A and 8091A Descriptions

Models 8081A and 8091A are quarter-width rate generator modules in the 8080 system. The 8081A produces pulses at rates up to 300 MHz, and the 8091A up to 1 GHz. An 8-position frequency range switch and 3-turn vernier potentiometer enable rapid, precise setting of the pulse repetition rate.

Both rate generators include an external trigger which enables you to synchronize the system to an external source. In this mode you can use the rate generators as pulse shapers and amplifiers.

Gating capability is also included in both modules to enable you to synchronously start the repetition rate oscillator to produce a burst of pulses.

8081A Specifications

Timing

Repetition rate: 10 Hz–300 MHz.

Period jitter: $\leq 0.1\% \pm 50$ ps.

External inputs

Trigger mode: 0–300 MHz repetition rate, >1.7 ns pulse width.

Gate mode: >2 ns gate on time, >15 ns gate off time.

Input impedance: 50 ohms typical.

Trigger level and slope: -1 V to $+1$ V, pos. or neg. edge selectable.

Sensitivity: 200 mV p-p.

Maximum input voltage: ± 6 V.

External trigger output

Output signal: >500 mV p-p amplitude, 0 V ± 100 mV high level.

Maximum external voltage: ± 2 V.

Duty cycle: $50\% \pm 10\%$.

Output impedance: 50 ohms typical.

Transition times (10% to 90%): ≤ 1.2 ns.

Internal output

Fan-out: one 8080 series module can be driven.

Output pulse: >500 mV p-p amplitude, 0 V ± 100 mV high level.

Maximum external voltage: ± 2 V.

Duty cycle: $50\% \pm 10\%$.

Output impedance: 50 ohms typical.

Transition times (10% to 90%): ≤ 1.2 ns.

- External gate and trigger
- Trigger slope and level controls



8091A

8091A Specifications

Timing

Repetition rate: 100 Hz–1 GHz

Period jitter: $\leq 0.1\% \pm 20$ ps

External inputs

Trigger mode: 0 to 1 GHz repetition rate, >0.5 ns pulse width.

Gate mode: >2 ns gate on time, >15 ns gate off time.

Input impedance: 50 ohms typical.

Trigger level and slope: -1 V to $+1$ V, pos. or neg. edge selectable.

Sensitivity: 0.2 V p-p (<500 MHz) for pulses with <2 ns trans. times.

0.5 V p-p (>500 MHz) for pulses and sinewaves.

1.0 V p-p (<500 MHz) for sinewaves.

Maximum input voltage: ± 5 V.

External trigger output

Output signal: >500 mV p-p amplitude, 0 V ± 100 mV high level.

Maximum external voltage: ± 2 V.

Duty cycle: $50\% \pm 10\%$.

Output impedance: 50 ohms typical

Transition times (10% to 90%): ≤ 500 ps.

Internal output

Fan-out: one 8080 series module can be driven.

Output pulse: 500 mV p-p amplitude, 0 V ± 100 mV high level.

Maximum external voltage: ± 2 V.

Duty cycle: $50\% \pm 10\%$.

Output impedance: 50 ohms typical.

Transition times (10% to 90%): ≤ 500 ps.

8081A and 8091A Operating modes

Normal: repetition rate is determined by front panel controls.

External trigger: outputs are shaped version of ext. input.

External gate: gate signal starts rate generator synchronously.

Internal gate: ext input disconnected. Generator gated internally.

Manual: all functions can be triggered manually by pushbutton.

8081A and 8091A Size

Quarter mainframe width.

8081A and 8091A option

910: additional operating and service manual

Price

add \$9

Model number and name

8081A 300 MHz Rep. Rate Generator module.

\$795

8091A 1 GHz Rep. Rate Generator module.

\$3145

PULSE GENERATORS

Economical 16 V output, pulse burst option

Model 8011A

- Repetition rate 0.1 Hz to 20 MHz
- Designed for easy operation
- Positive/negative/symmetrical output

- Normal/complement switch
- Switchable 50 ohm source
- Square wave mode for rapid pulse set-up



Introduction

The 8011A is a versatile, reliable, low cost pulse generator. This compact instrument features an uncomplicated design using high quality components to ensure long, dependable service. Ease of operation is a natural result of the logical and simple front panel layout. These qualities, and the variety of pulse formats available, make the model 8011A a very cost-effective solution to pulse problems encountered in a variety of situations.

Pulse burst option

For anyone working with counters, shift registers, memories or logic in general, 8011A option 001 offers a new approach to driving, troubleshooting or analyzing logic designs. With this original option, the 8011A can generate precisely any number of pulses from 1 to 9999, independent of pulse rate. The number of pulses required in the burst is set on thumbwheel switches. All other pulse parameters are set on the front panel as normal.

The burst can be started either by external electrical trigger or by pressing the single burst pushbutton. Synchronous trigger pulses occur for the duration of each burst. At the end of a burst, extra pulses can be generated individually by pressing the single pulse button. Thus, circuits can be clocked to a desired state at their operational clock rate and then analysed under static conditions.

Applications

The 8011A proves itself with its wide range of amplitudes to cover CMOS and the commonly used logic families as well as linear circuits. Students and engineers alike will find the clear and uncluttered front panel layout makes this a very easy pulse generator to use. With the pulse burst option, model 8011A is a powerful tool in the problems of logic design and troubleshooting. This compact instrument features a simple design with adjustments reduced to a minimum so that routine recalibration is a quick and easy operation. Reliability is assured by the high quality components mounted on a gold plated printed circuit board and a short circuit proof output prevents accidental damage. Also, rigorous testing in hostile conditions (such as 95% relative humidity at 40°C) has proved that model 8011A will meet specifications when operated at temperatures between 0°C and 55°C.

Specifications

Pulse characteristics

(50 ohm source and load impedances)

Transition times: < 10 ns fixed.

Overshoot, ringing and preshoot: < ±5% of pulse amplitude. May increase to 10% at counter-clockwise positions of amplitude vernier.

Pulse width: 25 ns to 100 ms in four ranges. Vernier provides continuous adjustment within each range.

Width jitter: < 0.1% + 50 ps of any width setting.

Maximum duty cycle: > 50% (100% using pulse complement).

Maximum output: 16 V, with internal 50 ohms and external high impedance or with internal high impedance and external 50 ohms. 8 V with 50 ohms source and load impedances.

Attenuator: three step attenuator provides the ranges 0.25 V-1 V-4 V-16 V. Vernier provides continuous adjustment within each range.

Source impedance: 0.25 V-1 V-4 V ranges, 50 ohms ± 10% shunted by 30 pF. 4 V-16 V range, 50 ohms ± 10% or high impedance, switch selectable.

Polarity: positive, negative or symmetrical switch selectable.

Format: normal or complement switch selectable.

Repetition rate and trigger

Repetition rate: 0.1 Hz to 20 MHz in 5 ranges. Vernier provides continuous adjustment within each range.

Period jitter: < 0.1% + 50 ps of any period setting.

Square wave: 0.05 Hz to 10 MHz.

Trigger output: dc coupled 50 ohm (typ) source delivering ≥ +1 V across 50 ohm load (can increase to +5 V).

Trigger pulse width: 20 ns ± 10 ns.

Externally controlled operation

External input

Input impedance: 50 ohms ± 10%.

Maximum input: ±5 V.

Trigger polarity: positive.

Sensitivity: 1 V.

Manual: front panel pushbutton for generating single pulse.

External triggering

Repetition rate: 0 to 20 MHz. In square wave, output frequency is half input frequency.

Trigger source: manual or external signal. Min external signal width 10 ns.

Pulse burst mode (option 001): preselected number of pulses generated on receipt of trigger.

Burst trigger source: external signal or manual. Min external signal width 25 ns.

General

Operating temperature range: 0°C to 55°C.

Power: 100 V, 120 V, 220 V or 240 V, +5%, -10%, 48 Hz to 440 Hz, 70 VA max.

Weight: net, 4 kg (9 lb). Shipping, 6.5 kg (14.6 lb).

Dimensions: 200 mm wide × 142 mm high × 300 mm deep (7.9 in. × 5.6 in. × 11.8 in.).

Options and Accessories

001: Pulse burst

15179A: adapter frame. Rack mounting for two units

910: Additional Operating and Service Manual

8011A Pulse Generator

Price

add \$300

\$85

add \$10.50

\$550

PULSE GENERATORS

Extremely flexible 50 MHz sources

Models 8012B & 8013B

- Variable transition times down to 5 ns
- ± 10 V amplitude; selectable source impedance
- Ideal for testing TTL



8012B

The 8012B and 8013B are at the top of their class for versatility, ease of operation and wide range of application. They provide the ideal solution to almost all digital logic testing problems with fixed 3.5 ns transition times on the 8013B and variable transition times down to 5 ns on the 8012B. The well-composed layout of the front panel controls (horizontal controls for horizontal parameters, vertical controls for vertical parameters) enables output pulses to be set up quickly and accurately with minimum risk of incompatible settings. Both models feature normal and complement outputs and a switchable internal 50 ohm source.

Specifications

Pulse characteristics

Parameter	8012B		8013B	
	Int. load IN	Int. load OUT	Int. load IN	Int. load OUT
Transition Times	5 ns–0.5 μ s 4 ranges, Verniers provide separate control of both edges within ranges up to max. ratios of 100:1 or 1:100.	6 ns–0.5 μ s	3.5 ns fixed	5 ns fixed
Source impedance	50 ohms $\pm 10\%$ shunted by typically 20 pF	>50 ohms	50 ohms $\pm 3\%$ shunted by typically 20 pF	>50 ohms

Parameter	8012B / 8013B	
	Internal load IN	Internal load OUT
Overshoot, ringing	$< \pm 5\%$ of pulse amplitude	May increase to $\pm 10\%$ when amplitude is between 0.4 V–4 V
Maximum output	5 V across 50 ohms, 10 V across open circuit. Short ccl. protection.	10 V across 50 ohms. Short ccl. protection.
Attenuator	4-step, reduces output to 0.2 V	4-step, reduces output to 0.4 V.
DC offset	± 2.5 V across 50 ohms. Independent of amplitude settings.	DC offset switched off.

Linearity (8012B): for transition times > 30 ns, maximum straight line deviation is 5% of pulse amplitude.

Preshoot: $< \pm 5\%$ of pulse amplitude.

Pulse width: < 10 ns to 1 s in four ranges. Vernier provides continuous adjustment within ranges.

Width jitter: $< 0.1\% + 50$ ps on any width setting.

Maximum duty cycle: $> 75\%$ from 1 Hz to 10 MHz, decreasing to $\geq 40\%$ at 50 MHz. Up to 100% in COMPL. mode.

- Fixed 3.5 ns transition times
- 10 V amplitude; selectable source impedance
- 2 outputs



8013B

Polarity: 8012B; positive or negative selectable, NORM/COMPL./SYM selectable; 8013B, one positive + one negative channel, NORM/COMPL selectable.

Pulse delay: < 35 ns to 1 s (with respect to trigger output) in four ranges; vernier provides continuous adjustment within ranges.

Delay jitter: $< 0.1\% + 50$ ps on any delay setting.

Repetition rate and trigger

1 Hz to 50 MHz in four ranges, continuous adjustment within ranges.

Period jitter: $< 0.1\% + 50$ ps on any rate setting.

Square wave: 0.5 Hz to 25 MHz in four ranges. Duty cycle 50% $\pm 5\%$ up to 1 MHz, tolerance increases to $\pm 15\%$ at 25 MHz.

Trigger output: $> +1$ V across 50 Ω , 16 ns ± 10 ns wide.

External triggering

0 to 50 MHz; for square wave output, frequency divided by factor 2.

Trigger input: sine waves 1.5 V p-p (about zero) or pulses > 0.8 V either polarity, > 7 ns wide. Maximum input ± 7 V.

Impedance: 50 Ω $\pm 10\%$, dc coupled.

Delay: 25 ns ± 8 ns leading edge trig. input to trig. output.

Manual: pushbutton for single pulse.

Gating

Synchronous gating: gating signal turns generator "on". Last pulse is completed even if the gate ends during pulse.

Gate input: dc-coupled; voltage at open connector approx. +1.8 V. Shorting current ≤ 12 mA. Input impedance approx. 160 Ω .

Gate input signal: voltage $> +1.5$ V or resistor > 1 k Ω to ground enables rep. rate generator. Voltage $< +0.8$ V or resistor $< 160\Omega$ disables rep. rate generator. Input TTL compatible, max. ± 5 V.

External width and RZ

External width: output pulse width determined by width of drive input signal. Amplitude, transition times selectable. Trigger output independent of external width input signal.

RZ mode: external drive input switched to delay generator. Period determined by period of drive input signal. Delay, amplitude and width selectable.

Input signal: $> +1$ V, > 7 ns wide. Max. ± 5 V, 50 Ω dc coupled.

General

Operating temperature range: 0°C to 55°C.

Power: 100/120/220/240 V $\pm 5\%$, -10% , 48 to 400 Hz, 100 VA max.

Weight: net, 4 kg (8.8 lb). Shipping, 6.5 kg (14.6 lb).

Dimensions: 200 mm wide, 142 mm high, 330 mm deep (7.9" \times 5.6" \times 13").

Options and accessories

15179A adapter frame. Rack mounting for two units add \$85

910: Additional Operating and Service Manual add \$10

Model number and name

8012B Pulse Generator add \$1050

8013B Pulse Generator add \$895

PULSE GENERATORS

Versatile source, unique level controls

Model 8015A

- 50 MHz repetition rate
- 2 output channels
- 16 V amplitude and offset
- Counted burst option, 0-9999 pulses
- Ideal for MOS, TTL and analog applications
- Each control ergonomically designed



The 8015A is a 50 MHz dual channel pulse generator with variable transition times, designed for optimum flexibility in the control of any pulse parameter. Each of the two independent output amplifiers can generate ± 16 V. A unique way of avoiding the usual offset and amplitude adjustment problems is provided by two independent pulse level sliders; with the aid of a calibrated scale the slider positions determine the pulse "high" and "low" levels.

In addition to control of pulse timing and amplitude parameters, it is possible to delay the pulse from channel B with respect to the pulse from channel A. For analyzing critical timing conditions or generating 2-phase clocks this B Delay mode offers continuous pulse delay between the two channels.

It is also possible to parallel both output amplifiers using A+B mode, which doubles the output current and enables a maximum output swing of 30 V (within a ± 16 V window). The combination of A+B mode and B Delay mode together with variable transition times and individual selection of Normal/Complement format for each output permits complex waveforms to be generated; waveforms such as three-level signals, special codes or simulated biomedical signals.

A range of options extends the 8015A's usefulness and offers new solutions to applications problems. Generation of an exact number of pulses, for example, is difficult to achieve by the usual techniques. With the pulse burst option (002), however, it is possible to generate an exact number of pulses (predetermined by thumbwheel switches) at rep. rates up to 50 MHz. This is achieved by means of a built-in preset counter. A pulse burst can be initiated by an external signal or push-button control thus enabling continuous, multiple or single burst operation.

Direct access to the linear output amplifiers (option 004) permits any TTL or even low level analog signal to be converted to MOS/CMOS levels. While one output delivers the normal pulse generator signal, the other can be used to amplify a PRBS/word generator output signal forming a test set for full parametric testing of MOS/CMOS shift registers, memories etc.

A safe and simple way to drive TTL devices is to use a separate TTL output with fixed levels, while all other parameters remain variable coincident with channel A output. This TTL output, available as option 005, requires no external termination because the internal 50 ohm source impedance ensures pulse fidelity when connected to the test circuit.

A particular problem with CMOS devices is that the input clock/data amplitudes must never exceed the power supply voltage or the CMOS circuit will be destroyed. This means that if the supply voltage is varied as part of a parametric test, the clock/data levels must be adjusted first. An option that completely eliminates this problem is the 8015A upper output level tracking option (006). This option enables the CMOS clock/data signals to track the CMOS power supply voltage. Thus when carrying out CMOS parametric tests at varying supply voltages, the signal upper levels automatically track the supply voltage and device safety and proper input levels are ensured. The test circuit is safe even if the power supply is switched off.

The 8015A can be used as part of an automatic test system using the remote control option (003). This option enables the range and vernier settings for the pulse period, delay, width, transition times and output levels to be remotely controlled. Range control is achieved by contact closure to ground using TTL compatible levels. Vernier control is achieved by voltage or current or resistor. Remote or local control of each parameter is selected using the appropriate front panel range switch. Both upper and lower signal levels of each output channel can be controlled independently.

Specifications

Pulse characteristics

Transition times: 6 ns to 0.5 s in four ranges (see table). Common for leading and trailing edges within each range up to maximum ratios of 100:1 or 1/100.

Non-linearity: transitions > 30 ns: $< 5\%$ of pulse amplitude.

Overshoot and ringing: $\pm 5\%$ of pulse amplitude, possibly increasing $< \pm 10\%$ at minimum amplitude.

Preshoot, droop: $< 5\%$ of pulse amplitude.

Pulse width: < 10 ns to 1 s in four ranges.

Width jitter: $< 0.1\% + 50$ ps for any width setting.

Maximum output: ± 16 V.

Maximum duty cycle: $> 75\%$ from 1 Hz to 1 MHz, decreasing to $\geq 50\%$ at 50 MHz. Square wave: $50\% \pm 5\%$ from 1 Hz to 1 MHz, $\pm 15\%$ at 25 MHz.

Pulse delay: 20 ns ($+25$ ns fixed) to 1 s, in four ranges.

Delay jitter: $< 0.1\% + 50$ ps for any delay setting.



Mode	Source/Load Impedance	Transition Times	Upper Level Voltage (V _{UL})	Lower Level Voltage (V _{LL})	Upper Level Current (I _{UL})	Lower Level Current (I _{LL})	V _{UL} -V _{LL} Max Min	I _{UL} -I _{LL} Max Min	Max. Rep. Rate
AsepB	50Ω/50Ω	*6 ns-0.5 s	+8 V to -7 V	+7 V to -8 V	+320 mA to -280 mA	+280 mA to -320 mA	8 V 1 V	320 mA 40 mA	50 MHz
	50Ω/1 kΩ or 1 kΩ/50Ω	8 ns-0.5 s	+16 V to -14 V	+14 V to -16 V			16 V 2 V		40 MHz
A + B	50Ω/50Ω	15 ns-0.5 s	+16 V to -14 V	+14 V to -16 V	+640 mA to -560 mA	+560 mA to -640 mA	16 V 2 V	640 mA 80 mA	20 MHz
	50Ω/1 kΩ or 1 kΩ/50Ω	15 ns-0.5 s	+16 V to -12 V	+12 V to -16 V			30 V 4 V		20 MHz

*6 ns at 8 V, may increase to 6.5 ns at 4 V.

Repetition rate and trigger

Repetition rate: 1 Hz to 50 MHz in four ranges (see table).
Period jitter: <0.1% +50 ps for any rep. rate setting.
Square wave: 0.5 Hz to 25 MHz.
Double pulse: 25 MHz max. (simulates 50 MHz).
B Delay: 20 MHz max. Channel B pulse delayed on channel A pulse by amount set on delay controls.
Trigger output: dc coupled, 50Ω (typ.) source impedance, delivering ≥1 V across 50Ω load. 9 ns ±5 ns width.

Externally controlled operation

External input: 50Ω ±10% or 500Ω ±10%, dc coupled.
Maximum input: ±7 V (50Ω input), ±25 V (500Ω input).
Trigger polarity: positive or negative slope selectable.
Threshold level: +1 V to -1 V (50Ω input impedance) or +10 V to -10 V (500Ω input impedance).
Sensitivity: 50Ω input impedance, sinewaves 1 V p-p, pulses ±0.5 V; 500Ω input impedance, sinewaves 10 V p-p, pulses ±5 V.
Minimum pulse width: 5 ns in Ext. Trig., 20 ns in Burst mode.
Delay: <50 ns between trigger input and trigger output.
Manual button: push to activate input.
External triggering: manual or 0 to 50 MHz signals, <50ns delay between trigger input and trigger output.
External width: output pulse width and rate determined by width and rate of drive signal.
Synchronous gating: gating signal turns on repetition rate. Last pulse completed even if gate ends during pulse. Max. repetition rate: 40 MHz.

Options

Option 002 pulse burst

Number of pulses: 1-9999
Burst trigger source: external signal or manual.
Repetition rate: 0 to 40 MHz
Minimum time between bursts: 200 ns
Trigger: all specifications as for EXT INPUT except minimum width: ≥20 ns.

Option 003 remote control

Timing ranges:
 pulse period }
 pulse delay } controlled by contact closure to ground,
 pulse width } TTL compatible — logic "0": I_{in} = -2.4 mA
 transition times } V_{in} = 5 V
 logic "1": I_{in} = -6 mA
 V_{in} = 0 V

Timing verniers:

pulse period } pulse delay } pulse width } transition times }	controlled by	current or voltage or resistor	Time max.	Time min.
			-1 mA	-0.1 mA
			0 V	9 V
			0Ω	90 kΩ

Absolute maximum input current limits: 0 mA to -1.1 mA

Absolute maximum input voltage limits: +10 V to 0 V

Output levels:

Input control voltage	Output level*
Upper level control set to max + (+8 V)	+8 V
0 (0 V)	0 V
max - (-7 V)	-7 V
Lower level control set to max + (+7 V)	+7 V
0 (0 V)	0 V
max - (-8 V)	-8 V

*50 ohm into 50 ohm

Minimum difference between upper level and lower level control voltage: 1 V (for 1 V output swing)
Absolute maximum input voltage: ±20 V
Input impedance: 10 kΩ ±5%
Settling time to within 5% of final value: 400 μs

Note: Option 003 includes option 006.

Option 004 direct output amplifier access

Input impedance: 50 ohms ±5%
Operation: asymmetrical
Input voltage for max. output: 2.5 V p-p (baseline 0 V, top +2.5 V).
Absolute maximum input voltage: ±5 V.
Gain: continuously variable between 0.8 and 6.4 by level controls (Z_s = 50 ohms, no load).
Frequency response (-3 dB): Z_s = 50 ohms, no load —
 0 to 50 MHz
 Z_s = 50 ohms, 50 ohm load —
 0 to 80 MHz
Polarity: inverting for NORM, non-inverting for COMPL.

Note: B DELAY mode cannot be used with this option.

Option 005 extra TTL output

Logic 1 level: 4.5 V min.
Logic 0 level: 0.2 V max. (20 mA sink current)
Source impedance: 50 ohms
Pulse delay: zero, coincident with channel A.
Pulse output: normal/complement as selected by channel A.

Option 006 upper output level tracking

Input voltage: +2 V to +16 V
Absolute max. input voltage: +20 V
Absolute min. input voltage: 0 V
Input impedance: 10 kΩ ±5%
Upper level accuracy: ±5% of control voltage.
Lower level accuracy: 0 V ±250 mV
Settling time to ±5% of final value: 400 μs

General

Operating temperature range: 0°C to 55°C.
Power: 100 V, 120 V, 220 V or 240 V, +5%, -10%, 48 to 440 Hz, 180 VA maximum.
Weight: net, 11 kg (24.26 lb). Shipping, 12 kg (26.46 lb).
Dimensions: 426 mm wide, 345 mm high, 380 mm deep. (16 1/4 in. × 5 1/4 in. × 15 in.).

Options and accessories

002: pulse burst	Price less \$450
003: remote control	add \$895
004: direct output amplifier access	add \$135
005: extra TTL output	add \$165
006: upper output level tracking	add \$110
907: Front Handle Kit	add \$15
908: Rack Flange Kit	add \$10
909: Rack Flange/Front Handle Kit	add \$20
910: Additional Operating and Service Manual	add \$18

8015A Pulse Generator

\$2400

PULSE GENERATORS

Very fast & variable transitions, 1 ns to 0.5 ms

Model 8082A

- <1 ns variable transition times
- 250 MHz repetition rate
- Ultra-clean 50 ohm source
- Switch-selectable ECL levels
- ± 5 V outputs



The 8082A is Hewlett-Packard's fastest pulse generator with all pulse parameters variable. With repetition rates to 250 MHz, transition times down to 1 ns and amplitudes to 5 V, the 8082A is ideally suited for state-of-the-art TTL and ECL logic designs. Using the 8082A, you can rapidly test logic circuits under all operating conditions by simply varying pulse parameters. Although a highly sophisticated instrument, the 8082A is still easy to operate because of its logical front panel layout and switch-selectable ECL output levels. Another feature that contributes to ease of operation is the square wave mode. You can, for example, carry out toggle rate tests in this mode up to 250 MHz without having to worry about pulse duty cycle.

Hybrid ICs, manufactured by Hewlett-Packard, are used extensively in the design of the 8082A. These ICs eliminate the need for fans, reduce power consumption and enable a low reactance 50 ohm source impedance to be used. This source impedance absorbs 98% of reflections from signals up to 4 V amplitude.

Specifications

Pulse characteristics

(50 Ω source and load impedance)

Transition times: <1 ns - 0.5 ms (10% to 90%) in 6 ranges. <750 ps (20% to 80%). Leading/trailing edges controlled separately on fastest range, independently variable over 1:10 ratio on other ranges.

Overshoot and ringing: $\leq \pm 5\%$ of pulse amplitude may increase to $\pm 10\%$ with amplitude vernier CCW.

Prehoot: $\leq \pm 5\%$ of pulse amplitude.

Linearity: linearity aberration for both slopes $\leq 5\%$ for transition times > 5 ns.

Output: maximum amplitude is 5 V from 50 Ω into 50 Ω . Maximum output voltage is ± 5 V (amplitude + offset).

Offset: ± 2 V, into 50 Ω .

DC-source impedance: 50 $\Omega \pm 5\%$.

Reflection coefficient: reflection is 2% typical for steps with 1 ns rise time applied to output connector on all amplitude ranges except 5 V range. On the 5 V range, the reflection may be 15%.

Output protection: cannot be damaged by open or short circuits or application of ext. $\leq \pm 6$ V or ± 200 mA independent of control settings.

Attenuator: two separate three-step attenuators reduce the outputs to 1 V. Vernier is common for both outputs and reduces the output to 0.4 V minimum. A further position provides ECL-compatible outputs (-0.9 V to -1.7 V typ. open circuit).

Timing

Repetition rate: 250 MHz to 1 kHz in 6 ranges.

Period jitter: <0.1% of setting + 50 ps.

Delay: 2 ns - 0.5 ms in 6 ranges plus typ. 17 ns fxd. with respect to trigger output. Duty cycle $> 50\%$.

Delay jitter: <0.1% of setting + 50 ps.

Double pulse: up to 125 MHz max. (simulates 250 MHz).

Pulse width: <2 ns - 0.5 ms in 6 ranges.

Width jitter: <0.1% of setting + 50 ps.

Width duty cycle: $> 50\%$.

Square wave: delay and double pulse are disabled. max. Rep. Rate 250 MHz. Duty cycle is 50% $\pm 10\%$ up to 100 MHz, 50% $\pm 15\%$ for > 100 MHz.

Trigger output: negative going Square Wave (50% duty cycle typ.) > 500 mV from 50 Ω into 50 Ω . Internal 50 Ω can be switched off by slide-switch on PC-board. Amplitude up to 1 V into 50 Ω up to 200 MHz.

Trigger output protection: cannot be damaged by short circuit or application of external ± 200 mA.

Externally controlled operation

External input

Input impedance: 50 $\Omega \pm 10\%$. DC coupled.

Maximum input: ± 6 V.

Trigger level: adjustable -1.5 V to $+1.5$ V.

Slope control: positive, negative or manual selectable. In the manual position all ext. functions can be controlled by push button. Button pushed in simulates an "on-signal."

Sensitivity: sine-wave > 200 mV p-p pulses > 200 mV.

Repetition rate: 0 to 250 MHz

Ext.-controlled modes

Ext. trigger: there is approximately 7 ns delay between the external input and the trigger output. Rep. rate is externally controlled (is triggered by external signal). Trigger output provides the pulse-shaped input signal. Square wave mode is disabled.

Synchronous gating: gating signal turns rep. rate generator on. Last pulse normal width even if gate ends during pulse.

External width: output pulse width determined by width of drive input. Rep. rate and delay are disabled. Trigger output provides shaped input signal.

General

Power requirements: 100 V, 120 V, 220 V, 240 V (+5%, -10%) 48-440 Hz. Power consumption 85 VA max.

Weight: net, 7.9 kg (17.44 lb). Shipping 8.9 kg (19.63 lb).

Dimensions: 426 mm wide, 145 mm high, 380 mm deep (16 1/2 in. \times 5 1/8 in. \times 15 in.).

Options

907: Front Handle Kit

908: Rack Flange Kit

909: Rack Flange & Front Handle Combination

910: Additional Operating and Service Manual

8082A Pulse Generator

Price

add \$15

add \$10

add \$20

add \$12

\$3575

PULSE GENERATORS

Clean waveshape, all parameters variable
Model 8007B



- 100 MHz repetition rate
- Variable transition times down to 2 ns.

- Extremely linear slopes
- Designed to drive TTL-S and commonly used ECL

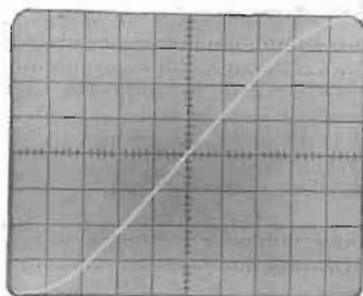
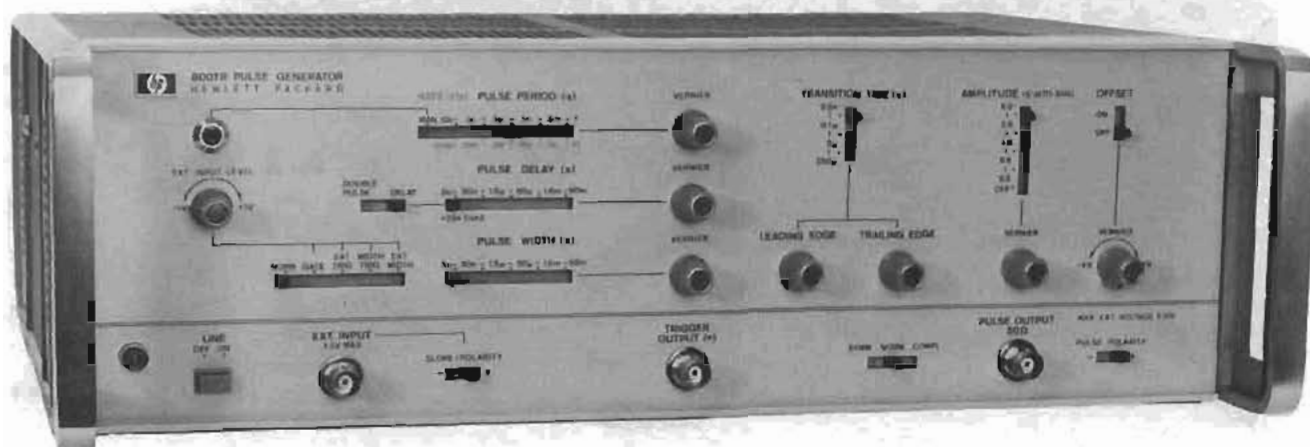

1 ns/cm
0.5 V/cm
1 GHz bandwidth

The 8007B is a high speed pulse generator that is well suited for STTL and ECL applications.

The output can be set to positive or negative polarity, complement or symmetrical to ground. A high dc-offset of up to ± 4 V is also included.

External triggering and synchronous gating are provided. The trigger level is adjustable for all externally controlled modes with the slope polarity selectable. This is very useful for avoiding malfunctions caused by noise and ringing on the external trigger signal.

In "External Width" mode the external input and pulse output have equal width. Transition times and amplitude of the output pulse can be set by the front panel controls. This mode is useful for shaping NRZ signals, as the width information is passed on to the output pulse unchanged.

The "Width Trigger" mode is suitable for RZ signal shaping. Delay, width, transition times and amplitude are determined by the front panel controls.

Specifications

Pulse characteristics (50 Ω source and load impedance):

Transition times: <2 ns to 250 μ s, three ranges (common for both transition times). Independent verniers for adjusting leading and trailing edge within each range up to maximum ratios of 1:50 or 50:1.

Linearity: maximum deviation from a straight line between 10% and 90% points $\leq 5\%$ of pulse amplitude.

Prehoot, overshoot, ringing: $< \pm 5\%$ of pulse amplitude.

Pulse width: <5 ns to 50 ms in five ranges. Vernier provides continuous adjustment within ranges.

Width jitter: <0.1% on any width setting.

Maximum duty cycle: normal >50%; complement approx. 100%.

Amplitude: 5 V max (10 V across open circuit) to 0.2 V in four ranges; vernier adjustment within ranges. Pulse can be switched off.

Pulse output: + or - polarity selectable; normal, complement, or symmetrical to ground.

Source impedance: 50 $\Omega \pm 4\Omega$ shunted by typ. 10 pF.

DC-offset: ± 4 V across 50 Ω load. Independent of amplitude setting, can be switched off.

Pulse delay: <30 ns to 50 ms with respect to trigger output. Five ranges, with continuous adjustment within ranges.

Delay jitter: <0.1% on any delay setting.

Repetition rate and trigger

10 Hz to 100 MHz in 5 ranges.

Continuous adjustment within ranges.

Period jitter: <0.1%.

Double pulse: available only up to pulse rate setting of 50 MHz, representing an output pulse rate of 100 MHz.

Trigger output: >+1 V across 50 Ω , 4 ns ± 2 ns wide.

External triggering (0 to 100 MHz)

Delay: approx. 15 ns between trig. input and trig. output.

Manual: front panel pushbutton for single pulse.

External width and width trigger

External width: output pulse width determined by width of drive input.

Width trigger: external drive input switched to the width generator. Pulse width determined by front panel width setting.

Rate generator: provides trigger pulses independent of drive input.

Synchronous gating

Gating signal turns generator "on." Last pulse is completed even if gate ends during pulse.

External input

Impedance: 50 Ω , dc-coupled. Max input ± 5 V.

Level: adjustable from +1 V to -1 V, Polarity: + or -

Sensitivity: sine waves 1 V p-p; pulses 1 V.

General

Operating temperature range: 0 $^{\circ}$ C to +55 $^{\circ}$ C.

Power requirements: 115 or 230 V $\pm 10\%$, -15%, 48 to 440 Hz, 100 VA (maximum).

Weight: net, 8 kg (17.6 lb). Shipping, 9 kg (19.8 lb).

Dimensions: 425 mm wide \times 140 mm high \times 344 mm deep (16 $\frac{1}{2}$ " \times 5 $\frac{1}{2}$ " \times 13 $\frac{3}{4}$ ").

Options

908: Rack Flange Kit

910: Additional Operating and Service Manual

8007B Pulse Generator

Price

add \$10

add \$11

\$2100

PULSE GENERATORS

General purpose, triple output

Model 8005B

- Dual outputs, +10 V and -10 V
- TTL output
- 50 ohm/high impedance source, selectable
- Five modes of operation

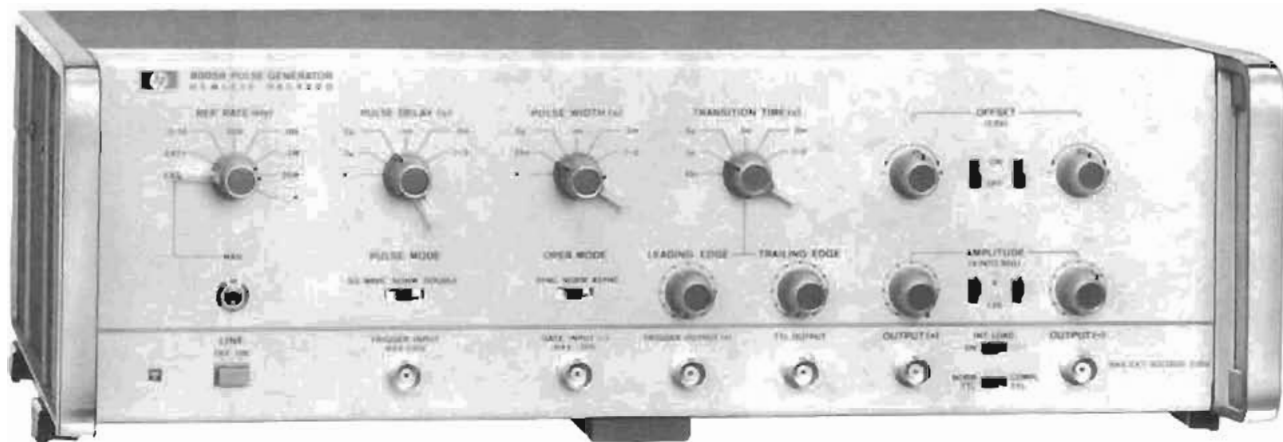

The 8005B is a general purpose, triple output pulse generator. This versatile instrument has all parameters variable and produces simultaneous positive and negative pulses. It also has a TTL output which has all parameters variable except amplitude. This feature, together with the normal/complement facility, greatly improves the ease of operation. Features which contribute to the flexibility of the 8005B are synchronous and asynchronous gating, double pulse and square wave modes and the selectable source impedance.

Specifications

Pulse characteristics

Internal Load	Load	Amplitude Range Selected	Amplitude	Offset	
				Output (+)	Output (-)
50Ω	ON	1.25/2.5 V	300 mV to 1.25 V ¹	±2 V	±2 V
	ON	High Z	600 mV to 2.5 V	±4 V	±4 V
	OFF	50Ω	1.25/2.5 V	600 mV to 2.5 V	±2 V
				to ±4 V ²	to ±4 V ²
50Ω	ON	5 V/10 V	1.25 V to 5 V	±2 V	±2 V
	ON	High Z	2.5 V to 10 V	±4 V ¹	±4 V ¹
	OFF	50Ω	2.5 V to 10 V	±2 V to	±2 V to
			0 V, -4 V ²	0 V, +4 V ²	

1. The maximum output (amplitude + offset) is 10 V.

2. Offset range with amplitude vernier CW is ±2 V. Offset range increases as shown when amplitude, vernier is CW.

Transition times: ≤10 ns to 2 s in six ranges. Separate verniers provide independent control of leading and trailing edges within each range. Max leading/trailing edge ratio, 1:30 or 30:1.

Linearity: for transition times >30 ns, straight line deviation is <4% of pulse amplitude.

Overshoot, preshoot, ringing: <5% of pulse amplitude.

Pulse width: <25 ns - 3 s, 5 ranges. Adjustment within ranges.

Width jitter: <0.1% of any width setting.

Maximum duty cycle: >80% for repetition rates from 0.3 Hz to 1 MHz >50% from 1 MHz to 20 MHz. Up to 100% in complement.

Square wave: 0.15 Hz to 10 MHz. Duty cycle: 50% ±5% for repetition rates ≤1 MHz, increasing to 50% ±15% at 10 MHz.

Pulse delay: <100 ns to 3 s (with respect to trigger output) in five ranges. Continuous adjustment within each range.

Delay jitter: <0.1% of any delay setting.

Pulse outputs: simultaneous pos., neg. and TTL compatible outputs.

Maximum pulse amplitude: (from positive and negative outputs) 5 V, with internal 50 ohms and external 50 ohms, 10 V with internal 50 ohms and external high impedance, or with internal high impedance and external 50 ohms.

Output protection: cannot be damaged by short circuit or application of external voltages ≤±10 V (at 25°C ambient) independent of control settings.

Source impedance: 50 ohms ±10% (shunted by typ 20 pF) or output impedance of a current source, switch selectable.

TTL compatible output: fixed +4.6 V across open circuit.

Source impedance: 50 ohms typ.

Pulse formats: normal or complement, switch selectable.

Repetition rate and trigger

Repetition rate: 0.3 Hz to 20 MHz in five ranges. Vernier provides continuous adjustment within each range.

Period jitter: <0.1% of any period setting.

Double pulse: 10 MHz max. Simulates 20 MHz.

Trigger output: positive pulses >2 V amplitude across external 50 ohm load. Pulse width >6 ns.

Externally controlled operation

External triggering

Repetition rate: dc to 20 MHz.

Delay: approx. 35 ns trig. input to trig. output.

Manual: push button for single pulse (two in double pulse).

Trigger input

Maximum input: ±10 V; impedance: approx. 1 kΩ dc-coupled.

Sensitivity: sine waves; 2 V p-p. Pulses 1 V peak.

Polarity: positive or negative, switch selectable.

Minimum pulse width: 10 ns.

Gating

Synchronous: gate signal turns on repetition rate. Time between start of gate and first pulse defined by delay control. Last pulse is always completed even if gate ends during pulse. Synchronous trigger pulses occur for duration of gate.

Asynchronous: gate signal controls output of rate generator.

Gate input

Input impedance: approx. 1 kΩ, dc coupled.

Gate amplitude: 2 V to 20 V (max), polarity: negative.

General

Operating temperature range: 0°C to 55°C.

Power: 115 V or 230 V, +10%, -15%, 48-440 Hz, 180 VA max.

Weight: net, 7 kg (16 lb). Shipping, 9 kg (20 lb).

Dimensions: 425 mm wide, 140 mm high, 336 mm deep, (16 1/2 in. × 5 1/2 in. × 13 1/4 in.).

Options:

908: Rack Flange Kit

910: Additional Operating and Service Manual

8005B Pulse Generator

Price

add \$10

add \$7

\$1480

PULSE GENERATORS

Simple operation, low cost

Models 211B, 8002A & 8004A

- 10 MHz repetition rate — 211B/8002A/8004A
- Variable transition times 10 ns to 2 s — 8002A
- Ramp, triangular, trapezoidal pulses — 8002A

- <1.5 ns transition times — 8004A
- Double pulse and 2 V offset — 8004A
- 60 V amplitude square wave — 211B



211B



8002A



8004A

211B Description

The 211B is a low-cost square wave generator with separate 50 ohm and 600 ohm outputs. Output pulses up to 60 V amplitude are produced at the 600 ohm output. The duty cycle of the output square wave can be varied from 25% to 75%. A positive or negative trigger pulse is also available for triggering test equipment.

211B Specifications

Repetition rate and trigger

Output: 50Ω: 1 Hz–10 MHz, 600Ω: 1 Hz–1 MHz, Period jitter: <0.2%.
External input: sine 4 V p-p, pulse +2 V peak, 1 Hz–10 MHz, 500 ohms.

Trigger output: width 10 ns ± 5 ns, amplitude ±2 V into 50 ohms.

Output

Symmetry: variable 25% to 75% duty cycle, negative polarity.

50 ohm source pulse shape (measured at 5 V into 50 ohms)

Rise/fall times: <5ns, Amplitude: 0.05 V to 5 V (10 V-open circuit)

600 ohm source pulse shape (measured at 30 V into 600 ohms)

Rise/fall times: <70 ns into 600 ohms; <140 ns into open circuit.
Amplitude: <0.3 V to 30 V into 600 ohms; to 60 V into open circuit.

General

Power: 115 V or 230 V ±10%, 48 to 440 Hz, approx. 23 watts.

Dimensions: 165 mm high × 198 mm wide × 299 mm deep (6½ × 7¾ × 11¼ in.)

Weight: net, 4 kg (9 lb), Shipping, 5 kg (11 lb).

8002A Description

The 8002A is a low cost pulse generator with variable rep. rate, pulse width, transition times and amplitude. The variable parameters enable the 8002A to produce triangular, sawtooth and trapezoidal waveforms as well as pulses. A synchronous gating mode is also available for testing logic and other circuits requiring pulse bursts.

8002A Specifications

Pulse characteristics (50 ohm source and load impedance)

Transition times: 10 ns to 2 s, separate rise and fall verniers.

Prehoot, Overshoot, ringing: <5% of pulse amplitude.

Non-linearity: for transitions >20 ns, <4% from 10%–90%.

Amplitude: 0.05 V to 5 V (across 50Ω), 10 V across open circuit.

Pulse width: 30 ns to 3 s, Polarity: + or – selectable.

Maximum duty cycle: >90% (≤1 MHz), >50% (>1 MHz).

Delay: 35 ns or 180 ns switchable delay between trigger and pulse.

Repetition rate and trigger (input impedance 1 kΩ dc coupled)

Free running: 0.3 Hz to 10 MHz, Manual: pushbutton for single pulse.

Trigger input: sine 2 V p-p, pulse ±1 V peak, ≥15 ns wide, ±10 V max.

Ext. trigger delay: approx. 35 ns ext. input to trig. output.

Trigger output pulse: >+2 V across 50 ohms, width 15 ns ± 5 ns.

Synchronous gating: –2 V to –20 V signal turns generator 'on'.

General

Power: 115 V or 230 V +10%, –15%, 50 Hz–400 Hz, 40 VA.

Dimensions: 197 mm wide × 165 mm high × 279 mm deep (7¾ × 6½ × 11 in.)

Weight: net, 4 kg (9 lb), Shipping, 5 kg (11 lb).

8004A Description

The 8004A is a low cost pulse generator with fast transition times. Both pulse width and delay are variable down to zero. A double pulse mode provides convenient test signals for logic and memory circuits and increases the max. rep. rate to 20 MHz. The ±2 V dc offset is independent of pulse amplitude controls.

8004A Specifications

Pulse characteristics (50 ohm source and load impedance)

Transition times: <1.5 ns, Polarity: + or – selectable.

Prehoot, overshoot, ringing: <5% of pulse amplitude.

Amplitude: <0.02 V to 5 V, DC offset: ±2 V across 50 ohms.

Pulse width: 0 to 1 ms, Width jitter: <0.1% + 50 ps.

Maximum duty cycle: >50% (≤1 MHz), >25% (>1 MHz).

Pulse delay: 0 to 1 ms (with respect to trigger output), Delay jitter: <0.1%.

Repetition rate and trigger

Free running: 100 Hz–10 MHz, Period jitter: <0.1%.

Double pulse: increases max. rate to 20 MHz.

Ext. triggering: 0–10 MHz (input impedance 1 kΩ dc coupled).

Sensitivity: sine 2 V p-p; pulse 1 V peak, >10 ns wide, ±10 V max.

Manual: pushbutton for single pulse.

Trigger output: ampl. >+2 V across 50Ω, 15 ns ±10 ns wide.

Gating

Synch: signal turns generator "on", Last pulse completed.

Asynch: signal turns output pulse "on", Trigger available.

Gate input: –2 V to –20 V enabling, Impedance 1 kΩ dc coupled.

General

Power: 115 V or 230 V, +10%, –15%, 50 to 400 Hz, 35 VA.

Dimensions: 197 mm wide × 165 mm high × 279 mm deep (7¾ × 6½ × 11 in.)

Weight: net, 3.2 kg (7 lb), Shipping, 4.1 kg (9 lb).

Options

211B – 910: Extra Operating and Service Manual

8002A – 910: Extra Operating and Service Manual

8004A – 910: Extra Operating and Service Manual

Model number and name

211B Pulse Generator \$900

8002A Pulse Generator \$950

8004A Pulse Generator \$1400

Price
add \$5
add \$7.50
add \$12

PULSE GENERATORS

Calibrated source of complex waveforms

Model 8010A

- 2 independent pulse generators in one
- Simulation of complex analog signals

- Independent timing for driving digital IC's
- No waveshape degradation when channels combined

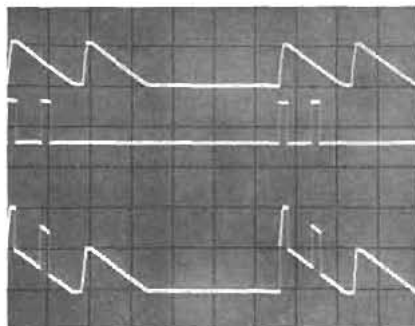

Figure 1. Channels A and B combined

The 8010A is a very versatile pulse generator because it is actually two pulse generators in one. All pulse parameters except repetition rate are generated separately for each channel. The two outputs can be used separately for digital logic applications or can be combined at the output amplifiers to provide extremely complex waveforms for analog applications. The repetition rate can be triggered separately for each channel thus enabling one channel to be controlled by the repetition rate generator while the other is triggered externally. Variable parameters, high stability and accuracy, and fully calibrated verniers (except for offset) enable exact pulse settings to be repeated accurately and easily.

Specifications

Pulse characteristics (with 50Ω load impedance)

Transition times: sep. outputs: <10 ns to 1 s in eight ranges. Independent verniers control leading and trailing edge within each range up to a max. ratio of 1:10. In A + B mode <12 ns to 1 s. With 10 V output <20 ns to 1 s.

Accuracy: ±10% of setting ±2% of full scale ±4 ns.

Linearity: for transition time > 30 ns, straight line deviation is <4% of pulse amplitude.

Overshoot and ringing: <5% of pulse amplitude.

Pulse width (A and B): <20 ns to 1 s eight ranges, continuous adjustment within ranges.

Accuracy: ±10% of setting ±2% of full scale ±4 ns.

Maximum duty cycle: >80% for repetition rates from 1 Hz to 1 MHz. >50% from 1 to 10 MHz.

Width jitter: <0.1% on any width setting.

Maximum output: 5 V sep., 10 V combined (channel B).

Attenuator: seven-step attenuator reduces output to 0.02 V.

Accuracy: ±10% of setting ±2% of full scale.

Source impedance: 50Ω ±10% shunted by typ. 20 pF.

DC offset: ±2 V across 50Ω load; can be switched off.

Pulse delay: (A and B) 50 ns to 1 s delay related to trig. output in 8 ranges. Accuracy: ±10% of setting, ±2% of full scale ±4 ns. Jitter <0.1% of setting.

Repetition rate and trigger

Free running: 1 Hz - 10 MHz in seven ranges.

Accuracy: ±10% of setting ±2% of full scale.

Period jitter: <0.1%

Square wave: 1 Hz - 10 MHz. Symmetrical to ground.

Double pulse: channel A and B independently selectable.

External triggering

Rep. rate: 0 to 10 MHz. ÷ 2 for square wave output.

Trigger input: sine waves 1 V p-p. Pulses 0.5 V, ≥20 ns.

Input impedance: 1.0 k

Delay: approximately 30 ns trig. input to trig. output.

Manual: pushbutton for single pulse. Sep. triggering for both channels: spikes +2 V amplitude, >50 ns width. Input impedance 50Ω (inputs on rear panel).

Trigger output

Amplitude: >+2 V across 50Ω, 15 ns ±10 ns, 50Ω impedance.

Gating

Synchronous: -2 V to -10 V signal turns rate generator "on."

Asynchronous: -2 V to -10 V signal turns the output pulse "on."

Trigger output always available.

General

Power: 115 or 230 V +10%, -15% 50 to 400 Hz 200 VA.

Dimensions: 425 mm wide × 184 mm high × 466 mm deep (16 1/4" × 7 1/2" × 18 1/8").

Options

908: Rack Flange Kit

910: Additional Operating and Service Manual

8010A Pulse Generator

Price

add \$10

add \$17.50

\$2900

PULSE GENERATORS

High pulse power: 100 V, 200 W output

Model 214A



- Wide amplitude range; 0.08 V to 100 V
- 15 ns transition times

- 1 MHz repetition rate
- Double pulse mode



The 214A is a well-proven pulse generator with a very wide range of applications. The high 200 watts of pulse power (2 amp peak, ± 100 volts into 50 ohms) and fast rise time of 15 ns are particularly suited for testing current-driven devices such as magnetic cores, as well as high-power modulators. The fast rise and fall times combined with high power output pulses facilitate checking switching time of high power semiconductors. The positive or negative pulse output, with identical characteristics, provides a simple means of checking either npn or pnp type transistors. By gating the Model 214A output, a burst of pulses may be obtained for making computer logic measurements. The double pulse feature may also be used for pulse resolution tests of amplifiers and memory cores. Because of its ability to provide a 100 V amplitude output pulse, the 214A is ideally suited as a trigger source in high power applications where a poor signal-to-noise ratio is present.

Source impedance is 50 ohms on all but the highest (100-volt) range, to minimize errors caused by re-reflections when operating into unmatched loads. At lower output levels (down to 80 mV), the rise time is less than 13 ns (typically less than 10 ns). Carefully controlled pulse shape, pulse rate and width, and minimum pulse jitter ensure accurate and dependable test results. All characteristics of the pulse waveform, including overshoot, preshoot, pulse droop, and pulse top variations, are completely specified, and pulse irregularities are kept to a minimum.

An external trigger source of dc to 1 MHz can be used instead of the internal rate generator to produce the output pulses. Positive or negative trigger signals of 0.5 volts peak may be used and trigger slope and level may be selected to determine the triggering point on the waveform. A single pulse may be obtained from an internal circuit each time a manual button is pushed. Gating of pulses is easily achieved by applying an external signal and an output occurs only when the gating signal reaches a positive 8 volt level. Three modes of pulse operation allow: (1) setting of the output pulse to occur from 0 to 10 ms before (advance) the trigger output, (2) setting of the output pulse to occur from 0 to 10 ms after (delay) the trigger output, or (3) a double pulse output with variable spacing between the two pulses.

Specifications

Pulse characteristics

Source impedance: 50 ohms on 50 V and lower ranges; approx. 1500 ohms on the 100 V range.

Transition times: <13 ns on 20 V and lower ranges and the -50 V range, <15 ns on the +50 V range; typically <10 ns with the vernier set for maximum attenuation and typically 15 ns on the 100 V range.

Pulse amplitude: 100 V into 50 ohms. Attenuator provides 0.2 to 100

V in 1, 2, 5, 10 sequence (9 ranges); vernier reduces output of 0.2 V setting to 80 mV and provides continuous adjustment within ranges.

Polarity: positive or negative.

Overshoot: <5%, both edges (measured on a 50 MHz oscilloscope).

Pulse top variation: <5%.

Droop: <6%.

Preshoot: <2%.

Pulse width: 50 ns to 10 ms in 5 decade ranges; continuously adjustable vernier.

Width jitter: <0.05% of pulse width + 1 ns.

Maximum duty cycle: 10% on 100 V and 50 V ranges; 25% on 20 V range; 50% on 10 V and lower ranges.

Repetition rate and trigger

Internal

Repetition rate: 10 Hz to 1 MHz (5 ranges), continuously adjustable vernier. Rate jitter: <0.5% of the period.

Manual: pushbutton single pulse, 2 Hz maximum rate.

External

Repetition rate: dc to 1 MHz.

Sensitivity: <0.5 V peak.

Slope: positive or negative.

Level: adjustable from -40 V to +40 V.

Delay: delay between input trigger and leading edge of pulse is approximately 250 ns in Pulse Advance mode (approx. 420 ns minimum in Pulse Delay mode).

External gating: +8 V input threshold. Maximum input 40 V peak.

Double pulse

Minimum Spacing: 1 μ s on the 0.05 to 1 μ s pulse width range and 25% of upper limit of width range for all other ranges.

Trigger output

Amplitude: >10 volts open circuit.

Source impedance: approximately 50 ohms.

Width: 0.05 μ s nominal.

Polarity: positive or negative.

General

Power: 115 or 230 V $\pm 10\%$, 48 to 66 Hz, approx. 325 VA.

Dimensions: 426 mm wide, 178 mm high, 467 mm deep (16 1/2" \times 7" \times 18 3/8").

Weight: net, 15.8 kg (35 lb). Shipping, 18.5 kg (41 lb).

Options

908: Rack Flange Kit

910: Additional Operating and Service Manual

214A Pulse Generator

Price

add \$10.00

add \$7.50

\$1600

PULSE GENERATORS

Model 1900 Plug-in pulse generator system

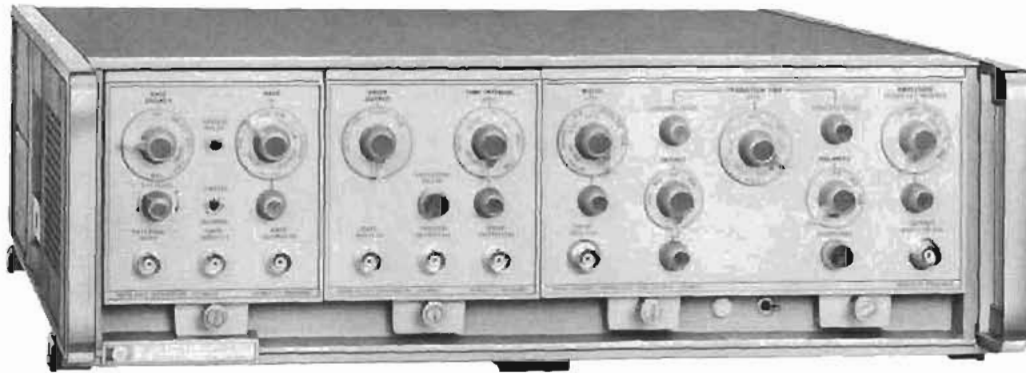

1900 System introduction

The Hewlett-Packard 1900 system with its modular construction offers the maximum possible flexibility and versatility in a pulse generator. It makes available an extremely wide range of facilities which could otherwise only be implemented by several conventional instruments.

The 1900 system comprises a series of fully compatible plug-in units with two main system repetition rates: 25 MHz and 100 MHz. The plug-ins fall into two categories as follows:

	Rate	Data/Timing	Output
25 MHz	1905A	1908A,	1915A,
		1925A,	1917A,
		1930A	1920A

	Rate	Timing	Output
100 MHz	1906A (125 MHz)	1909A	1916A
		(125 MHz)	

Applications

Because of its flexibility the 1900 system covers a very wide range of applications. The following applications areas, described in terms of plug-in capabilities, are typical.

The 1917A, the general-purpose output amplifier of the 1900 system, produces 0.2 V to 10 V pulses from 50 ohms into 50 ohms (14 V into Hi-Z) with transition times down to 7 ns. It covers a wide range of digital applications including logic design testing of TTL, ECL and MOS circuits.

The 1915A produces a ± 2.5 V to 50 V output at 1 A into a 50 ohm load and transition times down to 7 ns. The H51 special enables the 1915A to handle single pulses or low duty cycles of <0.2%. Thus the 1915A is ideally suited for testing CMOS logic or as a modulator in radar, microwave or plasma experiments, or any high voltage, high current application. An overload circuit and indicator lamp are provided to prevent output amplifier damage.

The 1916A is a high-speed output amplifier producing pulses with transition times down to 2.5 ns at rep. rates up to 100 MHz. These output characteristics are ideal for testing the wide range of high speed logic on the market today such as the Schottky TTL and ECL families. The normal and complement outputs are ideally suited to driving twisted pairs and differential amplifiers.

The 1920A provides pulses with 350 ps rise times and 400 ps fall

times. These very fast transition times suit the 1920A to rise time, propagation delay, bandwidth and storage time testing of high speed transistors and logic families such as ECLIII. The zero pulse width facility is useful for impulse testing. The H02-1920A special enables the 1920A to be used in fiber optics applications. This special modifies the 1920A to deliver pulses with ≤ 300 ps transition times and 10 V fixed amplitude into 50 ohms for driving LEDs and laser diodes.

The 1925A and 1930A plug-ins bring word generation and PRBS capabilities to the 1900 system. The 1925A can generate words of 2-16 bits in length at up to 50 MHz and PRBS of 32 767 bits for testing communications channels.

The 1930A can generate a variable length PRBS of 7 to 1 048 575 bits at rates up to 40 MHz, and also includes a bit-error-detection facility.

Programmability

Remote programming is available for the 1900 system which enables it to be built into systems for automatic testing of components or systems. With analog programming, pulse parameter ranges are controlled by external contact closure and verniers by analog current or resistance. For digital programming the 1900 system is interfaced to a computer via the 6940B Multiprogrammer.

1900A Mainframe description

The 1900A mainframe provides housing, power supplies and RFI shielding for all 1900 system plug-ins. Plug-ins in the mainframe can be connected either internally or externally.

1900A Mainframe specifications

General

Dimensions: 425 mm wide \times 133 mm high \times 543 mm deep overall (16 3/4" \times 5 1/4" \times 21 1/4").

Weight: net, 16 kg (35 lb). Shipping, 21 kg (46 lb).

Power: 115 or 230 V $\pm 10\%$, 48 to 66 Hz, 300 watts max.

Accessories and options

Analog programming kit: P/N 01900-69502, for option 001.

Blank plug-ins: 10481A — quarter size, 10482A — half size.

Plug-in extender: 10484A — for half and quarter size plug-ins.

Options

001: cables for remote programming facility

Price

add \$225

002: chassis slides

add \$95

007: rear panel inputs and outputs

add \$80

908: rack flange kit

add \$10

910: additional operating and service manual

add \$3.50

1900A Mainframe

\$4175

PULSE GENERATORS



1900 System: output plug-ins

Models 1915A, 1916A, 1917A & 1920A

- 50 V maximum amplitude
- ≤ 300 ps transition times

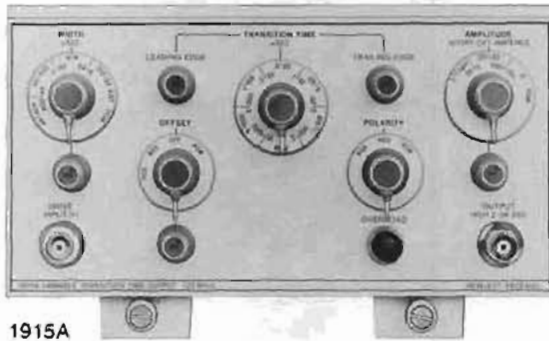

1915A

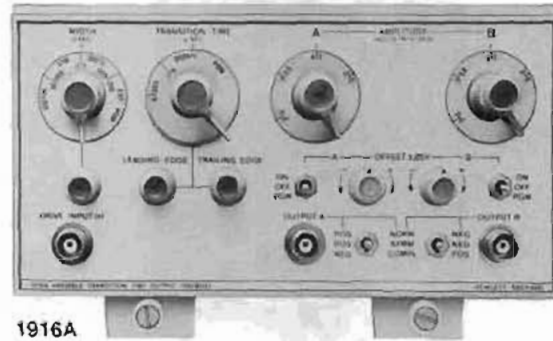

1916A

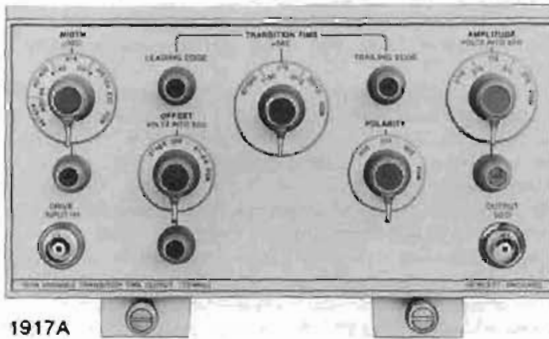

1917A

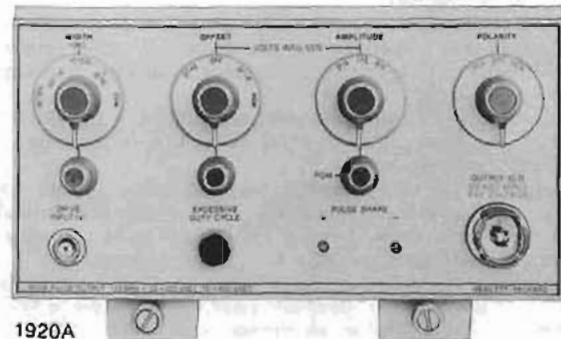

1920A

1915A Specifications

Source impedance: 50 ohms or 4 k Ω

Amplitude (short-circuit current): 50 mA to 1 A. Voltage: ± 2.5 V to ± 50 V (Hi-Z/50 Ω), ± 1.25 V to ± 25 V (50 Ω /50 Ω). Max amp. ± 50 V.

Pulse top variations: 50 Ω /50 Ω , $\pm 5\%$ (transitions 7–20 ns) or $\pm 2\%$ (transitions > 20 ns). Hi-Z/50 Ω , $\pm 5\%$ (all transitions).

Transition times: 7 ns (10 ns with Hi-Z source) to 1 ms.

Baseline offset: ± 1.5 V (50 Ω source), ± 3 V (Hi-Z source).

Internal width: 15 ns–40 ms. Jitter $< 0.5\%$.

External width: determined by drive input width.

Overload: lamp lights when protection circuit shuts off output current. For single pulse/low duty cycle operation, order special H51.

Drive input rep. rate: 0 to 25 MHz.

1916A Specifications

Pulse characteristics with source and load impedance 50 ohms.

Amplitude: < 200 mV to 5 V. DC offset: ± 2.5 V independent of amp.

Transition times: 2.5 ns to 250 μ s. Separate rise/fall controls.

Nonlinearity (10%–90% amplitude): $< 5\%$ pulse amplitude.

Overshoot, ringing, preshoot: $< 5\%$ of pulse amplitude.

Pulse output: dual channel, norm/compl/symm & polarity selectable.

Maximum duty cycle: $> 50\%$, up to 100% in compl. & external mode.

Pulse width: 5 ns to 1 ms. Jitter: $< 0.1\%$ +25 ps.

Drive input rep. rate: 0 to 100 MHz. Maximum amplitude, ± 5 V pk.

1917A Specifications

Source impedance: 50 ohms or 3 k Ω , 45 pF shunt.

Amplitude: 0.2 V–10 V into 50 ohms, 0–14 V into 3 k Ω .

Pulse top variations: $\pm 5\%$ for transition times > 7 ns.

Transition times: 7 ns to 500 μ s, separate rise/fall controls.

Polarity: pos. or neg. selectable.

- 2.5 ns minimum variable transitions
- 100 MHz maximum repetition rate

Baseline offset: ± 2.5 V (50 ohms into 50 ohms).

Internal width: 15 ns to 40 ms. Jitter $< 0.25\%$.

External width: determined by drive input width.

Drive input rep. rate: 0 to 25 MHz.

1920A Specifications

Source impedance: 50 ohms $\pm 5\%$

Amplitude: 0.5 V to 5 V into 50 ohms. Output short-circuit proof.

Pulse shape (measured at 5 V into 50 ohms):

Leading edge: transition < 350 ps, preshoot $< 1\%$, overshoot and ringing $< 10\%$, rounding $< 5\%$.

Trailing edge: transition < 400 ps, preshoot $< 1\%$ for pulse widths > 5 ns, overshoot and ringing $< 10\%$, rounding $< 5\%$.

Polarity: pos. or neg. Offset: 0 to ± 2 V into 50 ohms.

Width: 0 to 10 μ s. Jitter: < 20 ps or 0.1% whichever is greater.

Duty cycle: 0 to $> 25\%$ (0–20 MHz), 0 to 10% (> 20 MHz).

Drive input rep. rate: 0 to 25 MHz.

Options

001: analog programming

1915A/1920A

1917A

002 (1915A only): positive output

003 (1915A only): negative output

004 (1915A only): voltage calibration

005 (1915A/1917A): digital programming

007 (1915A/1917A): rear panel outputs

910: extra manual, 1915A;

1916A, 1917A or 1920A

Price

add \$300

add \$325

less \$225

less \$225

add \$25

add \$2995

add \$25

add \$7.50

add \$5.00

Model number and name

1915A Output plug-in

\$2300

1916A Output plug-in

\$1885

1917A Output plug-in

\$950

1920A Output plug-in

\$2650

PULSE GENERATORS

1900 System: Word/PRBS generator plug-ins

Models 1925A & 1930A

- 50 MHz, 1 × 16 bit
- RZ/NRZ format
- Fixed $2^{15}-1$ PRBS

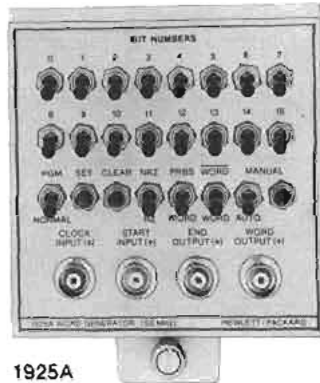

1925A Description

The 1925A is a digital word generator plug-in. It generates a variable length word at a repetition rate of 0–50 MHz. It can be driven by either the 1905A or 1906A rate generator plug-ins and will drive any of the 1900 system output plug-ins.

Word lengths of 2 to 16 bits can be selected using internal switches and the word content can be set either using the front panel switches or by external programming.

In word mode the 1925A is ideally suited for testing data transmission lines and systems, and digital integrated circuits such as multiplexers, decoders, shift registers and memories. An end-of-word output is available for synchronizing external test equipment.

Alternatively the 1925A can be switched to PRN to generate a pseudo-random sequence of fixed $2^{15}-1$ (32 767) bits. This capability is extremely useful for testing communications channels or LSI computer memories. The internal register can be set or cleared to establish reference points when PRN mode is being used.

The 1925A can output data in either RZ or NRZ and WORD or WORD mode which further increases its versatility.

1925A Specifications

Clock input

Repetition rate: 0 to 50 MHz (15–35°C), 0 to 45 MHz (0–50°C).

Input impedance: 50 ohms, dc coupled.

Amplitude: +1 V min, +5 V max.

Width: >4 ns, <18 ns at +0.6 V.

Propagation delay: 35 ns max, clock input to data output.

Transition time jitter: (between clock and word output) 100 ps.

Start input

Period: >(word length plus 30 ns).

Input impedance: 50 ohms, dc coupled.

Amplitude: +1 V min, +5 V max.

Width: >5 ns.

Functions

Word length: 2–16 bits by internal switches, not programmable.

Word content: set by front panel switches or external programming.

Word format: NRZ/RZ selectable from front panel or external program.

WORD/WORD selectable from front panel switch.

Word cycling: automatic (continuous with one clock period delay between words), external start command, or manual pushbutton.

Manual/Auto: front panel switch or external program.

End output: BNC output corresponding to end of word.

Set: serially loads ones into shift register.

Clear: parallel reset of shift register

Pseudo random noise: provides a linear shift-register sequence of 32 767 bits. The sequence starts with the last 16-bit word in shift register. Maximum clock rate is 30 MHz.

- 40 MHz PRBS 2^{15} up to $2^{20}-1$
- 40 MHz bit error detection

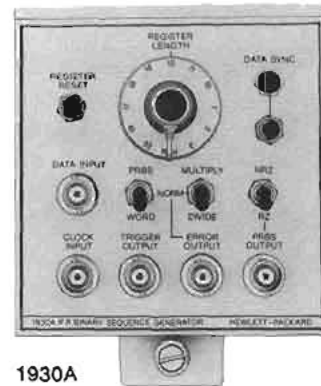

1930A Description

The 1930A is a Pseudo-Random-Binary-Sequence (PRBS) generator plug-in. It can generate a PRBS in either RZ or NRZ mode at clock rates up to 40 MHz. The length of the sequence can be varied from 7 to 1 048 575 bits.

The PRBS facility provides a fast, easy and complete method of generating all possible combinations of up to 20 bits in an apparently random sequence. This is necessary for detecting worst case patterns in noise sensitive devices and for checking all possible combinations in a multi-cell device.

Bit error detection in digital transmission systems is simplified by the ability of the 1930A to synchronize rapidly to a data stream (either words or pseudo-random sequences) and compare the incoming data bit by bit with an internally generated replica. For example, one 1930A generates a signal that is transmitted over a digital communication link while a second 1930A synchronizes to the incoming signal from the link. Each time the received signal differs from the locally generated replica an error pulse is produced at the error output.

1930A Specifications

Clock input

Repetition rate: 0–40 MHz.

Input impedance: 50 ohms dc coupled.

Amplitude: ±1 V min. Max input: ±5 V.

Width: >4 ns and <15 ns.

Propagation delay: 40 ns max (clock input to data output).

Data input

Repetition rate: 0–40 MHz.

Input impedance: 50 ohms dc coupled.

Amplitude: '1' level, +1 V min, '0' level, 0 V. Max input, ±5 V.

Trigger output:

Amplitude: 1 V (open circuit).

Width: 1 clock period.

Source impedance: 50 ohms.

Error output

Amplitude: 45 ±5 mA current source or >2 V into 50 ohms.

Width: >10 ns, <50% of period in RZ mode.

Source impedance: unterminated current source.

PRBS output

Amplitude: 45 mA ±5 mA or >2 V into 50 ohms.

Rise and fall times: <4 ns.

Width: >7 ns to <14 ns.

Source impedance: unterminated current source.

1925A and 1930A options

005: digital programming

910: additional operating and service manual

Model number and name

1925A Word/PRBS Generator plug-in

1930A PRBS Generator plug-in

Price
add \$310
add \$5

\$1100
\$1350

PULSE GENERATORS

1900 System: rate & delay plug-ins

Models 1905A, 1906A, 1908A, 1909A

- 1905A 25 MHz rate generator plug-in
- 1906A 125 MHz rate generator plug-in



1905A

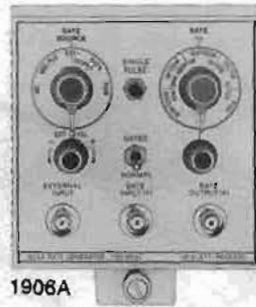

1906A

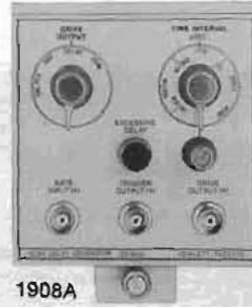

1908A

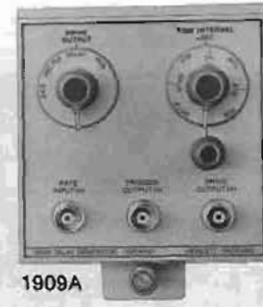

1909A

1905A 25 MHz rate generator specifications

Frequency

Internal: 25 Hz to 25 MHz, continuously adjustable.

External: 0 to 25 MHz.

Period jitter: <0.1% of selected period.

External Trigger

Amplitude: 0.5 V p-p to 5 V p-p.

Slope: positive or negative selectable.

Delay: 27 ns external input to rate output.

Input impedance: approx. 50 ohms dc coupled.

Synchronous gating

Amplitude: -2 V gates generator on, -5 V max. 50 ohms dc coupled.

Output pulse

Impedance: approx. 50 ohms dc coupled.

Amplitude: >1.5 V into 50 ohms (drives two 1900 series plug-ins).

Risetime: <5 ns.

Width: <10 ns.

1906A 125 MHz rate generator specifications

Frequency

Internal: 10 Hz to 125 MHz, continuously adjustable.

External: 0 to 125 MHz.

Period jitter: <0.1% of selected period.

External trigger

Amplitude: 0.5 V p-p min (0 to 50 MHz); 1.5 V p-p min (50 to 125 MHz) to 5 V p-p max.

Slope: positive or negative selectable.

Delay: 12 ns external input to rate output.

Input impedance: approx. 50 ohms dc coupled.

Synchronous gating

Amplitude: +1 V gates generator on, +5 V max 50 ohms dc coupled.

Output pulse

Impedance: approx. 50 ohms dc coupled.

Amplitude: >1.5 V into 50 ohms (drives two 1900 series plug-ins).

Risetime: <3 ns.

Width: <5 ns.

1908A 25 MHz delay generator specifications

Functions (drive output switch)

Delay/advance: drive delayed/advanced on trigger.

Double pulse: from drive output. Time interval sets spacing.

- 1908A 25 MHz delay generator plug-in
- 1909A 125 MHz delay/gate generator plug-in

Time interval (between trigger and drive outputs)

Range: 15 ns to 10 ms. Jitter: <0.1% of setting.

Excessive delay light: selected delay exceeds pulse period.

Rate input

Repetition rate: 0-25 MHz.

Amplitude: 1 V p-p min; 5 V p-p max.

Trigger and drive outputs (drive two 1900 series plug-ins)

Amplitude: >1.5 V into 25 ohms. Output impedance: approx. 50 ohms.

Risetime: <5 ns.

Width: <10 ns.

1909A 125 MHz delay/gate generator specifications

Functions (drive output switch)

Delay/advance: drive delayed/advanced on trigger.

Double pulse: from drive output. Time interval sets spacing.

Gate: gate signal generated. Time interval sets width.

Time interval (between trigger and drive outputs)

Range: 0-1 ms (delay), 8 ns-1 ms (double pulse and gate).

Jitter: <25 ps + 0.1% of range setting.

Rate input

Repetition rate: 0-125 MHz (delay), 0-65 MHz (double pulse, gate).

Drive output (drives two 1900 series plug-ins)

Amplitude: ≥1.5 V into 25 ohms, 2.5 V into 50 ohms in gate mode.

Width: ≤4 ns (delay, double pulse).

Output impedance: approx. 50 ohms, dc coupled.

Trigger output (drives two 1900 series plug-ins)

Amplitude: ≥1.5 V into 25 ohms.

Width: <5 ns.

Output impedance: approx. 50 ohms dc coupled.

Options and accessories

001 (all plug-ins): analog programming. add \$125/125/105

005 (1905A, 1908A): digital programming. add \$550

010: additional operating and service manual. add \$5

Programming kit: HP 01908-69501 for option 001. add \$103

Model number and name

1905A 25 MHz Rate Generator plug-in \$325

1906A 125 MHz Rate Generator plug-in \$400

1908A 25 MHz Delay Generator plug-in \$325

1909A 125 MHz Delay/Gate Generator plug-in \$400

PULSE GENERATORS

1900 System: programming information

- Full control of all parameters
- Both analog and digital control available

- Occupies only one controller I/O slot
- System can be easily expanded

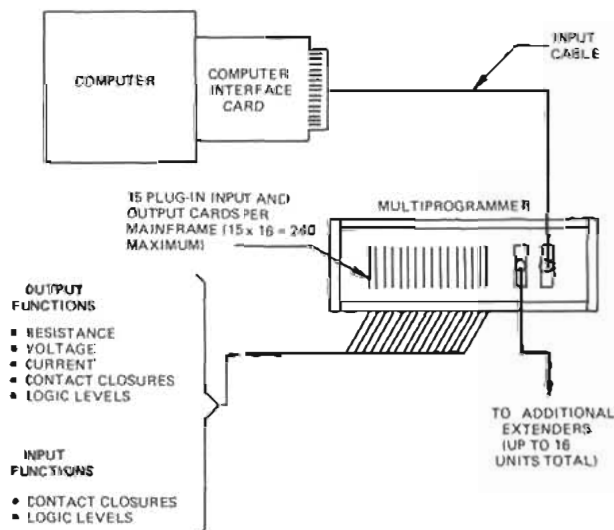
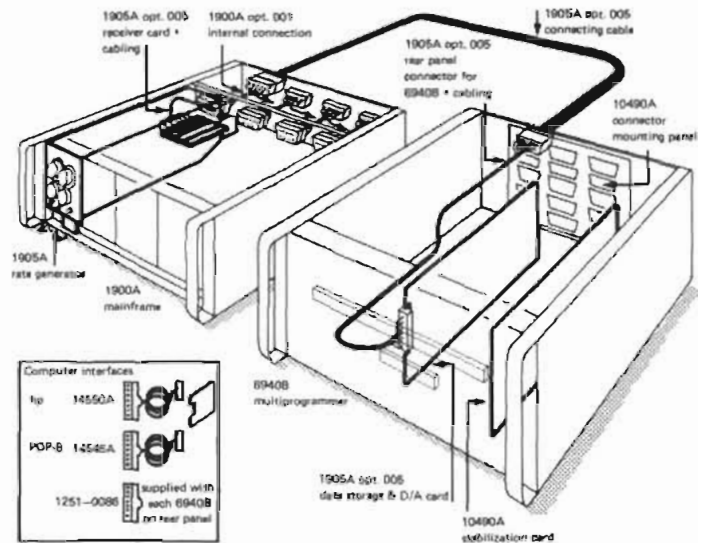
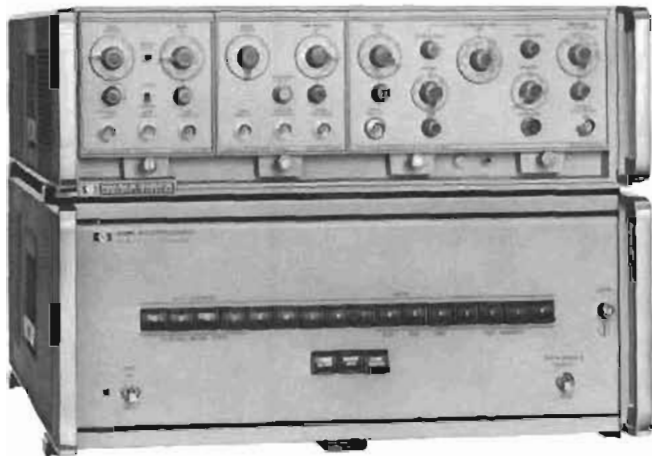

Introduction

Programmable pulse generators can be incorporated into automatic test systems. Programming adds flexibility which is invaluable for applications that require several different but repeatable pulse waveforms. This capability is available in a number of the components of the 1900 system.

Analog control

Analog control is particularly suitable for simple applications where only partial control is needed or when only a few pulse waveforms are required repeatedly. Available in the 1900 series are six plug-ins which feature analog programming as an option. They are:

1905A	001	1909A	001	Programming of these modules requires an option 001, 1900A mainframe.
1906A	001	1915A	001	
1908A	001	1920A	001	

Programming is by contact closure for ranges and by resistor or analog current for vernier functions.

Digital programming

For flexible control of a pulse generator, digital programming is the answer and Hewlett-Packard's contribution is the 1900/6940B programmable pulse generator.

The plug-in 1900 system and the 6940B Multiprogrammer allow reliable and efficient control of a large number of functions by a mini-computer, using only a single 16 bit I/O slot. Up to fifteen 6941B Extenders may be added to provide control of up to 240 separate functions still using only one computer I/O slot. A 10490A connector mounting panel and stabilization card are necessary when using the 6940B with a 1900 system.

Available in the 1900 series are six plug-ins which feature digital programming as an option. They are:

1905A	005	1917A	005	Programming of these modules requires an Option 001 1900A mainframe.
1908A	005	1925A	005	
1915A	005	1930A	005	

Only the functions with parameters to be varied need be programmable. For the others, standard plug-ins may be used or part of the programming hardware can be omitted. For example; if only the width of an output stage and not offset, amplitude, etc. is to be programmed, then the cards in the 6940/6941B which would be required to control these non-varying parameters can be omitted.

The 1900/6940B works with any digital computer, however, for Hewlett-Packard digital computers, software in FORTRAN and BASIC is available.

WORD GENERATORS

2 × 16 bit word & PRBS generator

Model 8006A

- 10 MHz repetition rate
- Selectable PRBS and word length
- Selectable formats RZ/NRZ, normal/complement
- TTL compatible output
- Bit pattern programmable
- Single and continuous cycling

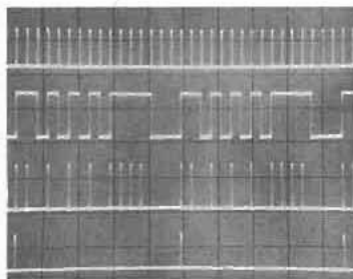
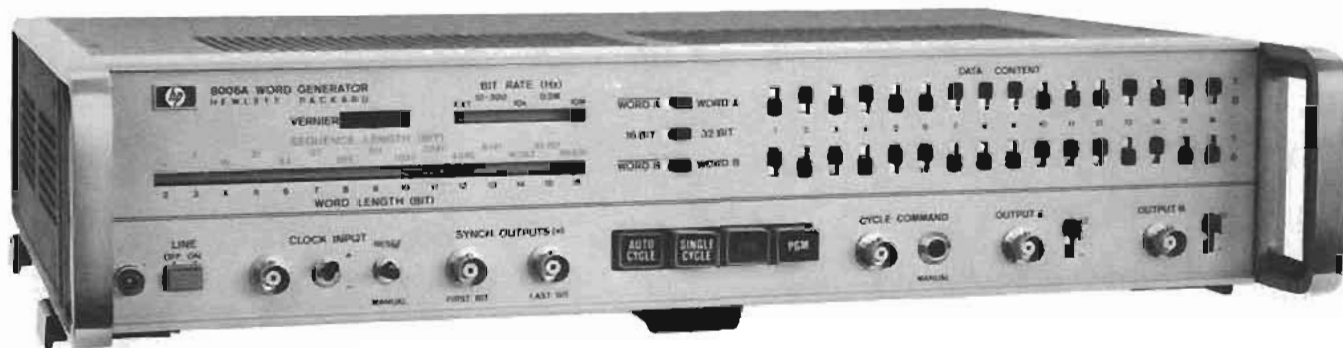

External clock

NRZ Output (16 bit continuous word recycling)

RZ Output signal

First bit synch pulse

The 8006A generates serial digital words of variable length at clock rates up to 10 MHz. An easy selection of two 16 bit words is available. These two words can be serialized to produce a 32 bit word at each output. Selectable operating modes include positive return-to-zero (RZ) format, positive and negative non-return-to-zero (NRZ) format, manual or automatic word cycling, complementary output signals, and remote programming of the data content. The remote programming feature allows conversion of parallel words to serial words. Two outputs provide trigger pulses coincident with the first and the last bit.

Additionally, a pseudo-random binary sequence variable from 7 to 65535 bits can be obtained from channel A output, with the inverted sequence available at channel B.

Specifications

Word generation

One 4 to 32 bit word (even numbers only) or two 2 to 16 bit words. No clock period between words.

Word content: independently set for both words by front panel switches or remote programming (parallel data input). Complement of each word selectable by front panel switches, WORD A - WORD A', WORD B - WORD B'.

Word cycling: continuous or by cycle command (external trigger or manual).

Bit rate: internal, 10 Hz to 10 MHz, four ranges, continuous adjustment within ranges. Manual or external clock 0 to 10 MHz.

Reset: manual reset of word outputs to bit 1 in AUTO CYCLE mode and to word pause in SINGLE CYCLE mode.

Word format: RZ/ NRZ/-NRZ selectable for each word output. Positive outputs have current sink capability to drive integrated circuits (TTL/DTL).

Synch outputs: trigger pulses corresponding to the first bit (leading edge) and last bit (trailing edge).

Pseudo-random sequence generation PRN: provides a linear shift register sequence at channel A output and the inverted sequence at channel B output. Maximum bit rate is 9 MHz.

Sequence length: variable from 7 to 65535 bits.

Trigger pulse: selectable for each bit in sequence.

Interface

Clock input

Repetition rate: 0 to 10 MHz, Amplitude $\geq \pm 2$ V, $\leq \pm 10$ V.

Width: > 15 ns at ± 1 V. Input impedance: $> 500\Omega$.

Cycle command input

Minimum period: word length plus 100 ns. Amplitude $> +2$ V, $< +10$ V.

Width: > 15 ns at $+1$ V. Input impedance: $> 500\Omega$.

External data inputs: no storage capability for programmed data.

Low state: contact closure, TTL low, or voltage source > 0 V, $< +0.8$ V.

High state: open, TTL high or voltage source $> +2.4$ V, $< +5$ V.

Synch outputs

Amplitude: $> +2$ V across 50Ω .

Width: approx 40 ns. Output impedance: 50Ω .

Clock output (rear panel)

Amplitude: 2 V across 50Ω

Source impedance: approximately 50Ω

Pulse width: approximately 30 ns

Word outputs

Positive NRZ, RZ: high: $+2.5$ V across 50Ω , source impedance 50Ω . Low: ≥ -0.3 V, $\leq +0.3$ V, source impedance approx. 0Ω . Current sink capability 80 mA maximum

RZ pulse width: approx. 45 ns.

Negative NRZ: high: 0 V, low: -5 V across 50Ω , source impedance 50Ω .

Transition times: < 10 ns.

General

Operating temperature: 0°C to 50°C .

Power: 115 V or 230 V, $+10\%$, -15% , 48 Hz to 440 Hz, 59 VA.

Weight: net 6 kg (13 1/4 lb).

Dimensions: 425.5 mm wide \times 88.2 mm high \times 337 mm deep (16 1/2" \times 3 1/2" \times 13 1/4").

Options

908: Rack Flange Kit

910: additional Operating and Service Manual

8006A 2x16 bit Word and PRBS Generator

Price

add \$10

add \$14

\$1720

WORD GENERATORS

Highly flexible word generator, 9 × 32 bit
Model 8016A

- 0.5 Hz to 50 MHz repetition rate
- 2 complementary outputs per channel, RZ/NRZ formats
- Variable RZ width, 4 delay channels
- Channel serializer
- TTL/ECL output levels selectable
- Optional HP-IB programming of Bit pattern

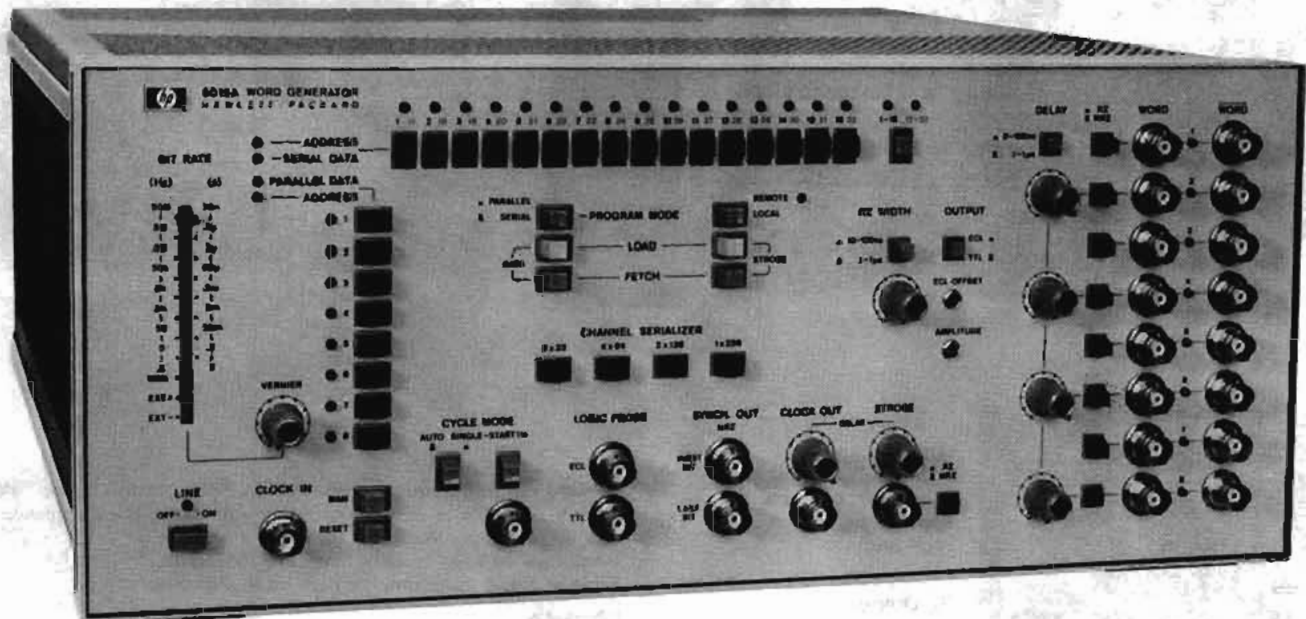

HP-IB 8016A

The 8016A is a parallel and serial data generator that provides digital stimulus for a very wide range of applications. For the digital designer the 8016A is a natural companion to multichannel data display devices such as logic analyzers. It forms an ideal system component for large test systems because it can provide the combination of digital patterns plus adjustable timing parameters necessary for testing IC's and circuit boards. It is also a quite useful time saver for design and test of complex communications systems.

The large memory size and ease with which bit patterns are programmed produce a flexibility of signal output, both in content and in format. Data loading and output can be in either a parallel or serial format. In parallel mode, data is input and output as 32 sequential bytes, each 8 bits wide. In serial mode data is handled as 32 bit serial words, and 8 independent words are available. A built-in channel serializer also permits cascading the channels to produce a word length of up to 256 bits. Maximum use of the memory is thus retained when fewer channels are required.

A strobe output provides additional data formatting capability. The strobe can function either as a ninth data channel 32 bits long, or as a floating 32 bit trigger word assignable to any or all of the 32 bit sections of a serialized data frame. The strobe is thus perfect as a word framing pulse or as a qualifier signal to label address and data information contained in the same data stream. Additional synchronizing signals are provided by the first and last bit outputs and the clock output.

The 8016A's front panel control scheme provides simple control of all of the 8016A's complex waveform generation capabilities. The data entry controls are optimized to a "row of 16, column of 8" arrangement. Each pushbutton and adjacent LED form one bit of a buffer switch register whose states are displayed on the LED's. Data is loaded either into the row pushbuttons as serial words or into the col-

umn pushbuttons as 8 bit parallel bytes. A single press of the load data switch then transfers the data to the high speed memory. If data needs to be edited, a "fetch" facility returns data to the buffer register, where it is again displayed on the LED's. Bit patterns may also be more rapidly loaded into the 8016A via an optional card reader. The entire memory may thus be loaded in less than 2 seconds.

Complete testing of digital circuits and systems requires not only digital patterns but control of the analog parameters of the pulses as well. Pulse widths, levels, and interchannel delays must all be adjustable both for proper functional testing and, in addition, to measure such dynamic parameters as setup and hold times, clock pulse width sensitivities, and the system sensitivity to propagation delay variations. To meet these testing requirements the 8016A first includes 6 independent delay circuits. Two selectable delay ranges, 0-100 ns or 0.1-1 μ s are provided. Output levels of the 8016A's 50 Ω output amplifiers may also be adjusted to meet either ECL or TTL test specifications. Transition times of <3 ns for TTL and <2.5 ns for ECL pulses are also in line with testing requirements. In addition a choice of RZ or NRZ formats with variable RZ pulse width is provided. This combination of pattern and pulse parameter control means the 8016A can often provide problem solutions which would otherwise require a setup of separate pulse and word generators.

Its simple but very flexible bit pattern programmability combined with its short cycle time (50 MHz clock) make the 8016A especially effective in simulating worst case conditions in IC testing, e.g. high speed testing of critical areas of memory. Similarly, the 8016A is a time saver in component evaluation environments because test setups can be rapidly built and reconfigured to meet the demands of testing small quantities of a wide variety of IC types. In addition the 8016A is very useful in feeding controlled bit patterns into data buses, data communications systems, and telemetry systems, both for testing and for simulation purposes.

Specifications

Data capacity

Number of channels: 8 data channels plus 1 strobe channel.

Number of bits per channel: 32 (fixed).

Total bit capacity: 288.

Data can be loaded in parallel or serial form depending on the position of the PROGRAM MODE switch. The data is loaded via a single row and single column of pushbuttons, each pushbutton controlling a one-bit buffer register.

Serial capacity

One word consists of 32 bits in serial. A front panel switch serializes words to form a frame.

Serial formats:

9 words on 9 channels, including strobe word, each 32 bits long.

4 frames on 4 channels, each consisting of 2 words or 64 bits.

2 frames on 2 channels, each consisting of 4 words or 128 bits.

1 frame on 1 channel consisting of 8 words or 256 bits.

Parallel capacity

Parallel format: 32 words with up to 9 bits in parallel-strobe channel included — will be generated. The number of bits per word depends on the number of output channels serialized.

Data outputs

Two separate outputs per channel, one for normal and one for complement.

Amplitude: TTL or ECL voltage levels, variable by front panel control.

Source impedance: 50 ohms.

Delay: four channels can be separately delayed between 0 ns and 1 μ sec with reference to the channels 1, 3, 5 or 7.

Two ranges: 0 ns – 100 ns
0.1 μ s – 1 μ s

Ranges are common to all delayable channels. Channels have individual vernier controls.

Delay jitter: $\leq 0.1\%$ + 50 ps

Skewtime: Skewtime of undelayable channels (3, 5, 7) in reference to channel one: ± 1 ns.

Format: RZ or NRZ separately selectable for each data channel and strobe channel.

RZ Width: 10 nsec to 1 μ sec in two ranges. Vernier provides continuous adjustment within ranges. Range switch and vernier common to all channels.

Width jitter: $\pm 0.2\%$ + 50 ps.

Aux. outputs

First bit: corresponds with parallel word one or with the first bit of the serial word. Format is NRZ.

Last bit: corresponds with the last parallel word or with the last bit of the last word of a frame. Format is NRZ.

Clock: delivers one pulse per bit. Format is RZ.

Clock pulse width: controlled by RZ-Width control. Clock pulse may be delayed between 0 ns and 1 μ s in reference to channels 1, 3, 5 or 7.

Strobe word: separate LOAD and FETCH pushbuttons and length 32 bits (can be extended to 256 bits by repetition). The strobe word may be delayed between 0 ns and 1 μ sec in reference to channels 1, 3, 5 or 7.

Amplitude of aux. outputs: TTL or ECL voltage levels variable by front panel control.

Source impedance: 50 ohms

Probe power

ECL: -5.2 V dc $\pm 10\%$; 80 mA.

TTL: +5 V dc $\pm 10\%$; 100 mA.

Bit rate

Internal: 0.5 Hz to 50 MHz in eight ranges. Vernier provides continuous adjustment within ranges.

External: dc up to 50 MHz or manual triggering.

Clock input

Repetition rate: 0 to 50 MHz.

Trigger pulse width: ≥ 10 nsec.

Trigger amplitude: selectable by internal switches on Bit Rate board A5. Max. Amplitude: ± 7 V at 100% duty cycle.

Ext. + (TTL): amplitude $\geq +2$ V, input impedance ≥ 1 k to GND.

Ext. +: amplitude $\geq +1$ V, input impedance 50 ohms to GND.

Ext. - (ECL): amplitude ≤ -1.6 V, input impedance 50 ohms to -2 V.

Ext. -: Trigger level adjustable at Potentiometer ASR114 from +1 V to -1 V.

Input impedance: 50 ohms to GND.

Recycling

Auto mode: data is recycled continuously.

Single cycle (2 modes):

a) one word generated for each cycle command.

b) words generated as long as the cycle command is active. Last word always completed. If channels are serialized, the serialized word (64 bits, 128 bits, 256 bits) is always completed.

Period between cycle commands: Byte (frame) length plus 200 ns.

Amplitude: $> +2$ V, $\leq +10$ V.

Width: ≥ 12 ns.

Input impedance: 1 k Ω .

Manual reset

Auto cycle: all channel outputs are set to "0". The next clock pulse after RESET generates byte number one.

Single cycle: all channel outputs are reset to word pause. Word pause can either be "ZERO" or "LAST BYTE", controlled by a rear panel switch.

Pulse characteristics

The level of all output signals is controlled by a TTL/ECL switch. Adjusts for amplitude and offset. Source Impedance is 50 ohms.

TTL (across 50 ohms): HIGH LEVEL variable from 2.5 V to 1 V. LOW LEVEL ≤ 0.2 V.

Transition times: ≤ 3.0 ns (First/Last Bit Trigger < 4.0 ns).

ECL (across 50 ohms): HIGH LEVEL OFFSET variable from -0.9 V to +1.1 V. Amplitude variable from 0.3 V to 1.0 V.

Transition times: ≤ 2.5 ns (First/Last Bit Trigger < 4.0 ns).

General

Operating temperature range: 0°C to +50°C.

Power requirements: 100 V/120 V/220 V or 240 V +5%, -10%, 48 Hz to 66 Hz, 200 VA (maximum).

Weight: net, 14.5 kg (31.96 lb). Shipping, 16 kg (35.27 lb).

Dimensions: 460 x 475 x 178 mm (18 x 18.650 x 7 inches).

Options and Accessories

001: remote programming. Bit pattern can be programmed by any controller that is compatible with the HP Interface Bus (HP-IB).

002: Card Reader. This option enables rapid loading of the data and strobe channel bit patterns. The card reader accepts marked or punched cards (HP Part Number 9320-0595) and transmits the data/control information to the 8016A via the HP-IB (Option 001 required).

907: Front Handle Kit

908: Rack Flange Kit

909: Rack Flange & Front Handle Combination Kit

910: Additional Operating and Service Manual

8016A 9 x 32 Bit Word Generator

Price

add \$550

add \$660

add \$15

add \$10

add \$20

add \$18

\$6400

WORD GENERATORS

PRBS and WORD generation up to 150 Mb/s

Model 3760A

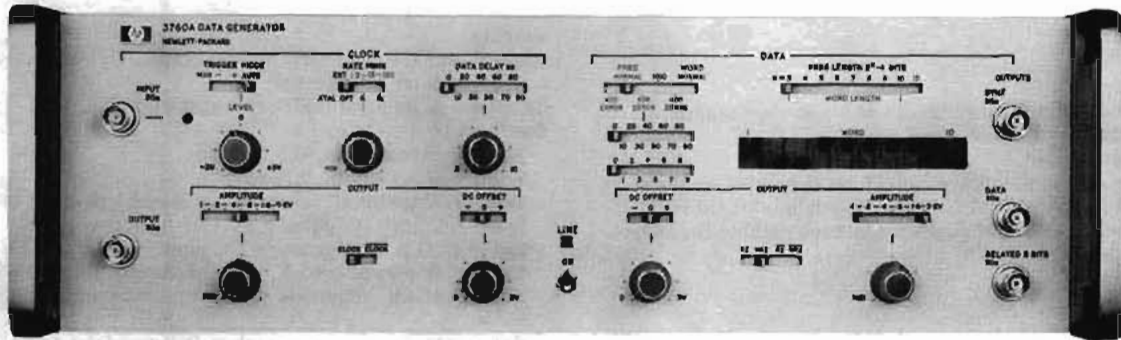

The 3760A Data Generator is a fast, versatile PRBS and WORD generator intended for both factory and field use, with many features which make it especially attractive for applications in high frequency digital communications.

The generator can be manually or automatically triggered from an external clock in the frequency range 1 kHz–150 MHz. Alternatively the clock can be derived from an optional internal clock source which can be variable or crystal controlled in the frequency range 1.5–150 MHz. A clock output is always provided in normal or complemented form, which is variable in amplitude and dc offset.

The pseudo-random binary sequence, PRBS, is variable in length from $2^3 - 1$ to $2^{10} - 1$ bits, with an additional long sequence of $2^{15} - 1$ bits. A sync pulse occurs once per PRBS and may be varied in position relative to the sequence. As the 3760A generator is often used in conjunction with the 3761A Error Detector, two errors can be inserted once per 4000 sequences to check the accuracy of the 3760A/3761A system.

The length of the binary WORD is variable from 3 to 10 bits and its content is selected on the front panel. A sync pulse is generated once per WORD. Alternatively, a repetitive 1010 pattern can be selected.

The sync pulse can be used to initiate a block of 1 to 99 zeros which can be added to the data stream and used to examine regenerator clock extraction and threshold circuits in PCM/TDM systems.

The data output which can be PRBS, WORD or the fixed pattern 1010, is available in normal or complemented form. Either RZ or NRZ formats may be selected and the data output can be delayed by up to 100 ns with respect to the clock. As with the clock, the data output can be varied in amplitude and dc offset. A second data output, which is synchronously delayed by 8 bits from the normal data output, is also available as an option. This feature makes the generator ideally suited for driving digital radio systems employing four phase modulation.

Specifications

Modes of operation

PRBS normal: generates a repetitive $2^n - 1$ bit maximal length PRBS where $n = 3$ to 10 and 15.

PRBS add zeros: addition of a block of 1 to 99 zeros with PRBS normal, occurring after the sync pulse.

PRBS add error: introduction of two errors per 4000 sequences.

1010: generates a preset repetitive word, content 1010.

WORD normal: generates a continuous 3 to 10 bit word with selectable content.

WORD add zeros: addition of a block of 1 to 99 zeros into WORD normal, occurring between words.

Clock input

Rate: 1 kHz to 150 MHz.

Impedance: 50 ohms $\pm 5\%$ dc coupled (75 ohms optional).

Trigger: manual with level range -3 V to $+3$ V, +ve or -ve slope. Auto with input mark:space ratio range 10:1 to 1:10.

Sensitivity: better than 500 mV pk-pk.

Amplitude: 5 V pk-pk maximum. Limits ± 5 V.

Pulse width: 3 ns minimum at 50% pulse amplitude.

Indicator: lamp showing clock present and triggering correctly.

Internal clock (optional)

Variable: range 1.5 to 150 MHz.

Crystal: two rates in the range 1.5 to 150 MHz, stability ± 20 ppm.

Jitter: $< 0.5\%$ of period $+0.05$ ns pk-pk.

Clock output

Outputs: CLOCK or $\overline{\text{CLOCK}}$.

Impedance: source impedance 50 ohms $\pm 5\%$ (75 ohms optional).

Amplitude: continuously variable in 5 ranges from 0.1 to 3.2 V symmetrical about offset level.

DC offset: Zero, $< 2\%$ of pulse amplitude.

Variable, continuous 0 to ± 3 V.

Transition times: < 1.4 ns into 50 ohms.

< 1.6 ns into 75 ohms.

Overshoot: $< 10\%$ of pulse amplitude.

Data output

Outputs: DATA or $\overline{\text{DATA}}$.

Format: NRZ or RZ (up to 130 Mb/s).

Delay: data (and sync) delayed with respect to clock continuously in 10 ranges from 0 to 100 ns.

Other specifications as for clock output.

Delayed data output (optional)

Outputs: DATA or $\overline{\text{DATA}}$ ganged with normal Data output.

Delay: synchronous 8 bits with respect to normal Data output. Other specifications as for normal Data output with ganged amplitude and dc offset controls.

Sync output

Rate: once per PRBS or WORD cycle.

Amplitude: $+1$ V into 50 ohms.

General

Power: 100 to 125 V or 200 to 250 V, 40 to 400 Hz, consumption 90 W.

Weight: 13.5 kg. (30 lb).

Dimensions: 425 mm wide, 140 mm high, 467 mm deep. ($16\frac{1}{2}$ " \times $5\frac{1}{2}$ " \times $18\frac{3}{4}$ ".)

3760A Data Generator

\$8000

Oscillators, function generators

Signal sources have been described by various names—oscillators, test oscillators, audio signal generators, function generators, etc. Different names are applied, depending on design and intended use of the source. The name "test oscillator" has been used to describe an oscillator having a calibrated attenuator and output monitor. The term "signal generator" is reserved for an oscillator with modulation capability.

A function generator is a signal generator that delivers a choice of different waveforms with frequencies adjustable over a wide range. Function generators produce sine, triangle, square wave, saw-tooth waves, pulses, sweep, and modulation. Hewlett-Packard's function generators extend from a low frequency of 0.00005 Hz (HP 203A Option 002) up to a high frequency of 13 MHz (HP 3312A).

Basic requirements

In selecting an oscillator or function generator, the user will be most interested in its frequency coverage. The question to be answered here is, "Will the instrument supply both the lowest and highest frequencies of interest for anticipated tests?" As shown in Table 1, Hewlett-Packard manufactures a broad range of oscillators and function generators covering the frequency spectrum from 0.00005 Hz to 13 MHz.

The user's next concern will be with available output power or voltage. Some tests require large amounts of power, while others merely require sufficient voltage output. For almost any application, there is a Hewlett-Packard oscillator capable of delivering desired voltage output into a high-impedance load or of supplying desired power into lower impedance loads.

Besides frequency range and power output, the user will be interested in instrument stability, its dial resolution, and the amount of harmonic distortion, hum and noise in the output signal, and functions available. See Table 1 for a comparison of Hewlett-Packard oscillators and function generators.

Frequency stability

Frequency stability of an oscillator determines the ability of the instrument to maintain a selected frequency over a period of time. Component aging, power-supply variations and temperature changes all affect stability. Carefully chosen components, such as precision resistors and variable capacitors in the frequency-determining networks, contribute to long-term stability.

Amplitude stability

Amplitude stability is important in certain

FUNCTIONS					FREQUENCY RANGE												POWER OUTPUT	INST.	PAGE
~	∩	∩	∩	∩	0.1 mHz	1 mHz	10 Hz	100 Hz	1 kHz	10 kHz	100 kHz	1 MHz	10 MHz						
●																3 W	201C	306	
●	●	●	●	●												1.1 W	3310A/B	313	
●	●	●	●	●												250 mW	3312A**	312	
●	●	●	●													200 mW	3311A	311	
●																200 mW	651B/652A 654A	309	
●																160 mW	200CD	306	
●																160 mW	4204A	308	
●	●															40 mW	203A*	310	
●	●															40 mW	203A* (Opt. 002)	310	
●	●															40 mW	209A	307	
●																20 mW	653A	***	
●																20 mW	3320A/B	316, 317	
●																10 mW	236A	499	
●																10 mW	204C	307	

* Four outputs; two variable phase

**Two Generators. AM, FM, Sweep, Trigger/Gate

***See data sheet

Table 1. Functions, frequency range and power output of Hewlett-Packard oscillators and function generators.

oscillator applications. Amplitude stability is inherent in the Hewlett-Packard RC oscillator circuit because of large negative feedback factor and amplitude stabilizing techniques. "Frequency response," or amplitude variation as frequency is changed, is of special interest when the oscillator is used for response measurements throughout a wide range of frequencies.

Distortion

Distortion in the oscillator's output signal is an inverse measure of the purity of the oscillator's waveform. Distortion is undesirable in that a harmonic of the test signal may feed through the circuits under test, generating a false indication at the output. If the oscillator is used for distortion measurements, the amount of distortion that it contributes to measurements should be far less than that contributed by the circuits under test.

Hum and noise

Hum and noise can be introduced at a variety of points in oscillator circuits; but when the circuit operates at a relatively high level, the amount of hum and noise introduced into the device under test is usually negligible. Hum and noise introduced by a power am-

plifier usually remain constant as output signal amplitude is diminished. Hence, even though hum and noise power may be quite small compared to rated output, these spurious signals sometimes become a significant portion of low-level output signals. To overcome such a limitation, many Hewlett-Packard oscillators have their amplitude control on the output side of the power amplifier so that hum and noise are reduced proportionally with the signal when low-level signals are desired for test purposes.

Function generators

The function generator is a versatile multi-waveform signal source capable of very wide frequency coverage. Available functions range from variable phase offset (203A) to modulation (3310A/B, 3311A, 3312A) to sweep and triggered/gated waveforms (3310A/B, 3312A). The function generator is an indispensable general purpose signal source for production testing, instrument repair, and the electronics laboratory. Diverse fields of applications in which the function generator is being used include medical research, education, chemical, communications, geo-physics, industrial control, military, and aerospace.

OSCILLATORS & FUNCTION GENERATORS

5 Hz to 600 kHz audio oscillators

Models 200CD, 200CD Opt: H20, & 201C



200CD



201C

Description

These Hewlett-Packard oscillators have high stability and accurate, easily resettable tuning circuits. Low-impedance operating levels, together with superior insulation, guarantee peak performance throughout years of trouble-free service. The instruments have a wide frequency range and long dial lengths and feature an improved vernier frequency control.

Accessories available:

11000A Cable Assembly
11001A Cable Assembly
11004A Line Matching Transformer
11005A Line Matching Transformer

Price

\$17
\$17
\$81
\$112

Specifications

	200CD	201C
Frequency Range	5 Hz to 600 kHz	20 Hz to 20 kHz
Number of Ranges	5 overlapping	3 overlapping
Dial Accuracy	±2%	±1%
Frequency Response	±1 dB (1 kHz ref)	±1 dB (1 kHz ref)
Output (into 600Ω load)	>160 mW (10 V) Opt. H20, 93 mW (7.5 V)	3 W (42.5 V)
Output Impedance	600Ω	600Ω ±10%, 20, 30 and 40 dB settings <600Ω, 0 dB and 10 dB settings
Output Balance	Balance and floating better than 0.1% at lower frequencies and approx. 1% at higher frequencies	One terminal at ground potential
Distortion	0.2%, 20 Hz to 200 kHz 0.5%, 5 Hz to 20 Hz and 200 kHz to 600 kHz Opt. H20: 0.06%, 60 Hz to 50 kHz 0.1%, 20 Hz to 60 Hz and 50 kHz to 400 kHz 0.5%, 5 Hz to 20 Hz and 400 kHz to 600 kHz	<0.5% 50 Hz to 20 kHz at 1 W <1%, 20 Hz to 20 kHz at 3 W
Hum and Noise	<0.1% of rated output	<0.03% of rated output
Attenuator	Bridged "T"	0 to 40 dB in 10 dB steps, coarse and fine controls
Input Power	115 or 230 V, 50 to 1000 Hz, 90 VA	115 or 230 V, 50 to 400 Hz, 75 VA
Weight (kg)	Net: 9.9 kg (22 lb) Shipping: 10.8 kg (24 lb)	Net: 7.2 kg (16 lb) Shipping: 8.6 (19 lb)
W × H × D Dimensions	187 mm × 292 mm × 365 mm (7½" × 11½" × 14½")	191 mm × 292 mm × 318 mm (7½" × 11½" × 12½")
Price	200CD: \$550. Opt. H20: add \$75.	201C: \$525

OSCILLATORS & FUNCTION GENERATORS

4 Hz to 2 MHz sine, square wave oscillators

Models 209A, 204C & 204D



209A



204C



204D

Description

The HP 209A is a small, lightweight, sine/square oscillator. Stable, accurate signals can be synchronized with an external source over a frequency range from 4 Hz to 2 MHz. Separately adjustable sine/square outputs are located on the front panel. Distortion and flatness can be minimized at low frequencies by a rear panel low distortion mode switch.

The HP 204C is a small, lightweight capacitive-tuned oscillator. Interchangeable power packs, line, rechargeable batteries or mercury batteries make this instrument ideal for both field and laboratory use.

The HP 204D Oscillator is identical to the 204C with the addition of an 80 dB attenuator and vernier. The attenuator with the vernier provides excellent output amplitude settability.

209A Specifications

Frequency: 4 Hz to 2 MHz in 6 ranges.

Dial accuracy: $\pm 3\%$ of frequency setting.

Flatness: at maximum output into 600 Ω load, 1 kHz reference.

	4	100	300 k	1 M	2 M (Hz)
Low distortion mode	+1%	$\pm 0.5\%$	$\pm 1\%$	$\pm 5\%$	
Normal mode	+5%, -1%	$\pm 0.5\%$	$\pm 1\%$	$\pm 5\%$	

Distortion: 200 Hz to 200 kHz, 0.1% (-60 dB); 4 Hz to 200 Hz, <0.2% (-54 dB); 200 kHz-2 MHz, <1% (-40 dB).

Hum and noise: <0.01% of input.

Output characteristics sine wave

Output voltage: 5 V rms (40 mW) into 600 Ω ; 10 V open circuit.

Output impedance: 600 Ω .

Output control: >26 dB range continuously adjustable.

Output balance: >40 dB below 20 kHz. Output can be floated up to ± 500 V peak between output and chassis ground.

Output characteristics square wave

Output voltage: 20 V p-p open circuit symmetrical about 0 V. Output can be floated up to ± 500 V p.

Rise and fall time: <50 ns into 600 Ω . Symmetry: $\pm 5\%$.

Output impedance: 600 Ω .

Synchronization

Sync output: sine wave in phase with output; 1.7 V rms open circuit (high end affected by capacitive loads); impedance 10 k Ω .

Sync input: same as 204C.

204C Specifications

Frequency: 5 Hz to 1.2 MHz in 6 overlapping ranges.

Dial accuracy: $\pm 3\%$ of frequency setting.

Flatness: at maximum output into 600 Ω load, 1 kHz reference.

	5	100	300 k	1.2 M (Hz)
Low distortion mode	$\pm 1\%$	$\pm 0.5\%$	$\pm 1\%$	
Normal mode	+5%, -1%	$\pm 0.5\%$	$\pm 1\%$	

Distortion: 30 Hz to 100 kHz, 0.1% (-60 dB); 5 Hz to 30 Hz, <0.6% (-44 dB); 100 kHz-1.2 MHz, linearly derated to <1%.

Hum and noise: <0.01% of output.

Output characteristics

Output voltage: >2.5 V rms (10 mW or +10 dBm) into 600 Ω ; >5 V rms open circuit.

Output impedance: 600 Ω .

Output control: >40 dB range; continuously adjustable.

Output balance: >40 dB below 20 kHz. Can be floated up to ± 500 V peak between output and chassis ground.

Synchronization

Sync output: sine wave in phase with output; >100 mV rms into <100 pF over entire range; impedance 10 k Ω .

Sync input: oscillator can be synchronized to external signal. Sync range, the difference between sync frequency and set frequency, is a linear function of sync voltage. $\pm 1\%/V$ rms for sine wave with a maximum input of ± 7 V peak (± 5 V rms).

204D Specifications

(Identical to 204C except "output control" is replaced by the following):

Output attenuator

Range: 80 dB in 10 dB steps.

Overall accuracy: ± 0.3 dB, +10 dB through -60 dB ranges; ± 0.5 dB on -70 dB range.

Output vernier: >10 dB range, continuously adjustable.

General

Operating temperature: specifications are met from 0°C to 55°C.

Power: standard: ac-line 115 V or 230 V $\pm 10\%$, 48 Hz to 66 Hz, <7 VA max. Opt. 001: mercury batteries 300 hours operation. Opt. 002: line/rechargeable batteries 115 V or 230V $\pm 10\%$, 48 Hz to 66 Hz, <7 VA max, 35 hours operation per recharge.

Dimensions: 130 mm wide, 155 mm high (without removable feet), 203 mm deep (5 $\frac{1}{8}$ " \times 6 $\frac{1}{8}$ " \times 8").

Weight: net 2.7 kg (6 lb). Shipping, 3.6 kg (8 lb).

Options and accessories

	Price
Option 001, 204C/D (for mercury batteries)	add \$85
Option 002, 204C/D (for rechargeable batt/ac line)	add \$95
11137A Rechargeable battery/AC power pack for 204C/D	\$116
11075A Instrument case	\$115
5060 — 8762 Rack adapter frame	\$55

Model number and name

209A Sine, square wave oscillator	\$475
204C Sine wave oscillator	\$400
204D Sine wave oscillator	\$475

OSCILLATORS & FUNCTION GENERATORS

10 Hz to 1 MHz digital oscillator

Model 4204A

- 0.2% frequency accuracy
- Accurate 80 dB output attenuator
- 0.01% frequency repeatability
- Excellent stability
- Flat frequency response



Description

Hewlett-Packard's 4204A Digital Oscillator provides accurate, stable test signals for both laboratory and production work. This one instrument does the job of an audio oscillator, an ac voltmeter, and an electronic counter where an accurate frequency source of known amplitude is required.

Any frequency between 10.0 Hz and 999.9 kHz can be digitally selected with an in-line rotary switch, to four significant figures. As many as 36,900 discrete frequencies are available. Infinite resolution is provided by one vernier control, which also extends the upper frequency limit to 1 MHz. Frequency accuracy is better than $\pm 0.2\%$ and repeatability is typically better than $\pm 0.01\%$.

A built-in high impedance voltmeter measures output. The meter is calibrated to read volts or dBm into a matched 600 ohm load. (0 dBm = 1 mW into 600 ohms.) The output attenuator has an 80 dB range, adjustable in 10 dB steps with a 20 dB vernier. Maximum output power can be increased to 10 volts (22 dBm) into 600 ohms or 20 volts open circuit.

Frequency response is flat with less than $\pm 3\%$ variation over the entire frequency range at any attenuator setting. Frequency stability is better than 10 parts in 10^6 per minute.

Specifications

Frequency range: 10 Hz to 1 MHz, 4 ranges.

Frequency accuracy: $\pm 0.2\%$ or ± 0.1 Hz (at 25°C).

Frequency stability:

$\pm 10\%$ line voltage variation: less than $\pm 0.01\%$.

Change of frequency with temperature: $< \pm 100$ ppm/°C.

Drift: < 10 ppm/minute.

Frequency response: flat within $\pm 3\%$, 9,999 kHz ref. (25°C $\pm 5^\circ$ C).

Output: 10 V (22 dBm) into 600 ohms (160 mW). 20 V open circuit.

Output attenuator: 80 dB in 10 dB steps; $< \pm 0.5$ dB error.

Output monitor: voltmeter monitors level at input of attenuator in volts or dB.

Accuracy: $\pm 2\%$ of full scale.

Flatness: $\pm 1\%$ at full scale, 10 Hz to 500 kHz; $\pm 2\%$ at full scale, 500 kHz to 1 MHz.

Distortion: less than 0.3%, 30 Hz to 100 kHz. Less than 1%, 10 Hz to 600 kHz. Less than 1.2%, 10 Hz to 1 MHz.

Hum and noise: less than 0.05% of output.

Temperature range: 0°C to +50°C.

Power: 115 V/230 V switch, $\pm 10\%$, 10 VA, 50 to 60 Hz.

Weight: net, 8.5 kg (19 lb). Shipping, 11 kg (28 lb).

Dimensions: 141 mm high \times 426 mm wide \times 336 mm deep (5½" \times 16¾" \times 13¼").

Accessories available:

	Price
11000A Cable: dual banana plugs	\$17
11001A Cable: banana plug to BNC male connector	\$17
11004A Line Matching Transformer has a frequency response of 5 kHz to 600 kHz providing fully balanced outputs for 135 or 600 ohms	\$81
11005A Line Matching Transformer has a frequency response of 20 Hz to 45 kHz providing full balanced output into 600 ohms	\$112
16252A Matching Transformer has a frequency response of 10 kHz to 1 MHz providing unbalanced 75 ohm output, terminated in UG-657/U female BNC connector	Price on request

Options

Option 908: Rack Flange Kit add \$10

Model number and name

Option 001, 4204A Output Monitor top scale calibrated in dBm/600Ω. Bottom scale calibrated in volts	add \$25
4204A Digital Oscillator	\$1390

OSCILLATORS AND FUNCTION GENERATORS

10 Hz to 10 MHz test oscillators

Models 651B, 652A, 654A

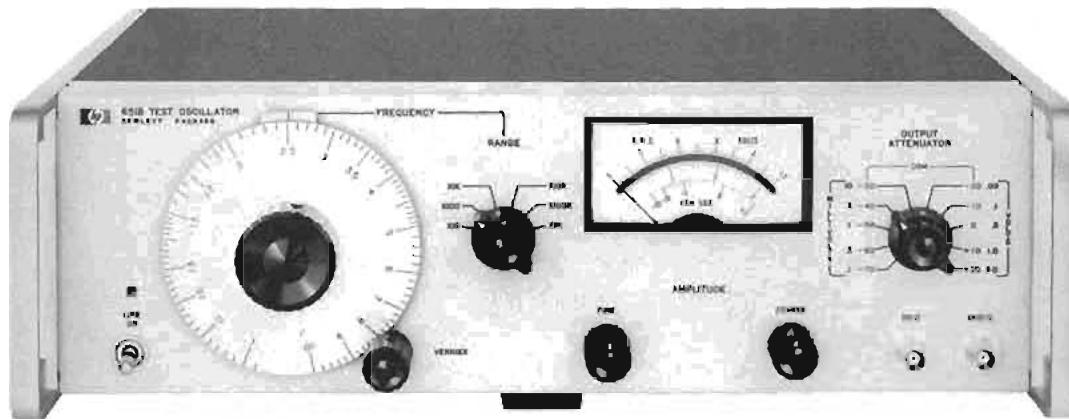

Specifications

MODEL NO.	651B	652A	654A
Description	Amplitude and frequency stability of this solid state capacitance-tuned test oscillator provides high quality signals for general purpose lab or production measurements.	Same as Model 651B, HP's Model 652A offers an expandable output monitor for amplitude control to 0.25% across its entire frequency band for greater output resolution and resellability.	Similar to the 651B Test Oscillator, HP's Model 654A has balanced outputs of 135Ω, 150Ω, and 600Ω. Automatic leveling over entire frequency range and expanded meter.
Frequency Range	10 Hz to 10 MHz, 6 bands.		
Frequency Accuracy	±2%, 100 Hz to 1 MHz; ±3%, 10 Hz to 100 Hz and 1 MHz to 10 MHz.		±2% 100 Hz to 5 MHz; ±3% 10 Hz to 100 Hz; ±4% 5 MHz to 10 MHz.
Frequency Response (Flatness)	±2%, 100 Hz to 1 MHz; ±3%, 10 Hz to 100 Hz; (±4%, 1 MHz to 10 MHz applies only at 50Ω or 75Ω output and amplitude readjusted to a reference on the output monitor.)	±0.25%, 3 V and 1 V range; ±0.75%, 0.3 V to 0.3 mV range; ±1.75%, 0.1 mV range. (Amplitude readjusted using expanded scale on output monitor)	(+10 dBm and 0 dBm) ±0.5% from 10 Hz to 10 MHz for unbalanced outputs and 10 Hz to 5 MHz for 135Ω and 150Ω outputs, and 10 Hz to 1 MHz for 600Ω output.
Distortion	<1%, 10 Hz to 2 MHz; <2%, 2 MHz to 5 MHz; <4%, 5 MHz to 10 MHz.		10 Hz to 1 MHz, >40 dB below fundamental; 1 MHz to 10 MHz, >34 dB below fundamental.
Output	3.16 V into 50Ω or 600Ω; 6.32 V open circuit. 0.1 mV to 3.16 V full scale, 10 steps in 1, 3, 10 sequence; -70 dBm to +23 dBm (50Ω output) full scale. 10 dBm per step; 20 dB coarse and fine adjustable amplitude control.		+11 dBm to -90 dBm, 10 dB and 1 dB steps with adjustable ±1 dB meter range, calibrated for each impedance of 50Ω and 75Ω unbalanced and 135Ω, 150Ω and 600Ω balanced.
Output Monitor (Monitor's Level at input of attenuator)	Top scale calibrated in volts, bottom scale in dB. Accuracy ±2% of full scale.	Same as 651B plus Expand Scale which expands reference voltage of the normal scale from 0.9 to 1.0 or 2.8 to 3.2.	±1 dBm full scale with 0.02 dB resolution, Accuracy ±0.05 dB.
Output* Connectors	BNC connectors.		
Attenuator	90 dB range in 10 dB steps: ±0.075 dB, -60 dBm to +20 dBm; ±0.2 dB, -70 dBm to -60 dBm.		99 dB range in 10 dB and 1 dB steps; ±1.5% (0.15 dB) except ±10% (1 dB) at output levels below 60 dBm at frequencies >300 kHz.
Temperature Range	0°C to +55°C (32°F to 130°F).		
Power	115 V or 230 V ±10%, 48 Hz to 66 Hz, 30 VA max.		115 V or 230 V ±10%, 50 Hz to 66 Hz, 35 VA max.
Weight	Net, 7.6 kg (17 lb). Shipping, 9.90 kg (22 lb).		Net, 9.4 kg (21 lb). Shipping, 11.8 kg (26 lb).
Dimensions	425 mm wide × 133 mm high × 286 mm deep (16½" × 5½" × 11¼").		
PRICE	\$870	\$1010	\$1195

*Maximum dc voltage that can be applied to output: <±3 V d.

OSCILLATORS & FUNCTION GENERATORS

0.00005 Hz to 60 kHz Variable-phase function generator

Model 203A

- Ultra low frequency
- Four simultaneous outputs
- Continuously adjustable phase shift
- Low distortion

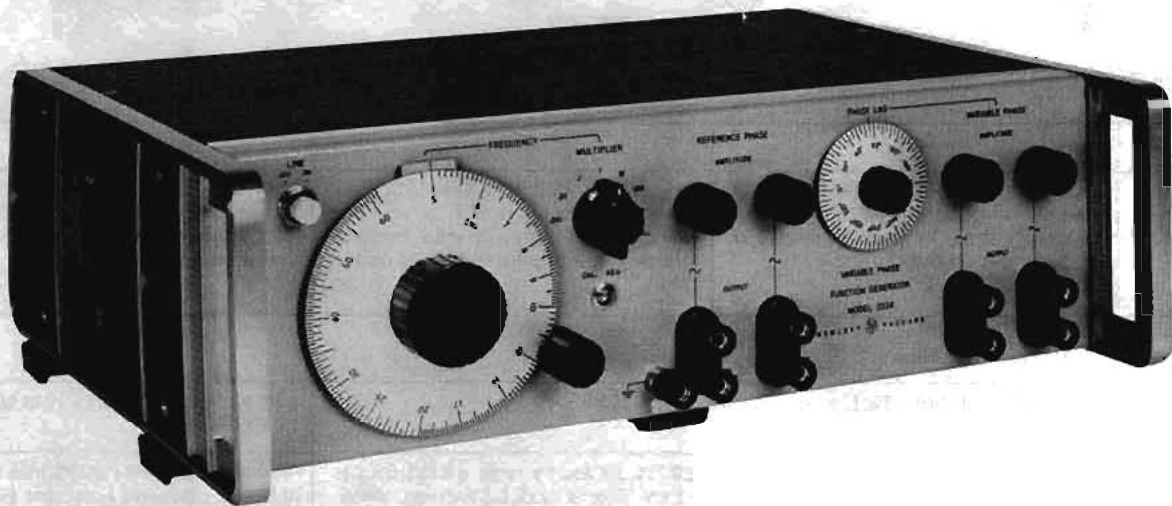

Description

HP's solid-state 203A Variable Phase Function Generator provides two transient-free square and low-distortion sinusoidal test signals particularly useful for a wide variety of low-frequency applications. Field and laboratory testing of servo, geophysical, medical and high-quality audio equipment becomes practical when using the 203A.

HP's 203A frequency range of 0.005 Hz to 60 kHz is covered in seven overlapping bands (two additional ranges available on special order offering frequency range to 0.00005 Hz). Accurate $\pm 1\%$ frequency setting is provided by 180 dial divisions. A vernier drive allows precise adjustment.

HP's 203A provides a maximum output voltage of 30 V peak-to-peak for all waveforms. Sinusoidal signals have less than 0.06% distortion and provide virtually transient-free outputs when frequency and operating conditions are varied rapidly. Four output circuits of the 203A have individual 40 dB continuously variable attenuators.

Outputs consist of a reference sine and square wave, and a variable-phase sine and square wave. Both sine-and-square-wave outputs are electrically identical except that one sine-and-square-wave output contains a 0-to-360 degree phase-shifter. These four signals (two reference phase and two variable phase) are available simultaneously from the 203A. The output system is floating with respect to ground and may be used to supply an output voltage that is terminal grounded, or may be floated up to 500 volts dc above chassis ground. Output impedance is 600 ohms for all outputs.

Specifications

Frequency range: 0.005 Hz to 60 kHz in seven decade ranges.*

Dial accuracy: $\pm 1\%$ of reading.

Frequency stability: within $\pm 1\%$ including warmup drift and line voltage variations of $\pm 10\%$.

Output waveforms: sine and square waves are available simultaneously; all outputs have common chassis terminal.

Reference phase: sine wave, 0 to 30 V peak-to-peak; square wave, 0 to 30 V peak-to-peak (open circuit).

Variable phase: sine wave, 0 to 30 V peak-to-peak; square wave, 0 to 30 V peak-to-peak; continuously variable, 0 to 360°; phase dial accuracy, $\pm 5^\circ$ sine wave, $\pm 10^\circ$ square wave (open circuit).

Output impedance: 600 ohms.

Output power: 5 volts into 600 ohms (40 mW); 40 dB continuously variable attenuation on all outputs.

Distortion: total harmonic distortion hum and noise > 64 dB below fundamental ($< 0.06\%$) at full output.

Output system: direct-coupled output is isolated from ground and may be operated floating up to 500 V dc.

Frequency response: $\pm 1\%$ referenced to 1 kHz.

Square wave response: rise and fall time, < 200 ns; overshoot, $< 5\%$ at full output.

Power: 115 or 230 V $\pm 10\%$, 50 to 66 Hz, 27.5 VA max.

Dimensions: cabinet: 425 mm wide \times 133 mm high \times 286 mm deep (16 1/2" \times 5 1/4" \times 11 1/4").

Weight: net, 9.17 kg (20 lb 4 oz). Shipping, 12.6 kg (28 lb).

Model number and name

Option 001, 0.0005 Hz

Option 002, 0.00005 Hz

203A, Variable Phase Function Generator

Price

add \$89

add \$270

\$2145

*Two lower ranges of 0.0005 Hz (Option 001) and 0.00005 Hz (Option 002) are available on special order



Description

The 3311A Function Generator offers wide functional capability at a modest price. This compact unit has seven decades of range from 0.1 Hz to 1 MHz. Pushbutton range and function selection add convenience to versatility. Added features normally not found on function generators in this price range are 10:1 voltage control and a separate pulse output suitable for synchronization or driving TTL logic circuits.

Output

Ten V p-p into 600Ω (20 V p-p O.C.). This output may be attenuated by >30 dB by a variable attenuator and offset by ±5 V. The dc offset allows the sine, square, and triangle functions to be positioned to the most desired level. This feature adds to the usefulness of all three functions.

VCO

The dc coupled voltage control allows the use of an external source to sweep the 3311A >10:1 in frequency.

A separate TTL compatible pulse output provides current sinking for up to 20 TTL loads. The pulse has a 15/85 aspect ratio with a <25 ns rise time.

Specifications

Waveforms: sinusoid, square, triangle, and positive pulse.

Frequency range: 0.1 Hz to 1 MHz in seven decade ranges.

Dial accuracy: ±5% of full scale.

Isolation: using an external supply, outputs may be floated up to ±500 V relative to the instrument case (earth ground).

600 Ohm output

Maximum output amplitude: 20 V p-p open circuit; 10 V p-p into 600 Ω.

Amplitude control: continuously variable, >30 dB range. DC offset: up to ±10 V open circuit, ±5 V into 600Ω, continuously adjust-

able and independent of amplitude control. Maximum V_{ac} peak + V_{dc} offset without clipping is ±10 V open circuit, ±5 V into 600Ω.

Output impedance: 600Ω ±10%.

Sine wave amplitude flatness: within ±3% of 10 kHz reference (maximum output amplitude) to 100 kHz, ±6% to 1 Hz.

Sine wave total harmonic distortion: <3% (maximum output amplitude).

Triangle linearity: deviation <1% from best straight line at 100 Hz (maximum output amplitude).

Square wave transition time: rise time: <100 ns; fall time: <100 ns.

Square wave time axis symmetry error: ±2% maximum to 100 kHz.

Pulse output

Output amplitude: >3 V positive (open circuit) TTL compatible.

Duty cycle: 13.5% to 16.5% of the total period.

Transition times: <25 ns.

External frequency control

VCO range: >10:1 on any frequency range.

Input requirement: with frequency dial set to 1.0, a linear ramp of 0.0 V to -10 V ±2 V will linearly increase frequency >10:1.

Input impedance: 10 kΩ ±10%.

General

Operating temperature: 0-55°C; specifications apply from +15°C to +35°C.

Storage temperature: -40°C to +75°C.

Power: 100/120/220/240 V -10%, +5% switchable; 48 Hz to 66 Hz; ≤12 VA.

Dimensions: 89 mm high × 160 mm wide × 248 mm deep (3½" × 6¼" × 9¾").

Weight: net, 1.5 kg (3½ lb); shipping, 2.5 kg (5½ lb).

3311A Function Generator

\$295

OSCILLATORS & FUNCTION GENERATORS

Function generator

Model 3312A

- AM, FM, sweep, trigger, gate and burst

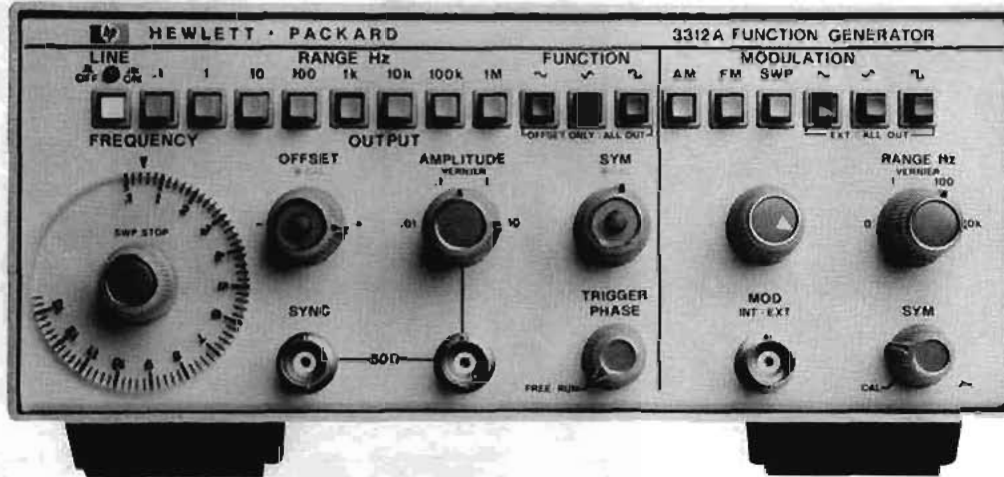

Description

Hewlett-Packard's 3312A Function Generator combines two separate, independent function generators with a modulator section in one compact instrument.

The main generator can—via pushbutton control—be triggered by the modulation generator to provide sweep functions, AM, FM, FSK, or tone burst.

Ten V p-p into 50 Ω provides adequate power for most applications. The output attenuator has a range of more than 10,000:1 so clean low-level signals from 10 V to 1 mV p-p into 50 Ω can be obtained.

The main generator includes dc offset up to 10 volts p-p into 50 Ω .

Hewlett-Packard's 3312A is an effective low cost solution for generating a multitude of functions.

3312A Specifications

Output waveforms: sine, square, triangle, \pm ramp, pulse, AM, FM, sweep, trigger and gate.

Frequency characteristics

Range: 0.1 Hz to 13 MHz in 8 decade ranges.

Dial accuracy: $\pm 5\%$ of full scale.

Square wave rise or fall time (10% to 90%): <18 nsec.

Aberrations: <10%.

Triangle linearity error: <1% at 100 Hz.

Variable symmetry: 80:20:80 to 1 MHz.

Sine wave distortion: <0.5% THD from 10 Hz to 50 kHz. >30 dB below fundamental from 50 kHz to 13 MHz.

Output characteristics

Impedance: 50 Ω \pm 10%.

Level: 20 V p-p into open circuit, 10 V p-p into 50 Ω .

Level flatness (sine wave): < $\pm 3\%$ from 10 Hz to 100 kHz at full rated output (1 kHz reference). < $\pm 10\%$ from 100 kHz to 10 MHz.

Attenuator: 1:1, 10:1, 100:1, 1000:1 and >10:1 continuous control; **Attenuator error:** <5%.

Sync output: impedance: 50 Ω \pm 10%, >1 V p-p square wave into open circuit. Duty cycle varies with symmetry control.

DC offset: ± 10 volts, continuously adjustable, independent of variable attenuator setting. Instantaneous ac voltage + Vdc offset must be between ± 10 V (not terminated) or ± 5 V (terminated with 50 Ω) in the 1:1 attenuator position.

Modulation characteristics

Types: internal AM, FM, sweep, trigger, gate or burst; external AM, FM, sweep, trigger, gate or burst.

Waveforms: sine, square, triangle, ramp or pulse variable symmetry.

Frequency range: 0.01 Hz to 10 kHz.

Output level: >1.0 V p-p into 10 k Ω .

Amplitude modulation

Depth: 0 to 100%.

Modulation frequency: 0.01 Hz to 10 kHz (internal). DC to >1 MHz (external).

Carrier 3 dB bandwidth: <100 Hz to >5 MHz.

Carrier envelope distortion: <2% at 70% sine wave modulation with $f_c = 1$ MHz, $f_m = 1$ kHz.

External sensitivity: <10 V p-p for 100% modulation.

Frequency modulation

Deviation: 0 to $\pm 5\%$ (internal).

Modulation frequency: internal: 0.01 Hz to 10 kHz; external: DC to >50 kHz.

Distortion: <-35 dB at $f_c = 10$ MHz, $f_m = 1$ kHz, 10% modulation.

Sweep characteristics

Sweep width: >100:1 on any range.

Sweep rate: 0.01 Hz to 100 Hz, 90:10 ramp, and 0 Hz (provides manual setting of "Sweep Start" without modulation generator oscillating).

Sweep mode: repetitive linear sweep between start and stop frequency settings. Retrace time can be increased with symmetry control.

Ramp output: 0 to >-4 p-p into 5 k Ω .

Gate characteristics: start/stop phase range: +90° to -80°.

Frequency range: 0.1 Hz to 1 MHz (useful to 10 MHz).

Gating signal frequency range (external): DC to 1 MHz, TTL compatible.

External frequency control

Range: 1000:1 on any range.

Input requirement: with dial set at 10, 0 to -2 V $\pm 20\%$ will linearly decrease frequency >1000:1. An ac voltage will FM the frequency about a dial setting within the limits $(0.1 < f < 10) \times$ range setting.

Linearity: ratio of output frequency to input voltage ($\Delta f/\Delta V$) will be linear within 0.5% over a 100:1 frequency range.

Input impedance: 2.8 k Ω $\pm 5\%$.

General

Operating temperature: 0°C to +50°C; specifications apply from 0°C to 40°C.

Storage temperature: -40°C to +75°C.

Power: 100 V, 120 V, 220 V, 240 V +5%, -10%, switchable; 48 Hz to 66 Hz; ≤ 25 VA.

Dimensions: 102 mm high \times 213 mm wide \times 377 mm deep (4" \times 8 1/2" \times 14 1/2").

Weight: net, 3.8 kg (8 lbs, 6 oz). Shipping, 5.9 kg (13 lbs).

3312A Function Generator

\$900

OSCILLATORS & FUNCTION GENERATORS



0.0005 Hz to 5 MHz function generators
Model 3310A/B

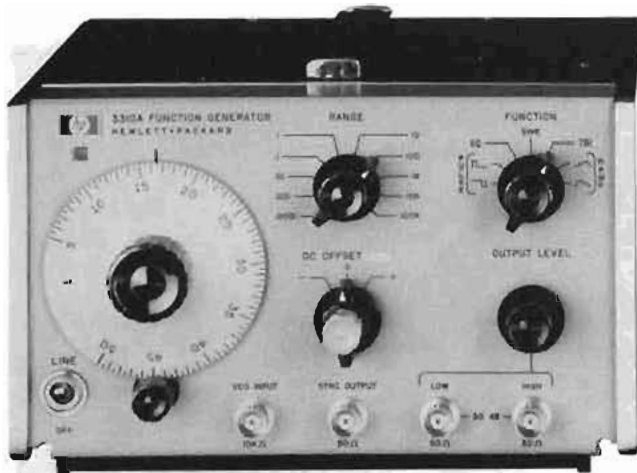

3310A

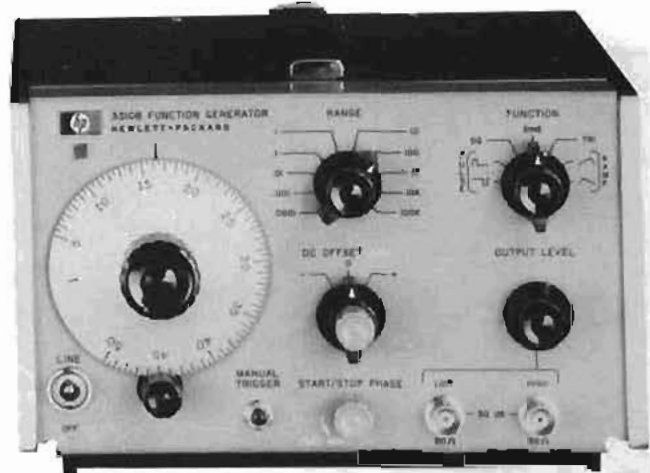

3310B

Description

The 3310A Function Generator is a compact voltage-controlled generator with 10 decades of range. Ramp and pulse functions are available in addition to sine, square and triangle. DC offset and external voltage control provide wide versatility. A fast rise time sync output is provided. Aspect ratio of nonsymmetrical function is 15%/85%.

The 3310B has all the features of the standard 3310A plus single and multiple cycle output capability.

3310A Specifications

Output waveforms: sinusoidal, square, triangle, positive pulse, negative pulse, positive ramp and negative ramp. Pulses and ramps have a 15% or 85% duty cycle.

Frequency range: 0.0005 Hz to 5 MHz in 10 decade ranges.

Sine wave frequency response

0.0005 Hz to 50 kHz: $\pm 1\%$; 50 kHz to 5 MHz: $\pm 4\%$. Reference, 1 kHz at full amplitude into 50 Ω .

Dial accuracy

0.0005 Hz to 500 kHz all functions: $\pm(1\%$ of setting + 1% of full scale).

500 kHz to 5 MHz sine, square and triangle: $\pm(3\%$ of setting + 3% of full scale).

500 kHz to 5 MHz pulse and ramps: $\pm(10\%$ of setting + 1% of full scale).

Maximum output on high: >30 V p-p open circuit; >15 V p-p into 50 Ω (except for pulses at frequency >2 MHz).

Pulse (frequency >2 MHz): >24 V p-p open circuit; >12 V p-p into 50 Ω .

Minimum output on low: <30 mV p-p open circuit; <15 mV p-p into 50 Ω .

Output level control: range >30 dB. High and low outputs overlap for a total range of >60 dB; low output is 30 dB down from high output.

Sine wave distortion

0.0005 Hz to 10 Hz: >40 dB (1%).

10 Hz to 50 kHz (on 1 k range): >46 dB (0.5%)

50 kHz to 500 kHz: >40 dB (1%).

500 kHz to 5 MHz: >30 dB (3%).

Square wave and pulse response: <30 ns rise and fall times at full output.

Triangle and ramp linearity: 0.0005 Hz to 50 kHz, <1%.

Impedance: 50 Ω .

Sync

Amplitude: >4 V p-p open circuit, >2 V p-p into 50 Ω .

DC offset

Amplitude: ± 10 V open circuit, ± 5 V into 50 Ω (adjustable).

Note: max V ac p + V dc offset is ± 15 V open circuit.

External frequency control: 50:1 on any range.

Input requirement: with dial set to low end mark, a positive ramp of 0 to +10 V ± 1 V will linearly increase frequency 50:1. With dial set at 50, a linear negative ramp of 0 to -10 V ± 1 V will linearly decrease frequency 50:1. An ac voltage will FM the frequency about a dial setting within the limits $(1 < f < 50) \times$ range setting.

Linearity: ratio of output frequency to input voltage ($\Delta F/\Delta V$) will be linear within 0.5%.

Sensitivity: approximately 100 mV/minor division.

Input impedance: 10 k Ω .

General

Power: 115 V or 230 V $\pm 10\%$, 48 Hz to 440 Hz, <20 VA max.

Dimensions: 197 mm wide, 114 mm high (without removable feet), 203 mm deep (7 $\frac{3}{4}$ " \times 4 $\frac{1}{2}$ " \times 8").

Weight: net, 2.7 kg (6 lb); shipping, 4.5 kg (10 lb).

Accessories available

HP Part No. 5060-8540 filler strip for use with HP 1051A Combining Case or HP 5060-8762 Rack Adapter Frame.

3310B Specifications

Same as 3310A with the following additions:

Modes of operation: free run, single cycle, multiple cycle.

Frequency range: 0.0005 Hz to 50 kHz (usable to 5 MHz).

Single cycle:** ext trigger (ac coupled) requires a positive-going square wave or pulse from 1 V p-p to 10 V p-p. The triggering signal can be dc offset, but $(V_{ac\ peak} + V_{dc}) \leq \pm 10$ V ext gate (dc coupled) will trigger a single cycle on any positive waveform ≥ 1 V but ≤ 10 V which has a period greater than the period of the 3310B output, and a duty cycle less than the period of the 3310B output. The gate signal cannot exceed 10 V.

Multiple cycle:** manual trigger will cause the 3310B to free run when depressed. When the trigger button is released, the waveform will stop on the same phase as it started. Ext gate will cause the 3310B to free run when the gate is held at between +1 and +10 V. When the gate signal goes to zero, the 3310B will stop on the same phase as it started.

Start-stop phase: The start-stop phase can be adjusted over a range of approximately $\pm 90^\circ$.

Model numbers and prices:

3310A Function Generator

3310B Function Generator

Price

\$735

\$850

**This specification applies on the X.0001 to X1 k range only.

FREQUENCY SYNTHESIZERS

General information



Hewlett-Packard frequency synthesizers translate the stable frequency of a precision frequency standard to one of thousands or even billions of frequencies over a broad spectrum that extends from dc to 2600 MHz. The table below highlights HP's complete line of frequency synthesizers.

HP Model	Frequency Range	Frequency Resolution	Frequency Stability	Level Range dBm - 50Ω	Level Resolution	Remote Control	Other Features*
3320A (Pg. 316)	DC - 13 MHz 5 ranges	0.01 Hz to 10 kHz (4 digits)	10 ⁻⁷ /day	0 to +13	¼ turn Vernier	Freq.	1
3320B (Pg. 316)	DC - 13 MHz 5 ranges	0.01 Hz to 10 kHz (4 digits)	10 ⁻⁷ /day	-73 to +27	0.01 dB (4 digits)	Freq. & Ampl.	1, 8
3320C (Pg. 506)	10 kHz to 17 MHz	10 kHz (20 Hz with Vernier in)	10 ⁻⁷ /day	-79.99 to +11.99	0.01 dB (4 digits)	-	1
3330B (Pg. 318)	DC - 13 MHz	0.1 Hz (9 digits)	10 ⁻⁸ /day	-87 to +13	0.01 dB (4 digits)	Freq. & Ampl.	2, 3, 4, 6, 8
8660A/C** (Pg. 328)	10 kHz to 2600 MHz (3 plug-ins)	1 Hz or 2 Hz (10 digits)	3 × 10 ⁻⁸ /day	-146 to +13	1 dB steps plus Vernier	Freq., Ampl. & Modulation	A/C: 5, 7, 8 C: 3
8671A (Pg. 334)	2 to 6.2 GHz	1 kHz	5 × 10 ⁻¹⁰ /day	> +8	-	Freq., FM Modulation	8, 9
8672A** (Pg. 332)	2 to 18 GHz	1, 2, 3 kHz	5 × 10 ⁻¹⁰ /day	-120 to +3	1 dB steps plus Vernier	Freq., Ampl. & Modulation	8, 10

* Other features: (1) 10⁻⁸/day freq. stability optional, (2) 10⁻⁹/day freq. stability optional, (3) digital freq. sweep, (4) digital ampl. sweep, (5) internal AM/FM, AM, (6) external AM, (7) 3 × 10⁻⁹/day stability Opt. 001, (8) HP-1B, (9) External FM, (10) External AM & FM.

** The 8660A/C and 8672A are synthesized signal generators. They are discussed in detail in the section labeled "Signal Generators."

General information

Today's measurement needs are placing increasingly stringent requirements on signal sources for greater frequency resolution and stability. Radio astronomy, secure communications, narrowband component testing, satellite and terrestrial communications, local oscillator and automatic test systems are only a few of the many applications that continually require better and better signal sources.

Increased amplitude accuracy and resolution are also must requirements in many applications. The telecommunication industry's Frequency Division Multiplex (FDM) systems require high amplitude accuracy and resolution (0.01 dB) as well as high frequency resolution and stability. These amplitude capabilities are also finding their place in many R&D and production test situations.

The answer to these requirements has been the frequency synthesizer. With technology producing continuing cost reductions in synthesis techniques, the synthesizer is finding use as a precision oscillator and signal generator as well as the more traditional uses as a synthesizer.

Frequency synthesizer definition

A frequency synthesizer is an instrument that translates the frequency stability of a single reference frequency to any one of many other desired frequencies. This definition of a synthesizer distinguishes it from the oscillator or signal generator which derives its frequency from a tuned circuit or resonant cavity. The desired output frequency of these types of sources is produced directly by adjusting the values of oscillator components. The stability and resolution of these sources are limited by these components. However, the synthesizer's output frequency is synthesized or created by some type of arithmetic operation on the basic frequency reference as shown in the synthesizer model below.



As the model above shows, any desired frequency can be obtained by selecting the appropriate values for m and n. The frequency reference in the above model is in many cases an internal crystal, either ambient temperature or oven stabilized, while in other cases the reference is an external standard such as a crystal, rubidium gas cell or cesium beam.

Frequency generation

Synthesizers employ two general methods of generating the output frequency — direct and indirect synthesis. In the direct synthesis method, a series of arithmetic operations (multiplying, dividing, mixing) is performed on the reference to achieve the desired output frequency. High switching speed (microseconds) is the primary advantage of direct synthesizers.

Hewlett Packard synthesizers use the indirect synthesis method which derives its output frequency from one or more voltage tuned oscillators (VTO). The stability of the synthesizer comes from phase-locking the VTOs to the reference frequency or a harmonic of the reference via a phase-lock loop (PLL). The VTO outputs are then combined to achieve the desired output frequency. The primary advantage of the indirect method is lower cost.

Signal quality

The common specifications which describe signal sources include frequency range and resolution, amplitude range and resolution, distortion and stability. These, plus several additional parameters must be considered when comparing synthesizers. The two primary additional specifications pertinent to the synthesizer are phase noise and spurious content.

Phase noise

Phase noise describes the short term frequency stability of a signal source. Internal short-term frequency fluctuations inherent in the signal source will produce phase modulation sidebands about the nominal frequency. Phase noise is a measure of the magnitude of these sidebands. There are two common methods of specifying phase noise — a sideband plot and integrated phase noise.

The first method expresses phase noise as the ratio of the power in one phase noise sideband per hertz of bandwidth to the total signal power. A sideband plot of the phase noise graphically displays the magnitude and frequency components (spectral density) of the phase noise.

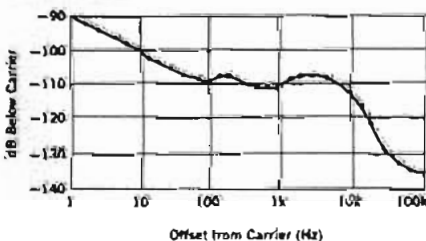

Typical single-sideband phase noise measured at output of Model 3330B Automatic Synthesizer in 1-Hz bandwidth with instrument operating at 12 MHz.

The second method, integrated phase noise, is the ratio of the rms value of the total phase noise sidebands in a 30 kHz bandwidth around the carrier (excluding ±1 Hz) to the power of the carrier.

For a detailed treatment of the subject of phase noise and practical methods of measuring it, refer to Application Note #207.

Spurious signals

Spurious signals are discrete non-harmonically related signals appearing in the output. The spurious output specification is the maximum level, in dB below the carrier, of any spurious signal.

Hewlett-Packard synthesizers

Hewlett-Packard offers a wide range of high quality frequency synthesizers covering the frequency range of DC to 18 GHz. In addition to being high performance synthesizers, they incorporate many additional features which allow them to fulfill the needs for either bench or programmable precision signal sources or as versatile programmable signal generators.

Precise level control

Precision amplitude capability consisting of 100 dB amplitude range, 0.05 dB flatness, and 0.01 dB resolution allow the 3320B/C and 3330B to perform as precision level generators as well as synthesizers. Precise level control using a True-RMS leveling loop eliminates the need for external leveling and level monitoring.

Level control

The 8660A/C uses several interchangeable plug-ins to provide output flexibility including a wide range attenuator and exceptionally flat frequency response across the full 2 to 18 GHz range.

Synthesized signal generator

The HP 8660A/C and 8672A synthesized signal generators cover the range of 10 kHz to 18 GHz. These instruments combine synthesizer accuracy and stability and HP-IB programmability along with the precise modulation and output level calibration of a high quality signal generator. For complete details on these and other signal generators, please refer to the "Signal Generators" section.

Synthesized level generator

The HP 3320C is a synthesized level generator covering the range of 10 kHz to 17 MHz. Balanced outputs, telecommunication output impedances and special connectors make this instrument ideal for the telecommunications industry as a stand-alone generator with synthesizer stability or as a companion generator for a selective level meter. For detailed information on this generator, refer to the "Telecommunications" section.

Digital sweep

The 3330B and 8660C are among the most linear sweepers ever built. Keyboard control of the built-in microprocessor gives both instruments digital sweep (a point-by-point sweep with frequency synthesizer accuracy).

The 3330B also offers digital amplitude sweeps. Amplitude can be swept in increments as small as 0.01 dB to test level-sensitive circuits like voltage-controlled oscillators and automatic gain control loops.

Programmability (HP-IB)

The 3320B, 8660A, C, 8671A, 8672A are programmable via the Hewlett-Packard Interface Bus (HP-IB), a fully isolated bit-parallel, character-serial interface. Multiple signal sources interfaced to the same interface bus each may be independently programmed for different functions or frequencies.

FREQUENCY SYNTHESIZERS

.01 Hz to 13 MHz frequency synthesizer

Models 3320A & 3320B

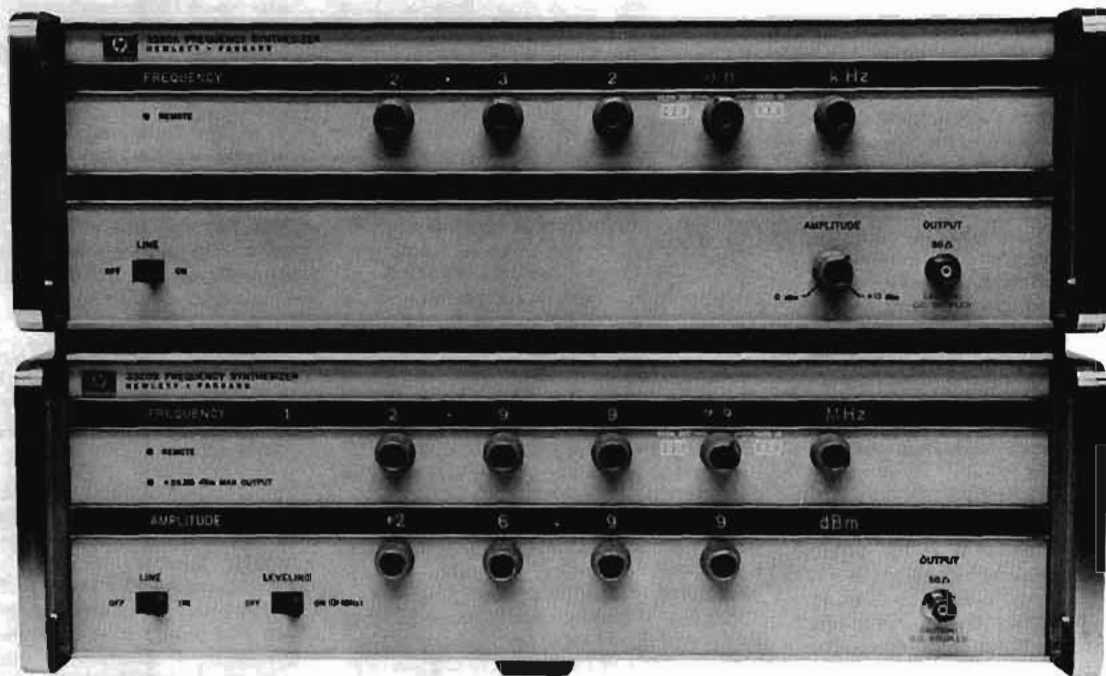

HP-IB

Description

The 3320A/B Frequency Synthesizer has the frequency accuracy, stability, and resolution demanded by many of today's exacting applications. The ease and flexibility of adding greater stability means the 3320A/B can be tailored to your needs as they emerge. Spectral purity and low signal-to-phase noise complement the frequency qualities of the 3320A/B.

The 3320B is more than a synthesizer. It offers precise level control, superior frequency response, low harmonic distortion and high power output.

Two choices of digital remote control afford great flexibility for today's system applications. High precision in both frequency and amplitude means that expensive system monitoring is unnecessary.

Frequency

The 3320A/B Frequency Synthesizer has a broad frequency range of 0.01 Hz to 13 MHz in seven frequency ranges.

Three digits plus a ten-turn two-digit continuous vernier, plus 30% overrange capability, gives the 3320A/B one part in 10^6 frequency resolution across its total frequency range.

Amplitude

The 3320A has a maximum one volt rms into 50 ohms output (+13 dBm) with a continuous +13 dBm to 0 dBm amplitude vernier.

The 3320B features a four-digit leveling loop with a 0.01 dB level

resolution of a calibrated output from +26.99 dBm to -69.99 dBm (-73.00 dBm under remote control).

Frequency response of ± 0.05 dB over the range of 10 Hz to 13 MHz, and level accuracy of ± 0.05 dBm absolute at 10 kHz, complement the level capability of the 3320B.

Programmability/remote control

The 3320A/B is a programmable signal source. Digital remote control capability may be purchased installed in the instrument, or may be added later if the need arises.

The 3320A, with its Option 003, allows parallel BCD remote control of frequency only. The first digit of the frequency vernier, the frequency range, and the main frequency digits may be controlled remotely.

The 3320B has two remote control options. Both options allow full control of all functions except the last vernier digit and the line switch. Option 004 is parallel BCD remote control capability. Option 007 (HP-IB) is a unique bit-parallel/word serial programming option. The Hewlett Packard Interface Bus (HP-IB) provides a low-cost versatile way to interconnect instruments digitally.

Specifications

Frequency range: 0.01 Hz to 13 MHz in 7 ranges.

Frequency ranges: 10 MHz, 1000 kHz, 100 kHz, 10 kHz, 1000 Hz, 100 Hz and 10 Hz (optional). 30% overrange on all ranges.

Frequency resolution

Range	Vernier Out (local or remote)	Vernier In (local)	Vernier in (remote)
10 MHz	10 kHz	10 Hz	1 kHz
1000 kHz	1 kHz	1 Hz	100 Hz
100 kHz	100 Hz	0.1 Hz	10 Hz
10 kHz	10 Hz	0.01 Hz	1 Hz
1000 Hz	1 Hz	1 mHz	0.1 Hz
100 Hz	0.1 Hz	0.1 mHz	0.01 Hz
10 Hz	0.01 Hz	0.01 mHz	0.001 Hz

Frequency accuracy

Vernier out: ±0.001% of setting for 6 mo, 0°C to 55°C.
Vernier in: ±0.01% of range for 6 mo, 0°C to 55°C.

Frequency stability

Long term: ±10 parts in 10⁶ of setting per year (vernier out) with ambient temperature reference. Optional high stability crystal reference oven available (Option 002).

Signal-to-phase noise (integrated): >40 dB down in 30 kHz band, excluding ±1 Hz, centered on carrier. 10 MHz range, vernier out. Improves on lower frequency ranges.

Harmonic distortion: with output frequencies >0.1% of range at full output amplitude, any harmonically related signal will be less than the following levels: -60 dB with output from 5 Hz to 100 kHz; -50 dB with output from 100 kHz to 1 MHz; -40 dB with output from 1 MHz to 13 MHz.

Spurious: >60 dB down.

Internal frequency standard: 20 MHz crystal.

Phase locking: the 3320A/B may be phase locked with a 200 mV to 2 V rms signal that is any subharmonic of 20 MHz.

Rear panel output: front or rear panel output is standard.

Auxiliary outputs

Tracking output: 20 MHz to 33 MHz offset signal. >100 mV rms/50Ω.

1 MHz reference output: 220 mV rms/50Ω (>0 dBm/50Ω).

Low level output: same frequency as main output but remains between 50 mV rms and 158 mV rms (into 50Ω) depending on main output level setting.

3320A Amplitude section

Amplitude: maximum 1 V rms ±10% into 50Ω.

Amplitude range: 0 dBm to +13 dBm range through ¼ turn front panel control (not programmable).

Frequency response: ±2 dB over total range.

Output impedance: 50Ω (75Ω, Option 001).

3320B Amplitude section

Amplitude range: +26.99 dBm (½ watt) to -69.99 dBm (-73.00 dBm under remote control) into 50Ω. (+26.99 dBm = 5 V rms into 50Ω).

Amplitude resolution: 0.01 dB.

Frequency response (10 kHz reference):

dc	10 Hz	13 MHz
±0.5 dB	±0.05 dB	10 +26.99 dBm
	±0.1 dB	- 3.00 dBm
	±0.2 dB	-23.00 dBm
	±0.4 dB	-53.00 dBm
		-73.00 dBm

Amplitude accuracy (absolute): +26.99 dBm, ±0.05 dB at 10 kHz and (20°C to 30°C).

Output impedance: 50Ω (75Ω Option 001).

Options

001 (3320A/B) 75 ohm: amplitude range (3320B only) +24.99 dBm to -69.99 dBm (-75.00 dBm under remote control) into 75Ω.

002 (3320A/B) crystal oven*: 5 MHz crystal in temperature stabilized oven. Long term stability: ±1 part in 10⁴/day; ±1 part in 10⁷/mo. Frequency accuracy: ±1 part in 10⁹ of setting per mo. For field installation order accessory kit HP 11237A.

003 (3320A only) BCD remote control*: allows digital remote control of frequency only on 3320A. The most significant digit of the vernier may be programmed, thus giving four digits, plus 30% overrange, control of frequency in seven ranges (two are optional). Frequency switching and settling time: ±0.1% of range, 15 ms, ±0.001% of range, 60 ms. For field installation order accessory kit HP 11238A.

004 (3320B only) BCD remote control*: allows digital remote control of frequency and amplitude. **Four digits of frequency, overrange, frequency range, Vernier In/Out, four digits of amplitude, and leveling loop response times are all controlled digitally. Frequency switching and settling time is ±0.01% of range, 15 ms; ±0.001% of range, 60 ms. Amplitude switching and setting time: <1.5 s to rated accuracy. For field installation, order accessory kit HP 11238C.

006 (3320A/B) 100 Hz, 10 Hz Ranges*: adds two lower frequency ranges, 100.0 Hz and 10.00 Hz, yielding greater resolution for low frequency outputs (see resolution section of specifications). These two ranges are fully programmable if digital remote options are installed. For field installation, order Accessory Kit HP 11240A.

007* (3320B only) HP-IB remote control: allows bit-parallel word-serial remote control of all functions. **This fully-isolated option allows the 3320B to be interconnected with up to 14 additional HP-IB compatible instruments on a common interface bus. Using a unique addressing scheme, the 3320B can be singled out to receive its individual programming instructions on the bus. This permits several 3320B's to be interconnected to the same interface bus, each programmed to different frequencies and amplitudes. All front panel controls are disabled when in remote control. For field installation, order Accessory Kit, HP 11239C.

Logic Level Requirements for all Digital Remote Control Options.

State	Requirements
"Low" (logical "1")	0 V to 0.4 V (5 mA max.) or contact closure to ground through <80 ohms.
"High" (logical "0")	+2.4 V to +5 V or removal of contact closure to ground.

General

Operating temperature: 0°C to 55°C.

Storage temperature: -40°C to +70°C.

Power requirements: 115 V or 230V ±10%, 48 Hz to 63 Hz, 110 VA max.

Weight

3320A: net. 14.4 kg (32 lb). Shipping, 18.1 kg (40 lb).

3320B: net. 15.9 kg (35 lb). Shipping, 19.5 kg (43 lb).

Dimensions: 425 mm wide, 542.9 mm deep, 132.6 mm high (16¼" × 21¼" × 5½").

Options and accessories

	Price
3320A/B Option 001, 75Ω output	N/C
3320A/B Option 002, Crystal Oven	add \$500
3320A Option 003, BCD remote control	add \$355
3320B Option 004, BCD remote control	\$425
3320A/B Option 006, 100 Hz/10 Hz ranges	add \$238
3320B Option 007, HP-IB remote control	\$765
11048C, 50Ω feedthrough termination	\$17
11094B, 75Ω feedthrough termination	\$17
11473-76A Balancing Transformers, (see page 483)	\$290 ea.

Model number and name

3320A Frequency Synthesizer	\$2700
3320B Frequency Synthesizer	\$3665

*Field installable.

**Except last vernier digit and line switch.

FREQUENCY SYNTHESIZERS

0.1 Hz to 13 Mhz automatic synthesizer

Model 3330B

- HP-IB
- Digital sweeping of frequency and amplitude



HP-IB

Description

The fully programmable (HP-IB) 3330B Frequency Synthesizer has a frequency stability of $\pm 1 \times 10^{-8}$ per day, -50 dB signal-to-phase noise, with a constant resolution of 0.1 Hz up to 13 MHz. Amplitude can be controlled to a resolution of 0.01 dB over a 100 dB range.

Solid-state displays show frequency and amplitude. Nine digits of frequency and four digits of amplitude are displayed on the Model 3330B.

Spectral purity, not normally associated with frequency synthesizers, is a unique feature of the 3330B. Spurious is >70 dB below the carrier and harmonics are >60 dB to 40 dB below the carrier, depending upon the frequency setting. As a sweeper, the 3330B uses digital sweeping for linearity. Either single or continuous sweeps may be set up. Parameters such as center frequency, frequency step, time per step, and the number of steps go into the memory, then are executed by pressing a single button. The ROM operates the sweep as set up until told to stop. Many of the sweep parameters can be changed while the instrument is sweeping. The instrument sweeps amplitude in steps as small as 0.01 dB. The amplitude can be stepped at the end of each frequency sweep cycle to produce a family of curves.

Specifications

Frequency range: 0.1 Hz to 13,000,999.9 Hz.

Frequency resolution: 0.1 Hz (8 digits + overrange).

Frequency stability

Long term: $\pm 1 \times 10^{-8}$ of frequency per day. $\pm 1 \times 10^{-7}$ of frequency per month.

Temperature: $\pm 1 \times 10^{-8}$ of frequency at $25^\circ\text{C} \pm 10^\circ\text{C}$. $\pm 1 \times 10^{-7}$ of frequency at 0°C to 55°C .

Signal to phase noise (Integrated): 50 dB down in a 30 kHz band, excluding ± 1 Hz, centered on carrier.

Harmonic distortion: with full output amplitude, any harmonically related signal will be less than the following specified levels.

5 Hz to 100 kHz: -60 dB.

100 kHz to 1 MHz: -50 dB.

1 MHz to 13 MHz: -40 dB.

Spurious

All nonharmonically related spurious signals will be greater than 70 dB below selected output level or ≤ 110 dBm/50 Ω , whichever is greater.

Frequency switching and settling time: the time required for frequency switching and settling is a function of the largest frequency digit affected by the frequency change in question.

Largest digit changed	0.1 Hz or 1 Hz	10 Hz or 100 Hz	1 kHz or 10 kHz	100 kHz, 1 MHz or 10 MHz
Switching and settling time	<1 ms to within 500 μHz	<1 ms to within 0.05 Hz	<1 ms to within 5 Hz <50 ms to within 0.01 Hz	<1 ms to within 500 Hz. <50 ms to within 1 Hz

Internal frequency reference: 5 MHz crystal oscillator in temperature stabilized oven.

Frequency adjustments

Coarse: internal adjustment adequate for five years of aging.

Fine: one turn pot or ± 5 V dc for 1.2 to 2.5×10^{-7} max control with internal reference or 3×10^{-3} max control with rear panel switch in ext. ref. position without an external reference applied.

External frequency reference: the 3330B may be phase locked with a 200 mV to 2 V rms signal that is any subharmonic of 20 MHz from 1 MHz through 10 MHz.

Rear panel output: front or rear panel output is standard.

Auxiliary outputs

20 - 33 MHz tracking output: >100 mV rms/50 Ω .

1 MHz reference output: >220 mV rms/50 Ω (0 dBm/50 Ω).

Synthesized search or tune: a frequency step (0.1 Hz min) may be entered. This step may be added to or subtracted from the synthesized output signal. Rate of search or tune is selected by the time per step control.

Digital sweeping of frequency: accomplished by entering and setting the center frequency, a frequency step, number of steps, time per step, and sweep direction.

Sweep width: the product of the step size and number of steps.

Step size: continuously adjustable in 0.1 Hz increments.

Step accuracy: $\pm 1 \times 10^{-8}$ per day for standard reference crystal.

Number of steps: 10, 100, or 1000.

Time per step: 1 ms, 3 ms, 10 ms, 30 ms, 100 ms, 300 ms, 1000 ms, and 3000 ms.

Direction of sweep: up, both, down.

Single sweep: initiated by momentary pushbutton.
Continuous sweep: initiated by momentary pushbutton.
Manual sweep: accomplished by holding down the freq ↑ or freq ↓ keys. Display will follow output.
Sweep output: stepped dc voltage proportional to sweep position, 0 to +10 V.
Accuracy: ±0.2% of full scale.
Linearity: ±0.1% of full scale.

Digital outputs

Step count: 0 to 1000 count on 12 BCD (1-2-4-8) lines to indicate sweep position.
Sweep status: line to indicate when instrument is sweeping.
Step ready: indicates instrument has spent the selected time per step and is ready to go to the next step.
Sweep modification (continuous): during a continuous sweep, the step size, center frequency, sweep direction, and time per step may be changed without stopping the sweep.
Center frequency modification: accomplished by pressing freq ↑ or freq ↓
Frequency step: to widen or narrow the sweep width, the frequency step size may be expanded or contracted by factors of 2 or 10. The keys labeled freq step ×2, freq step ÷2, freq step ×10 and freq step ÷10 may be pressed.
Sweep modification (single): during a single sweep, the time per step and direction sweep may be changed without stopping the sweep.

Amplitude section

Amplitude: maximum 2.1 V rms into open circuit; maximum 1.05 V rms into 50Ω.
Amplitude range: +13.44 dBm to -86.55 dBm into 50Ω.
Amplitude resolution: 0.01 dB.
Output impedance: 50Ω (75Ω Option 001).
Display: four digit readout in dBm with reference to 50Ω. Levelled frequency response (10 kHz reference) 10 Hz - 13 MHz.*
 +13.44 dBm to -16.55 dBm: ±0.05 dB.
 -16.55 dBm to -36.55 dBm: ±0.1 dB.
 -36.55 dBm to -66.55 dBm: ±0.2 dB.
 -66.55 dBm to -86.55 dBm: ±0.4 dB.
Amplitude attenuator accuracy: ±0.02 dB/10 dB step (at 10 kHz) of attenuation down from maximum output.
Amplitude accuracy (absolute): ±0.05 dB at 10 kHz and +13.44 dBm (15°C, ±5°C). (For absolute accuracy at other frequencies and amplitudes, add 0.05 dB to the levelled frequency response specification, plus the attenuator accuracy specification.)
Amplitude modulation: requires external modulation source. Rear panel BNC. ALC switch must be in slow position.
Modulating signal: 100 Hz to 100 kHz.
Modulation depth: 0.95 V rms modulating signal for 95% modulation depth.

Digital sweeping of amplitude: accomplished by entering and setting the center amplitude, an amplitude step, number of steps, time per step and sweep direction.
Type: linear and symmetrical about the center amplitude.
Sweep width: product of the step size and number of steps.
Step size: 0.01 dB to 99.99 dB in 0.01 dB increments.
Number of steps: 10, 100, or 1000.
Time per step: 30 ms, 100 ms, 300 ms, 1000 ms, 3000 ms.
Direction of sweep: up, both, down.
Single sweep: momentary pushbutton. Display follows output.
Continuous sweep: momentary pushbutton. Display of center amplitude or step.
Manual sweep: accomplished by holding down the ampl ↑ or ampl ↓ keys. Display will follow output. Sweep output, digital outputs, sweep

*Add ±0.5 dB for levelled off.

modification (continuous), sweep modification (single), all the same as with frequency sweep.

Digital remote control

Remote control of the 3330B is accomplished via the Hewlett-Packard Interface Bus (HP-IB) which is a standard feature of the instrument. Both the standard nonisolated HP-IB version and an optional isolated HP-IB version (Opt. 004) allow full programming of all frequency, amplitude and sweep functions.

The HP-IB interface allows the 3330B to be interconnected with up to 14 additional HP-IB compatible instruments on a common interface bus. Using an industry-standard addressing scheme, the 3330B can be singled out to receive its individual programming instructions. This permits multiple 3330B's, or other HP-IB sources, to be connected to the same interface bus, each programmed to different frequencies and amplitudes.

Connection of instruments to a system controller is vastly simplified since all HP-IB instruments are interfaced with a common I/O card and driver. Hewlett-Packard Models 9815A, 9820A, 9821A, 9825A, and 9830A Calculators, and Models 21MX and 2100 Series computers are all compatible with HP-IB.

Options

Option 001: 75 ohms - 1 V rms (factory installation only). Attenuation and output referenced to 75Ω.
Amplitude range: +11.25 dBm to -88.74 dBm.
Option 002: High Stability Crystal Oven
Long term frequency stability: ±1 × 10⁻³ per day, +2 × 10⁻⁶ per month.
Long term temperature: ±1 × 10⁻⁶ total frequency at 25°C, ±10°C, ±1 × 10⁻⁶ total of frequency at 25°C, 0°C to +55°C.
Frequency adjustments: same as standard instrument.
Option 003: deletion of Crystal Oven, 20 MHz ambient temperature crystal reference oscillator.
Frequency stability: ±10 parts in 10⁶/yr.
Frequency adjustments: rear panel 1 turn pot or rear panel voltage control input for 30 × 10⁻⁶ maximum control.
Option 004: isolated Digital Input (factory installation only.) With this option, the digital input lines are electrically isolated from the signal ground. (HP-IB).
DC isolation: ±250 V.
AC isolation: >30 dB, 0 to 1 MHz.
Option 005: 5 V rms - 50 ohm output. This option gives the 3330B a ½ watt output.
Amplitude range: +26.99 dBm to -73 dBm into 50 ohms.

General

Operating temperature: 0°C to +55°C.
Storage temperature: -40°C to +70°C.
Turn on time:
 application of power to "On": 20 min to within ±1 × 10⁻³ of the final frequency.
 "Standby" to "On": 15 s to full specifications.
Power requirements: 115 V or 230 V ±10%, 48 Hz to 63 Hz, 20 W standby, 200 W on.
Weight: net, 22.6 kg (53 lb). Shipping, 26.8 kg (63 lb).
Dimensions: 426 mm wide × 178 mm high × 547 mm deep (16 3/4" × 7" × 21 1/2").

Options

Option 001, 75Ω - 1 V output
 Option 002, crystal oven
 Option 003, deletion of oven
 Option 004, isolated HP-IB
 Option 005, 5 V - 50Ω output
3330B Automatic Synthesizer

Price

N/C
 add \$580
 less \$150
 add \$440
 add \$295

\$7015



TABLE 1.

FUNCTION	RANGE	RESOLUTION	MODEL NO.	PAGE
AC volts	1 mV — 1000 V*	1 ppm	745A	322
DC volts	0 — 1000 V	1 ppm	740B	324
DC differential voltmeters	1 μ V — 1000 V	1 ppm		
DC voltmeter	1 μ V — 1000 V	2%		
AC volts	0.01 V — 1000 V	3 digits	6920B	321
DC volts				
AC amps				
DC amps				

Hewlett-Packard calibration instruments provide accurate and precise dc and ac stimulus for your calibration needs. Accurate dc voltage measurements capability to 1000 volts is also available for testing dc power supplies and other precision dc sources. See Table 1 for a list of instrument features.

*x10 Amplifier for 745A

CALIBRATORS

AC/DC meter calibrator

Model 6920B



- Calibrate/test DC ammeters up to 4 amps
- Calibrate/test average reading AC ammeters up to 5 amps
- Calibrate/test DC voltmeters up to 1000 volts
- Calibrate/test average reading AC voltmeters up to 1000 volts



Description

Model 6920B is a versatile ac/dc meter calibrator, capable of both constant voltage and constant current output. Its absolute accuracy makes it suitable for laboratory or production testing of panel meters, multimeters, and other meters having accuracy of the order of 1.0% or higher. This calibrator has been designed for convenience, and combines in one instrument all the outputs needed to test the more commonly used meters.

Output switch

The output switch has two ON positions. The ON TEST position has a momentary contact and output is obtained only while the switch is held ON. This is convenient when several full scale readings are being checked successively and the meter and calibrator are being switched through their ranges. The ON HOLD position is used when continuous output is desired.

AC output waveshape

When the function switch is set on "AC", the output wave-shape is sinusoidal (to a first approximation) and has the same frequency as the input line power applied to the instrument (except when an external ac reference is used). The feedback loop, which controls and regulates this ac, is actually monitoring the average value of the ac output, although the front panel controls are calibrated in terms of rms. Thus, this calibrator is suitable for use with average reading ac voltmeters scaled in rms. In addition, the calibrator can be used with true rms meters, provided allowance is made for the total output distortions. This distortion is approximately equal to the line input waveshape distortion (or distortion of the external ac reference) plus 3%.

Specifications

Output voltage ranges

- 0.01-1 V: current capability 0 - 5 A
- 0.1-10 V: current capability 0 - 1 A
- 1-100 V: current capability 0 - 100 mA
- 10-1000 V: current capability 0 - 10 mA

Above output voltage ranges and maximum current capabilities for each range apply in full for either dc or ac operation.

Output current ranges

- (5 A maximum output)
- 1-100 μ A: voltage capability 0-500 V (uncalibrated in AC)
- 0.01-1 mA: voltage capability 0-500 V
- 0.1-10 mA: voltage capability 0-500 V
- 1-100 mA: voltage capability 0-50 V
- 0.01-1 A: voltage capability 0-5 V

0.1-10 A: (5 A max. output) voltage capability 0-0.5 V
Above output current ranges and maximum voltage capabilities for each range apply in full for either dc, 50 Hz or 60 Hz operation.

Output accuracy: DC — 0.2% of set value plus 1 digit. AC — 0.4% of set value plus 1 digit (when used with average reading meters). Above accuracy applicable over a temperature range from 15°C to 35°C, over full input voltage range, and after 1 hour warmup.

Controls

Function switch: this is a 3-position switch: "off", "AC" and "DC". In the "off" position the ac power input is disconnected from the unit. In the "AC" position the meter calibrator produces an ac output; similarly, in the "DC" position the calibrator produces a dc output.

Range switch: 10 positions, one for each voltage and current range.

Calibrated output control: digital potentiometer readout control (3 significant digits) determines exact value of output.

Output switch: switch described at left.

Output terminals: two front panel terminals are provided; these are the output terminals for both ac and dc operation. In voltage ranges, the negative terminal is grounded.

Ripple: in dc operation the output ripple is typically less than 1.0% rms/5% p-p of the output range switch setting.

Input: 115 V ac \pm 10%, single phase, 58-62 Hz, 0.7 A, 65 W max. (See options 005 and 028 for 50 Hz and 230 Vac operation).

Operating temperature range: 0-50°C; convection cooled.

Size: 172 mm H \times 198 mm W \times 279 mm D. (6 $\frac{3}{4}$ " H \times 7 $\frac{13}{16}$ " W \times 11" D).

Weight: 6.8 kg (15 lb) net, 7.71 kg (17 lb) shipping.

Options

005: 50 Hz output regulation realignment

028: 230 V ac \pm 10%, single phase input

Price

N/C

N/C

Accessories available

5060-8762 Rack kit for mounting one or two 6920B's in a 19" rack

\$55

5060-8760 Filler panel to block unused half of rack adapter

\$11

1051A Combining case for two 6920B's that is both portable and easily rack mounted

\$275

6920B Meter calibrator

\$880

CALIBRATORS

AC calibrator, high voltage amplifier

Models 745A & 746A



Description

Hewlett-Packard's Model 745A AC Calibrator combined with Model 746A High Voltage Amplifier is a compact, calibrated ac source with continuously adjustable frequency output from 10 Hz to 110 kHz. Output voltage can be varied from 0.1 mV to 1099.999 V in steps as small as 1 ppm of range over the entire frequency range.

HP's 745A provides the first six voltage ranges, 0.1 mV to 109.9999 V, while the combination of the 745A and 746A permits expansion to 1099.999 V as a seventh range. Model 746A can only be used with the 745A.

Specifications

Ranges

Output voltage ranges: seven ranges with 10% overrange as follows:

Range	Settability and resolution
1 mV	0.100000 mV to 1.099999 mV in 1 nV steps
10 mV	1.00000 mV to 10.99999 mV in 10 nV steps
100 mV	10.0000 mV to 109.9999 mV in 100 nV steps
1 V	0.100000 V to 1.099999 V in 1 μ V steps
10 V	1.00000 V to 10.99999 V in 10 μ V steps
100 V	10.0000 V to 109.9999 V in 100 μ V steps
1000 V	100.000 V to 1099.999 V in 1 mV steps

Output voltages from 100 μ V to 110 V are available from 745A output terminals; voltages from 100 V to 1100 V are available from the 746A output cable.

Output frequency ranges: continuously adjustable from 10 Hz to 110 kHz in four decade ranges with 10% overlap.

Error measurement: two ranges with zero center dial; $\pm 0.3\%$, $\pm 3\%$. A zero range is provided to easily switch out the effects of the error measurement system.

Performance rating

Accuracy: accuracy holds for a 90-day period and is met after a one-hour warm-up period at $25^\circ\text{C} \pm 5^\circ\text{C}$ with $<95\%$ RH. This applies only to the 745A. Warm-up time required for HP's 746A is approximately 30 s.

Voltage: specifications are absolute, traceable to National Bureau of Standards.

1 mV to 100 V ranges:

Frequency	Accuracy
50 Hz to 20 kHz	$\pm(0.02\%$ of setting $+0.002\%$ of range $+10 \mu\text{V})$
20 Hz to 50 Hz 20 kHz to 110 kHz	$\pm(0.05\%$ of setting $+0.005\%$ of range $+50 \mu\text{V})$
10 Hz to 20 Hz	$\pm(0.2\%$ of setting $+0.005\%$ of range $+50 \mu\text{V})$

1000 V range:

Frequency	Accuracy
50 Hz to 20 kHz	±0.04% of setting
20 Hz to 50 Hz 20 kHz to 50 kHz	±0.08% of setting
50 kHz to 110 kHz	±0.15% of setting
10 Hz to 20 Hz	±(0.2% of setting +0.005% of range)

Frequency: ±(2% of setting +0.2% of end scale).

Error measurement: ±(0.5% of setting +0.5% of range).

Temperature coefficient

Voltage: 1 mV to 100 V ranges: ±0.0003% of setting per °C, 0°C to 55°C. 1000 V range: ±0.0005% of setting per °C, 0°C to 55°C.

Frequency: ±0.05% of end scale per °C, 0°C to 55°C. Derate accuracy specification by this temperature coefficient for operation in temperature range of 0°C to 20°C and 30°C to 50°C.

Voltage stability: stability met after one-hour warm-up period at constant temperature with <95% RH. 1 mV to 100 V ranges:

Long-term: ±0.01% of setting for six months.

Short-term: ±0.005% of setting for 24 hours.

1000 V range

Long-term: 50 Hz to 20 kHz: ±0.01% of setting for six months; 10 Hz to 50 Hz and 20 kHz to 110 kHz: ±0.02% of setting for six months.

Short-term: ±0.005% of setting for 24 hours.

Output characteristics

Total distortion and noise: 0.05% of setting +10 μV over 100 kHz bandwidth on all ranges.

Total distortion, cycle-to-cycle instability and noise: will cause <±0.005% of error when used to calibrate an average-responding or true rms-responding instrument from 1 mV to 1100 V.

Load regulation (no load to full load):

Output impedance: <1Ω on 1 mV, 10 mV, 100 mV ranges. On the 1 V, 10 V, 100 V and 1000 V ranges for output current equal to or less than that shown in the diagram below, error is included in the accuracy specification.

Load capability: 1000 pF or 50 mA on 1 mV to 100 V ranges (50 mA allows 800 pF at 100 V, 100 kHz). 1000 pF or 63 mA on 1000 V range (63 mA allows 100 pF at 1000 V, 100 kHz).

Line regulation: ±0.001% of setting change in output voltage for a 10% change in line voltage (included in accuracy specs).

Output terminals: high and low output terminals can be floated ±500 V dc above chassis ground.

Counter output: frequency counter output on 745A rear panel, 2.2 V ±50%, protected against short circuits.

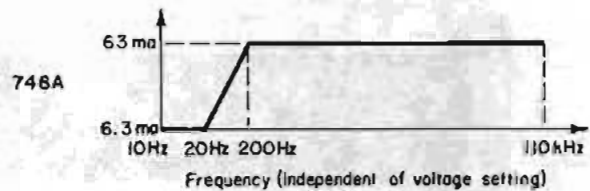
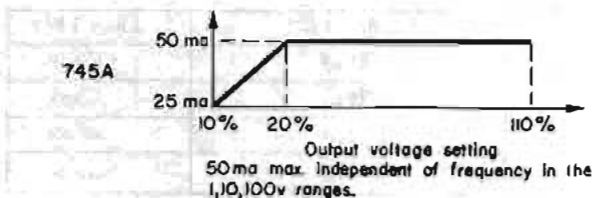
**Remote programming:**

Voltage range, frequency range, error range, and senses	Requirements
Contact closure	Less than 400Ω to ground
NPN transistor	Open circuit voltage 5 V Short circuit current 2 mA Maximum voltage on programming line at closure 0.8 V.
Reed switch through diode	
NPN transistor through diode	
Frequency vernier	Minimum to maximum of range
Analog voltage	+1 V to +10 V DC
Resistance to ground	500Ω - 10 kΩ

General

Operating temperature: 0°C to 55°C.

Storage temperature: -40°C to +75°C.

RFI: meets MIL-1-6181D when using shielded output connectors.

Power

745A: 115 V or 230 V ±10%, 50 Hz to 66 Hz, 100 VA max.

746A: 115 V or 230 V ±10%, 50 Hz to 60 Hz, 850 VA max.

746A aux power rated at 120 VA max.

Weight

745A: net, 29.3 kg (65 lb). Shipping, 36.3 kg (80 lb).

746A: net, 34 kg (75 lb). Shipping, 38.5 kg (85 lb).

Dimensions

745A: 425 mm wide × 221 mm high × 467 mm deep (16½" × 8¾" × 18¼").

746A: 425 mm wide × 177 mm high × 464 mm deep (16¾" × 7" × 18¼").

745A Accessories furnished:

Rack mount kit.

HP Part No. 5060-0630, 22-pin printed circuit board extender.

HP Part No. 5060-0043, 15-pin printed circuit board extender.

HP Part No. 5060-0031, 10-pin printed circuit board extender.

HP Part No. 1251-0084 remote programming plug.

746A Accessories furnished:

Rack mount kit.

HP Part No. 1251-0485, remote right angle connector.

HP Part No. 1450-0356, incandescent lamp.

HP Part No. 4040-0427, extractor.

HP Part No. 5040-0404, probe holder.

HP Part No. 5060-0216, joining kit bracket.

HP Part No. 5060-0630, 22-pin printed circuit board extender.

HP Part No. 00746-02701, foam filter.

Model number and name

HP 745A AC Calibrator

HP 746A High Voltage Amplifier

Price

\$5500

\$3400

CALIBRATORS

DC Standard / Δ DC voltmeter / DC amplifier

Model 740B



Description

DC standard

The 740B is an ultra stable, high resolution DC calibration source which delivers output voltage from zero to 1000 volts with specified accuracy of $\pm(0.002\%$ of setting $+0.0004\%$ of range). Designed for calibrating digital voltmeters, differential voltmeters, potentiometers, voltage dividers and for general standards lab application, the 740B has six digit resolution with discrete steps of 1 ppm of full scale.

The 740B will deliver current up to 50 mA and may be set at any desired limit between 5 mA and 50 mA by a continuously adjustable front panel control. A front panel indicator displays overload conditions if the load current exceeds the current limit setting. Low output impedance is maintained by remote sensing terminals which control the output voltage at the load. The entire circuit is floating and guarded.

Differential voltmeter

As a differential voltmeter, the 740B measures voltage from zero to 1000 volts dc with an input resistance of $>10^{10}$ ohms independent of null condition. Meter sensitivity pushbuttons allow input voltages to be measured to six digits for a maximum resolution of 1 ppm of range, with a maximum usable sensitivity of 1 μ V full scale. Specified accuracy is $\pm(0.005\%$ of reading $+0.0004\%$ of range $+1 \mu$ V).

Specifications

DC standard ranges

Output voltage: 0 to 1000 V* in 4 decade ranges as follows: 0 to 1 V in 1 μ V steps, 0 to 10 V in 10 μ V steps, 0 to 100 V in 100 μ V steps, 0 to 1000 V in 1 mV steps. Digital display tubes indicate first 5 digits, meter displays 6th digit.

DC standard performance

Accuracy: ($<70\%$ RH, constant line, load and temperature $\pm 1^\circ$ C.

Calibrated at factory at 115 V and 23°C.) 30 day: $\pm(0.002\%$ of setting $+0.0004\%$ of range). 90 day: $\pm(0.005\%$ of setting $+0.0004\%$ of range).
Stability: ($<70\%$ RH, constant line, load and temperature $\pm 1^\circ$ C.)

Period	Zero stability ppm of range	Voltage stability (excludes zero stability) ppm of setting + ppm of range
1 hr	± 1 ppm	$\pm(0 \text{ ppm} + 1 \text{ ppm})$
24 hr	± 2 ppm	$\pm(5 \text{ ppm} + 1 \text{ ppm})$

Temperature coefficient: 10°C to 40°C: $<\pm 0.0002\%$ of setting/ $^\circ$ C or $\pm 0.0001\%$ of range/ $^\circ$ C, whichever is greater.

Line regulation: $<\pm(0.0005\%$ of setting $+0.0001\%$ of range) for 10% line voltage change.

Load regulation (no load to full load): $<(0.0005\%$ of setting $+10 \mu$ V).

DC standard output characteristics

Terminals: plus and minus output, plus and minus sense, circuit guard, and chassis ground. Minus output and circuit guard can be floated up to ± 500 V with respect to chassis ground.

Output current: maximum output current 50 mA at 1 V output, decreasing linearly to 20 mA at 1000 V output. Current limiter continuously adjustable from 10% to 100% of maximum output current.

Output resistance: $<(0.0002 + 0.0001 E_{out})\Omega$.

Noise: (rms value)

Range	0.01 Hz - 1 Hz	1 Hz - 1 MHz
1 V	$<1 \mu$ V	$<100 \mu$ V
10 V	$<10 \mu$ V	$<100 \mu$ V
100 V	$<100 \mu$ V	<1 mV
1000 V	<1 mV	<10 mV

DC differential voltmeter ranges

Voltage: 1 mV to 1000 V* in 7 decade ranges.
Resolution: 6-digit readout yields resolution of 0.0001% of range (6th digit indicated on meter).

DC differential voltmeter performance

Accuracy: (<70% RH, constant line and temperature ±1°C. Calibrated at factory at 115 V and 23°C.)
30 day: ±(0.005% of reading + 0.0004% of range + 1 μV).
90 day: ±(0.008% of reading + 0.0004% of range + 1 μV).
Stability: (<70% RH, constant line and temperature ±1°C.)

Period	Zero stability	Reading stability (excludes zero stability) ppm of reading + ppm of range
1 hr	±(1 ppm of range + 1 μV)	±(0 ppm + 1 ppm)
24 hr	±(1 ppm of range + 2 μV)	±(5 ppm + 1 ppm)

Temperature coefficient: 10°C to 40°C: <±(0.0002% of reading + 1 μV)/°C.

Line regulation: <±(0.001% of reading + 2 μV) for 10% line voltage change.

DC differential voltmeter input characteristics

Terminals: plus and minus input, circuit guard and chassis ground. Minus input and circuit guard can be floated up to ±500 V with respect to chassis ground.

Input resistance (independent of null): 100 mV to 1000 V ranges: >10¹⁰Ω; 10 mV range: >10⁹Ω; 1 mV range: >10⁸Ω.

Effective common-mode rejection (ECMR): ECMR is the ratio of the common-mode signal to the resultant error in readout with 1 kΩ unbalance resistor in either lead. At 60 Hz and above >120 dB.

Normal-mode rejection (NMR): NMR is the ratio of the ac normal-mode signal to the resultant error in readout. At 60 Hz and above: >100 dB. Maximum ac normal-mode signal: 25 V rms.

Overload protection: 1000 V* dc may be applied on any range or sensitivity without damaging instrument.

DC voltmeter

Voltage ranges: 1 μV to 1000 V* in 10 decade ranges.
Accuracy: ±(2% of range + 0.1 μV).
Input resistance: 100 mV to 1000 V range: >10¹⁰Ω; 10 mV range: >10⁹Ω; 1 mV to 1 mV range: >±10⁸Ω.
Zero control limits: >±10 μV.
Zero drift: <2 μV per day.
Normal mode rejection: same as dc differential voltmeter.

DC amplifier

Voltage gain:

Range	Gain
1 mV	60 dB
10 mV	40 dB
100 mV	20 dB
1 V - 1000 V	0 dB

Bandwidth: dc to 0.2 Hz.
Gain accuracy: ±(0.01% of input + 0.0005% of range + 2 μV) referred to input.
Linearity: ±0.002% on any range.
Stability:
Temperature coefficient:
Line regulation:
Input resistance:
ECMR:
NMR:
Overload protection:
Load regulation:
Output current:
Output resistance:
Noise (rms value, referred to input):

} Same as DC Differential Voltmeter

} Same as DC Standard

Range	0.01 Hz - 1 Hz	1 Hz - 1 MHz
1 mV	<0.2 μV	<100 μV
10 mV	<0.4 μV	<100 μV
100 mV	<1 μV	<100 μV
1 V	<1 μV	<100 μV
10 V	<10 μV	<100 μV
100 V	<100 μV	<1 mV
1000 V	<1 mV	<10 mV

General

Recorder output: provides voltage proportional to meter deflection in all modes of operation. Adjustable output supplies up to ±1 V dc across 1 kΩ load; voltage polarity same as meter deflection.

Operating temperature: 10°C to 40°C unless specified otherwise.

Storage temperature: -40°C to +65°C.

RFI: meets MIL-1-6181D†.

Power: 115 V or 230 V ±10%, 50 to 66 Hz, <125 W.

Dimensions: 425 mm wide, 175 mm high, 464 mm deep (16 1/4" × 6 7/8" × 18 1/2").

Weight: net 21.3 kg (47.3 lb); shipping, 27 kg (60 lb).

Accessories furnished: 11054A input cable assembly; 4 banana jacks mounted on terminal box with 3-ft cable and mating connector. Terminals include positive and negative input, circuit guard, and chassis ground. Positive and negative terminals are solid copper, gold flashed. A switch allows reduction of input resistance to 2 MΩ.

11055B output cable assembly; 6 banana jacks mounted on terminal box with 3-ft cable and mating connector. Terminals include positive and negative output, positive and negative sense, circuit guard, and chassis ground. Output and sense terminals are solid copper, gold flashed. Rack mount kit.

740B DC Standard / Δ DC voltmeter

\$4500

*Maximum of -500 V dc with respect to line ground can be applied to or obtained from the HP 740B.
 †Positive or negative output terminals of the output box (HP 11055B) connected to chassis, and guard and chassis terminals of the input box (HP 11054A) connected together.

SIGNAL GENERATORS

Signal generators to 40 GHz



Signal generators

Hewlett-Packard offers a complete line of easy to use HF, VHF, UHF, and SHF signal generators covering frequencies between 10 kHz and 40 GHz. This line includes synthesized signal generators and solid-state generators as well as a complete line of performance-proven vacuum tube signal generators. Each includes the following features: 1) accurate, easy-to-read frequencies, calibrated and variable. 2) accurately calibrated variable output level. 3) wide modulation capability.

Beside these basic features, HP signal generator characteristics ensure the utmost convenience and accuracy for all kinds of measurements and signal simulations, including receiver sensitivity, selectivity or rejection, signal-to-noise ratio, gain bandwidth characteristics, conversion gain, antenna gain, and transmission line characteristics, as well as power to drive bridges, slotted lines, filter networks, etc.

New 2 to 18 GHz microwave synthesized signal generator

HP's newest signal generator, Model 8672A, provides AM/FM capability and calibrated output usually associated only with signal generators, along with the resolution, spectral purity, stability and programmability of a high quality synthesizer. 8672A covers 2 to 18 GHz with output from +3 to -120 dBm.

A companion unit, HP 8671A, is a synthesizer only, with a minimum of +8 dBm from

2 to 6.2 GHz and FM only. Both units are programmable via the HP Interface Bus.

The HP 8672A will find application in several important areas: 1) As a programmable signal simulator in automatic test systems; 2) For satellite receiver testing requiring highly stable (5×10^{-10} /day) signals; 3) General purpose lab use where its multi-band capability can replace a benchful of separate band generators; and, 4) Production use where short runs require different frequency ranges from run to run.

The 8671A will serve in local oscillator applications requiring up-conversion or multiplication for satellite communications or radio astronomy. SSB noise is -89 dB/Hz below the carrier at a 10 kHz offset. Non-harmonic spurious is -70 dB.

10 kHz to 2600 MHz synthesized generator

The HP 8660A/C is a particularly versatile synthesized generator family. Two mainframes are available. The 8660A utilizes thumbwheel switches for frequency selection. The 8660C mainframe has a more versatile keyboard control featuring synthesized digital sweep and frequency-step capability. Programming options for both BCD and HP-IB interfaces are provided.

Three plug-in RF sections provide three separate ranges; 10 kHz to 110 MHz, 1 MHz to 1300 MHz, and 1 MHz to 2600 MHz. Output levels are calibrated over >140 dB of range. A wide range of modulations can be configured with plug-in sections. AM, FM,

and phase modulation as well as external pulse modulation are available in various combinations.

Solid-state, high performance generators

This group of signal generators offers all the advantages of solid-state design, such as increased portability, ruggedness, and reliability, while still retaining the outstanding signal quality characteristic of Hewlett-Packard's older vacuum tube signal generators. In addition these generators offer many features not found on the older generators such as digital frequency readout (8640B, 8660C), ability to count external signals (8640B), field portability (8654A/B) and complete remote programming (8660A, 8660C).

HF to UHF

The performance leader of the solid-state family is the 8640 signal generator covering 450 kHz to 550 MHz. Frequency coverage can be extended to 1100 MHz with an internal doubler, (OPT 002) and an optional built-in audio oscillator extends the CW output range down to 20 Hz (OPT 001). This new generator is available in three models: the 8640A with mechanical slide rule frequency dial; the 8640B featuring a built-in 550 MHz counter; and the 8640M for ruggedized applications.

The 8640B with built-in counter includes two significant new features not previously found on Hewlett-Packard signal generators:

1) the ability to count external signals at frequencies up to 550 MHz and 2) a front panel pushbutton to phase-lock the generator's RF output to the built-in counter time base for frequency stability of better than 5×10^{-6} /hour.

Internally, the heart of the 8640 is a mechanically tuned high-Q cavity oscillator that operates over the range of 230 to 550 MHz. This oscillator has very good inherent stability and exceptionally low noise characteristics. Nine lower frequency ranges are obtained by dividing down the basic oscillator frequency and filtering out the unwanted harmonics.

The 8640M is a ruggedized version of the 8640B featuring phase-locked stability, digital read-out, built-in thermal cutoff and reverse power protection. The 'M' with its aluminum carrying case has been type-tested to withstand shock, vibration and humidity extremes, and is specified to operate over a temperature range of -40°C to $+55^{\circ}\text{C}$ for field and flight-line measurements.

Compact, field portable

Compact, portable signal generators form another part of the solid-state family. The 8654 covering 10 to 520 MHz features calibrated output level with a full range attenuator and both AM and FM modulation capability. Small size and light weight make it well suited for field maintenance and opera-

tional readiness checks in addition to general purpose signal generator applications. The 8654A is an AM generator with uncalibrated FM capability, while the 8654B has fully calibrated and metered FM and AM.

The 8655A Synchronizer/Counter combines with the 8654A and B to phase lock the generators RF output to the counter time base for frequency stability of better than 0.1 ppm/hour. In addition the 8655A is an RFI-proof counter with the capability to count external signals up to 520 MHz.

Performance-proven vacuum tube signal generators

HF to UHF

The HP 606B, 608E, and 612A signal generators collectively cover frequencies from 50 kHz to 1.23 GHz. All feature extremely low drift and incidental frequency modulation, and may be amplitude (sine, square, pulse) modulated.

UHF to SHF

A complete line of Hewlett-Packard microwave signal generators provides coverage from 800 MHz to 21 GHz. The 618C, 620B, 626A, and 628A incorporate cavity-tuned klystron oscillators with very low drift and residual FM. They may be pulse, square-wave and frequency modulated, making them useful for microwave receiver testing as well as SWR and transmission line measurements.

The HP 8614A and 8616A signal generators covering 0.8 to 2.4 GHz and 1.8 to 4.5 GHz feature built-in PIN diode modulators. These modulators allow internal or external output power leveling as well as a wide range of pulse and amplitude modulation.

HP 938A and 940A Frequency Doubler Sets provide low-cost signal generator capability in the 18 to 40 GHz range by doubling the frequency of signal sources in the 9 to 20 GHz range.

Special signal generators/accessories

For Avionics navigation and communications applications, the 8640B option 004 combines the digital readout, phase lock features with a demodulated output and special AM circuitry. Combined with suitable external modulation sources the 8640B provides for testing and calibration of aircraft VOR/ILS and Marker Beacon receivers.

A variety of accessories are available to enhance the operation of HP signal generators. The list includes a spectrum generator, frequency doublers, output terminations, a fuse holder, balanced mixers, filters and the HP 8730 Series of PIN modulators which increase the modulation capability of microwave signal sources. Also available is the HP 8403A Modulator providing complete control of the 8730 series of PIN modulators.

Signal generator summary

Model	Frequency range	Characteristics	Page
8671A Synthesizer	2 to 6.2 GHz	1 kHz frequency resolution, 5×10^{-10} /day stability, +8 dBm minimum output, completely HP-IB programmable, EXT FM	334
8672A Synthesized Generator	2 to 18.6 GHz	1 to 3 kHz frequency resolution, 5×10^{-10} /day stability. Calibrated output from +3 to -120 dBm. Completely HP-IB programmable, metered, external AM and FM	332
8660A/C Synthesized Generator	0.01 to 110 MHz 1 to 1300 MHz 1 to 2600 MHz	1 Hz frequency resolution, 3×10^{-9} /day stability. Calibrated output from +13 to -146 dBm. Completely TTL programmable. Plug-ins determine frequency range and modulation capability	328
606B Signal generator	50 kHz to 65 MHz	output 3 V to 0.1 μV , mod. BW dc to 20 kHz, low drift and noise, low incidental FM, low distortion, auxiliary RF output	342
8640A/B/M Signal Generator	0.5-1024 MHz	output +19 to -145 dBm into 50 Ω : AM, FM, and ext. pulse modulation, direct calibration, leveled output. 8640B has built-in counter and phase-lock capability. All solid state	335 339
8640B Opt. 004 Avionics Generator	0.5 to 512 MHz	Same as 8640B with phase shift <0.01 $^{\circ}$ at 30 Hz, demodulated AM output, 1 dB step attenuator, for use with external VOR/ILS Audio Generators	338
608E Signal Generator	10 to 480 MHz	output 1 V to 0.1 μV , into 50-ohm load; AM, pulse modulation, direct calibration, leveled power output, aux RF output	343
3200B Oscillator	10-1000MHz	1 V to 1 μV output into 50 Ω . 120 dB attenuator range 0.002% stability, compact, portable; weight 15 lb. Doubler extends frequency to 1000 MHz	348
8654A/B Signal Generator	10-520 MHz	output 0 to -120 dBm into 50 Ω , direct calibration, leveled output, amplitude and frequency modulation, solid-state, compact, weight 16 lb	340
8655A Synchronized Counter	10-520 MHz	phase-lock frequency stabilizer for 8654A and B. 6-digit LED display lock resolution, 500 Hz. Low RFI, external count capability to 520 MHz	341
612A Signal Generator	450 to 1230 MHz	output 0.5 V to 0.1 μV into 50-ohm load; pulse or square-wave modulation, direct calibration	344
8614A, 8616A Signal Generator	0.8 to 2.4 GHz 1.8 to 4.5 GHz	output +10 (8616: +3 dBm above 3 GHz) to -127 dBm into 50 ohms, leveled below 0 dBm; internal square-wave; external pulse, AM and FM; auxiliary RF output	345
618C, 620B Signal Generators	3.8 to 7.6 GHz 7 to 11 GHz	output 1 mW to -127 dBm (0.1 μV) into 50 ohms, pulse, frequency or square-wave modulation, direct calibration, ext FM and pulse modulation, auxiliary RF output	346
626A, 628A Signal Generators	10 to 15.5 GHz 15 to 21 GHz	output +10 dBm to -90 dBm; pulse, frequency or square-wave modulation, direct calibration	347
938A, 940A Frequency Doublers	18 to 26.5 GHz 26.5 to 40 GHz	driven by 9 to 13.25 GHz source 13.25 to 20 GHz source, HP 626A, 628A, 0 8690 series sweepers or klystrons; 100 dB precision attenuator	347

SIGNAL GENERATORS

Synthesized Signal Generators

Model 8660A and 8660C

- 10 kHz to 2600 MHz
- Synthesizer stability and accuracy
- 1 Hz resolution (2 Hz above 1300 MHz)
- Calibrated output over > 140 dB range
- AM, FM, ϕ M, or pulse modulation
- Fully TTL programmable

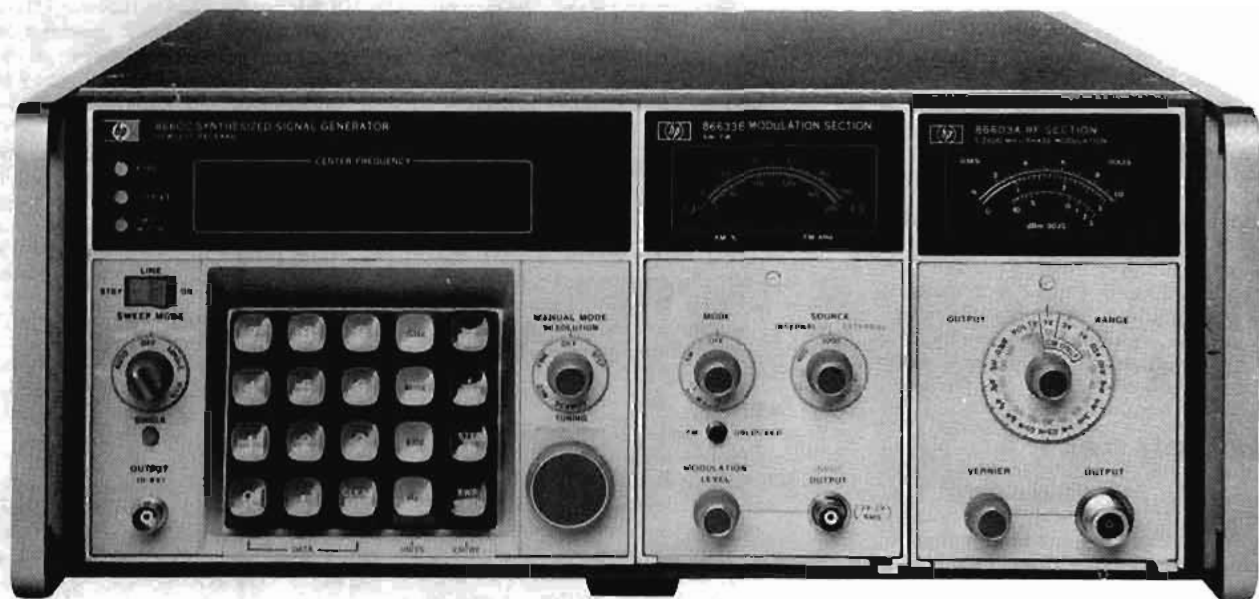

8660C

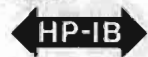

System Concept

The 8660A/C family is a modular solid-state plug-in system. Each system includes: 1) a programmable synthesized signal generator mainframe, 2) at least one RF section plug-in, and 3) at least one modulation section. This modular plug-in construction allows an 8660 system to be configured for any specific application while minimizing the added expense of unnecessary features.

As its name implies, the 8660 is a true frequency synthesizer. Yet it is finding even broader appeal as a high performance signal generator. And being completely programmable, the 8660 is the perfect choice for most automated receiver or component testing situations.

Mainframes

There are two different synthesized signal generator mainframes to choose from. Both feature complete TTL programming of frequency, output level, and most modulation functions. The standard programming interface is BCD and an optional HP-IB interface is available. Both mainframes can operate from an internal crystal reference or external frequency standard.

The 8660A mainframe uses thumbwheel switches to select CW output frequencies. Frequencies up to 1300 MHz can be entered directly with 1 Hz resolution. (For applications requiring frequencies above 1300 MHz the 8660A must be used with the 86603A Option 003. The frequency selection process involves selecting one-half of the desired RF output frequency and activating the 86603A Option 003 front panel doubler switch).

The 8660C keyboard mainframe provides direct keyboard entry of CW frequencies up to 2600 MHz. Added capabilities of the 8660C include digital sweep, frequency stepping, synthesized search, and a ten-digit numerical display.

Swept testing of very narrowband devices such as crystal filters is made possible by the 8660C's digital sweep. Since the RF output consists of discrete synthesized steps, the result is a very linear sweep with extremely low residual FM. A 0-8 V horizontal sweep output is provided for driving XY plotters, oscilloscopes, etc.

For applications which require frequency to be changed in uniform increments, a frequency stepping capability is provided on the 8660C. For example, if a receiver with 50 kHz channel spacing is being tested,

a 50 kHz step size can be entered and the frequency stepped to the next higher or lower channel with a single key-stroke.

Synthesized search provides the dial tuning convenience of a signal generator while maintaining synthesizer signal quality. As the dial is turned the output frequency is tuned up or down in discrete synthesized steps which may be chosen as small as 1 Hz.

Plug-In RF Sections

There are three RF sections to choose from. The 86601A covers the 10 kHz to 110 MHz frequency range with calibrated output of +13 to -146 dBm. The 86602B (used with the 11661B Frequency Extension Module) covers 1 MHz to 1300 MHz with output of +10 to -146 dBm. The 86603A (also used with the 11661B) covers 1 MHz to 2600 MHz with output of +7 to -136 dBm. All RF sections have 1 Hz frequency resolution except for 2 Hz above 1300 MHz with the 86603A. In the remote mode output level can be programmed in 1 dB steps over the full operating range.

Plug-In Modulation Sections

There are five modulation sections to choose from. The 86632B and 86633B are both AM/FM modulation sections. An accurate modulation meter indicates % AM or FM peak deviation. The 86633B differs from the 86632B in that the carrier is phase locked while FM modulating at rates and deviations up to 100 kHz. The 86632B utilizes a free running VCO during FM but allows rates and deviations up to 1 MHz. Any drift can be removed by depressing the FM CF CAL button.

The 86634A offers only analog phase modulation at rates to 10 MHz and metered deviations to 100° below 1300 MHz and 200° above 1300 MHz. The 86635A ϕ M/FM Modulation Section is similar in performance to the 86634A except rates are limited to 1 MHz and FM capability is also included. (The 86634A and 86635A must be used with Option 002 RF Sections).

The 86631B Auxiliary Section provides both external AM and pulse modulation. The 86631B Auxiliary Section must be used when another modulation section is not installed.

All modulation functions of the 86632B, 86633B, and 86635A are fully programmable.

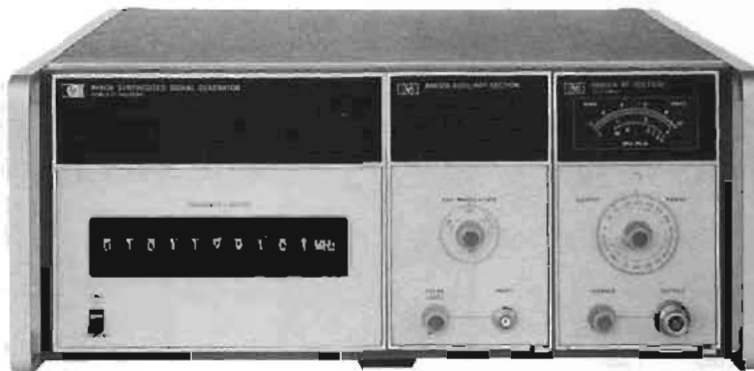

8660A

8660A/C mainframe specifications

Frequency accuracy and stability: CW frequency accuracy and long term stability are determined by reference oscillator in 8660A/C mainframe (3×10^{-9} /day) or by external reference if used.

Reference oscillator

Internal: 10 MHz quartz oscillator. Aging rate less than ± 3 parts in 10^6 per 24 hours after 72 hours warm-up. (± 3 parts in 10^6 per 24 hours, Option 001).

External: rear panel switch allows operation from 5 MHz or 10 MHz frequency standard at a level between 0.2 V and 2.0 V rms into 170 ohms.

Reference output: rear panel BNC connector provides output of reference signal selected at level of at least 0.5 V rms into 170 ohms.

Digital sweep (8660C): auto, single or manual. Selectable speeds 0.1, 1, or 50 seconds.

Remote programming

Functions

8660A: all front panel frequency and output level, and most modulation functions are programmable.

8660C: CW frequency, frequency stepping (STEP \uparrow , STEP \downarrow), and output level, and most modulation functions are programmable. Note: digital sweep is NOT programmable.

Programming input

Connector type: 36-pin Cinch type 57 (mating connector supplied). [Optional HP-IB interface; 24-pin Cinch type 57 (mating connector NOT supplied)].

Logic: TTL compatible (negative true)

Switching time: less than 5 ms to be within 100 Hz of any new frequency selected. (Less than 100 ms to be within 5 Hz).

Maximum stepping rate: 1 ms per step.

General

Operating temperature range: 0° to +55°C.

Power: 100, 120, 220, or 240 volts +5%, -10%, 48-66 Hz. Approximately 350 watts.

Weight: [Mainframe only]: net, 24.1 kg (53 lb). Shipping, 29.6 kg (65 lb).

Options for 8660A/C

001: $\pm 3 \times 10^{-9}$ /day internal reference oscillator.

002: no internal reference oscillator.

003: operation from 50 to 400 Hz line.

004: 100 Hz frequency resolution (200 Hz above 1300 MHz CF).

005: HP-IB programming interface.

100: 11661B factory installed.

009: (8660A only): front panel LED display indicates selected frequency in 1-2-4-8 BCD code.

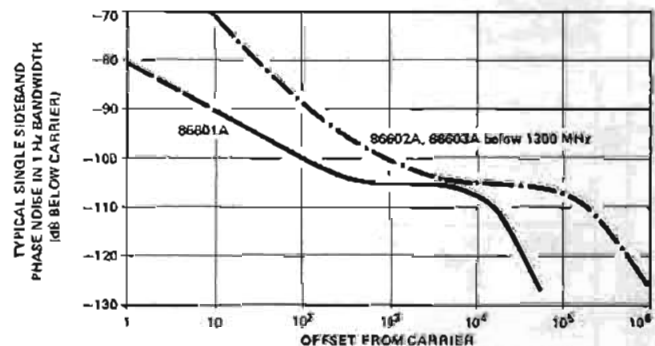

RF section specifications (Installed in 8660A or 8660C mainframe)

FREQUENCY CHARACTERISTICS	86601A	86602B (with 11661B)	86603A (with 11661B)	
	0.01 - 110 MHz (109.999999 MHz)	1 - 1300 MHz (1299.999999 MHz)	1 - 2600 MHz (2599.999998 MHz)	
Frequency Range			CF < 1300 MHz	CF \geq 1300 MHz
Frequency Resolution		1 Hz		2 Hz
Harmonics	< -40 dB	< -30 dB (< -25 dB above +3 dBm)		< -20 dB ¹
Spurious: Non Harmonically Related	-80 dB	-80 dB below 700 MHz -80 dB above 700 MHz within 45 MHz of carrier -70 dB above 700 MHz > 45 MHz from carrier		-74 dB within 45 MHz of carrier ¹ -64 dB > 45 MHz from carrier
Power Line Related (CW, AM, ϕ M only) ²	-70 dB	-50 dB on +10 dBm range < -70 dB		< -64 dB
Signal To Phase Noise Ratio (CW, AM, ϕ M only) ²	> 50 dB	> 45 dB		> 39 dB

¹For output levels +3 dBm and below, slightly higher from +3 to +7 dBm.

²Measured in a 50 kHz band centered on the carrier excluding a 1 Hz band centered in the carrier.

SIGNAL GENERATORS

8660A & 8660C (cont.)

• 10 kHz to 110 MHz

• 1 MHz to 1300 MHz

• 1 MHz to 2600 MHz



86601A



86602B



86603A

RF Section specifications (cont.)

		86601A	86602B (with 11661B)	86603A (with 11661B)		
		0.01–110 MHz	1–1300 MHz	1–1300 MHz	1300–2600 MHz	
OUTPUT CHARACTERISTICS	Output Level (into 50Ω)	+13 dBm to –146 dBm	+10 to –146 dBm	+10 to –136 dBm	+7 to –136 dBm ³	
	Output Accuracy (local and remote)	±1 dB, +13 to –66 dBm ±2 dB, –66 to –146 dBm	±1.5 to –76 dBm ±2.0 to –146 dBm	±2.5 dB, to –76 dBm ³ ±3.5 dB, to –136 dBm		
	Flatness (output level variation with frequency)	< ±0.5 dB	< ±1.0 dB	< ±2.0 dB (1–2600 MHz)		
	Impedance	50Ω				
MODULATION CHARACTERISTICS	AM	AM Modulation Depth	0 to 95%	0 to 90% ⁴	0–50% ⁴	
		3 dB Bandwidth: 0–30%	200 Hz, CF < 0.4 MHz 10 kHz, 0.4 ≤ CF < 4 MHz 100 kHz, CF ≥ 4 MHz	10 kHz, CF < 10 MHz 100 kHz, CF ≥ 10 MHz	5 kHz	
		0–70%	125 Hz, CF < 0.4 MHz 6 kHz, 0.4 ≤ CF < 4 MHz 60 kHz, CF ≥ 4 MHz	6 kHz, CF < 10 MHz 60 kHz, CF ≥ 10 MHz	N/A	
	0–90%	100 Hz, CF < 0.4 MHz 5 kHz, 0.4 < CF < 4 MHz 50 kHz, CF ≥ 4 MHz	5 kHz, CF < 10 MHz 50 kHz, CF ≥ 10 MHz	N/A		
	Distortion, ⁵ THD at 30% AM at 70% AM at 90% AM	<1%, 0.4–110 MHz <3%, 0.4–110 MHz <5%, 0.4–110 MHz	<1% <3% <5%	<5% N/A N/A		
	FM	FM Rate	DC to 1 MHz with 86632B 20 Hz to 100 kHz with 86633B	DC to 200 kHz with 86632B and 86635A 20 Hz to 100 kHz with 86633B		
		Maximum Deviation (peak)	1 MHz with 86632B 100 kHz with 86633B	200 kHz with 86632B and 86635A 100 kHz with 86633B	400 kHz w/86632B, 35A 200 kHz w/86633B	
		Distortion, THD (at rates up to 20 kHz)	<1% up to 200 kHz dev. <3% up to 1 MHz dev.	<1% up to 200 kHz dev.	<1% up to 400 kHz dev.	
	PULSE	Pulse Rise/Fall Time	200 ns	50 ns		
		ON/OFF Ratio (with pulse level control at max.)	>50 dB	>40 dB		
ΦM	ΦM Rate	N/A	DC to 1 MHz with 86635A DC to 1 MHz for CF < 100 MHz DC to 10 MHz for CF ≥ 100 MHz } with 86634A			
	Maximum Peak Deviation	N/A	0 to 100 degrees		0 to 200 degrees	
	Distortion, THD	N/A	<5% up to 1 MHz rates <7% up to 5 MHz rates <15% up to 10 MHz rates			
GENERAL	Weight	Net 5 kg (11 lb) Shipping 6.4 kg (14 lb)	Net 4.1 kg (9 lb) Shipping 5.5 kg (12 lb)	Net 5 kg (11 lb) Shipping 6.4 kg (14 lb)		
		11661B: Net 2.3 kg (5 lb), Shipping 2.7 kg (6 lb)				

3. For +3 to +7 dBm output levels, output accuracy and flatness will be slightly degraded (above 1300 MHz only).

4. For RF output level meter readings from +3 dB to –6 dB and only at +3 dBm and below.

5. Applies only at 400 Hz and 1 kHz rates with output meter set at 0 to +3 dB. At –6 dB meter setting the distortion approximately doubles.

6. Phase modulation is only possible with Option 002 RF Sections.

● Pulse/AM

● AM/FM

● AM/FM

● φM

● φM/FM



86631B

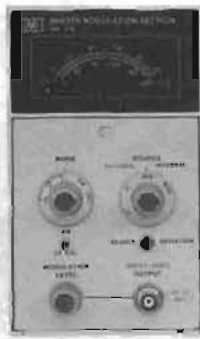

86632B



86633B



86634A

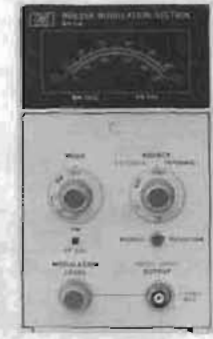

86635A

Modulation Section specifications

		86631B	86632B	86633B	86634A	86635A
AM	Functions	Ext. Only	Int. and Ext.	Int. and Ext.	—	—
	Indicated Accuracy (at 400 and 1000 Hz rates)	—	±5% of full scale (±10% of full scale for center frequencies ≥1300 MHz)		—	—
FM	Functions	—	Int. and Ext., FM CF CAL	Int. and Ext.	—	Int. and Ext., FM CF CAL
	Center Frequency Long Term Stability	—	Typically less than 200 Hz/hr.	Same as in CW Mode (3×10^{-6} /day)	—	Typically less than 200 Hz/hr.
	Indicated Accuracy (up to 20 kHz rates)	—	±5% of full scale		—	±5% of full scale
PULSE	Functions	Ext. Only	—	—	—	—
φM	Functions	—	—	—	Int. and Ext.	Int. and Ext.
	Indicated Accuracy (15°C to 35°C)	—	—	—	±5% of full scale up to 100 kHz rates ±8% of full scale up to 2 MHz rates ±15% of full scale up to 10 MHz rates	
Meter		—	0–100% AM 0–10, 100, 1000 kHz FM Pk. Dev. (0–20, 200, 2000 kHz FM for CF ≥ 1300 MHz)	0–100% AM 0–10, 100 kHz FM Pk. dev. (0–20, 200 kHz FM for CF ≥ 1300 MHz)	0–100° Peak φM, 0–200° for CF ≥ 1300 MHz)	0–10, 100, 1000 kHz FM, 0–100° Pk φM (0–20, 200, 2000 kHz FM, 0–200° Pk. φM for CF ≥ 1300 MHz)
Internal Modulation Source Output		None	400 Hz and 1 kHz ±5% 200 mV minimum into 10 kΩ. Available on front panel BNC connector			
Input Impedance		50Ω Pulse 600Ω AM	600Ω	600Ω	50Ω	600Ω
Weight		Net, 1.4 kg (3 lb) Shipping, 2.3 kg (5 lb)	Net, 2.7 kg (6 lb) Shipping, 4.1 kg (9 lb)	Net, 2.7 kg (6 lb) Shipping, 4.1 kg (9 lb)	Net, 1.8 kg (4 lb) Shipping, 3.2 kg (7 lb)	Net, 2.7 kg (6 lb) Shipping, 4.1 kg (9 lb)

Model number and name

8660A Synthesized Signal Generator Mainframe \$8800
 8660C Synthesized Signal Generator Mainframe \$8400
 Option 001: ±3 × 10⁻⁹/day internal reference oscillator \$210
 Option 002: no internal reference oscillator less \$300
 Option 003: operation from 50 to 400 Hz line \$155
 Option 004: 100 Hz frequency resolution (200 Hz above 1300 MHz) less \$350
 Option 005: HP-IB programming interface \$250
 Option 009: (8660A only) LED display indicates selected frequency in 1-2-4-8 BCD code \$210
 Option 100: 11661B factory installed inside mainframe \$3400

Price

86601A RF Section \$3400
 86602B RF Section \$4600
 86603A RF Section \$6400
 Option 001: no RF output attenuator (all RF Sections) less \$600
 Option 002: adds phase modulation capability (86602B, 86603A only) \$1500
 Option 003: allows operation of 86603A with 8660A mainframe
 11661B Frequency Extension Module \$3400
 86631B Auxiliary Section \$300
 86632B AM/FM Modulation Section \$1950
 86633B AM/FM Modulation Section \$1900
 86634A φM Modulation Section \$1550
 86635A φM/FM Modulation Section \$2350

SIGNAL GENERATORS

Synthesized signal generators

Model 8672A

- 2 to 18 GHz frequency range
- 1 to 3 kHz frequency resolution
- Low spurious and phase noise
- +3 to -120 dBm calibrated output
- $<5 \times 10^{-10}$ /day stability
- Metered AM/FM

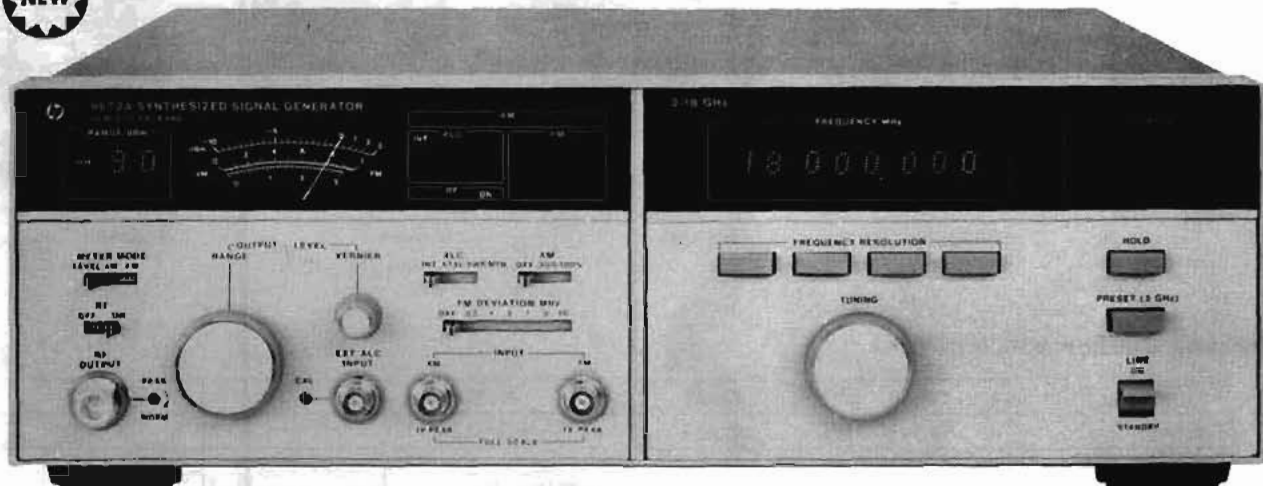

8672A



The 8672A synthesized signal generator covers the entire 2.0 to 18.0 GHz frequency range in one compact solid-state package (133 mm, 5¼ in. high) while providing calibrated output and complete AM/FM modulation capability. The 8672A can replace two, three, or even four instruments in many applications.

Advanced thin film technology

An indirect synthesis approach is used to phase lock a wideband 2.0 to 6.2 GHz YIG-tuned transistor oscillator (YTO) to the internal (or ext.) time base. The output of the YTO drives a YIG tuned multiplier (YTM), a product made possible by HP's advanced microcircuit technology, to achieve the 2 to 18 GHz coverage. This YTM produces spectrally pure harmonics of the input frequency and selects the proper harmonic automatically.

Excellent spectral purity

The 8672A has been designed for very low single sideband phase noise (see figure 2). This characteristic is very important for L.O. applications and many tests on communication and radar systems. Non-harmonic spurious are also controlled to prevent undesired responses. Such signals are -70 dB from 2 to 6.2 GHz and -60 dB from 12.4 to 18 GHz, excluding power line related frequencies.

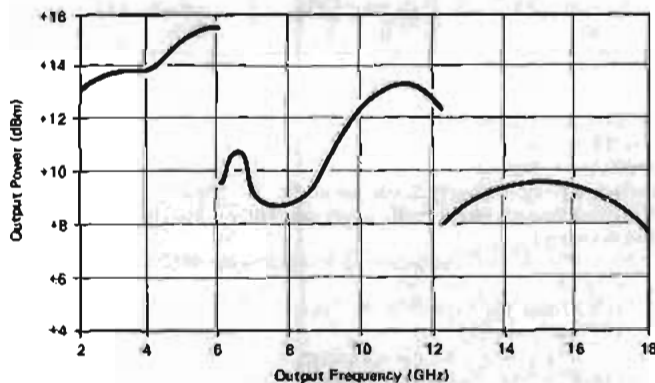

Figure 1. Maximum power typically available on "+10" attenuator setting (Overrange) at 25 C.

Wide dynamic output range

For broadband component and receiver testing applications the 8672A incorporates an exceptionally flat frequency response across the full 2 to 18 GHz range. The addition of a calibrated 110 dB RF step attenuator on the output results in accurate output control from +3 to -120 dBm, enabling very sensitive receiver tests to be made. For LO applications an "overrange" position provides additional power at most frequencies across the full 2 to 18 GHz band. See figure 1.

Calibrated AM/FM modulation

To expand the versatility of the 8672A for accurate receiver testing, AM/FM capability is provided (with externally applied modulation signals). AM depth at rates up to 100 kHz can be accurately set using the front panel meter. FM is allowed up to 10 MHz rates and peak deviations. The meter can also be used to monitor peak deviations on any of six selectable ranges. Both AM depth and FM deviation are linearly controlled by varying the input voltage up to 1 volt maximum. The 8672A remains phase locked in both the AM and FM modes.

Front panel status indicators

For unambiguous operation, a series of annunciators is conveniently located on the front panel to indicate the operational "status" of the instrument. These include:

1. AM/FM modes and selected ranges
2. Output level "overrange" selection
3. RF ON/OFF
4. "Not phase locked" indication
5. Unleveled condition
6. Remote operation.

All functions fully programmable

The 8672A provides full programmability of all of its front panel functions: frequency, output level (in 1 dB steps) and modulation selection. The 8672A has an HP-IB interface (standard on all units) and can be used with any HP 9800 series calculator or minicomputer for automatic systems application.

Fast pulse capability available

Many broadband applications such as EW receiver tests require pulsed RF. The 8672A has a pulse-modulation accessory available for the entire 2 to 18 GHz band. Contact HP for more information.

8672A specifications

Frequency characteristics

Frequency range: 2.0–18.0 GHz (with overrange to 18.599997 GHz).

Frequency resolution: 1 kHz to 6.2 GHz, 2 kHz to 12.4 GHz, 3 kHz to 18.0 GHz.

Time base: internal 10 MHz ($< 5 \times 10^{-10}$ /day aging rate) or external 5 or 10 MHz.

Frequency switching time: < 15 ms to be within 1 kHz, 2–6.2 GHz; 2 kHz, 6.2–12.4 GHz; 3 kHz, 12.4–18 GHz.

Harmonics (≤ 18 GHz) and subharmonics: < -25 dB.

Single-sideband phase noise (1 Hz BW, CW mode):

Offset from F_c	10 Hz	100 Hz	1 kHz	10 kHz	100 kHz
2.0– 6.2 GHz	-60 dB	-68 dB	-78 dB	-89 dB	-109 dB
6.2–12.4 GHz	-54 dB	-62 dB	-72 dB	-83 dB	-103 dB
12.4–18.0 GHz	-50 dB	-58 dB	-68 dB	-79 dB	-99 dB

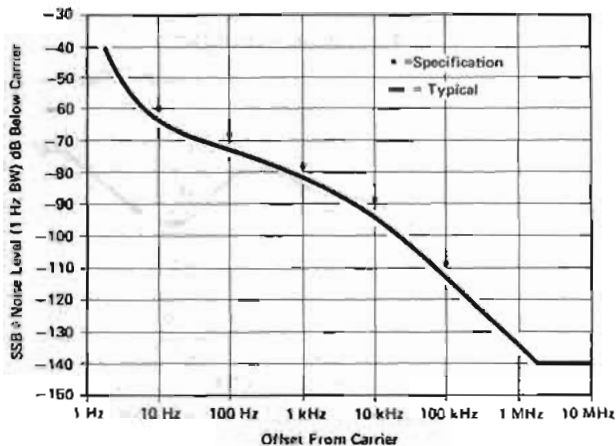

Figure 2. Typical 8672A single-sideband phase noise performance, 2.0–6.2 GHz. Add 8 dB for 6.2–12.4 GHz and 10 dB for 12.4–18 GHz.

Spurious

Non-harmonically related:

< -70 dB, 2.0–6.2 GHz.

< -64 dB, 6.2–12.4 GHz.

< -60 dB, 12.4–18.0 GHz.

Power line related (CW mode, and within 5 Hz of any line related frequency):

Offset from F_c	300 Hz	300 Hz to 1 kHz	> 1 kHz
2.0–6.2 GHz	-50 dB	-60 dB	-65 dB
6.2–12.4 GHz	-44 dB	-54 dB	-59 dB
12.4–18.0 GHz	-40 dB	-50 dB	-55 dB

Output characteristics

Output level (+15°C to +35°C): +3 to -120 dBm.

Flatness (+15°C to +35°C): ± 0.75 dB, 2.0–6.2 GHz; ± 1.00 dB, 2.0–12.4 GHz; ± 1.25 dB, 2.0–18.0 GHz.

Total indicated meter accuracy (+15°C to +35°C):

Attenuation Range	0 dBm	-10 dBm	-20 dBm	-30 dBm and below
2.0– 6.2 GHz	± 1.75 dB	± 2.25 dB	± 2.45 dB	± 1.75 dB ± 0.3 dB/ 10 dB step below 0 dBm range
6.2–12.4 GHz	± 2.0 dB	± 2.5 dB	± 2.7 dB	± 2.0 dB ± 0.3 dB/ 10 dB step below 0 dBm range
12.4–18.0 GHz	± 2.25 dB	± 2.85 dB	± 3.05 dB	± 2.25 dB ± 0.4 dB/ 10 dB step below 0 dBm range

Remote programming accuracy (+15°C +35°C): 0.75 dB better than indicated meter accuracy.

Output level switching time: < 30 ms.

Source impedance: 50 Ω .

Amplitude modulation

AM depth (for RF output meter readings ≤ 0 dB):

0–75%, 2.0–6.2 GHz

0–60%, 6.2–12.4 GHz

0–50%, 12.4–18.0 GHz

Sensitivity: 30%/V and 100%/V ranges. Max input 1 volt peak into 600 Ω .

Rates (3 dB BW): 10 Hz–100 kHz.

Frequency modulation

Peak deviation (max): the smaller of

10 MHz or $f_{mod} \times 5$, 2.0–6.2 GHz

10 MHz or $f_{mod} \times 10$, 6.2–12.4 GHz

10 MHz or $f_{mod} \times 15$, 12.4–18.0 GHz

Sensitivity: 30, 100, 300 kHz/V and 1, 3, 10 MHz/V ranges. Max input 1 volt peak into 50 Ω .

Rates (3 dB BW): 50 Hz to 10 MHz.

Remote programming capability

Frequency: programmable over full range with same resolution as in manual mode.

Output level: programmable over full range in 1 dB steps, including "overrange."

AM modulation: OFF, 30%/V, and 100%/V ranges.

FM modulation: OFF, 30, 100, 300 kHz/V and 1, 3, 10 MHz/V ranges.

Other: RF ON/OFF, ALC INT./EXT. (EXT. ALC from crystal or power meter).

Programming format: HP-IB (Hewlett-Packard Interface Bus) furnished.

General

Operating temperature range: 0 to +55°C.

Power: 100, 120, 220, 240 V +5, -10%, 48–66 Hz, 325 VA max.

Weight: net, 27 kg (60 lb).

Dimensions: 603 mm D \times 425 mm W \times 133 mm H, (23 $\frac{3}{4}$ " \times 16 $\frac{1}{4}$ " \times 5 $\frac{1}{4}$ ").

8672A Synthesized Signal Generator

\$26,000

SIGNAL GENERATORS

Microwave frequency synthesizer

Model 8671A

- 2–6.2 GHz frequency range
- 1 kHz frequency resolution
- $<5 \times 10^{-10}$ /day stability
- Low spurious and phase noise
- +8 dBm minimum output power
- HP-IB programmability

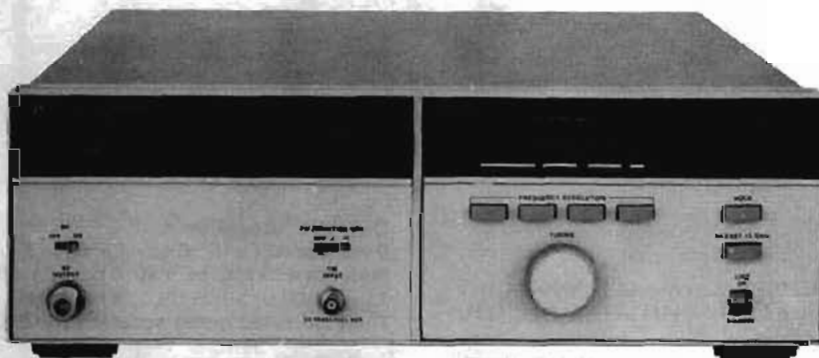

8671A



Description

The 8671A microwave frequency synthesizer covers the frequency range 2.0 to 6.2 GHz with 1 kHz resolution while offering excellent stability, spectral purity, and programming convenience. It is well suited for most LO applications that require state-of-the-art performance as well as broadband capability.

Spectral purity

Unwanted spurious responses (except power line related) are greater than -70 dB below the carrier across the full frequency band. And phase noise, a critical parameter in areas such as satellite communications, is low enough to permit extremely sensitive measurements. The single-sideband phase noise component 1 kHz away from the carrier is typically -83 dB below the carrier. At 100 kHz it is typically -114 dB.

Output power

The 8671A has a guaranteed output of +8 dBm at all frequencies. This is well within the operating range of most commercial mixers. However, for the few applications requiring greater power the 8671A produces clean outputs as high as +12 dBm at many frequencies. Since the 8671A is unleveled there is a frequency response associated with the output which is <6 dB in total variation.

Wideband FM

The 8671A also has frequency modulation capability at rates up to 10 MHz and peak deviations up to 10 MHz (with externally applied signals). There are two input sensitivity ranges, and carrier phase-lock is maintained in the FM mode.

HP-IB programmability

The standard programming interface offered with the 8671A is directly compatible with the Hewlett-Packard Interface Bus. Programmable functions include frequency, FM, and RF ON/OFF. Fast switching times enable the 8671A to be used as a programmable LO where LO frequency is rapidly shifting, as in certain surveillance applications.

Specifications

Frequency characteristics

Frequency range: 2.0–6.2 GHz (6.199999 GHz).

Frequency resolution: 1 kHz.

Time base: internal 10 MHz ($<5 \times 10^{-10}$ /day aging rate) or external 5 or 10 MHz.

Switching time: <15 ms to be within 1 kHz.

Harmonics: <-15 dB.

Single-sideband phase noise (1 Hz BW, CW mode):

Offset from F_c	10 Hz	100 Hz	1 kHz	10 kHz	100 kHz
SSB level	-60 dB	-68 dB	-78 dB	-89 dB	-109 dB

Spurious

Non-harmonically related: <-70 dB.

Power line related (CW mode, and within 5 Hz of any line related frequency):

Offset from F_c	<300 Hz	300 Hz to 1 kHz	>1 kHz
2.0–6.2 GHz	-50 dB	-60 dB	-65 dB

Output characteristics

Power (unleveled): +8 dBm (min.), +15 to 35°C.

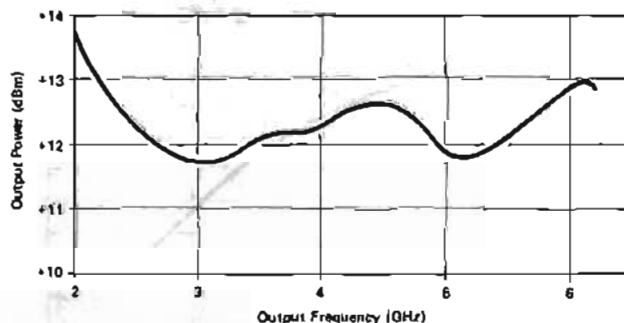

Figure 1. Typical output power available from 8671A (at 25°C).

Flatness: <6 dB total variation across full frequency band.

Source impedance: 50Ω.

Frequency modulation

Peak deviation (max): 10 MHz or $f_{mod} \times 5$, whichever is smaller.

Sensitivity: 50 kHz/V and 5 MHz/V ranges. Max input 2 volts peak into 50Ω.

Rates (3 dB BW): 50 Hz to 10 MHz.

Remote programming

Frequency: programmable over full range with 1 kHz resolution.

FM modulation: OFF, 50 kHz/V, and 5 MHz/V ranges.

Other: RF/ON/OFF.

Programming format: HP-IB (Hewlett-Packard Interface Bus).

General

Operating temperature range: 0 to 55°C.

Power: 100, 120, 220, or 240 V +5, -10%, 48–66 Hz, 300 VA max.

Weight: net, 24 kg (58 lb).

Dimensions: 603 mm D × 425 mm W × 133 mm H (23¼" × 16¼" × 5¼").

8671A Microwave frequency synthesizer

\$16,500

SIGNAL GENERATORS

Precision, high stability, AM-FM, 0.5 to 1024 MHz

Models 8640A, 8640B

- Wide frequency and power range
- Low broadband and close-in noise
- Calibrated, metered AM and FM

- The 8640B also features:
internal phase lock synchronizer
external counter to 550 MHz

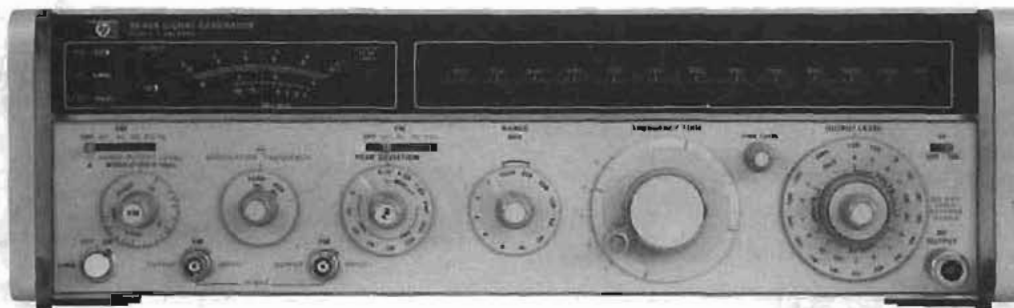

8640A

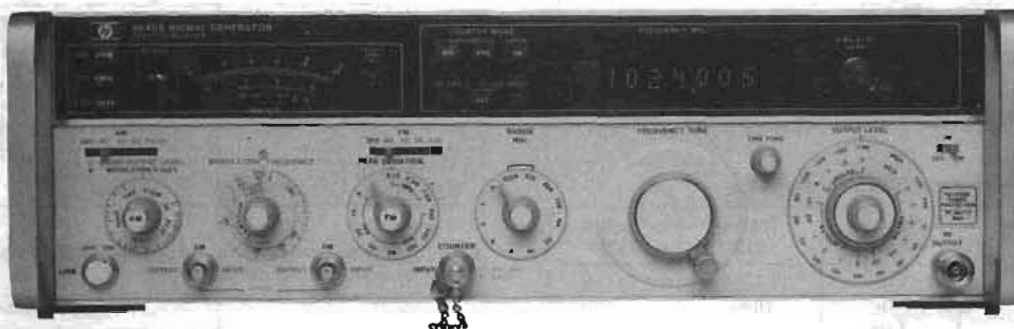

8640B

Description

The 8640 signal generator covers the frequency range 500 kHz to 512 MHz (450 kHz to 550 MHz with band overrange) and can be extended to 1100 MHz with an internal doubler (option 002). Using the 11710A Down Converter, the 8640 frequency range can be extended down to 5 kHz. An optional audio oscillator is also available with a frequency range of 20 Hz to 600 kHz. This broad coverage, together with calibrated output and modulation, provides for complete RF and IF performance tests on virtually any type of HF, VHF, and UHF receivers.

Both solid state generators 8640A and B have an output level range of +19 to -145 dBm (2 V to 0.013 μ V) which is calibrated, metered, and leveled to within ± 0.5 dB across the full frequency range of the instrument.

The 8640A/B generators provide AM, FM, and pulse modulation for a wide range of receiver test applications. This modulation is calibrated and metered for direct readout under all operating conditions.

A reverse power protection option (Opt 003) is available to eliminate instrument damage due to accidental transmitter keying. This module protects against up to 50 watts of applied power and automatically resets upon removal of the excessive signal.

Spectrally pure output signals

Noise performance of the 8640 is state-of-the-art for a solid-state generator. The high-Q cavity oscillator has been optimized with use of a low-noise microwave transistor for spectrally pure output signals.

At 20 kHz offsets from 230 to 450 MHz, SSB phase noise is > 130 dB/Hz below the carrier level and rises to 122 dB/Hz at 550 MHz. This signal-to-noise ratio increases by approximately 6 dB for each division of the output frequency down to the broadband noise floor of better than 140 dB/Hz. This exceptional noise performance is also preserved during FM modulation and in the phase-locked mode of the 8640B.

Mechanical dial or built-in counter

There are two versions of the 8640 Signal Generators. One, the 8640A, has an easy-to-read slide rule dial with scales for each of the 10 output frequency ranges. There is an additional scale, to provide direct readout of the output frequency even in the INTERNAL DOUBLER band, 512-1024 MHz.

The 8640B has the same performance features as the 8640A, but incorporates a built-in 550 MHz frequency counter and phase lock synchronizer.

The built-in 6-digit counter displays the output frequency and can also be used to count external input signals from 20 Hz to 550 MHz. This eliminates the need for a separate frequency counter in many measurement systems.

Internal pushbutton synchronizer

At the push of a button, the 8640B built-in phase lock synchronizer locks the RF output frequency to the crystal time base used in the counter. In this locked mode, the output stability is better than 5×10^{-8} /hr and the spectral purity and FM capability of the unlocked mode are preserved. For higher stability, it is possible to lock to an externally applied 5 MHz standard. Two 8640B's can also be locked together for various 2-tone measurements.

In the phase locked mode, increased resolution is available by using the $\frac{1}{2}$ digit increment button. For example, 500 Hz resolution is possible for frequencies between 100 and 1000 MHz.

FM while phase locked

When phase locked, full FM capability is preserved down to modulation rates of 50 Hz. The narrow bandwidth of the phase lock loop (< 5 Hz) provides for FM modulation up to 250 kHz rates and assures no degradation in noise from the unlocked mode. This crystal stability, coupled with the precision modulation and low noise, makes the 8640B ideal for testing narrowband FM or crystal-controlled receivers.

SIGNAL GENERATORS

Precision, high stability, AM-FM, 0.5 to 1024 MHz

Models 8640A, 8640B (cont.)

8640A/B specifications

(See Technical Data Sheet for Complete Specifications). All specifications apply over the nominal Frequency ranges and over the top 10 dB of the output level vernier range unless otherwise specified.

Frequency characteristics

Range: 500 kHz to 512 MHz in 10 octave ranges (to 1024 MHz with option 002 internal frequency doubler).

Ranges and range overlap: ranges extend 10% below and 7% above the nominal frequency ranges shown below.

Frequency ranges (MHz)		
0.5 - 1	8 - 16	128 - 256
1 - 2	16 - 32	256 - 512
2 - 4	32 - 64	512 - 1024
4 - 8	64 - 128	(opt 002)

Fine tuning

8640A and 8640B unlocked: > 1000 ppm total range.

8640B locked mode: ± 20 ppm by varying internal time base vernier.

Interval counter resolution (8640B unlocked):

Frequency Ranges (MHz)	Normal Mode	Expand X10	Expand X100
0.5 - 1	10 Hz	1 Hz	0.1 Hz
1 - 16	100 Hz	10 Hz	1 Hz
16 - 128	1 kHz	100 Hz	10 Hz
128 - 1024	10 kHz	1 kHz	100 Hz

Optimum counter resolution when phase-locked (8640B):

Frequency Ranges (MHz)	With 6 Digits	+ 1/2 Digit
0.5 - 0.9999995	1 Hz	0.5 Hz
1.0 - 9.999995	10 Hz	5 Hz
10.0 - 99.99995	100 Hz	50 Hz
100.0 - 999.9995	1 kHz	500 Hz
1000 - 1024	10 kHz	5 kHz

Accuracy

8640A: mechanical dial; accuracy better than $\pm 1.0\%$, resettability better than 0.1%.

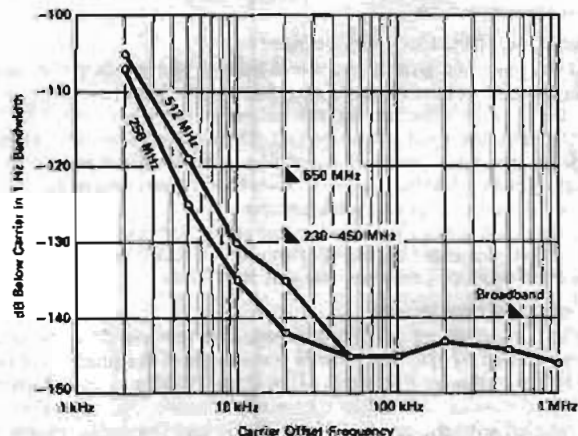

Measured SSB Noise vs. Offset from carrier. Markers indicate specified limits.

8640B: 6 1/2 digit LED display with X10 and X100 expand; accuracy depends on internal or external reference used.

Stability (after 2 hour warmup)

Normal: < 10 ppm/10 min.

Locked (8640B): < 0.05 ppm/hr.

Restabilization time after frequency change

Normal: < 15 min.

Locked (8640B): < 1 min after relocking to be within 0.1 ppm of steady state frequency.

Output characteristics

Range: 10 dB steps and 18 dB vernier provide the following output power settings into 50Ω:

Frequency Range (MHz)	8640A/B	With Option(s)		
		002	003	002/003
0.5 to 512	+19 to -145 dBm	+18.5 to -145 dBm	+18.5 to -145 dBm	+18 to -145 dBm
512 to 1024 (Option 002)	-	+13 to -145 dBm	-	+12 to -145 dBm

Level flatness (referred to output at 50 MHz and applies to 1 V range and for top 10 dB of vernier range):

Frequency Range (MHz)	8640A/B	With Option(s)		
		002	003	002/003
0.5 to 64	± 0.5 dB	± 0.5 dB	+0.75 dB -1.25 dB	+1.0 dB -2.0 dB
64 to 512	-	± 1.0 dB	-	-
512 to 1024 (Option 002)	-	± 1.5 dB	-	± 2.0 dB

Level accuracy: (worst case as indicated on level meter) ± 1.5 dB to ± 4.5 dB depending on level frequency and options installed.

Spectral purity

Harmonics (at 1 volt, +13 dBm output range and below):

> 30 dB below fundamental, 0.5 to 512 MHz.

> 12 dB below fundamental, 512 to 1024 MHz.

Spurious output signals (excluding frequencies within 15 kHz of the signal whose effects are specified in residual AM and FM):

Frequency Range (MHz)	Subharmonically Related		Non-harmonically Related	
	8640A	8640B	8640A	8640B
0.5 to 512	none detectable	> 100 dBc	none detectable	> 100 dBc
512 to 1024 (Option 002)	> 20 dBc ¹			

Residual AM (averaged rms): 0.3 to 3 kHz post detection noise bandwidth > 85 dBc.

Residual FM (averaged rms): 0.3 to 3 kHz post detection noise bandwidth. (CW and up to 1/4 maximum allowable peak deviation.) 0.5 to 512 MHz < 5 Hz.

512 to 1024 MHz < 10 Hz.

¹dBc = dB below the carrier.



Modulation characteristics

General

Types: Internal AM and FM; External AM, FM and PULSE; simultaneous AM and FM or PULSE and FM.

Internal modulation sources: (independently adjustable output is available at front panel).

Standard: 8640A or 8640B.

Frequency: fixed 400 Hz and 1 kHz, $\pm 3\%$.

Output level: 1 mV to 1 V rms into 600 Ω .

Optional: (internal variable audio oscillator Option 001, 8640A or 8640B).

Frequency: variable 20 Hz to 600 kHz, $\pm 15\%$ plus fixed 400 Hz and 1 kHz $\pm 3\%$.

Output level: 1 mV to 3 V rms into 600 Ω .

Amplitude modulation

Depth

0.5 to 512 MHz: 0 to 100% for output level range from +13 dBm and below.

512 to 1024 MHz: 0 to 100% for output levels of +7 dBm and below and for top 16 dB of output vernier range.

AM Rates: INT and EXT ac; 20 Hz to AM 3 dB bandwidth. EXT dc; dc to AM 3 dB bandwidth.

AM 3 dB Bandwidth:

Frequency Ranges	0 to 50% AM	50 to 90% AM
0.5 to 2 MHz	20 kHz	12.5 kHz
2 to 8 MHz	40 kHz	25 kHz
8 to 512 MHz	60 kHz	50 kHz
512 to 1024 MHz	60 kHz	50 kHz

AM Distortion (at 400 Hz and 1 kHz rates):

Frequency Ranges	0 to 30% AM	30 to 50% AM	50 to 90% AM
0.5 to 512 MHz	<1%		<3%
512 to 1024 MHz	<10%	<20%	

External AM Sensitivity (400 Hz and 1 kHz rates)

0.5 to 512 MHz: (0.1 \pm 0.005)% AM per mV peak into 600 Ω with AM vernier at full CW position.

512 to 1024 MHz: nominal 0.1% AM per mV peak into 600 Ω with AM vernier at full CW position.

Indicated AM Accuracy (400 Hz and 1 kHz rates using internal meter)

0.5 to 512 MHz: $\pm 5.5\%$ of reading $\pm 1.5\%$ of full scale from 0 to 50 $^{\circ}$ C.

512 to 1024 MHz: not specified; each generator can be individually calibrated using operating manual procedure.

Peak incidental phase modulation (at 30% AM)

0.5 to 128 MHz: <0.15 radians.

128 to 512 MHz: <0.3 radians.

512 to 1024 MHz: <0.6 radians.

Peak incidental frequency deviation: equals peak incidental phase modulation \times modulation rate.

Pulse modulation:

Frequency Ranges (MHz)	0.5-1	1-2	2-8	8-32	32-512	512-1024
Rise and Fall Times	<9 μ s	<4 μ s	<2 μ s	<1 μ s		<1 μ s typical
Pulse Repetition Rate	50 Hz to 50 kHz		50 Hz to 100 kHz	50 Hz to 250 kHz	50 Hz to 500 kHz	
Pulse Width Minimum ¹	10 μ s		5 μ s	2 μ s		
Pulse ON/OFF ratio at max. vernier	>40 dB					>60 dB
Peak Input Required	Nominally +0.5 V (5 V max). Sinewave or Pulse return to zero into 50 Ω .					

¹ For level accuracy within 1 dB of CW (<0.1% duty cycle)

Frequency modulation

Deviation: maximum allowable deviation equals 1% of lowest frequency in each nominal output frequency range.

Frequency Range (MHz)	Maximum Peak Deviation (kHz)
0.5 - 1	5
1 - 2	10
2 - 4	20
4 - 8	40
8 - 16	80
16 - 32	160
32 - 64	320
64 - 128	640
128 - 256	1280
256 - 512	2560
512 - 1024	5120

FM 3 dB bandwidth: internal and external ac; 20 Hz to 250 kHz. External dc; dc to 250 kHz. (8640B locked mode: FM above 50 Hz only.)

FM distortion: (at 400 Hz and 1 kHz rates)

<1% for deviations up to $\frac{1}{4}$ maximum allowable.

<3% up to maximum allowable deviation.

External FM sensitivity: 1 volt peak yields maximum deviation indicated on PEAK DEVIATION switch with FM vernier at full CW position.

Indicated FM accuracy: (400 Hz and 1 kHz rates using internal meter) $\pm 10\%$ of meter reading, above 10% of full scale.

Incidental AM (at 400 Hz and 1 kHz rates)

0.5 to 512 MHz: <0.5% AM for FM up to $\frac{1}{4}$ max allowable deviation. <1% AM for FM at maximum allowable deviation.

512 to 1024 MHz (Option 002): <1% AM for FM up to $\frac{1}{4}$ max allowable deviation.

Counter characteristics (8640B)

External RF input:

Frequency range: 1 Hz to 550 MHz.

Sensitivity: ≥ 100 mV rms into 50 Ω , ac only.

Resolution: 6-digit LED DISPLAY.

Mode	Normal	Expand X10	Expand X100
0 - 10 MHz	100 Hz	10 Hz	1 Hz
10 - 550 MHz	10 kHz	1 kHz	100 Hz

External reference input: 5 MHz, nominally >0.5 V p-p (5 V max) into 1 k Ω .

Internal reference characteristics: (after 2-hr warmup).

Accuracy: (after calibration at 25 $^{\circ}$ C)

Better than ± 2 ppm for 15 $^{\circ}$ to 35 $^{\circ}$ C.

Better than ± 10 ppm for 0 $^{\circ}$ to 55 $^{\circ}$ C.

Drift rate: (constant temperature and line voltage) <0.05 ppm per hour; <2 ppm per 90 days.

Frequency tuning: $> \pm 20$ ppm using internal time base vernier.

Rear output: >0.5 V p-p into 500 Ω . This will drive another 8640B.

General characteristics

Operating temperature range: 0 to 55 $^{\circ}$ C.

Power requirements: 100, 120, 220, and 240 volts, $\pm 5\%$, $\sim 10\%$, 48 to 440 Hz; 175 VA maximum. (Option 002, 190 VA max.)

Weight: 8640A and 8640B: net, 20.8 kg (46 lb). Shipping, 24.1 kg (53 lb).

Dimensions: 425 mm W \times 140 mm H \times 467 mm D (16 $\frac{1}{2}$ " \times 5 $\frac{1}{2}$ " \times 18 $\frac{3}{4}$ ").

Model number and name

8640A Signal Generator

8640B Signal Generator

Option 001: (internal variable audio oscillator, 20 Hz to 600 kHz)

Option 002: (internal doubler 512-1024 MHz)

Option 003: (reverse power protection)

Option 004: (avionics option) 8640B only

Price

\$4900

\$6400

add \$275

add \$850

add \$300

add \$800

SIGNAL GENERATORS

Avionics option

Model 8640B Opt 004

- Demodulated output from RF detector, AC and DC
- Phase shift; less than 0.01° at 30 Hz
- External Count Capability: 1 Hz to 550 MHz



8640B Opt 004

The Hewlett-Packard Model 8640B Option 004 NAV/COM Signal Generator is an 8640B AM/FM Signal Generator specially adapted for testing ILS (Marker Beacon, Localizer and Glide Slope), VOR and VHF communications receivers used throughout the Aviation industry. VOR, LOCALIZER and VHF communications frequencies (108 to 136 MHz) are available on one frequency band for rapid channel selection. GLIDE SLOPE (329 to 335 MHz) and MARKER BEACON (75 MHz) frequencies are also easily set using the 6-digit LED display.

The 8640B Option 004 provides highly stable, spectrally pure RF signals for testing narrow-channel, crystal controlled receivers. For avionics testing, external audio generators are required to provide the composite modulation. Designed with versatile AM and FM modulation, Option 004 features low distortion modulation when used with suitable, external VOR/ILS Audio Generators.

Operation and specifications of the 8640B Option 004 are the same as the Standard 8640B AM/FM Signal Generator with the following additions.

Demodulated output

One front panel BNC connector provides demodulated output from the RF peak detector for precise AM settings. A choice of combined AC/DC at 1 V rms or AC only at 5 V rms is provided.

Output level setting

To ensure the best possible demodulated output linearity, Option 004 combines a 1 dB step attenuator and a vernier with a 10 dB step attenuator. This provides output levels from +15 dBm to -142 dBm (1.3 V to 0.018 μ V). The output level can be read directly from the attenuator dial in dBm or from the front panel meter in dBm or volts.

External AM input impedance

External AM input impedance of 2 k Ω allows compatible operation with old and new generations of external audio generators.

Low distortion modulation

The 8640B Option 004 provides flat AM response and minimum phase shift at 30 Hz and 9960 Hz as well as constant group delay between 9 kHz and 11 kHz for accurate VOR and ILS testing.

Specifications

(These specifications apply to 8640B Option 004 in addition to standard 8640B specifications. See 8640B AM/FM Signal Generator Data Sheet for complete specifications.)

Spectral purity

Noise: SSB Broadband noise floor: greater than 1 MHz offset from carrier, >130 dB down.

Output characteristics

Range: +15 dBm to -142 dBm (1.3 V to 0.018 μ V)

Attenuators: a 10 dB step attenuator, a 1 dB step attenuator with vernier allow selection of any output level over the full output level range.

Vernier: 2 dB continuously variable from a CAL detent position.

Level flatness: $< \pm 0.75$ dB from 0.5 to 512 MHz referred to output at 190 MHz. $< \pm 0.5$ dB from 108 to 336 MHz referred to output at 190 MHz. (Flatness applies to +10 to -10 dBm.)

Level accuracy:

Output Level (dBm)	+15 to -10	-10 to -50	-50 to -142	With Option 003
Total Accuracy as Indicated on Level Meter	± 1.5 dB	± 2.0 dB	± 2.5 dB	Add ± 0.5 dB except from 108 to 336 MHz

Modulation characteristics

Demodulated output (Output vernier in CAL position) (108 to 118 and 329 to 336 MHz): an internal selector switch allows selection of AC only or AC and DC at the demodulated output.

AC only output: directly proportional to AM depth, (90 to 150 Hz modulation frequency).

%AM equals: $(20 \pm 0.6)\%$ per V rms, 0 to 55°C; $(20 \pm 0.4)\%$ per V rms, 20 to 30°C; $(20 \pm 0.2)\%$ per V rms (using calibration sheet provided by factory.)

AC and DC output: AC output voltage is directly proportional to AM depth (90 to 150 Hz modulation frequency)

%AM equals: $(100 \pm 3)\%$ per V rms, 0 to 55°C; $(100 \pm 2)\%$ per V rms, 20 to 30°C; $(100 \pm 1)\%$ per V rms (using calibration sheet provided by factory.)

DC output equals 1.41 V dc with vernier in CAL position.

Amplitude modulation characteristics (+10 dBm output and below):

External input impedance: nominally 2 k Ω .

Frequency response: ± 0.05 dB from 90 Hz through 150 Hz (108 to 118 and 329 to 336 MHz); ± 0.05 dB from 9 kHz through 11 kHz (108 to 118 MHz); ± 3 dB (0 to 70% AM) from dc through 50 kHz (8 to 512 MHz); ± 3 dB (0 to 90% AM) from dc through 35 kHz (8 to 512 MHz)

Phase shift from audio input to demodulated output (108 to 118 MHz) (AM EXT DC mode):

30 Hz $< \pm 0.01^\circ$

30 Hz to 10 kHz $< \pm 3^\circ$

9 kHz to 11 kHz $< \pm 2^\circ$ difference.

8640B Avionics Option 004

\$7200

SIGNAL GENERATORS

Ruggedized signal generator, down converter

Models 8640M, 11710A

- -40°C to +55°C operating temperature
- Drip proof front panel
- Phase lock stability



8640M

8640M Signal generator

The 8640M is a highly ruggedized version of the 8640B signal generator, which adds field useability, and retains the excellent stability and signal purity of the 8640B.

The waterproof combination case, constructed to the requirements of MIL-T-21200J, provides a protective outer shell and cushioned mounts to assure tolerance to the shock and vibration rigors of off-road transportation. All controls on the front panel are drip-proof, and the air ducts are louvered to allow operation in wind, rain, or snow.

Reliability testing to Mil-Std-781 allows prediction of MTBF's in excess of 2200 hours. The testing included vibration, -40°C to +55°C temperature cycling, and power cycling. Maintainability testing to Mil-Std-471 has verified that the mean time to repair the 8640M is less than 2 hours.

A built-in automatically resetting circuit protects the generator against up to 50 watts of reverse power due to accidental transmitter keying.

8640M Specifications

Frequency characteristics

Range: 500 kHz to 512 MHz in 10-Octave ranges (to 1024 MHz with External Frequency Doubler).

Internal counter resolution: same as 8640B (except no Expand X100 range; no extra 1/2 digit).

External counter resolution: from 0 to 10 MHz: 10 Hz; from 10 to 550 MHz: 1 kHz.

Stability:

	Normal (Typical)	Locked
Time (after 3-hr. warm-up)	<15 ppm/10 min	<2 ppm/10 min
Temperature	<50 ppm/°C	<1 ppm/°C

Output range and accuracy:

Output (dBm) Range	Using Top 10 dB of Vernier Range			Using Full Vernier Range
	+13 to -7	-7 to -47	-47 to -137	+18 to -145
Total Accuracy as Indicated on Level Meter	2.0 dB	2.5 dB	3.0 dB	Add ±0.5 dB

Modulation

Types: internal, AM, FM, and PULSE; external, AM, FM and PULSE.

Environmental performance

Temperature: MIL-STD-810B, Method 501, 502 Proc. 1.

Operating: continuous operation allowed between -40°C (-40°F) and +55°C (131°F). Intermittent operation (<20 min.) allowed up to +71°C (160°F).

Non-Operating: storage allowed between -60°C (-76°F) and +85°C (185°F).

- Extends frequency range down to 5 kHz on all 8640 series generators



11710A



Humidity: MIL-STD-810B, Method 507 Proc. 1, 10-day test.

Operating: -40°C (-40°F) to +40°C (104°F) at up to 95% RH.

Non-Operating: storage allowed between -60°C (-76°F) and +60°C (140°F) up to 95% RH. Condensation allowed.

Shock: MIL-T-21200J Class II. When mounted in its combination case, the 8640M will withstand 20 g's shock in any of 3 planes without damage.

Vibration: MIL-T-21200J Class II.

Rain: MIL-STD-810B Method 506 Proc. 1. Simulated rain and wind conditions up to 12 in./hour rainfall and up to 40 mph wind. Instrument was in normal operating configuration.

Explosive Atmosphere: MIL-STD-810B Method 511 Proc. 1. Type testing verified successful operation in potentially explosive atmosphere laden with avionic fuel vapor.

Salt Fog: MIL-STD-810B Method 509 Proc. 1. A mechanical mock-up was tested to verify the non-corrosive nature of parts, materials, and processes.

Fungus: non-fungus nutrient material used.

EMI: MIL-STD-461A, Class C1, Test Methods CE 03 and RE 02.

11710A Down converter

The 11710A Down Converter is an accessory for the 8640 series signal generators. Frequency inputs from the 8640 in the range of 5.005 to 5.500 MHz are down converted to the 5 kHz to 500 kHz range respectively. The frequency display, output level, and modulation functions of the 8640 remains calibrated. A straight through selection feature allows the input to pass through unchanged and thus minimizes the necessity to move cables when testing.

11710A Specifications

Input characteristics

Down conversion mode: 5.005 to 5.500 MHz at ≤0 dBm.

Straight-through mode: 0.5 to 1024 MHz.

Down converted output characteristics

Frequency range: 5 to 500 kHz.

Level range: 0 to -107 dBm.

Level flatness (referred to 100 kHz): ±0.5 dB.

Level accuracy: ±(1 dB plus input level accuracy).

Harmonics: >35 dBc.

Intermixing spurious: >60 dBc.

Local oscillator feed-through (5 MHz): <-80 dBm.

Straight through output characteristics

Frequency: 0.5 to 1024 MHz

Loss: <1 dB

General characteristics

Operating temperature range: 0 to 55°C

Power requirements: 100, 120, 220, 240 V ±5%, -10%, 48 to 440 Hz; 12.5 VA

Weight: net, 2.2 kg (4 lb 13 oz). Shipping 3 kg (6 lb 8 oz).

Dimensions: 130 mm W × 76 mm H × 279 mm D (5 1/8" × 3 1/4" × 11")

Model number and name

8640M Signal generator

11710A Down converter

Price

\$8400

\$930

SIGNAL GENERATORS

Rugged solid-state generator 10 to 520 MHz; synchronizer/counter

Models 8654A, 8654B, 8655A

- Calibrated output power
- Calibrated AM, FM, internal, external, independent
- 50 Watt reverse power protection (optional)

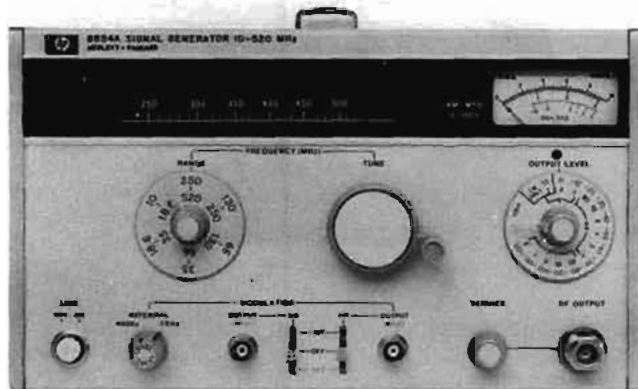

8654A

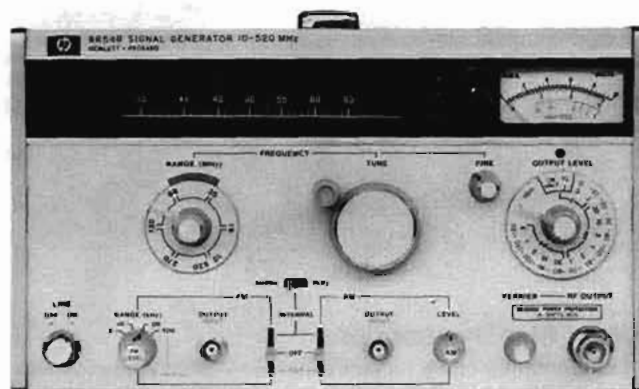

8654B

8654A/B Signal generators

The HP 8654A/B Signal Generators are portable, low-cost solid-state generators providing calibrated output and versatile modulation capabilities over the 10 to 520 MHz frequency range. The 8654 provides clean RF signals with harmonics >20 dBc (below carrier) and subharmonics and spurious >100 dBc for testing receivers, amplifiers, antennas, and filter networks. The 8654B has calibrated AM and FM while the 8654A has uncalibrated FM.

Its compactness and small size allow the 8654 to fit easily into production, mobile, airborne, and shipboard test locations. Its rugged, lightweight construction is also suitable for field maintenance and service applications.

Internal oscillators provide both amplitude modulation and frequency modulation at 400 Hz and 1000 Hz, or external modulation can be accomplished using standard audio oscillators.

A front-panel meter accurately indicates amplitude modulation depth from 0 to 90% when the meter mode switch is in the AM position. Additionally, the 8654B provides calibrated and metered FM over four deviation ranges: 0 to 3 kHz, 0 to 10 kHz, 0 to 30 kHz, 0 to 100 kHz.

Reverse power protection is available (Option 003) to protect against accidental triggering of transceivers of up to 50 watts into the signal generator.

Effective RF shielding and output range permit receiver sensitivity measurements to be made down to power levels of 0.1 μ V.

8654A/B specifications

Specifications apply from 10 to 520 MHz for output power \leq +10 dBm and over the top 10 dB of output level vernier range unless otherwise specified.

Frequency characteristics

Range: 10 to 520 MHz in 6 bands.

8654A bands (MHz): 10 to 18.6, 18.6 to 35, 35 to 66, 66 to 130, 130 to 250, 250 to 520.

8654B bands (MHz): 10 to 19, 19 to 35, 35 to 66, 66 to 130, 130 to 270, 270 to 520.

Accuracy: \pm 3% after 2-hour warm-up.

Settability: settable to within 5 ppm of the desired frequency with an external indicator after 1-hour warm-up.

Stability (after 2-hour warm-up and 15 min. after frequency change): <(1 kHz plus 20 ppm)/5 min.

Spectral purity

Harmonic distortion (output power \leq +3 dBm): >20 dBc, with option 003, >15 dBc.

Subharmonics and non-harmonic spurious (excluding line related): >100 dBc.

Residual AM (average rms): >55 dBc in a 50 Hz to 15 kHz post-detection noise bandwidth.

Residual FM on CW (averaged rms deviation): <0.3 ppm in a 0.3 to 3 kHz post-detection noise bandwidth. <0.5 ppm in a 50 Hz to 15 kHz post-detection noise bandwidth.

Output characteristics

Range: 10 dB steps and a 13 dB vernier provide power settings from +10 dBm to -130 dBm (0.7 V to 0.07 μ V) into 50 Ω . With Option 003, maximum output power is +8 dBm.

Impedance: 50 Ω ac coupled, 75 V dc maximum. SWR <1.3 on 0.1 V range or lower. With Option 003, SWR <1.5 on 0.1 V range or lower.

Level accuracy (total as indicated on level meter): +10 to -7 dBm, \pm 1.5 dB; -7 to -57 dBm, \pm 2.0 dB; -57 to -97 dBm, \pm 2.5 dB; -97 to -127 dBm, \pm 3 dB.

Level flatness: \pm 1 dB referenced to the output at 250 MHz for output levels > -7 dBm.

Auxiliary RF output: > -7 dBm (100 mV) into 50 Ω .

Leakage (with all RF outputs terminated properly): leakage limits are below those specified in MIL-I-6181D. Furthermore, with an output level <0.01 V, less than 0.5 μ V is induced in a 2-turn, 1-inch diameter loop 1 inch away from any surface and measured into a 50 Ω receiver.

Reverse power protection (Option 003): protects signal generator from accidental applications of up to 50 W of RF power into generator output.

Modulation characteristics

Amplitude modulation: specifications apply for output power < +3 dBm.¹

Depth: 0 to 90%.

Modulation rate: internal, 400 and 1000 Hz \pm 10%; external 3 dB bandwidth, dc coupled to >20 kHz.

External AM sensitivity:² (0.1 \pm 0.01)% AM/mV pk into 600 Ω .

Indicated AM accuracy:² \pm (5% of readings +5% of full scale).

Peak incidental frequency deviation (30% AM):¹ less than 200 Hz.

Envelope distortion:² <3%, 0 to 70% modulation; <5%, 90% modulation.

Frequency modulation, 8654B: fully calibrated.

Peak deviation: 0 to 30 kHz from 10 to 520 MHz.

0 to 100 kHz from 80 to 520 MHz.

Deviation ranges: 0 to 3 kHz, 0 to 10 kHz, 0 to 30 kHz, 0 to 100 kHz.

Modulation rate: internal, 400 and 1000 Hz \pm 10%. External 3 dB bandwidth, dc coupled to >25 kHz.

FM distortion:² <2% for deviations up to 30 kHz, <3% for deviations up to 100 kHz.

¹AM is possible above +3 dBm as long as the combination of the AM depth plus carrier output level does not exceed +3 dBm.

²400 and 1000 Hz modulation rates.

- Synchronize 8654A/B, stability 0.1 ppm/hr.
- 500 Hz lock resolution
- Low RFI counter to 520 MHz

External FM sensitivity:² 1-volt peak yields maximum deviation indicated on peak deviation meter with FM LEVEL vernier at full CW position.

Sensitivity accuracy:² ±10%.

Indicated FM accuracy (15° to 35°C):² ±(10% of reading + 3% of full scale). For 100 kHz deviation above 130 MHz, add 3% of reading.

Incidental AM:² <1% AM at 30 kHz deviation.

Frequency modulation, 8654A: uncalibrated.

Deviation: >0.1% of carrier frequency, maximum.

Modulation rate: internal, 400 & 1000 Hz ±10%. External 3 dB bandwidth, dc-coupled to >25 kHz driven from 600Ω or less.

External FM sensitivity: 10 V_{pk} into 600Ω yields >0.1% deviation (±15 volts max).

General characteristics

Power: 100, 120, 220, or 240 volts +5%, -10%, 48 to 440 Hz; 15 VA maximum. 2.29 m (7½ ft.) power cable furnished with mains plugs to match destination requirements.

Weight: net, 7.9 kg (17 lb 6 oz.). Shipping, 9.5 kg (21 lbs).

Dimensions: 267 mm W × 178 mm H × 306 mm D (10½" × 7" × 12").

8655A Synchronizer/Counter

The HP 8655A Synchronizer/Counter is a phase-lock frequency stabilizer that provides the HP 8654A and 8654B Signal Generators with crystal-oscillator frequency stability. It is also a frequency counter with very low RFI leakage. When used with an 8654 Signal Generator, the frequency can be phase-locked at any frequency from 10 to 520 MHz. In the locked mode the spectral purity and FM capability of the unlocked 8654 are preserved. This performance allows testing of new state-of-the-art crystal controlled receivers.

Phase locking the 8654 is simple with the 8655A Synchronizer. A push of the LOCK button establishes lock at the frequency shown on the LED display. Maximum lock resolution is 500 Hz. If lock is broken, the LED display flashes. Lock can be re-established by retuning and again pushing the LOCK button.

The 8655A can also be used to count external input signals from 1 kHz to 520 MHz. Input sensitivity is better than 100 mV into 50 ohms. Using the EXPAND button it is possible to achieve a resolution of 1 Hz in the 1 kHz-10 MHz EXT COUNT mode or 100 Hz in both the 10-520 MHz EXT COUNT and SYNCHRONIZE COUNT modes.

RF leakage from 8654B/8655A system is <1.5 μV in a 2-turn, 1-inch diameter loop 1 inch away from any surface and measured into a 50 ohm receiver.

8655A Specifications

Counter characteristics

Range: 1 kHz to 520 MHz

Sensitivity: <100 mV rms (-7 dBm), ac coupled into 50 ohms. (Typically <-20 dBm, 10 kHz to 200 MHz.)

Maximum input: AC: 707 mV (+10 dBm) for accurate count. DC: ±25 V on EXTERNAL COUNT INPUT, 0 V dc (ac only) on rear panel SYNCHRONIZE COUNT INPUT. Both inputs are protected with common fuse.

Count resolution: 6-digit LED display

Mode	Normal	X10 EXPAND ³
1 kHz to 10 MHz (EXTERNAL)	10 Hz	1 Hz
10 kHz to 520 MHz (EXTERNAL & SYNCHRONIZE COUNT)	1 kHz	100 Hz

Accuracy: ±1 count ± time base accuracy

³ Will continue to accurately count from 1 to 10 MHz and 100 to 520 MHz with loss of most significant digit (indicated by overflow light). Phase lock is not allowed.



8655A

Time base characteristics

Frequency: 1 MHz temperature-compensated crystal oscillator

Aging: (constant ambient temperature) <0.1 ppm/hr, <2 ppm/90 days

Temperature: ±5 ppm from 0° to 50°C. (Referenced to 25°C.)

Typical overall accuracy (after 2-hour warm-up and within 3 months of calibration): better than ±2 ppm from 15° to 35°C. (Optional higher stability time base available.)

Rear output: 1 MHz, nominally >0.5 V peak-to-peak into 500 ohms.

External reference input: 1 MHz, nominally >0.5 V peak-to-peak into 1000 ohms. (Not available with optional high stability time base.)

8654A/B-8655A Synchronization characteristics

Frequency range: 10-520 MHz

Frequency count resolution: 1 kHz, or 100 Hz in X10 EXPAND

Frequency lock resolution: 1 kHz. Depressing LOCK + 500 Hz button allows a locked resolution of 500 Hz.

Frequency accuracy: same as time base accuracy.

Lock time duration (after 5 minute warm-up, constant ambient): 45 min. typical.

FM rate while synchronized: 50 Hz to >25 kHz, (with 8654B only).

FM accuracy (with 8654B only):

$$\left[\text{Total FM Accuracy} \right] = \left[\text{8654B FM Accuracy} \right] \pm \left[\text{Frequency Correction Error} \right]$$

Frequency correction error⁴ is typically <±4%.

General

RF leakage (when operated with 8654B using furnished interface cables): less than 1.5 μV in a 2-turn, 1-inch diameter loop 1 inch away from any surface and measured into a 50 ohm receiver.

Power: 100, 120, 220, or 240 volts +5%, -10%, 48 to 400 Hz, 60 VA maximum. 2.29 m (7½ ft) power cable.

Weight: net, 6 kg (13 lbs 3 oz.). Shipping, 6.5 kg (14 lbs 4 oz.).

Dimensions: 267 mm W × 102 mm H × 318 mm D (10½" × 4" × 12½").

⁴ Frequency correction error is a function of the unlocked 8654B frequency drift. For optimum FM accuracy, this error may be eliminated by unlocking, returning to the desired frequency, and relocking.

Model number and name

Price

8654A AM signal generator	\$2000
8654B AM/FM signal generator	\$2450
Option 003: Reverse power protection (For 8654A/B)	add \$300
8655A Synchronizer/Counter	\$2075
Option 001: High stability time base (48655A)	add \$450

SIGNAL GENERATORS

HF signal generator

Model 606B

- 50 kHz to 65 MHz



The Hewlett-Packard 606B Signal Generator provides you with high quality, versatile performance with distinctive ease of operation in the important and widely used 50 kHz to 65 MHz frequency range. Output signals are stable and accurately known, output amplitude can be precisely established over a very wide dynamic range, and versatile modulation capabilities are incorporated to satisfy virtually all measurement requirements. Convenient size and shape, together with a simple, straightforward control panel layout, make the 606B well suited for production line use as well as laboratory or field applications.

Design

The 606B is a master oscillator-power amplifier (MOPA) design with a broadband buffer amplifier stage between the oscillator and power amplifier circuits for isolation. The MOPA design permits optimization of the oscillator circuit for highest stability including low drift, minimum residual FM, low harmonics, etc., without restricting the modulation characteristics. Modulation is applied to the power amplifier circuit with negligible effect on the oscillator frequency (because of the buffer stage). Very fine frequency settability is achieved through incorporation of a ΔF control which provides better than 10 ppm resolution.

606B Specifications

(All specifications apply over top 10 dB of output vernier range.)

Frequency and output characteristics

Range: 50 kHz to 65 MHz in 6 bands; accuracy: $\pm 1\%$.

Drift: (1 V output and below) less than 50 ppm (or 5 Hz, whichever is greater) per 10 min period after 2-hr warmup; less than 10 min to restabilize after changing frequency.

ΔF control: better than 10 ppm settability; range of ΔF control approximately 0.1%.

Resettability: better than 0.15% after warmup.

Crystal calibrator: provides frequency checkpoints every 100 kHz and 1 MHz; jack provided for audio frequency output; crystal frequency accuracy better than 0.01% from 0°-50°C.

Residual FM: less than ± 1 ppm or ± 20 Hz peak, whichever is greater.

Output level: continuously adjustable from 0.1 μV to 3 V into 50-ohm resistive load, calibrated in voltage and dBm.

Frequency response and output accuracy: at output below 1 V, output level variation with frequency is less than 2 dB; output accuracy is better than ± 1 dB at any frequency.

Impedance: 50 ohms, SWR less than 1.2 on 0.3 V attenuator range and below.

RFI: meets all conditions specified in MIL-I-6181D; permits receiver sensitivity measurements down to at least 0.1 μV .

Harmonic output: at least 25 dB below the carrier.

Spurious AM: hum and noise sidebands are 70 dB below carrier down to thermal level of 50-ohm output system.

Auxiliary RF output: (fixed level CW) on front panel: minimum output: 100 mV rms into 50 ohms from 50 kHz to 19.2 MHz, 200 mV rms from 19 to 65 MHz.

Modulation characteristics

Internal AM

Frequency: 400 and 1000 Hz, $\pm 5\%$.

Modulation level: 0 to 95% on 1 V attenuator range and below; 0 to at least 30% on 3 V range.

Incidental FM (attenuator on 1 V range and below, 30% modulation): less than 5×10^{-6} + 100 Hz peak.

Carrier envelope distortion: $< 1\%$ at 30% AM, $< 3\%$ at 70% AM (attenuator on 1 V range and below).

External AM

Frequency: dc to 20 kHz maximum, dependent on carrier frequency (F_c) and percent modulation as tabulated.

Maximum modulation frequency:

30% Mod:	70% Mod:	Square wave Mod:
$0.06 f_c$	$0.02 f_c$	$0.003 f_c$ (3 kHz max.)

Modulation level: 0 to 95% on 1 V attenuator range and below, 0 to at least 30% on 3 V range.

Input required: 4.5 V peak produces 95% modulation (maximum input 50 V peak); input impedance 1000 ohms.

Carrier envelope distortion: $< 3\%$ at 70% AM (≤ 1 V output).

Modulation meter accuracy: $\pm 5\%$ of full scale +5% of reading) from 0 to 90% for rates to 10 kHz; $\pm 10\%$ of full scale for rates to 20 kHz.

Modulation level constancy (internal or external AM; attenuator on 1 V range and below): modulation level of 70% or less stays constant within ± 0.5 dB regardless of carrier frequency and output level changes.

General

Power: 115 or 230 V $\pm 10\%$, 50 to 400 Hz, 135 W.

Dimensions: cabinet, 527 mm W \times 318 mm H \times 375 mm D, (20 $\frac{1}{2}$ " \times 12 $\frac{1}{2}$ " \times 14 $\frac{3}{4}$ "); rack, 483 mm W \times 267 mm H \times 371 mm D behind panel, (19" \times 10 $\frac{1}{2}$ " \times 14 $\frac{3}{4}$ ").

Weight: cabinet, net, 25 kg (55 lb). Shipping 30 kg (66 lb); rack, net, 22.7 kg (50 lb). Shipping 29.5 kg (65 lb).

Accessories available:

11507A Output Termination, provides 3 positions: 50 ohms, 5 ohms and IEEE Standard Dummy Antenna

11509A Fuseholder, protection for 606B transceiver tests.

10534A Mixer, for use as a nanosecond pulse modulator.

Model number and name

606B HF Signal Generator (cabinet)

606BR HF Signal Generator (rack)

Price

\$3500

\$3500

SIGNAL GENERATORS

VHF signal generator

Model 608E

- Versatility and value, 10-480 MHz

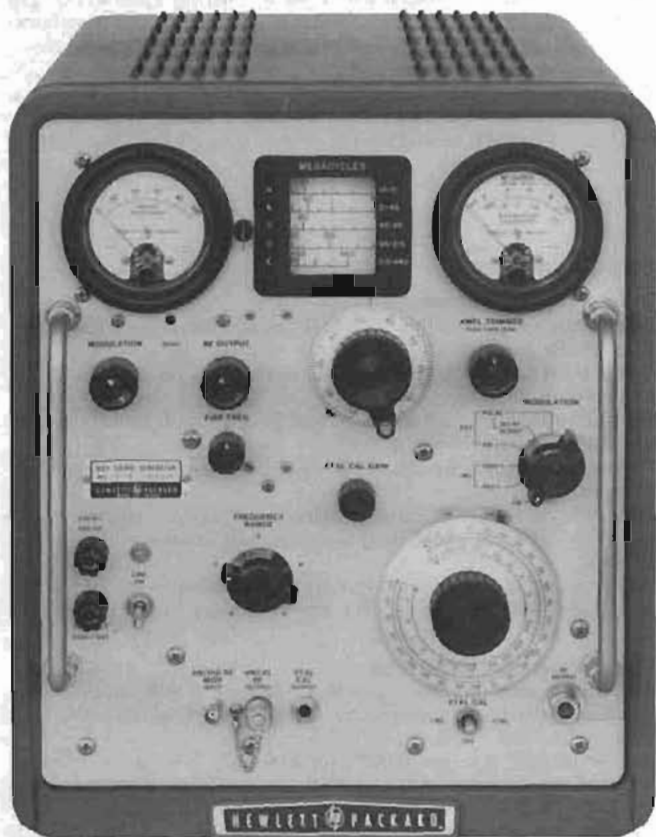

Model 608E provides high-quality, versatile performance with distinctive ease of operation. The 608E provides an output of up to 1 volt over the range from 10 to 480 MHz.

The 608E is an improved version of the popular and time-proven HP 608C/D Signal Generators. The instrument is a master oscillator-power amplifier (MOPA) type with a broadband buffer amplifier stage between the oscillator and power amplifier circuits for isolation. The MOPA design permits optimization of the oscillator stage for high stability of 0.005% per 10 minutes, minimum residual FM, and low harmonics without restricting the modulation characteristics. Modulation is applied to the power amplifier stage with negligible effect on the oscillator frequency.

608E specifications

Frequency characteristics

Range: 10-480 MHz in five bands

Accuracy: $\pm 0.5\%$ with cursor adjustment.

Drift: less than $50 \times 10^{-7}/10$ min after one hr warmup.

Resetability: better than $\pm 0.1\%$ after initial warmup; fine-frequency-adjust provides approximately 25 kHz settability at 480 MHz.

Crystal calibrator: provides frequency check points every 1 MHz up to 270 MHz or every 5 MHz over total range; jack provided for audio frequency output; crystal frequency accuracy better than 0.01% at room temperatures.

Residual FM: less than ± 5 parts in 10^7 in a 10 kHz post-detection bandwidth.

Harmonic output: at least 35 dB below the carrier for harmonic frequencies below 500 MHz.

Output characteristics

Output level: continuously adjustable from 0.1 μ V to 1.0 V into a 50-ohm resistive load; output calibrated in volts and dBm.

Accuracy: within ± 1 dB of attenuator dial reading at any frequency when RF output meter indicates "ATTENUATOR CALIBRATED."

Impedance: 50 Ω with a maximum SWR of 1.2 for attenuator setting below -7 dBm.

RFI: meets all conditions specified in MIL-I-6181D; permits receiver sensitivity measurements down to at least 0.1 μ V.

Auxiliary RF output: at least 180 mV rms into 50 Ω provided at front panel.

Modulation characteristics

Internal AM

Frequency: 400 and 1000 Hz, $\pm 10\%$.

Modulation level: 0 to 95% modulation at carrier levels 0.5 V and below

Carrier envelope distortion: less than 2% at 30% AM, less than 5% at 70% AM.

External AM

Frequency: 20 Hz to 20 kHz.

Modulation level: 0 to 95% modulation at carrier levels of 0.5 V and below; continuously adjustable from front panel MOD LEVEL control; input required, 1-10 V rms (1000 Ω input impedance).

Carrier envelope distortion: less than 2% at 30% AM, less than 5% at 70% AM (modulation source distortion less than 0.5%).

Modulation meter accuracy: $\pm 5\%$ of full scale 0 to 80%, $\pm 10\%$ from 80% to 95% (for INT AM or 20 Hz to 20 kHz EXT AM).

Incidental FM (at 400 and 1000 Hz modulation): less than 1000 Hz peak at 50% AM for frequencies above 100 MHz; below 100 MHz, less than 0.001% at 30% AM.

External pulse modulation

Rise and decay time: from 40 MHz to 220 MHz, combined rise and decay time less than 4 μ s; above 220 MHz combined rise and decay time less than 2.5 μ s.

On-off ratio: at least 20 dB for pulsed carrier levels of 0.5 V and above.

Input required: positive pulse, 10-50 V peak, input impedance 2 k Ω

General

Power: 115 or 230 V $\pm 10\%$, 50 to 400 Hz; approx. 220 W.

Dimensions: cabinet, 337 mm W \times 416 mm H \times 533 mm D (13 $\frac{1}{4}$ " \times 16 $\frac{3}{4}$ " \times 21"); rack mount, 483 mm W \times 355 mm H \times 467 mm D behind panel (19" \times 13 $\frac{3}{4}$ " \times 18 $\frac{1}{4}$ ").

Weight: cabinet mount: net, 28 kg (63 lb); shipping 33.4 kg (74 lb); rack mount: net, 28 kg (62 lb); shipping, 37.4 kg (83 lb).

Accessories available:

11508A Output Cable for high impedance circuits.

11509A Fuse Holder: protection for transceiver tests.

10514A Mixer for use as nanosecond pulse modulator.

Model number and name

608E VHF Signal Generator (cabinet)

608ER VHF Signal Generator (rack)

Price

\$4500

\$4500

SIGNAL GENERATORS

UHF signal generator

Model 612A

- 450 to 1230 MHz

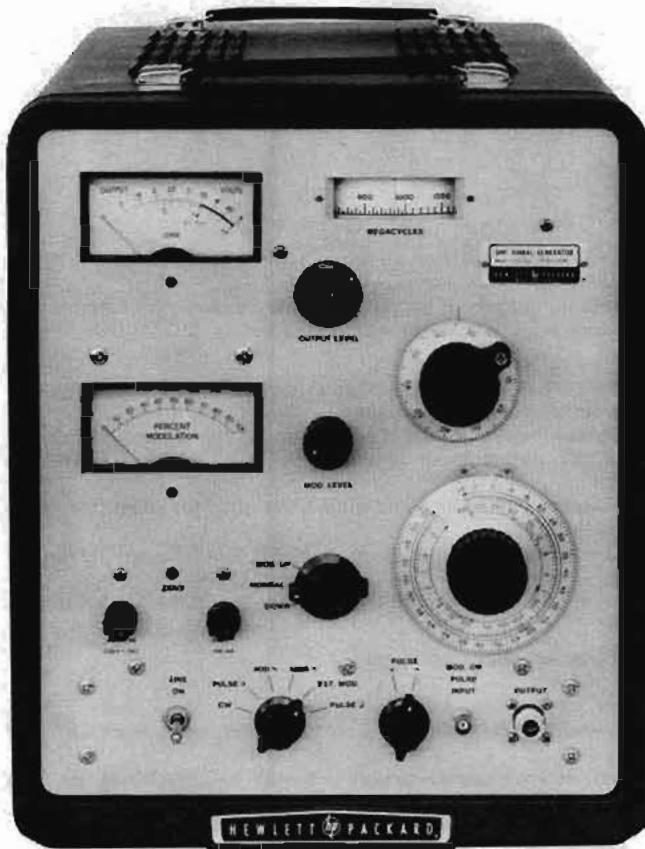

Here is an all-purpose, precision signal generator particularly designed for utmost convenience and applicability throughout the important UHF-TV frequency band. It is ideally suited for measurements in UHF-television broadcasting, studio-transmitter links, citizen's radio and public service communications systems. The HP 612A also covers the important frequencies used in aircraft navigation aids such as DME, TACAN and airborne transponders. Accessory modulators, available from many of the manufacturers of these navigational aids, enable the 612A to provide the complex modulation patterns required for testing and aligning these systems. In the laboratory, the 612A is a convenient power source for driving bridges, slotted lines, antennas and filter networks. In addition, the HP 8731 PIN Modulators can be used with the 612A to obtain RF pulses with 30 ns rise time and 0.1 μ s minimum duration—with on-off ratios approaching 80 dB.

MOPA circuit

The master oscillator-power amplifier circuit in the HP 612A provides 0.5 volt into 50 ohms over the full frequency range of 450 to 1230 MHz. There is very low incidental FM (less than 0.002% at 30% AM) and excellent amplitude modulation capabilities by all frequencies from 20 Hz to 5 MHz. The degree of modulation is easily read from the large percent modulation meter. The instrument can be amplitude-modulated (either internally or externally), and provision is made for external pulse modulation as well. Pulse modulation can be applied to the amplifier or directly to the oscillator when high on-off signal ratios are required (signal may be completely cut off between pulses). Modulation can be up or down from a preset level to simulate TV modulation characteristics accurately.

Cavity oscillator

The oscillator-amplifier circuit in the 612A employs high-frequency pencil triodes in a cavity-tuned circuit for precise tracking over the entire band. Noncontacting cavity plungers are die-cast to precise tolerances, then injection-molded with a plastic filler for optimum Q. The frequency drive is a direct screw-operated mechanism, free from backlash. A waveguide-beyond-cutoff piston attenuator and crystal monitor circuit are used to ensure accurate, reliable output down to 0.1 μ V. The attenuator is calibrated over a range of 131 dB and has been carefully designed to provide a constant impedance-versus-frequency characteristic. The SWR of the 50-ohm output system is less than 1.2 over the complete frequency range.

Specifications

Frequency and output characteristics

Frequency range: 450 to 1230 MHz in one band; scale length approximately 381 mm (15").

Calibration accuracy: within $\pm 1\%$, resettability better than 5 MHz at high frequencies.

Output voltage: 0.1 μ V to 0.5 V into 50-ohm load; calibrated in V and dBm (0 dBm = 1 mW).

Output accuracy: ± 1 dB, 0 to -127 dBm over entire frequency range.

Output impedance: 50 ohms; maximum reflection coefficient, 0.091 (1.2 SWR, 20.8 dB return loss) for attenuator settings of 0 dBm and below.

RF: conducted and radiated leakage limits are below those specified in MIL-I-6181D; permits receiver sensitivity measurements down to 1 μ V.

Modulation characteristics

Amplitude modulation: above 470 MHz, 0 to 90% at audio frequencies, indicated by panel meter; accuracy $\pm 10\%$ of full scale, 30 to 90% modulation.

Incidental FM: less than 0.002% for 30% AM.

Internal modulation: 400 and 1000 Hz $\pm 10\%$; envelope distortion less than 3% at 30% modulation.

External modulation: 20 Hz to 5 MHz; above 470 MHz, 2 V rms produces 85% AM at modulating frequencies up to 500 kHz, at least 40% AM at 5 MHz; modulation may be up or down from the carrier level or symmetrical about the carrier level; positive or negative pulses may be applied to increase or decrease RF output from the carrier level.

Pulse Modulation:

Pulse 1 (pulse applied to amplifier): positive or negative pulses, 4 to 40 V peak produce an RF on-off ratio of at least 20 dB; minimum RF output pulse length, 1.0 μ s.

Pulse 2 (pulse applied to oscillator): positive or negative pulses, 4 to 40 V peak; no RF output during off time; minimum RF output pulse length, 1.0 μ s.

General

Power: 115 or 230 volts $\pm 10\%$, 50 to 400 Hz, 215 watts.

Dimensions: cabinet: 343 mm W \times 419 mm H \times 546 mm D (13 $\frac{1}{2}$ " \times 16 $\frac{1}{2}$ " \times 21 $\frac{1}{2}$ "); rack mount: 483 mm W \times 355 mm H \times 514 mm D behind panel (19" \times 13 $\frac{1}{2}$ " \times 20 $\frac{1}{4}$ ").

Weight: net, 25.2 kg (56 lb). Shipping, 30.6 kg (68 lb) (cabinet); net, 25.2 kg (56 lb). Shipping, 34.6 kg (77 lb) (rack mount).

Accessories available: 11500A RF Cable Assembly; 10503A Video Cable Assembly; 360B Low-Pass Filter (may be used where harmonic output must be reduced to a minimum, as in slotted line measurements).

Model number and name

612A UHF Signal Generator (cabinet)

612AR UHF Signal Generator (rack)

Price

\$3600

\$3600

SIGNAL GENERATORS

UHF Signal generators

Models 8614A & 8616A



- Stable, easy to use, 800-4500 MHz



HP 8614A, 8616A Signal generators

The HP 8614A and 8616A Signal Generators provide stable, accurate signals from 800 to 2400 MHz (8614A) and from 1800 to 4500 MHz (8616A). Both frequency and attenuation are set on direct-reading digital dials, while selectable functions include CW, leveled output, square-wave modulation, and external AM, FM and pulse modulation. Modulation can be accomplished simultaneously with or without leveling.

Two RF power outputs are simultaneously available from separate front-panel connectors. One provides at least 10 mW (2 mW above 3000 MHz) or a leveled output from 0 to -127 dBm. The other is at least 0.5 mW across the band and is independent of attenuator setting. This signal can be used for phase-locking the signal generators for extreme stability, or it can be monitored with a frequency counter for extreme frequency resolution without adversely affecting the primary output.

A unique PIN diode modulator permits amplitude modulation from dc to 1 MHz or furnishes RF pulses with a 2 μ s rise time. This broad modulation bandwidth permits remote control of output level or precise leveling using external equipment. The internal leveling is also obtained by using a PIN modulator.

The 8614A and 8616A can also be used with companion modulators, HP 8403A modulators and HP 8730-series PIN modulators to provide 80 dB pulse on/off ratio (see page 349). In addition, TWT amplifiers can be used with these generators to provide high power levels.

Specifications

8614A

Frequency range: direct reading within 2 MHz 800 to 2400 MHz.

Vernier: ΔF control has a minimum range of 1.0 MHz for fine tuning.

Frequency calibration accuracy (0 dBm & below): ± 5 MHz

Frequency stability: approximately 50 ppm/ $^{\circ}$ C change in ambient temperature, less than 2500 Hz peak residual FM, negligible incidental FM in pulse and AM operation below -10 dBm, 30 ppm change for line voltage variation of $\pm 10\%$.

RF output power: +10 dBm (0.707 V) into 50 Ω load. Output attenuation dial directly calibrated in dBm from 0 to -127 dBm. A second uncalibrated output (approximately -3 dBm) is provided on front panel.

RF output power accuracy (with respect to attenuation dial): ± 0.75 dB + attenuator accuracy (0 to -127 dBm) including leveled output variations

Attenuator accuracy: +0, -3 dB from 0 to -10 dBm, ± 0.2 dB ± 0.06 dB/10dB from -10 to -127 dBm; direct reading dial, 0.2 dB increments.

Output impedance: 50 Ω ; SWR < 2.0

Modulation: on-off ratio at least 20 dB for square wave, pulse

Internal square wave: 950 to 1050 Hz. Square wave can be synchronized with a +1 to +10 V signal at PULSE input.

External pulse: 50 Hz to 50 kHz; 2 μ s rise time, +20 to +100 V peak input.

External AM: DC to 1 MHz

External FM: a) front panel connector capacity-coupled to repeller of klystron; b) four-terminal rear panel connector (Cinch-Jones type S304A B) is dc-coupled to repeller of klystron

Power source: 115 or 230 V $\pm 10\%$, 50 to 60 Hz, approximately 125 W

Dimensions: 425 mm W \times 467 mm D \times 141 mm H (16 $\frac{1}{2}$ " \times 18 $\frac{3}{8}$ " \times 5 $\frac{1}{2}$ "); rack mount 483 mm \times 416 mm \times 133 mm (19" \times 16 $\frac{1}{2}$ " \times 5 $\frac{1}{2}$ "")

Weight: net, 19.5 kg (43 lb). Shipping, 22.3 kg (49 lb)

Option 001: external modulation input connectors on rear panel in parallel with front-panel connectors; RF connectors on rear panel only.

8616A

Frequency range: direct reading within 2 MHz 1800 to 4500 MHz.

Vernier: ΔF control has a range of approximately 1.0 MHz for fine tuning.

Frequency calibration accuracy (0 dBm & below): ± 10 MHz

Frequency stability: approximately 50 ppm/ $^{\circ}$ C change in ambient temperature, less than 2500 Hz peak residual FM, negligible incidental FM in pulse and AM operation for attenuator settings below -10 dBm, 30 ppm change for line voltage variation of $\pm 10\%$.

RF output power: +10 dBm (0.707 V) to -127 dBm into 50 Ω load, 1800 to 3000 MHz; +3 dBm to -127 dBm from 3000 to 4500 MHz into a 50 Ω load. Output attenuation dial directly calibrated in dBm from 0 to -127 dBm. A second uncalibrated output (approximately -3 dBm) is provided on the front panel.

RF output power accuracy (with respect to attenuation dial): ± 1.0 dB + attenuator accuracy (0 to -127 dBm).

Attenuator accuracy: +1, -2 dB from 0 to -10 dBm, (± 0.2 dB + 0.06 dB/10 dB) from -10 to -127 dBm.

Output impedance: 50 Ω ; SWR less than 2.0.

Modulation: on-off ratio at least 20 dB for square wave, pulse.

Internal square wave: 950 to 1050 Hz. Other frequencies available on special order.

External pulse: 50 Hz to 50 kHz; 2 μ s rise time, +20 to +100 V peak input.

External AM: DC to 1 MHz

External FM: a) front panel connector capacity-coupled to repeller of klystron; b) four-terminal rear panel connector (Cinch-Jones type S304A B) is DC-coupled to repeller of klystron.

Dimensions: 425 mm W \times 467 mm D \times 141 mm H (16 $\frac{1}{2}$ " \times 18 $\frac{3}{8}$ " \times 5 $\frac{1}{2}$ "); rack mount 483 mm \times 416 mm \times 133 mm (19" \times 16 $\frac{1}{2}$ " \times 5 $\frac{1}{2}$ "")

Weight: net, 19.5 kg (43 lb). Shipping, 22.3 kg (49 lb).

Option 001: external modulation input connectors on rear panel in parallel with front-panel connectors; RF connectors on rear panel only.

Options

908: Rack Flange Kit

Model number and name

8614A Signal Generator (800-2400 MHz)

8616A Signal Generator (1800-4500 MHz)

8614A Option 001

8616A Option 001

Price

add \$10

\$4300

\$4300

add \$25

add \$25

SIGNAL GENERATORS

SHF Signal generators

Models 618C, 620B

- Multiple-purpose instruments, 3.8 to 11 GHz

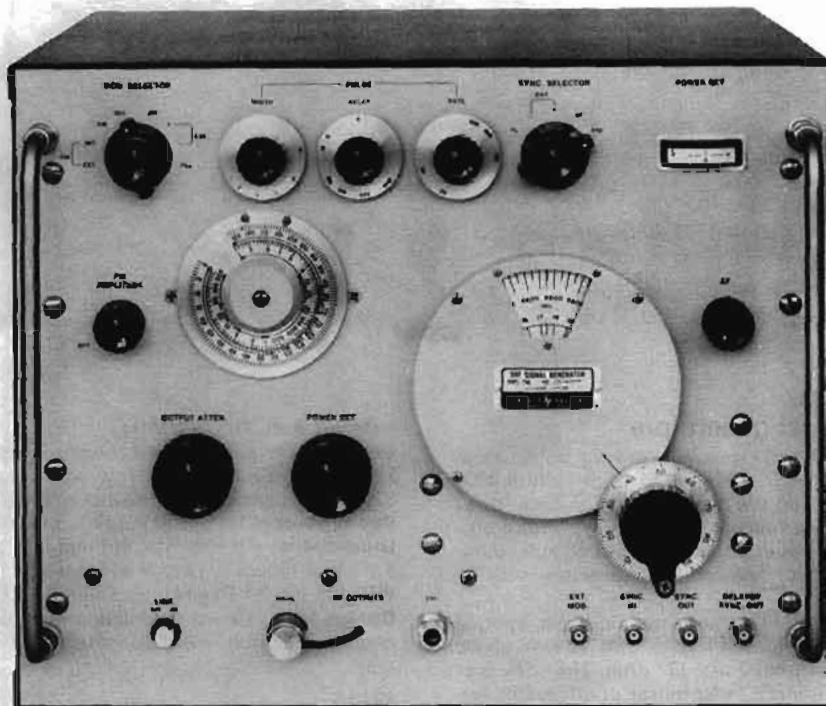

The Models 618C and 620B SHF Signal Generators provide versatility, accuracy, and stability in the range from 3.8 to 11 GHz. Frequency is set on a large, direct-reading dial. A ΔF vernier control provides ultra-fine tuning capability. There is also a provision for remote fine tuning.

A calibrated output from 0 to -127 dBm (0.224 volts to 0.1 microvolt) is also set on a large, direct-reading dial. The dial is calibrated in both dBm and volts. An auxiliary output of at least 0.3 milliwatt is available and is independent of attenuator setting. Thus, it can be used for phase-locking the signal generator when crystal-oscillator stability is required, or it can be monitored with a frequency counter for extreme frequency resolution.

The 618C and 620B Generators both feature oscillators of the reflex klystron type, with external resonant cavity. Oscillator frequency is determined by a movable plunger which varies the length of the cavity. Oscillator output is monitored by a temperature-compensated detector circuit. This circuit operates virtually unaffected by ambient temperature conditions.

Modulation includes internal pulse, square wave, and frequency modulation plus external pulse and frequency modulation.

618C and 620B specifications

Output

Frequency range

618C: 3.8 to 7.6 GHz covered in a single band.

620B: 7 to 11 GHz covered in a single band; repeller voltage automatically tracked and proper mode automatically selected.

Calibration: direct reading; frequency calibration accuracy better than $\pm 1\%$.

Frequency stability: with temperature: less than 60 ppm/ $^{\circ}$ C change in ambient temperature; with line voltage less than 200 ppm change for line voltage variation of $\pm 10\%$; residual FM: < 15 kHz peak.

Output range: 1 milliwatt or 0.224 volt to 0.1 microvolt (0 dBm to -127 dBm) into 50 ohms; directly calibrated in dBm and volts; coaxial type N connector.

Output accuracy: within ± 2 dB from -7 to -127 dBm, within ± 3 dB from 0 to -7 dBm, terminated in 50-ohm load.

Source impedance: 50 ohms nominal; SWR < 2.0 .

Modulation

Internal pulse modulation: repetition rate variable from 40 to 4,000 pps, pulse width variable $\frac{1}{2}$ to 10 microseconds.

Sync out signals: simultaneous with RF pulse, positive; in advance of RF pulse, positive, variable 3 to 300 microseconds (better than 1 microsecond rise time and 25 to 100 volts amplitude into 1,000-ohm load).

Internal synchronization: sine wave: 40 to 4,000 Hz, 5 to 50 V rms; pulse: 40 to 4,000 pps, 5 to 50 V peak, positive or negative, 0.5 to 5 μ s wide, 0.1 to 1 μ s rise time.

Internal square-wave modulation: variable 40 to 4,000 Hz.

Internal FM: sawtooth sweep rate adjustable 40 to 4,000 Hz; frequency deviation to 5 MHz peak-to-peak over most of the frequency range.

External pulse modulation: pulse requirements: amplitude from 20 to 70 volts positive or negative, width 0.5 to 2,500 microseconds.

External FM: frequency deviation approximately 5 MHz peak-to-peak over most of the band; sensitivity approximately 20 V/MHz at front-panel connector, approximately 10 V/MHz at rear-panel connector (mating connector supplied); front-panel connector is capacitively coupled to klystron repeller; rear-panel connector is dc-coupled to klystron repeller and is suitable for phase-lock control input.

General

RFI: conducted and radiated leakage limits are below those specified in MIL-I-6181D.

Power source: 115 or 230 volts $\pm 10\%$, 50 to 60 Hz 230 W.

Dimensions: cabinet, 445 mm W \times 353 mm H \times 518 mm D (17 $\frac{1}{2}$ " \times 13 $\frac{7}{8}$ " \times 20 $\frac{3}{8}$ "); rack mount 483 mm \times 355 mm \times 483 mm (19" \times 13 $\frac{3}{32}$ " \times 19").

Weight: net, 31.1 kg (69 lb). Shipping, 33.5 kg (74 lb).

Accessory furnished: 11500A Cable Assembly, 1830 mm (6 ft) of RG-214A/U 50-ohm coax, terminated on each end by type N male connectors.

Model number and name

618C or 620B SHF Signal Generator (cabinet mount)
618CR or 620BR SHF Signal Generator (rack mount)

Price

\$4900
\$4900

SIGNAL GENERATORS

SHF generators/doublers

Models 626A, 628A, 938A, 940A

- Generate stable signals, 10 to 40 GHz

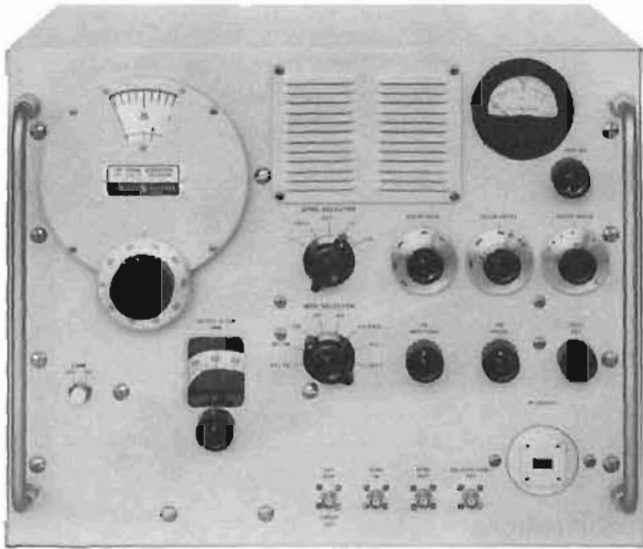

628A

Description

The 626A covers frequencies 10 to 15.5 GHz, and the 628A covers frequencies 15 to 21 GHz. In design and operation, the instruments are similar to Hewlett-Packard generators for lower frequency ranges. Carrier frequency is set and read directly on the large tuning dial. No voltage adjustment is necessary during tuning because repeller voltage is tracked with frequency changes automatically. Oscillator output is also set and read directly, and no frequency correction is necessary throughout operating range. A frequency logging scale permits frequency to be reset within 0.1%.

Both the 626A and 628A offer internal pulse, squarewave and frequency modulation, plus external pulse and frequency modulation. The pulse generators may be synchronized with an external sine wave and positive or negative pulse signals.

The high power output of these signal generators makes them ideally suited for driving HP 938A and 940A Frequency Doubler sets. These doubler sets retain the modulation and stability of the driving source and have accurate power monitors and attenuators.

626A, 628A specifications

Frequency range: 626A, 10 to 15.5 GHz; 628A, 15 to 21 GHz.

Frequency calibration: dial direct-reading in GHz, accuracy better than $\pm 1\%$.

Output range: 10 mW to 1 pW (+10 dBm to -90 dBm, 0 dBm = 1 mW); attenuator dial calibrated in output dBm.

Source SWR: <2.5 at +10 dBm; <1.35 at 0 dBm and below.

Output monitor accuracy: better than ± 1 dB; temperature-compensated thermistor bridge circuit monitors RF oscillator power level.

Output connector: 626A: WR75 waveguide, flat cover flange; 21.6 \times 12.0 mm (0.85 \times 0.475 in.). 628A: WR51 waveguide, flat cover flange; 15.0 \times 8.5 mm (0.59 \times 0.335 in.).

Output attenuator accuracy: better than $\pm 2\%$ of attenuation in dB introduced by output attenuator.

Modulation: internal pulse, FM, or square wave; external pulse and FM.



938A

Internal pulse modulation: repetition rate variable from 40 to 4000 pps; pulse width variable 0.5 to 10 μ s.

Internal square-wave modulation: variable 40 to 4000 Hz controlled by "pulse rate" control.

Internal frequency modulation: power line frequency, deviation up to ± 5 MHz.

External pulse modulation: pulse requirements: amplitude 15 to 70 volts peak positive or negative; width 1 to 2500 μ s.

External frequency modulation: provided by capacitive coupling to the klystron repeller; maximum deviation approximately ± 5 MHz.

Sync out signals: positive 20 to 100 V peak into 1000-ohm load; better than 1 μ s rise time; 1) simultaneous with RF pulse, positive; 2) in advance of RF pulse, positive, variable 5 to 300 μ s.

External synchronization: 1) sine wave, 40 to 4000 Hz, amplitude 5 to 50 V rms; 2) pulse signals 40 to 4000 pps, 5 to 50 V amplitude, positive or negative; pulse width 0.5 to 5 μ s; rise time 0.1 to 1 μ s.

Power: 115 or 230 volts $\pm 10\%$, 50 to 60 Hz, approx. 200 watts.

Dimensions: cabinet: 432 mm W \times 356 mm H \times 381 mm D (17" \times 14" \times 15"); rack mount: 483 mm W \times 356 mm H \times 313 mm D (19" \times 14" \times 12 $\frac{1}{4}$ ").

Weight: net, 26.8 kg (59 lb). Shipping, 29.8 kg (66 lb).

Accessories furnished: 626A, MX 292B and MP 292B Waveguide Adapters; 628A, NP 292A and NK 292A Waveguide Adapters.

Accessories available: M362A low-pass filter.

Frequency doubler sets

Model 938A supplies power from 18 to 26.5 GHz and Model 940A from 26.5 to 40 GHz when driven by 9 to 13.25 GHz and 13.25 to 20 GHz sources respectively. For a swept output, use a swept-frequency source such as Model 8690B or Model 8620A/B series with appropriate RF units.

938A, 940A specifications

Frequency range: 938A, 18 to 26.5 GHz; 940A, 26.5 to 40 GHz.

Conversion loss: less than 18 dB at 10 mW input.

Output power: approximately 0.5-1 mW when used with typical 626A, 628A signal generators; input power: 100 mW maximum.

Output attenuator: accuracy, $\pm 2\%$ of reading or ± 0.2 dB, whichever is greater; range, 100 dB.

Output reflection coefficient: approx. 0.33 at full output; less than 0.2 with attenuator set to 10 dB or greater.

Output flange: 938A K-band flat cover flange for WR-42 waveguide; 940A R-band flat flange for WR-28 waveguide.

Dimensions: 137 mm H \times 489 mm W \times 457 mm D (5 $\frac{3}{8}$ " \times 19 $\frac{1}{4}$ " \times 18").

Weight: net, 9 kg (20 lb). Shipping, 11.8 kg (26 lb).

Model number and name

626A or 628A (cabinet)

626AR or 628AR (rack mount)

938A or 940A

Price

\$7500

\$7500

\$5000

SIGNAL GENERATORS

VHF oscillator, frequency doubler probe

Models 3200B, 13515A

- 10 to 500 MHz
- to 1000 MHz with doubler probe

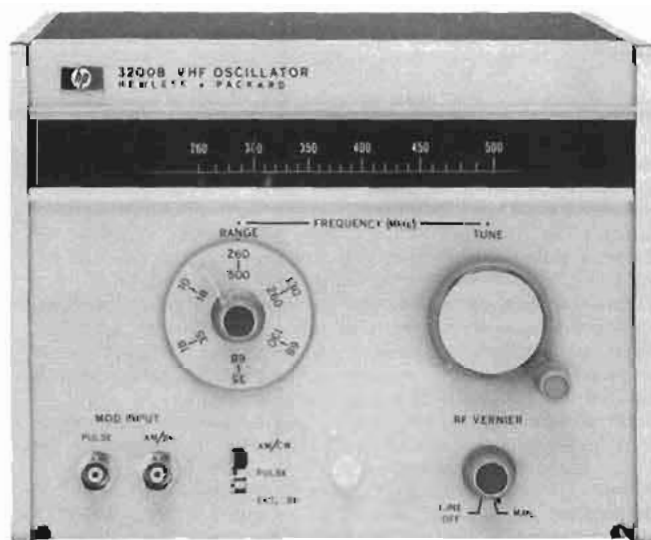

3200B

Description

The VHF oscillator, model 3200B, provides low cost, stable, 10 to 500 MHz RF for testing receivers and amplifiers, and driving bridges, slotted lines, antennas, and filter networks. Good pulse modulation sensitivity allows standard audio oscillators to be used to provide usable square wave modulation; a 2.5-volt sine wave will provide adequate drive for this type application. The 3200B can also serve as a local oscillator for heterodyne detector systems and as a marker source for swept systems. An optional accessory frequency doubler probe, model 13515A, provides additional frequency coverage from 500 to 1000 MHz.

The 3200B will typically recover specified stability in 30 minutes following a frequency band change. Long-term warmup (24 hours) can reduce this time as much as 50%. Following in-band frequency dial changes, the oscillator typically requires 10 minutes to recover specified stability. With the instrument in thermal equilibrium with its surroundings (i.e., long-term warmup and constant temperature lab), stabilities of 0.0001% are typical at some frequencies, if sufficient settling time is allowed after a frequency change.

Effective RF shielding permits measurements at levels down to 1 μ V.

A front panel vernier control varies the plate voltage in the oscillator, electrically refining the attenuator piston setting.

RF is read on an expanded slide-rule type scale. The oscillator may be precisely tuned by means of a mechanical vernier activated by the main tuning control.

The 3200B is well suited for bench use and may be adapted for standard 483 mm (19 in.) rack mounting.



13515A

Specifications

Frequency range: 10 to 500 MHz in six bands: 10 to 18.8 MHz, 18.5 to 35 MHz; 35 to 68 MHz; 68 to 130 MHz; 130 to 260 MHz; 260 to 500 MHz.

Frequency accuracy: within $\pm 2\%$ after $\frac{1}{2}$ hour warmup.

Frequency calibration: increments of less than 4%.

Frequency stability (after 4-hour warmup under 0.2 mW load): short term (5 min) $\pm 0.002\%$; long-term (1 hour) $\pm 0.02\%$; line voltage (5 V change) $\pm 0.001\%$.

RF output

Maximum power (across 50 ohm external load): 200 mW (10 to 130 MHz); >150 mW (130 to 260 MHz); >25 mW (260 to 500 MHz).

Range: 0 to >120 dB attenuation from maximum output.

Load impedance: 50 ohms nominal.

RF leakage: sufficiently low to permit measurements at 1 μ V.

RFI: meets requirements of MIL-1-61811D.

Amplitude modulation: externally modulated.

Range: 0 to 30%.

Distortion: $<1\%$ at 30% AM.

External requirements: approximately 32 volts rms into 600 ohms for 30% AM, 200 Hz to 100 kHz.

Pulse modulation: externally modulated.

External requirements: 2.5 volt negative pulse into 2000 ohms.

Power: 105 to 125 V or 210 to 250 V, 50 to 400 Hz, 30 W.

Dimensions: 194 mm wide \times 167 mm high \times 333 mm deep (7 $\frac{3}{4}$ " \times 6 $\frac{1}{4}$ " \times 13 $\frac{1}{8}$ ").

Weight: net, 6.8 kg (15 lb). Shipping, 7.7 kg (17 lb).

Accessories available: 13515A frequency doubler probe; 00502-60002 patching cable.

Frequency doubler probe

Frequency range: 500 to 1000 MHz with the 3200B operating 250 to 260 MHz (130 to 260 MHz range) or 260 to 500 MHz.

RF output: more than 4 mW across external 50 ohm load, controlled by probe depth.

Harmonic suppression: fundamental: >16 dB below desired signal.

Harmonic contribution of probe: >14 dB below desired signal.

Accessories available: HP model 360A and 360B low-pass filters.

Weight: net, 110 gm (4 oz). Shipping, 220 gm (8 oz).

Model number and name

3200B VHF oscillator

13515A Frequency doubler probe

Price

\$1025

\$110

SIGNAL GENERATORS

PIN modulators, modulators

8730 Series, 8403A



8730B

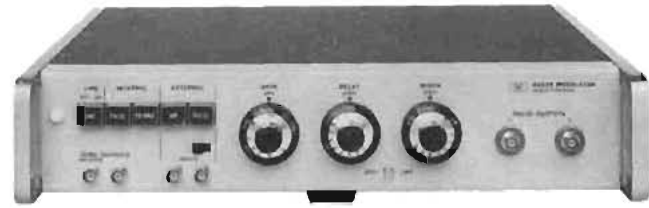

8403A

8732B PIN modulators

With HP 8730 series PIN Modulators, signal sources, including klystrons, can be pulse-modulated, leveled or amplitude-modulated with sinusoidal and complex waveforms. Fast rise-times, low incidental FM and a nearly constant impedance match to source and load are typical of these absorption-type modulators.

8403A Modulator

The Model 8403A provides complete control of the PIN modulators, supplying the appropriate modulation wave shapes and bias levels for fast rise times, rated on/off ratios and amplitude modulation. An internal square-wave and pulse modulator with PRF of 50 Hz to 50 kHz and adjustable pulse width and delay also provide square wave and pulses for general pulse applications. For applications requiring an absorption-type modulator plus controls in a single unit, a PIN modulator can be installed in the Model 8403A.

8403A specifications

Output characteristics

(available separately at front panel)

For driving 8730 pin modulators: AM and pulse output, pulse output specially shaped for optimum RF rise and decay times.

For general pulse applications: positive dc-coupled pulse 25 to 30 volts in amplitude, approximately symmetrical about 0 volt; no AM signal.

Modulation

Internal square wave

Frequency: variable from 50 Hz to 50 kHz.

Symmetry: better than 45/55%.

Internal pulse

Repetition rate: variable from 50 Hz to 50 kHz.

Delay: variable from 0.1 μ s to 100 μ s, between sync out pulse and RF output pulse.

Width: variable from 0.1 μ s to 100 μ s

External sync

Signal: 5 to 20 volts peak, + or -, pulse or sine wave.

Input Impedance: approximately 2000 ohms, dc-coupled.

Trigger out

Sync out: simultaneous with or 0.1 to 100 μ s in advance of RF pulse, as set by delay control.

Delayed sync out: simultaneous with output pulse.

Amplitude: approximately -2 volts.

Source Impedance: approximately 330 ohms.

External pulse rate

Amplitude and polarity: 5 volts to 20 volts peak, + or -.

Repetition rate: maximum average PRF, 500 kHz/sec.

Input impedance: approximately 2000 ohms, dc-coupled.

Width: minimum 0.1 μ s; maximum 1/PRF - 0.4 μ s.

Continuous amplitude modulation

(with 8730 series)

Frequency response: dc to approximately 10 MHz (3 dB).

Sensitivity: approx. 10 dB/volt with HP 8730A series; approx. 20 dB/volt with HP 8730B series.

Input impedance: approximately 100 ohms.

General

Power: 115 or 230 volts \pm 10%, 50 to 400 Hz, approx. 10 watts.

Dimensions: 425 mm W \times 96 mm H \times 467 mm D (16 $\frac{1}{2}$ " \times 3 $\frac{3}{8}$ " \times 18 $\frac{3}{4}$ "), hardware furnished for rack mount 483 mm W \times 89 mm H \times 416 mm D (19" \times 3 $\frac{1}{2}$ " \times 16 $\frac{1}{2}$ ").

Weight: net, 7.4 kg (16.5 lb). Shipping, 9 kg (20 lb).

Model number and name

8403A Modulator

Price

\$1550

PIN Modulators installed in 8403A:

Option 001, 8731A; 003, 8732A; 005, 8733A

add \$775

Option 007, 8734A

add \$800

Option 002, 8731B

add \$1025

Option 004, 8732B

add \$1050

Option 006, 8733B

add \$1100

Option 008, 8734B

add \$1150

Option 009 Input and Output Connectors on rear panel

add \$25

8730 Series specifications

HP Model	8731A	8731B	8732A	8732B	8733A	8733B	8734A	8734B	8735A	8735B	H10-8731B ¹
Frequency range (GHz)	0.8-2.4	0.8-2.4	1.8-4.5	1.8-4.5	3.7-8.3	3.7-8.3	7.0-12.4	7.0-12.4	8.2-12.4	8.2-12.4	0.4-1.2
Dynamic range (dB)	35	80	35	80	35	80	35	80	35	80	35
Max. residual atten. (dB) ¹	<1.5	<2.0	<2.0	<3.5 ²	<2.0	<3.0	<4.0	<5.0	<4.0	<5.0	<2.0
Typical rise time (ns) ³	40	30	40	30	30	30	30	30	30	30	40
Typical decay time (ns) ³	30	20	30	20	20	20	20	20	20	20	30
SWR, min. attenuation	1.5	1.6	1.5	1.6 ⁴	1.8	2.0	1.8	2.0	1.7	2.0	1.5 ²
SWR, max. attenuation	1.8	2.0	1.8	2.0	2.2	2.2	2.0	2.2	2.0	2.2	2.0 ²
Forward bias input resistance (ohms)	300	100	300	100	300	100	300	100	300	100	300
RF connector type	N	N	N	N	N	N	N	N	W/G ⁵	W/G ⁵	N
Weight, net kg (lb)	1.4 (3)	2.5 (5.5)	1.4 (3)	2.5 (5.5)	1.1 (2.5)	1.6 (3.5)	1.1 (2.5)	1.6 (3.5)	1.1 (2.5)	1.6 (3.5)	2.5 (5.5)
shipping kg (lb)	1.8 (4)	4.1 (9)	1.8 (4)	4.1 (9)	1.8 (4)	2.3 (5)	1.8 (4)	2.3 (5)	1.8 (4)	2.3 (5)	4.1 (9)
Dimensions											
Length, mm (in)	283 (11 $\frac{1}{4}$)	289 (11 $\frac{3}{8}$)	283 (11 $\frac{1}{4}$)	289 (11 $\frac{3}{8}$)	213 (8 $\frac{3}{8}$)	311 (12 $\frac{1}{4}$)	213 (8 $\frac{3}{8}$)	311 (12 $\frac{1}{4}$)	171 (6 $\frac{3}{4}$)	267 (10 $\frac{5}{8}$)	289 (11 $\frac{3}{8}$)
Width, mm (in)	83 (3 $\frac{1}{4}$)	124 (4 $\frac{7}{8}$)	83 (3 $\frac{1}{4}$)	124 (4 $\frac{7}{8}$)	83 (3 $\frac{1}{4}$)	83 (3 $\frac{1}{4}$)	83 (3 $\frac{1}{4}$)	83 (3 $\frac{1}{4}$)	83 (3 $\frac{1}{4}$)	83 (3 $\frac{1}{4}$)	124 (4 $\frac{7}{8}$)
Height, mm (in)	57 (2 $\frac{1}{4}$)	57 (2 $\frac{1}{4}$)	57 (2 $\frac{1}{4}$)	57 (2 $\frac{1}{4}$)	57 (2 $\frac{1}{4}$)	57 (2 $\frac{1}{4}$)	57 (2 $\frac{1}{4}$)	57 (2 $\frac{1}{4}$)	57 (2 $\frac{1}{4}$)	57 (2 $\frac{1}{4}$)	57 (2 $\frac{1}{4}$)
Price	\$675	\$975	\$675	\$1000	\$725	\$1050	\$750	\$1100	\$775	\$1100	\$975

Maximum ratings: maximum input power, peak or CW, 1 W; bias limits: +20 V, -10 V.

Bias polarity: negative voltage increases attenuation.

RF: radiated leakage limits are below those specified in MIL-I-6181D at input levels less than 1 mW; at all input levels radiated interference is sufficiently low to obtain rated attenuation.

1. With +5 V bias.

2. 4 dB, 4 to 4.5 GHz.

3. Driven by HP 8403A Modulator.

4. 2.0 SWR, 4 to 4.5 GHz.

5. Fits 1 \times 1/2 in. (WR 90) waveguide.

6. External high-pass filters required.

7. Excluding high-pass filters.

SIGNAL GENERATORS

Accessories

Models 10511A, 10514A, 10534A, 11507A, 11508A, 11509A, 11687A, 11690A, 11697A/B/C

• Additional Capabilities for Signal Generators

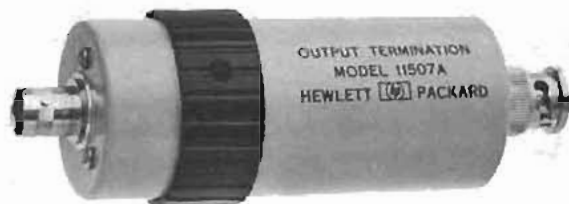

11507A



11509A



11687A



11690A



11697A

10511A Spectrum generator

Extends the useful frequency range of signal generators, sources and frequency synthesizers by providing a spectrum of harmonics up to 1 GHz from sine-wave inputs between 10 and 75 MHz. A 50Ω bandpass filter can then be cascaded with the 10511A to extract the desired harmonic. The harmonic power available is at least -19 dBm for harmonics 1 through 10.

Input requirements: 1 to 3 volts rms into 50Ω, 10 to 75 MHz.

10514A, 10534A Double balanced mixers

Used with signal generators in a variety of mixing as well as AM, pulse and square-wave modulation applications. The careful balancing of the hot carrier diodes in the 10514 and 10534A Mixers provides excellent suppression of the local oscillator and input frequencies at the output port. Frequency range of the 10514 is 0.2-500 MHz and the 10534 is 0.5-150 MHz.

11507A Output termination

A multi-purpose termination which enhances the usefulness of the 606A or 606B by providing the following:

1. A matched 50-ohm termination to permit use into high impedance circuits.
2. A 20-dB (10:1) terminated voltage divider which reduces the source impedance to 5 ohms.
3. A dummy antenna having the IEEE standard characteristics for receiver measurements (driven from 10:1 divider).

Frequency range: 50 kHz to 65 MHz on 0 to 20 dB positions. 540 kHz to 23 MHz on dummy antenna.

11508A Output cable

Provides 50Ω termination and standard binding posts at the end of a 610 mm (24-inch) length of cable. Allows direct connection of the signal generator to high impedance circuits.

11509A Fuseholder

Prevents accidental burnout of attenuators in HP 8640, HP 606 and 608 Signal Generators during transceiver testing by introducing a fuse element between the signal generator and the transceiver. Several watts of RF power could otherwise be applied to the signal generator attenuator should the transceiver accidentally be switched to "Transmit." While the fuseholder provides protection, it in no way limits the usable output from the signal generators.

Accessories furnished: 10 extra fuses.

11687A 50-75Ω Adapter

This 50-75Ω Adapter with Type N connectors is recommended for use with the 8640A/B for measurements in 75Ω systems. The voltage calibration on the output level meter is unaffected by use of the adapter, but a correction of 1.76 dB must be made when using the dB scale.

11690A Frequency doubler

The HP 11690A Frequency Doubler is designed to extend the 8640A or 8640B frequency range by doubling the 256-512 MHz Frequency Band up to 1024 MHz (to 1100 MHz with band overrange). Its recommended input level for optimum performance with AM modulation is +10 dBm.

The 8640A has a dial scale for the 512 to 1024 MHz external doubler band to indicate the correct doubled output frequency. The 8640B also displays the correct doubled output frequency when the 512 to 1024 range is selected. For FM in the doubled range, an additional position on the PEAK DEVIATION RANGE switch allows peak deviation up to 5.12 MHz.

The following specifications describe the 11690A when used with the 8640A or 8640B:

Input required: +10 to +19 dBm (0.707 V to 2 V).

Conversion loss: <13 dB.

Level flatness: 4 dB total variation.

Suppression of 1st and 3rd harmonic of input typically >20 dB.

11697A/B/C Bandpass filters

The 8640A/B Option 002 Internal Doubler covers several communication bands including UHF-TV, Mobile Radio and some ATC/DME. External band pass filters should be used to improve the generator spurious and harmonic performance in any of these bands. Three such filters are available, 11697A (512 to 674 MHz), 11697B (674 to 890 MHz), and 11697C (800 to 1100 MHz).

Pass band SWR: ≤ 1.4.

Pass band attenuation: ≤ 1.3 dB.

Midband attenuation: ≤ 0.6 dB.

Rejection band attenuation:

Model	Below Passband		Above Passband	
	Frequency (MHz)	Attenuation	Frequency (MHz)	Attenuation
11697A	≤ 337	≥ 20 dB	768 - 3000	≥ 20 dB
11697B	≤ 445	≥ 20 dB	1011 - 3000	≥ 20 dB
11697C	≤ 550	≥ 20 dB	1333 - 3000	≥ 20 dB

Model number and name

Model number and name	Price
10511A Spectrum Generator	\$300
10514A Double Balanced Mixer (0.2 - 500 MHz)	\$121
10534A Double Balanced Mixer (0.5 - 150 MHz)	\$95
11507A Output Termination	\$135
11508A Output Cable	\$40
11509A Fuseholder	\$80
11687A 50Ω-75Ω Adapter	\$100
11690A Frequency Doubler	\$155
11697A Bandpass Filter (512 - 674 MHz)	\$270
11697B Bandpass Filter (674 - 890 MHz)	\$270
11697C Bandpass Filter (800 - 1100 MHz)	\$270



Sweep oscillators

Swept frequency oscillators are used in applications where the characteristics of a device must be determined over a wide, continuous range of frequencies. Combined with a broadband detector and display test set, sweep oscillators provide many benefits compared to CW frequency sources. A swept measurement provides a dynamic display of the data. The results of any adjustments to the unknown test device are seen immediately (real time) on the display. By replacing laborious point-by-point techniques swept measurements increase the speed and convenience of broadband testing. The continuous frequency characterization of the unknown device also eliminates the chance of missing important information between frequency points. Swept techniques are applicable in all phases of design, manufacture and maintenance.

Hewlett-Packard sweep oscillators

Hewlett-Packard sweepers cover the entire frequency spectrum from dc to 50 GHz. Self-contained, multi-octave sweepers cover the frequency range to 110 MHz. The 8690 series of backward wave and solid state oscillators

features plug-ins from 400 kHz to 50 GHz. The 8620 family of solid state oscillators provide a versatile choice of configurations — single band, multiband, or very wide band plug-ins from 10 MHz to 18 GHz. A chart of the individual frequency bands available appears on page 353.

Sweep oscillator features

Sweep flexibility

Every HP sweeper has several different sweep modes available for setting the frequency limits of the instrument. A full band or independently adjustable start/stop frequency sweep can be selected. Alternatively, a marker sweep or a symmetrical ΔF sweep about the desired center frequency can be chosen. Switching from one sweep mode to another is a simple pushbutton operation. In the auto mode the sweep retriggers automatically. Sweep times of 0.01 to more than 100 seconds can be selected. A manual sweep is also available as a front panel control, a real convenience for calibrating displays such as X-Y recorders. An external trigger is provided as well for applications where the sweeper must be synched to other instrumentation or remotely controlled.

On all sweeps a linear voltage proportional to frequency is available on an external connector which is useful for driving the horizontal of the display. Blanking and pen lift signals are also provided at rear output connectors during flyback time when the RF is off.

The 8620 solid state family also features a self-contained multi-band capability in one compact instrument. Different octave range oscillators (up to three in one drawer) can be selected by simply pressing one band select lever. This results in performance, cost, and size benefits compared to externally multiplexed sweeper systems.

Power output and leveling

Power output is continuously adjustable at the front panel over approximately a 10 dB range. Built-in attenuators are also available for greater power control. Internal or external leveling is employed to obtain (1) a constant power output and (2) a good source match (low VSWR). This ensures high accuracy when making swept measurements.

Modulation

Modulation capabilities further extend the sweeper's usefulness both as a sweeper and a signal generator for signal simulations. Wide

SWEEP OSCILLATORS

General information

AM and FM bandwidths are useful for a variety of tests on communication receivers. The flexible FM capability allows remote analog frequency programming which is important for many applications.

MLA compatibility

In communications applications where up-converter simulation is required in conjunction with the HP Microwave Link Analyzer, the 86200 series of plug-ins provides this capability as an option in frequency ranges from 500 MHz to 18 GHz. Group delay of less than 3 nanoseconds and linearity of better than 2.5% across 30 MHz permit very accurate RF to RF, RF to IF and RF to BB distortion measurements.

Programming

The 8620C solid state sweeper mainframe provides optional BCD or HP-IB programming capability. More than ten thousand frequency points per band permit very fine frequency control. In addition, band selection, sweep mode, RF attenuator, and remote-local can be controlled remotely. This allows the sweeper to be used in a wide variety of automatic systems and sophisticated signal simulation applications.

For example, a 1 MHz to 18 GHz frequency synthesizer can be configured using the calculator, the 86290A/8620C 2 - 18 GHz

sweep oscillator, and the 8660 UHF synthesizer. (See Figure 1). Harmonics of the 8660 are used to phase lock the sweeper to the accuracy and stability of the synthesizer. The calculator is then used to control the sweeper, the UHF synthesizer, and RF switches to allow keyboard control of a CW signal or to step the source across a band of interest. Of course, the calculator can also be used to assimilate data gathered at each point.

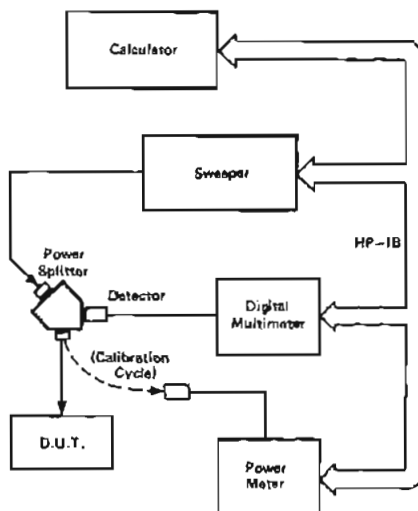

Figure 2

Precision power level control of the sweeper can be obtained by using the calculator to drive the sweeper's EXT AM input through a Digital-to-Analog Converter. A calibration array previously stored in the calculator would control the D-A voltage producing power level accuracy similar to that of the 436A power meter used in the calibration. (See Figure 2). Level control of the sweeper is important in measuring gain compression and when ratio measurements are not practical. If greater than 10 dB of control range is required, a programmable attenuator with as much as 110 dB of range may be used.

Digital sweeping synthesizers

The 8660C and 3330A/B combine the precision frequency accuracy and stability of a synthesizer with the time saving convenience of a sweeper. Parameters such as center frequency, frequency step, time per step, and sweep width are entered and executed through a convenient keyboard or remote

programming connector. An additional feature on the 3330B is amplitude sweeping in steps as small as 0.01 dB. The combination of frequency and amplitude sweeping can be used to produce a comprehensive family of curves.

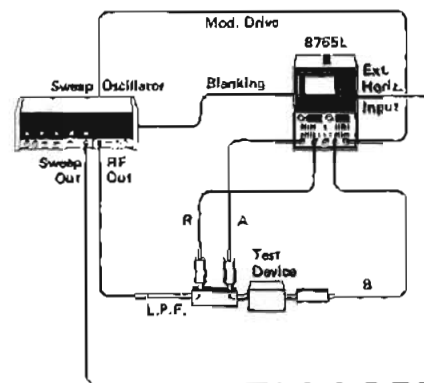

Figure 3

Sweeper applications

Sweepers are used extensively with swept frequency test sets to characterize the amplitude response of broadband devices or with network analyzers when the phase characteristics of the device (or S-parameters) are needed as well. Two RF measurements — transmission and reflection — are basic to both types of analyzer. Hewlett-Packard offers a complete line of directional couplers, power splitters, and other transducers which together with the analyzers and sweep oscillators provide a total swept measurement solution. Figure 3 shows a complete swept system that can be used to simultaneously characterize the scalar transmission and reflection properties of devices from 10 MHz to 18 GHz. This system has a sensitivity of better than -50 dBm.

For measurements requiring more sensitivity and/or phase information, sweepers may be used with network analyzers. Now with the HP 8620 family of solid state sweepers and the HP 8410B, these measurements can easily be made across many octaves of frequency. Previously the 8410 had to be retuned every octave. Now, for example, with the 8622A/B and the 8410B, phase-magnitude transmission or reflection coefficients can be measured across the full, 0.11-2.4 GHz range in one continuous sweep at full sweep speed. Since the 8410 is a tuned receiver this means a spurious-free sensitivity of -78 dBm.

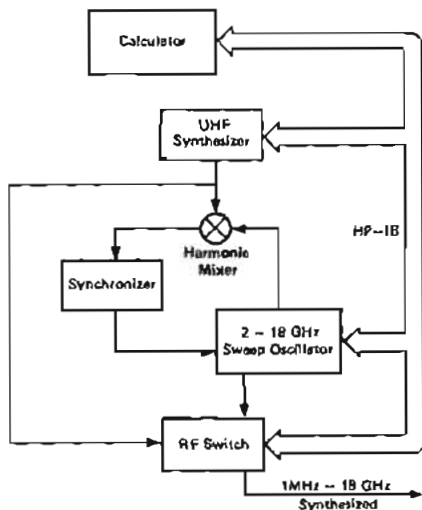

Figure 1

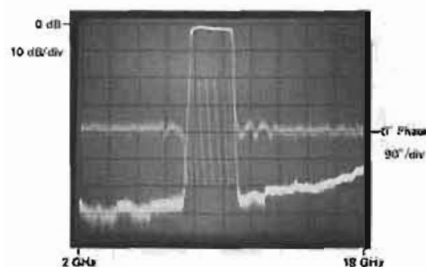

Figure 4

Figure 4 is a CRT photo of simultaneous phase and magnitude transmission characteristics of an 8 to 10 GHz bandpass filter across 2 to 18 GHz using the 86290A sweep oscillator plug-in.

For high power applications such as RFI-susceptibility tests and high attenuation measurements, Hewlett-Packard offers TWT amplifiers which provide better than 1 watt from 1 to 12.4 GHz.

Synthesizer accuracy and stability can be obtained by phase-locking the Hewlett-Packard sweep oscillators to a harmonic of a very stable source. This high stability is important

in many applications including microwave spectroscopy and high-Q swept frequency measurements.

Two-tone swept listing of devices such as mixers and receiver front ends requires two signals offset from each other by the IF. This is accomplished by phase-locking the difference frequency of two sweep oscillators to a very stable source. The sweepers may then be swept across the band of interest.

The modulation and built-in attenuator features of Hewlett-Packard sweep oscillators make them useful in many traditional CW signal generator applications.

In addition, accuracy, linearity, and flatness of the broadband 86222A/B and 86290A plug-ins make them more than adequate in many applications requiring a general purpose CW generator.

For wideband applications the 86290A, 2-18 GHz plug-in and the 86222A/B 0.01-2.4 GHz plug-in feature performance that rivals octave band oscillators in the area of frequency purity and accuracy, harmonics, and flatness.

For a complete discussion of swept frequency measurements the following applica-

tion notes and others are available from your local Hewlett-Packard sales office.

AN 95 "S-Parameters . . . Circuits Analysis and Design"

AN 117-1 "Microwave Network Analysis Applications"

AN 117-2 "Stripline Component Measurements"

AN 155-1 "Active Device Measurements with the 8755 . . ."

AN 183 "High Frequency Swept Measurements"

AN 187-1 "Configuration of A 2 - 18 GHz Synthesized Frequency Source with the 8620A mainframe"

AN 187-2 "Configuration of A 2 - 18 GHz Synthesized Frequency Source Using the 8620C Sweep Oscillator"

AN 187-3 "Three HP-1B Configurations for Making Microwave Scalar Measurements"

AN 187-4 "Configurations of a Two-Tone Sweeping Generator"

AN 187-5 "Calculator Control of the 8620C Sweep Oscillator using the HP-1B"

Sweep Oscillator - summary chart

Frequency Range*	Model Number			100 kHz	1 MHz	10 MHz	100 MHz	1 GHz	2 GHz	4 GHz	8 GHz	12 GHz	18 GHz	26 GHz	40 GHz
	8620 Series	8690 Series	Other Sweepers												
0.1 Hz - 13 MHz 10 kHz - 2600 MHz			3330B 8660A/C	←	←	←	←	←	←	←	←	←	←	←	←
100 kHz - 110 MHz 400 kHz - 110 MHz 10 - 1300 MHz 10 - 2400 MHz	86220A 86222A/B	8698B	8601A	←	←	←	←	←	←	←	←	←	←	←	←
100 MHz - 4 GHz 1.0 - 2.0 GHz 1.4 - 2.5 GHz 1.7 - 4.2 GHz	86330C/86320B	8699B 8691A/B 8691A Opt 200 8692B Opt 100						←	←	←	←	←	←	←	←
1.7 - 4.3 GHz 1.8 - 4.2 GHz 2 - 4 GHz 2 - 18 GHz	86331C 86230B or 86330C 86290A	8692A/B							←	←	←	←	←	←	←
3.2 - 6.5 GHz 3.5 - 6.75 GHz 3.7 - 8.3 GHz 4 - 8 GHz	86241A or 86341C	8693A Opt 200 8693B Opt 100 8693A/B							←	←	←	←	←	←	←
5.9 - 9.0 GHz 7 - 11 GHz 8 - 12.4 GHz 8 - 18 GHz	86242A/C or 86342C 86350C Opt H20 86250B/C or 86350C	8694A/B Opt 200 8694A/B 8694A/B Opt 300							←	←	←	←	←	←	←
10 - 15 GHz 12.4 - 18 GHz 18 - 26.5 GHz 26.5 - 40 GHz 33 - 50 GHz	86260A Opt H03 86260A	8695A Opt 100 8695A/B 8696A 8697A 8697A Opt H50							←	←	←	←	←	←	←

* Other Special Frequency Ranges Can Be Provided Upon Request.

SWEEP OSCILLATORS

Digital marker & generator/sweeper

Models 8600A & 8601A



8600A



8601A

Covering 100 kHz to 110 MHz, the Model 8601A Generator/Sweeper combines the high linearity and flatness of a precision sweeper with a signal generator's frequency accuracy and wide range of calibrated power levels. Though it's small and lightweight, it does the work of two instruments easily and conveniently.

8601A Specifications

Frequency range: low range, 0.1-11 MHz; high range, 1-110 MHz.

Frequency accuracy: approximately $\pm 1\%$ of frequency.

Power output: +20 to -110 dBm; 10-dB steps and 13-dB vernier provide continuous settings over entire range. Meter monitors output in dBm and rms volts into 50 Ω .

Power accuracy: ± 1 dB accuracy for any output level from +13 dBm to -110 dBm.

Flatness: ± 0.25 dB over full range, ± 0.1 dB over any 10 MHz portion (+10 dBm step or below).

Impedance: 50 Ω , SWR <1.2 on 0 dBm step and below.

Harmonics and spurious signals: (CW above 250 kHz, output levels below +10 dBm) harmonics at least 35 dB below carrier. Spurious at least 40 dB below carrier.

Residual FM: noise in a 20 kHz bandwidth including line related components (dominant component of residual FM is noise).

CW: <50 Hz rms, low range; <500 Hz rms high range.

SYM 0, sweep: <100 Hz rms, low range; <1 kHz rms, high range.

Residual AM: AM noise modulation index (rms, 10 kHz bandwidth) is <-50 dB; (typically -60 dB at 25°C).

Crystal calibrator: internal 5 MHz crystal allows frequency calibration to $\pm 0.01\%$ at any multiple of 5 MHz.

Sweep modes: full, video, and symmetrical.

Internal AM: fixed 30% $\pm 5\%$ at 1 kHz.

External AM: 0 to 50%, dc to 400 Hz; 0 to 30%, up to 1 kHz.

Internal FM: 1 kHz rate, fixed 75 kHz $\pm 5\%$ deviation, high range; 7.5 kHz $\pm 5\%$ deviation, low range; <3% distortion.

External FM: sensitivity, 5 MHz per volt $\pm 5\%$, high range; 0.5 MHz per volt $\pm 5\%$, low range; negative polarity; FM rates to 10 kHz.

Weight: net, 9.5 kg (21 lb). Shipping, 12.3 kg (27 lb).

Dimensions: 190 mm (7 $\frac{5}{16}$ ") wide, 155 mm (6 $\frac{1}{8}$ ") high, 416 mm (16 $\frac{3}{8}$ ") deep

The Model 8600A Digital Marker provides five independent, continuously variable frequency markers over the range 0.1 - 110 MHz when used with the HP 8601A or 8690B/8698B Generator Sweeper.

The high resolution controls and 6-digit readout permit 0.05% frequency settability. The frequency of any marker may be read while sweeping, simply by pushing a button within the marker control. The marker selected is brighter than the others and points in the opposite direction, ensuring positive marker identification.

8600A Specifications

Marker accuracy: any marker may be placed at a desired frequency $\pm (0.05\%$ of sweep width + sweeper stability).

Weight: net, 5.9 kg (13 lb); shipping 8.2 kg (18 lb).

Dimensions: 99 mm (3 $\frac{7}{8}$ ") high, 413 mm (16 $\frac{1}{8}$ ") wide, 337 mm (13 $\frac{1}{4}$ ") long.

Option 001: includes modification kit for 8690B/8698B; no additional charge.

Model number and name

8600A Digital Marker

8601A Generator/Sweeper

Price

\$1500

\$3000

SWEEP OSCILLATORS

Solid state sweeper family, 10 MHz to 18 GHz

8620 System

- Single-band, multi-band, and wide band plug-ins
- >10 mW to 18 GHz

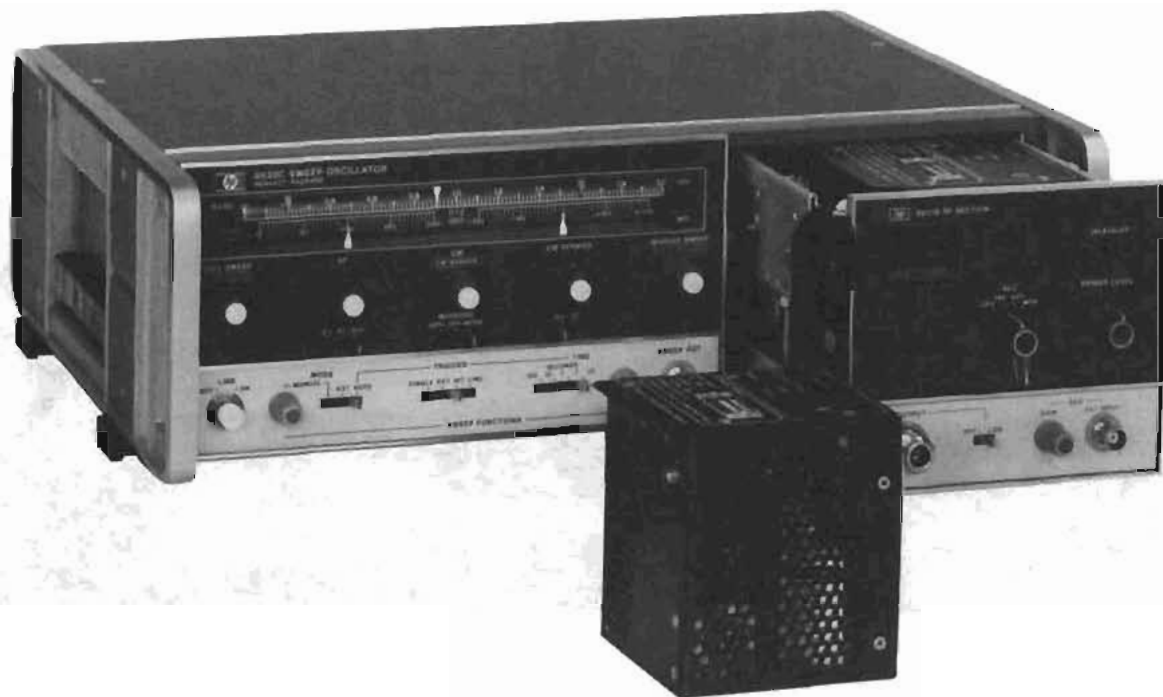

HP-IB

8620 System

The Hewlett-Packard 8620 solid state sweeper system offers the flexibility of the 8620C mainframe in addition to a choice of single-band, multiband, and the wide band plug-ins. The 8620 system also offers high power output with solid state reliability — greater than 10 mW leveled to 18 GHz.

Typical unleveled power output

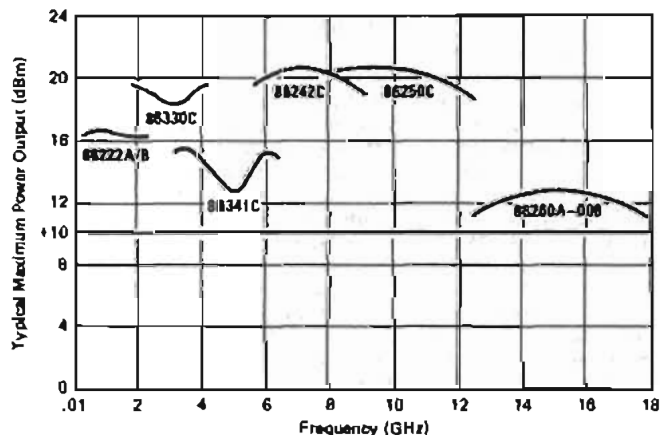

The fundamental oscillators used in the plug-ins and modules are YIG tuned transistor or bulk effect circuits. YIG tuning results in exceptional tuning linearity, low noise, and low spurious content; it also allows frequency modulation at high rates and wide deviations with low distortion.

8620C Sweeper mainframe

The 8620C has many features which are highly useful in stringent applications. With convenient functionally grouped controls and lighted pushbutton indicators the mainframe offers extreme ease of operation and flexibility. In addition, it can be a completely programmable source, either HP-IB or BCD, an indispensable feature for automatic systems and signal simulation applications.

86222A/B and 86250A wide band plug-ins

Now the 10 MHz to 18 GHz frequency range can be covered with just two plug-ins—the 86222A/B and the 86250A. Besides their broad frequency range these plug-ins offer many special features including unique crystal markers in the 86222B and better than ± 20 MHz frequency accuracy in the 86250A even at 18 GHz.

86200 Series single-band plug-ins

The 86200 series of plug-ins covers both ends of the frequency spectrum from 10 MHz to 18 GHz with a choice of more than nine plug-ins.

8621B and 86300 Series multiband plug-ins

The 8621B drawer provides capability for up to two fundamental oscillator modules (86300 series) plus a heterodyne module (86320B). Selecting the band is as simple as pressing a front panel lever.

SWEEP OSCILLATORS

8620 Family: mainframe
Model 8620C

- Optional BCD or HP-IB Programming
- 3 Markers
- 100% ΔF Capability, fully calibrated

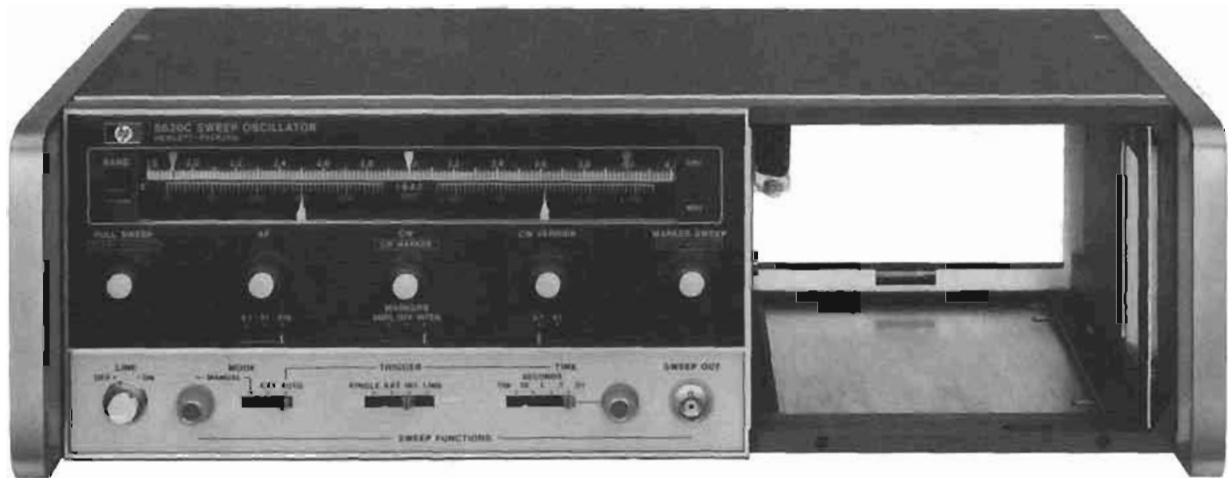

HP-IB



The new 8620C offers many features as standard equipment. For example, up to four separate bands and their respective frequency scales can be selected with a touch of the band select lever just to the left of the dial scale. This represents a truly convenient wide-band capacity, one which doesn't necessitate changing plug-ins or the addition of costly, bulky, additional instruments to make wide-band swept measurements. Pushbuttons, concentrically located in the frequency control knobs, light when actuated to indicate the sweep function in use. For example, depressing the FULLSWEEP pushbutton results in a sweep of the total range selected by the band select lever. In this mode three markers are available, controlled by the START MARKER, STOP MARKER, and CW MARKER knobs. The MARKER SWEEP function causes a sweep between START and STOP MARKERS. In MARKER SWEEP, the CW MARKER is still available for further flexibility in identifying specific frequencies.

The 8620C is fully and continuously calibrated for any ΔF sweep width. Having chosen an optimum width, one can read the total sweep width from the calibrated ΔF dial scale. The sweep is symmetrical about the CW MARKER setting and in this function the START and STOP MARKERS are available. Three continuously variable ΔF ranges are available by using the range switch below the ΔF knob. This allows calibrated sweep widths of up to 1%, 10%, or 100% of full band at the user's choice.

The CW function is selected by depressing the CW push button. It is possible to also engage the CW VERNIER knob to achieve very accurate setability. With the main dial scale cursor placed on any convenient mark, it is possible to accurately interpolate between dial scale markers by utilizing the CW VERNIER. This vernier makes the effective length of the dial scale $>7\frac{1}{2}$ meters (300 inches) and contributes to the increased setability.

Another feature is the capability to fully program the sweeper. The standard 8620C includes inputs for band selection, attenuator setting (with 8621B Opt 010 installed), sweep function selection, and analog frequency control. Option 011 provides, in addition, the capability to digitally program the sweeper with the HP-Interface Bus (HP-IB). With this option, the user can place the sweeper into any sweep function (ΔF , FULL SWEEP, etc.) and it will sweep according to the front panel frequency settings. In this mode a programmable digital marker is available. In addition, an extremely flexible digital frequency programming capability is included with this option. Resolution of 10,000 points per band or 10,000 points across the frequency range set by the front panel controls permit extremely high resolution limited only by the Residual FM of the sweeper. Option 001 BCD programming provides the same capabilities as the HP-IB option with the exception that no digital marker is available in the programmed sweep modes.

8620C Specifications

Frequency

Frequency range: determined by band select lever and RF unit.
Frequency linearity: refer to RF unit specifications.

Sweep functions

FULL sweep: sweeps the full band as determined by the plug-in and the band select lever.

MARKER sweep: sweeps from START MARKER to STOP MARKER frequency settings.

Range: both independent settings are fully calibrated and continuously adjustable over the entire frequency range; can be set to sweep either up or down in frequency.

End-point accuracy: refer to RF unit specifications, same as frequency accuracy.

ΔF Sweep: sweeps symmetrically upward in frequency, centered on CW setting. CW vernier can be activated for fine control of center frequency.

Width: continuously adjustable and calibrated from zero to 1%, zero to 10%, or zero to 100% of usable frequency band as selected with front panel switch. Dial scale calibrated directly in MHz.

Width accuracy: $\pm 1\%$ of maximum ΔF plus $\pm 2\%$ of ΔF being swept.

Center-frequency accuracy: refer to RF unit specifications, same as frequency accuracy.

CW operations: single-frequency RF output controlled by CW MARKER knob selected by depressing pushbutton in CW MARKER control.

Preset frequencies: START MARKER, STOP MARKER, and ΔF end points in manual sweep mode and CW MARKER frequency can be used as preset CW frequencies.

CW vernier: calibrated directly in MHz about CW setting. CW vernier activated by pushbutton in CW vernier control. Zero to $\pm 0.5\%$ or zero to $\pm 5\%$ of full bandwidth, selectable with front panel switch.

Accuracy: Refer to RF unit specifications, same as frequency accuracy.

Frequency markers: three constant width frequency markers are fully calibrated and independently adjustable over the entire range in FULL Sweep function, controlled by START MARKER, STOP MARKER, and CW MARKER controls. In ΔF sweep START and STOP MARKERS are available, and in MARKER SWEEP the CW MARKER is available. Front panel switch provides for the selection of either amplitude or intensity markers (amplitude modulating the RF output or Z-axis modulating the CRT display).

Resolution: better than 0.25% of RF unit bandwidth.

Marker output: rectangular pulse, typically -5 volts peak available from Z-axis BNC connector on rear panel. Source impedance, approximately 1000 ohms.

Accuracy: refer to RF unit specifications, same as frequency accuracy.

Sweep modes

Auto: sweep recurs automatically.

Line: sweep can be synchronized with the ac power line.

External trigger: sweep is actuated by external trigger signal.

Sweep time: continuously adjustable in four decade ranges typically 0.01 to 100 seconds.

Single sweep: activated by front panel switch.

Manual sweep: front panel control provides continuous manual adjustment of frequency between end frequencies set in any of the above sweep functions.

External sweep: sweep is controlled by external signal applied to programming connector. Zero volts for start of sweep increasing linearly to approximately +10 volts for end of sweep.

Sweep output: direct-coupled sawtooth, zero to approximately +10

volts, at front panel BNC connector, concurrent with swept RF output. Zero at start of sweep, approximately +10 volts at end of sweep regardless of sweep width or direction. In CW mode, dc output is proportional to frequency.

Modulation

Internal AM: square-wave modulation continuously adjustable from 950 to 1050 Hz on all sweep times. On/Off ratio, refer to RF unit specifications.

External AM: refer to RF unit specifications.

External FM: refer to RF unit specifications.

Phase-lock: refer to RF unit specifications.

Remote control

Remote band select: frequency range can be controlled remotely by three binary contact closure lines available at rear panel connector.

Remote attenuation select: 0 to 70 dB attenuation in 10 dB steps can be controlled by 4 binary contact closure lines when used with 8621B Option 010.

Remote frequency programming, options 001 (BCD) and 011 (HP-1B)

Functions

Band: manual enable or remote control of four bands

Mode: seven modes, including digital frequency control in three modes, with a resolution of 10,000 points across FULL band, between START MARKER and STOP MARKER as set by front panel controls, or across ΔF as set by front panel ΔF and CW controls; or selection of any of four analog sweep functions: ΔF or MARKER Sweep with end points set by appropriate front panel controls, CW as set by CW MARKER control, or FULL sweep of band selected.

Marker: with analog sweeps (FULL, ΔF , or MARKER SWEEP), a programmable marker is available (Opt 011 only), in either amplitude or intensity as selected with front panel switch.

General

Blanking

RF: with blanking switch enabled, RF automatically turns off during retrace, and remains off until start of next sweep. On automatic sweeps, RF is on long enough before sweep starts to stabilize external circuits and equipment whose response is compatible with the selected sweep rate.

Display (Z-axis/MKR/Pen Lift Output): direct-coupled rectangular pulse approximately +5.0 volts coincident in time with RF blanking is on rear panel

Negative (Negative blanking output): direct-coupled rectangular pulse approximately -5.0 volts coincident in time with RF blanking, fully compatible with 8410A/B network analyzer.

Pen lift: for use with X-Y recorders having positive power supplies. Transistor-switch signal is available on Z-axis/MKR/Pen lift connector. This signal is also available on the programming connector.

Furnished: 229 cm (7 1/2-foot) power cable with NEMA plug; 2 spare 3 amp fuses; extender board for servicing; and calibration scale.

Power: 100, 120, 220, or 240 volts $\pm 5\%$, 50 to 400 Hz. Approximately 140 watts.

Weight (not including RF unit): Net, 11.1 kg (24 lb). Shipping, 13.4 kg (30 lb).

Dimensions: 425 mm wide, 132.6 mm high, 337 mm deep (16 1/4" \times 5 3/8" \times 13 3/4").

Options

Option 001: BCD Frequency Programming

Option 011: HP-1B Frequency Programming

Option 908: Rack Flange Kit

Price
add \$650
add \$950
add \$10

8620C Sweep Oscillator Mainframe

\$1950

SWEEP OSCILLATORS

8620 System: broadband plug-in
Model 86290A

- 2 to 18 GHz continuous sweep
- Extended capability for network analysis

- Advanced technology provides outstanding performance



HP 86290A Typical Levelled Power Output

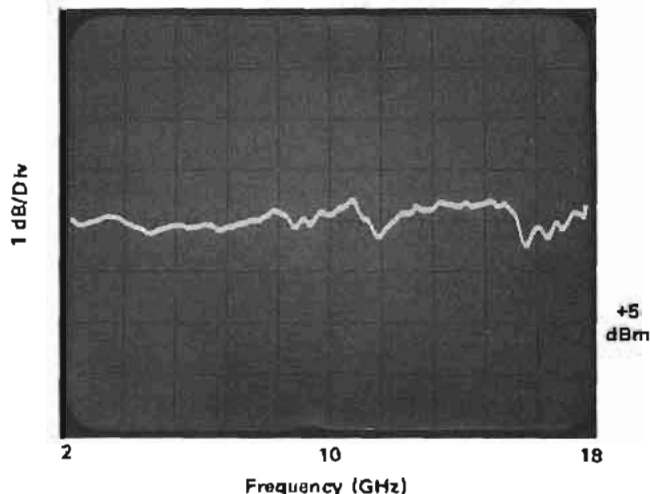

The 86290A broadband plug-in sets new standards in wideband sweeper value with versatile frequency coverage and excellent performance characteristics at an attractive size and price. For broadband testing, a continuous sweep from 2 to 18 GHz (or anywhere in between) is provided. In addition, higher frequency resolution is achieved by covering the 2 to 18 GHz range in three individual bands of 2 to 6.2 GHz, 6 to 12.4 GHz, and 12 to 18 GHz. Individual bands and corresponding dial scales are selected using the band select lever on the 8620C mainframe. Front panel lights indicate the frequency range selected. In each frequency band, all sweeper mainframe controls are operable.

The 86290A plug-in offers outstanding electrical performance along with small size and simplicity of operation. The key microelectronic elements of the 86290A are a 2 to 6.2 GHz fundamental oscillator, 100 mW amplifier, and high-efficiency multiplier integrated with a tracking YIG filter, which combine to produce a 5 dBm swept output over the 2 to 18 GHz range. This output is low in harmonic and spurious content and has excellent frequency linearity. On wideband sweeps, the 6.2 GHz and 12.4 GHz switch points can be Z-axis blanked as well as RF blanked, resulting in a spurious-free, clean continuous trace on any display.

The 86290A plug-in has unique advantages as a source for network measurements. For 2 to 18 GHz scalar measurements, the 86290A accepts direct 27.8 kHz square wave AM modulation from the HP 8755 Frequency Response Test Set. Thus the need for an external modulator is eliminated providing convenience and cost savings, and more important, making full sweeper power available at the test device. Phase/amplitude network analysis over the continuous 2 to 18 GHz range becomes a reality using the 86290A and the HP 8410B Network Analyzer. Interfacing between the 8410B and the sweeper permits the 8410B to automatically phase-lock over multi-octave sweeps. Together, the 86290A and the 8410B now make possible phase and amplitude measurements from 2 to 18 GHz in one continuous sweep.

As a stand-alone sweeper, the 8620C and 86290A plug-in provide still more features for ease in swept testing. Even at 18 GHz, frequency can be set with ± 20 MHz accuracy. Sweep linearity is 0.05% which means frequencies in the swept mode can be identified to accuracies comparable with wavemeters. Internal leveling is standard. External crystal and power meter leveling circuitry is also provided. A SLOPE control permits the frequency-dependent losses of a test setup to be compensated. The 2 to 6.2 GHz fundamental oscillator signal is always available through a rear output connector. Phase-locking from 2 to 18 GHz is accomplished using only 6.2 GHz hardware via this output. Accurate frequency readout is possible by connecting a DVM to the calibrated 1 volt/GHz output located on the rear panel.

With the plug-in flexibility and these exceptional features, the 8620/86290A sweeper is the ideal source for broadband sweep testing of components, transmission lines, antenna systems and ECM equipment.

General specifications

Switch points: broadband switch points are at 6.2 and 12.4 GHz. Frequency overlap is typically 0 to 20 MHz at switch points.

Auxiliary output: rear panel 2 to 6.2 GHz fundamental oscillator output, nominally -10 dBm.

Slope control: front panel control allowing compensation for frequency dependent losses of a test setup by attenuating power at lower frequencies.

Peak control: front panel control for peaking power over desired frequency range.

Frequency reference output: nom. 1 v/GHz (2—18 volts) rear panel BNC output, CW frequency accuracy typically ± 35 MHz.

Mainframe modification: order modification kit for sequential sweep capability on all 8620B mainframes, and on existing 8620A mainframes with serial prefix 1332A and below. (Kit included for 8620A mainframe with 86290A Option 060.)

Weight: net, 4.4 kg (9.6 lb). Shipping, 5.9 kg (13 lb).

86290A Broadband plug-in

Specifications with plug-in installed in an 8620C mainframe	BAND 1	BAND 2	BAND 3	BAND 4
Frequency range: (GHz)	2-6.2	6-12.4	12-18	2-18
Frequency accuracy (25°C) CW mode (or > 100 ms sweep time with FM switch in FM/PL): (MHz) All sweep modes: (MHz) Marker: (MHz) Frequency linearity (correlation between frequency and sweep out voltage) typically: (MHz)	±20 ±30 ±30	±20 ±30 ±30	±20 ±30 ±30	±80 ±80 ±80
Frequency stability With temperature: (MHz/°C) With 10% line voltage change: (kHz) With 10 dB power level change: (kHz) With 3:1 load VSWR, all phases: (kHz) Frequency drift (in 10 minute period after 30 minute warm-up): typically (kHz) Residual FM (10 kHz bandwidth; FM switch in norm) CW mode: (kHz peak)	±0.5 ±100 ±200 ±100 ±300 <10	±1.0 ±100 ±400 ±200 ±600 <20	±1.5 ±100 ±600 ±300 ±900 <30	±2.0 ±100 ±600 ±300 ±900 <30
Maximum leveled power (25°C): (dBm) Power level control range: (dB)	>5 >10	>5 >10	>5 >10	>5 >10
Power variation Internally leveled: (dB) Externally leveled (excluding coupler and detector variation) Crystal detector: Power meter: With temperature (typically): (dB/°C)	±0.7 ±0.15 ±0.15 ±0.1	±0.7 ±0.15 ±0.15 ±0.1	±0.8 ±0.15 ±0.15 ±0.1	±0.9 ±0.15 ±0.15 ±0.1
Spurious signals (below fundamental at specified maximum power) Harmonic related signals: (dB) Nonharmonics: (dB)	>25 >50	>25 >50	>25 >50	>25 >50
Residual AM in 100 kHz bandwidth (below fundamental at specified maximum power): (dB)	>55	>55	>55	>55
Source VSWR internally leveled, 50Ω nominal impedance	<1.9	<1.9	<1.9	<1.9
External FM Maximum deviations for modulation frequencies: DC to 100 Hz: (MHz) 100 Hz to 2 MHz: (MHz) Sensitivity (typically) FM mode: (MHz/volt) Phase-lock mode: (MHz/volt)	±75 ±5 -20 -6	±75 ±5 -20 -6	±75 ±5 -20 -6	±75 ±5 -20 -6
AM (At specified maximum power) Specific requirements guaranteeing HP 8755 operation with ±6 V, 27.8 kHz square wave mod drive connected to external AM input. On/Off ratio: (dB) Symmetry: Attenuation for +5 volt input: (dB) Internal 1 kHz square wave On/Off ratio: (dB) RF blanking (selected by mainframe switch) On/off ratio: (dB)	>30 40/60 >30 >25 >30	>30 40/60 >30 >25 >30	>30 40/60 >30 >25 >30	>30 40/60 >30 >25 >30
Sweep time typically: (ms)	10	10	10	60
CW remote programming settling time (typical time to settle into CW frequency accuracy specification, 8620C Opt. 00) or 01): (FM switch in FM/PL): (ms)	5	5	5	10

Model number and name
86290A 2 to 18 GHz plug-in (internal leveling standard):
Option 004, rear panel RF output:
 (See Data Sheet for specifications)
Option 005, APC-7 RF output connector:
Option 060, 08620-60099 kit included for modifying 8620A mainframes with serial prefix 1332A and below:

Price
 \$13,250
 add \$80
 add \$40
 add \$300

Sequential Sweep modification kits (ordered separately):
 08620-60099, for existing 8620A mainframes with serial prefix 1332A and below: \$300
 08620-60100, for all 8620B mainframes (8620B dial scales included): \$300

SWEEP OSCILLATORS

8620 Family: 10 MHz to 2.4 GHz Plug-ins

Models 86222A and 86222B

- 10 MHz to 2.4 GHz in ONE, CONTINUOUS sweep
- Internally leveled FLATNESS ± 0.25 dB over full range
- 1, 10, and 50 MHz crystal marker combs with 86222B
- Marker accuracy even in CW with 86222B



86222A

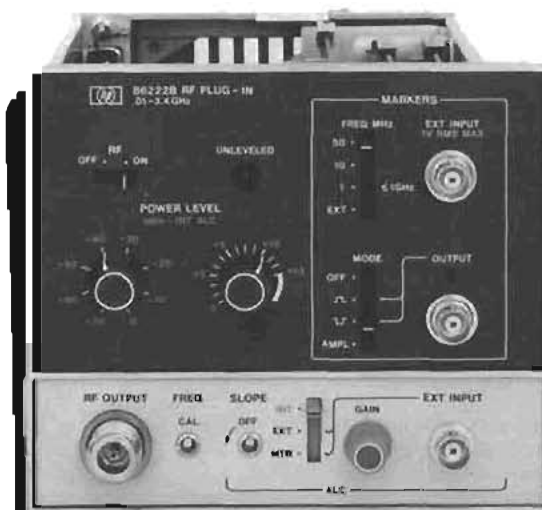

86222B

The HP 86222A/B sweeper provides uncompromising 10 MHz to 2.4 GHz frequency coverage. The entire range can be swept continuously — no need to break up your measurement into two or more sweeps. Yet narrowband resolution is not sacrificed. This precision is complemented by the 86222's good stability and frequency accuracy to make narrowband measurements truly practical. Both narrowband and wideband linearity is excellent (2 MHz over full band). The RF output characteristics of the 86222 feature similar high performance. Power output is calibrated 0 to +13 dBm in 1 dB increments. The output is internally leveled to ± 0.25 dB flatness over the entire 0.01 to 2.4 GHz range!

For applications demanding precise frequency identification, the 86222B offers an advanced digitally processed birdie marker system which provides the accuracy associated with standard birdie markers without their normal liabilities. The 86222B marker system internally generates a typical birdie marker, then processes it to produce a digital pulse. This pulse can then be used to produce an intensity dot on the CRT which corresponds to a precise frequency. This opens the applications of 86222B "birdie" markers to a wide variety of network analyzers and displays, such as the 8410B and 8755, where previously it was impossible to inject them on either the detected dc or RF signals. Alternately, an amplitude marker, derived from the birdie, can be selected which produces a dip in RF power at each marker frequency. This type of marker is useful for X-Y recordings. In addition, when the output frequency is coincident with a 50, 10, or 1 MHz comb of the internal crystal oscillator, a front-panel LED lights. Thus, independent of the display, an operator can accurately identify a CW frequency of the 86222B — within 75 kHz at 1 GHz! Provision is also made for injection of an external marker for identification of specific

frequencies between 1 MHz markers.

Continuous multi-octave vector measurements to 2.4 GHz are now possible using the HP 86222 together with the HP 8410B Network Analyzer. Previously, measurements could be made only one octave at a time because manual range switching of the HP 8410 was necessary. Now, the HP 86222/8620C combination automatically range switches the network analyzer for one continuous display, even from 0.1 to 2.4 GHz. In addition, with the 86222B crystal marker system the important third dimension, frequency, can be added to the polar display of the HP 8410B.

Increased dynamic range scalar measurements can be made using the HP 86222A/B together with the HP 8755 Sweep Frequency Response Test Set. Heterodyne plug-ins in the range of 0.01 — 2 GHz will typically have a broadband noise output only 45 to 50 dB below the fundamental output signal. This noise is due to the high gain output amplifier used in heterodyne approaches. The noise level will be higher than most broadband detectors' noise level and significantly higher than the noise of the Schottky diode used in the HP 8755. This will limit the dynamic range of measurements such as the transmission loss of high pass, low pass, and notch filters, or return loss of bandpass filters when broadband detectors are used. The HP 8755A, which is a 27.8 kHz receiver does not exhibit this problem when used with the HP 86222A/B. By designing an integral modulator in the sweeper, and an ALC loop which will handle the 27.8 KHz, the fundamental oscillator output can be modulated at 27.8 KHz without modulating the noise of the output amplifier. The HP 8755 will therefore not respond to the noise. The typical result is a 10 to 15 dB dynamic range improvement over other heterodyne sweepers and dc diode detection systems.

Specifications with plug-in installed in an 8620C mainframe

Frequency characteristics

Range: 10 MHz to 2.4 GHz

Accuracy (25°C)

CW mode: ±10 MHz.

Using Programming Input (8620C Option 001 or 011): typically ±6 MHz.

All sweep modes: ±15 MHz (<0.1 sec sweep time)

Accuracy of 86222B may be enhanced to better than ±200 kHz through use of crystal markers.

Linearity (correlation between frequency and SWEEP OUT Voltage): typically ±2 MHz.

Frequency reference output: nominally 1 V/GHz ±0.01 V.

Frequency cal control: permits fine frequency calibration.

Stability

With temperature: ±500 kHz/°C.

With 10% line voltage change: ±20 kHz.

With 3:1 load SWR, all phases: ±10 kHz.

With 10 dB power level change: ±20 kHz.

With time (after 1-hour warm-up): typically ±100 kHz/10 min.

Residual FM: (10 kHz bandwidth; FM switch in NORM; CW Mode): <5 kHz peak.

Output characteristics

Maximum leveled power (25°): >+13 dBm (20 mW); typically >+15 dBm.

Power Level Accuracy: (Internal leveling only); ±1 dB (includes frequency response).

Attenuator Option 002: add ±0.2 dB/10 dB step.

Power Variation

Internally leveled

0.01 to 2.4 GHz: ±0.25 dB.

Across any 50 MHz (0.03 to 2.3 GHz): typically ±0.05 dB.

Stability with temperature: typically ±0.02 dB/°C.

Externally leveled (excluding coupler and detector variation)

Crystal detector (-10 to -100 mV at rated output): ±0.1 dB.

Power meter (with HP 432A/B/C Series power meters): ±0.1 dB.

Unleveled indicator: lights when RF power level is set too high to permit leveling over sweep range selected.

Residual AM in 100 kHz BW: >50 dB below carrier at maximum power.

Spurious signals (below fundamental)

Harmonics: >25 dB at +13 dBm; typically >30 dB at +10 dBm.

Non-Harmonics

0.01 to 2.3 GHz: >30 dB at +13 dBm; typically >40 dB at +10 dBm.

2.3 to 2.4 GHz: >25 dB at +13 dBm; typically >35 dB at +10 dBm.

Broadband noise in 100 kHz bandwidth: typically <-70 dBm.

Impedance: 50Ω nominal.

SWR: <1.5

Slope control: allows variable compensation for frequency dependent losses in test set-up.

Output connector: type N Female.

Modulation characteristics

External FM:

Input impedance: approximately 10 kΩ.

Frequency response: typically 150 kHz.

External AM:

Square wave response: guarantees HP 8755 Frequency Response Test Set operation with 8755 Modulator Drive connected to EXT AM input.

ON/OFF ratio: >30 dB.

Symmetry: 40/60 at ≥10 dBm output power.

Attenuation for +8 V input: >30 dB.

Internal AM:

1 kHz square-wave On/Off ratio: >30 dB.

RF blanking On/Off ratio: >30 dB.

External FM:

Maximum deviations for modulation frequencies

DC to 100 Hz: ±75 MHz

100 Hz to 1 MHz: ±5 MHz

1 MHz to 2 MHz: ±2 MHz.

Sensitivity (typically)

FM mode: -20 MHz/V.

Phase-lock mode: -6 MHz/V.

Crystal marker capabilities (86222B Only)

Internal crystal markers: harmonic markers of 10 and 50 MHz usable over full 0.01 to 2.4 GHz range and 1 MHz markers usable 0.01 to 1 GHz. Positive (P) or negative (N) voltage output pulses can be selected to Z-axis intensify a scope trace; or RF amplitude pips can be selected. (At maximum sweep speed pulse width optimized for approximately 10 markers/sweep.)

Accuracy of center frequencies (25°C): ±5 × 10⁻⁶.

Typical marker width around center frequency

1 MHz markers: ±75 kHz.

10 MHz markers: ±200 kHz.

50 MHz markers: ±300 kHz.

Temperature stability: typically ±2 × 10⁻⁶/°C.

Marker output $\left\{ \begin{array}{l} \text{mode: nominally } >3 \text{ V.} \\ \text{mode: nominally } -4 \text{ to } -9 \text{ V, internally adjustable.} \end{array} \right.$

Amplitude mode: typically 0.5 dB.

External marker input: generates amplitude or Z-axis marker when sweep frequency equals external input frequency.

Frequency range: 0.01 to 2.4 GHz.

Marker width: typically ±300 kHz.

Marker indicator light: green LED lights coincident with crystal or external marker for accurate CW calibration.

General

Improved Network Measurements Capability

8410B Network Analyzer: interfacing through 8620C rear panel connector allows the 8410B to maintain phase lock over multi-octave sweeps at all sweep speeds.

8755 Frequency Response Test Set: direct connection of 8755 mod drive signal to external AM input of the 8620C eliminates the need for an external modulator.

Model number and name

86222A 0.01 - 2.4 GHz RF Plug-In (Internal Leveling Standard)

86222B 0.01 - 2.4 GHz RF Plug-In with Crystal and External Markers (Internal Leveling Standard)

Option 002 70 dB Step Attenuator (10 dB steps)

Option 004 Rear Panel RF Output

Price

\$3500

\$4100

add \$295

add \$80

SWEEP OSCILLATORS

8620 family: single band plug-ins

86200 Series

- 50 mW in J- and X-bands
- 10 MHz to 18 GHz coverage



86250C



86260A

Specifications

86200 Series

The 86200 series plug-ins feature a wide choice of bandwidths and power specifications for covering the 10 MHz to 18 GHz frequency range. The 86222 10 MHz to 2400 MHz unit and the 86290A 2 GHz to 18 GHz plug-in both cover multi-octave frequency ranges with exceptional frequency precision and RF output characteristics. See preceding pages for specifications on these plug-ins. For octave band applications, smaller range plug-ins covering, for instance, 3.2 GHz to 6.5 GHz are available with optional capability to operate as up-converters for MLA measurements.

Frequency linearity: typically $\pm 1\%$

Frequency reference output: typically 1 V/GHz DC-coupled voltage is available for referencing or phase-locking external equipment to the plug-in or for multi-octave operation with an 8410B.

RF power leveling: internal dc-coupled leveling amplifier and PIN modulator provided.

Internal, option 001: selected by front panel switch; refer to RF plug-in specifications. (Standard on 86220A.)

External

Crystal input: approximately ± 20 to ± 250 mV for specified leveling at rated output; for use with positive or negative polarity detectors such as 780 Series Directional Detectors, 423A/B and 8470 Series Crystal Detectors; polarity switch provided in RF plug-in.

Power meter input: the 8404A Leveling Amplifier and external AM input on the 8620 Mainframe must be used with all RF plug-ins except the 86242C, 86250C, and 86260A. They contain an internal leveling amplifier.

Indicator: front panel indicator lights when RF power level is set too high to permit leveling over entire selected sweep range or when operating in unlevelled mode.

Residual AM in 1 kHz bandwidth: > 50 dB below fundamental at specified maximum power.

External AM

Frequency response: typically dc to 100 kHz unlevelled, dc to 50 kHz levelled (at maximum levelled power).

Input impedance: approximately 5000 ohms.

RF output connector: type N Female.

Dimensions: 152 mm wide, 127 mm high, 295 mm deep (6" \times 5" \times 11 1/2").

Weight: net, 2.3 kg (5 lb). Shipping, 3.2 kg (7 lb).

Options:

001: internal leveling. Refer to RF plug-in specifications.

002: 70 dB attenuator in 10 dB steps, available in 86220A.

004: rear panel RF output

005: APC-7 RF output connector available on 86260A

008: $> +10$ dBm levelled output power guaranteed on 86260A

H70 series: upconverter simulation guaranteeing compatibility with HP 3710A/3702B Microwave Link Analyzer. Any communications band between 0.5 and 18 GHz can be covered with < 3 nsec group delay across 30 MHz. Information available on request.

Price

See model number

add \$275

add \$80

add \$40

add \$300

Single band plug-ins

Refer also to broadband models 86222A/B (0.01–2.4 GHz) and 86290A (2–18 GHz)

Specifications with plug-in installed in 8620C	86220A	86230B	86241A	86242A	NEW 86242C	86250B	NEW 86250C	86260A Std/Option 006
Frequency range ¹ (GHz):	0.01 – 1.3	1.8 – 4.2	3.2 – 6.5	5.9 – 9.0	5.9 – 9.0	8.0 – 12.4	8.0 – 12.4	12.4 – 18.0
Frequency accuracy CW mode (MHz): All sweep modes (sweep time > 100 ms) (MHz):	±10 ±15	±15 ±20	±30 ±33	±35 ±40	±35 ±40	±40 ±50	±40 ±50	±50 ±70
Residual FM (10 kHz BW) CW mode (kHz peak):	<5	<7	<7	<15	<15	<15	<15	<25
Maximum leveled power ¹ (dBm):	+10	>+10	>+8	>+10	>+17	>+10	>+17	>+7/>+10
Power variation: Internally leveled (dB): Externally leveled (dB) (excluding coupler & detector variation):	<±0.5 Internal leveling, cal'd output std	<±1.2 ±0.1	<±0.8 ±0.1	<±1 ±0.1	<±0.5 ±0.1	<±1 ±0.1	<±0.5 ±0.1	<±0.6 ±0.1
Spurious signals: (dB below fund at specified max power) Harmonics: Nonharmonics:	>25 >60	>20 >60	>16 (3.2 – 3.8 GHz) >20 (3.8 – 6.5 GHz) >60	>30 >60	>30 >60	>30 >60	>30 >60	>25 >50
Source VSWR: (50Ω nom, Internally leveled)	<1.3	<1.6	<1.6	<1.5	<1.6	<1.5	<1.6	<1.6
External FM: Max deviations (MHz) for modulation frequencies: DC – 100 Hz: DC – 1 MHz: Sensitivity (nom, MHz/V):	±15 ±0.5 +3.5	±25 ±2 –4	±25 ±2 –6	±25 ±2 –6	±180 ±7 –20/–6	±25 ±2 –6	±180 ±7 –20/–6	±75 ±5 (DC – 200 kHz) –20/–6
AM: Internal square Wave on/off ratio & Ext AM sensitivity To –10 V (dB):	>35	>25	>25	>40	>40	>40	>40	>25
Price: Plug-in: Option 006 (int. lev):	\$2100 Included	\$2400 add \$390	\$2150 add \$390	\$2700 add \$390	\$3850 add \$450	\$2800 add \$391	\$3850 add \$450	\$3050/\$3350 add \$550

¹Special frequency bands and higher power outputs available on request.

SWEEP OSCILLATORS

8620 Family: multiband plug-ins

Model 8621B, 86300 series

- Modular construction
- >40 mW in S-band



8621B



86300 Series



The 8621B RF Drawer houses the 86300 series RF Modules. The standard drawer will accept one fundamental oscillator module. In addition, with the 1.8 to 4.2 GHz fundamental oscillator module, the standard drawer also accepts the 0.1 to 2 GHz heterodyne module to give 0.1 to 4.2 GHz coverage. The 8621B Option 100 will accept two fundamental oscillator modules and the heterodyne module. This will allow, for example, 0.1 to 6.5 GHz coverage in one plug-in.

Specifications

8621B

70 dB step attenuator, option 010

Range: 70 dB in 10 dB steps set by front panel switch.

Insertion loss: <2.0 dB.

Accuracy (including frequency response):

For 10 dB: <±0.6 dB.

For >10 dB: <±5% of attenuation.

Remote control capability: 4-line binary logic, open or contact closure to ground. (8620A/C Mainframe only, input available at rear panel connector.)

Weight: net, 0.9 kg (2 lb).

RF power leveling: internal dc-coupled leveling amplifier provided.

Internal: selected by front panel switch; refer to RF module specifications.

External:

Crystal input: approximately ±20 to ±250 mV for specified leveling at rated output; for use with positive or negative polarity detectors such as 780 Series Directional Detectors, 423A/B and 424 Series Crystal Detectors; polarity switch provided in RF drawer.

Power meter input: switch in RF drawer selects proper compensation for Models 431B/C or 432A/B/C power meters.

Indicator: front panel indicator lights when RF power level is set too high to permit leveling over entire selected sweep range or when operating in unlevelled mode.

Frequency reference output: DC-coupled voltage nominally 1 V/GHz is available for referencing or phase locking external equipment to the sweeper or for multi-octave operation with the 8410B.

RF output connector: type N Female.

Dimensions: 152 mm wide, 127 mm high, 295 mm deep (6" × 5" × 11 3/4").

Weight: net, 1.4 kg (3 lb). Shipping, 2.3 kg (5 lb).

Common specifications

86300 series

Frequency linearity: typically ±1%.

Residual AM in 1 kHz bandwidth: >50 dB below fundamental at maximum power

External AM

Frequency response: typically dc to 100 kHz unlevelled, dc to 50 kHz levelled (at maximum levelled power).

Input impedance: approximately 5000 ohms.

Internal leveling: standard on all modules. Refer to RF module specifications.

Dimensions: 92 mm wide, 103 mm high, 95 mm deep (3 3/4" × 4" × 3 3/4").

Weight: net, 1.4 kg (3 lb). Shipping, 1.8 kg (4 lb).

Model number and name

8621B RF Drawer

8621B Options

004: Rear panel RF output

010: 70 dB Attenuator

100: Multiband capability

Price

\$625

add \$80

add \$950

add \$500

Multiband plug-ins

Specifications with unit installed in 8621B and 8620C	86320B ¹	86330C	86331C	86341C	86342C	86350C
Frequency range ² (GHz):	0.1 – 2.0	1.8 – 4.2	1.7 – 4.3	3.2 – 6.5	5.9 – 9.0	8.0 – 12.4
Frequency Accuracy: CW mode (MHz): All sweep modes (sweptimes > 100 ms) MHz:	±15 ±20	±15 ±20	±20 ±25	±30 ±33	±35 ±40	±40 ±50
Residual FM (10 kHz BW) CW mode (kHz Peak):	<15	<7	<7	<7	<15	<15
Maximum leveled power ² (dBm):	> +13	> +16 (40 mW)	> +16 (2 – 4 GHz) > +13 (1.7 – 4.3)	> +10	> +7	> +6
Power variation: Internally leveled Externally leveled (dB) (Excluding coupler-detector or thermistor variation):	±0.7 < ±0.1	< ±0.7 < ±0.1	< ±0.8 < ±0.1	< ±1 < ±0.1	±1 < ±0.1	±1 < ±0.1
Spurious signals: (dB below fund. at specified max power) Harmonics: Nonharmonics:	> 30 @ 10 dBm > 24 @ 13 dBm > 30 @ 10 dBm > 24 @ 13 dBm	> 20 > 60	> 20 > 60	> 14 (3.2 – 3.8 GHz) > 25 (3.8 – 6.5 GHz) > 60	> 30 > 60	> 30 > 60
Source VSWR: (50Ω nom, internally leveled)	< 1.6	< 1.6	< 1.6	< 1.6	< 1.5	< 1.5
External FM: Max deviations (MHz) for Modulation frequencies: DC – 100 Hz: DC – 1 MHz: DC – 2 MHz: Sensitivity: nominal FM mode (MHz/V): Phase lock mode (MHz/V):	±75 ±5 ±2 –20 –6	±75 ±5 ±2 –20 –6	±75 ±5 ±2 –20 –6	±75 ±5 ±2 –20 –6	±75 ±5 ±2 –20 –6	±75 ±5 ±2 –20 –6
AM: Internal square wave on/off ratio and Ext. AM sensitivity To –10 V (dB)	> 15	> 40	> 40	> 25	> 40	> 40
Price	\$2200	\$2580	\$2630	\$2480	\$2730	\$2730

¹86320B is a heterodyne unit which must be used with 86330C or 86331C.

²Special frequency bands and higher power outputs are available on request.

SWEEP OSCILLATORS

8690 Sweeper family, 400 kHz to 50 GHz

8690 System

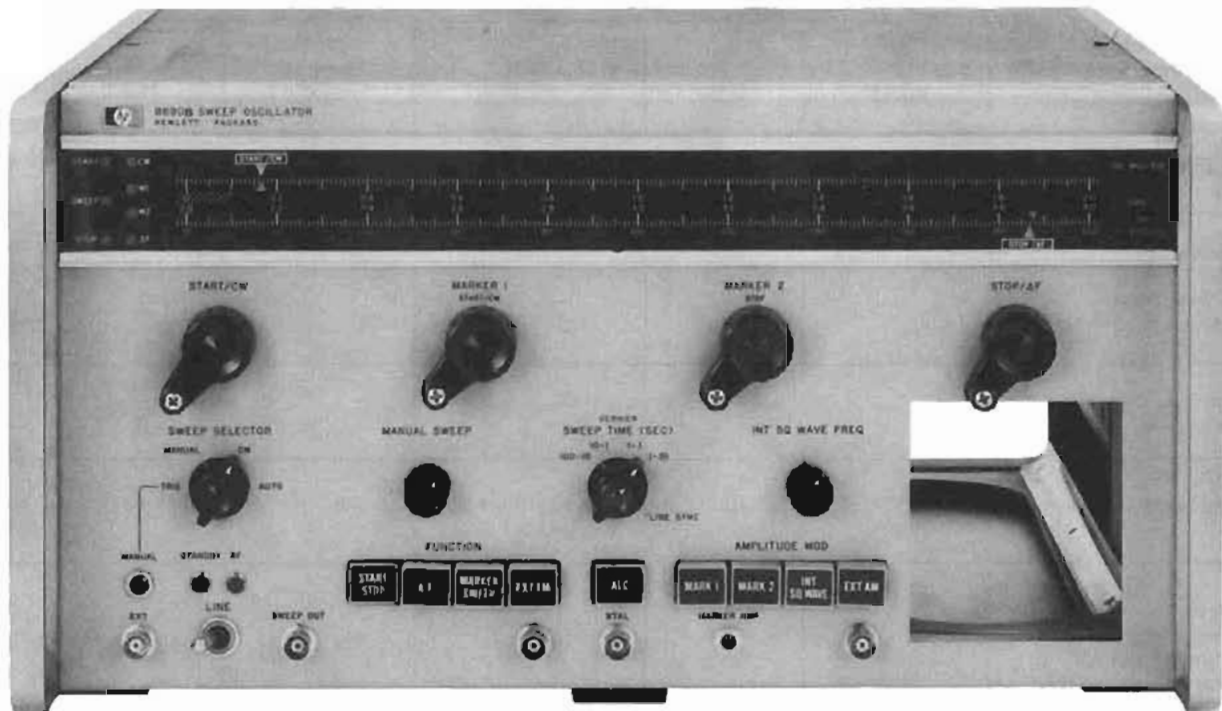

8690 System

The familiar 8690 BWO sweeper family offers exceptional value in performance, operation and versatility. With the ability to accept both BWO and solid state plug-ins, the 8690 mainframe allows BWO coverage where necessary, and more reliable, high performance solid state coverage at lower frequencies.

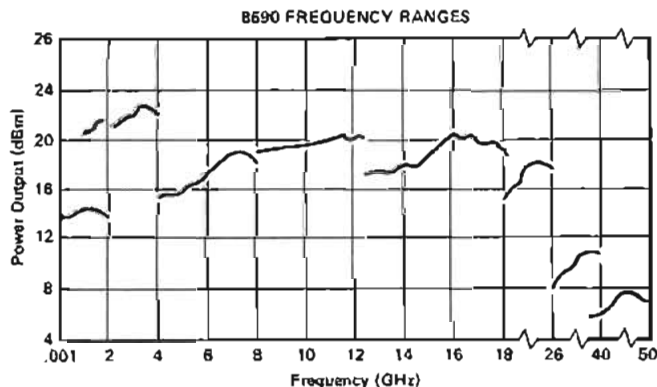

8690B Mainframe specifications

Sweep functions

START-STOP sweep: sweeps from "start" to "stop" frequency setting. Both settings continuously adjustable over entire frequency range.

MARKER sweep: sweeps from "Marker 1" to "Marker 2" frequency setting. Both settings continuously adjustable over entire fre-

quency range and accurate to 1% of full scale for all RF units.

ΔF sweep: sweeps upward in frequency, centered on CW setting. Width is continuously adjustable from zero to 10% of the frequency band and is calibrated in MHz. Accuracy is $\pm 1\%$ of maximum ΔF plus $\pm 10\%$ of ΔF being swept.

CW operation: single-frequency RF output selected by START/CW or MARKER 1 control, depending on sweep function selected.

Sweep modes

Auto, manual, and triggered sweep modes; sweep indicator lights during each sweep.

Sweep time: continuously adjustable in four decade ranges, 0.01 to 100 seconds.

Sweep output: direct-coupled sawtooth, zero to approximately +15 V, concurrent with swept RF output, regardless of sweep width or direction.

General

Frequency markers: two markers independently adjustable over entire frequency range accurate to 1% of full scale. Amplitude is adjustable from front panel. A -5 V (triangular pulse is available as an intensity marker on the rear panel).

Internal AM: square wave modulation continuously adjustable from 950 to 1050 Hz.

External AM: frequency response dc to 3 kHz. Deviation from CW setting approximately 6% of frequency band per volt.

Blanking: both negative (-4 V) and RF blanking available along with pen lift output.

Weight: net, 23.9 kg (53 lb). Shipping, 32 kg (71 lb).

Dimensions: 425 mm wide, 222 mm high, 467 mm deep (16 $\frac{1}{2}$ " \times 8 $\frac{3}{4}$ " \times 18 $\frac{3}{4}$ ").

8690B Sweeper mainframe

\$2600

- Solid state plug-ins

- Both pin and grid leveled BWO plug-ins
- Now with 50 GHz frequency coverage

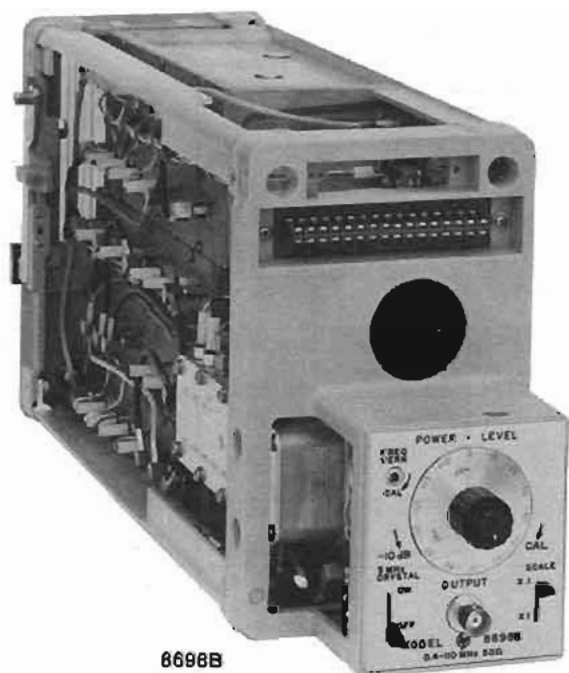

8698B



8693B

Solid state and BWO plug-ins

Solid state plug-ins from 400 kHz to 4 GHz are available for the 8690 mainframe. BWO replacement is both expensive and inconvenient. Solid state plug-ins not only offer high reliability, but also provide low residual FM and good spectral purity. This capability allows one mainframe to cover high frequency, high power BWO applications, yet facilitate high performance, longer life solid state coverage of lower frequencies. There are two solid state plug-ins. The 8698B covers 400 kHz to 110 MHz while the 8699B plug-in has a 100 MHz to 4 GHz range.

Both grid leveled and pin leveled BWO plug-ins are available covering 1 to 50 GHz. Grid leveled BWO oscillators achieve power and leveling control by varying bias on the BWO grid. Although some degradation in frequency performance specifications is seen by this method, grid leveling provides an economical means of power control and delivers higher power output since there are no components (pin modulators) between BWO and front panel output.

PIN leveled BWO plug-ins offer superior frequency stability characteristics. As in all solid state plug-ins, leveling is accomplished through use of a pin diode modulator between oscillator and output. Use of the pin allows the oscillator to work at constant bias and into a

constant impedance load, resulting in very low residual FM and very little frequency pulling. Pin leveling also results in a better source impedance match.

Common specifications: BWO plug-ins

- Warranty:** all BWO's are unconditionally warranted for one year.
- Spurious signals:** harmonics, >20 dB below CW output, nonharmonics, >40 dB below CW output.
- Residual AM:** >40 dB below CW output.
- Magnetic shielding:** all plug-ins except the 8691A/B have shielded BWO's.
- Reference output:** dc voltage proportional to frequency output ≈ 40 V/octave.
- Leveling Indicator:** front panel light indicates unlevelled operation.
- Power variation**
 - Unleveled: <10 dB over full band
 - Externally leveled: ± 0.2 dB for A units
 ± 0.1 dB for B units
- Frequency stability with temperature:** $\pm 0.01\%/^{\circ}\text{C}$.
- Weight**
 - 8691-8692: net, 7.7 kg (17 lb). Shipping, 11.3 kg (25 lb).
 - 8693-8697: net, 5.4 kg (12 lb). Shipping, 9 kg (20 lb).
 - 8698-8699: net, 5.0 kg (11 lb). Shipping, 8.6 kg (19 lb).

SWEEP OSCILLATORS

8690 Sweeper family (cont.)

Pin leveled solid state plug-ins

Frequency Range	Model Number	Maximum Leveled Power	Frequency Accuracy	Frequency Stability With		Residual FM ²	Option 001 Int. Leveling Power Variation	Connector	Price
				Temperature	10 dB Power Level Change				
0.4 - 11 MHz	8698B	>20 mW	±1% ±50 kHz	±0.05%/°C	—	<300 Hz rms	±0.3 dB	BNC ¹	\$2200
11 - 110 MHz		>20 mW	±1% ±500 kHz	±0.05%/°C	—	<500 Hz rms	±0.3 dB		
0.1 - 2 GHz	8699B	>20 mW	±10 MHz	±750 kHz/°C	<100 kHz	<3 kHz rms	—	Type N	\$4850
2 - 4 GHz		>6 mW	±10 MHz	±750 kHz/°C	<500 kHz	<3 kHz rms	—		

1. 75Ω BNC output available. Add \$55.

2. Residual FM measured with 10 kHz bandwidth.

Grid and pin leveled BWO plug-ins

Frequency	Model Number	Power Control	Maximum Leveled Power	Frequency Accuracy	Freq. Stability With Power Level Change ¹	Residual FM Peak ²	Option 001 Int. Leveling Power Variation	Connector	Price	Option 001 Int. Leveling Price-Add
1.0 - 2.0 GHz	8691A	GRID	>100 mW	±1%	<20 MHz	<30 kHz	±0.4 dB	Type N	\$3000	\$360
	8691B	PIN	>70 mW	±10 MHz	±500 kHz	<10 kHz	—	Type N	\$3750	—
1.4 - 2.5 GHz	8691A Opt. 200	GRID	>100 mW	±1%	<30 MHz	<30 kHz	—	Type N	\$3280	—
1.7 - 4.2 GHz	8692B Opt. 100	PIN	>15 mW	±25 MHz	±4 MHz	<20 kHz	—	Type N	\$3930	—
2.0 - 4.0 GHz	8692A	GRID	>70 mW	±1%	<40 MHz	<30 kHz	±0.4 dB	Type N	\$2900	\$360
	8692B	PIN	>40 mW	±20 MHz	4 MHz	<15 kHz	—	Type N	\$3500	—
3.5 - 6.75 GHz	8693A Opt. 200	GRID	>40 mW	±1%	<80 MHz	<50 kHz	—	Type N	\$3250	—
3.7 - 8.3 GHz	8693B Opt. 100	PIN	>5 mW	±45 MHz	±1 MHz	<20 kHz	±0.4 dB	Type N	\$3250	\$390
4.0 - 8.0 GHz	8693A	GRID	>30 mW	±1%	<80 MHz	<50 kHz	±0.5 dB	Type N	\$2450	\$390
	8693B	PIN	>15 mW	±40 MHz	±1 MHz	<15 kHz	±0.4 dB	Type N	\$2900	\$390
7.0 - 11.0 GHz	8694A Opt. 200	GRID	>25 mW	±1%	<160 MHz	<60 kHz	±0.75 dB	Type N	\$2755	\$490
	8694B Opt. 200	PIN	>15 mW	±40 MHz	±1 MHz	<20 kHz	±0.75 dB	Type N	\$3355	\$490
7.0 - 12.4 GHz	8694A Opt. 100	GRID	>25 mW	±1%	<160 MHz	<60 kHz	±0.75 dB	Type N	\$3060	\$490
	8694B Opt. 100	PIN	>15 mW	±50 MHz	±1 MHz	<20 kHz	±0.75 dB	Type N	\$3660	\$490
8.0 - 12.4 GHz	8694A	GRID	>50 mW	±1%	<160 MHz	<60 kHz	±0.75 dB	Type N	\$2700	\$490
	8694B	PIN	>30 mW	±40 MHz	±1 MHz	<15 kHz	±0.75 dB	Type N	\$3100	\$490
8.0 - 18.0 GHz	8694A Opt. 300	GRID	>10 mW	±1%	±150 MHz	<150 kHz	—	Type N	\$5700	—
	8694B Opt. 300	PIN	>5 mW	±1%	±1 MHz	<50 kHz	—	Type N	\$5775	—
10 - 15.5 GHz	8695A Opt. 100	GRID	>25 mW	±1%	<0.25 GHz	<150 kHz	—	Flat Flange for WR-75WG	\$4550	—
12.4 - 18.0 GHz	8695A	GRID	>40 mW	±1%	<0.25 GHz	<150 kHz	—	UG-419/U	\$2900	—
	8695B	PIN	>15 mW	±56 MHz	±1 MHz	<25 kHz	—	UG-419/U	\$3200	—
18.0 - 26.5 GHz	8696A	GRID	>10 mW	±1%	<0.36 GHz	<700 kHz	—	UG-595/U	\$3350	—
26.5 - 40 GHz	8697A	GRID	>5 mW	±1%	<0.53 GHz	<350 kHz	—	UG-599/U	\$5400	—
NEW 33 - 50 GHz	8697A Opt. H50	GRID	>3 mW	±1%	<0.68 GHz	<450 kHz	—	UG-383/U	\$11,400	—

1. Power level change specification for B units typically 10 dB. A units 6 dB.

2. Residual FM measured with 10 kHz bandwidth.

Options 004 rear output 8691-8694
Options 004 rear output 8695-8697
Option J54 phase lock input

add \$80
add \$155
add \$350

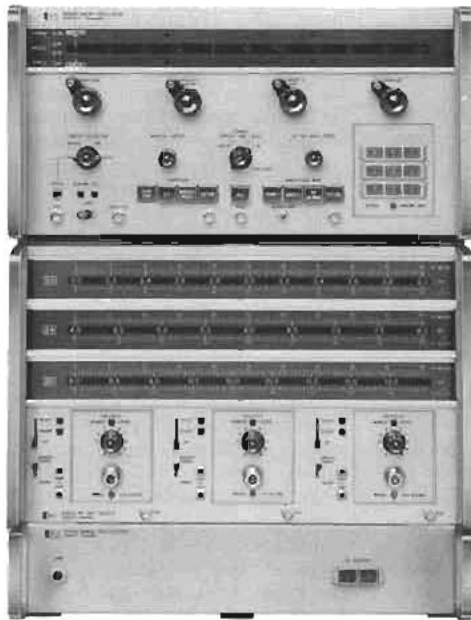

8690B/8706A, 8707A, 8705A



8709A



8404A



11531A

8705A, 8706A, 8707A Multiband system

Multiband systems 400 kHz to 50 GHz are available using the 8706A control unit plug-in and the 8707A RF unit holder. The 8706A allows pushbutton control of RF plug-ins installed in the 8707A. The 8705A multiplexer switches RF signals up to 12.4 GHz from three RF units and provides an ALC signal for the 8690B leveling circuits.

Specifications

8705A Multiplexer

Frequency range: dc to 12.4 GHz. Output port SWR ≤ 1.67 . Input port SWR ≤ 1.35 .

Insertion loss: 3 dB.

Weight: net, 7.8 kg (17 lb). Shipping, 10 kg (22 lb).

8706A Control plug-in

Compatibility: the 8706A controls up to three 8707A RF unit holders; Option H26 for remote band switching of the 8699B.

Weight: net, 7.3 kg (16 lb). Shipping, 11.4 kg (25 lb).

8707A RF Unit Holder

Capability: accepts up to three 8690 plug-ins.

Sweep functions

Normal: permits all 8690B sweep functions.

Preset: allows screwdriver setting of individual start/stop points.

Weight: net, 13.6 kg (30 lb). Shipping, 16.8 kg (37 lb).

8709A Phase lock synchronizer

The 8709A synchronizer is a phase comparator designed to stabilize the frequency of both HP BWO and solid state sources by phase locking to a reference oscillator. Under these conditions system stability is determined primarily by the stability of the reference oscillator. Phase lock capability is standard on solid state plug-ins from 0.01 to 18 GHz. Order Option J54 for BWO plug-ins. Information on complete phase-locked systems available on request.

Specifications

Input frequency: the locking frequency of the 8709A is 20 MHz. This signal is obtained by multiplying and mixing the reference oscillator with the microwave signal.

Sensitivity: -65 dBm.

Minimum output voltage: high level ± 12.0 V dc; low level ± 8.0 V dc.

Modulation sensitivity: 8690 BWO Option J54 plug-ins, 0.5 to 6.0 MHz/V. 8620 solid state plug-ins 6.0 MHz/V.

Weight: net, 4.5 kg (10 lb). Shipping, 5.3 kg (11.6 lb).

8404A Power meter leveling amplifier

The 8404A leveling amplifier permits the 431B/C or 432A/B/C power meter to level both the 8620 and 8690 sweeper plug-ins. RF output is leveled to ± 0.5 dB or less when connected to the AM input of the sweeper.

11531A Mainframe test plug-in

The 11531A test unit plug-in allows complete calibration of the 8690 mainframe, including sweep modes, markers and BWO. All voltages are selected from a front panel switch.

Model number and name

- 8404A power meter leveling amplifier
- Option 001, 4 line BCD level control
- 8705A signal multiplexer dc — 12.4 GHz
- 8706A control unit plug-in
- 8707A RF unit holder
- 8709A phase-lock synchronizer
- 11531A mainframe test unit plug-in

	Price
	\$550
	add \$210
	\$2800
	\$1100
	\$2400
	\$1400
	\$500

Average power measurements

At microwave frequencies, power is the best measure of signal amplitude because, unlike voltage and current, power remains constant along a lossless transmission line. For this reason, power meters are almost indispensable for microwave measurement. Typical applications include monitoring transmitter power levels, calibrating signal generators, leveling signal sources, and measuring transmission characteristics of unknown devices.

To satisfy the requirements of this broad range of applications, Hewlett-Packard has developed a family of general purpose microwave power meters. These power meters use either a diode, thermocouple, or thermistor as the power sensing element, and it is important to understand the merits of each of these sensors before choosing a particular power meter.

Power sensors

Diode power sensor

The newest addition to Hewlett-Packard's power measuring family is the 8484A Power Sensor. This sensor uses a Low-Barrier Schottky diode to achieve exceptional 100 pW (-70 dBm) sensitivity, and low noise and drift. Because the diode is always operated in its square law region [voltage out \propto (voltage in)²], the 8484A can be used to measure the true power of complex as well as CW waveforms.

The operating principle of the diode sensor is quite simple: First, microwave energy is coupled through a precision RF structure to the diode. The diode detects this energy and produces a voltage proportional to input power. This voltage is then fed from the power sensor to the power meter which amplifies the signal and produces a reading proportional to the power sensor's voltage.

Although simple, this system is an effective way of measuring power. However, Hewlett-Packard has added several refinements which improve the performance of this basic system. First, the 8484A power sensor is thermally well shielded to reduce drift caused by short-term temperature fluctuations such as those produced by holding the sensor while changing connections. This low drift is absolutely necessary in a sensor which measures down to 100 pW.

To reduce drift due to the power meter's amplifier, a chopper-stabilized system is used. By changing the low level dc signal into a low level ac signal the effects of dc drift can be eliminated.

Finally, the RF structure which couples microwave energy to the diode is precisely engineered to achieve low SWR and, therefore, exceptional accuracy.

Thermocouple power sensors

Hewlett-Packard produces a broad line of thermocouple power sensors. These sensors differ from each other primarily in the frequency and power ranges that they measure, but they all share the common characteristics of low SWR, low drift, wide power range, and simple operation.

A thermocouple measurement system consists of a power sensor which produces a dc output voltage proportional to the power dis-

sipated in it, and a power measurement circuit, which measures this dc voltage and displays it in units of power. This system is identical to that used with the diode sensor, the only difference being the method used to convert microwave power into a dc voltage. As a result, both diode and thermocouple power sensors can be used with the same power meter.

Thermistor power sensors

Thermistors offer an alternative means to measure microwave power. A thermistor is a resistive element whose resistance decreases with increasing temperature. In a thermistor type instrument, the sensor elements are contained in a mount and form one leg of a Wheatstone bridge through a bias connection to the power meter. DC or AC excitation biases the thermistor elements to balance the bridge. When microwave power is applied to the sensor elements, the resulting temperature rise causes the thermistor resistance to fall, unbalancing the bridge. Withdrawing an equal amount of bias power from the thermistors rebalances the bridge. The change in bias power is then measured and displayed on a meter.

Hewlett-Packard manufactures a broad line of thermistor power sensors which are available in both coax and waveguide mounts.

Power meters

Hewlett-Packard makes four average reading power meters, the 436A, 435A, 432A, and 432B. The 435A and 436A are analog and digital meters, respectively, which are designed to operate with HP's line of thermocouple and diode power sensors. The 432A and 432B are analog and digital meters, respectively, which are designed to operate with HP's line of thermistor power sensors.

435A and 436A Power meters

The Hewlett-Packard 435A and 436A power meters provide the necessary amplification and readout circuitry to convert the voltage from any 8480 diode or thermocouple sensor into a power reading.

With this type of power measuring system, accuracy is fundamentally dependent on the instrument's gain being matched to the power sensor's sensitivity. Since both thermocouple and diode sensitivity is subject to

change with variation in temperature, overload, aging, and also from unit to unit, a convenient means of calibration is absolutely mandatory. For this reason, both the 435A and 436A power meters provide an accurate, built-in 1 mW reference oscillator for use in calibrating the meter-power sensor combination. Not only does this reference oscillator assure long term accuracy by allowing power meter operation to be periodically checked, but it also allows the use of several power sensors with a single power meter for measurements over wide frequency and power ranges. This reference oscillator also allows damaged power sensors to be easily replaced in the field while maintaining full specified accuracy.

With the sensors presently available for use with the 435A and 436A power meters, it is possible to measure power from 100 pW (-70 dBm) to 3 W ($+35$ dBm), a 105 dB range.

In addition to these features, the 436A power meter's interface options allow full programmability of all functions and digital readout. Both HP-IB and BCD interfaces are available. With an interface option and a suitable controller, the 436A becomes more than a simple power meter. Specifically, a HP-IB equipped 436A power meter controlled by a 9820A or 9830A calculator can make highly accurate, digitally swept measurements of gain or loss; calibration factor of power sensors; output characteristics of signal generators; and accurate measurements of CW modulated AM. A typical HP-IB set-up is shown in Figure 1. These applications and more are described in Application Note 196, Automated Measurements Using the 436A Power Meter.

432A and 432B Power meters

The 432A and 432B power meters provide the bridge balancing circuitry necessary to convert the resistance change of a thermistor power sensor into a power reading. Both meters automatically maintain bridge balance and read power over a 10 microwatt to 10 milliwatt (full scale) range.

Since thermistor elements are temperature-sensing devices, they are unable to distinguish between applied power level changes and environmental temperature changes. As thermistor bridge sensitivity is increased,

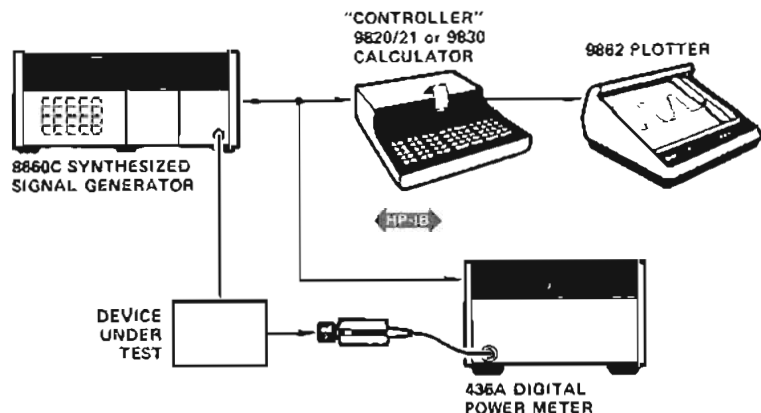

Figure 1. Example of 436A and 8660 system for frequency and amplitude resolution measurements

overn minute temperature variations can unbalance the bridge. This results, if uncompensated, in "zero drift" of the power meter and erroneous power measurements.

To overcome these potential drift problems, the 432A and 432B power meters use a dual bridge arrangement. The thermistor mounts used have two thermistor elements which are placed in close thermal proximity so that they are affected equally by changes in ambient temperature. This technique reduces zero drift by a factor of 100 over uncompensated thermistor meters.

Another advantage of this design is that when zeroed on the most sensitive range, the meter may be switched to any other power range without rezeroing (zero-carryover is within $\pm 0.5\%$ on all ranges). A dc output proportional to the meter deflection is available for recording purposes or control of external circuits such as power meter levelling of microwave sweep oscillators and signal generators.

Power measurement accuracy

The accuracy of power measurements is dependent on several factors. These factors include mismatch uncertainty, instrumentation uncertainty, calibration factor uncertainty, noise, zero drift, and for digital meters, plus and minus one count ambiguity.

Of these, by far the largest source of uncertainty is mismatch.

For example, consider the effects of mismatch when measuring the output of a microwave source operating at a frequency of 1

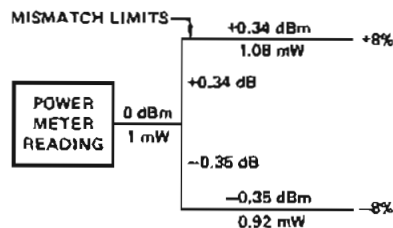

Figure 2. Limits of mismatch uncertainty when SWR of source is 1.5 and SWR of power sensor is also 1.5.

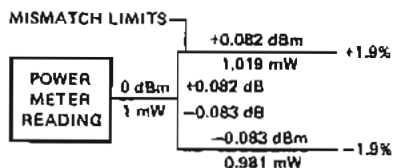

Figure 3. Reduced limits of mismatch uncertainty when SWR of source is 1.5 and SWR of power sensor is only 1.1.

GHz with an SWR of 1.5. If the power sensor also has an SWR of 1.5, the total mismatch uncertainty which cannot be calibrated out without tedious tuning at each frequency, is $\pm 8\%$ (+0.34, -0.35 dB), as shown in Figure 2.

Because of this large uncertainty which results from using sensors with a large SWR, Hewlett-Packard's sensors have been de-

signed to have the lowest possible SWR. The resulting improvement in accuracy can be dramatic.

For example, if HP's 8481A, which has a SWR of 1.1 at 1 GHz, were used to measure the power from the source in the previous example, uncertainty due to mismatch would drop from $\pm 8\%$ to only $\pm 1.9\%$ (± 0.083 dB) as shown in Figure 3. The HP Mismatch Error Limits Calculator, can be used for making these mismatch calculations.

To further increase measurement accuracy, HP provides an individually measured calibration factor curve with each power sensor. This curve (see Figure 4), which represents the frequency response of the sensor, is used in conjunction with the Cal Factor control on the power meter to compensate for effective efficiency and mismatch loss. Although calibration factor is measured only at discrete points, HP also sweep frequency tests each power sensor to assure that no narrow band anomalies exist.

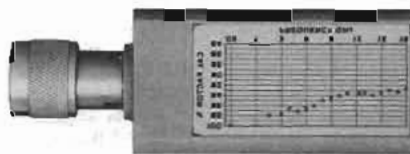

Figure 4. An individually measured calibration factor curve is supplied with each power sensor.

In most applications it is sufficient to correct for the various losses associated with the sensor by using Calibration Factor data. However, source mismatch is also a factor in any power measurement and, as already noted, the combination of source and load SWR can result in serious mismatch errors. Uncertainty can be reduced in X and P band by using an HP 870A Slidescrew Tuner, ahead of the sensor. When a tuner is used, only correction for effective efficiency is necessary.

In addition to calibrating each power sensor, HP also thoroughly tests each power meter to assure basic instrumentation accuracy of at least $\pm 1.0\%$ on all analog models and $\pm 0.5\%$ on all digital models.

The accuracy of power measured on HP

power meters is directly traceable to standards defined by the National Bureau of Standards (NBS). The uncertainty of this transfer is explicitly stated in the calibration factor uncertainty data given in the data sheet. This information, when added to the other sources of uncertainty, allows measurements to be defined in terms of primary standards with statements such as "1.23 mW $\pm 4.2\%$, traceable to NBS." Figure 5 shows how this total uncertainty is computed.

Information on virtually all aspects of microwave power measurement, including detailed descriptions and illustrations of instruments, measurement techniques, error analysis, and applications, is contained in Application Note 64. Sources of measurement error and systematic methods for error reduction allow selection of the best procedure for specific applications. Application Note 64, entitled "Microwave Power Measurement," is available on request through your Hewlett-Packard Sales Office.

Peak power measurement

A frequent requirement in microwave work is the measurement of peak power in a periodic pulse. This may be done by various indirect techniques using thermocouples or thermistors. Hewlett-Packard produces a versatile instrument that conveniently measures peak power directly in the 50 MHz to 2 GHz frequency range. This instrument (the model 8900B) utilizes a video comparator technique to bring a known dc voltage, supplied by the instrument, in a known impedance, to a level which is equal to the pulse being measured. This allows simple measurement of peak pulse power with a basic accuracy of 1.5 dB even when the waveform is not rectangular. A custom calibration chart increases accuracy to 0.6 dB for critical applications.

Noise measurements

The lowest level signal which can be passed through a device and successfully recovered is determined by the amount of noise added by that device. It is therefore important to be able to measure noise characteristics so that minimum level performance can be specified.

To this end, Hewlett-Packard manufactures a wide variety of noise sources and noise figure meters. The HP system of noise measurement automatically computes the ratio of power, both before and after the insertion of excess noise, and presents this ratio directly in dB of noise figure.

Figure 5. Sources of uncertainty in power measurements

Source of Uncertainty	Typical Values		Correctable to
	Thermocouple or Diode	Thermistor	
Mismatch	$\pm 2 - 6\%$	$\pm 4 - 14\%$	Negligible ³
Calibration ¹	$\pm 2 - 3\%$ ¹	$\pm 2 - 2\%$	2 - 3%
Instrumentation	$\pm 0.5 - 1.0\%$	$\pm 0.5 - 1.0\%$	0.2%
Other Sources ⁴	Negligible — $\pm 1.0\%$	Negligible — $\pm 1.0\%$	Negligible — $\pm 1.0\%$
Total	$\pm 4.5 - 11\%$	$\pm 5.5 - 18\%$	$\pm 2.2 - 4.2\%$

¹Traceable to NBS. Probable uncertainty.

²1.2% uncertainty of 50 MHz reference oscillator has been added.

³Requires laborious, time-consuming tuning at each frequency.

⁴Zero set, zero carry-over, noise, ± 1 count (digital instruments).

POWER & NOISE FIGURE METERS

Thermocouple power meter

Model 436A



HP-IB 436A

436A Power Meter

The HP Model 436A Power Meter is a general purpose digital power meter intended for manual and automatic RF and microwave power measurements. It is compatible with the entire series of 8480 power sensors. Depending on which power sensor is used, the 436A can measure power from -70 dBm (100 pW) to $+35$ dBm ($+3$ W) at frequencies up to 18 GHz.

The logically organized and uncluttered front panel, and the convenience of push-button operation and digital display make the 436A both easy to interpret and easy to use in any application. The auto-ranging capability allows for "hands-off" operation.

The 436A measures either absolute or relative power. It displays absolute power in either watts or dBm, while relative power is displayed in dB.

The 436A Power Meter also features optional programmability; both Hewlett-Packard Interface Bus (HP-IB) and BCD interfaces are available. These interfaces allow full remote control of all power meter functions (CAL function can be programmed to either 100 percent or the CAL factor which has been manually set on the front panel). These options may be added by the user at a later time.

Specifications

Frequency Range: 100 kHz to 18 GHz (depending on Power Sensor used).

Power range:

With 8481A, 8482A or 8483A sensors: 50 dB with 5 full scale ranges of 10 and 100 μ W; 1, 10 and 100 mW. The display is also calibrated in dBm and dB from -20 dBm to $+20$ dBm full scale in 10-dB steps.

With 8481H or 8482H sensors: 45 dB with 5 full-scale ranges of 1, 10 and 100 mW; 1 and 3 watts. The display is also calibrated in dBm and dB from 0 dBm to $+30$ dBm full scale in 10-dB steps, and a 5-dB step from $+30$ dBm to $+35$ dBm.

With 8484A sensor: 50 dB with 5 full scale ranges of 1, 10, 100 nW; 1, 10 μ W. The display is also calibrated in dBm and dB from -60 dBm to -20 dBm full scale in 10 dB steps.

Accuracy

Instrumentation

Watt mode: $\pm 0.5\%$ in ranges 1 through 4; $\pm 1.0\%$ in range 5.

dBm mode: ± 0.02 dB ± 0.001 dB/ $^{\circ}$ C in range 1 through 4; ± 0.04 dB ± 0.001 dB/ $^{\circ}$ C in range 5.

dB (REL) mode: ± 0.02 dB ± 0.001 dB/ $^{\circ}$ C in ranges 1 through 4; ± 0.04 dB ± 0.001 dB/ $^{\circ}$ C in range 5.

Zero: automatic, operated by a front-panel switch.

Zero set: $\pm 0.5\%$ of full scale on most sensitive range, typical. ± 1 count on other ranges.

Zero carry over: $\pm 0.2\%$ of full scale when zeroed on the most sensitive range.

Noise (typical at constant temperature):

8484A: 10 pW peak

8481A, 8482A, 8483A: 25 nW peak

8481H, 8482H: 2.5 μ W peak

General

Zero drift (8 hrs): $\pm 2\%$ of full scale on most sensitive range (typical at constant temperature).

Response time: (0 to 99% of reading)

Range 1 < 10 seconds (most sensitive range)

Range 2 < 1 second

Ranges 3 through 5 < 100 msec

(Typical, measured at recorder output).

Reference oscillator: internal 50 MHz oscillator with Type N female connector on front panel or rear panel (Option 003 only).

Power output: 1.0 mW. Factory set to $\pm 0.7\%$ traceable to the National Bureau of Standards.

Accuracy: $\pm 1.2\%$ worst case ($\pm 0.9\%$ rms) for one year (0° C to 55° C).

Cal factor: 16-position switch normalizes meter reading to account for calibration factor. Range 85% to 100% in 1% steps.

Cal adjustment: front-panel adjustment provides capability to adjust gain in meter to match power sensor in use.

Recorder Output: proportional to indicated power with 1 volt corresponding to full scale and 0.316 volts to -5 dB; 1 k Ω output impedance, BNC connector.

RF blanking: open collector TTL; low corresponds to blanking when auto-zero mode is engaged.

Display: digital display with four digits, 20% over-range capability on all ranges. Analog meter, uncalibrated peaking meter to see fast changes.

Power: 100, 120, 220, or 240 V $\pm 5\%$, -10% , 48 to 440 Hz, less than 20 watts (less than 23 with Option 022 or 024).

Weight: net, 4.5 kg (10 lb). Shipping, 5.5 kg (12 lb).

Dimensions: 133 mm high, 215 mm wide, 279 mm deep ($5\frac{1}{4}$ \times $8\frac{3}{4}$ \times 11 in.).

Accessories furnished: 1.5 m (5 ft) cable for power sensor; 2.3 m (7.5 ft) power cable. Main plug shipped to match destination requirements.

Accessories Available

To rack mount one 436A by itself order

5061-0057 Rack Mount Adapter Kit and accessories.

Options

002: input connector placed on rear panel in parallel with front

Price

add \$25

003: input connector and reference oscillator output on rear panel only

add \$10

009: 3 m (10 ft) cable for power sensor

add \$30

010: 6.1 m (20 ft) cable for power sensor

add \$55

011: 15.2 m (50 ft) cable for power sensor

add \$105

012: 30.5 m (100 ft) cable for power sensor

add \$155

013: 61 m (200 ft) cable for power sensor

add \$260

022: digital input/output, fully compatible with HP Interface Bus (HP-IB)

add \$400

024: digital input/output BCD Interface

add \$300

5061-0057 Rack Mount Kit

\$15

436A Power Meter

\$1900

POWER & NOISE FIGURE METERS

Thermocouple power meter, range calibrator

Model 435A, 11683A



435A



11683A

435A Power meter

The 435A Power Meter is an analog power meter, compatible with the entire series of 8480 power sensors. Depending on which sensor is used, the 435A can measure power from -65 dBm to $+35$ dBm, full scale, at frequencies from 100 kHz to 18 GHz. This versatile instrument also features $<1\%$ instrumentation uncertainty, low noise and drift, auto-zero, recorder output, optional battery operation, and long cable options (up to 200 ft).

11683A Range calibrator

The 11683A calibrator is specifically designed for use with the 435A and 436A power meters. It allows verification of full-scale meter readings on all ranges, as well as meter tracking. Simply connect the cable between the power meter and calibrator. The CAL ADJ control, on the power meter, is used to set the meter to full scale on the 1 mW range. The calibrator and meter are then stepped through the other ranges verifying accuracy within $\pm 1\%$ plus noise and drift. The 11683A also has a polarity switch which tests the Auto-Zero circuit.

Specifications

435A power meter

Frequency range: 100 kHz to 18 GHz (depending on power sensor used).

Power range

435A calibrated in watts and dB in 5 dB steps.

With 8481A, 8482A, or 8483A: -25 dBm ($3 \mu\text{W}$) to $+20$ dBm (100 mW) full scale.

With 8481H or 8482H: -5 dBm (0.3 mW) to $+35$ dBm (3W) full scale.

With 8484A: -65 dBm (300 pW) to -20 dBm (100 W) full scale.

Instrumentation uncertainty: $\pm 1\%$ of full scale on all ranges (0° to 55°C).

Zero carryover: $\pm 0.5\%$ of full scale when zeroed on the most sensitive range.

Reference Oscillator: internal 50 MHz oscillator with Type N female connector on front panel or rear panel (Option 003 only).

Power output: 1.0 mW. Factory set to $\pm 0.7\%$ traceable to the National Bureau of Standards.

Accuracy: $\pm 1.2\%$ worst case ($\pm 0.9\%$ rms) for one year (0°C to 55°C).

Noise and drift: (% of full scale peak on most sensitive range; typical, at constant temperature).

8481A, 8482A, 8483A: $<1.5\%$; less on higher ranges.

8481H, 8482H: $<1.5\%$; $<2\%$ of full scale on top range; less on other ranges.

8484A: $<5\%$; less on higher ranges.

Response time: 2 seconds on $3 \mu\text{W}$ range, 0.75 second on 10 μW range, 0.25 second on 30 μW range, and 100 msec on all other ranges. (Typical, time constant measured at recorder output.)

Zero: automatic, operated by front panel switch.

Cal factor: 16-Position switch normalizes meter reading to account

for calibration factor or effective efficiency. Range 85% to 100% in 1% steps.

Recorder output: proportional to indicated power with 1 volt corresponding to full scale; $1 \text{ k}\Omega$ output impedance, BNC connector.

RF blanking output: provides a contact closure to ground when auto-zero mode is engaged.

Cal adj: front panel adjustment provides capability to adjust gain of meter to match power sensor in use.

Power: 100, 120, 220, or 240 V $\pm 5\%$, -10% , 48 to 440 Hz, less than 4 watts (less than 10 watts for option 001 when recharging battery).

Weight: net, 2.6 kg (5 lb, 12 oz). Shipping, 4.2 kg (9 lb, 3 oz).

Dimensions: 155 mm high, 130 mm wide, and 279 mm deep ($6\frac{1}{2} \times 5\frac{1}{4} \times 11$ in.).

Accessories furnished: 1.52 m (5 ft) cable for the power sensor; 2.29 m (7 $\frac{1}{2}$ ft) power cable. Mains plug shipped to match destination requirements.

Accessories available

11076A carrying case.

5060-8762 rack adapter frame (holds three instruments the size of the 435A).

Combining cases

1051A: 286 mm (11 $\frac{1}{4}$ in.) deep.

1052A: 416 mm (16 $\frac{1}{4}$ in.) deep.

The combining cases accept the $\frac{1}{2}$ -module Hewlett-Packard instruments for bench use or rack mounting. See 1051A data sheet for details.

11683A Range calibrator

Calibration functions: outputs corresponding to meter readings of 3, 10, 30, 100 and 300 μW ; 1, 3, 10, 30, and 100 mW.

Calibration uncertainty: $\pm 0.25\%$ in all ranges.

Power: 115 or 230 V $\pm 10\%$; 50-400 Hz, less than 2 W.

Weight: net, 1.13 kg (2 lb 8 oz). Shipping, 1.9 kg (4 lb 3 oz).

Dimensions: 88.9 mm high, 133.35 mm wide, and 215.9 mm deep ($3\frac{1}{2} \times 5\frac{1}{4} \times 8\frac{1}{2}$ in.).

Options

001: rechargeable battery installed, provides up to 16 hours of continuous operation

002: input connector placed on rear panel in parallel with front

003: input connector and reference oscillator output on rear panel only

009: 3.05 m (10-foot) cable for power sensor

010: 6.10 m (20-foot) cable for power sensor

011: 15.24 m (50-foot) cable for power sensor

012: 30.48 m (100-foot) cable for power sensor

013: 60.96 m (200-foot) cable for power sensor

Model number and name

11683A range calibrator

435A power meter

Price

add \$100

add \$25

add \$10

add \$30

add \$55

add \$105

add \$155

add \$260

\$525

\$900



POWER & NOISE FIGURE METERS

Power sensors

Models 8481A, 8481H, 8482A, 8482H, 8483A, 8484A

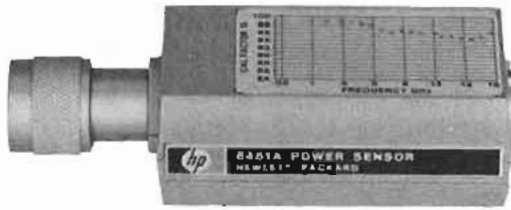

8481A



8481H



8482A



8482H



11708A



8483A



8484A

8480 Series power sensors

The 8480 Series sensors are designed for use with the 435A or 436A power meters. They cover a frequency range of 100 kHz to 18 GHz and a power range of -70 dBm to $+35$ dBm. These sensors feature *very low* SWR which results in a significant reduction in measurement uncertainty due to mismatch. Each sensor is individually calibrated for CAL FACTOR to allow compensation for power sensor efficiency and mismatch due to sensor SWR. The new model 8484A high sensitivity power sensor offers an extended range capability down to -70 dBm with exceptional temperature stability. Models 8481H and 8482H have an internal attenuator to allow measurements to 3 W.

8481A Power sensor

Wide frequency and amplitude range

Measure power from $0.3 \mu\text{W}$ to 100 mW, full scale, over a frequency range from 10 MHz to 18 GHz with a single power sensor.

Low SWR reduces measurement uncertainty

A silicon monolithic thermocouple is used as the sensing element and its small physical size allows reduction of SWR to <1.10 over the range of 50 MHz to 2 GHz; <1.18 up to 12.4 GHz; and <1.28 to 18 GHz. This assures low mismatch uncertainty, usually the largest single source of error in power measurement.

Individually calibrated

Each sensor is individually calibrated, traceable to the National Bureau of Standards, and a Cal Factor control on the meter compensates for power sensor efficiency at any frequency. In addition, a precise Automatic Network Analyzer printout at 17 frequencies for Cal Factor and reflection coefficient in magnitude and phase is supplied. This means you can eliminate mismatch uncertainty by calculating the mismatch error.

8481H Power sensor

Higher power version of the 8481A power sensor

Measure power from $30 \mu\text{W}$ to 3 W, full scale, over a frequency range from 10 MHz to 18 GHz with a single power sensor.

8482A Power sensor

RF sensor (similar to the 8481A power sensor)

Measure power from $0.3 \mu\text{W}$ to 100 mW, full scale, over a frequency range from 100 kHz to 4.2 GHz with a SWR <1.20 over the range of 300 kHz to 1 MHz; <1.10 between 1 MHz and 2 GHz, and <1.30 to 4 GHz.

8482H Power sensor

Higher power version of the 8482A power sensor

Measure power from $30 \mu\text{W}$ to 3 W, full scale, over a frequency range from 100 kHz to 4.2 GHz with a single power sensor.

8483A Power sensor

75 ohm RF sensor (similar to the 8482A power sensor)

Measure: 75 Ω source power from $0.3 \mu\text{W}$ to 100 mW, full scale, over a frequency range from 100 kHz to 2 GHz with a SWR <1.18 over the range of 100 kHz to 2 GHz.

8484A Power sensor

High sensitivity sensor

Measure power from 100 pW to $10 \mu\text{W}$ over a frequency range of 10 MHz to 18 GHz with a single power sensor. Furnished with 11708A 50 MHz Reference Attenuator for precise calibration with 1 mW Power Meter Reference Oscillator.

Low noise and drift

Noise and drift have been reduced to a minimum in this sensor, thus making readings at low power levels reliable and accurate. Noise and drift when used with the 435A power meter are typically less than 5% of full scale on the 300 pW range — only 15 pW. Noise and drift are even less with the 436A power meter.

8480 Series specifications

Model	Frequency Range (GHz)	Nominal Impedance	SWR Maximum (Reflection Coefficient)	Power Range	Maximum Power	Dimensions mm (in.)	Shipping Weight kg (lb)	RF Connector	Price
8481A	10 MHz – 18 GHz	50Ω	1.1 (0.048) 50 MHz – 2 GHz 1.18 (0.082) 30 MHz – 50 MHz 2 – 12.4 GHz 1.28 (0.123) 12.4 – 18 GHz	0.3 μW to 100 mW	300 mW Av. 15 W Peak 30 W μs (per pulse)	30 × 38 × 105 (1 3/16 × 1 1/2 × 4 1/4)	0.5 (1)	N (m)	\$400
Option 001								APC-7	Add \$25
8481H* (Formerly 8481A-H01)	10 MHz – 18 GHz	50Ω	1.2 (0.091), 10 MHz – 8 GHz 1.3 (0.13), 8 – 12.4 GHz 1.5 (0.20), 12.4 – 18 GHz	30 μW to 3 W	3.5 W Av. 100 W Peak 100 W μs (per pulse)	30 × 38 × 149 (1 3/16 × 1 1/2 × 5 3/4)	0.5 (1)	N (m)	\$525
8482A	100 kHz – 4.2 GHz	50Ω	1.1 (0.048), 1 MHz – 2 GHz 1.2 (0.091), 300 kHz – 1 MHz 1.3 (0.13), 2 – 4.2 GHz 1.6 (0.231), 100 – 300 Hz	0.3 μW to 100 mW	300 mW Av. 15 W Peak 30 W μs (per pulse)	30 × 38 × 105 (1 3/16 × 1 1/2 × 4 1/4)	0.5 (1)	N (m)	\$400
8482H* (Formerly 8482A-H01)	100 kHz – 4.2 GHz	50Ω	1.2 (0.091), 100 kHz – 4.2 GHz	30 μW to 3 W	3.5 W Av. 100 W Peak 100 W μs (per pulse)	30 × 38 × 149 (1 3/16 × 1 1/2 × 5 3/4)	0.5 (1)	N (m)	\$525
8483A	100 kHz – 2 GHz	75Ω	1.18 (0.082), 600 kHz – 2 GHz 1.8 (0.286), 100 – 600 Hz	0.3 μW to 100 mW	300 mW Av. 10 W Peak 30 W μs (per pulse)	30 × 38 × 105 (1 3/16 × 1 1/2 × 4 1/4)	0.5 (1)	N (m) 75Ω	\$425
8484A	10 MHz – 18 GHz	50Ω	1.15 (0.070) 30 MHz – 4 GHz 1.2 (0.091) 4 GHz – 10 GHz 1.3 (0.13) 10 GHz – 18 GHz 1.4 (0.17) 10 MHz – 30 MHz	0.1 nW to 10 μW	200 mW Av. 200 mW Peak	40 × 50 × 170 (1 3/16 × 2 × 6 1/16)	0.5 (1)	N (m)	\$550

* Only specifications listed in this table apply to 8481H and 8482H. No other specifications are implied.

Uncertainty of calibration factor data for 8482A and 8483A

Frequency (MHz)	Sum of Uncertainties (%) ¹		Probable Uncertainties (%) ²	
	8482A	8483A	8482A	8483A
0.1	1.85	3.05	1.33	1.79
0.3	1.85	3.05	1.33	1.79
1.0	1.85	3.05	1.33	1.79
3.0	1.85	3.05	1.33	1.79
10.0	1.85	3.05	1.33	1.79
30.0	1.85	3.05	1.33	1.79
50.0	1.45	1.75	1.03	1.07
100.0	2.95	3.25	1.58	1.61
300.0	2.95	3.25	1.58	1.61
1000.0	2.95	3.25	1.58	1.61
2000.0	3.45	3.75	1.92	1.94
4000.0	2.95	—	1.58	—

Uncertainty of calibration factor data for 8481A and 8484A

Frequency (GHz)	Sum of Uncertainties (%) ¹		Probable Uncertainties (%) ²	
	8481A	8484A	8481A	8484A
1.0	2.95	—	1.58	—
2.0	3.45	4.70	1.92	2.25
4.0	2.95	4.36	1.58	1.97
6.0	2.95	4.55	1.58	2.00
8.2	2.85	4.47	1.46	1.91
10.0	2.85	4.42	1.46	1.89
12.4	2.85	4.71	1.46	1.98
14.0	5.05	7.00	2.95	3.24
16.0	5.45	7.62	3.07	3.40
18.0	5.45	7.15	3.07	3.30

1. Includes uncertainty of reference standard and transfer uncertainty. Directly traceable to NBS.
2. Square root of the sum of the individual uncertainties squared (RSS).

POWER & NOISE FIGURE METERS

Thermistor power meters

Models 432A and 432B

- High accuracy
- Automatic zero
- Long cable options
- Analog recorder outputs
- BCD digital output (432B)



432A

432B

432A and 432B Power meters

DC bridge circuit: Using dc instead of the conventional 10 kHz bias current results in three benefits: 1) No signal emission from the mount to disturb sensitive circuits, 2) meter zeroing is independent of the impedance connected to the RF input of the thermistor mount, 3) the instrument is not affected by capacitance changes caused by movement of the thermistor mount cable.

High accuracy—no thermoelectric error: high accuracy over a wide temperature range is featured on the 432 Power Meters. By measuring the output voltage of the thermistor bridges, and computing the corresponding power, even higher accuracy of $\pm 0.2\% \pm 0.5 \mu\text{W}$ can be obtained.

Accuracy is maintained on even the most sensitive range because the error due to thermoelectric effect is reduced to a negligible level.

Calibrated mounts: each thermistor mount is furnished with data stating the Calibration Factor* and Effective Efficiency* at various frequencies across the operating range. For easy and accurate power measurements, the front panel of the 432 contains a calibration factor control, calibrated in 1% steps from 88% to 100%, that compensates for losses in the mount and eliminates the need for calculation.

*"Calibration Factor" and "Effective Efficiency" are figures of merit expressing the ratio of the substituted signal measured by the power meter to the microwave power incident on and absorbed by the mount, respectively.

Instrument type: automatic, self-balancing power meter for use with temperature-compensated thermistor mount.

Specifications

Power range

432A: seven ranges with full scale readings of 10, 30, 100, and 300 μW , 1, 3, and 10 mW; also calibrated in dBm from -20 dBm to $+10$ dBm full scale in 5 dB steps.

432B: four ranges with full scale readings of 10 and 100 μW , and 1 and 10 mW.

Noise

Less than 0.25% of full scale peak.

Response time

At recorder output, 35 ms (time constants (typical).

Fine zero

Automatic, operated by front panel switch.

Zero carryover

Less than 0.50% of full scale when zeroed on most sensitive range.

RFI

Meets all conditions specified in MIL-I-6181D.

Meter

432A: taut-band suspension, individually calibrated, mirror-backed scales. Milliwatt scale more than 108 mm (4 1/4") long.

432B: three digits with one digit overrange, 20% overrange capability on all ranges.

Calibration factor control

13-position switch normalizes meter reading to account for thermistor mount calibration factor. Range 100% to 88% in 1% steps.

Thermistor mount

External temperature-compensated thermistor mounts required for operation (HP 478, 8478B, and 486 Series; mount resistance 100 or 200 ohms).

Recorder output

Proportional to indicated power with 1 volt corresponding to full-scale, 1 k Ω output impedance.

BCD output

8, 4, 2, 1 code; "1" positive, TTL compatible logic. Operates with HP 5055A Digital Recorder. "Print" and "Inhibit" lines available. (432B only.)

Bridge outputs

(VRF and VCOMP); direct connections to the thermistor bridges; used in instrument calibration and precision power measurements.

Power consumption

432A: 115 or 230 V ac 10%, 50 to 400 Hz, 2 1/2 watts. Optional rechargeable battery provides up to 24 hours continuous operation. Automatic battery recharge.

432B: 115 or 230 V ac 10%, 50 to 400 Hz, 10 watts.

Weight

432A: net, 3.1 kg (6 lb 14 oz). Shipping, 4.7 kg (10 lb 5 oz).

432B: net, 3.1 kg (6 lb 14 oz). Shipping, 4.7 kg (10 lb 5 oz).

Dimensions

130 mm wide, 155 mm high, 279 mm deep (5 1/8" \times 6 1/2" \times 11").

Accessories furnished

1.52 m (5 ft), cable for Hewlett-Packard temperature-compensated thermistor mounts; 2.29 m (7 1/2 ft) power cable. Mains plug shipped to match destination requirements.

432A, 432B Power meter options

001: rechargeable battery installed, provides up to 24 hours continuous operation (432A only)

Price

add \$105

002: input connector placed on rear panel in parallel with front

add \$25

003: input connector on rear panel only

add \$10

Note: thermistor mount cable impedance is part of the 432 input bridge circuit. For cables over 10 feet long, the bridge is matched to specific cable options, so the various cables should not be interchanged.)

009: 3.05 m (10 ft) cable for 100-ohm or 200-ohm mount

add \$30

010: 6 m (20 ft) cable for 100-ohm or 200-ohm mount

add \$55

011: 15 m (50 ft) cable for 100-ohm or 200-ohm mount

add \$105

012: 30 m (100 ft) cable for 100-ohm or 200-ohm mount

add \$155

013: 61 m (200 ft) cable for 100-ohm or 200-ohm mount

add \$260

Model number and name

432A Power meter

\$750

432B Power meter

\$1325

POWER & NOISE FIGURE METERS

Thermistor mounts, Peak power calibrator & power meter calibrator
Models 478A, 8478B, 486 Series, and Models 8900B & 8477A



Temperature compensated thermistor mounts

High efficiency and good RF match are characteristic of the HP 478A and 8478B Coaxial and 486A-Series Waveguide Thermistor mounts which, in conjunction with the 432 Power Meter, provide you with high accuracy even in routine power measurements. These thermistor mounts are temperature-compensated for low drift, even in the presence of thermal shocks, permitting measurement of microwave power as low as one microwatt. Each mount contains data showing Calibration Factor and Effective Efficiency at six frequencies, directly traceable to the National Bureau of Standards at those frequencies where NBS provides calibration service.

Specifications

HP Model	Frequency range, GHz	Maximum SWR	Operating resistance (ohms)	Price
478A	10 MHz to 10 GHz	1.75, 10 to 25 MHz 1.3, 25 MHz to 7 GHz 1.5, 7 to 10 GHz	200	\$215
8478B ¹	10 MHz to 18 GHz	1.75, 10 to 30 MHz 1.35, 30 to 100 MHz 1.1, 0.1 to 1 GHz 1.35, 1 to 12.4 GHz 1.6, 12.4 to 18 GHz	200	\$335
S486A	2.60 to 3.95	1.35	100	\$475
G486A	3.95 to 5.85	1.5	100	\$375
M486A	5.30 to 8.20	1.5	100	\$375
H486A	7.05 to 10.0	1.5	100	\$375
X486A	8.20 to 12.4	1.5	100	\$260
M486A	10.0 to 15.0	1.5	100	\$395
P486A	12.4 to 18.0	1.5	100	\$290
K486A ²	18.0 to 26.5	2.0	200	\$395
R486A ²	26.5 to 40.0	2.0	200	\$450

¹Option 011, furnished with APC-7 RF connector

add \$25

²Circular flange adapters:

K-band (UG-425/U) HP 11515A	\$110
R-band (UG-381/U) HP 11516A	\$110



8900B



8477A

8900B Description

The HP 8900B peak power calibrator provides a convenient means for measuring the peak RF power of pulses in the range from 50 to 2000 MHz. The power level is read out directly on the panel meter and is completely independent of repetition rate and pulse width (>0.25 μ sec).

Specifications

Radio frequency measurement characteristics

Frequency range: 50 to 2000 MHz.

RF power range: 10-200 mW peak full scale (may be readily increased through use of external attenuators or directional couplers).

RF power accuracy: ± 1.5 dB (± 0.6 dB) with custom calibration curve furnished with instrument).

RF power precision: 0.1 dB.

RF pulse width: >0.25 μ s.

RF repetition rate: 1.5 MHz maximum.

RF impedance: 50 ohms.

RF VSWR: <1.25.

Monitor output

Level: >0.2 volt for 20 mW input (nominal).

Impedance: 150 ohms nominal.

Bandwidth: >7 MHz.

Physical characteristics

Dimensions: 197 mm wide, 156 mm high, 279 mm deep (7 $\frac{1}{2}$ " \times 6 $\frac{1}{8}$ " \times 11").

Weight: net, 4.5 kg (10 lb). Shipping, 5.9 kg (13 lb).

Power

105 to 125 or 210 to 250 volts, 50 to 60 Hz.

8477A Description

The 8477A Calibrator is specifically designed for use with the 432 Power Meter. It allows you to verify full-scale meter readings on all ranges, and meter tracking. Simply connect three cables between the power meter and calibrator; no charts or additional instruments are required.

Specifications

Calibration points: outputs corresponding to meter readings of: 0.01, 0.03, 0.1, 0.3, 1.0, 2.0, 3.0, and 10 mW (for mount resistance switch settings of both 100 and 200 ohms).

Calibration uncertainty: $\pm 0.2\%$ on the top five ranges, and $\pm 0.5\%$ on the 0.01 and 0.03 mW ranges from +20° to +30°C.

RFI: meets all conditions specified in MIL-I-6181D.

Power: 115 or 230 V $\pm 10\%$, 50-400 Hz, approximately 2 W.

Weight: net, 2.0 kg (4 $\frac{1}{2}$ lb). Shipping, 2.9 kg (6 $\frac{1}{4}$ lb).

Dimensions: 155 mm high, 130 mm wide, 203 mm deep (6 $\frac{1}{8}$ " \times 5 $\frac{1}{8}$ " \times 8").

Model number and name

8900B Peak power calibrator

8477A Power meter calibrator

Price

\$825

\$525

POWER & NOISE FIGURE METERS

Noise figure meters; sources

Models 340B, 342A; 343A, 345B, 347A, 349A

- Reads noise figure directly in dB
- Completely automatic measurement to 18 GHz
- No periodic recalibration needed
- Measure noise figure of radars, receivers, and amplifiers

- Compare unknown noise sources against known noise levels
- Adjust parametric amplifiers for optimum noise figure

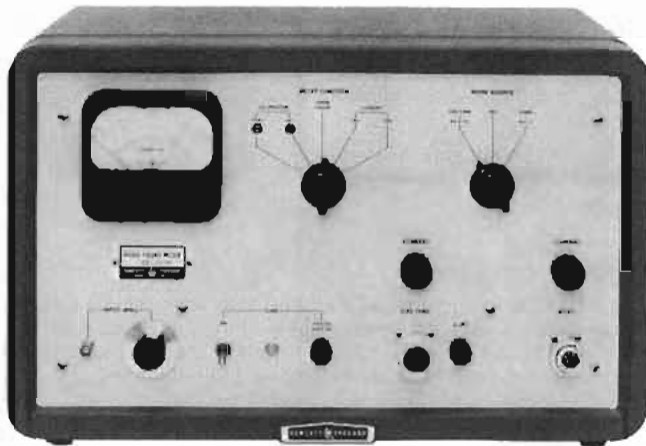

340B



349A



343A



345B



X347A

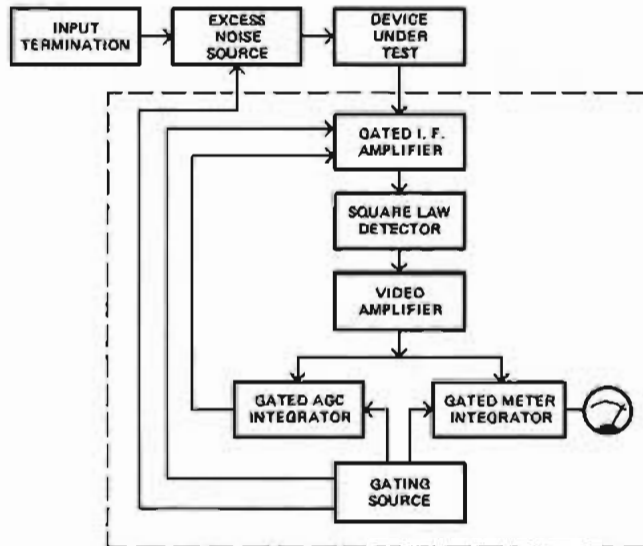

Figure 1. Noise figure measurement.

In microwave communications, radar, etc., the weakest signal that can be detected is usually determined by the amount of noise added by the receiving system. Thus, any decrease in the amount of noise generated in the receiving system will produce an increase in the output signal-to-noise ratio equivalent to a corresponding increase in received signal. From a performance standpoint, an increase in the signal-to-noise ratio by reducing the amount of noise in the receiver is more economical than increasing the power of the transmitter.

The quality of a receiver or amplifier is expressed in a figure of merit, or noise figure. Noise figure is the ratio, expressed in dB, of the actual output noise power of the device to the noise power which would be available if the device were perfect and merely amplified the thermal noise of the input termination rather than contributing any noise of its own.

The Hewlett-Packard system of automatic noise figure measurement depends upon the periodic insertion of a known excess noise power at the input of the device under test. Subsequent detection of noise power results in a pulse train of two power levels. The power ratio of these two levels contains the desired noise figure information. Hewlett-Packard noise figure meters automatically measure and present this ratio directly in dB of noise figure.

Noise figure is discussed in detail in Hewlett-Packard Application Note 57, which is available from your local Hewlett-Packard field office upon request. Application Note 57, "Noise Figure Primer," derives noise figure formulas, describes general noise figure measurements and discusses accuracy considerations. One of the measurement systems discussed in Application Note 57 is shown in Figure 1. The portion of the diagram within the dashed box is a simplified block diagram of the HP 340B and 342A Noise Figure Meters, and the excess noise source could be any of the noise sources described on these pages.

Operation

HP noise figure meters and noise sources offer time-saving and cost-reducing advantages. Their ease of operation and continuous, automatic metering of noise figure reduce the time required for alignment and adjustment and simplify measurements so that they can be done by nontechnical personnel. No periodic recalibration of the meters is needed, and accurate alignment is easy, so high-level, on-line performance is assured.

In operation, a noise source is connected to the input of the device under test. The IF output of the device is connected to the 340B or 342A. The noise figure meter gates the noise source on and off. When the noise source is on, the noise level is that of the device plus the noise source. When the noise source is off, the noise level is that of the device and its termination. The noise figure meter automatically compares the two conditions and displays noise figure directly in dB. Power to operate the noise source is supplied by the noise figure meter. Simply connect the noise source, adjust drive current using the controls and meter on the 340B or 342A, and the noise source is ready for operation.

Noise figure meters

Model 340B Noise Figure Meter, when used with an HP noise source, automatically measures and continuously displays noise figure for frequencies of 30 and 60 MHz. On special order up to four custom frequencies between 10 and 70 MHz, and some frequencies outside this range, can be supplied.

Model 342A is similar to Model 340B, except that it operates on five frequencies: 60, 70, 105, 200, and the basic tune-amplifier frequency of 30 MHz. Up to six custom frequencies between 10 and 200 MHz, including 21.4 MHz, are available on special order.

Noise sources

343A VHF noise source: specifically for 1F and RF amplifier noise measurement, a temperature-limited diode source with broadband noise output from 10 to 600 MHz with 50-ohm source impedance and low SWR.

345B IF noise source: operates at either 30 or 60 MHz, as selected by a switch; another selector permits matching 50-, 100-, 200-, and 400-ohm impedances.

347A Waveguide noise source: Argon gas discharge tubes mounted in waveguide sections; for waveguide bands 3.95 through 18 GHz, they provide uniform noise throughout the range; maximum SWR is 1.2.

349A UHF noise source: Argon gas discharge tubes in Type N coaxial configuration for automatic noise figure readings, 400 to 4000 MHz.

340B and 342A specifications

Noise figure range: with a 5.2 dB noise source, 0 to 15 dB, indication to infinity; with a 15.2 dB noise source, 3 to 30 dB, indication to infinity.

Accuracy (excluding source accuracy): noise diode scale: ±0.5 dB, 0 to 15 dB; gas tube scale: ±0.5 dB, 10 to 25 dB; ±1 dB, 3 to 10 dB and 25 to 30 dB.

Input frequency: 340B: 30 or 60 MHz, selected by switch; 342A: 30, 60, 70, 105, and 200 MHz, selected by switch. Other frequencies available; prices and details on request.

Bandwidth: 1 MHz minimum.

Input requirements: -60 to -10 dBm (noise source on); corresponds to gain between noise source and input of approximately 50 to 100 dB for 5.2 dB noise source and 40 to 90 dB for 15.2 dB noise source.

Input impedance: 50 ohms nominal.

AGC output: nominal 0 to -6 V from rear binding posts.

Recorder output: 1 mA maximum into 2000 ohms maximum.

Power input: 115 or 230 volts ±10%, 50 to 60 Hz, 185 to 435 watts, depending on noise source and line voltage.

Power output: sufficient to operate 343A, 345B, 347A or 349A Noise Sources.

Dimensions: cabinet: 527 mm wide, 324 mm high, 368 mm deep (20 3/4" × 12 3/4" × 14 1/2"); rack mount: 483 mm wide, 266 mm high, 353 mm deep behind panel (19" × 10 1/2" × 13 3/8").

Weights: net 19.4 kg (43 lb), shipping 23.9 kg (53 lb) (cabinet); net 16.2 kg (36 lb), shipping 22.5 kg (50 lb) (rack mount).

Accessory furnished: one 340A-16A Cable Assembly, connects noise figure meter to 347A or 349A Noise Source.

343A specifications

Frequency range: 10 to 600 MHz.

Excess noise ratio¹: 10 to 30 MHz, 5.20 dB ± 0.20 dB; 100 MHz, 5.50 dB ± 0.25 dB; 200 MHz, 5.80 dB ± 0.30 dB; 300 MHz, 6.05 dB ±

0.30 dB; 400 MHz, 6.30 dB ± 0.50 dB; 500 MHz, 6.50 dB ± 0.50 dB; 600 MHz, 6.60 dB ± 0.50 dB.

Source impedance: 50 ohms nominal.

Reflection coefficient: <0.091 (1.2 SWR), 10 to 400 MHz; <0.13 (1.3 SWR), 400 to 600 MHz.

Noise generator: temperature-limited diode.

Dimensions: 70 mm wide, 63 mm high, 127 mm deep (2 3/4" × 2 1/2" × 5").

Weight: net 0.34 kg (3/4 lb); shipping 0.9 kg (2 lb).

345B specifications

(Same weight and dimensions as 343A)

Spectrum center: 30 or 60 MHz, selected by switch.

Excess noise ratio¹: 5.2 dB.

Source impedance: 50, 100, 200 or 400 ohms, ±4%, as selected by switch; less than 1 pF shunt capacitance.

Noise generator: temperature-limited diode.

347A specifications

HP Model	Range (GHz)	Excess noise ratio ¹⁻²	Approx. length	
			(in.)	(mm)
G347A	3.95-5.85	15.2 ± 0.5	19	483
J347A	5.30-8.20	15.2 ± 0.5	19	483
H347A	7.05-10.0	15.6 ± 0.5	16	406
X347A	8.20-12.4	15.7 ± 0.4	14 1/4	375
P347A	12.4-18.0	15.8 ± 0.5	14 1/4	375

¹Reflection coefficient for all models, fired or unfired, 0.091 (SWR 1.2) max. (source terminated in well-matched load).

349A specifications

Frequency range: 400 to 4000 MHz, wider with correction.

Excess noise ratio¹: 15.6 dB ± 0.6 dB,² 400 to 1000 MHz; 15.7 dB ± 0.5 dB,² 1000 to 4000 MHz.

Source impedance: 50 ohms nominal.

SWR: <1.35 (fired), <1.55 (unfired) up to 2600 MHz; <1.55 (fired or unfired), 2600 to 3000 MHz; <2.0 (fired), <3.0 (unfired) 3000 to 4000 MHz.

Dimensions: 76 mm wide, 51 mm high, 381 mm long (3" × 2" × 15").

Weight: net 1.4 kg (3 1/4 lb); shipping 2.7 kg (6 lb).

Model number and name	Price
340B Noise Figure Meter (cabinet)	\$1300
340BR Noise Figure Meter (rackmount)	\$1280
342A Noise Figure Meter (cabinet)	\$1425
342AR Noise Figure Meter (rackmount)	\$1410
343A Noise Source	\$250
343A Noise Source Option 001: spare noise diodes calibrated and supplied with instrument	add \$60
345B Noise Source	\$400
349A Noise Source	\$475
G347A Noise Source	\$750
H347A Noise Source	\$925
J347 Noise Source	\$800
P347A Noise Source	\$700
X347 Noise Source	\$650

$$^1 \text{ENR (dB)} = 10 \log \frac{k(T - T_0)B}{kT_0B}$$

where kTB = available noise power, and kT_0B = available noise power with noise source at 290°K

²Includes factor for insertion loss.

MICROWAVE TEST EQUIPMENT

Microwave measurements; frequency, impedance, attenuation



Microwave test equipment product line

Hewlett-Packard offers a complete line of microwave test equipment from which measurements systems can be assembled for making accurate reflections, transmission and frequency measurements. Equipment ranges from inexpensive CW systems which measure a magnitude response to powerful network analyzers which furnish a dynamic CRT display of swept frequency magnitude and phase. Measurement techniques and equipment functions are discussed briefly in the following paragraphs. More detailed information is available in Application Notes 183 and 196. Complimentary copies are available from Hewlett-Packard sales offices.

HP also offers the I026A Microwave Laboratory Kit for instruction in microwave measurement techniques. Complete coverage of this kit is contained in the MTE catalog noted below.

New APC-3.5 coaxial connector, mode-free to 34 GHz

New microwave developments above 18 GHz have increasingly turned to coaxial transmission lines. However, there have been some practical and economic limits due primarily to a lack of precision connectors for the range to 34 GHz.

Now Hewlett-Packard has begun to supply coaxial measurement components with the new APC-3.5 coaxial connector which permits many components to operate above 18 GHz to as high as 34 GHz mode-free. APC-3.5 is an SMA-compatible connector intended for 3.5 mm air line. It is a beaded connector, designed for superior reliability and repeatability even after hundreds of connections. Thus it is ideally suited for measuring equipment.

New components available with the APC-3.5 connector in this catalog are noted on the appropriate page with an APC-3.5 subhead.

Coaxial & Waveguide Catalog and Microwave Measurement Handbook

This comprehensive catalog of over 300 microwave measurement components and techniques is a valuable reference tool for anyone making microwave measurements. Free copies are obtainable by contacting your nearby HP Sales Office, or by sending the literature request card at the back of this catalog.

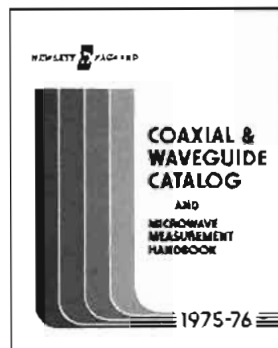

Frequency measurements

HP manufactures a complete line of frequency measuring instruments including active counters (e.g. electronic counters, frequency converters, and microwave counters) and passive meters. Where the accuracy of active devices is not required, passive devices offer direct readout at a considerable saving

in cost. Passive transmission-type frequency meters, such as the HP 532, 536A, and 537A, are two-port devices that absorb part of the input power in a tunable cavity. When the cavity is tuned to resonance, a dip occurs in the transmitted power level. This dip can be observed on a meter or oscilloscope display of the detected RF voltage. Frequency is then read from a calibrated dial driven by the cavity tuning mechanism. The frequency meters achieve accuracies of a few parts in 10^4 .

Impedance measurements

Impedance-matching a load to its source is one of the most important considerations in microwave transmission systems. If the load and source are mismatched, part of the power is reflected back along the transmission line toward the source. This reflection not only limits maximum power transfer, but also can be responsible for erroneous measurements of other parameters or even cause circuit damage in high-power applications.

The signal reflected from the load interferes with the incident (forward) signal, causing standing waves of voltage and current along the line. SWR, which is the ratio of standing wave maxima to minima, is directly related to the impedance mismatch of the load. There are two common methods for measuring SWR: slotted line measures the ratio of standing wave maxima to minima while a reflectometer separates the incident and reflected voltage waves and then measures their ratio.

Network analyzers, such as the 8410 system, give a more complete and convenient impedance characterization by providing simultaneous phase and amplitude information. For more details see the network analyzer section of this catalog.

Slotted line techniques — single frequency

Standing-wave ratio can be measured directly using a slotted line. The slotted line has a probe that is loosely coupled to the RF field in the line, thus sensing relative amplitudes of the standing-wave pattern as the probe is moved along the line. The ratio of maxima to minima (SWR) is displayed directly on a SWR meter, such as the HP 415E.

A typical slotted-line set up consists of a CW signal source; a low pass filter to eliminate spurious signals from the source; the slotted-line; the device under test, and an SWR meter.

The swept slotted line — swept frequency

A measuring system which combines the speed and convenience of swept-frequency measurements and the inherent accuracy of the slotted line can be built around the HP 817B Swept Slotted Line System. The setup is similar to the single frequency method except that the source is replaced with a sweep oscillator, the slotted line is an 817B and the 415E is replaced by the HP 8755A/181A.

This system will operate throughout the frequency range from 1.8 to 18 GHz. The measurement results are displayed on a storage oscilloscope as an envelope of the SWR in dB. See Figure 1. At any given frequency, the ratio of the maximum and minimum amplitude of the envelope is the SWR. A plot of SWR can be generated in a few seconds and retained on the CRT for evaluation or photography. Accuracy of slotted-line measurements is limited primarily by the residual SWR of the line itself, 1.01 in waveguide and 1.02 to 1.06 in coax depending upon the frequency and type of connector.

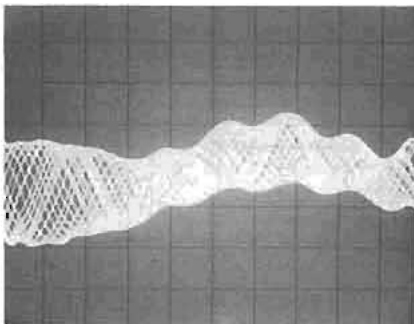

Figure 1. Multi-sweep slotted-line measurement. Vertical scale 0.5 dB/cm.

Reflectometer techniques

The reflection coefficient (ρ) of a device or system is another useful term in establishing the impedance match of microwave devices. The following relationships of ρ and SWR are frequently used in impedance work:

$$\rho = \frac{|E \text{ reflected}|}{|E \text{ incident}|} = \frac{SWR - 1}{SWR + 1}$$

Reflection coefficient (ρ) is a linear quantity varying between zero and one. The logarithmic expression of ρ is known as return loss and defined as: $dB = -20 \text{ LOG}_{10} |\rho|$. A reflection coefficient of 1.0 (total reflection) therefore, corresponds to zero dB return loss.

Reflection coefficient is measured by sepa-

rating the incident and reflected waves propagating in the transmission line connecting the source and load. The reflectometer uses either coaxial or waveguide couplers to accomplish this separation. Reflectometers permit dynamic oscilloscope displays or permanent X-Y recordings of reflection coefficient or return loss across complete operating bands.

The reflectometer technique is an economical way for making swept measurements (see Hewlett-Packard Application Note 183 for more information). Measured data can be either plotted on an X-Y recorder or read directly from a fully calibrated CRT display. See Figure 3.

Accuracy of reflectometer measurements is limited by directional coupler directivity. A residual SWR of 1.02 (40 dB directivity) is common in waveguide and 1.02 to 1.1 in coax depending on the frequency range and connectors.

Attenuation measurements

Attenuation is defined as the decrease in power (at the load) caused by inserting a device between a Z_0 source and Z_0 load. Under this condition, the measured value is a property of the device alone. The term Z_0 is used to describe a unity SWR condition where the load and source impedance equal the transmission line impedance.

There are three common methods for measuring RF attenuation: 1) square-law detection with audio substitution, 2) direct RF substitution, and 3) linear detection with IF substitution.

Square-law detection technique

Figure 2 shows a waveguide system for swept attenuation measurements of 25 to 30 dB.

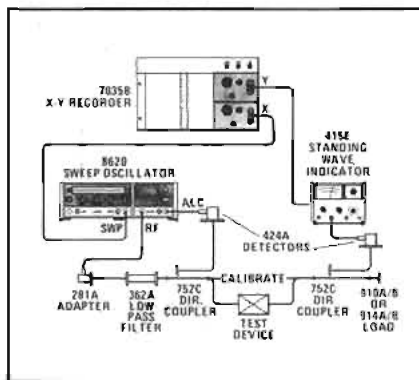

Figure 2. Swept attenuation system for measurements up to 30 dB.

With the 8620 sweeping the frequency range of interest, a zero-dB reference level is established on the X-Y recorder without the test device in the system. The device is then inserted as indicated in Figure 2 and its attenuation versus frequency determined by the amplitude decrease from the reference level previously established.

A much improved square-law detection technique uses the HP 8755L Frequency Re-

sponse Test Set. The setup diagram in Figure 3 permits simultaneous measurements of attenuation and return loss over a continuous 60 dB dynamic range. Readout is either on a CRT display calibrated directly in dB or an

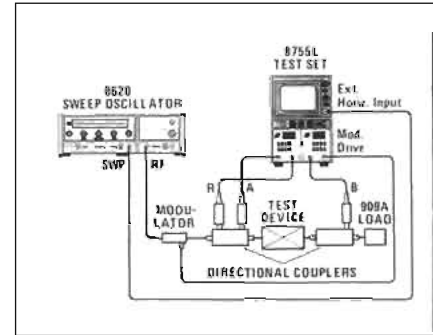

Figure 3. Setup for simultaneous swept measurement of transmission and reflection.

X-Y recorder. The 8755L has a frequency range of 15 MHz to 18 GHz.

RF substitution technique

Swept attenuation measurements up to 45 to 50 dB can be made using the RF pre-insertion X-Y recorder system shown in Figure 4. Coupler tracking and detector errors are eliminated by plotting a calibration grid on the X-Y recorder prior to the actual measurement. The grid is plotted by setting in specific values of attenuation on the 382A near the anticipated test device attenuation. The 382A is then set to 0 dB and the test device inserted as shown in Figure 4. A final sweep plots attenuation of the test device over the calibration grid.

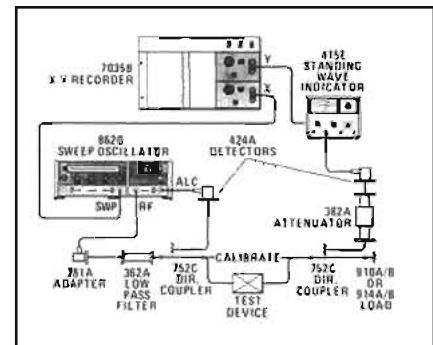

Figure 4. RF pre-insertion technique for swept attenuation measurements.

IF substitution technique

The IF substitution technique of attenuation measurement involves conversion of the microwave frequency to an intermediate frequency ≈ 20 MHz for which very accurately calibrated attenuators are available. Detection at a constant IF frequency improves the system sensitivity permitting measurements over a wide (>60 dB) dynamic range.

The 8410 Network Analyzer is an instrument where IF substitution is used; thus allowing accurate measurements to be made over a frequency range of 110 MHz to 40 GHz.

MICROWAVE TEST EQUIPMENT

Waveguide instrumentation table

Instrument Name	Uses	Family Model Number	Frequency Coverage by Band—GHz								
			S 2.6- 3.95	G 3.95- 5.85	J 5.30- 8.20	H 7.05- 10.0	X 8.20- 12.4	M 10.0- 15.0	P 12.4- 18.0	K 18.0- 26.5	R 26.5- 40.0
Adapters	Interconnect coaxial-waveguide systems. Interconnect two different waveguide systems.	281A 281B 292A 292B 11515A 11516A	X	X	X	X	X X	X	X X	X	X
Attenuators, Variable	Measure reflection coefficient, insertion loss, transfer characteristics by RF substitution; reduce power levels; improve source mismatch.	382A 375A	X	X	X	X	X X		X X	X	X
Detectors, Crystal	Detect RF power, CW or pulsed; Measure reflection coefficient, insertion loss.	424A 422A 485B	X	X	X	X	X X	X	X	X	X
Directional Couplers	Sample high power, level power, measure reflection coefficient, improve mismatch.	752A 752C 752D			X X X	X X X	X X X		X X X	X X X	X X X
Filters Low Pass	Reduce harmonics from signal sources.	362A					X	X	X	X	X
Frequency Meters	Measure frequency.	532A 532B			X	X	X		X	X	X
Mixers	Mix frequencies, generate harmonics.	932A 11521A 11517A					X		X X	X	X
Noise Sources	Measure noise figure of microwave components.	347A		X	X	X	X		X		
Modulators, Pin	Modulate RF signals with AM, pulse modulation with low incidental FM.	8735A 8735B					X X				
Power Sensors Thermistor	Measure microwave power: used with HP 432 Meter.	486A	X	X	X	X	X	X	X	X	X
Shorts Fixed Sliding Switched	Establish measurement planes, reflection phase and magnitude references.	920A 920B 923A 930A			X	X		X	X	X	X
Slide screw tuners Phase Shifters	Correct discontinuities in waveguide. Provide phase control.	870A 885A			X		X X		X X		
Slotted Line Systems	Measure SWR, wavelength, impedance; fixed and swept-frequency slotted line measurements.	810B 815B			X	X	X		X	X	X
Terminations Fixed and Sliding	Fixed loads for terminating waveguide systems, sliding loads for separating load reflections from other system reflections.	910A 910B 914A 914B			X X	X X	X X		X X	X	X

MICROWAVE TEST EQUIPMENT

Coaxial step attenuators

Models 355 series, 8494/5/6 series

- NEW APC-3.5 CONNECTOR
- Flat frequency response

- Small, compact
- Manual and programmable



355C



355D



355F



355C/D/E/F Manual and programmable step attenuators, dc to 1000 MHz

Precision attenuation from dc to 1000 MHz is available with these Hewlett-Packard attenuators. Models 355C/E provide 0 to 12 dB in 1-dB steps and models 355D/F provide 0 to 120 dB in 10-dB steps. All standard models are equipped with BNC connectors. To obtain 0 to 132 dB attenuation in 1-dB steps, these units can be coupled in series by using a standard UG-491A/U male-to-male BNC adapter.

The design provides for well shielded parts so that neither stray pickup nor signal leakage is a problem. This feature, in conjunction with Option 001 (Type N connectors) make the 355's ideally suited for applications such as receiver testing where minimum leakage is important.

The attenuator sections are inserted and removed by cam actuated microswitches which keep lead lengths short. This novel system minimizes stray capacitances and inductances and extends the frequency limit of the 355 attenuators to 1000 MHz. In addition, the phase shift is kept at a minimum. The electrical length for the 355C/D is approximately 60 cm at 0 dB (no sections engaged). For each section engaged the electrical length decreases by approximately 2 cm.

For the 355E and 355F models, attenuation programming is done through a 7-pin connector. The simplicity of programming, rapid switching time, and the wide frequency coverage make these step attenuators particularly useful for applications in automatic or remotely controlled equipment. To insure protection of the user's transistor drivers against transients associated with the switching process, a protective diode is placed between each solenoid and the driver (Option 007).

8494A/B/G/H, 8495A/B/D/G/H/K, 8496A/B/G/H manual and programmable step attenuators, dc to 26.5 GHz

This family of precision, microwave coaxial step attenuators represents the state-of-the-art in attenuator design. They offer outstanding performance at attractive prices. Three attenuation ranges are available: 0 to 11 dB in 1-dB steps (Model 8494), 0 to 70 dB in 10-dB steps (Model 8495) and 0 to 110 dB in 10-dB steps (Model 8496). There is a choice of three connectors Type N (f), SMA (f), and APC-7. Manual and programmable versions are available as well as coverage of three frequency ranges (dc - 4 GHz and dc - 18 GHz, and dc - 26.5 GHz).

Each attenuator consists of three or four attenuation sections connected in cascade. Each section consists of a precision thin-film card with 10, 20, or 40 dB of attenuation (1, 2 or 4 dB for the 8494, a lossless transmission line, and a ganged pair of SPDT switches that connect the input and output to either the attenuation element or the lossless line.

The attenuator cards are miniature thin-film T-pads, utilizing high stability tantalum resistive film on a sapphire substrate. The well controlled thin-film deposition process ensures high accuracy (typically 2% of the dB reading to 18 GHz) and low SWR (typically less than 1.3 up to 18 GHz) over the specified frequency range.

Attenuator sections are inserted and removed by low-torque cam-actuated contacts. These contacts are gold-plated leaf-springs that en-

sure long life (over a million steps) and high repeatability (typically 0.03 dB).

The G and H programmable models offer the same high performance as the manual models with the addition of fast switching solenoids.

The 20 millisecond maximum switching time is a significant advantage for automatic testing and other applications where speed is of prime importance. Once switched, the solenoids are held in place by strong, permanent magnets able to withstand shocks over 10 G's.

Attenuation programming is done through a 12-pin connector. For ease of connection to the driving circuit, each attenuator is provided with a five-foot cable assembly that includes the mating connector. These attenuators can be incorporated into automatic measuring systems that are controlled by either a computer or a desk top calculator. By using the HP 59306A Relay Actuator and a power supply as the driver mechanism, the attenuators are easily integrated into a Hewlett-Packard Interface Bus (HP-IB) automated system.

Equivalent versions of these attenuators, for incorporation in equipment (i.e., "OEM") are available under HP model numbers 33320, 33321, and 33322.

Performance to specifications is verified by fully testing each attenuator with the HP Automatic Network Analyzer. Specifications are traceable to the National Bureau of Standards.

New APC-3.5 connectors extend operation to 26.5 GHz

The 8495D (manual) and 8495K (programmable) models are 10 dB step attenuators that utilize the new APC-3.5 connector (compatible with SMA) and operate from dc to 26.5 GHz. The attenuation range is 70 dB in 10 dB steps. The attenuators consist of three 20 dB sections and one 10 dB section. They have similar performance to the 8495B and 8495H models to 18 GHz, and have slightly reduced performance from 18 GHz to 26.5 GHz. Contact HP for detailed specifications.

How to order the 8494/5/6 Series attenuators

To order, basic model number, suffix letter, and connector option must be specified:

Ordering example:

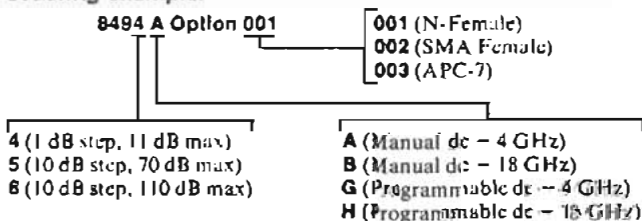

Prices shown in tables for 8494/5/6 models apply to Type N (f) (Opt 001) and SMA (f) (Opt 002).

APC-7 (Opt 003)

Price
add \$50

Our Coaxial & Waveguide Catalog and Microwave Measurement Handbook is available: 80 pages featuring over 300 measurement components. For a free copy, use request card at back of this catalog.



8494B

8496B

8495B

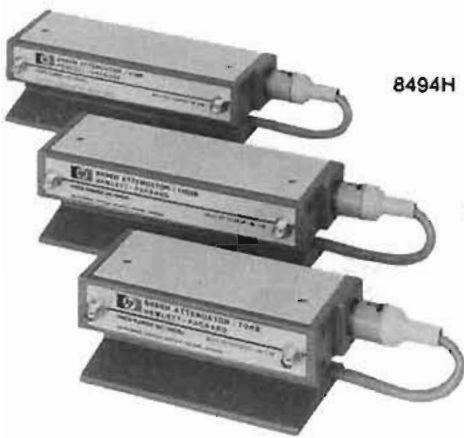

8494H

8496H

8495H

Model and (Switching Mode)	Frequency Range (GHz)	Incremental Attenuation (dB)	SWR Maximum (50Ω Nominal)	Insertion Loss (0 dB Setting)	Attenuation Accuracy	Power Rating	Minimum Life	Solenoid Characteristics			Dimensions mm (In.)	Shipping Weight kg (lb)	Connectors	Price
								Voltage	Switch Speed	Switch Power				
355C (Manual)	dc - 1	0 - 12 1 dB steps	1.2: dc - 0.25 GHz 1.3: dc - 0.5 GHz 1.5: dc - 1.0 GHz	0.25 dB @ 0.1 GHz 0.75 dB @ 0.5 GHz 1.5 dB @ 1.0 GHz (0.11 dB + 1.39 dB/GHz)	±0.1 dB @ 1000 Hz ±0.25 dB dc - 0.5 GHz ±0.35 dB dc - 1.0 GHz	0.5 W avg 350 W peak	0.6 million steps				152 × 70 × 67 (6 × 2 3/4 × 2 3/4)	1.4 (3)	BNC (f) See Note 1	\$225
355E (Programmable)								15 - 18 V	<65 ms	3.0 W				\$380
355D (Manual)	dc - 1	0 - 120 10 dB steps	1.2: dc - 0.25 GHz 1.3: dc - 0.5 GHz 1.5: dc - 1.0 GHz	0.25 dB @ 0.1 GHz 0.75 dB @ 0.5 GHz 1.5 dB @ 1.0 GHz (0.11 dB + 1.39 dB/GHz)	±0.3 dB @ 1000 Hz ±1.5 dB to 90 dB, and ±3 dB to 120 dB @ 1 GHz	0.5 W avg 350 W peak	0.6 million steps				152 × 70 × 67 (6 × 2 3/4 × 2 3/4)	1.4 (3)	BNC (f) See Note 1	\$225
355F (Programmable)								15 - 18 V	<65 ms	3.0 W				\$380
8494A (Manual)	dc - 4	0 - 11 1 dB Steps	1.5	0.65 dB @ 0.5 GHz 0.69 dB @ 1.0 GHz 0.96 dB @ 4.0 GHz (0.6 dB + 0.09 dB/GHz)	±0.2 dB: 1 - 2 dB ±0.3 dB: 3 - 6 dB ±0.4 dB: 7 - 10 dB ±0.5 dB: 11 dB	1 W avg 100 W peak 10 μs max.	1 million steps				170 × 79 × 43 (6.6 × 3.1 × 1.7)	0.9 (2)	See Note 2	\$450
8494G (Programmable)								20 - 30 V	<20 ms	2.7 W				\$715
8494B (Manual)	dc - 18	0 - 11 1 dB steps	1.5: dc - 8 GHz 1.6: dc - 12.4 GHz 1.9: dc - 18 GHz	0.59 dB @ 1 GHz 1.72 dB @ 12.4 GHz 2.22 dB @ 18 GHz (0.6 dB + 0.09 dB/GHz)	dc - 12.4 GHz ±0.3 dB: 1 - 2 dB ±0.4 dB: 3 - 4 dB ±0.5 dB: 5 - 6 dB ±0.6 dB: 7 - 10 dB ±0.7 dB: 11 dB dc - 18 GHz ±0.7 dB: 1 - 5 dB ±0.8 dB: 6 - 9 dB ±0.9 dB: 10 - 11 dB	1 W avg 100 W peak 10 μs max.	1 million steps				170 × 79 × 43 (6.6 × 3.1 × 1.7)	0.9 (2)	See Note 2	\$505
8494H (Programmable)								20 - 30 V	<20 ms	2.7 W				\$935
8495A (Manual)	dc - 4	0 - 70 10 dB steps	1.3	0.4 dB @ 0.5 GHz 0.5 dB @ 1.0 GHz 0.7 dB @ 4.0 GHz (0.4 dB + 0.07 dB/GHz)	±1.6% % in dB from Atten. Setting	1 W avg 100 W peak 10 μs max.	1 million steps				141 × 79 × 43 (5.5 × 3.1 × 1.7)	0.8 (2)	See Note 2	\$325
8495G (Programmable)								20 - 30 V	<20 ms	2.7 W				\$590
8495B (Manual)	dc - 18	0 - 70 10 dB steps	1.35: dc - 8 GHz 1.5: dc - 12.4 GHz 1.7: dc - 18 GHz	0.5 dB @ 1.0 GHz 1.3 dB @ 12.4 GHz 1.7 dB @ 18.0 GHz (0.4 dB + 0.07 dB/GHz)	±3%: dc - 12.4 GHz ±4%: dc - 18 GHz % in dB from Atten. Setting	1 W avg 100 W peak 10 μs max.	1 million steps				141 × 79 × 43 (5.5 × 3.1 × 1.7)	0.9 (2)	See Note 2	\$450
8495H (Programmable)								20 - 30 V	<20 ms	2.7 W				\$690
8496A (Manual)	dc - 4	0 - 110 10 dB steps	1.5	0.6 dB @ 0.5 GHz 0.7 dB @ 1.0 GHz 1.0 dB @ 4.0 GHz (0.6 dB + 0.09 dB/GHz)	±1.6% % in dB from Atten. Setting	1 W avg 100 W peak 10 μs max.	1 million steps				170 × 79 × 43 (6.5 × 3.1 × 1.7)	0.9 (2)	See Note 2	\$450
8496G (Programmable)								20 - 30 V	<20 ms	2.7 W				\$715
8496B (Manual)	dc - 18	0 - 110 10 dB steps	1.5: dc - 8 GHz 1.6: dc - 12.4 GHz 1.9: dc - 18 GHz	0.7 dB @ 1 GHz 1.7 dB @ 12.4 GHz 2.2 dB @ 18 GHz (0.6 dB + 0.09 dB/GHz)	±3%: dc - 12.4 GHz ±4%: dc - 18 GHz % in dB from Atten. Setting	1 W avg 100 W peak 10 μs max.	1 million steps				170 × 79 × 43 (6.6 × 3.1 × 1.7)	0.9 (2)	See Note 2	\$595
8496H (Programmable)								20 - 30 V	<20 ms	2.7 W				\$935

Note 1: 355C/D/E/F connector options (BNC (f) standard)
 Option 001 N(f) add \$25
 Option 005 TNC(f) add \$10

Note 2: 8494/5/6 models must specify connector option. See adjacent ordering example (page 386).

MICROWAVE TEST EQUIPMENT

Continuously variable attenuators and OEM step attenuators

Models 393A, 394A, 33300 series, 33320 series



394A



33300A



33321B



33321H

393A, 394A Attenuators, 500 MHz to 1 GHz and 1 GHz to 2 GHz

Each of these coaxial variable attenuators uses the principle of a directional coupler to achieve a wide range of attenuation over a full octave. The HP 393A covers 5 to 120 dB from 500 to 1000 MHz; HP 394A covers 6 to 120 dB from 1 to 2 GHz. With special high-power terminations they handle up to 200 watts average. Since these instruments are variable directional couplers, they are particularly useful for mixing signals while maintaining isolation.

33300/01/04/05 Programmable step attenuators

These step attenuators provide a fast and precise means for electrically controlling the level of signal attenuation in automatic test systems. They are available in four basic configurations: 0-70 dB in 10-dB steps (33300), 0-42 dB in 6-dB steps (33301); 0-11 dB in 1-dB steps (33304) and 0-110 dB in 10-dB steps (33305). Magnetic latching solenoids (12 or 24 volts) are used to switch individual attenuation elements into and out of contact with a 50-ohm transmission line. A and B are "no indicator contacts" and C and D are "with indicator contacts." Three digit connector options must be specified.

33320/A/B/G/H, 33321A/B/D/G/H/K, 33322A/B/G/H Manual or programmable OEM step attenuators

These compact step attenuators are configured for designing into microwave systems and instruments, wherever control of power level is required from dc to 26.5 GHz or 0 to 121 dB.

Manual or electrically programmable versions are available with microwave performance identical to 8494-5-6 Series step attenuators

described on the previous two pages. Physically, 33320 Series units have no base or knob and the electrically programmed versions have an additional 5 V coil option for compatibility with TTL type power supplies.

The manual versions take less than 1.5 square inches of panel space. The following table provides a cross-reference to 8490 Series model numbers for performance specifications. The 33320-1-2 series A, B, G, and H models are provided with SMA connectors, and the 33321D and 33321K models have the new APC-3.5 connectors (SMA compatible). Other connectors are available on special request. Contact HP for detailed specifications and discount price quotations on larger quantities.

Our Coaxial & Waveguide Catalog and Microwave Measurement Handbook is available: 80 pages featuring over 300 measurement components. For a free copy, use request card at back of this catalog.

33320 Series vs 8490 Series cross reference

Type of Attenuator	Range (dB)	Step (dB)	Similar Model (Pages 28-31)	Frequency Series			Comparable OEM Version
				4 GHz	18 GHz	26.5 GHz	
Manual	11	1	8494	A	B	D	33320A/B 33321A/B/G 33322A/B
	70	10	8495	A	B		
	110	10	8495	A	B		
Programmable	11	1	8494	G	H	K	33320G/H 33321G/H/K 33322G/H
	70	10	8495	G	H		
	110	10	8496	G	H		

1-9 Quantity prices for 33320-1-2 Attenuators are \$1 less than their corresponding 8494-5-6 Prices.

393A, 394A, 33300/01/04/05/A/B/C/D specifications

Model	Mode of Operation	Frequency Range (GHz)	SWR Maximum (50Ω Nominal)	Accuracy	Incremental Attenuation (dB)	Maximum Residual Attenuation (0 dB Setting)	Power Rating	Solenoid Characteristics			Dimensions mm(in.)	Shipping Weight kg (lb)	# of Connectors	Price
								Voltage	Switch Speed	Switch Power				
393A	Manual	0.5 - 1	2.5: 5 - 15 dB 1.5: 15 - 30 dB 1.4: 30 - 120 dB	±1.25 dB or ±1.75% whichever is greater.	5 - 120 dB Continuously Variable	—	200 W avg.	—	—	—	305 × 140 × 70 (12 × 5½ × 2¾)	4.1 (9)	N (4)	\$1320
394A	Manual	1 - 2	2.5: 6 - 10 dB 1.8: 10 - 15 dB 1.6: 15 - 120 dB	±1.25 dB or ±2.5% whichever is greater.	6 - 120 dB Continuously Variable	—	200 W avg.	—	—	—	—	—	—	\$1259
33300 A, B C, D	Program	dc - 18	1.3: dc - 8 GHz 1.4: dc - 12.4 GHz 1.6: dc - 18 GHz (with N (1) connector)	±3% of setting to 12.4 GHz ±4% of setting to 18 GHz	0 - 70 dB 10 dB steps	0.5 dB +0.08 dB/GHz	2 W avg 500 W peak (with 10 μs max. pulse width)	A and C models 33 to 15 V	< 50 ms	1 W	210 × 38 × 32 (8¼ × 1½ × 2¼)	1.4 (3)	3 digit connector option must be specified. 1st digit is always 0 2nd digit refers to input. 3rd digit refers to output 3 digit Code: 0: N (1) 1: N (2) 2: 7 mm (1) 3: 7 mm (2) 5: SMA (1) 6: SMA (2)	\$875 \$860
33301 A, B C, D	Program	dc - 18	0 - 42 dB 6 dB steps		0.5 dB +0.08 dB/GHz	\$875 \$860								
33304 A, B C, D	Program	dc - 18	1.45: dc - 8 GHz 1.55: dc - 12.4 GHz (with N (1) connector)		0 - 11 dB 1 dB steps	0.7 dB +0.1 dB/GHz								\$1700 \$1140
33305 A, B C, D	Program	dc - 18	0 - 110 dB 10 dB steps		0.7 dB +0.1 dB/GHz	\$1700 \$1140								

MICROWAVE TEST EQUIPMENT

Waveguide attenuators
Models 375A series, 382 series

- High accuracy
- Excellent repeatability

- Low SWR
- Frequency coverage to 40 GHz



K382A



S382C



X375A



P382A

382 Series, precision variable attenuators

Operation of these direct-reading, precision attenuators depends on a mathematical law, rather than on the resistivity of the attenuating material. Accurate attenuation from 0 to 50 dB (0 to 60 dB for S382C) is assured regardless of temperature and humidity. The instruments can handle considerable power and feature large, easily read dials. In addition, the S382C achieves both long electrical length and short physical dimensions through dielectric loading. The result is an S-band attenuator which is only 641 millimeters (24 1/4 inches) long and yet is more accurate than previously available units.

375A General purpose variable attenuators

Variable flap attenuators provide a simple, convenient means of adjusting waveguide power level or isolating source and load. They consist of a slotted section in which a matched resistive strip is inserted. The degree of strip penetration determines attenuation. A dial shows average reading over the frequency band, and a shielded dust cover reduces external radiation and eliminates hand capacity effects. Attenuation is variable from 0 to 20 dB. Dial calibration is accurate within ± 1 dB from 0 to 10 dB, ± 2 dB from 10 to 20 dB. Maximum SWR 1.15.

Our Coaxial & Waveguide Catalog and Microwave Measurement Handbook is available: 80 pages featuring over 300 measurement components. For a free copy, use request card at back of this catalog.

382 Series, 375A specifications

Model	Frequency Range (GHz)	SWR Maximum	Accuracy	Attenuation Range in dB	Maximum Residual Attenuation (0 dB Setting)	Maximum Power (watts)	Waveguide Size Nom. O.D. mm (in.) EIA	Equivalent Flange	Dimensions mm (in.)	Shipping Weight kg (lb)	Price
S382C	2.6 - 3.95	1.2 (2.6 - 3 GHz) 1.15 (3 - 3.95 GHz)	$\pm 1\%$ of reading or 0.1 dB whichever greater $\pm 2\%$ above 50 dB	0 - 60	1 dB	10	76.20 \times 38.10 (3.0 \times 1.5) WR284	UG-584/U	641 \times 152 \times 203 (25.4 \times 6 \times 8)	9.9 (22)	\$2400
G382A	3.95 - 5.85	1.15	$\pm 2\%$ of reading or 0.1 dB whichever greater	0 - 50	1 dB	15	50.80 \times 25.40 (2 \times 1) WR187	UG-407/U	803 \times 245 \times 197 (31.6 \times 9.6 \times 7.7)	13.8 (30.8)	\$1700
J382A	5.3 - 8.2	1.15	$\pm 2\%$ of reading or 0.1 dB whichever greater	0 - 50	1 dB	10	38.10 \times 19.05 (1.5 \times 0.75) WR137	UG-441/U	635 \times 200 \times 157 (25 \times 7.8 \times 6.2)	7.7 (17)	\$1400
H382A	7.05 - 10.0	1.15	$\pm 2\%$ of reading or 0.1 dB whichever greater	0 - 50	1 dB	10	31.75 \times 15.88 (1.25 \times 0.62) WR112	UG-138/U	508 \times 202 \times 165 (20 \times 7.9 \times 6.5)	6.8 (15)	\$1450
X382A	2 - 12.4	1.15	$\pm 2\%$ of reading or 0.1 dB whichever greater	0 - 50	1 dB	10	25.40 \times 12.70 (1.0 \times 0.5) WR90	UG-135/U	397 \times 194 \times 119 (15.6 \times 7.6 \times 4.7)	3.6 (8)	\$785
P382A	12.4 - 18.0	1.15	$\pm 2\%$ of reading or 0.1 dB whichever greater	0 - 50	1 dB	5	17.83 \times 9.93 (0.702 \times 0.391) WR62	UG-419/U	318 \times 197 \times 121 (12.5 \times 7.7 \times 4.8)	3.6 (8)	\$790
K382A	18.0 - 26.5	1.15	$\pm 2\%$ of reading or 0.1 dB whichever greater	0 - 50	1 dB	2	12.70 \times 6.35 (0.5 \times 0.25) WR42	UG-597/U	194 \times 156 \times 121 (7.6 \times 6.1 \times 4.8)	2.7 (6)	\$1400
R382A	26.5 - 40.0	1.15	$\pm 2\%$ of reading or 0.1 dB whichever greater	0 - 50	1 dB	1	9.14 \times 5.59 (0.36 \times 0.22) WR28	UG-595/U	162 \times 156 \times 121 (6.4 \times 6.1 \times 4.8)	2.7 (6)	\$1400
X375A	8.2 - 12.4	1.15	± 1 dB (0 - 10 dB) ± 2 dB (10 - 20 dB)	0 - 20	0.5 dB	2	25.40 \times 12.70 (1.0 \times 0.5) WR90	UG-39/U	198 \times 89 \times 47.6 (7.8 \times 3.5 \times 1.9)	1.4 (3)	\$365
P375A	12.4 - 18	1.15	± 1 dB (0 - 10 dB) ± 2 dB (10 - 20 dB)	0 - 20	0.5 dB	1	17.83 \times 9.93 (0.702 \times 0.391) WR62	UG-419/U	184 \times 89 \times 47.6 (7.2 \times 3.5 \times 1.9)	1.4 (3)	\$350
Circular Flange Adapters Available: For K-Band, Specify 11515A (UG-425/U)										\$110	
For R-Band, Specify 11516A (UG-381/U)										\$110	

MICROWAVE TEST EQUIPMENT

Coaxial dual-directional couplers

Models 770 series, 11692D

- Broadband coverage
- High directivity
- Close tracking



778D



11692D



774D

774D-777D Dual-directional couplers

The economical 774D-777D couplers cover frequency spreads of more than two-to-one, each centered on one of the important VHF/UHF bands. With their high directivity, and a mean coupling accuracy of ± 0.5 dB these couplers are ideal for reflectometer applications. Furthermore, the close tracking of the auxiliary arms makes these couplers particularly useful for reflectometers driven by externally leveled sweep oscillators such as the HP 8690B and 8620A/B. The forward signal is detected and used to level the output of the sweep oscillator while the reflected signal, after detection, is applied to the display device. Changes in the leveled power due to the coupling variation in the forward arm are virtually canceled by a similar coupling variation in the reverse arm.

778D Dual-directional coupler

The HP 778D is a 20-dB dual directional coupler with a frequency range of 100 MHz to 2 GHz. High directivity and close tracking (typically 0.7 dB and 4°) of the auxiliary arms make it ideal for reflectometer measurements of complex reflection coefficient.

11692D Dual-directional coupler

This high directivity, dual directional coupler is a precision instrument designed for broadband swept reflectometer applications in the 2 to 18 GHz frequency range. With its wide frequency coverage, the 11692D coupler can replace several couplers. This adds economy, convenience, and a significant reduction in setup and calibration time to swept reflection and transmission measurements.

778D Options

011: APC-7 output connector, N female input connectors

012: N male output connector, N female input connectors

11692D Options

001: N female input and output connectors N female auxiliary connectors

002: N female input, N male output, and N female auxiliary connectors

Price

add \$25

N/C

less \$15

less \$15

Our Coaxial & Waveguide Catalog and Microwave Measurement Handbook is available: 80 pages featuring over 300 measurement components. For a free copy, use request card at back of this catalog.

774D, 775D, 776D, 777D, 778D and 11692D specifications

Model	Frequency Range (GHz)	Nominal* Coupling (dB)	Maximum Coupling Variation (dB)	Minimum Directivity (dB)	SWR Primary Line Maximum (50Ω Nom.)	SWR Auxiliary Arm Maximum (50Ω Nom.)	Maximum Primary Line Power	Auxiliary Arm Load Avg. Power	Maximum Primary Line Residual Loss (dB)	Primary Line/Auxiliary Arm Connectors	Dimensions mm (in.)	Shipping Weight kg (lb)	Price
774D	0.215 - 0.450	20	± 1	40	1.15	1.2	50 W Avg. 500 W Peak	0.5 W	0.30	N (m.f.)/ N (f.f.)	230 × 70 × 45 (9 ¹ / ₈ × 3 ¹ / ₈ × 1 ³ / ₈)	1.8 (4)	\$475
775D	0.450 - 0.940	20	± 1	40	1.15	1.2	50 W Avg. 500 W Peak	0.5 W	0.40	N (m.f.)/ N (f.f.)	230 × 70 × 45 (9 ¹ / ₈ × 3 ¹ / ₈ × 1 ³ / ₈)	1.8 (4)	\$495
776D†	0.940 - 1.90	20	± 1	40	1.15	1.2	50 W Avg. 500 W Peak	0.5 W	0.35	N (m.f.)/ N (f.f.)	161 × 59 × 45 (6 ³ / ₈ × 2 ³ / ₈ × 1 ³ / ₈)	1.4 (3)	\$475
777D†	1.90 - 4.0	20	± 0.4	30	1.2	1.25	50 W Avg. 500 W Peak	0.5 W	0.75	N (m.f.)/ N (f.f.)	225 × 64 × 29 (8 ⁷ / ₈ × 2 ⁵ / ₈ × 1 ¹ / ₈)	1.4 (3)	\$550
778D	0.10 - 2.0	20	± 1	36: 0.1 - 1 GHz** 32: 1 - 2 GHz (test port)	1.1	1.1	50 W Avg. 500 W Peak	0.5 W	1.5	N (m.f.)/ N (f.f.)	425 × 111 × 30 (16 ³ / ₈ × 4 ¹ / ₈ × 1 ¹ / ₈)	2.3 (5)	\$570
11692D	2.0 - 18.0	22	± 1 Incident to test port	30: 2 - 8 GHz 26: 8 - 18 GHz†	1.3: 2 - 12.4 GHz 1.4: 12.4 - 18 GHz	1.3	50 W Avg. 250 W Peak	0.5 W	1.5	N (f) - APC-7/ N (f.f.)	405 × 133 × 43 (16 × 5 ¹ / ₈ × 1)	2.8 (6)	\$1550

* Nominal Coupling, Coupling Factor, Coupling Attenuation are terms that describe the same parameter. ± 24 dB with Type N connector on the test port.

† Maximum auxiliary arm tracking: 0.3 dB for 776D
0.5 dB for 777D

** 30 dB, 0.1 to 2 GHz, input port.

MICROWAVE TEST EQUIPMENT

Coaxial directional couplers and directional detectors

Models 779D, 780 series, 780 series, & 11691D

- Broadband coverage
- High directivity

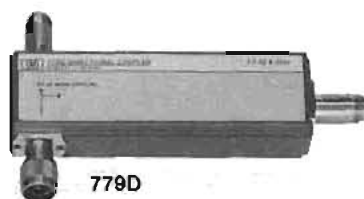

779D



786D



796D



11691D

- Flat frequency response
- Low SWR

779D Directional coupler

The HP 779D spans more than two octaves from 1.7 to 12.4 GHz with excellent directivity. With increased coupling factor (typically 24 dB), the 779D is useful down to 500 MHz. Upper frequency usefulness extends to 18 GHz with directivity reduced to about 15 dB.

The 779D is normally supplied with type N connectors on all ports. On special order, a precision APC-7 connector can be supplied on any, or all, ports.

790 Directional couplers

The 790 directional couplers are ultra-flat, high directivity couplers which are ideal for power-monitoring applications in coaxial systems. Output coupling (ratio of output power from main and auxiliary arms) is specified rather than coupling factor. Thus, no correction factor is required to account for insertion losses in the main arm.

11691D Directional coupler

The broadband frequency coverage of the 11691D coupler makes it ideal for leveling and power monitoring applications of broadband sources in the 2 to 18 GHz frequency range. Its high directivity makes it possible to achieve excellent source match³ not available with broadband directional detectors.

780 Series directional detectors

The 780 series detectors are directional couplers with built-in crystal detectors. The couplers have flat frequency response and good directivity, while the detectors have good frequency response plus high sensitivity. The configuration of the directional detector reduces the number of ambiguities over the standard system of separate coupler and detector and makes possible tighter correlation between main-arm power and detected signal. The directional detector is well suited for sweep oscillator leveling and can also be used to monitor power with a voltmeter or oscilloscope.

779D Options

010: N female (input connector, N male output connector, N female auxiliary connector).

APC: APC-7 connectors on any or all ports, on special order.

Price

N/C

Contact HP

11691D Options

001: N(f) input and output connector, N (f) auxiliary connectors

less \$30

002: N (f) input, N(m) output connector, N(f) auxiliary connector

less \$30

Our Coaxial & Waveguide Catalog and Microwave Measurement Handbook is available; 80 pages featuring over 300 measurement components. For a free copy, use request card at back of this catalog.

779, 790 Series, 11691D specifications

Model	Frequency Range (GHz)	Mean Output Coupling (dB) ¹	Output Coupling Variation (dB)	Minimum Directivity (dB)	SWR Primary Line Maximum (50Ω Norm.)	SWR Auxiliary Arm Maximum (50Ω Norm.)	Equivalent ¹ Source Match	Maximum Primary Line Power at 0.1 sec. Duty Cycle	Maximum Insertion Loss (dB) ²	Primary Line/Auxiliary Arm Connectors	Dimensions mm (in.)	Shipping Weight kg (lb)	Price
779D	1.7 - 12.4	20 ± 0.5	< ±0.15	1.7 - 4 GHz: 30 4 - 12.4 GHz: 26	1.2	1.2	1.2	50 W Avg. 500 W Peak	0.5	N (m,f)/ N (f)	196 × 114 × 26 (7.8 × 4.4 × 1)	1.4 (3)	\$625
796D	0.96 - 2.11	20 ± 0.5	±0.2	30	1.13	1.2	1.13	50 W Avg.	0.4	N (m,f)/ N (f)	152 × 76 × 62 (6 × 3 × 2 1/2)	0.9 (2)	\$375
797D	1.9 - 4.1	20 ± 0.5	±0.2	26	1.16	1.25	1.16	50 W Avg.	0.5	N (m,f)/ N (f)	124 × 29 × 66 (4.9 × 1.1 × 2 1/4)	0.9 (2)	\$375
798C	3.7 - 8.3	10 ± 0.3	±0.3	20	1.25	1.2	1.25	10 W Avg.	0.8	N (m,f)/ N (f)	124 × 29 × 99 (4.9 × 1.1 × 3 1/2)	0.9 (2)	\$450
11691D	2 - 18	22 Nominal	±1	2 - 8 GHz: 30 8 - 18 GHz: * 26	2 - 12.4 GHz: 1.3 12.4 - 18 GHz: 1.5	1.3	1.2	50 W Avg. 250 W Peak	2	APC-7-APC-7/ N (f)	405 × 133 × 43 (16 × 5 1/4 × 1)	2.25 (5)	\$925

¹ Difference in dB between power out of primary line and auxiliary arm.

² Includes loss due to coupling.

³ The apparent SWR at the output port of a directional coupler when used in a closed loop leveling system.

* Directivity is 24 dB in 2 to 8 GHz frequency range with Type N connector on the input port.

780 Series specifications

Model	Frequency Range (GHz)	Low Level Sensitivity (μV/μW)	Maximum Coupling Variation (dB)	Minimum Directivity (dB)	SWR Primary Line Maximum	Equivalent ¹ Source Match	Maximum Primary Line Power	Maximum Primary Line Residual Loss (dB)	Primary Line/Auxiliary Arm Connector	Length mm (in.)	Shipping Weight kg (lb)	Price
788D	0.96 - 2.11	>4	±0.2	30	1.15	1.13	10 W Avg.	0.25	N (m,f)/ BNC (f)	152 (6)	0.9 (2)	\$450
787D	1.9 - 4.1	>4	±0.2	26	1.15	1.16	10 W Avg.	0.35	N (m,f)/ BNC (f)	124 (4.9)	0.9 (2)	\$450
788C	3.7 - 8.3	>40	±0.3	20	1.20	1.25	1 W Avg.	0.60	N (m,f)/ BNC (f)	124 (4.9)	0.9 (2)	\$580
789C	8 - 12.4	>20	±0.5	17	1.40	1.25	1 W Avg.	0.70	N (m,f)/ BNC (f)	295 (11.6)	0.9 (2)	\$725

¹The apparent SWR at the output port of a directional coupler when used in a closed loop leveling system.

MICROWAVE TEST EQUIPMENT

Waveguide directional couplers

Models 752 series

- High directivity >40 dB
- Low SWR
- Coverage to 40 GHz



J752A



X752A

752 Series waveguide directional coupler

The HP 752 Series couplers are specified to meet a wide variety of microwave applications. Every coupler has a minimum directivity of 40 dB over its entire frequency range. Each coupler is swept-frequency tested to ensure that the main guide SWR and directivity specifications are accurate. Performance characteristics are unaffected by humidity, temperature, and time, making these units especially useful in microwave "standards" measurements.

The 752 couplers are an essential part of many microwave measurement systems. Attenuation measurements, reflectometer setups, power measurements, source leveling, and network analysis are just a few areas in which these couplers are used.

Ordering Information

When ordering a coupler, the complete model number as listed in the table below must be specified. Example: if a 20 dB coupler that operates in the frequency range of 12.4 GHz to 18 GHz is desired, the model number P752D must be ordered.



Our Coaxial & Waveguide Catalog and Microwave Measurement Handbook is available: 80 pages featuring over 300 measurement components. For a free copy, use request card at back of this catalog.

752 Series specifications

Model	Frequency Range (GHz)	Nominal* Coupling (dB)	Mean Coupling Accuracy (dB)	Maximum Coupling Variation (dB)	Minimum Directivity (dB)	SWR Primary Line Maximum	SWR Auxiliary Arm Maximum	Equivalent Flange	Maximum Primary Line Power (Watts)	Waveguide Size Nom. O.D. mm (in.) EIA	Length mm (in.)	Shipping Weight kg (lb)	Price
J752A	5.85-8.2	3	±0.4	±0.5	40	1.1	1.15	UG-441/U	2	38.10 × 18.05 (1.50 × 0.75) WR137	673 (26¼)	5.8 (13)	\$760
J752C	5.85-8.2	10	±0.4	±0.5	40	1.05	UG-441/U	10	649 (25½)		5.8 (13)	\$700	
J752D	5.85-8.2	20	±0.4	±0.5	40	1.05	UG-441/U	100	649 (25½)		5.8 (13)	\$730	
H752A	7.05-10.0	3	±0.4	±0.5	40	1.1	1.15	UG-138/U	2	31.75 × 15.88 (1.25 × 0.625) WR112	473 (18¾)	1.8 (4)	\$520
H752C	7.05-10.0	10	±0.4	±0.5	40	1.05	UG-138/U	10	445 (17½)		1.8 (4)	\$450	
H752D	7.05-10.0	20	±0.4	±0.5	40	1.05	UG-138/U	100	445 (17½)		1.8 (4)	\$450	
X752A	8.2-12.4	3	±0.4	±0.5	40	1.1	1.15	UG-135/U	2	25.40 × 12.70 (1.00 × 0.50) WR90	424 (16¾)	1.4 (3)	\$370
X752C	8.2-12.4	10	±0.4	±0.5	40	1.05	UG-135/U	10	399 (15½)		1.4 (3)	\$360	
X752D	8.2-12.4	20	±0.4	±0.5	40	1.05	UG-135/U	100	399 (15½)		1.4 (3)	\$360	
P752A	12.4-18.0	3	±0.4	±0.5	40	1.1	1.2	UG-419/U	2	17.83 × 9.93 (0.702 × 0.391) WR62	349 (13¾)	0.9 (2)	\$350
P752C	12.4-18.0	10	±0.4	±0.5	40	1.05	UG-419/U	10	311 (12¼)		0.9 (2)	\$350	
P752D	12.4-18.0	20	±0.4	±0.5	40	1.05	UG-419/U	100	311 (12¼)		0.9 (2)	\$350	
K752A	18.0-26.5	3	±0.7	±0.5	40	1.1	1.2	UG-595/U	1	12.70 × 6.35 (0.50 × 0.25) WR42	270 (10¾)	0.45 (1)	\$470
K752C	18.0-26.5	10	±0.7	±0.5	40	1.05	1.2	UG-595/U	5		252 (9¾)	0.45 (1)	\$440
K752D	18.0-26.5	20	±0.7	±0.5	40	1.05	1.2	UG-595/U	50		252 (9¾)	0.45 (1)	\$460
R752A	26.5-40.0	3	±0.7	±0.5	40	1.1	1.2	UG-599/U	1	9.14 × 5.59 (0.36 × 0.22) WR28	295 (11¾)	0.45 (1)	\$600
R752C	26.5-40.0	10	±0.7	±0.5	40	1.05	1.2	UG-599/U	5		219 (8¾)	0.45 (1)	\$600
R752D	26.5-40.0	20	±0.7	±0.6	40	1.05	1.2	UG-599/U	50		222 (8¾)	0.45 (1)	\$500
Circular flange adaptors available. For X-Band, specify 11515A (UG-425/U)													\$110
For R-Band, specify 11516A (UG-381/U)													\$110

* Nominal Coupling, Coupling Factor, and Coupling Attenuation are terms that describe the same parameter.

MICROWAVE TEST EQUIPMENT

Coaxial and waveguide frequency meters

Models 532A, 536A, 537A



- High resolution, easy-to-read dial



536A

- Direct reading
- Broadband



537A



H532A

Frequency meters 536A, 537A (coaxial), 532 Series (waveguide)

These direct-reading frequency meters measure frequencies from 5.30 to 40 GHz in waveguide and from 960 MHz to 12.4 GHz in coax quickly and accurately. Their long scale length and numerous calibration marks provide high resolution which is particularly useful when measuring frequency differences or small frequency changes. Frequency is read directly in GHz so interpolation or charts are not required.

The instruments comprise a special transmission section with a high-Q resonant cavity which is tuned by a choke plunger. A 1-dB or greater dip in output indicates resonance; virtually full power is transmitted off resonance. Tuning is by a precision lead screw, spring-loaded to eliminate backlash. Resolution is enhanced by a long, spiral

scale calibrated in small frequency increments. For example, Model X532B has an effective scale length of 1956 mm (77 inches) and is calibrated in 5-MHz increments. Resettability is extremely good, and all frequency calibrations are visible so that measurement point is directly indicated. Overall accuracy of each frequency meter includes allowance for 0 to 100 percent relative humidity and temperature variation from 13 to 33°C. Except for the J532A, there are no spurious modes or resonances. Because of the wide frequency range of the J532A, frequencies from 7.6 to 8.2 GHz can excite the TE₁₁ mode when the dial is set between 5.3 and 5.6 GHz.

Our Coaxial & Waveguide Catalog and Microwave Measurement Handbook is available: 80 pages featuring over 300 measurement components. For a free copy, use request card at back of this catalog.

532A Series, 536A and 537A specifications

Model	Frequency Range (GHz)	Dial Accuracy (%)	Overall Accuracy (%)	Minimum Dip at Resonance (dB)	Calibration Increment (MHz)	Waveguide Size Nom. O.D. mm (in.) EIA	Equivalent Flange (Connector)	Dimensions mm (in.)	Shipping Weight kg (lb)	Price
536A	0.96–4.20	0.15:0.96 to 1 GHz 0.10:1 to 4.2 GHz	0.22:0.96 to 1 GHz 0.17:1 to 4.2 GHz	0.6:0.96 to 1 GHz 1:1 to 4 GHz 0.6:4 to 4.2 GHz	2	Coaxial	(Type N)	152 × 232 × 152 (6 × 9¼ × 6)	5.9 (13)	\$ 875
537A	3.7–12.4	0.100	0.170	1	10	Coaxial	(Type N)	118 × 146 × 89 (4¾ × 5¾ × 3½)	2.3 (5)	\$ 650
J532A	5.30–8.20	0.033	0.065	1	2	38.1 × 19.05 (1½ × ¾) WR137	UG-441/U	159 × 232 × 114 (6¼ × 9¼ × 4¼)	11 (5.0)	\$1150
H532A	7.05–10.0	0.040	0.075	1	2	31.75 × 15.88 (1¼ × ¾) WR112	UG-138/U	159 × 203 × 111 (6¼ × 8 × 4¾)	4.1 (9)	\$1150
X532B	8.20–12.4	0.050	0.080	1	5	25.4 × 12.7 (1 × ½) WR90	UG-39/U	114 × 156 × 73 (4½ × 6¼ × 2¾)	1.8 (4)	\$ 595
P532A	12.4–18.0	0.068	0.100	1	5	17.83 × 9.93 (0.702 × 0.391) WR62	UG-419/U	114 × 159 × 70 (4½ × 6¼ × 2¾)	1.8 (4)	\$ 575
K532A	18.0–26.5	0.077	0.110	1	10	12.7 × 6.35 (0.50 × 0.25) WR42	UG-595/U	114 × 137 × 73 (4½ × 5¼ × 2¾)	1.4 (3)	\$ 775
R532A	26.5–40.0	0.083	0.120	1	10	9.14 × 5.59 (0.360 × 0.220) WR28	UG-599/U	114 × 140 × 70 (4½ × 5½ × 2¾)	1.4 (3)	\$ 775
Circular flange adapters available: For K-Band, Specify 11515A (UG-425/U) For R-Band, Specify 11516A (UG-381/U)										\$ 110 \$ 110

MICROWAVE TEST EQUIPMENT

Coaxial crystal detectors

Models 423A/B, 8470A/B, 8471A, 8472A/B, 33330B/C

- Flat frequency response
- High burnout protection
- New APC-3.5 connector

- Low SWR
- Field replaceable detector elements



423B, 8470B, 8472B, 33330B/C Low-Barrier Schottky (LBS) detectors

The Low-Barrier Schottky (LBS) detectors are a state-of-the-art addition to the HP family of high performance detectors. The integration of a Low-Barrier Schottky diode and special thin-film matching circuit provides significant improvements in flatness, SWR, higher sensitivity without bias, ruggedness, and burnout protection over point-contact models. Designated as 'B' models of the well known 423/8470/8472 family, the LBS line offers ultra high performance at an economical price. The 423B and 8470B Option 012 provide Type N connector versions to 12.4 GHz and 18 GHz respectively. The standard 8470B and 8472B offer APC-7 and SMA connector versions.

The 33330B and 33330C models are provided with the new APC-3.5 connector (SMA compatible) and operate to 18 GHz and 26.5 GHz respectively.

Matched pairs and square law loads are available, as well as field-replaceable detector elements.

423A, 8470A, 8471A, 8472A point-contact detectors

These point-contact detectors have been widely used for many years and provide high performance at an economical price. The 8470A, 8470A Option 012, and 8472A provide APC-7, Type N, and SMA connector versions to 18 GHz. Like the 423A and 424A Crystal Detectors, the 8470A and 8472A combine extremely flat frequency response with high sensitivity and low SWR, making them extremely useful as the detecting element in closed-loop leveling systems, and their performance is surpassed only by the LBS models. Matched pairs are available for applications requiring close detector tracking, and all but the 8472A can be supplied with video loads for optimum conformance to square law. Field-replaceable detector elements are available. All models except 8471A may exhibit some RF leakage at output connector below 1 GHz RF.

Our Coaxial & Waveguide Catalog and Microwave Measurement Handbook is available: 80 pages featuring over 300 measurement components. For a free copy, use request card at back of this catalog.

Coaxial crystal detectors specifications

Model	Frequency Range (GHz)	Diode Type (No Bias Required)	Frequency Response (dB)	SWR Maximum (50% Nom.)	Low Level Sensitivity	Maximum Input (Peak or Average)	Short-Term Maximum Input (<1 min.)	Option 001 Matched Pair (order 2 units for each pair)	Option 002 Square-Law Load	Option 003 Positive Polarity	Input Connector	Price
423B	0.01 - 12.4 GHz	LBS	±0.2/octave to 8 GHz ±0.3 overall	1.15 to 4 GHz 1.3 to 12.4 GHz	>0.5 mV/ μW	200 mW	1 watt	±0.2 dB to 12.4 GHz	Yes	Yes	N (m)	\$190
423A	0.01 - 12.4 GHz	Point Contact	±0.2/octave to 8 GHz ±0.3 overall	1.2 to 4.5 GHz 1.35 to 7 GHz 1.5 to 12.4 GHz	>0.4 mV/ μW	100 mW	0.1 watt	±0.2 dB to 8 GHz ±0.3 dB to 12.4 GHz	Yes	Yes	N (m)	\$155
8470B Option 012	0.01 - 18.0 GHz	LBS	±0.2/octave to 8 GHz ±0.3 to 12.4 GHz ±0.6 to 18 GHz	1.15 to 4 GHz 1.3 to 15 GHz 1.4 to 18 GHz	>0.5 mV/ μW	200 mW	1 watt	±0.2 dB to 12.4 GHz ±0.3 dB to 18 GHz	Yes	Yes	APC-7 N (m)	\$230 \$215
8470A Option 012	0.01 - 18.0 GHz	Point Contact	±0.2/octave to 8 GHz ±0.5 to 12.4 GHz ±1.0 to 18 GHz	1.2 to 4.5 GHz 1.35 to 7 GHz 1.5 to 12.4 GHz 1.7 to 18 GHz	>0.4 mV/ μW	100 mW	0.1 watt	±0.2 dB to 8 GHz ±0.3 dB to 12.4 GHz ±0.6 dB to 18 GHz	Yes	Yes	APC-7 N (m)	\$195 \$180
8472B	0.01 - 18.0 GHz	LBS	±0.2/octave to 8 GHz ±0.3 to 12.4 GHz ±0.6 to 18 GHz	1.2 to 4 GHz 1.35 to 7.0 GHz 1.5 to 12.4 GHz 1.7 to 18 GHz	>0.5 mV/ μW	200 mW	1 watt	±0.2 dB to 12.4 GHz ±0.3 dB to 18 GHz	No	Yes	SMA (m)	\$215
8472A	0.01 - 18.0 GHz	Point Contact	±0.2/octave to 8 GHz ±0.5 to 12.4 GHz ±1.0 to 18 GHz	1.2 to 4.5 GHz 1.35 to 7 GHz 1.5 to 12.4 GHz 1.7 to 18 GHz	>0.4 mV/ μW	100 mW	0.1 watt	±0.2 dB to 8 GHz ±0.3 dB to 12.4 GHz ±0.6 dB to 18 GHz	No	Yes	SMA (m)	\$180
33330B	0.01 - 18.0 GHz	LBS	±0.6 dB	1.5	>0.5 mV/ μW	200 mW	1 watt	±0.3 dB	No	Yes	APC-3.5 (m)	\$205
33330C	0.1 - 26.5 GHz	LBS	±0.6 dB to 20 GHz ±1.5 dB with a -3.5 dB slope 20 to 26.5 GHz	1.5 to 18 GHz 2.2 to 26.5 GHz	>0.5 mV/μW to 18 GHz. Degrades to 0.18 mV/μW at 26.5 GHz	200 mW	1 watt	±0.3 dB to 18 GHz ±0.5 dB to 26.5 GHz	No	Yes	APC-3.5 (m)	\$260
8471A	100 MHz - 1.2 GHz	Point Contact	±0.6 (Typical) ±0.1/100 MHz	1.3 (Typical) 50Ω	>0.35 mV/ μW	3 V rms	3 V rms	No	No	Positive Output Option 004	BNC (m)	\$70

*Model 8471A Option 003 (negative polarity, 75Ω); Option 006 (positive polarity, 75Ω).

Add \$10

MICROWAVE TEST EQUIPMENT

Waveguide crystal detectors

Models 422A, 424A, X485B

- Flat response
- High sensitivity

- Low VSWR
- Field replaceable detector elements



K422A



X424A



J424A

422 Series, 424 Series, X485B waveguide crystal detectors

The 422A and 424A family of crystal detectors combine high sensitivity with flat frequency response and low SWR to provide waveguide band coverage from 2.6 to 40 GHz. For reflectometer applications in which both flat frequency response and square-law character-

istics are important, these models can be supplied as matched pairs (Option 001) and also with an optimum square-law load (Option 002).

Model X 485B is a tuneable detector mount which accepts IN21 crystal or bolometer (not supplied).

Our Coaxial & Waveguide Catalog and Microwave Measurement Handbook is available: 80 pages featuring over 300 measurement components. For a free copy, use request card at back of this catalog.

422 Series, 424 Series, X485B waveguide crystal detector specifications

Model	Frequency Range (GHz)	Frequency Response (dB)	Option 001 Matched Pair Tracking (dB)	Option 003 Square-Law Load	Minimum Low-Level Sensitivity (mV/μW)	Maximum High-Level Sensitivity (mW)	SWR Maximum	Maximum Power (Av or Pk) (mW)	Waveguide Size Nom. O.D. mm (in.) EIA	Equivalent Flange	Length mm (in.)	Shipping Weight kg (lb)	Price
S424A	2.6 - 3.95	±0.2	±0.2 dB	Yes	0.4	0.35	1.35	100	76.2 × 38.1 (3 × 1.50) WR284	UG-584/U	62 (2.44)	0.9 (2)	\$250
G424A	3.95 - 5.85	±0.2	±0.2 dB	Yes	0.4	0.35	1.35	100	50.8 × 25.4 (2 × 1) WR187	UG-407/U	52 (2.06)	0.45 (1)	\$225
J424A	5.3 - 8.2	±0.2	±0.2 dB	Yes	0.4	0.35	1.35	100	38.1 × 19.1 (1.50 × 0.75) WR137	UG-441/U	48 (1.88)	0.23 (0.5)	\$225
H424A	7.05 - 10.0	±0.2	±0.2 dB	Yes	0.4	0.35	1.35	100	31.7 × 15.9 (1.25 × 0.625) WR112	UG-138/U	40 (1.56)	0.23 (0.5)	\$225
X424A	8.2 - 12.4	±0.3	±0.3 dB	Yes	0.4	0.35	1.35	100	25.4 × 12.7 (1 × 0.5) WR90	UG-135/U	35 (1.38)	0.23 (0.5)	\$190
X485B	8.2 - 12.4	—	—	No	—	—	1.25	—	25.4 × 12.7 (1 × 0.5) WR90	UG-135/U	164 (6.5)	0.9 (2)	\$300
M424A	10.0 - 15.0	±0.5	±0.5 dB	Yes	0.3	0.50	1.5	100	21.6 × 12.1 (0.850 × 0.475) WR75	Cover	25 (1.00)	0.23 (0.5)	\$300
P424A	12.4 - 18.0	±0.5	±0.5 dB	Yes	0.3	0.50	1.5	100	17.8 × 9.9 (0.702 × 0.391) WR62	UG-419/U	24 (0.94)	0.22 (0.5)	\$220
K422A	18.0 - 26.5	±2	±1 dB	No	0.3 (Typical)	—	2.5	100	12.7 × 6.4 (0.500 × 0.250) WR42	UG-595/U	51 (2.00)	0.45 (1)	\$475
R422A	26.5 - 40.0	±2	±1 dB	No	0.3 (Typical)	—	3	100	9.1 × 5.6 (0.360 × 0.220) WR28	UG-599/U	51 (2.00)	0.45 (1)	\$460
All Models—Option 001 Matched Pair												Add \$20/Unit	
All Models—Option 002 Optimum Square-Law Load												Add \$20/Unit	
Not All Models—Option 003 Positive Output												N/C	
Circular Flange Adapters Available: For K-Band, Specify 11515A (UG-425/U) For R-Band, Specify 11516A (UG-381/U)												\$110 \$110	

MICROWAVE TEST EQUIPMENT

Coaxial slotted lines

Models 447B, 448A/B, 805C, 809C, 816A, 817A/B

- Precision reflection measurements 0.5 to 18 GHz

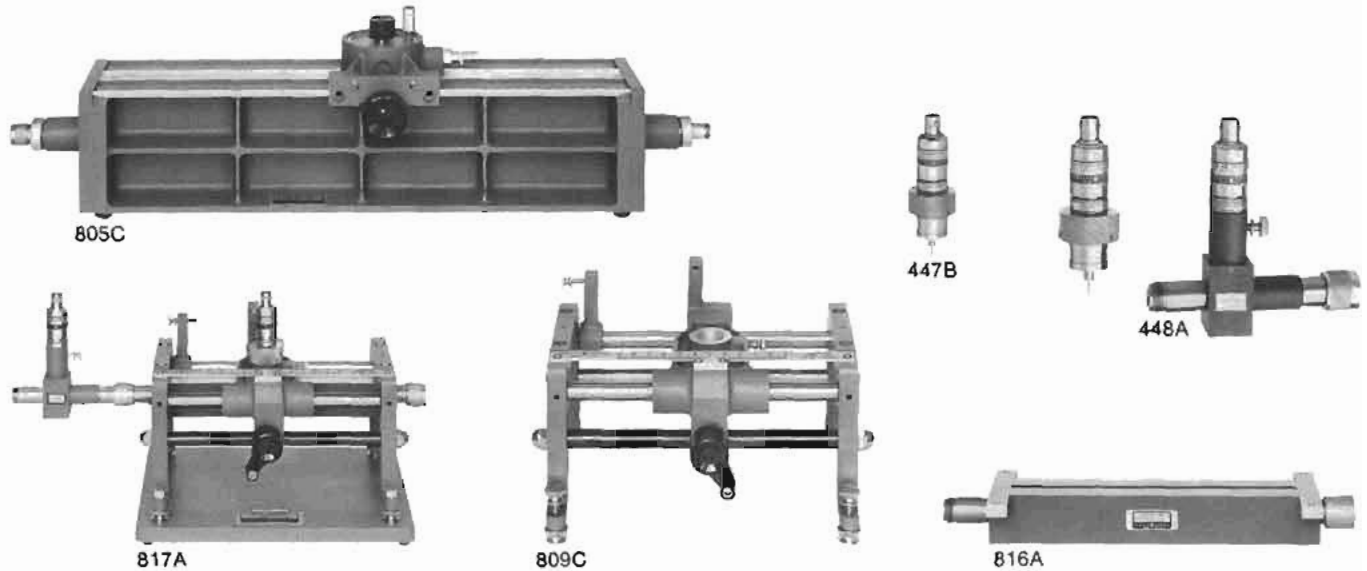

805C Coaxial slotted line system, 0.5 to 4 GHz

Model 805C is a complete slotted line system for measurements in the 0.5 to 4 GHz frequency range. The design employs two parallel planes and rigid center conductor, offering important advantages over a conventional coaxial slotted section. Besides providing greater structural stability, this configuration results in improved electrical characteristics, such as negligible slot radiation and less effect from variations in probe depth or centering. The probe circuit is tunable from 500 to 4000 MHz, and depth of probe penetration can be adjusted quickly and easily.

817A/B Coaxial swept slotted line systems 1.8 to 18 GHz

The 817A and 817B are fully tested systems that permit accurate swept-frequency SWR measurements in coax from 1.8 to 18 GHz. The 817A/B enables you to realize the accuracy of the slotted line technique and the broadband coverage and broadband time savings of swept-frequency testing. The 817A system consists of the 816A slotted line, the 809C carriage, and the 448A sweep adapter equipped with its own matched detectors for use with other logarithmic amplifiers.

The new Model 817B Swept Slotted Line System consists of an 816A coaxial slotted line, an 809C carriage with baseplate, and the 448B slotted line sweep adapter which accepts the detectors of the HP 8755 Frequency Response Test Set.

809C Slotted line carriage

The 809C Carriage operates with the 816A Coaxial Slotted Section and four 810B Waveguide Slotted Sections. It is compatible with the 447B and 448A/B coaxial probes. The carriage has a centimeter scale with a vernier reading to 0.1 mm, and provision is made also for mounting a dial gauge if more accurate probe position reading is required.

805C, 817A/B specifications

Model	Frequency Range (GHz)	SWR Maximum Residual	Maximum Slope and Irregularities	Maximum Power	Probe Travel	Slotted Line Connectors	Dimensions mm (in.)	Shipping Weight kg (lb)
805C	0.5-4.0	1.04	0.2 dB	—	40 cm	R (m) N (f)	673x378x178 (26 1/2x17x7)	12.1 (27)
817A	0.8-18	1.06	0.2 dB	2 W	10 cm	APC-7 N (f)	342x178x178 (13 3/8x7x7)	9.9 (22)
817B	1.8-18	1.06	0.2 dB	2 W	10 cm	APC-7 N (f)	343x178x178 (13 3/8x7x7)	9.9 (22)
817A/B Options	O1: APC-7 connectors on 448B Probes (Available on 817B only) O2: N (m) and N (f) connectors on 816A Slotted Line Section							

816A Coaxial slotted section, 1.8 - 18 GHz

(Used with 809C Carriages and 447B or 448A/B Detector Probes).

The 816A consists of two parallel planes and a rigid center conductor. This configuration virtually eliminates radiation and minimizes the effect of variation in probe penetration and centering. It is fitted with one APC-7 and one type N female connector.

816A Specifications

Frequency: 1.8 - 18 GHz.

Residual SWR: APC-7, 1.02-1.04 depending on frequency coverage.

Length: 248 mm (9 7/8 inches).

Weight: net, 0.68 kg (1 1/2 lb). Shipping, 1.4 kg (3 lb).

Accessories furnished: 11512A type N male short; 11565A APC-7

Option 011: both connectors APC-7.

Option 022: type N (m) connector in lieu of APC-7.

447B Detector probe

Model 447 consists of a crystal diode detector plus a small antenna probe for sampling energy in HP 816A Coaxial Slotted Lines. The untuned probe is extremely sensitive over its frequency range of 1.8 to 18 GHz. The 447B fits HP 809C Carriage or other carriages with a 19 mm (3/4") mounting hole.

448A/B Slotted line sweep adapter probes 1.8 - 18 GHz

The 448A consists of a short slotted line and two matched detectors with adjustable probes. One detector levels the signal source, the other monitors the standing waves in the 816A.

The 448B consists of a short section of slotted line and two adjustable probes fitted with Type N connectors for mating with the detectors of the 8755 Frequency Response Test Set.

Our Coaxial & Waveguide Catalog and Microwave Measurement Handbook is available: 80 pages featuring over 300 measurement components. For a free copy, use request card at back of this catalog.

Model number and name	Price
447B detector probe	\$215
448A slotted line sweep adapter probes 1.8 - 18 GHz	\$550
448B slotted line sweep adapter probes 1.8 - 18 GHz	\$425
805C coaxial slotted line system 0.5 - 4 GHz	\$1650
809C slotted line carriage	\$575
816A coaxial slotted section 1.8 - 18 GHz	\$575
Option 011: both connectors APC-7	add \$25
Option 022: type N (m) and N (f)	less \$15
817A slotted line system 1.8 - 18 GHz	\$1700
817B slotted line system 1.8 - 18 GHz	\$1575

MICROWAVE TEST EQUIPMENT

Waveguide Slotted Lines

Models 440A, 442B, 444A, 446B, 809C, 810B Series,
814B, 815B series

- Precision reflection measurements to 40 GHz



X810B



444A



K815B

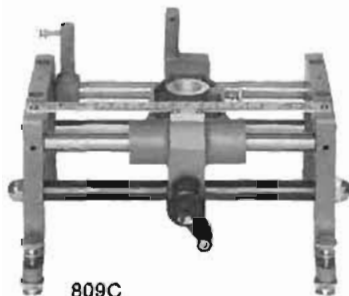

809C



440A



442B



446B



814B

809C Carriage

The 809C Carriage operates with the four 810B Waveguide Slotted Sections and the 816A Coaxial Slotted Section. It is compatible with the 444A and 442B probes. The carriage has a centimeter scale with a vernier reading to 0.1 mm, and provision is made also for mounting a dial gauge if more accurate probe position reading is required.

810B Slotted sections, 5.3–18 GHz

Waveguide slotted line measurements in the frequency range 5.3–18 GHz are made using the 810B Slotted Section, the 809C Carriage and 444A Probe or 440A plus 442B Probe combination.

810B Specifications

HP Model	Frequency range (GHz)	Fits Waveguide size EIA	Equivalent	Price
J810B	5.30–8.20	WR137	UG443/U	\$575
H810B	7.05–10.0	WR112	UG138/U	\$425
X810B	8.20–12.4	WR90	UG135/U	\$550
P810B	12.4–18.0	WR62	UG419/U	\$425

444A Untuned probe, 2.6–18 GHz

The 444A Untuned Probe, for use with HP 810B Waveguide Slotted Sections, consists of a crystal, plus a small antenna in a convenient housing. The probe is held in position by friction or may be fixed by a locking ring. No tuning is required and sensitivity equals or exceeds many elaborate single and double-tuned probes. The 444A fits the 809C Carriage or other carriages with a 3/8 inch (9 mm) mounting hole. Frequency range is 2.6 to 18 GHz. Accessory furnished, 11506A Probe Extension Kit.

440A Detector mount

The 440A is a tunable mount used for detecting RF energy in coaxial systems or in conjunction with the HP 442B in waveguide or coaxial slotted sections. Detector (not supplied) can be a 1N21 or 1N23 Crystal or 821 Series Barreiter.

442B Broadband probe, 2.6–12.4 GHz

Model 442B is a probe whose depth of penetration into a slotted section is variable. Held in position by friction, it may be fixed in place by a locking ring. Sampled RF appears at a type N jack. It can be connected to a 440A Detector Mount to form a sensitive and convenient tuned RF detector for HP 810B Waveguide Slotted Sections. The

442B fits the 809C Carriage. Frequency range is 2.6 to 12.4 GHz.

814B Carriage

The HP 814B Carriage is designed for use with the K815B (18 to 26.5 GHz) and R815B (26.5 to 40 GHz) Waveguide Slotted Sections and HP 446B Untuned Probe. The carriage is equipped with a dial indicator for accurate reading. Slotted sections are easily interchanged.

815B Slotted sections, 18–40 GHz

(used with 814B carriage and 446B detector)

The 815B Waveguide Slotted Sections are designed to fit the 814B Carriage. Like the lower-frequency slotted sections, each 815B is precision-manufactured, broached and checked with precision gauges for careful control of guide wavelength. The slot is tapered to insure a low SWR.

815B Specifications

	K815B*	R815B*
Frequency range (GHz):	18 to 26.5	26.5 to 40
Residual SWR:	1.01	1.01
Overall length:	192 mm (7 5/16")	192 mm (7 5/16")

*Circular Range adapters: K-band (UG425/U) 11515A, R-band (UG381/U) 11516A.

446B Broadband detector

The HP 446B is a broadband detector and probe which consists of a modified 1N53 silicon diode in a carefully designed shielded housing. No tuning is required, and probe penetration may be varied quickly and easily. Designed for use with the 814B Carriage, the 446B has a frequency range of 18 to 40 G.

Our Coaxial & Waveguide Catalog and Microwave Measurement Handbook is available: 80 pages featuring over 300 measurement components. For a free copy, use request card at back of this catalog.

Model number and name	Price
440A Detector Mount	\$195
442B RF Probe	\$150
444A Untuned Probe	\$120
446B Broadband Untuned Probe	\$450
814B Slotted Line Carriage Assembly	\$850
K815B Waveguide Slotted Line Section	\$695
R815B Waveguide Slotted Line Section	\$725

MICROWAVE TEST EQUIPMENT

Coaxial and waveguide terminations

Models 905, 907-911, 914, 920, 930

- Precision loads and shorts for measurements to 40 GHz

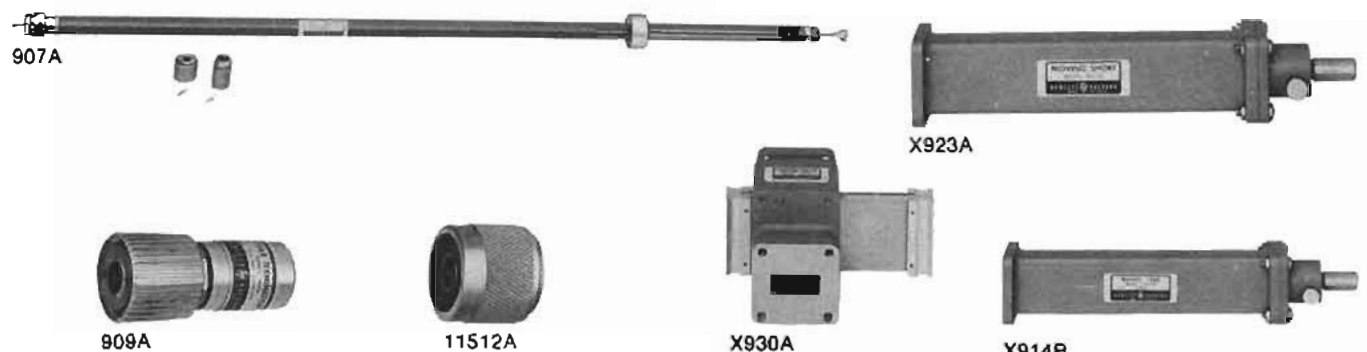

905A, 907A, 911A Coaxial sliding loads

The 905A, 907A and 911A are movable 50Ω, low reflection loads for precision measurements. The 905A and 907A are supplied with three interchangeable connectors, N-male, N-female and APC-7. The 911A is supplied with SMA male and female.

908A, 909A Coaxial fixed terminations

The 908A and 909A terminations are low-reflection loads for terminating 50Ω coaxial systems in their characteristic impedance.

905A, 907A, 911A specifications

HP Model	Frequency range	Load SWR	Power rating	Length in. (mm)	Shipping weight	Price
905A	1.8-18 GHz	1.05	1 W avg. 5 kW pk	17 1/4 (440)	3 lb (1.4 kg)	\$360
907A	1-18 GHz	1.1, 1-1.5 GHz; 1.05, 1.5-18 GHz	1 W avg. 5 kW pk	30 3/4 (778)	9 lb (4.1 kg)	\$725
911A	2-18 GHz	1.1, 2-4 GHz; 1.05, 4-18 GHz	1 W avg. 5 kW pk	14 1/2 (380)	3 lb (1.4 kg)	\$360

908A, 909A specifications

HP Model	Frequency Range	Impedance	SWR	Power Rating	Connector	Price
908A	dc-4 GHz	50 ohms	1.05	1/2 W avg. 1 kW pk	N male	\$175
909A	dc-18 GHz	50 ohms	1.05, 0-4 GHz 1.1, 4-12.4 GHz 1.25, 12.4-18 GHz	2 W avg. 300 W pk	APC-7	\$360
909A Option 012 and Option 013	dc-18 GHz	50 ohms	1.06 0-4 GHz 1.11, 4-12.4 GHz 1.3, 12.4-18 GHz	2 W avg. 300 W pk	Opt. 012 N male Opt. 013 N female	Subject \$15

11511A, 11512A, 11565A Coaxial shorts

These shorts are used for establishing measurement planes and known reflection phase and magnitude in 50Ω coaxial systems.

Our Coaxial & Waveguide Catalog and Microwave Measurement Handbook is available: 80 pages featuring over 300 measurement components. For a free copy, use request card at back of this catalog.

Model number and name

11511A N-female short
11512A N-male short
11565A APC-7 short

Price

\$20
\$15
\$40

910A/B, 914A Waveguide fixed and movable terminations

The 910A/B are fixed terminations for waveguide systems. The 914A/B are similar to the 910A/B, except that its absorptive element is movable and a lockable plunger controls the position of the element.

910A/B, 914A/B specifications

Model	Frequency Range (GHz)	SWR	Power Rating	Type	Waveguide Size (EIA)	Price
H910A	5.3-8.2	1.02	1 watt	fixed	WR137	\$180
H910A	7.05-10.0	1.02	1 watt	fixed	WR112	\$125
X910B	8.2-12.4	1.015	1 watt	fixed	WR90	\$125
P910A	12.4-18	1.02	1 watt	fixed	WR62	\$100
G914A	3.95-5.85	1.01	2 watt	sliding	WR187	\$380
H914A	5.3-8.2	1.01	2 watt	sliding	WR137	\$375
H914A	7.05-10.0	1.01	1 watt	sliding	WR112	\$375
X914B	8.2-12.4	1.01	1 watt	sliding	WR90	\$275
P914A	12.4-18	1.01	1/2 watt	sliding	WR62	\$275
K914B	18-26.5	1.01	1/2 watt	sliding	WR42	\$450
R914B	26.5-40	1.01	1/2 watt	sliding	WR28	\$415

920A/B, X923A, X930A Waveguide shorts

The 920A/B are movable shorts, adjustable through at least half a wavelength at the low end of the band. The X923A is also a movable short, but is adjustable through about two wavelengths at 8.2 GHz. The X930A is a shorting switch. SWR is less than 1.02 in "open", greater than 125 in "short."

920A/B, X923A, X930A specifications

Model	Frequency Range (GHz)	Waveguide Size EIA	Price
H920A	5.3-8.2	WR137	\$225
H920A	7.05-10.0	WR112	\$300
X923A	8.2-12.4	WR90	\$275
P920B	12.4-18	WR62	\$300
K920B	18.0-26.5	WR42	\$450
R920B	26.5-40.0	WR28	\$385
X930A	8.2-12.4	WR90	\$400

MICROWAVE TEST EQUIPMENT

Coaxial and waveguide low-pass bandpass filters

Models 360A-D; 362A; 8430A-8436A

- Effective elimination of undesirable signals
- Low insertion loss through passband
- No spurious response



360D



X362A



8432A

These Hewlett-Packard low-pass and bandpass filters facilitate microwave measurements by eliminating undesirable signals (such as harmonics) from the measurement system. Suppression of such signals is particularly important in applications such as broadband reflection and transmission measurements or slotted line measurements, where harmonics generated by the signal source could otherwise impair measurement accuracy. These filters also can be used as

preselectors for the HP 8555A Spectrum Analyzer. As such, they permit the maximum utilization of the analyzer's broad spectrum-width capability while ensuring virtually spurious-free displays.

Our Coaxial & Waveguide Catalog and Microwave Measurement Handbook is available: 80 pages featuring over 300 measurement components. For a free copy, use request card at back of this catalog.

360 Series coaxial filter specifications

Model	Cut-off Frequency MHz	Insertion Loss	Rejection	Impedance	VSWR Maximum	Connectors	Overall Length mm (in)	Shipping Weight kg (lb)	Price
360A	700	Less than 1 dB below 0.9 times cut-off frequency	Greater than 50 dB at 1.25 times cut-off frequency	50Ω	<1.6 to within 100 MHz of cut-off	Type N (M, f)	276 (10 7/8)	0.9 (2)	\$240
360B	1200			50Ω		Type N (M, f)	183 (7 1/2)	0.9 (2)	\$205
360C	2200			50Ω	<1.6 to within 200 MHz of cut-off	Type N (M, f)	274 (10 3/4)	0.9 (2)	\$140
360D	4100			50Ω	<1.6 to within 300 MHz of cut-off	Type N (M, f)	187 (7 3/8)	0.45 (1)	\$140

362 Series waveguide low pass filter specifications

Model	Passband GHz	Stopband GHz	Passband Insertion Loss	Stopband Rejection	SWR Maximum	Waveguide Size	Equivalent Flange	Length mm (in)	Shipping Weight kg (lb)	Price
X362A	8.2 - 12.4	16 - 37.5	<1 dB	At least 40 dB	1.5	WR 90	UG-39/U	136 (5 1/2)	0.9 (2)	\$700
M362A	10.0 - 15.5	19 - 47			1.5	WR 75	Cover	114 (4 1/2)	0.9 (2)	\$550
P362A	12.4 - 18.0	23 - 54			1.5	WR 62	UG-419/U	94 (3 1/8)	0.37 (13 oz)	\$720
K362A ¹	18.0 - 26.5	31 - 80			1.5	WR 42	UG-595/U	64 (2 1/2)	0.15 (5.3 oz)	\$550
R362A ¹	26.5 - 40.0	47 - 120	<2 dB	>35 dB	1.8	WR 28	UG-599/U	42 (1 21/32)	0.11 (4 oz)	\$485
¹ Circular Flange Adapters available: For K-Band, Specify 11515A (UG-425/U). For R-Band, Specify 11516A (UG-381/U).										\$110

8430 Series coaxial bandpass filters specifications

Model	Passband Frequency (GHz)	Maximum Passband Insertion Loss	Rejection Band Attenuation				Dimensions		Shipping Weight (kg) (lb)	Price
			Below Passband		Above Passband					
			Frequency (GHz)	Attenuation	Frequency (GHz)	Attenuation	(mm)	(in.)		
8430A	1 to 2	2 dB	≤0.8	≥50 dB	2.2 to 20	≥45 dB	140 × 121 × 25	5 1/4 × 4 3/4 × 1	1.4 (3)	\$695
8431A	2 to 4	2 dB	≤1.6	≥50 dB	4.4 to 20	≥45 dB	140 × 76 × 25	5 1/4 × 3 × 1	1.4 (3)	\$600
8432A	4 to 6	2 dB	≤3.5	≥50 dB	6.5 to 20	≥45 dB	114 × 51 × 25	4 1/2 × 2 × 1	0.9 (2)	\$410
8433A	6 to 8	2 dB	≤5.5	≥50 dB	8.5 to 20	≥45 dB	102 × 38 × 25	4 × 1 1/2 × 1	0.9 (2)	\$640
8434A	8 to 10	2 dB	≤7.5	≥50 dB	10.5 to 17	≥45 dB	118 × 25 × 25	4 3/4 × 1 × 1	0.9 (2)	\$560
8435A	4 to 8	2 dB	≤3.2	≥50 dB	8.8 to 20	≥45 dB	92 × 45 × 25	3 3/4 × 1 3/4 × 1	0.9 (3)	\$470
8436A	8 to 12.4	2 dB	≤6.9	≥50 dB	13.5 to 17	≥45 dB	73 × 25 × 25	2 7/8 × 1 × 1	0.45 (1)	\$410

MICROWAVE TEST EQUIPMENT

Harmonic mixers, tuners, phase shifters

Model 870A series, 885A series, P932A, 934A



X885A

885A Waveguide phase shifters

HP 885A Phase Shifters provide accurate, controllable phase variation in the J-, X-, and P-band frequency ranges. They are particularly useful in microwave bridge circuits where phase and amplitude must be adjusted independently. They are also used in the study of phased arrays.

The instruments are differential phase devices; that is, they add or subtract a known phase shift from the total phase shift which a wave undergoes in traveling through the device. They can be shifted continuously through any number of cycles.

The instruments have high accuracy over their entire phase range, -360 to $+360$ electrical degrees, have low power absorption, are simple to operate, and require no charts of interpolation. They are sturdily built, comprised of two rectangular-to-circular waveguide transitions with a dial-driven circular waveguide midsection. These waveguide phase shifters are housed in cast aluminum containers for extreme rigidity and durability.

870A Slide-screw tuners

Waveguide slide-screw tuners are used primarily for correcting discontinuities or for "flattening" waveguide systems. They are also used to match loads, terminations, power sensors, or antennas to the characteristic admittance of the waveguide. They are particularly valuable in determining experimentally the position and magnitude of matching structures required in waveguide systems.

885A specifications

Model	Frequency Range (GHz)	Differential Phase Angle Range	Differential Accuracy (the smaller of)	Insertion Loss	Insertion loss Variation vs. Frequency	SWR (max.)	Power Rating (Watts)	Waveguide Size Nom. O.D. mm (In.) EIA	Equivalent Flange	Length mm (In.)	Shipping Weight kg (lb)	Price
885A	5.3-8.2	-360° to $+360^\circ$	$\pm 3^\circ$ or $0.1 \Delta \phi$	< 2 dB	< 0.4 dB	1.35	10	38.1 \times 19.05 (1.5 \times 0.75) WR137	UG-344/U	638 (25 $\frac{1}{8}$)	8.0 (18)	\$1700
X885A	8.2-12.4	-360° to $+360^\circ$	$\pm 2^\circ$ ($\pm 3^\circ$, 10-12.4 GHz) or $0.1 \Delta \phi$	< 1 dB, 8.2-10 GHz; < 2 dB, 10-12.4 GHz	< 0.3 dB, 8.2-10 GHz; < 0.4 dB, 10-12.4 GHz	1.35	10	25.4 \times 12.7 (1 \times 0.5) WR90	UG-39/U	397 (15 $\frac{5}{8}$)	4.5 (10)	\$1300
P885A	12.4-18	-360° to $+360^\circ$	$\pm 4^\circ$ or $0.1 \Delta \phi$	< 3 dB	< 0.5 dB	1.35	5	17.83 \times 9.93 (0.702 \times 0.391) WR62	UG-419/U	312 (12 $\frac{3}{16}$)	4.0 (9)	\$1500

870A specifications

Model	Frequency Range (GHz)	Waveguide Size Nom. O.D. mm (In.) EIA	Equivalent Flange	Length (mm) (In.)	Net Weight (kg) (lb)	Shipping Weight (kg) (lb)	Price
X870A	8.20-12.40	25.4-12.7 (1 \times 0.5) WR90	UG-39/U	140 5 $\frac{1}{2}$	0.34 $\frac{3}{4}$	0.9 2	\$450
P870A	12.40-18.00	17.83 \times 9.93 (0.702 \times 0.391) WR62	UG-419/U	127 5	0.23 $\frac{1}{2}$	0.9 2	\$460



X870A



934A

HP 870A tuners consist of a waveguide slotted section with a precision-built carriage on which an adjustable probe is mounted. The position and penetration of the probe are adjusted to set up a reflection which cancels out an existing reflection in a system.

Probe penetration into the guide is varied by a micrometer drive. Position of the probe along the guide is adjusted by a thumb-operated wheel, and position can be read to 0.1 mm on a vernier scale. An SWR of 20 can be corrected to 1.02, with a maximum loss of 2 dB, and small SWRs can be corrected exactly.

934A, P932A harmonic mixers

The 934A and P932A simplify frequency measurements from 2 to 18 GHz. They are also excellent as RF mixers in phase-stabilized signal sources. Both feature high sensitivity, yet require no tuning.

934A, P932A specifications

Model	Frequency Range (GHz)	Maximum Input	Connector (waveguide size)	Min. video output*	Price
934A	2 to 12.4	100 mW	Type N	1.4 mV p-p	\$295
P932A	12.4 to 18	100 mW	(EIA, WR62)	0.4 mV p-p	\$525

*With 0 dBm input signal

Our Coaxial & Waveguide Catalog and Microwave Measurement Handbook is available: 80 pages featuring over 300 measurement components. For a free copy, use request card at back of this catalog.

MICROWAVE TEST EQUIPMENT

Coaxial switches
Models 8761A/B, 33311B

- High isolation
- Excellent repeatability

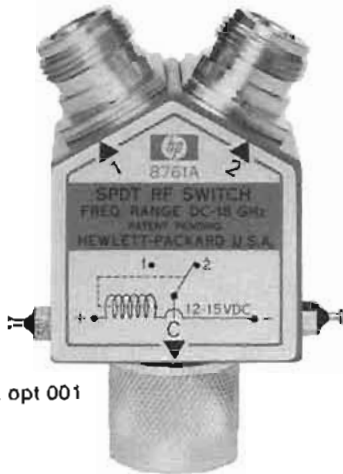

8761A opt 001

8761A/B Coaxial switch

The 8761 is a single-pole, double-throw coaxial switch with low standing-wave ratio, low insertion loss, and excellent isolation from dc to 18 GHz. Mechanically, the switch is a break-before-make type controlled by a latching solenoid. Any of seven coaxial connectors, or a 50-ohm termination, may be specified for each port.

8761A/B specifications

Characteristic impedance: 50 ohms.

Frequency range: dc to 18 GHz.

Standing-wave ratio: looking into one of the connected ports with 50 ohms (or built-in termination) on the other, third port open.

Frequency	SWR Connector type		
	7-mm	N	3-mm (SMA)
dc - 12.4 GHz	1.15 (1.20)	1.20 (1.25)	1.30 (1.30)
dc - 18 GHz	1.20 (1.25)	1.25 (1.30)	1.35 (1.35)

SWR in parenthesis applies to switch with built-in termination.

These specifications apply when connected ports are of the same connector type; for mixed connector types, the larger of the two SWRs applies. N-connector SWR specifications apply to Option 4 connectors.

Insertion loss: <0.5 dB, dc to 12.4 GHz; <0.8 dB, dc to 18 GHz.
Isolation: >50 dB, dc to 12.4 GHz; >45 dB, dc to 18 GHz.
Power: safely handles 10 W average, 5 kW peak, without built-in termination; built-in termination rated at 2 W average, 100 W peak.
Switching energy: 1.5 W for 20 ms (permanent magnet latching).
Solenoid voltages (dc or pulsed): 12 to 15 V, 8761A; 24 to 30 V, 8761B.
Switching speed: 35 to 50 ms (including settling time).
Life: >1,000,000 switchings.
Repeatability (typical): 0.03 dB after 1,000,000 switchings.
Dimensions: 41 × 38 × 38 mm (1.6 × 1.5 × 1.5 in.) excluding connectors and solenoid terminals.
Weight: net, 140 to 220 gm (5 to 8 oz). Shipping, 220 to 300 gm (8 to 11 oz).

Ordering information

Specify solenoid voltage and connectors (including built-in 50 ohm termination) by the alphabetic suffix on the switch model number and the appropriate three-digit option number.

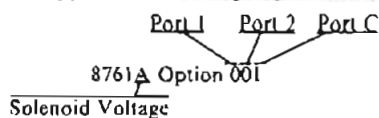

A: 12-15 V; B: 24-30 V

- Fast switching
- Magnetic latching



33311B

8761A/B Connector options

Option Code	Connector Type	Option Code	Connector Type
0	N Jack	4	7-mm for UT-250 Coax
1	N Plug	5	3-mm Jack
2	7-mm Jack	6	3-mm Plug
3	7-mm Plug	7	50Ω Termination

33311B Coaxial switch

The 33311B is a high-isolation (90 dB to 18 GHz), single-pole, double-throw coaxial switch with excellent characteristics through 18 GHz. It is designed for use in 50 ohm systems, and the unused port is automatically terminated internally with 50 ohms, thus eliminating the need for three-switch trees. This makes it particularly useful in systems which require low SWR on their lines at all times. It is small and lightweight. The switch is controlled by a latching solenoid and switching current is automatically cut off when switching is completed. Internal diodes suppress solenoid circuit transients.

33311B specifications

Characteristic impedance: 50 ohms.

Frequency range: dc to 18 GHz.

Connectors: 3 mm (SMA).

Standing-wave ratio: 1.25, dc to 12.4 GHz; 1.40, dc to 18 GHz.

Insertion loss: <0.5 dB, dc to 18 GHz.

Solenoid voltage (dc or pulsed): 24 volts. Diode protected to reduce voltage transients. Option 011, 5 V solenoids.

Life: >1,000,000 switchings.

Repeatability (typical): 0.03 dB after 1,000,000 switchings.

Dimensions: 54 × 54 × 14 mm (2 1/8 × 2 1/8 × 1/2 in.) excluding connectors and solenoid terminals.

Weight: net, 88 gm (3.1 oz). Shipping, 220 gm (8 oz).

Options: 011, 5-volt solenoid voltage.

Our Coaxial & Waveguide Catalog and Microwave Measurement Handbook is available: 80 pages featuring over 300 measurement components. For a free copy, use request card at back of this catalog.

Model number and name

Model number and name	Price
8761A/B order must include option number	
8761A/B Coaxial Switch (quantity 1 - 9)	\$195
8761A/B Coaxial Switch (quantity 10 - 24)	\$185
8761A/B Coaxial Switch with built-in termination	add \$35
33311B Coaxial Switch (quantity 1-9)	\$395
33311B Coaxial Switch (quantity 10-24)	\$365



MICROWAVE TEST EQUIPMENT

Adapters, waveguide stands, air lines

Models 281A/B, 292A/B, 11515/6/A, 11524/5/A, 11533/4/A, 11588A, 11606A, 11566/7/A

- Increase versatility of microwave measurements

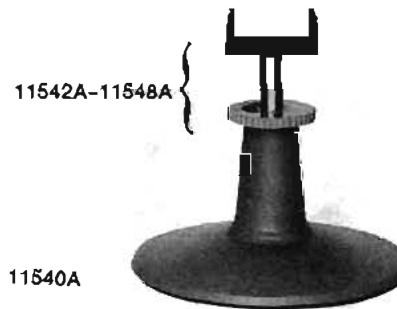

292A/B, 11515A, 11516A Waveguide to waveguide adapters

Models 292A,B waveguide-to-waveguide adapters connect two different waveguide sizes with overlapping frequency ranges. The 292A consists of a short tapered section of waveguide. The 292B is broached waveguide with a step transition between waveguide sizes.

11524A, 11525A, 11533A, 11534A Coax to coax adapters

These coaxial adapters permit easy interconnection of 50-ohm precision 7-mm (APC-7) connectors and 50-ohm Type N or SMA (3-mm type) connectors.

281A/B Coax to waveguide adapters

HP 281A,B adapters transform waveguide impedance into 50-ohm coaxial impedance. Power can be transmitted in either direction, and each adapter covers the full frequency range of its waveguide band with SWR less than 1.25.

The 11515A is a square to circular waveguide adapter for K-band (UG-595 to UG-425). The 11516A is a square to circular waveguide adapter for R-band (UG-599 to UG-381).

11588A Swivel adapter, 11606A rotary air line

The 11606A rotary air line and the 11588A swivel adapter are capable of a full 360° of rotation. A combination of the air line and the adapter permits rigid coax movement in three dimensions. Even the most awkwardly shaped devices can be easily connected or disconnected in a coax system with the aid of these components.

11566A, 11567A Air line extension

Impedance: 50 ohms.

Frequency: dc - 18 GHz.

Reflection coefficient: 0.018 + 0.001 (frequency in GHz).

Connector: APC-7.

Length: 11566A: 10.25 cm, 11567A: 20.25 cm.

Weight: 0.45 kg (1 lb) net.

11540 Series waveguide stand, waveguide holders

The 11540A waveguide stand locks HP waveguide holders at any height from 70 to 133 mm (2 7/8" to 5 1/4"). The stand is 64 mm (2 1/2") high, and the base measures 121 mm (4 3/4") in diameter. The waveguide holders are offered in seven sizes to hold waveguide covering frequencies from 3.95 to 40 GHz. They consist of a molded plastic cradle with a center rod.

11542A-11548A

11540A

292A/B specifications

HP Model	SWR	Length		Frequency range (GHz)	Price
		mm	(in.)		
HX292B	1.05	38	1 1/2	8.20 to 10.0	\$105
MX292B	1.05	60	2 3/4	10.0 to 12.4	\$135
MP292B	1.05	60	2 3/4	12.4 to 15.0	\$105
NP292A	1.05	60	2 3/4	15.0 to 18.0	\$95
NX292A	1.05	60	2 3/4	18.0 to 22.0	\$100

281A/B specifications

HP Model	SWR	Frequency Range (GHz)	Waveguide Size EIA	Coaxial Connector	Length ³		Price
					mm	(in.)	
S281A	1.25	2.60-3.95	WR284	N Female	140	5 1/2	\$115
G281A	1.25	3.95-5.85	WR187	N Female	95	3 3/4	\$100
J281A	1.25 ¹	5.30-8.20	WR137	N Female	51	2	\$75
H281A	1.25	7.05-10.0	WR112	N Female	41	1 3/4	\$75
X281A	1.25	8.20-12.4	WR90	N Female	35	1 1/4	\$75
X281B	1.25	8.20-12.4	WR90	APC-7 ²	35	1 1/4	\$165
P281B	1.25	12.4-18	WR62	APC-7 ²	64	2 1/2	\$145

1. 1.3 from 5.3 to 5.5 GHz.

2. Option 013. Furnished with stainless steel N-female connector, less \$15.

3. Shipping weight for all models, approximately 0.45 kg (1 lb).

11524A, 11525A, 11533A, 11534A specifications

HP Model	Description	Shipping Weight	Price
11524A	APC-7 to N female	110 g (4 oz)	\$85
11525A	APC-7 to N male	140 g (5 oz)	\$85
11533A	APC-7 to SMA male	140 g (5 oz)	\$135
11534A	APC-7 to SMA female	140 g (5 oz)	\$135

11588A, 11606A specifications

HP Model	Frequency Range GHz	VSWR	Connectors	Dimensions mm (in.)	Shipping Weight kg (lb)	Price
11588A	DC - 12.4	1-1 ^{1,2}	7 mm, male 7 mm, female	42 x 59 x 30 (1 1/2 x 2 3/16 x 1 1/16)	0.28 (10 oz.)	\$290
11606A	DC - 12.4	1-1 ^{1,2}	APC-7 7 mm, female	100 x 19 (4 x 3/4)	0.45 (1 lb)	\$230

1. Insertion Loss: <0.5 dB

2. Uncertainty due to rotation: -57 dB

Model number and name

Model number and name	Price
11515A Waveguide adapter	\$110
11516A Waveguide adapter	\$110
11566A Air line extension	\$150
11567A Air line extension	\$170
11540A Waveguide stand	\$25
11542A Waveguide holder	\$20
11543A to 48A Waveguide holder	\$15



415E

The Hewlett-Packard Model 415E SWR meter is a low noise, tuned amplifier-voltmeter calibrated in dB and SWR for use with square law detectors. It is an extremely useful instrument for measuring SWR, attenuation, and gain directly from metered scales, or as a tuned amplifier for driving an X-Y recorder when making RF substitution measurements. The 415E responds to a standard tuned frequency of 1000 Hz. This frequency is front panel adjustable over a range of 7% for exact matching to the internal 1 kHz modulation of the signal source being used. Amplifier bandwidth is also adjustable from 15 to 130 Hz. The narrow bandwidth allows maximum sensitivity at CW frequencies while the wider bandwidths enable swept tests to be displayed on an oscilloscope or X-Y recorder.

A precision 60 dB attenuator with an accuracy of 0.05 dB/10 dB assures high accuracy in making substitution measurements. An expand-offset feature allows any 2 dB range to be expanded to full scale for maximum resolution. Linearity is ± 0.02 dB on expanded ranges and is limited only by meter resolution on normal scales. This performance, together with the inherently low noise figure, allows maximum measurement range with exceptional resolution and linearity.

The Model 415E operates with either crystal or bolometer detectors. Both high and low-impedance inputs are available for crystal detectors. Precise bias currents of 4.5 and 8.7 mA (200 Ω) are available for operation with bolometers as selected at the front panel. This bias is peak limited for positive bolometer protection.

Both ac and dc outputs located on the rear panel allow use of the 415E as a high-gain tuned amplifier or for X-Y recorder operation. In addition, the 415E can be operated with an internally mounted battery pack (option 001) for completely portable use.

Specifications

Sensitivity: 0.15 μ V rms for full-scale deflection at maximum bandwidth (1 μ V rms on high impedance crystal input).

Noise: at least 7.5 dB below full scale at rated sensitivity and 130 Hz bandwidth with input terminated in 100 or 5000 Ω ; noise figure less than 4 dB.

Range: 70 dB in 10 and 2-dB steps.

Accuracy: ± 0.05 dB/10 dB step; maximum cumulative error between any two 10 dB steps, ± 0.10 dB; maximum cumulative error between any two 2 dB steps, ± 0.05 dB; linearity, ± 0.02 dB on expand scales, determined by inherent meter resolution on normal scales.

Input: unbiased low and high impedance crystal (50-200 and 2500-10,000 Ω optimum source impedance respectively for low noise); biased crystal (1 V into 1 k Ω); low and high current bolometer (4.5 and 8.7 mA $\pm 3\%$ into 200 Ω), positive bolometer protection; input connector, BNC female.

Input frequency: 1000 Hz adjustable 7%; other frequencies between 400 and 2500 Hz available on special order.

Bandwidth: variable, 15-130 Hz; typically less than 0.5 dB change in gain from minimum to maximum bandwidth.

Recorder output: 0-1 V dc into an open circuit from 1000 Ω source impedance for ungrounded recorders; output connector, BNC female.

Amplifier output: 0 - 0.3 V rms (Norm), 0 - 0.8 V rms (Expand) into at least 10,000 Ω for ungrounded equipment; output connector, dual banana jacks.

Meter scales: calibrated for square-law detectors; SWR: 1 - 4, 3.2 - 10 (Norm); 1 - 1.25 (Expand). dB: 0 - 10 (Norm); 0 - 2.0 (Expand); battery: charge state.

Meter movement: taut-band suspension, individually calibrated mirror-backed scales; expanded dB and SWR scales greater than 108 mm (4 $\frac{1}{4}$ " long).

RFI: conducted and radiated leakage limits are below those specified in MIL-I-6181D.

Power: 115-230 V $\pm 10\%$, 50-400 Hz, 1 W; optional rechargeable battery provides up to 36 hr continuous operation.

Dimensions: 190 mm wide, 155 mm high, 279 mm deep (7 $\frac{1}{2}$ " \times 6 $\frac{1}{32}$ " \times 11").

Weight: net 4 kg (9 lb). Shipping 5.8 kg (13 lb).

Combining cases: 1051A, 286 mm deep (11 $\frac{1}{4}$ "). 1052A 416 mm deep (16 $\frac{1}{4}$ ").

Options and accessories

Option 001: rechargeable battery installed
Option 002: rear panel input connector in parallel with front panel connector

Price
add \$105

add \$25

1051A Combining case

\$275

1052A Combining case

\$325

415E SWR meter

\$700

MICROWAVE TEST EQUIPMENT

Frequency response test sets, 15 MHz to 18 GHz

8755 System

- 15 MHz to 18 GHz frequency range
- Absolute and ratio measurement capability

- 60 dB dynamic measuring range
- Excellent stability with time and temperature



8755L

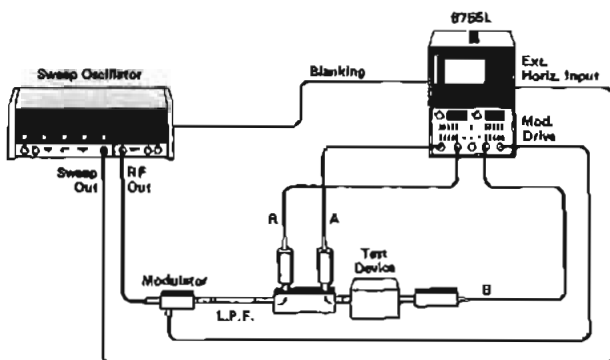
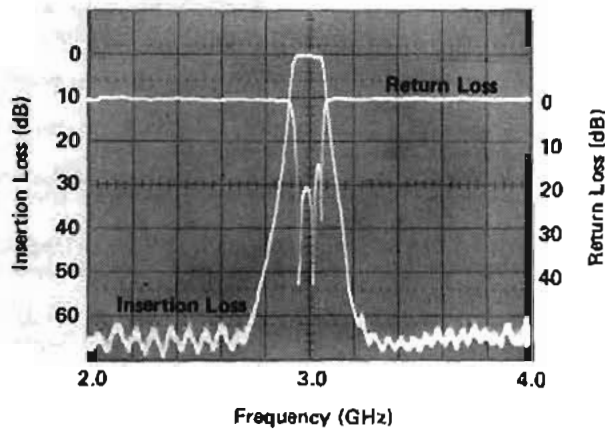

8755M

Swept amplitude measurements over a frequency range of 15 MHz to 18 GHz can be made using the 8755 Frequency Response Test Set. This versatile measuring system consists of an 8755A plug-in for 180 series oscilloscope displays, three 11664A Schottky diode detectors, and an 11665B modulator. The dual channel 8755 allows simultaneous swept-frequency display of two ratio measurements or measures absolute power at the push of a button. The 8755 offers a number of advantages besides covering a wide frequency range; the 11665B modulator allows AC signal processing enabling virtually drift-free operation with time and temperature compared to non-modulated systems. Use of Schottky diode detectors, which are completely interchangeable, enable a -50 dBm sensitivity as compared to -35 dBm with crystal detectors. This means a 60 dB dynamic measuring range is available with solid state sweepers having a 10 mW output (8620 Family). Front panel controls are easy to understand and operate. Each channel is separate, but identical, and all functions are push button controls. A direct reading digital dB off-set thumbwheel allows the magnitude of any displayed signal to be easily determined. An offset cal vernier is used to average frequency response variations of directional couplers and detectors, and to compensate for coupling factors.

Typical applications

Simultaneous insertion and return loss

A common measurement set-up for using the 8755 is shown in the diagram. A dual directional coupler enables the "R" detector to sample incident power while the "A" detector measures reflected power. The ratio "A/R" then provides return loss information while the "B/R" trace displays insertion gain/loss data simultaneously. A real-time display of a bandpass filter is shown in the photo. The ability to monitor the effect of adjustments on both parameters is especially advantageous for production use. Directional devices, including a 40-MHz to 18-GHz reflectometer bridge, decade range directional couplers, and a complete family of octave band couplers are available for reflectometer setups.

Active device gain and harmonic content

Both the absolute power and ratio capability of the 8755 are useful when testing active devices. Using the set-up shown in the diagram on the following page, swept frequency gain of a test amplifier is determined by selecting the "A/R" pushbutton. Absolute input and output levels can be measured by depressing individual detector channels. The "B/R" ratio gives a measure of harmonic content dependent on the range of bandpass filter used. This technique enables a quick measure of amplifier harmonic content to be made on a swept basis.

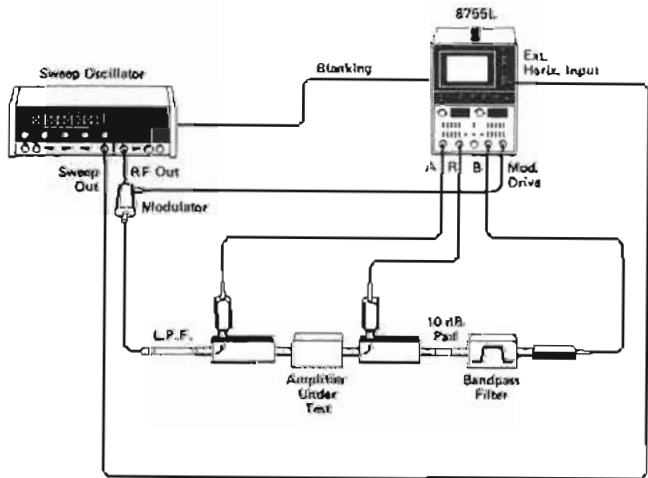
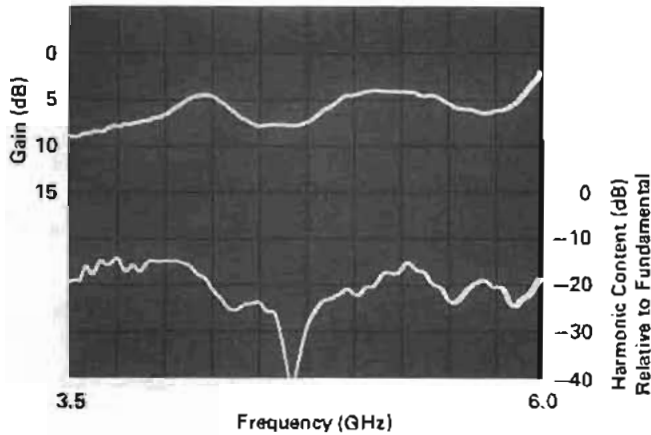

Its wide frequency coverage and simplicity of operation make the 8755 well-suited for a number of other microwave applications. Antenna measurements are simplified since the AC system enables use of long extension cables on detectors without performance degradation. Cable measurements, including fault location, are made quickly and accurately using the HP 11667A power splitter. Amplifier measurements including gain, harmonic content, and 1 dB gain compression, can be made while zero dc offset recorder outputs enable hard copy results. Since the 8755 responds only to the 27.8 kHz modulated signal, LO feedthrough can be eliminated from mixer measurements. Accurate SWR measurements from 1.8 to 18 GHz can be made using the HP 817B Swept Slotted Line. Simultaneous reflection and transmission measurements from 40 MHz to 18 GHz can be made using the HP 11666A Bridge with the HP 8620C/86222A/86290A broadband solid state sweepers.

Specifications

87555L and 87555M Systems

Function: the 8755L and 8755M are configured test sets complete with plug-in and display, three detectors, and modulator.

Frequency range: 15 MHz to 18 GHz.

Measurement range

Single channel: +10 dBm to -50 dBm (noise level).

Ratio of two channels: 60 dB

Frequency response (ratio measurement):

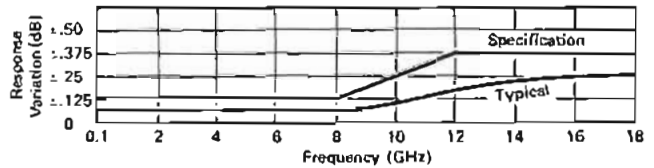

Curve does not include mismatch or coupler ambiguities.

Ratio measurement accuracy:

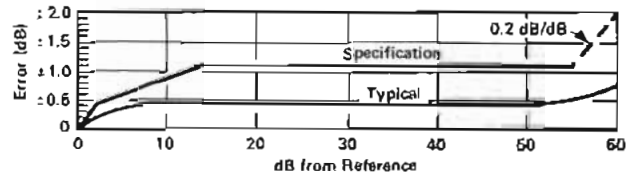

Accuracy curve shows system uncertainty for a relative measurement with +10 dBm incident at the test detector when the 0-dB reference is set. Accuracy when calibration levels below +10 dBm are used remains the same, except the additional 0.2 dB/dB uncertainty should be added for measurements below -45 dBm. This curve includes system noise, offset uncertainty, and crosstalk, and assumes the reference detector power remains fixed between calibration and test. System frequency response is specified separately.

Detector return loss:

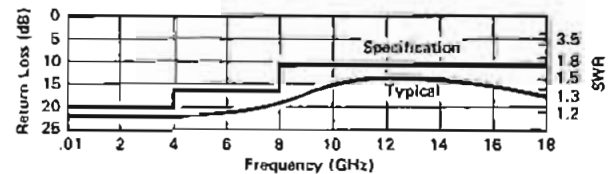

Impedance: 50Ω

Resolution: each channel independent, 10, 5, 1 or 0.25 dB per division.

Offset: each channel independent, ±59 dB in 1 dB steps.

Recorder outputs: 0.5 volt/division; zero dc offset.

Marker and blanking inputs: accepts both positive and negative marker and blanking inputs.

Temperature range: operation, 0 to 55°C; storage -40°C to 75°C. Temperature drift typically 0.01 dB/°C from 5° to 55°C.

Standard connectors

11664A detectors: Type N-male

11685B modulator: Input N-female, output N-male.

Dimensions

8755L (182T display): 202 mm wide, 338 mm high, 499 mm deep (7 7/8" × 5 3/8" × 21 1/4").

8755M (180TR display): 425 mm wide, 133 mm high, 543 mm deep (16 1/4" × 5 1/8" × 21 1/8").

Weight

8755L: net 15.5 kg (34.3 lb). Shipping 23 kg (50 lb).

8755M: net 14.5 kg (31.8 lb). Shipping 22 kg (50 lb)

MICROWAVE TEST EQUIPMENT

8755 System Accessories

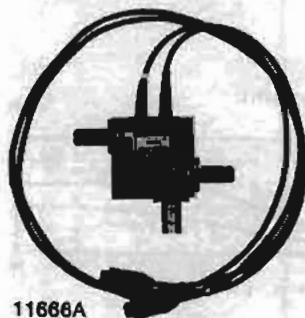

11666A



11668A



11667A



11678A

11666A Reflectometer Bridge

Reflection measurements covering from 40 MHz to 18 GHz with one coupling device can be made with the Model 11666A Reflectometer Bridge. Operation of this type of coupling device is based on principles of the resistive Wheatstone Bridge extended to microwave frequencies. When three bridge arms are 50Ω, the voltage across corners of the bridge is directly proportional to the reflection coefficient of the device connected in the fourth arm. Equivalent directivity is then a measure of how well the bridge circuit is balanced with a 50Ω termination connected. (Ideally this would create a voltage null representing infinite return loss.) The high equivalent directivity achievable over wide bandwidths makes the bridge configuration attractive.

The 11666A is completely dedicated to the 8755; two Schottky diode detectors (which sample the incident and reflected signals for ratioing by the 8755) are incorporated as an integral part of the bridge unit. The effective external leveling achieved by ratioing thus isolates the measurement port from source/bridge input mismatch. With the addition of an external 11664A detector, two simultaneous ratio measurements of insertion and return loss can be made. Small size combined with its wide frequency range and high directivity make the 11666A ideal for production use.

Specifications 11666A (connected to the 8755A Analyzer)

Frequency Range: 40 MHz to 18 GHz.

Frequency Range	Equivalent Directivity	Equivalent Output SWR
40 to 100 MHz	30 dB	1.25
0.1 to 1 GHz	38 dB	1.25
1 to 2 GHz	36 dB	1.25
2 to 4 GHz	33 dB	1.25
4 to 8 GHz	29 dB	1.25
8 to 12 GHz	27 dB	1.27
12 to 18 GHz	26 dB	1.52

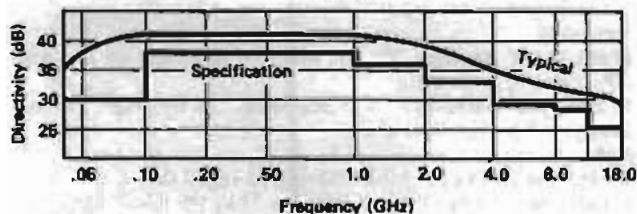

Frequency tracking

(between incident and reflected arms): ±1.6 dB

(between incident and test port, including ±0.5 dB from 11664A detector): ±2.1 dB

Nominal coupling: 6-dB incident arm.
9-dB reflected arm.
9-dB transmission loss.

Input SWR: 1.8

Maximum input power: +15 dBm.

Connectors: Type N-Female on input and output. APC-7 Optional.
Dimensions: 69.9 mm wide × 69.9 mm high × 46.6 mm deep (2.75" × 2.75" × 1.83"). Cable length, 1219 mm (48").

Weight: net, 0.7 kg (1.5 lb). Shipping, 2.26 kg (5.13 lb).

Accessories furnished: 11512A short, Type N-Male (11565A short, APC-7 with Options 002 and 003).

11667A Power splitter

The 11667A Power Splitter is recommended when making wide-band transmission measurements using the 8755 Test Set. This two-resistor type splitter provides excellent output SWR at the auxiliary arm when used for source leveling or ratio measurement applications. The 0.25 dB tracking between output arms over a frequency range from dc to 18 GHz allows wideband measurements to be made with a minimum of uncertainty.

Frequency range: dc to 18 GHz

Impedance: 50Ω

Input SWR	dc-4 GHz	dc-8 GHz	dc-18 GHz
Equivalent output SWR: (leveling or ratio measurement)	≤1.15	≤1.25	≤1.45
Output tracking: (between output arms)	1.10	1.20	1.33
	0.15	0.20	0.25

Insertion loss: 6 dB nominal (input to either output).

Maximum input power: +27 dBm.

Connectors: Type N female on all ports.

Dimensions: 50 mm wide, 46 mm high, 19 mm deep (2" × 1 13/16" × 3/4")

Weight: net, 0.06 kg (2 oz). Shipping 0.22 kg (8 oz).

11678A low pass filter kit

The 11678A Low Pass Filter Kit contains five filters conveniently matched to HP 8620 sweeper bands. These filters have <1.1 dB insertion loss with >40 dB rejection at 1.25 fc. Filter use is recommended to reduce undesirable harmonics causing errors in broadband detector measurements.

Frequency range: low pass filters, cutoff frequency fc: 11688A, 2.8 GHz; 11689A, 4.4 GHz; 11684A, 6.8 GHz; 11685A, 9.5 GHz; 11686A, 13.0 GHz.

Connectors: N-Male, N-Female

Weight: net 0.44 kg (1 lb). Shipping 1.2 kg (2.9 lb).

11688A High pass filter

The 11688A High Pass Filter accessory is recommended when making measurements on active devices which have gain below 50 MHz. Use of the 11688A, placed after the 11665B, reduces the modulator drive feedthrough from 8 mV to 1 mV and prevents possible amplifier saturation. Use of the 11688A filter is not necessary for passive measurements since the feedthrough from the 11665B is -65 dBm and causes no degradation in system performance.

Frequency range: 50 MHz to 18 GHz

	Insertion Loss	Return Loss
50 - 100 MHz	≤2.5 dB	≥12 dB
100 MHz - 8 GHz	≤1.0 dB	≥16 dB
8 - 12 GHz	≤1.0 dB	≥14 dB
12 - 18 GHz	≤1.5 dB	≥14 dB

Maximum Input: +27 dBm.

Connectors: N-female, N-male

Weight: 0.13 kg (5 oz). Shipping 0.28 kg (10 oz).

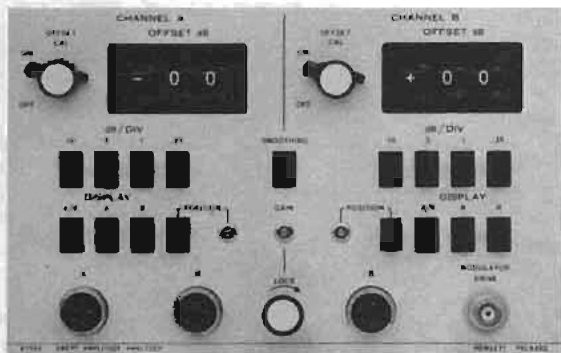

8755A



11665B



11664A

Individual instrument specifications

8755A Plug-in

Function: swept amplitude analyzer for 180 series displays. Has inputs for three 11664A detectors and supplies 27.8 kHz drive for 11665B modulator.

Weight: net, 2.8 kg (6.3 lb). Shipping, 4.5 kg (10 lb).

11665B Modulator

Function: absorptive on-off modulator designed for and powered by the 8755A plug-in.

Frequency Range	Return Loss On and Off	Insertion Loss	
		On	Off
15 - 40 MHz	≥10 dB	≤7.0 dB	≥35 dB
40 MHz - 4 GHz	≥15 dB	≤3.2 dB	≥35 dB
4 - 8 GHz	≥12 dB	≤3.8 dB	≥40 dB
8 - 12.4 GHz	≥8 dB	≤4.3 dB	≥45 dB
12.4 - 18 GHz	≥8 dB	≤5.0 dB	≥45 dB

Modulator drive feedthrough: ≤8 mV (peak) at 27.8 kHz at either port when powered by the 8755A. Reduced to ≤1 mV (peak) using the 11668A. (See 11668A High Pass Filter).

Drive current: nominally +50 mA in ON condition, -50 mA Off condition.

Weight: net, 0.17 kg (6 oz). Shipping, 0.9 kg (2 lb).

11664A Detectors

Function: hot carrier diode detects envelope of the modulated microwave signal, 10 MHz to 18 GHz.

Frequency response:

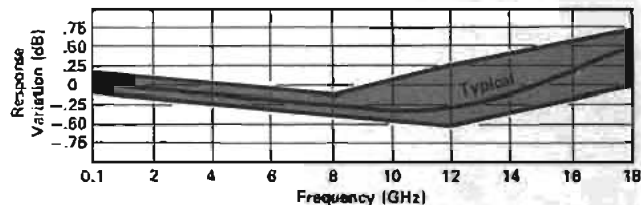

Note: Response of any 11664A detector falls within the shaded areas without any instrument adjustments.

Weight: net, 0.17 kg (6 oz). Shipping, 0.9 kg (2 lb).

Display units

The 8755A can be used with any 180 series display. However, the 180 "T" series displays are recommended. These mainframes provide long persistence P7 which reduces flicker on slow sweeps, negative z-access blanking input, and zero DC offset recorder outputs. Both 8755L and 8755M systems come with "T" displays. Retrofit kits are available.

Ordering information

Two complete test systems have been configured for ordering convenience. The 8755L is cabinet configured in a 182T large screen display. The 8755M provides the 180TR rack mount display. Both systems include the 8755A plug-in, three 11664A detectors and the 11665B modulator with standard connector options only. To order a different mainframe or non standard connector options each part of the system must be listed individually.

Model number and name	Price
8755L Complete cabinet test set	\$4425
8755M Complete rack test set	\$4425
8755A Test set plug-in only	\$1700
11665B 15 MHz - 18 GHz modulator	\$395
Option 011 Input N-female, Output N female	N/C
Option 013 Input N-female, output APC-7	add \$25
Option 021 Input N-male, output N-male	N/C
Option 022 Input N-male, output N-male	N/C
Option 023 Input N-male, output APC-7	add \$25
11664A 15 MHz - 18 GHz detector	\$250
Option 001 APC-7 connector	add \$25
Option 002 SMA female connector	N/C
Option 003 SMA male connector	N/C
182T Large screen cabinet scope display	\$1500
180TR Standard screen rack display	\$1500
181T Storage, cabinet display	\$2400
181TR Storage, rack display	\$2500

Accessories:

11666A Reflectometer bridge	\$2100
Option 001 Input N-female, Output N-male	N/C
Option 002 Input N-female, Output APC-7	add \$50
Option 003 Input & output APC-7	add \$75
11679A 25 Ω detector extension cable	\$55
11679B 200 Ω detector extension cable	\$195
11668A 50 MHz high pass filter	\$225
Option 001 APC-7 input and output	add \$55
Option 002 Type N female input and output	N/C
11667A DC - 18 GHz power splitter	\$525
Option 001 Type N male input, type N female outputs	N/C
Option 002 Type N female input, APC-7 outputs	add \$75
11678A Low pass filter kit	\$450
Individual filters, specify model number	\$90

NETWORK ANALYZERS

Complete characterization of linear networks

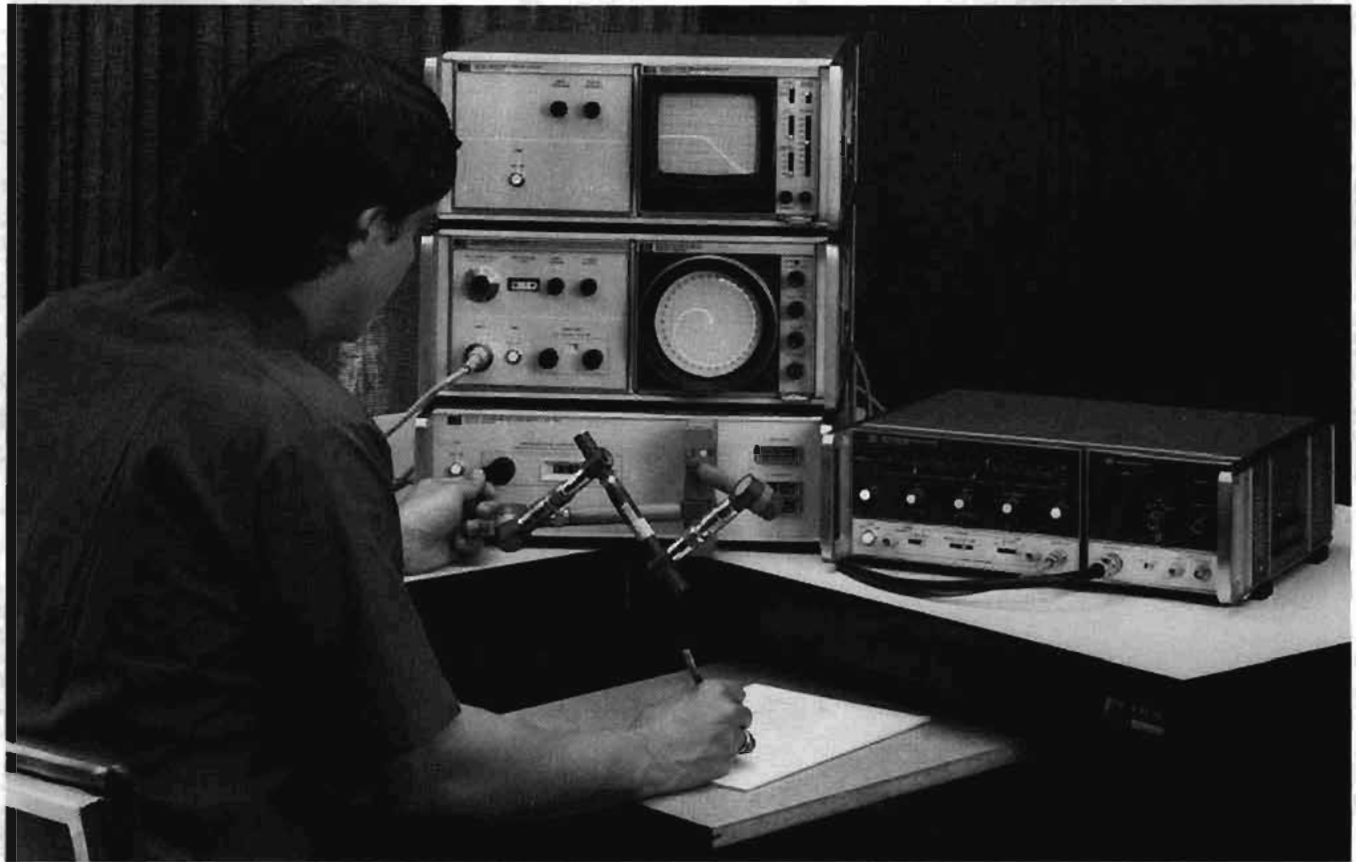

Why network analysis?

Characterizing the behavior of linear networks that will be stimulated by arbitrary signals and interfaced with a variety of other networks is a fundamental problem in both synthesis and test processes. For example, the engineer designing a multicomponent network must predict with some certainty the final network performance from his knowledge of the individual components. Similarly, a production manager must know allowable tolerances on the products he manufactures and whether the final products meet the specified tolerances. Network analysis offers a solution to these problems through complete description of linear network behavior in the frequency domain.

Network analysis accomplishes the description of both active and passive network by creating a data model of such component parameters as impedances and transfer functions. However, these parameters not only vary as a function of frequency but are also complex variables in that they have both magnitude and phase. Until the advent of the modern network analyzer, phase was difficult to measure at CW frequencies and often involved laborious calculations; these measurements were accomplished by conventional oscilloscopes at lower frequencies and slotted lines at microwave frequencies. However, swept network analyzers now measure amplitude and phase (the total complex quantity) as a function of frequency with less difficulty than conventional CW measurements. Impedance and transfer functions can

then be conveniently displayed on a swept CRT, X-Y recorder, or calculator (or computer) controlled peripherals such as a printer and/or a plotter. HP digital calculators (and computers) also combine with network analyzers to give new levels of speed and accuracy in swept measurement that could only be attained previously by long and laborious calculations at CW frequencies.

Thus, network analysis satisfies the engineering need to characterize the behavior of linear networks quickly, accurately, and completely over broad frequency ranges. In design situations, this minimizes the time required to test new designs and components, allowing more time to be spent on the design itself. Likewise, production test times may be minimized while reducing the uncertainties surrounding the test.

What is network analysis?

Network analysis is the process of creating a data model of transfer and/or impedance characteristics of a linear network through sine wave testing over the frequency range of interest. All network analyzers in the HP product line operate according to this definition.

Creating a data model is important in that actual circuit performance often varies considerably from the performance predicted by calculations. This occurs because the perfect circuit element doesn't exist and because some of the electrical characteristics of a circuit may vary with frequency.

At frequencies above 1 MHz lumped elements actually become "circuits" consisting of basic element plus parasitics like stray capacitance, lead inductance, and unknown absorptive losses. Since parasitics depend on the individual device and its construction they are almost impossible to predict. Above 1 GHz component geometries are comparable to a signal wavelength, intensifying the variance in circuit behavior due to device construction. Further, lumped-element circuit theory is useless at these frequencies and distributed-element (or transmission-line) parameters are required to completely characterize a circuit.

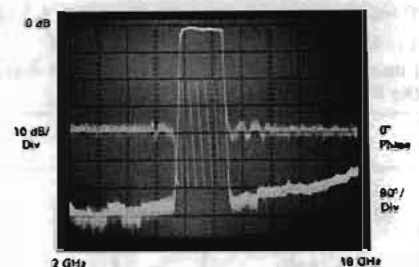

Figure 1. 2 GHz to 18 GHz measurement of magnitude and phase in a single sweep

Data models of both transfer and impedance functions must be obtained to completely describe the linear behavior of a circuit under test. At lower frequencies, h, y, and z-parameters are examples of transfer

and/or impedance functions used in network description; at higher frequencies, S-parameters are used to characterize input-output impedances and transfer functions. Therefore, a network analyzer must measure some form of a circuit's transfer and impedance functions to achieve its objective of complete network characterization.

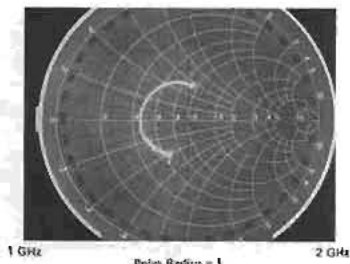

Figure 2. Input Impedance of microcircuit amplifier is read directly with Smith Chart Overlay for Polar Display

Network analysis is limited to the definition of linear networks. Since linearity constrains networks stimulated by a sine wave to produce a sine wave output, sine wave testing is an ideal method for characterizing linear network's amplitude and phase responses as a function of frequency. In nonlinear measurements phase is often meaningless and amplitude has to be defined with respect to individual frequency components. For nonlinear measurements see sections on spectrum analyzers and wave analyzers.

Network analyzers

Hewlett Packard Network Analyzers are instruments that measure transfer and/or impedance functions of linear networks through sine wave testing. A network analyzer system accomplishes these measurements by configuring its various components around the device under test. The first requirement of the measurement system is a sine wave signal source to stimulate the device under test. Since transfer and impedance functions are ratios of various voltages and currents, a means of separating the appropriate signals from the measurement ports of the device under test is required. Finally, the network analyzer itself must detect the separated signals, form the desired signal ratios, and display the results.

Signal sources and signal separation.

In the general case, any sine wave source meeting the network analyzer's specifications can be used to stimulate the device under test. For CW measurements a simple oscillator may suffice; for greater CW frequency accuracy a signal generator or synthesizer may also be desirable. If the analyzer is capable of swept measurements, great economies in time can be achieved by stimulating the device under test with a sweep oscillator or sweeping synthesizer. This allows quick and easy characterization of devices over broad frequency ranges. Some network analyzers will operate only with a companion source which both stimulates the device

under test and acts as the analyzer's internal oscillator.

At low frequencies it is not particularly difficult to separate the appropriate voltages and currents required for transfer and impedance function measurements. Signal separation is merely the process of establishing the proper shorts, opens, and connections at the measurement ports of the device under test. As frequencies increase the problem of signal separation usually involves traveling waves on transmission lines and becomes correspondingly more difficult. Hewlett Packard manufactures test sets (often called "transducers") applicable for separating the appropriate traveling waves in a variety of high frequency measurements.

Broadband and narrowband detection

After the desired signals have been obtained from the test set (or transducer) they must be detected by the network analyzer; HP network analyzers can use one of two detection methods. Broadband detection accepts the full frequency spectrum of the input signal while narrowband detection involves tuned receivers which convert CW or swept RF signals to a constant IF signal. There are certain advantages to each detection scheme.

Broadband detection reduces instrument cost by eliminating the IF section required by narrowband analyzers but sacrifices noise and harmonic rejection. However, noise is not a factor in many applications, and careful measurement techniques, using filters, can eliminate harmonic signals that would otherwise preclude accurate measurements. Broadband systems are generally source independent while some narrowband systems require companion tracking sources. Finally, broadband systems can make measurements where the input and output signals are not of the same frequency, as in the measurement of the insertion loss of mixers and frequency doublers. Narrowband systems cannot make these measurements.

Narrowband detection makes a more sensitive low noise detection of the constant IF possible. This allows increased accuracy and dynamic range for frequency selective measurements (as compared to broadband systems) and high resolution through IF substitution using precision IF attenuators. Source dependent narrowband systems utilize a companion tracking source not only to stimulate the device under test but also to produce a signal offset from the RF by a fixed frequency for tuning the analyzer's constant IF.

Signal processing and display

Once the RF has been detected, the network analyzer must process the detected signals and display the measured quantities. All HP network analyzers are multichannel receivers utilizing a reference channel and at least one test channel; absolute signal levels in the channels, relative signal levels (ratios) between the channels, or relative phase difference between channels can be measured depending on the analyzer. Using these measured quantities, it is possible to either display directly or compute the amplitude and phase of transfer or impedance functions.

Amplitude measurements fall into two categories, relative and absolute; absolute measurements involve the exact signal level in each channel while relative measurements involve the ratios of the two signal channels. Absolute measurements are usually expressed in voltage (dBV) or in power (dBm). The units dBV are derived by taking the log ratio of an unknown signal in volts to a one volt reference. Similarly, dBm is the log ratio of unknown signal power to a one milliwatt reference.

Relative ratio measurements are usually made in dB which is the log ratio of an unknown signal (Test Channel) with a chosen reference signal (Reference Channel). This allows the full dynamic range of the instrumentation to be used in measuring variations of both high and low level circuit responses. For example, 0 dB implies the two signal levels have a ratio of unity while ± 20 dB implies a 10:1 voltage ratio between two signals.

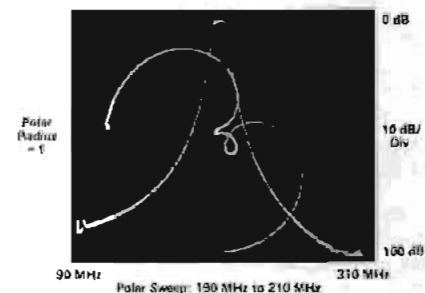

Figure 3. Simultaneous measurement of transmission response and passband reflection coefficient

All network analyzer phase measurements are relative measurements with the reference channel signal considered to have zero phase. The analyzer then measures the phase difference of the test channel with respect to the reference channel.

Measurement results at CW frequencies may be displayed on analog meters, LED's, or calculator (or computer) controlled printers. Swept frequency measurements of amplitude and phase may be displayed versus frequency on CRT's or X-Y plotters. Real-time dynamic displays are both fast and convenient in either design optimization or production testing.

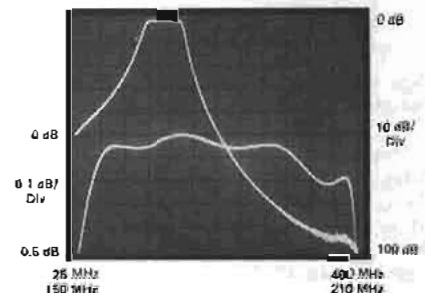

Figure 4. Automatic alternate sweep for coincident measurements filter passband and skirts

NETWORK ANALYZERS

Complete characterization of linear networks (cont.)

Low frequency network analysis.

Networks operating at frequencies below 10 MHz are generally characterized by measuring the gain and phase changes through the network and the associated input and output impedance; h, y, and z-parameters as well as other lumped-component models are typical analytical and computational tools used to represent these measurements. The first derivative of phase with respect to frequency, group delay, is an important measurement of distortion in communications systems. Hewlett-Packard produces a broad line of instrumentation capable of measuring all of these parameters.



Figure 5. Two independent techniques for measuring filter phase distortion

Phase information complements amplitude data in the measurement of low frequency parameters because it is more sensitive to network behavior and because it is a required component of complex impedance and transfer functions. For instance, phase is more sensitive than amplitude in determining the frequency of network resonances (poles) and anti-resonances (zeroes). This is because the phase shift of a network transfer function is exactly zero at the frequency of resonance. Phase information is also vital in circuit design, particularly loop design, where phase margins are critical.

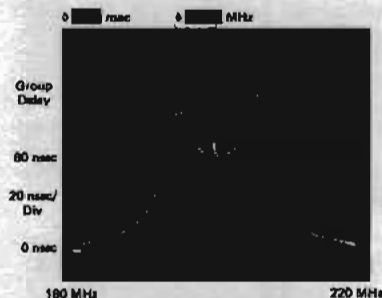

Figure 6. Direct Measurement of Group Delay with digital readout at marker

Phase data are also required to measure delay distortion or group delay of networks. Delay distortion occurs when different frequency components of a complex waveform experience nonlinear phase shifts as they are transmitted through a network. Group delay is a measure of this distortion and is defined as:

$$T_g = \frac{d\theta}{d\omega}$$

There are several techniques for measuring group delay; the most common techniques are phase slope, amplitude modulation, frequency modulation, and frequency deviation. Most HP network analyzers can make measurements with at least one of these techniques while several analyzers measure and display group delay directly. Choice of a group delay measurement technique is dependent on the particular device under test and the resolution required.

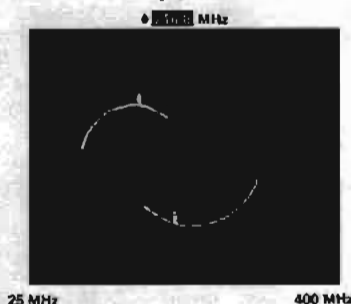

Figure 7. Simultaneous measurement of transistor S-parameters

An alternative method for measuring phase distortion is deviation from linear phase or differential phase. Deviations from linear phase can be measured by introducing enough electrical length in the network analyzer's measurement channel to linearize a device's phase shift. Once this has been accomplished it is possible to observe any variations in phase shift linearity at high resolution. Since group delay is the derivative of phase ($d\theta/d\omega$), nonlinearities in phase shift correspond directly to changes in a device's group delay. Introduction of electrical length in the measurement channel may be accomplished by physically adding cable, or it may be accomplished electronically on some network analyzers.

High frequency network analysis

Total voltage and current along a transmission line begin to vary periodically with distance as frequency increases. Consequently, it becomes difficult to establish the required shorts and opens in the correct measurement plane to determine low frequency parameters. Transmission-line theory explains the variations in total voltage and current at high frequencies through forward and reverse traveling waves. Thus, traveling waves are the logical variables to measure at higher frequencies.

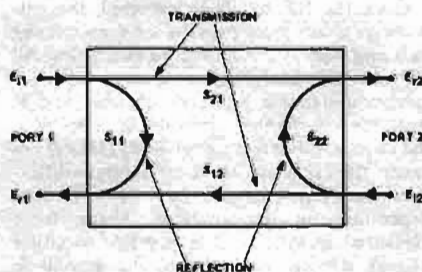

Figure 8. S-parameter model for a two-port linear network

Scattering parameters or S-parameters were developed to characterize linear networks at high frequencies. S-parameters define the ratios of reflected and transmitted traveling waves measured at the network ports. S_{11} is the complex reflection coefficient at port 1 and is the ratio of E_{r1}/E_{i1} , if $E_{i2} = 0$ (port 2 terminated in its characteristic impedance). S_{21} is the complex transmission coefficient from port 1 to port 2, E_{t2}/E_{i1} , if $E_{i2} = 0$. E_{i1} , E_{i2} , E_{r1} , and E_{r2} are normalized voltages (voltage divided by the characteristic impedance of the system) and represent the amplitude and phase of the traveling waves. By reversing the ports and terminating port 1 in its characteristic impedance, S_{22} and S_{12} can be similarly defined. From these definitions, the following equations can be derived:

$$E_{r1} = S_{11} E_{i1} + S_{12} E_{i2}$$

$$E_{r2} = S_{21} E_{i1} + S_{22} E_{i2}$$

where incident signals act as independent variables determining the signals leaving the network. The definition of a S-parameter can be easily extended to multiport networks; measurement is also easily accomplished by terminating additional ports in their characteristic impedances. Thus, S-parameters completely describe linear network behavior in the same manner as low frequency parameters.

S-parameters offer numerous advantages to the microwave engineer because they are both easy to use and easy to measure. They are easy to measure because the device is terminated in its characteristic impedance which is accurate at high frequencies, allows swept broadband frequency measurement without tuning, enhances the stability of active devices, and permits a test set up to be used for different devices. The design process is simplified because S-parameters are directly applicable to flow graph analysis. HP network analyzers with the appropriate test sets will measure and directly display S_{11} or S_{12} as gain or attenuation and S_{11} or S_{22} as reflection coefficient, return loss or impedance. Also, S-parameters may be directly related to h, y, and z-parameters through algebraic transformations.

With the increased utilization of microwave frequencies in a broad spectrum of applications, S-parameter measurements have become more important and more generally used in designing both active and passive networks. Hewlett-Packard has developed a series of tutorials for measurement and design with S-parameters; Application Notes 95, 117-1, 117-2, 154, video tapes #800586 and #800600 deal with general S-parameter techniques. Further aids include special S-parameter design seminars and a new set of calculator programs "Microwave Circuit Design PAC" for computationally aided design. A continuing program in all medias is underway to disseminate information on both designing and testing with S-parameters.

Additional capabilities

The computational capabilities of digital calculators and computers can complement the network analyzer's versatility through

simplifying and speeding measurements, data processing, and accuracy enhancement. Hewlett-Packard has integrated network analyzers into computer systems and now offers some analyzers that may be easily interfaced with HP programmable calculators through the Hewlett-Packard Interface Bus.

Precision design work and important manufacturing tolerances demand highly accurate measurements, but most errors in network measurements are complex quantities that vary as a function of frequency, making manual error correction prohibitive. However, the calculator or computer can make great contributions to measurement confidence by quickly and easily performing the complex mathematics for sophisticated error correction.

Aside from new levels of accuracy, calculator (or computer) controlled network analyzers can be programmed to set up and make many measurements automatically. The measurement process is further accelerated by the calculator's ability to store, transform, summarize, and output data in a variety of formats on a number of peripherals. These capabilities make the calculator controlled network analyzer ideal for both computationally aided design or automatic production testing.

Network Analyzer Product Line

Hewlett-Packard offers a complete line of network analyzers capable of measurements throughout the 1 Hz to 40 GHz frequency range. Brief descriptions of the individual instruments are given so that you can determine which instrument most economically satisfies your measurement needs. Further information and detailed specifications on individual network analyzers are available on the following pages (see matrix for specific page numbers).

3575A

The 3575A measures Phase and Amplitude or Gain. With the 3575A, the complete response picture is available at a reasonable cost from a single instrument, over an 80 dB range, from 1 Hz to 13 MHz. The 3575A uses a broadband measurement technique, which is attractive because the measurement is not constrained by an internal tracking source or dedicated external device. The 3575A is not dependent on the wave shape, thus measurements can be made on a variety of waveforms such as triangle and square waves. Noise and harmonic tolerance further enhances the range of measurement, so the instrument is useful under bench conditions.

3040A/3042A

The 3040A is a network analysis system capable of measuring amplitude and phase to 13 MHz. Group delay is an optional capability. The system consists of a synthesizer signal source and a two-channel tracking detector. The system has a 100 dB dynamic range, and measures amplitude to a resolution of 0.01 dB and phase to a resolution of 0.01°. Measurement applications include filter design and production, amplifier testing, delay measurements on communications devices, and measurements on any linear two-port device.

The 3042A is a fully automatic system which uses the Hewlett-Packard 9820A Calculator (9821A or 9830A are optional) as a controller. The memory computational power and decision making power of the calculator-controller extend the measurements to complex network solutions in the lab or rapid production line testing system. Accuracy can be improved by subtracting system errors from the measurements by using the memory and algebraic powers of the calculator.

8407A

The 8407A network analyzer tracks the 8601A generator/sweeper (or the 8690B/8698B sweeper) from 100 kHz to 110 MHz. The 8407A achieves great swept measurement versatility through a set of four different transducers. Measurement capabilities include:

- 1) Transmission (gain, loss, phase shift) and reflection (return loss, impedance) measured quickly and easily by sweeping over the frequency range of interest. Measurements can be made in 50Ω and 75Ω.
- 2) Complex impedance |Z|, θ, or R±jX over the wide impedance range 0.1Ω to >10 kΩ.
- 3) Voltage and current transfer functions (voltage or current gain, loss, phase shift).
- 4) High impedance in-circuit probing.

A rectangular and polar display and various CRT overlays permit direct readings of parameters of interest as frequency is swept. Applications are detailed in Application Notes 121-1, 121-2. A videotape "8407 Network Analyzer System," #800475, is also available.

8405A

The 8405A vector voltmeter is a dual-channel RF millivoltmeter and phasemeter. It reads the absolute voltages on either of two channels and simultaneously determines the phase relationship between them. CW measurements can be made over the frequency range 1 MHz to 1 GHz.

Besides its use as a voltmeter, applications of the 8405A include:

- 1) Transmission measurements (gain, loss, phase shift) and reflection measurements (impedance, return loss) in 50Ω systems.
- 2) Group delay and amplitude modulation index.
- 3) In-circuit probing.
- 4) S-parameters in 50Ω systems.

Application Notes 77-1, 77-3, 77-4, and 91 are available for more detail on the above measurements.

8505A/8507A

The 8505A Network Analyzer provides measurement capability from 500 kHz to 1.3 GHz. Three RF input ports, each with 100 dB of dynamic range, make possible simultaneous network measurements of reflection and transmission parameters. Two independent yet identical display channels are each capable of displaying magnitude, phase, deviation from linear phase and group delay of either the transmission or reflection characteristics of an RF Network. These parameters can be displayed in rectangular, in polar coordinates or both formats at the same time.

The Swept Source, which is an integral part of the analyzer, offers extreme frequency flexibility through seven different modes of operation.

The 8507A is an Automatic Network Analyzer using the 8505A with HP-IB interface and the HP-9830 calculator as the controller. The "Learn" mode of operation extends the traditional automatic operation to a new level of operator convenience. Accuracy enhancement, formatting of data, and the speed and ease with which data can be accumulated and summarized are all network measurement contributions made by the 8507A.

8410B

The 8410B network analyzer system measures the transmission and reflection characteristics of linear networks in the form of gain, attenuation phase shift, reflection coefficient, normalized impedance and S-parameters in the frequency range of 110 MHz to 40 GHz.

Harmonic frequency conversion of the RF to a constant IF is accomplished by the 8411A Harmonic Frequency Converter from 110 MHz to 12.4 GHz; the 8411A Options 018 operates from 110 MHz to 18 GHz. In the frequency ranges 18–26.5 GHz (K-band) and 26.5–40 GHz (R-band), the K8747A and R8747A Reflection/Transmission Test units use crystal mixers and a local oscillator to heterodyne the signals down into the range of the 8410B/8411A. In this manner, waveguide components can be measured from 18 to 40 GHz.

The 8410B is a ratiometer using both reference and test signal inputs; consequently, the sweeper output must be divided into channels. This is accomplished by a "Test Sel" whose other major function can be to provide the switching required for making transmission and reflection measurements with minimum or no changes in the measurement setup. Hewlett-Packard offers a total of twelve different test sets covering various frequency ranges and switching functions.

Another major instrument required in the 8410 measurement system is a unit for the detection and display of the IF amplitude and phase. Three plug-in displays (for the 8410B mainframe) are available for this purpose: a phase-gain indicator with meter readouts for CW measurements; a phase-gain display for displaying log amplitude and phase versus frequency; and a polar display for displaying amplitude and phase in polar coordinates.

The 8410B is capable of swept measurements over multi-octave bands through 18 GHz. Between 18 GHz and 40 GHz, 2 GHz windows may be viewed. Measurements of more than 60 dB of attenuation and 40 dB of gain are possible. The line stretcher in the reference channel of most test sets is an important feature making possible the equalization of electrical lengths in both channels for accurate differential phase measurements.

The variety of test sets, displays, and accessories for measuring both passive and active devices makes the 8410B adaptable to almost any linear network measurement. Further information is available in Application Notes 117-1, 117-2, 95 and in videotape #800473.



NETWORK ANALYZERS

Complete characterization of linear networks (cont.)

8540 Series

The 8540 series system (100 kHz to 18 GHz) couples the network analyzer's ability to completely characterize a linear network with the computer's ability to completely set-up a measurement, store data, and solve com-

plex mathematics. As a result, the automated system offers these advantages: increased speed of measurement; increased accuracy through sophisticated error-correction techniques; ease of operation; and a variable data output format (alphanumeric or graphic with

hardcopy, cassette or CRT presentations).

Data can also be made readily accessible to computer aided design programs to assist designer in evaluating overall network performance based on component measurement data.

NETWORK ANALYZER PRODUCT LINE SUMMARY

Model	Frequency Range	Source	Measurement Capabilities
3575A Gain Phase Meter Page 416	1 Hz - 13 MHz	None	Gain Phase and Amplitude Low Frequency Analysis
3040A Manual Network Analyzer Page 413	50 Hz - 13 MHz	3320A/B or 3330A/B	Amplitude and Phase Optional Group Delay Gain or Loss Linear Frequency Sweep
3042A Automatic Network Analyzer Page 413	50 Hz - 13 MHz	3330B Synthesizer	9820, 9821, or 9830 Calculator Control Complex Network Analysis Decision Making Ability Computational Capability
8407A Network Analyzer Page 424	100 Hz - 110 MHz	8601A Generator/Sweeper 8690B/8698B Sweep Oscillator	Transfer Functions, Impedance in 50Ω, 75Ω Systems Complex Impedance 0.1Ω to >10 kΩ High Impedance In-Circuit Probing S-parameters in 50Ω, 75Ω systems
8405A Vector Voltmeter Page 426	1 MHz - 1 GHz (CW)	3200B Oscillator, VHF Signal Generators, 608E (VHF), 612A (UHF), 8654 (UHF), and 8640 A/B	Voltmeter Transfer Functions, Impedance in 50Ω systems Group Delay, Amplitude Modulation Index S-parameters in 50Ω systems
8505A RF Network Analyzer Page 418	500 kHz - 1.3 GHz	Swept Source Included	Complex Transfer functions - Gain/Loss or S-parameters Complex Impedance - Γ, Return Loss, R ± jX Distortion - Group Delay, Deviation from Linear Phase Digital Readout of Data while sweeping Frequency Counter included HP-IB with Learn Mode
8507A Automatic RF Network Analyzer Page 422	500 kHz - 1.3 GHz	Swept Source Included	9830 Calculator Controller with 8505A HP-IB with Learn Mode Automatic Measurements with Data Formatting Accuracy Improved Measurements
8410B Network Analyzer Page 427	110 MHz - 40 GHz	8620 or 8690 Series Sweep Oscillators	Transmission/Reflection Characteristics 50Ω Coax Measurements 110 MHz to 18 GHz Waveguide Measurements 8.2 GHz to 40 GHz S-parameters Continuous Multi-octave Measurements with 8620 Series Sweepers DC Bias for Semiconductor Measurements
8542B Automatic Network Analyzer Page 455	100 MHz - 18 GHz	8620 or 8690 Series Sweep Oscillators	Automatic Measurements of Transmission/Reflection Characteristics Full Error Correction Virtually No Programming Required Versatile Output: 28 Parameter Alphanumeric or Graphic, Hardcopy Cassette or Cathode-Ray-Tube

NETWORK ANALYZERS

Network analysis from 50 Hz to 13 MHz

Model 3040A

- High resolution digital amplitude and phase measurements
- 100 dB dynamic range
- Precision digital sweep capability

- Narrow band analysis
- Optional group delay and limit test
- Full digital control via HP-IB



3040A Network Analyzer



Description

The 3040A Network Analyzer is designed to meet the demand for precise and fast characterization of both active and passive linear two-port devices. The Network Analyzer is a new, powerful bench system that makes digital amplitude, phase and group delay response measurements over a 50 Hz to 13 MHz frequency range. It uses the 3330B Automatic Synthesizer with leveled output and digital sweep capability to generate the local oscillator signal for the 3570A Tracking Receiver and to provide the stimulus to the device under test.

This system effectively combines the wide dynamic range and the high resolution of the 3570A Tracking Receiver with the high accuracy and stability of the 3330B Synthesizer, giving the design, production and Q.A. engineers working at audio, video and RF frequencies the precision, convenience and high information content of swept-frequency response measurements, but with the point by point accuracy of synthesized incremental frequency sweeps.

Residual FM, often a serious limitation to the frequency resolution of swept frequency measurements, is very low (< 1 Hz) in the 3040A System, allowing accurate narrow band sweeps.

The 3570A Analyzer (Tracking Receiver) has two identical channels for fast, high accuracy "B-A" measurements of gain or insertion loss of two-port devices and to measure the phase shift between input and output points. It can also function as a limit comparator to determine how closely the gain and phase response of a device matches that of a reference.

Both the passband and the stopband of a device can be examined in detail because the 3570A Analyzer has both a wide amplitude range of 120 dB ($1 \mu\text{V}$ to 1 V) and a high resolution display (0.01 dB increments). The digital readout also displays phase readings with 0.01° resolution.

Beyond the basic amplitude and phase measurements, the 3040A offers several automatic features not found in more conventional network analyzers.

One is Digital Offset: Values of amplitude and/or phase measured on a reference device are stored in the instrument's memory at the push of a button. Future measurements can then be displayed relative to the stored values. This could be used, for example, to quickly find the -3 dB passband limits of a filter or amplifier.

Another feature is Group Delay: As the synthesizer is stepped in frequency, the analyzer's internal digital processor calculates group delay from two phase shift measurements as $T_d = \Delta\phi/360\Delta f$ sec.

A third one is Limit Test: High and low limits can be entered as digital words from an external controller, for example, a paper tape. The analyzer can be set to stop or output a marker when a limit is reached. This capability is useful for example to precisely find the center frequency of a resonant circuit by stopping at the 0° phase reading.

The 3040A Network Analyzer introduces precision, convenience and built-in "intelligence" to the problem of characterizing the behavior of linear networks on the bench.

NETWORK ANALYZERS

Automatic network analysis from 50 Hz to 13 MHz

Model 3042A

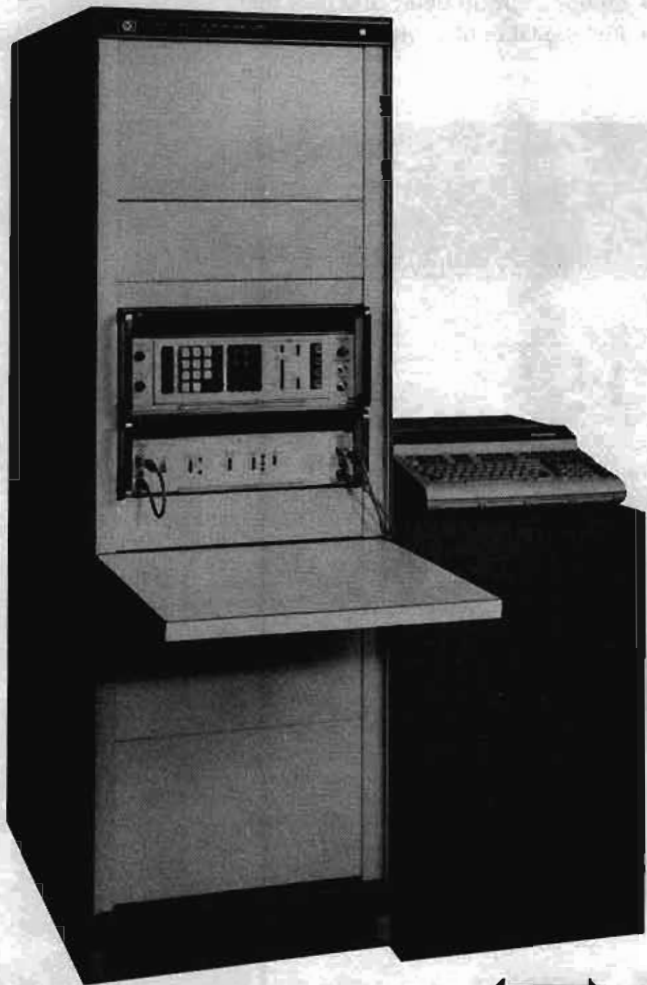

3042A Automatic Network Analyzer

HP-IB

Description

The 3042A Automatic Network Analyzer is a highly powerful, fully automatic calculator controlled system that is designed to meet the demand for precision, speed, automation, simple operation and low cost in the area of fully characterizing active or passive linear two-port devices.

The 3042A system uniquely integrates the

- wide dynamic range and high resolution of the 3570A Network Analyzer (tracking receiver)
- accuracy and high stability of the 3330B Synthesizer and the
- powerful computation, data processing and smart peripheral control capabilities of the 9825A Programmable Calculator/Controller

into a superior systems performance that results in a unique set of contributions to solve the problem of characterizing the behavior of linear two-port over the wide frequency range of 50 Hz to 13 MHz:

- Amplitude, phase and group delay measurement
- Wide amplitude range and high resolution
- Speed and precision in measurements
- Simplicity and flexibility in operation
- Data analysis and presentation of results
- Simple programming and powerful output
- Accuracy enhancement and decision making
- Full automation and substantial reduction in costs

- Full automation and low cost
- Speed and precision in measurements
- Accuracy enhancement
- Data analysis and presentation of results
- Simplicity and flexibility in operation
- HP-IB systems interfacing
- 9825A calculator-controller

The 3042A is a fully automatic two-channel Network Analyzer System that provides digital amplitude, phase and group delay measurements, on line data analysis, data reduction and decision making capability plus formatted graphic or tabular representation of results or data storage for further processing at a later time.

Environments such as production, quality assurance and the laboratory are now provided with the capability of extending precision network analysis to applications that were previously impractical because of the length of time it took to make the necessary measurements.

Production applications

In production applications the 3042A substantially reduces the time and cost of making a range of simple or complicated tests on all types of components, for example, crystals, amplifiers, filters and other analog devices. The system can run through a long series of tests on a device, checking performance at all specified points and deliver a simple pass/fail answer.

However, automatically compiled test data provides excellent production statistics for improved production control, more precise scheduling and accurate production cost analysis.

Testing programs with built-in operator instructions minimize the requirements for highly trained technicians as well as training costs. Furthermore, uniform test procedures may easily be established. The 3042's impact in the production environment can be directly traced to a substantial increase in total production throughput while at the same time increasing the number of test parameters, resulting in greater product confidence and lower production cost.

Quality assurance applications

In quality assurance applications the 3042A not only significantly reduces the cost of test equipment necessary to assure a comprehensive product testing job, but the system's inherent flexible HP-IB interface structure allows the system configuration to be easily changed by either simple software modifications or hardware additions. Adapting the 3042A System to an application, which may require a programmable power supply or contact closure to drive the device under test, becomes as simple as connecting the additional instruments via the standard HP-IB connector, loading a different program from the calculator's cassette and running it. Skilled technicians may be relieved from repetitive yet demanding tasks and placed in positions that maximize the use of their knowledge and skills. The 3042A provides reliable and repeatable results. Various parameters may be tested in greater detail and in less time, resulting in greater product confidence and quality but lower warranty cost.

Automatically compiled test data provides excellent quality assurance statistics which can easily be presented in any formatted graphic or tabular form by an optional plotter or line printer.

Laboratory applications

In laboratory applications, engineers gain greater insight into their circuit design due to the speed and ease with which data can be accumulated and summarized with the 3042A. The easy-to-use calculator programming format allows easy-to-write, customized programs which solve specialized measurement problems in a fraction of the time required to manually perform and evaluate the same measurements or to write a corresponding computer program. In addition the accuracy enhancement software furnished with the 3042A System significantly increases the accuracy of the system seven times over that of a single channel measurement (three times over a "B-A" measurement), by judiciously combining the capabilities of the instruments and the calculator.



System control and interface

The 3042A Automatic Network Analyzer incorporates the new 9825A Programmable Calculator as systems controller, operator interface and data processor. The 9825A offers the power and speed of much larger computers but features a high level programming language and editing capabilities that allow nearly instant use of the system with minimal effort.

System-operator interface is greatly simplified through the 9825A's alphanumeric display and typewriter-like keyboard.

Easy programmability which requires minimal training, versatile editing capability for reducing programming time, immediate feedback on errors made due to improper instructions, availability of large user memory for lengthy program or data storage, cassette convenience for permanent storage of programs or data and flexibility for input and output functions are features offered by the 9825A programmable calculator/controller.

Summary

The 3042A Automatic Network Analyzer provides a complete solution to production, quality assurance and laboratory applications at audio, video and RF frequencies with accurate, reliable, repeatable and fast results plus the high information content that automatic gain-phase-delay measurements can give.

Specifications 3040A and 3042A systems

Sources (Channel A & B outputs are isolated and electrically identical)

Frequency

Range: 0.1 to 13,000,999.9 Hz

Resolution: 0.1 Hz (9 digits)

Amplitude

Range: +13.44 to -86.55 dBm (50Ω)

+11.68 to -88.31 dBm (75Ω option)

Resolution: 0.01 dB

Accuracy:

Leveled frequency response (10 kHz reference)*:

10 Hz	13 MHz
±0.05 dB	+13.44 dBm
±0.1 dB	-16.55 dBm
±0.2 dB	-36.55 dBm
±0.4 dB	-66.65 dBm
	-86.55 dBm

* Add 0.5 dB for leveling switch in off position.

Attenuator: (10 kHz reference, 25°C ±5°C) ±0.2 dB/10 dB step of attenuation down from maximum output.

Absolute: (10 kHz, maximum output, 25°C ±5°C) ±0.45 dB

Stability: (24 hr., 25°C ±1°C): ±0.01 dB

Impedance: 50 or 75Ω (optional) ±2%

Receivers: (Channel A & B inputs are electrically identical and both tuned precisely to the signal source's frequency.)

Frequency

Range: 50 Hz to 13 MHz

Resolution: 0.1 Hz

Selectivity: 10 Hz, 100 Hz and 3 kHz bandwidths (60 dB/3 dB bandwidths, 20:1)

Amplitude (Output is in dB relative to 1 V, 0 dBm or 0.1 V, corresponding to the position of the "Max/Ref Input Voltage" switch.)

Measurement range: 1 V rms to 1 μV rms

Dynamic range: 0 to -100 dB (using A or B amplitude function); -100 dB to +100 dB (using B-A amplitude function).

Resolution: 0.01 dB

Accuracy: (25°C ±5°C): Accuracy of the 3042A is enhanced with software supplied with the system over the 50 Hz to 10 MHz and over the top 20 dB of the dynamic range as shown below.

Frequency Response: A or B "Amplitude Function" ±0.5 dB; B-A "Amplitude Function" ±0.1 dB; using Accuracy Enhancement Software ±0.03 dB furnished with 3042 system.

Linearity: (A or B amplitude function)

0 to -20 dB	} ±0.2 dB } ±0.06 dB with Accuracy Enhancement
-20 to -80 dB	
-80 to -100 dB	±0.5 dB ±1.5 dB

Stability (8 hr., 25°C ±1°C after 3 hr. warmup)

100 Hz & 3 kHz BW	Temp. Coefficient (20°C - 30°C)			
	0 dB	-20 dB	-80 dB	-100 dB
	±0.05 dB	±0.08 dB	Not specified	±0.02 dB/°C
10 Hz BW	±0.08 dB	±0.15 dB	Not specified	±0.05 dB/°C

Phase (Phase reference is Channel A)

Range: -179.5° to 179.5° (display recycles)

Resolution: 0.01°

Accuracy: (25°C ±5°C)

Frequency response: (Channel at 0 dB)

50 Hz	100 Hz	1 MHz	13 MHz
±0.8°	±0.2°	±1°	

Amplitude response: Channel B within 6 dB of Channel A.

0 dB	-20 dB	-70 dB	-80 dB	-100 dB
±0.4°	±0.6°	±1°	No Spec	

For channels at different levels (specification determination by lowest input).

0 dB	-20 dB	-60 dB	-80 dB	-100 dB
±1.3°	±1.5°	±3°	No Spec	

Linearity: ±0.2° (Channel B within 6 dB of Channel A).

Input impedance: 1 MΩ ±2% shunted by <30 pF.

General

Programmability: all controls, except power switches are programmable using the HP-1B format.

Ultra-high accuracy: the 3040/42A systems can be coupled with an external device such as a calibrated attenuator to provide relative measurements whose amplitude accuracy is limited the amplitude stability of the receiver and source and the accuracy of the external device.

3040A Options

The basic 3040A system options are listed below. For more information refer to the 3040/3042A data sheet.

3040A Network Analyzer	Price
(Order option 110 or 111 and option 120 or 121)	
Option 110 Standard 50Ω 3570A	\$6890
Option 111 Standard 75Ω 3570A	\$6890
Option 112 Delay/Limit Test/Offset (Hardware)	\$470
Option 113 Cable and Load Kit	\$87
Option 120 Standard 50Ω 3330B	\$7455
Option 121 Standard 75Ω 3330B	\$7455

3042A Options

The basic 3042A system options are listed below. For more information refer to the 3040/3042A data sheet.

Option 200 50Ω System	N/C
Option 201 75Ω System	N/C
Option 204 1201B Oscilloscope	\$2670
Option 215 9862A Plotter	\$3195
Option 230 9871A Impact Printer	\$3400

The 3042A system is fully integrated, tested, verified and specified as a system. It is supplied with complete software and documentation.

3042A Automatic Network Analyzer **\$24,915**
consisting of: 3330B Synthesizer, 3570A Network Analyzer, 9825A Calculator, 6.8k bytes memory, ROMs, Interface and documentation, 56" Rack

NETWORK ANALYZERS

Gain/phase meter

Model 3575A

- dBV, dB ratio and degrees from 1 Hz to 13 MHz



3575A Option 001 dual panel meters

Description

The HP 3575A Gain-Phase Meter is a versatile two-channel analyzer which can measure and display the absolute amplitude level or amplitude ratio of signals present at the inputs. In addition, the 3575A can measure the phase relationship of the two signals. This analyzer is a broadband detector which is easy to use because no frequency tuning is required.

Since a dedicated tracking source is not required to operate with the 3575A, a wide selection of stimuli is possible. This flexibility coupled with a variety of possible amplitude, gain and phase outputs (LED display, analog outputs, and optional BCD) give you a wide choice of cost/results tradeoffs. For example, you may wish to manually plot your network response data on a Bode diagram in which case a low cost sine wave oscillator stimulus may be used. For easier, quicker results you may select a sweeping oscillator and an x-y plotter and let the instruments plot your response. You may use a calculator or computer to control a programmable stimulus source and the 3575A to provide automatic measurements. Here you have a wide range of computation and output possibilities.

Phase

The phase relationship of two signals is indicated over a range of ± 192 degrees with 0.1 degree resolution. A unique logic circuit (patent) design allows the 3575A to make stable phase measurements in the presence of noise. This feature minimizes the error to less than two degrees for a signal-to-noise ratio of 30 dB. One of three band limiting filters may be selected to get further noise rejection.

The 3575A is also capable of measuring the phase relationship of a variety of waveforms such as square waves and triangle waves. Even harmonic and in-phase odd harmonic components of these signals cause no phase measurement error. For out-of-phase odd harmonic signal-to-harmonic ratios of 40 dB, measurement errors are less than 0.6 degree as shown in Figure 1.

Amplitude

The amplitude of either channel or the ratio of the two can be measured over an 80 dB dynamic range and 100 dB measurement range. Resolution is 0.1 dB. Results are displayed in dBV for channel amplitude and dB for ratio measurements. Digit blanking and channel overload annunciators will turn on if the maximum allowable signal level at either channel input is exceeded.

Readout

The standard three-digit LED display may be selected by the operator to indicate the amplitude of channel A or B or gain or phase. A second three-digit LED display is optionally available for simultaneous display of amplitude and phase readings. Lighted annunciators identify the measurement function, units and remote status.

Programmable

Two programmable options both offer full control of front panel functions and BCD output of information (amplitude, ratio or phase) contained in both digital displays. The two options give the user a choice of negative true or positive true outputs.

Applications

The 3575A can solve network analysis problems in the 1 Hz to 13 MHz frequency range where complex measurements (gain or phase or both) are required. A few of the many measurements it can make are: gain and phase response of feedback systems, envelope delay and return loss of transmission lines, complex impedance of components, and insertion loss of mixers and frequency doublers. Bode plots and Nichols charts are useful graphical tools for analyzing many of these response data.

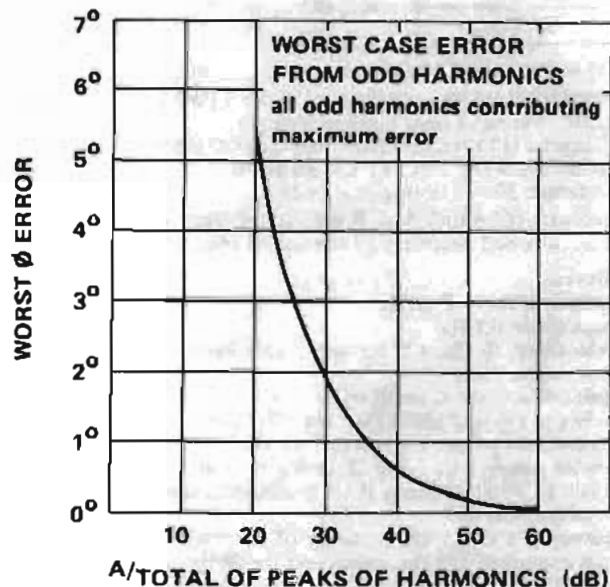
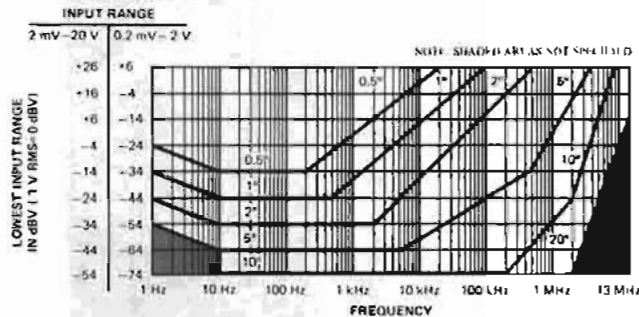

Figure 1. Worst case error from odd harmonics.

Specifications

Phase accuracy*



* Conditions: Temperature: 25°C ± 10°C; Frequency range switch on lowest applicable range; Analog Output accuracy (rear panel).

Input signal range: 200 μV rms to 20 V rms.

Harmonic rejection

Even harmonics no error.

Odd harmonics in phase no error.

Odd harmonics out of phase 0.57° worst case error when total odd harmonic distortion is 40 dB below the fundamental.

Noise tolerance: 2° error for a 10 kHz, 1 V sine wave on one channel. One volt sine wave added to Gaussian noise (limited to a 1 MHz bandwidth and 30 dB S/N ratio) on the other channel. The 100 Hz to 1 MHz frequency range was used.

Display

Range: ±180° with 12° of overrange.

Resolution: 0.1°.

Panel meter accuracy: ±3 counts (0.3 degrees, 0.3 dB/dBV). The panel meter error must be added to the phase and amplitude errors to obtain the display error.

Inputs

Impedance: 1 MΩ 30 pF.

Protection: ±50 V dc, 25 V rms.

Response time to achieve 90% of final reading:

Frequency Range	Time
1 Hz to 1 kHz	20 s
10 Hz to 100 kHz	2 s
100 Hz to 1 MHz	0.2 s
1 kHz to 13 MHz	20 ms

Rear terminal inputs are available as a special (3575A-C09). Digital (Opt. 002), 0, +5 ground true. Twelve lines to fully program all functions.

Outputs

Analog

Phase: 10 mV/degree.

Amplitude: 10 mV/dB or dBV.

Output impedance: 1 kΩ.

Digital (Opt. 002): 0, +5 V ground true. 31 output lines (1-2-4-8 BCD).

Digital readout: 3½ digits with sign and annunciators. Four readings per second, fixed.

Amplitude accuracy*

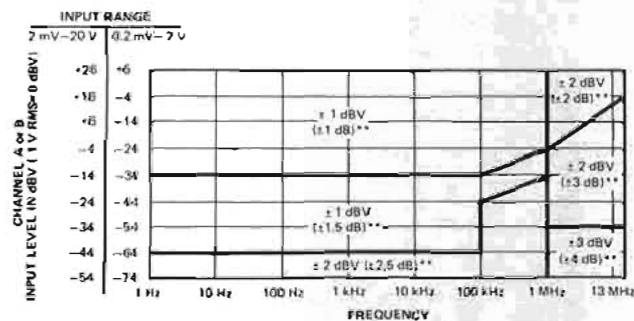

* Conditions: Temperature: 25°C ± 10°C; accuracy applies to dB V and ratio measurements with the same frequency on both channels; for ratio measurements, the lowest level channel determines accuracy; analog output accuracy (rear panel).

Amplitude functions: A dBV, B dBV or B/A dB.

Amplitude reference: (A dBV, B dBV) 1 V rms = 0 dBV.

Display

Range: A dBV, B dBV: -74 dBV to +26 dB (in two ranges). B/A dB: -100 to +100 dB. (Both input signals must be within the range of 0.2 mV rms to 20 V rms).

Resolution: 0.1 dBV, 0.1 dB.

Options

001 Dual panel meters

HP's 3575A Opt. 001 is equipped with two digital readouts and two analog outputs for simultaneous amplitude and phase readings. This option has no additional measurement capability over the standard instrument.

Dual analog outputs: rear panel BNC connectors provide dc output voltages that correspond to the respective panel meter readings.

002/003 Programmable

3575A Opt. 002 and Opt. 003 are equipped with dual panel meters and dual analog outputs (same as Opt. 001) plus BCD outputs and complete remote control capability. Option 002 has negative true output levels and Opt. 003 has positive true output levels. BCD information from the 3575A (Opt. 002) can be read by the 9800 series HP Calculators with appropriate interfacing.

908: Rack Flange Kit

General

Power: 115 V/230 V ± 10%, 48 Hz to 60 Hz, 40 VA.

Weight: net, 8.3 kg (18.4 lb). Shipping, 11.3 kg (25.8 lb).

Dimensions: 425 mm wide × 88 mm high × 337 mm deep (16½" × 3½" × 13¼").

Accessories furnished: extender boards, line cable and 50-pin connector (Opt. 002 and 003 only).

Options:

Opt. 001, Dual Readout

Opt. 002, Programmable (negative true output levels)

Opt. 003, Programmable (positive true output levels)

Opt. 908, Rack Flange Kit

Opt. 910, Extra Product Manual

3575A Gain/Phase Meter

Price

add \$525

add \$930

add \$930

add \$10

add \$22.50

\$3050

NETWORK ANALYZERS

RF network analyzer, 500 kHz to 1.3 GHz

Model 8505A

- 500 kHz to 1.3 GHz
- 100 dB of dynamic range
- Digital readout of data with analog display
- Direct group delay and deviation from linear phase
- High performance sweep oscillator
- Complete family of 50 Ω and 75 Ω test sets

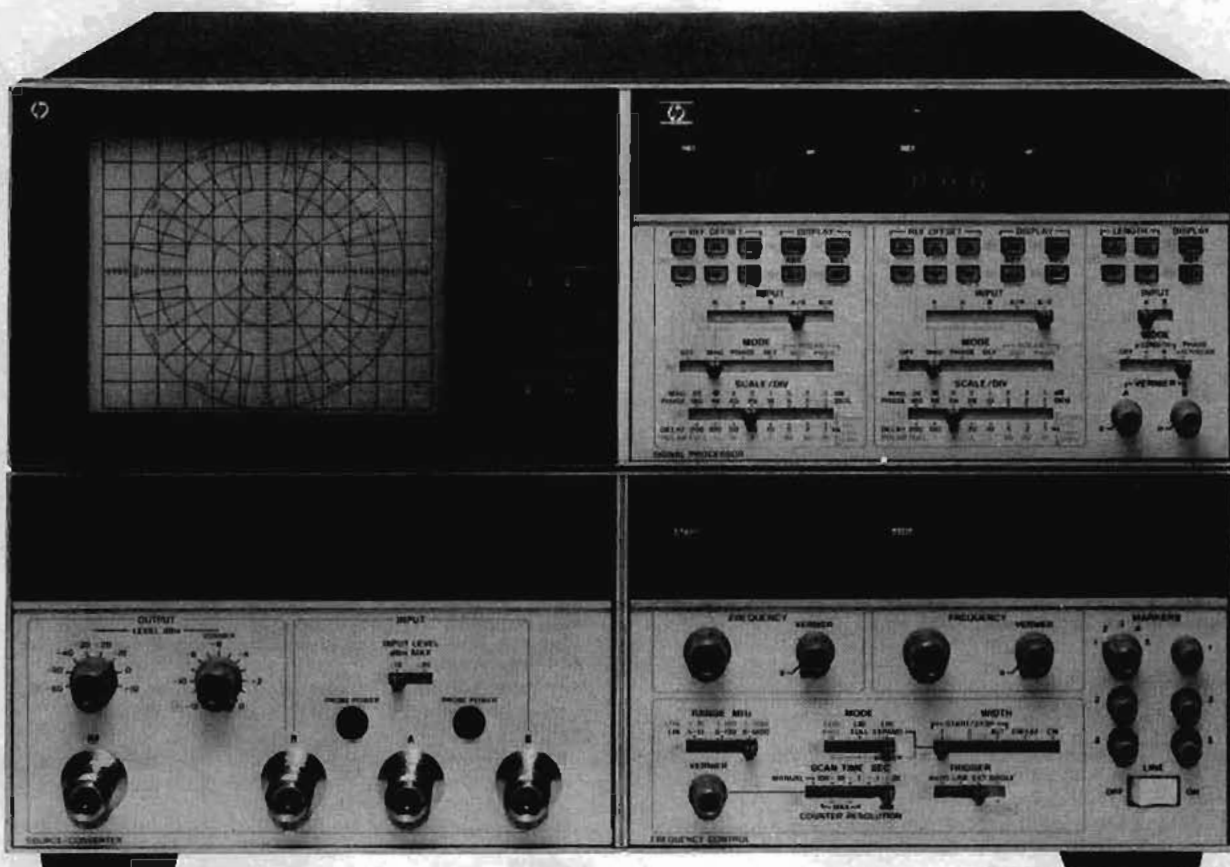

8505A

HP-IB

The HP 8505A is a high performance RF network analyzer operating over the 500 kHz to 1.3 GHz frequency range. It accurately and easily measures complex impedance, transfer functions and group delay of coaxial components and semiconductors. Because both magnitude and phase are measured, it is possible to completely characterize the linear behavior of either active or passive networks.

Since magnitude and phase can be measured and displayed over 100 dB of dynamic range (-10 to -110 dBm), it is a simple process for the 8505A to measure transmission loss of high rejection devices such as filters or gain and return loss of small signal devices like amplifiers. Distortion parameters like group delay, deviation from linear phase, and deviation from constant amplitude are measured in an equally straight-forward manner. Group delay is measured and displayed directly to resolutions of 1 nsec per major division using a new linear FM measurement technique. A unique new electrical line stretcher compensates for the linear phase shift of the device under test so that phase non-linearities may be examined at high resolution (1° per major division). Amplitude deviations with frequency can be similarly observed to resolutions 0.1 dB per major division with clear, crisp trace stability. In addition, it is possible to read out amplitude, phase and delay digitally while sweeping at any one of five continuously variable markers with resolutions of 0.01 dB, 0.1°, and 0.1 nsec respectively.

Many of the 8505A's high performance features and operating conveniences are derived from the fact that it is a completely integrated system including both the sweep oscillator and the receiver. The basic instrument also includes a built-in frequency counter, polar and rectangular displays on the same CRT, the new electronic line stretcher, group delay measurement, and frequency selective digital readings of amplitude, phase and delay while sweeping. The frequency counter with resolutions up to 100 Hz adds further precision to the measurements by allowing frequency as well as amplitude, phase and delay to be read out at any of the five markers. The 8505A is fully programmable in a straight-forward fashion using the Hewlett-Packard Interface Bus (Option 001). A fully configured calculator-based automatic network analyzer system, the 8507A, is offered (see page 422).

Companion instruments include the 11850A Three Way Power Splitter for high resolution transmission and transmission comparison measurements, the 8502A Transmission/Reflection Bridge for simultaneous transmission and reflection measurements, and the 8503A S-parameter Test Set for complete characterization of two port devices in a single test set-up. Specially shielded and phase balanced cables are also available to minimize cross-talk and tracking errors. Biasing inputs for semiconductor measurements are available on the 8503A.

8505A Specifications

Source

Frequency characteristics

Frequency range: 500 kHz to 1.3 GHz in three ranges: 500 kHz to 13 MHz, 500 kHz to 130 MHz and 500 kHz to 1.3 GHz.

Swept frequency accuracy: $\pm 1\%$ of range for linear sweep.

CW frequency accuracy: ± 2 counts \pm time-base accuracy.

Frequency stability: better than $\pm 0.01\%$ of reading $\pm 0.01\%$ of frequency range over 10 minutes after warm-up.

Frequency counter characteristics: frequency counter measurements are made at any one of five continuously variable marker positions without interrupting the swept RF signal.

Resolution (least significant digit):

Frequency Range (MHz)	0.5 to 13	0.5 to 130	0.5 to 1300
10 ms Sweep time	10 kHz	100 kHz	1 MHz
100 ms Sweep time	1 kHz	10 kHz	100 kHz
1 second Sweep time	100 Hz	1 kHz	10 kHz

Counter accuracy: ± 2 counts \pm time-base accuracy.

Marker frequency accuracy: $\pm 0.002\%$ of scan width \pm counter accuracy.

Time base accuracy: ± 5 ppm ± 1 ppm/ $^{\circ}$ C ± 3 ppm/90 days

Output characteristics

Output power range: +10 dBm to -72 dBm.

Attenuator accuracy: ± 1.5 dB over 70 dB range.

Vernier accuracy: ± 1 dB

Leveling: ± 0.5 dB from 500 kHz to 1.3 GHz

Impedance: 50 Ω ; ≥ 16 dB return loss at -10 dBm output level (< 1.38 SWR).

Residual FM:

Frequency Range (MHz)	0.5 to 13	0.5 to 130	0.5 to 1300
Residual FM	20 Hz rms	200 Hz rms	2 kHz rms
Bandwidth	20 Hz - 1 kHz	20 Hz - 1 kHz	20 Hz - 10 kHz

Harmonics: > 25 dB below main signal at +10 dBm output level.

Sub-harmonics and spurious signals: below -50 dBm at +10 dBm output level.

General characteristics

Sweep modes: Linear Full, Log Full, Start/Stop 1, Start/Stop 2, Alternate, CW $\pm \Delta F$, and CW.

Sweep times: 10 ms to 100 s in decade ranges.

Trigger modes: auto, line sync., single scan or external sync.

RF Output connector: Type N Female

Receiver

Frequency range: 500 kHz to 1.3 GHz

Input characteristics

Input channels: three channels (R, A, and B) with 100 dB dynamic range.

Damage level: +20 dBm or ≥ 50 V dc.

Noise (10 kHz BW): -110 dBm from 10 to 1300 MHz; -100 dBm from 0.5 to 10 MHz.

Impedance: 50 Ω ; ≥ 20 dB return loss (< 1.22 SWR). Typically > 26 dB return loss (< 1.14 SWR).

Magnitude Characteristics

Absolute frequency response (A, B, R): ± 1.5 dB

Ratio frequency response (A/R, B/R): ± 0.3 dB from 0.5 MHz to 1.3 GHz.

Dynamic accuracy: ± 0.01 dB/dB from -20 to -40 dBm; ± 0.2 dB from -10 to -50 dBm; ± 0.5 dB from -50 to -70 dBm; ± 1.0 dB from -70 to -90 dBm; ± 2.0 dB from -90 to -100 dBm; ± 4.0 dB from -100 to -110 dBm.

Crosstalk error limits: > 100 dB isolation between inputs.

Reference offset accuracy: ± 0.02 dB ± 0.003 dB/dB of offset

Marker measurement resolution: 0.01 dB over any < 10 dB range; 0.1 dB over any ≥ 10 dB range.

CRT Display resolution: 0.1 dB to 20 dB/division in 1, 2, 5 sequence.

Phase characteristics

Frequency response: $\pm 3^{\circ}$ from 500 kHz to 750 MHz; $\pm 5^{\circ}$ from 750 MHz to 1.3 GHz

Range: $\pm 180^{\circ}$

Accuracy: $\pm 0.01^{\circ}$ /degree for $\pm 170^{\circ}$; $\pm 0.01^{\circ}$ /degree $\pm 0.5^{\circ}$ for $\pm 180^{\circ}$

Dynamic accuracy (in 10 kHz Bandwidth): $\pm 0.02^{\circ}$ /dB from -20 to -40 dBm; $\pm 0.5^{\circ}$ from -10 to -50 dBm; $\pm 1^{\circ}$ from -50 to -70 dBm; $\pm 3^{\circ}$ from -70 to -90 dBm.

Crosstalk: see amplitude crosstalk specification

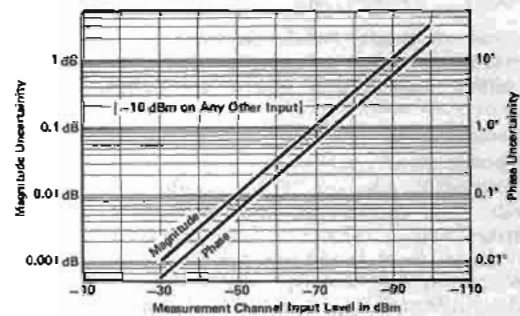

Reference offset accuracy: $\pm 0.5\%$ of offset

Marker measurement resolution: 0.1 $^{\circ}$ over $< 100^{\circ}$ range and 1 $^{\circ}$ for $\geq 100^{\circ}$ range.

CRT Display resolution: 1 $^{\circ}$ to 180 $^{\circ}$ per division in 8 steps

Polar characteristics: frequency Response, Dynamic Response, Reference Offset and Marker Measurement specifications are the same as magnitude and phase characteristics.

CRT Display Accuracy: actual value is within less than 3 mm circle of the displayed value.

Tracking between dB offset controls and polar full switch positions: ≤ 0.2 dB

Full scale magnitude range: 1 to 0.01 in a 1, 0.5, 0.2 sequence

Delay characteristics

Frequency response: ± 1 ns from 500 kHz to 1.3 GHz.

Delay accuracy: $\pm 3\%$ of reading ± 3 units. (Units =) ns for 0.5 to 1300 MHz range, 10 ns for 0.5 to 130 MHz range, and 100 ns for 0.5 to 13 MHz range.) Range, Resolution and Aperture:

Frequency Range (MHz)	0.5 to 13	0.5 to 130	0.5 to 1300
Range	0 to 80 μ s	0 to 8 μ s	0 to 800 ns
Resolution			
CRT:	100 ns	30 ns	1 ns
Marker:	100 ns	10 ns	1 ns
Marker over limited Range:	10 ns (< 1 μ s)	1 ns (≤ 100 ns)	0.1 ns (≤ 10 ns)
Aperture ²	7 kHz	20 kHz	200 kHz

Reference offset accuracy: ± 0.2 units $\pm 0.3\%$ of offset

¹ ± 3 units may be calibrated out

² Typical measurement Aperture using linear FM modulation technique

NETWORK ANALYZERS

RF network analyzer, 500 kHz to 1.3 GHz

Electrical length/ref. plane extension characteristics Calibrated electrical length range and resolution:¹

Frequency Range (MHz)		0.5 to 13	0.5 to 130	0.5 to 1300
Range	X1	±19.9 M	±1.99 m	±19.9 cm
	X10	±100 m	±10 m	±1 m
Resolution	X1	10 cm	1 cm	0.1 cm
	X10	1 m	10 cm	1 cm

Calibrated electrical length accuracy: ±3% of reading ±1% of range.

Linear phase substitution (degrees/scan) Range: ±1700° per scan with 0° offset.

$$\frac{\pm 1.4 \text{ km}}{\text{scan width (MHz)}} \text{ or } \frac{\pm 4.7 \text{ s}}{\text{scan width (MHz)}}$$

Linear phase substitution resolution: 10°

Linear phase substitution accuracy: ±3% of reading ±10°/scan

Linear phase substitution phase compensation linearity: <0.2% of phase slope inserted.

General Characteristics

RF Input connectors: type N Female

Display bandwidth: selectable IF bandwidths of 10 kHz and 1 kHz. A video filter position is also provided.

CRT overlays: Smith Charts (3.16, 1, 0.5, 0.2, 0.1 full scale), Log Charts (10 MHz, 100 MHz and 1000 MHz).

CRT photography: HP 197A Opt. 006 camera or HP 197A with 10375A Bezel Adapter required to fit 8505A display. A CRT illumination control is provided.

Auxiliary outputs

Channel 1 and 2 outputs: 0.25 V/display division.

Sweep output: 0.25 V/display division.

Pen lift: DC coupled, 200 mA current sink

Programming

Option 001 of the 8505A provides a remote programming interface using the Hewlett-Packard Interface Bus with Learn Mode.

Power: selection of 100, 120, 220 or 240 V +5% -10%. 50 to 60 Hz approximately 275 watts.

Dimensions: 426 mm wide, 279 mm high, 553 mm deep (16 3/4 in. X 11 in. X 21 1/4 in.).

8503A 50Ω S-Parameter Test Set

8503B 75Ω S-Parameter Test Set²

Frequency range: 500 kHz to 1.3 GHz

Impedance: 8503A, 50Ω; 8503B, 75Ω

Directivity: ≥40 dB

Frequency response

Transmission (S₁₁, S₂₂): ±1 dB, ±12° from 0.5-1300 MHz

Reflection (S₁₂, S₂₁): ±2 dB, ±20° from 0.5-1300 MHz; ±15° from 2-1300 MHz.

Port match

Test ports 1 and 2: ≥26 dB return loss from 2-1300 MHz; ≥20 dB return loss from 0.5-2 MHz.

Test port 1 and 2: Open/Short Ratio: ≤±0.75 dB and ±6° from 2-1000 MHz; ≤±0.9 dB and ±7.5° from 1000-1300 MHz; ±1.25 dB and ±10° from 0.5-2 MHz

Reference and return ports: ≥23 dB return loss from 2-1000 MHz; ≥20 dB return loss from 0.5-2 MHz and 1000-1300 MHz

RF input port: 20 dB return loss from 0.5-1300 MHz

Maximum operating level: +20 dBm

Damage level: 1 watt CW

Connectors: Test ports, 50Ω APC-7 for 8503A and 75Ω Type-N Female for 8503B; all other RF connectors, 50Ω Type-N Female; Bias inputs, BNC Female

DC Bias input: ±30 V dc, ±200 mA.

Includes: four 19 cm (7.5") cables for connection to 8505A

Recommended accessory: 11857A 50Ω Test Port Extension Cables or 11857B 75Ω Test Port Extension Cables

Programming: Opt. 001 allows programming via HP-IB

Power: 100, 120, 220, or 240 V ±5% -10%, 50 or 60 Hz. Approx. 10 watts

Dimensions: 432 mm wide, 90 mm high, 495 mm deep (17" X 3 1/2" X 19 1/2").

Weight: net, 9.1 kg (20 lb). Shipping, 11.3 kg (25 lb).

8502A 50Ω Transmission/Reflection Test Set

8502B 75Ω Transmission/Reflection Test Set²

Frequency range: 500 kHz to 1.3 GHz

Impedance: 8502A, 50Ω; 8502B 75Ω

Directivity: ≥40 dB

Frequency response

Transmission: ≤±0.8 dB and ≤±8°

Reflection: ≤±1.5 dB and ≤±15° from 0.5-1300 MHz; ≤±10° from 2-1300 MHz

Port match

Test port: ≥26 dB return loss from 2-1300 MHz; ≥20 dB return loss from 0.5-2 MHz

Test port open/short ratio: ±0.75 dB and ±6° from 2-1000 MHz; ±0.9 dB and ±7.5° from 1000-1300 MHz; ±1.25 dB and ±10° from 0.5-2 MHz.

Reference and reflection ports: ≥25 dB return loss from 2-1000 MHz; ≥23 dB return loss from 0.5-1300 MHz

Input port: ≥23 dB return loss

Maximum operating level: +20 dBm

Damage level: 1 watt CW

Connectors: Test Port; 50Ω Type N Female for 8502A and 75Ω Type N Female for 8502B; all other RF ports, 50Ω Type N Female; Bias input, BNC Female

DC Bias Input: ±30 V dc and ±200 mA.

Includes: 8502B includes 50Ω/75Ω minimum loss pad

Recommended accessory: 11851A RF Cable Kit

Dimensions: 101 mm wide, 61.5 mm high, 204 mm deep (7 1/2" X 2 1/4" X 8").

Weight: net, 1.7 kg (3 3/4 lb). Shipping, 3.1 kg (7 lb).

Accessories

11850A 50Ω Power Splitter

11850B 75Ω Power Splitter²

Frequency range: DC to 1.3 GHz

Impedance: 11850A, 50Ω; 11850B, 75Ω

Tracking between any two output ports: ≤0.1 dB and ≤1.5°

Equivalent source match (ratio or leveling): ≥32 dB return loss (≤1.05 SWR)

Input port match: ≥20 dB return loss

Maximum operating level: +20 dBm

Burn-out level: ≥1 watt CW

Connectors: 11850A, 50Ω Type N Female; 11850B, three outputs 75Ω Type N Female, RF input 50Ω Type N Female

Recommended accessory: 11851A RF Cable Kit

Includes: 11850B includes three (3) 50Ω/75Ω Minimum Loss Pads

Dimensions: 67 mm wide, 46 mm high, 67 mm deep (2 5/8" X 1 7/8" X 2 5/8")

Weight: net, 1.8 kg (4 lb). Shipping, 3.1 kg (7 lb).

¹ Vernier provides continuous adjustment of electrical length. Calibrated Electrical Length Linearity: Δφ = 0.7% X 1.21 (MHz) X 1 (metres)

² Tentative Specifications



8503A

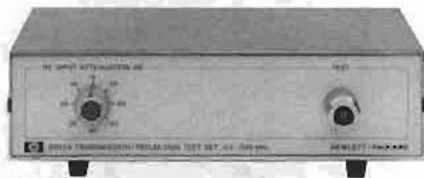
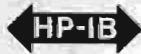

8502A



11850A



11851A

11851A RF Cable kit

General: four 61 cm (24 in.) shielded 50Ω cables, phase matched to 4° at 1.3 GHz. Connectors are Type N Male. Recommend for use with 8502A/B Transmission/Reflection Test Set and 11850A/B Power Splitter

Weight: net, 0.91 kg (2 lb). Shipping, 1.36 kg (3 lb).

11857A 50Ω Test Port Extension Cables

11857B 50Ω Test Port Extension Cables

General: two precision 61 cm (24 in.) cables, phase matched to 2° at 1.3 GHz for use with 8503A/B S-parameter test set. Connectors are 50Ω APC-7 (11857A) and 75Ω Type N Male and 75Ω GR-874.

Weight: net, 0.91 kg (2 lb). Shipping, 1.36 kg (3 lb).

11852A 50Ω/75Ω Minimum loss pad

General: the 11852A is a low SWR minimum loss pad required for transmission measurements on 75Ω devices with 8505A receiver (50Ω).

Frequency range: DC to 1.3 GHz

Insertion loss: 5.7 dB

Return loss: ≥30 dB (≤1.06 SWR)

Maximum input power: 250 mW (+24 dBm)

Connectors: 50Ω Type N Female and 75Ω Type N Male

Dimensions: diameter 14 mm, length 70 mm (5/16" × 2 3/4").

Weight: net, 0.11 kg (4 oz). Shipping, 0.26 kg (9 oz).

11853A 50Ω Type N accessory kit

General: the 11853A furnishes the RF components required for measurement of devices with 50Ω Type N Connectors using the 11850A, 8502A or 8503A (8503A also requires the 85032A). Kit contains a Type N Female short, a Type N Male short, to Type N Male barrels, to Type N Female barrels and storage case.

Weight: net, 0.91 kg (2 lb). Shipping, 1.36 kg (3 lb).

11854A 50Ω BNC accessory kit

General: the 11854A furnishes the RF components required for measurement of devices with 50Ω BNC connectors using the 11850A, 8502A, or 8503A (8503A also requires the 85032A). Kit contains two Type N Male to BNC Female adapters, two Type N Male to BNC Male adapters, two Type N Female to BNC Female adapters, two Type N Female to BNC Male adapters, a BNC Male short and storage case.

Weight: net, 1.13 kg (2 1/2 lb). Shipping, 1.59 kg (3 1/2 lb).

11855A 75Ω Type N accessory kit

General: the 11855 provides the RF connecting hardware generally required for measurement of devices with 75Ω Type N connectors using the 8502B, 11850B or 8503B. Kit contains two 75Ω Type N Male barrels, two 75Ω Type N Female barrels, a 75Ω Type N Male short, a 75Ω Type N Female short, and storage case.

Weight: net, 0.91 kg (2 lb). Shipping, 1.36 kg (3 lb).

11858A Rigid interconnect adapter

General: the 11858A adapts the 11600B and 11602B transistor Fixtures (vertical test port configuration) to the 8503A S-parameter test set. Connectors are APC-7.

Weight: net, 0.91 kg (2 lb). Shipping, 1.36 kg (3 lb).

Model number and name

Model number and name	Price
8505A RF Network Analyzer	\$22,500
Option 001 HP-IB	\$2950
Option 907 Front Handle Kit	\$30
Option 908 Rack Flange Kit	\$20
Option 909 Rack Flange/Front Handle Kit	\$40
8503A 50Ω S-Parameter Test Set	\$3700
Option 001 HP-IB	\$400
Option 907 Front Handle Kit	\$15
Option 908 Rack Flange Kit	\$10
Option 909 Rack Mount Flange/Front Handle Kit	\$20
8503B 75Ω S-parameter Test	\$3700
Option 001 HP-IB	\$400
Option 907 Front Handle Kit	\$15
Option 908 Rack Flange Kit	\$10
Option 909 Rack Mount Flange/Front Handle Kit	\$20
8502A 50Ω Transmission/Reflection Test Set	\$1850
8502B 75Ω Transmission/Reflection Test Set	\$1850
11850A 50Ω Power Splitter	\$450
11850B 75Ω Power Splitter	\$450
11851A RF Cable Kit	\$285
11852A 50Ω to 75Ω Minimum Loss Pad	\$180
11853A 50Ω Type N Accessory Kit	\$135
11854A 50Ω BNC Accessory Kit	\$135
11855A 75Ω Type N Accessory Kit	\$155
11857A 50Ω Test Port Extension Cables	\$550
11857B 75Ω Test Port Extension Cables	\$550
11858A Rigid Interconnect Adapter	\$450



NETWORK ANALYZERS

Automatic network analyzer, 500 kHz to 1.3 GHz

Model 8507A

- Improve productivity in lab and factory
- Accuracy enhancement
- Ease of operation via HP-IB
- 9830B calculator controller
- New learn mode



Description

The 8507A is the calculator-based automatic version of the 8505A RF Network Analyzer. The synergism of the easy-to-use 9830 calculator with the "most programmable" network analyzer yet designed provides a powerful RF network measurement tool for both lab and production uses.

Cost effective solutions

In laboratory applications, engineers gain greater circuit insight due to the speed and ease with which data can be accumulated and summarized with the 8507A. The easy-to-use calculator programming format reduces programming time to a fraction of what it would be for a corresponding computer program. With just a few hours' training, engineers with no previous programming experience have been able to write customized programs which solve specialized measurement problems. In production applications, the 8507A dramatically reduces the time and cost of making complicated limit tests on all types of components. Testing programs with built-in operator instructions can minimize training cost and assure uniform test procedures.

Simplicity and flexibility of HP-IB

Configuration of the standard 8507A or your own customized system is a simple matter since the 8507A is programmed via the Hewlett-Packard Interface Bus (HP-IB). For instance, your RF measurement application may require a programmable power supply for transistor biasing or a digital voltmeter. Merely choose an instrument from the already large but still growing list of HP-IB interfaced instruments and add it to your 8507A using universal HP-IB cables.

Getting started making measurements is equally easy since the 8507A comes complete with powerful calculator programs for system verification, accuracy enhancement and measurement applications. The system verification programs provide you with a fast operational check of the network analyzer, the calculator, and all system interfaces. However, one of the major contributions of the 8507A is its ease of operation and programming using the HP-IB with Learn Mode.

Learn mode operation

The "Learn" mode of operation extends traditional automatic operation to a new level of operator convenience. A single key stroke can cause the calculator to accept (learn) a data string from the network analyzer which defines all of the manually set front panel control settings. Once stored in the calculator (or permanently recorded) this data string can then be used to automatically return the network analyzer to its exact original test conditions. . . all without the operator ever writing a single program line!

New programmability features

1) Unique "marker mode" operation provides a real time swept display at the same time data (frequency or displayed parameters) is being logged.

So you can store data at a limited number of frequencies and still be sure you haven't missed a glitch.

2) Human-engineered HP-IB coding does away with complex code tables. To program a function, just type its name (shortened to first letter if you like) and switch position number (numbered 1 to N left to right).

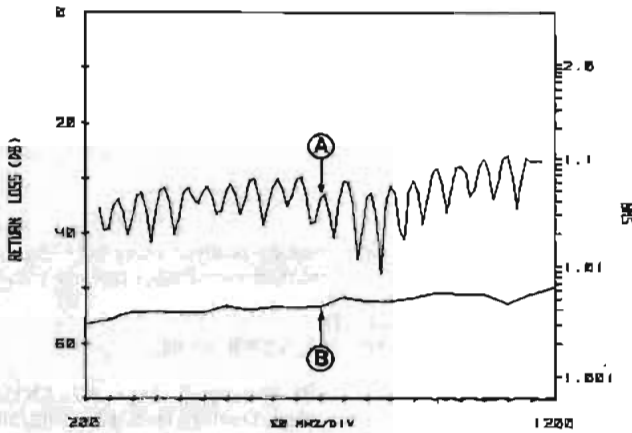

Accuracy enhancement

Each 8507A system is supplied with a program that permits frequency tracking, mismatch, and directivity errors to be characterized by applying known standards. These stored system errors at up to 100 frequency points are then removed from measurement of the unknown to provide a degree of accuracy exceeding that possible with the standard 8505A.

An example

The plots on the left show the result of software accuracy enhancement. Curve A depicts raw measurements on a 50 dB return loss termination at the end of a six-foot RG 214 cable — a typical application problem in testing in temperature chambers. Curve B shows the results after calibrating at the end of the cable — a 25 dB improvement.

Data in the form you need

With the BASIC language 9830A controller, it is a simple matter to obtain customized printed or plotted outputs. Or you may want to store data on a cassette for later analysis. Data can be analyzed or statistically summarized directly, bypassing the laborious and error-prone task of manually recording and re-entering data. Data reformatting such as converting return loss to SWR or s-parameters to y-parameters is easily done.

8507 Automatic network analyzer

General — Includes:

- 8505A Network Analyzer with HP-IB Interface
- 8503A S-Parameter Test Set with HP-IB Interface
- 9830B (8 K word memory and string variables) Controller with 9866A Printer, and Calculator/HP-IB interface including extended I/O ROM
- Calibration Kit, Systems Table, & Cables
- Controller programs including accuracy enhancement, verification, and measurement applications
- System Assembly and checkout

Power: 115 or 230 V, 50 — 60 Hz, 750 VA

Weight: net, 227 kg (500 lb). Shipping, 272 kg (600 lb)

8507A Calibration kits and programs

85030A Applications PAC for 8505A-9830A/B

Provides three cassette programs for system verification, accuracy enhancement (AIM-30), and basic measurement applications. Minimum equipment configuration required by 85030A is an 8505A Opt. 001, 8503A Opt. 001, 8503X Calibration Kit and a 9830 calculator with 8K word memory, string variable ROM and extended I/O ROM. The PAC also provides programs for the digital plotting if the 9862A Digital Plotter is added to the system.

85031A Verification and APC-7 Calibration kit

Included with 8507A. Contains Precision APC-7 Load, APC-7 Short, and two verification standards.

85032A Type N Calibration kit

For use with 8507A. Contains 2 APC-7 to N-Male Adapters, 2 APC-7 to N-Female Adapters, 1 N-Male Load, 1 N-Female Load, 1 N-Female Short, and 1 N-Male Short.

85033A SMA Calibration kit

For use with 8507A. Contains 2 APC-7 to SMA-Male Adapters, 2 APC-7 to SMA-Female Adapters, 1 SMA-Male load, 1 SMA-Female Load, 1 SMA-Female Short, and 1 SMA-Male Short.

Model number and name

Model number and name	Price
8507A Automatic Network Analyzer	\$45,490
Opt 001 9862A Plotter and 11271B Plotter Control ROM	add \$3520
Opt 002 Delete Systems Table	less \$600
Opt 003 Delete 9830B Calculator	less \$12,745
Opt 004 16K Word 9830B Calculator	add \$3200
Opt 005 Phase lock	\$1000
85030 Applications PAC for 8505A-9830A/B	\$250
85031A Verification/APC-7 Calibration Kit	\$600
85032A N Calibration Kit	\$725
85033A SMA Calibration Kit	\$360

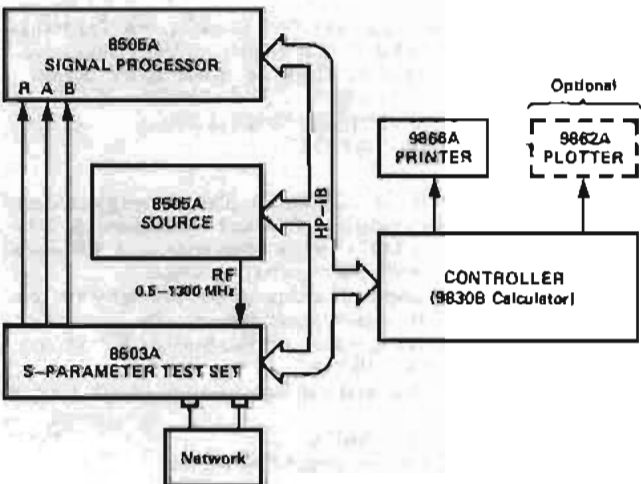
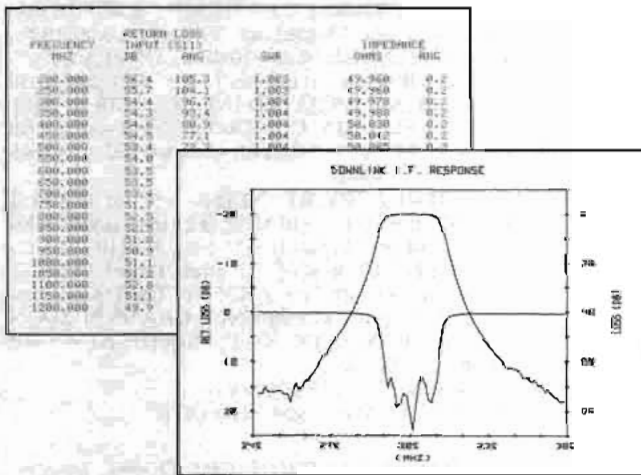

NETWORK ANALYZERS

RF network analyzer system, 100 kHz to 110 MHz

Model 8407 system

- Complete swept characterization of linear networks
- Modular system flexibility
- 50 Ω and 75 Ω measurements

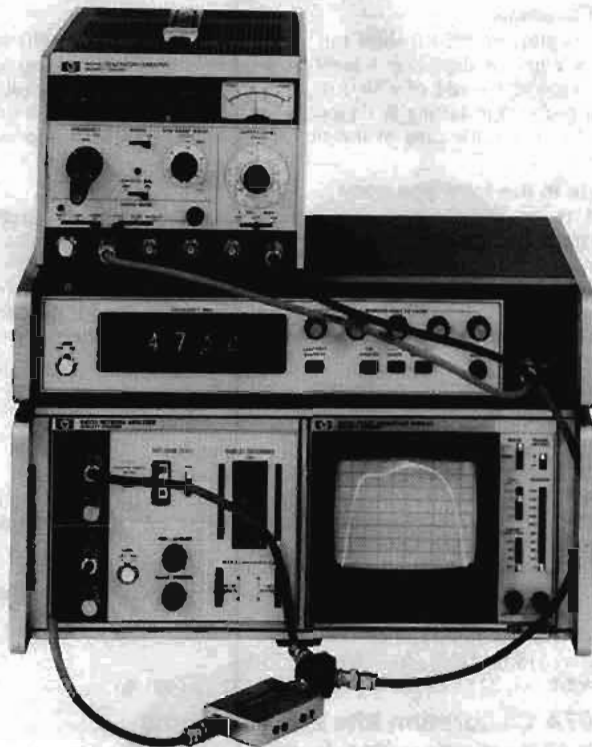

Swept measurements for either designing or testing are made with ease by HP's versatile 8407 Network Analyzer System. Since phase as well as magnitude is measured by a Network Analyzer, the behavior of both active and passive linear networks can be completely characterized from 100 kHz to 110 MHz by swept measurement.

Measurements of gain, loss, phase shift (compute group delay), return loss, and complex reflection coefficient are all possible in either 50 Ω or 75 Ω systems. These measurements allow the linear behavior of the networks under test to be completely characterized by their complex S-Parameters. Swept complex impedance $|Z|$ and θ (for $|Z|$) from 0.1 Ω to >10 k Ω as well as voltage and current transfer functions are also measured quickly and easily by the 8407 system. Typical linear networks designed and tested with the 8407 are filters, amplifiers, attenuators, antennae, detectors, cables, and recording heads.

Much of the 8407's versatility stems from its modular construction which allows the system to perform a variety of measurements or be economically tailored to one application. The basic instruments of the 8407 system are: The HP 8407A Network Analyzer, one of two REQUIRED sources (HP 8601A Sweeper/Generator or HP 8690B/8698B Sweep Oscillator), choice of two plug-in displays (HP 8412A Phase-Magnitude Display or HP 8414A Polar Display), an optional digital marker (HP 8600A), and one of four transducers (HP 11652A, 11654A, 11655A, or 1121A) depending on the measurement. Because the 8407A is a tracking receiver, the HP 8601A and HP 8690B/8698B are the only sources providing the VTO output required to operate the network analyzer. Thus, an operating system must be configured with one of the required sources, the network analyzer, a display and one or more of the transducers depending on the device under test and the network parameters desired.

Specifications

8407A

General: 8407A is a two input tracking receiver, using both inputs (reference and test channels) to form their magnitude ratio and phase difference before routing to display.

Frequency range: 0.1 - 110 MHz.

Impedance: 50 Ω , Option 008: 75 Ω . VSWR <1.08.

Dynamic range: 80 dB.

Test input: DIRECT -10 to -90 dBm signal range. ATTENUATED, +20 to -50 dBm signal range. Damage level +26 dBm/50 Vdc.

Reference input: DIRECT level required, -10 to -60 dBm. ATTENUATED level required +20 to -20 dBm. Damage level +26 dBm/50 Vdc.

Amplitude accuracy: FREQUENCY RESPONSE ± 0.2 dB for DIRECT input (test input > -60 dBm), 0.1 - 110 MHz; ± 0.05 dB over any 10 MHz portion; may be calibrated out. Typically ± 0.05 dB for DIRECT inputs. (REFERENCE level of -10 dBm). DISPLAY REFERENCE, <0.05 dB/1 dB step, total error ≤ 0.1 dB; <0.1 dB/10 dB step, total error ≤ 0.25 dB. ATTENUATED INPUTS, 40 dB ± 0.5 dB. REFERENCE CHANNEL GAIN CONTROL, 20 dB and 40 dB steps ± 0.5 dB/step. CROSSTALK, >0.03 dB when test/ref = -40 dB to <4 dB when test/ref = -80 dB.

Phase accuracy: FREQUENCY RESPONSE, $\pm 5^\circ$ for DIRECT input (test input > -60 dBm), 0.1 to 110 MHz; $\pm 2^\circ$ over any 20 MHz portion; may be calibrated out. Typically $\pm 2^\circ$ from 1 - 110 MHz for DIRECT inputs (REFERENCE level of -10 dBm). DISPLAY REFERENCE, <0.5 $^\circ$ /10 dB step; total error <3 $^\circ$. ATTENUATED inputs, $\pm 2^\circ$ from DIRECT inputs. REFERENCE CHANNEL GAIN CONTROL, $\pm 2^\circ$ /step. CROSSTALK, <0.3 $^\circ$ when test/ref = -40 $^\circ$ to <11 $^\circ$ when test/ref = -80 dB.

Power: 65 watts, 50-60 Hz, 115/230 $\pm 10\%$ Vac.

Weight: net, 14.6 kg (32 lb). Shipping, 17.8 kg (39 lb).

8412A

General: plug-in PHASE-MAGNITUDE CRT Display. Displays magnitude and/or phase vs. frequency.

Amplitude accuracy: display, 0.08 dB/dB from midscreen. Rear output: 0.03 dB/dB variation from 0 volt output.

Phase accuracy: DISPLAY, 0.065 $^\circ$ /degree from midscreen. PHASE OFFSET, 0.3 $^\circ$ /20 $^\circ$ step, $\leq 3^\circ$ for 360 $^\circ$ change, positive or negative direction. VS. DISPLAYED AMPLITUDE, <1 $^\circ$ /10 dB; total <6 $^\circ$ over 80 dB range.

Rear panel inputs: sweeping, ≤ 15 Vdc. Blanking, -4 Vdc blanks CRT. Z axis (marker), -5 Vdc intensified and +5 Vdc blanks trace.

Rear panel outputs: amplitude, 50 mV/dB; phase, 10 mV/degree.

Power: 23 watts, supplied by 8407A.

Weight: net, 7.8 kg (17 lb). Shipping, 10 kg (22 lb).

Detailed specifications on page 430.

8414A

General: normalized POLAR coordinate display with magnitude calibration in 0.2 of full scale gradations. Full scale is determined by DISPLAY REFERENCE on 8407A; phase calibration is in 10 $^\circ$ increments over 360 $^\circ$ range. Smith Chart overlays available.

Accuracy: all errors in amplitude and phase due to display are contained within a circle of 3mm about measurement point.

Rear panel inputs: blanking, -4 to -10 Vdc blanks CRT. Marker, intensified trace with -4 to -10 Vdc.

Rear panel outputs: horizontal and vertical both ± 2.5 V for full scale deflection.

Power: 35 watts, supplied by 8407A.

Weight: net, 5.9 kg (13 lb). Shipping, 8.0 kg (18 lb).

Detailed specifications on page 430.



11652A

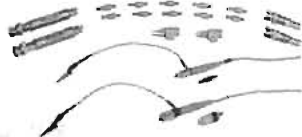

11654A



1121A

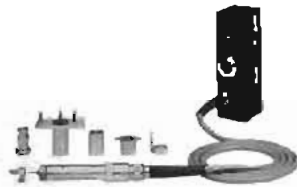

11655A



11658A



85428B

8601A

General: GENERATOR/SWEEPER operating in either CW or SWEEP modes. Sweep modes are full, variable stop frequency, and symmetrical (up to 10 MHz). Features very low residual FM, spurious, harmonics, and drift. 8601A provides the VTO signal required to operate the 8407A.

Frequency: 0.1 - 110 MHz in (two sweep ranges, 0.1 - 11 MHz and 1 - 110 MHz).

Impedance: 50 Ω , Option 008: 75 Ω , VSWR <1.2.

Accuracy: 1% of frequency, 0.5% linearity, and 2% of sweep width.

Calibrated output: ± 0.25 dB flatness over full range, output accuracy ± 1 dBm from +10 to -110 dBm.

Auxiliary outputs: sweep out, blanking (for 8412 and 8414), VTO (required by 8407A), and auxiliary output (0.1 - 11 MHz both ranges) for 8600 counter/digital marker.

Detailed specifications on page 354.

8600A

General: DIGITAL MARKER used with 8601A generator/sweeper to provide five continuously variable markers on a display while reading out the frequency of any one marker. Six digit display.

Markers/accuracy: 5 markers accurate at desired frequency \pm (0.05% sweep width + sweep stability).

Counter frequency range: 0.1 - 15 MHz (automatically scales up by ten when 8601A on 0.1 - 110 MHz range).

Detailed specifications on page 354.

11652A

General: REFLECTION-TRANSMISSION KIT containing power splitter, 8721A DIRECTIONAL BRIDGE, precision termination, calibrating short, three BNC adapters, and four matched, low-leakage cables for both transmission and reflection measurements. All 50 Ω BNC connectors, Option 008 75 Ω .

Directional bridge: 8721A: 6dB insertion loss and 6dB coupled to auxiliary arm. Frequency response ± 0.5 dB (0.1 - 110 MHz). Directivity >40 dB (1 to 110 MHz). Load port return loss >30 dB ($\rho < 0.03$). Max input power +20 dBm, 50 Ω , Option 008: 75 Ω .

Power splitter: 6 dB through each arm. Max input power +20 dBm, 50 Ω .

50 Ω termination: return loss >43 dB.

Weight: net, 0.7 kg (1.5 lb). Shipping, 1.2 kg (2.5 lb).

11654A

General: passive probe kit for measuring current and voltage trans-

fer functions and accurate complex impedance below 11 MHz contains a pair each of six resistive divider probes (1:1, 5:1, 10:1, 20:1, 50:1, 100:1), current probes and a variety of adapters.

Weight: net, 0.9 kg (2 lb). Shipping, 1.4 kg (3 lb).

11655A

General: swept or CW impedance probe mounting directly to 8407A. Mount contains internal calibrator, 100 $\Omega \pm 0.5\%$ and $0^\circ \pm 2^\circ$; parasitic capacitances are calibrated out; and simple charts are available for calculating out residual resistances. Contains component adapter, probe to BNC adapter, probe to type N adapter, and various ground assemblies.

Frequency: 0.5 - 110 MHz (usable to 0.1 MHz).

Measurement range: amplitude, 0.1 Ω to >10 k Ω ; phase, $0^\circ \pm 90^\circ$.

CW accuracy: amplitude $\pm 5\%$; $\pm 5^\circ$ for $|Z| > 3.16\Omega$.

Swept accuracy: typically $\pm 5\%$ in amplitude (3 - 110 MHz), $\pm 5^\circ$ in phase (5 - 110 MHz); accuracy decreases below 3 MHz. Note all accuracy specs valid only for proper input levels and calibration.

Max external voltage to probe: 50 Vdc, 5 V rms.

Weight: net, 0.9 kg (2 lb). Shipping, 2.7 kg (6 lb).

11658A

General: 50 Ω to 75 Ω matching resistor for matching the 50 Ω of the 8407A to a 75 Ω environment. Two 11658A's are very useful for frequent 50 Ω to 75 Ω changes. The 11658A's mount directly on the front panel of 8407A. FREQUENCY, 0.1 - 110 MHz. INSERTION LOSS, 3.5 dB. RETURN LOSS, >40 dB. CONNECTORS, 50 Ω BNC male and 75 Ω BNC female.

Net weight: 28 g (1 oz).

1121A

General: 1:1 active probe for making measurements without disturbing circuitry and measuring voltage transfer functions in systems different from 50 Ω , 10:1 and 100:1 dividers and BNC adapter also furnished.

Frequency response: ± 0.5 dB and $\pm 2\%$ from 0.1 - 110 MHz with a bandwidth (3 dB) of 1 kHz to >500 MHz and gain 0 dB ± 1 dB.

Input impedance: 100 k Ω , shunt capacitance of 3 pF at 100 MHz. With 10:1 or 100:1 divider, 1 M Ω , shunt capacitance 1 pF at 100 MHz.

Output impedance: 50 Ω nominal.

Maximum input: 300 mV rms, ± 80 V dc; with 10:1 divider, 3 V rms, ± 350 V dc; with 100:1 divider, 30 V rms, ± 350 V dc.

Power: supplied by 8407A through PROBE PWR jacks.

Weight: net, 0.7 kg (1.5 lb). Shipping, 1.2 kg (2.5 lb).

85426A

General: bias insertion network providing DC biasing to devices under test on RF transmission lines. Operating frequency range is 0.1 - 500 MHz with insertion loss <0.4 dB and return loss >28 dB. Max biasing current of 750 mA and max biasing voltage of 70 V. Connectors are BNC for DC biasing and APC-7 for RF.

Weight: net, 0.5 kg (1 lb). Shipping, 0.8 kg (1.7 lb).

85428B

General: 50 Ω to 75 Ω minimum loss pad. Pad operates from 0.1 - 110 MHz with an insertion loss of 5.7 dB and VSWR <1.05. Connectors are 50 Ω BNC male and 75 Ω BNC female.

Weight: net, 0.1 kg (2 oz). Shipping, 0.2 kg (6 oz).

Model number and name

Model number and name	Price
8407A Network Analyzer	\$4000
Option 008	add \$115
8412A Phase Magnitude Display	\$2025
8414A Polar Display	\$1800
8601A Sweeper/Generator	\$3000
Option 008	add \$50
8600A Digital Marker	\$1500
11652A Reflection/Transmission Kit	\$440
Option 008	add \$55
11654A Passive Probe Kit	\$550
11655A Impedance Probe Kit	\$1250
11658A Matching Resistor	\$40
1121A AC Probe Kit	\$595
85426A Bias Insertion Network	\$550
85428B Minimum Loss Pad	\$150
8721A Directional Bridge	\$180
Option 008	add \$10

NETWORK ANALYZERS

Vector voltmeter Model 8405A

- Accurate voltage and phase measurement
- 1 to 1000 MHz

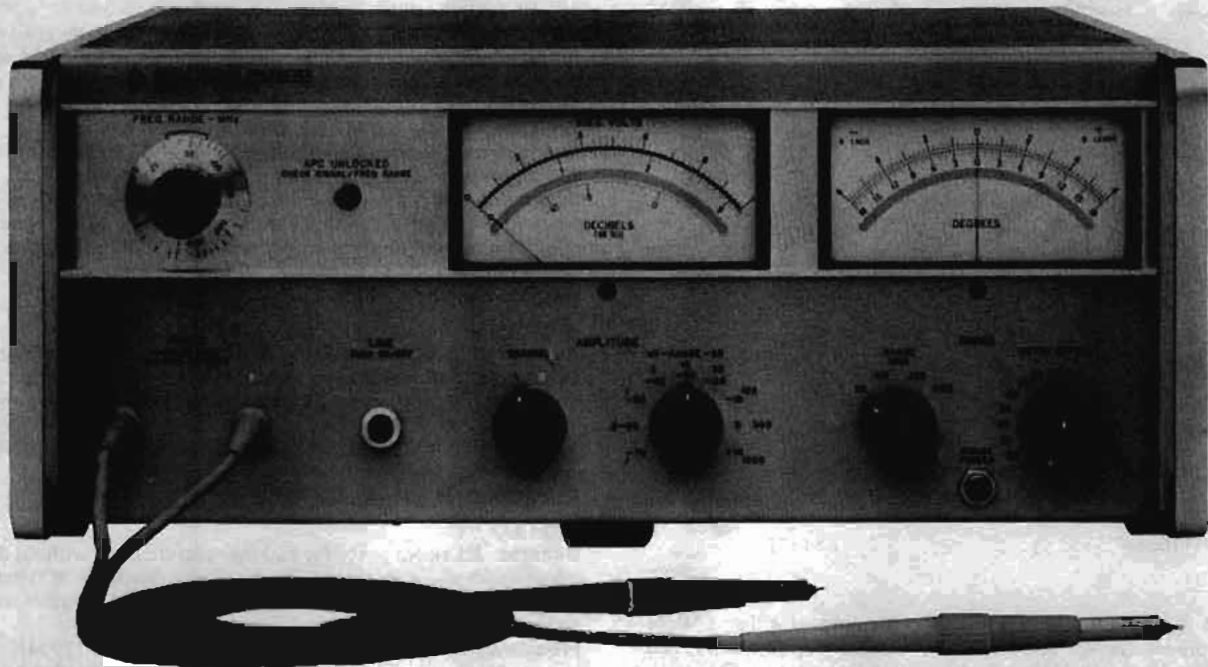

The 8405A Vector Voltmeter measures voltage vectors described by both magnitude and phase. This capability makes the 8405A a unique instrument for about any design and test application in the frequency range 1 to 1000 MHz.

In addition to absolute voltage measurements, capabilities include insertion loss and group delay of passband-filters and other transmission devices, gain and phase margin of amplifiers, complex impedance of mixers, antennas, matching the electrical lengths of cables, s-parameters of transistors, amplitude modulation index, RF distortion measurements and in-circuit probing.

The 8405A achieves this measurement versatility through its two-channel capability enabling voltage magnitude measurements in either channel, thus allowing ratio measurements, and phase difference measurements between the two channels. Gain or loss in excess of 90 dB and phase measurements with 0.1° resolution over a 360° phase range are possible.

Accuracy is achieved through the 1 kHz bandwidth entailing response only to the fundamental frequency of the input signal. Also, phase-locked coherent sampling to translate 1 to 1000 MHz RF signals to 20 kHz IF signals enables accurate detection of voltage magnitude and phase. Automatic phase-locked tuning makes it possible to select the one of 21 overlapping octave ranges which contains the input signal frequency by simply rotating a switch.

Specifications

Frequency range: 1 MHz to 1 GHz in 21 overlapping octave bands; tuning automatic within each band.

Isolation between channels: 1 to 300 MHz, >100 dB; 300 to 1,000 MHz >80 dB.

Maximum input: ac, 2 V peak; dc, ±50V.

Input impedance (nominal): 0.1 MΩ shunted by 2.5 pF; 1 MΩ shunted by 2 pF when 11576A 10:1 Divider is used; 0.1 MΩ shunted by 5 pF when 10216A Isolator is used. AC coupled.

Voltage range (rms):

Channel	1 - 10 MHz	10 - 500 MHz	500 - 1000 MHz
A	1.5 mV - 1.0 V	300 μV - 1.0 V	500 μV - 1.0 V
B	<20 μV - 1.0 V	<20 μV - 1.0 V	<20 μV - 1.0 V

Voltmeter ranges: 100 μV to 1 V rms full scale in 10 dB steps.

Voltage ratio accuracy: 1-200 MHz, 0.2 dB for -60 to 0 dB ranges; 200-1000 MHz, 0.2 dB for -60 to -10 dB ranges.

Phase range: 360° indicated on zero-center meter with end-scale ranges of ±180°, ±60°, ±18°, and ±6°.

Phase resolution: 0.1° at any phase angle.

Phase meter offset: ±180° in 10° steps.

Phase accuracy: ±1.5° (equal voltage Channel A and B).

Accessories furnished: two 11576A 10:1 Dividers, two 10216A Isolators, two 10218A BNC Adapters, six ground clips for 11576A or 10216A; six replacement probe tips.

Bandwidth: 1 kHz

Power: 115 or 230 V ±10%, 50 to 400 Hz, 35W.

Weight: net, 13.9 kg (31 lb). Shipping, 16.3 kg (36 lb).

Dimensions: 425 mm wide, 177 mm high, 467 mm deep (16 1/4" × 7" × 18 1/2")

11570A Accessory kit

50Ω TEE: 11536A: For monitoring signals on 50Ω transmission lines without terminating line. Kit contains two with type N RF fittings.

Power splitter: 11549A: All connectors Type N female.

50Ω termination: 908A: for terminating 50Ω coaxial systems in their characteristic impedance.

Shorting plug: 11512A: Shorting Plug, Type N male.

Model number and name

8405A Vector Voltmeter

Option 002, linear dB scale

11570A Accessory Kit (measurement in 50Ω system only)

Price

\$3500

add \$25

\$365

NETWORK ANALYZERS

Microwave network analyzer, 110 MHz to 40 GHz
Model 8410S systems

- Complete microwave measurement systems
- Measures all network parameters

- Multioctave swept frequency measurement
- System accuracy fully specified

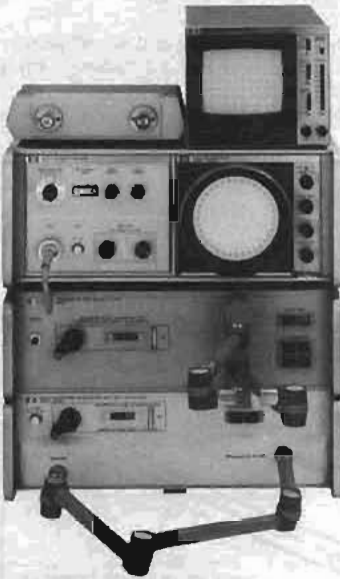

8410S option 310



8410S option 400



8410S option 500

All 8410S Systems measure transmission and reflection parameters of coaxial or semiconductor components in the form of gain, attenuation, phase, reflection coefficient or impedance. Each option has been configured and fully specified for making general measurements within a frequency range or for pushbutton S-parameter measurements on semiconductor devices in a variety of package styles. The 8410S Systems enable the operator to view a real time CRT display over octave or multioctave bands with a dynamic range of 60 dB am-

plitude and 360° phase. Multioctave, continuous network measurements over the frequency range of 2 to 18 GHz are possible when the 8410B is used with the HP 8620/86290A Sweep Oscillator.

The 8410S Systems' upper frequency limit for coaxial and semiconductor measurements is 12.4 GHz; however, individual instruments may be ordered that will expand coaxial measurement capability to 18 GHz (option 018 instruments) and waveguide measurements from 8.2 GHz to 40 GHz (8747A series).

8410S Network Analyzer Systems Table

GENERAL PURPOSE MEASUREMENTS			All 8410S Systems include the Following Instrument Model Numbers: 8410B, 8411A, 8412A*, 8414A and 11603A										PRICE
Frequency Range	Option No.	Measurement Port Configuration	8743A	8745A	8746A	8717B	11600B	11602B	11608A	11604A	11605A	11650	
0.11 to 2 GHz	110*	Coaxial (APC-7)		X						X		X	\$17,445
0.11 to 12.4 GHz	310*	Coaxial (APC-7)	X	X						X	X	X	\$22,695
2 to 12.4 GHz	210*	Coaxial (APC-7)	X								X	X	\$16,570
SEMICONDUCTOR CHARACTERIZATION													
0.11 to 2 GHz	400	T018/T072 Packages		X		X	X						\$18,240
0.11 to 2 GHz	401	T05/T012 Packages		X		X		X					\$18,240
0.5 to 12.4 GHz	500	T051 Package			X	X			X				\$20,740
0.5 to 12.4 GHz	501	HPAC-200 Package			X	X			X				\$20,740

*Options 100, 200 and 300 are identical to 110, 210 and 310 respectively except for the 8412A which is replaced by the 8413A.

8410S Systems (cont.)

Specifications

8410S Common performance specifications

Function: All systems measure transmission and reflection parameters on a swept-frequency or CW basis with readout of attenuation, gain, phase shift, reflection coefficient, return loss, impedance, depending on display unit.

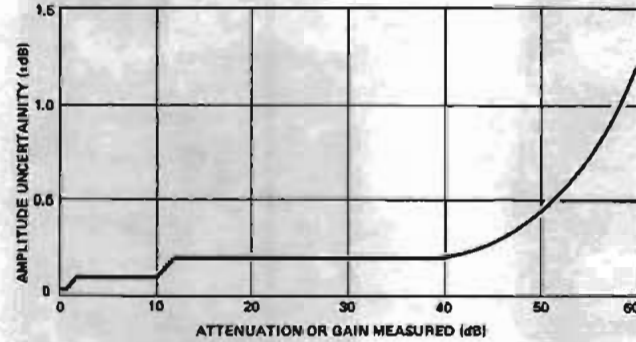

8412A Phase-magnitude display: rectangular coordinate dual-channel CRT.

Amplitude range: 80 dB.

Phase range: $\pm 180^\circ$.

Resolution

Selectable amplitude: 10, 2.5, 1, 0.25 dB/division.

Selectable phase: 90, 45, 10, 1 degree/division.

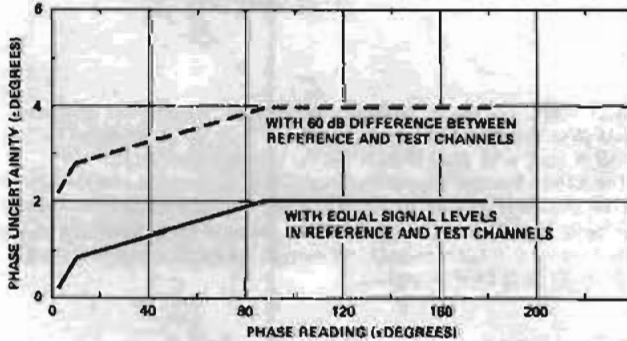

8414A Polar display: Polar Coordinate CRT with magnitude calibration divisions at 20, 40, 60, 80 and 100% of full scale. Outer range settable by IF gain control and amplitude vernier.

Connectors: RF Input, Type N female stainless steel; Measurement Ports, APC-7 precision 7-mm connectors.

Transmission measurement (using 8412A): accuracy curves show overall system uncertainty when measuring amplitude and phase. Sources of error included are IF gain control, display accuracy, phase offset, system noise and cross-talk. System frequency response is specified separately and is not included in accuracy curves.

Amplitude accuracy (60 dB dynamic range)

IF gain control: 69 dB in 10 dB and 1 dB steps.

± 0.1 dB/10 dB

± 0.05 dB/1 dB

} ± 0.2 dB maximum cumulative

Display: 0.08 dB/dB from midscreen.

Phase accuracy

Phase offset: $0.3^\circ/20^\circ$ step; maximum 3° for 360° change.

Display: $0.065^\circ/\text{degree}$ from midscreen.

8410S Options 100/110 specifications

Function: the 8410S option 100/110 measurement systems give all four s-parameters for a two-port network with pushbutton ease over the frequency range of 110 MHz to 2 GHz. A choice in Log display units is made by selecting the Option 100 (8413A display) or Option 110 (8412A display) system.

Frequency range: 0.11 to 2.0 GHz.

RF input: 20 dB range between -21 dBm and $+7$ dBm.

Source reflection coefficient: ≤ 0.09 , 0.11 - 2.0 GHz.

Termination reflection coefficient: ≤ 0.11 , 100 - 200 MHz; ≤ 0.09 , 200 - 2000 MHz.

Directivity: > 36 dB 0.11 - 1.0 GHz; > 32 dB 1.0 - 2.0 GHz.

Insertion loss, RF input to test port: 4 dB nominal.

Frequency response

Transmission: typically $< \pm 0.35$ dB amplitude and $< \pm 3^\circ$ phase.

Reflection: typically $< \pm 0.06$ magnitude and $\pm 5^\circ$ phase with a short on the test port.

Transmission measurement accuracy: (see common performance specifications).

Reflection measurement accuracy (using 8414A): sources of error included in the accuracy equations are directivity, source match, and polar display accuracy.

Magnitude accuracy:

$\rho_u = \pm(0.015 + 0.03 \rho_L + 0.06 \rho_L^2)$ 0.11 - 1.0 GHz

$\rho_u = \pm(0.025 + 0.03 \rho_L + 0.06 \rho_L^2)$ 1.0 - 2.0 GHz

$\rho_u =$ magnitude uncertainty

$\rho_L =$ measured reflection coefficient magnitude.

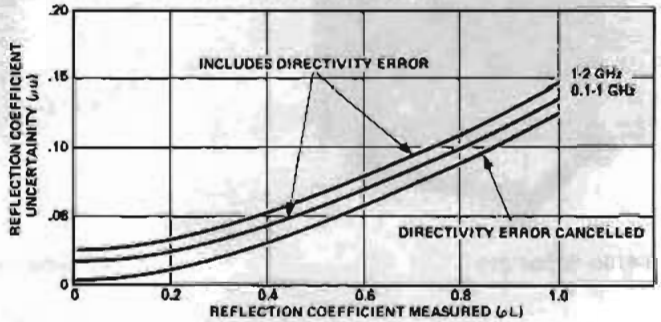
**Phase accuracy:**

$\Phi_u = \sin^{-1} \rho_u / \rho_L$ for $\Phi_u < 90^\circ$

$\Phi_u =$ phase uncertainty

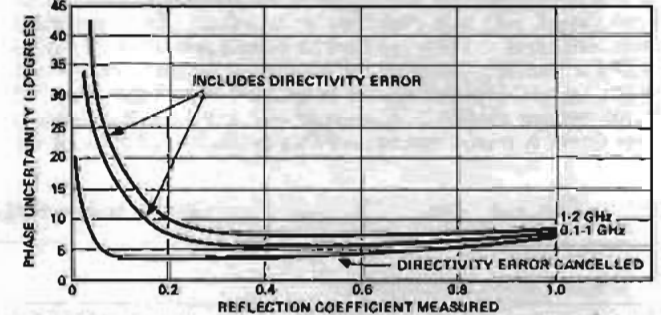

See 8410S network analyzer systems table for price and instrument breakdown.

8410S Options 200/210 specifications

Function: the 8410S Option 200/210 measurement systems cover a frequency range of 2 to 12.4 GHz. With just one simple setup and calibration both transmission and reflection measurements are easily made by pushing a button. A choice in Log display units is made by selecting the Option 200 (8413A display) or Option 210 (8412A display) system.

Frequency range: 2.0 to 12.4 GHz.

RF input: 20 dB range between -14 dBm and $+14$ dBm.

Source reflection coefficient: ≤ 0.09 , 2 - 8 GHz; ≤ 0.13 , 8 - 12.4 GHz.

Termination reflection coefficient: ≤ 0.09 , 2 - 8 GHz; ≤ 0.13 , 8 - 12.4 GHz.

Directivity: ≥ 30 dB, 2 - 12.4 GHz.

Insertion loss, RF input to test port: 20 dB nominal.

Frequency response

Transmission: typically $< \pm 0.5$ dB amplitude and $< \pm 5^\circ$ phase.

Reflection: typically $< \pm 0.06$ magnitude and $< \pm 7^\circ$ phase, with a short on the unknown port.

Transmission measurement accuracy: (see common performance specifications).

Reflection measurement accuracy (using 8414A): sources of error included in the accuracy equations are directivity, source match, and polar display accuracy.

Magnitude accuracy:

$$\rho_u = \pm(0.0316 + 0.03 \rho_l + 0.09 \rho_l^2) 2 - 8 \text{ GHz}$$

$$\rho_u = \pm(0.0316 + 0.03 \rho_l + 0.13 \rho_l^2) 8 - 12.4 \text{ GHz}$$

ρ_u = magnitude uncertainty

ρ_l = measured reflection coefficient magnitude

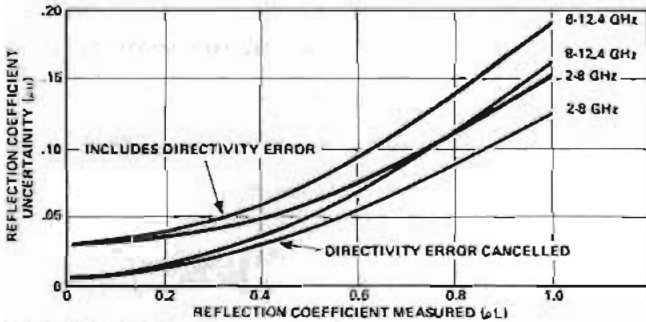

Phase accuracy:

$$\Phi_u = \sin^{-1} \rho_u / \rho_l \text{ for } \Phi_u < \pm 90^\circ$$

Φ_u = phase uncertainty

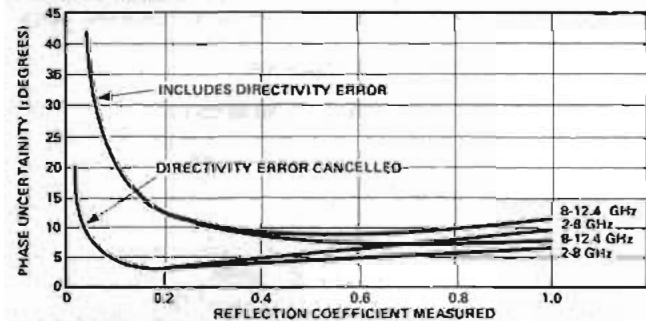

See 8410S network analyzer systems table for price and instrument breakdown.

8410S Options 300/310 specifications

Function: the 8410S Option 300/310 measurement systems encompass both the 8410S Option 110 and 210 system specifications and flexibility. The two RF transducer units cover the frequency range of 110 MHz to 12.4 GHz and both offer calibrated line stretchers for extending the reference plane. Coaxial rotary joints and airlines mounted on the front of the transducer units allow easy connections to the test device. A choice in log display units is made by selecting either the Option 300 (8413A display) or Option 310 (8412 display) system.

See 8410S network analyzer systems table for price and instrument breakdown.

8410S Options 400/401 specifications

Function: the 8410S Option 400/401 S-parameter measurement systems provides two port S-parameters for semiconductors in TO-18/TO-72 (Option 400) or TO-5/TO-12 (Option 401) packages. A short circuit Termination and a 50 ohm through section are included with each type fixture for reference plane calibration.

Frequency range: 0.11 to 2.0 GHz.

Transistor DC bias selection: front panel slide switches establish proper dc biasing for both Bi-polar and FET transistors. The voltage and current controls operate independently and are continuously adjustable over a current range of 0 to 500 ma and a voltage range of 0 to 30 V.

RF input: 20 dB range between -21 dBm and +7 dBm.

Incident power at device under test: +3 dBm to -25 dBm.

Source reflection coefficient

Option 400: typically <0.062

Option 401: typically <0.067

Termination reflection coefficient

Option 400: typically <0.11, 100 to 200 MHz

<0.09, 0.2 to 2.0 GHz

Option 401: typically <0.14, 100 to 200 MHz

<0.10, 0.2 to 2.0 GHz

Directivity

Option 400: typically <31 dB, 0.11 to 1.0 GHz

<29 dB, 1.0 to 2.0 GHz

Option 401: typically <28 dB, 0.11 to 1.0 GHz

<27 dB, 1.0 to 2.0 GHz

Frequency response

Transmission: typically <±0.35 dB, ±3°

Reflection: typically <±.5 dB, ±5°

Transmission measurement accuracy: (see common performance specification).

Reflection measurement accuracy (using 8414A): sources of error included in the accuracy equations are directivity and source match.

Magnitude accuracy

Option 400:

$$\rho_u = \pm(0.029 + 0.048 \rho_l + 0.06 \rho_l^2) 0.11 \text{ to } 1 \text{ GHz}$$

$$\rho_u = \pm(0.035 + 0.051 \rho_l + 0.062 \rho_l^2) 1.0 \text{ to } 2.0 \text{ GHz}$$

Option 401:

$$\rho_u = \pm(0.038 + 0.054 \rho_l + 0.067 \rho_l^2) 1.0 \text{ to } 2.0 \text{ GHz}$$

ρ_u = magnitude uncertainty

ρ_l = measured reflection coefficient magnitude

Phase accuracy:

$$\Phi_u = \sin^{-1} \rho_u / \rho_l \text{ for } \Phi_u < 90^\circ$$

Φ_u = phase uncertainty

See 8410S network analyzer systems table for price and instrument breakdown.

8410S Options 500/501 specifications

Function: the 8410S Option 500/501 S-parameter measurement systems provide the capability of biasing and measuring all four S-parameters of strip-line transistors in the TO-51 (Option 500), HPAC-200 (Option 501) packages. A short circuit termination and a 50-ohm through section are included with each fixture for reference plane calibration.

Frequency range: 0.5 to 12.4 GHz.

Transistor dc bias selection: front panel slide switches establish proper dc biasing for both Bi-polar and FET transistors. The voltage and current controls operate independently and are continuously adjustable over a current range of 0 to 500 ma and a range of 0 to 30 V dc.

RF input: 20 dB range between -7 and +13 dBm.

Incident power at device under test: -27 dBm to -7 dBm with INCIDENT ATTENUATION set to 0 dB.

Incident attenuation range: 0 to 70 dB in 10 dB steps.

Source reflection coefficient: (typically) <0.13, 0.5 to 8.0 GHz; <0.14, 8.0 to 12.4 GHz.

Termination reflection coefficient: (typically) <0.13, 0.5 to 8.0 GHz; ±0.14, 8.0 to 12.4 GHz.

Directivity: >28 dB, 0.5 to 4.0 GHz; >23 dB, 4 to 12.4 GHz.

Frequency response: (typically) <1.0 dB, ±5 degrees, 0.05 to 4.0 GHz; <1.5 dB, ±5 degrees, 4.0 to 8.0 GHz; <2.5 dB, ±5 degrees, 8.0 to 12.4 GHz.

Transmission measurement accuracy: (see common performance specifications).

Reflection measurement accuracy: sources of error included in the accuracy equation are directivity and source match.

Magnitude accuracy:

$$\rho_u = \pm(0.04 + 0.08 \rho_l + 0.13 \rho_l^2) 0.5 \text{ to } 4.0 \text{ GHz}$$

$$\rho_u = \pm(0.07 + 0.09 \rho_l + 0.135 \rho_l^2) 4.0 \text{ to } 8.0 \text{ GHz}$$

$$\rho_u = \pm(0.074 + 0.098 \rho_l + 0.14 \rho_l^2) 8.0 \text{ to } 12.4 \text{ GHz}$$

ρ_u = magnitude uncertainty

ρ_l = measured reflection coefficient magnitude

Phase accuracy:

$$\Phi_u = \sin^{-1} \rho_u / \rho_l \text{ for } \Phi_u < 90^\circ$$

Φ_u = phase uncertainty

See 8410S network analyzer systems table for price and instrument breakdown.

NETWORK ANALYZERS

Individual instruments

8410 family

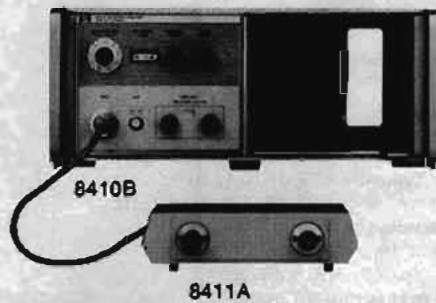

8412A



8413A

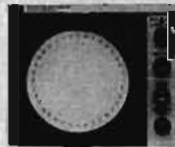

8414A

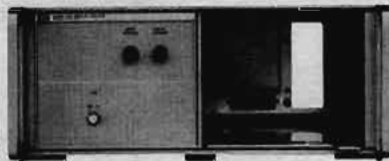

8418A

Specifications

8410B/8411A Network Analyzer

Function: 8411A converts RF signals to IF signals for processing in 8410B mainframe. 8410B is the mainframe for display plug-in units. Mainframe includes tuning circuits (octave bands or multioctave bands when used with HP 8620/86290 sweep oscillator), IF amplifiers and precision IF attenuator.

8410B frequency range: 0.11 to 18 GHz.

8411A frequency range: 0.11 to 12.4 GHz.

Option 018: 0.11 to 18 GHz.

8411A input impedance: 50 ohms nominal. SWR <1.5, 0.11 to 8.0 GHz; <2.0, 8.0 to 12.4 GHz; typically increases to a 10:1 SWR, 12.4 to 18 GHz.

Channel isolation: >65 dB, 0.1 to 6 GHz; >60 dB, 6 to 12.4 GHz; >50 dB, 12.4 to 18 GHz.

Amplitude

Reference channel: any 20 dB range between -16 and -44 dBm.

Test channel: -10 to -78 dBm from 0.11 to 12.4 GHz; -10 to -68 dBm from 12.4 to 18 GHz.

Maximum RF input to either channel: 50 mW.

IF gain control: 69 dB range in 10 dB and 1 dB steps with a maximum cumulative error of ± 0.2 dB.

Phase

Phase range: 0 to 360°.

Control: vernier control >90°.

Connectors (8411A): APC-7.

Power: 115 or 230 V ac $\pm 10\%$, 50-60 Hz, 70 watts (includes 8411A).

Weight

8410B: net, 14.9 kg (33 lb). Shipping, 18.5 kg (41 lb).

8411A: net, 3.2 kg (7 lb). Shipping, 4.5 kg (10 lb).

Dimensions

8410B: 425 mm wide, 191 mm high, 467 mm deep (16 $\frac{1}{2}$ " \times 7 $\frac{1}{2}$ " \times 18 $\frac{1}{8}$ ").

8411A: 228 mm wide, 67 mm high, 143 mm deep (9" \times 2 $\frac{5}{8}$ " \times 5 $\frac{5}{8}$ "), exclusive of connectors and cable.

8412A Phase-magnitude display

Function: plug-in CRT display unit for 8410B. Displays relative amplitude in dB and/or relative phase in degrees between reference and test channel inputs versus frequency.

Amplitude

Range: 80 dB display range with selectable resolutions of 10, 2.5, 1 and 0.25 dB/division.

Accuracy: 0.08 dB/dB from midscreen.

Phase

Range: $\pm 180^\circ$ display range with selectable resolutions of 90, 45, 10, and 1°/division.

Accuracy: 0.065°/degree from midscreen.

Phase offset: 0.3°/20° step cumulative <3°.

Power: 23 watts supplied by mainframe.

Weight: net, 7.8 kg (17 lb). Shipping, 10 kg (22 lb).

Dimensions: 186 mm wide, 152 mm high, 395 mm deep (7 $\frac{1}{2}$ " \times 6" \times 15 $\frac{5}{8}$ "), excluding front panel knobs.

8413A Phase-gain indicator

Function: plug-in meter display unit for 8410B. Displays relative amplitude in dB between reference and test channel inputs or relative phase in degrees. Pushbutton selection of meter function and range.

Amplitude

Range: ± 30 , ± 10 , and ± 3 dB full scale.

Accuracy: $\pm 3\%$ of end scale.

Log Output: 50 millivolts per dB up to 60 dB total.

Phase

Range: ± 180 , ± 60 , ± 18 , ± 6 degrees full scale.

Accuracy: $\pm 2\%$ of end scale.

Output: 10 millivolts per degree.

Phase offset: ± 180 degrees in 10-degree steps.

Accuracy: $\pm(0.2^\circ + 0.3^\circ/10^\circ \text{ step})$, cumulative <2°.

Power: additional 15 watts supplied by 8410B.

Weight: net, 4.9 kg (11 lb). Shipping, 6.7 kg (15 lb).

Dimensions: 186 mm wide, 152 mm high, 395 mm deep (7 $\frac{1}{2}$ " \times 6" \times 15 $\frac{5}{8}$ ").

8414A Polar display

Function: plug-in CRT display unit for 8410B. Displays amplitude and phase data in polar coordinates on 5-in. cathode ray tube.

Range: normalized polar coordinate display; magnitude calibration 20% of full scale per division. Scale factor is a function of IF setting on 8410B. Phase calibrated in 10-degree increments over 360-degree range.

Accuracy: error circle on CRT ± 3 mm.

Power: additional 35 watts supplied by 8410B.

Weight: net, 5.8 kg (13 lb). Shipping, 8.1 kg (18 lb).

Dimensions: 186 mm wide, 152 mm high, 395 mm deep (7 $\frac{1}{2}$ " \times 6" \times 15 $\frac{5}{8}$ "), excluding front panel knobs.

8418A Auxiliary power supply

Function: the 8418A power supply unit provides power for operation of the 8412A, 8413A or the 8414A display units. Used in conjunction with the 8410B Network Analyzer, it provides the capability of viewing amplitude and phase readout in both rectangular and polar coordinates simultaneously.

Weight: net, 11.2 kg (25 lb). Shipping, 19.7 kg (44 lb).

Dimensions: 483 mm wide, 177 mm high, 450 mm deep (19" \times 6 $\frac{1}{2}$ " \times 17 $\frac{1}{8}$ ").

Model number and name

Model number and name	Price
8410B mainframe	\$3400
Option 908: Rack Flange Kit	add \$10
8411A frequency converter	\$3100
Option 018	add \$500
8412A phase-magnitude display	\$2025
8413A phase-gain display	\$1600
8414A polar display	\$1800
8418A auxiliary power supply	\$1500



8745A



11604A



11600B

11602B



8743A



11605A

8745A S-Parameter test unit

Function: wideband RF power splitter and reflectometer with calibrated line stretcher. Pushbutton operated for either transmission or reflection measurements with network analyzer.

Frequency range: 100 MHz to 2 GHz.

Impedance: 50 ohms nominal.

Source reflection coefficient: ≤ 0.057 , 0.11 to 2.0 GHz.

Termination reflection coefficient: < 0.10 , 100 to 200 MHz; < 0.063 , 200 MHz to 2.0 GHz.

Directivity: ≥ 36 dB, below 1 GHz; ≥ 32 dB, 1 to 2 GHz.

Reference plane extension: 0 to 15 cm for reflection; 0 to 30 cm for transmission.

Maximum RF power: 2 watts.

Connectors: RF input, type N female; all other connectors APC-7.

Rear panel programming and bias inputs

Option 001: output connectors type N female.

Power: 115 or 120 V ac $\pm 10\%$, 50 to 400 Hz, 40 watts.

Weight: net, 15.4 kg (34 1/4 lb). Shipping, 18.0 kg (40 lb).

Dimensions: 425 mm wide, 140 mm high, 654 mm deep (16 1/4" \times 5 1/2" \times 25 3/4").

11604A Universal Extension

Function: mounts on front of 8745A; connects to device under test. Rotary air-lines and rotary joints connect to any two port geometry.

Frequency range: dc to 2 GHz.

Impedance: 50 ohms nominal.

Reflection coefficient: 0.035.

Acc. Included: semi-rigid coax. cable, HP Part #11604-20021.

Weight: net, 1.8 kg (4 lb). Shipping, 2.2 kg (5 lb).

Dimensions: 32 mm wide, 127 mm high, 267 mm deep (1 1/4" \times 5" \times 10 1/2").

11600B/11602B Transistor Fixtures

Function: mounts on front of 8745A S-parameter test set; holds devices for S-parameter measurements in a 50-ohm, coax circuit. Both fixtures provide bias for bipolar transistors and FETs. Other devices also fit the fixtures (tunnel diodes, etc.).

Transistor base patterns

Model 11600B: accepts TO-18/TO-72 packages.

Model 11602B: accepts TO-5/TO-12 packages.

Calibration references: short circuit termination and a 50-ohm through-section.

Frequency ranges: dc to 2 GHz.

Impedance: 50 ohms nominal.

Reflection coefficient: < 0.05 , 100 MHz to 1.0 GHz; < 0.09 , 1.0 to 2 GHz.

Connectors: hybrid APC-7; Option 001, type N female.

Weight: net, 1.1 kg (2 1/2 lb). Shipping, 1.8 kg (4 lb).

Dimensions: 44 mm wide, 152 mm high, 229 mm deep (1 3/4" \times 6" \times 9").

8743A Reflection/transmission test unit

Function: wideband RF power splitter and reflectometer with calibrated line stretcher. Pushbutton operated for either transmission or reflection measurements with network analyzer.

Frequency range: 2 to 12.4 GHz, (option 018: 2 to 18 GHz).

Impedance: 50 ohms nominal.

Source reflection coefficient: ≤ 0.09 , 2.0 to 8.0 GHz; ≤ 0.13 , 8.0 to 12.4 GHz; < 0.2 , 12.4 to 18 GHz.

Termination reflection coefficient: ≤ 0.13 in reflection mode, 2.0 to 12.4 GHz; ≤ 0.2 in transmission mode, 2.0 to 12.4 GHz; typically < 0.2 , 12.4 to 18 GHz.

Directivity: ≥ 30 dB, 2.0 to 12.4 GHz; ≥ 18 dB, 12.4 to 18 GHz.

Reference plane extension: 0 to 15 cm for reflection; 0 to 30 cm for transmission.

Connectors: RF input, type N female; all other connectors APC-7.

Power: 115 or 230 V ac $\pm 10\%$, 50-400 Hz, 15 W.

Weight: net, 12.1 kg (29 lb). Shipping, 15.3 kg (34 lb).

Dimensions: 425 mm wide, 140 mm high, 467 mm deep (16 1/4" \times 5 1/2" \times 18 3/8").

11605A Flexible arm

Function: mounts on front of 8743A; connects to device under test. Rotary air lines and rotary joints connect to any two-port geometry.

Frequency range: dc to 12.4 GHz, (Option 018, 2 to 18 GHz).

Impedance: 50 ohms nominal. Reflection coefficient of ports: ≤ 0.11 , dc to 12.4.

Option 018: ≤ 0.23 , 2.0 to 12.4 GHz; ≤ 0.31 , 12.4 to 18 GHz.

Connectors: APC-7.

Weight: net, 1.8 kg (4 lb). Shipping, 2.7 kg (6 lb).

Length: 257 mm (10 1/8") closed; 648 mm (25 1/2") extended.

Model number and name

Model number and name	Price
8745A test set	\$4500
Option 001	N/C
11604A universal arm	\$1450
11600B/11602B transistor fixtures	\$800
Option 001	less \$30
8743A reflection/transmission test set	\$4150
Option 018	add \$750
11605A flexible arm	\$1100
Option 018	add \$525

NETWORK ANALYZERS

8410 family (cont.)



8746B



11608A



8717B



8740A



8741A



8742A

8746B S-parameter test unit

Function: wideband RF power divider and reflectometer with calibrated line stretcher and a selectable 0 - 70 dB incident signal attenuator. Provides internal bias tees for completely characterizing two port active devices.

Frequency range: 0.5 to 12.4 GHz.

Source and termination reflection coefficient: ≤ 0.13 .

Directivity: ≥ 30 dB, 0.5 to 4.0 GHz; ≥ 26 dB, 4.0 to 12.4 GHz.

Incident attenuation: 0 - 70 dB in 10 dB steps $\pm 5\%$.

Reference plane extension: adds 0 - 15 cm (30 cm in transmission path).

Remote programming: ground closure to 36 Pin connector.

Transistor biasing: via 36 Pin connector.

Connectors: input type N female, test ports APC-7

Option 001: provides 10 dB higher power level at the test port.

Power: 115 or 230 V $\pm 10\%$, 48 to 440 Hz, 110 VA max.

Weight: net, 16.1 kg (35 lb). Shipping, 19.1 kg (42 lb).

Dimensions: 425 mm wide, 140 mm high, 467 mm deep ($16\frac{1}{2}'' \times 5\frac{1}{2}'' \times 18\frac{1}{2}''$).

11608A Transistor fixture

Function: provides the capability of completely characterizing strip-line transistors in either the TO-51 or HPAC-200 package styles. For special package styles, a through-line microstrip and bolt-in grounding structure machinable by customer is available.

Frequency range: dc to 12.4 GHz.

Reflection coefficient: < 0.05 , dc to 4 GHz; < 0.07 , 4.0 to 8.0 GHz; < 0.11 , 8 to 12.4 GHz.

Package styles

Option 001: Customer machinable.

Option 002: TO-51 (0.250" dia.).

Option 003: HPAC-200 (0.205" dia.).

Calibration references: options 002 and 003 only, short circuit termination and a 50-ohm through-section.

Connectors: APC-7 Hybrid (Option 100 type N female).

Weight: net, 0.9 kg (2 lb). Shipping, 1.4 kg (3 lb).

Dimensions: 143 mm wide, 25 mm high, 89 mm deep ($5\frac{1}{2}'' \times 1'' \times 3\frac{1}{2}''$).

8717B Transistor bias supply

The 8717B Transistor Bias Supply is an ideal power supply for manual or programmable transistor testing. It is particularly useful with the 11600B, 11602B, and 11608A Transistor Fixtures. The 8717B has two meters for independently monitoring current and voltage on any of the three leads of a transistor under test. Bias connections are conveniently selected for all transistor configurations with a front panel switch. Special circuitry protects sensitive devices from excessive current transients which commonly occur in less sophisticated supplies.

Voltage ranges: 1, 3, 10, 30, 100 V.

Current ranges: 0.1, 0.3, 1, 3, 10, 30, 100, 300, 1000 mA.

Accuracy: 4% of full scale for both current and voltage.

Option 001: programmable D/A converter.

Weight: net, 9.0 kg (20 lb). Shipping, 11.0 kg (25 lb).

Dimensions: 425 mm wide, 86 mm high, 336 mm deep ($16\frac{1}{2}'' \times 3\frac{1}{2}'' \times 13\frac{1}{2}''$).

8740A Transmission test unit

Function: RF power splitter and calibrated line stretcher for transmission measurement with network analyzer.

Frequency range: dc to 12.4 GHz.

Output reflection coefficient: < 0.07 , dc to 7 GHz; < 0.11 , 7.0 to 12.4 GHz.

Connectors: RF input, type N female; output, APC-7.

Reference plane extension: electrical, 0 to 10 cm; mechanical 1 - 10 cm.

Weight: net, 7.1 kg (16 lb). Shipping, 9.4 kg (21 lb).

Dimensions: 186 mm wide, 152 mm high, 410 mm deep ($7\frac{3}{8}'' \times 6'' \times 16\frac{1}{8}''$).

Recommended accessory: 11587A accessory kit.

8741A and 8742A Reflection test units

Function: wideband reflectometer, phase-balanced for swept or single frequency impedance tests with 8410B. Calibrated adjustable reference plane.

Frequency range: 0.11 - 2.0 GHz (8741A); 2.0 - 12.4 GHz (8742A).

Directivity: ≥ 36 dB 0.11 - 1 GHz, ≥ 32 dB 1 - 2 GHz (8741A); ≥ 30 dB 2 - 12.4 GHz (8742A).

Connectors: RF input, type N female; all others APC-7.

Reference plane extension: 0 - 15 cm.

Accessories furnished: 11565A, APC-7 short.

Weight: net, 6.7 kg (15 lb). Shipping, 8.9 kg (20 lb).

Dimensions: 186 mm wide, 152 mm high, 410 mm deep ($7\frac{3}{8}'' \times 6'' \times 16\frac{1}{8}''$).

Recommended accessory: 11587A Accessory Kit

Model number and name	Price
8746B Test Unit	\$7000
Option 001	N/C
Option 908: Rack Flange Kit	add \$10
11608A Transistor Fixture (must specify Option 001, 002, or 003)	
Option 001	\$750
Option 002	\$800
Option 003	\$800
Option 100	less \$30
8717B Transistor Bias Supply	\$2500
Option 001	add \$670
Option 908: Rack Flange Kit	add \$10
8740A Transmission Test Set	\$3025
8741A Reflection Test Set	\$2150
8742A Reflection Test Set	\$3025

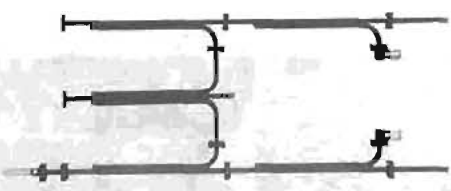

X8747A and P8747A

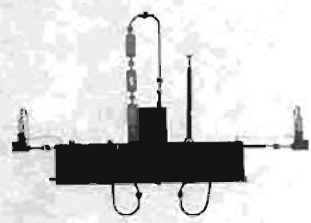

K8747A and R8747A



11587A



11650A

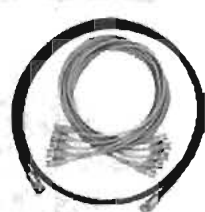

11609A



11589A and 11590A

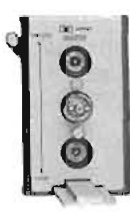

11599A



11607A

P, X 8747A Reflection/transmission test units

Function: waveguide setup for measuring reflection and transmission parameters of waveguide devices with the network analyzer.
Frequency range: X8747A: 8.2 - 12.4 GHz; P8747A: 12.4 - 18 GHz.

K, R 8747A Reflection/transmission test units

Function: waveguide setup for measuring reflection and transmission parameters of waveguide devices with the network analyzer; down-converts with built-in mixers to the frequency range of the 8411A.
Frequency range: K8747A: 18 - 26.5 GHz; R8747A: 26.5 - 40 GHz.

11587A Accessory kit

Function: accessories normally used for transmission and reflection tests with the 8740A, 8741A, and 8742A.
Weight: net, 1.34 kg (3 lb). Shipping, 2.23 kg (5 lb).

11650A Accessory kit

Function: accessories normally used for transmission and reflection tests with the 8745A and 8743A.
Weight: net, 1.34 kg (3 lb). Shipping, 2.23 kg (5 lb).

11609A Cable kit

Function: interconnecting cables normally required for network measurements using the 8410A network analyzer.
Weight: net, 0.9 kg (2 lb). Shipping, 1.36 kg (3 lb).

11589A and 11590A Bias networks

Function: auxiliary units for use with the 11600B, 11602B and 11608A transistor fixtures. These bias networks provide dc bias to the center conductor of a coaxial line while blocking the dc bias from the input RF circuit.
Frequency range: 11589A — 0.1 to 3.0 GHz; 11590A — 1.0 to 12.4 GHz.
Connectors: BNC for dc biasing; type N female for RF (Option 001: APC-7).
Weight: net, 0.3 kg (9 oz). Shipping, 0.5 kg (1 lb).
Dimensions: 76 mm wide, 29 mm high, 114 mm deep (3" x 1 1/8" x 4 1/2").

11599A Quick connect adapter

Function: quickly connects and disconnects the 8745A and the transistor fixtures or 11604A universal extension.
Weight: net, 397 gm (14 oz). Shipping, 652 gm (2 lb).
Dimensions: 76 mm wide, 127 mm high, 108 mm deep (3" x 5" x 4 1/2").

11607A Small signal adapter

Function: used with the 8745A S-parameter test set. The incident signal levels to the test device are reduced to the -20 to -40 dBm range.
Weight: net, 4.1 kg (4 3/4 lb). Shipping, 4.5 kg (10 lb).
Dimensions: 413 mm wide, 60 mm high, 244 mm deep (16 1/8" x 2 3/8" x 9 5/8").

Model number and name

Model number and name	Price
X8747A Waveguide Test Set	\$3100
P8747A Waveguide Test Set	\$3250
K8747A Waveguide Test Set	\$9000
R8747A Waveguide Test Set	\$9500
11587A Accessory Kit	\$1140
11650A Accessory Kit	\$880
11609A Cable Kit	\$115
11589A Bias Network	\$350
Option 001	add \$30
11590A Bias Network	\$400
Option 001	add \$30
11599A Quick Connect Adapter	\$175
11607A Small Signal Adapter	\$800

SIGNAL ANALYZERS

Wave, distortion, spectrum and Fourier analyzers



Analysis of signals in the frequency domain is an important measurement concept which is used in many fields of endeavor for providing electrical and physical system performance information. Several examples will illustrate some important applications where signal analyzers are useful.

The vibrational patterns of structures (aircraft, automobiles, bridges, etc.) must be known to predict behavior in dynamic operating environments. Noise and vibration levels are of vital concern to the manufacturers and users of rotating machinery and automobile and aircraft engines. Resonant modes and many other parameters may be measured with the HP Fourier Analyzer.

A need for signal analysis in fluid flow signature identification applications has emerged in recent years. Particles carried in a flowing fluid may be identified and quantified by observing its spectral response to ultrasonic stimulation.

In the fields of telecommunications, the spectrum and wave analyzers provides vital operational performance verification of multiplexing systems. Unwanted signals such as carrier leak signals, out-of-band noise, and cross modulated signals must be identified. System gain, loss, and pilot tone measurements must also be made. These measurements are discussed in more detail in the Tel-

communications Test Equipment section of this catalog.

Doppler Radar ranging systems require pure, stable CW signals for accurate determination of vehicle distance and movement. The phase noise of these CW signals limits the distance accuracy and resolution measuring capabilities of the system. Phase noise is an important parameter the spectrum analyzer can effectively display.

Finally, in the general field of electronics, there are three primary uses for the signal analyzer. First, the analyzer is used to quantify signals which result from non-linear effects in the process of amplification, filtering, mixing. Second, the purity of signal sources is commonly observed. Third, the signal analyzer with a companion tracking generator is used as a network analyzer for frequency response measurements of filters, amplifiers, and many other types of networks.

This section discusses the definition and use of four types of instruments for frequency response signal analysis: spectrum analyzers, digital Fourier analyzers, wave analyzers, and distortion analyzers.

Each of these instruments quantifies the magnitude of CW signals through a specific bandwidth, just the same as a tuned voltmeter. But each measurement technique is different. The spectrum analyzer is a swept receiver that provides a visual display of am-

plitude versus frequency. It shows on a single display how energy is distributed as a function of frequency, displaying the absolute value of Fourier components of a given waveform. The Fourier analyzer uses digital sampling and transformation techniques to form a Fourier spectrum display that has phase as well as amplitude information. The wave analyzer is the truly tuned voltmeter, showing on a meter the real time amplitude of the energy in a specific frequency window and tunable over a specific frequency range. The distortion analyzer performs an almost reciprocal function to that of the wave analyzer. It collectively measures the energy outside a specific bandwidth, tuning out the fundamental signal and displaying the energy of the harmonics and other distortion products on a meter.

Figure 1 shows a graphical representation of the way the three analyzers view a simple CW signal and one harmonic. The time domain scan of the CW signal is presented in 1.a. $A(t)$ is the complex voltage waveform as it would be viewed on an oscilloscope. The dashed lines represent the vector components of the signal: $A_1(t)$, the fundamental and $A_2(t)$, the second harmonic. In 1.b. the spectrum analyzer displays the frequency spectrum showing both vector components and their amplitude relationship. Spectrum analysis is useful from 5 Hz to over 40 GHz.

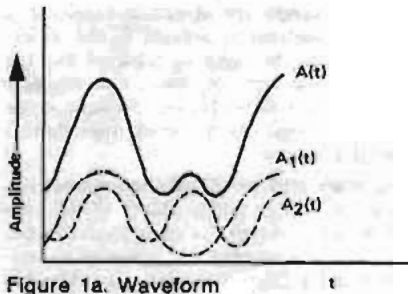

Figure 1a. Waveform

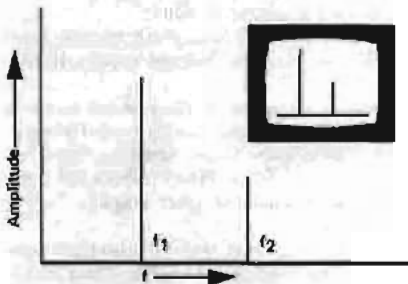

Figure 1b. Spectrum and Fourier analyzers

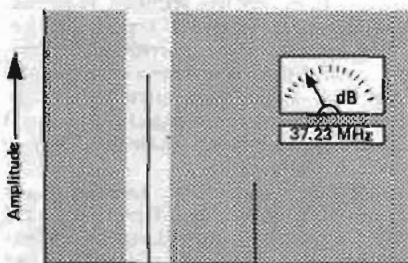

Figure 1c. Wave analyzer

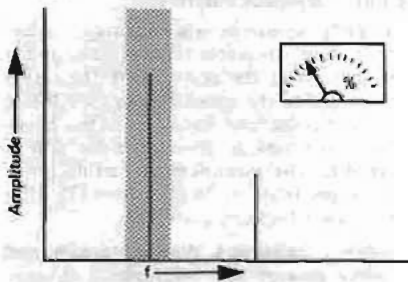

Figure 1d. Distortion analyzer

The Fourier Analyzer displays both the amplitude and phase components of each frequency so that accurate amplitude and phase relationships can be observed. Because the Fourier Analyzer uses digital techniques to extract frequency information rather than swept filter techniques, it can display the complete spectrum of a signal in the time it takes to analyze the lowest frequency component. Hewlett-Packard Fourier Analysis is presently practical in the range of DC to 100 kHz. The wave analyzer in Figure 1c, measures the amplitude and frequency of the signal in the frequency window to which it is tuned. This window can be moved to measure the amplitude of the second harmonic, thereby making a precise comparison with the

fundamental. This technique is practical from 10 Hz to above 18 MHz.

The distortion analyzer as pictured in Figure 1d, rejects the fundamental to which it has been tuned and measures the energy everywhere else within the instrument's frequency spectrum. Distortion, as a percentage or in dB down from the fundamental is displayed directly on a meter. Hewlett-Packard distortion analyzers cover 5 Hz to 600 kHz.

The following section probes each instrument technique, showing the particular strength and flexibility of each.

Spectrum analyzer

To display useful information about a frequency scan, a spectrum analyzer must be sensitive, frequency stable, wideband free of spurious responses, and have calibrated accuracy in the CRT display. The examples which follow best demonstrate the wide variety of information which can be measured on the spectrum analyzer.

Measurements with the spectrum analyzer

CW signal: the most basic spectrum analysis measurement is the single CW signal.

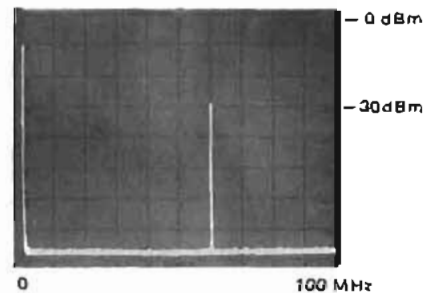

Pictured is a -30 dBm signal at 60 MHz. The zero frequency indicator is at the far left graticule.

Spectral purity of a CW signal: one very important oscillator signal measurement is spectral purity. This 70 MHz carrier has power line related sidebands (± 60 Hz) which are 65 dB down.

Such sidebands may result from power supply ripple. The 50 Hz/division spectrum analyzer scan and the 10 Hz analyzer bandwidth provide the high degree of resolution required to see these sidebands.

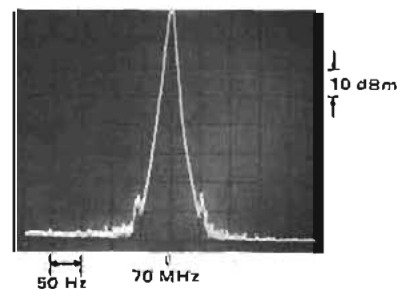

Frequency conversion products: the spectrum analyzer is well suited for frequency conversion measurements such as the

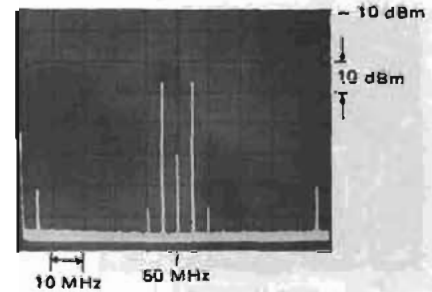

output of a balanced mixer as shown. With the 50 MHz local oscillator input at 0 dBm and a 5 MHz, -30 dBm mixer signal, two sidebands at 45 MHz and 55 MHz result. The sidebands are -36 dBm, giving the mixer a 6 dB conversion loss. Other information easily extracted from this spectrum analyzer display is the 60 dB local oscillator isolation and the 5 MHz signal has 41 dB isolation. Second order distortion products at 40 and 60 MHz are 40 dB below the desired mixer outputs.

Amplitude modulation: percent amplitude modulation is often more easily measured

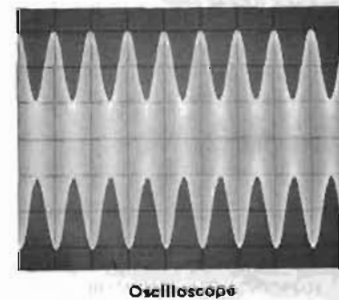

Oscilloscope

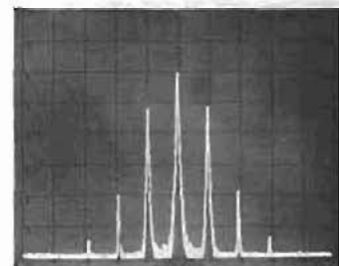

Spectrum Analyzer

with the spectrum analyzer than it is with the oscilloscope.

With the oscilloscope time display, percent modulation, M , is measured as a ratio of the signal's dimensions: $M = 100 \cdot (6 - 2) / (6 + 2) = 50\%$. In the spectrum analyzer display, whose vertical calibration is 10 dB/division, the carrier and sidebands differ by 12 dB, the voltages in the sidebands are $1/2$ that of the carrier and again, $M = 50\%$. At the same time the second and third harmonic distortion of the sidebands can be measured at 28 and 44 dB respectively.

Frequency modulation: information transmitted by FM can be thoroughly characterized by the spectrum analyzer.

SIGNAL ANALYZERS

Wave, distortion, spectrum and Fourier analyzers (cont.)

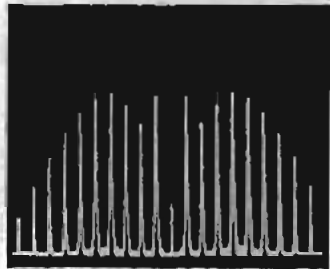

20 kHz Low Deviation FM



0.5 MHz High Deviation FM

Low deviation FM is applied to a 60 MHz carrier in the first photo. The deviation has been adjusted for the second carrier null ($M = 5.52$). The sidebands spacing is 10 kHz, the modulation frequency; therefore, Δf peak = $5.52 \times 10 \text{ kHz} = 552 \text{ kHz}$.

The second photo is an example of high deviation FM. The transmission bandwidth is 2.5 MHz.

Pulsed CW power: by viewing the spectra of a repetitive RF pulse on the spectrum analyzer, pulse width average and peak power, occupied bandwidth, and duty cycle can be determined.

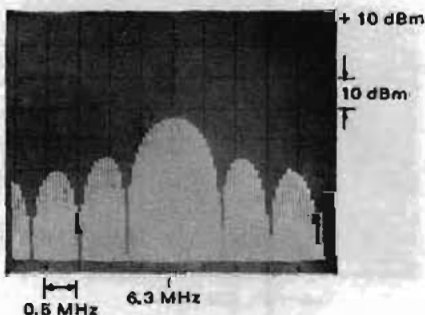

From the spectral output shown the pulse's complete characteristics are determined: 6.3 GHz RF at 0 dBm, pulsed at 50 kHz rate. The pulse width is 1.3 μsec .

Noise: spectrum analysis is effective in measuring impulse noise, random noise, carrier to noise ratio, and amplifier noise figure.

Phase noise: the short term frequency fluctuations of a sine wave source can be described in terms of the spectral density of the phase modulation sidebands. Making this measurement is a difficult task requiring bandwidth corrections, analyzer corrections, data averaging, and setup calibration factors. Hewlett-Packard Automatic Spectrum Analyzers with narrow resolution and high frequency stability can greatly simplify this

task. All instrument control, data transfer, and data reduction can be handled by easy-to-write software. For more information about this application, refer to Application Note 207.

Frequency response: using a tracking signal source and a spectrum analyzer the frequency response of filters can be displayed with ease.

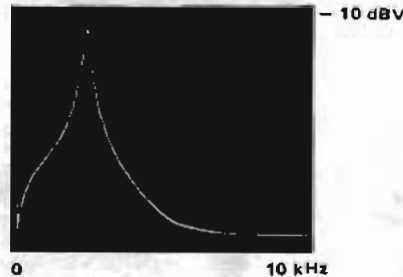

In this case, an audio filter used in a communications system is being measured. Since the input reference level to the filter is -13 dBV , the insertion loss at 2.4 kHz is 4 dB. Extremely high Q devices can be measured with this system.

Spectrum analyzer capabilities

To be useful in making measurements in the frequency domain, the analyzer must be capable of making quantitative measurements. Specifically, an analyzer must:

- 1) make absolute *frequency* measurements
- 2) make absolute *amplitude* measurements
- 3) operate over a *large amplitude dynamic range*
- 4) have *high resolution* of frequency and amplitude
- 5) have *high sensitivity*
- 6) provide means of *observing, preserving, and recording* its output in a convenient and rapid manner by using variable persistence, digital storage and adaptive sweep.

Hewlett-Packard spectrum analyzers excel in these six measures of performance.

Let us consider each of these performance standards in greater detail.

Absolute frequency measurements: there are two ways to measure absolute frequency with a Hewlett-Packard spectrum analyzer. The absolute frequency can be read off the slide-rule type of frequency dial. Accuracy in this case is approximately 1% of full scale. When the spectrum analyzer is used in conjunction with a tracking generator (a source whose frequency is the same as the analyzer tuning frequency) accuracy much better than 1% can be achieved by counting the generator output.

Absolute amplitude measurements: all Hewlett-Packard spectrum analyzers are absolutely calibrated for amplitude measurements. This means the spectrum analyzer indicates to the user what the log/reference level or linear sensitivity is regardless of control settings. An uncalibrated warning light makes operation of the analyzer easy and foolproof.

Dynamic range: the dynamic range of a spectrum analyzer is defined as the difference between the input signal level and the average noise level or distortion products whichever is greater. Hence, dynamic range can be either distortion limited, noise limited or display limited.

Frequency and amplitude resolution: frequency resolution is the ability of the analyzer to separate signals closely spaced in frequency. The frequency resolution of an analyzer is a function of three factors: 1) minimum IF bandwidth, 2) IF filter shape factor, 3) spectrum analyzer stability.

The minimum IF bandwidth ranges down to 1 Hz on Hewlett-Packard spectrum analyzers.

One way to define IF filter shape factor is the ratio of 60 dB bandwidth to 3 dB bandwidth. Filter shape factor specifies the selectivity of the IF filter. Hewlett-Packard spectrum analyzers have IF filter shape factors as low as 11:1.

Analyzer frequency stability also limits resolution. The residual FM (short term stability) should be less than the narrowest IF bandwidth. If not, the signal would drift in and out of the IF pass band. Hewlett-Packard analyzers have excellent stability. The residual FM ranges from $<1 \text{ Hz}$ at low frequency, to $<100 \text{ Hz}$ at microwave frequencies, enabling the measurement of noise sidebands. The stabilization circuitry is completely automatic and foolproof. No signal recentering, phase-lock loop, manual search, or checking is required.

Amplitude resolution is a function of the vertical scale calibration. Hewlett-Packard analyzers offer both log calibration for observing large amplitude variations (10, 2 and 1 dB/div) and linear calibration for observing small amplitude variations.

Sensitivity: sensitivity is a measure of an analyzer's ability to detect small signals, and is often defined as the point where the signal level is equal to the noise level or $(S + N)/N = 2$. Since noise level decreases as the bandwidth is decreased, sensitivity is a function of bandwidth. The maximum attainable sensitivity ranges from -150 dBm to -125 dBm with Hewlett-Packard analyzers.

Variable persistence, digital storage, and adaptive sweep: high resolution and sensitivity both require narrow bandwidths and consequently slow sweep rates. Because of these slow sweeps, variable persistence is virtually indispensable in providing a bright, steady, flicker-free trace. (In effect, variable persistence allows one to vary the length of time a trace remains on the CRT.)

Hewlett-Packard low frequency analyzers have two features which make measurement and CRT photography simple. Digital storage gives the CRT displays a dot matrix connected by line generators for an unbroken and uniform intensity scan. Adaptive sweep is the second feature. On the very slow sweep times required when using the 1 Hz bandwidth adaptive sweep allows the scan to sweep rapidly when no signals occur. At signals above a preset level the sweep is slowed for an accurate measurement. The measurement time savings can be greater than 20:1.

Tracking preselector

The only way to simultaneously avoid spurious, multiple, harmonic and image responses, is to filter the RF signal through a tracking preselector. This is an electronically tuned bandpass filter that automatically tracks the analyzer's tuning. A preselector improves the spurious-free range of the analyzer from less than 70 dB to 100 dB.

Tracking generator

A tracking generator expands the measurement capability of the spectrum analyzer by providing a signal source which tracks the tuning frequency of the analyzer. The source/receiver combination can be used to measure insertion loss, frequency response, return loss and precision frequency count.

It helps make these additional measurements with increased distortion-free dynamic range, sensitivity and selectivity. The tracking generator is also an excellent stable sweeping signal generator. The residual FM ranges from ± 1 Hz for low frequency tracking generators to ± 400 Hz for microwave tracking generators.

Frequency stability analysis

Frequency stability and spectral purity are important parameters when characterizing precision frequency sources. Long term stability or frequency drift due to aging or temperature effects is generally measured with a precision frequency counter such as the HP 5345A; random fluctuations in frequency or phase stability can be measured in the time domain with an electronic counter and the Allan Variance technique. Measurement dimensions for this method are rms Fractional Frequency Deviation in parts per million for various averaging (gate) times.

Another technique for estimating random fluctuations is by measuring phase spectral density in the frequency domain. The most commonly used dimensions for this measurement is the single sideband signal-to-phase noise ratio expressed in dBc (dB below the carrier) at various offset frequencies from the carrier. The most common method of making this measurement is to mix two signals together and feed the output into lower frequency wave analyzer or spectrum analyzer. The technique works well for offset frequencies far away enough from the carrier to be compatible with the bandwidths of the analyzer.

For offset frequencies close to the carrier, (eg. below 100 Hz) the bandwidths of analog analyzer become large in comparison to the frequencies being measured. As 1 Hz is approached, measurements become extremely difficult.

An automatic system for making phase noise measurements very close to the carrier is the HP 5390A Frequency Stability Analyzer which is based upon a high performance electronic counter and a programmable calculator. The counter is ideally suited to make measurements in the time domain, and the calculator can transform the data into the frequency domain. This technique allows measurements to be made from 0.01 Hz away from the carrier out to 10 kHz.

Sensitivities greater than -150 dBc can typically be obtained at a 1 Hz offset on carriers ranging from 500 kHz to 18 GHz. For a more complete description of this automated technique refer to the 5390A Frequency Stability Analyzer on page 468.

Automatic spectrum analyzers

The measurement capability of a spectrum analyzer can be greatly enhanced by allowing a desk top calculator to control instrument functions and record frequency and amplitude information. Data can be gathered and processed into a variety of formats at a very rapid rate. Through comprehensive self-calibration, automatic spectrum analysis offers amplitude accuracy of up to ± 0.2 dB with 0.02 dB resolution. User cost savings are realized through faster measurements, lower operator skill requirements, and unattended operation capability.

Further discussion of calculator based automatic spectrum analysis can be found on page 555.

Fourier analyzers

Fourier analysis is one of a variety of digital signal analysis techniques that allow analysis of signals that cannot be adequately measured by "traditional" instrumentation. Among these are: Random signals or signals obscured by noise, joint properties or relationships of two or more signals, statistical properties of signals, or very low-frequency signals (below 20 Hz).

The basis for Fourier analysis lies in the fact that time domain signals may be represented as a number of individual frequency components in the frequency domain. The Fourier transform calculates the amplitude and phase coefficients of each component frequency.

The fundamental steps involved are shown in Figure 2. One or more analog inputs are first sampled at regular intervals, Δt , then digitized and stored in memory. The desired function (i.e., power spectrum, transfer function, etc.) is then computed by the processing unit and stored in memory. The contents of memory can then be viewed on a CRT display, plotted, or processed further—based on the user's specific requirements.

Advantages

The digital nature of Fourier analysis ensures high accuracy, stability and essentially no low-frequency limit. Since the transform provides all frequency lines from DC to some maximum frequency at the same time, a great time savings is obtained over analog swept techniques.

This is especially advantageous when analyzing low-frequency signals which require long time periods or when extremely high resolution is desired.

One technique used by the Fourier Analyzer to obtain very high resolution is Band Selectable Fourier Analysis (BSFA). With BSFA, for example, a 1000 Hertz signal centered in a 100 Hertz band could be analyzed with 0.1 Hertz resolution.

The Fourier Analyzer accepts multiple inputs. With simultaneous sampling, the relationship between two or more signals may be calculated, such as the input and output of a mechanical, electrical, or acoustic system. This flexibility, as well as the ability to compute many different statistical functions and output the data in a variety of formats, result in an extremely cost effective, general-purpose analyzer.

Equally important, the Fourier Analyzer is easy to use. It can be operated without special programming and contains a built-in calibrated CRT display for easy interpretation of results.

These advantages have opened up several new applications for Fourier analysis, many of them in fields which are not traditional users of digital instrumentation.

Applications

The versatility and performance of the Fourier Analyzer make it an ideal tool for a variety of applications. Mechanical engineers, electrical engineers, geophysicists and bio-medical researchers are applying its advanced digital analysis capability to a broad spectrum of problems. Power spectrum analysis, ensemble averaging, cross spectrum measurements, transfer function measurements, and correlation are fundamental measurement techniques. Although the use or source of the data may differ, these analyses form the basis for understanding and solving complex dynamic problems.

Applications for Fourier analysis cover a broad range of areas. Rotating machinery analysis, structural dynamics, vibration con-

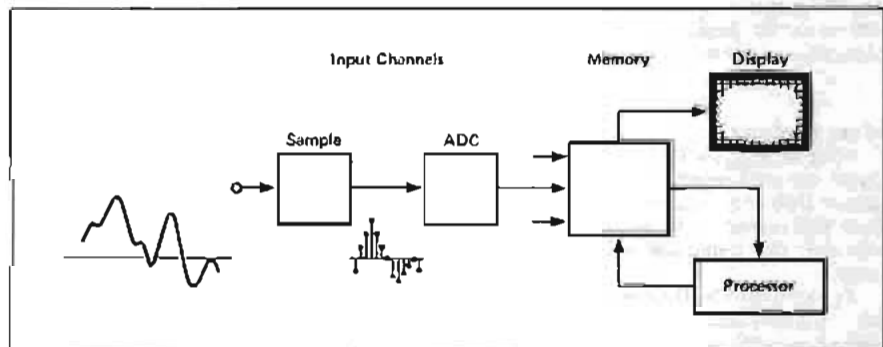

Figure 2. Basic Fourier Analyzer

SIGNAL ANALYZERS

Wave, distortion, spectrum and Fourier analyzers (cont.)

trol, electromechanical systems analysis, and acoustic studies, are just a few of the areas where these advanced techniques are being applied.

Correlator, spectrum display

Correlation analysis may be thought of as the time domain equivalent of spectrum analysis. It is particularly useful for the recovery of periodic signals buried in noise (without requiring a synchronizing signal), the measurement of delays in signal transmission path, and the identification of the time response of linear systems.

Correlation is the product of two signals expressed as a function of a time delay between them. In computing the cross correlation between two signals, one signal is delayed relative to the other by a known variable amount. For each value of relative delay the signals are multiplied together and the average product represents the correlation, or similarity for the particular delay. A peak value in a cross correlation of random signals indicates that for that delay value there is a high degree of similarity between the signals. Such information can be useful in determining propagation times of random phenomena.

Autocorrelation is a special case in which a signal is delayed relative to itself. At zero delay, a signal is of course identical to itself and the correlation value is merely a measure of the mean square voltage of the signal. At increasing values of delay the autocorrelation function can reveal small periodicities in a large random signal. Such a measurement finds application in acoustics, infrasound analysis, radio astronomy, and many other fields.

Since the correlation function and the power spectrum are Fourier transform pairs, the addition of a spectrum display turns a correlator into a powerful frequency and time domain measuring instrument. An autocorrelation function measured by the correlator can be transformed by the spectrum display into the auto power spectrum of the input signal. Similarly, a crosscorrelation function may be transformed into the corresponding cross power spectrum.

The simultaneous display of time domain functions and their corresponding spectra, coupled with the features of digital signal analysis mentioned above give the correlator and spectrum display some unique advantages as an economical signal analyzer.

Wave analyzer

Wave analyzers are known by several different names: frequency selective voltmeter, carrier frequency voltmeter, and tuned oscillator and selective level meter. These names describe the instrument's function rather well.

As mentioned in the introduction to this section a wave analyzer can be thought of as a finite bandwidth window filter which can be tuned throughout a particular frequency range.

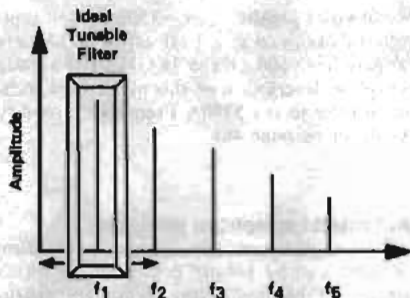

Figure 3. Wave analyzer tunable filter

Signals will be selectively measured as they are framed by the frequency window. Thus, for a particular signal, the wave analyzer can indicate its frequency (window position) and amplitude. Amplitude is read on an analog meter; frequency is read on either a mechanical or electronic readout.

The uses of wave analyzers can be categorized into three broad areas: 1) amplitude measurement of a single component of a complex frequency spectrum, 2) amplitude measurement in the presence of noise and interfering signals and, 3) measurement of signal energy appearing in a specified, well defined bandwidth.

Wave analyzer considerations

Frequency characteristics:

Range: should be selected with the future in mind as well as present requirements.

Accuracy and resolution: should be consistent with available bandwidths. Narrow bandwidths require frequency dial accuracy to place the narrow window in the proper position for measurement. Accuracy of instruments with selectable bandwidths is determined by the basic center frequency accuracy of the IF bandwidth filters in addition to the local oscillator frequency accuracy. Accuracy is usually specified as a fixed frequency error at any point on the dial, thus meaning poorer percentage accuracy at the low frequency settings.

Readout: usually a frequency dial but newer instruments use a frequency counter whose accuracy and ease of use outweigh the increased cost.

Stability: frequency stability is important when using narrow bandwidths and for long term signal monitoring. Stability is best achieved with automatic frequency control (AFC). AFC locks the local oscillator to the incoming signal and eliminates any relative drift between the two. It serves as a tuning aid to pull the signal to within the passband eliminating peaking the frequency control. The AFC always tunes within the passband improving accuracy on repetitive measurements.

Sweep: some instruments are equipped with sweep to allow use as a spectrum analyzer. Readout is a CRT or X-Y recorder.

Amplitude characteristics:

Range: the amplitude range is determined by the input attenuator and the internal noise of the instrument. Sensitivity is defined as the lowest measurable signal equal to the noise

level for a unity signal-to-noise ratio (often called tangential sensitivity). Sensitivity will vary with bandwidth and input impedance.

Dynamic range: defined as the dB ratio of the largest and smallest signals that can be simultaneously accommodated without causing an error in the measurement.

Attenuators: the amplitude range switch is an attenuator in the input and IF stages. Intermodulation distortion is lowest when the input amplifier has the minimum signal applied and the IF gain is greatest. Conversely the internal noise, important when making sensitive measurements, is lowest with maximum input signal and lowest IF gain. The two attenuator instruments allow this transfer of gain between input and IF to be accomplished easily.

Accuracy: amplitude accuracy is a function of frequency, input attenuator response, IF attenuator performance, calibration oscillator stability and accuracy, and meter tracking. Often specifications are broken up to separately describe each contributor.

Readout: amplitude readout is usually a meter calibrated in dB and/or volts. Linear voltage meters are used to allow the user to see down into the noise at the bottom of the scale. Digital readouts are not used because of their slow response and lack of directional and positional information. This is important since the readout is used as a tuning indicator to show presence of a signal in the passband and when it has reached a peak. Expanded scale meters allowing expansion of any 1 or 2 dB portion of the scale into a full scale presentation allow resolution of input level changes of a few hundredths of a dB. This is useful when the wave analyzer is used as a sensitive indicator in bridge or comparison measurements. The expanded scale meter is included in some instruments and is an optional accessory on others.

Input characteristics:

Impedance: may be high impedance bridging input or terminating impedance to match standard transmission lines. High frequency measurements require matched systems to avoid error-producing standing waves on interconnecting cables. The measure of impedance accuracy is usually return loss or reflection coefficient ($RL = 20 \log \rho$). In lower frequency instruments, percent accuracy is used. High input impedance instruments are usually poorer in frequency and noise performance and are usually low frequency instruments. High impedance at high frequencies is accomplished by using a bridging probe to place the impedance at the point of measurement. The probe may be active with unity gain or passive with 20-30 dB insertion loss.

Input arrangement: input may be balanced to ground or unbalanced. Communications system usage typically requires balanced input. Standard 600 and 135/150Ω balanced inputs are limited in frequency to less than 1 MHz and 124Ω balanced to less than 10 MHz in most instruments. The impedance may be balanced to ground or may be completely isolated from ground. Unbalanced inputs do not have frequency range limitations.

Network analysis application

Frequency response testing: with its BFO output, the wave analyzer is particularly useful for measuring filter and amplifier frequency responses. If a notch filter is being measured, for example, a narrow band measurement like that provided by a wave analyzer is essential for obtaining acceptable accuracy. A broadband technique will lead to some misleading results. For example, a notch filter may be driven with a flat oscillator and the response measured with a broadband voltmeter. The notch filter will reject the oscillator's fundamental tone, but pass its

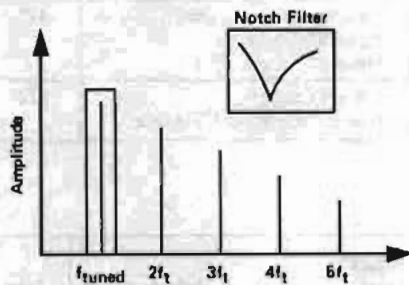

Figure 4. Only signal detected by wave analyzer. For example, the notch of a filter can be accurately measured to its full depth.

harmonics which are in the voltmeter's measurement range. Thus, an error results. If the voltmeter were frequency selective, like a wave analyzer, the harmonics would be rejected and the true level of the notch would be measured. Accurate and fast measurements can be made because Hewlett-Packard wave analyzers track and detect only the BFO frequency.

Distortion analyzers

Harmonic distortion is one of many types of distortion created in communications equipment and audio and ultrasonic sound systems. Nonlinear elements in amplifiers cause harmonic related frequencies from a pure tone stimulus to be created at the output. Hence, to a listener, a poor reproduction quality becomes apparent. The total of these frequency components present in a signal, in addition to the fundamental frequency can be measured quickly and easily with Hewlett-Packard distortion analyzers.

The ratio of these frequency components to the amplitude of the fundamental is the total harmonic distortion (THD) as defined by the following equation(1):

$$THD = \frac{\sqrt{\sum(\text{harmonics})^2}}{\text{fundamental}}$$

The Hewlett-Packard distortion analyzer consists of a narrow band rejection filter and broadband detector. Before the fundamental is rejected, the analyzer first measures the am-

plitude of the fundamental, all the harmonic components, and noise. Then the rejection filter is employed to remove the fundamental. The ratio of the two measurements is an approximation of equation (1) above and is defined by the following equation(2):

$$THD = \frac{\sqrt{\sum((\text{harmonics})^2 + (\text{noise})^2)}}{\sqrt{\sum((\text{fundamental})^2 + (\text{harmonics})^2 + (\text{noise})^2)}}$$

An approximation error of 1/2% can be expected for true THD levels of 10%. However, distortion levels as high as 10% are seldom encountered in most measurement situations. The harmonic content of the stimulus source must not be more than a third of the distortion expected to be caused by the system under test.

True harmonic distortion measurements

The Hewlett-Packard calculator controlled automatic spectrum analyzer provides the user a rapid means of measuring true harmonic distortion levels. The fundamental and its harmonic components are rapidly measured one at a time and the distortion is computed by applying equation (1). In production test situations, distortion calculations can be stored on tape for future reference and/or plotted for hard copy needs. Also, limit testing can be applied.

Signal analyzers selection guide

Spectrum analyzers

Frequency Range	Amplitude Calibration Range	Bandwidths		Model Description	Companion Instruments	Page
		Min	Max			
5 Hz - 50 kHz	-150 to +30 dBm	1 Hz	300 Hz	3580A Spectrum Analyzer		450
20 Hz - 300 kHz	-130 to +10 dBm	10 Hz	10 kHz	8556A Tuning Section Plug-In (See Note 1)		458
10 Hz - 13 kHz	-140 to 0 dBm	3 Hz	10 kHz	3044A/45A Spectrum Analyzer		447
1 kHz - 110 MHz	-130 to +10 dBm	10 Hz	300 kHz	8553B Tuning Section Plug-In (See Note 1)	8443A Tracking Generator (100 kHz - 110 MHz)/Counter	460
10 kHz - 350 MHz	-120 to +20 dBm	1 kHz	3 MHz	8557A Spectrum Analyzer Plug-In (See Note 2)		452
100 kHz - 1250 MHz	-122 to +10 dBm	100 Hz	300 kHz	8554B Tuning Section Plug-In (See Note 1)	8444A Tracking Generator (500 kHz - 1250 MHz)	462
100 kHz - 1500 MHz	-115 to +30 dBm	1 kHz	3 MHz	8558B Spectrum Analyzer Plug-In (See Note 2)	8444A Opt. 058 Tracking Generator (500 kHz - 1300 MHz)	454
10 MHz - 40 GHz	-130 to +10 dBm	100 Hz	300 kHz	8555A Tuning Section Plug-In (See Note 1)	8444A Tracking Generator (10 MHz - 1300 MHz) 8445B Automatic Preselector (10 MHz - 18 GHz)	464
0.01 Hz - 10 kHz offset from carrier 500 kHz - 18 GHz carrier range	-150 dBc min.	<100 μHz	10 kHz	5390A Frequency Stability Analyzer	59309A Digital Clock	468

NOTE 1: For use in oscilloscope mainframes 140T and 141T with IF section plug-ins 8552A or 8552B (page 456).
NOTE 2: For use in oscilloscope mainframes 180TR, 181T/TR and 182T.

SIGNAL ANALYZERS

Wave, distortion, spectrum and Fourier analyzers (cont.)

Digital Signal Analyzers

Frequency Range	Amplitude Calibration Range	Resolution Points		Model Description	Functions Available	Page
		Min	Max			
DC — 100 kHz (See Note 1)	7 steps from ± 0.125 to ± 8 V	32	2048	5451B Fourier Analyzer	Power spectrum Transfer function Coherence Correlation Convolution	470
0.1 — 25 kHz	7 steps from ± 0.125 to ± 8 V	256 PS 128 TF	1024 PS 512 TF	5425A Digital Vibration Control System (Analysis Mode)	Power Spectrum (PS) Transfer Function (TF) Transient Capture Shock Response Spectrum	471
DC — 250 kHz	40 mV to 4 V rms	100	100	3721A Correlator	Correlation (Auto and Cross) Probability Density Probability Integral	472
0.005 — 250 kHz	40 mV to 4 V rms	100	100	3720A Spectrum Display	Real and Complex Fourier Transform of 3721A data	472

NOTE 1: Standard range is DC to 50 kHz, expandable with options to 100 kHz.

Distortion analyzers

Frequency Range	Auto Nulling	Hi-Pass Filter	Lo-Pass Filter	AM Detector	Gear Reduction Tuning	Model No.	Page
5 Hz to 300 kHz					•	331A	442
				•	•	332A	442
			•	•	•	332A Opt. H05	442
	•	•				333A	442
	•	•		•	•	334A	442
10 Hz to 100 kHz	•	•				334A Opt. H05	442
						4333A	441

Wave analyzers

Frequency Range	Selective Bandpass	Dynamic Range		Freq. Readouts	Type of Inputs	Type of Outputs	Modes of Operation	Model Number	Page
		Absolute	Relative						
15 Hz to 50 kHz	3 Hz 10 Hz 30 Hz 100 Hz 300 Hz	0.1 μ V — 300 V full scale	>85 dB	5-place digital	Banana Jacks	rec: 5 V full scale, with pen lift BFO, Local Oscillator, tuning loudspeaker, and headphone jack	AFC, normal, BFO	3581A/ 3581C	446 494
1 kHz to 18 MHz 18 ranges	50 Hz or Optional 150 Hz 2300 Hz 3100 Hz	-120 to +23 dBm	>72 dB	7 place decade counter	75 Ω accepts WECO 358A 124 Ω accepts WECO 408A 135 Ω accepts WECO 305A External frequency standard	Recorder: 1 V dc full scale 1 k Ω source Aux: 1 MHz (1 V p-p) 30 MHz (40–70 mV) rms LO: (30–48 MHz) 60 to 90 mV rms Audio: +13 dBm into 600 Ω	AM, beat LSB, USB	312D/ 3320C	506
1 kHz to 18 MHz 18 ranges or 1 kHz to 22 MHz 18 ranges*	200 Hz 1000 Hz 3100 Hz	200 mV — 3.2 V full scale or -120 to +23 dBm -130 to +13 dBm (600 Ω only)	>72 dB	7-place decade counter	BNC & probe 11530A bridged/ terminated balanced or unbalanced or WE-477B input unbalanced* or BNC input 50 Ω unbalanced*	rec: 1 V dc full scale 1 k Ω source aux: 1 MHz (1 V p-p) 30 MHz (40–70 mV) rms LO: (30–48 MHz) 60 to 90 mV rms audio: >0.5 V into 10 k Ω 313A: Track or tuned 75 Ω unbalanced, -99.9 to +10 dBm (Opt. 001, 50 Ω unbalanced output)	AFC, AM, beat LSB, USB	312B/ 313A	444

* 312B/313A Opt. H01 (WE-477B input unbalanced); 312B/313A Opt. H05 (BNC input 50 Ω unbalanced)

SIGNAL ANALYZERS

Ultra low distortion

Model 4333A

- Ultra low distortion: 0.01% full scale
- Frequency range: 10 Hz to 100 kHz
- Automatic tuning

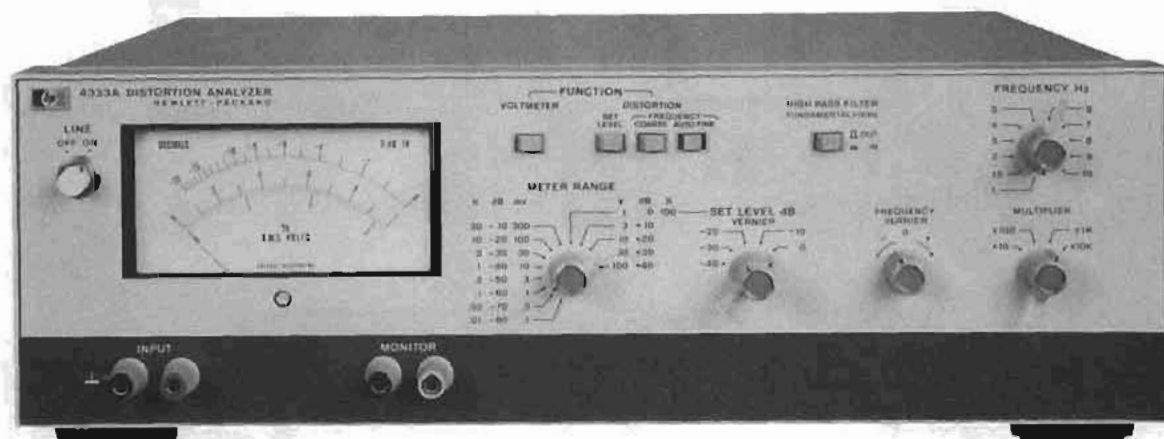

Description

Hewlett-Packard Model 4333A Distortion Analyzer measures total harmonic distortion down to 0.01% full scale at 41 spot frequencies between 10 Hz and 100 kHz; harmonics are indicated up to 600 kHz.

Automatic fundamental nulling reduces critical manual nulling operations where only coarse tuning of the frequency vernier ($\pm 8\%$ of spot frequency) to less than 3% of set level reference is required.

A 1 kHz high-pass filter which may be activated by a front panel switch is available for reducing the effects of hum components below 400 Hz.

A high sensitivity voltmeter mode offers 13 ranges in 10 dB steps; range is from 100 μ V to 100 V rms full scale. The bandwidth is 10 Hz to 600 kHz for the 300 μ V to 100 V ranges and 10 Hz to 200 kHz for the 100 μ V range. Meter indication is proportional to the average value of the sine wave and calibrated in rms volts/%; dB scale is calibrated dBV.

Specifications, Model 4333A

Distortion measurement ranges: nine ranges, 0.01% to 100% full scale.

Frequency range for distortion measurement: frequency vernier and multiplier controls 49 spot frequencies (not including overlapping points) for choosing between n 10 Hz through 100 kHz in a 1, 1.5, 2, 3, 4, 5, 6, 7, 8, 9, 10 sequence. Any set frequency is variable up to $\pm 8\%$ with frequency vernier.

Distortion measurement accuracy

Harmonic measurement accuracy (full scale):

Range/Accuracy	$\pm 3\%$	$\pm 6\%$
100% - 0.03%	10 Hz - 400 kHz	10 Hz - 600 kHz
0.01%	10 Hz - 100 kHz	10 Hz - 200 kHz

Elimination characteristics

Fundamental rejection:

> 100 dB, 10 Hz to 10 kHz (multiplier X10, X100, X1 K)

> 95 dB, 10 kHz to 100 kHz (multiplier X10 K)

Second harmonic accuracy: better than +0, -0.6 dB, 10 Hz to 100 kHz

Distortion introduced by instrument:

> -95 dB (0.0018%) from 10 Hz to 10 kHz (multiplier X10, X100, X1 K)

> -90 dB (0.0032%) from 10 kHz to 30 kHz (multiplier X10 K)

> -85 dB (0.0056%) from 40 kHz to 100 kHz (multiplier X10 K)

Input

Impedance: 100 k Ω $\pm 5\%$ shunted by <80 pF

Single ended, low side chassis ground

Input level for distortion measurement: for 100% (0 dB) set level 1.0 V rms to 130 V rms. Minimum input for auto nulling is 0.1 V rms.

Voltmeter range: 100 μ V to 100 V rms full scale (13 ranges) 10 dB per range.

Frequency range for voltage measurement

10 Hz to 600 kHz: (300 μ V - 100 V range)

10 Hz to 200 kHz: (100 μ V range)

Voltmeter accuracy:

Range/Accuracy	$\pm 2\%$	$\pm 5\%$
100 μ V	20 Hz to 50 kHz	10 Hz to 200 kHz
300 μ V to 100 V	20 Hz to 300 kHz	10 Hz to 600 kHz

Voltmeter residual noise (600 Ω termination):

300 μ V range: <25 μ V rms

100 μ V range: <10 μ V rms

Monitor output: 0.1 V rms ± 0.01 V rms open circuit for full scale meter indication, 2 k Ω $\pm 10\%$ output impedance.

High-pass filter: 3 dB point at 400 Hz with 18 dB per octave rolloff. Normally used only with fundamental frequencies greater than 1 kHz.

General

Power supply: 100, 120, 220, 240 V $\pm 10\%$, 45 to 66 Hz, approximately 11 VA. Rear terminals are provided for external battery supply. Positive and negative voltages between 22 V and 40 V are required. Current drain from each supply is less than 200 mA.

Weight: net, 7.5 kg (16.5 lb). Shipping, 9.9 kg (22 lb).

Dimensions: 42.6 cm wide (16.75 in.) \times 13.3 cm high (5.25 in.) \times 34.9 cm deep (13.75 in.)

Options

907: Front Handle Kit

908: Rack Flange Kit

909: Rack Flange & Front Handle Combination Kit

4333A Distortion Analyzer

Price

add \$15

add \$10

add \$20

\$1980

SIGNAL ANALYZERS

Distortion analyzers

Models 331A, 332A, 333A, 334A



331A



334A

Description

Hewlett-Packard's models 331A, 332A, 333A and 334A Distortion Analyzers measure total distortion down to 0.1% full scale at any frequency between 5 Hz to 600 kHz; harmonics are indicated up to 3 MHz. These instruments measure noise as low as 50 microvolts and measure voltages over a wide range of level and frequency. Refer to table below for available models and features.

Model No.	Auto Nulling	Hi-Pass Filter	Lo-Pass Filter	AM Detector
331A				
332A				X
332A Opt. H05			X	X
333A	X	X		
334A	X	X		X
334A Opt. H05	X		X	X

Option 001, for each model, features VU meter characteristics conforming to FCC requirements.

Automatic fundamental nulling

Automatic fundamental nulling speeds up the normally time-consuming portion of the measurement. This is done by manually nulling with the coarse tuning and balance controls to less than 10% of the Set Level Reference. The automatic mode is used to complete rejection of the fundamental on more sensitive ranges without any further manual tuning.

High-pass filter

In order to reduce the effect of hum components, a high pass filter is provided which attenuates frequencies below 400 Hz. The filter may be activated by a front panel switch when measuring distortion of signals greater than 1 kHz in frequency.

Amplitude modulation detector

HP's models 332A and 334A Analyzers are provided with an amplitude modulation detector having a frequency range from 550 kHz to greater than 65 MHz.

The high impedance dc restoring peak detector which utilizes a semiconductor diode measures distortion at carrier levels as low as 1 volt. Input to the detector is located on the rear of the instrument. HP's model 334A is similar to Model 332A, but is provided with Automatic Fundamental Nulling and a High-Pass Filter. The switchable RF Detector at the input of the instrument has a frequency range of 550 kHz to 65 MHz. Input connector is located on the rear panel of the instrument.

High impedance voltmeter

The transistorized metering circuit of HP 331A through 334A employs feedback to insure stability and a flat frequency response from 5 Hz to 3 MHz. The voltmeter mode offers 13 ranges in 10 dB steps. Range is from 300 μ V to 300 V rms full scale. The bandwidth is 5 Hz to 3 MHz for 1 mV to 30 V ranges; 5 Hz to 500 kHz for 100 V to 300 V ranges; and 20 Hz to 500 kHz for the 300 μ V range. Average responding meter is calibrated to rms value of a sine wave.

VU Option available

Option: 001 provides an indicating meter having VU ballistic characteristics.

Distortion analyzers: meet FCC requirements.

Models H05-332A, H05-334A

Two solid-state distortion analyzers offer extended frequency range, greater set level sensitivity, improved selectivity, greater overall accuracy, and unprecedented ease of use. The units meet FCC requirements on broadcast distortion levels. Both models measure total distortion down to 0.1% full scale. Model H05-334A features automatic fundamental nulling (>80 dB rejection). The H05-332A and 334A have a switchable low pass filter to reduce effect of unwanted high frequencies (noise, etc.) when measuring low frequency signals with high accuracy. Also included is a 3 MHz voltmeter, 300 μ V to 300 V full scale. Both models have an AM detector covering 550 kHz to >65 MHz at carrier levels as low as 1 V.

331A Specifications

Distortion measurement range: any fundamental frequency, 5 Hz to 600 kHz. Distortion levels of 0.1%–100% are measured full scale in 7 ranges.

Distortion measurement accuracy

Harmonic measurement accuracy (full scale):

Fundamental Input Less Than 30 V

Range	±3%	±6%	±12%
100%–0.3%	10 Hz–1 MHz	10 Hz–3 MHz	
0.1%	30 Hz–300 kHz	20 Hz–500 kHz	10 Hz–1.2 MHz

Fundamental Input Greater Than 30 V

Range	±3%	±6%	±12%
100%–0.3%	10 Hz–300 kHz	10 Hz–500 kHz	10 Hz–3 MHz
0.1%	30 Hz–300 kHz	20 Hz–500 kHz	10 Hz–1.2 MHz

Elimination characteristics: fundamental rejection >80 dB. Second harmonic accuracy for a fundamental of 5 to 20 Hz: better than +1 dB; 20 Hz to 20 kHz: better than ±0.6 dB; 20 kHz to 100 kHz: better than –1 dB; 100 kHz to 300 kHz: better than –2 dB; 300 kHz to 600 kHz: better than –3 dB.

Distortion introduced by instrument: >–70 dB (0.03%) from 5 Hz to 200 kHz. >–64 dB (0.06%) from 200 kHz to 600 kHz. Meter indication is proportional to average value of a sine wave.

Frequency calibration accuracy: better than ±5% from 5 Hz to 300 kHz. Better than ±10% from 300 to 600 kHz.

Input impedance: distortion mode; 1 MΩ ±5% shunted by <70 pF (10 MΩ shunted by <10 pF with HP 10001A 10:1 divider probe).

Voltmeter mode: 1 MΩ ±5% shunted by <35 pF 1 to 300 V rms; 1 MΩ ±5% shunted by <70 pF, 300 μV to 0.3 V rms.

Input level for distortion measurements: 0.3 V rms for 100% set level or 0.245 V for 0 dB set level (up to 300 V may be attenuated to set level reference).

DC isolation: signal ground may be ±400 V dc from external chassis.

Voltmeter range: 300 μV to 300 V rms full scale (13 ranges) 10 dB per range.

Voltmeter accuracy: (using front panel input terminals)

Range	±2%	±5%
300 μV	30 Hz–300 kHz	20 Hz–500 kHz
1 mV–30 V	10 Hz–1 MHz	5 Hz–3 MHz
100 V–300 V	10 Hz–300 kHz	5 Hz–500 kHz

Noise measurements: voltmeter residual noise on the 300 μV range: <25 μV rms, when terminated in 600 (shielded) ohms, <30 μV rms terminated with a shielded 100 kΩ resistor.

Output: 0.1 ±0.01 V rms open circuit and 0.05 ±0.005 V rms into 2 kΩ for full scale meter deflection.

Output impedance: 2 kΩ.

Power supply: 115 or 230 V ±10%, 50 to 66 Hz, approximately 4 VA.

332A Specifications

Same as Model 331A except as indicated below:

AM detector: high impedance DC restoring peak detector with semiconductor diode operates from 550 kHz to greater than 65 MHz. Broadband input, no tuning is required.

Maximum input: 40 V p-p AC or 40 V peak transient.

Distortion introduced by detector: carrier frequency: 550 kHz–1.6 MHz: <50 dB (0.3%) for 3–8 V rms carriers modulated 30%. 1.6 MHz–65 MHz: <40 dB (1%) for 3–8 V rms carriers modulated 30%.

Note: Distortion introduced at carrier levels as low as 1 Volt is normally <40 dB (1%) 550 kHz to 65 MHz for carriers modulated 30%.

333A Specifications

Same as Model 331A except as indicated below:

Automatic nulling mode: set level; at least 0.2 V rms.

Frequency ranges: X1, manual null tuned to less than 3% of set level; total frequency hold-in ±0.5% about true manual null. X10 through X10 k, manual null tuned to less than 10% of set level; total frequency hold-in ±1% about true manual null.

Automatic null accuracy: 5 Hz to 100 Hz: meter reading within 0 to +3 dB of manual null. 100 Hz to 600 kHz: meter reading within 0 to +1.5 dB of manual null.

High-pass filter: 3 dB point at 400 Hz with 18 dB per octave roll off. 60 Hz rejection >40 dB. Normally used only with fundamental frequencies greater than 1 kHz.

Power supply: same as Model 331A.

334A Specifications

Same as Model 333A except includes AM Detector described under Model 332A.

H05-332A and H05-334A Specifications

Same as HP 332A and 334A except as indicated below:

A low-pass filter is added in Model H05-332A and is substituted for a high-pass filter in Model H05-334A.

Frequency range: 5 Hz to 30 kHz, switchable to 3 MHz.

Low-pass filter: 4 pole, 3 dB down at 30 kHz.

Meter range switch: calibrated and referenced in dBm (0 dBm = 1 mW into 600Ω).

General

Dimensions: 426 mm wide × 126 mm high × 337 mm deep (16 1/2" × 5" × 13 1/4").

Weight: net, 7.98 kg (17 1/2 lb). Shipping, 10.35 kg (23 lb).

Model number and name

Option 001, indicating meter has VU characteristics conforming to FCC requirements for AM/FM and TV broadcasting

H05-332A (meets FCC requirements)

H05-334A (meets FCC requirements)

331A Distortion Analyzer

332A Distortion Analyzer

333A Distortion Analyzer

334A Distortion Analyzer

Price

add \$23

add \$129

add \$105

\$1000

\$1050

\$1150

\$1180

SIGNAL ANALYZERS

1 kHz to 18 MHz selective voltmeter/tracking oscillator

Models 312B & 313A

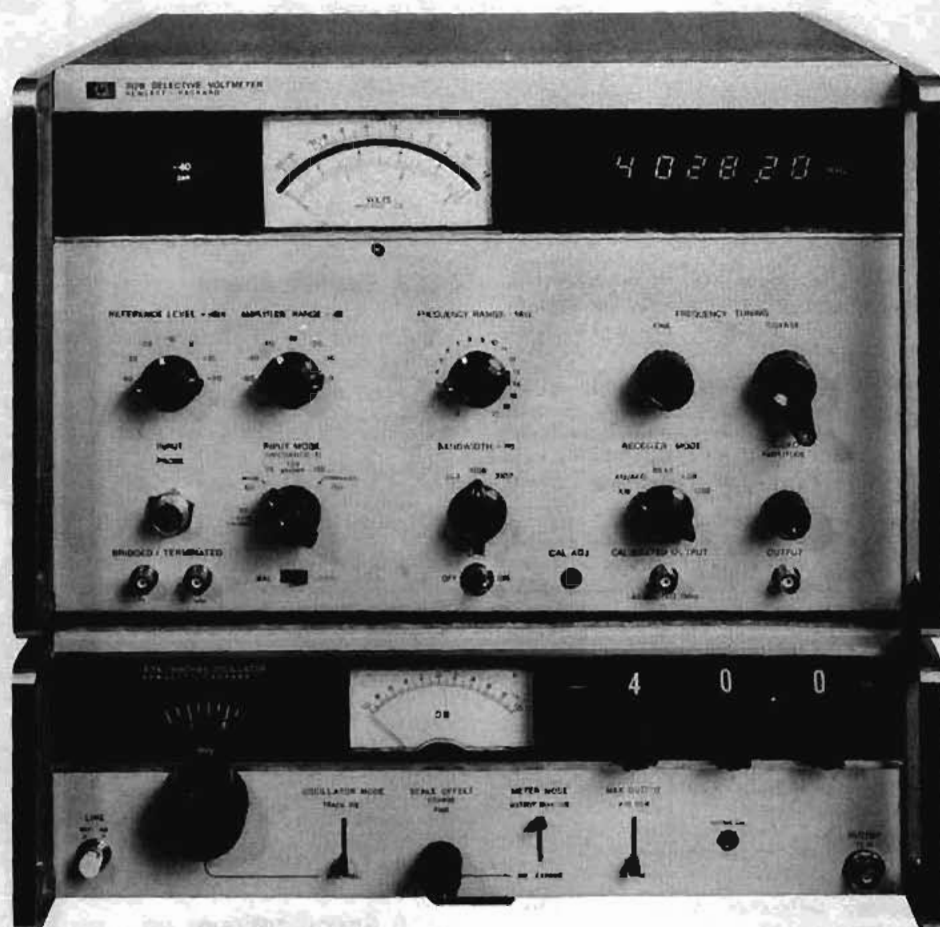

312B (top), 313A

Description

Hewlett-Packard Model 312B/313A is a frequency selective voltmeter/tracking oscillator operating in the frequency range of all commercially available carrier and radio systems. The set is capable of making transmission and noise measurements with excellent speed and accuracy. A 312D is available with special features for telecommunications applications. See page 500

HP's 312B uses a frequency synthesizer for tuning that is automatically phase locked in 1 MHz steps. Tuning between lock points is indicated on a 7-place digital readout with 10 Hz plus time-base accuracy. Coupled with this digital indication of unambiguous frequency is an automatic tuning aid known as automatic frequency control (AFC). The AFC will automatically fine tune frequency to the center of the set's passband, and automatically correct any relative frequency drift between the set and the signal being measured. Long term monitoring of signals is possible without periodic readjustment. High frequency accuracy coupled with AFC gives clear, instantaneous tuning and eliminates the need to search for signals.

Input and IF attenuators allow a maximum of dynamic range without concern for overloading the set. Attenuators can be easily set for

minimum distortion or noise performance. Attenuator settings are indicated clearly on a lighted annunciator which, when added to meter indication, gives a fast, error-free indication of input level. An accessory expanded scale meter allows 0.02 dB resolution of input level for accurate measurements.

The instrument is equipped with both balanced and unbalanced inputs to fit any measuring situation without the need for external accessory transformers. A wide selection of input impedances, either bridging or terminated, is provided along with provisions for an accessory high impedance, balanced bridging probe to eliminate measurement errors. The set always indicates directly in dBm or volts at any impedance, eliminating time consuming calculations or conversion charts.

Three selectable bandwidths are provided for all measurement situations. A narrow 200 Hz bandwidth is used for highly selective measurements, a 1000 Hz bandwidth for general measurements, and a 3100 Hz bandwidth for noise measurements.

Demodulation of upper or lower sideband channels with an audio output is provided for monitoring noise, traffic, or tones in any channel. The accurate digital frequency readout requires only a quick ref-

erence to the system frequency charts to determine frequency for perfect demodulation. No tuning around for natural sounding demodulation is required. In this respect, Model 312B can be thought of as a single-channel, tuneable, multiplex, receive terminal.

HP's Model 313A Tracking Oscillator provides an accurate, flat output at the frequency to which the 312B is tuned for frequency response measurements. Output frequency is quickly and easily set by the digital tuning indicator on the selective voltmeter.

Output level is easily set by a 3-digit presentation with 0.1 dB resolution. Output level is also easily read and remains constant with changes in frequency requiring no time consuming resetting of level at each new frequency.

A built-in meter provides an expanded scale display of the 312B's meter indication with 0.02 dB resolution of input level.

312B Specifications

Tuning characteristics

Frequency range: 1 kHz to 18 MHz in 18 overlapping bands, 200 kHz overlap between bands.

Frequency accuracy: ± 10 Hz + time base accuracy. Frequency indicated on in-line digital readout with ± 10 Hz resolution.

Selectivity:

Bandwidth Hz	3 dB BW	60 dB BW
200 Hz	200 Hz $\pm 10\%$	426 Hz $\pm 10\%$
1000 Hz	1 kHz $\pm 10\%$	2135 Hz $\pm 10\%$
3100 Hz	3100 Hz $\pm 10\%$	6200 Hz $\pm 10\%$

Amplitude characteristics

Amplitude measurement range

50 Ω to 150 Ω : -120 dBm to +23 dBm.

600 Ω : -130 dBm to +13 dBm.

Voltage: 200mV (full scale) to 3.2 V (50 Ω reference).

Amplitude accuracy

Frequency response (bridging input with external termination of 50 Ω $\pm 1\%$).

1 kHz to 10 kHz: ± 0.5 dB (5% of reading).

10 kHz to 10 MHz: ± 0.2 dB (2% of reading).

10 MHz to 18 MHz: ± 0.5 dB (5% of reading).

Matching impedance: 50 Ω , 60 Ω , 75 Ω , 124 Ω , 135 Ω , 150 Ω or 600 Ω , balanced or unbalanced on 312B.

Distortion

Harmonically related, 1 kHz to 1 MHz: >55 dB below zero reference. 1 MHz to 18 MHz: >65 dB below zero reference. Residual response (with no input and reference level in any position): 72 dB below zero reference.

Receiver characteristics

Receiver mode outputs

AM: diode-demodulated audio.

Beat: beat frequency audio centered at f_0 .

LSB: product-demodulated audio, carrier reinserted at $f_0 + 1.8$ kHz.

USB: product-demodulated audio, carrier reinserted at $f_0 - 1.8$ kHz.

Audio output level: >0.5 V rms into 10 k Ω with full-scale meter deflection.

Recorder output level: 1 V ± 0.1 V with full-scale meter deflection across open circuit.

Power: 115 V or 230 V $\pm 10\%$, 48 Hz to 66 Hz, <100 VA.

Dimensions: 425 mm wide \times 266 mm high \times 467 mm deep (16 $\frac{1}{2}$ " \times 10 $\frac{3}{8}$ " \times 18 $\frac{1}{4}$ ").

Weight: net, 20.7 kg (46 lb).

313A Specifications

Frequency range

As tracking oscillator: 10 kHz to 18 MHz.

As signal source: 10 kHz to 18 MHz in one band, continuous tuning.

Frequency accuracy

As tracking oscillator: 35 Hz ± 4 Hz above 312B tuning.

As signal source

10 kHz to 2 MHz: $\pm 1\%$ of max dial setting.

2 MHz to 8 MHz: $\pm 3\%$ of max dial setting.

8 MHz to 22 MHz: $\pm 5\%$ of max dial setting.

Frequency stability

As signal source: short-term (5 min) drift <1 kHz in stable environment after warmup.

Frequency response: ± 0.1 dB, 10 kHz to 18 MHz.

Amplitude stability: ± 0.1 dB for 90 days (0 $^\circ$ to 55 $^\circ$ C).

Maximum output: 0 dBm or +10 dBm ± 0.1 dB, selectable at front panel.

Output attenuator: 3-section attenuator provides 0 dB to 99.9 dB attenuation in 0.1 dB steps.

Attenuator accuracy

0.9 dB section (0.1 dB steps): ± 0.02 dB.

9 dB section (1 dB steps): ± 0.1 dB.

90 dB section (10 dB steps): ± 0.1 dB to 50 dB, ± 0.2 dB to 90 dB.

Output impedance: 75 Ω unbalanced, (50 Ω option: 01)

Harmonic distortion: more than 34 dB below fundamental.

Recorder output: ± 0.3 V for full-scale deflection. Output impedance 1 k Ω , BNC female connector.

Power: 115 V or 230 V $\pm 10\%$, 48 Hz to 66 Hz, <35 VA.

Dimensions: 425 mm wide \times 132.6 mm high \times 467 mm deep (16 $\frac{1}{2}$ " \times 5 $\frac{1}{8}$ " \times 18 $\frac{1}{4}$ ").

Weight: net, 11.3 kg (25 lb).

312B Options

001: carrier rejection notches inserted at $f_0 \pm 2$ kHz

H01: Frequency range: 1 kHz to 22 MHz in 22 overlapping bands

Meter calibration: dBm only (75 Ω reference).

Input impedance: 75 Ω or bridging (10 k Ω).

Input connector: equivalent to WECO-477B.

H10: same as H01-312B except uses BNC connectors

H05: same as H01-312B except uses 50 Ω reference and BNC connectors. Calibrated in volts and dBm

H21: meter referred to 1 mW into 600 Ω

H55: -50 Hz bandwidth substituted for 200 Hz bandwidth; -313 also modified so that the offset frequency is 15 Hz ± 2 Hz

H16: speaker included so operator can hear restored audio output

H15: speaker included so operator can hear restored audio output

H14: speaker included so operator can hear restored audio output

H13: speaker included so operator can hear restored audio output

H12: speaker included so operator can hear restored audio output

H11: speaker included so operator can hear restored audio output

H10: speaker included so operator can hear restored audio output

H09: speaker included so operator can hear restored audio output

H08: speaker included so operator can hear restored audio output

H07: speaker included so operator can hear restored audio output

H06: speaker included so operator can hear restored audio output

H05: speaker included so operator can hear restored audio output

H04: speaker included so operator can hear restored audio output

H03: speaker included so operator can hear restored audio output

H02: speaker included so operator can hear restored audio output

H01: speaker included so operator can hear restored audio output

Price

add \$133

add \$320

add \$320

add \$320

add \$320

add \$180

add \$200

add \$295

add \$295

add \$295

add \$295

add \$295

add \$295

add \$295

add \$295

add \$295

add \$295

add \$295

add \$295

add \$295

add \$295

add \$295

add \$295

add \$295

add \$295

add \$295

Model number and name

312B Selective Voltmeter

\$4950

313A Tracking Oscillator

\$2010

SIGNAL ANALYZERS

15 Hz to 50 kHz wave analyzer

Model 3581A



Description

Hewlett-Packard's 3581A Wave Analyzer separates and measures the amplitude and frequency of spectral components. This inexpensive instrument offers accurate amplitude and frequency resolution in a portable, easy to use measuring tool. Since not all signals originate from a stable frequency source, the 3581A incorporates an AFC circuit which locks to a drifting signal for stable, accurate measurements.

HP's 3581A has other important features that are necessary when making measurements of small voltages from transducers and harmonics signals. Its 30 nV sensitivity becomes important for these measurements. Battery operation or balanced input option can be used to reduce the line related interference common in low level measurements so only the real spectrum is measured.

Digital readout of tuned frequency is located above the analog meter. It has been grouped with the meter for ease of reading. Resolution of the digital readout is 1 Hz for any frequency between 15 Hz and 50 kHz. Readout is updated five times per second so delay between tuning and reading is minimized.

Four meter scales are used to provide a wide range of displays. Two scales are used for linear voltage readings. Two log scales provide either a 90 dB or 10 dB display. In any case, the large meter with its mirror backing can present readings in dB V or dBm or volts. A meter was specifically chosen for amplitude display rather than digital readout because it is easier to peak a meter reading and because it's much easier to get a feel for noise or other amplitude variations by watching the meter. The same voltage used to drive the meter is also available on the rear panel for driving X-Y recorders.

Specifications*

Frequency characteristics

Range: 15 Hz to 50 kHz.

Display: 5 digit LED readout.

Resolution: 1 Hz.

Accuracy: ± 3 Hz.

Typical stability: ± 10 Hz/hr after 1 hour and ± 5 Hz/ $^{\circ}$ C.

Automatic frequency control (AFC) hold-in range: ± 800 Hz.

Amplitude characteristics

Instrument range

Linear: 30 V to 100 nV full scale.

Log: +30 dBm or dBV to -150 dBm or dBV.

Amplitude accuracy:

Frequency response, 15 Hz - 50 kHz

Log

± 0.4 dB

Linear

$\pm 4\%$

Dynamic range: >80 dB.

Noise sidebands: greater than 70 dB below CW signal, 10 bandwidths away from signal.

Spurious responses: >80 dB below input reference level.

Sweep characteristics

Scan width: 50 Hz to 50 kHz. These scans can be adjusted to cover a group of frequencies within the overall instrument range.

Sweep error light: this LED indicates a sweep that is too fast to capture full response. When the light is on, response will be lower than it should be.

External trigger: a short to ground stops the normal sweep. Opening the short then enables a sweep.

Input characteristics

Impedance: 1 M Ω , 30 pF.

Maximum input level: 100 V rms, ± 100 V dc.

Output characteristics

Tracking generator output (also known as BFO or tracking oscillator output).

Restored output

Range: 0 to 2 V rms.

Frequency response: $\pm 3\%$ 15 Hz to 50 kHz.

X-Y recorder analog outputs

Vertical: 0 to +5 V $\pm 2.5\%$.

Horizontal: 0 to +5 V $\pm 2.5\%$.

Impedance: 1 k Ω .

Pen lift: contact closure to ground during sweep.

General

Power requirements: 100 V, 120 V, 220 V or 240 V $\pm 5\%$ -10%, 48 Hz to 66 Hz, 10 VA typical.

Dimensions: 412.8 mm high \times 203.2 mm wide \times 285.8 mm deep (16 1/4" \times 8" \times 11 1/4").

Weight: 11.5 kg (23 lb). Option 001: 13.5 kg (30 lb).

Option 001, battery: 12 hours from full charge. Internal battery is protected from deep discharge by an automatic turnoff. Useful life of this battery is over 100 cycles.

Model number and name

Option 001: battery

3581A Wave Analyzer

Price

add \$385

\$3155

*Note: for complete specifications, refer to page 498 (HP 3581C selective voltmeter) which is a dedicated telecommunications version of the HP3581A wave analyzer.

SIGNAL ANALYZERS

Automatic spectrum analyzers from 10 Hz to 13 MHz

Models 3044A/3045A



3044A

- High accuracy and resolution digital amplitude
- Synthesizer frequency accuracy and stability
- Wide amplitude range of 150 dB
- Narrow band analysis
- Full digital control via HP-IB

3045A

- Full automation and low cost
- Speed and precision in measurements
- Data analysis and presentation of results
- Simplicity and flexibility in operation
- HP-IB systems interfacing flexibility
- 9825A calculator-controller

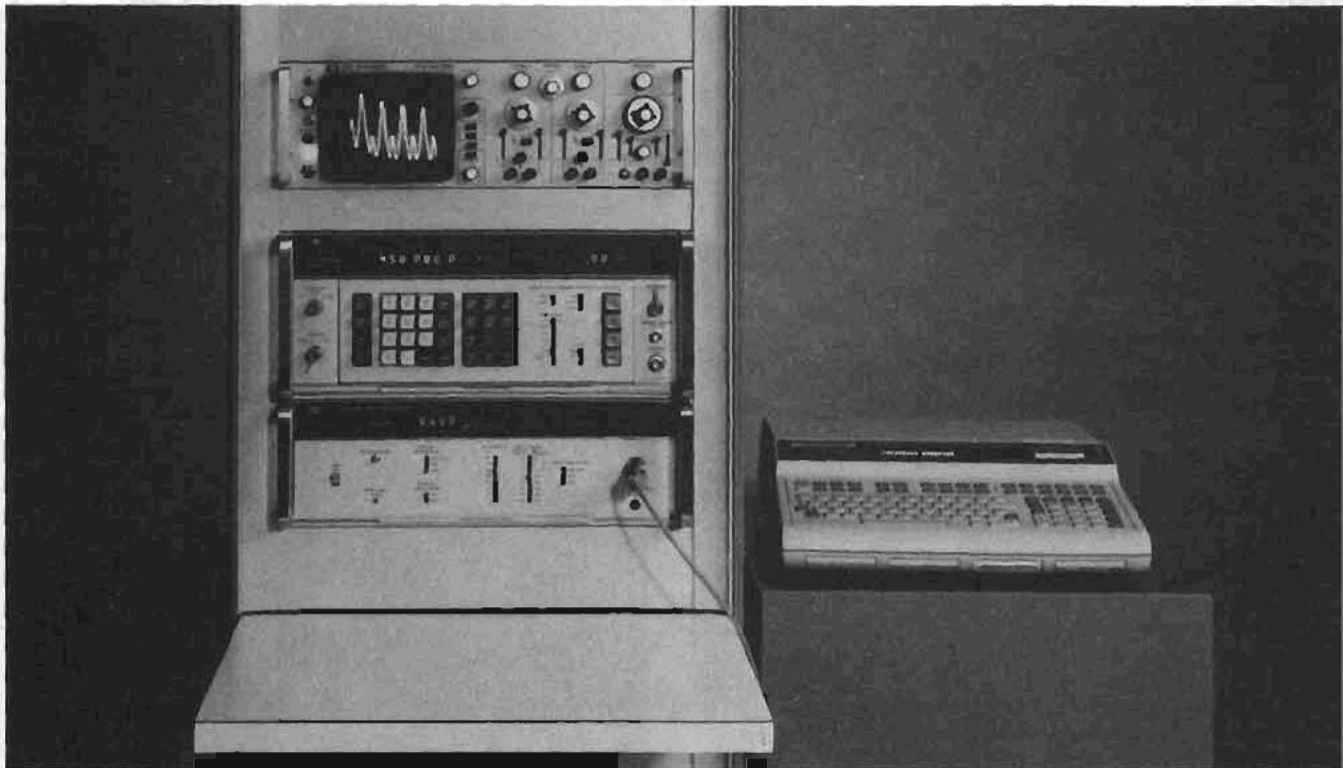

3045 System with Option 204 (HP Model 1201B Oscilloscope)

HP-IB

Description

3044A Spectrum analyzer

Meeting the demand for precise frequency and amplitude measurements in the 10 Hz to 13 MHz region, the 3044A is a spectrum analyzer with tracking generator. This system uses a synthesizer with leveled output and sweep capability to generate the local oscillator signal for the analyzer and the tracking generator output. This allows fast, extremely accurate "tuning" with the use of frequency up-down keys or keyboard entry of center frequency. The input impedance is front-panel switch selectable to 50 Ω , 75 Ω , and 1 M Ω . The units of the digital display are also front-panel selectable to dBm, dBV and dB relative to a user-entered offset. Digital display of amplitude and frequency gives an unambiguous, high-resolution readout commensurate with the wide dynamic range and high accuracy of this analyzer.

3045A Automatic spectrum analyzer

While the 3044A is an excellent stand-alone spectrum analyzer, the capabilities are greatly improved with the addition of the 9825A Calculator, which forms the 3045A system.

The 9825A Calculator allows program and data storage on its fast tape cassette. The tape cassette, short calculation times and buffered

input/output speed allow repeated, automated tests which can greatly reduce production and quality-assurance test times. Also the scope of possible measurements greatly increase with the 3045A System. Logarithmic sweeps and limit tests are only two examples. The calculator also allows data manipulation and presentation in units familiar to the system operator in graphic or tabular form. (A plotter and line printer are system's options.)

Because the user may not be familiar with HPL (the language of the 9825A Calculator) or even with programming, a compiler is furnished with the 3045A System. The compiler allows the calculator to converse in terms understood by the test engineer, like start and stop frequencies, plot results, and compare with limits. It also accepts and outputs in units of Hz, kHz, MHz, dBm and dBV. The compiler enables the execution of sophisticated tests, like intermodulation distortion measurements, with only a few minutes of initial "programming" time. It can also record the test parameters, which can then be used repeatedly, as in a production environment. The compiler's versatility and ease of use make the full power of the 3045A Spectrum Analyzer readily available to the user.

The 3045A Automatic Spectrum Analyzer system is fully integrated, tested, verified and specified as a system. It is supplied with complete software and documentation.



SIGNAL ANALYZERS

Automatic spectrum analysis from 10 Hz to 13 Hz

Applications

Sideband analysis

This is a more traditional spectrum analysis using HP's 3044A and 1201B Oscilloscope. Figure 3. is a polaroid picture of the spectrum. The carrier frequency was supposed to be at 10.7 MHz. Therefore, the synthesizer was set up with a 10.7 MHz center frequency and a ± 500 Hz sweep about the center frequency. From the picture, it is apparent that the carrier frequency is about where it should be. It is possible to move the center frequency in 0.1 Hz steps with the step buttons and look for the peak responses to more accurately identify the carrier frequency.

Using the 3 Hz resolution bandwidth, 60 Hz spurious responses are revealed. Noise products also appear very close to the carrier. Here the wide dynamic range of the system exposes the responses that are more than 70 dB below the carrier.

Distortion measurements

The spectrum analyzer system can be very powerful for characterizing the complete response of amplifiers. Gain, noise, spurious distortion and frequency response can all be done with one setup. This example of distortion measurement is one part of the total characterization that can be done.

Distortion of audio frequencies as they pass through amplifiers is measured by several methods. Total harmonic distortion is found by measuring the harmonic output assuming a pure sinewave input. Here again the 3045A offers benefits through calculation power. After the user enters the fundamental frequency, the calculator takes over and makes measurements at the appropriate frequencies and calculates the percentage distortion. Figure 2 shows the type of user-oriented printout that is possible using the 9830A Calculator and the 9866A Printer. The other calculators have built-in printers which could give the same type of printout.

Intermodulation distortion can similarly be measured as part of the same system provided the sources are available.

Modulation measurements

Both AM and FM modulation show up very well in the frequency domain. Figure 4 shows a typical wide band FM signal. This measurement could be made with the same setup as Figure 2. A more sophisticated measurement was made using the 3045A. The calculator is used to program the instruments for measurements at the carrier and sideband frequencies. From the data, the modulation index was calculated to be 1.53 with a calculator Bessel algorithm. This is a good example of using the 3045A to make measurements that are not easy with a simple spectrum analyzer.

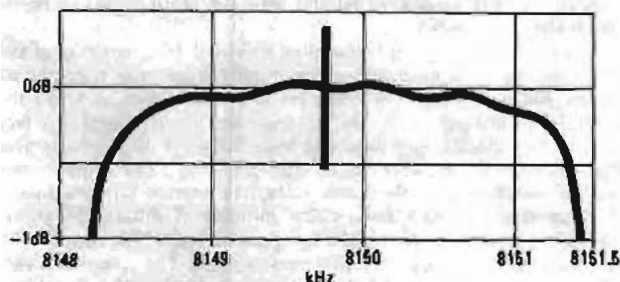

Figure 1. This bandpass filter was characterized using a 3044A system and an x-y recorder. By expanding the Y-axis so only 5 dB are covered, the ripple and 3 dB points are very easy to identify.

TOTAL HARMONIC DISTORTION TEST			
FUNDAMENTAL FREQUENCY		ABSOLUTE LEVEL	
	1231.0		0.7 DBV
HARMONIC FREQUENCY		RELATIVE LEVEL	
2	2462.0	-44.20	DB
3	3693.0	-49.20	DB
4	4924.0	-60.70	DB
5	6155.0	-60.40	DB
6	7386.0	-77.50	DB
TOTAL HARMONIC DISTORTION EQUALS			-42.95 DB
			OR 0.72 PERCENT

Figure 2. Using a 3045A system, an amplifier can be completely characterized for total harmonic distortion as well as intermodulation distortion, noise, spurious, frequency response and gain.

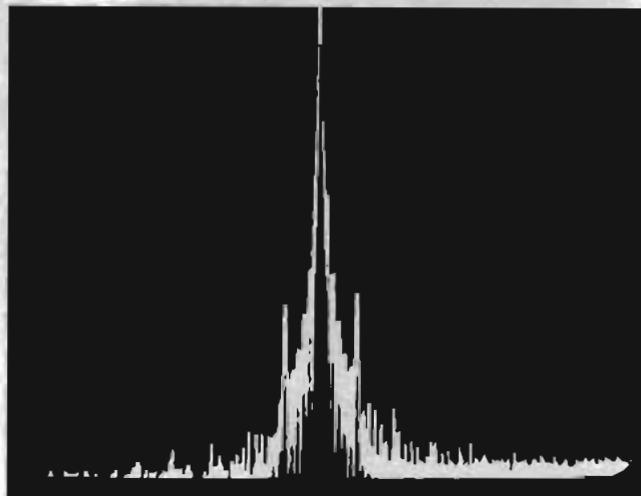

Figure 3. A 3044A was used to analyze close in spurious and noise of a 10.7 MHz carrier. The sweep covers 1 kHz around the carrier.

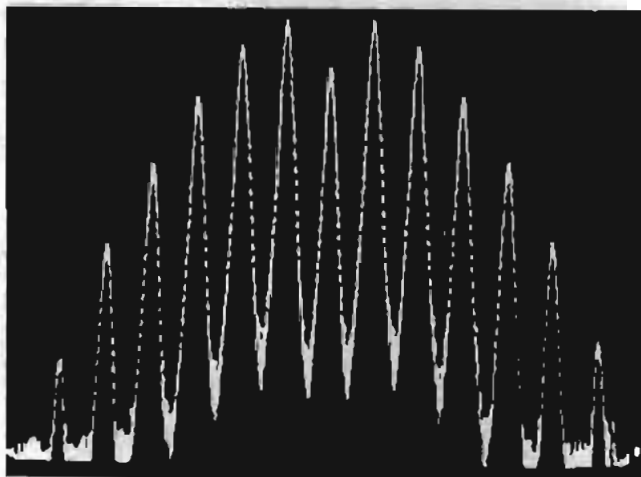

Figure 4. Wideband FM modulation with a 5.3 MHz carrier.

Telemetry

One of the most powerful applications for the spectrum analyzer is in monitoring frequency multiplexed telemetry or alarm systems.

The operating system may have many channels at different levels. When spurious signals appear or channels drop out, it is difficult to see them on a CRT. This is done by storing the spectrum of the system when it is running properly. Figure 5a shows a part of such a telemetry system. Then subsequent spectrums are subtracted from the normal spectrum. Channels that drop out or lose gain will appear as negative points as shown in Figure 5b. Spurious signals that were not present before will appear as points above the noise level. Rather than looking over the entire spectrum for problems, the system shows them graphically with enough frequency accuracy so the channel with problems can be quickly identified.

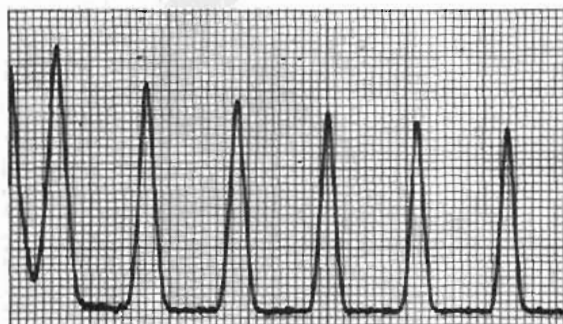

Figure 5a. This represents a portion of a frequency multiplexed system operating normally. Notice that not all channels are operating at the same level.

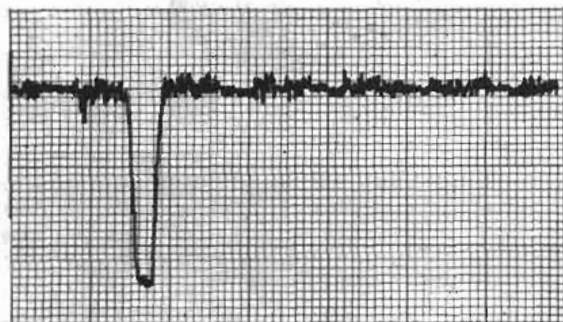

Figure 5b. The difference between a normal system and one that has problems is immediately apparent. One of the channels has dropped out.

3044A/3045A Specifications

Frequency specifications

Frequency range: 10 Hz to 13 MHz

Scan width: any desired scan is possible in 10, 100 or 1000 steps of frequency increments as small as 0.1 Hz and with 0.1 Hz resolution. The 3045A is additionally capable of taking any number of steps with direct calculator control of the sweep.

Resolution

Bandwidths: 3 Hz to 10 kHz in a 1, 3, 10 sequence

Bandwidth selectivity: 60 dB/3 dB bandwidth ratios $\leq 10:1$

Stability

Long term: $\pm 1 \times 10^{-8}$ /day
 $\pm 1 \times 10^{-7}$ /month

Temperature: 20° to 30°C: $\pm 1 \times 10^{-8}$ /°C of 20°C frequency

Phase noise: <50 dB below CW signal in a 30 kHz band around signal.

Amplitude specifications

Absolute amplitude calibration range: -130 dBm to +20 dBm (50 or 75 Ω), -140 dBV to +10 dBV

Digital amplitude readout: ± 199.99 dB with 0.01 dB resolution

Dynamic range

Average noise level: -127 dBV in 1 kHz resolution bandwidth.

Smoothing (Video filter): provides smoothing with a bandwidth of 1/30th the resolution bandwidth on all but the 3 Hz and 10 Hz bandwidths.

Spurious responses: >70 dB below input range setting.

Distortion responses: >80 dB below input signal at input range setting level.

Power-line related responses: 70 dB below input range on +10 dBV through -40 dBV ranges; 60 dB on -50 dBV; 50 dB on -60 dBV ranges.

Amplitude accuracy

Frequency response: ± 0.25 dB (250 kHz reference)

Input range: ± 0.05 dB/step, ± 0.15 dB total accumulation.

Log linearity: 0 to -30 dB ± 0.1 dB
 -30 to -60 dB ± 0.25 dB
 -60 to -80 dB ± 0.75 dB

Stability: (8 hr., 25°C ± 1 °C, after 1 hr. warmup) 10 kHz, 3 kHz, 100 Hz, 30 Hz, 10 Hz, BW's

0 dB	-30 dB	-60 dB	temp. coefficient
± 0.05 dB	± 0.08 dB		± 0.02 dB/°C

1 kHz, 300 Hz, 3 Hz BW's

0 dB	-30 dB	-60 dB	
± 0.08 dB	± 0.15 dB		± 0.04 dB/°C

Tracking generator (3330B output)

Frequency range: 0.1 to 13 000 999.9 Hz

Frequency resolution: 0.1 Hz (9 digits)

Amplitude range: +13.44 to -86.55 dBm (50 Ω)
 +11.68 to -88.31 dBm (75 Ω option)

Amplitude accuracy

Levelled frequency response (10 kHz reference)*

10 Hz	13 MHz	+13.44 dBm
± 0.05 dB		-16.55 dBm
± 0.1 dB		-36.55 dBm
± 0.2 dB		-66.65 dBm
± 0.4 dB		-86.55 dBm

* Add 0.5 dB for leveling switch in off position

Attenuator (10 kHz reference, 25°C ± 5 °C): ± 0.02 dB/10 dB step of attenuator down from maximum output.

Absolute accuracy: ± 0.05 dB at 10 kHz and +13.44 dBm (25°C ± 5 °C)

Amplitude stability (24 hr., 25°C ± 1 °C): ± 0.01 dB

General

Input impedance: 50 Ω , 75 Ω >30 dB return loss
 1 M Ω $\pm 5\%$ shunted by 30 pF BNC connector

Maximum input level: +20 dBm

Programmability: all controls, except power switches, are programmable using the HP-IB format.

3044A/3045A Options

The basic 3044A and 3045A system options are listed below. For more information refer to the 3044A/3045A data sheet.

Options

3044A Options	Price
Option 110 Standard 3571A	add \$6550
Option 120 Standard 50 Ω 3330B w/Isol, HP-IB	add \$7455
Option 121 Standard 75 Ω 3330B w/Isol, HP-IB	add \$7455
Option 122 5 V Output	add \$300
3045A Options:	
Option 200 50 Ω System	N/C
Option 201 75 Ω System	N/C
Option 204 1201B Oscilloscope	add \$2670
Option 215 9862A Plotter	add \$3195
Option 230 9871A Impact Printer	add \$3400

Model number and name

3044A Spectrum Analyzer	\$14,005
3045A Automatic Spectrum Analyzer consisting of: 3330B Synthesizer; 3571A Spectrum Analyzer; 9825A Calculator, 6.8 k bytes memory; ROMs, Interface, documentation; 56" Rack.	\$24,135

SIGNAL ANALYZERS

5 Hz to 50 kHz spectrum analyzer

Model 3580A

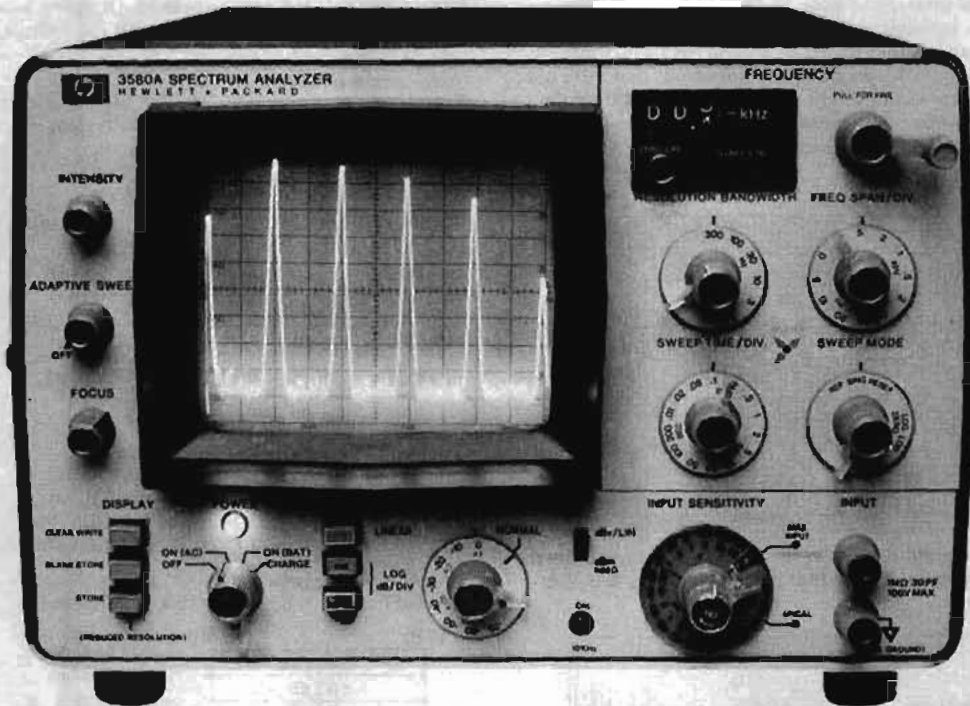

Description

Hewlett Packard's 3580A Spectrum Analyzer is a low frequency high performance analyzer. Its 1 Hz bandwidth allows the user to examine noise and extraneous signal content close in to a signal of interest.

For low frequency applications where sweep speeds can be slow and time-consuming, a special feature, adaptive sweep, allows the user to set a threshold above which only the spectra of interest is observed. In this mode, the CRT is rapidly swept. When a signal is encountered, the sweep slows down to reproduce full response. A factor of ten speed gain is possible.

Digital storage is another important feature which enhances the display for slowly swept low frequency signals. The analyzed signals are digitized and stored in memory. Trace information is then read from memory at a rate appropriate for obtaining an analog-like display.

Digital storage for spectra comparison

Digital storage makes it possible to store one or two traces. When two are stored, both may be simultaneously displayed for easy comparison as shown below.

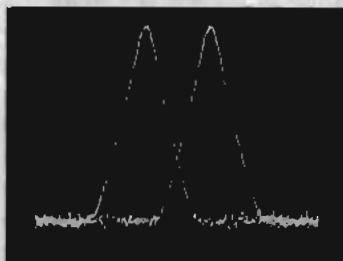

Adaptive sweep

A tremendous savings in sweep time can be achieved by using adap-

tive sweep. In the left trace below over 80 dB of dynamic range is used to look at low level signals and noise. Two hundred seconds were required to make the sweep. In the right trace. The baseline is raised to give 50 dB of dynamic range. Noise and other responses are not analyzed so sweep now takes only 14 seconds.

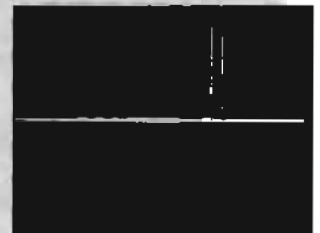
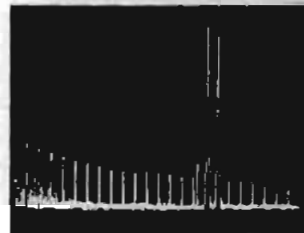

1 Hz bandwidth

When using a 1 Hz bandwidth 60 Hz line related spectra are clearly exposed as shown in the left trace. An analysis of the same signal with a 10 Hz bandwidth will not resolve the line related spectra as shown on the right.

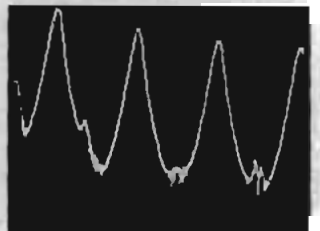
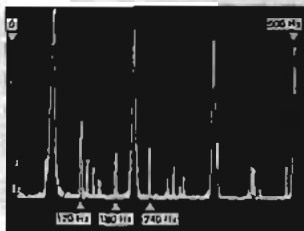

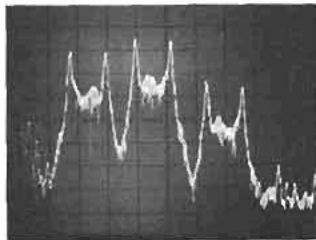

Telecommunications application

Besides analysis of voice spectrum, HP's 3580A gives a clear picture of frequency spectrum for digital transmission. This picture shows a 1200 baud full duplex modem using double sideband suppressed carrier FSK modulation. The "answer" band covers 850 Hz to 1450 Hz while the "transmit" band covers 1950 Hz to 2550 Hz. The higher frequency band at high levels from 3150 Hz to 3750 Hz comes from 3rd order products of the answer band.

Internal cal signal

A 10 kHz pulse derived from a crystal can be used to compensate for internal errors. A 10 kHz cal pot is provided so 10 kHz fundamental can be adjusted to fall on the top line of the display. With this feature, operation and calibration can be verified for most of the instrument.

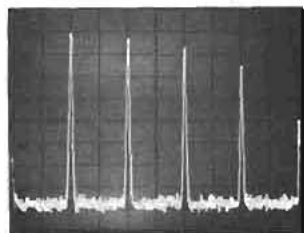

Specifications

Frequency characteristics

Range: 5 Hz to 50 kHz.

Frequency dial accuracy: ± 100 Hz, 20°C to 30°C; ± 300 Hz, 0°C to 55°C.

Display accuracy: frequency error between any two points is less than $\pm 2\%$ of their indicated separation.

Typical stability: ± 10 Hz/hr after 1 hour; ± 5 Hz/°C.

Frequency dial resolution: 20 Hz on frequency dial.

Bandwidths: (accuracy $\pm 15\%$)	1 Hz (25°C $\pm 5^\circ$ C)	3 Hz	10 Hz	30 Hz	100 Hz	300 Hz
Shape factor:	10				8	

Out of range blank: IF controls are set so portions of displayed signal lie below 0 Hz or above 50 kHz; the baseline is displayed.

Amplitude specifications

Overall instrument range:

Linear	20 V — 100 nV full scale
	+30 dBm or dB V;
Log	-150 dBm or dB V

Amplitude accuracy:	Log	Linear
Frequency response:		
20 Hz — 20 kHz	± 3 dB	$\pm 3\%$
5 Hz — 50 kHz	± 5 dB	$\pm 5\%$
Switching between bandwidths (25°C):		
3 Hz — 300 Hz	± 5 dB	$\pm 5\%$
1 Hz — 300 Hz	± 1 dB	$\pm 10\%$
Amplitude display:	± 2 dB	$\pm 2\%$
Input attenuator:	± 3 dB	$\pm 3\%$
Amplitude reference level: (IF attenuator)		
Most sensitive range:	± 1 dB	$\pm 10\%$
All other ranges:	± 1 dB	$\pm 3\%$
Dynamic range: 80 dB.		

IF feedthru: input level > 10 V, -60 dB; < 10 V, -70 dB.

Spurious responses: > 80 dB below input reference level.

Smoothing: 3 positions, rolloff is a function of bandwidth.

Overload indicator: this LED indicator warns of possible input amplifier overloading. Without this indication it would be possible to introduce spurious responses without knowing it.

Sweep characteristics

Scan width: 50 Hz to 50 kHz.

Log sweep: 20 Hz to 43 kHz $\pm 20\%$.

Sweep times: .1 sec to 2000 sec.

Rep: in the repetitive mode, sweep will continuously sweep specified band.

Reset: HP's 3580 is set to the start frequency of the sweep.

Manual: in combination with the concentric knob, manual sweep fully duplicates the span of the electronic sweep.

Adaptive sweep: when in adaptive sweep below the threshold level, scan speed is 20 to 25 times faster. Threshold is adjustable to cover 0-60% of screen. Signals greater than about 6 dB above threshold are detected and swept slowly.

Sweep error light: this LED indicates a sweep that is too fast to capture full response. When the light is on, response will be $> 5\%$ lower than it should.

Zero scan: to look at the time varying signal at the center or start frequency within the bandwidth selected, the zero scan is used.

Output characteristics

Tracking generator output: (also known as BFO or tracking oscillator output).

Range: 0 to 2 V rms.

Frequency response: $\pm 3\%$, 5 Hz to 50 kHz.

Impedance: 600 Ω .

Total harmonic and spurious content: 40 dB below 1 volt signal level.

X-Y recorder analog outputs

Vertical: 0 to +5 V $\pm 2.5\%$.

Horizontal: 0 to +5 V $\pm 2.5\%$.

Impedance: 1 k Ω .

Pen lift: contact closure to ground during sweep.

Dimensions: 412.8 mm wide \times 203.2 mm high \times 285.8 mm deep (16 $\frac{1}{4}$ " \times 8" \times 11 $\frac{1}{4}$ ").

Weight: net, 12.25 kg (27 lb); 3580A Opt. 001: net, 15.88 kg (35 lb).

Temperature range: 0°C to 55°C.

Power: 100 V, 120 V, 220 V, or 240 V $\pm 5\%$ — 10%. 48 Hz to 66 Hz, 35 VA max.

Option 001 battery: 5 hours from full charge. 14 hours to fully recharge. The internal battery is protected from deep discharge by an automatic turn off. Useful life of batteries is over 100 cycles.

Model Number and name

3580A Option 001: internal rechargeable battery

3580A Option 002: floating input

3580A Spectrum Analyzer

Price

add \$385

add \$107

\$4485

SIGNAL ANALYZERS

Spectrum Analyzer, 0.01 to 350 MHz

Model 8557A/182T

- Easy to operate
- Signal level displayed directly in dBm
- ± 2.25 dB amplitude accuracy

- Resolution bandwidths 1 kHz to 3 MHz
- Optional 75 Ω input with dBm or dBmV calibration

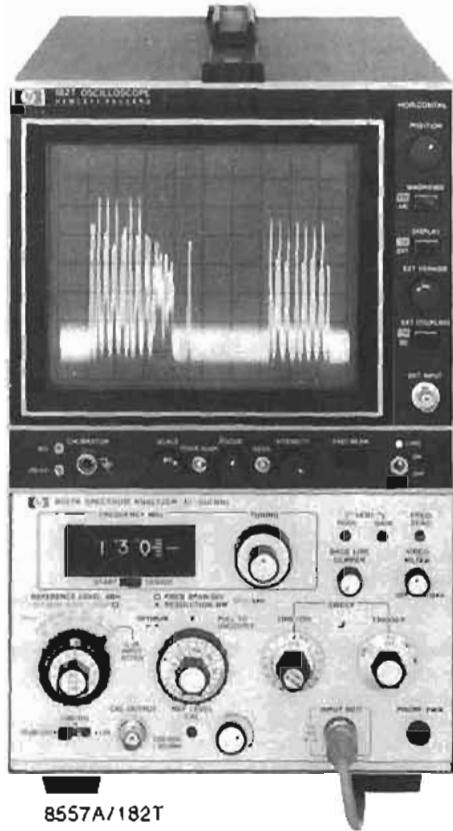

8557A/182T

8557A Spectrum analyzer

Oscilloscope plug-in spectrum analyzer

The Model 8557A is a 0.01 to 350 MHz spectrum analyzer which plugs into any 180 series oscilloscope display. It is fully calibrated, easy to use, and provides an economical means for making frequency domain measurements in the RF range. Although low in cost, the 8557A features high performance and accuracy.

Simple, 3-knob operation

Most measurements are a three step process. Center the inverted marker under the signal to be measured; its frequency is displayed on the digital readout. Zoom-in on the signal by decreasing the frequency span; bandwidth, sweep time, and video filtering are set automatically. Raise the signal to the top of the CRT; read its amplitude (in dBm) off the reference level control.

Absolute amplitude calibration

Signal levels can be read directly from the CRT in dBm (dBmV for Option 002) without the use of external standards or calculations. The signal level represented by the top CRT graticule line is always indicated by the reference level control, and vertical scale factors of 10 dB/div, 1 dB/div, or linear can be selected.

Continuously variable video filter

Video filtering is a function of resolution bandwidth. A constant degree of filtering is maintained when the bandwidth control is changed, as when zooming-in on a signal. Noise measurements can be easily made in the "MAX" position (1.5 Hz bandwidth).

Optional 75 ohm input

Two options are available which allow measurements in 75 ohm systems: Option 001 has 75 ohm impedance and retains the dBm power calibration; Option 002 is also 75 ohms, but the amplitude is calibrated in dBmV for measurements on systems such as CATV.

Suggested displays

The 8558B will function with any 180-series display. However, the following are suggested: For a low cost, large screen display, the Model 182T is ideal; the Model 181T offers variable persistence and storage; and the Model 180TR offers a rack mount configuration. In addition, it is advantageous to order the 180T, 180TR, 181T, 181TR or 182T displays which provide a long persistence P39 phosphor (except the 181T and 181TR variable persistence displays) and four non-buffered, rear panel outputs compatible with most X-Y recorders. 100 volt operation is available as Option 003.

8557A Specifications

Frequency specifications

Frequency range: 10 kHz to 350 MHz.

Frequency display span (on a 10-division CRT horizontal axis): 12 calibrated spans from 20 MHz/div to 5 kHz/div in a 1, 2, 5 sequence. In "F" or full span the analyzer displays the full 10 kHz to 350 MHz. In "0" the analyzer is a fixed-tuned receiver.

Accuracy: frequency error between any two points on the display is less than $\pm 10\%$ of the indicated frequency separation.

Digital frequency readout: indicates center frequency or start frequency of the frequency display span. In full span, the readout indicates the frequency at the marker. Resolution 100 kHz.

Accuracy: (after zeroing on the LO feedthrough): ± 3 MHz + 10% of FREQUENCY SPAN PER DIVISION setting.

Stability

Residual FM: less than 1 kHz peak-to-peak for time ≤ 0.1 sec (video filter full clockwise, but not in detent).

Noise sidebands: more than 75 dB below CW signal, 50 kHz or more away from signal with a 1 kHz resolution bandwidth and full video filtering.

Resolution

Bandwidth ranges: 3 dB resolution bandwidths of 1 kHz to 3 MHz in a 1, 3, 10 sequence. Resolution bandwidth may be coupled to frequency display span at a ratio of two display spans per resolution bandwidth.

Resolution bandwidth accuracy: individual resolution bandwidth 3 dB points calibrated to $\pm 20\%$, 10° - 40°C.

Resolution bandwidth selectivity: 60 dB/3 dB resolution bandwidth ratio $< 15:1$.

Video filter: post-detection low pass filter used to average displayed noise. Bandwidth variable from approximately 3X Resolution Bandwidth to approximately 0.01X Resolution Bandwidth. In the MAX position provides a noise averaging filter with a bandwidth of approximately 1.5 Hz.

Amplitude specifications

Absolute amplitude calibration range

Log calibration range: from -117 dBm to -20 dBm in 10 dB steps. Reference level vernier, 0 to -12 dB continuously.

Log display ranges: 10 dB/div on a 70 dB display and 1 dB/div on an 8 dB display.

Linear display: from 2.2 microvolts (-100 dBm) full-scale to 2.24 volts (+20 dBm) full-scale in 10 dB steps. Full-scale signals in linear translate to approximately full-scale signals in log.

Dynamic range

Average noise level: < -107 dBm with a 10 kHz resolution bandwidth (0 dB input attenuation), 1 - 350 MHz.

Spurious responses: for input signal level \leq Optimum Input Level setting, all image and out of band mixing responses, harmonic and inter-modulation distortion products are more than 70 dB below input signal level, 1 MHz to 350 MHz; 60 dB below, 20 kHz to 1 MHz.

Spurious responses due to 3rd order intermodulation distortion: for two input signals 10 dB above Optimum Input Level setting 3rd Order Intermodulation distortion products are >70 dB below the input signals, 1 - 350 MHz; 60 dB below, 10 kHz to 1 MHz (signal separation \geq 50 kHz).

Residual responses (no signal present at input): < -100 dBm with 0 dB input attenuation, 0.1 - 350 MHz.

Amplitude accuracy

Frequency response (flatness): ± 0.75 dB

Switching between bandwidths: (at 10° - 40°C, 90% relative humidity)

3 MHz to 300 kHz: ± 0.5 dB

3 MHz to 1 kHz: ± 1.0 dB

Reference level accuracy (at fixed center frequency, fixed resolution bandwidth): ± 1.5 dB (includes input attenuator and IF gain accuracy. May be improved using IF or RF substitution techniques).

Amplitude log display: ± 0.1 dB/dB but no more than ± 1.5 dB over full 70 dB display range.

Calibrator

Amplitude: -30 dBm ± 1 dB.

Frequency: 250 MHz ± 50 kHz, crystal controlled.

Input specifications

Input connector: Type BNC female.

Input impedance: 50 Ω nominal. Typical reflection coefficient < 0.27 (1.74 SWR) for all Optimum Input Level settings except -40 dBm (0 dB Input Attenuation).

Input attenuator: 50 dB range. Accuracy ± 0.5 dB per 10 dB step, but not more than ± 1.0 dB over full 50 dB range.

Maximum input levels

AC or peak: peak or average power +20 dBm (3.16 V ac peak or 0.1 W) incident on analyzer. (MAX input markings on front panel indicate maximum input allowable for < 1 dB gain compression or attenuator overload.)

DC: ± 30 V dc

Output characteristics

Cal output: -30 dBm, 250 MHz.

Probe power: +15 V, -12.6 V; 150 mA max. Powers: 1120A, 1121A, 1123A, or 1124A high impedance probes.

Note: oscilloscope display rear panel outputs refer to 180T-series displays and 180-series Option 807 displays only. See below for information on modifying standard displays.

Vertical output: (AUX A on oscilloscope display rear panel.) 10 to 0.8 V for 8-division deflection on CRT display; 50 Ω output impedance.

Pen lift/blinking output: (AUX B on oscilloscope display rear panel.) 0 to 15 V (0 V, pen down). Approximately 10 k Ω impedance when blanked. Compatible with HP 7004B, 7034B, 7005B, and 7035B X-Y RECORDERS.

21.4 MHz IF output: a 21.4 MHz output linearly related to the RF input to the analyzer. Bandwidth controlled by analyzer Resolution Bandwidth setting. Amplitude controlled by input attenuator, IF gain vernier, and first six IF step gain positions (-10 through -60 dBm Ref Level with 0 dB input attenuation). Output is approximately -10 dBm for full-scale signals on the CRT. (AUX C on oscilloscope display rear panel, 50 Ω output impedance.)

Horizontal output: (AUX D on oscilloscope display rear panel.) -5.0 to +5.0 V for 10 div CRT deflection, 5 k Ω output impedance.

Sweep characteristics

Sweep time

Auto: sweep time is automatically controlled by Frequency Span, Resolution Bandwidth, and Video Filter.

Manual: sweep determined by front panel control; continuously variable across CRT in either direction.

Calibrated sweep times: 16 internal sweep times from 0.1 ms/div to 10 sec/div in a 1, 2, 5 sequence. For sweep times of 2 ms/div to 10 sec/div, the analyzer is operable in its normal swept-frequency mode. Faster sweeps are useful for analyzing modulation waveforms when the analyzer is being operated as a fixed-tuned receiver with 0 Display Span. Sweep times may be reduced to an effective 10 μ sec/div by using the 180-series X10 horizontal magnifier.

Accuracy: $\pm 10\%$.

Sweep trigger

Internal: sweep internally triggered by envelope of RF input signal (signal amplitude of 1.0 division peak-to-peak required on CRT display).

Line: sweep triggered by power line frequency.

Free run: sweep triggered repetitively by internally generated ramp.

Single: sweep triggered by front panel sweep trigger switch (spring return position).

Display characteristics

Oscilloscope display sections

180 Series compatibility: The 8557A is compatible with all 180A/180AR, 180C, 180D, 180F, 181A, 181AR, 182A, 184A, and 184B mainframes. It is operable with the 183A, 183B mainframes, but the display is limited to 6 divisions by the 6-division CRT. The following 180-series oscilloscope displays are recommended for use with the 8558B Spectrum Analyzer because they provide 4 nonbuffered rear panel auxiliary outputs (for unattenuated vertical, horizontal, and penlift outputs) and P39 medium-persistence CRT phosphor (except with 181T, 181TR which provide variable persistence):

180TR P39 phosphor

181T P31 phosphor with variable persistence

181TR P31 phosphor with variable persistence

182T P39 phosphor

100 volts operation available as option 003.

See HP Service Notes 180A/AR-10, 180C/D-2, 181A/AR-8 and 182A/C-1 for information needed to modify standard display to provide auxiliary outputs.

Model number and name

8557A Spectrum Analyzer

182T Display

180TR Display

181T Display

181TR Display

Option 001: 75 ohm input (BNC), dBm calibration

Option 002: 75 ohm input (BNC), dBmV calibration

Price

\$3650

\$1500

\$1500

\$2400

\$2500

add \$100

add \$100

SIGNAL ANALYZERS

Spectrum analyzer, 0.1 to 1500 MHz

8558B/182T & 8444A

- Simple, 3 knob operation
- Digital frequency readout
- Display of signal levels directly in dBm

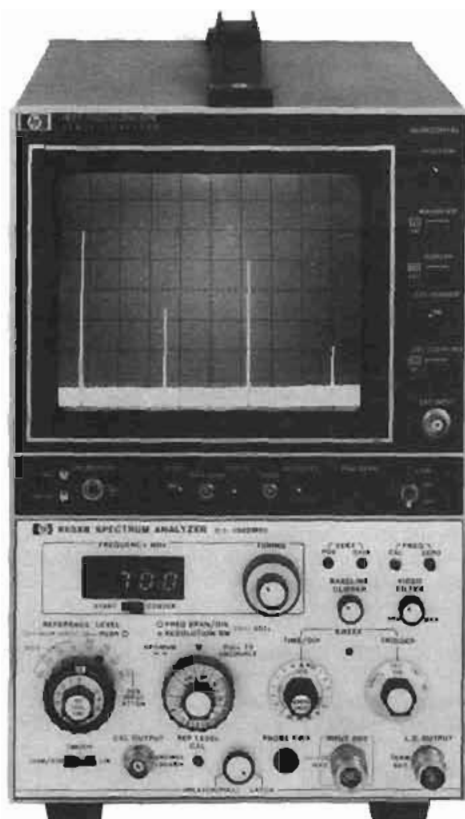

8558B/182T

8558B Spectrum analyzer

Economy plus performance

The Model 8558B is a 0.1 to 1500 MHz spectrum analyzer which plugs into any model 180-series oscilloscope display. This low cost, easy-to-use analyzer provides high accuracy in both amplitude and frequency measurements.

Simple, 3-knob operation

Most measurements are a simple three step process. Tune to the signal to be measured; its frequency is displayed on the LED readout. Zoom-in on the signal by decreasing the frequency span; bandwidth, sweep time, and video filtering are set automatically. Raise the signal to the top of the CRT; read its amplitude (in dBm) off the reference level control.

Absolute amplitude calibration

Signal levels can be read directly from the CRT in dBm (dBmV for Option 002) without the use of external standards or calculations. The signal level represented by the top CRT graticule line is always indicated by the reference level control, and scale factors of 10 dB/div, 1 dB/div, and linear can be selected.

Optional 75 ohm Input

Two options are available which allow measurements in 75 ohm systems: Option 003 has 75 ohms impedance and retains the dBm power calibration; Option 002 is also 75 ohms, but the amplitude is calibrated in dBmV for measurements on systems such as CATV.

- Resolution bandwidths from 1 kHz to 3 MHz
- Optional 75Ω input with dBm or dBmV calibration
- Available 0.5 to 1300 MHz Tracking Generator



8444A Opt. 058

Suggested displays

The 8558B will function with any 180-series display. However, the following are suggested: For a low cost, large screen display, the Model 182T is ideal; the Model 181T offers variable persistence and storage; and the Model 180TR offers a rack mount configuration. In addition, it is advantageous to order the 180T, 180TR, 181T, 181TR or 182T displays which provide a long persistence P39 phosphor (except the 181T and 181TR variable persistence displays) and four non-buffered, rear panel outputs compatible with most X-Y recorders. 100 volt operation available as option 003.

8444A Option 058 Tracking generator (0.5 - 1300 MHz)

Make swept frequency response measurements to ± 1.5 dB from 0.5 to 1300 MHz with greater than 90 dB of dynamic range. The output is absolutely calibrated at 0 dBm and continuously variable to -10 dBm. The frequency of unknown signals as well as the frequency of any point on the frequency response curve can be measured using the external counter output and Model 5383A Counter up to 500 MHz or Model 5341A Opt. 003 Counter to 1300 MHz.

8558B Specifications

Frequency specifications

Frequency range: 100 kHz to 1500 MHz.

Frequency display span (on a 10-division CRT horizontal axis): 14 calibrated spans from 100 MHz/div to 5 kHz/div in a 1, 2, 5 sequence. In "0" the analyzer is a fixed-tuned receiver.

Accuracy: frequency error between any two points on the display is less than $\pm 5\%$ of the indicated frequency separation.

Digital frequency readout: indicates center frequency or start frequency of the frequency display scan. Two ranges: 0 to greater than 195 MHz with 100 kHz resolution; 195 MHz to 1500 MHz with 1 MHz resolution. ZERO control allows frequency readout to be adjusted for accurate calibration anywhere in the frequency range; CAL control removes frequency hysteresis. Resolution 100 kHz.

Accuracy (after zeroing on the LO feedthrough and operation of the CAL button, 20°-40°C):

0 - 195 MHz: ± 1 MHz +20% of FREQUENCY SPAN PER DIVISION setting (≤ 1 MHz per division).

195 - 1500 MHz: ± 5 MHz +20% of FREQUENCY SPAN PER DIVISION setting.

Stability

Residual FM: less than 1 kHz peak-to-peak for time ≤ 0.1 sec.

Noise sidebands: more than 65 dB below CW signal, 50 kHz or more away from signal with a 1 kHz resolution bandwidth and full video filter.

Resolution

Bandwidth ranges: 3 dB resolution bandwidths of 1 kHz to 3 MHz in a 1, 3, 10 sequence. Resolution bandwidth may be coupled to frequency display span at a ratio of two display spans per resolution bandwidth.

Resolution bandwidth accuracy: individual resolution bandwidth 3 dB points calibrated to $\pm 20\%$.

Resolution bandwidth selectivity: 60 dB/3 dB resolution bandwidth ratio $< 15:1$.

Video filter: post-detection filter used to average displayed noise. Bandwidth variable from approximately 3X Resolution Bandwidth to approximately 0.01X Resolution Bandwidth. In the MAX position provides a noise averaging filter with a bandwidth of approximately 1.5 Hz.

Amplitude specifications

Absolute amplitude calibration range

Log calibration range: from -115 dBm to +30 dBm in 10 dB steps. Reference level vernier, 0 to -12 dB continuously.

Log display range: 10 dB/div on a 70 dB display, and 1 dB/div on an 8 dB display.

Linear display: from 2.2 microvolts (-100 dBm) full scale to 7.1 volts (+30 dBm) full-scale in 10 dB steps. Full-scale signals in linear translate to approximately full-scale signals in log.

Dynamic range

Average noise level: <-107 dBm with a 10 kHz resolution bandwidth (0 dB input attenuation).

Spurious responses: for input signal level ≤ Optimum Input Level setting, all image and out-of-band mixing responses, harmonic and intermodulation distortion products are more than 70 dB below input signal level, 5 MHz to 1500 MHz; 60 dB below, 100 kHz to 5 MHz.

Spurious responses due to 3rd order intermodulation distortion: for two input signals 10 dB above Optimum Input Level setting 3rd Order Intermodulation distortion products are >70 dB below the input signals, 5 - 1500 MHz; 60 dB below, 100 kHz to 5 MHz (signal separation ≥50 kHz).

Residual responses (no signal present at input): <-100 dBm with 0 dB input attenuation.

Amplitude accuracy

Frequency response (flatness): ±1.0 dB.

Switching between bandwidths (at 10°-40°C):

3 MHz to 300 kHz: ±0.5 dB.

3 MHz to 1 kHz: ±1.0 dB.

Reference level accuracy (at fixed center frequency, fixed resolution bandwidth): ±1.5 dB (includes input attenuator and IF gain accuracy. May be improved using IF or RF substitution techniques).

Amplitude log display: ±0.1 dB/dB but not more than ±1.5 dB over full 70 dB display range.

Calibrator

Amplitude: -30 dBm ±1.0 dB.

Frequency: 280 MHz ±50 kHz, crystal controlled.

Input specifications

Input connector: type N female.

Input impedance: 50Ω nominal.

Typical reflection coefficient <0.20 (1.5 SWR) for all Optimum Input Level settings except -40 dBm (0 dB input attenuation).

Input attenuator: 70 dB range.

Accuracy ±0.5 dB per 10 dB step but not more than ±1.0 dB over full 70 dB range.

Maximum input levels

AC or peak: peak or average power +10 dBm (1.0 V ac peak) incident on mixer (0 dB input attenuation), +30 dBm (10 V ac peak or 1 W), incident on input attenuator. (MAX input markings on front panel indicate maximum input allowable for <1 dB gain compression or attenuator overload).

DC: ±50 V dc.

Output characteristics

LO output: +10 dBm nominal, 50 ohms; 2.05-3.55 GHz.

Cal output: -30 dBm, 280 MHz with 2nd through 5th harmonics greater than -60 dBm.

Probe power: +15 V, -12.6 V; 150 mA max.

Powers 1120A, 1121A, 1123A, or 1124A high impedance probes.

Note: the following oscilloscope display rear panel outputs refer to 180T, 180TR, 181T, 181TR displays and older 180-series displays with Option 807 only.

Vertical output: (AUX A on oscilloscope display rear panel.) 0 to 0.8 V for 8-division deflection on CRT display; 50Ω output impedance.

Pen lift/blinking output: (AUX B on oscilloscope display rear panel.) 0 to 15 V (0 V, pen down). Approximately 10 kΩ impedance when blanked. Compatible with HP 7004B, 7034B, 7005B, and 7035B X-Y RECORDERS.

21.4 MHz IF output: a 21.4 MHz output linearly related to the RF input to the analyzer. Bandwidth controlled by analyzer Resolution Bandwidth setting. Amplitude controlled by input attenuator, IF gain vernier, and first six IF step gain positions (-10 through -60 dBm Ref Level with 0 dB input attenuation). Output is approximately -10 dBm for full-scale signals on the CRT. (AUX C on oscilloscope display rear panel, 50Ω output impedance.)

Horizontal output: (AUX D on oscilloscope display rear panel.) -5.0 to +5.0 V for 10 div CRT deflection, 5 kΩ output impedance.

Sweep characteristics

Sweep time

Auto: sweep time is automatically controlled by Frequency Span, Resolution Bandwidth, and Video Filter.

Manual: sweep determined by front panel control, continuously variable across CRT in either direction.

Calibrated sweep time: 16 internal sweep times from 0.1 ms/div to 10 sec/div in a 1, 2, 5 sequence. For sweep times of 2 ms/div to 10 sec/div, the analyzer is operable in its normal swept frequency mode. Faster sweeps are useful for analyzing modulation waveforms when the analyzer is being operated as a fixed-tuned receiver with 0 Display Span. Sweep times may be reduced to an effective 10 μsec/div by using the 180-series X10 horizontal magnifier.

Accuracy: ±10%.

Sweep trigger

Internal: sweep internally triggered by envelope of RF input signal (signal amplitude of 1.0 division peak-to-peak required on CRT display).

Line: sweep triggered by power line frequency.

Free run: sweep triggered repetitively by internally generated ramp.

Single: sweep triggered by front panel sweep trigger switch (spring return position).

Display characteristics

Oscilloscope display sections

180 Series compatibility: the 8558B is compatible with all 180A, 180AR, 180C, 180D, 180F, 181A, 181AR, 182A, 184A, and 184B mainframes. It is operable with the 183A, 183B mainframes, but the display is limited to 6 divisions by the 6-division CRT. The following 180-series oscilloscope displays are recommended for use with the 8558B Spectrum Analyzer because they provide 4 non-buffered rear panel auxiliary outputs (for unattenuated vertical, horizontal, and penlift outputs) and P39 medium-persistence CRT phosphor (except with 181T, 181TR which provide variable persistence):

180TR	P39 phosphor
181T	P31 phosphor with variable persistence
181TR	P31 phosphor with variable persistence
182T	P39 phosphor

100 volt operation of 180 series mainframes available as Option 003. See HP Service Notes 180A/AR-10, 180C/D-2, 181A/AR-8 and 182A/C-1 for information needed to modify standard displays to provide auxiliary outputs.

Model number and name

Model number and name	Price
8558B Spectrum Analyzer	\$4675
182T Display	\$1500
180TR Display	\$1500
181T Display	\$2400
181TR Display	\$2500
8444A Opt. 058 Tracking Generator	\$3800
Option 001: 75 ohm input (BNC), dBm calibration	add \$100
Option 002: 75 ohm input (BNC), dBmV calibration	add \$100

SIGNAL ANALYZERS

Plug-in spectrum analyzer system, 20 Hz to 40 GHz

Model 141T system

- 20 Hz to 40 GHz with just a tuning section change.
- Advantages of fully calibrated solid state system.
- Add measurement capability to your system as needed.

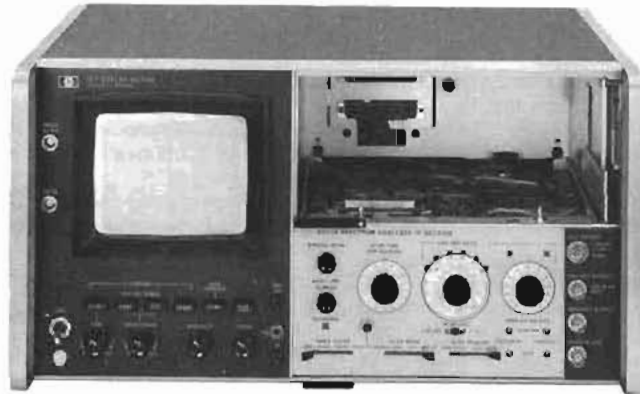

141T, 8552B



8443A



8444A



8445B Opt. 002, 003

Hewlett-Packard's high performance plug-in spectrum analyzer family makes frequency domain measurements from 20 Hz to 40 GHz. Because of the system's modularity, the user need purchase only analyzer components necessary to meet immediate production or laboratory measurement requirements. Then, as broader frequency capability is required, additional tuning sections or companion instruments can be added.

The models 8553B, 8554B, 8555A, and 8556A are tuning sections which plug into a 141T display mainframe along with an 8552B IF section to form a member of the Hewlett-Packard high performance spectrum analyzer family. Each tuning section covers a frequency range convenient for equipment design or spectrum surveillance: 8556A, 20 Hz to 300 kHz; 8553B, 1 kHz to 110 MHz; 8554B, 100 kHz to 1250 MHz; and 8555A, 10 MHz to 40 GHz. The IF section plug-in which is used with each tuning section, serves to condition the measurement signal for proper display on the CRT. Two IF sections are available, the 8552B high performance model and the 8552A model for economy. The spectrum analyzer specifications included in this catalog assume the use of the 8552B.

The 8443A and 8444A are tracking generators complementing the basic spectrum analyzer function with an RF source locked to the tuning frequency. The 8445B is an automatic preselector which enhances the dynamic range of the 10 MHz to 40 GHz 8555A tuning section analyzer.

The 141T based spectrum analyzer features absolute calibration of

- Tracking generator expands measurement capability.
- Increase dynamic range with tracking preselector.



8553B



8554B



8555A



8556A

frequency and amplitude, high resolution and sensitivity, wide dynamic range and simple to interpret display output.

The following pages cover spectrum analyzer performance with each of the tuning sections and comparison (tracking generator/preselector).

Absolute amplitude calibration

For ease and speed of measurement, full frequency band amplitude calibration allows direct interpretation of signal power or voltage from the CRT display. A choice of logarithmic or linear scaling calibrates the CRT in dBm or μV respectively. Front panel settings set the top horizontal graticule on the CRT as the reference power in the logarithmic mode, all other CRT measurements can be made relative to this reference. In linear scaling the CRT is calibrated in voltage per division using front panel settings. The bottom graticule is zero voltage.

When a combination of frequency scan, bandwidth or video filter settings are chosen such that the display becomes uncalibrated, a warning light indicates the condition.

High resolution frequency calibration

The frequency measurement capability of the spectrum analyzer is responsive to user need, making spectrum measurements simple and accurately with three frequency scan modes.

First is the FULL scan mode, which displays the entire tuning section frequency band on the 10 cm horizontal CRT graticule. This mode is effective in viewing broadband effects of circuit adjustments and refinements as they are made. In FULL scan and marker on the CRT corresponds in frequency to the position of the pointer on the tuning section frequency scale, so signals can be readily identified.

The second mode, PER DIVISION scan, centers the display about the frequency indicated by the tuning section pointer. In this mode, narrow, calibrated scan per division and automatic frequency STABILIZATION make high resolution measurements for analysis of signal purity, sidebands and low deviation FM.

In the third mode, ZERO scan, the analyzer becomes a receiver tuned to the frequency indicated on the scale. Amplitude modulation in an input signal at the tuned frequency is displayed on the CRT in the time domain. The scan time control provides a calibrated time base.

High resolution

The ability to resolve close-in signal sidebands, such as line related modulation is important in frequency domain analysis. The Hewlett-Packard 141T plug-in spectrum analyzers each have narrow bandwidths for such resolution. Up to 110 MHz, the analyzers offer 10 Hz bandwidths and to 18 GHz, 100 Hz bandwidths. The frequency stabilization feature already mentioned ensures high resolution by maintaining a jitter free display.

Wide dynamic range, sensitive.

Confidence in signal identification is given by the analyzer's ability to measure wide amplitude differentials without distortion products and to measure very low level signals. The plug-in spectrum analyzers

have typically 70 dB of distortion free dynamic range; that is, the capability of measuring 0.03% signal distortion from the CRT display. With the 8445A preselector the 8555A has a spurious free range of 100 dB. The CRT displays full dynamic range on a linear, easy to read scale.

Signals at as low a level as -142 dBm (20 nanovolts, 50 ohms) can be detected by the spectrum analyzer with 10 Hz bandwidth. At high frequencies and with 100 Hz bandwidth -125 dBm signals can be measured.

A parallax free, storable display

The 141T spectrum analyzer mainframe and display features a variable persistence CRT which enables response storage for any measurement. With very narrow bandwidth measurements, extremely slow sweeps are necessary to maintain amplitude calibration (allowing band pass filters time to respond). A recording CRT is necessary to save this response for viewing. Of course, any response can be stored for a display ready to be photographed. Another display mainframe, the 140T, is available with the standard persistence.

Interpretation of response levels on the CRT are free from parallax since the graticule is etched on the inside of the display screen adjacent to the phosphor.

IF section adds convenience features

The high resolution 8552B or the economic 8552A IF section features video filtering, recorder outputs and an internal calibration signal to make the spectrum analyzer easier to use. Video filtering is a low pass filter which averages out noise amplitude response for easier small signal readings. It also makes wide band noise measurements easier.

Recorder outputs, including pen lift, allow hard copy duplication of the CRT display. Manual scan allows setting up of accessories, such as X-Y recorders, adjusting signals on screen during slow scans and measuring frequency with a counter.

The internal calibration standard is a very stable -30 dBm, 30 MHz signal for quick front panel calibration.

Tracking generators for each frequency band

Either available internally, or as a companion instrument, are leveled signal sources designed to track the swept tuning frequency of the spectrum analyzer. Amplifiers, filters or any circuit which requires an input signal can be characterized to 1300 MHz, with typically wider dynamic range and more precise frequency accuracy than with the spectrum analyzer alone.

The 8556A low frequency tuning section has an internal tracking generator, standard with the instrument. The 8553B and 8554B/8555A use separate generators namely 8443A and 8444A respectively.

General specifications

141T spectrum analyzer system

Input impedance: 50Ω nominal. Reflection coefficient <0.30 (1.85 SWR). Input attenuator ≥10 dB.

Maximum input level: peak or average power +13 dBm (1.4 V ac peak), ±50 V dc.

Attenuator: 0 to 30 dB in 10 dB steps

Scan time: 16 internal scan rates from 0.1 ms/div to 10 sec/div in a 1, 2, 5 sequence, and manual scan (8552B only).

Scan time accuracy

0.1 ms/div to 20 ms/div: ±10%

50 ms/div to 10 s/div: ±20%

Scan Mode

Int: analyzer repetitively scanned by internally generated ramp; synchronization selected by scan trigger.

Single: single scan with front panel reset.

Ext: scan determined by 0 to +8 volt external signal.

Manual: scan determined by front panel control.

Scan trigger: for Internal scan mode, select between:

Auto: scan-free runs.

Line: scan synchronized with power line frequency.

Ext: scan synchronized with >2 volt (20 volt max.) signal.

Video: scan internally synchronized to envelope of RF input.

Auxiliary outputs

Vertical output: 0 to -0.8 V for full deflection.

Scan output: to +5 V for 10 div CRT deflection.

Pen lift output: 0 to 14 V (0 V, pen down).

Display characteristics

141T, 140T

Plug-ins: accepts Models 8552A/B, 8553B, 8554B, 8555A and 8556A and Model 1400-series Oscilloscope plug-ins.

Cathode-ray tube type

Model 141T: post-accelerator storage tube, 9000-volt accelerating potential; aluminized P31 phosphor.

Model 140T: post-accelerator, 7300 volt potential medium-short persistence (P7) phosphor.

Cathode-ray tube graticule

Model 141T: 8 × 10 division (approximately 7.1 × 8.9 cm) parallax-free internal graticule.

Persistence, model 141T only

Normal: natural persistence of P31 phosphor (0.1 second).

Variable:

Normal writing rate mode: continuously variable from less than 0.2 second to more than one minute.

Maximum writing rate mode: from 0.2 second to 15 seconds.

Erase: manual; erasure takes approximately 350 ms.

Storage times model 141T only: normal writing rate; more than 2 hours at reduced brightness (typically 4 hours).

Fast writing speed, model 141T only: more than 15 minutes.

Functions used with oscilloscope plug-ins only: intensity modulation, calibrator; beam finder.

EMI: conducted and radiated interference is within requirements of MIL-I-16910C and MIL-I-6181D and methods CE03, and RE02 of MIL-STD-461 (except 35 to 40 kHz) when appropriate RF tuning section and 8552A or 8552B are combined in a 140T or 141T Display Section.

Temperature range: operating, 0° to +55°C; storage, -40° to 75°C.

Power requirements: 100, 120, 220, or 240 V +5%, -10%, 50 to 60 Hz, normally less than 225 watts (includes plug-ins used).

Weight

Model 8552A or 8552B IF section: net, 4.1 kg (9 lb). Shipping, 6.4 kg (14 lb).

Model 140T display section: net, 16.8 kg (37 lb). Shipping, 20 kg (45 lb).

Model 141T display section: net, 18 kg (40 lb). Shipping, 23 kg (51 lb).

Tuning section: see following pages.

Dimensions: model 140T or 141T with plug-ins: 425 mm wide, 221 mm high, 416 mm deep (16 3/4" × 8 3/4" × 16 3/8").

Special order: chassis slides and adapter kit.

Model number and name

140T Normal Persistence Display

141T Variable Persistence Display

8552A Economy IF Section

8552B High Resolution IF Section

Price

\$1475

\$2325

\$3075

\$3775

SIGNAL ANALYZERS

141T spectrum analyzer system: 20 Hz to 300 kHz

Model 8556A

- Accurate signal level measurements (± 0.95 dB)
- Accurate frequency measurements (± 3 Hz)
- High sensitivity (-152 dBV)
- Built-in tracking generator



8556A

General purpose measurement flexibility

The 8556A Spectrum Analyzer covers the frequency range from 20 Hz to 300 kHz. It was designed to accommodate the variety of characteristic impedances and amplitude units used in making audio measurements. Balanced or unbalanced inputs are available, and open circuit voltages (dBV or linear) or power (dBm) in several characteristic impedances may be measured. The analyzer is capable of high resolution; frequencies can be measured very accurately. A built-in tracking generator further increases the instrument's utility.

Frequency range

The 8556A has two frequency scales, 0-300 kHz for full coverage and 0-30 kHz for better resolution at low frequencies. The analyzer may be swept symmetrically about a tunable center frequency, swept from 0 Hz to a selectable end point, or operated as a fixed tuned receiver. 20 kHz crystal markers (accurate to 0.01%) can be generated on the CRT to make very accurate frequency measurements.

Absolute amplitude calibration

The 8556 is calibrated for dBm in 600 Ω , dBm in 50 Ω , dBv, and volts. The very accurate reference level control (± 0.2 dB) and vernier (± 0.25 dB) allow the IF substitution technique to be used to improve amplitude measurement accuracy.

Low distortion

Careful design has decreased analyzer distortion to the point where a full 70 dB dynamic range is achieved. This allows small signals, such as harmonic or intermodulation distortion, to be measured in the presence of large ones.

Resolution - sensitivity

Resolution bandwidths between 10 kHz and 10 Hz are available on the 8556A. Using the narrow bandwidth, 50 or 60 Hz line related sidebands can be measured. The analyzer's extremely low noise figure together with its narrow bandwidths makes the 8556A very sensitive. Signals as low as -152 dBV (25 nV) can be measured in a 10 Hz bandwidth. The 8556A may be used to measure EMI, such as interference conducted along an AC power line.

Isolated input

The isolated input eliminates the possibility of spurious signal pickup which could be caused by line related ground currents flowing in the ground connections between the analyzer and signal source. The input impedance (1 M Ω) is high enough so that a scope probe may be used with a minimum of loading. An optional balanced input is available which is transformer coupled for isolation and high common mode rejection. The input impedance is 15 k Ω , and the analyzer is calibrated for either dBm-135 Ω or dBm-150 Ω as well as dBm-600 Ω and dBm-900 Ω . Balance (symmetry) is 80 dB at 50 Hz, and typically 50 dB at 300 kHz.

Tracking generator

A tracking generator is built into the 8556A. If an external counter is connected to the tracking generator, frequencies can be measured to an accuracy of ± 3 Hz. Swept insertion loss or return loss measurements can be made on a device such as an amplifier or filter. A 140 dB measurement range is possible using the narrowest resolution band-

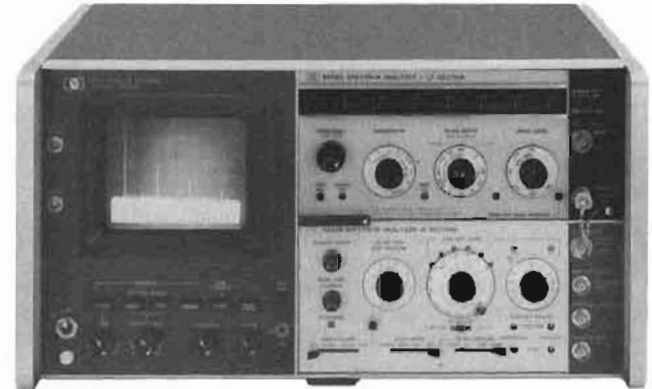

width. The tracking generator also provides a convenient signal for compensating an oscilloscope probe used with the 8556A.

Other applications

The combination of a tracking generator and spectrum analyzer in this frequency range is valuable in applications such as receiver testing and fault location.

Specifications - with 8552B IF Section

Frequency specifications

Frequency range: 20 Hz to 300 kHz. Tuning dial ranges of 0 - 30 kHz and 0 - 300 kHz.

Scan width: (on a 10-division CRT horizontal axis).

Per division: 10 calibrated scan widths from 20 Hz/div to 20 kHz/div in a 1, 2, 5 sequence.

0 - 10 f: 10 calibrated preset scans, from 200 Hz to 200 kHz in a 1, 2, 5 sequence. Analyzer scans from zero frequency to ten times the scan width per division setting.

Zero: analyzer is a fixed tuned receiver.

Frequency accuracy

Center frequency accuracy: 0 - 30 kHz Range: ± 500 Hz; 0 - 300 kHz Range: ± 3 kHz.

Marker accuracy: RF markers every 20 kHz accurate to within $\pm 0.01\%$. Markers controlled by front panel on/off switch.

Scan width accuracy: Frequency error between any two points on the display is less than $\pm 3\%$ of the indicated frequency separation.

Stability

Residual FM: sidebands > 60 dB down 50 Hz or more from CW signal, scan time ≥ 1 sec/div, 10 Hz bandwidth.

Noise sidebands: more than 90 dB below CW signal, 3 kHz away from signal, with a 100 Hz IF bandwidth.

Frequency drift: less than 200 Hz/10 min.

Resolution

Bandwidth ranges: IF bandwidths of 10 Hz to 10 kHz are provided in a 1, 3, 10 sequence.

Bandwidth accuracy: individual IF bandwidth 3 dB points calibrated to $\pm 20\%$ (10 kHz bandwidth $\pm 5\%$).

Bandwidth selectivity: 60 dB/3 dB IF bandwidth ratios, with IF section: $< 11:1$ for IF bandwidths from 10 Hz to 3 kHz; $< 20:1$ for 10 kHz bandwidth. For 10 Hz bandwidth, 60 dB points are separated by less than 100 Hz.

Amplitude specifications

Absolute amplitude calibration

Log calibration modes:

dBV	0 dBV = 1 V rms
dBm - 600 Ω	0 dBm = 1 mW - 600 Ω
dBm - 50 Ω	0 dBm = 1 mW - 50 Ω

Input impedance is 1 M Ω . dBm ranges are referenced with input properly terminated externally.

Log calibration range: from -150 dBm/dBV to +10 dBm/dBV.
Log display range: 10 dB/div on a 70 dB display, or 2 dB/div on a 16 dB display.
Linear sensitivity: from 0.1 μ V/div to 1 V/div in a 1, 2, 10 sequence. Linear sensitivity vernier X1 to X0.25 continuously.

Dynamic range

INPUT LEVEL control: -10 to -60 dBm/dBV in 10 dB steps. Accuracy ± 0.2 dB. Marking indicates maximum input levels for 70 dB spurious-free dynamic range. Average noise level (specified with a 600 Ω or less source impedance and INPUT LEVEL at -60 dBm/dBV):

Mode	1 kHz IF Bandwidth	10 Hz IF Bandwidth
dBm - 50 Ω	<-122 dBm (180 nV)	<-142 dBm (18 nV)
dBm - 600 Ω	<-130 dBm (250 nV)	<-150 dBm (25 nV)
dBV	<-132 dBV (250 nV)	<-152 dBV (25 nV)
Linear	<400 nV	<40 nV

Video filter: averages displayed noise, bandwidth of 10 kHz, 100 Hz, and 10 Hz. Bandwidth accuracy $\pm 20\%$.

Spurious responses: input signal level \leq INPUT LEVEL setting; out of band mixing responses, harmonic and intermodulation distortion products are all more than 70 dB below the input signal level 5 kHz to 300 kHz; 60 dB, 20 Hz to 5 kHz. Third order intermodulation products are more than 70 dB below the input signal level, 5 kHz to 300 kHz with signal separation >300 Hz.

Residual responses: (no signal present at input.) With the INPUT LEVEL at -60 dBm/dBV and the input terminated with 600 Ω or less, all line related residual responses from 0 to 500 Hz are below -120 dBm/dBV. All other residual responses are below -130 dBm/dBV.

Amplitude accuracy:	Log	Linear
Frequency response	± 0.2 dB	$\pm 2.3\%$
Amplitude display	± 0.25 dB/dB but not more than ± 1.5 dB over 70 dB display range	$\pm 2.8\%$ of full 8 div display

Log reference level control: provides 90 dB IF gain control in 10 dB steps. Accurate to ± 0.2 dB ($\pm 2.3\%$).

Log reference level vernier: provides continuous 12 dB range. Accurate to ± 0.1 dB ($\pm 1.2\%$) in 0, -6, -12 dB positions; otherwise ± 0.25 dB ($\pm 2.8\%$).

Amplitude measurement accuracy: ± 0.95 dB with proper technique.

General

Scan time: 16 internal scan rates from 0.1 ms/div to 10 sec/div in a 1, 2, 5 sequence.

Scan mode

Int: analyzer repetitively scanned internally.

Ext: scan determined by 0 to +8 volt external signal.

Single: single scan actuated by front panel button.

Manual: scan determined by front panel control.

Input level: provides 50 dB control of input preamplification and at-

tenuation to prevent input overload. INPUT LEVEL markings of -60 dBm/dBV to -10 dBm/dBV indicate maximum input level for a minimum of 70 dB spurious-free dynamic range. Accuracy ± 0.2 dB (2.3%).

Input impedance: 1 M Ω shunted by ≈ 32 pF.

Maximum input level: 10 V rms, ± 200 V dc. Ground terminals of BNC input connectors are isolated from the analyzer chassis ground to minimize ground loop pickup at low frequencies.

Maximum voltage, isolated ground to chassis ground: ± 100 V dc.

Isolated ground to chassis ground impedance: 100 k Ω shunted by approximately 0.3 μ F.

Gain compression: For input signal level 20 dB above INPUT LEVEL setting, gain compression is less than 1 dB.

Tracking generator specifications

Frequency range: tracks the analyzer tuning, 20 Hz to 300 kHz.

Amplitude range: continuously variable from 100 mV rms to greater than 3 V rms into an open circuit.

Amplitude accuracy: with TRACKING GEN LEVEL in CAL position and 20 kHz markers off, output level at 100 kHz is 100 mV ± 0.3 dB into an open circuit.

Frequency response: ± 0.25 dB 50 Hz to 300 kHz.

Output impedance: 600 Ω

Residual FM: <1 Hz peak-to-peak.

Power requirements: 100, 120, 200, or 240 V $\pm 5\%$, -10%, 50 to 60 Hz, normally less than 225 watts.

Weight: Model 8556A LF section: net, 3.7 kg (8 lb). Shipping, 5.3 kg (12 lb).

Dimensions: 226 mm wide, 102 mm high, 344 mm deep (8 $\frac{7}{8}$ " \times 4" \times 13 $\frac{1}{2}$ ").

Specifications with 8556A options 001, 002-balanced input Amplitude

Log calibration modes-balanced (bridged) input:

dBm - 135 Ω (Option 001)	0 dBm = 1 mW - 135 Ω
dBm - 150 Ω (Option 002)	0 dBm = 1 mW - 150 Ω
dBm - 600 Ω	0 dBm = 1 mW - 600 Ω
dBm - 900 Ω	0 dBm = 1 mW - 900 Ω

Input impedance is typically 15 k Ω . dBm ranges are referenced with input properly terminated externally.

Input

Maximum input levels: normal Mode, ± 20 V rms or ± 150 V dc for normal mode (symmetrical) signals between input signal connectors; Common Mode, 200 V rms at 60 Hz or ± 500 V dc for common mode (asymmetrical) voltages between input signal connectors and GUARD or instrument chassis; Guard, ± 100 V dc from GUARD to instrument chassis. (GUARD to chassis impedance is approximately 100 k Ω shunted by 0.3 μ F.)

Balance (Symmetry): 0 - 30 kHz Range, greater than 80 dB, 50 Hz to 1 kHz; 1 - 300 kHz range, greater than 60 dB, 1 kHz to 20 kHz.

Model number and name

8556A RF section

Option 001 Balanced input

Option 002 Balanced input

Price

\$2450

add \$220

add \$220

SIGNAL ANALYZERS

141T spectrum analyzer system: 1 kHz to 110 MHz

Models 8553B & 8443A

- Wide frequency range
- 10 Hz resolution bandwidth
- High sensitivity (-140 dBm)



8553B



8443A

General purpose

The 8553B Spectrum Analyzer makes absolute amplitude and frequency measurements over the 1 kHz to 110 MHz range. This frequency span includes audio, video, navigation aids, telemetry, multiplex communication systems basebands, commercial AM, FM, TV, and land mobile communication. The analyzer features high resolution and stability, low distortion, high sensitivity, and a wide dynamic range. A tracking generator is available which improves the frequency measurement accuracy of the analyzer and can be used to make swept measurements.

Wide frequency range

The broad frequency range of 1 kHz to 110 MHz extends from audio through the FM broadcast band. Scan widths from 200 Hz to 100 MHz allow a user to view all or selected parts of the frequency spectrum while the zero scan mode turns the analyzer into a fixed tuned receiver and displays amplitude variations in the time domain. The analyzer has two dial scales, 0-110 MHz for full coverage and 0-11 MHz for better resolution at low frequencies.

Resolution - stability

The 8553B has resolution bandwidths that range from 300 kHz to 10 Hz. Wide bandwidths are necessary for making measurements on a wideband spectrum such as FM. The extremely high resolution 10 Hz bandwidth allows measurement of 50 Hz sidebands 60 dB down. Such high resolution is made possible by automatic stabilization through phase lock, which reduces residual FM to a negligible level. Good stability is required to measure oscillator residual FM and drift.

Absolute amplitude calibration

The 8553B Spectrum Analyzer is absolutely calibrated in both dBm and volts from -142 dBm (.02 μ V) to +10 dBm (.7 V). This absolute calibration is derived from a built-in calibrator (-30 dBm at 30 MHz) and extremely flat analyzer frequency response (± 0.5 dB). A display uncal. light warns if the display becomes uncalibrated. The probe power output supplies power to a high impedance probe which can be used to make bridging measurements on circuits terminated at both ends.

High sensitivity

A low analyzer noise figure and narrow bandwidths give the 8553B very high sensitivity. Signal levels as low as -140 dBm can be measured in a 10 Hz bandwidth, and a preamplifier is available to further increase sensitivity by 16 dB. Video filtering in 10 kHz, 100 Hz, and 10 Hz bandwidths will average the displayed noise. High analyzer sensitivity is required if distortion in an amplifier or oscillator is to be mea-

- Accurate amplitude measurements (± 1.25 dB)
- 10 Hz frequency accuracy with tracking generator
- 130 dB swept measurement range



sured as a function of output level. In EMI studies, field strength can be measured with a calibrated antenna.

70 dB dynamic range

The 8553B has a 70 dB dynamic range when the signal level is properly conditioned at the input mixer. A wide dynamic range is necessary to measure small signals in the presence of large ones, such as harmonic or intermodulation distortion or to monitor signals of widely varying amplitudes, such as in EMC, RFI, and surveillance work.

8443A tracking generator

A tracking generator, 8443A, is available which covers the 100 kHz to 110 MHz frequency range of the 8553B. It has a built-in counter, and precision RF attenuators which are useful making substitution measurements.

Frequency accuracy

In conjunction with an 8443A tracking generator, the 8553B Spectrum Analyzer, can measure frequencies to an accuracy of ± 10 Hz. When the 8443A is operated in the "track analyzer" mode, the counter will read the frequency of a tunable marker which is generated on the analyzer CRT. The "restore signal" mode is a more convenient way to measure signal frequencies in wide scans because the counter reads the signal frequency automatically without fine tuning. The 8443A tracking generator may also be used externally as a 120 MHz direct reading counter.

Swept measurements

The 8443A tracking generator can be used with the 8553B to make swept insertion loss and return loss measurements over the 100 kHz to 110 MHz frequency range. Because the signal source tracks the analyzer's tuning, up to 130 dB dynamic measurement range is possible (at 10 Hz bandwidth). Excellent system flatness (± 1.0 dB) insures the accurate determination of swept response characteristics.

Specifications—with 8552B IF section

Frequency specifications

Frequency range: 1 kHz - 110 MHz (0 - 11 MHz and 0 - 110 MHz tuning ranges).

Scan width (on 10-division CRT horizontal axis)

Per division: 18 calibrated scan widths from 20 Hz/div to 10 MHz/div in a 1, 2, 5 sequence.

Preset: 0 - 100 MHz, automatically selects 300 kHz bandwidth IF Filter.

Zero: analyzer is fixed tuned receiver with selectable bandwidth.

Frequency accuracy

Center frequency accuracy: the dial indicates the display center frequency within ± 1 MHz on the 0-110 MHz tuning range; ± 200 kHz on the 0-11 MHz tuning range with FINE TUNE centered, and temperature range of 20° to 30°C.

Scan width accuracy: scan widths 10 MHz/div to 2 MHz/div and 20 kHz/div to 20 Hz/div; Frequency error between two points on the display is less than $\pm 3\%$ of the indicated frequency separation between the two points. Scan widths 1 MHz/div to 50 kHz/div; Frequency error between two points on the display is less than $\pm 10\%$ of the indicated frequency separation.

Resolution

Bandwidth: IF bandwidths of 10 Hz to 300 kHz are provided in a 1, 3 sequence.

Bandwidth accuracy: individual IF bandwidths' 3 dB points calibrated $\pm 20\%$ (10 kHz bandwidth $\pm 5\%$).

Bandwidth selectivity: 60 dB/3 dB IF bandwidth ratios. 10 Hz to 3 kHz bandwidths, $< 1:1$; 10 kHz to 300 kHz bandwidths, $< 20:1$; 60 dB points on 10 Hz bandwidth separated by < 100 Hz

Stability

Residual FM stabilized: Sidebands > 60 dB down 50 Hz or more from CW signal, scan time ≥ 1 sec/div. 10 Hz bandwidth (typically less than 1 Hz peak-to-peak).

Residual FM unstabilized: < 1 kHz peak-to-peak.

Noise sidebands: more than 70 dB below CW signal, 50 kHz or more away from signal, with 1 kHz IF bandwidth.

Long term drift (after 1-hour warm-up), stabilized: 50 Hz/min, 500 Hz/10 min; unstabilized: 5 kHz/min, 20 kHz/10 min.

Amplitude specifications

Absolute amplitude calibration range

Log: from -130 to +10 dBm, 10 dB/div on a 70 dB display or 2 dB/div on a 16 dB display

Linear: from 0.1 μ V/div to 100 mV/div in a 1, 2 sequence on an 8-division display.

Dynamic range

Average noise level: < -110 dBm with 10 kHz IF bandwidth.

Video filter: averages displayed noise, 10 kHz, 100 Hz, and 10 Hz bandwidths.

Spurious responses: are below a -40 dBm signal at the input mixer as follows: All image and out-of-band mixing responses, harmonic and intermodulation distortion less than 70 dB down, 2 MHz to 110 MHz; less than 60 dB down, 1 kHz to 2 MHz. Third order intermodulation products less than 70 dB down, 1 kHz to 110 MHz (Signal separation > 300 Hz).

Residual responses (no signal present at input): with input attenuation at 0 dB: < -110 dBm (200 kHz to 110 MHz); < -95 dBm (20 kHz to 200 kHz).

Amplitude accuracy:

Frequency response (Flatness: attenuator settings > 10 dB):
1 kHz to 110 MHz
Amplitude Display

Log

Linear

± 0.5 dB	$\pm 5.8\%$
± 0.25 dB/dB	$\pm 2.8\%$ of full 8 div deflection
but not more than ± 1.5 dB over the full 70 dB display range	

Calibrator amplitude: -30 dBm, ± 0.3 dB.

Calibrator frequency: 30 MHz, ± 3 kHz

Log reference level control: provides 70 dB range (60 dB below 200 kHz), in 10 dB steps. Accurate to ± 0.2 dB ($\pm 2.3\%$, Linear Sensitivity).

Log reference level vernier: provides continuous 12 dB range. Accurate to ± 0.1 dB ($\pm 1.2\%$) in 0, -6, and -12 dB positions; otherwise ± 0.25 dB ($\pm 2.8\%$).

Amplitude measurement accuracy: ± 1.25 dB with proper technique.

General

Input Impedance: 50 Ω nominal, BNC connector. Reflection coefficient < 0.13 (1.3 SWR), input attenuator ≥ 10 dB. A special 75 Ω 8553B/8552B is available.

Maximum input level: peak or average power +13 dBm (1.4 V ac peak), ± 50 V dc, 1 dB compression point, -10 dBm.

Scan time: 16 internal scan rates from 0.1 ms/div to 10 sec/div in a 1, 2, 5 sequence, or manual scan.

Scan mode

Int: analyzer repetitively scanned internally.

Single: single scan with reset actuated by front panel pushbutton.

Ext: scan determined by 0 to +8-volt external signal.

Manual: scan determined by front panel control.

Attenuator: 0 to 50 dB, in 10 dB increments, coupled to Log Reference Level indicator; automatically maintains absolute calibration. Attenuator accuracy ± 0.2 dB.

Power requirements: 100, 120, 220, or 240 V $\pm 5\%$, -10%, 50 to 60 Hz, normally less than 225 watts.

Weight: Model 8553B RF Section: Net, 12 lb (5.5 kg). Shipping, 17 lb (7.8 kg)

Dimensions: 226 mm wide, 102 mm high, 344 mm deep (8 $\frac{1}{2}$ " \times 4" \times 13 $\frac{1}{2}$ ").

Tracking generator (8443A)

Frequency range: 100 kHz to 110 MHz.

Amplitude range: < -120 dBm to +10 dBm in 10 and 1 dB steps with a continuous 1.2 dB vernier.

Amplitude accuracy

Frequency response (flatness): ± 0.5 dB.

Absolute: 0 dBm at 30 MHz: ± 0.3 dB.

Output impedance: 50 Ω , BNC connector, ac coupled, reflection coefficient ≤ 0.09 (1.2 SWR) with output < 0 dBm.

Counter

Display: 7 digits with 1 digit over-range. Reads to ± 10 Hz increments.

Resolution (gate time): 1 kHz (1 ms), 100 Hz (10 ms), 10 Hz (100 ms).

Accuracy: ± 1 count \pm time base accuracy.

Time base aging rate: $< 3 \times 10^{-9}$ /day (0.3 Hz/day) after warm-up.

External counter inputs: 10 kHz to 120 MHz, 50 Ω , -10 dBm min. Power: 100, 120, 220, or 240 V $\pm 5\%$, -10%, 48 to 440 Hz. 8443A, 75 watts.

Net weight: 8443A, 24 lb, 5 oz (11.04 kg). Shipping weight 31 lb, 14 oz (14.47 kg).

Dimensions: 425 mm wide, 88.2 mm high, 332 mm deep (16 $\frac{1}{2}$ " \times 3 $\frac{1}{2}$ " \times 13 $\frac{1}{4}$ ").

Model number and name

8553B RF section

8443A Tracking generator

Price

\$3150

\$4600

SIGNAL ANALYZERS

141T Spectrum analyzer system, 100 kHz to 1250 MHz

Models 8554B & 8444A

- High resolution to 100 Hz
- Flat frequency response ± 1 dB
- High sensitivity to -122 dBm (180 nV)

- Variable persistence display
- Companion Tracking Generator
- External counter capability

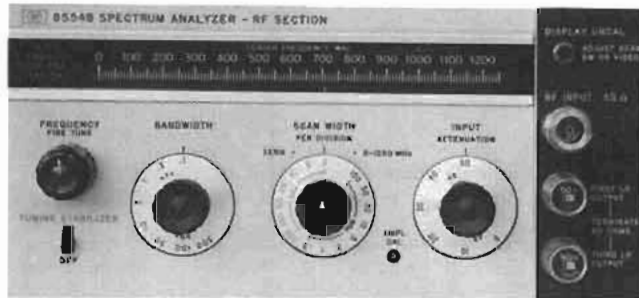

8554B



8444A

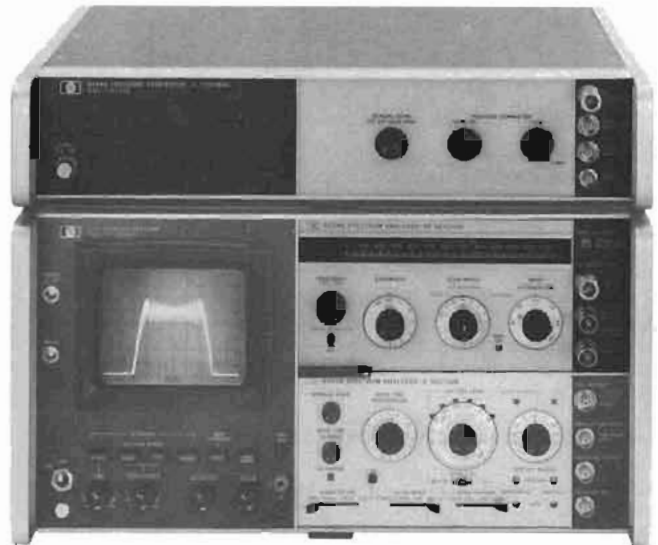

8554B Spectrum analyzer

The 8554B Spectrum Analyzer RF Section covers the frequency range from 100 kHz to 1250 MHz. This broad frequency coverage allows analysis from baseband through UHF navigation bands. Absolute amplitude calibration is maintained over the entire range. Some typical applications include power and frequency measurements on modulation, distortion and spurious outputs, frequency response measurements of filters, amplifiers, modulators and mixers. The analyzer can also be used to make noise measurements and EMI and EMC measurements using a calibrated antenna or current probe.

Absolute amplitude calibration

Absolute amplitude measurements can be made from $+10$ to -122 dBm with ± 2.8 dB accuracy. This accuracy can be increased to ± 1.75 dB using IF substitution. The display is calibrated in log (dBm) to obtain a wide display range and linear (voltage) for measurements requiring maximum resolution. The top graticule line on the CRT is a calibrated reference level which can be changed by the front panel controls from $+10$ to -72 dBm for greater IF substitution measurements. Amplitude calibration is dependent upon the proper relationship between sweep width, sweep time, resolution bandwidth and video filtering. An uncal warning light is present to indicate an uncalibrated situation.

Flat frequency response

In broadband use, the wide bandwidths allow fast sweeping of the entire spectrum. The analyzer is extremely flat (± 1 dB) over its entire range, allowing direct comparisons of signal amplitudes displayed on the CRT. A 0 to 50 dB input attenuator is provided to prevent overdriving the input mixer.

Resolution

The low residual FM (<100 Hz peak-to-peak) of the 8554B makes possible resolution bandwidths as narrow as 100 Hz. This enables resolving closely spaced signals such as 1 kHz and 400 Hz sidebands. Bandwidths range from 100 Hz to 300 kHz in a 1, 3, 10 sequence making it easy to select an optimum bandwidth to scan width ratio. The resolution bandwidths consist of synchronously tuned "gaussian" shaped filters to enable faster sweeping for any given bandwidth. In

addition, these filters have narrow shape factors making it possible to measure closely spaced signals differing greatly in amplitude.

Sensitivity

The high sensitivity (-122 dBm in 100 Hz bandwidth) and wide spurious-free measurement range (>65 dB) of the 8554B means accurate measurements can be made on low level signals and signals varying widely in amplitude. For example, modulation as low as 0.2% can be measured. Low level harmonic and intermodulation distortion, spectrum surveillance and EMI are just a few of the measurements possible. A video filter is provided in the IF section to average displayed noise and simplify the measurement of low level signals.

Automatic tuning stabilization

The 8554B Spectrum Analyzer is automatically stabilized in narrow scans. This gives the stability (<100 Hz peak-to-peak residual FM) needed for high resolution analysis. Stabilization is accomplished by phase locking the LO's (local oscillators) to a crystal reference in scan widths 10 MHz and below. No signal recentering or checking for stabilization is required because the signal remains on screen when phase locked.

8444A Tracking generator

The 8444A Tracking Generator is a signal source, which, when connected to the 8554B Spectrum Analyzer, has an output whose frequency is the same as the swept frequency of the analyzer. The tracking generator is used as a signal source to measure the frequency response of a device. It can also be used for precision frequency measurements. An external counter output is provided on the 8444A and the frequency of unknown signals as well as the frequency of any point on a frequency response curve can be measured. The use of the 5383A Counter is suggested for frequency measurements to 500 MHz and the 5341A, opt. 003 Counter for measurements to 1250 MHz.

The tracking generator-spectrum analyzer system can be used to supply test signals for other devices as a sweeper. The sweep widths and sweep rates are controlled from the spectrum analyzer and the output level from the tracking generator.

8554B Specifications — with 8552B IF Section

Frequency specifications

Frequency range: 100 kHz to 1250 MHz.

Scan width (on 10-division CRT horizontal axis)

Per division: 15 calibrated scan widths from 100 MHz/div to 2 kHz/div in a 1, 2, 5 sequence.

Preset: 0 — 1250 MHz, automatically selects 300 kHz bandwidth IF filter.

Zero: analyzer is fixed-tuned receiver.

Frequency accuracy

Center frequency accuracy: the dial indicates the display center frequency with 10 MHz.

Scan width accuracy: frequency error between two points on the display is less than 10% of the indicated separation.

Resolution

Bandwidth: IF bandwidths of 0.1 to 300 kHz provided in a 1, 3 sequence.

Bandwidth accuracy: individual IF bandwidths 3 dB points calibrated to $\pm 20\%$ (10 kHz bandwidth $\pm 5\%$).

Bandwidth selectivity: 60 dB/3 dB IF bandwidth ratio $< 20:1$ for IF bandwidths from 10 kHz to 200 kHz. 60 dB/3 dB bandwidth ratio $< 11:1$ for IF bandwidths 100 Hz to 3 kHz.

Stability (residual FM)

Stabilized: < 100 Hz peak-to-peak

Unstabilized: < 10 kHz peak-to-peak

Noise sidebands: more than 70 dB below CW signal, 50 kHz or more away from signal, with 1 kHz IF bandwidth.

Amplitude specifications

Absolute amplitude calibration range

Log: from -122 to $+10$ dBm. 10 dB/div on a 70 dB display, or 2 dB/div on a 16 dB display.

Linear: from 0.1 μ V/div to 100 mV/div in a 1, 2 sequence on an 8-division display.

Dynamic range

Average noise level: < -102 dBm with 10 kHz IF bandwidth.

Spurious responses: all image and out-of-band mixing responses, harmonic and intermodulation distortion products are more than 65 dB below a -40 dBm signal at the input mixer.

Residual responses (no signal present at input): with input attenuation at 0 dB: < -100 dBm.

Amplitude accuracy:

	Log	Linear
Frequency response (flatness)		
100 kHz to 1250 MHz	± 1 dB	$\pm 12\%$
Switching between bandwidths (at 20°C)	± 0.5 dB	$\pm 5.8\%$
Amplitude display	± 0.25 dB/dB but not more than ± 1.5 dB over the full 70 dB display range.	2.8% of full 8 div deflection

Calibrator output

Amplitude: -30 dBm, ± 0.3 dB.

Frequency: 30 MHz, ± 3 kHz.

RF input specifications

Input impedance: 50 Ω nominal. Typical reflection coefficient < 0.30 (1.85 SWR), input attenuator ≥ 10 dB.

Maximum input level: peak or average power $+13$ dBm (1.4 V ac peak), ± 50 V dc.

General

Scan time: 16 internal scan rates from 0.1 ms/div to 10 sec/div in a 1,

2, 5 sequence, and manual scan.

Scan time accuracy

0.1 ms/div to 20 ms/div: $\pm 10\%$

50 ms/div to 10 s/div: $\pm 20\%$

Weight

Model 8554B RF section: net, 4.7 kg (10 lb, 4 oz). Shipping 7.8 kg (17 lb).

8444A Specifications

Specifications for swept frequency response measurements

Dynamic range: > 90 dB from spectrum analyzer 1 dB gain compression point to average noise level (approximately -10 dBm to -100 dBm). Spurious responses not displayed.

Gain compression: for -10 dBm signal level at the input mixer, gain compression < 1 dB.

Absolute amplitude calibration range:

Tracking generator (drive level to test device): 0 to -10 dBm continuously variable. 0 dBm absolutely calibrated to ± 0.5 dB at 30 MHz.

Frequency range: 500 kHz to 1250 MHz.

Frequency resolution: 1 kHz.

Stability

Residual FM (peak-to-peak): stabilized, < 200 Hz; unstabilized, < 10 kHz.

Amplitude accuracy

System frequency response: ± 1.50 dB.

Tracking generator calibration: 0 dBm at 30 MHz to ± 0.5 dB.

Specifications for precision frequency measurements

Frequency accuracy: for unknown signals ± 10 kHz. (Tracking drift typically 50 kHz/10 min after 2-hour warm-up). For points on frequency response curve, counter accuracy \pm Residual FM (200 Hz).

Counter mode of operation

Manual scan: scan determined either by front panel control of 8552B IF Section or by external scan signal provided by the 8444A.

Zero scan: analyzer is fixed-tuned receiver. Counter reads center frequency to accuracy of tracking drift.

Counter output level: typically 0.1 V rms.

Specifications for sweep/CW generator

Frequency: controlled by spectrum analyzer. Range 500 kHz to 1250 MHz with 8554B. Scan widths are as enumerated on this page.

Frequency accuracy: ± 10 MHz using spectrum analyzer tuning dial. Can be substantially improved using external counter output.

Flatness: ± 0.5 dB.

Spectral purity

Residual FM (peak-to-peak): 200 Hz.

Harmonic distortion: 25 dB below output level (Typical).

Nonharmonic (spurious) signals: > 35 dB below output level.

Long term stability: drift typically less than 30 kHz/hour when stabilized after 2-hour warm-up.

Sweep width: 20 kHz to 1000 MHz.

Sweep rates: selected by Scan Time per Division on spectrum analyzer.

General

Temperature range: operation, 0 to 55°C, storage -40°C to 75°C.

EMI: conducted and radiated energy is within the requirements of MIL-I-6181D.

Power: 115 V and 230 V, 48 to 440 Hz, 12 watts max.

Weight: net, 7.1 kg (15 lb, 10 oz). Shipping, 9.5 kg (21 lb).

Model number and name

8554B RF Section

8444A Tracking Generator

Price

\$4025

\$3500

SIGNAL ANALYZERS

141T Spectrum analyzer system, 10 MHz to 40 GHz

Models 8555A, 8444A & 8445B

- Absolute amplitude calibration
- High sensitivity to -125 dBm (2.5 nV)
- Resolve signals to 100 Hz
- Scan up to 8 GHz full screen
- 100 dB distortion free dynamic range with preselector
- Companion tracking generator to 1.3 GHz

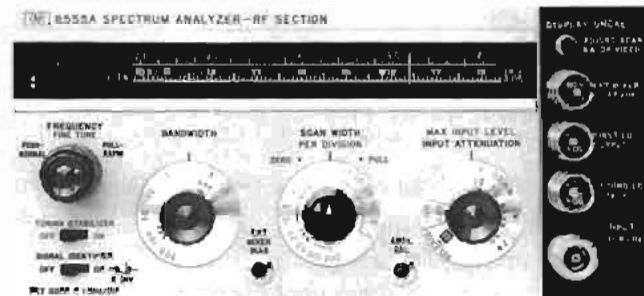

8555A



8444A



8445B Opt. 002, 003

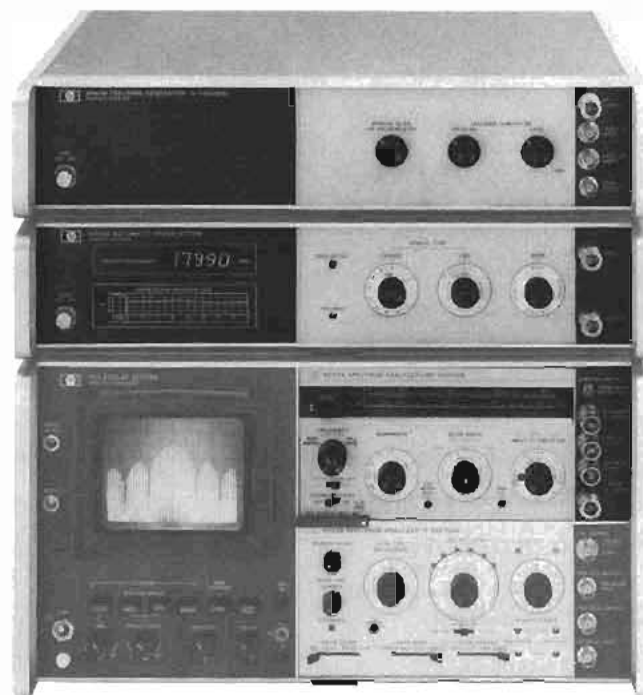

8555A Spectrum analyzer

The 8555A spectrum analyzer covers 10 MHz to 18 GHz with fundamental and harmonic mixing. External waveguide mixers can provide 12.4 GHz to 40 GHz coverage. This broad frequency range coupled with its high sensitivity and resolution bandwidth allow a variety of power measurements, frequency measurements, modulation and noise analysis on almost every type of design module: the frequency response of amplifiers, mixers, and modulators, response and alignment of filters isolators, couplers and limiters. With wide scan widths and calibrated amplitude the 8555A is ideal for spectrum surveillance and RFI/EMC field strength analysis with a calibrated antenna.

Absolute amplitude calibration

The 8555A offers absolute amplitude calibration from $+10$ dBm to -125 dBm over the 10 MHz to 18 GHz frequency range. This capability makes possible not only absolute signal power measurements, but also the measurement of the power differential between two signals separated by as much as 18 GHz. The parallax free CRT graticule can read as a log scale (dBm) or a linear scale (volts) with a frequency response accuracy of ± 1.5 dB to 6 GHz and ± 2.0 dB to 18 GHz. The top line of the display is established as the reference level by front panel controls. A light warns of an uncalibrated condition.

High sensitivity

The high sensitivity from -125 dBm (fundamental mixing) to -100 dBm (4th harmonic) in a 100 Hz bandwidth makes it possible to measure large values of attenuation, out of band filter and amplifier response, weak transmitted signals in surveillance work or microvolt signals in EMC applications. A post detection filter with 10 kHz, 100 Hz and 10 Hz position averages any noise and yields an extremely clean observed trace.

High resolution

Due to low residual FM (<100 Hz peak-to-peak) the 8555A offers outstanding 100 Hz resolution which allows the users to resolve closely spaced signals and low level sidebands resulting from a 1 kHz modulating signal. The resolution capability makes it possible to analyze spurious low frequency modulation of microwave signals. The high stability of the analyzer results in more accurate measurements of residual FM, long-term drift, phase noise and spectral purity. Furthermore, the Gaussian shape of the IF filters allow fastest sweep for a given resolution bandwidth.

Automatic tuning stabilization

When scanning over a relatively narrow frequency range, the frequency stability of the analyzer's internal local oscillators become important for high resolution and frequency measurements. For this reason the 8555A is equipped with a tuning stabilizer circuit which automatically phase locks the analyzer to a crystal oscillator. Display jitter and signal recentering are virtually eliminated.

Added Input Mixer protection

To prevent an inadvertent 0 dB setting of the input attenuator, a pushbutton lockout is provided on the attenuator knob.

8445B Tracking preselector, 10 MHz to 18 GHz

The 8445B tracking preselector is a YIG tuned to filter coupled to the 8555A spectrum analyzer in order to be tuned exactly to the analyzer's reception frequency. The preselector eliminates harmonic mixing image and multiple responses from 1.8 to 18 GHz. The result is a wide measurement range and an end to signal identification. Clean, full band sweeps possible in scans of 2, 4, 6 or 8 GHz depending upon the band selected.

Below 1.8 GHz the image and multiple responses are eliminated by a low pass filter in the preselector.

An optional five digit LED display with 1 MHz resolution allows accurate measurement of either the display frequency at the display marker in full scan mode or the center frequency in per division scan.

8444A Tracking generator, 10 MHz to 1300 MHz

The 8444A tracking generator provides a level, calibrated RF signal which is exactly the tuned frequency of the spectrum analyzer. This enables swept frequency tests such as frequency response and return loss measurements up to 1300 MHz. With an external counter the frequencies of unknown signals on points along a frequency response curve can be made.

8555A Specifications — with 8552B IF Section

Frequency specifications

Frequency range: 0.01 – 40 GHz.

Tuning range

With internal mixer: 0.01 – 18.0 GHz.

With external mixer: 12.4 – 40 GHz.

Harmonic mixing mode

Signal identification: not normally required with preselector. Signal identifier provided for positive identification of all responses. Rejection of images and multiple responses with preselector is >70 dB.

Scan width

Full scan: the width of the scan depends on mixing mode. Scan width = $n \times 2000$ MHz, where n is the mixing mode; e.g. for $n = 2$, scan width is 4 GHz. Maximum scan width full screen is 8 GHz with coaxial mixer. Preselector necessary to make wide scans usable.

Per division: 16 calibrated scan widths from 2 kHz/div to 200 MHz/div in a 2, 5, 10 sequence.

Zero scan: analyzer becomes fixed tuned receiver.

Frequency accuracy

Dial accuracy: $n \times (\pm 15 \text{ MHz})$ where n is the mixing mode.

Scan accuracy: frequency error between two points on the display is less than $\pm 10\%$ of the indicated separation.

Stability: residual FM stabilized <100 Hz (peak-to-peak) (fundamental mixing).

Noise sidebands: for fundamental mixing. More than 70 dB below CW signal 50 kHz or more away from signal, with 1 kHz IF bandwidth and 100 Hz video filter.

Frequency drift

Long term drift: (at fixed center frequency after 2-hour warm-up.) (Typical.)

Stabilized: $\pm 3.0 \text{ kHz}/10 \text{ min.}$

Unstabilized: $\pm 25 \text{ kHz}/10 \text{ min.}$

Stabilization range: first LO can be automatically stabilized to internal crystal reference for scan widths of 100 kHz/div or less.

Resolution

Bandwidth range: selectable 3 dB bandwidths from 100 Hz to 300 kHz in a 1, 3, 10 sequence.

Bandwidth shape: gaussian.

Bandwidth selectivity: 11:1 to 20:1 (60 dB/3 dB).

Bandwidth accuracy: individual IF bandwidth 3 dB points calibrated to $\pm 20\%$. (10 kHz bandwidth $\pm 5\%$.)

Amplitude specifications

Measurement range

Log reference level: from -60 dBm to +10 dBm.

Linear sensitivity: from 0.1 $\mu\text{V}/\text{div}$ to 100 mV/div.

Sensitivity and frequency response with internal coaxial mixer

Average noise level: specified for 1 kHz bandwidth.

Frequency response: with 10 dB input attenuator setting.

Frequency Range (GHz)	Mixing Mode (n)	Average Noise Level (dBm max.)	Frequency* Response (dB max.)
0.01 – 2.05	1-	-115	± 1.0
1.50 – 3.55	1-	-117	± 1.0
2.07 – 6.15	2-	-108	± 1.3
2.60 – 4.65	1+	-117	± 1.0
4.11 – 6.15	1+	-115	± 1.0
4.13 – 10.25	3-	-103	± 1.5
6.17 – 10.25	2+	-105	± 1.5
6.19 – 14.35	4-	-95	± 2.0
8.23 – 14.35	3+	-100	± 2.0
10.29 – 18.00	4+	-90	± 2.0

*Includes mixer frequency response, RF attenuator frequency response, mixing mode gain variation, RF input VSWR

Sensitivity and frequency response with 11517A external waveguide mixer and appropriate waveguide tapers

Average noise level: 10 kHz bandwidth (dBm typical).

10.31 – 22.55	6-	-90
14.41 – 26.65	6+	-85
18.55 – 38.95	10-	-85
22.65 – 43.05	10+	-75

Residual responses: referred to input on fundamental mixing: <-90 dBm.

Display range

Log: 70 dB, 10 dB/div and 2 dB/div log expand on a 16 dB display, 16 dB display.

Linear: from 0.1 μV to 100 mV/div in a 1, 2 sequence on an 8-division display.

Spurious responses due to second harmonic distortion with pre-selector:

Frequency Range	Power Incident on Input Mixer	2nd Harmonic Distortion
0.01 – 1.85 GHz	-40 dBm	-63 dB
1.85 – 18.0 GHz	0 dBm	-100 dB

Spurious responses due to third order intermodulation distortion with pre-selector:

Frequency Range	Signal Separation	Power Incident on Input Mixer	Third Order Intermodulation Distortion
0.01 – 18.0 GHz	> 1 MHz <20 MHz	-30 dBm	-70 dB
0.01 – 1.85 GHz	>70 MHz	-30 dBm	-70 dB
1.85 – 18.0 GHz	>70 MHz	0 dBm	-100 dB

Video filter: post detection filter used to average displayed noise. Nominal bandwidths: 10 kHz, 100 Hz, and 10 Hz.

Gain compression: for internal mixer gain compression <1 dB for -10 dBm peak or average signal level to input mixer, 11517A external mixer (12.4 – 40 GHz) gain compression <1 dB for -15 dBm peak or average signal level to input mixer.

Amplitude accuracy

IF gain variation with different bandwidth settings: (at 20°C)

SIGNAL ANALYZERS

141T Spectrum analyzer system, 10 MHz to 40 GHz

Models 8555A, 8444A & 8445B (cont.)

Log: ± 0.5 dB.

Linear: $\pm 5.8\%$.

Amplitude display

Log: ± 0.25 dB/dB, but not more than ± 1.5 dB over the full 70 dB display range.

Linear: $\pm 2.8\%$ of full 8-division deflection.

Log reference level: accurate to ± 0.2 dB ($\pm 2.3\%$ linear sensitivity).

Log reference level vernier: accurate to ± 0.1 dB (1.2%) in 0, -6, and -12 dB positions; otherwise, ± 0.25 dB ($\pm 2.8\%$).

Input attenuator range: 0 - 50 dB in 10 dB steps, manual safety lockout for 0 dB position.

Frequency response: typically ± 0.6 dB from 10 MHz to 18 GHz.

Calibrator output: amplitude -30 dBm, ± 0.3 dB. Frequency 30 MHz ± 3 kHz.

Absolute calibration accuracy: overall accuracy is a function of measurement technique. With the appropriate technique, absolute accuracy of ± 1.6 dB (fundamental mixing) and ± 2.6 dB (4th harmonic mixing) is achievable.

Input characteristics

Input impedance: 50 ohms nominal (0.01 - 18 GHz).

Reflection coefficient: < 0.130 (1.30 SWR) for input RF attenuator settings ≥ 10 dB.

Maximum input level: peak or average power +13 dBm (1.0 V ac rms) incident on mixer (+30 dBm with Option 002), +33 dBm incident on input attenuator.

RF input connector: type N female.

LO emission: -10 dBm without preselector, -80 dBm with preselector over recommended operating ranges (10 dB input attenuator setting).

Specifications with option 002; internal limiter installed:

All specifications are the same as for the standard unit except the following:

Maximum input level

Continuous: 1 W (+30 dBm).

Pulse: 75 watts peak, pulse width ≤ 1 μ sec, 0.001 duty cycle.

Reflection coefficient: < 0.33 (2.0 SWR).

Frequency response (flatness): $\leq \pm 0.5$ dB degradation in response, 0.1 - 12.4 GHz.

General

Scan time: 16 internal scan rates from 0.1 ms/div to 10 sec/div in a 1, 2, 5 sequence.

Power requirements: 100, 120, 220, 240 V + 5% - 10%, 50 - 60 Hz, normally less than 225 watts (varies with plug-in units used).

Dimensions: 226 mm wide, 102 mm high, 344 mm deep ($8\frac{7}{8}$ " \times 4.0" \times 13.5").

Weight: net, 16.8 kg (14 lb, 15 oz). Shipping, 8.7 kg (19 lb).

8445B Tracking preselector

Frequency specifications

Frequency range: DC - 1.8 GHz low-pass filter, 1.8 - 18 GHz tracking filter.

Tracking filter 3 dB bandwidth: typically 20 - 45 MHz.

Tracking filter skirt roll-off: characteristics of a three-pole filter. (Nominal: 18 dB/octave.)

Insertion loss:

	Frequency	Insertion Loss (Except Opt. 004)	Insertion Loss (Opt. 004)
Low-Pass Filter	DC - 1.8 GHz @ 2.05 GHz	< 2.5 dB > 50 dB	*
Tracking Filter	1.8 - 12 GHz 12 - 18 GHz	< 8 dB < 10 dB	< 7 dB < 8 dB

*Low-Pass filter deleted with Option 004

Typical preselector minimum insertion loss at 25°C.

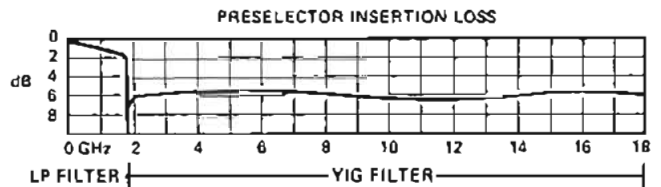

Out-of-band rejection: for YIG filter 1 GHz from center of pass-band > 70 dB.

Digital frequency readout (Option 003):

Function

Full scan mode: displays frequency at inverted marker.

Per division scan: displays center frequency.

Manual or remote operation of preselector: displays tuned frequency of filter.

Resolution: 1 MHz.

Accuracy: 0.01 - 1.0 GHz: ± 6 MHz.

1.0 - 4.0 GHz: ± 8 MHz.

4.0 - 18 GHz: $\pm 0.2\%$

Input specifications

Input connector: precision Type N female.

Input VSWR: typically < 2.0 (1.8 - 18 GHz).

Limiting level: (maximum input level for < 1 dB signal compression) $> +5$ dBm.

Damage level: $> +20$ dBm.

General

Remote function: YIG filter frequency can be set by externally supplied voltage.

Power requirements: 100, 120, 220 or 240 V + 5% - 10%, 48 to 440 Hz, less than 110 watts.

Dimensions: 425 mm wide, 88.2 mm high, 467 mm deep ($16\frac{1}{4}$ " \times $3\frac{1}{2}$ " \times $18\frac{3}{4}$ ").

Weight: net, 8.8 kg (19 lb 8 oz). Shipping, 11.9 kg (26 lb).

8444A Tracking generator

Frequency range: 10 MHz to 1300 MHz.

Frequency resolution: 1 kHz.

Residual FM (peak-to-peak): 200 Hz (stabilized).

Amplitude range

Spectrum analyzer display: from -130 dBm to +10 dBm, 10 dB/div on a 70 dB display or 2 dB/div on a 16 dB display (8552B only).

Tracking generator (drive level to test device): 0 to -10 dBm continuously variable.

Amplitude accuracy:

System frequency response: ± 1.50 dB.

Tracking generator calibration: 0 dBm at 30 MHz to ± 0.5 dB.

Dynamic range: > 90 dB.

Counter output: typically 0.1 V rms.

General

Power: 115 V and 230 V, 48 to 440 Hz, 12 watts max.

Dimensions: 425 mm wide, 85.2 mm high, 467 mm deep ($16\frac{1}{4}$ " \times $3\frac{1}{2}$ " \times $18\frac{3}{4}$ ").

Weight: net, 7.1 kg (15 lb, 10 oz). Shipping, 9.5 kg (21 lb).

Model number and name

8555A, tuning section

Option 001 APC-7 connectors

Option 002 Internal limiter

Option 005 Video tape

8445B tracking preselector, dc - 18 GHz

Option 001 APC-7 connectors

Option 002 Add manual controls

Option 003 Add digital frequency readout

Option 004 Delete low-pass filter

Option 005 Delete interconnect rigid coax

8444A tracking generator (10 MHz - 1300 MHz)

Price

\$7700

add \$40

add \$210

add \$105

\$2825

add \$155

add \$80

add \$670

less \$425

less \$50

\$3500

SIGNAL ANALYZERS

Spectrum analyzer accessories

8447 Series, 11694A, 1121A



11694A



1121A



11517A



11693A



8721A



8406A



197A



8447 Series

8447 Series amplifiers (0.1 – 1300 MHz)

The 8447 Series amplifiers feature low noise and wide bandwidth. This makes them ideal for improving spectrum analyzer sensitivity and noise figure while providing input isolation. Accurate measurements over a wide frequency range are assured due to the broad frequency coverage, flat frequency response and low distortion of these amplifiers. (See page 31).

11694A 75Ω Matching transformer (3 – 500 MHz)

Allows measurement in 75-ohm systems while retaining amplitude calibration. VSWR is less than 1.2, and insertion loss is less than 0.75 dB. Note: Also see Options 001 and 002 for 75Ω versions of 8557A and 8558B.

1121A Active probe (0.1 – 500 MHz)

Provides high impedance (>100 kΩ shunted by <3 pF) input to spectrum analyzer for measurements on sensitive circuits. Probe power is supplied by most HP Spectrum Analyzers and flat response with unity gain assures accurate, convenient measurements. (See page 425).

11517A External mixer

To extend the frequency range of the analyzer to 40 GHz. Taper sections for 12.4 – 18 GHz (11518A), 18 – 26.5 GHz (11519A) or 26.5 – 40 GHz (11520A) bands are required.

11693A Limiter (0.1 - 12.4 GHz)

The Model 11693A Limiter provides input protection for a variety of instruments in general applications (usable from 0.01 to 18 GHz). For example, the input circuits of spectrum analyzers, samplers, or amplifiers may be protected for inputs up to 75 watts peak or 1 watt average power. Also, signal generators can be protected from application of reverse power.

8721A Directional bridge

For making return loss measurements from 100 kHz to 110 MHz. (See page 425 under "11652A: Directional bridge").

8406A Frequency comb generator

Produces frequency markers at 1, 10, and 100 MHz increments accurate to ±0.01%. External oscillator can be used to generate precision interpolation sidebands. Comb is usable to 5 GHz.

197A Oscilloscope camera

For a permanent record of your measurements. The 10367A Adapter is required to use the camera with 182-series displays. (See page 161).

Model number and name

Model number and name	Price
11694A 75Ω Matching Transformer	\$75
11517A External Mixer (Mixer only)	\$250
11518A/11519A/11520A Waveguide Taper Sections	\$160
11693A Limiter	\$235
8406A Frequency Comb Generator	\$875

SIGNAL ANALYZERS

Frequency stability analyzer

Model 5390A

- Frequency domain phase noise analysis
- 0.01 Hz to 10 kHz offset frequency range
- 500 kHz to 18 GHz input frequency range
- > -150 dBc sensitivity at 1 Hz offset
- Time domain Allan Variance
- Fully automated measurements

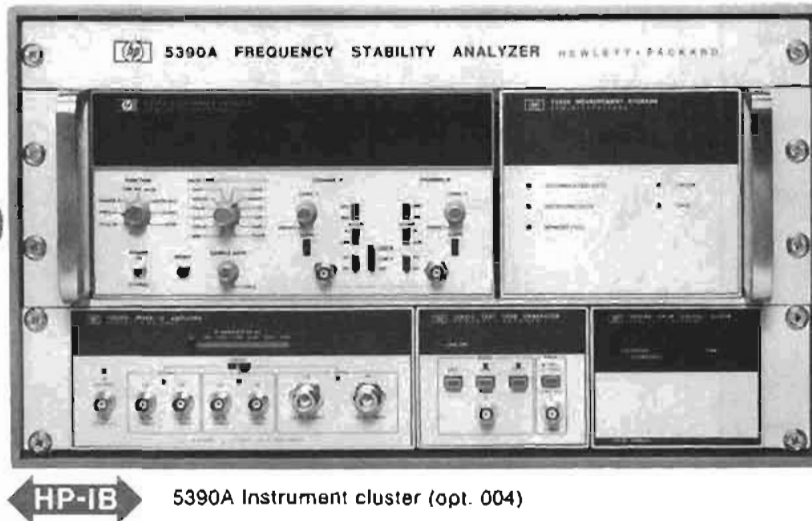

The 5390A is a time domain data acquisition system which uses a desk top calculator as an instrument controller to allow real time data reduction and presentation of data in either the time domain or frequency domain.

Besides being well suited to monitor long term drift trends on precision frequency sources, the 5390A can also measure the shorter term random fluctuations about long term trends. One method of estimating the value of such random phenomena is to measure the short term stability in the time domain and present the data in terms of RMS Fractional Frequency Deviation (in parts per million) for various averaging times. This method, referred to as the Allan Variance, is described in further detail in HP Application Note 174-7.

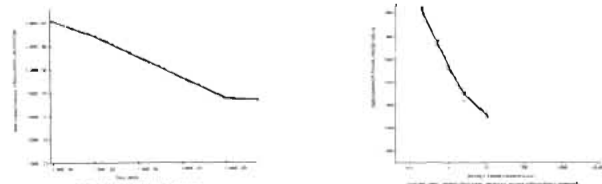

Figure 1. Short term stability in time domain

Figure 2. Phase spectral density, N frequency domain

Besides being able to make automated short term stability measurements, the 5390A can also measure and display random fluctuations in terms of phase noise in the frequency domain. In this mode of operation the system makes its greatest contribution by being able to measure phase spectral density very close to a carrier. Here the counter and calculator are made to appear as a programmable narrow band filter capable of achieving sub-millihertz bandwidths and moving in arbitrarily close to the carrier. Thus the system becomes complementary to wave analyzers and spectrum analyzers which are capable of taking measurements out to great distances away from the carrier but experience severe difficulty when trying to move closer in than 10 or 100 Hz.

In its normal mode of operation the 5390A requires the user to furnish two sources, one slightly offset from the other by the amount f_{IF} . The difference frequency, f_{IF} , determines the system sensitivity limits and maximum offset frequency obtainable (see figure three). The accepted industry technique is to use two of the same type sources and allow the software to assign half the noise to each source. The second or reference source can also be a low noise synthesizer. A reference source 10 dB better than the test source typically contributes <0.4 dBc error and 20 dB better <0.2 dB error.

For measurements on precision sources which cannot be offset in frequency such as cesiums, rubidiums and some crystal oscillators other signal conditioning techniques such as the "Dual Mixer Timer Difference" method described in National Bureau of Standards Technical Note 669, by David W. Allan, may be used.

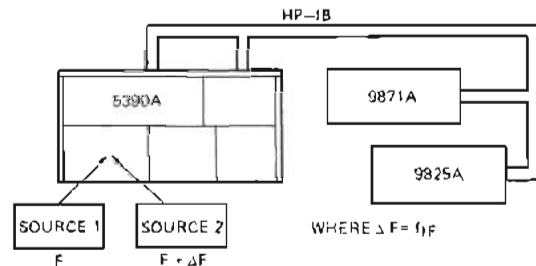

Figure 3. 5390A in operation

System operating characteristics

Phase spectral density measurements

Offset frequency from carrier

$$f = <0.01 \text{ Hz to } 10 \text{ kHz} \quad \text{where } f = \text{offset frequency}$$

$$= \frac{1}{2(\tau_m + \tau_d)} \quad \tau_m = \text{measurement time}$$

$$\tau_d = \text{dead time}$$

$$f_{max} = \frac{f_{IF}}{6}$$

Measurement bandwidth and plug-in memory requirements

Bandwidth is determined by the number of frequency difference readings, N, taken by the counter

$$B = \frac{f}{N}$$

For low offset frequencies (small f) the calculator can process data before the plug-in memory is full, then B can be made arbitrarily small. For minimum bandwidth estimation where the plug-in memory is filled, the minimum bandwidth will depend on the amount of plug-in memory available and can be estimated by

$$B_{min} = \frac{f(18 - \text{integer } \log_{10} \frac{6}{5} f)}{\text{Plug-in Memory}}$$

Where plug-in memory may be 2048, 4096, 6144, or 8192



5390A Frequency Stability Analyzer

Accuracy

Since measurements are actually made on zero crossings in the time domain calibration of the input signal's carrier level in the frequency domain is not necessary.

The value of phase noise being measured is actually a random variable rather than an absolute value, hence, the measurements are statistical in nature and result in an estimate of the mean value of phase noise during the observation period. The 1σ values are given along with the estimated mean to indicate the confidence value of the measurement. Longer observation periods increase the level of confidence.

Sensitivity

System sensitivity is based on a model of the counter being able to resolve time to ± 1 count of its 500 MHz clock and is a function of the offset frequency, f , desired and the IF frequency, f_{IF} , used as shown by the relationship.

$$\text{Sensitivity in dBc} = -173 + 20 \log f_{IF} - 10 \log f$$

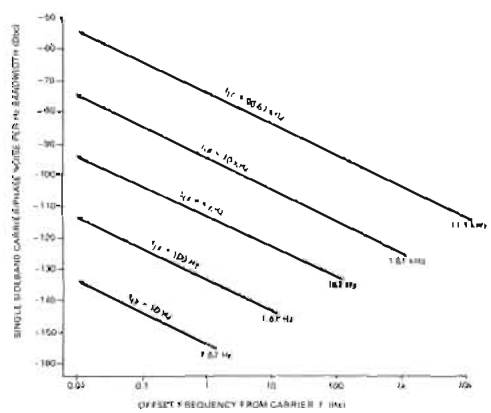

Figure 4. Relationship between sensitivity, f and f_{IF}

Input signal level requirements:

Band	Freq. Range	Port	Operating Level	VSWR
RF	0.5 to 500 MHz	RF	-15 to -5 dBm	<2.0:1
		LO	+5 to +10 dBm	<1.5:1
UHF	0.3 to 2 GHz	RF	-15 to -5 dBm	<3.0:1
		LO	+5 to +10 dBm	<2.0:1
μ W	2 to 18 GHz	RF	-15 to -5 dBm	<3.0:1
		LO	+5 to +15 dBm	<2.5:1
Ext. 1F	1 Hz to 67 kHz	Thru the 10831A	-15 to 0 dBm	<1.25:1

Fractional frequency deviation measurements

The 5390A can also employ the Allan Variance technique to monitor short term stability in the time domain. Capabilities are very similar to those described in HP Application Note 174-7 with the exception that the dead time between measurements is typically less than 20 μ seconds or one cycle of the input, whichever is greater, and can be ignored for averaging times down to 1 ms. The counter can now take measurements at rates up to 50 000 per second.

Ordering information

System options (see data sheet for complete listing)

001: adds memory to the 5358A Plug-in in 2k byte increments. Up to three opt. 001's may be added to a 5390A (5358A Plug-in) System. One or more opt. 001's are highly recommended as greater storage capability allows narrower bandwidths at higher offset frequencies.

Price
add \$300
add \$1085

004: adds 59309A Digital Clock and one 10631A cable to system.
Highly recommended. Time of day has been found to be very useful for initiating unattended measurement runs and long term oscillator measurements

101: expands 9825A memory from 8k to 16k bytes.

add \$1600

Highly recommended. Increases system efficiency by providing more on line data storage thus avoiding data storage and retrieval from the cassette.

102: expands 9825A memory from 8k to 24k bytes.

add \$3200

325: deletes 9825A Calculator. Appropriate if system is to be used with an existing 9825A Calculator.

less \$7550

330: deletes 9825A Calculator and substitutes 9830 Calculator software in system interface kit. Appropriate if system is to be used with an existing 9830A or 9830B Calculator.

less \$7550

371: deletes 9871A Printer/Plotter. Appropriate if system is to be used with an existing 9871A or 9862A Plotter.

less \$3400

5390A Basic system

- 5345A Opt. 011 Electronic Counter
- 5358A Measurement Storage Plug-In
- 10830A Mixer/IF Amplifier
- 10831A Test Tone Generator
- 9825A Calculator
- 98210A Adv. Program/String Variab. ROM
- 98213A Gen. Purpose/Ext. I/O ROM
- 98034A HP-IB Interface
- 9871A Opt. 011 Printer/Plotter
- 05390-80025 Systems Interface Kit

Cassette and software for Frequency Stability (Time Domain) and Phase Spectral Density (Frequency Domain) Programs; cables; manuals; Technical Handbook, Diagnostic Procedures

- System Cabinet
- Factory Assembly and Integration
- 90 day calculator on-site warranty
- 1 year instrument bench repair warranty

5390A Basic system

\$25,500

SIGNAL ANALYZERS

Digital Fourier/Modal/Signature analysis

Model 5451B

- Multichannel Operation, DC to 50 kHz
- Keyboard Controlled
- 80 dB Dynamic Range

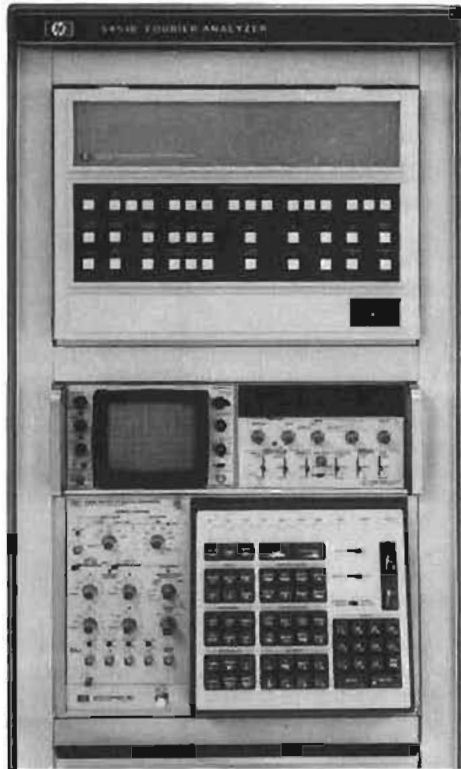

Description

The 5451B Fourier Analyzer provides digital frequency domain analysis of complex time signals in the low frequency range of DC to 50 kHz (100 kHz optional). The system is completely integrated and consists of a mini-computer for digital processing, a keyboard for operator control of the system, a dual-channel analog-to-digital converter, a display control unit and CRT, a teleprinter, and an operating software package. It is a fully calibrated, multi-purpose digital system for data acquisition, data storage, and data analysis. The primary analysis functions it performs are: forward or inverse Fourier transform, auto or cross power spectrum, transfer and coherence function, and time or frequency domain averaging.

The ability to measure these functions quickly and accurately and with large dynamic range makes the Fourier Analyzer a powerful tool for: stimulus-response measurements, system identification, vibration control, modal analysis, signature analysis, underwater sound, acoustics, communications, and more.

In most measurement situations, both broadband and narrowband analyses are necessary. With the measurement of baseband, band selectable, and proportional bandwidth ($1/3$ octave) analyses available, Hewlett-Packard's Fourier Analyzer is fully equipped to handle each situation. Used together, these techniques can provide a complete and detailed picture of a signal's spectrum.

Band selectable Fourier analysis

5451B Band Selectable Fourier Analysis (BSFA) allows the digital analyzer user to perform digital spectrum analysis over a frequency band whose center frequency and bandwidth are independently selectable by the operator. This frees the user from the DC to F_{max} restrictions of conventional baseband digital analysis. With BSFA the frequency resolution of a measurement can be increased by a factor of 400:1 without a corresponding increase in the amount of computer data space required because only a portion of the spectrum rather than the complete baseband is analyzed and stored. By using unique digital filtering, rather than analog filters or simple raised cosine digital filters, frequencies outside the band of interest are attenuated by more

- Dedicated Applications Packages
- BSFA (Zoom) Measurements
- Fully Calibrated Results

than 90 dB. Because of this the full dynamic range of the analyzer (80 dB) can be applied to the band of interest without interference from outside frequencies.

Features include: all-digital operation, on-line or off-line analysis, keyboard operation, dual-channel analysis for cross measurements, and center frequency range of DC to 100 kHz.

1/3 Octave analysis (optional)

With standard Fourier analysis, the frequency resolution of a measurement (Δf) is constant. With 5451B Option 740, the relative frequency resolution ($\Delta f/f$) is constant (the resolution is proportional to the center frequency). Option 740 allows selection of six different ranges within the overall frequency limits of 80 mHz to 20 kHz. It simultaneously calculates five different frequency ratios within the selected range: $1/2$ octave, $1/4$ octave, $1/3$ octave, $1/2$ octave, and full octave. Any ratio may be selected and displayed at any time, even while the measurement is being made. A, B, C and D weightings, power spectral density weighting, or no weighting along with microphone correction factors can be included in the analysis. Option 740 finds application in the mechanical vibration, acoustics, and environmental noise pollution areas where noise level requirements are specified in octave formats.

Fourier systems for mechanical applications

Modal analysis

Modal analysis, or modal survey testing, is a technique for determining the dynamic characteristics of an elastic body by measuring the resonant (natural) frequency, damping factor, and the spatial mode shape associated with each mode of vibration. This modal data can be used for developing or verifying a mathematical model of the structure, as well as providing valuable information for identifying and correcting noise, vibration, or failure problems which may exist in a dynamic operating environment.

Hewlett-Packard offers two modal analysis systems designed to meet the requirements of a wide range of modal testing applications. Both systems are based on the HP 5451B Fourier Analyzer, which provides the capability for acquisition and analysis of modal data. Option 402 is a versatile, disc-based system which offers maximum flexibility in the organization, manipulation and storage of large amounts of data required for large-scale modal survey tests, as well as sophisticated modal parameter identification techniques. Option V77 combines a complete set of modal measurement, analysis and display features in an efficient core-based operating system which is ideal for the user with smaller scale tests not requiring extensive data storage.

Both systems operate on measured transfer function data to determine modal properties. In addition, an animated isometric display of the part under test is generated to aid the engineer to better understand its dynamic characteristics. These systems offer significant time savings over traditional swept-sine analog techniques because they operate on transfer function data. The testing stimulus can accommodate random, pseudo-random, transient, or periodic excitation. Results are complete and no other off-line computers are needed.

Signature analysis (option 450)

Noise, vibration, and failure problems in rotating machinery are quickly analyzed using Hewlett-Packard's powerful Signature Analysis Subsystem. It combines key rotating machinery measurements into a dedicated, user-oriented system that's used for preventive maintenance, production quality control, design analysis, and noise and vibration studies.

Six measurements are pushbutton selectable from the operator's control panel: RPM and TIME Spectral Maps, Power Spectrum Analysis, Composite Power Spectrum, Order Ratio, and Order Tracking. By having Spectral Maps available at your fingertips, you can quickly gain insight into the overall dynamic characteristics of the device, eliminating the time-consuming trial-and-error procedures dictated by other systems.

5451B Base System

\$41,000

SIGNAL ANALYZERS

Digital vibration test control system

Model 5425A and 5451B Option 350



- Pushbutton operation eliminates programming
- Digital Accuracy and repeatability with wide dynamic range

Description

Closed-loop control of environmental and/or developmental vibration test stimuli for random, transient, or sine testing is available in either of two product concepts: Option 350 to the 5451B Fourier Analyzer system and the 5425A, a dedicated system offering essentially the same control performance but with reduced analysis capability.

The 5425A is the ideal control system for production vibration testing where random, transient and sine testing is required, and offers a selected set of analysis routines especially designed for easy operation by laboratory personnel. Option 350 would be a natural addition for the developmental or research vibration laboratory where a full-capability Fourier Analyzer is required. The following description of the vibration control capability applies to both Option 350 to the 5451B, and the 5425A.

System operation

In general, all three types of control follow the same logical operational phases. First, the test program or setup (reference envelope, alarm and abort limits, test time, transducer calibration, etc.) is loaded automatically from disc storage in response to one of 150 (50 each for random, transient, and sine) test search codes or names. If a new program or modifications are desired, a friendly question-and-answer sequence with full on-line editing is instantly available. Once the changes are made or a new setup generated, it can be assigned a new name and stored for later use. All setups recalled from disc automatically display key test parameters for the operator's review.

After a satisfactory setup is obtained, the system enters the operate phase. Here the operator controls the test by pushbuttons on a central control panel. Removable snap-on overlay panels clearly label buttons for each type of test control. Test status information is provided by easy-to-see indicators. During a test data displays are selected by pushbutton and any displayed data—reference, control, error or drive—may be saved for post-test documentation by pushing the "SAVE" button. Over 100 different spectra, waveforms or 40 sweeps may be saved during any one test.

After the test, results and saved data are available immediately for documentation. An optional digital plotter is available to make fully labeled plots of test results, or the data values may be printed on the system terminal.

Measurement capability (5425A only)

Power spectral density, transfer function (requires 2 ADC input channels) with coherence, input and output power spectra, transient capture and shock response spectrum analysis are provided by using a special "measurement" overlay panel.

Measurements are set up by a question-and-answer dialog. Six setups may be stored for each type of analysis, allowing routine laboratory measurements to be set up with little operator interaction.

Measurement results may be stored in any of 64 locations for later recall, display and/or plotting. During data display, a movable cursor provides single data value printouts and easy display expansion. The 5425A offers the environmental laboratory a fixed set of commonly used vibration measurements without requiring the operator to have Fourier analysis or computer programming knowledge.

5425A System enhancements

The following is a partial list of system options available at additional cost:

Additional input channel: for averaging, auxiliary PSD in Random Control and notching, averaging or peak select in Sine Control, and Transfer Function in measurement mode.

7210A Digital plotter: provides fully labeled report-quality plots of test results. Plots are pushbutton initiated and automatically calibrated.

2640A CRT Terminal: replaces 2752A Teleprinter for fast, silent terminal operation. Highly recommended where extensive operator-system interaction is anticipated.



5425A shown with 2640A CRT Terminal and Cabinet Options

Advanced capability display: provides H51-181AR Variable Persistence Oscilloscope and 5460A Display Control in place of standard display. Has connection for null detector X-Y plotters, provides frequency readout during Sine Control and greater display manipulation and flexibility.

Rugged, ventilated cabinets: highly recommended for all operating environments. One- and two-bay models are available. Provides required cooling, and includes primary power circuit breakers.

Specification summary (5425A and 5451B/option 350)

Random control

Resolution: 64, 128, 256 or 512 lines

Bandwidth: Δf to 5000 Hz

Loop time: < 1.8 s with 2500 Hz bandwidth, one control channel, 256 lines

Dynamic range: > 65 dB

Accuracy: ± 1.0 dB (90% confidence level)

Noise: ≤ 350 microvolts rms in 5 kHz bandwidth

Reference spectrum: programmable, 40 breakpoints

Sine control

Frequency range: 0.1 to 5000 Hz

Sweep rate: 0.001 to 10 octave/minutes log; 0.1 to 6000 Hz/minute linear

Harmonic components: > 60 dB below full level fundamental

Output dynamic range: 72 dB

Reference envelope: programmable; displacement, velocity acceleration control, 16 breakpoints

Transient control

Classical waveforms: half sine, terminal peak sawtooth, triangle, or rectangle

Polarity: positive or negative

Duration: 0.5 to 100 milliseconds

Shock response synthesis: Up to $\frac{1}{3}$ octave resolution

Frequency range: 2 decades nominal; 2.6 decades max

Maximum frequency: 1 component below 10 240 Hz

5425A Base System

\$55,900

SIGNAL ANALYZERS

Correlator and spectrum display

Models 3721A, 3720A

3721A Correlator

The Model 3721A Correlator is a digital statistical signal analyzer covering the range dc to 250 kHz. It computes autocorrelation, cross-correlation, and amplitude probability functions. In addition, a signal recovery facility uses signal averaging to improve the signal-to-noise ratio of a repetitive signal buried in noise. The resultant functions are displayed on a built-in CRT.

The versatile analysis and averaging capabilities combined with portability, automatic calibration, built-in CRT and real-time operation make the 3721A an ideal analyzer for both laboratory and field use.

Major Specifications

Input signal bandwidth: dc to 250 kHz.

Input range: 40 mV rms to 4 V rms.

Functions: Autocorrelation, Crosscorrelation, Probability (Density and Integral), Signal Recovery.

Number of points: 100 points computed and displayed for each function.

Sampling interval: 1 s to 1 μ s (1 Hz to 1 MHz sampling rates). External clock facility allows any interval $\geq 1 \mu$ s to be selected. In Correlation and Signal Recovery the time between displayed points is equal to the sampling interval.

Averaging: two modes are provided:

Summation: computation automatically stopped after a fixed number of samples has been taken. Number of samples selectable from 128 to 128 \times 1024.

Exponential: continuous averaging with time constant selectable from 36 ms to over 10⁷ seconds.

Calibration: vertical calibration is automatically displayed on an illuminated panel (except Probability).

Outputs: all computed functions are displayed on the built-in CRT. Analog outputs are provided for use with an X-Y recorder and external oscilloscope. Digital outputs allow the transfer of computed data to any HP digital computer or HP paper tape punch (2895A or 8100A). Extra plug-in assemblies are required, type depending on the peripheral used.

3720A Spectrum display

The 3720A Spectrum Display is a unique add-on unit for the Correlator, to complement and extend its capability by Fourier transforming any time display on the 3721A and presenting its equivalent frequency function on a built-in display.

The 3720A performs the Real and/or Complex transformation of autocorrelation and crosscorrelation functions to produce the Power and Cross Spectral Density functions respectively, and converts signal recovered data into frequency information.

Together the 3721A Correlator and 3720A Spectrum Display, each with its own CRT display, form an analysis system giving both time and frequency information simultaneously.

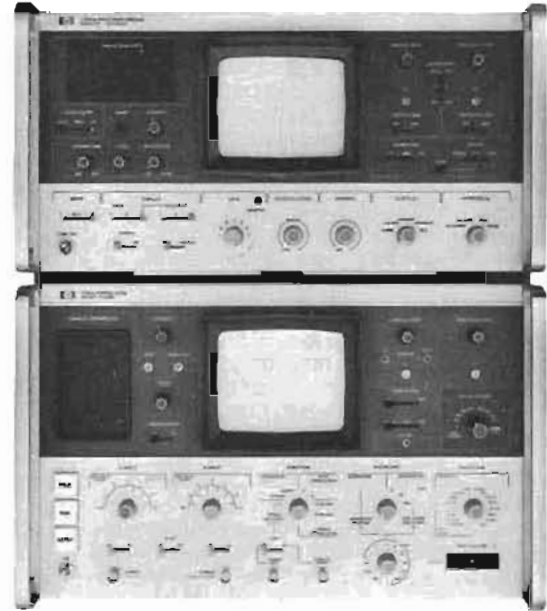

Models 3721A, 3720A

Major Specifications

Input data: digital data is transferred from the Correlator and held in either of two stores, labeled 1 and 2.

Computed transforms: either the Real or Complex transform can be computed of the contents of the store 1, the contents of store 2, or the contents of stores 1 and 2 together.

Frequency range: 0.005 Hz to 250 kHz using internal 3721A clock. Extendable down to dc with external clock.

Displayed frequency range: two decades of frequency are displayed, the highest frequency being $\frac{1}{2} \Delta t$ Hz (Δt is the 3721A Time-scale setting).

Dynamic range: ratio of full scale signal to noise level, for fixed integrator gain, is better than 50 dB.

Gain: continuously variable over a 2-decade, 40 dB, range in seven discrete steps, with intermediate vernier.

Window: two choices are available.

OFF: natural window, nominal bandwidth $\frac{1}{200} \Delta t$.

ON: triangular window, nominal bandwidth $\frac{1}{100} \Delta t$.

Interpolation: two modes available

MANUAL: computes and displays 100 frequency points. Frequencies of all 100 points can be simultaneously and equally varied over a frequency interval, $\frac{1}{100} \Delta t$.

AUTO: automates the manual interpolation, calculating 10 equally spaced points across each frequency interval.

Transform presentation: all combinations of the following axes are available for display.

Vertical axis: Phase, Log Mod, Modulus, Imaginary, Real.

Horizontal axis: Frequency, Log Frequency, Real, Phase.

CRT display: built-in variable persistence CRT with storage facility.

X-Y recorder: separate horizontal and vertical analog outputs corresponding to the CRT display.

Model number and name
3720A Spectrum Display
3721A Correlator

Price
\$7265
\$10125

SIGNAL ANALYZERS

Calibrated noise for system stimulation

Model 3722A

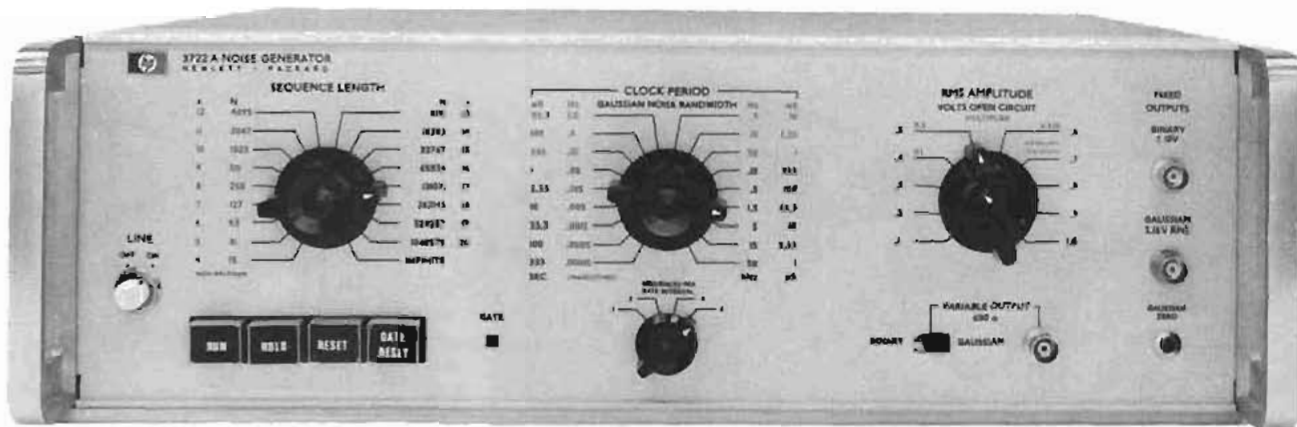

3722A

The Model 3722A Noise Generator uses digital techniques to synthesize binary and Gaussian noise patterns. These "pseudo-random" patterns, which are of known content and duration, are repeated over and over without interruption. Since one pattern is identical with the next, each pattern has the same effect on the system under test: For this reason, pseudo-random noise signals cause no statistical variance in test results. The Model 3722A also generates truly random binary and Gaussian noise.

The basis of the Model 3722A is a binary waveform generator. The binary output has a $(\sin x/x)^2$ shaped spectrum and the Gaussian output, which is derived from the binary signal by precision low-pass filtering, has an almost rectangular spectrum. Both binary and Gaussian outputs are controllable in bandwidth, but the output power remains constant regardless of selected bandwidth. The frequency of the first null in the binary spectrum is selectable from 0.003 Hz to 1 MHz, and the bandwidth (at -3 dB point) of the Gaussian noise is selectable from 0.00015 Hz to 50 kHz.

Option H01

Model 3722A Option H01 is a standard Model 3722A Noise Generator modified to provide a second binary output which can be delayed by a selectable number of clock periods with respect to the main binary output. The delayed binary output is available only when the instrument is in the pseudo-random mode. The delay introduced between the two binary outputs is selected by three decade switches on the front panel. These switches are set according to a conversion table supplied with the instrument.

Specifications

Binary output (fixed amplitude)

Amplitude: ± 10 V.
Output Impedance: $< 10\Omega$.
Load Impedance: 1 k Ω minimum.
Rise time: < 100 ns.
Power density: approximately equal to (clock period \times 200) V²/Hz at low frequency end of spectrum.
Power spectrum: $(\sin x/x)^2$ form: first null occurs at clock frequency, and -3 dB point occurs at $0.45 \times$ clock frequency.

Gaussian output (fixed amplitude)

Amplitude: 3.16 V rms.
Output Impedance: $< 1\Omega$.
Load Impedance: 600 Ω minimum.
Zero drift: < 5 mV change in zero level in any 10°C range from 0° to +55°C.
Power density: approximately equal to (clock period \times 200) V²/Hz at low frequency end of spectrum.
Power spectrum: rectangular, low-pass: nominal upper frequency f_0 (-3 dB point) equal to $\frac{1}{2}$ of clock frequency. Spectrum is flat within ± 0.3 dB up to $\frac{1}{2} f_0$, and more than 25 dB down at $2 f_0$.
Crest factor: up to 3.75, dependent on sequence length.

Variable output (binary or gaussian)

Amplitude (open circuit)

Binary: 4 ranges: ± 1 V, ± 3 V, ± 3.16 V, and ± 10 V, with ten steps in each range, from X0.1 to X1.0.
Gaussian: 3 ranges: 1 V rms, 3 V rms, and 3.16 V rms, with ten steps in each range, from X0.1 to X1.0.

Output impedance: 600 $\Omega \pm 1\%$.

Main controls

Sequence length switch: first 17 positions select different pseudo-random sequence lengths; final position selects random mode of operation (INFINITE sequence length). $N = 2^n - 1$, where n is the range 4 through 20.

Clock period switch: selects 18 frequencies from internal clock.

Internal clock

Crystal frequency: 3 MHz nominal.
Frequency stability: $< \pm 25$ ppm over ambient temperature range 0° to +55°C.
Output: +12.5 V rectangular wave, period as selected by CLOCK PERIOD switch.

External clock

Input frequency: usable BINARY output (pseudo-random only) with external clock frequencies up to 1 MHz.
Input level: negative-going signal from +5 V to +3 V initiates clock pulse.
Maximum Input: ± 20 V.

Remote control

Control inputs: remote control inputs for RUN, HOLD, RESET, and GATE RESET functions are connected to 36-way receptacle on rear panel.
Sequence length indication: 18 pins plus one common pin on the 36-way receptacle are used for remote signaling of selected sequence length (contact closure between common pin and any one of the 18 pins).

Delayed binary output (option H01)

Typical performance figures for the delayed output are:
Amplitude: switches between +1.5 V and +12 V
Maximum sink current at 1.5 V level: 10 mA.
Impedance: 50 Ω (+1.5 V) and 600 Ω (+12 V).
Rise Time: < 50 ns.
Fall Time: < 20 ns.*
 *Measured with \div probe shunted by 10 pF.

General

Dimensions: 425 mm wide \times 132.6 mm high \times 416 mm deep (16 1/2" \times 5 1/4" \times 16 1/4")
Weight: net, 10.5 kg (23 lb). Shipping, 13.5 kg (30 lb).

3722A Noise Generator
 Opt H01 Delayed Output

\$3615
 add \$340

CABINETS & MEASUREMENT ACCESSORIES

Modular enclosure system for individual HP products

System-II

- Truly modular, fits standard heights and widths
- Broad range of accessories for bench or rack use
- Strong frame, yet easy service access to interior

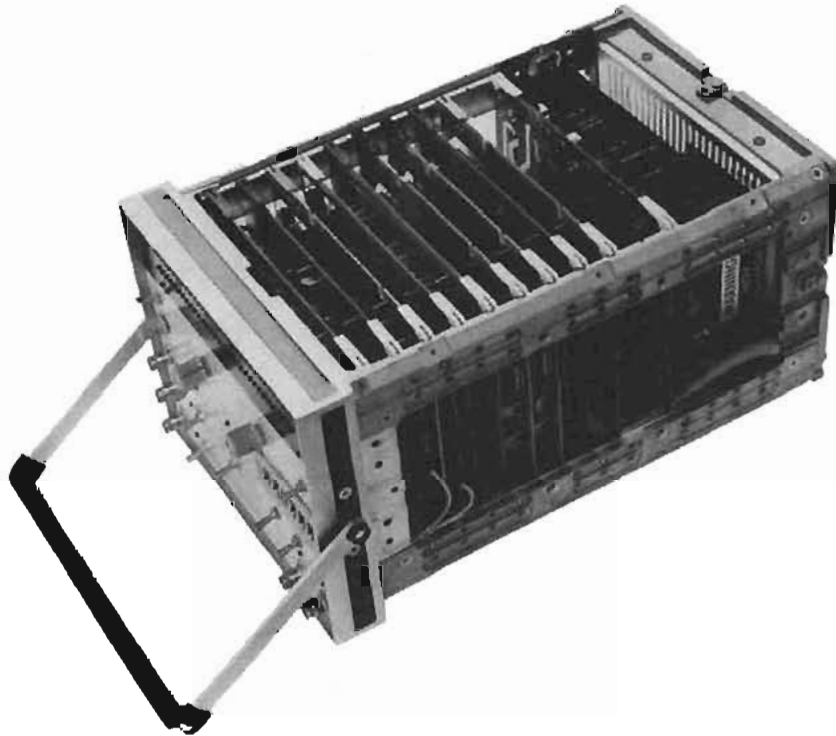

Look inside newer HP instruments housed in System-II cabinets, and you will find an extremely strong frame allowing maximum use of interior space. Yet, there's excellent service access from top, bottom and sides. (Optional ball handle is shown on this particular instrument.)

In 1961, Hewlett-Packard introduced a new universal enclosure system for instruments. That system (which is called "System-I" within HP) made it practical to stack instruments neatly for bench use, while at the same time providing a convenient means for mounting the instruments directly in a rack. It was also esthetically more appealing than the simple boxes of various sizes that had been the norm — and it provided more convenient access to internal parts and more efficient use of space than the conventional chassis-slipped-into-a-box approach commonly in use at that time.

Need for a new enclosure system

Continuing changes in the nature of electronic instrumentation have created new needs in enclosure systems. Foremost among these is the need for even better accessibility to internal parts, as circuits become more densely packed. Ideally, this not only means access from top and bottom, as provided by the 1961 system, but also from the sides, front and back as well.

Today's miniaturized circuits also lead to two other types of problems. First, the enclosures tend to be smaller than in the past — meaning that costly combining cases or space-consuming rack adapter frames are often required for grouping smaller products together on the bench or in the rack. Second,

there's the need to optimize utilization of smaller front panel areas — and it becomes increasingly difficult to arrange displays, nomenclature and the growing number of controls for convenient user operation.

Radiated electrical interference can also be a significant problem, as transition times of digital signals shorten to the nanosecond region. This means that instruments tend to radiate a greater amount of high-frequency energy, thereby creating potential problems for users operating sensitive devices in close proximity.

New standard enclosure: System-II

With the above in mind, Hewlett-Packard has developed a new enclosure system for HP products, using an "inside-out" design approach. That is, design priorities first concentrated on all servicing, manufacturing, electrical, mechanical, and thermal needs before turning to the esthetic considerations. The resulting enclosure has greater strength but is lighter in weight than the earlier design. Also, it provides better accessibility for servicing, has more versatility in bench/rack configurations, and it inherently provides significant attenuation of unwanted RF energy.

This new enclosure is called "System-II", and it is now the standard package in which new HP cabinet-enclosed products are being introduced.

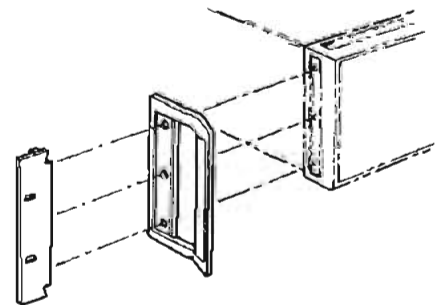
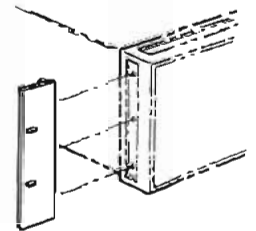
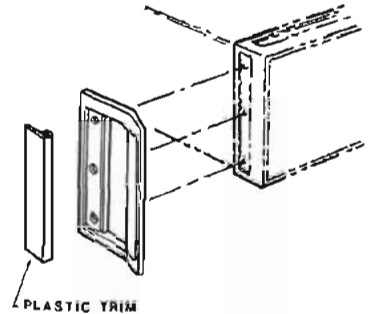

Three front handle and/or rack flange kits are available as standard options on full-width instruments — or, the kits may be purchased separately.

Compatibility with current System-I products has been carefully considered. Cabinet and panel colors for both systems are the same, and the new System-II instruments will conveniently stack on the older System-I enclosures (and vice-versa).

The basic System-II frame consists of six die-cast aluminum parts: a front panel frame, a rear panel frame, and four connecting side struts. It is rigid by itself and does not depend upon internal decking, front or rear panels, or covers for strength. The resulting open design makes maximum use of available space, and allows easy access inside.

The sturdy front panel frame is the heart of the design. It has integral pads for the side struts, mounting holes for fastening the front panel, recesses for front handles and rack flanges or for links that lock adjacent enclosures together, slots for plug-in latches, and narrow channels for holding top, side, and bottom covers.

Heights

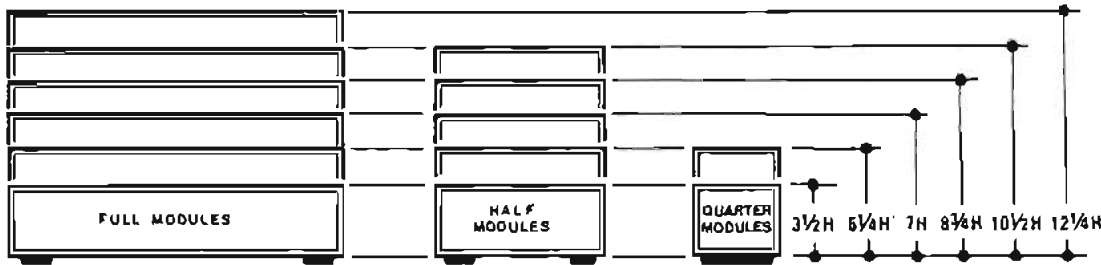

Widths

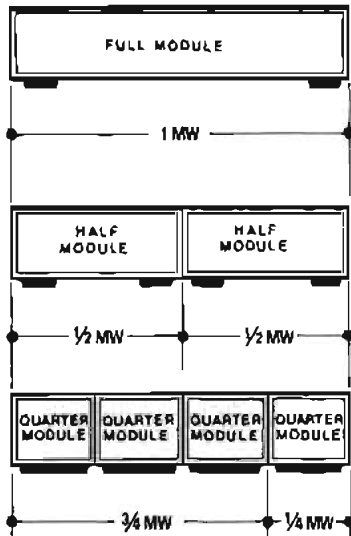

Depths

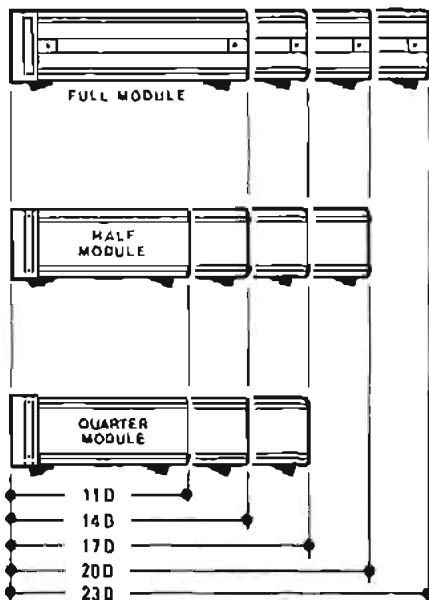

The narrow U-shaped channels serve as wave traps that reduce the radiation of (or susceptibility to) unwanted RF energy. As a further precaution, small ridges aligned in the direction of cover insertion provide high-pressure points for establishing good electrical contact. Only RF energy at wavelengths much shorter than those of concern can move between these contact points. Trim detail on the side covers provide the same kind of RF seal along the sides, as does a similar arrangement under the lip of the covers at the rear. The covers, however, are each retained by a single captive screw, enabling quick removal for servicing.

The sizes of holes such as those needed for mounting cabinet feet have been reduced to practical minimums.

Maximized panel area

Unlike the earlier design, the System-II front panel frame uses all the available area in full multiples of vertical EIA/IEC increments. Also, the front panel frame overhangs lower side members, completely filling the allotted rack space while still allowing room for the optional use of System-II rack support shelves.

The front panel mounts to the framework with screws accessible from the outside, and because it does not serve as a structural member, there is an increase in the amount of usable panel space. This reduces the crowding of controls so instruments become easier to operate.

All screws used in cabinet assembly are of the self-locking type with an inserted plastic patch on the threads, preventing the screws from working loose when subject to vibration.

Easier carrying

Front-panel handles (now optional) have been designed with an outward tilt. The angled handle is comfortable for the hand, while presenting a minimal visual obstruction of controls located along the edges of the front panel. (Optional rack-mounting flanges may be installed with or without the front handles in place.)

Full-width products have a handle on each side. Each side handle is in the form of a long

Summary of System-II dimension descriptors

Dimension Descriptor	Equivalent to:			
	"U"	mm	inches	
Height	3 1/2 H	2U	88.1	3.469
	5 1/4 H	3U	132.6	5.219
	7 H	4U	177.0	6.969
	8 3/4 H	5U	221.5	8.719
	10 1/2 H	6U	265.9	10.469
	12 1/4 H	7U	310.4	12.219
Width	1/4 MW		105.7	4.160
	1/2 MW		212.3	8.360
	3/4 MW ²		318.9	12.550
	1 MW ²		425.5	16.750
Depth ⁴	11D		269.2	10.600
	14D		345.4	13.600
	17D		421.6	16.600
	20D		497.8	19.600
	23D		574.0	22.600

¹ See ANSI C83.9-1972 or IEC 297-1975.

² HP products are not available in S-II cabinets 1/4 MW, but this is useful dimension to indicate filler panel widths.

³ Adding S-II rack flanges extends the 1 MW dimension for mounting in standard 482.6 mm (19.000 inch) rack.

⁴ Depth dimension includes basic cabinet only; does not include protrusions such as controls, front handles, etc.

strap, which provides more freedom in finding a balance point. The strap handle recess in each side panel also provides a place for mounting rack slides.

An optional front bail handle is available for smaller products, and some products are equipped with a strap handle on top.

Modular small enclosures

The smaller enclosures in System-II are dimensioned to be exact submultiples of the standard rack width design. Rack mounting frames are therefore not required; a simple extender to reach full rack width is all that is needed.

It is easy to group instruments together horizontally or vertically by using simple lock links. The links can be installed by using threaded holes already provided in the framework, allowing quick assembly and separation of instruments.

CABINETS & MEASUREMENT ACCESSORIES

Modular enclosure system for individual HP products

System-II general accessories and parts

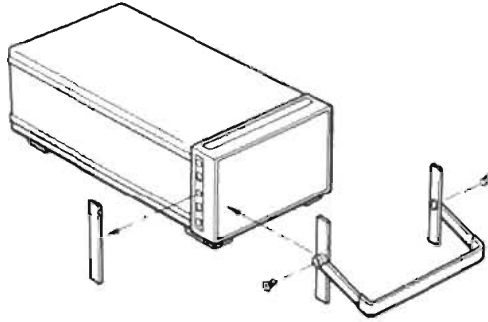

Bail-type carrying handles are available for 1/2 MW products having heights of 3 1/4 H, 5 1/4 H or 7 H.

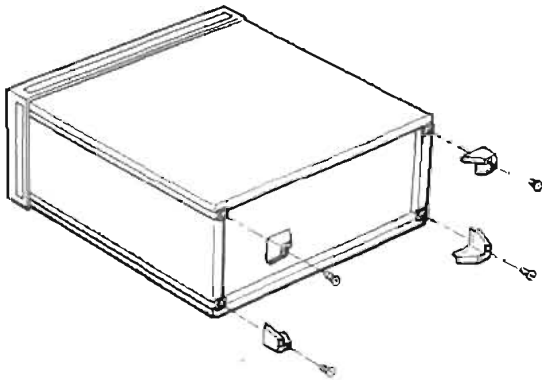

Standoff feet in Kit 5061-2009 provide rear panel protection for instruments operated, transported or stored vertically.

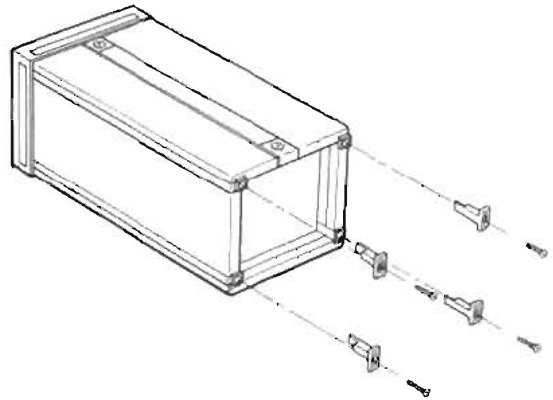

Kit 5061-0095 provides langed cord wrap posts as a convenient way to keep power cords and signal cables with an instrument.

Locking cabinets together

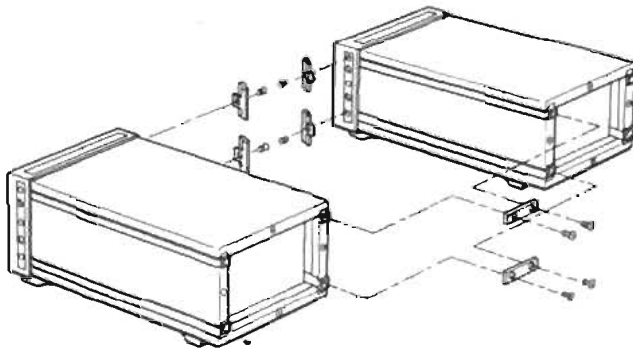

Sub-module cabinets (1/4 MW & 1/2 MW) of equal depths lock side-by-side, using horizontal lock links from Kit 5061-0094.

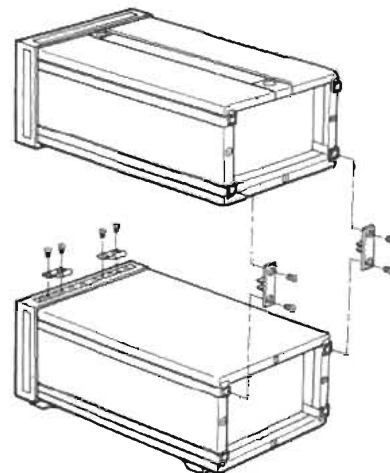

Cabinets of equal depths can be stacked and locked together securely, using vertical lock links from Kit 5061-0094.

General accessories and parts for System-II cabinets

Item ¹	Fits these System-II Cabinets	Description	Part Number	Price	
Front handle kit (Will be shipped with instrument, if ordered as Option 907 at same time. Otherwise available separately per Part Numbers listed at right.)	All cabinets — but principle use is on 1 MW (Full Module) cabinets, or on sub-Module cabinets locked together to form width of 1 MW.	Includes two front handles; fit on each side of front panel frames, for cabinets this high:	3½ H	5061-0088	\$20.00
			5¼ H	5061-0089	\$20.00
			7 H	5061-0090	\$30.00
			8¾ H	5061-0091	\$30.00
			10¾ H	5061-0092	\$45.00
			12¼ H	5061-0093	\$45.00
Bail handle kit	½ MW (Half Module)	Convenient carrying handle for lightweight cabinets this high:	3½ H	5061-2001	\$15.00
			5¼ H	5061-2002	\$20.00
			7 H	5061-2003	\$25.00
Cabinet lock-together kit	All cabinets, provided they are of equal depth.	Kit of lock link hardware and screws for joining instrument cabinets in several different configurations. Enough horizontal links (12 front, 6 rear) to form three side-by-side joints (up to 4 instruments), and enough vertical links (4 front, 4 rear) to form two over/under joints (up to 3 instruments). ²	5061-0094	\$15.00	
Cabinet feet	1 MW (Full Module) and ½ MW (Half Module)	Standard foot (1): fits bottom of 1 MW and ½ MW cabinets (requires 2 front, 2 rear).	5040-7201	\$2.00	
		Tilt stand (1): fits onto standard foot and is used in pairs (front or rear).	1460-1345	\$2.00	
		Non-skid foot (1): used (in pairs) in lieu of standard rear or front foot, to minimize bench-top creeping of instrument. (Some lighter-weight products are supplied with this type foot on rear.)	5040-7222	\$3.00	
	¼ MW (Quarter Module)	Standard foot (1): fits bottom of ¼ MW cabinet (requires 1 in front, 1 in rear).	5040-7205	\$2.50	
		Tilt stand (1): fits onto ¼ MW standard foot (only 1 used, for front or rear).	1460-1369	\$2.50	
		Non-skid foot (1): used singly in lieu of ¼ MW standard rear or front foot. (Is included on some lighter-weight products.)	5040-7226	\$3.50	
	Feet, rear panel standoff	All cabinets — except does not normally fit cabinets which are ¼ MW and 3½ H.	Kit of four special feet which provide 25.4 mm (1 in.) standoff protection to rear panel. Used when instrument is operated in vertical position, or when it is transported/stored on its rear panel.	5061-2009	\$10.00
	Cord-wrap kit, rear panel	Recommended for products only ¼ MW and ½ MW weighing less than 11 kg (24 lbs.)	Kit of four flanged posts around which power cords or signal cables may be wrapped for transport/storage. (Not designed for heavy duty support; use kit 5061-2009 for such applications.)	5061-0095	\$5.00

¹ All kits and rear panel standoff feet are supplied with appropriate mounting screws.

² Locking cabinets together horizontally in a configuration wider than 1 MW (Full Module) is not recommended.

CABINETS & MEASUREMENT ACCESSORIES

Modular enclosure system for individual HP products

System-II rack mounting accessories

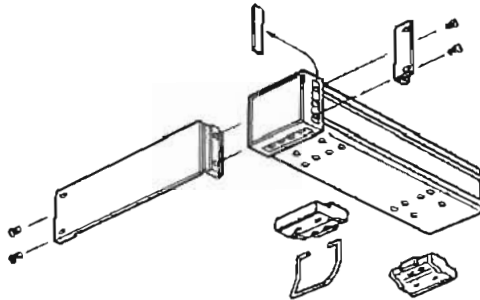

Cabinets $\frac{1}{4}$ MW utilize one broad foot each at front and rear (all except tilt stand). Note how rack mounting adapter and rack flange fit onto front frame, after trim strip is removed.

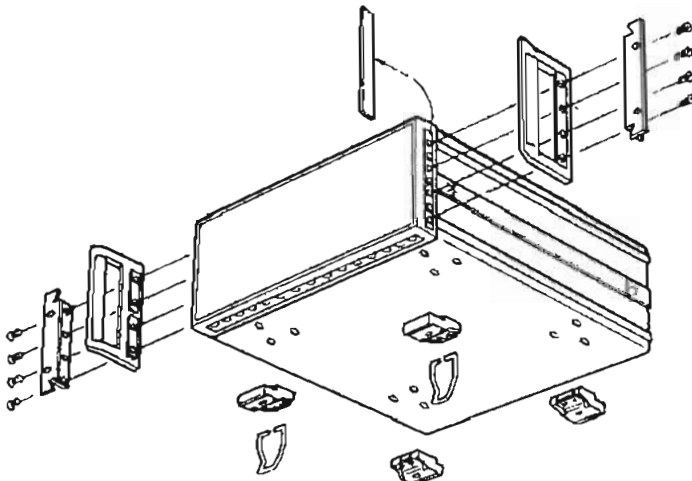

Cabinets $\frac{1}{2}$ MW and 1 MW utilize two feet each at both front and rear (all except tilt stand). Note how front handle and/or rack flange fit onto front frame.

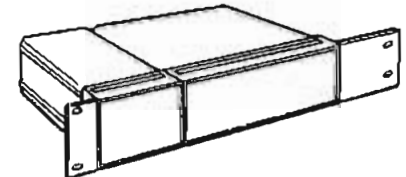
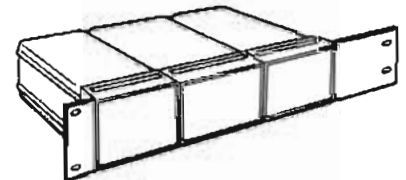
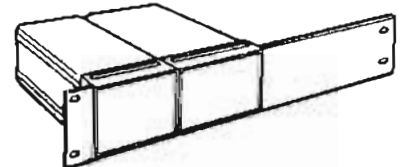
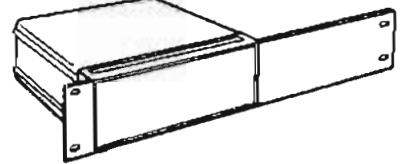
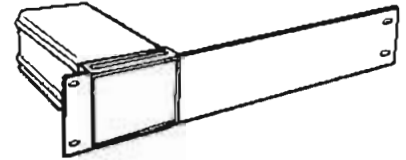

Sub-module cabinets ($\frac{1}{4}$ MW & $\frac{1}{2}$ MW) may be extended to full rack width, by using rack mounting adapters as shown above.

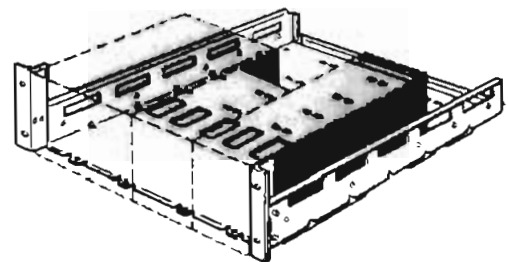
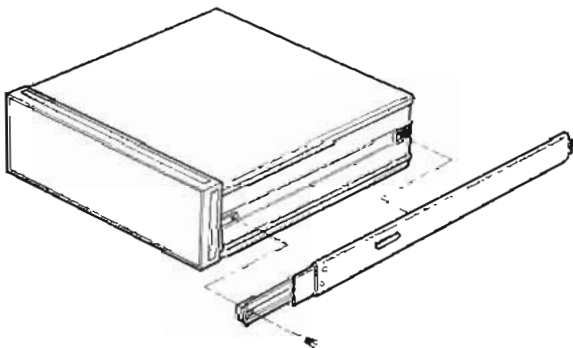

Sub-module cabinets ($\frac{1}{4}$ MW & $\frac{1}{2}$ MW) of equal height and of any depth may be rack mounted by using the support shelf.

Standard slides fit full module cabinets (1 MW) for installation in HP rack enclosures. Adapter brackets for using slides in non-HP rack enclosures are also available.

Rack mounting accessories for System-II cabinets

S-II Cabinet Width	Item ¹	Description		Part Number	Price	
1 MW (Full Module)	Rack flange kit (Will be shipped with instrument, if ordered as Option 908 at same time. Otherwise available separately per Part Numbers listed at right.)	Includes two rack flanges; fit on each side of front panel frames, for cabinets this high:	3½ H	5061-0076	\$15	
			5¼ H	5061-0077	\$15	
			7 H	5061-0078	\$20	
			8¾ H	5061-0079	\$20	
			10½ H	5061-0080	\$25	
			12¼ H	5061-0081	\$25	
	Rack flange & front handle combination kit (Will be shipped with instrument, if ordered as Option 909 at same time. Otherwise available separately per Part Numbers listed at right.)	Includes two rack flange/front handle combinations; fit on each side of front panel frame, for cabinets this high:	3½ H	5061-0082	\$20	
			5¼ H	5061-0083	\$30	
			7 H	5061-0084	\$45	
			8¾ H	5061-0085	\$45	
			10½ H	5061-0086	\$60	
			12¼ H	5061-0087	\$60	
	Standard slide kit for HP rack enclosures	Includes two standard slides for installing instrument weighing no more than 38.6 kg (85 lb.) into HP rack enclosures. Fit side handle recess on S-II cabinets this deep:	14D & 17D 20D & 23D	1494-0018 1494-0017	\$45 \$45	
	Standard tilt slide kit for HP rack enclosures	Same as standard slides above, plus permits tilting instruments up or down 90°. Fit:	14D & 17D 20D & 23D	1494-0025 1494-0026	\$95 \$95	
	Slide adapter bracket kit	Includes brackets for adapting the standard slides above for use in non-HP rack system enclosures of adequate depth.		1494-0023	\$20	
	Heavy-duty slide kit for HP rack enclosures	Includes two heavy-duty slides for installing instrument weighing no more than 79.6 kg (175 lb.) into HP rack enclosures. Fit S-II cabinets this deep:	20D & 23D	1494-0016	\$115	
¼ MW (Quarter Module) and ½ MW (Half Module)	Rack mounting adapter kit ²	Includes one rack flange and one extension adapter ¼ MW. For mounting one S-II cabinet ¼ MW, having a height 3½ H.		5061-0053	\$25	
			3½ H	5061-0054	\$25	
			5¼ H	5061-0057	\$25	
			7 H	5061-0060	\$35	
			Includes one rack flange and one extension adapter ½ MW. For mounting one S-II cabinet ½ MW or two cabinets ¼ MW, having these heights:	10½ H	5061-0066	\$45
			Includes one rack flange and one extension adapter ¼ MW. For mounting one S-II cabinet ¼ MW together with one cabinet ¼ MW, or for mounting three cabinets ¼ MW together; having a height of 3½ H.		5061-0055 ³	\$25
		Rack flange kit ²	May be used whenever S-II cabinets ¼ MW and/or ½ MW are combined to a full width of 1 MW (Full Module).		See 1 MW above	
		Rack flange & front handle combination kit ²	May be used whenever S-II cabinets ¼ MW and/or ½ MW are combined to a full width of 1 MW (Full Module).		See 1 MW above	
		Support shelf	For mounting one or more S-II cabinets which are ¼ MW or ½ MW. Cabinet depths need not be equal, but heights must match support shelf height:	3½ H 5¼ H 7 H	5061-0096 5061-0097 5061-0098	\$100 \$110 \$125
		Front filler panels for support shelf	For 3½ H support shelf partially filled with S-II instruments, and having the following front panel space to fill:	¼ MW to fill	5061-2021	\$15
½ MW to fill	5061-2022			\$20		
¾ MW to fill	5061-2023			\$25		
		For 5¼ H support shelf, and having ½ MW front panel space to fill:		5061-2025	\$25	
		For 7 H support shelf, and having ¾ MW front panel space to fill:		5061-2027	\$25	
	Slide kit for support shelf	Includes two slides for slide-mounting any of above three support shelves in HP rack enclosures.		1494-0015	\$45	

¹ All kits and support shelf items are supplied with appropriate mounting screws and hardware.

² Cabinet lock-together kit (5061-0094) is also required whenever two, three or four sub-modules (¼ MW and/or ½ MW) are to be joined in a configuration using Rack mounting adapters or Rack flanges. Also, sub-module cabinets must be of equal depth.

³ Requires two 5061-0055 kits if one cabinet ¼ MW is to be center-mounted.

CABINETS AND MEASUREMENT ACCESSORIES

Instrument accessories

Cables, adapters, connectors

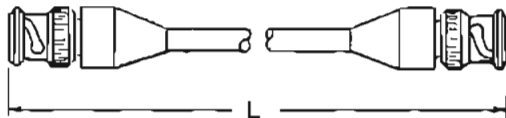

11170A L=12"
11170B L=24"
11170C L=48"

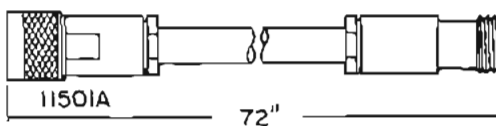
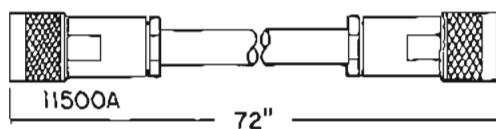
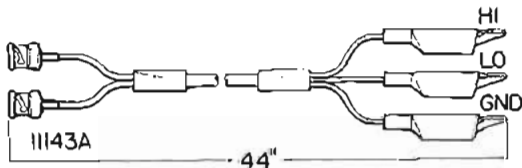
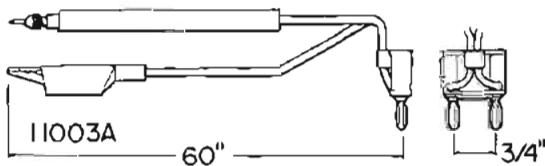
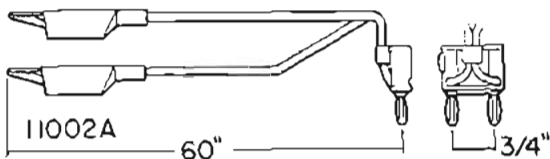
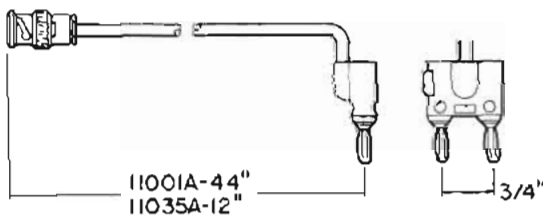
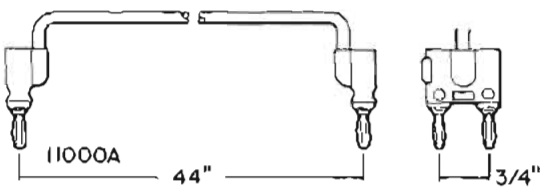

Cable assemblies

11170A Cable assembly

30 cm (12 in.) of 50-ohm coaxial cable terminated on both ends with BNC (m) connectors.

11170B Cable assembly

61 cm (24 in.) of 50-ohm coaxial cable terminated on both ends with BNC (m) connectors.

11170C Cable assembly

122 cm (48 in.) of 50-ohm coaxial cable terminated on both ends with BNC (m) connectors.

11000A Cable assembly

112 cm (44 in.) of 50-ohm coaxial cable terminated on both ends with a dual banana plug, for 3/8" binding posts.

11001A Cable assembly

112 cm (44 in.) of 50-ohm coaxial cable terminated on one end with a dual banana plug and on the other end with a UG-88C/U BNC (m) connector.

11002A Test leads

152 cm (60 in.) test leads alligator clips to dual banana plug.

11003A Test leads

152 cm (60 in.) test leads, probe and alligator clip to dual banana plug.

11035A Cable assembly

30 cm (12 in.) of 50-ohm coaxial cable terminated on one end with a dual banana plug and on the other end with a UG-88C/U BNC (m) connector.

11143A Cable assembly

112 cm (44 in.) test leads, dual BNC to alligator clips.

11500A Cable assembly

183 cm (72 in.) of 50-ohm coaxial cable terminated on both ends with UG-21D/U Type N (m) connectors.

11501A Cable assembly

183 cm (72 in.) of 50-ohm coaxial cable terminated with UG-21D/U Type N (m.) and UG-23D Type N (f) connectors

08441-6012 Cable assembly

Identical with 11500A except 61 cm (24 in.) long.

Model number and name

Model number and name	Price
11170A Cable Assembly	\$17
11170B Cable Assembly	\$17
11170C Cable Assembly	\$17
11000A Cable Assembly	\$17
11001A Cable Assembly	\$17
11002A Test Leads	\$12
11003A Test Leads	\$12
11035A Cable Assembly	\$17
11143A Cable Assembly	\$39
11500A Cable Assembly	\$45
11501A Cable Assembly	\$50
08441-6012 Cable Assembly	\$28

Accessories

Coaxial to coaxial adapters

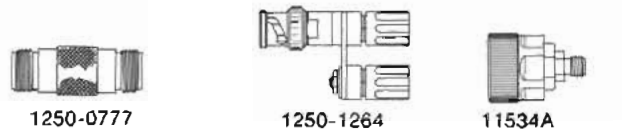
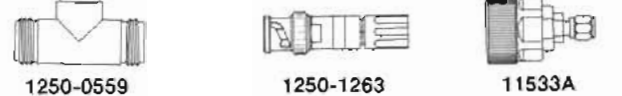
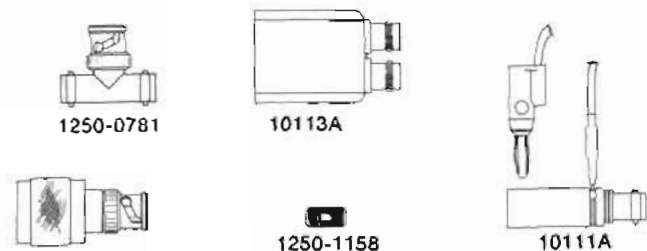
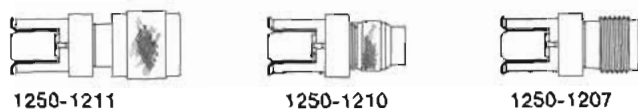
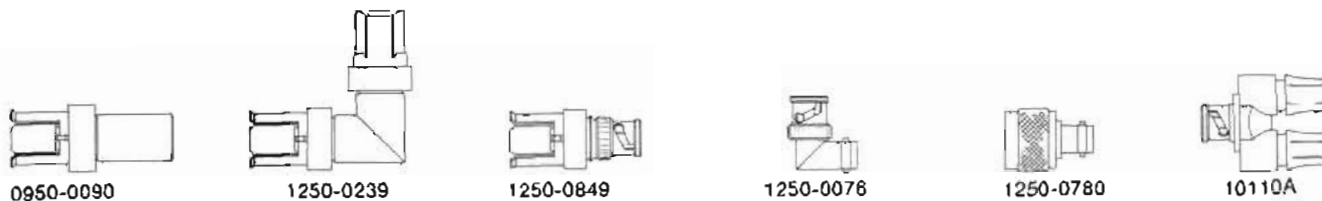

Adapters GR type 874

Part No.	Description	Price
0950-0090	GR Type 874 to 50 ohm Termination	\$100.00
1250-0239	GR Type 874 to GR Type 874, 90° elbow	\$72.50
1250-0240	GR Type 874 to Type N (f)	\$36.00
1250-0847	GR Type 874 to Type N (m)	\$28.00
1250-0849	GR Type 874 to BNC (m)	\$40.00
1250-0850	GR Type 874 to BNC (f)	\$24.50
1250-1206	GR Type 874 to Type C (m)	\$42.00
1250-1207	GR Type 874 to Type HN (f)	\$47.00
1250-1208	GR Type 874 to Type C (f)	\$32.00
1250-1209	GR Type 874 to TNC (f)	\$45.00
1250-1210	GR Type 874 to TNC (m)	\$50.00
1250-1211	GR Type 874 to Type HN (m)	\$57.50

Adapters type N

Part No.	Description	Price
1250-0077	Type N (f) to BNC (m)	\$7.90
1250-0082	Type N (m) to BNC (m)	\$14.00
1250-0176	Type N (m) to Type N (f) right angle	\$8.50
1250-0559	Type N tee, (m) (f) (f)	\$21.00
1250-0777	Type N (f) to Type N (f)	\$15.25
1250-0778	Type N (m) to Type N (m)	\$27.00
1250-0780	Type N (m) to BNC (f)	\$4.90
1250-0846	Type N tee (f) (f) (f)	\$7.25

Adapters SMA

Part No.	Description	Price
1250-1158	SMA (f) to SMA (f)	\$8.00
1250-1159	SMA (m) to SMA (m)	\$16.50

Adapters APC-7

Part No.	Description	Price
11524A	APC-7 to Type N (f)	\$85.00
11525A	APC-7 to Type N (m)	\$95.00
11533A	APC-7 to SMA (m)	\$135.00
11534A	APC-7 to SMA (f)	\$135.00

Adapter banana plug

Part No.	Description	Price
1251-2816	Dual Banana plug (for cables)	\$2.35

Adapters BNC

Part No.	Description	Price
1250-0076	Right angle BNC (f-m) (UG-306/D)	\$4.90
1250-0080	BNC (f) to BNC (f) (UG-914/U)	\$4.90
1250-0216	BNC (m) to BNC (m)	\$5.25
1250-0781	BNC Tee (m) (f) (f)	\$6.20
1250-1263	BNC (m) to single banana post	\$9.30
1250-1264	BNC (m) to dual banana post	\$16.00
1251-2277	BNC (f) to dual banana plug	\$10.00
10110A	BNC (m) to dual banana post	\$25.00
10111A	BNC (f) to shielded banana plug	\$17.00
10113A	Dual BNC (f) to triple banana plug	\$17.00

CABINETS & MEASUREMENT ACCESSORIES

Instrument accessories

Probes, voltage dividers



10007B



11021A



11036A



11040A



11045A



11047A

10007B, 10008B Probe

The 10007B and 10008B are straight-thru BNC probes with a retractable hook tip, and 20 cm (8 in.) ground lead with alligator tip included.

	Peak Voltage	Shunt Capacitance	Length
10007B	600 V	40 pF	1.1m (3.5) ft.
10008B	600 V	60 pF	1.8m (6) ft.

11021A Divider probe

1000:1 divider probe increases range of HP 425A DC Microvolt-Ammeter to 1000 volts.

11028A Current divider

100:1 divider for extended range measurements for 456A AC Current Probe.

11036A AC probe

Peak responding for use with 410C.

11040A Capacitive voltage divider

For 410 series voltmeters. Increases range so transmitter voltages can be measured quickly and easily. Accuracy $\pm 1\%$. Division ratio 100:1. Input capacity approximately 2 pF. Maximum voltage 2000 V at 50 MHz, decreasing to 100 V at 400 MHz. Frequency range 10 kHz to 400 MHz.

11044A DC voltage divider

For 410B voltmeter. Gives maximum safety and conveniences for measuring high voltages as in television receivers, etc. Accuracy $\pm 5\%$. Division ratio 100:1. Input impedance 12 G Ω . Maximum voltage 30 kV. Maximum current drain 2.5 μ A.

11045A DC voltage divider

For 410C voltmeter. Same as 11044A except input impedance, 10 G Ω .

11047A Output voltage divider

Input 600 Ω . Output 600 $\Omega \pm 1\%$. 6 $\Omega \pm 1\%$. Voltage rating $\frac{1}{2}$ watt.

Model number and name

Model number and name	Price
10007B Divider Probe	\$32
10008B Divider Probe	\$32
11021A Divider Probe	\$95
11028A Current Divider	\$85
11036A AC Probe	\$150
11040A Capacitive Voltage Divider	\$90
11044A DC Voltage Divider	\$73
11045A DC Voltage Divider	\$95
11047A Output Voltage Divider	\$30



456A Description

Conventional voltmeters or oscilloscopes can measure current quickly and dependably — without direct connection to the circuit under test or any appreciable loading to test circuit. HP's 456A AC Current Probe clamps around the current-carrying wire, and provides a voltage output read on a voltmeter or scope. Model 456A's 1 mA to 1 mV conversion permits direct reading up to 1 A rms.

456A Specifications

- Sensitivity:** 1 mV/mA $\pm 1\%$ at 1 kHz.
- Frequency response:** $\pm 2\%$, 100 Hz to 3 MHz; $\pm 5\%$, 60 Hz to 4 MHz; -3 dB at < 25 Hz and > 20 MHz.
- Pulse response:** rise time is < 20 ns, sag $< 16\%$ /ms.
- Maximum input:** 1 A rms, 1.5 A peak; 100 mA above 5 MHz.
- Effect of dc current:** no appreciable effect on sensitivity and distortion from dc current up to 0.5 A.
- Input impedance:** (impedance added in series with measured wire by probe) < 50 m Ω in series with 0.05 μ H (this is approximately the inductance of 1 1/2 in. of hookup wire).
- Probe aperture:** 4 mm (5/32") diameter.
- Probe shunt capacity:** approx. 4 pF added from wire to ground.
- Distortion at 1 kHz:** for 0.5 A input at least 50 dB down; for 10 mA input at least 70 dB down.
- Equivalent input noise:** < 50 μ A rms (100 μ A when ac powered).
- Output impedance:** 220 Ω at 1 kHz; approximately +1 V dc component; should work into load of not less than 100,000 Ω shunted by approximately 25 pF.
- Power:** battery life (two), approximately 400 hours; ac power supply; Option 001, 115 or 230 V $\pm 10\%$, 50 to 1000 Hz approx. 1 W.

11473A-11476A Description

New balancing transformers provide a balanced output from a single-ended input, or a single-ended output from a balanced input. Impedances available are 75 ohms unbalanced to 124 Ω , 135 Ω , 150 Ω , and 600 Ω balanced. Frequency response is ± 0.5 dB.

(Each module contains two transformers with the following specifications)

Model No.		11473A	11473B	11474A	11475A	11476A
Impedance*	Unbal	75 Ω	75 Ω	75 Ω	75 Ω	75 Ω
	Bal	600 Ω	600 Ω	135 Ω	150 Ω	124 Ω
Mating connectors	Unbal	BNC	BNC	BNC	BNC	BNC
	Bal	WECO 310	Siemens 9 REL STP-6AC	WECO 241	Siemens 9 REL STP-6AC	WECO 408A
Frequency range:		20 Hz—50 kHz	20 Hz—50 kHz	2 kHz—2 MHz	2 kHz—2 MHz	5 kHz—5 MHz
Frequency response:		± 0.5 dB	± 0.5 dB	± 0.5 dB	± 0.5 dB	± 0.5 dB
Insertion loss:		< 0.75 dB at 1 kHz	< 0.75 dB at 1 kHz	< 0.25 dB at 50 kHz	< 0.25 dB at 50 kHz	< 0.25 dB at 50 kHz
Longitudinal balance:		> 40 dB	> 40 dB	> 40 dB	> 40 dB	> 35 dB
Max input power:		+13 dBm	+13 dBm	+27 dBm	+27 dBm	+27 dBm

*50 Ω unbalanced to balanced transformer available on special basis. Above specifications apply.

Model number and name
456A AC Current Probe
Option 001 AC Power Supply
11473A Balancing Transformer

Price	11473B Balancing Transformer	\$296
\$425	11474A Balancing Transformer	\$290
add \$23	11475A Balancing Transformer	\$290
\$290	11476A Balancing Transformer	\$296

CABINETS AND MEASUREMENT ACCESSORIES

Combining cases, rack adapters, panel covers, carrying cases

1051A, 1052A, 11046A, 11075A, 5060 Series



1051A, 1052A

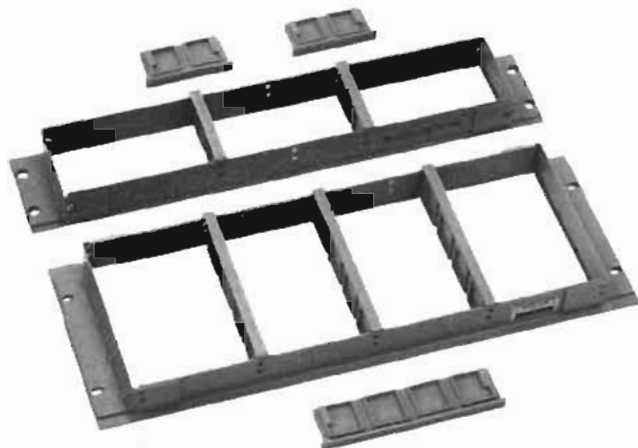

5060-8762, 5060-8764

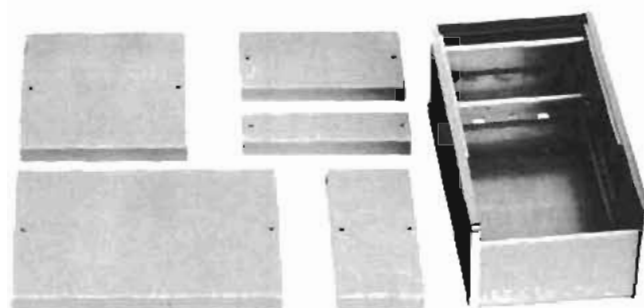

5060-8756 to 5060-8781

1051A, 1052A Combining cases

Models 1051A and 1052A combining cases conveniently rack or bench mount combinations of small modular Hewlett-Packard instruments. In addition, these cases can be stacked on each other or on any full module instrument. Both cases accept $\frac{1}{3}$ or $\frac{1}{2}$ instrument modules, 130 mm or 198 mm wide ($5\frac{1}{4}$ or $7\frac{7}{32}$ inches). The basic difference is that the 1052A is 130 mm ($5\frac{1}{4}$ ") deeper, and will accept modules up to 416 mm deep ($16\frac{1}{2}$ "). The extra length provides more space in the rear for wiring. The 1051A accepts instruments up to 286 mm deep ($11\frac{1}{4}$ "). Each case is furnished with two dividers.

1051A, 1052A Specifications

Dimensions

1051A: 178 × 483 × 337 mm (7 × 19 × 13 $\frac{1}{4}$ ").

1052A: 178 × 483 × 467 mm (7 × 19 × 18 $\frac{1}{2}$ ").

Weight

1051A: net, 4.5 kg (10 lb). Shipping, 6.7 kg (15 lb).

1052A: net, 5.4 kg (12 lb). Shipping, 8.1 kg (18 lb).

Rack adapter frames 5060-8762, 5060-8764

These frames can be used to hold combinations of $\frac{1}{3}$ and $\frac{1}{2}$ width module HP instruments. Each frame is furnished with mounting hardware and divider panels. Three different models are available for different instrument heights. Adapter frames are for permanent or semi-permanent rack mounting. Where quick removal and reinstallation of instruments is desirable, the 1051A and 1052A combining cases should be used.

5060-8762: accepts instrument heights of 38, 77, or 155 mm ($1\frac{1}{2}$, $3\frac{1}{32}$, or $6\frac{1}{32}$ ").

5060-8764: accepts only instrument heights of 38 or 77 mm ($1\frac{1}{2}$ or $3\frac{1}{32}$ ").

Filler panels, 5060-8757 to 5060-8761

Filler panels can be used to close off any leftover space after instruments are mounted in combining cases or adapter frames. Panels are made in a variety of widths and heights. Available widths are $\frac{1}{6}$, $\frac{1}{3}$, and $\frac{1}{2}$ modules; heights are $\frac{1}{4}$, $\frac{1}{2}$ and the full 155 mm ($6\frac{1}{32}$ ").

Specifications, filler panels

Part No.	Module Case Width × Height	Dimensions	
		mm	in
5060-8757	$\frac{1}{3} \times \frac{1}{4}$	130 × 38	$5\frac{1}{4} \times 1\frac{1}{2}$
5060-8758	$\frac{1}{3} \times \frac{1}{2}$	130 × 77	$5\frac{1}{4} \times 3\frac{1}{32}$
5060-8759	$\frac{1}{3} \times \text{full}$	130 × 155	$5\frac{1}{4} \times 6\frac{1}{32}$
5060-8760	$\frac{1}{2} \times \text{full}$	198 × 155	$7\frac{7}{32} \times 6\frac{1}{32}$
5060-8761	$\frac{1}{6} \times \text{full}$	63 × 155	$2\frac{31}{64} \times 6\frac{1}{32}$

Accessory drawer 5060-8756

The accessory drawer can be used in place of a filler panel to finish off unused space in the combining cases. The drawer is $\frac{1}{3}$ width and $\frac{1}{2}$ height.

Dimensions: 130 × 77 × 279 mm ($5\frac{1}{32} \times 3\frac{1}{32} \times 11$ ").



5060-0789

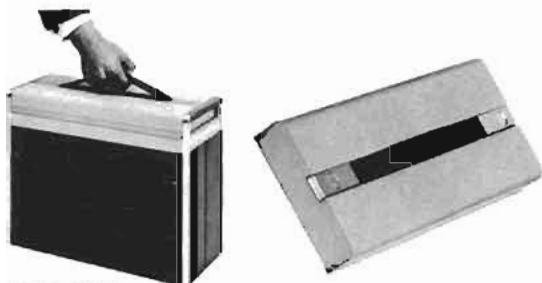

5060-8768



11046A

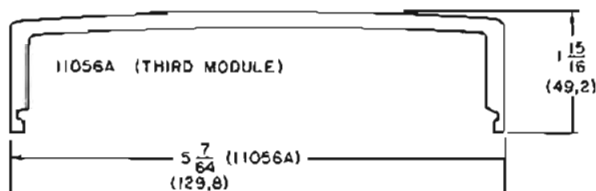

11056A



11075A

Cooling kits, 5060-0789 and 5060-0796

These cooling kits are designed to be easily installed in the 1052A combining case. They can be installed in the 1051A, at the factory upon special request, but installation in the shorter case limits the depth of instruments the case can accept, and makes it impossible to use the accessory drawer.

5060-0789: 115 V, 50 to 60 Hz

5060-0796: 230 V, 50 to 60 Hz

Control panel covers, 5060-8766 to 5060-8771

A series of control panel covers equipped with carrying handles are available for full rack width instruments. These covers protect instrument front panels and make rack mounted instruments tamper-proof.

One of these covers, the 5060-8768, fits either the 1051A or 1052A. Other covers are available to fit the six modular enclosures with front panel heights ranging from 89 to 311 mm (3 1/2 to 12 1/4").

5060-8766: 88 mm (3 1/2") EIA panel height.

5060-8767: 133 mm (5 1/4") EIA panel height.

5060-8768: 177 mm (6 1/2") EIA panel height.

5060-8769: 221 mm (8 3/4") EIA panel height.

5060-8770: 266 mm (10 1/2") EIA panel height.

5060-8771: 310 mm (12 1/4") EIA panel height.

11046A Carrying case

This rugged, splashproof carrying case accepts 1/2 width module instruments (maximum depth 203 mm or 8"). The case includes a shoulder carrying strap. Weight 5.4 kg (12 lb).

11056A Handle kit

A handle for carrying HP instrument modules of 1/2 width.

11075A, 11076A Module instrument case

A rugged, high impact plastic instrument case for HP 1/2 module instruments. Instruments can be operated, stored or carried in this splashproof case. Storage compartment for power cord in rear of case is accessible through a removable hatch. Front lid contains adequate storage space for cables, test leads, etc. The dual purpose tilt stand also serves as a carrying handle. 11075A is 203 mm deep (8"); 11076A is 279 mm (11") deep.

Model number and name

Model number and name	Price
1051A combining case	\$275
1052A combining case	\$325
Option 910: Extra manual	add \$1
5060-8762 rack adapter frame	\$55
5060-8764 rack adapter frame	\$50
5060-8757 filler panel	\$9
5060-8758 filler panel	\$10
5060-8759 filler panel	\$10
5060-8760 filler panel	\$11
5060-8761 filler panel	\$9
5060-8756 accessory drawer	\$75
5060-0789 cooling kit	\$200
5060-0796 cooling kit	\$200
5060-8766 control panel cover	\$75
5060-8767 control panel cover	\$80
5060-8768 control panel cover	\$85
5060-8769 control panel cover	\$90
5060-8770 control panel cover	\$95
5060-8771 control panel cover	\$100
11046A carrying case	\$250
11056A handle kit	\$5.00
11075A module instrument case	\$115
11076A module instrument case	\$135

TRANSCEIVER TEST EQUIPMENT

Automatic transceiver test system

Model 8950A

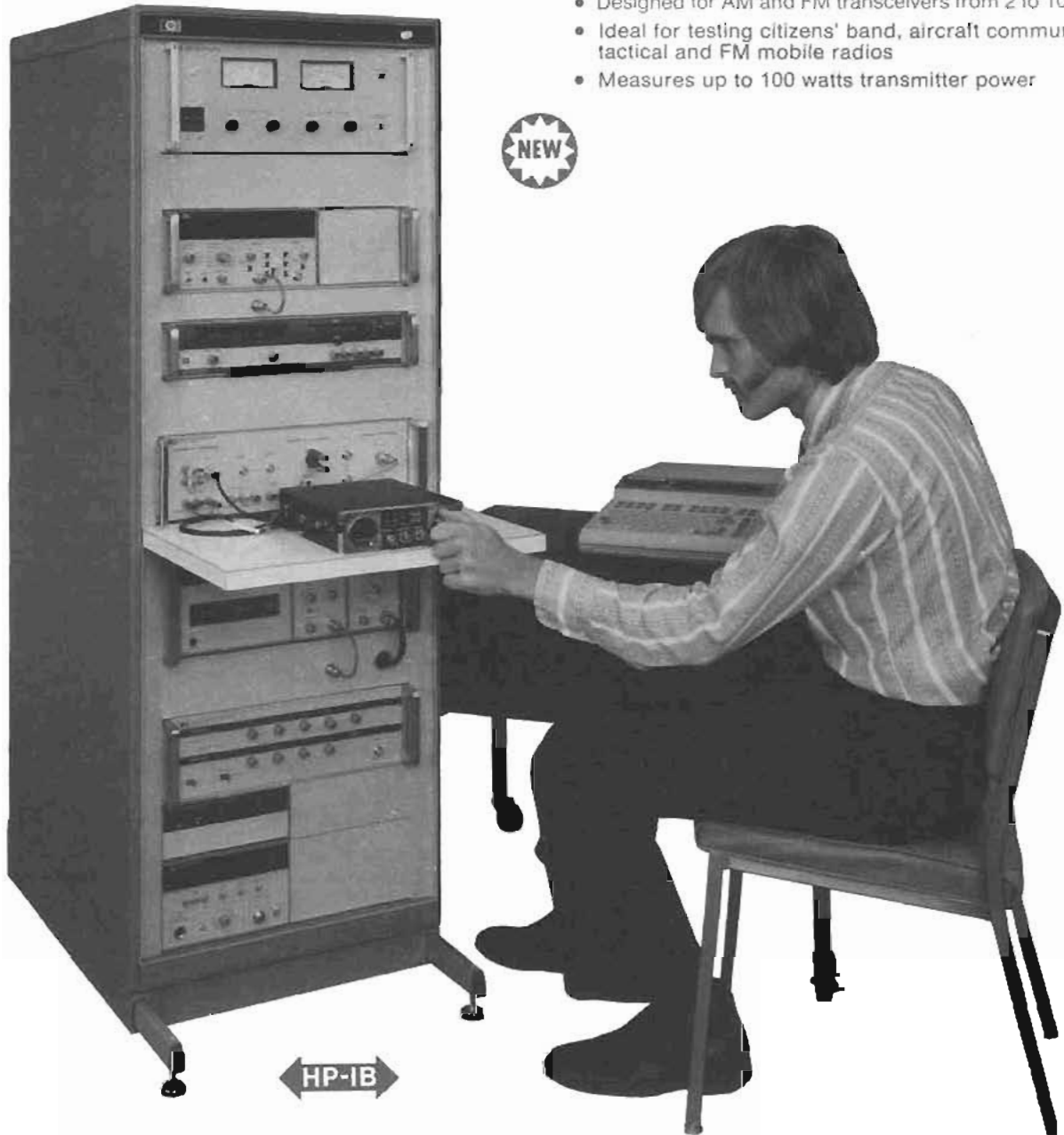

- Designed for AM and FM transceivers from 2 to 1000 MHz
- Ideal for testing citizens' band, aircraft communication, tactical and FM mobile radios
- Measures up to 100 watts transmitter power



HP-IB

The HP 8950A Transceiver Test System will automatically test AM and FM communications transceivers over the frequency range of 2 to 1000 MHz. It is nearly ideal for production line testing, R&D evaluation, quality assurance testing, incoming inspection, and user maintenance of many transceivers. An HP 9825A Calculator controls the stimulus and measurement capabilities of the system via the HP Interface Bus (HP-IB).

Speed

Using the 8950A system, transceiver test time can typically be reduced by a factor of 10 or more, resulting in greatly increased productivity. For example, the system can perform a typical set of tests on a mobile radio in about 2 minutes, while a manually operated setup would require about 20 minutes.

Accuracy

Operation of the 8950A under calculator control can offer better accuracy than a manual system. By automatically applying previously

measured calibration factors, repeatable system errors such as frequency response and insertion loss can be virtually eliminated.

Data presentation

The 9825A calculator includes a small thermal printer adequate for writing software or for short message printouts. Both the 9871A Character Impact Printer (Option 001) and the 9866B Thermal Printer are systems compatible to provide more sophisticated printouts.

A flexible HP-IB system

HP-IB interconnection insures that your 8950A will not become obsolete in the near future: as new and more advanced instrumentation is offered, your system can easily be updated to include added measurement capability. The 8950A employs general purpose, off-the-shelf instruments except for the 8951A System Interface. This means you may already be using nearly identical instruments in your measurements; therefore, test results will be directly comparable and operation and maintenance will be simplified.

8951A System interface

The 8951A System Interface contains all the signal switching and conditioning needed to route signals to and from the proper instruments and the radio under test. All radio connections are made at a single working panel and no manual switching or cable reconnection is necessary during a typical series of tests.

In addition to switches, the 8951A includes a 100 watt RF attenuator, a high quality FM discriminator, and a diode detector for AM measurements. Three band-reject filters with provision for an external filter are used for distortion and SINAD measurements.

9825A Calculator controller

The flexible and powerful 9825A is an almost ideal controller for this system. It uses a high-level programming language called HPL which offers power and efficiency for handling equations and controlling instruments, yet is easy to learn and use. The calculator and HPL allow easy storage and review of programs and data on a built-in, high speed, 250,000 byte tape cartridge.

System software

The 8950A is furnished with a tape cartridge containing a comprehensive library of system programs: 1) the *verification program* is a short system self-test to assure the user that the system is operational, 2) the *calibration program* generates calibration factors to correct repeatable errors in the system, 3) the *measurement subroutines* allow complex measurements to be made by writing only a single statement, 4) and the *instrument drivers* facilitate information transfer between the calculator and the instruments.

Writing programs

To perform a series of tests on a transceiver, a program must be written which accesses the appropriate measurement and instrument driver subroutines. Additional program statements will provide a printed copy of the results which can include the chosen test limits and a Pass-Fail indication of total test performance. Because of the software flexibility, special tests can easily be written using the instrument drivers provided with the system.

Typical system tests

Receiver:	Transmitter:
SINAD sensitivity	Carrier power
Quieting sensitivity	Carrier frequency and stability
Squelch threshold	AM depth
Audio power	FM deviation
Audio distortion	Audio distortion
Audio response	Audio response
Hum and noise	Audio sensitivity
AGC response	Squelch tone frequency
Modulation acceptance	Limited spurious measurement
bandwidth	Power supply sensitivity
Power supply sensitivity	Current drain
Current drain	Module and Subassembly:
	DC and AC voltage
	Resistance
	Frequency

8950A System specifications (includes software calibration)

General

System frequency range: 1-1000 MHz.

System power range: 0.5-100 watts.

Calculator controlled power supply voltages (preset at factory): +12.4, +13.8, +15.2 volts.

Current drain measurement range: 50 mA to 20 A.

Transmitter tests

Power measurement range (Antenna port): 1 mW to 100 watts.

Power measurement range (AUX RF input): 10 μ W to 1 watt.

Power measurement accuracy (Antenna port): expected ± 0.14 dB ($\pm 3.3\%$).

Frequency measurement range: 0 to 1000 MHz.

AM measurement

Frequency range: 2-400 MHz.

AM depth range: 0.2-90%.

AM accuracy (1 kHz rate 10% to 80%): $F_c < 200$ MHz: $\pm 2\% \pm 3\%$ of full scale; $F_c \geq 200$ MHz: $\pm 2\% \pm 5\%$ of reading.

AM rate range (3 dB): 50 Hz-25 kHz.

AM residual distortion (at 30% AM): $\leq 2\%$.

FM measurement

Frequency range: 4-1000 MHz.

Peak deviation range: 300 Hz-20 kHz.

FM accuracy (1 kHz rate): $\pm 3\% \pm 20$ Hz.

FM rate range: 50 Hz-20 kHz.

FM residual distortion (at ≥ 3 kHz peak deviation): $\leq 1.0\%$.

Spurious measurements (>1 MHz away from carrier): 0 to -50 dBc.

Receiver tests

Minimum measurable sensitivity (typical): 0.2 μ V.

Output level range (Antenna port, into 50 ohms): -140 to -19 dBm (0.02 μ V to 25 mV).

Output level accuracy (1 to 1000 MHz, at Antenna port): ± 1.5 dB.

Audio power measurement range: 10 mW to 100 watts.

Audio power measurement accuracy: 0.5% \pm speaker load tolerance.

Audio distortion measurement: At 400, 1000, and 3000 Hz rates.

Residual distortion: RF generator distortion +0.3%.

Audio frequency range:

AM: 50 Hz to 50 kHz (RF freq > 10 MHz)

FM: 50 Hz to 100 kHz.

Modulation acceptance bandwidth measurement range: 1 to 100 kHz.

General characteristics

Operating temperature range: 15° to 35°C.

Power requirements: 115 volts $\pm 10\%$, 60 Hz.

Net weight (less calculator): 216.8 kg (478 lb).

Model number and name

8950A Transceiver Test System (including calculator and programs) \$58,500

Option 001: 9871A Page-width Impact Printer add \$3400

Option 002: Additional 8192 bytes of calculator memory add \$1600

Option 003: 1 Hz resolution on 8660A Synthesized Signal Generator add \$350

Option 004: 230 V, 50 Hz operation N/C

Option 005: Delete 9825A Calculator less \$9150

General information

Voice data testing

Data communication systems operate simultaneously in the data, time and frequency domains.

The data terminal equipment (DTE) operates almost entirely in the data domain with bits, characters and blocks of characters.

The modem transforms the time domain signals from the data terminal equipment into the frequency domain for compatibility with the analog telephone plant.

The telephone line connected to the telephone plant provides the link to receiving modem(s).

Maintenance of a data communication system requires compatible test equipment capable of measuring in the appropriate domain.

Data domain measurements that are performed by Logic State Analyzers strip and monitor bits and characters. These instruments allow on-line testing and monitoring of both control and data information. Time domain and handshake problems on the RS232 (V 24) bus are measured by Digital Error Analyzers. The Digital Error Analyzers measure the overall characteristics of the line and modem with Bit Error Rate measurements and diagnose some common problems, e.g. line dropouts and clock slips. These measurements can be useful on the switched telephone network and on private leased lines. Interfaces are available in the U.S. for monitoring the new, all digital, Digital Data System (DDS) networks.

A complete set of frequency domain measurements on private line networks can be made by Transmission Impairment Measuring Sets in the U.S. and by Telephone Line/Data Line Analyzers outside the U.S. Typically these equipments operate to national and/or international standards such as Bell System, Technical Reference 41.009 and CCITT recommendation M.102.

Data measurements

Logic State Analyzers are capable of trapping and displaying both serial and parallel digital data in their natural binary forms. They are useful for monitoring serial data out of the modem, parallel data on the information bus, and both serial and parallel data within the Data Terminal Equipment.

The logic analyzer can trigger on the sync word of the serial bit stream and display the subsequent bytes of data. The instrument can delay from the sync point and display data far removed from the sync character. Digital memory allows easy examination of transient messages common in data communications.

Parallel data analysis can be used to examine data on the RS232/V24 bus between the data terminal equipment and the modem. The word trigger can be used to start the display on important signals, e.g. request-to-send or received-line-signal-detect. The display can be used to monitor simultaneously activity on the other lines of the bus.

Before a link can pass data, the subsystems must "handshake" with each other to establish a continuous, synchronized link. The data terminal equipment turns on the

modem transmit carrier by raising request-to-send. The modem will allow time for training sequences, echoes and receiver squelches before replying with a clear-to-send to the computer. Equipment exists for monitoring both standard and new handshake sequences on the information bus.

Digital measurements — time domain

Digital Error Analyzers are used to monitor the quality of both the modem and transmission facility. They provide more information about the modem and transmission line than Logic State Analyzers, but no information about the Data Terminal Equipment which they replace.

The overall quality of the link is indicated by its Bit Error Rate. A good link is typically better than 1×10^{-4} errors per bit. This measurement will include the effect of both transmission line impairments and the modem's ability to overcome them. Modems vary widely in their sensitivity to line impairments. Low speed (less than 300 bps) and adaptively equalized modems are less sensitive than high speed (more than 4800 bps) and non-adaptively equalized modems.

Since data communication systems transmit data and control error in blocks, these instruments also measure Block Error Rate. Bit Error Rate and Block Error Rate can be used together to examine the statistics of the error mechanism. If the Bit Error Rate and Block Error Rate are both high, the impairment is random and probably due to noise. If the Bit Error Rate is high but the Block Error Rate is low, the impairment is more sporadic as happens when lines are switched, sync is temporarily lost or impulse noise is too high.

Error rates are a qualitative check of the data communication system which can be made in a few seconds. If the system is bad, diagnostic measurements are provided to help isolate the problem. Dropouts, clock slips, error skew, jitter and total peak distortion indicate some of the problems that can occur on a link. These measurements are made simultaneously with the error rate measurements and can be printed in an automatic, unattended mode if desired.

These instruments are available in programmable versions for fully automatic system maintenance and checkout.

Catastrophic failures can usually be found with self tests and loop back switches built into the Data Terminal Equipment and Modem. A Transmission Test Set can find catastrophic failures of the transmission line. Logic Analyzers and Digital Error Analyzers can find catastrophic failures that are not illuminated by internal self tests.

Degradations of the modem or transmission line are more difficult to find and require more extensive test equipment. The most common degradation is an excessive error rate due to line impairments or a faulty modem.

The transmission line will have a set of steady state impairments, e.g. amplitude distortion, envelope delay distortion, nonlinear distortion, and frequency offset which smear the modem's symbols and make them harder to separate in the modem receiver. The line

will also have random impairments, e.g. message circuit noise, impulse noise, phase jitter, and gain hits which can temporarily push the symbols into the wrong slot, causing a digital error.

Line impairments — frequency domain

Transmission line analyzers are used to measure the transmission parameters that experience has shown to be those most likely to enable the modem to achieve a low bit error rate. They fall into two main areas: steady state and transient. Measurements on the telephone plant do not include the modem and provide no information about the Data or Time domains. They are typically diagnostic of the line distortions and include noise, steady state and impulsive. In most cases the measurements conform to CCITT or Bell standards, both in their result and in the method used.

A number of basic measurements are performed on all lines that are destined to carry data. Typically a line is conditioned for given data rates thereby qualifying the distortions allowed. Tariffs are aligned to performance as defined by the conditioning. The total line capability can be assessed if three transmission phenomena are established: (a) effective channel bandwidth as characterized by attenuation and group delay distortion. These two parameters impose an upper limit to transmission speed and reduce the noise margin to errors generated; (b) circuit net loss which affects signal-to-noise margin; and (c) noise. This includes steady state background noise and transient noise. Definition of gain hits, phase hits, dropouts and impulse noise are all contributors to transient noise. The incidence of impulse noise tends to follow the traffic fluctuations and often has peaks comparable to data signal.

Modems

The main dividing line for modems is at 2000 bps. Below 2000 bps modems are asynchronous and usually frequency shift keyed (FSK). These modems are not as sensitive to line impairments and can be maintained most of the time with simple test equipment like HP 3551A and 3555A. The digital measurements can all be made by the HP 1645A which is capable of either asynchronous or synchronous testing.

Data rates higher than 2000 bps are accomplished by transmitting more bits per symbol. This requires a synchronous modem of more sophisticated design. These modems, especially at 7200 and 9600 bps, are more sensitive to channel impairments. Bell modems are usually phase shift keyed (PSK) or quadrature amplitude modulation (QAM). Independents also use pulse amplitude modulation (PAM) and AM single sideband (SSB).

The 4940A and 4942A are capable of measuring all the tariffed impairments in the U.S. The 3770A and 3770B are capable of measuring all the tariffed impairments in the CCITT countries. The 1645A is capable of synchronous measurements according to both Bell and CCITT specifications. There is some overlapping of the frequency domain measurements. A 3551A might be used to make simple measurements on a synchro-

nous circuit and a 4940A might be used to investigate difficult problems on a low speed asynchronous circuit.

The choice between digital and frequency measurements depends on the application. A telephone company may not have access to or responsibility for the digital side of the modem, so frequency measurements would be best. A data communication end-user interested in go/no-go testing can make them fastest with a digital measurement of bit-error-rate or data characters. Since malfunctions know no boundaries, it is important that the test equipment fit the problem.

Outside plant test equipment

When installing, splicing and testing telephone cables, most of the larger cables contain hundreds of conductor pairs using non-color coded insulation for the cable pairs. Prior to the termination, the new pairs must be identified by pair number. The new HP Automatic Pair Identifier system reliably identifies and tests these telephone cable pairs.

Cable fault locating

With cable being buried underground, there is an increasing need for tracing cable path and determining cable depth. HP tone-type Fault Locators have varied capabilities for these applications. For example, water may enter a cable through a break in the

outer jacket and cause conductor-to-conductor faults. These are conveniently sectionalized and localized with the HP conductor Fault Locators. Another type of cable fault is the open conductor caused by cable damage or a poor splice — and these can be located with the Open Fault Locators. Splits, which are splicing errors, can be located as easily as opens with the new Open and Split Fault Locator. A cable is often pressurized with nitrogen or compressed air. The HP Ultrasonic Translator Detectors can locate such pressurized cable leaks in aerial and ducted underground cable. For more information, contact your local HP field engineer.

Voice/Data Channel Testing

Domain	Measurement	North American							CCITT				
		HP INST Page	3551A 496	4940A 500	4942A 501	3555A 498	1645S 490	1600A 96	3552A 496	3770A 492	3770B 492	3556A 498	1645S 490
Frequency	Loss		•	•	•	•			•	•	•	•	
	Atten. Distortion		•	•	•	•			•	•	•	•	
	Envelope Delay Dist.			•	•					•	•		
	Message Cir. Noise		•	•	•	•			•		•	•	
	Noise with Tone		•	"C"	"C"				•		•		
	Noise to Ground		•	•		•			•			•	
	Return Loss												
	Non-Linear Distr.												
	Single Freq. Int		•	•	•	•			•	•			
	Frequency Shift			•					•				
	Phase Jitter			•									
	Impulse Noise			•	•						•		
	Phase & Gain			•									
	Dropouts			•									
P/AR			•										
Time	Bit Error Rate							•					•
	Block Error Rate							•					•
	Skew							•					•
	Jitter							•					•
	Clock Slip							•					•
	Peak Distortion							•					•
	Carrier Loss							•					•
Data	Digital Traps							•					
	Digital Display							•					
	Data Comparison							•					
	Transient Capture							•					

TELECOMMUNICATIONS TEST EQUIPMENT

Six simultaneous, automatic data measurements

Models 1645A & 10235A

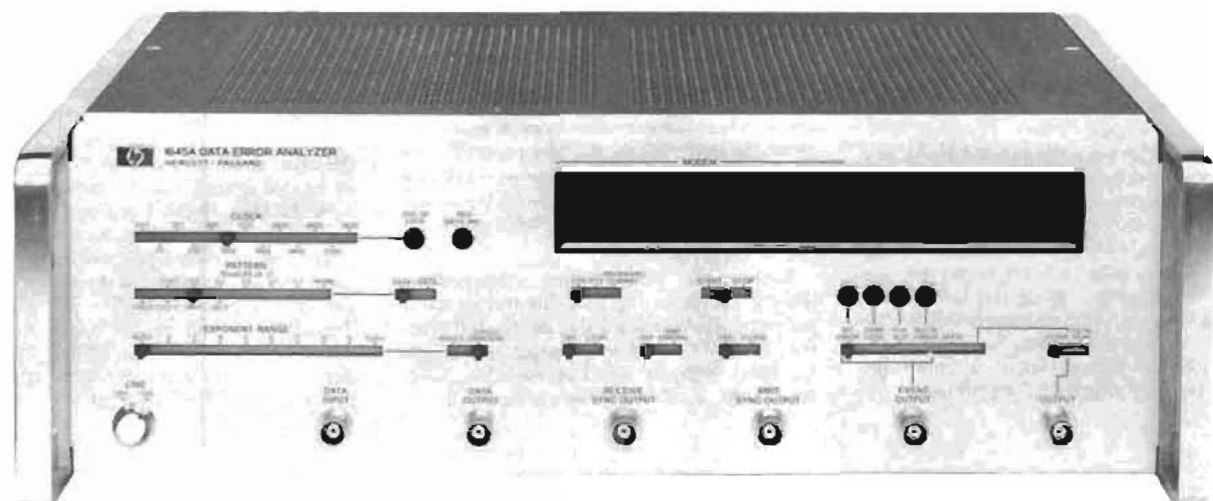

1645A



Direct reading, autoranged indications are displayed on an LED readout. Handshake signals conforming to CCITT convention are included for operation through any modem system.

1645A Description

Hewlett-Packard's Model 1645A Data Error Analyzer quickly isolates data communications link problems through six simultaneous measurements. During tests, the 1645A can be left totally unattended because it automatically maintains synchronization even in the presence of dropouts. And for added convenience, the 1645A can be equipped with a printer for hard-copy, permanent recordings of long tests.

Bit-error and block-error rate tests are autoranged and displayed directly on an LED readout, there is no need to perform any calculation. Additionally, the 1645A measures jitter or total peak distortion (the sum effect of jitter and bias), counts the number of times carrier loss or dropouts occur, measures data-error skew and counts the number of clock slips resulting from phase hits on the link or modem sync problems.

With all these measurements made during the same test interval, you'll know precisely what is causing your problems in modems, data channels, complete communications systems.

10235A Interface cover

The 10235A Interface Cover is designed for troubleshooting problems on the RS-232C interface bus. The most common problems such as wrong voltages and excessive turnaround times, which most commonly occur during installation, are easily pinpointed with the measurement capability of the interface cover.

Measurements include time interval, voltage measurements, audio monitoring, data set control signal monitoring, and the ability to send control signals to the data sets. This measurement capability can be easily patched through the 25 x 25 pin matrix to every pin of the RS-232C interface for complete testing.

The programmable matrix has the 25 pins of the RS-232C interface (modem and business machine) connected to the columns along with most of the RS-232C conductors from the 1645A to the modem. Several important signals, send data, receive data, transmit clock and receive clock, are separated and applied to the matrix rows for manual manipulation by the technician.

The most important row outputs are TP1 and TP2 which are connected to the time interval circuits for measuring the interval between signals occurring on two different leads in the matrix. The interval timer measures the time while a visual indication of which lead changed state first is supplied by LED's connected to TP1 and TP2. This permits accurate timing measurements of important signals such as turnaround time between Request to Send and Clear to Send responses. Test points 1 and 2 may also be monitored with the built-in loudspeaker. For maximum flexibility the voltmeter can be connected through jumper leads to TP1, TP2, or TP3 of the matrix to any of the 25 input leads. The external inputs also allow external voltage measurements such as telephone line signal levels.

Control information can also be exchanged between the 10235A and the data set by using any of the eight data set control switches. In addition control signals from the data set can be monitored through the matrix on the eight control signal indicators.

Interfaces

For versatility in design and troubleshooting, both CCITT V.24 (RS-232C) levels and TTL levels are available in the 1645A. TTL levels are through front panel BNC connectors. Interfacing with standard RS-232C systems is through a rear panel 25 pin connector. The system interface, including connector, is contained on one circuit card which is easily replaced for other interfaces. The Model 10388A interface card and cable is for modems conforming to CCITT V.35 (W.E. Type 306) high speed modems. The Model 10387A interface is for type 303 wideband modems. Interfacing with modems conforming to MFL-188C standards is available on special order. A breakout box, Model 10389A for RS-232C systems, is available as a convenient method of opening interconnecting lines. Test points on each side of the switches permit monitoring of signal levels, or with jumper leads offer a convenient method of matching different system installations.

1645S Data transmission test set

For communications companies that need to test both low and high speed systems the 1645S offers a complete data transmission test set. The test set includes a 1645A Data Error Analyzer with RS-232C interface; 10235A Interface Cover; CCITT V.35 and Type 303 interfaces with matching cables; Model 10389A RS-232C breakout box with cable; and two accessory pouches. The 1645A in this system incorporates a wider phase lock loop capture range which allows receiver lock-on to PRBS signals of other units that do not have crystal controlled transmitters for end-to-end testing. The 1645S includes two diode and two resistor pins for the 10235A matrix. This complete test system offers eight basic data communication measurements plus audio which is capable of detecting malfunctions ranging from crossed wires to intersymbol interference in a wide range of data communications systems.

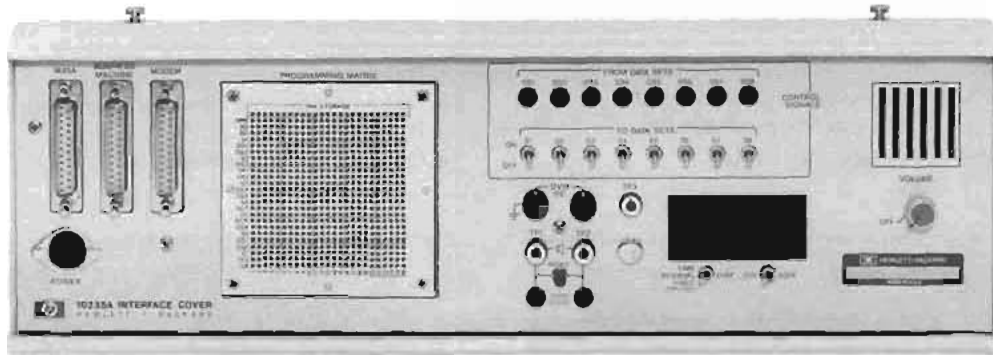

10235A

1645A Specifications

Bit rate

Internal

Transmitter bits per second: selectable 75, 150, 200, 300, 600, 1200, 1800, 2400, 3600, 4800, 7200, 9600.

Crystal frequency: 5.75 MHz $\pm 0.03\%$, $< 0.01\%$ jitter.

Receiver with bit synchronizer: same as internal transmitter.

External: transmitter and receiver, to 5 MHz.

Data outputs/inputs

Front panel

Input: data input requires TTL levels; max input 5.5 V.

Outputs: receiver sync, transmitter sync, and event at TTL levels; data output is > 2 V into 50 ohms; jitter/total peak is 1 V p-p for each 10% of p-p distortion from waveform causing distortion.

Rear panel

Inputs: backward channel data, external transmitter and receiver clocks require TTL levels; max input 5.5 V.

Outputs: bits lost at TTL levels; internal transmitter clock is > 2 V into 50 ohms.

Multiple connectors: 25 pin female connector for interfacing with standard RS-232C communications systems. 36 pin female printer output at TTL levels in BCD 8421 code.

General

Power: 115 or 230 V ac, 48 to 440 Hz, 150 VA max.

Operating environment: temperature, 0 to $+55^{\circ}\text{C}$ ($+32^{\circ}\text{F}$ to $+130^{\circ}\text{F}$); humidity, to 95% relative humidity at $+40^{\circ}\text{C}$ ($+104^{\circ}\text{F}$); altitude, to 4600m (15 000 ft); vibration, vibrated in three planes for 15 min, each with 0.254 mm (0.010 in.) excursion, 10 to 55 Hz.

Dimensions: 133 mm high (5 1/4 in.), 425 mm wide (16 1/2 in.), 286 mm deep (11 1/4 in.).

Weight: net, 8.2 kg (18 lb). Shipping, 10.9 kg (24 lb).

Accessories supplied: one 3m (10 ft) RS-232C interconnecting cable to connect the 1645A to the modem, connects to 10235A when used in the 1645S configuration (HP P/N 01645-61605), one 2.3m (7.5 ft) 3 wire power cord (HP P/N 8120-1378); one Operating and Service Manual.

1645A Indicators and controls

Indicators

Out of lock; received data inverted; bit error; carrier loss; clock slip; block error; data set ready (DSR); clear to send (CTS); loss of data; test on.

Selector switches

Clock; pattern; data/data; exponent range; single/cycle (printer); DTR/RTS/backward channel; start/stop; off/loop; off/transmit errors; off/filter; event, bit error, carrier loss, clock slip, block error, skew, jitter/total peak.

10235A Specifications

Time interval

Range: 999 ms full scale.

Resolution: 1 ms.

Accuracy: $\pm 2\%$ of measured interval ± 1 count.

Start-Stop: TP1 and TP2 input, LED indicates event start at TP1 or TP2.

Trigger slope: positive edge.

Trigger amplitude: ± 3 V.

Input resistance: approx. 4 k Ω .

DC digital voltmeter

Ranges: 19.99 V, 199.9 V full scale.

Accuracy: $\pm 1\%$ of reading, ± 1 count.

Digital units: 3 1/2 digits.

Input resistance: 1 M Ω .

Overload protection: to 1000 V.

General

Interface connectors: three 25 pin female connectors for connecting the 10235A to the 1645A, modem, and business machine. Interface conforms to RS-232C standard.

Power requirements: +15 V to +25 V and -15 V to -25 V supplied by the 1645A.

Dimensions: 399 mm (15.7 in.) wide, 132 mm (5.2 in.) high, and 48 mm (1.9 in.) deep.

Weight: net, 1.8 kg (4 lb). Shipping, 3.2 kg (7 lb).

Accessories supplied: one 46 cm (18 in.) RS-232C interconnecting cable connects 10235A to 1645A (HP P/N 10235-61606); one 46 cm (18 in.) power cable connects to 1645A (HP P/N 10235-61602); one accessory pouch, attaches to side of 1645A (HP P/N 1540-0385); one Operating Note.

Indicator and control functions

Indicators: eight light emitting diodes (LED) provide logic HI or LO indications for corresponding patch pins in the programming matrix, +3 V lights LED.

Audio: built-in loudspeaker and volume control.

Control switches: eight switches supply control signals through the program matrix to business machine/modem connectors. On is +5 V, OFF is -5 V.

Interfaces

Model 10388A for CCITT V35 (with cable)

Model 10387A for Type 303 modems (with cable)

Model 10389A Breakout Box (RS-232C) (with cable)

MIL-STD-188C and other interfaces available on special order. Contact HP Field Engineer.

Accessories

Printer interconnecting cable: Model 10233A cable connects the 1645A to HP Model 5055A or 5150A printers; 36 pin male connector on one end and 50 pin male connector on the other.

Front panel cover: protects 1645A front panel during transit and provides convenient carrying handle (HP P/N 5060-8767). This cover is not needed when a 10235A Interface Cover is ordered with a 1645A, or with a 1645S Data Transmission Test Set.

Model number and name

1645A Data Error Analyzer

1645A Option 908; includes rack mounting kit

10235A Interface Cover

1645S Data Communications Test Set*

*Includes 10388A, 10387A, 10389A, and interconnecting cables.

Price

\$290

\$390

\$165

\$50

\$80

\$2300

add \$10

\$1000

\$4100

TELECOMMUNICATIONS TEST EQUIPMENT

Amplitude/delay distortion analyzer; Telephone line analyzer

3770A, 3770B

3770A & 3770B

- Delay and Attenuation Distortion measurements
- Compatible with CCITT Recommendation 0.81
- Rugged, portable, and really easy to use



3770A

Description

The HP 3770A and 3770B are designed for audio data line characterization to CCITT standards. The 3770A measures the basic parameters affecting data lines. The 3770B makes, in one combined unit, all of the routine maintenance measurements listed in CCITT Recommendation M.1060 for high speed data lines. This includes the measurements performed by the 3770A.

The 3770A measures group delay, attenuation distortion, and absolute level in the frequency range 200 Hz to 20 kHz. It has automatic ranging, zeroing, and synchronization, with simultaneous LED read-out of measurement result and frequency. The sender and receiver are combined in a single, rugged, portable unit.

The 3770B, in addition, measures weighted noise, noise-with-tone, and impulse noise. Further, an optional slave facility for group delay and attenuation distortion measurements allows the measurement results for both directions of transmission on a 4-wire circuit to be displayed at one end of the circuit. Also, the measurements in both directions can be controlled from one end of the circuit, leaving the slave unit unattended.

The 3770A and 3770B both have X-Y recorder outputs to enable a permanent swept record of the measurement to be made. A suitable portable X-Y recorder can be supplied as an option. Pre-printed graph paper showing CCITT limits for group delay and attenuation distortion measurements can also be supplied.

Both instruments also have a built-in telephone facility to allow voice communication in a 2- or 4-wire mode over the line or lines under test. An integral loudspeaker allows the operator to monitor either the receiver input or sender output.

Measurement principles

For group delay and attenuation distortion measurements, the operation of the 3770A and 3770B is compatible with CCITT Recommendation 0.81. With this method, the sender generates a carrier signal which switches between the reference and measuring frequencies at a rate of 4.166 Hz. The composite signal is amplitude modulated by a 41.66 Hz sine wave and transmitted through the channel to be analyzed. The relative group delay of the channel at the two frequencies is measured by comparing the delay of the envelope recovered during the measuring period with that recovered during the reference period. The relative attenuation measurement is made by comparing the amplitude of the two envelopes.

The receiver can measure the absolute level of either the measuring or reference carrier within the range -50 to $+10$ dBm. As the sender

3770B only

- Makes all the maintenance measurements listed in CCITT Recommendation M.1060
- Optional slaving facilities

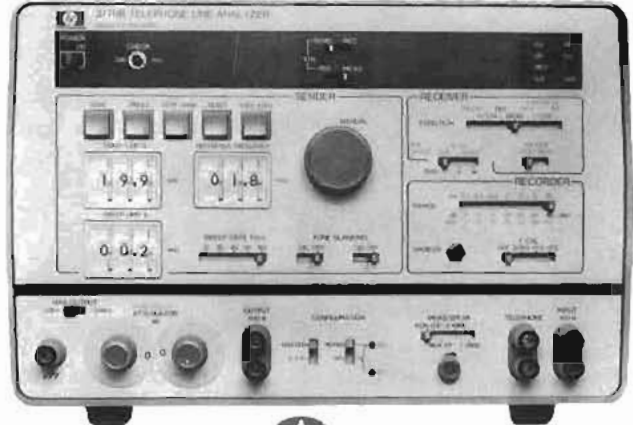

3770B

output is calibrated in dBm, this measurement allows the absolute loss of the transmission path to be calculated. In addition to normal operation, absolute level measurements can be made using a pure tone.

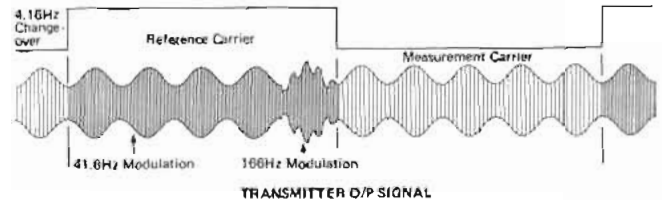

Background noise can be measured in two ways with the 3770B: weighted noise measurements, and weighted noise-with-tone measurements. Weighted noise measurements are made in accordance with CCITT Recommendation P.53A. The input is applied to a psychometric (or telephone) weighting filter and then the power is measured using a true rms detector. The filter simulates the combined characteristics of a telephone handset and the human ear, and is used to make the noise reading correspond to the subjective effect of the noise on the human ear. Also available with the 3770B is a 3 kHz flat filter which gives the noise power in the channel without psychometric weighting. In the weighted noise-with-tone mode, the 3770B measures the background noise while a 1004 Hz tone is applied to the channel. This is particularly important with, for example, PCM channels where the noise measurement would be inaccurate unless the channel is loaded. At the receiver, the 1004 Hz tone is filtered out before the noise power is measured.

The impulse noise measurement is compatible with CCITT Recommendation V.55. Impulse noise can be caused by switching, lightning, etc., and is characterized by large spikes exceeding the normal background noise level. It is measured by counting the number of spikes which exceed a given threshold level. In the 3770B, the threshold level is adjustable in 1 dB steps over the range 0 to -49 dB, where 0 dB corresponds to 1.1 V (the peak voltage of a 0 dBm sine wave into 600 Ω is 1.1 V). Pulses exceeding the threshold and of greater than 50 μ s duration are counted; pulses of less than 20 μ s duration are not. Also, there is a dead time of approximately 125 ns during which further impulses are not counted.

The specifications which follow apply to both the 3770A and 3770B, unless otherwise stated.

Specifications

Sender

Reference carrier: 0.4 to 19.9 kHz in 100 Hz steps.
Measuring carrier: 0.20 to 20.00 kHz in 10 Hz steps.
Modulation envelope frequency: 41.66 Hz (Mod. Index 0.4 ± 0.05).
Identification-burst frequency: 166 Hz* (Mod. Index 0.2 ± 0.05).
Carrier changeover frequency: 4.166 Hz.*
Accuracy of above frequencies: ±0.1%.

* Locked to envelope frequency.

Measuring frequency sweep rates: 10, 20, 40, 80, 160 Hz/s, nominal.
Measuring frequency sweep limits: settable in range 0.2 to 19.9 kHz (100 Hz steps). Accuracy as for measurement frequency.
Carrier level: 0 to -49 dBm in 1 dB steps.
Carrier harmonic distortion: < 1% (40 dB) total.

Receiver

Operating level range: < -50 dBm to > +10 dBm.
Frequency measurement accuracy: 0.1% (with sender other than 3770A/B, 0.1% ± 5 Hz).

Recorder

X-axis output: 0 to +5 V for 0 to 20 kHz or 0 to 5 kHz.
Y-axis output: ±5 V for ±FS of the recorder range selected; available for group delay, attenuation distortion, noise, and noise-with-tone measurements.

Output/input circuits

Impedance: 600Ω balanced.
Return loss: >40 dB.
Degree of balance: >50 dB. (Receiver 200 Hz to 6 kHz: >60 dB).
Maximum operating common mode voltage (having regard to balance): 10 V ac rms, 100 V dc.
Maximum safe common mode voltage: 150 V ac rms, 50 Hz to 20 kHz, or 100 V dc.

Combined sender and receiver

Frequency range: 0.2 to 20 kHz.

Group delay distortion

Delay range: 0 to ±10 μs.
Inherent group delay error of sender (rms): 0.2 to 0.4 kHz, < 5 μs; 0.4 to 0.6 kHz, < 2 μs; 0.6 to 20 kHz, < 1 μs.

Receiver measuring accuracy (rms): (5 to 40°C) 0.2 to 0.4 kHz, < 15 μs ± 1% of reading; 0.4 to 0.6 kHz, < 8 μs ± 1% of reading; 0.6 to 20 kHz, < 5 μs ± 1% of reading. For 0 to 50°C, ±1% of reading becomes ±2%. For additional group delay specifications, see Data Sheet.

Attenuation distortion

Receive Level Range within which both Measurement and Reference carrier levels are contained	Receiver Maximum Error of Attenuation in the range 0 to +40 dB		Sender Max. Error
	5 to 40°C	0 to 50°C	
+ 5 to -5 dBm	0.15 dB ± 1%	0.15 dB ± 1%	0.1 dB
+ 5 to -20 dBm	0.15 dB ± 1%	0.15 dB ± 1.5%	0.1 dB
+10 to -30 dBm	0.2 dB ± 1%	0.2 dB ± 2%	0.1 dB
+10 to -40 dBm	0.2 dB ± 1.5%	0.3 dB ± 2.5%	0.1 dB
+10 to -50 dBm	0.6 dB ± 2.5%	0.7 dB ± 3%	0.1 dB

Level measurement: (without changeover and unmodulated)

Receive range: +10 dBm to -50 dBm

Accuracy:

	5 to 40°C		0 to 50°C	
	Sender	Receiver	Sender	Receiver
+10 to -20 dBm	±0.2 dB	±0.2 dB	±0.3 dB	±0.3 dB
-20 to -30 dBm	±0.2 dB	±0.4 dB	±0.3 dB	±0.5 dB
-30 to -40 dBm	±0.3 dB	±0.7 dB	±0.4 dB	±0.8 dB
-40 to -50 dBm	±0.5 dB	±1.2 dB	±0.5 dB	±1.6 dB

Level measurements can also be made with modulation and changeover.

Weighted noise (3770B only)

Measurement range: 0 to -85 dBm.
Detector type: true rms.
Weighting filters: CCITT telephone, and 3 kHz flat.
Method: compatible with CCITT Recommendation P.53A.

Noise-with-tone (3770B only): as for weighted noise, except.

Measurement range: 0 to -80 dBm.

Tone frequency: 1004 Hz.

Impulse noise (3770B only)

Threshold: single level, adjustable in 1 dB steps from 0 to -49 dB (0 dB is equivalent to 1.1 V).

Dead time: 125 ± 25 ms.

Method: compatible with CCITT Recommendation V.55.

Slave facility (optional - 3770B only)

Modes: remote control, and remote retransmission. Slaving applies to group delay and attenuation distortion measurements only.

Remote control: the master unit controls the measurement and reference frequencies of the slave unit.

Remote retransmission: the slave returns the group delay and attenuation distortion information to the master for display and recording.

General

Dimensions: 200 mm H × 330 mm W × 560 mm D (7.9" × 13" × 22").

Weight: 3770A: 12 kg (26.5 lb); 3770B: 4 kg (30.9 lb).

Temperature ranges: operating: 0 to 50°C unless otherwise specified; storage: -40 to 75°C.

Supply voltages: 115 V ac +10 -22% or 230 V ac +10 -18%; 48 to 66 Hz.

Power consumption: 3770A: 75 VA; 3770B: 100 VA.

3770A Options

Option 001: send level range extended to -49 to +10 dBm.

Option 002: loop holding provided for sender output and receiver input.

Maximum dc loop holding current: 100 mA.

Voltage drop at maximum current: approximately 12 V.

Dynamic output impedance: approximately 50 kΩ.

Option 005: tone blanking.

Range: two bands in the range 0.2 to 9.9 kHz.

Range limits: any multiple of 100 Hz.

Frequency range blanked (kHz): Opt. number specifies range.

kHz	Opt	kHz	Opt	kHz	Opt
0.4 to 0.6	117	2.0 to 2.4	104	2.8 to 3.2	110
0.5 to 0.7	101	2.1 to 2.5	105	3.0 to 3.4	111
0.6 to 0.9	102	2.2 to 2.6	106	3.2 to 3.6	112
0.8 to 1.2	115	2.3 to 2.7	107	3.4 to 3.8	113
1.4 to 1.8	116	2.4 to 2.8	108	3.6 to 4.0	114
1.9 to 2.2	103	2.6 to 3.0	109		

Other ranges available on request. Quote Option 100 instead of the above numbers, and specify the required frequency ranges.

In-lid operating instructions: English — std; German — Option 031;

French — Option 032; Italian — Option 033; Spanish — Option 034.

Option 040: suitable portable X-Y Recorder in carrying case. Pre-printed graph paper showing CCITT limits also available — Amplitude Distortion (9280-0403), Delay Distortion (9280-0402).

Option 061: rack mount version.

Option 910: additional set of manuals.

3770B Options

When ordering a 3770B, select ONE option from the table below (i.e. select the standard instrument OR one option) This completely specifies the measurements selected. Note that group delay, attenuation distortion and absolute level measurement facilities are provided with ALL instruments.

Measurement facilities	Option										
	STD	001	002	003	004	005	006	007	008	009	010/011
Noise	•		•	•	•	•				•	•
Slaving		•	•				•	•	•	•	•
+10 dBm output				•		•	•		•	•	•
Tone blanking					•	•		•	•		•

Option 012: loop holding — see 3770A Options for specifications.

Tone Blanking: ranges and range limits as for 3770A. Other options (In-lid instructions, X-Y recorder, rack mount version, and additional manuals) as for 3770A.

Model number and name

3770A Amplitude/Delay Distortion Analyzer

3770B Telephone Line Analyzer

Price

\$6500

\$7445

TELECOMMUNICATIONS TEST EQUIPMENT

15 Hz to 50 kHz selective voltmeter

Model 3581C

- Voice grade testing
- Single frequency interference
- Spectrum analysis



Description

The 3581C Selective Voltmeter is useful in doing spectrum analysis and in measuring single frequency interference. A minimum bandwidth of 3 Hz (1 Hz on special basis) allows resolution of very closely spaced tones.

Specifications

Frequency range: 15 Hz to 50 kHz

Display: 5 digit LED readout. Resolution: 1 Hz. Accuracy: ± 3 Hz.

Typical stability: ± 10 Hz/hr after 1 hour. ± 5 Hz/ $^{\circ}$ C.

Automatic frequency control (AFC), hold-in range: ± 800 Hz.

Pull-in range: $> 5 \times$ bandwidth for 3 Hz to 100 Hz bandwidth: > 800 Hz for 300 Hz bandwidth for full-scale signal.

Lock frequency: center of passband ± 1 Hz.

Amplitude

Instrument range

Linear: 30 V to 100 nV full scale.

Log: +30 dBm or dBV to -150 dBm or dBV.

Amplitude accuracy*

15 Hz - 50 kHz, frequency response

Switching between bandwidths

Amplitude display

Input attenuator

Amplitude reference level

(IF Attenuator)

Most sensitive range

All other ranges

Log Linear

± 0.4 dB $\pm 4\%$

± 0.5 dB $\pm 5\%$

± 2 dB $\pm 2\%$

± 0.3 dB $\pm 3\%$

± 1 dB $\pm 10\%$

± 1 dB $\pm 3\%$

*Note: these specifications cover the full temperature, frequency and amplitude range, and represent worst case. Accuracy is significantly better for measurements not at the extremes.

Dynamic range: > 80 dB.

Noise level:

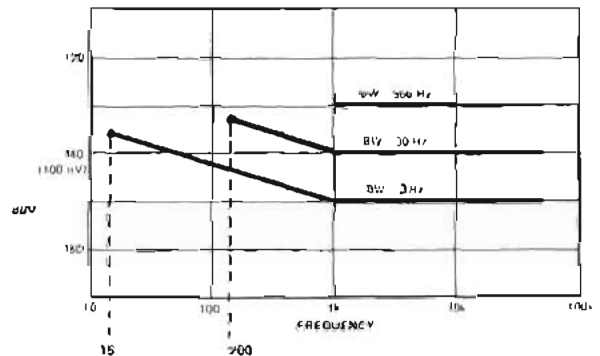

Noise sidebands: greater than 70 dB below CW signal, 10 bandwidths away from signal.

IF feedthrough: input level > 10 V: -60 dB; input level < 10 V: -70 dB.

Spurious responses: > 80 dB below input reference level.

Line related spurious: > 80 dB below input reference level or -140 dBV (0.1 μ V) or -90 dBm on 3581C in balanced terminated mode.

Zero beat response: > 30 dB below full scale at 25° C $\pm 5^{\circ}$ C. > 15 dB for 0° C to 55° C.

Smoothing: 3 position, rolloff is a function of BW.

Overload indicator: this LED warns of possible input amplifier overloading.

Uncal indicator: the variable input attenuator may be set to positions between steps. This is useful for scaling signals. When this feature is being used, the Uncal indicator clearly shows the instrument is not on a standard setting.

Meter scales: test band with mirror backing

0 dB to -90 dB Log
 0 dB to -10 dB
 0 to 1 Linear
 0 to 3.2

Calibrator: the 10 kHz fundamental of the calibrator may be used along with the 10 kHz cal adjustment to set the meter to full scale. This calibrates the circuitry that follows the input attenuator to an accuracy of $\pm 1.5\%$ at full scale, 10 kHz and same bandwidth.

Sweep

Scan width: 50 Hz to 50 kHz. These scans can be adjusted to cover a group of frequencies within the overall instrument range.

Sweep times: 0.1 sec to 2000 sec.

REP: in the repetitive mode, sweep will continuously sweep the specified band.

Single scan: after triggering a single sweep, HP's 3581C will remain at upper end of sweep. A sweep may also be triggered externally through a BNC connector on the rear panel labeled "external trigger." Grounding inhibits internal trigger.

Reset: HP's 3581C is set to the start frequency of sweep.

Manual: in combination with concentric knob, manual sweep fully duplicates span of electronic sweep.

Off: sweep circuits and associated controls are turned off.

Sweep error light: this LED indicates a sweep that is too fast to capture full response. When the light is on, response will be lower than it should.

Zero scan: to look at the time varying signal at center or start frequency within bandwidth selected.

External trigger: a short to ground stops normal sweep. Opening the short then enables a sweep.

Input

Meter Scale Buttons	Terminated	Bridging	Unbalanced
Volts 900 Ω dBm/LIN	Input impedance 900 Ω . Reads volts on volt scales of meter. 1 V rms input gives 1 V rms on meter.	Input impedance 10 k Ω . Reads volts on volt scales of meter. 1 V rms input gives 1 V rms on meter.	Input impedance 1 M Ω . Reads volts on volt scales of meter. 1 V rms input gives 1 V rms on meter.
dB 900 Ω dBm/LIN	Input impedance 900 Ω . Reads dBm 900 Ω on dB scales of meter. 0.949 V rms input gives 0 dB reading on meter.	Input impedance 10 k Ω . 900 Ω termination necessary to be calibrated with a source that has 900 Ω output impedance. 0.949 V rms input gives 0 dB reading on meter.	Input impedance 1 M Ω . 900 Ω termination necessary to be calibrated with a source that has 900 Ω output impedance. 0.949 V rms input gives 0 dB reading on meter.
Volts 600 Ω /dBm		Not a valid combination.	
dB 600 Ω /dBm	Input impedance 600 Ω . Reads dBm 600 Ω on dB scales of meter. 0.775 V rms input gives 0 dB reading on meter.	Input impedance 10 k Ω . Termination necessary to be calibrated with a source that has 600 Ω output impedance. 0.775 V rms input gives 0 dB reading on meter.	Input impedance 1 M Ω . Termination necessary to be calibrated with a source that has 600 Ω output impedance. 0.775 V rms input gives 0 dB reading on meter.

Unbalanced (UNBAL)

Impedance: 1 M Ω 40 pF

Max. Input level:

+30 dBm to -10 dBm sensitivity: 100 V rms or ± 100 V dc

-20 dBm to -70 dBm sensitivity: 50 V rms or ± 100 V dc

Balanced/bridged (BRDG)

Impedance: 10 k Ω

Max. Input level: 35 V rms or ± 100 V dc.

Frequency response: 40 Hz - 20 kHz, ± 0.5 dBm for signals <20 dBm.

Dynamic range: 80 dB for signals <0 dBm and >100 Hz

Common mode rejection: >70 dB at 60 Hz.

Balanced/terminated (TERM)

Impedance: 600 Ω /900 Ω balanced

Max. Input level: +27 dBm -0 V dc.

Frequency response: same as balanced/bridging

Dynamic range: same as balanced/bridging

Common mode rejection: >64 dB at 60 Hz.

Input connector: accepts WECO 310 plug - input is transformer coupled.

Output

Tracking generator output (also known as BFO or tracking oscillator output).

Restored output

Range: 0 to 2 V rms.

Frequency response: $\pm 3\%$ 15 Hz to 50 kHz.

Frequency accuracy: ± 1 Hz relative to center of filter.

Impedance: 600 Ω .

Total harmonic and spurious content: (for tracking generator output) >40 dB below 1 V rms signal level.

LO Output: 100 mV signal from 1 MHz to 1.5 MHz as input is tuned from 0 to 50 kHz.

Output connector: WECO 310, for connection to tracking generator output or restored output. In addition to monitoring restored output with headphones, an internal speaker also provides an audio indication of signal content.

Restored and tracking generator

Output impedance: 600 Ω balanced.

Frequency response: ± 0.5 dB 100 Hz to 20 kHz.

X-Y recorder analog outputs

Vertical: 0 to +5 V $\pm 2.5\%$.

Horizontal: 0 to +5 V $\pm 2.5\%$.

Impedance: 1 k Ω .

Pen lift: contact closure to ground during sweep.

General

Operating temperature range: 0 to 55°C.

Humidity: 95% relative, maximum at 40°C.

Power requirements: 100 V, 120 V, 220 V or 240 V +5% -10%, 10 VA typical, 48 Hz to 66 Hz.

Dimensions: 412.6 mm high \times 203.2 mm wide \times 285.8 mm deep (16 1/4" \times 8" \times 11 1/4").

Weight: 11.5 kg (23 lb); Option 001, 13.5 kg (30 lb).

Accessory available: 7035B Option 20, X-Y recorder.

Option 001 battery: used to make floating measurements or to break ground loops; 12 hours from full charge; 12 hours to fully charge. The internal battery is protected from deep discharge by an automatic turn-off.

Model number and name

7035B Option 20 X-Y Recorder

Option 001 Battery

3581C Selective Voltmeter

Price

add \$1590

add \$385

\$3250

TELECOMMUNICATIONS TEST EQUIPMENT

Transmission test sets

Models 3551A & 3552A

- Voice grade testing



3551A

(North American)



3552A

(CCITT)

Description

Hewlett-Packard's 3551A (North American Measurement Standard) and 3552A (CCITT) Transmission Test Sets are rugged, portable and ideally suited for measurements on voice, program and data circuits up to 50 Kb/s.

These four-function test sets are capable of measuring tone level, noise level, and frequency, while simultaneously sending tone. Both level and frequency are fully autoringing.

A normal sampling rate of 10/second in tone level and frequency allows a "direct feel" between an adjustment and the ensuing reading. In addition, a damped sample rate of 2/second is useful when reading noisy signals. The digital LED (Light Emitting Diode) readout displays either the level or frequency of the input or output regardless of terminal function selected.

Appropriate resolution, time constant and sample rate are automatically provided to simplify operation for the user.

These test sets can measure both two-wire and four-wire balanced circuits. Impedances of 135, 600, and 900 ohms can be selected on the 3551A; impedances of 150, 600, and 900 ohms are available on the 3552A. In addition, the receiver may be either terminated or bridged.

The test sets may be powered by either ac line or internal rechargeable batteries and are suited for both inside and outside plant maintenance.

A full wave average detector is used for tone level measurements. Automatic ranging eliminates the need to set attenuators and thus re-

duces the possibility of errors due to faulty calculations. Direct digital readout gives a 0.1 dB resolution over the entire 85 dB dynamic range.

For frequency measurements, a four-digit autoranging frequency counter is provided. The readout is calibrated in kHz and features 1 Hz resolution from 40 Hz to 10 kHz and 10 Hz resolution from 10 kHz to 60 kHz. The decimal point is automatically positioned to avoid the possibility of errors due to overflow of the four digits.

Noise measurements are made with a QUASI RMS detector and displayed in dBm on the 3551A and dBm on the 3552A, with 1.0 dB resolution. Display rate is slowed to 2 per second to provide analog feel of slowly changing noise levels. Both test sets have the capability of measuring noise-with-tone, message circuit noise, and noise-to-ground. Four switch selectable weighting networks are provided, C-message, Program, 3 kHz, and 15 kHz Flat in the 3551A; and Telephone (CCITT Psophometric), Programme (J16), 3 kHz and 15 kHz Flat in the 3552A. In the noise-with-tone position, a notch is inserted before the selected weighting network.

Send oscillator covers a frequency range of 40 Hz to 60 kHz in three bands; 40 Hz to 1 kHz, 200 Hz to 6 kHz, and 2 kHz to 60 kHz. The output level is continuously variable from +10 dBm to -60 dBm.

In addition, a fixed position is provided to be used as the holding tone when making a noise-with-tone measurement.

A convenient set of clip-on dial terminals for connecting a line-man's handset is provided. This allows a line connection to be dialed up and then held in an off-hook (busy) condition while making either receive or send measurements on a two-wire wet line.

Specifications, Model 3551A & 3552A

Receiver

Level measurements

Frequency range: 40 Hz to 60 kHz.

Dynamic range: +15 dBm to -70 dBm.

Resolution: 0.1 dB.

Sample rate: 10/second normal, 2/second damped.

Detector type: average responding.

Accuracy: at 25°C ±10°C, temperature coefficient: ±0.005 dB/°C beyond this range.

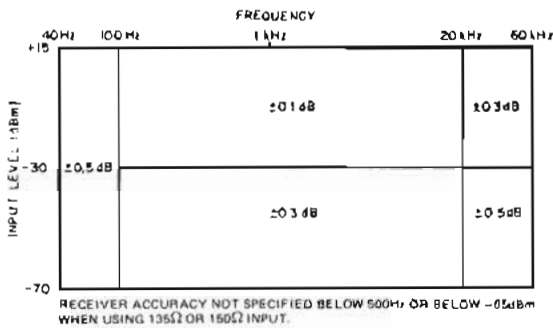

Frequency measurements

Frequency range: 40 Hz to 60 kHz.

Dynamic range: +15 dBm to -70 dBm.

Resolution: 1 Hz (40 Hz to 10 kHz), 10 Hz (10 kHz to 60 kHz).

Sample rate: 10/second normal, 2/second damped.

Accuracy: ±1 count.

Transmitter 3551A & 3552A

Frequency range: 40 Hz to 60 kHz.

Ranges: 40 Hz to 1 kHz, 200 Hz to 6 kHz, 2 kHz to 60 kHz, 800 Hz fixed. (Other frequencies available 3552A.) 1004 Hz fixed, 3551A.

Resolution: 1 Hz (40 Hz to 10 kHz), 10 Hz (10 kHz to 60 kHz).

Sample rate: 10/second.

Harmonic distortion: <-50 dB (THD 100 Hz to 4 kHz); <-40 dB (THD 40 Hz to 100 Hz and 4 kHz to 20 kHz); <-30 dB (THD 20 kHz to 60 kHz); <-55 dB (all harmonics 100 Hz to 4 kHz); <-60 dB (THD 1004 Hz fixed).

Accuracy: ±1 count.

Level range: +10 dBm to -60 dBm (40 Hz to 60 kHz), +6 dBm to -60 dBm, (1004 Hz fixed — 3551A; 800 Hz fixed — 3552A).

Resolution: 0.1 dB.

Sample rate: 10/second.

Accuracy: at 25°C ±10°C, temperature coefficient: ±0.005 dB/°C beyond this range.

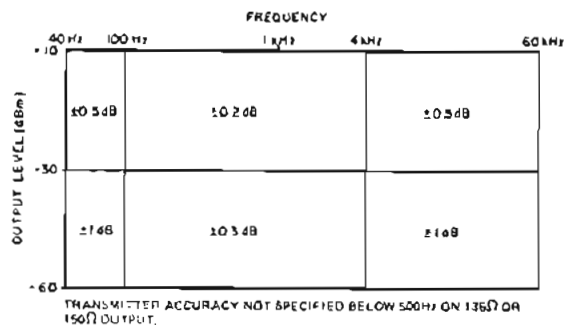

3551A Noise measurements

Dynamic range

Message circuit noise: 0 dBm to +85 dBm.

Noise-with-tone: 10 dBm to +85 dBm.

Noise-to-ground: 40 dBm to +125 dBm.

Resolution: 1 dB

Sample rate: 2/second.

Detector type: Quasi-RMS responding.

Accuracy

Message circuit noise: ±1 dB (+20 dBm to +85 dBm), ±2 dB (0 dBm to +20 dBm).

Noise-with-tone: ±1 dB (+20 dBm to +85 dBm), ±2 dB (+10 dBm to +20 dBm).

Noise-to-ground: ±1 dB (+60 dBm to +125 dBm), ±2 dB (+40 dBm to +60 dBm).

Weighting filters: C-message, 3 kHz flat, 15 kHz flat, program.

3552A Noise measurements

Dynamic range

Message circuit noise: -90 dBm to -5 dBm.

Noise-with-tone: -80 dBm to -5 dBm.

Noise-to-ground: -50 dBm to +35 dBm.

Resolution: 1 dB.

Sample rate: 2/second.

Detector type: Quasi-RMS responding.

Accuracy

Message circuit noise: ±1 dB (-70 dBm to -5 dBm), ±2 dB (-90 dBm to -70 dBm).

Noise-with-tone: ±1 dB (-70 dBm to -5 dBm), ±2 dB (-80 dBm to -70 dBm).

Noise-to-ground: ±1 dB (-30 dBm to +35 dBm), ±2 dB (-50 dBm to -30 dBm).

Weighting filters: Telephone (CCITT Psophometric), 3 kHz flat, 15 kHz flat, Programme (CCITT-J16).

General

Monitor: built-in speaker, monitors received or transmitted signal.

Balanced impedances: 135Ω, 600Ω, 900Ω (3551A).

Balanced impedances: 150Ω, 600Ω, 900Ω (3552A).

Bridging loss: <0.2 dB.

Return loss: >30 dB.

Longitudinal balance: >60 dB at 6 kHz, >126 dB at 50 Hz.

Hold circuit: 20 milliamps constant current, <0.2 dB holding loss, resistive fuse protection.

Input/output protection: blocks 300 V dc.

Maximum longitudinal voltage: 200 V rms.

Battery supply: >4 hours continuous operation on internal rechargeable batteries at 25°C. Battery drain is automatically turned off when discharged below proper operating level. Complete recharge in 12 hours.

Power requirements: 100 V, 120 V, 220 V, 240 V ±10%; 48 Hz to 66 Hz; 4 VA.

Temperature range: 0°C to 55°C, operating: -20°C to +66°C, storage.

Relative humidity: 0 to 95% (<40°C).

Dimensions: 343 mm wide × 133 mm high × 254 mm deep (13 1/2" × 5 1/4" × 10").

Weight: net, 6.6 kg (13 lb). Shipping, 7.3 kg (16 lb).

Options

C01-3351A, C01-3552A - 19 inch rack mount, ac power only (no batteries)

H10-3351A - Extends frequency range to 85 kHz

Price

add \$75
add \$215

Model number and name

3551A Transmission test set

3552A Transmission test set (CCITT)

\$2000
\$2080

TELECOMMUNICATIONS TEST EQUIPMENT

Transmission & noise measuring set

Models 3555B & 3556A

- Voice grade testing



Description

HP's 3555B Transmission and Noise Measuring Set is designed especially for telephone plant maintenance. It measures attenuation, distortion, cross-talk coupling, and noise. Weighting networks comply with Bell System Technical Reference Publication number 41009, and include C-message, 3 kHz, 15 kHz flat and program.

HP's 3556A performs the same tasks as the 3555B. It also has built-in weighting networks that comply with 1960 CCITT requirements, which include telephone (psophometric) 3 kHz flat, and 15 kHz flat, Programme (P53) weighting filters.

Operating instructions printed in the protective cover are available in different languages at no extra charge.

Complementary equipment for the 3555B is HP 236A Telephone Test Oscillator (236A Opt. H10 for the 3556A). When used together, they make a complete transmission test set for accurate, convenient voice and carrier measurements.

Specifications

	3555B (North American Standards)	3556A (CCITT Standards)
VOICE FREQUENCY LEVEL MEASUREMENTS: 20 Hz to 20 kHz		
dB/volt Range	-91 dBm to +31 dBm	-78 dBm to +32 dBm/0.1 mV to 30 V F.S.
Level accuracy**	±0.5 dB; ±0.2 dB, 40 Hz to 15 kHz, level >60 dBm	100 Hz to 5 kHz: ±0.2 dB; 20 Hz to 20 kHz: ±0.5 dB
Input	Terminated or bridged 600Ω or 900Ω balanced. Bridging loss: <0.3 dB at 1 kHz. Balance: >80 dB at 60 Hz, >70 dB at 6 kHz, >60 dB to 20 kHz. Return loss: 30 dB min (50 Hz to 20 kHz)	Terminated: 600Ω symmetrical. Non-terminated: 10 kΩ symmetrical. Non-terminated error: <0.4 dB at 800 Hz. Symmetry: >80 dB at 50 Hz, >70 dB at 6 kHz, >50 dB to 20 kHz. Return loss: 30 dB min (50 Hz to 20 kHz)
Holding circuit	700Ω dc resistance, 60 mA max. loop line current at 300 Hz. With holding circuit in, above specs apply from 300 Hz to 4 kHz	
NOISE MEASUREMENTS:		
dB/volt range	-1 dBm to +121 dBm	-78 dBm to +32 dBm/0.1 mV to 30 V F.S.
Weighting filters	3 & 15 kHz flat, C-message, and program (Bell system technical reference pub. #41009)	3 & 15 kHz flat, Telephone and Programme (P53, CCITT)
Input	Same as for voice frequency measurements	
CARRIER FREQUENCY LEVEL MEASUREMENTS:		
dB/volt range	-61 dBm to +11 dBm	-48 dBm to +12 dBm/3 mV to 3 V F.S.
Level accuracy	600Ω balanced (symmetrical): 1 kHz to 150 kHz, ±0.5 dB; 10 kHz to 100 kHz, ±0.2 dB. 135Ω balanced (or 150Ω balanced)†: 1 kHz to 600 kHz, ±0.5 dB; 10 kHz to 300 kHz, ±0.2 dB, 75Ω unbalanced (asymmetrical): 100 Hz to 600 kHz, ±0.2 dB; 30 Hz to 1 MHz, ±0.5 dB, 1 MHz to 3 MHz, ±0.5 dB ±10% of meter reading	
Input	Terminated or bridged 135Ω† or 600Ω balanced (symmetrical) and 75Ω unbalanced (asymmetrical)	
Return loss	600Ω: 26 dB min., 3 kHz to 150 kHz; 135Ω†: 26 dB min., 1 kHz to 600 kHz; 75Ω: 30 dB min. to 3 MHz	
Bal/symmetry	>70 dB to 10 kHz, >60 dB to 100 kHz, >40 dB to 600 kHz	
GENERAL:		
Meter	Linear dB scale	Linear dBm scale
External battery	24 V or 48 V office battery, <15 mA	
Internal battery	Single NEDA 202, 45 V "B" battery Option H03 uses rechargeable batteries and similar to 3556A	4 rechargeable batteries (25 V total) or power line from 90 V to 250 V ac, 48 Hz to 440 Hz, <10 VA. Option 001 uses same battery as 3555B
AC	115 or 230 V (specify for 3555B) (switch for 3556A) 48 Hz to 440 Hz, <10 VA	
Dimensions	197 mm wide × 299 mm high × 207 mm deep (7 7/8" × 11 3/4" × 8 1/4")	
Weight	Net, 6.8 kg (15 lb). Shipping, 7.5 kg (17 lb).	
Jacks	Will accept Western Electric 241, 309, 310, 358, 289 and 347 plugs; 1011B hand-set or 52 typo headset	Will accept Siemens 9 REL KL1-6A, 4 mm diameter banana plugs or 3-prong Siemens 9 REL STP-6AC connector
**For levels >1 dBm accuracy spec applies only for freq. above 100 Hz. †150Ω for 3556A		

Model number and name

HP 236A Telephone Test Oscillator (complementary equipment for 3555B) see page 499

HP 236A, Opt. H10 Telephone Test Oscillator (complementary equipment for 3556A) see page 499
3555B Transmission and Noise Measuring Set
3556A Psophometer

Price

\$1055
\$1205

TELECOMMUNICATIONS TEST EQUIPMENT

Telephone test oscillators

Model 236A (Bell) Model 236A Opt H10 (CCITT)

- Voice grade testing

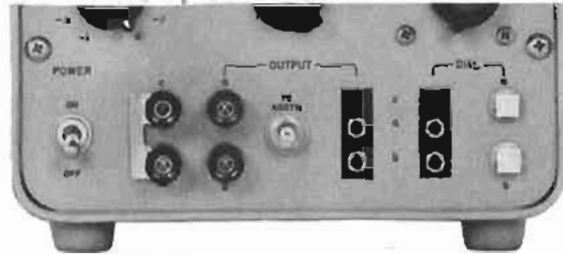

General

Hewlett-Packard's Models 236A and 236A Option H10/H20 Telephone Test Oscillators are particularly useful for lineup and maintenance of telephone voice and carrier systems when used with their companion instruments 3555B and 3556A Transmission Noise Meters. CCITT requirements are met with the HP 236A Option H10 and HP 3556A when used together.

Model number and name

HP 236A Option H10, CCITT (ac line and dry battery)
HP 236A Option H20, CCITT (ac line and rechargeable batteries)
HP 236A Telephone Oscillator (North American)

Price

add \$127
add \$250
\$780

Specifications

	236A (Bell)	236A Option H10 (CCITT)
Frequency range	50 Hz to 560 kHz	
Frequency dial accuracy	±3% of setting	
Frequency response		
600Ω output	±0.3 dB from 50 Hz to 20 kHz	
900Ω output	±0.3 dB from 50 Hz to 20 kHz	
135Ω output	±0.3 dB from 5 kHz to 560 kHz	
150 and 75Ω outputs	±0.3 dB from 5 kHz to 560 kHz	
Output level/accuracy	-31 to +10 dBm in 0.1 dBm step/±0.2 dBm from -31 to +10 dBm (1 kHz ref., Opt. H10, 800 Hz ref.).	
Noise	At least 65 dB below total output or -90 dBm - whichever noise is greater. 3kHz bandwidth	
Distortion	At least 40 dB below fundamental output.	
Output circuit	Balanced (symmetrical) and floating. Can be operated up to ±500 V dc above (earth) ground.	
Output impedance	600 and 900Ω ±5% 135Ω ±10%	600 and 150Ω symmetrical 75Ω asymmetrical
Output balance (output symmetry)	600 and 900Ω outputs: 70 dB at 100 Hz, 55 dB at 3 kHz 135 and 150Ω outputs: 50 dB at 5 kHz, 30 dB at 560 kHz	
Output jacks	Accepts Western Electric 241, 309, and 310 plugs.	Accepts 3-prong Siemens 9 REL, STP 6 AC or 4 mm diameter banana plugs.
	Binding posts accept banana plugs, spade lugs, phonetips or bare wires.	
Dial jacks	Accepts Western Electric 309 and 310 plugs. Clip posts accept Western Electric 1011B lineman's hand-set clips.	Accepts 3-prong Siemens 9 REL, STP 6 AC or 4 mm diameter plugs. Clip posts accept lineman's hand-set clips as alligator clips.
DC holding coil	600 and 900Ω outputs only. 700Ω ±10% dc resistance; 60 mA maximum loop current at 100 Hz.	
Power requirements	Line: 115 or 230 V (switch) ±10% ac, 48 Hz to 440 Hz, <2 VA. Internal battery: single NEDA 202 45 V "B" battery. 236A Option H20: (same as 236A Option H10 except) five 6.25 V rechargeable batteries; 90 V - 250 V ac, 48 Hz - 440 Hz, <10 VA during battery charge.	
Weight	Net, 6.1 kg (13.5 lb); Shipping, 7.7 kg (17 lb)	
Complementary equipment	HP 3555B Transmission and Noise Measuring Set	HP 3556A Psophometer

TELECOMMUNICATIONS TEST EQUIPMENT

Transmission impairment measuring set (TIMS)

Models 4940A and 4942A

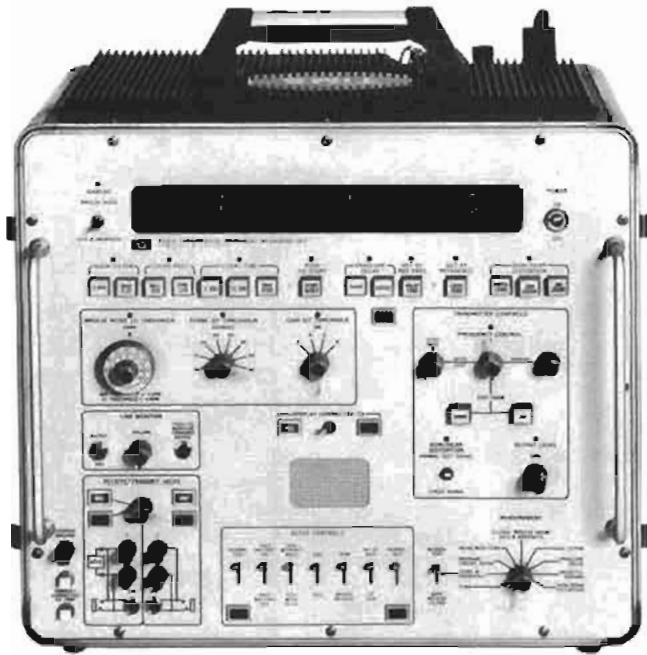

- Compatible with North American Standard
- Complete analog testing of the voice/data channel in communication systems



Description

Medium and high speed data transmission over voiceband channels require voice channels with high quality (transmission) characteristics. The Hewlett-Packard 4940A and 4942A Transmission Impairment Measuring System (TIMS) measure the key analog parameters of voiceband channels which are important for minimum-error, data transmission.

Most of the important analog parameters can be measured by a combined assortment of analog test sets which measure only a few parameters. However, TIMS are "stand alone" combination test sets that measure 7 to 15 parameters depending on the model and options selected. Thus TIMS can replace a large number of analog test sets. The major advantages of TIMS are that they cost significantly less and are more compact and more portable than a combination of test sets required to do the same measurements.

In addition to its cost savings and portability, TIMS are easy to operate. The switches on the front panel are logically arranged in functional groups. Simple straight-forward operating procedures allow the craftsperson or engineer to quickly and easily analyze voice channel-transmission lines.

Applications

There are a variety of applications where the Hewlett-Packard 4940A and 4942A Transmission Impairment Measuring Sets (TIMS) can be used. Operating telephone companies and other common carriers can utilize TIMS for installing and maintaining voice grade lines for data service.

Firms that are heavily dependent on large intra-company data systems can utilize TIMS for quickly isolating and restoring failures in their networks. In applications where a high reliability data network is essential, TIMS can be used to routinely test and measure the line quality of these systems in order to identify problems before the system actually fails.

Communications terminal suppliers, modem and computer processing service companies can utilize TIMS in their field service organization to help isolate the causes of reportedly defective equipment. Communication equipment manufacturers can further utilize TIMS in their R&D Labs to help correlate performance of their new designs to transmission parameters of a voice channel. These applications represent only a few examples of the type of situations for which TIMS are well suited.

Measurements and features

The Hewlett-Packard Transmission Impairment Measuring Set (TIMS) tests all telephone voice channel parameters required by tariff and transmission objectives.¹ Most measurement modes are compatible with test sets already in the field.

Envelope delay

The same automatic frequency step controls can be used to make envelope delay runs. Level, frequency, and delay are shown simultaneously. The delay is shown directly in microseconds. No calculation is required.

Noise

Background message circuit noise can be tested in two ways: the traditional message circuit noise measurement with a quiet termination at the end of the circuit, or a noise-with-tone measurement with typical signal power on the circuit. In addition, noise-to-ground measurement can show common mode noise problems.

Impulse noise and transient phenomena:

Using the 4940A to count phase hits, gain hits, drop outs, and 3 levels of impulse noise at the same time, more accurate analysis can be made of error causes and channel quality.

Phase jitter

TIMS measures the instantaneous peak to peak phase deviations of a special holding tone to calculate phase jitter.

Nonlinear distortion (optional feature)

TIMS utilizes a special intermodulation distortion technique which was developed to give consistent readings on typical telephone networks. Consequently, TIMS is only compatible with sets utilizing this improved technique. The technique is licensed under Hekimiam Laboratories, Inc., U.S.A. Patent No. 3,862,380.

P/AR—peak/average ratio (optional feature)

P/AR is a single number "bench mark" rating—indicative of the degradation a data signal might undergo over the channel caused by attenuation distortion, envelope delay distortion and message circuit noise.

¹ Bell System Technical References

PUB 49008 Transmission Parameters Affecting Voiceband Data Communications—Description of Parameters—October 1971. © American Telephone and Telegraph Company, 1971.

PUB 41809 Transmission Parameters Affecting Voiceband Data Communications—Measuring Techniques—May 1975. © American Telephone and Telegraph Company, 1975.

Signal to noise ratio

Signal to noise ratio of the channel is displayed directly in dB on HP 4942A and can be easily calculated using the HP 4940A.

Line loop back

Line loop back retransmits the received signal amplified to the transmit output level. This allows instruments at the far end to make such measurements as nonlinear distortion or peak to average ratio on a looped-around basis.

Self check

TIMS has a self check system which allows the user to completely verify that all components are functioning properly and TIMS will make all measurements accurately. Self check gives the user complete assurance that his test results are reliable.

Input circuitry and set-up controls

TIMS connects to most circuits without requiring additional test sets or interface hardware. TIMS is able to test on 2 or 4 wire, wet or dry circuits. TIMS also allows dialing, holding, and talking on the line under test.

HP 4940A and HP 4942A differences and similarities

The HP 4942A is designed to make the routine testing and installation of medium speed voiceband data channels faster and easier. The HP 4940A makes more measurements than the HP 4942A and is designed to measure all parameters necessary to completely and thoroughly analyze medium and high speed voiceband data channels.

With TIMS, attenuation distortion runs can be set up and logged in a fraction of the time previously needed because the frequency can be stepped up or down from 204 Hz to 3904 Hz in 100 Hz increments with attenuation distortion being automatically calculated and displayed directly in dB.

4940A Complete analog testing

The HP 4940A measures all the necessary parameters to completely describe the ability of a voiceband channel to carry medium and high speed data. The 4940A is the ideal tool for analyzing and troubleshooting T-channel and DI conditioned transmission lines.

With the HP 4940A it is possible to simultaneously observe all of the transients that cause data errors. By counting phase hits, gain hits, dropouts and three levels of impulse noise at the same time, a more accurate analysis can be made of error causes and channel quality. All of these transients are totalled by TIMS during the selected count time and stored in memory. The pushbutton-selectable count times are 5, 15 minutes and continuous. During the test and at the end of the count time, either the impulse noise totals or the hits and drop-out totals may be displayed from memory.

4940A Specifications

General

- Power:** 105 volts to 129 volts AC, 60 Hz, 130 watts
- Dimensions:** 18.50" wide, 18.25" high, 12.75" deep (47.0 x 46.4 x 32.4 cm).
- Weight:** net, 39 lb (18 kg). Shipping, 54 lb (25 kg).

Options

- 001: adds P/AR measurement Price add \$350
- 002: adds nonlinear distortion measurement add \$800
- 003: adds P/AR and nonlinear distortion measurements add \$1150
- 010: Field carrying case add \$250
- 023: 23" Rack Mounting Model N/C
- 019: 19" Rack Mounting Model N/C

4940A Transmission Impairment Measuring Set \$8850

Measures level and frequency, message circuit noise (C-message and 3 kHz flat weighted), noise-with-tone, 3 level impulse noise, hits and dropouts, phase jitter, envelope delay, noise-to-ground.

HP 4942A simple operation plus portability

The HP 4942A features speed and ease of testing. At 26 pounds the 4942A is easily portable.

The MASTER/SLAVE Control feature makes transmission impairment testing faster and easier. A 4942A operating in the SLAVE mode at far-end of the transmission line is controlled automatically from a 4942A operating in the MASTER mode at the operator end. One operator can control testing of all parameters in both directions of a full duplex (4-wire) circuit. All test results for each direction of test are displayed at the MASTER unit for ease of logging test data.

With the addition of HP-IB (Option 010) the HP 4942A can be remotely controlled by a calculator or computer and can output data for printing, plotting and further analysis.

4942A Specifications

For detailed specifications ask your local HP sales office for a 4942A TIMS data brochure.

General

- Power:** 117 V ac $\pm 10\%$, 50/60 Hz, 45 watts
- Dimensions:** 13.3" wide, 7.7" high, 21.0" deep (338 x 196 x 533 mm)
- Weight:** net, 26 lb (11.8 kg). Shipping, 45 lb (205 kg).

Options and accessories

- Option 010 Adds HP-IB Interface Price add \$500
- Option 910 Additional Set of Manuals add \$50
- Accessories for Model 4942A (To be used with Option 010 HP-IB Interface)
- Model 10631A ASCII Interface Cable 1 m (3.3') \$60
- Model 10631B ASCII Interface Cable 2 m (6.6') \$65
- Model 10631C ASCII Interface Cable 4 m (13.2') \$75
- Model 4942A.

4942A Transmission Impairment Measuring Set \$5800

Measures level and frequency, C-message circuit noise, noise-with-tone, channel signal-to-noise ratio, 1 level impulse noise, envelope delay. With MASTER/SLAVE control and portable mainframe.

**TABLE 1
4940A AND 4942A COMPARISON**

MEASUREMENT	4940A	4942A
Message Circuit Noise-C-Message	•	•
3 kHz Flat	•	
Noise with Tone	•	•
Attenuation Distortion	•	•
Envelope Delay Distortion	•	•
Impulse Noise 1 Level	•	•
3 Levels	•	
Phase Hits	•	
Gain Hits	•	
Drop Outs	•	
Phase Jitter	•	
Non-Linear Distortion	•	
Peak to Average Ratio	•	
Noise to Ground	•	
Signal to Noise Ratio		•
Line Loop Back		•

TELECOMMUNICATIONS TEST EQUIPMENT

Portable test set

Model 3550B

- Voice and carrier measurements



Description

Hewlett-Packard's Model 3550B Portable Test Set is designed specifically to measure transmission line and system characteristics such as continuity and attenuation distortion. It is particularly useful for lineup and maintenance of multi-channel communication systems. Model 3550B contains a wide range oscillator, a voltmeter, and a patch panel to match both oscillator and voltmeter to 135, 600, and 900 ohm lines. These instruments are mounted in a combining case that is equipped with a splash-proof cover. In addition, the oscillator, voltmeter, and patch panel may be used separately whether they are in or removed from the combining case.

Both the oscillator and voltmeter are transistorized and operate from their internal rechargeable batteries or from the ac line. Batteries provide 40 hours of operation between charges and are recharged automatically during operation from the ac line.

Specifications

Oscillator HP 204C opt. H20

(Refer to Page 307)

Voltmeter, HP 403B option 001

(Refer to Page 39)

Patch panel, HP 353A

(Specifications apply with oscillator and voltmeter).

Input: (receiver).

Frequency range: 50 Hz to 560 kHz.

Frequency response: ± 0.5 dB, 50 Hz to 560 kHz.

Impedance: 135 Ω , 600 Ω , and 900 Ω and bridging (10 k Ω center tapped).

Balance: better than 70 dB at 60 Hz for 600 Ω and 900 Ω ; better than 60 dB at 1 kHz for 600 Ω and 900 Ω ; better than 40 dB over entire frequency range for 135 Ω , 600 Ω , and 900 Ω .

Insertion loss: less than 0.75 dB at 1 kHz.

Maximum level: +22 dBm (10 V rms at 600 ohms).

Output: (send).

Frequency range: 50 Hz to 560 kHz.

Frequency response: ± 0.5 dB, 50 Hz to 560 kHz.

Impedance: 135 Ω , 600 Ω , and 900 Ω center tapped.

Balance: better than 70 dB at 60 Hz for 600 Ω and 900 Ω ; better than 60 dB at 1 kHz for 600 Ω and 900 Ω ; better than 40 dB over entire frequency range for 135 Ω , 600 Ω , and 900 Ω .

Insertion loss: less than 0.75 dB at 1 kHz.

Distortion: less than 1%, 50 Hz to 560 kHz.

Maximum level: +22 dBm (10 V rms into 600 ohms).

Attenuation: 110 dB in 10 and 1 dB steps.

Accuracy, 10 dB section: error is less than ± 0.25 dB at any step.

Accuracy, 100 dB section: error is less than ± 0.5 dB at any step.

Connectors: two 3-terminal binding posts for external circuit connection and two BNC female connectors for oscillator and voltmeter connection.

Patch panel, option H02-353A

(Same as Model 353A except as indicated below).

Attenuator: 23 dB ± 0.5 dB (1-step slide switch).

Hold circuit (send terminals)

***Frequency response:** 300 Hz to 3 kHz ± 0.5 dB, 1 kHz reference.

DC resistance: 240 ohms nominal.

Maximum DC current: 100 mA.

Maximum DC voltage: 150 volts.

Connectors: special telephone jacks to accept Western Electric No. 309 and 310 plugs. Sleeve jack is connected to sleeve of jacks 309 and 310. Two 3-terminal binding posts for external circuit connection.

Two terminal (Tel Set) connector for Hand Set, two BNC female connectors for oscillator and voltmeter connection.

Patch panel, option H03-353A

(Same as Model 353A except as indicated below).

Hold circuit (rec terminals)

***Frequency response:** 300 Hz to 3 kHz ± 0.5 dB, 1 kHz reference.

DC resistance: 240 ohms nominal.

Maximum DC current: 100 mA.

Maximum DC voltage: 150 volts.

Attenuation: 23 dB ± 0.5 dB (1-step slide switch).

Hold circuit (send terminals)

***Frequency response:** 300 Hz to 3 kHz ± 0.5 dB, 1 kHz reference.

DC resistance: 240 ohms nominal.

Maximum DC current: 100 mA.

Maximum DC voltage: 150 volts.

Connectors: special telephone jacks to accept Western Electric No. 309, 310 and 241 at send and rec terminals. Sleeve jack is connected to sleeve of jacks 309 and 310.

Two terminal (Tel Set) connector available for Hand Set. Two BNC female connectors for oscillator and voltmeter connection.

General

Dimensions: 213 mm wide \times 489 mm high \times 337 mm deep (8 $\frac{3}{8}$ " \times 19 $\frac{1}{4}$ " \times 13 $\frac{3}{4}$ ") with cover installed.

Weight: net, 13.5 kg (30 $\frac{1}{2}$ lb). Shipping, 18 kg (40 lb).

Model number and name

3550B Portable Test Set (with 353A Patch Panel)

Price

\$1535

H02-3550B (with H02-353A substituted for standard 353A)

add \$150

H03-3550B (with H03-353A substituted for standard 353)

add \$150

* This is the frequency response with the holding coil across the line. Refer to Model 353A Specifications for response in "non-holding" condition.

Carrier testing (FDM)

The most commonly used method of simultaneous transmitting large numbers of telephone voice channels over long distances is to stack them in the frequency spectrum using the technique of Frequency Division Multiplex (FDM). Currently up to 13 000 channels can be carried on a single transmission facility.

To ensure telephone interconnection from country to country, the format of the FDM must be the same. This is achieved by international agreement utilizing the FDM plans formulated by CCITT and, in North America, the Bell System.

In the manufacture and maintenance of such multiplex systems, many measurements are necessary, some of them on a routine basis. Power level in a well defined bandwidth is the basic measurement. The more common examples are:

- Pilot level
- Carrier leak
- Signaling tones
- Group power
- Channel power

Out of band noise monitoring is of interest as an indicator of total system performance. The intersuper-group slot is typically the position in the multiplex where this measurement is performed.

The Selective Level Measuring Set (SLMS), Receiver and Generator, is the traditional test set used for these measurements. The receiver is typically provided with selectable bandwidths optimized for pilot (20 to 50 Hz), channel (3.1 kHz) and group (48 kHz) measurements. Channel noise is usually related to a weighting characteristic, Psophometric for CCITT and "C" Message for Bell. Frequency setability and stability are necessarily compatible with the very narrow band filters used. More recent designs use local oscillators built around synthesizers. The generator is typically required to have level stability over its frequency range of better than 0.1 dB and be frequency tunable to be compatible with the receiver, or in a frequency offset mode compatible with the system under test. Its frequency stability must be comparable to the receiver and/or the multiplex system.

These requirements are met in Hewlett-Packard instruments that are either manually adjusted or automatically operated from other instruments or controllers, calculators or computers. In many situations manually operated instruments are completely adequate for all purposes. This is particularly true of low capacity systems and situations where portability and battery operation is needed.

However, the need for improved performance at no increase in cost for high capacity systems has stimulated the development of measuring systems that are automatically or semi-automatically operable, while not losing their manual operating capabilities.

The time taken to measure the level of all the pilots in a 10 000 channel system, using purely manually operated instruments is many hours. Similarly, to measure carrier leaks, as much as a day is needed. Remem-

bering the precise nature of the FDM composition, it is easy to understand how critical the tuning of the SLMS needs to be. There is a further complicating factor. The relationship between specific channels or specific pilots and their positions in frequency represents a multitudinous collection of data. Normally this is recorded on charts, published by CCITT or, in North America, Bell. The craftsman must first consult the chart to decide the frequency to which he needs to tune the SLMS. He then consults local information to decide the correct level; if all goes without previous mistake, he then adjusts the set and records (typically from an analog meter) the resultant measurement.

To say the least, this is a time consuming, potentially erroneous process. Consider this situation further aggravated by the pressures of a system failure or under conditions of personal fatigue. Quite often the interfering signal or tone is buried imperceptibly close to the group or supergroup pilot and the normal SLMS has a hard time providing the frequency selectivity necessary to identify the rogue. Narrow bandwidth filters with some 70 dB of attenuation require very stable local oscillators to be of use. A SLMS tuned just 50 Hz away from the required frequency would make the whole process useless!

In the HP 3745, all is different. The FDM chart is stored *within* the instrument. The attenuators are self-setting (autoranging) while the display is digital and can be routed to peripheral printers and/or a CRT trace. The craftsman addresses the instrument using the FDM nomenclature with which he is so familiar (i.e. master group (hypergroup) #, supergroup #, group #, channel #) and the SLMS does the rest. It tunes itself to the right frequency (no mistakes), ensures the right attenuator setting (no errors because of instrument overload) and provides, via a thermal printer option, a hard copy of the measurement it has made.

The set is not limited to single measurements. Thanks to the microprocessor, many of the necessary routines that have been mentioned can be semi-automated. Using its built-in knowledge of the FDM plan (all the known plans in use in the world are stored and available in just two HP SLMS's... the 3745A and 3745B), the 3745 can step from channel to channel, pilot to pilot, making the level measurements automatically. We call this the scan mode. Imagine checking all the carrier leaks in an L4 (3600 channel) system in minutes without touching the measuring set. Imagine, too, getting hard copy of those levels that are out of specification. The following chart illustrate time savings that are typical.

MEASUREMENT TIME COMPARISONS 960 Channel System		
Measurements	HP3745	Traditional SLMS
Group Reference Pilots (80 pilots)	> 40 s	Approximately 40 mins.
Channel Power (900 channels)	> 5 s	Approximately 8 hours
Carrier Leaks (960 carriers)	> 8 s	Approximately 8 hours
"Hot Tone" Scans (complete system)	> 22 s (scanning group at a time)	Can't be done on manual instrument

Using the Hewlett-Packard Interface Bus (HP-IB) complete remote control is possible. Any locally controlled function with the one exception of phase jitter measurement can be executed remotely using a calculator or some other controller. In this mode, that is, using a calculator, many routines can be made to follow one another automatically. A fault-finding procedure whereby the 3745 can make decisions against stored reference data and then proceed to other measurements is entirely possible.

CARRIER (FDM) TESTING

Manual Measurements	3745A	3745A	3120
	3320C	3320C	3320C
	Page 503	Page 503	Page 506
Channel Power, Unweighted 3.1 kHz	●	●	●
Channel Power, Weighted, Psophometric (CCITT)	●		●
Channel Power, Weighted, C-Message (North America)		●	●
Channel Test Tones	●	●	●
Group Power, 48 kHz Bandwidth	●	●	
Broadband Power	●	●	
Pilot Levels	●	●	●
Carrier Leak	●	●	●
Phase Jitter (direct)	●	●	
Tracking (Gain/Frequency Response)	●	●	●
Offset Tracking	●	●	
Out of Band Noise	●	●	●
Semi-Automatic Measurements			
Frequency Scan (Spectrum Analysis)	●	●	
FDM Plan Scan (CCITT)	■		
FDM Plan Scan (North America)		●	
Group Power Scan	●	●	
Hot Tone (High Talker) Scan	●	●	
FULL REMOTE CONTROL (with exception of Phase Jitter)	●	●	

TELECOMMUNICATIONS TEST EQUIPMENT

Selective level measuring set

Models 3745A, 3745B

- Frequency range, 1 kHz to 25 MHz
- Selective filters for Pilot, Channel and Group measurements
- Automatic tuning according to selected FDM Plans

- Results recorded directly on separate printer
- Automatic routines for unattended surveillance
- HP-IB compatible



3745A



3745B

HP-IB

Description

The Hewlett-Packard Models 3745A and 3745B Selective Level Measuring Sets have been designed to meet the requirements of operators and manufacturers of high-density FDM systems. The SLMS is a processor-controlled, synthesizer-based, high-quality tuneable receiver — which can measure true RMS levels between +15 dBm and -125 dBm, in the frequency range 1 kHz to 25 MHz.

Processor control plus accurate, autoranging attenuators, and dedicated, highly-selective filters allow the SLMS to perform repeatable measurements with a high-degree of speed and accuracy. This capability is used to provide automatic measurement routines, for unattended system surveillance. The processor, which controls all the instrument operations, can be programmed either manually (via the special-purpose keyboard) or remotely (by a calculator using the HP-IB — Hewlett-Packard Interface Bus).

Frequency tuning can be either manual or use a 'stored FDM Plans' facility, which provides tuning directly in terms of an FDM description. The FDM description (Channel number, Group number, Super-group number, etc.) is entered directly on the keyboard. The SLMS then performs the necessary calculations and tunes the appropriate filter to the correct frequency.

The Model 3745A SLMS is designed for operation on FDM systems using the CCITT 12 MHz FDM Plans, and their 4, 6, or 8 MHz derivatives.

The Model 3745B is designed for operation on the BELL FDM systems.

Two sweep facilities are provided: SPECTRUM (which is a frequency sweep) and SCAN (which is a sweep according to the selected FDM Plan numbering). These sweep facilities can be used to implement unattended surveillance routines. The SLMS provides a limit alarm facility, allowing the operator to preset upper and lower alarm limits. The subsequent detection of an 'out-of-limits' condition can be used to trigger an automatic print-out, or generate an alarm. Using these automatic surveillance facilities it is possible, for example, to measure 240 Pilot levels in 2 minutes or 2700 Channel powers in 15 minutes. Other surveillance routines include measurements of: carrier leaks, noise in intersubgroup slots, channel test points, signalling frequencies, etc.

An audio output in the range 300 Hz to 3.4 kHz is provided via a built-in loudspeaker, or through a jack-connection for a hand-set. Automatic selection of the demodulator carrier frequency ensures that the demodulated channel is always correct. A channel measurement option provides a weighted noise filter and phase jitter facility.

3745A/3745B Specifications

(Unless otherwise stated, all specifications are for 0° to 55°C after 30 minute warm-up).

Input circuits

Unbalanced

Connector: 3745A — BNC; 3745B — WECO type 477B (accepts WECO plug 358A).

Impedance: 75Ω.

Return loss: > 30 dB (50 kHz to 25 MHz).

Balanced (150Ω) — 3745A only

Connector: BNC pair at 25 mm (1") spacing.

Return loss: > 30 dB (50 kHz to 2 MHz).

Common mode rejection: > 40 dB (50 kHz to 2 MHz).

Balanced (124Ω) — 3745B only

Connector: Pair of WECO type 477B at 15.9 mm (5/8") spacing (accepts WECO plug 372A).

Return loss: > 30 dB (50 kHz to 10 MHz).

Common mode rejection: > 40 dB (50 kHz to 2 MHz).

> 35 dB (2 MHz to 10 MHz).

Balanced (135Ω) — 3745B only

Connector: Pair of WECO type 223A at 15.9 mm (5/8") spacing (accepts WECO plug 241A).

Return loss: > 30 dB (50 kHz to 1 MHz).

Common mode rejection: > 40 dB (50 kHz to 1 MHz).

Frequency range

Unbalanced 75Ω Input: 1 kHz to 25 MHz.

Balanced 150Ω Input (3745A): 10 kHz to 2 MHz.

Balanced 124Ω Input (3745B): 10 kHz to 10 MHz.

Balanced 135Ω Input (3745B): 10 kHz to 1 MHz.

Minimum frequency step size: 10 Hz.

Frequency accuracy

Internal reference oscillator

Initial settling accuracy: within $\pm 1 \times 10^{-7}$ parts ± 1 Hz.

Aging rate: less than $\pm 1.5 \times 10^{-7}$ parts ± 1 Hz/year.

External reference oscillator

Frequency error: \leq stability of external reference oscillator ± 1 Hz.

Measurement ranges

Unbalanced 75Ω input

Filter	Range (dBm)	Noise floor (dBm) — with open cct input	
		50 kHz—300 kHz	300 kHz—25 MHz
22 Hz — Pilot	+15 to -125	≤ -110	≤ -115
3.1 kHz — Channel	+15 to -115	≤ -100	≤ -115
48 kHz — Group	+15 to -75	—	≤ -100
I/P Pwr — Broadband	+15 to -35	—	—

Balanced 150Ω, 124Ω, and 135Ω inputs: as above, but maximum level is 0 dBm for all filter selections.

Measurement accuracy

Overall measurement accuracy: absolute accuracy at 0 dBm + (After autocalibration — flatness at 0 dBm + error at levels see note 1) other than 0 dBm.

Absolute accuracy at 0 dBm: (at 1 MHz ± 1 Hz)

	75Ω Unbalanced input	150, 124, and 135Ω Balanced inputs
Selective measurements (10° to 35°C)	±0.05 dB	±0.1 dB
Selective measurements (0° to 55°C)	±0.1 dB	±0.15 dB
Broadband measurements (0° to 55°C)	±0.2 dB	±0.25 dB

Flatness referred to 1 MHz and 0 dBm: (input signals within ± 1 Hz of tuning frequency)

75Ω Unbalanced input

Selective measurements

(10° to 35°C) 50 kHz to 20 MHz: ±0.15 dB.

10 kHz to 25 MHz: ±0.25 dB.

(0° to 55°C) 50 kHz to 20 MHz: ±0.25 dB.

10 kHz to 25 MHz: ±0.35 dB.

1 kHz to 25 MHz: ±1.0 dB.

Broadband measurements

(0° to 55°C) 10 kHz to 25 MHz: ±1.0 dB.

150Ω Balanced input (3745A)

Selective measurements

(10° to 35°C) 10 kHz to 2 MHz: ±0.2 dB.

(0° to 55°C) 10 kHz to 2 MHz: ±0.3 dB.

Broadband measurements

(0° to 55°C) 10 kHz to 2 MHz: ±1.0 dB.

124Ω Balanced input (3745B)

Selective measurements

(10° to 35°C) 10 kHz to 10 MHz: ±0.2 dB.

(0° to 55°C) 10 kHz to 10 MHz: ±0.3 dB.

Broadband measurements

(0° to 55°C) 10 kHz to 10 MHz: ±1.0 dB.

135Ω Balanced input (3745B)

Selective measurements

(10° to 35°C) 10 kHz to 1 MHz: ±0.2 dB.

(0° to 55°C) 10 kHz to 1 MHz: ±0.3 dB.

Broadband measurements

(0° to 55°C) 10 kHz to 1 MHz: ±1.0 dB.

Additional error for measurements in the range +5 to -80 dBm

(with respect to accuracy and flatness at 0 dBm and at frequencies > 50 kHz)

For each 10 dB step: ±0.03 dB.

For each 1 dB step: ±0.01 dB.

Maximum cumulative error for up to ten 1 dB steps: ±0.03 dB.

Note 1: the following errors are eliminated by autocalibration.

Temperature coefficient: 0.01 dB/°C.

Stability: 0.1 dB/24 hours.

Measurement display

Long averaging

Resolution: 0.01 dB.

Accuracy: equal to measurement accuracy.

Normal averaging

Resolution: 0.1 dB.

Accuracy: measurement accuracy + rounding error + averaging error.

Max rounding error: ±0.05 dB.

Max averaging error: ±0.03 dB.

Filters

Pilot filter — 22 Hz

Ripple over 22 Hz bandwidth: ≤ 0.1 dB pk-pk.

3 dB Bandwidth: 38 Hz ± 10%.

Rejection at ≥ ± 110 Hz: ≥ 60 dB.

Rejection at ≥ ± 1 kHz: ≥ 80 dB.

Adjacent pilot rejection (± 60 Hz): ≥ 40 dB.

Equivalent noise bandwidth: 44 Hz (nominal).

Channel filter — 3.1 kHz

Ripple over 2.6 kHz bandwidth: ≤ 0.5 dB pk-pk.

3 dB bandwidth: 3.1 kHz ± 10%.

Virtual carrier rejection at ± 1.85 kHz: ≥ 55 dB.

Adjacent channel rejection (± 4 kHz): ≥ 67 dB.

Equivalent noise bandwidth: 3.1 kHz (nominal).

Group filter — 48 kHz

Ripple over 34 kHz bandwidth: ≤ 1 dB pk-pk.

3 dB Bandwidth: 48 kHz ± 15%.

Rejection at ≥ ± 80 kHz: ≥ 40 dB.

Adjacent group rejection (± 48 kHz): ≥ 25 dB.

Equivalent noise bandwidth: 52 kHz (nominal).

Intermodulation and spurious products

Intermodulation rejection: > 70 dB.

Spurious products: either -80 dB with respect to input signal or -115 dBm, whichever is the greater.

Image and I.F. rejection: ≥ 60 dB.

General

Power

Voltage ranges: 100, 120, 220, 240 V.

Tolerance: ± 10%.

Power consumption: 200 VA.

Frequency: 48 Hz to 66 Hz.

Options

001 (3745A) (front panel only):

Unbalanced input connector: Siemens series 2.5/6 mm (75Ω).

Balanced input connector: pair of Siemens series 2.5/6 mm (75Ω) at 25 mm (1") center spacing.

002 (3745A) (front panel only):

Unbalanced input connector: Siemens series 1.6/5.6 mm (75Ω).

Balanced input connector: pair of Siemens series 1.6/5.6 mm (75Ω) at 25 mm (1") center spacing.

004 (3745B) (front panel only):

Unbalanced input connector: WECO type 560A (accepts WECO plug 439A or 440A).

Balanced input connector (124Ω): WECO type 562A (accepts WECO plug 443A).

Balanced input connector (135Ω): Pair of WECO type 223A at 15.9 mm (5/8") spacing (accepts WECO plug 241A).

021/022 — Channel measurements (Phase Jitter plus Weighted noise measurements):

Phase Jitter

Ranges: 3° and 30° FSD.

Residual phase jitter: 0.5°.

Accuracy: ± 15%.

Bandwidth: 20 to 300 Hz.

The measurement is performed on an input signal at a frequency corresponding to a tone in the range 1 kHz ± 50 Hz at the demodulated audio output. The result is displayed on a front panel meter.

021 (Weighting filter)

Weighting curve: CCITT recommendation P53 superimposed on 3.1 kHz channel filter as specified.

022 (Weighting filter)

Weighting curve: C-message weighting superimposed on 3.1 kHz channel filter as specified.

040—X-Y Recorder/X-Y Display Driver: allows SLMS to drive an X-Y Recorder or an X-Y CRT Display.

Accessories

15580A Active Probe: 0 dB insertion loss. \$350

15581A Passive Probe: 30 dB insertion loss. \$226

15582A Return Loss Bridge. \$405

15583A Rack Mount Kit. \$33

1332A (Option H01) X-Y Display. \$1643

5150A (Option H01) Thermal Printer. \$1735

Model number and name

Model 3745A Selective Level Measuring Set \$23 625

Model 3745B Selective Level Measuring Set \$23 625

Price

N/C

N/C

N/C

add \$975

add \$975

add \$1136

TELECOMMUNICATIONS TEST EQUIPMENT

Selective level meter/generator

Models 312D & 3320C

- Multiplex carrier testing



Description

General

Hewlett-Packard Model 312D Selective Level Meter and companion Model 3320C Level Generator provide an accurate, easy-to-use transmission measuring set in the 1 kHz to 18 MHz frequency range ideally suited for maintenance and operations requirements. It provides proper input and output connectors and impedances to interface directly into most FDM carrier multiplex equipment.

HP's 312D has a noise equivalent bandwidth that provides a direct reading of C-message or psophometric noise. The instrument has sufficient fidelity to act as an invisible channel bank to down-convert any 4 kHz voice channel and make typical measurements such as phase jitter and impulse noise. It also features 10 Hz frequency resolution, 0.02 dB level resolution on the meter expand scale, and an input overload lamp to assure valid measurements.

HP's 3320C companion generator is a frequency synthesizer that provides signals with an amplitude resolution of 0.01 dB over a frequency range of 10 kHz to 17 MHz with 20 Hz resolution.

Specifications, 312D

Frequency

Range: 1 kHz to 18 MHz; 18 bands; 200 kHz overlap; coarse and fine tuning.

Accuracy: ± 10 Hz plus time base stability

Stability

Aging rate: ± 20 ppm/year

Temperature ($25^\circ \pm 10^\circ\text{C}$): 20 ppm

Line voltage ($\pm 10\%$): 0.1 ppm

Resolution: 10 Hz read on a seven digit LED display

Amplitude level

Range: -120 dBm to $+23$ dBm, annunciator displays each 10 dB selected input level regardless of switch combinations.

Attenuator accuracy: ± 0.1 dB (0 through -50 dB range); ± 0.2 dB (-60 dB range).

Flatness (75Ω matched load; 0 dBm max. level): ± 0.5 dB, 1 kHz to 10 kHz; ± 0.2 dB, 10 kHz to 10 MHz; ± 0.5 dB, 10 MHz to 18 MHz.

Stability: 0.1 dB, 90 days
Overload: lamp indicates incorrect range selection
Selectivity:

Bandwidth	3 dB Rejection	60 dB Rejection
*50 Hz	50 Hz $\pm 10\%$	106 $\pm 10\%$
*150 Hz	150 Hz $\pm 10\%$	320 $\pm 10\%$
**1740/2300 Hz	2300 Hz $\pm 10\%$	4800 $\pm 10\%$
**3100 Hz	3100 Hz $\pm 10\%$	6200 $\pm 10\%$

* Select one bandwidth only; 50 Hz standard, 150 Hz Option 001.
 ** Carrier notches inserted at $f_0 \pm 2$ kHz. Notch filter down >55 dB at $f \pm 2$ kHz; down >45 dB at ± 7.5 Hz from center of rejection notch.

- Passband flatness: <0.2 dB
- The exact midband of the selected filter is identified by a 3 Hz rejection notch.

Meter (backlighted scale shows whether normal or expand mode is selected).

Range

Normal: -20 dB to +3 dB
Expand: -1 dB to +1 dB
 The expand meter will expand any two dB portion of the meter from -7 dB to +3 dB in 1 dB steps.
Tracking: ± 0.05 dB expand; ± 0.1 dB normal (to -10 dB indication).

Input impedance: 75 Ω unbalanced, accepts WECO 358A plug; 124 Ω balanced, accepts WECO 408A plug; 135 Ω balanced, accepts WECO 241A plug.

Receiver

Modes

AM: average responding diode demodulated audio.
Beat: beat frequency, carrier reinserted at f_c .
LSB: product demodulated audio, carrier reinserted at $f_c + 1.8$ kHz.
USB: product demodulated audio, carrier reinserted at $f_c - 1.8$ kHz.

Distortion

1 kHz to 1 MHz: >55 dB below zero reference
1 MHz to 18 MHz: >65 dB below zero reference

Residual response: 72 dB below zero reference with no input
Noise level: <-117 dB in 2300 Hz bandwidth
Internal calibrator output: 1 MHz square wave; -40 dBm ± 0.1 dB into 75 Ω termination; accepts WECO 358A plug
Common mode rejection: >40 dB, 1 kHz to 5 MHz; >30 dB, 5 MHz to 18 MHz.

Output level (front panel):

+14 dBm into 600 Ω with full scale meter deflection.
 Accepts WECO 464A plug for operator head set.
 Accepts WECO 310A plug for 600 Ω output.
 Speaker is normally in the output circuit unless a plug is inserted, then speaker is disconnected.

Auxiliary outputs (rear panel)

1 MHz: >0.5 volt p-p sine wave into 1 k Ω , BNC female
30 MHz: 40 mV to 70 mV rms into 50 Ω , BNC female
Local oscillator: 30 MHz to 48 MHz, 60 mV to 90 mV rms into 50 Ω , BNC female

Auxiliary input (rear panel)

External reference frequency: 1 MHz, 0 dBm ± 10 dBm into 50 Ω .

General

Dimensions: 483 mm wide \times 266 mm high \times 467 mm deep (19" \times 10 $\frac{1}{2}$ " \times 18 $\frac{3}{8}$ ")
Weight: net, 20.7 kg (46 lb). Shipping 26.6 kg (59 lb).
Power: 115 or 230 V $\pm 10\%$, 48 to 66 Hz, <100 VA

Specifications, 3320C

Frequency

Range: 10 kHz to 17 MHz in one range (75 Ω)

Resolution

Vernier out: 10 kHz
Vernier in: 20 Hz

The frequency counter in the 312D can be used to count the output frequency of the 3320C to within 10 Hz.

Accuracy

Vernier out: ± 10 ppm of setting
Vernier in: 10 kHz to 12.5 MHz; ± 600 Hz
 12.5 MHz to 17 MHz; ± 750 Hz

Stability: ± 10 ppm/year

TC: 20 $^\circ$ to 30 $^\circ$ C: ± 5 ppm
Line variations of 10%: 0.1 ppm
 High stability crystal reference oven available (Option 001).

Phase noise: <-40 dB in 30 kHz band, excluding ± 1 Hz.

Harmonics and spurious: >50 dB down

Internal frequency standard: 20 MHz

Amplitude level

Range: +11.99 dBm to -79.99 dBm

Resolution: 0.01 dB

Accuracy: +11.99 dBm to -60 dBm: ± 0.25 dB, -60 dBm to -79.99 dBm: ± 0.4 dB.

Output impedance (front panel switch selectable)

75 Ω unbalanced: accepts WECO 358A Plugs

124 Ω balanced: accepts WECO 408A Plugs

135 Ω balanced: accepts WECO 241A Plugs

Auxiliary outputs (rear panel):

- **Tracking output:** 20 MHz \pm 37 MHz offset signal. Tracks main output with 20 MHz offset. >106 mV rms into 50 Ω , Female BNC.

- **Low level output:** same frequency as main output but remains between 50 mV rms and 158 mV rms into 50 Ω Female BNC.

- **1 MHz output:** Reference output, 0 dBm ± 10 dBm into 50 Ω , Female BNC.

Can be used as external frequency source for the 312B or 312D.

Auxiliary input (rear panel)

External frequency reference input: may be phase locked with an external signal which is within 200 mV rms and 2 V rms and which is any subharmonic of 20 MHz from 1 MHz through 10 MHz (e.g., 1 MHz, 2 MHz, 2.5 MHz, 5 MHz, 10 MHz), Female BNC.

High stability crystal oven (Option 001)

5 MHz reference in temperature stabilized oven.
Stability: ± 1 part in 10^8 /day or 1 part in 10^7 /month
Accuracy: ± 1 part in 10^7 of setting/month
 For field installation order Accessory Kit 11237A

General

Operating temperature: 25 $^\circ$ C $\pm 5^\circ$
Power: 115 V or 230 V $\pm 10\%$, 48 Hz to 66 Hz, 110 VA
Weight: net, 15.4 kg (34 lb). Shipping, 22.2 kg (49 lb).

312D Selective Level Meter

\$5400

- Option 001: 150 Hz bandwidth
- Option 908: Rack Flange Kit
- Option H03: CCITT Version

N/C
 add \$15
 add \$400

3320C Level Generator

\$4100

- Option 001: Crystal Oven
- Option 908: Rack Flange Kit

add \$500
 add \$10

TELECOMMUNICATIONS TEST EQUIPMENT

Selective voltmeter, 20 Hz to 620 kHz

Models 3590A & 3591A

- Voice grade testing
- FDM testing



Description

Hewlett-Packard's 3591A is a general purpose 20 Hz to 620 kHz frequency selective voltmeter having balanced input with selectable impedances. With balanced input circuitry, HP's 3591A is particularly useful for communications applications in the lab, field, or production line. Other than input differences, the 3591A is essentially identical to the 3590A, having all the virtues of automatic ranging, wide dynamic range, and log and linear X and Y recorder outputs.

Specifications

Frequency range: 20 Hz to 620 kHz.

Amplitude ranges: 3 μ V to 30 V full scale in 15 ranges.

Amplitude accuracy with input terminated

Meter switch in normal position: overall accuracy: ± 0.43 dB to ± 0.67 dB of reading depending on frequency, including:

Frequency response flatness, total deviation: 600 Ω : 20 Hz to 100 Hz ± 0.53 dB ($\pm 5\%$); 100 Hz to 620 kHz ± 0.26 dB ($\pm 3\%$).

All other terminations: 5 kHz to 620 kHz ± 0.26 dB ($\pm 3\%$).

Meter tracking: ± 0.1 dB or $\pm 1\%$ of reading, 0 dB to -10 dB.

Meter switch in linear dB position: overall accuracy: ± 1 dB.

Internal calibrator: frequency, 100 kHz ± 10 Hz; amplitude, full scale on 0 dB range in CAL mode: accuracy, ± 0.1 dB.

Dynamic range: (1M and harmonic distortion products): > 85 dB below zero dB reference level when absolute measurements are being made (> 70 dB 20 Hz to 50 Hz). > 80 dB below zero dB reference level when relative adjustment is used (> 70 dB for 20 Hz to 50 Hz).

Residual responses

> 80 dB below zero reference (> 70 dB for 20 Hz to 50 Hz).

Return loss: 100 Hz to 620 kHz, 600 Ω > 30 dB; 5 kHz to 620 kHz, 150 Ω , 135 Ω , 75 Ω , > 35 dB.

Noise level:

Bandwidths	Input noise level (600 Ω input impedance)
10 Hz and 100 Hz	< -125 dBm or 0.44 μ V
1 kHz and 3.1 kHz	< -115 dBm or 1.38 μ V

Selectivity:

Rejection	Bandwidths			
	10 Hz	100 Hz	1 kHz	3.1 kHz
3 dB	10 Hz	100 Hz	1 kHz	3.1 kHz
60 dB	35 Hz	320 Hz	3.1 kHz	9.6 kHz

(Frequency accuracy $\pm 10\%$)

Inputs: balanced or single-ended, not floating, terminating, or bridging.

Automatic frequency control

Capture threshold: 75 dB below 0 dB reference.

Dynamic hold-in range: > 3 bandwidths. Tracking rate proportional to bandwidth.

Input functions

dBm: levels calibrated in dBm for impedances selected.

Abs Vm: level calibrated in volts.

Rel: input level can be set arbitrarily to 0 dB Ref. (10 dB set level range).

Input impedances*

Resistances: 75 Ω , 135 Ω , 150 Ω , 600 Ω terminated; 50 k Ω (single ended bridging) and 100 k Ω (balanced bridging).

Capacitance (each terminal to ground): 10 mV, 30 mV ranges < 55 pF; 100 mV to 30 V ranges < 40 pF.

Common mode rejection: 20 Hz to 620 kHz, > 40 dB.

Automatic ranging: 8 ranges, 0 dB to -70 dB. Ranging rate proportional to bandwidth.

Output: amplitude: adjustable 0 to 1 V rms open circuit.

BFO frequency response flatness: ± 0.2 dB or $\pm 2\%$.

Resistance: 600 Ω .

L.O. output: frequency, 1.28 MHz to 1.90 MHz (1.28 MHz + tuned frequency); amplitude, 0.65 V rms $\pm 20\%$ open circuit; resistance, 250 Ω .

Recorder outputs:

X-axis (3593A/3594A only)	Plug-in frequency ranges	
	62 kHz	620 kHz
X-axis linear output: (1 k Ω source resistance)	0 to -12.4 V (200 mV/kHz $\pm 5\%$)	0 to -12.4 V (20 mV/kHz $\pm 5\%$)
X-axis log output: (1 k Ω source resistance)	5 V/decade $\pm 5\%$ (50 Hz - 62 kHz)	5 V/decade $\pm 5\%$ (500 Hz - 620 kHz)

Y-Axis

Linear Y axis output: $+10$ V dc $\pm 2\%$ for full scale meter indication, 1 k Ω source resistance.

Log Y axis output: $+1$ V to $+10$ V dc, proportional to linear dB meter indication (-90 to 0 dB, 0.1 V/dB) 1k Ω source resistance.

Power: 115 V or 230 V $\pm 10\%$, 50 Hz to 400 Hz, < 70 VA.

Dimensions: 425 mm wide \times 221 mm high \times 467 mm deep (16 $\frac{1}{2}$ " \times 8 $\frac{1}{2}$ " \times 18 $\frac{1}{2}$ ").

Weight: net, 17.2 kg (38 lb). Shipping, 24.9 kg (55 lb).

Accessories furnished: rack mounting kit for 19" rack.

Options

908: Rack Flange Kit

Price
add \$15

Model number and name

3590A Wave Analyzer and 3594A sweeping local oscillator plug-in

\$6440

3591A Selective Voltmeter and 3594A sweeping local oscillator plug-in

\$6605

*Other terminations available on special order.

In many countries the main communication system consists of a network of FM microwave radio links. Typically, these links can carry up to 1800 FDM telephony channels, using a 70 MHz IF carrier and an RF band in the range 600 MHz to 18 GHz. However, some countries are now installing 140 MHz IF microwave links which can carry up to 2700 FDM telephony channels.

All information signals (speech, television, or data) carried by these links have a common objective — to convey the information with maximum fidelity. Failure to keep distortion in a link within specified limits results in an unacceptably high level of intermodulation noise. This prevents the link from carrying the designated channel capacity and the link operator incurs a severe financial penalty due to loss of revenue-earning channels. The qualitative tests shown in Table 1 are particularly relevant as indicators of overall system performance.

The use of noise-loading measurements to establish the intermodulation performance of

FDM telephony links is well known and they provide 'go/no-go' criteria for the transmission quality of a system between baseband (BB) terminals. Although such measurements can separate the basic and intermodulation noise components, they do not localize the noise sources.

The main contributors to distortion in FM microwave radio links are the modulators, demodulators, carrier circuits at IF such as amplifiers, and carrier circuits at RF such as filters. The distortion parameters of these circuits can be measured in terms of nonlinearity, amplitude variations and group delay variations. To do this, test equipment must interface with the links at BB, IF and RF. Commissioning microwave link equipment involves minimizing these circuit distortion parameters by adjustment or equalization.

On lower capacity systems, these adjustments are normally enough to reduce intermodulation distortion to an acceptable level. With increased traffic capacity, the tolerances imposed on the circuit parameters be-

come more and more strict and normal commissioning methods often do not produce satisfactory results. Consequently, relating the circuit parameters to the intermodulation noise (measured by a noise-loading test set) becomes increasingly more difficult.

The main source of discrepancy is the result of amplitude modulation to phase modulation (AM/PM) conversion in the transmission carrier path. This AM/PM conversion occurring in non-linear networks introduces additional intermodulation from the signal deviations arising in preceding networks. These 'coupled' responses can be assessed only by differential gain/differential phase (DG/DP) measurements with high-frequency test tones.

DG/DP measurements have the advantage of characterizing a link more completely and they yield valuable diagnostic information. Furthermore, these two measurements are mathematically related to the BB measurement of noise power ratio. This information allows microwave link manufacturers to design link parameters with much more certainty and it allows microwave link operators to optimize performance in a more cost effective way. HP Application Note AN 175-1 'Differential Phase and Gain at Work' covers this subject in considerable detail.

HP microwave link analyzers (MLA's), at 70 MHz IF and 140 MHz IF, were developed specifically for the purpose of measuring various forms of distortion on terrestrial and satellite microwave radio links. The measurement capabilities of HP link analyzers were established in close co-operation with the telecommunications industry. An MLA, along with a power meter, selective level meter, frequency counter and spectrum analyzer, allows all the diagnostic tests of Table 2 to be performed.

A valuable extension of the MLA measurement capability can be obtained using RF up and down converters. The circuit distortions at RF have identical effects to the IF circuit distortions when the carrier signal is eventually demodulated. Hence, the RF distortions can be analyzed using an MLA, provided a transparent RF to IF interface is available. A downconverter provides such an interface and allows independent measurements on microwave transmitters. A so-called 'up-converter' in fact provides a transparent BB to RF interface, allowing independent measurements on microwave receivers. Both converters used with an MLA provide an RF to RF measurement capability.

Table 1. Qualitative tests to verify radio system performance

Test	FDM	Video	Digital
1. Insertion Gain	●	●	●
2. Frequency Response	●	●	●
3. Envelope Delay Distortion		●	●
4. Spurious Interference Tones	●	●	●
5. Thermal Noise	●	●	●
6. White Noise Loading	●		
7. Video Waveform Tests		●	
8. Video System Program Channel (Subcarrier) Tests		●	
9. Bit Error Rate Tests			●

Table 2. Diagnostic tests to maintain radio system performance

Measurement	BB	IF	RF
1. Module Power Levels, Gains and Losses	●	●	●
2. Modem Centre Frequencies		●	●
3. TX and RX Local Oscillator Frequencies			●
4. Transmitter RF Output Frequency			●
5. Spurious Tones	●	●	●
6. FM Mod + Demod Deviation Sensitivity	●	●	
7. FM Mod + Demod Linearity	●	●	
8. Return Loss	●	●	
9. Amplitude Flatness	●	●	
10. Group Delay		●	●
11. Differential Gain and Phase		●	●

TELECOMMUNICATIONS TEST EQUIPMENT

Microwave link analyzer at BB, IF (70 MHz) and RF; 75 ohm Attenuator

Models 3710A/3702B/3730A/3750A

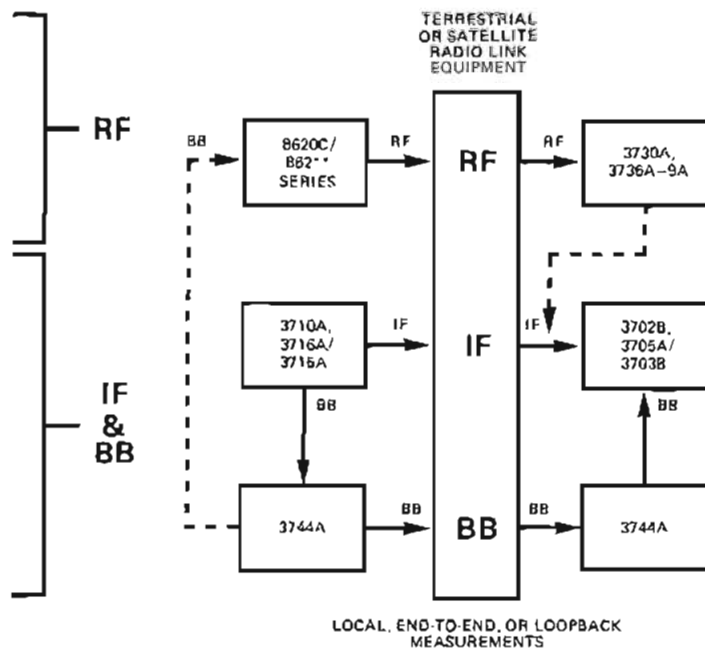
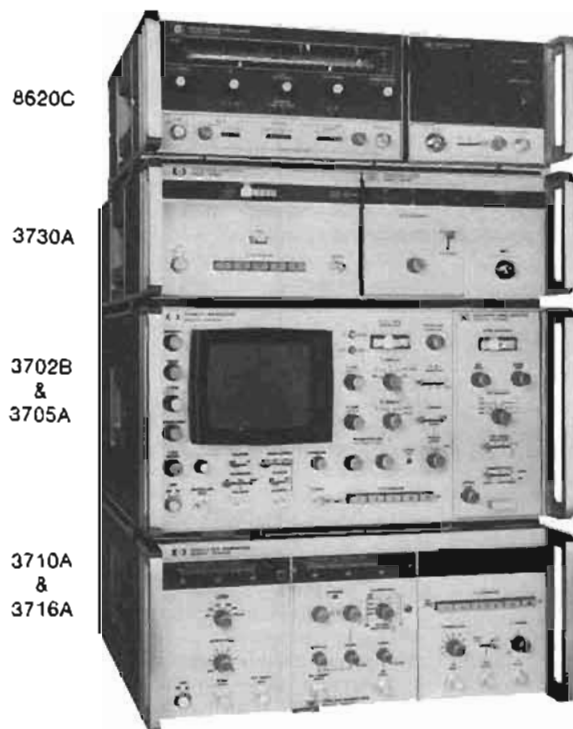

Description

The Microwave Link Analyzer, Down Converter and RF Sweeper, as a system enables the full BB, IF & RF capability of terrestrial and satellite radio links to be realized. The Microwave Link Analyzer (3710A IF/BB Transmitter + 3716A or 3715A plug-in and 3702B IF/BB Receiver + 3705A or 3703B plug-in) is a combined Baseband (BB) and Intermediate Frequency (IF) analyzer, allowing the various forms of distortion occurring in a link to be identified, measured and localized to BB and IF devices. The Down Converter (3730A + 3736A, 3737A, 3738A, 3739A or 37301A plug-in) and RF Sweeper (8620C/862** series of specials) which is used as an Up Converter, ensure that this capability is extended into the RF range.

Benefits

- An easy to operate, four instrument system.
- Comprehensive BB frequency coverage, 83.333 kHz to 8.2 MHz.
- Comprehensive IF coverage, 45 to 95 MHz
- Comprehensive RF coverage, in the range 1.7 to 11.7 GHz.
- Minimum cabling interconnections and alterations for changes in measurement.

MLA: seven selected baseband test tones up to 8.2 MHz.

- Internal demodulation up to 5.6 MHz.
- Inbuilt CRT with dual trace display.

Receiver can be remote from transmitter for between-station measurements. Slave facility for local display of remote measurements. IF frequency stability of ± 100 kHz/5 hr. period. IF frequency markers of 70 MHz, 2 MHz "comb" and sliding symmetrical pair.

RF capability: permits separate characterization of Radio Link Transmitter and Receiver by BB, IF, or RF to RF tests. No plotting and differentiating — easy equalization. Permits active and passive component tests — avoids the problems of other systems.

Specifications

MLA

IF frequency range: 45 to 95 MHz centered on 70 MHz.

IF flatness (residual): ± 0.05 dB from 45 to 95 MHz.

BB linearity and differential gain (residual): 0.1% (BB-BB), 0.4% (IF-IF) from 45 to 95 MHz.

Group delay (residual): 0.1 ns (BB-BB), 1 ns (IF-IF) from 45 to 95 MHz.

Differential phase (residual): 0.1° (BB-BB), 0.8° (IF-IF) from 45 to 95 MHz.

IF power range: +21 dBm to -10 dBm.

BB power range: -10 dBm to -49 dBm.

Modulator sensitivity: -49 dBm to 0 dBm

Demodulator sensitivity: -10 dBm to -49 dBm.

Impedances: 75 ohm.

Power: 100/120/220/240 V (+5 -10%), 48 to 66 Hz, approx. 150 VA for transmitter, approx. 190 VA for receiver.

Dimensions

3710A: 425 mm wide, 172 mm high, 457 mm deep ($16\frac{1}{4}'' \times 6\frac{1}{2}'' \times 18''$).

3702B: 425 mm wide, 216 mm high, 457 mm deep ($16\frac{1}{4}'' \times 8\frac{1}{2}'' \times 18''$).

Down converter

RF input

RF frequency range: 1.7 to 11.7 GHz.

Minimum input level: -20 dBm (-44 dBm with Opt. 010). 4 dB higher level for correct operation of MLA.

Impedance: 50 ohm.

IF output

Meter accuracy: ± 0.5 MHz at 70 MHz, (± 2 MHz f.s.).

Return loss: 28 dB min.

Impedance: 75 ohm.

Power: 115 or 230 V ($\pm 10\%$), 48 to 66 Hz.

Dimensions: 425 mm wide, 141 mm high, 467 mm deep ($16\frac{1}{4}'' \times 5\frac{1}{2}'' \times 18\frac{3}{4}''$).

Selection Chart

Instruments to suit your requirements may be compiled from the following groups. Specify only ONE choice from each group.

BB FREQUENCIES	INSTRUMENTS & OPTIONS
83.333, 250, 500 kHz	3710A, 3702B, 3715A, 3703B
83.333, 250, 500 kHz, 2.4, 4.43, 5.6, 8.2 MHz	3710A, 3702B, 3716A, 3705A
92.593, 277.778, 555.556 kHz	3710A, 3702B, 3715A Opt. 009, 3703B Opt. 009
92.593, 277.778, 555.556 kHz, 2.4, 3.58, 5.6, 8.2 MHz	3710A, 3702B, 3716A Opt. 010, 3705A Opt. 010
92.593, 277.778, 555.556 kHz, 2.4, 3.58, 4.43, 5.6 MHz	3710A, 3702B, 3716A Opt. 011, 3705A Opt. 011
92.593, 277.778, 555.556 kHz, 2.4, 4.43, 5.6, 8.2 MHz	3710A, 3702B, 3716A Opt. 012, 3705A Opt. 012
83.333, 250, 500 kHz, 2.4, 3.58, 5.6, 8.2 MHz	3710A, 3702B, 3716A Opt. 013, 3705A Opt. 013
83.333, 250, 500 kHz, 2.4, 3.5, 5.6, 8.2 MHz	3710A, 3702B, 3716A Opt. 014, 3705A Opt. 014
83.333, 250, 500 kHz, 2.4, 4.5, 5.6, 8.2 MHz	3710A, 3702B, 3716A Opt. 016, 3705A Opt. 016
83.333, 250, 500 kHz, 2.4, 3.58, 4.43, 8.2 MHz	3710A, 3702B, 3716A Opt. 018, 3705A Opt. 018
83.333, 250, 500 kHz, 2.4, 3.58, 4.43, 5.6 MHz	3710A, 3702B, 3716A Opt. 019, 3705A Opt. 019
SWEEP FREQUENCIES	INSTRUMENTS & OPTIONS
70 Hz internal	3710A, 3702B, 3715A & 3703B/ 3716A & 3705A
50 Hz internal	3710A Opt. 006, 3702B, 3715A & 3703B/ 3716A & 3705A
100 Hz internal	3710A Opt. 007, 3702B, 3715A & 3703B/ 3716A & 3705A
18 Hz, in addition to 70 Hz (with associated bandwidths of 90 and 100 Hz) Recommended for use on satellite systems	3710A Opt. 015, 3702B, 3716A & 3705A Opt. 015
CONNECTORS	INSTRUMENTS & OPTIONS
BNC	3710A, 3702B, 3715A & 3703B/3716A & 3705A
Siemens large (2.5 mm)	3710A Opt. 002, 3702B Opt. 002, 3715A Opt. 002, & 3703B/3716A Opt. 002 & 3705A
Siemens small (1.6 mm)	3710A Opt. 003, 3702B Opt. 003, 3715A Opt. 003, & 3703B/3716A Opt. 003 & 3705A
Commercial equivalent of WECO 477B (with 75/124Ω balance on mainframe)	3710A Opt. 004, 3702B Opt. 004, 3715A Opt. 004, & 3703B/3716A Opt. 004 & 3705A
VARIABLE PHASE SWEEP	INSTRUMENTS & OPTIONS
0° ±100°, 180° ±100° from 45 to 100 Hz	3710A Opt. 008, 3702B, 3715A & 3703B/ 3716A & 3705A
REFERENCE LEVEL	INSTRUMENTS & OPTIONS
Voltage reference instead of Power	3710A Opt. 017, 3702B Opt. 017, 3715A & 3703B/ 3716A & 3705A
RF FREQUENCIES	INSTRUMENTS & OPTIONS
1.7 to 4.3 GHz	3730A, 3736A, 8620C, 86230B (H80)
3.2 to 6.5 GHz	3730A, 3737A, 8620C, 86241A (H80)
5.9 to 9.0 GHz	3730A, 3738A, 8620C, 86242A (H80)
10.7 to 12.4 GHz	3730A, 3739A, 8620C, 86250B (H81)
1.0 to 12.0 GHz	3730A, 37301A (uses external oscillator)
HARDWARE	INSTRUMENTS & OPTIONS
Rack Mounting Kits	3710A Opt. 908, 3702B Opt. 908, 3730A Opt. 908, 8620C Opt. 908
SOFTWARE	INSTRUMENTS & OPTIONS
Additional Manuals	3710A Opt. 910, 3702B Opt. 910, 3730A Opt. 910, 8620C Opt. 910 For all plug-ins, add Opt. 910

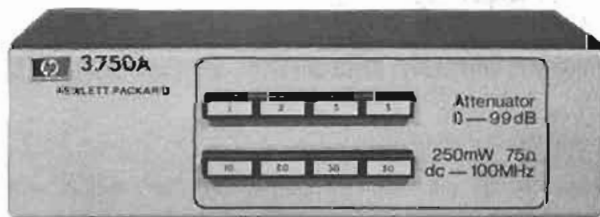

3750A Description

The 3750A Attenuator is a general-purpose 75 ohm-impedance attenuator for operation in the frequency range dc to 100 MHz. Attenuation from 0 to 99 dB is provided in 1 dB steps by the operation of pushbutton switches. The 3750A is symmetrical so that either port can be used as the input or output. The Attenuator is fitted with 75 ohm BNC connectors.

Specifications

Attenuation: 0 to 99 dB in 1 dB steps.

Frequency range: 0 to 100 MHz.

Impedance: 75 ohm.

Accuracy

Unit steps: ±0.1 dB.

Decade steps: ±0.2 dB.

Cumulative: ±0.5 dB to 79 dB, ±1.0 dB to 89 dB, ±2.0 dB to 99 dB.

Maximum input power: +24 dBm (250 mW).

Return loss: 28 dB at either port, when properly terminated.

SWR: 1.08.

Insertion loss: 0.1 dB at 10 MHz, 0.4 dB at 50 MHz, 0.6 dB at 100 MHz.

Dimensions: 203 mm wide, 70 mm high, 102 mm deep (8" × 2 3/4" × 4").

3750A general purpose 75 ohm attenuator

\$295

TELECOMMUNICATIONS TEST EQUIPMENT

BB sweeper accessory: IF amplifier

Models 3744A & 3743A



3744A



3743A



3744A Description

The 3744A BB Sweeper Accessory expands the measurement capability of any MLA, by supplying a convenient method of performing swept baseband measurements.

The standard 3744A is for use with 70 MHz IF MLA's, and the 3744A Option 140 is for use with 140 MHz IF MLA's. The various types of connector options available enable the 3744A to interface with existing link equipment and MLA connector options.

The BB Sweeper is a small, compact instrument comprising three operationally independent sections — a transmitter, a receiver, and an attenuator. The transmitter is essentially a mixer, accepting a fixed 70 MHz or 140 MHz IF signal and a swept signal, up to 15 MHz above the fixed IF signal. It thus produces a lower sideband in the baseband region, with a frequency range up to 15 MHz. The receiver is essentially a detector which accepts the swept baseband signal, then produces a calibrated output suitable for display on the MLA IF/BB Receiver. The attenuator has a range of 0 to 61 dB, in 1 dB steps, and is designed for use at baseband frequencies up to 15 MHz.

Specifications

Back-to-back losses

<0.1 dB from 100 kHz to 8.5 MHz (operating from 18°C to 28°C with an output level of -30 dBm)

<0.12 dB from 100 kHz to 10 MHz

<0.2 dB from 100 kHz to 15 MHz (<0.1 dB from 100 kHz to 15 MHz may be achieved by internal adjustment of the 3744A)

BB output

Frequency range: 100 kHz to 15 MHz

Output level: same as IF INPUT level ± 0.5 dB, up to 0 dBm max

Return loss: better than 28 dB

Impedance: 75 ohm

IF input

Frequency range: 70.1 MHz to 85 MHz

Input level: 0 dBm max

Sweep rate: 18 to 100 Hz

Impedance: 75 ohm

70 MHz input

Frequency: 70 MHz (crystal controlled from MLA)

Input level: +10 dBm ± 0.5 dB

Impedance: 75 ohm

BB input

Frequency range: 100 kHz to 15 MHz

Input reference level: -30 dBm

Dynamic range: +4 dB to -10 dB, on reference level

Return loss: better than 28 dB

Impedance: 75 ohm

Attenuator

Attenuation range: 0 to 61 dB in 1 dB steps

Accuracy: ± 0.1 dB, for 1, 2 & 4 dB steps

± 0.2 dB, for 8, 16 & 30 dB steps

Frequency range: 100 kHz to 15 MHz

General

Dimensions: 212.7 mm wide, 87.4 mm high, 282.6 mm deep (8 1/2 in. \times 3 1/2 in. \times 11 1/4 in.)

Power requirements: 100/120/220/240 V ac, 48 to 66 Hz, 12 VA max

3743A Description

The 3743A IF Amplifier can be used with any hp 70 MHz IF MLA to give an increased IF Input sensitivity. In practice, Radio Link monitoring points provide a signal level of approximately -30 dBm. The minimum IF Input level of the MLA IF/BB Receiver is -10 dBm, which is unsuitable for use with these low-level monitoring points. The 3743A features a fixed 30 dB amplifier with very low transmission deviations, which have minimal effect on the back-to-back performance of the MLA. Therefore, with the addition of the 3743A IF Amplifier, the minimum IF Input level of the MLA is extended down to -40 dBm.

Specifications

Frequency range: 45 to 95 MHz

Gain: > 30 dB

Maximum output level: +12 dBm

Amplitude variations: ≤ 0.2 dB

Group delay variations: ≤ 0.3 ns

Harmonic distortions: > 30 dB down for each harmonic, when fundamental is at +5 dBm

Noise figure: ≤ 8 dB

Impedance: 75 ohm (both ports)

Return loss: > 26 dB (both ports)

Dimensions: 127 mm wide, 50.8 mm high, 147.8 mm deep (5 in. \times 2 in. \times 7 in.)

3744A Options

002: Siemens 2.5 mm connectors

003: Siemens 1.6 mm connectors

004: WECO 477B (equivalent) connectors

(BNC connectors on rear panel)

140: 140 MHz version

Model number and name

3744A GB Sweeper Accessory

3743A IF Amplifier

Price

N/C

N/C

N/C

N/C

\$1690

\$670

- 140 MHz IF centre frequency
- 4-digit LED marker system
- Internal demodulation to 5.6 MHz
- 12.39 MHz test tone for 2700 channel systems
- Sensitivity of 0.025 dB/cm for amplitude measurements
- Sensitivity of 0.25 ns/cm for group delay measurements

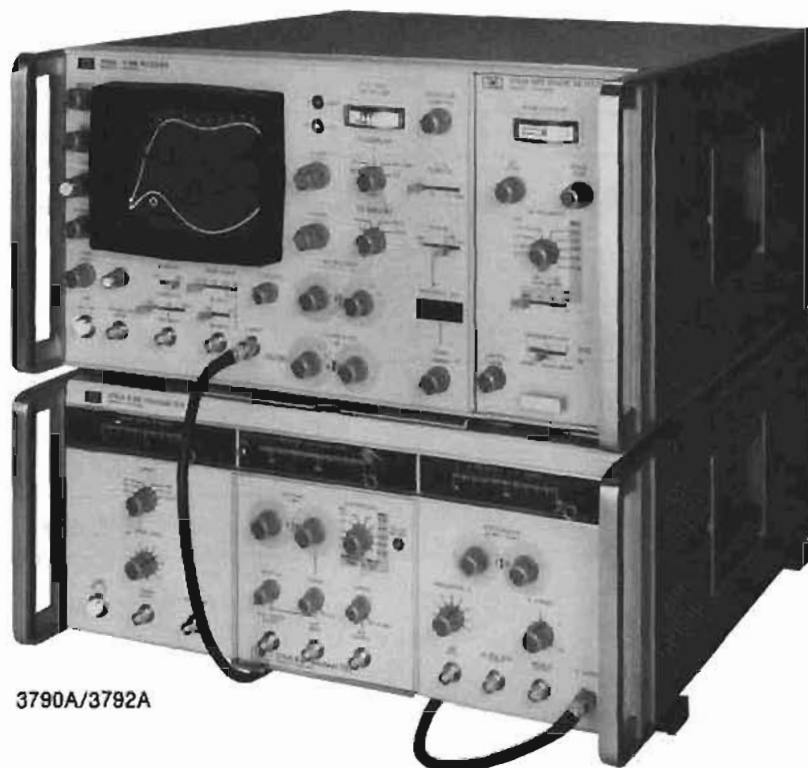

3790A/3792A

Description

With the advent of higher channel capacities — 2700 channel microwave links, operating with an IF centre frequency of 140 MHz — the use of high frequency test tone techniques and the need for improved back-to-back performance, are becoming increasingly more important (see 'MEASUREMENT CONSIDERATIONS').

The 3790A/3792A Microwave Link Analyzer (MLA) is a combined Baseband (BB) and Intermediate Frequency (IF) analyzer, designed for operation on the new 140 MHz IF microwave systems. The MLA (3790A IF/BB Transmitter + 3791A plug-in, and 3792A IF/BB Receiver + 3793A plug-in) allows the various forms of distortion occurring in a link to be identified, measured and localized to BB and IF devices.

The 3790A/3792A MLA is a versatile measuring instrument, performing swept measurements including: group delay, linearity, differential gain and differential phase — on microwave radio equipment operating with an IF in the band 115 to 165 MHz. The new 140 MHz MLA has applications in the development, production and maintenance of broadband microwave radio systems.

Benefits

- Complete microwave link analysis package.
- Receiver can be remote from Transmitter, for between station measurements. Slave facility for local display of remote measurements.
- Inbuilt CRT — with dual trace display.
- Comprehensive BB coverage, 83.333 kHz to 12.39 MHz.
- Eight selected baseband test tones up to 12.39 MHz, plus, an EXTERNAL test tone up to 15 MHz.
- Internal demodulation up to 5.6 MHz.
- Comprehensive IF coverage, 115 to 165 MHz.
- IF frequency stability of ± 200 kHz/5 hour period.
- IF frequency markers of 2 or 5 MHz "comb" and sliding marker.

Specifications

IF frequency range: 115 to 165 MHz, centered on 140 MHz.

IF flatness (residual): within 0.1 dB from 115 to 165 MHz.

BB linearity and differential gain (residual):

0.1% (BB-BB)

0.4% (IF-IF) from 115 to 165 MHz.

Differential phase (residual):

0.1° (BB-BB)

0.5° (IF-IF) from 115 to 165 MHz.

IF power range: +19 dBm to -10 dBm.

BB power range: -10 dBm to -49 dBm.

Modulator sensitivity: -49 dBm to 0 dBm.

Demodulator sensitivity: -10 dBm to -49 dBm.

Impedances: 75 ohm.

Power: 110, 120, 220, 240 V or +5 -10%, 48 to 66 Hz.

Consumption: approx. 150 VA for 3790A.

approx. 190 VA for 3792A.

Dimensions

3790A: 425 mm W, 172 mm H, 457 mm D (16½ × 6¾ × 18 in.).

3792A: 425 mm W, 216 mm H, 457 mm D (16½ × 8½ × 18 in.).

Options

910: Extra set manuals

908: Rack mount kit

Price

add \$90.40

add \$25.00

3790A/3792A Microwave Link Analyzer

\$22,030

3790A/3792A (cont.)

Selection chart

Instruments to suit your requirements may be compiled from the following groups. Specify only ONE choice from each group.

BB FREQUENCIES	INSTRUMENTS & OPTIONS
83.333, 250, 500 kHz and 2.40, 4.43, 5.60, 8.20, 12.39 MHz 83.333, 250, 500 kHz and 2.40, 3.58, 5.60, 8.20, 12.39 MHz	3790A, 3791A, 3792A, 3793A 3790A, 3791A Opt. 013, 3792A, 3793A Opt. 013
VARIABLE PHASE SWEEP	INSTRUMENTS & OPTIONS
0° ±100° and 180° ±100° from 45 to 100 Hz	3790A Opt. 008, 3791A, 3792A, 3793A
CONNECTORS	INSTRUMENTS & OPTIONS
BNC Siemens large (2.5 mm) Siemens small (1.6 mm)	3790A, 3791A, 3792A, 3793A 3790A Opt. 002, 3791A Opt. 002, 3792A Opt. 002, 3793A 3790A Opt. 003, 3791A Opt. 003, 3792A Opt. 003, 3793A
HARDWARE	INSTRUMENTS & OPTIONS
Rack Mounting Kits	3790A Opt. 908, 3791A, 3792A Opt. 908, 3793A
SOFTWARE	INSTRUMENTS & OPTIONS
Additional Manuals	3790A Opt. 910, 3791A Opt. 910, 3792A Opt. 910, 3793A Opt. 910

Measurement considerations

The use of high frequency test tone techniques to give a better assessment of the performance of microwave links, is described in Hewlett-Packard Application Note AN 175-1, "Differential Phase and Gain at Work". These techniques are invaluable for 2700 Channel capacity systems, as they emphasize the need for lower distortion parameters (eg: JF amplitude response, group delay, AM/PM). Consequently, there is a requirement for a link analyzer with extremely low residual distortions. The 3790A/3792A MLA meets this requirement. The oscillograms in Figures 1 and 2, show the back-to-back performance of the HP 140 MHz MLA.

Figure 1: IF Amplitude Response and Group Delay.

Sweep width: ±25 MHz.
Test tone: 500 kHz.
Calibration: 0.025 dB/cm, 0.25 ns/cm.
Frequency markers: 5 MHz spacing.

Figure 2: Differential Gain and Differential Phase.

Sweep width: ±20 MHz (±25 MHz less sweep reduction).
Test tone: 2.4 MHz
Calibration: 0.25%/cm, 0.5°/cm.
Frequency markers: 5 MHz spacing.

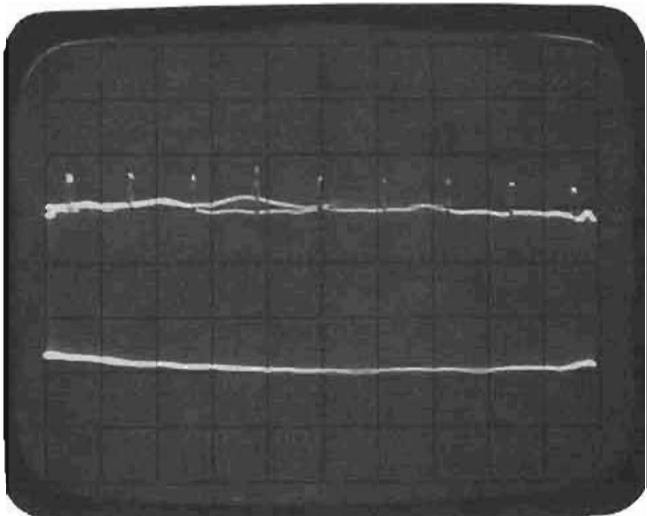

Figure 1

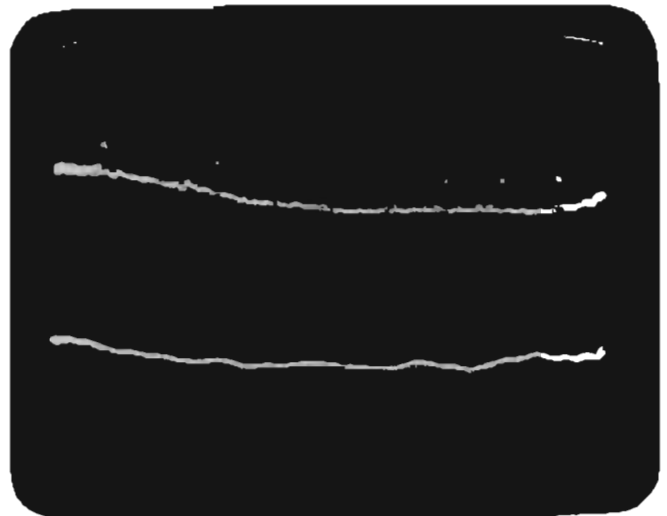

Figure 2

Transmission testing: time division multiplexing (TDM)

Development of TDM

Pulse code modulation (PCM) developed because of a need for greater capacity over local telephone circuits between exchanges. In its basic form, it replaces a system of one pair of wires per subscriber with a system of two pairs of wires for 24 or 30 subscribers.

This 12- or 15-fold increase in capacity is achieved by sampling each voice channel at 8 kHz, quantising and coding each sample and then time division multiplexing the samples from a number of channels. The result is a composite digital stream at 1.544 Mb/s or 2.048 Mb/s which includes framing information to allow separation of the individual channels at the receive terminal equipment.

The digital signal is transmitted over existing audio cable by replacing loading coils with digital regenerators.

To integrate these 24- or 30-channel terminals into a high capacity digital network, standard digital transmission "hierarchies" have been developed using further stages of TDM. The proposed hierarchies for Europe, North America, and Japan are shown in Figure 2.

Note that because the terminal may be physically separated from the transmission equipment, it may be undesirable to transmit the information in binary form between them. Instead, an interface code is used. A number of interface codes have been standardised and include AMI, HDB3, B3ZS, B6ZS, etc.

Measurements

Measurements on the digital multiplex or transmission link are aimed at establishing data transparency and quality in terms of error rate, clock offset, and timing jitter.

The principal measure of quality is bit error rate (BER), and is defined as the total number of errors in the received signal divided by the total number of transmitted bits. The standard method of measuring BER is to stimulate the equipment under test with a test pattern comprising a pseudo-random binary sequence. The sequence length should be chosen to simulate a normal traffic signal and vary sufficiently in pattern to adequately test pattern-sensitive parts of the circuit (e.g. clock recovery circuits). For low speed systems, a 2^9-1 to $2^{15}-1$ bit sequence test signal may be used. For high speed systems, the sequence length may need to be as long as $2^{33}-1$ bits.

The output from the system under test is applied to an error detector and compared bit-by-bit with a separate, internally-generated, error-free pattern, after initial synchronisation of the two patterns (i.e. errors) can be counted over a chosen gating period and displayed as bit error rate or total error count. Note that for systems where polarity integrity of the coded signal is not maintained throughout the system (e.g. the digital multiplex shown in Figure 2), the bit-by-bit comparison must be made at the binary level, even although the test pattern may be generated and received at the interface code level. However, it is also useful to measure code violation errors. This can be done without taking the system out of service.

BER measurements are made under a number of conditions, including:

- (a) normal condition of bit rate, signal level, noise, and crosstalk. (Here the bit rate usually has crystal accuracy and stability).
- (b) tests with added jitter.
- (c) tests at offset bit rate.
- (d) tests with added noise.
- (e) combinations of (a) to (d).

The measurement needs of development work and those of maintenance are quite different. Test instruments have been developed that address the specific problems of each area. These include wide band equipment with flexible binary capability for R&D use, such as the HP 3760A/61A Bit Error Rate Measurement system, and more dedicated equipment with clock generation, clock recovery and line-coded interfaces, such as HP 3780A Pattern Generator-Error Detector. The latter is ideal for use in field trials, commissioning and maintenance of digital transmission terminals and link equipment. It is particularly suited for testing digital multiplex, radio, and line systems. HP model 3780A can also be used in more advanced systems such as fiber optic transmission and time division switching.

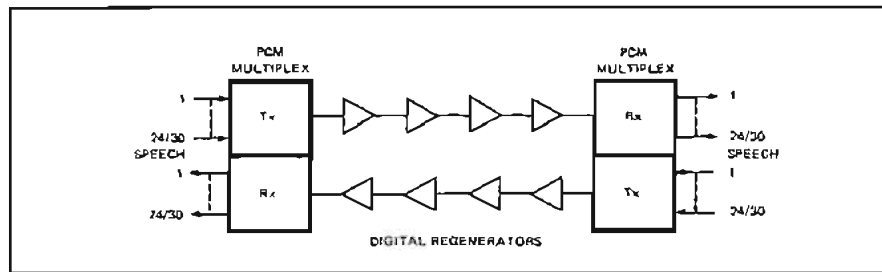
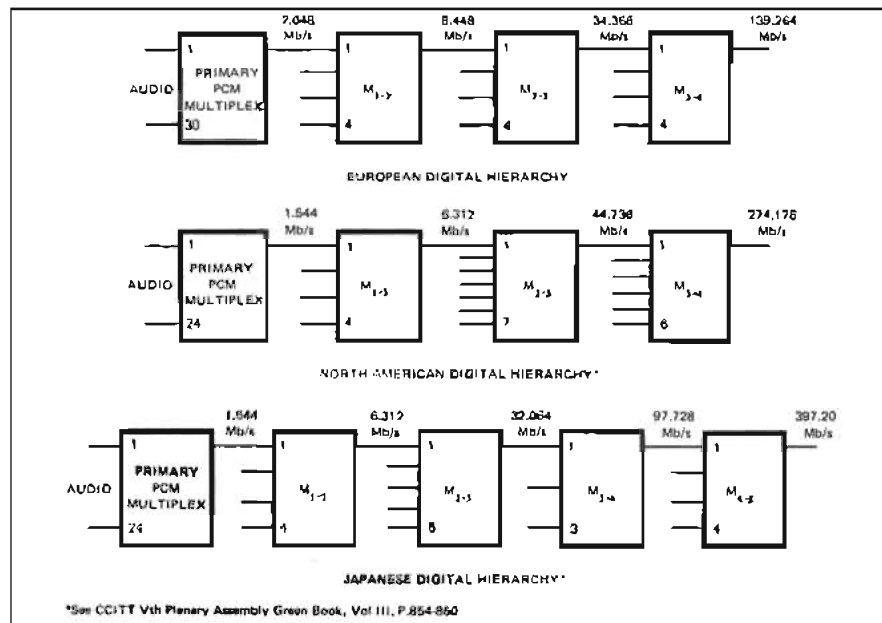

Figure 1. Basic PCM/TDM transmission system



*See CCITT Vth Plenary Assembly Green Book, Vol III, P.854-860

Figure 2. Proposed standard digital transmission hierarchies

TELECOMMUNICATIONS TEST EQUIPMENT

Error detection up to 150 Mb/s

Models 3760A & 3761A

- Internal variable or crystal clocks
- Wide range of test patterns
- Variable binary interfaces with optional delayed data output
- Clock/data phasing
- Automatic, manual, or external synchronisation
- Bit-by-bit error detection
- Wide choice of error count period
- BCD printer output

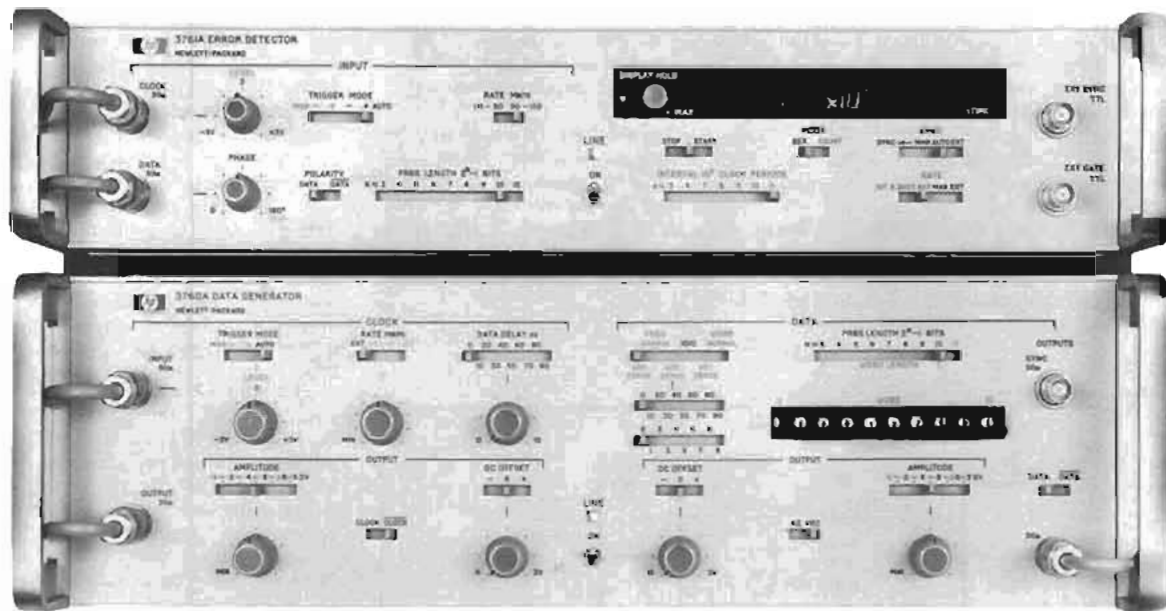

3760A (bottom) & 3761A

The 3760A/3761A Error Rate measurement system has been designed for general use in the evaluation of digital systems operating in the frequency range 1 kb/s – 150 Mb/s. It has particular applications in the design and development of PCM/TDM systems.

The measurement system comprises the 3760A Data Generator, which provides a variable length PRBS to the item or system under test, and the 3761A Error Detector which has been specifically designed for operation with the pseudo random sequences produced by the Data Generator. Error detection is accomplished by comparing the output from the item under test, bit-by-bit, with an independent, closed loop, reference sequence in the 3761A Error Detector. This technique ensures detection of every error, random or systematic, and avoids the problems associated with open loop reference sequence generation. Errors may be counted and directly displayed in the 3761A either as Bit Error Rate (BER) or Total Error Count (COUNT).

The 3760A Data Generator is a versatile PRBS and WORD generator and can supply many of the test sequences required for the development and evaluation of digital transmission equipment. Its features are described fully in the Data Generator Model 3760A Data Sheet and only those which complement the 3761A Error Detector are described here.

The Data Generator can be manually or automatically triggered from an external clock in the frequency range 1 kHz – 150 MHz. The clock input will accept continuous or burst information. Alternatively, the generator may be driven from an internal clock source which can be variable or crystal controlled in the frequency range 1.5 –

150 MHz. A clock output is always provided in normal or complemented form, which is variable in amplitude and dc offset.

The PRBS is variable in length from $2^1 - 1$ to $2^{16} - 1$ bits, with an additional long sequence of $2^{15} - 1$ bits. A sync pulse occurs once per PRBS and may be varied in position relative to the sequence. For back-to-back testing of the Data Generator and Error Detector, two errors can be inserted once per 4000 sequences. The data output is available in normal or complemented form and may be varied in amplitude and dc offset. Either RZ or NRZ formats may be selected and the data output can be delayed by up to 100 ns with respect to the clock.

The 3761A Error Detector requires both clock and data inputs. The inputs accept continuous or burst signals in the frequency range 1 kHz to 150 MHz. For the clock input manual and automatic triggering on both +ve and -ve slopes of the input waveform are provided. Indication of clock presence with correct triggering is given by a front panel lamp. The data input conditions for frequency range, waveshape, impedance and sensitivity are similar to those for the clock. Triggering on data is automatic for continuous inputs with compensation for dc offsets. For burst inputs a switch inside the 3761A can be used to set a ground threshold trigger level. The input can be inverted with a DATA/DATA switch to allow for an inversion in the item or system under test. A front panel variable phase control is used to ensure that coincidence between clock and data edges is avoided. A lamp indicates when a correct phase relationship between the clock and data has been attained.

Synchronization of the 3761A Error Detector to the incoming data can be accomplished automatically, manually or externally. In the automatic mode, correct synchronism is ensured by continually monitoring the average error rate over a period long enough to remove the effect of error bursts. In the manual synchronization mode, the Error Detector searches for synchronism on command from a front panel switch, and in the external mode, by command from an external TTL signal. A "gating" flag indicates the instrument is in synchronism and making a measurement. Whenever the instrument is out of synchronism a "sync loss" flag is displayed.

The BER measurement is computed from more than 100 errors and the results displayed directly in the form $A.B \times 10^{-n}$ giving a range 0.1×10^{-9} to 9.9×10^{-1} . The COUNT measurement totalises errors over a gating period, which may be controlled internally or externally, and the result is displayed as a four digit number with leading zeros blanked. The internal gating period can be selected within the range 10^3 to 10^{11} clock periods and can be single shot or repetitive in operation. When a count of 9999 is exceeded an "overflow" flag is lit. When using manual, external or internal single shot gating the display continues to register the least significant digits of the count. A TTL compatible external gate input is provided, and manual gating is controlled with a front panel start/stop switch.

In both BER and COUNT modes, the display is continually updated at a rate which may be set by the operator.

A BCD printer output of the current display is available from a rear panel socket. This output is in 8421 format and includes the sync loss and overflow flag indications. An output of one transition per error is also available at the rear panel for further analysis.

Specifications

Measurements

Bit error rate (BER)

Range: 0.1×10^{-9} to 9.9×10^{-1} , automatically scaled.

Gating: automatic.

Accuracy: computation based on at least 100 errors.

Total error count (COUNT)

Range: 0 to 9999.

Gating: internal, single shot or repetitive, manual or external.

Internal: 10^3 to 10^{11} clock periods.

Manual: front panel switch.

External: TTL logic levels.

Patterns:

PRBS: maximal length $2^n - 1$ where $n = 3$ to 10 and 15.

Data generator

Clock input

Rate: 1 kHz to 150 MHz.

Impedance: $50\Omega \pm 5\%$ dc coupled (75 Ω optional).

Trigger: manual with level range -3 V to $+3$ V, +ve or -ve slope. Auto with input mark: space ratio range 10:1 to 1:10.

Sensitivity: better than 500 mV pk-pk.

Amplitude: 5 V pk-pk maximum. Limits ± 5 V.

Pulse width: 3 ns minimum at 50% pulse amplitude.

Indicator: lamp showing clock present and triggering correctly.

Clock output

Outputs: CLOCK or $\overline{\text{CLOCK}}$ selectable.

Impedance: source impedance $50\Omega \pm 5\%$ (75 Ω optional).

Amplitude: continuously variable in 5 ranges from 0.1 to 3.2 V symmetrical about offset level.

DC offset: zero, <2% of pulse amplitude.

Variable, continuous 0 to ± 3 V.

Transition times: <1.4 ns into 50Ω , <1.6 ns into 75 Ω .

Overshoot: <10% of pulse amplitude.

Data output

Outputs: DATA or $\overline{\text{DATA}}$ selectable.

Format: NRZ or RZ (up to 130 Mb/s).

Delay: data (and Sync) delayed with respect to Clock continuously

in 10 ranges from 0 to 100 ns.

Other specifications as for clock output.

Sync output

Rate: once per PRBS.

Position: front panel selectable.

Amplitude: +1 V into 50Ω .

Error detector

Clock input: specifications as for Data Generator Clock Input except that both +ve and -ve slope triggering is available in automatic mode.

Data input

Inputs: DATA or $\overline{\text{DATA}}$ selectable.

Rate: 1 kb/s to 150 Mb/s.

Impedance: $50\Omega \pm 5\%$ dc coupled (75 Ω optional).

Trigger level: automatic.

Sensitivity: better than 500 mV pk-pk.

Amplitude: 5 V pk-pk maximum. Limits ± 5 V.

DC offset: ± 3 V maximum.

Pulse width: 5 ns minimum at 50% pulse amplitude.

Phasing

Control: clock phase variable relative to data.

Indication: lamp off when clock and data edges coincide.

Range: 0 to 180° for 1.5 to 50 Mb/s.

0 to 12 ns for 1 kb/s to 1.5 Mb/s and 50 to 150 Mb/s.

Synchronization

Modes: auto, manual, external.

Auto: automatically searches for synchronism if more than 20,000 errors in 100,000 bits.

Manual: resynchronization commanded from front panel.

External: resynchronization commanded by TTL input.

Display

BER: two digits plus exponent $A.B \times 10^{-n}$.

COUNT: four digits.

Flags: sync loss, overflow and gating.

Printer output

Format: 8421 BCD.

BER & COUNT: updated display for the duration of the print command pulse.

Flags: sync loss, 0 printed in column 1. Overflow in repetitive count, output inhibited.

Command: TTL pulse at display change.

Error output

Format: one transition per error.

Amplitude: +1 V into 50Ω .

General

3760A Data generator

Power: 100 to 125 V or 200 to 250 V, 40 to 400 Hz, 90 W.

Dimensions: 425 mm wide, 140 mm high, 467 mm deep (16 $\frac{1}{2}$ " \times 5 $\frac{1}{2}$ " \times 18 $\frac{3}{4}$ ").

Weight: 13.6 kg. (30 lb).

3761A Error detector

Power: 100 to 125 V or 200 to 250 V, 40 to 400 Hz, 70 W.

Dimensions: 425 mm wide, 95 mm high, 467 mm deep (16 $\frac{1}{2}$ " \times 3 $\frac{3}{4}$ " \times 18 $\frac{3}{4}$ ").

Weight: 10.4 kg. (23 lb).

Options

3760A Data generator: options available include continuously variable and crystal controlled clocks, and delayed data output. Full details are given in the 3760A Data Generator Data Sheets.

3761A Error detector

Option 001: 75 Ω CLOCK and DATA input impedances.

Option 002: Printer interface cable.

Model number and name

3760A Data Generator

3761A Error Detector

Price

N/C
add \$150

\$6525

\$5630

TELECOMMUNICATIONS TEST EQUIPMENT

1 kb/s – 50 Mb/s PCM/TDM error measuring set for field use

Model 3780A

- Binary and code error measurements
- Internal crystal clocks and clock recovery at standard bit rates
- Clock frequency offset generation and measurement capability
- Ternary coded and binary interfaces
- PRBS and WORD pattern generation and detection
- Automatic receiver synchronisation
- Printer and recorder outputs



3780A

Description

The 3780A Pattern Generator-Error Detector is a comprehensive error measuring set in one portable package. The instrument measures Binary Errors and Code Errors in digital transmission equipment operating at bit rates between 1 kb/s and 50 Mb/s. Frequency offset generation and measurement are also provided at the standard bit rates used in PCM/TDM transmission.

Binary errors are detected by stimulating the system with a test pattern and comparing the output bit-by-bit with a separate internally generated, error-free pattern. The errors can be counted over a chosen gating period and displayed directly as bit error rate (BER) or total error count (COUNT).

Code errors on interface or line coded information are detected during decoding into binary data and counted in the same way as for binary errors.

Error measurements can be made with PRBS or WORD patterns and the receiver has automatic pattern recognition and synchronisation. Zero add facilities allow investigation of regenerator clock recovery performance. This capability can be extended by the optional addition of programmable word and alternating word generation.

The clock frequency in the pattern generator can be offset and measured in the receiver. The offset is displayed as a fraction of the nomi-

nal crystal centre frequency. In addition, the offset of external clocks applied to the generator can be measured provided that the frequency is within 25 kHz of one of the installed crystal frequencies.

BER or COUNT results can be displayed directly by LED's on the front panel or monitored via a BCD printer and strip chart recorder. This makes the 3780A ideally suited for unattended long-term measurements.

The 3780A has been designed principally for use in field trial, commissioning, and maintenance of digital transmission terminal and link equipment. It is particularly suited for testing digital multiplex, radio, and line systems but will also find application in development of more advanced systems such as optical fibre transmission and time division switching.

Specifications

Measurements

Binary errors: closed loop bit-by-bit detection on any pattern produced by generator, excluding added zeros or alternating words.

Code errors: violations of coding rule detected on any pattern with AMI, HDB3, or HDB2 coding (optionally AMI, B6ZS, or B3ZS).

Frequency offset: measurement of fractional offset of generator clock output from installed crystal rates.

Pattern generator

Internal clock: three crystal clocks at 2048, 8448, and 1536 kHz; overall stability ± 17 ppm (for other frequencies see options).

Clock offset: range continuously variable up to at least ± 50 ppm about installed crystal frequencies; offset can be displayed in receiver.

External clock: 1 kHz to 50 MHz; 75 Ω ; auto or ground threshold triggering.

Clock output: CLOCK or $\overline{\text{CLOCK}}$; amplitude 3 V ± 0.3 V pk-pk; 75 Ω .

Patterns:

PRBS: maximal length 2^9-1 , $2^{15}-1$, $2^{20}-1$; randomly selectable 9, 15, or 20 bit sequences.*

Word: 0000, 1000, 1010, 1100, 1111 fixed words.

Zero add: 1-999 zeros may be added once per sequence to any pattern.

Error add: 10^{-2} binary error rate may be added to any pattern.

Data format: binary NRZ or RZ; ternary RZ AMI or coded; codes — HDB3 or HDB2 (optionally B6ZS or B3ZS).

Data output: amplitude — binary 3 V ± 0.3 V pk-pk, ternary 4.74 V ± 0.47 V pk-pk; 75 Ω .

Delay data output: binary format only; 6 bits advanced on main data output; amplitude 3 V ± 0.3 V pk-pk; 75 Ω .

Clock/data phasing: NRZ data — rising edge of clock nominally in middle of data; RZ data — clock and data nominally coincide.

Trigger output: square wave with one transition per sequence; output held at zero during zero add; amplitude 1 V pk-pk min; 50 Ω .

Error detector

Data input: 1 kb/s to 50 Mb/s; 75 Ω ; choice of nominal triggering threshold — 200 mV, 600 mV, or ground.

Data format: binary NRZ or RZ; ternary RZ AMI or coded; codes — HDB3 or HDB2 (optionally B6ZS or B3ZS).

Clock recovery: at the three internal rates of generator; operates on any data input provided there are 2 or more transitions every 20 bits.

External clock: 1 kHz to 50 MHz; CLOCK or $\overline{\text{CLOCK}}$; 75 Ω ; auto or ground threshold triggering.

Clock/data phasing: recovered clock — auto phasing; external clock — rising edge of clock should be nominally in middle of data pulse.

Patterns:

PRBS and Word: recognizes all patterns produced by generator excluding added zeros and alternating words; receiver also recognizes PRBS.

Indicators: LED indication of pattern lock for PRBS, $\overline{\text{PRBS}}$, WORD, and ALL ONES/ZEROS (indicator inhibited during sync loss and code error or frequency offset measurements).

Synchronization: auto with manual override; sync loss if greater than approx. 20 000 errors in 500 000 clock periods; manual sync override via pushbutton, forcing a sync loss; resync time typically <500 bits.

Display

BER: totalizes errors over selected gating period and automatically scales the answer; gating over 10^4 , 10^6 , or 10^{10} clock periods, repetitive; A.B $\times 10^{-n}$ LED format.

COUNT: totalizes errors over selected gating period; manual gating via start/stop pushbuttons; external gating via printer output; A.B $\times 10^{-n}$ LED format with auto round-up.

FREQ OFFSET: counts deviation frequency over 10^6 clock periods of internal standard crystal rate; automatic gating; A.B $\times 10^{-n}$ LED

format with auto round-up.

Flags (LED's):

GATING: indicates measurement in progress.

SYNC LOSS: indicates local pattern reference has lost sync.

OVERFLOW: indicates internal error or frequency count $\geq 10^9$.

<100 ERRORS: indicates less than 100 errors counted during last error measurement.

Printer output: 8421 BCD, 10 column format; TTL print command pulse.

Recorder output: current source with 500 ms min response; impedance greater than 50 k Ω ; 1 mA variation over 16 levels into 10 k Ω max; for BER, 11 levels are used; for COUNT, 4 levels are used; 2 rear panel pushbuttons for fsd and zero calibration.

Error output: one pulse per error (inhibited during sync loss); amplitude 1 V pk-pk min; 50 Ω .

Trigger output: one pulse per sequence (PRBS only); amplitude 1 V pk-pk min; 50 Ω .

Clock output: detector clock available as a monitor; amplitude 1 V pk-pk min; 50 Ω .

General

Power supply: 115 V ± 10 -22%, or 230 V ± 10 -18%, ac, 48 to 66 Hz, max consumption approx. 110 VA.

Probe power: external fused supplies of +5 V, 200 mA, and -5 V, 200 mA, for hp logic probes.

Connectors: all signal connectors are BNC (except Options 002, 003); printer output via 50-pin Amphenol connector; recorder output via 2 binding posts.

Dimensions: 195 mm high, 335 mm wide, 475 mm deep (7 $\frac{1}{2}$ in. \times 13 $\frac{1}{16}$ in. \times 18 $\frac{3}{8}$ in.).

Weight: net, 12.5 kg (27.5 lb). Shipping, 15 kg (33 lb).

Environment: operating temperature range 0 to +55 $^{\circ}$ C; storage temperature range -40 to +75 $^{\circ}$ C.

Options and Accessories

Price

Word/connector options

001: all words replaced by 16-bit front panel programmable word. This can also provide two 8-bit words alternated by an external signal applied via the rear panel. Changeover is synchronous with end of words. Zero add then operates on individual 8-bit words, and trigger output is 8-bits wide.

add \$250

002: Siemens 1.6 mm connectors.

add \$65

003: combination of 001 and 002.

add \$310

Frequency offset option

099: frequency offset capability — measurement only, generation facility deleted.

less \$421

Frequency/codec options

100: internal clock frequencies of 2048, 8448, and 34368 kHz.

N/C

101: internal clock frequencies of 1544, 6312, and 44736 kHz; B6ZS/B3ZS codec.

N/C

102: internal clock frequencies of 1544, 6312, and 3152 kHz; B6ZS/B3ZS codec.

N/C

910: Extra manual set

add \$5

HP 15508A: 75 Ω unbalanced to 110 Ω balanced passive converter; frequency range 1 to 10 MHz.

\$85

Model 3780A Pattern Generator—Error Detector

\$6815

CALCULATORS & PERIPHERALS

Pocket and desktop calculators; multiprogrammer

General Information

Wide range of capability

Hewlett-Packard introduced its first desktop programmable calculator in 1968 and the world's first pocket scientific calculator in 1972. Since then, Hewlett-Packard has introduced several desktop and pocket calculators with technologically advanced features; each with different capabilities for different levels of problem sophistication. To properly select a calculator, you must consider not only the problems you're facing today, but those you're likely to face tomorrow.

Personal calculators

If your problems are fairly straightforward but still include coordinate conversions, log and trig functions, the HP-21 may be just perfect for you. The HP-21 is the lowest priced scientific pocket calculator Hewlett-Packard offers, yet it has all the functions and features you'd expect to find in a quality scientific pocket calculator.

For similar problems where a printout is desirable, the HP-91 Scientific Printing Calculator is ideal. The HP-91 provides you with a full range of scientific and arithmetic functions—complete with a printed record—all in one personal-sized, battery-operated calculator.

For repetitive or iterative problems, two HP calculators are practically "custom made" for you—the HP-25 and the HP-25C. These two calculators have identical programming power and identical preprogrammed functions including conditional tests, full editing, eight addressable memories, and a great many mathematical and statistical functions. But the HP-25C also has a continuous memory that retains your programs and saves your data even when you turn the calculator off.

To bridge the gap between scientific and business calculations, you should consider the HP-27 Scientific/Plus, which gives you every scientific function we've ever offered in a preprogrammed calculator—plus the added power of statistics and finance. The HP-27 will be extremely valuable to any scientist, businessman or engineer whose responsibilities extend into targeting, budgets, cost analysis, and other financial and forecasting considerations.

If your problems are more business oriented, take a look at the HP-22 Business Management Pocket Calculator and the HP-80 Financial Pocket Calculator. The HP-22 provides an ideal combination of the financial, mathematical, and statistical capabilities you need in modern business. The HP-80 includes specialized features such as bond prices and yields, depreciation, and a 200-year calendar.

For the ultimate problem solving power in any field, Hewlett-Packard offers you two new compatible, fully programmable calculators—the HP-67 Pocket Calculator and the HP-97 Printing Calculator. The HP-97 combines exceptional programming power—plus a battery-operated printer—all in one self-



contained unit. The HP-67 provides the identical power of the HP-97 in the classic pocket size. Used separately—or together—these compatible, fully programmable calculators do the job faster and with less chance for error.

Whichever HP personal calculator you finally select, you can be assured that it is the finest in its class... because HP's standards of quality permit nothing less.

Desktop programmable calculators

Hewlett-Packard offers a selection of powerful desktop programmable calculators that combine computer-like power with the immediate accessibility and ease of operation found in HP personal calculators. These state-of-the-art computing devices will meet your needs now, and they can expand to meet your growing future needs.

The desktop units have a range of memory sizes, programming languages, and data-handling capabilities, with peripheral input and output devices that let them control measuring and data processing systems in many scientific, technical, and business applications.

Many users find the HP 9815A to be the most cost-effective solution to their computing and system control needs. If you are familiar with the Hewlett-Packard personal calculators, you'll feel at home with the 9815A's RPN language. Programs are easy to write and edit, and they can include messages that the calculator prints during program operation to prompt the user.

Several HP software libraries are available, or you may elect to write your own programs for specialized problems. Among the HP-designed programs are libraries for:

- Statistics
- Electrical engineering
- Clinical laboratory, radioimmunoassay
- Surveying
- General utility and test programs

In a system configuration, the 9815A can control up to 15 instruments and gather and process the data from them.

Weighing only 15 pounds, the 9815A can easily be moved from one desk to another—from your office to your home—so it can be at your fingertips to do anything from simple keystroke calculations to your most complex computational problems.

The 9825A's speed, interfacing abilities, and computer-like features make it particularly well suited for use as the controller of an instrument system, for pilot process control applications, remote data collection, production control, and as a powerful stand-alone computing tool.

In interfacing applications, the two-level priority interrupt and high-speed I/O capabilities help you to construct the system best suited to your present needs and to revise the system later for future requirements. Used with the 9878A I/O Expander, the 9825A controls up to 14 interface buses, 14 devices per bus, for a total of 196 HP-IB compatible instruments connected to one 9825A.

As a computing device, the 9825A offers several features designed especially to help you with computations and data processing.



The high-level programming language (HPL), for instance, is formulated for ease of use in both controller and data processing applications. You may either write your own programs or select from the following Hewlett-Packard program libraries:

- AC circuit analysis
- General utility routines (mathematics)
- General statistics
- Analysis of variance and regression analysis
- Nonparametrics

While a program is running, you can use the 9825A keyboard at the same time for other calculations or to actually change any of the program variables without interrupting program execution.

If it is necessary to make the 9825A available for a priority program while the calculator is executing a complex program, you can transfer the entire contents of the read/write memory to the data cartridge, which stores 250 k bytes of data and programs. Thus, you can preserve the current status of the unfinished program, then reload it and complete execution when it is convenient.

The Hewlett-Packard 9830A/B is a preferred computing device where data processing is required, in addition to general technical computations and system control. It has the simplicity of a calculator, but the versatility to allow it to be used as a terminal.

Like other HP desktop computing devices, the 9830A/B is economical because it can be ordered with minimum read/write memory as a stand-alone unit. As your needs in-

crease, you can add to the read/write memory, add read-only memories (ROMs) to enhance language and interfacing capabilities, and add peripherals to allow more forms of input and output. Possible input types include keyboard entry, tape cassettes, marked or punched cards, punched paper tape, or data from a digitizer for analysis of geometric shapes. Output can be charts or graphs from a plotter, printed text or tables from a thermal page printer or line printer, punched paper tape, answers on the internal LED display, or displays on an external CRT.

The 9830A/B's HP BASIC language allows dialogue with the machine. It prompts the user with displayed messages and displays data entries. HP BASIC is easy to learn and use, so you can choose either to write your own programs or to select from a variety of HP software libraries for your technical, scientific, or business applications. Statistical programs are available for almost any application. Other HP software libraries include applications in these areas:

- Scientific/technical
 - Electrical engineering
 - Medical
 - Construction engineering
 - Numerical control
 - Surveying
- Commercial
 - Financial services
 - Investment analysis
 - Accounting
 - Budget monitoring

Adding the mass memory subsystem to the 9830A/B allows it to handle up to 4.8 mil-

lion bytes of information, making possible the data processing functions encountered in accounts receivable and payable, inventory control, and similar applications.

Terminal capabilities are added to your 9830A/B by inserting the appropriate data communications ROMs and modem/automatic dialer interface cards. The 9830A/B can be configured to provide data communications capability in three ways:

- From 9830A/B to time-sharing system
- From 9830A/B to remote batch system
- From 9830A/B to 9830A/B

Whatever your requirements are for a computing system, one of the Hewlett-Packard desktop calculators may be the answer. Just call our engineers at the Hewlett-Packard sales office in your area. They will gladly guide you in selecting the most cost-effective solution to your computational needs.

Multiprogrammers

If you must build your own calculator- or computer-controlled system, the Multiprogrammer can solve many of the system-building problems you will face now and in the future.

The Multiprogrammer is input/output hardware consisting of mainframes and plug-in cards plus software user's guides. Multiprogrammers help you organize a control or test system confidently and economically.

To give you versatility to interface with many different types of external devices, there is a variety of Multiprogrammer plug-in cards. Plug-in cards are available to measure and control voltage, current, resistance, frequency, time, and digital signals. Other plug-in cards include digital word comparators, stepping motor controls, scanners, and interrupt cards. There are even do-it-yourself cards that give you room to build your own special control or measurement circuitry.

Up to 15 plug-in cards may be combined in a Multiprogrammer mainframe, which provides bias power and address logic for the cards. You have the flexibility to combine the cards in any order and mix input and output card types in any number. For larger systems that require more than 15 plug-in cards, you can connect up to 15 Multiprogrammer extender mainframes to the first mainframe. Each Multiprogrammer extender mainframe, like the first Multiprogrammer mainframe, can hold up to 15 plug-in cards. A full chain of 16 Multiprogrammer mainframes provides room for up to 240 plug-in cards. This means that you need not worry about running out of I/O slots in your calculator or computer when you use the Multiprogrammer to expand I/O capability.

Multiprogrammers have been designed to make it easy for you to control and measure even large numbers of different types of signals with your HP calculator or computer. Ask your HP field engineer for your copy of the 48-page Multiprogrammer Data Sheet, HP Publication Number 5952-3982, that describes Multiprogrammer capabilities, hardware, operating features, interface kits, and applications.

CALCULATORS & PERIPHERALS

Scientific programmable pocket calculators

HP-25/25C

- Keystroke programmable for fast solution of repetitive problems
- 8 Addressable memories with full register arithmetic
- HP-25C Features Continuous Memory that retains your programs and data even when you turn the calculator off.



HP-25C Scientific Programmable Pocket Calculator With Continuous Memory

Continuous Memory (HP-25C only)

The continuous memory capability of the new HP-25C can provide tremendous values in time-saving and convenience to any scientist, engineer or student who uses a few long programs repeatedly — for example, if twenty percent of your programs will solve most of your problems.

The HP-25C retains a program — no matter how often you switch it on and off — by means of sophisticated complementary metal oxide silicon circuitry (C-MOS). The last program you store is saved, ready for use, until you clear it or enter a new program.

As a result, you can program a frequently-needed calculation once, and then perform it as often as necessary — hour after hour, day after day — without the bother or lost time caused by re-entering your program.

Lets you add special functions not on the keyboard

Continuous memory makes it possible to add specialized functions to those already pre-programmed into the HP-25C.

For example, if you anticipate extensive work with hyperbolics, you can program them into the HP-25C where they will be retained by the continuous memory for repeated calculations at the touch of a key.

Many specialized functions can be programmed into the HP-25C for fast keystroke calculations, including conversions such as decimal degree/radian, octal/decimal; statistical functions; pricing analysis functions; real estate functions; business functions and many others.

Remembers data collected for later use

The HP-25C with continuous memory not only retains all information in its 49-step program memory, it also retains all data in the 8 addressable registers and the LAST-X register.

This capability lets you use the HP-25C as a notebook to save data from previous problems for later use or to keep the sum of statistical data entries while taking samples in the field. For example, surveyors doing traverses in the field can keep intermediate results even while the calculator is turned off between readings.

Engineers will find the HP-25C convenient in storing conversion constants until needed later.

HP-25/25C Specifications

Pre-programmed functions

Trigonometric (all in decimal degrees, radians, or grads): Sin x; Arc Sin x; Cos x; Arc Cos x; Tan x; Arc Tan x.

Logarithmic: Log x; Ln x; e^x ; 10^x .

Statistical: mean and standard deviation; summations giving n , Σx , Σx^2 , Σy , Σxy .

Other: y^x ; \sqrt{x} ; $1/x$; π ; x^2 ; ϕ ; conversions between decimal hours, degrees, radians, or grads and hours (degrees)/minutes/seconds; rectangular/polar coordinate conversions, integer/traction truncation; absolute value, full register arithmetic.

Programming features

49-step program memory; conditional branching based on any of eight relational tests ($x < y$, $x \geq y$, $x \neq y$, $x = y$, $x < 0$, $x \geq 0$, $x \neq 0$, $x = 0$); direct branching; ability to review or execute programs step-by-step; ability to add or modify program steps; PAUSE and NO-OPERATION program instructions.

General

Memory: eight addressable registers; four-register operational stack; Last-X register.

Display: up to 10 significant digits in fixed-decimal notation; up to 8 significant digits plus 2-digit exponent in scientific or engineering notation (in engineering notation all exponents are displayed as multiples of ± 3); full display formatting in any mode with selective round-off; indicators for improper operations, low battery; line-number/key matrix program display.

Dynamic range: 10^{-99} to 10^{99} (200 decades).

Power: AC: 115 or 230 V, $\pm 10\%$, 50 to 60 Hz. Battery: 2.5 V dc nickel-cadmium rechargeable battery pack.

Dimensions: length: 13.0 cm (5.1"). Width: 6.8 cm (2.7"). Height: 3.0 cm (1.2").

Model number and name:

HP-25 Scientific Programmable Pocket Calculator
HP-25C Scientific Programmable with Continuous Memory

Price

\$145

\$200

CALCULATORS & PERIPHERALS



Scientific/plus pocket calculator

HP-27

- Every scientific function we've ever offered in a preprogrammed calculator — plus the added power of statistics and finance.
- 20 Memories help simplify your most difficult calculations.



HP-27 Scientific/plus pocket calculator

The new HP-27 Scientific/Plus is the most powerful preprogrammed pocket calculator Hewlett-Packard has ever built. Its highly sophisticated design effectively integrates every significant and financial function — and thus eliminates the need for two separate calculators.

The extraordinary versatility of the HP-27 will be extremely valuable to any scientist or engineer whose responsibilities extend into targeting, budgets, cost analysis and other financial and forecasting considerations.

New statistical and financial functions greatly expand your calculating power

The HP-27 gives you all the most-used statistical and financial functions, including five new functions never before made available on an HP pocket calculator—variance, correlation coefficient normal distribution, net present value and internal rate of return for uneven cash flows.

With the remarkable HP-27, you can handle not only scientific calculations but other vital calculations you need to arrive at intelligent financial decisions and recommendations.

All the fundamental scientific, statistical and financial functions are preprogrammed and permanently stored in the HP-27. All you have to do is key in your data, press the appropriate function keys and see your answer displayed in seconds.

And for added convenience, the HP-27 provides an exceptionally large memory capacity, flexible display controls and selective clearing operations.

HP-27 specifications

Pre-programmed functions

Mathematical: Sin, Cos, Tan, Sin⁻¹, Cos⁻¹, Tan⁻¹; Degrees, radians, and grads angular modes; Ln, e^x, log, 10^x, y^x, x^y, 1/x, π, +, -, ×, ÷, → H.M.S. → H, H.M.S ±; Coordinate conversion.

Statistical: Σ+ accumulates x, y, x², y², xy, and n; Σ- deletes unwanted data; linear regression; correlation coefficient; mean and standard deviation; variance; normal distribution factorial.

Financial: time-value-of-money calculations involving n (number of compounding periods), i (periodic interest rate), PMT (payment), PV (present value of money), FV (future value), net present value; internal rate of return; percent, percent difference, and percent of total.

General

Memory: 10 addressable registers; five financial registers; four-register automatic memory stack; and a Last-X register.

Clearing options: clear the display; clear the stack; clear statistical registers; clear addressable registers; clear the status of the financial registers; clear the prefix keys.

Display: up to 10 significant digits in fixed-decimal notation; up to 8 significant digits plus 2-digit exponent in scientific or engineering notation (values are displayed with exponents that are multiples of 3); full display formatting in any mode with selective round-off; indicators for improper operations, low battery.

Dynamic range: 10⁻⁹⁹ to 10⁹⁹ (200 decades).

Power: AC: 115 or 230 V, ±10%, 50 to 60 Hz, Battery: 2.5 V dc nickel cadmium rechargeable battery pack.

Dimensions: length: 130.2 mm (5.1"); width: 68.3 mm (2.7"); height: 30.2 mm (1.2").

HP-27 Scientific/Plus Pocket Calculator

\$175

CALCULATORS & PERIPHERALS

Scientific & business pocket calculators

HP-21, HP-22

- Full range of functions plus rectangular/polar conversions
- Two display formats: two angular modes
- Hewlett-Packard's efficient RPN logic system
- A new pocket calculator designed specifically for complete business management



HP-21 Scientific Pocket Calculator

The HP-21 performs 32 preprogrammed functions and operations including logarithms, and trig calculations, and polar to rectangular conversions in either radians or degrees. Full display formatting allows you to choose between fixed decimal and scientific notation.

The RPN logic system tackles even the most complex problems efficiently and gives you continuous and immediate feedback. Combine the HP-21's capability with its low cost, and you have a price-performance ratio that's simply unbeatable.

HP-21 Specifications

Pre-programmed functions:

Trigonometric (all in degrees or radians): Sin x; Arc Sin x; Cos x; Arc Cos x; Tan x; Arc Tan x.

Logarithmic: Log x; Ln x; e^x ; 10^x .

Other: y^x ; \sqrt{x} ; $1/x$; π ; rectangular/polar coordinate conversion; full register arithmetic.

General

Memory: one addressable register; four-register operational stack.

Display: up to 10 significant digits in fixed-decimal notation; up to 8 significant digits plus two-digit exponent in scientific notation; full display formatting in either mode with selective round-off; indicators for improper operations, low battery.

Dynamic range: 10^{-99} to 10^{99} (200 decades).

Power: AC: 115 or 230 V, $\pm 10\%$, 50 to 60 Hz. Battery: 2.5 V dc nickel-cadmium rechargeable battery pack.

Dimensions: length: 13.0 cm (5.1"). Width: 6.8 cm (2.7"). Height: 3.0 cm (1.2").

HP-21 Scientific Pocket Calculator

\$89



HP-22 Business Management Pocket Calculator

The HP-22 business management pocket calculator puts an ideal combination of financial, mathematical and statistical functions at your fingertips. With it, you can handle everything from simple arithmetic to complex time-value-of-money computations. You can even handle planning, forecasting and decision analysis. And, you can approach business problems in a variety of ways to arrive at intelligent decisions and recommendations based on facts.

The HP-22 automatically calculates discounted cash flows; percentages; ratios; proportions; compound interest; remaining balance; annuities; depreciation; mean and standard deviation; rate of return; amortization and more.

HP-22 Specifications

Pre-programmed functions

Financial: time-value-of-money calculations involving n (number of compounding periods), i (periodic interest rate), PMT (payment amount), PV (present value of money), FV (future value of money); simple interest; accumulated interest between payment periods of a loan; remaining balance of a loan.

Statistical: mean and standard deviation; linear regression; linear estimate; summations giving n, Σx , Σy , Σx^2 , Σxy .

Percent: %, $\Delta\%$, percent one number is of another; percent one number is of a total; markups; discounts.

Other: Ln; e^x ; y^x ; \sqrt{x} ; full register arithmetic.

General

Memory: 10 addressable registers; five financial registers; four-register operational stack.

Display: up to 10 significant digits with selective round-off to desired number of decimal places (0 to 9) in fixed-decimal notation; 8 significant digits plus two-digit exponent and appropriate signs in scientific notation; indicators for improper operations, low battery.

Dynamic range: 10^{-99} to 10^{99} (200 decades).

Power: AC: 115 or 230 V, $\pm 10\%$, 50 to 60 Hz. Battery: 2.5 V dc nickel-cadmium rechargeable battery pack.

Dimensions: length: 13.0 cm (5.1"). Width: 6.8 cm (2.7"). Height: 3.0 cm (1.2").

HP-22 Business Management Pocket Calculator

\$125

CALCULATORS & PERIPHERALS



Fully programmable calculators
HP-97, HP-67

- Exceptional programming power and ease of use for lengthy, repetitive calculations.

- "Smart" magnetic card reader frees your mind by automatically recording the display mode setting, angular mode setting, and the status of the four flags when you record your program.



HP-67 Fully-Programmable Pocket Calculator

HP-97 Fully-Programmable Printing Calculator

These are the most powerful personal calculators Hewlett-Packard has ever made. The HP-97 combines exceptional programming power—plus a battery-operated printer all in one self-contained unit. The HP-67 provides the identical programming power of the HP-97 in the classic pocket size.

The HP-67 is completely compatible with the HP-97. Programs recorded on the unit may be loaded and executed on the other — even the print commands (e.g., when the HP-67 executes a Print X command, it pauses, and displays the current results).

Used separately — or together — these compatible fully programmable calculators do the job faster and with less chance for error.

HP-97/67 specifications

Pre-programmed functions

Mathematical: Sin, Cos, Tan, \sin^{-1} , \cos^{-1} , \tan^{-1} ; Degrees, radians, grads angular modes; Coordinate conversion; Degree/radian conversion; Hour/minutes/seconds addition and conversion to decimal hours; Log, 10^x , Ln, e^x ; Integer truncation; Fraction truncation; Absolute value; Rounding; +, -, \times , \div , y^x , x^y , $1/x$, \sqrt{x} , N1, %, %CH, π .
Statistical: mean and standard deviations; Summations Σx , Σx^2 , Σy , Σy^2 , Σxy ; Deletion of unwanted data.

Programming features

Card Reader features: Record/Load all data registers; Load selected data registers; Record/Load entire program memory; Merge program subsections; Angular mode, flag settings, and display status are recorded with program recording and reset with program loading; User is prompted for proper operation when loading; Card reader operations can be initiated manually or under program control (except program recording).

Addressing: label addressing; indirect addressing of labels and data storage; Relative addressing; 10 user-definable keys or 20 user-definable labels; Three levels of subroutines (GSB).

Conditionals: $x=y$, $x \neq y$, $x > y$, $x \leq y$, $x \neq 0$, $x=0$, $x < 0$, $x > 0$; Four flags; Increment, decrement storage registers and skip on zero.

Editing: single step execution; Single step and back step inspection of a program; Insert/Delete editing. Position the calculator at any step in program memory (GTO · nnn).

Other Programming features

PAUSE to review intermediate results, key in data or load magnetic cards.

General

Memory: 224 steps of program memory (all functions are merged and occupy only one step of program memory); 26 data registers; Four-register automatic memory stack; Last-X register.

Display: up to 10 significant digits with selective round-off to desired number of places in fixed decimal notation; up to 10 significant digits plus two digit exponent and appropriate signs in scientific and engineering notation (where values are displayed with exponents that are multiples of 3).

HP-97 Printing features

Quiet, thermal printer lets you record and label your calculations. Print mode switch selects three printing modes. In addition you can print and label the contents of the stack registers, the primary data storage registers, program memory, and the display.

Dynamic range: 10^{-99} to 10^{99} (200 decades).

HP-97 Power: 90-127 Vac or 200-254 Vac, 50 to 60 Hz or 5.0 V dc nickel cadmium rechargeable battery pack.

HP-67 Power: 86-127 Vac or 172-254 Vac, 50 to 60 Hz or 3.75 V dc nickel cadmium rechargeable battery pack.

HP-97 Dimensions: length 203.2 mm (8"); width 228.6 mm (9"); height 63.5 mm (2.5")

HP-67 Dimensions: length 152.4 mm (6"); width 81 mm (3.2"); height 18 to 34 mm (0.7 to 1.4").

Model number and name

HP-97 Fully Programmable Printing Calculator

HP-67 Fully Programmable Pocket Calculator

Price

\$750⁰

\$450⁰

CALCULATORS & PERIPHERALS

Business pocket & scientific printing calculators

HP-80 & HP-91

- The financial pocket calculator that solves nearly all time-value-of-money calculations
- Quiet thermal printer provides a complete record of all your calculations
- Operate on battery or AC
- All the most-needed scientific functions — preprogrammed for speed and accuracy



HP-80 Financial Pocket Calculator

The HP-80 financial pocket calculator offers even more financial problem-solving power than the HP-22. With 36 separate financial functions, the HP-80 automatically computes bond yield and price; conversions from add-on interest to APR; sum-of-the-digits depreciation schedules and Rule of 78's interest rebates and more — plus all the financial functions of the HP-22.

In addition, the HP-80 gives you a built-in 200-year calendar so that you can quickly figure the exact number of days in a bond or loan transaction; mean and standard deviation; and trend-line analysis using linear regression.

HP-80 Specifications

Pre-programmed functions

Financial: all functions of the HP-22, plus: bond yield and price (both yield-to-maturity and yield-to-call); conversion from add-on interest to APR; sum-of-the-digits depreciation schedules and Rule of 78's interest rebates.

Statistical: mean and standard deviation, trend-line analysis using linear regression; summations giving n , Σx , Σx^2 .

Percent: %, $\Delta\%$, markup, discount.

Other: y^x , \sqrt{x}

General

Memory: one addressable memory; four-register operational stack.

Display: up to 10 significant digits with selective round-off to desired number of decimal places (0 to 6) in fixed-decimal notation; 10 significant digits plus two-digit exponent and appropriate signs in scientific notation; indicators for improper operations; low battery.

Dynamic range: 10^{-99} to 10^{99} (200 decades).

Power: AC: 86–127 or 172–254, 50 to 60 Hz. Battery: 3.75 V dc nickel-cadmium rechargeable battery pack.

Dimensions: length: 14.7 cm (5.8"). Width: 8.1 cm (3.2"). Height: 1.8 to 3.3 cm (0.7 to 1.3").

HP-80 Financial Pocket Calculator

\$295



HP-91 Scientific Printing Calculator

The new HP-91 Scientific Printing Calculator provides you with a full range of scientific and arithmetic functions — complete with a printed record — all in one compact calculator. And because the HP-91 prints and operates on AC or its own built-in batteries you can use it anywhere — in the office or in the remotest field locations.

HP-91 Specifications

Pre-programmed functions

Mathematical: angular mode switch selects degrees, radians, or grads; Sin, Cos, Tan, Sin^{-1} , Cos^{-1} , Tan^{-1} ; Ln, e^x , log, 10^x ; H.M.S.[±] → H.M.S, H.M.S →; Coordinate conversion: y^x , $1/x$, \sqrt{x} , π , x^2 , %, $\Delta\%$, $\% \Sigma$, +, −, ×, ÷.

Statistical: Σ accumulates x , y , x^2 , y^2 , xy , n ; $\Sigma-$ deletes unwanted data; mean and standard deviation; linear regression; linear estimate; factorial.

General

Memory: 16 addressable registers; four-register automatic memory stack; last-x register.

Clearing options: clear the display; clear addressable registers and stack; clear statistical registers; clear addressable registers R_0 – R_9 .

Display: up to 10 significant digits with selective round-off to desired number of places in fixed decimal notation; up to 10 significant digits plus two digit exponent and appropriate signs in scientific and engineering notation (where values are displayed with exponents that are multiples of 3).

Printing features: quiet, thermal printer lets you record and label your calculations. Print mode switch selects three printing modes. In addition, you can list the stack, list the addressable registers, list the statistical registers and print the displayed value.

Dynamic range: 10^{-99} to 10^{99} .

Power: 90–127 V ac or 200–254 V ac, 50 to 60 Hz or 5.0 V dc nickel cadmium rechargeable battery pack.

Dimensions: length: 203.2 mm (8"); width: 228.6 mm (9"); height: 63.5 mm (2.5").

HP-91 Scientific Printing Calculator

\$425

CALCULATORS & PERIPHERALS



Programmable calculator and character impact printer

9815A, 9871A

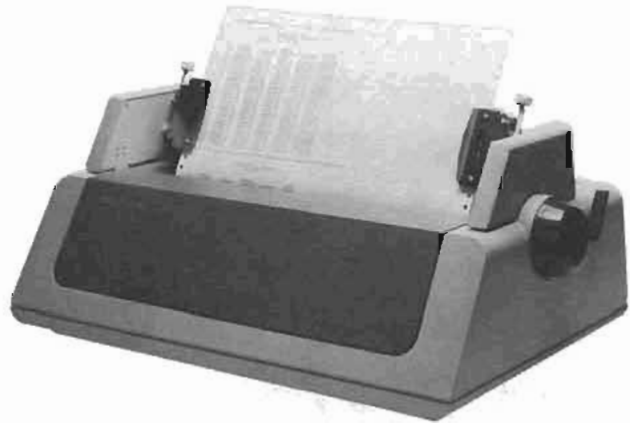

9815A

The 9815A features a built-in high speed data cartridge, a 16-character alphanumeric thermal printer, an auto-start switch, programming keys that double as special function keys, and two optional I/O channels. These capabilities can be used in four basic ways:

1. **Quick keystroke calculations** — 28 built-in scientific functions, the powerful Reverse Polish Notation Logic System also used by the HP pocket calculators, a buffered keyboard, large display, and readable permanent printout provide you with advanced problem solving at your fingertips.

2. **Dedicated problem solving** — Hewlett-Packard offers several software packages with a prerecorded cartridge, special function key overlay, and easy-to-follow instructions for each program. Set the switch to auto-start, slip in the cartridge, put the overlay in place, and turn on the 9815A. The first file will be automatically loaded and the program executed. The tedious set-up work is done for you.

3. **Programmable problem solving** — The standard 9815A has 472 program steps and 10 data registers and can be expanded to 2008 steps. The memory can be allocated by you into any combination of program steps and data registers you wish. The programming language includes such sophisticated features as FOR-NEXT loops; symbolic, absolute or calculated addresses; automatic address updating during editing; descriptive error messages; and subroutines nested to 7 deep. The 9815A has the programming power and memory flexibility to handle many of your most complex computational problems.

4. **Interfacing** — The 9815A has six interface cards. The HP 98131A is a 9871A Character Impact Printer Interface Card. The HP 98132A is an interface card for the 9862A Plotter. The HP 98133A BCD I/O accommodates 9-digit BCD input with high-speed mode and 8-bit parallel output. The HP 98134A General I/O is a bidirectional 8-bit parallel interface which enables you to connect to the 9800 Series calculator peripherals. The HP 98135A HP-IB I/O will accept up to 4 HP-IB interconnected instruments. The 9815A can be used to control the data flow to and from your instruments, gather and process that data simultaneously. The HP 98136A Serial I/O provides RS-232-C compatibility as well as 20mA and 60mA current-loop, receive-only options.

9871A

The HP 9871A is a character impact printer for use with the 9800 Series programmable calculators. It features a bidirectional carrier and platen that holds paper up to 15 inches wide and can handle up to 6-part forms. The 9871A prints 132 10-char/in. columns at 30 char/s. Character and line spacing are variable. The 158-character buffer automatically fills if characters are received faster than the print rate.

Plotting and form filling

The 9871A has a 96-character interchangeable printing disc that is externally programmable along with such functions as space, backspace, carrier return, horizontal and vertical tabs, line feed and reverse line feed, top of form, and form length. These programmable functions along with the bidirectional motions of the platen provide you plotting capabilities for charts and graphs and simplifies form filling.

Physical dimensions

Height: 190 mm (7.75 in.)

Width: 565 mm (22.25 in.)

Depth: 387 mm (15.25 in.)

Weight: 18.4 kg (40.5 lb) net

Options and accessories

The optional form feed mechanism helps give you clear multiple copies and is recommended for continuous feed or Z-fold paper.

You can choose from five print wheels:

- Standard Print Wheel
- ASCII Print Wheel
- European Print Wheel
- Katakana Print Wheel
- Cyrillic Print Wheel

The accessories supplied with the 9871A are:

- Package of 3 ribbon cartridges
- Package of 3 buyer specified print wheels
- Operating manual for the proper calculator
- Service Manual
- Interface cable for the proper calculator

Model number and name

9815A Desktop Programmable Calculator

9871A Character Impact Printer

Price

\$2900

\$3400

CALCULATORS & PERIPHERALS

2-level priority interrupt; flexible disk mass storage

Models 9825A, 9885M/S



9825A



9885M/S



9825A

The 9825A Calculator, designed principally for use in engineering, research, and statistics, has many features previously found only on minicomputers. It is a powerful stand-alone calculator and is particularly suited to controller applications.

Significant contributions include two-level priority interrupt, live keyboard, direct memory access with input speeds up to 400 k 16-bit words per second, high-performance bidirectional tape drive, multidimensional arrays, automatic memory record and load, and extended internal calculation range ($\pm 10^{311}$ to $\pm 10^{-311}$). Some of these are standard features and others are available in optional plug-in read-only memories (ROMs).

HPL, a high-level, formula-oriented language, is easy to learn and is designed for controller applications as well as for data processing. HPL provides for subroutine nesting and flags and allows 26 simple variables and 26 multidimensional array variables, limited only by the size of the calculator memory. Editing of lines and characters is simple, and error locations are identified by a flashing cursor in the display. Fixed- and floating-point formats can be set from the typewriter-like keyboard.

The keyboard has 12 special function keys that, combined with the shift key, can handle 24 different operations. These keys help in program writing and in peripheral and instrument control. They can serve as immediate execute keys, as call keys for subroutines, and as typing aids.

With the live keyboard, never before found on a desktop calculator, the user can examine and change program variables, perform complex calculations, call subroutines, and record and list programs while the calculator is performing other operations.

Interrupt capability, available in the Extended I/O ROM, permits the calculator to act as a controller for several instruments or peripherals requiring attention at unpredictable rates or times.

A 32-character LED display and a built-in 16-character thermal printer provide alphanumeric readout including both capital and lower-case letters. Some European and Greek characters are also available in an optional ROM.

The high-speed bidirectional data cartridge holds 250 k bytes of information and has an average access time of 6 seconds to any place on the tape. Bidirectional search speed is 2286 mm/s (90 in./s), and read/write speed is 559 mm/s (22 in./s). The entire calculator memory can be recorded on the cartridge for reloading at a later time. Verification of files is automatic on recording.

9885M/S

The 9885M/S Flexible Disk Drive provides the 9825A user a convenient, reliable, and low-cost method of transferring programs and data to and from the calculator at high speeds. It is a random access, removable, mass storage device with a capacity of up to 468 480 bytes per disk. The 9885M (Master) contains a built-in controller. Up to three 9885S's (Slaves) can be connected to each 9885M.

Average transfer rate is 23 k bytes/s. Double-density read/write on the flexible disk further enhances access rate and increases total storage capacity. Average access time to any place on the disk is 267 ms, and average transfer time is 11.1 ms/record.

The write-verify feature ensures that the information recorded on the flexible disk is identical to the source information in the calculator memory.

The disk holds 256 bytes per record, 30 records per track, 61 user-available tracks, and 320 files maximum.

The 9885M/S is self-contained and incorporates a self-test feature.

Features

- Double-density read/write
- Write-verify for greater reliability
- High-level system software
- Self-contained package
- 468 480 bytes of total user-available space per disk
- Low-cost, removable media
- Up to 32 flexible disk drives per calculator
- Data recovery routines available to the user

Software system

The software system's built-in friendliness, efficiency, and power make it easy to take advantage of the hardware features. For interfacing to the 9825A, it is contained in Option 025, which consists of a ROM and bootstraps on a data cartridge. The system requires 1140 bytes of calculator read/write memory for data buffer, bootstrap area, pointers, and status words. All statements are programmable. The file-by-name system has a directory that maintains user files and available space.

Model number and name

- 9825A Programmable Calculator
- 9885M Flexible Disk Drive Master and Opt. 025
- 9885S Flexible Disk Drive Slave

Price

- \$5900
- \$3900
- \$2500

CALCULATORS & PERIPHERALS

Desktop programmable calculators

9830A/B, 9880B



HP-IB 9830A/B

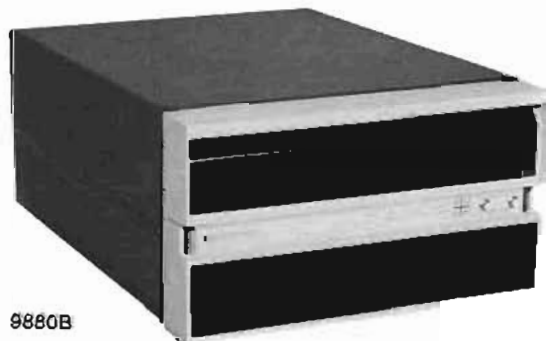

9880B

9830A/B

The Hewlett-Packard 9830 is a general purpose, programmable calculator designed for a wide range of applications.

The language of the 9830 is BASIC. This easy-to-use language couples simplicity with power and appeals to the new calculator owner as well as the experienced programmer. The 9830 automatically inherits a comprehensive range of proven software packages, including finance, mathematics, statistics, and education.

A minimum 9830A provides 3520 8-bit bytes (1760 words) of user read/write memory. This can be expanded to 15 808 bytes (7904 words). In addition, the user can select from a wide range of read-only-memory (ROM) plug-in blocks for increased computational capability or peripheral control, or both. The 9830A allows up to 16k bytes of add-on ROM for a total of eight plug-in blocks.

The 9830B has 15 808 8-bit bytes (7904 words) of user read/write memory, expandable to 30 144 bytes (15 072 words). Matrix operations and string variables are built in, and six additional ROM blocks are available.

A broad range of peripherals is available with either 9830 calculator to allow the user maximum flexibility in putting together that specific system required to solve your problem.

The result is a cost-effective calculator that can meet your data handling problems today and continue meeting them as your needs expand.

Features

- Alpha Keyboard
- 32-Character, LED, Alphanumeric Display
- Built-In Tape Cassette
- BASIC Language
- 12 Significant Digits
- Full Trigonometric Capability
- Boolean Algebra Capability
- Special Function Keys
- Easy Editing
- Expandable User Memory
- Add-On Read-Only-Memory
- Formatted Output
- Broad Range of Peripherals

Programming in BASIC

The 9830 is programmed in BASIC, a formal, interactive language similar to FORTRAN. Depending on your needs, you may choose to do all your own programming. If you've already been working with BASIC, you can, with minor modifications, use your existing program. Since BASIC is a standard computer language, you will find there are many programs already written and available at nominal cost.

9880B Mass memory subsystem

The HP 9880B Mass Memory Subsystem supplies the HP 9830A and 9830B Calculators with the substantial data storage required for such industrial, scientific, and commercial applications as structural design, statistical analysis, payroll, account maintenance, inventory control, patient records, and credit verification.

The memory media of this peripheral is a permanently installed memory platter and an interchangeable cartridge (HP 12869A), each having a capacity of 2.4 million bytes; this is the equivalent of more than 600 000 total items of data of 12 digits each.

One of the main advantages of this system is data safety and security. Master data can be recorded on the removable cartridge, transferred into the calculator for manipulation, stored temporarily on the fixed memory platter for further use by the calculator's program, and modified on the removable cartridge. Duplication of data files is also easily accomplished. Errors are corrected simply by repeating the operation, since the initial data still resides on the removable memory cartridge.

A 10 X 10 array can be transferred to the 9880B cartridge in about one second, and a typical 250-line program of 2000 words can be transferred in less than two seconds.

Model number and name

9830A Programmable calculator	\$4900
9830B Programmable calculator	\$8350
9880B Mass memory subsystem	\$10,950

Price	
9830A Programmable calculator	\$4900
9830B Programmable calculator	\$8350
9880B Mass memory subsystem	\$10,950



9870A



9869A

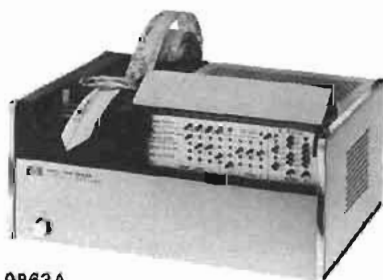

9863A



9865A

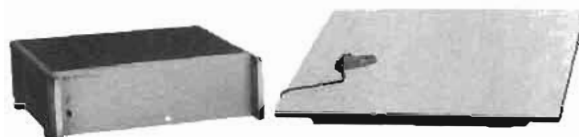

9864A

Calculator peripherals

Calculator peripherals are the input/output devices that let you tailor your programmable calculator to your specific computing requirement.

High speed tape reader subsystem

The 9883A uses the HP 2748B Photo Reader to increase the speed of the 9863A Paper Tape Reader. The 9883A optically reads tapes at 300 char/s.

Tape punch subsystem

The 9884A provides a fast and reliable method of directly transferring output onto punched tape at 75 char/s.

Card readers

The high-speed 9869A Hopper Card Reader handles 80-column punched cards as well as mark-sense cards. For smaller applications, the low-cost, hand-fed 9870A Card Reader optically reads mark-sense cards.

Tape cassette

The high-speed 9865A Tape Cassette lets you easily store, update, and retrieve data and programs. A fast, bidirectional search feature lets you find any file on the tape without rewinding. The 9865A has a minimum capacity of 48 k bytes.

Paper tape reader

Data from analytical instruments, machine tools, and computer terminals goes directly into your calculator. The 9863A reads a wide variety of formats at 20 char/s.

I/O expanders

The 9868A I/O Expander allows you to plug up to 13 peripherals or test instruments into your 9810A, 9820A, 9821A, and 9830A/B. The 9878A provides six additional I/O slots for the 9825A.

Digitizer

The 9864A Digitizer reads a curve or any irregular shape as a series of discrete points. Your HP calculator then prints out the dimensions of the line and the area of the contained shape.

Model number and name

Model number and name	Price
9863A Paper Tape Reader	\$1710
9864A Digitizer	\$5140
9865A Tape Cassette	\$1885
9868A I/O Expander	\$1060
9869A Hopper Card Reader	\$4075
9870A Card Reader (hand fed)	\$580
9878A I/O Expander	\$1200
9883A High Speed Tape Reader Subsystem	\$2510
9884A Tape Punch Subsystem	\$3080

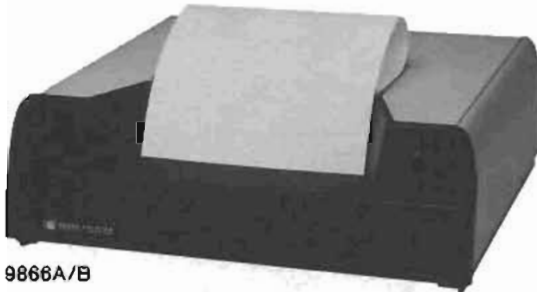

9866A/B



11285A

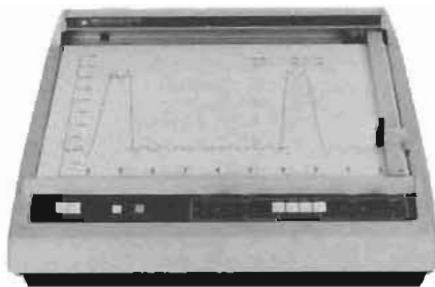

9862A

CRT subsystem

The 9882A CRT Subsystem consists of a 2640A CRT Terminal and a 9830A/B Calculator Interface Card.

Line printer

The 9881A Line Printer Subsystem consists of the 2607A Line Printer, which is a reliable, low-cost, 5 x 7 dot-matrix printer, and the 11287A Line Printer Interface Card. Its unique print mechanism makes it quiet enough for any business environment and provides up to 6 consistent, clean copies. It prints at 200 lines/min regardless of the line length and has full 132-column line width.

Thermal printers

For high quality, hard-copy output, the 9866A/B Thermal Printers are hard to beat. The 9866A/B printers produce page-width, fully-formatted, alphanumeric text, tables, or simple plots at 240 lines/min. The 9866B has upper- and lower-case characters and vertical line printer capabilities.

X-Y plotter

The 9862A X-Y Plotter with a peripheral control function block automatically scales your data, generates words as well as numbers, and sets up both axes, complete with labels and tick marks — all in your designated units.

Interfacing

HP offers many interface cards designed for those customers who desire to build custom, calculator-controlled instrumentation systems. These cards are:

9815A Interface cards

- 98133A BCD Interface — 8-digit BCD input with high-speed mode, 8-bit parallel output.
- 98134A General Interface — bidirectional 8-bit parallel interface.
- 98135A HP-IB Interface — general connection for HP-IB compatible instruments (in conformance with IEEE Std. 488-1975).
- 98136A RS-232-C Serial Interface — conforms to EIA RS-232-C recommended specifications.

9825A Interface cards

- 98032A 16-bit Duplex Interface — latched 16-bit input/output for bidirectional transfer of information.
- 98033A BCD Input Interface — connects the 9825A with bit-parallel, digit-parallel BCD devices.
- 98034A HP-IB Interface — allows communication with as many as 14 HP-IB compatible instruments per interface.

9830A/B Interface cards

- 11202A I/O Interface — 8-bit parallel input/output card with TTL compatible drivers and receivers.
- 11203A BCD Input Card — 9 digits of 8421-coded BCD data, plus other functions (input from instrument to 9830A/B only).
- 11205A Serial I/O Interface — bit serial input/output card conforming to EIA RS-232-C recommended specifications.
- 59405A Hewlett-Packard Interface Bus — byte serial interface offers plug-to-plug compatibility between instruments.
- 11285A Data Communications Interface — allows communication with other 9830A/B's and computers via telephone lines and modems that meet EIA Specification RS-232-C.
- 11297B Binary Synchronous ROM — when used with 11285A allows 9830A/B to act as a remote batch terminal emulating IBM 2780.
- 11298B Interactive ROM — when used with 11285A allows 9830A/B to act as time-sharing terminal emulating ASCII Teletypewriter.

Model number and name

Model number and name	Price
9862A X-Y Plotter	\$2995
9866A Thermal Printer	\$3145
9866B Thermal Printer	\$3350
9881A Line Printer Subsystem	\$7990
9882A CRT Subsystem	\$4675
98133A BCD Interface	\$600
98134A General 8-bit Parallel Interface	\$300
98135A HP-IB (IEEE Std. 488-1975) Interface	\$600
98136A RS-232-C Serial Interface	\$600
98032A 16-bit Duplex Interface	\$400
98033A BCD Input Interface	\$400
98034A HP-IB (IEEE Std. 488-1975) Interface	\$400
11202A 8-bit Parallel I/O Interface Card	\$225
11203A BCD Input Interface Card	\$330
11205A Serial Interface Card	\$435
11285A Data Communications Interface and ROM	\$1575
11297B Binary Synchronous ROM	\$525
11298B Interactive ROM	\$525

CALCULATORS & PERIPHERALS

Multiprogrammer: versatile I/O expander & converter

Model 6940B

• Build Your Own Automatic System

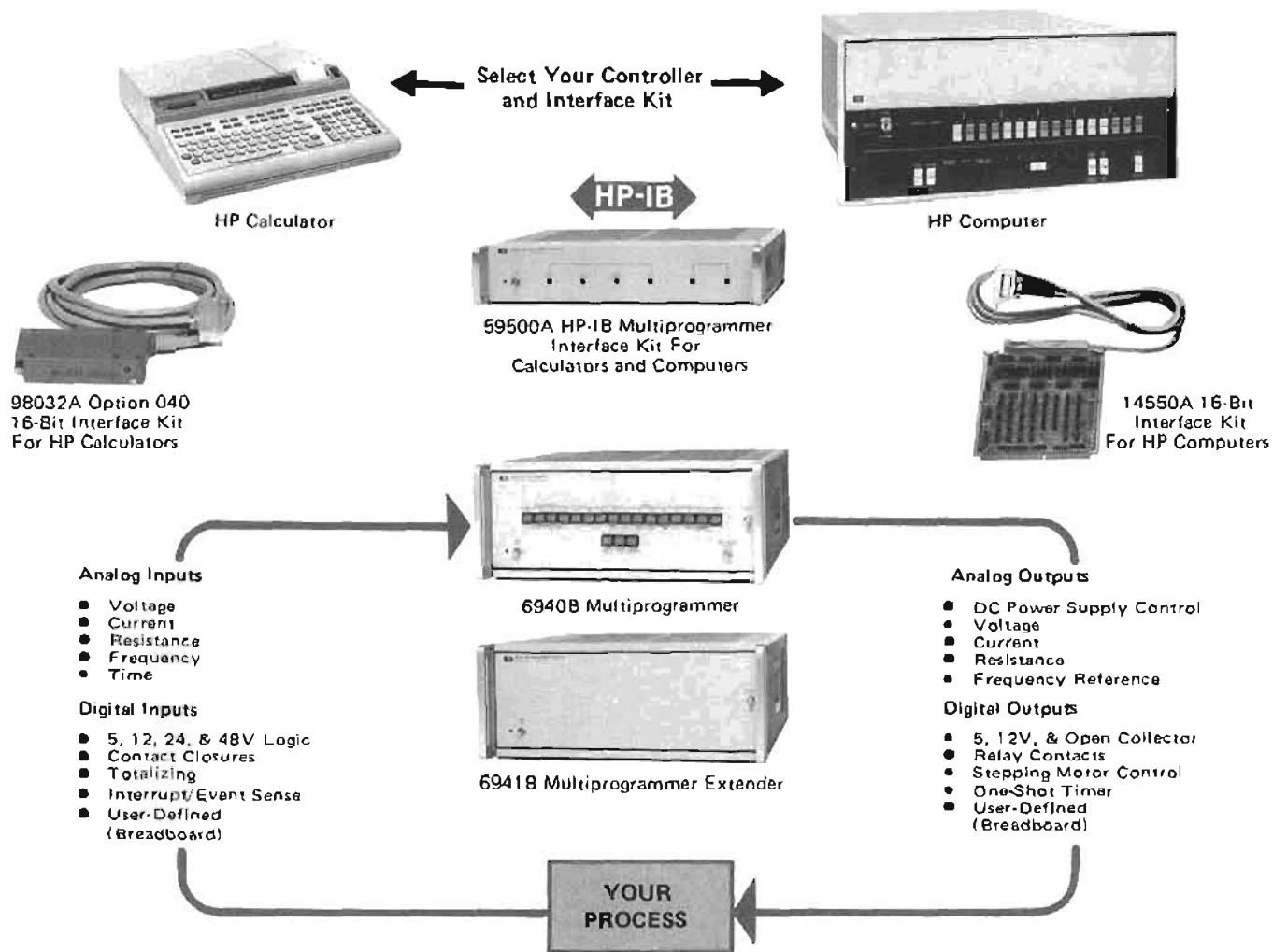

Description

The Multiprogrammer is the vital link between a Hewlett-Packard calculator or computer and your test or control process. As shown above, Multiprogrammer products include interface kits, mainframes, and plug-in cards that provide the capabilities shown on the adjacent page.

Each 6940B Multiprogrammer holds up to fifteen plug-in cards. For additional I/O capability, a chain of up to fifteen 6941B Multiprogrammer Extenders may be cabled to the 6940B Multiprogrammer to hold up to 240 plug-in cards.







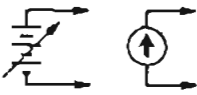

Thousands of Multiprogrammers are in use now as part of user-defined-and-assembled systems for production testing and control, data acquisition, process monitoring, life testing, quality control, and component evaluation. Production Engineers find that the Multiprogrammer is a versatile and convenient instrument for industrial measurement and control applications.

Detailed specifications for Multiprogrammer products including descriptions of utility software, sample programs, applications, and User's Guides are available from your local HP Field Engineer. Ask for literature #5952-3982, the 48-page Technical Data Brochure.

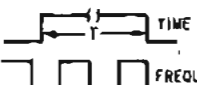
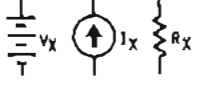
- Stimulus
- Measurement

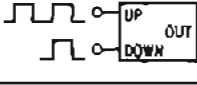
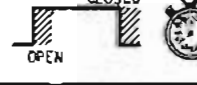
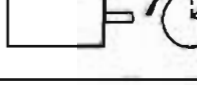
- Control
- Data acquisition

Multiprogrammer I/O card functions

	Functions	Applications	Cards Used
S T I M U L U S	 <p>Programmable DC Voltage and Current</p>	The output voltage (up to 100 V) and current (up to 1000 A) of forty different HP power supplies can be programmed to provide bias in automatic test systems or control of electromechanical process equipment.	Resistance Output 69501A-69513A
	 <p>Digital-to-Analog Conversion</p>	Twelve-bit voltage and current DAC's for strip chart, x-y, and analog tape recordings as well as control of analog programmable instruments and process control devices with 0.5 volt or 4.20 mA inputs.	Voltage DAC, 69321B; Current DAC, 69370A; Regulator 69351B
	 <p>Time and Frequency Reference</p>	One-shot (timing pulses, programmable from 1 μ sec to 40 days, and crystal-controlled pulse trains in fixed frequencies of 1, 10, 100, 1 K, 10 K, and 100 kHz serve as time-base references for control, measurement, and data acquisition.	Timer, 69600B; Frequency Ref. 69601B.
M E A S U R E M E N T	 <p>Voltage, Current and Resistance Measurements</p>	Measure voltages in the presence of 100 V of common-mode noise. Connecting a resistor across the input permits current measurements for 4.20 mA current loops used in process control. Combine voltage monitor and current DAC cards for resistance measurements.	Voltage Monitor, 69421A; Current DAC, 69370A; Regulator 69351B
	 <p>Frequency Measurements</p>	The pulse counter card accumulates counts over a precise time interval when a programmable timer card is connected to the enable line of the counter. The program divides the count by the time interval to measure frequencies from 200 kHz to 0.001 Hz.	Pulse Counter, 69435A; Timer, 69600B.
	 <p>Pulse Counting Preset Up/Down</p>	Counter may be preset to any value within count range of 0 to 4095. The program can examine the counter without disturbing the counting process (read-on-the-fly).	Pulse Counter, 69435A.
	 <p>Time Interval Measurement</p>	Elapsed time between two events can be measured in the range of 10 μ sec to 1 hour by counting a known frequency over the unknown interval. The program divides the accumulated count by the known frequency to determine the interval.	Pulse Counter, 69435A; Frequency Reference, 69601B.
C O N T R O L	 <p>Stepping Motor Control</p>	One output word to card produces from 1 to 2047 square-wave pulses at either of two outputs (CW or CCW) to control motor translators. Output pulses are also used for pulse-train update of supervisory control stations.	Stepping Motor Control, 69335A.
	 <p>Digital Output and Switching</p>	Twelve-bits of data in TTL, open collector, or SPST relay-contact form provide digital control of instruments, indicators, and solid-state AC relays.	TTL, 69331A; Open Collector, 69332A; Relay Out, 69330A; Relay Out/Readback, 69434A.
A C Q U I S I T I O N	 <p>Scanning and Input Multiplexing</p>	Simple single-ended switches or multi-wire scanner matrices are formed by interconnecting relays on a Relay Output or a Relay Output/Readback Card. The relay output card scanners act as input multiplexers for Voltage Monitor, Pulse Counter, and Digital Input Cards.	Relay Output, 69330A; Relay Output/Readback, 69433A.
	 <p>Event Sensing</p>	It is often necessary for a system to respond quickly to alarm conditions, operator intervention or other requests for immediate service. This service request is made via a program interrupt generated by either an event sense or a process interrupt card.	Event Sense, 69434A; Process Interrupt, 69436A.
	 <p>Digital Input</p>	Digital input cards accept 12 bits of data from digital measuring instruments, push-buttons, switches, relays, and other digital devices in the form of logic levels or contact closures. Digital data sources with more than 12 bits of data use several digital input cards.	Digital Input, 69431A; Isolated Digital Input, 69430A.

CALCULATORS & PERIPHERALS

Model 6940B (cont.)

6940B/6941B Common specifications

Input/output card positions: maximum of 15 plug-in input or output cards per mainframe. Side-hinged front panel provides access to card slots.

Mainframe data connectors: two 50-contact, ribbon connectors.

Data transfer rate: 20 k words/sec.

Maximum data resolution: 12 bits per plug-in card.

Accessories furnished: Data Input Plug, PC Board Extender Card.

Cooling: natural convection.

Temperature: 0 to +55°C operating, -40 to +75°C storage.

Dimensions: 425.4 mm W × 172.2 mm H × 539.8 mm D (16.75" × 6.78" × 21.25").

Power: 100/120/220/240 V ac (selectable), 48-440 Hz, 230 W.

Front panel controls: power ON/OFF switch and indicator lamp. REMOTE/LOCAL switch for selecting computer or manual control. 19 proximity switches for manual data entry and control.

Weight: net, 15.9 kg (35.0 lb). Shipping, 19.5 kg (43.0 lb).

6941B Specifications

Front panel controls: power ON/OFF switch and indicator lamp.

Weight: net, 15.2 kg (33.5 lb). Shipping, 18.3 kg (40.3 lb).

59500A Interface unit specifications

Converts the serial ASCII alphanumerics of the HP-1B to the 16-bit parallel format required by the 6940B/6941B Multiprogrammer. The 59500A design is optimized for ease of programming the 6940B/6941B.

Front panel controls: power ON/OFF switch and indicator. LED's indicate mode and gate/flag status between HP-1B and the Multiprogrammer for system check-out and maintenance.

Cooling: natural convection.

Temperature: 0 to +55°C operating; -40 to +75°C storage.

Dimensions: 425.4 mm W × 82.6 mm H × 463.6 mm D (16.75" W × 3.25" H × 18.25" D).

Weight: 5.4 kg (12 lb).

Power: 100/120/220/240 V ac (selectable) 48-440 Hz, 15 W.

Programmable plug-in cards/Output cards

69500A-69504A Resistance output cards: provide a single 12-bit resistance programming channel. The programming coefficients of these models are compatible with HP programmable power supplies equipped with Option 040. Model 69500A is supplied without resistors allowing the user to install his own series adding elements.

69510A-69513A Resistance output cards: provide two 6-bit resistance programming channels; these models program the current limit of HP power supplies equipped with Option 040.

69321B Voltage D/A converter card: provides a high speed, bipolar output voltage. Output range is from -10.240 to +10.235 V, at 0-5 mA. Conversion speed is 30 μsec maximum to within 5 mV of final value. (69351B voltage regulator also required.)

69370A Current D/A converter card: provides a high speed constant current output. Output range is 0 to +20.475 mA, at 0-10.5 V dc. Conversion speed is 30 μsec maximum to 5 μA of final value (69351B voltage regulator also required.)

69330A Relay output card: provides 12 separate form A (SPST, normally open) mercury-wetted contact outputs that reflect the status of 12 programmed data bits. Includes gate/flag circuits for exchange of control signals with user's device.

\$1700

69433A Relay output/readback card: provides 12 separate form A (SPST, normally open) mercury-wetted contact outputs. Also supplies 12 input data lines that can be read by the controller and which indicate the relay coil voltage status.

\$300

69331A Digital output card: provides programmed microcircuit logic level outputs on 12 separate output lines. Card includes gate/flag circuits for exchange of control signals with user's device.

\$210

69332A Open collector output card: provides 12 open-collector driver outputs. IC buffers on the card act as switches for voltages up to 30 volts dc and currents up to 40 mA.

\$130

69335A Stepping motor control card: used to drive stepper motor and pulse-update type controls. Can be programmed to generate from 1 to 2047 pulse outputs to either of two terminals.

\$400

69600B Programmable timer card: can be programmed to generate crystal controlled, one-shot timing pulses. Time increment is variable from 1 μs to 40 days.

\$300

69380A Breadboard output card: this card allows user to design and build a custom analog or digital output card. Card includes basic address, storage and control signal buffer circuits.

\$125

69325A-69328A Power amplifier control cards: provide resistance outputs for controlling the voltage, current and gain of HP Model 6825A-6827A Power Supply/Amplifiers.

\$400

69601B Frequency reference card: provides six fixed square wave outputs derived from a 1 MHz crystal at frequencies from 1 Hz to 100 kHz.

\$250

Input cards

69421A Voltage monitor card: this card monitors bipolar dc voltages in the range of +10.235 to -10.240 V, and returns a 12-bit two's complement digital word to the controller to indicate the magnitude and sign of the measured voltage. Up to 150 conversions per second can be performed as commanded by the program or an external gate input. ±1 V and ±100 V inputs available.

\$500

69431A Digital input card: this card monitors 12 bits of TTL, DTL, or contact closure data from user's device. Card includes gate/flag circuits for exchange of control signals with user's device. Return bits to controller reflect the status of 12 input bits.

\$210

69430A Isolated digital input card: this card monitors 12 bits of input data from user's device. All input lines are isolated from one another and from the Multiprogrammer power supply. Eight options of the card are available to accommodate either ground-true or positive-true logic sense inputs and a wide range of input levels.

\$250

69434A Event sense card: this card compares the magnitude of an external 12-bit input word with a stored reference word and generates a service request for any of four conditions, depending on the placement of a jumper on the card. The four possible conditions are: In = Ref, In ≠ Ref, In > Ref, In < Ref. The reference word is loaded from the controller. Both the input and reference words can be read back to the controller.

\$400

69435A Pulse counter card: this card counts pulses, up or down, in the range of 0 to 4095. A carry or borrow pulse is generated as the count goes above 4095 or below 0. These pulses allow multiple counter cards to be cascaded for greater counting capability or they can serve as alarm signals. The card can also be used as a pre-set counter.

\$250

69438A Process Interrupt card: this card provides TTL and open collector compatible edge detectors; one positive and one negative for each of 12 storage latches. Logic transitions lasting 100 ns or longer are detected, stored, and used to generate a service request to the controller.

\$400

69480A Breadboard input card: allows user to design and build a custom analog or digital input card. Card includes basic address and control circuits.

\$125

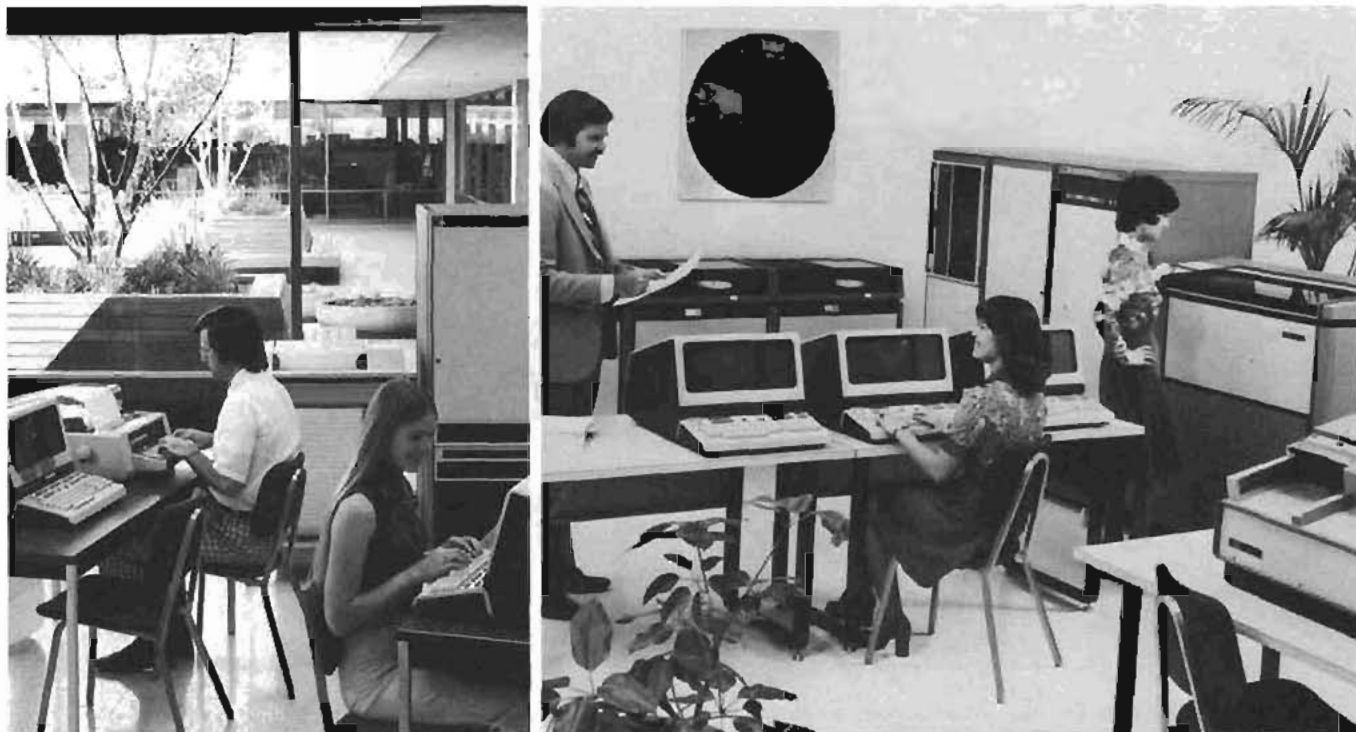

Dedicated, time-shared, and general purpose computer systems and system components from Hewlett-Packard

Hewlett-Packard, a world-wide leader in the minicomputer field, produces computers, small and medium scale systems and a host of add-ons. This equipment is finding increasing use in companies of all sizes for data management, information retrieval and for automating measurement. To complement this equipment, Hewlett-Packard provides the largest selection of operating software in the industry.

The company's entrance into the computational field began with a minicomputer designed specifically to interface with HP's test and measurement instruments so customers could easily combine data gathering with data processing. HP minicomputers have since entered other areas of application including science, industry, education and business.

As key elements in the company's time-shared and data management systems, for example, the minicomputers handle such tasks as order processing, inventory control, sales analysis, production scheduling and financial reporting. In schools and colleges HP computing systems are used at all levels of education for problem solving, computer-assisted instruction, complex model simulations, computer science education and curriculum development. Systems also are available to perform administrative and student record keeping tasks.

Customer value through product research

When you purchase computational equipment from HP, you are assured of receiving the same value you have learned to expect of Hewlett-Packard instruments. HP assures

this high value by consistently investing 10% of net income in new product research and development.

Customer value through product innovation

In-depth research has provided innovations such as the first time-shared computer system based on a minicomputer and the first user microprogrammable CPU from a major manufacturer. A recent innovation, the first minicomputer with all semiconductor memory from a major manufacturer is an advancement that provides simultaneous reductions in size, weight, power consumption and cost while improving speed and reliability.

Customer value through HP experience

Hewlett-Packard has one of the largest installed customer bases in the world. Over 15,000 HP computers are presently in operation on every continent and in most countries of the world. To support this large installed base, Hewlett-Packard has extensive sales and service organizations plus the experience to meet your individual needs.

The new family of computer terminals from HP has established the industry standard for serviceability. These units are easily serviced by replacement of plug-in boards and built-in self-testing circuitry. This means the units can be built for less and maintained at lower cost for you.

Customer value through HP support

Additional customer support is provided by hardware and software training courses at central locations throughout the world. Both maintenance and user oriented courses are

provided. Video tape facilities are used successfully to bring HP factory expertise to remote locations. Hewlett-Packard also supports a number of user groups with up to date information, information exchanges, periodic publications and regional meetings.

Customer value through human engineering

Product excellence does not stop with well designed circuitry at Hewlett-Packard. HP applies the same diligence to the human interface with its equipment. The new family of computer terminals, for instance, features dot-shifting techniques to improve readability and a non-glare CRT screen. This same terminal family provides a movable keyboard so operator convenience is maximized whatever the situation.

Customer value through quality control

For years, users involved in critical applications have specified Hewlett-Packard products because of HP's known high reliability and environmental standards. This quality control excellence can be traced partially to HP's management practices. All HP quality control functions report directly to division management, not to manufacturing management. This means that any product inadequacies receive top priority attention and products that do not meet tough standards are not shipped until they do.

Customer value — the HP way

In the following pages you will find descriptions of products designed for your maximum customer value obtained through HP's product research, innovation, experience, support, human engineering and quality control.

COMPUTERS: COMPONENTS

Technology leading products

21MX Series

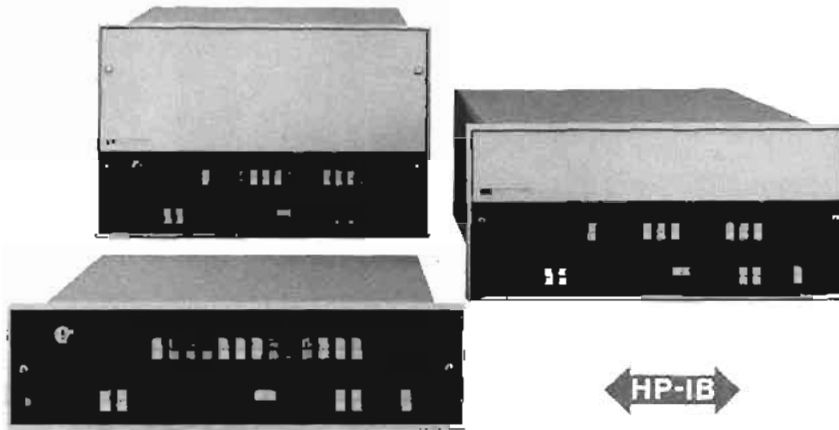

HP's 21MX general purpose minicomputers combine a wide choice of user-microprogrammable processors, semiconductor memory systems, and customized instruction sets for both OEM's and End Users. These features provide a more reliable, more efficient, smaller, and less expensive computing source than with traditional core memory.

These 16-bit minicomputers use 4k random access memory (RAMs) as the main memory — the latest in semiconductor technology, which means greater reliability and reduced power requirements.

The optional Dynamic Mapping System gives users the capability to address memory configurations larger than the usual 32k word limitation. It adds 38 instructions for controlling up to one million words of memory from four independent memory spaces.

21MX design includes a brown-out proof power supply that protects against over- and under-voltage conditions to 20% of line voltage, and storage, to sustain loss of 2.5 cycles. A battery provides standby protection for complete power loss.

Modular design keeps I/O configuration independent of memory expansion. Maximum memory, I/O, and firmware expansion within a given mainframe are possible without sacrificing any one for the other.

Standard features include a powerful instruction set with floating point and data communications instructions, 178 user accessible micro-orders, power fail interrupt, memory parity check, multi-level-vectored priority interrupt structure, and up to four separate internal bootstrap loaders which are switch-selectable from the front panel.

Choose from a complete line of HP-manufactured peripherals and data communications interface kits to enhance your computing operations. These include discs, magnetic tape units, card readers, line printers, plotters, paper tape devices and terminals. Local HP Field Representatives can provide detailed computer product catalogs, OEM prices and discount schedules for quantity purchases are also available.

New 21MX E-series processors

Latest addition to the Mx Family are 21MX E-Series high-performance minicomputers, designed for a wide range of computing needs. Combining successful 21MX architecture with a unique new design philosophy, the E-Series has a variety of product enhancements incorporated as standard features; optional features can be easily added at a low cost. The E-Series is fully-compatible with other 21MX products and uses the same base instruction set.

For optimal performance, these processors have a microprogrammable control section that has been speeded up by a sophisticated technique of varying microinstruction cycle time.

E-Series execution time is 40 percent faster than the 21MX; its 550-nanosecond memory speed is also greater because the CPU-to-memory interface is totally asynchronous in the E-Series.

2109A	2113A		
Mainframe Memory	64k	Mainframe Memory	128k
Memory Extender	192k	Memory Extender	256k
I/O Standard Channels	9	I/O Standard Channels	14
I/O W. One Extender	25	I/O W. One Extender	30
I/O W. Two Extenders	41	I/O W. Two Extenders	46

Three traditional M-Series processors are available for optimal price and performance. These include the 2105A, 5 1/4 inches high with four powered I/O channels and capacity for 32k memory; the 2108A, 8 1/4 inches with nine I/O channels and capacity for 64k memory; and the 2112A, 12 1/4 inches with 14 I/O channels and 128k memory capacity.

A memory extender supplies eight additional memory modules to the CPU, and I/O extenders can increase I/O capability by 32 channels on each of the mainframes.

Supported by a comprehensive software library, over 10,000 Hewlett-Packard 2100 Series computers have been delivered to date.

2105A	\$4,150	2108A	\$5,300	2112A	\$6,200
Mainframe Memory	32k	Mainframe Memory	64k	Mainframe Memory	128k
		Memory Extender	192k	Memory Extender	256k
I/O Standard Channels	4	I/O Standard Channels	9	I/O Standard Channels	14
I/O W. One Extender	20	I/O W. One Extender	25	I/O W. One Extender	30
I/O W. Two Extenders	36	I/O W. Two Extenders	41	I/O W. Two Extenders	46

HP 2102A memory system

Available in 4k, 8k, and 16k modules using high density 4k MOS memory components. These modules provide 650 ns access speeds:

Data communications interfaces

	Price
Controller	\$600
4k Module	\$1000
8k Module	\$1600
16k Module	\$2100

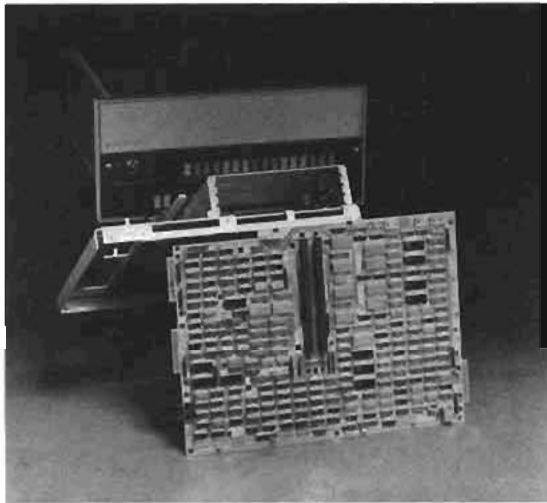

2108K Processor Board



2125A DISComputer

21 MX K-Series component products

Available for the first time as a component for system integration is the 21MX-K Miniprocessor, the powerful 21MX minicomputer processing board. It is supported by a broad line of standard accessories including memory systems, user control store, and writable control store. It is also fully-compatible with 21MX instruction sets, I/O cards, and peripherals. Users simply supply the power to operate the miniprocessor and its accessories, which include card cages, backplane, and front panel assembly.

Beside being viewed as a 21MX-compatible minicomputer, the 21MX-K is also a high-performance, 24-bit microprocessor capable of performing a register-to-register add in one 325-nanosecond machine cycle.

2108K Miniprocessor Board \$1475

DISComputers

Other 21MX Family highlights include the powerful 2124B and 2125A DISComputer packages combining a disc, controller, and minicomputer which have been designed together, not just put together. The HP 2124B includes a 2108A processor and 7900A 5 Mbyte disc drive. The HP 2125A offers the same processor with the new, fully-interfaced 7905A 15 Mbyte disc. Both systems include a Dual Channel Port Controller and a module of semiconductor memory.

Each can be expanded by substituting the 2112A processor for the 2108A, allowing a mainframe memory expansion to 128k, and to 256k with an extender.

DISComputer packages are also available with E-Series processors.

2123A DISComputer \$24,500

Chart 2

2124B	\$18,250		2125A	\$72,250
I/O Channels Standard	9	I/O Channels Standard	9	
I/O W. One Extender	25	I/O W. One Extender	25	
I/O W. Two Extenders	41	I/O W. Two Extenders	41	
Mainframe Memory	64k	Mainframe Memory	64k	
Memory Extender	192k	Memory Extender	192k	
Disc Memory	5 Megabytes	Disc Memory	15 Megabytes	
W. Three Additional	26 Megabytes	W. Seven Additional	120 Megabytes	

Microprogramming options

12977A Fast FORTRAN processor

Firmware microcode for more than a dozen instructions, four word double precision operations, two and three dimensional array addressing, and other commonly-used routines previously written in FORTRAN, is two to 30 times faster than the normal execution speed.

Price

\$1250

12978A Writable control store

Dynamically alterable, 256 24-bit word storage for microprograms. Enables access to additional high speed registers and read/write capabilities from memory.

\$1000

Data communications interfaces

HP data communication interface cards permit HP 21MX Series and 2100 computer users to transmit data through a wide variety of privately-owned and common-carrier communication facilities. All communication interfaces conform to EIA specification RS-232, provide programmable character size, programmable parity checking, and a variety of programmable or jumper selectable data rates. All interfaces can be operated under program or DMA control.

21MX Series (cont.)

Data communications interfaces (cont.)**12966A Buffered asynchronous communications interface****\$950**

Provides two-way communications with Bell 103 or 202 Data Sets or equivalent units at speeds up to 9600 baud. Unique features are a 128-character first-in/first-out buffer, and a special recognition/interrupt feature with a 256 special character memory. Operates in simple half-duplex, or echoplex mode, and has hardware break detect capability.

12968A Asynchronous communications interface**\$600**

Provides all the capability of the 12966A, except that it has a two-character buffer and no special character capability.

12967A Synchronous communications interface**\$650**

Provides interface capability to Bell 201 or 208 Data Sets or equivalent. Operates in half-duplex mode at speeds up to 20,000 baud. Parity checking is software selectable, and the synchronization character is hardware selectable.

12587B Asynchronous data set interface**\$550**

Provides two-way communications with Bell 103 or 202 Data Sets or equivalent. Operates from 26 to 3110 baud in simplex, half-duplex or echoplex mode. Programmable character size is from 1 to 8 bits plus an optional parity bit.

12618A Synchronous data set interface**\$700**

Provides two-way communications with devices such as a Bell 201A/B Data Set or equivalent. Operates up to 9600 baud in half or full-duplex mode with fully-independent transmit and receive channels. Programmable functions include parity checking, synchronization, special character recognition, and character size.

12589A Automatic dialer interface**\$400**

Permits automatic dialing of a computer-generated phone number when used in conjunction with a Bell 801 Automatic Dialing Unit or equivalent. Can be used with either HP asynchronous or synchronous data set interfaces.

12920B Asynchronous multiplexer**\$2500**

Provides interfacing for up to 16 communications devices at programmable rates from 57 to 2400 baud, with automatic speed detection at seven standard rates including that of the IBM 2741. Operates in full-duplex, half-duplex or echoplex modes with automatic answering and automatic break detection. Programmable functions include parity generation and checking, split speed operation, and character length selection from 5 to 12 bits.

Provides two-way communication between an HP computer and teleprinters, keyboard-display terminals, and Bell 103 Data Sets or equivalent units.

12880A Display terminal interface**\$350**

Provides local two-way communication with a keyboard/display terminal. Data rates from 110 to 9600 baud are automatically determined by the terminal external clock signal.

12889A Hardwired serial interface**\$750**

Provides high-speed, asynchronous, long distance, point-to-point data transfer between two HP computers. Capable of transmitting up to 1000 feet at 2.5 million baud or up to 2400 feet at 1.25 million baud.

General purpose interfaces

HP general purpose interfaces are contained on individual plug-in I/O cards. In addition to the appropriate data registers, each interface has independent flag and control logic, allowing two-way communication between an HP 21MX 2100 computer, and one or more external devices. All interfaces operate under either program or direct memory access control. A wide choice of interfaces allows external connection via floating contact closures, DTL/TTL, transistor or differential logic.

12551B 16-Bit Relay register**\$515**

Provides 16 floating contact closures and optional read-back circuitry for data verification.

12554A 16-Bit Duplex register**\$450**

Provides 16 input and 16 output transistor logic lines.

12597A 8-Bit Duplex register**\$415**

Provides 8 input and 8 output register logic lines.

12565B Microcircuit interface**\$500**

Provides 16 input and 16 output DTL/TTL compatible lines.

12930A Universal interface**\$905**

Provides 16 input and 16 output lines with differential transmitters and receiver for operation up to 500 feet. Can be operated in either a single or dual-channel mode.

12604B Data source interface**\$875**

Provides 32 input lines for sensing external voltages relative to an externally provided reference level.

12555B Digital to Analog Converter**\$600**

Provides two analog output channels ranging from 0 to +10 volts with 8 bits per channel resolution. Also provides two logic level outputs for external device control.

59310B Hewlett-Packard Interface Bus Controller**\$1000**

Allows any 21MX or 2100 Series processor to interface with instruments that are programmable via the HP Interface Bus. The HP-IB is Hewlett-Packard's implementation of IEEE Standard 488-1975, "Digital Interface for Programmable Instrumentation."

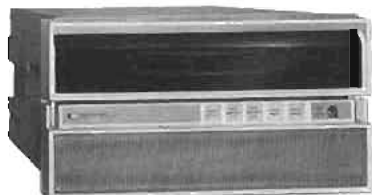

7900A



DISCU/15 (13390A)

Hewlett-Packard 7900 and 7905 series disc drives are highly-reliable, random access moving-head memory devices. They are compactly designed for use as peripheral units in small and medium size computing systems.

7900A 5 Megabyte Disc Drive

This dual platter disc drive uses one permanent disc and one removable 2315 type cartridge to provide 4.9 million bytes of formatted storage. This highly-reliable drive has an average seek time of 30 milliseconds, and a data transfer rate of 2.5 million bits per second. Rotational speed is 2400 RPM. A photoelectric positioning system, working in conjunction with a velocity transducer and voice coil driven actuator, provides exceptionally fast and accurate head positioning over a wide temperature range. Cartridge interchangeability between drives of the same type is guaranteed. Model 13215A Power Supply is required.

7905A 15 Megabyte Disc Drive

This dual platter disc drive has one removable and one fixed disc. It provides 10 megabytes of formatted, removable storage in a front-loading cartridge. One side of the fixed disc is used for track following servo positioning. The other contains 5 megabytes of formatted data. Track to track seek time is 5 ms and the average random seek time is 25 ms. Rotational speed is 3600 RPM, yielding a data transfer rate of 7.5 million bits per second.

13037A Storage Control Unit

The 13037A Storage Control Unit is a microprocessor-based controller with a powerful set of instructions implemented with a 1K-24 bit word ROM. It offers a unique high-level interface which simplifies the design of the CPU I/O card. Multiple drives and CPU's may be connected to the SCU. All drive-related functions have been included, leaving only the processor-related design. A flexible architecture is used which will accommodate future additions to a family of drives. Macro I/O commands reduce CPU overhead. Error detection and correction, plus several means of data protection, are included.

DISCU/15 13390A

A new high-performance pair from HP consists of the 7905A Disc Drive and 13037A Storage Control Unit. The DISCU/15 is designed for OEM systems where improved throughput, redundancy reliability, and quick interfacing are required.

The DISCU/15's high-performance moving-head mass storage is ideal for demanding minicomputer system applications. The capacity is from 15 megabytes (1 drive) to 120 megabytes (8 drives) with two CPU's accessing the data base. Big system data base features such as track following head positioner, error correction and macro I/O operations, plus broad environmental specifications, offer the OEM a new level of performance.

7905A Disc drive specifications

Seek time: track-to-track, 5 ms (avg); average random, 25 ms; maximum stroke, 45 ms (max)

Rotational speed: 3600 RPM

Average rotational delay: 8.3 ms

Recording: MFM (modified FM)

4680 bits/inch (inside track)

192 tracks/inch

411 tracks/surface; 406 usable, guaranteed

Data transfer rate:

7.5 million bits/sec

937.5 K bytes/sec

Cartridge change

Spindle stop time: 25 s

Spindle start time: 30 s

Power requirements:

100, 120, 200, 220, 240 V, all +5%, -10%

Single phase, 47 to 66 Hz

500 watts (1707 BTU) at 120 V/60 Hz or 220 V/50 Hz

Environmental specifications:

50° to 104°F (+10°C to +40°C)

8% to 80% Rel. Hum., non-condensing

(78°F max. wet bulb)

Non-operating specifications:

-40°F to +149°F (-40°C to +65°C)

5% to 95% Rel. Hum., non-condensing

(85°F max. wet bulb)

Actuator: voice coil actuator with track follower servo and velocity feedback

Interchangeability: the 7905A allows any disc written on any 7905A within its operating specification to be read on any other 7905A unit operating within that range.

Altitude

Operating: Sea Level to 10 000 ft.

Non-operating: 1,000 ft. below Sea Level to 15 000 ft.

Tilt: ±30° about either horizontal axis.

Weight: 73.5 kg; 162 lb. Power Supply integrated into drive.

Vibration: meets HP Class C vibration specs. Test is 15 min. in each of 3 mutually perpendicular axes. Vibration input of 0.010 inches from 10 to 55 Hz results in amplitude of 1.54 g's at 55 Hz.

Dimensions

Panel Height: 10.44 in. (26.52 cm)

Width: 18.91 in. (48.03 cm)

17.38 in. (44.15 cm) behind panel

Depth: 28.00 in. (71.12 cm)

26.81 in. (68.10 cm) behind panel

13037A Storage control unit specifications

Environment: HP Class B

Temperature

Operating: 0° to 55°C (32°F to 131°F)

Non-Operating: -40° to 75°C (-40°F to 167°F)

Humidity: 0% to 95% non-condensing

Encoding: MFM

Altitude: operating 0 to 15 000 ft.

Non-Operating: 0 to 25 000 ft.

Card Size: 11.5" × 13.7". SCU has two empty slots available with 3 Amps at +5 V on one.

Logic Levels: Schottky TTL

Line Voltages: 100, 120, 220, 240 V ac at 50 or 60 Hz. All +5%, -10%.

Power Dissipation: 190 W (648 BTU) at 120 V/60 Hz or 220 V/50 Hz

Weight: 15.9 kg (35 lb).

Dimensions

Panel Height: 5.25 in. (13.34 cm)

Width: 18.91 in. (48.03 cm)

16.75 in. (42.55 cm) behind panel

Depth: 22.69 in. (57.63 cm)

21.55 in. (54.61 cm) behind panel

Options

908: Rack Flange Kit for 7900A or 7905A

908: Rack Flange Kit for 13037A or 13215A

Model number

Model 7900A Disc Drive

Model 13215A Power Supply

DISCU/15

Model 7905A Add-on Drive

OEM prices and discount schedules are available.

Price

add \$15

add \$10

\$7975

\$1400

\$12,800

\$8975



COMPUTERS: COMPONENTS

Compact and reliable tape subsystems

Models 7970, 12970A, 12971A, 12972A



Hewlett-Packard offers a wide variety of digital magnetic tape units in its 7970 Series, plus a number of fully interfaced magnetic tape subsystems.

Magnetic tape subsystem for use with 2100/21MX based systems

12970A Magnetic tape subsystem **\$9500**

NRZI format 7970B, 9-track tape drive subsystem. Provides 800 cpi capability at speeds of 25, 37.5, or 45 ips.

12971A Magnetic tape subsystem **\$15,950**

NRZI format 7970B, 7-track tape drive subsystem. Provides switch selectable 200, 556, and 800 cpi capabilities at speeds of 25, 37.5, or 45 ips.

12972A Magnetic tape subsystem **\$10,900**

Phase-encoded format 7970E, 9-track tape drive subsystem. Provides 1600 cpi capability at speeds of 25, 37.5, or 45 ips.

7970 Magnetic tape units

Hewlett-Packard Series 7970 Digital Magnetic Tape Units offer a compact and reliable solution to your tape system needs. Units are available in a wide range of 7-track and 9-track configurations utilizing either NRZI or phase encoded electronics. All Series 7970 Tape Units have been designed to include the same features you would expect to find in higher-priced and more complex equipment. Plus you receive complete interchangeability of data with other IBM or ANSI compatible equipment.

Reel motors provide direct drive, eliminating troublesome belts and pulleys. Tape tensioning is performed by photo-resistive controlled tension arms that eliminate the need for vacuum system components. Head assemblies consist of read stack, write stack and full width erase head. All major transport assemblies are easily accessible for servicing and/or replacement when required.

Model-Option	Density				master	slave	7-tr	9-tr	NRZI	PE	RO	RAW
	200	556	800	1600								
7970B-127			•		NA	NA		•	•			•
7970B-136	•	•	•		NA	NA	•		•			•
7970E-150				•		•		•		•		•
7970E-151				•	•			•		•		•
7970E-152				•		•		•		•	•	
7970E-153				•	•			•		•	•	
7970E-162			•	•		•		•	•	•	•	
7970E-163			•	•	•			•	•	•	•	
7970E-164	•	•	•	•		•	•	•	•	•	•	
7970E-165	•	•	•	•	•		•	•	•	•	•	

All above units operate at 45 ips

RAW = Read After Write

RO = Read Only

Master = initial PE unit

Slave = additional PE unit (3 per master)

Options

001: Change speed to 37.5 ips

002: Change speed to 25.0 ips

003: Change speed to 22.5 ips (7970E only)

007: Add front panel unit select (not available with Opt 020)

020: Add front panel parity select (7970E -164 and 165 only)

021: Add dual speed (7970E -162, -163, -164, and -165 only)

048: For operation from 42 to 60 V dc source

Price

N/C

N/C

N/C

add \$155

add \$80

add \$105

add \$750

Specifications, 7970 series

Tape speed: 22.5, 25, 37.5, or 45 ips.

Reel diameter: up to 10.5 in. (26.7 cm).

Tape: computer grade.

Width: 0.5 in.

Thickness: 1.5 mils

Tape tension: 8.5 ounces nominal.

Tape format: IBM/ANSI compatible

Rewind speed: 160 ips

Start/Stop Travel: Read-After-Write: 0 to 187 in. ± 0.020 in.

Power requirements: 115 or 230 ($\pm 10\%$) V ac. 48 to 60 Hz single phase. 400 VA maximum (on high line).

Operating environment (hardware)

Ambient temperature: 0 to +55°C (+32 to +131°F).

Relative Humidity: 20% to 80% noncondensing

Altitude: 10,000 ft. (3,048 metres)

Physical characteristics

Size: 610 × 483 × 400 mm (24 in. H, 19 in. W, 15.75 in. D). Depth from mounting surface, 305 mm (12 in.).

Weight: 63.5 kg (140 lb) maximum.

Model number

7970B-127

\$6360

7970E-151

\$8885

For complete specifications and a list of accessories, request technical data sheets (7970B/C or 7970E). OEM prices and discount schedules are available.



2645A



Hewlett-Packard has a growing family of general-purpose display terminals which include: the new 2640B Display Terminal, the high performance 2645A Display Station, the 2640C/N/S International Terminals, the 2641A APL Display Terminal, and a number of accessories for filling the needs of a variety of applications. Hewlett-Packard display terminals are in wide use today in manufacturing, service organizations, government and education performing in such applications as:

- data entry
- inquiry/response
- editing text
- file updating
- transaction processing
- programming
- off-line operation
- data storage
- printing
- order entry
- batch operation
- time-sharing

Model 2640B display terminal

Easy to read display: the large 5 inch by 10 inch display of the 2640B presents up to 1,920 characters in a 24 line by 80 column format. A 9 X 15 dot character cell allows large characters to be represented accurately. Wide character and line separation, inverse video, and optional plug-in character sets with underlining, half-bright, and blinking are enhancements designed to increase clarity and ease sessions at the terminal.

Full editing capability: the 2640B transmits character-by-character as an interactive terminal or is capable of operating on variable length blocks of information. Local editing allows the user to modify data before transmission to the computer. Editing and computer connect times can be significantly reduced by such standard features as:

- character or line insertion and deletion
- cursor addressability and positioning (up, down, left, right, home)
- programmable protected fields in any combination of display positions
- off-screen storage with scrolling (scroll up, scroll down, next page, previous page)
- standard horizontal tabs and protected field tabulation

- eight special function keys for user-defined routines, such as forms entry or on-line error detection
- positional memory lock

Plug-in character sets: there is the capacity to use up to four 128-character sets concurrently (switch selectable on a character-by-character basis): the Roman set including displayable control codes for program debugging; the line drawing set for forms drawing and limited graphics capability; the math set with frequently used math symbols and Greek characters; the large character set for enlarged character presentation; or user-defined character sets.

Choice of communications capabilities: the standard 2640B operates at up to 2400 baud and offers both full and half duplex asynchronous communication using an EIA RS232C interface. It is Bell 103A and 202C/D/S/T modem compatible with a choice of main channel and reverse channel protocols. Options include 20 mA DC current loop, split input/output speed and custom baud rates.

Versatile keyboard: the detachable, expanded ASCII keyboard is easy to use and flexible enough to fill a wide variety of applications. It contains a ten key numeric pad, cursor control, tab and page control pad, editing and special function keys.

Multi-page display memory: because of efficient memory allocation, the standard 2640B with its 1024 bytes of memory can display from 8 to 50 lines dependent on line length. With memory expansion to 8 k bytes, over three pages of data can be stored. Information can be viewed 24 lines at a time by scrolling forward or backward a line or a page at a time.

Hard-copy interface: a wide variety of hard-copy devices can be accommodated via an optional RS232C serial interface or HP printer compatible parallel interface. Commands to print data can be initiated either locally from the terminal keyboard or remotely from a computer.

Self-test: every element of the 2640B has been engineered for high reliability and ease of service. For example, the Self-Test feature gives the user an instant diagnostic test that the terminal is operating properly.

Modular architecture, microprocessor controlled: microprocessor implementation and modular architecture produce a terminal with a wide range of capabilities; and, as needs grow, the potential for flexibly adding such features as additional display memory, printer interfaces and other character sets.

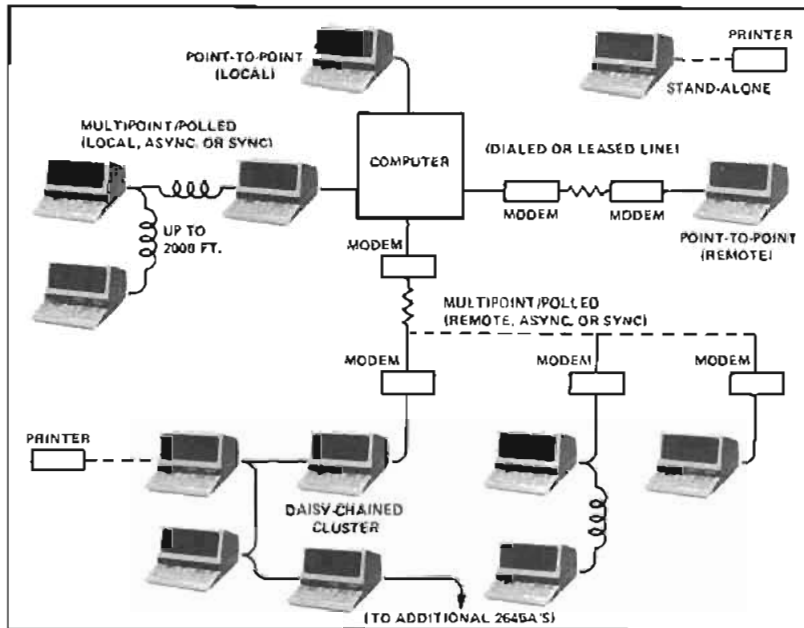

Model 2645A display station

All 2640B features: the high performance 2645A Display Station offers a superset of the capabilities of the 2640B. It has the same features and benefits as the 2640B (see 2640B features description) and has the many significant additional features described below.

High speed: the 2645A can operate at speeds up to 9600 bits per second and, like the 2640B, transmits either character-by-character as a fully interactive terminal or can operate on variable length blocks of information.

Choice of communications capabilities: the standard 2645A is a teletypewriter compatible (EIA RS232C serial asynchronous, ASCII, half or full duplex). Optional capabilities include 20 mA current loop; and either asynchronous or synchronous polling for multipoint communications networks. Polling offers the cost saving benefits of shared communications resources — modems, data lines and computer I/O channels; as well as improved transmission error checking and communications compatibility with a wide range of computer systems. The 2645A operates as a single unit or can be daisy-chained to other 2645A's on a single communication line. Synchronous multipoint (IBM Binary Synchronous Multipoint Communications, Bisync) and asynchronous multipoint (patterned after Bisync) can optionally be used for polled communications networks. Also, the 2645A can be used with a wide selection of modems over dialed or leased lines.

User-defined soft keys: each of 8 special function keys can be easily set to issue a user-defined string of up to 80 data characters or several control sequences stored in the 2645A. This feature allows the keyboard to be more specialized to each application, and can considerably simplify use of the keyboard and result in greater efficiency — each soft key performs the operations of several key sequences. For example, the soft keys can issue frequently used programming sequences: search for files; aid forms construction for data entry; dynamically configure the terminal; or issue instructions to the user, computer or both.

Fully integrated mass storage: many operations normally requiring connection to a computer system can now be done off-line with the 2645A. Optional, dual cartridge tape units allow batching of information, and add extensive stand-alone capabilities which can: significantly reduce user time; conserve both computer and communications resources; provide a tape backup; and very importantly, allow the terminal to keep on working even when a computer is unavailable. Single keys for the most frequently performed functions, and color-coded prefix keys to exercise the 2645A's full capabilities suit the 2645A to a wide variety of users and applications. Gold and green prefix keys provide full access to the 2645A's multiple data paths to allow information to be moved between any of the functional units of the display station—cartridge, display, keyboard, printer, and data communications interface. Also, the tapes are fully controllable from either keyboard or computer. The highly reliable, interchangeable MiniCartridge tapes each provide the capacity of I.C.E. up to 110 000 characters of storage formatted in variable length records and files. The tape units feature rapid data transfer and bi-directional high-speed search to access any file in seconds. The MiniCartridge is ideally suited for storing data, forms, programs, or text, and is an excellent substitute for paper tape.

Additional capabilities

- Numeric/Alpha field checking
- Display memory expandable to 12 k bytes
- Automatic data logging—stores data as it leaves the display automatically on the optional tape cartridges
- Line wraparound—when inserted text requires more than 80 columns per line.
- Adjustable margins—for variable column width/multiple columns/split screen



Actual photograph of 2640C's display repertoire
(Shown with optional roman lower case and control codes)

International terminals

The 2640C, 2640N, and 2640S are international versions of the 2640B Display Terminal. Each has basically the same features and benefits as the 2640B (see 2640B features description).

Model 2640C—Cyrillic (Russian): the 2640C is capable of displaying the full 128-character Cyrillic character set in addition to the 64-character Roman set (128-character set opt.). Cyrillic and Roman characters can be generated from a single keyboard with all keys labeled and located in the accepted positions for Cyrillic keyboards. Pressing a single key switches between standard Roman and Cyrillic. Adjacent characters on the display can be from the Roman, Cyrillic, or optional plug-in character sets.

2640N—Danish/Norwegian: the 2640N is a unilingual terminal in which the Danish/Norwegian character sets are displayed and present on the keyboard.

Model 2640S—Swedish/Finnish: the 2640S is a unilingual terminal in which the Swedish/Finnish character sets are displayed and present on the keyboard.

Model 2641A APL Display Terminal

The 2641A APL Display Terminal retains all features and capabilities of the 2645A. An additional APL character set, including over-strike characters, is standard. Keyboard layout conforms to industry conventions. Integrated cartridge tape storage optional.

Family enhancements and accessories

13231A Display enhancement: with the 13231A individual characters or fields of characters can be displayed in any of the sixteen possible combinations of blinking, underline, half-bright or standard inverse video. The 13231A also provides the capacity for adding up to three 128-character sets. A line drawing set, math symbol set and large character set are currently available.

13245A Character set generation kit: the high resolution display and 9×15 dot character cell are available for special character set design with the 13245A. An included manual documents the steps necessary to design individual characters, assign the desired ASCII code equivalent, and generate the information to purchase Programmable Read Only Memories (PROM) which store the user-defined character sets.

13238A Duplex register: the 13238A provides a parallel output interface which supports the HP 9866 thermal line printer and 9871 character-serial impact printer.

13250B Serial printer interface: the versatile 13250B supports a wide variety of RS232C serial interface compatible printers at speeds up to 9600 bits per second. Hewlett-Packard printers that the 13250B interface supports are the HP 2762A and 2762B.

13264A Video output interface: the 13264A provides the capability of generating video output which can be used by compatible television monitors and video hardcopy units to duplicate whatever is being displayed by one of the Hewlett-Packard family of display terminals.

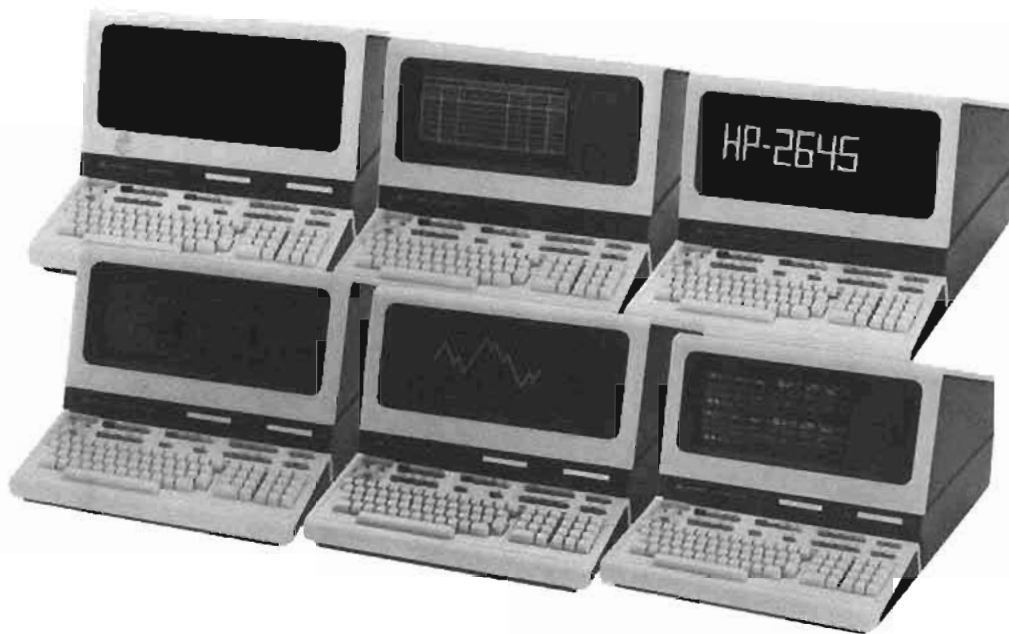

Family specifications

General

Screen size: 127 mm (5 in.) × 254 mm (10 in.)
Screen capacity: 24 lines × 80 columns (1,920 characters)
Character generation: 7 × 9 enhanced dot matrix; 9 × 15 dot character cell; non-interlaced raster scan
Character size: 2.46 mm (0.097 in.) × 3.175 mm (0.125 in.)
Character set: 64 upper-case Roman; 128 character APL set with 2641A; 64 character Danish/Norwegian set with 2640N; 64 character Swedish/Finnish set with 2640S
Cursor: blinking-underline
Display modes: white on black; black on white (inverse video)
Refresh rate: 60 Hz (50 Hz optional)
Tube phosphor: P4
Implosion protection: bonded implosion panel
Display memory: 2640B 1 k std., 8 k max; 2645A 4 k std., 12 k max.
Keyboard: detachable. Full ASCII/APL keyboard for 2641A. Full ASCII code keyboard; 2640B 20 control/editing keys, 2645 8 user-defined soft keys and 16 additional control/editing keys; ten-key numeric pad; cursor pad; multi-speed auto-repeat, n-key roll-over; 1.22 m (4 ft.) cable.
Cartridge tape: two mechanisms, 10 ips read/write speed, 60 ips search rewind speed, 800 bpi recording, max 110 k bytes of storage per MiniCartridge. Optionally available for 2641A and 2645A only.

Data communications

Data rate: 110, 150, 300, 1200, 2400 (4800 on 2641A, 9600 also on 2645A) and external-switch selectable (110 selects two stop bits).
Std. asynchronous communications: EIA RS232C; compatible with Bell 103A modems; compatible with Bell 202C/D/S/T modems.
Transmission modes: full or half duplex, asynchronous
Optional communications interfaces:
 Current loop, split speed, custom baud rates
 Asynchronous multipoint (2641A, 2645A only)
 Synchronous multipoint (2641A, 2645A only)
Operating modes: on-line, off-line; character, block
Parity: switch selectable (even/odd/none)

Environmental conditions

Ambient temperature

Non-operating: -40° to 75°C (-40 to 167°F); -10° to 60°C (-15° to 140°F) with tape

Operating: 0° to 55°C (32° to 131°F); 5° to 40°C (41° to 104°F) with tape

Humidity (non-condensing): 5 to 95% (20 to 80% with tape).

Heat dissipation: 540 Btu/hour (158 W)

Altitude

Non-operating: sea level to 7620 metres (25 000 feet)

Operating: sea level to 4572 metres (15 000 feet)

Vibration and shock (type tested to qualify for normal shipping and handling in original shipping container)

Vibration: 0.25 mm (0.010") pp, 10 to 55 Hz, 3 axes

Shock: 30 g, 11 ms, 1/2 sine

Physical specifications

Display monitor weight: 19.6 kg (43 lb).

Keyboard weight: 3.2 kg (7 lb).

Display monitor dimensions: 444 mm W × 457 XxD × 342 mm H (17.5" × 18" × 13.5"), 648 mm D (25.5") including keyboard)

Keyboard dimensions: 444 mm W × 216 mm D × 90 mm H (17.5" × 8.5" × 3.5")

Power requirements

Input voltage: 115 (+10%, -23%) at 60 Hz

230 (+10%, -23%) at 60 Hz

Power consumption: 85 W to 140 W max.

Product support

Warranty: 90 day on-site parts and labor warranty

Model number and name

Model 2640B Interactive Display Terminal	\$2600
Model 2640C Cyrillic Display Terminal	\$4250
Model 2640N Norwegian/Danish Display Terminal	\$2750
Model 2640S Swedish/Finnish Display Terminal	\$2750
Model 2641A APL Display Terminal with tape	\$4100
Model 2645A Display Station with tape	\$4600
Model 2645A Display Station with tape	\$3500
Model 2645A Display Station with tape	\$5100

Short-term lease and quantity discounts available.

Price

\$2600
 \$4250
 \$2750
 \$2750
 \$4100
 \$4600
 \$3500
 \$5100
 quote

COMPUTERS: COMPONENTS

Optical mark readers for data entry and collection

Models 7260A & 7261A

- Flexible card format
- High speed operation
- Easy to interface

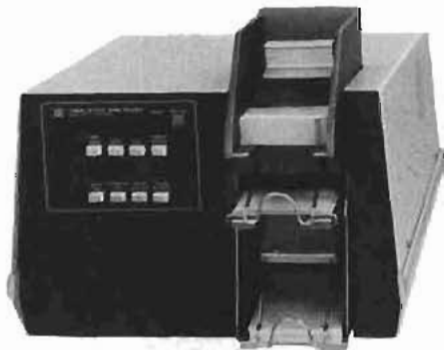

7260A

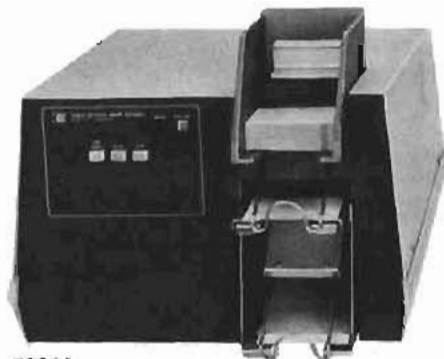

7261A

The Hewlett-Packard Models 7260A and 7261A Optical Mark Readers are desk-top data transmission instruments. The Readers optically (photo-reflectively) read standard 82.6 mm (3 1/4 in.) wide paper information processing cards. Card lengths from 187.3 mm to 282.6 mm (7 1/4 in. to 11 1/4 in.), having 40 or 80-column marked or key-punched information using on-data or after-data clocking are accepted. With Option 003, the Readers can also read cards without clock marks. They can handle 450 processing cards at a time at feed rates of up to 300 cards per minute.

7260A Optical Mark Reader Specifications

Code capacity: recognizes 128 characters Hollerith code. Other codes available on request.

Translation: translates to bit serial 7-level ASCII with selectable parity.

Operational modes: demand and continuous feed.

Parity: generates and transmits selectable parity.

Data rates: 110, 150, 300, 600, 1050, 1200, 2400 baud, switch selectable.

Tab cards dimensions: standard tab card size 82.6 × 187.3 mm (3 1/4 × 7 1/4 inches) or 82.6 × 282.6 mm (3 1/4 up to 11 1/4 inches).

Hopper capacity: 450 cards input, 450 cards output.

Interface: RS-232C and CCITT V24.

Interface Connectors: 2 Cinch/Cannon DBM-25S-rear panel.

Invalid Code: transmits a selectable character when data outside 128 character set is marked.

Mute and Line — Local Operation: allows operation with local terminal, and allows muting of terminal Printer.

Mnemonic Control: allows 3 letter mnemonics to control Reader when control codes would interfere with system operation.

- OEM and quantity discounts available
- Service contracts available
- Customer service kit available

Image: transmits Binary card image as two typing characters with selectable parity, activated by control codes from computer.

Software available

7260A OMR DOS III-B Logical Driver (ACR01)

Binary Tape	07260-16001
Manual	24307-90012

7260A operates with HP 2000 Access system. No special software required.

7261A Optical Mark Reader Specifications

Card code and output codes: the information from each card is converted by the Reader to a parallel 12-channel format. Tab cards dimensions: standard tab card size, 82.6 × 187.3 mm (3 1/4 × 7 1/4 inches) or 82.6 × 282.6 mm (3 1/4 up to 11 1/4 inches).

Hopper capacity: 450 cards input, 450 cards output.

Interface connector: 36 Pin Cinch Micro-Ribbon — rear panel.

Software available

7261A — DOS III-B Driver (DVR-15)

Binary Tape	24307-16017
Manual	24307-90020

7261A — RTE Driver (DVR-15)

Binary Tape	92201-16001
Manual	09601-93014

7261A Diagnostic

Binary Tape	07261-16005
Manual	07261-90005

7261A — BCS Driver (D.15)

Relocatable Tape	20819-60001C
Manual	12602-90021

7261A — SIO Drivers

4K Binary Tape	20520-60001C
8K Binary Tape	20521-60001C
16K Binary Tape	20522-60001C
Manual	12602-90022

All software for Model 7261A is included in the 12986A Optical Mark Reader Subsystem.

Common Specifications

Dimensions: 610 × 368 × 305 mm (24 × 14 1/2 × 12 inches).

Weight: net, 24.6 kg (54 lb). Shipping, 33.2 kg (73 lb).

Environment (exclusive of tab cards):

Storage temperature: -40°C to +75°C.

Exposure power on: -20°C to +65°C

Meets specifications: 0°C to +55°C

Humidity: 5% - 95% at 25°C to 40°C

Vibration: 10-55 Hz, 01 in. peak-to-peak excursions

Environment (tab cards): from 20% to 75% RH at 23°C

AC Power: (see Option 005 for 220/240 V ac operation) 100 or 120 V ac, +5% -10%, switch selected 47.5 Hz, 66 Hz; 300 VA

Line fuse: 4 A SB

Transformer fuse: 2 A SB

U.L. approval: the reader has U.L. approval and CSA approval pending and meets IEC specifications.

Options

Options	Price
002: Select Hopper	add \$230
003: Encoder	add \$230
004: Bell	add \$60
005: 220/240 V ac +5% -10% (line fuse 2 A SB, Transformer 1 A SB).	N/C
006: 50 Hz	N/C
421: DOS III B Logical Driver (7260A only)	add \$55

Model number

7260A Optical Mark Reader	\$3820
7261A Optical Mark Reader	\$3275
12986A Optical Mark Reader Subsystem for 7261A with interface to HP 2000 computer systems (includes software described above)	\$4100

COMPUTERS: SYSTEMS

Information management systems

HP 1000 systems, 9640A systems



HP 1000 System model 80



9640A Subsystem



Hewlett-Packard offers data management software and system capabilities necessary to handle today's information explosion.

New HP 1000 Computer Systems

The new HP 1000 family offers a choice of computer systems for computational and data management applications in research, industry and business. The systems are disc-based, use HP's new 21MX E-Series processors, and are managed by RTE-II or RTE-III executive software.

Multi-Terminal

HP 1000 Computer Systems are multiprogrammable, multi-terminal systems capable of serving several users concurrently; applications include engineering computation, automated test/measurement systems, process control, and operations management. While they are providing interactive multi-terminal access, HP 1000 Systems can execute batched jobs with minimal operator intervention. The systems also offer a choice of program languages, including Real-Time BASIC, FORTRAN II or IV, HP ALGOL, and HP Assembly.

HP 1000 Computer Systems come in four models. Models 30 and 31 are intended for computational, automated test/measurement, or process control applications which can be adequately supported by a file-oriented data management system. Models 80 and 81 combine all the functional capabilities of the 30 and 31 with the IMAGE/1000 Data Base Management System. With IMAGE/1000, users can build and maintain a true data base which can serve many people and purposes, minimizing the need for multiple, redundant data files. A simple, English-like inquiry language (called QUERY) lets users access all stored information and makes report generation easy.

High-Speed peripherals

All HP 1000 Computer Systems support a wide range of peripherals, including line printers, card readers, magnetic tape units, terminals, and graphic subsystems. For instrumentation needs, Hewlett-Packard Interface Bus I/O Kits (HP 59310B) connect one or several instrument clusters to an HP 1000 System.

Distributed multi-computer networks

Cooperative program and data communications—between an HP 1000 System and memory-based 21MX computer systems via hard-wire or telephone links—can be provided by adding network data

communications hardware/software packages, proven by users in over 100 installations.

Four models to choose from

Model 30: includes 2113A Processor with 64k bytes of main memory, 14.7M bytes of disc storage, and a 2645A Display Station. The system is supplied in an attractive desk-style workstation with matching Mini-Rack Cabinet for the disc subsystem. RTE-II Executive software is standard; RTE-III is available as an option.

Model 31: functionally identical to the Model 30. The Model 31 is supplied in a single 56-inch high upright cabinet.

Model 80: includes all equipment supplied with the Model 30 plus a line printer and magnetic tape Subsystem. The Model 80 comes with 128k bytes of main memory and is managed by RTE-III executive software. The IMAGE/1000 Data Base Management System is standard. Model 80 is supplied in a desk-style workstation for CPU and system console, plus a single 56-inch high upright cabinet for the disc and magnetic tape subsystems.

Model 81: functionally identical to the Model 80, the Model 81 is supplied in two 56-inch high upright cabinets.

Model number

Model number	Price
HP 1000 Computer System—Model 30	\$37,500
HP 1000 Computer System—Model 31 with 7905A Disc Drive	\$33,500
HP 1000 Computer System—Model 80	\$67,200
HP 1000 Computer System—Model 81	\$68,200

9640A Subsystem

The HP 9640A system combines powerful computational capability with fast multi-terminal access to data files on disc memory. It also has multiprogramming capability for developing and executing programs concurrently within a work environment. Concurrent program execution means maximum utilization of both computer and human resources. Long, drawn-out statistical computations can be efficiently carried out at the same time as terminal data the IMAGE/1000 Data Base Management System. This allows users to easily establish, maintain, and access data bases on the system disc and backup magnetic tape. Sorting, report format generation, and immediate inquiry into the data base are provided.

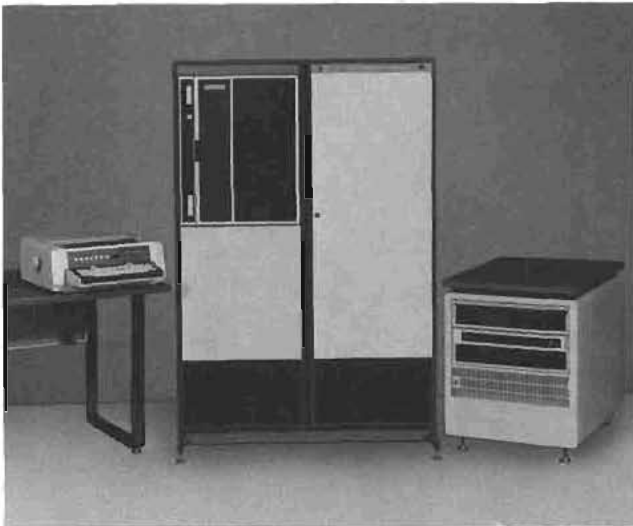

HP 2000 Computer Systems

Unlike any other minicomputer-based system, the Hewlett-Packard 2000 System offers now, multiterminal, on-line data processing capability with unique, concurrent multiterminal remote job entry (RJE) available at each terminal.

This outstanding combination of data management and data communication capabilities is made possible by the use of two state-of-the-art processors with high speed semiconductor memories. A system processor is dedicated to disc storage management (up to 8 disc drives or 120 megabytes), program interpretation and computing. Additionally, a communications processor assures fast response to users at terminals and efficient use of peripheral devices. This processor manages local peripherals, asynchronous terminal communication at speeds up to 2400 baud, and synchronous communication to IBM or CDC computers, or another HP 2000 at speeds up to 4800 baud.

Data communication

The HP 2000 System emulates either an IBM HASP II Multi-leaving Work Station or a CDC 200 User Terminal for synchronous communication. As a result, as many as 32 interactive terminals on the HP 2000 System can smoothly manage concurrent batch RJE functions. They also can initiate data transfers to another 2000 system in distributed computer networks. An optional RJE Telecommunications Supervisory Package (TSP/2000-HASP), can automatically direct the output from an IBM host system to a particular device specified by the user, or to a file in the user's library. Moreover, automatic supervision frees the user's port for execution of other on-line programs, and allows the user to periodically check the status of a job.

Resource sharing

All terminals on the system also have access to the system with full processing power for comparison, data entry, administration, data management, program development, instructional problem solving, etc. A user may execute applications that can access up to seven card readers, seven line printers, seven card/reader punches, seven paper tape readers or punches, and four magnetic tape drives. Data to be sent to the central host system may, of course, be processed on the HP 2000 System before transmission.

Source data entry

The collection of data at the source is an ideal application for the HP 2000 System since this technique reduces data preparation errors and costs and reduces host CPU processing. The system also operates efficiently with the new microprocessor-equipped Hewlett-Packard family of interactive CRT terminals. With these in the system, and the optional Source Data Entry (SDE/2000), non-technical persons can easily format the screen to resemble source documents, then enter data conversationally by filling-in blanks. Data entered through all of HP's interactive terminals can be transmitted concurrently to the central host system.

Extended BASIC language facilities

Simple enough for the novice to use, HP 2000 BASIC includes an English-oriented conversational BASIC language processor, which permits the development and execution of BASIC programs from all user terminals simultaneously. A few simple statements formed with meaningful words provide the basic capabilities for manipulating data, performing calculations, and controlling program flow.

Yet, HP 2000 BASIC is versatile and powerful enough for more advanced users to efficiently implement sophisticated applications involving data base management, remote job entry to central IBM and CDC computers, or data transfers to another 2000 System.

Data management

In addition to the computation facilities normally found in BASIC, HP's 2000 BASIC provides extensive character string manipulation and powerful data file management abilities. Disc files may be both sequential and direct access. Files may be created and purged under program control. New statements and functions make it easy to develop file-oriented applications accessed by multiple terminals concurrently. Each program may access up to 16 data files at the same time, and each file can be opened and closed dynamically.

In addition to these data management facilities, each 2000 System includes FCOPY/2000 as standard system software. FCOPY/2000 is a file utility package that provides general file copying operations, including capabilities for comparing files, code translations, and printing files at line printers or terminals. It can be used interactively from a terminal or controlled programmatically through a user-written BASIC program.

Text processing

Included with the system is EDITOR/2000, an interactive text processing software package that permits users to edit and format text from any of up to 32 video display or typewriter keyboard terminals on an HP 2000 System. It performs such tasks as adding, deleting, replacing, changing, searching, storing, retrieving, justifying, copying, and moving lines, strings and words of textual material.

EDITOR/2000 can be used to prepare and manipulate textual material such as contracts, proposals, correspondence, technical manuals, specifications and legal documents. Special facilities are provided to edit the images of source language programs, such as BASIC programs to be executed locally on an HP 2000 System or COBOL programs to be compiled and executed on a host computer via Remote Job Entry. Source programs for other host programming languages, e.g., FORTRAN, PLI, etc., may also be locally edited for Remote Job Entry to host systems.

2000 Hardware — Models 30 and 40

Each includes two HP 21 MX processors and magnetic tape drive within the system cabinet, plus a separate 30 cps system console, system table and system disc(s) in separate, low profile cabinet(s).

Model 30 has 96 k bytes of main memory, a 15 megabyte cartridge disc, 800 bpi magnetic tape drive, and a 16-port asynchronous communication multiplexer.

Model 40 has 128 k bytes of main memory, two 15-megabyte cartridge discs (each in a separate cabinet), 1600 bpi magnetic tape drive, and a 32-port asynchronous communication multiplexer.

Both models include the operating system software with firmware, RJE emulators, BASIC language processor, EDITOR/2000 and FCOPY/2000.

Ordering information

2000 System — Model 30
2000 System — Model 40

Price

\$66,000
\$83,000

COMPUTERS: SYSTEMS

General purpose computers

HP 3000 Series II Systems



Designed for small-to-medium businesses or divisions of larger corporations, educational institutions, and scientific computer users, the HP 3000 Series II represents a new state-of-the-art in low cost, disc-based computer systems. With exceptional processing capabilities, large memory capacity, and convenient operation, Series II Systems present a fresh approach to data processing for many users of small general purpose computers.

Features

Concurrent processing

A key feature of the systems is their capability to perform batch as well as multi-terminal (on-line) processing concurrently. This powerful processing capability is achieved through an operating system that automatically controls both batch and on-line jobs to increase the amount of actual work accomplished in a given period.

Multi-level security

Protection for any program or file is easily established by assigning passwords to different tasks and system users. This prevents unauthorized use of programs or data files.

On-line program development

Programmers can input their source statements directly from a terminal. On-line program development minimizes software costs by reducing turnaround time and providing instantaneous access during the debug and test cycles. Programs can be written in COBOL, RPG, FORTRAN, BASIC, and SPL (System Programming Language).

Data base management

IMAGE/3000, the general purpose data base management system for the HP 3000, provides the basis for developing the information system needed to meet applications requirements. IMAGE operates in both terminal and batch environments. QUERY/3000 software, used in conjunction with IMAGE, enables easy locating, reporting, and updating of data within the data base.

System configurations

Hewlett-Packard 3000 Series II Computer Systems are available in three standard configurations — Models 5, 7, and 9. Models 5 and 7 can be upgraded at any time to higher capability and performance standards with no applications software changes.

Model 5

As the basic system in the Series II family, Model 5 is ideal for small commercial and interactive scientific applications. The system includes a 128 k byte fault control memory, 15 megabyte disc, 1600 bpi magnetic tape unit, system console, and a 16-port asynchronous terminal controller.

Model 7

Configured to handle small-to-medium scale data processing jobs, the Model 7 is suited to a broad spectrum of commercial and administrative applications. The configuration consists of a 192 k byte fault control memory, two 47 megabyte disc units, 1600 bpi magnetic tape unit, system console, and a 16-port asynchronous terminal controller.

Model 9

The most powerful standard configuration in the Series II family, this system supports a large number of terminals performing commercial, industrial, educational, and scientific processing. Model 9 comes with five programming languages and IMAGE and QUERY. System components are the 320 k byte fault control memory, two 47 megabyte disc units, 1600 bpi magnetic tape unit, system console, and a 16-port asynchronous terminal controller.

Model number

HP 3000 Series II, Model 5
HP 3000 Series II, Model 7
HP 3000 Series II, Model 9

Price

\$110,000
\$150,000
\$190,000

COMPUTERS: SYSTEMS

Automatic measurement and control systems

9600 Series



Industrial measurement and control system (doors removed to show screw-terminal signal connection assemblies).

Hewlett-Packard 9600 automatic measurement and control systems speed data acquisition, processing, and output operations. They are available in a variety of configurations to meet virtually every sensor-based measurement and control need:

9604A

For scientific measurement and control with fast sampling of analog inputs (to 45 Hz) and optional digital I/O.

9611A

For industrial measurement and control with conditioned analog and digital I/O and convenient screw-terminal connection of inputs and outputs.

9640A

For computation, program development, and instrumentation support via the Hewlett-Packard Interface Bus (HP-IB) and other mini-computer plug-in cards.

There are five software operating systems to choose from, including four Real-Time Executive Systems (RTE-B, RTE-C, RTE II, RTE III), and a Basic Control System (BCS).

Computation and system control

Central element in the 9600 systems is an HP microprogrammable computer using highly-reliable, low-cost 4 K RAM semiconductor memory. A series of processors is available, offering a choice of maximum I/O channel and memory capacity.

9603A/9604A/9611A High-speed analog input/output

For recovery of signal dynamics from accelerometers, or for frequent sampling of many channels, the 9603A, 9604A, and 9611A systems use a high-speed analog I/O subsystem. Plug-in functions provide a variety of performance capabilities, as summarized below.

Plug-in Function	Throughput Rate	Range (fs)	Number of Channels*	Accuracy (fs)
High-Level Multiplexer	45,000 chan/sec	± 10.24 V	Up to 1056 S.E. or 528 diff.	$\pm 0.09\%$ $\pm \frac{1}{2}$ LSB
Low-Level Multiplexer	8,000 chan/sec	± 10 mV to ± 800 mV	Up to 528 differential (16 per multiplexer)	$\pm 0.33\%$ to $\pm 0.14\%$
Relay Multiplexer	150 chan/sec	± 10 mV to ± 200 mV		$\pm 0.29\%$ to $\pm 0.14\%$
D-A Converter	45,000 points/sec	± 10.24 V	Up to 44 (two chan/converter)	$\pm 0.025\%$

*Number of channels of each input/output function depends upon options in each maximum numbers shown assume only that function is used.

A sample-and-hold amplifier in the analog I/O subsystem assures minimum sample-sample timing variation when used with an optional HP pacer, that provides measurement commands with very low jitter. The subsystem achieves a 50-nanosecond absolute aperture time when paced and measuring inputs via the high-level multiplexer.

9602A/9603A/9604A/9611A Digital input/output

Hewlett-Packard 9600 Systems can be equipped to receive contact closures and other digital inputs, and to send digital outputs to displays or controlled devices. The 9603A and 9604A systems offer a choice of digital I/O via computer interface, each using one computer I/O channel, or via a digital I/O subsystem capable of multiplexing hundreds of digital I/O signals via a single computer I/O channel. The digital I/O subsystem is standard on the 9611A system.

The digital I/O subsystem offers a wide range of plug-in capability, consisting of: (a) 12-bit direct and isolated digital inputs with NPN/PNP, DTL/TTL, and higher contact closure logic levels, (b) event sense inputs that interrupt the system when the external 12-bit input satisfies specified comparison with a programmed 12-bit reference word, (c) a 12-bit counter that counts up/down from 4095, (d) 12-bit TTL output, (e) relay output with 12 normally-open contacts, (f) a stepping motor control output capable of up to 2047 programmed steps clockwise or counterclockwise, (g) a 1 microsecond to 409.5 second programmable timer, (h) a frequency reference with decade-multiple outputs from 1 Hz to 100 kHz, (i) a digital-to-analog current converter with 0 to 20.475 mA fs output, and (j) a 0 to ± 10.24 volt digital-to-analog converter.

COMPUTERS: SYSTEMS

Automatic Measurement and Control Systems

9600 Series (cont.)

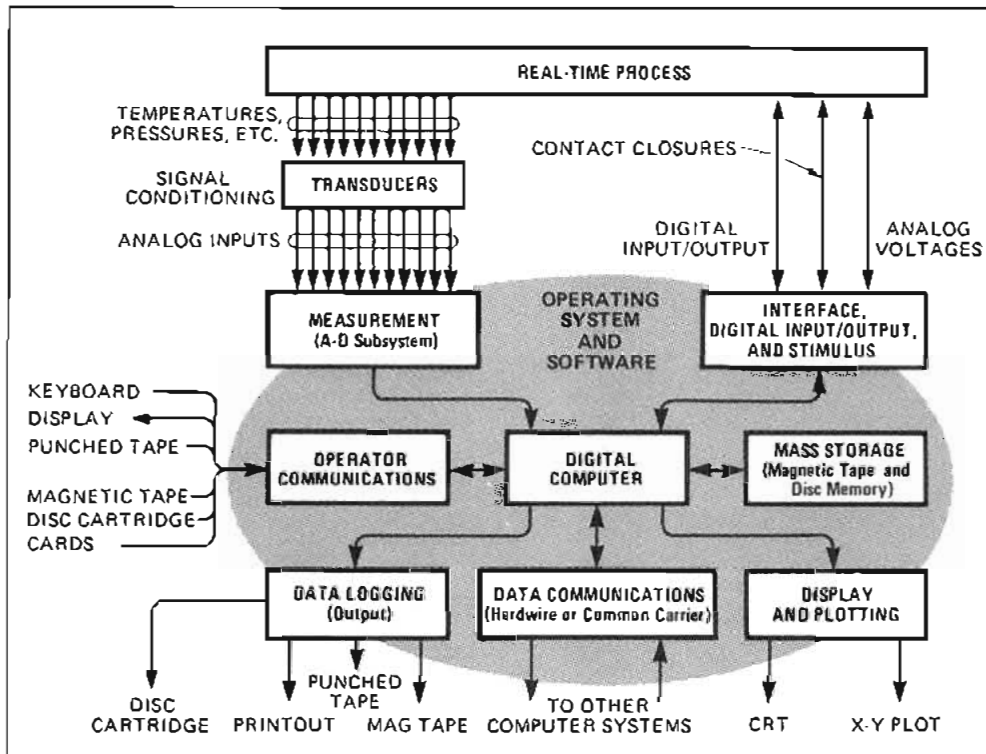

The major functions of these HP measurement and control systems are shown in this block diagram

In the 9611A system, the digital I/O subsystem plug-ins include screw-terminal connection assemblies that, optionally, may provide for plug-in, single-line modules accommodating contact closure inputs to 130 volts rms ac or 55 volts dc. Similarly, plug-in solid-state relay modules may be used to switch digital outputs up to 250 volts rms ac or 55 volts dc. Each of these plug-ins provides up to 250 volts isolation.

Digital I/O capabilities offered by computer plug-in interfaces are available for: (a) 32-bit data source input of a wide range of levels, (b) 16-bit duplex input and output in a choice of registers offering NPN/PNP, DTL/TTL, or differential logic levels, (c) relay output from 16 isolated, normally open contact pairs, and (d) 40-bit output with a choice of jumper-selectable NPN/PNP or DTL/TTL logic levels.

9603R/9611R Remote measurement and control stations

The analog and digital I/O subsystems of the 9603A/9611A can be remoted in 9603R/9611R Remote Measurement and Control Stations, up to 3 km (10,000 feet) from a 9603A, 9611A, or 9640A master (controlling) system. Measurement and control instrumentation can thus be located close to signal sources and destinations, simplifying installation and reducing cable costs without requiring computers at the remote sites.

9603A/9604A/9611A/9640A Operator communications

Hewlett-Packard offers a wide choice of keyboard terminals for operator communication with 9600 systems. These include 240 char/sec keyboard-CRT display terminals, 30 and 120 char/sec terminal printers, and a modified ASR-33 Teleprinter with tape punch-read capabilities in addition to keyboard and printout, all at 10 char/sec.

A 500 char/sec punched tape reader for fast input of programs or data is included in 9600 systems. For program and/or data input via tab cards, 9600 systems can be equipped with a 300 card/min optical mark reader (for both mark-sense and punched cards) or a 600 card/min card reader (for punched cards only).

Data recording, storage, and display

In addition to the direct printout provided by the terminal printer or teleprinter used for operator communication, 9600 Systems can be provided with a medium or high-speed line printer, with capability of printing 132 columns/line at rates from 200 to 1250 lines/minute. Data can also be recorded by a 75 char/sec tape punch, or on 7 or 9 track magnetic tape unit capable of read/write rates to 72,000 char/sec. In 9603A/9611A/9640A systems with RTE-II or RTE-III operating system, data can be stored on/retrieved from disc at transfer rates as fast as 937 k bytes/sec. Data can be displayed on a 25 x 38 cm (10 x 15 in.) graphic plotter subsystem, or on a low-cost, user-furnished commercial TV monitor interfaced to the system via Hewlett-Packard's new TV Interface Kit.

Model number

9603A^{1,2}
9604A¹
9611A^{1,2}
9640A^{1,2}

Price

\$22,900
\$27,900
\$29,900
\$15,800

¹Requires a system console.

²Requires an operating system from the RTE-B and RTE-C to the RTE-III systems with 15 megabyte, disc, cabinet, and dynamic mapping components.

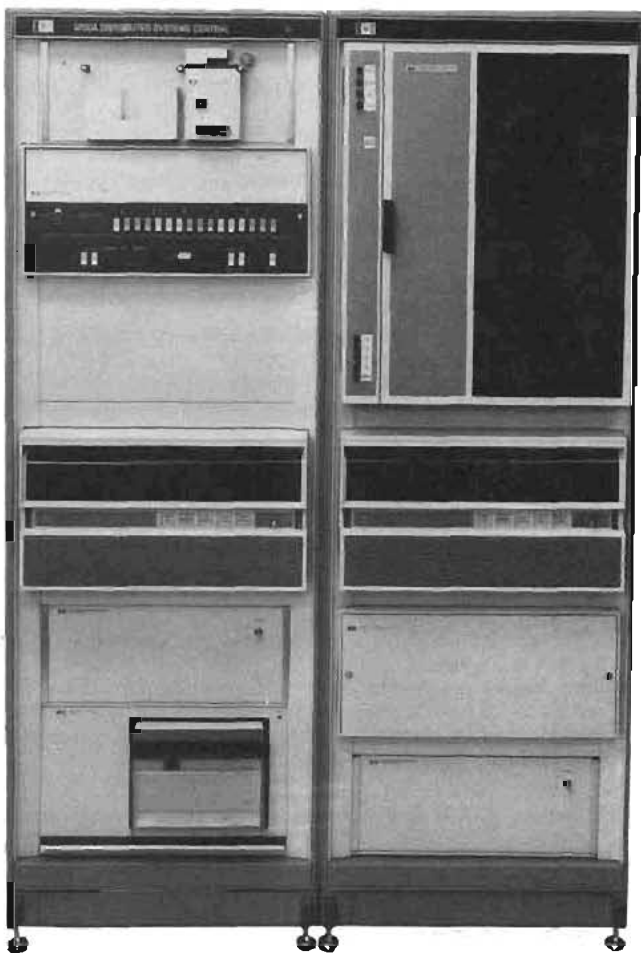

Distributed systems central system

Hewlett-Packard computer network capabilities assure a fast and accurate flow for increased productivity and profitability. This concept consists of individual satellite systems which share peripherals and a common data base provided by a central system.

The HP 9700A Network Central is a disc-based system which supports HP 8500, 9500, or 9600 distributed system networks. The central is equipped with either the RTE-II multiprogramming real-time executive or the new 64-partition RTE-III system. It includes a data communications interface and a central communications executive that responds to high-level program requests, working with the RTE-II/III operating system and communication executives in the satellite systems. The central is thus equipped to communicate with and support a single satellite system; can support additional satellites with the simple addition of more data communications interfaces. It can also be equipped with card readers, line printers, tape punches, magnetic tape units, or plotters, which can be shared among all of the satellites via the communication networks.

Linking to IBM 360/370 and HP 3000

In addition to supporting multiple satellite systems, the 9700A Central can be equipped to communicate with IBM 360/370 or HP 3000 systems, using a remote data transmission subsystem. Thus, the distributed system can take advantage of the tremendous processing power and extensive libraries of data processing and report generating programs available at large FDP centers.

A choice of communication modes

The satellite systems can communicate with the Central via either direct wire or modems and telephone lines. Direct wire can be used in lengths up to 3 km (10,000 feet) to provide fastest transmission and lowest line cost. Modem and telephone line communication is available for longer distances, or where great routing flexibility is important.

Model number	Price
30130B 2780/3780 Emulation Subsystem (for 3000CX)	\$4500
9700A Network Central (requires system console)	\$34,800
91007A - 91008A Distributed Systems Kits for 8500 Satellites (complete, two-interface link to Central, includes installation)	\$6000
91703A - 91705A Distributed Systems Kits for 9600 Satellites (complete two-interface link to Central)	\$4000
91707A - 91708A Distributed Systems Kits for 9500 Satellites (complete two-interface link to Central)	\$5500
91780A Remote Data Transmission Subsystem	\$4500

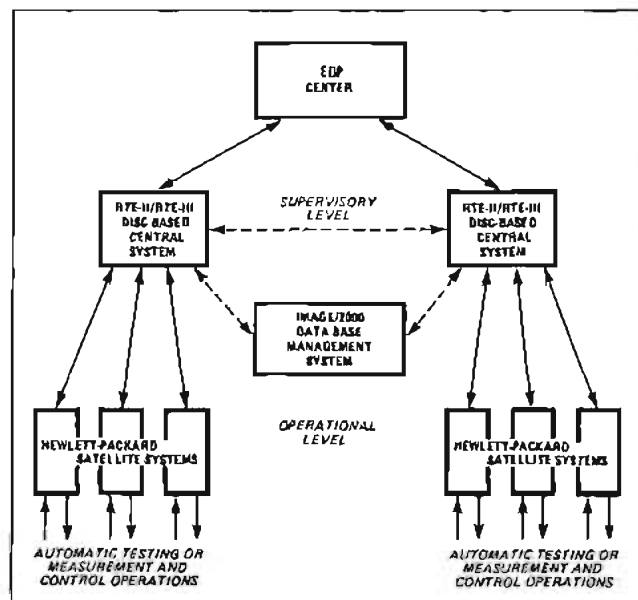

COMPUTERS: SYSTEMS

Compatible operating software

RTE, IMAGE

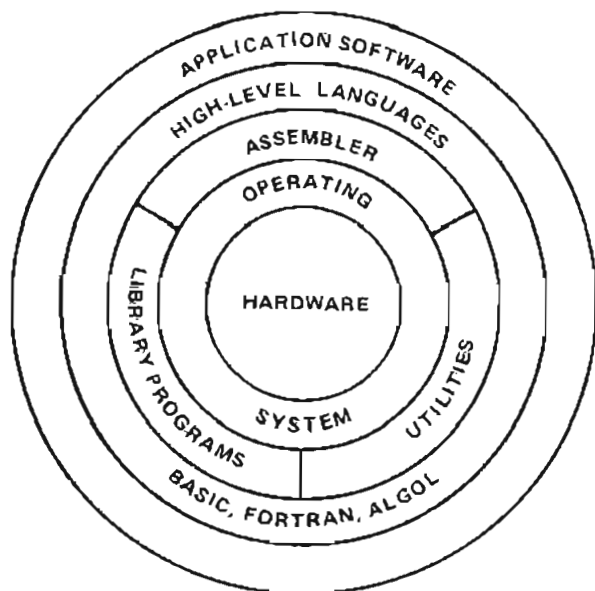

As the illustration shows, hardware is only the basic core of a computer system. Every computer system requires operating software, which provides a basis of intelligent, systematic functioning for application programs and operations. The operating system sets up conditions for program development, loading, and scheduling for execution. It also manages input and output, and may provide disc file and memory management services as well as data base management.

A key factor in Hewlett-Packard operating system design is compatibility. HP's smallest memory-based, real-time operating system can be upgraded to the largest configuration without discarding any user investment in hardware or application programs. This provides opportunity to start small and grow big to meet as increasing demands.

RTE-B system

This memory-based real-time system for novice computer users supports:

- Conversational, off-line Real-Time BASIC programming.
- Time and event-scheduled operation of up to 16 user tasks.
- High-level subroutine instrumentation calls.
- Program-compatible upgrading to disc based RTE-II or RTE-III system.
- Operation as satellite system in distributed multiprocessor networks.

RTE-C system

RTE-C is a memory-based real-time multiprogramming system that supports:

- Off-line programming in FORTRAN and HP Assembly language.
- Time and event-scheduled multiprogramming.
- On-line task installation and removal.
- Program-compatible upgrading to disc-based RTE-II or RTE-III system.
- Operation as satellite system in distributed multiprocessor networks.

Foreground-background RTE-II system

RTE-II is a disc-based, time and event scheduled real-time multiprogramming system that supports:

- Foreground and background multi-user swapping partitions.
- Up to 32 k words of main memory.
- Up to 118 m bytes of on-line disc storage with file management to provide ample capacity for programs and a fast-access data base.
- Optional IMAGE/1000 Data Base Management System.
- Concurrent processing and program development in FORTRAN II/IV, conversational.
- Multi-User Real-Time BASIC, ALGOL, and HP Assembly language.
- Multi-terminal access to all system resources, serving multiple users concurrently.
- Input/output spooling to disc to speed throughput without excessive use of main memory for buffering.
- Powerful on-line interactive editor to aid program development.
- Management of distributed multiprocessor networks.
- Communication with HP 3000 or IBM 360/370.

Multipartition RTE-III system

It is HP's most powerful disc-based, time and event scheduled real-time multiprogramming system, and supports:

- Up to 64 separate multi-user swapping partitions, up to 17 k words per partition, for fast response to needs of many multiple users.
- Up to 256 k words of 4 k RAM memory for real-time applications and RTE-III supported capabilities.
- Up to 118 m bytes of on-line disc storage with file management to provide ample capacity for programs and a fast-access data base.
- Optional IMAGE/1000 Data Base Management System.
- Concurrent processing and program development in FORTRAN II/IV, conversational Multi-User Real-Time BASIC, ALGOL, and HP Assembly language.
- Multi-terminal access to all system resources, serving multiple users concurrently.
- Input/output spooling to disc to speed throughput without excessive use of main memory for buffering.
- Powerful on-line interactive editor to aid program development.
- Management of distributed multiprocessor networks.

Batch-spool monitor

Optional on RTE-II and standard in RTE-III, the Batch-Spool Monitor provides powerful additional data handling and program development capabilities, including:

- Batch processing supervision.
- Management of disc storage in easily-accessed, automatically-extendable, named files.
- Spools I/O, optimizing throughput and use of system resources.

IMAGE/1000 data base management system

Newly available on HP disc-based RTE systems, this supports:

- Keyword access to data base information items.
- Consolidation of files, minimizing information redundancy.
- Automatic linkage between related items.
- Protection against unauthorized access down to the data item level.
- Sequential or random data access.
- Interactive multi-terminal retrieval using English-like words of QUERY language.

Model number

Model number	Price
2300B Real-Time BASIC (RTE-B) System	\$3000
2300C Real-Time Executive C (RTE-C) System	\$3000
92001A Real-Time Executive II (RTE-II) System	\$4000
92002A Batch-Spool Monitor for RTE-II System	\$1000
92060A Real-Time Executive III (RTE-III) System	\$6000
92063A IMAGE/1000 Data Base Management System for RTE-II/III System	\$6000

COMPUTERS: SYSTEMS

Digital test and measurement system

Models DTS-70, 9571A & 91075B



DTS-70 Digital Test System



Digital test system

The DTS-70 Digital Test System is designed for production testing with high throughput and fast, accurate fault location of loaded digital printed circuit boards. Its capabilities include automated test program generation, large PC board capacity, multiple station capability on one minicomputer plus analog testing capability. The system is versatile in that it can be used for test program generation and production testing concurrently on a single system minicomputer.

The DTS-70 is comprised of three basic elements, a 9571A Digital Test Station, a multiprogramming system, and the 91075B TEST-AID-III test generation software. With these basic elements the user can generate test programs for loaded PC boards with up to 200 MSI IC's (10 000 gate equivalents), perform tests at speeds of up to 10 000 patterns/second, and test PC boards with pin capacity of up to 360 pins. Digital driver-comparator cards available include TTL, CMOS, or programmable logic with highs and lows in the +16 V to -16 V range. The multiprogramming system uses a minicomputer with 32 K words of 16-bit memory and 14 input/output channels. A 15 megabyte (7.5 million words) disc drive is provided for mass storage.

The system is designed for fast production testing. A typical GO/NO-GO test of a medium density PC board (100 to 150 MSI IC's) executes in just a few seconds. If the PC board fails the GO/NO-GO test, the system directs the operator with FASTTRACE guided probing to quickly locate the fault. Most faults can be located in less than a minute, and a repair ticket printer provides a printed record of the fault so that it can be attached to the PC board and routed to the repair center.

Automated test generation

An element used in the DTS-70 system is the 91075B TEST-AID-III Test Generation Software. TEST-AID-III is an advanced software simulator that enables comprehensive test programs to be generated economically for large and complex digital PC boards. Modeling tools contained in TEST-AID-III include an extensive library of commonly used devices and 15 primitive elements, including ROM's, RAM's, and shift registers. There are three methods available for generating input stimulus patterns — automatic path-sensitization, pseudo-random patterns, and manual techniques. The path-sensitizing, or automatic pattern generator is particularly powerful, often replacing days of skilled manual analysis with a few hours of computer time. TEST-AID-III generates test data, fault signature, circuit topology, and node state files which are used by the DTS-70 FASTTRACE fault location programs.

DTS-70 Digital Test System, Model 9571A Digital Test Station, and Model 91075B TEST-AID-III Test Generation Software



Computer-assisted guided probe fault location

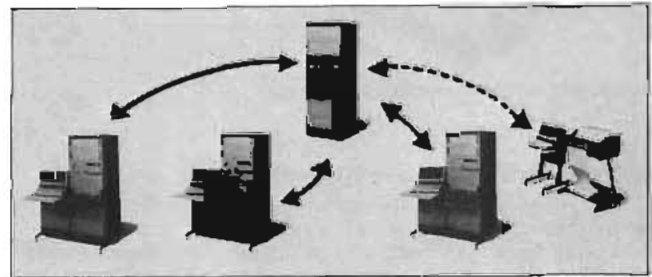

Concurrent test generation and multiple test stations capability

Concurrent test generation

The DTS-70 system allows you to perform production testing while preparing test programs for new PC boards concurrently — on the same minicomputer. The program preparation station can be located remotely from the production line so that each task, production testing and program preparation, does not physically interfere with each other.

Multiple test stations

As your test needs expand, the DTS-70 system allows you to optimize your testing capabilities in a cost effective manner. The modular design of the DTS-70 system enables you to add up to two more 9571A Digital Test Stations, for a total of three test stations, and operate all three test stations from the original minicomputer acquired during the initial purchase. The DTS-70 is designed for expansion — not obsolescence. This gives the user multiple test station capability at the lowest possible cost.

Model number	Price
9571A Digital Test Station	\$24,000
91075B TEST-AID-III Test Generation Software	\$15,000

COMPUTERS: SYSTEMS

Automatic test and measurement systems
Model 9500 Series Automatic Test Systems



Automatic stimulus-response testing

Automatic stimulus-response testing

The 9510D and 9500D Automatic Test Systems utilize stimulus-response techniques and encompass a wide range of testing capability, from individual circuit modules and sub-assemblies to highly complex avionic systems. The block diagram shows a general layout typical of Hewlett-Packard automatic test systems.

The 9510D Automatic Test System is a stimulus-response system that covers the frequency range from dc to 10 MHz, and optionally, up to 500 MHz.

The 9510D offers a significant contribution to the field of automatic testing because it is a total system, thoroughly engineered with system-level performance specified at the point where the UUT interfaces with the system.

The 9510D System stimulates and measures dc and ac voltages, resistance, and frequency functions. In addition, distortion, FM deviation, and phase are measured by means of innovative techniques using software algorithms. This eliminates the need for corresponding measuring instruments while providing equivalent performance at far less cost. Optional RF (to 500 MHz) test capability provides for automatic stimulus and measurement of carrier frequency, RF power, AM modulation depth, FM deviation, plus AM and FM modulation distortion. Other optional capabilities include pulse stimulus and waveform analysis. While the majority of applications involve testing of analog devices, the 9510D can also perform digital testing with an optional Digital Test Module.

The 9510D System is supplied (optional in 9500D Systems) with a UUT adapter module that provides a general purpose cabling interface between the system stimulus, measurement, and switching modules and the UUT.

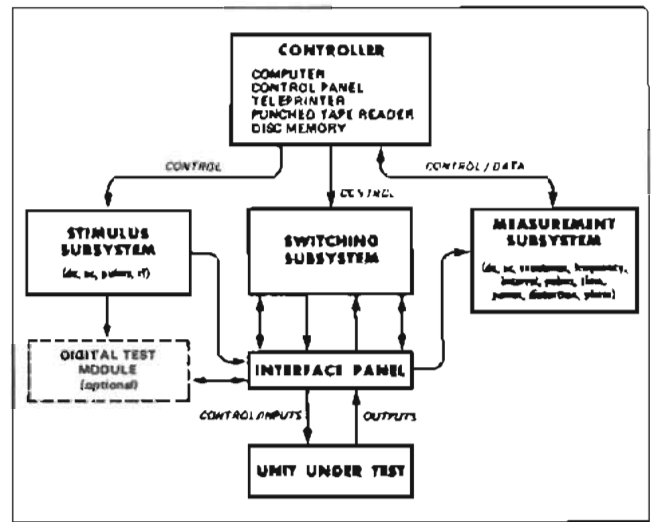

Hewlett-Packard Automatic Test System overall concept

The 9500D Automatic Test Systems are general-purpose systems based on modular building-block techniques, that provide a wide latitude in testing capabilities, with easy expansion to handle future testing needs. The Systems cover stimulus-response testing over the frequency range of dc to 18 GHz.

Hewlett-Packard's 9500 Systems are, at the same time, fully standardized and fully flexible in configuration and operation. The broad testing capabilities of the 9500 System lies in the fact it is supplied with a standard disc-based controller while all stimulus, measurement, switching, and interface hardware are available as options.

The automatic test systems incorporate HP ATS BASIC as the primary test language. Additionally, the disc-based 9500D/9510D Systems incorporate a software control executive — Hewlett-Packard's Test-Oriented Disc System (TODS).

Powerful software capabilities — TESTAID-II/FASTRACE and HP ATLAS — are optionally available for use on 9500 disc-based systems.

TESTAID-II/FASTRACE is digital test generation and fault isolation software. TESTAID-II is a fault-inserting digital logic simulator which runs on a Hewlett-Packard minicomputer. TESTAID-II accepts patterns entered by the operator and augments this procedure with automatic pattern generation capability. A path-sensitizing pattern generator and a pseudo-random generator may be used to generate patterns; faults in a digital network are identified by the response to these patterns, and faults which may not be detectable are listed for further operator action. FASTRACE is a software search program and logic probe instrument which compares failed PC board output data and internal logic states with expected responses (generated by TESTAID-II) to accurately locate digital faults to the failing circuit node.

Hewlett-Packard ATLAS is a common test language that can easily be used by designers, test engineers, and test technicians. HP ATLAS is compatible with and meets the standards of ARINC ATLAS, the official standard for the ATLAS language.

Model number	Price
9500D Automatic Test System	\$100,000—300,000
9510D Automatic Test System	\$150,000—200,000

COMPUTERS: SYSTEMS



Automatic test and measurement systems

Model 8542B, Model 8580B, and ARS-400
Automatic RF/Microwave Systems



ARS-400 Automatic Receiver System

Automatic network analysis

The 8542B Automatic Network Analyzer is a precision phase and amplitude measurement system used to measure complex or transfer functions, to 18 GHz, in order to characterize components or circuits. The 8542B achieves high accuracy by calibrating with precision standards to characterize, store, and correct for systematic errors — mismatch, directivity, crosstalk, and frequency response errors are thus removed.

The 8542B is supplied with a complete set of ready-to-run Microwave Applications Programs (MAP). The General Purpose Measurement programs GPM-1 and GPM-2 provide for display of any seven of 28 different parameters, including VSWR, insertion loss, phase deviation, and group delay. The multi-measurement program, VAT-1, provides forward characterization of up to eight measurement paths with cross comparison of any two paths. Program XTR-2 is used for measuring transistors, including device biasing. Program CUP-1 provides highly accurate coupler directivity measurements.

The 8542B is also supplied with a BASIC language interpreter containing high-level microwave measurement instructions. Interactive graphics (optional) allows rapid display of data in either graphical or tabular format. Optional test-oriented disc system capability allows loading of MAP software from the disc to eliminate tape loading and thus save production test time.

OPNODE, a software package that aids engineers in designing linear circuits and systems from dc to microwave frequencies, is available for use with 8542B Systems.

Automatic spectrum analysis

The 8580B Automatic Spectrum Analyzer measures absolute frequency and characterizes mixers, doublers, and other frequency conversion devices, to 18 GHz.

The key measuring instrument in the 8580B Automatic Spectrum Analyzer is a calibrated receiver with programmable tuning and band-

width. The receiver can be tuned from 10 kHz to 18 GHz by BASIC language measurement programs using simple, one-line statements. Receiver bandwidth is selectable from 10 Hz to 300 kHz. Other programmable system functions include: input port selection, input attenuation, IF bandwidth, IF gain, and video filtering.

The 8580B Automatic Spectrum Analyzer is a valuable tool for gathering spectral data on signals present in complex electronic equipment or in a geographic region.

Automatic component test system

The 8580B Automatic Spectrum Analyzer with Option 300 comprises an automatic component test system for testing of RF/microwave components and subsystems. The 8580B option 300 provides fast and accurate automatic testing of non-linear devices for parameters previously achievable only by tedious manual point-by-point test methods. Option 300 makes available CTEST, a flexible, ready-to-run application program that provides complete device characterization from 1 MHz to 2.6 GHz and +15 dBm to -146 dBm power for parameters such as conversion loss or gain, isolation, unwanted mixing products, and two-tone intermodulation distortion.

The automatic component test system enables you to execute accurately in minutes measurements that previously took hours. CTEST enables the test engineer to write test programs remotely from the system, and gives test results in the form that you need. In addition, the ability to plot reference measurements gives comparison capability for device selection, thus saving many hours of manual data reduction.

Automatic receiver system

The ARS-400 Automatic Receiver System provides automatic signal monitoring, detection, and analysis in the 100 kHz to 18 GHz frequency range. The system is used in a variety of applications including: spectrum management, system monitoring, electronic intelligence, electromagnetic interference, and site surveillance.

The ARS-400 Automatic Receiver System features: synthesized high speed tuning, self-calibration of all receiver modes, flexible detection (AM, FM, SSB), broad dynamic range, exceptional frequency accuracy and resolution, automatically-tuned preselection for spurious-free response, and time-calibrated data collection.

The system incorporates a digital computer with 32 K words of memory and 14 I/O channels to communicate with instruments and/or peripherals. Final measurement information is displayed on a CRT, printed out, or stored on disc or magnetic tape.

With the ARS-400, key system performance characteristics are verified and guaranteed so that you can rely upon them for your requirements.

Distributed systems capability

Particularly useful and advantageous in multiple test station applications (remote test sites) is Hewlett-Packard's Distributed Systems capability. A distributed system consists of a central computer (disc-based) system and a number of satellite systems (usually one at each remote site). Satellites commonly concentrate the measured data prior to transmission to central. Satellites and central share the use of peripherals (disc, line printer, card reader, plotter, etc.), thus minimizing total system cost. The concept and applications of distributed systems is covered in greater detail on the next page.

Brochures covering the 8500/9500 Series systems described here are available from Hewlett-Packard Field Sales Offices.

Model number	Price
8542B Automatic Network Analyzer	\$200,000
8580B Automatic Spectrum Analyzer	\$150,000—250,000
ARS-400 Automatic Receiver System	\$200,000—250,000

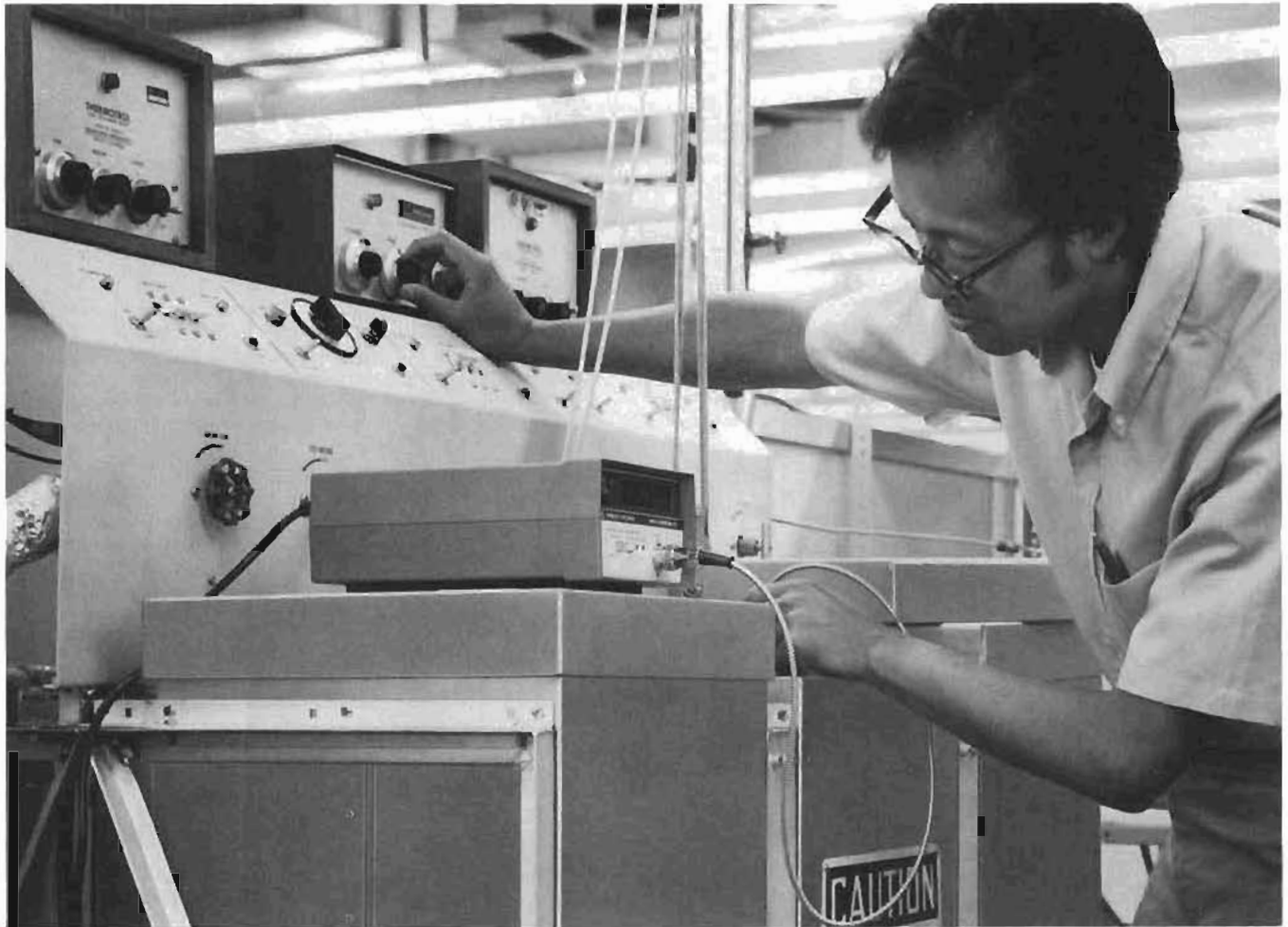

Model 2802A Platinum Resistance Thermometer

Laser Measurement

The Hewlett-Packard 5526A Laser Calibration System utilizes a precisely-known wavelength of light to provide a portable, easily used dimensional measurement tool for such parameters as length, angle, straightness, squareness and flatness.

The 5526A Laser Calibration System is used in a wide variety of applications where very accurate physical measurements are required, such as characterizing the positioning accuracy and geometry of machine tools and measuring machines.

A wide variety of output devices are available to record the measurement data including digital printers and X-Y recorders. The Option X55 Laser/Calculator System allows the measurement data to be transferred directly from the Laser Calibration System to the 9815A Programmable Calculator and immediately processed by pre-written metrology programs. The reduced data is then presented in either printed format or plotted to provide report quality graphs of the measurements.

Quartz Crystal Technology

Hewlett-Packard laboratories have developed quartz crystals which respond to temperature or pressure with amazing linearity, stability, accuracy, and sensitivity. Quartz

crystals resonate in electronic oscillator circuitry at a very precise frequency. Hewlett-Packard has discovered a way to produce quartz crystals whose resonate frequencies vary extremely linearly with temperature or pressure. For example, the resonate frequency of a 2850 temperature sensing crystal varies 1000 Hz (nominal) per °C. These resonate frequencies are conditioned by electronic circuitry to produce exceptionally high resolution temperature or pressure measurements.

Digital Thermometer

HP's 2801A Quartz Thermometer provides extremely precise, reliable measurements with standard resolution of 0.0001°C over the range -80 to +250°C. The excellent sensing characteristics of the quartz thermometer are enhanced by the advantages of *direct digital readout* (no bridge balancing, or reference to resistance- or voltage-temperature tables or curves), immunity to noise and cable resistance effects, and no requirement for external equipment such as reference junction. Temperature can be measured up to 4500 feet from the 2801A with optional amplifiers.

Nearly all intermediate range digital thermometers use resistance, thermistor, or ther-

mocouple sensors. Because of its good sensing characteristics, Hewlett-Packard uses a platinum resistance sensor in its general purpose 2802A thermometer. Platinum resistance sensors have very good accuracy, stability, linearity and reproducibility. The 2802A features two ranges: -200°C to +600°C with 0.1°C resolution and -100°C to +200°C with 0.01°C resolution. Battery, BCD, or ASCII output accessories easily snap into place. Also, the display unit may be used with other HP snap-in modules to make a voltmeter, a multimeter as well as other instruments.

Quartz Pressure Gauge

The Hewlett Packard 2811B Quartz Pressure Gauge can detect pressure changes as small as 0.01 psi in 10,000 psia. Precision pressure measuring capability and rugged construction make the HP 2811B Quartz Pressure Gauge (Probe and Signal Processor) ideal for applications requiring surface readout such as oil well logging, oceanographic research, and studies of subterranean hydrodynamics. The 2811B recording options can be connected directly to the pressure gauge output for direct readout, strip chart recording or digital printout of pressure data.

Quartz pressure gauge Model 2811B

- 0.01 psi resolution (69 Pa)
- 0.025% Full Scale Accuracy
- Direct Surface Readout

- Simple Operation
- Long Term Stability

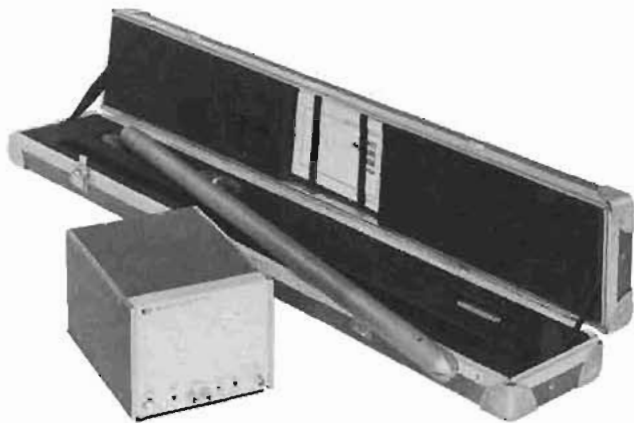

2811B Quartz Pressure Gauge

0.01 psi Resolution at 11 000 psi (69 Pa @ 69 MPa)

The HP 2811B Quartz Pressure Gauge measures wellbore pressure with a resolution of 0.01 psi over a dynamic range in excess of 11 000 psi. This capability makes it possible accurately to measure pressure changes that cannot be detected with conventional gauges using bourdon tube transducers.

This ability to detect and record small pressure changes allows sophisticated test techniques to be used economically. For example, since the super-sensitive HP Quartz Pressure Gauge can detect small pressure transients at observation wells, pulse tests can be conducted with extremely short pulse cycle times at the stimulus well. Because the shut-in time is reduced, the permeability and formation thickness between wells can be determined at a substantially lower cost.

With the 2811B recording options, pressure transients can be observed and recorded on the surface while the test is in progress. It is not necessary to wait to retrieve down-hole recording gauges. Pressure data can be read and recorded directly without intermediate scaling or other calculations.

The 2811B Quartz Pressure Gauge was specifically designed for pressure measurement in oil and gas wells and it is used by many oil companies and well service companies. However, its high resolution pressure measuring capability and rugged construction also make it ideally suited for oceanographic research and subterranean hydrodynamic studies.

Description

The 2811B consists of a 2813B Quartz Pressure Probe and a 2816A Pressure Signal Processor. A frequency signal proportional to pressure is transmitted from the bottom-hole pressure probe to the signal processor on the surface. It travels through a single conductor, armored electric line. The processor conditions the pressure-related signal to drive a separate electronic frequency counter for direct readout. If a preset counter is used (included in 2811B recording options), wellbore pressure will be displayed in psi. No scaling or intermediate calculations are necessary.

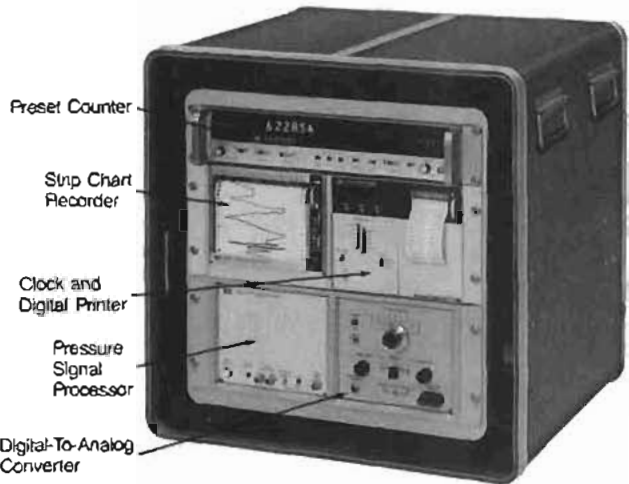

HP 2811B Analog & Digital Recording Option 026/027
Mounted in Field Case

For field use, the 2811B Analog & Digital Recording Option is available. It provides a convenient method of obtaining direct visual display and a permanent record of pressure data. Pressure transients are recorded on a strip chart recorder and a digital printer. All instruments are shock mounted in a rugged field case to withstand rough handling.

System specifications

Sensitivity: 105 Hz/psi nominal (105 Hz/6.9 kPa) output of signal processor

Probe operating pressure range: 0-12 000 psi (0-82.7 MPa)

Probe operating temperature range: 32° to 302°F (0 to 150°C)

Signal processor operating temperature range: 32° to 131°F (0° to 55°C)

Resolution: 0.01 psi (69 Pa) when sampling for a 1-second period

Repeatability: ±0.4 psi (±2.76 kPa) over entire range

Accuracy (at thermal equilibrium) if operating temperature is known

within 1.8°F (1°C): ±0.5 psi or ±0.025% of reading (±3.45 kPa or ±0.025%R)

within 18°F (10°C): ±1 psi or ±0.1% of reading (±6.89 kPa or ±0.1%R)

within 36°F (20°C): ±5 psi or ±0.25% of reading (±34.5 kPa or ±0.25%R)

Dimensions and weights

2813B Probe: 1 7/16 in. (36.5 mm) OD by 39 3/4 in. (1000 mm) long. Weight: 11 lb (5.0 kg)

2816A Signal processor: 6 1/16 in. high × 7 3/4 in. wide × 11 in. deep (154 mm × 197 mm × 279 mm). Weight: 3.2 kg (7 lb.)

2811B options

026: Analog & Digital Recording, 60 Hz, and English units

027: Analog & Digital Recording, 50 Hz, and Metric units

2811B Quartz Pressure Gauge

Price

add \$9850

add \$9850

14,075

Includes HP 2813B Quartz pressure probe and carrying case, calibration tables, manual and HP 2816A Pressure signal processor. Output of HP 2816A Pressure Signal Processor connects directly to recording options.

PHYSICAL AND OPTICAL MEASUREMENTS

Laser transducer for "build-in" applications

Model 5501A

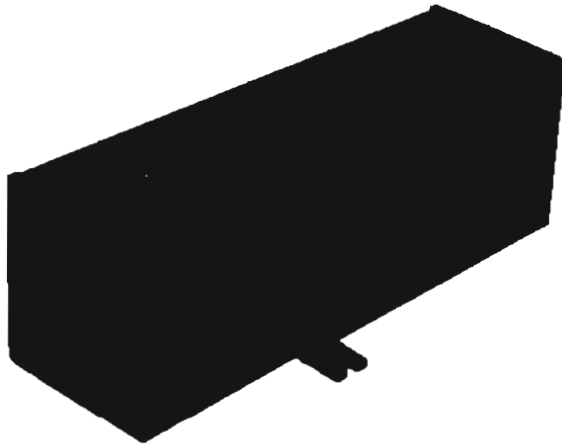

HP-IB



Systems description

The 5501A Laser Transducer is the basis of a linear displacement measuring system which brings the many advantages of interferometry to builders and users of accurate positioning equipment at a cost comparable with conventional devices. Using a single laser source, up to 6 axes of motion may be monitored simultaneously. This feature, plus numerous other design innovations, significantly lowers the cost of laser interferometer feedback. A range of output devices offers the choice of feedback control or digital display. Although the Laser Transducer is designed for original equipment manufacturers (OEM), simple installation techniques make it attractive for retrofit by end-users as well.

Optical accessories

A wide variety of Interferometers, Retroreflectors, Beam Splitters, and Beam Benders allows application of the 5501A Laser Transducer to the most complex measurement problems.

Linear Interferometer — most economical and widely used for linear displacement measurements.

Plane mirror Interferometer — used for precision measurement and control of X-Y stage motion.

Single beam Interferometer — extremely small linear measurement interferometer for applications where size and weight are critical.

Beam splitters and benders — optical components to divide and direct the laser beam to the individual measurement axes.

Electronic outputs

A range of output formats are available for the 5501A Laser Transducer which provide compatibility with a wide variety of measurement applications.

Computer Interface electronics interface the 5501A Laser Transducer to virtually any digital processor or controller. This universal binary interface is ideal for position control systems with the most demanding response requirements.

Calculator Interface electronics based on Hewlett-Packard Programmable Calculators and the Hewlett-Packard Interface Bus provide completely integrated measurement packages. Designed for acquiring, reducing and displaying measurement data, this interface allows simple application of the 5501A Laser Transducer to a wide variety of measurement oriented machines.

English/metric pulse output electronics provide a universal interface to almost all numerical controls for machine tools. Designed primarily to facilitate installation of the 5501A Laser Transducer on machine tools by Original Equipment Manufacturers, this interface provides inch or metric value pulses over a wide range of resolutions.

Specifications

Resolution: 0.16 μm (6 microinches) or 0.08 μm (3 microinches) using Plane Mirror Interferometer. Resolution Extension can increase measurement resolution up to a factor of 10.

Accuracy: ± 0.5 parts per million.

Range: up to 60 meters (200 feet) depending upon conditions (sum of axes for multi-axis configurations).

Number of axes: up to six, depending on system configuration and environmental conditions. Maximum allowable measurement velocity. 18.3 meters/min (720 inches/min).

PHYSICAL AND OPTICAL MEASUREMENTS

Laser system for dimensional measurements

Model 5526A



Model 5526A Laser/Display System Base

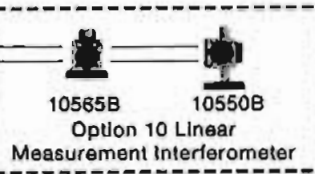

Choice of options for Length, Angle, Flatness, Straightness Non-contact and 2 Axes

Configuration

The 5526A Laser Measurement System is a major advance in economical dimensional metrology. A choice of options allows the measurement of length, angle, flatness, straightness, squareness, and parallelism. In addition, output options are available to reduce the data to printed or plotted format. The 5526A, which forms the base of the system includes the 5500C Laser Head and the 5505A Laser Display. Measuring and output options are added to this base system to allow modular build-up of measurement capability.

General capabilities

The system is a highly accurate displacement measuring tool with a resolution of one millionth of an inch ($0.01 \mu\text{m}$) for linear measurements and 0.1 arc-second for angular measurements. Fully automatic tuning, instant warm-up and remote interferometric measurement techniques assure drift-free accuracy from the moment of switch-on. A laser tube lifetime in excess of 10,000 hours can be confidently expected and the unique optical heterodyning principle makes for practical, convenient measurements in adverse environments.

Measurement options

Option 010 linear interferometer

This option consists of the 10565B Remote Interferometer and a 10550B Retroreflector. Since the Remote Interferometer is completely passive, it makes for an almost perfect linear measuring instrument. Complete thermal stability is assured since the laser head can be some distance away on a tripod.

Option 020 linear + angular/flatness interferometer

While including all the capabilities of the Option 010 Linear Interferometer, this option also provides angular measurement ability. The addition of passive optical modules allows fast, accurate measurements of pitch, yaw, or flatness. The option also includes two turning mirrors designed especially for rapid calibration of surface plates.

Option 030 straightness interferometer

This option converts the 5526A into an interferometric straight-edge. Lateral deviations from a perfectly straight line are displayed to a resolution of one millionth of an inch ($0.01 \mu\text{m}$) over an axial range of 10 feet (3 m). Unlike alignment lasers, the Hewlett-Packard system does not depend on the pointing stability of the laser beam for its reference, but instead uses two rigidly mounted plane mirrors and a special prism interferometer. A long range version (Option 31) is also available with a resolution of ten millionths of an inch ($0.1 \mu\text{m}$) over an axial range of 100 feet (30 m).

Ideal for determining geometric characteristics of machine tools, the Straightness Option can also measure such parameters as parallelism and with an optional optical square, squareness.

Option X55 series laser measurement/calculator systems

The combination of the 5526A Laser Measurement System with the Model 9815A Calculator provides a complete problem solving system for a wide variety of measurements.

A package of metrology applications programs enables fast data reduction and plotting of measurements such as surface plate calibration, lead error analysis and geometry characteristics of machine tools and measuring machines, including straightness, parallelism and squareness. One important program included implements the NMTBA (National Machine Tool Builders Association) recommendations for accuracy and repeatability of numerically controlled machine tools.

5510A Automatic compensator

The 5510A Automatic Compensator provides accurate, continuous correction for variations in the refractive index of air and for temperature of the material being measured. Air temperature, pressure, humidity and material temperature are measured by rugged sensors designed especially for use in machine shops.

Additional options

Other options to the 5526A Laser Measurement System are available including a Single Beam Interferometer which in conjunction with the non-Contact Converter measures displacement of reflective surfaces. The Plane Mirror Converter when added to the Remote Interferometer of Option 010 allows measurements from a plane mirror surface with relative insensitivity to mirror tilt.

Brief specification

5526A Laser/display

Laser: Helium-Neon type. Fully automatic tuning. Instant warmup. Accuracy (for all linear displacement measurements): ± 0.5 parts per million ± 1 count (Metric ± 0.5 parts per million ± 2 counts).

Resolution: normal and smooth modes

Normal 0.000,01 in. Metric 0.1 μm . Angular: 1 arc-sec X10
0.000,001 in. Metric 0.01 μm . Angular: 0.1 arc-sec.

Maximum allowable signal loss: 95% (-13 dB).

Maximum measuring velocity: 720 in/min (182 m/min).

Atmospheric and material compensation: manual input from tables.

5510A Automatic compensator optional.

Option 10 linear Interferometer

Accuracy: as for 5526A Laser Display

Maximum measuring range: up to 200 feet (60 m) depending on conditions.

Option 20 linear + angular/flatness interferometer

Linear specifications are as for Option 10.

Accuracy: ± 0.1 arc-second (± 1 count in last digit) up to ± 100 arc-seconds. ± 1 arc-seconds (± 1 count in last digit) up to ± 1000 arc-seconds. ± 4 arc-seconds per degree (± 1 count in last digit) up to ± 10 degrees using correction table.

Option 30 short range straightness interferometer

Accuracy

Inch: ± 5 microinches/foot ± 1 count in last digit.

Metric: ± 0.4 micrometer/meter ± 2 counts in last digit.

Calibration: $\pm 3\%$ of reading.

Resolution: as for 5526A Laser/Display

Lateral range: ± 0.1 inch (± 2.5 mm).

Axial range: 10 feet (3 m)

Option 31 long range straightness interferometer

Accuracy: as for Option 030.

Calibration: $\pm 10\%$ of reading.

Resolution

Normal: 0.0001 inch ($1 \mu\text{m}$).

X10: 0.00001 inch ($0.1 \mu\text{m}$).

5510A automatic compensator

5526A/5510A System accuracy (worst case):

1. For air temperature within range 68–85°F (20–30°C) 1.3 ppm ± 1 count (metric 1.3 ppm ± 2 counts).
2. For air temperature within range 55–105°F (13–40°C) 1.5 ppm ± 1 count (metric 1.3 ppm ± 2 counts).

Options

010 Linear Interferometer

020 Linear + Angular/Flatness Interferometer

030 Straightness Interferometer

908 Rack Flange Kit

X55 Laser Measurement/Calculator System

Price

add \$4095

add \$6285

add \$4095

add \$10

\$33,845

Model number and name

5510A Automatic Compensator

\$4500

5526A Laser/Display

\$11,295

PHYSICAL AND OPTICAL MEASUREMENTS

Quartz crystal thermometer and probes

Models 2801A, 2830, 2831, 2833C, 2850 A/B/C/D

- 0.0001°C or °F Resolution
- Simple operation
- Direct Digital Readout
- Remote Measurement up to 1372 m (4500 ft)
- No cable or noise resistance problems
- Compatible with digital and analog recorders



2801A Quartz Thermometer

The Model 2801A Quartz Thermometer provides exceptionally high accuracy, resolution and stability with a direct reading digital display. There is no need to balance a bridge or perform calculations using resistance- or voltage-temperature tables or curves. All electronic circuits are contained in a single instrument case. No external equipment such as a reference junction is required.

The HP 2801A is equipped with two temperature sensing probes. The HP 2801A will display the temperature at either probe or the temperature difference between the probes. Display of the temperature of either probe or their difference can be selected either by push button or external signals. A 6-digit display provides direct temperature readout in degrees Celsius. Option 001 features readout in degrees Fahrenheit. Standard resolutions of 0.01, 0.001, 0.0001 °C or °F can be selected by pushbuttons on external signals.

Quartz crystal thermometry

The method of temperature sensing employed in the HP 2801A Quartz Thermometer is based on the sensitivity of the resonant frequency of a quartz crystal to temperature change. Use of this characteristic to measure temperature is known as quartz crystal thermometry.

While the principle of the quartz crystal thermometer is not new, a new and unique angle of cut is used in the HP 2801A Quartz Thermometer which exhibits a very linear and yet sensitive correspondence between resonant frequency and temperature. This has been named the LC cut, standing for Linear Coefficient of resonant frequency change with temperature.

Temperature range of the HP 2801A Quartz Thermometer is -80 to +250°C (-112 to +482°F). The quartz thermometer is considerably more linear than a platinum resistance thermometer: $\pm 0.55\%$ for the same range. Linearity of the quartz thermometer is also considerably superior to that of thermocouples, and thermistors (which have a characteristic that is approximately exponential).

The quartz thermometer offers very high resolution. Usable resolution of the HP 2801A is 0.0001°C for both absolute and differential measurements. In comparison, useful resolution of platinum resistance and thermistor systems (assuming instrumentation comparable in cost to the quartz thermometer) is in the order of 0.01°C. While it is possible to obtain resolution of several tenths of a millidegree with a platinum resistance thermometer, this requires a high quality Mueller bridge and a sensitive galvanometer, at a combined cost considerably higher than that of the quartz thermometer, and without the convenience of direct readout. In regard to other performance characteristics such as measurement repeatability, long-term stability, speed of response, self-heating, probe interchangeability, etc., the quartz thermometer is equal to or better than commercial-grade platinum resistance, thermistor, and thermocouple measuring systems.

Simplicity of operations

The excellent sensing characteristics of the quartz thermometer are supplemented by the advantages of direct digital display (no bridge balancing, or reference to resistance- or voltage-temperature tables or curves), immunity to noise and cable resistance effects, and no requirement for external equipment such as a reference junction.

Data recording

As a standard feature, the HP 2801A Quartz Thermometer provides electrical (binary-coded decimal) outputs for each displayed digit, polarity, decimal position, and for the operating mode (i.e., T_1 , T_2 , $T_1 - T_2$). Temperature readings can therefore be printed out on paper tape by connecting these outputs directly to an HP 5050B Digital Recorder. Maximum printing rate is 4 readings per second (for 0.01° resolution).

Quartz thermometer readings can also be recorded graphically on a strip-chart recorder by first converting the digital output to analog form. Full scale deflections from 250°C down to 0.01°C are obtainable with this feature. (Or down to 0.001°C with the optional 100-second sample period for the HP 2801A.)

2801A Specifications

Temperature range: -80 to +250°C (-112 to +482°F with Option 001.)

Calibration accuracy: thermometer-probe combination calibrated at factory to within 0.02°C (0.04°F) absolute, traceable to NBS.

Linearity: 0.2°C (.36°F) over range -40°C (-40°F) to +250°C (+482°F), referred to best-fit straight line through 0°C; increases to 1°C below -40°C, referred to same line. Note: Factory calibration also includes correction factors which significantly reduce the linearity distortion quantities indicated above.

Stability

Short term: less than $\pm 0.0001^\circ$.

Long term: zero drift less than $\pm 0.01^\circ\text{C}$ (0.018°F) at constant probe temperature for 30 days.

Hysteresis: less than $\pm 0.05^\circ\text{C}$ over -80° to +250°.

Ambient temperature effect: less than 0.002°C per °C change.

Narrow range operation

Calibration accuracy: since HP 2801A can be calibrated to accuracy of user's temperature reference, absolute accuracy at given temperature can be enhanced by calibrating close to that temperature, e.g., $\pm 0.001^\circ\text{C}$ in region of 0°C, using good ice-point reference.

Linearity: 0.002°C, over any 10°C span between 0° and 100°C.

Hysteresis: 0.001°C typical, over any 10°C span between -80° and +250°C.

Display: 6-digit in-line readout in °C, or °F. Decimal point, °C or (°F) annunciator, and polarity indication included.

Display: 6-digit in-line readout in °C, or °F. Decimal point, °C or (°F) annunciator, and polarity indication included.

Digital recorder output: BCD, 4-2-2-1, positive true, for each digit, decimal point (exponent), polarity, and operating mode. 8-4-2-1 positive true BCD output optionally available.

External programming: selected by contact closures or transistor circuit closures to ground. Measurement initiation, probe selection (T₁, T₂, or T₁-T₂), and resolution (0.01, 0.001, or 0.0001°) programmable.

Power required: 115/230 V ±10%, 50 to 60 Hz, 85 W.

Instrument environment: ambient temperatures from 0 to +55°C (+32 to +130°F), at relative humidity to 95% at 40°C.

Weight: net, 10.1 kg (22.5 lb). Shipping, 15.9 kg (35 lb).

Dimensions (h×w×d): 88 × 425 × 414 mm (3¹/₂" × 16¹/₂" × 16¹/₂").

Quartz temperature sensing probes (2850A,B,C,D)

In all probe models, the sensor crystal is hermetically sealed in a cylindrical copper case, in a helium atmosphere. This case is enclosed within a stainless steel tubular body which varies in length with the probe model. The only probe material in contact with the measurand is therefore stainless steel (type 304). The sensitive quartz disc is situated parallel to and about 0.25 mm (0.010 inch) away from the flat end of the probe.

The HP 2850B and HP 2850C probes are equipped with a 1/4 inch NPT fitting and hexagonal end piece for easy insertion into pipes and tanks, at pressures to 3000 psi (20 × 10⁶ Pa).

With all models, a 3.7 m (12-foot) length of flexible coaxial cable is permanently attached to the probe. TFE Teflon is used both as the dielectric and outer sheath; this material can withstand temperatures as high as 250°C. The cable is sealed to the probe body, and is terminated at the other end with a water-tight connector mating with the associated sensor oscillator in the 2801A main frame assembly. With the HP 2850C probe, the cable is enclosed in a stainless steel, strip-wound, flexible hose to prevent the kinking or crushing that could occur during frequent handling or in exposed installations.

Remote operation of probes

The standard 3.7 m (12-foot) cable length from the probe to the 2801A main frame assembly may be extended up to 1372 m (4,500 feet) without any loss of accuracy or sensitivity. This extension is accomplished by using RG-59/U coaxial cable and inserting one or two 2831A Amplifiers at appropriate intervals along the cable.

HP 2850 series probes specifications

Response time: [response to step function of temperature, measured by inserting probe into water at dissimilar temperature flowing at 0.6 m/s (2 fps)]:

63.2% of final value in < 2.5 s

99.0% of final value in < 9.0 s

99.9% of final value in < 14.0 s

Thermal mass: (equivalent mass of water) HP 2850A 0.5 gm, HP 2850D 1.5 gm (Thermal mass of HP 2840B and C probes is considerably greater because of threaded fitting and metal cable sheath.)

Thermal leak rate: for probes without metal cable sheath, heat loss from cable to relatively still surrounding air is approximately 4.2 × 10⁻³ J/s/°C (1 × 10⁻³ cal/s/°C).

Probe material: probe body is made of type 304 stainless steel. Cable external covering is TFE Teflon.

Probe environment

Measurand: gases and liquids non-reactive with probe materials.

Temperature: -80 to +250°C (-112 to +480°F). Probe life reduced if subjected to temperature outside this range.

Pressure: 20.7 MPa (3000 psi) maximum for probes 2850B and C when inserted in pressure vessel. Probes 2850A and D sealed for immersion of the metal sheath. Probe-to-cable seal will withstand occasional immersion to depths less than 3 m (10 feet) of water.

Weight: net, including 3.7 m (12-foot) cable. Less than 90 gm (3 oz.).
Shipping: 0.5 kg (1 lb) approx.

DIMENSIONS

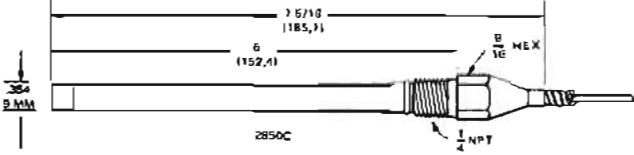
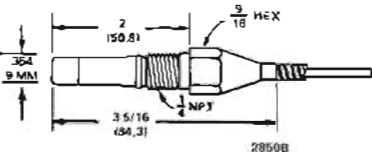
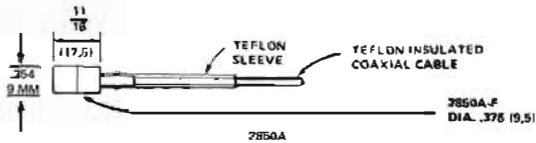

	Price
2801A Options, probes, accessories	
Option 006: 8-4-2-1 positive-true BCD output in lieu of standard BCD (4-2-2-1) output	N/C
Option 908: rack flange kit	\$10
2850A probe 17.5 mm (1 ¹ / ₂ " long)	\$685
2850D probe 228.6 mm (9" long)	\$685
2850B probe 50.8 mm (2" long, 1/4" NPT fitting)	\$785
2850C probe 152.4 mm (6" long, 1/4" NPT fitting)	\$785
2830A Sensor Oscillator	\$110
2831A Amplifier, one increases allowable distance to probe to 762 m (2500 ft); two amplifiers increase allowable distance to 1372 m (4500 ft)	\$125
2801A Quartz Thermometer, °C readout*	\$4050

*Includes two 2830A Oscillators and two 2850 series probes. (May be different types)

hp PHYSICAL AND OPTICAL MEASUREMENTS

Platinum Resistance Thermometer

Model 2802A

- Unique Dual Range
- Linear Analog Output
- Digital Temperature Display



Description

Two modular units make up the HP 2802A Thermometer: a thermomodule (lower unit) which contains temperature measuring circuits, probe connections, and operating controls; an HP 34740A display unit with 4½ digit light-emitting diodes, which snaps into place on the thermomodule. Battery or BCD module accessories easily snap into place between the thermomodule and display unit. In addition, the display unit may be used with other HP snap-in modules to make a voltmeter, a multimeter, a pre-amp ammeter, as well as other combinations offered by Hewlett-Packard in this catalog under Digital Voltmeters.

A variety of probes can be used with the 2802A. All HP probes offered are interchangeable and meet high standard, in-house electrical specifications which allow them to provide maximum accuracy. The HP 2802A drives very low current through the platinum sensor, so self-heating is negligible. Less than 0.1 mW is dissipated. A four-wire technique used to measure sensor resistance eliminates errors due to connector or lead resistances.

Rugged cast aluminum cases with shock resistant slides and chemically resistant paint provide ample protection for the HP 2802A in just about any operating environment.

- Simple one-point calibration
- Battery operation and BCD output available

Specifications

These specifications are "total system specifications" meaning they apply to both the instrument and the probe working together (not just the best electronic specifications for the instrument by itself). HP 2802A Thermometer specifications relate directly to system performance under actual working conditions.

Range: -200 to +600°C and -100 to +200°C

Resolution: 0.1°C on -200 to +600°C range
0.01°C on -100 to +200°C range

Accuracy: ±0.5°C ±0.25% of reading on both ranges

Display: 4½ digits LED on HP 34740A Module

Stability: ±0.2°C for 7 days (23°C ±5°C ambient)

Linear Analog Output

1 mV/°C on -200 to +600°C range (-0.2 V to +0.6 V F.S.)

10 mV/°C on -100 to +200°C range (-1.0 V to +2.0 V F.S.)

Voltage accuracy equal to that of digital display.

Output impedance 1 kΩ on both ranges.

Environmental standard: HP 2802A Thermometer operates within above specifications in environments of 0 to 50°C and up to 95% relative humidity over most of this temperature range. After calibration in some arbitrary ambient temperature, instrument calibration remains valid with ambient temperature changes up to 10°C.

Power requirements: operated on any of four, single phase ac line voltages: 100, 120, 220, or 240 volts rms (+5%, -10%), 48 to 440 Hz. Power dissipation is 8.7 volt-amperes.

Dimensions: thermomodule with display unit is 159 mm wide, 98 mm high, 248 mm deep (6¼ × 3⅞ × 9¾ in.); net weight is 2.27 kg (5 lb), shipping weight about 3.39 kg (7½ lb).

Thermometer options

2802A HP digital thermometer — Includes 4½ digit 34740A Display. Requires HP 18640 series probe and option 050 or 060. See list which follows.

050: 50 Hz, ac, single phase

060: 60 Hz, ac, single phase

001: HP digital thermomodule-Thermometer unit only, without display unit or probe. NOTE: Since thermomodule will not operate without display, this option is for those planning to use thermomodule with their own HP 34740A or HP 34750A Display Modules.

Price

\$795

N/C

N/C

less \$420

Probes

Note: Time constant for probes measured in water flowing at 3 m per sec.

1861A High Temperature Probe

Stainless steel sheath. For -200 to +500°C, to +600°C short term (prevent cable movement above 250°C). Time Constant 5 sec.

\$165

18642A General Purpose Probe

Same as 18641A probe except with teflon-insulated cable. Cable must be kept below 250°C.

\$150

18643A Fast Response Probe

Stainless steel sheath, for -200 to +500°C, to 600°C short term. Teflon cable must be kept below 250°C. Time constant 1.8 sec.

\$180

18644 Probe Kit

Includes platinum sensor cartridge, cable connector, complete instructions for four wire hookup. Time constant 0.5 sec.

\$105

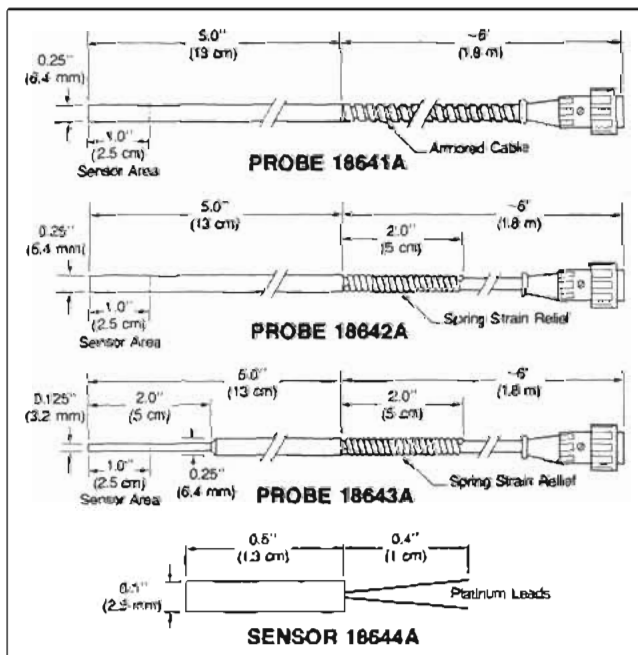

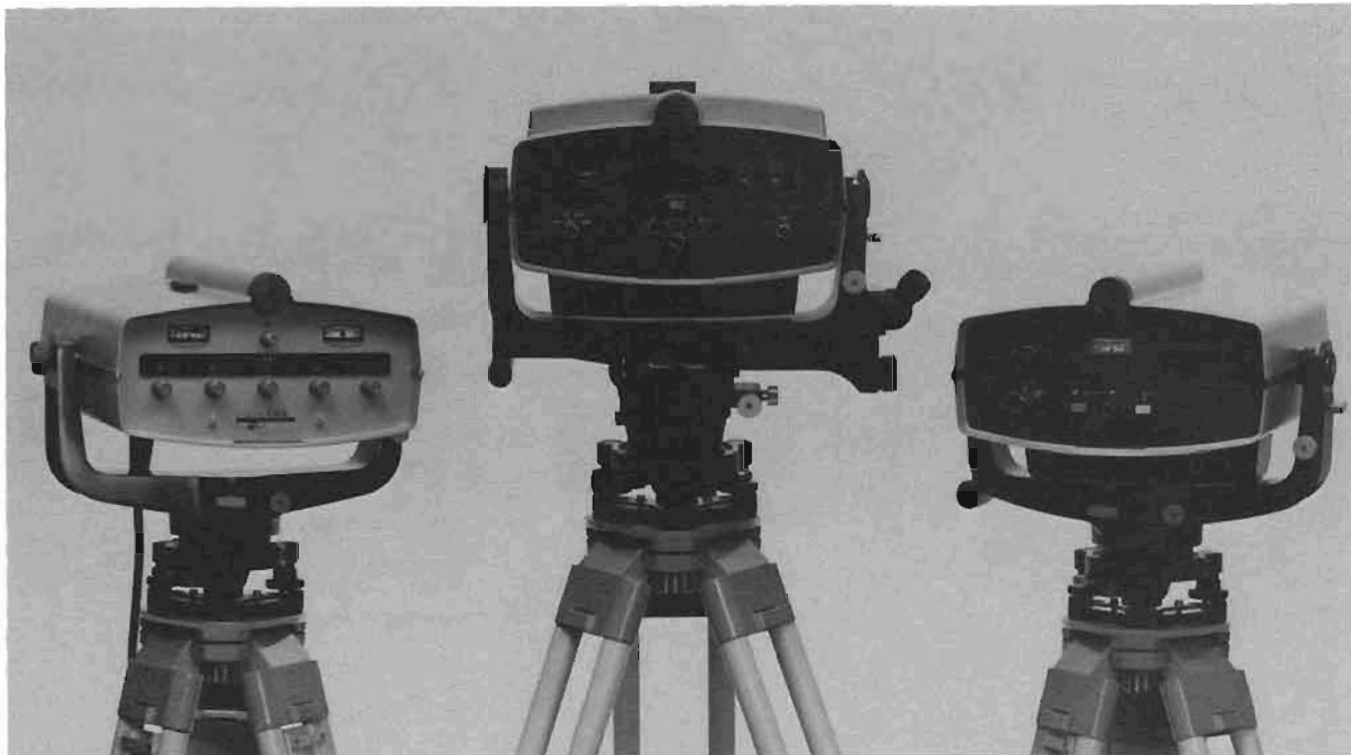

Hewlett-Packard, long recognized as the leading supplier of electronic measuring instruments for the engineer, has developed a similar position in electronic distance/angle measurement and computation instrumentation for the surveyor. These instruments are briefly described on this page.

HP3800 Series distance meters

The Series 3800 Distance Meters are medium range, electro-optical distance measuring instruments employing an infrared light source. The HP3800A measures in feet, the HP3800B in metres. The HP3800's combine a range of 10 000 feet (3000 metres), high accuracy and ease of operation into one lightweight, rugged instrument. Use of graphic symbol notation on the operating panel serves as a constant reminder of the measurement sequence. A visual display of the total measured distance in feet or metres, corrected for atmospheric conditions, is accomplished in less than two minutes. Unique circuitry eliminates effects on measured distance caused by momentary beam interruptions. The compact HP3801 Power Unit with atmospheric correction dial and built-in charger gives long operating time and provision for operating from an external source.

HP3805A Distance meter

The HP3805A Distance Meter is a low cost, short range, automatic readout, infrared light source instrument. The range of the HP3805A is one mile (1600 metres) with the measured distance displayed in feet or me-

tres at the flip of a switch. The HP3805A features a built-in computer that controls the instrument's internal functions and communicates the quality of the measurement to the operator through the communicative display. A minimum of 3,000 readings are taken for each measurement and displayed in as little as six seconds. This instrument also has an internal self-check capability of verifying electronic performance in the field or office, and automatic atmospheric correction. The optional battery pod that snaps into the bottom of the instrument provides cable free battery operation for a lightweight portable field system.

HP3810A Total station

The new HP3810A Total Station is a short range, automatic direct reading, electro-optical distance and angle measuring instrument utilizing an infrared light source. The range of the HP3810A is one mile (1600 metres) with the measured distance displayed in feet or metres and angles displayed in degrees or grads. This new instrument has the ability to measure the slope distance, zenith angle, vertical distance, correct for the curvature and refraction of the earth and automatically compute and display the horizontal distance. Four parameters are selectable for display: zenith angle, slope distance, horizontal distance and vertical distance. The key to the Total Station's power is a built-in microcomputer and a vertical angle sensing device. The communicative display indicates the quality of the measurement, on target indication, and

notifies the operator of a low battery. Horizontal angle measurements are made with the 20-second least count horizontal angle base with readings to 5 seconds or 10" on the micrometer scale. The HP3810A also features built-in atmospheric correction to one part per million, a snap-in battery pod, and a tracking mode for rapid point setting to one-tenth of a foot with updated measurements every three seconds. Precise measurements to one-thousandth of a foot can be made in less than six seconds.

Hewlett-Packard's versatile distance meters and total station are suited for such applications as layout, location, boundary, hydrographic, topographic, control and mine surveys. A short demonstration is all that is necessary for operator training on these instruments.

Surveying calculators

The Civil Engineering Division also markets Hewlett-Packard's line of desk-top programmable calculators and peripherals filling the surveyor's requirements for distance/angle measurement and computation instrumentation. Application and programming specialists have developed libraries of surveying programs for these systems. For specifications and details on HP calculators and peripherals, see pages 520-534.

For detailed specifications and prices on these instruments and optional accessories, contact the Civil Engineering Division, P.O. Box 301, Loveland, Colorado 80537.

SOLID STATE COMPONENTS AND CIRCUITS

Diode, transistor & optoelectronic products

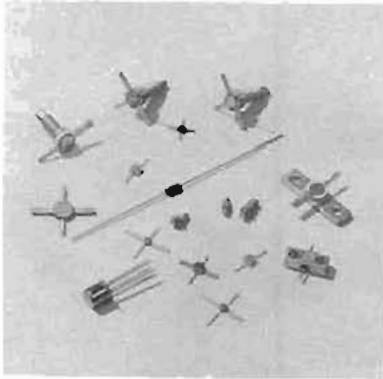

Diodes and transistors

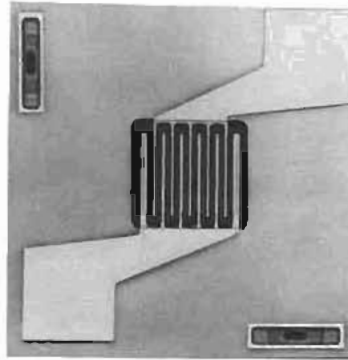

HXTR 6101 chip

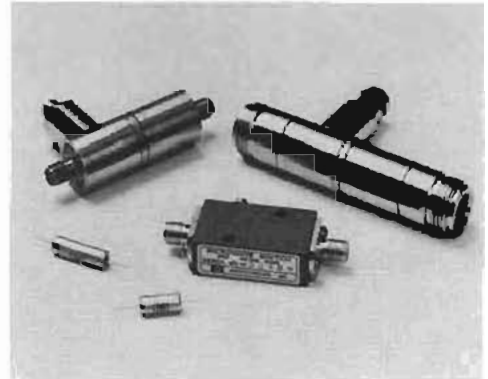

Integrated products

Low cost components, now available from Hewlett-Packard, offer exceptional performance in consumer, industrial, and other OEM equipment. With sophisticated semiconductor processing equipment, and the industry's most extensive hybrid thin-film microcircuit manufacturing facilities, Hewlett-Packard applies newly developed technologies to component manufacturing, offering high performance diodes, transistors, solid state numeric and alphanumeric readouts plus LEDs and other optoelectronic devices — in quantity at economically attractive prices.

Transistors

Hewlett-Packard transistors fill all requirements for multistage VHF-UHF and microwave amplifiers: low-noise input stage, high-gain intermediate stages, and power output stage. For example, the HXTR-6101 low noise silicon bipolar transistor offers typically 2.7 dB NF with 9 dB associated gain at 4 GHz.

Hewlett-Packard transistors are supplied in chip form, or in various stripline packages in either common-base or common-emitter configurations. Complete data sheet characterization and excellent processing uniformity make it possible to design your circuit by calculation instead of by trial-and-error.

Diodes

Step recovery diodes: These are intended for use as comb generators and harmonic frequency multipliers. When used as a comb generator, the abrupt termination of the diode's reverse recovery current generates voltage pulses up to tens of volts with pulse widths as narrow as 100 ps giving useful power at frequencies in excess of 20 GHz. By optimizing the circuit around any specific harmonic, high efficiency frequency multiplication can be accomplished.

Impatt diodes: Impatt diodes are a fundamental source of RF power at frequencies above 4 GHz. CW devices can supply 3.5 W at 6 GHz with 10% efficiency, while pulse-optimized devices operating at 10 GHz offer 14 W at 800 ns pulse width and 25% duty cycle.

Schottky barrier diodes: These metal semiconductor diodes combine extremely high rectification efficiency with pico second switching speeds, low series resistance, and low noise characteristics. This combination makes the Schottky an excellent mixer/detector diode.

At HF, VHF and UHF frequencies, HP delivers glass packaged devices in million piece quantities at economical prices. These same diodes have many digital circuit applications where switching speed is important such as clipping and clamping.

At microwave frequencies, their low noise and repeatable RF impedance lead to outstanding performance either as mixers or detectors. Package configurations include beam leaded devices as well as conventional ceramic and axial lead packages.

PIN diodes: PIN diodes function as variable resistors at microwave frequencies. By controlling the DC bias, the RF resistance of a PIN diode can be varied from 1Ω to about 10kΩ. This unique property of the PIN diode makes it extremely useful as a switch, attenuator, modulator, phase shifter, limiter or AGC element at all frequencies from 1 MHz to microwave. Package configurations include beam-led devices as well as conventional microstrip, ceramic and axial-leaded packages.

Tuning varactors: these diodes are designed for applications that require both a high Q and a high tuning ration. Applications include voltage tuned oscillators, tunable filters and AFC loops. The diode chip is passivated with silicon dioxide and silicon nitride to ensure low surface leakage and maximum stability in harsh environments.

MIS chip capacitors: these Metal-Insulator-Silicon capacitor chips are processed with a composite insulator on silicon. The high density thermal oxide-nitride composite layer yields excellent reliability due to dielectric breakdown stability for both DC and RF fields. Capacitance values from 0.5–100 pF are available.

Integrated products

The combination of chip and beam lead diodes with hybrid thin-film circuit technology has led to an extensive product line of components for the conversion and control of RF signals.

SPST Switches covering the frequency range from 0.1 to 18 GHz are offered either in modules or with connectors. Absorptive Modulators with up to 80 dB of isolation at 18 GHz are available.

Other components include Limiters, Comb Generators, Mixer/Detectors, and Double Balanced Mixers.

High reliability testing

Many Hewlett-Packard components are SPACE QUALIFIED. The reliability of these devices is established by one of the finest high reliability testing facilities in the microwave component industry. Hewlett-Packard's High Reliability Test group maintains military approved JAN and JANTX parts in stock and can recommend Standard Screening programs, patterned after MIL-S-19500, for any HP component. Those who wish to design their own screening specifications can consult with and obtain quotations from Hewlett-Packard's staff of Reliability Engineers.

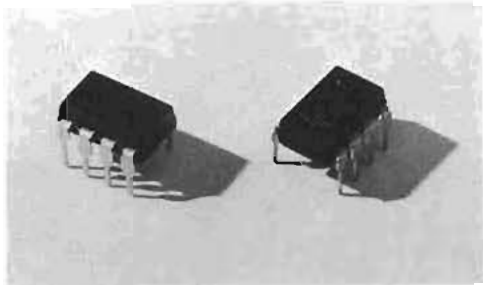

Optically coupled isolators

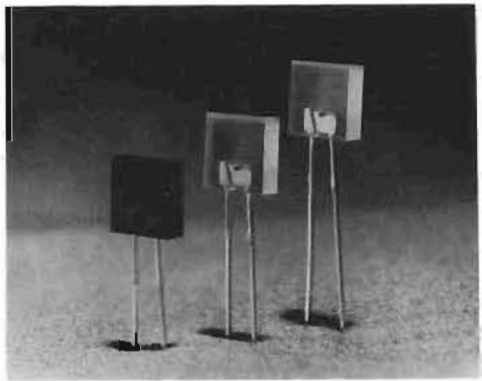

Rectangular LED lamps

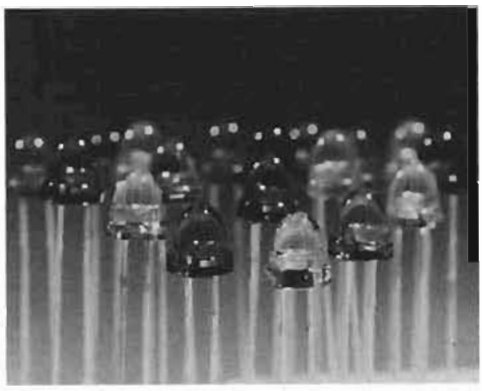

Low profile LED lamps

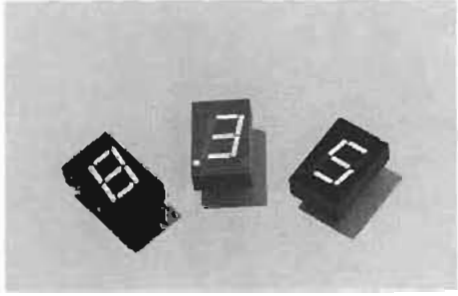

0.43" Seven-segment display

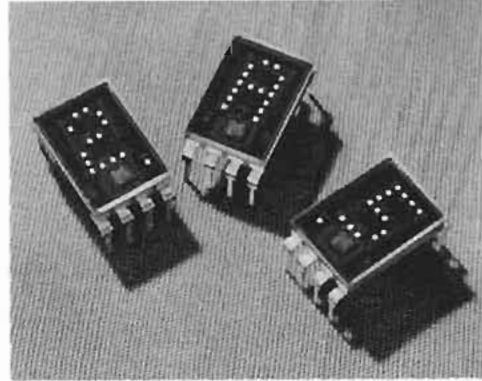

Hermetic hexadecimal displays

Solid state displays and optoelectronics

Hewlett-Packard offers a complete line of GaAsP and GaP discrete light emitting diodes (LEDs), numeric, and alphanumeric displays. These components provide solid state reliability to visible data transmission. As status indicators, arrays, and solid state displays, these compact light emitting diodes are electrically compatible with monolithic integrated circuits, with useful life greater than 100,000 hours. HP offers visible emitters and displays in red, yellow and green.

Low cost numeric displays, packaged single or clustered, with or without on-board electronics, are available in character heights from 1/8 to 1 1/2". In addition, alphanumeric and hexadecimal displays are available in single or multi-digit packaging for a variety of applications. Small character, low power displays have been designed for portable instrumentation and calculator applications.

These light emitting diode (LED) displays are offered in plastic encapsulated or hermetic packages. Designed for low cost and ease of application, these displays are ideal for conventional indicator requirements as well as allowing many new applications in the display of information.

Discrete LED indicator lamps are designed for easy panel mounting with clips or direct PC board application. Both plastic and hermetic packages offer high brightness over a wide viewing angle with low power requirements. Hewlett-Packard offers a wide selection of leads, lens, brightness, and package combinations.

Hewlett-Packard offers high gain and high speed optically coupled

isolators designed for analog and digital applications. These devices operate up to 20 M bits with an isolation greater than 2500 volts. High speed and high gain is achieved using an advanced photo integrated-circuit construction. Low input, dual and hermetic versions are also available. All devices are available in standard DIP packages.

Hewlett-Packard PIN photodiodes are excellent light detectors with an exceptionally fast response of 1 ns, wide spectral response from near infrared to ultra-violet, and wide range linearity (constant efficiency over 6 decades of amplitude). With dark current as low as 250 pA at 10 V, these detectors are especially well-suited for operation at low light levels.

Write for more information

Hewlett-Packard component capabilities are described in catalogs and data sheets available for the asking.

Diode and Transistor Designer's Catalog: this contains key parameters for our line of microwave transistors, Schottky, PIN, Step Recovery and IMPATT diodes, including chips and devices for hybrid integrated circuits.

Solid State Display and Optoelectronics Designer's Catalog: this contains key parameters for our broad line of LED readouts, LED lamps, new Optically Coupled Isolators and Detectors.

These catalogs, application notes and other literature, including prices, are as near as your phone. Call any Hewlett-Packard Sales Office.

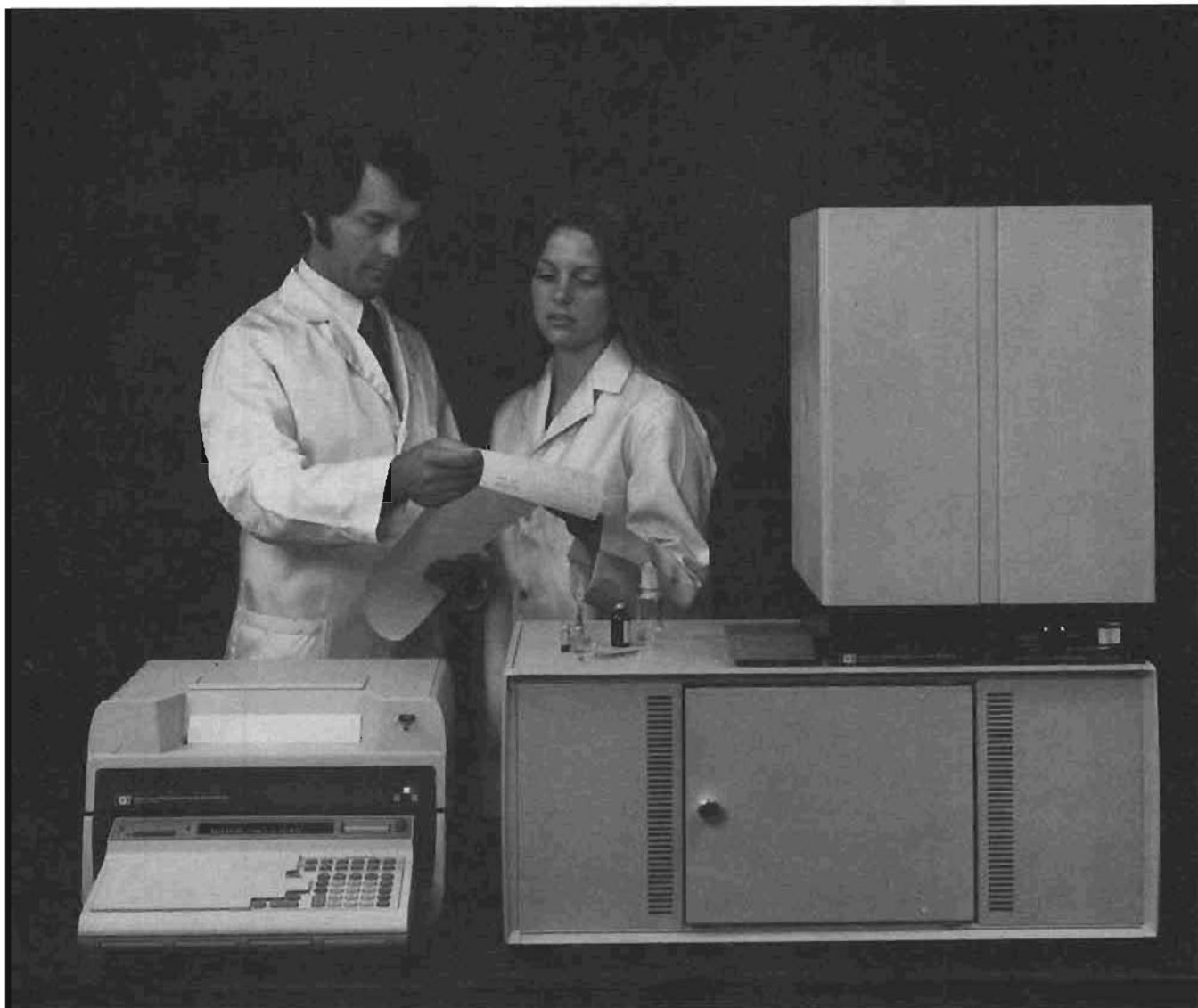

Widely recognized as a leading supplier of electronic measuring instruments and data handling equipment for the engineer, Hewlett-Packard is also rapidly developing a similar position in analytical instrumentation for the scientist. HP's analytical products now include a full line of gas chromatographs, liquid chromatographs, automatic sampling systems for GC, data handling devices and systems for the analytical laboratory as well as GC/Mass Spectrometers and accessories.

Gas chromatographs

Although less than 20 years old, gas chromatography (GC) has taken over from classical methods of analysis the bulk of analytical work performed in laboratories around

the world. There is an excellent reason for the revolutionary popularity of the gas chromatograph in analytical chemistry: no other method gets more accurate results, at greater speed, and for less cost.

For the scientist whose interest is the chemical analysis of unknown samples, Hewlett-Packard offers two basic types of gas chromatographs.

NEW — Model 5840A reporting gas chromatograph

The second generation HP 5840A is a complete GC analytical system. It has an integral digital processor that operates the gas chromatograph and its accessories throughout the analytical run, following precisely the in-

structions that you give it *before the run*, on an easy-to-use keyboard or magnetic card reader.

The intelligent control center of the 5840A, the built-in digital processor, controls all aspects of the GC analysis: all temperatures, carrier flow rate measurement, detector operation, integration of peak areas, identification of components, calculation of concentrations, plotting of chromatogram and analysis report. After you set the analysis parameters on the keyboard and inject a standard sample, a single keyboard entry causes the 5840A to initiate a simple dialog which calibrates for the method; thereafter, the 5840A will analyze your samples, make the calculations by whatever method you specify — nor-

malization, internal standard or external standard — and report the results . . . all automatically.

Other HP 5840A features include: choice of universal injection port with glass or metal liners and on-column injection capability; a multi-purpose glass capillary inlet system; time programming which lets you make changes throughout an analysis at a precise, preset retention time; run programming which lets you preset analysis parameters for a series of samples before injecting the first one; plus a variety of glass, metal, packed or capillary columns . . . all in a high performance oven that can be controlled and programmed from -60° to 400°C , to meet separation requirements for almost any type of sample!

HP 5700 Series GC's . . .

Digital, Compact, Modular, Capable of Full Automation

The HP 5700 Series breaks the traditional barrier between versatile but expensive "research" instruments and dedicated, more cost-conscious "routine" instruments. This series embraces HP 5710 Dual Column, HP 5720 Single Column, and HP 5730 Dual Column/Multiple Detector GC's which serve every research or routine laboratory need.

New features of the 5700 include: specific detectors, including nitrogen/phosphorous FID and flame photometric . . . multi-detector capability, including simultaneous ECD/FID operation with N_2 carrier . . . inert TC detector . . . dual input/dual output electrometer . . . electronic baseline compensation . . . inlet system for glass capillaries . . . metal capillary splitter . . . all-glass packed column system . . . low bleed septum mounting.

Liquid chromatographs

New 1080 series . . . first LC with built-in processor

The first high-performance liquid chromatograph (HPLC) to be controlled by a built-in central processor, the HP 1080 Series gives users full control over separation parameters, minimizes quantitative errors and is simpler to use than conventional instruments in routine chemical analyses and in developing new analytical methods.

Solvent preparation capability, semi-automatic injection system, feedback flow control, and a detector with low noise and drift characteristics are features of this new system.

Two-way communication with the HP 1080 is via keyboard in terms that are simple and familiar to the chromatographer. Once instructed, the instrument injects the desired sample size (from 10 to 200 microliters) at full column pressure without interrupting flow; controls solvent composition, generates gradients, then collects and computes chromatographic data and reports them on heat-sensitive, smudgeless paper . . . all automatically!

The new HP 1080 Series includes two models, the fully equipped HP 1084A featuring gradient elution and the HP 1082A, an economical isocratic system which can be upgraded to full gradient capability when desired.

Laboratory automation systems

HP Series 3350 Laboratory Automation Systems satisfy the combined data handling, control, and reporting needs of the analytical laboratory, from the chemist's to the lab manager's.

Chromatographic software supplied with all systems automatically processes the output of gas and liquid chromatographs using standard chromatographic methods. Through computer-initiated dialog, entirely in terms familiar to the chromatographer, the user determines the setting up of events, sample-handling tasks, data reduction parameters and report formats. No special knowledge of computers or programming is required by lab personnel. Self-checking procedures further assist the system operator.

The 3351A system, a low cost answer to your data analysis needs, handles data from up to 15 instruments and has capacity for 4 fully powered input/output devices.

The 3352C Lab Data System is a fully expandable system that allows your data processing needs to grow with those of your laboratory up to 30 on-line instruments with up to 8 terminals. BASIC language programming capability can be added and the 3352C is expandable to a 3354A system.

The new 3354A Lab Automation/Management System is a superior lab automation system which can handle as many as 30 instruments on-line, and handle up to 11 input/output devices through which users can develop methods, BASIC programs and route final reports for which any number of copies can be specified.

Reporting integrators

HP 3380 Series Reporting Integrators provide an excellent data handling function for an existing gas or liquid chromatograph. Both integrators in this series provide the unique printer/plotter that draws the chromatogram, labels peaks with their retention times, lists instrument settings and prints a complete analysis report, all on a single piece of paper.

GC/Mass spectrometer data systems

The Hewlett-Packard 5980A Series GC/Mass Spectrometer is one of the most powerful analytical tools offered for qualitative and quantitative measurements. Integration with an HP 5934A Dual Disc Data System further increases its analytical power and operator convenience.

Two GC/MS systems are offered: Model 5981A has an electron ionization (EI) source;

Model 5982A has a dual chemical/electron ionization (CI/EI) source with switching between CI and EI modes taking less than a minute. Both systems have a 4-1000 amu mass range and combine rapid scan rate with a new inlet design to make capillary column GC/MS studies rapid and easy. Sensitivity is to picogram levels, essential for analysis of samples encountered in typical pesticide, pollution, drug, and biological problems.

Hewlett-Packard GC/Mass Spectrometers can be operated either manually or automatically using an HP 5934A Dual Disc Data System. The data system controls the operation of the GC/MS and accumulates the analytical data while it performs the necessary calculations. It completes a mass scan in less than one second, fast enough to analyze every peak separated by the gas chromatograph, and stores all the analytical data from continuous GC/MS analyses, even those lasting as long as 10 hours. Data handling is enhanced by the ability to search spectral libraries and by powerful graphic CRT display software.

Analytical service support

With 172 service locations in 65 countries, HP lends a supporting hand where you need it, when you need it. Your local HP service engineer is factory trained and supported by an extensive inventory of parts, the latest test instruments, and complete service kits for the maintenance and repair of your HP instrument systems.

Service Agreements: choose from a variety of plans and options that:

- Supplement or eliminate the staffing and training of your own maintenance personnel
- Provide complete and timely worldwide service
- Maximize instrument reliability through regularly scheduled maintenance visits
- Minimize maintenance costs through efficient planning
- Simplify budgets through a known annual cost
- Tailor your agreement to match your specific support requirements

Training: in-depth customer training is available in both operation and maintenance. A broad range of courses and training materials have been developed for HP customers.

Documentation: complete documentation is supplied with each HP instrument or system. In addition, supplemental tutorial texts are available from your local HP sales office.

Applications: Hewlett-Packard Applications Chemists are available to help you get the most out of your HP instruments. In addition, the company has published numerous Application Notes which describe the practical uses of HP instrumentation for a variety of studies.

MEDICAL INSTRUMENTATION



Computer-assisted ECG Management System collects, interprets, edits and stores electrocardiograms. Resulting increased efficiency helps reduce costs, improve ECG services and optimize use of professional time in processing large numbers of electrocardiograms.



Compact, flexible Cardiograph permits choice of up to four FHR monitoring methods in one instrument. extremely simple operation, non-fade scope, digital displays, self-check facilities for faster operational tests.

Growth of experience

Today physicians and researchers are using more than 300 different HP medical products to acquire, display, record, store, and in some cases analyze, biomedical signals. This major instrumentation resource had its beginnings in blood pressure and metabolism equipment developed in the early 1920's by Sanborn Company, and has been steadily augmented during the last five decades. Sanborn became part of HP in 1961 and the combined experience and resources have now resulted in products and services for perinatal medicine, pulmonary function testing, anesthesiology, neurology, emergency care, radiology, pathology and intensive care monitoring. HP also serves medicine with a variety of application planning, maintenance and staff training services. In recent years, more than 800 hospital people responsible for maintaining monitoring and ECG instruments have gained valuable knowledge through training seminars conducted by HP.

Where HP Instruments serve medicine

Cardiology applications: these involve HP instruments and systems for single- and three-channel ECG recording; ECG stress testing; ECG Data Management System for computer-aided interpretation of ECGs; ECG recording with simultaneous registration of heart sound and pulse tracings; and ECG computer terminals for telephone transmission or tape recording of ECG data. Instrument/system highlights: briefcase-size portable ECG weighs less than 20 lb (9.1 kg) complete, operates on AC or batteries; 3-channel automated ECGs produce 12-lead records automatically in 10 sec.; ECG stress testing system includes ECG, 3-channel memory scope, heart rate meter and defibrillator in mobile cart.

Patient monitoring: an established part of modern intensive care of the coronary, general medical and post-operative patient in critical condition, patient monitoring is a major area of HP medical instrument contri-

but ion. Currently more than 100 modular instruments, systems, transducers, carts and a central station console are available, for monitoring the ECG, heart rate, pulse, cardiac arrhythmias, blood pressures, temperature, respiration rate, etc. A sophisticated Coronary Care Monitoring System can automatically detect, classify, log and warn of most premonitory ventricular arrhythmias, for as many as 16 patients simultaneously. Patient status display and a 9-hour trend display are continuously updated; 3-level visual and audible alarms, graded by severity, alert staff to significant changes in patient's rhythm status. Central station instruments include non-fade scopes, numerical and meter displays, recorders and automatic alarms. For monitoring ambulatory patients, the HP ECG telemetry system transmits the ECG from a battery-powered unit worn by the patient, to receivers and displays at the central station. To provide accurate record keeping and instant retrieval of monitored data in many forms to aid diagnosis, the HP patient data management system links the monitoring system to an HP computer. Operation is simplified by direct keyboard communication with the system, and response by video-displayed messages, charts, graphs, etc. In addition, HP also offers a choice of mobile resuscitation systems which provide the specific combination of defibrillator, pacemaker, monitors and organized storage for medications needed by various medical, nursing and surgical services.

Perinatal applications: these applications include instruments and systems for fetal/maternal and neonatal intensive care monitoring. Fetal monitors measure beat-to-beat fetal heart rate and record it simultaneously with labor activity. Relating fetal heart rate to labor contractions gives valuable information for obstetrical diagnosis and management of labor and delivery, with the potential end-result of reduced fetal mortality and morbidity — i.e., "better babies." HP fetal monitors offer all of the methods of detecting fetal heart rate: internal scalp electrode; external heart sound, ultrasound, and the new state-of-the-art, unique abdominal ECG technique. Comprehensive fetal monitoring systems are analogous to intensive care monitoring systems, with central station display and recording capabilities. Neonatal intensive care monitoring systems employ heart rate and respiration rate monitors (e.g., cardiorespirographs), and also have recording and alarm features.

Pulmonary function testing: pulmonary Function testing can be accomplished efficiently, with repeatable accuracy and virtually all data reduction and calculating chores performed automatically, with HP instru-



Ear Oximeter measures O₂ saturation non-invasively, continuously — independent of skin pigmentation, ear thickness, ear-plate motion. No individual patient calibration needed.

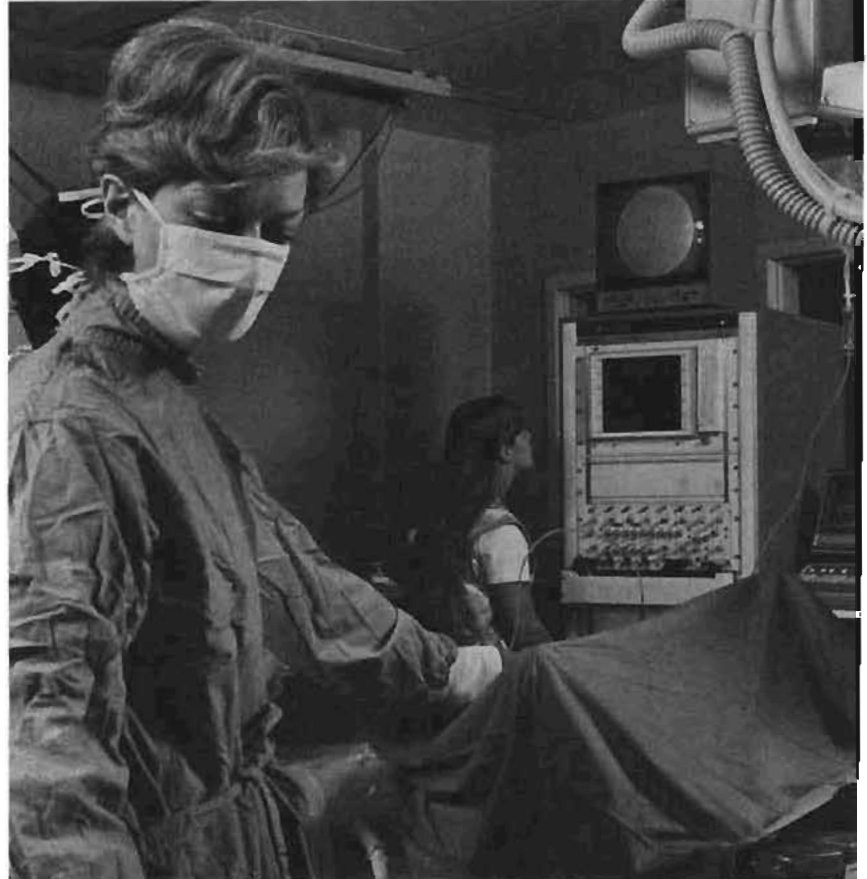

Catheterization Data Analysis Systems enhance the cardiologist's decision-making ability by providing immediate analysis of hemodynamic data during cardiac catheterization.

ments employing electronics and digital technology. A Pulmonary Function Analyzer automatically presets and calibrates itself, and graphs spirometry, FVC, flow-volume, or single-breath N₂ washout with closing volume, and digitally displays FRC for a multiple-breath washout test. Addition of an HP calculator with on-line signal analysis capability provides rapid workups and reporting. For special systems and pulmonary research, HP offers a nitrogen analyzer, digital pneumotach, flow transducer, X-Y recorder, and recording systems capable of measuring TV, MV, work of breathing, RR, resistance and compliance. For measuring arterial oxygen saturation non-invasively, with convenience, continuity and speed, the HP Oximeter offers unusual advantages. Optical transmission of the ear is measured using a patented multi-wavelength technique, and arterial O₂ saturation is numerically displayed within 30 seconds. Accuracy is unaffected by patient's ear thickness or skin pigmentation.

Cardiovascular and research applications: these use multi-channel heated stylus or optical recording systems, complete in all elements from transducers to data displays. System capability and flexibility comes from more than a dozen different interchangeable plug-in signal conditioners and a choice of scopes, meter and numerical displays, plus

magnetic tape recorders for analog data storage and playback. With signal conditioners for DC signals, physiological pressures, flow, temperature, ECG, EEG, muscle potentials, heart rate, heart sounds, pressure and pulse waveforms, etc., these systems are widely used for clinical and research studies in cardiac catheterization laboratories, operating rooms and pulmonary labs, as well as medical and pharmaceutical research labs. The widely accepted Catheterization Data Analysis System aids the physician by assimilating and rapidly calculating data on blood pressures, flows and cardiac volumes, as well as preparing complete reports with much less time and effort. The system handles data from congenital and acquired heart disease from multiple labs, displays information in lab, and stores in a patient data base allowing retrospective analysis.

Medical Consumable products: HP offers a broad selection for use with HP medical electronic instrumentation as well as equipment of other manufacturers. Hp consumables include chart recording papers, record inserters, mounts and rulers; electrodes and electrolytes; disposable pressure transducer dome; and an intrauterine pressure monitoring kit.

Radiology: in Radiology applications, HP now offers a group of high-performance X-ray machines with automatic exposure control. They include a 350 kV chest X-ray system which improves soft tissue visibility throughout the entire chest, with considerably less radiation exposure to the patient; and Faxitron® cabinet X-ray systems for specimen radiography and for laboratory training of radiological technicians.

Hospital and independent clinical laboratories: for hospitals and clinical laboratories as well as medical research institutions, HP offers a full line of chemical analysis instruments. The wide variety available includes two different types of gas chromatographs, a high-pressure reporting liquid chromatograph, and gas chromatograph/mass spectrometer/data systems. In addition, automatic liquid samplers for gas chromatographs and laboratory data handling systems for GC and LC are also available from HP chemical analysis product line Divisions.

Detailed information: for more detailed information on any HP medical instrument or system, please call or write Hewlett-Packard, indicating specific product(s) of interest.



Faxitron® cabinet systems

Radiography, the art and science of making pictures with X-rays, has an important place in modern technology. It is one of the major nondestructive test methods available to industry, provides an indispensable tool in scientific investigations and is a valuable aid to law enforcement agencies. Hewlett-Packard makes a major contribution to these activities with X-ray equipment that offers a "better way" through advanced technology and design. This equipment makes radiographs easier and safer to take, provides portability for field use or offers stop-motion capability for the study of dynamic events.

Industrial inspection

Industrial quality control and inspection procedures, especially in the field of electronics, benefit from nondestructive testing by radiography. The advantages of a testing method which does not harm the test objects are obvious. Radiography, therefore, offers benefits in design engineering, incoming inspection, production quality control, product reliability and failure analysis. X-rays are used to detect misregistration or plate-thru problems in multi-layer P.C. boards; porosity, poor substrate bonding and wiring or lead location in transistors and integrated circuits; voids and other encapsulation problems in potted components; and solder balls or other defects in sealed relays.

Die casting is another industry that benefits from the nondestructive aspects and ability to "see inside" provided by radiography. Porosity, gas voids, tramp metal inclusion and other common defects can be easily detected and the cause determined. Expensive machining time can be avoided for castings found to be defective through X-ray inspection. The integrity of welds, alignment of con-

nectors, inspection for proper assembly and mechanical defects are further examples of tests which radiography performs for industry. The benefits of X-ray testing are reduced production costs, better quality assurance and product safety. The results are increased profits.

Scientific applications

Oceanography, geology, marine biology, paleontology, pathology, botany, forestry and agricultural research are a few examples

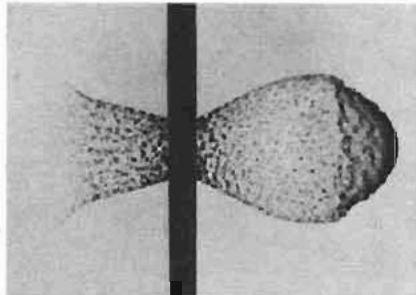

of scientific disciplines that use X-rays. Applications range from the study of the interior anatomy of fossils to determining the viability of seeds.

Law enforcement applications

Radiography aids many law enforcement groups. Crime labs use X-rays to visualize certain types of latent fingerprints, for powder and lead splatter patterns in ballistics and for questioned-document examination. Medical examiners use X-rays for cause-of-death investigations and identification of remains. X-rays aid in examining parcels or mail to identify dangerous devices and to verify bomb circuitry.

These are among the many applications served by HP Faxitron® Cabinet X-ray Systems. They offer a unique combination of high quality radiographic capability, simplicity of operation and convenience of use which is expanding the capabilities of scientific and industrial concerns throughout the world.

Portable X-ray systems

Portable systems of lightweight and small size are made possible by the field emission type tube. Hewlett-Packard markets several portable systems including the Model 43501, a self-contained battery-operated portable system specifically designed for the unique field use requirements of explosive ordnance demolition squads. Integral power capability and small, remotely operated X-ray tubes make possible X-ray examination of suspected bombs.

X-ray inspection of otherwise inaccessible components in complex structures is also facilitated by the 43501.



Model 43501B Portable X-ray

Pulsed radiation sources

Hewlett-Packard has pioneered in the design and manufacture of cold-cathode, flash X-ray tubes and systems. Cold-cathode tubes, based on the field emission principle, are combined with a pulse generator and appropriate control units. The systems produce nanosecond bursts of X-rays, electrons or super radiant light (SRL). Output voltage and energy are provided by Marx-surge type energy storage modules charged in parallel and discharged in series through a pressurized spark gap switch mechanism.

A number of channels can often be operated from common controls enabling a series of stop motion radiographs at desired intervals.

Other capabilities include slow and fast cine-systems providing a series of motion picture-like radiographs at rates from 1 to 1000 frames/sec. These systems are custom designed from standard units.

HP pulse radiation systems yield a reproducible 5-10,000 ampere electron beam in air at energies of 400-2300 keV and pulse widths of 3-40 nanoseconds. Current densities of 12,500 amperes per cm² and dose rates up to 10¹⁵ Rads/second can be obtained.

Their reproducibility, high dose-rate output, ease of operation and instrumentation and small space requirement make them ideal for radiation chemistry or pulsed radiolysis studies as well as radiation effects studies, radiation biology and laser pumping.

For specific information and consultation regarding HP X-ray systems, contact Hewlett-Packard, 1700 S. Baker Street, McMinnville, Oregon 97128, telephone: (503) 472-5101.

Communicating with HP

HP is committed to providing convenient local support and the best possible attention to customer needs on a worldwide basis, and we now have more than 172 sales and service offices located in 65 countries. (A complete listing of our offices appears on the inside back cover of this catalog.)

Your entry point to the resources of Hewlett-Packard is through the local HP office nearest you. Our field engineers and order support specialists there are well-equipped to provide you with pre-sale assistance in product selection, as well as related business information such as current product availability and price delivered to your location.

HP field offices are tied into a sophisticated intra-company communications system. This not only means prompt transmission of orders to any of the 30 HP product responsible divisions — it also speeds the flow of regular messages among all HP field offices and factories. The objective, of course, is to provide the fastest possible response to your product interests.

Placing your order

Hewlett-Packard people at the field office nearest you will be pleased to provide assistance in selecting the HP equipment most appropriate to your needs, and to help you prepare your order.

The information in this catalog will, in many cases, be sufficient for you to decide to buy a particular HP product. In those instances, a telephone call to the nearest HP office will provide you with (1) information on product availability, and (2) the product's price, delivered to your location (since any budgetary prices provided with this catalog are FOB appropriate HP factory or warehouse facility, and do not include import surcharge, if any).

We want to be sure the product we deliver to you is exactly the one you want. Therefore, when placing your order, please specify the product's catalog (model, accessory, or part) number, as well as the product's name. Be as complete as possible in specifying exactly what you'd like, including standard options.

In the event you want special features or

capabilities such as different color or a non-standard power line voltage, ask your HP field engineer about availability and cost of these "specials" first — and then, to prevent misunderstandings, include special instructions and specification details with your order.

Shipping methods

Inside the USA: Shipments to destinations in the USA are made directly from factories or local warehouses. Unless specifically requested otherwise, express or truck transportation is used, whichever is less expensive and most serviceable to you. Small items are sent parcel post. If fast delivery is needed, we gladly ship by air freight, air express, or air parcel post, when specified on your order, at prevailing rates. In many parts of the USA, a consolidated air freight service provides the speed of air transport at surface rates. Ask your HP field engineer for details.

Outside the USA: Shipments to destinations outside the USA are made from the appropriate Hewlett-Packard facility by either surface or air, as requested. Sea shipments usually require commercial export packaging at a nominal extra charge.

Budgetary prices

Price information which may be supplied with this catalog is designed to provide you with helpful budgetary guidance. Unless otherwise noted, prices are based on HP factory or warehouse shipping point, so please call your nearby HP field office to determine a product's delivered price at your location.

Any prices which appear printed on the product pages in blue ink apply only to domestic USA customers. They do not include an import surcharge on applicable products; such surcharge is to be added to the price shown.

Prices furnished with this catalog are net prices prevailing at the time of printing. Hewlett-Packard reserves the right to change prices, and those prices prevailing at the time an order is received will apply.

Quotations and pro forma invoices

Destination prices and other details you

may need to know before ordering can be quickly obtained via telephone. Just call your nearest HP office.

If you are an international customer requiring formal paperwork such as pro forma invoices or FAX, CIF, or C&F quotations, please contact the Hewlett-Packard office or representative serving your area. Exportation or importation assistance is also available.

Terms of sale

Inside the USA: Terms are net 30 days from invoice date. Unless credit with Hewlett-Packard has already been established, shipments will be made COD or on receipt of cash in advance.

Leasing and extended financial terms are available. However, the associated costs are not included in any product prices furnished with this catalog. Your nearby HP office will be pleased to discuss your requirements, and work with you in setting up an appropriate program.

Outside the USA: Terms for orders from customers outside the United States of America which are placed with the Hewlett-Packard Company, Hewlett-Packard S.A. or Hewlett-Packard Inter-Americas, are irrevocable letters of credit or cash in advance — unless other terms have been previously arranged. Terms for orders placed with authorized Hewlett-Packard representatives or distributors are mutually determined between the customer and the representative or distributor organization.

U.S. government sales

Most products in this catalog are covered on GSA federal supply schedule multi-award contracts.

Product changes

Although product information and illustrations in this catalog were current at the time it was approved for printing, Hewlett-Packard, in a continuing effort to offer excellent products at a fair value, reserves the right to change specifications, designs, and models without notice.

AFTER-SALE SERVICES

Warranty, certification, repair service, parts

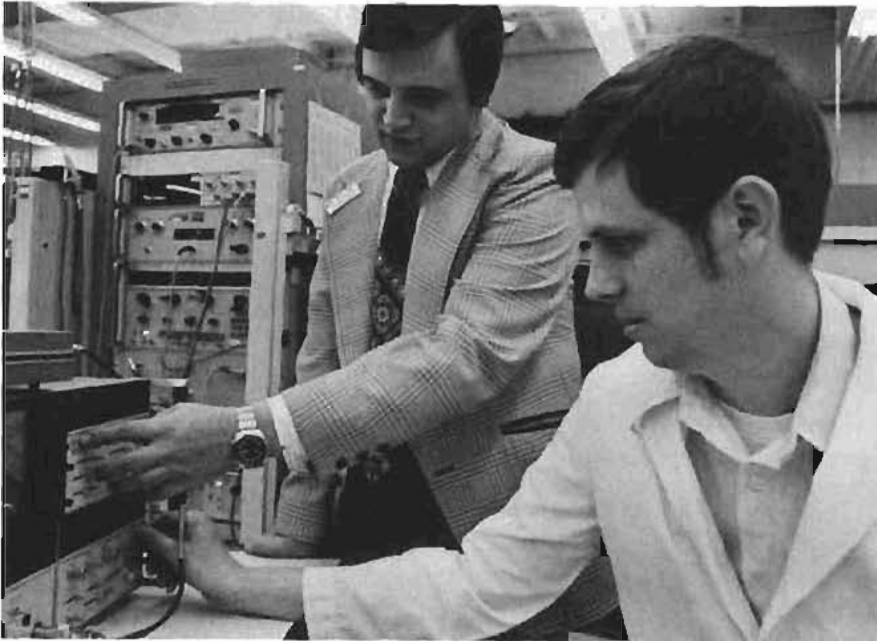

With Hewlett-Packard, you get excellent products backed by a responsive customer service program

When you purchase a Hewlett-Packard product, you also receive the assurance that it will continue to perform to its published specifications today, tomorrow, next week — and for a reasonable number of months and years in the future.

We firmly believe that our obligation to you as a customer goes much beyond just the delivery of your new HP product. This philosophy is implemented by Hewlett-Packard in two basic ways: (1) by designing and building excellent products with good serviceability, and (2) by backing up those products with a customer service program which can respond to your needs with speed and completeness.

The HP customer service program is one of the most important facets of our worldwide operations, providing a local service capability in virtually every one of our field offices (listed inside the back cover of this catalog.) Indeed, this customer service program is one of the major factors in Hewlett-Packard's reputation for integrity and responsibility towards its customers.

Warranty

As an expression of confidence in our products to continue meeting the high standards of reliability and performance that customers have come to expect, Hewlett-Packard products carry the following warranty:

All Hewlett-Packard products are warranted against defects in materials and workmanship. The period of coverage is specified in a warranty statement provided with each product. Hewlett-Packard will repair or replace products which prove to be defective during the warranty period. In some cases, reference is made to a requirement for preventive maintenance. No other warranty is expressed or implied. Hewlett-Packard is not liable for consequential damages.

Certification

Some customers are especially interested in the test and quality assurance programs that HP applies to its products. These Hewlett-Packard programs are documented in a Certificate of Conformance which is available upon request at the time of purchase. This certification states:

Products, materials, parts, and services furnished on this order have been provided in accordance with all applicable Hewlett-Packard specifications. Actual inspection and test data pertaining to this order is on file and available for examination.

Hewlett-Packard's calibration measurements are traceable to the National Bureau of Standards to the extent allowed by the Bureau's calibration facilities.

The Hewlett-Packard Quality Program satisfies the requirements of MIL-Q-9858, MIL-I-45208, and MIL-C-45662.

Repair service

Help in maintaining your Hewlett-Packard equipment in first-rate operating condition is as close as a telephone call to the nearest Hewlett-Packard field office. Whether you want to repair an instrument yourself, or send it to a Hewlett-Packard facility for repair, recalibration, or overhaul, your local Hewlett-Packard field office can offer a complete range of technical assistance.

Local repair facilities are backed up by Regional Repair Centers, located in major industrial areas around the world. The Regional Repair Centers have more sophisticated test equipment, factory-trained specialists, and a full line of replacement parts.

If your equipment installation is fixed, and if justified by the type of service required, Hewlett-Packard will perform service at your facility.

You have access to all of Hewlett-Packard's extensive service network through your local Hewlett-Packard field office.

Replacement parts

Replacement parts play a key role in Hewlett-Packard's customer service program. Prompt product maintenance, whether it's performed in your shop or ours, depends on the ready availability of replacement parts. Your replacement parts orders are transmitted via high speed communications systems to Parts Centers located in Germany and California. Most orders are shipped the same day received at the Parts Centers.

To sustain equipment operation in remote areas, or where equipment downtime is extremely critical, spare parts kits are available.

When ordering a replacement part, please specify the Hewlett-Packard part number listed in the table and give the complete name. If circumstances require your ordering a part without specifying the part number, please include in your order the instrument model number, its serial number, a complete description of the part, its function, and its location in the equipment.

Customer service agreements

Your instrument maintenance requirements in many cases may be handled most economically by entering into a Hewlett-Packard Customer Service Agreement. When you have a customer service agreement, HP assumes your maintenance responsibilities for a basic annual fee. This relieves you of having to hire your own trained maintenance specialist, of having to maintain replacement parts inventories, and of having to set up the administrative procedures needed for proper maintenance scheduling. Please contact your nearest HP office for details.

Service publications

The Operating and Service Manual supplied with each Hewlett-Packard test and measuring product contains maintenance, calibration, diagnostic and repair procedures, with troubleshooting charts and circuit diagrams. All replaceable parts are listed. Extra manuals are available at reasonable cost from your nearby Hewlett-Packard field office. Most operating and service manuals with changes and service notes are now available on COSATI standard, positive microfiche.

New or special calibration procedures, instrument modifications, and special repair procedures are described in detail in Hewlett-Packard Service Notes. This series of publications serves as a convenient means of updating operating and service manuals.

Bench Briefs, a periodic newsletter, has servicing tips, new modifications and other suggestions to help repair and maintenance personnel get maximum performance from Hewlett-Packard instruments. It describes new service notes and other company publications as they become available. To become a regular subscriber, ask your local HP field office to place your name on the mailing list.



With Hewlett-Packard's extensive product line and worldwide customer mix there are two main avenues for technical customer training. These are live training sessions and video tapes. Live training sessions fall into three subcategories: *applications*, *service* and *tutorial*. *Application* seminars aimed at increasing your utilization of general purpose test instrumentation are often available at no charge. On the other hand, seminars on the operation of dedicated systems are more specific in nature and are generally charged for. *Service* seminars are available on a supply-and-demand basis and, as such, there is usually a charge.

For detailed information on all HP seminars, contact your Hewlett-Packard field engineer or call the Hewlett-Packard office nearest you—see the inside back cover.

Digital troubleshooting, a 14 tape series:

This training package is available to keep service personnel up to date with current instrumentation technology.

Entitled Digital Troubleshooting Techniques, this video tape series is intended for repair technicians and other personnel desiring a practical approach to understanding digital logic circuits (order 90500).

Topics covered include: Digital vs Analog; RTL, DTL, TTL, ECL, EECL, PMOS, and CMOS, IC Technologies; Gate circuits, Troubleshooting tools and techniques; octal and binary number systems; flip flops, counters, dividers and shift registers; display technologies and data transfer techniques, and logic symbols. Also included are recommended techniques for removing ICs from P.C. boards.

HP video tapes

A better way to learn

Part of the "extra value" which comes with each Hewlett-Packard product is our continuing commitment to provide Hewlett-Packard customers with useful training information in the areas of applications and service. In the past, this information has often been in the form of classroom seminars, either at your nearby Hewlett-Packard sales office or at one of our training facilities in California.

Now our capability is expanding by offering you both service and applications training via video tape. Video tape training is exceptionally convenient and readily available, ready for your own use at any time or any place, including within your own facilities.

Effective: Hewlett-Packard has found that video tape is a highly effective training medium. Video tapes can convey more information in *less time*, and with *higher retention*, than even the best live instruction. Hewlett-Packard programs are professionally produced and are based on measurable instructional objectives. They consider what the student already knows, emphasize what he needs to know, and omit what he does not need to know. Many video tapes utilize *split-screen* techniques, allowing students to watch a procedure on one part of the screen while observing its *effect* on another part. Most Hewlett-Packard video tapes are *100% visualized*, as opposed to conventional, partially visualized video tape "lectures."

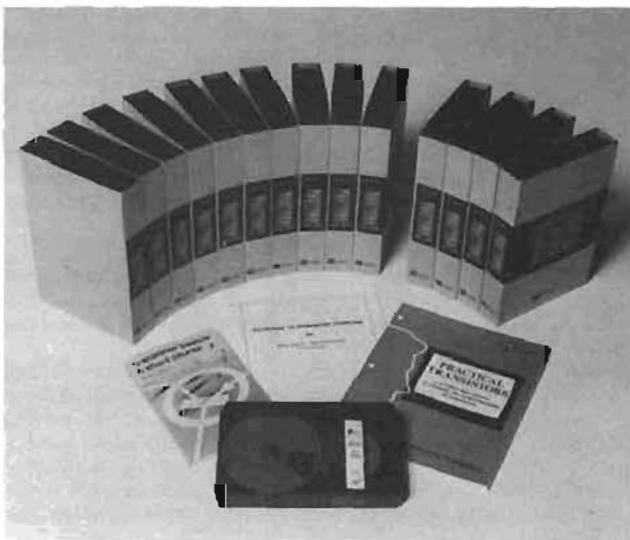
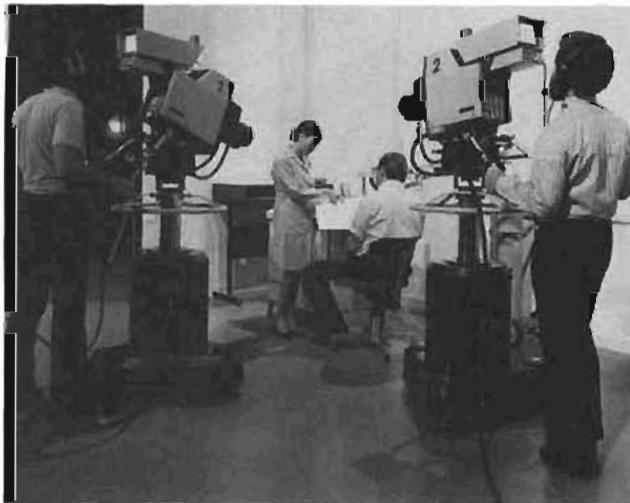

Flexible: With video tapes, you can *tailor* your training program to suit the many needs of your organization. You may select training programs for individuals with different backgrounds and specific needs, present effective programs to audiences of just one or hundreds, and offer a library of technical programs your staff members can easily consult on their own . . . for *new information* or for *refresher* purposes.

Faster: It has been our experience that Hewlett-Packard video programs *compress learning time* by a factor of up to 6-to-1. A video tape library also reduces the time needed to organize and schedule your training. You can schedule highly professional presentations anytime and anywhere, without arranging for outside instructors or juggling the detailed logistics that are often required for live training sessions. More effective training in one-sixth the time!

Convenient: Video tape programs come on small, *easy-to-file* magnetic tape reels or cassettes. Inexpensive playback equipment is easily operated by unskilled personnel. Programs may be viewed on small portable monitors or on full-screen TV sets. Video tapes can be quickly searched for specific information using "fast forward" or "fast rewind," and many recorders can stop on a single frame for more detailed study.

Time-Tested: All the video tapes offered in the Hewlett-Packard Videotape Catalog were developed to serve Hewlett-Packard's needs for a practical, low cost source of up-to-date training in a wide variety of subjects. Now, after having been tested in Hewlett-Packard training activities throughout the world, many of these video programs are available to help meet your training objectives.

A best seller

Practical Transistors, a 15-program series for training electronics service technicians, is one of the most *effective* and widely used video tape courses of its kind.

The purpose of the series is to teach technical service personnel the truly practical aspects of transistor and other semiconductor circuitry. The programs avoid the use of complex mathematical equivalent circuits, and instead concentrate on presenting a clear and understandable look at the *what, why and how of transistor circuits* and the common techniques for troubleshooting them.

Throughout the tapes, ample use is made of demonstrations to compare measured with predicted results. Actual user experience has shown that the course is not only well received by technicians, but also creates a definite improvement in their troubleshooting and maintenance performance.

This Hewlett-Packard video tape course is in wide use throughout industry, colleges and universities, technical institutes, research organizations, vocational schools, and military training departments.

A supplementary textbook and a workbook, plus a complete set of homework problems and answers, is included with the nearly nine hours of video taped material (additional texts and workbooks are available at a nominal charge). Available in $\frac{1}{2}$ " or cassette formats (order 90100). For complete details, ask for the free catalog *HP VIDEO TAPES: A Better Way to Learn* (HP 5952-0055).

A selected listing of publications to help you in your measurements



Hewlett-Packard Application Notes are a compilation of applications research and experience which have been written in collaboration with HP engineers and our customers.

Some notes are tutorial in nature, while others describe very specific "how to" procedures. Copies are available from your local field engineer or sales office.

The *Application Note Index* abstracts the current notes available. A listing of the HP instruments for which notes are available as well as a subject index are included.

If you wish to receive a copy of the Index, write on your letterhead to: Iona M. Smith, Hewlett-Packard, Marketing Communications, 19L, 1501 Page Mill Road, Palo Alto, California 94303 U.S.A.

Calculators

161-2 Transformer engineers save time, improve accuracy with calculator-aided design

HP uses its own 9830 programmable calculator to streamline design. Designs that took 4 hours manually, now take only 15 minutes.

161-4 Tracking job costs was a problem . . . until they utilized an HP 9830 calculator

A consulting company administering 250 jobs in progress at one time describes the benefits from utilization of the desktop programmable calculator. In addition to cost accounting, billing and generating major reports, the 9830 is capable of analyzing structural and mechanical problems as well as electrical design work.

Computers

202-02 Optical mark readers provide low cost data entry into an HP 3000 computer system

Combining HP 7260A optical mark readers with the 3000 mini-computer and associated remote job entry stations, data collection problems have been greatly simplified in a complex, statewide information network.

CRT Displays

199 Small screen displays—medical diagnostic system applications and interfacing

Designed to assist the designer with the task of interfacing one of three HP CRT X-Y displays with an electronic medical diagnostic system. Provides in-depth descriptions of the operation of the displays including electrical interface characteristics, packing and internal circuits.

Digital troubleshooting

167-4 thru 18 Data domain measurement series

This series of 14 notes define the data domain, explain how the concept applies to digital design and troubleshooting. The use of logic state analyzers in solving data domain measurement problems for specific microprocessor systems is described in nine of these notes. Five of the notes explain how the concept applies to digital design and troubleshooting.

Diodes

922 Applications of PIN diodes

Offers a thorough treatment of the theory and characteristics of PIN diodes, and relates these characteristics to applications such as switches, attenuators and phase shifters.

Electronic counters

173 Recent advances in pulsed RF and microwave frequency measurements

The HP 5345A 500 MHz electronic counter, together with the HP 5354A automatic frequency converter plug-in, measures pulsed RF as easily as CW signals up to 4 GHz automatically. Using high-frequency plug-in units, the range can be extended to 18 GHz.

Fourier analysis

140 Fourier Analyzer training manual

An introduction to the powerful and useful method of analyzing complex signals known as Fourier Analysis. Major applications include analyzing mechanical vibrations and sonar, seismic and neuro-physiological signals. Electronic uses include servo, filter and communications system analysis.

Frequency and time measurements

52-1 Fundamentals of time and frequency standards

Provides an introduction to the various types of time and frequency standards including cesium beam, rubidium vapor frequency standards, and quartz oscillators. Definitions of time and international standards are provided in detailed appendices.

Gas chromatography/mass spectrometry

176-18 Reactant gas selection in chemical ionization mass spectrometry

A practical guide to the use of some of the more common reactant gases. Although methane historically has been the choice reactant gas, the note shows that other gases such as hydrogen, isobutane and ammonia can be used effectively to complement chemical ionization results.

Instrumentation tape recorders

89 Magnetic tape recording handbook

Will provide you with a better understanding of the theories and techniques of magnetic recording. Practical considerations are offered relating to the application and limitations of direct and FM recording processes.

Logic test analysis

163-1 Techniques of digital troubleshooting

Explains how to troubleshoot digital integrated circuits quickly with inexpensive digital instruments. Develops an analytic algorithm that will help remedy virtually every digital IC problem.

Medical

735 Using electrically operated equipment safely

A guide for physicians, nurses, and technicians in the safe operation of monitors and other electrically operated equipment at the patient's bedside, this note includes recommended safe operating practices and cautions for hospital personnel.

Microwave measurements

155-1 Active device measurements with the HP 8755 frequency response test set

Being able to make swept-frequency measurements of such important parameters as gain and power output, gain compression, and harmonic content at a much faster rate are described. CW Gain vs Power Output is also described — a more convenient test than the traditional Gain vs Power input.

183 High frequency swept measurements

A comprehensive presentation, including test set-ups and accuracy considerations, of swept impedance and transmission measurements in both coaxial and waveguide systems.

185 Waveform parameter measurements using the microprocessor-controlled 1722A oscilloscope

Describes the operation and measurement techniques unique to the 1722A oscilloscope. Includes the waveform parameter measurements of period, frequency, pulse duration, risetime, amplitude, percent overshoot, average voltage, dc offset, propagation delay, and percent RF modulation.

198 Automatic measurements using the HP 436A microwave power meter

Describes five practical mini-systems which can be built around the HP Interface Bus compatible 436A power meter under calculator control. Included are procedures for automatically recording power measurements, generating a 50 dB dynamic range logarithmic recorder output, calibrating signal generators, precisely measuring attenuation, and verifying power sensor cal factor.

Network analysis

117-1 Microwave network analyzer applications

Discusses the basic theoretical concepts of microwave measurements, and presents a complete description of the HP 8410 network analyzer system.

117-2 Stripline component measurements

Describes how stripline components may be characterized in terms of s-parameters over the frequency range from 0.5 to 12.4 GHz using the HP 8410A network analyzer.

Optoelectronics

951-1 Applications for low input current, high gain optically coupled isolators

Optically-coupled isolators are useful in line receivers, logic isolation, power lines, medical equipment, and telephone lines. This note discusses use of the 5082-4370 series high CTR isolators in each of these areas.

951-2 Linear applications of optically coupled isolators

In many cases, isolators can replace expensive transformers, instrumentation amplifiers, and A/D conversion schemes to transfer an analog signal between two isolat-

ed systems. Several circuit techniques using 5082-4350 isolators are explained.

Oscillators

174 series Systems using the HP 5345A counter and HP desktop programmable calculators

There are 13 notes in this series describing HP Interface Bus systems. Each note describes a measurement set-up, discusses important measurement considerations, and provides a complete listing of the 9820/21 and 9830 calculator programs. For a copy of the index, request Pub Number 02-5952-7348.

Oscilloscopes

185 Waveform parameter measurements using the microprocessor-controlled 1722A oscilloscope

Describes the operation and measurement techniques unique to the 1722A oscilloscope. Includes the waveform parameter measurements of period, frequency, pulse duration, risetime, amplitude, percent overshoot, average voltage, dc offset, propagation delay, and percent RF modulation.

186 Dual-delayed sweep for precise time interval measurements

Explains why brief time interval measurements are easier with the use of a dual-delayed sweep oscilloscope.

Physical and optical measurements

Measuring with the HP 3810A total station—detail and location surveying

Explains the advantages of using the new HP Total Station in place of conventional equipment, i.e., levels, transits, theodolites, tapes or slope distance measuring instruments. Measure and automatically display horizontal, slope and vertical distances, plus measure electronically horizontal and zenith angles. Publication Number 5952-9124.

Power supplies

128 Applications of a DC constant current source

Discusses the desirable features of a constant current source. Applications are divided into 3 groups: resistance measurements, semi-conductor device measurements and component testing. Other applications are cited in the cryogenic and electrochemical laboratories. Each application is well illustrated and includes details necessary for the reader to immediately perform the tests or measurements using the HP 6177B, 6181B, and 6186B.

Pulse and word generators

195 Pulse generator techniques in CMOS applications

This note offers a brief introduction to CMOS technology, explains the tests required to evaluate CMOS devices, and describes the pulse generator techniques for making tests and measurements.

Quartz pressure gauge saves money

A field case study in the North Sea is presented. The HP 2811B quartz pressure probe shortens test time and increases pressure testing capability for use in oil exploration and production. Pub. No. 5952-4926.

Synthesized signal generators

164 Using the 8660 synthesized signal generator

A four-part series of notes covering programming of the 8660C, phase lock loop analysis techniques, and principles of phase modulation.

187-4 Configuration of a two-tone sweeping generator

Describes a configuration of a source which will allow sweep testing of mixers, receiver front ends, etc. Measure parameters including conversion loss, RF and IF bandwidths, isolation, noise figure and phase and amplitude tracking. Cut test time from hours to minutes in the 1–300 MHz IF range.

Spectrum analyzers

150 Spectrum analysis . . . spectrum analyzer basics

Describes the theory and operation of spectrum analyzers and their applications. Includes information on the fundamentals, harmonic mixing, preselection, and tracking generators. Also included is a glossary of spectrum analyzer terms.

192 Using a narrow band analyzer for characterizing audio products

Describes the use of the HP 3580A spectrum analyzer and the HP 3581 wave analyzer to provide an inexpensive and easy-to-use method to make swept response measurements faster than the simple oscillator, voltmeter system.

Telecommunications test equipment

175-1 Differential phase and gain at work

Is intended to provide a more complete understanding of the swept frequency measurements performed by the HP microwave link analyzer (MLA). The relationships between telephony baseband distortion and swept measurements are clearly defined.

Time interval measurements

191 Time interval measurement using an electronic counter

Time interval measurement is discussed from the theoretical side to point up factors having great influence on measurement accuracy as well as practical applications for specific measurements including pulse width and spacing on a complex pulse train and phase measurement.

Transistors

967 A Low noise 4 GHz transistor amplifier using the HXTR-6101 silicon bipolar transistor

Describes the design of a single-stage state-of-the-art low noise amplifier at 4 GHz.

X-ray

Describes the use of the Faxitron 43805 for nondestructive testing at your workbench or in your lab. Look inside encapsulated components, pinpoint defects in electronic assemblies, castings, or quickly view registration problems in PC boards. Applications requiring 10 kV to 130 kV as well as an explanation of the automatic exposure control are included. Order Pub Number 5952-6700.