

HP Archive

This vintage Hewlett Packard document was preserved
and distributed by

[www. hparchive.com](http://www.hparchive.com)

Please visit us on the web !

On-line curator: Glenn Robb

HEWLETT  PACKARD
MEASUREMENT/COMPUTATION

ELECTRONIC INSTRUMENTS AND SYSTEMS 1979





AT HEWLETT-PACKARD

Our business is the practical application of high technologies. HP applies its scientific and engineering resources to two fundamental areas: Measurement and Computation. More than 4000 HP products are involved with measurement or computation, or both, and are applied to customer needs in science, industry, medicine and education.

HP does research, development, marketing, and manufacturing in 32 facilities in 8 countries. Annual sales are approaching two billion dollars, of which approximately 10 percent goes to research and development. At this level of commitment, HP can employ the latest technologies to innovate products that can be reliably produced, delivered, and supported on a continuing basis.

Worldwide Support

All HP products come with complete documentation, including instructions to operate them effectively. Wherever they are sold, worldwide, they are supported by customer training programs, assistance by systems analysts and customer engineers where required, and a worldwide network of parts and repair centers for maintenance and service.

Customer Experience

Because all HP products are functionally interrelated, the exchange of ideas throughout Hewlett-Packard is continuous. A technological achievement in one product area often contributes to improved capabilities in other products and systems. Similarly, the wide range of customer needs improves HP's sensitivity and response to more than the 100,000 customer organizations served. Thus, a Hewlett-Packard customer is an integral part of a versatile and resourceful organization which thrives on the exchange of ideas and experience. To locate the HP office nearest you, please see the listing inside the back cover of this catalog.

CONTENTS

ALPHABETICAL INDEX	1
MODEL NUMBER INDEX	10
After-Sale Service	671
Application Notes	665
Information Request Card	back of catalog
Ordering Information	672
Sales/Service Offices	inside back cover
Warranty	671

PRODUCTS:

Amplifiers	32	Medical Instrumentation	658
Analog Voltmeters	35	Microwave Test Equipment	427
Board Test Systems	105	Network Analyzers	448
Cabinets & Measurement Accessories	540	Oscillators & Function Generators	345
Calibrators	368	Oscilloscopes	150
Cathode-Ray Tube Displays	194	Personal Calculators	608
Chemical Analysis, Instruments for	656	Physical & Optical Measurements	648
Civil Engineering/Surveying	660	Power & Noise Figure Meters	418
Component Measurement	78	Power Supplies	214
Computation: Computers, Systems/ Peripherals	614	Pulse & Word Generators	319
DC Power Supplies	214	Recorders, Printers & Plotters	242
Digital Circuit Testers	110	Signal Analyzers	480
Digital Voltmeters	46	Signal Generators	372
Electronic Counters	286	Sweep Oscillators	397
Frequency Synthesizers	358	Solid State Components & Circuits	652
Frequency & Time Standards	274	Telecommunications Test Equipment	558
Hewlett-Packard Interface Bus (HP-IB)	20	Training/Video Tapes	661
Logic Analyzers	122	Transceiver Test Equipment	556
		X-Ray Systems, Scientific & Industrial	647



Identifies products having the Hewlett-Packard Interface Bus (HP-IB) capability. HP-IB is our implementation of the IEEE Standard 488 and the identical ANSI Standard MC1.1, "Digital interface for programmable instrumentation." For the complete story, see pages 20-31.



Identifies newly introduced products or capabilities. New products are also indicated by boldface listings in the Model Number Index.

- A**
- AC**
- Calibrator 370, 371
 - Current Probe 555
 - Digital Voltmeter 46-77
 - Divider Probe 554
 - Probes 555
 - Resistance Meter 94-95
 - True RMS Voltmeters 35-77
- Accessories**
- Cables/Connectors 552
 - Cameras 189
 - Carrying Cases 546-551
 - Connectors, Adapters 553
 - Modular Enclosures (System II) 540-545
 - Modular Power Supplies 239
 - Oscilloscope 182
 - Signal Generators 396
 - SLMS 595
 - Spectrum Analyzer 515
 - Transit Cases 548
 - Voltmeter 73
- AC/DC Meter Calibrator** 368, 369, 555
- Active Probes** 185, 595
- Adapters**
- 50-75Ω 396, 465, 469, 515
 - Cables/Connectors 396, 552, 553
 - Coaxial and Waveguide 441
 - Four Channel 343
 - Slotted Line Sweep 433
- Air Line Extensions** 441
- Alphanumeric LED Displays** 652
- Alphanumeric Printer** 624-627
- AM/FM Signal Generators** 374, 378, 381, 386
- AM/FM/ΦM Modulation Analyzer** 536
- Amplifiers**
- AC Calibrator/High Voltage 370, 371
 - AC Carrier Preamplifier 263
 - Broadband Preamp 33, 312
 - Frequency Standard Distribution 284
 - General Purpose 32
 - Logarithmic 45
 - Low Noise 595
 - Plug-Ins for
 - Oscillographic Recorders 263-265, 267-269
 - Power 34
 - Power Supply 235
 - RF/Microwave 33, 34
- Analog Board Tester** 108, 109
- Analog-to-Digital Converter** 26, 646
- Analytical Instrumentation** 656
- Analizers**
- Automatic Network 453-455, 466, 478
 - Audio Spectrum 488-491, 506, 518-522, 524
 - Automatic Spectrum 488-491, 497, 527-529
 - Bus System 25
 - Correlation 522, 524
 - Data Line 574
 - Digital Signal 488-491, 518-522, 524
 - Distortion 488-491, 522, 524, 530-532
 - Fourier (FFT) 518-522, 524
 - Frequency Stability 522, 538
 - Gain-Phase 456, 457, 518-522, 524
 - Logic 122-149
 - Low Frequency Spectrum 506, 516, 517, 522, 524
 - Mechanical Impedance 522, 524
 - Microwave Link 602
 - Modulation 536
 - Network 448-479, 518-522, 524
 - Noise 488-491, 522, 524, 538
 - Power Spectrum 522, 524
 - Primary Multiplex 560
 - RF Signal Modulation 536
 - Serial Data 147
 - Spectrum 177, 488-515, 518-522, 524, 525
 - Signature 110, 118
 - Telephone Line 572
 - Timing, Logic 144
 - Transfer Function 518-522, 524
 - Vibration 522, 524
- Application Notes** 665-670
- Application Terminals** 637
- APC-7 Series Adapters** 553
- Atomic Clock/Frequency Standard** 274
- Attenuators**
- 75 ohm General Purpose 605
 - Coaxial, Fixed 428
 - Coaxial, Microwave, OEM 432
 - High Power Microwave 428
 - HP-IB Driver 430
 - Coaxial Step 430, 432
 - Waveguide 432
- Automatic Calibration DMM** 66-69
- Automatic Capacitance Bridge** 85
- Automatic Data Acquisition System** 293
- Automatic Data Logger** 272, 273
- Automatic LCR Meter** 94, 95
- Automatic Measurement & Control Syst.** 26, 629, 643
- Automatic Microwave Counters** 292, 314-317
- Automatic Modulation Analyzer** 536
- Automatic Test Systems** 74, 106-109, 453-527, 466, 478, 497, 556, 628, 643
- Automatic Network Analyzer** 466, 478
- Automatic Synthesizer** 352, 353
- Automatic Spectrum Analyzer** 488-491, 497
- Automatic Transceiver Test System** 556
- B**
- Balanced 2/4-wire Audio Channel Selector** 563
- Battery Operated**
- Counters 303, 304, 307-312
 - DVM 49-53, 58-63
 - Microwave Power Meter 420, 424
 - Multifunction Meter 49-53, 60-63
 - Voltmeter 49-53, 60-63
- Board Tester, Analog** 108, 109
- Board Tester, Digital** 106, 107
- Bridge, Directional** 444, 464, 469
- Broadband Detectors** 436
- Business Computers** 615
- Broadband Sampling Voltmeter** 44, 56, 57
- C**
- Cables/Connectors 552
 - Cabinet X-Ray Systems 647
 - Cabinets 540-551
 - Cabinets, System II 540-545
 - Cable Assemblies 552-554
 - Calculators, Personal
 - Business 611, 612
 - Printing 609, 612

ALPHABETICAL INDEX

- Programmable 609-612
 Scientific 609, 610
 Calibration Data, Attenuators 429
 Calibrators
 AC 369-371
 Power Meter Calibrator for
 432 Series Power Meters 425
 Range Calibrator for 435A Power Meter 421
 Peak Power 425
 Cameras
 Adapters 190
 Oscilloscope 189
 Oscilloscope Camera Adapter Table 191
 Capacitance Bridges; Meters 78-97
 Capacitive Voltage Divider 554
 Capacitors, Decade 104
 Card Readers 625, 636
 Card Reader for 1600A Logic State Analyzer 142
 Carriage, Slotted Section 433
 Carrier Preamplifiers 267
 Carrier Testing 588
 Cartridge Disc 642
 Cartridge Tape Unit 623
 Cases, Combining 546
 Cavity Frequency Meters 437
 Cesium Beam Frequency Standard 276
 Chromatographic Data Systems 656
 Circuit Board Test Systems 105-109
 Civil Engineering Products 660
 Clips, Logic 114
 Clip, IC Test 183
 Clip-on, DC Milliammeter 38
 Clip-on, AC Current Probe 555
 Clock, Atomic 274
 Coaxial Instrumentation
 Accessories 552, 553
 Attenuators 428, 430, 432
 Crystal Detectors 436
 Directional Bridge 444, 464, 469
 Directional Couplers 434
 Directional Detectors 435, 607
 Dual Directional Coupler 434
 Fixed Attenuators 428
 Filters 176, 439, 445
 Frequency Meters 437
 Harmonic Mixer 439
 High Pass Filter 176
 Low-Pass Filters 439, 445
 Pad. Attenuators 428
 Power Splitter 444, 464, 470
 Sliding Load 438
 Slotted Line 433
 Slotted Section 433
 Step Attenuators 430, 432
 Swept Slotted Line Systems 433
 Switch 440
 Termination 438
 Thermistor Mount 425
 Thermocouple Mount 422
 Waveguide Adapters 441
 Comb Generator 515
 Combining Cases 546
 Communications, Data 558, 568
 Communications Test Equipment 147, 558-607
 Communications Test Set 578, 579
 Comparator, Logic 115
 Component Measurement 78-104
 Components, Microwave, OEM 432, 436, 440
 Component Oscillators 283
 Digital IC Tester 100
 Digital IC Test System 102
 Digital IC Tester Interface Kit 103
 Computers & Peripherals 30, 31, 614-646
 Application Terminals 637
 Business, Small 615, 616
 Desktop 30, 31, 620-622
 Disc Drives 627, 640, 641
 Disc Media 642
 Display Terminals, CRT 630
 External Tape Memory 625
 Line Printer 624, 625, 639
 Plotter 252-256, 624
 Printing Terminals 638
 Serial Interface 624
 Computer-based Network Analyzer 453-455, 466, 478
 Computer-based Spectrum Analyzer 497
 Computer (Desk Top)
 Controlled Instrument Systems 643
 Computer System Test 147
 Computing Controller 30, 31, 620-622
 Connector Adapters 553
 Connectors, Microwave Precision 441, 553
 Constant Current Sources 234
 Controller, Vibration 524
 Controllers for HP-IB 30, 31
 Converters
 A-to-D 26, 46-72, 646
 D-to-A 26, 646
 DC to DC Converters 238
 HP-IB Programmable 26
 Series-to-Parallel Converters 26
 Correlator 522, 525
 Counters, Electronic 286-318
 Auto. Ranging 308, 309, 311
 Counter/Timer 309, 311
 Counter/Tracking Generator 508
 Digital Multimeter/Counter 310
 DVM 299, 300
 F&T Data Acquisition System 293
 Heterodyne Converter Plug-Ins 292, 297
 Low Cost 313
 Microwave 292, 297, 314-317
 Plug-In Adapters 292
 Portable, Battery Operated 303, 304, 307-312
 Programmable 298, 312
 Reciprocal 289, 311
 Time Interval 289, 297, 303, 304, 308, 309, 311
 Time Interval Probes 318
 Universal 294, 298, 308, 311
 Couplers, Directional (Coax and Waveguide) 434, 435
 CRT Displays 194
 CRT Terminals 630
 Crystal Detectors 436
 Crystal Oscillators 282, 283
 Current
 Divider 554
 Probe 186, 555
 Sources 234
 Current Tracer, Logic 113

 D
 D/A Converter 26, 646
 Data
 Acquisition Systems 74, 75, 293
 Attenuator Calibration 429

Capture/Data Retrieval Terminal 637
 Communications 568
 Generator 336, 338, 344, 564
 Line Analyzers 574
 Logger 272, 273
 Normalizer 463, 479
 Serial Analyzer 147
 Transmission Test Set 568
 Voice Channel Test Set 578-581, 584

DC

Amplifier 235
 Amplifier Plug-In Module 244
 Attenuator Plug-In Module 244
 Bridge Amplifier 263
 Coupler Plug-In Module 244
 Digital Voltmeter 46-53, 56-72
 Milliammeter 38
 Nullmeter 37
 Offset Plug-In Module 244
 Preamplifier Plug-In Module 244
 Voltage Divider 554
 Voltmeters 35, 46

DC-to-DC Converters 238

DC Power Supplies 214

Amplifier/Power Supply 235
 Condensed Listing 216
 Constant Current Sources 234
 Digitally Controlled 228, 229, 240, 241, 643
 Dual Tracking 230
 General Information 214
 General Purpose: 25-200 W Output 222
 General Purpose: 100-2000 W Output 224
 General Purpose: 300-11,000 W Output 226
 High Voltage 231
 HP-IB Programmable 26, 228, 229, 240, 643
 Low Cost Lab 218-221
 Microprocessor 220, 238
 Modular, DC-to-DC Converters 238
 Modular, Single Output, Series Regulated 238
 Modular, Dual Output, Series Regulated 238
 Modular, 200-600 W, Switching Regulated 238
 Modular, 110 W Switching Regulated 238
 Modular, Triple-Output Switching 238
 Options 236
 Precision Voltage Sources 232
 Programmable 228, 229, 240, 241, 643
 Specifications Definitions 215

Decade Capacitors and Attenuators 104

Delay Generator/Frequency Divider 26, 324, 335

Delay and Rate Plug-ins 328, 334, 335

Desktop Computers and Peripherals 30, 31, 620-627

16-bit Parallel Interface 624
 16-bit Duplex Interface 643
 BCD Input Interface 624
 Card Reader 625, 636
 Cartridge Tape Unit 623
 Character Impact Printer 627
 Desktop Computers 30, 31, 620-622
 Digitizer 623
 Disk Interface 625
 External Tape Memory 625
 Flexible Disk Drive 627
 General Interface 624
 HP-IB Interface 624, 643

High-Speed Tape Reader Subsystem 625
 Hopper Card Reader 625
 Incremental Plotter Interface 624
 I/O Expander 625, 643
 Line Printer Subsystem 624
 Mass Memory Subsystem 625
 Paper Tape Punch 625
 Paper Tape Reader 625
 Plotter (Incremental) Interface 624
 Real Time Clock Interface 624
 Serial Interface 624
 RS-232-C Serial Interface 624
 Tape Cartridge Unit 623
 Tape Cassette Unit 625
 Tape Punch Subsystem 625
 Thermal Printer 254, 255, 625
 X-Y Plotter 252-256, 624

Detectors

Coaxial, Microwave, OEM 436
 Crystal, Coaxial and Waveguide 436, 437
 Directional 435, 607
 Error 564
 Slotted Line 433

Diagnostic Kit 595

Digital

AC Voltmeters 39-44, 64, 65
 Analyzer, Logic 122
 Analyzer, Signature 118
 Board Tester 106, 107
 Capacitance Meter 78-98
 Circuit Test 105-107, 110
 Clock 26
 Comparator, Logic 115
 Computers 614-646
 Current Tracer 113
 DC Voltmeters 35-40, 49-72
 IC Tester, Interface Kit 103
 IC Tester 100
 IC Test System 102
 Impedance Meter 94, 95
 Interface (HP-IB, IEEE, ANSI) 30, 31, 624
 LCR Meter 88-91, 94, 95
 Microprocessor Troubleshooting 110, 118
 Microprocessor Training 121
 Multimeter 39, 40, 49-72
 Ohmmeter 39, 40, 49-53, 60-72
 Oscillator 349
 Pressure Gauge 650
 Printer 254, 272, 273
 Programmable Power Supplies 228, 229, 240, 643
 Magnetic Tape Units 623, 625
 Signal Analyzers 480, 488-491, 518-522, 524
 Signature Analyzer 110, 118
 Spectrum Analyzers 488-491, 518-522
 Storage Unit 463, 479
 Test Set, Digital Logic 116
 Thermometer 64, 65, 651
 Training 120
 Trouble Shooting 661
 Vibration Controller 524
 Voltmeters 46-72

Digital-to-Analog Converters 26, 228, 643

Digitizer 623

Dimensional Measurement 649

Diode Tester 64, 65

Diodes 654

- Directional Bridge 444, 464, 469
 Directional Couplers
 Coaxial 434
 Waveguide 435
 Directional Detectors 435, 607
 Disc Cartridge 642
 Disc Drives 627, 640, 641
 Disc Media 642
 Disc Pack 642
 Displays, Cathode-Ray Tube 194-213
 Graphics Translator (HP-IB Interface) 196
 Large Screen 201-204
 Small Screen 205-213
 Tricolor 200
 Distance Meter 660
 Distortion Analyzers 527-532
 Distribution Amplifier 284
 Divider Probe 554
 Double Balanced Mixers 655
 Down Converter, 0.5 to 550 kHz, (1 to 12 GHz, to 70 MHz or 140 MHz IF) 606
 Down Converter, 10 kHz to 11 MHz 385
 Dual Tracking, Power Supply 230
- E**
 EIA Registered Visible Light Emitting
 Diodes 653
 Electronic Counters 286-318
 Equalizers, Cable 595
 Envelope Analyzer, Modulation 536
 Error Measuring Set (1 kb/s - 50 Mb/s) 566
 Error Measuring Set (1 kb/s - 150 Mb/s) 564
 Error Rate Measurement 564, 566
 Expander, I/O 625, 643
- F**
 Faxitron® X-Ray Systems 647
 Fiber Optic Power Meter 419
 Filters
 Bandpass 396, 512
 Coaxial and Waveguide 439, 445
 High Pass 176, 445
 Low Pass 439, 445
 Low Pass Plug-In Module 245
 Four Channel Adapter 343
 Four Channel Scanner 64, 65
 Four Channel TTL-CMOS Translator 343
 Fourier Analyzer 518-524
 FM Modulation Analyzer 536
 FM Signal Generators 374, 378, 381, 386
- Frequency**
 Counters 286-318, 646
 Counter/Modulation Analyzer 536
 Counter/Track Generator 508
 Doublers 394
 Meters, Coaxial and Waveguide 437
 Response Test Set 442
 Stability Analyzer 538
 Synthesizer, Microwave 378, 380
- Frequency Standards** 274
 Cesium 276
 Distribution Amplifier 284
 General Information 274
 Quartz 282
 Rubidium 276
 Standby Power Supplies 285
- Frequency Doubler** 393, 396
Frequency and Time Standards 274
Frequency Selective Voltmeter and Tracking Oscillator 533
Frequency Synthesizers 352, 353, 358-367, 374, 378, 380
Function Generators 350-354
Fuseholder, RF 396
- G**
 Ga As Field Effect Transistors 654
 Gas Chromatographs 656
 General Purpose Interface Bus Controllers 30, 31
Generators
 Data 338, 344, 564
 Noise 526
 Pattern 336, 566
 Pulse 112, 320
 Signal 372-394
 Square Wave 349
 Sweep 352, 354, 358-367, 397-417
 Tracking 498, 502, 506, 508, 510, 513, 598, 599
 Word 319
 Graphic Plotters 242, 243, 252-256
 Graphics Plotters Terminal 252-256
 Graphics Translator (HP-IB Interface for displays) 196
 Graphics Printer 638
 Group Delay (Network Analyzer) 460
 Group Delay Network Computer 252-256
 Guarded Digital Multimeter 66-69
- H**
 Harmonic Analyzer 522
 Harmonic Mixer (Coaxial and Waveguide) 439
 Hewlett-Packard Interface
 Bus (HP-IB) 20-31
 High Gain Preamplifier 267
 High Power Attenuators 428
 High Power Attenuators 422
 Hi-Rel Numeric Displays 652
 HP-IB controlled attenuator/switch 430
 HP-IB controlled Channel Selector 26, 563, 643
 HP-IB Extender 310
- I**
 IC Tester, Digital 100
 IC Test System, Digital 102
 Impatt Diodes 655
 Impedance Meter 88-97, 99
 Impedance Meter, RF Vector 99
 Impedance Probe 469
 Impedance Transformers (50-75Ω) 465, 469, 515
 Input/Output Computer Cards 646
 Inspection Systems, X-Ray 647
 Instrument Accessories 540-555
 Instrument Cart 595
 Insulation Resistance Meter 82
 Insulation Test 82
 Integrated Products 655
 Intelligent Terminals 630
 Interface Bus 20-31
 Interface Cards for Desktop Computers 30, 31, 624, 625
 Interface Cover for 1645A 571
 Interface, Digital (HP-IB, IEEE, ANSI) 30, 31, 624, 625
 Interface Kit, Digitally Controlled Power Supply 240
 Interface Kit, Multiprogrammer 645

Integration Services, ATS 628
 Intermodulation Analyzer 522
 Inverter Power Supply (1700 Series Oscilloscopes) ... 188
 I/O Expander for Desktop Computers 625

L

Laboratory, Strip Chart Recorders 242, 243, 257-262
 Laboratory, X-Y Recorders 242-251
 Laser Measurement 649
 Laser Transducer 649
 LCR Meter 85, 88-91, 94, 95
 Light Emitting Diodes 652
 Limiter 515
 Liquid Chromatographs 656
 Loads/Termination, Coaxial and Waveguide 438
 Logarithmic Preamplifier 268
 Logarithmic Voltmeter 45
 Logging Multimeter 64, 65
 Logic
 Analyzers 118, 122-149
 Analyzer, Personality Modules for 1611A 129
 Clip 114
 Current Tracer 113
 Comparator 115
 Lab 120
 Pattern Generator 336
 Probes 111
 Pulser 112
 Troubleshooting Kits 116
 Low Distortion Generator 347, 366, 367
 Low Distortion Measurement Set 530, 531
 Low Frequency Spectrum
 Analyzer 506, 516-522, 524
 Low Gain Preamplifier 263-265, 267
 Low Resistance Meter 81

M

Machinery Analyzer 522, 524
 Magnetic Tape Recorders, Analog 270, 271
 Mark Reader, Optical 636
 Marker Generator 400
 Mass Spectrometers 656
 Mechanical Impedance Analyzer 522, 524
 Medical Instrumentation 658, 659
 Medium Gain Preamplifier 263-265, 267
 Medium Range Distance Meter 660
 Memory Systems 625, 627
 Meters
 AC 38-45, 49-72
 AC Resistance 94, 95
 Capacitance 85, 88-97
 Conductance 94, 95
 Digital Multimeter 46-72
 ESR 94, 95
 Frequency 437
 Gain Phase 456
 High Capacitance 92, 93
 Impedance 83-95
 LCR 78-91, 94-95
 Logarithmic Voltmeters 45
 Milliammeter AC 60, 555
 Milliammeter, DC 38, 60
 Milliohmmer 62, 81
 Modulation 536
 Multifunction 39, 40, 49-53
 Noise Figure 426

Ohmmeter 39, 40, 49-53, 60-75
 Peak Power 425
 Phase 94, 95
 Power (RF/Microwave) 420, 421, 424
 Reactance 94, 95
 Standing-Wave-Ratio (SWR) 447
 Susceptance 94, 95
 True RMS 43, 54, 62, 64-66, 70
 Microprocessor Power Supplies 220, 238
 Microprocessor Troubleshooting 110, 118
 Microprocessor Training 121
 Microwave
 Catalog 427
 Counters 314-317
 Link Analyzers 602
 Power Measuring Equipment 418-425
 Radio Testing 601
 Signal Generators 372-393
 Synthesizer 378, 380
 Test Equipment 427-447
 Milliohmmer 62, 66, 81
 Mixers, Coaxial and Waveguide 439, 515
 Modal Analysis 522, 524
 Modem 29
 Modular Power Supplies 238
 Modulation Analyzer 536
 Modulators, PIN 394, 395
 Motor Controller, Programmable 646
 Multi-frequency LCR Meter 94, 95
 Multimeter 39, 40, 49-53, 64, 65
 Multiple Span Plug-In Module 259
 Multiplex (Primary) Analyzer 560
 Multiplexer 646
 Multiprogrammer 643

N

Network Analysis, General Information 448-452
 Network Analyzers 448-479, 488-491, 522
 Automatic 466, 478
 Noise
 Analyzer, Acoustic 522, 524
 Analyzer/Modulation 536
 Figure Meter 426
 Generator 526
 Source (IF) (UHF) (VHF) and Waveguide 426
 Normalizer, Data 463, 479
 Null Detector Plug-In Module 245
 Null meter 37
 Numeric LED Displays 652

O

OEM

Component Oscillators 283
 Computers 620, 622
 Displays, CRT 194
 Microwave Attenuators 432
 Microwave Crystal Detectors 436
 Microwave Switches 440
 Modular Power Supplies 237
 Strip Chart Recorders 257-262
 X-Y Recorders 244-251
 Ohmmeters 38, 40, 49-53, 60, 62, 64-66, 70
 Optical Mark Readers 636
 Optoelectronics 652, 653
 Ordering Information 672
 Oscillators

- Audio 346-349
 Function Generator 350-354, 356
 General Information 345
 Low Distortion 347
 Low Frequency 346, 350-354
 Quartz 282
 Quartz Component 283
 Sweep 351, 352, 358, 397-417
 Telephone Test 581
 Test 355
 Tracking 534, 535
 VHF 394
 Oscillographic Recorders 263-269
 Oscilloscopes 150-193
 Accessories 182
 Cameras 189
 Contrast Filters 187
 100 MHz Third-Channel Trigger View 154
 100 MHz Variable Persistence Storage,
 Third-Channel Trigger View 154
 100 MHz Delta Time,
 Third-Channel Trigger View 154
 100 MHz Crystal Delta Time,
 Third-Channel Trigger View 154
 100 MHz Fast Variable Persistence Storage,
 Third-Channel Trigger View 154
 200 MHz Delta Time Measurements 160
 275 MHz Delta Time Measurements 160
 275 MHz Delta Time Measurements with
 Microprocessor 160
 General Information 150
 High Writing Speed Mainframe 166
 Inverter Power Supply for 1700 Series Oscilloscopes 188
 Large Screen Mainframe 166
 Light Shields 187
 Low Frequency 178
 Plug-In, 180 series 164
 Rack Mount Slides and Adapters 187
 Sampling 173-176
 Spectrum Analyzer Plug-In 177, 500, 502
 Testmobiles 192
 Variable Persistence Storage 156, 167
 Viewing Hoods 187
 Outside Plant Telecommunications
 Test Equipment 585
P
 Pack, Disc 642
 Pad, Coaxial Attenuator 428
 Pattern Generator/Error Detector 566
 PC Board Testers 105-109
 PCM Test Equipment 558-567
 Peak Power Calibrator 425
 Peak Power Meter, Analog 425
 Personal Calculators
 Accessories 613
 Financial Pocket Calculators 611, 612
 Scientific Pocket Calculators 609, 610
 Briefcase 612
 Personality Modules 128, 242, 256
 Phase Meters 94, 95, 458, 460, 468, 470, 471
 Phase Modulation Analyzer 536
 Phase Modulation, Signal Generator 374
 Phase Sensitive Demodulator Preamplifiers 268
 Physical & Optical Measurements 648
 PIN Diodes 654
 PIN Modulators, Microwave 394, 395
 PIN Photodiodes 653
 Plotter, Graphic 242, 243, 252-256
 Plotter/Printer 254, 255
 Plotter, X-Y 242, 243, 252-256, 624
 Plug-In Counters 289, 296
 Plug-In Oscilloscopes 164
 Plug-In Pulse Generator System 328
 Point Plotter Plug-In Modules 245
 Portable
 Calculators 608-613
 Counters 303, 304, 307-312
 Desktop Computers 30, 31, 620-622
 Instrumentation Tape Recorders 270, 271
 Signal Generators 386
 Strip Chart Recorders 262
 Test Set 584
 Voltmeter 49-53, 60-63
 X-Ray Systems 647
 Power Meters, RF & Microwave 420, 421, 424
 Power Sensors
 Fiber Optic 419
 RF & Microwave 422, 425
 Power Meter Calibrators 421, 425
 Power Meter/Modulation Analyzer 536
 Power Splitter 444, 464, 470
 Power Supplies
 Amplifier/Power Supplies 235
 Atomic Clock 235, 285
 Condensed Listing 216
 Constant Current Sources 234
 Digitally Controlled 26, 228, 229, 240, 643
 Dual Tracking 230
 Frequency Standards 285
 General Purpose: 25-200 W Output 222
 General Purpose: 120-2000 W Output 224
 General Purpose: 300-11,000 W
 Output 226
 High Voltage 231
 HP-IB Programmable 26, 228, 229, 240, 643
 Inverter for 1700 Series Oscilloscopes 188
 Low Cost Lab 218-221
 Microprocessor 220, 238
 Modular, DC to DC Converters 238
 Modular, Single Output, Series Regulated 238
 Modular, Dual Output Series Regulated 238
 Modular, 200-600 W, Switching 238
 Modular, 110 W, Switching 238
 Modular, Triple-Output Switching 238
 Precision Voltage Sources 232
 Programmable 26, 228, 229, 240, 643
 Specifications Definitions 215
 Standby 285
 Transistor Bias Supply 476
 Power Supply/Amplifier 235
 Practical Transistors 663
 Preamplifiers 33, 263-265, 267-269, 312
 Precision Coaxial Connectors 553
 Precision Frequency Source 274, 352, 353
 Precision Oscillator 283, 358
 Precision Voltage Sources 232
 Preselector 512
 Printer, Character Impact 627
 Printer, Instrumentation 272, 273
 Printer, Line 624, 625

Probes

Accessories 183, 187, 554
 Active 185, 469, 595
 Cable Assembly 184, 552
 Current 38, 113, 186, 554
 Digital Multimeter 49-72
 Frequency Doubler 394
 High Frequency 73, 554
 Impedance 469
 Jumper Cable 184
 Logic 111
 Miniature 182
 Passive 595
 Slotted Line 433
 Trigger (TTL) 143
 Time Interval 318
 Voltage Divider 182, 554
 Process Control Interface 643
 Programmable
 Counters 646
 Programmable Pulse Generator 322
 Programmable Signal Source 356
 Pulse and Word Generators 319
 Pulse Generators 112, 319, 320, 324
 Pulse Modulator 394, 395
 Pulse Pattern Generator Plug-ins (1900 System) 328
 Pulse/Word Generator System, 300 MHz/1 GHz 334, 335
 Pulsers, Logic 112

Q

Q-Meter 98
 Quartz Component Oscillator 283
 Quartz Frequency Standard 282
 Quartz Pressure Gauge 650
 Quartz Thermometer 651

R

Radiology 659
 Random Noise Generator 426
 Range Calibrator (for 435A Power Meter) 421
 Readers, Card 625, 636
 Reader, Optical Mark 636
 Real Time Application Terminals 637
 Reciprocal Counters 289, 304, 311
 Recorders
 Oscillographic 263-269
 Portable Instrumentation Tape 270, 271
 Strip Chart 257-262
 X-Y 244-251
 Reflection/Transmission Test Sets 444, 464, 469, 475-477
 Reflectometer Bridge 444
 Relay Output Cards 646
 Relay Register 26, 646
 Remote Automatic Surveillance Systems 596
 Repetition Rate Generators (8080 System) 333
 Resistance Meter 38, 39, 49-53, 64-72, 80-82
 Return Loss Kit 595
 RMS Voltmeter 37-43, 49-53, 64, 65
 Rotary Air Line, Coaxial 441
 Rotary Joint, Coaxial 441
 Rotary Vane Attenuators, Waveguide 432
 Rubidium Frequency Standard 276

S

S-Parameter Test Sets 459, 464, 475, 476

Sampling Oscilloscopes 173
 Sampling & TDR Accessories 176
 Scanner 64, 65, 76, 643
 Scanner Plug-In Module 244, 646
 Schottky Diodes 654
 Scientific & Industrial X-Ray Systems 647
 Selective Level Measuring Set 590
 Selective Level Voltmeters 600
 Selective Voltmeter 600
 Self-Test Digital Multimeter 64-66, 70
 Sensors, Microwave Power 422, 425
 Serial Data Analyzer 147
 Serial Data Generator 338
 Serial-to-Parallel Converter 26, 143
 Signal Analyzers 177, 480-539
 Automatic Spectrum Analyzer 497
 Digital 488-491, 518-522, 524
 Distortion 530, 531
 General Information 480-487
 Modulation Analyzer 536
 Spectrum Analyzers 177, 488-522, 525-529
 Signal Conditioners 267-269
 Signal Coupler Preamplifier 268
 Signal Generators
 Accessories 396
 Down Converter, 0.5 to 500 kHz 385
 General Information 372
 HF, VHF, UHF 381-390
 Microwave 378, 391-393
 Pulse Modulator 394, 395
 Synthesized 374-379
 Signal Sources 358
 Signal Source, Programmable 356
 Signature Analysis 110, 516
 Signature Analyzer, Digital 118
 Silicon Bipolar Transistors 655
 Sinewave Generators 345, 347
 Sinewave Oscillator 345, 347
 Single Span Plug-In Module 259
 Slotted Lines (Coaxial and Waveguide) 433
 Sliding Load (Coaxial and Waveguide) 438
 Small Business Computers 615
 Solid State Displays/Lamps 652
 Spectrum Analyzers, General Information 480-487
 Spectrum Analyzers 117, 492-522, 527-529
 Spectrum Analyzer Preselector 512
 Spectrum Display 525
 Square Wave Generators 350
 Stability Analyzer, Frequency 522, 538
 Standards: Frequency and Time 274
 Standing Wave Ratio (SWR) Meter 447
 Stepping Motor Control 646
 Step Attenuators, Coaxial 430-432
 Storage-Normalizer 463, 479
 Strip Chart Recorders 242, 243, 257-262
 Structural Dynamics 522, 524
 Surveying Products 660
 Sweep Oscillators, General Information 397-399
 Sweep Oscillators 350, 352, 358, 397-417
 Swept Slotted Line 433
 Switch Controller 628
 Switches 26
 Access, Distribution and Bi-directional 592
 Switches, Automatic Test 628
 Coaxial, Microwave OEM 440
 HP-IB Driver 430

ALPHABETICAL INDEX

- Swivel Adapter 441
 Synthesizer, Automatic 362, 363, 374, 378, 380
 Synthesizer, Frequency 352, 353, 358, 374, 378, 380
 Synthesized Signal Generators 374, 378, 380
 Synthesizers, Spectrum 372
 System Digital LCR Meter 94, 95
 System Digital Voltmeter 56-59, 66-72
 Systems Accessories 26
- T**
- Tape Cartridge Unit 623
 Tape Cassette, Punch, Reader Sub-systems 625
 Tape Degausser 271
 Tape Memory, External 625
 Tape Recorders, Analog Magnetic 270, 271
 Telecommunications Test Equipment 558-607
 Access Switch 592
 Amplifier, Error Detector Input 567
 Amplifier—IF 605
 Amplitude/Delay Distortion Analyzer 572
 Attenuator—75Ω General Purpose 605
 Audio Channel Selector: HP-IB Controlled 563
 BB Sweeper 605
 Balanced 2/4-wire Audio Channel Selector 563
 Bi-directional Switch 592
 Carrier Testing 588
 Controller: Switch 592
 Converter, 75Ω Unbal/110Ω Bal 567
 Data Generator 344, 564
 Data Line Analyzers 574
 Detector, Error 564
 Down Converter 606
 Error Measuring Set (1 kb/s - 50 Mb/s) 566
 Error Measuring Set (1 kb/s - 150 Mb/s) 564
 Error Rate Measurements 564, 566
 FDM Measurements 588
 HP-IB Controlled Channel Selector 26, 563
 Isolator, PCM Test Equipment 567
 Remote Automatic Surveillance Systems 596
 Microwave Link Analyzers 602
 Microwave Radio Testing 601
 Modulator Analyzer 536
 Pattern Generator/Error Detector 566
 PCM Testing 558
 Primary Multiplex Analyzer 560
 Selective Level/Meter 598, 599
 Selective VM 533, 600
 Selective Level Measuring Set 590
 SLMS Accessories 595
 Sweeper, RF 607
 Switch: Access 592
 Switch Controller 26, 592
 Telephone Line Analyzer 572, 578, 579
 Transmission Impairment Measuring Set 582
 Test Set 578, 579
 Upconverter Simulator for
 Microwave Link Analyzer 607
 Voice Data Testing 568
 Telephone Test Oscillators 581
 Temperature Measurement 64, 65, 259, 651
 Terminal, CRT 630
 Terminal, Data Capture/Data Retrieval 637
 Terminations, Coaxial and Waveguide 176, 438
 Test Data, Attenuator Calibration 429
 Test Leads 73, 552, 554
 Testmobiles, Oscilloscope 192
 Test Oscillators 355
 Test Set, Voice Band 568
 Test Sets, Digital Logic 116
 Test Sets, Transmission 568
 Thermal Printer 254, 255, 272, 625
 Thermistor
 Sensors, Coaxial and Waveguide 425
 Fiber Optic 419
 Thermocouple Power Meter 420, 421
 Thermocouple Power Sensors 422
 Thermometer 64, 651
 Time Base External Module 245
 Time Domain Reflectometers 173
 Time Interval
 Counters 289, 297, 303, 304, 308, 309, 311, 646
 Time Standard 274
 Time Synthesizer 324
 Timer/Pacer 64, 65
 Timing Analyzer, Logic 144
 TIMS 582
 Total Harmonic Distortion Measuring Set 530, 531
 Total Station 660
 Touch-Hold Probe 53, 59, 73
 Tracer, Current 113
 Tracking Generators 488-491, 498, 502, 506,
 508, 510, 513, 598, 599
 Training/Logic 120
 Training/Video Tapes 661-664
 Transceiver Modulation Analyzer 536
 Transceiver Test System 556
 Transfer Function Analyzer 522, 524
 Transistors, Siliconbipolar 654
 Translator, Four Channel TTL CMOS 343
 Transmission Impairment Measuring Set 582
 Transistor Bias Supply 476
 Transistor Test Fixtures 475-477
 Transistors 654
 Triangle Wave Generator 349, 350
 Trigger Countdown 176
 True RMS Detector 530, 531
 True RMS Voltmeter 43, 54, 55, 62-69
 Tuners, Microwave 439
 Two-Channel Real Time Spectrum Analyzer 518-521
 TWT Amplifiers 34
 Type N Short 438
- U**
- Universal Bridge 83, 84, 88, 89
 Universal Carriage (Slotted Section) 433
 Universal Counters 289, 296, 298, 308, 311
 Upconverter Simulator
 for Microwave Link Analyzer 607
- V**
- Variable Phase Function Generator 366, 367, 594
 Vector Impedance Meter 99
 Vector Voltmeter 470
 VHF Oscillator 394
 Vibration Analyzer 522, 524
 Vibration Controller 524
 Video Tapes 661-664
 Voice Data Testing 568
 Voltmeters 35-77
 Voltmeter, Vector 470

W	
Warranty	671
Wave Analyzer	488-491, 576, 577
Wave and Distortion	
Analyzers	527-529, 532
Waveform Analyzer, Fourier	522, 524
Waveguide	
Attenuators	432
Coaxial Adapters	441
Crystal Detectors	437
Directional Couplers	435
Frequency Meters	437
Harmonic Mixer	439
Holder	441
Low-Pass Filters	439
Movable Shorts	438
Precision Attenuators	432
Reflection/Transmission Test Sets	477
Shorting Switch	438
Slide Screw Tuners	439
Sliding Loads	438
Sliding Short	438
Slotted Section	433
Stand	441
Terminations	438
Thermistor Mounts	425
Variable Attenuators	432
Waveguide-Waveguide Adapters	441
Word Generators	319
X	
X-Ray Systems, Scientific & Industrial	647
X-Y Displays	194-213
X-Y Plotters/Recorders	242, 243, 252-262, 624

MODEL NUMBER INDEX

New product listings are printed in bold face type

HP-19C Hand-held Programmable Printing Calculator	609	360 series Coaxial Low-pass Filters	439
HP-29C Hand-held Programmable Calculator	609	362A series Waveguide Low-pass Filters	439
HP-31E Scientific Pocket Calculator	610	375 series Waveguide Variable Attenuators	432
HP-32E Advanced Scientific Pocket Calculator	610	382 series Waveguide Precision Variable Attenuators	432
HP-33E Programmable Scientific Pocket Calculator	610	393A Coaxial Variable Attenuator	432
HP-37E Business Management Pocket Calculator	611	394A Coaxial Variable Attenuator	432
HP-38E Financial Programmable Pocket Calculator	611	400	
HP-67 Fully Programmable Pocket Calculator	612	400E & EL AC Voltmeters	42
DTS-70 Digital Test Systems	106	400F & FL AC Voltmeter	42
HP-92A Business Printing Calculator	612	400 GL AC Voltmeter	42
HP-97 Fully Programmable Printing Calculator	612	403B AC Voltmeter	41
100		410C Voltmeter	40
105A & B Quartz Frequency Standards	282	415E SWR Meter	447
123A Oscilloscope Camera	189	419A DC Null Voltmeter	37
140T Spectrum Analyzer Mainframe	505	422A Series Waveguide Crystal Detectors	437
141T System Spectrum Analyzers	504	423A/B Coaxial Crystal Detectors	436
141T Spectrum Analyzer Mainframe	505	424A Series Waveguide Crystal Detectors	437
180 series Plug-in Oscilloscopes	164	427A Voltmeter	39
180C, D High Writing Speed Oscilloscope Mainframes	166	428B Clip-on DC Milliammeter	38
180TR Rack-mount Display Mainframe	446, 500, 502	432 Series Power Meters	419
181A, AR, Variable Persistence Storage Mainframes	167	435A Power Meter	421
181T, TR Variable Persistence/Storage Display Mainframes	446, 500, 502	436A Power Meter	420
182C Large Screen Oscilloscope Mainframe	166	440A Detector Mount	433
182T Large Screen Display Mainframe	446, 500, 502	442B Slotted Line RF Probe	433
184A High Speed Oscilloscope Mainframe	167	444A Slotted Line Detector	433
197A Oscilloscope Camera	189	447B Slotted Line Detector	433
200		448B Slotted Line Sweep Adapters	433
200CD Wide Range Oscillator	346	456A Current Probe for voltmeters	555
201C Audio Oscillator	346	461A Amplifier	32
204C Oscillator	348	465A Amplifier	32
204D Oscillator	348	467A Power Amplifier	32
209A Oscillator	348	478A Coaxial Thermistor Mount	425
214B Pulse Generator	327	486A Series Waveguide Thermistor Mounts	425
236A Telephone Test Oscillator	581	489A TWT Amplifier	34
239A Low Distortion Oscillator	347	491C TWT Amplifier	34
HP250 Small Business Computer	615	493A TWT Amplifier	34
281 series Coaxial-Waveguide Adapters	441	495A TWT Amplifier	34
292 series Waveguide-Waveguide & Adaptors	441	500	
300		532 Series Waveguide Frequency Meters	437
HP 300 Computer System	616	536A Coaxial Frequency Meter	437
312A & 313A Frequency Selective Voltmeter and tracking Oscillator	534	537A Coaxial Frequency Meter	437
312D Selective Levelmeter & Generator	598	545A Logic Probe	111
331A Distortion Analyzer	532	546A Logic Pulser	112
332A Distortion Analyzer	532	547A Current Tracer	113
333A Distortion Analyzer	532	548A Logic Clip	114
334A Distortion Analyzer	532	600	
339A Distortion Measuring Set	530	606B Signal Generator	388
340B Noise Figure Meter	426	608E Signal Generator	389
342A Noise Figure Meter	426	612A Signal Generator	390
343A VHF Noise Source	426	618C Signal Generator	392
345B IF Noise Source	426	620B Signal Generator	392
347A series Noise Sources	426	626A Signal Generator	393
349A Noise Source	426	628A Signal Generator	393
350D Attenuator Set	104	651B Test Oscillator	355
355 series Coaxial Step Attenuators	430	652A Test Oscillator	355
		654A Test Oscillator	355
		680 Strip Chart Recorder	257
		700	
		745A AC Calibrator	370
		746A Hi Voltage Amplifier	370

752 Series Waveguide Directional Couplers 435

774D Coaxial Dual Directional Coupler 434

775D Coaxial Dual Directional Coupler 434

776D Coaxial Dual Directional Coupler 434

777D Coaxial Dual Directional Coupler 434

778D Coaxial Dual Directional Coupler 434

779D Coaxial Dual Directional Coupler 434

784B Coaxial Directional Detector 607

786D Coaxial Directional Detector 435

787D Coaxial Directional Detector 435

788C Coaxial Directional Detector 435

789C Coaxial Directional Detector 435

796D Coaxial Directional Coupler 434

797D Coaxial Directional Coupler 434

798C Coaxial Directional Coupler 434

800

805C Coaxial Slotted Line 433

809C Universal Carriage 433

810B series Waveguide Slotted Sections 433

816A Slotted Coaxial Section 433

817A & B Coaxial Swept Slotted
Line Systems 433

870A series Waveguide Slide Screw Tuners 439

900

905A Coaxial Sliding Load 438

907A Coaxial Sliding Load 438

908A Coaxial 50-Ohm Termination 176

909A Coaxial Termination 438

910 series Waveguide Terminations 438

911A/C Coaxial Sliding Load 438

914 series Waveguide Sliding Loads 438

920 series Waveguide Moving Shorts 438

923A Waveguide Sliding Short 438

930A Waveguide Shorting Switch 438

932A Waveguide Harmonic Mixer 439

934A Coaxial Harmonic Mixer 439

938A Frequency Doubler Set 393

940A Frequency Doubler Set 393

970A Probe Digital Multimeter 49

1000

HP 1000 Systems 618

1006A Testmobile **192**

1007A Testmobile 192

1008A Testmobile 192

1051A & 1052A Combining Cases 546

1104A/1106B Opt 001 18 GHz Trigger
Countdown 175

1104A/1108A 10 GHz Trigger Countdown 175

1105A/1106B 20 ps Pulse Generator 176

1105A/1108A 60 ps Pulse Generator 176

1109B High Pass Filter (type N) 176

1110A Current Probe 186

1111A AC Current Amplifier 186

1112A Inverter Power Supply **188**

1117B Testmobile, Oscilloscope 192

1120A 500 MHz Active Probe 185

1121A AC Probe 469

1122A Probe Power Supply 186

1124A 100 MHz Active Probe 186

1200B Dual Channel Oscilloscope,
100 μ V/div 178

1201B Dual Channel Storage
Oscilloscopes, 100 μ V/div 178

1205B Dual Channel Oscilloscope,
5mV/div 178

1220A Dual Channel Oscilloscope, 15 MHz 180

1222A Dual Channel, Delay Line
Oscilloscope, 15 MHz 180

1230A Logic Trigger 143

1304A 32 cm. (13 in.) Display 201

1310A 48.3 cm (19 in.) Display 201

1311A 35.6 cm (14 in.) Display 201

1317 A 43.2 cm (17 in.) Display 201

1321A 53.3 cm (21 in.) Display 201

1332A Small Screen Display 207

1333A Small Screen Display 207

1335A Small Screen Display 207

1336S Small Screen Display 207

1338A Tricolor Display **200**

1340A Display Module 205

1350A Graphics Translator 26, 196

1430C Sampling Head, 18 GHz for 1811A 174

1600A 16 Bit Logic State Analyzer 140

1600S 32/16 Bit General Purpose
Logic State Analyzer 140

1602A 16 Bit Logic State Analyzer 136

1607A 16 Bit Logic State Analyzer 140

1610A 32 Bit General Purpose Logic State Analyzer 132

1611A Logic State Analyzer for
Microprocessor Based Systems 128

1615A Logic Analyzer (Time & State) **144**

1640A Serial Data Analyzer **147**

1645A Data Error Analyzer 570

1645S Data Transmission Test Set 571

1700 series Oscilloscopes 154

1715A 200 MHz Δ Time Oscilloscope 160

1722B 275 MHz Δ Time Oscilloscope, Delta
with Microprocessor 160

1725A 275 MHz Δ Time Oscilloscope 160

1740A 100 MHz Oscilloscope,
Third-Channel Trigger View 154

1741A 100 MHz Oscilloscope, Variable Persistence
Storage, Third-Channel Trigger View 154

1742A 100 MHz Δ T Oscilloscope, Trigger View **154**

1743A 100 MHz Crystal Δ Time Oscilloscope,
Third Channel Trigger View 154

**1744A 100 MHz Oscilloscope, Fast Variable
Persistence Storage, Trigger View** **154**

1801A Dual Channel Vertical Amplifier,
50 MHz 168

1803A Differential DC Offset Amplifier 168

1804A Four Channel Vertical Amplifier,
50 MHz 170

1805A Dual Channel Vertical Amplifier,
100 MHz 168

1806A 100 μ V Dual Channel Differential
Amplifier 168

1809A Four Channel Vertical Amplifier,
100 MHz 170

1810A 1 GHz Dual Channel Sampler 173

1811A 18 GHz Sampler 173

1815B TDR/Sampler 175

1817A Sampling Head 12.4 GHz for 1815B 175

1818A Time Domain Reflectometer, 170 ps t_r 174

1820C Time Base 171

1821A Time Base/Delay Generator 171

1825A Time Base and Delay Generator 172

1900A Pulse Generator Mainframe 328

1905A Rate Generator Plug-in 328



MODEL NUMBER INDEX

New product listings are printed in bold face type

1915A Output Amplifier Plug-in	328	3466A 4½ Digit Autoranging DMM	62
1917A Output Amplifier Plug-in	328	3467A Logging DMM	64
1920 Output Amplifier Plug-in	328	3476A/B 3½ Digit DMM	50
2000		3490A Multimeter	70
2105A Computer	617	3495A Scanner	76
2108M Computer	617	3529A Magnetometer Probe	38
2109E Computer	617	3550B Communications Test Set	584
2111F Computer	617	3551A Transmission Test Set	578
2112M Computer	617	3552A Transmission Test Set	578
2113E Computer	617	3555B Transmission & Noise Measuring Set	580
2117F Computer	617	3556A Psophometer	580
2240A Measurement & Control Processor	629	3570A Tracking Receiver	580
2313B Analog I/O Subsystem	629	3575A Gain/Phase Meter	456
2608A Line Printer	639	3580A Spectrum Analyzer	516
2631A Printer	638	3581A Wave Analyzer	533
2631G Graphics Printer	638	3581C Selective Voltmeter	576
2635A Printing Terminal	638	3582A Spectrum Analyzer	518
2640B Interactive Display Terminal	632	3585A Spectrum Analyzer	488
2640C Cyrillic Display Terminal	634	3591A Selective Voltmeter	600
2641A APL Display Terminal	634	3594A Sweeping Local Oscillator Plug-in	600
2645A Display Station	633	3702B IF/BB Receiver (70 MHz IF)	602
2645K Katakana Display Station	634	3710A IF/BB Transmitter (70 MHz IF)	602
2645N Danish/Norwegian Display Station	634	3720A Spectrum Display	525
2645R Arabic Display Station	634	3721A Correlator	525
2645S Swedish/Finnish Display Station	634	3722A Noise Generator	526
2647A Intelligent Graphics Terminal	630	3730A Down Converter: RF to IF	606
2648A Graphics Terminal	631	3743A IF Amplifier	605
2649A Microprogrammable Terminal	632	3744A BB Sweeper Accessory	605
2804A Quartz Thermometer	651	3745A/B Selective Level Measuring Set	590
2811B Quartz Pressure Gauge	650	3747A/B Selective Level Measuring Set	590
3000		3750A Attenuator:75Ω	605
HP 3000 Series II and Series III Systems	614	3754A Access Switch	592
3040A Network Analyzer	453	3755A Switch Controller	592
3042A Network Analyzer	453	3756A 90 MHz Bi-directional Switch	592
3044A Automatic Spectrum Analyzer	527	3757A 8.5 MHz Access Switch	592
3045A Automatic Spectrum Analyzer	527	3762A Data Generator	344, 564
3052A Automatic Data Acquisition System	74	3763A Error Detector	564
3060A Analog Board Tester	108	3770A Amplitude/Delay Distortion Analyzer	572
3070B Data Capture/Data Retrieval Terminal	637	3770B Telephone Line Analyzer	572
3200B VHF Oscillator	394	3771A Data Line Analyzer (CCITT)	574
3310A Function Generator	354	3771B Data Line Analyzer (BELL)	574
3310B Function Generator	354	3777A HP-IB-controlled Channel Selector	563
3311A Function Generator	350	3779A Primary Multiplex Analyzer (CEPT)	560
3312A Function Generator	351	3779B Primary Multiplex Analyzer (BELL)	560
3320A Frequency Synthesizer	360	3780A Pattern Generator/Error Detector	566
3320B Frequency Synthesizer	360	3790A IF/BB Transmitter (140 MHz IF)	602
3320C Level Generator	598	3792A IF/BB Receiver (140 MHz IF)	602
3325A Function Generator/Frequency Synthesizer/Sweeper	352, 364	3805A Distance Meter	660
3330B Automatic Synthesizer	362	3808A Medium Range Distance Meter	660
3335A Frequency Synthesizer	366, 594	3810A Total Station	660
3350A Laboratory Automation Systems	656	3964A Instrumentation Tape Recorder	270
3352A Laboratory Data System	656	3968A Instrumentation Tape Recorder	270
3380A Reporting Integrator	656	4000	
3400A RMS Voltmeter	43	4204A Oscillator	349
3403A True RMS Voltmeter	54	4260A Universal Bridge	83
3406A Broadband Sampling Voltmeter	44	4261A Digital LCR Meter	88-89
3435A Digital Voltmeter	52	4262A Digital LCR Meter	86-87
3437A High Speed Digital Voltmeter	56	4265B Universal Bridge	84
3438A 5-Function DMM;HP-IB	58	4270A Automatic Capacitance Bridge	85
3455A 6½ Digit DMM	66	4271B Component Test 1 MHz Digital LCR Meter	90-91
3465A 4½ Digit DMM	60	4272A 1 MHz Preset Capacitance Meter	92
3465B Digital Multimeter	60		

4273A 1 kHz Preset C Meter	93
4274A LCR Meter	94
4275A LCR Meter	94
4282A Digital High Capacitance Meter	96-97
4328A Milliohmmeter	81
4329A High Resistance Meter	82
4332A LCR Meter	80
4342A Q Meter	98
4436A Attenuator	104
4437A Attenuator	104
4440B Decade Capacitor	104
4800A Vector Impedance Meter	99
4815A Vector Impedance Meter	99
4904A Cable Fault Locator	587
4905A Ultrasonic Leak Detector	587
4910G Open and Split Locator	587
4930A Conductor Fault Locator	586
4960A/4961A Automatic Pair Identifier	586
4940A Transmission Impairment Measuring Set	582
4943A Transmission Impairment Measuring Set	583
4944A Transmission Impairment Measuring Set	583
5000	
5004A Signature Analyzer	118
5011T Logic Troubleshooting Kit	116
5015T Logic Troubleshooting Kit	116
5021A Logic Troubleshooting Kit	116
5022A Logic Troubleshooting Kit	116
5023A Logic Troubleshooting Kit	116
5024A Logic Troubleshooting Kit	116
5035A Basic Logic Lab	120
5035T Logic Lab	120
5036A Microprocessor Lab	121
5045A Digital IC Tester	100
5046A Digital IC Test System	102
5055A Digital Recorder	273
5060-Series Rack Frames and Adapters	546
K02-5060A Standby Power Supply	285
5061A Cesium Beam Frequency Standard	276
5061A with Option 004 Tube	276
E21-5061A Flying Clock (Cesium)	277
5062C Cesium Beam Frequency Reference	278
5065A Rubidium Frequency Standard	279
E21-5065A Portable Rubidium Time Standard	279
5085A Standby Power Supply	285
5087A Distribution Amplifier	284
5150A Thermal Printer	272
5245L Electronic Counter	296
5253B Frequency Converter Plug-in	297
5254C Frequency Converter Plug-in	297
5255A Frequency Converter Plug-in	297
5256A Frequency Converter Plug-in	297
5257A Transfer Oscillator Plug-in	297
5262A Time Interval Plug-in	297
5300A Counter Mainframe	307
5300B Counter Mainframe	307
5301A 10 MHz Counter Module	308
5302A 50 MHz Universal Counter Module	308
5303B 500 MHz Counter Module	309
5304A Timer/Counter Module	309
5305B 1300 MHz Counter Module	310
5306A Digital Multimeter/Counter	310
5307A Frequency Counter Module	311
5308A Timer Counter Module	311
5310A Battery Pack Module	312

5311B Digital-to-Analog Converter	312
5312A ASCII Converter	312
5314A Universal Counter	303
5315A Universal Counter	304
5328A Universal Counter	298
5340A Microwave Frequency Counter	316
5341A Microwave Frequency Counter	317
5342A Microwave Frequency Counter	314
5345A Electronic Counter	289
5353A Channel C: Plug-in for 5345A	292
5354A 4 GHz Frequency Converter	292
5359A Time Synthesizer	324
5363B Time Interval Probes	318
5370A Universal Counter	294
5381A Frequency Counter	313
5382A Frequency Counter	313
5383A Frequency Counter	313
5390A Frequency Stability Analyzer	538
5391A Frequency and Time Data Acquisition System	293
5420A Digital Signal Analyzer	522
5427A Digital Vibration Control System	524
5451C Fourier Analyzer	524
5501A Laser Transducer	649
5526A Laser Interferometer	649
5700A Laboratory Gas Chromatographs	656
5840A Reporting Gas Chromatographs	656
5985B GC/Mass Spectrometer	656
5992/3B GC/Mass Spectrometers	656
6000	
6002A Extended Range DC Power Supply	229
6110A-6116A Precision DC Power Supplies	232
6129C-6131C Digitally Controlled Voltage Sources	240
6140A Digital Current Source	240
6177C Precision DC Current Source	234
6181C Precision DC Current Source	234
6186C Precision DC Current Source	234
6200B-6209B DC Power Supplies	218
6211A-6218A Dual Range DC Power Supplies	218
6220B DC Power Supply	222
6224B DC Power Supply	222
6226B DC Power Supply	222
6227B Dual Tracking DC Power Supply	230
6228B Dual Tracking DC Power Supply	230
6234A Dual Output Power Supply	219
6235A Triple Output Power Supply	220
6236B Triple Output DC Power Supply	220
6237B Triple Output DC Power Supply	220
6253A Dual Output DC Power Supply	222
6255A Dual Output DC Power Supply	222
6259B DC Power Supply	224
6260B DC Power Supply	224
6261B DC Power Supply	224
6263B DC Power Supply	224
6264B DC Power Supply	224
6265B DC Power Supply	224
6266B DC Power Supply	224
6267B DC Power Supply	224
6268B DC Power Supply	224
6269B DC Power Supply	224
6271B DC Power Supply	224
6274B DC Power Supply	224
6281A DC Power Supply	222
6282A DC Power Supply	222
6284A DC Power Supply	222



MODEL NUMBER INDEX

New product listings are printed in bold face type

6286A DC Power Supply	222
6289A DC Power Supply	222
6291A DC Power Supply	222
6294A DC Power Supply	222
6296A DC Power Supply	222
6299A DC Power Supply	222
6384A DC Power Supply	218
6427B DC Power Supply	226
6428B DC Power Supply	226
6433B DC Power Supply	226
6434B DC Power Supply	226
6438B DC Power Supply	226
6439B DC Power Supply	226
6443B DC Power Supply	226
6448B DC Power Supply	226
6453A DC Power Supply	226
6456B DC Power Supply	226
6459A DC Power Supply	226
6464C DC Power Supply	226
6466C DC Power Supply	226
6469C DC Power Supply	226
6472C DC Power Supply	226
6475C DC Power Supply	226
6477C DC Power Supply	226
6479C DC Power Supply	226
6483C DC Power Supply	226
6515A High Voltage DC Power Supply	231
6516A High Voltage DC Power Supply	231
6521A High Voltage DC Power Supply	231
6522A High Voltage DC Power Supply	231
6525A High Voltage DC Power Supply	231
6824A DC Power Supply/Amplifier	235
6825A DC Power Supply/Amplifier	235
6826A DC Power Supply/Amplifier	235
6827A DC Power Supply/Amplifier	235
6920B AC/DC Meter Calibrator	369
6940B Multiprogrammer	643
6941B Multiprogrammer Extender	643
7000	
7004B X-Y Recorder	244
7010B X-Y Recorder	247
7015B X-Y Recorder	247
7034A X-Y Recorder	244
7035B X-Y Recorder	246
7040A X-Y Recorder	248
7041A X-Y Recorder	248
7044A X-Y Recorder	250
7045A X-Y Recorder	250
7046A X-Y Recorder	249
7047A X-Y Recorder	250
7100B Strip Chart Recorder, 2 Pen	258
7101B Strip Chart Recorder, 1 Pen	258
7130A Strip Chart Recorder, 2 Pen	260
7131A Strip Chart Recorder, 1 Pen	260
7132A Strip Chart Recorder, 2 Pen	261
7133A Strip Chart Recorder, 1 Pen	261
7155B Portable Strip Chart Recorder	262
7221A Digital Plotter	252
7225A Graphics Plotter	256
7245A Plotter/Printer	254
7260A Optical Mark Reader	636
7402A 2-Channel Oscillographic Recorder	263
7404A 4-Channel Oscillographic Recorder	263
7414A 4-Channel Oscillographic Recorder	266
7418A 6 to 8 Channel Oscillographic Recorder	266
7562A Log Voltmeter/Converter	45
7563A Log Voltmeter/Amplifier	45
7702B 2-Channel Oscillographic Recorder	266
7906 Disc Drive	640
7920 Disc Drive	641
7925 Disc Drive	641
8000	
8005B Pulse Generator	329
8006A Pulse Generator	342
8007B Pulse Generator	332
8011A Pulse Generator	329
8012B Pulse Generator	330
8013B Pulse Generator	330
8015A Pulse Generator	325
8016A Word Generator	340
8018A 50 M bits/s Serial Data Generator	338
8080A Mainframe	333
8081A Repetition Rate Generator, 300MHz	334
8082A Pulse Generator	331
8083A Output Amplifier, 300 MHz	334
8084A Word Generator, 300 MHz	334
8091A Repetition Rate Generator, 1 GHz	335
8092A Delay Generator/Freq. Divider	335
8093A Output Amplifier, 1 GHz	335
8160A Programmable Pulse Generator	322
8165A Programmable Signal Source	321, 356
8170A Logic Pattern Generator	336
8403A Modulator	395
8404A Leveling Amplifier	417
8405A Vector Voltmeter	470
8406A Comb Generator	515
8407A Network Analyzer	468
8409A Automatic Network Analyzer	478
8410B Network Analyzer Mainframe	474
8410S series Network Analyzers	471
8411A Harmonic Frequency Converter	474
8412A Phase-Magnitude Display	468, 474
8413A Phase Gain Indicator	474
8414A Polar Display	468, 474
8418A Auxiliary Power Supply	474
8443A Tracking Generator	508
8444A Tracking Generator	510, 513
8444A Option 058 Tracking Generator	498, 502
8445B Automatic Preselector	512
8447 series Amplifiers	33
8470A Coaxial Crystal Detectors	436
8471A Coaxial Crystal Detector	436
8472A/B Coaxial Crystal Detector	436
8473B/C Coaxial Crystal Detectors	436
8477A Power Meter Calibrator	425
8478B Coaxial Thermistor Mount	425
8481A/H Power Sensor	422
8481B Power Sensor	422
8482A/H Power Sensor	422
8482B Power Sensor	422
8483A Power Sensor	422
8484A Power Sensor	422
8491A/B Coaxial Fixed Attenuators	428
8492A Coaxial Fixed Attenuator	428
8493A/B series Coaxial Fixed Attenuators	428
8494A/B/G/H series Coaxial Step Attenuators	430
8495A/B/D/G/H/K series Coaxial Step Attenuators	430
8495A/B/D/G/H/K series Coaxial Step Attenuators	430
8496A/B/G/H series Coaxial Step Attenuators	430

8498A Coaxial Fixed Attenuator	428
8501A Storage-Normalizer	463
8502A & B Reflection Transmission Bridges	464
8503A & B S-Parameter Test Sets	464
8505A Network Analyzer	460
8507B Automatic Network Analyzer	466
8552A Spectrum Analyzer—IF Section	505
8552B Spectrum Analyzer—IF Section	505
8553B Spectrum Analyzer, Tuning Section	508
8554B Spectrum Analyzer, Tuning Section	510
8555A Spectrum Analyzer, Tuning Section	512
8556A Spectrum Analyzer, Tuning Section	506
8557A Spectrum Analyzer	177, 500
8558B Spectrum Analyzer	177, 502
8565A Spectrum Analyzer	498
8568A Spectrum Analyzer	492
8581A Automatic Spectrum Analyzer	497
8600A Digital Marker	400
8601A Generator/Sweeper	400
8614A Signal Generator	391
8616A Signal Generator	391
8620 system Sweep Oscillators	400, 607
8620C Sweeper Mainframe	402
8621B Multiband Sweeper Drawer	412
8640A AM/FM Signal Generator	381
8640B AM/FM Signal Generator	381
8640B Option 004, Avionics Signal Generator	384
8640M Signal Generator	385
8654A Signal Generator	386
8654B Signal Generator	386
8655A Synchronizer/Counter	386
8660A Synthesized Signal Generator	374
8660C Synthesized Signal Generator	374
8671A Microwave Frequency Synthesizer	380
8672A Synthesized Signal Generator	378
8690B Sweep Oscillator	414
8691B-8695B RF Units (PIN leveled BWO) for 8690B	415
8691A-8697A RF Units (Grid Leveled BWO) for 8690B	415
8698B, 8699B Solid State RF Units for 8690B	415
8705A Signal Multiplexer for 8690B	417
8706A Control Unit for 8690B	417
8707A RF Unit Holder for 8690B	417
8709A Phase-lock Synchronizer	417
8717B Transistor Bias Supply	476
8721A Coaxial Directional Bridge	469
8731-8735 series PIN Modulators	395
8740A Transmission Test Unit	476
8741A Reflection Test Unit	476
8742A Reflection Test Unit	476
8743A Reflection/Transmission Test Unit	475
8745A S-Parameter Test Set	475
8746B S-Parameter Test Set	476
8747A Waveguide series Reflection/Transmission Test Units	477
8748A S-Parameter Test Set	459
8750A Storage- Normalizer	446, 468, 474, 479, 498, 500, 502, 515
8754A Network Analyzer	458
8755B Frequency Response Test Set Plug-in	446
8755S Frequency Response Test Sets	442
8761A & B Coaxial Switches	440
8801A Low Gain Preamplifier	267
8802A Medium Gain Preamplifier	267
8803A High Gain Preamplifier	267

8805A Carrier Preamplifier	267
8805B Carrier Preamplifier	267
8806B Phase Sensitive Demodulator	268
8807A AC/DC Converter	268
8808A Logarithmic Preamplifier	268
8809A Signal Coupler	268
8820A DC Bank Amplifier	268
8821A DC Bank Amplifier	268
8900B Peak Power Calibrator	425
8901A Modulation Analyzer	536
8950B Automatic Transceiver Test System	556

9000

9411A Switch Controller	628
9412A Modular Switch	628
9413A VHF Switch	628
9414A Matrix Switch	628
9815A,S Desktop Computer	30, 620
9825A Desktop Computer	30, 31, 620
9835A, B Desktop Computer	30, 31, 621
9845A,S Desktop Computer	30, 31, 622
9862A X-Y Plotter	624
9865A Tape Cassette	625
9866B Thermal Printer	625
9868A I/O Expander	625
9869A Hopper Card Reader	625
9870A Card Reader	625
9871A Character Impact Printer	627
9872A Four Color Plotter	253, 624
9874A Digitizer	623
9875A Cartridge Tape Unit	623
9877A External Tape Memory	625
9878A I/O Expander	625
9880B Mass Memory Subsystem	625
9881A Line Printer Subsystem	624
9883A High Speed Tape Reader Subsystem	625
9884A Tape Punch Subsystem	625
9885M/S Flexible Disc Drive	627

10000

10001A 10:1 Divider Probe	184
10001B 10:1 Divider Probe	184
10002A 50:1 Divider Probe	184
10002B 50:1 Divider Probe	184
10003A 10:1 Divider Probe	184
10004D 10:1 Divider Probe	184
10005D 10:1 Divider Probe	184
10006D 10:1 Divider Probe	184
10007B 1:1 Probe	73, 184, 554
10008B 1:1 Probe	73, 184, 554
10011B BNC Adapter Tip	187
10013A 10:1 Divider Probe	185
10014A 10:1 Divider Probe	184
10016B 10:1 Divider Probe	184
10017A Miniature Divider Probe	182
10018A Miniature Divider Probe	182
10019A Cable Assembly	184
10020A Resistance Divider	184
10021A Miniature 1:1 Probe	182
10022A Miniature 1:1 Probe	182
10024A IC Test Clip	183
10026A Miniature 1:1 Probe (50Ω)	182
10027A Miniature 1:1 Probe (50Ω)	182
10028A Jumper Cable	184
10034A Probe Ground Lead Kit	187

MODEL NUMBER INDEX

New product listings are printed in bold face type

10035A Probe Tip Kit	187	10388A Interface, CCITT V35 (1645A)	571
10036B Probe Tip Kit	187	10389A Interface, Breakout Box (RS-232C)	
10037B Probe Tip Kit	187	(1645A)	571
10040A 10:1 Miniature Divider Probe	182	10407B Plug-in Extender (180 system)	187
10041A 10:1 Miniature Divider Probe	182	10475A 3 in. Drawer for 1117B	193
10042A 10:1 Miniature Divider Probe	182	10476A 8 in. Drawer for 1117B	193
10050A HP-IB Adapter for 1602A	138	10491B Rack Mount Adapter, 1700 series,	
10051A Test Probe (includes 10050A)	138	1600A	187
for 1602A	138	10492A Interconnecting Cable	
10100C 50 ohm Feedthrough Termination	187	for 1338A/1350A (1 m)	200
10100B 100 ohm Feedthrough Termination	187	10493A Interconnecting Cable	
10110B BNC Male to Dual Banana Plug	553	for 1338A/1350A (3 m)	200
10111A Shielded Banana Plug		10511A Spectrum Generator	396
to BNC Female	553	10514A Double Balanced Mixer	396
10113A Triple Banana Plug to Dual BNC		10525T, & 10525E Logic Probes	111
Female	553	10526T Logic Pulser	112
10116A Light Shield		10528A Logic Clip	114
for 1220 Series Oscilloscopes	181, 187	10529A Logic Comparator	115
10117A Panel Cover		10534A Double Balanced Mixer	396
for 1220 Series Oscilloscopes	181	10541A Reference Boards	117
10119A Rack Mount Kit		10541B Preprogrammed Reference Boards	117
for 1220 Series Oscilloscopes	181	10544A/B/C Component Oscillator	283
10140A Viewing Hood		10590A Plug-in Adapter	292
for 1700 Series Oscilloscopes	187	10595A Board Extender Kit	291
10173A RFI Filter and Contrast Screen		10651A/B/C/D HP-IB Cables	25
for 1700 Series Oscilloscopes	187	10653B, C Cesium Beam Retrofit Kits	277
10176A Viewing Hood		10844A Programming Interface Kit (5045A)	103
for 12.7 cm (5 in.) Rect. CRT	187	10855A Broadband Preamplifier	312
10178A Metal Mesh Contrast Screen		10851A, 10852A Rack Mount Kits	
for 181, 184 Oscilloscopes	187		
10183A Light Shield for 1332A, 1333A, 1335A, 1338A	213	11000	
10233A Cable, 1645A to 5055A or 5150A	571	11000A Cable Assembly	552
10235A Interface Cover for 1645A	570	11001A Cable Assembly	552
10250A TTL Trigger Probe	143	11002A Test Leads	552
10253A Card Reader for 1600A Logic State		11003A Test Leads	552
Analyzer	142	11004A Line Transformer	346
10254A Serial-to-Parallel Converter	143	11005A Line Transformer	346
10257B Personality Module for 1611A (6800 μ P)	129	11021A Divider Probe	554
10258B Personality Module for 1611A (8080 μ P)	129	11028A Current Divider	554
10259A Personality Module for 1611A (0F8 μ P)	130	11035A Cable Assembly	552
10260A Personality Module for 1611A (Z80 μ P)	130	11036A AC Probe for 410C	40, 554
10261A Personality Module for 1611A (6502 μP)	130	11040A Capacitive Voltage Divider	554
10262A Personality Module for 1611A (1802 μP)	130	11045A DC Voltage Divider for 410C	554
10263A Personality Module for 1611A (8085 μP)	131	11046A Carrying Case	547
10275A PDP-11 UNIBUS Interface		11047A Output Voltage Divider	554
for HP Logic Analyzers	135	11056A Handle Kit	547
10276A LSI-11 Interface		11067A Test Lead Kit	73
for HP Logic Analyzers	135	11068A Soft Carrying Case	73
10277A,B,C General Purpose Interface		11075A & 11076A Instrument	
for HP Logic Analyzers	135	Cases	547
10352B Graflok Back	190	11096B High Frequency Probe	73
10353A Pack Film Back	190	11143A BNC to Clip Leads	
10358B Camera Carrying Case	191	Cable Assembly	552
10361A Camera Bezel Adapter	190	11170A/B/C Cable Assembly	552
10362A Camera Bezel Adapter	190	11473A-11476A Probes, Voltage Dividers	555
10363A Camera Bezel Adapter	190	11500A/B Cable Assembly	552
10367A Camera Bezel Adapter	190	11501A Cable Assembly	552
10369A Camera Bezel Adapter	190	11507A Output Termination	396
10370A Camera Bezel Adapter	190	11508A Terminated Output Cable	396
10371A Camera Bezel Adapter	190	11509A Fuseholder	396
10372A Camera Bezel Adapter	190	11511A Type N Short	438
10374A Camera Carrying Case	191	11512A Type N Short	438
10375A Camera Bezel Adapter	190	11515A Waveguide Adapter	441
10376A Camera Bezel Adapter	191	11516A Waveguide Adapter	441
10377A Camera Bezel Adapter	191	11517A Mixer	515
10387A Interface, Type 303 Modems (1645A)	571	11518A-11520A Waveguide Taper Sections	515

11524A APC-7 to N Adapter	553
11525A APC-7 to N Adapter	553
11531A Test Plug-in for 8690B	417
11533A APC-7 to SMA Adapter	553
11534A APC-7 to SMA Adapter	553
11536A Probe Tee for 8405A	470
11540A Waveguide Stand	441
11542A-11548A Waveguide Clamps	441
11549A Power Splitter for 8405A	470
11566A Air Line Extension	441
11567A Air Line Extension	441
11570A Accessory Kit for 8405A	470
11581A Attenuator Set	429
11582A Attenuator Set	429
11583A Attenuator Set	429
11587A Accessory Kit for 8410 series	477
11588A Swivel Adapter	441
11589A & 11590A Bias Networks	477
11599A Quick-Connect Adapter for 8745A	477
11600B Transistor Fixture	475
11602B Transistor Fixture	475
11604A Universal Extension for 8743A	475
11605A Flexible Arm for 8743A	475
11606A Rotary Air Line	441
11607A Small Signal Adapter for 8745A	477
11608A Transistor Fixture	476
11609A Cable Kit for 8410S	477
11650A Accessory Kit for 8410S	477
11652A Reflection/Transmission Kit for 8407A	469
11654A Passive Probe Kit for 8407A	469
11655A Impedance Probe for 8407A	469
11658A Matching Resistor for 8407A	469
11661A Frequency Extension Module	374
11664A Detector for 8755	446
11664B Detector for 8755	446
11665B Modulator for 8755	444
11666A Reflectometer Bridge for 8755	444
11667A DC-18 GHz Power Splitter	444
11668A 50 MHz High Pass Filter for 8755	445
11675B Leveling Cable Assembly for 784B	607
11678A Low Pass Filter Kit	445
11679A/B Extension Cables for 8755	445
11683A Range Calibrator	421
11684/5/6/8/9A Low Pass Filters	445
11687A Adapter, 50 to 75Ω	396
11690A Frequency Doubler	396
11691D Coaxial Directional Coupler	434
11692D Coaxial Dual Directional Coupler	434
11693A Limiter	515
11694A Matching Transformer, 50-75Ω	515
11697A, B & C Bandpass Filters	396
11708A Attenuator (for Calibrating of 8484A)	422
11710B Down Converter	385
11713A Attenuator/Switch Driver	430
11720A Pulse Modulator	394
11850A & B Power Splitters	464
11851A RF Cable Kit for 8505A	465
11852A 50-75Ω Minimum Loss Pad	465
11853A 50Ω Type N Accessory Kit	465
11854A 50Ω BNC Accessory Kit	465
11855A 75Ω Type N Accessory Kit	465
11856A 75Ω BNC Accessory Kit	465
11857A/B/C Test Port Extension Cables for 8503A & B	465
11858A Rigid Interconnect Adapter	465

12000	
12551B 16-Bit Relay Output Register	629
12555B Digital-to-Analog Converter	629
12556B 40-Bit Register	629
12604B Data Source Interface	629
12930A Dual-Channel Interface	629
12940A 20 Mbyte Disc Cartridge	642
13000	
13064A Tape Degausser	270
13290B Development Terminal	632
13356A 120 Mbyte Disc Pack	642
13394A 50 Mbyte Disc Pack	642
13515A Frequency Doubler Probe	394
14000	
14513A Rack Kit (for one unit, 3½"H)	236
14515A Rack Kit (for one unit, 5¼"H)	236
14521A Rack Kit (for Bench Series)	236
14523A Rack Kit (for two units, 3½"H)	236
14525A Rack Kit (for two units, 5¼"H)	236
14533B Pocket Programmer	241
14534A Pocket Programmer Cable	241
14535A Interface Kit, DCPS-to-21 MX Computer	241
14536A DCPS Chaining Cable	241
14539A Cable Assembly, DCPS to 21 MX Computers	241
14540 Cable Assembly, Multiprogrammer-to 21 MX Computer	645
14541A Chaining Cable, 6940B or 6941B to 6941B	645
14550A Interface Kit, Multiprogrammer-to-21 MX Computer	645
14551A Multiprogrammer Service Kit	645
14555A Multiprogrammer Card Connector	645
15000	
15263A Card Reader	343
15450A Four-Channel Adapter	343
15451A Four-Channel TTL-CMOS Translator	343
15507A Isolator	567
15508B Impedance Converter	567
15509A Amplifier	567
15575A-H Equalizers	595
15578A 90 MHz High-Impedance Active Probe	595
15580A 25 MHz High-Impedance Active Probe	595
15581B 25 MHz High-Impedance Passive Probe	595
15582A Return Loss Kit	595
15584A Transit Case	595
15585A Diagnostic Kit	595
15587A 25 MHz Low-Noise Amplifier	595
15588A 90 MHz Low-Noise Amplifier	595
15589A Instrument Cart	595
16000	
16005A Probes	81
16006A Probe	81
16007A Test Leads	81
16008A Resistivity Cell	82
16011A BNC Connector Test Fixtures	85
16012A, 16013A Test Fixtures	85
16014A Series Loss Test Adapter	98
16019A Test Fixture	80
16021A Calibration Connector	92



MODEL NUMBER INDEX

New product listings are printed in bold face type

16022A Test Fixture	92	33322 series Coaxial Step Attenuators	432
16023A DC Bias Controller	91	33330B/C Coaxial Crystal Detectors	436
16029A Test Fixture	84	34110A Carrying Case	73
16032A Test Leads (BNC)	92	34111A High Voltage Probe	73
16033A Test Leads	92	34112A Touch-Hold Probe	73
16034A Test Fixtures	92	37201A HP-IB Extender	28
16035A Test Leads	96	37210A/B 4800 b/s Modem	29
16036A Test Leads	96	37220B 9600 b/s Modem	29
16037A Test Fixture	96		
16038A Test Fixture	92	40000	
16039A Test Fixture	91	43501B X-Ray System	647
16045A Test Leads	93	43804 X-Ray System	647
16061A Test Fixture	89	43805 X-Ray System	647
16062A Test Lead	89	43807 X-Ray System	647
16063A Test Lead	89		
16117A Test Lead	82	50000	
16138A Test Leads	80	59301A ASCII—Parallel Converter	26
16143A Probe Cable	81	59303A Digital-to-Analog Converter	26
16252A Matching Transformer	349	59304A Numeric Display	26
16411A HP-IB Interface Kit	85	59306A HP-IB Relay Actuator	26
16413A HP-IB Interface Kit	97	59307A HP-IB VHF Switch	26
16462A Auxilliary Capacitor	98	59308A HP-IB Timing Generator	26
16470A Reference Inductors	98	59309A HP-IB Digital Clock	26
16491A Camera Bezel Adapter	191	59310B HP-IB Computer Interface	31
		59313A HP-IB Analog-to-Digital Converter	26
17000		59401A Bus System Analyzer	25
17005A Chart Advance for 7004B Recorder	245	59403A HP-IB Common Carrier Interface	28
17012B Point Plotter	245	59500A Multiprogrammer HP-IB Interface	26, 643
17012C Point Plotter	245	59501A HP-IB Power Supply Programmer	26, 228
17108A Time Base	246		
17170A DC Coupler	245	60000	
17171A DC Amplifier	245	61000 Modular Power Supplies (OEM)	238
17172A Time Base	245	61005C DC-to-DC Converter (single output)	238
17173A Null Detector	245	61315D DC-to-DC Converter (triple output)	238
17174B DC Offset	245	62000 & 63000 Modular	
17175A Filter	245	Power Supplies (OEM)	238
17176A Scanner	245	62005A-62048G Modular Power Supplies	238
17177A AC/DC Converter DC Preamplifier	245	62212A-62215G Dual Output Modular	
17178A DC Attenuator	245	Supplies	238
17400A High Gain Preamplifier	263	62312D Triple Output Modular Supply	238
17401A Medium Gain Preamplifier	263	62410A Modular Supply Rack Mounting Tray	238
17402A Low Gain Preamplifier	263	62411A Rack Tray Blank Front Panel	239
17403A AC Carrier Preamplifier	263	62412A Rack Tray Blank Rear Panel	239
17404A DC Bridge Amplifier	263	62413A Rack Tray Cooling Unit (45 cfm)	239
17500A Multiple Span	258	62414A Rack Slice Kit (for standard cabinets)	239
17501A Multiple Span	258	62415A Rack Tray AC Distribution Panel	239
17502A Temperature Module	258	62416A Rack Tray Cooling Unit (160 cfm)	239
17503A Single Span	258	62605L, 62605M, 62615M 300-600W	
17504A Single Span	258	Switching Power Supplies	238
17505A High Sensitivity	258	63005C 110W Switching Power Supply	238
17506A Single Span	258	63312F Multiple Output DC Power Supply	238
		63315D Triple Output Switching	
20000		Power Supply	238
22900A Analog Input Card	629	69322A Quad D/A Voltage Converter Card	646
22901A Analog Output Card	629	69330A Relay Output Card	646
22902A Digital Input Card	629	69331A Digital Output Card	646
22903A Common Interrupt Card	629	69332A Open Collector Output Card	646
22904A Digital Output Card	629	69335A Stepping Motor Control Card	646
22905A Counter/Stepper Motor Card	629	69351B Voltage Regulator Card	646
22920A Signal Conditioning Tray	629	69370A D/A Current Converter Card	646
		69380A Breadboard Output Card	646
30000		69422A High Speed A/D Converter Card	646
33300 series Step Attenuators	432	69423A Low Level A/D Converter Card	646
33311B/C Coaxial Switches	440	69430A Isolated Digital Input Card	646
33320 series Coaxial Step Attenuators	432	69431A Digital Input Card	646
33321 series Coaxial Step Attenuators	432	69433A Relay Output With Readback Card	646

69434A Event Sense Card	646	98034A HP-IB Interface	30, 624
69435A Pulse Counter Card	646	98035A Real Time Clock Interface	624
69436A Process Interrupt Card	646	98036A Serial Interface	624
69480A Breadboard Input Card	646	98040A Incremental Plotter Interface	624
69500A Unloaded Resistance Output Card	646	98041A Disc Interface	625
69501A-69513A Power Supply Control Cards	646	98133A BCD Interface	624
69600B Programmable Timer Card	646	98134A General Interface	624
69601B Frequency Reference Card	646	98135A HP-IB Interface	30, 624
		98136A RS-232-C Serial Interface	624
80000		0960-0054 SMA Female Short (5052)	
84801A Fiber Optic Power Sensor	419	0960-0055 SMA Male Short (5052)	
85010B Basic Measurement Program Pac		1250-0076 90° BNC Male-Female	553
for 8501A/8505A & 9825A	467	1250-0077 Type N Female to BNC Male	553
85030B Applications Pac for 8507B-9825A	467	1250-0080 BNC Female to Female	553
85031A APC-7 Calibration and Verification		1250-0082 Type N Male to BNC Male	553
Kit for 8507B	467	1250-0176 Type N Male	
85032A 50Ω Type-N Calibration Kit		to Type N Female 90°	553
for 8507B	467	1250-0216 BNC Male to Male	553
85033A SMA Calibration Kit for 8507B	467	1250-0559 Type N Tee, 1 Male, 2 Female	553
85036A 75Ω Type N Calibration Kit		1250-0777 Type N Female to Type N Female	553
for 8507B	467	1250-0778 Type N Male to Male	553
85426A Bias Insertion Network	469	1250-0780 Type N Male to BNC Female	553
85428B Minimum Loss Pad	469	1250-0781 BNC Tee 1 Male, 2 Female	553
86200 series Sweeper Plug-ins for 8620C	410, 607	1250-0846 Type N Tee, 3 Female	553
86222A & B Sweeper Plug-ins for 8620C	408, 607	1250-1158 SMA Female to Female	553
86240A/B/C Sweeper Plug-ins for 8620C	406, 607	1250-1159 SMA Male to Male	533
86290A & 86290B Broadband Sweeper		1250-1286 Right Angle BNC (f)	553
Plug-ins for 8620C	404	1250-1287 BNC (f) to BNC (f)	553
86300 series Sweeper Modules for 8620C	412	1250-1288 BNC (m) to BNC (m)	553
86601A RF Section for 8660A/C	376	1250-1454 BNC Adapter Tip for HP	
86602B RF Section for 8660A/C	376	Miniature Probes	184
86603A RF Section for 8660A/C	376	1250-1472 N (f) to N (f) Precision (50Ω)	553
86631B Auxiliary Section for 8660A/C	377	1250-1473 N (m) to BNC (m) Precision (50Ω)	553
86632B AM/FM Section for 8660A/C	377	1250-1474 N (f) to BNC (f) Precision (50Ω)	553
86633B AM/FM Section for 8660A/C	377	1250-1475 N (m) to N (m) Precision (50Ω)	553
86634A Phase Modulation Section for		1250-1476 N (m) to BNC (f) Precision (50Ω)	553
8660A/C	377	1250-1477 N (f) to BNC (m) Precision (50Ω)	553
86635A M, FM Section for 8660A/C	377	1250-1528 N (m) (75Ω)	553
		1250-1529 N (f) to N (f) (75Ω)	553
90000		1250-1530 N (m) Short (75Ω)	438
90100D Practical Transistor Series (Video Tape)	663	1250-1531 N (f) Short (75Ω)	438
90420D Digital Troubleshooting (Video Tape)	661	1250-1533 N (m) to BNC (m) (75Ω)	553
91000A Analog-To-Digital Interface for HP 1000	629	1250-1534 N (f) to BNC (m) (75Ω)	553
93282A ATS Consolidation Service	628	1250-1535 N (m) to BNC (f) (75Ω)	553
93283A ATS Racking and Cabling Service	628	1250-1536 N (f) to BNC (f) (75Ω)	553
93284A ATS Configuration/System Test Service	628	1251-2277 Dual Banana plug to BNC Female	553
97001A Rechargeable Battery Pack for 970A	49	1251-2816 Dual Banana plug (for cable)	553
97002A AC/DC Current Shunt/Bench Cradle		10004-69515 IC Probe Tip Adapter	187
for 970A	49	10017-67603 Adapter Cable, HP standard probe to 0.64 mm	
97003A RF Adapter for 970A	49	(0.025 in.) square pin	184
97004A Accessory Kit for 970A	49	10017-67604 Adapter, converts HP miniature probes for use	
98032A 16-bit Parallel Interface	624	with standard probe accessories	184
98033A BCD Input Interface	624	10024-69501 Interface Pen Kit for 10024A	183

HEWLETT-PACKARD INTERFACE BUS

Versatile interconnect system for instruments and controllers

- HP's implementation of IEEE Standard 488 and identical ANSI Standard MC 1.1
- Useful over wide range of problems, from simple to very complex—add capabilities as your system requirements grow
- Very broad selection of HP-IB instruments and accessory devices—available now
- Wide choice of computing controllers for the reduction, analysis, storage and management of measurement data.

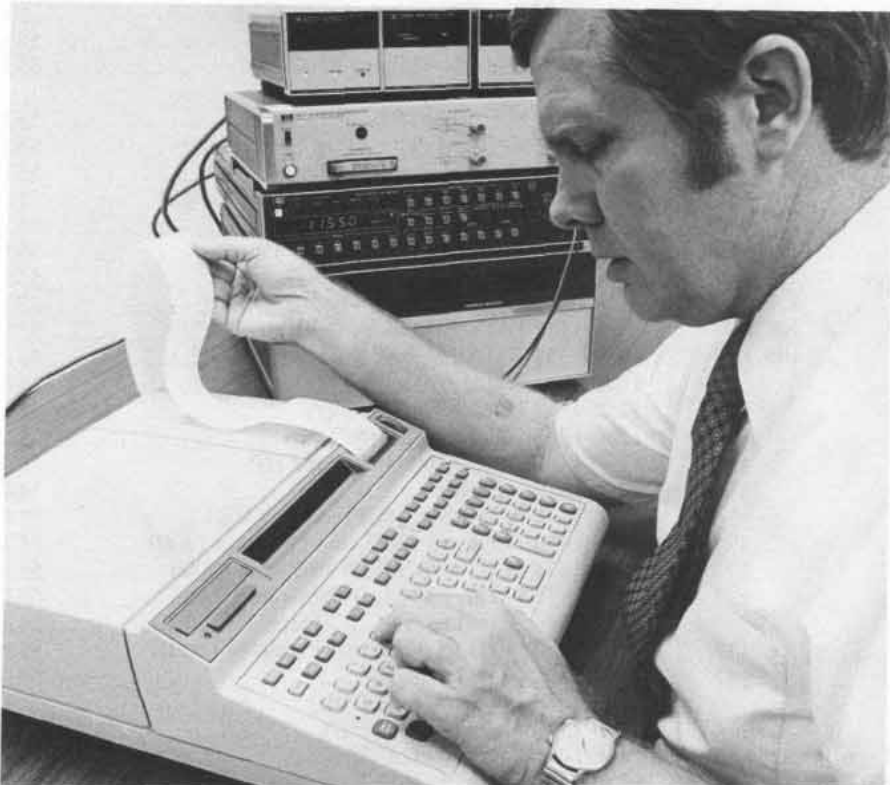

Make accurate, problem-oriented measurements, controlled by computer.

There are many measurement applications where interactive instruments coupled with a controller can provide superior, error-free results as compared with conventional manual methods.

Now, three things combine to reduce significantly the engineering costs of putting such a system together. These are: (1) the Hewlett-Packard Interface Bus, also known simply as "HP-IB"; (2) the growing number of "smart" instruments having internal processor capability; and (3) the broad choice of computing controllers, ranging from individual "friendly" keyboard units through those capable of multi-station measurements and sophisticated data management.

Benefits of a systems approach

The decision to use a "system" instead of conventional manual methods must be based on an engineering evaluation of benefits vs. costs. Among the many benefits associated with a systems approach:

- More consistent results in repeated measurements—a system is not subject to operator fatigue.
- Greater throughput because systems are

generally faster.

- More thorough testing because system speed allows more parameters to be measured in a shorter time.
- Results expressed in engineering or scientific units since many systems controllers are capable of on-line data manipulation.
- Greater accuracy because system errors can be measured automatically, stored, and accounted for in the results.
- "Adaptive" data acquisition wherein a system can be programmed to branch to other measurements to help pinpoint the problem when it senses an abnormal condition.

Relationship of HP-IB to present and proposed interface standards: Hewlett-Packard is committed to the overall advancement of measurement technology, and has for quite some time been working on the problems of simplifying and standardizing instrument interconnection.

Concurrent with the considerable practical experience HP has gained (with both HP-IB and interface techniques in general) over recent years has been the growing international interest in establishing a suitable standard

for programming measuring apparatus—a standard that will allow instrument systems to be configured from the products made by different manufacturers. European organizations, particularly in Germany, have been instrumental in initiating an international standardization effort.

In mid-1972, HP began to participate in various international standardization bodies. The U.S. Advisory Committee, composed of diverse interests represented by both users and manufacturers, first established initial goals—and then adopted the interface concept utilized by the HP Interface Bus as an appropriate starting point. A draft document was subsequently written and evaluated by members of the Committee, and then submitted as the U.S. Advisory Committee, and then submitted as the U.S. proposal to an IEC (International Electrotechnical Commission) Working Group in the autumn of 1972. Since then, the interface definition has undergone a number of minor changes to accommodate various needs at the international level.

In September 1974, the parent technical committee, IEC TC66, approved the main interface draft document for a formal ballot among the member nations of the IEC. Balloting took place in 1976, and is anticipated that an IEC document will be available in 1979. *The present definition of the HP-IB is compatible with the main IEC draft document.*

Meanwhile, the IEEE Standards Board approved IEEE Standard 488-1975 "Digital Interface for Programmable Instrumentation", as published in April 1975.¹ The IEEE standard is based on work initiated by the IEC, and follows the general concepts of the document now under consideration by IEC member nations. *The HP Interface Bus is Hewlett-Packard's implementation of IEEE Standard 488.* (NOTE: In January 1976, the American National Standards Institute adapted the above and published it as ANSI Standard MC 1.1).

The standardized interface concept is now well accepted, and more than 400 products utilizing the concepts articulated in IEEE 488 are today available from more than 150 different manufacturers.

A revision to IEEE Standard 488 was published in mid-1978 to clarify a few potentially ambiguous statements. The forward to the new revised Standard states in part, "The principal improvements to the written text of this Revised Standard focus on editorial changes rather than substantive technical changes to the Standard itself." Hewlett-Packard products are in concert with both the original and the revised IEEE 488 Standard.

Why the HP Interface Bus name?

As the list of HP products available with the "new digital interface" has grown, our customers have in the past sought a convenient way to identify those products having

¹To purchase a copy of IEEE Standard 488-1975, contact: The Institute of Electrical and Electronic Engineers, 345 East 47th Street, New York, N.Y. 10017.

Measurement and user information is available from Hewlett-Packard, Publication No. 5952-0058: HP-IB Improving Measurement in Engineering and Manufacturing.

the interface capability. In response, we in 1974 adopted the name "Hewlett-Packard Interface Bus" (commonly shortened to "HP Interface Bus" or simply "HP-IB"). We will continue to use the identifying name and this symbol:



Both will be used with appropriate HP products so that their interface capabilities may be readily identified. **HP-IB products fully comply with IEEE-488, ANSI standard MC1.1 and the IEC draft document.**

As additional instrumentation interface standards become approved, HP will clearly indicate the relationship of the Hewlett-Packard Interface Bus to those standards—just as we have done with IEEE Standard 488 (and identical ANSI Standard MC 1.1).

It should be pointed out that as a practical matter, device-dependent operational characteristics have been excluded from the IEEE and proposed IEC Standards definitions. In this way, users retain maximum flexibility in selecting instruments from different manufacturers and in utilizing each instrument's particular capabilities to best advantage.

Relative to the great progress made in standardizing three of the four interface system elements (*mechanical, electrical, functional*), understanding the remaining device-dependent operational parameters referred to in the IEEE document is a relatively small but essential ingredient necessary to ensure complete operational systems.

It would be presumptuous for Hewlett-Packard to speak for other manufacturers; however, it is our objective to reduce as much as practical any device-related ambiguities associated with HP products operating per the IEEE Standard (and proposed IEC Standard). We expect to do this through product design considerations; through new message concepts, as well as further code and format guidelines; and through various printed materials and training activities.

How the HP Interface Bus operates

All active interface circuitry is contained within the various HP-IB devices, and the interconnecting cable (containing 16 signal lines) is entirely passive. The cable's role is limited to that of interconnecting all devices together in parallel, whereby any one device may transfer data to one or more other participating devices.

Every participating device (instrument, controller, accessory module) must be able to perform at least one of the roles of **TALKER, LISTENER** or **CONTROLLER**. A **TALKER** can transmit data to other devices via the bus, and a **LISTENER** can receive data from

other devices via the bus. Some devices can perform both roles (e.g. a programmable instrument can **LISTEN** to receive its control instructions and **TALK** to send its measurement).

A **CONTROLLER** manages the operation of the bus system primarily by designating which devices are to send and receive data, and it may also command specific actions within other devices.

A minimum HP-IB system configuration consists of one **TALKER** and one **LISTENER**, but without a **CONTROLLER**. In this configuration, data transfer is limited to direct transfer between one device manually set to "talk only" and one or more devices manually set to "listen only" (e.g. a measuring instrument talking to a printer, for semi-automatic data logging).

The full flexibility and power of the HP-IB become more apparent, however, when one device which can serve as **CONTROLLER/TALKER/LISTENER** (e.g. calculator or computer) is interconnected with other devices which may be either **TALKERS** or **LISTENERS**, or both (e.g. frequency synthesizers, counters, power meters, relay actuators, displays, printers, etc.), depending on the application. An HP-IB computing controller participates in the measurement by scheduling measurement tasks, setting up individual devices so that they can perform these tasks, monitoring the progress of the measurement as it proceeds, and interpreting the results of the measurement. (See page 28 for additional details about HP-IB computing controllers.)

HP-IB connections and structure

The 16 signal lines within the passive interconnecting HP-IB cable are grouped into three sets, according to their function.

Eight **DATA** lines carry coded messages in bit-parallel, byte-serial form to and from devices, with each byte being transferred from one **TALKER** to one or more **LISTENERS**. Data flow is bidirectional in that the same lines are used both to input program data and to output measurement data from an individual device. Data is exchanged asynchronously, enabling compatibility among a wide variety of devices. All interface messages (to set up, maintain, and terminate an orderly flow of device-dependent messages) are 7-bit coded. Device-dependent messages may be from 1 to 8 bits; however, the codes containing printable characters of the ASCII (American Standard Code for Information Interchange) code set are most commonly used, and messages containing numbers are typically presented in scientific notation (FORTRAN-type) format.

Three **DATA BYTE TRANSFER CONTROL** (handshake) lines are used to effect the transfer of each byte of coded data on the eight **DATA** lines.

The five remaining **GENERAL INTERFACE MANAGEMENT** lines ensure an or-

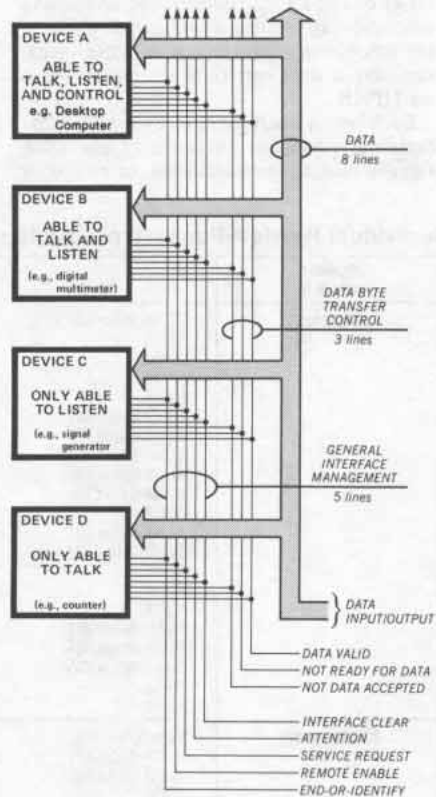

Interface connections and bus structure.



Rear panel switches are set so instrument will either be addressable by controller in a multi-device system, or will simply "talk only" to another device such as a printer.

derly flow of information within the HP-IB system. One of these is called the "ATTENTION" line.

Several listeners can be active simultaneously, but only one talker can be active at a time. Whenever a talk address is put on the **DATA** lines (while **ATTENTION** is low), all other talkers are automatically unaddressed.

It is not possible in this limited space to go into detail on each signal line's role. But you should note that every HP-IB device need not be able to respond to all the lines. As a practical and cost-effective matter, each HP-IB device will usually be designed to respond only to those lines that are pertinent to its typical function on the bus. (Details appear in each device's operating manual.)

*The term "device" is used in the standard. In system terms, device is usually an instrument or controller.



HEWLETT-PACKARD INTERFACE BUS

Versatile interconnect system for instruments and controllers

Products for "do-it-yourself" HP-IB system solutions

Hewlett-Packard has an extremely broad range of HP-IB instruments and computing controller capabilities, as indicated on the table below—capabilities you can use in assembling a wide variety of system solutions via HP-IB.

Each bench instrument is, by itself, an exceptional performer in terms of providing signals, making measurements, or recording

results. Each has the additional capability which allows its use in HP-IB instrumentation systems—either in "do-it-yourself" systems configured and assembled by users themselves, or in some of the standard systems which are designed, preassembled and supported by HP. While the HP-IB interface is optional in many instruments, it is increasingly becoming "standard" in some of the newer products.

Most principle functions on the instru-

ments are HP-IB programmable. For specific details, please consult the appropriate catalog page, or the technical data sheet which is available for each product.

Just as with the instruments, HP's computing controllers (desktop computers and computer systems) which are available for use with HP-IB are all proven performers. Regardless of your need for reducing, analyzing, storing or managing measurement data, HP has a computing controller that should be right for your application.

Individual Hewlett-Packard products available with HP-IB (IEEE 488)

Products related to:	Model	Product name/characteristics	See Page	
Stimulus	3320B Option 007	Frequency Synthesizer: 0.01 Hz to 13 MHz	360	
	3325A	Synthesizer/Function generator/Sweeper: 1 μ Hz to 22 MHz	352 & 364	
	3330B	Automatic Synthesizer/Sweeper: 0.1 Hz to 13 MHz	362	
	3335A	Synthesizer/Level Generator: 200 Hz to 80 MHz	366	
	5359A	Time Synthesizer: 1 ns accuracy	324	
	6002A Option 001	DC Power Supply: 200 W extended range	229	
	6129C Option J99	Digital Voltage Sources: \pm 50 Vdc at 5 A (requires 59301A Converter)	240	
	6130C Option J99	Digital Voltage Source: \pm 50 Vdc at 1A (requires 59301A Converter)	240	
	6131C Option J99	Digital Voltage Source: \pm 100 Vdc at 0.5 A (requires 59301A Converter)	240	
	6140A Option J99	Digital Current Source: \pm 100 mA at 100 Vdc (requires 59301A Converter)	240	
	6940B	Multiprogrammer (requires 59500A interface)	643	
	8016A Option 001	Word Generator: 9 x 32 bit	340	
	8018A Option 001	Serial Data Generator: 50 MHz, 2048-bit memory	338	
	8160A	Programmable Pulse Generator: 20 ns to 999 ms period	322	
	8165A	Programmable Signal Source: 0.001 Hz to 50 MHz	321 & 356	
	8170A	Logic Pattern Generator: 8 x 1024/16 x 512 bit	336	
	8620C Option 011	Sweep Oscillator: 10 MHz to 22 GHz	402	
	8660A Option 005	Synthesized Signal Generator: 10 kHz to 2.6 GHz	374	
	8660C Option 005	Synthesized Signal Generator: 10 kHz to 2.6 GHz	374	
	8671A	Microwave Frequency Synthesizer: 2 to 6.2 GHz	380	
	8672A	Synthesized Signal Generator: 2 to 18 GHz	378	
	Measurement	436A Option 022	Power Meter: -70 dBm to +44 dBm, to 18 GHz	420
		1602A Option 001	Logic State Analyzer: 64 x 16 bit memory	136
1640A Option 001		Serial Data Analyzer: 2048 bit memory	147	
2240A		Measurement & Control Subsystem	629	
2804A Option 010		Quartz Thermometer: 0.05°C accuracy	651	
3437A		System Digital Voltmeter: high speed, 3½ digits	56	
3438A		Digital Voltmeter: low-cost, 3½ digits	58	
3455A		Digital Voltmeter: 5½ or 6½ digits, auto calibration	66	
3490A Option 030		Digital Voltmeter: 5 digits, self test	70	
3582A		2-channel Real Time (FFT) Spectrum Analyzer: 20 MHz to 25.6 kHz	518	
3585A		Swept Spectrum Analyzer: 20 Hz to 40 MHz, 3 Hz BW, 0.5% amplitude accuracy	488	
3745A		25 MHz Selective Level Measuring Set: CCITT FDM systems	590	
3745B		25 MHz Selective Level Measuring Set: Bell FDM systems	590	
3747A		90 MHz Selective Level Measuring Set: CCITT FDM systems	590	
3747B		90 MHz Selective Level Measuring Set: Bell FDM systems	590	
3771A Option 005		Data Line Analyzer: CCITT measurement standards	574	
3771B Option 005		Data Line Analyzer: Bell measurement standards	574	
3779A		Primary Multiplex Analyzer: CEPT 2 Mb/s PCM systems	560	
3779B		Primary Multiplex Analyzer: Bell 1.5 Mb/s PCM systems	560	
4262A Option 101		Automatic LCR Meter	86	
4270A Option 101		Automatic Capacitance Bridge	85	
4271B Option 101		1 MHz Digital LCR Meter	90	
4272A Option 101		1 MHz Preset C Meter	92	
4274A Option 101		Multifrequency LCR Meter: 10 Steps, 100 Hz to 100 KHz	94	
4274A Option 102		Multifrequency LCR Meter: as above, but with isolation	94	
4275A Option 101		Multifrequency LCR Meter: 10 steps, 10 kHz to 10 MHz	95	
4275A Option 102		Multifrequency LCR Meter: as above, but with isolation	95	
4282A Option 101		Digital High Capacitance Meter	96	
4943A Option 010		Transmission Impairment Measurement System (TIMS)	582	
4944A Option 010		Transmission Impairment Measurement System (TIMS)	582	
5312A		HP-IB interface (Talker) for 5300B Counter System	312	
5328A Option 011		Universal Counter: to 512 MHz, 10 ns time interval	298	
5340A Option 011		Automatic Microwave Counter: 10 Hz to 18 GHz	316	
5341A Option 011		Automatic Microwave Counter: high speed, to 4.5 GHz	316	
5342A Option 011		Automatic Microwave Counter: 10 Hz to 18 GHz	314	
5345A Option 011,012		General Purpose Plug-In Counter	289	
5363A		Time Interval Probes	318	
5370A		Time Interval Counter: \pm 20 ps single-shot resolution	294	
5420A		Digital Signal Analyzer (requires 10920A cards)	522	
5501A Option 251		Laser Transducer: for accurate positioning measurements	649	
8501A		Storage Normalizer for 8505A RF network analyzer	463	
8503A & 8503B		S-Parameter Test Set: 50 or 75 Ohm, for 8505A	464	
8505A		RF Network Analyzer: 500 kHz to 1.3 GHz	460	
8568A		Spectrum Analyzer: 100 Hz to 1.5 GHz	492	
8901A		Modulation Analyzer: 150 kHz to 1.3 GHz	536	
			<i>Also see models 2240A and 6940B.</i>	
Storage		3964A Option 007	Instrumentation Tape Recorder: 4 channel	270
	3968A Option 007	Instrumentation Tape Recorder: 8 channel	270	
		<i>Storage also via Desktop Computers and Computer Systems</i>		

Standard HP-IB measurement systems

Many application requirements can be satisfied with a standard HP-IB measurement system—already preassembled, tested, and documented by Hewlett-Packard. Preconfigured systems save you design and setup time, and HP guarantees overall specified system performance. Installation and service contracts are available. See listing on the following page.

Warranty considerations

Every HP-IB device (instrument or computing controller) carries the standard Hewlett-Packard warranty appropriate to that individual product—regardless of whether it is purchased separately as a stand-alone item for use in customer-assembled HP-IB systems, or furnished as part of a standard HP-IB system assembled by Hewlett-Packard.

HP additionally takes responsibility for standard HP-IB systems performing as

specified. However, software or interfacing which has not been provided by Hewlett-Packard as part of the standard system delivered by HP are not covered by this warranty.

In all cases, overall operational responsibility for those HP-IB systems assembled by a customer from individual HP-IB devices shall rest with the customer.

Individual Hewlett-Packard products available with HP-IB (IEEE 488) capability

Products related to	Model	Product name/characteristics	See page
Display	1350A	Graphics Translator: for directed-beam CRT displays	196
	5150A Option 001	Alphanumeric Thermal Printer: 20 Columns	272
	9871A Option 001	Character-Impact Printer: 132 columns	627
	7225A	Graphic Plotter: ISO A4 and 8½ × 11 inch chart size	256
	7245A	Thermal Plotter/Printer: Vector graphics, matrix printing	254
	9872A	Graphics Plotter: multicolor (4 colors) programmable	253 & 624
	59304A	Numeric Display: 12 LED characters, decimal point <i>Display also via Desktop Computers and Computer Systems</i>	26
Switching Scanning Translation or Timing	2240A	Measurement and Control Subsystem	629
	3070A	Data Entry Terminal	637
	3495A	Scanner: to 80 channels, low thermal; to 40 channels, relay	76
	3754A	25 MHz Access Switch (requires 3755A switch controller)	592
	3756A	90 MHz Switch (requires 3755A)	592
	3757A	8.5 MHz Access Switch (requires 3755A)	592
	3777A	Telecommunications Channel Selector: up to 30 channels; dc to 110 KHz	562
	6940B	Multiprogrammer (requires 59500A interface)	643
	9412A	Modular Switch (requires 9411A switch controller)	577
	9413A	VHF Switch (requires 9411A)	577
	9414A	Matrix Switch (requires 9411A)	577
	11713A	Attenuator/Switch Driver (for DC to 26.6 GHz switching and attenuator control)	470
	37201A	HP-IB Extender	28
	37210A/B	4800 b/s Modem: switched or leased lines	29
	37220B	9600 b/s Modem: leased lines	29
	59301A	ASCII-to-Parallel Converter: string to 16 characters	26
	59303A	Digital-to-Analog Converter	26
	59306A	Relay Actuator: for programmable switches, attenuators	26
	59307A	VHF Switch: two 50 Ohm, bidirectional, dc to 500 MHz	26
59308A	Timing Generator	26	
59309A	Digital Clock: month, day, hour, minute, second	26	
59313A	Analog-to-Digital Converter	26	
59403A	HP-IB/Common Carrier Interface: RS232C or CCITT V24	28	
59501A	Power Supply Programmer: isolated D-to-A converter ± 10 V dc at 10 mA	228	
Control and Computation	9815A/S	Desktop Computer (uses 98135A Interface)	30 & 620
	9825A	Desktop Computer (uses 98034A Interface)	30 & 620
	9835A/B	Desktop Computer (uses 98034A Interface)	30 & 621
	9845A/S	Desktop Computer System 45 (uses 98034A Interface)	30 & 622
	HP1000 M-series	Computers (2105A, 2108M & 2112M; use 59310B Interface)	
	HP1000 E-series HP 1000 F-series	Computers (2109E & 2113E; use 59310B Interface) High-performance computers (2111F and 2117F use 59310B Interface)	
Interface Cabling	10631A	HP-IB Interconnection Cable: 1 m (3.3 ft)	25
	10631B	HP-IB Interconnection Cable: 2 m (6.6 ft)	25
	10631C	HP-IB Interconnection Cable: 4 m (13.2 ft)	25
	10631D	HP-IB Interconnection Cable: 0.5 m (1.6 ft)	25
		<i>For distance extension, also see Models 3070A and 59403A listed above.</i>	
Design and Servicing	59401A	Bus System Analyzer	25

HEWLETT-PACKARD INTERFACE BUS

Versatile interconnect system for instruments and controllers

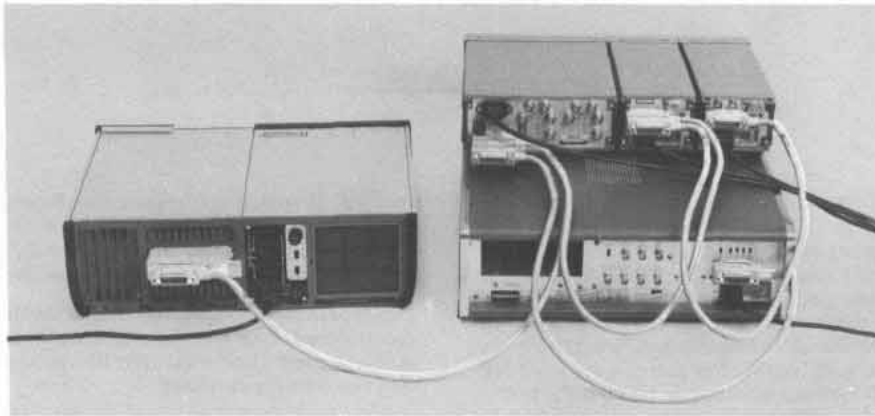

Rear view of 5-device HP-IB bench system. Note single and stacked connections.

HP-IB specification summary

Interconnect devices: up to 15 maximum on one contiguous bus.

Interconnection path: star or linear bus network; total transmission path length 2 metres times number of devices or 20 metres, whichever is less (see HP59403A for extending operating distance.)

Message transfer scheme: byte-serial, bit-parallel asynchronous data transfer using interlocked 3-wire handshake technique.

Data rate: one megabyte per second maximum over limited distance; 250–500 kilobytes per second typical over full transmission path (depends on device).

Address capability: primary addresses, 31 TALK and 31 LISTEN; secondary (2-byte) addresses, 961 TALK and 961 LISTEN. Maximum of 1 TALKER and up to 14 LISTENERS at a time.

Control shift: in systems with more than one controller, only one can be active at a time. A currently active controller can pass control to

another, but only designated system controller can assume control over others.

Interface circuits: driver and receiver circuits are TTL-compatible.

Connector lock screw compatibility

HP-IB products delivered now and in recent years are equipped with connectors having ISO metric-threaded lock screws and stud mounts. (Very early HP-IB products have non-metric parts, but are readily distinguished from the metric by color: metric threaded parts are black and stamped with the letter "M" whereas non-metric parts have a shiny nickel finish. HP-IB Metric Conversion Kit (PN 5060-0138) is available to convert these early instruments).

Standard HP-IB measurement systems

Application	Model	System name/characteristic	See Page
Data Logging and Acquisition	3052A	Automatic Data Acquisition: fast and precise low-level measurements, powerful computation.	74
	5391A	Frequency and Time Data Acquisition Systems: over 50,000 four-digit frequency and time interval measurements per second	293
	9875A	Tape Cartridge Unit	27 & 623
Network Analysis	3040A	Network Analyzer: complete amplitude and phase characterization, 50 Hz to 13 MHz. Group delay optional.	453
	3042A	Automatic Network analyzer: same as 3040A, and includes the faster 9825A as computing controller.	453
	8409A	Automatic Microwave Network Analyzer: measures transmission and reflection parameters, 110 MHz to 18 GHz.	478
	8507B	Automatic RF Network Analyzer: measures complex impedance, transfer functions, group delay; 500 kHz to 1.3 GHz.	466
Spectrum Analysis	3044A	Spectrum Analyzer: precise amplitude and frequency measurements, 10 Hz to 13 MHz.	527
	3045A	Automatic Spectrum Analyzer: same as 3044A, and includes the faster 9825A as computing controller.	527
	8581A	Automatic Spectrum Analyzer: covers 100 Hz to 1.5 GHz; exceptional frequency tuning accuracy and resolution.	497
Frequency Stability Analysis	5390A	Frequency Stability Analyzer: short and long-term characterization of precision frequency sources, 500 kHz to 18 GHz.	538
Transceiver Testing	8950B	Automatic Transceiver Test System: for AM and FM transceivers, 2 to 1000 MHz, transmitters to 100 W.	556
Digital Circuit Board Testing	DTS-70	Digital Test System; fast, accurate fault location on loaded printed circuit boards.	106
Analog & Digital Circuit Board Testing	3060A	Analog and Digital Test System: Fast, accurate fault location on loaded printed circuit boards	108

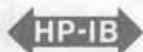

Versatile interconnect system for instruments and controllers

Bus system analyzer, cables & accessory modules



59401A

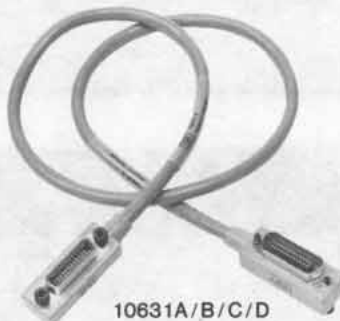

10631A/B/C/D

59401A Bus system analyzer

The HP-IB (IEEE 488) concept has greatly simplified many of those things which have in the past made instrument interfacing a burdensome task. Even so, software errors can occur if the system designer does not completely understand the bus system or the capabilities of the instruments and other devices being interfaced. Hardware problems can occur if the instruments/devices are not functioning properly, or if they are not completely compatible with the bus standard.

The 59401 Bus System Analyzer is especially useful in design and service work. It simplifies and speeds up the diagnosis of software and hardware problems by allowing the user to see the status of all bus lines, including the actual characters on the bus data lines. Because the 59401A can also drive all bus lines, it can completely exercise another Talker, Listener or Controller—which is especially useful in verifying compatibility of new or user-designed products with the HP-IB.

There are several choices of analyzer operating speed. It may be operated at one character at a time (useful for software debugging), at 2 characters per second, or at regular bus speed. It may also be operated at a variable rate as determined by the external clock input.

The analyzer's 32 character memory can be used to store bus characters in the Listen mode, or to output characters to the bus in the Talk mode. When the analyzer is in the Compare mode, a stream of bus traffic may be stopped on a pre-selected character—and at that time, a trigger pulse is available, which is very useful when analyzing transient or timing problems related to the bus.

59401A Specifications

Display: monitors all bus lines. Represents data lines, any memory location, or DIO front panel switch settings; in octal code and ASCII character.

Listen mode: stores up to 32 characters of bus traffic in memory for real time and repetitive testing. In compare mode, halts bus traffic when a selected character is present, and user can display any one of the previous 31 characters stored in memory.

Timing: accept <750 ns; ready <750 ns.

Talk mode: bus lines can be driven directly from front panel switches; memory can be loaded from front panel switches for driving bus with a 32 character sequence.

Timing: (1) data changed >500 ns before DAV pulled low; (2) ATN driven low >1 μs before DAV pulled low; (3) DAV driven high <700 ns after NDAC is false; (4) DAV driven low <700 ns after NRFD is false, if conditions 1 and 2 are met.

Operating speeds: one character at a time, 2 characters per second, regular bus speed, or variable rate determined by external clock input; in either Listen or Talk mode.

External clock input: 1 standard power TTL gate input; ≤10 MHz repetition rate.

Compare output: provides 1 standard power TTL gate output (LOW TRUE) sync pulse when bus character is same as front panel switches.

HP-IB load: 1 bus load (capable of driving 14 other bus devices).

General

Temperature ranges: operating, 0 to 50°C; storage, -40 to +75°C.

Humidity: 95% relative, 0 to 40°C.

Power requirements: 100, 120, 220 or 240 V +5%, -10%; 48 to 66 Hz; ≤42 VA.

Size: 145.5 H, 205.1 W, 495.3 mm D (5.730" x 8.075" x 19.500")

Weight: net, 5.64 kg (12.44 lb).

Options and accessories

5061-0089 front handle kit

10631B 2 m (6.6 ft) bus cable, furnished

59401A Bus System Analyzer

Price

\$15

N/C

\$2700

HP-IB Interconnection cables

Cables for interconnecting HP-IB devices are available in four different lengths. The connector block at both ends of each HP-IB cable (photo above) has a plug on one side and a matching receptacle on the other, so that several cables may be conveniently connected in parallel, thus simplifying system interconnection. Lock screws provide for secure mounting of each connector block to an HP-IB instrument, or to another cable connector block.

SPECIAL NOTE: HP-IB cables are not included with individual HP-IB devices, and must be ordered separately (exception: HP-IB computing controller interfaces include cable with connector).

Ordering information

10631A HP-IB Cable, 1 m (3.3 ft)

10631B HP-IB Cable, 2 m (6.6 ft)

10631C HP-IB Cable, 4 m (13.2 ft)

10631D HP-IB Cable, 0.5 m (1.6 ft)

Price

\$60

\$65

\$75

\$60

HP-IB Accessory modules

Modules in the HP 59300, 59400 and 59500-series are ideal building blocks for use with instruments to extend measurement capabilities. Modules listed here can be interconnected via the HP-IB to HP measuring instruments, signal sources and recording devices capable of operating directly on the HP-IB. In addition, these modules frequently serve as useful ways to interconnect with devices which are not themselves capable of direct HP-IB operation.

Instrument requirements differ. Some only output or accept data on the HP-IB. Others can be remotely programmed by ASCII characters sent along the HP-IB. These modules can work with instruments on any of these levels with or without a controller. Each module having controls can be operated stand-alone from its front panel, or it can be placed in automatic operation under program control.

Module provision for stand-alone, local operation also has important system benefits. The operator can set up and check out the system under manual control, avoiding otherwise complex and time consuming error tracing. Each module has status indicator lights that make it easy to monitor operation.



HEWLETT-PACKARD INTERFACE BUS

Versatile interconnect system for instruments and controllers



Accessory modules

59301A



59306A

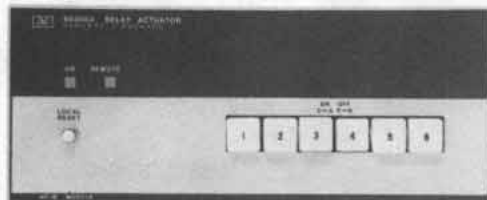

59307A

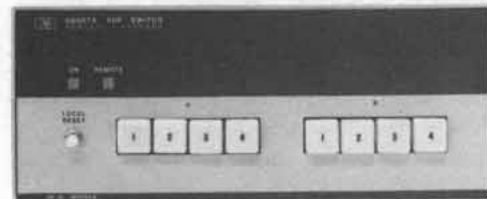

59308A



59309A



59313A



59501A



59303A



59304A

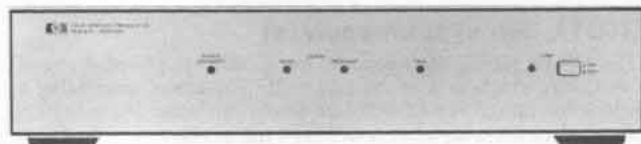

1350A

1350A graphics translator

Accepts digital information from the HP-IB (or optionally RS-232C) and converts it to X, Y, and Z analog voltages for driving high-resolution, directed-beam, non-storage CRT displays. An internal 2k word digital memory (RAM) stores the data, and is continually accessed in order to generate vectors or characters for refreshing one or more CRT displays. Each digital word can be a vector coordinate, or an ROM-generated upper or lower case ASCII character. (Additional details on page 184.)

59301A ASCII-to-parallel converter

Accepts byte-serial ASCII characters from the HP-IB and converts them to parallel output. A string of up to 16 characters terminated by linefeed is converted to 1-2-4-8 BCD and placed on the output lines; the ASCII linefeed character causes a print command (strobe) to be output by the 59301A.

With the 59301A, instruments with the HP-IB interface can be operated with HP 5050B/5055A Printers (requires two output cables, HP 562-16C, not furnished). Or, the 59301A can be used with HP 6129C thru 6131C and 6140A (Option J99) digitally-controlled power supplies for HP-IB programmable voltage and current. The 59301A can additionally be used to control other functions using its hexadecimal format.

59303A digital-to-analog converter

Accepts an ASCII string and converts any three consecutive digits to a dc voltage accurate to 0.1% in 30 μ s. Fully programmable via the HP-IB or operates stand-alone from the front panel. Offers three output modes for conversion: normal, offset, or plus-minus (9.99 volts to -9.99 volts) to make it convenient for operating strip chart recorders.

A primary application for the HP 59303A is to present on a logging device the data points being taken during a measurement, such as with the HP 5345A Counter. No controller is required for operation. Compatible logging devices include strip chart recorders, X-Y plotters, and displays.

59304A numeric display

Provides a highly visible readout of up to 12 ASCII characters (0 thru 9E.-). It can be addressed to display the output of measurement devices or the results from a calculator/desktop computer. It can also be used as a remote display in the "listen only" mode.

59306A relay actuator

Has six Form-C relays that provide for control of external devices either manually from front panel pushbuttons or remotely from the HP-IB. Relay contacts are specified to switch 24 V dc or 115 V ac @ 0.5 A. Use the 59306A with HP 8761A/B SPDT switches for HP-IB programmable microwave switching dc-18 GHz; use it with HP 8494 thru 8496G/H attenuators for HP-IB programmable attenuation dc-18 GHz (external power supply required).

59307A dual VHF switch

This module offers a pair of single throw 4-pole switches (dc to 500 MHz, 50 ohm) optimized for fast risetime (1 ns) pulse waveforms. Switches are independent and bidirectional, and can be operated either from front panel pushbuttons or remotely from the HP-IB.

59308A timing generator

Has two modes of operation—a pacing function which provides output at a specified rate, and a timing function which provides a delay with respect to a trigger for a specified period of time. Timed intervals can be selected by thumbwheel switches on the front panel, or can be programmed remotely from the HP-IB. Times from 1 μs to more than a day are available. Trigger inputs are available via HP-IB commands and rear panel connector. Timing outputs are available for both TTL and ECL levels, with switch selection of a squarewave or pulse output positive or negative-going edge. Output pulses are 500 ns ± 100 ns wide, and rise time is <50 ns.

59309A digital clock

Displays month, day, hour, minute and seconds, and upon command will output time via the interface bus. Time can be set into the clock by local control, or by remote commands received from the HP-IB. The clock accepts a small internal battery which can provide more than a day's standby during short power interruptions. Alternately, an external source such as the K10-59992 can sustain the clock for up to one year.

59313A analog-to-digital converter

This medium-speed 4-channel unit can accept a full scale input of ± 10 V dc on each channel, individually selectable in four ranges. It also has a program-controlled reverse channel for driving small signal lamps, relays, or TTL circuits. An HP-IB controller can command this unit to perform a single conversion, or initiate a series of internally-paced conversions at one of six selectable rates (up to 200/s on one channel; up to 50/s on each of four channels). Sampling can also be initiated externally by TTL transition or contact closure to ground.



9875A Cartridge Tape Unit

59501A power supply programmer (isolated DAC)

This single-channel digital-to-analog converter can control a wide range of power supplies (output voltage, or current), as well as other analog programmable devices. It may also be used as a low level signal source, depending on the speed of the controller. It has two output ranges (0-1 and 0-10V dc in unipolar mode; -1 to +1 and -10 to +10 V dc in bipolar mode), as well as photo-isolators which electrically separate HP-IB control and data lines from power supply circuitry by up to 600 V dc. (Additional details on page 228.)

9875A Cartridge tape unit

Provides a standard for data interchange among HP Series 9800 Desktop Computers via the Hewlett-Packard Interface Bus and also provides remote data acquisition capabilities. Any desktop computer in the series can store data on the 9875 tape unit, which can then read the data into any other desktop computer in the series. The tape unit stores data in HP's Standard Interchange Format.

An internal microprocessor enables the 9875 to become a stand-alone data logger in a simple HP-IB system. In the LISTEN-only mode the 9875 will automatically record data on the bus from another HP-IB device without a controller. When it's in the TALK-only mode, the 9875 will automatically output directly to another HP-IB device without a controller. Using a built-in programmable time interval (1 second to 18 hours) allows automatic delays between successive inputs or outputs.

The 9875 is rack mountable and is available as either a single or double tape drive unit. Each cartridge has 225k byte capacity.

Model	Description	Dimensions—max. height ¹ x width x depth mm (inches)	Net Weight kg (lb)	Shipping Weight kg (lb)	Price
1350A	Graphics Translator	101.6 x 425.5 x 497.8 (4 x 16.8 x 19.6)	9.55 (21.0)	11.8 (26.0)	\$3450
59301A	ASCII-to-parallel Converter	101.6 x 212.9 x 294.6 (4 x 8.38 x 11.6)	1.70 (3.78)	2.32 (5.16)	\$ 575
59303A	Digital-to-analog Converter	101.6 x 105.9 x 294.6 (4 x 4.17 x 11.6)	2.61 (5.80)	3.17 (7.04)	\$ 950
59304A	Numeric Display	101.6 x 105.9 x 294.6 (4 x 4.17 x 11.6)	1.23 (2.73)	1.58 (3.51)	\$ 800
59306A	Relay Actuator	101.6 x 212.9 x 294.6 (4 x 8.38 x 11.6)	2.64 (5.87)	3.23 (7.18)	\$ 700
59307A	VHF Switch	101.6 x 212.9 x 294.6 (4 x 8.38 x 11.6)	2.64 (5.87)	3.23 (7.18)	\$ 750
59308A	Timing Generator	101.6 x 212.9 x 294.6 (4 x 8.38 x 11.6)	2.10 (4.67)	3.83 (8.51)	\$1150
59309A	HP-IB Digital Clock	101.6 x 105.9 x 294.6 (4 x 4.17 x 11.6)	1.70 (3.78)	2.84 (6.31)	\$1025
59313A	Analog-to-digital Converter	101.6 x 212.9 x 345.4 (4 x 8.38 x 13.6)	5.45 (12.0)	6.36 (14.0)	\$1500
59403A	HP-IB/Common Carrier Interface	101.6 x 212.9 x 430.0 (4 x 8.38 x 16.9)	4.50 (10.0)	6.10 (13.5)	\$1500
59501A	Power Supply Programmer	101.6 x 212.9 x 194.6 (4 x 8.38 x 11.6)	2.61 (5.80)	3.17 (7.04)	\$ 550

¹Height above includes feet, with feet removed height is 88.1 mm (3.47").

HEWLETT-PACKARD INTERFACE BUS

Versatile interconnect system for instruments and controllers
Models 37201A and 59403A



37201A



59403A



The distance between HP-IB devices may be extended by up to 1000 metres, using two 59403A's; even further with modems.

37201A HP-IB Extender

- Extends HP-IB using twisted wire pairs or modems
- Transparent device
- Auto error correction
- Output for autodialler

The 37201A HP-IB Extender allows an HP-IB link to operate over distances greater than the normal cabling lengths. The parallel HP-IB information is converted into serial form, and transmission can be over twisted wire pairs or modem connections. A second 37201A converts the serial line signal back to normal HP-IB format.

The 37201A is a transparent device. Subject to certain limitations, a pair of HP-IB Extenders can be incorporated and no additional HP-IB information is required. This is an extremely valuable feature, as it usually allows the user to include HP-IB Extenders into his system without altering the program in the HP-IB controller. The limitations are that it is not possible to pass control or parallel poll across the extended portion of the HP-IB.

The maximum data transfer rate is 750 HP-IB characters/second and this corresponds to a line transmission rate of 20k bit/s. The 37201A has automatic error detection using longitudinal and vertical parity checks, and information will be retransmitted until it is received correctly. Errors can slow the HP-IB information transfer rate across the extenders, but the probability of an error being introduced on to the HP-IB is very small. Communication between the two 37201A's is always full duplex.

With operation over twisted wire pairs, the cable contains two pairs and can be ordered as an accessory, part number 8120-1184. The cable length must be specified and the maximum length is 1 km. Transformer coupling provides longitudinal isolation from the line up to 30 V, and the data format on the line is coded and has no net dc component. The line transmission rate is nominally 20 k bit/s.

For operation with distances in excess of 1 km, a full duplex modem connection over the telephone network is used. The modem interface provided is compatible with both RS 232C and V.24 standards and the transmission rates are:

Asynchronous 150, 300, 600, 1200 bit/s
Synchronous up to 20 k bit/s

Some modems are available which operate in full duplex mode over the switched telephone network. In this situation an autodial capability

is extremely valuable as it allows the system to operate unattended, and telephone connections are made automatically as required. An output for an autodialler is provided and is compatible with recommendations RS 366 and V.25. This output is controlled directly from the HP-IB.

Other features of the 37201A include the automatic recovery of synchronization in synchronous mode, should a sync loss occur. In addition, HP-IB Extenders can be commanded to idle. In this mode, no HP-IB information is passed to the remote end, and the remote part of the system is effectively disconnected. This enables a remote end user to operate the remote equipment manually, once the system controller has set its HP-IB Extender to idle. It also allows the local system to run more quickly.

59403A HP-IB/Common Carrier Interface

Provides a way to extend the separation of component parts in an HP-IB system by more than the 20 metre maximum transmission path length specified in various interface standards, and it is especially useful for production or remote site applications. Distances up to 1000 metres are possible by using two 59403A modules (one at each location) interconnected by a dedicated and shielded two-twisted-pair cable. And even longer distances can be achieved by using a telephone line (with appropriate modems) instead of the dedicated cable.

Each 59403A module converts HP-IB data and control lines to a serial bit stream of digital information for transmission over the dedicated or telephone lines, and vice versa in the reverse direction. In both cases, operation is full duplex, so that (for example) one HP-IB device at a remote location can request service from the controller at the same time the controller is sending data to another HP-IB device at the remote location.

The recommended dedicated cable is available from HP as Part Number 8120-1197 (Belden type 8723). The 59403A is designed to operate with 110, 300, and 1200 baud asynchronous or synchronous full duplex modems which are EIA RS 232C or CCITT V.24 compatible. In the U.S., Bell 103A modems with "soft carrier turn-off" are recommended for the direct dial (DDD) network. (Check your local telephone authorities regarding data communication regulations.)

Ordering Information

37201A HP-IB Extender
59403A HP-IB/Common Carrier Interface

Price
\$2100
\$1500

HEWLETT-PACKARD INTERFACE BUS

Versatile interconnect system for instruments and controllers

Models 37210A, 37210B and 37220B



37210A



37210B

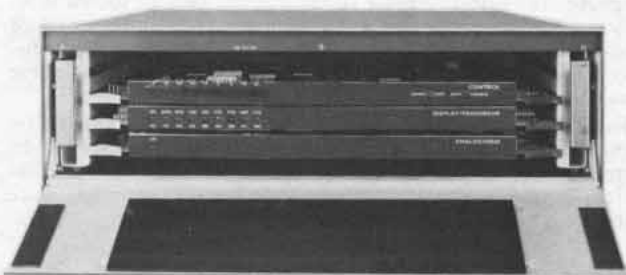

37220B



Model 37210A 4800 b/s Modem

Model 37210A is an automatically-equalized, 4800 b/s, synchronous modem. It is microprocessor controlled and is compatible with CCITT Recommendations V.27 bis and V.27 ter. It can be used over leased or switched telephone circuits, and a secondary channel is available. The data interface is CCITT V.24 compatible.

Point-to-point or multipoint operation is possible on two- or four-wire circuits. On two-wire circuits, the transmission can be simplex or half duplex. On four-wire circuits, half duplex or full duplex can be used. With leased circuits, it is possible to employ a switched circuit as back-up in the event of a line fault.

An automatic equalizer in the modem compensates for a wide range of group delay and attenuation distortions. At the start of a transmission, a training sequence is sent to the equalizer. A relatively short sequence is used for high quality M.1020 circuits and a longer sequence for poorer quality circuits. The equalizer can withstand a drop out of up to one second without retraining, and it can train on a normal data signal.

The normal operating speed is 4800 b/s and the modulation technique employed is 8-phase Differential Phase Shift Keying (DPSK). For circuits of very poor quality, a fall-back rate of 2400 b/s is available, and this employs 4-phase DPSK modulation. The carrier frequency is 1800 Hz \pm 1 Hz.

Model 37210B 4800 b/s Modem

Model 37210B is an automatically-equalized, 4800 b/s, synchronous modem. It is microprocessor controlled and is designed for use on 3002 type leased or dialled telephone lines. A secondary channel is available and the data interface is RS-232C compatible.

Point-to-point or multipoint operation is possible on two- or four-wire lines. On two-wire lines, the transmission can be simplex or half duplex. On four-wire lines, half duplex or full duplex transmission can be used. With leased lines, it is possible to employ a switched line as back-up in the event of a fault.

An automatic equalizer in the modem compensates for a wide range of group delay and attenuation distortions. At the start of transmission, a training sequence is sent to the equalizer. The equalizer can withstand dropouts of up to one second without retraining, and if necessary it will automatically retrain using the normal data signal.

The normal operating speed is 4800 b/s and the modulation technique used is 8-phase Differential Phase Shift Keying (DPSK). The carrier frequency is 1800 Hz \pm 1 Hz, and the modulation scheme is compatible with CCITT Recommendations V.27 bis, ter.

Model 37220B 9600 b/s Modem

Model 37220B is an automatically-equalized, 9600 b/s synchronous modem. It is designed for operation over conditioned or unconditioned leased telephone circuits, and provides full duplex communications using a four-wire circuit. The data interface is CCITT V.24/RS-232C compatible.

The normal data rate is 9600 b/s. A fallback rate of 4800 b/s is available for poorer quality lines and is front-panel selectable. It is also possible to select a fallback rate using the V.24 interface. Where permitted, a switched telephone circuit can be used as back-up in the event of a line fault. This connection normally operates at 4800 b/s.

An automatic equalizer in the modem compensates for a wide range of group delay and attenuation distortions. At the start of a transmission, a training sequence is sent to the equalizer. The equalizer can withstand transient distortions for up to two seconds without retraining. Retraining can be initiated automatically, or manually using a front-panel control.

At the normal operating speed of 9600 b/s, the modulation technique employed is 4-level Pulse Amplitude Modulation (PAM). This is transmitted as a vestigial sideband using a carrier frequency of 2853 Hz. At the fallback rate of 4800 b/s, the modulation technique is 2-level PAM.

Options

The following options are available:

Option Number	37210A	37210B	37220B
001	•		•
002	•		
003	•	•	
004	•	•	
005	•	•	

Opt 001: 4-wire line isolation to European standards for leased line applications.

Opt 002: 2-wire line isolation to European standards for switched line applications.

Opt 003: DAA control; auto answer; switched lines only; for U.S. applications.

Opt 004: secondary channel

Opt 005: remote loopback facility.

Ordering Information

37210A 4800 b/s Modem

37210B 4800 b/s Modem

37220B 9600 b/s Modem

Price

\$3700

\$3700

\$5500

HEWLETT-PACKARD INTERFACE BUS

Versatile interconnect system for instruments and controllers

Computing controllers/interfaces



HP 9815A Desktop Computer (HP 98135A Interface)

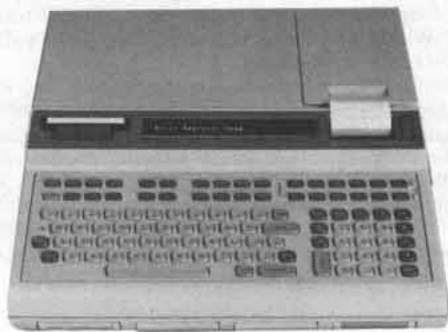

HP 9825A Desktop Computer (HP 98034A Interface)



System 35 Desktop Computer (HP 98034A Interface)

A separate controller is not required for simple HP-IB configurations (e.g. data logging). However, the full flexibility and potential of the Hewlett-Packard Interface Bus are more obvious when used with HP Computing Controllers.

Role of a computing controller

In addition to managing the flow of information over the bus, the computing controller in an operating measurement system actively participates by scheduling measurement tasks, by setting up individual devices so they can perform the tasks, by monitoring the progress of the measurement as it proceeds, and by interpreting the results of the measurement.

HP computing controllers serve another important function by providing access to a large number of display, input/output and data storage peripherals. These include plotters, line printers, floppy disks, tape cassettes, etc. Additionally, HP computing controllers can perform the job of interfacing with other instrument subsystems or computer systems using serial communication links—thereby gaining access to common data bases, sharing results, etc.

Finally, a computing controller can provide the tools for program development. These will normally include an editor that can be used in generating source programs, debug aids that can be used in analyzing and modifying program flow, and a means of storing and recalling programs and/or results.

Wide choice of HP computing controllers

Hewlett-Packard has a continuum of HP-IB (IEEE 488) computing controllers from which to select. If your interfaced-system application is of the "lab bench" variety (as in engineering design or metrology), you may prefer to use one of the desktop keyboard units such as the 9815A, 9825A, System 35 or System 45. On the other hand, if your application calls for complex or high volume production testing at multiple locations, simultaneously, and in several programming languages, your choice will probably be one of the solutions offered by the HP 1000 Computer.

HP-IB interfaces for each computing controller are described below. For more comprehensive details on the computing controllers please consult pages 620-622.

98135A HP-IB interface for 9815A

HP's most economical computing controller is the 9815A desktop unit, for handling the less complex tasks associated with small sys-

tems. If you are familiar with HP's hand-held personal calculators, you'll feel at home with the 9815A's Reverse Polish Notation (RPN) language. The keyboard has a 10-key numeric pad, 15 special function keys, program language and control keys, editing keys, and 28 scientific function keys. The 9815A has a 16-character numeric display, a thermal printer, and a high-speed bidirectional magnetic tape data cartridge system.

For HP-IB applications, the 9815A can accept one *HP 98135A Interface*, which allows the 9815A to communicate with up to 14 HP-IB instruments or peripheral devices. If your application requires an interrupt capability, please see other HP computing controllers, since interrupt is not available with the 9815A/98135A.

98034A HP-IB interface for 9825A or System 35 or 45

The 9825A Desktop Computing Controller is an extremely flexible performer. It uses HPL, a high level, formula-oriented programming language which offers power and efficiency for handling equations, data manipulation, and input/output operations. HPL provides for subroutine nesting and flags, and allows 26 simple variables and 26 multidimensional array variables, limited only by the size of the 9825A's memory. Also, HPL has a language compatibility with the HP 9820A and HP 9821A, permitting programs for these earlier models to be converted for use with the 9825A.

Significant capabilities of the 9825A include two-level priority interrupt (for controlling several instruments or peripherals requiring attention at unpredictable rate or times), live keyboard, direct memory access, multi-dimensional arrays, automatic memory record and load, and an extended range of internal computation. The 9825A has a typewriter-like keyboard with upper/lower case, a numeric pad, and 12 special function keys (shiftable to 24). It has a built-in 32-character alphanumeric display, a 16-character printer (both upper/lower case), and a high-performance data cartridge system. There are three I/O slots and four ROM slots.

The Series 9800 System 35 (Models 9835A and B) is a powerful, integrated desktop computer ideal for many scientific and engineering applications involving computation, data acquisition or both. It offers large memory (64 k to 256 k bytes), built-in tape cartridge drive (217 k bytes) optional thermal printer (16-character) and an impressive range of interfacing capabilities including buffered I/O, Direct Memory Access (DMA), fast read/write, 15 levels of priority



System 45 Desktop Computer (HP 98034A interface)

interrupt and built-in I/O drivers. System 35A has a 12-inch CRT (24 lines x 80 characters), and System 35B has a lower-cost 32-character single line display. Both can be programmed in HP's powerful, enhanced BASIC and in assembly language. Assembly-level programming can offer speed increases of two to 100 times to experienced programmers in specialized applications.

System 35's enhanced BASIC has many of the powerful features of FORTRAN while remaining easy to learn and use. ANSI BASIC programs as well as HP enhanced BASIC programs written for System 45 will run on System 35. With unified mass storage commands and unified graphics commands, the same programs work regardless of which mass storage device or plotter is used.

The Series 9800 System 45 (Model 9845A) is an integrated desktop computer for such applications as mathematical modeling, design analysis, production test control, text processing and linear programming. It provides fifteen levels of programmable priority interrupt and it includes a CRT display, an optional 80-character thermal line printer, enhanced BASIC language, and a unified mass storage system with two tape cartridge drives.

In the alpha mode, the CRT lists programs for viewing and editing, or displays data, keyboard inputs, user prompts and system messages. In the graphics mode, the CRT displays plots within a 560 x 455 dot matrix and allows dot-for-dot duplication of the graphic data in hard-copy form using the optional high-speed thermal printer.

System 45's language uses the same set of commands to address any selected storage medium, such as the HP 9885 Flexible Disc Drive, the HP 7900 Series large fixed disc drives, and the built-in 217 k byte tape cartridges.

The HP 98034A Interface is required for operating the 9825A, System 35 or System 45 in HP-IB applications. A 9825A equipped with a General I/O ROM can handle fundamental HP-IB input/output operations. With an Extended I/O ROM, the 9825A is capable of complete HP-IB control. All these operations are available on the 9835A/B with just the General I/O ROM. Up to three interfaces can be plugged directly into the System 35's I/O slots and as many as 14 interfaces (with up to 14 devices on each) can be connected to System 35 using 9878A I/O expanders. System 45 has complete HP-IB capability with the Opt. 320 I/O ROM. Up to four interfaces can be plugged directly into System 45's I/O slots and as many as 12 interfaces (with up to 14 devices on each) can be connected using 9878A I/O expanders.



HP 1000 Computer System (HP 59310B interface)

59310B HP-IB interface for HP 1000

The HP 1000 computer system is especially well suited for broad measurement and data management requirements such as those found in quality assurance, production testing, etc. This is because the HP 1000 (combining an E-series or F-series computer and Real Time Executive Software) is capable of concurrently controlling multiple clusters of HP-IB test and measuring equipment which may be organized into separate physical or functional groupings, each of which may have up to 14 HP-IB devices per cluster. The HP 1000 also: (1) makes it possible to develop new programs while existing programs are actively controlling and communicating with the bus-interfaced devices; (2) can be programmed in HP Real Time BASIC, FORTRAN, and HP Assembly language; and (3) can be linked to distributed computer networks to achieve centralized test record maintenance, yield analysis, and work order scheduling and tracing.

Each separate bus cluster (of up to 14 HP-IB devices) connected to the HP 1000 requires one 59310B Interface. The 59310B is supported by a driver, utility software and a manual supporting operation in HP's memory-based RTE-M and disc RTE-II and RTE-IV Real Time Executive systems. A diagnostic routine for quickly confirming correct operation is included with the interface, and each interface has a 4-metre cable terminated in an HP-IB connector with metric fasteners. Compatibilities between various HP computer systems, computers, and operating systems are indicated below. The E-series and F-series Computers include the HP 2170A, 2171A, 2172A, 2174A/B, 2175A/B, 2176A/B, and 2177A/B. Note that the 59310B interface may also be used with HP 2100A/S computers.

	HP 1000	HP 2105A	HP 2176A/B 2177A/B	HP 2100A/S
RTE-M:	Yes	Yes	Yes	No
RTE-II:	Yes	No	Yes	Yes
RTE-IV:	Yes	No	Yes	No

HP-IB interface ordering information

59310B: Interface, RTE-II/IV for HP 1000	\$600
98034A: Interface for 9825A, 9835A/B or 9845A	\$400
98135A: Interface for 9815A	\$600

Price

AMPLIFIERS

General purpose amplifiers

Model 461A, 465A, 467A



461A



465A



467A

461A Description

This general purpose amplifier can be used as a preamplifier to raise the level of a signal or as a buffer.

The solid-state HP amplifier Model 461A provides stable 20 and 40 dB gain over a wide frequency range with fast rise time.

461A Specifications

Frequency response: ± 1 dB, 1 kHz to 150 MHz when operating into a 50 Ω resistive load (500 kHz reference).

Gain at 500 kHz: 40 dB ± 0.5 dB or 20 dB ± 1.0 dB, selected by front panel switch (inverting).

Input impedance: nominal 50 Ω .

Maximum input: 1 V rms or 2 V p-p pulse.

Maximum dc input: ± 2 V.

Maximum output: 0.5 V rms into 50 Ω resistive load.

Equivalent wide-band input noise level: $< 40 \mu\text{V}$ in 40 dB position when loaded with 50 Ω .

Distortion: $< 5\%$ at maximum output and rated load.

Overload recovery: $< 1 \mu\text{s}$ for 10 times overload.

Dimensions: 76 mm H x 130 mm W x 279 mm D (3" x 5 $\frac{1}{8}$ " x 11").

Weight: net, 1.8 kg (4 lb). Shipping, 2.7 kg (6 lb).

465A Description

HP's 465A amplifier provides 20 dB or 40 dB gain (X10 or X100) with flat frequency response from 5 Hz to 1 MHz with floating inputs.

465A Specifications

Voltage gain: 20 dB (X10) or 40 dB (X100), open circuit.

Gain accuracy: ± 0.1 dB, ($\pm 1\%$) at 1 kHz.

Frequency response: ± 0.1 dB, 100 Hz to 50 kHz; < 2 dB down at 5 Hz and 1 MHz.

Output: > 10 V rms open circuit; > 5 V rms into 50 Ω (0.5 W).

Distortion: $< 1\%$, 10 Hz to 100 kHz; $< 2\%$, 5 Hz to 10 Hz and 100 kHz to 1 MHz.

Input impedance: 10 M Ω shunted by < 20 pF.

Output impedance: 50 Ω .

Noise: $< 25 \mu\text{V}$ rms referred to input (with 1 M Ω source resistance).

Dimensions: 76 mm H x 130 mm W x 279 mm D (3" x 5 $\frac{1}{8}$ " x 11").

Weight: net, 1.8 kg (4 lb). Shipping, 3.2 kg (7 lb).

467A Description

HP's 467A Power Amplifier/Supply is a 10 watt peak power amplifier and -20 V (to $+20$ V) dc power supply. The wide bandwidth offers low dc drift from dc to 1 MHz and 0.3% gain. With continuously variable gain and floating inputs, HP's 467A can also be used as a power supply.

467A Specifications

Power amplifier

Voltage gain (non-inverting): fixed steps: X1, X2, X5, X10. Variable: 0-10, resolution is better than 0.1% of full output.

Accuracy: $\pm 0.3\%$ from dc to 10 kHz $\pm 1.0\%$ from 10 kHz to 100 kHz; $\pm 10\%$ from 100 kHz to 1 MHz with load of $> 40\Omega$.

Output: ± 20 V p at 0.5 A p.

Distortion: $< 0.01\%$ at 1 kHz; $< 1\%$ at 100 kHz; $< 3\%$ at 1 MHz.

Input impedance: 50 k Ω shunted by 100 pF.

DC power supply

Voltage range: $> \pm 20$ V, ± 10 V, ± 4 V, ± 2 V, ± 1 V with adjustable vernier. Resolution: better than 0.1% of full output.

Current: ± 0.5 A p.

Load regulation: (front panel) < 10 mV, no load to full load.

Line regulation: < 10 mV for a $\pm 10\%$ change in line voltage.

General

Output impedance: (front panel): 5 m Ω in series with 1 μH .

Current limit: < 800 mA.

Dimensions: 159 mm H x 130 mm W x 279 mm D (6 $\frac{1}{4}$ " x 5 $\frac{1}{8}$ " x 11").

Weight: net, 4.5 kg (10 lb). Shipping, 6.8 kg (15 lb).

Ordering information

461A Amplifier

465A Amplifier

467A Power Amplifier/Supply

Price

\$495

\$400

\$920

- Wide Band
- Flat Response
- Low Noise



8447D

The HP 8447 series of general purpose amplifiers combines high reliability and convenience.

High performance

The performance of these amplifiers qualifies them for a number of

uses: to improve the sensitivity of counters, spectrum analyzers, RF voltmeters, EMI meters, power meters and other devices without distortion or degradation of amplitude accuracy; to increase the maximum power available from a signal generator or sweeper.

Broadband frequency coverage

The 8447 series offers an amplifier for nearly every application in the 100 kHz to 1.3 GHz frequency range. The wide bandwidths are compatible with other wideband instruments and accommodate wide-band spectra.

Options

A variety of options are available: a 75Ω impedance model (Option 002) for applications such as television/FM broadcasting and CATV; two dual channel versions (Option 001-BNC connectors and Option 011-Type N connectors) which operate with dual channel systems such as oscilloscopes or network analyzers (or the channels may be cascaded for increased gain); Type N connectors rather than the standard BNC connectors (Option 010).

General

Weight: net, 1.56 kg (3 pounds, 7 ounces). Shipping, 2.30 kg (5 lb, 1 oz).

Size: 85.8 H x 130 W x 216 mm D (3 3/8" x 5 1/8" x 8 1/2").

Power requirements: 110 or 230 V ac ± 10%, 48-440 Hz, 15 watts.

Ordering information

	Price
8447A Preamp	\$700
8447C Power Amp	\$625
8447D Preamp	\$765
8447E Power Amp	\$815
8447F Preamp-Power Amp	\$1365

Specifications

	8447A Preamp	8447C Power Amp	8447D Preamp	8447E Power Amp	8447F Preamp-Power Amp
Frequency Range	0.1-400 MHz	30-300 MHz	100 kHz-1.3 GHz	100 kHz-1.3 GHz	100 kHz-1.3 GHz
Typical 3 dB Bandwidth	50 kHz-700 MHz	10-400 MHz	50 kHz-1.4 GHz	50 kHz-1.4 GHz	50 kHz-1.4 GHz
Gain (Mean)	20 dB ± 0.5 dB at 10 MHz	30 dB ± 1 dB	26 dB ± 1.5 dB (20°C-30°C)	22 dB ± 1.5 dB (20°C-30°C)	
Gain Flatness Across Full Frequency Range	± 0.5 dB	± 1 dB	± 1.5 dB	± 1.5 dB	
Noise Figure	< 5 dB	< 11 dB	< 8.5 dB	< 11 dB typical	
Output Power for 1 dB Gain Compression	> +6 dBm	> +17 dBm	> +7 dBm typical	> +15 dBm	
Harmonic Distortion	-32 dB for 0 dBm output	-35 dB for +10 dBm output	-30 dB for 0 dBm output (typical)	-30 dB for +10 dBm output	
Typical Output for < -60 dB Harmonic Distortion	-25 dBm	-15 dBm	-30 dBm	-20 dBm	
VSWR	< 1.7	< 2.0	< 2.0 input < 2.2 output 1-1300 MHz	< 2.2 1-1300 MHz	
Impedance	50Ω	50Ω	50Ω	50Ω	
Reverse Isolation	> 30 dB	> 35 dB	> 40 dB	> 40 dB	
Maximum DC Voltage Input	± 10 V	± 10 V	± 10 V	± 10 V	
Options Available	001	002	001, 010, 011	010	010
Option Prices	add \$415	add \$10	add \$515, 35, \$570	add \$35	add \$70

—8447D AND 8447E COMBINED IN A SINGLE PACKAGE—

AMPLIFIERS

Microwave power amplifiers

Models 489A, 491C, 493A & 495A

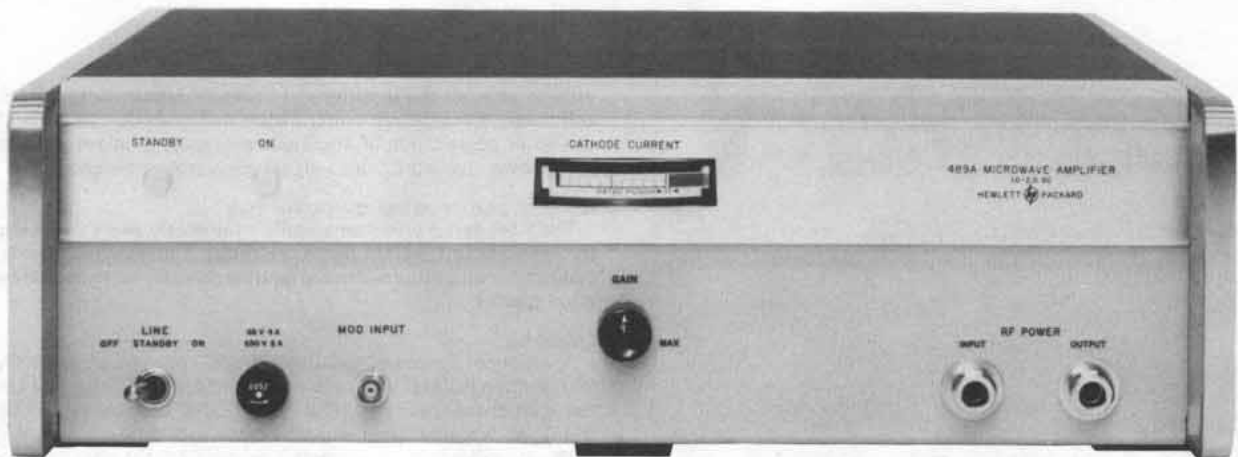

489A

Microwave TWT Amplifiers

Amplification of frequencies from 1 to 12.4 GHz is accomplished in four ranges by the Hewlett-Packard medium-power, microwave amplifiers. Each delivers at least 1 watt for a 1-milliwatt input—a gain of at least 30 dB.

All four TWT amplifiers have provision for amplitude modulation, and since the internal modulation amplifier is dc-coupled, remote programming and power leveling are possible. Sensitivity is high for large output power changes from relatively small modulation signals, obviating the need for an external modulation amplifier.

The dc amplifier has a gain of 20 dB and exhibits a passband from dc to 500 kHz when modulation index is in the neighborhood of 1 dB, as might be encountered in RF leveling. When the modulating levels are high, in the region of 20 volts, the passband will be a minimum of 100 kHz: a 20-volt change at the MOD INPUT produces a minimum of 20 dB off/on ratio.

Cathode current in the TWT is monitored by a front panel meter and can be conveniently controlled by the GAIN adjustment for rated power output, or for reducing tube current to extend tube life when full output power is not required. And helix, collector, and anode current can be measured at an easily accessible test point board. Combined with the 8620 or 8690 Sweep Oscillator they make an excellent high power swept source.

Advantages

DC coupled modulation circuitry allows power leveling and remote programming.

Periodic-permanent-magnet focusing means fewer alignment problems.

Applications

Antenna efficiency and pattern measurements.

Extends attenuation measuring systems capability by at least 30 dB.

RFI susceptibility tests.

489A-495A Specifications

Output power: 1 watt for an input of ≤ 1 mW.

Gain: 30 dB at rated output.

Input/output: impedance, 50 Ω ; connectors, type N female.

Noise figure: ≤ 30 dB.

Amplitude modulation:

Sensitivity: modulation input of > -20 V peak reduces RF output by ≤ 20 dB from dc to 50 kHz.

Frequency response: dc to 500 kHz (3 dB).

Pulse response: < 1 μ s rise and fall times.

Size: 140 H \times 426 W \times 467 mm (5 $\frac{1}{2}$ " \times 16 $\frac{3}{4}$ " \times 18 $\frac{3}{8}$ ").

Weight: net, 14.9 kg (33 lb). Shipping, 18.0 kg (40 lb).

	489A	491C	493A	495A
Frequency range (GHz)	1-2	2-4	4-8	7-12.4
Gain variation with freq. at rated output	≤ 6 dB	≤ 6 dB	≤ 6 dB	≤ 6 dB
small signal across any 10% of band	≤ 5 dB	≤ 5 dB	≤ 5 dB	≤ 5 dB for 300 MHz
across full band	≤ 12 dB	≤ 12 dB	≤ 12 dB	≤ 10 dB

Ordering information

489A 1 to 2 GHz TWT Amplifier

491C 2 to 4 GHz TWT Amplifier

493A 4 to 8 GHz TWT Amplifier

495A 7 to 12.4 GHz TWT Amplifier

Opt 908: Rack Flange Kit (for all models)

Price

\$3400

\$3400

\$3700

\$3700

add \$10

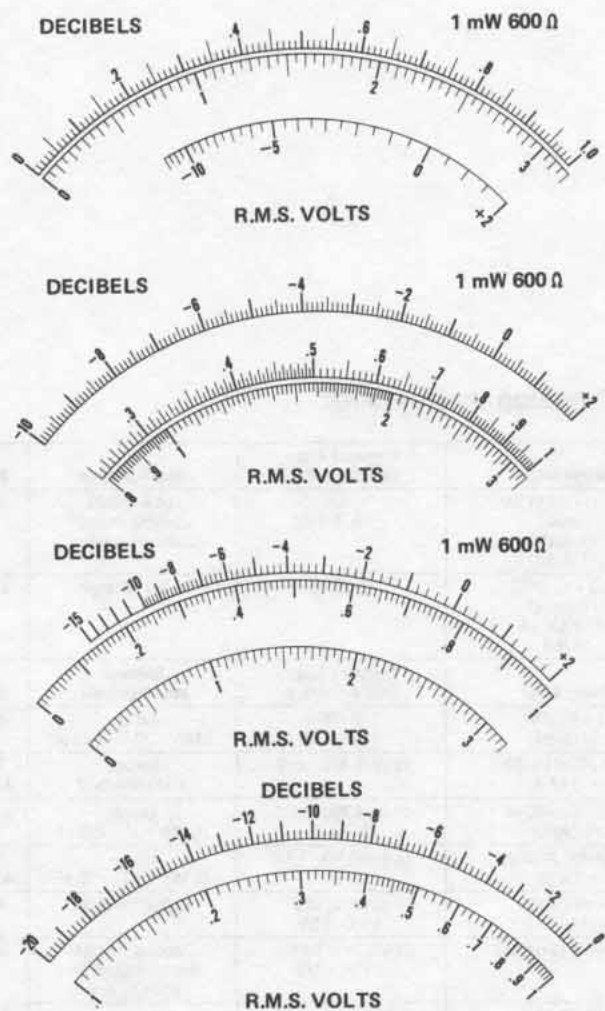

Figure 1. Four different types of meter scales available. (a) Linear 0-3 V and 0-10 V scales plus a dB scale. (b) Linear dB scale plus non-linear (logarithmic) voltage scales. (c) dB scale placed on larger arc for greater resolution. (d) Linear -20 to 0 dB scale useful for acoustical and communications applications.

Analog voltmeter considerations

Accuracy—Before we can discuss meter accuracy, we must have a familiarity with the various meter scales available. Many instruments have meter scales marked in both volts and decibel (dB) units. It should be noted that dB and voltage are complements of each other. That is, if a voltage scale is made linear, the dB scale on the same meter face will be logarithmic or nonlinear. Likewise, if the dB scale is made linear, the voltage scale becomes nonlinear. The term "linear-log scale" is applied to an instrument that has a linear dB scale and, therefore, a nonlinear voltage scale. Several different types of meter faces are illustrated in Figure 1.

Analog meters (Figure 2) usually have nonlinearities and/or offsets present in the attenuators and amplifiers. The meter movement itself can have nonlinearities/even with individually calibrated meter scales. Nonlinearities cause percent of reading errors, and

offsets cause percent of full scale errors. Percent of reading errors are constant no matter where the meter pointer is. Percent of full-scale error increases as the pointer goes further down scale.

Looking at instrument specification sheets, accuracy specifications are usually expressed in one of three ways: 1. percent of the full-scale value, 2. percent of the reading, 3. (percent of reading + percent of full-scale). The first is probably the most commonly used accuracy specification. The second (percent of reading) is more commonly applied to meters having a logarithmic scale. The last method has been used more recently to obtain a tighter accuracy specification on a linear-scale instrument.

Hewlett-Packard uses the two-part accuracy specification to take advantage of the upper-scale accuracy and yet maintain a reasonable specification for the lower portion of the scale.

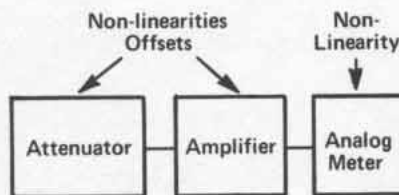

Figure 2. Non-linearities cause % of reading errors. Offsets cause % of full scale errors.

For a thorough evaluation of accuracy, the following should be considered: Does it apply at all input-voltage levels up to the maximum overrange point? (Linearity specifications may be added to qualify this point.) Does it apply to all frequencies throughout its specified bandwidth? Does it apply on all ranges? Does it apply over a useful temperature range for the application? If not, is temperature coefficient specified?

Selecting an analog voltmeter

1. For measurements involving dc applications, select the instrument with the broadest capability meeting your requirements.
2. For ac measurements involving sine waves with only modest amounts of distortion (<10%), the average-responding voltmeter can perform over a bandwidth extending to several megahertz.
3. For high-frequency measurements (>10 MHz), the peak-responding voltmeter with the diode-probe input is the most economical choice. Peak-responding circuits are acceptable if inaccuracies caused by distortion in the input waveform can be tolerated.
4. For measurements where it is important to determine the effective power of waveforms that depart from a true sinusoidal form, the true rms-responding voltmeter is the appropriate choice. In general, true-rms meters reveal only the rms value of an ac signal. Because they are ac coupled, most voltmeters have a frequency cut-off around 20 Hz. This restriction keeps the true-rms voltmeter from accounting for any low frequencies or dc components in a signal.

The 3403C RMS Digital Voltmeter measures dc plus ac from 2 Hz to 100 MHz. See page 54.

For very wide bandwidths (up to 1 GHz) and high-sensitivity measurements of sinusoidal or nonsinusoidal waveforms, the HP 3406A is the proper choice. Although the 3406A is average-responding, it has a sample hold output which makes analysis of waveforms possible.

For applications requiring monitoring signals with large excursions and in applications requiring log values to be plotted on a graphic recorder, the HP 7562A and HP 7563A log voltmeters provide a large dynamic range (110 dB) and displays the input on a single meter range while providing an output voltage that is the log of the input.

ANALOG VOLTMETERS

General information (cont.)

Table 1. HP analog instruments

DC VOLTMETERS	Voltage Range	Frequency Range Accuracy at FS*	Input Impedance	Model	See Page
DC NULL VOLTMETER	$\pm 3 \mu\text{V}$ – $\pm 1 \text{ kV}$ end scale 0.1 μV resolution (18 ranges)	dc $\pm 2\% + 1 \mu\text{V}$	100 k–100M Ω depending on range (infinite when nulled)	419A	37
DC VOLT-AMMETER	DC: $\pm 1 \text{ mV}$, $\pm 300 \text{ V}$, (12 ranges) $\pm 1 \text{ nA}$, $\pm 300 \mu\text{A}$ (12 ranges)	$\pm 3\%$ dc	10 M Ω all ranges	4304B	See Data Sheet
AC VOLTMETERS	Voltage Range	Frequency Range Typical Accuracy	Response Input Impedance	Model	See Page
RECHARGEABLE BATTERY AC VOLTMETER	1 mV–300V (12 ranges)	5 Hz–2MHz $\pm 2\%$ – $\pm 5\%$	Average 2 M Ω /<30 – <60 pF	403B	41
FAST-RESPONSE AC VOLTMETER 100 kHz low-pass filter ac amplifier	100 μV –300 V–90 dB–+52 dB	20 Hz–4 MHz– $\pm 1\%$ – $\pm 4\%$	Average 10 M Ω /10–25 pF	400F 400 FL	42
HIGH ACCURACY dB VOLTMETER 20 dB log scale (0 dB = 1 V)	–100 dB–+60 dB (8 ranges)	20 Hz–4 MHz– ± 0.2 dB–0.4 dB	Average 10 M Ω /<15–<30 pF	400GL	42
HIGH ACCURACY AC VOLTMETER has dc output ($\pm 0.5\%$) for driving recorder	1 mV–300 V–70 dB –+52 dB	10 Hz–10 MHz $\pm 1\%$ $\pm 5\%$	Average 10 M Ω /<12–<25 pF	400E 400 EL	42
RMS VOLTMETER provides rms readings of complex signals. Has dc output for driving DVM's or recorders	1 mV–300 V (12 ranges)	10 Hz–10 MHz $\pm 1\%$ – $\pm 5\%$	10 M Ω /15–40 pF	3400A	43
SAMPLING RF VOLTMETER provides true rms measurements when used with 3400A. Many accessories	1 mV–3 V (8 ranges)	10 kHz to >1.2 GHz $\pm 3\%$ – $\pm 13\%$	Statistical Average: Input Z depends on probe tip used	3406A	44
VECTOR VOLTMETER phase and amplitude measurements	100 μV –10 V (9 ranges)	1 MHz–1 GHz ± 0.5 dB– ± 1 dB	Average 0.1 M Ω /2.5 pF	8405A	470
MILLIOHMETER; two probes used when making 4 terminal measurements	0.001 to 100 Ω FS (11 ranges)	1 kHz (fixed) $\pm 2\%$ FS	Max. output Voltage: 20 mV	4328A	81
HIGH RESISTANCE METER and picoammeter	0.5 M Ω to $2 \times 10^{16}\Omega$ FS (7 ranges) 0.05 pA –20 μA	Voltage: $\pm 10\%$ Current: $\pm 5\%$	Max. output Voltage: 1 kV	4329A	82
MULTI-FUNCTION METERS	Voltage Range (Accuracy)	Current Range (Accuracy)	Resistance Range (Accuracy)	Model	See Page
BATTERY-OPERATED MULTI-FUNCTION METER has 10 M Ω dc input impedance and 10M Ω /20 pF ac input impedance	DC: $\pm 100 \text{ mV}$ to 1000 V ($\pm 2\%$) 9 ranges AC: 10 mV– 300 V 10 Hz–1 MHz ($\pm 2\%$) 10 ranges		10 Ω –10 M Ω mid- scale $\pm 5\%$; from 0.3 to 3 on the meter scale (7 ranges)	427A	39
VERSATILE VOLTMETER has 100 M Ω dc input impedance and 10 M Ω /1.5 pF ac impedance	DC: $\pm 15 \text{ mV}$ to $\pm 1500 \text{ V}$ ($\pm 2\%$) 11 ranges AC: 0.5 V– 300 V 20 Hz–>700 MHz ($\pm 3\%$ at 400 Hz) 7 ranges	DC: $\pm 1.5 \mu\text{A}$ to $\pm 150 \text{ mA}$ ($\pm 3\%$) 11 ranges	10 Ω –10 M Ω (center scale) 0 to midscale: $\pm 5\%$ or $\pm 2\%$ of mid-scale (whichever is greater) 7 ranges	410C	40
CURRENT METERS	Current Range	Accuracy	Frequency Range	Model	See Page
DC MILLIAMMETER with clip-on probe eliminates direct connection	1 mA–10 A FS (9 ranges)	$\pm 3\%$	dc–400 Hz	428B	38
LOG VOLTMETER	Voltage Range	Accuracy Frequency Response	Input Impedance	Model	See Page
LOGARITHMIC VOLTMETER/CONVERTER true RMS responding	80 dB (2 ranges) 1 mV–10 V or 10 mV–100 V	0.5 Hz–100 kHz ± 0.5 dB––3, +1 dB dc = ± 0.25 dB	dc mode: 100 k Ω /<100 pF ac mode: 1 M Ω /<100 pF	7562A	45
LOGARITHMIC VOLTMETER/AMPLIFIER	110 dB (1 range) 316 μV –100 V dc	dc = ± 0.25 dB – ± 1.5 dB	100 k Ω /100 pF	7563A	45

*For exact accuracy refer to page designated.



Description

Eighteen voltage ranges with $0.1 \mu\text{V}$ resolution on the lowest range. Accuracy of this rechargeable battery-operated instrument is $\pm 2\%$ of end scale $\pm 0.1 \mu\text{V}$ on all ranges. Noise is less than $0.3 \mu\text{V}$ p-p, and drift is less than $0.5 \mu\text{V}/\text{day}$.

An internal nulling voltage allows input voltages up to 300 mV to be nulled giving an infinite input impedance. Input impedance above 300 mV range is 100 megohms.

Seven pushbuttons allow rapid function selection. This dc null voltmeter operates from an ac line or from internal rechargeable batteries. During operation from ac line, batteries are trickle-charged. A fast-charge pushbutton is provided to increase the charging rate, recharging batteries in approximately 16 hours. Battery voltage may be checked with the battery-test pushbutton. The zero pushbutton allows compensation for any internal offsets before measurement. When this pushbutton is depressed, the positive leg of the voltmeter is disconnected from the positive input terminal.

When the voltmeter pushbutton is depressed, HP 419A functions as a zero-center scale $3 \mu\text{V}$ to 1000 V dc voltmeter.

When the AM pushbutton is depressed, HP 419A functions as a zero-center scale 30 pA to 30 nA ammeter.

Specifications

DC null voltmeter

Ranges: $\pm 3 \mu\text{V}$ to $\pm 1000 \text{ V}$ dc in 18 zero-center ranges.

Accuracy: $\pm (2\% \text{ of range} + 0.1 \mu\text{V})$.

Zero control range: $> \pm 15 \mu\text{V}$.

Zero drift: $< 0.5 \mu\text{V}/\text{day}$ after 30 min warm-up.

Zero temperature coefficient: $< 0.05 \mu\text{V}/^\circ\text{C}$.

Response time: 3 s to within 95% of final reading on $3 \mu\text{V}$ range; 1 s to within 95% of final reading on $10 \mu\text{V}$ to 1000 V ranges.

Noise: $< 0.3 \mu\text{V}$ p-p, input shorted. Noise amplitude approximates Gaussian distribution. RMS value (standard deviation) is $< 0.075 \mu\text{V}$, p-p noise value is $< 0.3 \mu\text{V}$ 95% of the time.

Input characteristics

At null: infinite resistance on $3 \mu\text{V}$ through 300 mV ranges in set null mode. Negative input terminal can be floated to $\pm 500 \text{ V}$ dc from power line ground.

Off null

Voltage range	Input resistance
$3 \mu\text{V} - 3 \text{ mV}$	100 k Ω
$10 \text{ mV} - 30 \text{ mV}$	1 M Ω
$100 \text{ mV} - 300 \text{ mV}$	10 M Ω
$1 \text{ V} - 1000 \text{ V}$	100 M Ω

Negative input terminal can be floated up to $\pm 500 \text{ V}$ dc from power-line ground.

AC normal mode rejection: ac voltages 50 Hz and above and 80 dB greater than end scale affect reading $< 2\%$. Peak ac voltage not to exceed maximum overload voltage.

DC ammeter

Ranges: $\pm 30 \text{ pA}$ to $\pm 30 \text{ nA}$ in 7 zero-center ranges.

Accuracy: $\pm (3\% \text{ of range} + 1 \text{ pA})$.

Zero control range: $> \pm 150 \text{ pA}$.

Zero drift: $< 5 \text{ pA}/\text{day}$ after 30 min warm-up.

Zero temperature coefficient: $< 0.5 \text{ pA}/^\circ\text{C}$.

Noise: $< 3 \text{ pA}$ p-p, input shorted.

Input resistance: 100 k Ω on all ranges.

Amplifier

Gain: 110 dB on $3 \mu\text{V}$ range, decreases 10 dB per range.

Output: 0 to $\pm 1 \text{ V}$ at 1 mA maximum for end-scale reading. Output level adjustable for convenience when used with recorders.

Output resistance: depends on setting of output level control. $< 35 \Omega$ when output control is set to maximum.

Noise: 0.01 Hz to 5 Hz: same as voltmeter (referred to input). $> 5 \text{ Hz}$: $< 10 \text{ mV rms}$ (referred to output).

General

Overload protection: the following voltages can be applied without damage to instrument.

1 V to 1000 V range: 1200 V dc.

10 mV to 300 mV range: 500 V dc.

$3 \mu\text{V}$ to 300 mV range: 50 V dc.

Operating temperature: instrument will operate within specifications from 0°C to 50°C .

Operating humidity: $< 70\% \text{ R.H.}$

Storage temperature: -20°C to $+50^\circ\text{C}$.

Power: 115 V or 230 V $\pm 10\%$, 48 Hz to 440 Hz, 2 VA max. or 4 internal rechargeable batteries (furnished). 30-hr operation per recharge. Operation from ac line permissible during recharge.

Size: 156 mm H (without removable feet), 197 mm W, 203 mm D ($6\frac{1}{4}'' \times 7\frac{3}{4}'' \times 8''$).

Weight: net, 3.7 kg (8.3 lb). Shipping, 5.4 kg (12 lb).

419A DC Null Volt-Ammeter

\$1175

ANALOG VOLTMETERS

1 mA to 10 A clip-on dc milliammeter

Model 428B

- No circuit interruption
- No circuit loading



Description

Direct current from 1 milliampere to 10 amperes full scale can be measured without interrupting your measured circuit or producing loading errors. With the HP Model 428B Clip-on Milliammeter, cutting wires for insertion of current meters and calculating current from voltage and resistance readings are eliminated. All that is required for fast, accurate readings is to clip around the wire and select the proper current range.

The 428B measures current by utilizing a clip-on transducer that converts the magnetic field around the conductor to an ac voltage proportional to dc current. This voltage is detected and displayed as direct current on the 428B's meter. Since there is no direct contact with the circuit being measured, complete dc isolation is assured.

The meter responds to dc current only and is therefore not susceptible to common mode currents. However, low frequency currents up to 400 Hz can be measured by connecting an oscilloscope or voltmeter to the convenient front panel output; or this output can be used to drive a strip chart recorder for permanent long term records.

For even greater sensitivity, several loops of the measured conductor can be put through the probe, increasing sensitivity by the same factor as the number of turns used.

Specifications

DC current range: 1 mA to 10 A full scale, nine ranges.

Accuracy: $\pm 3\%$ of full scale ± 0.15 mA, from 0°C to 55°C (when instrument is calibrated to probe).

Probe inductance: $< 0.5 \mu\text{H}$.

Probe inducted voltage: < 15 mV p (worst case at 20 kHz and harmonics).

Output: variable linear output level with switch position for calibrated 1 V into open circuit (corresponds to full scale deflection). 1.5 V

max. into open circuit in uncalibrated position. $0.73 \pm .01$ V into 1 k Ω in calibrated position.

Noise: 1 mA range, < 15 mV rms across 1 k Ω ; 3 mA range, < 5 mV rms across 1 k Ω ; 10 mA through 10 A ranges, < 2 mV rms across 1 k Ω .

Frequency range: dc to 400 Hz (3 dB point).

AC rejection: signals above 5 Hz with p value $<$ full scale affect meter accuracy $< 2\%$ (except at 40 kHz carrier frequency and its harmonics). On the 10 A range, ac p value is limited to 4 A.

Power: 115 or 230 V $\pm 10\%$, 50 to 60 Hz, approx. 75 V A max.

Operating temperature range: -20°C to $+55^\circ\text{C}$.

Storage temperature: -40°C to $+65^\circ\text{C}$.

Probe insulation: 300 V maximum.

Probe tip size: approximately $1/4"$ by $21/32"$ aperture diameter $5/32"$.
Size: cabinet: 292 mm H x 191 mm W x 368 mm D ($11 1/2"$ x $7 1/2"$ x $14 1/2"$).

Weight: net, 8.6 kg (19 lb). Shipping, 10.9 kg (24 lb).

Accessories available

3529A Magnetometer Probe: this probe measures magnetic field strength and direction. The component of magnetic field sensed is parallel to the cylindrical axis of the probe. Applications include the testing of magnetic materials for air shipment.

Range: 1 mG to 10 G full scale, nine ranges. 1 mG = 1 mA conversion factor.

Accuracy: $\pm 3\%$ of full scale (0°C to $+55^\circ\text{C}$) after calibration.

Frequency range: DC to 80 Hz (3 dB point).

Weight: net 0.45 kg (1 lb). Shipping 0.91 kg (2 lb).

Ordering information

3529A Magnetometer Probe
428B Analog Milliammeter (cabinet)

Price

\$119
\$1110



427A

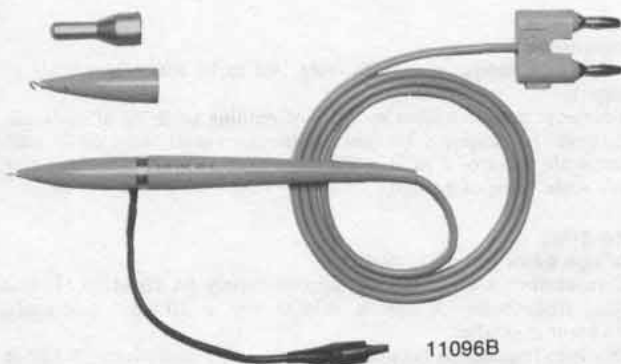

11096B

Description

Hewlett-Packard's Model 427A is a portable, versatile, low cost multi-function meter which is valuable in any laboratory, production line, service department, or in the field. It is capable of measuring dc voltages from 100 mV to 1 kV full scale; ac voltage from 10 mV to 300 V full scale at frequencies up to 1 MHz (>500 MHz with the 11096B High Frequency Probe); and resistance from 10 Ω to 10 M Ω center scale.

The 427A will operate continuously for more than 300 hours on its internal 22.5 V dry cell battery. AC line and battery operation is available with option 001.

Specifications

DC voltmeter

Ranges: ± 100 mV to ± 1000 V in 9 ranges in 10 dB steps.

Accuracy: $\pm 2\%$ of range.

Input resistance: 10 M Ω .

AC normal mode rejection (ACNMR): ACNMR is the ratio of the normal mode signal to the resultant error in readout. 50 Hz and above: >80 dB.

Overload protection: 1200 V dc.

AC voltmeter

Ranges: 10 mV to 300 V in 10 ranges in 10 dB steps.

Frequency range: 10 Hz to 1 MHz.

Response: responds to average value, calibrated in rms.

Accuracy

Frequency	Range	
		0.01 V to 30 V
10 Hz to 100 kHz	2% of range	
100 kHz to 1 MHz	2% of range	

Input impedance: 10 mV to 1 V range, 10 M Ω shunted by <40 pF; 3 V to 300 V range, 10 M Ω shunted by <20 pF.

Overload protection: 300 V rms momentarily, 1 V range and below; 425 V rms max above 1 V range.

Ohmmeter

Ranges: 10 Ω to 10 M Ω center scale in 7 decade ranges. Accuracy (from 0.3 to 3 on scale): $\pm 5\%$ of reading.

Source current (ohms terminal positive)

Range	Open circuit Voltage	Short circuit Current
X 10	0.1 V	10 mA
X 100	0.1 V	1 mA
X 1 k	1 V	1 mA
X 10 k	1 V	100 μ A
X 100 k	1 V	10 μ A
X 1 M	1 V	1 μ A
X 10 M	1 V	0.1 μ A

General

Input: may be floated up to ± 500 V dc above chassis ground. Ohms input open in any function except ohms. Volts input open when instrument is off.

Operating temperature: 0°C to 50°C.

Power: >300 hr operation per battery.

HP 427A. 22.5 V dry cell battery, Eveready No. 763 or RCA VS102. HP 427A Option 001: battery operation or ac line operation, selectable on rear panel. 115 V or 230 V $\pm 20\%$, 48 Hz to 440 Hz, 2 V A max.

Size: (standard $\frac{1}{2}$ module): 159 mm H (without removable feet), 130 mm W, 203 mm D (6 $\frac{1}{4}$ " x 5 $\frac{1}{8}$ " x 8").

Weight: net, 2.4 kg (5.3 lb). Shipping, 3.6 kg (8 lb).

Accessories available

HP 11096B High Frequency AC Probe extends range to >500 MHz. With the 11096B, you can measure 0.25 to 30 V rms signals out to 500 MHz with better than ± 1 dB accuracy. Usable relative measurements can be made up to 1 GHz (3 dB point at 700 MHz). The 11096B is a peak-responding detector calibrated to produce a dc output proportional to the rms value of a sine wave input. Input impedance is 4 M Ω shunted by 2 pF.

Options and accessories

Options and accessories	Price
11075A High Impact Case. A rugged case for carrying, storing and operating the 427A	\$145
11096B High Frequency AC probe	\$90
11001A 45" test lead, dual banana plug to male BNC	\$17
11002A 60" test lead, dual banana plug to alligator clips	\$12
11003A 60" test lead, dual banana plug to pencil probe and alligator clip.	\$12
10111A BNC female to dual banana adapter	\$17
11067A Test lead kit	\$5

Ordering information

427A Multi-function Meter (includes batteries)	\$600
427A Option 001 AC power supply & battery	Add \$630

ANALOG VOLTMETERS

General purpose multi-function voltmeter

Model 410C



410C with 11036A

Description

HP's Model 410C is a versatile general purpose instrument for use anywhere electrical measurements are made. This instrument measures dc voltages from 15 mV to 1500 V, direct current from 1.5 μ A to 150 mA full scale, and resistance from 0.2 Ω to 500 M Ω . With a standard plug-in probe, ac voltages at 20 Hz to 700 MHz from 50 mV to 300 V and comparative indications to 3 GHz are attainable.

Specifications

DC voltmeter

Voltage ranges: ± 15 mV to ± 1500 V full scale in 15, 50 sequence (11 ranges).

Accuracy: $\pm 2\%$ of full scale on any range.

Input resistance: 100 M Ω $\pm 1\%$ on 500 mV range and above, 10 M Ω $\pm 3\%$ on 150 mV range and below.

AC voltmeter

Voltage ranges: 0.5 V to 300 V full scale in 0.5, 1.5, 5 sequence (7 ranges)

Frequency range: 20 Hz to 700 MHz.

Accuracy: $\pm 3\%$ of full scale at 400 Hz for sinusoidal voltages from 0.5 V–300 V rms. The ac probe responds to the positive peak-above-average value of the applied signal. The meter is calibrated in rms.

Frequency response: $\pm 2\%$ from 100 Hz to 50 MHz (400 Hz ref.); 0 to -4% from 50 MHz to 100 MHz; $\pm 10\%$ from 20 Hz to 100 Hz and ± 1.5 dB from 100 MHz to 700 MHz.

Input impedance: input capacitance 1.5 pF, input resistance > 10 M Ω at low frequencies. At high frequencies, impedance drops off due to dielectric loss.

Safety: the probe body is grounded to chassis at all times for safety. All ac measurements are referenced to chassis ground.

DC ammeter

Current ranges: ± 1.5 μ A to ± 150 mA full scale in 1.5, 5 sequence (11 ranges).

Accuracy: $\pm 3\%$ of full scale on any range.

Input resistance: decreasing from 9 k Ω on 1.5 μ A range to approximately 0.3 Ω on the 150 mA range.

Special current ranges: ± 1.5 , ± 5 and ± 15 nA may be measured on the 15, 50 and 150 mV ranges using the dc voltmeter probe, with $\pm 5\%$ accuracy and 10 M Ω input resistance.

Ohmmeter

Resistance range: resistance from 10 Ω to 10 M Ω center scale (7 ranges).

Accuracy: zero to midscale: $\pm 5\%$ of reading or $\pm 2\%$ of midscale, whichever is greater; $\pm 7\%$ from midscale to scale value of 2; $\pm 8\%$ from scale value of 2 to 3; $\pm 9\%$ from scale value of 3 to 5; $\pm 10\%$ from scale value of 5 to 10.

Amplifier

Voltage gain: 100 maximum.

AC rejection: 3 dB at 0.5 Hz; approximately 66 dB at 50 Hz and higher frequencies for signals < 1600 V p or 30 times full scale, whichever is smaller.

Isolation: impedance between common and chassis is > 10 M Ω in parallel with 0.1 μ F. Common may be floated up to 400 V dc above chassis for dc and resistance measurements.

Output: proportional to meter indications; 1.5 V dc at full scale, maximum current, 1 mA.

Output impedance: $< 3\Omega$ at DC.

Noise: $< 0.5\%$ of full scale/on any range (p-p).

DC drift: $< 0.5\%$ of full scale/yr at constant temperature. $< 0.02\%$ of full scale/ $^{\circ}$ C.

Overload recovery: recovers from 100:1 overload in < 3 s.

General

Maximum input: (see overload recovery). DC: 100 V on 15, 50 and 150 mV ranges, 500 V on 0.5 to 15 V ranges, 1600 V on higher ranges. AC: 100 times full scale or 450 V p whichever is less.

Power: 115 V or 230 V $\pm 10\%$, 48 Hz to 440 Hz, 13 VA (20 VA with 11036A ac probe).

Size: 165 mm H (without removable feet), x 130.2 mm W x 280 mm D (6 $\frac{1}{2}$ " x 5 $\frac{1}{8}$ " x 11") behind panel.

Weight: net, 4 kg (8 lb). Shipping, 5.44 kg (12 lb).

Accessories furnished: detachable power cord, NEMA plug, 11036A AC probe.

Accessories available: see Pages 552–55

Ordering information

410C Option 002 (less ac probe)
410C with HP 11036A Detachable AC probe

Price

less \$44
 \$1110

ANALOG VOLTMETERS

5 Hz to 2 MHz AC solid-state voltmeters

Model 403B

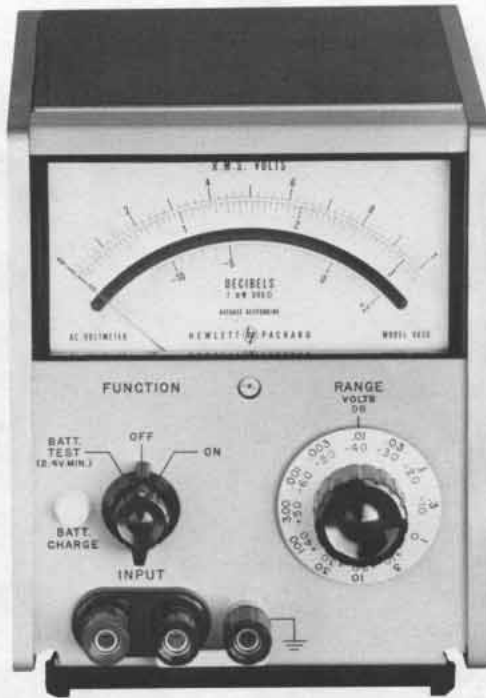

Description

The Hewlett-Packard 403B AC Voltmeter is a versatile, general purpose instrument for laboratory and production work, yet is ideal for use in the field since it is solid-state, battery operated, and portable.

It measures from 100 microvolts to 300 volts, covering 5 Hz to 2 MHz. It operates from internal batteries and thus may be completely isolated from the power line and external grounds, permitting accurate measurements at power line frequency and its harmonics without concern for beat effects. Isolation from external ground also permits use where ground loops are troublesome. Turnover effect and waveform errors are minimized because the meter responds to the average value of the input signal.

The 403B operates from an AC line as well as from the internal battery pack, and batteries recharge during AC operation. Battery charge may be easily checked with a front-panel switch to assure reliable measurements. Normally, about 60 hours of AC operation recharges the batteries; but an internal adjustment is provided which nearly doubles the charging rate. The Model 403B can be used while its batteries charge. A sturdy taut-band meter eliminates friction and provides greater precision and repeatability.

For improved resolution in dB measurements, the 403B Option 001 is available. This version spreads out the dB scale by making it the top scale of the meter.

Specifications

HP Model	403B	403B Option 001
Range	0.001 to 300 V rms full scale, 12 ranges, in a 1, 3, 10 sequence. -60 dB to +50 dB in 12 ranges with 10 dB steps.	
Meter	Responds to average value of input waveform, calibrated in the rms value of a sine wave.	
Frequency Range	5 Hz to 2 MHz	5 Hz to 2 MHz
Accuracy	Within $\pm 2\%$ of full scale from 10 Hz to 1 MHz; within $\pm 5\%$ of full scale from 5 to 10 Hz and 1 to 2 MHz, except $\pm 10\%$ 1 to 2 MHz on the 300 V range (0 to 50°C).*	Within ± 0.20 dB of full scale from 10 Hz to 1 MHz; within ± 0.4 dB of full scale from 5 to 10 Hz and 1 to 2 MHz, except ± 0.8 MHz on the 300 V range (0 to 50°C).*
Input Impedance	2 M Ω ; shunted by <60 pF; 0.001 to 0.03 V ranges; <30 pF, 0.1 to 300 V ranges.	same as 403B
Maximum Input	Fuse protected (signal ground can be ± 500 V DC from chassis).	same as 403B
Power	4 rechargeable batteries, 40 hr. operation per recharge, up to 500 recharging cycles; self-contained recharging circuit functions during operation from AC line.	same as 403B
Size	159 H (without removable feet) x 130 W x 203 mm D (6 $\frac{1}{4}$ " x 5 $\frac{1}{4}$ " x 8").	same as 403B
Weight	net, 2.9 kg (6 $\frac{1}{2}$ lb). Shipping, 3.6 kg (8 lb).	same as 403B
Price	\$535	add \$30

*Use 10001A 10:1 Divider and 10111A Adapter to retain $\pm 5\%$ (± 0.4 dB) accuracy while measuring up to 425 V rms at 1 to 2 MHz.

ANALOG VOLTMETERS

AC voltmeter, 10 Hz to 10 MHz

Models 400E, EL, F, FL, GL

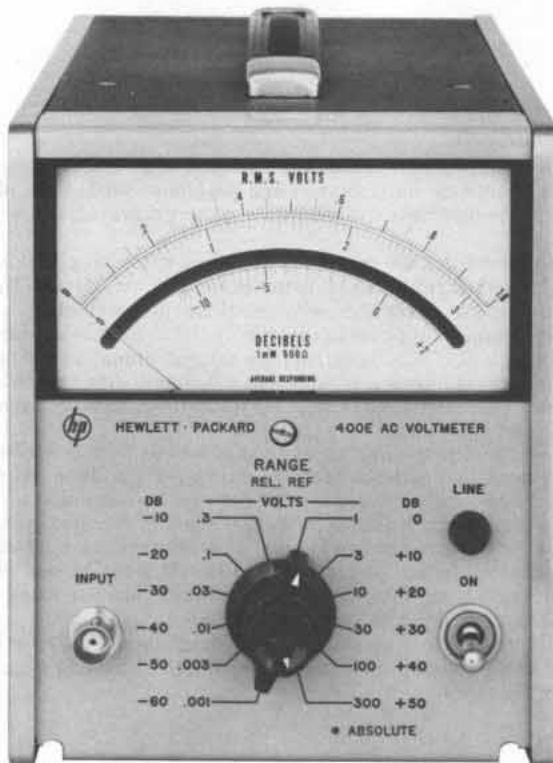

400E

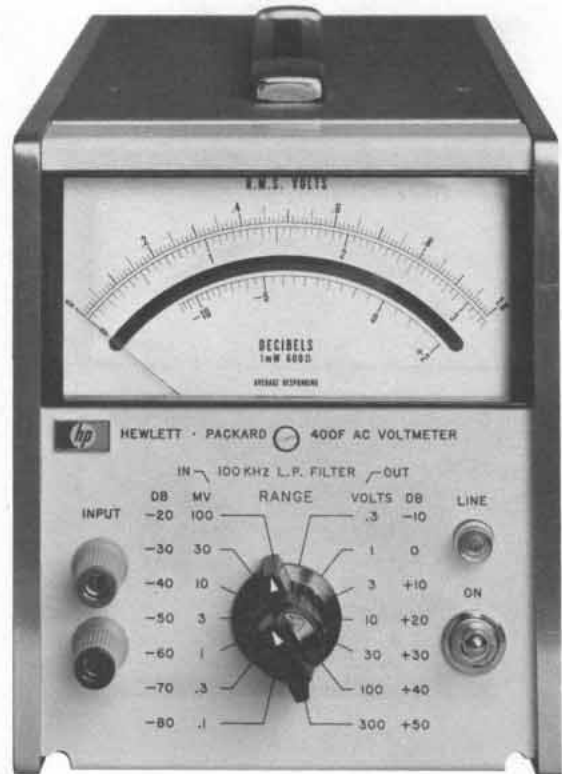

400F

Specifications

	400E/EL*	400F/FL*	400 GL
Voltage range	1 mV to 300 V F.S. 12 ranges	100 μ V to 300 V F.S. 14 ranges	-80 dB to +60 dB F. S. 8 ranges
Frequency range	10 Hz-10 MHz	20 Hz-4MHz	20 Hz-4 MHz
Input impedance	10 M Ω on all ranges <25 pF to <12 pF depending on ranges	10 M Ω on all ranges <25 pF to <10 pF depending on ranges	10 M Ω on all ranges <300 pF to <15 pF depending on ranges
Accuracy*	\pm (% reading + % range) 3 mV-300 V ranges 10 Hz-40 Hz: \pm (2.5 + 2.5) 40 Hz-2 MHz: \pm (1 + 0) 2 MHz-4 MHz: \pm (1.5 + 1.5) 4 MHz-10 MHz 3 mV range: \pm (2.5 + 2.5) 10 mV-3 V range: \pm (3.0 + 2.0) 10 V-30 V: \pm (3.5 + 3.5) 1 mV range 10 Hz-40 Hz: \pm (2.5 + 2.5) 40 Hz-500 kHz: \pm (1 + 0) 500 kHz-4 MHz: \pm (2.5 + 2.5)	(% reading + % range) 300 μ V-300 V ranges 20 Hz-40 Hz: \pm (2 + 2) 40 Hz-100 Hz: \pm (1 + 1) 100 Hz-1 MHz: \pm ($\frac{1}{2}$ + $\frac{1}{2}$) 1 MHz-2 MHz: \pm (1 + 1) 2 MHz-4 MHz: \pm (2 + 2) 100 μ V range 30 Hz-60 Hz: \pm (2 + 2) 60 Hz-100 kHz: \pm (1 + 1) 100 kHz-500 kHz: \pm 1 + (+0-7)	+60 dB range 20 Hz-40 kHz: \pm 0.4 dB 40 kHz-100 kHz: \pm 0.2 dB -60 dB thru +40 dB ranges 20 Hz-40 Hz: \pm 0.4 dB 40 Hz-500 kHz: \pm 0.2 dB 500 kHz-2 MHz: \pm 0.4 dB 2 MHz-4 MHz: +0.2-0.8 dB -80 dB range 30 Hz-60 Hz: \pm 0.4 dB 60 Hz-100 kHz: \pm 0.2 dB 100 kHz-500 kHz: + 0.2 -0.8 dB
Recovery		<2 s for 80 dB overload	
Overload		**500 V rms ac, 300 V dc	**1200 V rms max. input; 1000 V dc max. input
Calibration		Scale -10 to +2 dB between ranges, 100 divisions on 0 to 1 scale. The dB scale reads -10 to +2 dB; 10 dB between ranges.	Linear dB scale, 100 divisions from -20 to 0 dB. Long voltage scale 0 dB = 1V.
Weight		Net, 2.7 kg (6 lb). Shipping, 4.1 kg (9 lb)	
Size		159 H (without removable feet) x 130 W x 279 mm D (6 $\frac{1}{4}$ " x 5 $\frac{1}{8}$ " x 11")	
Power		AC: 115 or 230 V +10%, 48 to 440 Hz, 6 VA max. DC: External batteries: + and - voltages between 35 V and 55 V	
Price:	400E, \$550; 400 EL \$565	400F, \$545; 400 FL, \$550	400 GL, \$575

* NOTE: 400 EL same as 400E, and 400FL same as 400F, except for calibration. Linear dB scale -10 dB to +2 dB, 10 dB between ranges. Log voltage scales 0.3 to 1 and 0.8 to 3, 120 divisions from -10 dB +2 dB. 400 FL accuracy is % of reading in dB only.

** AC overload voltage increases with increasing frequency

ANALOG VOLTMETERS

10 Hz to 10 MHz true RMS voltmeter

Model 3400A



- 10 MHz bandwidth
- High crest factor for accurate pulse measurements
- Stable, linear DC output

- 1 mV full-scale sensitivity
- 10 MΩ input impedance
- Taut-band individually calibrated meter

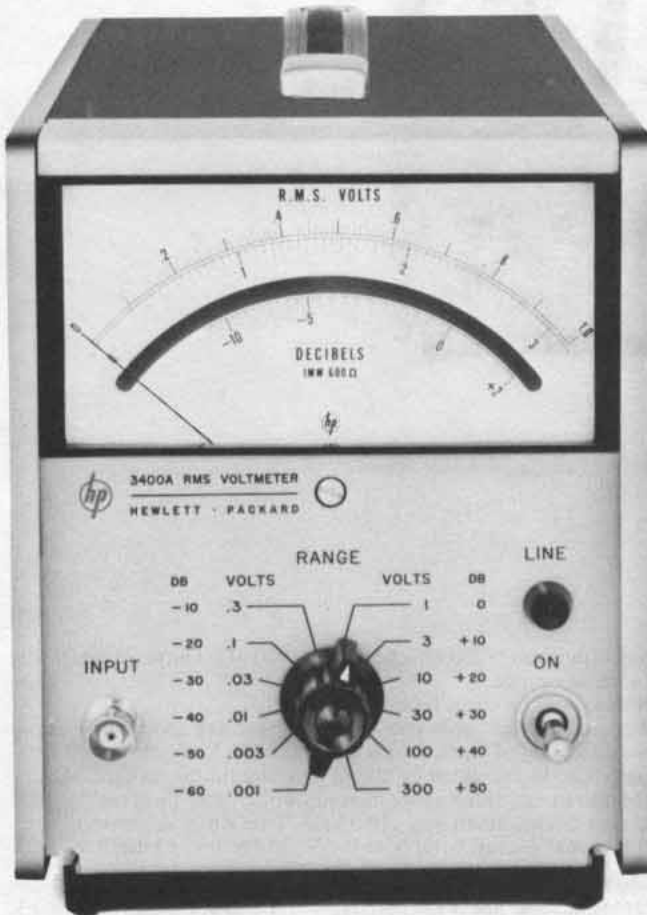

RMS current

True rms current measurements can be made conveniently by using the HP Model 456A Current Probe with the Mode 3400A. See page 555.

Specifications

Voltage range: 1 mV to 300 V full scale, 12 ranges.

DB range: -72 to +52 dBm (0 dBm = 1 mW into 600Ω).

Frequency range: 10 Hz to 10 MHz.

Response: responds to rms value (heating value) of the input signal for all waveforms.

Meter accuracy: % of full scale (20°C to 30°C)*

10Hz	50Hz	1MHz	2MHz	3MHz	10MHz
±5%	±1%	±2%	±3%	±3%	±5%

AC-to-DC converter accuracy: % of full scale (20°C to 30°C)*

10Hz	50Hz	1MHz	2MHz	3MHz	10MHz
±5%	±0.75%	±2%	±3%	±3%	±5%

Crest factor: (ratio of peak to rms amplitude of input signal): 10 to 1 at full scale (except where limited by maximum input) inversely proportional to meter deflection (e.g., 20 to 1 at half-scale, 100 to 1 at tenth scale).

Maximum continuous input voltage: 500 V ac peak at 1 kHz on all ranges; 600 V dc on all ranges.

Input impedance: from 0.001 V to 0.3 V range: 10 MΩ shunted by <50 pF. From 1.0 V to 300 V range: 10 MΩ shunted by <20 pF ac coupled input.

Response time: for a step function, <5 s to final value.

AC overload: 30 dB above full scale or 800 V p, whichever is less, on each range.

Output: negative 1 V dc into open circuit at full-scale deflection, proportional to meter deflection from 10-100% of full scale. 1 mA maximum; nominal source impedance is 1000Ω. Output noise <1 mV rms.

Power: 115 or 230 V ±10%, 48 to 66 Hz, 15 VA max.

Size: 159 H (without removable feet) x 130 W x 279 mm D (6¼" x 5¼" x 11"); ½ module.

Weight: net, 3.3 kg (7¼ lb). Shipping, 4.5 kg (10 lb).

Accessories furnished: 10110A Adapter, BNC to dual banana jack.

Description

The Hewlett-Packard Model 3400A is a true root-mean-square (rms) voltmeter, providing a meter indication proportional to the dc heating power of the input waveform.

Six-decade frequency coverage makes the 3400A extremely flexible for all audio and most RF measurements and permits the measurement of broadband noise and fast-rise pulses.

Pulses or other non-sinusoids with crest factors (ratio of peak to rms) up to 10:1 can be measured full scale. Crest factor is inversely proportional to meter deflection, permitting up to 100:1 crest factor at 10% of full scale.

Permanent plots of measured data and higher resolution measurements can be obtained by connecting an X-Y plotter, strip chart recorder or digital voltmeter to the convenient rear-panel dc output. The dc output provides a linear 0 to 1 volt drive proportional to meter deflection.

Accessories available

Accessories available	Price
11001A Cable, 45 in. long, male BNC to dual banana plug	\$17
11170A Cable, 12 in., male BNC connectors	\$17
11170B Cable, 24 in., male BNC connectors	\$17
11170C Cable, 48 in., male BNC connectors	\$17
11002A Test lead, dual banana plug to alligator clips	\$12
11003A Test Leads, dual banana plug to probe and alligator clip	\$12
11076A Carrying Case	\$135

Ordering information

3400A Opt 001 spreads out the dB scale by making it the top scale of the meter. Rear terminals in parallel with front panel terminals and linear log scale uppermost on the meter face are available on special order. add \$30

3400A RMS voltmeter

* TC: ±0.1% from 0°C to 20°C and 30°C to 55°C.

\$950

ANALOG VOLTMETERS

10 kHz to 1.2 GHz RF Voltmeter

Model 3406A



Description

High frequency voltages can be measured easily with HP's 3406A Sampling Voltmeter. Employing sampling techniques, the HP 3406A has extremely wide bandwidth (10kHz to 1.2 GHz) with high input impedance. Signals as small as $50 \mu\text{V}$ can be resolved. Full scale sensitivity from 1 mV to 3 V is selected in eight 10 dB steps and may be read directly from -62 dBm to $+23 \text{ dBm}$. Accessory probe tips convert the HP 3406A for voltage measurements in applications such as receivers, amplifiers and coaxial transmission lines.

Measurement can be retained on the 3406A meter by depressing a pushbutton located on the pen-type probe. This is useful when measurements are made in awkward positions where the operator cannot observe the meter indication and probe placement at the same time.

Specifications

Voltage range: 1 mV to 3 V full scale in 8 ranges; decibels from -50 to $+20 \text{ dBm}$ ($0 \text{ dBm} = 1 \text{ mW}$ into 50Ω); average-responding instrument calibrated to rms value of sine wave.

Frequency range: 10 kHz to 1.2 GHz; useful sensitivity from 1 kHz to beyond 2 GHz.

Full-scale accuracy (%) with appropriate accessory (after probe is properly calibrated)

10 kHz	20 kHz	25 kHz	100 kHz	100 MHz	700 MHz	1 GHz	1.2 GHz
± 13	± 8	± 5	± 3	± 5	± 8	± 13	

Input impedance: input capacity and resistance will depend upon accessory tip used. $100,000\Omega$ shunted by $<2.1 \text{ pF}$ at 100 kHz with bare probe; $<10 \text{ pF}$ with 11072A isolator tip supplied.

Sample hold output

Provides ac signal whose unclamped portion has statistics that are narrowly distributed about the statistics of the input, inverted in sign

(operating into $>200 \text{ k}\Omega$ load with $<1000 \text{ pF}$). Output is 0.316 V at f.s. on any range.

Noise: $<175 \mu\text{V}$ rms referred to input.

Accuracy (after calibration): 0.01 V range and above: same as full scale accuracy of instrument. 0.001 V to 0.003 V range: value of input signal can be computed by taking into account the residual noise of the instrument. Jitter: meter indicates within $\pm 2\%$ pk of reading 95% of time (as measured with HP 3400A True RMS Voltmeter).

RMS crest factor: 0.001 V to 0.3 V, 20 dB; 1 V, 13 dB; 3 V, 3 dB.

Meter

Meter scales: linear voltage, 0 to 1 and 0 to 3; decibel, -12 to $+3$. Individually calibrated taut-band meter.

Response time: Indicates within specified accuracy in $<3 \text{ s}$. Jitter: $\pm 1\%$ peak (of reading).

General

DC recorder output: adjustable from 0 to 1.2 mA into 1000 ohms at full scale, proportional to meter deflection.

Overload recovery time: meter indicates within specified accuracy in $<5^{\circ}\text{s}$ (30 V p-p max.).

Maximum input: $\pm 100 \text{ V}$ dc, 30 V p-p.

RFI: conducted and radiated leakage limits are below those specified in MIL-6181D and MIL-1-16910C except for pulses emitted from probe. Spectral intensity of these pulses is nominally $50 \text{ nV}/\sqrt{\text{Hz}}$; spectrum, extends beyond 2 GHz.

Temperature range: Instrument, 0°C to $+55^{\circ}\text{C}$; probe, $+10^{\circ}\text{C}$ to $+40^{\circ}\text{C}$.

Power: 115 or 230 V $\pm 10\%$, 48 Hz to 66 Hz, 25 VA max.

Size: 159 H (without removable feet), x 197 W x 279 mm D ($6.25'' \times 7.75'' \times 11''$); $\frac{1}{2}$ module.

Weight: net, 5.4 kg (12 lb). Shipping, 6.8 kg (15 lb).

Accessories: refer to data sheet.

3406A RF Voltmeter

\$1670

Logarithmic voltmeters, ac or dc log scaling

Models 7562A and 7563A



7563A

Description

Hewlett-Packard Model 7562A is a wide range (80 dB), single channel logarithmic voltmeter/converter designed to produce dc output voltages in a logarithmic relationship to dc input voltages or the true RMS value of an ac input voltage. It contains a true RMS detector which is not dependent on pure sinusoidal signals to achieve measurement accuracy. A self-contained meter calibrated in volts and dB results in an accurate voltmeter. A constant amplitude oscilloscope output makes the converter compatible with a variety of oscilloscope readout and phase meter applications.

The Model 7563A Logarithmic Voltmeter/Amplifier is a low cost, single channel, dc logarithmic amplifier with a very high dynamic range (110 dB) designed to produce a logarithmic-related dc output voltage for a very wide range of dc input voltages. A single input range of 316 μ V to 100 V is coupled with an input polarity switch for ease and versatility of operation. A high input impedance (100 k Ω) and a low output impedance (less than 5 Ω) allows the 7563A to be used in systems or on the bench. A front panel meter calibrated in dB and mV provides instantaneous visual indication of operating levels. Applications include log scaling of recorder axes, pulse height analyzers, scope displays, and almost any circumstances where log compression of dc voltage ranges is required. Dual or single mounting capability is afforded by a field installable rack mounting adapter, utilizing a minimum of rack space.

7562A Specifications

Performance specifications

AC and DC modes

Input

Dynamic range: 80 dB.

Voltage range: 1 mV to 10 V or 10 mV to 100 V selectable by front panel switch. Accepts either ac or positive signals.

Output

Voltage: 0 to 800 mV dc corresponding to 10 mV/dB.

Output impedance: 100 ohms.

DC mode

Accuracy: ± 0.25 dB at 25°C.

Input impedance: 100 k Ω , shunted by less than 100 pF; single ended.

Temperature coefficient: ± 0.02 dB/°C maximum.

Zero stability: ± 0.25 dB.

AC mode

Input impedance: 1 M Ω , shunted by less than 100 pF; single ended.

Accuracy and frequency response: (at 25°C).

Range Setting	0.5 Hz		5 Hz		20 Hz		50 Hz		200 Hz		50 kHz		100 kHz	
											(<10 V)		(>10 V)	
0.5 Hz	± 1 dB										± 1 dB		+1 -3 dB	
5 Hz			± 1 dB								± 1 dB		+1 -3 dB	
50 Hz							± 1 dB		± 0.5 dB		± 1 dB		+1 -3 dB	

Temperature coefficient: ± 0.04 dB/°C maximum.

Slewing speed:

Range setting	Minimum slewing speed
0.5 Hz	1 dB/s
5 Hz	10 dB/s
50 Hz	60 dB/s

Oscilloscope output: approx. 0.5 V rms regardless of input.

Crest factor: 5:1 unless limited by max input voltage.

Maximum peak input voltage: ± 25 V on 1 mV to 10 V range; ± 250 V on 10 mV to 100 range.

General specifications

Operating temperature: 10°C to 40°C.

Warm-up time: 20 minutes nominal.

Connectors: front and rear input and output BNC connectors.

Power requirements: 115/230 Vac, 50 to 400 Hz, 40 VA.

Size: 88 mm H x 197 mm W x 292 mm D (3 $\frac{7}{16}$ " x 7 $\frac{3}{4}$ " x 11 $\frac{1}{2}$ ").

Weight: net, 3.6 kg (8 lb). Shipping 5.4 (12 lb).

7563A Specifications

Performance specifications

Input

Dynamic range: 110 dB.

Voltage range: 316 μ V to 100 V. Accepts either positive or negative signals, selectable by front panel switch.

Output

Voltage: 0 to 1.1 V dc corresponding to 10 mV/dB. Rear terminals; adjustable to 1 to 10 mV/B.

Output impedance: less than 5 Ω front panel, 300 Ω rear.

Meter accuracy: reading accurate to ± 1.5 dB, referred to output.

Input impedance: 100 k Ω , shunted by less than 100 pF, single ended.

Accuracy: (at 25°C).

316 μ V	1 mV	10 V	31.6 V	100 V
± 0.5 dB	± 0.25 dB	± 1.0 dB	± 1.5 dB	

Temperature coefficient: ± 0.02 dB/°C maximum and ± 3 μ V/°C referred to input.

Zero stability: ± 0.25 dB at constant temperature.

Rise Time

Signal Level	Maximum Rise Time	
	1 mV-10 V Range	
316 μ V-1 mV	2000 μ s	
1 mV-10 mV	400 μ s	
10 mV-100 mV	40 μ s	
100 mV-1 V	4 μ s	
1 V-100 V	2 μ s	

General specifications

Operating temperature: 10°C to 40°C.

Warm-up time: 20 minutes nominal.

Connectors: front and rear input and output BNC connectors.

Power requirements: 115/230 V ac, 50 to 400 Hz, 40 VA.

Size: 88.1 mm H x 197 mm W x 292 mm D (3 $\frac{7}{16}$ " x 7 $\frac{3}{4}$ " x 11 $\frac{1}{2}$ ").

Weight: net, 3.6 kg (8 lb). Shipping, 5.4 kg (12 lb).

Ordering information

7562A Logarithmic Voltmeter/Converter

7563A Logarithmic Voltmeter/Amplifier

Price

\$1800

\$1350



Digital voltmeters (DVM's) offer many advantages over other types of voltmeters. Among the advantages of DVM's are greater speed, increased accuracy and resolution, reduction of operator errors and the ability to make automatic measurements.

Digital voltmeters display measurement results as discrete numerals rather than as a pointer deflection on a continuous scale. Human error and tedium are reduced by direct numerical readout, and operator training is minimized by automatic polarity and range-changing features of some DVM's.

Digital voltmeters are available to measure AC and DC voltages, current and resistance. Appropriate transducers can be used to measure other parameters such as strain or temperature. A popular use of DVM's is in automatic measurement systems. A system can be as simple as connecting the DVM digital output to a digital printer or as powerful as a calculator or computer controlled system that provides automatic data reduction and unattended operation.

A new generation of DVM's

Now a greater range of capability than ever before is available in a new generation of digital voltmeters. The technology of integrated circuits and microprocessors has resulted in new solutions ranging from a hand-held unit where the reading is at the point of measurement to powerful new systems voltmeters which can measure at thousands of readings per second.

New technology was developed to meet today's expanding measurement needs. For example, hybrid technology has allowed many functions to be placed on a single substrate. This has made possible instruments such as the 970A probe where the complete instrument is in a hand-held unit.

Other instruments such as the 3476A/B, 3435A, 3438A, 3465A/B, 3466A and the 3467A have benefited by another new process-tantalum nitride on sapphire. Most digital voltmeter designs require a precision attenuator to scale the input voltage. Now a single chip replaces the attenuator which

used up to 20 precision wirewound resistors. The benefits are lower cost, improved reliability, excellent stability, and better than 25 ppm/°C tracking.

To meet the expanding needs of our system users, HP has developed three new voltmeters. The heart of these voltmeters is a high-speed microprocessor tailored especially to system instrument requirements. An example of the resulting capability is automatic calibration that compensates for temperature changes and aging. Other benefits are self-test, self-diagnosis, and internal math capability which allows direct display in engineering units.

Abuse testing

DVM's are often subjected to accidental abuse. To assure survival, our instruments are designed to a new and tougher set of standards. For example, static discharge can be fatal to some integrated circuits so HP tests their designs by discharging >10KV to any exposed metal. Input circuits should be

accident proof. HP DVM designs are tested by applying 240 V RMS to all input terminals and all combinations of input terminals. Some units are routinely exposed to rough use in field service applications requiring design and test to shock levels of 100 G's.

HP-IB

Hewlett-Packard offers three voltmeters which have HP-IB data interface. This versatile interconnect system allows communication with a growing number of instruments, calculators, and computers. Historically the high cost of interfacing related to the lack of interface standardization. Interfacing methods proliferated as each engineer designed custom links between instrumentation devices—resulting in different codes, formats, levels, and timing factors. Today there is a new interface concept tailored to general purpose instrumentation. It is commonly referred to as the IEEE 488 Bus, Hewlett-Packard Interface Bus (HP-IB). Industry acceptance is widespread for there are currently 200 Bus compatible instruments from 56 manufacturers and the list is growing.

Noise rejection

Source and type of noise are important in determining the type of noise rejection needed. There are two types of noise which may affect accuracy and sensitivity of a DVM: normal mode and common mode.

Normal mode noise enters the DVM with the signal and is super-imposed on it. Filtering is the simplest way to cut down on noise but it slows measurement speed. Integration "calculates" noise out of the measurement by looking at the input signal over a period of time equal to the period of expected noise. Filtering is advantageous for rejecting broadband noise, while integration is better for rejecting line related noise. Figure 1 shows typical noise rejection for filtering and integrating methods.

Common mode noise appears between the DVM's input terminals and ground. It is usu-

ally caused by grounding differences between the DVM and the device being measured.

Errors caused by common mode noise may be reduced by a passive technique called "guarding." Guarding shunts the noise-to-ground away from input terminals. By proper connection of the guard (Figure 2), a remarkable improvement can be seen in a DVM's ability to reject common mode noise.

"Effective" common mode rejection is the specification that usually appears in data sheets. Effective refers to the final reading. Effective CMR is the combined result of "pure" CMR due to guarding plus normal mode rejection by the instrument.

Specifications

Resolution and sensitivity

DVM's are generally classified according to the number of full digits. An overrange digit is an extra digit added to allow the user to read beyond full scale. This overrange digit is often called a "one-half" or a "partial" digit since it cannot display all numbers 0 through 9. Overranging greatly extends a DVM's usefulness by maintaining resolution up to, and beyond, full scale. For example, if a signal changes from 9.999 V to 10.012 V, a four-digit DVM without overranging could measure the first voltage as "9.999V," but would require a range change to make the second measurement with a resulting reading of "10.01V." The 0.002 V change would not be seen. With overranging, the second measurement could be made as "10.012 V" with no loss of resolution.

Overrange can be expressed as either a percentage of full scale or as part of the range itself. A four-digit DVM with 100% overrange would have a maximum display of "19999." Alternatively, the range can be described as 2 V, 20 V, etc., with no overrange specification. The maximum display remains "19999." A specification of 20% overranging

would have a maximum reading of "11999." This can also be expressed as 1.2 V, 12 V, etc., range with no overrange.

Resolution is the ratio of the maximum number of counts that can be displayed to the least number of counts. Full-scale resolution of a five-digit DVM is 100,000 to 1, or 0.001%. Overranging is generally ignored in resolution.

Sensitivity refers to the smallest incremental voltage change that the DVM is able to detect. Mathematically, it is the lowest full-scale range multiplied by the resolution of the DVM. Sensitivity of a five-digit DVM with resolution of 0.001% and a 100 mV lowest full-scale range is $0.001\% \times 100 \text{ mV} = 1\mu\text{V}$.

Accuracy

Accuracy is the exactness to which a voltage can be determined, relative to the Legal Volt maintained by the U.S. National Bureau of Standards. Accuracy specification equals errors involved in traceability to N.B.S. as well as errors made by the instrument.

To be meaningful, accuracy must be stated along with the conditions under which it will hold. These conditions should include time, temperature, line variations and humidity. Conditions specified should be realistic relative to intended use. For example, a DVM specified with a temperature range of $25^\circ\text{C} \pm 1^\circ\text{C}$ would require a highly controlled environment, whereas $\pm 5^\circ\text{C}$ would cover the majority of environments.

The period of time over which accuracy holds is especially important since it indicates the DVM's stability and how often it will have to be calibrated.

Accuracy is usually expressed as $\pm X\%$ of reading, $\pm Y\%$ of range, or preferably, as $\pm X\%$ of reading $\pm N$ digits. To be meaningful, accuracy specifications must always consider the effects of time, temperature and humidity.

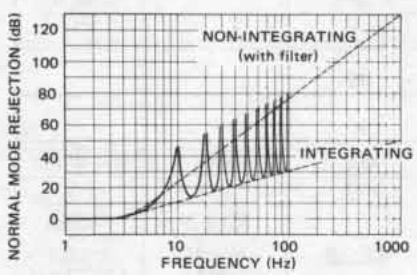

Figure 1. Normal mode noise rejection for two DVM's, one using filtering and the other using integration.

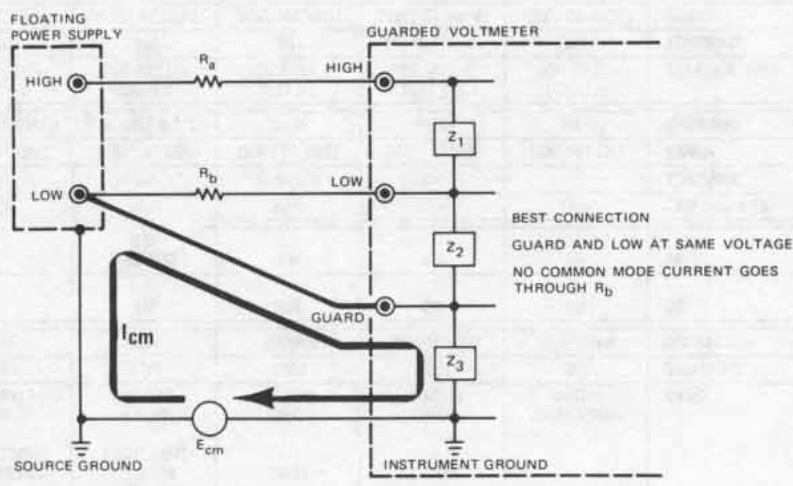

Figure 2. Best CMR connection—guard connected to low at source.

DVM SELECTION GUIDE



3476A/B



3465A/B



3438A



3437A



3467A



3435A



3466A



3455A

BENCH DVM'S

SYSTEM DVM'S

FEATURES	• Low Cost	• Accuracy	• 1 μ V Sensitivity	• Autorange	• Temperature	• HP-IB	• High Speed	• High Performance	
	• Autorange	• 10 Milli Ω	• Bench/Field	• 1 μ V Sensitivity	• Math	• Low Cost	• HP-IB	• Auto Cal	
	• 3 1/2 Digit	• 3 1/2 Digit	• 4 1/2 Digit	• 4 1/2 Digit	• 4 1/2 Digit	• 3 1/2 Digit	• 3 1/2 Digit	• 5 1/2/6 1/2 Digit	
DC VOLTS	MAX INPUT 1000V	1200V	1000V	1200V	350V	1200V	20V	1000V	
	MAX RDGS/SEC 3	4.7	2.5	4.7	4.5	4.7	5700	24	
	RANGES 100mV TO 1000V	100mV TO 1200V	10mV TO 1000V	10mV TO 1200V	20mV TO 350V	200mV TO 1200V	100mV TO 10V	100mV TO 1000V	
	SENSITIVITY 100 μ V	100 μ V	1 μ V	1 μ V	1 μ V	100 μ V	100 μ V	1 μ V	
	BASIC ACCURACY \pm 0.3% RDG. \pm 1 DIGIT	\pm 0.1% RDG. \pm 1 DIGIT	\pm 0.02% RDG. \pm 1 DIGIT	\pm 0.03% RDG. \pm 1 DIGIT	\pm 0.03% RDG. \pm 1 DIGIT	\pm 0.1% RDG. \pm 1 DIGIT	\pm 0.03% RDG. \pm 2 DIGITS	\pm 0.02% RDG. \pm 1 DIGIT	
AC VOLTS	BANDWIDTH 10kHz	100kHz	20kHz	100kHz TRUE RMS	100kHz TRUE RMS	100kHz		1 MHz TRUE RMS	
	RANGES 1k Ω TO 10M Ω	10 Ω TO 10M Ω	100 Ω TO 10M Ω	10 Ω TO 10M Ω	200 Ω TO 20M Ω	10 Ω TO 10M Ω		100 Ω TO 10M Ω	
RESISTANCE	SENSITIVITY 1 Ω	10 milli Ω	10 milli Ω	1 milli Ω	10 milli Ω	10 milli Ω		1 milli Ω	
	OPEN CKT. VOLT <4V	<5V	<5V	<5V	<5V	<5V		<5V	
CURRENT	AC	YES	YES	YES	YES TRUE RMS	YES			
	DC	YES	YES	YES	YES	YES			
	RANGING	AUTO/HOLD	AUTO/MANUAL	MANUAL	AUTO	AUTO	MANUAL	AUTO/MANUAL	
	OVERRANGE	10%	100%	100%	100%	100%	100%	50%	
GENERAL	OTHER	BATTERY POWER-3476B	BATTERY POWER	BATTERY POWER	BATTERY POWER	4 CHANNEL SCANNER	HP-IB INTERNAL TIMER	HP-IB GUARDED 4 TERMINAL Ω	
			OPT 002	3465B	TRMS EITHER AC OR DC DIODE TEST	PRINTER WITH TIMER/PACER	SAMPLE-HOLD	MATH	
	DVM'S	3476A/B	3435A	3465A/B	3466A	3467A	3438A	3437A	3455A
	PAGE	50	52	60	62	64	58	56	66
	PRICE	\$225-\$275	\$335-\$400	\$450-\$550	\$575-\$650	\$2200	\$875	\$2100	\$3200-\$3400



Description

Hewlett-Packard's 970A Probe Digital Multimeter is completely self-contained and autoranges through five ranges of AC and DC volts and ohms. This pocket-sized multimeter is ideal for field, lab, or bench application. All electronics, including display and batteries, are in one seven-ounce package. The basic 970A multimeter is provided with a set of batteries. The battery charger, the short probe tip and the belt carrying case are also provided as standard accessories.

HP's 970A Probe Digital Multimeter can be converted into a five-function bench instrument with optional 97002A Current Shunt/Bench Cradle. A six-position manual switch selects five ranges of AC and DC volts and ohms. Two general purpose binding posts accept wrap-around, screw-down, clip-on or banana plug terminations.

The HP 97003A RF Adapter measures AC voltage over a frequency range of 100 kHz to 500 MHz from 0.25 V to 30 V. A broad line of tips, adapters and tees are also available.

Specifications, Model 970A

DC voltmeter

Ranges: 0.1 V, 1 V, 10 V, 100 V, 1000 V (500 V max input).

Accuracy (20°C to 30°C): \pm (0.7% of reading + 2 digits).

Input resistance: 10 M Ω , \pm 5%.

Input protection: \leq 750 V peak.

Temperature coefficient: \pm (0.05% of reading + 0.2 digits)/°C.

AC voltmeter

Ranges: 0.1 V, 1 V, 10 V, 100 V, 1000 V (500 V rms sine wave max input).

Accuracy (20°C to 30°C)

Range	45 Hz to 1 kHz	1 kHz to 3.5 kHz
1 V to 1000 V	\pm (2% of reading + 5 digits)	\pm (3% of reading + 5 digits)
0.1 V (>3 mV)	\pm (2% of reading + 5 digits)	\pm (5% of reading + 5 digits)

Input resistance: 10 M Ω , \pm 5%.

Input capacitance: \leq 30 pF.

Input protection: \leq 750 V peak.

Temperature coefficient: \pm (0.05% of reading + 0.5 digits)/°C.

Ohmmeter

Ranges: 1 k Ω , 10 k Ω , 100 k Ω , 1000 k Ω , 10,000 k Ω .

Accuracy: (20°C to 30°C): \pm (1.5% of reading + 2 digits).

Input voltage protection (resistor fused—clip mounted): \leq 115 V rms for up to 1 minute. \leq 250 V rms for up to 10 seconds.

Temperature coefficient: \pm (0.05% of reading + 0.2 digits)/°C.

- Puts a complete DMM in the palm of your hand
- Autoranging, autozero, autopolarity

General

Ranging: automatic.

Sample rate: 3/second.

Overrange: 10%.

Calibration cycle: 1 year.

Operating environmental conditions:

Temperature range: 0°C to 40°C.

Humidity: \leq 95% RH.

Power: rechargeable batteries.

Typical operating time using fully charged battery: 2 hours continuous at 25°C.

Typical battery charging time: 14 hours at 25°C. (Indefinite charging will not damage battery).

Weight (with battery pack): net, 200 g (7 oz). Shipping, 1.8 kg (4 lb).

Size: 165 L x 45 W x 30 mm D (6½" x 1¾" x 1¼").

97002A Specifications

DC ammeter

Ranges: 0.1 mA, 1 mA, 10 mA, 0.1 A, 1 A FS.

Accuracy (20°C to 30°C): \pm (2.5% of reading + 2 digits).

AC ammeter

Ranges: 0.1 mA, 1 mA, 10 mA, 0.1 A, 1 A FS.

Accuracy (20°C to 30°C, >3% of range): 45 Hz to 1 kHz; \pm (4% of reading + 5 digits). 1 kHz to 3.5 kHz; \pm (7% of reading + 5 digits).

DCV, ACV, OHMS: Same as 970A specifications

General

Full range insertion voltage: \leq 0.25 V.

Input protection: 2 amp fast acting fuse.

Weight: net, 170 g (6 oz). Shipping 1.8 kg (4 lb).

Size: 95 L x 95 W x 51 mm D (3¾" x 3¾" x 2").

97003A Specifications

Response: the 97003A is a peak responding detector and is calibrated to read rms value of a sine wave.

Voltage range: 0.25 V to 30 V rms.

Max input: 30 V rms ac; 200 V dc.

AC to DC transfer accuracy when operating into HP 970A

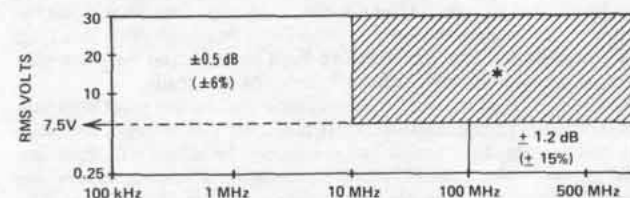

*HP's 97003A is usable from 10 MHz to 500 MHz and 7.5 V rms to 30 V rms. It is not traceable to the United States National Bureau of Standards over that range.

Input impedance: input resistance: $>$ 25 k Ω .

Shunt capacitance: \leq 3 pF for plastic tips. \leq 4 pF for metal high frequency adapter tip.

General

Accessories supplied: ground lead, straight tip, battery charger, soft carrying case.

Accessories available: 11063A, 50-ohm tee; 11536A, 50-ohm tee; 10218A, BNC Adapter; 10219A, Type 874 Adapter; 10220A, Micro-dot Adapter. See data sheet for information on ordering chargers.

Ordering information

	Price
97001A extra rechargeable battery pack	\$27
97002A ac/dc current shunt/bench cradle	\$49
97003A RF adapter	\$88
97004A accessory kit	\$36
970A Digital Multimeter (includes soft carrying case, battery and charger)	\$425

DIGITAL VOLTMETERS

Low-cost autoranging 3½ digit DMM

Model 3476A/B



Description

If you measure current, voltage or resistance, you can use the 3476A/B to make these measurements faster and with fewer reading errors. This versatile instrument incorporates autorange to let you concentrate on your measurement, not the range or range multiplier. With autorange, readings always have the same multiplier: voltage always in volts, current in amps, and resistance in kilohms. In addition to autorange, the 3476A/B has auto-zero and auto-polarity. Auto-zero eliminates the need to zero the instrument prior to a test, and auto-polarity lets you measure both positive and negative voltages without the inconvenience of reversing test leads.

The 3476A/B saves you time by combining the five most common measurements in one instrument. It measures AC voltage, DC voltage, AC current, DC current and resistance. In addition to these five basic measurements, the 3476A/B has additional features to save you time and effort. For example, there are two units to choose from. The lower cost 3476A operates on AC for your bench measurements. The 3476B will operate on either AC or nickel-cadmium batteries. Under battery operation you can break ground loops resulting in quieter readings or make measurements in remote locations. The 3476B will give you eight hours of continuous service before a recharge is required. Keep it plugged in and it will charge overnight and be ready for your next trip.

Convenience

An instrument designed to make your most common measurements should be convenient to use. The 3476A/B was designed to be convenient. An example is the replacement of the input protection fuses. Replacement is easy—no disassembly or re-calibration is necessary—simply slide back the input terminal cover plate to expose the defective fuse. Convenience means attention to design detail. A multiposition bail allows convenient positioning. There is even a vertical detent for viewing from above. Another convenient detail is the shape of the case. Small instruments with pushbuttons have trouble staying put when the buttons are pressed. The 3476A/B solves this problem with a finger grip ridge allowing one-handed operation.

3476A/B specifications

DC Voltmeter

Ranges:	±0.1100V	Maximum display:	±0.1098 V
	±1.100 V		±1.098V
	±11.00 V		±10.98 V
	±110.0 V		±109.8 V
	±1100 V		±1098 V

Maximum input: 1000 V (DC + Peak AC).

Accuracy (20°C to 30°C)*

Range	Accuracy*
0.1100 V	± (0.3% of reading + 2 digits)
1.100 V 11.00 V	± (0.3% of reading + 1 digit)
110.0 V 1100 V	± (0.4% of reading + 1 digit)

*90 day cal. cycle. Add (0.2% of reading) for one year cal. cycle.

Common mode rejection: (1 kΩ unbalance) >100 dB @ 50 Hz, 60 Hz.

Input resistance: 10 MΩ ± 5%.

Input protection: <1100 V peak.

Temperature coefficient: ± (0.05% of reading + 0.2 digit)/°C.

AC Voltmeter

Ranges:	0.1100 V	Maximum Display:	0.1098 V
	1.100 V		1.098 V
	11.00 V		10.98 V
	110.0 V		109.8 V
	1100 V		1098 V

Maximum input: 700 V rms.

Accuracy: converter is average responding calibrated in rms (20°C to 30°C)*

Ranges**	45 Hz to 2 kHz	2 kHz to 5 kHz	5 kHz to 10 kHz
1.100 V to 1100 V	± (1.5% of reading + 4 digits)	± (3% of reading + 6 digits)	± (8% of reading + 10 digits)
0.1100 V	± (2% of reading + 6 digits)	± (5% of reading + 6 digits)	± (18% of reading + 10 digits)

*90 day cal. cycle. Add (0.2% of reading + 1 digit) for one year cal. cycle

**Ranges usable from 3% of range to full scale.

DIGITAL VOLTMETERS

3½ Digit, high accuracy DMM

Model 3435A



Description

The 3435A is a 3½ digit multimeter providing five functions of ACV, DCV, ACI, DCI and Ω . It is available with rechargeable batteries or AC line power only. The 34112A Touch-Hold probe provides "eyes-on" probing of AC and DC voltages by holding the 3435A display using a button on the probe. The 3435A case is rugged with a detent position carrying handle which is used also as a tilt stand.

Specifications

DC voltmeter

Ranges:	Maximum display:
± 200 mV	± 199.9 mV
± 2 V	± 1.999 V
± 20 V	± 19.99 V
± 200 V	± 199.9 V
± 1200 V	± 1199 V

Maximum input: 1200 V (DC + Peak AC).

Ranging: automatic or manual.

Sensitivity: 100 μ V on 200 mV range.

Polarity: automatically sensed and displayed.

Accuracy: 1 year, 15 to 30°C.

Range	Specifications
200 mV	$\pm (0.1\% \text{ of reading} + 2 \text{ digits})$
2 V to 1200 V	$\pm (0.1\% \text{ of reading} + 1 \text{ digit})$

Temperature coefficient: (0 to 15°C and 30 to 55°C) $\pm (0.018\%$ of reading + 0.1 digit)/°C.

Input resistance: 10 M Ω $\pm 1\%$.

Input type: floating, 500 V maximum com. to ground.

Normal mode rejection: 40 dB at 50 Hz/60 Hz ± 0.1 Hz.

Response time: <0.7 second to within 1 digit of final value on one range. Add 1 second for each range change.

Effective common mode rejection: (1 k Ω unbalance) >120 dB at 50/60 Hz $\pm 0.1\%$.

DC Current

Ranges:	Maximum display:
± 200 μ A	± 199.9 μ A
± 2 mA	± 1.999 mA
± 20 mA	± 19.99 mA
± 200 mA	± 199.9 mA
± 2000 mA	± 1999 mA

Maximum input: current: 2 amp (fuse protected). Voltage: 250 V.

Ranging: manual only.

Sensitivity: 100 nA on 200 μ A range.

Polarity: automatically sensed and displayed.

Accuracy: 1 year, 15 to 30°C.

Range	Specifications
200 μ A to 200 mA	$\pm (0.3\% \text{ of reading} + 2 \text{ digits})$
2000 mA	$\pm (0.6\% \text{ of reading} + 2 \text{ digits})$

Temperature coefficient: (0 to 15°C and 30 to 55°C) $\pm (0.028\%$ of reading + 0.1 digit)/°C.

Voltage burden

Range	Maximum Burden at Full Scale
200 μ A to 20 mA	<220 mV
200 mA	<240 mV
2000 mA	<400 mV

Response time: 0.7 second on any range to within 1 digit of final value.

AC voltmeter

AC converter: avg. responding rms calibrated.

Ranges:	Maximum display:
200 mV	199.9 mV
2 V	1.999 V
20 V	19.99 V
200 V	199.9 V
1200 V	1199 V

Maximum input: 1700 V (DC + Peak AC), 10⁷ volt-Hz max.
Ranging: automatic or manual.
Sensitivity: 100 μV on 200 mV range.
Accuracy: (with display of ≥20 digits) 1 year, 15 to 30°C.

Range	Specification
30 Hz-50 Hz	± (1.5% of reading +3 digits)
50 Hz-20 kHz	± (0.3% of reading +3 digits)
20 kHz-100 kHz	± (1.5% of reading +10 digits)

Temperature coefficient: (0 to 15°C and 30 to 55°C) ± (0.04% of reading +0.2 digit)/°C.
Input impedance: resistance: 5 MΩ. Shunt capacitance: <50 pF.
Response time: 1.6 seconds to within 3 digits of final value on one range. Add 1.2 seconds for each range change.
Input type: floating, 500 V maximum com. to ground.

AC current

Ranges:	200 μA	Maximum display:	199.9 μA
	2 mA		1.999 mA
	20 mA		19.99 mA
	200 mA		199.9 mA
	2000 mA		1999 mA

Maximum input: current: 2 amp (fuse protected). Voltage: 250 V.
Ranging: manual only.
Sensitivity: 100 nA on 200 μA range.
Accuracy: (with display of ≥20 digits)—1 year, 15 to 30°C.

Current Range	Frequency of Input Signal	2000 mA	200 mA	200 μA
		± (2% of reading +4 digits)	± (1.2% of reading +4 digits)	± (1.7% of reading +4 digits)

Temperature coefficient: (0 to 15°C and 30 to 55°C) ± (0.05% of reading +0.2 digit)/°C
Voltage burden

Range	Maximum Burden at Full Scale
200 μA to 20 mA	<220 mV rms
200 mA range	<240 mV rms
2000 mA range	<400 mV rms

Response time: 1.6 seconds on any range to within 3 digits of final value.
Input type: floating, 500 V maximum com. to ground.

Ohmmeter

Ranges:	20Ω	Maximum display:	19.99Ω
	200Ω		199.9Ω
	2 kΩ		1.999 kΩ
	20 kΩ		19.99 kΩ
	200 kΩ		199.9 kΩ
	2000 kΩ		1999 kΩ
	20 MΩ		19.99 MΩ

Input protection: 250 V rms.
Ranging: automatic or manual.
Sensitivity: 10 milliohm on 20Ω range.
Accuracy: 1 year, 15 to 30°C.

Range	Specifications
20Ω	± (0.5% of reading +10 digits)
200Ω-2000 kΩ	± (0.2% of reading + 2 digits)
20 MΩ	± (0.8% of reading + 2 digits)

Temperature coefficient: (0 to 15°C and 30 to 55°C)

Range	Specifications
20Ω-2000 kΩ	± (0.04% of reading +0.2 digit)/°C
20 MΩ	± (0.18% of reading +0.2 digit)/°C

Configuration: 2 wire.
Open circuit voltage: <5 V.
Current through unknown
Range: 20Ω, 200Ω, 2 kΩ, 20 kΩ, 200 kΩ, 2000 kΩ, 20 MΩ.
Current: 5 mA, 5 mA, 500 μA, 50 μA, 5 μA, 500 nA, 50 nA.
Response time: 0.8 second to within 1 digit. Add 0.8 second for each range change.

General

Calibration: data sheet specifications guaranteed for 1 year.
Display: 7 segment red 0.3 inch high LED's. Function and range announcement.
Reading rate: 2.4 - 4.7/s depending on input level.
A-D conversion: dual slope.
Integration time: 100 ms.
Ranging: automatic or manual on ACV, DCV and ohms. Manual only on AC & DC current.
Storage temperature: AC line power only, -40 to +75°C; with batteries, -40 to +65°C.
Operating temperature: (0 to 55)°C.
Humidity: 95% RH, +15 to +40°C.
Power: AC line: 48-440 Hz; 86-250 V (see configuration). Battery: rechargeable lead-acid 10 hours minimum continuous operation with full charge. Recharge time: 16 hours operating, 12 hours nonoperating. Batteries and charger available separately; consult operating manual. Total instrument power dissipated: AC only; 3 watts; with charger; 8 watts.

Size:

	3435A	3435A Option 002
	23.81 cm (9 1/4") wide	20.96 cm (8 1/4") wide
	9.84 cm (3 7/8") high	8.57 cm (3 3/8") high
	27.62 cm (10 7/8") long	26.67 cm (10 1/2") long

Weights: 3435A 2.41 kg (5 lb 5 oz)
 3435A Opt. 001 1.84 kg (4 lb 1 oz)
 3435A Opt. 002 1.81 kg (4 lb)

Configuration

3435A, streamlined portable case with handle, AC line power. Batteries and charger included. **Price** \$400
 3435A Opt. 001, streamlined portable case, AC line power only. **less** \$65
 3435A Opt. 002, Rack and Stack case, AC line power only. (Rack mount kit not included.) **less** \$35
 All orders must include one of the power options: 86-106 V Opt. 100; 190-233 V Opt. 210; 104-127 V Opt. 115; 208-250 V Opt. 230. **N/C**

***Accessories**

11000A Test leads, dual banana both ends. \$17
11002A Test leads, dual banana to dual alligator. \$12
11003A Test leads, dual banana to probe and alligator. \$12
11096B RF Probe, 10 kHz to 700 MHz. \$90
34110A Soft vinyl carrying/operating case. \$25
34111A High-voltage probe 40 kV DC. \$75
34112A Touch-Hold Probe. \$40
11067A Test lead kit. \$5
5061-0072 1/2 Module rack mount kit. (Available on Opt 002 only). \$25

Ordering information

3435A \$400
3435A Opt 001 less \$65
3435A Opt 002 less \$35

*Domestic U.S. prices only.



DIGITAL VOLTMETERS

True RMS voltmeter

Model 3403C

- DC and 2 Hz to 100 MHz
- 3½ digit



Description

The Model 3403C is usable from dc to 100 MHz. True rms is especially valuable for measurements of noise, multiplexed signals, modulated waves and signals with high harmonic content.

dB display

The dB display option provides readings directly in dB, a major convenience to ac users. The dB reference to which the measurement is made is conveniently adjustable from the front panel to provide referenced dB measurements, or to provide a convenient means to offset the reading by as much as 13 dB for unreferenced measurements.

Specifications

Ranges

Full range display: 10.00 mV (ac only); 100.0 mV; 1.000 V; 10.00 V; 100.0 V; 1000 V.

Overrange: >90% on all ranges except as limited by max input voltage.

Ranging information: front panel annunciators indicate overrange (approximately 190% of full range), or underrange (approximately 17% of full range) conditions.

Performance

AC frequency range

Slow response: 2 Hz to 100 MHz.

Fast response: 25 Hz to 100 MHz.

Response time

Fast response: 1 s.

Slow response: 10 s.

Instrument reads final reading $\pm 0.1\%$ of input change in stated response time.

Display rate

Fast response: 4 readings per s.

Slow response: 2 readings per s.

READING ACCURACY = \pm % OF RANGE + \pm % OF READING **

RANGE	VOLTS			FREQUENCY (Hz)							
	DC	DC+AC	AC	DC	25	100K	1M	10M	100M		
1000V	.3	.3	.3	.2	.4*	.2	[Hatched Area]				
100V	.2	.2	.2	.2	.4*	.2					1
10V	.2	.2	.2	.2	.4*	.2	.5	1	[Hatched Area]		
1V	.2	.2	.2	.2	.4*	.2	.5	1			2
100mV	.6	.6	$\frac{2}{.4}$.2	.4*	.2	.5	2	2	5	10
10mV			$\frac{2}{.4}$.3	1.2	3	[Hatched Area]		

CAUTION: frequencies and ranges in this area may result in invalid readings without ranging indication.

* DC + AC function and slow response time only

** % of reading specification is representative of typical flatness.

Functions

DC: responds to dc component of input signal.
AC: responds to true rms value of ac coupled input signal.
AC+ DC: responds to true rms value of dc and ac input signal; reading is $\sqrt{(dc)^2 + (ac\ rms)^2}$
Temperature coefficient: ± 0.1 x reading accuracy*/°C outside the 25°C \pm 5°C temperature range.

Accuracy: 90 days (25°C + 5°C, <95% RH, 17% of range to 190% of range).

Input characteristics

Input impedance: <10 MHz.
1 V to 1000 V range: 10 M Ω \pm 10% shunted by 19 pF \pm 10%.
10 mV and 100 mV range: 20 M Ω \pm 10% shunted by 16 pF \pm 10%.
10 MHz to 100 MHz: the following table gives maximum loading due to input shunt impedance across a terminated source.

System impedance (source and load)	Frequency	
	10 MHz	100 MHz
50 Ω	1%	10%
75 Ω	2%	20%

Crest factor

2 Hz to 25 Hz	2:1 at full range input.
>25 Hz	10:1 at full range input.

Maximum input voltage

High to low: 1000 V rms, 1500 peak or 10⁸ V-Hz on any range. Maximum dc voltage in ac mode: 500 V dc.
Low to chassis: \pm 500 V dc, when floated with special banana to BNC adapter.

Options:

Autoranging (3403C option 001)

Automatic ranging: uprange at approximately 190% of full range; downranges at approximately 17% of full range.
Autorange time: fast response: 1 s per range change. Slow response: 10 s per range change.

Remote control+ digital output+ autoranging (3403C option 003): Provides remote control of all front panel functions, ranges, digital output and autoranging.

dB display (3403C option 006)

Measurement range: 108 dB (-48 dBV to +60 dBV).
Calibrated dB reference: 0 dB = 1.000 V; reference level may be set for 0 dBm (600 Ω) by adjusting front panel dB calibration adjustment.
Variable dB reference: reference level may be shifted downward from calibrated position >13 dB.

*Data from accuracy charts.

dB recorder output: output voltage: 200 mV for 20 dB. Output resistance: 1 k Ω \pm 500 Ω .

Accuracy: 90 days (25°C + 5°C, <95% RH).

READING
 ACCURACY = (\pm dB) + (\pm dB)**

RANGE	dB		FREQUENCY (Hz)						
	AC	DC+AC	DC	25	100K	1M	10M	100M	
1000V	.15	.15	.02	.04*	.02				
100V	.15	.15	.02	.04*	.02	.1			
10V	.15	.15	.02	.04*	.02	.05	.1		
1V	.15	.15	.02	.04*	.02	.05	.1	.2, 5, 1	
100mV	.15	.15	.02	.04*	.02	.05	.2	.2, 5, 1	
10mV	.15				.03	.12	.3		

 CAUTION: frequencies and ranges in this area may result in invalid readings without ranging indication.

* DC + AC function and slow response time only

** specification is representative of typical flatness.

General

Operating conditions

Temperature range: 0°C to 50°C.
Humidity: <95% RH.

Recorder output

Output voltage: 1 V dc open circuit for full range input.
Output resistance: 1 k Ω \pm 10%.

Power: 115 V or 230 V \pm 10%, 48 Hz to 440 Hz, 35 VA max. (including all options).

Input terminals: BNC front panel connector standard for low to high terminals: rear panel connector available by internally reversing position of ac converter module.

Weight: including all options: net, 5 kg (11 lb). Shipping, including all options: Net, 7.2 kg (16 lb).

Size: 127 mm H x 234.9 mm W x 196.8 mm D (5" x 9 1/4" x 7 3/4").

Accessories furnished: floating adapter-banana to BNC.

3403C True RMS Voltmeter

- Opt 001** autoranging \$2760
- Opt 003** remote control + digital output + autoranging add \$156
- Opt 006** dB display add \$355

*Options 003 and 006 are available only as factory installed options.

DIGITAL VOLTMETERS

High speed 3½ digit system voltmeter

Model 3437A



Description

The Hewlett-Packard 3437A System Voltmeter has been designed to be used in systems. It is a 3½ digit high speed dc voltmeter with sample and hold. The standard unit measures DC volts, provides trigger delay, burst reading capability and Hewlett-Packard Interface Bus (HP-IB).

There are three DC floating input ranges: 0.1V, 1.0V and 10.0V full scale with a maximum display of "1999." Sample and Hold allows the 3437A to be an instantaneous reading voltmeter. The trigger delay can be set from 0.1μs to 1.0 second and the number of readings can be set from 0 to 9999 readings.

Typical operation

Example: set Delay to 1 ms and Number of Readings is set to 1000. The 3437A will now take 1000 readings spaced 1 ms apart upon receiving one trigger.

Data output

All front panel switches are programmable from the HP-IB. Two data output formats are available: (1) ASCII output (Serial ASCII characters) and (2) Packed output (two 8-bit bytes on the HP-IB to send the complete reading).

High speed

The Packed output mode allows more data to be stored in the calculator or computer as well as increasing the maximum reading rate from 3000 readings/second to greater than 5000 readings/second.

Systems capability

The user may select the mode for which the voltmeter requests service from the controller. Request Service can be programmed manually or automatically to request service for: (1) Data Ready, (2) Trigger Ignore, or (3) Invalid Program. Any combination of these three can be selected.

Applications

Waveform analysis—The 3437A can be used to analyze a wide variety of waveforms. The delay and burst reading capability allows frequency, positive or negative peak values, RMS value and harmonic distortion to be measured. The accuracy of these measurements is comparable to more traditional measurement techniques.

Transient signal analysis—The 3437A is capable of measuring transient signals because of the wide bandwidth input (>1 MHz), high measuring speed and sample-and-hold.

Fast AC measurements—Sinusoidal signals of known frequency can be measured in less than one cycle of the signal. Very low frequency measurements can be made more quickly than with conventional techniques.

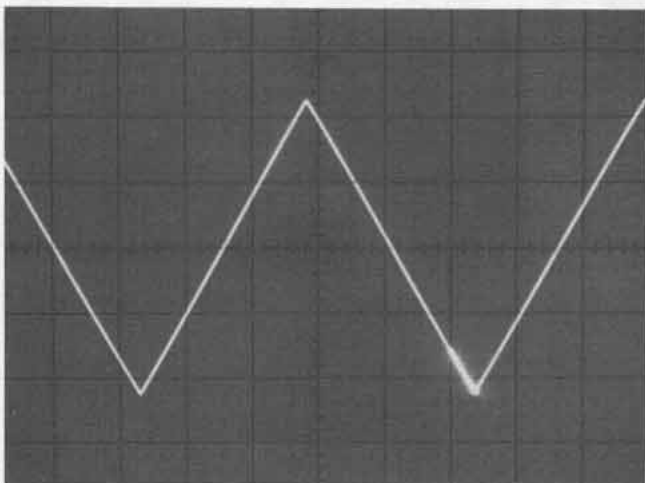

Figure 1 shows a signal to be measured by both an oscilloscope and the 3437A. The oscilloscope delayed sweep is used to intensify the point of interest. The delayed gate output is used to trigger the 3437A at the same point in time as indicated on the oscilloscope display. The voltage at the point of interest is now known to the accuracy of the 3437A.

High speed scanning: multiple input measurement applications can be satisfied with the 3437A and the HP 3495A Scanner. Reading rates of up to 1000 channels/second can be attained.

Bench measurements: in addition to systems applications, the 3437A can be used to improve oscilloscope amplitude and measurement accuracy.

Data-sheeted systems

The 3437A is part of the 3052A Data Acquisition System. (Refer to page 74). The 3052A includes the 3437A, 3455A 5½/6½ digit DVM, 3495A Scanner and 9825A Controller. The combination of the 3437A and 3455A voltmeters provides systems versatility such as high speed, system timing and high sensitivity measurements. The delay generator in the 3437A is used to provide timing triggers for the 3455A DVM. The 3455A provides 1 µV sensitivity and high speed DC measurements with greater than 60 dB normal mode noise rejection.

Specifications

DC volts

Ranges	Max. Display	Overload Reading
10 V	±19.98	±99.99
1 V	±1.998	±9.999
0.1V	±.1998	±.9999

Ranging: Manual or Remote.

Performance

Static accuracy (90 days, 23°C ± 5°C)

10 V range: ±0.05% of reading ±1.6 digits.

1 V range: ±0.03% of reading ±1.6 digits.

0.1 V range: ±0.06% of reading ±1.8 digits.

Static accuracy (1 year, 23°C ± 5°C)

10 V range: ±0.05% of reading ±2 digits.

1 V range: ±0.03% of reading ±2 digits.

0.1 V range: ±0.06% of reading ±2.2 digits.

Static accuracy temperature coefficient (0°C–50°C): ±0.002% reading/°C ±0.05 digits/°C.

Input characteristics

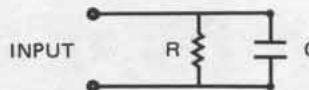

10 V range: R = 1 MΩ ±20%; C < 75 pF.

1 V range: R > 10⁸Ω; C < 75 pF.

0.1 V range: R > 10⁸Ω; C < 75 pF.

Maximum input voltage high to low on all ranges: < ±30 V peak.

Maximum voltage low to chassis: ±42 V peak.

Number of Readings (N Readings): 0 to 9,999.

Readings are not internally stored.

For N = 0 the 3437 operates in delay mode only.

Maximum reading rate (Remote, N Rdgs. > 1, and a zero delay listener*)

ASCII: 3600 Readings/s.

Packed: 5700 Readings/s.

Actual Reading Rate is given by

$$\text{ASCII: } \frac{3600 (\text{listen rate})}{3600 + \text{listen rate}}$$

Listen rate is maximum speed (minimum delay) that listener can accept 7 data bytes.

$$\text{PACKED: } \frac{5700 (\text{listen rate})}{5700 + \text{listen rate}}$$

Listen rate is maximum speed (minimum delay) that listener can accept 2 data bytes.

Delay

N Rdgs. = 0 or 1

DELAY (setting): 0 to 0.999 999 9 sec. in 0.1 µs steps.

N Rdgs. > 1 (Remote and a zero delay listener)

ASCII: 0.0002778 s ≤ DELAY ≤ 0.9999999 s.

PACKED: 0.0001754 s ≤ DELAY ≤ 0.9999999 s.

Minimum delay is a function of listener delay related by:

ASCII: 277.8 µs + listener delay.

PACKED: 175.4 µs + listener delay.

Accuracy (EXT. TRIG to DELAY OUT, 0°C to 50°C)

Delay offset: 100 ns ± 25 ns (with <150 pF cable capacitance)

Delay accuracy: ±0.008% DELAY Setting + Delay offset.

Delay repeatability (jitter) for N Rdgs = 0 or 1

DELAY of 0 or 0.1 µs: 2 ns

DELAY of 0.2 µs to 50 ms: 10 ns + 0.0002% DELAY setting.

DELAY of > 50 ms: ±110 ns.

Input bandwidth (3 dB)

10 V range: 1.0 MHz.

1 V range: 1.1 MHz.

0.1 V range: 40 kHz.

Settling time:

10 V range: 10 V Range with 10 V step input:

Reading settles to within 30 mV of final value in 7.5 µs or to within 200 mV of final value in 700 ns.

1 V range: 1 V Range with 1 V step input:

Reading settles to within 3 mV of final value in 1.5 µs or to within 20 mV of final value in 700 ns.

0.1 V range: 0.1 V Range with .1 V step input

Reading settles to within 200 µV of final value in 25 µs.

General

Operating temperature: 0 to 55°C.

Storage temperature: -40°C to 75°C.

Humidity range: <95% R.H., 0°C to 40°C.

Power: 100 V, 120 V, 220 V, 240 V +5%, -10%, 48 Hz to 440 Hz line operation, <42 VA with all options.

Dimensions: 88.9 mm H x 212.7 mm W x 527.1 mm D (3½" x 8½" x 20¾").

Weight: net, 5.6 kg (12 lb 4 oz). Shipping, 7.6 kg (16 lb 12 oz).

3437A System Voltmeter

\$2100

DIGITAL VOLTMETER

HP-IB 5 Function DMM

Model 3438A



Description

The 3438A is an autoranging 3½ digit Multimeter with 5 functions of ACV, DCV, ACI, DCI, and Ω . It interfaces to the HP-IB providing both addressable and talk-only modes.

The addressable mode allows triggering either from the Calculating Controller (remote) or internally (local). Function and range are selected manually on the front panel with autoranging of volts and ohms.

Specifications

DC Voltmeter

Ranges:	Maximum display:
± 200 mV	± 199.9 mV
± 2 V	± 1.999 V
± 20 V	± 19.99 V
± 200 V	± 199.9 V
± 1200 V	± 1199 V

Maximum input: 1200 V (DC + peak AC).

Ranging: Automatic or manual.

Sensitivity: 100 μ V on 200 mV range.

Polarity: Automatically sensed and displayed.

Accuracy (1 year, 15 to 30°C)

Range	Specifications
200 mV	$\pm (0.1\% \text{ of reading} + 2 \text{ digits})$
2 V to 1200 V	$\pm (0.1\% \text{ of reading} + 1 \text{ digit})$

Temperature coefficient: (0 to 15°C and 30 to 55°C) $\pm (.018\% \text{ reading} + 0.1 \text{ digit})/^\circ\text{C}$.

Input resistance: 10 meg $\Omega \pm 1\%$.

Input Type: floating, 500 V maximum com. to ground.

Normal Mode Rejection: 40 dB at 50 Hz and 60 Hz $\pm .1$ Hz.

Response time: <0.7 seconds to within 1 digit of final value on one range. Add 1 second for each range change.

Effective common mode rejection: (1 k Ω unbalance) > 120 dB at 50/60 Hz $\pm 0.1\%$.

DC Current

Ranges:	Maximum display:
± 200 μ A	± 199.9 μ A
± 2 mA	± 1.999 mA
± 20 mA	± 19.99 mA
± 200 mA	± 199.9 mA
± 2000 mA	± 1999 mA

Maximum input: current: 2 amp (fuse protected); voltage: 250 V

Ranging: manual only.

Sensitivity: 100 nA on 200 μ A range.

Polarity: automatically sensed and displayed.

Accuracy (1 year, 15 to 30°C)

Range	Specifications
200 μ A to 200 mA	$\pm (0.3\% \text{ of reading} + 2 \text{ digits})$
2000 mA	$\pm (0.6\% \text{ of reading} + 2 \text{ digits})$

Temperature coefficient: (0 to 15°C and 30 to 55°C) $\pm (.028\% \text{ of reading} + 0.1 \text{ digits})/^\circ\text{C}$.

Voltage burden:

Range	Maximum Burden at Full Scale
200 μ A to 20 mA	< 220 mV
200 mA	< 240 mV
2000 mA	< 400 mV

Response time: 0.7 seconds on any range to within 1 digit of final value.

AC Voltmeter

AC Converter (average responding RMS calibrated)

Ranges:	Maximum Display:
200 mV	199.9 mV
2 V	1.999 V
20 V	19.99 V
200 V	199.9 V
1200 V	1199 V

Maximum input: 1700 V (DC + Peak AC), 10⁷ Volt-Hz max.
Ranging: Automatic or manual.
Sensitivity: 100 μV on 200 mV range.

Accuracy (with display of ≥20 digits) 1 year, 15 to 30°C

Range	Specifications
30 Hz-50 Hz	±(1.5% of reading ±3 digits)
50 Hz-20 kHz	±(0.3% of reading ±3 digits)
20 kHz-100 kHz	±(1.5% of reading ±10 digits)

Temperature coefficient: (0 to 15°C and 30 to 55°C) ±(0.04% of reading +0.2 digit)/°C.
Input impedance: resistance: 5 meg Ω; shunt capacitance: <50 pf.
Response time: 1.6 seconds to within 3 digits of final value on one range. Add 1.2 seconds for each range change.
Input type: floating, 500 V maximum com. to ground.

AC Current

Ranges:	Maximum display:
200 μA	199.9 μA
2mA	1.999 mA
20 mA	19.99 mA
200 mA	199.9 mA
2000 mA	1999 mA

Maximum input: current: 2 amp (fuse protected) voltage: 250 V.
Ranging: Manual only.
Sensitivity: 100 nA on 200 μA range.
Accuracy (With display of ≥20 digits) 1 year, 15 to 30°C

Current Range	Accuracy	
	30 Hz	50 Hz
2000 mA	±(2% of reading +4 digits)	±(1.2% of reading +4 digits)
200 mA	±(1.7% of reading +4 digits)	±(0.9% of reading +4 digits)
200 μA	±(1.7% of reading +4 digits)	±(0.9% of reading +4 digits)

Frequency of Input Signal

Temperature coefficient: (0 to 15°C and 30 to 55°C) ±(0.05% of reading +0.2 digits)/°C.
Voltage burden

Range	Maximum Burden at Full Scale
200 μA to 20 mA	<220 mV RMS
200 mA range	<240 mV RMS
2000 mA range	<400 mV RMS

Response time: 1.6 seconds on any range to within 3 digits of final value.

Input type: floating, 500 V maximum com. to ground.

Ohmmeter

Ranges:	Maximum display
20Ω	19.99Ω
200Ω	199.9Ω
2kΩ	1.999 kΩ
20 kΩ	19.99 kΩ
200 kΩ	199.9 kΩ
2000 kΩ	1999 kΩ
20 MΩ	19.99 MΩ

Input protection: 250 V RMS.
Ranging: automatic or manual.
Sensitivity: 10 milliohm on 20Ω range.
Accuracy (1 year, 15 to 30°C)

Range	Specifications
20Ω	±(0.5% of reading +10 digits)
200Ω to 2 MΩ	±(0.2% of reading +2 digits)
20 MΩ	±(0.8% of reading +2 digits)

Temperature coefficient (0 to 15°C and 30 to 55°C)

Range	Specifications
20Ω-2 MΩ	±(0.04% of reading + 0.2 digits)/°C
20 MΩ	±(.18% of reading + 0.2 digits)/°C

Configuration: 2 wire.
Open circuit voltage: <5 V.
Current through unknown
Range: 20Ω, 200Ω, 2kΩ, 20 kΩ, 200 kΩ, 2 MΩ, 20 MΩ.
Current: 5 mA, 5 mA, 500 μA, 50 μA, 5 μA, 500 nA, 50 nA.
Response time: 0.8 seconds to within 1 digit. Add 0.8 seconds for each range change.

HP-IB

Data output format:
 ±X.XXX E±X, Fn CR LF (13 byte, fixed)

DISPLAY EXPONENT FUNCTION

Function Code: DCV, 1; ACV, 2; DCI, 3; ACI, 4; Ω, 5
Overload Indication: ±1.XXX E + 9

Talk Modes (Selected by internal switch)

Addressed to talk
Local: continuously sampling input; outputs on Bus when addressed to talk.
Remote: samples input only on command from controller.

Talk only (used without controller)
Input: switch selectable, front or rear.
Reading rate: is function of input level and ranging (2.5 to 4.7/sec. if in proper range).
With Range change

ACV, ACI: add 1.2 seconds for each range change. After arrival on proper range, the first six readings are always discarded. The seventh reading is output on Bus. Allow 1.6 seconds additional for first reading on Bus.
DCV, DCI, kΩ: Add 1 second for each range change. After arrival on proper range, the first reading is always discarded. Allow 310 ms additional for first reading on Bus.

General

Calibration: data sheet specifications guaranteed for 1 year.
Display: 7 segment red 0.3 inch high LED's. Function and range announcement.
Reading rate: 2.4-4.7/sec. depending on input level.
A-D Conversion: dual slope.
Integration time: 100 msec.
Ranging: automatic or manual on ACV, DCV, and ohms. Manual only on AC & DC current.
Storage temperature: -40 to +75°C.
Operating temperature: (0 to 55)°C.
Humidity: 95% RH at +40°C.
Power: 48-440 Hz, 12 watts; 86-106 V Opt 100; 104-127 V Opt 115; 190-233 V Opt 210; 208-250 V Opt 230.
Size: 85.7 mm H x 209.6 mm W x 292.2 mm D (3 3/8" x 8 1/4" x 11 1/2").
Weight: 2.8 kg (6 lb 5 oz).

Ordering information

Ordering information	Price
11000A Test leads, dual banana both ends	\$17
11002A Test leads, dual banana to dual alligator	\$12
11003A Test leads, dual banana to probe and alligator	\$12
11096B RF Probe 10 kHz to 700 MHz	\$90
34110A Soft vinyl carrying/operating case	\$25
34111A High-voltage Probe 40 kV DC	\$75
34112A Touch-Hold Probe	\$40
11067A Test lead kit	\$5
5061-0072 1/2 module rackmount kit	\$25
10631A 1 m (39.37")	\$60
10631B 2 m (39.37")	\$65
10631C 4 m (39.37")	\$75

3438A \$875
Opt 100, 115, 210, 230 N/C

DIGITAL VOLTMETERS

1 μ V Sensitivity, 4½-digit, 5-function multimeter

Models 3465A/B Digital Multimeters



3465A



3465B

Description

The 3465A and B are 4½ digit multimeters providing five functions of ACV, DCV, ACI, DCI and Ω . They feature both portability and bench applications by offering a choice of line and battery power options. The 3465A is offered in the half-module rack and stack case. The 3465B is offered in the rugged streamlined synthetic case with a carrying handle. Both units accept the 34112A touch-hold probe for "eyes-on" measurements of AC and DC voltage.

Specifications

DC Voltmeter

Voltage ranges: ± 20.000 mV
 ± 200.00 mV
 ± 2.0000 V
 ± 20.000 V
 ± 200.00 V
 ± 1000.0 V

Maximum input: 1000 VDC and peak AC.

Sensitivity: 1 microvolt on lowest range.

Polarity: automatically sensed and displayed.

Accuracy (1 year, 23°C $\pm 5^\circ$ C).

Range	Specifications
20 mV	± 0.03 of reading ± 2 digits
200 mV thru 200 V	$\pm 0.02\%$ of reading ± 1 digit
1000 V	$\pm 0.025\%$ of reading ± 1 digit

Temperature coefficient: (0°C to 50°C): $\pm 0.003\%$ of reading/ $^\circ$ C.

Input resistance:

Range	Specifications
20 mV thru 2 V	$\geq 10^9\Omega$
20V thru 1000 V	10 M Ω $\pm 1\%$

Normal mode rejection: > 60 dB at 50/60 Hz $\pm 0.1\%$.

Effective common mode rejection: (1 k Ω unbalanced) AC: > 120 dB at 50/60 Hz $\pm 0.1\%$.

DC Current

Current ranges ± 200.00 μ A
 ± 2.0000 mA
 ± 20.000 mA
 ± 200.00 mA
 ± 2000.0 mA

Maximum input: 2A from < 250 V source (fuse protected).

Sensitivity: 10 nA on lowest range.

Polarity: automatically sensed and displayed.

Accuracy (1 year, 23°C $\pm 5^\circ$ C)

Range	Specifications
200 μ A, 2 mA	$\pm 0.07\%$ of reading ± 1 digit
20 mA	$\pm 0.11\%$ of reading ± 1 digit
200 mA, 2000 mA	$\pm 0.6\%$ of reading ± 1 digit

Temperature coefficient (0°C to 50°C)

Range	Specifications
200 μ A	$\pm 0.006\%$ of reading/ $^\circ$ C
2 mA, 20 mA	$\pm 0.004\%$ of reading/ $^\circ$ C
200 mA 2000 mA	$\pm 0.01\%$ of reading/ $^\circ$ C

Voltage burden

Highest range: < 700 mV FS.

All other ranges: < 250 mV FS.

Ohmmeter

Ohms range: 200.00 Ω
 2.0000 k Ω
 20.000 k Ω
 200.00 k Ω
 2000.0 k Ω
 20.000 M Ω

Protection: 350 V (DC + peak AC); 250 V rms.

Sensitivity: 10 milliohm on lowest range.

Accuracy: (1 year, 23°C $\pm 5^\circ$ C)

Range	Specifications
200 Ω	± 0.02 of reading ± 2 digits
2 k Ω thru 2 M Ω	$\pm 0.02\%$ of reading ± 1 digit
20 M Ω	$\pm 0.1\%$ of reading ± 1 digit

Temperature coefficient (0°C to 50°C).

Range	Specifications
200 Ω thru 2 M Ω	$\pm 0.0015\%$ of reading/ $^\circ$ C
20 M Ω	$\pm 0.004\%$ of reading/ $^\circ$ C

Configuration: 2 wire.

Open circuit voltage: <5 V max.
Current through unknown

Range	I
200Ω	1 mA
2 kΩ	1 mA
20 kΩ	10 μA
200 kΩ	10 μA
2000 kΩ	1 μA
20 MΩ	0.1 μA

AC voltmeter

Voltage range: 200.00 mV
 2.0000 V
 20.000 V
 200.00 V
 500 V

Maximum input: full scale to 10 kHz decreasing linearly to 50% of full scale at 20 kHz; except on 500 V range, 2 kHz.

Overload protection: 600 V DC max.
 500 V AC rms
 800 V peak.

Sensitivity: 10 μV on lowest range.

Accuracy: converter is average responding calibrated to rms (1 year + 23°C ± 5°C)

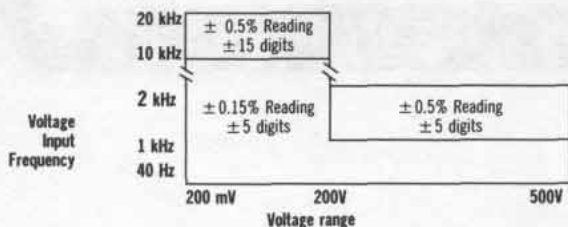

Temperature coefficient: (0°C to 50°C): ± 0.01% of reading /°C.

Voltage burden:

1A range: <700 mV FS.

All other ranges: <250 mV FS.

General

Integration time: 100 ms.

Reading rate: 2½ readings per second.

Display: light-emitting diodes.

Overload indication: display blanks.

Humidity range: 95%, 40°C.

Operating temperature: 0°C to +55°C. (Nickel Cadmium Batteries 0°C to +40°C).

Storage temperature: -40°C to +75°C. (Nickel Cadmium Batteries -40°C to +40°C).

Size:

3465A 85.7 mm H × 209.6 mm W × 266.7 mm D (3⅜" × 8¼" × 10½")

3465B 98.4 mm H × 238.1 mm W × 276.2 mm D (3⅞" × 9⅝" × 10⅞")

Weights: net, 2 kg (4.5 lbs). Shipping, 4.5 kg (10 lbs).

Power (see Options):

3465A: batteries or AC line; built-in battery charger.

AC line: 86 to 127 V or 176 to 250 V, 48 to 440 Hz.

Batteries: 2 rechargeable Nickel Cadmium battery packs (HP 82001A's), provide 6 hours continuous use when fully charged. 14 hours to recharge batteries fully (instrument off).

3465B: batteries or AC line; built-in battery charger, batteries when fully charged provide 6 hours continuous operation. 8 hours to recharge batteries fully (instrument off). Must order one power line option.

Options, accessories & parts (3465A)

Price

Opt 001: AC operation only (no battery packs supplied; battery charger built-in) less \$20

Opt 002: 4 type D alkaline dry cells, in lieu of 82001A's, provide 60 hours continuous use at 23°C; has receptacle for HP 82002A battery eliminator, 82002A not included less \$100

82001A battery pack (uses 2 packs) \$10 ea.

82002A Battery eliminator (hand-held calculator charger) \$20

1420-0224 Type D Alkaline cell (equal to U-2); 4 required \$1.05 ea.

3465B options (must specify one)

100: 86 to 106 VAC line; 48 to 440Hz N/C

115: 104 to 127 VAC line; 48 to 440Hz N/C

210: 190 to 230 VAC line; 48 to 440Hz N/C

230: 208 to 250 VAC line; 48 to 440Hz N/C

Ordering information

Price

3465A DMM with two 82001A's & charger \$550

3465B DMM with batteries and charger* \$525

*Must order one power line option

Temperature coefficient: (0°C to 50°C): ± 0.005% of reading + 0.2 digit.

Input impedance: resistance: 1 MΩ, <100 pF shunt.

AC current

Current range: 200.00 μA
 2.0000 mA
 20.000 mA
 200.00 mA
 2000.0 mA

Maximum input: full scale to 10 kHz decreasing linearly to 50% of full scale at 20 kHz.

Maximum input: 2 A from < 250 V source (fuse protected).

Sensitivity: 10 nA on lowest range.

Accuracy: (1 year + 23°C ± 5°C)

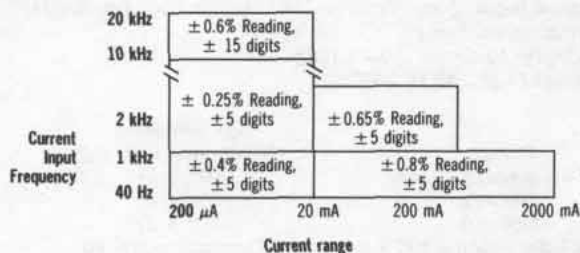



DIGITAL VOLTMETERS

4½ digit autoranging DMM

Model 3466A

- 1 μ V dc sensitivity
- 1 milliohm sensitivity

- True-Rms (DC + AC)
- Diode Test

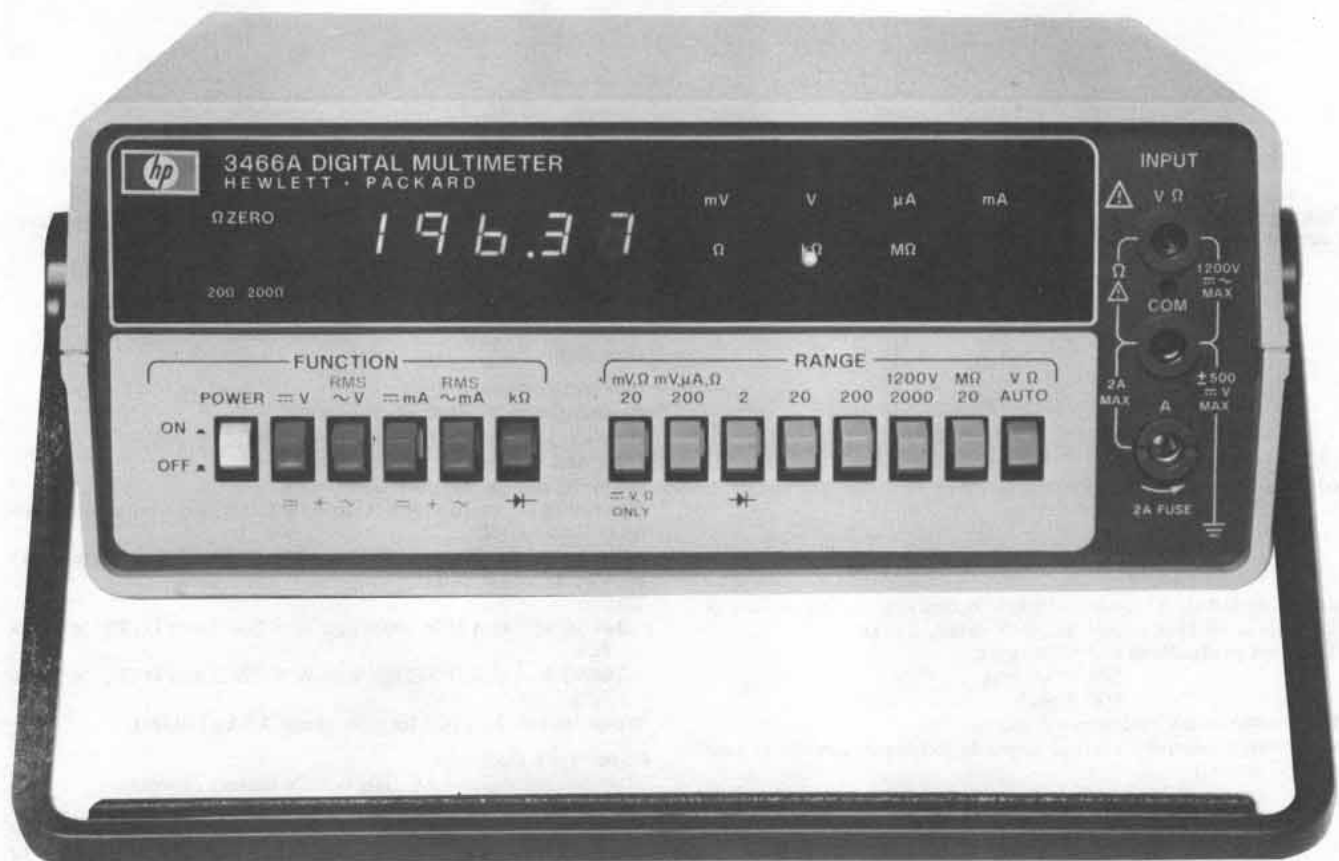

Description

The 3466A is a 4½ digit Multimeter with autoranging volts and ohms. Functional capability includes ACV, DCV, (AC + DC) V, ACI, DCI, (AC + DC) I, Ω , and diode test. AC measurements are true-rms with selectable AC or DC coupling. Available with rechargeable batteries or AC power only, it has 1 μ V DC and 1 m Ω sensitivity with zero adjustment on lowest ranges to compensate for external offsets.

Specifications

DC Voltmeter

Voltage Range	Maximum Display
± 20 mV	19.999 mV
± 200 mV	199.99 mV
± 2 V	1.9999 V
± 20 V	19.999 V
± 200 V	199.99 V
± 1200 V	1199.9 V

Maximum input: ± 1200 V maximum DC and peak AC.

Ranging: automatic or manual.

Sensitivity: 1 μ V on 20 mV range.

Accuracy: (1 yr., 18 to 28°C assuming rear panel zero adjustment on lowest two ranges)

Range	Specification \pm (% of reading + # digits)
20 mV	(.05 + 3)
200 mV	(.04 + 2)
2 V — 200 V	(.03 + 1)
1200 V	(.035 + 1)

Input resistance: 10 meg Ω $\pm 0.5\%$ all ranges.

Normal mode rejection: ≥ 60 dB @ 50/60 Hz $\pm 0.1\%$.

Effective common mode rejection (1 K Ω unbalance): ≥ 120 dB @ 50/60 Hz $\pm 0.1\%$; ≥ 140 dB @ DC

Input type: floating, 500 V maximum common to ground.

DC Current

Current Range	Maximum Display
± 200 μ A	199.99 μ A
± 2 mA	1.9999 mA
± 20 mA	19.999 mA
± 200 mA	199.99 mA
± 2000 mA	1999.9 mA

Maximum input: 2 amp from < 250 V source (fuse protected).

Ranging: manual only.

Sensitivity: 10 nA on 200 μ A range.

Accuracy (1 yr., 18 to 28°C):

Range	Specification \pm (% reading + # digits)
200 μ A through 20 mA	(.07 + 2)
200 mA	(.15 + 2)
2000 mA	(.5 + 2)

Input type: floating 500 V maximum Common to ground.

AC Voltmeter

AC Converter: True-rms Responding True-rms Calibrated

Range	Maximum Display
200 mV	199.99 mV
2 V	1.9999 V
20 V	19.999 V
200 V	199.99 V
1200 V	1199.9 V

Maximum input: (AC + DC): ± 1700 V (DC + Peak AC), 10^7 V \cdot Hz, AC: ± 600 V DC; 1700 V (Peak AC + DC), 10^7 V \cdot Hz.

Ranging: automatic or manual.

Sensitivity: 10μ V on 200 mV range.

Crest factor: 4:1 at Full Scale.

Accuracy (with display of $\geq 10\%$ of range): 1 yr., 18 to 28°C sinusoid waveform.

AC TRMS (20 Hz to 100 kHz)

Frequency Range	Specification \pm (% of reading + # digits)
20 Hz to 30 Hz	(2 + 50)
30 Hz to 50 Hz	(1 + 30)
50 Hz to 10 kHz	(0.3 + 20)
10 kHz to 20 kHz	(1 + 40)
20 kHz to 100 kHz	(2 + 150)

DC + AC TRMS: DC + (20 Hz to 100 kHz).
(Accuracy applies after 10 minute warmup)

DC + Frequency Range	Specification \pm (% of reading + # digits)
20 Hz to 50 kHz	(1 + 80)
50 kHz to 100 kHz	(2 + 200)

Input impedance: resistance 2 M Ω , $\pm 1\%$ Shunt Capacitance <50 pF.

Input type: Floating, 500 V Maximum common to ground.

AC Current

Current Range	Maximum Display
200 μ A	199.99 μ A
2 mA	1.9999 mA
20 mA	19.999 mA
200 mA	199.99 mA
2000 mA	1999.9 mA

Detector: true RMS.

Crest factor: 4:1 at Full Scale

Maximum input: 2 Amp RMS from <250 V source (fuse protected).

Ranging: manual only.

Sensitivity: 10 nA on 200 μ A range.

Accuracy: (with display $\geq 10\%$ of range) 1 yr., 18°C to 28°C, sinusoid waveform.

AC TRMS: 20 Hz to 10 kHz.

Range	Frequency	Specification \pm (% of reading + # digits)
200 μ A–200 mA	20 Hz–30 Hz	2 + 50
	30 Hz–10 kHz	0.9 + 35
2000 mA	20 Hz–30 Hz	2 + 50
	30 Hz–10 kHz	1.2 + 20

(DC + AC) TRMS: DC + (20 Hz to 10 kHz).
(Accuracy applies after 10 minute warmup)

All ranges: 20 Hz to 10 kHz, $\pm (1.5\%$ of reading + 80 digits).

Input type: floating, 500 V maximum common to ground.

Ohms

Range	Maximum Display
20 Ω	19.999 Ω
200 Ω	199.99 Ω
2 k Ω	1.9999 k Ω
20 k Ω	19.999 k Ω
200 k Ω	199.99 k Ω
2000 k Ω	1999.9 k Ω
20 M Ω	19.999 M Ω

Range	Specification \pm (% of reading + # digits)
20 Ω –200 Ω	.08 + 2
2 k Ω –200 k Ω	.03 + 1
2000 k Ω	.04 + 1
20 M Ω	.15 + 1

Input protection: 250 V RMS or 350 V (DC + peak AC).

Ranging: automatic or manual.

Sensitivity: 1 milliohm on 20 ohm range.

Accuracy: 1 yr., 18 to 28°C (assuming use of front panel zero on lowest two ranges).

Configuration: 2 wire.

Zero adjustment: range of 700 m Ω . Use on 20 Ω , and 200 Ω ranges.

Open circuit voltage: <5 V maximum.

Current through unknown:

Range: 20 Ω 200 Ω 2k Ω 20 k Ω 200 k Ω 2000 k Ω 20 M Ω

Current: 5 mA 5 mA 1 mA 100 μ A 10 μ A 1 μ A 100 nA

Diode Test $\rightarrow \leftarrow$

Function: $\rightarrow \leftarrow$ (k Ω).

Current source: 1 mA $\pm 1.5\%$.

Diode voltage drop displayed in volts: 1.9999 volts maximum.

Open circuit voltage: <5 volts maximum.

Overload protection: 350 V (DC + peak AC).

General

Display: 7 segments red 0.3 in high LED. Function and range annunciated.

Reading rate: 2.4 to 4.7/sec. depending on input level.

Remote trigger: shorting COM to A stops sampling in Volts functions.

Storage temperature: AC only, -55° C to $+75^\circ$ C; with batteries, -55° C to $+65^\circ$ C.

Operating temperature: (0 to 55) $^\circ$ C.

Humidity: 95% RH at $+40^\circ$ C.

Power: AC line; 48–440 Hz; 86–250 V.

Battery: rechargeable lead-acid 8 hours maximum continuous operation with full charge. Recharge time: 16 hours operating, 12 hours non-operating. Batteries and charger available separately, consult operating manual. Total power dissipated: AC only, 4 watts; with charger, 9 watts.

Size: 3466A: 98.4 mm H x 238.1 mm W x 276.2 mm D (3 $\frac{7}{8}$ " x 9 $\frac{3}{8}$ " x 10 $\frac{7}{8}$ "). 3466A Opt. 002: 81 mm H x 215 mm W x 279 mm D (3 $\frac{1}{4}$ " x 8 $\frac{3}{8}$ " x 10 $\frac{7}{8}$ ").

Weight: 3466A: 2.9 kg (6 lb 5 oz).

3466A Opt 001: 2 kg (4 lb 7 oz).

3466A Opt. 002: 2.6 kg (5 lb. 11 oz).

Configuration: 3466A streamlined portable case with handle, AC line power, batteries and charger included—\$650; 3466A Opt 001, eliminate battery and charger, AC line power only—less \$75. Opt 002 Rack and Stack case, AC line power only—less \$35 (rack mount kit not included). All orders must include one of these line power options: Opt 100, 86–106 V; Opt 115, 104–127 V; Opt 210, 190–233 V; Opt 230, 208–250 V.

Options

Opt 001

less \$75

Opt 002

less 35

Opt 100, 115, 210, 230

N/C

3466A

\$650



DIGITAL VOLTMETERS

4½ digit logging multimeter

Model 3467A

- DC voltmeter, true-rms voltmeter, ohmmeter
- Digital thermometer
- Four channel scanner
- Math functions
- Printer & timer
- Diode test



3467A

Description

Hewlett-Packard's 3467A Logging DMM is a total measurement station, doing jobs that used to require several instruments. The HP 3467A combines a high performance 4½ digit DMM, four channel scanner, digital thermometer, math functions, and printer with timer in a single instrument. It simplifies setups and measurements and gives you a record of data in the units you need (°C, dB, etc.)... unattended or manually.

The 3467A can be used to measure DC volts, resistance, true-rms AC volts, or temperature. Temperature can be measured simultaneously with voltage or resistance to allow convenient analysis of temperature dependent parameters. Using thermistors, the temperature measurements can be made directly in °C or °F. Other built-in math functions can be performed on the first three channels with respect to a measured input on the fourth channel or a manually entered constant.

Specifications

DC voltmeter

Range	Maximum Reading
20mV	19.999mV
200mV	199.99mV
2V	1.9999V
20V	19.999V
200V	199.99V
350V	349.9V

Maximum input: ±350 V from any terminal to ground and between any two terminals

Ranging: Automatic or Hold/Step

Sensitivity: 1 μV on 20 mV range

Polarity: Automatically sensed and displayed

Zero adjustment: Front panel pushbutton compensated for up to ±2 mV offset for each channel

Accuracy: 6 months, 18°C to 28°C (Assuming 30 minute warmup and use of zero adjustment):

Range	±(% of Reading + Number of Counts)
20mV	0.05 + 10
200mV	0.04 + 2
2V - 200V, 350V	0.03 + 1

Temperature coefficient: (0° to 18°C, 28° to 50°C): ±(.003% of reading + 0.15 counts)/°C

Input resistance: 10 MΩ ±5% on all ranges

Normal mode rejection: > 60 dB at 50/60 Hz ±0.1%

Effective common mode rejection (1 KΩ unbalance): > 120 dB at 50/60 Hz ±0.1%

Single channel response time (no print): < 0.7 seconds to within 1 count of final value on one range. Add 0.8 seconds for each range change.

Ohmmeter

Range	Maximum Reading	Current Through Unknown
200Ω	199.99Ω	5 mA
2KΩ	1.9999Ω	1 mA
20KΩ	19.999KΩ	100 μA
200KΩ	199.99KΩ	10 μA
2MΩ	1.9999MΩ	1 μA
20MΩ	19.999MΩ	100 nA

Input Protection: 250 V RMS or 350 V (DC + peak AC)

Ranging: Automatic or Hold/Step

Sensitivity: 10 mΩ on 200Ω range

Configuration: 2 wire with front panel pushbutton zero adjustment.

Lead resistance of up to 20Ω can be nulled out for each channel

Accuracy: 6 months, 18°C to 28°C (Assuming use of zero adjustment on 200Ω range):

Range	±(% of Reading + Number of Counts)
200Ω	0.08 + 10
2KΩ	0.03 + 3
20KΩ-200KΩ	0.03 + 1
2MΩ	0.04 + 1
20MΩ	0.15 + 1

Temperature coefficient:

Range	(0°C to 18°C, 28°C to 50°C)
200Ω	±(0.002% of reading + 1 count)/°C
2KΩ-2MΩ	±(0.002% of reading + 0.1 count)/°C
20MΩ	±(0.01% of reading + 0.1 count)/°C

Open circuit voltage: <5V

Single channel response time (no print): <1.1 seconds to within 1 count of final value on one range. Add 0.8 seconds for each range change.

Diode test

Function: $\overrightarrow{+}$ (kΩ)

Range: 2 kΩ

Current source: 1mA ±4%

Diode voltage drop displayed in volts: 1.9999 volts maximum measurable voltage

AC Voltmeter

AC converter: True RMS Responding and calibrated in true RMS; AC coupled

Range	Maximum Reading
200mV	199.99mV
2V	1.9999V
20V	19.999V
200V	199.99V
250V	249.9V

Maximum input: ±350V (DC + peak AC), 10⁷ V·Hz from any terminal to ground and between any two terminals

Ranging: Automatic or Hold/Step

Sensitivity: 10 μV on 200 mV range

Crest factor: 4:1 at full scale

Accuracy: Accuracy applies with readings of ≥9% of full scale (≥1800 counts on 250 V range): 6 months, 18°C to 28°C; sinusoid waveform

Frequency	±(% of Reading + Number of Counts)
45 Hz-100 Hz	1 + 40
100 Hz-10 kHz	0.2 + 40
10 kHz-20 kHz	1 + 40
20 kHz-100 kHz	2 + 200

Temperature coefficient:

Frequency	(0°C to 18°C, 28°C to 50°C)
45 Hz-100 Hz	±(0.05% of reading + 2 counts)/°C
100 Hz-10 kHz	±(0.03% of reading + 2 counts)/°C
10 kHz-20 kHz	±(0.05% of reading + 2 counts)/°C
20 kHz-100 kHz	±(0.05% of reading + 15 counts)/°C

Input impedance: 2MΩ ± 5% in parallel with <100 pF

Single channel response time (no print): <2 seconds to within 4 counts of final value on one range. Add 1.2 seconds for each range change.

Temperature Measurement

Technique: Temperature measurements using thermistors can be made directly in °C or °F, selectable by an internal switch.

Thermistor linearization is included for the following thermistors: YSI 44007, OMEGA UUA 35J3, FENWAL UUA 35J1 or equivalent. (One thermistor is furnished with each 3467A).

Accuracy: The accuracy specification includes ohmmeter accuracy, thermistor curve fit accuracy, and thermistor self-heating:

-80°C to + 80°C:	±0.3°C
+80°C to +110°C:	±0.5°C
+110°C to +150°C:	±1.3°C

Four-Channel Scanner

Type: One 2-pole low thermal dry reed relay per channel.

Inputs: Floating inputs. Any combination of four channels may be selected to measure one of these functions: DC volts, true-rms AC volts, resistance or temperature. Measurements of temperature on channels 1 and 2, and either DC volts, AC volts, or resistance on channels 3 and 4 can also be made.

Channel-to-Channel Isolation:

Source Impedance	Up to 1 kHz	Up to 100 kHz
600 Ω	>100 dB	>60 dB
10 KΩ	> 80 dB	>40 dB

Printer and Timer

Type: Thermal Printer

Print modes: Manual: Initiates a printout of selected input channels; Automatic: Scans, measures and prints selected input channels at preset time intervals

Time interval: 1, 3, 6, 10, 18, 30, 60, or 180 seconds/minutes interval selectable via front panel pushbuttons

Timer: Internal 24-hour crystal controlled interval timer. Timer starts at 00:00:00 (HH:MM:SS). A time offset can be manually entered to synchronize the timer with the time of day.

Timer accuracy: Within 1 minute in 24 hours

Power failure protection: Should a momentary power failure occur (up to 5 seconds), the 3467A will retain the math constant, elapsed time, zero offsets, and ranges.

*Time intervals ≤10 seconds may be shorter than the actual time required to completely measure and print the selected channels.

General

Reading rate: Depends on input signal level. 2 to 4½ readings/second.

Operating temperature: 0°C to +50°C

Storage temperature: -40°C to +55°C without thermal paper

Thermal paper storage temperature: -40°C to +30°C

Humidity: 95% R.H., +15°C to +40°C without thermal paper
60% R.H., +15°C to +30°C with thermal paper

Power: 100/120/220/240 +5%, -10%

48 to 440 Hz line operation, <25 VA

Dimension: 190.5mm high × 212.9mm wide × 304.8mm deep (7½" × 8 ¾" × 12")

Weight: Net: 4.77 kg (10.5 lbs.); **Shipping:** 5.44 kg (12 lbs.)

Accessories

5061-2003 Carrying Handle Kit (44416A is also required with this accessory) \$25

44416A Rear Panel Support and Cord Wrap Kit \$25

44414A Four Thermistor Pack \$20

82045A Six Rolls of Thermal Paper \$6

Ordering information

3467A Logging Multimeter (includes 1 roll of thermal paper and a thermistor) \$2200



DIGITAL VOLTMETERS

5½/6½-digit DVM with Auto Cal

Model 3455A

- AutoCal
- Self test
- Bench/system

- AC/DC/OHMS
- High speed
- Removable reference



HP-IB

Description

Hewlett-Packard's 3455A Digital Voltmeter is a microprocessor controlled 5½- or 6½-digit integrating voltmeter for bench or systems applications. The standard instrument measures DC volts, AC volts, and resistance. HP-IB I/O for systems applications is also standard.

Measuring speed

The 3455A is fully guarded and has greater than 60 dB normal mode noise rejection at reading rates of up to 24 readings per second on all DC ranges. Ohms reading rates are up to 12 readings/second and an AC fast mode gives reading rates of up to 13 readings/second at frequencies above 300 Hz. (Readings/seconds given for 60 Hz operation and high resolution off.)

Performance

DC measurements can be made with up to 1μV sensitivity. Ohms measurements are made with either a 2-wire and 4-wire mode. The High Resolution (6½-digit) mode gives DC and Ohms measurements with greater than 1 part per million resolution. AC voltage measurements can be made from 30 Hz to 250 kHz with the optional average responding converter.

True rms

The standard true rms converter gives AC measurements from 30 Hz to 1 MHz. Complex signals with crest factors of up to 7:1 at full scale can be measured.

Math

The math functions provide the user with unique computational capability. The Scale mode ($\frac{X}{Y}$) allows the user to offset, take ratios, or scale readings to give readouts in physical units. The % Error mode ($\frac{X}{Y} \times 100\%$) converts readings into percentage change from Y which is entered as a reference. For the math functions X is the present reading. Y and Z are previously entered readings or numbers entered from the front panel or by remote program.

Auto Cal

The auto cal feature gives the user accurate DC volts and ohms measurements and simplifies calibration of these functions. The DC and ohms operating circuits are checked against internal references and any errors are corrected digitally. All dc and ohms adjustments are in a removable reference assembly.

Serviceability

The self-test feature is used to aid in troubleshooting as well as verifying operation of the 3455A. Test verifies proper operation of the DC measuring circuits by comparing their parameters against predetermined limits. If a problem is found, the display is used to assist in finding the problem area by indicating which parameter is in error. Detailed troubleshooting can then be used to quickly isolate the problem.

Routine maintenance and calibration has been simplified with the removable reference assembly. Calibration of DC and ohms functions can be done by replacing the reference assembly with a recently calibrated one. Extra reference assemblies are available as HP accessory number 11177A. A spare assembly is ideal for one or more 3455A's. Calibrate DC and ohms in a 3455A without removing it from the bench or system. Just return the extra reference assembly to the cal lab or HP for calibration and have it back in time to calibrate the 3455A next time.

Data-sheet systems

The 3455A is included as part of the 3052A standard system. The 3052A is fully integrated, tested, verified and specified as a system and comes with complete systems software and documentation. This system provides complete solutions to many of your measurement problems.

3052A Automatic data acquisition system

The 3052A Automatic Data Acquisition System has been designed to solve your data acquisition, control and automatic testing problems.

The 3052A consists of:

- 3455A DVM
- 3437A System Voltmeter
- 3495A Scanner
- 9825A, 9835A/B, or 9845A System Controller & ROMs

These 3052A features give you a wide range of problem solutions:

- Signal digitizing (>5000 readings/second)
- High speed scanning (≤1000 channels/second)
- System timing
- Vectored interrupt system for simultaneous control and processing of multiple tasks
- High speed data access and storage
- Alphanumeric CRT display for easy operator interaction

Typical applications are:

- Process control development
- Signal analysis
- Thermocouple measurements

For further information on this system, refer to page 74-75 or contact your local HP field engineer.

HP Technology

HP has developed an instrument oriented microprocessor to provide the high performance of the 3455A. The microprocessor has a parallel architecture to give the high speed necessary to control the measurement processes of a bench/systems voltmeter. Two microprocessors are used: one for control of the measurement and the second for interface to the HP-IB and computation of the math functions.

Auto cal is a process by which the 3455A internally checks its DC and ohms operating circuits against internal references and corrects for errors. The benefits of auto cal are high accuracy and simplified calibration. Only four adjustments for calibration of DC and ohms are required and these are in the removable reference assembly. The microprocessor is also used to control the auto cal process and compute the correction factors.

The HP-developed fineline tantalum nitride resistor technology used in several HP digital voltmeters is also used in the 3455A. This technology provides accurate temperature tracking resistors that result in excellent long term DC accuracy.

Specifications

DC Voltage

Ranges		Maximum Display	
High Resolution Off	High Resolution On	High Resolution Off	High Resolution On
0.1	—	±0.149999 V	—
1	1	±1.49999 V	±1.499999 V
10	10	±14.9999 V	±14.99999 V
100	100	±149.999 V	±149.9999 V
1000	1000	±1000.00 V	±1000.000 V

Performance

(High Resolution Off)

Accuracy

24 Hours: 23°C ±1°C

10 V range: ±(0.002% of reading + 1 digit).

1 V range: ±(0.003% of reading + 1 digit).

0.1 V range: ±(0.004% of reading + 4 digits).

100 & 1000 V range: ±(0.004% of reading + 1 digit).

90 days 23°C ±5°C

10 V range: ±(0.005% of reading + 1 digit).

1 V range: ±(0.006% of reading + 1 digit).

0.1 V range: ±(0.007% of reading + 4 digits).

100 & 1000 V range: ±(0.007% of reading + 1 digit).

6 months 23°C ±5°C

10 V range: ±(0.008% of reading + 1 digit).

1 V range: ±(0.009% of reading + 1 digit).

0.1 V range: ±(0.010% of reading + 5 digits).

100 & 1000 V range: ±(0.010% of reading + 1 digit).

1 year 23°C ±5°C

10 V range: ±(0.013% of reading + 1 digit).

1 V range: ±(0.014% of reading + 1 digit).

0.1 V range: ±(0.015% of reading + 6 digits).

100 & 1000 V range: ±(0.015% of reading + 1 digit).

(High Resolution On)

Accuracy

24 hours 23°C ±1°C

10 V range: ±(0.002% of reading + 3 digits).

100 & 1000 V range: ±(0.004% of reading + 3 digits).

1 V range: ±(0.003% of reading + 4 digits).

90 days 23°C ±5°C

10 V range: ±(0.005% of reading + 3 digits).

100 & 1000 V range: ±(0.007% of reading + 3 digits).

1 V range: ±(0.006% of reading + 4 digits).

6 months 23°C ±5°C

10 V range: ±(0.008% of reading + 3 digits).

100 & 1000 V range: ±(0.010% of reading + 3 digits).

1 V range: ±(0.009% of reading + 5 digits).

1 year 23°C ±5°C

10 V range: ±(0.013% of reading + 3 digits).

100 & 1000 V range: ±(0.015% of reading + 3 digits).

1 V range: ±(0.014% of reading + 6 digits).

Input characteristics

Input resistance: 0.1 V through 10 V range: >10¹⁰ ohms. 100 V and 1000 V range: 10 megohm ±0.1% with Auto Cal. "off".

Maximum input voltage

High to low input terminals: ±1000 V peak.

Guard to chassis: ±500 V peak.

Guard to low terminal: ±200 V peak.

Normal mode rejection (NMR): NMR is the ratio of the peak normal-mode voltage to the peak error voltage in the reading.

NMR at 50 or 60 Hz ±0.1%: >60 dB.

Effective common mode rejection (ECMR): ECMR is the ratio of the peak common-mode voltage to the resultant peak error voltage in the reading.

ECMR with 1 kΩ unbalance in low lead at

DC: >140 dB.

50 Hz or 60 Hz ±0.1%: >160 dB.

Maximum reading rate

	60 Hz Gate Length		50 Hz Gate Length	
	High Resolution Off	High Resolution On	High Resolution Off	High Resolution On
Local	5 rdg/s	3 rdg/s	3.5 rdg/s	2.5 rdg/s
Remote	24 rdg/s	6 rdg/s	22 rdg/s	5 rdg/s



DIGITAL VOLTMETERS

5½/6½-digit DVM with Auto Cal

Model 3455A (cont.)

AC Voltage (rms converter)

(High Resolution On or Off)

Ranges: 1.00000 V Maximum Display: 1.49999 V
 10.0000 V 14.9999 V
 100.000 V 149.999 V
 1000.00 V 1000.00 V

Range selection: Manual, Automatic or Remote.

Function selection: ACV or Fact ACV.

Input characteristics

Input impedance

Front terminals: 2 MΩ ± 1% shunted by less than 100 pf.

Rear terminals: 2 MΩ ± 1% shunted by less than 75 pf.

Maximum input voltage

High to low terminals: ± 1414 volts peak.

Subject to a 10⁷ volts—Hz limitation.

Guard to chassis: ± 500 V peak.

Guard to low terminal: ± 200 V peak.

Maximum reading rate

60 Hz Gate Length

	ACV	FAST ACV
Local	1.3 rdg/s	4.5 rdg/s
Remote	1.3 rdg/s	13 rdg/s

50 Hz Gate Length

	ACV	FAST ACV
Local	1.1 rdg/s	3.5 rdg/s
Remote	1.1 rdg/s	12 rdg/s

Response time

ACV and FAST ACV

First reading to <0.1% of step size when triggered coincident with step change when on correct range (for AC signals with no DC component).

AC voltage (average converter) Opt 001

(High Resolution On or Off)

Ranges: 1 V Maximum Display: 1.49999 V
 10 V 14.9999 V
 100 V 149.999 V
 1000 V 1000.00 V

Range selection: Manual, Automatic or Remote.

Function selection: ACV or Fast ACV.

Performance (rms converter)

Accuracy ± (% of reading + digits)

Guard must be connected to low. On the 1000 V range add 0.01 ppm/volt—kHz. For inputs above 500 V multiply the accuracy by $\frac{500 + V}{1000}$

	AC coupling:					
	FAST ACV ACV	300 Hz-20 kHz 30 Hz-20 kHz	20 kHz-100 kHz*	100 kHz-250 kHz**	250 kHz-500 kHz**	500 kHz-1 MHz**
24 hrs: 23°C ± 1°C		0.04% + 40 digits	0.4% + 80 digits	1.8% + 200 digits	4% + 400 digits	5% + 2600 digits
90 days: 23°C ± 5°C		0.05% + 50 digits	0.5% + 100 digits	2.0% + 250 digits	5% + 500 digits	6% + 3100 digits
6 mos: 23°C ± 5°C		0.06% + 60 digits	0.6% + 130 digits	2.1% + 300 digits	5.1% + 600 digits	6.3% + 3500 digits
1 year: 23°C ± 5°C		0.07% + 70 digits	0.7% + 160 digits	2.2% + 350 digits	5.3% + 700 digits	6.6% + 3900 digits

AC < 1% of range and AC/DC: add 20 digits.

*AC/DC coupled or AC coupled with frequency > 50 kHz and with input < 5% of full scale: Add 150 digits.

**Frequencies greater than 100 kHz specified on 1 and 10 V ranges only. Subject to a 10⁷ volts—Hz limitation.

Crest Factor: 7:1 at Full Scale

Performance (average converter)

Accuracy ± (% of reading + digits)

Guard must be connected to Low. On the 1000 V range, add 0.01 ppm/volt—kHz. Specifications are for input levels above 1/100th of range.

	FAST ACV ACV	300 Hz-500 Hz 30 Hz-50 Hz	500 Hz-1 kHz 50 Hz-100 Hz	1 kHz-100 kHz 100 Hz-100 kHz	100 kHz-250 kHz* 100 kHz-250 kHz*
	24 hrs: 23°C ± 1°C		0.47% + 70 digits	0.32% + 50 digits	0.09% + 25 digits
90 days: 23°C ± 5°C		0.50% + 70 digits	0.35% + 50 digits	0.1% + 25 digits	0.75% + 60 digits
6 mos: 23°C ± 5°C		0.50% + 70 digits	0.40% + 60 digits	0.1% + 30 digits	0.75% + 70 digits
1 yr.: 23°C ± 5°C		0.50% + 70 digits	0.40% + 70 digits	0.12% + 35 digits	0.75% + 80 digits

*Frequencies greater than 100 kHz specified on 1 and 10 V ranges only. Subject to a 10⁷ volts—Hz limitation.

Input characteristics

Input impedance:

Front Terminals—2 MΩ ± 1% shunted by less than 100 pf.

Rear Terminals—2 MΩ ± 1% shunted by less than 75 pf.

Maximum input voltage

High to low terminals: ± 1414 volts peak.

Subject to a 10⁷ volts—Hz limitation.

Guard to chassis: ± 500 V peak.

Guard to low terminal: ± 200 V peak.

Maximum reading rate

	60 Hz Gate Length		50 Hz Gate Length	
	ACV	FAST ACV	ACV	FAST ACV
Local	1.3 rdg/s	4.5 rdg/s	1.1 rdg/s	3.5 rdg/s
Remote	1.3 rdg/s	13 rdg/s	1.1 rdg/s	12 rdg/s

Ohms

Ranges	Maximum Display	
	High Resolution Off	High Resolution On
0.100000 kΩ	—	0.149999 kΩ
1.00000 kΩ	1.000000 kΩ	1.49999 kΩ
10.0000 kΩ	10.00000 kΩ	14.9999 kΩ
100.000 kΩ	100.00000 kΩ	149.999 kΩ
1000.00 kΩ	1000.00000 kΩ	1499.99 kΩ
10000.0 kΩ	10000.00000 kΩ	14999.9 kΩ

Range selection: Manual, Automatic, or Remote.

Function selection: 2-wire kΩ or 4-wire kΩ.

Performance

(High Resolution Off)

Accuracy: 4-wire kΩ (1 digit = .001% of range)

24 hours: 23°C ± 1°C.

0.1 kΩ range: ± (0.003% of reading + 4 digits).

1 kΩ range: ± (0.003% of reading + 1 digit).

10 kΩ range: ± (0.005% of reading + 2 digits).

100 kΩ range: ± (0.002% of reading + 2 digits).

1000 kΩ range: ± (0.012% of reading + 5 digits).

10 000 kΩ range: ± (0.1% of reading + 5 digits).

90 days: 23°C ± 5°C

0.1 kΩ range: ± (0.005% of reading + 5 digits).

1 kΩ range: ± (0.005% of reading + 1 digit).

10 kΩ range: ± (0.007% of reading + 2 digits).

100 kΩ range: ± (0.004% of reading + 2 digits).

1000 kΩ range: ± (0.014% of reading + 5 digits).

10 000 kΩ range: ± (0.100% of reading + 5 digits).

6 months: 23°C ±5°C.

- 0.1 kΩ range: ±(0.005% of reading +6 digits).
- 1 kΩ range: ±(0.005% of reading +1 digit).
- 10 kΩ range: ±(0.007% of reading +2 digits).
- 100 kΩ range: ±(0.004% of reading +3 digits).
- 1000 kΩ range: ±(0.014% of reading +5 digits).
- 10,000 kΩ range: ±(0.100% of reading +5 digits).

1 year: 23°C ±5°C

- 0.1 kΩ range: ±(0.006% of reading +7 digits).
- 1 kΩ range: ±(0.006% of reading +2 digits).
- 10 kΩ range: ±(0.008% of reading +3 digits).
- 100 kΩ range: ±(0.005% of reading +4 digits).
- 1000 kΩ range: ±(0.015% of reading +6 digits).
- 10,000 kΩ range: ±(0.100% of reading +6 digits).

4-wire kΩ (1 digit = .0001% of range)

High Resolution On

24 hours: 23°C ± 1°C

- 1 kΩ range: ±(0.0025% of reading +4 digits).
- 10 kΩ range: ±(0.0045% of reading +4 digits).
- 100 kΩ range: ±(0.0020% of reading +5 digits).
- 1000 kΩ range: ±(0.0120% of reading +4 digits).
- 10,000 kΩ range: ±(0.1000% of reading +4 digits).

90 days: 23°C ±5°C

- 1 kΩ range: ±(0.0035% of reading +5 digits).
- 10 kΩ range: ±(0.0060% of reading +5 digits).
- 100 kΩ range: ±(0.0035% of reading +6 digits).
- 1000 kΩ range: ±(0.0135% of reading +5 digits).
- 10,000 kΩ range: ±(0.1000% of reading +5 digits).

6 months: 23°C ±5°C

- 1 kΩ range: ±(0.0040% of reading +6 digits).
- 10 kΩ range: ±(0.0065% of reading +6 digits).
- 100 kΩ range: ±(0.0040% of reading +7 digits).
- 1000 kΩ range: ±(0.0140% of reading +6 digits).
- 10,000 kΩ range: ±(0.1000% of reading +6 digits).

1 year: 23°C ±5°C

- 1 kΩ range: ±(0.0045% of reading +7 digits).
- 10 kΩ range: ±(0.0070% of reading +7 digits).
- 100 kΩ range: ±(0.0045% of reading +8 digits).
- 1000 kΩ range: ±(0.0145% of reading +7 digits).
- 10,000 kΩ range: ±(0.1000% of reading +7 digits).

2-wire kΩ: all accuracy specifications are the same as 4-wire kΩ except add 0.0004 kΩ to all readings.

Input characteristics

Maximum voltage generated across unknown: <5 volts for open circuit; <4.7 volts for valid reading.

Signal source driving unknown (nominal): 0.1 kΩ, 1 kΩ & 10 kΩ ranges.

Overload protection

Non-destruction: ±350 V peak.

Equivalent ohmmeter circuits:

0.1 kΩ, 1 kΩ & 10 kΩ RANGES

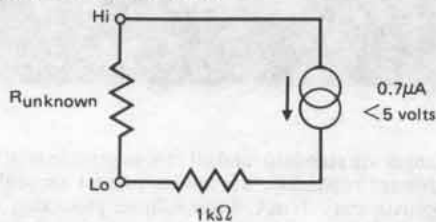

100 kΩ

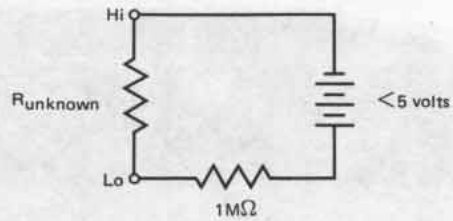

1 MΩ & 10 MΩ RANGES

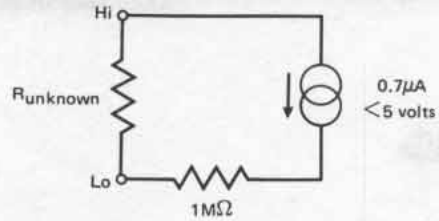

Maximum reading rate

	60 Hz Gate Length		50 HZ Gate Length	
	High Resolution Off	High Resolution On	High Resolution Off	High Resolution On
Local	4.5 rdg/s	2 rdg/s	4 rdg/s	1.8 rdg/s
Remote	12rdg/s	3 rdg/s	11 rdg/s	2.5 rdg/s

Math

Scale ($\frac{X-Z}{Y}$): X is present reading. Y and Z are previously entered readings, or numbers entered from the front panel or by external program.

Maximum number (entered or displayed): ±199,999.9.

Accuracy: ±(Accuracy of X reading ± 1 digit of displayed answer). This assumes no "Y" or "Z" error.

%Error ($\frac{X-Y}{Y} \times 100\%$): X is present reading. Y is a previously entered reading, or number entered from the front panel or by external program.

Maximum number (entered or displayed): ±199,999.9.

Accuracy: ±(Accuracy of X reading ± 1 digit of displayed answer). This assumes no "Y" error.

How to enter numbers in "Y" or "Z"

From a current displayed reading: press STORE "Y" or "Z".

From front panel: Press ENTER "Y" or "Z". The front panel is now set for numerical entry. These numbers are in blue next to the keys. Enter number and press STORE "Y" or "Z".

By remote program: send program codes for equivalent front panel operations.

General

Power: 100 V, 120 V, 240 V +5% -10%, 48 Hz to 400 Hz line operation; <60 VA with all options.

Size: 88.9 H x 425.5 W x 527.1 mm D (3½" x 16¾" x 20¾").

Weight: net, 9.38 kg (20 lb 11 oz). Shipping, 11.79 kg (26 lb).

Options

001: Average converter

3455A Digital Voltmeter

Price
less \$200
\$3400



DIGITAL VOLTMETERS

Five-digit digital multimeter with self test

Model 3490A



Description

Hewlett-Packard's Model 3490A Multimeter is a five-digit integrating digital voltmeter. The basic instrument measures dc voltages, ac voltages, and resistances. Additional measurement capability is achieved by the addition of low cost options.

HP's 3490A uses a dual slope integrating technique and is fully guarded, providing excellent noise immunity at five readings per second on all dc ranges. Ranging is automatic over all ranges on all functions. DC measurements can be made with $1\mu\text{V}$ resolution on the 100 mV range. AC voltage measurements can be made from 20 Hz to 250 kHz in four ranges. The 1 V range provides $10\mu\text{V}$ of ac voltage resolution. Ohms measurements can be made, utilizing the four-wire conversion technique which eliminates errors due to test lead resistances. Six ranges of ohms, including a 1000Ω range, are provided. All functions and ranges include 20% overranging except the 1000 V range.

Display

The 3490A uses Hewlett-Packard's light emitting diodes (LED's). These display digits are the seven segment type. The extremely high reliability of this LED display assures maximum life.

Self-test

At the flip of a switch, Hewlett-Packard's 3490A Digital Multimeter sequences itself through 10 tests that check timing signals and autoranging circuits, validate the performance of most logic-circuit IC's and check the six-digit LED display. These tests, and six others provided by six additional front-panel switches, cut calibration costs and ensure the DMM is ready to make accurate measurements.



DC functions

The standard 3490A includes five ranges of dc measurement capability from 100 mV to 1000 V. Measurements are made from the front panel at precise five readings/s, and at slower rates, using digitally controlled sampled rate selector. High input resistance, $>10^{10}\Omega$ on 100 mV, 1 V, and 10 V range, assures accurate measurement of high impedance sources.



AC functions

Four ranges of ac measurements are provided. The average ac value is accurately detected, and the rms value is displayed with five digits of resolution. Full autoranging, wide frequency response, and 20% overranging are designed-in features to permit easy operation.

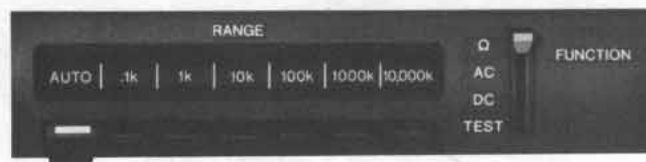

Ohms

Six ohms ranges are standard, and all ranges provide true four-wire ohms measurement capability. Maximum current through the unknown is approximately 1 mA. Over-voltage protection for ohms sensing terminals insures maximum protection against inadvertent application of a high voltage to ohms terminals. Over-voltage protection is provided to 250 V and fuse protection to 1000 V.

Serviceability

HP's 3490A has been "designed for serviceability." Inside, the 3490's low parts density provides easy access for servicing. Test points and jumpers are keyed to detailed diagnostics.

Several diagnostic aids are available to further minimize 3490A repair time. A service video tape, Accessory No. 11128A, will demonstrate use of self-test and front panel symptoms to isolate failures. The 11126A accessory provides a set of IC reference boards with most of the 3490A logic IC's for use with HP 10529A Logic Comparator. Using these boards with the Logic Comparator, a faulty IC can be isolated in seconds without removing it from the circuit. Also, spare parts set, Accessory No. 11127A, containing most critical components of the 3490A, will be available.

Options

Systems applications

Model 3490A offers built-in flexibility for systems applications. HP's 3490A offers both HP-IB interface and a bit parallel (BCD coded) interface. This combination provides the necessary versatility to configure the lowest cost instrument system.

Ratio, opt 080

DC/DC and AC/DC three-wire ratio measurements can be conveniently added to the 3490A. This capability offers both autopolarity and a selection of two reference ranges. The 1 V and 10 V ranges are specified from 10% to 120% of selected range. Ratio function is not programmable.

50 Hz operation, opt 050; 60 Hz operation, opt 060

Maximum noise immunity is achieved when power line frequency is harmonically related to the sample period of the integrating DMM. Option 050 will maximize normal and common mode rejection for 50 Hz power line frequency, and Option 060 will provide this rejection for 60 Hz.

Sample/hold, option 040 and 045

Sample/hold provides HP's 3490A with extra and unique measurement capability.

The Sample/hold option has two modes of operation to solve difficult measurement problems.

Track and hold: in this mode, input voltage is held instantly upon receiving an external command. This mode is useful in digitization of repetitive or transient waveforms.

Acquire and hold: in this mode, a known delay is inserted to permit the input amplifier to settle to a specified accuracy. This is useful in measuring pulse height or any similar step input.

Digital output, opt 021 and remote control, opt 022

These options provide digital control and data output in the parallel BCD code 8-4-2-1, either negative or positive true logic. Selection is accomplished by positioning an internal switch. The remote control option provides complete control of all functions, ranges, and external trigger commands. The digital output option provides nine columns of information which include function, polarity, data, and range. These options may be purchased separately to meet specific application requirements. Either of these options require Option 020 Systems Expand.

BCD/remote

Both Option 021 and 022 require Option 020, BCD/Remote Expand. This option provides the required internal and external connectors to permit user installation of Digital Output, Opt 021 and/or Remote Control, Opt 022 and should be ordered as an initial option on HP's 3490A. This option includes rear terminals in parallel (switchable front/rear terminals are available as a special - H19).

HP-IB data input/output, opt 030

The HP-IB option permits HP Model 3490A to operate on a single data/control bus with up to 14 other instruments. This serial code is an eight-bit byte typically using an ASCII-type coding. A unique "talker/listener" address structure makes the system's hardware more economical and associated software much simpler. The HP-IB is compatible with Hewlett-Packard Models 9825A, 9835A/B, and 9845A system controllers, as well as Hewlett-Packard computers.

Specifications

DC voltage ranges

Full range display: ± 1.00000 V, ± 1.00000 V, ± 10.0000 V, ± 100.000 V, ± 1000.00 V.

Overrange: 20% on all ranges except 1000 V range.

Range selection: manual, automatic, or remote (optional).

DC voltage performance

Accuracy \pm (% of reading + % of range)

		0.1 V Range		1 V to 1000 V Range	
		% rdg.	% rng.	%rdg.	%rng.
24 hrs	(23°C \pm 1°C)	\pm (0.005 + 0.001)		\pm (0.004 + 0.001)	
30 days	(23°C \pm 5°C)	\pm (0.01 + 0.005)		\pm (0.008 + 0.002)	
90 days	(23°C \pm 5°C)	\pm (0.01 + 0.005)		\pm (0.01 + 0.002)	
6 months	(23°C \pm 5°C)	\pm (0.013 + 0.005)		\pm (0.013 + 0.002)	
1 year	(23°C \pm 5°C)	\pm (0.015 + 0.005)		\pm (0.015 + 0.002)	

DC voltage input characteristics: fully guarded with 140 dB ECMR at dc and 60 Hz \pm 0.1% with 1 k Ω imbalance between guard and low.

Maximum input voltage

0.1 V to 1000 V ranges: \pm 1500 V peak.

Guard to chassis: \pm 500 V peak.

Guard to low: \pm 200 V peak.

Input resistance

0.1 V to 10 V ranges: $> 2 \times 10^{10}$ Ω . (<70% R.H.).

100 V and 1000 V ranges: 10 M Ω \pm 0.15%.

Maximum reading rate: 5 readings/s.

Normal mode rejection ratio: 50 Hz \pm 0.1%; 60 Hz \pm 0.1%; > 50 dB.

Notes:

1. On the 1000 V range, add 0.04 ppm/volt to the % of reading specification.

2. Thermal EMF's generated external to the DVM may be compensated to achieve the % of range accuracy specified by utilizing the rear panel zero adjust provided in the 3490A.

AC voltage ranges

Full range display: 1.00000 V, 10.0000 V, 100.000 V, 1000.00 V.

Overrange: 20% on all ranges except 1000 V range.

Range selection: manual, automatic, or remote (optional).

DIGITAL VOLTMETERS

Five-digit digital multimeter with self-test

Model 3490A (cont.)

AC voltage performance

Accuracy \pm (% of reading + % of range)

		20 Hz–50 Hz	50 Hz–100 kHz	100 kHz–250 kHz
24 hrs	(23°C \pm 1°C)	\pm (0.32 + 0.05)	\pm (0.09 + 0.025)	\pm (0.7 + 0.06)
30 days	(23°C \pm 5°C)	\pm (0.35 + 0.05)	\pm (0.1 + 0.025)	\pm (0.75 + 0.06)
90 days	(23°C \pm 5°C)	\pm (0.35 + 0.05)	\pm (0.1 + 0.025)	\pm (0.75 + 0.06)
6 months	(23°C \pm 5°C)	\pm (0.40 + 0.06)	\pm (0.1 + 0.03)	\pm (0.75 + 0.07)
1 year	(23°C \pm 5°C)	\pm (0.45 + 0.07)	\pm (0.12 + 0.035)	\pm (0.75 + 0.08)

AC voltage input impedance

Without rear terminals: 2 M Ω \pm 1% shunted by < 65 pF.With rear terminals: 2 M Ω \pm 1% shunted by < 90% pF.

AC voltage maximum reading rate: 1 reading/s.

AC voltage response time: < 1 s to within rated accuracy for a step input applied coincident with encoder trigger.

AC maximum input voltage: 1000 V rms; \pm 1500 V peak.

Notes:

- Guard must be connected to low.
- On the 1000 V range, add 0.01 ppm/(volt-kHz).
- Frequencies > 100 kHz specified on 1 V and 10 V ranges only.
- Specifications are for input levels above 1/100th of full scale.

Ohms ranges

Full range display: .100000 k Ω , 1.00000 k Ω , 10.0000 k Ω , 100.000 k Ω , 1000.00 k Ω , 10000.0 k Ω .

Overrange: 20% on all ranges.

Range selection: manual, automatic, or remote (optional).

Ohms performance

Accuracy: \pm (% of reading + % of range)

Note: Thermal EMF's generated external to the DVM may be compensated to achieve the % of range accuracy specified by utilizing the rear panel zero adjust provided in HP's 3490A.

		0.1k Ω		1 k Ω –100 k Ω		1000 k Ω		10,000 k Ω	
		% rdg.	% mg.	% rdg.	% mg.	% rdg.	% mg.	% rdg.	% mg.
24 hrs	(23°C \pm 1°C)	\pm (0.006 + 0.001)		\pm (0.005 + 0.001)		\pm (0.007 + 0.001)		\pm (0.025 + 0.001)	
30 days	(23°C \pm 5°C)	\pm (0.012 + 0.005)		\pm (0.010 + 0.002)		\pm (0.012 + 0.002)		\pm (0.035 + 0.002)	
90 days	(23°C \pm 5°C)	\pm (0.012 + 0.005)		\pm (0.012 + 0.002)		\pm (0.015 + 0.002)		\pm (0.035 + 0.002)	
6 months	(23°C \pm 5°C)	\pm (0.015 + 0.005)		\pm (0.015 + 0.002)		\pm (0.020 + 0.002)		\pm (0.040 + 0.002)	
1 year	(23°C \pm 5°C)	\pm (0.018 + 0.005)		\pm (0.018 + 0.002)		\pm (0.025 + 0.002)		\pm (0.050 + 0.002)	

Ohms terminal characteristics

Maximum voltage generated across unknown: 20 V for overload; 13 V for valid reading.

Ohms current thru unknown

0.1 k Ω to 10 k Ω range: 1 mA.100 k Ω to 1000 k Ω range: 10 μ A.10,000 k Ω range: 1 μ A.

Ohms overload protection

Nondestructive: 250 V rms.

Fuse destructive: \pm 1000 V peak.

Ohms maximum reading rate

0.1 k Ω to 100 k Ω range: 5 reading/s.1000 k Ω range: 4 reading/s.10,000 k Ω range: 2 reading/s.

General

Data output (BCD), option 021

Data output is 1-2-4-8 TTL output which is compatible with HP 5050B, and 5055A Digital Recorders. Either high true or low true logic code can be selected with an internal switch.

Storage temperature: -40°C to $+75^{\circ}\text{C}$.

Remote control, option 022

The remote control option uses a low true logic (BCD type) code. Required voltage levels for input signal and output signal levels are listed below.

BCD and remote terminals

	High Level	Low Level
DVM Inputs	+3.9 V \pm 1.5 V, 100 μ A max	+0.3 \pm 0.3 V, 2 mA max
DVM Outputs	+3.9 V \pm 1.5 V, 400 μ A max	+0.3 V \pm 0.3V, 15 mA max

Operating temperature: 0°C to 50°C .Warm-up time: one hour warm-up required to meet all specifications on the 0.1 V range and the 0.1 k Ω range. Thirty minutes warm-up required to meet all other specifications.Humidity range: < 95% R.H., 0°C to 40°C .Power: 100 V, 120 V, 220 V, 240 V +5%, -10% , 48 Hz to 400 Hz line operation \leq 60 VA with all options.Size: 85.7 mm H x 425.4 mm W x 466.7 mm D (3 $\frac{3}{8}$ " x 16 $\frac{3}{4}$ " x 18 $\frac{3}{8}$ ").

Weight: net, 9.38 kg (20.7 lb). Shipping, 11.79 kg (26 lb).

Options

Options	Price
020: BCD/remote expand, includes rear terminals in parallel	\$310
021: BCD*—full parallel, 1-2-4-8 code	\$305
022: Remote*—full parallel, 1-2-4-8 code	\$265
030: HP-IB remote control and data output	\$1045
040: Sample-and-hold*	\$545
045: Sample-and-hold (without Opt 020 or 030)	\$700
050 or 060: 50 Hz or 60 Hz operation	N/C
080: Three-wire ratio	\$245
908: Rack mounting kit	\$10

3490A Digital Multimeter

\$2450

(includes ac, dc, & ohms)

Opt 050: Noise Rejection for 50 Hz

N/C

Opt 060: Noise Rejection for 60 Hz

N/C

*These options require BCD/Remote Expand Option 020 or HP-IB Opt 030.

Note: Rack mounting requires support in rear of instrument.

Voltmeter accessories

Probes, dividers, carrying cases

10007B Straight-thru probe

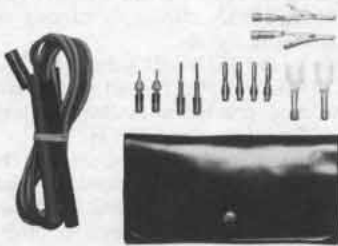
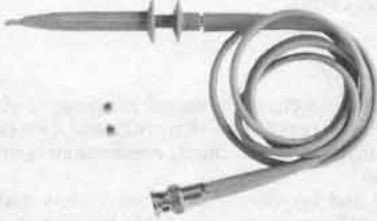

11067A Test lead kit



34110A Soft vinyl carrying case

10007B, 10008B Probe

The 10007B and 10008B are straight-thru BNC probes with a retractable hook tip and 20 cm (8 in.) ground lead with alligator tip.

	Peak Voltage	Shunt Capacitance	Length
10007B	600 V	40 pF	1.1 m (3.5 ft.)
10008B	600 V	60 pF	1.8 m (6 ft.)

11067A Test lead kit

Includes two leads with many interchangeable tips to accommodate various applications.

11068A

Soft carrying case for 3476A and B DMM. Has shoulder strap and zippered opening for instrument and accessory pouch.

11096B High frequency probe

Converts dc voltmeter with 10 MΩ input to high-frequency ac voltmeter. Works with any dc voltmeter with 10 MΩ input impedance.

11096B Specifications

Voltage range: 0.25 to 30 V rms.

Transfer accuracy (when used with 10 MΩ ± 10% dc voltmeter)

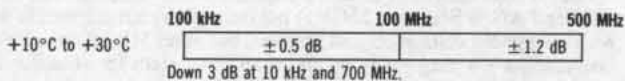

Response: peak responding. Calibrated to read rms value of sine wave.

Input impedance: 4 MΩ shunted by 2 pF.

Maximum input: 30 V rms ac; 200 V dc.

Cable length: 4' long (1219 mm).

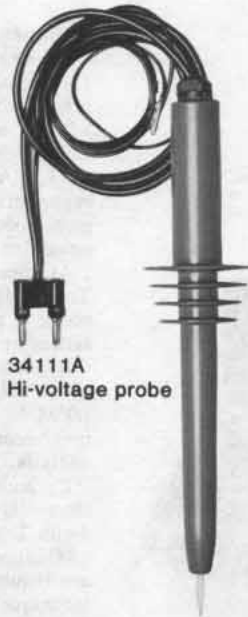

34111A Hi-voltage probe



34112A Touch-hold probe



11096B High frequency probe

Accessories furnished: High-Frequency Adapter; Straight Tip; Hook Tip; Ground Lead.

Accessories available: HP 10218A BNC Adapter; HP 10219A Type 874 Adapter; HP 10220A Microdot Adapter; HP 11063A 50Ω Tee.

34110A

Carrying case for ½ rack size instruments. Inside dimensions of 25.4 cm x 22.9 cm x 10.2 cm or 10" deep x 9" wide x 4" thick. Zipper flip top lid and zippered accessory pouch. Has shoulder carrying strap.

34111A DC Hi-voltage probe

1000:1 divider will accept up to 40 kV. Input Z = 10⁹Ω. Divider accuracy meets specifications when connected to 10 MΩ input resistance instrument.

0–20 kV	<4%	
30–40 kV	<2%	Divider has interchangeable hook and pointed tip.
20–30 kV	<2%	

34112A Touch-hold probe

Allows user to hold DMM display by depressing button on probe body. Both AC and DC voltage up to 1200 V max. DC or AC RMS may be measured and held. Usable on the 3435A, 3438A, 3465A/B, and 3466A.

Ordering information

10007B Probe	\$32
10008B Probe	\$32
11067A Test Lead Kit	\$5
11068A Soft Carrying Case for 3476A and B DMM	\$20
11096B High Frequency Probe	\$90
34110A Carrying Case for ½ Rack Size Instruments	\$25
34111A DC Hi-Voltage Probe	\$75
34112A Touch-Hold Probe	\$40

Price

DIGITAL VOLTMETERS

Automatic data acquisition system

Model 3052A

- Improve productivity in research and manufacturing
- Increase throughput and lower the cost in Q.A. testing
- Conserve plant energy through electric load monitoring/control

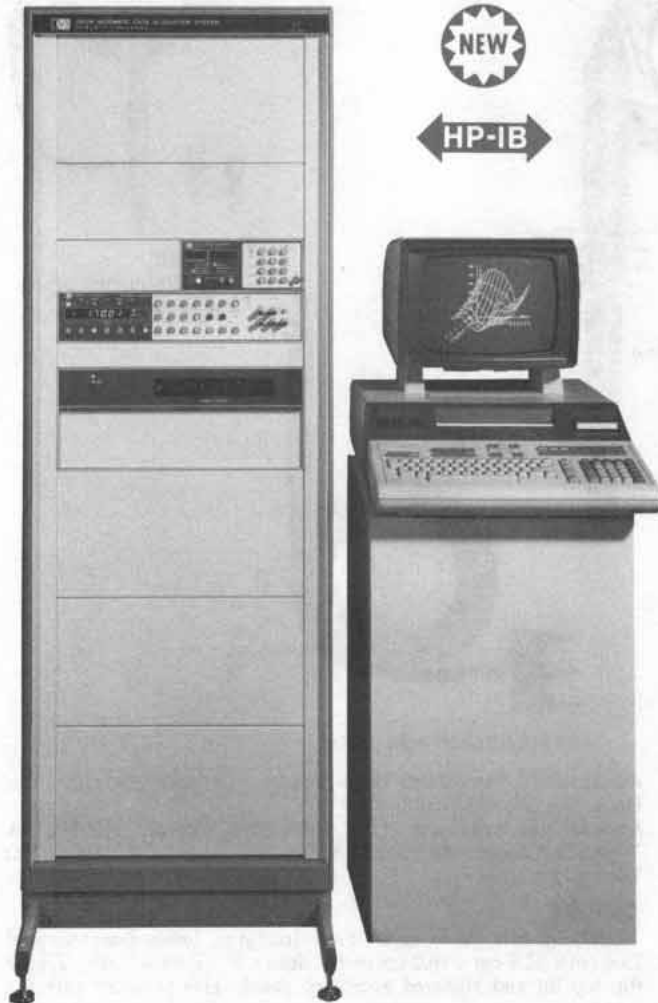

3052A with 9845S

Description

The 3052A Automatic Data Acquisition System combines speed, precision and repeatability in low level measurements with full computation and analysis capabilities. This system provides a highly capable, yet economical solution to process control development, transducer measurements, production testing, and signal analysis applications. Powerful system software for instrument driver routines, data analysis and presentation programs, instrument verification routines and application programs are provided with the standard system.

System Configuration

The 3052A consists of the following:

- 3455A High Accuracy/High Resolution DVM
- 3437A High Speed Sampling DVM
- 3495A Scanner (See 3495A Multiplexer/Scanner for details)
- 98034A HP-IB Card
- 98035A Real Time Clock

Must order option 400, 500, 600 or 700

Two digital voltmeters in the 3052A provide a unique combination of high speed and high accuracy measurements.

- Monitor pilot and production processes
- Perform on-line data analysis and processing
- Measure DC, AC, and Ohms

Measurement and control

DC measurement rates up to 19 channels/second are possible with 1 μ V resolution on the 100 mV range. This sensitivity and dynamic range are required, for example, in thermocouple measurements with a 0.5°C or better resolution.

Excellent noise rejection and very low thermal uncertainty make the 3052A particularly suited for accurate, repeatable, low-level measurements even in the presence of noise. The > 120 dB effective common-mode rejection of the 3455A/3495A effectively cancels out unwanted offsets or superimposed noise signals.

AC measurements can be made up to 1 MHz with the standard AC True RMS converter or up to 250 kHz with the optional average converter. A programmable Fast AC mode provides an AC measurement rate of up to 10 channels/second for inputs about 300 Hz.

Repetitive waveforms up to 1 MHz or low frequency transients (below 1 kHz) can be digitized by the 3437A High Speed Sampling DVM. With this DVM and 9845S Calculator, more than 4500 readings/second on a single high speed channel can be stored for further analysis.

By multiplexing the 3437A input with the scanner, up to 1000 channels/second can be measured with 100 μ V resolution and 3 1/2 digits. Use of the 20 Channel Low Thermal Relay Assemblies or the 19 Channel Reference Assemblies with Thermocouple Compensation are required to attain this speed. The sample-and-hold measuring technique of the 3437A makes it more suited for high quality inputs with minimum noise and common mode signals.

Resistance measurements can be made with either an easy-to-connect 2-wire technique or the more accurate 4-wire method. Multiplexed high resistance measurements up to 15 megohms can be made with the full accuracy of the 3455A.

The system can assume an active role in application processes by performing control, alarm, and multiple switching functions with the relay actuator cards in the 3495A. Each of these cards provides ten double-pole single-throw contact closures for connection to external devices.

The 98035A Real Time Clock standard with the 3052A has an accuracy of 30 ppm (.003%) and provides the following capability:

- Real time information - calendar and time of day
- Interrupts at a specified time, after a time delay and at periodic intervals
- Counters incremented every millisecond to time events
- An integral NiCd battery that allows the clock to maintain the real time for up to two months when it is not in use
- An optional external trigger cable which can be used to output pulses to external devices

Power and performance in calculator controllers

Offering four system controllers provide you with choices of languages, displays, memory options and printouts (see the chart below). These choices provide the flexibility, simplicity and ease for resolving simple or complex applications. All four system controllers offer easy interaction to greatly simplify your tasks of writing and editing programs. And during system programming or operation, interaction with the operator is greatly enhanced with the immediate feedback from the controllers. When the system is on line, you will notice the efficiency and effectiveness which each calculator provides in controlling instruments, performing data manipulation, controlling input/output operations and storing data. This is possible because of the Hewlett-Packard Interface Bus (HP-IB).

The HP-IB (Hewlett-Packard's implementation of IEEE Std. 488-1975 and ANSI Standard MC1.1) not only allows simple interfacing with the system voltmeters and scanner, but other HP-IB compatible instrumentation may easily be added to the system for stimulus-response testing applications. Plus a large variety of system controller peripherals are readily available as your requirements change. Producing finished test reports, completely documenting problem solutions or other desired system outputs are handled by such devices as HP's plotters, printers, or floppy disks.

System software

Usually application software is expensive and time consuming to develop. Programming the 3052A, however, is greatly simplified. When using the supplied software, you can have the system fully operational in a short time. The easy-to-use programming languages of the controllers, the supplied and well-documented instrument control routines, and the data analysis programs allow you to conveniently and rapidly develop your own software. Examples of the data analysis routines would be transient analysis, harmonic distortion and thermocouple linearization.

The various subroutine packages are arranged in order by the user

to suit his particular application. An "auto-loader" routine configures the subroutines automatically into a single program and stores the program on tape for use at any time. Thus, the major emphasis of the software is to enable fast system start-up and easy operation.

The 3052A System is fully integrated, tested, verified and specified as a system with complete software and documentation supplied. Once you receive this system, you will note that installation and verification, as well as detailed operating instructions and application programs, are explained in step-by-step instructions.

For more information, contact your local HP Field Engineer or nearest HP Sales Office.



**Standard System Controller Options
(Standard Features With Each Controller)**

FEATURE	9825A	9835A	9835B	9845S
Language	HPL	BASIC	BASIC	BASIC
Display	32 Character Alpha-Numeric	CRT w/Printing and Character Plotting	32 Character Alpha-Numeric	CRT w/Printing and Full Graphics
Printout	16 Character Thermal Strip Printer	16 Character Thermal Strip Printer	16 Character Thermal Strip Printer	80 Character Thermal Line Printer
Memory (Std.)*	23K	49K	56K	62K
Additional Memory Options	Contact local HP Field Engineer	115K 180K 246K	122K 187K 253K	Contact local HP Field Engineer
Standard ROMS	98210A String-Advanced Programming 98216A 9872A Plotter-General I/O - Extended I/O	98332A I/O	98332A I/O	98432A I/O 98437A Graphics
Tape Cartridge Storage	250K bytes	217K bytes	217K bytes	217K bytes**

*Memory given as user read write memory in 8-bit bytes. **9845S has dual tape cartridge drives, therefore, total storage on tape is 434K bytes.

Scanner and Mainframe

- 102:** Ten Channel Low Thermal Assembly \$600
- 104:** Twenty Channel Low Thermal Assembly \$700
- 106:** Nine Channel Reference Assembly with Thermocouple Compensation \$700
- 108:** Nineteen Channel Reference Assembly with Thermocouple Compensation \$800
- 110:** Ten Channel Relay Actuator Assembly \$400
- 120:** Additional 3495A Scanner with High Speed Control Board and 10631A HP-IB Cable \$1560

System Controllers

- 400:** 9825S System Controller with 24K bytes total RWM (23K bytes user RWM) 98210A String-Advanced Programming ROM; 98216A 9872A Plotter-General I/O-Extended I/O ROM \$7700
- 500:** 9835A System Controller with 65K total bytes RWM (49K bytes user RWM); CRT, 98332A I/O ROM, 16 Character ASCII Thermal Printer \$11,150
- 520:** 128K total bytes RWM (115K bytes user RWM) \$3,200
- 522:** 192K total bytes RWM (180K bytes user RWM) \$6,080
- 524:** 256K total bytes RWM (246K bytes user RWM) \$8,640
- 600:** 9835B System Controller with 65K total bytes RWM (56K bytes user RWM); 98332A I/O ROM, 16

- Character ASCII Thermal Printer; 32 Character LED Display
- 620:** 128K total bytes RWM (122K bytes 9835B user RWM) \$3,200
- 622:** 192K total bytes RWM (187K bytes 9835B user RWM) \$6,080
- 624:** 256K total bytes RWM (253K bytes 9835B user RWM) \$8,640
- 700:** 9845S System Controller with 64K total bytes RWM (62K bytes user RWM); CRT, Graphics Package, 2nd Tape Cartridge Drive, 98432A I/O ROM \$20,750
- 910:** Extra set of Standard System Documentation (Does not include special option documentation) \$350

Ordering information

(Select one system controller from option blocks 400, 500, 600, or 700. Select scanner relay assemblies and additional 3495A Scanner Mainframes from options 102 through 120; each scanner mainframe requires at least one relay assembly and will hold up to four assemblies.)

3052A Automatic Data Acquisition System from \$10,250

DIGITAL VOLTMETERS

Multiplexer Scanner

Model 3495A

- Low level switching
- Multichannel closure
- Switched guard
- Relay actuation

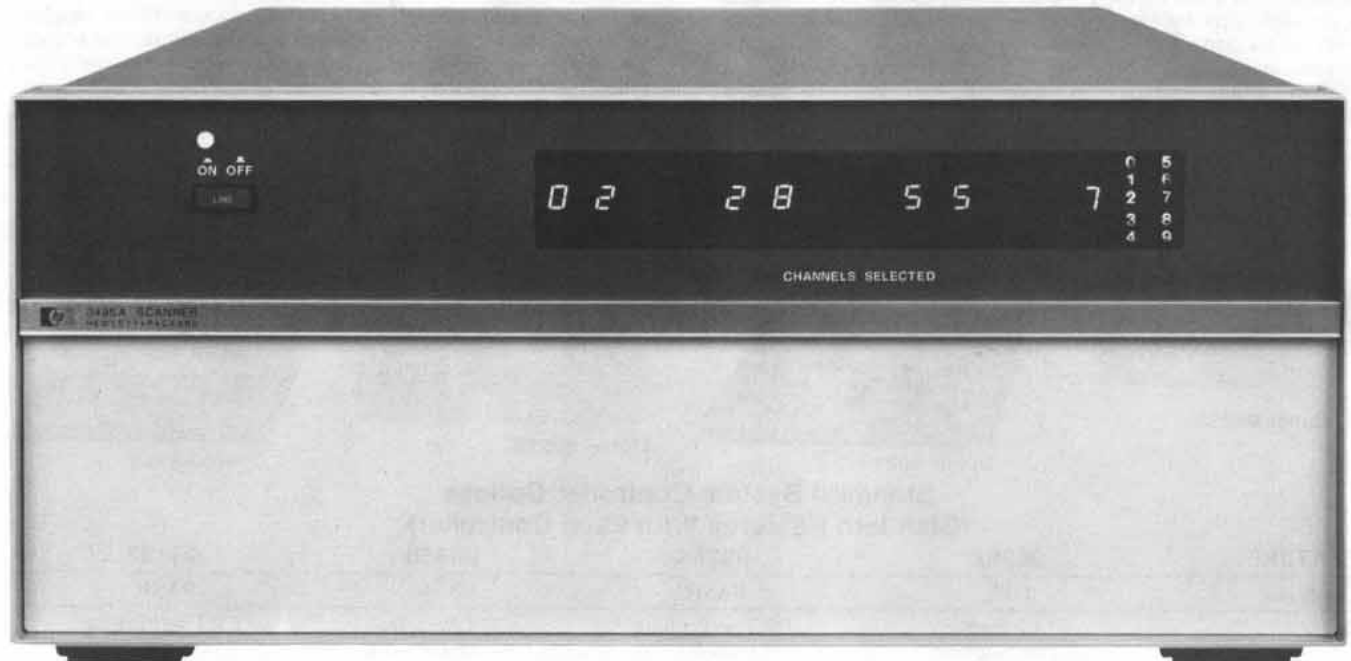

3495A

Description

General

The 3495A Scanner switches analog input signals to an appropriate measuring device (voltmeter). It can also control external devices with relay actuator closures. Ideal for many data logging and data acquisition applications, the scanner can be used for sequential or random scanning. Any Hewlett-Packard Interface Bus (HP-IB) compatible controller can be used to operate the Scanner. Any combination of four relay assemblies (discussed below) can be used per scanner mainframe. More than four assemblies require additional scanner mainframes.

Five optional relay assemblies are available with the scanner, four low thermal assemblies and one actuator assembly.



OPTION 001

Low thermal relay assemblies

Applications: low level dc measurements; dc volts and resistance scanning.

Transducer sensing: thermocouples, thermistors, strain gauges, pH meters.

1. Ten Channel Low Thermal Relay Assembly (Opt. 001). This assembly provides ten 3-wire input channels for switching voltages up to

230V peak. A separate guard relay for each channel minimizes the effects of common mode voltage on low level measurements. A break-before-make feature ensures that only one channel at a time is closed, which prevents connecting two inputs simultaneously.

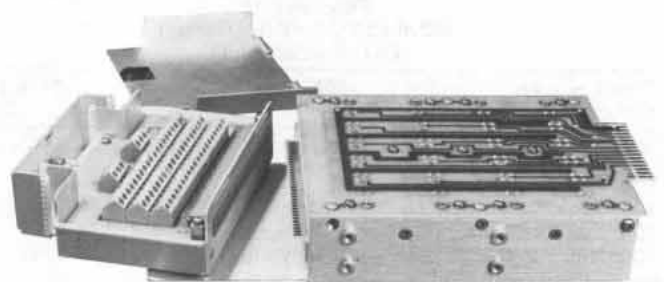

OPTION 004

Maximum contact ratings: Voltage: 200V peak; Current: 200 mA (non-inductive); Maximum input voltage: 230V peak; Thermal Offset: $< 2\mu\text{V}$ differential EMF; Isolation: $> 10^{10}\Omega$; Switching Time: 10 msec. max.

2. Twenty Channel Low Thermal Relay Assembly (Opt. 004). Designed for switching voltages below 42V peak, this assembly contains twenty 3-pole input channels. Very low thermal offset voltages are maintained in the assembly for low level switching. When used in conjunction with the High Speed Controller Board (Opt. 100) and the 3437A System Voltmeter, switching speeds of up to 1000 channels/sec. with $100\mu\text{V}$ resolution can be obtained.

Maximum contact ratings: Voltage: 42V peak; Current: 40mA (non-inductive); Maximum input voltage: 42V peak; Thermal Offset: $< 1\mu\text{V}$ differential EMF; Isolation: $> 10^9\Omega$; Switching Time: 1 msec. max.

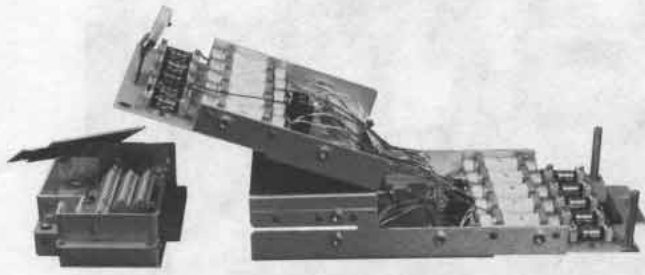

3. Nine Channel Reference Assembly with Thermocouple Compensation (Opt. 003). An isothermal block, which replaces the standard terminal connector, acts as a reference junction for up to nine thermocouples. The remaining channel measures the temperature of the reference junction with a built-in thermistor. This temperature information is used for automatic reference junction compensation. When used in conjunction with Option 100 and the 3437A SVM, switching speeds of up to 1000 channels/sec. with 100 μ V resolution can be achieved.

Maximum contact ratings: Voltage: 42V peak; Current: 200 mA (non-inductive); Maximum input voltage: 42V peak; Thermal offset < 2 μ V differential EMF; Isolation: > 10⁵ Ω ; Switching time: 10 msec. max.

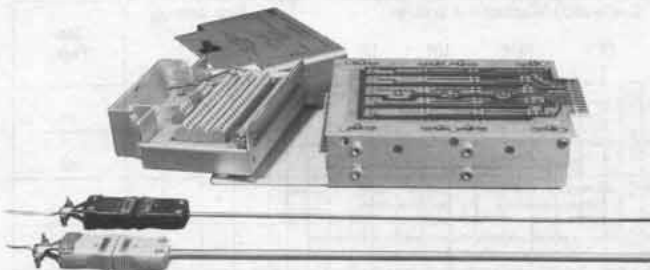

4. Nineteen Channel Reference Assembly with Thermocouple Compensation (Opt. 005). Similar in operation to Option 003 except there are nineteen low thermal channels instead of nine channels.

Maximum contact ratings: Voltage: 42V peak; Current: 40 mA (non-inductive); Maximum input voltage: 42V peak; Thermal offset < 1 μ V differential EMF; Isolation: > 10⁵ Ω ; Switching time: 10 msec. max.

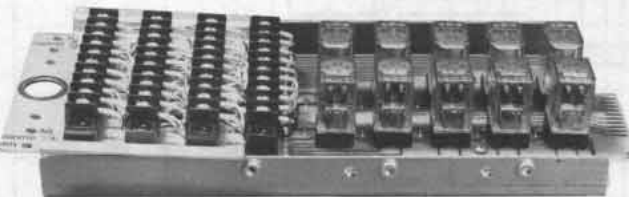

5. Relay Actuator Assembly (Opt. 002).

Applications: process control, actuate visual or audio indicators, control high current relays, up to 8 X 10 Matrix switching.

Ten Channel Relay Actuator Assembly: This relay actuator assembly provides ten independently programmable 2-wire closures for controlling high current relays, distributing low current dc or ac voltages, or external control function. Each two-pole relay can switch currents between 5 mA and 2 A rms. Any combination of channels on this assembly may be closed or opened simultaneously.

Maximum contact ratings: voltage: 100V rms; Current: 2 A rms; Maximum input voltage: 230V peak; Thermal offset: < 30 μ V differential EMF; Switching time: 40 msec. max. (Caution: For use in cir-

cuits fused at 2 amperes or less and less than 200 VA).

High Speed Control Board (Opt. 100): Replacing the standard control board with the High Speed Control Board adds high speed capability to the 3495A Scanner. When Opt. 004 or Opt. 005 low thermal assemblies are used in conjunction with an external triggering device, such as a 3437A System Voltmeter, speeds of up to 1000 channels/sec. with 100 μ V resolution can be obtained. The High Speed Control Board is compatible with other relay assemblies, but no speed improvements are achieved.

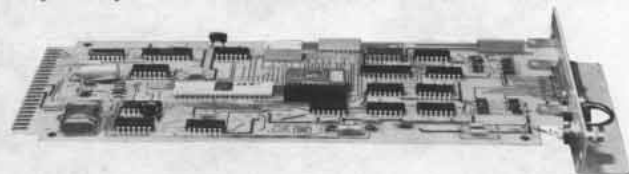

General

Operating temperature: 0°C to +55°C

Humidity range: 95% R.H., 0°C to +40°C

Power: 100/120/220/240 +5%, -10%

48 to 66 Hz line operation, <100VA

Dimension: 190.5 mm H x 428.6 mm W x 520.7 mm D (7 1/2" x 16 3/4" x 20 1/2").

Weight: Depends on options. Net: 18 kg (39.6 lbs.) maximum with four relay assemblies. Shipping: 22 kg (48.4 lbs.) maximum.

Options, accessories and field installation kits

Order one or more optional relay assemblies to obtain desired number of channels. Up to a total of four assemblies may be used in any combination in each scanner mainframe.

Option	Price
001: Ten Channel Low Thermal Relay Assembly	+\$600
002: Ten Channel Relay Actuator Assembly	+\$400
003: Nine Channel Reference Assembly with Thermocouple Compensation	+\$700
004: Twenty Channel Low Thermal Relay Assembly	+\$700
005: Nineteen Channel Reference Assembly With Thermocouple Compensation	+\$800
100: High Speed Control Board	+\$250

Field installation kits

44401A Ten Channel Low Thermal Relay Assembly	+\$600
44402A Ten Channel Relay Actuator Assembly	+\$400
44403A Nine Channel Reference Assembly With Thermocouple Compensation	+\$700
44404A Twenty Channel Low Thermal Relay Assembly	+\$700
44405A Nineteen Channel Reference Assembly With Thermocouple Compensation	+\$800
44413A High Speed Control Board	+\$350

In addition, options 001 or 004 can be field modified to include thermocouple compensation by ordering the appropriate terminal connectors.

Additional terminal connectors for:

Ten Channel Low Thermal Relay Assembly 03495-64101	+\$ 65
Ten Channel Relay Actuator Assembly 03495-64102	+\$ 95
Nine Channel Thermocouple Reference Assembly 03495-64103	+\$125
Twenty Channel Low Thermal Relay Assembly 03495A-64114	+\$ 95
Nineteen Channel Thermocouple Reference Assembly 03495-64115	+\$135

3495A Scanner **\$1250**

COMPONENT MEASUREMENT

General information

C, R, L, D, Q, Z, θ and IC's

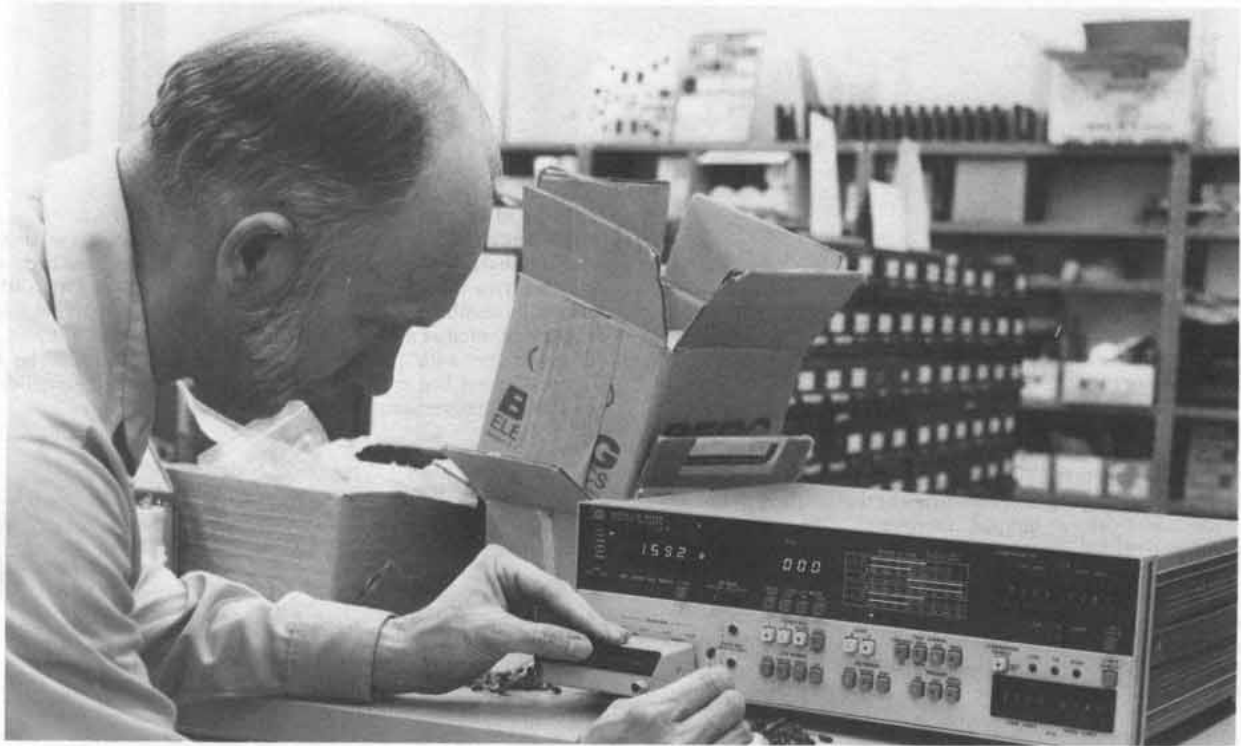

Instrument	Frequency				Q or D		C in farads, L in henries or R in ohms							Basic Accuracy			See Page	
	DC	1 Hz	1 kHz	1 MHz	1 GHz	10 ⁰	10 ³	10 ⁻¹²	10 ⁻⁹	10 ⁻⁶	10 ⁻³	10 ⁰	10 ³	10 ⁶	0.1%	1%		10%
Universal Bridge 4260A	•					—	—	—	—	—	—	—	—	—	•			83
Digital LCR Meter 4261A		••				—	—	—	—	—	—	—	—	—	•			88
Digital LCR Meter 4262A		••	••			—	—	—	—	—	—	—	—	—	•			86
Universal Bridge 4265B						—	—	—	—	—	—	—	—	—	•			84
Auto C-Bridge 4270A						—	—	—	—	—	—	—	—	—	•			85
1 MHz LCR Meter 4271B						—	—	—	—	—	—	—	—	—	•			90
1 MHz Preset C Meter 4272A						—	—	—	—	—	—	—	—	—	•			92
1 kHz Preset C Meter 4273A						—	—	—	—	—	—	—	—	—	•			93
Multi-frequency LCR Meter 4274A		•••••				—	—	—	—	—	—	—	—	—	•			94
Multi-frequency LCR Meter 4275A		•••••				—	—	—	—	—	—	—	—	—	•			95
Digital High Capacitance Meter 4282A		••••				—	—	—	—	—	—	—	—	—	•			96
Milliohm Meter 4328A																•		81
High Resistance Meter 4329A																•		82
LCR Meter 4332A		•	•			—	—	—	—	—	—	—	—	—	•			80
Q Meter 4342A						—	—	—	—	—	—	—	—	—	•			98
Vector/Z/Meter 4800A		••••				—	—	—	—	—	—	—	—	—	•			99
RF Vector/Z/Meter 4815A						—	—	—	—	—	—	—	—	—	•			99
Digital IC Tester 5045A																		100-103

Functional and DC Parameter measurements on TTL, CMOS, ECL, HTL, and DTL logic families.

Impedance/Z/θ, C, R, L, D & Q

Hewlett-Packard's family of component measurement instruments covers the impedance range from less than one milliohm to greater than 10¹⁶ ohms. Instruments range from the traditional manual null measurement technique to the completely automatic, microprocessor controlled, systems oriented type.

The basic characteristics of each instrument are summarized in the selection guide on the preceding page. This guide is convenient for selecting the most suitable instrument for a particular application or for considering trade-offs of key characteristics.

Impedance considerations

Impedance measuring instruments can be categorized, according to the technique used, into the bridge, voltage/current and Q methods. In the bridge technique, circuit conditioning required to achieve a balance or null condition is detected and processed to indicate the measured value. The voltage/current method essentially uses Ohm's Law in that a constant voltage or current is applied to the unknown and the converse current or voltage is indicative of the unknown value. The Q method utilizes unique characteristics of the series resonant circuit to determine Q, and indirectly L, C and R.

Traditionally, the bridge has been the most accurate measurement technique. It required operator skill to manually null the bridge and determine the value of the unknown. Today's technology yields automatic, digital readout bridges with accuracy exceeding the less sophisticated manual bridges.

The manual HP 4265B Universal Bridge offers the traditional laboratory oriented adjustment procedures ideal for tutorial environments. It also allows the use of an external oscillator input for special test frequencies or test signal levels. It offers excellent accuracy at low cost.

The HP 4260A Universal Bridge is a semi-automatic bridge that eliminates the tedious balancing operation by automatically nulling the loss component of the device under test (DUT). A unique circuit using semiconductor diodes permits bridge balancing of complex impedances with only one simple reference component adjustment. This feature yields speed and convenience at a nominal cost.

Several fully automatic digital bridges are available from Hewlett-Packard, each with special features. The HP 4271B 1 MHz LCR Meter uses a state-of-the-art four terminal pair terminal arrangement in a bridge configuration. This technique virtually eliminates the mutual inductance of the test leads — a principle consideration at 1 MHz. The HP 4272A 1 MHz Preset C Meter has an internal comparator for automatic sorting operation. The HP 4282A Digital High Capacitance Meter uses the automatic bridge technique to measure C values in excess of 1 Farad.

In the past, the voltage/current technique utilized analog meter readouts for speed and convenience, but offered less accuracy than the bridge method. With recent advances in technology, this is no longer the case. The

new fully automatic digital instruments using the voltage/current method offer accuracy exceeding all but the most sophisticated manual bridges.

The first of these instruments introduced by Hewlett-Packard was the 4261A. It offers fully automatic L, C, R and D measurements at two test frequencies with excellent accuracy. The HP 4262A is the first of a new generation of microprocessor-based instruments, featuring three test frequencies, predefined initial turn-on conditions and automatic self-test capability. The addition of the HP 4274A and 4275A will allow the user to test components under actual operating conditions. Both instruments feature variable test signal levels, ten spot frequencies, self test capability, digital offset to compensate for test leads and fixtures, and vector/phase angle measurements ($Z \angle \theta$).

Other impedance measuring instruments utilizing analog meter readouts are available from Hewlett-Packard offering measurement speed at a nominal cost. The HP 4328A Milliohmmeter features a 1 milliohm full scale range using a four-terminal Kelvin lead arrangement. Resistances of up to 2×10^{16} ohms are measured by the HP 4329A High Resistance Meter. The 4332A LCR meter measures L, C and R at two test frequencies.

The HP 4342A Q Meter features good accuracy over a wide range of frequencies, indicating Q directly. Inductance, capacitance and resistance can also be easily determined.

Integration into HP-IB system

Adding the HP-IB option to a component measuring instrument enables the instrument to be incorporated into an HP-IB system. This permits high speed measurement of many components along with arithmetic processing of the data and allows a remarkable efficiency increase to be realized in the production line testing of discrete components, in quality assurance tests, or in laboratory evaluations.

The HP-IB option (Opt 101) for LCR measuring instruments is available for HP models 4262A, 4271B, 4272A, 4274A, 4275A and 4282A.

The system controller may be an HP model 9825A Computing Controller with an HP-IB interface card (98034A), a model 9830A

Calculator with a bus interface kit (HP 59405A Opt. 030), or an HP System 45 with HP-IB interface (98034A, Opt. 445).

If other system components such as a plotter, printer, scanner or measurement instrument are added to the system, the integrated system reaches a high level of usefulness. For example, it would provide a component manufacturer with inspection/reliability test capabilities in the quality control or in-process test/inspection departments. In semiconductor device measurements, the combination can process the especially needed complex arithmetic manipulation of the measured data to determine various device characteristics.

Figure 1 is the block diagram of a semiconductor device characteristic measurement system using the 4275A Opt. 101. This calculator controlled system graphically shows the relationships between either bias voltage (measured with digital multimeter) and capacitance (measured with the 4275A), or between impurity concentration and depletion layer width, on a graphic plotter. Bias is automatically applied to the device and its capacitance is measured as directed by the calculator.

Summary

To assist in the selection of an impedance meter suitable for your needs, the following guidelines may be used:

- (1) Choose an instrument which measures the device under test (DUT) under the identical conditions (frequency, signal level, bias, ...) as its intended use.
- (2) Consider the environmental parameters (lead resistance and inductance, stray capacitance, temperature variations, ...) that will affect your measurement and choose a measurement technique that will tend to counteract them.
- (3) Then select the instrument with the broadest measurement capability within accuracy and cost constraints.

Hewlett-Packard's impedance measuring instruments have been used in numerous diverse applications. If you have an unusual application or need assistance, contact your nearest Hewlett-Packard sales office for information.

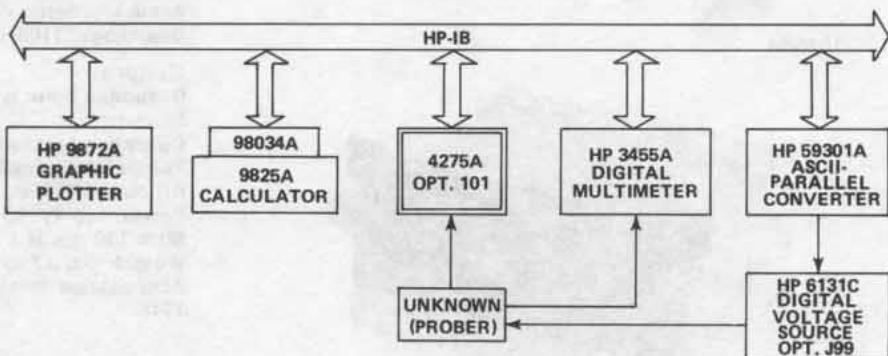

COMPONENT MEASUREMENT

LCR meter

Model 4332A

- Touch and read operation
- Wide range
- Low test voltage
- Guarded measurement

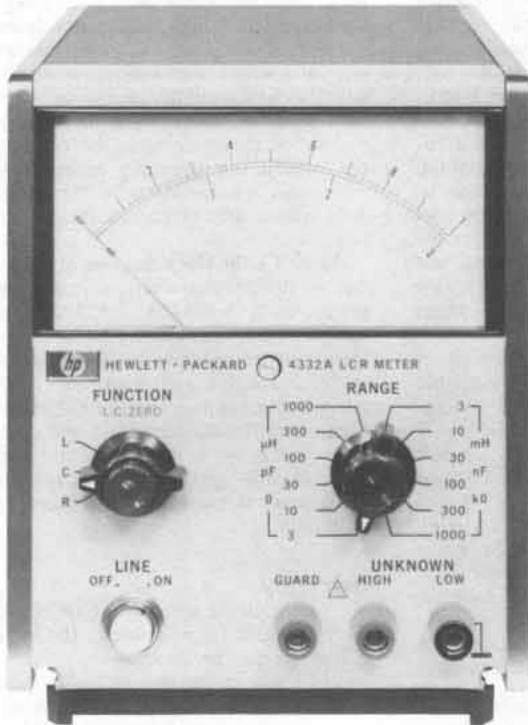

4332A

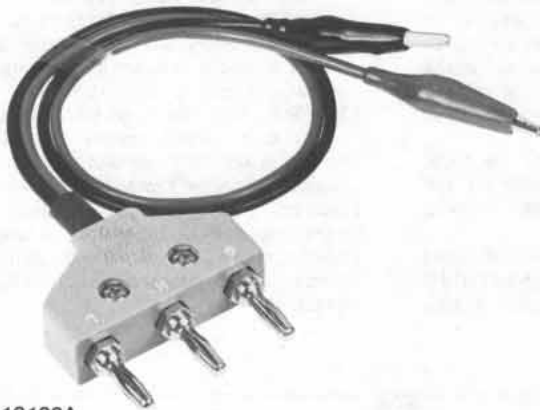

16138A

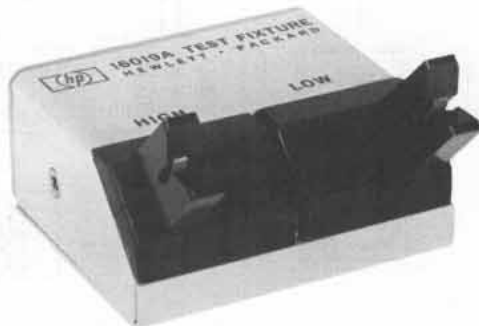

16019A

Description

Hewlett-Packard's Model 4332A LCR Meter measures inductance, capacitance, and resistance with speed and accuracy. The instrument provides direct-readings of L, C, and R with linear meter scales. The 4332A is extremely useful for measurements of both linear and non-linear components such as semiconductor capacitor values and inductance of coils with ferrite core.

Specifications

Inductance measurement

Measurement equivalent circuit: series.

Range: 3 μ H to 1 H full scale, 12 ranges.

Measuring frequency

3 μ H to 1000 μ H ranges: 100 kHz \pm 5%.

3 mH to 1000 mH ranges: 1 kHz \pm 5%.

Voltage across sample: <1.5 mV rms.

Accuracy (at 25°C): \pm [1% reading + (1.5 + 3/Q)% of full scale + 0.03 μ H].

Capacitance measurement

Measurement equivalent circuit: parallel.

Range: 3 pF to 1 μ F full scale, 12 ranges.

Measuring frequency

3 pF to 1000 pF ranges: 100 kHz \pm 5%.

3 nF to 1000 nF ranges: 1 kHz \pm 5%.

Voltage across sample: approximately 70 mV rms.

Accuracy (at 25°C): \pm [1% reading + (1.5 + 3/Q)% of full scale + 0.03 pF].

Resistance measurement

Range: 3 Ω to 1 M Ω full scale, 12 ranges.

Measuring frequency: 1 kHz \pm 5%.

Voltage across sample: <1 mV rms.

Accuracy (at 25°C)

3 Ω to 30 k Ω ranges: \pm (0.5% reading + 2% full scale + 0.03 Ω).

100 k Ω to 1000 k Ω ranges: \pm (1% reading + 2% full scale).

Analog outputs: 1.0 V dc full scale, independent of range in use and 1.0 V or 0.3 V dc full scale, corresponding to the range in use.

Output impedance: approximately 500 Ω .

Accuracy: better than meter reading accuracy by 0.5% full scale.

Overrange: 110% of full scale.

General

Response time: typically 0.25 s for analog outputs. Typically 1.0 s for meter.

Operating temperature: 0°C to 50°C.

Temperature coefficient: \pm 0.05% of full scale/°C (0°C to 50°C).

DC bias: 100 V dc maximum can be applied from external source.

Power: 115 V/230 V \pm 10%, 48 Hz to 66 Hz, 8VA.

Size: 130 mm H x 155 mm W x 279 mm D (5 $\frac{1}{8}$ " x 6 $\frac{3}{32}$ " x 11").

Weight: net, 3.5 kg (7 lb 11 oz).

Accessories furnished: 16138A Test Leads, Power Cord 8120-1348.

Accessories available: 16019A Test Fixture

4332A LCR Meter
Opt 910: extra manual

\$1490
\$9.00

- 20 $\mu\Omega$ resolution on 1 m Ω range
- Four terminal measurement
- Low test voltage



4328 (with 16005A Probes included)

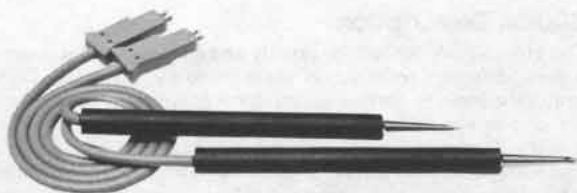

16006A Probe (2 each included)

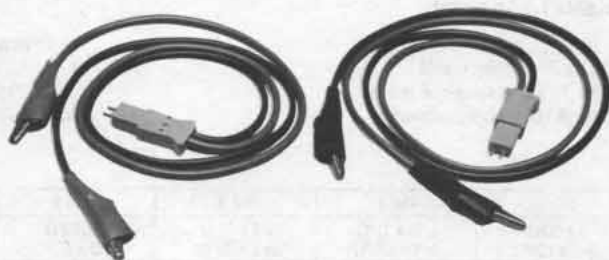

16007A/B Test leads (1 each included)

Description

HP's 4328A Milliohmmeter is a portable instrument for measurement of low resistances. It uses a Kelvin Bridge method to obtain its high sensitivity, but has incorporated both the current and voltage drives into one probe, so that only two probes are needed in actual measurement.

The range of the 4328A extends from one milliohm to 100 ohms full scale. Maximum sensitivity is 20 micro-ohms, making it ideal for measuring contact resistance of switches, relays, and connectors.

A unique phase discriminator in the meter circuit permits accurate resistive measurements on samples with a series reactance up to twice full scale resistance.

The milliohmmeter is internally driven by a one kilohertz signal. With an ac drive signal, dc bias up to 150 volts can be superimposed without affecting accuracy of measurement. Hence, HP's 4328A can make dynamic resistance measurements on forward-biased diodes.

Maximum voltage across any sample with proper range selection is less than 200 microvolts peak. In case of incorrect range setting, a maximum voltage of 20 millivolts peak will never be exceeded, so that explosive devices such as fuses and squibs can be safely checked.

The basic 4328A is line operated. With Opt 001, it can be operated from four rechargeable batteries for 15 continuous hours. A recorder output provides an output proportional to meter deflection.

Specifications

Range: 0.001 to 100 ohms full scale in a 1, 3 sequence.

Accuracy: $\pm 2\%$ of full scale. No additional error is caused by series reactance of samples up to two times full scale.

Measuring frequency: 1000 Hz ± 100 Hz.

Voltage across sample: 200 μ V peak at full scale.

Maximum voltage across sample: 20 mV peak in any case.

Superimposed dc: 150 V dc maximum may be superimposed on samples from an external source.

Recorder output: 0.1 V dc output at full scale meter deflection, output resistance approx. 1k Ω .

Range (ohms)	Applied Current (mA)	Maximum Dissipation in Samples (μ W)
0.001	150	23
0.003	50	8
0.01	15	2.3
0.03	5	0.8
0.1	1.5	0.23
0.3	0.5	0.08
1	0.15	0.023
3	0.05	0.008
10	0.015	0.0023
30	0.005	0.0008
100	0.0015	0.00023

General

Power requirements: 115/230 V switch selectable $\pm 10\%$, 50 to 60 Hz, 1.5 VA.

Weight: 3.2 kg (7 lb).

Size: 155.1 mm H x 130 mm W x 279 mm D (6 $\frac{1}{2}$ " x 5 $\frac{1}{8}$ " x 11").

Accessories furnished: Model 16005A Probe, 16006A Probe and 16007A/B Test Leads. 16143A Probe Cable. Detachable Power Cord.

Ordering information

4328A Milliohmmeter

Opt 001: Rechargeable battery operation

Opt 910: extra manual

Price

\$1315

\$85

\$12.50



COMPONENT MEASUREMENT

High resistance meter

Model 4329A

- Wide range: 500 k Ω to 2 x 10¹⁶ Ω



Description

The HP 4329A is a solid-state insulation resistance meter designed for easy, accurate and direct readings of the very high resistance values typically found in synthetic resins, porcelain, insulating oils and similar materials. It is also useful for measurements in electrical components like capacitors, transformers, switches and cables. Seven fully regulated dc test voltages (between 10 and 1000 V) are provided as test sources.

Selected scales are identified by illuminated indicators on the meter face. Selected resistance or current multiplying factors are also illuminated for rapid, error-free measurement. Three resistance scales and one current scale are provided. The HP 4329A is instantly convertible from ungrounded-to-grounded-sample operation via a simple relocation of the front panel ground strap from "guard" to "+" position. The instrument cabinet itself is always at ground potential. Test voltage shorts or sample breakdown currents will not damage instrument circuitry.

The HP 4329A also has a current measurement capability. Minute currents as low as 0.05 pA can be readily measured. The standard instrument package includes HP 16117A Low Noise Test Leads; these are used in most types of measurement.

4329A Specifications

Resistance measurement

Range: 500 k Ω to 2 x 10¹⁶ Ω .

Accuracy: total accuracy is determined by test voltage and range used. At low resistance end of each scale, accuracy is $\pm 3\%$, near center scale $\pm 5\%$, and near the specified upper limit on the meter scale (see table below), accuracy is $\pm 10\%$. Accuracy is not specified above these limits. On all voltage ranges, if multiplier is set to Rmax., an additional $\pm 3\%$ is included.

Test voltage	10 V	25 V	50 V	100 V	250 V	500 V	1000 V
Available resistance readings	5 x 10 ⁴ Ω to 2 x 10 ¹⁴ Ω	1.25 x 10 ⁴ Ω to 5 x 10 ¹⁴ Ω	2.5 x 10 ⁴ Ω to 1 x 10 ¹⁵ Ω	5 x 10 ⁴ Ω to 2 x 10 ¹⁵ Ω	1.25 x 10 ⁵ Ω to 5 x 10 ¹⁵ Ω	2.5 x 10 ⁵ Ω to 1 x 10 ¹⁶ Ω	5 x 10 ⁵ Ω to 2 x 10 ¹⁶ Ω
Meter scale	.5 to 20	.125 to 5	.25 to 10	.5 to 20	.125 to 5	.25 to 10	.5 to 20
Upper limit	5	1.25	2.5	5	1.25	2.5	5

*Accuracy of test voltage is $< \pm 3\%$

- Selectable test voltages: 10 V to 1000 V

Current measurement

Range: 5 x 10⁻¹⁴ to 2 x 10⁻⁵ A in 8 ranges.

Meter scale: 0 to 20 in 40 linear divisions.

Input resistance: 10⁴ to 10¹¹ Ω $\pm 1\%$, depending on range.

Accuracy: $\pm 5\%$ of full scale deflection (there can be an additional $\pm 3\%$ error at the top decade).

General

Recorder output: 0 to 100 mV dc, proportional to meter deflection; 1k Ω output resistance.

Power: 115/230 V $\pm 10\%$, 50-60 Hz, approximately 3 VA.

Size: 166 mm H, 198 mm W, 224 mm D (6 $\frac{1}{2}$ " x 7 $\frac{25}{32}$ " x 8 $\frac{25}{32}$ ").

Weight: 3.5 kg (7.7 lb).

Accessory furnished: HP 16117A Low Noise Test Leads.

Accessory available: Model 16008A Resistivity Cell.



16008A Description

The HP 16008A can safely, rapidly and conveniently measure the volume and surface resistivity of sheet insulation materials. Conversion from volume to surface resistivity measurement requires operation of one switch only; no lead interchange or disconnection is necessary. Designed for use with the HP 4329A Resistance Meter (other voltage supplies and picoammeters may be used), the complete system allows direct measurement of volume resistivity up to approximately 4 x 10¹⁶ Ω (on samples 0.1 cm thick)—and surface resistivity up to approximately 4 x 10¹⁷ Ω . Test voltages up to 1000 V may be used.

16008A Specifications

Inner electrode: 50 mm diam.

Guard electrode: 70 mm diam.

Auxiliary electrode: 100 mm x 120 mm.

Maximum sample size: 125 mm x 125 mm x 7 mm.

Maximum test voltage: 1000 V dc.

Size: 49 mm H, 198 mm W, 152 mm D (2" x 7 $\frac{13}{16}$ " x 6 $\frac{1}{8}$ ").

Weight: 1.8 kg (4 lb).

Ordering information

16008A Resistivity cell

4329A High resistance meter

Opt 910: extra manual

Price

\$610

\$1795

add \$12.50



- Electronic autobalance—single control null
- Digital readout for C, R, L
- Direction indicators for fast range selection and balance



Description

Measurements of C, R, L, D (dissipation factor of capacitors), and Q are easily made with Hewlett-Packard's Model 4260A Universal Impedance Bridge.

Readout for C, R, and L is digital with the decimal point automatically positioned. Units of measurement and equivalent circuit automatically appear with a twist of the function switch. There are no multipliers or confusing nonlinear dials which need interpolation.

Operation is simple. Set the function knob for the parameter to be measured, adjust range switch for an on-scale indication, and obtain a null with CRL control. There are no interacting controls to adjust and readjust, nor any false nulls. A unique electronic autobalance circuit solves all these problems. Components with low Q or high D are as easy to measure as those without loss.

For D or Q measurements, switch out of auto and turn DQ control until another null is obtained. Only one adjustment is needed for each measurement.

Five bridge circuits are incorporated in HP's 4260A; each is composed of stable, high-quality components for good accuracy and linearity. An internal 1 kHz drives the bridge.

Nulling is easy. Illuminated pointers (<<CRL>>) automatically tell whether a null is up- or down-scale. Both range and CRL controls can be set watching these pointers.

Components may be biased by connecting a battery to rear terminals. An external oscillator and detector can be used for measurements in the 20 Hz–20 kHz range.

Specifications

Capacitance measurement

Range: 1000 pF to 1000 μF, in 7 full scale ranges (1 pF resolution).
Accuracy: ±(1% + 1 digit), from 1 nF to 100 μF. ±(2% + 1 digit), from 1 pF to 1 nF and 100 μF to 1000 μF. All accuracies are stated as % of reading.

Dissipation factor

Range

Low D—(of series C): 0.001 to 0.12.

High D—(of parallel C): 0.05 to 50.

Accuracy: for C > 100 pF.

$$\text{Low D} \dots \pm \frac{2}{\sqrt{D \text{ of reading}}} \%$$

$$\text{High D} \dots + (10 D \text{ of reading} + 4) \%$$

$$-(10 \sqrt{D \text{ of reading}} + 2) \%$$

Add ±1 dial division for frequencies other than 1 kHz.

Inductance measurement

Range: 1000 μH to 1000 H, in 7 full scale ranges (1 μH resolution).
Accuracy: ±(1% + 1 digit), from 1 mH to 100 H. ±(2% + 1 digit), from 1 μH to 1 mH and 100 H to 1000 H.

Quality factor

Range

Low Q—(of series L): 0.02 to 20.

High Q—(of parallel L): 8 to 1000.

Accuracy: for L > 100 μH.

$$\text{Low Q} \dots + \left(\frac{10}{Q \text{ of reading}} + 4 \right) \%$$

$$- \left(\frac{10}{\sqrt{Q \text{ of reading}}} + 2 \right) \%$$

$$\text{High Q} \dots \pm 2 \sqrt{Q \text{ of reading}} \%$$

Add ±1 dial division for frequencies other than 1 kHz.

Auto-balance

Eliminates need for DQ adjustments in parallel C and series L measurements at 1 kHz.

Accuracy: for D < 1 and Q > 1 add ±0.5% to C and L accuracy specifications.

Resistance measurement

Range: 10Ω to 10 MΩ, in 7 full scale ranges (10 mΩ resolution).

Accuracy: 10 mΩ to 10Ω ±(2% + 1 digit). 10Ω to 1 MΩ ±(1% + 1 digit). 1 MΩ to 10 MΩ ±(2% + 1 digit).

Oscillator and detector

Internal oscillator: 1 kHz ±2%, 100 mV rms ±20%.

Internal detector: tuned amplifier at 1 kHz; functions as a broadband amplifier for measurements with external oscillator.

General

Power: 115 or 230 volts ±10%, 50–60 Hz, approx. 7 VA.

Size: 166 mm H x 198 mm W x 279 mm D (6¹¹/₃₂" x 7²⁵/₃₂" x 11").

Weight: net, 5 kg (11 lb). Shipping, 6.8 kg (15 lb).

Options

Opt 910: extra manual

Price

add \$9

4260A Universal Bridge

\$1425



COMPONENT MEASUREMENT

Universal bridge

Model 4265B

- High accuracy: 0.2%
- Wide range
C: 0.1 pF to 1111 μ F
L: 0.1 μ H to 1111 H
R: 0.1 m Ω to 1.111 M Ω



4265B

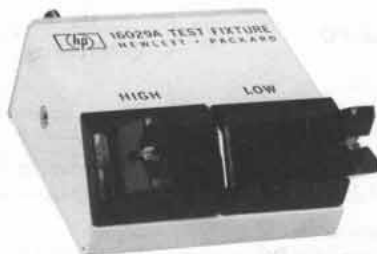

16029A Test Fixture

Description

Hewlett-Packard's Model 4265B Universal Bridge provides an economical way to make high precision measurements of L, C, or R and D or Q. Components can be measured in ranges of 0.1 μ H to 1111 H in inductance, 0.1 pF to 1111 μ F in capacitance and 0.1 m Ω to 1.111 M Ω in resistance. L and C measurements are performed over a wide range of loss with either series or parallel equivalent circuits selected by the function switch. Basic measurement accuracy is 0.2% of reading for L, C, and R.

Measurement frequency range is 50 Hz to 10 kHz with an external oscillator, and 1 kHz with internal oscillator. A dc measurement for resistance is also available with external dc power supply and null detector.

The front panel design provides appropriate space and convenient positioning of knobs for easy balancing. The rugged handle is used as the tilt stand at angles of 0, 40, or 60 degrees.

Specifications

Resistance measurement

Full scale range: 1000.0 m Ω to 1.0000 M Ω , 7 ranges.

Overrange: 11.1%.

Minimum resolution: 0.1 m Ω .

****Accuracy (at 1 kHz):** \pm (0.2% of reading + 0.01% of F.S.), \pm (0.4% of reading + 0.01% F.S.) for 1000.0 m Ω range.

Residual resistance: 1 m Ω .

Inductance measurement

Full scale range: 1000.0 μ H to 1000.0 H, 7 ranges.

Overrange: 11.1%

Minimum resolution: 0.1 μ H.

****Accuracy (at 1 kHz):** \pm (0.2% of reading + 0.01% of F.S.), \pm (0.4% of reading + 0.01% F.S.) for 1000.0 μ H range.

Residual inductance: 0.04 μ H (in series with 1 m Ω).

Loss factor range: (at 1 kHz).

Q of series L: 0.001 to 10, accuracy \pm (5% of reading + 2 minor divisions).

Q of parallel L: 1 to 1000, accuracy \pm (5% of reading + 2 minor divisions) for 1/Q.

Capacitance measurement

Full scale range: 1000.0 pF to 1000.0 μ F, 7 ranges.

Overrange: 11.1%

Minimum resolution: 0.1 pF.

****Accuracy (at 1 kHz):** \pm (0.2% of reading + 0.01% of F.S.), \pm (0.4% of reading + 0.01% F.S.) for 1000.0 μ F range.

Residual capacitance: 0.4 pF.

Loss factor range: (at 1 kHz).

D of series C: 0.001 to 1, accuracy \pm (5% of reading + 2 minor divisions).

D of parallel C: 0.1 to 1000, accuracy \pm (5% of reading + 2 minor divisions) for 1/D.

****For temperature of 25°C \pm 10°C.**

General

Internal oscillator

Frequency: 1 kHz \pm 15 Hz.

Output: continuously variable with front panel control. Maximum voltage is 0.4 V rms.

External oscillator

Frequency range: 50 Hz to 10 kHz or dc for resistance measurement; \leq 4 V rms.

Internal detector: tuned amplifier at 1 kHz. In 1 kHz position, maximum sensitivity of 10 μ V, selectivity better than 26 dB. In "flat," operates as a broad band detector from 50 Hz to 10 kHz.

External dc bias: capacitance measurements in Cs mode, maximum bias voltage of 250 V dc. Inductance measurements in Lp mode, maximum bias current of 10 mA.

Operating temperature: 0° to 55°C.

Power: 100/120/200/240 V \pm 10%; 48 to 440 Hz, 5 VA.

Size: 376 mm H x 393 mm W x 115 mm D (14³/₁₆" x 15³/₁₆" x 4¹/₃₂").

Weight: net, 5.5 kg (12.1 lb). Shipping, 7.1 kg (15.7 lb).

Accessories furnished: power cord, 2.3 m (7¹/₂ ft). Crystal earphone.

Accessories available: 16029A Test Fixture.

Ordering information

16029A Test Fixture

Opt 910: Extra Manual

4265B Universal Bridge

Price

\$130

add \$9

\$1375

- Fully automatic
- 1 kHz to 1 MHz
- Measure from 10.000 pF to 1.0000 μ F Full Scale



Description

A unique instrument from Hewlett-Packard, the 4270A Automatic Capacitance Bridge provides a wide variety of high speed measurements of both active and passive capacity values. Five-digit readout of capacitance from 18.000 pF to 1.2000 μ F is complemented by .001 pF resolution and measurement speed of 0.5 seconds. In addition, a second in-line 4-digit Nixie® display of capacitor loss is given simultaneously in terms of parallel conductance (G) or dissipation factor (D). In the laboratory, HP's 4270A will be extremely useful for examination of semiconductor junction capacities, input capacitances of amplifiers and other active devices, as well as analysis of stray capacity values, cables and simple capacitors. DC biasing, four frequencies from 1 kHz to 1 MHz and a fully guarded measurement will add to laboratory flexibility.

Specifications

Measuring circuit

Float: guarded terminals of unknown are floated from ground.

L-GND: one side of known terminals is grounded; guard is retained.

Parameters measured: capacitance, equivalent parallel conductance and dissipation factor.

Measuring frequency: 1 kHz, 10 kHz, 100 kHz and 1 MHz \pm 1%.

Range modes

Auto: range selection and balance performed automatically.

Hold: range is held on fixed position, balance begins with most significant digit. Range determined by previous auto or track range selected or by manually stepping range step.

Track: range held on fixed position, balance begins with last digit.

Balancing time: typically 0.5 s.

Measuring rate: measurement cycle equals balance time plus display time. Balance time typically 0.5 s; display times selected by meas rate are 70 ms, 2 secs, 5 secs, and manual.

Test voltage across unknown

Normal: 1 V rms constant in pF or nF at 1 kHz, 0.1 V rms constant, in μ F at 1 kHz. 0.5 V rms constant at 10 kHz, 100 kHz and 1 MHz.

Low: $\frac{1}{2}$ of normal.

Repeatability: \pm 2 digits at normal test voltage, \pm 10 digits at low test voltage.

DC bias: Internal or external to \pm 200 V, in hold and track mode.

Internal bias at float measurement

Voltage: 0 to 20 V dc; 0 to 200 V dc; continuously variable on front panel, monitored on rear panel.

Dial accuracy: \pm 5% of full scale.

Source resistance: 100 k Ω .

Polarity: low unknown terminal (-), high unknown terminal (+) in float position of meas. ckt. control.

Remote: programmable by resistor with 250 Ω /V rate at 20 V range, 25 Ω /V rate at 200 V range.

Remote accuracy: \pm 2% of full scale.

Internal bias at L-ground: an additional connection using a blocking capacitor and a coaxial cable is necessary for internal source.

Available measurement ranges

Capacitance				Conductance	Dissipation Factor
1 kHz	10 kHz	100 kHz	1 MHz		
180.00 pF	18.000 pF			899.9n Ω	.8999
1800.0 pF*	180.00 pF	18.000 pF		8.999 μ Ω	
18.000 nF	1800.0 pF	180.00 pF	18.000 pF	89.99 μ Ω	
180.00 nF	18.000 nF	1800.0 pF	180.00 pF	899.9 μ Ω	
1.2000 μ F	180.00 nF	18.000 nF	1200.0 pF	8.999m Ω	

NOTE: heavy line encloses available full-scale ranges in L-GROUND full display of D/G is obtained at TRACK MODE, and is limited by AUTO RESET of 1.5 sec at AUTO/HOLD MODE

*Accuracy at L-GND is not specified on this range.

Basic accuracy: \pm % of reading; \pm number of digits

	Frequency	1 kHz & 10 kHz	100 kHz	1 MHz
C	D < 0.1	\pm (0.1% + 1 digit + 0.01 pF)	\pm (0.3% + 1 digit + 0.01 pF)	\pm (1% + 1 digit + 0.02 pF)
	Basic Accuracy 0.1 < D < 0.899	\pm (0.2% + 1 digit + 0.01 pF)	\pm (0.5% + 1 digit + 0.01 pF)	\pm (2% + 1 digit + 0.01 pF)
G	Basic Accuracy	\pm (1% + 10 digits)		\pm (3% + 10 digits)
D	Basic Accuracy	\pm [1% + (10 + C_s/C_x) digits]		\pm [3% + (10 + C_s/C_x) digits]

NOTE: C_s : internal standard capacitor

C_x : capacitance measured

Outputs: 4 line BCD.

Inputs

Trigger hold off level: level must be between 10 V and 15 V.

Remote programming: eight front-panel functions can be remotely controlled by external contact closure to ground with impedance less than 400 Ω . Programmable functions are reset, frequency, range mode, test voltage, loss meas, range step, dc bias, bias vernier.

Operating temperature: 0°C to 50°C.

Power requirements: 115 or 230 V AC \pm 10%, 50 to 60 Hz (approximately 110 W).

Weight: net, 15.5 kg (34 lb). Shipping, 21.6 kg (48 lb).

Accessories available:

Accessories for HP's 4270A Automatic Capacitance Bridge:
The following adapters convert BNC Connectors on HP's 4270A to allow direct insertion of components. 16011A converts from BNC to binding posts. 16012A converts from BNC to test axial lead devices. It has a centrally located guard plane to reduce errors due to stray capacitance. 16013A converts from BNC to test vertical lead devices. It has a guard plane similar to 16012A. 11143A converts from BNC to clip leads. 44" overall length with third lead to preserve guard terminal.

Options and accessories

Opt 910: Extra Manual

Opt 101: HP-IB Data Output & Remote Control

16011A Test Fixture

16012A Test Fixture

16013A Test Fixture

16411A HP-IB Interface Kit

11143A BNC Cable

Price

add \$35

add \$2890

\$80

\$135

\$100

\$2890

\$45

4270A Automatic Capacitance Bridge

\$9035



COMPONENT MEASUREMENT

Digital LCR Meter

Model 4262A

- Automatic balancing, ranging & circuit mode selection
- Test frequencies of 120 (100) Hz, 1 kHz and 10 kHz

- HP-IB, BCD and Comparator options available
- Microprocessor control features self test and deviation measurement capabilities

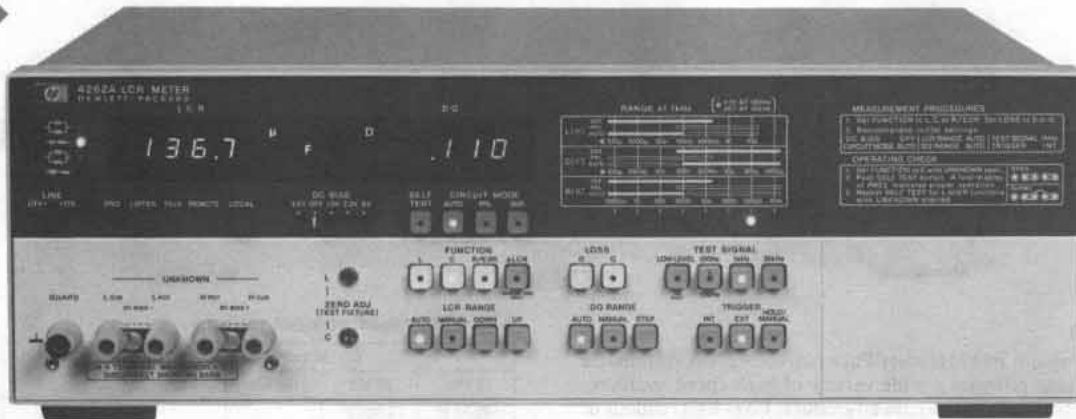

The HP 4262A is a 3½ digit microprocessor based Digital LCR Meter that meets today's requirements for component measurements in the lab, on the production line, and in the QA inspection area. The 4262A features fully automatic operation over a wide range of measurements. Simply select the function and loss parameters, one of three test frequencies, and insert the device to be measured. The instrument does the rest—automatically selecting the proper measurement range and equivalent circuit mode.

In addition to automatic measurements and wide range, the 4262A features high accuracy (typically 0.2% of reading), 120 (100) Hz, 1 kHz, and 10 kHz measurement frequencies, 1 V test signal level (1 V or 50 mV in Cp mode), three internal DC bias levels (plus external) and series and parallel equivalent circuit modes. The microprocessor control allows other features such as an automatic self test capability and deviation measurements. These features make the 4262A capable of meeting the measurement needs of the diversified electronics

industry by measuring such things as the parameters of semiconductors, pulse transformers, filter coils, electrolytic and film capacitors, or determining the internal resistance of a dry cell.

The arrangement of the front panel keyboard switches insure maximum operating convenience and error-free operation. When the instrument is turned on, the microprocessor automatically selects capacitance, dissipation factor, 1 kHz test signal, autorange, auto circuit mode selection, internal trigger and normal test voltage mode of operation. Individually LED lighted keys allow the user to easily determine the selected functions at a glance.

Several options are available for the user that needs systems capability. A BCD output of LCR and DQ data is available for use with a printer or calculator. If both data output and remote control are required, HP-IB compatibility is available. A comparator option (for both LCR and DQ data) is also available.

Specifications

Accuracy: All accuracies apply over a temperature range of 23°C ± 5°C (at 0°C to 55°C, error doubles)

C-D and C-Q Measurement

Range	C	120 (100) Hz 1 kHz 10 kHz	1000 pF 100.0 pF 10.00 pF	10.00 nF 1000 pF 100.0 pF	100.0 nF 10.00 nF 1000 pF	1000 nF 100.0 nF 10.00 nF	10.00 μF 1000 nF 100.0 nF	100.0 μF 10.00 μF 1000 nF	1000 μF 100.0 μF 10.00 μF	10.00 mF 1000 μF 100.0 μF	
	D	.001-19.9 (2 Ranges)									
Q	*1 .050-1000 (4 Ranges)										
Test Signal Level *2	1 V or 50 mV										
	AUTO	Same as Mode					Same as Mode				
C Accuracy *3		0.2% + 2 counts					(Test signal level: 1 V)				
		0.5% + 3 Counts		0.3% + 2 counts			(Test signal level: 50 mV)				
		At 120 (100) Hz, 1 kHz					0.3% + 2 counts			0.5% + 2 counts	1% + 2 counts *4
D (1/Q) Accuracy *3		At 10 kHz					0.3% + 2 counts			1% + 2 counts	5% + 2 counts
		Same as Mode					Same as Mode				
		0.2% + (2 + 200/Cx) counts					At 120 (100) Hz, 1 kHz (Test signal level: 1 V) At 10 kHz				
		0.5% + (2 + 200/Cx) counts					0.3% + (2 + 1000/Cx) counts			At 120 (100) Hz, 1 kHz (Test signal level: 50 mV) At 10 kHz	
AUTO	At 120 (100) Hz, 1 kHz					0.3% + (2 + Cx/500) counts			1% + (5 + Cx/500) counts	5% + (5 + Cx/500) counts	
	At 10 kHz					0.5% + (2 + Cx/500) counts			1% + (5 + Cx/500) counts	5% + (5 + Cx/500) counts	
AUTO	Same as Mode					Same as Mode					

*1. Calculated from D value as a reciprocal number.

*2. Typical data, varies with value of D and number of counts.

*3. ± (% of reading + counts) Cx is capacitance readout in counts. Accuracies in this table apply when D < 1.999.

*4. 5% + 2 counts at 1 kHz.

L-D and L-Q Measurement

Range	L	120 (100) Hz 1 kHz 10 kHz	1000 μH 100.0 μH 10.00 μH	10.00 mH 1000 μH 100.0 μH	100.0 mH 10.00 mH 1000 μH	1000 mH 100.0 mH 10.00 mH	10.00 H 1000 mH 100.0 mH	100.0 H 10.00 H 1000 mH	1000 H 100.0 H 10.00 H	
	D	*1	.001-19.9 (2 Ranges)							
	Q		.050-1000 (4 Ranges)							
Test Signal Level *2			40 mA				10 mA	1 mA	100 μA	10 μA
			Same as Mode				Same as Mode			
L Accuracy *3			At 120 (100) Hz, 1 kHz			0.3% + 2 counts		1% + 2 counts		
			At 10 kHz					1% + 2 counts	5% + 2 counts	
			0.2% + 2 counts							
			0.3% + 2 counts	0.2% + 2 counts				At 120 (100) Hz, 1 kHz		
	AUTO		Same as Mode				Same as Mode			
D (1/Q) Accuracy *3			At 120 (100) Hz, 1 kHz			0.3% + (3 + Lx/500) counts		1% + (3 + Lx/500) counts		
			At 10 kHz			0.5% + (3 + Lx/500) counts		1% + (3 + Lx/500) counts	5% + (5 + Lx/500) counts	
			0.2% + (3 + 200/Lx) counts							
			0.5% + (3 + 200/Lx) counts				At 120 (100) Hz, 1 kHz			
	AUTO		Same as Mode				Same as Mode			

*1 Calculated from D value as a reciprocal number
 *2 Typical data varies with value of D and number of counts
 *3 ± (% of reading + counts) Lx is inductance readout in counts. Accuracies in this table apply when D < 1.999.

R/ESR** Measurement

Range	120 (100) Hz 1 kHz 10 kHz	1000 mΩ	10.00 Ω	100.0 Ω	1000 Ω	10.00 kΩ	100.0 kΩ	1000 kΩ	10.00 MΩ	
Test Signal Level *1			40 mA				10 mA	1 mA	100 μA	10 μA
			Same as Mode				Same as Mode			
Accuracy			0.3% + 2 counts *3							
*2			0.2% + 2 counts							
	AUTO		Same as Mode				Same as Mode			

*1 Typical data, varies with number of counts
 *2 ± (% of reading + counts)
 *3 ± (5% + 2 counts) on 10.00 MΩ range at 10 kHz test frequency.

** The measurement range for ESR is from 1 mΩ to 19 kΩ (typical). These values vary depending on the series capacitance or inductance value of the device under test.

Parameters measured: C-D or C-Q (1/D), L-D or L-Q (I/D), R (ESR).

Display: dual 3½ digit, maximum display of 1999. For D value greater than 10, maximum D display is 199.

Measurement terminals: 5-terminal configuration.

Measurement circuit modes: auto, parallel and series.

Test frequencies: 120 (100) Hz, 1 kHz and 10 kHz ± 3%.

Range mode: LCR—Auto and manual (up-down), D/Q Auto and manual (step).

Trigger: internal, external or manual.

Deviation measurement: when the ΔLCR switch is depressed, the measurement value is stored in memory as a standard value. At the same time, the range is set to "Manual" and the display is offset to zero. Deviation is displayed as the difference between the stored value and subsequent measurement data. Deviation is in counts from -999 to 1999.

Offset adjustments: front panel adjustments to compensate for stray capacitance and residual inductance of the test fixtures.

C: 0 to 10 pF. **L:** 0 to 1 μH.

Self test indicators: when the SELF TEST function is selected, the results of the test are displayed in the LCR and DQ window. Results are indicated by PASS, FAIL 1, FAIL 2 or FAIL 3.

DC bias: internal: 1.5 V, 2.2 V and 6 V (selectable on front panel). Accuracy ±5%; external: Provision for external DC bias (0 to +40V).

General

Measurement time (typical) for a 1000 count measurement on a low loss component on a fixed range;

1 kHz, 10 kHz: C/L 220-260 ms, R 120-160 ms

120 (100) Hz: C/L 900 ms, R 700 ms

When autorange is selected, the following times per range step must be added to the above time:

1 kHz, 10 kHz: 45 ms/180 ms per range step

120 (100) Hz: 150 ms/670 ms per range step
 When the uncal lamp is lit, the faster ranging time is selected.

Reading rate: INT (Internal Trigger) approximately 30 ms between the end of a measurement cycle and the start of the next cycle. EXT (External Trigger) measurement cycle is initiated by a remote trigger input.

Operating temperature and humidity: 0°C to 55°C; to 40°C at 95% RH.

Power requirements: 100/120/220 VAC ±10%, 240 Vac +5% -10%; 48-66 Hz.

Power consumption: ≤55 VA with any option.

Size: 147 mm H x 426 mm W x 345 mm D (5¾" x 16¾" x 13¾").

Weight: Approximately 8 kg (17.5 lbs).

Accessories available: 16061A: test fixture, direct coupled, 5-terminal; 16062A: test leads with alligator clips, 4-terminal (for low impedance measurements); 16063A: test leads with alligator clips, 3-terminal (for high impedance measurements).

Options available: Opt 001: BCD data output of LCR and DQ data.

Opt 004: Digital comparator for LCR and DQ data. Comparison output (HIGH, IN, LOW): visual, relay contact closure and TTL level. Not compatible with Opt 101. Opt 101: HP-IB Data Output and Remote Control. Not compatible with Opt 001 and 004.

Options and accessories

001: BCD Output	\$315
004: Digital Comparator	\$760
010: 100 Hz Test Frequency	nc
101: HP-IB Interface	\$510
908: Rack Flange Kit	\$10
910: Extra Manual	\$15
16061A Test Fixture	\$130
16062A Test Cables	\$65
16063A Test Cables	\$65
4262A Digital LCR Meter	\$2625

COMPONENT MEASUREMENT

Digital LCR Meter

Model 4261A

- Fully automatic—autoranging
- Wide range C = 0.1 pF to 19 mF, L = 0.1 μ H to 1900 H, R = 1 m Ω to 19 M Ω
- Low cost with high performance
- Versatile accessories/options
- High reliability



Description

The Model 4261A Digital LCR Meter is a new, fully automatic instrument that satisfies many of today's user requirements in the LCR measurement field.

The 4261A features high speed, accurate measurements. The devices under test need only be connected and the function L, C, or R selected. The instrument automatically displays the desired parameter. Tedious balancing operations typically used in conventional manual bridges are completely eliminated. Measurement circuit mode (series or parallel) is also automatically selected.

Complementing its wide LCR measurement range, HP's 4261A has other features such as high accuracy (basically 0.2% of reading), high speed measurement (typically 4 per second), 120 Hz or 1 kHz measurement frequencies, 1 V or 50 mV test signal levels, internal bias sources and parallel or series equivalent circuit modes.

Measurements are taken using the five-terminal method, which easily converts to four, three or two terminals to meet most LCR measurement applications. For example, the four-terminal input could be

used to measure the capacitance of an electrolytic capacitor, the inductance of transformer or the internal resistance of a dry cell. The three-terminal input is appropriate for semiconductor junction capacitance or cable capacitance measurements. To fit these needs, three kinds of optional test leads and fixtures are available. The 4261A can easily measure parameters of pulse transformers, filter coils and electrolytes in addition to ordinary LCR components.

Expanded use features of this highly reliable instrument include optionally available digital output and remote control which enable a wide range of applications from the research laboratory to the production line.

Specifications

Parameter measured: C-D (Capacitance & Dissipation Factor), L-D (Inductance & Dissipation Factor), and R (Resistance).

Display: 3½ digits, max. display 1900.

Circuit mode: Auto, Parallel and Series.

Measuring circuit: 5-terminal method.

Range mode: Auto or Range Hold.

Measurement frequencies: 120 Hz \pm 3% and 1 kHz \pm 3%.

Trigger: Internal, Manual or External.

Measurement ranges, measurement accuracies & test signal levels: see tables on next page for C-D, L-D, and R measurements. Accuracy applies over a temperature range of 23°C \pm 5°C (at 0°C to 55°C, error doubles).

DC Bias

Internal source: 1.5 V, 2.2 V, 6 V (selectable on front panel).

Accuracy: \pm 5%.

External source: provision for external DC bias voltage of +30 V maximum at binding posts on rear panel.

General

Measuring time: typical for approx. 1000 counts on fixed range for low loss measurements. Specific data follows:

1 kHz: C/L 220-260 ms, R 120-160 ms.

120 Hz: C/L 900 ms, R 700 ms.

When auto range is selected, a range selection time of 180 ms at 1 kHz and a range step time 670 ms at 120 Hz is added to the above typical times.

Reading rate: internal trigger—approx. 30 ms between end of measurement and start of next cycle; External trigger—measurement cycle is initiated by remote trigger input.

Data format: + 1-2-4-8 BCD, TTL logic level, "1" (high level).

Operating temperature: 0°C to 55°C.

Humidity: to 95% RH at 40°C.

Voltage requirements: 100/120/220/240 V \pm 10%, 48 to 66 Hz.

Power consumption: \leq 25 VA with any option.

Altitude: 15,240 m (50,000 ft.).

Size: 132.6 H x 213 W x 422 mm D (5¼" x 8¾" x 16¾").

Weight: approx. 7.5 kg (16.5 lb).

R Measurement

RANGE	120 Hz or 1 kHz	1000 m Ω	10.00 Ω	100.0 Ω	1000 Ω	10.00 k Ω	100.0 k Ω	1000.0 k Ω	10.00 M Ω
Test Signal		1 V							
		70 mA	10 mA	1 mA	100 μ A	10 μ A			
	AUTO	Same as Mode				Same as Mode			
R Accuracy Note 2		0.3% + 2 counts							
		0.2% + 2 counts							
	AUTO	Same as Mode				Same as Mode			

1. Typical data, varies with number of counts.

2. \pm (% of reading + counts).

C-D Measurement

RANGE	C	120 Hz 1 kHz	1000 pF 100.0 pF	10.00 nF 1000 pF	100.0 nF 10.00 nF	1000 nF 100.0 nF	10.00 μF 1000 nF	100.0 μF 10.00 μF	1000 μF 100.0 μF	10.00 mF 1000 μF			
	D	0.001 to 1.900, common to all C ranges.											
Test Signal Level Note 1		1 V or 50 mV											
		10 μA					100 μA		1 mA		10 mA		70 mA
	AUTO	Same as Mode					Same as Mode						
C Accuracy Note 2		0.2% + 1 count + 0.2 pF					(Test signal level; 1 V)						
		0.5% + 3 counts		0.3% + 2 counts								(Test signal level; 50 mV)	
	AUTO	Same as Mode					0.3% + 2 counts		0.5% + 2 counts		1% + 2 counts ‡		
D Accuracy Note 2		0.2% + (2 + 200/Cx) counts					(Test signal level); 1 V						
		0.3% + (2 + 1000/Cx) counts					(Test signal level; 50 mV)						
	AUTO	Same as Mode					0.3% + (2 + Cx/500) counts		1% + (5 + Cx/500) counts				

1. Typical data, varies with value of D and number of counts.
2. ± (% of reading + counts + α). Cx is capacitance readout in counts.
‡ (5% + 2 counts) at 1 kHz.

L-D Measurement

RANGE	L	120 Hz 1 kHz	1000 μH 100.0 μH	10.00 mH 1000 μH	100.0 mH 10.00 mH	1000 mH 100.0 mH	10.00 H 1000 mH	100.0 H 10.00 H	1000 H 100.0 H	
	D	0.001 to 1.900, common to all L ranges.								
Test Signal Level Note 1		1 V								
		70 mA		10 mA		1 mA		100 μA		10 μA
	AUTO	Same as Mode					Same as Mode			
L Accuracy Note 2		0.3% + 2 counts		1% + 2 counts						
		0.2% + 2 counts + 0.2 μH								
	AUTO	Same as Mode					Same as Mode			
D Accuracy Note 2		0.3% + (3 + Lx/500) counts		1% + (3 + Lx/500) counts						
		0.2% + (3 + 200/Lx) counts								
	AUTO	Same as Mode					Same as Mode			

1. Typical data, varies with value of D and number of counts.
2. ± (% of reading + counts + α). Lx is inductance readout in counts.

Accessories available

16061A: Test Fixture (direct coupled type), 5-terminal	Price \$130
16062A: Test Leads with alligator clips, 4-terminal (for low impedance measurements)	\$65
16063A: Test Leads with alligator clips, 3-terminal (for high impedance measurements)	\$65

Options available

Opt 001: BCD Output of C/L/R and D (simultaneous)	add \$175
Opt 002: BCD Output of C/D, L/D and R (alternately)	add \$155

Opt 003: BCD Remote Control (except for DC bias function) add \$75

Ordering information

16061A Test Fixture	Price \$130
16062A Test Leads	\$65
16063A Test Leads	\$65
Opt 001: BCD Output (Simultaneous)	add \$175
Opt 002: BCD Output (Alternately)	add \$155
Opt 003: BCD Remote Control	add \$75

4261A Digital LCR Meter \$2060

COMPONENT MEASUREMENT

1 MHz Digital LCR Meter

Model 4271B

- Automatic high-speed measurements of low value components
- Precision LCR and loss measurements
- HP-IB interface for easy systems integration
- Wide measurement range (resolution to overrange):
 - C: 0.001 pF to 19.000 nF
 - L: 0.1 nH to 1900.0 μH
 - R: 0.001 Ω to 19.000 kΩ



HP-IB

Description

The HP 4271B 1 MHz LCR Meter meets the requirements of the laboratory, manufacturing and quality assurance where speed and accuracy are essential. Fully automatic inductance, capacitance and loss measurements can be made at the rate of up to 5 readings per second.

The four-terminal pair measurement technique used in the 4271B reduces errors due to electromagnetic coupling of leads as well as reducing residual inductance and stray capacitance. Offset adjustments are provided to cancel the residuals of the test fixtures.

Typical applications for the 4271B include microcircuit measurements, capacitance-voltage characteristics of semiconductor devices and passive component tests on devices such as ceramic and mica capacitors, reed relays and pulse transformers.

Specifications

Parameters measured: capacitance and conductance (C-G) or capacitance and dissipation factor (C-D) using parallel equivalent circuit.

Inductance and dissipation factor (L-D) or inductance and resistance (L-R) using series equivalent circuit. R is equivalent series resistance.

Display: dual 4½ digit LED displays.

Overrange: 90% on C, G, L, and R; 60% on D.

Test frequency: 1 MHz ±0.01%.

Ranging: automatic and manual. Remote control with Opt 101.

Measurement terminals: four-terminal pair construction.

Offset adjustment: offset adjustment compensates for (a) stray capacitance and residual conductance of test fixture; variable ranges are 1 pF and 1 μS, or (b) residual inductance and residual resistance of test fixture. Variable ranges are 100 nH and 100 mΩ.

DC Bias (optional)

Internal source: DC bias is available as Opt 001 with the following specifications:

Range: 00.0 V to 39.9 V, variable in steps of 0.1 V.

Accuracy: ±0.2% of setting ±5 mV (when ambient temperature is at 23°C ±5°C and warm-up time is more than 60 minutes.).

C-G and C-D Measurements

			RANGE 1	RANGE 2	RANGE 3	RANGE 4
Full Scale Display		C	10.000 pF	100.00 pF	1000.0 pF	10.000 nF
		G	100.00 μS	1000.0 μS	10.000 mS	100.00 mS
		D	1.0000 on all ranges when C reading is greater than 1500 counts			
Test Signal Level		HIGH	500 mV rms ±10%			20 mV rms ±20%
		LOW	20 mV rms ±10%			
*Accuracy ± (% of reading + counts)	C	HIGH	0.1 + 7	0.1 + 3	0.1 + 3	0.4 + 3
		LOW	0.2 + 8	0.2 + 4	0.2 + 3	
	G	HIGH	$0.2 + \left(7 + \frac{N_c}{1000}\right)$	$0.2 + \left(3 + \frac{N_c}{1000}\right)$	$1.2 + \left(2 + \frac{2 \cdot N_c}{1000}\right)$	
		LOW	$0.3 + \left(7 + \frac{2 \cdot N_c}{1000}\right)$	$0.3 + \left(3 + \frac{2 \cdot N_c}{1000}\right)$		
	D	HIGH	$1.0 + \left(10 + \frac{20,000}{N_c}\right)$	$1.0 + \left(10 + \frac{10,000}{N_c}\right)$		$1.0 + \left(15 + \frac{30,000}{N_c}\right)$
		LOW	$1.0 + \left(15 + \frac{30,000}{N_c}\right)$	$1.0 + \left(15 + \frac{20,000}{N_c}\right)$		
Overrange		C	90% all ranges			
		G	90% all ranges			
		D	60% all ranges			

*When conductance reading is less than 1000 counts.

N_c is the capacitance readout in counts.

L—D and L—R Measurements

		RANGE 1	RANGE 2	RANGE 3	RANGE 4	
Full Scale Display	L	1000.0 nH	10.000 μH	100.00 μH	1000.0 μH	
	R	10.000 Ω	100.00 Ω	1000.0 Ω	10.000 kΩ	
	D	1.0000 on all ranges when L reading is greater than 1500 counts				
Test Signal Level	HIGH	2 mA rms ± 20%	5 mA rms ± 10%	500 μA rms ± 10%	50 μA rms ± 10%	
	LOW		200 μA rms ± 10%	20 μA rms ± 10%	2 μA rms ± 10%	
*Accuracy ± (% of reading + counts)	L	HIGH	0.6 + 4	0.2 + 4		
		LOW	1.0 + 15	0.3 + 6		
	R	HIGH	1.2 + (8 + $\frac{2 \cdot N_L}{1000}$)	0.3 + (2 + $\frac{2 \cdot N_L}{1000}$)		
		LOW		1.2 + (2 + $\frac{2 \cdot N_L}{1000}$)	0.5 + (2 + $\frac{2 \cdot N_L}{1000}$)	
	D	HIGH	1.0 + (20 + $\frac{30,000}{N_L}$)	1.0 + (15 + $\frac{10,000}{N_L}$)	1.0 + (15 + $\frac{20,000}{N_L}$)	
		LOW		1.0 + (20 + $\frac{20,000}{N_L}$)	1.0 + (20 + $\frac{30,000}{N_L}$)	
Overrange	L	90% All Ranges				
	R	90% All Ranges				
	D	60% All Ranges				

*When resistance reading is less than 1000 counts, N_L is the inductance reading in counts.

Conductance and Resistance Measurements

		RANGE 1	RANGE 2	RANGE 3	RANGE 4
G	Full Scale Display	100.00 μS	1000.0 μS	10.000 mS	100.00 mS
	Test Signal Level	HIGH	500 mV rms ± 10%		
		LOW	20 mV rms ± 10%		
	Accuracy* ± (% of Rdg + counts)	HIGH	0.2 + 8	0.2 + 4	1.2 + 4
LOW		0.3 + 9	0.3 + 5		
R	Full Scale Display	10.000 Ω	100.00 Ω	1000.0 Ω	10.000 kΩ
	Test Signal Level	HIGH	2 mA rms ± 20%	5 mA rms ± 10%	500 μA rms ± 10%
		LOW		200 μA rms ± 10%	20 μA rms ± 10%
	Accuracy* ± (% of Rdg + counts)	HIGH	1.2 + 10	1.2 + 4	0.3 + 4
LOW		0.5 + 4			

*When capacitance or inductance is less than 1,000 counts.

Accuracies listed in the above tables apply over a temperature range of 23°C ± 5°C. (At 0°C to 50°C, accuracy percentages are doubled.)
Warm-Up Time: One hour minimum required to meet all specifications.

DC BIAS (cont.)

Output resistance: 1.5 kΩ ± 10%. Bias voltage is applied to H_{CUR} terminal.

Short circuit current: less than 6 mA.

Control: controlled by HP Model 16023A DC Bias Controller (optionally available) or by the HP-IB when Opt 101 is installed.

Control input connector: HP P/N 1251-0143, 14-pin receptacle (Amphenol 57-40140).

Mating connector: HP Part No. 1251-0142 (Amphenol 57-30140).

External source: Provision for external dc bias voltage of ± 200 V maximum to BNC connector (EXT INPUT) on rear panel. Max bias current 20 mA. Input resistance 10.5 kΩ ± 10%.

Monitor output: bias voltage monitoring BNC connector (MONITOR) on rear panel. Output resistance: 480 Ω ± 10% to H_{CUR} terminal.

General

Measuring Speed

Fixed range: 100 ms to 250 ms for C—G and L—R measurement. 160 ms to 400 ms for C—D and L—D measurements.

Autorange: 100 ms/range step added to above values.

Operating temperature: 0°C to 50°C.

Relative humidity: to 95% at 40°C.

Power: 100/120/220 V ± 10%, 240 V + 5% - 10%, 48-66 Hz, 80 VA max.

Size: 88 mm H x 425 mm W x 496 mm D (3⁵/₃₂" x 16³/₄" x 19⁵/₁₆".)

Weight: 10 kg (22 lb).

Accessory furnished: 16038A Test Fixture for radial and axial lead components.

Ordering information

16021A Calibration Test Fixture (GR900 connector) \$645

16022A General Purpose Test Fixture \$530

16023A DC Bias Voltage Controller (used with Opt 001) \$565

16032A Test Leads (BNC) \$210

16033A Test Leads with miniature coaxial connectors \$260

16034A Test Fixture for chip capacitor measurement \$465

16039A Test Fixture with "D" offset. \$340

Opt 001: DC Bias supply; 0.0 V to 39.9 V add \$310

Opt 002: C/L BCD output; may be used with Opt 003 for simultaneous outputs +8421 Code add \$160

Opt 003: G/R/D BCD output. +8421 Code (see Opt 002) add \$160

Opt 004: Parameter Serial BCD output add \$280

Opt 010: 4271B Less Test Fixture 16038A less \$155

Opt 101: HP-IB Data Output and Remote Control add \$895

4271B 1 MHz Digital LCR Meter

\$5605

COMPONENT MEASUREMENT

1 MHz Preset C Meter

Model 4272A

- Simultaneous go/no go check on production line
- High accuracy—basically 0.1% of reading
- High speed measurements—8 per second



HP-IB

Description

The 4272A 1 MHz Preset C Meter is a unique instrument in which a 5 digit "in-house" comparator is combined with 1 MHz capacitance measurement capability. Capacitance can be measured from 10 pF full scale (resolution 0.001 pF) to 1000 pF full scale (maximum display 1900 pF).

With the comparator capability, the instrument can be set to high and low limits with the built-in thumbwheel switches. Limit indications include panel lamp display, relay contact and TTL outputs for HI, IN and LO comparisons.

The combination of measurement and comparator capability makes this instrument very applicable for production line GO/NO GO checking. When relatively small capacitors such as ceramic or mica are checked for quality in the production process, there is no necessity to read the digital display. A GO/NO GO check requires only a glance at the HI-IN-LO lamp display. Decision type outputs can be utilized in an automatic selection system.

BCD data output for data processing of variable is optionally available. An HP-IB option is also available.

Specifications

Parameter measured: capacitance—equivalent parallel circuit by four terminal pair method.

Test signal

Frequency: 1 MHz \pm 0.01%.

Level: 1 V rms \pm 10%.

Measurement range and accuracy: 0.001 pF-1900.0 pF in 3 decade ranges, manually selected. Remote ranging is optionally available.

Range	Full Scale Display	Overrange	Accuracy*
10 pF	10.000 pF	90%	0.1 + 7
100 pF	100.00 pF	on	0.1 + 3
1000 pF	1000.0 pF	each range	0.1 + 2

* \pm (% of reading + counts)

Accuracy applies over a temperature range of 23°C \pm 5°C at dissipation factors $D < 0.1$ (At 0°C-50°C, error doubles). Warm-up time is > 60 min.

Offset adjustment: offset adjustment compensates for stray capacitances of 0 to 1 pF and residual inductances of 0 to 100 nH existing at test fixture.

Function: compares measured value with HI and LOW LIMIT setting and provides HI, IN and LO comparison outputs.

HI and LOW LIMIT SETTING RANGE: 00000-19999 at each limit switch.

Comparison output: visual, relay contacts and TTL level.

Visual: 3 LEDs indicate HI, IN or LO.

Relay contacts: 3 SPST contacts to circuit common for HI, IN or LO output.

TTL level: 3 open collector circuits to HI level (open) for HI, IN or LO output (Fanout max 30 mA).

Measuring time: < 120 ms.

Reading rate

Internal: < 300 ms between start of measurement and start of next measurement.

External: a new cycle may be started by pushing manual trigger button or by remote trigger input to remote trigger connector.

Remote trigger input: a measurement cycle may be initiated at remote trigger connector by changing logic level state from "0" (zero volts or connection to ground though less than 25 Ω) to "1" (TTL high level or open), pulse width > 1 μ s.

General

Operating temperature & humidity: 0°C to 50°C, relative humidity to 95% at 40°C.

Power requirements: 100/120/220/240 V \pm 10%, 48-66 Hz.

Power consumption: ≤ 60 VA with any option.

Dimensions: 88 mm H x 426 mm W x 467 mm D (3 $\frac{15}{32}$ " \times 16 $\frac{3}{4}$ " \times 19 $\frac{9}{16}$ ").

Weight: approximately 10 kg (22 lbs).

Accessories furnished: 16032A Test Leads with BNC Connectors.

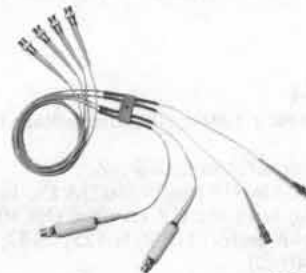

16032A

Accessories available

16021A: Calibration connector \$645

16022A: Test Fixture, General Purpose \$530

16033A: Test Leads with Miniature Coaxial Connectors \$260

16034A: Chip Capacitor Test Fixture \$465

16038A: Test Fixture \$215

Note: The above accessories are the same as for the 4271B.

Options available

002: BCD and Decision Outputs add \$100

006: BCD Remote Control add \$145

101: HP-IB Data Output and Remote Control add \$2915

4272A 1 MHz Preset C Meter

\$5290

- Simultaneous Go/No-Go check on production line
- High Accuracy—basically 0.1% of reading
- High speed measurements—6 per second

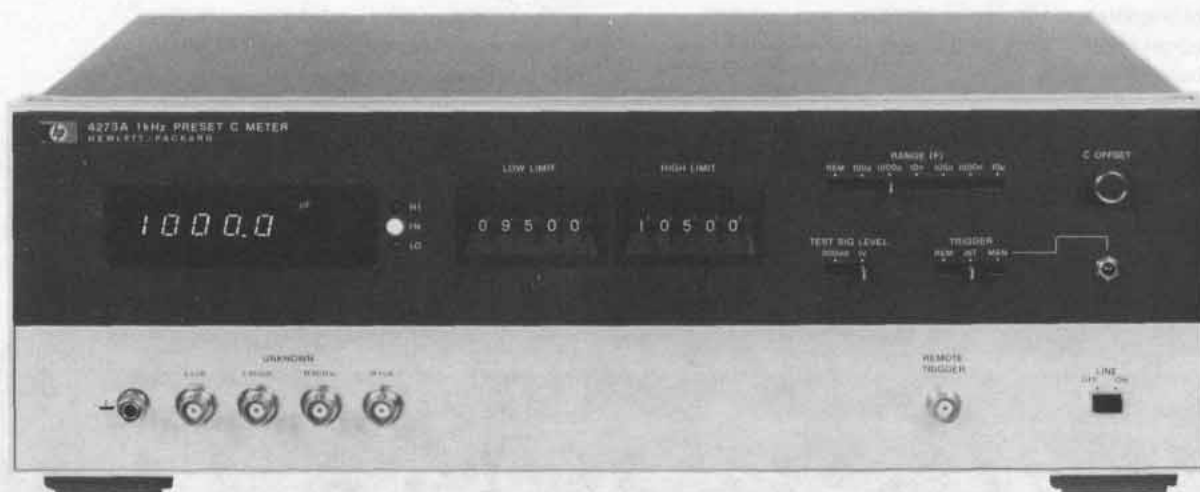

Description

Most components are measured and their characteristics are evaluated at 1 kHz. The model 4273A 1 kHz Preset C Meter is a 4 digit capacitance meter which, combined with a 5 digit comparator, provides Go/No-Go information on medium range capacitors in production line testing or incoming inspection.

The 4273A measures capacitance from 100.00 pF full scale (0.01 pF resolution) to 10.000 μ F full scale in six decade ranges with an overrange of 20%. The instrument's two test signal levels (1 Vrms and 300 mVrms) and wide measurement range covers most capacitor types, including plastic film, mica and ceramic capacitors. The 300 mV test level is especially useful when measuring the capacitance of semiconductor devices.

The 5-digit comparator allows upper and lower comparison limits to be set by thumbwheel switches on the front panel. The measured capacitance values are compared with the limit switch settings and the results are displayed on the front panel. This information is simultaneously applied to relay contact and TTL outputs on the rear panel connector for use with an automatic sorting machine. BCD output of measurement data is also provided.

Measurement time is important, especially in automatic sorting applications. The 4273A can typically make 4 measurements per second (assuming a transfer time of 100 ms). For higher sorting speeds, a high speed version, Option H01 is available.

The 5 terminal configuration of the unknown terminals and the capacitance offset capability insures accurate measurements and easier test fixture design for connection to the device under test.

Specifications

Capacitance measurement

Parameter measured: capacitance—equivalent parallel by four terminal method.

Test signal: frequency: 1kHz $\pm 2\%$; test level: 1Vrms $\pm 10\%$ and 300 mVrms $\pm 10\%$

Measurement range: 100.00 pF — 10.000 μ F in 6 decade ranges, manually selectable. Remote ranging is optionally available.

Overrange: 20%

Accuracy: $\pm (0.1\%$ of reading + 3 counts); conditions: accuracy applies over a temperature range of 23°C $\pm 5^\circ$ C at dissipation factors of $D < 0.1$. At 0°C–50°C, error doubles. Warm-up time is 30 minutes.

Offset adjustments: compensates for stray capacitance of 0 to 10 pF.

Comparator

Function: compares measured value with HI and LOW LIMIT settings and provides HI, IN and LO comparison outputs.

HI and LOW LIMIT setting ranges: 00000-11999 at each limit switch

Comparison outputs: visual, relay contacts and TTL level

Visual: 3 LEDs indicate HI, IN or LO

Relay contacts: 3 SPST contacts to circuit common for HI, IN or LO output.

TTL level: 3 open collector circuits to high level (open) for HI, IN or LO output (Fanout max. 40 mA).

General

Measuring time: < 150 ms.

Reading rate: internal: < 300 ms between start of measurement and start of next cycle; **external:** after completion of a measurement cycle, a new cycle may be started by pushing the manual trigger button or by remote trigger input to the remote trigger connector; **remote trigger input:** a measurement cycle may be initiated at the remote trigger connector by changing the logic level state from "0" (zero volts or connection to ground through less than 25 Ω) to "1" (TTL high level or open), pulse width; $\geq 20\mu$ s.

BCD output: connector: 50 pin, P/N 1251-0087 (Amphenol 51-40500-375). Mating connector is P/N 1251-0086 (Amphenol 57-30500-375).

Output level: TTL. "0" 0-0.4V, "1" 2.4-5V. Max. sink current 16 mA (8 mA for "out of range"), output impedance 300 Ω .

Operating temperature & humidity: 0°C to 50°C, relative humidity to 95% at 40°C.

Power requirements: 100/120/220/240 V $\pm 10\%$, 48-66 Hz.

Power consumption: ≤ 25 VA with any option.

Size: 147 H x 426 W x 349 mm D (5 $\frac{1}{4}$ " x 16 $\frac{3}{4}$ " x 13 $\frac{3}{4}$ ").

Weight: approx 8 kg (17.5 lb).

Accessories furnished: 16045A Test leads with BNC connectors.

Options available: 006: BCD remote control. H01: Hi speed version. 3 digit display with 4 digit comparator. Accuracy: 0.2% of reading. Measurement time: < 75 ms.

Ordering information

Opt 006: BCD Remote Control

Opt H01: Hi Speed Version

4273A 1 kHz Preset C Meter

Price

\$70

add \$195

\$3205

COMPONENT MEASUREMENT

Multi-Frequency LCR Meters

Models 4274A & 4275A

- Measure L/C - D/Q/ESR/G
R - X/B/L/C
Z - θ

4274A

- Test frequencies - 100 Hz to 100 kHz
- Test signal level - 1 mV to 5 V rms
- 0.1% basic accuracy

4275A

- Test frequencies - 10 kHz to 10 MHz
- Test signal level - 1 mV to 1 V rms
- 0.1% basic accuracy

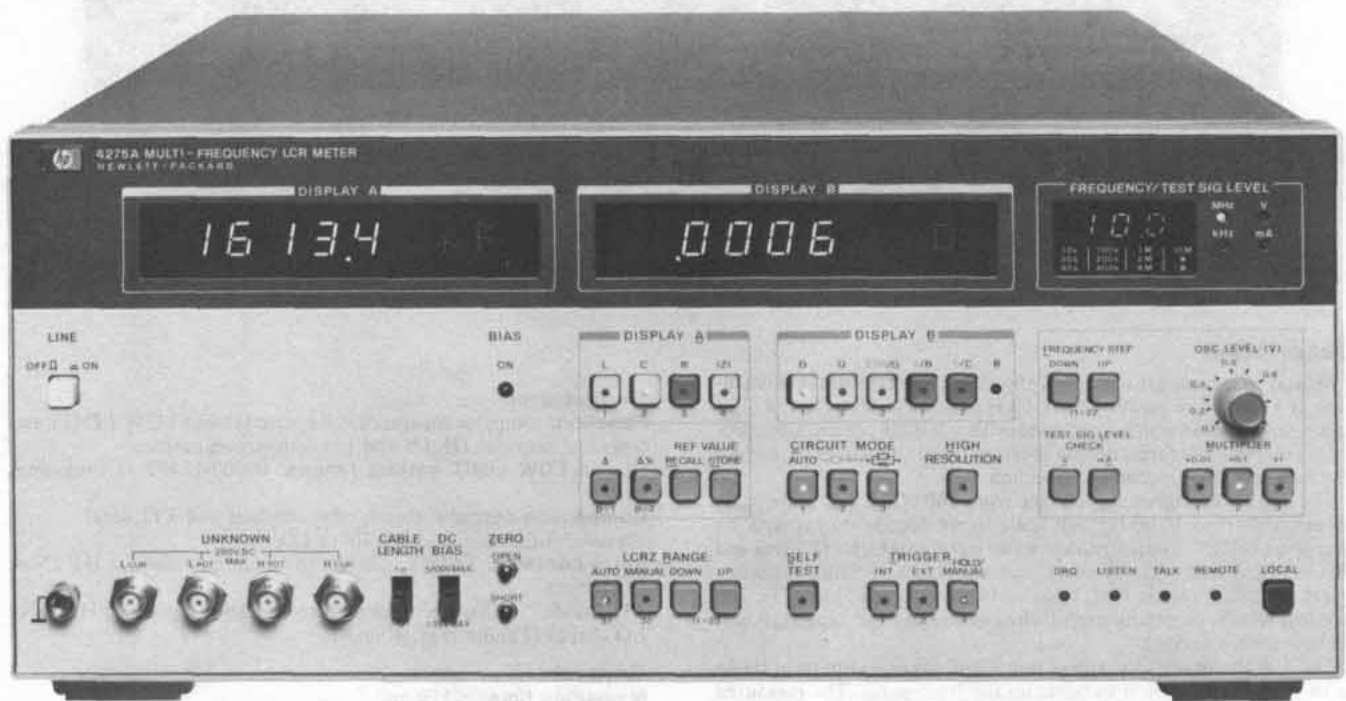

4275A

Description

The 4274A and 4275A Multi-Frequency LCR Meters are the most recent additions to the new generation of microprocessor controlled LCR meters from Hewlett-Packard. Both instruments offer many unique features such as multi-spot frequencies, continuously variable test signal levels, multi-parameter measurements and basic accuracy of 0.1% with 4½ or 5½ (high resolution mode) digit resolution. These features, plus many others, allow the 4274A and 4275A to cover a wide variety of measurement requirements on most electronic materials and devices over a frequency range of 100 Hz to 10 MHz.

The 4274A operates over a frequency range of 100 Hz to 100 kHz and is ideally suited for such applications as impedance measurements on aluminum electrolytic capacitors used in switching power supplies and audio magnetic heads. The eleven spot frequencies allow the user to measure the frequency characteristics of the ESR of tantalum capacitors and make conventional measurements on discrete devices as specified in MIL and IEC specifications. L-Q measurements

on most inductors are easily made at specific frequencies and test current levels.

The 4275A meets the relatively high frequency measurement requirements of the electronic component and semiconductor industry, covering a frequency range of 10 kHz to 10 MHz in 10 spot frequencies. Applications include the L-Q measurement of magnetic components such as ferrite cores and filter coils as well as the capacitance, equivalent series resistance or impedance of tantalum, film or ceramic chip capacitors. Measurements such as impedance vs. frequency characteristics of VTR magnetic heads and high frequency C-V characteristics of semiconductor materials or devices can be made manually or under HP-IB control.

Both the 4274A and 4275A will contribute to the quality of component measurements in laboratory, quality control and production line applications. The selectable frequency, test signal level and optional dc bias capability allow the user to test a device under conditions similar to its intended use. The high resolution mode may be selected to give 5½ digit measurements without loss of accuracy.

Systems integration is easily accomplished with the two available HP-IB options (isolated and non-isolated). These interfaces offer the improved efficiency of total automation of complex measurements and arithmetic manipulation of measurement data. Two dc bias options are available covering the range of 0 to ± 100 Vdc to eliminate the need for external dc power supplies.

Together the 4274A and 4275A provide 17 discrete frequencies between 100 Hz and 10 MHz — wide enough to cover most impedance measurement applications. Additional spot frequencies are optionally available in the operating range of each instrument for unique customer applications.

Specifications (Tentative)

Common specifications (4274A & 4275A)

Parameter measured: L/C - D/Q/ESR/G
R - X/B/L/C
Z - θ

Display: 4½ digit, max. display 19999; (5½ digit, max. display 199999 in High Resolution mode).

Circuit Mode: Series, parallel or auto

Terminal configuration: 4-terminal pair

Trigger: INT, EXT and Hold/Manual

Range Mode: Auto or manual (up/down)

Deviation measurement: Difference from stored reference displayed as absolute value or per cent

High resolution mode: 5½ digit display (measurement speed times 10)

Zero adjustment: Compensates for residuals of test fixtures and cables ($C < 20$ pF, $G < 10 \mu S$, $L < 1 \mu H$, $R < 1 \Omega$)

Self test: Automatic operational check

DC bias: Internal: 0 - ± 35 V, 1 mV resolution (option 001)

Internal: 0 - ± 99.9 V, 100 mV resolution (option 002)

Bias control: HP-IB or 16203B Bias Controller

External: 0 - ± 200 V

Frequency/Test signal level check: Monitors frequency, test signal level or current at UNKNOWN terminals.

4274A Specifications (only)

Measurement frequencies: 100 Hz - 100 kHz in 1-2-4 steps (100 Hz, 120 Hz, 200 Hz, 400 Hz, 1 kHz, 2 kHz, 4 kHz, 10 kHz, 20 kHz, 40 kHz, 100 kHz $\pm 0.01\%$)

Test signal level: 1 mV - 5 Vrms continuously variable

Measurement range¹ and basic accuracy:

Inductance (L): 100.00 nH - 1000.0 H, 0.1%

Capacitance (C): 1.0000 pF - 1.00 F, 0.1%

Resistance (R), Impedance (Z), Equivalent Series

Resistance (ESR) and Reactance (X): 100.00 m Ω - 10.000 M Ω , 0.1%

Dissipation factor (D): .0001 - 9.999, ± 0.001

Quality factor (Q): 0.100 - 1000 (1/D)

Conductance (G) and Susceptance (B): 1.0000 μS - 100.00 S, 0.1%

Phase angle (θ): 0 - ± 180.00 degrees, 0.1 degree

4275A Specifications (only)

Measurement frequencies: 10 kHz - 10 MHz in 1-2-4 steps (10 kHz, 20 kHz, 40 kHz, 100 kHz, 200 kHz, 400 kHz, 1 MHz, 2 MHz, 4 MHz, 10 MHz $\pm 0.01\%$)

Test signal level: 1 mV - 1 Vrms, continuously variable

Measurement range¹ and basic accuracy:

L: 100.00 nH - 1.0000 H, 0.1%

C: 1.0000 pF - 100.00 μF , 0.1%

R, Z, ESR & X: 1.0000 Ω - 10.000 M Ω , 0.1%

D: .0001 - 9.999, ± 0.001

Q (1/D): .100 - 1000

G & B: 1.0000 μS - 10.000S, 0.1%

θ : 0 - ± 180 degrees, 0.1 degree

General

Measurement time: Approx. 200 ms (< 1 kHz); 4274A only
Approx. 130 ms (1 kHz - 10 MHz); 4274A & 4275A

Power: 100/120/220 Vac $\pm 10\%$, 240 Vac $+5\%$ -10%, 48 - 66 Hz

Size: 177 mm H x 425.5 mm W x 574 mm D (6.969" x 16.7" x 22.6")

Weight: Approx. 18 kg (39.7 lbs)

Accessories available

16047A Test Fixture; general purpose, direct coupled

16047B Test Fixture; safety guarded with extension cables

16048A Test Leads; BNC connectors

16048B Test Leads; RF connectors

16048C Test Leads; alligator clips

16034B Test Fixture; for chip capacitors

16023B DC Bias Controller

Options

001: Internal DC Bias Supply, 0 - ± 35 V, 1 mV steps

002: Internal DC Bias Supply, 0 - ± 99.9 V, 100 mV steps

003: Battery Backup for Memory Circuits

004: Frequency steps in 1-3-5 sequence

101: HP-IB data output and remote control

102: HP-IB with isolation

Special options

H01: High speed version (3 digit display); 1-2-4 steps

H02: High speed version (3 digit display); 1-3-5 steps

Additional specific frequency options (no option number assigned):

Selectable arbitrarily from 100 Hz thru 100 kHz on 4274A, 10 kHz thru 10.7 MHz on 4275A.

4274A Multi-Frequency LCR Meter

Price

\$7930

4275A Multi-Frequency LCR Meter

\$8720

¹Varies with test frequency and test signal level. Range for minor parameters of ESR, G, X, B, L and C depends upon range of major L, C and R parameters.

COMPONENT MEASUREMENT

Digital high capacitance meter

Model 4282A

- Wide range—10nF to 1 F full scale
- Dissipation factor or ohm-farad measurements
- Internal bias supply
- Digital and analog outputs for recording



HP-IB



16035A



16036A

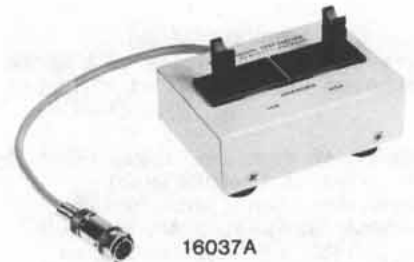

16037A

Description

Hewlett-Packard's Model 4282A Digital High Capacitance Meter can make precision measurements on high value tantalum or aluminum electrolytic capacitors. Applications include both capacitor design measurements and production testing—either in incoming or outgoing inspection.

Two types of leads are supplied with the HP 4282A. One is the standard four-wire alligator clip style, and the other comprises two specially designed clips that maintain the Kelvin four-wire measurement.

Two unique features of the HP 4282A are: alternating mode alternately displays either capacitance and dissipation factor, (C-D), or capacitance and the product of ohms and farads, (C- Ω F) and the capability to double as a three-digit DVM.

Both digital and analog outputs are available for making permanent recordings.

The standard model has four measuring frequencies: 50, 60, 100, 120 Hz. These represent power line frequencies and their second harmonics. Most large value capacitors are used as filters in power supplies and are operated at these frequencies. If your application requires tests at other frequencies, please refer to Models 4260A, 4261A, 4262A, 4265B, 4270A and 4271B on the adjoining pages.

Specifications

Measuring functions: capacitance, dissipation factor, *ohm-farad and dc voltage. Selectable by function switch.

Ohm-farad: the product of the capacitance and equivalent series resistance of the capacitor.

Function switch setting	Function and display
C	Capacitance measurement.
D	Dissipation factor measurement.
Ω F	Ohm-farad measurement.
C-D	Capacitance and dissipation factor measurements (alternately).
C- Ω F	Capacitance and ohm-farad measurements (alternately).
V	DC bias voltage or external voltage measurements.
	Note
	All measurements are continuously repeated as long as unknown is connected.

Measuring ranges:

Function	Full-scale display	Over ranging
C (capacitance)	10.000 nF to 1.0000 F, four full digits, 9 ranges in decade steps, manual selection.	18%
D (dissipation factor)	1.000 to 10.00, three full digits, 2 ranges, auto selection.	18%
Ω F (ohm-farad)	1.000 Ω mF to 10.00 Ω mF three full digits, 2 ranges, auto selection.	18%
V (dc voltage)	10.00 V to 1.000 kV, three full digits, 3 ranges, in decade steps, manual selection (maximum voltage is 600 V).	18%

Measuring circuit: series equivalent circuit using four-terminal method.

Measuring frequencies: 50 Hz, 60 Hz, 100 Hz and 120 Hz (50 Hz and 60 Hz synchronized by line frequency). Accuracy: $\pm 1.5\%$.

Measuring voltages

10 nF to 10 mF ranges: <1 V rms.

100 mF range: <0.1 V rms.

1 F range: <10 mV rms.

Accuracy: (+23°C $\pm 5^\circ$ C after half hour warm up): \pm (% of reading + % of full-scale).

Capacitance

C Range	% of reading	% of full-scale
10 nF	1.0 + 0.9 • Drdg	0.2
100 nF	0.5 + 0.5 • Drdg	0.1
1 μ F to 1 mF	0.4 + 0.5 • Drdg	0.05
10 mF	1.0 + 0.5 • Drdg	0.05
100 mF	1.5 + 0.5 • Drdg	0.5
1 F	2.5 + 0.5 • Drdg	1.0

Dissipation factor

C Range	% of reading	% of full-scale
10 nF	1.5 + 0.5 • Drdg	0.2 • Cfs/Crdg + 0.3
100 nF to 1 mF	1.5 + 0.2 • Drdg	0.2 • Cfs/Crdg + 0.3
10 mF	1.5 + 0.2 • Drdg	0.2 • Cfs/Crdg + 0.5
100 mF to 1 F	1.5 + 0.2 • Drdg	0.2 • Cfs/Crdg + 3

Ohm-farad

C Range	% of reading	% of full-scale
10 nF	1.0 + 0.5 • Ω Frdg	0.2 • Cfs/Drdg + 0.3
100 nF to 1 mF	1.0 + 0.2 • Ω Frdg	0.2 • Cfs/Crdg + 0.3
10 mF	1.0 + 0.2 • Ω Frdg	0.2 • Cfs/Crdg + 0.5
100 mF, 1 F	1.0 + 0.2 • Ω Frdg	0.2 • Cfs/Crdg + 3

Drdg: reading of dissipation factor

Ω Frdg: reading of ohm-farad.

Crdg: reading of capacitance.

Cfs: full-scale of C range setting.

DC voltage measurement accuracy

10 V range: \pm (0.05% of reading + 0.1% of full-scale).

100 V and 1 kV ranges: \pm (0.2% of reading + 0.1% of full-scale).

Temperature coefficient

(referred to +23°C, and temperature range of 0°C to 50°C)

Function	Temperature coefficient
C	$\pm 0.02\%$ of reading/ $^\circ$ C
D, Ω F	$\pm 0.03\%$ of reading/ $^\circ$ C
V	$\pm 0.01\%$ of reading/ $^\circ$ C

Option 001 Leakage Current Measurements adds following capabilities to standard model

Leakage current measurement (I_L)

Range: 1.000 μ A to 10.00 mA, 5 ranges, three full digits.

Overranging: 18%.

Accuracy: 1 μ A range: \pm (2% of reading + 2.0% of full-scale). 10 μ A to 10 mA ranges: \pm (2% of reading + 0.3% of full-scale).

Bias voltages: internal source: 0 to 10 V, 0 to 100 V, 2 ranges, continuously variable over each range. Maximum current is 100 mA for 10 V range and 60 mA (for 1 minute) for 100 V range.

External source: usable up to 600 V dc across ext bias terminals on rear panel.

Protective resistor: 1k Ω for 100 V range and for external bias, 1 Ω for 10 V range.

General

DC bias voltage: 0 to 10 V, continuously adjustable with DC bias control. Maximum charging current is 100 mA.

Balancing time: normally one second (when measuring on C ranges of 10 nF through 10 mF, capacitance value near full-scale, dissipation factor less than one and without dc bias).

Reading rate: continuously variable from 0.3 to 2 seconds with rate control.

Reset: initiates one reading by depressing Reset Int pushbutton or contact closure to ground or TTL low level at reset ext line. Mating plug for reset test jack: HP part No. 1251-0918.

Digital output: output signals: BCD + 1-2-4-8, data parallel, decimal point, function and unit, overload and unbalance, and polarity.

Level

State	Level	Characteristics
Low	0.3 V \pm 0.3 V	Max sink current 15 mA
High	3.9 V \pm 1.5 V	Max load current 300 μ A

Print command output: negative going TTL pulse of approx. 1 ms.

Printer hold input: TTL low level or contact closure to ground.

Connector: mating, HP P/N 1251-0084; Amphenol 57-30360-375 (36-pin blue ribbon).

Remote programming: programmable functions, C-range, I_L range (option 001) and reset by TTL low level of contact closure to ground.

Connector: mating, HP P/N 1251-0084; Amphenol 57-30360-375 (36-pin blue ribbon).

Analog output: DC output of 1 V full-scale in proportion to displayed value.

Accuracy: add $\pm 0.5\%$ of reading to accuracy specification.

Operating environment: 0°C to +50°C, <90% RH.

Power requirements: 100 V, 120 V, 220 V or 240 V $\pm 10\%$, 50 Hz or 60 Hz, approx 70 VA.

Size: 88.1 mm H x 425 mm W x 467 mm D (3½" x 16¼" x 18½").

Weight: net, 8.8 kg (19.5 lb). Shipping, 12.9 kg (28.5 lb).

Accessories furnished

16035A test leads: four alligator clips.

16036A test leads: two alligator-jaw clips.

Power cord: 230 cm (7½ ft), HP Part No. 8120-1378.

Accessories available

16037A: Test Fixture

16413A: HP-IB Interface Kit

Price

\$275

\$3020

Options

001: Leakage current measurement

101: HP-IB Data Output and Remote Control

908: Rack Flange Kit

910: Extra Manual

add \$385

\$3020

add \$10

add \$35

4282A Digital High Capacitance Meter

\$4485

COMPONENT MEASUREMENT

Q Meter Model 4342A

- Frequency range: 22 kHz to 70 MHz
- Q range: 5 to 1000



Description

The direct-reading expanded scale of the 4342A permits measurement of Q from 5 to 1000 and readings of very small changes in Q resulting from variation in test parameters. The 4342A is solid state with the elimination of specially matched, fragile thermocouple components.

The 4342A will measure dissipation factor and dielectric constant of insulating materials. The Q meter can measure coefficient of coupling, mutual inductance, and frequency response of transformers. RF resistance, reactance, and Q of resistors and capacitors can also be determined.

Push button operation of frequency range and Q/ Δ Q range selection provides straightforward measurement. Automatic indication of meter scales, frequency dials and frequency multipliers are featured, adding to simplicity and reading speed.

Specifications

RF characteristics

RF range: 22 kHz to 70 MHz in 7 bands: 22 to 70 kHz, 70 to 220 kHz, 220 to 700 kHz, 700 to 2200 kHz, 2.2 to 7 MHz, 7 to 22 MHz, 22 to 70 MHz.

4342A Opt 001: 10 kHz to 32 MHz in 7 bands: 10 to 32 kHz, 32 to 100 kHz, 100 to 320 kHz, 320 to 1000 kHz, 1 to 3.2 MHz, 3.2 to 10 MHz, 10 to 32 MHz.

RF accuracy: $\pm 1.5\%$ from 22 kHz to 22 MHz; $\pm 2\%$ from 22 MHz to 70 MHz; $\pm 1\%$ at "L" point on frequency dial.

4342A Opt 001: $\pm 1.5\%$ from 10 kHz to 10 MHz; $\pm 2\%$ from 10 MHz to 32 MHz; $\pm 1\%$ at "L" point on frequency dial.

RF increments: approximately 1% resolution.

Q measurement characteristics

Q range: 5 to 1000 in 4 ranges: 5 to 30, 20 to 100, 50 to 300, 200 to 1000.

Q accuracy: % of indicated value: (at 25°C)

Q	4342A & 4342A Opt. 001		4342A
	22 kHz-30MHz		30 MHz-70 MHz
5-300	± 7		± 10
300-600	± 10		± 15
600-1000	± 15		± 20

Q increments: upper scale: 1 from 20 to 100; lower scale: 0.5 from 5 to 30.

Δ Q range: 0 to 100 in 4 ranges: 0 to 3, 0 to 10, 0 to 30, 0 to 100.

Δ Q accuracy: $\pm 10\%$ of full scale.

Δ Q increments: upper scale: 0.1 from 0 to 10; lower scale: 0.05 from 0 to 3.

Inductance measurement characteristics

L range: 0.09 μ H to 1.2 H, direct reading at 7 specific frequencies.

L accuracy: $\pm 3\%$ after substitution of residuals (approx. 10 nH).

Resonating capacitor characteristics

Capacitor range: main dial: 25 to 470 pF; vernier dial -5 to $+5$ pF.

Capacitor accuracy: main dial: $\pm 1\%$ or 1 pF, whichever is greater; vernier dial ± 0.1 pF.

Capacitor increments: main dial: 1 pF from 25 to 30 pF; 2 pF from 30 to 200 pF; 5 pF from 200 to 470 pF; vernier dial: 0.1 pF.

General

Rear panel outputs

Frequency monitor: 170 mV rms min. into 50 Ω .

Q analog output: 0 to 1 V ± 50 mV dc after 15 minutes warmup, proportional to meter deflection. Output impedance approximately 1 k Ω .

Over limit signal output: contact closure at the rear panel. Relay contact capacity 0.5 A/15 VA.

Over limit display time: selectable, 1 s or continuously on, after limit exceeded.

Temperature range: 0°C to 50°C.

Power: 115 or 230 V $\pm 10\%$, 50-400 Hz, 25 VA max.

Size: 129 mm H x 425 mm W x 414 mm D (5 $\frac{1}{16}$ " x 16 $\frac{3}{4}$ " x 16 $\frac{1}{16}$ ")

Weight: net, 14 kg (31 lb). Shipping, 18.45 kg (41 lb).

Accessories available:

HP 16014A: Series Loss Test Adaptor is designed for measuring low impedance components, low-value inductors and resistors, and also high-value capacitors. Using the adaptor adds convenience in connecting components in series with the test circuit of the 4342A Q Meter. This adaptor consists of a teflon printed-circuit base on which are mounted binding posts, to accept the Reference Inductors, and a pair of low-inductance series terminals for the unknown.

HP 16462A: Auxiliary Capacitor is designed to extend the Q and L measurement capability of the 4342A Q Meter. It is especially useful for measuring small inductors at low frequencies.

HP 16470A reference inductors: A range of 20 inductors, any of which can be supplied separately, is available for use with the 4342A Q Meter for measuring the RF characteristics of capacitors, resistors, and insulating materials. These inductors have three terminals. One terminal is connected to the case to stabilize measurements.

Options & accessories

Opt 001: Frequency Range

Opt 910: Extra Manual

16014A Series Loss Test Adaptor

16462A Auxiliary Capacitor

16470A Reference Inductors, set of 20

Price

add \$210

add \$17.50

\$75

\$360

\$1050

or \$53 ea.

4342A Q Meter

\$3080



4800A



4815A

Model 4800A

HP's 4800A measures the vector impedance of components, complex networks, and other two-terminal devices. Besides measuring vector impedance, the 4800A measures component values. At frequencies that are decade multiples of $\frac{1}{2}\pi$, as marked on the frequency dial, L and 1/C are read directly if the phase is approximately $\pm 90^\circ$, respectively. R is equal to the impedance magnitude at frequencies where the phase is approximately 0° . The vector impedance meter also yields Q and inductor values by using either f_0/Δ , R_p/wL or the wL/R_s technique.

The unit is equipped with analog outputs for three parameters: impedance magnitude, impedance phase, and frequency. The rear panel provision for an external oscillator input makes possible swept frequency characterization of "unknown." The impedance meter can be swept over any decade range of frequency and impedance within the range of the instrument.

Specifications

Frequency characteristics

Range: 5 Hz to 500 kHz in five bands: 5 to 50 Hz, 50 to 500 Hz, 0.5 to 5 kHz, 5 to 50 kHz, 50 to 500 kHz

Accuracy: $\pm 2\%$, 50 Hz to 500 kHz; $\pm 4\%$, 5 to 50 Hz; $\pm 1\%$ at 15.92 on frequency dial from 159.2 Hz to 159.2 kHz; $\pm 2\%$ at 15.92 Hz.

Impedance measurement characteristics: 1 ohm to 10 megohms in seven decade ranges from X1 to X10M. Accuracy is $\pm 5\%$ of reading.

Phase angle measurement characteristics: 0° to $\pm 90^\circ$ in 5° increments. Accuracy is $\pm 6^\circ$.

Direct capacitance measurement capabilities: 0.1 pF to 10,000 uF direct reading at decade multiples of 15.92 Hz. Accuracy $\pm 7\%$ of reading for D less than 0.1 at 159.2 Hz to 159.2 kHz; $\pm 8\%$ of reading for D less than 0.1 at 15.92 Hz.

Direct inductance measurement capabilities: 1 uH to 100,000 H direct reading at decade multiples of 15.92 Hz. Accuracy is $\pm 7\%$ of reading for Q greater than 10 from 159.2 Hz to 159.2 kHz; $\pm 8\%$ of reading for Q greater than 10 at 15.92 Hz.

Measuring terminal characteristics: both terminals above ground, ground terminals provided for shielding convenience; binding posts space $\frac{3}{4}$ " at centers.

Waveshape: sinusoidal.

External oscillator requirements: 0.9 V $\pm 20\%$ into 20 k Ω

Recorder outputs

Frequency: level: 0 to V nom.; source impedance: 0 to 1 k Ω nom.; proportional to frequency dial rotation.

Impedance: level: 0 to 1 V nom.; source impedance: 1 k Ω nom.

Phase angle: level: 0 ± 0.9 V nom.; source impedance: 1 k Ω nom.

Accessories furnished: 13525A Calibration Resistor, 00610A Terminal Shield, Vector Impedance Calculator.

Size: 426 mm W x 133 mm H x 467 mm D (16 $\frac{3}{4}$ " x 5 $\frac{1}{4}$ " x 18 $\frac{3}{8}$ ").

Weight: net, 10.8 kg (24 lb); shipping, 13.5 kg (30 lb).

Power: 115 or 230 V $\pm 10\%$, 48 to 440 Hz, 29.7 VA.

Model 4815A

The RF Vector Impedance Meter offers these significant advantages:

- Direct reading of impedance and phase
- Convenient probe for in-circuit measurements
- Self calibration check provides measurement confidence
- Analog outputs for data recording
- Low-level test signal minimizes circuit disturbance

The HP 4815A RF Vector Impedance Meter provides all of the convenience of "probe and read" measurements. In use, the probe is connected directly into the circuit to be evaluated, frequency is selected, and complex impedance is read. This type measurement allows a straightforward adaptation to various jigs and fixtures for special measurements. Where only component values are to be determined, a quick-mount adapter is provided to allow rapid measurements. For critical component applications, the unit to be evaluated may be mounted directly in its working circuit and its value determined in its actual environment, at the frequency of interest.

Specifications

Frequency

Range: 500 kHz to 108 MHz in five bands: 500 kHz to 1.5 MHz, 1.5 to 4.5 MHz, 4.5 to 14 MHz, 14 to 35 MHz, 35 to 108 MHz.

Accuracy: $\pm 2\%$ of reading; $\pm 1\%$ of reading at 1.592 and 15.92 MHz.

RF monitor output: 150 mV minimum into 50 ohms.

Impedance magnitude measurement

Range: 1 ohm to 100 k Ω ; full-scale ranges: 10, 30, 100, 300, 1 K, 3 K, 10 K, 30 K, 100 k Ω .

Accuracy: $\pm 4\%$ of full scale $\pm (f/30 \text{ MHz} + Z/25 \text{ k}\Omega)\%$ of reading, where f = frequency in MHz and Z is in ohms.

Calibration: linear meter scale with increments 2% of full scale.

Phase angle measurement

Range: 0 to 360° in two ranges: $0 \pm 90^\circ$, $180^\circ \pm 90^\circ$.

Accuracy: $\pm (3 + f/30 \text{ MHz} + Z/50 \text{ k}\Omega)$ degrees where f = frequency in MHz and Z is in ohms.

Calibration: increments of 2° .

Adjustments: screwdriver adj. for Magnitude and Phase Zero.

Recorder outputs

Frequency: 0 to 1 V from 0 to 1 k Ω source, proportional to setting.

Impedance magnitude: 0 to 1 volt from 1 k Ω source.

Phase angle: 0 ± 0.9 volt from 1 k Ω source.

Size: 426 mm W, 185 mm H, 476 mm D (16 $\frac{3}{4}$ " x 7 $\frac{1}{4}$ " x 18 $\frac{3}{8}$ ").

Weight: 17.6 kg (net 39 lb), shipping 24.8 kg (55 lb).

Power: 105 to 125 V or 210 to 250 V, 50 to 400 Hz, 50 W.

Accessories furnished:

00600A Probe Socket Accessory Kit: contains BNC Type "N" adapter. Probe Socket, 00601A Component Mounting Adapter, 2 probe center pins, probe ground assembly.

Options

908: Rack Flange Kit

Price

add \$10

Model number and name

4815A RF vector impedance meter

\$4100

4800A Vector impedance meter

\$2500

COMPONENT MEASUREMENT**Digital IC Tester**

Models 5045A, 5046A

- Tests CMOS, ECL, TTL, DTL
- Printed record of IC failures
- Magnetic card programmable
- Tests IC's to 16 pins-24 pins optional

**5045A Digital IC Tester**

The HP Model 5045A is a processor controlled, microprogrammed digital IC Tester. Well suited for high volume incoming inspection as well as engineering evaluation and failure analysis, it's simple enough to be used by an unskilled operator yet it includes capabilities usually found only in large, computer-based test systems. To test a device, all that's required is a preprogrammed magnetic card. Insert the card into the front panel slot, and the tester is ready to provide complete DC parametric and functional verification of one of the many devices listed in our comprehensive program catalog.

To provide a permanent record of individual IC failures as the test is being made, the quiet HP thermal printer has been included in the 5045A to record detailed failure information for every bad IC. Your operator just keeps on testing—the record is automatically kept and can be reviewed later or returned with the bad IC's to the manufacturer.

**Tests all these families
ECL, CMOS, TTL, HTL, DTL**

The universal pin electronics in the 5045A let each pin act as power supply, input, output, or open circuit. This provides the great flexibility and capability needed to test circuits all the way from basic gates to arithmetic logic units, and ROM's. Devices with power supply voltages up to 15 volts or both positive and negative voltages up to 7.5 volts may be tested. As your testing requirements expand to new devices, your 5045A can be easily and inexpensively updated by adding

new program cards. The nominal cost of these cards means that you don't have to be satisfied with testing a small fraction of your circuit types. You can keep your program library complete — and still stay within your budget.

DC parametric and functional tests

The 5045A thoroughly tests devices both functionally and parametrically to ensure that those expensive failures don't get loaded into your PC boards. Functional tests check the ability of the device to correctly operate according to its truth table as the appropriate input stimulus is applied. DC parametric tests check the voltages and currents on device inputs and outputs under various conditions specified by the manufacturer. These tests eliminate almost all defective devices and avoid the expense of finding and replacing bad circuits once they have been soldered into PC boards and perhaps become part of a complex system.

Unique test technique

To provide the accuracy of direct comparison testing without expensive performance or reference boards, the 5045A uses a unique IC simulation technique. The correct functional operation of the device under test is simulated and this simulation is used as a reference. As both the device under test and simulator are driven with the same inputs, their outputs are compared on a step-by-step basis. If a failure occurs, the 5045A can indicate exactly where it happened by printed message or can stop on the failure so the fault can be investigated in more detail.

Economical ROM testing

To test the many different truth tables which may be programmed in ROM's of the same generic type, it is not necessary to buy a card for each one. A single card containing stimulus information for the generic ROM type is loaded into the 5045A and the unique truth table of a known good ROM is "memorized" by the 5045A. The complete program is then recorded on a blank card for future use. Duplicates of any card may be made from the original by programming the 5045A, pressing "write", and then inserting a blank card.

Automatic IC handlers

The 5045A was designed to work with automatic IC handlers needed for high volume testing. The special circuits which generate the fast rise and fall times for testing digital circuits are in a removable test deck which can be placed within inches of the IC being tested. Problems caused by long cables between handler and tester—ringing, oscillation, slow rise/fall times—are eliminated.

HP in cooperation with major automatic handler manufacturers, has designed custom interface kits for popular handlers. So, interfacing the 5045A and a handler requires nothing more than plugging the two together.

Printer gives permanent copy of test results

A built-in thermal printer provides useful test information: a) it tells whether a program is loaded correctly and what program it is, b) it records the number of failed and passed IC's, and c) it provides failure analysis information for each failed IC.

In its failure analysis modes, the printer can provide very detailed information; a special voltage/current printout, for example. This makes the printer a digital multimeter PLUS!

Self test feature

In an incoming inspection or production environment it is important to know your equipment is operating as it should. The tester has self-test cards to automatically exercise all major circuitry (the drivers and receivers for all pins, the central processor, the memory, and associated circuits). This way, you know every day that the tester is functioning correctly and that none of those bad IC's are getting into your production run, and cutting into your company's profits. Also included are diagnostic cards.

Ordering the pre-programmed magnetic cards

The 5045A is programmed by pre-recorded magnetic cards available from HP. These cards, covering most common device types, are listed in our IC PROGRAM CATALOG. This catalog contains a wide variety of logic families and includes the majority of common device types. When additional programs are needed after the original purchase, they may be ordered through your local HP sales office or by mail with a prepaid coupon.

Each IC program ordered comes complete with both PASS/FAIL and DIAGNOSTIC test cards and includes duplicates of each. The PASS/FAIL test is used for the majority of testing since it is complete and fast (typical test time for MSI sequential devices is 300 ms). The DIAGNOSTIC test provides extra information by supplementing the PASS/FAIL card. Data sheets containing test descriptions and all parameters are included for both PASS/FAIL and DIAGNOSTIC cards.

Condensed Specifications

Test set-up method

Test conditions including parametric information, input stimuli and output data contained on magnetic card; program verified when loaded.

Test structure

Functional test: truth table verified by comparing device under test to software-generated IC simulator (or, stored truth table for some circuits).

Parametric test: DC parameters tested to IC device manufacturers data sheet specs, except where limited by 5045A capabilities. Test limits indicated on sheet sent with each program card.

Continuity test: verifies pin contact by checking current flow in or out of active pins; test failure shown by front panel indicator.

Test pattern generation

Test patterns derived using algorithmic techniques or from stored truth tables; tests individually tailored to each IC.

Universal pin drivers

Same circuit drives or monitors each pin whether an input, output, power supply, clock or open. Voltages and currents individually programmable for each pin. No external test fixtures required.

Voltage applied to the device under test (Supply Voltage, Input Voltage, and Output Voltage)

Range (15 Volts)	Accuracy
-7.5 V ≤ to < -1.875 V	± 25 mV
-1.875 V ≤ to ≤ +1.875 V	± 15 mV
+1.875 V < to ≤ +7.5 V	± 25 mV

Current applied to the device under test (Supply Current, Input Current, and Output Current)

Range	Accuracy*
-200 mA ≤ to < -2.5 mA	± 0.4 mA or ± 6%
-2.5 mA ≤ to ≤ 2.5 mA	± 10 μA or ± 6%
2.5 mA < to ≤ 200 mA	± 0.4 mA or ± 6%

*whichever is greater

Slew rate: 30 ns/volt.

Rear panel outputs

Automatic handler interface: 14 pin Amphenol connector provides +5 V @ <100 mA, "End of Test", "Pass", "Fail", and "Fail Continuity" signals, accepts "Start Test". All signals are negative true TTL levels.

General

Power: 100/120/200/240 V (+5%, -10%), 48-66 Hz, 240 VA.

Size: 19 H x 42.5 W x 58 cm D (7.5" x 16.7" x 22.8").

Shipping weight: 27.7 kg (61 lb.)

Operating temperature: 0°C to 50°C.

Relative humidity: 80%.

Prices: see page 103.

5046A Digital IC Test System

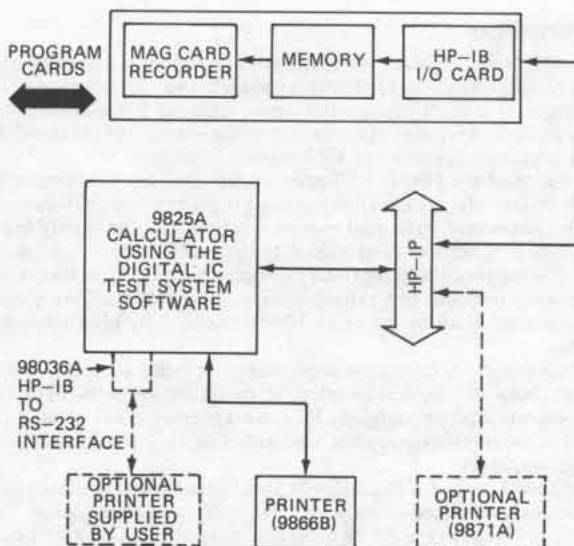

5046A Digital IC Test System Functional Block Diagram

COMPONENT MEASUREMENT

Digital IC Test System

Models 5045A, 5046A (cont)

- Modify existing device programs
- Generate one-of-a-kind device programs
- Change test parameters quickly, simply
- In-house programming—on your own schedule



Description

The HP 5046A Digital IC Test System gives you capability previously available only at the factory: the ability to write or change IC test programs to meet your special needs. Also, the 5046A consists of the same equipment used at the factory to generate all of the standard device programs listed in our IC Program Catalog.

Built around the 5045A IC Tester, 9825A Desktop Computer and 9866B Printer, the system allows you to program proprietary devices, change parameters, write your own special programs, or modify existing device programs to meet special testing needs. This helps you to keep information about proprietary devices confidential, it saves time by allowing in-house programming capability, and it allows you to evaluate devices, all by use of an HP-IB based, fully programmable system.

In incoming QA inspection departments, quality control is a key concern. New IC's need to be tested to assure conformance to design requirements—bad or marginal IC's can generate great costs if installed in production equipment, and sometimes IC specifications can change overnight.

The 5046A provides flexibility in these areas because device programs can be changed quickly and simply by a few keystrokes. The user simply loads in the device program, using either a magnetic card or a tape cassette, lists the program, keys in the changes and generates a new program.

The 5046A system is a complete system consisting of hardware and software—it is fully integrated, specified, documented and tested as a

system prior to shipment. For easy on-site installation and verification, full hardware and software manuals are provided. The operating and programming manual, for example, is written to three different levels, each progressively deeper, to enable easy start-up and operation, quick comprehension of the operating system and its hardware, and complete self-instruction on the system software.

Each system requires a printer for operation; the 5046A includes a Model 9866B Thermal Printer as standard equipment, and the Model 9871A Impact Printer is also available as an option (Opt 001). Other RS-232 compatible printers, supplied by the user, can be interfaced to the system in lieu of the 9866B by ordering the HP-IB to RS-232 interface (opt 002).

Software

The 5046A system software is stored on one standard 9825A tape cassette. The programs are accessible using the special function keys on the desktop computer. The software package consists of the following programs:

The **Editor** provides the capability to:

1. Enter IC test programs from the 9825A keyboard.
2. Read in source program from the 9825A cartridges.
3. Modify source programs.
4. Store source programs on 9825A cartridges.
5. Provide on-line editing.
6. Print-out listing of source programs.

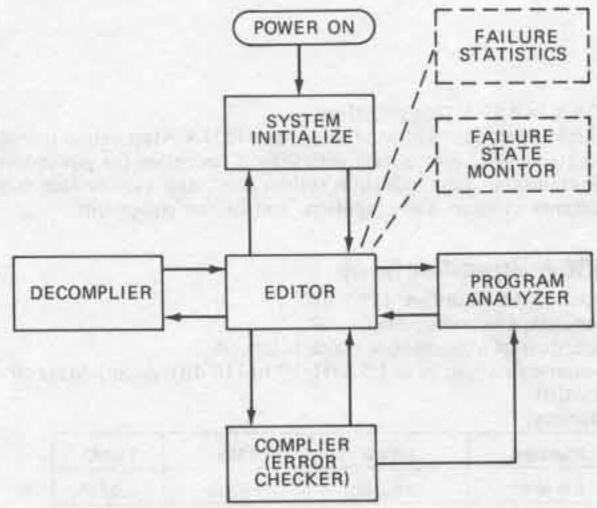

5046A Digital IC Test System Software Organization

- The Compiler** provides the capability to:
1. Do syntax checking on source program statement.
 2. Convert the source program into an object (machine code) program.
 3. Output the object program to the 5045A IC Tester.
- The Decompiler** provides the capability to:
1. Read an object program from the 5045A IC Tester.
 2. Generate the corresponding source program.
- The Program Analyzer** is used for error checking and debugging source program. It interrogates the 5045A IC processor as it is run through a completed test program, then prints the following:
1. Listing of actual test sequence.
 2. Programmed test parameters for each pin in each test.
 3. The "1" and "0" logic state for each pin in each test.
- The Failure Statistics** program provides the following:
1. Printout of failure by pin for each specific test failed.
 2. Summary of failure and failure percentage for each test in the program.
- The Failure State Monitor** program interacts with the 5045A while an IC is being tested. When a failure is encountered, it displays the state in which the IC failed.

The Operating and Programming Manual provides detailed information and modular program examples that enable the user to quickly and easily learn the 5046A programming language (it isn't necessary to learn the 9825A HPL language in order to generate IC test programs).

To generate an original IC test program, the user need only understand the IC technology of the device under test (DUT) and be able to design simple logic circuits using Boolean techniques.

The manual provides step-by-step instruction for programming. In addition, individual chapters in the manual cover the HP test philosophy and testing techniques used with the TTL, ECL, CMOS and DTL technologies.

Ordering information	Price
5045A Digital IC Tester: standard 16-pin version; includes self-check and diagnostic cards, 16 and 24 pin dummy IC's and socket adapter.	\$9,500
5046A Digital IC Tester System: basic system includes 5045A IC Tester, 9825A Option 001 Desk Top computer with 98210A and 98213A plug-in ROM's, Programming Interface, 98034A HP-IB Interface and Model 9866B, Option 025 Thermal Printer, Programming Manual and 40 blank magnetic program cards.	\$25,000

Options and accessories, 5045A/5046	Price
Opt 024: expands 5045A capability to 24 pins	\$2,000
Opt 025: Flat-Pack adapter for 14, 16 and 24 pin IC	\$225
05045-90003: Card Holder, One Each	\$1
05045-90027: Card Holder 50 ea of 05045-90003	\$25
5952-7499: Program Catalog	N/C
9164-0071: blank magnetic PASS/FAIL program card	\$2
9164-0072: blank magnetic DIAGNOSTIC program card	\$2
9281-0401: 250 foot roll of thermal printer paper for 5045A (minimum order, six rolls)	\$2.70 ea.
9270-0488: 250 foot roll of thermal printer paper for 9866B (minimum order, six rolls)	\$11.50 ea.
10845A: preprogrammed magnetic card for any device listed in the <i>Program Catalog</i> HP Publication Number 1-9	\$40 ea.
5952-7499)	10-500 \$35 ea.
10846A: book containing ten coupons, each redeemable for one IC program listed in the <i>IC Program Catalog</i> (HP Publication Number 5952-7499). Coupons are mailed to factory, programs sent by return mail. Coupons expire after two years	\$350

Automatic Handler Options, 5045A/5046A	Price
Opt 004‡: interface package for IPT Model 806 automatic IC handler	\$1,000
Opt 005‡: interface package for Sym-Tek model 7191ND automatic IC handler and other related models	\$1,000
Opt 006‡: interface package for Daymarc 952/3 automatic IC handler	\$1,000
Opt 007‡: interface package for Micro Component Technology Model 2604/8 automatic IC handler	\$1,000
Opt 008‡: interface package for Delta Model 8040 ambient naked DIP handler	\$1,000
Opt 009‡: interface package for Control Model H310 automatic IC handler	\$1,000
Opt 010‡: interface package for PAE Model 3033LP naked DIP handler	\$1,000
Opt 013‡: interface package for TRIGON Model T2000 multi-size Ambient Test Handler	\$1,000

‡: All interface packages include a test head extender cable, an interface board unique to the particular handler, and a cable to supply control signals to the handler.

Options and accessories, 5045A only	Price
10844A: programming interface retrofit kit; contains all necessary parts, cables, interface board, and instructions to modify the 5045A for use in the 5046A Digital IC Test System. Programming manual and 40 blank magnetic program cards included.	\$2,475

Options and accessories, 5046A Only	Price
Opt 001: Substitute Model 9871 impact printer for 9866B and 98226A	-\$275
Opt 002: Substitute 98036 HP-IB to RS-232 interface for 9866B and 98226A	-\$3,275
Opt 125#: Delete Model 9825 desk top computer, 98034A, 98210A, and 98213A	-\$9,150
Opt 145#: Delete Model 5045A IC Tester from system	-\$9,500
Opt 166#: Delete Model 9866B, Option 025, and 98226A cradle from system	-\$3,875

Only one of these options can be on any one order.
 *The 5046A system should have a 9866A/B or 9871 (Opt 001) printer, or 98036 (Opt 002) HP-IB to RS-232 interface.

COMPONENT MEASUREMENT

Decade capacitors and attenuators

Models 4440B, 4436A, 4437A, 350D



4440B



4437A

4440B Description

The Hewlett-Packard 4440B Decade Capacitor is a high accuracy instrument providing usable capacitances from 40 pF to 1.2 μF. Its 0.25% accuracy makes it an ideal aid for circuit design or as a working standard.

Use of silvered-mica capacitors in four decades of 100 pF provides higher accuracy, lower dissipation factors and good temperature coefficient. An air capacitor vernier provides 100 pF (from 40 pF to 140 pF) with resolution of 1 pF. Capacitors are housed in a double shield in such a way that increased capacitance from two terminals to three terminals is held to 1 pF.

4440B Specifications

Capacitance: 40 pF to 1.2 μF in steps of 100 pF with a 40 pF to 140 pF variable air capacitor providing continuous adjustment to better than 2 pF between steps.

Direct reading accuracy: ±(0.25% + 3 pF) at 1 kHz for three-terminal connection.

Resonant frequency: typical values of the resonant frequency are 450 kHz at 1 μF, 4 MHz at 0.01 μF and 40 MHz at 100 pF

Dissipation factor: for C > 1040 pF, 0.001 MAX at 1 kHz.
for C < 1040 pF, 0.005 MAX at 1 kHz.

Temperature coefficient: < +70 ppm/°C.

Insulation resistance: 5 GΩ minimum, after 5 minutes at 500 V dc.

Maximum voltage: 42 V dc or 30 V rms.

Weight: net 2.5 kg (5½ lb); shipping 3.6 kg (8 lb).

Dimensions: 76 mm H x 264 mm W x 152 mm D (3" x 11" x 6").

4436A/4437A Description

The Hewlett-Packard Models 4436A/4437A Attenuators provide accurate steps of attenuation with 0.1 dB resolution for power-level measurements, communication system tests, and gain or loss measurements on filters and amplifiers, and similar equipment.

4436A Specifications

Maximum attenuation: 119.9 dB.

Attenuation increments: 0.1 dB.

Input/output impedance: 600Ω, balanced.

Frequency range: dc to 1.5 MHz (0 to 110 dB); dc to 1 MHz (0 to 119.9 dB).

Accuracy:

Attenuation	100 kHz	1 MHz	1.5MHz*
0 to 60 dB	±0.1 dB	±0.2 dB	±0.2 dB
60 to 90 dB	±0.1 dB	±0.3 dB	±0.3 dB
90 to 110 dB	±0.2 dB	±0.5 dB	±0.5 dB
110 to 119.9 dB	±0.3 dB	±1.0 dB	

*Typical value

Maximum input power: +30 dBm.

DC isolation: signal ground may be ±300 V dc from external chassis.

Size: 76 mm H x 198 mm W x 177 mm D (3" x 7¾" x 6⅞").

Weight: net, 1.7 kg (3⅞ lb). Shipping, 2.9 kg (6½ lbs).

4437A Specifications

The Model 4437A is a 600 ohms unbalanced type, and its specifications are identical to the 4436A.

350D Description

Two attenuator sections make up the Hewlett-Packard 350D Attenuator. One section is a 100 dB attenuator, adjustable in 10 dB steps. The other is a 10 dB attenuator, adjustable in 1 dB step.

350D Specifications

Attenuation: 0 to 110 dB, 1 dB and 10 dB steps.

Power capacity: 600Ω unbalanced; 5 W (55 V dc or rms) max, continuous duty.

DC isolation: signal ground may be ±500 V dc from chassis.

Accuracy

10 dB section

	0 dB	10 dB
dc to 100 kHz		< ±0.125 dB/at any step
100 kHz to 1 MHz		< ±0.25 dB/at any step

100 dB section

	0 dB	70 dB	100 dB
dc to 100 kHz		< ±0.25 dB	< ±0.5 dB/at any step
100 kHz to 1 MHz		< ±0.5 dB	< ±0.75 dB/at any step.

Dimensions: standard HP ⅓ module (system I) 159 mm H x 130 mm W x 203 mm D (6¼" x 5⅞" x 8").

Weight: net, 1.8 kg (4 lb). Shipping, 2.7 kg (6 lb).

Ordering information

	Price
4440B Decade Capacitor	\$740
4436A Attenuator	\$1085
4437A Attenuator	\$740
350D Attenuator	\$250



Production testing of electronic printed circuit board assemblies

All electronic production processes are similar. Each step of the production process is subject to a level of testing. These major steps are parts receiving, printed circuit board assembly, final product assembly, and customer incoming inspection. The level of testing is a function of philosophy, problems encountered, costs, and resources. There is a very high incentive to catch faults as early in the production process as possible because the cost of finding a fault escalates by a factor of 10 for each step.

Production environment

The desired end product of any electronic product manufacturer is a high turn-on rate for the final assembly when all of the elements and PC boards are installed. The key to high turn-on rates in the final product is high yield at printed circuit board assembly. The probability of good PCB's depends on two factors:

1. selecting all good parts.
2. installing these parts without introducing process problems, such as misloaded or damaged parts.

How much testing and where?

The big question facing the production engineer is how much testing and where to catch faults early. The good parts are the first step to a good PCB, but is 100% incoming inspection needed? The probability of selecting all good parts for a PCB is $P_n = (P)^n$ where P is the probability of a good part. For example, if incoming inspection is performed on all lots of incoming parts to screen defects to less than 1% for each lot, and a typical PCB assembly contains 100 parts, then, $P = 0.99$, $n = 100$, $P_n = (.99)^{100} = .37$. The yield at the end of the assembly line, if no other manufacturing defects were introduced, is 37%. This is a strong incentive to increase incoming parts inspection to increase production yield. The following set of curves reflect the severe demand electronic PCB production places upon incoming parts inspection.

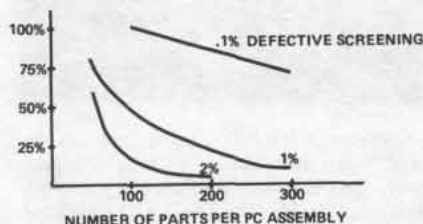

Several other variables become important as soon as the components are placed together to form the PCB assembly. Experience at HP indicates that defective parts only account for 40% of the reasons why PCB's fail after assembly. A new set of problems must be dealt with at the board assembly level and cannot be eliminated by 100% incoming inspection. Some of these typical problems are handling breakage, misloaded parts, incorrect parts loaded, soldering problems, PC board problems such as shorted traces, and

heat damage to the parts as they are being assembled. It is mainly this factor that determines the amount of cost and manpower that should be devoted to incoming parts inspection.

The objective of these activities is to maximize the probability of system turn-on. Good parts and PC test reduce the problem level at final product test. Of course, the same statistical relationship that held for parts assembly also holds for final assembly. It is here that the need for effective board testing becomes apparent. The only way to improve final product yield is to improve the quality of the PCB assembly. This is directly related to the quality of the test being applied to the PCB.

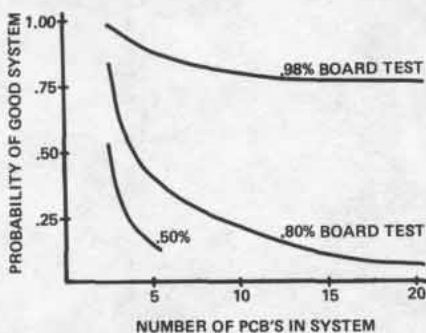

Ideally, if there are one hundred potential faults that could occur on a PCB, the test for that board should be able to exercise the PCB in such a manner that all 100 faults could be discovered if they occurred. The set of statistical curves for final assembly look identical to those of PCB assembly.

It is easy to deduce that increased system complexity places a great demand upon the quality of the board and the test being applied to the PCB.

There are many different approaches to testing PCB assemblies commercially available. Each method has advantages and disadvantages and are being improved on an ongoing basis. Certain techniques are better suited for specific types of boards. As a generality, testing analog and mixed analog and digital circuitry is a hardware intensive activity. That is, a collection of sophisticated programmable stimulus response units and power supplies are needed to examine and test analog and hybrid circuitry.

Complex digital circuitry requires a good deal of computational capability. The problem here is to determine the bit stream that should be applied to adequately test the board and what the proper response bit pattern should be. Also, if the response is different from what is expected, what information does that difference convey?

In-circuit versus functional testing

The distinction between these two methods of testing is easily understood. In-circuit testing can be defined as a power-off automatic inspection system. Functional testing applies power to the board and discerns if it is operating as it was designed.

In-circuit testing is actually a type of process monitoring which is most effective in identifying solder shorts, board problems, and measuring resistors, capacitors, orientation of diodes and transistors, locating bad parts or incorrect parts. In applications where both in-circuit and functional testing is used in tandem, it was found that as the content of discrete components increased, the production yield through in-circuit testing decreased and the yield at functional test increased.

Conversely, as the number of active components increased on a board, there was a higher yield at in-circuit test and lower functional test yield. In all cases, the combination of in-circuit and functional testing was most effective for analog/hybrid boards.

Because of the different nature of digital boards, a functional tester with fault resolution to the node level will often eliminate the need for in-circuit testing.

Functional performance testing is a means of maximizing PCB yield, which results in a high turn-on rate in final test. Even with good in-circuit fault coverage, board level functional testing is necessary for high yield PCB's.

The addition of board level functional testing to in-circuit testing can significantly increase the probability of a good product in final test. Small increases in PCB testing confidence results in large increases in PCB production yield.

Balanced testing

One hundred percent testing at all stages in the production process is expensive and inefficient. This balance must be tailored to individual problems and requirements. Thoughtful consideration of testing requirements will improve product yield and at the same time reduce costs. Other benefits are a smoother production line and lower test and troubleshooting times.

HP's electronic manufacturing experience has led to the development of two major automatic board test products, the HP 3060A and the DTS-70. Each system approaches the problem of PCB testing differently, focusing upon the different types of boards being manufactured. The HP 3060A is a combined in-circuit and functional analog/digital board test system, and the DTS-70 is a simulator based digital board test system.

Chart 1

	3060A	DTS-70
In-Circuit	X	
Bed-of-Nails	X	
Edge Connector		X
Functional Analog	X	X
Functional Digital	X	X
Signature Analysis	X	
Board Simulator		X
HP-IB	X	X
Controller	HP 9825A	System 1000

CIRCUIT TEST SYSTEMS

DIGITAL PC BOARD TEST SYSTEM

Model DTS-70

- High Speed, High Volume Digital Testing
- Isolate Faults Quickly and Easily
- Eliminate Production Bottlenecks

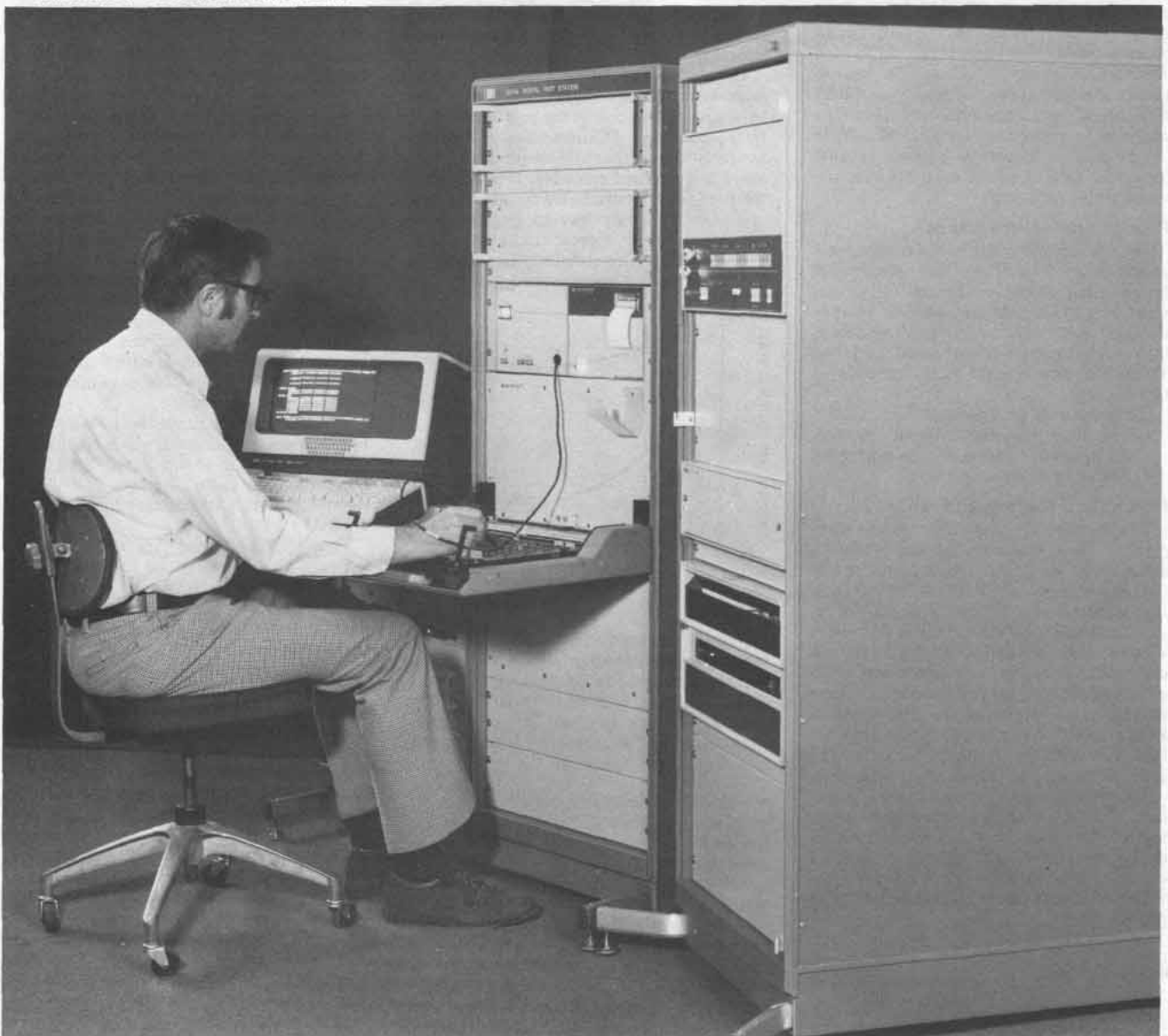

Description

The DTS-70 Digital Printed Circuit Board Test System can solve your digital board testing needs. The DTS-70 can test your boards and isolate faulty components in seconds. Typical tests take only a few seconds and isolation of the failed component typically takes less than a minute. All this testing is performed to a known level of test effectiveness. The TESTAID board simulation software, provided with the system, enables you to model and test the largest and most complex of your digital printed circuit boards and to determine the overall effectiveness of your testing process, a benefit not possible on hardware comparison testers. The FASTRACE fault isolation software guides your test operator to probe for the faulty component quickly and easily, all but eliminating costly manual troubleshooting.

The DTS-70 System is a complete system consisting of the 9571A Test Station, the HP 1000 System computer and a complete software package. The 9571A Test Station comes complete with digital test unit, programmable power for your board under test, and fault isolation probe. The test station is expandable to do added analog testing

that may be required. The field proven HP 1000 System includes the 21MX Series E computer and 7906A disc. The HP 1000 System provides both testing and software test generation expandability through the Real Time Executive operating system. The TESTAID simulator software and FASTRACE fault isolation software provide powerful test generation capability and advanced fault isolation which even enable you to isolate intermittent faults.

The DTS-70 is a test system with the capability, expandability, and reliability you expect from HP.

No more Production Down-Time to Develop Test Programs

The multi-terminal capability of the DTS-70 allows you to generate test programs without shutting down testing on your production line. No longer do you have to choose between production shut downs and spending tens of thousands of dollars for off-line test generation capability. All you need is a relatively inexpensive terminal. Need more programming capability to keep up with new boards? Add up to six terminals to the DTS-70 for use as programming stations.

Model Your Designs in R & D

Catch costly design and testability problems before they become designed-in problems. The DTS-70 TESTAID simulator software models the behavior of your designs, points out testing trouble spots, and predicts race and hazard conditions to your designers. Simulation at the design stage can prevent marginal designs and designed-in problems from reaching your end-users, preventing high warranty costs or costly on-site repairs.

High Speed, High Volume Digital Testing

Test complex boards in only seconds compared to the minutes or even hours necessary for manual test and fault isolation. The DTS-70 is capable of testing tens of thousands of PC assemblies a month for high through-put requirements.

Isolate Faults Quickly and Easily

Troubleshooting and isolation of faulty components is done automatically. The computer instructs your test operator to isolate the fault in seconds using the guided probe. Avoid time-consuming manual fault diagnosis and reduce the need for highly skilled technicians.

Eliminate Production Bottlenecks

The DTS-70 can test those complex boards that are so hard to troubleshoot at your final product test station and which hold up your shipments. The DTS-70 is capable of testing complex boards with over 200 MSI components.

How Effective is Your Test?

Only a simulator-based tester such as the DTS-70 can tell you how effective your tests are. Testing of complex digital assemblies is difficult and ordinarily does not provide this kind of feedback to the test programmer. As a result, the test programmer does not know when to stop test development. The DTS-70 not only tells you how effective your test is, but also which nodes on the board need further attention. This has improved test quality over manual test generation methods by factors of two or more.

Worldwide Service

The DTS-70 Digital Test System is designed and manufactured by Hewlett-Packard and is backed up by HP worldwide support. HP recognizes that in a high volume production environment, each hour of operation affects a large portion of your profit dollars. When you take delivery of a DTS-70 system, the following support is available to you, worldwide, to keep your system working for you.

Installation

Installation services will be provided with each purchase of a DTS-70 Test System. These services consist of site preparation data in advance of system delivery and installation when your system arrives.

Warranty

A complete warranty program covers the complete DTS-70 system for 90 days beyond the system installation date. This warranty provides complete repair service during the warranty period.

Customer Assistance Agreements

For system support beyond the warranty period, Customer Assistance Agreements are offered for hardware support and software support. You may select these services together or you may tailor a service program to match your individual needs. With the exception of extremely remote areas, these support programs are available throughout HP's worldwide service organization.

Documentation

Every DTS-70 System is delivered with a complete set of operating and service documentation. The documentation set includes system level manuals, instrument level manuals, software manuals and quick reference guides.



Training

A digital test programming course is included for customer personnel responsible for developing test programs. This 10-day course teaches system operation, FASTRACE fault isolation and emphasizes use of TESTAID to generate digital test programs. Two enrollments are provided with the purchase of a DTS-70 system.



Field Support Package

For those DTS-70 users who choose to do their own servicing, HP offers special field support packages in the form of service kits that contain replacements assemblies. These service kits are designed to allow a user to support his DTS-70 system. For more information on these field support packages, contact your local HP field engineer.

Ordering Information

DTS-70

(Depends Upon Test Configuration)

Price

Complete System Starts At \$90,000

CIRCUIT TEST SYSTEMS

In-circuit/functional test system

Model 3060A

- Increase PCB yields
- Advanced in-circuit testing
- Board level analog/digital functional testing
- Reduce production costs



3060A

Description

A new, automatic printed circuit board testing system permits greater fault coverage for in-circuit testing as well as a wide range of analog and digital function testing tools to maximize yields. This system, called the HP 3060A Board Test System, incorporates state-of-the-art measurement processing and interfacing technology combined with years of internal experience in board testing.

The 3060A has the ability to perform both advanced in-circuit component tests and board level functional stimulus/response tests. This new dimension in testing efficiency allows the testing of Printed Circuit Boards (PCB's) to a higher level of confidence all in a single operation. Not only is the board handling minimized, but the added expense of two test systems is eliminated. The 3060A not only promises broad functional testing, but delivers a complete test capability as standard equipment. For example, the 3060A can perform functional tests on a digital-to-analog converter using both analog and digital functions.

Combining board level functional testing with in-circuit tests can significantly increase yields. For example, a 15% increase in board yield from 80% to 95% through the addition of functional testing increases system yield by 100% for a five board system. This leverage is even greater for more complex systems.

Testing power

Components and component configurations, which were previously not testable, can be tested with HP's 3060A. The addition of extended guarding, phase-synchronous detection, and accuracy enhancement make this level of testing possible.

Functional testing is accomplished on the same fixture used to perform in-circuit component measurements. Increased productivity results since boards are only handled once for all tests. The 3060A offers a wide range of functional testing capability, both analog and digital. Signals up to 1 MHz can be multiplexed through the scanner to and from the board under test. Flexibility in analog testing allows the use of sources and detectors which are standard on the HP 3060A, or instruments can be easily added for special test requirements. A "bed-of-nails" interface provides direct hardware connection to each node of the board under test. This approach not only provides the necessary visibility for component measurements in-circuit, but simplifies digital testing as well. The response of the circuit to digital stimulus is available at these nodes. The need for a manually guided probe is eliminated.

Board test sequence.

The HP 3060A follows a logical testing sequence which places a minimum stress on the board and minimizes testing time. Since the majority of PCB problems may be detected by shorts testing and in-circuit testing, these tests are performed first. By terminating the test sequence when shorts or faulty components are located, redundant functional testing is avoided. In addition, potentially catastrophic failures, caused by applying power to a defective PCB, are avoided. Finally, programmable power supplies are turned on for functional testing of both analog and digital circuits. This sequence gives maximum confidence that the PCB is working properly while minimizing test time and reducing the risk of PCB damage.



3060A BOARD TESTING

Shorts testing

Shorts testing depends on the bed-of-nails fixture for access to all circuit nodes on the board. This approach allows direct testing for

manufacturing defects such as solder splashes and open traces. Since these can be a significant portion of all faults and can be identified very quickly, the 3060A shorts tests are very valuable. Software to generate shorts tests is greatly simplified by two specialized programming instructions supplied with the 3060A. During the programming phase, a table of shorts and opens is generated from a known good board with the "shorts table" command and stored on flexible disk memory. To run a shorts test in production it is only necessary to load the shorts table from the disk and execute the "shorts" command. The shorts testing algorithm is optimized to make the test with a minimum required number of measurements. Discrepancies between the board under test and the shorts table are automatically listed.

In-circuit testing

In-Circuit testing verifies that discrete components, such as diodes and resistors, are correctly loaded on the PCB and are functioning within specified tolerances. Bed-of-nails fixturing provides access to each circuit node and the system sequentially tests each part for placement, valve tolerance and in the case of transistors, for beta. Accurate in-circuit tests are not practical without isolating each part from the effects of parallel paths. This component isolation is called guarding. The 3060A not only uses the simple guarding found in other systems, but offers advanced in-circuit techniques, such as extended guarding and accuracy enhancement. Extended guarding removes the effects of lead length and relay contact resistance and accuracy enhancement removes the effects of scanner thermal offsets. These advanced measurement techniques mean a greater range of components can be tested to a better accuracy. This means higher board yields.

Analog functional test

After shorts and in-circuit testing are completed, a board level functional test adds confidence that it will work when installed in the finished product. The 3060A simulates the environment of the finished product by applying power and the necessary stimulus response tests. This active testing finds problems missed by in-circuit and shorts testing and allows the tuning or adjustment of complete circuits.

Digital functional test

The 3060A has two separate digital test capabilities: Static pattern testing and dynamic Signature Analysis. Static pattern testing is ideally suited for testing combined digital and analog circuits such as A to D and D to A converters. Signature Analysis (SA) adds the capability of testing LSI circuits including microprocessor based boards at full operating speeds (up to 10 MHz). In addition, a portable HP 5004A Signature Analyzer can be used to troubleshoot these same boards when the finished product requires field service.

Signature analysis

SA is a method of toggling a board's key nodes using a special test program stored in the board's ROM or RAM. The program stimulates these nodes and the 3060A looks for correct activity in the form of correct "Signatures." "Signatures" are the last four hexadecimal digits of a large number for a given time interval. A fault can be traced to a specific device by checking the signature from point to point and comparing each with the correct signature stored in memory. This process resembles troubleshooting by checking a series of voltages on a schematic with a DVM.

Real and imaginary

Phase-synchronous detection adds a new capability to in-circuit testing. It is now possible to separate parallel reactances via measurement. The detector measures the real and reactive portions of the current through the unknown. The impedance contributions of the resistive and reactive elements in parallel are separated, allowing both components to be measured accurately in-circuit.

Many errors are created by components in parallel with the component under test and may be removed through guarding and phase-synchronous detection. These unique capabilities provide the test programmer with the tools to test a broad spectrum of circuit configurations.

Extended guarding and accuracy enhancement

All relays and scanner configurations have some contact resistance and thermal offsets. New capability available with the 3060A re-

moves these effects—extended guarding and accuracy enhancement. Extended guarding provides the option of remote sending; i.e., accurate measurements of voltage directly at the unknown. This has the effect of removing the contributions of lead resistance from the measurement.

The scanner thermal design minimizes thermal EMF's caused by temperature differences. In addition, any remaining offset is compensated for in the measurement. This accuracy enhancement, made automatically, stores in memory measurement Op-Amp offsets for use in enhancing the accuracy of in-circuit component measurements.

Fast programming

HP's 3060A reduces overall production test costs and programming time through a powerful, high level software called Board Test Language (BTL). As a further aid, the 3060A offers an In-Circuit Program Generator (IPG). IPG automatically generates the in-circuit portion of the program, prints out the finished program in BTL, and generates a fixturing map.

HP's 3060A uses the HP 9825A Desktop Computer for system programming and control. The 9825A provides easy programming with minimal training through its High Level Programming Language (HPL).

HPL is a highly versatile, easy to use language. Its programming statements consist of combinations of several common languages optimized for power and efficiency in controlling instruments, performing data manipulation, controlling input/output operations, and storing information. A set of over 40 high level PC board testing program statements (BTL) specifically designed for efficient 3060A application program writing, complements the power of HPL.



Support

The 3060A Board Test System is backed up by HP's worldwide network of sales and service centers including board test specialists. In addition, a complete range of support services and materials are available to you such as: on site turn-on, complete warranty program, extensive operating/service documentation and factory training.

3060A Board Test System

Standard system including 384 analog pins, 32 digital driver pins, and 32 digital receiver pins

\$74,000

DIGITAL CIRCUIT TESTERS

Signature Analysis, IC Troubleshooters, Digital Education



Signature Analysis

Designing for serviceability

Today's microprocessor-based products are complex, high-density systems which can be just as difficult to troubleshoot and repair in the field as large computer systems. In order to reduce product service and support costs, manufacturers are including such service-oriented features as test points, self check modes, circuit partitioning and thorough service documentation. Now a new measurement technique, Signature Analysis, enables digital designers to develop products which are field serviceable to the component level. Incremental design and production costs for including SA are negligible, and result in significant service support cost savings.

Signature analyzer

The new Model 5004A Signature Analyzer is an economical tool for field troubleshooting of complex logic circuits. It detects and displays digital signatures unique to the bit streams present at data nodes of a circuit under test. By comparing these actual signatures to the correct ones, a service technician can isolate a faulty component and replace it. The technique is especially useful in checking microprocessor-based products and high-speed state machines, where data streams are long and complex and where there are no conventional means of component-level troubleshooting.

By designing the digital portion of a product with the 5004A in mind, you can set up a service support program for component-level field repair, without having to invest in board exchange or in special-purpose test equipment.

Signature Analysis is also attractive for production line troubleshooting. The 5004A can detect speed-related failures in assembled systems, which may not have been caught by subassembly testers.

Economics of field service

To meet the service requirements of digital products, most support programs have relied on board exchange. This approach minimizes

down time, yields economies of scale through centralized board repair, and enables field service personnel to repair a wide range of products, with minimum training.

As the number and complexity of digital products increases, however, the economic burden of board exchange becomes apparent:

- Inventory carrying costs for boards in various stages of float increase with the number of products installed.
- Administrative and handling costs are high, especially for products approaching obsolescence.
- Overseas support bogs down with long transit times, high duties, and import delays.
- System-related, "soft" failures are difficult to detect on individual boards, and some faulty boards are reintroduced into the exchange loop.

Signature Analysis can reduce these repair costs on microprocessor-based products by enabling field repair to the component level, and by testing fully assembled products, without board removal. The results are:

- Decreased cost of ownership for end users (parts, downtime, training, etc.)
- Reduced warranty and support costs for manufacturers.
- Increased confidence in field repair results.

Experience shows that incremental development costs for designing Signature Analysis into a product run about 1%. Incremental hardware costs are largely offset by decreases in other material, since there is no longer a need to divide the hardware into replaceable modules. The 5004A and HP Application Note 222, *A Designer's Guide to Signature Analysis*, can help you take advantage of the technique.

The IC Troubleshooters

General

The IC Troubleshooters have become the "digital screwdrivers" for today's laboratories, production lines, service facilities and electronic classrooms. They are low-cost, hand-held "instruments-on-a-chip," and

have proven very effective in the functional testing and troubleshooting of digital circuits. HP Application Note 163-1, *Techniques of Digital Troubleshooting*, can help put the IC Troubleshooters to work for you.

Logic comparator: the Model 10529A Logic Comparator utilizes comparison techniques to identify faulty nodes in a digital circuit. It tests an IC dynamically, in-circuit, by comparing output responses to those of a known-good IC which is plugged into the Comparator. Having located bad nodes, use other IC Troubleshooters to isolate the defective component causing the fault.

Logic probes: detect logic levels at any circuit point and display them via a light at the probe tip. A logic high is indicated by a bright light. A logic low extinguishes the light. A bad level causes a dim light. Pulse activity is shown by a 10 Hz flashing light.

Logic clips: are multi-pin state indicators which clip directly onto ICs. The logic state of each pin is displayed by an individual LED, enabling the user to check the device's truth table.

Logic pulser: pulse stimulation is essential in checking digital logic circuits. Logic pulsers inject digital pulses between gates, without requiring unsoldering of components. They automatically drive low nodes high, or high nodes low, with substantial override current.

Current tracer: often a bad node is identified, but the specific device causing the fault can only be isolated by cutting traces, or replacing circuit elements. The 547A Current Tracer eliminates just such "shotgun" techniques by showing exactly where digital current pulses are flowing in the circuit. Use of current tracing techniques solves the most vexing troubleshooting problems: stuck data buses, solder-bridges, stuck nodes containing many circuit elements, and the wired-AND gate.

Stimulus-response testing: the Pulser/Probe or Pulser/Clip combination helps the user to identify the faulty circuits causing a system malfunction. These instruments permit signal injection and readout between gates.

Troubleshooting kits: a variety of kits is available, combining IC Troubleshooters for stimulus-response testing. Each kit includes a carrying case, and offers a price saving over the individual instruments.

Education: HP's 5035T Logic Lab and 5036A Microprocessor Lab meet the need for thorough training in digital electronics. Both models are comprehensive hardware, software and hands-on troubleshooting courses. The 5035T deals with digital electronics and logic and the 5036A with microprocessor systems. Both are ideal for either self-study or use in industrial training, and include extensive use of HP's IC Troubleshooters.

- Dynamic multi-family logic indicators
- Pulse stretching for narrow pulses
- Bad level/open circuit detection

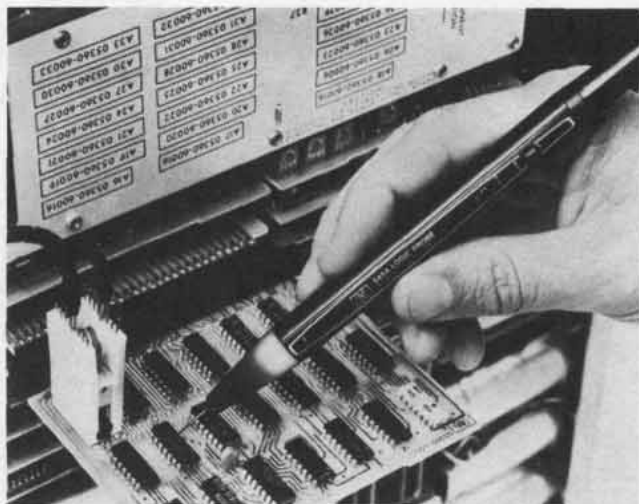

Logic probes

Logic Probes greatly simplify tracing logic levels and pulses in IC circuits to find nodes stuck HIGH or LOW, intermittent pulse activity, and normal pulse activity. That's because they instantly show whether the node probed is high, low, bad level, open circuited, or pulsing.

Logic probes require a simple connection to the circuit under test's power supply, and they're ready to use. The strain-relieved power cord, and line-voltage protected tip insure long life and durability. High input impedance protects against circuit loading, not just in the HIGH state, but for logic LOWs as well.

545A TTL/CMOS Logic probe

The HP Model 545A Logic Probe contains all the features built into other HP probes, plus switch-selectable, multi-family operation and built-in pulse memory. Employing the same straightforward one-lamp display as our other probes, the 545A operates from 3 to 18 volts in CMOS applications or from 4.5 to 15 V dc supplies in the TTL mode while maintaining standard TTL thresholds.

The probe's independent, built-in pulse memory and LED display help you capture hard to see, intermittent pulses. Just connect the probe tip to a circuit point, reset the memory, and wait for the probe to catch those hard to find glitches. The memory captures and retains a pulse until reset.

The hand-held 545A is light, rugged, overload protected, and very fast: 80 MHz in TTL, 40 MHz in CMOS. It also employs unique new power supply connectors that enable you to probe using several different methods.

545A Specifications

Input current: $\leq 15 \mu\text{A}$ (source or sink).

Input capacitance: $\leq 15 \text{ pF}$.

Logic thresholds

TTL: Logic one $2.0 + 0.4$, -0.2 V dc . Logic zero $0.8 + 0.2$, -0.4 V dc .

CMOS: 3–10 V dc supply

Logic one: $0.7 \times V_{\text{supply}} \pm 0.5 \text{ V dc}$.

Logic zero: $0.3 \times V_{\text{supply}} \pm 0.5 \text{ V dc}$.

CMOS: ≥ 10 –18 V dc supply.

Logic ONE: $0.7 \times V_{\text{supply}} \pm 1.0 \text{ V dc}$.

Logic ZERO: $0.3 \times V_{\text{supply}} \pm 1.0 \text{ V dc}$.

Input minimum pulse width: 10 ns using ground lead (typically 20 ns without ground lead).

* $\pm 5 \pm 10\%$ V dc power supply; usable to +15 V dc with slightly increased logic low threshold.

- One lamp, finger-tip display
- Pulse memory capability
- Overload protected

Input maximum pulse repetition frequency:

TTL, 80 MHz. CMOS, 40 MHz.

Input overload protection: $\pm 120 \text{ V}$ continuous (dc to 1 KHz); ± 250 for 15 seconds (dc to 1 kHz).

Pulse memory: indicates first entry into valid logic level; also indicates return to initial valid level from bad level for pulse $\geq 1 \mu\text{s}$ wide.

Power requirements

TTL: 4.5 to 15 V dc*.

CMOS: 3 to 18 V dc.

Maximum current: 70 mA.

Overload protection: $\pm 25 \text{ V dc}$ for one minute.

Accessory included: Ground Clip (HP Part No. 00545-60105).

10525T Logic probe

The Model 10525T Logic Probe provides TTL/DTL trouble-shooting at low cost. Ideally suited to 5 volt logic applications, the 10525T has high input impedance, overload protection, and 50 MHz data rate capability.

10525T Specifications

Input impedance: $> 25 \text{ k}\Omega$ in both the high and low state (< 1 low power TTL load).

Logic one threshold: $2.0 \text{ V} + 0.4$, -0.2 V .

Logic zero threshold: $0.8 \text{ V} + 0.2 \text{ V}$, -0.4 V

Input minimum pulse width: 10 ns.

Input maximum pulse repetition frequency: $> 50 \text{ MHz}$.

Input overload protection: ± 70 volts continuous, ± 200 volts intermittent, 120 V ac for 30 seconds, 240 V ac for 10 seconds.

Power requirements: $5 \text{ V} \pm 10\%$ at 60 mA, internal overload protection for voltages from +7 to -15 volts. Includes power lead reversal protection.

Accessories included: BNC to alligator clips; ground clip.

ECL logic probe

The HP Model 10525E Logic Probe extends time-proven, cost-saving logic probe troubleshooting techniques to high-speed ECL logic.

Operation of the ECL probe is analogous to that of the 10525T except the 10525E's high speed circuitry stretches single shot phenomena so that single pulses as narrow as 5 nanoseconds may be observed.

The 10525E may be powered directly from any -5.2 volt source and its high input impedance minimizes circuit loading.

10525E Specifications

Input impedance: $12 \text{ k}\Omega$ in both the high and low state.

Logic one threshold: $-1.1 \text{ V} \pm 0.1 \text{ V}$.

Logic zero threshold: $-1.5 \text{ V} \pm 0.1 \text{ V}$.

Input minimum pulse width: 5 ns.

Input maximum pulse repetition frequency: 50 MHz (typically 100 MHz at 50% duty cycle).

Input overload protection: ± 70 volts continuous, 200 volts intermittent, 120 V ac for 30 seconds.

Power requirements: $-5.2 \text{ V} \pm 10\%$ at 80 mA; supply overload protection for voltages from -7 to +400 volts.

Accessories included: BNC to alligator clips, ground clip.

Accessories available

Accessories available	Price
00545-60104 Tip Kit for 545A Probe	\$30
10525-60012 Tip Kit for 10525T Probe, 10526T Pulser	\$40
10525-60015 Pulse Memory for 10525T Probe	\$80

Ordering information

545A Logic Probe	\$125
10525T Logic Probe	\$90
10525E Logic Probe	\$150

DIGITAL CIRCUIT TESTERS

Logic pulsers

Models 546A & 10526T

- In-circuit stimulation without unsoldering
- Greatly simplifies digital troubleshooting
- High current, low duty cycle output

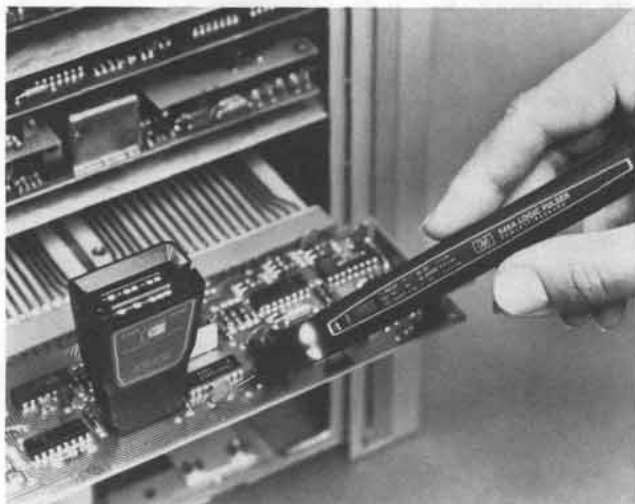

Logic pulser

The Logic Pulser solves the old problem of pulsing ICs on digital logic boards for designers and troubleshooters. Merely touch the Pulser to the circuit under test, press the pulse button and all circuits connected to the node (outputs as well as inputs) are briefly driven to their opposite state. No unsoldering of IC outputs is required. Pulse injection is automatic so the user need not concern himself whether the test node is in the high or low state; high nodes are pulsed low and low nodes, high, each time the button is pressed.

The Pulser is essentially a pulse generator with high output current capability packed in a convenient, easy-to-use probe. Ability to source or sink up to 0.65 Amperes insures sufficient current to override IC outputs in either the high or low state. Output pulse width is limited so the amount of energy delivered to the device under test is never excessive. Additionally, the Pulser output is three-state so that the circuit under test is unaffected until the Pulser is activated.

Combining in-circuit pulse injection with the unique detection capabilities of Logic Probes, Logic Clips, and the 547A Current Tracer helps to focus new power on solving the problems of fault isolation. Pulser/Probe, Pulser/Clip, and Pulser/Tracer combinations enable the digital designer or troubleshooter to hold complete stimulus-response capability at his finger tips.

Gate operation is tested using the Pulser to drive the input while the probe monitors transmitted pulses at the output. When pulses are not received, place the Pulser and Probe on the same pin to detect if the failure is due to a short to ground or V_{cc} .

Testing sequential circuits is the domain of the Logic Clip and Logic Pulser. The Clip simultaneously monitors all output states while the Pulser applies clock and reset pulses to the device. Improper operation, if present is immediately obvious since the IC will not go through its prescribed truth table.

Finally, when Pulsers are used with the 547A Current Tracer, the Pulser acts as a current pulse source to enable exact location of faulty gates on a node, solder bridges, or stuck devices on bus structures.

546A Logic Pulser

Automatic polarity pulse output, pulse width, and amplitude make for easy multi-family operation when you use the 546A Logic Pulser. But, the real surprise comes when you code in one of its six ROM-programmable output patterns (single pulses; pulse streams of either 1, 10, or 100 Hz; or bursts of 10 or 100 pulses). This feature allows you to continually pulse a circuit when necessary, or it also provides an easy means to put an exact number of pulses into counters and shift registers. Used with our multi-family IC Troubleshooters, the 546A acts as both a voltage and current source in digital troubleshooting applications.

- Automatic pulse width
- Automatic pulse amplitude
- Automatic pulse polarity

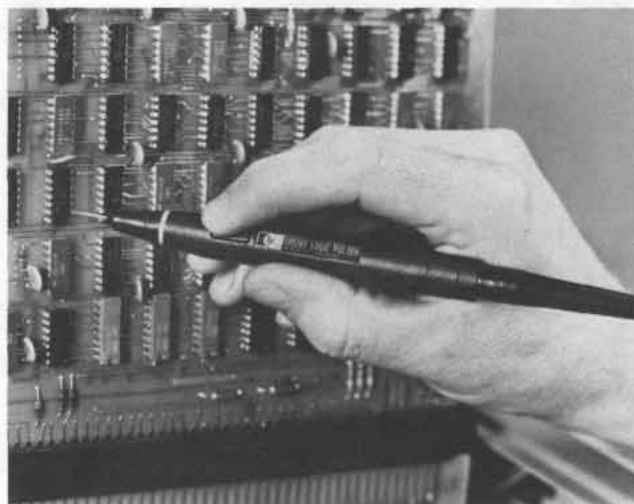

546A Specifications

Output

Family	Output Current	Pulse Width	Typical Output Voltage	
			HIGH	LOW
TTL/DTL	≤ 650 mA	≥ 0.5 μ s	≥ 3 V dc	≤ 0.8 V dc
CMOS	≤ 100 mA	≥ 5.0 μ s	$V(\text{supply}) - 1$ V dc	≤ 0.5 V dc

Power supply requirements: TTL; 4.5 to 5.5 V dc at 35 mA, CMOS; 3 to 18 V dc at 35 mA, protected to 25 V dc.

10526T Logic pulser

The economical 10526T provides dependable single-shot operation in TTL/DTL applications. Just press the pulse button, and the pulser delivers a single powerful pulse of the correct pulse width, polarity and amplitude.

10526T Specifications

Output high pulse voltage: > 2 V at 0.65 A (1 A typical at $V_{ps} = 5$ V, 25°C).

Output low pulse voltage: < 0.8 V at 0.65 A (1 A typical at $V_{ps} = 5$ V, 25°C).

Output impedance, active state: < 2 ohms.

Output impedance, off state: > 1 Megohm.

Pulse width: 0.3 μ s nominal.

Input overload protection: ± 50 volts continuous.

Power supply input protection: ± 7 volts (includes power lead reversal protection).

Power requirements: 5V $\pm 10\%$ at 25 mA.

Accessories included: BNC to alligator clips, ground clip.

Accessories available

	Price
00545-60104: Tip Kit for 546A Pulser	\$30
10525-60012: Tip Kit for 10526T Pulser	\$40
10526-60002: Multi-Pin Stimulus Kit	\$25

Ordering information

546A Logic Pulser	\$175
10526T Logic Pulser	\$115

- Troubleshoots three-state busses
- Solves the "Wired-AND" problem
- Displays in-circuit digital current flow

- Pinpoints supply-to-ground shorts
- All family: 1 mA to 1A
- Finger-tip indicator

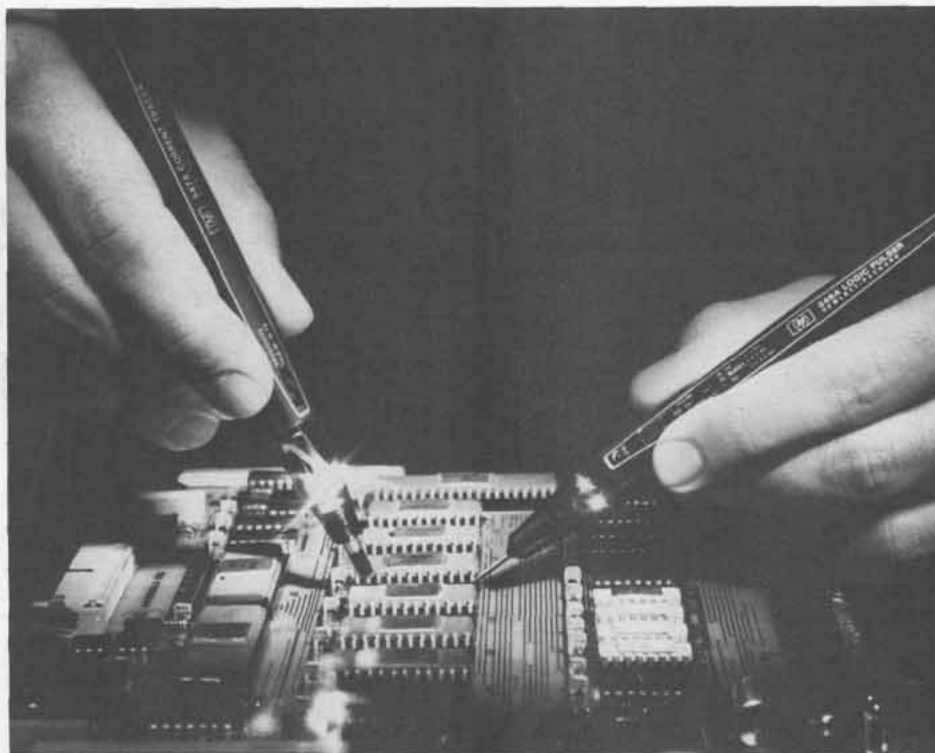

The 547A Current Tracer precisely locates low-impedance faults in digital circuits by locating current sources or sinks. On a shorted node, all points are stuck in one state by the short. Many similar troubleshooting problems such as shorted wired-AND/OR configurations, result in wasted time and excessive costs: several ICs have to be removed before finding the bad one, and in the process the circuit board may be damaged. Now, the 547A exactly pinpoints the one faulty point on a node, even on multilayer boards. In addition, the Tracer locates hairline solder bridges that manage to pass unnoticed until a circuit is operated for the first time.

Constructed as a hand-held probe, the Tracer is a sophisticated instrument designed to troubleshoot circuits carrying fast rise-time current pulses. The Tracer senses the magnetic field generated by these signals in the circuit (or, provided by a Logic Pulser), and displays transitions, single pulses, and pulse trains using a simple one-light indicator. Because it is not voltage sensitive, the Tracer operates on all logic families having current pulses exceeding 1 mA, and repetition rates less than 10 MHz, including CMOS, where even lightly loaded outputs can have up to 2 to 3 mA of instantaneous charging current.

Prior to introduction of the 547A, logic state indicators were limited to displaying voltage information. A node was HIGH, LOW, open, or pulsing. When a node is stuck, however, it may be trying to change state but isn't able to cross threshold levels. Use of the Current Tracer adds the final bit of information necessary to pinpoint just such logic faults on bad nodes. For example, on a bad node the Tracer can verify that the driver is functioning and also show where the problem is by

tracing current flow to the source or sink causing the node to be stuck.

To use the Tracer, simply align the dot on its tip at a reference point, usually the output of a node driver. Set the sensitivity control to indicate the presence of AC current activity. Then, trace the circuit to see where current is flowing. As you probe from point to point or follow traces, the lamp will change intensity, and when you find the fault the Tracer will indicate the same brightness found at the reference point.

547A Specifications

Input

Sensitivity: 1 mA to 1 A.

Frequency response: light indicates single-step current transitions; single pulses ≥ 50 ns in width; pulse trains to 10 MHz (typically 20 MHz for current pulses ≥ 10 mA).

Risetime: light indicates current transitions with risetime ≤ 200 ns at 1 mA.

Power supply requirements

Voltage: 4.5 to 18 V dc.

Input current: ≤ 75 mA.

Maximum ripple: ± 500 mV above 5 V dc.

Overvoltage protection: ± 25 Vdc for one minute.

547A Digital Current Tracer

\$350

DIGITAL CIRCUIT TESTERS

Logic clips

Models 548A & 10528A

- Displays IC logic states at a glance
- Self-powered, self-contained
- Sees up to 16 pins at a glance
- Easily verifies device truth table



Logic clips

The Logic Clip is an extremely handy service and design tool which clips onto dual-in-line-package (DIP) ICs, instantly displaying the states of up to 16 pins. Each of the clip's 16 LEDs independently follows level changes at its associated pin. Lit diodes are logic High, extinguished diodes are Low.

The Logic Clip's real value is in its ease of use. It has no controls to be set, needs no power connections, and requires practically no explanation as to how it is used. The clip has its own gating logic for locating the ground and V_{cc} pins and its buffered inputs reduce circuit loading.

The Logic Clip is much easier to use than either an oscilloscope or a voltmeter when a logic designer or service engineer is interested in whether a circuit is in the high or low state, rather than its actual voltage. The Clip, in effect, is 16 binary voltmeters, and the user does not have to shift his eyes away from his circuit to make the readings.

The intuitive relationship of the input to the output—lighted diodes corresponding to high logic states—greatly simplifies the troubleshooting procedure. The user is free to concentrate his attention on his circuits, rather than on measurement techniques. Also, timing relationships become especially apparent when clock rates can be slowed to about 1 pulse per second.

When used in conjunction with the Logic Pulser, the Logic Clip offers unparalleled analysis capability for troubleshooting sequential circuits. The Clip attaches to the IC to be tested; the Pulser is then used to inject pulses between gates allowing it to supply signals to the IC under test absolutely independent of gates connected to the IC. All outputs may then be observed simultaneously on the Logic Clip. Deviations from expected results are immediately apparent as the Pulser steps the IC through its truth table.

548 Multi-family Logic Clip

Fully automatic, protected to 30 V dc, and employing bright new LEDs in its display, the 548A brings multi-family operation to the

HP line of IC Troubleshooters. The Clip can be externally powered, if desired, using a simple power connector.

548A Specifications

Input threshold: ($\geq 0.4 \times$ Supply Voltage) = Logic High.

Input impedance: 1 CMOS load per input.

Input protection: 30 V dc for 1 minute.

Supply voltage: 4-18 V dc across any two pins.

Auxiliary supply input: 4.5 to 18 V dc applied via connector. Supply must be ≥ 1.5 V dc more positive than any pin of IC under test.

Supply current: <50 mA.

10528A Logic clip

Protection to +7 V dc, automatic operation, and low circuit loading in TTL/DTL applications helps make the 10528A a valuable replacement for more expensive test equipment like scopes and voltmeters. The clip is, in effect, like 16 binary voltmeters, allowing the user to look at the circuit rather than having to shift his attention toward test equipment.

10528A Specifications

Input threshold: 1.4 ± 0.6 V; TTL or DTL compatible (except gates with expander inputs).

Input impedance: one TTL load (-1.2 mA typical) per input.

Input protection: voltages < -1 V or > 7 V must be current limited to 10 mA.

Supply voltage: 5 V $\pm 10\%$ across any two or more inputs.

Maximum current consumption: 120 mA.

Ordering information

548A Logic Clip

10528A Logic Clip

Price

\$125

\$90

- Finds faulty nodes
- Dramatically cuts troubleshooting time
- Performs in-circuit IC testing with no unsoldering

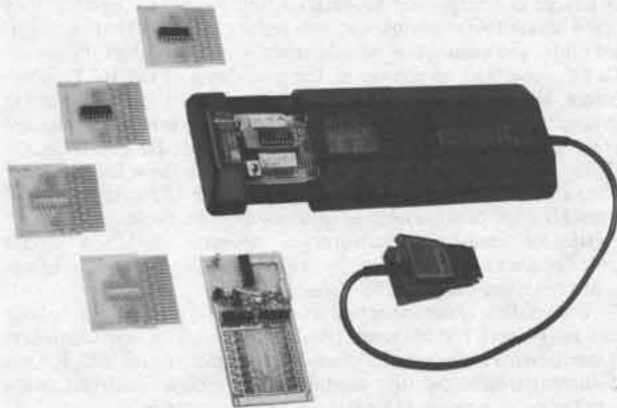

The Model 10529A Logic Comparator checks the operation of dozens of ICs in less than a minute per IC. The Comparator clips onto powered TTL or DTL ICs and detects functional failures by comparing the in-circuit test IC with a known good reference IC inserted in the Comparator. Any logic state difference between the test IC and reference IC is identified to the specific pin(s) on 14- or 16-pin dual in-line packages on the Comparator's display. A lighted LED corresponds to a logic difference. The Logic Comparator can save considerable time in locating a faulty IC. There are no controls to be set and no power connections.

The procedure is very simple. First the IC to be tested is identified. An IC of the same type is placed in the Comparator's IC socket, or a reference board with an IC of the same type is inserted in the Comparator. The Comparator is clipped onto the test IC, and an immediate indication is given if the test IC operates differently from the reference IC. Even very brief dynamic errors are detected, stretched, and displayed.

The 10529A operates by connecting the test and reference IC inputs in parallel; thus the reference IC is exercised by input signals identical to those of the test IC. The outputs of the two IC's are compared; any differences in outputs are detected, and LEDs corresponding to the particular pin are lit on the Comparator's display. Intermittent errors as short as 300 nanoseconds (using the socket board) are detected, and the error indication on the Comparator's display is stretched for a visual indication. A failure on an input pin, such as an internal short, will appear as a failure on the IC driving the failed IC; thus a failure indication actually pinpoints a malfunctioning node.

Programming for the specific IC is easily accomplished by two different methods. First, the socket board included with the Comparator is inserted in the Comparator drawer. Outputs of the particular IC to be tested are selected via 16 miniature switches which tell the Comparator which pins of the reference IC are inputs and which are outputs. The reference IC is then inserted into the socket and locked into place. An IC may be set up in seconds. Alternatively, if specific IC types are to be tested repeatedly, the reference IC may be soldered into one of the 10 reference boards provided with the Comparator. The reference board is programmed by opening the connections between the tests and reference ICs outputs and solder-bridging V_{cc} and ground.

- Easy-to-use comparison technique
- Versatile "socket board" included for seldom-tested IC's

When troubleshooting you want to know that the tester is operating properly. A test board is supplied with the Logic Comparator for this purpose. When inserted in the comparator the test board exercises all of the circuitry, test leads, and display elements to verify proper operation.

The Logic Comparator's ease of use and small size make it an invaluable addition to the troubleshooter's test gear either in the field or in the factory. With TTL and DTL failures that are functionally related, the Comparator can find bad nodes up to ten times faster than conventional signal tracing techniques. At its low price, the Logic Comparator can pay for itself in days.

10541A: twenty additional blank reference boards; identical to the 10 boards provided with the Logic Comparator, they allow additional ICs to be programmed for Comparator testing.

10541B: twenty preprogrammed reference boards; 20 of the most common TTL ICs already programmed and ready for use with the Logic Comparator. The 10541B includes the following ICs: 7400 Quad 2-input NAND; 7402 Quad 2-input NOR; 7404 Hex inverter; 7408 Quad 2-input AND; 7410 Triple 3-input NAND; 7420 Dual 4-input NAND; 7430 8-input NAND; 7440 Dual 4-input NAND buffer; 7451 Dual 2-wide, 2-input AND-OR-INVERT; 7454 4-wide, 2-input AND-OR-INVERT; 7473 Dual J-K master-slave flip-flop; 7474 Dual D flip-flop; 7475 Quad bistable D latch; 7476 Dual J-K flip-flop with preset and clear; 7483 4-bit binary full adder; 7486 Quad 2-input exclusive-OR; 7490 Decade counter; 7493 4-bit binary counter; 74121 Monostable multivibrator; 9601 Monostable multivibrator, retriggerable.

10529A Specifications

Input threshold: 1.4 V nominal (1.8 V nominal with socket board), TTL or DTL compatible.

Test IC loading: outputs driving Test IC inputs are loaded by 5 low-power TTL loads plus input of Reference IC. Test IC outputs are loaded by 2 low-power TTL loads.

Input protection: voltages < -1 V or > 7 V must be current limited to 10 mA.

Supply voltage: 5 V \pm 10%, at 300 mA.

Supply protection: supply voltage must be limited to 7 V.

Maximum current consumption: 300 mA.

Sensitivity

Error sensitivity: 200 ns with reference board or 300 ns with socket board. Errors greater than this are detected and stretched to at least 0.1 seconds.

Delayed variation immunity: 50 ns. Errors shorter than this value are considered spurious and ignored.

Frequency range: maximum operational frequency varies with duty cycle. An error existing for a full clock cycle will be detected if the cycle rate is less than 3 MHz.

Accessories included: 1 test board; 10 blank reference boards; 1 programmable socket board; 1 carrying case.

Accessories available

Accessories available	Price
10541A: Twenty Blank Reference Boards for the Logic Comparator	\$95
10541B: Twenty Pre-programmed Boards for the Logic Comparator	\$195
10529A Logic Comparator	\$525

DIGITAL CIRCUIT TESTERS

Logic Troubleshooting Kits

Models 5011T, 5015T, 5021A, 5022A, 5023A & 5024A

- Complete multi-family kits
- Stimulus-Response capability
- In-circuit fault finding

- In-circuit analysis
- Dynamic and static testing
- Multi-pin testing



10529A

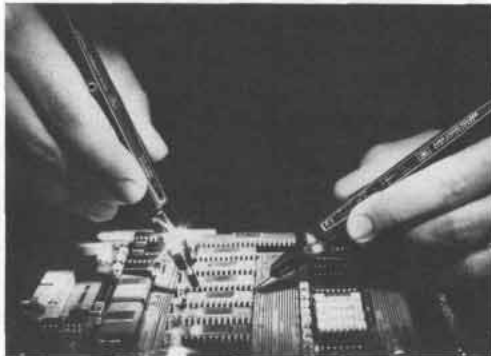

547A/546A

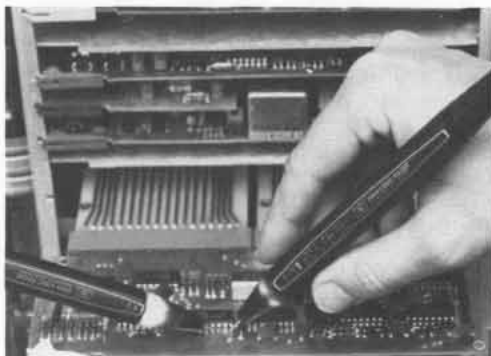

545A/546A

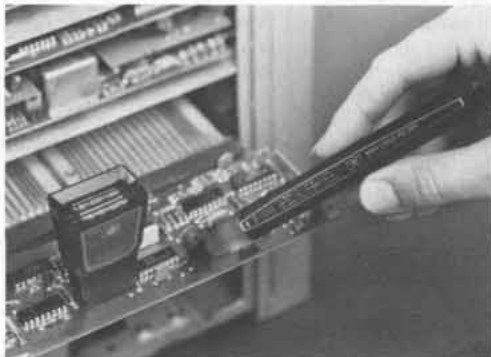

548A/546A

Used individually, each of HP's IC Troubleshooters provide their own unique and important troubleshooting function. Together they become invaluable stimulus-response testing partners that help pinpoint faults and ensure fast non-destructive repair of digital circuits.

To help you take advantage of the usefulness of the IC Troubleshooters, HP has packaged them into kits which offer both ordering convenience, and cost savings. Also, handy applications information is available, such as AN-163-1, "Techniques of Digital Troubleshooting", to help users derive maximum benefit from these instruments.

The table below shows a series of typical node and gate faults and the combination of tools used to troubleshoot the circuit. As with all sophisticated measuring instruments, operator skill and circuit knowledge are key factors once the various clues, or "bits" of information are obtained using the IC Troubleshooters.

To accomplish troubleshooting at the node and gate level, both stimulus (Pulser) and response (Probe, Tracer, Clip and Comparator) instruments are needed. Moreover, instruments with both voltage and current troubleshooting capability help isolate electrical faults where the precise physical location is hard to identify.

The 547A Current Tracer, the latest and most sophisticated of these troubleshooters, lets you "see" current flow on nodes and buses that otherwise appear stuck at one voltage level. Used with the 546A Pulser, stimulus-response testing is now also possible in the current domain.

FAULT	STIMULUS	RESPONSE	TEST METHOD
Shorted Node ¹	Pulser ²	Current Tracer	<ul style="list-style-type: none"> • Pulse shorted node • Follow current pulses to short
Stuck Data Bus	Pulser ²	Current Tracer	<ul style="list-style-type: none"> • Pulse bus line(s) • Trace current to device holding the bus in a stuck condition
Signal Line Short to Vcc or Ground	Pulser	Probe, Current Tracer	<ul style="list-style-type: none"> • Pulse and probe test point simultaneously • Short to Vcc or Ground cannot be overridden by pulsing • Pulse test point, and follow current pulses to the short
Supply to Ground Short	Pulser	Current Tracer	<ul style="list-style-type: none"> • Remove power from circuit under test • Disconnect electrolytic bypass capacitors • Pulse across Vcc and ground using accessory connectors provided • Trace current to fault
Internally Open IC	Pulser ²	Probe	<ul style="list-style-type: none"> • Pulse device input(s) • Probe output for response
Solder Bridge	Pulser ²	Current Tracer	<ul style="list-style-type: none"> • Pulse suspect line(s) • Trace current pulses to the fault • Light goes out when solder bridge passed
Sequential Logic Fault in Counter or Shift Register	Pulser	Clip	<ul style="list-style-type: none"> • Circuit clock de-activated • Use Pulser to enter desired number of pulses • Place Clip on counter or shift register and verify device truth table

1. A node is an interconnection between two or more IC's.

2. Use the Pulser to provide stimulus or use normal circuit signals, whichever is most convenient.



5011T

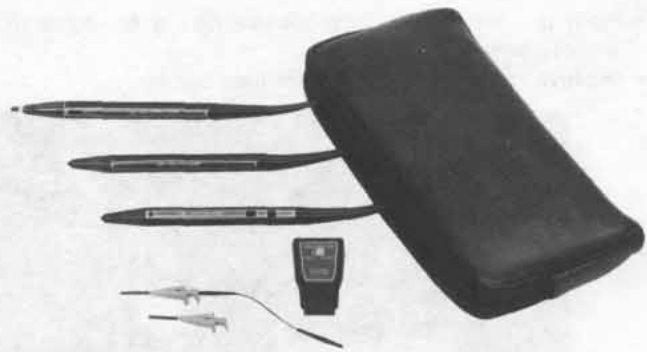

5022A

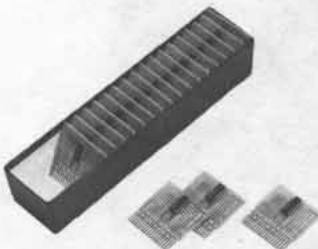

10541B

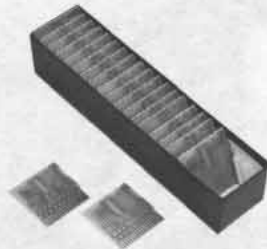

10541A



10526-60002

10525-60012

Ordering Information
5021A TTL/CMOS Troubleshooting Kit

Includes:
 545A Logic Probe
 546A Logic Pulser
 548A Logic Clip
 Size: 64 H x 146 W x 298 mm D (2.5" x 5.75" x 11.75").
 Weight: net, 0.6 kg (13 oz). Shipping, 0.72 kg (16 oz).

Price
 \$ 425

5022A TTL/CMOS Troubleshooting Kit

Includes:
 545A Logic Probe
 546A Logic Pulser
 547A Current Tracer
 548A Logic Clip
 Size: 64 H x 146 W x 298 mm D (2.5" x 5.75" x 11.75").
 Weight: net, 0.43 kg (15 oz). Shipping 0.51 kg (1 lb 2 oz).

\$ 725

5023A TTL/CMOS Troubleshooting Kit

Includes:
 545A Logic Probe
 546A Logic Pulser
 547A Current Tracer
 548A Logic Clip
 10529A Logic Comparator
 Size: 225 H x 200 W x 337 mm D (8.875" x 7.875" x 13.25").
 Weight: net, 1.64 kg (3 lb 10 oz). Shipping, 2.12 kg (4 lb 12 oz).

\$ 1225

5024A TTL/CMOS Troubleshooting Kit

Includes:
 545A Logic Probe
 546A Logic Pulser
 547A Current Tracer
 Size: 64 H x 146 W x 298 mm D (2.5" x 5.75" x 11.75").
 Weight: net, 0.54 kg (12 oz). Shipping, 0.43 kg (15 oz).

\$ 625

IC Troubleshooter Kits Selection Guide

	545A TTL/CMOS Probe	546A TTL/CMOS Pulser	547A TTL/CMOS Current Tracer	548A TTL/CMOS Clip	10525T TTL Probe	10526T TTL Pulser	10528A TTL Clip	10529A TTL Comparator
5011T Kit					X	X	X	X
5015T Kit					X	X	X	
5021A Kit	X	X		X				
5022A Kit	X	X	X	X				
5023A Kit	X	X	X	X				X
5024A Kit	X	X	X					

5011T TTL Troubleshooting Kit

Includes:
 10525T Logic Probe
 10526T Logic Pulser
 10528A Logic Clip
 10529A Logic Comparator
 Size: 82.6 H x 203 W x 311.2 mm D (3.25" x 8" x 12.25").
 Weight: net, 1.36 kg (3 lb). Shipping, 2.27 kg (5 lb).

\$750

5015T TTL Troubleshooting Kit

Includes:
 Model 10525T Logic Probe
 Model 10526T Logic Pulser
 Model 10528A Logic Clip
 Size: 64 H x 133 W x 286 mm D (2.5" x 5.25" x 11.25").
 Weight: net, 0.63 kg (1 lb 6 oz). Shipping, 0.74 kg (1 lb 10 oz).

\$ 275

Accessories Available

00545-60104: Tip Kit for 545A Probe, and 546A Pulser \$30
10525-60012: Tip Kit for 10525T Probe, 10526T Pulser \$40
10525-60015: Pulse Memory for 10525T Probe \$80
10526-60002: Multi-pin Stimulus Kit for Logic Pulsers \$25
10529-60006: External Reference Kit for 10529A Comparator \$175
10541A: Twenty blank reference boards for 10529A Comparator \$95
10541B: Twenty pre-programmed reference boards for 10529A Comparator \$195

Price

DIGITAL CIRCUIT TESTERS

Signature Analyzer, a μ P service solution

Model 5004A

- Field troubleshoot microprocessor-based products to the component level
- Improve the confidence level of field service
- Reduce warranty and service support costs
- Reduce the end-user's cost of ownership



5004A

The product

The HP 5004A Signature Analyzer is a tool for field troubleshooting of complex logic circuits. It recognizes and displays unique digital signatures associated with data nodes in a circuit under test. By comparing these actual signatures to the correct ones, a service technician can back-trace to a faulty node. The technique is especially useful in checking operation of microprocessor-based products and high-speed state machines, where data streams are long and complex and where there are no conventional means to troubleshoot to the component level.

By designing or retrofitting the digital portion of a product with the Signature Analyzer in mind, a manufacturer can provide field troubleshooting procedures for component level repair, without having to invest in a board exchange program, or in expensive special-purpose equipment.

Signature Analysis is also attractive for production line troubleshooting. The 5004A can detect speed-related failures in assembled systems, which may not have been caught by subassembly testers.

The technique

HP's patented Signature Analysis technique enables the 5004A to display a compressed, four-digit "fingerprint" of the data stream present at a node. This signature is generated from a linear feedback shift register in the 5004A, and is unique for a specific good node. Any fault associated with a device on that node will force a change in the data stream and, therefore, result in an erroneous signature.

The 5004A utilizes a 16-bit shift register, with maximal-length feedback taps. The data stream being measured is summed, modulo

2, with the register feedback. The resulting probability of detecting an erroneous data stream is 99.998%. More importantly, the probability of detecting a single-bit error in a data stream is 100%. Signature Analysis detects time-related faults, such as mid-cycle displaced bits, which are not detectable by traditional transition and ones counting techniques.

The 5004A does not require programming, since the test stimulus is stored in the product under test. Gating and clock signals are also derived from the product under test.

The application

For a product which has been designed and documented for Signature Analysis, troubleshooting typically consists of:

- Switching the product to be tested into a test mode of operation.
- Attaching the 5004A's START, STOP, CLOCK, and GND leads to the test points of the product to be tested (no board or component removal required).
- Probing circuit nodes and observing the signatures displayed on the 5004A.
- Comparing them to correct signatures preprinted on a schematic or troubleshooting procedure in the service manual of the product under test.
- Isolating a faulty node by observing an erroneous signature.
- Tracing signatures back through gates and memory elements, until an element with correct inputs and faulty outputs is isolated.
- Replacing only the faulty component.

These steps can be performed quickly on-site, at a field service facility, or on a production line.



5004A Specifications

Display

Signature: four-digit hexadecimal.
Characters: 0,1,2,3,4,5,6,7,8,9,A,C,F,H,P,U.

GATE, UNSTABLE SIGNATURE indicators:

Panel lights

Stretching: 100 ms.

Probe-tip indicator: light indicates high, low, bad-level and pulsing states.

Minimum pulse width: 10 ns.

Stretching: 50 ms.

Probability of classifying correct data stream as correct: 100%.

Probability of classifying faulty data stream as faulty: 99.998%.

Minimum gate length: 1 clock cycle.

Minimum timing between gates (from last STOP to next START): 1 clock cycle.

Data Probe

Input impedance: 50 k Ω to 1.4 V, nominal. Shunted by 7 pF, nominal.

Threshold

Logic one: 2.0 V +0.1 -0.4

Logic zero: 0.8 V +0.4 -0

Setup Time: 15 ns, with 0.2 V over-drive. (Data to be valid at least 15 ns before selected clock edge).

Hold Time: 0 ns (Data to be held until occurrence of selected clock edge).

MEASUREMENT GATING EXAMPLE, POSITIVE-EDGE START, STOP, AND CLOCK

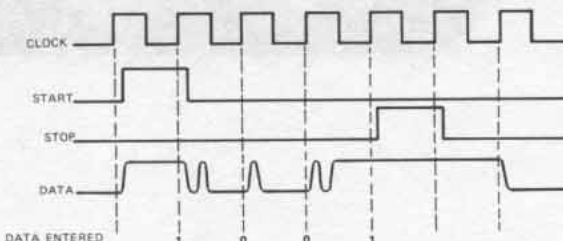

Designing for signature analysis

Use of the 5004A Signature Analyzer requires that some test features be designed or retrofitted into the product to be tested.

First, a short repetitive test stimulus should be stored in the product's ROM. The routine simulates circuit nodes, generating signatures detectable by the 5004A. It needs only to force a state change on each node, and does not have to create meaningful data. This stimulus can be merged with the product's self-check program, and enabled by a switch or jumper.

Second, data feedback paths should be opened, during part of the troubleshooting procedure, by switches, connectors, or disabling software. This prevents a fault from feeding back around, perturbing all data nodes.

Third, gating signals (START, STOP, CLOCK) should be brought out to test points for Signature Analyzer hookup.

HP Application Note 222, A Designer's Guide to Signature Analysis, provides examples and advice on designing products to be serviced by the 5004A.

Operational features

The active DATA PROBE is also a TTL Logic Probe, similar to the HP 545A, indicating high, low, bad-level, and pulsing states, for additional troubleshooting information.

The gating inputs (START, STOP, and CLOCK) are brought out to an active pod, for fast response and low circuit loading.

Front-panel controls allow selection of either rising or falling edges of start, stop, and clock waveforms.

The GATE light indicates proper start/stop gating operation.

The UNSTABLE SIGNATURE light indicates a difference between successive signatures, alerting the user to intermittent faults, which may not be observed from the display.

The HOLD/RESET controls allow observation of signatures associated with one-shot operations, such as power-on routines.

The front-panel SELF-TEST feature allows go/no-go checkout of the entire Signature Analyzer, including probe, pod, and cables, increasing confidence in on-site service.

Gating Input Lines

START, STOP, CLOCK Inputs

Input impedance: 50 Ω to 1.4 V, nominal. Shunted by 7 pF, nominal.

Threshold: 1.4 V \pm 0.6 (0.1 V hysteresis, typical).

START, STOP Inputs

Setup time: 25 ns. (START, STOP to be valid at least 25 ns before selected clock edge).

CLOCK Input

Maximum clock frequency: 10 MHz

Minimum clock time in high or low state: 50 ns.

Overload protection (all inputs): \pm 150 V continuous. \pm 250 V intermittent. 250 V ac for 1 minute.

Operating Environment

Temperature: 0°C-55°C.

Humidity: 95% RH at 40°C.

Altitude: 4,600 m.

Power Requirements: 15 VA max. See Options below for power line voltage and frequency.

Weight: net, 2.5 kg (5.5 lb.) Shipping 5 kg (11 lb.)

Size: 90 H x 215 W x 300 mm D (3.50" x 5.50" x 12"). Dimensions exclude bale, probe and pouch.

5004A Signature Analyzer

Opt 910. Extra manual

Orders must specify one of these power line options.

Opt 100: 100 V ac line, +5%, -10%, 48-440 Hz

Opt 120: 120 V ac line, +5%, -10%, 48-440 Hz

Opt 220: 220 V ac line, +5%, -10%, 48-66 Hz

Opt 240: 240 V ac line, +5%, -10%, 48-66 Hz

\$990
add \$10

DIGITAL CIRCUIT TESTERS

Digital Education Courses

Models 5035A, 5035T Logic Labs

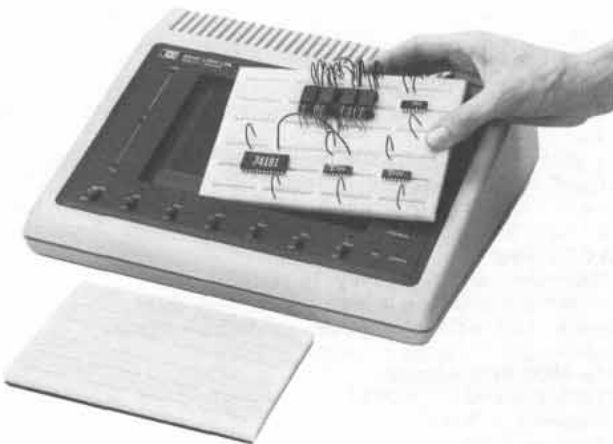

5035T Complete Logic Lab

Learn logic . . . the practical way. HP's Model 5035T Logic Lab combines theory and lab so you'll learn digital logic quickly, enjoyably, and memorably. Start by building simple circuits and work up to complete numerical readout clocks. Adopted by schools, industrial firms and individuals who want to keep up with the changing world of electronics, and enjoy doing it.

5035T Logic Lab ordering information

Includes

5035A Mainframe with removable breadboard (see below)
"Practical Digital Electronics"—An Introductory Course

- Complete textbook
- 26 Experiment Workbook
- TTL/DTL Test Instruments**
- 10525T Logic Probe
- 10526T Logic Pulser
- 10528A Logic Clip
- Wire and Component Kit**
- 32 TTL, MSI, LSI ICs
- 285 Pre-stripped Wires
- 4 Large LED numerical displays
- IC Remover

Accessories available

	Price
1258-0121: Additional Breadboard Assembly	\$62.50
10656A: Set of 10 "Practical Digital Electronics" An Introductory Course—Texts and Lab Workbooks	\$150
10657A: Additional Component and Wire Kit	\$150

5035T Logic Lab

\$750

5035A Logic Lab Mainframe

The 5035A Logic Lab Mainframe brings convenience and flexibility to breadboarding by allowing solderless connection of new circuit ideas. Fully self-contained, the mainframe has a 5-volt 1-amp power supply, two clocks, four LED indicators, six data switches, two 5-volt BNC connectors, and a handy removable breadboard. To use it, just connect up circuits using standard 24-gauge wire, then power up either one or several breadboards to quickly and easily verify new circuit ideas before incurring expensive PC board layout and rework charges.

5035A Mainframe ordering information

Power supply: 5 volts $\pm 5\%$, over 0-1 Amp range; 10 mV rms ripple maximum. Continuous short circuit protection.

Data switches: 6 bounceless slide switches for TTL high/low outputs.

LED indicators: 4 high/low indicators.

Clocks: 2 independent; 1 Hz and 100 kHz.

Breadboard assembly (HP part number 1258-0121): removable.

Interconnections: all power supply, data switch, LED indicator, and component contact points may be interconnected by standard 24-gauge hook-up wire.

Power requirements: 100/120/220/240 V ac $\pm 5\%$, -10% 50 or 60 Hz line frequency; 30 watts max; $0^{\circ}\text{C}-55^{\circ}\text{C}$.

Size: mainframe, 311 H x 89 W x 267 mm D ($3\frac{1}{2}''$ x $12\frac{1}{4}''$ x $10\frac{1}{2}''$). Breadboard assembly: 165 H x 114 W x 13 mm D ($6\frac{1}{2}''$ x $4\frac{1}{2}''$ x $\frac{1}{2}''$).

Weight: net, 5.9 kg (13 lb). Shipping, 6.9 kg (15.13 lb).

Accessories available

	Price
1258-0121: Additional breadboard assembly	\$62.50
1540-0258: Heavy duty, padded vinyl carrying case	\$15
05035-60006: Wire interconnect kit (258 prestripped, assorted length and color, 24 gauge hook-up wires)	\$15

5035A Logic Lab

\$425

- Covers hardware, software and troubleshooting in one course.
- A practical, hands-on course for the general technical community.

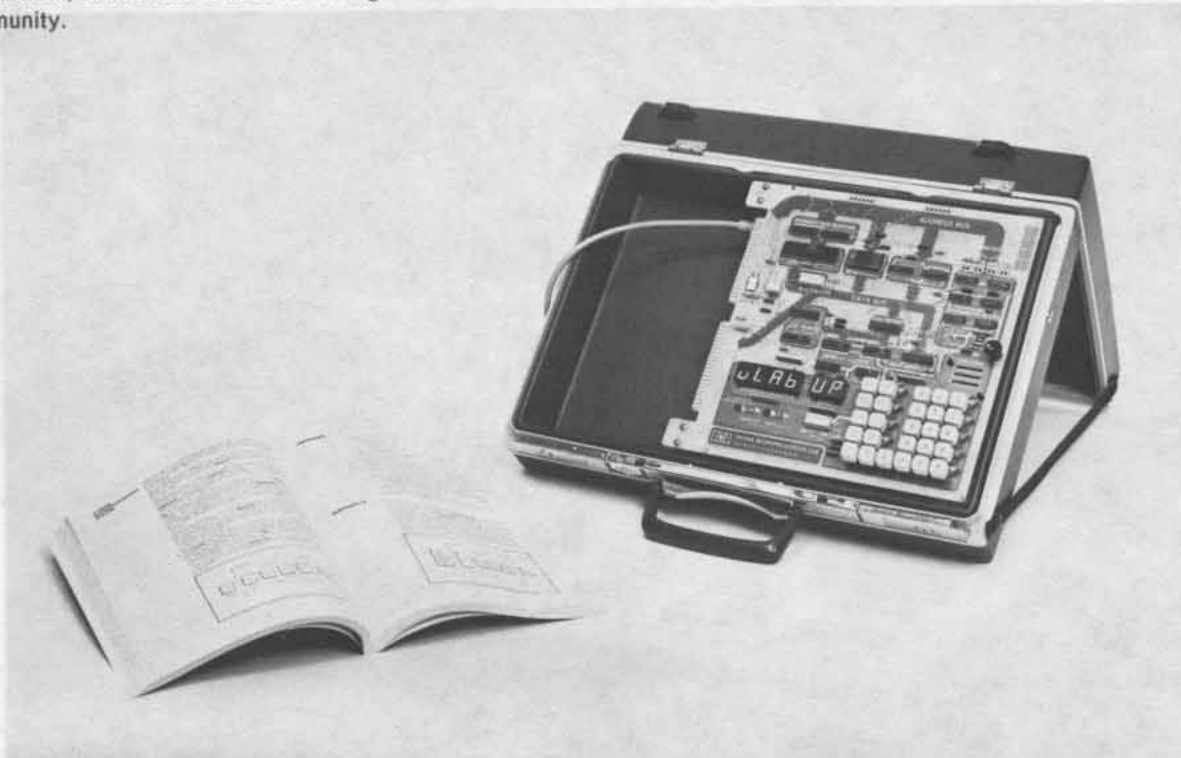

Staying current with technology is a constant problem. Now, with the increasing use of microprocessors, schools, industry, government and military training groups have to deal with digital electronics on an ever more extensive basis.

The microprocessor represents another extension of electronics technology into areas previously dominated by mechanical devices, older electronic or electrical means, or even hydraulics. This means more versatile, less expensive electronic tools are rapidly replacing older less efficient equipment. However, repair of microprocessor-based systems by engineers, scientists and technicians trained on older equipment is a problem area ignored until now.

The microprocessor presents a repair problem partially due to its complexity, but also because it is used in many diverse products. Repair of microprocessor products is currently a challenge to manufacturers. Little imagination is required to sense problems in repairing great quantities of microprocessor-based products like the following:

- | | |
|----------------------|---------------------------|
| - Traffic Controller | - Pipeline Control System |
| - Typesetter | - Medical Instrumentation |
| - POS Terminal | - Telephone Exchange |
| - Tire Balancer | - Taxi Meter |
| - Photo Finisher | - Oceanographic Telemeter |
| - Test Instruments | - Elevator Control System |

There are great numbers of people who will benefit from learning about both the hardware and software in microprocessor systems, but there is a virtual army of technical people of all kinds who need to learn to troubleshoot those same microprocessor systems. The 5036A Microprocessor Lab provides both the hardware and software basics and vital troubleshooting information needed to solve the microprocessor puzzle.

To help fully understand how to repair faulty microcomputer systems, a user should understand both software and hardware. The 5036A course book, *Practical Microprocessors*, covers both areas in detail in separate chapters containing summaries, hands-on experiments and quizzes. Once these chapters are completed, the course builds up to a series of troubleshooting experiments employing recommended accessory troubleshooting instruments that challenge the user and reinforce major microprocessor operating concepts.

In addition to the basics, the book contains information on microprocessors other than the 8085A used in the 5036A hardware design, use of oscilloscopes, signature analyzers, logic analyzers and many other topics.

A practical hands-on course, *Practical Microprocessors*, removes the mystery from this exciting area and helps the user become current in a subject bound to be required knowledge in most engineering, scientific and technical disciplines for years to come.

5036A Major Features

- Multi-colored block diagram PC board graphics illustrate system organization to enhance learning.
- Multiple-experiment troubleshooting chapter highlights IC Troubleshooters such as 545A Probe, 546A Pulser, 547A Current Tracer and 5004A Signature Analyzer.
- Plug-in jumpers create hardware faults allowing realistic troubleshooting experiments.
- Complete resident software.
 - Easy program entry and modification.
 - Extensive program debugging aids.
 - Interesting sample programs.
 - Built-in signature analysis and self-test routines.
 - 1K-Byte of user program space.
- Large, easy-to-read displays.
- Dual 5-Volt power supplies, plus edge connectors for expandability.
- Software-controlled speaker.
- LED monitors on all data, address, status and output lines.

Ordering Information

5036A Microprocessor Lab and Power Supply mounted in briefcase, plus *Practical Microprocessors* text and lab book.

Price
\$800

Recommended Accessories for Troubleshooting Experiments:

5024A Logic Troubleshooting Kit; includes 545A Probe, 546A Pulser, 547A Current Tracer and vinyl case.

\$625

5004A Signature Analyzer

\$990



Introduction

The increasing number and complexity of digital systems in business and industry has created a concurrent need for analysis equipment for use in the design, production, and service of these systems. The measurement problems encountered are numerous and diverse, and do not lend themselves to solution by conventional instrumentation. Regardless of the complexity of digital systems, which can vary from simple Algorithmic State Machines to complex processor-based systems, they represent a combination of hardware circuits that decode and respond to software or firmware instructions. With the proper digital analysis instruments, solutions to complex problems become straightforward and comparatively easy.

Hewlett-Packard has set the pace in development of logic analyzers to meet modern digital instrumentation needs, utilizing new concepts in logic state and logic timing analysis. The wide selection of analyzers offered allows discrimination in choosing the best instrument to meet particular digital analysis requirements.

In choosing a logic analyzer, one of the first distinctions to be made is whether the requirement is for timing analysis or state analysis. Timing analysis primarily depicts multichannel, low repetition rate, or single-shot timing events, in addition to negative

time analysis which is not possible with an oscilloscope. The latter capability permits capture of the events preceding a specified trigger condition. Timing analysis along with glitch triggering also uncovers hardware problems such as glitches and race conditions. State analysis records logic state sequences which are often complex and require sophisticated recognition techniques. The logic state analyzer can resolve both hardware and software problems by tracing improper state sequences.

Timing Analyzer

The timing analyzer samples all data channels simultaneously on an internal reference clock. The recorded data indicates whether the input lines are high or low relative to a defined threshold voltage at the active clock transition. Data from all channels are subsequently displayed on a CRT with any changes appearing as ideal transitions. The timing resolution or uncertainty is determined by the sampling clock period and any skew on input channels adds to the uncertainty.

The timing analyzer's strength is in functional timing measurements. For example, the timing analyzer is ideal for displaying sequences on control buses, I/O data transfers, or examining handshakes on HP-IB (IEEE-

488) interface buses. It is the presentation of the sequence in which the lines toggle that is the timing analyzer's strength, not the precision resolution of these transitions. For example, a microprocessor based real time controller may have intricate timing sequences, however, since clock frequencies of only a few megahertz are present, a 20 MHz timing analyzer with 50 ns resolution is adequate to show timing relationships needed to troubleshoot the controller. Sampling rates of five times the data usually provide more than adequate resolution for functional displays.

An essential feature of a timing analyzer is the ability to capture and display glitches, i.e., narrow spikes that occur within a sample period. Some timing analyzers use latch circuits that stretch a glitch and give it the appearance of a minimum width pulse. These analyzers will miss the glitch on a signal transition. The Hewlett-Packard 1615A, however, has special circuits that capture any glitch and distinctively display it on the CRT.

Another essential feature of a timing analyzer is triggering capability. If data recognition (or nonrecognition) is sufficiently definitive, it often provides answers directly, eliminating the need for large memories and high sampling rates. There are several ways to trigger logic timing analyzers.

Asynchronously, with any Boolean expression of up to three ORed terms existing for a minimum selectable time.

Synchronously, with an ANDed condition on the inputs of highs, lows, and "don't cares" at the instant of sampling. This technique has limitations, i.e., the timing analyzer may trigger on a transient state, or, when the sample period is increased, may miss the trigger word entirely.

On a glitch, with a glitch on a given channel, between successive samples, and simultaneously with any allowed Boolean expression.

(For analyzers with latched glitch detection, triggering on a latched glitch combined with a specified high or low condition on the same channel is not possible.)

Externally, with an additional nondisplayed input that permits triggering from either an edge or level, depending on the instrument.

Delayed, with triggering hold-off until a digital delay is counted down or a specific time interval passes.

Armed, with a two-condition sequential trigger in which any of the outlined triggering methods are possible once the arming signal is received.

Not all triggering methods are available on one logic timing analyzer. However, the more precisely the instrument can window in on a problem, the less dependent it is on large memories or high sample rates.

State analyzer

A state analyzer uses a clock or strobe from the system under test, not an internal reference clock, to synchronously sample system data. It monitors the word (state) parameters and the word (state) sequence of the system under test and must read data exactly the same as the system hardware. This implies that a state analyzer should require no hold time, i.e., there should be no period during which the data must remain stable after the strobe edge. If the analyzer hold time is positive, the state clocked into the analyzer becomes ambiguous, with three possibilities (figure 1). The state recorded may be (1) the present state (2) the next state or (3) a transitional state.

A typical application for a state analyzer is to troubleshoot a microprocessor system. For the most common microprocessors this consists of monitoring a 16-bit address field, an 8-bit data bus, plus some control and I/O activity. The state analyzer must be multinodal to monitor this much data. For an easily interpreted presentation the state analyzer condenses the data into an appropriately coded display such as hexadecimal, or it may

even perform inverse assembly to reconstruct the microprocessor mnemonics. To allow for different data formats, a state analyzer should offer flexible formatting so that data can be grouped in the format that fits the application.

A special case of a state analyzer that is not multinodal is that required for analysis of a communications network. Here the interface is typically an RS-232C serial link. In this case it is desirable to not only passively monitor but to also simulate any of the system components. Again, the instrument should have formatting that is flexible enough to handle common encoding (e.g., ASCII, EBCDIC, etc.). It should also be able to operate properly within common communications protocols.

Another specific state analysis application example is the real time tracing of stack operations on a microprocessor system. A state analyzer in "trace triggers" mode can record successive stack pushes (writes) and pulls (reads) as they occur. Such measurements are readily performed with a state analyzer, and can rapidly track down lost programs caused by stack overflows.

Selective tracing

Because of the quantity of data present in a typical digital system, it is essential that any monitoring instrument window on the desired activity, select the desired portions of the activity, and then display only the activity that highlights desired features. To achieve this, state analyzers should contain extensive qualification and triggering capabilities.

Selective tracing records only the desired system activity in memory. Without selective tracing, no practical memory is deep enough to solve all possible state analysis problems. Data may be selectively traced in two ways. With clock qualification, data will be strobed into the analyzer only if additional inputs (qualifiers) are true at the clock edge. In a processor system the qualifiers may be valid memory address line, read/write, etc. This type of qualification is essential to deciphering data on a multiplexed bus. The second method to qualify recorded data is to program the analyzer to trace only specified states. A state analyzer ideally should be able to do both.

A "trace triggers" state analyzer mode records only data that meets trigger specifications. Trace selectivity is controlled by varying the trigger specifications. Varying the selectivity allows monitoring activity at specific memory location(s), which is often more significant than what occurs at each strobe signal. Digital delay, when combined with "trace triggers," gives a "trace events" mode and the *n*th word beyond the trigger is traced into memory. In most problems, a prior analysis will show that only a small fraction of the data transactions need be monitored.

In the selective trace mode a state analyzer's time and count events capability may also be used to resolve a functional problem. The number of low order states occurring between successive high order states (trigger or trace words) is often a clue to an anomaly. By actually depicting path length, a state count highlights problems.

To window the trace to the desired activity within complex state sequences calls for sophisticated triggering techniques. In many instances it will be a sequence of states, not just a single state, that must be satisfied in order to meet the trigger conditions. For example, the state analyzer may be required to trace at a specified state only when this state is reached via an infrequently traveled path or sequence of events. The state analyzer must ignore entry via other paths. A second example is nested loops where it is required to trace the *N*th pass of the *J* loop on the *M*th pass of the *K* loop etc.

The map

To provide an overview or "global" presentation the state analyzer may present data in pictorial form. The map is essentially a dot matrix with each dot corresponding to a word, the most significant portion of the word plotted vertically, the least significant horizontally. The map shows those states in which system activity occurs. Each system activity has its own unique map and digressions are readily recognizable by the operator. The map helps answer the following types of questions. Does the system respond to a stimulus? Does state XXXX ever occur? Does the system ever make excursions across certain bounds? The last question in particular may only be addressed effectively with a dynamic map or range trigger.

The graph

Another pictorial presentation is the graph, which plots state magnitude as a function of sequence. Any discontinuity in the state sequence, such as program jumps or branches, are visible as discontinuities on the graph. In practice the operator will look for any unexpected discontinuities to quickly point to program problems.

Menu control of logic analyzers

The extensive functions of most logic analyzers would result in a complicated keyboard if a conventional key per function arrangement were used. To reduce complexity, most HP logic analyzers use a "menu" concept with directive displays and simplified keyboards. To use the menus the operator selects the display of interest which presents all operator defined parameters in inverse video. A movable flashing cursor is positioned to one of the parameters which indicates that this parameter may be modified by use of a field select key. In some cases new alphanumeric data may be programmed directly; to change other parameters the operator presses the field select key which steps the parameter through a number of alternatives preprogrammed into the analyzer. Once satisfied, the operator moves the cursor to the next parameter. The cursor moves automatically on entering alphanumeric data.

Matching the analyzer to the application

With an understanding of logic analyzer basics as discussed in the preceding sections, selecting an analyzer becomes easier. To ensure selection of the best analyzer for a particular application, a thorough knowledge of the features and intended use of individual instruments is also necessary. The following discussion and illustrations are to assist in this final selection process.

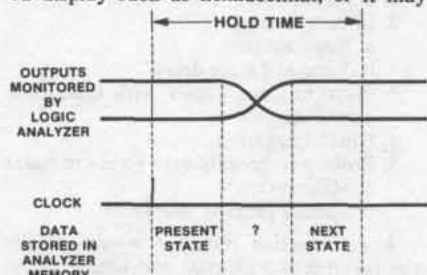

Figure 1. The data captured by a synchronous analyzer may be ambiguous, if the hold time is positive.

If the desired feature set is already known, selection may be made directly from the logic analyzer selection chart on page 127 (figure 7). If, however, the feature set is not known, the overall measurement should be reviewed. First identify the measurement environment. Then describe the system's architecture which determines where to look, the number of channels, and the type of connections. Once the measurement environment and system architecture are determined, the required measurements become apparent for expected problem sets. These determine both the features that are necessary and those that are desirable.

Measurement environment

The measurement environment may be broken into three major areas: design, production, and service. Of these, design normally requires the most sophisticated type of logic analysis. The algorithmic process depicted in figure 2 represents the design cycle for a typical digital system. This may be a microprocessor or a minicomputer-based system, or even a ROM-based controller with no CPU, but with a simple automatic sequencer.

Software and hardware development are distinctly different tasks whose measurement environments also differ, within the design area. And, since the two disciplines must ultimately be integrated, the measurement environment changes again when software and hardware are combined.

The software team is concerned with the generation of code, so is interested in detect-

ing algorithmic errors and execution efficiency, while the hardware team is interested in circuit problems such as race conditions, glitches, and coupling errors. On integrating the software and hardware, interaction problems are of interest. At this stage I/O and interrupts operate in real time, therefore timing, protocol, and even stack problems may manifest themselves for the first time. Different interpretations of the design definition also need to be resolved at this point.

The design group needs very sophisticated instruments to accomplish its tasks. In production, rapid functional tests performed by personnel with a limited technical background dictates a programmable logic analyzer with well designed probing for the production environment. The service environment is not unlike the production environment, particularly depot service, however, there is less emphasis on speed, with portability becoming an important criteria for on-site service.

System architecture

Figures 3, 4, and 5 are generalized digital system block diagrams that localize the key areas where problems can be detected and measurements applied. Knowing the architecture of the system helps to determine some basic features that are needed in an analyzer to trace activity on the system buses.

The address and data buses are typically synchronous parallel. In order to trace address and therefore program activity flow, at least 16 inputs are required for most systems.

And to correlate the address flow to the states on the data bus, another 8 to 16 channels are needed. Additional inputs are also needed if qualification is to be used. If an error condition is recognized in the state flow, it may be desirable to trigger an oscilloscope and obtain a time domain presentation of the problem. A logic analyzer with its trigger output may be used to synchronize the oscilloscope display with the problem state sequence.

A summary of features that should be available on any logic state analyzer in order to perform simple tracing on a bus is listed:

- 16 or more input channels
- Internal storage
 - Negative time
 - Digital delay
- Clock (display) and trigger qualifiers
- Pattern trigger
- Proper setup and hold specifications on both trigger and data
 - Setup time minimum
 - Hold time of zero
- Probing to provide easy access to buses.
 - Miniature connectors
 - Square pin connectors
 - Quick disconnect
 - Special purpose interfaces
- Pattern trigger output
- Functional display

Status changes in the control lines may occur asynchronously to the program flow. These lines may need to be monitored asynchronously in order to measure timing relationships. However, this type of information is not very meaningful unless it can be related to state or address flow on another bus. A combination logic timing and logic state analyzer with cross-triggering capabilities meets this requirement.

The I/O buses of a digital system may exhibit many different formats depending on the type of peripheral devices that are present. Serial communication is common, both synchronous and asynchronous. The HP-IB (IEEE 488) interface has additional requirements because the data is transmitted in parallel, and there are three handshake lines that change state asynchronously. Here, as in the previous cases, the data on I/O lines may be monitored with simple tracing techniques but becomes much more meaningful and useful when correlated to data or program flow on one of the other buses.

A summary of the logic timing analyzer features necessary to monitor control and I/O buses is listed:

- 8 channels
 - Negative time
 - Time and state delay
- Asynchronous trigger with time duration filter
- Glitch triggering
- Probing to provide easy access to buses
 - Miniature
 - Special purpose interfaces

A combination analyzer would require the features of both state and timing analyzers and include cross-triggering (i.e., state triggers time, time triggers state) and cross-arming.

DIGITAL SYSTEM DEVELOPMENT PROCESS

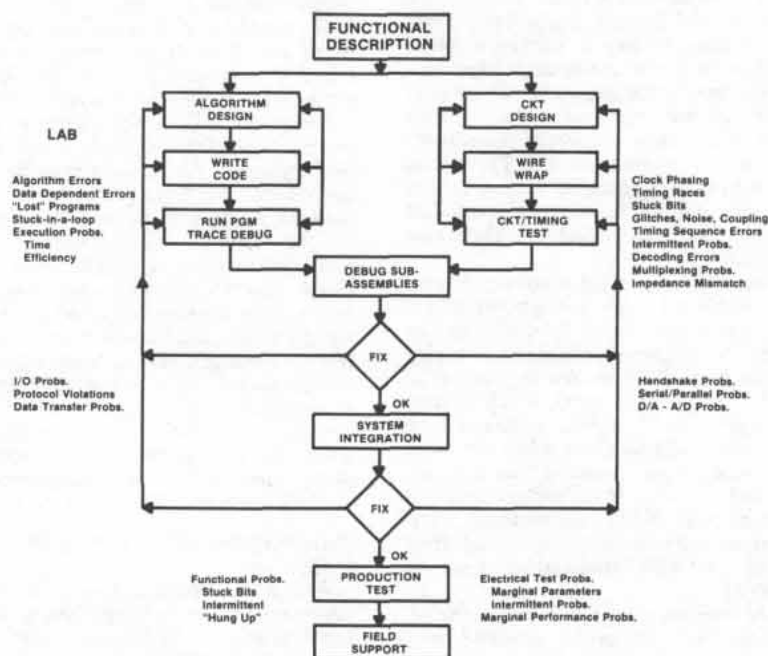

Figure 2. Flow diagram of typical microprocessor controlled digital system development cycle.

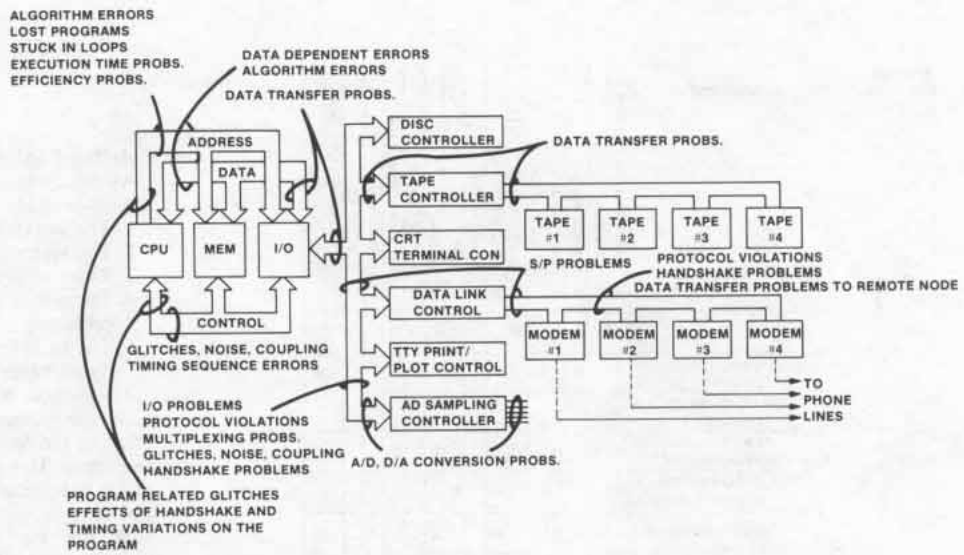

Figure 3. Typical digital system showing which buses are monitored to isolate different types of problems.

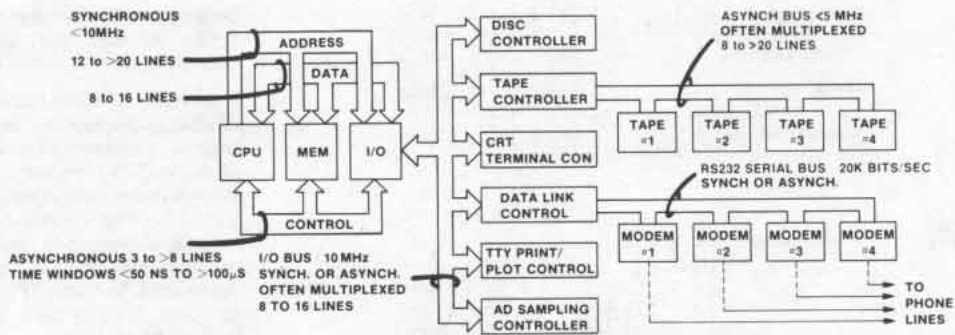

Figure 4. Most of these digital system buses are multinodal and require a logic analyzer with an input of at least 16 data lines for analysis.

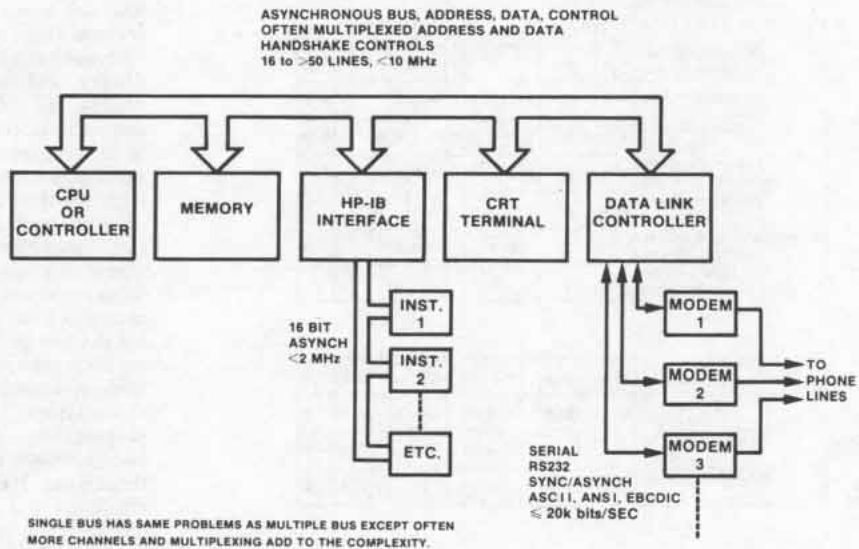

Figure 5. Alternate architectures in common use in minicomputers.



BUS MEASUREMENT	TYPE OF ANALYSIS	MEASUREMENT	MEASUREMENT																	
			PATTERN TRIG	SEQ TRIG	RANGE TRIG	TRIG OCCUR	GLITCH TRIG	SELECTIVE TRACE	TRACE COMPARE	DUAL OR COMPLEX CLK	ASYNCH CLK	MAP	GRAPH	STATE COUNT	INTERNAL TIME BASE	SER TO PAR	GLITCH DET	ASYNCH PATTERN TRIG	ARMING	
SINGLE BUS	STATE (SYNCH)	TRACE ADDRESS	R	D	D	D	D	D	D	D	D	D	D	D						
		PROGRAM OVERVIEW	D		D	D	R					D	D	D						
		TRACE ON FORBIDDEN MEMORY SPACE	R		R							D							D	
		TRACE OF NTH PASS THROUGH A LOOP	R	D		R	D						D							
		TRACE ON SEQ OF EVENTS (PROGRAM PATH)	R	R		R	D	D					D	D	D					
		COMPARE TRACE WITH REFERENCE	R							R		D	D							
		TRACE SERIAL I/O	R	D	D	D	D	D					D	D	R				D	
		COUNT EVENTS	R	D			D							R						
		EXECUTE TIME OF LOOP OR SUBROUTINE	R	D		D									R					
		TIME (ASYNCH)	TIME INTERVALS									R							R	D
GLITCH LOCATE						R				R					R	R	D			
TRACE ON STATUS CHANGE										D					D	D	R			
TIME HANDSHAKE										D			D		D	R	D			
D-DESIRED FEATURES R-REQUIRED FEATURES																				
MULTI BUS	STATE (SYNCH)	TRACE ADDRESS AND DATA	R	D	D	D	D	D	R		D	D	D	D				D	D	
		TRACE I/O & DATA	R	D	D	D	D	D	R					D	D	D			D	
		TRACE ADDR AND CONTROL BUS	R	D	D				R					D	D				D	
		PROGRAM TRACE	R	D	D	D	D	R				D	D	D	D				R	D
		TRACE I/O AND ADDRESS	R	D	D	D	D	D	R			D	D	D	D	D			D	D
		TRACE SELECTED MEMORY LOCATION	R	D	D	D	R	D				D	D	D	D				D	
		TRACE ADDR AND SERIAL I/O	R	D	D	D	D	R						D	R				D	
		CORRELATE SYNC SERIAL I/O TO ADDRESS	R	D	D	D	D	R						D	D	R			D	
		EXECUTE TIME OF LOOP OR SUBROUTINE	R	D		D									R					
		TIME (ASYNCH)	TRACE ADDR AND HANDSHAKE	R	D	D	D	D	R	R			D	D	D		R	D		D
TRACE CONTROL AND ADDR.	R			D	D	D	R	R				D			R	D		D		
RELATE GLITCH TO ADDR.	R			D	R			R	R						R	R		D		
RELATE GLITCH TO I/O.	R			D	R			R	R						D	R	R	D		
D-DESIRED FEATURES R-REQUIRED FEATURES																				

Relating Features to Measurements

At this point, the following should have been identified:

1. The working environment
2. The system architecture
3. Types of problems encountered
4. The measurements required to solve the problems
5. The basic features needed to trace activity on buses

The purpose of the charts in figure 6 are to relate the measurements that have been identified to the features available on HP logic analyzers. The measurements fall into two major categories, single bus, and multibus, and may require state or time analysis, or both. The chart can be used to identify needed measurements and relate them to features. A list of required features and desired features may be made and used to select the proper logic analyzer from the logic analyzer selection chart (figure 7).

Selecting the analyzer

The selection chart begins with a flow chart with three possible branches:

1. **Software:** if the required types of measurements emphasize program tracing, loop analysis, and subroutine analysis, follow the software (SW) branch. The next question asked is if the requirements are general in nature or involve a specific microprocessor. If the requirements are general in nature, the selection chart will point to the analyzer with the needed features. If a particular microprocessor is being used, the 1611A feature set may be preferred.

2. **Hardware:** if the measurements are primarily concerned with such measurements as locating glitches, clock phasing, and time intervals between events on control lines, follow the hardware (HW) branch. If the features that asynchronous analysis can provide, such as glitch triggering, negative time display, and more than four channels are needed, the 1615A may be the preferred analyzer. In some cases the measurements of interest may involve time interval measurements where the time resolution required is greater than that provided by current asynchronous techniques. Also, the two state vertical resolution may not provide enough information about the signal in question. In these situations, a real time window into the circuit as well as state tracing is needed. Using the two techniques allows correlation of the state information on a system bus to activity monitored in real time in another part of the system, and for comparatively simple program tracing, an HP logic analyzer/oscilloscope "Gold-button" system may provide the solution. If the state tracing requirements are complex, a selection may be made from any logic analyzer on the chart, all of which have *pattern trigger out* for driving an oscilloscope.

Figure 6. Charts show features required to make single bus and multibus measurements.

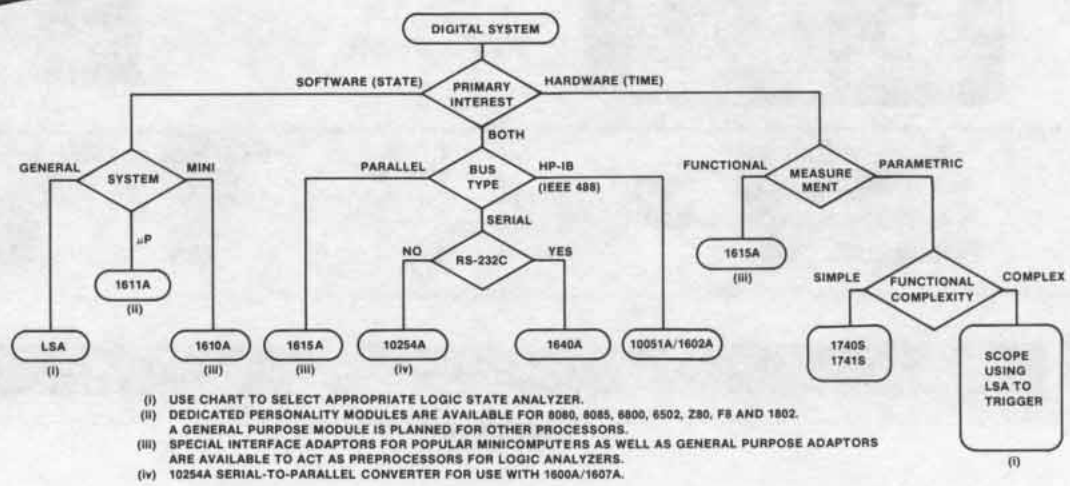

- (i) USE CHART TO SELECT APPROPRIATE LOGIC STATE ANALYZER.
- (ii) DEDICATED PERSONALITY MODULES ARE AVAILABLE FOR 8080, 8085, 8000, 6502, Z80, F8 AND 1802. A GENERAL PURPOSE MODULE IS PLANNED FOR OTHER PROCESSORS.
- (iii) SPECIAL INTERFACE ADAPTORS FOR POPULAR MINICOMPUTERS AS WELL AS GENERAL PURPOSE ADAPTORS ARE AVAILABLE TO ACT AS PREPROCESSORS FOR LOGIC ANALYZERS.
- (iv) 10254A SERIAL-TO-PARALLEL CONVERTER FOR USE WITH 1600A/1607A.

	1602A	1607A	1600A	1600S	1611A	1615A	1610A
DATA INPUTS	16	16	16	32	32	24	32
INT STOR	64	16	16	16	64	256	64
THRESHOLD	TTL	TTL VAR	TTL VAR	TTL VAR	TTL VAR	TTL VAR	TTL VAR
QUAL	2	2	2	4	8	8	32
SEQ TRIGS	-	-	-	1	1	1	7
MAX SYNC CLK (MHz)	10	20	20	20	N/A	20	10
DISPLAY FORMAT	*1	B	B	B	MNE	*1 TIME	*1
COMPARE	-	-	STOP #	STOP #	-	-	STOP #
DUAL CLK				X			
MAP			X	X			
GRAPH							X
TRIG OCCUR	X				X	X	X
TRACE ONLY	*2	*2	*2	*2		*2	X
TRACE TRIG	X				X	X	
RANGE TRIG					X		
SEQ RESTART							X
SIMUL SYNC/ASYN						X	
GLITCH TRIG						X	
GLITCH DET						X	
STATE COUNT					X		X
TIME INT					X	X	X
SERIAL		*3	*3	*3			
HP-IB	X						
MNEMONIC					X		
STIMULUS					*4		

*1 HEX, OCTAL, BINARY, DECIMAL
 *2 DISPLAY OR CLOCK QUALIFIER
 *3 WITH 10254A ACCESSORY
 *4 HALT, SINGLE STEP

Figure 7. Logic analyzer selection flow diagram.

3. **Software and hardware:** If both software and hardware analysis is needed, the center branch leads to the 1615A as the probable solution, especially for the hardware analysis. Checking the 1615A features on the

chart will determine if this is the analyzer needed to solve the hardware and software problems expected. For a reply card and listing of application notes that explain how logic analyzers can

solve measurement problems, write to Hewlett-Packard Co., 1820 Embarcadero Rd., Palo Alto, California 94303, Attention: Inquiries Manager, and request publication number 5952-2080D.

LOGIC ANALYZERS

System debugging in microprocessor based operating systems

Model 1611A Opt A68, A80, OF8, Z80, A65, A18 & A85

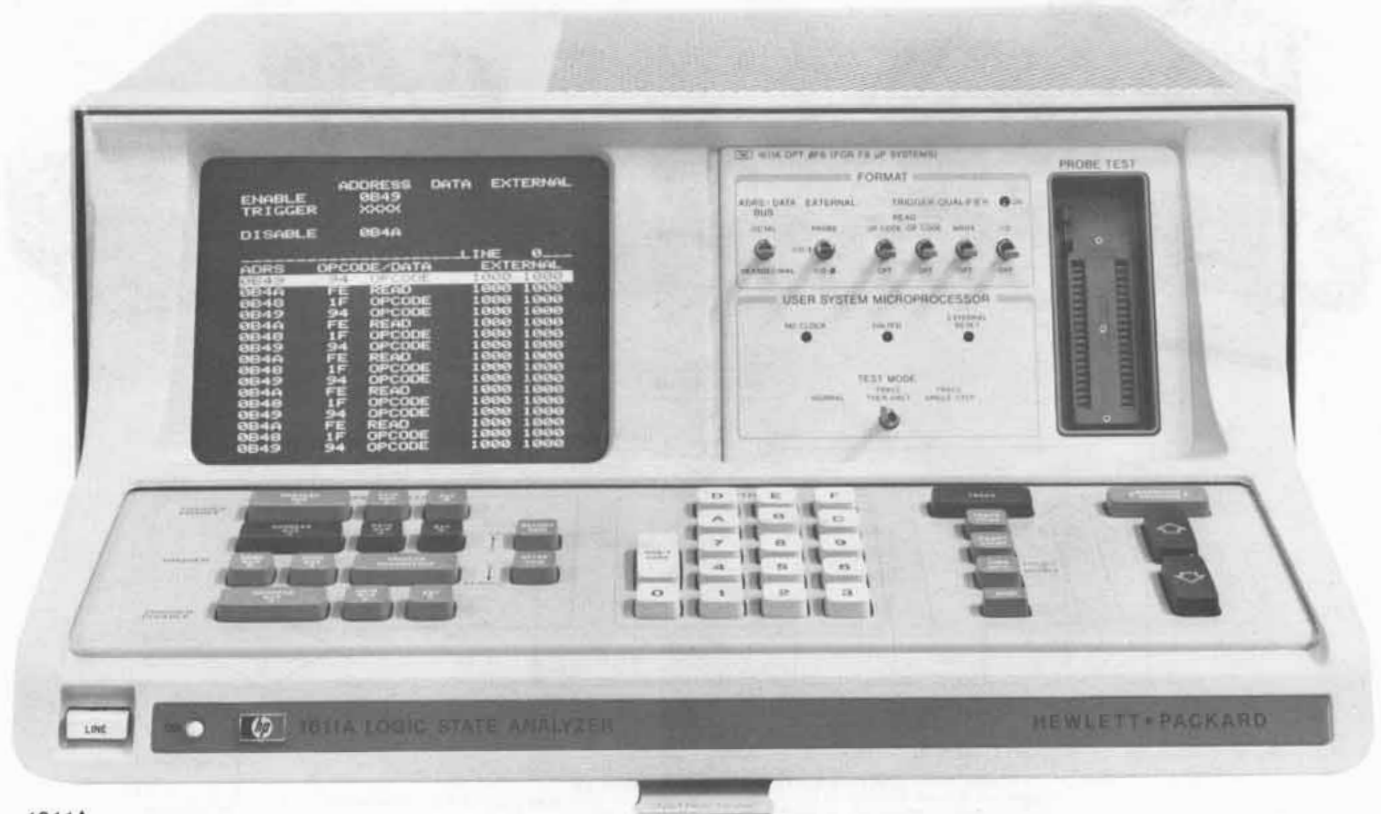

1611A

Description

The Hewlett-Packard Model 1611A keyboard controlled Logic State Analyzer is dedicated to the design and troubleshooting of microprocessor based systems. For ease-of-use, a special probe offers two methods of connection to 40-pin microprocessors, a 40-pin clip and a 40-pin connector for interfacing with microprocessors in sockets. Measurements of system activity are displayed on the analyzer's CRT screen in selectable mnemonic or absolute codes of the microprocessor's own instruction set. The display is divided into three distinct fields of address, data, and external information. The events and activity displayed in the address and data fields are collected directly from the system microprocessor's address and data buses with an additional eight bits of binary information gathered by auxiliary probes for display of activity on control or other functional lines.

The relational triggering capabilities of the Analyzer permit the framing of real-time data window around virtually any event, or set of related events—any desired sequence of system operations. With the 1611A you can selectively trace only those events of interest, eliminating irrelevant data. The Analyzer also accurately measures execution time, or counts selected events between two keyboard selected events. At a desired point, defined from a keyboard entry, the Analyzer can be commanded to halt microprocessor operation; then, if desired, the 1611A can control the following transactions in single or multiple steps. Keyboard entry of address or data bus trigger words may be made in either octal or hexadecimal notation and the external trigger information is entered in binary format.

To increase operator confidence in the instrument, it performs a self-test during the turn-on period and indicates the results on the

CRT. The microprocessor probe data gathering circuits may also be checked by connecting the probe to the front panel probe test socket with the test results displayed on the CRT.

ADDRESS	DATA	EXTERNAL
TRIGGER	000F	
		PRE-TRIGR=7
		LINE 8
ADRS	OPCODE/DATA	EXTERNAL
0009	LD C,B	0000 0000
000A	LD L,00	0000 0000
000C	LD H,D	0000 0000
000D	LD A,<HL>	0000 0000
0400	00 READ	0000 0000
000E	LD H,B	0000 0000
000F	LD <HL>,A	0000 0000
3400	00 WRITE	0000 0000
0010	INC L	0000 0000
0011	JP NZ,000C	0000 0000
000C	LD H,D	0000 0000
000D	LD A,<HL>	0000 0000
0401	31 READ	0000 0000
000E	LD H,B	0000 0000
000F	LD <HL>,A	0000 0000
3401	31 WRITE	0000 0000

Inverse assembly of the data on the data buses is possible with personality modules. This mnemonic display is in the familiar assembler format for easy interpretation.



The time interval mode and the ability to select enable and disable trigger conditions allows direct measurements of execution time in loops, subroutines, and responses to interrupts. The 1611A can record the time for one measurement or provide the minimum and maximum values along with the last measurement from repeated measurements.

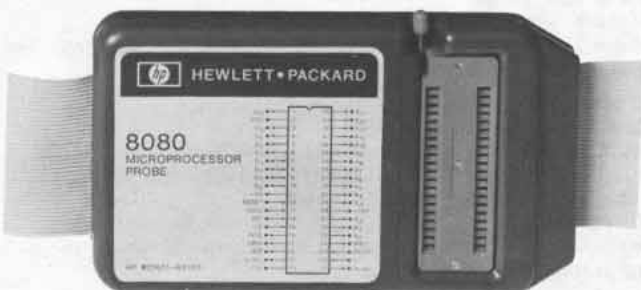

Connection to the system microprocessor is with a 40-pin dual-inline package clip or the microprocessor may be relocated to the probe body and the probe connected to the system with a 40-pin connector.

Configuration

The convenience of a dedicated probe and mnemonic instruction decoding is possible only by configuring the Analyzer for specific microprocessors. On initial order, the 1611A is specified to fit a particular microprocessor. Option A68 for the 6800, Option A80 for the 8080, Option 0F8 for the F8, Option Z80 for the Z80, Option A65 for the 6502, Option A18 for the 1802, Option A85 for the 8085.

All of the specialization is contained within two printed circuit boards, a removable section of front panel, and the dedicated microprocessor probe. A personality module containing the parts to configure the 1611A to another microprocessor may be ordered separately, and easily exchanged in about 15 minutes.

Option A68 (6800 Microprocessors)

Note: Model 10257B personality module may be ordered separately for installation in a 1611A to provide Opt A68 capability.

Microprocessor compatibility

Motorola: 6800, 68A00, 68B00.

Motorola: 6802.

AMI: 6800.

Note: The 1611A Opt A68 is designed to be compatible with any microprocessor that meets specifications of the Motorola 6800.

Clock and data inputs

Clock rate: 70 kHz to 2.0 MHz; (70 kHz to 1.66 MHz with 10257B installed in 1611A with serial prefix below 1723A).

Input loading

A₀-A₁₆, R/W, VMA: ≈ 1 MΩ shunted by ≈ 40 pF, including capacitance of 30.4 cm (12") cable; ≈ 30 pF with 7.6 cm (3") cable.

D₀-D₇, BA: 20 μA max with V_{in} = 2.7 V; -0.2 mA max with V_{in} = 0.4 V.

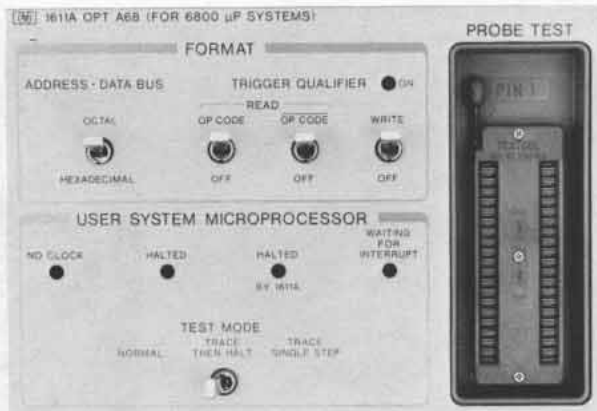

Opt A68

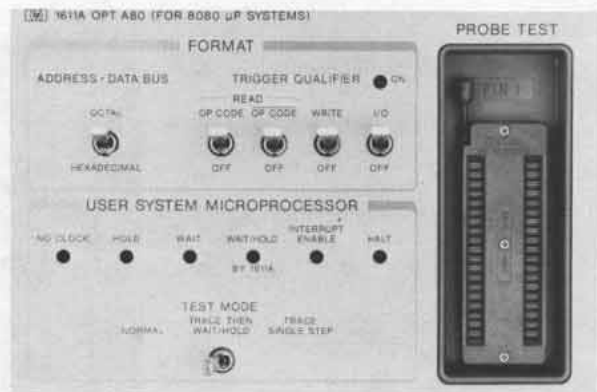

Opt A80

Halt: 120 μA max with V_{in} = 2.7 V; -0.2 mA max with V_{in} = 0.4 V.
Φ2: 0.2 mA max with V_{in} = 5 V; -0.4 mA max with V_{in} = 0.4 V.
Threshold: 2.4 V to 5.5 V, logic 1 (high); -0.8 V to 0.8 V, logic 0 (low).
Halt output: TTL open-collector compatible output capable of sinking at least 8 mA when active.

Option A80 (8080 microprocessors)

Note: Model 10258B personality module may be ordered separately for installation in a 1611A to provide Opt A80 capability.

Microprocessor compatibility

Intel: 8080, 8080A, 8080A-2, 8080A-1.

AMD: 9080A, 9080A-1, 9080A-2, 9080A-4.

NEC: μPD8080, μPD8080A-E.

Ti: TMS8080, TMS8080A.

National: INS8080A.

Note: The 1611A Opt A80 is designed to be compatible with any microprocessor that meets specifications of the Intel 8080A.

Clock (Φ2 only)

Repetition rate: 300 kHz to 4 MHz.

Width: 75 ns min for either high or low state.

Input resistance: ≈ 12 kΩ.

Input capacitance: ≈ 25 pF, includes capacitance of 30.5 cm (12") cable, ≈ 15 pF with 7.6 cm (3") cable.

Threshold: 9 to 13 V, logic 1 (high); -1 to 0.8 V, logic 0 (low).

Data, Address, Wait, Ready, HLDA, INTE, SYNC

Input resistance: ≈ 1 MΩ.

Input capacitance: ≈ 25 pF, includes capacitance of 30.5 cm (12") cable, ≈ 15 pF with 7.6 cm (3") cable.

Threshold: 3 V to 6 V, logic 1 (high); -1 to 0.8 V, logic 0 (low).

Ready output: TTL open-collector compatible output capable of sinking at least 8 mA when active.

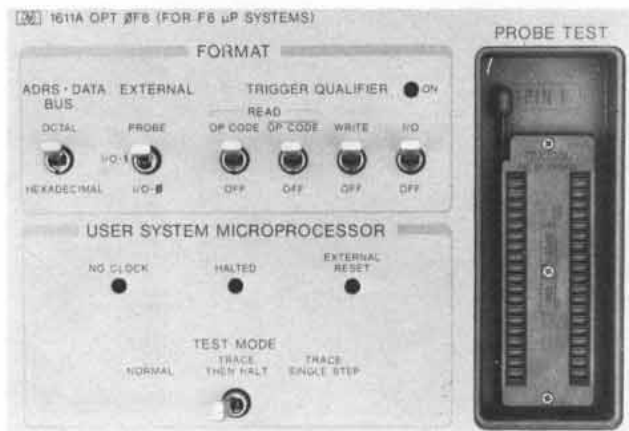

Opt 0F8

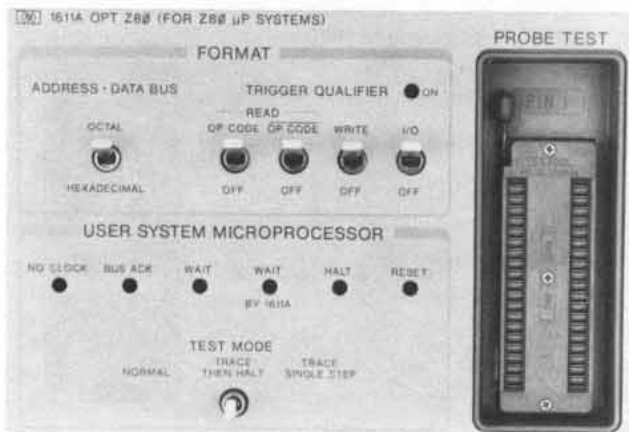

Opt Z80

Option 0F8 (F8 microprocessors)

Note: Model 10259A personality module may be ordered separately for installation in a 1611A to provide Option 0F8 capability.

Microprocessor compatibility

Fairchild: F8 (3850).

Mostek: F8 (3850).

Note: The 1611A Opt 0F8 is compatible with any microprocessor that meets specifications of the Fairchild F8.

Clock and write

Clock rate: 100 kHz to 2 MHz.

Width: 180 ns min for either high or low state.

Input current: $\approx 50 \mu\text{A}$, logic 0 (low) and logic 1 (high).

Input capacitance: $\approx 25 \text{ pF}$, includes capacitance of 30.4 cm (12") cable; $\approx 15 \text{ pF}$ with 7.6 cm (3") cable.

Threshold: 2.4 V to 5.5 V, logic 1 (high); -0.8 to 0.8 V, logic 0 (low).

Write period: either 4 or 6 times the clock period.

Write pulse width: max = clock period, min = clock period -100 ns .

ROMC

Input current: $\approx 22 \mu\text{A}$, logic 0 (low); $\approx 40 \mu\text{A}$, logic 1 (high).

Input capacitance: $\approx 25 \text{ pF}$, includes capacitance of 30.4 cm (12") cable; $\approx 15 \text{ pF}$ with 7.6 cm (3") cable.

Threshold: 2 V min, logic 1 (high); 0.7 V max, logic 0 (low).

Data, I/O0, I/O1, EXT RES

Input current: $\approx 200 \mu\text{A}$, logic 0 (low); $\approx 20 \mu\text{A}$, logic 1 (high).

Input capacitance: $\approx 25 \text{ pF}$, includes capacitance of 30.4 cm (12") cable; $\approx 15 \text{ pF}$ with 7.6 cm (3") cable.

Threshold: 2 V min, logic 1 (high); 0.7 V max, logic 0 (low).

Halting

The F8 CPU must be placed in the 1611A Probe socket to halt or single-step the F8 microprocessor.

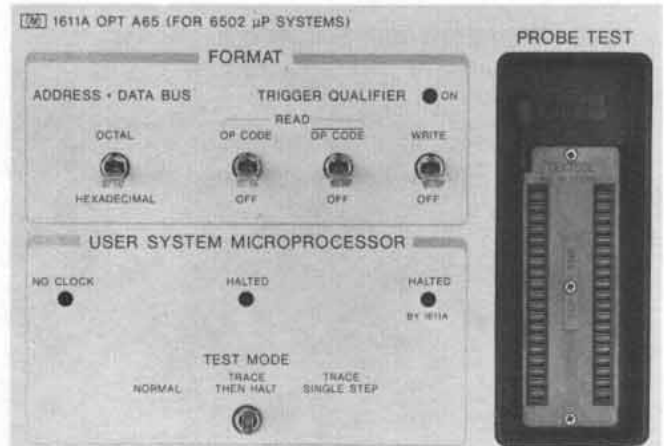

Opt A65

Option Z80 (Z80 microprocessor)

Note: Model 10260A personality module may be ordered separately for installation in a 1611A to provide Option Z80 capability.

Microprocessor compatibility

Zilog: Z80, Z80A.

Mostek: Z80, Z80A.

Note: The 1611A Opt Z80 is compatible with any microprocessor that meets specifications of the Zilog Z80.

Clock, data, address, and control inputs

Clock rate: 500 kHz to 4 MHz.

Input current: $\approx 200 \mu\text{A}$, logic 0 (low); $\approx 20 \mu\text{A}$, logic 1 (high).

Input capacitance: $\approx 25 \text{ pF}$, includes capacitance of 30.4 cm (12") cable; $\approx 15 \text{ pF}$ with 7.6 cm (3") cable.

Threshold: 2 V min, logic 1 (high); 0.7 V max, logic 0 (low).

Wait output: TTL open-collector compatible output capable of sinking at least 8 mA when active.

Option A65 (6502 microprocessors)

Note: Model 10261A personality module may be ordered separately for installation in a 1611A to provide Option A65 capability.

Microprocessor compatibility

Rockwell: R6502A, R6502, R6512A, R6512.

MOS Technology: MCS6502, MCS6502A.

Synertek: SY6502.

Note: The 1611A Opt A65 is compatible with any microprocessor that meets specifications of the MOS Technology MCS6502.

Clock and data inputs

Clock rate: 70 kHz to 2.0 MHz.

Input loading

AO-A15, R/W, Sync: $\approx 1 \text{ M}\Omega$ shunted by $\approx 40 \text{ pF}$, including capacitance of 30.4 cm (12") connecting cable, $\approx 30 \text{ pF}$ with 2.6 cm (3") cable.

DO - D7: 20 μA max with $V_{in} = 2.7 \text{ V}$; -0.2 mA max with $V_{in} = 0.4 \text{ V}$.

Rdy: 120 μA max with $V_{in} = 2.7 \text{ V}$; -0.2 mA max with $V_{in} = -0.4 \text{ V}$.

$\Phi 2$: 0.2 mA max with $V_{in} = 5 \text{ V}$; -0.4 mA max with $V_{in} = 0.4 \text{ V}$.

Threshold: 2.4 to 5.5 V, logic 1 (high); -0.8 V to 0.8 V logic 0 (low).

RDY output: TTL compatible open collector output capable of sinking at least 8 mA when active.

Option A18 (1802 microprocessors)

Note: Model 10262A personality module may be ordered separately for installation in a 1611A to provide Option A18 capability.

Microprocessor compatibility

RCA[®]: CDP1802D, CDP1802CD. Example of RCA acceptable operating conditions at $+25^\circ\text{C}$ with a shunt capacitance of 50 pF are:

V_{cc}	V_{dd}	CLOCK SPEED
5	5	2 MHz
5	10	4 MHz
10	10	5 MHz

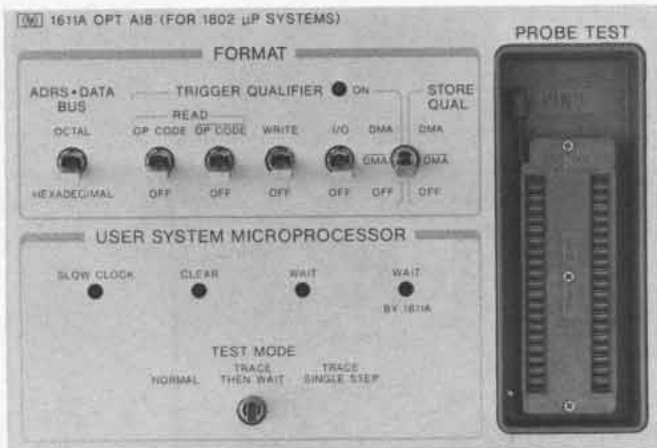

Opt A18

Note: The 1611A Opt A18 (Model 10262A) is designed to be compatible with any microprocessor that is functionally identical to the RCA 1802. Microprocessor operating conditions (clock rate, supply voltages and signal timing) must be compatible with the 10262A set-up and hold specifications.
 ®Registered Trade Mark RCA Corp.

Clock and data inputs

Input loading, MA 0—MA 7, Bus 0—Bus 7, TPA, TPB, XTAL, SC0, SC1, MRD, MWR, NO, N1, N2, WAIT, CLEAR: $\approx 32\text{ k}\Omega$ shunted by $\approx 25\text{ pF}$ including the capacitance of a 30.5 cm (12") cable or $\approx 15\text{ pF}$ with a 7.6 cm (3") cable.

Threshold: automatically adjusted internally to $\approx V_{DD}/2$.

Wait output: series current limit. Open collector output series with current limited to 10 mA.

Waiting: with the Test Mode Switch in TRACE THEN WAIT or TRACE SINGLE STEP with the CPU in the 1611A probe socket, the 1611A will cause the CPU to wait. If the CPU is not in the probe socket, waiting cannot be guaranteed.

Option A85 (8085 microprocessors)

Note: Model 10263A personality module may be ordered separately for installation in a 1611A to provide Option A85 capability.

Microprocessor compatibility

Intel: 8085, 8085A, 8085A-2.

AMD: AM9085.

Siemens: 8085.

NEC: $\mu\text{PD}8085$.

Note: The 1611A Opt A85 is compatible with any microprocessor that meets specifications of the Intel 8085.

Clock, data, address, status, and control inputs

Clock rate: 300 kHz to 5 MHz.

Threshold: 2 V to 5.5 V. logic 1 (high); -0.5 V to 0.8 V logic 0 (low).

Input current

Clock and Control: $\approx 50\text{ }\mu\text{A}$ max with $V_{in} = 2.7\text{ V}$; -0.4 mA max with $V_{in} = 0.5\text{ V}$.

Data, Address, and Status: $\approx 20\text{ }\mu\text{A}$ max with $V_{in} = 2.7\text{ V}$; -0.2 mA max with $V_{in} = 0.4\text{ V}$.

Input capacitance: $\approx 25\text{ pF}$ including capacitance of 30.5 cm (12") cable; $\approx 15\text{ pF}$ with 7.6 cm (3") cable.

Ready output: TTL compatible open-collector output capable of sinking at least 8 mA when active.

General

Connection between μP and 1611A input buffers: one 40 pin dual in-line package connector with 30.5 cm (12") cable, one 40 pin male socket with 30.5 cm (12") cable, or one 40 pin male socket with 7.6 cm (3") cable.

External probe inputs

Current: $\approx 50\text{ }\mu\text{A}$ logic 0 or logic 1

Capacitance: $\approx 25\text{ pF}$ at probe tip.

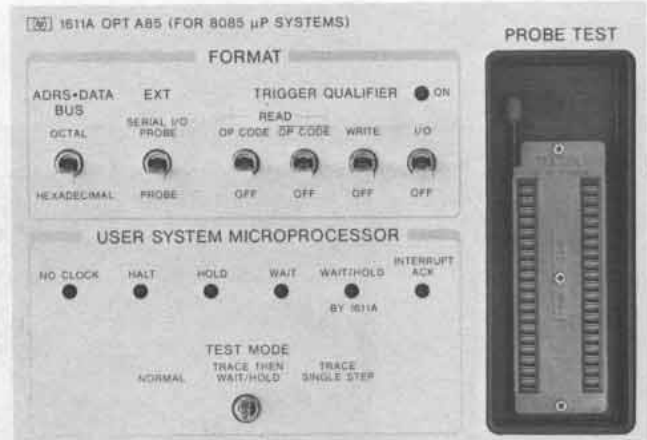

Opt A85

Threshold: 2.4 V to 5.5 V logic 1 (high); -0.8 to 0.8 V logic 0 (low).

Hold time: zero, relative to appropriate strobe edge.

Outputs

Low: $< 0.4\text{ V}$ into 50 Ω .

High: $> 2.0\text{ V}$ into 50 Ω (nominally 3.9 V into an open circuit).

Trigger: duration $\approx 75\text{ ns}$ in RZ format; delay ≈ 350 to 400 ns after the appropriate strobe edge during the cycle that defines a valid trigger.

Trace Point (\lceil): provides a positive edge ≈ 350 to 400 ns after the appropriate strobe edge during the cycle that defines the specific valid trigger to be displayed on the 1611A. If the 1611A Delay is set so that the trigger word is not displayed, Trace Point output occurs for the cycle that defines the valid word immediately preceding the first displayed word.

Trace Point (\lfloor): complement of Trace Point (\lceil).

Memory depth: 64 data transactions; 16 transactions are displayed at one time, roll keys permit viewing of all 64 transactions.

Time interval: accuracy, 0.1% $\pm 1\text{ }\mu\text{s}$. Max time, $(2^{24}-1)\text{ }\mu\text{s}$ (16.7 s).

Events count: $2^{24}-1$ events (16.7 million) max.

Logic probe output power: 5 V dc at 0.1 A max.

Power: 100, 120, 220, 240 V ac; -10% $+5\%$; 48 to 440 Hz; 120 VA max.

Size: 206 H x 426 W x 522 mm D (8 1/8" x 16 3/4" x 22 1/2").

Operating environment: temperature, 0°C to +55°C (+32°F to 132°F); humidity, to 95% relative humidity at +40°C (+104°F); altitude to 4600 m (15 000 ft); vibrated in three planes for 15 min. each with 0.38 mm (0.015 in.) excursions, 10 to 55 Hz.

Weight: net, 15 kg (33 lb); shipping, 19.5 kg (43 lb).

Accessories supplied: one microprocessor probe, external 8-bit probe; one 40 pin clip with 30.5 cm (12") cable, one 40 pin male socket with 30.5 cm (12") cable; one 40 pin male socket with 7.6 cm (3") cable; one 2.3 m (7.5 ft) power cord; and one Operating and Service Manual.

Ordering information

Model	Price
1611A Opt A68 Logic State Analyzer for 6800 μP	\$5200
1611A Opt A80 Logic State Analyzer for 8080 μP	\$5200
1611A Opt 0F8 Logic State Analyzer for F8 μP	\$5200
1611A Opt Z80 Logic State Analyzer for Z80 μP	\$5200
1611A Opt A65 Logic State Analyzer for 6502 μP	\$5200
1611A Opt A18 Logic State Analyzer for 1802 μP	\$5200
1611A Opt A85 Logic State Analyzer for 8085 μP	\$5200
Opt 910: extra set of product manuals	add \$9

Personality modules for field installation

10257B for 6800 μP	\$1250
10258B for 8080 μP	\$1250
10259A for F8 μP	\$1250
10260A for Z80 μP	\$1250
10261A for 6502 μP	\$1250
10262A for 1802 μP	\$1250
10263A for 8085 μP	\$1250

LOGIC ANALYZERS

Analysis of mini-microcomputer and random logic systems

Model 1610A

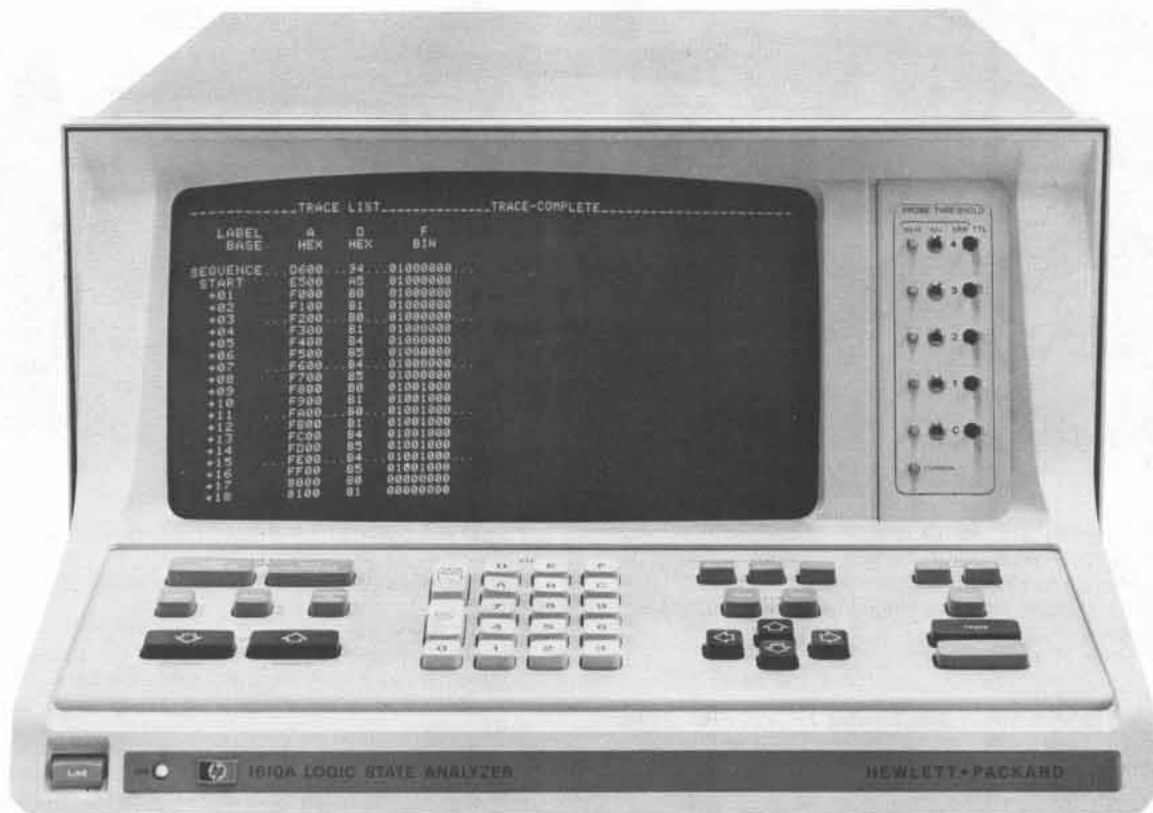

1610A

1610A Description

The Model 1610A keyboard controlled Logic State Analyzer offers general purpose measurements in microprocessor based systems, minicomputers, or virtually any digital circuit. The 1610A synchronously performs real time trace and count measurement to 10 MHz with powerful triggering capabilities on words up to 32 bits wide to allow you to capture the data of interest.

Measurements of system activity are displayed on the analyzer's CRT screen in selectable hexadecimal, octal, binary, or decimal codes. Setup for a measurement is aided with the Format and Trace specification menus which indicate the test parameters you are to enter. The events and activity that are captured and displayed from the system are gathered at clock transitions after the 1610A locates the specified trace position and then captures 64 words of data. The displayed trace may be a simple breakpoint with the trace position at the beginning, end, or center of the captured data; or, in a state sequence where one to seven words must be found in a specified order before data is captured. This state sequence permits you to directly locate sections of branched, looped, or nested loops of state flow. A selective trace of from one to seven words may be OR specified which allows only the words of interest to be captured and eliminates data that is not necessary for your measurement.

A count measurement capability allows you to perform a time or state count on all 64 traced states in either absolute or relative modes. With the count measurement you can determine how much time a program spends in loops, servicing interrupts, as well as the time between program steps. This measurement is performed simultaneously with the trace and all 64 words traced are assigned a count record which is displayed as positive or negative time in relation to the location of the trace position (absolute mode), or in relation to the previously acquired state (relative mode).

One complete measurement, including Format and Trace Specifications, may be internally stored to be recalled at a later time or for use in a trace compare mode. When a trace compare mode is called,

the display presents an exclusive OR tabular listing of the differences between the current and stored measurements. The trace compare mode may be also used to direct the Analyzer to continuously rerun a measurement until the current and stored measurements are equal or not equal and the 1610A automatically halts and retains the current measurement.

The 1610A includes a Trace Graph to provide a display of data magnitude versus time sequence for all 64 words in memory. Each dot representing a word is given a vertical displacement corresponding to its magnitude and is positioned horizontally in the order of its occurrence. The result is a waveform that offers a quick overview of program operation.

For increased confidence of the instrument's operation, there are self-tests for the keyboard, ROM/RAM, display, a trace test which includes all probe pods, an interrupt test, and a printer test.

Hard copy of both the Format and Trace specifications as well as the Trace List and Trace Compare can be obtained by adding a Hewlett-Packard printer (Model 9866A or 9866B). Rear panel printer outputs are included in the 1610A for direct interfacing.

Data entry

Entries are made in inverse video fields with the entry location indicated by a blinking cursor. Entry fields (enclosed with brackets) are multiple choice with the desired test parameter selected by using the Field Select key (e.g. positive or negative edge of clock transition). Trace specifications are entered through the keyboard directly in octal, hexadecimal, binary, or decimal notation which permits working in a familiar format without worrying about base conversions.

Menu

The displays which are called up by keyboard commands are referred to as menus because they include the selections for setting up test parameters and labeling of test results. These menus include Format Specification, Trace Specification, Trace List, Trace Compare, and Trace Graph.

Format specification

The formatting capabilities allow you to separate the 32 input data channels into the desired test parameters. This allows those data bits which act as a unit to be assigned to one of six labels (e.g. 16 bits of address bus assigned as "A" and 8 bits of data bus assigned as "D"). This labeling capability then permits all trace specifications to be assigned as a unit rather than on individual lines. Each assigned label may be independently defined in positive or negative logic as well as different bases of binary, octal, decimal, or hexadecimal. Another feature of this menu is that active channels are shown as exclamation marks (!) for a quick overview of system activity.

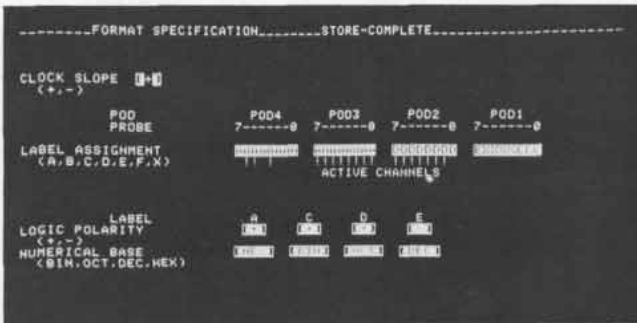

Format specification menu lets you define which group of bits will act as a unit by assigning labels which may be separately defined as to numerical base and polarity. The allowed selections are defined on-screen to minimize front panel controls.

Trace specification

After the Format Specifications have been defined, the Trace Specification menu is called up and the measurement parameters are entered. The Trace measurement may be defined as a single word or may be in a sequence of from one to seven words which must be found in the specified order. The ability to select a sequence of words allows you to locate sections of branched, looped, or nested loops during machine operation. To further qualify the sequence, each word in a sequence may be specified to occur from 1 to 65 536 times so you can capture the nth pass of a loop beginning at a given word.

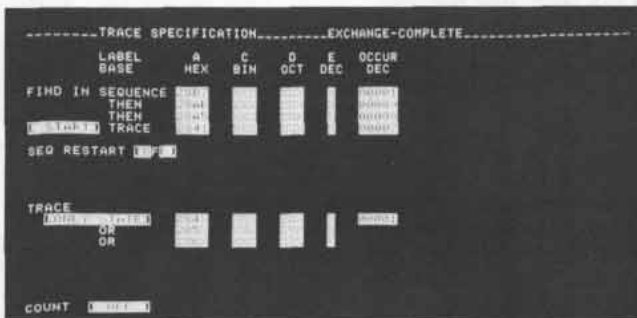

Typical trace specification for defining a test sequence that will capture a nested loop as well as only selected states in the loop.

Trace list

When the Trace key is pressed, the 1610A searches for the word sequence defined in the Trace Specification. As the data is captured it is displayed on the CRT along with a line number and alphabetically formatted into the assigned labels and in their numerical base. The display contains 20 words, and Roll keys permit you to view the entire 64 word listing. To make it easier to locate the Trace position, which may be selected to start, be in the center, or end a trace, Start is spelled out on the display. Any count information is also presented adjacent to each word.

The count measurement may be specified to be either Time or State (word) count for all 64 words in memory and may be in either absolute mode or relative mode. The absolute mode gives you the time or count between the trace position and a selected word, while the relative mode presents the time or count between each consecutively acquired state. This allows you to directly determine the time spent in loops, interrupts, or program time between steps.

TRACE LIST					EXCHANGE-COMPLETE	
LABEL	A	C	D	E	TIME	DEC
BASE	HEX	BIN	OCT	DEC	SEC	US
SEQUENCE	2887	000	286	1		
SEQUENCE	28AE	000	286	1	1.089	S
SEQUENCE	28A5	000	286	1	68.00	MS
START	2841	000	000	1	6.849	US
+01	2842	000	232	1	4.0	US
+02	2843	000	000	1	2.0	US
+03	2844	000	232	1	4.0	US
+04	2845	000	002	1	4.0	US
+05	2846	000	280	1	4.0	US
+06	2847	000	002	1	2.0	US
+07	2848	000	046	1	2.0	US
+08	2849	000	004	1	2.0	US
+09	284A	000	212	1	6.0	US
+10	284B	000	000	1	2.0	US
+11	284C	000	204	1	2.0	US
+12	284D	000	002	1	2.0	US
+13	284E	000	316	1	2.0	US
+14	284F	000	058	1	2.0	US
+15	2850	000	74	1	2.0	US
+16	2851	000	010	1	2.0	US

Trace list displays the label and numerical bases, as well as the sequence requirements and resulting state flow. This example also shows time in the relative mode which is the elapsed real time between each state and the previously acquired state.

Trace graph

Trace Graph is a presentation of data magnitude versus time sequence which provides a display of all 64 words in memory. This graph allows you to see at a glance in which part of a program the machine under test is operating. Each word is displaced vertically according to its magnitude and positioned horizontally in order of its occurrence. The data to be graphed is selected by label with its base displayed on screen.

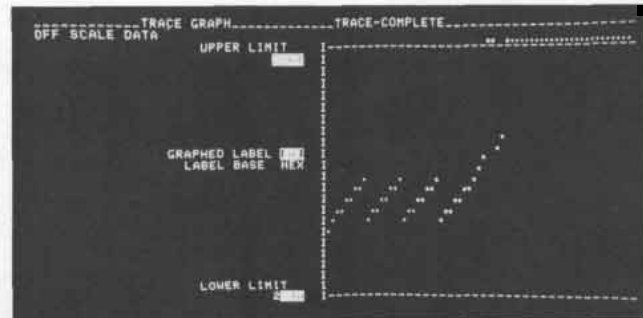

A trace graph may be selected to give you a view of all 64 states in the analyzer's memory. Each dot's vertical position is determined by its numerical value and its horizontal position is determined by its time sequence of occurrence.

Trace compare

One complete trace measurement including format and specification may be stored internally which allows comparison between a current and stored measurement. The current and stored measurement may also be interchanged which allows you to quickly review the stored measurement as well as its specifications.

Trace Compare presents an exclusive OR tabular listing of the differences between the current and stored measurements. The listing is formatted and rolled as a trace list with identical bits displayed as zeros and different bits displayed as nonzeros. For example, in the octal base, 03 is equivalent to a binary 000 011 which means that the least significant bits are different in the two measurements. A compared Trace mode is also available which directs the 1610A to continuously rerun a measurement until the current and stored measurements are either equal or not equal which makes it much easier to capture intermittent problems.

Model 1610A (cont.)

Probes

Input data is sensed through 32 high impedance probes at rates to 10 MHz. Data probes are separated into four 8-bit pods for easier connection to a system, with a fifth probe pod for connecting to a clock source. To make it easier for connecting to different systems, the front section of each probe may be disconnected from its pod. This allows the individual probe leads for each probe pod to be wired to connectors for specific systems. Additional probe lead kits as well as probe tips are available separately as accessories.

TRACE COMPARE		COMPARED TRACE-COMPLETE			
LABEL BASE	A HEX	C BIN	D BIN	E DEC	COMPARED TRACE MODE
START	0000	000	00000000	0	
+01	0000	000	00000000	0	
+02	0000	000	00000000	0	
+03	0000	000	00000000	0	
+04	0000	000	00000000	0	
+05	0000	000	00000000	0	
+06	0000	000	00001100	0	
+07	0000	000	00000000	0	
+08	0000	000	00000000	0	
+09	0000	000	00000000	0	
+10	0000	000	00000000	0	
+11	0000	000	00000000	0	
+12	0000	000	00000000	0	
+13	0000	000	00000000	0	
+14	0000	000	00000000	0	
+15	0000	000	00000000	0	
+16	0000	000	00000000	0	
+17	0000	000	00000000	0	
+18	0000	000	00000000	0	
+19	0000	000	00000000	0	

The trace compare mode offers an exclusive OR comparison of stored versus active data. In this example, the 1610A stopped data acquisition when the active data was not equal to the stored data at state +06.

Trigger outputs

Once a fault is found, another type of analysis instrument, usually an oscilloscope, is often required to pinpoint the problem. The analyzer's Trigger Output is stable with respect to the system clock so an oscilloscope can be used for critical timing measurements. The Measurement Enable output is useful for gating clocks or interrupting the device under test or for added "clock stopper" circuits in other parts of the system.

1610A Specifications

Clock and data inputs

Repetition rate: to 10 MHz.

Input RC: 50 k Ω shunted by ≤ 14 pF at the probe tip.

Input bias current: ≤ 20 μ A.

Input threshold: TTL, fixed at $\approx +1.5$ V; variable, ± 10 Vdc.

Max input: -15 V to $+15$ V.

Min input

Swing: 0.5 V.

Clock pulse width: 20 ns at threshold level.

Data setup time: time data must be present prior to clock transition, 20 ns.

Hold time: time data must be present after clock transition, 0 ns.

Delay from input clock: ≤ 150 ns.

Trigger and meas enable outputs

Trigger output (rear panel): a 50 ns ± 10 ns positive TTL level trigger pulse is generated each time the trace position is recognized. If the trace position includes a word sequence, the pulse occurs when the last word is found. Trigger outputs continue until a new specification is traced or the Stop key is pressed. Pulse rep-rate is 0 to 10 MHz depending on input data rates. In continuous or compared trace modes, the internal display process blanks out pulses for 100 μ s at rep-rates of < 20 Hz.

Measurement enable output (rear panel): the positive TTL level measurement enable output goes high and remains high when the 1610A is looking for a trace position and goes low when a trace position is recognized or if the Stop key is pressed. In continuous or compared trace modes the transitions repeat each time the 1610A makes a new measurement.

Delay from input clock: ≤ 150 ns.

General

Memory depth: 64 data transactions; 20 transactions are displayed on screen, roll keys permit viewing all 64 data transactions.

Time interval: resolution, 100 ns; accuracy, 0.01%. Maximum time, 429.4 seconds.

Events count: 0 to $2^{32} - 1$ events.

Power: 100, 120, 220, 240 Vac; -10% to $+5\%$; 48 to 63 Hz; 260 VA max.

Size: 230 H x 425 W x 752 mm D (9 $\frac{1}{16}$ " x 16 $\frac{3}{4}$ " x 29 $\frac{5}{8}$ ").

Operating environment

Temperature: 0°C to +55°C (+32°F to +132°F).

Humidity: up to 95% relative humidity at +40°C (+104°F)

Altitude: to 4600 m (15 000 ft).

Vibration: vibrated in three planes for 15 min. each with 0.25 mm (0.010 in.) excursions, 10 to 55 Hz.

Weight: net, 26.5 kg (58.5 lb); shipping, 32.2 kg (71 lb).

Accessories supplied: four 10248A data probes, one 10247A clock probe, one 2.3 m (7.5 ft) power cord, one Operating manual, and one Service manual.

Accessories

Probe lead kit: the probe lead kit (HP P/N 10248-69501) provides a set of 12 probe lead cables and a ganging bar for one 10248A probe. These extra leads provide a convenient method of wiring special connectors to quickly interface with different systems.

Probe tips: separate probe tips (HP P/N 10230-62101) available for use with extra probe lead kits or as replacement tips.

Ordering information

1610A Logic State Analyzer

Opt 001: adds 9866 Thermal Printer

Opt 002: adds 9866B Thermal Printer

10248-69501 Probe Lead Kit

10230-62101 Probe Tip

Price

\$9500

add \$3145

add \$3350

\$ 30 ea

\$2.50 ea

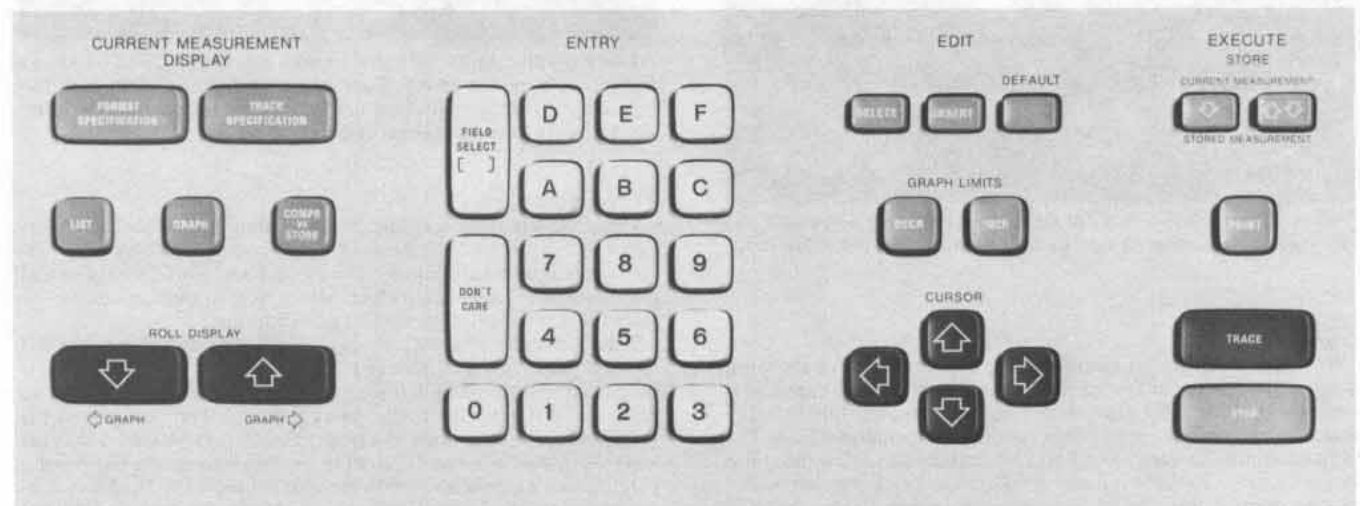

Logically arranged Logic State Analyzer keyboard, divided into functional blocks, and an interactive display, allow entry of complex measurements with a minimum of controls.



Interfaces for digital systems, minicomputers

Models 10275A, 10276A, 10277A, B, C



Model 10275A interface plugs directly into the PDP®-11 minicomputer unibus. For maximum measurement flexibility, Model 10277A general purpose interface connects directly to the logic analyzer pods and the 10275A.

Analyzer interfaces, description

Three interfaces are available for convenient connecting of HP Logic Analyzers to digital systems and minicomputers. Two of the interfaces, Models 10275A and 10276A, connect directly to Digital Equipment Corporation's PDP-11 and LSI-11® minicomputers, and the third, general purpose interface Model 10277 (A, B, or C), connects a logic analyzer to either the special interfaces, or directly to a digital system.

10275A Unibus interface

Model 10275A Unibus Interface is a quad-height board that plugs directly into the PDP-11 Small Peripheral Control (SPC) slots to access the 56 bus signals. Active circuits on the interface board generate the analyzer clock signal from asynchronous bus activity. Switches on the interface allow selective qualification of unibus activity so that reads, writes, interrupt vectors, or DMA transfers can be selectively captured for detailed analysis.

10276A LSI-11 interface

Model 10276A LSI-11 Q-bus interface is a dual-height board that plugs directly into the minicomputer to access Q-bus signals. Active circuits are used to demultiplex the address and data bus and generate a clock signal for analysis of asynchronous bus activity. Selective qualification of Q-bus activity permits capture or exclusion of reads, writes, interrupt vectors, refresh activity, or DMA transfers. Control of minicomputer operation is made possible by the capability to activate the minicomputer Halt input. The Q-bus interface can be used as (1) an I/O peripheral, (2) an expansion module for connecting to another mainframe, or (3) by using three DIP Terminators (available from Digital Equipment Corporation) as a terminator module.

10277A, B, C general purpose interface

Model 10277A, B, or C general purpose interface provides interconnection between HP logic analyzers and digital systems. The HP logic analyzer probe pods plug into the interface, and connection to the digital system is through two 40-pin connectors with ribbon cables. A quick-change board in the interface contains wire-wrap pins so the user can define the system signals which are applied to the analyzer. The board also has space for active components for signal preprocessing such as serial-to-parallel conversion, latching data, or generating OR'ed clocks, before entry into the analyzer. Two of these quick-disconnect wire-wrap boards are supplied with each 10277 to allow quick change from one type of analysis to another. The 10277A or 10277B Option 001 replaces one of the supplied wire-wrap boards with a quick-disconnect printed-circuit board for immediate connec-

tion to HP interface boards such as the 10275A and 10276A, without having to wire-wrap for state flow.

Model 10277A is used with the 1610A Logic Analyzer, Model 10277B with the 1615A Logic Analyzer, and the 10277C with the 1600A or 1607A Logic Analyzers.

10275A Specifications

Bus loading: one unit DEC® load (P/N DEC 8640 Bus Receiver) with 12 pF maximum shunt capacitance at the edge connector (nominally 6 pF).

General

Weight: net, 0.28 kg (10 oz); shipping, 0.6 kg (1 lb 5 oz).

Power: 900 mA maximum at 5 Vdc (nominally 550 mA), supplied by the minicomputer.

Size: interface board plugs directly into PDP-11.

Operating Environment: temperature, +5°C to +40°C; humidity, to 95% relative humidity at +40°C; altitude, to 4600 m (15 000 ft); vibration, vibrated in three planes for 15 min. each with 0.3 mm (0.015 in.) excursions, 10 to 55 Hz.

Recommended Accessory: Model 10277A General Purpose Probe Interface.

10276A Specifications

Bus loading: one unit DEC® load (type 956, P/N DEC 8640 Bus Receiver) with 12 pF maximum shunt capacitance at the edge connector (nominally 6 pF).

General

Weight: net, 0.28 kg (10 oz); shipping, 0.6 kg (1 lb 5 oz).

Power: when used as interface, 520 mA nominal, 890 mA max, when used as a terminator, 990 mA nominal, 1630 mA max.

Size: interface board plugs directly into LSI-11.

Operating Environment: temperature, +5°C to +40°C; humidity, to 95% relative humidity at +40°C; altitude, to 4600 m (15 000 ft); vibration, vibrated in three planes for 15 min. each with 0.3 mm (0.015 in.) excursions, 10 to 55 Hz.

Recommended Accessories: HP Model 10277 General Purpose Probe Interface. Three DIP Terminators (DEC P/N 13-11003) available from Digital Equipment Corporation (required to use the 10276A as a terminator).

®Registered Trademark of Digital Equipment Corporation.

10277A, B, C Specifications

Input connectors: two 40 pin connectors to interface with a system. Two BNC connectors are included on the interconnecting board to allow external signals such as Measurement Enable from the analyzer, or power to user constructed circuits on the board.

Output connectors: four data connectors for HP Logic Analyzers with Model 10248 or 10231C data probes. One clock connector for HP Logic Analyzers with 10247, 10248 or 10230C clock probes.

General

Weight: net, 0.75 kg (1.7 lb); shipping, 2 kg (4.4 lb).

Size: 36 H x 188 W x 254 mm D (1.4" x 7.4" x 10")

Accessories supplied: two removable interconnecting wire-wrap boards (HP P/N 10277-66501), two 36 cm (14 in.) ribbon cables with 40 pin female connectors on each end (HP P/N 10277-61601), and two 40 pin male connectors (HP P/N 1251-3004).

10277A, B, C Accessories

	Price
10277-66501: Interconnecting Wire-wrap Board with connectors (two supplied on initial order of a 10277).	\$100
01611-61609: Ribbon Cable, 30.5 cm (12 in.), with a 40 pin female connector and a 40 pin clip.	\$80
01611-61612: Ribbon cable, 10.2 cm (4 in.), with a 40 pin female connector and a 40 pin plug.	\$26
01611-61610: Ribbon Cable, 30.5 cm (12 in.) with a 40 pin female connector and a 40 pin plug.	\$30

Ordering information

10275A PDP-11 Unibus Interface	\$300
10276A LSI-11 Interface	\$375
10277A Interface for 1610A	\$400
Opt 001: replaces one wire-wrap board with printed-circuit board with 91.4 cm (36 in.) cable for immediate minicomputer analysis	N/C
10277B Interface for 1615A	\$400
Opt 001: same descrip as 10277A Opt 001	N/C
10277C Interface for 1600A or 1607A	\$400

LOGIC ANALYZERS

Gen purpose logic analysis, automated testing, HP-IB (IEEE 488) debugging

Model 1602A



1602A



1602A Description

Hewlett-Packard's extremely easy-to-use Model 1602A keyboard controlled Logic State Analyzer is for use in the design and troubleshooting of digital systems. The 16-bit wide and 64-word deep memory operates at clock speeds to 10 MHz allowing the instrument to capture virtually any 64-word sequence in a system. The data may be registered with versatile pattern recognition trigger and digital delay. Measurements of system activity are displayed on the Analyzer's LED readout in hexadecimal, octal, or binary format, which eliminates the need for base conversions by the operator. Keyboard entry of the desired trigger is in the same base as selected for the display.

A Hewlett-Packard Interface Bus option (HP's implementation of IEEE Standard 488) allows you to make automated functional tests of digital systems. This means more consistent and repeatable measurements as well as more thorough testing because the test speed of the automated system allows more measurements in a shorter time in both production and service environments.

Ease of use

The 1602's keyboard with its key-per-function layout is basically self-teaching. Entry of triggering and display conditions is a series of self-explanatory keystrokes with all entries displayed as they are entered enabling you to check their accuracy every step of the way.

Data Probe

The simplicity of the Analyzer starts with the probe which is a single pod containing all 16 data lines, clock, qualifier, and ground. At the front of the pod is a standard edge connector which allows you to quickly move the test connection from an address bus to the data bus, control lines, or I/O structures. You need only incorporate a few simple mating printed circuit board connectors in your system.

Tracing data flow

Capturing data flow is also easy and only requires a logical sequence of key strokes. The first item to define is the Logic Polarity of your system by pressing the Logic Polarity key. The panel LED's indicate your selection, positive for high true and negative for low true. Next select the clock edge on which you want to gather data which is also indicated by panel LED's.

Now select the display format that you want to use for the test. If you are running tests on an address or data bus, you would most likely select either hexadecimal or octal display format. However, if the test is on an I/O bus with numerical data, decimal may be preferred. For activity on control lines, binary is a meaningful base. In all cases the display indicates the selected format with a base (b) notation on the right. Many times all of the input lines are not used and if you want to blank the more significant bits, just press the Word Width key and enter the number of bits to be displayed from 2 to 16.

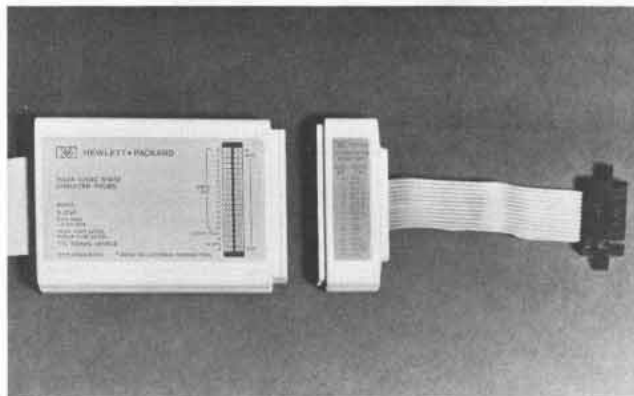

The desired data window is entered from the Trace Specification section of the keyboard. If you want to view data after the desired trigger point, press Trigger Plus Delay Starts Trace which directs the 1602A to start collecting data as soon as the Trace Specification is satisfied. If you are more interested in data preceding the trigger point, select Trigger Plus Delay Ends Trace. For either mode, Start or End, an LED indicates the selected mode.

To define a trigger point, press the Trigger = key and enter the desired trigger point, e.g. 2805, in the same format previously selected for the display. The selected trigger word is displayed for verification.



To enter a delay that will position the start or stop of data collection a specific number of clock pulses from the trigger word, press the Delay = key and enter the number of desired clock pulses. The delay count is entered and displayed in decimal format. Delays of up to 65 535 clock pulses after the trigger point may be entered and used to either start or end data collection.

The trace specification is now complete and the 1602A is ready to capture data. Pressing the Trace key instructs the Analyzer to start looking for the trigger word. Once the trigger word is recognized, the Analyzer captures and stores 64 words in memory as defined by the preset trace specifications.



Two words are normally displayed in the viewing window. The number at the far left (0 in this example) is the memory location of the word 2805₁₆. The word on the far right is in the next higher location of the Analyzer's memory.

The data in the Analyzer's memory may be viewed on the display using the four keys in the display block. The Prior Word and Next Word keys permit you to view the memory contents one word at a time, or if you hold a key, the memory contents will sequence rapidly through the display. The Word Number = key allows you to quickly address any memory location and the At Trigger Word key automatically restores the display to the trigger point.

Measurement flexibility

This Analyzer, with all its operating simplicity, has the power required to capture more than basic data lists. For example, to determine if a data line is stuck in one state, a Trace Continuous mode permits the suspected line to be monitored for activity. The mode is entered by pressing TRACE followed by C and may be used with any number base.

To capture data on the ninth pass of a loop, a Delay By Events mode is available. Delay By Events is entered by pressing in sequence Delay =, E, and then entering in decimal format the desired number of events to 65 535. The display then shows that the Analyzer is set to Delay By Events with an E, and also the selected number of events, 352. When Trace is pressed the 1602A will count the selected number of Events (trigger points) before capturing data.

For viewing consecutive occurrences at specific points, such as data being sent to a peripheral, a Trace Events Mode is provided. This mode is entered by pressing Trace followed by E which directs the 1602A to capture only the data that is described by the trigger word plus delay.

When additional qualification is needed for data collection, such as restricting the data to only reads, writes, or outputs, the rear panel trigger and clock qualifiers are available. These inputs are compatible with the HP Model 10250A TTL trigger probe allowing expansion to four qualifier inputs.

Once a functional fault is located in execution of the program, another form of analysis instrument, usually an oscilloscope, is frequently desired to pinpoint the problem. The Analyzer's trigger output is stable with the system clock which allows an oscilloscope to be used for critical timing measurements.

A Trace Point Output is available for generating interrupt signals or for added "clock stopper" circuits in other parts of the system un-

der test. The rear panel outputs can also be used to cascade 1602A's or other analyzers.

And, for those occasions where the data being gathered are mixtures of information from buses and control lines, a mixed mode of binary and either hex, decimal, or octal bases can be easily entered with a few keystrokes. Pressing Word Width = 16 and Hex 8 gives the display shown.



The resulting trace then displays the captured data in the format most convenient for analysis.



The Analyzer also interacts with message codes which assist the operator in gathering and sorting data. The definitions of these message codes are included inside the storage compartment top cover for easy reference.

For increased confidence of the Analyzer's operation, it performs a self-test during turn-on and indicates the results on the display. In addition, there is a multi-level diagnostic software which allows the Analyzer to identify virtually any internal fault.

Automatic testing

In addition to stand-alone operation the Analyzer can be configured for use with the Hewlett-Packard Interface Bus (IEE 488) family of interactive instruments. An optional HP-IB interface is available which when combined with a computing controller and suitable stimulus allows the data captured by the programmable 1602A to be transferred to the controller for analysis, providing fast, easily repeatable checkout and troubleshooting in production and service environments. Now, the engineer who designs a system can establish proper vs improper operating characteristics and provide an automatic test sequence which will functionally check the system. By developing the tests in an HP-IB configuration, he can print out a complete data record for each test, greatly simplifying documentation of test procedures.

The biggest benefit of automated testing is that each instrument is tested identically; a QA inspector can functionally test the system with the same parameters used in final test. System failures that occur during testing can be readily defined and documented, and since they are stored in an automated test routine, the failure test conditions can be duplicated at will. Libraries of faults can be rapidly generated using these automated test procedures, with each fault documented and stored in a data cartridge file for use in automated debugging in production or field service.

Programming

A learn mode feature provides an easy way for a designer to program the Analyzer with an HP Model 9825A Computing Controller without using the formal HPL language. A few special function keys are all that is needed for most test programs, and the procedure for using them is also easy. Just make the measurement once manually using the 1602A and then press LEARN on the computing controller. The system will then become conversational and ask for the test number, number of words of 1602A memory to be compared, desired measurement time limit, and which test to go to if the present test passes or fails. The computing controller then automatically reads the Analyzer's keyboard and memory and transfers this data to its cassette. The first test of the "test procedure" is now completed and documented. A complete test procedure can be rapidly generated and documented by using this method. To use the test procedure, simply connect to the system or device under test and press the special function "Run" key on the Computing Controller. Your "Automated" test system then sets up each test in the procedure, compares the data collected to the reference data stored on the cassette, and indicates where functional errors exist. This means that all your devices can be functionally tested in minutes, automatically, with identical procedures eliminating variations due to differences between operators.

Model 1602A (cont.)

Debugging HP-IB (IEEE 488) systems

Hewlett-Packard's Models 10050A and 10051A HP-IB Adapter and Test Probe offer a convenient method of Monitoring HP-IB (IEEE 488) lines with a 1602A Logic State Analyzer. These accessories connect directly to the interface system, do not interfere with operation, and are capable of monitoring activity at full operating speeds. The 1602A's mixed display mode allows decoding of bus information to match the bus format of eight data, and eight control and handshake lines. With a few keystrokes, the display may be configured with eight lines in binary and the remaining eight in either hexadecimal, octal, or decimal format.



HP-IB adapter

For basic monitoring of an HP-IB system, the Model 10050A Adapter is quickly connected to the 1602A probe and HP-IB piggyback connector. There are no time consuming problems of connecting individual probe leads to an HP-IB connector.

HP-IB test probe

More complete tests of an HP-IB system can be performed by using the model 10051A Test Probe in conjunction with the 10050A Adapter. Connection to the system under test is simply accomplished by plugging in the test probe, adapter, and connecting to the HP-IB connector.

With the 10051A, you automatically check for protocol violations on three handshake wires. Any time one of the eight possible states occurs out of sequence the LED on the probe flashes to indicate a possible problem and also supplies a pulse for triggering the 1602A or external instrumentation so that a problem can be quickly located. The timing diagram shows the normal sequence on the three handshake lines.

SEQUENTIAL REQUIREMENTS OF THE THREE WIRE TRANSFER

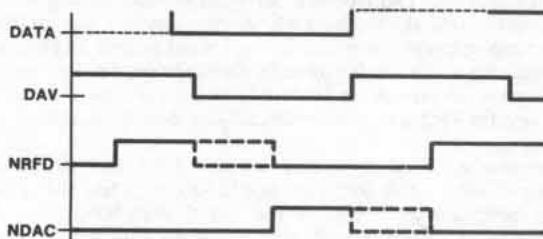

A Clock Qualifier switch allows selection of Commands, Data, or Both to control the type of bus activity that is loaded into the 1602A's memory. A Clock Source switch allows you to strobe data into the 1602A on the positive edge of NDAC, negative edge of DAV, completion of a parallel poll, or with a manual pushbutton. By selecting Parallel Poll as a clock the 1602A monitors DIO lines to check device status when a parallel poll is conducted. If there are no handshake operations being conducted, the Manual pushbutton allows you to clock the current bus state into the 1602A.

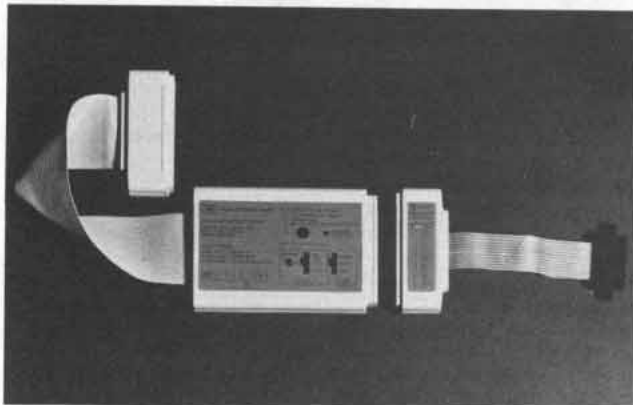

1602A Specifications

Probe Inputs

Repetition rates: to 10 MHz.

Input load: one low power Schottky gate (<400 μ A source).

Input threshold: TTL, fixed at ≈ 1.5 V.

Max input: <+5.5 V.

Min input

Level: >-0.5 V.

Swing: from $\leq +0.4$ V (low) to $\geq +2.4$ V (high).

Clock pulse width: ≥ 25 ns at threshold.

Data setup time: time data must be present prior to a clock transition, 35 ns at threshold.

Hold time: time data must be present after a clock transition, zero.

Trigger and clock qualifier inputs (rear panel)

Input load: 8 mA max source.

Max input: <+5.5 V.

Min input

Level: >-0.5 V.

Swing: from $\leq +0.4$ V (low) to $\geq +2.5$ V (high).

Setup time: time data must be present prior to a clock transition, 40 ns with 10250A probe, 10 ns without probe.

Hold time: time data must be present after a clock transition, 15 ns with 10250A probe, 30 ns without probe.

Trigger and trace point outputs

High: ≥ 2 V into 50 Ω .

Low: ≤ 0.4 V into 50 Ω .

Pulse duration (width)

Trigger: high for \approx one clock period.

Trace point: sets low when Trace key is pressed, returns high when the Trace Specification is met.

Delay from input clock: <150 ns.

General

Power: 100, 120, 220, and 240 Vac; -10% +5%; 48 to 66 Hz; 50 VA max.

Size: 107 H x 275 W x 421 mm D (4 $\frac{7}{32}$ " x 10 $\frac{13}{16}$ " x 16 $\frac{9}{16}$ ").

Operating environment

Temperature: 0°C to +55°C (+32°F to +132°F).

Humidity: up to 95% relative humidity at +40°C (+104°F).

Altitude: to 4600 m (15 000 ft).

Vibration: vibrated in three planes for 15 min. each with 0.38 mm (0.015 in.) excursions, 10 to 55 Hz.

Weight: net, 4.5 kg (10 lb); shipping, 5.9 kg (13 lb).

Accessories supplied: one external probe pod, one connector with individual clock, ground, and data probe leads with tips, three display labels (HP P/N 01602-94302), one 2.3 m (7.5 ft) power cord, one Operating and Service Manual.

Probe interface: the probe interface is a standard, two row, edge connector which may be easily added to instruments during development, providing easily accessed test points for production and field service requirements.

Options

001: HP-IB Interface

Operating instruction labels are available in five additional languages. On initial order of a 1602A, one special language label may be ordered as an option. Additional labels must be ordered by part number.

400: French (HP P/N 7120-6467)

401: Spanish (HP P/N 7120-6468)

402: Italian (HP P/N 7120-6469)

403: German (HP P/N 7120-6960)

404: Japanese (HP P/N 7120-6697)

Accessories

10250A TTL trigger probe: Model 10250A Trigger Probe offers a convenient method of expanding the qualification capabilities of the 1602A. With the 10250A connected to the 1602A rear panel Trigger or Clock Qualifier inputs, you have an additional four bits of qualification. The four inputs may be switched to HI, LO, or OFF (don't care) for selection of the desired qualification pattern. Power for the trigger probe is obtained from the circuit under test.

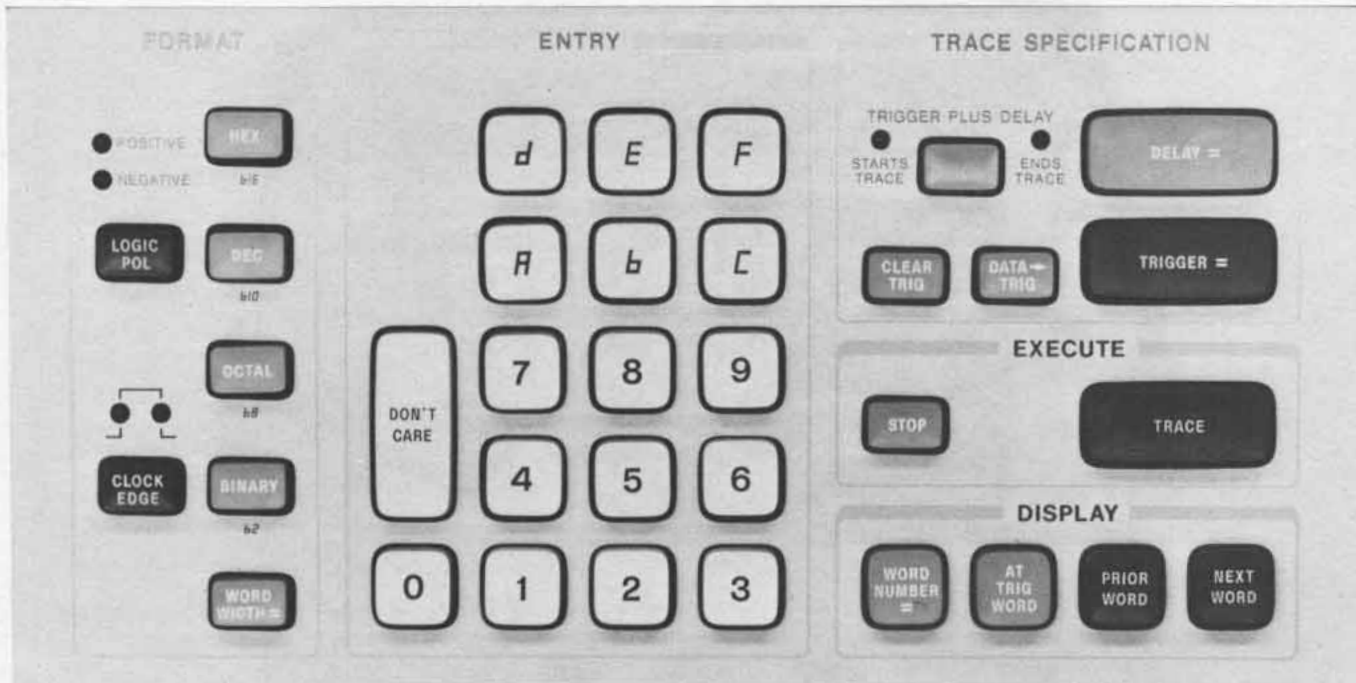

The keyboard of the Model 1602A Logic State Analyzer is easy to use with its key-per-function layout. Entry of triggering and display conditions is a series of self-explanatory keystrokes with entries displayed as they are entered, permitting a quick check of input accuracy.

Probe interfacing

- 01602-68701:** connector with leads (without slip-on probe tips).
- 01602-68702:** connector kit (without leads).
- 10230-68702:** package of ten slip-on probe tips.

The probe interface is a standard two row, edge connector which may be easily added to instruments during development, providing easily accessed test points for production and field service requirements.

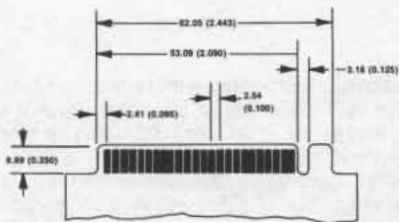

Notes
Dimensions in millimetres and (inches)
1.67 (0.062) Thick PC Board
Dimension Tolerance -0.13 (0.005)

HP-IB controllers and accessories

The following computing controller and accessories combined with a 1602A Option 001 provide a complete HP-IB Test System.

Model 9825A computing controller: Opt 002 with a 23 000 byte memory is recommended for maximum flexibility. Accessories required are Model 98210A String and Advanced Program ROM, Model 98213A General and Extended I/O ROM, and a Model 98034A HP-IB Interface Card.

Software: the Model 10060A Automatic Logic State Analysis Application Program for the 9825A controller is available and virtually eliminates the need to learn controller or HP-IB language.

10050A/10051A Specifications

Specifications apply with the 10050A/10051A connected to the 1602A.

Adapter, 10050A: when used as passive connection to the 1602A, loads each HP-IB signal line with one Schottky TTL gate (<400 μ A source) except DAV which is loaded with two low power Schottky TTL gates (<800 μ A source).

Test probe, 10051A

Input Load: one low power Schottky TTL gate (<400 μ A source) on each HP-IB signal line.

Input threshold: TTL fixed at \approx 1.5 V except DAV, NRFD, NDAC, ATN, EOI which are buffered with low power Schottky TTL hysteresis gates (positive going threshold \approx 1.7 V, negative going threshold \approx 0.9 V).

Max input: < \pm 5.5 V.

Min input: > -0.5 V.

Differential signal delay: signals on the ATN and EOI lines are delayed approx 30 ns more than DIO 1-8, SRQ, IFC, REN which are applied to the 1602A data inputs without buffering.

Data setup time: data must be present 35 ns prior to a clock transition.

Data hold time: data must remain stable 50 ns after a clock transition.

Ordering information

	Price
1602A Logic State Analyzer	\$1800
Opt 001: HP-IB Interface	add \$300
10250A TTL Trigger Probe	\$125
10050A HP-IB Adapter	\$35
10051A HP-IB Test Probe (includes 10050A)	\$185
10060A Automatic Logic State Analysis Applications Program for 9825A	\$58
01602-68701 Connector with leads (without slip-on probe tips)	\$65
01602-68702 Connector Kit (without leads)	\$21
10230-68702 Slip-on probe tips (10)	\$22.50

LOGIC ANALYZERS

Parallel or serial analysis of digital systems

Models 1600S and 10253A

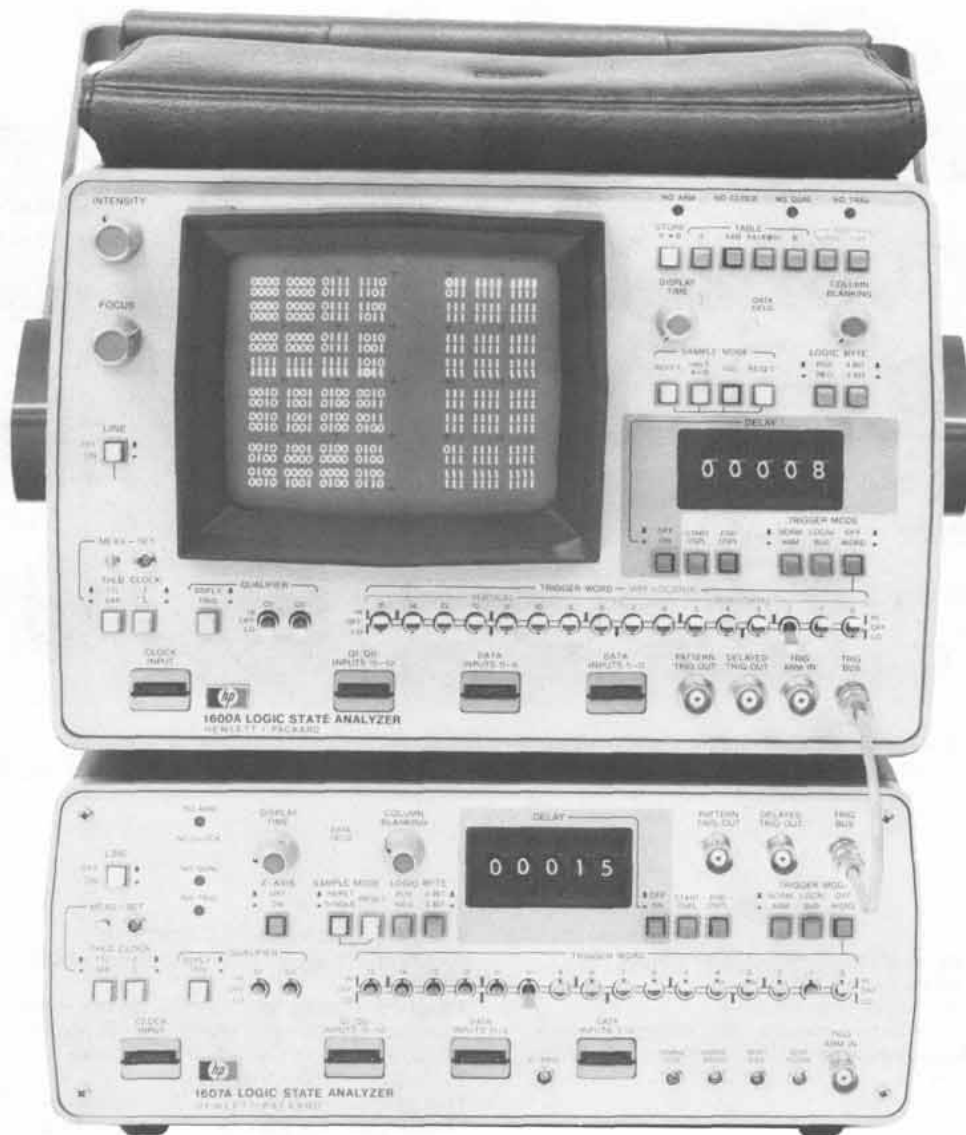

1600S

1600S Description

The 1600S Logic State Analyzer is a versatile, general purpose data domain instrument for use in design and troubleshooting of minicomputer and microprocessor based systems as well as other digital systems. Parallel data is captured at clock speeds to 20 MHz and presented in an easy-to-read one's and zero's display format for fast functional analysis of digital data flow. The ability to capture and display words up to 32-bits wide lets you observe, in real time, microcodes or addresses with resulting data, saving time in system design and development, hardware troubleshooting, software evaluation, and service and maintenance. Convenient and flexible functional analysis is provided by features such as sequential triggering, dual clock, separately configured data tables, display qualification, exclusive OR comparison of Tables A and B, dynamic mapping, and halt when A is not equal to B.

The 1600S consists of a 1600A Logic State Analyzer, a 1607A Logic State Analyzer, a 10236A Trigger Bus Cable, and a 10237A Data Cable. The Trigger Bus Cable logically AND's the trigger registers of both the 1600A and 1607A for a trigger word up to 36 bits wide (four qualifiers not displayed). The Data Cable connects the 1600A Table B memory to the 1607A to enable the display of words up to 32 bits wide, to display two 16-bit data sequences at the same

time—such as addresses and instructions, to display 32 consecutive 16-bit words, or for dual clock application. When the full system capabilities are not needed, the 1600A or 1607A may be used separately. The 1600A by itself is a complete logic state analyzer with 16-bit triggering plus two qualifiers, and a 32-bit wide table display as well as dynamic mapping. The 1607A needs only the proper oscilloscope or X-Y display for another complete analyzer, also with 16-bit triggering plus two qualifiers. Both the 1600A and 1607A have a pattern trigger output to trigger an oscilloscope for electrical analysis.

Mapping program flow

The map display provides a dynamic overview of a system's operation—a pattern of dots interconnected with vectors that are unique for each area of program implementation. Each dot represents a specific word; its location indicates binary magnitude and its brightness indicates relative frequency of occurrence. The vectors between each dot allow you to observe the sequence of data transactions. The vector gets brighter as it moves toward a new point to show the direction of data flow.

With the map you can identify program loops, improper data flow, as well as lost portions of a program. You can also map single-shot events such as those in turn-on sequences.

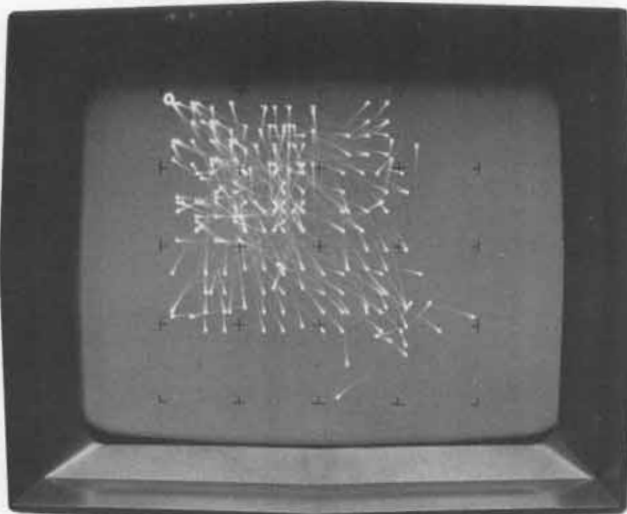

The map display offers an overall view of machine operation, with each dot representing one input word. The real time display allows you to identify program loops, improper data flow, as well as lost portions of a program.

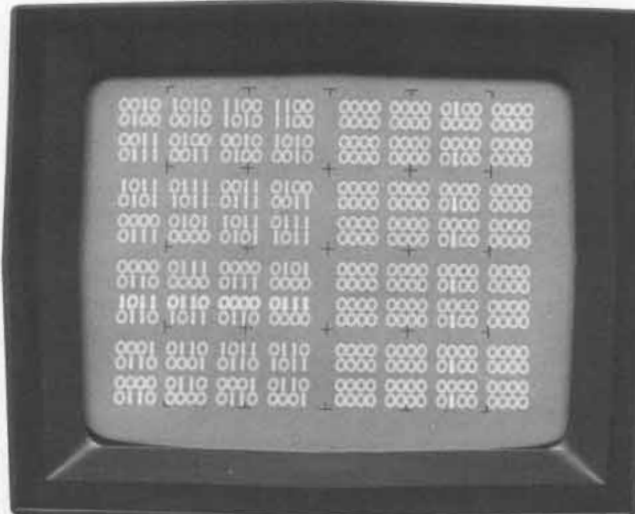

In the exclusive OR mode, A & (A ⊕ B), A memory data is displayed on the left while the table on the right displays logic differences between A and B memories. This provides very fast "at-a-glance" comparisons.

Table display

In the Table display mode you can display up to sixteen 32-bit words which allows you to view address and resultant data flow at the same time. You can look at events leading up to, surrounding, or following the trigger word; and delay up to 99 999 clock cycles beyond the trigger point to view events anywhere in a program. Two 16-bit by 16-bit table displays, A and B, can be used separately or in various combinations to satisfy a wide variety of applications.

Exclusive OR mode

An exclusive OR mode, A & (A ⊕ B), makes comparison of Table A and Table B data easy by displaying any differences as intensified one's on Table B. This display mode allows you to quickly compare active data to known stored data, or to compare data from two active systems simultaneously.

Another useful mode is the halt when A does not equal B mode (A ≠ B), which automatically halts and stores the data in the A memory when it does not equal the data in the B memory. Used in conjunction with the A & (A ⊕ B) mode, this mode frees you from the tedious waiting and watching for intermittent malfunctions.

Display qualification

The 1600S has a total of four qualifier channels which in the Display Mode allow only selected data to be captured, greatly expanding the effectiveness of the memory since irrelevant or extraneous data is not strobed into memory. The 1607A pattern trigger output (PTO) can be used as a qualifier input to the 1600A which permits very sophisticated analysis of multiplexed buses in minicomputers.

Sequential triggering

The 1600S permits you to define two events which must occur in sequence to trigger a data acquisition cycle. The trigger output of the 1607A can be used to arm the 1600A on a selected event, enabling it to look for the second event. Sequential triggering is useful for analyzing branch operations.

Dual clock

The 1600A and 1607A may be clocked at different rates which permits you to examine simultaneously up to 16 bits on both sides of an I/O port even though state flow is from two different sources running at different speeds. You can also easily relate bus activity to events occurring elsewhere at different clock rates, such as system peripherals. Dual clock capability can be particularly useful in determining design incompatibilities between hardware and software in micro-computer-controlled systems.

Start and End display triggering

Both the 1607A and the 1600A may be operated in the Start Display or End Display modes. In Start Display, the Analyzer triggers on a unique word established by the trigger word switches and displays that trigger word and the fifteen following words as they are clocked in. This is a valuable mode for paging through a system while following an algorithm to trace data flow.

End Display triggering captures events leading up to and including the trigger word, providing a "negative time" display. This is extremely helpful for troubleshooting, since you can trigger on an unallowed state or a fault and see where the machine malfunctioned rather than the end results of the error. In addition, delay may be combined with the End Display trigger to capture both positive and negative time data, allowing you to see events before and after the trigger event and reduce analysis time.

Digital delay

When the data you want to see does not immediately follow the desired trigger word, delay can be used to position the sixteen word "window" an exact number of clock pulses from the trigger word. The 1600A and the 1607A each permit selection of up to 99 999 clock cycles of delay. Digital delay is used with the start and end display modes for precise paging through data, or indexing. It is useful for moving the display window past loops and measuring lengths of sub-routines while maintaining a desired pattern trigger point.

Trigger outputs

The 1600A and 1607A have trigger outputs that extend troubleshooting capabilities in digital circuit analysis by windowing oscilloscopes to the proper digital point in time for electrical analysis of circuit operation.

Versatile miniature probes

The 1600S acquires data through six, 6-channel high impedance probes. Two separate clock probes allow connection to the desired strobe source. The miniature probe tips are small enough to connect to adjacent pins on DIP's, or can be slipped off the probe wire for direct connection to 0.6 mm (0.025 in.) square pins, IC test clips, Model 10024A IC clip, and wire wrap pins.

Individual probes are connected to each data or clock pod through a quick disconnect ganging-bar which permits hardwired or semipermanent connections to system nodes that do not need to be disturbed when the Logic State Analyzer and its probe pods are removed.

Models 1600S and 10253 (cont.)



10253A Card Reader

1600S Specifications**Clock and data inputs****Repetition rate:** 0 to 20 MHz.**Input RC:** 40 k Ω \pm 3 k Ω shunted by \leq 14 pF (at the probe tip).**Input bias current:** \leq 30 μ A.**Input threshold:** TTL, fixed at \approx +1.5 V; variable \pm 10 Vdc.**Max input:** level, -15 to +15 Vdc; swing, 15 V peak from threshold.**Min input:** swing, 0.5 V +5% of p-p threshold voltage; clock pulse width, 20 ns at threshold; data pulse width, 25 ns at threshold; data setup time, 20 ns; hold time, zero.**Pattern and delayed trigger outputs****High:** \geq 2 V into 50 Ω (line driver interface).**Low:** $<$ 0.4 V into 50 Ω (line driver interface).**Pulse duration****Delayed trigger:** \approx 25 ns (RZ format) at 1 V level.**Pattern trigger:** \approx 25 ns in RZ format at 1 V level, delay zero or off. With delay on and not zero, pattern trigger output starts on receipt of a pattern trigger signal and ends when delay ends.**Trigger arm input****Impedance:** 50 Ω .**Level:** low state, 0 V to $<$ 0.4 V; high state, 2 V to $<$ 5 V.**Pulse width:** 15 ns min at 1.5 V level.**Arming conditions:** if the arming pulse positive edge occurs $<$ 45 ns after a clock, triggering occurs on the same clock cycle that it is armed. If the arming pulse positive edge occurs $>$ 75 ns after a clock, triggering occurs on the next clock cycle.**1607A X-, Y- and Z-axis outputs****X-axis:** $<$ 0.6 V to $>$ 6 V p-p, \pm 8 V max into \geq 100 k Ω **Y-axis:** $<$ 0.6 V to $>$ 6 V p-p, \pm 8 V max into \geq 100 k Ω .**Z-axis:** 0 to 10 V p-p into \geq 1 k Ω .**Display interface requirements:** the 1607A interfaces with oscilloscope or display with the following input parameters (Not recommended for storage oscilloscopes or displays).**X and Y inputs:** 0.1 to 1 V/div deflection factors; dc coupled input; and $>$ 500 kHz bandwidth.**Z-axis input:** dc coupled with positive blanking; full blanking must occur with 10 V input at 10 mA.**General****Display rate:** variable from $<$ 200 ms to $>$ 5 s (1600A), $<$ 50 ms to $>$ 5 s (1607A).**Power:** 100, 120, 220, 240 Vac; -10%, +5%; 48 to 440 Hz; 120 VA max.**Logic probe power:** rear panel BNC connector, +5V, 0.1 A.**Size****1600A:** 197 H x 335 W x 540 mm L with handle (7 $\frac{3}{4}$ " x 13 $\frac{3}{16}$ " x 21 $\frac{1}{4}$ "); 460 mm (18 $\frac{1}{8}$ ") L without handle.**1607A:** 121 H x 284 W x 460 mm D (4 $\frac{3}{4}$ " x 11 $\frac{3}{16}$ " x 18 $\frac{1}{8}$ ").**Operating environment:** temperature, 0 to +55 $^{\circ}$ C (+32 $^{\circ}$ F to +130 $^{\circ}$ F); humidity to 95% relative humidity at +40 $^{\circ}$ C (+104 $^{\circ}$ F); altitude to 4600 m (15 000 ft); vibrated in three planes for 15 minutes each with 0.254 mm (0.010 in.) excursion, 10 to 55 Hz.**Weight****1600S:** net, 19.1 kg (42 lb); shipping, 22.7 kg (50 lb).**1600A:** net, 12.7 kg (28 lb); shipping, 15.9 kg (35 lb).**1607A:** net, 6.4 kg (14 lb); shipping, 8.2 kg (18 lb).**Accessories supplied****1600S:** six 10231C data probes, two 10230C clock probes, one 10236A Trigger Bus Cable, one 10237A Data Cable, two 2.3 m (7.5 ft) power cords, one accessory case for each analyzer, one 1600A and one 1607A Operating and Service Manual.**1600A or 1607A:** three 10231C data probes, one 10230C clock probe, one accessory case, one Operating and Service Manual.**Accessories****Card reader:** 10253A Card Reader plugs directly into the 1600A and provides a convenient method of performing repetitive tests on digital components or systems. Cards provide a low cost method of storing fixed data that may represent a complete system test procedure or a simple QC test. Applications include incoming inspection, production testing, service and maintenance, engineering, and environmental testing.**Cards:** special printed cards are in format required for loading data into the 1600A Logic State Analyzer Table B memory; 187 mm (7 $\frac{3}{8}$ in.) length cards are loaded into Table B in $<$ 2 s.**Power:** supplied by 1600A.**Weight:** net, 1 kg (2.1 lb); shipping, 1.8 kg (4 lb).**Operating environment:** same as 1600A except: temperature, +10 $^{\circ}$ C to +40 $^{\circ}$ C (+50 $^{\circ}$ F to +104 $^{\circ}$ F); humidity, to 80% relative humidity at +40 $^{\circ}$ C (+104 $^{\circ}$ F)**Accessories supplied:** one drum card, HP P/N 10253-90001; one exerciser card, HP P/N 10253-90002; 100 data cards, HP P/N 9320-3324; one interface box mounting bracket, HP P/N 01120-64701; and one Operating Note.**Serial-to-parallel converter:** 10254A Serial-to-parallel Converter acts as the interface between a serial data system and a 1600A or 1607A, converting serial data to parallel format for full utilization of these analyzers in serial data stream analysis.**Trigger bus cable:** 10236A Trigger Bus Cable interconnects the 1600A and 1607A for 32-bit word capability (supplied with 1600S).**Weight:** net, 0.2 kg (6 oz); shipping, 0.5 kg (1 lb).**Data cable:** 10237A Data Cable interconnects the 1607A and 1600A to provide 32-bit data display (supplied with 1600S).**Weight:** net, 0.23 kg (8 oz); shipping, 0.5 kg (1 lb).**General purpose probe interface:** 10277C provides convenient interface between 1600A or 1607A (data and clock probes) and digital systems through two 40-pin connectors and ribbon cables; includes two removable interconnecting wire-wrap boards for signal pre-processing, two 36 cm (14 in.) ribbon cables with 40-pin female connectors, and two 40-pin male connectors.**Rack mount adapter:** 10491B Rack Mount Adapter, 222 mm (8 $\frac{3}{4}$ in.) high and 540 mm (21 $\frac{1}{4}$ in.) deep; adapts the 1600A to a standard 483 mm (19 in.) rack.**Weight:** net, 1.4 kg (3 lb); shipping, 2.3 kg (5 lb).**IC test clip:** 10024A IC Clip allows convenient connection of analyzer probe leads to dual in-line packages, reducing the possibility of shorting between IC pins. Refer to Probes and Other Oscilloscope Accessories for description of 10024A and other probe accessories.**Ordering information**

	Price
1600S 32-channel Logic State Analyzer, includes a 1600A and 1607A	\$7100
Opt 910: extra set of manuals	add \$24
1600A 16-channel Logic State Analyzer	\$4200
Opt 910: extra Operating and Service Manual	add \$13
1607A 16-channel Logic State Analyzer	\$2900
Opt 910: extra Operating and Service Manual	add \$11
10236A Trigger Bus Cable (supplied with 1600S)	\$20
10237A Data Cable (supplied with 1600S)	\$60
10253A Card Reader	\$800
10277C General Purpose Probe Interface	\$400
10491B Rack Mount Adapter	\$120
10024A IC Test Clip	\$15
10247-68701 Quick Disconnect Probe Lead Kit for 10230C Clock Probe	\$10
10231-68703 Quick Disconnect Probe Lead Kit for 10231C Data Probe	\$30
10230-62101 Probe Tip for use with Probe Lead Kits or as replacement tips	\$2.50

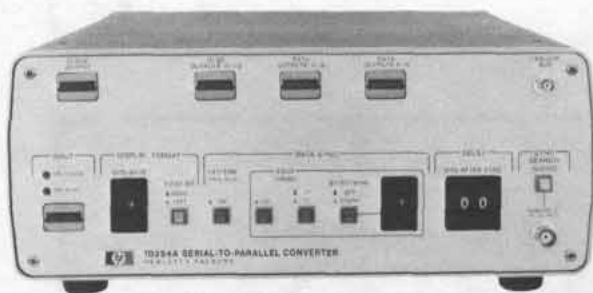

10254A

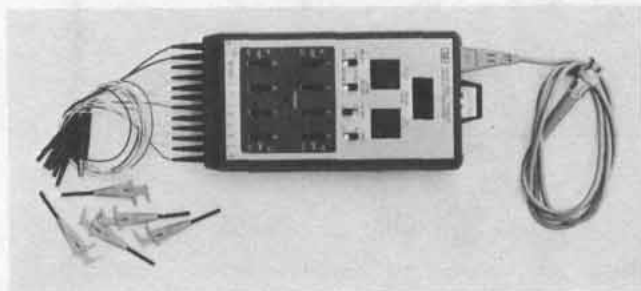

1230A

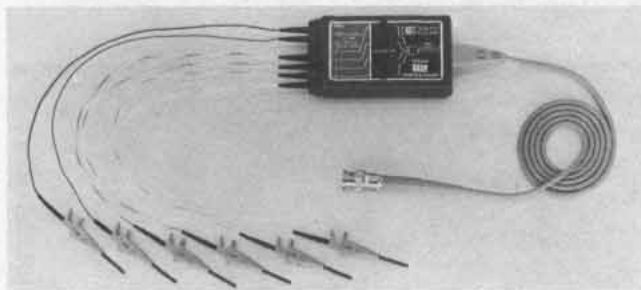

10250A

10254A Serial-to-parallel converter

Specifications (Accessory to the 1600A and 1607A Logic State Analyzers.)

Probe inputs

Rep rate: ≤ 10 MHz in Edge Sync, ≤ 7 MHz in Pattern Sync.

Input RC: $40\text{ k}\Omega \pm 3\text{ k}\Omega$ shunted by $\leq 14\text{ pF}$ (at the probe tip).

Input threshold: TTL, fixed at 1.5 Vdc; variable ± 10 Vdc selected at the logic state analyzer.

Max input: level, ± 15 Vdc; swing, 15 V peak from threshold.

Pulse width: 40 ns min at threshold.

Setup time: 50 ns min.

Hold time: zero.

Operating modes

Display format

Bits/byte: 1 to 16 bits (a byte is displayed as one line on the Analyzer.)

First bit, left/right: displays most significant bit left or right.

Data sync

Pattern: synchronizes on a unique pattern in the serial data stream selected with the analyzer Trigger Word switches.

Edge: synchronizes on input probe sync signal with positive or negative edge selectable.

Bytes/sync: permits memory qualification by acquiring 1 to 16 bytes of data following a sync.

Delay (bit after sync): selects the number of clock pulses from 1 to 99 after a sync signal is received before data acquisition begins.

Sync search: Initiate pushbutton or a positive-going input pulse starts a new search cycle.

General

Weight: net, 3.2 kg (7 lb). Shipping, 5 kg (11 lb).

Power: +5 Vdc, +12 Vdc and -12 Vdc; supplied by the 1600A or 1607A Logic State Analyzer.

Size: 12.1 H x 28.4 W x 41.4 cm D ($4\frac{3}{4}$ " x $11\frac{3}{16}$ " x $16\frac{3}{16}$ ").

Accessories supplied: one Model 10236A Trigger Bus Cable, four interface cables (HP P/N 10254-61601), and one Operating Note.

Equipment required: 1600A or 1607A plus a 10231C data probe from the 1600A, 1607A or ordered separately, for use as the 10254A input data probe (labels supplied with 10254A).

8 Bit trigger probe with delay

1230A Specifications

Input

Frequency: 15 MHz max.

Logic levels: logic '0': 0 V to 0.8 V; logic '1': 2 V to 15 V.

Current: $-360\text{ }\mu\text{A}$ for logic '0' input ($-400\text{ }\mu\text{A}$ for GATE input); $100\text{ }\mu\text{A}$ for logic '1' input.

Max input: -1 V to +15 V.

Output (negative-going edge true)

Logic '0': 0.5 V max (60 mA current sinking capability).

Logic '1': 2 V min into 50Ω (40 mA source current).

Operating modes

Word recognition

Synchronous pattern recognition: trigger word input recognition only during pos. or neg. edge of CLOCK input signal.

Min setup time: 20 ns.

Min hold time: zero ns.

Async pattern recognition: independent of CLOCK input.

Max propagation delay after word recognition: 45 ns.

Min input pulse width: 25 ns.

GATE input: for strobing or expanding word recognizer. GATE switch set to LO, GATE input pulse must be 20 ns longer than 'word-true' time. Set to HI, GATE input pulse must be 10 ns longer than 'word-true' time.

Events delay: 1-9998 events start counting on pos. edge or neg. edge (selectable) of CLOCK input signal after word recognition.

General

Power requirements: 300 mA at 5 V.

Voltage on power inputs: +4.75 V to +15 V max dc. Protected against reverse polarity.

Weight: net, 454 g (1 lb). Shipping, 907 g (2 lb).

4 Bit trigger probe (TTL)

10250A Specifications

Input

Low level: 0.8 V (-0.6 V min); -0.8 mA max at 0.4 V (0.5 standard TTL load).

High level: 2 V. (5.0 V max); $100\text{ }\mu\text{A max}$ at 2 V.

Output

Swing: 0.5 V to 4.5 V min into 1 megohm.

Transition time: 7 ns max from 0.6 V to 1 V; 50 ns min to 4 V with 1 megohm, 20 pF load.

Delay

Propagation: 30 ns max from any input to trigger output.

Difference: 10 ns max between any two inputs.

Power (supplied by circuit under test)

Voltage: +5 V $\pm 5\%$; $-0.4\text{ V to }+7\text{ V max}$.

Current: 30 mA max; normal operation, 17 mA.

Overall length: $\approx 168\text{ cm}$ (66 in.)

Weight: net, 227 g (8 oz). Shipping, 907 g (2 lb).

Accessories included: six miniature probe tips, one Operating Note, and one vinyl carrying case.

Ordering information

10254A Serial-to-parallel Converter

1230A Logic Trigger

Opt 910: extra manual

10250A Trigger Probe (TTL)

Price

\$1275

\$495

\$6.50

\$125



LOGIC ANALYZERS

Captures time, state & glitch information simultaneously

Model 1615A

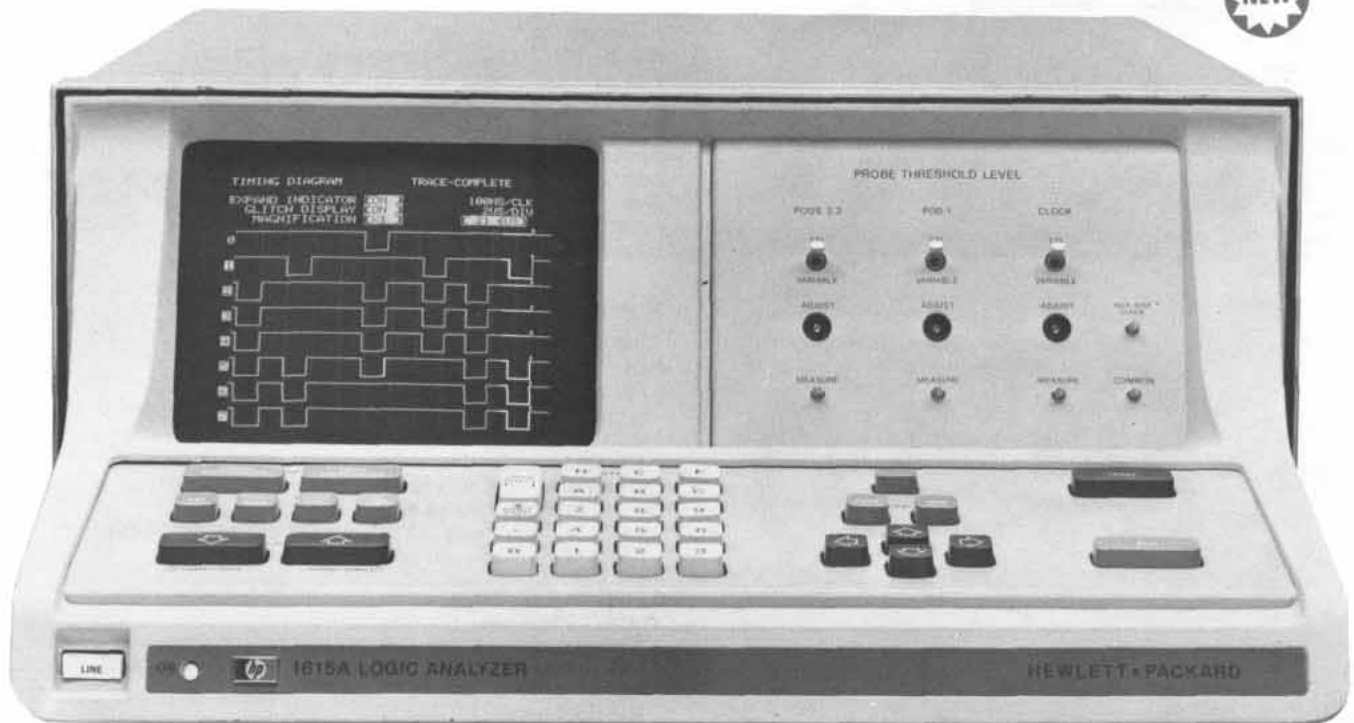

1615A Description

Hewlett-Packard's Model 1615A Logic Analyzer offers asynchronous, synchronous, and simultaneous time and state measurements in the design and troubleshooting of digital systems. The Logic Analyzer can be configured for three modes of operation with simple keyboard entries: as an 8-bit timing analyzer 256 words deep; a combined 8-bit timing and 16-bit state analyzer, each 256 words deep with both operating simultaneously; or as a 24-bit state analyzer 256 words deep. Powerful triggering capability, six clock qualifiers, sophisticated delay and occurrence capabilities assure that the desired timing and state information can be captured.

Setup for measurements is simplified with a menu system which reduces the number and complexity of front panel keys. With the Format Specification called, you select the desired mode of operation, timing, state, or a dual-mode with simultaneous operation. The Trace Specification menu then allows you to enter the desired test parameters so that the information needed for analysis is captured.

Asynchronous measurements

Much of the activity in digital systems is asynchronous in nature and interrogation of the non-clocked devices must be accomplished using a strobe other than a system clock. The 1615A makes asynchronous measurements in its time mode of operation which is selected by calling the Format Specification and selecting the 8-bit mode of operation. Also selectable at this time, is Ext Clock Slope, assignment of labels to group the eight lines for convenient interpretation of data, logic polarity, and the desired numerical base. The Trace Specification menu (figure 1) is now used to enter the desired trace parameters. The clock period can be selected using increment and decrement keys on the panel. Up to three OR'ed trigger fields are available for selecting one or a combination of asynchronous trigger patterns. In addition, a "NOT" pattern ON NOT for triggering can be selected so that status words can be monitored for any changes, or an external trigger can be selected. Either time or external clock delay can be added to the trigger condition. The recognition of this pattern is truly asynchronous and to eliminate triggering on transients, the pattern duration may be specified from 15 ns to 2000 ns.

Tracing now captures and displays a timing diagram of the data on the eight timing lines (figure 2). The trigger point selected in the Trace Specification menu is indicated by a short vertical bar between each timing line. Any part of the timing display, selected with an ex-



Figure 1. Trace Specifications menu shows the label assigned to the timing lines and the numerical base in which to enter data. This Trace Specification defines the start of data collection using an internal clock running 100 ns/clock on any one of three OR'ed 8-bit patterns but only if a glitch appears on channel four.

panded indicator, may be magnified by a factor of 10 for higher display resolution. A listing of the timing data in the area of the expand indicator can be obtained by pressing the list key. For convenience, the timing channels may be organized in any order.

The 1615A also detects glitches greater than 5 ns wide. In addition to recognizing glitches, the 1615A can separate them from data which allows glitches to be used as part of a trigger word. A Trace Specification can include both pattern and/or glitch requirements (figure 1) on any combination of lines—glitches can even be captured during data transitions. Glitches on data transitions are displayed as brightened edges with those between transitions displayed as bright vertical bars (figure 2).

Relative time measurements between any two points on the timing display may be made by using the expand indicator (figure 3). One edge of the brightened segment is aligned at the desired point of inter-

est (figure 3a) and the relative time field is zeroed using the Field Select key. The expand indicator can then be moved to any other point of interest to obtain a direct readout of time between the two points (figure 3b). As an additional feature, an external clock may be used in the timing mode.

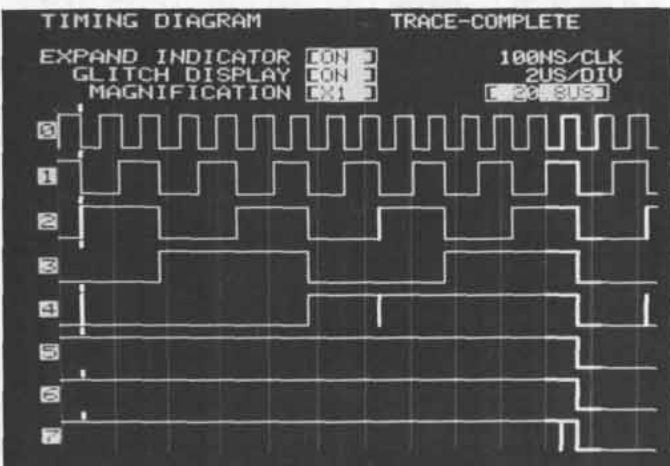

Figure 2. Timing diagram of data collected as defined by the Trace Specification in figure 1. The Analyzer displays timing information and glitches which are displayed as brightened edges and vertical bars. In addition, the sampling clock period and time per division are displayed. The trigger point is indicated at the left of the timing display by a short vertical bar on each timing line.

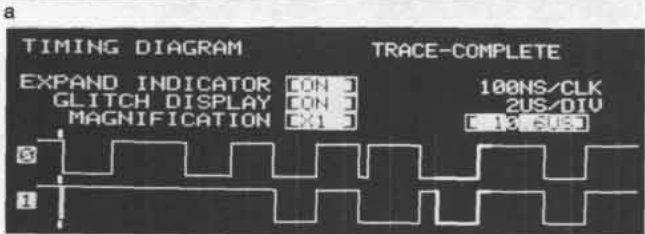
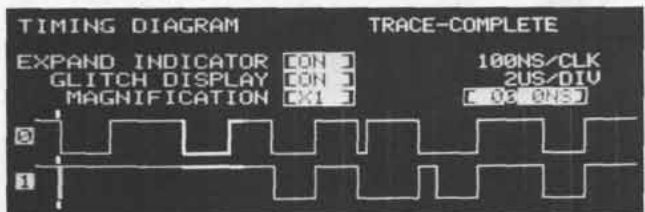

Figure 3. Relative time measurements can be made between points of interest on the timing display. In this example, the leading edge of the expand indicator (brightened trace segment) is positioned at the falling edge of a pulse on line zero (3a) and the relative time indicator zeroed; the expand indicator is then positioned on the falling edge of a pulse on line one with a direct readout of 10.6 μ s (3b) between these two edges.

Simultaneous asynchronous and synchronous measurements.

Since both timing and state information are captured simultaneously, the analyzer is capable of capturing the time sequences that occur before or after a specific state has been accessed, or state sequences before or after a specific timing condition has been accessed. This interactive capability allows the activity on control lines, address decoder outputs, and asynchronous I/O structures to be related to specific points in program flow.

Asynchronous activity registers synchronous data collection

The cause of a glitch or the source of a timing problem is frequently related to the step a system is executing at the time of malfunction. These problems can be easily solved by relating the asynchronous malfunction in time to the synchronous activity in the system. Since

the 1615A can operate in a mode where simultaneous time and state information is captured, it can make this powerful measurement.

The 1615A is configured for time and state operation by calling the Format Specification and selecting 16-bit and 8-bit mode of operation and assigning the desired labels, bases, and clock slopes. Switching to the Trace Specification menu, four interactive modes of operation may be selected: the 8-Bit Triggers or Arms 16-Bit, or 16-Bit Triggers or Arms 8-Bit. For example, the 8-Bit Triggers 16-Bit mode may be selected which directs the 1615A to capture synchronous data as soon as the asynchronous trigger is recognized. Now you can observe state information directly related to a timing event such as the activity on an address bus when an interrupt or glitch occurs. If you select the 8-Bit Arms 16-Bit mode, the 1615A may be directed to capture data at a specific point in program execution but only after an asynchronous trigger event is encountered. This allows you to view a specific part of program flow, such as an output subroutine, only after a specific asynchronous event such as a service request.

Synchronous activity registers asynchronous data collection

Another problem frequently encountered is the need to display timing information only after a specific point in program implementation. This is accomplished by selecting either 16-Bit Triggers or Arms the 8-Bit mode of operation. A typical application of this would be to look at the conditions of lines on an input port for a short time prior to reading the port to be sure that the data is valid. Now when a trace is accomplished, the state measurement triggers the timing measurement which, in the end display mode, captures the timing information prior to reading the port.

Synchronous measurements

The fastest method of locating faults in a state machine is to monitor program execution because the symptom of a machine failure is a deviation from its program sequence. The 1615A is also a powerful state analyzer; by calling the Format Specification menu, a 24-bit mode (figure 4) can be selected for monitoring system bus activity. For convenience the inputs can be configured in hexadecimal, octal, decimal, or binary display formats and the 24 lines can be identified with three labels for grouping lines as independent variables. Triggering parameters are entered in the Trace Specification menu (figure 5) in the base selected for display. Any bit pattern on the 24 inputs may be established as a trigger point. Part of the trigger specification can be "Don't Cares" to obtain range triggering. In addition, the type of data collected may be further qualified with the six Clock Qualifiers presented in two OR'ed fields, trigger occurrence counting, and clock delays of up to 999 999, so that only data of interest is captured. Also, a Trace All States mode allows collection of qualified sequential activity following or preceding the trigger word; or a trace trigger events mode can be specified to capture only specific events, such as data to an I/O port.



Figure 4. To monitor 24 lines of synchronous activity, a 24 Bit mode of operation may be selected. Labels, Clock Slope, Logic Polarity, and Bases are assigned to obtain the desired Format. This Format is selected to display 16 address lines (Label A) and 8 data lines (Label C) both in hexadecimal.

Model 1615A (cont.)



Figure 5. Trace Specification menu (resulting from the Format Specification in figure 4) shows the labels assigned and the numerical base in which to enter data. This Trace Specification defines that the trace point will start data collection when address 03E3₁₆ is recognized.

TRACE LIST		TRACE-COMPLETE
LINE NO.	A HEX	C HEX
000	03E3	E1
001	03E4	03
002	03E1	1D
003	03E2	C2
004	03E3	E1
005	03E4	03
006	03E1	1D
007	03E2	C2
008	03E3	E1
009	03E4	03
010	03E1	1D
011	03E2	C2
012	03E3	E1
013	03E4	03
014	03E1	1D

Figure 6. Resulting Trace list of synchronous activity captured using the triggering parameters entered in the Trace Specification of figure 5.

When a trace is performed, the 1615A captures the desired area of program execution and presents it on the display in the selected format (figure 6). The memory location of the data is recorded on the far left of the display with 256 words stored for analysis. Any memory location from 000₁₆ to 255₁₆ may be called directly by entering the line number or the display may be rolled through memory with roll keys.

Probes

Input data are sensed through 24 high-impedance probes at rates to 20 MHz with the probes separated into three 8-bit pods for easier connection to a system. A fourth pod is used to connect a clock source, six qualifiers, and an external trigger. To make it easier to connect to different systems, the front section of each probe may be disconnected from its pod. This allows the individual probe leads for each probe pod to be wired into connectors for specific systems. Additional probe lead kits as well as probe tip kits are available separately as accessories.

For greater flexibility, the pods may be set for TTL threshold levels or adjusted over a -10 V to +10 V range. This variable threshold capability allows simultaneous measurements in systems with different logic families, i.e., ECL, TTL, MOS, etc.

Trigger outputs

Once a fault is found it may be desirable to register other types of analysis instruments, such as oscilloscopes, to the problem area. The analyzer's state trigger output is stable with respect to the system clock so an oscilloscope can be used for critical timing measurements. The timing trigger output is referenced to the pattern recognition

trigger at the probe so it too may be used as a stable reference point. A trace point output is also available so that interrupt signals may be generated or for "clock stopper" circuits in other parts of the system under test.

Self test

A built-in self test capability provides assurance that the 1615A is operating properly. The self test during turn-on checks ROM/RAM which is indicated on the display with Power Up Complete on the CRT. More extensive self-tests are initiated during turn-on by using four keys which permit keyboard and extensive operational checks.

1615A Specifications

Clock, qualifier, and data inputs

Repetition rate: to 20 MHz.

Input RC: 50 k Ω shunted by ≤ 14 pF at the probe tip.

Input threshold: TTL, fixed, $\approx +1.4$ V; variable ± 10 Vdc.

Maximum input: -15 V to +15 V.

Minimum input

Swing: 0.6 V

Clock pulse width: 20 ns at threshold level.

Setup time: time data must be present prior to clock transition, 20 ns.

Hold time: time data must be present after clock transition, zero.

Synchronous operation

Trigger delay: to 999 999 clocks.

Trigger occurrence: to 999 999.

Asynchronous operation

Sample rate: 2 Hz to 20 MHz.

Data skew: 9 ns max.

Minimum detectable glitch: 5 ns with 30% peak overdrive or 250 mV, whichever is greater.

Glitch trigger: on any selected channel(s), if a glitch is captured, the glitch is AND'ed with the asynchronous pattern trigger.

External trigger pulse width: 5 ns min with 30% peak overdrive or 250 mV, whichever is greater.

Pattern trigger: any 8-bit pattern. Trigger duration required is selectable 15, 50, 100, 200, 500, 1000, or 2000 ns ± 15 ns or 15%, whichever is greater.

Delay time: to 1 048 575 x sample period.

Trigger outputs (rear panel)

16/24 Bit trigger output

Level: high, ≥ 2 V into 50 Ω ; low, ≤ 0.4 V into 50 Ω .

Pulse duration: ≈ 25 ns.

Delay from input clock: ≈ 85 ns.

16/24 Bit trace point output

Level: high, ≥ 2 V into 50 Ω ; low, ≤ 0.4 V into 50 Ω .

Pulse duration: starts at beginning of trace and ends at trigger point (pattern trigger plus delay).

Delay from input clock: ≈ 85 ns.

8 Bit pattern output

Level: high ≥ 2 V into 50 Ω ; low ≤ 0.4 V into 50 Ω .

Pulse duration: pattern duration minus asynchronous trigger duration width.

Delay from pattern at probe: ≈ 75 ns plus synchronous trigger duration width.

General

Memory depth: 256 data transactions (in timing display mode, 249 samples are displayed).

Power: 100, 120, 220, 240 Vac; -10% to +5%; 48 to 66 Hz; 230 VA max.

Size: 189 H x 426 W x 664 cm D (7 ⁷/₁₆" x 16 ³/₄" x 26 ¹/₈").

Operating environment

Temperature: 0°C to +55°C.

Humidity: up to 95% relative humidity at +40°C.

Altitude: to 4600 m (15 000 ft).

Vibration: vibrated in three planes for 15 min. each with 0.3 mm (0.015 in.) excursions, 10 to 55 Hz.

Weight: net, 19.1 kg (42 lb); shipping, 23.6 kg (52 lb).

Accessories supplied: three 8-bit Model 10248B data probes and one Model 10248B Opt 001 clock probe with probe leads and tips (three probes for data and one probe for clock, qualifiers, and external trigger), one 2.3 m (7.5 ft) power cord, and one Operating and Service Manual.

1615A Logic Analyzer

\$6800



1640A

1640A Description

Model 1640A Serial Data Analyzer offers an efficient method for locating faulty system components in computer networks or, in general, anywhere RS-232C (V24) serial interfaces are used. The network may be small, consisting of a minicomputer or microprocessor and a few terminals, or a complex, centralized CPU-based communications network, either of which require rapid problem location to minimize system downtime. The 1640A can also be used during system design for debugging software, during systems integration, and for preventive maintenance.

As a serial data analyzer, the 1640A monitors RS-232C (V24) status information and records serial data in its 2048 character memory. This passive monitoring capability makes it possible to locate network problems without interrupting communication links other than during initial connection.

In an active mode, the 1640A can simulate a network component and interact with the network by generating specific messages. This allows the 1640A to be connected to a terminal and exercise it as if it were a computer or it can replace a terminal and, when addressed, reply to the computer.

Easy-to-use

Operating simplicity is achieved using menus which present listings of the possible measurement parameters on the CRT. Menu keys across the top of the keyboard are FORMAT, MODE (either Monitor or Simulate), TX ENTRY, and LIST. Each menu presents a display of the parameters and various selections adjacent to each parameter. In most cases, selections are already defined and the operator simply uses (1) the cursor keys to position the cursor to the desired parameter and (2) the Field Select key until the desired selection is displayed in the inverse video field.

Format, Mode, and TX Entry menus can be automatically set up with an optional PROM (10291A) which is installed in the HP-IB board (Option 001). Up to 10 different instrument setups can be specified (two per PROM) by setting rear panel switches and pressing the "Load" pushbutton.

One of the distinguishing characteristics of the 1640A is that it is completely preprogrammed, yet versatile because of the comprehensive set of variables which are menu-entered. If additional capability is desired, the 1640A's feature set can be extended with the Hewlett-Packard Interface Bus (HP-IB, HP's implementation of IEEE-488-1975).

Computer network troubleshooting

The 1640A is much more than a line monitor which observes serial data; it is also an analyzer capable of identifying and locating network problems. Most of these fall into one of three categories: (1) software related problems, usually in protocol sequences; (2) errors in the data; or (3) interface problems—particularly in the RS-232C timing relationships. There are three different internal trigger modes and an external trigger mode to help identify these problems.

With the 1640's powerful trigger capability and a basic set of preprogrammed run modes, common network problems can be quickly located, even by semi-skilled personnel, keeping failure costs to a minimum.

Trigger sources: (1) Protocol errors can be detected with character sequence triggering where up to eight characters in sequence on either the transmit or receive data leads can be specified as the trigger event. (2) Errors in the data, either parity or optional LRC/CRC, can be used as a trigger source. (3) Time interval violations, particularly at the RS-232C (V24) interface, can be detected and used as a trigger. In addition to these three internal trigger sources, the 1640A can be triggered externally from RS-232C handshake ON conditions, or from another source such as a Computer Halt flag output.

Serial data analysis

Most network problems can be diagnosed while passively monitoring the RS-232C (V24) interface. The 1640A's Monitor MODE menu allows selection of Trigger Source and Suppression conditions, as well as one of three preprogrammed RUN modes: Count Triggers, Trigger Starts Display, and Trigger Ends Display. In the Count Triggers mode, data is continuously acquired until the analyzer is manually stopped. The last 2048 characters are retained in memory. In the Trigger Starts Display mode, data collection starts when the trigger event occurs. One complete record of 2048 characters is made and the measurement automatically stops. In the Trigger Ends Display mode, data is continuously acquired until the trigger event occurs, then an additional 64 characters are acquired and the measurement automatically stops. This allows you to see data sequences leading up to the trigger, and the network's attempt to recover after the trigger. After any of the three RUN modes are completed, the 1640A displays the results of the most recent time interval measurement and the number of trigger occurrences which took place during the run.

Model 1640A (cont.)

Network component simulation

Because some network problems cannot be located without interactive testing, the 1640A can simulate both Data Terminal Equipment (DTE) and Data Communications Equipment (DCE) at the RS-232C (V24) interface. Simulation allows loop-back testing so that the precise location of a problem can be found after it is isolated to a particular link. Also, system components can be checked at the site to determine if they are operating properly. A simple matrix setup establishes the proper hardware interface, and the TX ENTRY and Simulate MODE menus provide the software interface.

The TX ENTRY menu allows up to 1024 characters to be sent in up to eleven separate blocks. Transmit data can be entered through the keyboard, a "copy" or "learn" feature, or remote entry.

Messages can be composed directly from the 1640A's hexadecimal keyboard with the characters displayed in any code set during composition. A cursor shows the position of the next character to be entered. Only information bits have to be entered because parity or optional CRC characters are automatically added during transmission. Edit keys allow the composer to insert or delete characters during any phase of the composition.

Protocol sequences are often too long and complicated for convenient manual entry. If the 1640A's monitor mode is used to record the actual network protocol, its "Copy Transmit Monitor" or "Copy Receive Monitor" feature will automatically transfer appropriate data to the transmit message buffer. After transfer, the message can be edited, broken into blocks, syncs added, address changed, idles deleted, etc., through the keyboard.

Messages may be entered remotely using a teletype through the current loop interface (HP Model 10284A) or with the optional HP-IB interface (IEEE-488-1975) and an HP Model 9825A Computing Controller.

PROMS (10291A) containing user-definable "canned" messages can be installed on the HP-IB board and automatically loaded into the TX ENTRY buffer with a rear panel pushbutton. This allows fast and error-free message entry without an accompanying Computing Controller—a feature especially useful in field service applications.

The 1640A's Simulate Mode menu allows selection of HDX/FDX operation, the choice of Transmit First or Receive First, the Reply condition and three different preprogrammed RUN (execute) modes. In addition, you can specify any of the three internal trigger sources and a suppression condition if desired.

Preprogrammed run modes: Single and Count Trigger mode directs the 1640A to send an entire message once. After a total of 2048 TX and RX characters has been captured the run stops automatically. The Repeat and Count Triggers mode causes the message to be sent each time the reply condition occurs. The run must be manually halted. The Repeat and End on Trigger mode causes the message to be sent after each occurrence of the reply condition until the specified trigger condition occurs. This allows repetitive testing with a permanent display of the data at a suspected fault. At the end of any test, the number of trigger events, number of transmit message repetitions, and results of the last time interval measurement are displayed.

Programmable operation

The 1640A is designed to solve most network problems in a passive sense, or when necessary, as an interactive simulator. For more complex network interaction the HP-IB option, along with a suitable controller, adds such capabilities as remote control, sophisticated programming, mass storage, data manipulation, and hard copy.

1640A Specifications

Note: Specifications describe the instrument's warranted performance. Supplemental Characteristics provide information useful for applying the instrument by giving non-warranted operating parameters.

Inputs

Impedance: > 30 k Ω on all interface connections except ground.

Connector: mates with RS-232C (V24) interfaces.

Format

Framing: 5, 6, 7, or 8 information bits with or without a parity bit.
Data codes: ASCII, Hex, or EBCDIC. Other optional code sets in addition to or in lieu of EBCDIC are available.

Data modes

Asynchronous: 1 or 2 stop bits in addition to information and parity bits.

Synchronous: 1 or 2 user-entered synchronizing characters. Sync search may be initiated on a user-entered character immediately followed by a user-entered number of idle characters from 0 to 99. Idle is defined as a steady mark (logic 1's) in all bit positions.

Speed

External Clock (Synchronous):

CHARACTER SIZE INCLUDING PARITY (bits)	NORMAL OPERATION		HIGH SPEED MODE*	
	Bits Per Second		Bits Per Second	
	HDX	FDX	HDX	FDX
9	19200	9600	19200	9600
8	14400	7200	19200	9600
7	14400	7200	19200	9600
6	9600	6400	14400	7200
5	9600	4800	9600	7200

*Memory data is not displayed while a run is in progress. High speed switch located on rear of Patch Panel Matrix.

Internal Clock (Asynchronous): 50, 75, 110, 134.5, 150, 200, 300, 400, 600, 900, 1200, 1800, 2400, 4800, and 9600 bps, $\pm 1\%$. Also, any external X1 clock to a maximum of 9600 bps may be used for asynchronous operation.

Note: asynchronous operation follows the same speed vs. character specification as synchronous operation.

ERROR CHECK: odd, even, or no parity; optional (003) BCC generation and checking based on LRC-8, CRC-16, or CRC-CCITT from a user-entered beginning to a user-entered ending character. Optional (002) SDLC frame check sum (FCS) generation and error checking for SDLC frames.

Triggering (trap) modes

Character sequence: up to 8 sequential characters including NOT and DON'T CARE may be used as a trigger and may be specified on either the send or receive data lead.

Note: DON'T CARE is the set of all possible bit patterns of any given character framing length. The NOT character is the set of all characters except the one specified. For example, NOT C (\bar{C}) is set of all non C (A, B, D, etc.).

Time interval: time intervals between two RS-232C events may be used as a trigger. Max or min times to 6553 ms with 1 ms resolution may be specified.

Error: data errors, as defined in the FORMAT menu under ERROR CHECK, may be used as a trigger.

External: trigger supplied from user hardware or RS-232C ON conditions (>+3 V).

General

Memory: 2048 characters of monitor buffer and 1024 characters of transmit message buffer.

Display: 10 cm by 13 cm CRT which displays up to 480 characters. All characters in memory can be viewed via the $\uparrow\downarrow$ Cursor keys.

1640A supplemental characteristics

Patch panel matrix: permits the 1640A to be configured to a variety of system interface formats depending on the application. The 1640A has 9 inputs which allow the following RS-232C (V24) pin assignments: TX (transmit data) -2, RX (receive data) -3, RTS (request to send) -4, CTS (clear to send) -5, DSR (data set ready) -6, CAR DET (carrier detect) -8, SCT (serial clock transmitter) -15 or -24, SCR (serial clock receiver) -17, and DTR (data terminal ready) -20. For modem simulation applications, the matrix would be reconfigured. Mylar overlays are provided with prepared pin configurations for common applications to facilitate matrix setup. An auxiliary, tri-state LED may be used to monitor any pin 2 through 25. The matrix also provides access to the time interval counter, external trigger input, trigger output, clock output, and buffered power supplies (± 12 V, ground).

Test results: after any of the three run modes (monitor and simulate) is stopped, the following test results are displayed:

1. Last time interval measured, or the time interval trigger event, between user-definable start and stop events available on the patch panel matrix.

2. Number of trigger events counted during the run.
 3. Number of messages transmitted by the 1640A (simulate only).
Default: returns the displayed menu to its wakeup condition.
Display hold: pressing and holding the RUN key prevents the display from being over-written with new data for extended viewing of data of interest while a run is in progress.
Suppression: allows capturing only information of interest for efficient use of memory, easier data analysis. Synchronizing characters, idles (all logic one's), nulls (all logic zero's), or everything but trigger and next n characters (with n from 0 to 99) may be suppressed.

Monitor mode

Run (execute) modes

Count Triggers: continuously monitors and records data and counts trigger occurrences; record stopped manually.
Trigger Starts Display: trigger starts a single record of 2048 characters (any combination of transmit and receive data).
Trigger Ends Display: trigger stops a continuous record. Built-in delay of 64 characters captures 64 characters after trigger event.

Simulate mode

The 1640A can simulate a CPU, terminal, or the digital side of a modem.

Output: ≥ 3 V into 3 k Ω load. Output rows on the patch panel matrix are TX (Transmit Data), RTS (Request To Send), and DTR (Data Terminal Ready).

Interface control signaling: automatic with additional control available through the matrix.

State: ON is $> +3$ V; OFF is < -3 V. Nominal values of driven leads are ± 8 V to ± 12 V.

HDX: Request To Send is on only during transmission. Data Terminal Ready is always on.

FDX: Data Terminal Ready is always on; Request To Send is programmable via the matrix, either always on or on only during transmission. Idle condition between transmissions is a steady mark (asynchronous) or the user-entered sync character (synchronous).

Reply on: similar to, but separate from, trigger. A Reply On sequence of from 1 to 8 characters, including DON'T CARE and NOT characters, immediately followed by an internally generated time delay from 0 to 6553 ms may be entered which enables a message block to be sent only when these two events occur.

Run (execute) modes

Single and Count Triggers: a message block is transmitted after each occurrence of the REPLY ON condition until all message blocks have been sent once. The RUN automatically stops when a total of 2048 characters (including the transmitted message) have been recorded in the monitor buffer.

Repeat and Count Triggers: a message block is transmitted after each occurrence of the REPLY ON condition until all message blocks have been sent. The process repeats until manually stopped with the last 2048 characters retained in memory.

Repeat and End on Trigger: a message block is transmitted after each occurrence of the REPLY ON condition until all message blocks have been sent. The process repeats and automatically stops when the trigger event occurs with the last 2048 characters prior to the trigger event retained in memory.

Transmit modes

Transmit First: the first message block is sent by pressing RUN. Succeeding blocks are sent following each occurrence of the REPLY ON condition.

Receive First: a message block is sent after each occurrence of the REPLY ON condition.

Transmit message entry: a total of 1024 characters including block delimiter continue symbols ($>$) and the end symbol ($-$), may be entered. The transmit memory may be loaded through the Hex keyboard, by transferring contents of monitor memory to the transmit memory with a single keystroke, or, with Option 001 (HP-IB), through a remote ASCII keyboard or user-definable PROMS (10291A).

Message Editing Keys

CONTINUE: Places a $>$ symbol in the message as a block delimiter. Up to 10 continue symbols may be entered. The continue symbol is recognized only by the 1640A and is not sent as part of data.

END: places a $-$ symbol as a message terminator. Additional messages may be added after end symbol as user instructions but will not be transmitted. The end symbol is not sent as part of data.

INSERT: inserts a space for an additional character at the point indicated by a moveable cursor by automatically shifting all following characters one cell to the right.

DELETE: deletes character immediately above a moveable cursor. All following characters are automatically shifted one space left.

General

Power: 100, 120, 220, 240 Vac; -10% to $+5\%$; 48 to 440 Hz; 150 VA max.

Size: 251 H x 335 W x 546 mm D with handle ($9\frac{7}{8}$ x $13\frac{3}{16}$ x $21\frac{1}{2}$ "); 445 mm D without handle ($17\frac{1}{2}$ ").

Operating environment: temperature, 0°C to $+55^{\circ}\text{C}$; humidity, to 95% relative humidity at $+40^{\circ}\text{C}$; altitude, to 4600 m (15 000 ft); vibration, vibrated in three planes for 15 min. each with 0.3 mm (0.015 in.) excursions, 10 to 55 Hz.

Weight: net 11.4 kg (25 lb); shipping, 15.9 kg (35 lb).

Accessories supplied: one 3 m (10 ft) RS-232C interface cable; Model 10289A Mylar overlay kit, shorting pins and Mylar punch; front panel cover; one 2.3 m (7.5 ft) power cord; one operator's guide; and one service manual.

Options and accessories

001: HP-IB Interface Price add \$475

002: SDLC (Synchronous Data Link Control)/HDLC (High Level Data Link Control) Interface add \$200

003: LRC, CRC-16, and CRC-CCITT Check/Generation add \$150

H07: Adds capability for up to seven additional internal code sets in addition to ASCII and Hex. Any combination of 5, 6, 7, or 8 bit codes may be specified with the appropriate 10290A option \$100

10281A HP-IB Interface: field installable kit to provide Option 001 capability \$475

10282A SDLC/HDLC Interface: field installable kit to provide Option 002 capability \$200

10283A LRC, CRC-16, and CRC-CCITT Check Generation: field install kit provides Opt 003 capability \$150

10284A Current Loop Interface: provides 20/60 mA interface to most common teletype units

10287A MIL 188-C Interface

10289A Mylar Overlay Kit: consists of 3 prepunched matrix overlays for common applications and 20 blank overlays for user-definable tests \$40

10290A Special Code Set ROM: special PROM's for displaying data in other codes such as BCD, TRANS-CODE etc., in lieu of (or, on special order, in addition to) the standard code set

10291A User-Definable Menu PROM: special PROM's that allow up to 2 different user-definable tests for fast reconfiguring of the 1640's menus. The 1640A must have the HP-IB Option. Up to 5 PROMS (10 tests) may be installed

10292A Firmware Package for 9825A: application programs allow tests to be performed without learning 1640A Opt 001 (HP-IB) device dependent commands and 9825A controller instructions

10299A Rack Mount Adapter: adapts 1640A to standard 483 mm (19 in.) rack. Adapter is 310 mm ($12\frac{3}{16}$ in.) H, 540 mm ($21\frac{1}{4}$ in.) W, and 540 mm ($21\frac{1}{4}$ in.) D \$225

1007A Testmobile: offers efficient mobility for the 1640A Serial Data Analyzer which makes it easier to move to different test locations. The 1007A is a basic testmobile which is configured to your needs through add-on options. These options range from trays to drawers plus a power strip. \$245

1640A Serial Data Analyzer \$5800

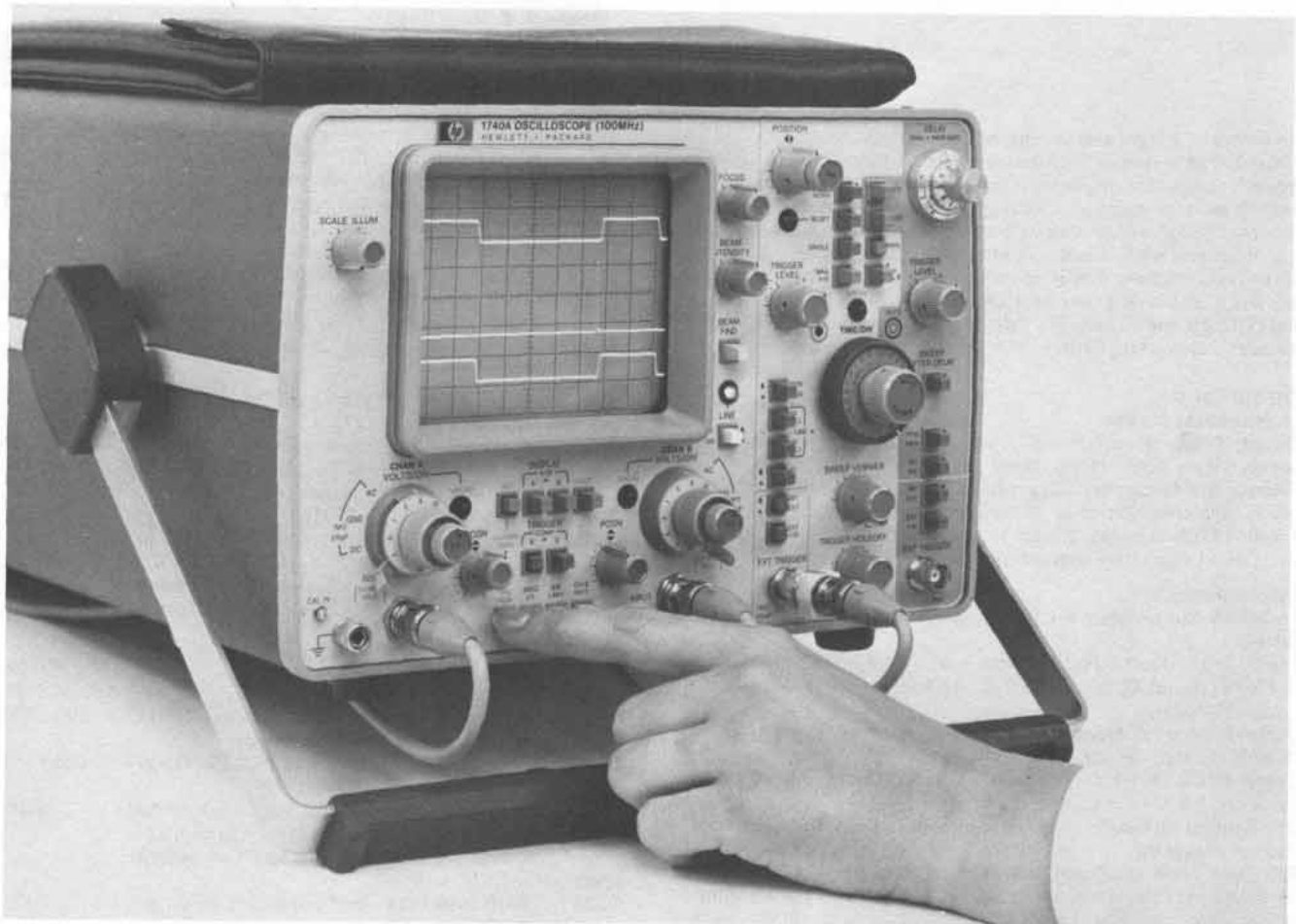

The oscilloscope—the most general purpose and basic tool of the electronic industry—has evolved into a very accurate and versatile measurement tool. With the rapid growth, in the past few years, of technology in integrated circuits, the measuring capabilities have increased tremendously. New capabilities include the Hewlett-Packard developed delta time measurements and the crystal referenced time base of the 1743A. In general, the most versatile test instrument has become even more accurate and more flexible.

Hewlett-Packard pioneered many of the measurement capabilities that are now taken for granted in oscilloscopes. A few of these are internal graticule CRT, beam finder, expansion mesh CRT, trigger holdoff, mixed sweep, general purpose sampling to 18 GHz, time domain reflectometry, and rugged variable persistence storage.

Selecting an oscilloscope

When selecting an oscilloscope you will need to match your present and future measurement needs with the oscilloscope feature set. Price is always a consideration and incremental cost must be weighed against incremental measurement capability. In many cases ease-of-use should be considered along with measurement accuracy and the overall feature set. Some of the major feature decisions include:

- Bandwidth
- Number of channels
- Rack or cabinet configuration
- Portability
- Plug-in versatility
- Vertical and horizontal accuracy
- Ease-of-use
- Price
- Time interval capability
- Variable persistence storage
- Various combinations of the above.

Hewlett-Packard manufactures several oscilloscope families. Each family optimizes a different combination of the considerations previously listed. Refer to the Oscilloscope Selection Chart on page 153 for feature sets and page references.

The 180 system for versatility

The 180 series of oscilloscopes provides up to 100 MHz real-time bandwidth in seven different mainframes and up to 18 GHz bandwidth with a sampling plug-in system. The 180 series has 16 plug-ins for measurement versatility. These include:

- General purpose dual channel verticals, 50 MHz—100 MHz
- General purpose time base systems
- Four channel verticals (50 MHz—100 MHz)
- 18 GHz sampling

- 100 μ V deflection factors with differential input
- Differential offset amplifier for precise peak-to-peak pulse measurements
- TDR systems
- Spectrum Analysis to 1.5 GHz
- Swept frequency analysis to 18 GHz

In addition, the 180 family is available in cabinet or rack mount (5¼ in.) versions with 8 x 10 cm CRT display or in a large screen cabinet version with a 16.5 cm diagonal CRT (8 x 10 div, 1.29 cm/div).

The 180 family also provides variable persistence storage mainframes for bright flicker-free viewing of low duty cycle waveforms and for capture of single-shot transients and glitches in digital systems.

The plug-in system, 5¼ in. rack or cabinet configuration, plus variable persistence storage versions, permits the 180 system to be configured to satisfy a broad range of measurement needs for R & D, production, and general bench applications.

The 1700 family for general purpose applications

The 1700 family of oscilloscopes provides a wide selection of dedicated instruments. It is further divided into the 1740 series (dc to 100 MHz), and the 1715 and 1720 series which are dc to 200 MHz and dc to 275 MHz respectively.

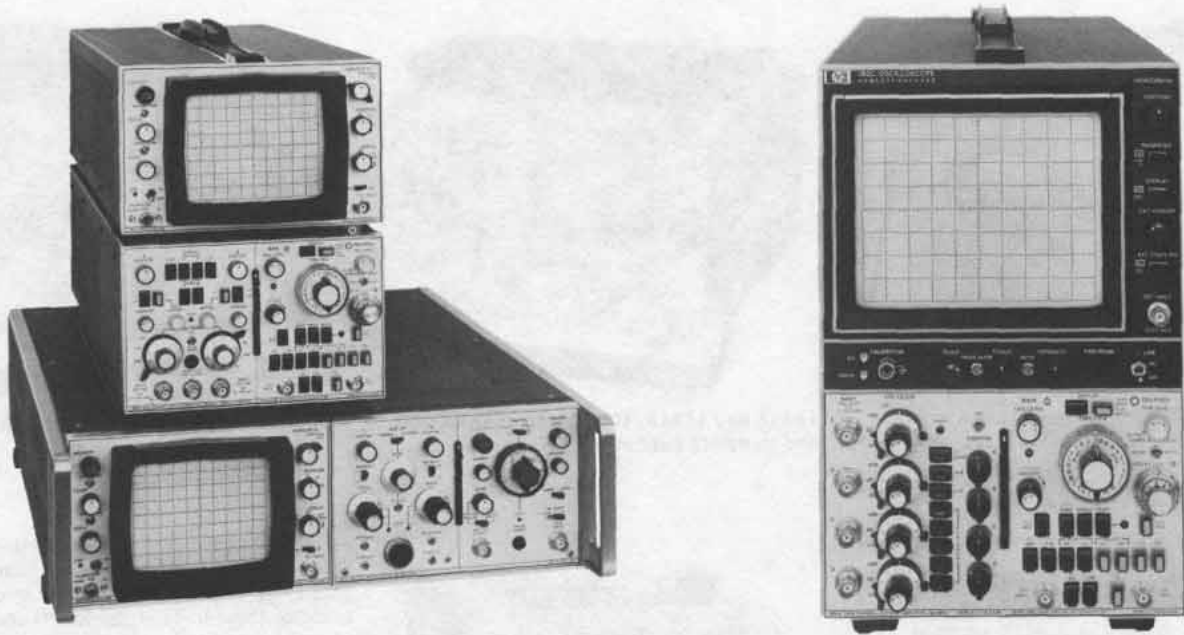

Representative plug-in oscilloscopes from Hewlett-Packard's 180 series.

The 1740 series

The 1740 100 MHz series offers both general purpose and specialized versions. The series consists of the 1740A (HP Journal, December 1975) for general purpose work; the 1742A and 1743A (HP Journal, December 1977) for applications requiring easier, more consistent and more accurate time interval measurements; and the 1741A (HP Journal, September 1976) and 1744A for applications where variable persistence storage is required.

All of the 1740 series are dual channel 100 MHz oscilloscopes with a third channel trigger view. The series has 5 mV/div deflection factors and a times 5 vertical magnifier that increases sensitivity to 1 mV on both channels to 40 MHz* without the need to cascade channels. Also featured are a main and delayed sweep time base with a 5 ns/div maximum sweep speed, and vertical inputs that provide a switchable input impedance of 1 MΩ or 50Ω for convenience and optimum matching of oscilloscope input to source impedance.

*The 1741A and 1744A have 30 MHz bandwidth in this mode.

Variable persistence storage in the 1740 family

The 1741A and 1744A provide all of the oscilloscope features of the 1740A with the addition of a variable persistence storage CRT. For general purpose work with digital circuits the 1741A provides an excellent solution. Its 100 cm/μs writing speed permits easy viewing of low repetition rate signals and with its light integrating capability can display transitions as fast as 3.5 ns over the full screen height after only 20 occurrences of the sweep. The 100 cm/μs writing speed of the 1741A also permits single-shot capture of 5 MHz events with full screen amplitude. Proportionately higher frequency transients may be captured and displayed at a lesser

amplitude.

The 1744A variable persistence storage oscilloscope offers a writing speed of 1800 cm/μs which permits the 1744A to capture and display single-shot events from dc to 100 MHz and display them over a 6 × 8 division quality area.

The Hewlett-Packard developed system of expansion storage used in the 1744A has a writing speed consistent with the 100 MHz oscilloscope bandwidth while providing sharp trace quality. This technology provides a larger display area of the stored 100 MHz transients than any other 100 MHz storage oscilloscope available today.

Delta time means ease-of-use and accuracy

Many of the 1700 series oscilloscopes provide a new time interval capability known as DELTA TIME (ΔT). This capability is presently provided on the 1742A, 1743A, 1715A, 1722B, and 1725A. The demand for precise and consistent time interval measurements has expanded with the growth of digital systems. System timing is an all important consideration in the design, manufacture, and troubleshooting of digital circuits. The Hewlett-Packard DELTA TIME system uses a two marker method with the markers defining the start and stop events. The interval contained by the two markers can be read directly on an LED display. This technique eliminates the error prone procedures required when using conventional delayed sweep where careful readings of a 10-turn helidial must be taken for both the START and STOP events, and the difference multiplied by the MAIN TIME base setting. These steps are eliminated using the Hewlett-Packard introduced DELTA TIME system. In addition to speed and ease-of-use, the DELTA TIME system is more accurate since it eliminates the mechanical non-lin-

earities of a 10-turn potentiometer. The DELTA TIME system also permits the operator to view two events which are separated in time on alternate sweeps with the high resolution of the delayed sweep. This allows the operator to measure pulse width and period jitter, or compare events separated in time, with higher resolution and accuracy than is possible without DELTA TIME.

Precision timing

Oscilloscopes which rely on a Miller Integrator ramp for their timing reference can approach accuracies of ±1% using delayed sweep methods. The 1743A has a crystal referenced time base with timing accuracy of ±0.002% of reading ±1 count. It has a built in 5-digit LED readout for time interval with resolution up to 100 ps. The 1743A has the two marker delta time system and in addition offers unprecedented time interval accuracy. Sweep speeds can be continuously calibrated so that the CRT graticule lines can be calibrated to your system's units. Triggered delta time measurements mean that the time interval readout automatically tracks changes in the input signal without operator intervention; and delay goes all the way to zero to allow the delayed sweep precision to be used on low duty cycle and non periodic events. The 1743A also provides a precise on-screen indication of the trigger level at which the start and stop events are being measured without any hysteresis error.

The high frequency 1700 series

Hewlett-Packard offers three high speed delta time oscilloscopes that are ideal for use in the design, manufacturing, and testing of high speed computers and peripherals, with fast interface logic, high speed digital communications, and high frequency RF and analog applications.

The 275 MHz Model 1722B ("A" version described in HP Journal, December, 1974)

OSCILLOSCOPES

General information (cont.)



1740A, 100 MHz general purpose.



1741A and 1744A, 100 MHz for measurements requiring variable persistence storage and transient capture.



1743A and 1742A, 100 MHz delta time measurements.



set. The 1725A and 1715A have a selectable input impedance on both vertical channels (1 M Ω , 11 pF or 50 Ω). The 11 pF shunt capacitance of these units is the lowest input capacitance presently available on a high impedance input oscilloscope. The specified bandwidth of the 1725A in the high impedance input mode is also the highest presently available.

Low frequency 1220 series 500 kHz

Low frequency oscilloscopes which have 500 kHz bandwidth are used in educational, medical, system monitors, engineering, production, and in some cases field service. These could be classified as the "workhorses" of the electronics industry since they are most commonly found in system applications. The 1200 series oscilloscopes easily fill these requirements with their 100 μ V and 5 mV sensitivity, differential inputs, solid-state and lightweight construction, and reliable and stable operation. Also available are storage and variable persistence models which eliminate annoying flicker from low rep rate signals and retain single-shot traces that are common in biomedical or electromechanical applications.

15 MHz

In the dc to 15 MHz range the 1220A and 1222A dual channel oscilloscopes are designed for industrial and educational applications, and production line testing. Logical front panel layout, large 8 \times 10 division internal graticule, and automatic triggering reduce familiarization time and assure maximum efficiency in production and student environments. The 120A and 1222A environments. The 1220A and 1222A have TV Sync for triggering on video frames.

Additional measurement features Time and state displays

The Hewlett-Packard 1700 series option 101 permits one-button switching between time domain waveforms and data domain state displays. The State display is obtained from the 1607A, a 16-channel logic analyzer with pattern trigger recognition, digital delay, variable threshold selection, data qualifier lines, and pretrigger display. The outputs of the 1607A are displayed on the 1700 series

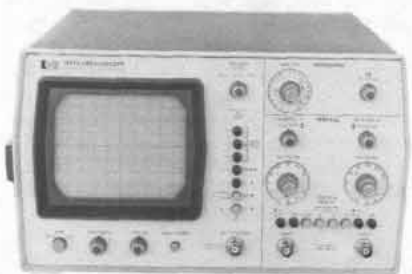

1222A, 15 MHz for industrial and educational use.

with its microprocessor and LED display provides a measurement set which provides ease-of-use and increased accuracy on both the voltage and time axes.

The 1722B incorporates the two marker Delta Time System. In addition, a Δ V system is provided to make voltage measurements between any two points on a displayed waveform. The 1722B also has a vertical mode which scales measurements in percentages so that measurements such as percent overshoot can be easily made. Another vertical mode on the 1722B allows dc voltages to be measured through the oscilloscope probe. The microprocessor can provide the reciprocal of delta time readings for a direct frequency readout. The vertical and horizontal measurement capabilities of the 1722B make it a remarkably versatile test instrument which economizes on bench space while providing a high quality 275 MHz laboratory oscilloscope with a greatly expanded measurement set.

Models 1725A and 1715A offer 275 MHz and 200 MHz bandwidths respectively and both have the delta time system advantages. These oscilloscopes are available with an optional built-in DMM for direct readout of time interval and the DMM measurement

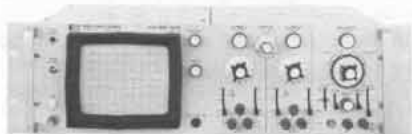

1205B, a 500 kHz "workhorse" of industry.



1715A (200 MHz), 1725A and 1722B (275 MHz) provide convenient high frequency measurements and 1% delta time accuracy.

oscilloscope via rear panel inputs. The front panel inputs of the oscilloscope remain free for waveform inputs. The 1607A triggers the oscilloscope when a specified word occurs and by switching from the State display to the waveform display it is possible to vector the oscilloscope with its high resolution directly to the vicinity of errors located on the State display.

DMM option for delta time oscilloscopes

Hewlett-Packard models 1742A, 1715A and 1725A have Delta Time as a standard feature. The DMM option provides a 3½ digit DMM built into the top cover of the oscilloscope with an internal connection which allows the DMM to read out time intervals on its display. The DMM can be used for time interval readouts or as a DMM with separate inputs. The DMM includes ac and dc volts and amps, ohms, and has autoranging. A delta time oscilloscope with the optional DMM provides a multi-measurement test station, yet offers easy portability.

Sampling oscilloscopes

The sampling oscilloscope provides more bandwidth per dollar than any other oscilloscope. The only requirement for using a sampling oscilloscope is that the waveform be repetitive. It offers many benefits in addition to high bandwidth which are worthy of consideration.

- High dynamic range—approximately 20 screen diameters
- High sensitivity
- Very fast sweep speeds
- Large bright displays
- High frequency Lissajous patterns with low phase distortion
- To 18 GHz bandwidth

Oscilloscope accessories

Cameras and adapters, testmobiles, active and passive probes, and adapters to meet most any need are available to help you get the most out of your oscilloscope investment. See page 182.

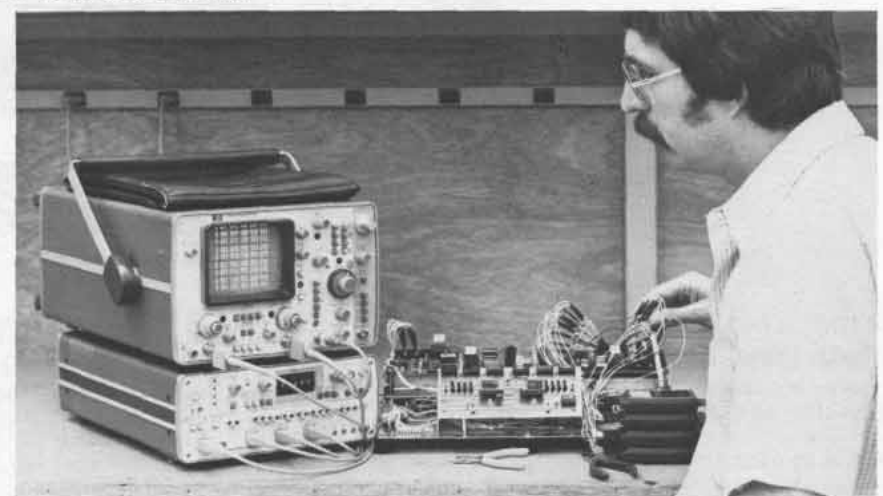

Option 101 to 1740A offers one button switching between Logic State Analysis and volts vs. time measurements.

Oscilloscope Selection Chart

Characteristics	1700 Series			180* Series					1220 Series		1200 Series			
	1715A	1722B	1725A	1740A	1741A	1742A	1743A	1744A	1220A	1222A	1200B	1201B	1205B	
Bandwidth	200 MHz	275 MHz	275 MHz	100 MHz	100 MHz	100 MHz	100 MHz	100 MHz	0.5 to 100 MHz	15 MHz	15 MHz	500 kHz	500 kHz	500 kHz
Deflection Factors/Div.	5 mV to 5 V	10 mV to 5 V	10 mV to 5 V	5 mV to 20 V	5 mV to 20 V	5 mV to 20 V	5 mV to 20 V	5 mV to 20 V	100 µV Min.	2 mV to 10 V	2 mV to 10 V	0.1 mV to 20 V	0.1 mV to 20 V	5 mV to 20 V
Sweep Speeds/Incl. Mag.	10 ns to 0.5 s	10 ns to 0.5 s	10 ns to 0.5 s	50 ns to 2 s	50 ns to 2 s	50 ns to 2 s	50 ns to 2 s	50 ns to 2 s	5 ns to 1 s	0.1 s to 0.5 s	0.1 s to 0.5 s	1 µs to 5 s	1 µs to 5 s	1 µs to 5 s
Channels	2	2	2	2	2	2	2	2	1,2,4	2	2	2	2	2
Δ Time Measurements	•	•	•			•	•							
Variable Persistence Storage					•			•	•				•	
3rd Channel Trigger View				•	•	•	•	•						
Sampling									•					
TDR									•					
Differential Inputs									•			•	•	
Optional Logic State Switch	•	•	•	•	•	•	•							
LED Readout/DMM	Optional	•	Optional			Optional	•							
Page	160	160	160	154	154	154	154	154	164	180	180	178	178	178

*Detailed selection chart for 180 Series oscilloscopes on page 165.

OSCILLOSCOPES

100 MHz crystal delta time, storage

Models 1740A, 1741A, 1742A, 1743A & 1744A

- Dual channel, 5 mV/div to 100 MHz
- 3rd Channel trigger view
- Selectable input impedance



1740A

1740A, 1741A, 1742A (new), 1743A, 1744A (new) Description

Hewlett-Packard's 1740 series of 100 MHz, dual-channel oscilloscopes offer the high performance necessary to meet the demanding requirements of both laboratory and field applications. These oscilloscopes have the performance and features to make accurate measurements with ease. The front panel includes a large, high-resolution CRT with color-coded controls which reduce operator learning time and make repetitious measurements easier. Several features that add to the versatility of these 100 MHz portable oscilloscopes include a third channel trigger view for viewing the external signal with both vertical channels; a X5 vertical magnifier for 1 mV/div deflection factors on both channels; selectable input impedance (1 M Ω /50 Ω) for general purpose probing and precise rise time measurements; and a Logic State Display option (except for the 1744A) for convenient switching between logic state and electrical analysis.

8 X 10 cm Display

1740A, 1742A, 1743A Conventional CRT

The CRT has a crisp, bright trace over the fully specified 8 x 10 cm display area. An accelerating potential of 15 kV makes the display compatible with the 5 ns/cm sweep speeds for easier viewing of low rep rate, fast transition time signals. The small spot size of the lab quality CRT along with the no parallax internal graticule makes critical and difficult timing measurements easier to perform. An internal floodgun uniformly illuminates the CRT phosphor for high quality trace photos with a sharp well defined internal graticule.

3rd Channel trigger view

In many measurements, especially in digital applications, it is desirable to externally trigger the main sweep using a signal synchronous with the displayed waveforms. The third channel trigger view offers several measurement conveniences in dual channel timing applications.

- The external trigger signal can be displayed without the need to physically connect it to one of the vertical input channels.

- Trigger threshold can be viewed for either an internal or external trigger source. Trigger threshold is the center horizontal graticule line and the trigger point is selected by positioning the trigger waveform vertically using the Sweep Trigger Level control.

- With the trigger view mode, the shape of the trigger waveform can be viewed to verify that the correct signal is used as the trigger source. Trigger view also allows you to verify that the trigger threshold is not set to portions of a waveform containing irregularities and reflections.

- With trigger view, three channels of information are displayed so that timing analysis can be accomplished. The trigger channel is displayed with a specified delay of 2.5 ns \pm 1 ns relative to the two vertical channels.

Stable Flexible Triggering

Stable internal triggering to greater than 100 MHz requires only 1 cm of vertical deflection. The internal trigger sync take-off is immediately after the attenuator which maintains a stable display regardless of changes in position, vernier, or polarity controls. The desired trigger signal conditioning for your measurement application is quickly achieved with easy-to-use push-button controls. In the external trigger mode, signals of only 100 mV trigger the oscilloscope to 100 MHz (only 50 mV to 50 MHz).

Vertical amplifiers

To meet many measurement requirements, vertical deflection factors from 5 mV/div to 20 V/div are provided with 3% accuracy. For low level, dual channel measurements, a times five vertical magnifier provides 1 mV/div and 2 mV/div capability which allows you to analyze both input and output signals such as those on tape and disc heads or power supply ripple and its influence on other waveforms.

- Delta time measurements
- Optional built-in DMM for increased accuracy, flexibility
- Dual channel, 5 mV/div to 100 MHz
- 3rd Channel trigger view and selectable input impedance



1742A

Selectable input impedance

For maximum measurement flexibility, switchable 50Ω and 1 MΩ inputs are provided. The internal 50Ω input with low reflections is useful for measurements requiring a 50Ω termination for accurate pulse reproduction.

Serviceability

Innovations in circuit design along with custom integrated hybrid circuits reduce calibration time because of a minimum of adjustments. Wire harnesses and interconnection cables between boards are reduced with an interface board which connects the main boards together. This interface board helps to reduce service time and reassembly errors normally encountered with instruments containing many cables. These oscilloscopes, with the exception of the high writing speed 1744A, do not require a fan or ventilating holes for convection cooling which reduces the amount of dust and dirt that can accumulate internally.

General Purpose 1740A

The Model 1740A contains all of the standard 1740 series features described, such as third channel trigger view, flexible triggering, 1 mV/div deflection factor in the X 5 mode, large 8 X 10 cm CRT, and selectable input impedance. The versatility of this 100 MHz oscilloscope simplifies both real-time and data domain measurements.

Delta Time Measurements

1742A time interval measurements

Model 1742A provides two methods for making time interval measurements. One is the familiar single marker delayed sweep using the helical delay control for differential time relationship measurements or for convenient expansion of selected areas of waveforms. The second method is the Hewlett-Packard developed system of dual intensified markers, known as delta time, which greatly simplifies time interval measurements while improving the accuracy and resolution. In delta time mode, Start and Stop markers are alternately displayed on the Main Intensified sweep and the time interval between the markers are read directly on the optional DMM or on the calibrated ten turn dial, or available as a rear panel scaled voltage output compatible with most DVM's. When the delayed sweep mode is selected, the region of the intensified markers is expanded and alternately displayed with the increased resolution of the faster delayed sweep. Now, when the waveforms are overlapped, the maximum precision of delta time interval measurement is obtained. The delta time measure-

- Precise delta time measurements with crystal timing reference
- Dual channel, 5 mV/div to 100 MHz
- 3rd Channel trigger view and selectable input impedance

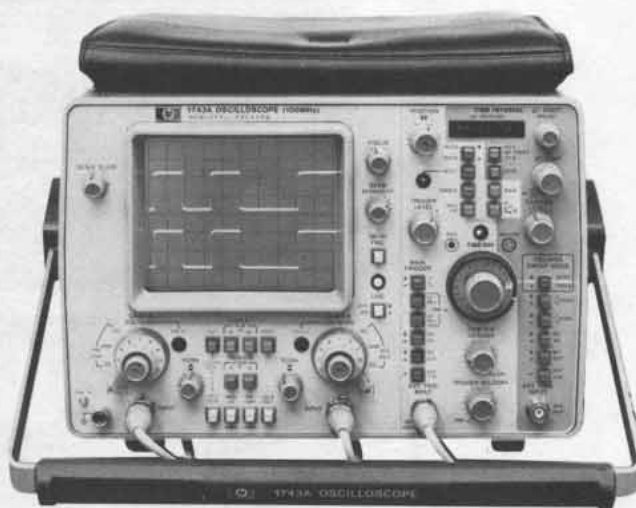

1743A

ment system with Option 034 improves the percent of full scale error by a factor of two over the single marker delayed sweep method.

1743A Crystal accurate timing

The 1743A incorporates a second generation delta time system based on a 100 MHz crystal timing reference rather than the traditional analog ramp reference. This internal crystal reference offers additional measurement capability and increased accuracy. The time between the two intensified marks is displayed on a five digit LED readout with an accuracy of 0.002% plus or minus one count. For main sweep speeds of five microseconds or less, the one count corresponds to plus or minus 100 ps.

First pulse measurements: The 1743A, by using a crystal reference, allows you to measure time intervals relative to the leading edge of the first pulse in the main sweep display. The first pulse measurement capability makes high resolution measurements possible on asynchronous pulses that are common in digital system interfaces.

Triggered measurements: The triggered delay mode of the 1743A offers a major improvement in measurement ease, as well as increased capability. Simply select the proper trigger level and slopes for the Start and Stop markers and the 1743A will perform the measurement with minimum operator involvement. The oscilloscope will track changes in the signal, making this mode well suited for production test applications.

There is no need to operate the 1743A in the delayed sweep mode when the triggered delta time mode is used. This mode expands the measurement window to that of the main sweep.

Sweep vernier: Crystal timing now allows you to use the sweep vernier out of its detent position to calibrate the CRT divisions for various measurements without uncalibrating the LED time readout. For example, you can set up the graticule lines to represent clock periods and then make tow channel measurements of other signals related to the pre-calibrated "clock" signal.

The sweep vernier also increases the display resolution by up to three times. With the vernier in detent, the resolution of a full screen display is a maximum of one part in 50 000 and with the vernier full ccw, full screen resolution is a maximum of one part in 150 000.

This increased resolution is obtained by using a faster main sweep speed. For example, by switching from a 1 μs/div range to a 0.5 μs/div range the last digit of the five digit display becomes hundreds of picoseconds instead of tens of nanoseconds. The same display of the 1 μs/div sweep can now be obtained on the 0.5 μs/div sweep by adjusting the sweep vernier.

Models 1740A, 1741A, 1742A, 1743A & 1744A (cont.)

- Variable persistence storage with auto-store, auto-erase, 100 cm/ μ s writing speed
- Dual channel, 5 mV/div to 100 MHz
- 3rd Channel trigger view and selectable input impedance

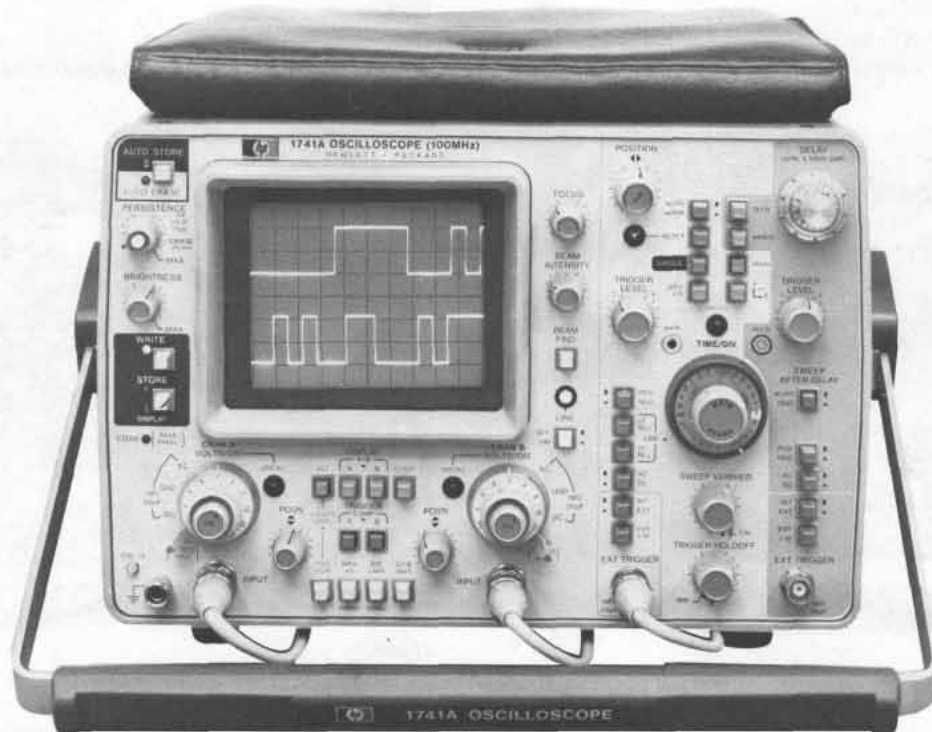

1741A

1741A, 1744A, variable persistence storage

The Hewlett-Packard variable persistence CRT extends the oscilloscope's usefulness into areas beyond the capabilities of conventional CRT technology. The 1741A and 1744A provide well-defined, easily viewed traces in applications that otherwise require a camera or produce annoying flicker. Applications that require sweep speeds slower than 2 ms/div produce a flickering display on a conventional CRT and as the sweep speed is reduced further the display decays to a moving dot. The variable persistence CRT solves these problems by allowing adjustment of the persistence control to obtain an easily viewed display.

Low repetition rate signals at fast sweep speeds produce very low light output from conventional CRT's, requiring use of a viewing hood or CRT photography to obtain a viewable display. In these applications the variable persistence CRT becomes a light amplifier by integrating several sweeps to produce bright sharp traces.

The variable persistence storage oscilloscope allows convenient analysis of single-shot events without use of a camera. The 100 cm/ μ s writing rate of the 1741A is comparable with that of ASA 3000 film. The 1800 cm/ μ s writing rate of the 1744A is higher than can be obtained with ASA 10 000 film without special techniques such as post fogging.

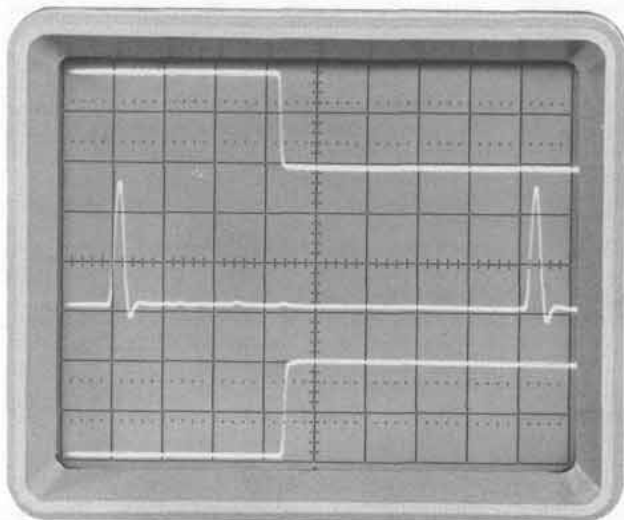

Third channel trigger view of the external trigger signal provides increased measurement convenience. Center screen is the trigger threshold which allows you to see which portion of the signal is triggering the display. A specified delay of 2.5 ns \pm 1 ns between the external trigger input and either vertical channel offers valid timing measurements.

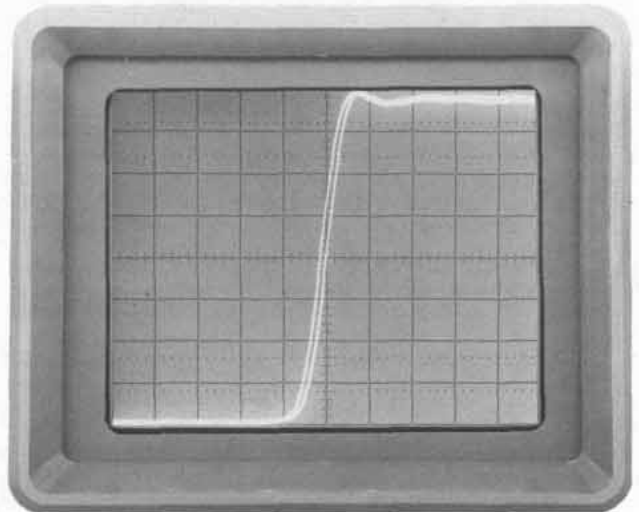

Exceptionally fine trace in the variable persistence mode permits high resolution timing measurements as shown with this dual trace, alternate sweep display at a sweep speed of 5 ns/div.

- Variable persistence storage with auto-store, auto-erase
- Expansion storage CRT for 1800 cm/μs writing speed

- Dual channel, 5 mV/div to 100 MHz
- 3rd Channel trigger view and selectable input impedance



1744A

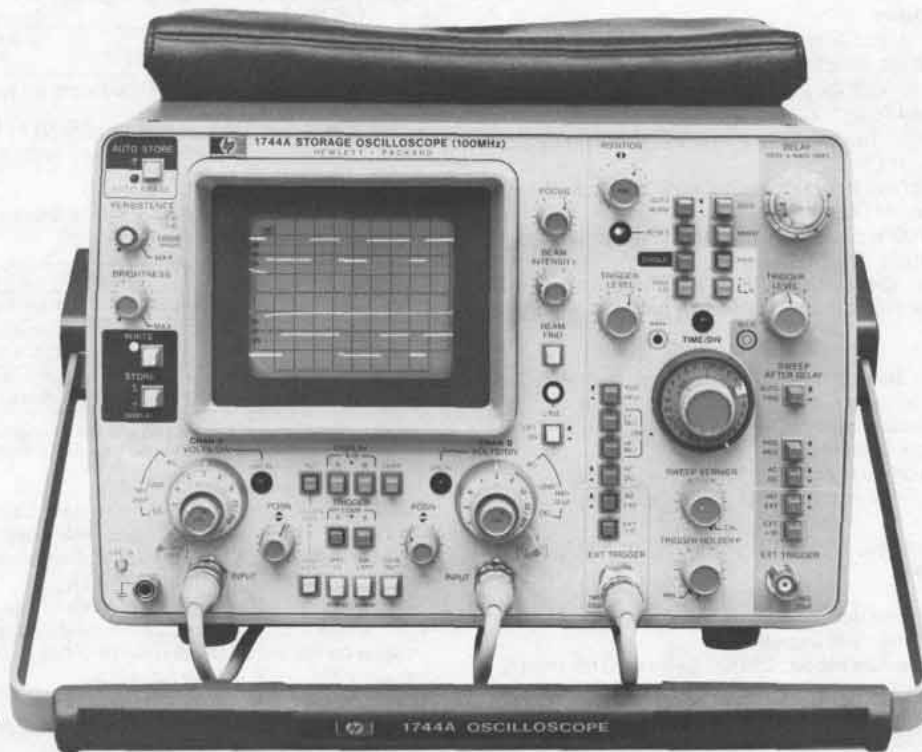

The cathode-ray tube technology used in both the 1741A and 1744A results in full variable persistence performance in all storage operating modes. Neither of these CRT's require reduced scan display modes or unusually long erase cycle times. With minimum erase cycle time, these oscilloscopes are not "blind" to transients that might be present in the system under test.

The 1741A CRT has a writing rate greater than 100 cm/μs and a highly burn resistant storage surface which results in an oscilloscope that is ideally suited to the majority of applications.

For those applications requiring the ultimate in writing rate performance, the 1744A provides a writing rate of 1800 cm/μs. With this writing rate the 1744A can capture a 100 MHz sine wave with an amplitude of 8 divisions. Any signal within the bandwidth of the 1744A's 100 MHz vertical amplifier system can be captured and displayed in one sweep.

The ability to capture transients at the full bandwidth of the 1744A vertical deflection system is achieved with a new CRT technology called Expansion Storage. With expansion storage the waveform to be captured is written on a storage mesh positioned close to the deflection plates. The storage mesh is about the size of a postage stamp and is capable of storing very sharp waveform images. A flood gun electron cloud projects the image through a lens system onto the CRT phosphor for viewing. This combination of a small storage surface

and the expansion lens system provides a storage CRT capable of capturing transients at or beyond the slew rate of the 100 MHz deflection systems.

1741A, 1744A Operation

The brightness control adjusts the sensitivity of the storage surface. This allows the display to be optimized at all sweep speeds for maximum display contrast. With a high writing speed and slow scan rate, the storage target becomes saturated and blooms brightly. A slow writing rate and fast scan rate will provide a very dim display. With the brightness control it is a simple matter to obtain the best possible display.

The storage control mode LED indicators provide positive indication of the oscilloscope's operational condition. Two automatic operating modes further simplify operation of these oscilloscopes.

The auto-erase mode provides a series of individual "snapshots" of a waveform automatically, freeing the operator to simply probe a circuit at desired points and observe the display. The auto-erase mode also provides a convenient method of setting the focus and intensity for single-shot events. If you are displaying traces on two or more channels, the 1741A or 1744A will wait for the required number of sweeps to be displayed before automatically erasing the display.

For maximum convenience in single-shot applications, an auto-store mode, which operates in single-shot mode, makes it easy to capture random events. To prevent the possibility of recording the wrong event, the 1741A and 1744A automatically switch from Write mode to Store mode at the end of the sweep. This is shown by the mode indicators. To view the signal, a press of the Store/Display pushbutton displays the trace. For convenience, a push of the Erase pushbutton erases the CRT and resets the time base.

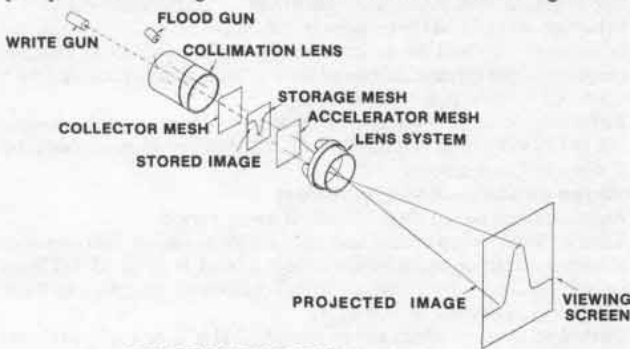

1744A EXPANSION STORAGE CRT



Models 1740A, 1741A, 1742A, 1743A & 1744A (cont.)

1740A, 1741A, 1742A, 1743A, 1744A

Specifications

Vertical display modes

Channel A; channel B; A and B displayed alternately on successive sweeps (ALT); A and B displayed by switching between channels at ≈ 250 kHz rate with blanking during switching (CHOP); A plus B (Algebraic addition); and trigger view.

Vertical amplifiers (2) Bandwidth and Rise Time at all deflection factors from 0°C to +55°C.

Bandwidth: 3 dB down from 8 div reference signal; 3 dB down from 6 div reference signal for 1741A, 1744A.

DC-coupled: dc to 100 MHz in both 50 Ω and 1 M Ω input modes.

AC-coupled: ≈ 10 Hz to 100 MHz.

Bandwidth limit: limits upper bandwidth to ≈ 20 MHz.

Rise Time: ≤ 3.5 ns measured from 10% to 90% points of a 6 div (5 div, 1744A) input step.

Deflection factor

Ranges: 5 mV/div to 20 V/div (12 calibrated positions) in 1, 2, 5 sequence, attenuator accuracy $\pm 3\%$.

Vernier: extends deflection factor to ≥ 50 V/div.

Polarity: channel B may be inverted.

Input coupling: selectable AC or DC, 50 Ω (dc), or ground.

Input RC (selectable): AC or DC, 1 M Ω $\pm 2\%$ shunted by ≈ 20 pF; 50 Ω , 50 Ω $\pm 3\%$.

Maximum input: AC or DC, 250 V (dc + peak ac) or 500 V p-p at ≤ 1 kHz; 50 Ω , 5 V rms.

A + B operation

Amplifier: bandwidth and deflection factors are unchanged; channel B may be inverted for A-B operation.

Differential (A-B) common mode: CMR is at least 20 dB from dc to MHz. Common mode signal amplitude equivalent to 8 div (6 div, 1744A) with one vernier adjusted for optimum rejection.

Vertical magnification (X5)

Bandwidth: 3 dB down from 8 div (6 div, 1744A) reference signal.

DC-coupled: dc to ≈ 40 MHz; dc to ≈ 30 MHz for 1741A, 1744A.

AC-coupled: ≈ 10 Hz to 40 MHz; ≈ 10 Hz to 30 MHz for 1741A, 1744A.

Rise time: ≤ 9 ns, ≤ 12 ns for 1741A, 1744A (measured from 10% to 90% points of 8 div, 5 div 1744A, input step).

Deflection factor: increases sensitivity of 5 and 10 mV settings by a factor of 5 with max sensitivity of 1 mV on channels A and B.

Trigger source

Selectable from channel A, channel B, composite, or line frequency.

Trigger view

Displays internal or external trigger signal. In Alternate or Chop mode, channel A, channel B, and the trigger signals are displayed. In channel A or B mode, Trigger view overrides that channel. Internal trigger signal amplitude approximates vertical signal amplitude. Ext trigger signal deflection factor is 100 mV/div or 1 V/div in EXT $\div 10$. Triggering point is approx center screen. With identically timed signals to a vertical input and the EXT trigger input, trigger signal delay is 2.5 ns ± 1 ns.

Horizontal display modes

Main, Δ time with channel A or B start (1742A, 1743A), main intensified, mixed (except 1743A), delayed, mag X 10, and A vs. B.

Main and delayed time bases

Ranges

Main: 50 ns/div to 2 s/div (24 ranges) in 1, 2, 5 sequence.

Delayed: 50 ns/div to 20 ms/div (18 ranges) in 1, 2, 5 sequence.

Accuracy

Sweep Time/Div	*Accuracy		Temp Range
	X1	X10	
50 ns to 20 ms	$\pm 3\%$	$\pm 4\%$	0°C to +15°C
	$\pm 2\%$	$\pm 3\%$	+15°C to +35°C
	$\pm 3\%$	$\pm 4\%$	+35°C to +55°C

*Add 1% for 50 ms to 2 s ranges

Main sweep vernier: extends slowest sweep to at least 5/s div.

Magnifier (X10): extends fastest sweep to 5 ns/div.

Calibrated sweep delay (except 1743A)

Delay time range: 0.5 to 10 X Main Time/Div settings of 100 ns to 2 s (min delay 150 ns).

Differential time measurement accuracy

(Using one intensified marker and helical control)

Main Time Base Setting	Accuracy* (+15°C to +35°C)
100 ns/div to 20 ms/div 50 ms/div to 2 s/div	$\pm (0.5\% \text{ of range } \pm 0.1\% \text{ of fs})$ $\pm (1\% \text{ of range } \pm 0.1\% \text{ of fs})$

*Add 1% for temperature from 0°C to +15°C and +35°C to +50°C.

Delay jitter: $< 0.002\%$ (1 part in 50 000) of max delay in each step from +15°C to +35°C; $< 0.005\%$ (1 part in 20 000) from 0°C to +15°C and +35°C to +50°C.

Differential time measurement accuracy (1742A)

(Using Δ time dual intensified markers)

Main Time Base Setting	Accuracy* (+15°C to +35°C)		
	Opt 034/035	External DVM	Helical
100 ns** to 20 ms/div	$\pm (0.5\% \text{ of range } \pm 0.5\% \text{ of fs})$	$\pm (0.5\% \text{ of range } \pm 0.05\% \text{ of fs})$	$\pm (0.5\% \text{ of range } \pm 0.1\% \text{ of fs})$
50 ms to 2 s/div	$\pm (1\% \text{ of range } \pm 0.1\% \text{ of fs})$	$\pm (1\% \text{ of range } \pm 0.1\% \text{ of fs})$	$\pm (1\% \text{ of range } \pm 0.1\% \text{ of fs})$

*On 100 ns/div range, specification applies after first cm of main sweep.

**Add 1% for temperatures from 0°C to +15°C and +35°C to +55°C.

Time interval (Δ time) 1742A

Function: measures time interval between two events on channel A (A display); two events on channel B (B display); or two events starting from an event on either channel A or B and ending with an event on either channel A or B (alt display).

Time interval output voltage: varies from 50 V to 100 mV full scale. Full scale output voltage can be determined by multiplying the number on the Time/Div dial by 10 V (e.g. 0.05 s, 0.05 ms, or 0.05 μ s per div gives 0.5 V output full-scale).

Stability (0°C to +55°C): short-term 0.005%. Temperature, $\pm 0.03\%/^{\circ}\text{C}$ deviation from calibration temperature range.

Crystal referenced Δ time (1743A)

Delay time range: 0 to 10 X Main Time/Div settings of 100 ns to 2 s.

Differential time measurement accuracy

Accuracy: $\pm 0.002\%$ of reading ± 1 count from +15°C to +35°C; $+0.005\%$ of reading ± 1 count from 0°C to +15°C and +35°C to +55°C.

Time resolution of ± 1 count

Sweep Ranges/div	± 1 Count	Averages
0.1 μ s, 0.2 μ s, 0.5 μ s	± 100 ps	10 000
1 μ s, 2 μ s, 5 μ s	± 1 ns	1 000
10 μ s, 20 μ s, 50 μ s	± 10 ns	100
0.1 ms, 0.2 ms, 0.5 ms	± 100 ns	direct

Readout: 5 digit LED plus exponent.

Crystal Aging: 0.0005% per year.

Delay jitter: same as other 1740 series oscilloscopes.

Triggering

Main sweep

Normal: sweep is triggered by internal or external signal.

Automatic: baseline displayed in absence of input signal. Above 45 Hz, triggering is same as normal.

Single: sweep occurs once with same triggering as Normal. Reset arms sweep and lights indicator. (1741A, 1744A) Single sweep is also initiated with Erase, sweep is armed after the erase cycle.

Internal: dc to 25 MHz on signals ≥ 0.3 div vertical deflection, increasing to 1 div vertical deflection at 100 MHz in all display modes (required signal level is increased by 2 when in Chop mode and by 5 when X5 vertical magnifier is used).

External: dc to 50 MHz on signals of 50 mV p-p or more, increasing to 100 mV p-p at 100 MHz (required signal level is increased by 2 when in Chop mode).

Delayed sweep (sweep after delay)

Auto: delayed sweep starts at end of delay period.

Trig: delayed sweep armed and triggerable at end of delay period.

Internal: same as Main Sweep except 1743A is dc to 25 MHz on signals causing 1 div or more vertical deflection, increasing to 2 div of vertical deflection at 100 MHz.

External: same as Main sweep except 1743A is dc to 50 MHz on signals 100 mV p-p increasing to 200 mV p-p at 100 MHz.

External input RC: $\approx 1\text{ M}\Omega$ shunted by $\approx 20\text{ pF}$; max external input, 250 V (dc + peak ac) or 500 V p-p at $\leq 1\text{ kHz}$.

Level and slope: internal, at any point on positive or negative slope of displayed waveform; external, continuously variable from +1 V to -1 V on either slope of trigger signal, +10 V to -10 V in ± 10 .

Coupling: AC, DC, LF REJ, OR HF REJ.

Trigger holdoff (main sweep): increases sweep holdoff in all ranges.

Calibrated mixed time base (except 1743A)

Dual time base in which the main time base drives the first portion of sweep and the delayed time base completes the sweep at the faster delayed sweep. Also operates in single sweep mode. Accuracy, add 2% to main time base accuracy.

A vs. B operation

Bandwidth: channel A (Y-axis), same as channel A; channel B (X-axis), dc to 5 MHz.

Deflection factor: 5 mV/div to 20 V/div (12 cal positions) in 1, 2, 5 sequence; phase difference between channels, $< 3^\circ$, dc to 100 kHz (75 kHz, 1743A).

Cathode-ray tube and controls (1740A, 1742A, 1743A)

Type: 12.7 cm (5 in.) rectangular CRT, post accelerator, $\approx 15\text{ kV}$ accelerating potential, aluminized P31 phosphor.

Graticule: 8 x 10 div (1 div = 1 cm) internal non-parallax graticule, 0.2 subdivision markings on major horizontal and vertical axes and markings for transition time measurements. Internal floodgun graticule illumination.

Beam finder: returns trace to CRT screen.

Z-axis input (intensity modulation): +4 V, $\geq 50\text{ ns}$ width pulse blanks trace of any intensity, usable to $\leq 10\text{ MHz}$ for normal intensity. Input R, $1\text{ k}\Omega \pm 10\%$. Max input $\pm 20\text{ V}$ (dc + peak ac).

Rear panel controls: astigmatism and trace align.

Cathode-ray tube and controls (1741A)

Type: 12.7 cm (5 in.) rectangular CRT, post accelerator, $\approx 7.5\text{ kV}$ accelerating potential, aluminized P31 phosphor.

Graticule: 8 x 10 div (1 div = 0.85 cm) internal, non-parallax graticule, 0.2 subdivision markings on major horizontal and vertical axes, with markings for transition time measurements. Graticule illumination is achieved with Persistence control set to min.

Beam finder: returns trace to CRT screen.

Z-axis input (intensity modulation): same as 1740A.

Operating modes: write, store, display, auto-store, auto-erase, and conventional (rear panel control).

Persistence: variable, $\approx 100\text{ ms}$ to 1 min; conventional, natural persistence of P31 phosphor ($\approx 40\text{ }\mu\text{s}$).

Storage writing speed: $\geq 100\text{ cm}/\mu\text{s}$ (118 div/ μs) over center 7 x 9 div (with viewing hood).

Storage time: display mode, at least 10 s at 22°C; store mode, at least 30 s at 22°C.

Brightness: $\approx 170\text{ cd}/\text{m}^2$ (50 fl) increasing to $\approx 340\text{ cd}/\text{m}^2$ (100 fl) depending on brightness control setting.

Erase time: $\approx 300\text{ ms}$.

Rear panel controls: astigmatism, trace align, conventional push-button, and view time.

Cathode-ray tube and controls (1744A)

Type: 12.7 cm (5 in.) rectangular CRT, post accelerator, $\approx 10\text{ kV}$ accelerating potential, aluminized P31 phosphor.

Graticule: 8 x 10 div (1 div = 0.72 cm) internal graticule, 0.2 subdivision markings on major horizontal and vertical axes, with markings for transition time measurements. Graticule illumination is achieved with Persistence control set to min.

Beam finder, Z-axis input (intensity modulation): Same as 1740A.

Operating modes: write, store, display, auto-store, and auto-erase.

Storage writing speed: $\geq 1800\text{ cm}/\mu\text{s}$ over center 6 x 8 div (with viewing hood).

Storage time: store mode, at least 30 s; view mode, at least 10 s; wait time, at least 60 s, at 22°C.

Persistence: variable (100 ms min).

Erase time: $\approx 300\text{ ms}$.

Rear panel controls: astigmatism and trace align.

General

Rear Panel outputs: main and delayed gates, 0.8 V to $\geq +2.5\text{ V}$ capable of supplying $\approx 5\text{ mA}$.

Amplitude calibrator (0°C to +55°C)

Output voltage	1 V p-p into $\geq 1\text{ M}\Omega$ 0.1 V p-p into 50 Ω	$\pm 1\%$
Rise time	0.1 μs	
Frequency	$\approx 1.4\text{ kHz}$	

Power: 100, 120, 220, 240 V ac $\pm 10\%$; 48 to 440 Hz; 100 VA max.
Weight: (1740A, 1742A) net, 13 kg (28.6 lb); shipping 15.7 kg (34.6 lb). (1741, 1743, 1744A) net 13.8 kg (30.5 lb); shipping 17.7 kg (39 lb).

Operating environment: temperature 0°C to +55°C; humidity to 95% relative humidity at +40°C; altitude, to 4600 m (15 000 ft); vibration, vibrated in three planes for 15 min. each with 0.254 mm (0.010 in.) excursion, 10 to 55 Hz.

Size: (1740A) 197 H x 335 W x 597 mm D (7 $\frac{3}{4}$ " x 13 $\frac{1}{8}$ " x 23 $\frac{1}{2}$ " with handle, 492 mm D (19 $\frac{3}{8}$ " without); (1741A) 616 mm D (24 $\frac{1}{4}$ " with handle, 552 mm D (21 $\frac{3}{4}$ " without); (1742A) 570 mm D (22 $\frac{3}{8}$ " with handle, 502 mm D (19 $\frac{3}{8}$ " without); (1743A) 613 mm D (24 $\frac{1}{8}$ " with handle, 549 mm D (21 $\frac{3}{8}$ " without); (1744A) 635 mm D (25" with handle; 511 mm D (20 $\frac{1}{4}$ " without).

Accessories furnished: one blue light filter HP P/N 01740-02701, one front panel cover, one 2.3 m (7.5 ft) power cord, one vinyl accessory storage pouch, one Operators Guide and one Service Manual, two Model 10041A 10:1 divider probes $\approx 2\text{ m}$ (6.6 ft) long. The 1741A and 1744A also include one Model 10173A RFI filter and contrast screen, and one Model 10140A viewing hood.

Options and accessories

Time interval multimeter kit (1742A): HP P/N 01742-69501 adapts a standard Model 1742A to an Option 034, built-in LED readout, delta time oscilloscope. The kit includes a multimeter, a new top oscilloscope cover, a vinyl storage pouch, and mounting hardware for fast installation.

1112A Inverter Power Supply: provides a portable power source for 1700 series oscilloscopes (see Probes and Other Accessories). \$900

001: fixed power cord (U.S. only) in lieu of detachable power cord. add \$15

005 (1740A and 1741A): TV sync add \$215

034 (1742A): built-in DMM (60 Hz operation) add \$325

035 (1742A): built-in DMM (50 Hz operation) add \$325

091: two 3 m (9.8 ft) 10042A 10:1 probes in lieu of 10041A probes N/C

096: two 1.8 m (6 ft) 10006D 10:1 probes in lieu of 10041A probes. N/C

101 (except 1744A): state display, single switch interface option for operation with the HP Model 1607A Logic State Analyzer. Adds interface circuits for switching between front panel logic state inputs. add \$150

910: extra set of product manuals. add \$11

1740A Opt 910 add \$12

1741A Opt 910 add \$12

1742A Opt 910 add \$12

1743A Opt 910 add \$12

Logic state analysis equipment required for Option 101

1607A: 16-Bit Logic State Analyzer including three data probes and one clock probe. \$2900

Four 10121A: 20 cm (8") cables. Three for X, Y, and Z interconnections and one for pattern triggering connection to the oscilloscope. \$11 ea.

Adapter plate and strap: (HP P/N 5061-1213) for mounting the oscilloscope on top of the 1607A. \$21

1740S: includes 1740A Opt 101, Model 1607A Logic State Analyzer, four 10121A 20 cm (8") BNC interconnecting cables with adapter plate and strap (HP P/N 5061-1213) for combining into a single package. \$5375

Ordering information

1740A 100 MHz Oscilloscope \$2250

1741A 100 MHz Storage Oscilloscope \$4250

1742A 100 MHz Δ Time Oscilloscope \$2650

1743A 100 MHz Δ Time Oscilloscope \$3300

1744A 100 MHz Storage Oscilloscope \$5250

OSCILLOSCOPES

200 MHz & 275 MHz delta time measurements

Models 1722B, 1715A & 1725A

- Microprocessor calculated delta time measurements
- Direct LED readout with 20 ps resolution



1722B

1722B Description

Model 1722B is a 275 MHz bandwidth, 1 ns/div sweep speed, dual channel oscilloscope with a built-in microprocessor and five function LED display for precise real time measurements. In addition to the conventional volts versus time CRT display, the microprocessor gives you direct readout of delta time, frequency, dc voltage, instantaneous waveform voltage, and percent amplitude. The 1722B's outstanding repeatability and 20 ps resolution make it ideally suited for making clock phasing measurements in large computer timing applications.

Delta time measurements

Delta time measurement, developed by Hewlett-Packard, is used in the Time Interval mode for making accurate time interval measurements including transition time, pulse duration (width), period, and propagation delay. Time interval measurements can be made between two events on Channel A, two events on Channel B, or between an event beginning on Channel A and ending on Channel B.

The delta time measurement technique is to select Main Intensified mode and set the first intensified marker to t_1 . The second intensified marker is positioned by using the DEC \leftrightarrow INC controls (coarse, medium, or fine) which causes the microprocessor to develop the voltage to position the second marker. While developing the voltage ($t_2 - t_1$) to separate the two markers, the microprocessor drives and updates the 3 1/2 digit LED display. Time interval measurements are automatically scaled for the proper sweep speed and displayed in units of seconds (exponent 0), milliseconds (exponent -3); microseconds (exponent -6); or nanoseconds (exponent -9).

Additional precision is obtained by switching to the Delayed Sweep mode where the two intensified markers are expanded and displayed alternately. Maximum accuracy is quickly obtained by overlapping the two expanded sweeps using the DEC \leftrightarrow INC controls. Superimposing the start and stop points of the measured time interval provides a more accurate digital readout by nulling any amplifier or CRT nonlinearities. Separate portions of a sweep can be magnified and examined simultaneously, enabling you to view two events separated in time while maintaining their relative time relationship.

The microprocessor not only keeps track of the distance between the two markers but automatically expands the measurement resolution by a factor of 10 whenever the two markers are within 1 div of each other. The microprocessor also interrogates the function switches to help prevent inaccurate measurements.

1/Time (frequency) measurements

The 1722B gives an automatic 3 or 4 digit display of the reciprocal of time, eliminating the need for calculations when setting up clock frequencies and measuring the frequency or repetition rate of a waveform.

DC voltage measurements

The Input (dc volts) mode provides a direct digital display of the average value of a waveform at the input to channel A. The built-in DVM measurement is made using a successive approximation algorithm controlled by the microprocessor which allows you to establish a reference level with respect to any voltage and enables differential dc measurements.

- 200 MHz (1715A) and 275 MHz (1725A) bandwidths
- Delta Time and delayed sweep
- Optional DMM
- Easy-to-use color-coded controls



1715A

Model 1715A Opt 034 includes an optional DMM with direct LED readout of time interval measurements, or ac and dc voltage, or current and resistance measurements.



1725A

The standard Model 1725A may be converted to an Opt 034 by ordering a Time Interval Multimeter Kit (HP P/N 01715-69501).

Instantaneous voltage measurements

In the Position mode you can measure the voltage at any point on a waveform in channel A without the need to count divisions from a base line and multiply by the attenuator setting. The measurement mode is useful for measuring peak voltages, crossover, and threshold points in logic circuits, or any time you need to know a precise voltage at a particular point on a waveform.

Percentage measurements

Percentage measurements are made in the Position mode with the channel A vernier out of the Cal position to establish 5 div separation between the 0% and 100% points. By positioning the desired 0% point on a convenient graticule line, zeroing the LED display, and then positioning the waveform to the 100% point, percent amplitude of any point on the waveform with respect to the 100% point is measured by positioning that point at the reference graticule and reading the LED display. Relative amplitude measurements such as pulse overshoot, ringing, preshoot, and percent amplitude modulation on an rf carrier are easily measured using this measurement mode.

1715A, 1725A Description

Hewlett-Packard's Models 1725A, 275 MHz, and 1715A, 200 MHz oscilloscopes offer delta time measurements with an optional DMM for direct delta time readout and current, voltage, or resistance measurements. The large 8 x 10 cm display provides easy viewing of dual trace signals on which timing measurements can be made conveniently and accurately using the Hewlett-Packard developed delta time technique. For easier percentage measurements, reference lines of 0% and 100% amplitude are 5 divisions apart and markings for 10% and 90% and 20% and 80% are also provided for easier transition time measurements. Vertical deflection factors of 10 mV/div to 5 V/div over the full bandwidth (5 mV/div to 150 MHz in the

1715A) and a selectable 50 ohm or 1 megohm input offer the high performance required for both laboratory and field applications.

Delta time measurements

These oscilloscopes offer two methods for making timing measurements; one is the familiar single marker delayed sweep, using the calibrated delay control to accurately measure time relationship; the second is a system of dual intensified markers which significantly improves accuracy while conveniently reducing the time necessary to make a measurement. The latter, better known as the Delta Time measurement method, incorporates a system of two intensified markers which are two delayed sweeps displayed alternately.

The Delta Time measurement technique is to select the Main Intensified mode and position the first marker at t_1 with the Time Interval Start control and position the second marker at t_2 with the Time Interval Stop control. The difference between the two selected points is then read directly on the optional DMM or on the calibrated delay time control, or is available as a rear panel scaled voltage output compatible with most DVM's. Units of seconds, milliseconds, or microseconds are read on the Main Time/Div control.

For increased precision, Delayed Sweep mode is selected where the two intensified portions are displayed alternately. Maximum accuracy is achieved by superimposing the start and stop points using the Time Interval Stop control. Even without an external voltmeter and using only the Time Interval Stop control, this optical nulling technique reduces the chance of error in time interval measurements.

The Delta Time technique makes timing measurements such as transition times, propagation delay, clock phasing, and other high speed digital timing measurements faster and with more repeatability than was previously possible with standard delayed sweep oscilloscopes. Time interval measurements can be made between two events on channel A, two events on channel B, or between two events on alternate channels.

For added convenience, the Delta Time capability can be selected with the time interval start marker on channel A or channel B.

Models 1722B, 1715A & 1725A (cont.)

1715A, 1722B, 1725A Specifications

Vertical display modes

Channel A; channel B; A and B displayed alternately on successive sweeps (ALT); A and B displayed by switching between channels at ≈ 1 MHz rate with blanking during switching (CHOP); A plus B (algebraic addition); X-Y (A vs. B).

Vertical amplifiers (2)

Bandwidth: (3 dB down from 6 div reference signal).

DC-coupled: (1722B, 1725A) dc to 275 MHz, (1715A) dc to 200 MHz 10 mV/div to 5 V/div (to 150 MHz at 5 MV/div, 1715A), in both 50 Ω and high Z input modes.

AC-coupled: lower limit ≈ 10 Hz.

Bandwidth limit: limits upper bandwidth to ≈ 20 MHz.

Rise time: (1722B, 1725A) < 1.3 ns; (1715A) < 1.75 ns 10 mV/div to 5 V/div, < 2.3 ns at 5 mV/div.

Deflection factor

Ranges: 10 mV/div to 5 V/div (9 calibrated positions) in 1, 2, 5 sequence, $\pm 2\%$ attenuator accuracy (5 mV/div in 1715A).

Vernier: extends max deflection factor to ≥ 12.5 V/div.

Polarity: channel B may be inverted.

Input coupling: selectable, AC or DC, 50 Ω (dc) or ground.

Input RC (selectable): AC and DC, 1 M Ω $\pm 2\%$ shunted by ≈ 11 pF; 50 Ω , 50 Ω $\pm 2\%$; SWR (1722B, 1725A) ≤ 1.3 on 10, 20, and 50 mV ranges, $< 1:15$ on all other ranges; SWR (1715A) ≤ 1.3 on 5, 10, 20, and 50 mV ranges and $< 1:15$ on all other ranges.

Max input: AC and DC, ± 250 V (dc + peak ac) at ≤ 1 kHz; 50 Ω , 5 V rms.

A+B operation

Amplifier: bandwidth and deflection factors are unchanged; channel B may be inverted for A-B operation.

Differential (A-B) Common Mode: CMR is ≥ 40 dB from dc to 5 MHz decreasing to 26 dB at 50 MHz. Common mode signal amplitude equivalent to 12 cm with one vernier adjusted for optimum rejection.

Trigger source

Selectable from channel A, channel B, or Composite.

Channel A input-dc volts (1722B)

Display: $3\frac{1}{2}$ digits (LED's).

Display units: 0 exponent, volts; -3 exponent, millivolts.

X1 range: 95 mV to 47 V full scale vertical deflection (10 mV/div to 5 V/div).

X10 range: 0.95 V to 470 V full scale vertical deflection (100 mV/div to 50 V/div with X10 probe).

Accuracy: $\pm 0.5\%$ reading $\pm 0.5\%$ full scale (f.s. = 10 cm), $+20^\circ\text{C}$ to $+30^\circ\text{C}$.

Stability: temperature coefficient, $< \pm 0.02\%/^\circ\text{C}$.

Input impedance: X1 range, 1 M Ω shunted by ≈ 11 pF; X10 range (with X10 probe) 10 M Ω shunted by ≈ 10 pF.

Sample rate: $\approx 2/s$, response time ≤ 1 s.

Reference set: meter may be zeroed permitting dc voltage measurements with respect to any voltage within selected range. Drift may be eliminated by the REF SET control.

Overrange: flashing display indicates overrange condition.

Channel A position - volts (1722B)

(Channel A vernier in CAL detent.) With the following exceptions, specifications are the same as Channel A input - DC Volts.

Measurement: dc substitution method using channel A position control to determine voltage of any point on displayed waveform using any graticule line as reference.

Bandwidth: dc to 275 MHz (≤ 3 dB down from 6 div ref signal).

Dynamic range: ± 6 cm from ground referenced to center screen.

Reference set: meter may be zeroed, permits instantaneous voltage measurements with respect to any voltage within selected range.

Accuracy: $\pm 1\%$ reading $\pm 0.5\%$ of full scale (10X the volts/div range) measured at dc.

Channel A position - % (1722B)

(Channel A vernier out of CAL detent.)

Measurement: dc substitution method using channel A position control to determine percent of any waveform point with respect to user defined 0 and 100% points.

Range: 0 to $\pm 140\%$ (set with vernier so that 100% equals 5 div).

Accuracy: $\pm 1\%$.

Zero reference: meter may be zeroed to permit percent measurements with respect to any waveform point.

Vertical Output

Amplitude: one div of vertical deflection produces ≈ 100 mV output, dc to 50 MHz in 1722B, 1725A, dc to 25 MHz in 1715A.

Cascaded deflection factor: 1 mV/div with both vert channels set to 10 mV/div. Bandwidth, dc to 5 MHz (with bandwidth limit). Source resistance, $\approx 100\Omega$; selection, trig source set to A selects channel A output, to B selects channel B output.

Horizontal display modes

Main, main intensified, delayed, mixed, X-Y, and mag X10. In main intensified, mixed, and delayed modes, 1715A and 1725A have selectable channel A or B start time interval measurements.

Main time base

Sweep

Ranges: 10 ns/div to 0.5 s/div (24 ranges) 1, 2, 5 sequence.

Accuracy

Main Sweep Time/Div	Accuracy (0°C to $+55^\circ\text{C}$)	
	X1	X10
10 ns to 50 ns	$\pm 3\%$	$\pm 5\%$
100 ns to 20 ms	$\pm 2\%$	$\pm 3\%$
50 ms to 0.5s	$\pm 3\%$	$\pm 3\%$

Vernier: extends slowest sweep to at least 1.25 s/div.

Magnifier: extends fastest sweep to 1 ns/div.

Sweep mode

Normal: sweep is triggered by internal or external signal.

Automatic: baseline displayed in absence of input signal. Triggering is same as normal above 40 Hz.

Single: in Normal, sweep occurs once with same triggering as normal, reset arms sweep and lights indicators; in Auto, sweep occurs once each time Reset is pressed.

Triggering

Internal: dc to 50 MHz on signals causing ≥ 0.5 div vertical deflection, increasing to 1 div of vert deflection at 300 MHz (200 MHz, 1715A) in all display modes. Line frequency triggering selectable.

External: dc to 100 MHz on signals ≥ 50 mV p-p increasing to 100 mV p-p at 300 MHz (200 MHz, 1715A). Max input, ± 250 V (dc + peak ac) at 1 kHz. External input RC ≈ 1 M Ω shunted by ≈ 15 pF.

Trigger level and slope

Internal: at any point on the vertical waveform displayed.

External: continuously variable from +1.0 V to -1.0 V in (+10) mode.

Coupling: AC, DC, LF REJ, or HF REJ.

Trigger holdoff: variable, to > 1 sweep from 10 ns/div to 50 ms/div.

Main Intensified

Delta time intensifies two parts of main time base to be expanded to full screen in delayed time base mode.

Delayed Sweep (1715A, 1725A): intensifies that part of main time base to be expanded to full screen in delayed time base mode.

Delayed time base

Sweep

Ranges: 10 ns/div to 20 ms/div (20 ranges) in 1, 2, 5 sequence.

Accuracy: same as main time base.

Triggering

Internal: same as main time base except there is no Line Frequency triggering.

Starts after delay: delayed sweep automatically starts at end of delay period.

Trigger: with delayed trigger level control out of detent (starts after delay) delayed sweep is triggerable at end of delay period.

Delay time range: 0.5 to 10X Main Time/Div settings of 20 ns to 0.5 s (min delay 50 ns).

External triggering, external input RC, max external input, trigger level and slope, and coupling are same as main time base.

Differential time measurement accuracy (1715A, 1725A)

Main Time Base Setting	Accuracy (+15°C to +35°C)
50 ns/div to 20 ms/div	± (0.5% ± 0.1% of full scale)
20 ns/div	± (1% ± 0.2% of full scale)
50 ms/div to 0.5 s/div	± 3%

Delay jitter: <0.005% of max delay in each step.
Stability (0°C to +55°C): short term 0.005%. Temperature, ± 0.03%/°C deviation from calibration temperature range.

Time interval (Δ time mode—1715A, 1725A)
Function: measures time interval between two events on channel A (A display), on channel B (B display), or starting from an event on either A or B and ending with an event on either A or B (alt display).
Time interval output voltage: from 50 V to 100 mV full scale.
Accuracy: measurement accuracy is the Time Interval Accuracy plus the external DVM accuracy.

Main Time Base Setting	Accuracy (+20°C to +30°C)
100 ns/div to 20 ms/div	± 0.5% of reading ± 0.05% of fs
50 ns/div	± 0.5% of reading ± 0.1% of fs
20 ns/div*	± 0.5% of reading ± 0.2% of fs
50 ms/div to 0.5 s/div	± 3%

*Starting after 60 ns of sweep
Stability (0°C to +55°C): short term 0.005%. Temperature, ± 0.03%/°C deviation from calibration temperature range.

Time interval measurements (1722B)
Time interval delay: continuously variable from 10 ns to 5 s.
Delay jitter: refer to Time Interval Measurements, Stability.
Time interval measurement (time)
Function: measures time interval between two events on channel A (A display), on channel B (B display), or between two events starting from an event on A and ending with an event on channel B (alt display).
Display units: 0 (s), -3 (ms), -6 (μs), or -9 (ns).
Time interval accuracy

Main time base setting	Accuracy (+20°C to +30°C)
100 ns/div to 20 ms/div	± 0.5% of measurement ± 0.02% of full scale (for measurements <1 cm). For measurements >1 cm, ± 0.5% of measurement ± 0.05% of full scale.
50 ns/div*	± 0.5% of measurement ± 0.6% of full scale.
20 ns/div*	± 0.5% of measurement ± 0.12% of full scale.
50 ms/div to 0.5 s/div.	± 3%

*Starting after 60 ns of sweep.
Resolution: intervals <1 cm, >0.01% of full scale; intervals >1 cm, 0.1% of full scale; max display resolution, 20 ps.
Stability (0 to +55°C): short term, <0.01%. Temperature, ± 0.03%/°C deviation from calibration temperature range.

Reciprocal of time interval measurement (1/time)
Display units: 0 (Hz); 3 (kHz); 6 (MHz).
Accuracy, resolution, stability: same as time interval measurements.

Mixed Time Base
 Dual time base in which the main time base drives the first portion of sweep and the delayed time base completes the sweep at the faster delayed sweep. Also operates in single sweep mode.

X-Y operation
Bandwidth
Y-axis Channel A: same as channel A.
X-axis (channel B): dc to >1 MHz.

Deflection factor: 5 mV/div to 5 V/div, 10 cal positions (10 mV/div to 5 V/div, 9 cal positions, 1722B) in 1, 2, 5 sequence.
Phase diff between channels: <3°, dc to 1 MHz (3 MHz, 1722B).

Cathode-ray tube and controls
Type: post accelerator, ≈ 20.5 kV, aluminized P31 phosphor.
Graticule: 8 x 10 div internal graticule, 0.2 subdiv markings on major horiz and vert axes, 1 div = 1 cm. Internal floodgun illum.
Beam finder: returns trace to CRT screen.
Intensity modulation (Z-axis): +8 V, ≥50 ns width pulse blanks trace of any intensity, usable to 20 MHz for normal intensities. Input R, 1 kΩ ± 10%. Max input, ±10 V (dc + peak ac).
Auto-focus: maintains beam focus with variations of intensity.
Intensity limit: limits beam current to decrease possibility of CRT damage. Circuit response time ensures full writing speed for viewing low duty cycle, fast transition time pulses.

General
Rear panel outputs: main and delayed gates, -0.7 V to +1.3 V capable of supplying ≈ 3 mA.
Calibrator: type, 1 kHz ± 15% (± 10%, 1722B) square wave; 3 V p-p ± 1%, <0.1 μs transition time.
Power: 100, 120, 220, and 240 Vac, -10% + 5%; 48 to 440 Hz; 110 VA max.
Weight
1715A, 1725A: net, 12.9 kg (28.5 lb); shipping, 17.9 kg (39.5 lb).
1722B: net 13.6 kg (30 lb); shipping, 19.5 kg (43 lb).

Operating environment: temp, 0°C to +55°C; humidity, to 95% rel humidity at +40°C; altitude, to 4600 m (15 000 ft); vibration, in three planes for 15 min. each with 0.254 mm excursion, 10 to 55 Hz.
Size: 197 H x 335 W x 570 mm D with handle; 1715A, 1725A, 502 mm D without handle, 1722B, 510 mm (7³/₁₆" x 13³/₁₆" x 22⁷/₁₆" ; 18⁷/₁₆" , 20⁷/₁₆").
Accessories furnished: one blue light filter; one panel cover; two 10017A 10:1 divider probes with 1722B, 1725A; two 10018A 10:1 divider probes with 1715A; one 2.3 m (7.5 ft) power cord; one vinyl storage pouch; one Operating and Service Manual.

- Options and accessories**
- Time interval multiplier kit:** (HP P/N 01715-69501) adapts a standard Model 1715A or 1725A to an Opt 034, built-in, LED readout, delta time oscilloscope. The kit includes a multimeter, a new top oscilloscope cover, a vinyl storage pouch, and mounting hardware. **Price \$375**
 - 1112A Inverter Power Supply:** provides portable power source for 1700 series oscilloscopes (see pg 188) **\$900**
 - 001:** U.S. fixed line cord **add \$15**
 - 003:** probe power supply with two rear panel jacks for use with HP active probes. Provides power to operate two 1120A, 1124A, or 1125A active probes. **add \$50**
 - 034 (1715A, 1725A):** built-in DMM (60 Hz operation) **add \$325**
 - 035 (1715A, 1725A):** built-in DMM (50 Hz operation) **add \$325**
 - 091 (1722B, 1725A):** two 2 m (6.6 ft) 10018A, 10:1 probes substituted for two 10017A miniature probes **N/C**
 - 091 (1715A):** two 1 m (3.3 ft) 10017A, 10:1 probes substituted for two 10018A miniature probes **N/C**
 - 092:** two 1.8 m (6 ft) 10016B, 10:1 probes substituted for two miniature probes **N/C**
 - 101:** logic state display interface for operation with Model 1607A Logic State Analyzer **add \$150**
 - 910:** additional set of manuals **add \$12**
 - Logic state analysis equip required for Opt 101**
 - 1607A:** 16-bit Logic State Analyzer including three data probes and one clock probe **\$2900**
 - Four 10121A:** 20 cm (8") cables. Three for X, Y, and Z and one for pattern trigger connections **\$11 ea**
 - 5061-1213:** Adapter plate and strap for mounting the oscilloscope on top of the 1607A **\$21**
- Ordering information**
- 1715A** 200 MHz Oscilloscope **\$3195**
 - 1725A** 275 MHz Oscilloscope **\$3500**
 - 1722B** 275 MHz Oscilloscope with Microprocessor **\$5050**

OSCILLOSCOPES

General purpose plug-in oscilloscopes, to 18 GHz

Model 180 Series

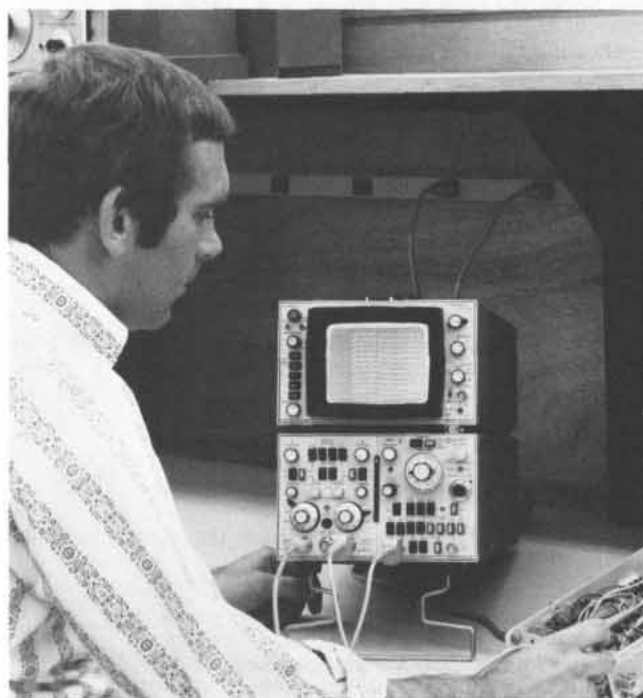

Introduction

The 180 plug-in oscilloscope combines high performance, plug-in versatility, and operating ease to give you a flexible operating system with laboratory quality throughout. Whether you require four channel real time measurements to 100 MHz, sampling to 18 GHz, 170 ps rise time Time Domain Reflectometry, High Resolution Spectrum Analysis, or precision Swept Frequency testing, each of these and more are available in a compact package with a large CRT display.

The focal point for performance is the mainframe with a high quality CRT for accurate measurements. Four mainframes, including one with a large screen, and a selection of plug-ins allow you to configure an oscilloscope for general purpose use through 100 MHz, 18 GHz sampling, Time Domain Reflectometry, Spectrum Analysis, and

Network Analysis. You can meet your present measurement needs, selecting only those plug-ins to meet present requirements at minimum cost, yet keep the full capability of the mainframe for future requirements.

Models 180C, 180D, and 182C mainframes have bright, easy-to-see displays for maximum resolution and measurement accuracy. Models 180C and 180D each have a CRT display with a full 8 x 10 cm internal graticule and a writing speed of 1500 cm/ μ s. For multi-trace viewing and easy-to-see displays the 182C CRT display has a large 8 x 10 division (one division equals 1.29 cm) internal graticule.

Variable persistence storage

Variable persistence storage mainframes give you the widest selection of general purpose and high speed storage applications. Advances in processing and target material have resulted in a very rugged storage surface as well as extremely high writing speeds. This storage surface is so burn resistant that special operating procedures are not required, extending the versatility of storage measurements to general purpose applications.

Storage writing speeds of 100 cm/ μ s and 400 cm/ μ s are available in the 184A and 184A Option 005 respectively, which allows you to capture those elusive transients. With these fast writing speeds you can easily make pulse timing adjustments, locate noise pulses and missing bits from low duty-cycle digital signals. Low duty-cycle pulse trains from disc, tape, or drum peripheral units can also be viewed through repetitive sweeps by using variable persistence to build up the intensity of dim traces.

For medium speed storage and variable persistence applications, Models 181A/AR mainframes are available. Variable persistence mode, in both models, allows you to adjust display retention time to match the speed of slowly changing signals for maximum viewing ease. This allows direct viewing of complete waveforms without clutter in electromechanical, biomedical, chemical, geological, oceanographical, and many other areas with slowly changing signals. The light amplification capability of the 181A/AR permits easy viewing of low rep rate, fast pulses.

Real time measurements

A selection of high performance, vertical real time plug-ins assures the right plug-in for most measurement applications. Real time, dual channel plug-ins are available in 500 kHz, 50 MHz, and 100 MHz bandwidths with deflection factors of 100 μ V, and 5 mV. Additional measurement capability is provided by four channel 100 MHz, and 50 MHz plug-ins and a differential/dc offset plug-in with 40 MHz bandwidth.

A selection of time base plug-ins gives you a choice of single or main and delayed sweeps with magnified sweep speeds to 5 ns/div in 180 mainframes. Models 1820C and 1825A have triggering capabilities to 150 MHz and the 1821A triggers in excess of 50 MHz. Models 1821A and 1825A have calibrated delayed and mixed sweeps for accurate timing measurements and detailed examination of selected portions of waveforms.

Sampling

Models 1810A and 1811A sampling plug-ins provide fast, easy, low level, high frequency measurements. The 1810A looks and operates like a real time plug-in which reduces familiarization time for accurate, low-level measurements to 1 GHz. Measurements to 18 GHz are available with the 1811A and the 1430C remote feedthrough sampling head. The remote sampling head reduces measurement errors at high frequencies by eliminating long high frequency interconnecting cables. The feedthrough method of measurement in the sampling head increases accuracy by allowing measurements to be made while the system is operating with its own loads.

Time domain reflectometry

Time Domain Reflectometry is a fast, convenient technique for measuring the electrical characteristics of transmission systems. This measurement technique provides a display of the impedance profile of a system showing magnitude, nature, and distance of discontinuities. Model 1818A is an easy-to-use 170 ps rise time TDR plug-in for design and installation evaluation of transmission or interconnecting systems. For critical design work or system installation, the 1815B with its remote sampling head will display discontinuities as close as 6.4 mm (0.25 in.) with a system rise time of 35 ps.



180 System Selection Charts

MAINFRAMES		
Model No.	Description	Page
180C/D	High speed, 8 x 10 cm internal graticule (180D rack style)	166
181A/AR	5 cm/ μ s storage writing speed/variable persistence (181AR rack style)	167
182C	Large screen, 8 x 10 div internal graticule (10.3 x 12.9 cm)	166
184A	100 cm/ μ s storage writing speed/variable persistence	167
184A Opt 005	400 cm/ μ s storage writing speed/variable persistence	167

Model No.	VERTICAL PLUG-INS						SAMPLING (Vertical Section)		
	1801A	1803A	1804A	1805A	1806A	1809A	*1810A	*1815B	*1811A
Bandwidth MHz	50	40 (30)	50	100	0.5	100	1 GHz	12.4 GHz	18 GHz
Min. deflection factor/div	5 mV (500 μ V Opt 001 cascaded)	10 mV (1 mV cascaded)	20 mV	5 mV	100 μ V	10 mV	2 mV	5 mV	2 mV
Channels	2 (Opt 001, 1 cascaded)	1 diff	4	2 (1 cascaded)	2 (both diff)	4	2	1	2
Input RC	1 M Ω /25 pF	1 M Ω /27 pF	1 M Ω /25 pF	1 M Ω /13 pF or 50 Ω	1 M Ω /45 pF	1 M Ω /12 pF or 50 Ω	50 Ω	50 Ω	50 Ω
Differential input	yes	yes (with dc offset)	no	yes	yes	yes	yes	no	yes
A \pm B	yes	no	no	yes	no	yes	yes	no	yes
Page	168	168	170	168	168	170	173	175	173

Model No.	TIME BASE PLUG-INS			SAMPLING (Time Base Section)			TDR		FREQUENCY-DOMAIN PLUG-INS		
	1820C	*1821A	1825A	*1810A	*1815B	*1811A	*1818A	*1815B	8557A	8558B	*8755B
Ext Trig Freq (MHz)	150	100	150	>1 GHz	18 GHz with trigger countdown	18 GHz with trigger countdown	<170 ps rise time TDR system	<35 ps rise time TDR	Spectrum Analyzer 0.1—350 MHz. Measurements from -117 dBm to +20 dBm	Spectrum Analyzer plug-in, 0.1—1500 MHz. Measurements from -117 dBm to +30 dBm.	Sweet Amplitude Analyzer plug-in measures insertion gain/loss and return loss from 15 MHz to 18 GHz.
Int Trig Freq.	Determined by Vert. Amp. Plug-in.			1 GHz			Calibrated in feet and metres	Calibrated in metres			
Sweep Speeds/div*	5 ns 1 s	10 ns 1 s	5 ns 1 s	100 ps (expanded) -50 μ s	10 ps -1 μ s	10 ps (expanded) -1 μ s					
Delayed and mixed sweep	No	Yes	Yes	No	No	No					
Page	171	171	172	173	175	173	174	175	177,500	177,502	442

- NOTES
- Double width plug-ins.
 - Requires remote sampling head.
 - Requires Remote Pulse Generator.
 - Includes X10 main-frame magnification.
 - For vertical plug-ins up to 50 MHz.
 - Requires remote modulator and detectors.

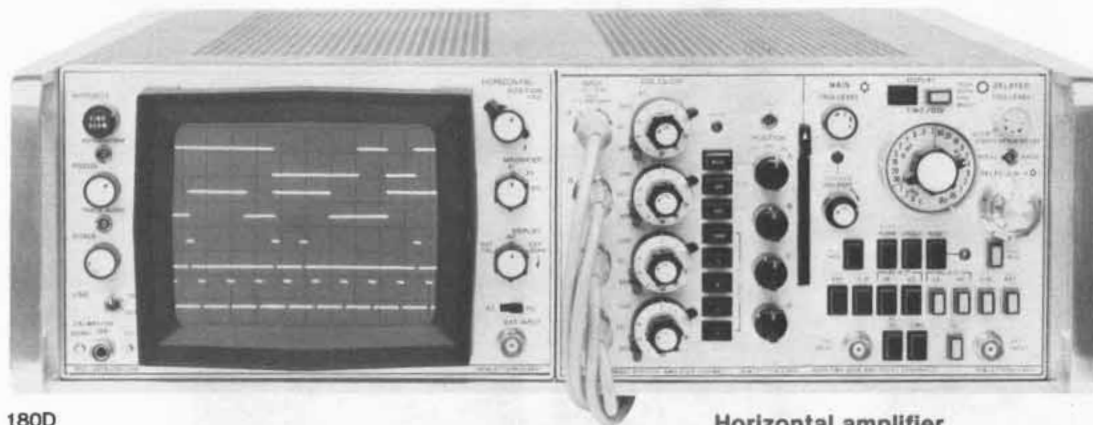

180D

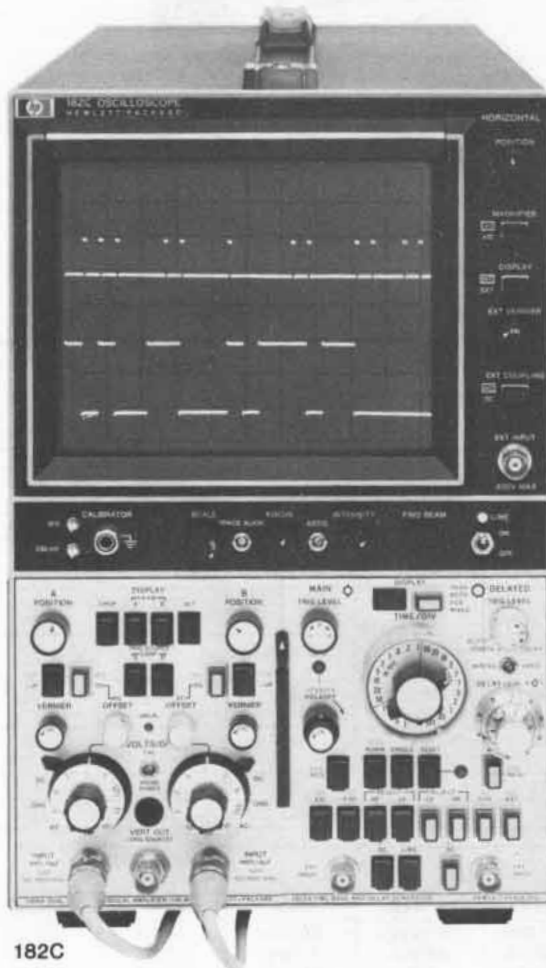

182C

180 C/D, 182C Specifications

Cathode-ray tube and controls

Type: post accelerator, 15 kV (180 C/D), 21 kV (182C); aluminized P31 phosphor.

Graticule: 8 x 10 div internal graticule, 0.2 div subdivisions on major axes; (180 C/D) 1 div=1 cm, (182C) 1 div=1.29 cm. Scale control illuminates CRT phosphor for viewing with hood or taking photos.

Beam finder: returns trace to CRT screen.

Intensity modulation (external input): input, $\approx +2$ V, ≥ 50 ns pulse width blanks trace of normal intensity; input $R \approx 50$ k Ω ; Max input, ± 20 V (dc + peak ac).

Horizontal amplifier

External input

Bandwidth: dc-coupled, dc to 5 MHz; ac-coupled, 5 Hz to 5 MHz.
Deflection factor: 1 V/div, X1; 0.2 V/div, X5 (180C/D); 0.1 V/div, X10; accuracy, $\pm 5\%$.

Dynamic range: ± 20 V.

Max input: (180C/D) 600 V dc (ac-coupled input); (182 C) ± 300 V (dc + peak ac).

Input RC: ≈ 1 M Ω shunted by ≈ 30 pF.

Sweep magnifier: X10, X5 (180 C/D); accuracy, $\pm 5\%$ (with 3% accuracy time base).

Calibrator: ≈ 1 kHz square wave, $< 3\mu$ s rise time; 250 mV p-p and 10 V p-p into 1 M Ω , $+1\%$.

Outputs

Four rear panel emitter follower outputs for main and delayed gates, main and delayed sweeps, or vertical and horizontal outputs when used with TDR/Sampling plug-ins. Max current available, ± 3 mA. Will drive impedances ≥ 1000 ohms without distortion.

General

Operating environment: temperature, 0 to 55°C (+32°F to +130°F); humidity, to 95% relative humidity at 40°C (104°F); altitude, to 4600 m (15 000 ft); vibration, vibrated in three planes for 15 min. each with 0.254 mm (0.010 in.) excursion, 10 to 55 Hz.

Size

180C (cabinet): 289 H x 200 W x 540 mm D behind panel (11 $\frac{3}{8}$ " x 7 $\frac{7}{8}$ " x 21 $\frac{1}{4}$ ").

180D (rack): 133 H x 425 W x 543 mm D overall (5 $\frac{1}{32}$ " x 16 $\frac{3}{4}$ " x 21 $\frac{3}{8}$ "); 493 mm (19 $\frac{3}{8}$ ") D behind rack mount tabs.

182C (cabinet): 338.1 H x 201.6 W x 498.5 mm D overall (13 $\frac{15}{16}$ " x 7 $\frac{15}{16}$ " x 19 $\frac{5}{8}$ ").

Weight (without plug-ins).

180C (cabinet): net, 10.4 kg (23 lb); shipping, 15.4 kg (34 lb).

180D (rack): net, 11.8 kg (26 lb); shipping, 17.2 kg (38 lb).

182C (cabinet): net, 12.2 kg (27 lb); shipping, 15.4 kg (34 lb).

Power: 115 or 230 V, $\pm 10\%$, 48 to 440 Hz; normally < 110 watts with plug-ins at normal line. Max mainframe power, 200 VA.

Accessories supplied

180C/D: 2.3 m (7 $\frac{1}{2}$ ft) power cord, blue plastic light filter (HP P/N 5060-0548), one Operating and Service Manual. A rack mount kit (HP P/N 5060-0552) and 2 clip-on probe holders (HP P/N 5040-0464) are supplied with the 180D rack model.

182C: 2.3 m (7 $\frac{1}{2}$ ft) power cord, blue plastic light filter (HP P/N 5060-0547), one Operating and Service Manual.

Ordering information

	Price
180C Cabinet Style Mainframe	\$1700
Opt 010: deletes rear panel outputs for main and delayed gates and main and delayed sweeps.	less \$100
Opt 910: additional Operating and Service Manual	add \$8
180D Rack Style Mainframe	\$1900
Opt 010: (see 180C Option 010)	less \$100
Opt 910: additional Operating and Service Manual	add \$8
182C Cabinet Style Mainframe	\$1850
Opt 010: (see 180C Opt 010)	less \$100
Opt 910: additional Operating and Service Manual	add \$9

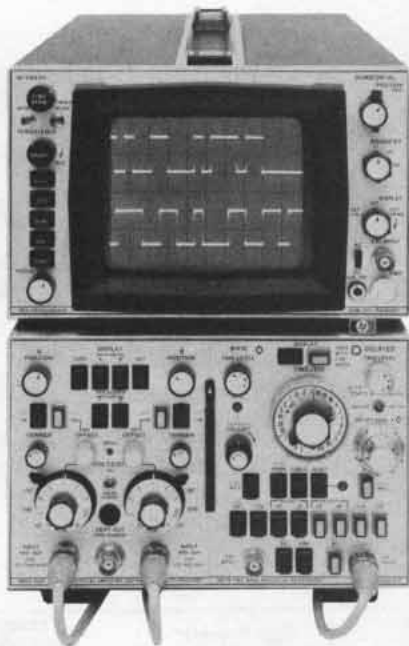

181A

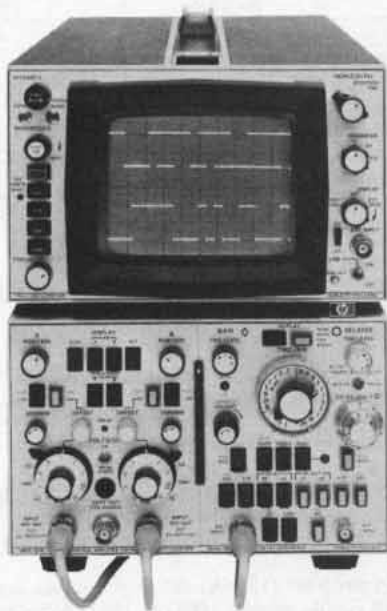

184A

181A/AR, 184A Specifications

Cathode-ray tube and controls

Type: post-accelerator storage tube, 8.5 kV (181A/AR); aluminized P31 phosphor.

Graticule: 8 x 10 div internal graticule, 0.2 div subdivisions on major axes; 1 div = 0.95 cm. (184A) 8 x 10 div internal graticule superimposed in center of normal scope graticule (for fast writing speed mode); 1 div = 0.475 cm.

Beam finder: returns trace to CRT screen.

Intensity modulation (external input)

Input: $\approx +2V$, ≥ 50 ns pulse width blanks normal intensity trace. Input R ≈ 5 k Ω . Max input, ± 20 V (dc + peak ac).

Persistence, storage, 181A/AR

Persistence: normal, ≈ 40 μ s; variable, <0.2 to >1 min.

Storage writing speed: write mode, >20 cm/ms; max write mode, >5 cm/ μ s.

Brightness: >342.6 cd/m² (100 fl).

Storage time: from Write to Store, trace may be stored at reduced intensity for >1 hr; to View, traces may be viewed at normal intensity for >1 min. From max Write to Store, traces may be stored at reduced intensity for >5 min.; to View, traces may be viewed at normal intensity for >15 s.

Erase: manual, pushbutton erasure takes ≈ 300 ms.

Persistence, storage, 184A

Writing modes: conventional (non-storage), standard, and fast (variable persistence and storage). Pressing STORE and either STD or FAST provides max persistence with floodguns off for a ready-to-write state. CRT will remain primed for the storage time of >10 min. in STD/STORE and >30 s in FAST/STORE.

Persistence: conventional, ≈ 40 μ s; variable, <50 ms to >1 min.

Storage writing speed

Model No.	Standard*	Fast**
184A	>0.2 cm/ μ s	>100 cm/ μ s
184A Opt 005	>0.2 cm/ μ s	>400 cm/ μ s

*Adjustable writing speeds to ≈ 10 cm/ μ s are available with rear panel controls.

**Calibrated 3.8 x 4.75 cm reduced scan area.

Brightness: standard, 342.6 cd/m² (100 fl); fast, >173.3 cd/m² (50 fl).

Storage time

Standard writing speed: variable from >1 min. at normal intensity to >10 min. at reduced brightness.

Fast writing speed: at 22°C variable from >10 s (8s for Opt 005) at normal intensity to >30 s at reduced brightness.

Erase: manual, pushbutton erasure takes ≈ 300 ms.

Horizontal amplifier

External input

Bandwidth: dc-coupled, dc to 5 MHz, ac-coupled, ≈ 5 Hz to 5 MHz.

Deflection factor: 1 V/div in X1; 0.2 V/div in X5; 0.1 V/div in X10.

Dynamic range: ± 20 V.

Max input: 600 V dc (ac-coupled input).

Input RC: ≈ 1 M Ω shunted by ≈ 30 pF.

Sweep magnifier: X5, X10; accuracy, $\pm 5\%$ (with 3% time base).

General

Outputs

Four rear panel emitter follower outputs for main and delayed gates, main and delayed sweeps, or vertical and horizontal outputs when used with TDR/Sampling plug-ins. Max current available, ± 3 mA. Will drive impedances $\geq 1000\Omega$ without distortion.

Calibrator: ≈ 1 kHz square wave, 3 μ s rise time; 10 V p-p into ≥ 1 M Ω ; accuracy, $\pm 1\%$.

Operating environment: same as 180 C/D.

Dimensions

181A, 184A (cabinet): 289 H x 200 W x 540 mm D behind panel (11 $\frac{1}{8}$ " x 7 $\frac{7}{8}$ " x 21 $\frac{1}{4}$ ").

181AR (rack): 133 H x 425 W x 543 mm D overall (5 $\frac{1}{32}$ " x 16 $\frac{3}{4}$ " x 21 $\frac{3}{8}$ "); 493 mm (19 $\frac{3}{8}$ ") D behind rack mount tabs.

Weight (without plug-ins)

181A, 184A (cabinet): net, 10.9 kg (24 lb); shipping, 15.4 kg (34 lb).

181AR (rack): net, 11.8 kg (26 lb); shipping, 17.2 kg (38 lb).

Power: 115 or 230 V $\pm 10\%$, 48 to 440 Hz; 115 watts at normal line with plug-ins; max mainframe power, 225 VA.

Accessories supplied: 2.3 m (7 $\frac{1}{2}$ ft) power cord, Model 10178A mesh contrast filter, blue plastic light filter (HP P/N 5060-0548) and 2 clip-on probe holders (HP P/N 5040-0464) are supplied with the 181AR rack model.

Ordering Information

181A Storage Mainframe, Cabinet Style	\$2700
Opt 910: additional Operating and Service Manual	add \$8
181AR Storage Mainframe, Rack Style	\$2900
Opt 910: additional Operating and Service Manual	add \$8
184A Storage Mainframe, Cabinet Style	\$3200
Opt 005: Fast Storage CRT	add \$500
Opt 910: additional Operating and Service Manual	add \$11

Price

OSCILLOSCOPES

180 Verticals: 100 MHz, 50 MHz, 0.5 MHz, dc offset

Models 1805A, 1801A, 1806A & 1803A

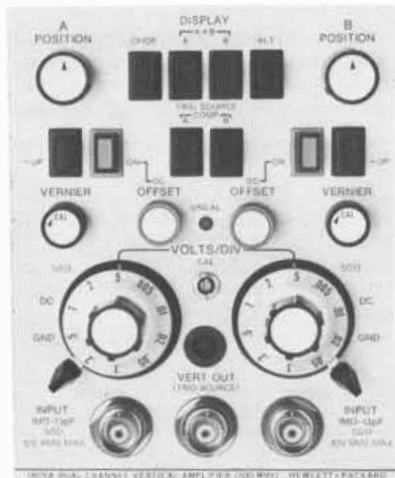

1805A

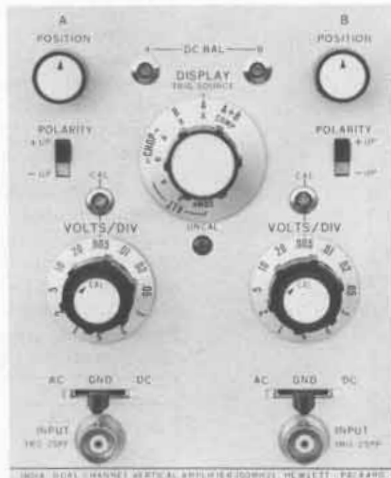

1801A

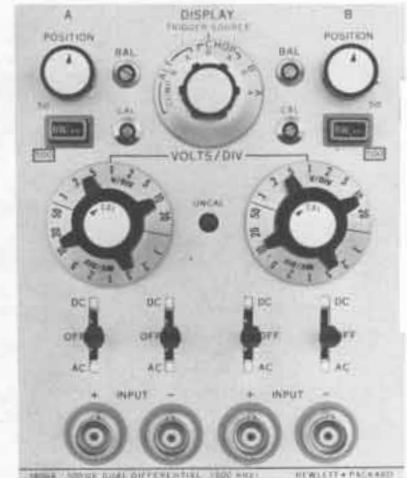

1806A

1805A, 1801A Specifications

Modes of operation

Channel A; Channel B; A and B displayed alternately on successive sweeps (ALT); A and B displayed by switching between channels at approx 400 kHz rate (CHOP) with blanking during switching; A plus B (algebraic addition).

Each channel (2)

Bandwidth: (measured with or without 10014A probe (1805A), 10004D probe (1801A), 3 dB down from 8 div ref signal from a terminated 50Ω source.)

DC-coupled: (1805A) dc to 100 MHz, (1801A) dc to 500 kHz.

AC-coupled: (1805A) ≈ 10 Hz to 100 MHz, (1801A) ≈ 8 Hz to 50 MHz.

Rise Time: (1805A) < 3.5 ns (measured with or without 10014A probes, 10% to 90% points of 6 div input step from a terminated 50Ω source); (1801A) < 7 ns (measured with or without 10004D probe, 10% to 90% points of 8 div input step from a terminated 50Ω source).

Deflection factor

Ranges: (1805A) 5 mV/div to 5 V/div (10 cal positions) in 1, 2, 5 sequence; $\pm 2\%$ attenuator accuracy. (1801A) 5 mV/div to 20 V/div (12 positions) in 1, 2, 5 sequence; $\pm 3\%$ attenuator accuracy.

Vernier: extends max deflection factor ≥ 12.5 V/div (1805A), ≥ 50 V/div (1801A).

Polarity: + up or - up selectable.

Input coupling: (1805A) AC, DC, 50Ω (dc), or ground; (1801A) AC, DC, or ground.

Input RC: (1805A) AC and DC, 1 MΩ $\pm 1\%$ shunted by ≈ 13 pF; 50Ω, 50Ω $\pm 2\%$; SWR < 1.2 at 100 MHz on all ranges. (1801A) ≈ 1 MΩ shunted by ≈ 25 pF.

Max input: (1805A) AC and DC, ± 300 V (dc + peak ac) at 1 kHz; ± 150 V (dc + peak ac) on 5 mV/div range at ≤ 1 kHz. (1801A) DC-coupled ± 350 V (dc + peak ac) at ≤ 10 kHz; ± 150 V (dc + peak ac) on 5 mV/div range at ≤ 1 kHz; AC-coupled, ± 600 V dc.

Dynamic range (1805A): 6 div at 100 MHz to 16 div at ≤ 15 MHz. **Positioning range (1805A):** 16 div.

+ B operation: amplifier bandwidth and deflection factors unchanged; either channel may be inverted for $\pm A \pm B$ operation. Differential input (A-B) common mode, (1805A) CMR ≥ 40 dB dc to 1 MHz for common mode signals ≤ 16 div, ≥ 20 dB at 50 MHz for (1801A) signals ≤ 6 div; (1801A) CMR ≥ 40 dB at 5 mV/div and ≥ 20 dB on other ranges, dc to 1 MHz, for common mode signals ≤ 24 div.

Offset (1805A): ± 200 div of offset.

Triggering (1805A)

Source: selectable from channel A, channel B, or a composite (Comp) signal from A and B in any display mode. Composite is A and B signals switched for Alt and Chop modes and added for A and B mode. Vernier and position controls do not affect A, B, or composite trigger signals. A and B signals are independent of polarity selection.

Frequency

Time Base Plug-in	Trigger Frequency*	Required Vertical Deflection
1820C, 1825A	dc-50 MHz	$\frac{1}{2}$ div
	dc-100 MHz	1 div
1821A	dc-50 MHz	1 div

*all display modes except Chop, dc to 100 kHz in Chop.

Triggering (1801A)

Source: for channel A or B, on signal displayed; Chop selectable from A or B; Alt selectable from A, B, or Comp (A and B switched). **Frequency:** dc to > 500 kHz on signals causing ≥ 0.5 div vert deflection in all display modes except Chop which is dc to 100 kHz.

Vertical signal output (1805A)

Bandwidth: > 50 MHz into 50Ω.

Amplitude: > 50 mV for each div of display into 50Ω with useable amplitudes up to 500 mV p-p.

Source impedance: ≈ 50 ohms.

General

Operating environment: same as 180 C/D mainframes.

Weight

1805A: net 2.3 kg (5 lb); shipping, 3.6 kg (8 lb).

1801A: net 1.8 kg (4 lb); shipping, 3.6 kg (8 lb).

Accessories supplied: (1805A) two 10014A 10:1 divider probes ≈ 1.1 m (3½ ft), one Operating and Service Manual. (1801A) two 10004D, 10:1 divider probes, ≈ 1.1 m (3½ ft), one Operating and Service Manual.

Recommended probes: (1805A) full performance maintained by 10014A, 10016B passive probes, 10017A, 10018A miniature passive probes, 10026A, 10027A miniature 50Ω probes, 10020A resistive divider probe kit, and the 1120A and 1125A active probes; (1801A) full performance maintained by 10004D, 10005D, and 10006D passive probes and 10041A, 10042A miniature passive probes.

1806A Specifications

Modes of operation

Channel A; channel B; A and B displayed alternately on successive sweeps (ALT); A and B displayed by switching between channels at approx 100 kHz, in CHOP mode with blanking during switching; A plus B, algebraic addition.

Each channel (2)

Bandwidth (measured with or without a Model 10001A/B probe, 3 dB down from 8 div ref signal from a terminated 50Ω source.)

DC-coupled: dc to 500 kHz.

AC-coupled: ≈ 2 Hz to 500 kHz.

Bandwidth limit switch: limits bandwidth to ≈ 50 kHz.

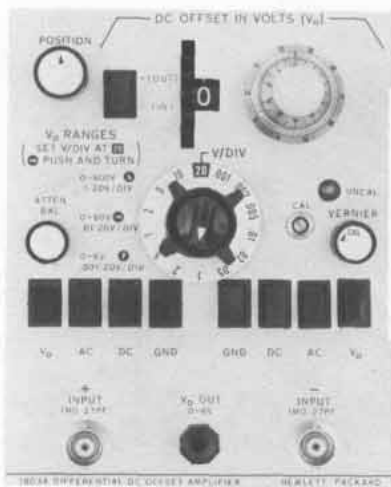

1803A

Deflection factor: Ranges, 100 μ V/div to 20 V/div (17 positions) in 1, 2, 5 sequence, \pm 3% attenuator accuracy; Vernier, extends max deflection factor to at least 50 V/div.

Input: differential or single-ended on all ranges, selectable.

Input coupling: selectable AC, DC, or OFF for both + and - inputs.

Input RC: \approx 1 M Ω shunted by \approx 45 pF.

Maximum input: \pm 400 V (dc + peak ac).

Input isolation: \geq 80 dB between channels at 500 kHz with shielded connectors.

Noise: $<$ 20 μ V, measured tangentially at full bandwidth.

Common mode:

Frequency: dc to 10 kHz on all ranges.

Rejection ratio: \geq 100 dB (100 000 to 1) with dc-coupled input on 100 μ V/div range, decreasing 20 dB per decade of deflection factor to \geq 40 dB on the 200 mV/div range; CMR is \geq 30 dB on the 500 mV/div to 20 V/div ranges.

Maximum signal: \pm 10 V (dc + peak ac) on 100 μ V/div to 200 mV/div ranges; \pm 400 V (dc + peak ac) on all ranges.

Triggering

Source: for channel A or B, on signal displayed; Chop selectable from A or B; Alt selectable from A, B, or Comp (A and B switched).

Frequency: dc to $>$ 500 kHz on signals causing \geq 0.5 div vertical deflection in all display modes except Chop which is dc to 100 kHz.

General

Operating environment: same as 180C/D mainframe.

Weight: net, 1.8 kg (4 lb); shipping, 3.6 kg (8 lb).

Accessories supplied: two BNC to dual banana plug binding post adapters (HP P/N 1250-1264), one Operating and Service Manual.

Recommended probes: 10001A/B, 10002A/B, 10003A passive divider probes and 10021A, 10022A miniature passive probes maintain full performance of the 1806A.

1803 Specifications

Bandwidth: (measured with or without 10004D probe, 3 dB down from 8 div ref signal from a terminated 50 Ω source.)

DC-coupled: dc to 40 MHz from 0.005V/div to 20 V/div; dc to 30 MHz on 0.001 V/div and 0.002 V/div or when using V_0 range of 0 to 6 V or two most sensitive volts/div settings for other V_0 ranges.

AC-coupled: lower bandwidth \approx 2 Hz.

Rise time: $<$ 10 ns for deflection factors of 0.005 V/div to 20 V/div; $<$ 12 ns on 0.001 V/div and 0.002 V/div, on V_0 range of 0 to 6 V and on the most sensitive volts/div settings for other V_0 ranges. Measured with or without 10004D probe, 10% to 90% points of 8 div input step from terminated 50 Ω source.

Deflection factor

Ranges: from 0.001 V/div (14 cal positions) in 1, 2, 5 sequence; attenuator accuracy \pm 3%.

Vernier: extends max deflection factor to \geq 50 V/div.

Input coupling: AC, DC, Ground, or V_0 for both + and - inputs.

Input RC: \approx 1 m Ω shunted by \approx 27 pF.

Maximum input

V_0 Range	Deflection Factor	Maximum Input (dc + peak ac)
0 to 6 V	0.001 V/div to 0.02 V/div	\pm 15 V
0 to 6 V	0.05 V/div to 0.2 V/div	\pm 150V
0 to 6 V	0.5 V/div to 20 V/div	\pm 600 V
0 to 60 V	0.01 V/div to 0.2 V/div	\pm 150 V
0 to 60 V	0.5 V/div to 20 V/div	\pm 600 V
0 to 600 V	0.1 V/div to 20 V/div	\pm 600 V

Overload recovery

6 V overload: within \pm 10 mV of final signal value in \leq 0.3 μ s, within \pm 5 mV in \leq 1 μ s, and within 1 mV in \leq 1 ms.

60 V overload: within \pm 100 mV of final signal value in \leq 0.3 μ s, within \pm 50 mV in \leq 1 μ s, and within \pm 10 mV in \leq 1 ms.

600 V overload: within \pm 1 V of final signal value in \leq 0.3 μ s, within \pm 0.5 V in \leq 1 μ s, and within \pm 100 mV in \leq 1 ms.

Common mode rejection: measured at a deflection factor of 0.001 V/div. (CMR decreases with increasing deflection settings.)

Frequency Range	CMR	Common Mode Input Sine Wave (max p-p)
dc to $<$ 100 kHz	\geq 20 000:1 (\geq 86 dB)	10 V
100 kHz to $<$ 1 MHz	\geq 10 000:1 (\geq 80 db)	10 V
1 MHz to $<$ 10 MHz	\geq 5 000:1	10V
	\geq Freq in MHz	Freq in MHz
20 MHz	\geq 50:1 (\geq 34 dB)	1 V
60 Hz	\geq 2 000:1 (\geq 66 dB)*	10 V

*AC-coupled (all others dc-coupled).

DC offset

V_0 Range	Deflection Factor	Comparison Accuracy
0 to \pm 6 V	0.001 V/div to 0.02 V/div	\geq (0.15% + 8 mV)
	0.05 V/div to 0.2 V/div	\pm (0.75% + 8 mV)
	0.5 V/div to 2 V/div	\pm 1%
	5 V/div to 20 V/div	\pm 3%
0 to \pm 60 V	0.01 V/div to 0.2 V/div	\pm (0.4% + 8 mV)
	0.5 V/div to 2 V/div	\pm (0.75% + 8 mV)
	5V/div to 20 V/div	\pm 3%
0 to 600 V	0.1 V/div to 2 V/div	\pm (0.65% + 0.8 V)
	5 V/div to 20 V/div	\pm 3%

V_0 Output: calibrated dc offset voltage at front panel, variable from 0 to \pm 0.006 V, 0 to \pm 0.06 V, 0 to \pm 0.6 V or 0 to \pm 6 V. Accuracy of 6 V range is \pm 0.15% of reading \pm 8 mV into \geq 10 M Ω .

Triggering: dc to 40 MHz on signals \geq 0.5 div.

General

Operating environment: same as 180C/D mainframe.

Weight: net, 2.3 kg (5 lb); shipping, 4.5 kg (10 lb).

Accessories supplied: one Operating and Service Manual.

Recommended probes: 10004D, 10005D, and 10006D passive probes and 10040A, 10041A, 10042A miniature passive probes maintain full performance of 1803A.

Ordering information

	Price
1805A Dual Channel Vertical Amplifier	\$1600
Opt 910: additional Operating and Service Manual	add \$6
1801A Dual Channel Vertical Amplifier	\$1050
Opt 001: channel B output and X5 magnifier	add \$155
Opt 090: 1.8 m (6 ft) 10006D probes in lieu of 10004D	N/C
Opt 091: 3 m (10 ft) 10005D probes in lieu of 10004D	N/C
Opt 910: additional Operating and Service Manual	add \$6
1806A Dual Channel Vertical Amplifier	\$1100
Opt 910: additional Operating and Service Manual	add \$7
1803A Dual Channel Vertical Amplifier	\$1725
Opt 910: additional Operating and Service Manual	add \$7

OSCILLOSCOPES

180 Verticals: 4 channel, 100 MHz and 50 MHz

Models 1809A & 1804A

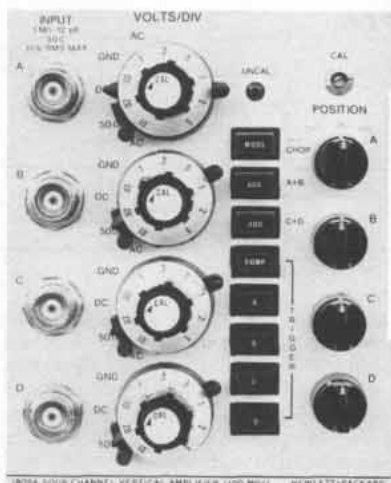

1809A

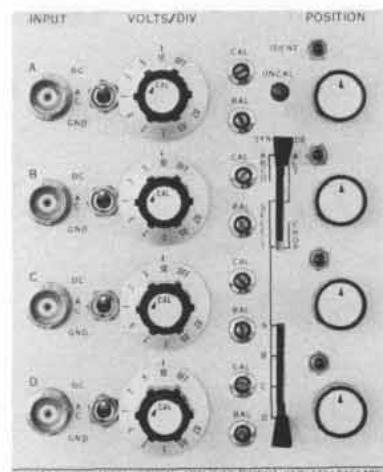

1804A

1809A Specifications

Modes of operation

Channels A, B, C, or D or any combination displayed alternately on successive sweeps (ALT) or chopped (CHOP) with blanking during switching; either A and B or C and D may be algebraically added ($\pm A \pm B$) or ($\pm C \pm D$). Approx chop rate for two channels displayed is 1 MHz, 3 channels is 667 kHz, 4 channels is 500 kHz.

Each channel (4)

Bandwidth (measured with or without 10014A probe, 3 dB down from a terminated 50Ω source.)

DC-coupled: dc to 100 MHz.

AC-coupled: ≈ 10 Hz to 100 MHz.

Rise time: < 3.5 ns. Measured with or without 10014A probe, 10% to 90% of 6 div input step from a terminated 50Ω source.

Deflection factor

Ranges: from 0.01 V/div to 5 V/div (9 cal positions) in 1, 2, 5 sequence. Attenuator accuracy, $\pm 2\%$.

Vernier: extends max deflection factor to ≥ 12.5 V/div.

Input coupling: ac, dc, 50Ω (dc), or ground.

Input RC (selectable): AC or DC, 1 MΩ, $\pm 1\%$ shunted by ≈ 12 pF; 50Ω, 50Ω $\pm 2\%$. SWR, 1.3 at 100 MHz on all ranges.

Max input: AC and DC, ± 300 V (dc + peak ac) at ≤ 1 kHz; ± 150 V (dc + peak ac) on 10 mV/div range at ≤ 1 kHz; 50Ω, 10 V rms (dc-coupled input).

Polarity: any channel may be inverted ($\pm A$, $\pm B$, $\pm C$, $\pm D$).

Algebraic addition (A + B), (C + D)

Amplifier: bandwidth and deflection factors are unchanged, any channel may be inverted for ($\pm A \pm B$) or ($\pm C \pm D$) operation.

Differential input (A - B) or (C - D) common mode: CMR is ≥ 20 dB from dc to 80 MHz on all ranges.

Triggering

Source: selectable from channel A, B, C, D, or composite (on displayed signals) in all display modes.

Frequency

Time Base Plug-in	Trigger Frequency*	Required Vertical Deflection
1820C, 1825A	dc-50 MHz	1/2 div
	dc-100 MHz	1 div
1821A	dc-50 MHz	1 div

*All display modes except Chop, dc to 100 kHz in Chop.

General

Operating environment: same as 180C/D mainframes.

Weight: net, 3.2 kg (7 lb); shipping, 4.5 kg (10 lb).

Accessories supplied: one Operating and Service Manual.

Recommended probes

Models 10014A, 10015A, 10016B, 10017A, and 10018A will main-

tain 1809A bandwidth and rise time in the high impedance (ac or dc) mode. Models 10020A, 10026A, and 10027A will maintain bandwidth and rise time in the 50Ω input mode.

1804A Specifications

Modes of Operation

Channels A, B, C, or D or any combination displayed alternately on successive sweeps (ALT) or chopped (CHOP) with blanking during switching. Approx chop rate for two channels displayed is 500 kHz, 3 channels is 333 kHz, and 4 channels is 250 kHz.

Each channel (4)

Bandwidth (measured with or without 10004D probe, 3 dB down from 8 div ref signal from a terminated 50Ω source.)

DC-coupled: dc to 50 MHz.

AC-coupled: ≈ 10 Hz to 50 MHz.

Rise time: < 7 ns (measured with or without 10004D probe, 10% to 90% of 8 div input step from a terminated 50Ω source).

Deflection factor

Ranges: 0.02 V/div to 10 V/div (9 cal positions) in 1, 2, 5 sequence, attenuator accuracy, $\pm 3\%$.

Vernier: extends max deflection factor to ≥ 25 V/div.

Input coupling: AC, DC, and Ground.

Input RC: ≈ 1 MΩ shunted by ≈ 25 pF.

Max input: DC-coupled, ± 350 V (dc + peak ac), ± 150 V (dc + peak ac) on 20 mV/div at 10 kHz or less; AC-coupled, ± 400 V dc.

Trace identification: pushbutton displaces respective trace ≈ 0.5 div.

Triggering

Source: selectable on signal from any channel in Chop or Alt mode, or successively from displayed signal on each channel in Alt mode.

Frequency: dc to 50 MHz on signals causing ≥ 0.5 div vert deflection in all display modes except Chop, dc to 200 kHz in Chop.

General

Operating environment: same as 180C/D mainframes.

Weight: net, 2.3 kg (5 lb); shipping, 3.6 kg (8 lb).

Accessories supplied: one Operating and Service Manual.

Recommended probes

10004D, 10005D, 10006D passive probes and, 10040A, 10041A, 10042A miniature passive probes, maintain full performance of 1804A.

Ordering information

1809A 100 MHz 4 Channel Amplifier

Opt 910: additional Operating and Service Manual

1804A 50 MHz 4 Channel Amplifier

Opt 910: additional Operating and Service Manual

Price

\$2500

add \$9

\$1600

add \$7

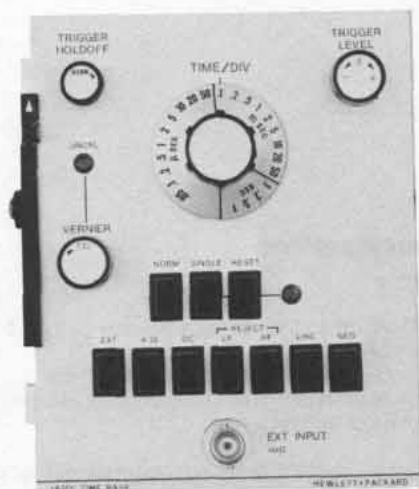

1820C



1821A

1820C Specifications

Time base

Sweep

Ranges: 0.05 μ s/div to 1 s/div (23 positions) in 1,2,5 sequence; $\pm 3\%$ accuracy with vernier in CAL position.

Vernier: extends slowest sweep to at least 2.5 s/div.

Magnifier: (mainframe) expands fastest sweep to 5 ns/div.

Sweep mode

Normal: triggered by an int, ext, or power line signal.

Automatic: baseline displayed in absence of trigger signal. Triggering is same as Normal except low frequency limit is 40 Hz.

Single: in Normal, sweep occurs once with the same triggering as Normal (reset pushbutton arms sweep and lights indicator); in Auto, sweep occurs once each time reset is pressed.

Triggering

Internal: refer to vertical plug-in specifications.

External: dc to 50 MHz on signals 50 mV p-p or more increasing to 100 mV at 100 MHz and 150 mV at 150 MHz.

Line: power line frequency signal.

Level

Internal: at any point on the vertical waveform displayed.

External: continuously variable from +2V to -2V on either slope of trigger signal, from +20V to -20V in ± 10 setting.

Slope: pushbutton selection of + or - slope of trigger signal.

Coupling: AC, DC, HF Reject or LF Reject.

Trigger holdoff: time between sweeps continuously variable, exceeding one full sweep on all ranges.

General

Operating environment: same as 180C/D mainframe.

Weight: net, 1.4 kg (3 lb); shipping, 3.2 kg (7 lb).

1821 Specifications

Main time base

Sweep

Ranges: from 0.1 μ s/div to 1 s/div (22 positions) in 1, 2, 5 sequence; $\pm 3\%$ accuracy with vernier in CAL position.

Vernier: extends slowest sweep to at least 2.5 s/div.

Magnifier: (mainframe) expands fastest sweep to 10 ns/div (main or delayed).

Sweep mode

Normal: triggered by an int, ext, or power line signal.

Automatic: baseline displayed in absence of input signal. Triggering same as normal except low frequency limit is 40 Hz for internal or external modes.

Single: sweep occurs once with same triggering as normal; reset pushbutton with indicator light.

Trace intensification

In Main sweep mode, intensifies that part of Main time base to be expanded to full screen on Delayed time base. Rotating Delayed time base sweep switch from Off position activates intensified mode. Front panel screwdriver adjustment sets relative intensity of brightened segment.

Delayed time base

Delayed time base sweeps after a time delay set by Main time base and Delay controls.

Sweep

Ranges: from 0.1 μ s/div to 50 ms/div (18 positions) in 1, 2, 5 sequence; $\pm 3\%$ accuracy with vernier in CAL position.

Vernier: continuously variable between all ranges; extends slowest sweep to at least 125 ms/div.

Triggering

(Main and Delayed time base)

Internal: refer to vertical plug-in specifications.

External: dc to 50 MHz on signals 0.5 V p-p or more, increasing to 100 MHz on signals 1 V p-p or more.

Line: power line frequency signal (main only).

Level and slope: internal, at any point on the vertical waveform displayed; external, continuously variable from +3 V to -3 V on either slope of the sync signal, from +30 V to -30 V in ± 10 .

Automatic (delayed only): triggered at end of set time delay.

Coupling: AC, DC, ACF (ac-fast), or ACS (ac-slow).

Delay (before start of Delayed sweep)

Time: continuously variable from 0.1 μ s to 10 s.

Accuracy: $\pm 1\%$ of differential delay ± 2 minor divisions of delay dial. Time jitter is 0.005% of max delay of each step.

Trigger output: (at end of Delay time) ≈ 1.5 V with < 50 ns rise time from 1000 Ω source resistance.

Mixed time base

Dual time base in which Main time base drives first portion of sweep and delayed time base completes sweep at up to 1000 times faster. Also operates in single sweep mode.

General

Operating environment: same as 180 C/D mainframes

Weight: net, 1.8 kg (4 lb); shipping, 3.6 kg (8 lb)

Ordering information

1821A Time Base and Delay Generator

Opt 910: additional Operating and Service Manual

1820C Time Base

Opt 910: additional Operating and Service Manual

Price

\$1150

add \$6

\$560

add \$6

OSCILLOSCOPES

180 Time base: delayed

Model 1825A

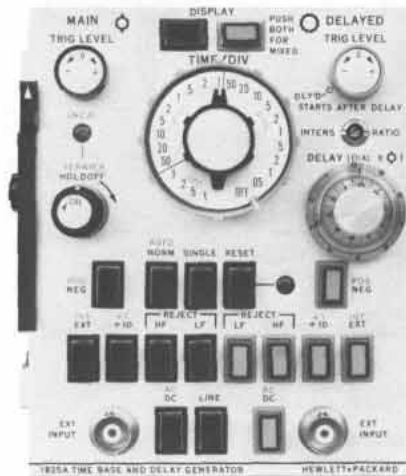

1825A

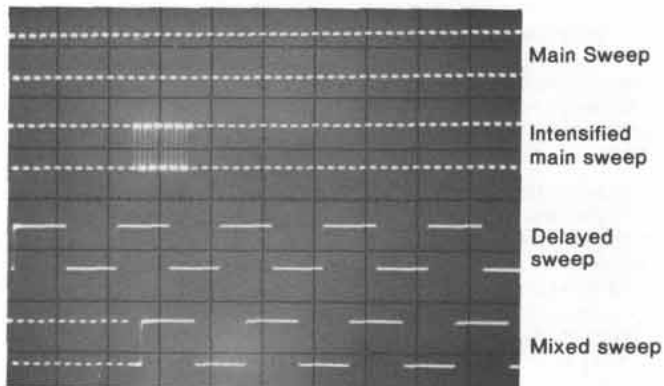

Multiple exposure shows four modes of operation for 1825A, with time relationship maintained in all modes.

1825A Description

Model 1825A time base and delay generator provides sweep speeds ranging from 0.05 $\mu\text{s}/\text{div}$ to 1 s/div in 23 positions. Delay times are continuously variable from 50 ns to 10 s and are accurate to 0.75% with extremely low jitter of 1 part in 50 000. Also, a calibrated mixed sweep mode is provided. A mainframe X10 magnifier increases sweep-speed capability to 5 ns/div with 5% accuracy.

One knob control makes triggering easy in main, delayed, and mixed modes. Stable, accurate time displays are provided in main, delayed, and mixed modes with the highly sensitive 50 mV external trigger capability at 50 MHz which increases to only 150 mV at 150 MHz. Trigger synchronization is maintained when switching between main, delayed, and mixed modes, further simplifying use.

Front panel controls are logically arranged for quick familiarization and easy use. Pushbuttons eliminate front panel clutter and reduce the possibility of errors. Easy-to-operate pushbuttons establish main, delayed, and mixed modes of operation.

Trigger level controls on main and delayed sweeps allow selection of the triggering point on the desired portion of the signal for almost every measurement application. Also, the $\div 10$ function provides a wide dynamic range of triggering in both external and internal modes of operation.

External trigger sensitivity of 50 mV on both main and delayed sweeps allows a 10:1 divider probe to be used to reduce circuit loading at trigger pick-off points and reduces the possibility of circuit malfunction caused by the measuring instrument.

1825A Specifications

Main time base

Sweep

Ranges: 0.05 $\mu\text{s}/\text{div}$ to 1 s/div (23 positions) in 1, 2, 5 sequence; $\pm 3\%$ accuracy with vernier in CAL position.

Vernier: extends slowest sweep to at least 2.5 s/div.

Magnifier: (on mainframe) expands fastest sweep to 5 ns/div, accuracy $\pm 5\%$ (main or delayed).

Sweep mode

Normal: sweep is triggered by an internal, external, or power line signal.

Automatic: baseline displayed in absence of trigger signal. Triggering is same as normal except low frequency limit is 40 Hz.

Single: in Normal, sweep occurs once with same triggering as Normal (reset pushbutton arms sweep and lights indicator); in Auto, sweep occurs once each time reset pushbutton is pressed.

Trace intensification

In Main sweep mode, intensifies that part of main time base to be expanded to full screen in delayed time base mode. Rotating time base switch from OFF position activates intensified mode.

Delayed time base

Delayed time base sweeps after a time delay set by Main time base and Delay controls. Delayed time base is triggered on first trigger pulse after set delay or automatically triggers after set delay when delayed level control is in detent position.

Sweep Ranges: 0.05 $\mu\text{s}/\text{div}$ to 20 ms/div (18 positions) in 1, 2, 5 sequence; $\pm 3\%$ accuracy.

Triggering

(Main and Delayed time base)

Internal: refer to vertical amplifier plug-in specifications.

External: dc to 50 MHz on signals 50 mV p-p or more increasing to 100 mV p-p at 100 MHz and 150 mV p-p at 150 MHz.

Line: power line frequency signal (Main only).

Level

Internal: at any point on the vertical waveform displayed.

External: continuously variable from +2 V to -2 V on either slope of trigger signal, from +20 V to -20 V in $\div 10$ setting.

Slope: pushbutton selects either positive or negative slope of trigger signal.

Coupling: AC, DC, HF Reject, or LF Reject. AC, attenuates signals below ≈ 20 Hz; LF reject, attenuates signals below ≈ 15 kHz; HF reject, attenuates signals above 15 kHz.

Trigger holdoff: time between sweeps continuously variable, exceeding one full sweep on all ranges (Main only).

Delay (before start of delayed sweep)

Time: continuously variable from 50 ns to 10 s.

Accuracy: $\pm 0.75\%$ of differential delay ± 2 minor divisions of delay dial.

Time jitter: $\pm 0.002\%$ of max delay on each range.

Calibrated mixed sweep

Combines Main and Delayed Sweeps into one display. Sweep is started by the Main time base and is completed by the faster Delayed time base.

General

Operating environment: same as 180C/D mainframes.

Weight: net, 1.8 kg (4 lb); shipping 2.7 kg (6 lb).

Accessories supplied: one Operating and Service Manual.

Ordering information

1825A Time Base and Delay Generator

Opt 910: additional Operating and Service Manual

Price

\$1000

add \$8

1 GHz, 18 GHz sampling, 170 ps t_r TDR

Models 1810A, 1811A, 1430C & 1818A

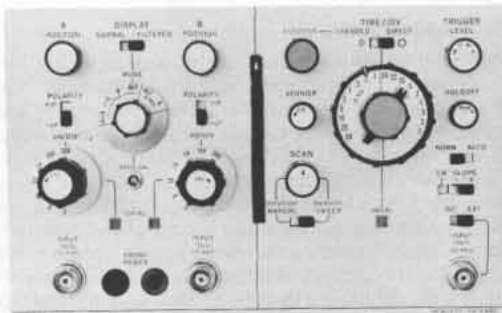

1810A

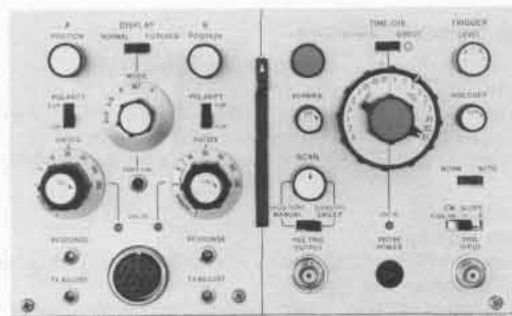

1811A

1810A Specifications

Modes of operation

Channels: A; B; A and B displayed on alternate samples (ALT); A plus B (algebraic addition); and A vs. B.

Vertical channels

Bandwidth: dc to 1 GHz; rise time, < 350 ps.

Pulse response: $\leq \pm 5\%$ or 3 mV p-p (overshoot and perturbations) in normal display mode.

Deflection factor

Ranges: 2 mV/div to 200 mV/div (7 calibrated positions) in 1, 2, 5 sequence; $\pm 3\%$ accuracy.

Vernier: extends min deflection factor to < 1 mV/div.

Polarity: + up or - up.

Dynamic range: > 1.6 V.

Positioning range: $\geq \pm 1$ V on all deflection factors.

Input R: 50 Ω , $\pm 2\%$; max input ± 5 V (dc + peak ac).

SWR: < 1.1 to 300 MHz, increasing to < 1.5 at 1 GHz.

Reflection coefficient: < 6%, measured with 150 ps TDR.

Random noise: normal, < 2 mV, observed from center 80% of dots; filtered, reduces noise at least 2 to 1.

Isolation between channels: ≥ 40 dB with 350 ps rise time input.

Time difference between channels: < 100 ps.

A + B operation: bandwidth and deflection factors are unchanged; either channel may be inverted for $\pm A \pm B$ operation.

Time base

Ranges

Normal: 10 ns/div to 50 μ s/div (12 cal positions) in 1, 2, 5 sequence; $\pm 3\%$ accuracy with vernier in calibrated position.

Expanded: direct reading expansion to X100 in seven calibrated steps on all normal time scales, extends range to 100 ps/div. Accuracy, $\pm 4\%$ (10 ps/div, $\pm 10\%$, with mainframe magnifier).

Vernier: increases fastest sweep to < 40 ps/div.

Triggering

Automatic: baseline displayed in the absence of an input signal.

Normal: can be set to trigger on variety of signals.

Internal

Source: selectable; channel A triggers channel A or alternate; channel B triggers channel B, alternate, A + B, or A vs B.

Sine Wave: 30 mV p-p from 1 kHz to 200 MHz, 100 mV p-p from 200 MHz to 1 GHz for jitter of < 30 ps plus 1% of 1 period.

Pulse: 30 mV peak, 3 ns pulses for < 30 ps jitter.

External

Sine wave: 30 mV p-p from 1 kHz to 1 GHz for jitter of < 30 ps plus 1% of 1 period.

Pulse: 30 mV peak, 3 ns wide pulses for < 30 ps jitter.

Either internal or external

Auto: 50 mV p-p for CW signals from 10 kHz to 200 MHz for < 30 ps jitter plus 2% of 1 period (to 1 GHz with increased jitter). Pulse triggering requires 50 mV peak, 3 ns pulses for < 30 ps jitter.

Level and slope: variable ± 800 mV on \pm slope of sync signal.

Coupling: ac coupling attenuates signals below ≈ 1 kHz.

Variable holdoff: variable over at least a 3:1 range.

Marker position: intensified marker segment indicates point about which sweep is to be expanded.

Scan: internal, dot density, continuously variable from < 100 to > 1000 dots full screen or from ≈ 500 to > 2000 dots in filtered mode; manual, scan is positioned manually.

General

Probe power: supplies power to operate two HP active probes.

Recorder outputs: vertical, uncal 1 V vert output from each channel on rear panel of 180 system mainframes; horizontal, uncal 0.75 V signal on rear panel of 180 series mainframes.

Operating environment: same as 180C/D mainframes.

Weight: net, 3.2 kg (7 lb); shipping, 5 kg (11 lb).

Accessories supplied: one Operating and Service Manual.

1811A Specifications

Modes of operation

Channels: A; B; A and B displayed on alternate samples (ALT); A plus B (algebraic addition); and A vs. B.

Vertical channels

Deflection factor

Ranges: 2 mV/div to 200 mV/div in 1, 2, 5 sequence; accuracy $\pm 3\%$.

Vernier: extends min. deflection factor to < 1 mV/div.

Polarity: + up or - up.

Positioning range: $\geq \pm 1$ V on all deflection factors.

A + B operation: either channel may be inverted for $\pm A \pm B$ operation.

Time base

Ranges

Normal: 1 ns/div to 5 μ s/div (12 cal positions) in 1, 2, 5 sequence; $\pm 3\%$ accuracy (vernier in calibrated position).

Expanded: direct reading expansion to X100 in seven calibrated steps on all normal time scales, extends range to 10 ps/div. Accuracy is $\pm 4\%$ (1 ps/div, $\pm 10\%$ with mainframe magnifier).

Vernier: increases fastest sweep to 4 ps/div.

Triggering

Auto: baseline displayed in absence of an input signal.

Normal: can be set to trigger on variety of signals.

CW: 80 mV p-p for sine wave signals from 1 kHz to 1 GHz for jitter of < 10 ps plus 1% of 1 period of trigger signal. Triggering to 18 GHz with 1104A/1106B trigger countdown.

\pm **Slope:** triggers on 50 mV/peak, 3 ns pulses, for < 30 ps jitter.

Level and slope: variable ± 800 mV on \pm slope of sync signal.

Coupling: ac coupling attenuates signals below ≈ 1 kHz.

Holdoff: variable over at least a 3:1 range.

Marker position: intensified marker indicates point about which sweep is to be expanded.

Scan: internal, dot density, continuously variable from < 100 to > 1000 dots full screen or from ≈ 500 to > 2000 dots in filtered mode; manual, scan is positioned manually.

Triggering output: 1 ns, 1.5 V into 50 Ω .

General

Probe power: supplies power to operate HP active probe.

Recorder outputs: vertical, uncal 1 V vert output signal each channel on rear panel of 180 series mainframes; horizontal, uncal 0.75 V signal on rear panel of 180 series mainframes.

Operating environment: same as 180C/D mainframes.

Weight: net, 2.3 kg (5 lb); shipping, 5 kg (11 lb).

Accessories supplied: one Operating and Service Manual.

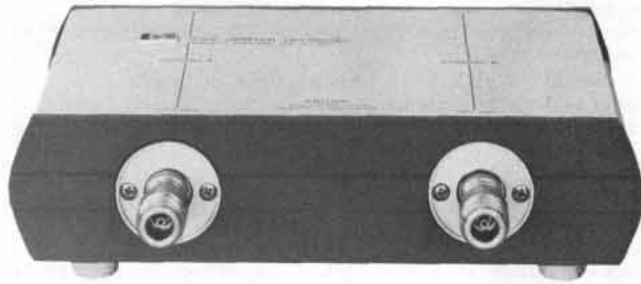

1430C

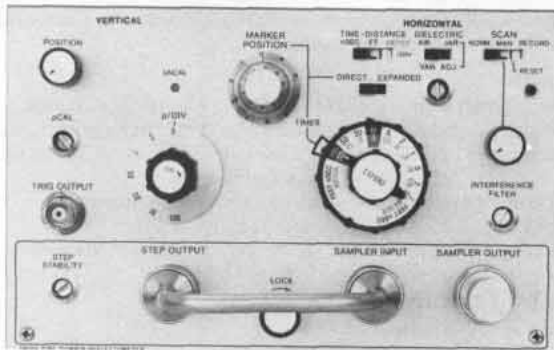

1818A

1430C Specifications

Sampling head

Rise time: ≈ 20 ps (< 28 ps observed with 1105A/1106B pulse generator and 909A Option 012, 50 Ω load).

Bandwidth: dc to > 18 GHz.

Overshoot: $< 7.5\%$.

Noise: ≈ 10 mV observed noise on CRT excluding 10% of random dots. Noise decreases to ≈ 2.5 mV on the auto filtered 2 mV/div and 5 mV/div ranges and all other ranges when display switch (on 1811A) is set to filtered position.

Dynamic range: 1 V p-p.

Low frequency distortion: $< \pm 5\%$.

Max input: ± 3 volts.

Input characteristics: mechanical, type N female connectors; electrical, 50 Ω feedthrough, dc-coupled. Sampler reflection $\approx 10\%$, measured with a 40 ps TDR system. Pulses from sampler input are ≈ 10 mV amplitude and 5 ns duration.

Time difference between channels: < 5 ps.

Isolation between channels: ≥ 40 dB over sampler bandwidth.

General

Weight: net, 1.8 kg (4 lb); shipping, 4.1 kg (9 lb).

Accessories supplied: two 50 Ω loads, type N male connectors (909A Option 012), one 1.5 m (5 ft) sampling head to 1811A interconnecting cable and one Operating and Service Manual.

*Components required for sampling systems

1811A Sampling plug-in
Sampling to 18 GHz with 1430C Sampling Head (Type N Female input/output connectors)
Trigger Accessories
<1GHz: Cable 11500A Type N Male to Type N Male 1.8 m (6 ft), Adapter 1250-0077 Type N Female to BNC Male.
1 GHz to 10 GHz: 1104A Trigger Countdown, 1108A Tunnel Diode, Adapter 1250-0847 GR Type 874 to Type N Male, 1109B High Pass Filter, 11170C Male BNC to Male BNC Trigger Cable 1.2 m (4 ft).
1GHz to 18 GHz: 1104A Trigger Countdown, 1106B Tunnel Diode, 1109B High Pass Filter, 11170C Male BNC to Male BNC Trigger Cable 1.2 m (4 ft).
TDR with 1430C Sampling Head
1105A Pulse Generator, 1106B Tunnel Diode 20 ps tr, 11170C Male BNC to Male BNC Trigger Cable 1.2 m (4 ft).
1105A Pulse Generator, 1108A Tunnel Diode 60 ps tr, Adapter 1250-0847 GR 874 to Type N Male, 11170C 1.2 m (4 ft) Male BNC to Male BNC Trigger Cable.

*Use any 180 series mainframe

1818A Description

The 1818A time Domain Reflectometer plug-in with a 180 series mainframe gives you a completely integrated wide band system for testing of transmission lines, strip lines, cables, connectors, and many other devices in high frequency systems. The easy-to-use controls provide accurate direct distance calibrated displays of up to 300 metres or 1000 feet with dielectric materials from $\epsilon = 1.0$ (air) to $\epsilon = 4.0$. This allows you to quickly determine the magnitude and nature of each resistive or reactive discontinuity in coaxial components such as attenuators, cables, connectors, and delay lines in microwave or pulse circuits. You can also locate and identify faults such as shorts, opens, loose connectors, defective tap offs, splices, and mismatches with measurement resolution as close as 2.54 cm.

1818A Specifications

System (in reflectometer configuration)

Rise time: < 170 ps.

Overshoot: $\leq 5\%$ overshoot and ringing (down to $\frac{1}{2}\%$ in 3 ns).

Internal reflections: $< 10\%$ (does not limit resolution).

Reflectometer sensitivity: 0.001 reflection coefficients observable.

Signal channel

Rise time: ≈ 150 ps.

Reflection coefficient: 0.5/div to 0.005/div in a 1, 2, 5 sequence.

Input: 50 Ω , feedthrough type.

Noise & internal pickup, peak: 0.1% of step (terminated in 50 Ω).

Dynamic range: ± 0.5 V.

External signal level: up to 1 V to Sampler output connector.

Attenuator accuracy: $\pm 3\%$.

Step generator

Amplitude: ≈ 0.25 V into 50 Ω (0.5 V into open circuit).

Rise time: ≈ 50 ps.

Source impedance: 50 $\Omega \pm 1\Omega$ (dc-coupled).

Droop: $< 1\%$ in 1 μ s.

Distance/time

Distance scale: 3 metres/div and 30 metres/div; 10 ft/div and 100 ft/div. Accuracy, $\pm 3\%$.

Variable dielectric: $\epsilon = 1$ to $\epsilon = 4$.

Time scale: 10 ns/div and 100 ns/div. Accuracy, $\pm 3\%$.

Magnification: X1 to X100 in a 1, 2, 5 sequence provides time scales to 0.1 ns/div and distance scales to 0.03 metres/div or 0.1 ft/div. Basic sweep accuracy is maintained at all magnifier settings.

Delay control: 0 to 10 div of unmagnified sweep. Accuracy, $\pm 3\%$.

Jitter: < 20 ps.

General

Recorder outputs: vertical, ≈ 1 V vert output signal is provided at rear panel of 180 series mainframes; horizontal, ≈ 1 V horiz output signal provided at rear panel of 180, 181, 182 or 184 mainframe.

Operating environment: temperature, 0 to $+35^\circ\text{C}$ (35°C to 55°C with small increase in system rise time); humidity, altitude, vibration same as 180 C/D mainframes.

Weight: net, 2.3 kg (5 lb); shipping, 5 kg (11 lb).

Accessories supplied: one type N connector assembly, one 50 Ω load with Type N male connector, one Operating and Service Manual.

Ordering information

	Price
1810A 1 GHz Sampling Plug-in	\$2625
Opt 910: additional Operating and Service Manual	add \$10
1811A 18 GHz Sampling Plug-in	\$2300
Opt 910: additional Operating and Service Manual	add \$9
1430C Sampling Head, 18 GHz	\$3500
Opt 910: additional Operating and Service Manual	add \$4
1818A Time Domain Reflectometer	\$1650
Opt 910: additional Operating and Service Manual	add \$6
10457A Adapter, 50Ω GR to 75Ω Type N female	\$150
(converts 1818A 50 Ω output to 75 Ω system.)	

35 ps t_r TDR, sampling & TDR accessories 1815B, 1817A, 1104A, 1105A, 1106B, 1108A & 1109B

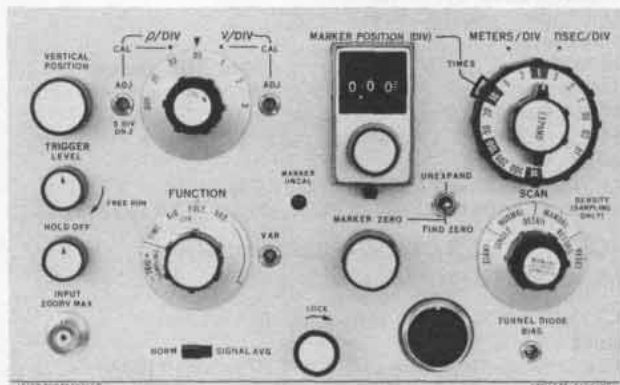

1815B

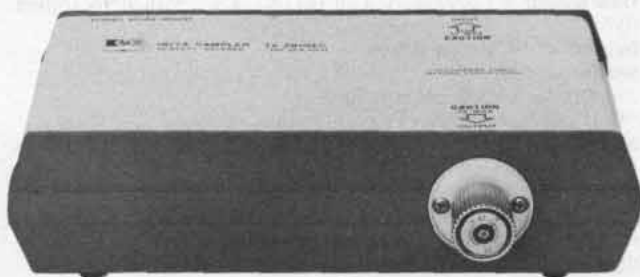

1817A

1815B Description

Model 1815B provides calibrated 35 ps system rise time, time domain reflectometry and 12.4 GHz (28 ps rise time) sampling capability with a remote feedthrough sampling head for extremely accurate measurements. This TDR system can locate impedance discontinuities in transmission systems up to 10 000 metres long and also measures discontinuities spaced only a few millimetres apart. As a single channel, general purpose sampling oscilloscope, you have deflection factors to 2 mV/div and sweep times to 10 ps/div.

1815B Specifications

Unless indicated otherwise, TDR and sampling performance specifications are the same. Where applicable, TDR specification is given first, followed by Sampler specification in parentheses. Model 1815B is calibrated in metres.

Vertical

Scale: reflection coefficient ρ (volts) from 0.005/div to 0.5/div in 7 calibrated ranges; 1, 2, 5 sequence.

Accuracy: $\pm 3\%$; TDR only, $\pm 5\%$ on 0.01/div and 0.005/div in signal average mode.

Vernier: extends scale to >0.002 /div.

Signal average: reduces noise and jitter $\approx 2:1$.

Horizontal

Scale: provides up to 10 000 metre display window with round-trip time or distance (time) in four calibrated decade ranges of 1/div, 10/div, 100/div, and 1000/div. Concentric expand control provides direct read-out in 28 calibrated steps in 1, 2, 5 sequence from 0.01 ns/div to 1000 ns/div or from 0.01 metre/div to 1000 metres/div.

Accuracy: time, $\pm 3\%$; distance (TDR only) $\pm 3\%$, \pm variations in propagation velocity.

Marker position: indicator, calibrator in divisions, provides direct read-out of round-trip time or distance (time), number of divisions \times decade range in units/div.

Marker zero: ten-turn control provides variable reference for marker position dial, allows direct read-out of round trip or distance (time) between two or more displayed events.

Zero finder: permits instant location of marker reference.

Dielectric, TDR only: calibrated for air, $\epsilon = 1$ and for polyethylene, $\epsilon = 2.25$. Settings for dielectric constants $\epsilon = 1$ to $\epsilon \approx 4$.

Triggering, sampling only: pulses, <50 mV for pulses 5 ns or wider for jitter <20 ps; CW, signals from 500 kHz to 500 MHz require at least 80 mV for jitter $<2\%$ of signal period plus 10 ps, usable to 1 GHz; CW triggering to 12.4 GHz with HP models 1104A/1106B trigger countdown.

General

Recorder outputs: ≈ 100 mV/div; vert and horiz outputs at BNC connectors on rear panel of mainframe.

Display modes: repetitive scan, normal or detail; single scan; manual scan; record.

Operating environment: same as 180 C/D mainframes.

Weight: net, 2.3 kg (5 lb); shipping, 4.5 kg (10 lb).

Accessories supplied: one Operating and Service Manual.

1817A (28 ps t_r) sampler specifications

TDR system (requires 1106B Opt 001)

System rise time: <35 ps incident measured with 1106B Opt 001.

Overshoot: $<\pm 5\%$.

Internal reflections: $<10\%$ with 45 ps TDR; use reflected pulse from shorted output.

Jitter: <15 ps; with signal averaging, ≈ 5 ps. Internal pickup: $\rho \leq 0.01$.

Noise: measured tangentially as a percentage of the incident pulse when terminated in 50 Ω and operated in signal averaging mode. $<1\%$ on 0.005/div to 0.02/div; $<3\%$ on 0.05/div to 0.5/div.

Low frequency distortion: $\leq \pm 3\%$.

Maximum safe input: 1 V.

Tunnel diode mount: direct connection of 1106B Opt 001 to 1817A.

Sampler system

Rise time: <28 ps.

Input: 50 Ω feedthrough.

Dynamic range: 1 V p-p; max safe input, 3 V.

Low frequency distortion: $\leq \pm 3\%$.

Noise: normal, <8 mV tangential noise on 0.01 V/div to 0.5 V/div, noise decreases automatically on 0.005 V/div range; signal average, reduces noise and jitter $\approx 2:1$.

General

Weight: net, 1.4 kg (3 lb); shipping, 5 kg (11 lb).

Accessories supplied: cable, plug-in to sampler, connects sampler (1817A) to plug-in (1815B), HP P/N 5060-0441; cable, tunnel diode to sampler, connects tunnel diode (1106B Opt 001 or 1108A) to sampler, type N male connectors on each end, HP P/N 01817-61603; one Operating and Service Manual.

Recommended accessories

Trigger source: ext trigger source required for triggering >500 MHz. 10 GHz source provided by 1104A Trigger Countdown with 1108A Tunnel Diode Mount. 18 GHz source provided by 1104A Trigger Countdown with 1106B Opt 001 Tunnel Diode Mount.

*Components required for TDR/sampling systems

1815B TDR/SAMPLING PLUG-IN	
1817A SAMPLING HEAD (APC-7 Input/Output Connectors) TDR, 35 ps t_r (1106B Opt 001 Tunnel Diode)	
SAMPLING up to 12.4 GHz	Adapter 1250-0847 GR Type 874 to Type N Male
Termination, 50 Ω Model 909A, APC-7 connector	1109B High Pass Filter Adapter 1250-0750 APC-7 to Type N Female 11170C Male BNC to Male BNC Trigger Cable, 1.2 m (4 ft)
TRIGGER ACCESSORIES <500 MHz	500 MHz to 12.4 GHz 1104A Trigger Countdown 1106B Opt 001 Tunnel Diode Adapter 1250-0749 APC-7 to Type N Male 1109B High Pass Filter Adapter 1250-0750 APC-7 to Type N Female 11170C Male BNC to Male BNC Trigger Cable, 1.2 m (4 ft)
500 MHz to 10 GHz	1104A Trigger Countdown 1108A Tunnel Diode

*Use any 180 series mainframe

1815B, 1817A, 1104A, 1105A, 1106B, 1108A & 1109B (cont.)



1104A



1105A



1106B



1108A



1109B



908A

1106B Opt 001 (20 ps t_r)/1108A (60 ps t_r) tunnel diode mounts specifications

Tunnel diode is required for a TDR system. Refer to sampling head specifications for mounting requirements.

Amplitude (both): >200 mV into 50 Ω .

Rise time: 1106B Opt 001 \approx 20 ps; 1108A, < 60 ps.

Source impedance: 50 Ω , \pm 2%.

Source reflections: 1106B Option 001, < 10% with 45 ps TDR; 1108A, < 10% with 145 ps TDR.

Weight (both): net, 0.5 kg (1 lb); shipping, 1.4 kg (3 lb).

1104A/1106B/1108A Specifications

1104A/1106B 18 GHz trigger countdown

1104A/1108A 10 GHz trigger countdown

Input

Frequency range: (1106B) 1 GHz to 18 GHz. (1108A) 1 GHz to 10 GHz.

Sensitivity: (1106B) signals \geq 100 mV to 12.4 GHz, produce < 20 ps of jitter (200 mV to 18 GHz). (1108A) signals to 50 mV or larger to 10 GHz produce < 20 ps jitter.

Max safe input: \pm 1 V.

Input impedance: dc resistance \approx 50 Ω . Reflection from input connector is < 10% using a 40 ps TDR system.

Signal appearing at input connector: \approx 250 mV.

Output

Center frequency: \approx 100 MHz.

Amplitude: typically 150 mV.

Connectors

1104A: input, type N male; trigger output, BNC female.

1106B: input, type N male; output, type N female.

1106B Opt 001: input, APC-7; output, type N female.

1108A: input, GR Type 874; output type N female.

Weight

1104A: net, 0.9 kg (2 lb); shipping, 1.8 kg (4 lb).

1106B or 1108A: net 0.5 kg (1 lb); shipping, 0.9 kg (2 lb).

1105A/1106B/1108A Specifications

1105A/1106B/20 ps pulse generator

1105A/1108A/60 ps pulse generator

Output

Rise time: \approx 20 ps with 1106B, (< 60 ps with 1108A), < 28 ps observed with 1411A/1430C 28 ps Sampler and 909A Option 012 50 Ω termination.

Overshoot: \pm 7.5% observed on 1411A/1430C with 909A Option 012.

Droop: < 3% in first 100 ns.

Width: \approx 3 μ s.

Amplitude: 1+200 mV into 50 Ω .

Output characteristics (1106B/1108A)

Mechanical: (1106B) Male Type N input connector, Female Type N output connector; (1108A) GR-874 input connector, Female Type N output connector.

Electrical: dc resistance, 50 Ω \pm 2%. Source reflection, < 10%, using a 40 ps TDR system. DC offset V, \approx 0.1 V.

Triggering

Amplitude: \geq \pm 0.5 V peak; max safe input 1 V.

Rise time: < 20 ns required. Jitter < 15 ps when triggered by 1 ns rise time sync pulse.

Width: > 2 ns.

Input impedance: 200 Ω , ac-coupled through 20 pF.

Repetition rate: 0 to 100 kHz; free runs at 100 kHz.

Accessories supplied (with Model 1105A): 10132A 1.8 m (6 ft) 50 Ω cable, Type N Male connectors each end.

Weight

1106B or 1108A: net, 0.5 kg (1 lb); shipping, 0.9 kg (2 lb).

1105A: net, 0.9 kg (2 lb); shipping, 1.4 kg (3 lb).

1109B High-pass filter

The 1109B High-pass Filter transmits only frequencies above 1 GHz. It is useful for blocking the 100 MHz "kickout" encountered when using a tunnel diode countdown to view high frequency signals on a sampling oscilloscope. The 1109B is designed for use with the Model 1104A/1106B Trigger countdown.

Other sampling accessories

50 Ω loads: Models 908A with Type N male connector (4 GHz) and 909A Option 012 with Type N male connector (18 GHz).

50 Ω adapters: Model 11524A has Type N Female and APC-7 connectors; Model 11525A has Type N Male and APC-7 connectors.

Air line extension: Model 11566A, 10 cm, APC-7 connector. Model 11567A, 20 cm, APC-7 connector.

Ordering information

	Price
1815B TDR/Sampler (calibrated in metres)	\$2050
Opt 910: additional Operating and Service Manual covers 1815B and 1817A	add \$10
1817A 28 ps Rise Time Sampling Head	\$2500
1104A Trigger Countdown	\$350
1105A Pulse Generator	\$450
1106B 20 ps Tunnel Diode Mount (Type N Connector)	\$650
1106B Opt 001 (APC-7 Connector)	\$700
1108A 60 ps Tunnel Diode Mount (GR-874 Connector)	\$475
1109B High Pass Filter	\$230
908A 50 Ω Termination	\$55
909A Opt 012 50 Ω Termination	\$110
11524A 50 Ω Adapter	\$95
11525A 50 Ω Adapter	\$105
11566A Air Line Extension	\$170
11567A Air Line Extension	\$195

- Economic spectrum analysis 0.01 to 1500 MHz
- Simple, 3 knob operation
- Direct signal power display in dBm

- Resolution bandwidths from 1 kHz to 3 MHz
- Optional 75Ω input impedance
- Companion tracking generator (for 8558B only)

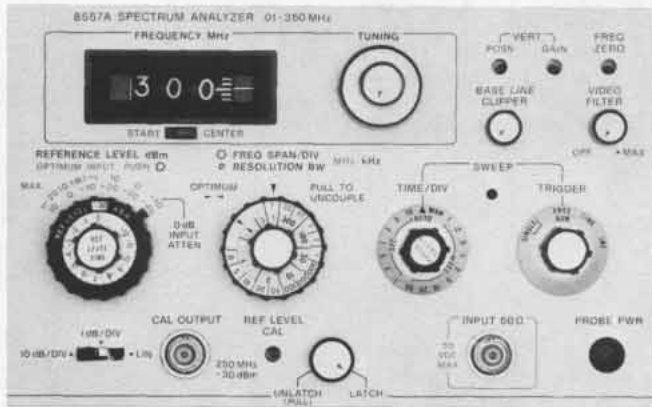

8558B



8557A

8558B and 8557A Spectrum Analyzers

The 8557A/8558B Spectrum Analyzers plug into any 180 series oscilloscope mainframe to provide low cost 0.01 to 350 MHz or 0.1 to 1500 MHz performance with high amplitude and frequency accuracy, and they're easy to use.

Simple three knob operation

For most measurements only three controls are required; one for amplitude calibration and two for frequency calibration. The center or start frequency of the display is shown on a digital readout, and the analyzer automatically selects the resolution bandwidth and proper scan time to provide calibrated measurements with any desired frequency scan.

Absolute amplitude calibration

Signal levels can be read directly from the CRT display in dBm (or dBmV for option 002) without the use of external standards or calculations. The signal level represented by the top CRT graticule line is always indicated by the reference level control, and scale factors of 10 dB/div, 1 dB/div, and linear can be selected.

Optional 75 ohm input impedance

Two options are available which allow measurements in 75 ohm systems: Option 001 has 75 ohm impedance and retains the dBm power calibration; Option 002 has 75 ohm impedance with the amplitude calibrated in dBmV for measurements in systems such as CATV.

Companion tracking generator

The 8444A Option 058 Tracking Generator provides a calibrated RF signal matching exactly the 8558B analyzer tuned frequency. This makes swept frequency tests, such as insertion loss and return loss measurement, possible over 0.5 to 1300 MHz frequency range. The 8444A Option 058 is specified on page 502.

8557A and 8558B Specifications

Frequency specifications

Frequency display span: (on a 10-division CRT horizontal axis): **8557A:** (full span, 0.01–350 MHz), 12 calibrated spans from 20 MHz/div to 5 kHz/div in a 1, 2, 5 sequence; **8558B:** 14 calibrated spans from 100 MHz/div to 5 kHz/div. In 0 kHz/div both analyzers become fixed-tuned receivers.

Digital frequency readout: indicates center frequency or start frequency of the frequency display scan.

Stability:

Residual FM: less than 1 kHz peak-to-peak for time ≤ 0.1 sec.

Noise sidebands: more than 75 dB (8557A), 65 dB (8558B) below CW signal, 50 kHz or more away from signal with a 1 kHz resolution bandwidth and full video filter.

Resolution

Bandwidth ranges: 3 dB resolution bandwidths of 1 kHz to 3 MHz in a 1, 3, 10 sequence.

Resolution bandwidth selectivity: 60 dB/3 dB resolution bandwidth ratio $< 15:1$.

Video filter: post-detection filter used to average displayed noise.

Amplitude specifications

Absolute amplitude calibration range

Log calibration range: from -117 dBm to $+20$ dBm (8557A), $+30$ dBm (8558B) in 10 dB steps. Reference level vernier, 0 to -12 dB continuously.

Log display ranges: 10 dB/div on a 70 dB display, and 1 dB/div on an 8 dB display.

Dynamic range

Average noise level: < -107 dBm with 10 kHz resolution bandwidth (0 dB input attenuation).

Spurious responses: for input signal level \leq Optimum Input Level setting, all image and out-of-band mixing responses, harmonic and intermodulation distortion products are more than 70 dB below input signal level, 1 MHz to 350 MHz (8557A), 5 MHz to 1500 MHz (8558B); 60 dB below, 20 kHz to 1 MHz (8557A), 100 kHz to 5 MHz (8558B).

Residual responses: (no signal present at input): < -100 dBm with 0 dB input attenuation.

Calibrator

Amplitude: -30 dBm ± 1.0 dB.

Frequency: 250 MHz (8557A), 280 MHz (8558B) ± 50 kHz, crystal controlled.

Input specifications

Input impedance: 50Ω nominal.

Typical reflection coefficient < 0.27 (1.74 SWR) 8557A, < 0.20 (1.5 SWR) 8558B for all Optimum Input Level settings except -40 dBm (0 dB Input Attenuation).

Input connector: BNC female (8557A), type N female (8558B).

Input attenuator: 50 dB range (8557A), 70 dB range (8558B).

Price and further information: see pages 500 & 502.

OSCILLOSCOPES

500 kHz General Purpose

Models 1200B, 1201B & 1205B

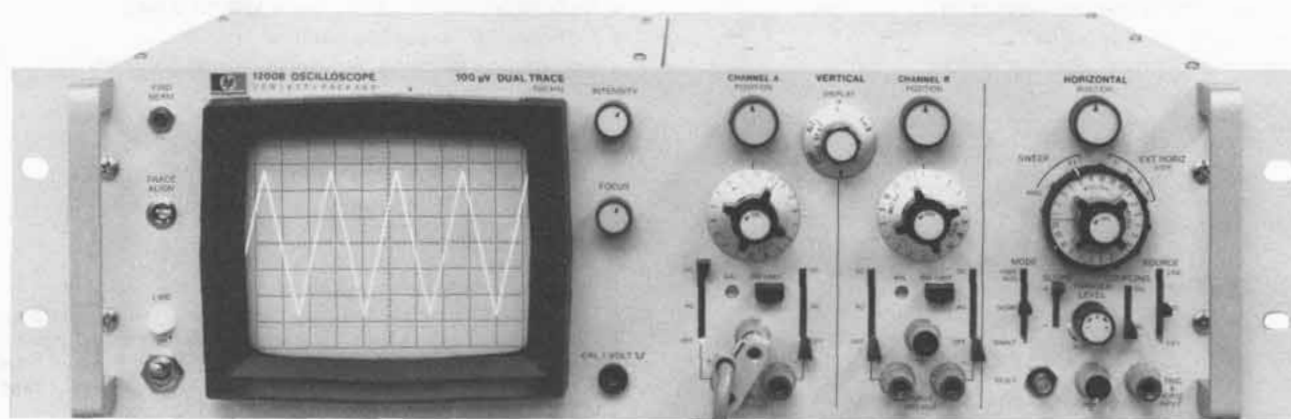

1200B

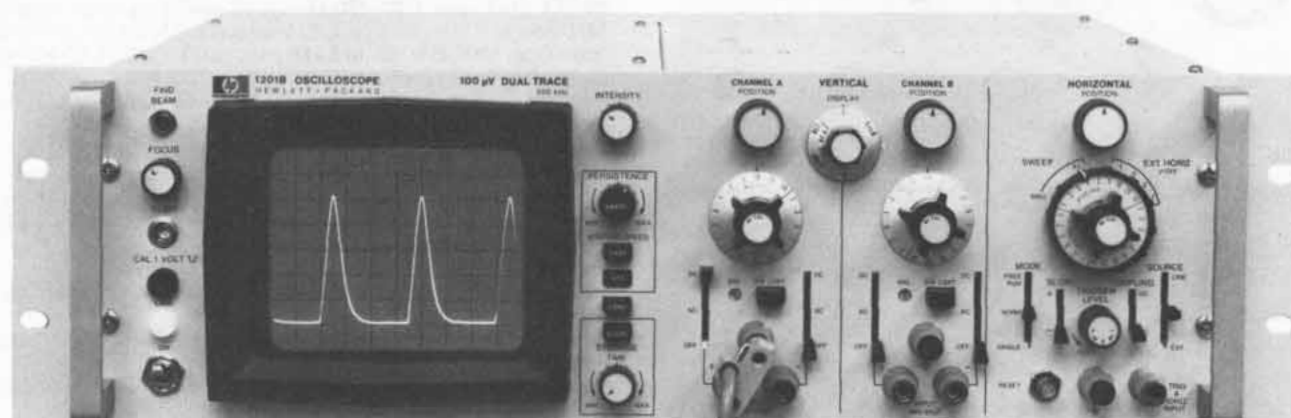

1201B

1200B, 1201B, 1205B Specifications

Vertical amplifiers

Modes of operation: channel A; channel B; channels A and B (either Chop or Alternate triggered by channel A), Chop frequency is ≈ 100 kHz; channel A vs B (A-vertical, B-horizontal).

Bandwidth: dc-coupled, dc to 500 kHz; ac-coupled, 2 Hz to 500 kHz. A bandwidth limit switch (1200 and 1201) selects upper bandwidth to ≈ 50 kHz or 500 kHz.

Rise time: 0.7 μ s max.

Deflection factor

Ranges (1200 and 1201): from 0.1 mV/div to 20 V/div (17 positions) in 1, 2, 5 sequence.

Ranges (1205): from 5 mV/div to 20 V/div (12 positions) in 1, 2, 5 sequence.

Attenuator accuracy: $\pm 3\%$ with vernier in Cal.

Vernier: extends max deflection factor to at least 50 V/div.

Noise (1200 and 1201): < 20 μ V measured tangentially at full bandwidth.

Input: differential or single-ended on all ranges.

Common mode

Frequency: dc to 10 kHz.

Rejection ratio

1200 and 1201: 100 dB (100 000 to 1) with dc-coupled input on 0.1 mV/div range, decreasing by < 20 dB per decade of deflection factor to at least 40 dB on the 0.2 V/div range; CMR is at least 30 dB on 0.5 V/div to 20 V/div ranges. Max signal is ± 10 V (dc + peak ac) on 0.1 mV/div to 0.2 V/div ranges; ± 400 V (dc + peak ac) on all other ranges.

1205: 50 dB with dc-coupled input on 5 mV/div to 0.2 V/div ranges; CMR ≥ 30 dB on the 0.5 V/div to 20 V/div ranges. Max signal is ± 3 V (dc + peak ac) on 5 mV/div to 0.2 V/div ranges; ± 300 V (dc + peak ac) on all other ranges.

Input coupling: selectable AC, DC, or OFF for + and - inputs.

Input RC: ≈ 1 M Ω shunted by ≈ 45 pF.

Max input: ± 400 V (dc + peak ac).

Internal trigger source: on channel A signal for A, Chop, and Alternate displays, on channel B signal for B display.

Isolation: > 80 dB between channels at 500 kHz, with shielded input connectors.

Phase shift: A vs B mode, $< 1^\circ$ to 100 kHz with verniers in Cal.

Time base

Sweep

Ranges: from 1 μ s/div to 5 s/div (21 positions) in 1, 2, 5 sequence; $\pm 3\%$ accuracy with vernier in Cal.

Vernier: extends slowest sweep to at least 12.5 s/div.

Magnifier: direct reading X10 magnifier expands fastest sweep to 100 ns/div with $\pm 5\%$ accuracy.

Automatic triggering

Baseline is displayed in absence of an input signal.

Internal: 50 Hz to above 500 kHz on most signals causing 0.5 div or more vertical deflection. Triggering on line frequency also selectable.

External: 50 Hz to above 1 MHz on most signals ≥ 0.2 V p-p.

Trigger slope: positive or negative slope on internal, external or line trigger signals.

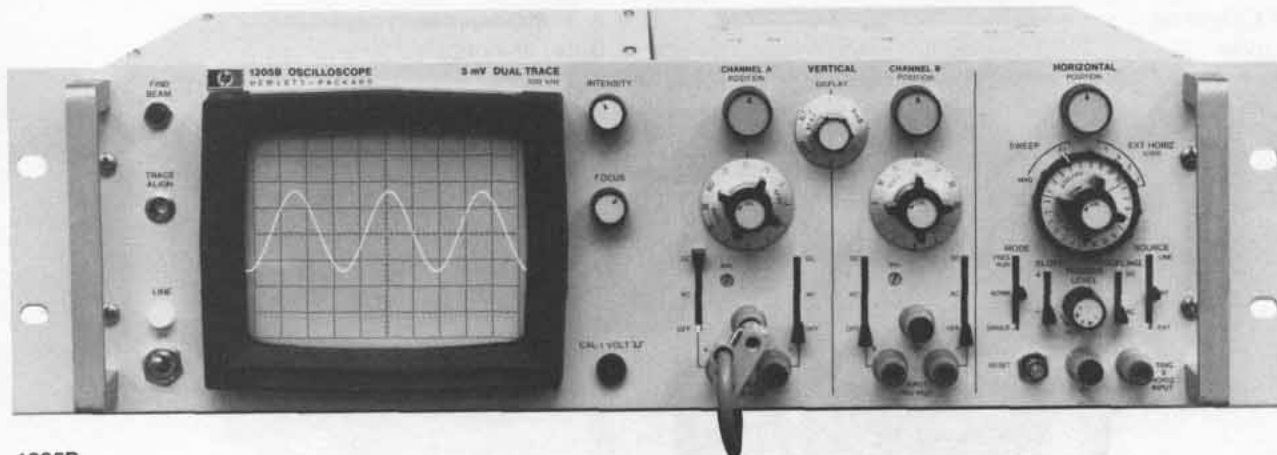

1205B

Amplitude selection triggering

Internal: dc to above 500 kHz on signals causing 0.5 div or more vertical deflection.

External: dc to 1 MHz on signals ≥ 0.2 V p-p. Input impedance ≈ 1 M Ω shunted by ≈ 20 pF.

Trigger level and slope: internal, at any point on vertical waveform displayed; or continuously variable from +100 V to -100 V on either slope of the external trigger signal.

Trigger coupling: dc or ac for external, line, or internal triggering. Lower ac cutoff is 2 Hz for external; 5 Hz for internal.

Single sweep: selectable by front panel switch. Reset switch with armed indicator light.

Free run: selectable by front panel switch.

Max input: ± 350 V (dc + peak ac).

Horizontal amplifier

Bandwidth: dc-coupled, dc to 300 kHz; ac-coupled, 2 Hz to 300 kHz.

Deflection factor: ranges, 0.1 V/div, 0.2 V/div, 0.5 V/div, and 1 V/div. Vernier, extends max deflection to at least 2.5 V/div.

Max input: ± 350 V (dc + peak ac).

Input RC: ≈ 1 M Ω shunted by ≈ 20 pF.

Input: single-ended on all ranges.

Cathode-ray tube and controls

Beam finder: returns trace to CRT screen.

Intensity modulation: +2 V signal blanks trace of normal intensity, +8V signal blanks any intensity trace. DC-coupled rear panel input; amplifier rise time, ≈ 200 ns; input R ≈ 5 k Ω .

Standard CRT, 1200, 1205

Type: mono-accelerator, ≈ 3000 V accelerating potential, P-31 phosphor standard.

Graticule: 8 x 10 div internal graticule, 0.2 subdivision markings on horizontal and vertical major axes; 1 div = 1 cm.

Variable persistence/storage CRT, 1201

Type: post-accelerator, variable persistence storage tube; ≈ 10.5 kV accelerating potential; aluminized P-31 phosphor.

Graticule: 8 x 10 div internal graticule, 0.2 subdivision markings on major axes; 1 div = 0.95 cm.

Persistence storage characteristics

(Referenced to a centered 7 x 9 div area in STD mode and to 2 centered 6 x 8 div area in FAST mode.)

Persistence: conventional, ≈ 40 μ s; variable, continuously variable from 0.2 s to > 1 min. in STD mode; and from 0.2 s to 15 s in FAST mode.

Storage writing speed: STD, 20 div/ms; FAST, 0.5 div/ μ s.

Brightness: 343 cd/m² (100 f) in write mode.

Storage time: STD writing speed variable from ≈ 1 min. to > 2 hr. FAST writing speed, variable from ≈ 115 s to > 15 min.

Erase: pushbutton erasure takes ≈ 1.2 s. Write gun is blanked and sweep is reset until erasure is completed.

General

Calibrator: 1 V $\pm 1.5\%$ line frequency square wave.

Size: 133 H x 483 W x 466 mm D overall; 423 mm D behind front panel (5 $\frac{1}{32}$ " x 19" x 18 $\frac{1}{16}$ "; 16 $\frac{1}{8}$ ").

Power: 115/230 V $\pm 10\%$, 48 to 440 Hz, 150 VA max.

Weight:

1200B, 1205B: net, 10.2 kg (22 $\frac{1}{2}$ lb); shipping, 15.9 kg (35 lb).

1201B: net, 12.5 kg (27 $\frac{1}{2}$ lb); shipping, 18.2 kg (40 lb).

Vertical output signals specifications (Opt 015)

Output: 0.3 V/div $\pm 10\%$, 0 V offset unaffected by position setting.

Bandwidth: dc to 500 kHz.

Dynamic range: ± 3.5 V.

Max slewing rate: 12 V/ μ s with 300 pF load.

Min load RC: 10 k Ω shunted by ≈ 300 pF.

Source impedance: ≈ 300 Ω .

Options

006: rear input terminals wired in parallel with front panel vertical and horizontal input terminals. Vertical input shunt capacitance is increased to ≈ 100 pF. Horizontal input shunt capacitance is increased to ≈ 75 pF.

009: storage model only, remote erase through rear panel banana jack, shorting to ground provides erasure (not compatible with Opt 006).

015: vertical channel signal outputs through rear panel connectors.

910: additional Operating and Service Manual

1200B

1201B

1205B

Price
add \$60

add \$25

add \$125

add \$12

add \$12

add \$13

Ordering information

1200B Dual Channel, 100 μ V Oscilloscope \$1725

1201B Dual Channel, 100 μ V Storage Oscilloscope \$2700

1205B Dual Channel, 5 mV Oscilloscope \$1625

OSCILLOSCOPES

15 MHz dual channel, general purpose

Models 1220A & 1222A

- X-Y Operation
- TV Sync
- Auto or Normal trigger selection (1222A)
- A \pm B Operation (1222A)
- Delay line (1222A)

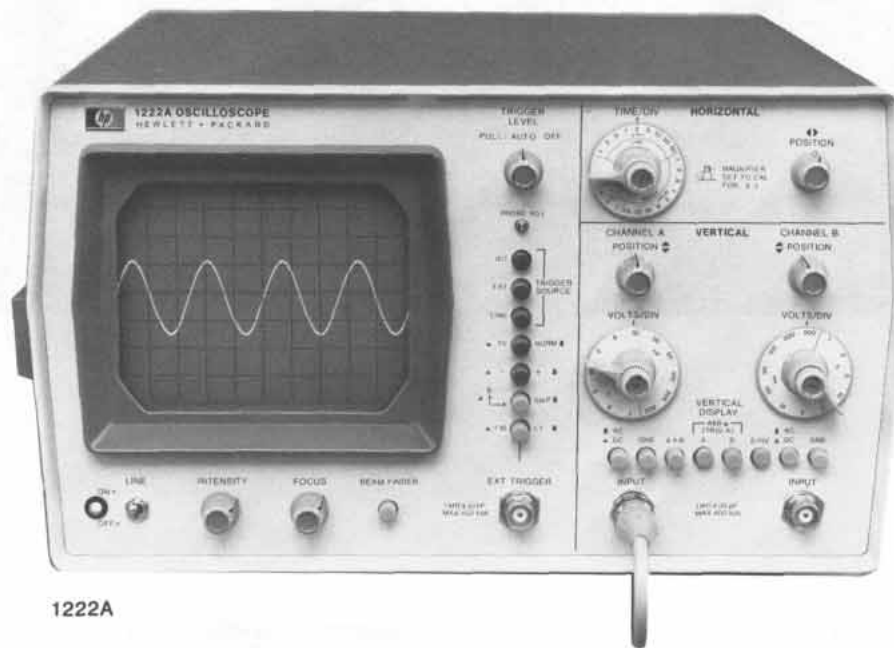

1222A

1220A, 1222A Description

Hewlett-Packard Models 1220A and 1222A dual channel 15 MHz oscilloscopes are high quality instruments with the performance necessary for a wide variety of applications. Features include a large 8 x 10 cm internal graticule for no-parallax measurements, 3% vertical attenuator accuracy, 4% horizontal accuracy, calibrated sweep times from 0.5 s/div to 0.1 μ s/div, dc coupling, automatic triggering, a sweep magnifier to expand the display up to ten times for detailed analysis, a pushbutton beam finder, X-Y display capability and TV Sync separator.

The ability of the 1220A to measure and compare input and output signals makes it an excellent choice for basic electronic laboratories, service, production, and educational purposes. Model 1222A includes a delay line that allows viewing of the leading edge of the pulse that triggered a sweep and provides selection of automatic or normal triggering. Measurements in the design and checkout of logic systems such as calculators and appliance controllers are easily made with the 1222A.

Easy operation

The human engineered front panel with functionally grouped controls and color-coded pushbuttons makes measurements easier and faster. Inputs are protected to 350 V, reducing chances of accidental electrical damage. Automatic triggering assures that a base-line is present even in the absence of a signal or if the trigger level control is set beyond the range of the trigger signal. And, although the oscilloscopes operate in either a chopped or alternate mode, with automatic triggering the operator need not concern himself with making a choice since the Time/Div switch automatically selects the best display mode.

The basic stability of the solid-state circuits and components used throughout is such that internal adjustments have been reduced to a minimum. This decreases calibration requirements and provides real savings over the oscilloscope's lifetime. Recalibration, when necessary is simple and straightforward.

Triggering

Even though the instruments are easy to operate, these oscilloscopes have the flexibility for multi-purpose use. The operator can select the source of sweep trigger (internal, external, ac line, TV) and he can select the trigger slope, adding to the oscilloscope's versatility by allowing triggering on either the positive or negative going transitions

of the signal. Further flexibility is added by the ability to preset the signal amplitude required to trigger the sweep, assuring that perturbations below the desired amplitude will not trigger the oscilloscope.

With automatically triggered sweep, displays are stable because the observed signal itself determines when a sweep should start. Automatic triggering produces a free running trace in the absence of a signal for fast setup. It locks onto any input signal of the proper polarity and amplitude.

CRT

The internal 8 x 10 cm CRT graticule eliminates parallax errors that occur when the graticule is external to the CRT. The 3% vertical accuracy combined with the no-parallax graticule enables the oscilloscope to be used as a voltmeter as well as for waveform display. CRT beam intensity can be modulated through a rear panel Z-axis input.

X-Y Inputs

Phase shift measurements through the vertical amplifiers in the 1222A permit maximum measurement flexibility with the wide selection of deflection factors. In the 1220A, external signals can be applied to the horizontal deflection amplifiers. This X-Y capability permits X-Y plots for Lissajous figures with a phase shift of less than 3° to 100 kHz.

TV sync

The built-in TV sync separator assures stable, automatic triggering on frame or line for convenient TV troubleshooting. With the instrument's times-ten magnifier, signals can be pulled out easily. The calibrated time base makes it easy to identify timing problems in vertical or horizontal TV circuits. The external horizontal input allows vector presentations of color CRT drive signals. Dual channels make it easy to set color demodulator circuits.

Rugged lightweight design

These oscilloscopes are, except for the CRT, entirely of solid-state design, resulting in low power consumption. The consequent low heat has made possible a rugged, lightweight cabinet with a vinyl-clad aluminum cover that is resistant to shock and moisture. A convenient side-panel handle and stabilizing feet on the opposite side make handling easy. This allows these oscilloscopes to be used in areas where ruggedness is a necessity. These areas include production lines, numerically controlled machinery, process control equipment, automotive, aircraft and marine electronics, and communications.

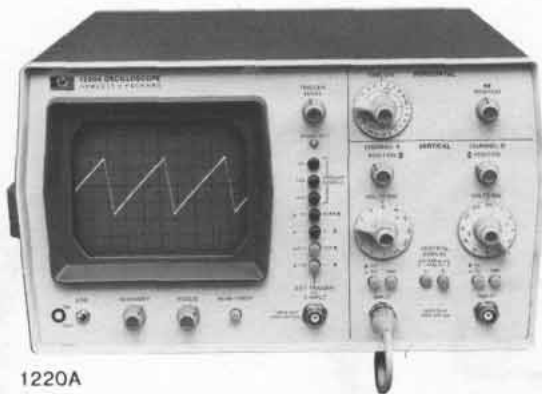

1220A

Optional Accessories

General purpose probing is provided with the Model 10013A 10:1 divider probe with an input impedance of 10 megohms shunted by only 13 pF. It extends input range to 100 V/div and multiplies input impedance without degrading frequency response. An optional front panel cover, Model 10117A, is available for protection during transportation and to provide storage space for probes and other accessories. With a rack mount kit, Model 10119A, the oscilloscopes can be mounted in only 22.2 cm (8 $\frac{3}{4}$ in.) of vertical space. Model 10116A light shield is available for viewing in brightly lighted areas.

1220A, 1222A Specifications

Modes of operation

Channel A; channel B; channel B inverted (1222A); channel A \pm B (1222A); channels A and B displayed alternately on successive sweeps (Alt); triggering by A channel; channels A and B displayed by switching between channels at approx 200 kHz rate with blanking during switching (Chop). Automatic selection of alternate or chop mode—chop, at speeds from 0.5 s/div to 1 ms/div, alternate, 0.5 ms/div to 0.1 μ s/div.

Vertical amplifiers (2)

Bandwidth (3 dB down from 50 kHz, 6 div reference signal from a terminated 50 Ω source.)

DC-coupled: dc to 15 MHz.

AC-coupled: lower limit is \approx 2 Hz.

Rise time: \approx 23 ns (measured from 10% to 90% points of 6 div input step from a terminated 50 Ω source).

Deflection factor

Ranges: from 2 mV/div to 10 V/div (12 calibrated positions) in 1, 2, 5 sequence. \pm 3% Accuracy with vernier in cal position on 20 mV/div to 10 mV/div ranges, \pm 5% on 2 mV/div, 5 mV/div, and 10 mV/div ranges.

Vernier: extends max deflection factor to at least 25 V/div.

Polarity (1222A): Channel B may be inverted.

Signal delay (1222A): input signals are delayed sufficiently to view leading edge of input signal without advanced external trigger.

Input RC: AC or DC, \approx 1 M Ω shunted by \approx 30 pF.

Input coupling: AC, DC, or GND.

Maximum input: \pm 350 V (dc + peak ac).

A + B operation (1222A): bandwidth and deflection factors are unchanged; channel B may be inverted for A - B operation.

Differential (A - B) common mode (1222A): CMR is at least 30 dB from dc to 1 MHz.

Time base

Sweep Ranges: from 0.1 μ s/div to 0.5 s/div (21 ranges) in 1, 2, 5 sequence; \pm 4% accuracy over full scale with Magnifier/Expander in calibrated position.

Sweep trigger mode: sweep is triggered by internal or external signal. Bright baseline displayed in absence of input signal except with 1222A in Normal triggering mode.

Triggering

Internal: \approx 2 Hz to 15 MHz on signals with \geq 1 div vertical deflection.

External: \approx 2 Hz to 15 MHz on signals of 0.1 V p-p or more.

External input RC: \approx 1 M Ω shunted by \approx 30 pF.

Line: triggers on line frequency.

TV sync: separator for + or - video, requires 1 div of video signal to trigger, automatic frame (0.5 s/div to 100 μ s/div) and line select (50 μ s/div to 0.1 μ s/div). Usable also as a low pass filter.

Level and Slope

Internal: at any point on the positive or negative slope of the displayed waveform.

External: continuously variable from +0.5 V to -0.5 V on either slope of the trigger waveform; +10 extends trigger range to +5 V to -5 V.

Calibrated X-Y operation (1222A)

Operation is via channel A (X-axis) and channel B (Y-axis).

Bandwidth: X-axis dc to 1 MHz, otherwise see Vertical Amplifiers Bandwidth specifications.

Accuracy: see Vertical Amplifiers Deflection Factor specifications. X-Y phase shift $<$ 3 $^\circ$ at 100 kHz.

Cathode-ray tube and controls

Type: mono-accelerator, \approx 2 kV accelerating potential, P31 phosphor.

Graticule: 8 x 10 cm internal graticule; 0.2 cm subdivisions on major horizontal and vertical axes.

Beam finder: returns trace to CRT screen.

Intensity modulation: +5 V (TTL compatible) 2 Hz to 1 MHz blanks trace of any intensity. Input R \approx 1 k Ω . Max input, 7 V rms, ac-coupled.

External horizontal input (1220A)

Bandwidth: dc to 1 MHz.

Coupling: dc

EXPANDER	X MODE ATTENUATOR	DEFLECTION FACTOR
Cal.	1:1	1 V/div
Cal.	1:10	10 V/div
cw	1:1	100 mV/div

Continuous adjustment between ranges by Expander.

Input RC: \approx 1 M Ω shunted by \approx 30 pF.

X-Y Phase shift: $<$ 3 $^\circ$ at 100 kHz.

General

Probe adjust: \approx 0.5 V p-p, 1 kHz square wave for adjusting probe compensation.

Power: 100, 120, 220, 240 V, +5%, -10%, 60 VA max.

Weight

1220A: net, 7.3 kg (16 lb); shipping 10 kg (22 lb).

1222A: net, 7.3 kg (16 lb); shipping 10 kg (22 lb).

Size: 181 H x 311.2 W x 412.8 mm D (7 $\frac{1}{8}$ " x 12 $\frac{1}{4}$ " x 16 $\frac{1}{4}$ ").

Accessories furnished: one blue light filter, one power cord, one fuse for 100 V, 120 V, 220 V or 240 V operation, and one Operating and Service Manual.

Environment

Operating temperature: 0 $^\circ$ C to +45 $^\circ$ C (+32 $^\circ$ F to 113 $^\circ$ F).

Non-operating temperature: -40 $^\circ$ C to +75 $^\circ$ C (-40 $^\circ$ F to +167 $^\circ$ F).

Relative humidity: to 95% at +40 $^\circ$ C (+104 $^\circ$ F).

Altitude: to 4600 m (15 000 ft).

Vibration: vibrated in three planes for 15 minutes each with 0.254 mm (0.01 in.) excursion, 10 to 55 Hz.

Accessories available

Accessories available	Price
10116A: Light Shield.	\$13
10117A: Front Panel Cover	\$28
10119A: Rack Mount Kit	\$80
Note: Probes are not supplied	
10013A: 10:1 Divider Probe recommended	\$45

Ordering information

1220A Dual Channel Oscilloscope	\$795
Opt 910: extra Operating and Service Manual	add \$7
1222A Dual Channel Oscilloscope	\$895
Opt 910: extra Operating and Service Manual	add \$7

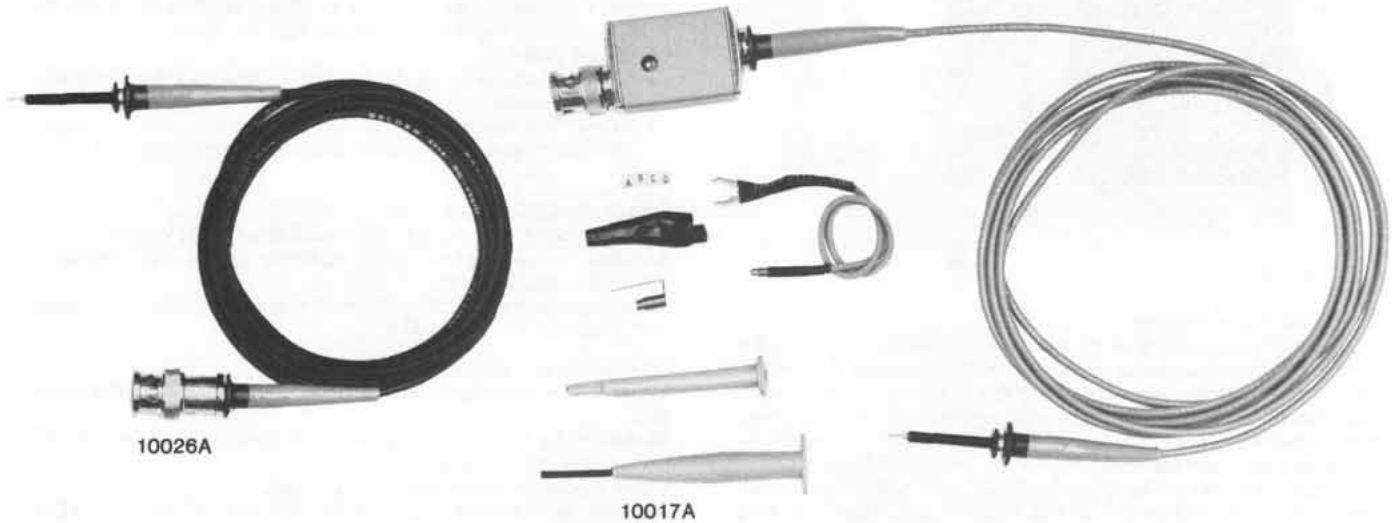

Typical miniature 50Ω probe, left, and 10:1 divider probe, right (accessories shown are supplied with each probe).

Miniature oscilloscope probes

Small, lightweight

Hewlett-Packard's series of miniature, oscilloscope probes easily access test points in densely populated circuits. These small, lightweight probes, which fit in the hand much like a pencil, simplify previously difficult measurements. The basic probe is a small (2.4 mm diameter, 25 mm long) cylinder with a needle-like tip which is used with a variety of interfacing/insulating accessories to meet a variety of testing situations. The narrow body provides easier access to test points in congested areas without worrying about accidental shorts to adjacent leads.

Conventional probing

An insulating sleeve added to the basic probe provides a miniature version of the traditional oscilloscope probe. In this configuration, the probe looks and handles like a small-scale version of the traditional oscilloscope probe except that the forward barrel insulator is retracta-

ble which makes the traditional slip-on insulators for protection against shorts unnecessary. With the barrel insulator retracted, the ground spring configures the probe with a very short ground lead for high-frequency point-to-point probing.

With the barrel insulator in the forward position, the probe is used with the 20 cm flexible ground lead for probing where this type of grounding allows adequate response fidelity. The probe tip makes positive metallic contact to narrow conductors and penetrates commonly-used protective coatings while the extended insulating sleeve prevents shorts to closely-spaced adjacent leads.

With the barrel insulator retracted and using the flexible ground lead, the probe may be used with the slip-on hook tip (figure 1) for attaching to various component leads. For monitoring signals on dual in-line packages, a slip-on IC probe tip adapter allows connection to closely spaced leads without shorting (figure 2).

OSCILLOSCOPE/MINIATURE PROBE COMPATIBILITY AND PROBE CHARACTERISTICS								
HP Oscilloscope/ Plug-in Model No. and Bandwidth	Probe Model No.	Approx Overall Length in Metres (ft)	Division Ratio	Input R	Shunt Capacitance	Compensates Oscilloscope Input	Max DC Volts	Price
1725A/275 MHz 1722A/275 MHz	10017A	1 m (3.3)	10:1	1 MΩ	8pF	9 to 14pF	300	\$90
1715A/200 MHz 1809A/100 MHz 1805A/100 MHz	10018A	2 m (6.6)	10:1	1 MΩ	10pF	9 to 14pF	300	\$90
1741A, 1742A, 1743A, 1744 A/ 100 MHz	10040A	1 m (3.3)	10:1	1 MΩ	9pF	20 to 30pF	300	\$90
	10041A	2 m (6.6)	10:1	1 MΩ	12pF	20 to 26pF	300	\$90
	10042A	3 m (9.8)	10:1	1 MΩ	15pF	20 to 24 pF	300	\$90
All Scopes with high Z inputs (may reduce bandwidth)	10021A	1 m (3.3)	1:1		36 pF		300	\$45
	10022A	2 m (6.6)	1:1		62 pF		300	\$45
All Scopes with 50Ω inputs and signal sources (with a 50Ω source impedance)	10026A	1 m (3.3)	1:1	50Ω			2 Amps	\$45
	10027A	2 m (6.6)	1:1	50Ω			2 Amps	\$45

Accessories supplied with each probe: one retractable hook tip, one IC probe tip adapter, one alligator clip, one 20 cm (8") ground lead, four indicator sleeves (A, B, C, D), one grounding spring, and one Operating Note.

*These miniature probes may be used with other oscilloscopes and test instruments with the proper input capacitance with no noticeable bandwidth degradation. However, due to variations of input characteristics, the probes may require recalibration for optimum performance.

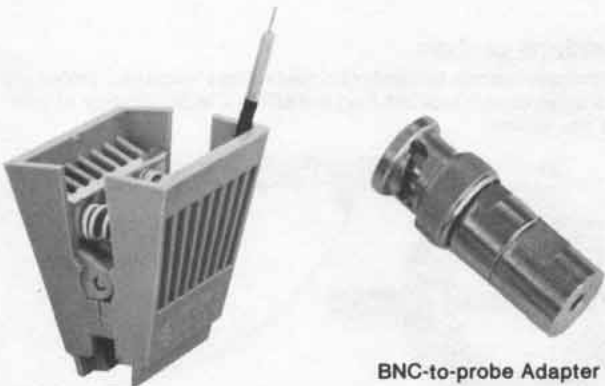

10024A IC Test Clip

BNC-to-probe Adapter

DIP probing

By removing the probe's insulating sleeve and using the accessory clip (10024A), you can monitor points on 14- and 16-pin DIP's with improved pulse fidelity (figure 3) and without worrying about shorting adjacent pins.

In this application, the clip is installed on the DIP, a circuit interface pin is inserted into the appropriate position, and one or more probes are inserted to contact the desired package leads. The circuit interface pin contacts reference planes in the clip to provide a ground reference for any probe inserted in the clip. This grounding arrangement is extremely effective; high-speed pulse fidelity achieves a level previously associated only with probe-to-BNC adapters or high frequency, point-to-point probing. In addition, the clip makes it extremely easy to monitor two channel signals while using a third probe to provide an external trigger signal.

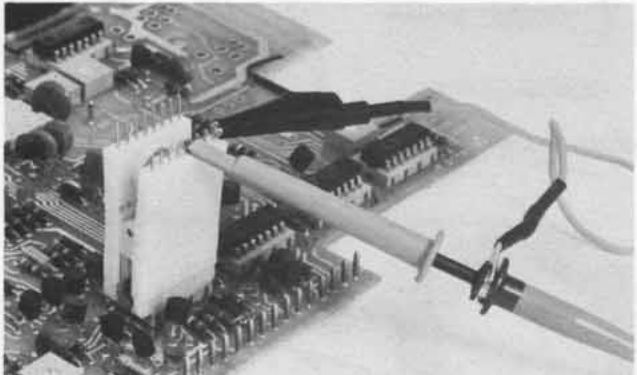

Figure 1. With the slip-on hook tip and flexible ground lead in place, the miniature probe can be used like a conventional probe for attachment to test points or component leads.

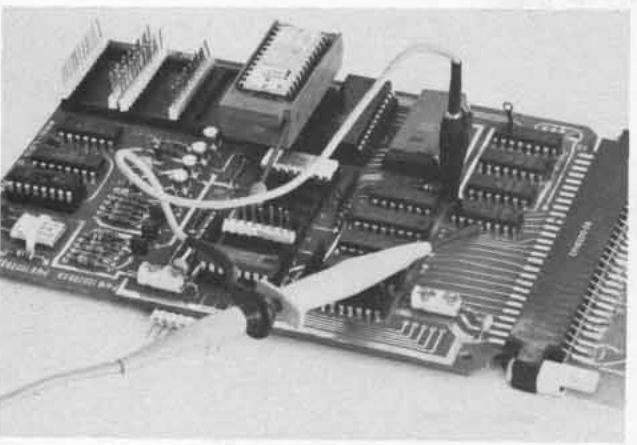

Figure 2. The slip-on IC probe tip adapter provides convenient connection to closely spaced leads on DIP's without shorting.

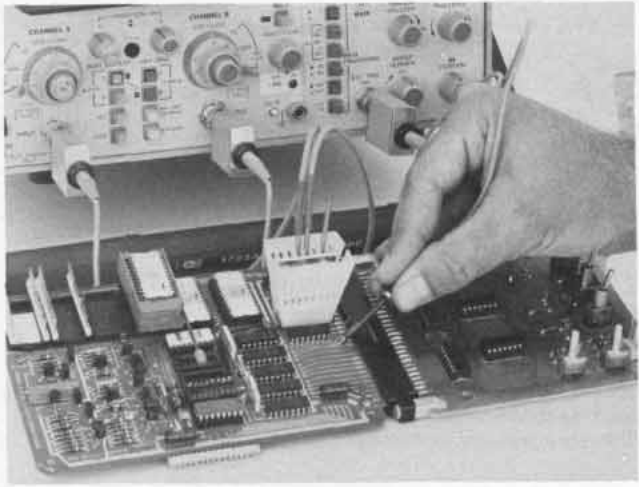

Figure 3. Miniature probes with insulating sleeves removed are held in place on an IC lead by the optional IC clip. The circuit interface pin in the right hand corner of the clip can be inserted at any lead position to ground reference planes that contact the barrel of the probe(s). Rise times as short as 1.3 ns are preserved by this arrangement. The hand held probe's insulating tip has been retracted to allow the spring ground tip to establish a ground-reference point at the end of the barrel for measurements of high speed signals.

The circuit interface pins have a section of insulation which allows them to be inverted from the grounding position for using other types of probes to couple signals into or out of an IC. When the circuit interface pins are used in this position they are isolated from the ground bus in the IC clip.

By using the 50Ω, 1:1 probes, you can insert signals from a pulse generator to determine the IC's response. In other applications, the circuit containing the IC may be removed from the instrument and it can be powered through the 50Ω probes, the IC clip, and the interface pins. This means that the IC clip, circuit interface pins, and miniature probes provide you with a complete testing system for locating IC faults.

Additional circuit interface pins are available in packages of 12 pins so that the clip can be used with other instruments. Each pin has a tip on each end so that probes such as those on HP Logic State Analyzers can be connected for fast, functional checks of circuit operation.

Digital trigger probes

Model 10250A (TTL) 4-bit Trigger Probe is a useful service, production, and design troubleshooting tool that offers digital pattern triggering to enhance the use of oscilloscopes, logic analyzers, and other test equipment.

The compact Model 1230A 8-bit Logic Trigger unit generates a trigger output pulse (TTL compatible) from parallel digital pattern recognition with digital delay capability for oscilloscopes or other externally triggered test equipment.

For 4- and 8-bit parallel trigger probe specifications and prices refer to page 143.

Miniature probe accessories

Probe tip adapter kits: to increase probing versatility, Models 10036B and 10037B probe tip adapter kits are supplied with an assortment of 6/32 screw-on tips with 6/32 to slip-on adapters which permit their use with both miniature and standard probes that accept slip-on tips. Refer to page 187 for ordering information.

Ordering information

	Price
10024A IC Test Clip for easy probing of dual in-line packages; includes 4 insulated circuit interface pins.	\$15
10024-69501 Interface Pin Kit for 10024A; includes 12 interface pins.	\$16
1250-1454 BNC to probe adapter permits the miniature probes to be connected to BNC connectors to maintain fast pulse response.	\$8.25

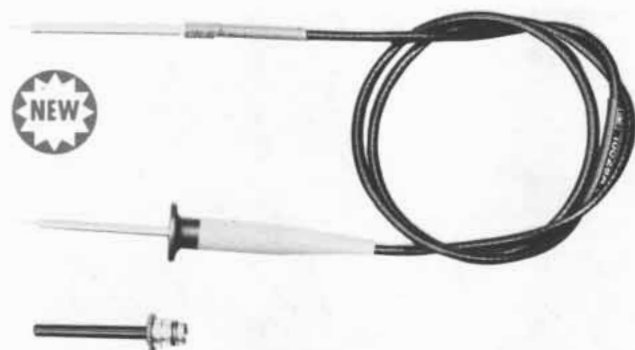

10028A Jumper Cable is supplied with the same probe tip accessories as the miniature probes shown on page 182. A slip-on IC probe tip adapter provides easy access to IC leads.

Multipurpose accessories

10028A Jumper cable

Model 10028A 50 ohm 610 mm (24 in.) miniature probe/jumper cable is designed primarily for bypassing suspected faulty circuits in densely populated IC circuits. The basic tip on either end of the cable inserts directly into a 10024A IC Test Clip, allowing easy temporary connections between IC's without the danger of shorting between pins. The cable can also be used as a 50 ohm 1:1 probe to insert signals from an external source or as an input source to an external measuring device. For the latter uses, Probe Tip to BNC Adapter (HP P/N 1250-1454) is available.

10019A BNC-to square-pin cable assembly

Model 10019A cable assembly is designed for connecting test equipment to 0.64 mm - 0.76 mm (0.025 in. - 0.030 in.) square pin signal nodes or to integrated circuits through the 10024A IC Test Clip. This adaptable cable assembly is primarily used as:

a. A signal pick-off device for applying circuit signals to the input of test equipment such as oscilloscopes, voltmeters, etc. An application is the checking of voltages on computer back plane pins.

b. A signal insertion cable for inserting signals into suspected faulty circuits from power supplies, pulse generators, etc. Used in conjunction with Model 10024A IC Test Clip, signals are easily inserted into the proper IC leads.

For applications requiring greater separation between the circuit nodes and the instrumentation, the 10019A may be extended by using a BNC-to-BNC adapter (HP P/N 1250-0080) and a 50 ohm test cable such as the 122 cm (48 in.) Model 11170C. And when the test equipment hookup requires a dual banana plug, BNC-to-Dual Banana Plug Adapter (HP P/N 1251-2277) is available.

10017-67603 Coaxial Adapter cable

HP P/N 10017-67603 is a 230 mm (9 in.) slip-on adapter cable for standard HP probes that provides a coaxial interface to 0.64 mm (0.025 in.) square pin circuit nodes. The adapter is ideal for probing computer back planes as well as wire wrap terminals.

10017-67604 Coaxial Adapter

HP P/N 10017-67604 allows standard size probe tip accessories to be used with HP miniature probes. With the retractable insulating barrel removed from the miniature probe and replaced with the 10017-67604 adapter, the probe slides directly onto the standard size probe tip accessories.

Ordering Information

	Price
10028A Jumper Cable	\$45
1250-1454 Probe Tip to BNC Adapter	\$8.25
10019A Cable Assembly	\$20
10017-67603 Adapter Cable	\$20
10017-67604 Adapter	\$5
1250-0080 BNC to BNC Adapter	\$4.90
11170C 50 ohm BNC to BNC cable, 122 cm, (48 in.)	\$17
1251-2277 BNC to Dual Banana Plug Adapter	\$10

Standard probes

For measurements in standard circuits where miniature probes are not a requirement, Hewlett-Packard offers a wide selection of standard size probes.

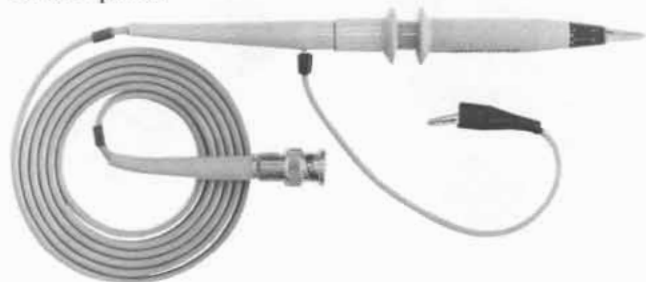

10001-10003A



10004D-10006D, 10014A, 10016B

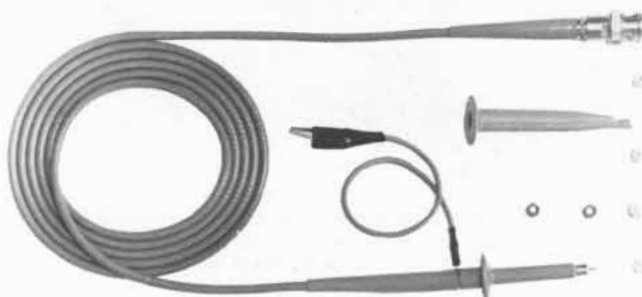

10007B, 10008B

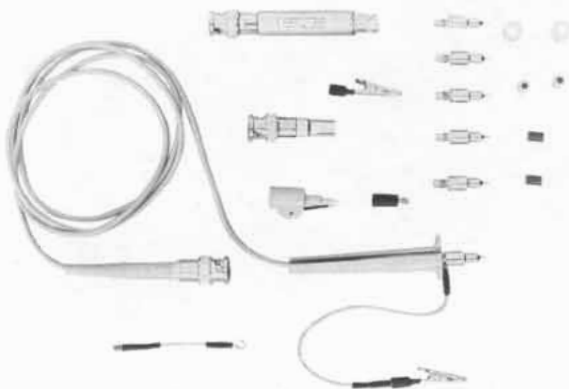

10020A

Standard probe/instrument compatibility

Scope/ Plug-in	1200 Series	1220 Series	1715A/1725A	1722B	1740A thru 1744A	1801A thru 1804A	1805A	1806A	1809A	1810A	1811A	1815B
Probe												
10001A	X	X			L	L		X				
10001B	X	X			L	L		X				
10002A	X	X			L	L		X				
10002B	X	X			L	L		X				
10003A	X	X			L	L		X				
10004D		X			X	X						
10005D		X			L	X						
10006D		X			X	X						
10007B	X	X	L	L	L	L	L	X	L			
10008B	X	L	L	L	L	L	L	X	L			
10013A	X	X				L		X				
10014A			X	X			X		X			
10016B			X	X			X		X			
10020A			X	v	X		X		X	L	L	L
1120A			X	X	X		X		X	L	L	L
1124A			L	L	L		L		L	L	L	L

Notes:
 X Indicates that probe will maintain the bandwidth of the instrument
 L Indicates that probe may limit the bandwidth of the instrument.

Standard divider probe specifications

Model No.	Division Ratio	Resistance (M Ω)	Shunt Capacitance (pF)	Compensates Scope Input C (pF)	Max DC Volts	Overall Length m (ft)	Price
10001A	10:1	10	10	15-55	600	1.5 (5)	\$80
10001B	10:1	10	20	15-45	600	2.7 (9)	\$90
1002A	50:1	9	2.5	15-55	1000	1.5 (5)	\$80
10002B	50:1	9	5	15-55	1000	2.7 (9)	\$90
10003A	10:1	10	10	15-55	600	1.3 (4)	\$80
10004D	10:1	10	10	20-30	500	1.1 (3.5)	\$65
10005D	10:1	10	17	20-30	500	3.0 (10)	\$65
10006D	10:1	10	14	20-30	500	1.8 (6)	\$65
10007B	1:1	—	40	—	600	1.1 (3.5)	\$40
10008B	1:1	—	60	—	600	1.8 (6)	\$40
10013A	10:1	10	13	24-45	500	1.8 (6)	\$45
10014A	10:1	10	10	9-13	500	1.1 (3.5)	\$65
10016B	10:1	10	14	9-13	500	1.8 (6)	\$75

10020A Resistive dividers

Division Ratio	Input R* (ohms)	Division Accuracy	Max V** (rms)	Input C (pF)
1:1	50	—	6	—
5:1	250	±3%	9	<0.7
10:1	500	±3%	12	<0.7
20:1	1000	±3%	15	<0.7
50:1	2500	±3%	25	<0.7
100:1	5000	±3%	35	<0.7

*When terminated in 50 ohms.
 **Limited by power dissipation of resistive element.

Probe length (overall): ≈ 121.9 cm (4 ft).
Weight: net, 0.45 kg (1 lb); shipping, 1.36 kg (3 lb).
Accessories supplied: blocking capacitor, BNC adapter tip, 6-32 adapter tip, alligator tip, boot extension, cable assy's 5.1 cm (2 in.) and 15.2 cm (6 in.) ground, spanner tip, insulating cap, colored sleeve.

10020A Resistive Divider Probe Kit \$190



1120A

1120A 500 MHz active probe

For probing high source impedances at high frequencies, the Model 1120A 1:1 active probe provides a probe tip impedance of 100 kΩ shunted by approx 3 pF at 100 MHz. When used with the 10:1 or 100:1 divider tips, the shunt capacitance is <1 pF at 100 MHz. The 50 ohm output provides the optimum impedance match for 50 ohm input plug-ins for accurate measurements. Power is supplied by instruments with probe power jacks or the 1122A probe power supply.

1120A Specifications

(Measured with output connected to a 50Ω load.)
Bandwidth: (measured from a terminated 50Ω source) dc-coupled, dc to >500 MHz; ac-coupled, <1.5 kHz to >500 MHz.
Pulse response: (measured from a terminated 50Ω source) transition time, <0.75 ns; perturbations, <±10% measured with 1 GHz sampler.
Dynamic range: ±0.5 V with ±5 V dc offset.
Noise: ≈ 2.5 mV (measured tangentially).
Input RC: 100 kΩ, shunt capacitance ≈ 3 pF at 100 MHz; with 10:1 or 100:1 dividers, shunt capacitance is <1 pF at 100 MHz.
Maximum input: ±80 V.
Weight: net, 1.8 kg (4 lb); shipping, 3.2 kg (7 lb).
Power: supplied by oscilloscopes with probe power jacks or a Model 1122A probe power supply.
Length: 1.2 m (4 ft) overall; with Option 001, 1.8 m (6 ft).

Accessories furnished

Model 10241A 10:1 divider: increases input R to ≈ 1 MΩ shunted by <1 pF at 100 MHz.
Model 10243A 100:1 divider: increases input R to ≈ 1 MΩ shunted by <1 pF at 100 MHz.
Model 10242A bandwidth limiter: reduces bandwidth to ≈ 27 MHz shunted by ≈ 6 pF and reduces gain <2%.
Also included: slip-on hook tip, 6.4 cm (2.5 in.) ground lead, spare probe tips, a slip-on BNC probe adapter, and a probe divider adjustment tool (PN 5020-0570).

Ordering information

1120A 500 MHz Active Probe
1120A Opt 001, 1.8 m (6 ft) length

Price
 \$650
 add \$35

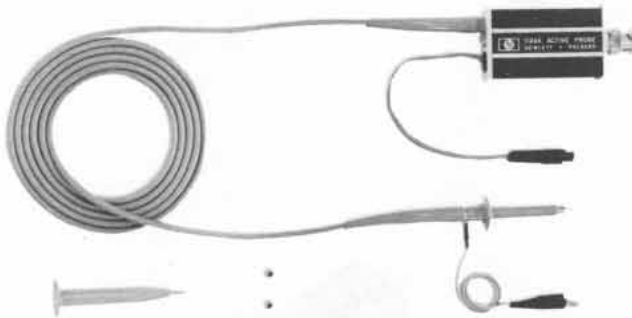

1124A



1122A



1111A



1110A

1124A 100 MHz active probe

Model 1124A Active Divider Probe provides high voltage, general purpose probing capabilities for instruments having 50 ohm inputs without selectable high impedance inputs. This 10 megohm 10 pF probe allows direct measurements of 100 volts, in the 100:1 division ratio mode, from dc to 100 MHz. In the 10:1 division ratio mode, input voltage range is ± 10 volts. Power is supplied by instruments with probe power jacks or the 1122A probe power supply.

1124A Specifications

(Measured when connected to a 50 Ω load.)

Bandwidth: (measured from a terminated 50 Ω source) dc-coupled,

dc to 100 MHz; ac-coupled, 2 Hz to 100 MHz.

Pulse response: (measured from a terminated 50 Ω source) transition time, <3.5 ns; perturbations, 5% p-p. Measured with pulse transition time of >2.5 ns.

Attenuation ratio: 10:1 $\pm 5\%$; 100:1 $\pm 5\%$.

Dynamic range: X10, ± 10 V; X100, ± 100 V.

Input RC: 10 M Ω shunted by ≈ 10 pF.

Maximum safe input

DC-coupled: X10, ± 300 V (dc + peak ac) ≤ 100 MHz; X100, ± 500 V (dc + peak ac) ≤ 100 MHz.

AC-coupled: X10, ± 300 V (dc + peak ac) ≤ 100 MHz. DC component must not exceed ± 200 V; X100, ± 500 V (dc + peak ac) ≤ 100 MHz. DC component must not exceed ± 200 V.

Accessories supplied: one 20.3 cm (8 in.) ground lead, one retractable hook tip, and two probe tip insulating caps.

Power: supplied by instruments with probe power jacks or Model 1122A probe power supply.

Weight: net, 0.2 kg (5 oz.); shipping, 0.91 kg (2 lb).

Length: ≈ 1.5 m (5 ft) overall.

Available accessory: 10131B 91.4 cm (36 in.) extender cable (refer to 1122A Probe Power Supply). Required for use with 1700 oscilloscopes with probe power option.

1122A Probe power supply

Model 1122A is a regulated power supply that provides all power requirements for simultaneous operation of up to four active probes.

1122A Specifications

Probe driving capability: up to four HP active probes.

Power output: -12.6 V and $+15$ V, $\pm 3\%$.

Power input: 115 V or 230 V $\pm 10\%$, 48 to 440 Hz, 40 W (with four probes).

Weight: net, 2.7 Kg (6 lb); shipping, 3.6 kg (8 lb).

Accessories supplied: four Model 10131B 91.4 cm (36 in.) extender cables.

1111A AC current amplifier

Deflection factor: (with a 50 mV/div oscilloscope deflection factor) in X1, 1 mA/div to 50 mA/div; in X100, 100 mA/div to 5 A/div; 1, 2, 5 sequence in X1 or X100.

Accuracy: in X1, $\pm 3\%$; in X100, $\pm 4\%$.

Rise time: 18 ns.

Noise: <100 μ A p-p, referenced to input signal.

Maximum ac current: above 700 Hz, 50 A p-p; below 700 Hz, decreases at 1.4 A/20 Hz.

Output impedance: 50 Ω .

Size: 38.1 H \times 130.2 W \times 152.4 mm D (1 $\frac{1}{2}$ " \times 5 $\frac{1}{8}$ " \times 6").

Weight: net, ≈ 0.9 kg (2 lb); shipping, 1.4 kg (3 lb).

Power: 115 or 230 V $\pm 10\%$, 50 to 440 Hz, 1.5 watts.

1110A Current probe

Sensitivity: without 100 Ω termination, 1 mV/mA; with 100 Ω termination, 0.5 mV/mA.

Accuracy: $\pm 3\%$.

Bandwidth

Lower -3 dB point: without 100 Ω termination, ≈ 1700 Hz; with 100 Ω termination, ≈ 850 Hz.

Upper -3 dB point: with 4 pF capacitive load, ≈ 45 MHz; with 30 pF capacitive load ≈ 35 MHz.

Rise time: with 4 pF capacitive load, ≈ 7 ns; with 30 pF capacitive load, ≈ 9 ns.

Insertion impedance: $\approx 0.01\Omega$ shunted by 1 μ H; capacitance to ground <3 pF.

Maximum dc current: 0.5 A.

Maximum ac current: 15 A p-p above 4 kHz; decreasing below 4 kHz at 3.8 A/kHz rate.

Weight: net, 0.5 kg (1 lb); shipping, 0.9 kg (2 lb).

Dimensions: probe aperture, 3.9 mm ($\frac{1}{16}$ " diameter); overall length, 1.5 m (5 ft).

Ordering information

1122A Probe Power Supply	\$425
1124A 100 MHz Active Probe	\$170
1111A Current Amplifier	\$500
1110A Current Probe	\$220

Price

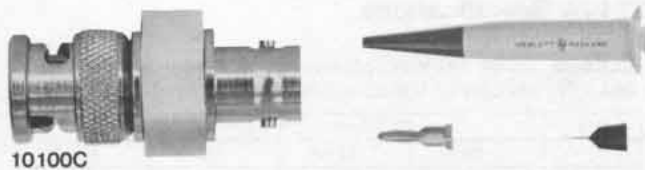

10100C



10011B



10035A



10116A

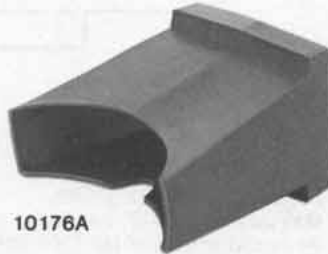

10176A

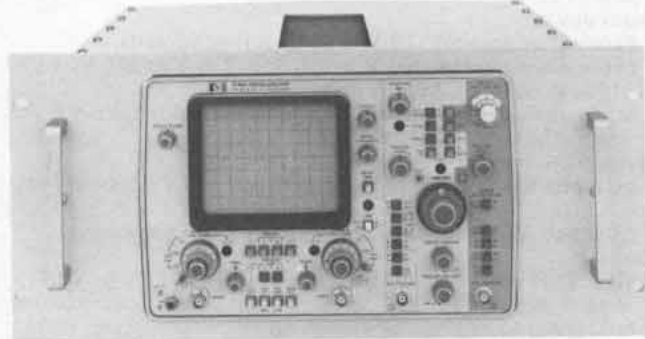

10491B

Probe accessories

Terminations

- 10100C:** 50Ω feedthrough.
- 10100B:** 100Ω (±2Ω) feedthrough for 1110A current probe.

Probe tip adapters

10011B BNC probe tip adapter: for probes 10004D-10006D, 10007B, 10008B, 10013A, 10014A, 10016B, and 1124A.
HP P/N 10004-69515 IC probe tip adapter: provides convenient connection to dual in-line packages for probes 10004D-10006D, 10007B, 10008B, 10013A, 10014A, 10016B, and 1124A.

Probe tip kits

Probe tip kits, Models 10036B and 10037B, extend usefulness of 10004D, 10005D, 10006D, 10007B, 10008B, 10013A, 10014A, 10016B, 1124A standard size probes and HP miniature probes. Model 10036B includes an assortment of tips for the following: 2.0 mm (0.08 in.) jack; 0.6 mm (0.025 in.) and 1.14 mm (0.045 in.) square pin; 1.0 mm-1.6 mm (0.040-0.062 in.) dia pin. Model 10037B includes six 0.6 mm (0.025 in.) square pin tips. Probe tip kit Model 10035A for 10001A-10003A probes contains pincer jaw, banana tip, pin tip, and spring tip.

Model 10034A probe adapter kit consists of an assortment of 6-32 screw-on tips, and two ground lead cables which allow many methods of connecting the ground leads in a circuit. A 6-32 to slip-on adapter allows these tips to be used on 10004D-10006D, 10007B, 10008B, 10013A, 10014A, 10016B, and 1124A probe. The kit consists of one 15.2 cm (6 in.) and one 30.5 cm (12 in.) ground lead, one hook tip, one alligator tip, one pin tip, one tip for 0.6 mm (0.025 in.) square pins, one banana tip, and one slip-on to 6-32 adapter.

Servicing and viewing accessories

Plug-in extender

Model 10407B: 180 system extender (metal frame extends both plug-ins). Allows calibration and maintenance while a unit is operating.

Viewing hoods

- 10116A:** collapsible light shield for 1220 series oscilloscopes.
- 10140A:** collapsible viewing hood for 1700 series oscilloscopes.
- 10176A:** viewing hood for 12.7 cm (5 in.) rectangular CRT bezels.

Light filters

- 10173A:** RFI filter and contrast screen for 1700 series oscilloscopes.
- 10178A:** metal mesh contrast screen for 181, 184 oscilloscopes.
- Amber plastic filter:** HP P/N 5020-0530, for 12.7 cm (5 in.) rectangular CRT.
- Smoke gray plastic filter:** HP P/N 5020-0567, for 12.7 cm (5 in.) rectangular CRT.
- Blue plastic filter:** HP P/N 5060-0548, for 12.7 cm (5 in.) rectangular CRT.
- Blue light filter:** HP P/N 01740-02701 for 1700 series oscilloscopes.

Rack mount slides and adapters

1700 series oscilloscopes, 1600A Logic State Analyzer

- 10491B rack mount adapter:** adapts 1700 series oscilloscopes and 1600A Logic State Analyzer to standard 483 mm (19") rack; 222 mm (8¾") high, 540 mm (21¼") deep.
- 180 and 181 rack style oscilloscopes**
- A slide adapter is required to secure an oscilloscope to the slides.
- Fixed slides:** HP P/N 1490-0714, 55.9 cm (22").
- Pivot slides:** HP P/N 1490-0719, 55.9 cm (22").
- Slide adapter:** HP P/N 1490-0768 (required for all slides).

Front panel cover

HP P/N 5040-0516: provides front panel protection for 1700 series oscilloscopes, 1600A Logic State Analyzer.

Ordering information

	Price
10100C 50Ω Feedthrough Termination	\$22
10100B 100Ω (±2Ω) Feedthrough Termination	\$30
10011B BNC Probe Tip Adapter	\$12
10004-69515 IC Probe Tip Adapter	\$6
10034A Probe Tip Kit	\$32
10035A Probe Tip Kit	\$15
10036B Probe Tip Kit	\$45
10037B Probe Tip Kit	\$45
10407B Plug-in Extender	\$200
10116A Light Shield for 1220 series oscilloscopes	\$13
10140A Viewing Hood for 1700 series (8x10 div. CRT)	\$15
10176A Viewing Hood for 12.7 cm (5 in.) rect. CRT	\$19
10173A RFI Filter and Contrast Screen for 1700 series oscilloscopes (8x10 div. CRT)	\$20
10178A Metal Mesh Contrast Screen for 181, 184 oscilloscopes	\$20
5020-0530 Amber Plastic Filter for 12.7 cm (5 in.) rectangular CRT	\$10.50
5020-0567 Smoke Gray Plastic Filter for 12.7 cm (5 in.) rectangular CRT.	\$13.50
5060-0548 Blue Plastic Filter for 12.7 cm (5 in.) rectangular CRT	\$5
01740-02701 Blue Light Filter for 1700 series oscilloscopes (8x10 div. CRT)	\$3.75
10491B Rack Adapter for 1700 series oscilloscopes, 1600A Logic State Analyzer	\$120
1490-0714 Fixed Slides for 180, 181 rack style oscilloscopes	\$57.50
1490-0719 Pivoted Slides for 180, 181 rack style oscilloscopes	\$110
1490-0768 Slide Adapter, required for securing slides to 180, 181 rack style oscilloscopes	\$125
5040-0516 Front Panel Cover for 1700 series oscilloscopes, 1600A Logic State Analyzer	\$7.50



1112A

1112A Inverter power supply

Model 1112A Inverter Power Supply provides a portable power source for HP 1700 series oscilloscopes. The regulated 400 Hz, 120 V or 240 V power output can be derived from either an internal nickel cadmium battery pack or from an external 11.5 V to 50 V dc source.

No modifications are required to 1700 series oscilloscopes when using the 1112A; simply set the power supply line voltage to match your normal line voltage and you are ready to make measurements. A mounting bracket kit is supplied so that the 1112A can be mounted on the top or bottom of the oscilloscope for a unified package. With a fully charged internal battery pack, the 1112A is capable of operating a Model 1740A oscilloscope for approximately two hours. Operating time is dependent on battery condition (full or partial charge) and the oscilloscope power requirements which vary with operating modes. For example, oscilloscopes power requirements increase when using a high intensity trace, delayed sweep, and/or the verniers which turn on the Uncal indicators.

The inverter allows the full measurement capabilities of your oscilloscope to be used in areas where adequate line power is not available.

Note: The Model 1112A Inverter Power Supply is *not* intended for use in floating (non-grounded) measurements. Hewlett-Packard 1700 series oscilloscopes are constructed with their chassis common to the low side of the BNC input terminals. Therefore, if the oscilloscope chassis is not grounded and the probe ground lead is connected to a potential other than ground, a serious shock hazard could be present.

Grounding

When operating the Inverter on its internal battery pack or from an external dc source (with its ac line disconnected), inverter/oscilloscope combination grounding is provided by the 2.1 m (7 ft) ground lead supplied with each inverter. When the inverter ac power cord is connected to an approved three-contact electrical outlet, both the oscilloscope and inverter chassis are automatically grounded.

Battery operation

The inverter can be powered from either an external dc source, such as a marine battery* or from its supplied internal battery pack. When operating from the internal battery pack, excessive discharging is prevented by a built-in protection circuit which flashes a front panel LED for about 10 minutes when the battery power is low and then disables the inverter output. Charging of the internal battery can be accomplished from either an ac or dc source. When using an ac charging source, line power is also applied to the inverter output which allows oscilloscope operation while the battery is charging. Temperature sensors inside the battery pack prevent cell damage during a charging cycle. These sensors also prevent battery damage if the charging source remains connected beyond the full charging time.

*Automobile batteries, when used as a stand-alone power source, will not provide satisfactory life due to their poor recovery from deep discharge.

Output power

The 400 Hz Inverter output waveform is a complex wave shape with the same ratio of peak to rms values of sine waves (1:0.707) that matches the oscilloscope input requirements. The use of a complex waveform output, rather than a square wave output with a peak to rms value of 1:1, assures that there is no additional stress in your oscilloscope's power supply circuits and CRT filament when using the 1112A as a power source.

1112A Specifications

Output

Voltage: 120 or 240 V ac, peak-to-peak output is fixed at 285 V; rms value changes with load; minimum usable load, 20 W.

Load	120 V Range		240 V Range	
	400 Hz	60 Hz*	400 Hz	60 Hz*
65 W	≥ 96 V rms	≥ 99 V rms	≥ 192 V rms	≥ 198 V rms
20 W	≤ 126 V rms	≤ 126 V rms	≤ 250 V rms	≤ 250 V rms

*With Option 060



Waveform: duty cycle is 50% for loads of 40 W, increasing to 65 as the load decreases to 20 W.

Frequency: 400 Hz \pm 10%.

Max power: \approx 80 W, compatible with line voltage and 60 to 70 VA load requirements of HP 1700 series oscilloscopes.

Operating time: \approx 140 watt hours with a fully charged battery pack at 25°C.

Input power

External dc source: 11.5 V to 50 V, at least 90 watts.

External ac source: 100 V to 120 V or 220 V to 240 V, +5%, -10%; 48 to 66 Hz; 250 VA max.

AC feedthrough operation: output voltage and frequency is the same as the input; output power, 120 VA max.

Battery charging

AC input: full charge in 14 hrs at 25°C with 120 V rms input (80% in 8 hrs).

DC input: full charge in 24 hrs at 25°C with 18 watts input.

General

Size: 92 H x 273 W x 403 mm D (3 $\frac{3}{8}$ " x 10 $\frac{3}{4}$ " x 15 $\frac{7}{8}$ ").

Weight: net, 9.4 kg (20 $\frac{3}{4}$ lb) with battery pack and mounting bracket kit, 4.8 kg (10 $\frac{1}{2}$ lb) without battery pack; shipping, 10.3 kg (23 $\frac{3}{4}$ lb) with battery pack and mounting bracket kit, 5.7 kg (12 $\frac{1}{2}$ lb) without battery pack.

Oscilloscope compatibility: HP Models 1740A, 1741A, 1742A, 1743A, 1744A, 1715A, 1725A, 1722B. For compatibility with other instruments call your Hewlett-Packard Field Engineer.

Operating environment: temperature, 0 to +55°C (+32°F to +130°F), non-operating -40°C to +55°C (-40°F to +130°F); humidity, to 95% relative humidity at +40°C (+104°F); altitude, to 4600 m (15 000 ft); vibration, vibrated in three planes for 15 min. each with 0.38 mm (0.015 in.) excursion, 10 to 55 Hz.

Accessories supplied: one Model 10421A battery pack, one mounting bracket kit, one 2.3 m (7.5 ft) power cord, one 2.1 m (7 ft) grounding cable, and one operating and service manual.

1112A Accessories

10421A Battery pack: the battery pack consists of 30 size "D" nickel cadmium cells and includes temperature sensors to reduce the possibility of cell damage during charging.

Weight: net, 4.6 kg (10 $\frac{1}{4}$ lb); shipping, 5.6 kg (12 $\frac{1}{4}$ lb).

01112-61605 Grounding cable: grounds inverter and oscilloscope chassis (supplied with 1112A).

01112-69501 Mounting bracket kit: for mounting the 1112A on top or bottom of 1700 series oscilloscopes (supplied with 1112A).

Ordering information

1112A Inverter power supply (400 Hz)

Opt 001: without battery pack

Opt 002: without mounting bracket kit

Opt 060: 60 Hz output frequency, interval battery operation reduced to 120 watt hours

10421A Battery pack

01112-61605 Grounding cable

01112-69501 Mounting bracket kit

Price

\$900

less \$275

less \$15

add \$25

\$300

\$5

\$30

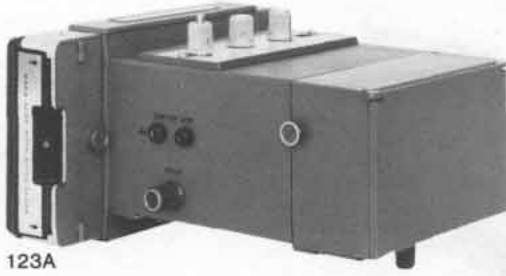

123A



197A

123A Description

Model 123A is a lightweight compact camera which fits directly on HP 1700 series oscilloscopes with 6 x 10 div CRT's. The camera does not require external power and only weighs 1.6 kg (3½ lb) making it ideal for use in field applications. The 123A has a range finder for easy focusing using a split image technique. This range finder also serves as a viewing port so that you can make minor CRT intensity and graticule illumination adjustments with the camera in place. For convenience in setting up the display the camera has a swing-away feature allowing full visibility of the CRT screen. Controls are color coded for optimum settings and are located outside of the camera for easy reading and fast adjustment to reduce initial setup time.

The 123A mounts directly or with adapters to the oscilloscopes as listed in the oscilloscope/camera adapter table.

123A Specifications

Reduction ratio: continuously adjustable from 1:1 to 1:0.65.
Lens: 56 mm, f/3.5 lens; aperture ranges f/3.5, f/4, f/5.6, f/8, f/11, f/16, and f/22.
Shutter speeds: 1/60, 1/30, 1/15, 1/8, 1/4, 1/2, and 1 second, and Bulb. Cable has thumbscrew lock for time exposures. X-type contacts trigger or synchronize other equipment with shutter release.
Graticule illumination: supplied by the oscilloscope.
Camera back: 83 mm x 108 mm (3 1/4" x 4 1/4"). Polaroid® pack back.
Mounting: lift on/off mounting with positive lock. Mounts directly on HP 1700 series oscilloscope with 6 x 10 div CRT's. Adapters are available to fit other scopes, see Camera Accessories.
Range finder: viewing port provides split image of the CRT to allow setting of the focus.
Viewing: range finder viewing port allows viewing the CRT with camera in position. Camera swings away for wide angle viewing.
Focus: adjustable with camera back closed or open; split image focusing plate provided for use when object-to-image ratio is changed.
Size: 122 H x 192 W x 220 mm D (4 13/16" x 7 9/16" x 8 13/16").
Weight: net, 1.6 kg (3 1/2 lb). Shipping, 2.3 kg (5 lb).
Accessories furnished: combination split image focusing plate and reduction ratio scale, and instruction manual.

*Polaroid® by Polaroid Corp.

197A Description

Model 197A is a versatile, general purpose oscilloscope camera that can be used for many trace recording applications. All controls are located outside of the camera for easy reading and fast adjustment during setup. The controls are also color coded for optimum settings for most photos which reduces initial setup time.

An electronically-controlled shutter, with all solid-state circuits for reliable operation, provides accurate exposure times from 1/60 to 4 seconds. The shutter may be operated remotely by providing a closure to ground and a contact closure is provided when the shutter is open to allow synchronization of other equipment.

The reduction ratio (i.e., object-to-image ratio) may be varied from 1:1 to 1:0.7 with a screwdriver adjustment. This allows the optimum amount of a graticule to be photographed, which is useful when making multiple exposures or when used on different size graticules. The camera can be quickly focused to match the reduction ratio with the split-image focus plate supplied with the camera.

The 197A is supplied with an 83 mm x 108 mm (3 1/4" x 4 1/4") Polaroid pack back. The back may be rotated 90° from the normal horizontal position to a vertical position and can be moved through 11 detented positions for multiple exposures. It may also be replaced with a Graflok® back which allows use of sheet or roll film.

*Graflok® by Graflex, Inc.

197A Specifications

Reduction ratio: continuously adjustable from 1:1 to 1:0.7. Reference scale provided on focus plate.
Lens: 75 mm, f/1.9 high transmission lens; aperture, f/1.9 to f/16.
Shutter speeds: 1/60, 1/30, 1/15, 1/8, 1/4, 1/2, 1, 2, 4 seconds, Time and Bulb; shutter has a sync contact closure output for triggering external equipment and an input jack for remote operation.
Graticule illumination: supplied by oscilloscope. Refer to Options for internal graticule illumination.
Camera back: 83 mm x 108 mm (3 1/4" x 4 1/4") Polaroid pack back (another back is available, see Options); backs may be interchanged without refocusing and may be rotated in 90-degree increments.
Mounting: lift on/off mounting with positive lock, swing-away hinging to left. Mounts directly on most HP oscilloscopes with 12.7 cm (5") round or rectangular 180-style CRTs. Adapters are available to fit other scopes and displays, see Camera Accessories.
Viewing: low-angle, direct viewing through a flexible facemask.
Multiple exposure: back can be moved through 11 detented positions (1/2 cm per detent at 1:0.9 object-to-image ratio).
Focus: adjustable focusing with lock; split image focusing plate provided.
Size: 267 H x 194 W x 356 mm D (10 1/2" x 7 5/8" x 14").
Weight: net, 4.5 kg (10 lb). Shipping, 7.3 kg (16 lb).
Power: 115 V ± 10%, 48 to 440 Hz, 6 watts.
Accessories furnished: comb. split image focusing plate and reduction ratio scale, 2.3m (7.5 ft) power cord, and manual.

197A Options

	Price
003: Graflok back in place of pack back (on initial order)	N/C
006: replaces standard 197A adapter with 10375A adapter to directly fit 1332A, 1333A, 1335A, and 1336A displays. Adds shutter open light indicator.	add \$80
007: meets UL listing requirements for medical and dental electronic equipment (minimum order 10)	add \$25
008: replaces standard 197A adapter with 10376A adapter to directly fit 1715A, 1722B, 1725A 1740A, 1741A, 1742A, 1743A, and 1744A, oscilloscopes	add \$50
012: factory wired for 230 V operation	N/C
H02: provides internal graticule illumination using ultraviolet light with an OFF, ON switch. Not required for oscilloscopes with graticule illumination	\$125

Ordering information

123A Oscilloscope Camera	\$810
Opt 910: additional manual	add \$10
197A Opt 001: Oscilloscope Camera (less ultraviolet light)	\$925
Opt 910: additional manual	add \$4

Film backs for 197A camera

Model 197A has the Polaroid Film Back as standard equipment. The Graflok Back may be ordered initially as an option at no extra charge.



10353A Pack film back: uses Polaroid Land Film, 83 mm × 108 mm (3¼" × 4¼"), with eight exposures.



10352B Graflok back: requires a film holder. For Polaroid Type 52 Polapan 102 mm × 127 mm (4" × 5") Land film use Polaroid 545 Land film holder. Standard cut-film holders, film-pack adapters, and roll film holders are available from Graflex Inc., 210 Brant Road, Lake, Florida 33403.

Camera bezel adapters

The following Hewlett-Packard adapters provide mounting of Hewlett-Packard, Tektronix, and Dumont cameras to Hewlett-Packard as well as Tektronix and Dumont oscilloscopes. Refer to the oscilloscope/camera adapter table for a cross-reference of these adapter/camera/oscilloscope combinations.



10361A: adapts Tektronix C12 camera to HP 127 mm (5") rectangular CRT (180C style bezels).



10362A: adapts Tektronix C27 and C50 cameras to HP 127 mm (5") rectangular CRT (180C style bezels); C50, C51, C52, C53 require Tektronix battery pack.



10363A: adapts Tektronix C30A, C31, C32, or C40 cameras to HP 127 mm (5") rectangular CRT (180C style bezels).



10367A: adapts 195A & 197A cameras to HP 182 oscilloscope.



10369A: adapts 123 camera to HP 127 mm (5") rectangular CRT (180C style) & HP 127 mm (5") round CRT.



10370A: adapts 123A camera to HP 182 large screen CRT.



10371A: adapts 123A camera to Tektronix 422/453/454/485 oscilloscopes.



10372A: adapts 123A camera to Tektronix 455/464/465/466/475.



***10375A:** adapts 197A, 195A cameras to 1332A, 1333A, 1335A, & 1336A displays, Tektronix 600, 5100, & 7000 series oscilloscopes.



***10376A:** adapts 195A & 197A cameras to 1700 series oscilloscopes with 8 x 10 div CRT's.
*See 197A Options 006 & 008 before ordering these adapters for 197A.



10377A: adapts Tektronix C30A, C31, C32, or C40 cameras to HP 1700 series oscilloscopes with 8 x 10 div CRT's.



16491A: adapts 123A camera to 1700 series oscilloscopes with 8 x 10 div CRT's.



Carrying cases
10358B: constructed of fiberglass and aluminum with padding for protection during transit. The carrying case will accommodate the 195A, 197A, & 198A cameras.



10374A: carrying case for 123A camera with storage space for 1 pack of film.

Ordering information

10353A Pack Film Back	\$130
10352B Graflok Back	\$250
10361A Camera Adapter	\$40
10362A Camera Adapter	\$40
10363A Camera Adapter	\$50
10367A Camera Adapter	\$40
10369A Camera Adapter	\$110
10370A Camera Adapter	\$43
10371A Camera Adapter	\$48
10372A Camera Adapter	\$120
10375A Camera Adapter	\$90
10376A Camera Adapter	\$65
10377A Camera Adapter	\$75
16491A Camera Adapter	\$130
10358B Carrying Case	\$200
10374A Carrying Case	\$43

Oscilloscope/Camera Adapter Table¹

OSCILLOSCOPE	CAMERA												
	HEWLETT-PACKARD					TEKTRONIX INC.				DUMONT			
HEWLETT-PACKARD	123A	*195A	*196A/B	197A	*198A	C12	C27	C30A/31/32/40	C50 Series	450A-1	453A-1	450A-7B	321A
5-in. Round CRT	10369A	Direct	Direct	Direct	Direct					Direct	Direct	Direct	Direct
5-in. Rectangular CRT ⁹	10369A	Direct	*10360A	Direct	Direct	*10361A	*10362A	10363A	**10362A	*10360A	*10360A	*10360A	*10360A
182	10370A	10367A		10367A									
1332A/1333A/1335A/1336A	7	10375A		*10375A		5	5	5	Direct				
1700 Series (6 x 10 div CRT's)	Direct							10106A					
1700 Series (8 x 10 div CRT's)	16491A	10376A		*10376A				10377A					
TEKTRONIX INC													
5-in. Round 549	10369A & *10355A	*10355A	*10355A	*10355A	*10355A								
5-in. Rect. & 560 Series		*10356A		*10356A	*10356A								
529 Series	10369A & *10356A	*10356A		*10356A	*10356A								
455,464,465,466,475		10372A											
422,453,454,485		10371A											
600,5100 & 7000 series		10375A		*10375A									
DUMONT													
5-in. Round CRT	10369A & *10355A	*10355A	Direct	*10355A	*10355A								

Notes

- This chart only includes HP adapter and camera compatibility, for other combinations, contact your Field Engineer.
- The 10361A and 10362A adapter hinge mounts interfere with the Find Beam pushbutton on some 180 mainframes.
- Model 195A, 196A/B, 198A cameras and 10106A, 10355A, 10356A, 10360A camera adapters are no longer in production.
- 197A Option 008 includes the 10376A which directly fits 1715A, 1722B, 1725A, 1740A series oscilloscopes.
- Tektronix Inc. cameras with adapters for 7000 series scopes can be used with HP 1332A, 1333A, 1335A & 1336A Displays.
- 197A Option 006 includes the 10375A which fits HP 1332A, 1333A, 1335A & 1336A displays, Tektronix 600, 5100 & 7000 series oscilloscopes directly.
- Adapter available on special order, contact your HP Field Engineer.
- Tektronix C50, C51, C52, C53 require Tektronix battery pack.
- 5 in. rectangular CRT's with 180C type bezels, e.g. 1600A.

OSCILLOSCOPES

Testmobiles: save bench space, easily moved

Models 1006A, 1007A, 1008A & 1117A

Introduction

Hewlett-Packard Testmobiles offer convenient portability for your oscilloscopes or instrumentation systems. The top tray on these testmobiles may be tilted to position your instrument for easy operation. The selection of testmobiles range from a basic model designed to hold a single oscilloscope or other instrument, such as the 1006A, to a testmobile that can be adapted to provide a complete mobile test system, such as the 1008A or 1117B. Refer to the testmobile/instrument compatibility chart for assistance in selecting the testmobile that will best fit your requirements.

Testmobile/Instrument compatibility

Testmobile Model Number	Instrument
1006A	180 and 1200 cabinet style, 1220 and 1700 Series, 1600A, and 1600S.
1007A	All Hewlett-Packard 180, 1200, 1220, and 1700 Series cabinet style oscilloscopes, or other instruments that meet the height and weight requirements.
1008A	All Hewlett-Packard instruments that are configured to be mounted in a standard 48.3 cm (19 in.) rack and meet the testmobile height and weight requirements.
1117B	All instruments listed above.



1006A

1006A Description

This is a sturdy general purpose testmobile for cabinet style oscilloscopes and other instruments (see compatibility chart). The tilt tray adjusts $\pm 30^\circ$ in 10° increments. A base tray and an accessory rack add space for other instruments and accessories; and a convenient bracket holds three HP probes. Large rear wheels allow easy movement and locking front casters hold the testmobile in position. A five outlet power strip accessory is available for mounting under the tilt tray or beneath the accessory rack.



1007A



1008A

1007A, 1008A Description

These versatile testmobiles provide a sturdy, lightweight, stable platform for your oscilloscope or instrumentation system (see compatibility chart.) Large mar-resistant rubber wheels move smoothly over uneven surfaces. The top trays are table-top height and can be tilted to a convenient viewing angle between 30° above and 30° below the horizontal position with a total of seven detent positions in 10° increments. The caps on each side rail are designed to conveniently hold three probes to reduce the possibility of damaging probes not in use.

1007A, 1008A Options

Many options are available so that the 1007A or 1008A can be easily tailored to your specific requirements. Refer to the option photographs with description to select the testmobile best suited to your requirements. Options apply to either the 1007A or 1008A. Option 008, U.S. only five outlet power strip option, is also available for convenient instrument operation.



Opt 001: storage shelf, load limit 18 kg (40 lb).



Opt 002: storage shelf and lower cabinet, load limit 18 kg (40 lb) on each.



Opt 003: 15 cm (6 in.) lockable drawer with shelf on top, load limit 11 kg (25 lb) in drawer and 18 kg (40 lb) on shelf.



Opt 004: two storage cabinets with shelf on top, combined load limit, cabinets and shelf, 45 kg (100 lb).



Opt 005: storage cabinet and drawer in upper position with shelf on top, load limit 18 kg (40 lb) on shelf, 18 kg (40 lb) in cabinet and 11 kg (25 lb) in drawer.



Opt 006: storage cabinet with shelf on top, and drawer in lower position, load limit 18 kg (40 lb) on shelf, 18 kg (40 lb) in cabinet, and 11 kg (25 lb) in drawer.



Opt 007: two lockable drawers with shelf on top; load limit 18 kg (40 lb) on the shelf and 11 kg (25 lb) in each drawer.



1117B

1117B Description

Model 1117B provides a mobile test station for cabinet and rack model instruments, with tilt tray angles from -15° to $+30^{\circ}$ in $7\frac{1}{2}^{\circ}$ increments for easy viewing. In addition, other instruments can be mounted in the standard EIA racks of the lower compartment. Rack mounting height is 62.2 cm (24½ in.), depth is 58.4 cm (23 in.) and power distribution is supplied. Optional accessory drawers 7.6 cm (3 in.) and 20.3 cm (8 in.) deep are available to provide convenient storage space. The drawers may be installed in many vertical positions of the lower compartment, allowing room for other rack mounted equipment.

Specifications

(see Testmobile data sheet for complete specifications)

	1006A	1007A	1008A	1117B
Height	819mm (32¼")	940mm (37")	940mm (37")	1003mm (39½")
Overall width	495mm (19½")	327mm (12¾")	625mm (24¾")	511mm (20")
Width of tray	330mm (13")	321mm (12¾")	476mm (18¾")	
Tilt tray angle	$\pm 30^{\circ}$	$\pm 30^{\circ}$	$\pm 30^{\circ}$	-15° to $+30^{\circ}$
Weight	net	11.8 kg (26 lb)	11 kg (25 lb)	13 kg (28 lb)
	shipping	14.5 kg (32 lb)	19 kg (41 lb)	22 kg (48 lb)
Max load on tilt tray	23 kg (50 lb)	34 kg (75 lb)	45 kg (100 lb)	45 kg (100 lb)
Max load below tilt tray	23 kg (50 lb)	see Option descriptions	see Option descriptions	56.7 kg (125 lb)

Optional accessories

Price

10475A 7.6 cm (3") drawer for 1117B testmobile Weight: net, 4.1 kg (9 lb); shipping, 5.9 kg (13 lb).	\$90
10476A: 20.3 cm (8") drawer for 1117B testmobile Weight: net, 5.4 kg (11 lb); shipping, 8.2 kg (18 lb).	\$120
01008-68701 Rack Mount Kit for 1008A, 13.3 cm (5¼") high for mounting under the tilt tray	\$56
01008-68702 Rack Mount Kit for 1008A, 19 cm (7½") high for mounting under the tilt tray	\$83
01007-60008 Power Strip kit adds Opt 008 power strip to all versions of 1006A, 1007A, 1008A testmobiles	\$59

Ordering information

1006A Testmobile	\$175	
Opt 008 Power Strip	add \$30	
1007A, 1008A Testmobiles	(1007A) \$245	(1008A) \$275
(see 1007A, 1008A Options for option descriptions)		
Opt 001: storage shelf	add \$30	add \$35
Opt 002: storage shelf, lower cabinet	add \$90	add \$100
Opt 003: storage shelf, locking drawer	add \$150	add \$160
Opt 004: two storage cabinets, shelf	add \$145	add \$145
Opt 005: upper drawer, lower storage	add \$205	add \$215
Opt 006: lower drawer, upper storage	add \$205	add \$215
Opt 007: two locking drawers	add \$260	add \$275
Opt 008: power strip (5 outlet)	add \$30	add \$30

1117B Testmobile

\$400

CATHODE-RAY TUBE DISPLAYS

OEM displays & translator for graphic applications

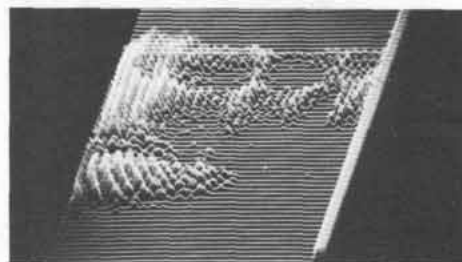
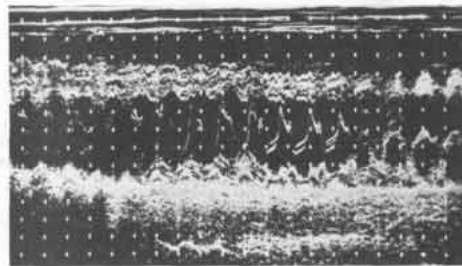
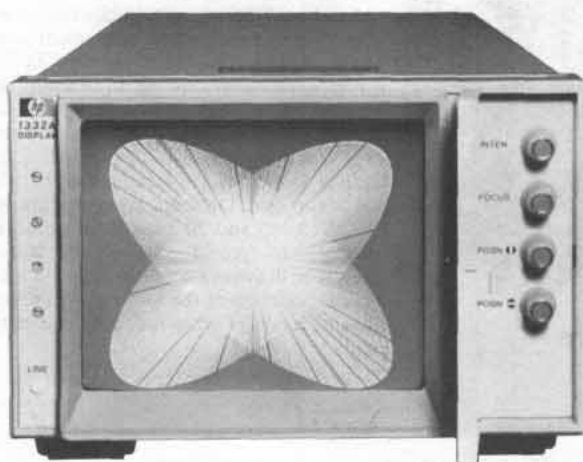

Hewlett-Packard's cathode ray-tube displays offer OEM's and end users top performance, versatility, and reliability for all types of systems — from spectrum, network, and chemical analyzers, and automatic test systems to computer graphics and radar. These displays are complete units which include the cathode-ray tube, vertical and horizontal deflection amplifiers, a video (Z-axis) amplifier, and high and low voltage power supplies. A Graphics Translator is available which accepts digital data from the Hewlett-Packard interface bus (HP-IB) or RS-232C interface bus and converts it to analog vector voltages for driving the non-storage HP small screen and large screen displays.

Performance features include high resolution, high writing speed, constant light output, bright easy-to-read displays, and reduced power requirements. Versatility is assured with a variety of standard options that allow you to tailor a display to your system's needs. Reliability and serviceability are built into these displays with well-designed interior layout, plug-in board construction, and other features made possible by Hewlett-Packard's highly developed CRT technology.

The yokeless electrostatic deflection used in HP displays increases writing speed, reduces power requirements, and simplifies operation when compared to magnetic deflection displays. The most important advantage is that characters and vectors can be written about ten times faster than with magnetic displays.

Small screen displays

Model 1340A features flexibility, convenience, and cost effectiveness, making it ideal for most instrumentation systems. Resolution, viewing area, and brightness are suitable for spectrum, network, vibration, transient, pulse height, and digital logic analyzers. The 1340A may be ordered in a variety

of configurations: with or without cabinet, with or without control panel, without dc supply, or almost any combination to allow easy integration into a system or instrument.

Model 1332A is a high resolution, high brightness display with a 158.8 mm (6 1/4 in.) diagonal CRT with an overall height of only 133.4 mm (5 1/4 in.). The 1332A is designed to meet the stringent requirements of medical diagnostic and instrumentation system applications. The major features in the 1332A include a small crisp spot size over the entire quality area; multiple gray levels with focus independent of intensity setting; high stability of position, gain, and brightness; regulated CRT filament voltage to reduce light output variations with changes in line voltage; large 115 cm² display area; bright 22.5 kV CRT; and Underwriters Laboratories Listing.

One application of the 1332A is in medical diagnostic ultrasound. In this valuable diagnostic technique, a focused beam of harmless ultrasound energy is used to image the internal structure of the body. This technique is especially useful in obstetrics, as it is often able to reveal potential problems early in pregnancy, with no danger of harmful side effects to mother or fetus. The 1332A's brightness and large screen area allow easy viewing, while its stable light output and uniform spot size characteristics yield high quality photographs for later study and for permanent records.

5 MHz bandwidth, large display area, and excellent picture quality make the 1332A ideal for use in instrumentation systems. System applications include spectrum analyzers, network analyzers, automatic test systems, Fourier analyzers, spectrophotometry, chemical analysis, and nuclear magnetic resonance.

The 1333A is a high resolution 8x10 cm display especially designed to permit diag-

nostic-quality photographs from state-of-the-art nuclear, ultrasonic, thermographic, and X-ray scanning systems. The small 0.02 mm spot size, wide range of gray scales, good contrast, and stable light output provide exceptional image quality, a necessity in medical diagnostic systems and applications requiring precisely controlled image parameters. Image quality combined with excellent light output uniformity and speed make the 1333A ideal for recording rapid sequence dynamic studies in nuclear medicine and for capturing transient displays in ultrasound work.

Model 1336S Display System consists of a 1336A Display Module and a 1336P Power Supply Module which may be separated from the 1336A for application flexibility. The Display Module's 140 lines/cm resolution makes it ideal for all high-resolution imaging requirements such as multi-imaging gamma cameras, scanning electron microscopes, and scanning auger microprobes. This display uses a mono-accelerator CRT to produce an intense 0.13 mm (0.0049 in.) diameter spot. Internal switches allow selection of X, Y, and Z amplifier characteristics. The gamma corrected Z-axis amplifier gain characteristic causes the CRT light output to vary linearly within 20% in response to Z-axis input signal changes. This gamma correction is especially convenient for photographic recording when using film having a linear but narrow dynamic range.

Small screen storage displays

Model 1335A high resolution, storage CRT display offers medical and instrumentation OEM users a variable persistence, storage, and non-storage CRT display with excellent performance. Outstanding picture quality and amplifier performance with a frame designed for OEM use make the 1335A a significant advancement in storage displays.



A stored resolution of approximately 20 lines per cm (50 lines per in.) with a spot size that is relatively independent of intensity setting or Z-axis input signals enhances the CRT image in applications requiring focusing over a wide range of intensity levels. Variable persistence allows the elimination of flicker in some presentations with the ability to increase the persistence to match the refresh rate.

The 1335A CRT is optimized for information display and offers a high resolution image with excellent contrast and uniformity in medical diagnostic applications. Fine image detail and well focused spot at all intensity levels and positions make the 1335A ideal for use in spectrum, Fourier, network, and chemical analysis as well as automatic test systems.

In system applications, the 1335A offers flexibility in selecting Erase, Store, Write, Conventional and Variable Persistence modes. These operating modes can be selected with the manual front panel controls, remote program inputs, or a combination of both.

Tricolor display

Model 1338A is a high speed electrostatic display that produces three separate color hues in red, green, and yellow for high density information displays. The 159 mm (6 1/4 in.) diagonal display uses a beam penetration phosphor technique for color generation. The 1338A is designed to interface with the 1350A Graphics Translator or can be used as a stand-alone X, Y, Z display. Color program control is via a remote connector or manually from the front panel.

This display allows the use of color for easy differentiation between groups of data. Applications include radar, process control, and

real time simulation where high resolution and quick data differentiation is essential for decision making.

Graphics Translator

Model 1350A Graphics Translator accepts digital data from an interface bus and converts it to X, Y, and Z analog vector voltages for driving HP's high speed, high resolution electrostatic non-storage displays. The 1350A is compatible with the Hewlett-Packard interface bus (HP-IB) and the HP non-storage small screen (including the 1338A Tricolor Display) and large screen displays. An optional RS-232C interface is available. The 1350A has multiple outputs so that up to four different presentations on four different displays are possible simultaneously. Because program listing is possible on the 1350A, program development and editing is fast and easy. Applications include graphics for data acquisition, network analysis, analytical chemistry and real time simulation.

Large screen displays

Five large screen graphic displays are available for computer graphic and instrumentation applications. Linear writing speed, in these displays, is an unmatched 25.5 cm/ μ s (10 in./ μ s) for visible writing and slow rates in excess of 255 cm/ μ s (100 in./ μ s) are possible when the spot does not have to be seen. These speeds are attained with a yokeless, electrostatic deflection system which consumes much less power than the multi-winding coils of magnetic deflection systems. Maximum power consumption of these displays is a low 110 watts compared to 500 watts or more for magnetic displays. Additionally, the much faster response of electrostatic deflection permits as much as 10 times the amount of information to be dis-

played at a given refresh rate as that of magnetic displays.

Fast amplifier response (5 ns settling time) and electrostatic CRT deflection also simplify system programming since vectors and characters can be written randomly from anywhere in the display area in less time than the sequential programming necessary for magnetic displays. Since coils are not used for deflection, no delay line is needed to properly synchronize Z-axis blanking with spot movement thus reducing the possibility of display smearing and also making system design simpler.

Model 1321A has a 533 mm (21 in.) diagonal display with excellent geometry and linearity and a small 0.51 mm (0.020 in.) spot size. The large 305 x 305 mm (12 x 12 in.) quality area is ideal for presenting complex graphic information while using the additional viewing area for character writing.

Model 1317A is a 432 mm (17 in.) diagonal display which is the largest X-Y display presently made that mounts directly in a 483 mm (19 in.) rack with its long CRT axis horizontal. This large, high resolution display is ideal for the readout in computer graphic and instrumentation systems, since it mounts directly in standard 483 mm (19 in.) EIA racks.

Model 1310A (483 mm, 19 in. diagonal) and 1311A (356 mm, 14 in. diagonal) displays are housed in attractive plastic covers which, when ordered with an optional tilt stand, make them ideal for table top applications.

Model 1304A has a 20 x 25 cm (7.9 x 9.8 in.) display area. The cabinet is fully compatible with the Hewlett-Packard System-II modular enclosure system for more versatility in OEM applications and better access for servicing.

CATHODE-RAY TUBE DISPLAYS

Graphics translator, HP-IB interface for displays

Model 1350A

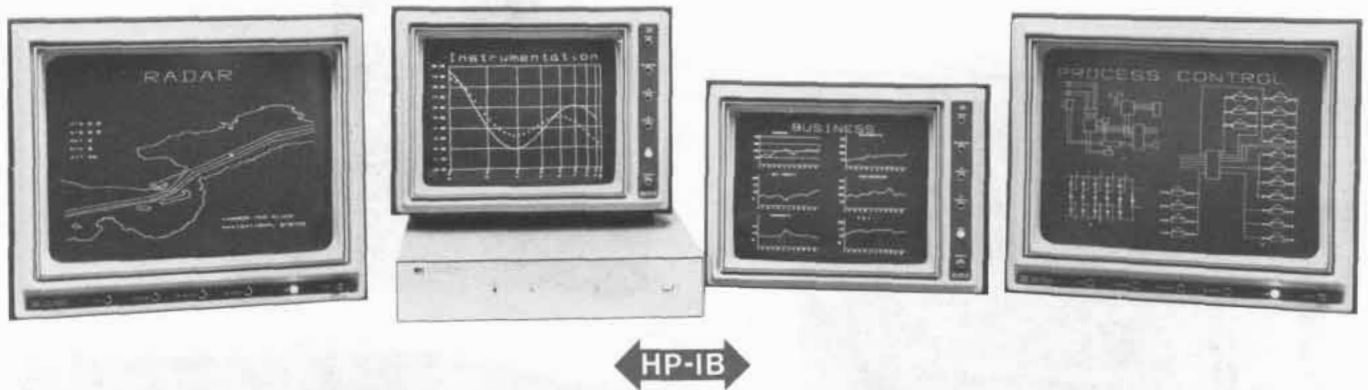

The 1350A Graphics Translator can present different information simultaneously on up to four CRT displays.

1350A Description

Introduction

The Model 1350A Graphics Translator converts digital data to X, Y, and Z analog voltages for driving high resolution directed beam non-storage displays such as the HP small screen and large screen displays. The 1350A accepts digital information from the Hewlett-Packard interface bus (HP-IB) or RS-232C interface bus (optional) and stores the data in a 2K word digital memory (RAM) which is continually accessed to generate vectors or characters to refresh one or more directed beam displays. TTL outputs allow different information to be presented on different displays. Each digital word can be a vector coordinate or an upper or lower case ASCII character. A character ROM generates the vectors for each ASCII character, therefore each character uses only one word of RAM. The use of stroke vectors results in a much higher resolution display than is possible with a raster scan technique.

The high speed graphics of the 1350A is ideal for radar, instrumentation, business, and process control graphics. Addressable resolution

meets the requirements of analytical chemistry and spectrum analysis.

The RAM memory can be divided into 32 addressable and selectively erasable files. A file of information can be flashed on and off for highlighting display information of special interest, e.g., a malfunctioning pump in a process control system. Individual alphanumeric or vectors within a file can be flashed under program control. Erasing a waveform that intersects other waveforms and graticules does not leave blank spaces at intersections, which is a common problem with raster scan displays.

The 1350A Graphics Translator is recommended for use with directed beam displays with at least 3 MHz bandwidth to take advantage of the 1350A high speed vector generating capability. Use of the HP 1332A, 1333A, 1336S, 1338A, or 1340A small screen displays or the HP 1304A, 1310A, 1311A, 1317A or 1321A large screen displays will insure bright vectors with good contrast.

Applications

Telecommunications analysis



Graphics Translator draws all 96 upper and lower case letters and most of the special characters of the full ASCII set. They can be drawn in four different sizes and be rotated 90°.

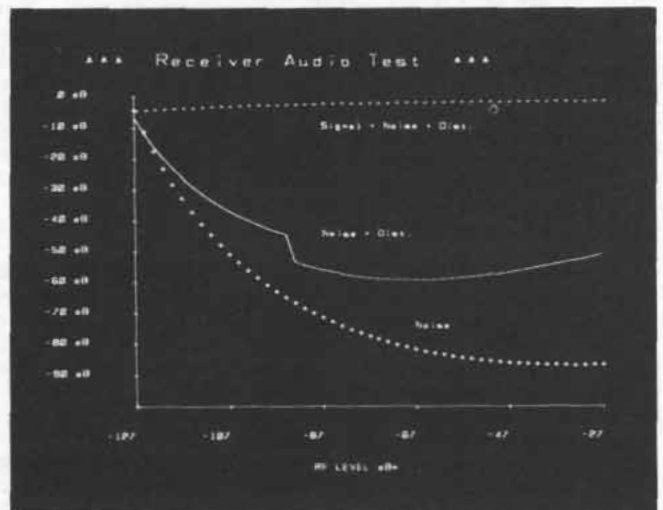

The 1350A may be used to generate displays for an automatic transceiver test system such as the HP 8950B. File capability of the 1350A allows rapid changing of waveforms without erasing and rewriting the entire display.

Data acquisition

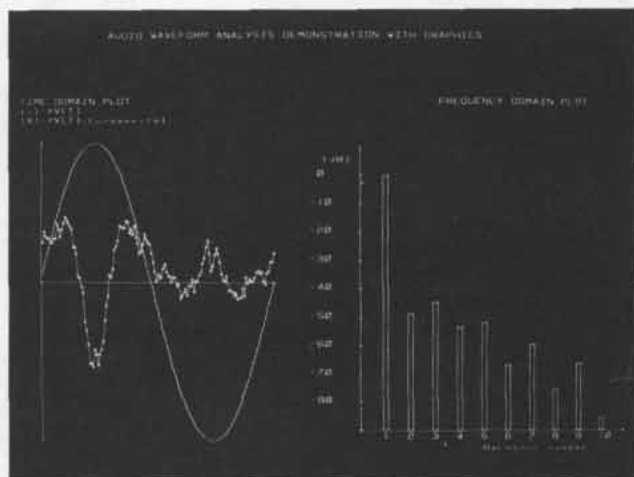
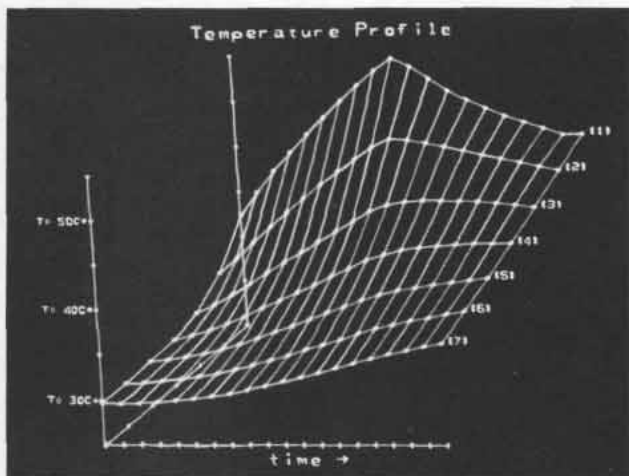

The 1350A Graphics Translator is ideal for generating a dynamic display of information from an automatic data acquisition system such as the HP 3052A controlled by the HP 9825A computing controller.

Network analysis

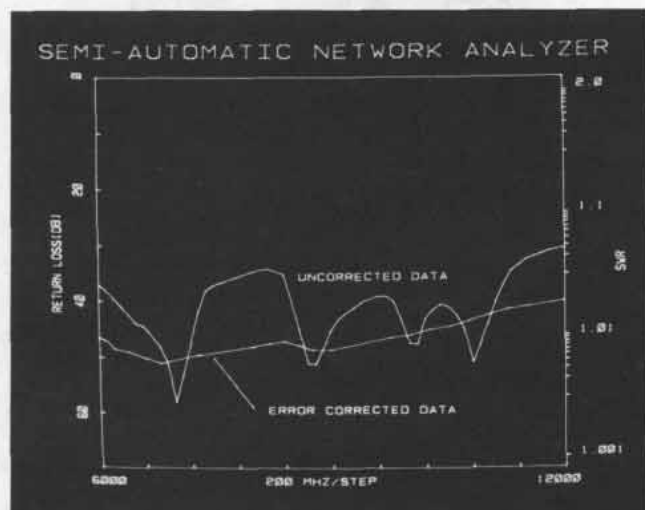

The 1350A provides rapid updating of data files based on changes of input parameters for driving the displays of systems such as the HP 8409A Automatic Network Analyzer.

Integrated circuit layout: the selectable 32 files of memory of the graphics translator soft copy can represent 32 different layers of an IC, providing quick layer by layer analysis to insure every rectangle is in the correct layer and location.

Process control systems: complicated process control systems require high resolution graphic representation for analysis and quick update.

Numerical control: soft copy display plots of tool path reveal programming errors before actual machining is done. An alphanumeric listing with text mode permits quick location of errors.

Additional applications include: land use layout; auto and airframe design; aircraft simulation and trainer; air traffic control; building, bridge, and tunnel design; structural analysis of components; molecular structure display; highway design and analysis; medical EKG/EEG analysis; and financial and stock market analysis.



A complete, mobile soft copy graphics test station can be assembled using HP's Model 1008A Option C01 Testmobile. With this configuration, HP small screen displays or the 1311A Large Screen Display may be used and a slide-out tray is provided for the 9825A computing controller.

CATHODE-RAY TUBE DISPLAYS

Model 1350A (cont.)

Selecting a display

The 1350A Graphics Translator requires a CRT Display with at least 3 MHz X, Y, and Z axes bandwidths and a full scale deflection sensitivity of one volt. Hewlett-Packard displays compatible with the 1350A are in the following list along with some possible controllers.

Possible Controllers

- HP9825A
- HP9830A
- HP1000
- DEC PDP II
- DATA GENERAL
- WANG 2100

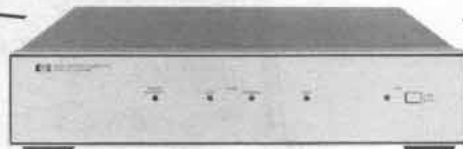

Interface
HP-IB or
Optional RS-232C

HP Displays

HP Displays	Approx Screen Area	Approx Spot Size
1321A	1590 cm ²	0.51 mm
1317A	884 cm ²	0.51 mm
1311A	616 cm ²	0.38 mm
1310A	1064 cm ²	0.51 mm
1304A	500 cm ²	0.51 mm
1340A	115 cm ²	0.43 mm
1335A	72 cm ²	0.25 mm
1333A	80 cm ²	0.2 mm
1338A	114 cm ²	0.3 mm
1332A	114 cm ²	0.3 mm

9825A Software

The 10184A Binary Tape Cartridge is available for use with the 9825A desktop computer for higher level programming of the 1350A. The 10184A tape contains two binary programs for use in the 9825A, one for the 9872A plotter and one for the 9862A plotter. With the first binary program, the command set used in the 9872A four color plotter can be used with both the 9872A and the 1350A/Display system. This binary program permits rapid development of graphics on the 1350A, and allows hard copy when required. Most commands can be used directly with both peripherals; however there are some unique commands for each. For example, the plotter uses COLOR SELECT and SLANT, and the 1350A uses BLANK and FLASH. The second binary program allows the 9862A plotter command set to be used for both the 9862A and 1350A peripherals.

HP system 1000 software

The 92841A graphics plotting software package provides a 1350A driver in the HP 1000 computers and systems operating under the RTE-MII/MIII or RTE-IV real time executive system. The package makes a powerful set of primitive plotting subroutines available to the FORTRAN, BASIC, OR ASSEMBLY language programmer.



1311A Option 010 demonstrates the high tilt stand which allows a 9825A desktop computer or 1350A graphics translator to be positioned beneath the 1311A display.

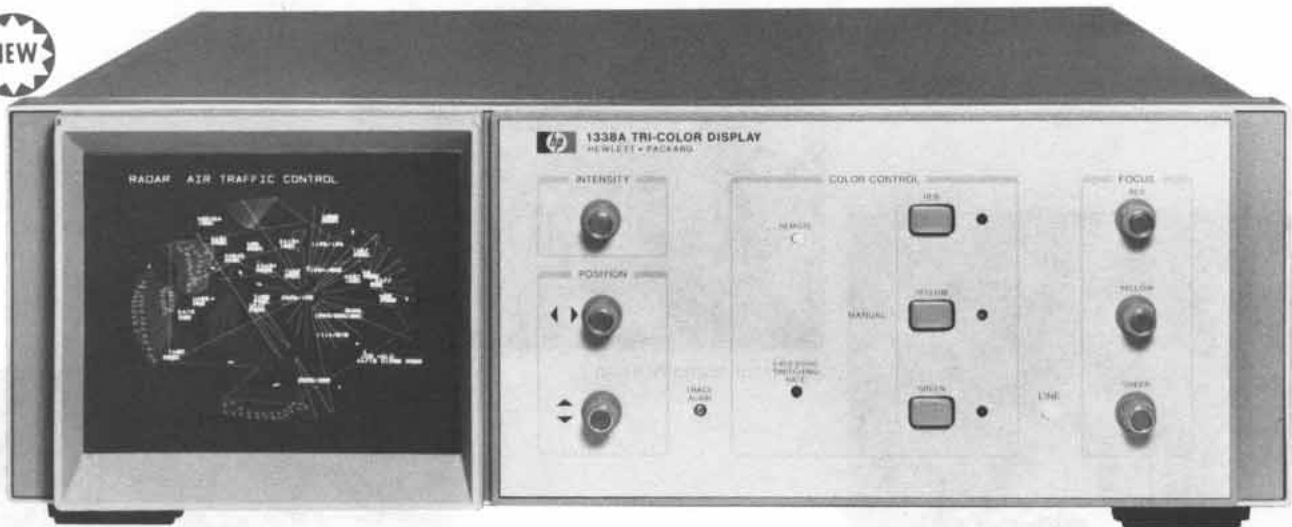

1338A

1338A Description

The Model 1338A tricolor display uses a beam penetration phosphor technique for high resolution color generation and an electrostatic CRT gun for high speed. The 178 mm (7 in.) diagonal display produces three separate color hues in red, green, and yellow and is designed to interface with the 1350A Graphics Translator for a color graphics system with digital inputs. TTL level color switching, color busy, and color valid signals allow control of the color of each vector or character. The 1338A may also be used as a stand-alone X, Y, Z display with analog inputs.

The 1338A tricolor display has significant advantages over monochrome displays when the density of information to be displayed becomes high or the data presented needs to be divided into groups for decision making. Applications include radar, real time simulation, medical diagnostics, process control, and general instrumentation.

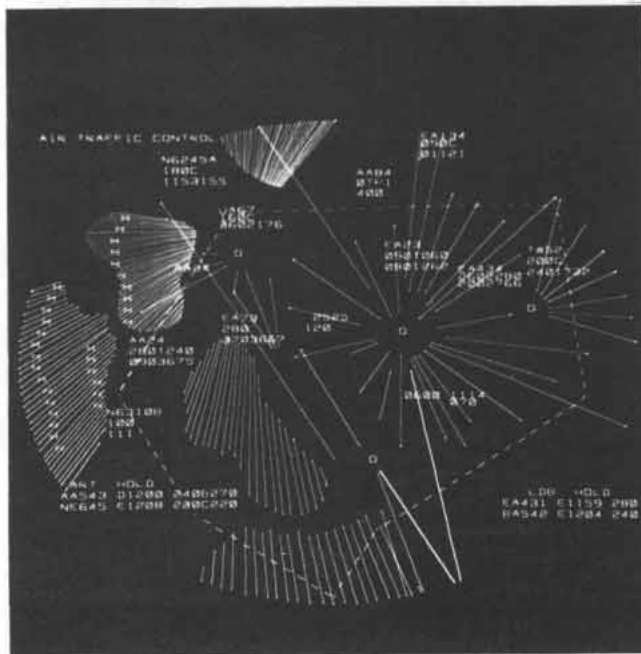

With high density information presentations such as this air traffic control application, separation of information for rapid decision making is difficult. The 1338A groups the information into categories and presents a high resolution display in three contrasting colors for easy identification.

1338A Specifications

For complete specifications contact your HP Field Engineer.

Vertical and horizontal amplifiers

Rise time: ≤ 100 ns for full screen deflection or less.

Bandwidth: typically ≥ 3 MHz.

Deflection factor: 1 V for full screen deflection. Internally adjustable from ≈ 0.9 V to 2.5 V for full deflection. Independently switch-selectable 5:1 and 10:1 attenuators.

Linear writing speed: ≥ 25.4 cm/ μ s (10 in./ μ s).

Inputs: fully differential BNC connectors with shields grounded. Remote program connector, single ended only.

Input RC: ≈ 100 k Ω shunted by ≈ 70 pF, switchable to 50 Ω .

Z-axis amplifier

Rise time: ≤ 30 ns.

Blanking: fully differential.

Inputs: fully differential BNC connectors with shields grounded, plus a TTL blanking input.

Input RC: ≈ 100 k Ω shunted by ≈ 70 pF, switchable to 50 Ω .

Gain: internally adjustable over a 2.5:1 attenuation range.

Cathode-ray tube.

Type: post accelerator, electrostatic focus and deflection.

Viewing area: ≈ 9.6 cm vert by 11.9 cm horiz.

Spot size: ≤ 0.3 mm (0.012 in.).

Color input: 25 pin subminiature D connector.

Safety

X-ray emission: < 0.5 mr/hr meas. with Victoreen Model 440 RF/C.

General

Front panel controls and adjustments: intensity, X position, Y position, red focus, yellow focus, green focus, and trace align. Push-buttons for manual selection of red, yellow, or green.

Line power: 100, 120, 220, or 240 Vac, +5%, -10%; 48 to 440 Hz.

Operating Environment: operating temp., 0°C to 55°C (0°F to +131°F); humidity, 5% to 95% relative humidity at +40°C (+104°F); altitude, to 4600 m (15 000 ft), non-operating to 7600 m (25 000 ft); shock, 30 g level with 11 ms duration and 1/2 sine wave shape; vibration, 0.38 mm (0.015 in.) excursion, 5 to 55 Hz for 15 min.

Accessories supplied: one 2.3 m (7.5 ft) line cord (90° IEC to NEMA 5-15P, 3-conductor for use in Canada, Japan, and U.S.), one Operating Guide.

Weight: net, 16.1 kg (35.5 lb); shipping, 19.1 kg (42 lb).

Accessories

10183A Light Shield

10492A Interconnecting Cable for 1338A/1350A, 1 m

10493A Interconnecting Cable for 1338A/1350A, 3 m

Price

\$15

\$145

\$165

1338A Tricolor Display

\$4750

CATHODE-RAY TUBE DISPLAYS

Large screen displays

Models 1304A, 1310A, 1311A, 1317A & 1321A

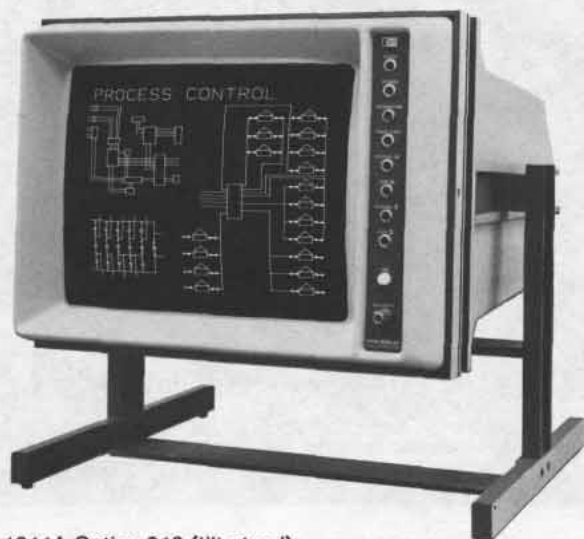

1311A Option 010 (tilt stand)

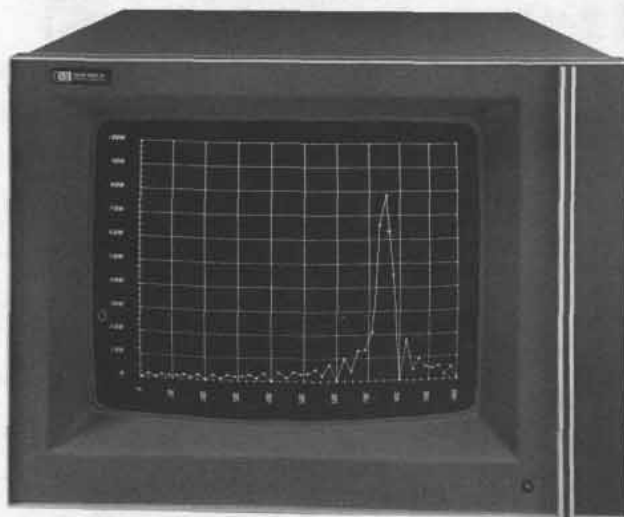

1304A

1304A, 1310A, 1311A, 1317A, 1321A Description

Hewlett-Packard's Models 1304A, 1310A, 1311A, 1317A, and 1321A Large Screen Displays offer the high writing speed and fast settling time needed in high density information systems such as computer graphics, analytical research, and radar. The advanced electrostatic deflection systems used in these displays provide writing speeds of 25 cm/ μ s (10 in./ μ s), and large and small step settling times of 1 μ s or less. The yokeless electrostatic deflection also simplifies operation, eliminates geometric correction circuits and unnecessary delay lines, and reduces power requirements and weight. High CRT accelerating potentials of 27 or 28.5 kV assure bright, easy-to-read displays, and a small spot size gives a crisp, clear image over the large quality area.

Model 1304A offers high writing speed and fast settling time, and is a cost-effective solution for applications such as Fourier or spectrum analysis, chemical or physical analysis, calculator-based graphics, or other applications where information density does not require the higher resolution of the 1310A, 1311A, 1317A, or 1321A. The display is housed in the Hewlett-Packard System II modular chassis with its mounting flexibility and selection of accessory hardware.

The 1310A, 1311A, 1317A, and 1321A are electrically almost identical but offer a wide variety of display sizes and configurations to fit almost any high-speed, large screen OEM display requirements.

The 1321A has the highest overall resolution (screen area divided by spot size) of any HP CRT display, making it the choice for computer graphics or other applications where maximum information density is the main consideration. The 1317A is ideal for standard 48.3 cm (19 in.) rack-mount applications requiring the largest possible screen area in the minimum vertical rack space. For table-top applications such as remote monitors, Models 1310A and 1311A offer an attractive modern styled stand-alone package. Both of these displays may be ordered without top and bottom protective covers (Opt 001) and mounted in standard 48.3 cm (19 in.) racks or in your own customer designed enclosures.

1304A Specifications

For complete specifications, refer to the Large Screen CRT Displays Data Sheet.

Vertical and horizontal amplifiers

Risetime: ≤ 70 ns, 10% to 90% points, \leq full screen deflection.

Bandwidth: dc to 5 MHz (3 dB down) for ≤ 10 cm deflection.

Phase shift: $< 1^\circ$ to 250 kHz for full screen signal inputs.

Deflection factor: from 80 to 120 mV/div, 1 div = 20 mm (0.8 in.). Internally selectable 5:1 or 10:1 attenuators independently settable for X and Y inputs.

Linear writing speed: > 25 cm/ μ s (> 9.8 in./ μ s).

Settling time: (large and small step) signal settles to within one spot diameter of final value in ≤ 300 ns for any on screen final location. Initial off screen deflection (if any) must not exceed specified dynamic range.

Inputs: fully differential; BNC connectors have grounded shields.

Input RC: ≥ 100 k Ω shunted by ≤ 65 pF. Settable to 50 Ω internally.

Polarity: a positive signal input to the (+) input moves beam up or to the right. A negative signal input to the (-) input moves the beam up or to the right.

Dynamic range: beam may be deflected off screen up to $\frac{1}{2}$ screen diameter in any direction provided that zero input position is on screen without degradation of specifications.

Drift

Position: 1.0 mm/hr. (0.04 in./hr.) and a max of 2.5 mm (0.1 in.) in 24 hrs. with covers installed after 15 min. warmup.

Gain: $< 1\%$ under all conditions of specified line voltage with covers installed after 15 min. warmup and temperature between $+20^\circ\text{C}$ and $+55^\circ\text{C}$ ($+68^\circ\text{F}$ and $+131^\circ\text{F}$).

Z-axis amplifier

Risetime: < 25 ns (cw bandwidth is ≈ 5 MHz).

Blanking range: a 1 V change in Z-axis input voltage causes a full scale change in brightness (internally switch-selectable to 5V or 10 V). The cutoff level can be set from $+0.2$ Vdc to -1 Vdc with the intensity control. With the intensity control full ccw, brightness is limited to a safe level for any Z-axis input voltage.

Blanking polarity: fully differential. A positive or negative going input voltage into the positive or negative inputs, respectively, increases brightness.

Input: fully differential; BNC connectors have grounded shields.

Input RC: $\approx \geq 100$ k Ω shunted by ≤ 65 pF. Settable to 50 Ω .

Gain: internally adjustable over 2.5:1 attenuation range.

Focus correction: amplifier automatically corrects focus voltage for changes in grid to cathode voltage.

Cathode-ray tube

Type: post deflection accelerator, ≈ 27 kV accelerating potential. Aluminized P31 phosphor, electrostatic focus and deflection.

Viewing area: 500 cm² (77.4 cm²); 20 cm (7.9 in.) vert by 25 cm (9.8 in.) horiz.

Graticule: none with standard instrument (see 1304A Options).

Quality area: 20 cm (7.9 in.) vert by 25 cm (9.8 in.) horiz.

Resolution

Spot size: < 0.5 mm (0.02 in.) (with 30 V drive, grid to cathode) over entire quality area measured using shrinking raster method.

Lines: ≈ 20 lines/cm (50 lines/in.); measured with shrinking raster method, inside quality area.

CATHODE-RAY TUBE DISPLAYS

Models 1304A, 1310A, 1311A, 1317A & 1321A (cont.)



The yokeless electrostatic deflection system used in the 1310A and other HP large screen displays results in low power consumption and increased reliability, important factors in remote locations such as this round-the-clock weather radar. Notice the line of tornadoes and rain squalls. (Radar photo courtesy of Bendix Avionics, Inc.)

Line brightness: 19.2 cd/m² (5.6 fl) at writing speed of 2.5 mm/μs (0.1 in./μs), 60 Hz refresh rate, P 31 phosphor, and focused spot.

Linearity: <3% of full scale along major axes.

Geometry: <3% pincushion/barrel distortion within quality area.

Trace align: rotates X-axis into geometric alignment with CRT viewing area.

Orthogonality: separately aligns Y-axis perpendicular to X-axis.

Safety protection

Implosion and impact: CRT meets UL safety requirements and exceeds requirements of IEC 348 (IEC 65).

High voltage: anode lead is permanently bonded to CRT.

X-ray emission: <0.5 mr/hr measured with Victoreen Model 440 RF/C.

UL listings: standard instrument meets requirements of UL 478 for Electronic Data Products, thereby meeting OSHA (Sub-part S) approval. Option 330 meets requirements of UL 544 for medical and dental equipment. See 1304A Options (Operator Safety) for additional safety standard compliances.

General

X, Y, and Z inputs: rear panel BNC (f) connectors, two each axis.

Front panel controls: located behind door on front panel. Knobs—Intensity, Focus, X Position, Y Positions. Screwdriver adjustments—Trace Align, X Gain, Y Gain, Astigmatism.

Line indicator: front panel green LED.

Power: selectable 100, 120, 220, or 240 Vac +5%, -20%; 48 to 66 Hz*; max power 100 VA (≈ 85 W). Average power dissipation at 60 Hz and 120 Vac is ≈ 60 W.

*Note: these displays meet all electrical specifications from 48 to 440 Hz, but do not meet the ac line to chassis leakage requirements of UL 544 (Medical and Dental) listing above 66 Hz.

Size: 321 H x 425 W x 530 mm D (12³/₄" x 16³/₄" x 20³/₄").

Weight: net, 20 kg (44 lb.); shipping, 28.2 kg (62 lb.).

Operating environment: temperature 0°C to +55°C (+32°F to +131°F)—non-operating, -40°C to +70°C (-40°F to +158°F); humidity, 5% to 95% RH/ at +40°C (+104°F); altitude, to 4600 m (15 000 ft)—non-operating to 15 300 m (50 000 ft); vibration, vibrated in three planes for 15 min. each with 0.38 mm (0.015 in.) excursion, 5 Hz to 55 Hz, 1 min. per octave, 10 min. each resonance.

Accessories supplied: one Operating and Service Manual, one 2.3 m (7.5 ft) line cord (90° IEC to NEMA 5-15P, 3-conductor) for use in Canada, Mexico, Japan, and the United States. See 1304A Options for other available line cords.

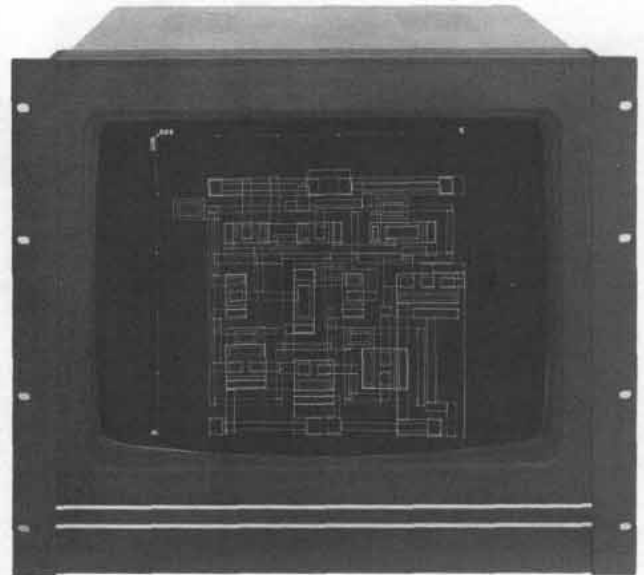

Application shows 1317A Large Screen Display being used in IC layout development.

1310A, 1311A, 1317A, 1321A Specifications

For complete specifications refer to the Large Screen CRT Displays Data Sheet.

Vertical and horizontal amplifiers

Rise time: ≤75 ns, 10% to 90% points, for ≤full screen deflection.

Bandwidth: dc to ≈ 5 MHz (3 dB down) for ≤8.9 cm (3.5 in.) deflection in 1311A, 10.2 cm (4 in.) in 1317A, 12.7 cm (5 in.) in 1310A or 1321A.

Phase shift: <0.1° to 50 kHz and <1° to 250 kHz for full screen signal inputs.

Deflection factor (1317A, 1321A): adjustable through range indicated.

1317A: from ≈ 39 mV/cm (100 mV/in.) to 69 mV/cm (175 mV/in.).

1321A: from ≈ 33 mV/cm (83 mV/in.) to 58 mV/cm (147 mV/in.).

Deflection factor (1310A, 1311A): adjustable through range indicated.

	Vertical	Horizontal
1310A	from ≈ 35.8 mV/cm (90 mV/in.) to 60.9 mV/cm (153 mV/in.)	from ≈ 26.2 mV/cm (67 mV/in.) to 45.9 mV/cm (117 mV/in.)
1311A	from ≈ 46.3 mV/cm (118 mV/in.) to 81 mV/cm (207 mV/in.)	from ≈ 35.8 mV/cm (90 mV/in.) to 60.9 mV/cm (153 mV/in.)

Linear writing speed: >25.4 cm/μs (>10 in./μs).

Settling time: (large step) signal settles to within 1 spot diameter of final value in <500 ns (1310A, 1311A, 1321A), <1 μs (1317A), for any on or off screen movement. Off screen deflection not to exceed one screen diameter. (Small step) signal settles to within 0.25 mm of final value in <200 ns for any 2.5 mm (0.10 in.) step.

Inputs: (1310A, 1311A) BNC connectors with floating shield; (1317A, 1321A) BNC connectors with grounded shield. Separate differential inputs (shield grounded) available for 1317A, 1321A; see Options.

Input RC: center conductor 10 kΩ shunted by ≈ 40 pF. Shield input (1310A, 1311A only) is 47Ω to ground and can be replaced with 10 kΩ for full differential input. A switchable 50Ω termination between shield and ground is also provided.

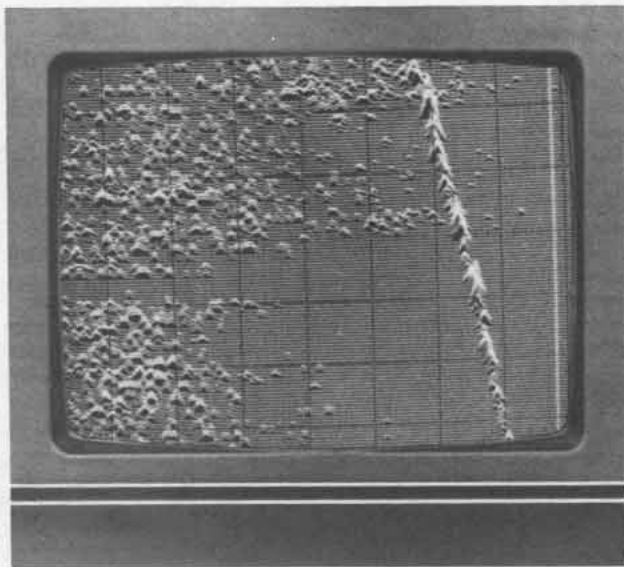

1321A large screen display is ideal for high density information such as this waterfall display, showing machine vibration frequency and amplitude versus time. (Photo courtesy of Spectral Dynamics, Inc.)

Polarity: positive vertical input moves beam up; positive horizontal input moves beam right. Polarity can be reversed by changing internal lead connections.

Dynamic range: at least ± 1.5 screen diameters from center screen.

Linearity: (1310A, 1311A, 1321A) 1% of full scale display along major axes within quality area; (1317A) <3% of full scale display along major axes within quality area.

Drift: 1.3 mm/hr. (0.05 in./hr.) and 2.5 mm (0.10 in.) in 24 hr. with covers installed after 1/2 hour warmup.

Z-axis amplifier

Rise time: <20 ns (cw bandwidth \approx 15 MHz).

Blanking range: 1 V Z-axis input change causes full scale brightness change. Cutoff level settable 0 Vdc to -1 Vdc with intensity control.

Blanking polarity: positive input unblanks CRT, internally reversible for negative unblanking.

Input: BNC connector (shield grounded). Differential input available on 1317A, 1321A; see Options.

Input RC: \approx 10 k Ω shunted by \approx 60 pF; 50 Ω selectable internally.

Offset: (1317A, 1321A) internal adjustment provides \pm 1 V offset (continuous) to blanking range.

Gain: internally adjustable over 2.5:1 attenuation range.

Cathode-ray tube

Type: post deflection accelerator, \approx 28.5 kV accelerating potential; P31 aluminized phosphor standard (refer to Options for other phosphors); electrostatic focus and deflection.

Viewing area

1310A: 48 cm (19") diag; \approx 28 cm (11") vert x 38 cm (15") horiz.

1311A: 36 cm (14") diag; \approx 22 cm (8 1/2") vert x 28 cm (11") horiz.

1317A: 43 cm (17") diag; \approx 26 cm (10 1/4") vert x 34 cm (13 1/2") horiz.

1321A: 53 cm (21") diag; \approx 30 cm (12") vert x 35 cm (14") horiz.

Spot size and resolution: measured using shrinking raster method, at center screen, at indicated drive level.

Model	Spot Size	Resolution	Drive Level (Volts above cutoff at CRT grid)
1310A 1317A 1321A	0.51 mm (0.020 in.)	19.7 lines/cm (50 lines/in.)	50 V
1311A	0.38 mm (0.015 in.)	26.3 lines/cm (66.7 lines/in.)	30 V

Spot size within quality area: measured using shrinking raster method, no more than 1.5 times spot size at center screen.

Quality area

1310A: 27.9 cm (11") by 27.9 cm (11").

1311A: 21.6 cm (8 1/2") by 21.6 cm (8 1/2").

1317A: 25.4 cm (10") by 25.4 cm (10").

1321A: 30.5 cm (12") by 30.5 cm (12").

Line brightness: \geq 82.4 cd/m² (24 fl) at a writing speed of 2.5 mm/ μ s (0.1 in./ μ s), 60 Hz refresh rate, P31 phosphor, 0.51 mm (0.02 in.) spot size on 1310A, 1317A, 1321A, and 0.38 mm (0.015 in.) spot size on 1311A.

Geometry: (1317A, 1321A) <3% (1317A), <2% (1321A) pincushion and barrel distortion within quality area.

Phosphor protection: circuit automatically detects absence of beam deflection and limits beam current to safe but viewable level.

Dynamic focus: automatically corrects spot geometry for position on screen and beam intensity (video drive level).

Contrast ratio: 4:1 or greater with 340 cd/m² (100 fl) ambient light and CRT face in a vertical plane. Measured by photometrically summing the trace and background brightness and then dividing by background brightness.

Trace align: rotates X-axis into geometric alignment with CRT viewing area.

Orthogonality: separately aligns Y-axis perpendicular to X-axis.

Safety Protection

Implosion and impact: CRT meets UL implosion and impact safety requirements and exceeds requirements of IEC 348 (IEC 65).

High voltage: anode lead is permanently bonded to CRT.

X-ray emission: <0.5 mr/hr meas with Victoreen Model 440 RF/C.

UL listings

1310A, 1311A: Opt 008 meets requirements of UL 544 for Medical and Dental equipment.

1317A, 1321A: standard instrument meets requirements of UL 478 for Electronic Data Products, thereby meeting OSHA (Subpart S) approval. Opt 008 meets requirements of UL 544 for Medical and Dental equipment.

General

X, Y, Z inputs: rear panel BNC female connectors. X and Y inputs have a floating shield and the Z input has a grounded shield.

Front panel controls

1310A, 1311A: Intensity (knob control), Focus, Astigmatism, X position, Y position, Trace Align, Orthogonality, Gain X, and Gain Y (screwdriver adjustments).

1317A, 1321A: Intensity, Position X, Gain X, Position Y, Gain Y, Trace Align, Orthogonality, Focus, and Astigmatism controls located below the CRT behind a hinged door.

Line indicator: lamp mounted behind front panel (behind hinged door on 1317A, 1321A).

Power

1310A, 1311A: 115 Vac \pm 10% or 230 Vac \pm 10%, 48 to 66 Hz* max power 115 VA (\approx 100 W).

1317A, 1321A: selectable 100, 120, 220, or 240 Vac +5%, -10%; 48 to 66 Hz*; max power in 1317A, 115 VA (\approx 100 W), in 1321A, 135 VA (\approx 110 W).

*Note: these displays meet all electrical specifications from 48 to 440 Hz, but do not meet the ac line to chassis leakage requirements of UL 544 (Medical and Dental) listing above 66 Hz.

TTL blanking (1310A, 1311A) input: rear panel BNC female connector. High state (+2.5 V to +5 V) blanks any Z-axis analog input signal. Low state (0.0 V to 0.8 V) returns blanking to analog Z-axis input.

Size

1310A, 1311A: (\approx overall size without rack mount adapters, tilt stand) 1310A, 422 H x 497 W x 660 mm D (16 1/4" x 19 1/8" x 26"); 1311A, 319 H x 425 W x 578 mm D (12 5/16" x 16 3/4" x 22 3/4"). Contact HP Engineer for data sheet with dimensional drawings.

1317A: \approx 410 H (including feet) x 419 W x 572 W x 632 mm D overall (16 1/8" x 16 1/2" x 22 1/2").

1321A: \approx 483 H (with feet) x 527 W x 632 mm D overall (19" x 20 3/4" x 24 3/8").

CATHODE-RAY TUBE DISPLAYS

Models 1304A, 1310A, 1311A, 1317A & 1321A (cont.)

Weight:

1310A: net with covers 26.8 kg (59 lb); shipping 41.7 kg (92 lb.)
1311A: net with covers 20.4 kg (45 lb); shipping, 28.1 kg (53 lb.)
1317A: net, 26.3 kg (58 lb); shipping, 33.4 kg (75 lb.)
1321A: net, 36.3 kg (80 lb); shipping, 43.1 kg (95 lb.)

Operating environment: temperature, 0 to +55°C (+32°F to +131°F)—non-operating, -40°C to +70°C (-40°F to +158°F); humidity, to 95% RH at +40°C (+104°F); altitude, to 4600 m (15000 ft)—non-operating, to 7600 m (25000 ft); vibrated in three planes for 15 min. each with 0.25 mm (0.010 in.) excursion, 10 to 55 Hz.

Accessories supplied

1310A, 1311A: rack mount adapter, front panel cover, protective covers, one power cord, and one Operating and Service Manual.
1317A, 1321A: one 2.3 m (7.5 ft) power cord, and one manual.

1304A Options and accessories

Options	Price
X and Y Amplifiers	
Deflection factor	
100*: 500 mV/div, 5 V p-p for full screen deflection	add \$5
101*: 1V/div, 10 V p-p for full screen deflection	add \$5
Input impedance	
110*: 50 Ω	add \$5
Z-axis input (video amplifier)	
Blanking range	
200*: 0 to 5 V	add \$5
201*: 0 to 10 V	add \$5
Input impedance	
210*: 50 Ω	add \$5

*These options are internally switch selectable on standard 1304A displays.

Digital Input

216: TTL blanking level. High state (+2.5 V to +5V) blanks any Z-axis analog input signal. Low state (0.0V to 0.8 V) returns blanking to analog Z-axis input. Input through rear panel BNC connector.	add \$50
217: same as 216, except polarity reversed	add \$50
218: 4-bit binary input allows binary selection of 16 levels of gray shades, TTL levels. Settling time ≤300 ns. Levels linear within ±20%. Includes 25 pin program connector mounted to rear panel. When Option 218 is ordered with Option 216 or 217, TTL blanking input is provided through both a BNC connector and the 25 pin remote connector.	add \$100

Cathode-ray tube

Graticule/Phosphor type

004: P4 aluminized phosphor with 10 x 12 div internal graticule (1 div = 2.0 cm, 0.79 in.)	add \$30
031: P31 aluminized phosphor with 10 x 12 div internal graticule (1 div = 2.0 cm, 0.79 in.)	N/C
039: P39 aluminized phosphor with 10 x 12 div internal graticule (1 div = 2.0 cm, 0.79 in.)	add \$30
604: P4 aluminized phosphor in lieu of P43	add \$30
639: P39 aluminized phosphor in lieu of P43	add \$30

Contrast Filters

561: clear anti-glare filter replaces standard neutral density contrast filter	N/C
563: blue anti-glare filter replaces standard neutral density contrast filter	N/C

General

AC line cords

300: 2.3 m (7.5 ft) removable, 240 V max, 3 conductor 90° IEC to Great Britain, Singapore	N/C
301: 2.3 m (7.5 ft) removable, 240 V max, 3 conductor IEC to Australia, New Zealand	N/C
302: 2.3 m (7.5 ft) removable, 240 V max, 3 conductor IEC to East and West Europe	N/C
303: 2.3 m (7.5 ft) removable, 240 V max, 3 conductor IEC to NEMA 5-15 P (USA, Canada, Japan, Mexico)	N/C
304: 77.2 cm (30 in.) coiled, extends to 1.8 m (6 ft) removable, 120 V max, 3 conductor IEC to NEMA 5-	add \$5

15 P (USA, Canada, Japan, Mexico) (not available with Opt 330)

306: 2.3 m (7.5 ft) removable, 3 conductor IEC to Switzerland N/C

307: hospital grade power cord add \$10

Rear panel connector

324: adds 25 pin connector to rear panel. X, Y, Z-signal inputs wired to the positive signal inputs add \$30
 (NOTE: input capacitance increases to ≈ 120 pF)

Operator safety

330: meets UL Listing 544 for Medical and Dental Electronic Equipment. Includes special three conductor ac line cord, specially marked covers, and UL label. add \$50

331: meets HTM8 Listing for use in Medical Equip. add \$50

332: meets CSA standards for use in Medical Equip. add \$50

333: meets VDE standards for use in Medical Equip. add \$50

Accessories

See Cabinets, System II for handle and rack mounting kits

10488A Input signal cable: contains three color-coded 50Ω coaxial cables with three male BNC connectors on each end; length 3.6 m (12 ft). \$55

1310A, 1311A, 1317A, 1321A Options and accessories

Options	Price
001: (1310A, 1311A) delete top and bottom covers	less \$50
005: green contrast filter	add \$50
006: blue contrast filter	add \$45
008: (1310A, 1311A) meets UL Listing 544 for Medical and Dental Electronic Equipment	add \$100
008: (1317A, 1321A) meets UL Listing 544 for Medical and Dental Electronic Equipment	add \$25
009: (1310A, 1311A) standard tilt stand for use with Opt 008 instruments	add \$175
010: (1311A) tall tilt stand provides space beneath 1311A for 9825A or 1350A	add \$200
050: (1317A, 1321A) TTL blanking level. High State, +2.5 V to +5 V blanks any analog Z-axis input. Low state, 0.0 V to 0.8 V returns blanking to Z-axis input	add \$25
051: (1317A, 1321A) differential inputs to X, Y, and Z amplifiers. Inputs for each axis through separate BNC connectors (shields grounded)	add \$25
052: (1317A, 1321A) 4-bit binary Z-axis input provides 16 levels of gray shades (TTL compatible). Settling time ≤300 ns	add \$100
053: (1317A, 1321A) linear light output (±20%) with respect to Z-axis drive change (gamma correction)	add \$50
054: (1317A, 1321A) same as 050, polarity reversed	add \$25
055: (1317A) fixed slides for EIA rack, 48.3 cm (19 in.)	add \$100
604: aluminized P4 phosphor in lieu of P31	add \$30
607: aluminized P7 phosphor in lieu of P31, includes amber contrast filter with anti-glare surface	add \$100
639: aluminized P39 phosphor in lieu of P31	add \$30

Accessories

(1310A, 1311A) Refer to data sheet for rack mounting and slide kits, and 1310A panel inserts

10488A Input signal cable: contains three color-coded 50Ω coaxial cables with three male BNC connectors on each end; length 3.6 m (12 ft) \$55

Ordering information

	Price
1304A Large Screen Display	\$2600
Opt 910: extra manual	add \$9.50
1310A 48 cm (19 in.) Display	\$4100
Opt 910: extra manual (covers 1310A & 1311A)	add \$8.50
1311A 36 cm (14 in.) Display	\$3800
Opt 910: extra manual (covers 1310A & 1311A)	add \$8.50
1317A Large Screen Display	\$3900
Opt 910: extra manual	add \$10
1321A Large Screen Display	\$4500
Opt 910: extra manual	add \$10

OEM discounts available

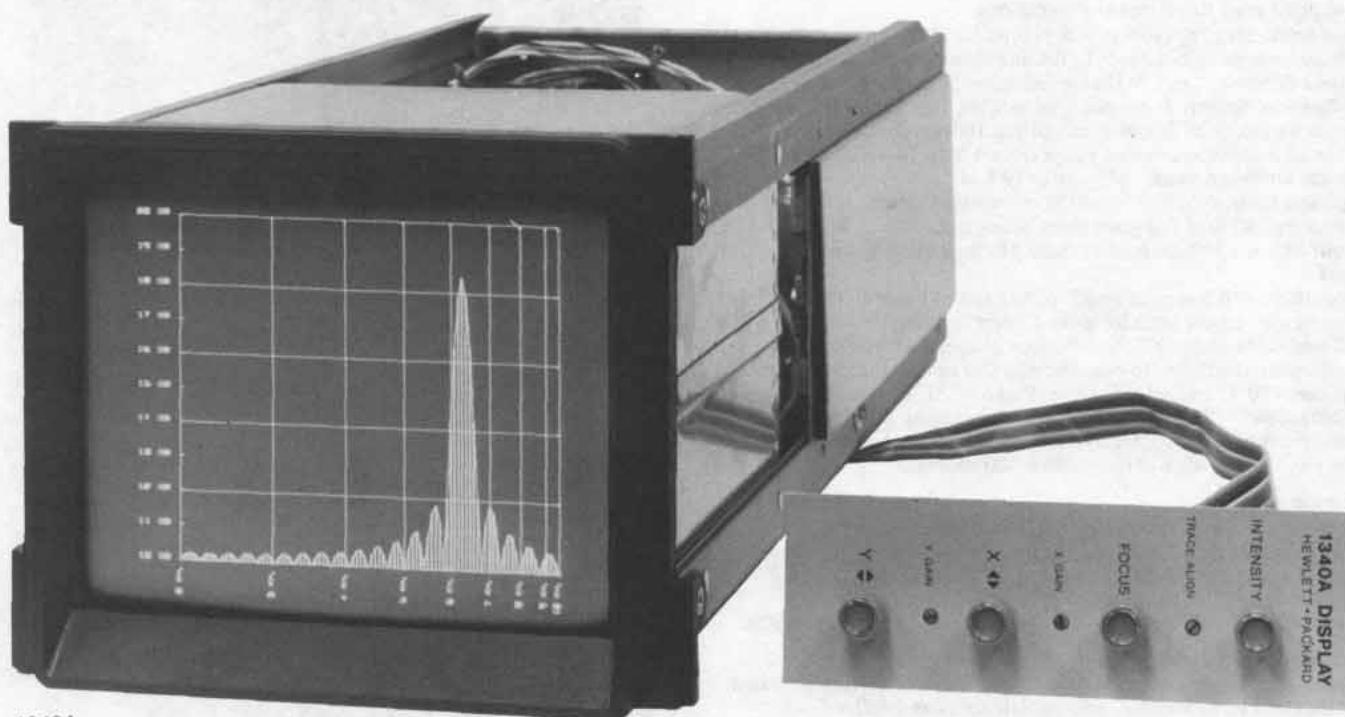

1340A

1340 Description

Model 1340A modular 15.3 cm display offers flexibility, convenience, and cost-effectiveness for OEM system designers with a basic display module that is rugged and easy to integrate into an instrument or system console.

Functional controls for intensity, focus, X and Y position, X and Y gain, and trace alignment can be located to suit design criteria. The standard display module includes a control panel that can be located to the right of the module or in a remote position. With Option 001 you can omit the control panel and use your own controls. Since the control functions are dc inputs to the integrated-circuit amplifiers, you can provide them from an appropriate part of your system.

Electronics

Integrated circuits contain most of the X, Y and Z amplifier components, improving reliability as well as reducing cost. X and Y attenuators, input impedance, polarity, and bandwidth limiting are internally switch selectable. This provides flexibility to designers and inventory convenience when you use the 1340A in more than one instrument or system.

A dc supply option deletes the power transformer, rectifiers, and power line cable, allowing power to be supplied from your own instrument or system. Two voltages are required: regulated +20 Vdc and regulated -15 Vdc.

Mechanical Construction

The 1340A module is a unitized structure, which is independently rugged without a cabinet. The display integrates easily into almost any instrument or system console design. If you wish to simplify the cabinet design for your system, there are several OEM cabinets for the 1340A (see Options). These are attractively styled and designed to accommodate circuitry for a variety of instrument applications.

Serviceability

Ease of service is designed into the 1340A, beginning with the mechanical construction which provides easy accessibility and continuing with an electrical design that incorporates IC's which reduce the number of components that can fail.

The power supply and amplifier boards are easily removed, giving you several service options: remove the entire module for service off-site, substitute pc boards and repair removed boards at a central location, or on-site component level repair. Your HP Field Engineer can arrange a service support plan to meet your needs.

Applications

The price-performance ratio of the 1340A makes it ideal for almost every instrumentation system. Resolution, viewing area, and brightness are suitable for spectrum, network, vibration, transient, pulse height, and digital logic analyzers. The CRT writes a clear, crisp trace.

The 1340A can be used in a number of non-destructive test systems or instruments. The dc gain adjustment is helpful in remotely programming changes of the parameters being displayed. This capability is particularly useful in programmed test systems where operator interaction is impossible or undesirable.

The 1340A is adaptable to geophysical measurement systems, particularly the dc power Option 002. This option simplifies integration into a system and reduces weight, a benefit with portable equipment or other systems that require minimum size and weight.

The 1340A may also be used as a basic display for communication system analyzers, chemical and scientific analysis systems, and some medical diagnostic systems. And it provides an economical operator interface in special production test systems. With the optional full rack module cabinets you have space to mount your own test system circuitry.

Accessories

Model 10380A Cabinet and Frame Kit provides an empty 13.4 cm (5¼") high half-rack module for mounting beside the 1340A. The kit includes the half-rack module, connecting hardware for the 1340A, and full rack width top and bottom covers. Model 10386A Cabinet and Frame Kit provides the same features for mounting an empty module above or below the 1340A.

CATHODE-RAY TUBE DISPLAYS

Model 1340A (cont.)

1340A Specifications

For complete specifications refer to the 1340A Data Sheet.

Vertical and horizontal amplifiers

Rise time: ≤ 120 ns (10% to 90% points) for \leq full screen deflection.

Bandwidth: dc to > 3 MHz (3 dB down) for ≤ 5 cm deflection.

Phase Shift: $< 3^\circ$ to 1 MHz for full screen signal inputs.

Deflection factor: Front panel adjustable, 800 mv to 2 V, for full screen deflection of X and Y amplifiers. Independently switch selectable 5:1 attenuators extend range from 4 V to 10 V full scale.

Linear writing speed: ≥ 25 cm/ μ s (9.8 in./ μ s).

Settling time: ≤ 300 ns to within one spot diameter.

Linearity: $\leq 5\%$ of full scale along major axes.

Input RC: ≈ 1 M Ω shunted by ≤ 50 pF. Internal 50 Ω switch.

Drift

Position: ≤ 0.5 mm/hr (0.02 in./hr) and ≤ 1 mm (0.04 in.) in 24 hours with covers installed after 15 min. warmup.

Gain: $< 1\%$ under all combinations of specified line voltage with covers installed after 15 min. warmup and constant temperature between $+20^\circ\text{C}$ and $+55^\circ\text{C}$ ($+68^\circ\text{F}$ and $+131^\circ\text{F}$).

Crosstalk: < 0.25 mm (0.01 in.) with one input terminated in 50 Ω and the other axis excited by a 1V, 500 kHz signal; < 0.5 mm (0.02 in.) at 3 MHz when driven from a 50 Ω source.

Z-axis amplifier

Rise time: < 70 ns (cw bandwidth ≈ 5 MHz).

Blanking range: a 1V change in the Z input voltage causes a full scale change in brightness. The cutoff level can be set from $+0.2$ Vdc to -1 Vdc with the intensity control.

Input RC: ≈ 1 M Ω shunted by ≤ 40 pF. Internally settable to 50 Ω .

Cathode-ray tube

Type: post deflection accelerator ≈ 6.6 kV accelerating potential. Aluminized P31 phosphor, electrostatic focus and deflection.

Viewing area: 114 cm² (17.7 in.²); 96 mm (3.8 in.) vert by 119 mm (4.7 in.) horiz.

Graticule: 8 x 10 div internal graticule; 1 div = 1.2 cm (0.47 in.).

Spot size: ≤ 0.46 mm (0.018 in.) at center screen measured using shrinking raster method. Line resolution ≈ 25 lines/cm (64 lines/in.).

Trace align: geometrically aligns X-axis with viewing area.

General

Input connectors: BNC female connector with grounded shield for each axis mounted on rear panel.

Line power: 100, 120, 220, or 240 Vac, $+5\%$ to -10% ; 48 Hz to 66 Hz. Average power dissipation at 60 Hz and 120 Vac is ≈ 30 watts.

Size: 128 H (front panel opening) x 163 W x 438 mm D (5.1" x 6.4" x 17.2").

Weight: Opt 315: net, 8.2 kg (18 lb), with covers and feet; shipping, 9.1 kg (20 lb).

Operating environment

Same as 1332A, refer to Small Screen Displays Specifications.

Accessories supplied: one blue contrast filter, one operator's note, one 2.3 m (7.5 ft) line cord (90° IEC to NEMA 5-15 P, 3-conductor) for use in Canada, Mexico, Japan and the United States.

NOTICE TO USERS: The 1340A is primarily for OEM system applications. Therefore, without Opt 315 or Opt 317, protective covers are not provided and internal wiring connections of HAZARDOUS VOLTAGES ARE EXPOSED. Operator protection from these hazardous voltages must be provided by the purchaser and/or user of the instrument. If in doubt, ORDER OPT 315 or OPT 317.

Options

For complete listing, including power cord options, refer to 1340A Data Sheet.

Modules

001: display module without control panel less \$25

002: display module and control panel without internal less \$25

power supply (requires $+20$ Vdc regulated $\pm 5\%$ including ripple, 1.5A; and -15 Vdc regulated $\pm 5\%$ including ripple, 0.25A; each supply floating with its own ground return)

Cabinets

315: Display module with HP System II 133 mm (5 1/4 in.) high, half-rack width cabinet, 381 mm (15 in.) long add \$75

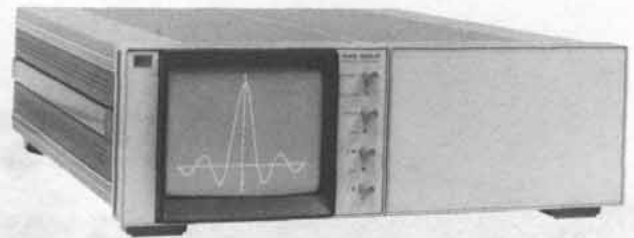

1340A Option 316 installed in 10380 cabinet.

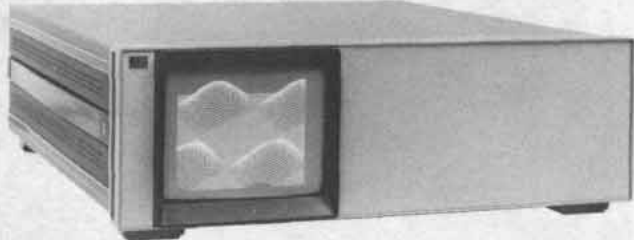

1340A Option 317.

and with control panel (Model 1340A is supplied without cabinet and with control panel)

316: Display Module with rear bracket for mounting in 10380A (side-by-side cabinet) or 10386A (vertically stacked cabinet) with 457 mm (18 in.) side struts. Front casting, rear casting, two 457 mm (18 in.) struts, no covers, rear cover panel. add \$50

317: Display Module with HP System II 133 mm (5 1/4 in.) high, full-rack width cabinet with 381 mm (15 in.) long struts, 488 mm (17 1/4 in.) overall length. Painted blank front panel and rear filler panel included. add \$150

X and Y amplifiers

110: 4 to 10 V/div deflection factor add \$5

Cathode-ray tube

Graticule/Phosphor Type

004: P4 phosphor with 8 x 10 div internal graticule add \$30

039: P39 phosphor with 8 x 10 div internal graticule add \$30

604: P4 phosphor, no graticule add \$30

631: P31 phosphor, no graticule N/C

639: P39 phosphor, no graticule add \$30

Contrast filters

561: clear CRT implosion shield replaces standard blue contrast filter (Opt 561 and Opt 315 required for UL 478 electronic data products listing) N/C

Signal inputs

324: add 25-pin connector to rear panel. X, Y, and Z-axes signal inputs wired in parallel with BNC inputs. X, Y, and Z input capacitance increases to approx 120 pF add \$30

Z-axis digital input

216: TTL blanking level. High state ($+2.5$ V to $+5$ V) blanks any analog Z-input signal. Low state (0.0 V to 0.8 V) returns blanking to analog Z-axis input add \$15

Safety

330: Display Module with HP System II half-rack cabinet, UL Listed for use in Medical and Dental Equipment (UL 544). Includes special hospital-grade ac line cord, special line transformer, and clear CRT implosion shield in lieu of standard blue contrast filter add \$125

335: UL recognized component for use in Medical and Dental Equipment (UL 544) (display module without cabinet). Includes special hospital-grade ac line cord, special line transformer, and clear CRT implosion shield in lieu of standard blue contrast filter add \$50

580: Meets measurement equipment requirements for Canadian Standards Association safety certification. Includes Option 315 with CSA labeling add \$75

Ordering information

1340A Display Module (with control panel) \$1000

10380A Cabinet and Frame Kit (side-by-side) \$150

10386A Cabinet and Frame Kit (vertically stacked) \$150

CATHODE-RAY TUBE DISPLAYS

Small screen displays

Models 1332A, 1333A, 1335A & 1336S

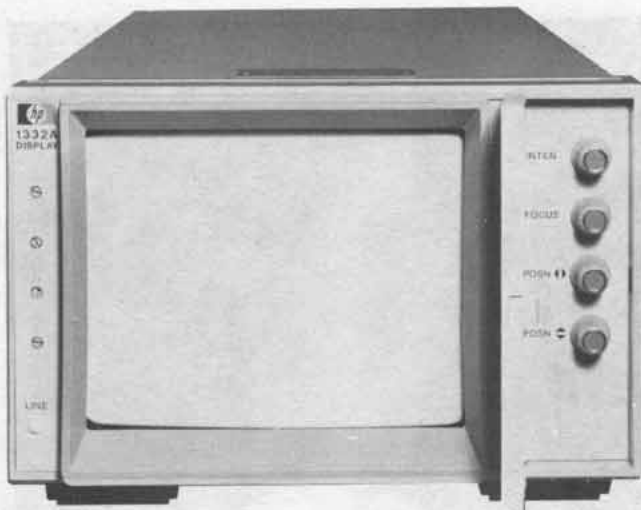

1332A

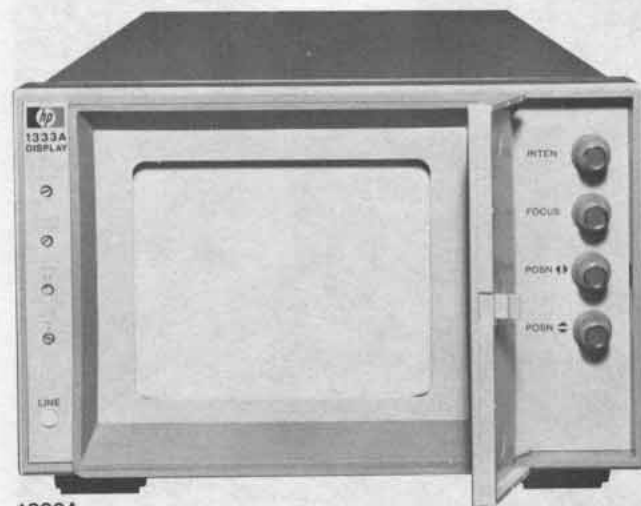

1333A

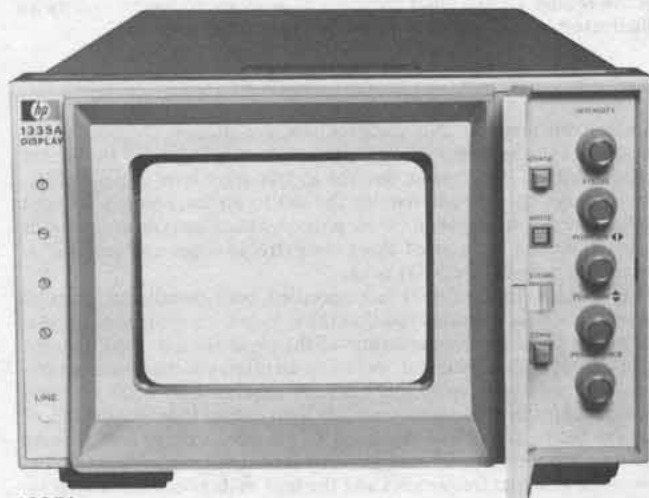

1335A

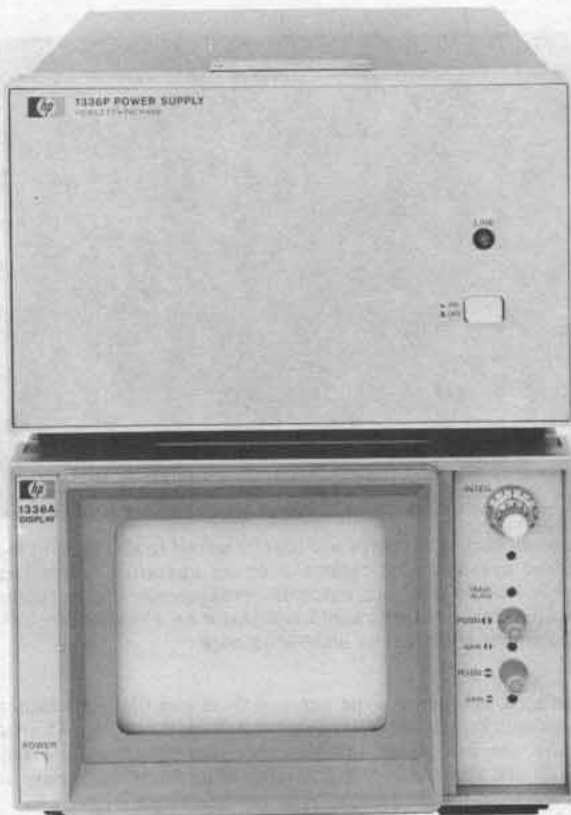

1336S

1332A, 1333A, 1335A, and 1336S Description

Models 1332A, 1333A, 1335A, and 1336S are high-quality cathode-ray tube displays designed to satisfy a wide range of OEM medical and electronic instrument display needs. The major differences between these displays are their CRT's.

Model 1332A has a large 9.6×11.9 cm display area with the resolution and picture quality required for medical diagnosis systems plus a bright display for differentiating between many gray shades, or for viewing in brightly lighted areas. Option 530 provides even greater brightness with up to 500cd/m^2 line brightness (see Specifications).

Model 1333A has a high resolution CRT with an 8×10 cm viewing area specifically optimized for photographic applications such as gamma camera systems. The 1333A's combination of high resolution, excellent uniformity, and speed permits crisp easy-to-read, diagnostic-quality photographs to be obtained from state-of-the-art nuclear, ultrasonic, thermographic, and X-ray scanning systems.

Model 1335A's high resolution 8×10 cm storage display offers medical and instrumentation OEM users a variable persistence, storage, and non-storage CRT display with excellent performance. Outstanding picture quality and amplifier performance combine to make the 1335A a significant advancement in storage displays.

Model 1336S consists of an 8×10 cm display module (1336A) and a separate power supply module (1336P) for mounting flexibility. With up to 140 lines/cm resolution the 1336S is ideal for all high resolution imaging requirements.

The 1332A, 1333A, and 1335A have post deflection accelerator CRT's to assure a bright, crisp trace. The 1336S display uses a mono-accelerator CRT design to achieve 140 lines/cm resolution at center screen with low power consumption. An opaque aluminum layer behind the phosphor (except in model 1336S, which is non-aluminized) enhances trace brightness.

CATHODE-RAY TUBE DISPLAYS

Models 1332A, 1333A, 1335A & 1336S (cont.)

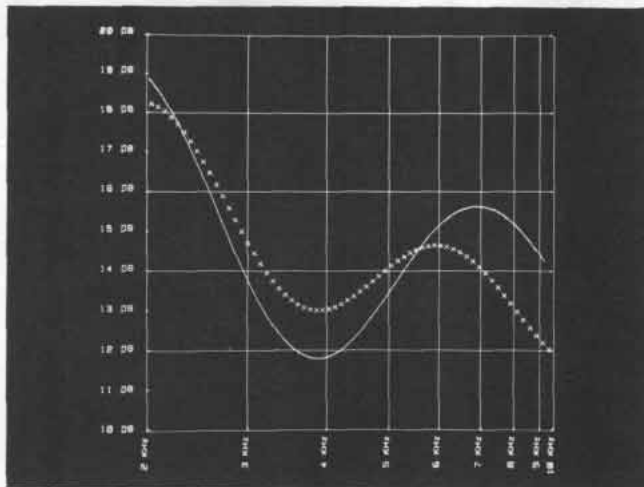

HP's small screen displays are ideally suited to all types of measurement systems applications such as spectrum and network analysis, Fourier analysis, automatic measurement, or in conjunction with Model 1350A Graphic Translator as a readout for HP-IB measurement systems, as illustrated here.

Regulated, low power write gun and flood gun filaments assure a constant light output under varying line voltage conditions. More importantly, the low power filament operation significantly extends CRT life and eliminates grid and other stray emissions common to older, less efficient designs.

Models 1332A, 1333A, 1336S, and 1335A (Opt 330) are listed with Underwriters Laboratories in accordance with the UL 544 Medical Safety Standard which defines detailed patient protection requirements. Regular inspection of our production facility by UL assures you that this patient protection is built into the display that you purchase.

Models 1332A, 1333A, and 1335A are 13.3 cm (5- $\frac{1}{4}$ in.) high, half rack width, 49.5 cm (19 $\frac{1}{2}$ in.) long packages that can be combined with identical empty modules to form an attractive full width horizontal or vertically stacked OEM instrument. The 1336A Display Module has the same dimensions and the 1336P Power Supply Module has the same height and width but is 33.5 cm (13 $\frac{3}{16}$ in.) deep. If the 1336A/P are to be mounted together, 1336P Option 018 may be ordered to provide the same cabinet depth as the 1336A, with locking hardware to form a standard EIA rack width unit.

Picture clarity

Model 1332A: spot size is only 0.305 mm (0.012 in.) diameter at high intensity levels and remains focused over the entire range of intensity levels. This resolution makes the 1332A well suited for applications requiring sharp focusing on multiple gray shades or varying writing speeds with frequent video drive level changes. Spot size is 0.3 mm over the entire quality area, making the display especially useful in applications where sharp focus is required. An example of this is where alphanumeric characters are mixed with traces, curves, or graphs.

The large 9.6 cm x 11.9 cm viewing area and bright display make the 1332A ideal for the OEM with both visual and some photographic requirements. Display brightness lets you view the display in high ambient light conditions while maintaining resolution and gray shades for photographic work. Whenever uniform photographic recording of the display becomes critical, the 1333A or 1336S should be used.

Model 1333A: is specifically designed for photographic recording where display uniformity and high image quality are essential. Spot size is a crisp 0.20 mm (0.008 in.) diameter everywhere on its 8 x 10 cm display, which allows resolution of 193 354 picture elements. The spot remains round and sharply focused in all areas of the screen and at varying intensity levels, eliminating the need to readjust focus or

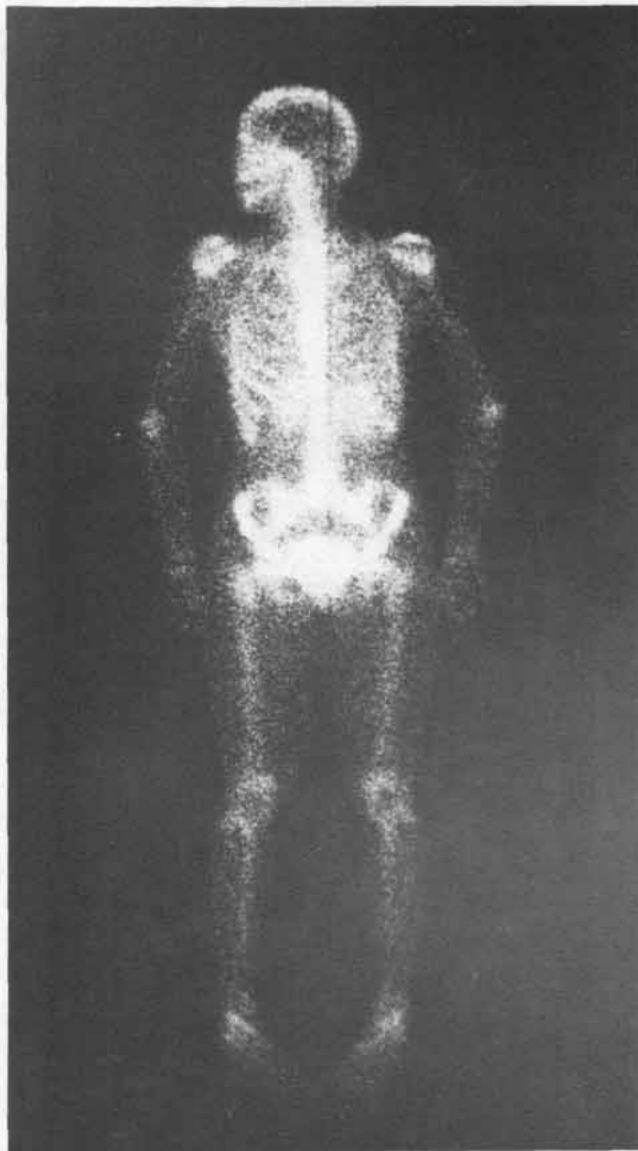

Ultra-high resolution, uniform light output, and long-term stability of the Model 1336S yield optimum photographic image quality as illustrated in this full body gamma camera bone study.

astigmatism controls. No compromises are needed for optimizing overall image sharpness in applications where all areas of the screen contain critical information and the Z-axis drive level varies widely. For displays that do not require the entire screen, sharply focused alphanumeric messages such as patient identification or operator instructions can be inserted along the extreme edges and corners for maximum use of the display area.

Light output uniformity is fully specified, both overall and for small increments, which assures you that the information content of the display is an accurate representation of the input signals. Additionally, light output drift is specified, including all effects of the Z-axis amplifier, high voltage supply, and CRT. A regulated dc CRT filament voltage is also used to assure constant light output independent of line voltage fluctuations. The regulated dc filament voltage also reduces the possibility of interference patterns resulting from correlation between input signal frequencies and the high voltage oscillator or power line frequencies.

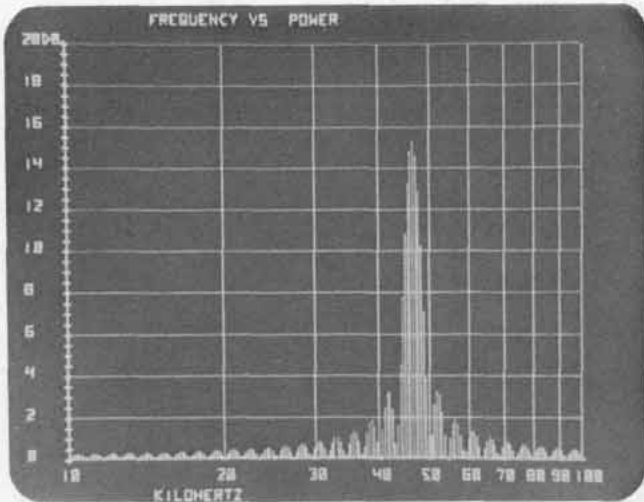

Fine image detail and a well-focused spot at all intensity levels make the 1335A ideal for use in Spectrum, Fourier, Network, and Chemical analysis as well as automatic test systems.

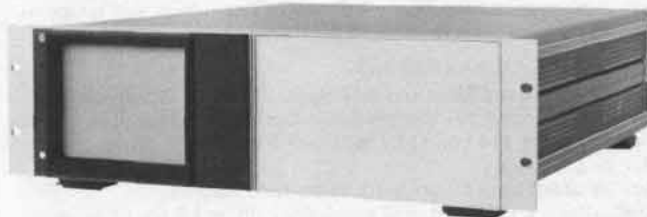

Empty half-width frame, available as an accessory, provides an attractive full-width or double-height package with an integrated appearance with space for your special circuits.

Model 1335A: The CRT can be operated in non-storage, storage, or variable persistence modes. In the non-storage mode (called CONVENTIONAL), the CRT operates similar to a mono-accelerator conventional CRT with an exceptionally small spot that focuses uniformly over the entire quality area. Resolution is approximately 40 lines per cm (100 lines per in.). In addition, spot size is relatively independent of intensity settings or Z-axis input signals, eliminating the need to refocus at each intensity setting. This characteristic enhances the CRT image in applications requiring the CRT to focus on a wide range of intensity levels. Applications include those where markers intensify areas of interest, where characters or vectors are written, and anywhere that the writing speed or drive levels of the beam vary. The light output remains extremely stable because of regulated CRT filament voltages and an exceptionally stable Z-axis amplifier.

The same excellent CRT performance is maintained in the Variable Persistence operating mode. Persistence is continuously adjustable with a front panel control, from approximately 0.20s to full storage. This mode allows you to eliminate flicker on some presentations by increasing the persistence to match the refresh rate. The variable persistence mode is selected by pressing the WRITE pushbutton.

The storage CRT is preset to store dots having a Z-axis width of 1 μ s or greater for up to 30 minutes. The storage mode offers the greatest contrast because the background is completely dark. An internal adjustment allows an increase of writing speed to capture faster signals with reduced storage time and trace-to-background contrast. Another adjustment may be used to enhance either the storage time of the trace or the stored brightness of the stored images. Stored resolution is over 20 lines per cm (50 lines per in.) and stored traces retain sharp details.

Model 1336S: with 140 lines/cm resolution at center screen this display is ideal for all high-resolution imaging requirements such as multi-imaging gamma cameras, scanning electron microscopes, and scanning auger microprobes. A mono-accelerator CRT with an accel-

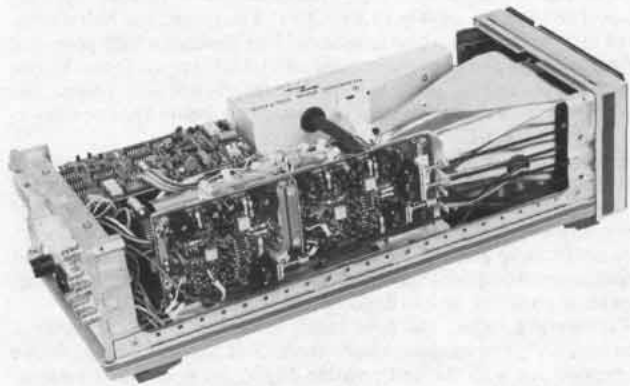

The well-designed interior layout and use of plug-in boards, multi-conductor cables, and multi-pin connectors make the 1332A, 1333A, 1335A, and 1336S very serviceable.

erating potential of approximately 5 kV produces an intense, 0.07 mm (0.0028 in.) diameter spot at center screen. HP contributions in electron gun and circuit design make it possible to provide this high resolution with only 100 watts power consumption.

The CRT is designed to prevent spurious light from reaching photographic film during long time exposures. Light output uniformity is tested to assure that the information content of the displayed image is an accurate representation of the input signals.

Programmability (1335A)

The Model 1335A offers users great flexibility in selecting ERASE, STORE, WRITE, CONVENTIONAL, and VARIABLE PERSISTENCE modes. These modes can be selected with the manual front panel controls, remote program inputs, or a combination of both.

In manual operation, the front panel controls select the operational mode. In program mode, a single program line inhibits the manual controls and prevents operator intervention. Additional control lines can be used to selectively enable the front panel ERASE and VARIABLE PERSISTENCE controls during remote operation to provide interactive capability. Provisions have been made so that any programmable functions can be hard wired to operate through the front panel controls during remote operation.

Electronics

Models 1332A, 1333A, and 1335A

The X and Y amplifiers have 70 ns rise time (bandwidth is 5 MHz) and the Z-axis blanking amplifier has a 25 ns rise time. When faster X and Y amplifier response is required, Model 1332A has an Option available to obtain 25 ns rise times. All amplifiers are fully differential and operate at exceptionally low power levels for stable, drift-free performance over wide ranges of operating temperatures.

The time required to make any size movement on the CRT, including the response time for the amplifiers to settle within one spot diameter of final position, is less than 300 ns. This means that many thousands of vectors and characters can be written on the display without flicker or annoying distortions.

Model 1336S

The 1336A's deflection amplifiers settle to within one spot diameter in < 500 ns after receiving an input step command. All amplifiers are fully differential and operate at low power levels for stable operation and minimum warm-up time. Dynamic focus circuits automatically correct for spot position to assure optimum resolution over the entire CRT face. A regulated dc CRT filament supply assures a stable light output.

Interfacing flexibility is provided by internal switches which allow selection of X, Y, and Z amplifier input characteristics. An optional TTL blanking input unconditionally overrides any analog Z-axis input and the intensity control, and can be used to provide CRT protection in the event of CRT failure.

OEM Frame

The 1332A, 1333A, 1335A, and 1336A displays are built around a comprehensive, modular mechanical frame which allows OEM's to

CATHODE-RAY TUBE DISPLAYS

Models 1332A, 1333A, 1335A & 1336S (cont.)

develop many integrated package combinations to fit their applications. The basic package is 13.3 cm (5 1/4 in.) high, and half a standard rack width. The frame consists of four castings which provide a strong package and does not require additional support from the system it is installed in. These half module frames are fully compatible with Hewlett-Packard's System II modular enclosure system; refer to Cabinets, System-II.

Empty modules of equal size allow the frame to be combined into either a full width module suitable for rack mounting or bench use, or in a vertically stacked configuration. Your custom-designed circuits can easily be installed in these empty modules. Combining covers are also available to give the combined frames an integrated, single-unit appearance. Additional hardware is also available for rack mounting, mounting on slides, and to dress up the basic frame.

Considerable effort has been taken in developing the structural, thermal, RFI, and modular characteristics of this mechanical frame to provide you with the best possible display for your OEM system.

All frequently used controls are adjustable from the front panel for maximum accessibility when the display is mounted in a rack, cabinet, or system. The most frequently used controls, such as intensity, focus, and position have knobs while infrequently used controls such as astigmatism, trace align, and X and Y Gain are screw-driver adjustments. The 1336A has a 10-turn dial on the intensity control to allow precise resetting of trace brightness for repeatable photographic results. A front panel door covers the controls of the 1332A, 1333A, and 1335A for a more pleasant appearance and reduces the chance of misadjustment by untrained personnel. The ac line switch is mounted on the rear panel to prevent inadvertent turn-off allowing the display to be powered through the common system power bus.

Serviceability

Construction of these displays is modular, rugged, and extremely serviceable. Printed circuit boards are plug-in type with interconnections through edge connectors and multiconductor wire strips that connect to sockets on the boards. Serviceability also extends to CRT replacement which, with a knowledgeable technician, can be accomplished in approximately ten minutes. Calibration time is kept to a minimum with easily accessed and independent adjustments.

Options and accessories

A wide range of options is available for tailoring the display to specific requirements; refer to Specifications for complete listing. Accessories available include rack mounting kits, OEM half module frames and rack slides, a light shield (Model 10183A), and BNC shorting caps for use with certain options. For convenient system interconnection, Model 10488A 3.6 m (12 ft) Display Cable is available as an accessory. Model 197A Opt 001/006 camera is adapted for direct recording of 1332A, 1333A, 1335A, and 1336S displays. Refer to the individual display data sheets for a complete description of accessories.

1332A, 1333A, and 1335A Specifications

Vertical and horizontal amplifiers

Response

Rise time: ≤ 70 ns (10% to 90% points) for \leq full screen deflection.

Bandwidth: dc to ≈ 5 MHz for 7.6 cm (3 in.) deflection (1332A), 5.1 cm (2 in.) deflection (1333A, 1335A).

Phase shift (1332A, 1335A): $< 1^\circ$ dc to 1 MHz (measured with X and Y gain set to max).

Deflection factor (horizontal and vertical): 100 mV/div (1 V p-p for 10 div deflection horizontal; 0.8 V p-p for 8 div deflection, vertical). Adjustable from ≈ 80 mV/div to 200 mV/div.

Settling time: signal settles to within one spot diameter of final value in ≤ 300 ns.

Linear writing speed: ≥ 25.4 cm/ μ s (10 in./ μ s).

Inputs: rear panel BNC connectors with shield grounded. Fully differential inputs available, see Options.

Input RC: ≈ 1 M Ω shunted by ≤ 60 pF.

Max input: ± 50 V (dc + peak ac).

Dynamic range: beam may be deflected off screen up to 1/2 screen diameter in any direction provided that the zero input position is on screen, without degradation of specification.

Crosstalk: ≤ 0.254 mm (0.010 in.) with one input terminated in 50 Ω

and other driven by 1 V, 500 kHz signal; < 0.38 mm (0.015 in.) at 5 MHz when driven from 50 Ω source.

Drift

Position: ≤ 0.5 mm/hr (0.02 in./hr) and ≤ 1.02 mm (0.040 in.) in 24 hr with covers installed and after 15 min. warmup.

Gain: $< 1\%$ under all combinations of specified line voltage with covers installed after 15 min. warmup and temperature between $+20^\circ\text{C}$ and $+55^\circ\text{C}$ ($+68^\circ\text{F}$ and $+131^\circ\text{F}$).

Common mode rejection ratio: (Opt 106 only) at least 40 dB (100:1) up to 10 kHz for 1 V (full screen) inputs; at least 25 dB (18:1) at 1 MHz for 1 V (full screen) inputs.

Z-axis amplifier

Rise time: ≤ 25 ns; cw bandwidth ≈ 5 MHz.

Blanking range: a 1 V change in Z-axis input voltage causes a full scale change in brightness.

Blanking polarity: a positive-going input Z-axis voltage increases brightness.

Input: rear panel BNC connector with shield grounded. Fully differential inputs available, see Options.

Input RC: ≈ 1 M Ω shunted by < 60 pF.

Max input: ± 50 V (dc + peak ac).

Gain: internally adjustable over 2.5:1 attenuation range.

Light output stability (drift): spot photometer measurements of light output made at one hour intervals will not vary more than 10% from previous measurement for any location within the useable display area, under all specified conditions of line voltage and temperature with intensity set to $> 5\%$ of peak brightness.

Cathode-ray tube (1332A)

Type: electrostatic focus and deflection, ≈ 22.5 kV accelerating potential, aluminized P31 phosphor (see Options for other phosphors).

Viewing area: 114 cm² (17.7 in.²), ≈ 9.6 cm vert by 11.9 cm horiz (3.8 in. x 4.7 in.).

Quality area: center 9 div horiz by center 7 div vert.

Graticule: 8 x 10 div internal graticule. 1 div = 1.2 cm (0.47 in.).

Spot size: ≤ 0.3 mm (0.012 in.) over entire quality area, measured using shrinking raster method. Line resolution ≈ 31.5 lines/cm (80 lines/in.).

Line brightness: ≥ 170 cd/m² (50 fl) at writing speed of 0.25 cm/ μ s (0.1 in./ μ s), 60 Hz refresh rate, P31 phosphor, 0.3 mm (0.012 in.) spot size.

Geometry: $< 3\%$ pincushion and barrel distortion over useable display area.

Linearity: $< 3\%$ of full scale along major axes.

Cathode-ray tube (1333A)

Type: electrostatic focus and deflection, ≈ 12 kV accelerating potential, aluminized P31 phosphor.

Viewing area: 80 cm² (12.4 in.²), 8 cm vert by 10 cm horiz (3.1 in. x 3.9 in.).

Quality area: 8 cm vert by 10 cm horiz (3.1 in. x 3.9 in.).

Graticule: none, see Options.

Spot size: ≤ 0.20 mm (0.008 in.), over entire quality area. Measured using shrinking raster method, line resolution ≈ 49 lines/cm (125 lines/in.).

Light output

Line brightness: 34.3 cd/m² (10 fl) at writing speed of 0.254 cm/ μ s (0.1 in./ μ s), 60 Hz refresh rate, P31 phosphor, 0.02 mm (0.008 in.) spot size.

Uniformity: with a 1:1 photograph of the CRT display using Polaroid Type 107-084 film, input signals adjusted for uniform stimulation of the entire CRT screen area and exposure parameters adjusted for an average reflection density of 0.3 to 0.6 in the resultant print, the difference between any two points on the photograph in a centered 7 x 9 cm rectangular area is less than one step on a Kodak 12-step gray scale.

Linearity: $< 3\%$ of full scale along major axes.

Stray emission: no stray emissions from the CRT will be visible on Polarity Type 107 ASA 3000 film after a 30 min. time exposure with the camera lens set to f/1.9, 1:1 magnification ratio.

Cathode-ray tube (1335A)

Type: electrostatic focus and deflection, ≈ 8.5 kV accelerating potential, aluminized P31 phosphor.

Viewing area: 72.2 cm² (11.2 in.²), 7.6 cm vert by 9.5 cm horiz (3 in. x 3.7 in.).

Quality area: center 9 div horiz by center 7 div vert.

Graticule: 8 x 10 div internal graticule, 1 div = 0.95 cm (0.37 in.).

Geometry: <3% pincushion and barrel distortion over useable display area.

Linearity: <3% of full scale along major axes.

Conventional (non-store) parameters

Spot size: 0.254 mm (0.010 in.) over entire quality area. Measured using shrinking raster method. Non-stored line resolution is 39 lines/cm (100 lines/in.).

Line brightness: 68 cd/m² (20 fl) at writing speed of 0.254 cm/ μ s (0.1 in./ μ s), 60 Hz refresh rate, P31 phosphor, 0.0254 mm (0.010 in.) spot size.

Persistence: \approx 40 μ s.

Storage parameters

Stored resolution: \approx 20 lines/cm (51 lines/in.).

Brightness: >680 cd/m² (>200 fl) in WRITE mode.

Erase time: <500 ms.

Storage time: >1 min. at full brightness in WRITE mode, extending to >30 min. in STORE mode at lower brightness.

Variable persistence: continuously adjustable from 0.2 s to full storage (one min.).

Dot writing time: will store a dot anywhere inside the quality area having an unblanking time of 1 μ s.

Writing speed: >50 cm/ms.

Remote programming (1335A)

(TTL compatible, except Variable Persistence)

Remotely programmable functions: Erase, Write, Store, Conventional, and Variable Persistence.

Remote selection: a single TTL control line disables the front panel Erase, Write, Store, Conventional, and Variable Persistence functions and transfers control to the remote inputs.

Control Enable: separate TTL inputs to enable front panel Erase and/or Variable Persistence controls during remote operation.

Variable persistence: an external dc voltage between 0 and +10 V sets the persistence. Or, a pot can be connected through the Remote Input connector to control persistence if 10 Vdc is not available.

Erase verify: A TTL High output during Erase (will drive ten low power gates).

Safety

Implosion: transparent safety panel between CRT and bezel protects viewer (Opt 561 or 330).

X-ray emission: 0.5 mr/hr measured with Victoreen Model 440 RF/C.

UL listing: with Opt 315 and 561 meets Underwriters Laboratories Listing 478 for Electronic Data Processing Equipment; with Opt 330 meets UL for Dental and Medical Electronic Equipment.

NOTICE: these displays are designed and manufactured primarily for OEM system applications. Therefore, without Opt 315 or Opt 330, the top and bottom protective covers are not provided and internal wiring connections of HAZARDOUS VOLTAGES ARE EXPOSED and operator protection must be provided by the purchaser and/or user of the instrument. If in doubt order Opt 315 or 330 which provide the covers.

General

Input connectors: rear panel BNC for X, Y, and Z inputs with shields grounded.

Front panel controls

Knobs: position X, position Y, focus and intensity.

Pushbuttons (1335A): erase, write, store, and conventional.

Screwdriver adjustments: trace align, astigmatism, gain X, and gain Y.

Line power indicator: front panel lamp.

Operating environment: temperature, 0°C to +55°C (0°F to +131°F), non-operating, -40°C to 70°C (-40°F to +158°F); humidity, 5% to 95% relative humidity at +40°C (+104°F); altitude, to 4600 m (15 000 ft), non-operating to 7600 m (25 000 ft); shock, 30 g level with 11 ms duration and 1/2 sine wave shape; vibration, vibrated in three planes for 15 min. each with 0.254 mm (0.010 in.) excursion.

Line power: selectable 100, 120, 220, or 240 Vac, +5%, -10%; 48 Hz to 66 Hz*; max power (1332A) 50 VA (\approx 40 W), (1333A) 60 VA

(\approx 50 W), (1335A) 65 VA (\approx 55 W). Average power dissipation at 60 Hz and 120V without any options is \approx 24 W (1332A), \approx 40 W (1333A), \approx 35 W (1335A).

*Units meet all electrical specifications 48-440 Hz, but do not meet ac line to chassis leakage requirements of UL 544 (Medical and Dental) Listing above 66 Hz.

Size: 146 H (including feet) x 213 W x 524 mm D (5 $\frac{3}{4}$ " x 8 $\frac{3}{8}$ " x 20 $\frac{3}{8}$ ").

Weight: net, 8.6 kg (19 lb) with covers, feet; shipping, 10.5 kg (23 lb).

Covers, feet, tilt stand, and trim not supplied with standard displays.

Accessories supplied: one blue contrast filter, one 2.3 m (7.5 ft) line cord (90° IEC to NEMA 5-15P, 3-conductor for use in Canada, Mexico, Japan, and the United States), one Operating and Service Manual, and for the 1335A one remote program connector.

1336S Specifications

Vertical and horizontal amplifiers

Deflection factor and input resistance: deflection factors and input resistances may be selected by internal switches independently for X and Y axes. Front panel X and Y gain controls vary the deflection factor through the range indicated.

Deflection Factor Range	Nominal Input Resistance
≤ 100 mV/cm to ≥ 200 mV/cm	10 k Ω
≤ 100 mV/cm to ≥ 200 mV/cm	50 k Ω
≤ 0.5 V/cm to ≥ 1 V/cm	113 k Ω
≤ 1 V/cm to ≥ 2 V/cm	100 k Ω

Settling Time: signal settles to within ± 0.5 spot diameters of final value in <500 ns for any on-screen final location. Initial off-screen deflection (if any) must not exceed specified dynamic range.

Repeatability: <0.15% error (full screen) for readdressing a point from any on- or off-screen location within specified dynamic range.

Dynamic range: beam may be deflected off-screen up to 1/2 screen diameter in any direction provided that the zero input position is on screen, without degradation of specifications.

Input capacitance: ≤ 70 pF.

Inputs: fully differential BNC connectors with shield grounded.

Max input: ± 50 V (dc + peak ac) for high impedance; ± 2.5 V (dc + peak ac) for 50 Ω input impedance.

Position: front panel controls allow undeflected spot to be set off screen from anywhere within the viewing area.

Drift: typically <0.5 mm/hr (0.02 in./hr) and ≤ 1.02 mm (0.04 in.) in 24 hrs. with covers installed after 15 min. warm-up.

Z-axis amplifier

Blanking range and input resistance: blanking ranges and input resistances may be selected by internal switches. An internal Z-axis gain adjustment varies the blanking through the range indicated. The blanking range is the peak-to-peak variation in Z-axis input voltage required to vary CRT beam current from cutoff to maximum.

Blanking Range	Approx Input Resistance
≤ 1 V p-p to ≥ 2.5 V p-p	10 k Ω
≤ 1 V p-p to ≥ 2.5 V p-p	50 Ω
≤ 5 V p-p to ≥ 12.5 V p-p	113 k Ω
≤ 10 V p-p to ≥ 25 V p-p	100 k Ω

Rise time: ≤ 40 ns, measured with a 10% duty cycle pulse at a repetition rate of 100 kHz.

CW bandwidth: ≈ 5 MHz.

Linearity: light output typically varies linearly with Z-axis input voltage within $\approx 20\%$.

Input: fully differential BNC connectors, shields grounded to chassis.

Input capacitance: ≤ 70 pF.

Max. input: ± 50 V (dc + peak ac) with high input impedance; ± 2.5 V (dc + peak ac) for 50 Ω input impedance.

Light output stability: raster scan photometer measurements of light output made at one hour intervals will typically not vary more than 5% from the previous measurements for any location within the useable display area, under all specified conditions of line voltage with intensity set to >5% of peak brightness and constant ambient temperature after 15 minutes warmup time.

CATHODE-RAY TUBE DISPLAYS

Models 1332A, 1333A, 1335A & 1336S (cont.)

Temperature coefficient of light output: $\approx 1\%/deg\ C$, for light output $\geq 5\%$ of max light output.

Cathode-ray tube

Type: mono-accelerator, $\approx 5\ kV$ accelerating potential, electrostatic focus and deflection, P31 non-aluminized phosphor, and no graticule.
Viewing area: 80 cm², 8 cm vert by 10 cm horiz, centered on CRT.
Resolution: within a 6.4 cm \times 8 cm rectangle with a 0.8 cm radius on each corner, centered on the electrical center of the CRT, the resolution is ≥ 80 lines/cm at $25^\circ C \pm 10^\circ C$. At the electrical center of the CRT, the resolution is ≥ 140 lines/cm at $25^\circ C \pm 10^\circ C$. After 4000 operating hrs or 12 mos from date of shipment, whichever comes first, resolution at electrical center of CRT shall be ≥ 100 lines/cm at $25^\circ C \pm 10^\circ C$, provided unit has been calibrated at intervals of 6 months or less. Electrical center of CRT is located within 0.5 cm of geometric center.

Radiant power output: 2 $\mu W/cm^2$ steradian, measured with a 100-line, 4 cm \times 4 cm, focused raster with 50% duty cycle.

Light output uniformity: the difference in light output between any two points within a 7 cm \times 9 cm area centered on the cathode-ray tube face is $\leq 16\%$. Within this 7 cm \times 9 cm area, the gradient of light output with respect to position does not exceed 6% per cm averaged over any 2% p-p variation, excluding gradients which are not continuous for a distance of at least 1 cm.

Note: light output uniformity is not warranted after customer use, since normal use may degrade light output uniformity beyond the stated limits within the warranty period.

Linearity: $< 3\%$ of full scale along major axes.

Geometry: $< 3\%$ pincushion or barrel distortion within quality area.

Safety

UL listing: UL listed for use in medical and dental systems (UL 544).

X-ray emission: < 0.5 mr/hr measured with Victoreen Model 440 RF/C.

General

Line power: 100, 120, 220, or 240 Vac selectable on rear panel, $+5\%$ to -20% ; 48 to 66 Hz*; max power 125 VA (≈ 100 W).

*1336S meets all electrical specifications 48–440 Hz, but does not meet ac line to chassis leakage requirements of UL 544 (Medical and Dental) listing above 66 Hz.

Operating environment

(Same as 1332A with following exception)

Vibration: vibrated in three planes for 15 min. each with 0.38mm excursion, 5 Hz to 55 Hz; 1 min./octave, 10 min. each resonance.

Signal input connectors: two BNC female connectors for each axis mounted on rear panel.

Front panel controls

Knobs: intensity (10-turn knob with turn-counting dial), position X, position Y.

Screwdriver adjustments: trace align, X gain, Y gain, focus (focus adjustment requires special tool, supplied with Model 1336A).

Line indicator: white LED mounted on front panel.

Accessories supplied: One operator's Note, one 2.3 m (7.5 ft) line cord (IECA to NEMA 5-15P, 3 conductor for use in Canada, Mexico, Japan, and the United States – see Options for other available line cords), one 1.5 m (5 ft) cable for interconnection of power supply and display module.

Size: 1336A, 146 H (including feet) \times 213 W \times 524 mm D ($5\frac{5}{8}$ " \times $8\frac{3}{8}$ " \times $20\frac{3}{8}$ "). Standard 1336P Power Supply is 335 mm D ($13\frac{1}{8}$ "); order 1336P Opt 018 for same depth as 1336A.

Weight:

1336A: net, 7.1 kg (15½ lb); shipping 10 kg (22 lb).

1336P: net, 7 kg (15½ lb); shipping, 10.4 kg (23 lb).

1336S: net, 14.2 kg (31¼ lb); shipping, 20.4 kg (45 lb).

OPTIONS (1332A, 1333A, 1335A)**Price****X and Y amplifiers****Deflection factor**

100: 500 mV/div, 5 p-p for full-screen deflection add \$20

101: 1 V/div, 10 V p-p for full-screen deflection add \$20

Polarity

105: negative X and Y inputs move beam up and right (BNC connectors). N/C

106: fully differential inputs, shield grounded (BNC connectors). add \$25

Input impedance

110: 50 Ω add \$10

Rise time

120 (1332A): 25 ns X & Y amplifier rise time add \$25

Z-axis input (video amplifier)**Blanking range**

200: 0 to 5 V add \$10

201: 0 to 10 V add \$10

Polarity

205: negative input unblanks trace, BNC connector with shield grounded N/C

206: fully differential input, BNC connector with shield grounded add \$15

Input impedance

210: 50 Ω add \$10

Gain characteristics

215: light output varies linearly ($\pm 20\%$) with a linear change in Z-axis input voltage (gamma correction) add \$15

Digital input

216: TTL blanking level. High state (+2.5 V to +5V) blanks any analog Z-input signal. Low state (0.0 V to 0.8 V) returns blanking to analog Z-axis input. add \$50

Cathode-ray tube**Graticule/phosphor type**

004 (1332A): P4 aluminized phosphor with 8 \times 10 div internal graticule add \$30

007* (1332A): P7 aluminized phosphor with 8 \times 10 div internal graticule and amber contrast filter add \$30

011 (1332A, 1333A): P11 aluminized phosphor with 8 \times 10 div internal graticule add \$30

031 (1333A): P31 aluminized phosphor with 8 \times 10 div internal graticule N/C

039 (1332A): P39 aluminized phosphor with 8 \times 10 div internal graticule add \$30

604 (1332A): P4 aluminized phosphor without internal graticule add \$30

607* (1332A): P7 aluminized phosphor with amber filter without internal graticule. add \$30

611 (1332A, 1333A): P11 aluminized phosphor, without internal graticule. add \$30

631 (1332A, 1335A): P31 aluminized phosphor, without internal graticule N/C

639 (1332A): P39 aluminized phosphor without internal graticule add \$30

*P39 phosphor is recommended in lieu of P7.

Brightness

530 (1332A): line brightness ≥ 500 cd/m² (146 fl) at a writing speed of 0.25 cm/ μs (0.1 in./ μs), 60 Hz refresh rate, P31 phosphor. Spot size ≤ 0.38 mm (0.015 in.) over entire quality area. add \$100

Note: Opt 530 not available with Opt 007, 011, 039, 607, 611, or 639.

Magnetic shield

550 (1332A): full magnetic shield on CRT add \$95

Contrast filters

NOTE: the plastic filter serves as integral implosion protection for the viewer, therefore these displays cannot be ordered without the standard or an optional filter.

561: clear, replaces filter supplied with standard and some optional phosphors, and is required for UL EDP Equipment Listing. N/C

562 (1332A, 1335A): clear, RFI coated surface also includes metalized front panel. add \$150

General**AC line cords**

300: 2.3 m (7.5 ft) removable, 240 V max, 3-conductor 90° IEC to Great Britain, Singapore. N/C

301: 2.3 m (7.5 ft) removable, 240 V max, 3-conductor 90° IEC to Australia, New Zealand. N/C

302: 2.3 m (7.5 ft) removable, 240 V max, 3-conductor 90° IEC to East and West Europe. N/C

303: 2.3 m (7.5 ft) removable, 240 V max, 3-conductor IEC to NEMA 6-15P (USA, Canada, Japan, Mexico)	N/C
304: 77 cm (30 in.) coiled, extends to 1.8 m (6 ft), removable, 120 V max, 3-conductor IEC to NEMA 5-15P (USA, Canada, Japan, Mexico) (not available with Opt 315 or 330).	add \$5
307: USA only hospital grade power cord	add \$10
AC line voltage tolerance	
310 (1332A, 1335A): +5%, -20% tolerance at 100, 120, 220, 240 Vac setting. Increases power dissipation to \approx 50 watts (1332A), 60 watts (1335A).	add \$50
Front and rear panel modifications	
322: replaces standard intensity control with a 10-turn control with counting dial.	add \$50
323: front panel screwdriver adjustments on left side of front panel changed to internal adjustments.	add \$10
324 (1332A, 1333A): adds 25-pin connector to rear panel. X, Y and Z-axis signal inputs wired to positive signal inputs (input capacitance is increased to \approx 120 pF).	add \$30
326: front panel controls on right side changed to screwdriver adjustments. These include intensity, focus, position X, and position Y. When Opt 322 is specified with Opt 326, the intensity control is as described in Opt 322 and the focus, position X, and position Y become screwdriver adjustments.	add \$25
Safety	
315: includes covers, feet, trim, and tilt stand (required for UL EDP Equipment Listing)	add \$70
330: meets requirements for UL Listing for Dental and Medical Electronic Equipment. Includes special three-conductor ac line cord, specially marked covers, feet, tilt stand, trim, UL label, and Opt 561.	add \$75
580: meets requirements for Canadian Standards Association Safety Certification. Includes Opt 315 with CSA labeling.	add \$75
Operating/service literature	
910 (1332A): extra set of product manuals	add \$5.50
910 (1333A): extra set of product manuals	add \$7.50
910 (1335A): extra product manual	add \$7

OPTIONS (1336S)

Safety

Safety option applies to 1336A Display Module, 1336P Power Supply Module, or 1336S Display System (includes 1336A display and 1336P power supply modules).

332: meets CSA standard for use in Medical Equipment.	add \$50
--	----------

OPTIONS (1336A Display Module)

These display module options also apply when ordering the 1336S Display System.

X and Y amplifiers

Deflection factor

100: 500 mV/div, 5 V p-p for full screen deflection	add \$5
--	---------

101: 1 V/div, 10 V p-p for full screen deflection	add \$5
--	---------

Input impedance

110: 50 Ω	add \$5
-------------------------	---------

Z-axis input (video amplifier)

Blanking range

200: 0 to 5 V	add \$5
----------------------	---------

201: 0 to 10 V	add \$5
-----------------------	---------

Input impedance

210: 50 Ω	add \$5
-------------------------	---------

Digital input

216: TTL blanking level. High state (+2.5 V to +5 V) blanks any analog Z-input signal. Low state (0.0V to 0.8V) returns blanking to analog Z-axis input. Rear panel input through BNC connector. Max input -0.2 Vdc to +5 Vdc.	add \$50
---	----------

217: same as 216 except polarity reversed.	add \$50
---	----------

*These options may also be internally switch-selected on a standard 1336A.

Front and rear panel modifications

323: all knob controls on front panel (intensity, position X, position Y) changed to screwdriver adjustments	add \$25
---	----------

324: adds 25-pin connector to rear panel. X, Y, and Z-axis signal inputs wired to the positive signal inputs (input capacitance increases to \approx 120 pF, and crosstalk specification is waived).	add \$30
---	----------

OPTIONS (1336P Power Supply Module)

These power supply module options also apply when ordering the 1336S Display System.

AC line cord

300: 2.3 m (7.5 ft) removable, 240 V max, 3 conductor 90° IEC to Great Britain, Singapore	N/C
--	-----

301: 2.3 m (7.5 ft) removable, 240 V max, 3 conductor 90° IEC to Australia, New Zealand	N/C
--	-----

302: 2.3 m (7.5 ft) removable, 240 V max, 3 conductor 90° IEC to East and West Europe.	N/C
---	-----

303: 2.3 m (7.5 ft) removable, 240 V max, 3 conductor IEC to NEMA 6-15P (USA, Canada, Japan, Mexico)	N/C
---	-----

304: 77.2 cm (30 in.) coiled, extends to 1.8 m (6 ft) removable 120 V max, 3 conductor IEC to NEMA 5-15P (USA, Canada, Japan, Mexico).	\$25
---	------

Note: units ordered with Options 300-304 not UL listed for use in Medical and Dental systems (UL 544).

Connecting cable

001: 0.3 m (1 ft) interconnecting cable in lieu of 1.5 m (5 ft) cable	N/C
--	-----

002: no interconnecting cable for supplying power to display module	N/C
--	-----

Cabinet length

018: cabinet length same as 1336A. Includes locking hardware to attach power supply module to display module. Assembled pair is one standard EIA rack width. Rack mounting flanges, with or without handles, and pivoting or fixed slides are available for rack mounting the combined units; see Cabinets, System II.	\$25
---	------

Accessories (small screen displays)

10380A OEM Horizontal Frame \$150

The Model 10380A Frame Kit provides an empty 13.4 cm (5¼ in.) high half-module frame for mounting on the left or right of a display. The kit includes an empty half-module with locking hardware for side-by-side mounting; combining covers that cover both the display and empty module (covers supplied with Option 315 or 330 are not compatible with this kit); side covers with strap handles for both sides; and blank front, front sub, and rear panels for the empty module.

10382A Bench Hardware Kit for 10380A \$25

The Model 10382A Bench Hardware Kit provides hardware for finishing the 10380A for bench use. The kit includes plastic trim for the front handles, plastic feet, tilt stands, and front rack handles.

10386A OEM Vertical Frame \$150

The Model 10386A Frame Kit provides an empty half-module for mounting above or below a display. The empty half-module frame is ideal for user designed circuits and has an integrated appearance. The kit includes an empty half-module with locking hardware for mounting above or below the display; top and bottom covers (covers supplied with Option 315 or 330 are not compatible with this kit); combining side covers; blank front, front sub, and rear panels for the empty module; and cabinet trim.

10183A Light Shield for 1332A, 1333A, 1335A, 1338A \$15

Ordering information

1332A Small Screen Display	\$1575
-----------------------------------	--------

1333A Small Screen Display	\$1900
-----------------------------------	--------

1335A Small Screen Display	\$2200
-----------------------------------	--------

1336A Display Module	\$3800
-----------------------------	--------

1336P Power Supply Module	\$900
----------------------------------	-------

1336S Display System (includes 1336A, 1336P) OEM and quantity discounts available.	\$4700
---	--------

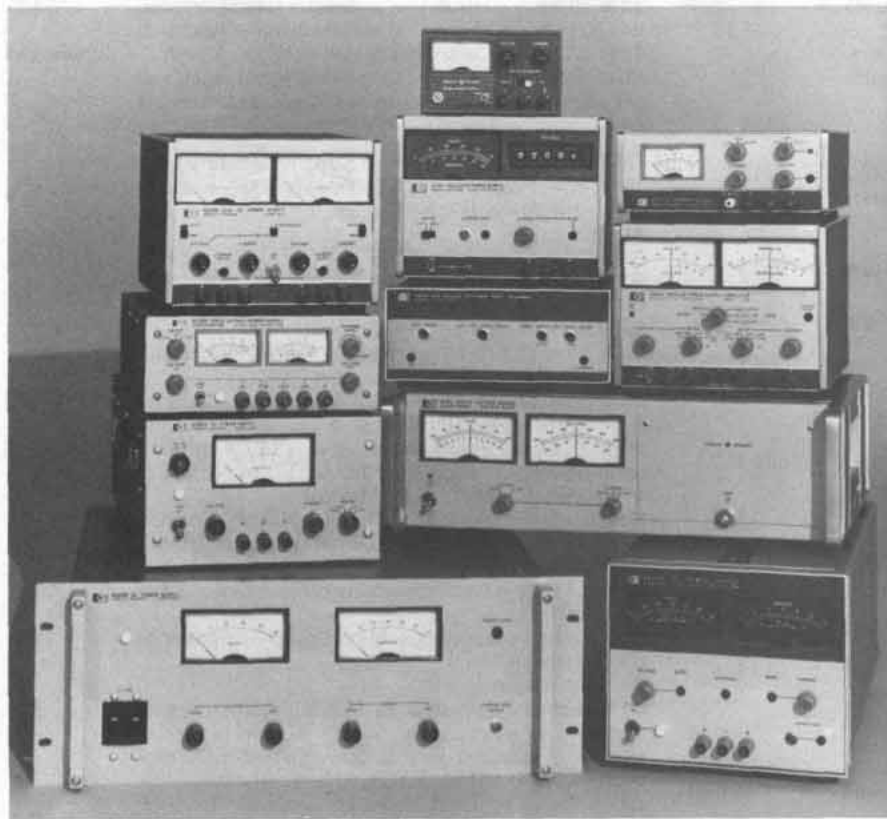

Introduction

Hewlett-Packard power supplies are available in many types, sizes, and ratings. There are laboratory supplies used in circuit development, modular supplies to power systems, high-power supplies for industrial processes, and many special purpose supplies ranging from constant-current sources to bipolar power supply amplifiers.

The true value of a power supply

The best power supply for the job must first satisfy all the physical criteria: voltage and current ratings, performance specifications, size, and features. But equally important are the less tangible aspects that affect the real cost of ownership. Such factors as the experience and expertise of the manufacturer's engineering staff should be considered. Are his designs conservative—does he use quality components, does he have established QA procedures?

If you have a problem or need application assistance, are the manufacturers' reps accessible, responsive, and knowledgeable? Are spare parts and service available on a worldwide scale?

These factors do not show up on a spec sheet, but are closely related to a company's capability and responsibility towards its customers. When you purchase a power supply from Hewlett-Packard, you receive guaranteed product performance plus the intangibles that add up to long-term value—and it usually costs no more.

Regulation techniques

HP power supplies are designed using one of four proven stabilization techniques: series, switching, SCR, and SCR preregulator/series regulator.

Series regulation: this technique uses a feedback loop to control the voltage drop across a series-pass transistor located between the rectified dc input and the output terminals of the power supply. The feedback network senses changes in the output voltage and develops an error signal which adjusts the drop across the series transistor such that it maintains the output terminal voltage at the desired level. Good regulation (0.001% to 0.05%), low ripple and noise (50 μ V to 1 mV), and fast transient response (<50 μ s) characterize this type of regulator.

With all its attributes of excellent performance and circuit simplicity, the series regulator has one drawback; it is relatively inefficient (typically 30 to 40%). Heat sinks are employed to dissipate the heat generated by the series transistors and this necessarily increases the size and weight of the supply.

All linear OEM modular and low power lab supplies use this technique.

Extended range series regulation: this technique uses a pair of triac switches with appropriate control logic to automatically select different transformer secondary taps depending on the output voltage and current demand placed on the supply, and the AC input voltage and frequency. Several voltage-current combinations can thereby be supplied from the input rectifier to the following

series regulator. This extends the range of voltage (or current) output available within the power rating of the supply beyond that obtained from a simple series regulator. Model 6002A uses this technique.

Switching regulation: this technique regulates the output voltage by essentially switching a series transistor on and off at a rapid rate (about 20 kHz) and delivering this "chopped" current to an output filter. A feedback network senses changes in the output and feeds back a correction signal which adjusts the transistors on-off duty cycle to maintain a constant output voltage. Since a transistor dissipates very little power when it's fully on or off, the regulator has excellent efficiency (typically 65-80%).

Besides low power dissipation, another advantage of this technique is that the high pulse repetition rates make possible the use of transformers, inductors, and filter capacitors that are much smaller than those required for operation at power line frequencies.

Stabilization performance of the switching regulator is somewhat lower than the series regulator (typically 0.2% regulation; 20 mV rms, 40 mV p-p ripple and noise) but well suited for the majority of OEM system applications.

SCR regulation: In many high power applications, the tight regulation and low ripple and noise characteristics of the series regulator can be beneficially traded for economy, efficiency, and compact size. This is where the SCR regulator is most valuable. Typical performance specifications for SCR supplies are 0.05 to 1% regulation, 50 mV rms, 500 mV p-p ripple and noise, 50-200 ms transient response, and 70% efficiency. Regulation is accomplished by sensing both the AC input and DC output of the supply and generating a firing pulse for SCR's located in two legs of a bridge rectifier. If the output voltage tries to decrease, the control circuit generates the firing pulse earlier in the input half cycle. More voltage is then passed through the SCR to the output filter to raise the output voltage to the correct level.

SCR pre-regulator/series regulator: this technique incorporates the best of both worlds, and is used in most medium to high power, high performance power supplies. In these supplies, the SCR pre-regulator changes the rectifier output in coordination with the output voltage of the supply so that only a small voltage drop is maintained across the series pass transistor. This reduces the power dissipation in the series elements and greatly improves the efficiency (up to 70%). Typical performance specifications are similar to series regulated supplies except for slower transient response.

Selecting power supplies

By model number: if you know the model number, you can find the power supply description page from the numerical index in the front of this catalog.

By voltage rating: the condensed listing on the following two pages lists power supplies in order of output voltage rating. The referenced catalog page covers detailed specifications.



Specification definitions

Ambient temperature: the temperature of the air immediately surrounding the power supply.

Auto-parallel operation: a master-slave connection of the outputs of two or more supplies used for obtaining a current output greater than can be obtained from one supply.

Auto-series operation: a master-slave connection of the outputs of two or more supplies used for obtaining a voltage greater than can be obtained from one supply.

Auto-tracking operation: a master-slave connection of two or more supplies each of which has one of its output terminals in common with one of the output terminals of all of the other supplies.

Complementary tracking: a master-slave interconnection of two supplies in which the voltage of the slave is equal to or proportional to that of the master and of opposite polarity with respect to a common point.

Compliance voltage: the output voltage of a power supply operating in the constant-current mode.

Constant-current (CC) power supply: a power supply that stabilizes output current with respect to changes in influence quantities. Thus, for a change in load resistance, the output current remains constant while the output voltage changes by whatever amount necessary to accomplish this.

Constant-voltage (CV) power supply: a power supply that stabilizes output voltage with respect to changes in influence quantities. Thus, for a change in load resistance, the output voltage remains constant while the output current changes by whatever amount necessary to accomplish this.

Constant-voltage/constant-current (CV/CC) power supply: a power supply that operates as a constant voltage power supply or a constant-current power supply depending on load conditions. It acts as a constant-voltage source for comparatively large values of load resistance and as a constant-current source for comparatively small values of load resistance.

Constant-voltage/current-limiting (CV/CL) power supply: a power supply similar to a constant-voltage/constant current supply except that at comparatively small values of load resistance, its output current is limited instead of being stabilized.

Crowbar: see overvoltage protection.

Current limiting: the action of limiting the output current of a constant-voltage supply to some predetermined maximum value (fixed or adjustable) and automatically restoring the output voltage to its normal value when the overload or short circuit is removed. There are three types of current limiting: 1) by constant-voltage/constant-current crossover, 2) by decreasing the output voltage as the current increases, 3) by decreasing both voltage and current as the load resistance decreases (referred to as foldback or cutback current limiting).

Drift: the maximum change of an output voltage or current during an 8-hour period following a 30-minute warmup, with all influence and control quantities maintained constant during the warm-up time and the period of drift measurement. Drift includes both periodic and random deviations over the bandwidth from zero frequency (dc) to a specified upper frequency limit (usually 20 Hz).

Load effect: formerly known as load regulation, load effect is the change in the steady-state value of the stabilized output voltage or current resulting from a full-load change in the load current of a constant-voltage supply or the load voltage of a constant-current supply, with all other influence quantities maintained constant.

Load effect transient recovery time: the time interval between a specified step change in the load current of a constant-voltage supply (usually a full-load or 5-amp change, whichever is smaller) or in the load voltage of a constant-current supply and the instant when the stabilized output quantity returns to and stays within the specified transient recovery band.

Master-slave operation: a method of interconnecting two or more supplies such that one of them (the master) serves to control the others (the slaves). The outputs of the slave supplies always remain equal to or proportional to the output of the master. The outputs of the

master supply and of one or more slaves may be connected in series, in parallel, or with just their negative or positive output terminals in common. (See also complementary tracking.)

Nominal value: the value that exists "in name only," not the actual value. For example, in the case of a power supply with a calibrated output control, the nominal value is the value indicated by the control setting. For a supply with a fixed output, the nominal output is the output indicated on the nameplate. The nominal value of a 120-volt $\pm 10\%$ line voltage is 120 volts.

Output impedance: the complex ratio of a sinusoidal voltage and sinusoidal current at the output terminals, the one being caused by the other and being of external origin.

Overcurrent protection: protection of the power supply and/or connected equipment against excessive output current.

Overtemperature protection: protection of the power supply or parts of it against temperatures exceeding specified values.

Overvoltage protection: protection of the power supply and/or connected equipment against excessive output voltage. Overvoltage protection is usually by means of a crowbar protection circuit, which rapidly places a low resistance shunt across the supply's output terminals to reduce output voltage to a low value if a predetermined voltage is exceeded. A supply equipped with an overvoltage crowbar must also be protected by a means of limiting or interrupting output current.

PARD (acronym for periodic and random deviation): the term PARD replaces the former term ripple and noise. PARD is the periodic and random deviation of a dc output voltage or current from its average value, over a specified bandwidth (20 Hz to 20 MHz; except Models 6515A-6525A: 1 Hz to 20 MHz) and with all influence and control quantities maintained constant).

Programming speed: the maximum time required for the programmed output voltage or current to change from a specified initial value (usually zero or maximum output) to a value within a specified tolerance band of a specified newly programmed value (for most models 99.9% or 0.1% of maximum output, respectively; 99% and 1% for the 6104A-6116A, 6177C-6186C, and 6427B-6483C) following the onset of a step change in the programming input signal.

Remote control: also referred to as remote programming, remote control is the setting of the power supply voltage, current, or other function by means of an external control quantity such as a variable resistance, voltage, or current, or a digital signal.

Remote sensing: remote sensing, or remote error sensing, is a means by which a power supply monitors the stabilized voltage directly at the load using extra sensing leads. The resulting circuit action compensates for voltage drops in the load leads (up to a specified limit).

Resolution: the smallest change in output voltage or current that can be obtained using the front panel controls.

Reverse voltage protection: protection of the power supply against reverse voltage applied at the output terminals.

Slave operation: see master-slave operation.

Source effect: formerly known as line regulation, source effect is the change in the steady-state value of the stabilized output voltage on current resulting from any change in the source voltage within its specified range, with all other influence quantities maintained constant. Source effect may be measured at any output voltage and current within rating.

Temperature effect coefficient: the maximum steady-state change in a power supply's output voltage or current per degree Celsius following a change in the ambient temperature within specified limits, with all other influence quantities maintained constant.

Voltage limiting: the action of limiting the output voltage of a constant-current supply to some predetermined maximum value (fixed or adjustable) and automatically restoring the output current to its normal value when the load conditions are restored to normal. There are two types of voltage limiting: 1) by constant-voltage/constant-current crossover, 2) by decreasing the output current as the voltage increases.

Warm-up time: the time interval after switching on a power supply until it complies with all performance specifications.



POWER SUPPLIES

Condensed Listing

DC Volts	DC Amps (Max.)	Type	Model	Page
4-5.5	8	Low Cost Lab	6384A†	218
0 ± 5 & ± 20 Dual Range	1	BPSA*	6825A†	235
0 ± 5 & ± 50 Dual Range	1	BPSA*	6826A†	235
5 ± 0.50	2	Modular	62005A†	238
5 ± 0.50	8	Modular	62005E†	238
5 ± 0.50	16	Modular	62005G†	238
5, 5-12, 5-12 Microprocessor	3, 0.6, 0.6	Modular	62312D	238
5, & ± 12 to 15, ± 0.25 Triple	18 & 2A max	Modular	63315D†	238
4.75 to 5.25	50	Modular	63312F†	238
+11.4 to +15.75	10			
-11.4 to -15.75	10			
Multi-output Microprocessor System				
5 ± 0.25	22	DC-to-DC	61005C	238
5 ± 0.25	22	Modular	63005C†	238
5 & 12 to 15, ± 0.25 Triple	18 & 2A max	DC-to-DC	61315D	238
	40 & 10A			
5 ± 0.25	60	Modular	62605L†	238
5 ± 0.25	100	Modular	62605M†	238
0-6, 0 ± 18 Triple	1 & 0.2	Low Cost Lab	6235A†	220
0-6, 0 ± 20, Triple	2.5 & 0.5	Low Cost Lab	6236B†	220
0-7.5	3	Low Cost Lab	6203B†♦	
0-7.5	5	Gen. Purpose	6281A†♦♦	222
0-8	1000	High Pwr.	6464C†♦♦	226
0-10	1	Low Cost Lab	6213A†	218
0-10	1	Low Cost Lab	6214A†	218
0-10	2	Prec. Volt	6113A†♦♦	232
0-10	10	Gen. Purpose	6282A†♦♦	222
0-10	20	Gen. Purpose	6256B†♦♦	224
0-10	50	Gen. Purpose	6259B†♦♦	224
0-10	100	Gen. Purpose	6260B†♦♦	224
0 ± 10 & 0 ± 10 Dual Range	0.5	BPSA*	6827A†	234
12 ± 0.60	1.5	Modular	62012A	238
12 ± 0.60	6	Modular	62012E†	238
12 ± 0.60	12	Modular	62012G†	238
± 12 ± 0.60 Dual	1.4	Modular	62212A†	238
12-5, 12-5, 5 Microprocessor	0.6, 0.6, 3	Modular	62312D	238
± 12 to ± 15 & 5 ± 0.25 Triple	2 & 18A max	Modular	63315D†	238
+11.4 to +15.75	10	Modular	63312F†	238
-11.4 to -15.75	10			
4.75 to 5.25	50			
Multi-output Microprocessor System				
± 12 ± 0.60 Dual	3.3	Modular	62212E†	238
± 12 ± 0.60 Dual	6	Modular	62212G†	238
0-15	200	High Pwr.	6453A†	226
15 ± 0.75	1.25	Modular	62015A†	238

†Available on GSA Contract Number GS-OOS-04663.

♦May be used with the 59501A HP-IB Isolated D/A Converter/Power Supply Programmer.

★May be used with the 6940B Multiprogrammer when equipped with Option 040.

*BPSA = Bipolar Power Supply/Amplifier.

DC Volts	DC Amps (Max.)	Type	Model	Page
15 ± 0.75	5	Modular	62015E†	238
15 ± 0.75	10	Modular	62015G†	238
± 15 ± 0.75 Dual	1.25	Modular	62215A†	238
± 15 & 5 ± 0.25	2 & 18 max	Modular	63315D†	238
± 15 ± 0.75 Dual	3	Modular	62215E†	238
± 15 ± 0.75 Dual	5.2	Modular	62215G†	238
0-16 or 0-18	600 or 500	High Pwr.	6446C†	220
0-18 & 0-± 20 Dual Tracking	1 & 0.5	Low Cost Lab	6237B†	220
0 ± 18, 0-6 Triple	0.2 & 1	Low Cost Lab	6235A†	220
0 ± 20, 0-6 Triple	0.5 & 2.5	Low Cost Lab	6236B†	220
0 ± 20, 0-18 Triple	0.5 & 1	Low Cost Lab	6237B†	220
0-20 & 0-40 Dual Range	0.6 & 0.3	Low Cost Lab	6204B†♦	218
0-20 & 0-40 Two Dual Range	0.6 & 0.3	Low Cost Lab	6205B†♦♦	218
0-20	1	Prec. Volt.	6111A†♦♦	232
0-20	1.5	Low Cost Lab	6201B†♦	218
0-20 & 0-40 Dual Range	1.5 & 0.75	Low Cost Lab	6200B†♦	218
0-20 & 20-40 Dual Range	2 & 1	Prec. Volt.	6114A†♦♦	232
0-20	3	Gen. Purpose	6284A†♦♦	222
0-20 & 0-20 Two Outputs	3 & 3	Gen. Purpose	6253A†♦♦	222
0-20	10	Gen. Purpose	6263B†♦♦	224
0-20	10	Gen. Purpose	6286A†♦	222
0-20	15	High Pwr.	6427B†♦	226
0-20	20	Gen. Purpose	6264B†♦	224
0-20	45	High Pwr.	6428B†♦	226
0-20	50	Gen. Purpose	6261B†♦♦	224
20-40 & 0-20 Dual Range	1 & 2	Prec. Volt.	6114A†♦♦	232
0-24	3	Gen. Purpose	6224B†♦♦	222
24 ± 1.20	3.75	Modular	62024E†	238
24 ± 1.20	7.5	Modular	62024G†	238
24 ± 1.20	12.5	Modular	62624J†	238
0 ± 25 Dual Output	0.2 ea	Low Cost Lab	6234A†	218
0-25	0.4	Low Cost Lab	6215A†	218
0-25	0.4	Low Cost Lab	6216A†	218
0-25 & 0-50 Dual Range	1 & 0.5	Gen. Purpose	6220B†♦♦	222
0-25 & 0-25 Two-Tracking	2	Gen. Purpose	6227B†♦♦	230
28 ± 1.40	0.7	Modular	62028A†	238
28 ± 1.40	3.25	Modular	62028E†	238
28 ± 1.40	6.5	Modular	62028G†	238
0-30 & 0-60 Dual Range	1 & 0.5	Low Cost Lab	6206B†♦	218
0-36	10	High Pwr.	6433B†♦	226
0-36	100	High Pwr.	6456B†♦	226
0-36	300	High Pwr.	6469C†♦♦	226
0-40 & 0-20 Dual Range	0.3 & 0.6	Low Cost Lab	6204B†♦	218

†Available on GSA Contract Number GS-OOS-04663.

♦May be used with the 59501A HP-IB Isolated D/A Converter/Power Supply Programmer.

★May be used with the 6940B Multiprogrammer when equipped with Option 040.

*BPSA = Bipolar Power Supply/Amplifier.

DC Volts	DC Amps (Max.)	Type	Model	Page
0-40 & 0-20 Dual Range	0.3 & 0.6	Low Cost Lab	6205B†◆	219
0-40	0.5	Prec. Volt	6112A†◆★	232
0-40	0.75	Low Cost Lab	6202B†◆	218
0-40 & 0-20 Dual Range	0.75 & 1.5	Low Cost Lab	6200B†◆	218
0-40 & 0-40 Two Outputs	1.5 & 1.5	Gen. Purpose	6255A†◆	221
0-40	1.5	Gen. Purpose	6289A†◆★	221
0-40	3	Gen. Purpose	6265B†◆★	224
0-40	5	Gen. Purpose	6266B†◆★	224
0-40	5	Gen. Purpose	6291A†◆	222
0-40	10	Gen. Purpose	6267B†◆★	224
0-40	25	High Pwr.	6434B†◆	226
0-40	30	Gen. Purpose	6268B†◆★	224
0-40	50	Gen. Purpose	6269B†◆★	224
48 ± 2.40	0.45	Modular	62048A†	238
48 ± 2.40	2	Modular	62048E†	238
48 ± 2.40	4	Modular	62048G†	238
0-50	0.2	Low Cost Lab	6217A†	218
0-50	0.2	Low Cost	6218A†	218
0-50 (Compliance)	0-0.5	Prec. Cur.	6177C†◆	234
0-50 & 0-25	0.5 & 1	Gen. Purpose	6220B†◆★	221
0-50 & 50-100 Dual Range	0.8 & 0.4	Prec. Volt.	6115A†◆★	232
0-50 & 0-50 Two-Tracking	1	Gen. Purpose	6228B†◆★	230
0-50	1.5	Gen. Purpose	6226B†◆★	221
50-100 & 0-50 Dual Range	0.4 & 0.8	Prec. Volt.	6115A†◆★	221
0-50	10-4	HP-IB	6002A	229
0 ± 50	5	Dig. Prog. Volt.	6129C†	240
0 ± 50	1	Dig. Prog. Volt.	6130C†	240
0 ± 50	1	BPSA*	6824A†◆	235
0-60 & 0-30 Dual Range	0.5 & 1	Low Cost Lab	6206B†◆	218
0-60	1	Gen. Purpose	6294A†◆★	221
0-60	3	Gen. Purpose	6296A†◆	221
0-60	3	Gen. Purpose	6271B†◆★	224
0-60	5	High Pwr.	6438B†◆	226
0-60	15	Gen. Purpose	6274B†◆★	224
0-60	15	High Pwr.	6439B†◆	226
0-64	50	High Pwr.	6459A†◆	226
0-64	150	High Pwr.	6472C†	226
0-100 (Compliance)	± 0.016	Dig. Prog. Cur.	6140A	240
0-100	0.1	Low Cost Lab	6211A†	218
0-100	0.1	Low Cost Lab	6212A†	218
0-100	0.2	Prec. Volt.	6116A†◆★	232
0-100 (Compliance)	0.25	Prec. Cur.	6181C†◆	234
0-100	0.75	Gen. Purpose	6299A†◆★	221
0 ± 100	0.5	Dig. Prog. Volt.	6131C†	240
0-110	100	High Pwr.	6475C†◆	226
0-120	2.5	High Pwr.	6443B†◆	226
0-160	0.2	Low Cost Lab	6207B†◆	218
0-220	50	High Pwr.	6477C†◆	226

DC Volts	DC Amps (Max.)	Type	Model	Page
0-300 (Compliance)	0.1	Prec. Cur.	6186C†◆	234
0-300	35	High Pwr.	6479C†◆	226
0-320	0.1	Low Cost Lab	6209B†◆	218
0-320	1.5	Gen. Purpose	895A†	221
0-440 or 0-500 or 0-600	25 or 20 or 15	High Pwr.	6483C†◆	226
1-600	1.5	High Pwr.	6448B†	226
0-1000	0.2	High Volt.	6521A†	231
0-1600	0.005	High Volt.	6515A†	231
0-2000	0.1	High Volt.	6522A†	231
0-3000	0.006	Prec. Volt.	6110A†	231
0-3000	0.006	High Volt.	6516A†	231
0-4000	0.05	High Volt.	6525A†	231

†Available on GSA Contract Number GS-OOS-04663.
◆May be used with the 59501A HP-IB Isolated D/A Converter/Power Supply Programmer.
★May be used with the 6940B Multiprogrammer when equipped with Option 040.
*BPSA = Bipolar Power Supply/Amplifier.

Power Supply Digital Programming Interfaces

Description	Model	Page
HP-IB Isolated D/A Converter/Power Supply Programmer: one channel, two programmable ranges. Provides HP-IB interface for programming either output voltage, or current (where current programming is available as described in specifications for individual power supply model) of power supplies designated with a ● symbol in the above condensed listing "model" column. Interfacing details are covered in publication 5952-3990.	59501A	228
Multiprogrammer: a highly versatile I/O expander and converter that can control up to 240 power supplies from one HP-IB port or one 16-bit duplex I/O channel. It will control output voltage and current of power supplies designated with a ★ symbol in the above condensed listing "model" column when they are equipped with Option 040. Additional Multiprogrammer capabilities include digital I/O for monitoring crowbars, relays for output switching, A/D converters or measuring power supply output, timers for automatic power supply sequencing, etc. Ask your HP field engineer for the 48-page Multiprogrammer Data Sheet, publication number 5952-3982, for complete details.	6940B	643

†Available on GSA Contract Number GS-OOS-04663.
◆May be used with the 59501A HP-IB Isolated D/A Converter/Power Supply Programmer.
★May be used with the 6940B Multiprogrammer when equipped with Option 040.
*BPSA = Bipolar Power Supply/Amplifier.

POWER SUPPLIES

Low cost lab: Single output 10W-30W

Models 6200B-6218A and 6384A

- 10 Watts output...Low ripple and noise
- Compact, Impact-resistant stackable case
- Short-circuit proof



6211A-6217A



6212A-6218A

Description

These popular low-cost bench supplies are designed for general laboratory use and are equipped with front-panel mounted voltage controls, a combination volt/ammeter, and output binding posts. Output voltage is continuously variable, via coarse and fine controls from 0V to 15% above the maximum rated output. A switch selects either output voltage or current for display on the panel meter.

Load connections are made via three binding posts. Either the + or the - post may be grounded through an adjacent GND terminal or the supply may be operated floating at up to 300 volts above ground.

The Constant Voltage/Constant Current Models have concentric coarse and fine current controls which allow setting the current-limit point to any value within the current rating. Using these controls the CV/CC supplies can also be operated as constant current sources with 500 μ A load regulation. All CV/CC models can be connected in series or parallel.

The Constant Voltage/Current Limiting (CV/CL) Model supplies are short-circuit protected by a fixed current limiting circuit which is activated at approximately 120% of rated load current. The CV/CL models can be connected in series only.

The molded, impact-resistant case includes an interlocking feature for stacking several units vertically, thus minimizing bench space required for multiple supplies. Alternatively, up to three units can be mounted side by side in a 19" rack using Rack Mounting Kit 14521A. These supplies measure 133H x 83W x 368mm D (3.25" x 5.25" x 8") and weigh 2kg (4.4 lb).

Specifications

See page 221 for ratings, performance specifications and ordering information on SINGLE OUTPUT — 10 WATT power supplies.

- 30 watts output
- Multi-function meter
- Remote sensing



6200B-6203B, 6207B, 6209B



6204B, 6206B and 6384A

Description

Models 6200-6209B

This series of low-cost bench supplies includes eight models covering an output voltage range from 0-7.5 V to 0-320 V. All models equipped with coarse and fine output voltage controls (except Models 6207B and 6209B, which have 10-turn voltage controls), volt/ampere meter, meter function/range switch, and front and rear output terminals. In addition, on the dual-range models (6200B, 6204B and 6206B), an output range switch permits the selection of either a high or a low output voltage range.

The Constant-Voltage/Current-Limiting supplies are short-circuit protected by a fixed current limiting circuit which is activated at approximately 110% of rated load current. The current-limit point can be reduced by changing the value of a single internal resistor. For the Constant-Voltage/Constant-Current supplies, concentric coarse and fine current controls allow the current-limit point to be set to any value within the current rating. Using these controls the CV/CC supplies can also be operated as constant-current sources.

Units may be bench operated or rack mounted individually or in pairs using accessory rack mounting hardware.

Model 6384A

This low-cost bench supply is designed specifically for use with digital-logic integrated circuits. Its output ratings and superior performance, combined with the protection of built-in overvoltage crowbar and current limiting circuits, make it an excellent IC supply for both laboratory and systems use.

All models in this group of supplies measure 89H x 216W x 317mm D (3.50" x 8.50" x 12.50") and weigh 4.5kg (10 lb).

Specifications

See page 221 for ratings, performance specifications and ordering information on SINGLE OUTPUT — 30 WATT power supplies.

- 10 watts output, Model 6234A
- Short-circuit proof
- Independent voltage controls



6234A

Description

Model 6234A is a low-cost, dual-output bench power supply with two independently adjustable and isolated power sources in one compact unit. Both of the dc power sources are of the constant voltage/current limit type with each output voltage being adjustable continuously over a 0 to 25V range. The maximum current available per output is 0.2A and is limited automatically to prevent over-load.

The HP 6234A offers considerable flexibility to the user with output voltages that can be arranged to provide identical or different voltages in any polarity combination with respect to 0 or other common positive or negative voltage points. The outputs can also be connected in series to provide up to 50V at 0.2A. Both sources are fully isolated to permit either of the output terminals to be grounded.

With pushbutton switches, users can select either voltage or current for each output to be monitored on the unit's meter. Other features include two multiple-turn controls for precise voltage setting, regulation to 0.01% and ripple and noise of less than 200 microvolts rms.

With dimensions of only 90 mm high, 155 mm wide and 190 mm deep (3 1/8" x 6 1/8" x 7 1/2"), the HP 6234A supply takes up a minimum amount of bench space. Its weight is 2.3 kg (5 lbs.). The unit can be powered from a 115V or an optional 230V, 47-63Hz ac input, (Option 028).

Specifications

See page 221, under listing for DUAL OUTPUT - 10 WATT power supplies for detailed performance specifications and ordering information for model 6234A.

- 24 watts output, Model 6205A
- Multi-function meter



6205B

Description

Model 6205B

This low-cost bench supply is equipped with coarse and fine output voltage controls, volt/ampere meter, meter function/range switch, and front and rear output terminals. In addition, an output range switch permits the selection of either a high or a low output voltage range.

Model 6205B combines the versatility of a dual power supply with the flexibility of auto-parallel and auto-series operation to extend the output ratings of this supply to 20 V/1.2 A, 40 V/0.6 A, and 80 V/0.3 A. In addition, using the supply's auto-tracking capability, opposite polarity voltages (± 20 V, ± 40 V) can conveniently be obtained from this one supply.

This Constant-Voltage/Current-Limiting supply is short-circuit protected by a fixed current limiting circuit which is activated at approximately 110% of rated load current. The current-limit point can be reduced by changing the value of a single internal resistor. Units may be bench operated or rack mounted individually or in pairs using accessory rack mounting hardware.

Specifications

See page 221, under listing for DUAL OUTPUT-30 WATT power supplies, for detailed performance specifications and ordering information for model 6205B.

POWER SUPPLIES

Low cost lab: triple outputs 10W-30W

Models 6235A, 6236B & 6237B

- 10 watts output
- 0 to 6 V & 0 to ± 18 V, Model 6235A



6235A

Description

This compact, low-cost, three-in-one power supply is a handy addition to the lab bench where single or multiple voltages are needed for designing and testing breadboards and prototypes. The Hewlett-Packard Model 6235A delivers three adjustable dc output voltages: 0 to +6 V at 1 A, 0 to +18 V at 0.2 A, and 0 to -18 V at 0.2 A. A single 0 to 36 volt output at 0.2 A can also be obtained by connecting across the +18 V and -18 V terminals.

The controls, meter, and binding posts are conveniently arranged on the front panel. One voltage control simultaneously adjusts the +18 V and -18 V outputs, which track one another and can be used to power operational amplifiers and other circuits requiring balanced positive and negative voltages. The supply's dual outputs have added versatility with an adjustable tracking ratio control (TRACK) that can set the negative output to a lower voltage than the positive output. Once the tracking ratio control has established a voltage ratio between the positive and negative outputs, the ratio remains constant as the +18 V voltage control is adjusted. A third control sets the 0 to +6 V output voltage.

The supply is a constant voltage/current limit type with each output voltage continuously adjustable over its range, while the maximum current available is automatically limited to prevent overloading. The power supply's outputs share a common terminal and are isolated from chassis ground so that any output terminal can be grounded if desired. Each output voltage or current can be quickly selected and monitored with the push-button meter switches.

Model 6235A measures 93 H \times 157 W \times 210 mm D (3.64" \times 6.17" \times 8.25") and weighs 2.3 kg (5 lb).

Specifications

See next page for performance specifications and ordering information under TRIPLE OUTPUT—10 WATTS.

- Up to 30 watts output
- 0 to 6 V & 0 to ± 20 V, Model 6236B
- 0 to 18 V & 0 to ± 20 V, Model 6237B



6236B, 6237B

Description

Microprocessors, digital and linear integrated circuits, and displays used in lab development frequently require triple output power supplies for operating prototypes. The 6236B and 6237B are valued additions to the design bench due to their multiple output voltages, small size, ease of operation and application-related performance.

These compact constant-voltage/current-limiting supplies combine 0 to ± 20 V tracking outputs rated at 0.5 amps with a single output rated at 0 to +6 volts at up to 2.5 amps in the 6236B, and 0 to +18 volts at 1 amp in the 6237B.

Controls, meters, and binding posts are logically arranged on a neatly laid out front panel. One voltage control simultaneously adjusts the 20 V and -20 V outputs, which track within 1% to power operational amplifiers and circuits requiring balanced voltages. A tracking ratio control can disable the 1:1 tracking feature and set the negative output to a lower voltage than that of the positive output. Once the tracking ratio control has established a voltage ratio between the positive and negative outputs, the ratio remains constant as the ± 20 V voltage control varies both outputs. Another voltage control sets the 0 to +6 V (6236B) or 0 to +18 V (6237B) output.

All outputs are protected against overload and short-circuit damage by fixed current limiting circuits. For any overload condition, the +20 V and -20 V outputs in both models are limited to 0.55 amps and the +18 V output in the 6237B is limited to 1.1 amps. The overload protection circuit for the +6 V output in the 6236B has a current foldback characteristic that reduces the maximum available current from about 2.75 amps at a 6 V terminal voltage to 1 amp at zero volts (or short circuited). This foldback limiting characteristic maximizes the available current in the important 5 to 6-volt range while minimizing semiconductor dissipation during overloads.

Another protective feature safeguards sensitive load circuitry by preventing an output voltage overshoot when the supply is turned on or off.

Separate dual-range panel meters allow both the voltage and current of any output to be monitored simultaneously. A three-position switch selects the supply output and the proper meter ranges.

Both models measure only 89 H \times 216 W \times 319 mm D (3½" \times 8½" \times 12½") and weigh 4.3 kg (9.5 lb).

Specifications

See next page for performance specifications and ordering information under TRIPLE OUTPUT — UP TO 30 WATTS.

Low cost lab: general bench applications

Models 6200B-6218A, 6234A-6237B & 6384A

Specifications

RATINGS		PERFORMANCE							GENERAL	
DC Output		Model	Load Effect	Source Effect	PAR rms/p-p	Control Mode and Resolution	Remote Control Coefficients	Power* 115 V ac ± 10%	Options*	Price
Volts	Amps									
SINGLE OUTPUT—10 WATTS										
0-10	1	6213A	4 mV	4 mV	200 μ V/1 mV	CV/CL	NA	48-440 Hz 0.3 A, 28 W	28	\$130
0-10	0-1	6214A	4 mV	4 mV	200 μ V/1 mV	CV/CC	NA	48-440 Hz 0.3 A, 28 W	28	\$155
0-25	0.4	6215A	4 mV	4 mV	200 μ V/1 mV	CV/CL	NA	48-440 Hz 0.3 A, 28 W	28	\$130
0-25	0-0.4	6216A	4 mV	4 mV	200 μ V/1 mV	CV/CC	NA	48-440 Hz 0.3 A, 28 W	28	\$155
0-50	0.2	6217A	4 mV	4 mV	200 μ V/1 mV	CV/CL	NA	48-440 Hz 0.3 A, 28 W	28	\$130
0-50	0-0.2	6218A	4 mV	4 mV	200 μ V/1 mV	CV/CC	NA	48-440 Hz 0.3 A, 28 W	28	\$155
0-100	0.1	6211A	8 mV	4 mV	200 μ V/1 mV	CV/CL	NA	48-440 Hz 0.3 A, 28 W	28	\$160
0-100	0-0.1	6212A	8 mV	4 mV	200 μ V/1 mV	CV/CC	NA	48-440 Hz 0.3 A, 28 W	28	\$185
SINGLE OUTPUT—UP TO 30 WATTS										
4.4-5.5	0-8	6384A	2 mV	2 mV	1 mV/5 mV	CV/CL 15 mV/NA	NA	48-63 Hz 1.4 A, 120 W	28	\$395
0-7.5	0-3	6203B	5 mV	3 mV	200 μ V/1 mV	CV/CC 5 mV/2 mA	200 Ω /V ± 1% 500 Ω /A ± 10%	48-440 Hz 0.9 A, 70 W	9, 11, 15, 28	\$275
0-20	0-1.5	6201B	0.01% + 4 mV	0.01% + 4 mV	200 μ V/1 mV	CV/CC 5 mV/1 mA	200 Ω /V ± 1% 1 k Ω /A ± 10%	48-440 Hz 0.8 A, 66 W	9, 11, 15, 28	\$255
Dual range 0-20 or 0-40	0-0.6 0-0.3	6204B	0.01% + 4 mV	0.01% + 4 mV	200 μ V/1 mV	CV/CL 10 mV/NA	200 Ω /V ± 1% NA	48-440 Hz 0.4 A, 24 W	9, 11, 15, 28	\$250
Dual range 0-20 or 0-40	0-1.5 0-0.75	6200B	0.01% + 4 mV	0.01% + 4 mV	200 μ V/1 mV	CV/CC 10 mV/2 mA	200 Ω /V ± 1% 0.5 k Ω /A ± 10% or 1 k Ω /A ± 10%	48-440 Hz 0.9 A, 70 W	9, 11, 15, 28	\$280
Dual range 0-30 or 0-60	0-1 0-0.5	6206B	0.01% + 4 mV	0.01% + 4 mV	200 μ V/1 mV	CV/CL 10 mV/NA	300 Ω /V ± 1% N/A	48-440 Hz 1 A, 66 W	9, 11, 15, 28	\$275
0-40	0-0.75	6202B	0.01% + 4 mV	0.01% + 4 mV	200 μ V/1 mV	CV/CC 10 mV/1 mA	200 Ω /V ± 1% 1 k Ω /A ± 10%	48-440 Hz 0.8 A, 66 W	9, 11, 15, 28	\$255
0-160	0.2	6207B	0.02% + 2 mV	0.02% + 2 mV	500 μ V/40 mV	CV/CC 25 mV/500 μ A	300 Ω /V ± 1% 75 k Ω /A ± 10%	48-63 Hz 1 A, 60 W	9, 15, 28	\$350
0-320	0-0.1	6209B	0.02% + 2 mV	0.02% + 2 mV	1 mV/40 mV	CV/CC 40 mV/200 μ A	300 Ω /V ± 1% 150 k Ω /A ± 10%	48-63 Hz 1 A, 60 W	9, 15, 28	\$350
DUAL OUTPUT—10 WATTS										
Dual output 0-25 and 0-25	0.2 0.2	6234A	0.01% + 1 mV	0.01% + 1 mV	200 μ V/1 mV	CV/CL	NA	104-127 Vac 47-63 Hz 0.26A, 35 W	28	\$175
DUAL OUTPUT—UP TO 30 WATTS										
Two dual ranges 0-20/0-40 and 0-20/0-40	0-0.6/0.3 0-0.6/0.3	6205B	0.01% + 4 mV	0.01% + 4 mV	200 μ V/1 mV	CV/CL 10 mV/NA	200 Ω /V ± 1% N/A	48-440 Hz 0.5 A, 50 W	9, 11, 15, 28 40	\$350
TRIPLE OUTPUT—10 WATTS										
Triple output 0 to 6 and 0 to 18 and 0 to -18	0-1 0-0.2 0-0.2	6235A	8 mV 10 mV 10 mV	8 mV 15 mV 15 mV	1 mV/5 mV 1 mV/5 mV 1 mV/5 mV	CV/CL CV/CL CV/CL	NA NA NA	47-63 Hz 0.26 A, 35 W	28	\$195
TRIPLE OUTPUT—UP TO 30 WATTS										
Triple output 0 to +6 and 0 to +20 and 0 to -20	1-2.5 0.5 0.5	6236A	0.01% + 2 mV	0.01% + 2 mV	350 μ V/1.5 mV	CV/CL 70 mV/NA	NA	104-127 Vac 47-63 Hz 1.2 A, 112 W	100-100 Vac 220-220 Vac 240-240 Vac	\$355
Triple Output 0 to +18 and 0 to +20 and 0 to -20	1 0.5 0.5	6237A	0.01% + 2 mV	0.01% + 2 mV	350 μ V/1.5 mV	CV/CL 70 mV/NA	NA	104-127 Vac 47-63 Hz 1.2 A, 112 W	100-100 Vac 220-220 Vac 240-240 Vac	\$355

*For 230 V ac ± 10% operation, order Opt 0.28. See page 236 for complete option descriptions.

POWER SUPPLIES

General purpose: 25–200 W output

Models 6220B–6299A

- Constant voltage/constant current operation
- Remote sensing and programming
- Auto-series, -parallel, & -tracking operation

- Front and rear output terminals
- Floating output—use as positive or negative source
- Bench or rack mounting



6281A, 6284A, 6289A,
6294A, 6299A



6282A, 6286A,
6291A, 6296A

Description

6281A–6299A

This series of medium-power Constant-Voltage/Constant-Current power supplies is available in two power ranges: 37–75 watts (packaged in 3½-inch high half-rack cases), and 100–200 watts (packaged in 5¼-inch high half-rack cases). All models except 6294A and 6299A have separate coarse and fine voltage and current controls that allow the voltage and current outputs to be varied from zero to the maximum rated values. The latter two models have ten-turn voltage controls. Crossover from constant-voltage to constant-current operation occurs automatically when the load current exceeds the value established by the current control settings. A four-position meter function switch selects either of two output voltage or output current ranges (X1, X0.01) for display on the panel meter.

The 37–75 watt models are of the series-regulated type. They have excellent regulation and ripple characteristics and include a special output-capacitor discharge circuit for improved programming speed. The 100–200 watt models employ a series-regulator/SCR-preregulator configuration to achieve the high efficiency necessary for a convection-cooled package of this size. They also have excellent regulation, low ripple and noise, and moderate programming speeds.

6253A and 6255A

These versatile dual-output models each contain two identical, independently-adjustable 60-watt power supplies in a full-rack width case. The regulator, voltage and current control, and metering circuits of each section of the supply are electrically identical to those of the individual 37–75 watt models described above.

Specification

RATINGS			PERFORMANCE							
DC Output		Model	Load Effect		Source Effect		PARD (rms/p-p)		Drift (stability)	
Volts	Amps		Voltage	Current	Voltage	Current	Voltage	Current	Voltage	Current
0–7.5	0–5	6281A	5 mV	0.01% + 250 μ A	0.01% + 2 mV	0.01% + 250 μ A	200 μ V/1 mV	4 mA rms	0.1% + 2.5 mV	0.1% + 12.5 mA
0–10	0–10	6282A	0.01% + 1 mV	0.05% + 1 mA	0.01% + 1 mV	0.05% + 1 mA	500 μ V/25 mV	5 mA rms	0.1% + 2.5 mV	0.1% + 25 mA
0–20	0–3	6253A*	0.01% + 4 mV	0.01% + 250 μ A	0.02% + 2 mV	0.01% + 250 μ A	200 μ V/1 mV	2 mA rms	0.1% + 2.5 mV	0.1% + 7.5 mA
0–20	0–3	6284A	0.01% + 4 mV	0.01% + 250 μ A	0.01% + 2 mV	0.01% + 250 μ A	200 μ V/1 mV	2 mA rms	0.1% + 2.5 mV	0.1% + 7.5 mA
0–20	0–10	6286A	0.01% + 1 mV	0.05% + 1 mA	0.01% + 1 mV	0.05% + 1 mA	500 μ V/25 mV	5 mA rms	0.1% + 2.5 mV	0.1% + 25 mA
0–24	0–3	6224B	0.01% + 4 mV	0.01% + 250 μ A	0.01% + 2 mV	0.01% + 250 μ A	200 μ V/1 mV	200 μ A/1 mA	0.1% + 2.5 mV	0.1% + 7.5 mA
0–25	0–1	6220B**	0.01% + 2 mV	0.01% + 250 μ A	0.01% + 2 mV	0.01% + 250 μ A	200 μ V/2 mV	200 μ A/1 mA	0.1% + 5 mV	0.1% + 5 mA
0–50	0–0.5									
0–40	0–1.5	6255A*	0.01% + 2 mV	0.01% + 250 μ A	0.01% + 2 mV	0.01% + 250 μ A	200 μ V/1 mV	500 μ A rms	0.1% + 2.5 mV	0.1% + 4 mA
0–40	0–1.5	6289A	0.01% + 2 mV	0.01% + 250 μ A	0.01% + 2 mV	0.01% + 250 μ A	200 μ V/1 mV	500 μ A rms	0.1% + 2.5 mV	0.1% + 4 mA
0–40	0–5	6291A	0.01% + 1 mV	0.05% + 1 mA	0.01% + 1 mV	0.5% + 1 mA	500 μ V/25 mV	3 mA	0.1% + 2.5 mV	0.1% + 12.5 mA
0–50	0–1.5	6226B	0.01% + 2 mV	0.1% + 250 μ A	0.1% + 2 mV	0.01% + 250 μ A	200 μ V/1 mV	200 μ A/1 mA	0.1% + 2.5 mV	0.1% + 4 mA
0–60	0–1	6294A	0.01% + 2 mV	0.01% + 250 μ A	0.01% + 2 mV	0.01% + 250 μ A	200 μ V/1 mV	500 μ A rms	0.1% + 2.5 mV	0.1% + 2.5 mA
0–60	0–3	6296A	0.01% + 1 mV	0.5% + 1 mA	0.01% + 1 mV	0.05% + 1 mA	500 μ V/25 mV	3 mA rms	0.1% + 2.5 mV	0.1% + 7.5 mA
0–100	0–0.75	6299A	0.01% + 2 mV	0.01% + 250 μ A	0.01% + 2 mV	0.01% + 250 μ A	200 μ V/1 mV	500 μ A rms	0.1% + 2.5 mV	0.1% + 2 mA

*Models 6253A and 6255A contain two identical, independently-adjustable power supplies.

**Model 6220B has a single, dual range output with ratings of 0–25 V at 0–1 A or 0–50 V at 0–0.5 A.



6220B, 6224B, 6226B

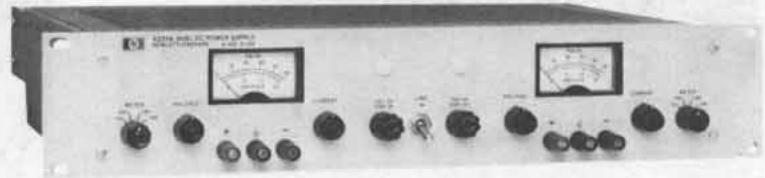

6253A, 6255A

By combining the versatility of a dual power supply with the flexibility of auto-series and auto-parallel operation, twice the maximum rated output voltage or current of each section can be obtained from the one supply. In addition, using the supply's auto-tracking capability, opposite-polarity voltages (± 20 V for Model 6253A or ± 40 V for Model 6255A) are possible.

6220B, 6224B, and 6226B

These Constant-Voltage/Constant-Current supplies are designed for general laboratory use. All have excellent regulation, low ripple and noise, and high speed programming characteristics. Large easy-to-read meter scales, 10-turn voltage and current controls, and front and rear output terminals enhance ease of operation. Model 6220B is a dual-range instrument with output ratings of 0–25 V at 0–1 A or 0–50 V at 0–0.5 A. It is the only model of the three employing convection cooling. Models 6224B and 6226B have single outputs of 0–24 V at 0–3 A and 0–50 V at 0–1.5 A, respectively.

Accessories and options

The accessories and options available for use with Models 6220B–6299A are listed on page 236.

Specifications—general

Load effect transient recovery: time, 50 μ s. Level, 15 mV.

Meter accuracy: 3% of full scale.

Power: standard input voltage is 115 V ac $\pm 10\%$. Order option 028 for 230 V ac $\pm 10\%$ operation. Input power frequency, maximum input current, maximum power consumption are:

- 6220B, 48–440 Hz, 0.5 A, 44 W; 6224B, 48–63 Hz, 1.8 A, 164 W
- 6226B, 48–63 Hz, 1.8 A, 164 W; 6253A, 48–440 Hz, 2.6 A, 235 W
- 6255A, 48–440 Hz, 2.6 A, 235 W; 6281A, 48–440 Hz, 1.3 A, 118 W
- 6282A, 57–63 Hz, 3.5 A, 200 W; 6284A, 48–440 Hz, 1.5 A, 128 W
- 6286A, 57–63 Hz, 5.5 A, 320 W; 6289A, 48–440 Hz, 1.3 A, 110 W
- 6291A, 57–63 Hz, 5.5 A, 280 W; 6294A, 48–440 Hz, 1.3 A, 114 W
- 6296A, 57–63 Hz, 4.5 A, 250 W; 6299A, 48–440 Hz, 1.5 A, 135 W.

Size: 6220B, 6224B, & 6226B: 166 H x 130 W x 294 mm D (6 $\frac{1}{2}$ " x 5 $\frac{1}{8}$ " x 11 $\frac{7}{8}$ "). 6253A, 6255A: 87 H x 483 W x 403 mm D (3 $\frac{3}{8}$ " x 19" x 15 $\frac{7}{8}$ "). 6281A, 6284A, 6289A, 6294A, 6299A: 87 H x 209 W x 398 mm D (3 $\frac{7}{16}$ " x 8 $\frac{7}{32}$ " x 15 $\frac{7}{8}$ "). 6282A, 6286A, 6291A, 6296A: 131 H x 210 W x 435 mm D (5 $\frac{1}{32}$ " x 8 $\frac{1}{4}$ " x 17 $\frac{1}{8}$ ").

Temperature: operating, 0 to 55°C; storage, –40 to 75°C.

Specifications, continued

REMOTE CONTROL FEATURES								GENERAL					
Resistance Coefficient		Voltage Coefficient		Speed, UP*		Speed, DOWN*		Overvoltage		Weight		Options [▲]	Price
Voltage	Current	Voltage	Current	NL	FL	NL	FL	Range	Margin	Net	Shipping		
200 Ω /V $\pm 1\%$	200 Ω /A $\pm 10\%$	1 V/V $\pm 1\%$	0.2 V/A $\pm 10\%$	1 ms	2 ms	10 ms	6 ms	2.5–10 V	4% + 2 V	6.4 kg/14 lb	7.2 kg/16 lb	9, 11, 15, 28, 40	\$395
200 Ω /V $\pm 1\%$	100 Ω /A $\pm 10\%$	1 V/V $\pm 1\%$	100 mV/A $\pm 10\%$	70 ms	200 ms	9 s	40 ms	1–13 V	7% + 1 V	11.3 kg/25 lb	13.6 kg/30 lb	5, 9, 11, 15, 28, 40	\$495
200 Ω /V $\pm 1\%$	500 Ω /A $\pm 10\%$	1 V/V $\pm 1\%$	0.33 V/A $\pm 10\%$	30 ms	80 ms	400 ms	100 ms	2.5–23 V	4% + 2V	12.7 kg/28 lb	17.7 kg/39 lb	9, 10, 11, 15, 28, 40	\$650
200 Ω /V $\pm 1\%$	500 Ω /A $\pm 10\%$	1 V/V $\pm 1\%$	0.33 V/A $\pm 10\%$	30 ms	80 ms	400 ms	100 ms	2.5–23 V	4% + 2 V	6.4 kg/14 lb	7.2 kg/16 lb	9, 11, 15, 28, 40	\$340
200 Ω /V $\pm 1\%$	100 Ω /A $\pm 10\%$	1 V/V $\pm 1\%$	100 mV/A $\pm 10\%$	150 ms	150 ms	9 s	70 ms	2–22 V	7% + 1 V	10.8 kg/26 lb	13.1 kg/29 lb	5, 9, 11, 15, 28	\$495
200 Ω /V $\pm 1\%$	500 Ω /A $\pm 10\%$	1 V/V $\pm 1\%$	0.33 V/A $\pm 10\%$	4 ms	10 ms	50 ms	15 ms	NA	NA	7.3 kg/16 lb	9.5 kg/21 lb	15, 28, 40	\$525
200 Ω /V	1 kA $\pm 10\%$ 2 kA $\pm 10\%$	1 V/V $\pm 1\%$	1 V/A $\pm 10\%$ 2 V/A $\pm 10\%$	12 ms	30 ms	200 ms	30 ms	NA	NA	5.9 kg/13 lb	6.8 kg/15 lb	15, 28, 40	\$495
200 Ω /V $\pm 1\%$	500 Ω /A $\pm 10\%$	1 V/V $\pm 1\%$	0.66 V/A $\pm 10\%$	15 ms	45 ms	200 ms	40 ms	2.5–44 V	4% + 2 V	12.7 kg/28 lb	17.7 kg/39 lb	9, 10, 11, 15, 28, 40	\$650
200 Ω /V $\pm 1\%$	500 Ω /A $\pm 10\%$	1 V/V $\pm 1\%$	0.66 V/A $\pm 10\%$	15 ms	45 ms	200 ms	40 ms	2.5–44 V	4% + 2 V	6.4 kg/14 lb	7.2 kg/16 lb	9, 11, 15, 28, 40	\$340
200 Ω /V $\pm 1\%$	200 Ω /A $\pm 10\%$	1V/V $\pm 1\%$	200 mV/A $\pm 10\%$	275 ms	275 ms	13 s	275 ms	6–43 V	7% + 1V	11.3 kg/25 lb	12.7 kg/28 lb	5, 9, 11, 15, 28	\$495
200 Ω /V $\pm 1\%$	500 Ω /A $\pm 10\%$	1V/V	1 V/A	20 ms	65 ms	200 ms	50 ms	NA	NA	7.3 kg/16 lb	8.2 kg/18 lb	15, 28, 40	\$495
300 Ω /V $\pm 1\%$	1 k Ω /A $\pm 10\%$	1 V/V $\pm 1\%$	1 V/A $\pm 10\%$	25 ms	80 ms	2 s	175 ms	5–65 V	4% + 2 V	5.9 kg/13 lb	6.8 kg/15 lb	9, 11, 15, 28, 40	\$360
300 Ω /V $\pm 1\%$	500 Ω /A $\pm 10\%$	1V/V $\pm 1\%$	333 mV/A $\pm 10\%$	600 ms	600 ms	5 s	200 ms	9–66 V	7% + 1 V	11.3 kg/25 lb	12.7 kg/28 lb	5, 9, 11, 15, 28	\$495
300 Ω /V $\pm 1\%$	1 k Ω /A $\pm 10\%$	1 V/V $\pm 1\%$	1.3 V/A $\pm 10\%$	25 ms	200 ms	1.5 s	200 ms	20–106 V	4% + 2 V	5.9 kg/13 lb	6.8 kg/15 lb	11, 15, 28, 40	\$375

[▲]See page 236 for complete option and accessory descriptions.
*Up = increasing output voltage. NL = No output load current. FL = Full rated output load current.

POWER SUPPLIES

General purpose: 120-2000 W output

Models 6256B-6274B & 895A

- Built-in overvoltage protection*
- Constant voltage/constant current operation
- Remote programming and sensing

- Remote sensing
- Auto-series, -parallel, and -tracking operation
- $\leq 50 \mu\text{sec}$ load transient recovery



6263B, 6265B, 6266B, 6271B

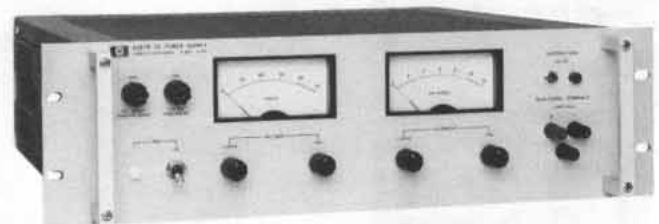

6256B, 6264B, 6267B

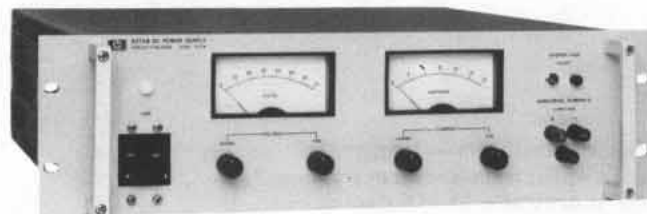

6274B



895A

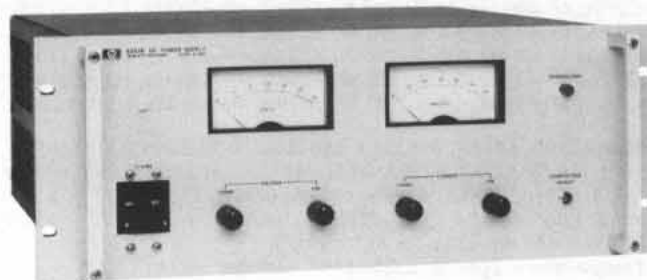

6259B, 6260B, 6261B, 6268B, 6269B

Models 6256B-6274B

The series of high-performance Constant Voltage/Constant Current supplies includes thirteen models with output rating from 10 to 60 V. All models employ a transistor series-regulator/triac-preregulator circuit to achieve high efficiency, excellent regulation, low ripple and noise, and moderate programming speeds in a compact full-rack width package.

Separate coarse and fine voltage and current controls allow the voltage and current outputs to be varied from zero to the maximum rated value. Crossover from constant voltage to constant current operation occurs automatically when the load current exceeds the value established by the current control settings.

*These six features apply to models 6256B-6274B, but not to model 895A.

Specifications†

RATINGS			PERFORMANCE							
DC Output		Model	Load Effect		Source Effect		PAR (rms/p-p)		Drift (stability)	
Volts	Amps		Voltage	Current	Voltage	Current	Voltage	Current	Voltage	Current
0-10	0-20	6256B	0.01% + 200 μV	0.02% + 500 μA	0.01% + 200 μV	0.02% + 500 μA	200 $\mu\text{V}/10 \text{ mV}$	5 mA rms	0.03% + 500 μV	0.03% + 6 mA
0-10	0-50	6259B	0.01% + 200 μV	0.02% + 1 mA	0.01% + 200 μV	0.02% + 1 mA	500 $\mu\text{V}/5 \text{ mV}$	25 mA rms	0.03% + 2 mV	0.03% + 10 mA
0-10	0-100	6260B	0.01% + 200 μV	0.02% + 2 mA	0.01% + 200 μV	0.02% + 2 mA	500 $\mu\text{V}/5 \text{ mV}$	50 mA rms	0.03% + 2 mV	0.03% + 20 mA
0-20	0-10	6263B	0.01% + 200 μV	0.02% + 500 μA	0.01% + 200 μV	0.02% + 500 μA	200 $\mu\text{V}/10 \text{ mV}$	3 mA rms	0.03% + 500 μV	0.03% + 6 mA
0-20	0-20	6264B	0.01% + 200 μV	0.02% + 500 μA	0.01% + 200 μV	0.02% + 500 μA	200 $\mu\text{V}/10 \text{ mV}$	5 mA rms	0.03% + 500 μV	0.03% + 6 mA
0-20	0-50	6261B	0.01% + 200 μV	0.02% + 1 mA	0.01% + 200 μV	0.02% + 1 mA	500 $\mu\text{V}/5 \text{ mV}$	25 mA rms	0.03% + 2 mV	0.03% + 10 mA
0-40	0-3	6265B	0.01% + 200 μV	0.02% + 500 μA	0.01% + 200 μV	0.02% + 500 μA	200 $\mu\text{V}/10 \text{ mV}$	3 mA rms	0.03% + 500 μV	0.03% + 3 mA
0-40	0-5	6266B	0.01% + 200 μV	0.02% + 500 μA	0.01% + 200 μV	0.02% + 500 μA	200 $\mu\text{V}/10 \text{ mV}$	3 mA rms	0.03% + 500 μV	0.03% + 3 mA
0-40	0-10	6267B	0.01% + 200 μV	0.02% + 500 μA	0.01% + 200 μV	0.02% + 500 μA	200 $\mu\text{V}/10 \text{ mV}$	3 mA rms	0.03% + 2 mV	0.03% + 3 mA
0-40	0-30	6268B	0.01% + 200 μV	0.02% + 2 mA	0.01% + 200 μV	0.02% + 2 mA	1 mV/5 mV	20 mA rms	0.03% + 2 mV	0.03% + 5 mA
0-40	0-50	6269B	0.01% + 200 μV	0.02% + 2 mA	0.01% + 200 μV	0.02% + 2 mA	1 mV/5 mV	25 mA rms	0.03% + 2 mV	0.03% + 10 mA
0-60	0-3	6271B	0.01% + 200 μV	0.02% + 500 μA	0.01% + 200 μV	0.02% + 500 μA	200 $\mu\text{V}/10 \text{ mV}$	3 mA rms	0.03% + 500 μV	0.03% + 3 mA
0-60	0-15	6274B	0.01% + 200 μV	0.02% + 500 μA	0.01% + 200 μV	0.02% + 500 μA	200 $\mu\text{V}/20 \text{ mV}$	5 mA rms	0.03% + 2 mV	0.03% + 5 mA
0-320	0-1.5	895A	0.007% or 20 mV	—	0.007% or 20 mV	—	1 mV rms	—	0.01% + 5 mV	—

†Refer to page 215 or complete specification definitions.

Additional features include built-in overvoltage crowbar protection; remote error sensing; and auto-series, auto-parallel, and auto-tracking operation. The crowbar trip point adjustment and associated overvoltage indicator are conveniently located on the front panel.

Auto-series, auto-parallel, and auto-tracking connections should ordinarily include no more than three supplies. If a specific application requires the use of more than three supplies in any of the three connections, consult your local HP Field Engineer for additional information.

All dc output, ac input, sensing, control, and programming connections are made to rear-panel terminals. Either the positive or negative output terminal may be grounded or the supplies may be operated floating at up to 300 volts above ground. Models 6256B, 6263B, 6264B, 6265B, 6266B, 6267B, and 6271B are convection cooled. All other models in this series employ cooling fans.

Model 895A

Model 895A is a general purpose Constant-Voltage/Current-Limit supply. Output voltage is adjustable from 0-320 V via a front panel 10-turn potentiometer with concentric lock and a single-turn fine control. Separate voltage and current meters provide continuous indication of power supply outputs. High performance specifications include 0.007% line and load regulation and 1 mV rms ripple and noise. Remote sensing and programming are standard features.

Accessories and options

The accessories and options available for use with Models 6256B-6274B, 895A are listed on page 236.

Specifications—general

Load effect transient recovery: time—50 μ s. Level—10 mV
Resolution: voltage control—less than 0.02%. Current control—less than 0.15%.
Temperature coefficient per °C: 0.01% of output plus 200 μ V (895A—0.03% + 1.5 mV).
Temperature ratings: operating, 0 to 55°C; Storage, -40 to 75°C.

Remote control programming: these power supplies are capable of being programmed in constant voltage and constant current operation by using an external resistance or DC voltage with coefficients as shown in the table below.

Rear terminal wiring configurations for remote control operation are specified in the operation and service manual supplied with the power supply. For remote control programming procedures and timing considerations, contact your local HP field engineer.

Power: input voltage is 115V ac or 230 V ac \pm 10%, 57-63 Hz. For other input voltage and frequency options available, see option listing below and page 236. Standard input voltage, maximum input current, and maximum power are:

- 6256B, 115 V ac, 5 A, 375 W†; 6259B, 230 V ac, 6 A, 850 W†;
- 6260B, 230 V ac, 12 A, 1600 W†; 6261B, 230 V ac, 12 A 1500 W†;
- 6263B, 115 V ac, 4.5 A, 350 W*; 6264B, 115 V ac, 8 A, 600 W†;
- 6265B, 115 V ac, 3 A, 180 W*; 6266B, 115 V ac, 4 A, 325 W*;
- 6267B, 115 V ac, 8 A, 550 W†; 6268B, 230V ac, 12 A, 1600 W†;
- 6269B, 230 V ac, 18 A, 2500 W†; 6271B, 115 V ac, 4 A, 300 W*;
- 6274B, 115 V ac, 15 A, 1200 W†; 895A, 115 V ac, 8.7 A, 585 W†.

*Three-wire, five-foot AC power cord included with power supply.
 †Three-terminal barrier strip provided on power supply for AC power connections.

Size:

- 6263B, 6265B, 6266B, 6271B: 83.7 H x 483 W x 479.4 mm D (3.296" x 19" x 18.875").
- 6256B, 6264B, 6267B, 6274B: 127 H x 483 W x 479.4 mm D (5.00" x 19" x 18.875").
- 6259B, 6260B, 6216B, 6268B, 6269B: 173 H x 483 W x 479.4 mm D; (6.812" x 19" x 18.875").
- 895A: 128.6 H x 483 W x 463.6 mm D (5.062" x 19" x 18.25").

Typical output impedance: approximated by a resistance in series with an inductance:

- 6256B, 0.1 m Ω , 1 μ H;
- 6260B, 20 $\mu\Omega$, 1 μ H;
- 6263B, 500 $\mu\Omega$, 1 μ H;
- 6265B, 2 m Ω , 1 μ H;
- 6267B, 500 $\mu\Omega$, 1 μ H;
- 6269B, 100 $\mu\Omega$, 1 μ H;
- 6274B, 1 m Ω , 1 μ H;
- 6259B, 50 $\mu\Omega$, 1 μ H;
- 6261B, 100 $\mu\Omega$, 1 μ H;
- 6264B, 200 $\mu\Omega$, 1 μ H;
- 6266B, 1 m Ω , 1 μ H;
- 6268B, 200 $\mu\Omega$, 1 μ H;
- 6271B, 5 m Ω , 1 μ H;
- 895A, 40 m Ω , 16 μ H.

Specifications, continued

REMOTE CONTROL FEATURES								GENERAL					
Resistance Coeff.		Voltage Coeff.		Speed Up*		Speed Down*		Overvoltage		Weight		Options ^Δ	Price
Voltage	Current	Voltage	Current	NL	FL	NL	FL	Range	Margin	Net	Shipping		
200 Ω /V \pm 1%	10 Ω /A \pm 10%	1 V/V \pm 1%	25 mV/A \pm 10%	60 ms	60 ms	5 s	100 ms	2-12 V	5% + 1 V	15.8 kg/35 lb	18.1 lb/40 lb	5,9,10,15,22,27,28,40	\$725
200 Ω /V \pm 1%	4 Ω /A \pm 10%	1 V/V \pm 1%	10 mV/A \pm 10%	70 ms	70 ms	200 ms	100 ms	2-12 V	5% + 2V	31.3 kg/69 lb	35.3 kg/78 lb	5, 9, 10, 15, 22, 26, 27, 40	\$1000
200 Ω /V \pm 1%	2 Ω /A \pm 10%	1 V/V \pm 1%	5 mV/A \pm 10%	70 ms	70 ms	200 ms	75 ms	2-12 V	5% + 2 V	43.9 kg/97 lb	48 kg/106 lb	5, 9, 10, 15, 16, 22, 27, 40	\$1160
200 Ω /V \pm 1%	100 Ω /A \pm 10%	1 V/V \pm 1%	50 mV/A \pm 10%	150 ms	150 ms	7 s	350 ms	2-23 V	5% + 1 V	15.4 kg/34 lb	18.6 kg/41 lb	5, 9, 10, 15, 22, 27, 28, 40	\$635
200 Ω /V \pm 1%	10 Ω /A \pm 10%	1 V/V \pm 1%	25 mV/A \pm 10%	140 ms	140 ms	10 s	150 ms	2.5-23V	5% + 1 V	21.3 kg/47 lb	24.5 kg/54 lb	5, 9, 10, 15, 22, 27, 28, 40	\$720
200 Ω /V \pm 1%	4 Ω /A \pm 10%	1 V/V \pm 1%	10 mV/A \pm 10%	150 ms	150 ms	250 ms	250 ms	2-23 V	5% + 2 V	35.3 kg/78 lb	39.4 kg/87 lb	5, 9, 10, 15, 22, 26, 27, 40	\$1080
200 Ω /V \pm 1%	300 Ω /A \pm 10%	1 V/V \pm 1%	167 mV/A \pm 10%	275 ms	275 ms	12 s	1.5 s	2.5-45 V	5% + 1 V	15.4 kg/34 lb	18.6 kg/41 lb	5, 9, 10, 15, 22, 27, 28, 40	\$560
200 Ω /V \pm 1%	200 Ω /A \pm 10%	1 V/V \pm 1%	100 mV/A \pm 10%	275 ms	275 ms	13 s	1.5 s	2.5-45 V	5% + 1 V	15.4 kg/34 lb	18.6 kg/41 lb	5, 9, 10, 15, 22, 27, 28, 40	\$635
200 Ω /V \pm 1%	100 Ω /A \pm 10%	1 V/V \pm 1%	50 mV/A \pm 10%	275 ms	275 ms	13 s	750 ms	2.5-45 V	5% + 1 V	17.7 kg/39 lb	20.8 kg/46 lb	5, 9, 10, 15, 22, 27, 28, 40	\$720
200 Ω /V \pm 1%	6 Ω /A \pm 10%	1 V/V \pm 1%	16.7 mV/A \pm 10%	300 ms	300 ms	1 s	650 ms	4-45 V	5% + 1 V	34.4 kg/76 lb	38.1 kg/84 lb	5, 9, 10, 15, 22, 26, 27, 40	\$1060
200 Ω /V \pm 1%	4 Ω /A \pm 10%	1 V/V \pm 1%	10 mV/A \pm 10%	350 ms	350 ms	1 s	600 ms	4-45 V	5% + 1 V	40.3 kg/89 lb	44 kg/98 lb	5, 9, 10, 15, 22, 27, 40	\$1110
300 Ω /V \pm 1%	300 Ω /A \pm 10%	1 V/V \pm 1%	167 mV/A \pm 10%	600 ms	600 ms	7 s	2 s	6-66 V	5% + 1 V	15.4 kg/34 lb	18.6 kg/41 lb	5, 9, 10, 15, 22, 27, 28, 40	\$645
300 Ω /V \pm 1%	67 Ω /A \pm 10%	1 V/V \pm 1%	33.3 mV/A \pm 10%	600 ms	600 ms	40 s	800 ms	6-66 V	5% + 1 V	21.7 kg/48 lb	24.5 kg/54 lb	5, 9, 10, 15, 22, 27, 28, 40	\$840
300 Ω /V	—	—	—	—	—	—	—	NA	NA	22.6 kg/50 lb	29.4 kg/65 lb	—	\$945

*Up = increasing output voltage. NL = No output load current. FL = Full rated output load current
^ΔSee page 236 for complete option and accessory descriptions.

POWER SUPPLIES

General purpose: 300—11,000 W output

Models 6427B—6483C

- Outstanding value—low cost/watt
- Up to 75% efficiency at full output
- Constant voltage/current operation

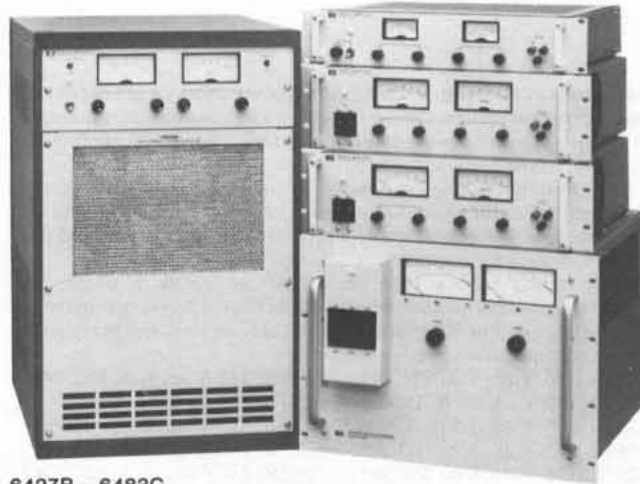

6427B—6483C

Description

This series of SCR-regulated power supplies is designed for high-power applications requiring a fixed or variable DC source with moderate regulation and ripple. For supplies with better regulation, faster response time, and lower ripple, see models 6256B—6274B and 895A, on page 224.

Operating features

All supplies in this series are of the Constant-Voltage/Constant-Current type. Large easy-to-read panel meters continuously monitor output voltage current.

Specifications†

RATINGS			PERFORMANCE						
DC Output		Model	Load Effect		Source Effect		PAR Δ p-p/rms	Temperature Coefficient	Drift
Volts§	Amps§		Voltage	Current	Voltage	Current			
0-8	0-1000	6464C	0.05% + 5 mV	0.1% + 1 A	0.05% + 5 mV	0.1% + 1A	80 mV/1V	0.03% + 100 μV	0.03% + 1 mV
0-15	0-200	6453A	0.2% + 10 mV††	1% or 2A††	0.2% + 10 mV††	1% or 2A††	150 mV rms	0.05% + 2 mV	0.25% + 10 mV
0-16 or 18	0-600 or 500*	6466C	0.05% + 5mV	0.1% + 0.6 A	0.05% + 5 mV	0.1% + 0.6 A	180 mV/1V	0.03% + 200 μV	0.2% + 1 mV
0-20	0-15	6427B	20 mV	150 mA	10 mV	150 mA	40 mV/400 mV	0.05% + 5 mV	0.15% + 15 mV
0-20	0-45	6428B	40 mV	450 mA	20 mV	450 mA	40 mV/500 mV	0.05% + 5 mV	0.15% + 15 mV
0-36	0-10	6433B	36 mV	100 mA	18 mV	100 mA	36 mV/400 mV	0.03% + 5 mV	0.1% + 15 mV
0-36	0-100	6456B	0.2% + 10 mV††	1% or 1 A††	0.2% + 10 mV††	1% or 1 A††	180 mV rms	0.05% + 2 mV	0.25% + 10 mV
0-36	0-300	6469C	0.05% + 5 mV	0.1% + 0.3 A	0.05% + 5 mV	0.1% + 0.3A	180 mV/1 V	0.03% + 400 μV	0.15% + 1 mV
0-40	0-25	6434B	40 mV	200 mA	18 mV	200 mA	40 mV/500 mV	0.03% + 5 mV	0.1% + 20 mV
0-60	0-5	6438B	60 mV	50 mA	30 mV	50 mA	120 mV/400 mV	0.03% + 10 mV	0.1% + 30 mV
0-60	0-15	6439B	120 mV	150 mA	60 mV	150 mA	60 mV/500 mV	0.03% + 10 mV	0.1% + 30 mV
0-64	0-50	6459A	0.2% + 10 mV††	1% or 0.5 A††	0.2% + 10 mV††	1% or 0.5 A††	160 mV rms	0.05% + 2 mV	0.25% + 10 mV
0-64	0-150	6472C	0.05% + 100 mV	0.1% + 0.15 A	0.05% + 100 mV	0.1% + 0.15 A	160 mV/2V	0.03% + 4 mV	0.15% + 16 mV
0-110	0-100	6475C	0.05% + 100 mV	0.1% + 0.1 A	0.05% + 100 mV	0.1% + 0.1 A	200 mV/2 V	0.03% + 5 mV	0.15% + 20 mV
0-120	0-2.5	6443B	120 mV	25 mA	60 mV	25 mA	240 mV/400 mV	0.03% + 20 mV	0.1% + 60 mV
0-220	0-50	6477C	0.05% + 100 mV	0.1% + 50 mA	0.05% + 100 mV	0.1% + 50 mA	330 mV/2 V	0.03% + 8 mV	0.15% + 35 mV
0-300	0-35	6479C	0.05% + 100 mV	0.1% + 35 mA	0.05% + 100 mV	0.1% + 35 mA	330 mV/3 V	0.03% + 11 mV	0.15% + 45 mV
0-440, 500 or 600	0-25, 20, 15*	6483C	0.05% + 100 mV	0.1% + 35 mA	0.5% + 100 mV	0.1% + 35 mA	600 mV/5 V	0.03% + 20 mV	0.15% + 80 mV
1-600	5 mA-1.5 A	6448B	1 V	40 mA	600 mV	15 mA	600 mV/2 V	0.03% + 100 mV	0.1% + 300 mV

†Refer to page 215 for complete specification definitions.

††Specified for combined line and load regulation.

Δ For operation with a 50 Hz input (possible only with Option 05), the rms ripple and transient response specifications are increased by 50%.

* The output current rating is given in the same order corresponding with the voltage rating.

Input and output power, remote sensing, remote programming, and auto-series, -parallel, and -tracking connections are made to bus bars and terminal blocks on the rear panel.

Protective features

In addition to the overload protection inherent in Constant voltage/Constant Current operation, there are many other built-in protective features included in these supplies. The features vary within the three model classifications as follows:

6427B—6448B: (1) Reverse voltage protection. (2) Fused AC input.

6453A, 6456B, 6459A: (1) AC line loss protection circuit monitors 3-phase input and cuts off SCR's and opens output bus if a phase drops out; operation resumes when AC input returns to normal. (2) 3-phase input circuit breaker. (3) Optional internal crowbar (Option 006) protects load from overvoltage condition.

6464C—6483C: (1) High-temperature protection thermostat opens input to power transformer and lights front panel indicator if supply overheats. (2) Prolonged overload protection circuit is activated and lights front panel indicator if output current exceeds approximately 115% of maximum rating. (3) Optional internal crowbar (except on 6464C) protects load from overvoltage condition. (4) Turn-on circuit limits peak line current during start-up into low impedance loads. (5) Phase-balance circuit permits operation with line-to-line input voltage imbalance up to 8%. (6) Overcurrent and overvoltage circuits of master slave supplies used in auto-series, -parallel, or -tracking operation can be interlocked.

Auto-series, -parallel, -tracking operation

Supplies may be connected in auto-series, or auto-tracking. (Except 6448B and 6483C, which cannot be connected in auto-series.)

Up to three lower power models (6427B—6448B) may be connected in any of the above configurations. Higher-power model (6453A/6483C) interconnection should ordinarily include no more than two supplies.

Remote sensing

Remote sensing permits regulation at the load connection, rather than at the output terminals of the power supply. In all cases, there are limits to the permissible load-lead voltage drops, as follows:

Models 6427B—6448B: 2 volts in negative output lead.

Models 6453A, 6456B, 6459A: 1 volt in negative output lead.

Models 6464C—6483C: 3 volts in negative output lead.

§ Under light loading conditions, power supply may not meet all published specifications. The graph on the next page defines the permissible operating regions for CV and CC modes of operation.

For operation with a 50 Hz input (possible only with Option 05), output current is linearly derated from 100% at 40°C to 80% at 50°C.

POWER SUPPLY OUTPUT RESTRICTIONS AS A FUNCTION OF LOADING

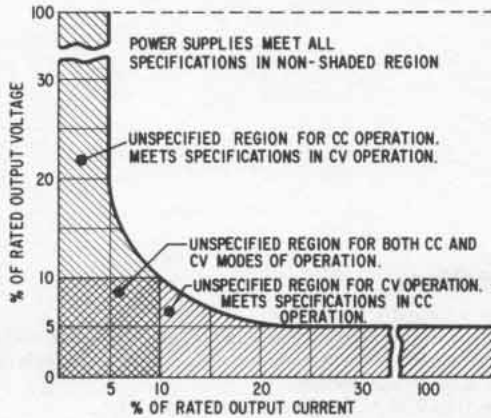

Remote programming

The voltage and current outputs of the supplies can be programmed by a remote resistance, or, for most models, a remote voltage source. Programming speeds and coefficients are detailed in the specifications table.

AC power requirements

The AC power requirements vary with the three model classifications (see option listings). When powered from a 50 Hz source (possible with Option 005), the rms ripple and transient response specifications increase by 50%. The p-p ripple specification is unchanged by line frequency.

Size

Models 6427B, 6433B, 6438B and 6443B: 89 H x 483 W x 445 mm D (3½" x 19" x 17½").

Models 6428B, 6434B, 6439B, & 6448B: 133 H x 483 W x 426 mm D (5¼" x 19" x 16¾").

Models 6453A, 6456B, & 6459A: 356 H x 483 W x 464 mm D (14" x 19" x 18¼").

Models 6464C, 6466C, 6469C, 6472C, 6475C, 6477C, 6479C, & 6483C: 667 H x 426 W x 664 mm D (26¼" x 19" x 26½").

Options

AC, input power

6427B-6448B

Std: 115 V ac, ±10%, single phase, 57-63 Hz

027: 208 V ac, ±10%, single phase, 57-63 Hz

028: 230 V ac, ±10%, single phase, 57-63 Hz

005: realignment for 50 Hz operation

6453A, 6456B, 6459A: AC input connections are by means of a 4-conductor connector at rear of unit. A matching Hubbell No. 7413G plug (HP part number 1251-1570) is furnished.

001: 208 V ac, ±10%, 3-phase, 15.5 A/phase, 57-63 Hz

002: 230 V ac, ±10%, 3-phase, 14 A/phase, 57-63 Hz

031: 380 V ac, ±10%, 3-phase, 8.5 A/phase, 57-63 Hz

032: 400 V ac, ±10%, 3-phase, 8.0 A/phase, 57-63 Hz

003: 460 V ac, ±10%, 3-phase, 7 A/phase, 57-63 Hz

005: realignment for 50 Hz operation

6464C-6483C: AC input connections are by means of enclosed 4-wire terminal block.

001: 208 V ac, ±10%, 3-phase, 55 A/phase, 57-63 Hz

002: 230 V ac, ±10%, 3-phase, 50 A/phase, 57-63 Hz

031: 380 V ac, ±10%, 3-phase, 30 A/phase, 57-63 Hz

032: 400 V ac, ±10%, 3-phase, 28.5 A/phase, 57-63 Hz

003: 460 V ac, ±10%, 3-phase, 25 A/phase, 57-63 Hz

005: realignment for 50 Hz operation

006: internal overvoltage protection crowbar

6459A, 6477C, 6479C, 6483C

6453A, 6456B

6472C, 6475C

6469C

6466C

Price

N/C

N/C

N/C

N/C

N/C

N/C

add \$100

add \$100

\$100

N/C

N/C

N/C

add \$250

add \$250

add \$250

N/C

add \$345

add \$395

add \$460

add \$510

add \$570

Specifications, continued

REMOTE CONTROL										GENERAL				
Resolution		Load Transient Recovery Δ	Resistance Coefficient		Voltage Coefficient		Up		Down		Net Weight		Options Δ	Price
			Voltage	Current	Voltage	Current	NL	FL	NL	FL	Kg	lb		
V	C													
8 mV	1 A	100 ms, 500 mV	200 Ω /V \pm 2%	1 Ω /A \pm 2%	1 V/V \pm 1%	6.2 mV/A \pm 7%	1.6 s	0.6 s	6 s	0.1 s	235	518	1, 2, 3, 5, 23, 31, 32	\$4950
65 mV	1 A	50 ms, 150 mV	200 Ω /V \pm 2%	1 Ω /A	0.4 V/V	30 mV/A	1 s	0.5 s	20 s	0.2 s	108	238	1, 2, 3, 5, 6, 10, 31, 32	\$2150
18 mV	0.5 A	100 ms, 500 mV	200 Ω /V \pm 2%	1.66 Ω /A \pm 2%	1 V/V \pm 1%	10.3 mV/A \pm 7%	1.6 s	0.6 s	15 s	0.2 s	226	500	1, 2, 3, 5, 6, 23, 31, 32	\$4100
10 mV	7.5 mA	200 ms, 200 mV	200 Ω /V \pm 2%	20 Ω /A	1 V/V	NA	0.3 s	1.4 s	100 s	1.4 s	16.3	36	5, 10, 27, 28	\$595
10 mV	22.5 mA	200 ms, 200 mV	200 Ω /V \pm 2%	6 Ω /A	1 V/V	NA	0.2 s	0.7 s	65 s	0.7 s	30.4	67	5, 10, 27, 28	\$825
9 mV	5 mA	200 ms, 200 mV	200 Ω /V \pm 2%	30 Ω /A	1 V/V	NA	0.3 s	1.4 s	110 s	1.4 s	14.9	33	5, 10, 27, 28	\$575
90 mV	0.5 A	50 ms, 300 mV	200 Ω /V \pm 2%	2 Ω /A	166 mV/V	60 mV/A	1 s	0.5 s	60 s	0.5 s	108	238	1, 2, 3, 5, 6, 10, 31, 32	\$2050
36 mV	0.3 A	100 ms, 500 mV	200 Ω /V \pm 2%	3.33 Ω /A \pm 2%	1 V/V	20.6 mV/A \pm 7%	1.6 s	3 s	20 s	0.5 s	226	500	1, 2, 3, 5, 6, 23, 31, 32	\$3900
10 mV	12.5 mA	200 ms, 200 mV	200 Ω /V \pm 2%	12 Ω /A	1 V/V	NA	0.3 s	1.2 s	75 s	1.2 s	30.4	67	5, 10, 27, 28	\$795
9 mV	2.5 mA	200 ms, 300 mV	300 Ω /V \pm 2%	60 Ω /A	1 V/V	NA	0.5 s	2.5 s	200 s	2.5 s	14	31	5, 10, 27, 28	\$595
9 mV	7.5 mA	200 ms, 600 mV	300 Ω /V \pm 2%	20 Ω /A	1 V/V	NA	0.3 s	1.3 s	75 s	1.3 s	27.6	61	5, 10, 27, 28	\$690
100 mV	0.25 A	50 ms, 600 mV	300 Ω /V \pm 2%	4 Ω /A	94 mV/V	120 mV/A	1 s	0.5 s	45 s	0.7 s	108	238	1, 2, 3, 5, 6, 10, 31, 32	\$2050
64 mV	0.15 mA	100 ms, 750 mV	300 Ω /V \pm 2%	6.7 Ω /A \pm 2%	1 V/V \pm 3%	41.2 mV/A \pm 7%	1.4 s	2.5 s	55 s	0.7 s	226	500	1, 2, 3, 5, 6, 23, 31, 32	\$3900
22 mV	0.1 A	100 ms, 1 V	300 Ω /V \pm 2%	10 Ω /A \pm 2%	1 V/V \pm 3%	62 mV/A \pm 7%	1.5 s	2 s	80 s	0.7 s	226	500	1, 2, 3, 5, 6, 23, 31, 32	\$4100
30 mV	1.3 mA	200 ms, 600 mV	300 Ω /V \pm 2%	120 Ω /A	1 V/V	NA	0.5 s	2 s	210 s	2 s	14	31	5, 10, 27, 28	\$530
44 mV	50 mA	100 ms, 2 V	300 Ω /V \pm 2%	20 Ω /V \pm 2%	1 V/V \pm 3%	124 mV/A \pm 7%	1.5 s	2 s	95 s	1 s	226	500	1, 2, 3, 5, 6, 23, 31, 32	\$4100
60 mV	35 mA	100 ms, 3 V	300 Ω /V \pm 2%	28.6 Ω /A \pm 2%	1 V/V \pm 3%	177 mV/A \pm 7%	1.5 s	2 s	75 s	1.6 s	226	500	1, 2, 3, 5, 6, 23, 31, 32	\$4100
60 mV	25 mA	100 ms, 5 V	300 Ω /V \pm 2%	40 Ω /A \pm 2%	1 V/V \pm 3%	0.25 V/A \pm 7%	1.5 s	2 s	120 s	2 s	226	500	1, 2, 3, 5, 6, 23, 31, 32	\$4300
60 mV	0.75 mA	200 ms, 3 V	300 Ω /V \pm 2%	600 Ω /A	1 V/V	NA	0.2 s	1 s	45 s	2 s	27.6	61	5, 10, 27, 28	\$750

Δ For operation with a 50 Hz input (possible only with Option 005), the rms ripple and transient response specifications are increased by 50%.

Δ See page 236 for complete option and accessory descriptions.

POWER SUPPLIES

General Purpose: HP-IB Programmer

Model 59501A

- HP-IB power supply control
- HP-IB-to-power-supply isolation
- Programmable range

- Programmable 10-volt DC output
- Unipolar/Bipolar operation
- Fast digital to analog conversion



HP-IB

Description

The 59501A is an isolated digital-to-analog converter designed to provide a convenient interface between the Hewlett-Packard Interface Bus and HP power supplies. With the 59501A, a wide range of DC voltages and currents becomes automatically controllable via the HP-IB. With proper wiring, the built-in isolation devices protect other instrumentation on the HP-IB from damage that could be caused by power supply outputs. In addition, an internal control circuit holds the output level near zero until programmed data is received. A programmable High/Low range control improves resolution by ten-to-one.

Power supply control is accomplished through the 59501A's programmable output voltage and programming network (see figure 1). By making the appropriate connections between the 59501A's rear terminals and the remote programming terminals on the supply, the output voltage (or current) of the supply can be programmed from zero to its full rated output. The 59501A front panel controls provide fast and easy calibration of power supply outputs. The Zero Adjust enables the user to correct for small offsets in power supply response to programmed inputs. The Power Supply Full Scale Adjust (part of programming network) enables the user to set the maximum output desired from the power supply when the 59501A is programmed to its maximum value. For example, this adjustment would normally be used to calibrate the maximum programmable output of a 320Vdc power supply to 320 volts. However, it could also be used to set the maximum to 200 volts.

In addition to its ability to program power supplies, the 59501A also can be used directly as a low level DC signal source. Unipolar and bipolar output modes are available with output voltages programmable from zero to 9.99 volts, or minus 10.0 to plus 9.98 volts. Output current up to 10 milliamps is available and is automatically limited to protect the 59501A and user equipment. The 59501A produces a full scale voltage change in approximately 250 μ s from the time the digital data is received.

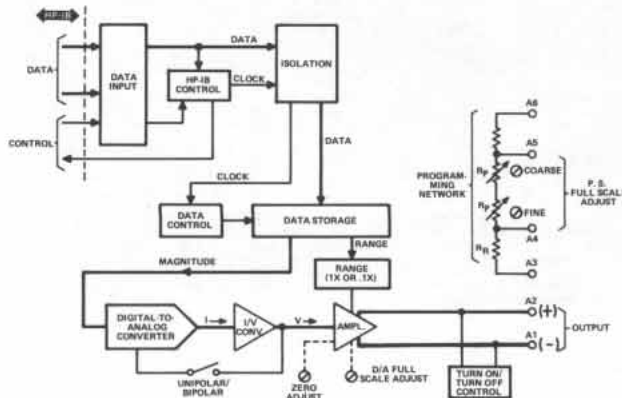

Specifications

Digital to Analog Converter

DC Output voltage: programmable in high or low ranges within the voltage limits shown below. Output mode is unipolar or bipolar and is selected by a rear panel switch.

Unipolar: 0 to 9.99 V (low range, 0 to 9.999 V).

Bipolar: -10 to +9.98 V, (low range, -1 to +0.998 V).

DC Output current: 10 mA maximum.

PARD (Ripple and Noise): 2 mV rms/10 mV p-p.

Resolution: unipolar, 10 mV (low range, 1 mV). Bipolar, 20 mV (low range, 2 mV).

Accuracy: specified at 23°C \pm 5°C.

Unipolar: 0.1% + 5 mV (low range, 0.1% + 1 mV).

Bipolar: 0.1% + 10 mV (low range, 0.1% + 2 mV).

Stability: change in output over 8 hour interval under constant line, load, and ambient following a 30 minute warm-up. Stability is included in accuracy specification measurements over the temperature range indicated.

Unipolar: 0.04% + 0.5 mV (low range, 0.04% + .1 mV).

Bipolar: 0.04% + 1 mV (low range, 0.04% + .2 mV)

Temperature Coefficient: unipolar, 0.01%/°C + 0.5 mV/°C (low range, 0.1%/°C + 0.1 mV/°C). Bipolar, 0.01%/°C + 0.5 mV/°C (low range, 0.01%/°C + 0.1 mV/°C).

Zero adjust: plus or minus 250 millivolts.

D/A Full scale adjust: plus or minus 5%.

Programming speed: the time required for output to go from zero to 99% of programmed output change is 250 μ s (measured with resistive load connected to output terminals).

Power Supply Programming

Programming network specifications: in the following specifications, M represents the calibrated full scale value of the supply being programmed and P is the actual programmed output. The full scale value (M) can be any value within the supply's output range and is calibrated with the 59501A programmed to its maximum high range output.

Accuracy: specified at 23°C \pm 5°C.

Unipolar: 0.05% M + 0.25% P (low range, 0.01% M + 0.25% P).

Bipolar: 0.1% M + 0.25% P (low range, 0.02% M + 0.25% P).

Isolation: 600 V dc between HP-IB data lines and output terminals.

Temperature Coefficient: 0.005% M/°C + 0.015% P/°C (low range, 0.01% M/°C + 0.015% P/°C).

Programming resolution: 0.1% M (low range, 0.01% M).

Programming speed: D/A programming speed plus the programming speed of the power supply.

General

Temperature range: operation: 0 to 55°C, Storage: -40 to 75°C.

Power: 100, 120, 220, or 240 Vac (+6% -13%) 47-63 Hz, 10 VA (selectable on rear panel).

Size: 101.6 H x 212.9 W x 294.6 mm D (4" x 8.38" x 11.6")

Weight: Net 1.36 kg (3 lb). Shipping 1.81 kg (4 lb).

Ordering information

59501A HP-IB Isolated D/A Power Supply

Programmer

10631A HP-IB cable 1 m (3.3 ft)

10631B HP-IB cable 2 m (6.6 ft)

10631C HP-IB cable 4 m (13.2 ft)

Price

\$550

\$ 60

\$ 65

\$ 75

- 200-watt extended range
- Constant-voltage/constant-current operation
- HP-IB programming option

- Built-in overvoltage protection crowbar
- CV/CC operating status indicators
- Remote analog programming and sensing

HP-IB



6002A

Description

The Model 6002A offers a new level of performance and usefulness in laboratory power supplies. It employs a unique regulation control concept that automatically yields a continuous span of voltage and current ratings within the basic 200-watt power rating boundary. This is beneficial in that more current is available at lower voltages, and higher voltages are available at a given current level than can be obtained from conventional 200-watt supplies.

Conventional 200-watt power supplies, rated for 50 volts or 20 volts can operate only within the shaded regions shown in Figure 1. The 6002A not only provides the outputs of the two conventional supplies, but also delivers the extra output capability shown between 20 and 50 volts.

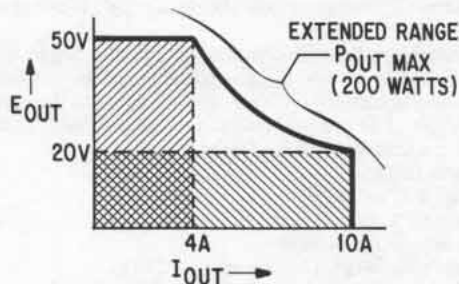

This "extended range" capability of the 6002A provides the user with a single power supply that can cover a wide variety of applications in the lab or as a system component without his having to overspecify both the output voltage and current.

System features/remote control

Analog programming of output voltages and current can be accomplished through the use of remotely controlled resistance or voltage applied to rear panel terminals. Additional control terminals are provided for remote load voltage sensing, auto-series or parallel operation, and for remotely activating the crowbar circuit. A pulse output from the crowbar terminal indicates the overvoltage circuit has been self-activated. A voltage step change appearing on terminal indicates a changeover to or from constant-current operation.

HP-IB option

Digital programming via Opt 001 permits control of output voltage or current by the Hewlett-Packard Interface Bus (HP-IB). Two programmable ranges allow better resolution below 10 volts or 2 amps. The selection of HP-IB control of either voltage or current is done by rear panel switches.

Specifications

DC output: voltage and current output can be adjusted over the ranges indicated by front panel controls, analog programming, or an optional HP-IB interface.

Voltage: 0–50 V. **Current:** 0–10 A.

Maximum 200 Watts output from 20 V to 50 V.

Load effect: constant-voltage, 0.01% +1 mV. Constant-current, 0.01% +1 mA.

Source effect: CV, 0.01% +1 mV; CC, 0.01% +1 mA.

PARD (ripple and noise): rms/p-p, 20 Hz to 20 MHz; CV, 1 mV/10 mV; CC, 5 mA rms.

Temperature coefficient: CV, 0.02% +200 μ V/°C; CC 0.02% +5 mA/°C.

Drift: CV, 0.05% +1 mV/8 hrs; CC, 0.05% +5 mA/8 hrs.

Resolution: front panel controls; CV, 10 mV; CC, 10 mA.

Output impedance: approximately 0.5 Ω in series with 1 μ H.

Load transient recovery: 100 μ s for output voltage to recover within 15 mV or nominal voltage setting following a load current change of 50% to 100% or 100% to 50% of full load current.

Remote control coefficients:

Resistance programming: CV, 1 k Ω /V \pm 7%. CC, 100 Ω /A \pm 7%.

Voltage programming: CV 1 V/V \pm 20 mV. CC, 50 mV/A \pm 10%.

Response time: maximum time for output voltage to change between 0 to 99.9% or 100% to 0.1% of maximum rated output voltage. Up Programming: no load, 100 ms; full load, 100 ms. Down - Programming: no load, 400 ms; full load, 200 ms.

Overvoltage protection: trip voltage adjustable from 2.5 V to 60 V.

DC output isolation: 150 V dc.

Power: 100, 120, 220, or 240 V ac (–13%, +6%), 48–63 Hz.

Temperature rating: 0°C to 55°C operating, –40°C to +75°C storage. Supply is cooled by built-in fan.

Size: 180 H x 212 W x 422 mm D (6.97" x 8.36" x 16.6").

Weight: net, 14.5 kg (32 lb). Shipping, 15.9 kg (35 lb).

HP-IB Option

Programmable ranges: high (0–50 V or 0–10 A), low (0–10 V or 0–2 A).

Programming speed: same as response time.

Accuracy: Hi range: CV, 0.2% +25 mV; CC, 0.2% +25 mA.

Lo range: CV, 0.2% +10 mV; CC, 0.2% +25 mA.

Resolution: Hi range: CV, 50 mV; CC, 10 mA.

Lo range: CV, 10 mV; CC, 2 mA.

Isolation: 250 Volts dc from bus data lines to power supply.

Options

001: HP-IB Interface

Price
add \$425

6002A Extended Range DC Power Supply

\$900

POWER SUPPLIES

General Purpose: dual-tracking outputs

Models 6227B & 6228B

- Two 50-watt power supplies for independent or tracking operation
- Built-in overvoltage protection crowbars
- Auto-parallel and auto-series capability
- Constant-current in addition to constant-voltage outputs



6227B

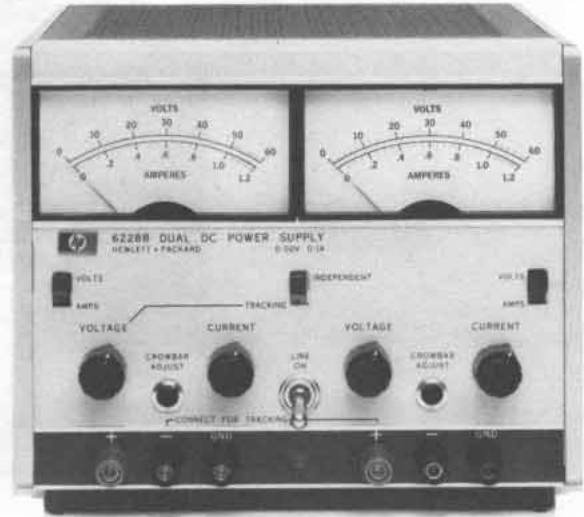

6228B

Description

These versatile lab supplies each house two identical 50 W regulated power supplies. A convenient front panel switch selects either independent or tracking operation. In the track mode, the right supply tracks the left within $0.2\% \pm 2$ mV. The tracking mode is especially useful for powering operational amplifiers, push-pull stages, deflection systems, or any application where plus and minus voltages must track with insignificant error. The independent mode permits operation of the two supplies individually, in auto-parallel or in auto-series.

Each side of the dual supply can be operated as a constant-voltage or constant-current source, and each has its own crowbar for overvoltage protection. In the tracking mode, an overvoltage condition in either supply trips both crowbars. The power supply outputs are isolated up to 300 V from output to chassis or output to output.

Specifications

DC output: 6227B, 0-25 V @ 0-2 A; 6228B, 0-50 V @ 0-1 A.

AC input: 115 or 230 V ac $\pm 10\%$, 48-63 Hz, 260 W. Selected by rear panel switch.

CV load effect (load regulation): for a load current change equal to the current rating of the supply; $0.01\% + 1$ mV.

CC load effect: for a load voltage change equal to the voltage rating of the supply; $0.01\% + 250$ μ A.

Source effect (line regulation): for a change in line voltage between 104 and 127 V ac or 208 and 254 V ac at any output voltage and current within rating; CV, 1 mV; CC, 100 μ A.

PARD (ripple and noise): at any line voltage and under any load condition within rating (20 Hz to 20 MHz); CV, 250 μ V rms/4 mV p-p; CC, 250 μ A rms/2 mA p-p.

Temperature coefficient: output change per degree Celsius change in ambient following 30-minute warm-up; CV, $0.02\% + 200$ μ V; CC, $0.02\% + 300$ μ A (6227B); $0.02\% + 150$ μ A (6228B).

Drift (stability): total drift in output (dc to 20 Hz) over 8-hour interval under constant line, load, and ambient following 30-minute warm up; CV, $0.2\% + 2$ mV; CC, $0.2\% + 3$ mA ($0.2\% + 1.5$ mA, 6228B).

Remote resistance programming: CV, $200\Omega/V \pm 1\%$; CC, $500\Omega/A \pm 10\%$ (6227B), $1k\Omega/A \pm 10\%$ (6228B).

Programming speed (CV): up-programming: no load, 40 ms/50 ms; full load, 200 ms/350 ms. Down-programming: no load, 400 ms/1 s; full load, 75 ms/50 ms.

Output impedance (typical): approximated by a resistance in series with an inductance; 2 m Ω /2 μ H (6227B); 6 m Ω /6 μ H (6228B).

Resolution (fine control): voltage, 5 mV (6227B), 10 mV (6228B); current, 1 mA (6227B), 0.5 mA (6228B)

Internal overvoltage crowbars: during independent operation, each supply is protected by its own crowbar. In the tracking mode, an overvoltage in either supply results in firing both crowbars.

Trip voltage margin: the minimum trip voltage above the operating output voltage of the supply to prevent false crowbar tripping: 7% of the output voltage + 1.5 V.

Trip voltage range: 6227B, 5-28 V dc. 6228B, 5-55 V dc.

Tracking error: in tracking mode, the slave supply is matched within $0.2\% \pm 2$ mV of the master.

Transient recovery time: in constant voltage, the output will recover in 50 μ s to within 10 mV of its nominal value for a resistive load change demanding an output current change equal to the current rating of the supply. The nominal output voltage is defined as the mean between the no load and full load voltages.

Temperature ratings

Operating: 0°C to 55°C.

Storage: -40°C to +75°C.

Cooling: natural convection.

Weight (net/shipping): 11/12.9 kg (24/28 lb).

Size: 155H x 197 W x 310 mm D (6 $\frac{1}{8}$ " x 7 $\frac{3}{4}$ " x 12 $\frac{1}{4}$ ").

Finish: mint gray panel with olive gray case.

Options

009: four ten-turn output voltage and current controls replace all four concentric coarse and fine voltage and current controls. **Price** add \$100

015: four 3-digit graduated turns-counting dials and 10-turn controls replace concentric coarse and fine voltage and current controls. add \$250

040: interfacing for Multiprogrammer operation. Prepares standard HP power supplies for resistance programming by the HP Multiprogrammer. add \$150

Accessories

5060-8762: rack kit for mounting one or two dual supplies \$65

5060-8760: filler panel to block unused half of rack when mounting only one dual supply \$17.50

Ordering information

6227B Dual Tracking Power Supply \$815

6228B Dual Tracking Power Supply \$815



General purpose: high voltage output

Models 6515A-6525A

- Short circuit proof
- Precise voltage control—four-decade thumbwheel or switch-and vernier
- Convection cooling

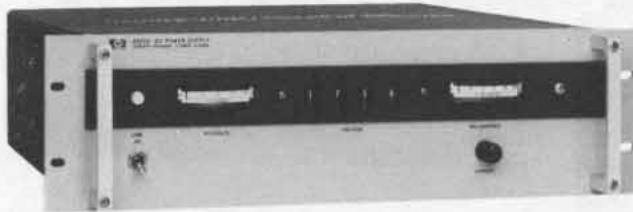

6521A, 6522A, 6525A



6515A



6516A

Description

6521A, 6522A, 6525A

This series of high performance power supplies has broad application both in the laboratory and in the system. They have sufficient output current to power devices such as TWT's, klystrons, magnetrons, backward-wave oscillators, high-power gas lasers, electron-beam welding devices, etc. Output voltage is set easily and precisely by a three-decade thumbwheel switch plus a thumbwheel vernier providing 0.002% resolution. In constant-voltage operation, a single-turn current control allows the current-limit point to be set to any value within the current rating. In constant-current operation, the current control varies the output current while the voltage controls (thumbwheels) provide an adjustable voltage limit. The supplies are protected against reverse voltage that could be generated by an active load. Protection from reverse current requires pre-loading the supply with a dummy load to ensure that the supply outputs current through the entire operating cycle of the load. Either the positive or negative terminal may be grounded or the supply may be operated floating at up to 2000 V above ground.

6515A and 6516A

These high-voltage power supplies are lower in cost and output power than the 6521A-6525A supplies. Their small size, low price, and short-circuit-proof operation make them excellent high-voltage laboratory supplies, or high-voltage systems supplies where current requirements are not more than 6 mA.

Model 6515A employs a sixteen-position rotary switch and a ten-turn vernier control to adjust the output voltage. The rotary switch selects output voltage increments from 1 to 1500 V in 100-volt steps; the vernier control permits fine adjustment (100 mV resolution) over any 100-volt span. Model 6516A uses a three-decade thumbwheel switch plus a thumbwheel vernier for convenient and precise (1.0 V resolution) output voltage control.

- Floating output—can be used as a positive or negative source
- Front-panel meters
- Bench or rack mounting

Non-adjustable current-limit protection is provided on both models. On Model 6516A, the current-limit point is fixed at approximately 8 mA. On Model 6515A, the current limit value varies with the selected output voltage range as follows (voltage range/current limit): 0-300 V/7.5 mA, 400-700 V/65 mA, 800-1100 V/32 mA, 1200-1500 V/25 mA. Both supplies are protected against reverse voltage that could be generated by an active load. Pre-loading is necessary to protect the supplies from reverse current. Either the positive or negative terminal may be grounded or the supply may be operated floating at up to 1000 V above ground. Units are packaged in half-rack-width cases. They may be bench operated or mounted individually or in pairs using accessory rack-mounting kits.

Specifications

6521A, 6522A, 6525A

Accuracy: 1% of thumbwheel switch setting.

Temperature rating: operating, 0 to 55°C; storage, -40 to +75°C.

Temperature coefficient, per °C: voltage, 0.012% of +1 mV. Current: 6521A, 0.2% + 0.2 mA; 6522A, 0.2% + 0.1 mA; 6525A, 0.2% + 0.05 mA.

Output impedance, typical: 0.1 ohm in series with 1 μH.

Load effect transient recovery: 50 μs to recover within 0.005% or 20 mV, whichever is greater.

Output modes: automatic cross-over constant-voltage/constant-current.

Meters: 2% of full scale accuracy. Scales: 6521A: 0-1 kV & 0-200 mA; 6522A: 0-2 kV & 0-100 mA; 6525A: 0-4 kV & 0-50 mA.

Power: 115 V ac ± 10%, 48-440 Hz, 4 A, 270 W (230 Vac available on special order).

Weight: net, 19 kg (42 lb). Shipping, 28.5 kg (63 lb).

Size: 133 H x 483 W x 457 mm D (525" x 19" x 18").

6515A and 6516A

Accuracy: 6516A, 1% of thumbwheel switch setting.

Temperature rating: operating, 0 to 55°C; storage, -40 to +75°C.

Temperature coefficient, per °C: voltage, 0.02% + 2 mV.

Load effect transient recovery: 100 μs to recover within 0.01% or 16 mV, whichever is greater.

Output modes: constant voltage with fixed current limit.

Meters: 2% of full scale accuracy. Scales: 6515A: 1.8 kV; 6516A: 3.5 kV.

Power: 6515A: 115 V ac ± 10%, 60 ± 0.3 Hz, 016 A, 19 W. (230 Vac available on special order) 6516A: 115 V ac ± 10%, 57-63 Hz, 1 A, 40 W.

Weight: 6515A: net, 4.1 kg (9 lb). Shipping, 5.0 kg (11 lb). 6516A: net, 7.7 kg (17 lb). Shipping, 9.5 kg (21 lb).

Size: 6515A, 89 H x 216 W x 299 mm D (3.50" x 8.50" x 11.75"). 6516A, 133 H x 216 W x 406 mm D (5.25" x 8.50" x 16").

RATINGS			PERFORMANCE										GENERAL	
DC Output		Model	Load Effect		Source Effect		PARD (rms/p-p)		Drift		Resolution		Options	Price
Volts	mA		Voltage	Current	Voltage	Current	Voltage	Current	Voltage	Current	V	C		
0-1000	0-200	6521A	0.005% or 20 mV	2% or 1 mA	0.005% or 20 mV*	1 mA	1 mV/500 mV	2 mA rms	0.036%+3 mV	0.25%+0.5 mA	20 mV	0.6 mA	—	\$1350
0-1600	5	6515A	0.01% or 16 mV*	NA	0.01% or 16 mV*	NA	2mV/15 mV	NA	0.05%+5 mV	NA	100 mV	NA	15, 19	\$375
0-2000	0-100	6522A	0.005% or 20 mV	2% or 1 mA*	0.005% or 20 mV*	1 mA	1mV/500 mV	1 mA rms	0.036% + 3 mV	0.25% + 0.25 mA	40 mV	0.3 mA	—	\$1350
0-3000	6	6516A	0.01% or 16 mV*	NA	0.01% or 16 mV*	NA	1 mV/50 mV	NA	0.05%+5 mV	NA	1 V	NA	19	\$575
0-4000	0-50-	6525A	0.005% or 20 mV*	2% or 1 mA*	0.005% or 20 mV	1 mA	1 mV/500 mV	500 μA rms	0.036%+3 mV	0.25%+0.12 mA	80 mV	0.15 mA	—	\$1375

*whichever is larger.

▲See page 238 for complete option and accessory descriptions.

POWER SUPPLIES

Special purpose: precision source

Models 6110A-6116A

- 0.025% output voltage accuracy
- 5-minute warm-up
- Built-in overvoltage crowbar



6110A

- Constant-voltage/current-operation
- Thumbwheel or ten-turn voltage controls
- 0.1% output voltage accuracy



6111A, 6112A, 6113A, 6116A



6114A, 6115A

Description

6114A, 6115A

These 40-watt precision power supplies are ideal for applications where an accurate, highly stable, and easy-to-use source of dc voltage is required. Both models feature automatic dual range operation. For example, Model 6114A can supply 0–20 V at 0–2 A, and 20–40 V at 0–1 A, without manual range switching. Automatic output current range crossover occurs when the supply is providing greater than one-half of the maximum rated output voltage.

Output voltage controls

Pushbutton voltage controls on Models 6114A and 6115A allow the output voltage to be set rapidly and accurately. The setting is displayed in large, easy-to-read numerals. A fifth digit, set via a thumbwheel on the switch assembly, provides output voltage resolution of 200 μ V.

Output current controls

A front-panel control allows the output current to be set to any desired value within the maximum rating. Using this control, the supplies can be operated as constant-current sources with 0.01% current regulation. A light-emitting diode current mode indicator immediately lights either when the supply is operated in the gross current limit region, or when the output current level established by the setting of the front panel control is reached.

Specifications†

RATINGS			PERFORMANCE								
DC Output		Model	Load Effect		Source Effect		PARD (ms/p-p)		Temperature coefficient	Drift (Stability)	
Volts	Amps		Voltage	Current	Voltage	Current	Voltage	Current		8-hour	90 day
0–10	0–2	6113A	0.001% + 100 μ V	NA	0.001%	NA	40 μ V/100 μ V	NA	0.001% + 10 μ V	0.01% + 100 μ V	—
0–20	0–1	6111A	0.001% + 100 μ V	NA	0.001%	NA	40 μ V/100 μ V	NA	0.001% + 10 μ V	0.01% + 100 μ V	—
0–20, 20–40	0–2, 0–1	6114A	0.0005% + 100 μ V +100 μ V	0.01% +500 μ V	0.0005% +40 μ V	0.005% +40 μ A	40 μ V/200 μ V* 200 μ A/1 mA	200 μ A/1 mA	0.001% + 15 μ V	0.0015% +15 μ V	0.0075% +30 μ V**
0–40	0–0.5	6112A	0.001% + 100 μ V	NA	0.001%	NA	40 μ V/100 μ V	NA	0.001% + 10 μ V	0.01% + 100 μ V	—
0–50, 50–100	0–0.8 0–0.4	6115A	0.0005% + 50 μ V	0.01% +500 μ A	0.0005% +100 μ A	0.005% +20 μ A	40 μ V/200 μ V* 200 μ A/1 mA	200 μ A/1 mA	0.001% + 15 μ V**	0.0015% +15 μ V	0.0075% +30 μ V
0–100	0–200 mA	6116A	0.001%+100 μ V	NA	0.001%	NA	40 μ V/100 μ V	NA	0.001%+10 μ V	0.01% + 100 μ V	—
0–3000	0–6 mA	6110A	0.001%+100 μ V	NA	0.001%	NA	2 mV/5 mV	NA	0.001%+50 μ V	0.01%+500 μ V	—

† Refer to page 215 for complete specification definitions and page 236 for option descriptions.

** Specified with final decade pot set to zero. If pot is set to value other than zero, pot wiper jump effect may cause drift of 0.0015% + 200 μ V (90-day).* 200 μ V p-p noise is typical with a maximum 400 μ V p-p spike of less than 1 μ s duration occurring repetition rate of twice power line frequency under worst case conditions of high line, full output voltage. When operated at 400 Hz input, peak-to-peak ripple is less than 10 mV.

Remote programming

These supplies can be remote programmed by means of an external voltage or resistance. When remote resistance programmed, put voltage accuracy is 0.01% plus the accuracy of the remote programming resistor, and output current accuracy is 0.25% plus the accuracy of the remote programming resistor.

For computer controlled applications, these supplies are designed to be digitally programmed with the HP Model 6940B Multiprogrammer or 6941B Multiprogrammer Extender. They can also be used with the 59501A HP-IB Isolated D/A Power Supply Programmer.

Overvoltage protection

A circuit technique used in these supplies causes the output voltage to drop completely to zero once the overvoltage protection circuit has been triggered, rather than to only 1–3 V as is typical with other SCR crowbars. This same circuit technique also permits the trip threshold to be set as low as 0.5 V, thus providing load protection at very low output voltage levels.

6111A, 6112A, 6113A and 6116A

Although these 20-watt precision power supplies do not provide quite the level of performance and flexibility of Models 6114A and 6115A, they are lower in cost and are suitable for many precision power applications. Output voltage is adjusted by a five-decade thumbwheel voltage programmer for convenient and precise (100 μ V resolution) adjustment of output voltage. A single-turn current control allows full-range adjustment of the current-limit point. Additional features include a volt/ampere meter and associated meter function switch. The four-position function switch selects either of two output voltage or output current ranges (XI, X0.1) for display on the panel meter.

The d-c output of these supplies is floating, allowing the supplies to be used as either positive or negative sources. Terminals for +OUT, -OUT, and GND are provided on both the front and rear of the supply. The rear terminal strip also includes terminals for remote resistance programming, remote sensing, and auto-series, auto-tracking operations.

Units are packaged in 5/4-inch high, half-rack cases which may be bench operated or rack mounted using accessory rack mounting hardware.

6110A

Model 6110A is designed for applications requiring a precise and stable source of high-voltage dc power. Output voltage is set easily and precisely by a five-digit thumbwheel programmer providing 2 mV resolution. A non-adjustable current-limit circuit protects the supply from all overload conditions regardless of degree or duration. Plus and minus output connectors (Type UG-931/U) are provided on the front panel. Mating connectors (Type UG-932/U) are supplied with each unit. Either the positive or the negative terminal may be grounded, or the supply may be operated floating at up to 1,000 volts above ground. Units are packaged in 5/4-inch high, half-rack cases which are suitable for bench or rack installation.

General specifications—(see table also)

Temperature rating: all precision models; operating 0° to 50°C. Storage, -40° to +75°C.

DC output isolation: output terminals of precision models may be floated up to 300 V above ground. High voltage precision model 6110A may be floated to 1000 V.

Remote sensing: provided on all precision models except 6110A.

Power: 104–127 or 208–250 V ac selected by switch, 48–440 Hz, 150 VA maximum.

Size: 166 H x 197 W x 336 mm D (6 1/2" x 7 3/4" x 13 1/4").

Weight: net, 7.7 kg (17 lb). Shipping, 9.5 kg (21 lb).

6111A, 6112A, 6113A and 6116A

Power: 115 V ac \pm 10%, 43–63 Hz, 0.5 A, 52 W (for 230 V, order Optn. 028).

Size: 133 H X 216 W x 318 mm D (5 1/4" x 8 1/2" x 12 1/2").

Weight: net, 5 kg (11 lb). Shipping, 6.8 kg (14 lb).

6110A

Power: 115 V ac \pm 10%, 57–63 Hz, 1 A, 50 W (for 230 V, 50 Hz, order Opt 019).

Size: 133 H x 216 W x 406 mm D (5 1/4" x 8 1/2" x 16").

Weight: net, 8.6 kg (19 lb). Shipping, 10.4 kg (23 lb).

Accuracy	Resolution	Output Z (Typical)	Load Transient Recovery	Output Mode	REMOTE CONTROL								GENERAL			
					Resistance Coefficient		Voltage Coefficient		UP \blacklozenge		DOWN \blacklozenge		Overvoltage Protection	\blacktriangle Options	Price	
					Voltage	Current	Voltage	Current	NL	FL	NL	FL				
0.1% + 1 mV	20 μ V	0.2 m Ω +1 μ H	NA	CV/CL	1 k Ω /V \pm 0.1%	NA	1 V/V \pm 0.1%	NA	NA	NA	NA	NA	NA	Opt 11, 3–13 V	11, 28, 40	\$545
0.1% + 1 mV	200 μ V	0.5 m Ω +1 μ H	NA	CV/CL	1 k Ω /V \pm 0.1%	NA	1 V/V \pm 0.1%	NA	NA	NA	NA	NA	NA	Opt 11, 2.5–23	11, 28, 40	\$495
0.025% + 1 mV	200 μ V	0.05 m Ω +3 μ H	<50 μ s, 50 mV	CV/CC	2 k Ω /V \pm 0.01%	500 Ω /A \pm 0.25%	1V/V \ddagger	0.5 V/A \pm 1%	1.75 s	1.75 s	350 ms	100 ms	STD, 0.5–45V	9, 15	\$795	
0.1% + 1 mV	200 μ V	2 m Ω +1 μ H	NA	CV/CL	1 k Ω /V \pm 0.1%	NA	1 V/V \pm 0.1%	NA	NA	NA	NA	NA	NA	Opt 11, 2.5–44 V	11, 28, 40	\$495
0.025% + 1 mV	200 μ V	0.05 m Ω +3 μ H	<50 μ s, 50 mV	CV/CC	2 k Ω /V \pm 0.01%	1 k Ω /A \pm 0.25%	1 V/V \ddagger	1 V/A \pm 1%	4.5 s	4.5 s	500 ms	175 ms	STD, 0.5–110 V	9, 15	\$825	
0.01% + 1mV	200 μ V	10 m Ω +1 μ H	NA	CV/CL	1 k Ω /V \pm 0.1%	NA	1 V/V \pm 0.1%	NA	NA	NA	NA	NA	NA	Opt 11, 20–106 V	11, 28	\$545
0.1% +100 mV	20 mV	—	NA	CV/CL	NA	NA	NA	NA	NA	NA	NA	NA	NA	19	\$850	

\blacktriangle See page 236 for complete option and accessory descriptions.

\blacklozenge UP = increasing output voltage. NL = No output load current. FL = Full rated output load current.

\ddagger Accuracy is equal to accuracy of remote programming device \pm 200 μ V.

POWER SUPPLIES

Special purpose: constant current sources

Models 6177C, 6181C & 6186C

- Continuously variable voltage limit
- Output useful to micro-ampere region

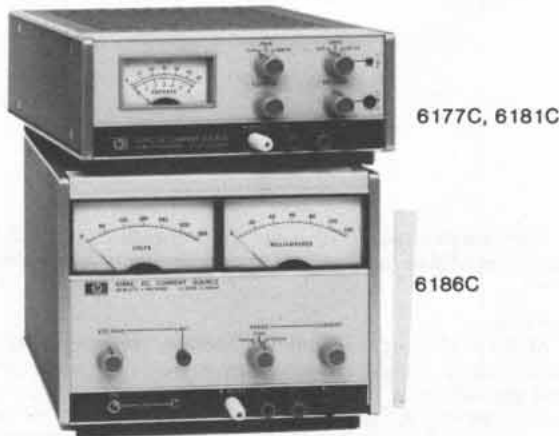

6177C, 6181C

6186C

Description

These solid-state constant-current sources are ideal for semiconductor circuit development, component testing, and precision electroplating applications.

Their high-speed remote programming characteristics make these supplies useful in testing and sorting semiconductors, resistors, relays, meters, etc. The ability to superimpose ac modulation on the dc output permits the supplies to be used for measurement of dynamic or incremental impedance of circuit components.

Specifications

Load effect (load regulation): less than 25 ppm of output + 5 ppm of range switch setting for a load change which causes the output

- High output impedance—no output capacitor

voltage to vary from zero to maximum.

Source effect (line regulation): less than 25 ppm of output + 5 ppm of range switch setting for a change in the line voltage from 104 to 127 V ac (or 127 to 104 V ac) at any output current and voltage within rating.

Load effect transient recovery: less than 800 μ s for recovery to within 1% of nominal output current following a full load change in output voltage. (On 6186C, recovery time for 100 mA/10 mA/1 mA ranges is 1 ms/1.6 ms/4 ms, respectively.)

Temperature coefficient: output change per degree C is less than 75 ppm of output current +5 ppm of range switch setting.

Drift (stability): less than 100 ppm of output current +25 ppm of range switch setting. Stability is measured for eight hours after one hour warm-up under conditions of constant line, load, temperature, and output setting.

Resolution: 0.03% of range switch setting.

Temperature rating: operating 0, to 55°C, storage, -40 to +75°C.

Accessories

Accessories	Price
5060-8764: rack adapter for rack mounting one or two 6177C or 6181C supplies	\$60
5060-8762: rack adapter for rack mounting one or two 6186C supplies	\$65
5060-8530: filler panel for Models 6177C, 6181C	\$16.50
5060-8760: filler panel for Model 6186C	\$17.50

Options

015: three-digit graduated turns-counting current control replaces front panel current knob	add \$50
028: 230 V ac \pm 10%, single-phase input. Models 6177C and 6181C only	N/C

Ordering information

6177C, 6181C Constant Current Source	\$775
6186C Constant Current Source	\$1050

Model		6177C	6181C	6186C	
Output Current \ddagger		0-500 mA	0-250 mA	0-100 mA	
Voltage Compliance Δ		0-50 V dc	0-100 V dc	0-300 V dc	
Output Ranges	A	0-5 mA	0-2.5 mA	0-1 mA	
	B	0-50 mA	0-25 mA	0-10 mA	
	C	0-500 mA	0-250 mA	0-100 mA	
AC Input		115V ac \pm 10%, 48-63 Hz; 0.6 A, 55 W at 115 V ac For 230 V ac see Option 028	115 V ac \pm 10%, 48-63 Hz; 0.6 A, 55 W at 115 V ac For 230 V ac see Option 028	115/230 V ac, 48-63 Hz; 0.9 A, 90 W at 115 V ac 115/230 V ac switch	
Constant Current	Voltage Control (accuracy: 0.5% of output current +0.4% of range)	Range A	200 mV/mA	1 V/mA	10 V/mA
		Range B	20 mV/mA	100 mV/mA	1 V/mA
Range C		2 mV/mA	10 mV/mA	100 mV/mA	
Remote Programming	Resistance Control 1% of output control +0.04% of range)	Range A	400 ohms/mA	2 k Ω /mA	10 k Ω /mA
		Range B	40 ohms/mA	200 ohms/mA	1 k Ω /mA
		Range C	4 ohms/mA	20 ohms/mA	100 k Ω /mA
Voltage Limit Remote Programming	Voltage Control (Accuracy: 20%)	1 V/V	1 V/V	1 V/V	
	Resistance Control	870 ohms/V	435 ohms/V	820 ohms/V	
	Accuracy	25%	25%	15%	
Typical Output Impedance (R in parallel with C)*	Range A	= 330 Meg, C = 500 pF	= 1330 Meg, C = 10 pF	R = 10,000 Meg, C = 900 pF	
	Range B	R = 33 Meg, C = 0.005 μ F	R = 133 Meg, C = 100 pF	R = 1,000 Meg, C = 700 pF	
	Range C	R = 3.3 Meg, C = 0.05 μ F	R = 13.3 Meg, C = 1000 pF	R = 100 Meg, C = 1500 pF	
PARD (Ripple and Noise): rms/p-p (dc to 20 MHz) with either output terminal grounded	Range A	1.6 μ A rms/40 μ A p-p	0.8 μ A rms/20 μ A p-p	0.2 μ A rms/5 μ A p-p	
	Range B	16 μ A rms/200 μ A p-p	8 μ A rms/100 μ A p-p	2 μ A rms/50 μ A p-p	
	Range C	160 μ A rms/1 mA p-p	80 μ A rms/500 μ A p-p	20 μ A rms/500 μ A p-p	
Programming Speed: from 0 to 99% of range switch setting with a resistive load		6 ms	6 ms	10 ms	
** (Output Current Modulation)					
Dimensions:		7 $\frac{1}{4}$ " (W) x 3 $\frac{3}{8}$ " (H) x 12 $\frac{1}{2}$ " (D) 197 mm (W) x 88 mm (H) x 315 mm (D)	7 $\frac{1}{4}$ " (W) x 3 $\frac{3}{8}$ " (H) x 12 $\frac{1}{2}$ " (D) 197 mm (W) x 88 mm (H) x 315 mm (D)	7 $\frac{1}{4}$ " (W) x 3 $\frac{3}{8}$ " (H) x 12 $\frac{1}{2}$ " (D) 197 mm (W) x 158 mm (H) x 315 mm (D)	
Weight: (Net/Shipping)		4.53 kg (10 lb)/5.9 kg (13 lb)	4.53 kg (10 lb)/5.9 kg (13 lb)	5.9 kg (13 lb)/7.7 kg (17 lb)	

* This network is a simplified representation of a complex network. The formula $Z = R \times C \sqrt{R^2 + X_c^2}$ is used for frequencies up to 1 MHz by substituting the values given for R and C. Above 1 MHz, the output impedance is greater than the formula would indicate.

** Output current can be modulated 100% up to 50 Hz; percent modulation decreases

linearly to 10% at 500 Hz.

\ddagger For operation above 40°C the maximum output current must be reduced linearly to 80% of rating at 55°C (maximum temperature).

Δ Minimum voltage obtainable with voltage limit control is 0.5 V.



Special purpose: dc power supply/amplifiers

Models 6824A-6827A

- High-speed remote programming
- Overload protection
- Wide-band response



6825A-6827A



6824A

Description

The Power Supply/Amplifier is a general-purpose instrument useful in any laboratory engaged in research and development of electronic systems, circuitry, or components. The unit can be operated in one of two basic operating modes: power supply or amplifier. Terminals at the rear permit access to various internal control points to further expand the operational capabilities of the instrument. The resulting flexibility lends the Power Supply/Amplifier to an almost unlimited number of applications.

Models 6825A through 6827A

These models feature dual-range output, Constant-Voltage/Constant-Current operation, and metering of the ac and dc output voltage and current. Output voltage and current as a dc supply, or gain as a power amplifier, are remotely controllable and are compatible with Hewlett-Packard Multiprogrammer Systems.

As a dc power supply, the unit can furnish a bipolar, Constant-Voltage or Constant-Current output. It can be remotely programmed with a resistance, voltage, or current and its high speed programming characteristics adapt it to a wide variety of laboratory and production testing applications. The supply can sink, as well as source, current permitting it to serve as a variable load device.

As a direct-coupled power amplifier, each unit offers a signal-to-noise ratio of approximately 80 dB at full output with low distortion and a frequency response up to 40 kHz in the fixed gain mode.

Model 6824A

Although this model does not provide quite the level of performance and flexibility of Models 6825A through 6827A, it is lower in cost and is suitable for many applications.

As a power supply, this unit offers Constant-Voltage/Current-Limiting operation, remote programming, and Auto-Series, Auto-Parallel operation.

As a power amplifier, the unit exhibits a high signal-to-noise ratio with a 20 dB gain from dc to 10 kHz. It is useful in servo systems, as a pulse or oscillator amplifier, for motor control, and a variety of other applications.

General specifications

Temperature: operating, 0 to 55°C, storage, -40 to +75°C.

Power: 6824A, standard input voltage is 104-127 V ac, 48-63 Hz. Order Option 028 for 230 V \pm 10% operation. 6825A & 6826A, 6827A, switchable, 100, 120, 220, or 240 V ac, -13% +6%, 48-63 Hz, 150 W.

Size: 6824A, 131 H x 209 W x 303 mm D (5¹/₂" x 8⁷/₃₂" x 11¹⁵/₁₆"). 6825A, 6826A & 6827A, 155 H x 198 W x 316 mm D (6¹/₃₂" x 7²⁵/₃₂" x 12⁷/₁₆").

Weight: 6824A, 7.7 kg (17 lb), 6825A, 6826A & 6827A, 8.2 kg (18 lb).

Power supply specifications

RATINGS			PERFORMANCE												
DC Output		Model	LOAD EFFECT		Source Effect		Pard (rms/p-p)		Transient Recovery		Resolution		Output Z (Typical)	Options ▲	Price
Volts	Amps		Voltage	Current	Voltage	Current	Voltage	Current	Time	Level	Voltage	Current			
-5 V to +5 V/ -20 V to +20 V	0-2.0 A Both Ranges	6825A	0.01%+1 mV	0.01%+250 μ A	0.01%+2 mV	0.01%+250 μ A	10/30 mV	5/15mA	100 μ s	20 mV	40 mV	6 mA	0.5 m Ω , 1.5 μ H	9	\$1025
-5 V to +5 V/ -50 V to +50 V	0-1.0 A Both Ranges	6826A	0.01%+1 mV	0.01%+250 μ A	0.01%+5 mV	0.01%+250 μ A	6/35 mV	0.8/5mA	100 μ s	50 mV	100 mV	3 mA	1 m Ω , 1.5 μ H	9	\$1025
-10 V to +10 V/ -100 V to +100 V	0-0.5 A Both Ranges	6827A	0.01%+1 mV	0.01%+250 μ A	0.01%10 mV	0.01%+250 μ A	10/50 mV	0.4/5mA	100 μ s	100 mV	200 mV	1.5 mA	2 m Ω , 4 μ H	9	\$1045
-50 V to +50 V	0-1.0 A	6824A	0.02%+5 mV	—	0.02%+5 mV	—	10 mV rms	—	100 μ s	0.02%+5 mV	—	—	—	9, 28	\$575

‡ Refer to page 215 for complete specification definitions.

▲ See page 236 for complete option and accessory descriptions.

Power amplifier specifications

RATINGS			PERFORMANCE									
Output		Model	Voltage Gain		Frequency Response, +1, -3dB		Distortion at full output		Input Z (Typical)	Programming Coefficients		
Volts	Amps		Fixed	Variable	Fixed Gain	Variable Gain	100 Hz	10 kHz		Gain*	Voltage	Current
10 V p-p or 40 V p-p	2 A pk	6825A	1X 4X	0-2X 0-8X	dc -40 kHz	dc -15 kHz	0.1% THD	0.5%	10 k Ω	Rf/10.24 k Ω 4 Rf/10.24	1 V/V 4 V/V	2 A/V
10 V p-p or 100 Vp-p	1 A pk	6826A	1X 10X	0-2X 0-20X	dc -40 kHz	dc -15 kHz	0.1% THD	0.5%	10 k Ω	Rf/10.24 k Ω 10 Rf/10.24 k Ω	1 V/V 10 V/V	1 A/V
20 V p-p or 200 V p-p or	0.5A pk	6827A	2X 20X	0-4X 0-40X	dc -30 kHz	dc -15 kHz	0.1% THD	1%	10 k Ω	2 Rf/10.24 k Ω 20 Rf/10.24 k Ω	2 V/V 20 V/V	1 A/V
100 V p-p	1 A pk	6824A	—	0-10X	—	dc -10 kHz	0.1% THD	—	2 k Ω	—	1 V/V	—

*RF is the gain programming resistance.

POWER SUPPLIES

Options and accessories

For low cost lab, general, and special purpose models

A wide range of options is available to modify standard models to meet the requirements of a particular application. Various low cost lab, general purpose and special purpose power supply description are found on pages 218 through 235. To determine which options are available for a particular power supply, refer to the appropriate product page. Always check the AC input voltage, current, and frequency requirements for the standard model and the AC power available in the area or country where the power supply will be used. If options are required, they must be specified with the order.

Options

005: 50 Hz ac input: optimizes power supplies that require adjustment/modification for 50 Hz operation. Order only when listed as required in specifications for a particular model.

009: ten-turn output controls. Replaces single-turn output voltage and current controls (where applicable and available). 6114A, 6115A, 6204B, 6206B-6209B, 6294A, 6299A and 6824A-6827A
6200B-6203B, 6205B, 6256B-6291A, and 6296A
6227B, 6228B, 6253A, and 6255A

010: chassis slides. For access to rack mounted power supplies. 6256B, & 6263B-6267B
6253A, 6255A, 6259B-6261B, 6268B, 6269B, & 6427B-6448B
6453A, 6456B & 6459A

011: internal overvoltage protection crowbar. Protects delicate loads against power supply failure or operator error. Dual output models have dual crowbars. Single output models, where available.

Dual output models, 6205B, 6253A, & 6255A

015: three-digit graduated turns-counting dial and ten-turn controls for output voltage and current (where applicable and available). Improves resettability of power supply output

6177C, 6181C, 6186C, and 6515A

6114A, 6115A, 6204B, 6206B, & 6220B-6226B

6207B, 6209B, 6294A & 6299A

6200B-6203B, 6205B, 6256B-6291A, & 6296A

6227B, 6228B, 6253A, & 6255A

016: 115 V ac $\pm 10\%$ single phase input. Consists of replacing power transformer and circuit breaker, and reconnecting bias transformer, RFI choke and fans. For model 6260B only

019: 230 V ac $\pm 10\%$, 50 ± 0.3 Hz, single phase input. Consists of replacing input transformer, line cord and fuse. Option 019 applies only to models 6110A, 6515A, & 6516A

022: voltage and current programming adjust. Allows the V and I programming coefficients and zero output to be conveniently adjusted to 0.1% accuracy via access holes in the rear panel. Consists of four potentiometers and resistors located inside the rear panel. Option 022 applies only to models 6556B-6274B

023: rack mounting attachments. Factory installed for mounting model 6464C-6483C in a standard 19" rack.

026: 115 V ac $\pm 10\%$, single phase input. Consists of replacing the input circuit breaker and reconnecting the power transformer, bias transformer, RFI choke, and fans. Option 026 applies only to models 6259B, 6261B, and 6268B

027: 208 V ac, $\pm 10\%$, single phase input. Consists of reconnecting power transformer taps, and other components where necessary. Order only when listed in the specifications for a particular model

028: 230 V ac $\pm 10\%$, single phase input. Consists of reconnecting power transformer taps, and other components where necessary. Order only when listed in the specifications for a particular model

040: multiprogrammer interface. Prepares standard HP power supplies for resistance programming by the 6940B Multiprogrammer or 6941B Multiprogrammer Extender. This option includes Option 022, special calibration, and protection check-out procedures (where required)

Price

N/C

\$30

\$60

\$100

\$85

\$160

\$250

\$70

\$130

\$50

\$75

\$100

\$125

\$250

\$80

\$50

\$60

\$30

N/C

N/C

N/C

6111A-6113A

6205B, 6220B, 6224B, 6226B, 6256B-6274B, & 6281A-6299A

6464C, 6466C, 6469C, & 6472C

6227B, 6228B, 6253A & 6255A

100: 87-106 V ac, 47-63 Hz, single phase input

220: 191-233 V ac, 47-63 Hz, single phase input

240: 208-250 V ac, 47-63 Hz, single phase input

(Note: options 100, 220 and 240 are for models 6236B and 6237B only, and consist of setting an internal AC voltage selection switch and selecting appropriate line fuse.)

\$40

\$75

\$100

\$150

N/C

N/C

N/C



14513A Rack Kit for one 3 1/2" high supply

14515A Rack Kit for one 5 1/4" high supply



14523A Rack Kit for two 3 1/2" high supplies

14525A Rack Kit for two 5 1/4" high supplies

Accessories

14513A: high rack kit for one supply

14513A and 14523A rack kits apply to the following models: 6200-6209B, 6237B, 6281A, 6284A, 6289A, 6294A, 6299, 6515A

14523A: 3 1/2" high rack kit for two supplies

14515A: 5 1/4" high rack kit for two supplies

14525A: 5 1/4" high rack kit for two supplies

14515A and 14525A rack kits apply to the following models: 6110A-6113A, 6116A, 6282A, 6286A, 6291A, 6296A, 6516A, 6824A.

14521A: rack kit for one, two or three supplies

Includes two filler panels. 14521A rack kit applies to the following models: 6211A-6218A.

5060-8762: adapter frame for rack mounting one or two 1/2 rack width units or one, two or three 1/2 rack width units

This frame applies to the following models: 6114A, 6115A, 6186C, 6220B, 6224B-6228B, 6825A, 6826A, 6827A.

5060-8764: adapter frame for rack mounting one or two 1/2 rack width units.

This frame applies to the following models: 6177C, 6181C.

5060-8759: Blank Filler Panel

This 1/2 rack width panel applies to the following models: 6220B, 6224B, 6226B.

5060-8760: Blank Filler Panel

This 1/2 rack width panel applies to the following models: 6114A, 6115A, 6186C, 6227B, 6228B, 6825A, 6826A, 6827A.

5060-8530: Blank Filler Panel

This 1/2 rack width panel applies to the following models: 6177C, 6181C.

14545A: casters-set of four

Snap-on casters for one 6464C-6483C power supply. (For rack mounting information on these supplies, see Opt 023.)

\$25

\$15

\$30

\$20

\$45

\$65

\$60

\$10

\$17.50

\$16.50

\$50

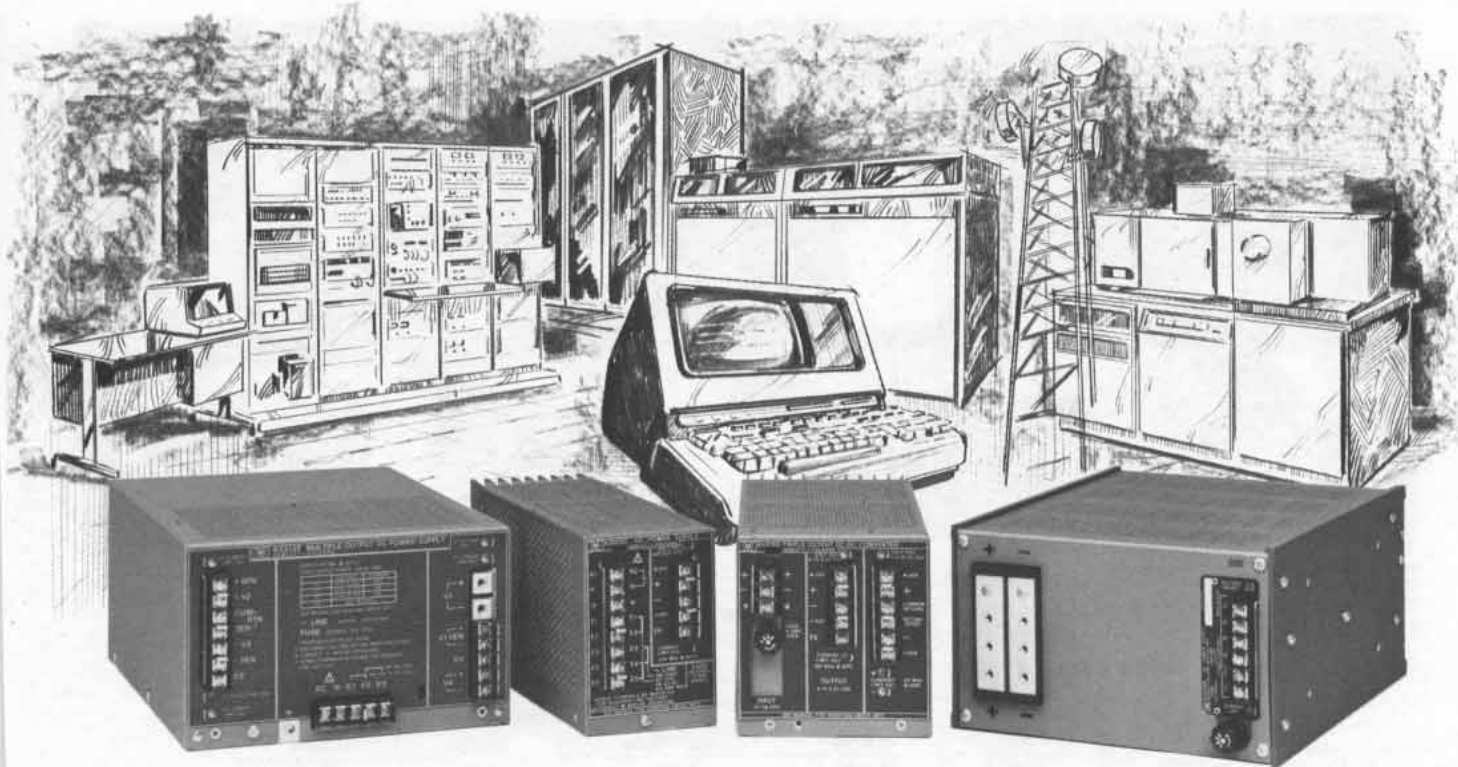

Introduction

The selection of a power supply for today's system requires a critical and prudent evaluation. Sophisticated system electronics have placed more demands on the supply and, as always, the power supply is the very heart of your system. If it stops delivering power, your system will cease to operate.

Your evaluation should include not only the more obvious technical and cost considerations, but also a look at some of the less tangible factors that make up the total purchasing power of your OEM dollar.

Quality

HP's OEM supplies are totally tested before they are introduced. Each product goes through a complete development cycle, consisting of: (a) Engineering Breadboarding; (b) Lab Prototyping; (c) Production Pilot Runs. At each phase the units are evaluated for safety, specification compliance, environmental performance, workmanship, and serviceability. In addition, all models undergo formal environmental testing at a certified facility before introduction.

MTBF

Mean Time Between Failure (MTBF) is a figure of merit that can be calculated and actually verified. It is a number that is often quoted but seldom understood. Frequently, the MTBF's of different manufacturers cannot be compared because they are calculated by different means. HP employs a comprehensive and conservative method of determining MTBF. A component data base is maintained to provide actual component failure statistics and the MTBF is adjusted downward, if necessary, to reflect the actual working environment that the components will be exposed to.

Moreover, in products where new design concepts are used, we verify their reliability by running an actual MTBF life test. Such was the base with the 62605M where Mil Spec 781B, Test Plan IV, was utilized. As indicated by the curve, after 140,000 hours of testing the design hypothesis was verified.

Life Test Acceptance Curve—62605M

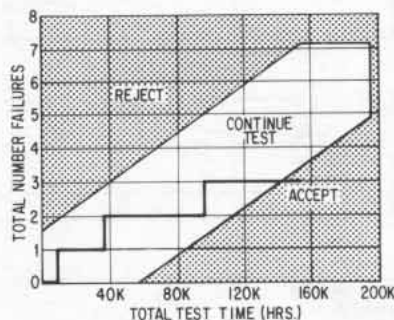

Although this method is expensive and time consuming, it assures you of the HP quality that you have come to accept.

Safety

To assist you in complying with tightening safety regulations, all HP modular power supplies (including switching regulated) are designed to meet UL specs for U.S. applications. Considerations have also been given to international safety regulations. Only when the manufacturer can provide you with a UL yellow card number, can you be assured of UL compliance.

Service Support

Hewlett-Packard's service support is an

other contributing factor in the lasting value of their products. HP is ready to respond to your service needs with an extensive chain of world-wide service and spare parts facilities. Staffed by competent technical personnel, these facilities can provide minimum turn-around time and are backed by the full resources of the manufacturing division. In addition, all units are shipped with a complete Operating and Service Manual.

Special Design Group

In some applications off-the-shelf power supplies may not meet your needs. In these instances, our Special Design Group can provide product modifications, assembled power systems, and applications assistance to help with your specific requirement.

Make or Buy

A crucial question in the make or buy decision is whether or not you have the technical and financial resources available to manufacture your own supplies.

It is important not to underestimate the difficulty involved in a power supply design. When evaluating your technical capabilities keep in mind that: (a) Modern power supplies are state of the art components; (b) Time will be required for electrical and mechanical definition as well as for design, lab and production prototypes and evaluation; and (c) Engineers will be diverted from other projects.

To assist you in the cost aspects of your evaluation, we have prepared application note 236-1. This note assists you in conducting a Return on Investment (ROI) analysis by revealing both the obvious and hidden costs incurred in the manufacture of your own power supplies. Contact your local HP sales office for a free copy.



POWER SUPPLIES

OEM Modular: The total solution concept.

Model series 61000-63000

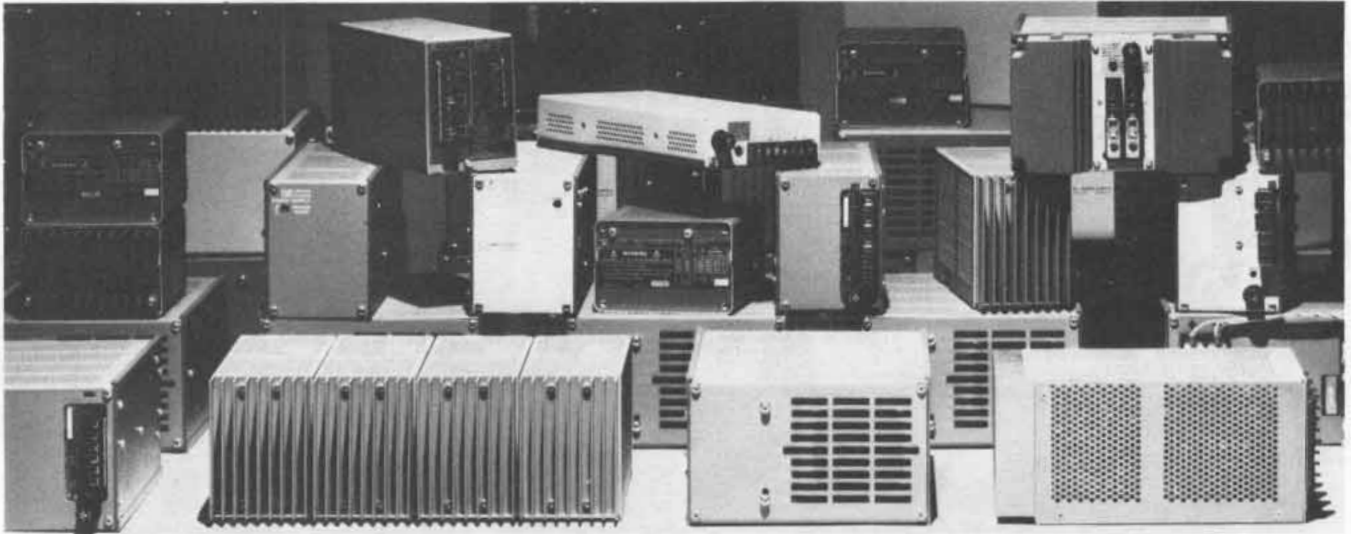

EXAMPLE OF RATINGS AVAILABLE.

Contact your local HP Field Engineer for information on models to meet your specific requirements.

*Quantity and OEM discount are available. All prices on this page are for OEM 100 unit quantity.

Single Output—UL yellow card E51529

	Linear Regulated			20 kHz Switching Regulated		
	A-Series	E-Series	G-Series	63000C-Series	L-Series	M-Series
5 V	62005A (2.0A)	62005E (8.0A)	62005G (16.0A)	63005C (22.0A)	62605L (60.0A)	62605M (100.0A)
12 V	62012A (1.5A)	62012E (6.0A)	62012G (12.0A)	(Note 2) (10.0A)	(Note 1) (30.0A)	(Note 1) (50.0A)
15 V	62015A (1.25A)	62015E (5.0A)	62015G (10.0A)	(Note 2) (8.0A)	(Note 1) (24.0A)	62615M (40.0A)
24 V (0.75A)	62024A (3.75A)	62024E (7.5A)	62024G	▲62624J (12.5A)	(Note 2) (24.0A)	
28 V (0.7A)	62028A (3.25A)	62028E (6.5A)	62028G	▲62628J (10.7A)	(Note 2) (21.4A)	
48 V	62048A (0.45A)	62048E (2.0A)	62048G (4.0A)	—	(Note 2) (7.5A)	(Note 2) (12.5A)
OEM Price*	\$156	\$192	\$280	\$300	\$464	\$556

Dual-Output—UL yellow card E51529

±12V	62212A (1.4A)	62212E (3.3A)	62212G (6.0A)	—	—	—
±15 V	62215A (1.25A)	62215E (3.0A)	62215G (5.2A)	—	—	—
OEM Price •	\$172	\$220	—	—	—	—

Multiple-Output—UL yellow card E51529

	Linear Regulated Model 62312D	20 kHz Switching Regulated Model 63315D	20kHz Switching Regulated Model 63312F
Output 1	4.75 to 5.25 V 3A	4.75 to 5.25 V 18A (Note 3)	4.75 to 5.25 V 50A (Note 4)
Output 2	4.75 V at 0.38A, to 12.6 V at 0.60A	+11.4 to +15.75 V 2A (Note 3)	+11.4 to +15.75 V 10A (Note 4)
Output 3	4.75 V at 0.38A, to 12.6 V at 0.60A	-11.4 to -15.75 V 2A (Note 3)	-11.4 to -15.75 V 10A (Note 4)
Output 4	—	—	Up to 120 watts at customer specified voltage (Note 2 & 4)
OEM Prices*	\$132	\$396	\$636

DC-to-DC Converters

Output Ratings	Single Output	Triple Output
	Model 61005C	Model 61315D
	4.75 to 5.25 V at 22A	(Same as Model 63315D) Note 3
OEM Price*	\$320	\$420

1: Special ratings on special order basis at no additional cost.

2: Special ratings on special order basis at additional cost.

3: The outputs of the Models 61315D and 63315D can be operated anywhere within their 18A, 2A, and 2A individual current ratings providing the total output power is within a 110-watt total output rating.

4: The outputs of Model 63312F may be operated anywhere within their 50A, 10A and 10A individual current ratings provided total power is under 550 watts for three output operation.

HP's technical support

- Standard products
- Modified products
- Systems power requirements
- Power supply cooling
- Criteria for make-or-buy analysis

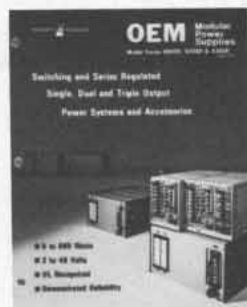

OEM Modular Power Supply Technical Data and AN 236-1 are available from your local HP Field Engineer.

Power systems

- Custom designed systems are available assembled, tested and documented by Hewlett-Packard
- System component units for "do it yourself" power system solutions



Custom systems

Custom power systems can be assembled by installing suitable combinations of single and dual-output linear supplies and switching regulated supplies in rack mounting trays. If desired, Hewlett-Packard will assemble, wire, and test complete power supply systems to customer specifications using these modular power supplies and rack mounting accessories. Meters, switches, input and output connectors, and other components will be installed to meet your specific needs. Consult your local Hewlett-Packard Field Engineer for price and delivery information.

Accessories for power systems

The Model 62410A Rack Mounting Tray can accommodate any combination of Series 62000 linear supplies, Series 6200 dual linear supplies, Series 62200 switching-regulated supplies totaling a full rack width or less. It can be installed in a 19-inch rack directly or on slides. Detachable handles are included. The 62411A Blank Front Panel has a 2.25-inch clearance when installed on the tray for meters, switches, test jacks. Model 62413A Cooling Unit delivers 45 CFM of cooling air while occupying only 1.75-inches of rack space. The 62414A Slide Kit has a 20-inch slide for use with standard 19-inch wide racks of 20-inch depth. (not for HP 29400A or -B cabinets.) Model 62415A AC Distribution Panel is a mounting tray rear panel with a 3-terminal barrier strip, line cord, and fuse holder already installed. The 62416A Cooling Unit is 5.25 inches high and delivers 150 CFM of rack cooling air. A 12692B Slide Kit has 22-inch slides for use with HP 29400A or -B cabinets.



62411A

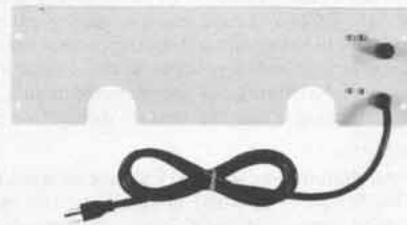

62414A

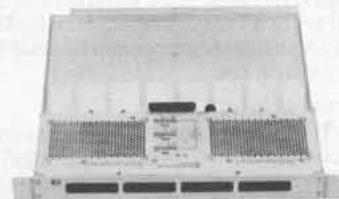

62413A

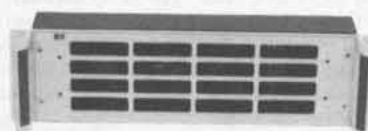

62416A



62414A

62410A

12692B

POWER SUPPLIES

Digitally controlled: binary or BCD

Models 6129C-6131C & 6140A

- Digitally programmable in binary or BCD
- HP-IB compatible option J99 & 59301A
- Fast, accurate, bipolar output
- Digital inputs isolated from analog output
- Internal storage of digital data
- Digitally programmable current latch (on DVS models)- or voltage limit (on DCS model)



6129C

Digital voltage sources

HP's family of digital voltage sources (DVS's) includes models 6129C, 6130C, and 6131C. All models are programmable in binary or 8421 BCD and have many system-oriented features that enhance their use in automatic testing and control environments. Among these features are: isolation between the digital input and analog output lines, digital storage of programmed inputs, programmable current latch, analog input, and current monitoring terminals.

Isolation

All digital lines of the DVS's are isolated from the analog output. This feature is essential in automatic test systems to avoid forming ground loops that could impair system operation and damage the computer and instruments.

Nearly all computer manufacturers ground the power supplies for the digital I/O logic to the mainframe of the computer, which is connected to the ac power line ground. If a DVS did not have isolation, one of its analog output terminals would be connected to the digital input common line.

Internal storage

The DVS's internally store the computer's output magnitude (voltage setting), polarity, range, and output latch/limit digital inputs when the computer's gate command is received. When the DVS has finished processing the digital input, it notifies the computer by transmitting its flag. Since the DVS stores the digital data, the computer does not have to continually refresh the DVS; it is free to carry out other important tasks. The DVS maintains its programmed output indefinitely, changing the output only when the computer changes the digital input data and sends another gate command.

In addition to eliminating the need for redundant programming by the computer, internal storage also facilitates the control of multiple DVS's from a single computer I/O channel. The number of DVS's that can be controlled from a single I/O channel depends on the capabilities of the computer's I/O data bus drivers. Most computers can easily drive up to eight DVS's.

Programmable current latch

Overcurrent protection is provided by a current latch circuit which can be externally programmed to one of eight values between 2% and 100% (six values for the 6131C) of the unit's rated output current. When activated, the current latch circuit turns off the output power amplifier reducing the output current to less than 20 mA. The reaction time of the current latch circuit (time between the start of a current overload and turn off of the power amplifier) can be adjusted by adding an external capacitor at the rear terminals. The upper current limit is safeguarded by a separate fixed current limit circuit that prevents the output current from exceeding 110% of the current rating. The computer is continuously informed of possible current overload or current latch conditions by status outputs which are fed back to the programming source.

Analog input

In automatic test systems, it is often desirable to inject an ac "wiggle" on top of a programmable dc level to measure impedance at various voltage levels, to simulate worst case power supply conditions for a module under test, or measure component parameters such as dynamic gain or transconductance. Many automatic control systems require this feature to provide "dither" for the system. All DVS's provide an analog input to fulfill this need.

Current monitoring terminals

The output current of all DVS's can be measured without upsetting voltage accuracy by connecting a voltmeter across the current monitoring terminals on the rear barrier strip.

Digital current sources

The Digital Current Source, Model 6140A is ideally suited for system applications requiring a rapidly programmable, high-precision source of current.

The isolation, internal storage, and analog input features described for the DVS's also apply to the DCS's. In addition, the DCS's have programmable voltage limiting and voltage monitoring terminals.

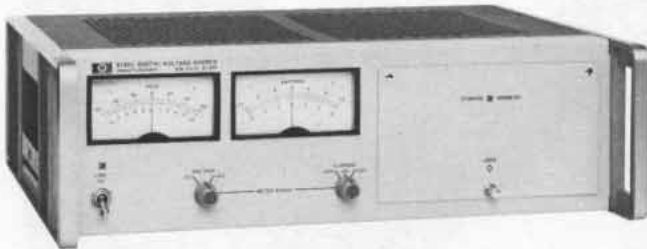

6130C, 6131C

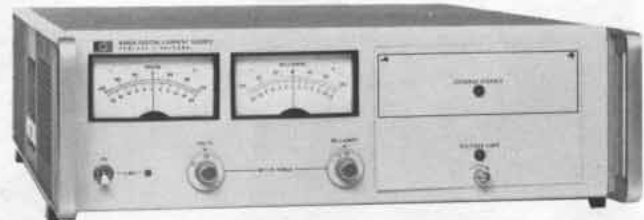

6140A

Common specifications

AC power input

6129C: 115/230 V ac, 48-63 Hz; 6.4 A, 780 W @ 115 V ac; 115/230 V ac switch-selected.

6130C, 6131C: 115 V ac $\pm 10\%$, 48-440 Hz; 1.2 A, 100 W.

6140A: 115/230 V ac, 48-63 Hz; 1.2 A, 100 W @ 115 V ac; 115/230 V ac switch selected.

Dimensions

6129C: 266.7 H x 425.5 W x 542.9 mm D (10½" x 16¾" x 21¾").

6130C, 6131C: 133.4 H x 425.5 W x 396.9 mm D (5¼" x 16¾" x 15¾").

6140A: 133.4 H x 425.5 W x 542.9 mm D (5¼" x 16¾" x 21¾").

Weight

6129C: net, 35 kg (78 lb). Shipping, 39 kg (85 lb).

6130C, 6131C: net, 15 kg (32 lb). Shipping, 18 kg (40 lb).

6140A: net, 17 kg (38 lb). Shipping, 20 kg (44 lb).

Cooling

6130C, 6131C: are convection cooled.

6129C, 6140A: are forced air cooled.

Programming time: less than 300 μ sec for output to settle to within 0.1% of programmed change. Range change requires 2 ms.

Software for HP computers

Drivers in the form of punched paper tape with accompanying operating manuals are available for Hewlett-Packard BCS, DOS, RTE, and BASIC software operating systems. Contact your HP Field Engineer for prices and ordering information.

AC power option

O28: transformer tap change for 230 V ac $\pm 10\%$, single-phase input on 6130C and 6131C.

Price

N/C

Standard interface options

J20: binary interface for 12661A I/O programmer card for Hewlett-Packard computers

N/C

J99: interfacing DCPS's with calculator-based test control systems. All DCPS's may be modified to be compatible with ASCII-to-Parallel Converter, Model 59301A in calculator-based systems. In addition to DCPS modification, two items are supplied as part of Option J99: (1) a 1.83 m cable to connect DCPS to Model 59301A; (2) J99 Interface Note, containing Installation Instructions, Software Listings, Operating Instructions, and Diagnostics.

\$170

O63: BCD interface for microcircuit logic levels

N/C

O64: binary interface for microcircuit logic levels

N/C

Special Options

If none of the standard interface options meet your requirements, quotations for special options may be obtained from your Hewlett-Packard field engineer.

Accessories available

14533B: Pocket programmer permits manual programming of all input functions by switch closure

\$200

14534A: Pocket programmer extension cable (3 ft)

\$100

14535A: HP computer interface kit includes 12661A computer I/O card, 14539A cable, verification software and BCS Driver. Up to eight DCPS's may be controlled from one 14535A

\$1700

14539A: cable connects the first DCPS in a chain of up to eight instruments to the 12661A DVS programming card for Hewlett-Packard computers

\$170

14536A: chaining cable connects an additional DCPS to the existing chain of DCPS's

\$170

Ordering information

6129C: Digital Voltage Source

\$3750

Opt 908: Rack Flange Kit

add \$15

6130C, 6131C: Digital Voltage Source

\$1900

6140A: Digital Current Source

\$3750

Opt 908: Rack Flange Kit

add \$10

	Binary Instruments Option J20 & 064		BCD Instruments Option J99 & 063	
	X1 Range	X10 Range	X1 Range	X10 Range
6129C				
Output	± 16.384 V, 5 A	± 50.00 V, 5 A	± 9.999 V, 5 A	± 50.00 V, 5 A
Accuracy	1.5 mV	15 mV	1.5 mV	15 mV
Resolution	0.5 mV	5 mV	1 mV	10 mV
6130C				
Output	± 16.384 V, 1 A	± 50.00 V, 1 A	± 9.999 V, 1 A	± 50.00 V, 1A
Accuracy	1 mV	10 mV	1 mV	10 mV
Resolution	0.5 mV	5 mV	1 mV	10 mV
6131C				
Output	± 16.384 V, 0.5 A	± 100.00 V, 0.5 A	± 9.999 V, 0.5 A	± 99.99 V, 0.5 A
Accuracy	1 mV	10 mV	1 mV	10 mV
Resolution	0.5 mV	5 mV	1 mV	10 mV
6140A				
Output	± 16.384 mA, 100 V	± 163.84 mA, 100 V	± 9.999 mA, 100 V	± 99.99 mA, 100 V
Accuracy	1 μ A $\pm 0.01\%$	10 μ A, $\pm 0.01\%$	10 μ A, $\pm 0.01\%$	10 μ A, $\pm 0.01\%$
Resolution	0.5 μ A	5 μ A	1 μ A	10 μ A

Accessories furnished:

1251-0086 50-contact rear plug.

5060-7948 Plug-in extender board for DVS models.

5060-7948/5060-7982 Two plug-in extender boards for DCS.

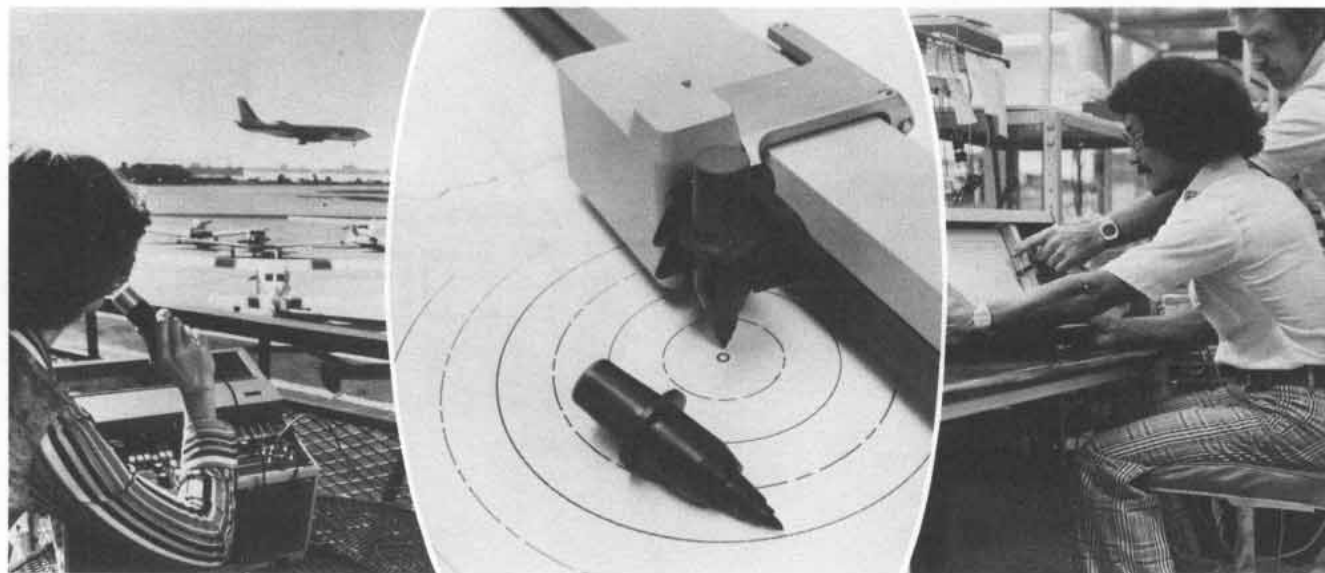

Introduction

Hewlett-Packard offers recorders and plotters that record and display data accurately, quickly, and reliably. Application areas are manufacturing, business, education, laboratories, R & D, and hospitals. The recorders can also be utilized by the original equipment manufacturer (OEM) to fulfill the need for recording and displaying from the OEM's equipment. Models may be chosen from X-Y, strip chart, oscillographic, and instrumentation tape recorders, as well as graphic plotters for computer, timeshare, and calculator users.

Graphic plotters

Complete graphic capability to computers or terminals, with little programming effort and software, is available from Hewlett-Packard Graphic Plotters. Simple commands and data formats, generated by almost any computer in any language, are used to control the plotter.

The 7221A and 9872A models are included in this family. Both are microprocessor plotters that produce high quality, multicolor (red, green, blue, black) graphic plots on any size chart up to 280 mm x 432 mm (ISO A3). The 7221A plots from remote facilities; EIA RS232C/CCITT V.24 asynchronous serial ASCII interface operates at any of eight switch selectable baud rates from 75 to 240 BAUD. The 9872 plots through HP-IB interface to a calculator, computer, or other controller using the IEEE 488-1975 standard interface.

Two new additions are the 7245A Plotter/Printer and the 7225A Graphics Plotter. The 7245A is a single unit desktop thermal model designed to fill scientific, engineering, and business needs. Quality graphics, flexible labeling, long-axis plotting, and unattended graphics and printing are provided. The 7245A plots through HP-IB interface to desktop controllers and systems using IEEE 488-1975 standard interface. The 7225A is a microprocessor based vector graphics plotter that accepts either ISO A4 or 8½ x 11-inch size chart paper. In addition to the mainframe, the 17600 Series Personality Modules are available for specific requirements. The selected Personality Module, installed from the rear, determines the interface, language, and capability of the 7225A. For instance, the 17601A Personality Module is HP-IB interface with HP-GL language plus an internal character generator.

X-Y recorders

X-Y recorders are designed to plot Cartesian coordinate graphs from dc electrical information. They may be selected in two basic sizes and from three basic levels of performance depending upon measurement needs. Models are available with and without time sweep capability. Metric and English instruments may also be selected. Additionally, two-pen models, capable of simultaneously plotting two curves may also be chosen.

Plug-in modules

To expand the versatility and application of one group of X-Y recorders, plug-in modules are provided. If the application changes, simply add the plug-in for the new requirement.

Strip chart recorders

Strip Chart Recorders produce accurate records in rectilinear coordinates. All two-pen models permit both channels to realize the full resolution of the chart width simultaneously since the pens can overlap on the same chart without interference.

Selection of a servo-driven strip chart recorder depends upon the specific application. The 7100B Series and 7130A Series models offer one-pen and two-pen servo drive systems. The 7155B battery-operated unit is useful in field applications as well as laboratory uses.

Oscillographic recorders

Time correlation of multiple channels of data, instantaneous read-out, and the capability to use calibrated units of the customer's choice are just some of the advantages of using direct writing Oscillographic Recorders. Permanent and easily reproduced records of signals from dc to 150 Hz can be made. From two to eight channels of recording are available.

These recorders, with appropriate plug-in signal conditioners, can record electrical signals from microvolts to volts. Applications include telemetry readings, materials testing, patient monitoring, oceanography research or engine testing.

Instrumentation tape recorders

The 3964A and 3968A are instrumentation tape recorders that provide significant benefits by recording on ¼" tape as compared to recording on ½" tape. The units are designed to meet the demands of the individual and OEM users. Versatility, portability, and durability are additional characteristics of these units.

Standard features supplied are E-to-E mode for FM recording, Tape/Tach servo, Equalization, Remote Control, AC/DC calibrator, Flutter compensation, Voice capability, Unipolar operation (FM only), and Re-recording (Dubbing).

Recorder supplies kit

Use of Hewlett-Packard recorder supplies products insure optimum performance from X-Y, Strip Chart, Oscillographic, Graphic Plotter, or Instrument Tape Recorders.

Recorder supplies starter kits are available to allow a working quantity of applicable supplies (pens, paper, ink, and tape) to be purchased with the recorder. These kits appear as model numbers along with the appropriate instrument in this catalog. A complete list of all supplies available is listed in the *Recorder Supplies Catalog*.

X-Y Recorders Model	Description	Chart Size ISO (Inches)	No. of Pens	Time Base	Max. Sensitivity		Standard Writing Method	Plug-ins
					mV/cm	mV/in.		
7010B	OEM	A4 (8 1/2 x 11)	1	Option	5	10	Disposable Pen	No
7015B	Lab-General Purpose	A4 (8 1/2 x 11)	1	Standard	5	10	Disposable Pen	No
7034A	Fast Response, AC Capability	22 cm x 28 cm (8 1/2 x 11)	1	Plug-in	0.25	0.5	Disposable Pen	Yes
7035B	General Purpose	22 cm x 28 cm (8 1/2 x 11)	1	17108A Plug-On	0.4	1.0	Disposable Pen	No
7004B	Fast Response, AC Capability	28 cm x 42 cm (11 x 17)	1	Plug-in	0.25	0.5	Disposable Pen	Yes
7040A	OEM	A3 (11 x 17)	1	Option	0.2	0.5	Disposable Pen	No
7041A	OEM Fast Response	A3 (11 x 17)	1	Option	0.2	0.5	Disposable Pen	No
7044A	General Purpose	A3 (11 x 17)	1	Option	0.25	0.5	Disposable Pen	No
7045A	Fast Response	A3 (11 x 17)	1	Option	0.25	0.5	Disposable Pen	No
7046A	Fast Response	A3 (11 x 17)	2	Option	0.25	0.5	Disposable Pen	No
7047A	Fast Response	A3 (11 x 17)	1	Standard	0.02	0.05	Disposable Pen	No

Plotters Model	Description	Code	Interface	Plotter Commands	Data Transmission Rate	Maximum Plotting Speed	Plot Accuracy	Resetability	Numerical Resolution	
7221A	High Speed Four Color Programmable Remote Terminal Plotter	Serial ASCII	EIA RS232C (CCITT V.24)	41 Programmable High Level Commands	Switch selectable. 7.5 to 240 char/s. Asynchronous	36 cm/s in each axis Programmable	± 0.2% deflection ± 0.2 mm	For given Pen 0.1 mm For Pen to Pen 0.2 mm	0.025 mm (0.001 in.) Programmable	
7225A	Low Cost ISO A4 (8 1/2" x 11") Graphic Plotter	Determined by 17600 Series Personality Module					25 cm/s in each axis	± 0.4 mm	0.4 mm	0.032 mm (0.00125 in.)
		17600A - Parallel Binary 17601A - Parallel ASCII	17600A - General I/O (8-bit) 17601A - HP-IB (IEEE 488-1975)	17600A - 4 Commands 17601A - 38 2-letter mnemonic commands	17600A - 2K byte/s 17601A - Bit Parallel by Handshake					
7245A	Thermal Vector Plotter/Matrix Printer	Parallel ASCII	HP-IB (conforms to IEEE 488-1975)	46 two-letter mnemonic commands plus standard printing commands	Bit Parallel by handshake	50 cm/s Pen off Vector 25 cm/s Pen on vector in each axis	± 0.2% deflection ± 0.35 mm (± 0.014 in.)	0.25 mm (0.01 in.)	0.016 mm (0.0006 in.) physical resolution ± 1 x 10 ⁻⁴ user unit dynamic range	
9872A	High Speed Four Color Programmable Plotter	Parallel ASCII	HP-IB (conforms to IEEE 488-1975)	38 two-letter mnemonic commands	Bit Parallel by handshake	36 cm/s in each axis	± 0.2% deflection ± 0.2 mm	For given Pen 0.1 mm For Pen to Pen 0.2 mm	0.025 mm (0.001 in.) Programmable	

Oscillographic Recorders System	No. of Channels X Chart Width (mm)	Writing Method	With Amp Model No.	Max Sensitivity mV/Div	Vertical Rack Space Requirement	
					(mm)	Inches
7402A	2 x 50	Pressurized Ink	17400A thru 17404A	0.001 1 20	267	10 1/2
7404A	4 x 40	Pressurized Ink	17400A thru 17404A	0.001 1 20	267	10 1/2
7414A	4 x 40	Thermal	8800 Series Preamps	0.001	267	10 1/2
7418A	6 x 40 8 x 40	Thermal	8800 Series Preamps	0.001	451 406	17 1/2 16.0

Instrumentation Tape Recorders Model	Description	Tape Speeds (ips)	FM Response	Direct Response	Size	Weight
3964A	Four Channel Multiple Speed on 1/2 inch (6.3 mm) wide tape	15, 7 1/2, 3 3/4, 1 7/8, 1 1/2, 1 1/4, 1 1/8, 3/4, 1/2, 1/4, 1/8, 1/16	DC-5000Hz @ 15 ips DC-156 Hz @ 15 1/2 ips	70-64000 Hz @ 15 ips 56-2000 Hz @ 15 1/2 ips	400 H (15.7") x 427 W (16.7") x 256 mm D (10.1")	29.5 kg (65 lb)
3968A	Eight Channel Multiple Speed on 1/2 inch (6.3 mm) wide tape	15, 7 1/2, 3 3/4, 1 7/8, 1 1/2, 1 1/4, 1 1/8, 3/4, 1/2, 1/4, 1/8, 1/16	DC-5000 Hz @ 15 ips DC-156 Hz @ 15 1/2 ips	500-64000 Hz @ 15 ips 100-2000 Hz @ 15 1/2 ips	445 H (17.5") x 427 W (16.7") x 256 mm D (10.1")	31.3 kg (69 lb)

Strip Charts Model	Description	Chart Width		No. of Channels	Standard No. Chart Speeds	Chart Speed Range				Standard Writing Method	Maximum Sensitivity		Signal Input Sensitivity
		Cm	In.			Min Cm/Hr	Max Cm/Min	Min In./Hr	Max In./Min		mV (metric)	Full Scale	
680	Lab-OEM	12	5	1	8	2.5	20	1	8	Caply ink pen w/replace cart	5	(6)	10 Spans
7155B	Lab-OEM	12	5	1	7	1	12			Disp. Ink Pen	1	(1.2)	16 Spans
7100B	Lab-OEM	25	10	2	12	2.5	5 cm/sec	1	2 in./s	Caply ink pen w/replace cart	0.1	(0.1)	Plug-In
7101B	Gen Purpose-OEM	25	10	1	12	2.5	5 cm/sec	1	2 in./s	Caply ink pen w/replace cart	0.1	(0.1)	Plug-In
7130A	OEM	25	10	2	Deter. by Opt.	3	15	1	6	Disp. Ink Pen, Therm Opt.	1	(1)	Single Span
7131A	OEM	25	10	1	Deter. by Opt.	3	15	1	6	Disp. Ink Pen, Therm Opt.	1	(1)	Single Span
7132A	Lab	25	10	2	8	2.5	15	1	6	Disp. Ink Pen, Therm Opt.	1	(1)	11 Spans
7133A	Lab	25	10	1	8	2.5	15	1	6	Disp. Ink Pen, Therm Opt.	1	(1)	11 Spans

RECORDERS, PRINTERS & PLOTTERS

Fast response X-Y recorder, plug-in-modules

Models 7004B, 7034A, & 17170 series plug-ins

- High performance

- Plug-in versatility

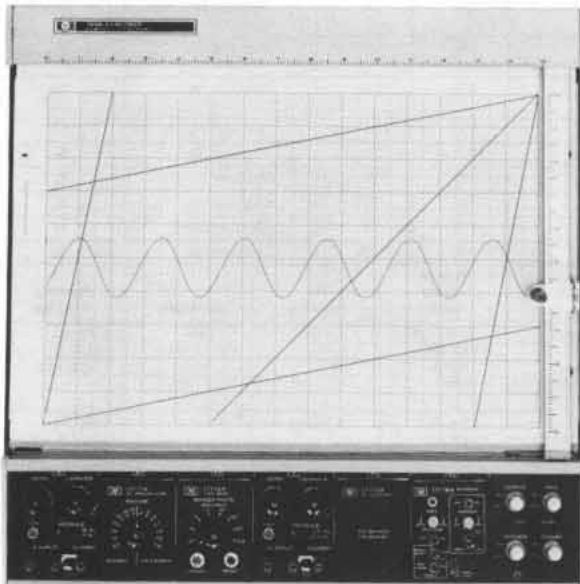

7004B

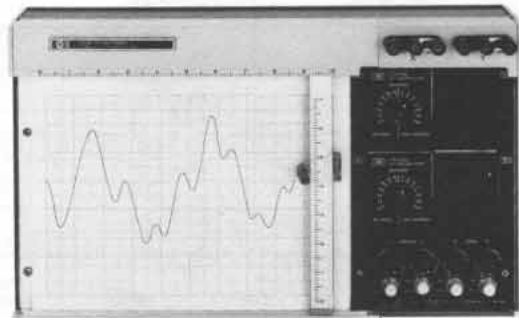

7034A



17170A



17171A



17172A

The Hewlett-Packard Models 7004B and 7034A provide acceleration of more than 3800 cm/s^2 (1500 in./s^2) and slewing speed of 76 cm/s (30 in./s). The high acceleration allows the pen to follow small, quick input changes. Front and rear guard terminals are available for signal inputs. Guarding helps eliminate the common mode voltage effects that are troublesome when recording from low-level sources such as thermocouples, strain gauges and similar sources. Additional features include the proven electrostatic paper holddown, the disposable ink pen, a RECORD/SETUP switch, knob locks, five-way binding posts, tilt stand, to name a few.

Selection of the plug-ins is dependent upon the type of X-Y recorder, as well as purpose. Two plug-ins per axis are placed in the mainframe. Each may be used individually or in series by setting the front panel switch.

7004B, 7034A, 17170 Series plug-ins specifications

7004B and 7034A Performance specifications

Plug-ins: accept 4 single-width; 2 per axis.

Type of input: floating and guarded signal pair. Available through front panel or rear connector.

Zero set: may be set $\pm 1 \text{ fs}$ from zero index.

Zero check switches: pushbutton in each axis allows verification of recorder's zero position without removal or shorting of input signal.

Mainframe accuracy: $\pm 0.2\%$ of full scale.

Range vernier: lockable, covers 2.5 times range setting.

Slewing speed: more than 75 cm/s (30 in./s) independent of line voltage & frequency.

Acceleration (Peak): more than 3800 cm/s^2 (1500 in./s^2).

Reference stability: better than $0.003\%/^{\circ}\text{C}$.

Terminal based linearity: $\pm 0.1\%$ of full scale.

Resettability: $\pm 0.05\%$ of full scale.

7004B and 7034A General specifications

Electrostatic paper holddown: grips charts up to size of platen.

Pen lift: local and remote control (contact closure or TTL).

Size: 7004B: $267 \text{ H} \times 445 \text{ W} \times 121 \text{ mm D}$ ($10\frac{1}{2}'' \times 17\frac{1}{2}'' \times 4\frac{3}{4}''$).

7034A: $267 \text{ H} \times 445 \text{ W} \times 121 \text{ mm D}$ ($10\frac{1}{2}'' \times 17\frac{1}{2}'' \times 4\frac{3}{4}''$).

Weight: 7004B: net 12.7 kg (28 lb). Shipping 14.1 kg (42 lb).

7034A: net 7.3 kg (16 lb). Shipping 14.1 kg (31 lb).

Power: 115 or $230 \text{ V ac} \pm 10\%$, 50 to 400 Hz , approx. 85 VA (dependent on plug-in).

17170A DC Coupler specifications

Input range: single, fixed calib range of 50 mV/cm (100 mV/in.).

Input resistance: $1 \text{ M}\Omega$ constant.

Common mode rejection: 120 dB at dc & 70 dB at 50 Hz & above with 100Ω between low side & guard connect point with source impeded. $10 \text{ k}\Omega$ or less.

17171A DC Pre-amplifier specifications

Input ranges: $0.25, 0.5, 1, 2.5, 5, 10, 25 \text{ mV/cm}$, $0.05, 0.1, 0.25, 0.5, 1, 2.5, 5 \text{ V/cm}$ ($0.5, 1, 2, 5, 10, 20, 50 \text{ mV/in.}$, $0.1, 0.2, 0.5, 1, 2, 5, 10 \text{ V/in.}$).

Input resistance: $1 \text{ M}\Omega$.

Common mode rejection: 120 dB at dc & 100 dB at 50 Hz & above with 100Ω between low side & guard connect point at 0.25 mV/cm (0.5 mV/in.). CMR on others decreases 20 dB/decade step in attenuation.

System accuracy: $\pm 0.2\%$ full scale.

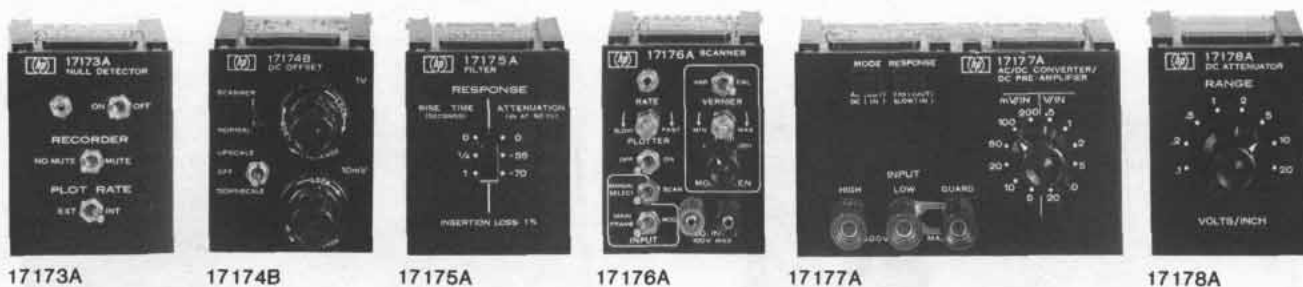

17173A 17174B 17175A 17176A 17177A 17178A



17012B/C

17172A Time Base specifications

Sweep speeds: 0.25, 0.5, 1, 2.5, 5, 10, 25, 50 s/cm (0.5, 1, 2, 5, 10, 20, 50, 100 s/in.).

System accuracy: ±1% of fs on 6 fastest ranges; ±2.5% on remaining 2.

17173A Null Detector specifications

Plot rate: up to 50 plots/s.

Enable/disable: required disable voltage +3 V min. to +20 V max. Required enable voltage—0 V dc or no connect. Other voltage combinations available on request.

Muting: local or remote.

Plotting accuracy: ±0.25% of full scale.

17174B DC Offset specifications

Offset: <1 mV to approx. 1 V.

Controls: 2 lockable, 10-T high resolution controls (<1 mV to approx. 10 mV & <1 mV to approx. 1 V). An offset polarity switch allows upscale or downscale zero offset.

Offset voltage stability: >0.005%/°C.

17175A Filter specifications

Input ranges: -5 to +45 V dc, 10 V ac max p-p.

Maximum source impedance: 1 kΩ; higher impedance decreases filter response.

Rejection: >55 dB at 50 Hz & higher (¼ s rise time) or >70 dB at 50 Hz & higher (1 s rise time). Front panel selection.

17176A Scanner specifications

Input: front panel miniature binding posts isolated from ground (high & low only). Mainframe input—utilizes existing input connectors.

Attenuator: fixed attenuator in decade steps from X1 to X0.001. Variable attenuator provides continuous coverage.

Input impedance: 100 kΩ.

Accuracy: 0.2% of full scale.

Scan rate: adjust. from 0.1 to 4 s/scan.

17177A AC/DC Converter DC Pre-amplifier specifications

Input ranges: 2.5 mV/cm to 10 V/cm (5 cV/in. to 20 V/in.) in 1, 2, 5 steps.

Minimum usable input (ac only): ±0.2% of full scale.

Maximum allowable input: 300 V peak.

Type of input: floating & guarded sig. pair. No rear inputs.

Input impedance: 1 MΩ shunted by less than 40 pF.

Maximum allowable source resistance: 10KΩ.

Common mode rejection: 80 dB at dc & 50 Hz & above with 100Ω between low side & guard connect point & at 2.5 mV/cm (5 mV/in.). CMR on other ranges, decreases 20 dB/decade step in attenuation.

Rise/fall time (ac only, 10-90%): Slow response (5 Hz to 100 kHz) 2.5 s max; fast response (50 Hz to 100 kHz) 0.5 s max.

Calibration (ac only): responds to average value of input waveform; calibrated in rms value of sine wave.

Accuracy: (% of fs): DC—±0.5%; AC (fast response)—±0.25% from 150 Hz to 50 kHz, ±0.5% from 50 Hz to 150 Hz & 50 kHz to

100 kHz; AC (slow response)—±0.25% from 30 Hz to 50 kHz from 5 Hz to 30 Hz & 50 kHz to 100 kHz.

Linearity (ac): expressed as % of fs, measuring from 0.5% of fs.

5 Hz	50 Hz	50 kHz	100 kHz
±0.35%	±0.25%	±0.35%	

Warmup time: 3 minutes nominal.

Zero drift (referred to input) ±30 μV°C.

Offset: up to 1 fs of offset using recorder's zero.

Size: double width occupies both plug-in spaces in axis.

17178A DC Attenuator specifications

Input ranges: 0.05, 0.1, 0.25, 0.5, 1, 2.5, 5, 10 V/cm (0.1, 0.2, 0.5, 1, 2, 5, 10, 20 V/in.).

Input resistance: 1 MΩ.

Common mode rejection: 120 dB at dc & 70 dB at 50 Hz & above with 100Ω between low side & point where guard is connected (at 50 mV/cm or 100 mV/in.). Other ranges CMR decreases 20 dB/decade step in attenuation.

System accuracy: ±0.2% of full scale.

17012B/C Point plotter specifications

The 7004B or 7034A, equipped with 17012B or 17012C respectively, point plot when used with appropriate plug-in. Plotting rate: 50 points per second. Power: supplied from recorder.

Options and accessories

	Price
001: metrically scaled & calibrated (7004B/7034A)	N/C
002: X-axis retrans pot. 5 kΩ ±0.1% linearity (7004B)	\$110
004: power supply for 17005-04 increment chart adv. (7004B)	\$60
001: metrically scaled (17170A/17171A/17172A/17177A/17178A)	N/C
001: +3 to 20 V enable, 0 V disable (17173A)	\$25
001: symbol plotting capability (6) (17012B/C)	\$55
002: -3 to -20 V disable, 0 V enable (17173A)	\$25
003: -3 to -20 V enable, 0 V disable (17173A)	\$25
908: rack mount kit	add \$20
910: extra manual	add \$15

Recorder supplies starter kit

17024A English (7034A)	\$42
17025A Metric (7034A)	\$46
17026A English (7004A)	\$52
17027A Metric (7004B)	\$58

Ordering Information

7004B X-Y Recorder (28.26 x 43.18 cm) (11" x 17")	\$2300
7034A X-Y Recorder (21.59 x 28.26 cm) (8½" x 11")	\$2250
17005A Chart Advance (7004B only)	\$1800
17170A DC Coupler Plug-in	\$65
17171A DC Amplifier Plug-in	\$430
17172A Time Base Plug-in	\$325
17173A Null Detector	\$400
17174B DC Offset Plug-in	\$200
17175A Filter Plug-in	\$175
17176A Scanner Plug-in	\$575
17177A AC/DC Converter Plug-in	\$875
17178A DC Attenuator Plug-in	\$225
17012B/C Point Plotter	\$200



RECORDERS, PRINTERS & PLOTTERS

General performance X-Y recorder, time base

Models 7035B & 17108A

- Floating Guarded inputs

- Disposable pens

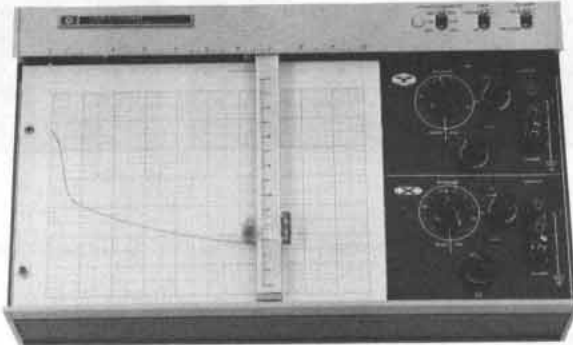

7035B

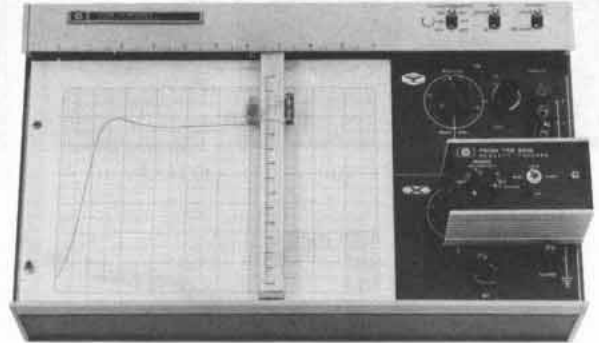

7035B with 17108A

The 7035B is a high-quality, low cost instrument designed for use in general purpose applications. Each axis has an independent servo system with no interaction between channels. The 7035B plots two graphs from two dc signals representing the function being measured.

Input terminals accept either open wires or plug-type connectors. Five calibrated ranges from 0.4 mV/cm (1 mV/in.) to 4 V/cm (10 V/in.) are provided in each axis. A variable range control permits scaling of signal for full scale deflection. High input impedance (1 megohm on all but the first two ranges), floated and guarded input, and 0.2% accuracy is provided.

Each closed-loop servo system uses a high-gain, solid-state servo amplifier, servo motor, long-life balance potentiometers, photochopper, low pass filter, guarded inputs, and attenuator and balance circuit.

A plug-in time base, Model 17108A, operates on either axis to provide five sweep speeds from 0.2 to 20 s/cm. The unit is self-contained, external, and designed to directly plug into the 7035B input terminals. Any number of recorders may be driven simultaneously, provided the combined parallel input resistance is 20 k Ω or more.

7035B Specifications

Performance specifications

Input ranges

Metric: 0.4, 4, 40, 400 mV/cm and 4 V/cm.

English: 1, 10, 100 mV/in.; 1 and 10 V/in. Continuous vernier between ranges.

Types of inputs: floated and guarded signal pair; rear input connector.

Input resistance

Range	Input resistance
0.4 mV/cm (1 mV/in.)	Potentiometric (essentially infinite at null)
Variable	11 k Ω
4 mV/cm (10 mV/in.)	100 k Ω
Variable	100 k Ω
40 mV/cm (100 mV/in.)	1 M Ω
Variable	1 M Ω
400 mV/cm (1 V/in.)	1 M Ω
Variable	1 M Ω
4 V/cm (10 V/in.)	1 M Ω
Variable	1 M Ω

Normal mode rejection: >30 dB at 60 Hz; 18 dB octave above 60 Hz.

Maximum allowable source impedance: no restrictions except on fixed 0.4 mV/cm (1 mV/in.) range. Up to 20 k Ω source impedance will not alter recorder's performance.

Accuracy: $\pm 0.2\%$ of full scale.

Linearity: $\pm 0.1\%$ of full scale.

Resettability: $\pm 0.1\%$ of full scale.

Zero set: zero may be set up to one full scale in any direction from zero index. Lockable zero controls.

Slewing speed: 50 cm/s, (20 in./s) nominal at 115 V.

Common mode rejection: conditions for the following data are line frequency with up to 1 k Ω between the positive input and guard connection point. Max. dc common mode voltage is 500 V.

Range	DC (CMR)	AC (CMR)
Metric		
0.4 mV/cm	130 dB	100 dB
4 mV/cm	110 dB	80 dB
40 mV/cm	100 mV/in.	60 dB
400 mV/cm	1 V/in.	40 dB
4 V/cm	10 V/in.	20 dB

General specifications

Electrostatic paper holddown: grips 216 mm x 279 mm (8½ in. x 11 in.) charts or smaller. Special paper not required.

Pen lift: electric pen lift capable of being remotely controlled.

Size: 265 H x 445 W x 121 mm D (10 7/16" x 17 1/2" x 4 3/4").

Weight: net, 8 kg (18 lb). Shipping, 10.9 kg (24 lb).

Power: 115 or 230 V $\pm 10\%$, 50 to 60 Hz, approximately 45 VA.

17108A Specifications

Sweep speeds: 0.2, 0.4, 2, 4, 20 s/cm (0.5, 1, 5, 10, 50 s/in.).

Accuracy: 5% of recorder full scale.

Linearity: 0.5% of full scale (20°C to 30°C).

Output voltage: 0 to 1.5 V.

Power: replaceable mercury battery (100 hr).

7035B Options and accessories

Opt 001: metric calibration

Opt 003: retransmitting potentiometer on X-axis 5 k Ω $\pm 3\%$

Opt 020: modification for use with models 3580A and 3581A/C

Opt 908: rack mount kit

Opt 910: extra manual

17108A Time Base Plug-In

17108AM Time Base Plug-In (metric)

Recorder supplies starter kits

17024 English

17025A Metric

7035B General Purpose X-Y recorder

Price

N/C

add \$100

add \$295

add \$15

add \$10

\$325

\$325

\$325

\$42

\$46

\$1600

• Low Cost

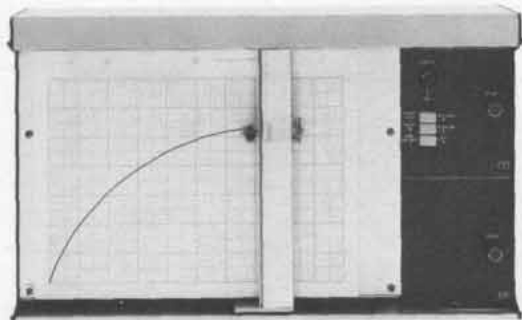

7010B

• Full Capability

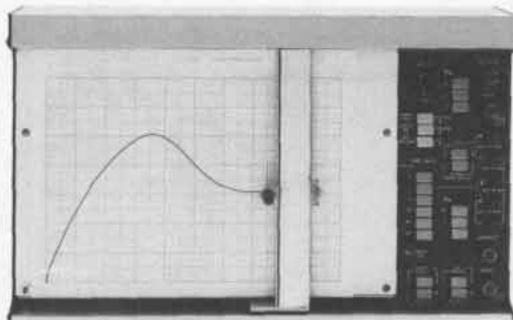

7015B

The 7010B is a low cost, one-pen X-Y recorder that accepts either ISO A4 or 8½ x 11 inch chart size. Featuring maximum electrical and mechanical flexibility, it is specifically designed for the OEM user concerned with cost and space. Options include sensitivity from 5 mV/cm, a time base sweep with remote TTL triggering, input filters, electric pen lift with TTL remote control, control panel, and carrying case.

A low cost, full capability X-Y recorder, the 7015B offers full recording without add-on options or external equipment. Full capability features include Internal Time Base, Matched Input Filters, Remote Pen Lift, and TTL Level Remote Control. The internal time base can be slowed to ¼ hour sweep and has automatic pen control and remote triggering for sweep start and reset. The filters reduce the always present signal noise. Remote pen lift provides the assurance of an acceptable graph during a quick plot. TTL level remote control provides an easy interface with external equipment or systems.

Standard equipment on both units includes the electrostatic paper holddown, rear connector, and disposable pen writing system which includes a universal pen holder that will accept most commercial fiber tipped pens.

7010B & 7015B Specifications

Performance specifications

Ranges

Input voltages: 7010B—single range, 0.1 V/in. (Metric opt.: 5 mV/cm).

7015B Metric Option: .5 mV/cm, 50 mV/cm, 500 mV/cm.

English: 0.01 V/in., 0.1 V/in., 1V/in. Vernier adjustment overlapping all ranges.

Time Base: 7015B 0.5, 1, 5, 10, 50, 100 s/in. (Option 001, metric calibration is 0.1, 0.5, 1, 5, 10, 50 s/cm). Remote sweep start and reset via TTL level or contact closure.

Type of inputs: 7010B—Floating with inputs thru rear connector on circuit board; 7015B—Floating with inputs thru binding posts or rear connector on circuit board. Mating rear connectors furnished for both units.

Input resistance: 1 MΩ constant.

Normal mode rejection: 7015B—greater than 50 dB at 50 and 60 Hz (40 dB/decade roll-off above 60 Hz).

Common mode rejection: 100 dB dc, 90 dB ac (decreases 20 dB/decade step in attenuation). Measured with 1k unbalance in HI terminal on most sensitive range.

Common mode voltage: 40 V dc and peak ac maximum (conforms to IEC 348).

Accuracy: ±0.3% of full scale at 25°C (includes linearity and reset-ability). For 7015B add ±0.2% of deflection when on other than most sensitive range. Temperature coefficient ±0.2%/°C. Time Base 1.5% ±0.1%/°C.

Resettability: less than 0.2% of full scale.

Overshoot: less than 2% of full scale.

Slewing Speed: greater than 50 cm/s (20 in./s).

Zero set: 7015B—zero may be placed anywhere on writing area or electrically offscale up to one full scale from zero index. Adjustment by 10-turn high resolution control.

Environmental: operating temperature 0°C to 55°C; relative humidity 95% RH to 40°C.

General specifications

Writing system: fiber tipped disposable pen. For specialized applications, a universal pen holder is provide to accept most commercial fiber tipped pens.

Writing area: 18 x 25 cm (7 x 10").

Platen size: holds ISO A4 (21 x 29.7 cm) and 8½ x 11 in. Chart size or smaller.

Size: 267 H, 432 W, 135 mm D (10.50" x 17" x 5").

Electrostatic paper holddown: grips ISO A4 chart size or smaller.

Pen lift: 7010B—manual (electric with TTL remote control is optional); 7015B—electric (remote via TTL level or contact closure).

Power: switch selectable for 100, 120, 220, 240 V ac + 5-10%; 47.5 to 440 Hz; 70 VA maximum.

Weight: net, 7.2 kg (16 lb); shipping 10 kg (22 lb).

Options and accessories

	Price
7010B	
001: Metric calibration	N/C
002: Control panel—provides power on/off, power indicator light, servo standby, chart hold, zero controls, and if ordered, electric pen lift	\$75
003: Electric pen lift (remote via TTL or contact closure)	\$65
004: Deletes recorder case	less \$10
005: X-axis single sensitivity 10 mV/in. (5 mV/cm with Opt 001)	N/C
006: X-axis single sensitivity 1 V/in. (0.5 V/cm with option 001)	N/C
007: Y-Axis single sensitivity 10 mV/in. (5 mV/cm with Opt 001)	N/C
008: Y-axis single sensitivity 1 V/in. (0.5 V/cm with Opt 001)	N/C
009: X-axis sweep rate of 1 s/in. (0.5 s/cm with Opt 001*)	\$100
010: X-axis sweep rate of 10s/in. (5 s/cm with Opt 001*)	\$100
011: Carrying case (not to be used for shipping)	\$105
012: Input filter (both axes)	\$40
013: Rear Connector (37 pin subminiature "D")	\$65
*Options 009 and 010 include electric pen lift	
7015B	
001: Metric calibration	N/C
004: Carrying case (not to be used for shipping)	\$105
908: Rack mount kit	\$15
910: Extra manual	\$10

Recorder supplies starter kits

17024A English	\$42
17025A Metric	\$45
908: Rack mount kit	\$15

7010B OEM X-Y Recorder **\$1150**

7015B Lab X-Y Recorder **\$1400**

RECORDERS, PRINTERS & PLOTTERS

OEM, Dedicated applications X-Y recorders

Models 7040A & 7041A

- Rugged one-piece casting
- Over 40 options

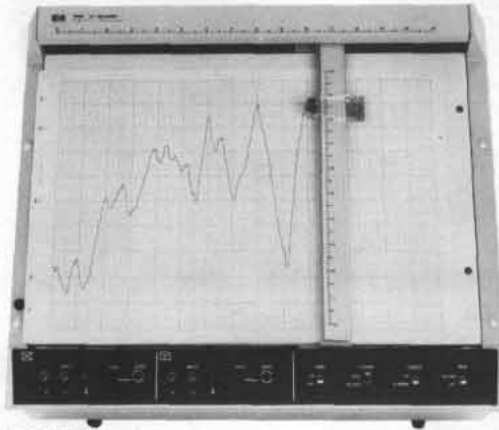

7040A-038

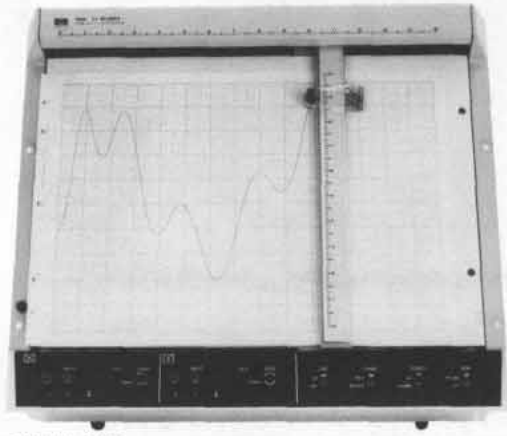

7041A-038

The 7040A and 7041A X-Y recorders are specifically designed for dedicated, single-purpose recording applications. The 7040A is a medium-speed unit while the 7041A is a high-speed unit featuring fast acceleration for applications where recording time is critical or incoming data is at a high rate.

Both models use a one-piece aluminum casting mainframe which eliminates the need for critical mechanical adjustments. They are also equipped with the electrostatic paper holddown system and the quick-change disposable pen.

Additionally, over 40 options give these recorders the ability to be customized for the needed application. Most of the options can be easily and quickly installed or changed in the field. This includes a control panel (Option 038) which would provide the basic recorder functions such as zero set, servo, pen, and chart operation. Other options include a time base, a plug-in X-axis event marker, TTL logic remote control, plus a variety of input ranges.

A functional and quantity discount is available for both units when qualified for the OEM purchase agreement.

7040A & 7041A Specifications

Performance specifications

Input ranges: single range from 0.2 to 500 mV/cm (0.5 mV/in. to 1 V/in.), specified by option choice.

Type of input: floating, 200 V dc or peak ac max; internal polarity switch; inputs through rear barrier strip or optional connector.

Input resistance: 1 M Ω constant.

Common mode rejection: 100 dB dc; 80 dB at line frequency.

Slowing speed

7040A: 50 cm/s (20 in./s) min.

7041A: 76 cm/s (30 in./s) min.

Acceleration (peak)

7040A: Y axis 2540 cm/s² (1000 in./s²); X axis 1270 cm/s² (500 in./s²).

7041A: Y axis 7620 cm/s² (3000 in./s²); X axis 5080 cm/s² (2000 in./s²).

Accuracy: $\pm 0.2\%$ of full scale.

Sweep: optional, single range.

Zero set: external control provided by user; front panel controls available as Option 038.

General specifications

Electrostatic paper holddown: grips ISO A3 or 11" x 17" charts or smaller.

Pen lift: electric pen lift controlled remotely by contact closure; TTL logic level provided by Option 039.

Size: 356 H x 483 W x 165 mm D (14" x 19" x 6 $\frac{1}{2}$ "); rack mounting structure integral with unit.

Weight: net, 13.2 kg (29 lb). Shipping, 16.8 kg (37 lb).

Power: 100, 120, 220, 240 V ac $\pm 5-10\%$, 47.5 to 440 Hz, 130 VA.

Options

Input range: specify one range option for each axis; must be both English or both metric.

X	Y	Range	Price	X	Y	Range	Price
001	007	0.5 mV/in.	\$100	013	019	0.2 mV/cm	\$100
002	008	1 mV/in.	\$100	014	020	0.5 mV/cm	\$100
003	009	10 mV/in.	\$100	015	021	5 mV/cm	\$100
004	010	100 mV/in.	\$50	016	022	50 mV/cm	\$50
005	011	500 mV/in.	\$50	017	023	100 mV/cm	\$50
006	012	1 V/in.	\$50	018	024	500 mV/cm	\$50

Note: other ranges available on special order.

Sweep range: specified by option, X axis only; accuracy $\pm 1\%$ of full scale $\pm 0.1\%/^{\circ}\text{C}$ max; TTL logic start and reset.

X	Sweep	Price	X	Sweep	Price
025	1 s/in.	\$150	030	0.5 s/cm	\$150
026	5 s/in.	\$150	031	5 s/cm	\$150
027	10 s/in.	\$150	032	5 s/cm	\$150
028	50 s/in.	\$150	033	10 s/cm	\$150
029	100 s/in.	\$150	034	50 s/cm	\$150

Note: other sweep ranges available on special order.

035: event marker, upper margin of X axis add \$100

038: control panel; for line, pen lift, chart, servo standby, zero, and zero check; add 44 mm (1 $\frac{3}{4}$ " to height add \$140

039: TTL logic remote control; for pen lift and servo standby; also event marker if installed add \$60

040: rear connector; X, Y input signals and retransmitting potentiometers, time base controls, Autogrip servo standby, pen lift, event marker and Option 039 control lines brought to a single locking connector add \$90

041: side trim panels and dust cover (356 mm, [14"]) for standard unit add \$20

042: side trim panels and dust cover (400 mm, [15 $\frac{7}{8}$ "]) for unit with Option 038 installed add \$20

910: extra manual add \$10

Recorder supplies starter kits

17026A English \$52

17027A Metric \$58

Ordering information

7040A Medium speed X-Y recorder \$1400

7041A High speed X-Y recorder \$1625

Note: OEM discounts available on both models.

RECORDERS, PRINTERS & PLOTTERS

Two-pen, three parameter X-Y/Y recorder

Model 7046A



• Small pen separation

• Virtually no overshoot

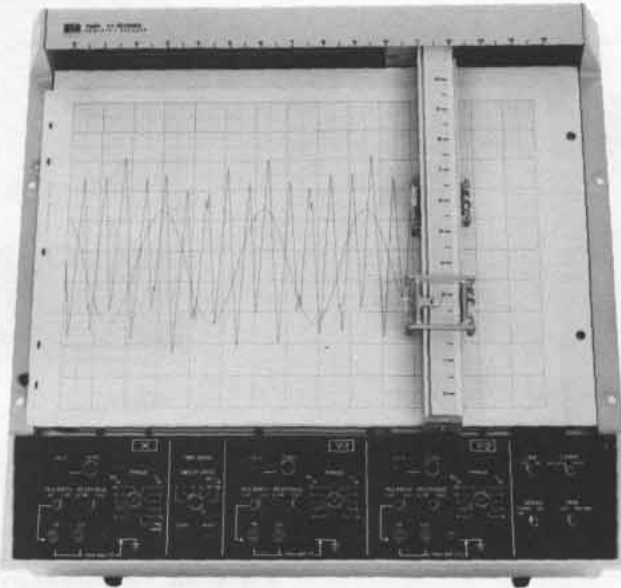

The Model 7046A is a general-purpose 2-pen laboratory X-Y recorder designed to assure high quality recordings without sacrificing ruggedness, reliability and high performance so necessary for a laboratory recorder. The unit has dynamic performance that surpasses most 2-pen recorders by offering Y-axis acceleration exceeding 6350 cm/s² (2500 in./s²). This high acceleration plus very little overshoot results in the 7046A reproducing a wide range of fast changing input signals.

A front panel polarity switch that switches pen direction, and the response switch which reduces the speed of the unit, are also available. The electrostatic paper holddown system which holds ISO A3, up to 27.9 cm x 43.2 cm (11 x 17 in.) size paper is also standard.

7046A Specifications

Performance specifications

Input ranges: metric calibration available in 0.25, 0.5, 2.5, 5, 25 mV/cm; 0.05, 0.25, 0.5, 2.5, 5 V/cm (0.5, 1, 5, 10, 50 mV/in.; 0.1, 0.5, 1, 5, 10 V/in.). Continuous vernier between ranges.

Type of input: floating and guarded, 500 V dc or peak ac maximum. Polarity reversal switch located on front panel, guard internally connected. Inputs through front panel binding posts or rear connector.

Input resistance: 1 megohm constant on all ranges.

Common mode: 110 dB dc and 90 dB at 50 Hz and above (exceed 130 dB dc and 110 dB ac under normal lab environmental conditions) with 1 kΩ between HI and LO terminals. CMV applied between ground and LO, and attenuator on most sensitive range. On other ranges, CMR decreases 20 dB per decade step in attenuation.

Slewing speed: Fast Response, 76 cm/s (30 in./s) minimum; Slow Response, 36 cm/s (15 in./s) typical.

Acceleration: (peak, fast response only): Y-axis 6350 cm/s² (2500 in./s²), X-axis 3800 cm/s² (1500 in./s²).

Accuracy: ±0.2% of full scale (includes linearity and deadband) at 25°C. Temp Coefficient ±0.01% per °C.

Range accuracy: ±0.2% of full scale ±0.2% of deflection (includes linearity and deadband) at 25°C. Temp Coefficient ±0.01% per °C.

Deadband: 0.1% of full scale.

Overshoot: 1% of full scale (maximum).

Zero set: zero may be placed anywhere on the writing area or electrically off scale up to one full scale from zero index.

Environmental (operating): 0 to 55°C and <95% relative humidity (40°C).

General specifications

Writing mechanism: servo actuated ink pens.

Writing area: 25 cm x 38 cm (10" x 15").

Electrostatic paper holddown: grips ISO A3 or 11 in. x 17 in. Special paper not required.

Pen lift: electric (remote, via contact closure or TTL level).

Size: 441 H x 483 W x 173 mm D (17 3/8" x 19" x 6 13/16"); rack mounting structure integral with unit.

Power: 100, 120, 220, 240 Vac +5-10%, 48 to 400 Hz, 175 VA.

Weight: net, 16 kg (35 lb). Shipping, 21.4 kg (47 lb).

Options and accessories

007: metric calibration

001: time base

Sweep rates: Metric calibration is 0.25, 0.5, 2.5, 5, 25, 50 s/cm (0.5, 1, 5, 10, 50, 100 s/in.).

Accuracy: 1% at 25°C (Temp. Coeff. ±0.1%/°C max).

General: switchable to X-axis. Start and reset by front panel control, remote by momentary contact closure to ground or TTL levels. Automatic reset at full scale, recycle accomplished by continuous start signal.

002: event marker

Writes in upper margin, aligned with X-axis position of Y pen, approximately 0.12 cm (0.05 in.) excursion completed 50 ms after application of signal. Controlled remotely by contact closure to ground or by TTL levels. Contact resistance: 4 kΩ (maximum).

910: extra manual

Recorder supplies starter kits

17028A English

17054A Metric

7046A 2-pen, X-Y/Y, recorder

Price

N/C

add \$225

add \$100

add \$10

\$48

\$54

\$3450

RECORDERS, PRINTERS & PLOTTERS

High performance X-Y recorders

Models 7044A, 7045A, & 7047A

- High Dynamic response

- Performs laboratory measurements

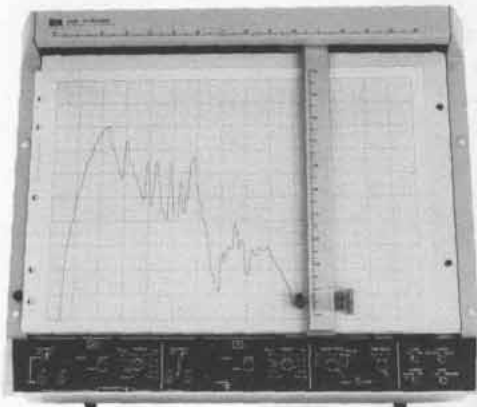

7044A

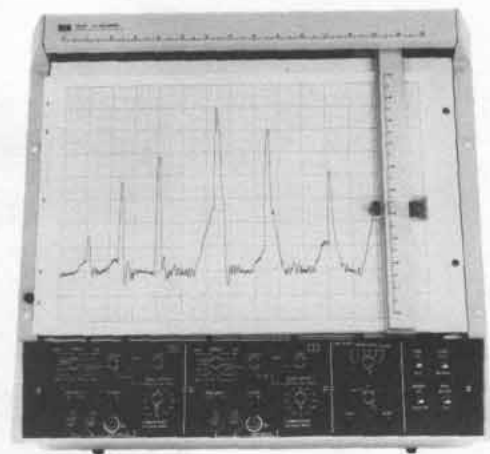

7047A

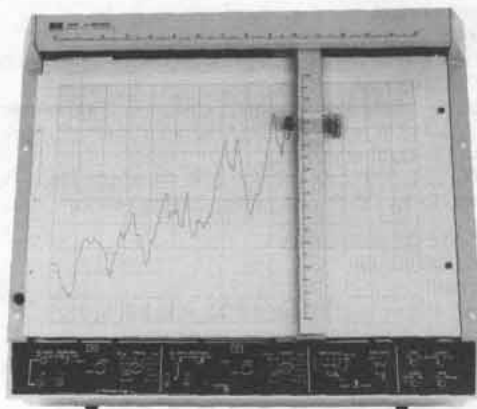

7045A

The Models 7044A, 7045A, and the 7047A are general purpose X-Y recorders specifically designed to offer the needed requirements to perform laboratory measurements. This allows for a wide range of quick-changing signals to be reproduced accurately and dependably. The 7044A is a medium-speed recorder designed for most general-purpose applications. The 7045A and 7047A offer higher speed and Y-axis acceleration exceeding 7620 cm/s^2 (3000 in./s^2).

Other outstanding features found on the recorders include 10 calibrated dc input ranges on each axis of the 7044A and 7045A from 0.25 mV/cm to 5 V/cm (0.5 mV/in. to 20 V/in.) and 12 calibrated dc input ranges on each axis of the 7047A from 0.02 mV/cm to 5 V/cm (0.05 mV/in. to 10 V/in.). In between, a 1-5-10 sequence is used (except for the 0.02 mV/cm , most sensitive range setting of the metric option on the 7047A.) On all three, arbitrary full scale voltage ranges may be established with the vernier control in conjunction with the calibrated dc ranges.

Additionally, these recorders are equipped with front panel polarity switches which reverse pen direction, eliminating the need for reversing the input leads. The 7045A and 7047A are provided with a RESPONSE switch which allows the user to slow the response of the recorder for easier setup. The 7047A preamplifiers for the X and Y axes are contained in two specially designed aluminum enclosures. These contain chopper dc amplifiers and have the unique serviceability feature of being removable and operational outside of the main-frame, using the cable extender included in the Accessory Kit.

Also available on all models is the continuous duty, aluminum framed dc servo motor; the X-axis of the 7045A and 7047A contain the larger, faster motor. This reduces overheating and wear if the pen is driven offscale for an indefinite time. The trouble-free electrostatic paper holddown capable of holding ISO A3 and 11 in. x 17 in. size chart paper is included, as well as a disposable pen with four color choices, and plastic coated wirewound balance potentiometer. Latest circuitry design and assembly techniques have also been incorporated, thereby reducing failure and maintenance time.

Options include the Time Base (standard on the 7047A) Event Marker and Metric Scaling. TTL Remote Control and Rear Connector are standard on all models.

7044A, 7045A Specifications

Performance specifications

Input ranges: 0.25, 0.5, 2.5, 4, 25 mV/cm; 0.05, 0.25, 0.5, 2.5, 5 V/cm (English calibration available in 0.5, 1, 5, 10, 50 mV/in.; 0.1, 0.5, 1, 5, 10 V/in.). Continuous vernier between ranges.

Type of input: floating and guarded, 500 V dc or peak ac maximum. Polarity reversal switch located on front panel, guard internally connected. Inputs through front panel 5-way binding posts or rear connector.

Input resistance: 1 megohm constant on all ranges.

Common mode: 110 dB dc and 90 dB at 50 Hz and above (exceeds 130 dB dc and 110 dB ac under normal lab environmental conditions) with 1 k Ω between HI and LO terminals, CMV applied between ground and LO, and attenuator on most sensitive range. CMR decreases 20 dB per decade step in attenuation.

Slowing speed

7044A: 50 cm/s (20 in./s) minimum.

7045A: Fast Response, 76 cm/s (30 in./s) minimum. Slow Response, 36 cm/s (15 in./s) typical.

Acceleration (peak)

7044A: Y-axis 2540 cm/s² (1000 in./s²), X-axis 1270 cm/s² (500 in./s²).

7045A: (Fast Response only) Y-axis 7620 cm/s² (3000 in./s²), X-axis 5080 cm/s² (2000 in./s²)

Accuracy: $\pm 0.2\%$ of full scale (includes linearity and deadband) at 25°C. Temp Coefficient $\pm 0.01\%$ per °C.

Range Accuracy: $\pm 0.2\%$ of full scale $\pm 0.2\%$ of deflection (includes linearity and deadband) at 25°C. Temp Coefficient $\pm 0.01\%$ per °C.

Deadband: 0.1% of full scale.

Overshoot: 7044A—2% of full scale (maximum). 7045A—1% of full scale (maximum).

Zero set: zero may be placed anywhere on the writing area or electrically off scale up to one full scale from zero index.

Environmental (operating): 0° to 55°C and <95% relative humidity (40°C).

General specifications

Writing mechanism: servo actuated ink pen.

Writing area: 25 cm x 38 cm (10" x 15").

Electrostatic paper holddown: grips ISO A3 or 11 in. x 17 in. charts or smaller. Special paper not required.

Pen lift: electric. (Remote via TTL.)

Size: 400 H 483 W 165 mm D (15 $\frac{3}{4}$ " x 19" x 6 $\frac{1}{2}$ "); rack mounting structure integral with unit.

Power: 100, 120, 220, 240 V ac +5 -10%, 48 to 400 Hz; 7044A, 135 VA; 7045A, 175 VA.

Weight: net, 13.7 kg (30 lb). Shipping, 19.1 kg (42 lb).

7044A & 7045A Options

006: metric calibration

001: time base

Sweep rates: 0.25, 0.5, 2.5, 5, 25, 50 s/cm (0.5, 1, 5, 10, 50, 100 s/in.).

Time Base Accuracy: 1.0% at 25°C

Temp Coefficient $\pm 0.1\%$ per °C

General: Switchable to either X or Y axis. Start and reset by front panel control, remote by momentary contact closure to ground or TTL levels. Automatic reset at full scale, recycle accomplished by continuous start signal.

002: event marker: writes in upper margin, aligned with X-axis position, approximately 0.13 cm (0.05 in.) excursion completed 50 ms after application of signal. Controlled remotely by contact closure to ground or by TTL levels. add \$100

7047A Specifications

Performance specifications

Input ranges: 0.02, 0.05, 0.1, 0.5, 1, 5 mV/cm; 0.01, 0.05, 0.1, 0.5, 1, 5 V/cm (0.05, 0.1, 0.5, 1, 5, 10 mV/in.; 0.05, 0.1, 0.5, 1, 5, 10 V/in.).

Continuous vernier between ranges.

Type of input: floating and guarded (front input only). Employs a unique common mode driver circuit that eliminates the need for connecting CMV to the recorder if CMV is less than or equal to 10 V pk.

Input resistance: 1 megohm constant on all ranges.

Accuracy: $\pm 0.2\%$ of full scale (includes linearity and deadband) at 25°C. Temp Coefficient $\pm 0.01\%$ per °C.

Range accuracy: $\pm 0.2\%$ of full scale $\pm 0.2\%$ of deflection (includes linearity and deadband) at 25°C. Temp Coefficient $\pm 0.01\%$ per °C.

Deadband: 0.1% of full scale.

Common mode rejection: 140 dB dc and 130 dB ac with 1 k Ω imbalance in either the high or low terminal (exceeds 150 dB under normal laboratory conditions.) CMR decreases 20 dB per decade step in attenuation.

Normal mode rejection: 30 dB minimum at line frequency with FILTER IN. (50 dB typical at 60 Hz and 40 dB typical at 50 Hz).

Slowing speed: 76 cm/s (30 in./s) minimum. 97 cm/s (38 in./s) typical under normal lab conditions.

Acceleration (peak): Y-axis 7620 cm/s² (3000 in./s²)
X-axis 5080 cm/s² (2000 in./s²)

Overshoot: 1% of full scale maximum.

Calibrated zero offset: provides eleven scales of calibrated zero offset in both axes. Switchable in steps of one full scale from +1 to -10 scales.

Offset accuracy: at 25°C, $\pm 0.1\%$ of full scale times N where N = number of scales of offset.

Temperature coefficient: $\pm 0.004\%$ of full scale times N per °C.

Time base: speeds of 0.1, 0.5, 1, 5, 10, 50 s/cm (0.5, 1, 5, 10, 50, 100 s/in.). Switchable into X or Y axis.

Time base accuracy: 1.0% at 25°C. Temp Coefficient $\pm 0.1\%$ per °C.

General specifications

Writing mechanism: servo actuated ink pen.

Writing area: 25 cm x 38 cm (10" x 15").

Electrostatic paper holddown: grips ISO A3 or 11 in. x 17 in. charts or smaller. Special paper not required.

Pen lift: electric (remote via TTL level).

Size: 441 H x 483 W x 173 mm D (17 $\frac{3}{8}$ " x 19" x 6 $\frac{3}{16}$ "); rack mounting structure integral with unit.

Power: 100, 120, 220, 240 V ac +5 -10%, 48 to 66 Hz, 180 VA maximum.

Weight: net, 18.6 kg (41 lb). Shipping, 24 kg (53 lb).

7047A Options

001: metric calibration

Ranges are 0.02, 0.05, 0.10, 0.50, 1, 5 mV/cm; 0.01, 0.05, 0.1, 0.5, 1, 5 V/cm

002: event marker

Marking area: in margin at same X coordinate as recorder pen

Excursion: approximately 0.050 inch

Actuation time: stroke complete 50 ms after application of signal

Ink capacity: 0.45 cc cartridge, cartridge reloading type. Writing distance 500 ft minimum add \$100

Options and accessories (all models)

910: extra manual add \$15

Recorder supplies starter kits

17026A English \$52

17027A Metric \$58

Ordering Information

7044A Medium speed X-Y recorder \$1975

7045A High speed X-Y recorder \$2375

7047A High sensitivity X-Y recorder \$3650



RECORDERS, PRINTERS & PLOTTERS

Programmable 4-color remote terminal plotter

Model 7221A

- RS232C/CCITT V.24 Interface
- Programmable selection of 4 pens
- Arc and circle generation

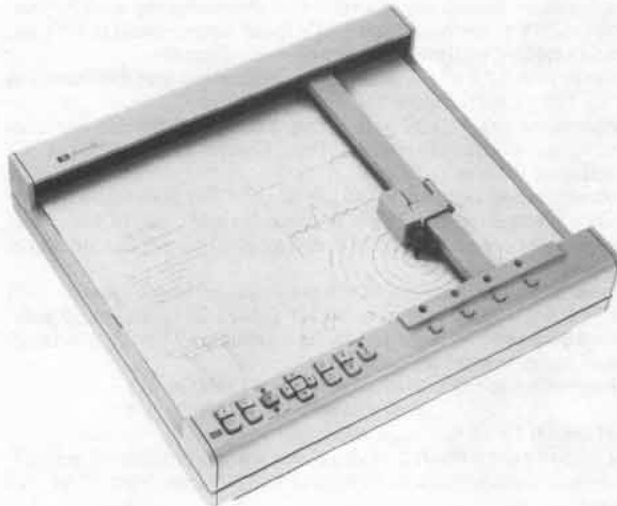

The HP 7221A is a microprocessor controlled plotter (ISO A3 size) that produces low cost, multicolor, high quality graphic plots from remote terminal processing facilities. The standard EIA RS232C/CCITT V.24 asynchronous serial ASCII interface operates at any of eight switch selectable baud rates from 75 to 2400 BAUD. Internal arc, circle, dashed lines and character generation capability combine with 40 high level commands to provide simplified programming. An 1158 byte input data buffer, optionally expandable to 3086 bytes, allows operation at higher speeds. Up to 64 macroinstructions may be defined and stored in the data buffer. Internal self test and confidence test capability verifies correct plotter and interface circuitry operation.

HP-PLOT/21, a library of high level Fortran subroutines available for HP computer systems and major timeshare services, provides all data formatting and communications. The user accesses all of the plotter's capability through familiar program call statements.

7221A Specifications

Plotting area: Y-axis 280 mm (11"), X-axis 400 mm (15.75"). Accommodates up to ISO A3 and 280 x 432 mm (11" x 17") chart paper.

Plotting accuracy: $\pm 0.2\%$ of deflection ± 0.2 mm (0.008").

Repeatability: for given pen 0.10 mm (0.004"), pen-to-pen 0.20 mm (0.008").

Addressable resolution: smallest addressable move 0.25 mm (0.001").

Speed: maximum: 360 mm/s (14 in/s) in each axis, 509 mm/s (20 in/s) on 45° angle; programmable: pen speed may be adjusted to any one of 36 speeds from 10 mm/s (0.4 in/s) to 360 mm/s (14 in/s) in 10 mm/s (0.4 in/s) increments under program control.

Vector length: no limit—any length vector within plotter's mechanical limits will be plotted to within previously mentioned accuracy.

Offscale plotting: when offscale data received, the plotter automatically calculates intercept of that vector and currently defined plotting area and proceeds to that point. As additional offscale data received, plotter monitors location of this data and resumes plotting once on-scale data received by again calculating new intercept with defined plotting area then plotting from that intercept to on-scale data point. Plotting accuracy and repeatability specifications are preserved.

Character plotting speed: 3 characters/s typically for 2.5 mm (0.01 in.) characters.

Pen control: remote control by program commands; local control by front panel switches; capable of up to 20 operations/s. Local control provides vector rates of 4.2 mm/s (slow) and 932 mm/s (fast) (0.167 ips and 3.67 ips).

Power requirements: source 100 V, 120 V, 220 V, 240 V -10% $+5\%$, switch selectable, 240 W maximum.

Environmental range: temperature 0°C to 55°C; relative humidity 5% to 95% (below 40°C).

Size: 189 H x 497 W x 455 mm D (7.5" x 19.5" x 18").

Weight: net 18.2 kg (40 lb). Shipping 25.4 kg (56 lb).

Interface: standard RS-232C/CCITT V.24 asynchronous serial ASCII with switch selectable baud rates of 75, 110, 150, 200, 300, 600, 1200, or 2400 baud.

Accessories supplied

	HP Part Number
1. Accessory kit	09872-60070
4 Pkgs Disposable Pens (4-color pack, one of each red, blue, green, black)	5060-6810
1 Digitizing Sight	09872-60027
2. Operating and Programming Manual	07221-90001
3. Dust Cover	9222-0564
4. Power Cord (appropriate cord supplied)	
5. Male-to-Male Interface Cable RS-232C/CCITT V.24	07221-60157
6. Graph Paper, Standard Grid, English, 10 sheets	9270-1004
7. Graph Paper, Standard Grid, Metric 10 Sheets	9270-1024

Supplies available

Disposable Pens (package of 5)

Red	5060-6784
Blue	5060-6785
Green	5060-6786
Black	5060-6787
4-color pack, one each of red, blue, green, black	5060-6810

Graph Paper (box of 10 sheets)

Linear	25 cm x 38 cm	9270-1024
	10 in. x 15 in.	9270-1004
	18 cm x 25 cm	9270-1023
	7 in. x 10 in.	9270-1006
Semi-Log	10 in. x 2 cycle	9280-0159
	10 in. x 3 cycle	9280-0160
	2 cycle x 15 in.	9280-0169
	3 cycle x 15 in.	9280-0168
Log-Log	2 cycle x 3 cycle	9280-0167
	3 cycle x 2 cycle	9280-0165
	3 cycle x 4 cycle	9280-0171
Blank	10 in. x 15 in.	9280-0180
Smith Chart	7.25 in. Diameter	9280-0137
	7.15 in. Diameter	9280-0147
	Expanded	

Manuals

Operating and Service Manual	07221-90000
HP-PLOT/21 Software Manual	07221-90002
HP-PLOT/21 Software Conversion Guide, AN 229-1	5952-2871
Software available: HP-PLOT/21 GRAPHIC SOFTWARE PACKAGE consists of user's manual, loading instructions and set of 86 FORTRAN subroutines (in source form) on 9-track magnetic tape.	

Ordering Information

72021A Graphics Package

Specify Option:

001: HP 3000 Series II (800 bpi, ASCII)	N/C
002: HP 3000 Series II (1600 bpi, ASCII)	N/C
003: GE Mark III Tymesshare (1600 bpi, EBCDIC)	N/C
004: Tymesshare X (DEC PDP-10, 800 bpi, ASCII)	N/C
006: DEC PDP-11 (RSTS/E, 800 bpi, ASCII)	N/C
007: DEC PDP-11 (RSTS/E, 1600 bpi, ASCII)	N/C

7221A Option

001: Additional 2048 bytes of input Buffer	add \$225
7221A Graphic Plotter	\$4600



- Programmable selection of 4 pens
- HP-IB interface
- Error free offscale data handling
- 38 executable commands

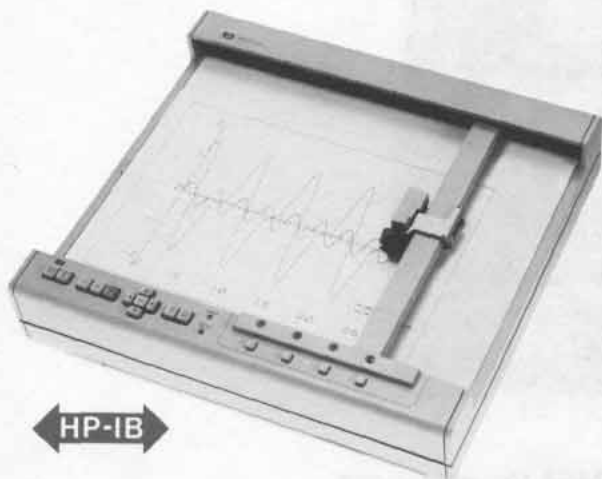

Pen control: local control by front panel switches or remote control by program commands; capable of >20 operations/s.

Power requirements: source 100 V, 120 V, 220 V, 240 V -10% +5%, switch selectable. 220 W max.

Environmental range: temperature 0°C to 55°C; relative humidity 5% to 95% (below 40°C).

Size: 189 H x 497 W x 455 mm D (7.5" x 19.5" x 18").

Weight: net 18.2 kg (40 lb); shipping 25.4 kg (56 lb).

Accessories supplied	HP Part Number
1. Accessory Kit, includes 4 Pkgs Disposable Pens (4-color pack, one of each, red, blue, green, black)	09872-60070 5060-6810
1 Digitizing Sight	09872-60027
2. Operating and Service Manual	09872-90002
3. Dust Cover	9222-0564
4. Power Cord (appropriate cord supplied)	—
5. Graph Paper, Standard Grid, English 10 Sheets	9270-1004
6. Graph Paper, Standard Grid, Metric, 10 Sheets	9270-1024

Supplies available	
Disposable Pens (package of 5)	
Red	5060-6784
Blue	5060-6785
Green	5060-6786
Black	5060-6787
4-Color Pkg, 1 each red, blue, green, black	5060-6810
Graph Paper (box of 100 sheets)	
Linear	
25 cm x 38 cm	9270-1024
10 in x 15 in.	9270-1004
18 cm x 25 cm	9270-1023
7 in. x 10 in.	9270-1006
Semi-Log	
10 in. x 2 cycle	9280-0159
10 in. x 3 cycle	9280-0160
2 cycle x 15 in.	9280-0169
3 cycle x 15 in.	9280-0168
Log-Log	
2 cycle x 3 cycle	9280-0167
3 cycle x 2 cycle	9280-0165
3 cycle x 4 cycle	9280-0171
Blank	9280-0180
10 in. x 15 in.	1540-0483
Carrying Case	98034A

HP-IB card for use with 9825A and 9831A

Cables: If using multiple HP-IB instruments order one of the following:

10631A HP-IB Cable	1 m (3.23 ft)
10631B HP-IB Cable	2 m (6.56 ft)
10631C HP-IB Cable	4 m (13.12 ft)
10631D HP-IB Cable	0.5 (1.64 ft)

Manual
Interface and Programming Manual 09872-90003

ROM'S available

9815A ROM: see option 015
9825A ROMS: 98215A (for 9872A) Plotter and General I/O ROM
98216A (for 9872A) Plotter and General I/O-Extended I/O ROM
9831A ROM: 98223B Matrix-Plotter ROM
9845A ROM: 98437A Graphics ROM

Options	Price
015: for use with 9815A (include interface cable with ROM)	\$400
025: for use with 9825A (98034A HP-IB Card not supplied)	N/C
031: for use with 9831A (9831A HP-IB Card not supplied)	N/C
045: for use with 9845A (98034A HP-IB Card not supplied)	N/C

9872A Graphic Plotter \$4200

The Hewlett-Packard Model 9872A is a microprocessor-based HP-IB plotter that produces high quality, multicolor graphic plots on any size chart up to 280 mm x 432 mm or ISO A3. The 9872A offers exceptional line and character quality with addressable moves as small as 0.025 mm (0.001 in.). Thirty-eight different instructions are built in to equip the Plotter with capabilities, such as point digitizing, labeling, character sizing, and window plotting. The 9872A, interfaced through the Hewlett-Packard Interface Bus (conforms to IEEE 488-1975), connects to any HP-IB compatible calculator, computer, or other controller.

This Plotter is designed to be useful in statistics, medicine, numerical control, surveying, and engineering design. Whether tabulated, measured, or computed, the 9872A quickly prepares multicolor plots of good line quality and high resolution.

9872A Specification

Plotting area: Y-axis 280 mm (11"), X-axis 400 mm (15.75") accommodates up to ISO A3 and 280 mm x 432 mm (11" x 17") chart paper.

Plotting accuracy: ±0.2% of deflection ±0.2 mm (0.008").

Repeatability: for given pen 0.10 mm (0.004"), pen-to-pen 0.20 mm (0.008").

Addressable resolution: smallest addressable move 0.025 mm (0.001").

Speed: maximum: 360 mm/s (14 in/s) in each axis, 509 mm/s (20 in/s) on 45° angle; programmable: pen speed may be adjusted to any one of 36 speeds from 10 mm/s (0.4 in/s) to 360 mm/s (14 in/s) in 10 mm/s (0.4 in/s) increments under program control.

Vector length: no limit— any length vector within plotter's mechanical limits will be plotted to within previously mentioned accuracy.

Offscale plotting: when offscale data received, the plotter automatically calculates mechanical limit intercept of that vector and proceeds to that point. As additional offscale data received, plotter monitors location of this data and resumes plotting once on-scale data received by again calculating new mechanical limit intercept and plotting from that limit to on-scale data point. Plotting accuracy and repeatability specifications are preserved.

Character plotting speed: 3 characters/s typically for 2.5 mm (0.1 in.) characters.



RECORDERS, PRINTERS AND PLOTTERS

Plotter/Printer for desktop controllers and systems

Model 7245A

- Quality Plotting/Printing in One Unit
- Optional Raster "Dump" Capability
- HP-IB Interface
- Scientific and Business Uses



The Hewlett-Packard 7245A Plotter/Printer is a desktop thermal plotter and printer, which, with a standard interface cable can be connected through the Hewlett-Packard Interface Bus, HP-IB, (conforms to IEEE-488-1975) to desktop controllers and systems. As a multifunctional peripheral, the 7245A operates quietly to provide quality graphics, flexible labelling, and clean printing.

Using the Hewlett-Packard Graphics Language, HP-GL, the plotter is programmed using 46 different graphic instructions. These instructions allow the user to plot, select from both drawn and dot matrix resident character sets with choice of size and slant for drawn characters, and direction for both drawn and dot matrix characters. See illustration for partial capabilities.

The printer responds to the generalized printer escape sequences and ASCII control characters. Functioning as a printer, the 7245A prints with two selectable character widths at speeds of 19 and 38 characters per second up to 88 columns across the page. The versatility of the 7245A allows combined plotting and printing as well as providing unattended operation.

Further increasing the capabilities of the 7245A is the Option 001, CRT Raster Dump, which provides hard copy records of the graphics being displayed on the HP 2647A and HP 2648A Graphics Terminals. This addition permits the user to obtain a high quality, hard copy record of the CRT display. The hard copy is a dot-for-dot representation of the display, with an approximate resolution of 106 dots per inch.

Ten additional HP-GL instructions have been included when using this option which further enhances the operation of the plotter/printer. Using the same two-letter mnemonic format, as with the standard 7245A, these instructions provide arc and circle drawing, axes generation, user-unit direction and character sizing, relative graph development, 132-column compressed characters, and a standardized European character set.

Finally, other special features include a 5-meter (16.4 ft) bi-directional paper drive for long axis plotting; line printer performance with functions, such as left margin control, 10 horizontal tabs, and underlining; pushbutton-actuated user confidence test; built-in self test system; thin film print head for long-life with built-in cursor for precise digitizing; plotting speeds of 25.6 cm/s (10.1 in./s) and move speed of 51.3 cm/s (20.2 in./s) in each axis, and a stepper motor drive with resolution of 0.016 mm (0.0006 in.) for pinpoint accuracy.

7245A Specifications

Plotting/printing areas:

Maximum: 188 mm × 5 m (7.4 in. × 16.4 ft) with full paper return
188 mm × 61 m (7.4 in. × 200 ft) without full paper return

English Page: 188 × 279 mm (7.4 × 11 in.)

Metric Page: 188 × 298.5 mm (7.4 × 11.75 in.)

Addressable dynamic range: ±1 × 10⁻⁹⁹ scaled units

Plotting accuracy: ±0.2% of deflection ±0.35 mm (±0.014 in.). Includes linearity and repeatability.

Repeatability: 0.25 mm (0.01 in.) from any given point.

Motor resolution: 0.016 mm (0.0006 in.)

Maximum plotting speed:

Acceleration: 4.48 m/s² (14.7 ft/s²)

Velocity: Pen Off: 513 mm/s (20.2 in./s) in each axis
725 mm/s (28.6 in./s) at 45° angle

Pen On: 256 mm/s (10.1 in./s) in each axis
363 mm/s (14.3 in./s) at 45° angle

Print head positioning:

With arrow button: 6.1 mm/s (.24 in./s)

With arrow and fast button: 95.5 mm/s (3.76 in./s)

Character printing speed: 7 × 9 dot matrix character at 38 char/s;
14 × 9 dot matrix character at 19 char/s; 2.5 mm (0.1 in.) character typically drawn at 3 char/s.

Offscale plotting: When off-scale data are received by the 7245A the unit will automatically calculate the mechanical limit intercept of that vector and proceed to that point. As additional offscale data are received, the 7245A will monitor the location of these data and resume plotting, once on-scale data are received, by again calculating the new mechanical limit intercept and plotting from that limit to the on-scale data point. Plotting accuracy and repeatability specifications are preserved.

Print head control: Local control by front-panel switches or remote control by HP-IB controller program commands.

Power requirements:

Source: 100V, 120V, 220V, 240V -10% +5%, internally selectable

Frequency: 48 - 66 Hz

Consumption: 100V/2.8A, 120V/2.5A, 220V/1.3A, 240V/1.2A, 300 W max.

Environmental range: temperature - 0°C to 55°C; relative humidity - 5% to 95% (below 40°C)

Sizes: 201 H × 442 W × 483 mm D (7.9" × 17.4" × 19")

Weight: net - 19.1 kg (42 lb); shipping - 26.8 kg (59 lb); cube - 0.11 m³ (3.96 ft³)

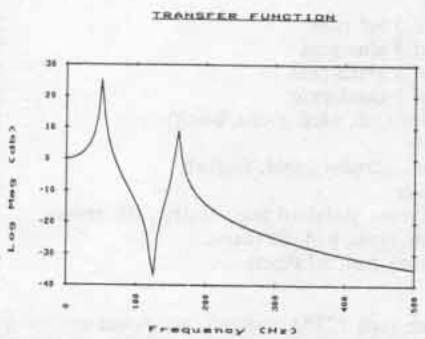

MENU

Measurement: Transfer function
 Averages: 20, stable
 Trigger: free running
 Channel #: 1
 Signal: random
 Freq. range: 0-500Hz

7245A FEATURES

- Combined Vector Plotting and Fast Matrix Printing
- Long Axis Plotting with 5 Meter Backup Capability
- Unattended Plotting Operation

<p>5 Draw character sets with control over SIZE</p>	<p>Matrix characters for 8x8 matrix. Leading and Listing. Standard characters are in a 5x5 matrix. Matrix font uses a 10x10 matrix.</p>	<p>7 Dashed Line Types Are Available</p>
<p>High Resolution Plotting</p>	<p>Labelled Axes and Grids</p>	<p>0.5 B.S. (Bench Scale)</p>

- User-Unit Scaling
- Point Digitizing
- Built-In Confidence & Self-Test
- Quiet Operation
- English and Metric Paper Handling
- User-Defined Characters

Accessories supplied

- Operating and Programming Manual
- Pocket Guide
- 1 Box (2 rolls) 216 mm x 61 m (8.5 in. x 200 ft) each, perforated sheets 216 x 279 mm (8.5 x 11 in.)
- Dust Cover
- Power Cord (appropriate to the origin of sales order)
- Thermal Print Head

HP Part No.
 07245-90001
 07245-90002

9270-0561
 9222-0607

07245-60001

Supplies available

Plotter paper (blue):

- 1 box (2 rolls) 216 mm x 61 m (8.5 in. x 200 ft) each, perforated sheets 216 x 279 mm (8.5 x 11 in.)
- 1 box (2 rolls) 210 mm x 61 m (8.27 in. x 200 ft) each, perforated sheets 210 x 298.5 mm (8.27 x 11.75 in.)
- 1 box (2 rolls) 216 mm x 61 m (8.5 in. x 200 ft) non-perforated

9270-0561

9270-0606

9270-0608

Thermal print head

07245-60001

HP-IB card for use with 9825A, 9831A and

9845A desktop computers

98034A

Cables:

If using multiple HP-IB instruments, order one of the following:

- 10631A HP-IB Cable 1 m (3.28 ft)
- 10631B HP-IB Cable 2 m (6.56 ft)
- 10631C HP-IB Cable 4 m (13.12 ft)
- 10631D HP-IB Cable 0.5 m (1.64 ft)

7245A Plotter/Printer Service Manual

07245-90000

ROMs available:

Additional read-only memory blocks for the HP 9825A, 9831A and 9845A desktop computers are available to expand their languages for plotter operation. Although not required, these language ROMs are helpful.

- 9825A ROMs: 98215A (9872A Plotter-General I/O ROM)
- 98216A (9872A Plotter-General I/O-extended I/O ROM)
- 9831A ROM: 98223B (Matrix-Plotter ROM)
- 9845A ROM: 98437A (Graphics ROM)

Options:

- 001: 2647A and 2648A CRT Raster Dump and HP-GL Enhancements
- 7245A Plotter/Printer

\$ 250
 \$4600



RECORDERS, PRINTERS, AND PLOTTERS

High Quality/Cost Efficient Graphics Plotter

Model 7225A

- Flexibility Through Personality Modules
- Fast Text Drawn at 3 char/s

- ISO A4 (8½ x 11 in.) Writing Area
- HP-IB Interface

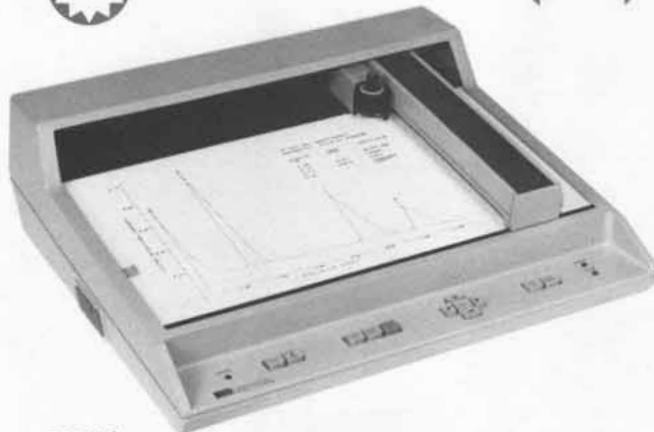

7225A

The Hewlett-Packard 7225A microprocessor-controlled plotter produces high quality, hard copy vector graphics. Depending upon the selected Personality Module plug-in board, installed from the rear of the mainframe, the 7225A will provide the appropriate interface, language, and graphics capability for desktop computers, computer systems, and intelligent instrument systems.

Using the 17600A Personality Module provides the 7225A compatibility with the HP 9815A, 9820A, 9821A, 9825A, and the 9830A/B desktop computers. The module decodes computer commands and sends vector plotting and pen status instructions to the plotter mechanics.

The 17601A Personality Module adapts the 7225A to computer systems using the Hewlett-Packard Interface Bus, HP-IB (IEEE 488-1975). Using HP-GL instruction set, 38 instructions are available for vector plotting character set and line type selection, point digitizing, user-unit scaling, and labeling with programmable size, slant, and direction of characters.

7225A Specifications

Plotting area: Y axis: 203 mm (8 in.); X axis: 285 mm (11.2 in.); Accepts up to ISO A4 or 8½ x 11-in. chart paper.

Plotting accuracy: ±0.4 mm (0.016 in.) [includes linearity and repeatability and assumes the plotter has been "zeroed" exactly to the lower left (0,0) coordinates]

Repeatability: 0.4 mm (0.016 in.) from any given point Addressable step size: 0.032 mm (0.0013 in.) (smallest)

Speed: 250 mm/s (10 in./s) in each axis,
350 mm/s (14 in./s) on 45° angle.

Vector length: No limit - any length vector within the plotter's mechanical limits will be plotted.

Character plotting speed: Up to 3 characters/s for 2.5-mm (0.1-in.) characters.

Power requirements:

Source: 100, 120, 220, 240V, -10%, +5%, internally selectable

Frequency: 48 - 66 Hz

Consumption: 70 W maximum

Environmental range:

Temperature: 0°C to 55°C

Relative humidity: 5% to 95% (below 40°C)

Size: 140 H x 413 W x 379 mm D (5.5" x 16.3" x 14.9")

Weight: net, 8 kg (17.6 lb); shipping, 11.4 kg (25 lb)

Accessories supplied

1. One pad (50 sheets) 8½ x 11-in. blank paper
2. One package of 5 black pens
3. One 4-color pack (red, blue, green, black) of pens
4. One power cord (appropriate cord supplied)

HP Part No.

9280-0475
5060-6787

5060-6810

Supplies available

Digitizing sight

HP Part No.

09872-60066

7225A Service Manual

07225-90000

Plotter pens

Package of 5 red pens

5060-6784

Package of 5 blue pens

5060-6785

Package of 5 green pens

5060-6786

Package of 5 black pens

5060-6787

4-color pack (red, blue, green, black)

5060-6810

Plotter paper

8½ x 11-in., standard grid, English,
100 sheets

9270-1006

216 x 280-mm, standard grid, Metric, 100 sheets

9270-1023

8½ x 11-in. blank pad, 50 sheets

9280-0475

A4 size blank pad, 50 sheets

9280-0476

Options:

NOTE: With each 7225A ordered, one power option, under 7225A option list, (001 through 004) and a Personality Module must be ordered. With the 17600A Personality Module, select one Operating and Programming Manual option (015, 020, 021, 025, or 030) for use with selected HP desktop computer. With the 17601A Personality Module, select one Operating and Programming Manual option, listed under 17601A option list (001, 025, 035, or 045) with applicable computer.

7225A Graphics Plotter Options

Price

001: 100 Vac power

N/C

002: 120 Vac power

N/C

003: 220 Vac power

N/C

004: 240 Vac power

N/C

006: Paper/pen supplies kit (A4 size)

add \$ 75

007: Paper/pen supplies kit (8½ x 11-in. size)

add \$ 75

009: Dust cover

add \$ 10

010: Vinyl carrying case

add \$125

17600A Personality Module Options

001: Cable with plotter ROM for 9815A

add \$ 250

002: Cable with plotter ROM for 9820A/21A

add \$ 350

003: Cable for 9825A

add \$ 350

004: Cable for 9830A

add \$ 250

015: Operating and Programming Manual for use with 9815A Desktop Computers

N/C

020: Operating and Programming Manual for use with 9820A Desktop Computers

N/C

021: Operating and Programming Manual for use with 9821A Desktop Computers

N/C

025: Operating and Programming Manual for use with 9825A Desktop Computers

N/C

030: Operating and Programming Manual for use with 9830A/B Desktop Computers

N/C

17601A Personality Module Options

001: Operating and Programming Manual for general HP-IB system use

N/C

025: Operating and Programming Manual for use with 9825A Desktop Computers

N/C

035: Operating and Programming Manual for use with 9835A Desk Top Computers

N/C

045: Operating and Programming Manual for use with 9845A Desktop Computers

N/C

7225A Graphics Plotter (OEM discounts available) **\$1850**

- Multi-range—Compact

- High accuracy, fast response

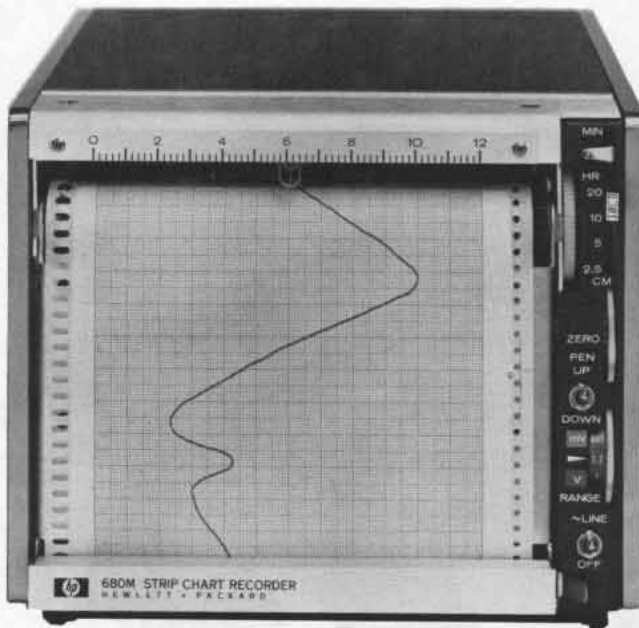

680M

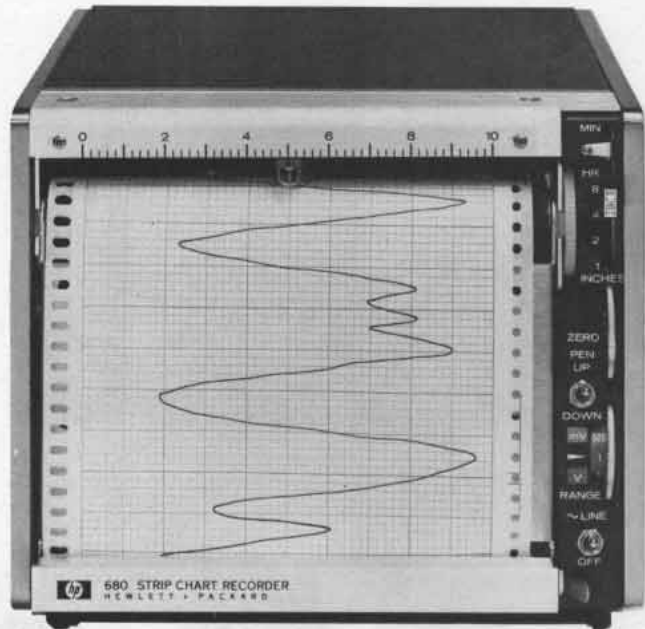

680

The Hewlett-Packard Model 680 12 cm (5 in.) strip chart recorders provide high accuracy and fast response for a wide range of performance for general or specialized use. The 680 is equipped with multi-range spans, multispeed chart transport, full range zero set, and electric pen lift. Model 680 is useful as a monitor for instrumentation with dc outputs and for digital devices utilizing digital to analog converters.

Features include modular construction with all-transistor circuitry, synchronous motor chart drive, and full-view tilting chart magazine.

680 Specifications

Performance specifications

Spans: ten calibrated spans; Metric—6, 12, 60, 120, 600 mV; 1.2, 6, 12, 60, 120 V (English—5, 10, 50, 100, 500 mV; 1, 5, 10, 50, 100 V).

Type of input: input floating with respect to ground.

Maximum dc common mode voltage: 500 V.

Input resistance: 200 k Ω /V (166 k Ω /V, metric models) full scale, through 10 V span; 2 M Ω on all others. Constant 100 k Ω input resistance on all spans, Option H02.

Common mode rejection: dc 100 dB on most sensitive range. Decreases 20 dB per decade step in attenuation.

Accuracy: $\pm 0.2\%$ of full scale.

Response time: maximum, 0.5 s full scale.

Resettability: 0.1% of full scale.

Chart speed: synchronous motor driver; Metric—2.5, 5, 10, 20 cm/min; 2.5, 5, 10, 20 cm/hr (English—1, 2, 4, 8 in./min; 1, 2, 4, 8 in./hr). Option 008, gear ratio 16/1 instead of 60/1 speeds— $\frac{1}{16}$, $\frac{1}{8}$, $\frac{1}{4}$, $\frac{1}{2}$, 1, 2, 4, 8 in./min.

Zero set: adjustable over full span.

General specifications

Writing mechanism: ink.

Pen lift: electric, controlled by local switch or remote contact closure.

Power: 115/230 V, 60 Hz, 22 VA.

Weight: net, 5 kg (11 lb); shipping 7.6 kg (17 lb).

Size: 165 H x 197 W x 219 mm D (6 $\frac{1}{2}$ " x 7 $\frac{3}{4}$ " x 8 $\frac{5}{8}$ ").

Accessory kit supplied with each instrument

1. Slidewire, cleaner, slidewire lubricant, remote pen lift connector, spare pen; pen cleaning wire, syringe, four cartridges each of red ink and blue ink.
2. One roll of graph paper.
3. Power Cord 2.1 m (7 ft).
4. Instruction Manual
5. *Your Strip Chart Recorder*—a brief manual.

Options and accessories

001: with installed 5 k Ω , 0.1% linearity retransmitting potentiometer

002: with ink event marker installed

003: with installed high-low limit switches

008: with 16/1 instead of 60/1 speed reducer.

009: with remote chart drive switch

010: For 50 Hz operation

014: glass door with lock

018: disposable pen tips

910: extra manual

H01: 1 mV span added (H01-680)

1.2 mV span added (H01-680M)

H02: 100 k Ω input resistance, all spans

Note: options H01 and H02 not compatible.

Recorder supplies starter kits

17046A English

\$33

17047A Metric

\$38

Ordering information

680M Strip chart recorder (metric)

\$1375

680 Strip chart recorder (English)

\$1375

OEM discounts available.

RECORDERS, PRINTERS & PLOTTERS

Lab strip chart recorders, plug-in modules

Models 7100B 7101B, 17500A thru 17506A

- One and two pen mainframes
- Seven plug-in modules

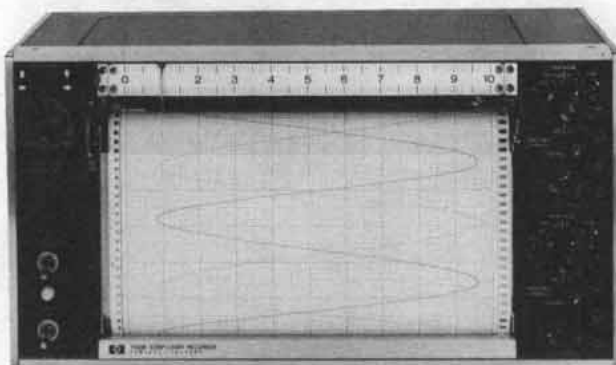

7100B

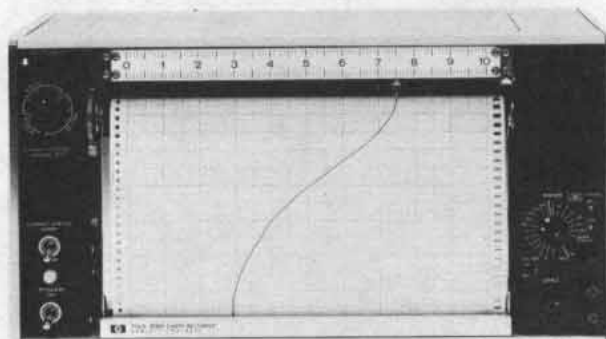

7101B



17500A



17501A



17502A



17505A



17506A

The Hewlett-Packard Models 7100B and 7101B Strip Chart Recorders are basic recorder frames containing all the mechanical and electrical elements for strip chart recording. A wide line of interchangeable plug-ins complete their recording ability. Model 7100B has two independent pens and requires two input modules; Model 7101B is a single pen recorder and requires one input module.

7100 Series specifications

Performance specifications

Response time: <0.5s (50 Hz, <0.6 s).

Linearity (terminal based): $\pm 0.1\%$ full scale.

Resettability: $\pm 0.1\%$ full scale.

Chart Speeds

7100BM/7101BM: 2.5, 5, 15, 30 cm/h; 1.25, 2.5, 5, 15, 30 cm/min; 1.25, 2.5, 5 cm/s.

7100B/7101B: 1, 2, in./h; 0.1, 0.2, 0.5, 1, 2 in./min; 0.1, 0.2, 0.5, 1, 2 in./s.

Chart speed accuracy: synchronous with line frequency.

General specifications

Writing system: servo actuated ink pen.

Grid width: 25 cm or 10 in.

Chart length: 36 m or 120 ft.

Pen lift: manual (remote optional).

Power 115/230 V $\pm 10\%$, 60 Hz (50 Hz optional)

7100B: 65 VA; **7101B:** 42 VA.

Weight:

7100B: net, 11.8 kg (26 lb). Shipping, 18.2 kg (40 lb).

7101B: net, 10.9 kg (24 lb). Shipping, 17.3 kg (38 lb).

Size:

7100B/7101B series (cabinet): 304 H 445 W 210 D (12" x 17½" x 8¼").

7100B/7101B (rack): 222 H 483 W 210 D (8²³/₃₂" x 19" x 8¼").

17500A/17501A Specifications

Voltage spans:

17500A: 5, 10, 50, 100, 500 mV; 1, 5, 10, 50, 100 V full scale.

17501A: 1, 2, 5, 10, 20, 50, 100, 200 mV; 0.5, 1, 2, 5, 10, 20, 50, 100 V full scale.

Accuracy: $\pm 0.2\%$ of full scale.

Input resistance: 1 megohm at null on all fixed calibrated and variable spans except 100 k Ω in the variable mode on the four most sensitive spans on the 17500A only.

Interference rejection: dc common mode; 120 dB on the four most sensitive spans of the 17500A and the three most sensitive of the 17501A. Line frequency, 100 dB on the four most sensitive spans of 17500A and the three most sensitive of 17501A.

Zero-set: adj. full scale, plus one full scale of suppression. 5 scales of zero suppression available on the 17501A.

Maximum source impedance: up to 10 k Ω source impedance will not alter the recorder's performance on the four most sensitive spans of the 17500A and the six most sensitive of the 17501A. No source impedance restrictions on spans above 100 mV full scale.

Reference stability: 0.005%/°C.

Weight: net, 0.9 kg (2 lb). Shipping, 2.2 kg (5 lb).

17502A Specifications

Voltage spans: single span to match cold-junction thermocouples of types J, K, R, S, and T.

Accuracy: ±0.5% or ±1°C, (whichever is greater): refer to NBS CIR 561, dated 1955.

Input resistance: potentiometric.

Interference rejection: dc common mode, 120 dB; line frequency, 100 dB.

Weight: net, 1.8 kg (4 lb). Shipping, 3.2 kg (7 lb).

17503A Specifications

Voltage span: 1 mV.

Type of input: floating (500 V dc max) rear input only.

Input resistance: potentiometric.

Maximum allowable source resistance: 5 kΩ.

Normal mode rejection: >60 dB at 60 Hz.

Common mode rejection: 120 dB (dc) and 100 dB (60 Hz).

Accuracy: ±0.2% full scale.

Reference stability: 0.005%/°C.

Zero set: ±1 scale.

Weight: net 0.9 kg (2 lb). Shipping, 2.2 kg (5 lb).

17504A Specifications

Voltage spans: 5 mV thru 100 V, determined by range card, no vernier.

Type of input: floating (500 V dc max) rear input only.

Input resistance: 1 MΩ at null on all spans.

Maximum allowable source resistance: 10 kΩ.

Normal mode rejection: >60 dB at 60 Hz.

Common mode rejection: 120 dB (dc) and 90 dB (60 Hz) four most sensitive range cards.

Accuracy: ±0.2% full scale.

Reference stability: 0.005%/°C.

Zero set: ±1 scale, screwdriver adjust.

Weight: net, 0.9 kg (2 lb). Shipping, 2.2 kg (5 lb).

17505A/17506A Specifications

Voltage Spans

17505A: .1, .2, .5, 1, 2, 5, 10, 20, 50, 100, 200, 500 mV; 1, 2, 5, 10, 20, 50, 100 V full scale.

17506A: any one of the above spans (specify).

Accuracy: ±0.25% of full scale.

Input resistance: 1 MΩ at null.

Interference rejection: dc CMR: 120 dB on most sensitive span. Line frequency CMR: 100 dB on most sensitive span. Line frequency normal mode: 17505A: switchable, 60 dB or 100 dB. 17506A: 100 dB.

Zero set: +2, -1.5 scales. Optional calibrated offset of +1 to -10 scales in one scale steps on 17505A.

Zero stability: ±1 μV after one hour.

Maximum source impedance: 10 kΩ on nine most sensitive spans; no source impedance restrictions on spans above 100 mV full scale.

Reference stability: 0.005%/°C.

Weight: net, 0.9 kg (2 lb). Shipping, 2.2 kg (5 lb).

7100 Series options

Option descriptions		7100B 7101B	Price
Retransmitting	Channel 1	004	\$100
5 kΩ Potentiometer	Channel 2	016	\$100
High-Low Limit	Channel 1	005	\$100
Switches (Each limit	Channel 2	017	\$100
SPDT with 0.5 A,	Both Channels	018	\$200
30 V dc contacts)			
Event Marker	Left side: ink	012	\$55
	Both sides: ink	014	\$110

7100 Series options (con't)

Option descriptions		7100B 7101B	Price
Remote Control	Pen Lift	006	\$100
	Chart ON-OFF	007	\$50
Right Hand Zero	Hard (scale, 10 to 0)	020	N/C
	Soft (scale, 10 to -0.5) ¹	025	N/C
50 Hz Operation		010	N/C
Locking Glass Door		011	\$185
Disposable Pen Tips		024	N/C
Mint Gray Control Panel		029	N/C
Rack mount		908	\$20
Extra manual		910	\$10

1. Requires special Hewlett-Packard chart paper, not compatible with metric models.

Plug-in options

17500A/17501A/17502A

001: 5 scale zero suppression (17501A) add \$55

029: mint gray control panel N/C

910: extra manual add \$7

17503A

001: detector Selector Switch \$25

002: 50 Hz N/C

029: mint gray control panel N/C

910: extra manual add \$6

17504A

001: 50 Hz N/C

010-019: range cards (specify opt) N/C

17505A

001: +1 to -10 scales of calibrated offset in one scale steps. Accuracy ±0.25% per step add \$115

003: 50 Hz N/C

029: mint gray control panel N/C

910: extra manual add \$6

17506A

003: 50 Hz N/C

005-023: range cards (specify opt) N/C

029: mint gray control panel N/C

910: extra manual add \$5

Recorder supplies starter kits

17029A English \$43

17030A Metric \$46

Ordering information

Single Channel

7101B, 7101BM Strip chart recorder \$1700

Dual Channel

7100B, 7100BM Strip chart recorder \$2200

Plug-ins

17500A Multiple span plug-in \$465

17501A Multiple span plug-in \$575

17502A Temperature plug-in \$575

17503A Single span plug-in \$500

17504A Single span plug-in \$475

17505A High sensitivity plug-in \$625

17506A (specify voltage span) \$475

RECORDERS, PRINTERS & PLOTTERS

OEM 10-inch strip chart recorders

Models 7130A & 7131A

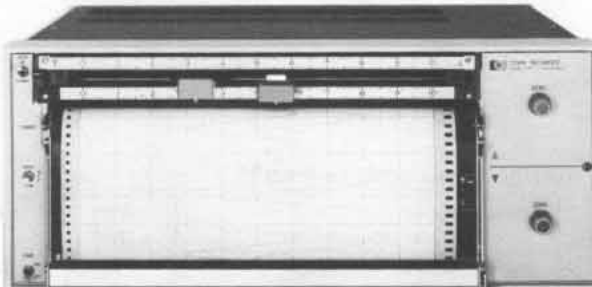

7130A

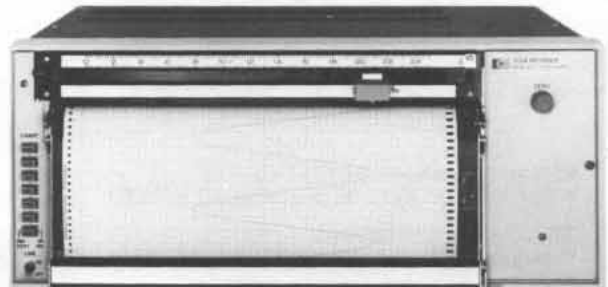

7131A

The Model 7130A is a 10-inch, two-pen recorder; the 7131A is a 10-inch, one-pen recorder. Spans and chart speeds are selected by options.

7130A and 7131A Specifications

Performance specifications

Input ranges: single span, 1 mV thru 100 V (specified option)

Type of input: single ended, floating.

Maximum allowable source resistance Rs: 10 kΩ

Normal mode rejection (at line frequency): >40 dB.

Common mode rejection: >120 dB at dc & >100 dB at line frequency.

Response time: <1/2 s.

Overshoot: <2% of full scale.

Accuracy (Including linearity and deadband): ±0.2% of full scale at 25°C.

Deadband: ±0.1% of full scale.

Chart speeds: speed determined by option choice.

Chart speed accuracy: ±0.08% plus line frequency accuracy.

Zero set: left hand, adjustable ±1 full scale (right hand optional).

Environmental (operation): 0°C to 55°C, 95% RH (40°C).

General specifications

Writing mechanism: disposable ink pens (thermal writing option).

Grid width: 25 cm or 10 in.

Chart length: 27 metres or 90 ft.

Pen lift: manual (electric or independent optional).

Size: 178 H, 432 W, 340 mm D (7" x 17" x 13 3/8").

Power: 7130A, 7131A: 115/230 V ±10%, 60 Hz, 120 VA.

7130B, 7131B: 115/230 V ±10%, 50 Hz, 120 VA.

Weight: net, 12.3 kg (27 lb). Shipping, 17.4 kg (38 lb).

Accessory kits: two-channel (7130A), 07130-60055; one-channel (7131A), 07131-60109; thermal writing (7130A/7131A), 07130-60068.

Span: must specify one for each channel; spans may be different. The front scale is determined by choice of English or metric chart speed. The 500 series options are for the lower channel of the 7130A only.

Option				Option			
Span	Chnl	Chnl	Price	Span	Chnl	Chnl	Price
1 mV	001	501	\$210	1 V	008	508	\$50
5 mV	002	502	\$210	5 V	009	509	\$50
10 mV	003	503	\$155	10 V	010	510	\$50
50 mV	004	504	\$155	50 V	011	511	\$50
100 mV	005	505	\$155	100 V	012	512	\$50
500 mV	006	506	\$155				

Chart speeds: must specify one basic speed.

Speed	Option	Price	Speed	Option	Price
6 in./min	016	\$25	15 cm/min	022	\$25
4 in./min	017	\$25	10 cm/min	023	\$25
1 in./min	018	\$25	5 cm/min	024	\$25
1/2 in./min	019	\$25	3 cm/min	025	\$25
1/4 in./min	020	\$25	15 cm/hr	026	\$25
1 in./hr	021	\$25	3 cm/hr	027	\$25

Speed reducers

Option	Price	Option	Price
60:1 Speed Reducer*	028 \$55	4:1 Speed Reducer*	030 \$55
10:1 Speed Reducer	029 \$55	2:1 Speed Reducer*	031 \$55

*The slowest speed resulting from the addition of a speed reducer must not be less than 2.54 cm/hr (1 in./hr).

Multiple speeds

4 speed: 1/4, 1/2, 1, 2, in./min, plus extern input

4 speed: 0.625, 1.25, 2.5, 5 cm/min plus external input

Option Price
046 \$175

049 \$175

Options Requiring Option Power Supply

Option Power Supply	041	\$80
8 chrt spds: 1, 2, 4, 6 in./min & hr + ext input	045	\$210
8 chrt spds: 2.5, 5, 10, 15 cm/min & hr + ext input	048	\$210
Remote Speed Change*	032	\$55
Remote Chart On-Off*	033	\$55
Remote Pen Lift*	036	\$55
Right Hand Event Marker* (not compatible with option 054)	037	\$80
Right Hand Event Marker Thermal* (must order option 054)	038	\$155
Left Hand Event Marker*	537	\$80

*Actuated by contact closure to ground or TTL levels. Closed circuit current 1.5 mA (maximum), open circuit voltage +1.5 V minimum.

Other Options

	Upr Chnl	Lwr Chnl	Price
Retransmitting Potentiometers	040	540	\$80
Limit Switches*	044	544	\$155
Input Filter (1-500 mV)	007	507	\$105
Right Hand Zero Hard, Scale 10 to 0		014	N/C
Right Hand Zero Soft, Scale 10 to -0.5		015	N/C
Independent Mech. Pen Lift (7130 only)		034	N/C
Rack Slides		042	\$80
Thermal Writing: Model 7130A**		054	\$290
Model 7131A**		054	200
Rear Control Connector		056	\$55
50 Hz & 60 Hz Operation	050,060		N/C
Rack Mounting Brackets		908	\$15
Extral Manual		910	\$10

*Contact rating 1 A at 1.5 V, 0.5 A at 250 V non-inductive.

**Recommended for pen speeds below 5 inches per second.

Analytical option combinations: the following options are for analytical applications such as chromatography and include 1 mV span each channel, right hand soft zero, front panel detector switch on the 7131A, and two chart speeds as indicated.

	Option	7130	7131
2 speeds: (1/2 and 1/4 in./min)	090	\$550	\$360
2 speeds: (1 and 1/4 in./min)	091	\$550	\$360
4 speeds: (2, 1, 1/2, 1/4 in./min)	092	\$705	\$455

Recorder supplies starter kits

17036A English	\$54
17037A Metric	\$54
17038A English-Thermal	\$47
17039A Metric-Thermal	\$47
17040A English-R.H. soft zero	\$54

Ordering information

7130A OEM Two-Pen Recorder	\$1950
7131A OEM One-Pen Recorder	\$1600

- Multi-range attenuators

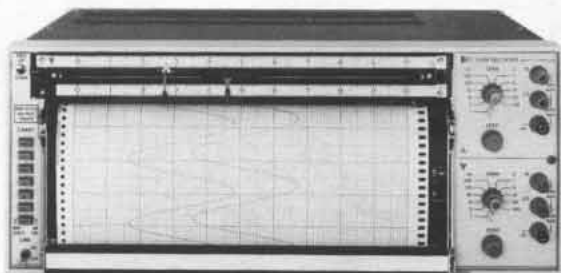

7132A—Opt 054

- Disposable pens

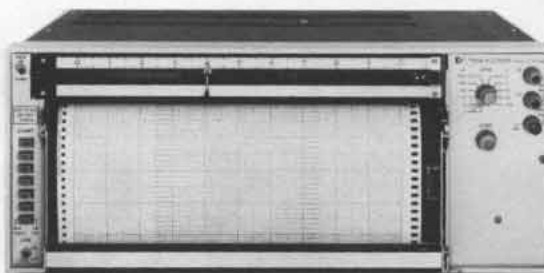

7133A—Opt 054

The Hewlett-Packard Models 7132A two-pen and 7133A one-pen Strip Chart Recorders are laboratory instruments equipped with standard features that qualify them to accommodate your laboratory or scientific application needs.

The 7132A and 7133A are equipped with multi-range attenuators providing eleven input ranges from 1 mV to 100 V full scale in a 1-5-10 sequence. Both models have eight chart speeds of 2.5, 5, 10, 15 cm/minute and 2.5, 5, 10, 15 cm/hour (1, 2, 4, 6 inches per minute and 1, 2, 4, 6 inches per hour). Disposable ink pens are standard. These pens provide a clear, continuous trace, and are easily replaced.

Modular construction facilitates easy removal of the servo module for inspection and maintenance of the drive system, slidewire, or pen lift. The elimination of slip clutches in the servo module contributes to quiet, reliable operation. In addition, should the pen go off scale, the amplifier gain is automatically reduced, preventing noise or damage to the equipment. A stepper motor chart drive eliminates mechanical shifting of gears.

The chart magazine may be adjusted to any of three angles to provide a comfortable writing surface. Chart paper may be automatically rolled up or fed out of the recorder. A convenient front panel indicator lets you know when the paper supply is low.

Options include: Metric Calibration, Right Hand Zero (Hard), Right Hand Marker, 50 or 60 Hz Operation, and Thermal Writing.

7132A and 7133A Specifications

Performance specifications

Input ranges: eleven ranges from 1 mV to 100 V full scale in 1-5-10 sequence with overlapping vernier.

Type of input: single ended, floating.

Input resistance: 1 megohm on all ranges.

Maximum source resistance: 10 k Ω (to within rated response).

Normal mode rejection (at line frequency): greater than 40 dB.

Common mode rejection: greater than 120 dB dc and 100 dB ac.

Accuracy: $\pm 0.2\%$ of full scale (includes linearity and deadband) at 25°C. Temp coefficient $\pm 0.01\%$ per °C.

Range accuracy: $\pm 0.2\%$ of full scale $\pm 0.2\%$ of deflection (includes linearity and deadband) at 25°C. Temp Coefficient $\pm 0.01\%$ per °C.

Deadband: 0.1% of full scale.

Response time: less than 0.5 second.

Overshoot: less than 2% of full scale.

Chart speeds: 2.5, 5, 10, 15 cm/min, and 2.5, 5, 10, 15 cm/hour (1, 2, 4, 6 inches/minute, and 1, 2, 4, 6 inches/hour).

Chart speed accuracy: $\pm 0.08\%$ plus line frequency accuracy.

Zero set: provides three full scales of offset.

Environmental (operating): 0 to 55°C, less than 95% relative humidity (40°C).

General specifications:

Writing mechanism: disposable ink pens (thermal writing optional).

Grid width: 25 cm (10 inches).

Chart length: 30 metres (100 ft).

Pen lift: solenoid operated with remote capabilities.

Power: 115/230 V $\pm 10\%$, 50 or 60 Hz, 120 VA.

Size: 178 H 432 W 340 mm D (7" x 17" x 13 $\frac{3}{8}$ ").

Weight: net, 12.3 kg (27 lb). Shipping, 17.4 kg (38 lb).

Supplied furnished with each instrument:

- Accessory kit:
 - Disposable Pens—Blue (Package of 3)
 - Disposable Pens—Red (Package of 3)
 - Plastic Kit Box
 - Slidewire Cleaner
 - Flexible Tubing, 0.032 ID, 0.4 ft
 - Pen Cleaning Assembly
 - Syringe for Pen Cleaning
- Operating and Service Manual
- One roll of Chart Paper
 - Chart Paper, English
 - Chart Paper, Metric
 - Chart Paper, Thermal—English
 - Chart Paper, Thermal—Metric
- Power Cord (2.1 meters or 7 ft)
- Ink Cartridge, Black k (for Event Marker)
- Your Strip Chart Recorder—a brief manual

Options & accessories

Options & accessories	Price
001: metric calibration. Provides chart speeds of 2.5, 5, 10, and 15 cm per minute, and 2.5, 5, 10 and 15 cm per hour	N/C
014: Right Hand Zero (Hard). Positive voltage input causes pen to deflect from right to left	N/C
037: Right Hand Event Marker (not compatible with Opt 054)	add \$80
038: Thermal Event Marker (Opt 054 required)	add \$155
537: 7132A Only. Left Hand Event Marker (Not Available with Thermal Writing, Option 054)	add \$80
050: 50 Hz Line Power	N/C
060: 60 Hz Line Power	N/C
054: Thermal Writing. Model 7132A (recommended for pen speed below 5"/s)	add \$275
054: Thermal Writing. Model 7133A (recommended for pen speed below 5"/s)	add \$200
908: Rack mount brackets	add \$15
910: Extra manual	add \$10

Recorder supplies starter kits

17036A English	\$54
17037A Metric	\$54
17038A English—Thermal	\$47
17039A Metric—Thermal	\$47

Ordering information

7132A Laboratory Two-Pen Recorder	\$2450
7133 Laboratory One-Pen Recorder	\$1850

RECORDERS, PRINTERS & PLOTTERS

Portable, battery power strip chart recorder

Model 7155B

- Under 30 pounds with internal battery
- 12 centimeter chart width
- Operates at -28° to $+65^{\circ}\text{C}$

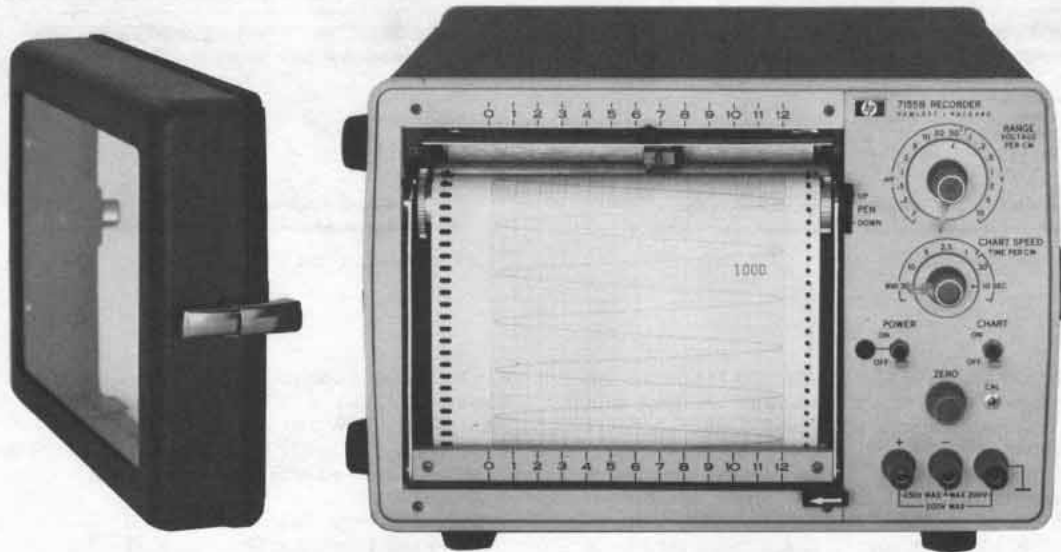

7155B

The Hewlett-Packard 7155B is a 12 cm portable strip chart recorder designed especially for field applications while maintaining laboratory specifications. It is a rugged, light-weight instrument weighing under 30 pounds with the rechargeable battery installed. The standard unit operates on external dc or ac from 48 to 440 Hz. The optional internal battery, which operates for nine hours on a single charge, may be selected. The instrument operates within HP Class A temperature range (-28°C to $+65^{\circ}\text{C}$); a first in the strip chart recording field.

This unit is provided with 16 calibrated spans, seven chart speeds, and a totally-electronic transmission that eliminates the need for mechanically shifting the gears. Additional standard items include the disposable pen, front plexiglass cover, three chart magazine tilt angles, and easy access to PC boards for serviceability. A sealed jelled electrolyte battery is optionally available.

7155B Specifications

Performance specifications

Input range: 0.1 mV/cm thru 10 V/cm in a 1, 2, 5 sequence with overlapping vernier (12 cm full scale).

Type in input: single ended, floating.

Input resistance: 1 megohm.

Maximum allowable source resistance: 5 k Ω for rated response.

Common mode rejection: 100 dB dc and 80 dB ac.

Full scale response time: 0.6 sec to within rate accuracy.

Overshoot: 1% of full scale maximum.

Accuracy: $\pm 0.4\%$ of full scale (includes linearity and deadband) at 25°C . Temp Coefficient $\pm 0.01\%$ per $^{\circ}\text{C}$.

Range accuracy: $\pm 0.4\%$ of full scale $\pm 0.2\%$ of deflection (includes linearity and deadband) at 25°C . Temp Coefficient $\pm 0.01\%$ / $^{\circ}\text{C}$.

Chart speeds: 30, 10, 5, 2.5, 1 minute/cm; 30 and 10 sec/cm.

Chart speed accuracy: $\pm 1\%$.

Environmental (operating): -28°C to $+65^{\circ}\text{C}$ <95% relative humidity (40°C).

General specifications

Writing mechanism: disposable ink pens.

Grid width: 12 cm.

Chart length: 21 metres (70 ft).

Pen lift: mechanical.

Weight: net 14 kg (30 lb) with battery option installed.

Size: 197 H x 304 W x 416 mm D ($7\frac{3}{4}''$ x $12''$ x $16\frac{3}{8}''$)

Power: external ac (48 to 440 Hz, 85 V to 130 V or 172 V to 260 V). External dc (10.5 to 36 V, 0.5 amp typical 0.9 amp maximum independent of voltage).

Supplies furnished

1. *Your Strip Chart Recorder*.—a brief manual
2. Operating and service manual
3. Chart paper, 21.3 m (70 ft)
4. Power cord, 2.3 m (7.5 ft)
5. Accessory kit includes:
 - DC connector
 - slidewire cleaner
 - 3 red disposable pens
 - 3 red event marker pens (if ordered)

Options

005: right hand zero

(Positive voltage input causes pen to deflect from right to left).

006: event marker

Contact closure on rear panel causes approximately 0.06 cm (0.025 inch) deflection of event pen. Marking occurs along left hand edge of paper.

008: internal battery

The jelled electrolyte battery operates nine hours on a single charge (at 25°C). Recharging is from external AC only and requires approximately 14 hours to full charge. Instrument may be operated while charging.

910: extra manual

Recorder supplies starter kit

17051A Kit

7155B Portable strip chart recorder

Price
N/C

add \$165

add \$360

add \$7

\$59

\$1900

RECORDERS, PRINTERS & PLOTTERS

Two and four-channel oscillographic recorders

Models 7402A, 7404A, & 17400A series preamps



263

- Instant drying ink

- Interchangeable plug-ins

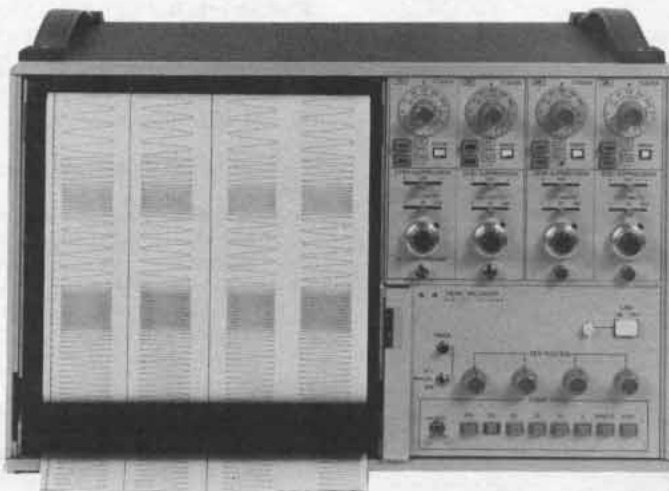

7404A

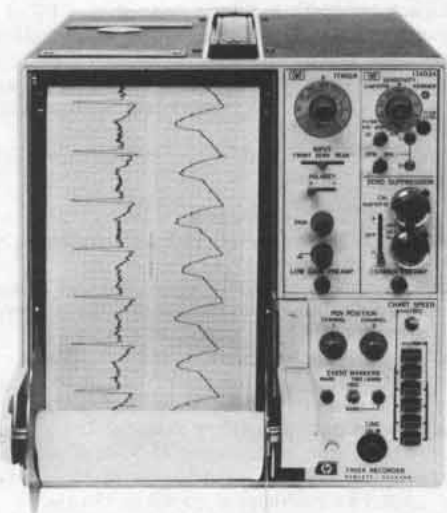

7402A

The Hewlett-Packard Models 7402A and 7404A are rectilinear, low pressure ink writing oscillographic recorders, which, when used with interchangeable 17400A Series Preamplifiers, measure and record one to four input signals against time. The 7402A Recorder is portable and records on either two 50 mm channels or a single 100 mm channel. The 7404A is a four channel recorder, but will also record on two 80 mm channels.

Clean traces that dry immediately on contact with the paper are produced by the pressurized ink system of these units. The pen is constructed with stainless steel with a tough carbide tip. Pens can last the life of the instrument. Four chart speeds are provided on the 7402A, while 12 are available on the 7404A. Remote control of the chart speed is either by contact closure or TTL.

The 7402A may be equipped with a Left Hand Event Marker (Option 001), Right Hand Event Marker/Timer (Option 008), or Left and Right Hand Event Marker/Timer (Option 003). It may be actuated by a front panel pushbutton labeled MARK or by remote contact closure or TTL through the rear terminal strip. On Option 003, a 1 SEC toggle switch provides one second timing sequences; Option 008 provides marks in second or minute sequences. The 7404A records event marks in Channel 1 (Left Edge) and provides automatic mark-per-second or mark-per-minute sequences when the front panel sec-mark-min toggle switch is set to SEC or MIN position. A mark

may be recorded when the MARKER/TIMER pushbutton is pressed. Additionally, it can be actuated by a remote marker command through a rear panel connector or by remote contact closure or TTL. Event markers for channels 2, 3, and 4 are available as Options 013, 014, and 015, respectively.

Oscillographic recorders with plug-ins can be used to measure parameters such as voltage, pressure, flow, force, displacement, and temperature with respect to time. These recorders can be used in applications such as line production, troubleshooting, or physical measurements.

17400A High gain

This plug-in is equipped to handle all normally encountered dc signal sources. A unique error indicator is included to signal overdriven inputs. It provides $1 \mu\text{V}/\text{div}$ sensitivity, 1 megohm input resistance, guarded and floated inputs, and calibrated zero suppression.

17401A Medium gain

Stable and solid, this dc-coupled preamplifier provides the basic signal conditioning required to cover the majority of applications. The optional calibrated zero suppression supports 1 mV/div maximum sensitivity balance-to-ground inputs.

17402A Low gain

As an economical unit, no compromises are made in basic performance. The single-ended input is available through a conventional rear connector as well as convenient front panel binding posts. Eight calibrated ranges are provided from 20 mV/div to 5 V/div.

17403A AC Carrier

The 17403A supplies excitation of 5V at 2.4 kHz to the passive transducer and receives the returning transducer output. The 17403A operates with full or half-bridge transducers including transformer, strain gage, and potentiometer types. Front panel selection of nine different input sensitivity ranges from 0.1 mV/V/full scale is provided. When used, a 2.4 kHz Carrier Frequency Oscillator must be ordered for the mainframe.

17404A DC Bridge

This plug-in supplies dc excitation voltage to the transducer and receives the returning transducer output. Front panel selection of seven input sensitivity ranges from 0.1 mV/div to 10 mV/div are provided.

7402A, 7404A, 17400A Series plug-ins specifications

7402A General specifications

Number of channels: two analog channels. One event marker/timer (optional); one event marker (optional).

Models 7402A, 7404A, & 17400 series (cont.)

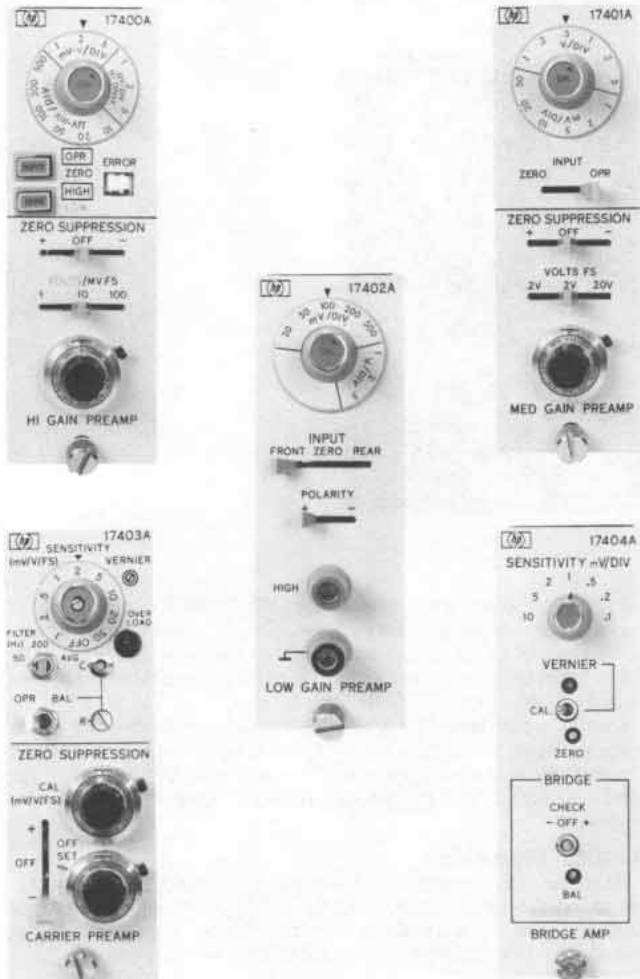

Chart description: 50 mm wide channels with 50 div full scale. Time lines every 1 mm. Chart length 84 m (275 ft).

Chart speeds: 1, 5, 25, 125 mm/s controlled by front panel, rear panel TTL or contact closure.

Chart speed accuracy (at 25°C): $\pm 0.5\%$ plus power line frequency variation. Temp coeff $0.01\%/^{\circ}\text{C}$.

Chart weave: ± 0.25 mm maximum.

Zero: adjustable to ± 30 div either side of grid center.

Writing system: blue-black ink with rectilinear presentation: 55 cc replaceable throw-away cartridge.

Environmental (operating): 0°C to 55°C and up to 95% relative humidity from 25°C to 40°C for mm/s speeds (80% relative humidity for mm/min.)

Power: 100/120/220/240 V ac $+5\%$ -10% , 60 Hz, 140 VA.

Weight: net, 18.2 kg (40 lb) with 2 17400A's & paper. Shipping, 26.9 kg (59 lb).

Size: 284 H x 253 W x 384 mm D (11 $\frac{1}{8}$ " x 9 $\frac{5}{8}$ " x 15 $\frac{1}{8}$ ")

7404A General specifications

Number of channels: four analog channels. Left hand event marker/timer

Chart description: 40 mm wide channels with 50 div full scale. Time lines every 1 mm. Chart length 84 m (275 ft).

Chart speeds: 5, 10, 25, 50, 100, 200 mm/s and mm/min controlled by front panel, rear panel TTL or contact closure.

Chart speed accuracy (at 25°C): same as 7402A.

Chart weave: same as 7402A.

Zero: same as 7402A.

Writing system: same as 7402A.

Environmental (operating): same as 7402A.

Power: 100/120/220/240 V ac $\pm 10\%$ 60 Hz, 300 VA.

Weight: net, 31.4 kg (69 lb). Shipping, 43.2 kg (95 lb).

Size: 290 H x 438 W x 384 mm D (11 $\frac{3}{8}$ " x 17 $\frac{1}{4}$ " x 15 $\frac{1}{8}$ ").

17400A with 7402A and 7404A

Input ranges: 1, 2, 5, 10, 20, 50, 100, 200, 500 $\mu\text{V}/\text{div}$; 1, 2, 5, 10, 20, 50, 100, 200, 500 mV/div; 1, 2, 5 V/div. Continuous vernier between ranges.

Type of input: differential, floated and guarded. Inputs thru rear connector.

Maximum allowable input (continuous): 500 V dc on 10 mV/div range and above; other ranges 120 V dc or 120 V ac rms.

Input resistance: 1 Megohm (min.)

Common mode rejection: 150 dB dc and 140 dB at line frequency with 1 k Ω source imbalance. 90 dB dc and 80 dB at 60 Hz on 10 mV/div range and above.

Maximum allowable common mode voltage: ± 200 V dc max voltage.

Frequency response: for 10 divisions deflection -3 dB at 110 Hz on 10 $\mu\text{V}/\text{div}$ range and above.

Rise time (typical, 10 to 90% of full scale deflection): 7.5 ms.

Overshoot: less than 2% of full scale.

Accuracy (on calibrated range, at 25°C, includes linearity): $\pm 1\%$ of full scale. Temp Coeff $0.06\%/^{\circ}\text{C}$. Allows for ability to interchange unit without recalibration.

Range accuracy (at 25°C, includes linearity): $\pm 1\%$ of full scale $\pm 0.2\%$ of reading. Temp Coeff $0.06\%/^{\circ}\text{C}$. Allows for ability to interchange unit without recalibration.

Zero suppression: 1, 10, 100 V on 10 mV/div range and above; other ranges 1, 10, 100 mV. Continuous calibrated vernier between suppression steps.

Zero suppression accuracy: $\pm 0.5\%$ of suppression $\pm 0.5\%$ of full scale. $\pm 0.02\%/^{\circ}\text{C}$

17401A with 7402A and 7404A

Input ranges: 1, 2, 5, 10, 20, 50, 100, 200, 500 mV/div; 1, 2, 5 V/div. Continuous vernier between ranges.

Type of input: balanced to ground. Inputs thru rear connector

Maximum allowable input (continuous): 230 V rms on 500 mV/div range and above; other ranges 120 V rms.

Input resistance: 1 Megohm (min.)

Common mode rejection: greater than 50 dB dc to line frequency with 100 ohm source imbalance.

Maximum allowable common mode voltage: 250 V dc or peak ac on 500 mV/div range and above; other ranges 15 V dc or peak ac.

Frequency response: 7402A — For 10 div deflection -3 dB at 140 Hz; 7404A — For 10 div deflection -3 dB at 150 Hz.

Rise time (typical, 10 to 90% of full scale deflection): 7 ms

Overshoot: less than 2% of full scale.

Accuracy (on calibrated range, at 25°C, includes linearity): $\pm 1\%$ of full scale. Temp Coeff $0.06\%/^{\circ}\text{C}$. Allows for ability to interchange unit without recalibration.

Range accuracy (at 25°C, includes linearity): $\pm 1\%$ of full scale $\pm 0.2\%$ of reading. Temp Coeff $0.06\%/^{\circ}\text{C}$. Allows for ability to interchange unit without recalibration.

Zero suppression: (optional) 0.2, 2, 20 V. Continuous calibrated vernier between suppression steps.

Zero suppression accuracy: $\pm 0.5\%$ of suppression $\pm 0.5\%$ of full scale. $\pm 0.02\%/^{\circ}\text{C}$.

17402A with 7402A and 7404A

Input ranges: 20, 50, 100, 200, 500 mV/div; 1, 2, 5 V/div. Continuous vernier between ranges.

Type of input: single ended. Inputs thru front or rear connector.

Maximum allowable input (continuous): 230 V rms on 200 mV/div range and above; other ranges 120 V rms.

Input resistance: 1 Megohm (min.)

Frequency response: 7402A — For 10 div deflection -3 dB at 140 Hz; 7404A — For 10 div deflection -3 dB at 150 Hz.

Rise time (typical, 10 to 90% of full scale deflection): 7 ms.

Overshoot: less than 2% of full scale.

Accuracy (on calibrated range, at 25°C, includes linearity): $\pm 1\%$ of full scale. Temp Coeff $0.06\%/^{\circ}\text{C}$. Allows for ability to interchange unit without recalibration.

Range accuracy (at 25°C, includes linearity): ±1% of full scale ±0.2% of reading. Temp Coeff 0.06%/°C. Allows for ability to interchange unit without recalibration.

17403A with 7402A and 7404A

Input ranges: 0.1, 0.2, 0.5, 1, 2, 5, 10, 20, 50 mV/V full scale. Continuous vernier between ranges. Also provides division of above sensitivities by 100.

Type of input: differential, floating.

Maximum allowable input (continuous): 50 V rms at 2.4 kHz.

Input resistance: 100 k at 2.4 kHz.

Common mode rejection: 120 dB dc to line frequency with 1 kΩ source imbalance.

Maximum allowable common mode voltage: ±200 V dc or peak ac.

Frequency response: 7402A—For 10 div deflection -3 dB at 140 Hz; 7404A—For 10 div deflection -3 dB at 150 Hz. For Preamp only—output available on rear of recorder. Filter switch to 50 -3 dB at 50 Hz; rolloff 40 dB/decade. Filter switch to 200 -3 dB at 200 Hz; rolloff 40 dB/decade. Filter switch to AVG—Time constant 1.0 s ±10% dc to 0.16 Hz; rolloff 20 dB/decade.

Rise time (typical, 10 to 90% of full scale deflection): preamp filter switch to 50 or 200: 7.5 ms. Preamp filter to AVG; 1 s.

Overshoot: less than 2% of full scale.

Accuracy (on calibrated range, at 25°C, includes linearity): ±0.6% of full scale at 25°C. Temp Coeff 0.06%/°C.

Range accuracy (at 25°C, includes linearity): ±0.6% of full scale ±0.2% of reading. Temp coeff 0.06%/°C.

Zero suppression: ten turn control from 1 to 100% of full scale.

Zero suppression accuracy: ±0.5% of setting ±0.5% of full scale.

Drift (zero line referenced to input): ±0.2 μV/V/week (includes excitation drift).

Source resistance: compensated by front panel adjustment.

Balance controls: R Balance ±5 mV/V Temp Coeff ±1.8 μV/V/°C.

Quadrature rejection: 40 dB at 2.4 kHz. Quadrature tolerance: 2:1. **Transducer excitation:** full Bridge—5.0 V rms ±5% 2.4 kHz ±3%. Half Bridge—One half full bridge excitation.

Excitation load resistance: 100 ohms min. (Unlimited output short circuit duration.)

17404A with 7402A and 7404A

Input ranges: 0.1, 0.2, 0.5, 1, 2, 5, 10 mV/div with overlapping vernier between ranges.

Type of input: differential, floating and guarded.

Maximum allowable input (continuous): 17 V dc or peak ac.

Input resistance: 100 k (min).

Common mode rejection: 100 dB dc and 80 dB at line frequency with 1 k source imbalance.

Maximum allowable common mode voltage: ±165 V dc or peak ac.

Frequency response: 7402A—For 10 div deflection -3 dB at 140 Hz; 7404A—For 10 div deflection -3 dB at 150 Hz. Amplifier only (output available on rear of recorder). -3 dB at 3 KHz.

Rise time (typical, 10 to 90% of full scale deflection): 7 ms.

Overshoot: less than 2% of full scale.

Accuracy (on calibrated range, at 25°C, includes linearity): ±1.0% of full scale at 25°C (excludes excitation supply errors). Temp Coeff. 0.06%/°C.

Range accuracy (at 25°C, includes linearity): ±1.0% of full scale at 25°C (excludes excitation supply error). Temp Coeff 0.06%/°C.

Drift (zero line referenced to input): ±0.2% μ V/V/week (includes excitation drift).

Source resistance: 1 kΩ max.

Balance controls: unloaded bridge completion board. Front panel balance and cal controls (balance up to 5 V).

Transducer excitation: 5 V dc ±1.0%.

Excitation load resistance: 50 ohms min. (Unlimited output short circuit duration.)

Accessories supplied

Description	HP Part Number
1. Model 7402A Operating and Service Manual	07402-90007
Model 7404A Operating and Service Manual	07404-90000

2. Chart Paper (One 275 ft. (84 m) roll)—7402A	9280-0258
Chart Paper (One 275 ft (84 m) roll)—7404A	9280-0293
3. Ink Cartridge (55 cc, installed)	07402-60066
4. Rear Plug-in Connectors (2 each 7402A, 4 each 7404A)	1251-1895
5. Power Cord (7.5 ft (2.3m))	8120-1378
6. Miscellaneous Fuses (spares for internal supplies)	
7. Pen Cleaning Wires	17999-15126
8. Ink Line Plugs, 3 each	07402-20048

Supplies/accessories available

Description	HP Part Number
7402A Paper: 275 ft (84 m) roll, two 50 mm channels	9280-0258
7402A Paper: 275 ft (84 m) roll, one 100 mm channel	9280-0276
7404A Paper: 275 ft (84 m) roll, four 50 div channels	9280-0293
7404A Paper: 275 ft (84 m) roll, two 100 div channels	9280-0294
Ink Cartridge (55 cc)	07402-60066
Mobile cart for 7404A	1064A-018
Input Adapter Plug	17133A

Field Installation Kits as follows:

Rack Mounting Kit for 7402A	07402-60023
Rack Mounting Kit for 7404A	07404-60074
Rack Mounting Kit for 7404A in 1064A-018 Cart	07404-60082
Paper Take-up Kit for 7402A	07402-60022
Paper Take-up Kit for 7404A	07404-60076
Hard Cover Kit for 7402A	07402-60062
Hard Cover Kit for 7404A	07404-60072
Opt 011 Circuit Board for Models 7402A/7404A	07402-60252

7402A Options

Option	Price
001: Event marker (left hand)	add \$105
003: Event marker (left hand) and event marker/timer (right hand) for 1 s intervals.	add \$210
004: 50 Hz power line operation	N/C
005: Paper take-up (external)	add \$160
008: Event marker/timer (right hand) for minutes and seconds (not compatible with Opt 001 or 003)	add \$180
009: 60:1 speed reducer	add \$225
010: Hard cover (not compatible with Opt 005 or 908)	add \$50
011: 2.4 kHz oscillator for use with 17403A	add \$50
016: White paint	add \$100
017: UL544 Listing, white paint	add \$375
018: UL544 Listing, standard paint	add \$325
908: Rack mount adapter	add \$130

7404A Options

Option	Price
004: 50 Hz power line operation	N/C
005: Paper take-up (external)	add \$240
010: Hard cover (not compatible with Opt 005, 012 or 908)	add \$75
011: 2.4 kHz oscillator for use with 17403A	add \$50
012: Rack mount adapter for use with 1064A mobile cart	add \$110
013: Channel 2 event marker	add \$65
014: Channel 3 event marker	add \$65
015: Channel 4 event marker	add \$65
016: white paint	add \$100
908: Rack mount adapter	add \$160

Recorder supplies starter kit

17052A Kit—7402A	\$52
17053A Kit—7404A	\$54

Ordering information

7402A Mainframe (less plug-ins)	\$2800
7404A Mainframe (less plug-ins)	\$5300
17400A High Gain Preamplifier	\$860
17401A Medium Gain Preamplifier	\$310
17401A Opt 001 (Zero suppression)	add \$150
17402A Low Gain Preamplifier	\$210
17403A AC Carrier Preamplifier	\$800
17404A DC Bridge Amplifier	\$590

RECORDERS, PRINTERS & PLOTTERS

Two, four and eight-channel oscillographic recorders

Models 7702B, 7414A, 7418A & 8800 series signal conditioners

- Versatile configurations
- Thermal writing

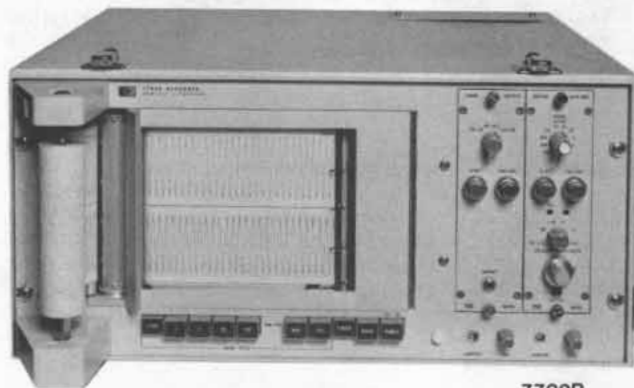

7702B

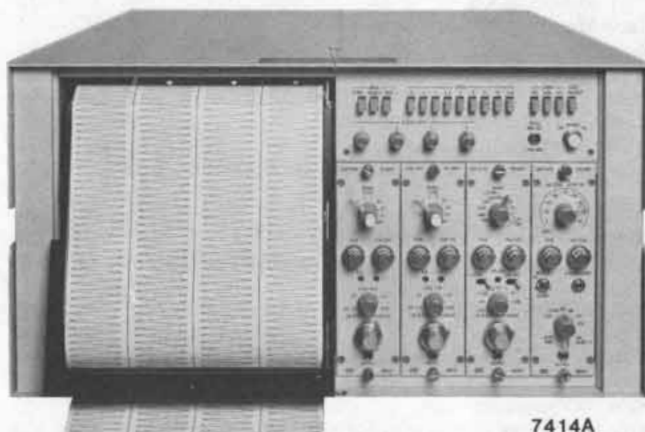

7414A

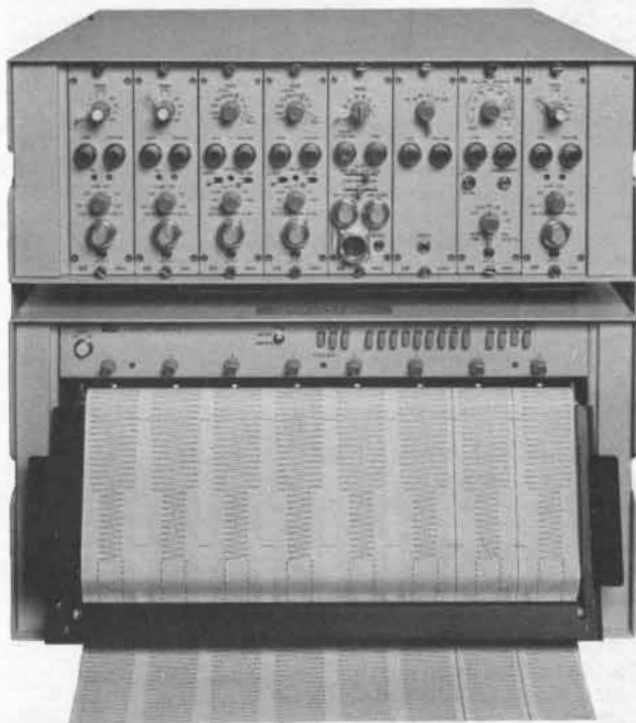

7418A

The Hewlett-Packard Models 7702B 2-channel, 7414A 4-channel, and 7418A 6- and 8-channel Oscillographic Recorders provide permanent reproducible records of multichannel, real-time, low frequency data. They can be contained in a single benchtop package, a mobile cart, or in an upright cabinet. The unit selected, depending upon channel needs, represents a unique combination of reliability, high performance, and flexibility. A complement of the 8800 Series Plug-In Signal Conditioners results in a system capable of meeting many measurements requirements.

Thermal writing tips in Models 7414A and 7418A, featuring long stylus life and rectilinear presentations, are provided. A 500-sheet, Z-fold chart paper pack loads easily, allows for convenient data review, and storage capability. Two event markers are supplied. One is activated by either a one-second or one-minute front panel timer button, the other by the event button. Both markers can be activated remotely.

7702B, 7414A, 7418A, 8800 Series plug-in specifications

7702B General specifications

Chart speeds: 1, 5, 20, and 100 mm/s; plus eight optional.

Markers: event-right side marker standard, center marker optional.

Chart paper: two 50 mm wide channels each with 50 div; time lines every 1 mm; roll type Permapaper®.

Paper loading and takeup: front panel loading and paper take-up. **Power:** 115/230 V ac $\pm 10\%$, 60 Hz, 230 VA (including plug-ins), 50 Hz optional.

Size: 221.5 H x 482.6 W x 438.2 mm D (8 $\frac{3}{4}$ " x 19" x 17 $\frac{1}{4}$ ") for standard rack. For Portable Case: 235 H x 498 W x 546 mm D (9 $\frac{1}{4}$ " x 19.6" x 21.5"). For Mobile Cart: 997 H x 680 W x 521 mm D (39 $\frac{1}{4}$ " x 26 $\frac{3}{4}$ " x 20.5").

Weight: 27.2 kg (60 lb) for rack mount; 40.4 kg (89 lb) in Portable Case; 59 kg (130 lb) in Mobile Cart.

7414A General specifications

Chart speeds: 0.25, 0.5, 1.0, 2.5, 10, 25, 50, 100 mm/s. Speed regulation $\pm 1\%$. Paper weave less than 0.5 mm. Speed selected via front panel pushbuttons.

Limiting: electrical limiting keeps stylus within a range of 1.5 mm beyond edge of channel.

Markers: event—local or remote control (monopolar), located on right side, between channels 3 and 4. Timed—1 min or 1 s interval (monopolar), located on left side, between channels 1 and 2.

Chart paper: four 40 mm wide channels each with 50 div; time lines every 1 mm; heat sensitivity Z-fold Permapaper® with green grid lines available in packs of 500 sheets, each 30 cm (12").

Paper loading: no threading required.

Remote operation: rear panel connector provides for chart drive and event marker.

Power: 115/230 V ac $\pm 10\%$, 60 Hz, 350 VA (includes plug-ins) 50 Hz optional.

Size: 266.7 H x 482.6 W x 577.9 mm D (10 $\frac{1}{2}$ " x 19" x 22 $\frac{3}{4}$ "). Projection: 76.2 mm (3") from rack front.

Weight: net, 50.5 kg (112 lb). Shipping, 59.5 kg (132 lb).

7418A General specifications

Chart speeds: 0.5, 1, 2.5, 5, 10, 25, 50, 100, 200 mm/s. Speed regulation $\pm 1\%$. Paper weave less than 0.5 mm. Speed selected via front panel pushbuttons.

Remote operation: rear panel connector provides for chart drive and event marker, optional extra markers. Remote connector supplies -20 V.

Power: 115/230 V ac $\pm 10\%$, 60 Hz. Recorder only 575 VA; system plug-ins 695 VA.

Size: rack: 266.7 H x 482.6 W x 577.9 mm D (10 $\frac{1}{2}$ " x 19" x 22 $\frac{3}{4}$ "). Projection: 76.2 mm (3") from front of rack.

Weight: 50 kg (110 lb) including driver amplifiers.

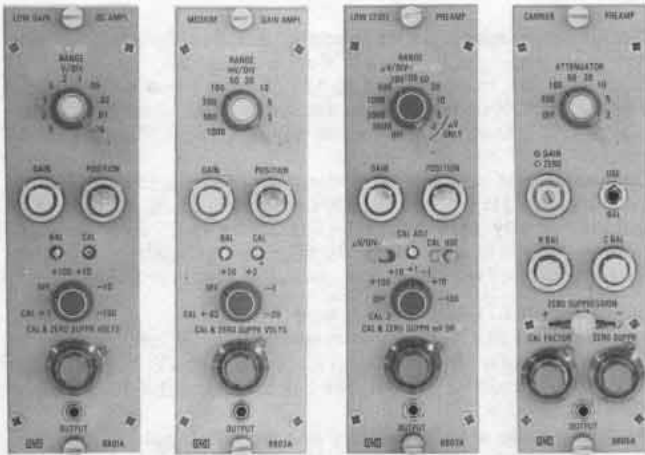

8801A 8802A 8803A 8805A

8801A with 7702B, 7414A and 7418A

Input ranges: 5, 10, 20, 50, 100, 200, 500, 1000 mV/div; accuracy $\pm 1\%$.

Maximum calibrated sensitivity and max fs input: 5mV/div (gain 20) 250V.

Input circuit & input frequency range: resist. 500 k Ω $\pm 1\%$ each side bal to gnd; parallel with approx. 100 pF

Rise time (10 div, 10-90%, 4% overshoot): 5 ms.

Calibration (referred to input): 100 mV, $\pm 1\%$, internal.

Output frequency response (-0.5 dB at 50 div): 50 Hz.

Zero suppression: ± 10 and ± 100 V for single-ended or diff. signals. 10-T pot sets precise values of zero suppression voltages; ± 50 V max suppress on 5, 10, 20 mV/div ranges; max error of suppression $\pm 0.5\%$ of suppression range, and 1% of indicated suppression.

Output noise, max (less trace width): 0.2 div, p-p.

Zero drift, 20° to 40°C, 103 to 127 V (less trace width): temp—1.25 div/10°C, 0.5 div/hr, constant ambient. Line voltage—0.15 div.

Common mode rejection and tolerance: 48 dB min, dc to 150 Hz; ± 50 V max on other ranges for $< 1\%$ change in differential sensitivity.

Output linearity (less trace width): 0.25 div, after calibration for zero error to center scale +20 div.

8802A with 7702B, 7414A and 7418A

Input ranges: 1, 2, 5, 10, 20, 50, 100, 200, 500, 1000 mV/div; accuracy $\pm 1\%$.

Maximum calibrated sensitivity and max fs input: 1 mV/div (gain 100) 50 V.

Input circuit and input frequency range: resist 180 k Ω $\pm 1\%$, each side bal to gnd, parallel with approx 100 pF.

Rise time (10 div, 10-90%, 4% overshoot): 5 ms.

Calibration (referred to input): 20 mV, $\pm 1\%$, internal.

Output frequency response (-0.5 dB at 50 div): 50 Hz.

Zero suppression: ± 2 V and 20 V for single-ended or differential signals; 10-T pot sets precise values of zero suppression voltages; ± 12.5 max suppression on 1, 2, 5 mV/div ranges; max error of suppression $\pm 0.5\%$ of suppression range and 1% of indicated suppression.

Output noise, max (less trace width): 0.2 div, p-p.

Zero drift, 20° to 40° C, 103 to 127 V (less trace width): same as 8801A.

Common mode rejection and tolerance: 48 dB min dc to 60 Hz, 1000 mV/div range; 48 dB min. dc to 150 Hz other ranges ± 12.5 V on 1, 2, 5 mV/div ranges; ± 125 V on 10, 20, 50 mV/div ranges; ± 500 V max other ranges for less than 1% change in differential sensitivity.

Output linearity (less trace width): same as 8801A.

8803A with 7702B, 7414A and 7418A.

Input ranges: 1, 2, 5, 10, 20, 50, 100, 200, 500, 1000, 2000, 5000 μ V/div; 10, 20, 100, 200, 500, 1000, 2000, 5000 mV/div; accuracy $\pm 1\%$ on 5000 μ V/div to 20 μ V/div ranges, $\pm 2\%$ on 10 μ V/div to 1 μ V/div; accuracy of x 1000 attenuator $\pm 1\%$.

Maximum calibrated sensitivity and max fs input 1 μ V/div (gain 100,000) 250 V.

Input circuit and input frequency range: 1 M Ω min on μ V range, independent of gain; 5 M Ω on mV range; floating and guarded.

Rise time (10 div, 10-90%, 4% overshoot): 5 ms. 6% overshoot.

Calibration (referred to input): 200 μ V $\pm 1\%$ internal on μ V/div range; 200 mV $\pm 1\%$ internal on mV/div range.

Output frequency response (-0.5 dB at 50 div): 50 Hz.

Zero suppression: μ V ranges ± 1 , ± 10 , ± 100 mV; mV ranges ± 1 , ± 10 , ± 100 V, 10-T pot sets precise values of zero suppression voltages; accuracy $\pm 1\%$ suppression range.

Output noise, max (less trace width): 1.5 mm p-p at 1 μ V/div; 0.1 div, p-p min gain.

Zero drift, 20% to 40%, 103 to 127 V (less trace width): temp— μ V range 1 Ω V/10° referred to input, ± 0.26 div/10° C for 0 output & ± 0.65 div/10° C for fs output. mV range, 1 mV/10° C referred to input, ± 0.26 div/10° C for 0 output. Line voltage 0-0.07 div; fs 0.35 div.

Common mode rejection and tolerance: μ V range, max source unbal of 1 k Ω ; 160 dB min at dc, 120 dB min at 60 Hz; mV range, max source unbal of 500 k Ω ; 100 dB min at dc, 60 dB min at 60 Hz dc. 300 V pk; 60 Hz. 1 μ V/div, 10 V rms; 2 μ V/div, 20 V rms; 5 μ V/div, 50 V rms; 10 μ V/div and 10 mV/div, 100 V rms; 20 μ V to 5000 μ V/div and 20 mV to 5000 mV/div, 200 V rms.

Output linearity (less trace width): 1 mV range 0.35 div, others 0.25 div after calibrating for zero error at center scale and +20 div.

8805A/B with 7702B, 7414A and 7418A

Input ranges: X1, 2, 5, 10, 20, 50, 100, 200; accuracy $\pm 2\%$.

Maximum calibrated sensitivity and max fs input: 10 μ V rms/div (gain 10,000 rms ac to dc); 100 mV rms.

Input circuit and input frequency range: input impedance—8805A approx 10 k Ω ; 8805B 1 M Ω $\pm 10\%$; single-ended. Min load resistance across excitation 100 Ω . Max impedance in series with input (transducer output impedance) 5 k Ω . Excitation—floating source 5 V rms nominal at 2400 Hz $\pm 2\%$. Internal full bridge—half bridge switch grounds C.T. of excitation for use with half bridge transducer.

Rise time (10 div, 10-90%, 4% overshoot): 5.6 ms.

Calibration (referred to input): 2% $\pm 0.02\%$ of transducer fs output. Adjust by Cal Factor control; accuracy ± 55 μ V/V out of 10mV/V. 8805B switchable Cal voltage to 2%, 10%, 50%, or 100% $\pm 1\%$ of fs.

Output frequency response (-0.5 dB at 50 div): 50 Hz.

Zero suppression: 0-100% of transducer full load rating, for transducers having Cal Factor up to 10 mV/V at full load, 10-T pot with calibration dial; accuracy—1 dial div $\pm 0.5\%$ of suppress range. Zero Supp Polarity switch, Separate R Bal control allows bucking of inphase unbal to ± 3 mV/V regardless of Cal Factor.

Output noise, max (less trace width): approx. 0.2 div, p-p.

Zero drift, 20% to 40%, 103 to 127 V (less trace width): temp—0.45 div/10° C; Line voltage—0.25 div.

Common mode rejection and tolerance: quadrature rejection and tolerance: > 40 dB. Tolerance error: $< \pm 2\%$ fs when quadrature voltage equal to twice in-phase signal required for center to edge deflection on chart. C Balance control permits bucking of transducer's quad unbalance of up to ± 5 mV/V.

Output linearity (less trace width): 0.4 div after calibrating for zero error at center scale and +20 div.

RECORDERS, PRINTERS & PLOTTERS

Two, four and eight-channel oscillographic recorders

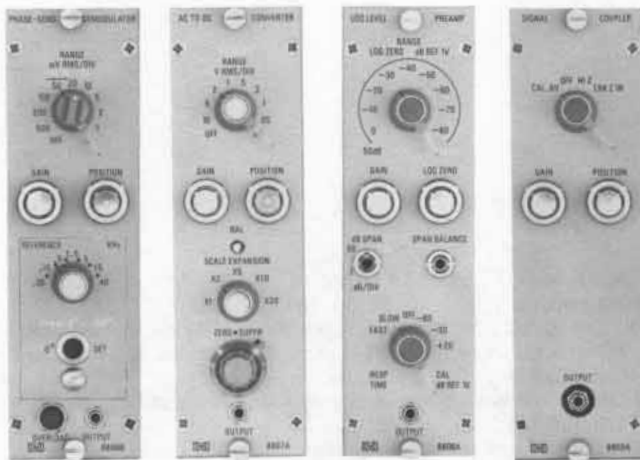

8806B

8807A

8808A

8809A

8806B with 7702B, 7414A and 7418A

Input ranges: sig input—0.5, 1, 2.5, 10, 20, 50, 100, 200, 500 mV/div; $\pm 1\%$, 50 Hz to 10 kHz; $\pm 2\%$, 10 kHz; $\pm 3\%$, 20 kHz to 40 kHz. Reference voltage—3 to 20 rms, 20 to 133 V rms.

Maximum calibrated sensitivity and max fs input: 0.5 mV rms/div (gain 200 rms ac to dc) 25 V rms.

Input circuit and input frequency range: signal input—transformer isolated, floating point and guarded; resistance approx 1 M Ω . Reference input: differential, transformer coupled; resistance approx 500 k Ω each side to ground, may be used single ended. 50 Hz to 40 kHz in 6 bauds with variable frequency plug-in; 60 Hz, 400 Hz and 5 kHz fixed frequency phase shifter plug-in; special order phase shifter plug-ins 50 Hz to 40 kHz.

Rise time (10 div, 10-90%, 4% overshoot): 5 ms (5 kHz ref).

Calibration (referred to input): 1 V rms internal at carrier reference frequency; $\pm 1\%$ 50 Hz to 10 kHz; $\pm 2\%$ 10 kHz to 20 kHz; $\pm 3\%$ 20 kHz to 40 kHz.

Zero suppression: none. Phase shifter plug-ins allow control of reference phase over 360°. Fixed frequency: 0° to 90° dial; 2° graduations; any of 4 quadrants by panel switches; dial accuracy within $\pm 3^\circ$. Variable frequency: adjust thru 360°.

Output noise, max (less trace width): 7 μ V x sq root of frequency response, referred to input.

Zero drift, 20° to 40°C, 103 to 127 V (less trace width): temp: 0.5 div/10°C; Line voltage: 0.25 div.

Common mode rejection and tolerance: CM: >40 dB up to 10 kHz 500 V rms, max. Quadrature tolerance: equal to amplitude of a fs, in-phase signal.

Output linearity (less trace width): 0.4 div after calibrating for zero error at center scale and +20 div.

8807A with 7702B, 7414A and 7418A

Input ranges: 0.02, 0.05, 0.1, 0.2, 0.5, 1, 2, 5, 10 V rms/div, $\pm 2\%$ (midband). Scale expansion: X1, 2, 5, 10, 20, $\pm 2\%$.

Maximum calibrated sensitivity and max fs input: 1 mV rms/div (gain 100 rms ac to dc). 20 mV rms/div with X1 scale expansion 500 V rms.

Input circuit and input frequency range: approx 1 M Ω resistive in parallel with 10 pF and stray cable capacitance; floating and guarded. Standard model: 330 Hz to 100 kHz; Opt 001: 50 Hz to 100 kHz.

Rise time (10 div, 10-90%, 4% overshoot): 11.2 ms. Opt 001: 70 ms, approx 10% overshoot.

Calibration (referred to input): 1 V internal $\pm 1\%$; approx 500 Hz. **Output frequency response (-0.5 dB at 50 div):** 54 Hz (3 dB at 10 div). Opt 001—9 Hz.

Zero suppression: up to 100% of fs on any range can be suppressed; 10-T pot with calibrating dial. Scale expansion: 5, 10, 20, or 50% of fs can be expanded to cover full chart.

Output noise, max (less trace width): baseline offset/noise: 2 mV rms referred to input +0.025 div \times scale expansion

Zero drift, 20° to 40°C, 103 to 127 V (less trace width): temp 0.03 div/10°C \times scale expansion +0.35 div/10°C; at constant ambient 0.005 div/hr \times scale expansion. Line voltage 0.005 div \times scale expansion +0.1 div.

Common mode rejection and tolerance: 60 dB min at 60 Hz; 40 dB min at 400 Hz with up to 10 K source unbalance; ± 500 V pk.

Output linearity (less trace width): 0.55 div +0.05 div \times scale expansion, 330 Hz to 5 kHz; Opt 001: 60 Hz to 5 kHz, after calibration for zero error at lower and upper ends of printed coordinates.

8808A with 7702B, 7414A and 7418A

Input ranges: 50 dB span: bottom scale -80, -70, -60, -50, -40, -20, -10, and 0 dB below 1 V (i.e. 100 μ V, 320 μ V, 1, 3.2, 10, 32, 100, 320 mV and 1V). 100 dB span bottom scale -80, -70, -60, and -50 dB below 1 V.

Maximum calibrated sensitivity and max fs input: 100 μ V rms sine wave corresponds to bottom scale output, -80 dB below 1 V 320 V rms.

Input circuit and input frequency range: single ended, resistance 1 M Ω min. 5 Hz to 100 kHz for <3dB down from the midband level on "Slow" response range; 500 Hz to 100 kHz on "Fast" response range.

Rise time (10 div, 10-90%, 4% overshoot): fast: 20.5 rms (875 dB/s) Slow: 2 s (9 dB/s).

Calibration (referred to input): internal from oscillator at approx 500 Hz. -80, -30, and ± 20 dBV = dB ref. to 1 V (100 μ V, 32mV and 10 V) -80 +20 dBV internally adjustable: -30 dBV accuracy ± 0.25 dB (at 115 V line at 25°C).

Output noise, max (less trace width): 50 dB range: 0.8 div, p-p, 100 dB range: 0.4 div, p-p (max noise at bottom of recording chart).

Output linearity (less trace width): departure from log characteristics 50 dB: 1.25 div, 100 dB: 1 div, after calibrating for zero error at lower and upper ends of printed coordinates.

8809A with 7702B, 7414B and 7418A

Input ranges: continuously adjustable from 20 to 50 mV/div.

Max calibrated sensitivity and max fs input: 30 mV/div (gain 3.33). 0 to +2.5 V or 0 to -2.5 V.

Input circuit and input frequency range: switch selected: 1500 Ω $\pm 2\%$ or 100 k Ω min, incremental; single ended.

Rise time (10 div, 10-90%, 4% overshoot): 5 ms.

Calibration (referred to input): 600 mV $\pm 2\%$, internal.

Output frequency response (-0.5 dB at 50 div): 50 Hz.

Output noise, max (Less trace width): 0.1 div, p-p.

Zero drift, 20° to 40°C, 103 to 127 V (less trace width): temp: 0.4 div/10°C at 30 mV sensitivity. Line voltage: 0.3 div.

Common mode rejection and tolerance: 50,000: 1 at dc.

Output linearity (less trace width): 0.4 div after calibrating for zero error at center scale and +20 div.

8820A with 7418A

Sensitivity: 0.05 V/div (Amplifier Gain 2).

Maximum fs input: 250 V (edge to edge).

Input ranges (attenuation): 0.05, 0.1, 0.2, 0.5, 1, 2, 5 V/div. Attenuator accuracy $\pm 2\%$.

Input circuit: single ended, 1M Ω min.

Frequency response: dc to <0.5 dB down at 50 Hz (50 div p-p); dc to <3 dB down at 100 Hz (10 div p-p).

Rise time (10 div, 10-90%, 4% overshoot): <6 ms.

Output linearity (less trace width): linear within ± 0.25 div after setting mechanical zero of stylus to within ± 1 div of chart center and calibrating for zero error at center scale and ± 20 div.

Drift, 20° -40°, 115 V $\pm 10\%$, 60 Hz (less trace width): temp: <0.55%/10°C. Line voltage: < ± 0.2 div.

Calibration: 1 V \pm calibration voltage for all channels.

Temp rating: operating: 0°C to +55°C; storage: -40°C to 75°C.

8821A with 7418A

Sensitivity: 0.001 V/div (Amplifier Gain 100).

Maximum fs input: 250 V (edge to edge).

Input ranges (attenuation): 0.001, 0.002, 0.005, 0.010, 0.020, 0.050, 0.1, 0.2, 0.5, 1, 2, 5 V/div. Attenuator accuracy (dc) $\frac{1}{2}\%$ on 0.001 to 0.050 V/div ranges; 1% on 0.1 to 5 V/div ranges.



8820A

Input circuit: balanced, floating and guarded, 9 MΩ constant for all gain settings (0.001 to 0.050 V/div); 4.5 mΩ each side to ground (0.1 to 5 V/div).

Common mode rejection: 100 dB at 60 Hz, 0.001 V/div sensitivity, 1 kΩ source unbalance decreases to 66 dB at 0.05 V/div, 66 dB at 60 Hz, 0.01 to 5 V/div sensitivity. 1 kΩ source unbalance.

Common mode tolerance: ±20 V on 0.001 to 0.05 V/div ranges (6 most sensitive); ±250 V on 0.1 to 5 V/div ranges (6 least sensitive).

Frequency response: dc to <0.5 dB down at 50 Hz (50 div, p-p). dc to <3 dB down at 200 Hz (10 div p-p).

Rise time (10 div, 10-90%, 4% overshoot): <6 ms.

Output linearity (less trace width): same as 8820A.

Drift, 20° to 40°C, 115 V ± 10%, 60 Hz (less trace width): same as 8820A.

Calibration: +0.02 V ± 1% on 6 most sensitive ranges. Simulates +2 V ± 2% at input on 6 least sensitive ranges.

Temperature rating: same as 8820A.

7702B Options

- 002:** Portable Case and Cover add \$225
- 003:** One-Channel Decrease less \$55
- 005:** Mobile Cart (1062A) add \$350
- 008:** 50Hz Operation add \$55
- 009:** Speeds 2.5, 5, 25, and 50 mm/sec (50 Hz) add \$90
- 010:** Speeds 2.5, 5, 25, and 50 mm/sec (60 Hz only) N/C
- 011:** 60:1 Speed Reduction (60 Hz) add \$205
- 012:** 60:1 Speed Reduction (50 Hz) add \$205
- 015:** Extra Event Marker installed between channels add \$90
- 018:** 60 Hz Speed Kit 2:1 Reduction. Speeds of 0.5, 2.5, 10, 50 mm/sec. (Not compatible with Opt 010, 011) add \$190
- 019:** 50 Hz Speed Kit 2.1 Reduction. Speeds of 0.5, 2.5, 10, and 50 mm/sec. (Not compatible with Opt 009 and 012) add \$190

Note: Option 008 required when ordering Option 009, 012, or 019.

7414A Options

- 001:** Rack mount (include slides, mounting hardware; delete case) N/C
- 008:** 50 Hz operation N/C
- 012:** 1 channel decrease; extreme RH channel deleted, blank panel instal; not compatible with Opt 015 less \$225
- 015:** Extra Event Marker, installed between channel 2 and 3; not compatible with Opt 012 add \$100
- 025:** 50 Hz speed reduction, 60:1 (Opt 008 required) add \$320
- 026:** 60 Hz speed reduction, 60:1 add \$320
- 054:** Installed in mobile cart. Includes paper takeup drawer add \$575

7418A Options

- 001:** 6 channel Hot-Tip Therm Recorder only* (includes takeup tray) (*For plug-in preamps, Opt 030 Power Supply required; for Bank Amps, select 1 of options 031, 32) less \$620
- 002:** Rack mount kit add \$205

- 003:** Bench top configuration add \$500
- 004:** 63-in. Cabinet (includes 7-in. drawer) add \$1850
- 005:** 42-in. Cabinet (includes 7-in. drawer) add \$1850
- 006:** 28-in. Portable cart (includes Opt 002) add \$950
- 008:** 50 Hz operation N/C
- 009:** 230 V ac operation N/C
- 014:** Extra Event Marker between Channels 4 & 5 add \$90
- 015:** Extra Event Marker between Channels 5 & 6 add \$90
- 025:** 50 Hz speed reduction 60:1 (Opt 008 required) add \$310
- 026:** 60 Hz speed reduction 60:1 add \$310
- 030:** 8848A plug-in preamp power supply (required for operation of 8800 Preamps) add \$1970
- 031:** 8820A 8-channel bank amp (not compatible with Opt 001) add \$3000
- 032:** 8821A 8-channel bank amp (not compatible with Opt 001) add \$3800
- 035:** Rack Mount Kit add \$290

8801A, 8802A, & 8809A Options

- 001:** Bench top unit with power supply & portable case add \$760

8803A Options

- 001:** Bench top unit with power supply & portable case add \$760

8805A Options

- 001:** Bench top unit with power supply & portable case add \$760
- 002:** Harmonic filter kit (required when 267, 268, 270, or 1280B/C transducers are used) add \$30

8805B Options

- 001:** Bench top unit with power supply and portable case add \$760
- 002:** delete Harmonic Filter less \$25

8806B Options

- 001:** Bench top unit with power supply & portable case add \$760
- 002:** Variable frequency phase shifter plug-in, 50 Hz to 40 kHz add \$260
- 003:** calibrated phase shifter plug-in, 60 Hz add \$205
- 004:** calibrated phase shifter plug-in, 400 Hz add \$165
- 005:** calibrated phase shifter plug-in, 5 kHz add \$165

8807A Options

- 001:** 50 Hz to 100 kHz signal filter N/C
- 002:** Dc plug-in N/C
- 003:** Bench top unit with power supply & portable case add \$760

8808A Options

- 001:** Bench top unit with power supply & portable case add \$760

Ordering information

- 7702B** 2-channel oscillographic recorder \$2990
- 7414A** 4-channel oscillographic recorder \$5300
- 7418A** 6 to 8-channel oscillographic recorder \$7000
- 8801A** Low gain preamplifier \$430
- 8802A** Medium gain preamplifier \$500
- 8803A** High gain preamplifier \$1000
- 8805A** Carrier preamplifier \$750
- 8805B** Carrier preamplifier with Harmonic Filter \$900
- 8806B** Phase sense demodulator preamplifier \$900
- 8807A** Ac/dc converter preamplifier \$945
- 8808A** Logarithmic preamplifier \$1000
- 8809A** Signal coupler preamplifier \$250
- 8820A** Low gain bank preamplifier \$3000
- 8821A** Medium gain bank amplifier \$3800

RECORDERS, PRINTERS & PLOTTERS

Instrumentation tape recorders, tape degausser

Models 3964A, 3968A, and 13064A

- 1/4-inch magnetic tape benefit
- Selectable FM/Direct electronics



3964A



13064A



- Eight channels or four channels
- Laboratory, field, medical applications



3968A



The instrumentation tape recorders, the 3964A, 4-channel and 3968A, 8-channel, utilizing a 1/4-inch format, are designed to meet the demands of the individual and OEM users. Versatility, portability, and durability are three important characteristics of these recorders. Excellent performance is assured in the laboratory, field, or medical environment.

These reasonably priced units are equipped with many standard features usually only found on more expensive recorders.

The 13064A Tape Degausser erases previous magnetic recordings from an entire reel of tape. Cleanly erased tape is an indispensable factor for obtaining optimum performance.

3964A/3968A standard features

"E-to-E" mode for FM recording: input signal is automatically transferred to the output when in fast forward, rewind, or stop. Simplifies recorder setup and calibration.

Tape/Tach servo: in the reproduce mode the capstan servo can be controlled either by the internal tach frequency or for maximum time base accuracy from a pre-recorded signal on one of the data channels.

Equalization: direct electronics can be optimized for a wide variety of tapes.

Remote control: multi-pin connector located at rear of instrument provides remote control and state (TTL or contact closure) for all tape speeds and operational modes.

AC/DC calibrator: provides internal AC/DC voltage source for setting up input and output levels for each of the data channels. Voltage levels and channel monitoring selected with pushbutton ease.

Flutter compensation: available with the flip of a switch. Flutter modulation introduced during the record mode is reduced providing an improvement in FM signal-to-noise ratio by up to 12 dB.

Voice capability: recorded data can be voice annotated on Channel 4 of 3964A or Channel 8 of 3969A with press-to-talk microphone.

Unipolar operation for FM recording: when a signal has a positive only or negative only deviation, the FM input reference level can be offset to plus or minus full deviation to permit full utilization of the channel's dynamic range.

Re-recording (dubbing): FM data cards can be set up for dubbing, allowing duplicate recordings to be made with minimum degradation to signal-to-noise.

3964A and 3968A specifications

Transport specifications

Tape width: 1/4 inch (6.3 mm).

Reel size: standard 7-inch (177.8 mm) plastic reel; totally enclosed by reel cover.

Heads: 3964A—one four-track record and one four-track reproduce using in-line track configuration. 3968A—one eight-track record and one eight-track reproduce. Interlaced odd-even track configuration.

Tape speeds: 15/32, 15/16, 1 1/8, 3 3/4, 7 1/2, and 15 ips.

Capstan drive: DC motor with phaselock servo.

Tape speed accuracy: ±0.2% (tach servo).

Time base error (tape servo)

Tape speeds	15	7 1/2	3 3/4	1 1/8	15/16	15/32
TBE (microsec)	±4	±5	±7.5	±15	±25	±50

Flutter

Tape speed (ips)	Pass Band (Hz)	Flutter (% p-p)	Tape speed (ips)	Pass Band (Hz)	Flutter (% p-p)
15	0.2-2500	0.35	1 1/8	0.2-312	0.50
7 1/2	0.2-1250	0.35	15/16	0.2-156	0.70
3 3/4	0.2-625	0.40	15/32	0.2-78	1.50

Tape motion controls: forward, reverse record; forward, reverse play; fast forward; fast rewind; stop; pushbutton selectable.

Start and stop times (typical)

Tape speeds	15	7 1/2	3 3/4	1 1/8	15/16	15/32
Start (sec)	3	1.50	0.90	0.50	0.50	0.50
Stop (sec)	0.30	0.30	0.30	0.30	0.30	0.30

Rewind time (typical): 1800 foot (549 m) reel in 100 seconds; 2300 foot (701m) reel in 145 seconds.

Braking: fail-safe mechanical differential brakes.

End of tape sensing: tape drive stops automatically at the end of the tape.

Reel revolution counter: 4-digit revolution counter with pushbutton reset.

FM record/reproduce specifications (using 3M-888 Tape or equivalent)

Tape Speed	Carrier Center Frequency	Passband ¹ (Hz)	Signal-to-Noise Ratio	
			3964A	3968A
15	27	DC-5000	48	46
7½	13.50	DC-2500	48	46
3¾	6.75	DC-1250	48	46
1½	3.38	DC-625	46	46
¾	1.69	DC-312	44	44
¾	0.85	DC-156	40	40

1. Frequency response over passband is ±1.0 dB referenced to 10% of upper bandedge frequency.
 2. Signal measured with carrier deviation ±40% of upper passband without flutter compensation. Output filters of reproduce amplifiers selected for constant amplitude response. May also be selected for linear phase (transient) response.

Flutter compensation: can improve signal-to-noise by up to 4 dB under static conditions and as much as 12 dB under conditions of vibration. Selected by rear panel switch.

Distortion: total harmonic distortion <1.2% @ 15 to 1½ ips, <2% @ ¾ to ¾ ips.

Linearity: ±1.0% of peak-to-peak output for best straight line through zero at ±40% deviation.

DC Drift: ±0.1% (max) of full scale output per °C.

Input level: 1 V to 30 V (peak-to-peak); continuously adjustable.

Input impedance: 100 kΩ nominal, shunted by <100 pF single-ended.

Output level: 1 to 5 V (peak-to-peak); continuously adjustable.

Output impedance: minimum load impedance 600 ohms.

Non-bias recording: available by internal jumper selection.

Direct record/reproduce specifications (using 3M-888 Tape or equivalent)

Tape Speed (ips)	Passband(±3 dB) ¹		S/N Ratio (dB) ²	
	3964A	3968A	3964A	3968A
15	70-64,000 Hz	500-64,000 Hz	38	36
7½	50-32,000 Hz	250-32,000 Hz	38	36
3¾	50-16,000 Hz	100-16,000 Hz	38	36
1½	50-8,000 Hz	100-8,000 Hz	38	36
¾	50-4,000 Hz	100-4,000 Hz	38	35
¾	50-2,010 Hz	100-2,000 Hz	37	35

1. Reference to 10% of upper bandedge.
 2. Referenced to a 500 Hz sine wave with a maximum of 1% third harmonic distortion when reproduced at 3¾ ips.

Input level: 1 V to 30 V (p-p); continuously adjustable.

Input impedance: 100 kΩ nominal, single-ended.

Output level: 0.5 to 5 V (p-p); continuously adjustable.

Output impedance: minimum load impedance 600 ohms.

Signal monitoring

Meter modes: peak AC or DC (selected by front panel switch).

Meter accuracy (peak AC mode): better than ±½ dB for signals with duty cycle of 20% or greater.

Selector: front panel pushbuttons select metered channels.

Calibrator

Signal source: pushbutton selectable internal or external signal source.

Internal signal source: peak AC and ±DC levels of 0, 1.0, 1.414, 2.5, 5.0, and 10.0 volts.

Level of accuracy: ±2% of selected voltage.

AC frequency: 500 Hz ±5%; <0.25% second or third harmonic distortion.

Voice annotation

Modes of operation: data only, voice only, or data interrupted by voice.

Microphone: dynamic, hand-held, with press to talk switch.

Record level: automatic leveling.

Monitoring: built-in speaker, headphone jack.

General specifications

Size: 3964A—400 H x 427 W x 256 mm D (15.7" x 16.8" x 10.1"). 3968A—445 H x 427 W x 256 mm D (17.5" x 16.8" x 10.1").

Weight: without inverter; 3964A—29.5 kg (65 lb). 3968A—31.3 kg (69 lb). With inverter (Opt 021): 3964A—25.0 kg (55 lb); 3968A—26.8 kg (59 lb).

Power requirements: 100, 120, 220, or 240 V, +5%, -10%, 48-440 Hz, 110 W average (except opt 009, 010, 48-66 Hz).

Temperature: storage, -40°C to 75°C; operating, 0°C to 55°C; tape limit, 10°C to 40°C.

Altitude: storage, 15,240 m (50,000 ft.); operating, 4500 m (15000 ft.).

Humidity: the system, excluding tape limitations, will operate from 10% to 95% RH (25°C to 40°C), non-condensing.

Shock: 30 g maximum (11 ms) non-operating.

Mounting: supplied with rack mounting kit for standard 19-inch equipment racks.

13064A Tape Degausser Specifications

Tape size: ¼-inch (6.33 mm) tape on reels up to 10½ inch (266 mm) in diameter.

Erase: 60 dB minimum.

Duty cycle: one minute ON—three minutes OFF.

Size: 67 H x 133 W x 171 mm D (2.6" x 5.25" x 6.75").

Weight: approximately 4.3 kg (9½ lb).

Power requirements: 115 V ac ±10%, 50-60 Hz (Opt 001). 230 V ac ±10%, 50-60 Hz (Opt 002).

Options 3964A/3968A

001: FM Record/Reproduce. Provides one FM data card. Specify number of FM channels required when ordering. **Price** add \$360

030: FM Record/Reproduce. This option provides one FM data card for medical unit only. Order option 009 or 010. Specify number of FM channels requested when ordering. **Price** add \$360

002: Direct Record/Reproduce. Provides one Direct data card. Specify number of Direct channels required when ordering. **Price** add \$330

031: Direct Record/Reproduce. Provides one Direct data card for medical unit only. Order option 009 or 010. Specify number of Direct channels required when ordering. **Price** add \$330

003: rear Input/Output Connectors. A rear panel with BNC input and output connectors for each channel and in parallel with front cover panel connectors. **Price** add \$70

004: locking knobs. Factory installed, screwdriver adjustable locking knobs ensure input level setting on a given channel(s) is not accidentally changed (four on 3964A, eight on 3968A). **Price** add \$35

005: metric speed designations. Provides metric speed designations of 38.10, 19.05, 9.52, 4.75, 2.38 and 1.19 cm/s on front panel speed selector pushbuttons. **Price** N/C

007: HP-IB Remote Control. HP-IB compatible remote control of all tape speeds and operational modes. **Price** add \$350

009: UL listed (UL standard No. 544 Safety standard for Medical and Dental equipment) includes white paint. (Not compatible with opt 001, 002, 003, 021.) **Price** \$250

010: UL listed (UL Std. No. 544 Safety Standard for Medical and Dental Equipment), standard colors. (Not compatible with opt 001, 002, 003, 021.) **Price** add \$200

021: DC-AC Inverter, operates from 12 and 28 VDC in addition to standard AC voltages. **Price** \$775

024: loop adapter. Simplifies data analysis application requiring continual replay of significant data. A tape loop from 5 to 30 feet can be accommodated by this option. **Price** add \$550

026 and 027: rack slides, which provide 90° instrumentation rotation. **Price** add \$100

Opt 026, Rack Slides for 19" racks **Price** add \$140

Opt 027, Rack Slides for HP cabinets **Price** add \$150

041: IRIG servo reference frequency. Changes standard servo reference from 27 kHz to 25 kHz at 15 ips. **Price** add \$210

070: overlap. With two 3964A or 3968A units, option provides automatic play/record commands for second recorder when first unit electronically senses tape is low. **Price** add \$30

910: extra manual. **Price** add \$30

Transit case: moisture and dustproof; vibration and shock resistant. **Price** add \$250

3964A part no. 13107A **Price** \$250

3968A part no. 13106A **Price** \$250

Ordering information

3964A 4-channel Instrumentation Tape Recorder Mainframe **Price** \$5300

3968A 8-channel Instrumentation Tape Recorder Mainframe **Price** \$6900

13064A Tape Degausser (specify Opt 001 or 002)¹ **Price** \$125

¹ 115 V ac or 230 V ac operation, respectively

RECORDERS, PRINTERS & PLOTTERS

Alphanumeric, 20 column thermal printer

Model 5150A

- Silent operation
- Optional scanner and clock
- Alphanumeric

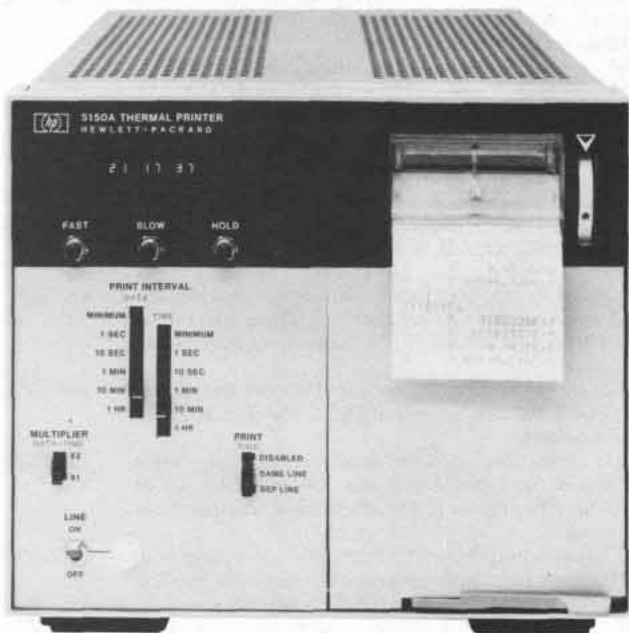

HP-IB 5150A Opt 004

General

The 5150A Thermal Printer is a versatile instrumentation printer designed to accept and record up to 20 columns of data from most HP digital instruments. Because it uses a thermal printing technique, it is extraordinarily quiet while in operation. Two input interfaces are available (one must be specified with the order) to allow data input from the HP Interface Bus (use Option 001) or from BCD-coded sources (use Option 002). Other options which add to the flexibility of this printer are the Option 003 Scanner, which can sequentially address and interrogate up to 13 instruments on the HP-IB, and the Option 004 Clock, which can be used with either the HP-IB or BCD Interfaces.

Opt 001 HP-IB interface

With Option 001 installed, the printer can accept up to 20 ASCII characters per line via the HP-IB. Inputs are interpreted according to the 64 member upper-case ASCII character set. With this interface, the printer can also serve as an "addressable listener" in a controller-based HP-IB system.

Opt 002 BCD interface

With Option 002 installed, the printer will accept 10 columns of TTL-level BCD data. Two Options 002's may be installed for 20-column print-out from one or two sources. The standard 16-member character set consists of 0 through 9, +, -, V, A, R, and [blank]. Special characters set which draw from the 64-character upper-case ASCII set may also be specified.

Opt 003 scanner

With both Options 001 and 003 installed, the printers can log data from up to 13 instruments on the HP-IB. Operation is asynchronous; that is, the printer will address the lowest address instrument, wait for data, print, then go to the next instrument.

Opt 004 clock

Used with either the HP-IB Interface or BCD Interface, this option gives the printer two additional capabilities: it can control the elapsed time between successive data printouts, and it can print the time of day immediately following each data printout. When used with the Option 003 Scanner, the clock controls the elapsed time between the initiation of successive scans.

Specifications

Character printer: 5 x 7 dot matrix.

Printing rate: 3 lines per second.

Line spacing: approximately 2.5 lines per cm. (6 lines per inch).

Paper advance mechanism: direct drive, stepping motor.

Paper: thermal sensitive, in rolls (one roll supplied).

Operating environment: 0°C to 50°C temperature; 95% relative humidity.

Power: 100, 120, 220, or 240 volts, 48 to 440 Hz (50 or 60 Hz only for Opt 004), 100 VA.

Dimensions: half-rack module, 178 mm H x 216 mm W x 356 mm D (7" x 8½" x 14¼").

Weight: approx. 7 kg (16 lb) (5150A +1 option).

HP-IB interface (Opt 001)

Columns: 20.

Printed character set: 64 ASCII characters (columns 2, 3, 4, and 5 of ANSI X3.4-1968, except "I" in column 5, row 14).

Input Logic Levels: TTL (low <0.4 V, high >2.5 V).

Data format: byte-serial with storage, compatible with HP-IB.

Inhibit (output): holds NRFD line of HP Interface Bus low following receipt of either CR or LF (selectable) until print is completed. This interval is approx. 250 ms minimum, or the duration of Option 004 Clock data print interval with clock in Hold mode.

BCD interface (Opt 002)

Columns: 10 (20 columns with two Options 002's installed).

Character set: 0 through 9, +, -, V, A, R, and [blank].

Input logic levels: TTL (low <0.4 V, high >2.5 V).

Data format: parallel BCD (8421); switch selects + or - true logic.

Print command: pos. or neg. TTL transition; 2 kΩ input impedance.

Inhibit (output): + or -, same levels as above; remains at true level until print is completed (approx. 250 ms minimum) or during Option 004 Clock data print interval with clock in Hold mode.

Scanner (Opt 003)

Instruments scanned: 1 to 13.

Cycle time of scan: limited by the slowest of (a) response of instruments scanned, (b) 3 samples per second, or (c) Data Print Interval setting on Option 004 Clock.

Compatibility: HP Interface Bus (utilizes ASCII code).

Identifier: labels data line of each instrument with letters A-M.

Protect feature: bypasses non-responding instrument after 3 sec.

Clock (Opt 004)

Data print interval: selectable by front panel switches: minimum, 1 s, 2 s, 10 s, 20 s, 1 min, 2 min, 10 min, 20 min, 1 hr, 2 hrs. Print interval will be that of input device if it is slower than the selected interval.

Time print interval: selectable by front panel switch, same intervals as above (intervals shorter than data interval prevented).

Time print format: selectable by front panel switch: disabled, same as data, or separate line from data.

Display: six-digit, seven-segment LED display of hours, minutes, seconds (00:00:00 to 23:59:59); settable via front panel switches.

Time base: line frequency (50 or 60 Hz, selectable by jumper).

Operating supplies/accessories

	Price
562A-16C General purpose BCD Interface Cable	\$85
9281-0401 Roll of paper, 76 metres (box of six)	\$2.20
05150-60002 HP-IB Interface Kit	\$220
05150-60005 BCD Interface Kit	\$135
05150-60008 Scanner Kit	\$275
10533A BCD Interface Cable for 5300A	\$225
10631A Interface Bus Cable, 1 metre	\$60
10631B Interface Bus Cable, 2 metres	\$65
10631C Interface Bus Cable, 4 metres	\$75
10631D Interface Bus Cable, .5 metre	\$60

Options

001: HP-IB Interface	add \$250
002: BCD Interface	add \$125
003: Scanner	add \$250
004: Clock	add \$350
005: BCD Interface Cable (562A-16C)	add \$85
910: Extra manual	add \$15

5150A Thermal Printer

\$900

- 10 lines/sec.
- 10 columns of data
- 4-line ± 8421 BCD

- TTL logic levels
- Ink or pressure sensitive printing

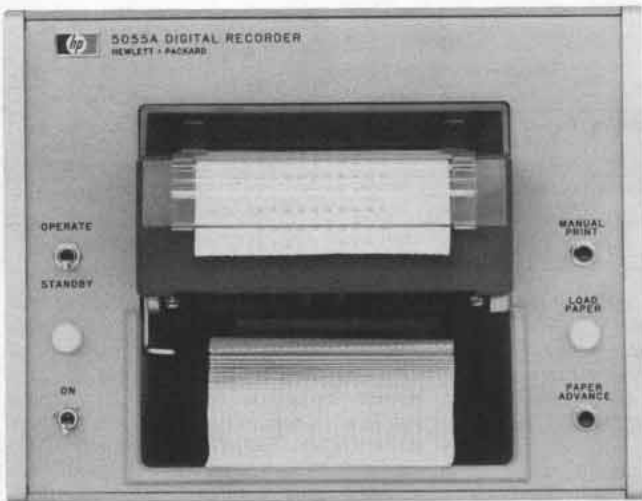

5055A

Description

General

The Hewlett-Packard Model 5055A Digital Recorder provides a high-performance economical method of making a permanent record of digital data. It prints up to 10 columns of data from 4-line BCD data sources at rates up to 10 lines/sec. Printing is asynchronous; i.e. the print cycle starts the instant the external print command is received and requires only 100 ms under any condition. The 203mm (8") cabinet width allows for either bench use or side-by-side rack mounting, using the HP Adapter Frame, 5060-0797. The codes offered are ± 8421 , selectable by a rear panel switch. Each column has an individual print wheel with 16 characters—10 numeric and 6 non-numeric. Special wheels can be ordered at minimal cost. The 5055A is supplied ready to print 10 columns of data and accepts TTL compatible integrated circuit logic levels. Leading zeros are suppressed when the printer is used with HP instruments which have blanking.

Reliability

Reliability is enhanced by design simplicity; i.e. there are an unusually small number of moving parts in the printer. The printer mechanism, manufactured by Hewlett-Packard, is a modified version of a mechanism whose reliability and serviceability has been demonstrated in other HP printers for many years.

Ink or pressure sensitive printing

The 5055A prints in ink on regular paper or on pressure sensitive paper. For ink printing, the mechanism includes a continuously rotating ink roller—inherently more reliable than a start-stop ribbon mechanism. Paper loading is easy from the front, and when the paper runs out an alarm lamp lights and recording stops automatically. An output signal is provided for inhibiting the data source.

Versatile

Each column has an individual print wheel which can be changed independently of the other 9 wheels if a different character set is desired. This can apply to as many columns as desired. Special print wheels can be factory installed or may be field installed at a later date. Both can be done at a nominal cost.

Specifications

Printing

Accuracy: identical to input device used.

Print cycle time: 100 ms.

Printing rate: 10 lines/sec maximum, asynchronous.

Line spacing: fixed, 1.6 to 2 lines per cm (4 to 5 lines per inch).

Printing: ink roller or pressure sensitive paper. Pressure sensitive paper is recommended for operation under extreme temperature.

Print wheels: 16 positions, numerals 0 to 9, +, -, V, A, Ω , *; special wheels available.

Column capacity: supplied complete for 10-column operation.

Electrical

Data input: parallel entry, BCD ± 8421 (selected by rear panel switch).

Blanking: Hewlett-Packard counters with blanking will give insignificant zero suppression when blanked digits output is (1111). May be defeated with rear panel switch.

Logic levels: high state $\geq +2.4$ V, +5 V maximum (open input line results in high state); low state $\leq +0.4$ V (1.6 mA max., low), 0 V minimum.

Print command: line 1-low to high transition causes print (nominal 1k Ω input impedance). Line 2-high to low transition causes print (nominal 400 Ω input impedance). Voltage levels are same as logic levels above, and a minimum pulse width of 0.5 μ s is required.

Inhibit voltage: (+) inhibit = transition from ($\geq 0, \leq 0.4$ V) to (≥ 2.4 V, ≤ 5.0 V) upon receipt of print command. Remains at high state until paper advance occurs, approximately 85 ms (< 5 mA in low state). (-) inhibit = inverse of (+) inhibit.

General

Operating temperature: 0°C to +50°C with pressure sensitive paper, +10°C to +40°C with ink roller.

Input connector: Amphenol 57-40500-375, HP Part No. 1251-0087, 50-pin female. Mating input cable connector: Amphenol 57-30500-375, HP Part No. 1251-0086, 50-pin male.

Front panel controls: power switch, power on indicator light, manual print pushbutton, manual paper advance pushbutton, out-of-paper light, standby/operate switch. (Paper loaded from front.)

Power: 115 or 230 V $\pm 10\%$, 60 or 50 Hz (two-speed motor pulley incorporated), approx. 25 W idle, 55 W at 10 lines/sec.

Dimensions: cabinet: 154 mm H x 203 mm W x 406 mm D (6 $\frac{3}{32}$ " x 8" x 16").

Weight: net, 10 kg approx. (18 $\frac{1}{2}$ lb). Shipping, 8.9 kg (22 lb).

Operating supplies/accessories

	Price
9260-0071 Ink roller (black)	\$16.50
9281-0386 Standard paper 76 metre (250') pad	\$2.50
9281-0387 Pressure sensitive paper 93 metre (305') pad	\$4.50
5060-0797 Rack adapter frame	\$55
10533A Interface Cable for 5300A	\$225

Options

001: 50 Hz operation	N/C
002: 562-16C input cable interconnects with 3450B, 3480C/D, 5326A/B/C, and 8443A	add \$85

\$2100

5055A Digital Recorder

Supplied with ink roller (9260-0071), one pad standard paper (9281-0386) and one pad pressure sensitive paper (9281-0387). Each pad provides two loadings of recorder.

Hewlett-Packard offers frequency standards and clocks which provide accurate frequency, time interval and timekeeping capabilities. Further, Hewlett-Packard standards provide means for comparing these quantities against national standards such as the National Bureau of Standards (NBS) and the U.S. Naval Observatory. Units of frequency or time cannot be kept in a vault for ready reference. They must be generated for each use, hence be regularly compared against recognized primary standards.

Frequency standard and clock systems manufactured by Hewlett-Packard are used for control and calibration at observatories, national centers for measurement standards, physical research laboratories, missile and satellite tracking stations, communication systems, radio navigation systems, manufacturing plants and radio monitoring and transmitting stations.

Types of frequency standards

At the present time, three types of frequency standards are in common use. These are:

1. The cesium atomic beam controlled oscillator.
2. The rubidium gas cell controlled oscillator, and
3. The quartz crystal oscillator.

Hewlett-Packard is the only manufacturer of all three types of frequency standards. Of these three standards, the first is a primary frequency standard and the last two are secondary frequency standards. The distinction between a primary standard and a secondary standard is that the primary standard does not require any other reference for calibration; whereas the secondary standard requires calibrations both during manufacturing and at intervals during use depending on the accuracy desired.

Cesium beam frequency standard

Cesium beam standards are in use wherever the goal is a very high accuracy primary frequency standard. In fact, the NBS frequency standard itself is of the cesium beam type. The cesium beam standard is an atomic resonance device which provides access to one of nature's invariant frequencies in accord with the principles of quantum mechanics. The cesium standard is a true primary standard and requires no other reference for calibration.

The HP Model 5061A and the newer 5062C are portable cesium beam standards proved capable of realizing the cesium transition frequency approaching levels of accuracy and long term stability achieved by large-scale laboratory models. Recent beam tube improvements have made the short-

TABLE 1

Comparison of Frequency Standards

Standard	Principal construction feature	Principal advantage
Cesium Atomic Beam Resonator Controlled Oscillator.	Beam of free Cesium atoms, spatially state selected, is subjected to a microwave signal at resonance frequency.	High intrinsic reproducibility and long-term stability. Designated as primary standard for definition of time interval.
Rubidium Gas Cell Resonator Controlled Oscillator.	Gas buffered resonance cell with optically pumped state selection.	Compact and light weight. High degree of short-term stability.
Quartz Crystal Oscillator.	Piezoelectrically active quartz crystal with electronic stabilization.	Very compact, light and rugged. Inexpensive.

term stability comparable to that of the rubidium frequency standard. With this improved performance cesium standards now have the capability of rapid measurement to high precision along with the excellent long term stability necessary for timekeeping.

Rubidium frequency standard

Rubidium frequency standards feature a high order of both short-term and long-term frequency stability. These are both important in certain fields such as deep-space communications, satellite ranging, and doppler radar.

Rubidium standards are similar to cesium beam standards in that an atomic resonant element prevents drift of a quartz oscillator through a frequency lock loop. Yet the rubidium gas cell is dependent upon gas mixture and gas pressure in the cell. It must be calibrated and then it is subject to a small degree of drift. The drift is typically 100 times less than the best quartz crystal standard.

Quartz crystal oscillators

Quartz oscillators are used in virtually every frequency control application including atomic standards. The excellent short-term stability and spectral purity of the quartz oscillators used in Hewlett-Packard atomic standards contribute to the high quality of the output signal of these standards. For less demanding applications where some long-term drift can be tolerated, quartz oscillators are used as independent frequency sources. The quartz oscillator designs have improved over the years to provide a relatively low cost, small-size source of frequency.

However, an inherent characteristic of crystal oscillators is that their resonant frequency changes with time. After an initial aging period of a few days to a month, the rate-of-change of frequency, or aging rate, is almost constant. Over a long period the accumulated drift could amount to a serious error, and periodic frequency checks are needed to maintain an accurate quartz crystal frequency standard.

Stability

Stability is specified in two ways. Long term stability refers to slow changes in the

average frequency with time due to secular changes in the resonator and is usually expressed as a ratio, $\Delta f/f$ for a given period of time. For quartz oscillators this is often termed "aging rate" and specified in "parts per day." Rubidium standards being more stable are specified in "parts per month." On the other hand, cesium beam standards are primary units with no systematic drift. Therefore, the frequency of these primary standards is guaranteed to a specified accuracy.

Short-term stability refers to changes in frequency over a time sufficiently short so that change in frequency due to long term effects is negligible.

Since short-term stability is a very broad term, it may refer to a number of different measurement methods and types of instability. In order to be clear when testing or specifying frequency standards, there are two classes of variations and two classes of measurement methods to be considered. The two classes of frequency variation are random, and non-random (or systematic, periodic, discrete, secular). The two classes of measurement are time domain (example: two sample deviation) and frequency domain (example: spectral density). Each of these measurement methods responds to both random and non-random variations.

Time domain

The subcommittee on Frequency Stability of the Technical Committee on Frequency and Time of the IEEE Group on Instrumentation and Measurement* has established a standard method of measuring frequency stability in the time domain as the rms of the differences between adjacent pairs of frequency measurements, normalized, called the two-sample-deviation (also square root of Allan variance). Figure 1 is a comparison of the two-sample-deviation of various frequency standards.

Frequency domain

In a frequency domain measurement, the spectrum of phase or frequency variations can be plotted, hence the term, spectral purity.

*Barnes et al, (May 1971) IEEE Trans. on Inst. & Meas. Vol. 1M-20, 1

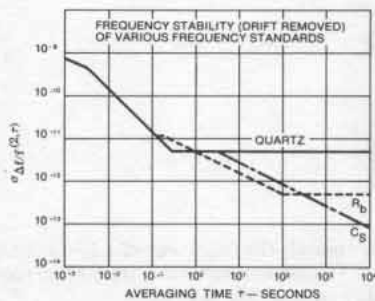

Figure 1. Time Domain stability of various standards.

Spectral purity is the degree to which a signal is coherent, or, expressed in another way, a single frequency with a minimum of sideband noise power. It is very desirable to have high spectral purity in a standard signal. This is especially important in applications where the standard frequency is multiplied to very high or microwave frequencies (so that the frequency spectrum of the multiplied signal will be reasonably narrow).

The signal and its frequency spectrum are analogous to a frequency modulated wave where the total power is constant. If the frequency multiplying device is broadband, the ratio of the total sideband power to the signal power increases as the square of the multiplying factor. With frequency multiplication the signal-to-noise ratio will be degraded 6 dB per octave and 20 dB per decade.

Frequency Domain measurements respond to both random and non-random variations, but in many cases, the effects are more readily separated and identified. For example, clearly separate measurements can be made of white noise combined with discrete spectral components ("bright lines").

The recommended specifications for the frequency domain are S_V and S_ϕ . The widely used \mathcal{L} or single-sideband phase-noise-to-signal-ratio is, for low modulation index, one half of S_ϕ (or $\mathcal{L}(f) \sim S_\phi(f) - 3$ dB).

Hewlett-Packard oscillators are designed to give high spectral purity. Figure 2 shows the performance of the HP 5061A, Opt. 004 Cesium Beam Atomic Frequency Standard.

Frequency standards and clocks

Frequency standards and clocks have no

fundamental differences—they are based upon dual aspects of the same phenomenon. Time and frequency are intangible quantities which can be measured only with respect to some physical quantity. The basic unit of time, the second, is defined as the duration of 9,192,631,770 periods of transition within the cesium atom. Conversely an unknown frequency is determined by counting the number of cycles over the period of a second. The Master Clock at the U.S. Naval Observatory, one of the world's most accurate clocks, is made of an ensemble of more than a dozen Hewlett-Packard cesium beam frequency standards. The USNO directly controls the distribution of precise time and time interval (frequency) from Naval radio stations, Loran-C (operated by U.S. Coast Guard), Omega and Satellite Navigation Systems. Hewlett-Packard portable cesium standards, "flying clocks," are used to periodically check the synchronization between these stations and the Master Clock.

Hewlett-Packard cesium beam standards are widely used to drive precision clocks because of the extremely good long-term stability and reliability of this primary standard. If a quartz oscillator or other secondary standard is used, it must be evaluated for rate of drift and be corrected periodically.

Time scale

The time interval of the atomic time scale is the International Second, defined in October 1967 by the Thirteenth General Conference of Weight and Measures. Since January 1972 the frequency offset between UTC and Atomic Time has been zero and the UTC time scale is kept in synchronism with the rotation of the earth to within ± 0.9 second by step-time adjustments of exactly 1 second, when needed.

The U.S. National Bureau of Standards (NBS) and USNO provide the official basis for Standard Time for the United States. The UTC signal is broadcast from the NBS stations WWV and WWVB and by several other stations throughout the world. (See Hewlett-Packard Application Note 52-1, Fundamentals of Time and Frequency Standards, for a list of stations broadcasting time signals).

Standby power supplies

Minimum down-time, important for any system, is vital to a time standard. Its worth depends directly on continuity of operation. Noninterrupted operation is also important to ultra-precise quartz oscillators.

Hewlett-Packard standby power supplies ensure continued operation despite line interruptions, and operate over a range of ac line voltage to supply regulated dc to operate frequency standards and frequency dividers and clocks. The batteries in the supplies assume the full load immediately when ac power fails.

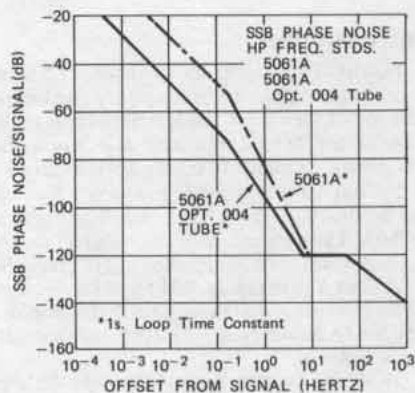

Figure 2. 5062C Phase Noise

Hewlett-Packard time and frequency standard

The Hewlett-Packard House Standard at the Santa Clara Division consists of an ensemble of four Hewlett-Packard Cesium Beam Standards each with the Option 004 High Performance Tube.

The standard is compared to the U.S. Naval Observatory Master Clock in Washington, D.C. by means of Loran C and TV Line 10 measurements through the USASTRATCOM satellite system. It is also compared with the U.S. National Bureau of Standards Frequency Standard (NBS FS) at Boulder, Colorado by means of Loran-C through the Naval Observatory. The frequency uncertainty of the standard is within a few parts in 10^{13} with respect to the standards maintained by the NBS and the USNO.

Time is maintained relative to the Naval Observatory and the National Bureau of Standards master clocks to an accuracy of better than ± 2.5 microseconds. This accuracy is verified with flying clock trips from the Naval Observatory to both Hewlett-Packard Santa Clara Division and Hewlett-Packard Geneva. Both locations have been designated U.S. Naval Observatory Time Reference Stations.

FREQUENCY & TIME STANDARDS

Atomic frequency standards

Models 5061A, 5062C, 5065A

5061A

- Primary standard, $\pm 1 \times 10^{-11}$ accuracy
- Proven reliability
- World-wide usage 5061A, Opt 004

5061A, Opt 004

- Accuracy $\pm 7 \times 10^{-12}$
- Settability $\pm 1 \times 10^{-13}$
- Short term 5×10^{-12} (1 sec avg)



5061A

Introduction

Hewlett-Packard Atomic Frequency Standards have become the world-wide standards for frequency and time keeping since the introduction of the 5060A Cesium Standards in 1964. With the introduction of the 5062C, the user now has a choice of four different frequency standards to satisfy a wide variety of applications:

1) 5061A Cesium Beam Frequency Standard. This standard with an accuracy of $\pm 1 \times 10^{-11}$ was introduced in 1967 to replace the 5060A. The high accuracy and excellent reliability of these units have gained world-wide acceptance of HP frequency standards.

2) 5061A with Option 004 High Performance Cesium Beam Tube. With the unique design features in this improved Cesium Beam Tube, the 5061A accuracy is $\pm 7 \times 10^{-12}$ and short term stability is improved by a factor of 10.

3) 5062C Cesium Beam Frequency Reference. This unit with its small cesium beam tube is designed for on-line system applications where a rugged primary standard is required.

4) 5065A Rubidium Frequency Standard. This instrument features excellent long and short term stability performance at approximately one-half the cost of a cesium standard.

The units are described in detail on the following pages and the specifications are combined in a table to facilitate the comparison and selection of the best unit to suit the user's application.

Principles of operation

The basic block diagram of both cesium and rubidium standards is the same (see Figure 1). The output of the 5 MHz crystal oscillator

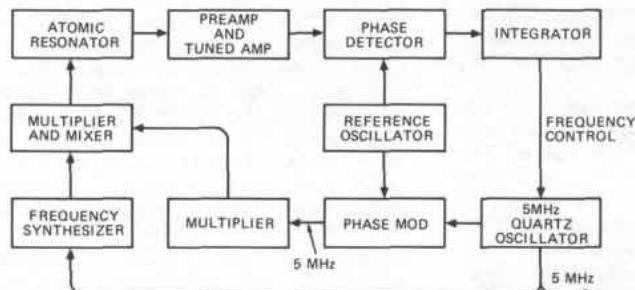

Figure 1. Block diagram of atomic frequency standards.

is multiplied and synthesized to the atomic resonance frequency (6834+ MHz for rubidium and 9192+ MHz for cesium). The signal is frequency modulated to sweep through the atomic resonance frequency causing the beam intensity in the cesium tube or transmitted light through the rubidium cell to vary. The output signal is amplified

and through a phase detector controls the frequency of a low noise 5 MHz quartz crystal oscillator. The oscillator provides the 5 MHz output. Dividers produce 1 MHz and 100 kHz outputs.

The invariant resonance frequency of the cesium atoms passing through the microwave cavity maintain the output frequency of the cesium standard constant to extremely high accuracy. The accuracy is in part a function of the microwave cavity length and is highest in the 5061A with the long cavity of the high performance beam tube.

In the rubidium standard a buffer gas is required to reduce collisions between the rubidium atoms in the gas cell and the resonant frequency varies slightly with the pressure of the buffer gas. As a result, the rubidium standard has to be calibrated and the frequency drifts slowly with time because of small changes in gas pressure and other effects within the rubidium cell and lamp. Offsetting this disadvantage are: 1) high signal-to-noise ratio of the rubidium cell output which results in excellent short term stability and; 2) a lower cost standard because of the simpler rubidium cell and associated electronics.

Each of the instruments has front panel controls, a circuit check switch and meter for monitoring performance. These and other controls are protected by a panel door. Front panel lights indicate any interruption of continuous operation and that the crystal oscillator is locked to the atomic resonance.

Applications: starting with their initial usage as reference standards in national laboratories the applications of HP atomic standards have expanded to include use in operational systems such as the Loran C and Omega navigation transmitters, satellite tracking and guidance stations, very long base line interferometers, navigation receivers based on direct distance measurement (Loran Rho-Rho), geophysical survey positioning systems and communications systems. Precise timing for frequency control is required for some secure communications systems and to improve efficiency of PCM and spread spectrum systems.

Cesium standard accuracy: the cesium beam standard is a primary frequency standard. A cesium beam tube carefully constructed along with the required supporting electronics will, when independently aligned, put out the correct frequency within very narrow limits. The frequency spread of the output for over 250 independently aligned 5061A standards with the standard beam tube is shown in Figure 2. It can be seen from this data that the frequency perturbations in the standard beam tube are so small that all the units are within $\pm 5 \times 10^{-12}$ of each other and of NBS frequency. The one sigma standard deviation is 1×10^{-12} between units. This performance is intrinsic to the 5061A and is achieved without calibration. The absolute accuracy, intrinsic reproducibility and absence of any perceptible long-term drift or aging are important advantages of cesium standards and assure that the output frequency of a cesium standard is always within the specific accuracy.



E21-5061A

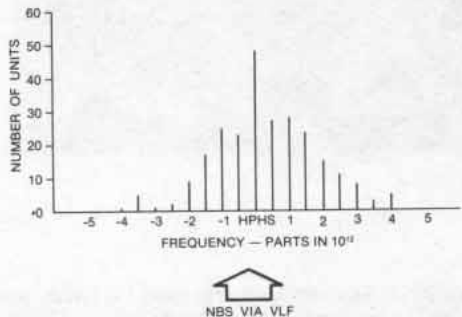

Figure 2. Frequency of independently aligned 5061A Cesium Beam Standards with standard beam tube.

5061A Cesium Beam Standard

The first Hewlett-Packard Cesium Beam Standard, the 5060A, was introduced in 1964. This was followed in 1967 with the improved 5061A and in 1973 with the high performance beam tube option for the 5061A. Since this time the accuracy and reliability of Hewlett-Packard cesium beam standards has been demonstrated and these standards have become the world-wide standard for frequency and time keeping. The 5061A has provision for an optional digital divider and reliable, easy-to-read LED clock (Option 001) and for a battery with ½ hour standby power capacity with automatic charging (Option 002).

Reliability and Warranty: over 60 million operation hours have proven the performance and reliability of Hewlett-Packard cesium beam standards in various world-wide applications. The units have provided dependable microsecond accuracy in aircraft, ship and fixed environments.

A three-year warranty on the 5061A and the standard cesium beam tube is provided as a result of proven field reliability over an extended period. This warranty includes replacement of the cesium beam tube if it should fail within the warranty period. Typically, beam tube life has been in excess of four years.

5061A with Opt 004, High Performance Cesium Beam Tube

The Hewlett-Packard Model 5061A primary frequency standard with the Option 004 Cesium Beam Tube offers increased stability and accuracy in the instrument which has become the worldwide standard of frequency and time keeping since its introduction in 1967. Improvements in magnetic shielding, ruggedization and environmental performance permit improved performance and expansion of navigation and communication systems that have been made practical by the 5061A.

The design concept of the high performance beam tube includes unique HP designed dual beam optics with higher beam intensity to accomplish better short term stability and greater immunity to effects of shock and vibration. A 50 percent increase in resonance cavity length without change in the overall beam tube size contributes to better accuracy and settability because of the high Q of the narrower resonant line width. This tube retains the unique cesium standard feature of virtually no long term instability or aging.

The intrinsic accuracy is improved to $\pm 7 \times 10^{-12}$ which provides an excellent reference standard without need of calibration. If desired, as in many timekeeping applications, two or more units may be calibrated to determine the difference in rate or may be adjusted to the same frequency. With the improved settability specifications of 1×10^{-13} small changes in frequency are accomplished rapidly and accurately. A provision for degaussing the tube without adversely affecting the instrument operation allows removal of any residual magnetic field in the tube. This is important in achieving the settability performance.

The short term stability specification is improved by a factor of ten with the new tube. The 5×10^{-12} (1 sec avg.) performance compares very favorably with that of rubidium type standards which are noted for their excellent short term stability. An important advantage from the better short term stability is the capability to make measurements to 1 sigma precision of 1×10^{-12} in about one minute compared to the two hours required previously. The 5061A with the Option 004 High Performance Tube has the same high reliability as the 5061A with the standard tube. The new high performance tube is warranted for 14 months (10,000 hours) and is designed to have the same long life as the standard tube.

10653B/C Retrofit kit

The high performance beam tube may be installed in place of the standard tube in existing HP 5061A Cesium Standards. The 10653B/C Kit includes the new tube and the parts necessary for installation. Further information on the 10653B/C Retrofit Kit is available from HP Sales Offices.

10638 Degausser

The Model 10638A Degausser is designed for use with the Option 004 High Performance Beam Tube to achieve settability of $\pm 1 \times 10^{-13}$ and reproducibility of $\pm 3 \times 10^{-12}$. The degausser removes residual magnetic fields in the beam tube which slowly decay and cause a small frequency change. The degausser should be used when initially setting up the 5061A with Option 004 or after the instrument has been moved or adjusted.

10810A/B LED Clock Kit

The LED clock readout is available as a retrofit kit to replace the mechanical clock used in earlier models of the 5061A and in the 5065A Rubidium Standard.

E21-5061A Flying Clock

The E21-5061A consists of a 5061A Cesium Beam Standard with Option 001 LED Clock and K02-5060A Power Supply joined together to make one portable unit. The power supply, which can be operated from 6 or 12 V dc, 24 to 30 V dc, or 115/230 V $\pm 10\%$, 50 to 400 Hz, will provide approximately 7 hours standby power (from sealed nickel-cadmium batteries) for the 5061A Cesium Beam Standard.

This wide range of operating power capabilities enable the E21-5061A to operate on local power in virtually any country in the world. Operation is approved aboard commercial aircraft. The seven hours standby capability make it possible to travel where there is no power available and, of course, allow the E21-5061A to conveniently be transported between power sources and operated in almost any air or surface vehicle as a "flying clock" (see Hewlett-Packard Journal, August 1966 and December 1967).

The Option 004 tube, because of the improved shielding, offers a significant increase in accuracy under the varying earth's magnetic field conditions experienced by flying clocks and is a desirable addition to the E21-5061A. In addition, the better short term stability permits more accurate and rapid comparison of standards. The Option 002 Battery may also be added to increase standby capability.

FREQUENCY & TIME STANDARDS

Atomic frequency standards

Models 5061A, 5062C, 5065A (cont.)

- Primary frequency/time reference
- Fast warm-up
- Rugged, reliable

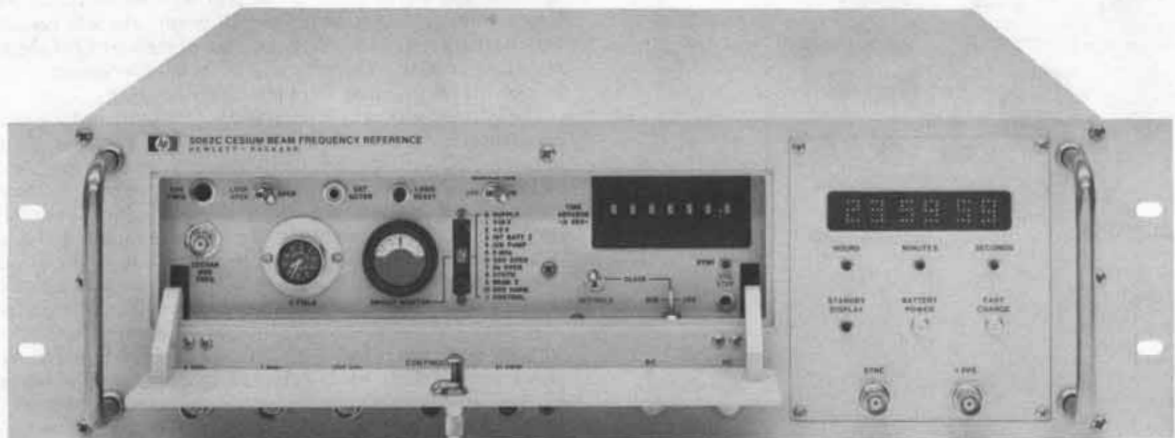

5062C

5062C Cesium Beam Frequency Reference

The Model 5062C Cesium Beam Frequency Reference is a rugged and compact precision oscillator designed for use in surface and airborne systems such as shipboard navigation systems and air transport communication systems. It combines the precision of a laboratory primary standard with the rugged, compact features required for on-line system operations in the extreme environments sometimes encountered in ships and aircraft.

Features important for system operation are the expanded operating temperature range (-28°C to $+65^{\circ}\text{C}$), 20 minute warm-up, frequency accuracy of within ± 3 parts in 10^{11} (including temperature and magnetic field effects) with negligible long-term drift and no need for calibration.

The basic design of the Model 5062C is patterned after that of the Hewlett-Packard Model 5060A and the 5061A Cesium Beam Clocks, but this rugged unit is 25% smaller in size. Yet, space is provided for an optional clock and standby batteries. Other features such as special output frequencies or a time code generator may be added. The key to the smaller size is a small, rugged cesium beam tube. This tube, approximately six inches long and four inches diameter, includes all the features of the sixteen inch tube used in the HP 5061A to insure high accuracy and stability plus long life. In addition, multiple cesium beams assure accuracy under the shock, vibration and acceleration encountered in operating systems.

Compact electronics compliment the small beam tube in accomplishing the 5062C design. Plug-in keyed printed circuit cards assure ease of maintenance. Particular attention has been given to both the electronics and mechanical design to the temperature, shock and vibration encountered in system applications. The resulting rugged design assures stable operation under extreme environmental conditions. The 5062C meets many of the requirements of MIL-E-16400 specification for ship and shore equipment. These include the wide operating temperature range, the 400 pound hammer blow specified by MIL-S-901 and the Type I shipboard vibration of MIL-STD-167-1 (4–50 Hz).

With minor circuit additions the rugged, commercial, design of the 5062C meets the operating requirements of military specification MIL-F-28811 (EC). The nomenclature, 0-1695/U has been assigned to this version of the instrument which is identified as the 5062C, Option 010. The added features are described below.

Reliability: the unit incorporates conservatively designed circuits to

insure reliability. Similar designs in the 5061A Cesium Beam Standard have demonstrated mean time between failures (MTBF) in excess of 40,000 hours in laboratory environments.

Ease of maintenance was included along with reliability and ruggedness as design goals of the 5062C. The front panel circuit monitoring switch and meter permit checks for proper operation and monitoring of critical functions. In the event of a malfunction, troubleshooting is simplified by well marked test points on the circuit cards and mother boards. Board extenders permit access to individual boards while operating. The circuit boards are keyed to assure that they are properly located. The few board adjustments are readily accessible when the instrument covers are removed. The 5062C is supplied with pivot slides for easy access when the unit is rack mounted. All these features simplify troubleshooting and minimize mean time to repair (MTTR) in the event of failure.

Options: the 5062C is designed to include clock and battery options and space is available to add other features required to meet systems requirements. Special output frequencies, time code generators, and additional buffered outputs may be added. The following standard options are available.

Option 001 Digital Clock: this option adds a front panel LED display of hour, minutes and seconds. A digital divider generates one pulse-per-second from 5 MHz. This master pulse may be synchronized to a reference pulse. The digital clock and the clock 1 PPS are adjustable in phase with respect to the master pulse in 0.1 microsecond steps.

Option 002 Standby Battery: the sealed gelled-electrolyte battery provides a minimum of one hour standby at 25°C after full charge. The battery is automatically recharged after use. When external power fails, the standby battery assures continuous output without interruption.

Option 003 Digital Clock and Standby Battery: this option combines Option 001 and 002.

Option 010 Time-code Generator: this option includes the Option 001 Digital Clock and Option 002 Standby Battery along with other special features required to meet the operating requirements of the 0-1695/U Frequency Standard, Cesium Beam in accordance with Military Specification MIL-F-28811(EC). These include a time code generator, four one-pulse-per-minute outputs, additional 5 MHz outputs, added RFI shielding and special rear panel and mating connectors. The rugged design of the 5062C meets the environmental requirements of the military specification.

- Compact, low-price atomic standard
- Long term drift rate $<1 \times 10^{-11}/\text{mo}$
- Short term stability $<5 \times 10^{-13}$ (100 sec avg)



5065A Rubidium frequency standard

The HP Model 5065A is an atomic-type secondary frequency standard which uses a rubidium vapor resonance cell as the stabilizing element. As a result, it has long term stability of better than 1×10^{-11} per month which exceeds that of high quality quartz oscillator frequency standards by 50 to 100 times. Furthermore, it has excellent short term stability. These features contribute to its desirability as a coherent signal source, as a master oscillator for radio and radar systems where special requirements for stability and/or narrow bandwidth must be met, as a precision time keeper where the better performance of a cesium beam primary standard is not required, and as a house frequency standard for improved accuracy with fewer NBS calibrations compared to that required with quartz standards.

Front panel controls and circuit check meter of the 5065A are protected by a panel door. The magnetic field control provides fine frequency adjustment with which the frequency can be set to a precision of better than 2×10^{-12} without reference to a chart. The 5 MHz low noise quartz oscillator is phase locked to the atomic frequency and provides the standard 5 MHz, 1 MHz, and 100 kHz outputs. The circuit check meter with selector switch monitors key voltages and currents for routine maintenance readings, calibration procedures, and fault finding.

The 5065A is designed for assured operation—to give the user confidence that the standard output signals are correct and locked to the atomic frequency. Logic within the unit maintains power to a “continuous” operation light on the front panel. If operation is interrupted, even momentarily, for any reason the light goes out and stays out until manually reset. An integrator limit light warns when the frequency correcting servo loop is approaching the limit of its dynamic range.

The HP Model 5065A is contained in a small sized package and is lightweight in comparison to a cesium beam standard. Additionally the rubidium resonance cell is much more frequency stable than quartz oscillators while subjected to shock and vibration, EMC, humidity, and magnetic field effects.

Reliability and warranty: the most significant module in the HP 5065A in terms of performance is the Rubidium Vapor Frequency Reference (RVFR). This temperature controlled, magnetically shielded unit includes the Rb gas cell and a photo sensitive detector designed for maximum possible reliability. Field experience, includ-

ing several million hours of operation, have demonstrated this reliability and the module is now warranted for a period of three years. This increased warranty protects the owner in the event of random failure.

The Option 001 Digital Clock has an easy to read LED time-of-day display. The olive black upper panel provides a dark background around the readout for excellent contrast and readability. Initial clock setting is accomplished by means of pushbuttons easily accessible by removing the top cover. The LED display offers high reliability, freedom from errors due to mechanical shock, and performance over the full environmental range of the 5065A. A sync button on the digital divider permits automatic synchronization of this 1 PPS pulse to an external pulse. The clock 1 PPS is adjustable in decade steps from $1 \mu\text{s}$ to 1 s, with respect to the synchronized reference, with 6 thumbwheel switches. A screwdriver adjustment allows fine continuous adjustment over a range of $1 \mu\text{sec}$.

To conserve battery power, the display is not illuminated when ac power is not available. A STANDBY READ pushbutton below the display is used for readout when operating on the internal battery or external dc.

The LED clock readout is available as a retrofit kit, HP Model 10810A/B, to replace the mechanical clock in earlier models of the 5065A. Contact your Hewlett-Packard sales office for full details.

The Option 002 Standby Battery provides the 5065A with a minimum of 10 minutes standby power at 25°C . Switchover from line to battery is automatic so there is no interruption of operation if ac line power should fail. A front panel ac interruption light warns when ac power has failed or has been disconnected. Fast or float charging rates may be selected when ac power is available.

The Option 003 combines the Option 001 Clock and Option 002 Battery and should be specified if both Options 001 and 002 are required.

E21-5065A Portable time standard

E21-5065A Portable Time Standard is a complete system for precision timekeeping and for transporting time from one location to another. It consists of the 5065A Rubidium Standard with digital clock and divider (Option 001) and the K02-5060A Power Supply with 6 or more hours standby capability. The component units are held together by side bars, and the interconnecting cables are protected by a back cover.

FREQUENCY & TIME STANDARDS

Atomic frequency standards

Models 5061A, 5062C, 5065A (cont.)

Specifications

Instrument:	5061A Option 004	5061A	5062C	5065A	
Type of Standard:	Cesium	Cesium	Cesium	Rubidium	
Accuracy: maintained in magnetic field to 2 gauss and over temperature range of:	$\pm 7 \times 10^{-12}$ 0 to 50°C	$\pm 1 \times 10^{-11}$ 0 to 50°C	$\pm 3 \times 10^{-11}$ -28°C to +65°C		
Stability:					
Long Term:	$\pm 3 \times 10^{-12(1)}$	$\pm 5 \times 10^{-12(1)}$	$\pm 1 \times 10^{-11(3)}$	$\pm 1 \times 10^{-11}$ /month	
Short Term 5 MHz ⁽²⁾ : Averaging time: 0.01 sec	1.5×10^{-10}	1.5×10^{-10}	4×10^{-10}	1.5×10^{-10}	
1 sec	5×10^{-12}	5.6×10^{-11}	7×10^{-11}	5×10^{-12}	
10 sec	2.7×10^{-12}	2.5×10^{-11}	2.2×10^{-11}	1.6×10^{-12}	
100 sec	8.5×10^{-13}	8×10^{-12}	7×10^{-12}	5×10^{-13}	
SSB Phase Noise					
Signal (1 Hz BW)					
Offset from signal:	Hz: 10^{-3}	-28 dB	-8 dB	-6 dB	-25 dB
	10^{-2}	-48 dB	-28 dB	-26 dB	-52 dB
	10^{-1}	-68 dB	-48 dB	-46 dB	-72 dB
	0	-96 dB	-82 dB	-74 dB	-93 dB
	10^1	-120 dB	-120 dB	-114 dB	-120 dB
	10^2	-125 dB	-125 dB	-134 dB	-126 dB
	10^3	-140 dB	-140 dB	-144 dB	-140 dB
Reproducibility	$\pm 3 \times 10^{-12(3)}$	$\pm 5 \times 10^{-12}$	$\pm 1 \times 10^{-11}$		
Settability (frequency):	$\pm 1 \times 10^{-13(3)}$	$\pm 7 \times 10^{-13}$	$\pm 2 \times 10^{-12}$	$\pm 2 \times 10^{-12}$	
DC Magnetic Field Stability:	$\pm 2 \times 10^{-13}$ 2 Gauss Field	$\pm 2 \times 10^{-12}$ 2 Gauss Field	$< 2 \times 10^{-12}$ 2 Gauss Field	$< 5 \times 10^{-12}$ 1 Gauss Field	
Warm-up:	At 25°C 30 Min.	At 25°C 45 Min.	At -28°C 20 Min.	At 25°C 1×10^{-10} 1 hr. 5×10^{-11} 4 hrs.	
Sinusoidal Outputs:	5 MHz, 1 MHz, 100 kHz, Front & Rear BNC 1 V into 50 ohms				
Output Voltage					
Harmonic Distortion: (below rated output)	>40 dB	>40 dB	>40 dB	>40 dB	
Non-Harmonic related output: (below rated output)	>80 dB	>80 dB	>80 dB	>80 dB	
Under vibration or AC Mag Field:	>60 dB	>60 dB	>60 dB	>60 dB	
Signal-to-Phase Noise Ratio in 30 kHz noise BW (1 and 5 MHz):	>87 dB	>87 dB	>87 dB	>87 dB	
Environmental					
Temperature, operating with Option 001, 002 or 010 ⁽⁴⁾	0 to 50°C	0 to 50°C	-28 to +65°C	0 to 50°C	
Freq. change from 25°C:	$< 5 \times 10^{-12}$	$< 5 \times 10^{-12}$	$< 2 \times 10^{-11}$	$< 4 \times 10^{-11}$	
Temperature, non-operating without options:	-40°C to 75°C	-40°C to 75°C	-62°C to 75°C	-40°C to 75°C	
with Option 001:	-40°C to 75°C	-40°C to 75°C	-40°C to 75°C	-40°C to 75°C	
with Option 002 or 010 ⁽⁴⁾ :	-40°C to 50°C	-40°C to 50°C	-40°C to 60°C	-40°C to 50°C	
Humidity, operating: 95% up to	40°C	40°C	50°C	40°C	
Altitude, operating:	40,000 Ft.	40,000 Ft.	50,000 Ft.	40,000 Ft.	
Max. frequency change:	2×10^{-12}	2×10^{-12}	5×10^{-12}	2×10^{-11}	
NOTES:					
(1) For life of beam tube.					
(2) Short-term stability for the 5061A with both standard and high performance tubes is given for the normal loop time constant. For improved short-term stability in controlled environments the long time constant may be used.					
(3) With 10638 Degausser.					
(4) 5062C only.					

FREQUENCY & TIME STANDARDS

Atomic frequency standards
Models 5061A, 5062A, 5065A (cont.)



Instrument	5061A Opt 004	5061A	5062C	5065A
AC Magnetic Field: 50, 60 and 400 Hz $\pm 10\%$	$< 2 \times 10^{-12}$ for 2 Gauss peak	$< 2 \times 10^{-12}$ for 2 Gauss peak	$< 2 \times 10^{-12}$ for 2 Gauss peak	$< 5 \times 10^{-12}$ for 1 Gauss peak
Vibration: with isolators:	MIL-STD-167-1 MIL-T-21200	MIL-STD-167-1 MIL-T-21200	MIL-STD-167-1	MIL-STD-167-1
Shock:	MIL-E-5400, Class 1 (30G)			
	1-MIL-T-21200, C.1		MIL-E-16400	MIL-T-21200, C.1
EMC:	MIL-STD-461, Notice 3, Class A			
General				
Power: AC:	50, 60 or 400 Hz $\pm 10\%$, 115/230 V $\pm 10\%$			
DC:	43 W 22 to 30 V 27 W	43 W 22 to 30 V 27 W	48 W 22 to 30 V 33 W	49 W 23 to 30 V 35 W
Option 001: Add (AC/DC)	10/7.5 W	10/7.5 W	12/7.5 W	10/7.5 W
Option 002: Add (AC/DC)	22/4.5 W	22/4.5 W	25/3W	6/0 W
Option 010: Add (AC/DC)			62/15 W	
Dimensions (H x W x D): mm:	221 x 425 x 416	221 x 425 x 416	133 x 482 x 533	133 x 425 x 416
inches:	8 7/8 x 16 3/4 x 16 1/2	8 7/8 x 16 3/4 x 16 1/2	5 1/4 x 19 x 21	5 1/4 x 16 3/4 x 16 1/2
Weight: (lb/kg)	70/31.8	67/30.5	50/22.7	34/15.4
Option 001: Add (lb/kg)	2/0.9	2/0.9	5/2.3	2/0.9
Option 002: Add (lb/kg)	5/2.3	5/2.3	15/6.8	3.5/1.6
Option 001, Clock				
1 PPS Outputs: Master:	Front & Rear BNC	Front & Rear BNC	Rear BNC Front & Rear BNC	Front & Rear BNC
Clock:	10 V peak into 50 Ω load			
Amplitude:				
Width:	20 μ s min	20 μ s min	20 μ s min $\pm 5\%$	20 μ s min
Rise Time:	<50 ns	<50 ns	<20 ns	<50 ns
Fall Time:	<2 μ s	<2 μ s	<1 μ s	<2 μ s
Jitter, pulse-to-pulse:	<5 ns, rms	<5 ns, rms	<5 ns, rms	<5 ns, rms
Synchronization:	Automatic, 10 ± 1 μ s delay	Automatic, 10 ± 1 μ s delay	Auto., to within ± 500 ns	Auto., 10 ± 1 μ s delay
Clock pulse adjustment range:	1 μ s to 1 s	1 μ s to 1 s	0.1 μ s to 1 s	1 μ s to 1 s
CLock display:	Solid State Digital			
Option 002, Standby Power Supply Capacity at 25°C with Option 001 Clock:	30 Minutes	30 Minutes	One Hour	10 Minutes
Recharge, Fast/Float:	Automatic, fast charge			Switch

Ordering information

5061A Cesium Beam Frequency Standard	Price
Opt 001: Clock	\$20,450
Opt 002: Standby Power Supply	add \$2125
Opt 003: Clock and Standby Power Supply	add \$1025
Opt 004: High Performance Beam Tube	add \$3150
Opt 908: Rack Flange Kit	add \$3250
E21-5061A Flying Clock	add \$15
Consists of: 5061A with Opt 001 (not included in E21 price) and K02-5060A Standby Power Supply.	add \$4500
Weight: 64 kg (141 lb).	
Size: 425 H x 405 W x 546 mm D (16 3/4" x 15 15/16" x 21 1/2") (includes handles).	
10638A Degausser	\$880
Weight: 1.2 kg (3 lb).	
Size: 130 H x 77 W x 279 mm D (5 1/8" x 3 1/32" x 11").	

5062C Cesium Beam Frequency Reference	\$19,000
Opt 001: Clock	add \$2150
Opt 002: Standby Power Supply	add \$1025
Opt 003: Clock and Standby Power Supply	add \$3175
Opt 010: Clock, Battery, Time-Code Generator	add \$5750
5065A Rubidium Frequency Standard	\$9250
Opt 001: Clock	add \$2125
Opt 002: Standby Power Supply	add \$495
Opt 003: Clock and Standby Power Supply	add \$2620
Opt 908: Rack Flange Kit	add \$10
E21-5065A Portable Time Standard	add \$4500
Consists of: 5065A with Opt 001 (not included in E21 price) and K02-5060A Standby Power Supply.	
Weight: 50 kg (110 lb).	
Size: 425 H x 405 W x 546 mm D (16 3/4" x 15 15/16" x 21 1/2") (includes handles).	

FREQUENCY & TIME STANDARDS

Quartz frequency standards

Models 105A/B

- High spectral purity
- Well-buffered outputs
- Aging $<5 \times 10^{-10}$ per day

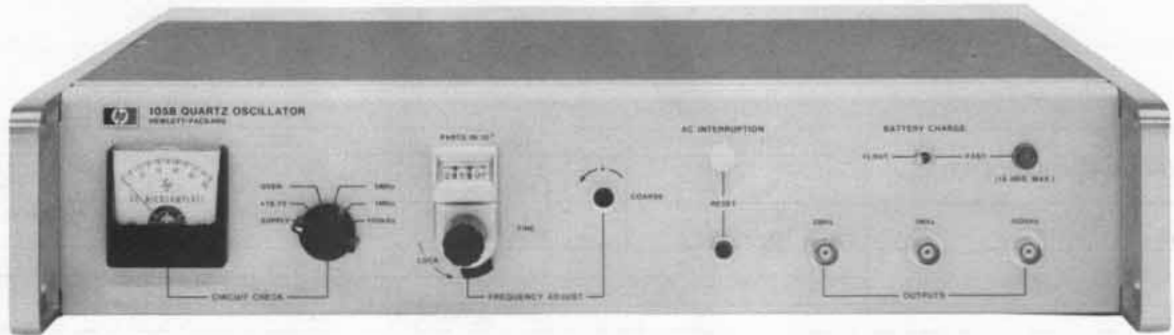

105B

Models 105A and B Quartz Oscillators provide state-of-the-art performance in precision frequency and time systems because of their excellent long and short term stability characteristics, spectrally pure outputs, unexcelled reliability, and ability to operate under a wide range of environmental conditions. They fill a need for a small and economical yet highly stable precision quartz oscillator for frequency and time standards. Both models can be operated from the ac line; the 105B has a built-in 8-hour standby battery for uninterrupted operation should line power fail. Both have 5 MHz, 1 MHz and 100 kHz buffered sinusoidal outputs with excellent short term stability (5 parts in 10^{12} rms for 1 s averaging time) and aging rate (<5 parts in 10^{10} per day).

The 1050A/B features rapid warm-up. Typically, the oscillator will be within 1 part in 10^9 of the previous frequency in 30 minutes after an "off" period of 24 hours. The basis of these oscillators is an extremely stable 5 MHz, 5th overtone quartz crystal developed by Hewlett-Packard. New technologies in the crystal mounting and packaging have resulted in a cleaner crystal which in turn has a lower aging rate. The crystal, oscillator and AGC circuit are all enclosed in a proportional oven which reduces the temperature effects on these components and circuits.

The 68 mm x 68 mm x 137 mm (2.7" x 2.7" x 5.4") package containing the oven enclosed crystal oscillator with AGC circuit and buffer amplifier are available separately as a component oscillator, the K07-105A, for use in equipment where a high quality 5 MHz source is required. Details are available from Hewlett-Packard sales offices.

Particular care was taken to provide a spectrally pure 5 MHz output which, when multiplied high into the microwave region, provides signals with spectra only a few cycles wide. Spectra less than 1 Hz wide can be obtained in X-band (8.2 to 12.4 GHz). The stability and purity of the 5 MHz output make it suitable for doppler measurements, microwave spectroscopy, and similar applications where the reference frequency must be multiplied by a large factor.

Specifications

Outputs: 5 MHz, 1 MHz, 100 kHz; 1 V rms into 50 Ω front and rear connectors.

Clock output: 1 MHz or 100 kHz; 0.5 V rms into 1 k Ω , rear connector. Normally supplied wired for 1 MHz output.

Frequency stability

Aging rate: $<5 \times 10^{-10}$ per 24 hours.

Short-term stability: for 5 MHz output only.

τ (sec)	$\sigma_{\Delta f}/f(2,\tau)$	$\sigma_{\Delta t}(2,\tau)$ sec
10^{-2}	1.5×10^{-10}	1.5×10^{-12}
10^{-1}	1.5×10^{-11}	1.5×10^{-12}
10^0	5×10^{-12}	5×10^{-12}

Temperature: $<2.5 \times 10^{-9}$ total change 0°C to 50°C .

Load: $\pm 2 \times 10^{-11}$ open to short circuit, 50 Ω R, L or C load change.

Supply voltage: $\pm 5 \times 10^{-11}$ for 22–30 V dc from 26 V dc reference and for 115/230 V $\pm 10\%$.

Warm-up (at 25°C): to within 1×10^{-7} of previous frequency in 15 min., 1×10^{-8} in 20 min., 1×10^{-9} in 30 min.

Distortion (5 MHz, 1 MHz, 100 kHz) below rated output

Harmonic: >40 dB.

Non-harmonic: >80 dB.

Signal-to-noise ratio: for 1 and 5 MHz, >90 dB in a 30 kHz noise BW (5 MHz output filter BW is approximately 100 Hz).

Frequency adjustments

Fine: 5×10^{-8} range with digital dial reading parts in 10^{10} .

Coarse: 1×10^{-6} front panel screwdriver control.

Phase locking: external +5 V to –5 V allows $>2 \times 10^{-8}$ frequency control for locking to external source.

Environmental

Temperature, operating: 0°C to $+50^\circ\text{C}$.

Temperature, storage: -40°C to $+75^\circ\text{C}$ ($+50^\circ$ for 105B).

Altitude: 15.24 km (50 000 ft.).

Shock: MIL-STD-167 and MIL-T-21200 (30 Gs).

Vibration: MIL-STD-167 and MIL-T-21200.

Electromagnetic compatibility (EMC): MIL-I-6181D.

Standby supply capacity: model 105B only, 8 hours at 25°C ambient temperatures.

Power requirements: 115/230 V $\pm 10\%$, 50–400 Hz at 17 W (70 W warm-up) for 105A. For 105B add 1 W for float charge and 12 W for fast charge. 22–30 V dc at 6.4 W (10.3 W warm-up).

Size: 88 H x 425 W x 286 mm D ($3\frac{15}{32}$ " x $16\frac{1}{4}$ " x $11\frac{1}{4}$ ").

Weight: 105A—net, 8 kg (16 lb). Shipping, 10.5 kg (23 lb). 105B—net, 11 kg (24 lb). Shipping, 14 kg (31 lb).

Options

908: Rack Flange Kit

910: Extra manual

Price

add \$10

add \$10.50

Ordering information

105A Quartz Oscillators

\$3000

105B Quartz Oscillators

\$3500

- Excellent spectral purity
- Low power
- Fast warm-up

- High reliability
- Rugged
- Compact

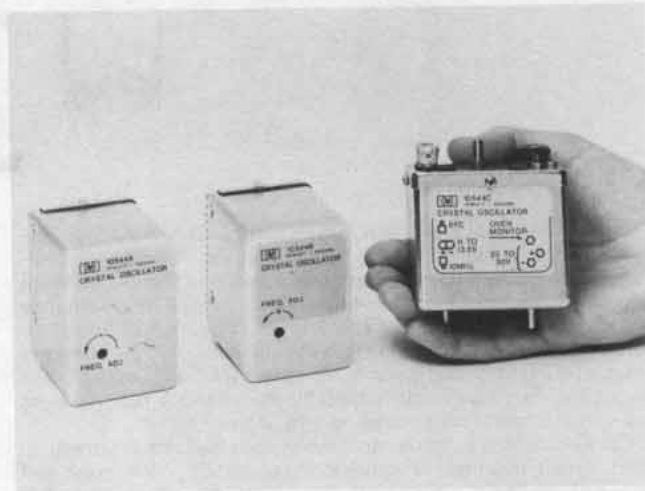
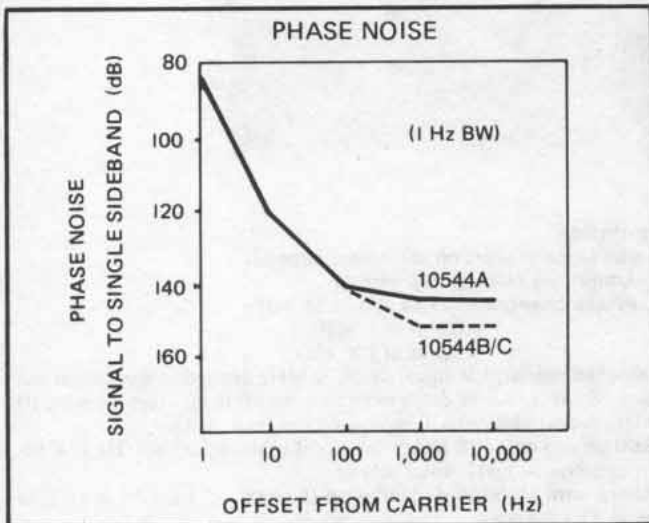

The 10544 Quartz Crystal Oscillators were developed by Hewlett-Packard to meet the needs for compact, high stability oscillators in test equipment and systems. Their excellent short-term stability and high spectral purity are especially desirable in applications where multiplication and synthesis are used to generate microwave frequencies. Rugged construction and high quality components assure high reliability and optimum performance. With the extremely low aging rate of these oscillators, significant cost savings can be realized at the end user by reducing the frequency of calibration needed to stay within FCC accuracy requirements.

The crystal for the oscillator is supported in a new rugged mounting in a cold-welded, high bake-out enclosure. The housing around the crystal enclosure is massive with high thermal conductivity which contributes both to rapid warmup and excellent temperature stability. The oscillator, AGC amplifier and oven control circuits are all inside a thermally insulated oven. Rigid plastic foam with extremely low thermal conductivity is used to provide thermal insulation and firm mechanical support for the oven enclosure.

The 10544A has low power consumption because of the use of a switching regulator in the oven controller circuits. The 10544B/C uses a dc oven controller which requires a little bit more power but results in better phase noise and short-term stability specifications. The 10544C has provisions for shock mounting and uses SMB snap-on rf connectors for the 10 MHz output and for the EFC input, versus PC-board connectors in the A and B versions. Other differences are listed in the specification section.

The 10544 oscillators are ideally suited for use in communication and navigation systems, synthesizers, time-code generators, counters and spectrum analyzers. The 10 MHz output frequency is a convenient starting point since it is easily divided or multiplied.

A screwdriver adjustment through the top of the oven enclosure permits frequency adjustment over a range of 2×10^{-6} (20 Hz), yet the control is sensitive enough to allow adjustment to better than 1×10^{-9} (0.01 Hz). Frequency can also be controlled electronically over a 1 Hz range with an externally applied voltage.

Specifications

	10544A	10544B/C
Output:	10 MHz	10 MHz.
	1.0 ± 0.2 V rms	0.6 ± 0.1 V rms
Impedance:	1000 Ω	50 Ω

Aging rate (after 24-hour warmup): $< 5 \times 10^{-10}$ /day.

Short term stability:

Averaging time(s)	10544A	10544B/C
10^{-4}	5×10^{-8}	1×10^{-8}
10^{-3}	5×10^{-9}	1×10^{-9}
10^{-2}	5×10^{-10}	1×10^{-10}
10^{-1}	5×10^{-11}	1×10^{-11}
10^0	1×10^{-11}	1×10^{-11}
10^1	1×10^{-11}	1×10^{-11}
10^2	2×10^{-11}	2×10^{-11}

Temperature:	$< 7 \times 10^{-9}$ (0 to 71°C)
Load:	$< 5 \times 10^{-10}$ ($\pm 25\%$ load change)
	$< 5 \times 10^{-9}$ ($\pm 10\%$ load change)

Warmup: Within 5×10^{-9} of final value 20 min. after turn on.

Frequency adjustment

Coarse:	$> 2 \times 10^{-6}$ (20 Hz)
Fine (EFC):	$> 1 \times 10^{-7}$

Harmonic distortion: > 25 dB from rated output

Non-harmonic distortion: > 80 dB > 100 dB

SSB phase noise ratio (1 Hz bw)

For offsets of 1 Hz:	10544A	10544B/C
10 Hz:	83 dB	85 dB
100 Hz:	120 dB	120 dB
1000 Hz:	140 dB	140 dB
10000 Hz:	145 dB	150 dB

Power: 3W 4.5W

Case size: 72 H x 52 W x 62 mm D (2.8" x 2" x 2.4").

Weight: 0.31 kg (11 oz.).

	Price		
Quantity	10544A	10544B	10544C
1 to 4:	\$625	\$690	\$775
5 to 9:	600	665	745
10 to 25:	575	635	715
25 to 49:	525	580	650

FREQUENCY & TIME STANDARDS

Distribution amplifier

Model 5087A

- Versatile with 3 input and 12 output channels
- Low noise, high stability, and isolation

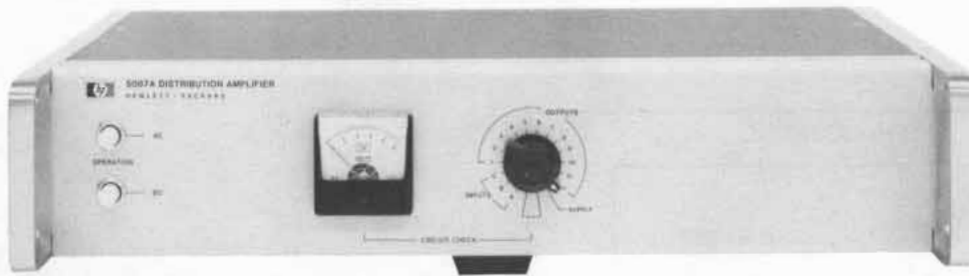

The Hewlett-Packard Model 5087A Distribution Amplifier provides the isolation and flexibility required for distribution of the output of high quality frequency standards. Low distortion and excellent isolation make it ideal for providing multiple outputs from atomic or crystal frequency standards. The 3 input channels will accept 10 MHz, 5 MHz, 1 MHz or 100 kHz in any combination. The number of outputs for each channel is selectable up to a total of 12 outputs. The output levels are individually adjustable from 0 to 3 V rms. All input and output levels are monitored on a front panel meter.

The Distribution Amplifier features plug-in modular construction, short circuit isolation, exceptional phase stability, low noise and cross-talk, and uninterrupted switchover to standby dc in event of ac power failure.

The shielding around each input and output plug-in amplifier assures minimum noise and crosstalk. The tuned output amplifiers provide clean signals and high channel-to-channel isolation.

The instrument is designed for maximum versatility and can be supplied to meet a wide variety of special requirements. The standard configuration of input and output amplifiers is shown in Figure 1.

Several other commonly used configurations are also available and special combinations of the various input and output modules can be supplied. Input and output amplifiers can be added or the configuration easily changed at any time.

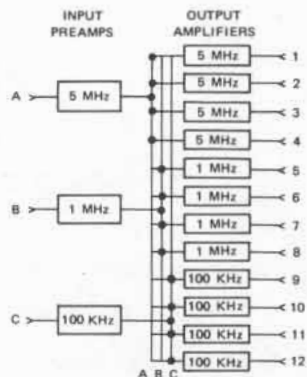

Figure 1. 5087A Distribution Amplifier with Option 031, Standard Configuration input and output amplifiers.

Specifications

Inputs: (up to three, rear panel BNC).

Frequencies: 10 MHz, 5 MHz, 1 MHz or 100 kHz.

Level: 0.3 to 3.0 V rms, 50 ohms.

Outputs: (up to 12 rear panel BNC).

Frequencies: 10 MHz, 5 MHz, 1 MHz or 100 kHz.

Level: 0-3 V into 50 ohms (screwdriver adjustment).

Harmonic distortion: >40 dB below rated output.

Non-harmonic distortion: >80 dB below rated output

Isolation

Load (open or short on any other channel)

Amplitude change: 0.1 percent.

Phase change: <0.1 ns at 5 or 10 MHz.

<0.5 ns at 1 MHz.

<5.0 ns at 100 kHz.

Injected signal: 1 V signal up to 50 MHz applied to any output except 10 MHz, will be down more than 60 dB in all other outputs; 10 MHz output channel will be down more than 50 dB.

SSB phase noise (5 MHz): >145 dB below signal in 1 Hz BW for frequencies > 1 kHz from carrier.

Short term stability degradation (5 MHz): < 1 x 10⁻¹² in 10 kHz band. (1 s average).

Environmental

Temperature: MIL-E-16400, Class 4.

Operating: 0-50°C; storage: -62° to +75°C.

Stability:

Amplitude: ±0.5 dB, 0° to 50°C.

Phase: <0.1 ns/°C., 5 and 10 MHz.

EMC: MIL-STD-461A.

Humidity: 95% at 40°C.

Vibration: MIL-STD-167.

Altitude: up to 30,000 ft.

Shock: MIL-T-21200, Class 1 and MIL-E-5400 (30 Gs).

General

Power: 115 or 230 V ±10%, 48 to 440 Hz, 20 VA, max, or 22-30 V dc, 500 milliamperes, max.

Dimensions: 88 mm H x 425 mm W x 286 mm D (3¹⁵/₃₂" x 16¹/₄" x 1¹/₄").

Weight: typical, Opt 031-Net 7 kg (15 lb).

Options

Normal configurations (input and output amplifiers) add \$1160

031: 5, 1 and 0.1 MHz inputs and 4 outputs at each frequency

032: Single 5 MHz input and 12 outputs add \$1110

033: Single 10 MHz input and 12 outputs add \$1110

034: Single 5 MHz input, 4 each outputs at 5, 1 and 0.1 MHz add \$1270

Special configurations

Input preamplifiers (up to 3 total)

004: Input Preamplifier (0.1 to 10 MHz) add \$35

005: 5 to 1 MHz Input Divider add \$95

006: 1 to 0.1 MHz Input Divider add \$95

011: 5 to 10 MHz Input Doubler add \$95

013: 10 to 5 MHz Input Divider add \$95

014: 10 to 1 MHz Input Divider add \$95

Output amplifiers (up to 12 total)

001: 5 MHz Output Amplifier add \$95

002: 1 MHz Output Amplifier add \$95

003: 0.1 MHz Output Amplifier add \$95

012: 10 MHz Output Amplifier add \$95

908: Rack Flange Kit add \$10

5087A: Distribution Amplifier Mainframe \$1100

- 12 Amp-hr capacity
- Sealed nickel-cadmium cells
- Used in "flying clocks"



K02-5060A

- 18 Amp-hr capacity
- Vented nickel-cadmium cells



5085A

The HP Models 5085A and K02-5060A Standby Power Supplies furnish dc power to keep frequency or time standard systems operating during extended interruptions of ac line power. For applications where it is essential to maintain continuous operation and avoid loss of precise time, the use of a standby power supply is an absolute necessity. These units are designed for use with the Hewlett-Packard Cesium Beam Standards, Rubidium Vapor Standards, Quartz Oscillators and other equipment which will operate from 22 to 30 V dc. No switching is used in transferring power from line to battery operation and back again thus assuring uninterrupted operation.

HP K02-5060A

The K02-5060A is a very versatile unit which was designed specifically as a portable power supply for the 5061A and 5065A "Flying Clocks" where it is necessary to operate from a wide range of power sources along with the standby capability to maintain continuous operation where no external power is available. A special inverter permits operation from a 6 or 12 V dc car battery in addition to the 115/230 V ac and 24-30 V dc capability. The 12 ampere-hour standby batteries are the sealed, nickel-cadmium type and thus spill-proof. Mounting hardware is available to attach the K02-5060A to either the 5061A or 5065A Standards to make a portable standard, the E21-5061A or E21-5065A.

HP5085

The HP 5085A is intended for installation where 115 or 230 V ac is available. Vented nickel-cadmium batteries with an 18 ampere-hour guaranteed capacity (derated from 25) are used. They provide about 10 hours of standby power for the 5061A Cesium Standard or 5065A Rubidium Standard (at average ambient temperature of 25°C).

Front panel lights indicate mode of operation, report fuse failure, and ac interrupt. A float-charge switch permits rapid recharge after an ac power failure.

K02-5060A Specifications

Input and output voltages

Input	Output
6 or 12 V dc	0-230 V, 60 Hz nominal
115 or 230 V ac, 50-400 Hz	0-230 V ac
24-30 V dc	24-30 V dc

Standby battery, 26 ± 4 V dc available at all times.

AC and both dc inputs may be connected simultaneously.

Output current: 0.5A ac, 2 A dc.

Standby capacity: 12 ampere-hour at 25°C, 7 hours standby when used in E21-5061A, 6 hours in E21-5065A.

Recharging: 1.6 hours recharging time required for each ampere hour of discharge.

Alarm indicator: external power failure.

Panel meters: voltmeter, ammeter indicating voltage and current of 4 internal batteries and load.

Battery: four paralleled rechargeable battery packs each containing 20 sealed nickel-cadmium cells. Packs may be removed individually without interfering with power supply operation.

Temperature

Operating: 0 to 50°C.

Storage: -40 to 60°C

Dimensions: 177 mm H × 425 mm W × 416 mm D (6³¹/₃₂" × 16³/₄" × 16³/₈").

Weight: net, 30.5 kg (67 lb).

Accessories furnished: ac and dc input and output cables.

5085A Specifications

Output voltage: 24 ± 2 V dc at rated current.

Output current: 2 amperes (2.5 A for 30 min.).

Standby capacity: (at 25°C) 18 amp-hrs. after 48 hours charge.

Alarm indicators: panel lamps indicate: (1) FUSE FAILURE, (2) AC POWER, (3) AC INTERRUPT, (4) CHARGE.

Remote alarm provisions: SPDT relay contacts provided at rear terminals for operating remote alarm from separate power system.

Panel meters: battery voltage and charge/discharge current.

Power requirements: 115 or 230 ± 10% V ac; 50 to 400 Hz (2.0 A max. at 115 V line).

Battery (supplied): vented nickel-cadmium 25 ampere-hour capacity derated to 18 ampere-hours. Periodic maintenance required.

Additional (external) battery provision: rear connector.

Temperature

Operating: 0 to 50°C.

Storage: -40 to 75°C.

Dimensions: 177 mm H × 425 mm W × 416 mm D (6³¹/₃₂" × 16³/₄" × 16³/₈").

Weight: net, 34.1 kg (75 lb). Shipping, 45.9 kg (101 lb) including battery. Option 001 (no batteries) is 22.8 kg (50 lb) less.

Accessories furnished:

AC Power Line Cable, 6 ft. long, DC Output Connector, Instrument Extension Slides (for std. 24" deep rack).

Ordering Information

5085A (complete with batteries)

Opt 001: without batteries

K02-5060A

Price

\$2850

less \$640

\$4000

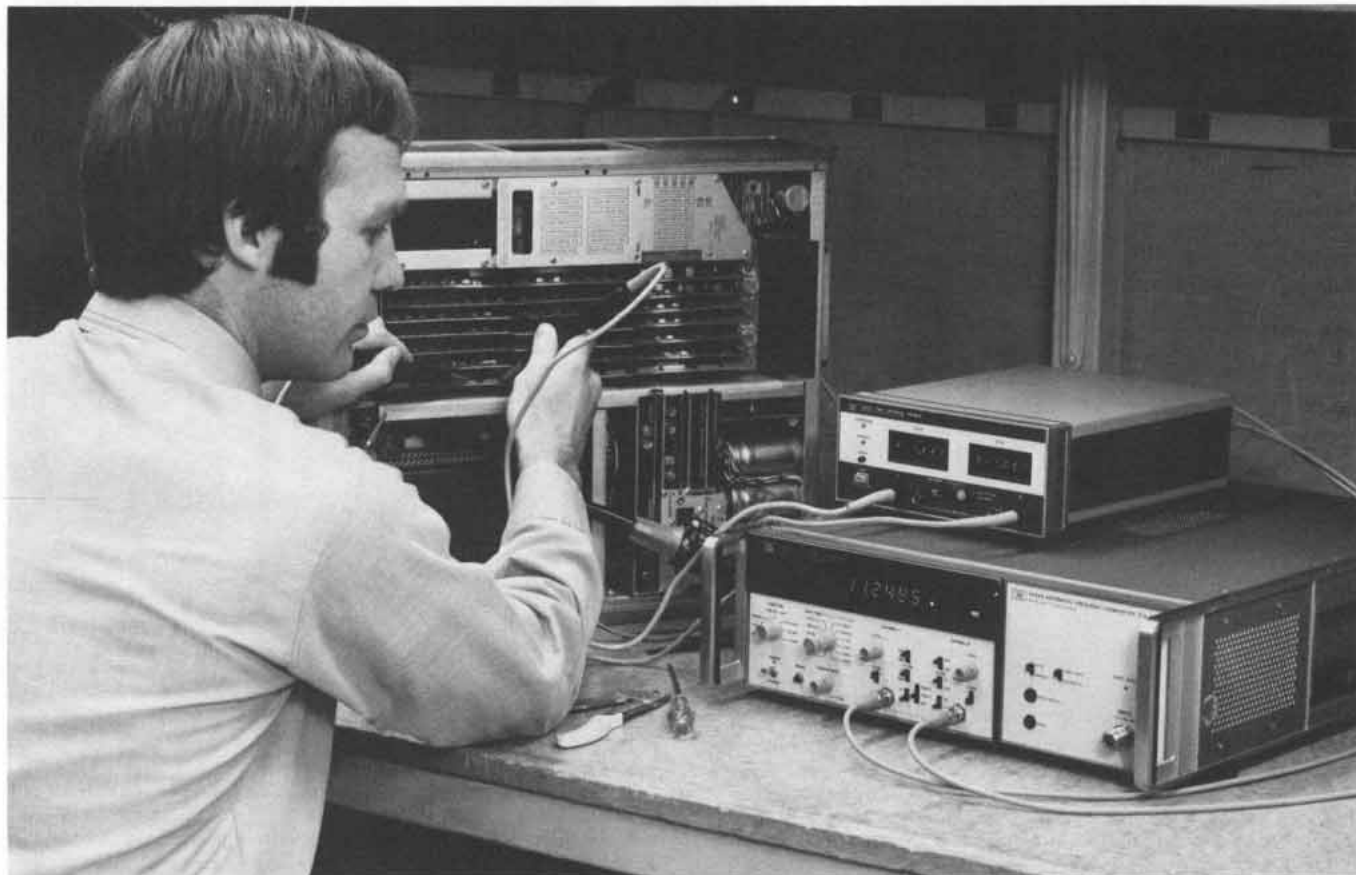

Introduction

The digital electronic frequency counter has come a long way since the first versions appeared over two decades ago. Once the luxury of large metrology labs and some crystal manufacturers, the frequency counter is now common-place in laboratories, on production lines, as a service tool and in automatic instrumentation systems. Moreover, counters have become increasingly more versatile and more powerful in the measurements they perform, thereby finding much wider applications. When Hewlett-Packard introduced the 524A in 1952 it was considered a milestone; the counter could measure frequencies up to 10 MHz, or the time between two electrical events to a resolution of 100 ns. Twenty-seven years later, HP's product lines feature counters that can measure the frequency of a 40 mV signal at 24 GHz completely automatically, or can resolve time to 20 ps, the same time it takes light to travel about 6 mm.

Basic counter measurements

The basic measurements which counters are capable of performing are described in this section.

Frequency

This fundamental measurement is performed by totalizing the number of input cycles or events for a precisely known period of time. The total count that results is proportional to the unknown frequency, and logic circuits internal to the counter position the decimal point such that the display directly indicates the input frequency. The time ref-

erence is usually derived from a precision quartz oscillator internal to the counter.

Using this basic technique allows measurements to 500 MHz to be made. Several methods are available, however, to extend this frequency range to 24 GHz and more. These are described in more detail below.

Period

This inverse of frequency capability is sometimes offered to provide the user with high resolution, low frequency measurements. In digital systems a period measurement represents the average bit to bit time of the input signal.

Totalize

The measurement is similar to frequency except that the user now controls the time over which the measurement takes place. With digital systems becoming more prevalent, this fundamental measurement assumes considerable importance. The HP 5345A, with its ability to totalize at a 500 megabit rate, represents the state of the art at this time.

Ratio

The ratio between two input frequencies is a measurement that is also offered by some counters. The major application for ratio is measurement of harmonically related signals.

Scaling

Some counters offer the capability of providing a digital output signal whose frequency is a scaled or divided version of the input frequency.

Time interval

The measurement of the time between two events or the time between two points on a common event, commonly referred to as time interval, is of major importance and is used in a wide variety of applications.

The ± 20 pS single shot resolution of the 5370A represents today's state of the art. This unit utilizes a new concept of phase locked vernier interpolation which eliminates quantization errors. HP also pioneered the concept of time interval averaging, whereby for repetitive inputs substantial improvement in resolution over the single shot measurement can be obtained.

Time interval averaging is offered in five HP counters (5370A; 5345A; 5328A; 5315A/B and 5308A). Also available for precision time interval measurements is the 5363B Time Interval Probes box usable with any time interval counter. The 5363B has a wide dynamic range as well as a built in calibration feature and digitally set trigger voltages to eliminate the major uncertainties associated with TI measurements. The 5363B is fully programmable via the HP Interface Bus for systems applications.

All manner of time interval measurements are discussed in detail in Application Note AN 200-3 "Precision Time Interval Measurements Using an Electronic Counter" available on request from any Hewlett-Packard sales office.

Application Note 200: Fundamentals of the Electronic Counters

This forty-four page application note describes in detail the measurements mentioned above. In addition, the key considerations in making frequency and time measurements, plus the major characteristics required of a counter for certain applications are also described. For those readers who require more than the brief resumé above, this application note is available on request at any Hewlett-Packard sales office.

The contents of AN 200 are as follows:

- Introduction
- Fundamentals of the Conventional Counters
 - Functions
 - Input Considerations
 - Time Base Oscillator Considerations
 - Main Gate Requirements
 - Sources of Measurement Error
- Reciprocal Counters
- Time Interval Measurement
 - Input Considerations
 - Trigger Level
 - Increasing Accuracy and Resolution
 - Use of Time Interval Probes
- Automatic Microwave Frequency Counters
 - Down-Conversion Techniques
 - Comparison of Performance of the Down-Conversion Techniques

The major types of electronic counters

While counters can potentially offer all the measurement capabilities described above, they essentially fall into three classes: frequency counters; universal counters; and microwave counters. These are described below.

Frequency counters

These counters offer the basic capability of frequency measurement and in addition sometimes provide some or all of the other measurements described above except time interval. HP has a wide range of counters that fall into this class including: a) the 5380 low cost bench series, a family of three counters featuring 80 MHz—7 digit, 225 MHz—8 digit and 520 MHz—9 digit instruments; b) the 5300 portable, battery operated snap-on series with the 5303B snap-on covering 525 MHz and the 5305B 1300 MHz counter.

Table 1. Frequency counters summary

Model No.	Frequency Range	Number of Digits	Time Base	Other Functions*
5300/5301A	10 MHz	6	3×10^{-7}	T
5381A	80 MHz	7	3×10^{-7}	
5382A	225 MHz	8	3×10^{-7}	
5383A	520 MHz	9	3×10^{-7}	
5300/5303B	525 MHz	8	3×10^{-7}	
5300/5305B	1300 MHz	8	3×10^{-7}	
5341; Opt. 003	1500 MHz	10	1×10^{-7}	
5341A	4500 MHz	10	1×10^{-7}	
5340A	23000 MHz	8	3×10^{-7}	
5342A	24000 MHz	11	1×10^{-7}	A, Fo, Ao

*See legend next page

Table 2. Universal counter summary

Model No.	Frequency Range	Time Interval Resolution		Time Base	Other Functions*
		Single Shot	Averaging		
5300A/5304A	10 MHz	100 ns	—	3×10^{-7} per Month	MPA, T, R
5300/5302A	50 MHz	100 ns	—	3×10^{-7} per Month	P, MPA, T, R
5300A/5308A	75 MHz	100 ns	100 ps	3×10^{-7} per Month	P, MPA, T, R
5314A	100 MHz	100 ns	—	3×10^{-7} per Month	P, MPA, T, R
5315A/B	100 MHz	100 ns	10 ps	3×10^{-7} per Month	P, MPA, T, R, E
5328A	100 MHz	100 ns or 10 ns	10 ps	3×10^{-7} per Month	P, MPA, T, R, E, V**
5370A	100 MHz	± 20 ps	1 ps	1×10^{-7} per Month	P, MPA, E
5345A	500 MHz	2 ns	2 ps	5×10^{-10} per Day	P, MPA, T, R
5328A Opt 030	512 MHz	100 ns or 10 ns	10 ps	3×10^{-7} per Month	P, MPA, T, R, E, V**
5328A Opt 031	1300 MHz	100 ns or 10 ns	10 ps	3×10^{-7} per Month	P, MPA, T, R, E, V**

*See legend next page
**Optional function

Universal counters

These instruments provide time interval capability in addition to the other measurements provided by the frequency counter.

The new 5314A is a perfect example of such an instrument featuring 100 MHz frequency, 100 ns time interval plus period, ratio and totalize. The new 5315A/B provides all these functions plus time interval average and reciprocal frequency measurements. The 5302A features 50 MHz frequency, 100 ns time interval plus period, ratio and totalize. Another member of the same family, the 5308A is ideally suited as a general purpose bench instrument, for in addition to the 5302A capabilities the 5308A offers time interval averaging, totalizing (with electronic start and stop) and frequency to 75 MHz. The 5304A snap-on is especially oriented towards time interval featuring adjustable hold-off. The 5328A (100 MHz) and 5328A Opt 031 (1300 MHz) are high performance rack mount instruments programmable (Opt 011) via the HP Interface Bus. Time interval averaging gives resolution to 10 ps on repetitive signals and Opt 040 also has 10 ns one shot resolution. The 5345A offers a 500 MHz bandwidth, with totalizing, ratio and period capability to this speed (500 MHz), plus 2 ns single shot time interval and 2 ps time interval averaging. This extremely powerful instrument features plug-in flexibility (see page 289), and a reciprocal frequency measurement mode (see next page).

Finally, the 5370A offers the ultimate in time interval measurement resolution with

20 ps single shot and 1 ps time interval averaging!

Microwave counters

These instruments provide high accuracy frequency measurements into the microwave spectrum. The 5342A harmonic heterodyne microwave counter automatically measures frequencies to 24 GHz under microprocessor control, and features 1 Hz resolution and wideband FM tolerance. The keyboard controls allow the user to program his own frequency offsets. The amplitude option will simultaneously display input frequency and input level for readily monitoring microwave devices and equipment. The 5340A automatic transfer oscillator counter can measure frequency from 10 Hz to 23 GHz via a single input at -35 dBm sensitivity! The 5341A automatic heterodyne counter provides coverage to 4.5 GHz using the switchable filter technique for super fast acquisition times. The 5354A is a 4 GHz heterodyne converter that plugs into the 5345A mainframe and provides extremely high resolution automatic measurements for CW and pulsed RF down to pulse widths of 20 ns. Application Note 173 discusses automatic pulsed RF measurements in detail. Application Note 190 discusses making frequency measurements to 40 GHz with counter accuracy using a 4 GHz Microwave Counter together with readily available microwave generators and mixers.

Application Note 200-1 deals with the fundamentals of microwave frequency counters and compares the various techniques.

Table 3. Microwave counter summary

Model No.	Frequency Range	Technique	Time Base	Sensitivity	Number of Digits
5354A*	4 GHz	Auto Heterodyne	5×10^{-10} /Day	-10 dBm	11
5341A	4.5 GHz	Auto Heterodyne	1×10^{-7} /Month	-20 dBm	10
5254C/5255A/5256A**	to 18 GHz	Manual Heterodyne	3×10^{-9} /Day	-13 dBm	8
5257A**	18 GHz	Manual Transfer Osc	3×10^{-9} /Day	-7 dBm	8
5340A	23 GHz	Auto Transfer Osc	3×10^{-7} /Month	-35 dBm	8
5242A	24 GHz	Auto Harm Heterodyne	1×10^{-7} /Month	-25 dBm	11

*Plug-in to 5345A Counter

**Plug-in to 5245 Series Counter or 5345A with adapter

Reciprocal Counting Technique

The extremely powerful reciprocal counting technique is employed in several counters available from Hewlett-Packard. The distinction between this and the conventional technique is that the latter provides 1 Hz resolution in one second, whereas the resolution of the reciprocal technique is proportional to the frequency of the internal counted clock. The four instruments available are summarized in Table 4 below. Note that the 5345A is a plug-in instrument and hence the high mainframe resolving power offered applies to any of the compatible plug-ins. It has pulsed RF measurement capability via an external gate mode. In addition the 5345A includes a unique frequency averaging mode that allows high resolution measurements on repetitive pulses even if pulse width is 50 nsecs. The 5370A extends the reciprocal technique by means of phase locked vernier interpolation to give the ultimate in resolution. Fre-

quency measurements to better than 10 digits may be made in 1 sec.

HP Interface bus

The more recently introduced counters (and other HP digital instruments) have a digital input/output structure which is compatible with the interface bus which is Hewlett-Packard's implementation of the IEEE Digital Interface Standard 488-1975. HP Desktop Calculators in the 9825/30 Series and Minicomputers in the HP 2100/21MX Series are also compatible with the in-

terface bus, making it possible to expand the capabilities of the individual instruments even into areas of real time data reduction and control. Interfacing is available for interconnecting up to 14 compatible devices on one I/O slot. The HP 59310B Computer Interface serves for minicomputers and the HP 98034A or 59405A HP-IB Calculator Interface interconnects up to 14 devices using one I/O slot and one ROM. At this time, compatible instruments are the 5345A, 5370A, 5340A, 5341A, 5342A, 5328A, and 5312A (for 5300B system).

Table 4. Reciprocal frequency counters

Model No.	Frequency Range	Measurement Resolution	Number of Digits	Time Base	Sensitivity
5300A/5307A	2 MHz	3×10^{-5}	6	3×10^{-7} per Month	10 mV rms
5315A/B	100 MHz	1×10^{-7}	8	3×10^{-7} per Month	10 mV rms
5370A	100 MHz	1×10^{-10}	16	3×10^{-7} per Month	20 mV rms
5345A	500 MHz	2×10^{-9}	11	5×10^{-10} per Day	20 mV rms

Table 5. Counter selection guide

Classification	Description	Frequency	Functions*	Time Base	Price	Page
5381A, 5382A & 5383A Low Cost	Traditional HP quality and reliability at low prices.	To 520 MHz	F	3×10^{-6} /Mo. Optional 1×10^{-7} /Mo.	From \$295	313
5314A Low Cost Universal Portable	Traditional HP quality and reliability at new low price	100 MHz	F, P, MPA, TI, T, R	3×10^{-7} /mo. Optional 1×10^{-7} /mo.	From \$375	303
5315A/B Economic Reciprocal Portable	A new high performance micro-processor controlled universal counter with sub nanosecond time interval averaging capability and optional high frequency coverage. 5315B offers rack/stack package and improved RFI.	100 MHz Optional higher frequency	F, P, MPA, TI TI AVG, T, R, E	3×10^{-7} /mo. Optional 1×10^{-7} /mo.	From \$800	304
5300 Series Economic Portable	Select from 8 plug-ons to meet present needs. Move up in functions or frequency range when needed. Battery pack, D to A converter and HP Interface Bus output module extend versatility.	To 1300 MHz	F, P, MPA, TI TI AVG, T, R V, E	3×10^{-7} /Mo. Optional 1×10^{-7} /Mo.	From \$685	306
5328A Universal Counter	A high performance universal counter with sub nanosecond time interval averaging capability that can include high frequency measurement, DVM or HP Interface Bus options.	To 1300 MHz	F, P, MPA, TI TI AVG, T, R, V, E	3×10^{-7} /Mo. Optional 1.5×10^{-6} /Mo.	From \$1300	298
5245 Series General Purpose Plug-in Counters	A mainframe and 6 plug-ins provide unmatched versatility. Plug-ins provide up to 18 GHz frequency and 100 nsec time interval capabilities.	To 18 GHz	F, P, MPA, TI T, R	1×10^{-7} /Mo. ($< 3 \times 10^{-9}$ /Day)	From \$5000	296
5345 Series High Performance Plug-in Counters	A series of high performance mainframe and plug-ins, providing 500 MHz direct count, 2 nsec time interval, and 4 GHz automatic pulsed RF measurements.	To 18 GHz	F, P, MPA, TI, TI AVG, T, R E	1.5×10^{-6} /Mo. ($< 5 \times 10^{-10}$ /Day)	From \$4400	289
5340, 5341, 5342A Automatic Counters	Broad band, high sensitivity, microwave frequency measurements 10 Hz-1.5 GHz; 10 Hz-4.5 GHz and 10 Hz-24 GHz.	To 24 GHz	F, Fo, A, Ao	Optional to 1.5×10^{-9} /Mo. ($< 5 \times 10^{-10}$ /Day)	From \$4500	314
5370A	Highest resolution frequency measurements and time interval measurements to ± 20 ps resolution	100 MHz	F, P, MPA, TI, TI AVG	3×10^{-7} /Mo. Optional 1.5×10^{-9} /mo.	\$6500	294

*Legend for Functions

F = Frequency	A = Amplitude	V = Voltage
P = Period	TI AVG = Time Interval Average	E = Electronically Controlled Totalize
MPA = Multiple Period Average	T = Totalize	Fo = Frequency Offsets
TI = Time Interval	R = Ratio	Ao = Amplitude Offsets



HP-IB

The 5345A Electronic Counter represents the most advanced general purpose instrument in the Hewlett-Packard Counter Product line. Utilizing state of the art monolithic bipolar integrated circuit technology especially designed and manufactured at Hewlett-Packard, this instrument provides unsurpassed power, versatility and flexibility in frequency and time measurements.

Major mainframe features

- Frequency:** direct from DC to 500 MHz—Reciprocal technique provides high measurement resolution.
- Time interval:** resolution of 2 ns single shot.
- Averaging:** new modulated clock technique gives true averages under all conditions. T.I. resolution extended to 2 ps. Frequency averaging improves RF pulse measurements similarly.
- Totalize:** to 500 megabit rate on both A and B inputs. A ± B functions also available.
- Ratio:** from DC to 500 MHz on both inputs.
- Fully programmable:** provides great flexibility when used with calculators and computers.
- Plug-in versatility:** two plug-ins presently available (see page 292) with an on-going R&D program to extend this number. In addition the 10590A plug-in adapter allows most existing 5245 plug-ins to be used.

Signal input circuits

Signal conditioning: fully optimized front end includes switchable

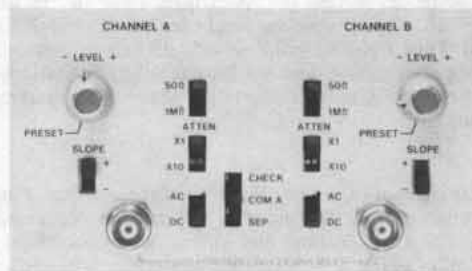

Figure 1. Input Switches

50Ω/1 MΩ input impedances, DC/AC coupling, and slope selection that assures triggering on any waveform.

Sensitivity, dynamic range: highly sensitive wideband amplifiers

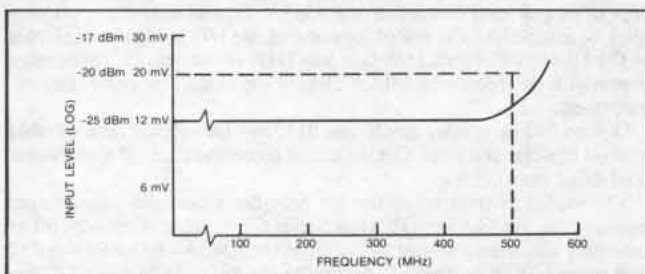

Figure 2. Typical Amplifier Sensitivity

- 500 MHz Direct Counting
- 20 mV Sensitivity DC to 500 MHz
- 2 ns Single Shot T.I. Resolution
- Averaging to 2 ps resolution
- Pulsed RF and Microwave Measurements
- Programmable for systems applications via HP-IB

assure measurements on even the lowest level sinusoidal and digital signals. The inputs also feature an extremely wide linear dynamic range of -2 to +5 V DC that greatly increases measurement versatility, especially on digital input signals.

Frequency measurements

Reciprocal capability: one of the advantages of measuring period

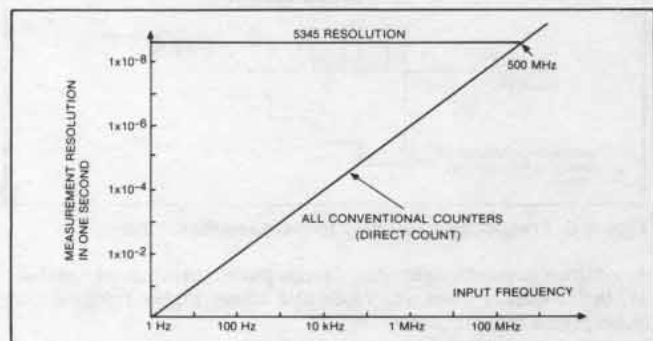

Figure 3. Measurement Resolution

and computing the frequency is that measurement resolution is independent of input frequency and at the maximum to which the instrument is capable of resolving. Thus for example, a 1 MHz input can be resolved to 2×10^{-9} (=0.002 Hz) in one second, whereas the conventional counter provides 1 Hz resolution, some 500 times less.

Measurement speed

Mode of Operation	Readings per Second
Normal Operation (Max sample rate)	10
Externally armed	500
Externally gated	500
Computer dump	9,000

The extremely high resolution obtained in one second can be traded for measurement speed. For example of 100 μs gate time provides a resolution of 2×10^{-5} yet the measurement can now be made 5000 times a second, thus making the 5345A an invaluable tool in high speed data acquisition systems.

Ext. gated capability: via the rear panel gate control input; this capability allows the operator to determine at what point in real time and for how long the measurement is to be made. This capability essentially replaces the front panel "sample rate" and "gate time" controls.

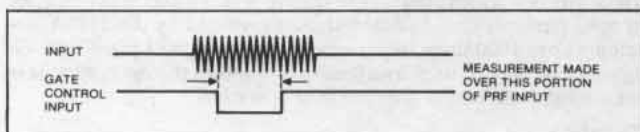

Figure 4. External Gate Control

Model 5345A (cont.)

The major application is in the measurement of pulsed RF signals. **Frequency averaging:** the minimum pulse width for which the input frequency can be measured is 20 ns. The single shot measurement resolution is 2×10^{-9} divided by the GATE TIME. This resolution can be improved up to 1000 times by a unique mode of operation known as frequency averaging that is built into the mainframe. The only requirement for this mode is that the signal is repetitive.

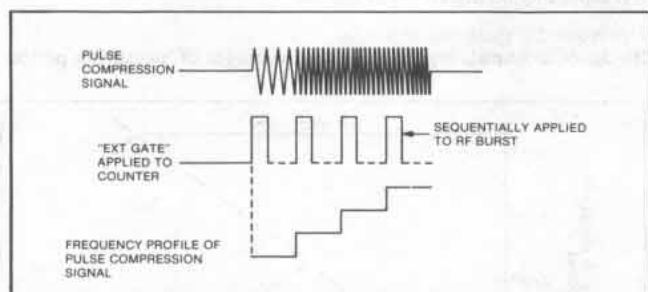

Figure 5. Frequency Averaging to Increase Resolution

In addition to greatly enhancing narrow pulse measurement capability, the frequency averaging mode also allows higher resolution on pulse profile measurements.

Time interval

Precision measurement: the single shot time interval measurement resolution of the 5345A is 2 ns, which is the time it takes light to travel approximately 2 Ft—the 5345A is an extremely high resolving time measuring device.

Trigger level: quantitative high speed time interval measurements are provided by the 5345A since the user can simply determine where triggering occurs even on complex waveforms. The method of determination involves measuring the DC levels at which triggering occurs. These DC levels are available at rear panel BNC's.

The ability to determine trigger level, together with high sensitivity and wide dynamic range of the inputs greatly enhances the versatility and power of the 5345A in time interval measurements.

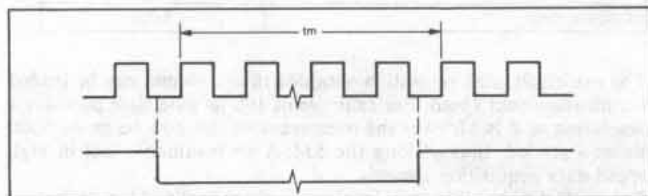

Figure 6. Using EXT GATE to Measure T_m

Ext. gate capability: external gating adds even more versatility to the time interval measurements of the 5345A, as measurements such as that shown in figure (6) indicate.

Time interval averaging: for repetitive inputs a successive number of measurements may be automatically averaged by the 5345A, obtaining up to 1000 times improvement in resolution (2 ps). This averaging mode may be used irrespective of whether the instrument is in the conventional or ext. gate mode of operation.

Totalize

High speed: the 5345A has the ability to totalize to a 500 megabit

rate through either or both A and B inputs. Coupled with the high sensitivity and full signal conditioning of both channels, this capability enables measurements to be made on most modern digital systems.

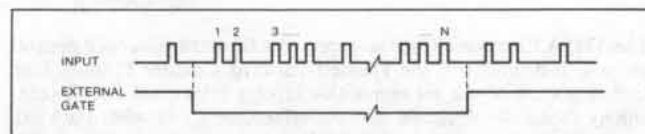

Figure 7. Selecting a Portion of a Pulse Train

Ext. gate capability: using the external gated mode allows the user to select only the desired portion of the input pulse train for measurement.

A ± B Modes

The A—B mode is used for comparison tests between high speed reference and test signals applied to the two mainframe inputs.

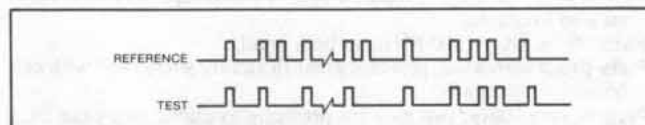

Figure 8. Comparison Measurements

Any difference between the total number of events accumulated in each channel is indicated by the 5345A display after the measurement is completed.

The primary application for the A + B mode is in the measurement of NRZ signals. By setting the "A" trigger slope to "+" and the B slope to "-" allows all transitions and hence bits of the NRZ signal to be counted. Thus 1 gigabit NRZ waveforms can be measured.

This mode of operation does not introduce any limitations—maximum input rate is 500 megabits on either channel and external gating may be used.

Ratio

This measurement represents the ratio of the number of events occurring through channel B divided by the number occurring through channel A. The major features are: a) that the measurement or comparison (similar to the A ± B totalize modes); and, b) the frequency or bit rate of either channel can vary from DC to 500 MHz. These features allow this measurement to be extremely useful in digital systems and synthesizer check out.

Digital I/O

Option 011 provides complete digital input-output capability (except slope and level control) to the 5345A. Digital output is a bit parallel, byte serial ASCII coded format and the I/O structure conforms to the Hewlett-Packard Interface Bus (HP-IB) standard. This option is particularly recommended for a bench top calculator controlled environment.

Option 012 is similar to Option 011, but includes programmable control of slope and level. Option 012 is recommended for a computer controlled environment.

The model 59310B Interface Kit provides a complete operational package for use with the HP 2100 Series Computers. Similarly, other interface kits allow the user to interface the 5345A Option 011 or 012 and other HP-IB compatible devices to the 9820, 9825 and 9830 Series HP Desktop Computers.

5345A Condensed specifications

Frequency/period measurements

Range: 0.00005 Hz to 500 MHz.

Accuracy: $\frac{\pm 2 \times 10^{-9}}{\text{gate time}} \pm \text{trigger error}^* \pm \text{time base error}$.

Gate time: 1000 seconds to 100 nanoseconds in decade steps; <50 ns in MIN position.

Time interval/time interval average

Range: 10 nsec to 20,000 sec.

Minimum dead time: 10 nsec.

Trigger pulse width: 1 nsec minimum width input at minimum voltage input.

Accuracy

Time interval: $\pm \text{trigger error}^{**} \pm 2 \text{ ns} \pm \text{time base error}$.

Time interval averaging:

$\pm \frac{\text{trigger error}^{**} \pm 2 \text{ nsec}}{\sqrt{\text{intervals averaged}}} \pm 0.7 \text{ nsec} \pm \text{time base accuracy}$

Not affected by harmonics of clock frequency.

Resolution:

Time interval: 2 nsec.

Time interval average:

$\pm \frac{2 \text{ nsec}}{\sqrt{\text{intervals averaged}}} \pm 2 \text{ picoseconds}$.

Ratio B/A

Range: both channels accept dc to 500 MHz.

Accuracy: $\pm \text{L.S.D.} \pm \text{trigger error}^*$.

Start/stop

Range: both inputs dc to 500 MHz.

Modes: A, A \pm B determined by rear panel switch.

Scaling

Range: dc to 500 MHz.

Scaling factor: selectable by GATE TIME setting. Scaling factor equals GATE TIME setting/10⁻⁹ seconds.

Input: input signal through channel A.

Output: output frequency equals input frequency divided by scaling factor. Rear panel BNC supplies 80% duty cycle TTL compatible pulses.

Input channels A and B

Range: 0 to 500 MHz dc coupled 50 Ω and 1 M Ω ; 4 MHz to 500 MHz ac coupled, 50 Ω ; 200 Hz to 500 MHz ac coupled, 1 M Ω .

Impedance: selectable, 1 M Ω shunted by less than 30 pF or 50 Ω (nominal).

Sensitivity: X1, 20 mV rms sine wave and 60 mV peak-to-peak pulse. X10, 250 mV rms sine wave and 750 mV peak-to-peak pulse.

Dynamic range: 50 Ω & 1 M Ω : 20 mV to 250 mV rms sine wave (X1); 250 mV to 2.0 V rms (X10).

Trigger level: adjustable over $\pm 1.3 \text{ V}$ dc.

Output: rear panel BNC connectors bring out CHAN A TRIG LEVEL and CHAN B TRIG LEVEL for convenient DVM monitoring. Accurate to $\pm 15 \text{ mV}$.

Common input

In this mode the signal is applied to channel A.

Range: ac coupled 50 Ω , 4 MHz to 400 MHz; ac coupled 1 M Ω , 300 Hz to 400 MHz.

Impedance: 50 Ω remains 50 Ω ; 1 M Ω becomes 500 k Ω shunted by <60 pF.

Sensitivity: 50 Ω : 40 mV rms; 1 M Ω : No change.

Dynamic range: 50 Ω : 40 mV to 500 mV rms (X1); 500 mV to 4 V rms (X10); 1 M Ω : No change.

*Trigger error for sinewaves of 40 dB signal-to-noise amplitude ratio is $<[\pm 0.3\% \text{ of one period} + \text{number of periods averaged}]$. If peak noise amplitude is greater than 10 millivolts, additional miscounting may occur (this situation can arise when measuring high-level outputs of broadband synthesized signal sources).

**For any wave shape, trigger error is less than

$$\pm \frac{0.0025}{\text{Signal Slope in } V/\mu\text{s}} \mu\text{s}$$

General

Display: 11 digit LED display and sign. Annunciator displays ksec to nsec, k to n, μHz to GHz. Decimal point is positioned with DISPLAY POSITION control or positioned after the first, second or third most significant digit if DISPLAY POSITION is in AUTO. Leading zeros are suppressed.

Overflow: asterisk is illuminated when display is overflowed.

Sample rate: continuously variable from <0.1 sec to >5 sec with front panel control. In HOLD position the last reading is maintained until the counter is reset.

External arm input: counter can be armed by a -1.0 V signal applied to the rear panel 50 Ω input.

External gate input: same conditions as for EXT ARM.

Gate output: >1 volt into 50 Ω .

Time base

Standard high stability time base: crystal frequency, 10 MHz (10544A).

Stability

Aging rate: $<5 \times 10^{-10}$ per day.

Short term: $<1 \times 10^{-11}$ for 1 sec average.

Temperature: $<7 \times 10^{-9}$, 0 $^\circ\text{C}$ to 55 $^\circ\text{C}$.

Opt 001: crystal frequency, 10 MHz.

Stability:

Aging rate: $<3 \times 10^{-7}$ per month.

Short term: $<2 \times 10^{-9}$ rms for 1 sec.

Temperature: $<2 \times 10^{-6}$, 25 $^\circ\text{C}$ to 35 $^\circ\text{C}$.
 $<5 \times 10^{-6}$, 0 $^\circ\text{C}$ to 55 $^\circ\text{C}$.

Line voltage: $<1 \times 10^{-8}$, $\pm 10\%$ from nominal.

Self test: a 100 MHz signal is internally applied.

External frequency standard input: input voltage >1.0 V rms into 1 k Ω required from source of 1, 2, 2.5, 5 or 10 MHz $\pm 5 \times 10^{-8}$ ($\pm 5 \times 10^{-6}$ for opt. 001). Input can be sine or square wave.

Frequency Standard Output: >1 V rms into 50 Ω at 10.0 MHz sine wave.

Operating temperature: 0 $^\circ\text{C}$ to 55 $^\circ\text{C}$.

Power requirements: 100/120/220/240 V rms $\pm 5\%$ -10% 48 to 66 Hz, maximum power 250 VA.

Weight: 17 kg (37 lb).

Size: 132.6 H x 425 W x 495 mmD (5 $\frac{1}{32}$ " x 16 $\frac{3}{4}$ " x 19 $\frac{1}{2}$ ").

Options and accessories

	Price
001: Room Temperature Time Base	less \$350
010: Digital output only. HP Interface Bus format, talk only. Useful with 59301A ASCII-to-Parallel Converter and 5050B or 5055A Digital Printers	add \$250
011: Digital Input/Output same as Opt 010, Compatible with HP Interface Bus and allows 5345A to be remotely programmed.	add \$800
012: Digital I/O similar to Opt 011. Includes slope and level control	\$1450
908: Rack flange kit	add \$10
K13-59992A: includes state machine tester as an aid for trouble-shooting the arithmetic processor	\$2340
10595A Board extender kit: useful for troubleshooting plug-in boards while in operation	\$575
10590A Plug-in adapter: adapts 5245 series plug-ins to 5345 (see next page)	\$700
K15-59992A Standby power unit: plug-in to maintain oscillator operation for prolonged periods without line voltage	\$1200

Available reference material

- 5345A Data Sheet
- 5345A Users Handbook
- AN-173 Recent Advances in Pulsed RF and Microwave Measurements
- AN-173-1 Dynamic Measurement of Microwave VCO's
- AN-174 Applications Series on Counter/Calculator Instrument Groupings
- AN-190 40 GHz Frequency Measurements
- AN-200-3 Precision Time Interval Measurements
- HP Journal June 1974
- I.D. #90337D Color Video Tape Applications and Demonstrations

5345A Plug-In Counter

\$4400

- Fully automatic to 4 GHz
- Pulse Measurements
- Frequency averaging
- Count a group of events between A and B
- Frequency sum and difference measurements

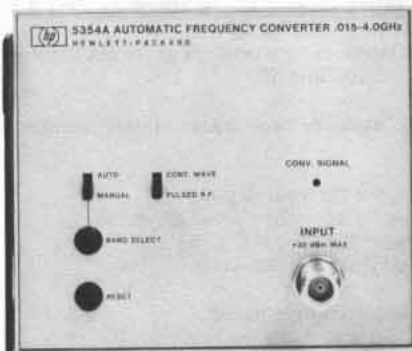

5354A

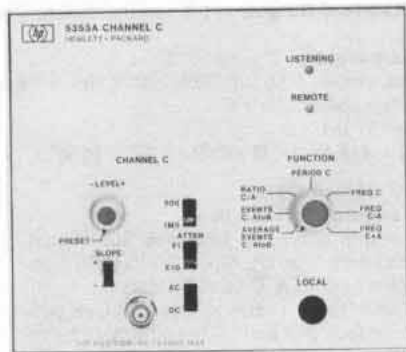

5353A

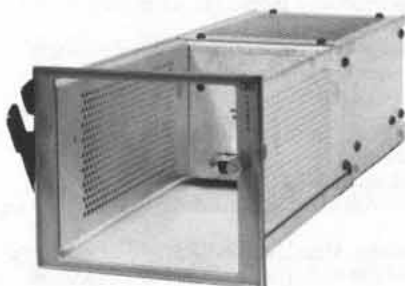

10590A

5354A Automatic frequency converter

The 5354A translates not only the microwave signal but all its modulation directly to the 500 MHz window of the counter (via the heterodyne technique). It allows signals with a large amount of FM to be easily characterized.

Perhaps even more powerful is its ability to take direct measurements on the carriers of very narrow microwave pulses. Pulse measurements can be easily automated.

Range: 15 MHz to 4 GHz.

Sensitivity: -10 dBm (70 mV rms) auto mode, -20 dBm typical (22 mV rms) Manual/Pulse mode to 20 dBm (2.2 V rms).

Input signal capability: CW signals. Pulsed microwave signals. Signals with very high FM content.

RF Pulse width: determined by counter GATE TIME setting.

FM Sensitivity: overlap at band edges ± 10 MHz. Maximum deviation at band center

± 250 MHz, above 1 GHz and below 500 MHz.

± 125 MHz, between 500 MHz and 1 GHz.

Operating modes: Automatic and Manual.

Automatic: measures lowest frequency signal of sufficient amplitude to trigger counter.

Manual: measures signal within selected band. Signals of sufficient amplitude between 15 MHz and 525 MHz will also be counted.

Acquisition time:

Automatic mode: CONT. WAVE, <2 ms; PULSED R.F., <1s.

Manual mode: when proper band has been selected CONT. WAVE <5 μ s; PULSED R.F. <20 ns.

Options

O11: remote control via HP Interface Bus and L.O. \pm I.F.

Price

add \$200

5354A Automatic Frequency Converter

\$3400

5353A Channel C plug-in

The 5353A Channel C Plug-In consists of a third input to the 5345A Counter. When the plug-in counting capability is combined with the mainframe gating capability it becomes quite easy to make frequency sum and frequency difference measurements.

For high speed digital applications, the greatest benefit the plug-in offers is the ability to count a specific group of events while ignoring others. This measurement is required in many applications such as computer peripheral testing and digital communications systems. It is accomplished in the events C between A and B mode by applying a start signal to CHAN A and a stop signal to CHAN B while applying the data to be counted to CHAN C.

Range: dc coupled: 0 to 500 MHz; ac coupled: 1 M Ω : 200 Hz to 500 MHz; 50 Ω : 4 MHz to 500 MHz.

Impedance: 50 Ω ; (nominal), or 1 M Ω shunted by less than 30 pF. **Sensitivity:** variable to 20 mV rms sine wave and 60 mV peak-to-peak pulse. Attenuator settings are X1 and X10.

Modes of operation: Frequency C + A; Frequency C - A; Period C; Frequency C; Ratio C/A; Average Events C, A to B; Events C, A to B.

Events accuracy: Plus or minus one count worst case.

Options

O11: Digital Input. Full compatibility with HP Interface Bus. Provides for digital control over all functions excluding amplifier.

Price

add \$250

5353A Channel C plug-in

\$1250

10590 Plug-in adapter

The 10590A allows the user to interface any of the 5245 series of plug-ins (except the 5264A) to the 5345A (see page 297 for details on these plug-ins). The major application is to extend the frequency range to 18 GHz via the 5255A, 5256A and 5257A plug-ins. In addition the adapter is "intelligent" in that it detects the plug-in being used and automatically adjusts the 5345A accordingly.

10590A Plug-in adapter

\$700

- Capable of 100,000 measurements/second



5391A Frequency and Time Data Acquisition System

GENERAL

The HP5391A Frequency and Time Data Acquisition System combines the power of the HP5345A Universal Counter with the speed and storage capability of the HP5358A Measurement Storage Plug-In to allow you to make and store frequency or time measurements at rates as high as 100,000 measurements per second. The 5391A can help you characterize pulse width jitter by measuring and storing each pulse width and then computing statistical parameters such as min, max, mean, and standard deviation. Other application areas include nuclear time of flight studies, explosive testing and characterization, and frequency profile measurements.

The 5391A is a compact HP-IB system consisting of the 5345A Universal Counter with the 5358A Measurement Storage Plug-In, the 9825A Option 001 Computing Controller, and a versatile software package providing utility application routines and diagnostic service routines.

APPLICATION EXAMPLE

Frequencies, periods, ratios, and time intervals may be measured and stored by the 5391A. A typical application, shown in the figure, is to measure and store every pulse width in a burst of pulses:

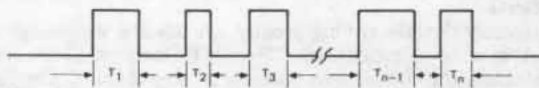

The 5345A counter makes a single shot time interval measurement (2 nanosecond resolution) for each pulse width. During the dead time between successive time intervals, the 5345A transfers the data to the 5358A Measurement Storage Plug-In. The time required for this transfer is $7 \mu s + 1 \mu s/\text{digit transferred}$. The graph plots transfer time required versus the time interval measured. If the dead time immediately following a measured time interval is greater than the required transfer time, the 5391A can make the measurement.

The number of measurements which can be consecutively made at this high rate is limited in most cases by the size of the 9825A memory. For the standard 5391A with 9825A Option 001, 700 measurements can be consecutively made and stored for time intervals less than 200 seconds. For the 5391A Option 102 (which has a 9825 Option 002), 1200 consecutive measurements may be made for time intervals less than 2 milliseconds. Above 2 milliseconds, the 8K memory size of the 5358A is limiting.

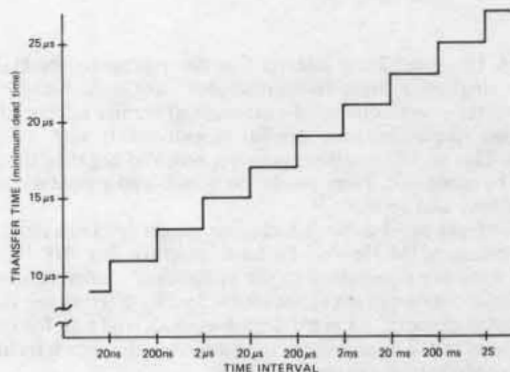

When the desired number of measurements in a run exceeds the maximum allowable, the maximum is taken and then stored as a block on the 9825A cassette. Subsequent blocks of measurements are taken and stored on cassette until the total desired number of measurements has been accumulated. The time required to transfer the measurement data from the 5358A to the 9825A and store it on cassette is on the order of seconds. During this time, no measurements can be made. The total number of measurements is program selectable from 1 to 9999.

SYSTEMS OPTIONS

- 102:** Expands 9825A memory to 23,228 bytes add \$800
- 325:** Deletes 9825A Controller (as well as ROMS and HP-IB Interface) less \$7,950

Ordering Information

- 5391A** basic system includes:
- 5345A** Option 011 Electronic Counter
- 5358A** Measurement Storage Plug-In with 8K bytes of memory
- 9825A** Option 001 Computing Controller with 15,036 bytes of memory
- 98034A** HP-IB Interface
- 98210A** Adv. Prog., String Variable ROM
- 98213A** Gen. Purpose I/O, Extended I/O ROM
- System Software Cartridge
- System and Instrument Manuals
- 5391A Basic System** Price 17,900

ELECTRONIC COUNTERS

UNIVERSAL TIME INTERVAL COUNTER

MODEL 5370A

- 20 ps single shot time interval counter
- Statistics
- Automatic calibration of systematic errors
- Positive or negative time intervals
- Frequency and period to 100 MHz

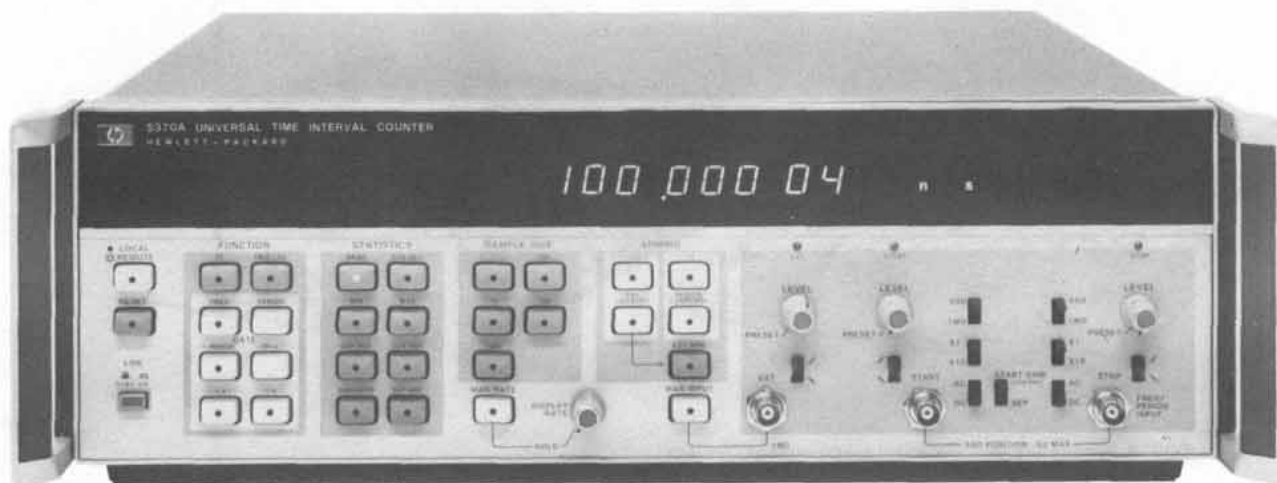

5370A



The 5370A Universal Time Interval Counter represents the highest resolution single-shot time interval counter available today. The counter utilizes a new concept of phase locked vernier interpolation, which allows single-shot time interval measurements with ± 20 ps resolution. This technique allows positive, zero and negative time intervals to be measured. High resolution period and frequency measurements may also be made.

All major front panel controls including trigger level are programmable by means of the Hewlett-Packard Interface Bus (HP-IB).

User convenience is increased by the inclusion of a microprocessor, which extends the usefulness of the instrument by offering the statistical functions of mean, standard deviation, max, and min for repetitive time intervals. A user-defined time interval reference is included for the cancellations of systematic errors.

The high resolution time interval capability makes the instrument ideal for IC testing, radar and laser ranging, digital communications, ballistics and nuclear measurements.

FUNCTIONS

TI: Time Interval function measures time difference from the START to the STOP channel. In the \pm TI mode, the counter will measure the time from the first event in either channel to the first event in the other channel. The microprocessor affixes a negative sign to the display if the stop channel event occurred first.

The negative time feature allows applications like differential phase measurement between two waveforms to be continuously monitored even though the phase changes from a positive to a negative drift. Statistical functions are available in both TI modes.

Trig Lev: Measures the trigger levels of START and STOP channels and displays both levels simultaneously with 10 mV resolution. Additional equipment like oscilloscopes or DVM's is not required.

Freq: Measures the frequency of the STOP channel signal by taking the reciprocal of a period average. Both timed gates and single period gates are available. In the single period mode, resolution may be improved by using a larger sample size. Statistics are available in the single period mode.

The exceptionally high resolution (11-12 digits per second) of the 5370A makes the instrument ideal for directly measuring the drift of oscillators and other applications requiring exceptionally high frequency resolution.

Period: Measures the period average of STOP channel events. Statistics are available in the single period mode, but not with timed gates.

STATISTICS

Statistical functions allow much more complete characterization of time intervals. In addition to the mean, both the max and min within a selected sample size are available and also the standard deviation. In many cases, these parameters are of more interest than the mean. For example, in a digital communications system, the limits of pulse jitter as described by the max and min could be of primary interest. For a normal distribution of jitter, the standard deviation gives the rms jitter directly.

Sample size: push-button selectable to 1,100, 1K, 10K, and 100K samples.

Mean: displays the mean estimate which is the average for the selected sample size.

Std dev: displays a standard deviation estimate for the selected sample size.

Min: displays the minimum time interval measured within the selected sample size.

Max: displays the maximum time interval measured within the selected sample size.

ARMING

Extremely flexible arming greatly extends the usefulness of the 5370A into new applications. "Hold-off" features allow complex pulse trains to be measured by preventing "stop channel" arming until the removal of an external "gating" signal. An example could be the measurement of time from a radar or laser send pulse to the return pulse, where depending on the range of the object, several return pulses may occur before the return pulse of interest.

Other methods of arming allow the counter to be externally gated by an input waveform which very precisely controls both measurement duration and the time position at which the measurement occurs. Applications are in the frequency profiling of VCO's, pulsed rf bursts, or sweep linearity investigations.

The following modes of arming are available:

+TI

Internally armed - no hold-off

Externally armed - no hold-off

Externally armed - external hold-off

\pm TI

External arming

Internal arming

Programming

All major controls are programmable as standard by means of the HP-IB making the 5370A an economical, versatile unit for systems applications.

Data Output Rate

- 1) HP-IB 10-20 readings per second.
Dead time between measurements within a sample is 330 μ s.
- 2) Fast Binary: 6 KHz
Dead time between measurements is 165 μ s.

5370 Specifications

Sensitivity: 100 mV p-p, 35 mV rms sine wave times attenuator setting.

Impedance: Selectable 1 M Ω || 30 pF or 50 Ω nominal.

Trigger Level: Adjustable from -1.3V to 0.5V with 10 mV displayed resolution.

Trigger Slope: Independent selection of + or - slope.

Attenuators: X1 and X10 nominal.

Dynamic Range (preset):

- 50 Ω X1 100 mV to 1V p-p pulse
X10 1V to 7V p-p pulse
1 M Ω X1 100 mV to 1V p-p pulse
X10 1V to 10V p-p pulse

Dynamic range for rms sine wave is one-third of the above values.

Signal Operating Range:

- 50 Ω X1 -2.5V to 1V
X10 -7V to 7V
1 M Ω X1 -2.5 to 1V
X10 -25V to 10V

Coupling: AC or DC switch selectable.

Minimum Pulse Width: 5 ns

Maximum Input:

- 50 Ω X1 \pm 7V DC
7V rms below 5 MHz
3.5V rms (+24 dBm) above 5 MHz
X10 \pm 7V DC, 7V rms (+30 dBm)
1 M Ω X1 \pm 350V DC
250V rms to 20 KHz decreasing to 3.5V rms above 5 MHz
X10 \pm 350V
250V rms to 20 KHz decreasing to 35V rms above 5 MHz

Common Input

All specifications are the same as for separate operation with the following differences:

Impedance: 1 M Ω becomes 500 K Ω shunted by <60pF. 50 Ω same as in separate.

Sensitivity: (preset)

- 50 Ω X1 200mV p-p, 70 mV rms
X10 2V p-p, 700 mV rms
1 M Ω same as in separate

Dynamic Range: (preset)

- 50 Ω X1 200mV to 2V p-p pulse
X10 2V to 5V p-p pulse
1 M Ω Same as in separate

Maximum Input:

- 50 Ω \pm 5V DC or 5V rms
1 M Ω same as in separate

Attenuators: Becomes X2 and X20 for 50

Frequency and Period Measurements

Frequency Range: 0 to 100 MHz

Period Range: 10 ns to 10 seconds

Resolution: $\frac{20 \text{ ps}}{\text{Gate Time}}$

Internal Gate Time: 1 period 0.01, 0.1, 1 seconds

Accuracy: $\frac{100 \text{ ps rms} \pm \text{trigger error}}{\text{Gate Time}} \pm \text{time base}$

Period/Frequency Statistics: (1 period gate only) mean, standard deviation, maximum, minimum

Sample Size: 1, 100, 1000, 10,000, 100,000

External Gate Input: 20 ns to 10s/sample size

Time Interval Measurements

Time Interval Range:

- \pm Mode -10 seconds to +10 seconds
+ Only Mode 10 ns to 10 seconds

Time Interval Statistics: Mean, Standard deviation, maximum, minimum

Sample Size: 1, 100, 1000, 10,000, 100,000

Minimum Time Between Measurements: 330 μ s

Resolution: $\frac{\pm 20 \text{ ps}}{\sqrt{\text{sample size}}} \pm 2 \text{ ps}$

Accuracy: jitter \pm 700 ps systematic \pm time base \dagger \pm trigger error/ \sqrt{N}

Jitter: $\frac{35 \text{ ps rms}}{\sqrt{N}}$ typical $\frac{100 \text{ ps rms}}{\sqrt{N}}$ maximum

Trigger Error: $\frac{\pm 2 \times \text{noise peak voltage}}{\text{Signal Slope } V/\mu\text{s}} \mu\text{s}$

Trigger error due to input signal noise is usually the limiting factor in high resolution frequency measurements at low frequencies. If peak noise amplitude is greater than 10 mV, additional miscounting may occur. (This situation can arise when measuring high-level outputs of broadband synthesized signal sources.)

Timebase

Frequency: 10 MHz

Aging: $<3 \times 10^{-7}$ /month

Temperature: $<2.5 \times 10^{-8}$, 0°C to 50°C

Display: 16 digits, suppressed leading zeros.

Size: 133 H x 426 W x 521 mm D (5 $\frac{1}{4}$ " x 16 $\frac{3}{4}$ " x 20 $\frac{1}{2}$ ".)

Weight: 32 lbs.

Options and Accessories

001: High Stability Time Base

908: Rack Flange Kit

10870A: Service Kit

5370A Universal Time Interval Counter

Price

add \$575

add \$20

add \$430

\$6500

ELECTRONIC COUNTERS

General purpose plug-in counters

Model 5245L

- High performance in a general purpose counter
- Wide selection of plug-ins provide wide versatility
- Extremely high reliability proven from over forty million hours of field operation



5245L

The 5245L has gained unprecedented popularity due to its high performance, flexibility and years of proven stability. Even though its performance has been recently upstaged by the 5345A, the 5245L is still considered the standard of the industry for instruments of this type with more 5245L counters in operation today than all other plug-in counters combined.

The 5245 series consists of a mainframe and a series of plug-ins. The plug-ins provide frequency measurement to 18 GHz and time interval capability. The wide choice of mainframes and plug-ins means that virtually any measurement task performable by counters can be accomplished by appropriate selection within this family.

The 5245 series counters are not only leaders in terms of performance and versatility, they are unsurpassed in the industry for ruggedness, wide operating temperature range, and field-proven reliability.

Specifications

5245L

Frequency measurements

Range: dc to 50 MHz.

Gate time: 1 μ s to 10 seconds in decade steps.

Accuracy: ± 1 count \pm time base accuracy.

Period average measurements

Range: dc to 1 MHz for single period; dc to 300 KHz for multiple period.

Periods averaged: 1 period to 10^5 periods in decade steps.

Accuracy: ± 1 count ± 1 time base accuracy \pm trigger error*

Mainframe measurement functions: frequency, period, period average, ratio, scaling.

Signal input

Sensitivity: 100 mV rms.

Coupling: AC and DC.

Impedance: 1 M Ω in parallel with approx. 25 pF all ranges.

Attenuation: step attenuator provides nominal sensitivities of 0.1, 1, and 10 V rms (SENSITIVITY switch).

Trigger Level: continuously adjustable over ± 3 V multiplied by the setting of the SENSITIVITY switch.

Compatible 5245 series plug-ins: all.

Time base: 10 MHz oscillator, aging rate $< 3 \times 10^{-9}$ /day.

Display: 8 digits.

Operating temperature range: -20°C to $+65^\circ\text{C}$.

Weight: net, 14.4 kg (32 lb) with blank plug-in panel.

Size: 133 H \times 425 W \times 416 mm D (5 $\frac{1}{4}$ " \times 16 $\frac{3}{4}$ " \times 16 $\frac{3}{8}$ ").

Options

908: Rack Flange Kit

5245L 50 MHz Electronic Counter

Price

add \$35

\$5000

*Trigger error is $< (\pm .3\%$ of one period + number periods averaged) for signals with 40 dB signal-to-noise ratio and 100 mV rms amplitude; error decreases as signal to noise ratio increases.

ELECTRONIC COUNTERS

Plug-ins for 5245L/M, 5246L, 5248L/M & 5345A

Models 5253B—5262A



The 5245 series of plug-ins adds greatly to the versatility of the 5245 series of plug-in counters. In addition, these plug-ins enhance the measurement capability of the 5345A Electronic Counter and the 5360A Computing Counter by the use of plug-in adapters which provide an interface between the plug-in and the 5345A and 5360A mainframes. A compatibility summary for presently available plug-ins is shown below, followed by brief descriptions of the individual plug-ins. Refer to the 5245 series data sheet for complete details and specifications for all the plug-ins.

Plug-in compatibility summary

5345A compatibility (using 10590A plug-in adapter): all except the 5264A.

5360A compatibility (using 10536A plug-in adapter): all except the 5262A, 5264A, 5265A, and 5267A.

5245L/M compatibility: all.

5248L/M compatibility: all.

5246L compatibility: all except the 5264A.

Specifications

5253B Heterodyne converter

\$1350

Frequency range: 50 MHz to 512 MHz.

Sensitivity: -13 dBm to +13 dBm.

Mixing frequencies: 50 to 500 MHz in 10 MHz steps.

Input coupling: ac.

Accuracy: maintains counter accuracy.

Input impedance: 50Ω.

5254C Heterodyne converter

\$2000

Frequency range: 150 MHz to 3 GHz.

Sensitivity: -13 dBm to +13 dBm.

Mixing frequencies: 0.15 to 3 GHz in 50 MHz steps.

Input coupling: ac.

Accuracy: maintains counter accuracy.

Input impedance: 50Ω.

Auxiliary outputs: 1 MHz-50 MHz.

5255A Heterodyne converter

\$2750

Frequency range: 3 GHz to 12.4 GHz.

Sensitivity: -7 dBm to + dBm.

Mixing frequencies: 2.8 to 12.4 GHz in 200 MHz steps.

Input coupling: dc.

Accuracy: maintains counter accuracy.

Input impedance: 50Ω.

Auxiliary input: 1 MHz-200 MHz at 5 mV sensitivity.

Auxiliary output: 1 MHz-200 MHz.

5256A Heterodyne converter

\$3225

Frequency range: 8 GHz to 18 GHz.

Sensitivity: -7 dBm to +10 dBm.

Mixing frequencies: 8 to 18 GHz in 200 MHz steps.

Input coupling: dc.

Accuracy: maintains counter accuracy.

Input impedance: 50Ω

Auxiliary input: 1 MHz-200 MHz at 5 mV sensitivity.

Auxiliary output: 1 MHz-200 MHz.



5253B

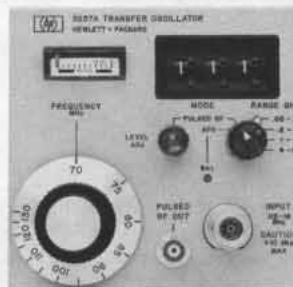

5262A

5257A Transfer oscillator

\$3500

Frequency range: 50 MHz to 18 GHz.

Input signal: CW, pulsed RF or FM modulated.

Sensitivity: -7 dBm, 50 MHz to 15 GHz; -4 dBm, 15 GHz to 18 GHz.

APC lock range: approximately $\pm 0.2\%$ of input frequency.

Pulse carrier frequency measurements: minimum pulse width: 0.5 μ s. Minimum repetition rate: 10 pulses per second.

Input impedance: 50Ω.

VFO stability: typically 1×10^{-7} per minute after 2 hours.

5262A Time interval unit

\$800

Range: 1 μ s to 10⁸ s

Resolution: 0.1 μ s.

Input sensitivity: 100 mV rms.

Start-Stop: independent or common channels.

Trigger slope: positive or negative on Start and Stop channels, independently selected.

Trigger amplitude: both channels adjustable from -250 to +250 V peak.

Input repetition rate: better than 2 MHz.

Input impedance: from 10 kΩ/80 pF at x0.1 multiplier setting to 10 MΩ/20 pF at x 100 setting.



ELECTRONIC COUNTERS

100 MHz Universal counter

Model 5328A

- 100 MHz, 512 MHz and 1300 MHz
- 100 ns or 10 ns time interval
- T.I. averaging to 10 ps resolution

- "Armed" measurements
- DVM options
- HP-IB interface option

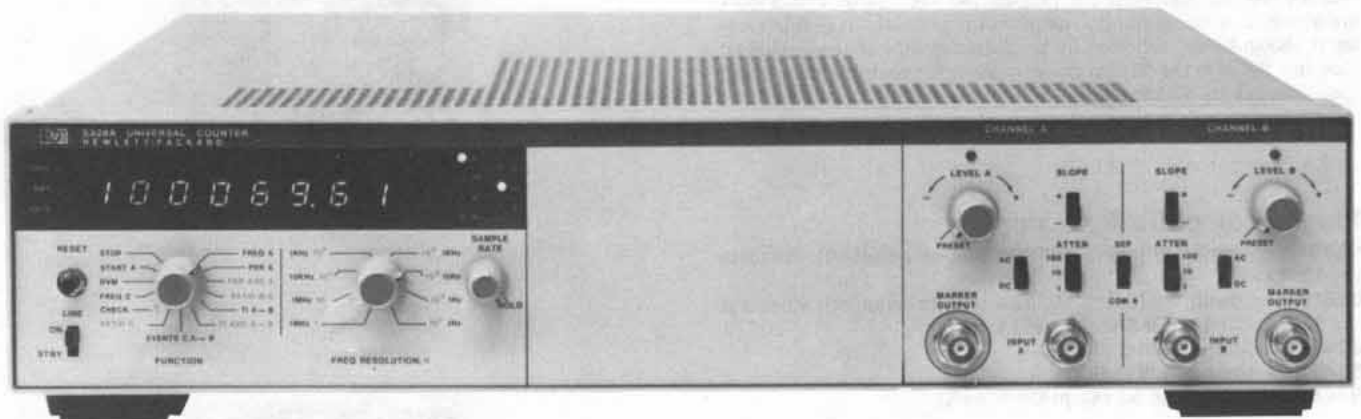

Model 5328A

Description

The 5328A, thru the use of the latest technology (such as a ROM controlled measurement cycle) and a modular design, provides you with the optimum in universal counter price/performance. Optional modules allow you to tailor the performance of the 5328A to meet your particular measurement needs. In many instances, however, the standard 5328A offers all the capability you're ever likely to need.

Burst and CW measurements to 100 MHz: special gating circuits start a measurement only when the input signal is present, allowing burst frequencies to be measured as easily as CW signals. The option 030 channel C extends this capability to 512 MHz; option 031, to 1300 MHz.

Single shot time interval measurements: the standard universal module's 100 ns single shot resolution meets or exceeds the requirements for a wide range of applications such as mechanical and electromechanical device timing (relays), time of flight measurements (ballistics), sonar ranging, radio ranging and navigation

Time interval averaging: resolution better than 10 ps (10^{-11} seconds) for repetitive time intervals as short as 100 ps.

Period, period average, ratio, totalize, scale: extra problem solving power for your special requirements.

Armed measurements: versatile arming modes (controlled by a rear panel switch) allow real time control over when a measurement begins. Useful for measurements such as frequency burst profile and frequency sweep linearity.

Trigger lights: trigger light blinks when channel is triggering; light is ON when input is above trigger level; OFF when input is below trigger level. Simplifies trigger level adjustments.

High performance marker outputs: marker outputs (operational to 100 MHz) indicate where channel is triggering in real time for oscilloscope monitoring applications. Provides measurement feedback to the operator for greatly simplified measurement set-ups.

These features and capabilities make the 5328A an excellent choice for general purpose lab use, electronic service, and production test. For more demanding applications, a variety of options offer extended performance at a modest increase in price.

Summary of characteristics

Model No.	Description	Features
5328A	Universal Counter	Frequency to 100 MHz; 100 ns single shot T.I.; T.I. averaging; Period; Period Avg; ratio; totalize Oven oscillator with aging rate $<5 \times 10^{-10}$ /day
Opt. 010	High Stability Time Base	
Opt. 011	HP-IB Interface	Allows 5328A to output data and be controlled via the HP Interface Bus.
Opt. 020	DVM	Single ended DVM for trigger level and external voltage measurements
Opt. 021	High Performance DVM	Floating DVM for trigger level and high accuracy external voltage measurements.
Opt. 030	512 MHz Channel C	Frequency measurements to 512 MHz; 9 digit display.
Opt. 031	1300 MHz Channel C	Frequency measurements to 1300 MHz; 9 digit display.
Opt. 040	High Performance Universal Module	Same as standard 5328A but with 10 ns single shot T.I.; improved T.I. averaging; improved T.I. accuracy; measurements with delay; T.LA \rightarrow B marker; hysteresis compensation; switchable input impedance (1 M Ω /50 Ω).
Opt. 041	Programmable Input Module	Full remote programming of all universal module controls thru opt. 011; 10 ns single shot T.I.; switchable 1 M Ω /50 Ω input impedance.



5328A with Opt 021, 031, 041

5328A Option descriptions

High stability time base (Opt 010)

The standard time base for the 5328A is a room temperature 10 MHz crystal providing a long term aging rate of less than 3 parts in 10^7 per month. The option 010 oven oscillator offers excellent short term and temperature stability which can contribute to higher measurement accuracy. The low aging rate of $<5 \times 10^{-10}$ /day permits longer intervals between time base calibrations.

HP Interface Bus for systems use (Opt 011)

The option 011 HP-IB Interface brings the full capability and power of the HP Interface Bus. The 5328A can accept program code words over the HP-IB which remotely program various front and rear panel controls. In addition, measurement results may be output over the bus to HP-IB compatible instruments, calculators, or computers.

Remotely programmable controls include FUNCTION selection, RESOLUTION selection, ARMING, SAMPLE RATE (max. or manual), RESET, measurement modes, output modes, and display modes. Option 041 adds programming of channel A and B input signal conditioning controls.

Digital voltmeters (Opt 020, 021)

The unique combination of an integrating digital voltmeter with a universal counter produces a superb general purpose measuring instrument. By using a voltage to frequency conversion technique, the incremental cost of adding DVM capability to the 5328A is very low.

Two DVM options are available; the option 020 DVM with single-ended input and the option 021 High Performance DVM with floating input. You can use these DVMs to measure channel A and B trigger levels and external voltages. Since a built-in DVM greatly simplifies time interval measurement set-ups, it is highly recommended that one of the DVM options be selected, particularly if time interval measurements are one of your major applications.

High frequency channel C (Opt 030, 031)

With a high frequency channel C module the 5328 is ideally suited for use in a wide variety of communications measurements. Option 030 gives direct count measurements to 512 MHz with 15 mV rms sensitivity; option 031 counts to a full 1300 MHz with 20 mV rms sensitivity. Typical applications include servicing, maintaining, calibrating, and monitoring communications transmitters and receivers

such as found in two-way radio, radio and television broadcasting, mobile radio, and common carrier multiplexing and transmission.

Extended capability universal modules (Opt 040, 041)

Options 040 and 041 give extended performance for time interval measurements. Option 040 is designed for bench use and includes "delay" capability for increased measurement versatility. Option 041 adds full programming of the input signal conditioning controls.

Both of these options generate a 100 MHz clock to give 10 ns single shot resolution for time interval measurements. This resolution is useful in applications such as computer/peripheral timing measurements, logic timing measurements, radar ranging, and optical ranging.

For improved time interval averaging performance, the options have input channels adjusted for delay matching to better than 2 ns. Additionally, options 040 and 041 use a jittered clock in T.I. AVG. function to give averaging even for those cases when the input repetition rate is synchronous with the counter's internal time base.

Selectable input impedance adapts the counter to the measurement environment: 50Ω for fast signals in a 50Ω environment, 1 MΩ to reduce circuit loading or to use with scope probes.

The "delay" feature of option 040 allows you to disable the inputs from triggering for selected periods of time (20 μs to 20 ms). Delay is useful for ignoring high amplitude noise such as from chattering relays or ignoring stop pulses in multiple stop T.I. measurements.

Option 041 allows remote programming of input trigger level, slope, coupling, and attenuator setting. Under remote control, the input impedance is independently selectable on the A and B channels. Also, a remote "Invert" function switches the A and B channel signals internally. "Invert" gives exceptional flexibility for two channel time interval measurements.

Retrofit kits

Retrofit kits, available for all options, allow you to upgrade the performance of your 5328A in response to your changing measurement requirements.

The condensed specifications on the following pages highlight some of the important performance characteristics of the 5328A and its options. Complete specifications and detailed applications information are available in the 5328A data sheet.

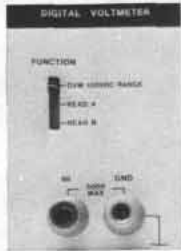
Opt 020
DVMOpt 021
High Performance DVMOpt 030
512 MHz
Channel COpt 031 1300 MHz
Channel C

10855A Preamp

Digital voltmeter modules

Digital voltmeter measurements†

DVM (Opt 020 and 021): trigger levels of input channels A and B and external voltages may be measured.

Maximum sensitivity	Opt 020	Opt 021
Meas. time:		
10 s (N = 10 ⁷)	1 mV	10 μV
1 s (N = 10 ⁶)	1 mV	100 μV
0.1 s (N = 10 ⁵)	2 mV	1 mV
10 ms (N = 10 ⁴)	20 mV	10 mV
1 ms (N = 10 ³)	200 mV	100 mV
Range	0 to ±125 V dc	±10, ±100, ±1000 V dc, and Autorange
Accuracy (20 min. warm-up)	±0.5% reading ±4 mV	±0.03% reading ±0.004% range; for 1000 V range: ±0.087% reading ±0.004% range
Input terminals	Single ended	Floating pair
Input impedance	10 MΩ	10 MΩ
Normal mode rejection ratio	>60 dB at 60 Hz (50 Hz) ±0.1%	>80 dB at 50 Hz or greater with filter on
Effective common mode rejection ratio (1 kΩ unbalance)		DC: >120 dB AC: >120 dB for multiples of 60 Hz (50 Hz) with filter on
Maximum input	±500 V	HI to LO: ±1100 V all ranges; LO to chassis ground: ±500 V
Trigger level measurements	2 mV display resolution	1 mV display resolution: trigger level reading automatically multiplied by setting of attenuator switch if using Opt 040 or 041 universal modules

†Performance: 60 days at 23°C ±5°C and RH <80%

Channel C modules

Input characteristics	Opt 030	Opt 031
Sensitivity	15 mV rms	20 mV rms
Coupling	dc	ac
Trigger level	0 V, fixed	0 V, fixed
Impedance	50Ω	50Ω
Maximum input	5 V rms	5 V rms, ±5 V dc
Input protection	fused	fused
Attenuator	No	Variable for optimum noise suppression on signals to 5 V rms
Frequency C measurements		
Range	5-512 MHz (direct count)	90-1300 MHz (prescaled, ÷4)
Resolution	1 MHz to 0.1 Hz in decade steps	1 MHz to 0.1 Hz in decade steps
Accuracy	±1 count ± time base error	±1 count ± time base error
Ratio C/A measurement		
Range: A	0-10 MHz	0-10 MHz
Range: C	5-512 MHz	90-1300 MHz
General		
Probe power	No	Power to operate 10855A Preamp or HP active probe

Events C, A to B (with Opt 030 only)

The number of events at the C input are totalized during the synchronized time interval defined by inputs to channels A and B. The synchronized time interval is a multiple of 100 ns with the standard universal module; a multiple of 10 ns with Opt 040 or 041 universal modules.



Standard Universal Module

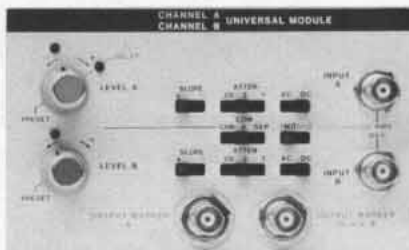

Opt 040 High Performance Universal Module



Opt 041 Programmable Input Universal Module

Accessories

10855A Preamp: (for use with Opt 031): gives >22 dB gain with ±1 dB flatness over the entire frequency range of the Opt 031 1300 MHz Channel C. For more details see page (14.30).

Universal modules, channels A and B

Input characteristics	Standard	Opt 040, Opt 041
Sensitivity: 0-40 MHz (dc coupled) 20 Hz-40 MHz (ac coupled) 40-100 MHz	25 mV rms 25 mV rms 50 mV rms	25 mV rms 25 mV rms 50 mV rms
Min pulse width	5 ns, 140 mV p-p	
Coupling	ac or dc, switchable	
Impedance	1 MΩ, 40 pF shunt	1 MΩ or 50Ω, switchable
Trigger level	variable ±2.5 V times atten. setting	
Trigger slope	independent selection of + or - slope	
Attenuators	X1, X10, X100	Opt 040: X1, X2, X20 Opt 041: X1, X10
Dynamic range	25 mV to 1 V rms times attenuator setting for 0-40 MHz; 50 mV to 500 mV times attenuator setting for 40-100 MHz	
Channel input	Separate or Common A	Separate, Common A, or Check
Delay	No	Opt 040 only: 20μs to 20 ms
Programmable Controls	No	Opt 041 only: level, slope coupling, atten, impedance SEP-COM-CHK

Frequency A measurement	
Range	0-100 MHz, direct count
Resolution	1 MHz to 0.1 MHz in decade steps
Accuracy	±1 count ± time base error

Period A measurement	
Range	0-10 MHz
Resolution	100 ns to 1 s in decade steps 10 ns to 0.1 s in decade steps
Accuracy	±1 count ± time base error ± trigger error*

Period Average A measurements

Range	0-10 MHz	
Resolution	100 ns to 0.01 ps in decade steps	10 ns to 0.01 ps in decade steps
Accuracy	±1 count displayed ± time base error ± trigger error* N	

Time interval A to B measurements

Range	100 ns to 10 ⁶ s	10 ns to 10 ⁷ s
Resolution	100 ns to 1 s in decade steps	10 ns to 0.1 s in decade steps
Accuracy	±1 count ± time base error ± trigger error*	

Time interval average A to B

Range	0.1 ns to 10 s	0.1 ns to 1 s
Resolution	±100 ns ± trigger error* √N ±10 ps	±10 ns ± trigger error* √N ±10 ps
Accuracy	± resolution ± 4 ns ± time base error	± resolution ± 2 ns ± time base error
Min. pulse width	25 ns	10 ns
Min. dead time (from each stop event to next start event)	150 ns	40 ns

Ratio B/A measurement

Range: A B	0-10 MHz 0-100 MHz
Totalizing and scaling, Start A The number of counts at the A input are totalized for N = 1 on the resolution switch. For N > 1, A/N is totalized and the scaled output (A/N) is available at the Time Base Out rear panel connector.	
Range: N = 1 N > 1	0-100 MHz 0-10 MHz

* Trigger error is <0.3% of one period for sinewaves of 40 dB S/N or better and amplitude equal to sensitivity of counter. For any waveshape, trigger error is less than

$$\pm 2 \times \frac{\text{peak noise voltage}}{\text{signal slope}}$$

$$\left(\text{or } \frac{\pm 0.025 \mu\text{s}}{\text{signal slope in V}/\mu\text{s}} \text{ for } 40 \text{ dB S/N} \right)$$

Model 5328A (cont.)

Measurements with delay (Opt 040)

Delay mode is activated by the inner concentric knob on Level A control of option 040 Universal Module. A red LED indicates delay is activated. In delay mode, Channel A triggers and is then disabled from triggering again until the delay times out (disabled state occurs within 1 μ s after triggering.) Channel B is continuously disabled until the delay times out. After the delay, both A and B are enabled. The delay time may be measured by placing the counter in T.I.A \rightarrow B and the Universal Module in check (CHK).

Delay range: 20 μ s to 20 ms continuously adjustable.

Minimum dead time: 1 μ s between stop and next start (T.I. average measurements only).

General

Display: 9 digit LED display, ninth digit used only with channel C functions (FREQ. C, Ratio C/A, Events C, A \rightarrow B).

Blanking: suppresses display of unwanted zeros to left of most significant digit.

Storage: holds reading between samples; can be overridden by rear panel switch.

Sample rate: variable from less than 2 ms between measurements to HOLD which holds display indefinitely.

Gate output: rear panel output, TTL levels; high when counter gate open.

Time base output: rear panel output: TTL levels.

Check signal: with function switch in CHECK, counter should display 10 MHz \pm 1 count. With options 040 and 041, place function switch in FREQ A and universal module in CHECK (CHK). Counter should display 100 MHz \pm 1 count.

Trigger lights: light is ON when input is above trigger level; OFF when input is below trigger level; BLINKING when channel is triggering. Operate over full frequency range of 0-10 MHz.

Marker outputs: indicate actual change of state of input Schmitt trigger for channels A and B with <20ns delay. Output levels into 50 Ω are 0 to -100 mV for the standard universal module, 0 to -50 mV for option 040, and 0 to +1 V for option 041. Outputs are protected from inadvertently applied voltage to \pm 5 V dc.

Arm: rear panel switch turns arming ON or OFF. With arming ON the measurement is armed by an input other than the input involved in the measurement. The following are armed by an event at B: Freq A, Period A, Period Avg A, Freq C, DVM, Ratio C/A; the following are armed by an event at C: T.I. A \rightarrow B, Ratio B/A.

Operating temperature: 0 $^{\circ}$ to 50 $^{\circ}$ C.

Power requirements: 100/120/220/240 V rms, +5%, -10% (switch selectable), 48-66 Hz; 150 VA max.

Time base oscillators**Standard crystal oscillator**

Frequency: 10 MHz.

Aging rate: <3 x 10 $^{-7}$ /month.

Temperature: <2.5 x 10 $^{-6}$, 0 $^{\circ}$ to 50 $^{\circ}$ C.

Line voltage: <1 x 10 $^{-7}$ for 10% change.

Opt 010 oven oscillator

Frequency: 10 MHz.

Aging rate: <5 x 10 $^{-10}$ /day after 24-hour warm-up.

Short term: <1 x 10 $^{-10}$ rms/s.

Temperature: <7 x 10 $^{-9}$, 0 $^{\circ}$ to 50 $^{\circ}$ C.

Line voltage: \pm 5 x 10 $^{-9}$ for 10% variation.

Warm-up: within 5 x 10 $^{-9}$ of final value in 20 min.

Ext. freq. std. input: 30 kHz to 10 MHz signal of amplitude >1.0 V rms into 1 k Ω . Maximum input: 5 V p-p. With options 040 and 041 the following constraints apply: ext. freq. std. must be 10 MHz for Period Avg., T.I. Avg., Period (N = 1), and T.I. (N = 1).

HP-IB Interface (Opt 011)

Option 011 provides digital output of measurement data ("talker") as well as input for remote program control ("listener").

Programmable features: function, resolution, sample rate (max or manual control), arming, display modes, measurement cycle modes, output modes, and reset commands. Option 041 adds control of channel A and B trigger level, slope, attenuator, coupling, input impedance, and SEP-COM-CHECK selection.

HP-IB commands: responds to the following bus commands (see HP-IB Users Guides for definitions)—Unlisten, Untalk, Local Lockout, Device Clear, Serial Poll Enable, Serial Poll Disable, Go to Local, Selected Device Clear, and Group Execute Trigger.

Service request (SRQ): if enabled, indicates end of measurement.

Maximum data output rate: 500 readings/sec.

Accessories

5363A Time Interval Probes: solve many of the "hidden" problems of precision time interval measurements. The 5363A Time Interval Probes minimize circuit loading, give calibrated trigger level settings, increase input dynamic range, and allow differential channel delay calibration. See page 318 for more details.

Options and accessories

Options and accessories	Price
010: High Stability Time Base	\$525
011: HP-IB Interface	\$350
020: DVM	\$200
021: High Performance DVM	\$500
030: 512 MHz Channel C	\$400
031: 1300 MHz Channel C	\$600
040: High Performance Universal Module	\$350
041: Programmable Input Controls Module	\$950
907: Front Handle Kit	\$15
908: Rack Flange Kit	\$10
909: Rack Flange and Front Handle Combination Kit	\$20
10855A Preamp	\$225
5363A Time Interval Probes	\$2250

5328A Universal Counter

\$1300

- 100 MHz
- 100 ns Time Interval
- Portable



5314A

The 5314A Universal Counter is the newest result of HP's continuing low cost counter product development effort. It combines excellent performance and traditional HP quality at a very attractive price. This counter is designed to deliver reliable, high quality operation in such areas as: Production Test, Frequency Monitoring, Education, Training, Service and Calibration. Additionally, the optional battery (option 002) makes the 5314A especially attractive for field and portable applications.

Input Characteristics (Channels A and B):

Range: CHANNEL A: 10 Hz to 100 MHz.

CHANNEL B: 10 Hz to 2.5 MHz.

Sensitivity: CHANNEL A: 25 mv rms to 100 MHz.

75 mv peak-to-peak at minimum pulse width of 5 ns.

CHANNEL B: 25 mv rms to 2.5 MHz.

75 mv peak-to-peak at minimum pulse width of 200 ns.

Coupling: AC.

Impedance: 1 MΩ NOMINAL shunted by less than 30 pf.

Attenuator: X1 or X20 NOMINAL (A channel only).

Trigger Level: Continuously variable ± 350 mV times attenuator setting around average value of signal.

Slope: Independent selection of + or - slope.

Channel Input: Selectable SEPARATE OR COMMON A.

Frequency:

Range: 10 Hz to 10 MHz direct count.

10 Hz to 100 MHz prescaled by 10.

Least Significant Digit (LSD) Displayed: Direct count 0.1 Hz, 1 Hz, 10 Hz switch selectable. Prescaled 10 Hz, 100 Hz, 1 KHz switch selectable.

Resolution: \pm LSD.

Accuracy: \pm LSD \pm (time base error) x Freq.

Period:

Range: 10 Hz to 2.5 MHz.

LSD Displayed: $\frac{100}{N}$ ns for N=1 to 1000 in decade steps of N.

Resolution: \pm LSD $\pm \frac{(1.4x \text{ TRIGGER ERROR})}{N}$ x Per.

Accuracy: \pm LSD $\pm \frac{(1.4x \text{ TRIGGER ERROR})}{N}$ x Per.

\pm (time base error) x Per.

Time Interval:

Range: 250 ns to 1 sec.

LSD Displayed: 100 ns.

Resolution: \pm LSD \pm START trigger error \pm STOP trigger error.

Accuracy: \pm LSD \pm START trigger error

\pm STOP trigger error \pm (time base error) x TI.

Ratio:

Range: 10 Hz to 10.0 MHz CHANNEL A.

10 Hz to 2.5 MHz CHANNEL B.

LSD Displayed: 1/N in decade steps of N for N = 1 to 1000.

Resolution: \pm LSD \pm (B trigger error x Frequency A)/N.

Accuracy: \pm LSD \pm B trigger error x Frequency A.

Totalize:

Range: 10 Hz to 10 MHz.

Resolution: \pm 1 count of input.

Totalize controlled by front panel switch.

General:

Check: Counts internal 10 MHz oscillator.

Display: 7 digit amber LED display with gate and overflow indication.

Max Sample Rate: 5 readings per second.

Operating Temperature: 0° to 50 °C.

Power Requirement: 100/120/230/240 V RMS +5%, -10%, 48-66 Hz; 10 VA max.

Weight: 2.0 kg (4.4 lb.).

Dimension: 238 mm W x 98 mm H x 276 mm D (9 $\frac{3}{8}$ x 3 $\frac{3}{8}$ x 10 $\frac{3}{8}$ in.).

Time Base:

Frequency: 10 MHz.

Aging Rate: < 3 part in 10⁷ per month.

Temperature: < \pm 10 parts in 10⁶, 0 to 50°C.

Line Voltage: < \pm 1 part in 10⁷ for \pm 10% variation.

Options:

Option 001: High stability time base (TCXO).

Frequency: 10 MHz.

Aging Rate: < 1 part in 10⁷ per month.

Temperature: < \pm 1 part in 10⁶, 0 to 40°C.

Line Voltage: < \pm 1 part in 10⁶ for \pm 10% variation.

Option 002: Battery.

Type: Rechargeable lead-acid (sealed).

Capacity: Typically 8 hours of continuous operation at 25°C.

Recharging Time: Typically 16 hours to 98% of full charge, instrument non-operating. Charging circuitry included with option. Batteries not charged during instrument operation.

Battery Voltage Sensor: Automatically shuts instrument off when low battery condition exists.

Line Failure Protection: Instrument automatically switches to batteries in case of line failure.

Weight: Option 002 adds typically 1.5 kg (3.3 lb.) to weight of instrument.

Definitions:

Resolution: Smallest discernible change of measurement result due to a minimum change in the input.

Accuracy: Deviation from the actual value as fixed by universally accepted standards of frequency and time.

Trigger Error: (RMS)

$\sqrt{(80\mu\text{V})^2 + e_n^2}$ /input slew rate at trigger point ($\mu\text{V/s}$).

Where e_n is the RMS noise of the input for a 100 MHz bandwidth in CHANNEL A and 10 MHz bandwidth in CHANNEL B.

Options

001 High Stability time Base

Price

add \$100

002 Battery

add \$95

All orders must include one (1) of these line power options:

Option 115: 86-127V

N/C

Option 230: 190-250V

N/C

5314A 100 MHz/100 ns Universal Counter

\$375

ELECTRONIC COUNTERS

UNIVERSAL COUNTER

Model 5315A/B

- 100 MHz/Reciprocal
- 100 ns Time interval
- Portable

- Trigger lights
- Delay (Hold-off)
- Microprocessor controlled

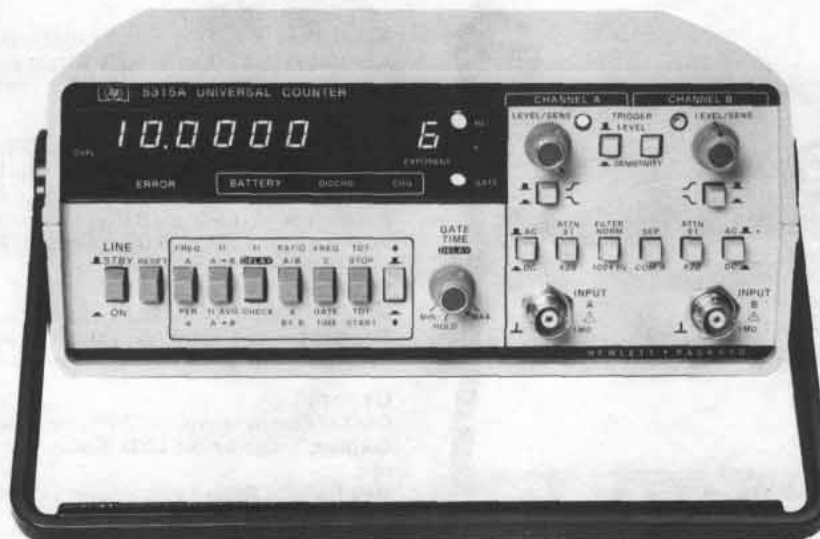

5315A

Description

All the universal counter capability you've come to expect, and more, is included in the smart, portable 5315A Universal Counter. And just as important, this advanced capability and high technology costs much less than you might expect. This achievement is possible by the utilization of HP's unique state-of-the-art LSI counter-on-a-chip and 2 standard commercial LSI circuits (a single chip microprocessor and a display driver chip).

The 5315A offers frequency or period measurements to 100 MHz, 3 time interval measurement modes (single shot time interval to 100 ns, time interval with delay, and time interval average to 10 ps), ratio, 2 totalize modes (manual or electrically controlled), as well as input signal conditioning that is optimized for not only frequency measurements but also for time interval measurements. Additional features of the 5315A include reciprocal counting (high resolution frequency measurements at low frequencies), continuously variable gate time, tri-state trigger lights, and a conservative, low component count design for years of reliable service.

The 5315B is identical to the 5315A except for the package. The package of the 5315B is a metal System II package for rack mounting or stacking applications. This metal package is also recommended when a lower level of RFI (radio frequency interference) is desired.

5315A/B Specifications

Input Characteristics: (Channel A and Channel B)

Range: DC coupled 0 to 100 MHz.

AC coupled 30 Hz to 100 MHz.

Sensitivity: 10 mV rms sine wave to 10 MHz.

25 mV rms sine wave to 100 MHz.

75 mV peak-to-peak pulse at minimum pulse width of 5 ns.

Sensitivity can be varied continuously up to 500 mV rms *NOMINAL* by adjusting sensitivity control. In sensitivity mode, trigger level is automatically set to 0 V *NOMINAL*.

Coupling: AC or DC, switchable.

Impedance: 1 MΩ *NOMINAL* shunted by less than 40 pf.

500 KΩ *NOMINAL* shunted by less than 70 pf (*COMMON A*).

Signal Operating Range: +2V and -2V.

Attenuator: X1 or X20 *NOMINAL*.

Trigger Level: Variable between +2V and -2V.

Slope: Independent selection of + or - slope.

Frequency:

Range: .1 Hz to 100 MHz

LSD Displayed: 10 Hz to 1 n Hz depending upon gate time and input signal. At least 7 digits displayed per second of gate time.

Resolution: $\pm \text{LSD} \pm 1.4 \times \frac{\text{Trigger Error}}{\text{Gate Time}} \times \text{FREQ.}$

Accuracy: $\pm \text{LSD} \pm 1.4 \times \frac{\text{Trigger Error}}{\text{Gate Time}} \times \text{FREQ.}$
 $\pm (\text{time base error}) \times \text{FREQ.}$

Period:

Range: 10 ns to 10⁵ s.

LSD Displayed: 100 ns to 1 fs depending upon gate time and input signal. At least 7 digits displayed per second of gate time.

Resolution: $\pm \text{LSD} \pm 1.4 \times \frac{\text{Trigger Error}}{\text{Gate Time}} \times \text{PER.}$

Accuracy: $\pm \text{LSD} \pm 1.4 \times \frac{\text{Trigger Error}}{\text{Gate Time}} \times \text{PER.}$
 $\pm (\text{time base error}) \times \text{PER.}$

Time Interval:

Range: 100 ns to 10⁵ s.

LSD Displayed: 100 ns.

Resolution: $\pm \text{LSD} \pm \text{Start Trigger Error} \pm \text{Stop Trigger Error.}$

Accuracy: $\pm \text{LSD} \pm \text{Start Trigger Error} \pm \text{Stop Trigger Error}$
 $\pm (\text{time base error}) \times \text{TI.}$

Time Interval Average:

Range: 0 ns to 10⁵ s

LSD Displayed: 100 ns to 10 ps depending upon gate time and input signal.

Resolution: $\pm \text{LSD} \pm \frac{\text{Start Trigger Error}}{\sqrt{N}} \pm \frac{\text{Stop Trigger Error}}{\sqrt{N}}$

Accuracy: $\pm \text{LSD} \pm \frac{\text{Start Trigger Error}}{\sqrt{N}} \pm \frac{\text{Stop Trigger Error}}{\sqrt{N}}$
 $\pm (\text{time base error}) \times \text{TI} \pm 4 \text{ ns.}$

Number of intervals averaged (N) = Gate Time x FREQ.

Minimum Dead Time (stop to start): 200 ns.

Time Interval Holdoff (Delay):

Front panel gate time knob inserts a variable delay of *NOMINALLY* 500 μ s to 20 ms between START (Channel A) and enabling of STOP (Channel B). Electrical inputs during delay time are ignored. Delay time may be digitally measured by simultaneously pressing T.I. Averaging, T.I. Delay and blue key. Other specifications of T.I. Holdoff are identical to Time Interval.

Ratio:

Range: 0.1 Hz to 100 MHz, both channels.

LSD: $\frac{2.5 \times \text{Period A}}{\text{Gate Time}} \times \text{Ratio}$. (rounded to nearest decade)

Resolution: $\pm \text{LSD} \pm \frac{\text{B Trigger Error}}{\text{Gate Time}} \times \text{Ratio}$.

Accuracy: Same as resolution.

Totalize:

Manual:

Range: 0 to 100 MHz.

A gated by B:

Totalizes input A between two events of B. Instrument must be reset to make new measurement. Gate opens on A slope, closes on B slope.

Range: 0 to 100 MHz.

Resolution: ± 1 count.

Accuracy: ± 1 count \pm B Trigger Error \times Frequency A.

TIME BASE:

Frequency: 10 MHz.

Aging Rate: < 3 parts in 10^7 /mo.

Temperature: $\leq \pm 5$ parts in 10^6 , 0 to 50°C.

Line Voltage: $\leq \pm 1$ part in 10^7 for $\pm 10\%$ variation.

General:

Check: Counts internal 10 MHz reference frequency over gate time range *NOMINALLY* 500 μ s to 20 ms.

Error Light: LED warning light activated if logic error is found during instrument turn-on self-check.

Display: 8 digit amber LED display, with engineering units annunciator.

Overflow: Only frequency and totalize measurements will overflow. In case of overflow, eight least significant digits will be displayed and amber front panel overflow LED will be actuated.

All other measurements which would theoretically cause a display of more than 8 digits will result in the display of the 8 most significant digits.

Gate Time: Continuously variable, *NOMINALLY* from 50 ms to 10 s or 1 period of the input, whichever is longer.

Sample Rate: Up to 5 readings per second *NOMINAL* except in time interval mode, where it is continuously variable *NOMINALLY* from 250 ms to 10 s via Gate Time Control.

Operating Temperature: 0° to 50°C.

Power Requirements: 100, 115, 210, 230V (+ 5%, -10%) 48 - 66 Hz; 10 VA maximum

Weight: 2.9 Kg (6 lbs. 5 oz.)

Dimensions: 238 mm W x 98 mm H x 276 mm L (9 $\frac{3}{8}$ x 3 $\frac{3}{8}$ x 10 $\frac{1}{2}$ in.)

†Due to arithmetic truncation, quantization error will be ± 1 or ± 2 counts of the LSD (Least Significant Digit) as follows:

± 2 counts of LSD if $\text{LSD}/(\text{FREQ or PER}) < 1 \times 10^{-7}$, FREQ < 10 MHz.

± 2 counts of LSD if $\text{LSD}/(\text{FREQ or PER}) < [1/(\text{Gate Time})]/\text{FREQ}$, FREQ ≥ 10 MHz.

± 1 count of LSD for all other cases.

Options:

Opt. 001: High Stability Time Base (TCXO)

Frequency: 10 MHz.

Aging Rate: < 1 part in 10^7 /mo.

Temperature: $\leq \pm 1$ part in 10^6 , 0° to 40°C.

Line Voltage: $\leq \pm 1$ part in 10^6 for $\pm 10\%$ variation.

Opt. 002: Battery

Type: Rechargeable lead-acid (sealed).

Capacity: TYPICALLY 4 hours of continuous operation at 25°C.

Recharging Time: TYPICALLY 16 hours to 98% of full charge, instrument non-operating. Charging circuitry included with Option. Batteries not charged during instrument operation.

Low Voltage Indicator: Instrument turns itself off automatically when low battery condition exists. *Discharge* LED flashes slowly when this happens. *Discharge* LED is on whenever battery is supplying power to instrument.

Charge LED indicates state of charge of battery during charging only and is on whenever battery is charged to 95% *NOMINAL* of capacity. *Charge* LED flashes when 90% *NOMINAL* of charge taken out is replaced. *Charge* LED is off if charge is less than 70% *NOMINAL* of capacity.

Line Failure Protection: Instrument automatically switches to battery in case of line failure.

Weight: Opt. 002 adds 1.4 Kg (3 lbs.) to weight of instrument.

5315B:

Rack and stack metal case; AC line power only. Specifications same as 5315A except as follows:

Rack Mount: 5315B is recommended for rack mounting via Rack Mount Kit 5061 - 0072.

Oscillator Output: 10 MHz, 50 mV pk-pk into 50 Ω load.

External Frequency Standard: 10 MHz, 1 V RMS into 500 Ω .

Dimensions: 215 mm W x 81 mm H x 279 mm L (8 $\frac{3}{8}$ x 3 $\frac{1}{8}$ x 10 $\frac{1}{2}$ in.).

Weight: 4 Kg (8 lbs. 13 oz.).

Definitions:

Resolution: Smallest discernible change of measurement result due to a minimum change in the input.

Accuracy: Deviation from the actual value as fixed by universally accepted standards of frequency and time.

Least Significant Digit (LSD) Displayed:

Frequency: $(2.5 \times 10^{-7}/\text{Gate Time}) \times \text{FREQ}$, FREQ < 10 MHz.
2.5/Gate Time, FREQ ≥ 10 MHz.

Period: $(2.5 \times 10^{-7}/\text{Gate Time}) \text{PER}$, PER > 100 ns.
 $(2.5/\text{Gate Time}) \times \text{PER}^2$, PER ≤ 100 ns.

All above calculations should be rounded to nearest decade (i.e., 0.5 Hz will become 1 Hz and 0.4 ns will be 0.1 ns).

Time Interval Average:	LSD
1 to 25 intervals	100 ns
25 to 2500 intervals	10 ns
2500 to 250,000 intervals	1 ns
250,000 to 25,000,000 intervals	100 ps
$> 25,000,000$ intervals	10 ps

Time Interval Average is a statistical process. LED displayed is calculated for 1 standard deviation (σ) confidence level.

Trigger Error: $[\sqrt{(80 \mu\text{V})^2 + e_n^2}/\text{Input slew rate at trigger point} (\mu\text{V/S})]$ rms.

Where e_n is the rms noise of the input for a 100 MHz bandwidth.

Options:

001 High Stability Time base Price
add \$100

002 Battery (available with 5315A only) add \$225

All 5315A orders must include one (1) of these line

power options:

Option 100: 86-106V	N/C
Option 115: 104-127V	N/C
Option 210: 190-233V	N/C
Option 230: 208-250V	N/C

5315A 100 MHz/100 ns Universal Counter \$800

5315B 100 MHz/100 ns Universal Counter \$950
in Metal Rack/Stack Package

ELECTRONIC COUNTERS

Plug-on modular/portable counter system

Model 5300 A/B system & 5301A-5312A



5300 Measuring system

Features include

- 10 MHz, 50 MHz, 525 MHz and 1.3 GHz
- 100 ns time interval resolution and time interval averaging
- Up to 8 digits
- Auto ranging
- Unique time interval hold off
- Expandable with interchangeable modules
- Optional FCC type approved TCXO time base
- Portable-battery operation with all modules
- Compact and rugged
- High reliability MOS/LSI circuitry and LED display
- Designed for quick & easy owner-servicing
- Output via BCD, HP Interface Bus (HP-IB), or D to A converters

Description

Large scale integration and solid state display technology have helped to produce a uniquely versatile and capable counter at a surprisingly low cost. Easy to use and reliable, this counter does what is important—solves your measurement problems while saving your money. Versatility and antiobsolescence come from modular construction. Take your choice from two mainframes and select the snap

on module that you need now. Expand the capability later with more modules, if and when you need them.

Autoranging

Autoranging is included in many of the functions, enhancing the ease of operation by automatically selecting a correct gate time to fill the display. Any frequency within the range of the 5301A, 5302A, 5304A, 5307A and 5308A may be counted, with the counter's logic circuits automatically selecting the correct gate time (up to 1 second) for maximum resolution without exceeding the display range.

Time interval holdoff

Time interval holdoff is a unique feature of the 5304A Timer/Counter module. This feature allows you to add a fixed delay between the start of a time interval measurement and the enabling of the stop channel. Thus any electrical pulses or irregularities in a waveshape that occur between the desired trigger points can be ignored.

Digital and analog output

Digital output is available in BCD format (standard in 5300A mainframe) or ASCII format via the HP Interface Bus (to be used with 5300B mainframe) to provide interfacing with digital printers or with desktop calculators and other data processing equipment. Analog output for long term monitoring with strip chart recorders is provided by a digital-to-analog converter. This provides the capability to generate hard copy results of any measurements made by any of the 5300 modules.

Battery pack

A snap between battery pack provides a truly portable, light weight, go-anywhere measuring system for any of the 5300 Systems.

Serviceability

Reliability and easy servicing have been major design criteria for all of the 5300 modules. A check function is built into most of the functional modules to allow immediate checking of the basic counter circuits from the front panel. A user-oriented service support package is available that provides plug-in cards with automatic diagnostic routines that allow the 5300 mainframes to troubleshoot themselves.



Typical Configuration

Frequency Measurement System
for Mobile Communications.
Go Anywhere Portability

5300B, 5310A, 5305B

Model	Frequency MHz	Period	Period Average	Time Interval	Time Interval Average	Totalize	Ratio	Multimeter ACV, DCV, Ω	High Resolution Reciprocal	
5300A 6 DIGIT MAINFRAME										\$500 307
5300B 8 DIGIT MAINFRAME										\$460 307
5310A BATTERY PACK										\$275 312
5311B DIGITAL TO ANALOG CONVERTER										\$395 312
5312A HP-IB INTERFACE										\$350 312
5301A	10					•				\$225 308
5302A	50	•	•	•		•	•			\$325 308
5303B	525									\$825 309
5304A	10		•	•		•				\$385 309
5305B	1300									\$900 310
5306A	10							•		\$625 310
5307A	2								•	\$395 311
5308A	75	•	•	•	•	•	•			\$450 311



5300A



5300B



5300A and 5300B measurement system mainframe

The mainframe units provide the system with power, reference frequency, display, counting logic and timing control.

The 5300A has a 6-digit dot matrix display, standard time base, external time base input and BCD output as a standard rear panel output. The 5300B has an 8-digit 7-segment display, standard time base or optional TCXO time base, external time base input and no digital output from the mainframe. See mainframe/plug-on display chart below for number of display digits with a particular mainframe and plug-on combination.

Time base

Standard crystal frequency: 10 MHz.

Stability

- Aging rate:** <3 parts in 10⁷/mo.
- Temperature:** <±5 parts in 10⁶, 0° to 50°C.
- Typically:** <±2 parts in 10⁶, 15° to 40°C.
- Line voltage:** <±1 part in 10⁷ for 10% line variation.

Oscillator output: 10 MHz, approximately 1 V rms at rear panel BNC, 100Ω source impedance.

External input: 1 MHz to 10 MHz, 1 V rms into 200Ω.

Opt 001 High stability time base (5300B only)

Frequency: 10 MHz.

Stability

- Aging rate:** <1.2 parts in 10⁶/year.
- Temperature:** <±5 parts in 10⁷, 0° to 50°C.
- Line voltage:** <±5 parts in 10⁶ for 10% line variation.

Oscillator output: 10 MHz, approximately 1 V rms at rear panel BNC, 100Ω source impedance.

External input: 1 to 10 MHz, 1 V rms into 500Ω.

General

Display: 6-digit, dot matrix (5300A) or 8-digit, 7-segment matrix (5300B), solid state LED display (gallium arsenide phosphide light emitting diodes) including decimal point and annunciator units.

Overflow: LED light indicates when display range is exceeded.

Display storage: holds reading between samples. Sample rate: Sample rate control adjusts the delay from the end of one measurement to the start of a new measurement. Continuously variable from less than 50 msec to greater than 5 seconds. HOLD position: display can be held indefinitely. Reset: Front panel pushbutton switch resets all registers and initiates new measurement. Reset input by contact closure to ground or TTL type low level also available on rear panel connector (5300A only).

Operating temperature: 0° to 50°C.

Power requirements: 115 or 230 volts ±10%, 48 to 60 Hz, 25 VA maximum (depends on plug-on module). Mainframe power without plug-on nominally 5 watts. Battery operation: with 5310A rechargeable battery pack (see 5310A specifications).

Weight: net, 1.5 kg (3½ lb). Shipping, 2.5 kg (5½ lb).
Dimensions: (with snap-on module): 89 mm H x 160 mm W x 248 mm D (3½" x 6¼" x 9¾").

Digital output (5300A only)

- Digital serial, 4-bit BCD parallel available at rear panel connector.
- Code:** 4-line 1-2-4-8 BCD, "1" state low, TTL type logic levels.
- Decimal point:** decimal point code (binary "1111") automatically inserted at correct digit position.
- Print command:** positive step, TTL output.
- Holdoff:** contact closure to ground or TTL low level, inhibits start of new measurement cycle.
- Connector:** 20-pin PC connector. Mating connector Viking 2VH10/1JN or equivalent.
- Parallel data output:** available from Printer Interface. See 10533A specification.
- Note:** digital output for 5300B Mainframe is provided by 5312A HP-IB Interface module.

Mainframe/plug-on compatibility

Plug-on	Display Digits	
	with 5300A	with 5300B
5301A	6	7
5302A	6	7
5303B	6	8
5304A	6	7
5305B	N/A	8
5306A (Frequency)	6	7
(ACV, DCV, OHMS)	5	5
5307A	6	6
5308A	N/A	8

Accessories

- Digital Recorder Interface:** (for use with 5300A, BCD output) See 10533A Specifications, Page 308 \$95
- 10548A Service support package:** Contains an interface card and 4 diagnostic cards for easy trouble shooting of 5300A or 5300B \$35
- 18019A Leather carrying case:** Holds 5300A or 5300B, snap-on module and 5310A battery pack plus accessories
- Rack mount kits**
- 10851A Single \$40
- 10852A Double \$40
- 10853A Single/with plug-between \$65
- 10854A Double/with plug-between \$65

Ordering instructions

- 5300A 6 digit mainframe \$500
- 5300B 8 digit mainframe \$460
- Opt 001: TCXO (5300B only) add \$180

5300A/B System (cont.)

- 10 MHz
- Auto ranging
- External gate

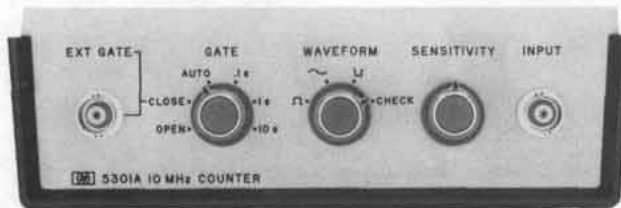

5301A

5301A 10 MHz frequency counter module**Input**

Range: 10 Hz to 10 MHz.

Sensitivity (min): 25 mV rms sine wave 50 Hz to 1 MHz, 50 mV rms sine wave 10 Hz to 10 MHz; 150 mV p-p pulse at minimum pulse width, 50 ns. Sensitivity variable to 2.5 V rms.

Impedance: 1 MΩ shunted by less than 30 pF.

Overload protection: 500 V (dc + peak ac), 250 V rms dc to 400 Hz, 10 V rms at 10 MHz.

Trigger level: selectable positive, negative, or zero volts.

Frequency measurement

Range: 10 Hz to 10 MHz.

Gate times: manually selected 0.1, 1, or 10 seconds AUTO position selects gate time of 1 second for maximum resolution.

Accuracy: ± 1 count ± time base accuracy.

Open/close (totalizing)

Range: 10 MHz max count rate.

External gate: gate signal by contact closure to ground or TTL low.

General

Check: counts internal 10 MHz reference frequency.

Operating temperature: 0° to 50°C.

Power requirements: including mainframe, nominally 8 watts.

Weight: net, 0.9 kg (2 lb). Shipping, 1.5 kg (3 ¼ lb).

Dimensions: see Mainframe.

5301A 10 MHz Frequency Counter Module \$225

10533A Recorder interface specifications

The 10533A accessory provides an interface between the 5300A measurement system mainframe and a standard parallel-input recorder such as the HP 5055A. The interface module provides conversion from the 5300A serial data output to a standard parallel format. **Output format:** 10 parallel digits; 6 data, 1 decimal point, 1 overflow, 1 exponent and 1 exponent sign.

Code: 4-line 1-2-4-8 BCD; "1" state low TTL levels.

Decimal point: floating decimal point automatically inserted at correct digit position. Coded "1111" ("**" on standard HP 5055A print wheels). Internal jumper wire removes decimal point from data format if desired.

Overflow: coded "1111" ("**") printed in first column when 5300A overflow light is on.

Exponent: ±0, ±3, ±6 corresponding with 5300A measurement units.

Print command: negative step, TTL levels.

Inhibit input: +2.0V or higher prevents the 5300A from recycling.

Power requirements: 100 mA at 5 volts, provided by 5300A mainframe.

10533A Recorder Interface \$225

*For any wave shape, trigger error (μs) is less than

$$\pm \frac{0.005 \mu\text{s}}{\text{Signal Slope (V}/\mu\text{s})}$$

For period average this is less than ±0.3% of one period + period average for signals with 40 dB or better signal-to-noise ratio.

- 50 MHz universal counter
- Automatic or manual gate selection
- 100 nsec time interval resolution

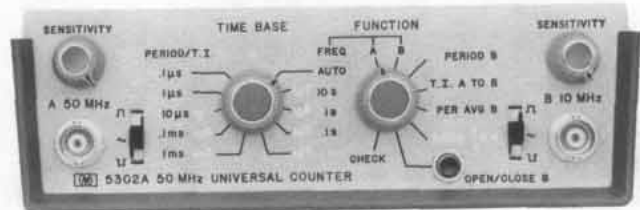

5302A

5302A 50 MHz universal counter module**Input channels A and B**

Range: Channel A: 10 Hz to 50 MHz, Channel B: 10 Hz to 10 MHz.

Sensitivity (min): 25 mV rms sine wave 50 Hz to 1 MHz, 50 mV rms sine wave 10 Hz to 10 MHz, 100 mV rms sine wave at 50 MHz, 150 mV p-p pulse at minimum pulse width, 50 ns. Sensitivity variable to 2.5 V rms.

Impedance: 1 MΩ shunted by less than 30 pF.

Overload protection: 500 V (dc + peak ac), 250 V rms, dc to 400 Hz, 10 V rms above 10 MHz.

Trigger level: selectable positive, negative, or zero volts.

Slope: automatically switched to trigger on positive slope for positive pulse and negative slope for negative pulse. Positive slope for sinusoidal inputs.

Marker outputs: rear BNC, TTL low level while gate is open.

Frequency

Range: channel A: 10 Hz to 50 MHz, prescaled by 10; channel B: 10 Hz to 10 MHz.

Gate times: manually selected 0.1, 1, or 10 seconds. AUTO position selects gate time of 1 second for maximum resolution.

Accuracy: ± 1 count ± time base accuracy.

Time interval

Range: 500 nsec to 1000 seconds.

Input: channels A and B.

Resolution: 100 ns to 1 ms in decade steps.

Accuracy: ± 1 count ± time base accuracy ± trigger error*.

Period

Range: 10 Hz to 1 MHz.

Input: channel B.

Resolution: 100 ns to 1 ms in decade steps.

Accuracy: ± 1 count ± time base accuracy ± trigger error*.

Period average

Range: 10 Hz to 1 MHz.

Input: channel B.

Periods averaged: 1 to 10³ automatically selected.

Frequency counted: 10 MHz.

Accuracy: ± 1 count ± time base accuracy ± trigger error*.

Ratio

Display: F_A/F_B times multiplier (N), N = 10 to 10⁷, selectable in decade steps.

Range: channel A: 10 Hz to 1 MHz, Channel B: 10 Hz to 10 MHz.

Accuracy: ± count of F_B ± trigger error of F_A*.

Open/close (totalizing)

Range: 10 MHz max.

Input: channel B opening and closing of gate initiated by front panel pushbutton switch.

General

Check: counts internal 10 MHz reference frequency.

Operating temperature: 0° to 50°C.

Power requirements: including mainframe, nominally 10 watts.

Weight: net, 0.9 kg (2 lb). Shipping, 1.5 kg (3 ¼ lb).

Dimensions: see Mainframe.

5302A 50 MHz Universal Counter Module \$325

- CW or burst to 525 MHz
- Automatic gain control and fused input
- FCC type approved

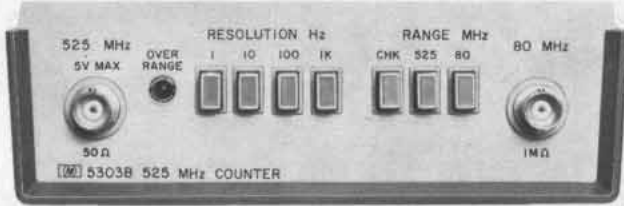

5303B

5303B Frequency counter module

This counter module was especially designed for servicing and calibrating mobile communications equipment and AM & FM broadcast equipment. An automatic gain control (AGC) amplifier has been provided on the 80 MHz channel. This provides ease-of-use by compensating for input level variations and rejecting noise up to 50% of the peak-to-peak level of the input signal. The front end circuitry of the 525 MHz channel is fuse-protected against high input signal levels that would normally cause expensive front end damage. The addition of the battery pack makes this an ideal portable instrument for the lab or the field.

Input channel A (CW or burst)

Range: DC to 525 MHz, prescaled by 8.

Sensitivity (fixed):

100 mV rms sine wave, dc to 500 MHz.
125 mV rms sine wave, 500 MHz to 525 MHz.
Signal must pass through zero.

Impedance: 50Ω.

Overload protection: 5 V rms (input circuitry fuse-protected).

Input channel B (CW or burst)

Range: 50 Hz to 80 MHz, direct.

Sensitivity (automatic):

25 mV rms sine wave, 100 Hz to 50 MHz.
50 mV rms sine wave, 50 Hz to 100 Hz and 50 MHz to 80 MHz.
Sensitivity is adjusted automatically by AGC (automatic gain control). Effective up to input clipping levels of 10 V p-p.
Impedance: 1 MΩ shunted by less than 40 pF.
Overload protection: 250 V rms, 50 Hz to 10 KHz declining to 10 V rms above 10 MHz.

Frequency measurement

Resolution: (selectable): 1, 10, 100, 1000 Hz.

Accuracy: ±1 digit ± time base accuracy.

General

Check: counts internal 10 MHz reference frequency.
Overflow: light indicates display exceeded.
Operating temperature: 0° to 50°C.
Power requirements: including mainframe, nominally 10 watts.
Weight: net, 0.9 kg (2 lb). Shipping, 1.5 kg (3¼ lb).
Dimensions: see mainframe.

5303B 525 MHz Counter

\$825

Opt 001:

add \$180

High stability time base (for use with 5300A)

Frequency: 10 MHz.

Stability

Aging rate: <1.2 part in 10⁶/year.
Temperature: <±5 parts in 10⁷, 0° to 50°C.
Line voltage: <±5 parts in 10⁸ for 10% line variation.
Oscillator output: 10 MHz, approximately 1 V rms at rear panel BNC, 200Ω source impedance.
External input: 1 to 10 MHz, 1 V rms into 500Ω.

*For any waveshape, trigger error is less than

$$\pm \frac{0.005 \mu s}{\text{Signal Slope (V/\mu s)}}$$

**Trigger error is less than ±0.3% of one period ÷ periods averaged for 40 dB or better signal-to-noise ratio.

- Matched input amplifiers
- Time interval hold-off
- 100 nsec time interval resolution

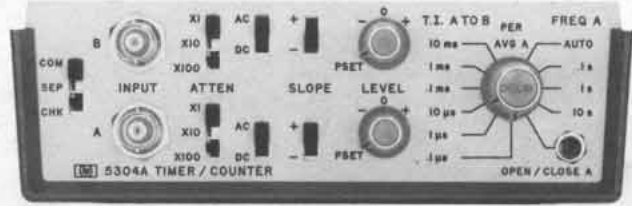

5304A

5304A Timer/counter module

Input channels A and B

Range: DC coupled; 0 to 10 MHz, AC coupled; 100 Hz to 10 MHz.

Sensitivity (min): 25 mV rms sine wave to 1 MHz, 50 mV rms sine wave to 10 MHz, 150 mV p-p pulse at minimum pulse width, 40 nsec. Sensitivity can be decreased by 10 or 100 times using ATTENUATOR switch.

Impedance: 1 MΩ shunted by less than 30 pF.

Overload protection: 250 V rms on X10 and X100 attenuator settings. On X1 attenuator setting 120 V rms up to 1 kHz, decreasing to 10 V rms at 10 MHz.

Trigger-level: PRESET position centers triggering about 0 volts, or continuously variable over the range of -1 V to +1 V times attenuator setting.

Slope: independent selection of triggering on positive or negative slope.

Channel inputs: common or separate lines.

Gate output: rear panel BNC. TTL low level while gate is open.

Time Interval

Range: 500 ns to 10⁴ sec.

Input: channels A and B; can be common or separate.

Resolution: 100 ns to 10 ms in decade steps.

Accuracy: ±1 count ± time base accuracy ± trigger error.*

Time interval holdoff: front panel concentric knob which inserts variable delay of approximately 100 μs to 100 ms between START (channel A) and enabling of STOP (channel B); may be disabled. Electrical inputs during delay time are ignored. Delay may be digitally measured in CHECK and TIME INTERVAL positions. Delay output: rear panel BNC. TTL low level during delay time.

Period average

Range: 10 Hz to 1 MHz.

Input: channel A.

Periods averaged: 1 to 10³ automatically selected.

Frequency counted: 10 MHz.

Accuracy: ±1 count ± time base accuracy ± trigger error.**

Frequency

Range: 0 to 10 MHz.

Input: channel A.

Gate times: manually selected 0.1, 1, or 10 seconds. AUTO position selects gate time to 1 second for maximum resolution.

Accuracy: ±1 count ± time base accuracy.

Open/close (totalizing)

Range: 10 MHz max.

Input: channel A opening and closing of gate initiated by front panel pushbutton switch.

General

Check: inserts internal 10 MHz reference frequency into channels A and B.

Operating temperature: 0° to 50°C

Power requirements: including mainframe, nominally 10 watts.

Weight: net, 0.9 kg (2 lb). Shipping, 1.5 kg (3¼ lb).

Dimensions: see mainframe.

5304A Timer/counter module

\$385



5300A/B System (cont.)

- 1300 MHz
- Preamp Power
- Fast high resolution tone measurements



5305B

5305B 1300 MHz frequency counter module

Input Channel A (CW or burst)

Range: 90 MHz to 1300 MHz, prescaled by 16.

Sensitivity: 20 mV rms.

Impedance: 50Ω.

Attenuator: continuously variable to give optimum noise suppression for signals up to 3.5 V rms.

Overload protection: 5 V rms, maximum. Input circuitry is fuse protected; fuse is located in BNC connector and is accessible from the front panel.

Operating dynamic range: >47 dB

Input Channel B (Normal and High Resolution mode)

Range: 50 Hz to 100 MHz, direct count in normal mode. 50 Hz to 10 kHz in high resolution mode. In the high resolution mode the 5305B uses a phase-locked multiplier to increase resolution X1000 over normal measurement resolution.

Sensitivity: 20 mV rms.

Impedance: 1 MΩ shunted by less than 40 pF.

Overload protection: 250 V rms from 50 Hz to 10 kHz, declining to 10 V rms above 10 MHz.

Automatic hold: in high resolution mode, the last valid reading is held in display when input is terminated.

Frequency Measurement

Resolution (selectable)

Normal mode (50 Hz to 1300 MHz): 0.1 Hz to 10,000 Hz in decade steps corresponding to gate times of 10 s to 0.0001 s in decade steps on channel B and to gate times of 160 s to 0.0016 s in decade steps on channel A.

High resolution mode (50 Hz to 10 kHz): 0.0001, 0.001, 0.01, 0.1, 1, 10 Hz corresponding to 10, 1, 0.1, 0.01, 0.001, 0.0001 second gate times on channel B.

Accuracy: ±1 digit displayed ± time base accuracy.

Display: Hz, kHz, MHz with positioned decimal point.

General

Check: counts internal 10 MHz reference frequency to check counting circuits.

Operating temperature: 0°C to 50°C.

Power requirements: nominally 12 watts including mainframe.

Weight: net, 1.0 kg (2¼ lb). Shipping, 1.8 kg (4 lb).

Size: with mainframe, 89 mm H (3½") x 160 mm W (6¼") x 248 mm L (9¾").

Compatible mainframes: 5300B (8 digits).

Accessory

10855A Preamp: 22dB gain with ±1 dB flatness from 2 MHz to 1300 MHz. See 312

5305B 1300 MHz counter

Price

\$225

\$900

- DC volts, AC volts, ohms and frequency



5306A

5306A Digital multimeter/counter module

DC voltage

Range	Accuracy (60 days, 23°C ±5°C, <80% RH)	Sensitivity
10 V	± (0.03% of reading + 0.003% of range)	100 μV
100 V	± (0.03% of reading + 0.003% of range)	1 mV
1000 V	± (0.097% of reading + 0.03% of range)	10 mV

Temperature coefficient: ± (0.002% of reading/°C + 0.0002% of range/°C).

Sample times: normal, 0.5 sec; fast, 0.05 sec.

Input: floating pair, 10 MΩ resistance, all ranges.

Effective common mode rejection (1 kΩ imbalance): DC: >80 dB; 50 Hz or 60 Hz ±0.1%: >80 dB.

Normal mode rejection: 50 Hz or 60 Hz ±0.1%: >50 dB.

Maximum input

High to low: 1100 V dc all ranges.

Low to guard: ±200 V dc or peak ac.

Guard to ground: ±500 V dc or 240 V rms at 50 or 60 Hz.

AC voltage

Range	Frequency	Accuracy (60 days, 23°C ±5°C, <80% RH)
10 V	40 Hz to 10 kHz	± (0.98% of reading + 0.02% of range)
	10 kHz to 100 kHz	± (0.98% of reading + 0.10% of range)
100 V	40 Hz to 500 Hz	± (1.5% of reading + 0.05% of range)
1000 V	40 Hz to 500 Hz	± (1.5% of reading + 0.05% of range)

Temperature coefficient

10 V and 100 V range: ± (0.5% of reading + .003% of range/°C).

1000 V range: ± (0.5% of reading + .003% of range/°C).

Input impedance: 10 MΩ shunted by <75 pF maximum.

Maximum input voltage: see DC voltage specification.

Effective common mode rejection (1 kΩ imbalance): DC: >80 dB; 50 Hz or 60 Hz ±0.1%: >50 dB (10 V range).

Ohms

Range	Accuracy (60 days, 23°C, ±5°C, <80% RH)	Sensitivity
10 kΩ	± (0.5% of reading + 0.003% of range)	0.1Ω
100 kΩ	± (0.5% of reading + 0.003% of range)	1Ω
10 MΩ	± (0.75% of reading + 0.003% of range)	100Ω

Temperature coefficient: ± (0.0002% of range/°C).

Current through unknown: 1 mA on 10 kΩ range; 100 μA on 100 kΩ range; 1 μA on 10 MΩ range.

Overload protection: 10 kΩ range; 240 V rms for 1 min. 140 V rms continuous (warning lamp indicates overvoltage). 100 kΩ, 10 MΩ ranges; 240 V rms continuous.

Frequency

Range: 40 Hz to 10 MHz.

Sensitivity (min): 50 mV rms to 1 MHz; 125 mV rms to 10 MHz.

Trigger level: automatically adjust to 40% of peak level of input.

Overload protection: 1000 V rms. On 10 V range: 240 V rms from 40 Hz to 400 kHz, 10⁶ V Hz from 400 kHz to 10 MHz.

Gate times: normal: 1 sec, fast: 0.1 sec.

Accuracy: ±1 count ± time base accuracy.

Power requirements: including mainframe, nominally 12 watts.

Weight: net, 1.1 kg (2.3 lb). Shipping, 1.7 kg (3.6 lb).

5306A Digital Multimeter/Counter

\$625

- High resolution at low frequencies
- 10 mV rms sensitivity
- 100 Hz and 10 kHz low pass filters

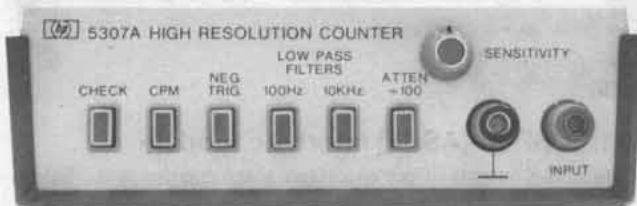

5307A High resolution counter module

The 5307A is a period average measuring, frequency indicating (reciprocal) counter that provides very high resolution measurements in a minimum of time: (i.e. 60.0000 Hz in $\frac{1}{2}$ second). The CPM mode converts Hz to counts/minute.

Input

Range: Hz mode: 5 Hz to 2 MHz. CPM mode: 50 to 10 M counts/minute (0.8333 Hz to 166 kHz).

Sensitivity (min.):

10 mV rms	5 Hz-1.2 MHz	120 CPM-10 MCPM
25 mV rms	1.2 MHz-2.0 MHz	50 CPM-120 CPM

Pulses:

For low duty-cycle pulses (<math><15\%</math>).

15 mV peak for 250 nsec pulses.

100 mV peak for 100 nsec pulses.

Basic sensitivity can be varied continuously up to 2.5 V rms by adjusting sensitivity control.

Attenuator: +1 or +100 effectively raises basic input sensitivity by a factor of 100 (10 mV \rightarrow 2.5 V to 1V \rightarrow 250 V).

Low pass filters: (3 dB point) **100 Hz** **10 kHz**

Max. attenuation	60 dB	40 dB
Roll-off	20 dB per decade	

Impedance:

No filters: 1 M Ω shunted by <math><50</math> pF

100 Hz filters: 1 M Ω shunted by series of 100 k Ω and 0.015 μ F

10 kHz filters: 1 M Ω shunted by series of 100 k Ω and 150 pF

Coupling: AC coupled amplifier.

Overload protection: 200 V rms below 10 kHz; 2 x 10⁶ V Hz rms to 0.4 MHz; 5 V rms above 0.4 MHz; 300 V rms with +100 attenuator.

Trigger level: selected positive or negative for optimum triggering from sinusoidal inputs or \pm pulses.

Frequency measurement

Periods averaged: automatically selected for maximum resolution. Two periods are averaged for signals up to 100 Hz. Periods averaged increase decade for decade up to 200,000 periods averaged above 1 MHz.

Measurement time: varies from 312 msec for a display of 170000 to 815 msec for a display of 999000. Hold-off adjustable from .35 μ sec to 3.5 μ sec and 1 msec to 10 msec.

Accuracy: $\pm 3 \times 10^{-4}$ \pm trigger error** \pm time base error.

Display: Hz mode: Hz and MHz with automatic decimal point. CPM mode: M with automatic decimal point.

General

Check: measures internal reference frequency. Displays 1.00000 MHz in Hz mode, 100 000 M in CPM mode.

Operating temperature: 0°C to 50°C.

Power requirements: including Mainframe, nominally 10 watts.

Weight: net, 0.98 kg (2 lb). Shipping, 1.5 kg (3 $\frac{1}{4}$ lb).

5307A High resolution counter \$395

* $\pm 3 \times 10^{-4}$ is due to reciprocation scheme and is worst case.

** For any wave shape, trigger error (μ s) is less than

$$\pm \frac{0.005 \mu\text{s}}{\text{Signal Slope (V}/\mu\text{s})}$$

For period average this is less than $\pm 0.3\%$ of one period + periods averaged for signal with 40 dB or better signal-to-noise ratio.

- 75 MHz
- Time interval averaging
- Auto ranging or manual operation



5308A Universal counter/timer module

Input (channels A and B)

Range: DC coupled; 0 to 75 MHz, AC coupled; 20 Hz to 75 MHz.

Sensitivity (min): 25 mV rms to 10 MHz, 50 mV rms to 75 MHz, 150 mV p-p pulse at pulse width of 10 nsec.

Impedance: 1 M Ω shunted by less than 50 pF.

Overload protection: X1: 125 V rms to 400 kHz declining to 10 V rms at 75 MHz. X10: 250 V rms to 4 MHz declining to 13 V rms at 75 MHz.

Trigger level: variable over the range of ± 2.0 V and ± 20 V.

Slope: independent selection of triggering on + or - slope.

Rear outputs: gate, trigger levels and time base/scaling.

Frequency

Range: 0 to 75 MHz, Channel A or Channel B.

Gate times: 8 selectable times from 1 μ s to 10 s.

Accuracy: ± 1 count \pm time base accuracy.

Frequency ratio

Display: Fa/Fb, 1 to 10⁶ periods selectable manual or auto.

Range: channel A: 0 to 75 MHz, Channel B: 0 to 5 MHz.

Accuracy: ± 1 count of Fa \pm trigger error of Fb.**

Period

Range: 0 Hz to 5 MHz, Channel B.

Resolution: 100 nsec to 10 sec.

Accuracy: ± 1 count \pm time base accuracy \pm trigger error.**

Display: μ s, or s with positioned decimal point.

Period average

Range: 0.1-5 MHz; (200 nsec to 10 sec), Channel B.

Periods averaged: 1-10⁶ selectable manual or automatic.

Accuracy: ± 1 count \pm time base accuracy \pm trigger error.**

Time interval

Range: 200 nsec to 10⁶ sec. 25 ns minimum pulse width.

Inputs: separate A and B or Common B.

Resolution: 100 nsec to 10 sec.

Accuracy: ± 1 count \pm time base accuracy \pm trigger error.**

Display: μ s, ks or s with positioned decimal point.

Time interval average

Range: 1 ns to 10 s, 200 ns dead time between intervals.

Inputs: channels A and B separate or common B.

Intervals averaged: 1 to 10⁶, selectable manual or automatic.

Accuracy: \pm time base accuracy ± 5 ns.

$$\pm \frac{[\text{Trigger Error}^{**} \pm 100 \text{ ns}]}{\sqrt{\text{Intervals Averaged}}}$$

Totalize

totalizes Channel A while Channel B is low.

totalizes Channel A between pulses on channel B.

Range: 75 MHz in X1 position, 5 MHz in X10⁶ positions.

Accuracy: ± 1 count \pm trigger error** on Channel B.

General

Auto position: automatically sets time base to give maximum resolution within 1.1 second measurement time for Frequency, Frequency Ratio, Period Average, and Time Interval Average.

Operating temperature: 0°C to 50°C.

Power requirements: including 5300B, nominally 15 watts.

Weight: net, 0.9 kg (2 lb). Shipping, 1.5 kg (3 $\frac{1}{4}$ lb).

Note: compatible with 5300B only.

5308A 75 MHz Timer/counter

\$450

Low cost counters for frequency measurements

Models 5381A, 5382A & 5383A



5381A



5382A



5383A

Description

General

The 5381A, 5382A and 5383A are a logical result of HP's long standing leadership in frequency counter development. Leadership in quality, technology and efficient production procedures allows HP to offer a price/performance combination in these three precision instrument unsurpassed in their product category. These counters are designed to deliver reliable, high quality operation in such diverse areas as: production line testing, service and calibration (2-Way Radio and test equipment), frequency monitoring, education and training.

Resolution

The 5381A, 5382A and 5383A employ the direct counting technique and, with 7, 8 and 9 digits respectively, offer resolution of 10 Hz in 0.1 sec., 1 Hz in 1 sec and 0.1 Hz in 10 seconds.

Specifications

5381A

Frequency range: 10 Hz to 80 MHz.

Sensitivity: 25 mV rms—30 Hz to 20 MHz, 50 mV rms—10 Hz to 80 MHz.

Input impedance: 1 M Ω , <50 pF.

Input attenuation: X1, X10, X100.

Accuracy: ± 1 count \pm time base error.

Resolution: direct count; 1 Hz in 1 second.

Gate times: 0.1 second, 1 second, 10 seconds.

Display: 7 LED digits.

Rear panel input: sensitivity: TTL levels or 2.5 V rms.

Ratio: Rear Panel Input, 10 kHz to 2 MHz.

External frequency standard: Rear Panel Input, 1 MHz.

Time base

Frequency: 1 MHz.

Aging: <0.3 ppm/month.

Temperature: ± 10 ppm 0°C to 40°C.

Line voltage: ± 1 ppm for 10% line change.

5382A

Frequency range: 10 Hz to 225 MHz.

Sensitivity: 25 mV rms—30 Hz to 10 MHz, 50 mV rms—10 Hz to 225 MHz.

Input impedance: 1 M Ω , <40 pF.

Input attenuation: X1, X10, X100.

Accuracy: ± 1 count \pm time base error.

Resolution: direct count; 1 Hz in 1 second.

Gate time: 0.1 second, 1 second, 10 seconds.

Display: 8 LED digits, nonsignificant zero blanking.

Rear panel input: sensitivity: 250 mV rms.

Ratio: Rear Panel Input, 100 kHz to 10 MHz.

External frequency standard: Rear Panel Input, 10 MHz.

Time base

Frequency: 10 MHz.

Aging: <0.3 ppm/month.

Temperature: ± 2.5 ppm 0°C to 40°C.

Line voltage: ± 0.5 ppm for 10% line change.

5383A

Frequency range: 10 Hz to 520 MHz.

Sensitivity:

1 M Ω : 25 mV rms—20 Hz to 10 MHz.

50 mV rms—10 Hz to 50 MHz.

50 Ω : 25 mV rms—20 Hz to 520 MHz.

Input impedance: selectable: 1 M Ω , <40 pF or 50 Ω .

Input attenuation: 1 M Ω x 1, x 10; 50 Ω x 1—fuse protected.

Accuracy: ± 1 count \pm time base error.

Resolution: direct count; 1 Hz in 1 second.

Gate time: 0.1 second, 1 second, 10 seconds.

Display: 9 LED digits, nonsignificant zero blanking.

Display test: RESET function (activated with GATE TIME switch) illuminates all segments of all digits.

Rear panel input: sensitivity: 250 mV rms.

Ratio: Rear Panel Input, 100 kHz to 10 MHz.

External frequency standard: Rear Panel Input, 10 MHz.

Time base output

Frequency: 10 MHz.

Voltage: 200 mV p-p into 50 Ω load.

Control: active with Rear Panel Internal/External switch in internal position.

Time base

Frequency: 10 MHz.

Aging: <0.3 ppm/month.

Temperature: ± 2.5 ppm 0°C to 40°C.

Line voltage: ± 0.5 ppm for $\pm 10\%$ line change.

TCXO Option

Opt 001: (available for all models) Temperature Compensated Crystal Oscillator time base

Frequency: 10 MHz.

Aging: <0.1 ppm/month.

Temperature: <1 ppm 0°C to 40°C.

Line voltage: ± 0.1 ppm for $\pm 10\%$ line change.

Note: Time base output available for both 5382A and 5383A with Option 001. Rear Panel Input not available.

5380 Family general data

Overflow: LED lamp indicator when most significant digit overflows.

Reset: manual selection of reset occurs when GATE TIME switch is between three normal positions.

Package: rugged, high strength metal case.

Operating temperature: 0°C to 40°C.

Power requirements: 100, 120, 220, 240, V rms (+5%, -10%) 48-440 Hz; 20 VA maximum.

Weight: net, 2.2 kg (4 $\frac{3}{4}$ lb). Shipping, 2.8 kg (6 lb).

Dimensions: 98 mm H x 60 mm W x 248 mm D (3 $\frac{1}{2}$ " x 6 $\frac{1}{4}$ " x 9 $\frac{3}{4}$ ").

Ordering information

5381A Frequency Counter

5382A Frequency Counter

5383A Frequency Counter

Opt 001: TCXO (all models)

Price

\$295

\$395

\$650

add \$100

ELECTRONIC COUNTERS

Automatic microwave counter

Model 5342A

- Microprocessor controlled
- Automatic measurement to 18 GHz (24 GHz Option)
- Wide FM tolerance
- Simultaneous display input level
- High sensitivity
- Automatic or manual operation



5342A

HP-IB

Description

The 5342A automatic microwave counter provides frequency and amplitude measurement coverage from 10 MHz through 18 GHz in a highly portable package.

The powerful and versatile microprocessor controlled keyboard can accomplish offset tasks as a standard feature as well as providing user interactive diagnostic information. The eleven-digit display is sectionalized for easy readout to one hertz resolution.

The 5342A uses a harmonic heterodyne down conversion technique which combines the best performance features of the heterodyne converter and transfer oscillator techniques. Now wide FM tolerance is achievable along with high input sensitivity, and automatic amplitude discrimination. Automatic amplitude discrimination allows for the measurement of the largest signal present in the spectrum (500 MHz–18 GHz) while ignoring all others.

Amplitude measurements (Opt 002)

Option 002 adds for the first time in a microwave counter the ability to measure input level of the incident sinewave signal. The instrument then displays this level in dBm. The eleven-digit LED display simultaneously presents frequency to 1 MHz resolution and amplitude to 0.1 dB resolution. An added benefit from Option 002 is that dynamic range is extended so that frequency measurements to +20 dBm are accomplished. This extended dynamic range is also available without the amplitude measurement capability by ordering Option 003.

FM Tolerance

The ability to measure a carrier frequency while being frequency modulated has broad appeal in the communications industry and elsewhere. The 5342A can tolerate 50 MHz peak-to-peak worst case FM in the wide mode, or the normal mode with accompanying faster acquisition time can be selected which gives 20 MHz peak-to-peak worst case FM.

Offset functions

The power and versatility of the microprocessor controlled keyboard allow the user to perform offset functions by way of a few key-strokes. Frequency values to 1 Hz resolution can be added to or subtracted from the measured incoming frequency for IF offset applications and also for monitoring variances about a given frequency value. With Option 002 installed, this same offset capability is applied to the amplitude measurements being displayed. At any time, these offset values can be recalled to the display for reviewing.

Digital-to-analog converter (Opt. 004)

The ability to convert any three consecutive displayed digits (frequency or amplitude) into an analog voltage output on the rear panel of the 5342A is added by option 004. This makes the monitoring of microwave oscillator frequency drift easy to make with only a strip chart recorder.

HP Interface Bus for systems use (Opt 011)

The full power of HP-IB (IEEE488-1975) is brought to fruition with the addition of Option 011. Front and rear panel controls can now be remotely programmed and measurement results can be outputted to HP-IB-compatible instruments, calculators, or computers. This interface also can select a given frequency in the manual mode and reduce acquisition time to typically less than 80 msec.

5342A Specifications

Signal Input

Input 1

Frequency range: 500 MHz to 18 GHz.
Sensitivity: 500 MHz to 12.4 GHz: -25 dBm. 12.4 GHz to 18 GHz: -20 dBm.
Maximum input: +5 dBm (see Opt 002, 003 for higher level).
Dynamic range: 500 MHz to 12.4 GHz: 30 dB. 12.4 GHz to 18 GHz: 25 dB.
Impedance: 50 ohms, nominal.
Connector: precision Type N female.
Damage level: +25 dBm.
Coupling: DC to load, AC to instrument.
SWR: <2:1, 500 MHz - 10 GHz.
 <3:1, 10 GHz - 18 GHz.

FM Tolerance: Switch selectable (rear panel)

FM (Wide): 50 MHz peak-to-peak worst case.
CW (Normal): 20 MHz peak-to-peak worst case.
 For modulation rates from DC to 10 MHz.

AM Tolerance: any modulation index provided the minimum signal level is not less than the sensitivity specification.

Automatic amplitude discrimination: automatically measures the largest of all signals present, providing that signal is 6 dB above any signal within 500 MHz; 20 dB above any signal, 500 MHz - 18 GHz.

Modes of Operation

Automatic: counter automatically acquires and displays highest level signal within sensitivity range.
Manual: center frequency entered to within ±50 MHz of true value.

Acquisition time

Automatic mode, normal FM: 530 msec worst case.
Automatic mode, wide FM: 2.4 sec worst case.
Manual mode: 80 msec after frequency entered.

Input 2

Frequency range: 10 Hz to 520 MHz direct count.
Sensitivity: 50Ω: 10 Hz to 520 MHz: 25 mV rms. 1 MΩ: 10 Hz to 25 MHz: 50 mV rms.
Impedance: selectable 1 MΩ, <50 pF or 50Ω nominal.
Coupling: AC.
Connector: type BNC female.
Maximum input
 50Ω: 3.5 V rms (+24 dBm) or 5 V DC, fuse protected
 1 MΩ: 200 V DC +5.0 V rms

Time Base

Crystal frequency: 10 MHz.

Stability

Aging rate: <1 × 10⁻⁷ per month.
Temperature: <±1 × 10⁻⁶ over the range 0°C to 50°C.
Short term: <1 × 10⁻⁹ for 1 second averaging time.
Line variation: <±1 × 10⁻⁷ for 10% change from nominal.
Output frequency: 10 MHz, ≥2.4 V square wave (TTL compatible) 1.5 V p-p into 50Ω available from rear panel BNC.
External time base: requires 10 MHz, 1.5 V p-p sinewave or squarewave into 1 KΩ via rear panel BNC connector. Switch selects either internal or external time base.

Optional time base (Opt 001)

Crystal frequency: 10 MHz.

Stability

Aging rate: <5 × 10⁻¹⁰/day after 24-hour warmup.
Temperature: <7 × 10⁻⁹ over the range 0°C to 50°C.
Short term: <1 × 10⁻¹¹ for 1 s avg. time.
Line variation: <1 × 10⁻¹⁰ for 10% change from nominal.
Warm-up: <5 × 10⁻⁹ of final value 20 minutes after turn-on, at 25°C.

General

Accuracy: ±1 count ± time base error.
Resolution: front panel push buttons select 1 Hz to 1 MHz
Display: 11 digit LED display, sectionalized to read GHz, MHz, kHz, and Hz.
Self-check: selected from front panel pushbuttons displays 75 MHz for resolution chosen.
Frequency offset: selected from front panel pushbuttons. Displayed frequency is offset by entered value to 1 Hz resolution.
Sample rate: variable from less than 20 ms between measurements to HOLD which holds display indefinitely.
IF out: rear panel BNC connector provides 25 MHz to 125 MHz output of down-converted microwave signal.
Operating temperature: 0°C to 50°C.
Power requirements: 100/120/220/240 V rms, +5%, -10%, 48-66 Hz; 100 VA max.
Accessories furnished: power cord, 229 cm (7½ ft).
Weight: net 9.1 Kg (20 lb). Shipping 12.7 Kg (28 lbs).
Size: 133 H × 213 W × 498 mm D (5¼" × 8⅝" × 19⅞").

Amplitude Measurement (Opt 002)

Input 1

Frequency range: 500 MHz - 18 GHz.
Dynamic range (frequency and level):
 -22 dBm to +20 dBm 500 MHz to 12.4 GHz
 -15 dBm to +20 dBm 12.4 GHz to 18 GHz
Maximum operating level: +20 dBm.
Damage level: +25 dBm.
Resolution: 0.1 dBm.
Accuracy: ±1.5 dB (excluding mismatch uncertainty).
SWR: <2:1 (amplitude measurement).
 <5:1 (frequency measurement).

Measurement time: 100 ms + frequency measurement time.
Display: Simultaneously displays frequency to 1 MHz resolution and input level. (Option 11 provides full frequency resolution on HP-1B output).

Input 2 (50Ω impedance only)

Frequency range: 10 MHz-520 MHz.
Dynamic range (frequency and level): -17 dBm to +20 dBm.
Damage level: +24 dBm.
Resolution: 0.1 dBm.
Accuracy: ±1.5 dB (excluding mismatch uncertainty).
SWR: <1.8:1.
Measurement time: 100 ms + frequency measurement time.
Display: Simultaneously displays frequency to 1 MHz resolution and input level.

Extended Dynamic Range (Opt 003)

Frequency range: 500 MHz to 18 GHz.
Sensitivity: 500 MHz to 12.4 GHz: -22 dBm.
 12.4 GHz to 18 GHz: -15 dBm
Maximum operating level: +20 dBm.
Dynamic range: 500 MHz to 12.4 GHz: 42 dB.
 12.4 GHz to 18 GHz: 35 dB.
Damage level: +25 dBm.
SWR: <5:1

Options and accessories

	Price
001: High Stability Time Base	add \$500
002: Amplitude Measurement	add \$1000
003: Extended Dynamic Range	add \$375
004: Digital-to-Analog Converter	add \$250
011: Digital Input/Output (HP-IB)	add \$350
H10: Frequency extension to 24 GHz	add \$350
908: Rack Mounting Adapter Kit	\$25
K70-59992A: Rack Mounting adapter kit with slot for access to front connectors from rear.	
5061-2002: Bail Handle Kit	\$20
9211-2682: Transit Case	\$250
10842A: Extender Board Kit	\$300
5342A Frequency Counter	\$4500

ELECTRONIC COUNTERS

Automatic microwave counters

Models 5340A & 5341A

- Single input 10 Hz to 18 GHz
- Automatic amplitude discrimination
- High sensitivity-35 dBm
- Optional extension to 23 GHz
- High AM and FM tolerance
- Exceptional reliability



5340A



The 5340A Frequency Counter provides a modern, easily used, more versatile instrument for the direct measurement of frequencies from 10 Hz through 18 GHz via a single input connector. Utilizing new microwave samplers incorporated in advanced phase-lock loops, this counter excels in virtually every specification parameter. It is therefore suited to a wider range of applications than ever before possible for a fully automatic microwave counter.

The exceptional sensitivity of this instrument enhances measurement in the microwave field, where signals are commonly low level and many times are connected via directional couplers or lossy devices. Wide tolerance of AM, FM, and residual noise insure accurate measurement of microwave carrier frequencies despite the presence of these deviations. Automatic amplitude discrimination allows the 5340A to choose the largest signal in a spectrum (250 MHz to 18 GHz) and measure only that signal's frequency, ignoring all others.

Access to the HP Interface Bus via Option 011 provides a particularly flexible system interface. The ability to program octave range via this input allows reduction of acquisition time to typically less than 40 ms. AN 181-1 describes the use of a calculator-controlled measurement system built around the HP Interface Bus for microwave component testing.

5340A Specifications

Signal input

Input 1

Range: 10 Hz to 18 GHz.

Symmetry: sine wave or square wave input (40% duty factor, worst case).

Sensitivity: -30 dBm, 10 Hz to 500 MHz; -35 dBm, 500 MHz to 10 GHz; -25 dBm, 10 to 18 GHz.

Dynamic range: 37 dB, 10 Hz to 500 MHz; 42 dB, 500 MHz to 10 GHz; 32 dB, 10 GHz to 18 GHz.

Impedance: 50Ω.

VSWR: <2:1, 10 Hz-12.4 GHz; <3:1, 12.4-18 GHz.

Connector: Precision Type N.

Coupling: dc to load, ac to instrument.

Damage level: +30 dBm. Total power (ac + dc) not to exceed 1 watt.

Acquisition time: <150 ms mean typical.

Input 2

Range: 10 Hz-250 MHz direct count.

Sensitivity: 50 mV rms. 150 mV p-p pulses to 0.1% duty factor; minimum pulse width 2 ns.

Impedance: 1 MΩ shunted by <25 pF.

Connector: type BNC female.

Coupling: ac

Maximum input: 200 V rms, 10 Hz to 100 Hz; 20 V rms, 100 Hz to 100 kHz; 2 V rms, 100 kHz to 250 MHz.

Automatic amplitude discrimination: automatically selects the strongest of all signals present (within 250 MHz to 18 GHz phase-lock range), providing signal level is: 6 dB above any signal within 200 MHz; 10 dB above any signal within 500 MHz; 20 dB above any signal, 250 MHz-18 GHz.

Maximum AM modulation: any modulation index as long as the minimum voltage of the signal is not less than the sensitivity specification.

Time Base

Crystal frequency: 10 MHz.

Stability

Aging rate: <3 × 10⁻⁷ per month.

Short term: <5 × 10⁻¹⁰ rms for 1 second averaging time.

Temperature: <±2 × 10⁻⁶ over the range of 0°C to 50°C.

Line variation: <±1 × 10⁻⁷ for 10% line variation from nominal.

Output frequency: 10 MHz, ≥2.4 V square wave (TTL compatible) available from rear panel BNC.

External time base: requires 10 MHz approximately 1.5 V p-p sine wave or square wave into 1 kΩ via rear panel BNC. Switch selects either internal or external time base.

Optional time base (Opt 001) aging rate: <5 × 10⁻¹⁰ per day after 24 our warm-up for less than 24 hour off-time.

General

Accuracy: ±1 count ± time base error.

Resolution: front panel switch selects 1 MHz, 100 kHz, 10 kHz, 1 kHz, 100 Hz, 10 Hz, or 1 Hz.

Display: eight in-line long life display tubes with positioned decimal point and appropriate measurement units of kHz, MHz, or GHz.

Self check: counts and displays 10 MHz for resolution chosen.

Sample rate: controls time between measurements. Continuously adjustable from 50 ms typical to 5 seconds. HOLD position holds display indefinitely. RESET button resets display to zero and activates a new measurement.

Operating temperature: 0°C to 50°C.

Power: 115 V or 230 V ±10%, 48-66 Hz, 100 VA.

Weight: net, 11.3 kg (25 lb). Shipping, 14.1 kg (31 lb).

Size: 88.2 H × 425 W × 467 mm D (3¹⁵/₃₂" × 16³/₄" × 18³/₄").

Options

001: High Stability Time Base

002: Rear Panel Connectors

011: Remote Programming-Digital Output (HP-IB)

H10: Frequency Extension to 23 GHz

908: Rack Flange Kit

Price

add \$500

add \$105

add \$390

add \$150

add \$10

5340A Frequency Counter

\$6200

- Automatic or manual band-selection
- Wide FM tolerance
- Optional 1.5 GHz range
- Fast acquisition time
- High sensitivity
- Fully automatic diagnosis



5341A



The 5341A Frequency Counter performs exceptionally fast measurements of frequency up to 4.5 GHz. Using a unique HP-designed microwave switchable filter, its automatic heterodyne measurement technique insures high tolerance of FM on the measured signal. In the normal mode of operation, the 5341A will automatically measure and display the lowest frequency CW signal within its sensitivity; in the manual mode, the operator can choose to search within any of ten frequency bands which cover the counter's full range. Also at the operator's command, a convenient routine provides "qualifiers" in the display for complete diagnostic information concerning both the measured signal and the counter's internal operation.

The high sensitivity (-15 dBm in automatic mode, -20 dBm in manual) of the 5341A makes it ideal for measurement of low-level signals in the testing of UHF and microwave components and equipment. An extremely fast acquisition time (100 μsec in manual mode) makes this counter the optimum choice for systems applications.

Option 003 limits the frequency range of the 5341A to 1.5 GHz, at a considerably reduced cost. Option 011 connects the 5341A to the high-speed HP Interface Bus for data output and complete programmability, including the ability to remotely select the manual search bands.

5341A Specifications

Signal input

Input 1

- Range:** 50 MHz to 4.5 GHz.
- Impedance:** 50Ω nominal.
- Connector:** precision Type N.
- Sensitivity:** -15 dBm (AUTO operating mode); -20 dBm (MANUAL operating mode).
- Maximum input:** +20 dBm.
- Damage level:** +30 dBm.
- Operating modes:** AUTO: counter automatically selects and displays lowest frequency within its sensitivity range; MANUAL: Measurement band is selected manually, and counter measures within a 525 MHz range above displayed band number (in the 500 MHz and 750 MHz bands, counter measures within a 250 MHz range).
- Measurement time:** acquisition time + gate time.
- Acquisition time:** 600 μs (AUTO operating mode); 100 μs (MANUAL operating mode).
- FM tolerance:** 30 MHz peak-to-peak worst case. Tolerates 500 MHz peak-to-peak (0-500 MHz and 1.0-4.5 GHz) and 250 MHz peak-to-peak (500 MHz to 1.0 GHz) in center of bands.

Input 2

- Range:** 10 Hz to 80 MHz.
- Impedance:** 1 MΩ, shunted by 50 pF.
- Connector:** type BNC female.
- Coupling:** ac.
- Sensitivity:** 10 millivolts.
- Maximum input:** 5 volts peak-to-peak.
- Damage level:** 400 volts dc; 250 volts rms ac, 10 Hz to 100 kHz, decreasing 6 dB per octave to 80 MHz.

Time base

Crystal frequency: 10 MHz.

Stability

- Aging rate:** < 1 x 10⁻⁷ per month.
- Temperature:** < ± 1 x 10⁻⁶ over the range 0°C to 50°C.
- Output frequency:** 10 MHz ≥ 2.4 V square wave (TTL compatible) available from rear panel BNC.
- External time base:** requires 10 MHz approximately 1.5 V p-p sine wave or square wave into 1 kΩ via rear panel BNC. Switch selects either internal or external time base.
- Optional time base (Opt 001) aging rate:** < 5 x 10⁻¹⁰ per day after 24 hour warm-up for less than 24 hour off-time.

General

- Accuracy:** ± 1 count ± time base error
- Resolution:** front panel switch selects 1 MHz, 100 kHz, 10 kHz, 1 kHz, 100 Hz, 10 Hz, or 1 Hz.
- Display:** ten-digit sectionalized LED display and appropriate measurement units of kHz, MHz, or GHz.
- Self check:** counts and displays 1 GHz for resolution chosen.
- Sample rate:** continuously adjustable from 40 msec to 10 seconds and HOLD.
- Operating temperature:** 0°C to 50°C
- Power:** 115 or 230 volts, with +5% to -10% tolerance, 48 to 66 Hz, 104 VA
- Remote programming and digital output:** optional (Option 001) via 24-pin, series 57 Microribbon connector. Program and output information are 7-bit ASCII code. Compatible with HP Interface Bus.
- Weight:** Net 10.5 kg (23 lb). Shipping 13.2 kg (29 lb).
- Size:** 88.2 H x 425 W x 467 mm D (3¹⁵/₃₂" x 16³/₄" x 18³/₈").

Options

- 001:** High Stability Time Base add \$500
- 002:** Rear Panel Connectors add \$105
- 003:** 1.5 GHz Frequency Range less \$1000
- 011:** Remote Programming-Digital Output (HP-IB) add \$390
- 908:** Rack Flange Kit add \$10

5341A Frequency Counter

\$4950

ELECTRONIC COUNTERS

Time interval probes

Model 5363B

- Solves major T.I. problems
- Precisely defines trigger points
- Greatly improves dynamic range



HP-IB programmable Time Interval Probes

Repeatable measurements

The 5363B provides the necessary input signal conditioning to allow a precision time interval counter to make highly accurate and repeatable measurements on time varying waveforms. No longer are

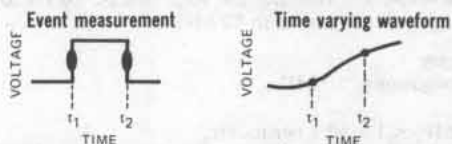

counters restricted to "event" type measurements. Counters such as the 5345A, 5328A and 5370A can now be adapted to make measurements such as rise time, fall time, slew rate, propagation delay and phase jitter analysis.

Trigger point calibration

A unique scheme of Trigger Point Calibration is used instead of hysteresis compensation to insure that the value selected on the digital dials or via the HP-IB is the actual triggering point rather than some unspecified "best estimate" of the trigger point or the center of the hysteresis window.

20 V dynamic range with 10 mV resolution

Greatly improved dynamic range allows the trigger point to be selected in 10 mV increments from -4.99 V to +9.99 V covering the range of most commonly used logic circuits. The use of attenuators on traditional T.I. counters to extend their range increases the effective hysteresis window by the same attenuation amount. This prevents trigger points close to the top or bottom (i.e. 10% or 20% points) of the waveform from being selected and sometimes creates "holes" where certain trigger points cannot be selected at all. The wide dynamic range of the 5363B overcomes these problems.

Minimized circuit loading

Active high impedance, low capacitance probes minimize circuit loading and pulse distortion while permitting test points to be monitored without the need for built-in pulse transformers or impedance matching devices. Each probe contains both a start and stop channel so that a rise time into a device can be measured with one probe, the rise time out of the device with the other and the propagation delay thru the device can be measured between the probes.

Systematic timing errors eliminated

Delays through probes, cables and the inherent differential delays inside the counter's timing channels (i.e., <700 ps in 5345A) limit

- Equalizes system timing errors
- Active probes minimize circuit loading
- Measures to zero time interval

the absolute accuracy of the time interval measurement to some unknown but fixed amount.

The 5363B calibration procedure equalizes out such system delays and allows the counter and probes to be set for 0.0 ns. When a counter with a minimum T.I. range is used (such as HP 5345A or 5328A) a fixed offset of 10.0 ns can be switched in allowing the counter to measure down to zero time interval.

Automated operation

Under calculator control the standard HP-IB capability allows the probes and a counter to perform a wide variety of automated waveform analysis. In the lab or production line complex measurements or go-no-go decisions can be made with push button simplicity. For further details refer to the 5363B Technical Data Sheet and AN 191 on Time Interval Measurements.

Specifications

Dynamic range: +9.99 V to -4.99 V.

Voltage resolution: 10 mV.

Time resolution: depends on counter used (typ. 10 ps with 5345A T.I. Avg).

Impedance: 1 MΩ shunted by <15 pF.

Effective bandwidth: 350 MHz (or 1 ns rise time).

Minimum pulse width: input signal must remain below and above trigger point for at least 5 ns (i.e., max repetition rate of square wave = 100 MHz).

Absolute accuracy

$$\pm 1 \text{ ns} \pm \frac{\text{START trigger level accuracy}}{\text{START signal slew rate at trigger point}} \pm \frac{\text{STOP trigger level accuracy}}{\text{STOP signal slew rate at trigger point}}$$

Trigger level accuracy (A&B): = $\pm 8 \text{ mV} \pm 0.2 \text{ mV}/^\circ\text{C} \pm 0.15\%$ of trigger point.

Differential trigger level accuracy (A&B): used when A&B are set to the same voltage, same slope, and identical wave forms: $\pm 3 \text{ mV} \pm 0.3\%$ of trigger point.

Max input voltage: 30 V peak.

Linear operating range: $\pm 10 \text{ V}$.

Output to counter: separate start and stop channels, -0.5 to +0.5 V into 50Ω, <2 ns rise time.

Trigger level outputs: trigger point setting $\pm 75 \text{ mV}$.

Delay compensation range: 2 ns adjustable about 0.0 ns or 10.0 ns.

Power: 100, 120, 220, or 240 V ac (+5 -10%); 48 to 440 Hz; 30 VA max.

Weight: 16.2 kg (7 lb, 6 oz.).

Dimensions: rack height 88.9 mm (3 1/2"); half rack width module 212 mm (8 3/8"); depth 248 mm (11 1/8"). Probe length 122 cm (4ft.).

Environmental: operating temperature 0°C to 55°C.

Systems interface: HP-IB programming of all functions except delay adjust vernier (which can be measured in a system).

*After calibration and within the range between 100 mV or 8% (whichever is greater) from the top or bottom of input signal.



Recommended counters	Price
5345A Electronic Counter; 2 ns single shot T.I., True T.I. averaging	\$4400
5328A Opt. 040 Universal Counter; 10 ns single shot T.I., True T.I. averaging	\$1650
5370A Universal Time Interval Counter 20 ps single shot, true T.I. averaging	\$6500

5363B Accessories

10229A Hook Tip	\$5
10218A BNC BNC to Probe Adapter	\$11
1250-0655 BNC Tee to Probe Adapter	\$15
10100C 50Ω Feedthru termination for non-50Ω T.I. counter	\$22
10821A Accessory Kit with 2 each of above plus adapters	\$125

5363B Time Interval Probes **\$2250**

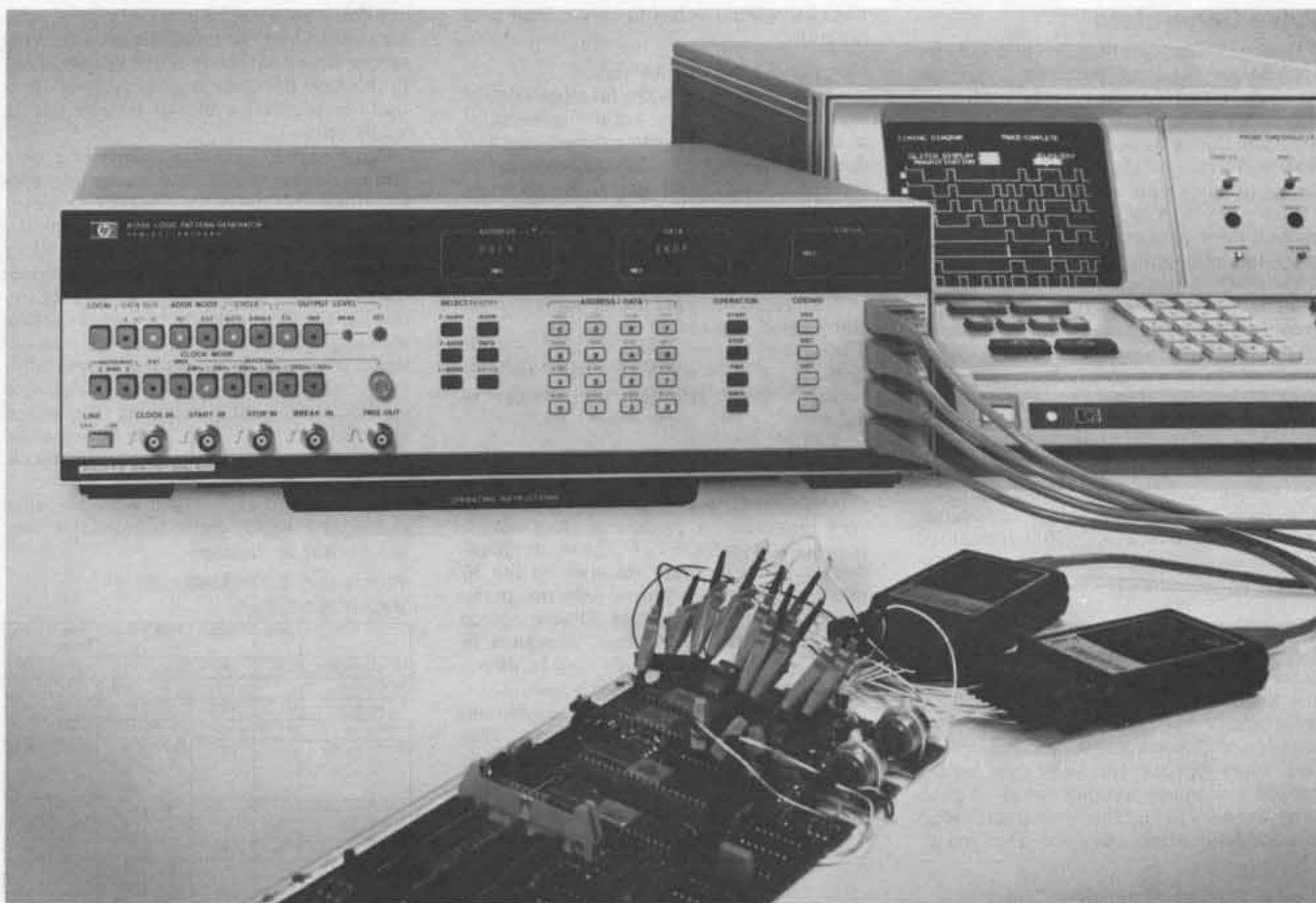

Hewlett-Packard's comprehensive range of pulse and word generators ensures a cost-effective solution to the vast majority of pulse test applications. In analog/digital applications demanding detailed parametric analysis, pulse generators range from simple, inexpensive units, with independent parameter control, to high performance, microprocessor-based units offering precision pulse generation. Individual clock speeds range from 1 MHz through 1 GHz, while output levels vary from a few millivolts to 100 V. Where complex functional checkout is required, word/data generators in the HP range offer up to 32 k bit of freely programmable memory. With multi-channel or single channel instruments available, parallel or serial requirements are easily accommodated. The extensive range thus enables you to select a stimulus ideal for your test requirements.

With the ever-increasing complexity and performance of today's devices under test, recent additions to the pulse/word generator range meet the challenge with microprocessor-based control schemes. By allocating complex instrument functions to microprocessor management, many user oriented features emerge which minimize familiarization time, and make device evaluation a quick, simple task. Features include storage of complete mode and parameter sets, com-

mand sequences identical for both remote and front panel operation, LED display of individual parameter values, and precise error indication for rapid correction of erroneous instructions. Direct benefits of this new generation of HP test instruments are faster setup times in bench applications, and reduced software costs in automatic test systems.

Word generators

Designed for applications demanding complex digital data patterns, Hewlett-Packard's range of word generators offers multi-channel and single channel capability to suit parallel or serial data needs. Standard features include:

- freely programmable memory for worst case pattern generation.
- manual and remote memory programming for bench and automatic test setups.
- variable clock speeds to supply dynamic test capability.
- selectable output levels to suit changing logic families and determine marginal conditions.
- sync outputs (first bit, last bit, clock) to provide easy interfacing to the device setup.
- single/auto cycling for intermittent or continuous testing.

Additionally, individual features of each instrument contribute valuable testing pow-

er. These include PRBS for extended serial data-streams, inter-channel delay for testing critical time relationships, clock speeds to 300 MHz for high speed logic test, and microprocessor control over all functions/parameters to enable simple, straightforward programming syntax.

Serial

In serial applications, a recent addition, the Model 8018A, offers 2 k bit of freely programmable memory, PRBS generation, and up to 50 MHz clock speeds to generate the most complex serial data patterns. For this reason, the 8018A provides unique benefits in modern application sectors such as avionics, fibre optic links, telecommunications and PCM telephone networks.

Parallel

For parallel applications, the latest addition to the HP range is the microprocessor-controlled Model 8170A. Generating data in parallel 8-bit or 16-bit format, to memory depth of 4 k or 2 k words, the 8170A is designed for functional checkout of today's multi-channel logic devices and subassemblies. With data traffic in modern digital systems concentrated on a shared bus, the 8170A's direct bus driving capability, combined with an HP logic state analyzer, provides the ideal stimulus/response setup for complete system checkout.

Pulse Generators

Pulse generators are designed primarily for applications requiring parametric analysis. As a result, all HP pulse generators offer independent pulse parameter control together with high timing stability. Instruments range from basic units for clocking simple logic circuits, to the high performance models, 8160A and 8165A, offering precision control over all pulse parameters, full HP-IB capability and microprocessor control schemes.

For every instrument in the range, logical front panel layout, where related controls are grouped together, guarantees quick familiarization and rapid, error-free use. In addition, great emphasis has always been placed on ruggedness, reliability and serviceability. The generators are developed and produced using high quality standard components, together with custom-designed IC's for achieving unique specifications. Resultant technical benefits are, for example, broad operating temperature range (0°-50°C), essential to rack applications, and output protection against open- and short-circuits.

Independent parameters

All variable pulse parameters on HP pulse generators can be adjusted independently of one another. This means, for example, if pulse offset is varied, the amplitude is not affected, and if amplitude is changed, transition times remain the same. A further feature is complete specification of all pulse parameters including thorough specification of pulse perturbations and jitter. Thus you al-

ways know what pulses to expect from your generator.

Counted burst generation

Applications such as digital circuit design or radar testing often require a burst of pulses with an exact predetermined length. A digital circuit such as a shift register could be clocked to a particular state at its operating frequency using such a pulse burst. Counted burst mode is available in several Hewlett-Packard generators and greatly simplifies stable burst generation. The number of pulses desired is simply dialed into a thumb-wheel switch and a burst of this length will be produced upon command. All pulse parameters (frequency, width etc.) may then be varied without affecting the number of pulses.

50 ohm source impedance

All Hewlett-Packard pulse generators have constant 50 ohm source impedance, a feature very important in producing clean output pulses. Signal reflections from the circuit under test are effectively absorbed by the 50 ohm source thus avoiding re-reflection to the tested circuit. The internal 50 ohm source also enables back terminated operation in which high impedance loads may be driven without an external terminating resistor.

Many HP generators provide, in addition, a switch selectable source impedance. This way, you can choose the best termination configuration for your application.

Time synthesizers

A time synthesizer (sometimes referred to

as a delay generator) is a special type of pulse generator where the emphasis is on the very precise time positioning of the output pulse. In this case the delay is generated very precisely by counting cycles of a stable quartz oscillator.

Other important characteristics of a time synthesizer are the ability to generate a precise, jitter-free delay with respect to a randomly occurring external pulse. In the Hewlett Packard 5359A, this is achieved by means of a unique circuit involving a phase-startable-phase-lockable oscillator. This circuit has the characteristic of always starting with a constant phase relationship to an external pulse and thereafter frequency stability is maintained by phase locking to a stable reference while still retaining the initial phase information. Thus, the ± 1 count clock errors inherent in digital counting schemes is completely eliminated.

Time synthesizers are mainly used in radar and laser ranging, digital communications, and nuclear applications.

Word and Data Generator Selection Chart

	8006A	8018A	8016A	8170A	8080 System	3762A
Max. rep. rate (MHz)	10	50	50	2	300	150
No. of channels	2	2	9	8/16	1	2
Bits per channels	16 ^{var}	1024 ^{var}	32	4K/2K	16/32/64	10 OF16
Serialized bits	up to 32	up to 2048	up to 256		up to 64	
Output V into 50 Ω	+2.5/-5	15	ECL/TTL var.	TTL/CMOS (Not 50 Ω)	± 2 /ECL	2/ECL
Width/Delay control			•			
RZ/NRZ formats	•	•	•	NRZ	•	•
PRBS	•	•				•
Programmable	•	HP-IB	HP-IB	HP-IB	RS 232C	

Logic Family Selection Chart

	Pulse Generators								Programmable Pulse Generators			Word And Data Generators					
	214B	8005B*	8007B*	8011A	8012B	8013B	8015A	8082A	8080 System	8160A	8165A	1900* System	8016A	8006A*	8018A	8080 System	8170A
CMOS	○	○		●	○	○	●			●	○	○	□	□	●		●
TTL/LS-TTL	○	○	●	○	●	●	●	●		●	●	○	●	○	●		●
S-TTL			●	○	○	○	●			○	○		○		○		
ECL 10K			○				●	●					○		○	●	
ECL III							○	●							●	●	
High Power	●										●						

● ideal ○ applicable □ with adapter 15451A

Pulse Generators Selection Chart

	Pulse Generators									Programmable Pulse Generators			Time Synthesizer
	214B	8005B	8011A	8012B	8013B	8015A	8007B	8082A	8080 System	1900 System	8160A	8165A	5359A
Max. rep. rate (MHz)	10	20	20	50	50	50	100	250	1000	25	50	50	10
Output V into 50 Ω	± 100	± 10	± 16	± 10	± 10	± 16	± 5	± 5	± 1.2	± 50	± 20	20Vpp	± 5
Offset V into 50 Ω		± 2		± 2.5	± 2.5	± 14	± 4	± 2	± 1.2	± 3	± 20	± 10	± 1
Number of outputs	1	3	1	1	2	3	1	2	2	1	2	1	2
Selectable Z_s	●	●	●	●	●	●				●	●	●	
Transition times	15 ns	10 ns var.	10 ns	5 ns var.	3.5 ns	6 ns var.	2 ns var.	1 ns var.	300 ps	7 ns var.	6 ns var.	5 ns	<4 ns
Min. width	25 ns	25 ns	25 ns	10 ns	10 ns	10 ns	5 ns	2 ns	500 ps	15 ns	10 ns	Sine 20%, 50%, 180% VCO, FM, AM	5 ns
Delay	●	●		●	●	●	●	●	●	●	●	●	0-160 ms
Double pulse mode	●	●		●	●	●	●	●	●	●	●	●	
Ext. trigger	●	●	●	●	●	●	●	●	●	●	●	●	●
Gated output	●	●		●	●	●	●	●	●	●	●	●	●
Burst mode	option		option			option					●	●	●
Programmable						analog				digital or analog	HP-IB	HP-IB	HP-IB

PULSE GENERATORS

50 MHz programmable signal source

Model 8165A



- 1 MHz to 50 MHz
- sine, ramp and pulse waveforms
- counted burst

- 20 Vpp amplitude
- Fully programmable
- Storage of operating parameters

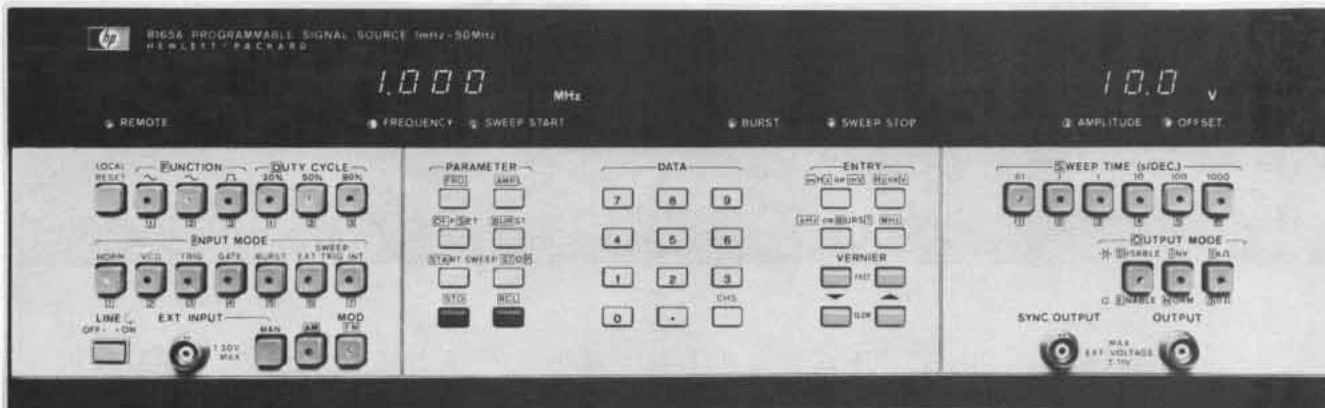

HP-IB

8165A with AM + Sweep Option 002

50% Symmetry/duty cycle

Sine
Triangle
Square

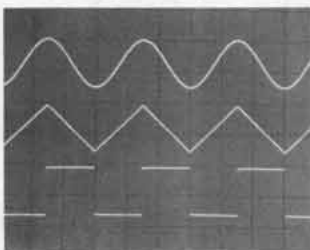

20% Symmetry/duty cycle.

Ramp
Square

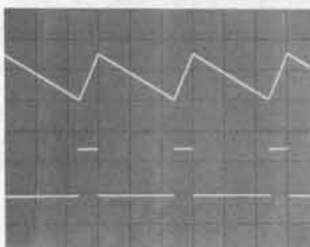

80% Symmetry/duty cycle

Ramp
Square

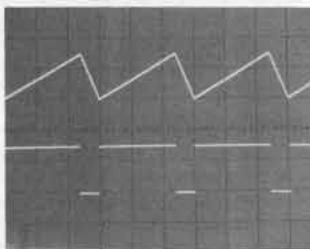

Introduction

The 8165A Programmable Signal Source generates sinewaves, triangles, ramps, square waves and pulses over a frequency range of 1 MHz to 50 MHz. The pushbutton front panel controls and the LED parameter display enable rapid and accurate setting of parameters with no repeatability problems. When you include other features such as microprocessor control, remote programmability of all parameters, and seven operating modes, you have a versatile signal source in just a single instrument that can be used in a wide range of applications.

Microprocessor control

The 8165A contains a microprocessor-controlled interface and keyboard designed to simplify operating and programming. Whether operating the instrument from its keyboard or from a controller via the HP-IB, the microprocessor simplifies parameter and data entry. It

also checks for illegal operations, incompatible settings, and sets up front panel displays. The microprocessor greatly simplifies front panel operation by enabling any parameter to be changed using only 3 steps; a PARAMETER key, DATA keys, and an ENTRY key.

Operating set storage

Up to 10 complete operating sets (functions and parameters) can be stored in the built-in memory. Subsequently you can recall any of the 10 sets instantaneously by pressing only two keys or using one program statement. And you don't have to worry about losing operating sets if the 8165A is accidentally switched off or if the power fails. Internal batteries preserve the current and stored operating sets for up to four weeks.

Stability, accuracy and resolution

The use of phase lock loop techniques, plus a 10 MHz internal or external crystal reference, ensures very stable output frequencies with an accuracy of $\pm 1 \times 10^{-5}$ deviation from programmed value. Resolution is four digits over the frequency range of 1 MHz to 50 MHz. For example, in the frequency range 1-9.999 MHz, this is equivalent to a resolution of 1 μ Hz.

Multiple waveform generation

The multiple waveforms that can be generated by the 8165A suit it to a wide range of digital and analog applications. Sine, triangle or square waves can be generated at frequencies up to 50 MHz. Ramps and rectangular pulses with 20% or 80% duty cycle/symmetry can be generated at frequencies up to 19.99 MHz.

Operating modes

The 8165A can be operated in any of eight different modes: normal, voltage controlled oscillator (VCO), trigger, gate, counted burst, frequency modulation (FM), and optional sweep and amplitude modulation (AM). This wide range of modes enables the 8165A to be used in any operating environment.

Output capability

The 8165A has been designed to fulfil the requirements of analog and digital testing. The source impedance can be set to 50 ohms or 1k ohms for best termination, i.e. minimum distortion and reflection in each application. The 8165A can also be used as a current source, or supply a variable dc level.

HP-IB programming

The use of a microprocessor makes the 8165A very easy to program across the HP-IB, and ideal in automatic test systems. All operating parameters and functions can be programmed and in learn mode the 8165A can report its status and its current or stored operating sets. Programming is further simplified by the codes on the instrument front panel. The framed mnemonics are the ASCII characters required for programming.

For specifications see page 357.

PULSE GENERATORS

Programmable pulse generator

Model 8160A

- 50 MHz repetition rate
- 20 V output amplitude
- Full dual channel capability (option 020)
- 1-3% pulse parameter accuracy
- HP-IB programming interface
- Storage of operating parameters

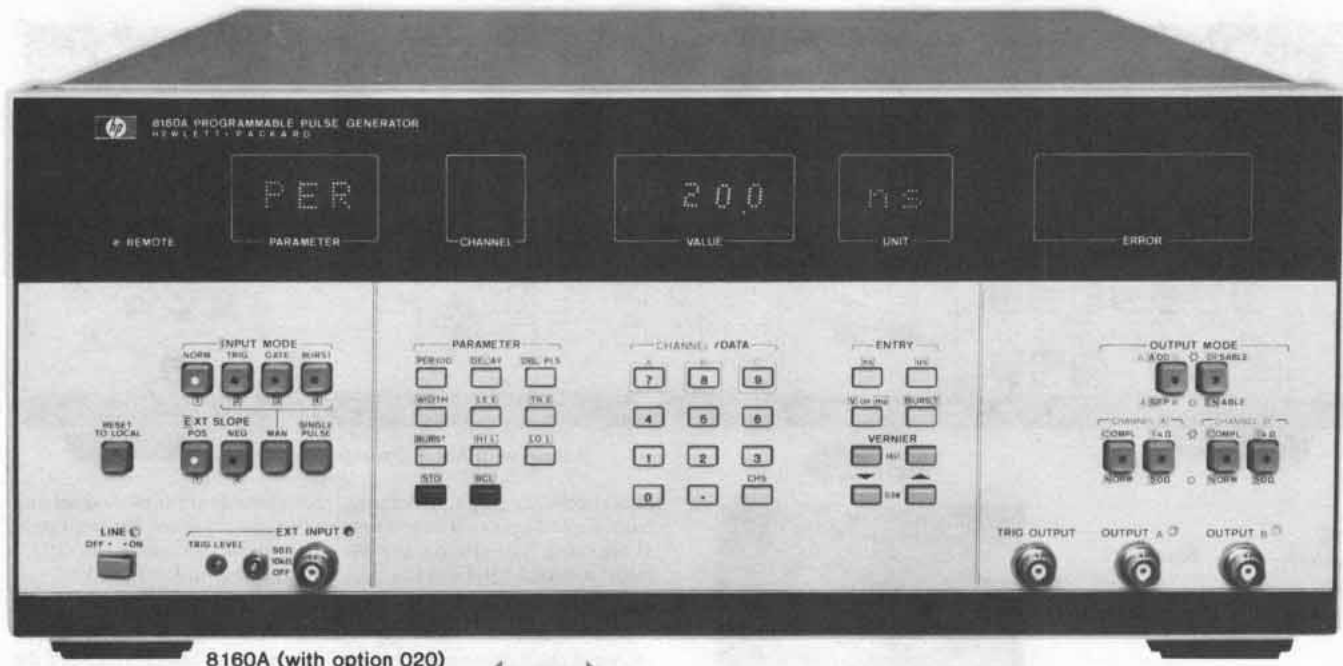

8160A (with option 020)

HP-IB

Introduction

The Hewlett-Packard model 8160A is a fully programmable 50 MHz pulse generator designed for high performance applications on the bench and in automatic systems. Its single or dual (option 020) output channels provide 20 V, 6 ns variable transition time pulses ideal for the majority of testing requirements. Combining high programming accuracy with new, microprocessor-based control capabilities model 8160A represents a significant departure from its pulse generator predecessors.

For the first time, pulses can be set up without a measuring instrument to adjust each of its parameters. Pulse parameters are directly entered as numerical quantities using the 8160A's keyboard, and are then displayed on LED's. The desired pulse is generated with an unmatched accuracy of 1-3%, depending upon parameter.

An advanced, easy-to-use HP-IB interface brings model 8160A's high accuracy pulses to automatic testing applications. All parameters and operating modes are remotely programmable using simple, straight-forward command sequences made possible by the microprocessor. Faster, easier program generation and reduced software costs are direct benefits.

Precision pulse generation

Model 8160A provides precision control over all parameters of its 50 MHz, 20 V output pulse. Leading and trailing edge transition times may be independently programmed down to 6 ns. With ratios up to 20:1 possible, triangular and sawtooth waveforms are easily generated.

Variable transition times enable you to make an exact match between the output pulse and the rise/fall time requirements of the application. In systems applications, for example, decreasing pulse edge speeds vastly reduce reflections.

Direct entry of the high and low levels of the output pulse enable easy simulation of logic signals. Pulse width is variable from 10 ns to 1 s, and delay shifts the output pulse in relation to the trigger output. Double pulse mode is also provided, and when 2 output channels are included (option 020), double pulse can be independently selected on either or both channels.

Counted burst.

Using Burst Mode a predetermined number of pulses is generated

independent of frequency. Bursts from 0 to 9999 pulses in length may be produced, and can be triggered via an external signal, manually or with an HP-IB command.

Microprocessor-based instrument control

The microprocessor is the center of a new control scheme designed to promote the highly accurate pulse generating hardware. Pulse parameters are directly entered via the instrument's keyboard, and are then displayed on numeric LED's with 3-digit resolution.

In bench applications, the vernier controls give you a fine adjust capability to 'tweak-in' any pulse parameter. You can increment or decrement the selected parameter either in single steps or automatically at one of two speeds.

Error detection by the microprocessor further simplifies pulse set-up by solving the old problem of incompatible settings. Should pulse width exceed pulse period, for example, the microprocessor indicates a TIMING error. All possible mis-settings are detected and the type of error is indicated to aid rapid correction.

HP-IB Programming

Microprocessor control over all interface functions makes remote programming as easy and straight-forward as manual control. The 8160A employs keystroke programming so that data entry via the HP-IB is an exact simulation of manual entry. Bus commands for each front panel key simply replace manual keystrokes.

Parameter storage

The 8160A stores complete parameter and mode information for 9 independent instrument set-ups. Waveforms may be stored and recalled either manually or via the HP-IB.

By utilizing a single command to recall an entire instrument set-up, this feature is an important saver of controller time. In simple repetitive testing applications, storage of test waveforms can even eliminate the need for an external controller.

Learn mode

When interrogated by the system controller, the 8160A outputs a character string to the interface bus. This string completely describes the pulser's current set-up or any one of its 10 stored parameter sets. Using Learn Mode, you can enter and try out waveforms manually and then automatically transfer them via the HP-IB to the controller for storage in a program.

Specifications (50 Ω source/load)

Timing (with minimum transition times)

Period

Range: 20.0 ns to 999 ms (see table 2).
Accuracy: 3% of progr. value ± 0.3 ns (per. < 100 ns).
 2% of progr. value (per. ≥ 100 ns)

Max. Jitter: 0.1% of programmed value + 50 ps.

Width

Range: 10.0 ns to 999 ms (see table 2).
Accuracy: 1% of programmed value ± 1 ns.
Max. Jitter: 0.1% + 50 ps (width ≤ 999 ns).
 0.05% (999 ns < width ≤ 9.99 μs).
 0.005% (width > 9.99 μs)

Delay

Range: 0.00 ns to 999 ms (measured from 50% point of leading edge of trigger output).
Accuracy: 1% of progr. value ± 1 ns (see table 2)
Max. Jitter: 0.1% + 50 ps (delay ≤ 999 ns)
 0.05% (999 ns < delay ≤ 9.99 μs)
 0.005% (delay > 9.99 μs)

Double Pulse (DBL)

Range: 20.0 ns to 999 ms
Accuracy: 1% of programmed value ± 1 ns
Max. Jitter: 0.1% + 50 ps (DBL ≤ 999 ns).
 0.05% (999 ns < DBL ≤ 9.99 μs)
 0.005% (DBL > 9.99 μs)

Output signals

Output levels

High level range: -9.89 V to 9.99 V
Low level range: -9.99 V to 9.89 V
Amplitude: 0.10 V min, 9.99 V max. (increases with hi-Z source or load, see table 1)
Accuracy: 1% of progr. value ± 50 mV ± 1% of ampl.
Settling Time: 40 ns to specified accuracy.

Transition times (10-90% amplitude).

Leading edge: 06.0 ns to 9.99 ms (see table 2).
Trailing edge: 06.0 ns to 9.99 ms (see table 2). Leading and trailing edge transition times are independently programmable within a common range. Ranges are overlapping.
Accuracy: 3% of progr. value ± 1 ns (see table 2)
Linearity: 3% for transition times > 30 ns.

Prashoot, overshoot, ringing: 5% ampl. ± 10 mV.

A ADD B: adds channel A and B outputs (opt. 020).

Output format: normal or complement.

Source impedance (see table 1).

Auxiliary inputs and outputs

External input

Trigger level: +10 V to -10 V.
Max. input: ± 12 V in 50Ω, ± 20 V in 10 KΩ.
Minimum amplitude: 500 mVpp.
Slope: positive or negative.
Min. pulse width: 3 ns.
Typical inp. resistance: 50Ω or (also in OFF) 10kΩ.
Delay from trig. inp. to trig. outp.: 90 ns ± 10 ns

Table 1: Output Levels (8160A into 50 Ω)

OUTPUT MODE	Typical Z _s	HIL min max	LOL min max	HIL/LOL accuracy	AMPL. min max
A SEP B 50 Ω	50 Ω 25 pF	-9.89 V +9.99 V	-9.99 V +9.89 V	1% ± 1% ampl. ± 50 mV	100 mV 9.99 V
A SEP B 1 kΩ	1 kΩ 25 pF	-19.7 V +19.9 V	-19.9 V +19.7 V	1% ± 1% ampl. ± 100 mV	200 mV 19.9 V
A ADD B 50 Ω	48 Ω 60 pF	-9.89 V +9.99 V	-9.99 V +9.89 V	2 (A SEP B, 50 Ω) -2.5%	100 mV 19.5 V
A ADD B 1 kΩ	500 Ω 60 pF	-19.7 V +19.9 V	-19.9 V +19.7 V	2 (A SEP B, 1 kΩ) -5%	200 mV 20.0 V

Table 2: Output Modes/Timing (8160A into 50 Ω)

OUTPUT MODE	PER min	WID min	DEL accuracy	LEE/TRE min	accuracy
A SEP B, 50 Ω	20 ns	10 ns	1% ± 1 ns	6.0 ns	3% ± 1 ns
A SEP B, kΩ	25 ns	12.5 ns	1% ± 2.5 ns	8.0 ns	3% ± 2 ns
A ADD B, 50 Ω	50 ns	25 ns	1% ± 0 ns	15 ns	3% ± 4 ns
A ADD B, 1 kΩ	50 ns	25 ns	1% ± 0 ns	15 ns	3% ± 4 ns

Trigger output

Amplitude: ≥ 2.5 V into 50Ω
Typical source resistance: 50Ω
Typical pulse width: 8 ns (period < 100 ns)
 40 ns (100 ns < period < 1 μs)
 400 ns (period ≥ 1 μs)

HP-IB capability

All modes and parameters can be programmed.
Memory: 9 addressable locations plus 1 for current oper. state.
Capacity: 1 complete operating state per location.

General

Repeatability: 50% of specified accuracy.
Power-off storage: batteries maintain all stored data for up to 2 weeks with instrument off. Hard-wired addressable location contains fixed operating state for confidence check.
Power: 115/230 Vac + 10%, -22%; 48-66 Hz; 675 VA max.
Temperature range: 15-35°C as specified.
Accuracy derating factors for temp: 0-15°C or 35-50°C.
Delay, width, double pulse: 0.07% /°C
Period, high level, low level: 0.14% /°C
Leading edge, trailing edge: 0.21% /°C.
Weight: net 20.8 kg (46 lbs). Shipping 25 kg (55 lbs).
Dimensions: 178 H × 426 W × 430 mm D (7 × 16.8 × 17 in.)

Options

Opt. 001: Rear panel inputs and outputs	N/C
Opt. 020: Second channel	add \$4800
Opt. 907: Front handle kit (Part No. 5061-0090)	add \$30
Opt. 908: Rack flange kit (Part No. 5061-0078)	add \$20
Opt. 909: Combined rack flange and front handle kit	add \$45
Opt. 910: Additional operating manual	add \$20

8160A Programmable Pulse Generator **\$11000**

PULSE GENERATORS

High resolution time synthesizer

Model 5359A

- Precise digital delays 0-160 ms
- Jitter < 100 ps
- Increments 50 ps
- Programmable
- Fully synchronous to external trigger
- Automatic Calibration

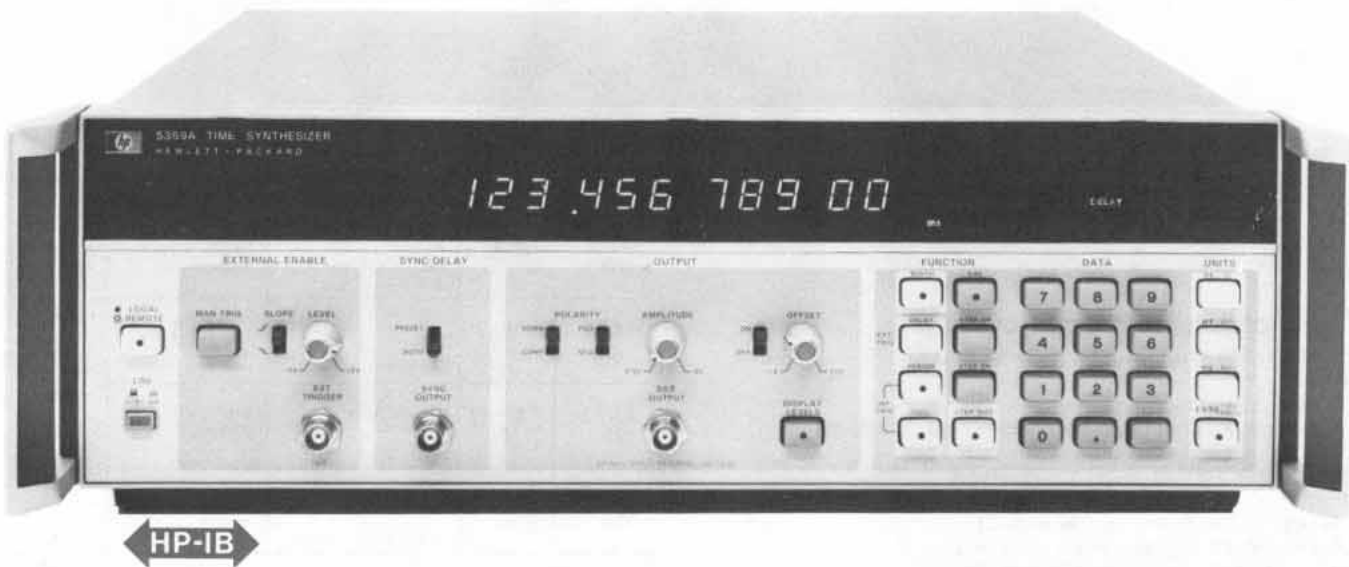

The 5359A Time Synthesizer produces two extremely precise, low jitter time delays. These delays, T_d and T_w , are individually selectable by means of the keyboard, in 50 ps or greater steps to generate delays of up to 160 ms.

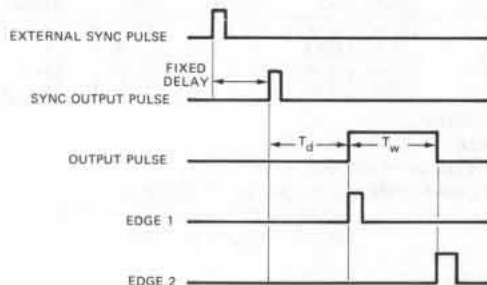

The 5359A has many applications and may be used for the calibration of Radar, Loran, DME and Tacan Systems, or for precision generation of delayed sweeps in oscilloscopes, and for extremely accurate "time positioning" control of external gates on frequency counters. In component and circuit test, the instrument may be used for extremely accurate delay line simulation.

Specifications

Modes

External Trigger Mode: the delays from the sync out to the beginning of the output pulse, and the width of the output pulse, are selected.

Internal Trigger Mode: the "period" or "frequency", and the width of the output pulse, are selected.

Range

Delay T_d : 0 ns to 160 ms.

Width T_w : 5 ns to 160 ms (width & delay \leq 160 ms).

Period: 100 ns min. or width + 80 ns, 160 ms max.

Frequency: same as corresponding "period".

Repetition rate: 10 MHz max.

Accuracy: ± 1 ns \pm time base error.

Insertion delay: fixed at < 150 ns; selectable as < 50 ns for delays > 100 ns.

Jitter: typical 100 ps rms; maximum 200 ps rms

External trigger input: -2 V to + 2 V slope selectable.

Sync output: 1 V - 50 Ω ; 5 V - 1M Ω . Width 35 ns nominal.

Output pulse

Amplitude: 0.5 V to 5 V into 50 Ω .

Polarity: positive or negative.

Offset: -1 V to 1 V, or OFF.

Transition time: < 5 ns.

External voltage must not be applied. Offset and Amplitude voltage into 50 Ω may be displayed.

EDGE 1 OUTPUT (rear panel): occurs in Sync with leading edge of output pulse (same spec. as Sync out).

EDGE 2 OUTPUT (rear panel): occurs in Sync with falling edge of output pulse (same spec. as Sync out).

Events mode: substitutes external input (to 100 MHz) for the internally counted clock (Delay and width must both be specified in events and not time).

Triggered frequency mode: the same as internal frequency mode except the output is a burst beginning in synchronism with an external trigger signal, and continues for the duration of this signal.

Calibrate mode: performs an internal calibration to remove the effects of internal delay differences.

External probes: provides outputs to control the 5363B probes and accepts inputs from the probes to include external devices in the calibration loop.

HP-IB: All controls except trigger levels are programmable as standard.

Time base

Frequency: 10 MHz

Aging: $< 3 \times 10^{-7}$ /month

Temperature: $< 2.5 \times 10^{-6}$, 0°C to 50°C

Line voltage: 1×10^{-7} for 10% change

001 High stability time base

Frequency: 10 MHz. Aging 5×10^{-10} /day.

Temperature: 3×10^{-9} , 0° to 55°

Size: 146.1 H \times 425.5 W \times 520.7 mm D (5.75" \times 16.75" \times 20.50").

Weight: 30 lbs.

Options and accessories

001: High Stability Time Base

908: Rack Flange Kit

10870A: Service Kit

5359A Time Synthesizer

Price

add \$575

add \$20

add \$430

\$6500

PULSE GENERATORS

Versatile source, unique level controls

Model 8015A



- 50 MHz repetition rate
- 2 output channels
- 16 V amplitude and offset

- Counted burst option, 0-9999 pulses
- Ideal for MOS, TTL and analog applications
- Each control ergonomically designed



The 8015A is a 50 MHz dual channel pulse generator with variable transition times, designed for optimum flexibility in the control of any pulse parameter. Each of the two independent output amplifiers can generate ± 16 V. A unique way of avoiding the usual offset and amplitude adjustment problems is provided by two independent pulse level sliders; with the aid of a calibrated scale the slider positions determine the pulse "high" and "low" levels.

In addition to control of pulse timing and amplitude parameters, it is possible to delay the pulse from channel B with respect to the pulse from channel A. For analyzing critical timing conditions or generating 2-phase clocks this B Delay mode offers continuous pulse delay between the two channels.

It is also possible to parallel both output amplifiers using A + B mode, which doubles the output current and enables a maximum output swing of 30 V (within a ± 16 V window). The combination of A + B mode and B Delay mode together with variable transition times and individual selection of Normal/Complement format for each output permits complex waveforms to be generated; waveforms such as three-level signals, special codes or simulated biomedical signals.

A range of options extends the 8015As usefulness and offers new solutions to applications problems. Generation of an exact number of pulses, for example, is difficult to achieve by the usual techniques. With the pulse burst option (002), however, it is possible to generate an exact number of pulses (predetermined by thumbwheel switches) at rep. rates up to 50 MHz. This is achieved by means of a built-in preset counter. A pulse burst can be initiated by an external signal or pushbutton control thus enabling continuous, multiple or single burst operation.

Direct access to the linear output amplifiers (option 004) permits any TTL or even low level analog signal to be converted to MOS/CMOS levels. While one output delivers the normal pulse generator signal, the other can be used to amplify a PRBS/word generator output signal forming a test set for full parametric testing of MOS/CMOS shift registers, memories, etc.

A safe and simple way to drive TTL devices is to use a separate TTL output with fixed levels, while all other parameters remain variable coincident with channel A output. This TTL output, available as option 005, requires no external termination because the internal 50 ohm source impedance ensures pulse fidelity when connected to the test circuit.

A particular problem with CMOS devices is that the input clock/data amplitudes must never exceed the power supply voltage or the CMOS circuit will be destroyed. This means that if the supply voltage is varied as part of a parametric test, the clock/data levels must be adjusted first. An option that completely eliminates this problem is the 8015A upper output level tracking option (006). This option enables the CMOS clock/data signals to track the CMOS power supply voltage. Thus when carrying out CMOS parametric tests at varying supply voltages, the signal upper levels automatically track the supply voltage and device safety and proper input levels are ensured. The test circuit is safe even if the power supply is switched off.

The 8015A can be used as part of an automatic test system using the remote control option (003). This option enables the range and vernier settings for the pulse period, delay, width, transition times and output levels to be remotely controlled. Range control is achieved by contact closure to ground using TTL compatible levels. Vernier control is achieved by voltage or current or resistor. Remote or local control of each parameter is selected using the appropriate front panel range switch. Both upper and lower signal levels of each output channel can be controlled independently.

Specifications

Pulse characteristics

Transition times: 6 ns to 0.5 s in four ranges (see table). Common for leading and trailing edges within each range up to maximum ratios of 100:1 or 1:100.

Non-linearity: transitions > 30 ns: $< 5\%$ of pulse amplitude.

Overshoot and ringing: $\pm 5\%$ of pulse amplitude, possibly increasing $< \pm 10\%$ at minimum amplitude.

Preshoot, droop: $< 5\%$ of pulse amplitude.

Pulse width: < 10 ns to 1 s in four ranges.

Width jitter: $< 0.1\% + 50$ ps for any width setting.

Maximum output: ± 16 V.

Maximum duty cycle: $> 75\%$ from 1 Hz to 1 MHz, decreasing to $\geq 50\%$ at 50 MHz. Square wave; $50\% \pm 5\%$ from 1 Hz to 1 MHz, $\pm 15\%$ at 25 MHz.

Pulse delay: 20 ns ($+ 25$ ns fixed) to 1 s, in four ranges.

Delay jitter: $< 0.1\% + 50$ ps for any delay setting.

Mode	Source/Load Impedance	Transition Times	Upper Level Voltage (V _u)	Lower Level Voltage (V _l)	Upper Level Current (I _u)	Lower Level Current (I _l)	V _u -V _l Max Min	I _u -I _l Max Min	Max. Rep. Rate
AsepB	50Ω/50Ω 50Ω/1 kΩ or 1 kΩ/50Ω	*6 ns-0.5 s 8 ns-0.5 s	+8 V to -7 V +16 V to -14 V	+7 V to -8 V +14 V to -16 V	+320 mA to -280 mA	+280 mA to -320 mA	8V 1 V 16 V 2 V	320 mA 40 mA	50 MHz 40 MHz
A + B	50Ω/50Ω 50Ω/1 kΩ or 1 kΩ/50Ω	15 ns-0.5 s 15 ns-0.5 s	+16 V to -14 V +16 V to -12 V	+14 V to -16 V +12 V to -16 V	+640 mA to -560 mA	+560 mA to -640 mA	16 V 2 V 30 V 4 V	640 mA 80 mA	20 MHz 20 MHz

*6 ns at 8 V, may increase to 6.5 ns at 4 V.

Repetition rate and trigger

Repetition rate: 1 Hz to 50 MHz in four ranges (see table).

Period jitter: <0.1% +50 ps for any rep. rate setting.

Square wave: 0.5 Hz to 25 MHz.

Double pulse: 25 MHz max. (simulates 50 MHz).

B Delay: 20 MHz max. Channel B pulse delayed on channel A pulse by amount set on delay controls.

Trigger output: dc coupled, 50Ω (typ.) source impedance, delivering ≥1 V across 50Ω load. 9 ns ± 5 ns width.

Externally controlled operation

External input: 50Ω ± 10% or 500Ω ± 10%, dc coupled.

Maximum input: ± 7 V (50Ω input), ± 25 V (500Ω input).

Trigger polarity: positive or negative slope selectable.

Threshold level: +1 V to -1 V (50Ω input impedance) or +10 V to -10V (500Ω input impedance).

Sensitivity: 50Ω input impedance, sinewaves 1 V p-p, pulses ± 0.5 V; 500Ω input impedance, sinewaves 10 V p-p, pulses ± 5 V.

Minimum pulse width: 5 ns in Ext. Trig., 20 ns in Burst mode.

Delay: <50 ns between trigger input and trigger output.

Manual button: push to activate input.

External width: output pulse width and rate determined by width and rate of drive signal.

Synchronous gating: gating signal turns on repetition rate. Last pulse completed even if gate ends during pulse. Max. repetition rate: 40 MHz.

Options

Opt 002 pulse burst

Number of pulses: 1-9999.

Burst trigger source: external signal or manual.

Repetition rate: 0 to 40 MHz.

Minimum time between bursts: 200 ns.

Trigger: all specifications as for EXT INPUT except minimum width: ≥ 20 ns.

Opt 003 remote control

Timing ranges:

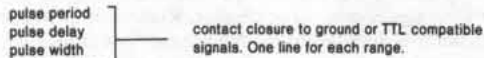

Threshold voltages: logic 0 = 0.4 V, logic 1 = 2.4 V

Timing verniers:

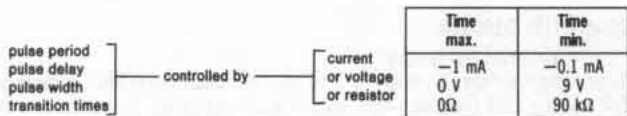

Absolute maximum input current limits: 0 mA to -1.1 mA.

Absolute maximum input voltage limits: + 10 V to -0.1 V.

Output levels

Input control voltage	Output level*
Upper level control set to max + (+8 V)	+8 V
0 (0 V)	0 V
max - (-7 V)	-7 V
Lower level control set to max + (+7 V)	+7 V
0 (0 V)	0 V
max - (-8 V)	-8 V

*50 ohm into 50 ohm

Minimum difference between upper level and lower level control voltage: 1 V (for 1 V output swing).

Absolute maximum input voltage limits: ± 20 V.

Pulse burst: 4 decades (1-9999), 4 lines per decade (1248 BCD format). Contact closure to gnd. or TTL compatible levels. Threshold voltages are logic 0=0.4V, logic 1=2.4 V.

Note: Opt 003 includes Opt 008. To use pulse burst, Opt 002 must be ordered with 003

Opt 004 direct output amplifier access

Input impedance: 50 ohms ± 5%.

Operation: asymmetrical.

Input voltage for max. output: 2.5 V p-p (baseline 0 V, top +2.5 V).

Absolute maximum input voltage: ± 5 V.

Gain: continuously variable between 0.8 and 6.4 by level controls (Z_s=50 ohms, no load).

Frequency response (-3 dB): Z_s = 50 ohms, no load—

0 to 50 MHz

Z_s = 50 ohms, 50 ohm load—

0 to 80 MHz

Polarity: inverting for NORM, non-inverting for COMPL.

Note: B DELAY mode cannot be used with this option.

Opt 005 extra TTL output

Logic 1 level: 4.5 V min.

Logic 0 level: 0.2 V max. (20 mA sink current).

Source impedance: 50 ohms.

Pulse delay: zero, coincident with channel A.

Pulse output: normal/complement as selected by channel A.

Opt 006 upper output level tracking

Input voltage: +2 V to +16 V.

Absolute max. input voltage: +20 V.

Absolute min. input voltage: 0 V.

Input impedance: 10 kΩ ± 5%.

Upper level accuracy: ± 5% of control voltage.

Lower level accuracy: 0 V ± 250 mV.

Settling time to ± 5% of final value: 400 μs.

General

Operating temperature range: 0°C to 55°C.

Power: 100 V, 120 V, 220 V, or 240 V, +5%, -10%, 48 to 440 Hz, 180 VA maximum.

Weight: net, 11kg (24.26 lb). Shipping, 14.7 kg (32.4 lb).

Size: 133 H x 426 W x 346 mm D (5.2" x 16.75" x 13.6").

Options and accessories

002: pulse burst	add \$450
003: remote control	add \$895
004: direct output amplifier access	add \$215
005: extra TTL output	add \$190
006: upper output level tracking	add \$110
907: Front Handle Kit	add \$20
908: Rack Flange Kit	add \$15
909: Rack Flange/Front Handle Kit	add \$30
910: Additional Operating and Service Manual	add \$18

8015A Pulse Generator

\$3015

PULSE GENERATORS

Fast, high power pulse generator
Model 214B



- High power 100 V, 2 A output
- 10 MHz repetition rate

- Constant duty cycle
- Counted pulse burst option

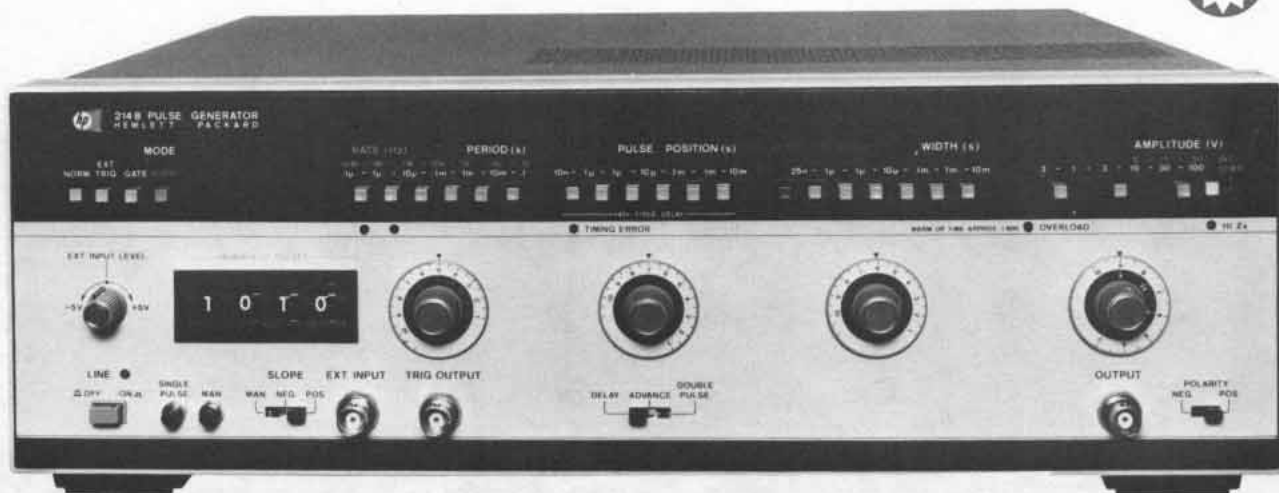

214B (with option 001)

The HP 214B pulse generator employs semiconductor technology for high power pulse generation at up to 10 MHz repetition rate. Delivering 100V pulses with 15 ns risetimes, the 214B meets the speed demands of today's applications.

State-of-the-art VMOS FETS used as current sources for the output amplifier tubes enable pulse width to be specified down to 25 ns. The 214B is thus well-equipped for low duty cycle applications such as laser diode pulsing or transient simulation.

Where changing duty cycle threatens destruction to the device under test, the 214B Constant Duty Cycle (CDC) mode provides device protection. In CDC operation the duty cycle, hence power, remains constant as frequency is varied. The 214B is itself protected against excessive duty cycles via an overload protect circuit.

Easy operation is assured by the timing error indication. Calibrated dials enable fast accurate adjustments. Operating into unmatched loads, clean pulse shape is guaranteed by the low reactance 50 Ω source impedance. Pulse distortions such as preshoot and overshoot are specified as 5% at all amplitudes.

Specifications

Timing

Repetition rate: 10 Hz to 10 MHz in 6 ranges. In 30V - 100V amplitude range, maximum rep. rate is 4 MHz. Calibrated vernier provides continuous adjustment within ranges. **Vernier accuracy:** $\pm(10\%$ of setting + 1% full scale). **Period Jitter:** $\leq 0.1\% + 300$ ps.

Pulse delay/advance: pulse can be delayed/advanced with respect to the trigger output from 10 ns to 10 ms (\pm fixed delay of 45 ns) in 5 ranges. Calibrated vernier provides continuous adjustment within ranges. **Vernier accuracy:** $\pm(10\%$ of setting + 1% full scale) + fixed delay. **Position Jitter:** $\leq 0.1\% + 500$ ps

Maximum pulse position duty cycle: $\geq 50\%$

Double pulse: 5 MHz maximum in all ranges except 30V - 100V range which is max. 2 MHz. Minimum separation is 100 ns.

Pulse width: 25 ns to 10 ms in 6 decade ranges. Calibrated vernier provides continuous adjustment within ranges. **Accuracy:** $\pm(10\%$ of setting + 1% full scale) + 5 ns. **Width Jitter:** $\leq 0.1\% + 500$ ps.

Max. duty cycle: $\geq 10\%$ for 30 - 100V range. $\geq 50\%$ all other ranges.

Constant duty cycle mode (disabled in ext. trigger mode): duty cycle of output pulse remains constant as the period is varied. The duty cycle limits in this mode are typically 8% fixed for the 10 M - 1 MHz range (max. 4 MHz); 2.5% to 10% for 1 MHz - .1 MHz range; .25% to 10% for .1 MHz - 10 kHz range; 0.1% for all other ranges. Calibrated vernier provides continuous adjustment within ranges.

Accuracy: $\pm(15\%$ of setting + 1% of full scale).

Trigger output:

Amplitude: $\geq +5$ V (50 ohm into open circuit).

Pulse width: 10 ns typical.

Externally controlled operation

External input (impedance 10 k ohm, dc coupled)

Repetition rate: dc to 10 MHz. **Sensitivity:** 500 mVpp, dc coupled.

Slope: pos. or neg. **Trigger level:** +5 V to -5 V adjustable.

Maximum input level: ± 100 V. **Trigger pulse width:** ≥ 10 ns.

EXT TRIG mode: An output pulse is generated for each input pulse. **GATE mode:** gate signal turns on rep. rate generator synchronously. Last pulse always completed.

BURST mode (optional): preselected number of pulses generated on receipt of trigger signal. **Number of pulses:** 1 to 9999. Minimum spacing between bursts: 200 ns.

Manual: pushbutton can be used for triggering single pulses (EXT TRIG mode), generating gate signals (GATE mode) or triggering pulse bursts (BURST mode).

Output

Amplitude: 0.3 V to 100 V in 5 ranges. Calibrated vernier provides adjustment within ranges. **Vernier accuracy:** $\pm 10\%$ of setting.

Source impedance: fixed 50 Ω nominal on ranges up to 10 V. Selectable 50 Ω nominal or HI-Z on 10 - 30 - 100 V ranges (with 50 Ω / 50 Ω impedance, amplitude decreases to 5 - 15 - 50 V).

Polarity: pos. or neg. selectable.

Transition times: ≤ 15 ns for leading and trailing edges.

Pulse top perturbations: $\leq \pm 5\%$ of amplitude.

General

Operating temperature: 0°C to 55°C.

Power: 100 V, 120 V, 220 V or 240 V, +5%, -10%, 48 to 66 Hz, 360 VA max.

Size: 133 mm H x 426 mm W x 422 mm D (5.2 x 16.8 x 16.6 in.)

Weight: net 13.6 kg (30 lb), shipping 15.6 kg (34.3 lb).

Options

001: Counted Burst

907: Front Handle Kit (5061-0089)

908: Rack Mounting Kit (5061-0079)

909: Combined Front Handle and Rack Mount Kit

910: extra Operating and Service Manual

214B Pulse Generator

Prices

add \$350

add \$20

add \$15

add \$30

add \$12

\$2550

Model 1900 Plug-in pulse generator system

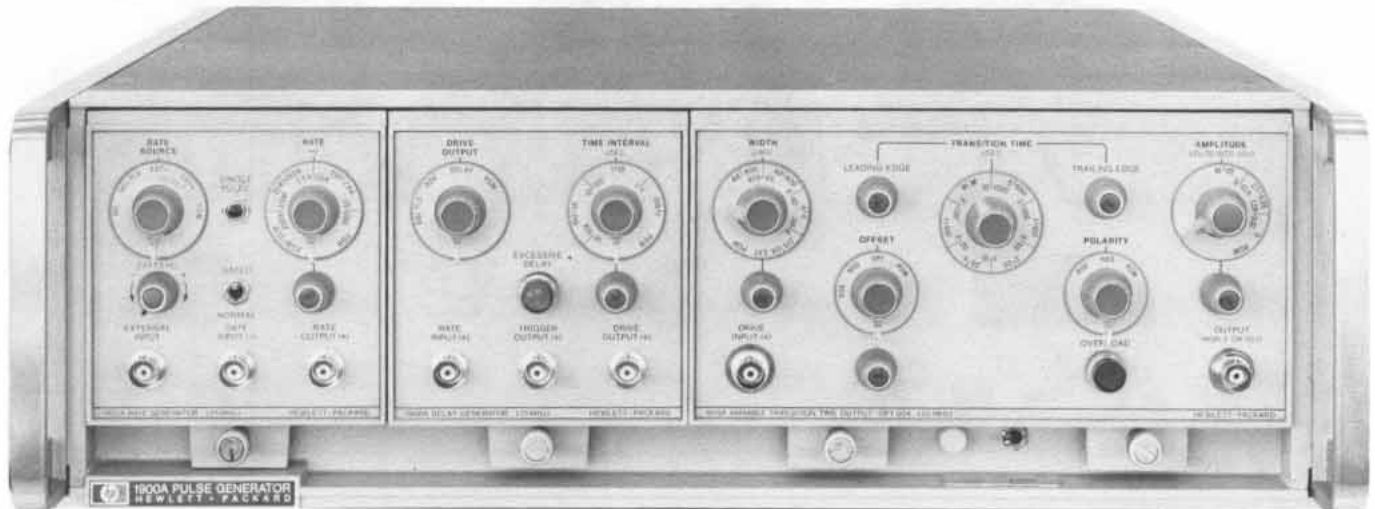

1900 System introduction

The 1900 system with its modular construction offers flexibility and versatility in a pulse generator. The system comprises a series of fully compatible plug-in units with a maximum repetition rate of 25 MHz.

Rate	Data/Timing	Output
1905A	1908A, 1925A, 1930A	1915A 1917A 1920A

Programmability

Remote programming is available for the 1900 system which enables it to be built into systems for automatic testing of components or systems. With analog programming, pulse parameter ranges are controlled by external contact closure and verniers by analog current or resistance. For digital programming the 1900 system is interfaced to a computer via the 6940B Multiprogrammer.

1900A Mainframe

The 1900A mainframe provides housing, power supplies and RFI shielding for all 1900 system plug-ins. Plug-ins in the mainframe can be connected either internally or externally.

1900A Mainframe specifications

Size: 133H x 426W x 492 mm D (5.3" x 16.7" x 19.4").

Weight: net, 16 kg (35 lb). Shipping, 21 kg (46 lb).

Power: 115 V or 230 V $\pm 10\%$, 48 to 66 Hz, 300 watts max.

Accessories

Analog programming kit: P/N 01900-69502 for Opt. 001.

Blank plug-ins: 10481A for half and quarter size plug-ins.

1905A 25 MHz rate generator specifications

Frequency: 25 Hz-25 MHz (int.), 0-25 MHz (ext.).

Period jitter: $< 0.1\%$.

External trigger: amplitude 0.5V to 5 V p-p. Slope pos. or neg.

Input impedance: 50 ohms dc coupled.

Synch gating: -2 V gates generator on, -5 V max. 50 Ω imp.

Output pulse: amp. > 1.5 V (50 Ω /50 Ω).

Risetime: < 5 ns. **Width:** < 10 ns.

1908A 25 MHz delay generator specifications

Delay range: 15 ns to 10 ms. **Jitter:** $< 0.1\%$ of setting.

Rate input: 0-25 MHz; 1 V p-p min, 5 V p-p max.

Trigger and drive outputs

Amplitude: > 1.5 V (50 Ω /50 Ω).

Risetime: < 5 ns.

Width: < 10 ns

Impedance: 50 ohms

1915A Output amplifier specifications

Source impedance: 50 ohms or 4 k ohms

Amplitude: ± 1.25 V to ± 25 V (50 Ω /50 Ω), ± 2.5 V to ± 50 V (HI-Z/50 Ω).

Transition times: 7 ns (10 ns with Hi-Z source) to 1 ms.

Internal width: 15 ns to 40 ms. **Jitter:** $< 0.5\%$.

External width: determined by drive input width.

1917A Output Amplifier specifications

Source impedance: 50 ohms or 3 k ohms, 45 pF shunt.

Amplitude: ± 0.2 V to ± 10 V into 50 Ω , 0 V to ± 14 V into 3 k Ω .

Transition times: 7 ns to 500 μ s. Separate rise and fall controls.

Baseline offset: ± 2.5 V (50 ohms into 50 ohms).

Internal width: 15 ns to 40 ms. **Jitter:** $< 0.25\%$.

External width: determined by drive input width.

Options

001-1900A: cables for rem. program facility

001-1905A, 1908A: analog programming

001-1916A, 1920A: analog programming

001-1917A: analog programming

Programming kit: HP 01908-69 for Opt 001

002-1900A: chassis slides

005-1905A, 1908A: digital programming

005-1925A, 1930A: digital programming

005-1915A: digital programming

005-1917: digital programming

007-1900A: rear panel inputs and outputs

007-1915A, 1917A: rear panel outputs

Ordering information

1900A Mainframe

1905A 25 MHz Rate Generator plug-in

1908A Delay Generator plug-in

1925A PRBS/Word Generator plug-in

1930A PRBS Generator plug-in

1915A Output Amplifier plug-in

1917A Output Amplifier plug-in

1920A Output Amplifier plug-in

Price

add \$225

add \$125

add \$300

add \$325

\$145

add \$95

add \$550

add \$310

add \$2995

add \$2295

add \$80

add \$25

\$1600

\$375

\$375

\$1300

\$1400

\$2400

\$1150

\$2900

- Repetition rate 0.1 Hz to 20 MHz
- Positive/negative/symmetrical output
- Normal/complement switch

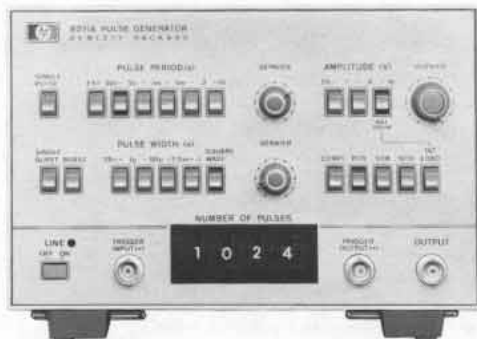

8011A

The 8011A is a versatile, reliable, low cost pulse generator. This compact instrument features an uncomplicated design using high quality components to ensure long, dependable service. Ease of operation results from the logical and simple front panel layout. These qualities and the many pulse formats available emphasize the Model 8011A's cost-effectiveness in a wide application range.

8011A Specifications

Pulse characteristics (50 ohm source/load impedances)

Transition times: < 10 ns fixed.

Overshoot, ringing and preshoot: < ± 5% of pulse amplitude. May increase to 10% at counter-clock wise positions of amplitude vernier.

Pulse width: 25 ns to 100 ms in four ranges. Vernier provides continuous adjustment within each range.

Width jitter: < 0.1% + 50 ps on any width setting.

Maximum duty cycle: > 50% (100% using pulse complement)

Maximum output: 8 V. With internal 50Ω and external Hi-Z or internal Hi-Z/external 50Ω, then 16 V max.

Attenuator: 3-step attenuator provides the ranges 0.25 V – 1 V – 4 V – 16 V. Vernier provides continuous adjustment within each range.

Source impedance: 50Ω ± 10% shunted by 30 pF, except in 4 V – 16 V range which is 50Ω/Hi-Z, switch selectable.

Polarity/Format: pos., neg., or sym./norm. or compl., switch select.

Repetition rate and trigger

0.1 Hz to 20 MHz in 5 ranges. Vernier provides continuous adjustment within each range. **Period jitter:** < 0.1% + 50 ps of per. setting.

Square Wave: 0.05 Hz to 10 MHz.

Trigger output: dc coupled 50Ω (typ.) source delivering ≥ +1 V into 50Ω (can increase to +5 V). **Trigger pulse width:** 20 ns ± 10 ns.

Externally controlled operation

Input impedance: 50Ω ± 10%. **Trigger polarity:** positive.

Maximum input: ± 5 V. **Sensitivity:** 1 V.

Manual: front panel pushbutton for generating single pulse.

Repetition rate: 0 to 20 MHz. In square wave, output frequency is half the input frequency.

Trigger source: manual or ext. signal. Min. ext. signal width 20 ns.

Pulse burst mode (option 001): preselected number of pulses generated on receipt of trigger.

Burst trigger source: man. or ext. signal. Min. signal width 25 ns.

General

Operating temperature range: 0°C to 55°C.

Power: 100 V, 120 V, 220 V, or 240 V, +5%, -10%, 48 Hz to 440 Hz, 70 VA max.

Weight: net, 4 kg (9 lb). Shipping, 6.5 kg (14.6 lb).

Dimensions: 126 H x 200 W x 280 mmD (5" x 7.9" x 11")

- Dual outputs, +10 V and -10 V
- TTL output
- Gating, square wave, double pulse modes



8005B

The 8005B is a general purpose, triple output pulse generator. This instrument has all parameters variable and produces simultaneous pos. and neg. pulses. It also has a TTL output with all parameters variable except amplitude. This feature, together with the normal/complement facility, greatly improves the ease of operation.

8005B Specifications

Pulse characteristics

Transition times: ≤ 10 ns to 2 s. Edges independently variable.

Non-linearity: for transition times > 30 ns, < 4% of pulse amplitude.

Preshoot, overshoot, ringing: < 5% of pulse amplitude.

Pulse width: < 25 ns to 3 s. **Jitter:** < 0.1% of setting + 50 ps.

Max. duty cycle: > 80% (0.3 Hz – 1 MHz), > 50% (1–20 MHz).

Square wave: 0.15 Hz – 10 MHz.

Pulse delay: < 100 ns to 3 s. **Jitter:** < 0.1% of setting + 50 ps.

Pulse outputs: simultaneous pos., neg. and TTL outputs.

Pulse amplitude: 300 mV to 10 V.

Output protection: max. external voltage ± 10 V.

Source impedance: 50 ohms ± 10% or high impedance selectable.

TTL compatible output: +4.6 V norm. or comp. 50Ω impedance.

Repetition rate and trigger

Repetition rate: 0.3 Hz to 20 MHz in 5 ranges. **Jitter:** < 0.1% + 50 ps.

Double pulse: 10 MHz max. Simulates 20 MHz.

Trigger output: > +2 V ampl. across 50 ohms. **Width:** > 6 ns.

Externally controlled operation

External triggering (dc to 20 MHz)

Delay: approx. 35 ns trig. input to trig. output.

Maximum input: ± 10 V. **Sensitivity:** sine 2 Vpp.

Impedance: approx. 1 k ohms, dc coupled. **Pulses:** ± 1 Vpeak.

Input pulse width: ≥ 10 ns.

Gating

Synchronous: gate signal turns on repetition rate. Last pulse is always completed.

Asynchronous: gate signal controls output of rate generator.

Gate input (impedance 1 k ohms dc coupled).

Amplitude: 2 V to 20 V (max.). **Polarity:** negative.

General

Operating temperature range: 0°C to 55°C.

Power: 115 V or 230 V, +10%, -15%, 48 to 440 Hz, 180 VA max.

Weight: net 7 kg (15.5 lb). Shipping 9 kg (20 lb).

Size: 130 H x 426 W x 290 mmD (5.1" x 16.8" x 11.4").

Options and accessories

8011A-001: Pulse Burst

add \$300

8011A-910: extra Operating and Service Manual

add \$10.50

15179A (for 8011A): Adapter frame, Rack mount for

\$195

2 units.

8005B-908: Rack Flange Kit.

add \$10

8005B-910: extra Operating and Service Manual.

add \$7

Ordering information

8011A Pulse Generator

\$650

8005B Pulse Generator.

\$1975



PULSE GENERATORS

Extremely flexible 50 MHz sources

Models 8012B & 8013B

- Variable transition times down to 5 ns
- ± 10 V amplitude; selectable source impedance
- Ideal for testing TTL



8012B

- Fixed 3.5 ns transition times
- 10 V amplitude; selectable source impedance
- 2 outputs

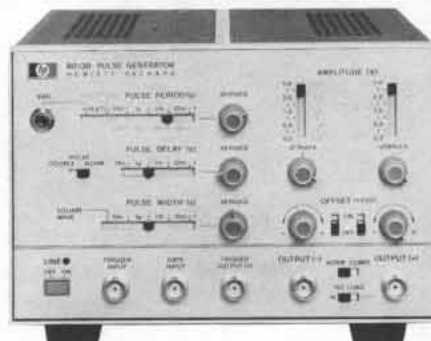

8013B

The 8012B and 8013B are at the top of their class for versatility, ease of operation and wide range of application. They provide the ideal solution to almost all digital logic testing problems with fixed 3.5 ns transition times on the 8013B and variable transition times down to 5 ns on the 8012B. The well-composed layout of the front panel controls (horizontal controls for horizontal parameters, vertical controls for vertical parameters) enables output pulses to be set up quickly and accurately with minimum risk of incompatible settings. Both models feature normal and complement outputs and a switchable internal 50 ohm source.

Specifications

Pulse characteristics

Parameter	8012B		8013B	
	Int. load IN	Int. load OUT	Int. load IN	Int. load OUT
Transition times	5 ns—0.5s 4 ranges, Verniers provide separate control of both edges within ranges up to max. ratios of 100:1 or 1:100.	6 ns—0.5s	3.5 ns fixed	5 ns fixed
Source impedance	50 ohms $\pm 10\%$ shunted by typically 20 pF	>50 ohms	50 ohms $\pm 3\%$ shunted by typically 20 pF	>50 ohms

Parameter	8012B/8013B	
	Internal load IN	Internal load OUT
Overshoot ringing	$\pm 5\%$ of pulse amplitude	May increase to $\pm 10\%$ when amplitude is between 0.4—4 V
Maximum output	5 V across 50 ohms, 10 V across open circuit. Short cct. protection.	10 V across 50 ohms, Short cct. protection.
Attenuator	4-step, reduces output to 0.2 V.	4-step, reduces output to 0.4 V.
DC offset	± 2.5 V across 50 ohms. Independent of amplitude settings.	DC offset switched off.

Linearity (8012B): for transition times >30 ns, maximum straight line deviation is 5% of pulse amplitude.

Prehoot: $< \pm 5\%$ of pulse amplitude.

Pulse width: < 10 ns to 1 s in four ranges. Vernier provides continuous adjustment within ranges.

Width jitter: $< 0.1\% + 50$ ps on any width setting.

Maximum duty cycle: $> 75\%$ from 1 Hz to 10 MHz, decreasing to $\geq 40\%$ at 50 MHz. Up to 100% in COMPL mode.

Polarity: 8012B; positive or negative selectable, NORM/COMPL/SYM selectable; 8013B, one positive + one negative channel, NORM/COMPL selectable.

Pulse delay: < 35 ns to 1 s (with respect to trigger output) in four ranges; vernier provides continuous adjustment within ranges.

Delay jitter: $< 0.1\% + 50$ ps on any delay setting.

Repetition rate and trigger

1 Hz to 50 MHz in four ranges, continuous adjustment within ranges.

Period jitter: $< 0.1\% + 50$ ps on any rate setting.

Square wave: 0.5 Hz to 25 MHz in four ranges. Duty cycle 50% $\pm 5\%$ up to 1 MHz, tolerance increases to $\pm 15\%$ at 25 MHz.

Trigger output: $> +1$ V across 50 Ω , 16 ns ± 10 ns wide.

External triggering

0 to 50 MHz; for square wave output, frequency divided by factor 2.

Trigger input: sine waves 1.5 V p-p (about zero) or pulses > 0.8 V either polarity, > 7 ns wide. Maximum input ± 7 V.

Impedance: 50 $\Omega \pm 10\%$, dc coupled.

Delay: 25 ns ± 8 ns leading edge trig. input to trig. output.

Manual: pushbutton for single pulse.

Gating

Synchronous gating: gating signal turns generator "on". Last pulse is completed even if the gate ends during pulse.

Gate input: dc-coupled; voltage at open connector approx. +1.8 V. Shorting current ≤ 12 mA. Input impedance $\approx 160\Omega$

Gate input signal: voltage $> +1.5$ V or resistor > 1 k Ω to ground enables rep. rate generator. Voltage $< +0.8$ V or resistor $< 160\Omega$ disables rep. rate generator. Input TTL compatible, max. ± 5 V.

External width and RZ

External width: output pulse width determined by width of drive input signal. Amplitude, transition times selectable. Trigger output independent of external width input signal.

RZ mode: external drive input switched to delay generator. Period determined by period of drive input signal. Delay, amplitude and width selectable.

Input signal: $> +1$ V, > 7 ns wide. Max. ± 5 V, 50 Ω dc coupled.

General

Operating temperature range: 0°C to 55°C.

Power: 100/120/220/240 V $+5\%$, -10% , 48 to 400 Hz, 100 VA max.

Weight: net, 4kg (8.8 lb). Shipping, 6.5 kg (14.6 lb).

Size: 126 H \times 200 W \times 280 mm D (5 \times 7.9 \times 11 in.)

Options and accessories

15179A Adapter frame. Rack mounting for two units

Opt 910: extra operating and service manual

Price

\$195

add \$13

Ordering information

8012B Pulse Generator

8013B Pulse Generator

\$1150

\$950

Very fast & variable transitions, 1 ns to 0.5 ms

Model 8082A

- < 1 ns variable transition times
- 250 MHz repetition rate
- Ultra-clean 50 ohm source

- Switch-selectable ECL levels
- ± 5 V outputs



The 8082A is Hewlett-Packard's fastest pulse generator with all pulse parameters variable. With repetition rates to 250 MHz, transition times down to 1 ns and amplitudes to 5 V, the 8082A is ideally suited for state-of-the-art TTL and ECL logic designs. Using the 8082A, you can rapidly test logic circuits under all operating conditions by simply varying pulse parameters. Although a highly sophisticated instrument, the 8082A is still easy to operate because of its logical front panel layout and switch selectable ECL output levels. Another feature that contributes to ease of operation is the square wave mode. You can, for example, carry out toggle rate tests in this mode up to 250 MHz without having to worry about pulse duty cycle.

Hybrid IC's, manufactured by Hewlett-Packard, are used extensively in the design of the 8082A. These ICs eliminate the need for fans, reduce power consumption and enable a low reactance 50 ohm source impedance to be used. This source impedance absorbs 98% of reflections from signals up to 4 V amplitude.

Specifications

Pulse characteristics (50 Ω source and load impedance)

Transition times: < 1 ns - 0.5 ms (10% to 90%) in 6 ranges. < 750 ps (20% to 80%). Leading/trailing edges controlled separately on fastest range, independently variable over 1:10 ratio on other ranges.

Overshoot and ringing: $\leq \pm 5\%$ of pulse amplitude may increase to $\pm 10\%$ with amplitude vernier CCW.

Preshoot: $\leq \pm 5\%$ of pulse amplitude.

Linearity: linearity aberration for both slopes $\leq 5\%$ for transition times > 5 ns.

Output: maximum amplitude is 5 V from 50 Ω into 50 Ω . Maximum output voltage is ± 5 V (amplitude + offset).

Offset: ± 2 V, into 50 Ω .

DC-source impedance: 50 $\Omega \pm 5\%$.

Reflection coefficient: reflection is 2% typical for steps with 1 ns rise time applied to output connector on all amplitude ranges except 5 V range. On the 5 V range, the reflection may be 15%.

Output protection: cannot be damaged by open or short circuits or application of ext. $\leq \pm 6$ V or ± 200 mA independent of control settings.

Attenuator: two separate three step-attenuators reduce the outputs to 1 V. Vernier is common for both outputs and reduces the output to 0.4 V minimum. A further position provides ECL-compatible outputs (-0.9 V to -1.7 V typ. open circuit).

Timing

Repetition rate: 250 MHz to 1 kHz in 6 ranges.

Period jitter: < 0.1% of setting + 50 ps.

Delay: 2 ns - 0.5ms in 6 ranges plus typ. 17 ns fxd. with respect to trigger output. Duty cycle > 50%.

Delay jitter: < 0.1% of setting + 50ps.

Double pulse: up to 125 MHz max. (simulates 250 MHz).

Pulse width: < 2 ns - 0.5 ms in 6 ranges.

Width jitter: < 0.1% of setting + 50 ps.

Width duty cycle: > 50%.

Square wave: delay and double pulse are disabled, max. Rep. Rate 250 MHz. Duty cycle is 50% $\pm 10\%$ up to 100 MHz, 50% $\pm 15\%$ for > 100 MHz.

Trigger output: negative going Square Wave (50% duty cycle typ.) > 500 mV from 50 Ω into 50 Ω . Internal 50 Ω can be switched off by slide-switch on PC-board. Amplitude up to 1 V into 50 Ω up to 200 MHz.

Trigger output protection: cannot be damaged by short circuit or application of external ± 200 mA.

Externally controlled operation

External input

Input impedance: 50 $\Omega \pm 10\%$. DC coupled.

Maximum input: ± 6 V.

Trigger level: adjustable -1.5 V to +1.5 V.

Slope control: positive, negative or manual selectable. In the manual position all ext. functions can be controlled by push button. Button pushed in simulates an "on-signal."

Sensitivity: sine-wave > 200 mV p-p pulses > 200 mV.

Repetition rate: 0 to 250 MHz.

External-controlled modes:

External trigger: there is approximately 7 ns delay between the external input and the trigger output. Rep. rate is externally controlled (is triggered by external signal). Trigger output provides the pulse-shaped input signal. Square wave mode is disabled.

Synchronous gating: gating signal turns rep. rate generator on. Last pulse normal width even if gate ends during pulse.

External width: output pulse width determined by width of drive input. Rep. rate and delay are disabled. Trigger output provides shaped input signal.

General

Operating temperature: 0 $^{\circ}$ C to 55 $^{\circ}$ C.

Power requirements: 100 V, 120 V, 220 V, 240 V(+5%, -10%) 48-440 Hz. Power consumption 85 VA max.

Weight: net, 7.9 kg (17.44 lb). Shipping 8.9 kg (19.63 lb).

Size: 133 mm H x 426 W x 345 mm D(5.2" x 16.75" x 13.6").

Options

907: Front Handle Kit

908: Rack Flange Kit

909: Rack Flange & Front Handle Combination

910: Additional Operating and Service Manual

Price

add \$20

add \$15

add \$30

add \$12

8082A Pulse Generator

\$3800

PULSE GENERATORS

Clean waveshape, all parameters variable

Model 8007B

- 100 MHz repetition rate
- Variable transition times down to 2 ns.
- Extremely linear slopes
- Designed to drive TTL-S and commonly used ECL

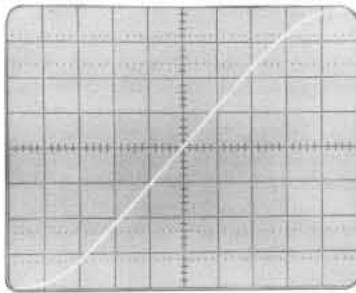
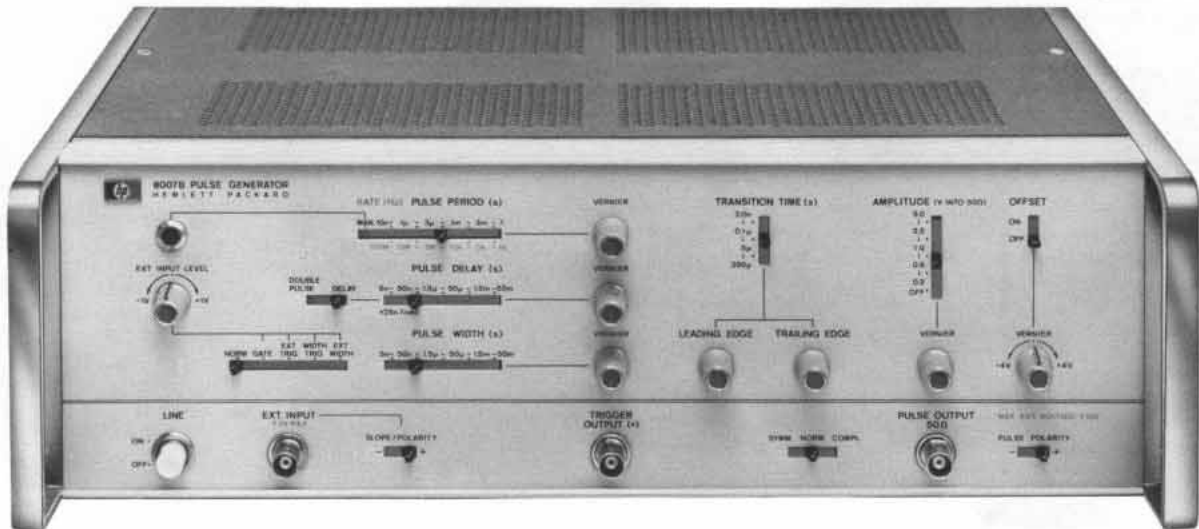

1 ns/cm
0.5 V/cm
1 GHz bandwidth

The 8007B is a high speed pulse generator that is well suited for STTL and ECL applications.

The output can be set to positive or negative polarity, complement or symmetrical to ground. A high dc-offset of up to ± 4 V is also included.

External triggering and synchronous gating are provided. The trigger level is adjustable for all externally controlled modes with the slope polarity selectable. This is very useful for avoiding malfunctions caused by noise and ringing on the external trigger signal.

In "External Width" mode the external input and pulse output have equal width. Transition times and amplitude of the output pulse can be set by the front panel controls. This mode is useful for shaping NRZ signals, as the width information is passed on to the output pulse unchanged.

The "Width Trigger" mode is suitable for RZ signal shaping. Delay, width, transition times and amplitude are determined by the front panel controls.

Specifications

Pulse characteristics (50 Ω source and load impedance)

Transition times: <2 ns to 250 μ s, three ranges (common for both transition times). Independent verniers for adjusting leading and trailing edge within each range up to maximum ratios of 1:50 or 50:1.

Linearity: maximum deviation from a straight line between 10% and 90% points $\leq 5\%$ of pulse amplitude.

Preshoot, overshoot, ringing: < $\pm 5\%$ of pulse amplitude.

Pulse width: <5 ns to 50 ms in five ranges. Vernier provides continuous adjustment within ranges.

Width jitter: <0.1% on any width setting.

Maximum duty cycle: normal >50%; complement approx. 100%.

Amplitude: 5 V max (10 V across open circuit) to 0.2 V in four ranges; vernier adjustment within ranges. Pulse can be switched off.

Pulse output: + or - polarity selectable; normal, complement, or symmetrical to ground.

Source impedance: 50 Ω \pm 4 Ω shunted by typ. 10 pF.

DC-offset: ± 4 V across 50 Ω load. Independent of amplitude setting, can be switched off.

Pulse delay: <30 ns to 50 ms with respect to trigger output. Five ranges, with continuous adjustment within ranges.

Delay jitter: <0.1% on any delay setting.

Repetition rate and trigger

10 Hz to 100 MHz in 5 ranges. Continuous adjustment within ranges.

Period jitter: <0.1%.

Double pulse: available only up to pulse rate setting of 50 MHz, representing an output pulse rate of 100 MHz.

Trigger output: >+1 V across 50 Ω , 4ns \pm 2 ns wide.

External triggering (0 to 100 MHz)

Delay: approx. 15 ns between trig. input and trig. output.

Manual: front panel pushbutton for single pulse.

External width and width trigger

External width: output pulse width determined by width of drive input.

Width trigger: external drive input switched to the width generator. Pulse width determined by front panel width setting.

Rate generator: provides trigger pulses independent of drive input.

Synchronous gating

Gating signal turns generator "on." Last pulse is completed even if gate ends during pulse.

External input

Impedance: 50 Ω , dc-coupled. Max input ± 5 V.

Level: adjustable from +1 V to -1 V, Polarity: + or -.

Sensitivity: sine waves 1 V p-p; pulses 1 V.

General

Operating temperature range: 0 $^{\circ}$ C to +55 $^{\circ}$ C.

Power requirements: 115 or 230 V +10%, -15%, 48 to 440 Hz, 100 VA (maximum).

Weight: net, 8 kg (17.6 lb). Shipping, 9 kg (19.8 lb).

Size: 128 H x 426 W x 345 mm D (5" x 16.8" x 13.6").

Options

908: Rack Flange Kit

910: Additional Operating and Service Manual

8007B Pulse Generator

Price

add \$10

add \$11

\$2600

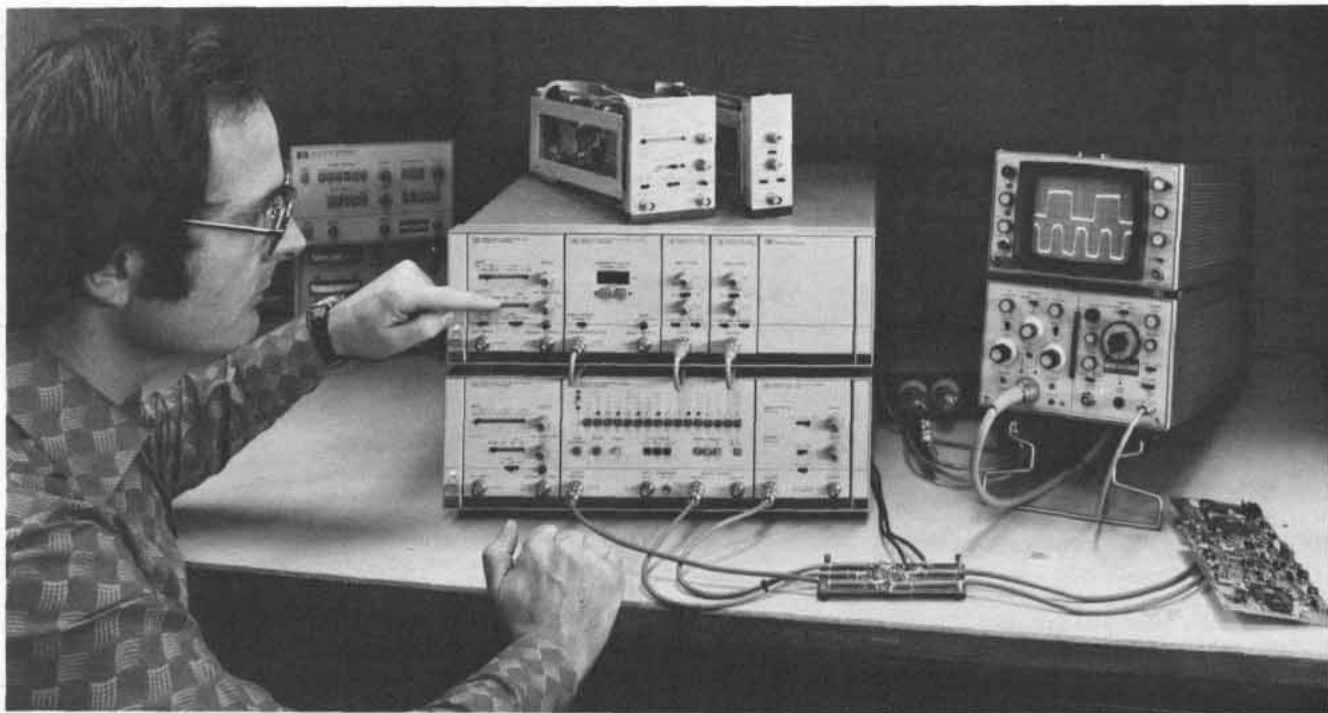

General introduction

The Hewlett-Packard 8080 Pulse/Word Generator System is a powerful new tool in the design of subnanosecond logic and communications systems. The 8080 system combines the waveform generation techniques necessary for testing today's high speed circuits with the modularity for future system upgrading and expansion.

Flexibility built into the system gives you a choice of components from two fully compatible module families. Building blocks are available for either 300 MHz or 1 GHz operation. You can incorporate valuable test capabilities such as pulse advance and delay, interchannel delay, word generation and multichannel operation in your system. The result is a high performance, precision pulse generator tailored to fit your application at minimum cost.

System description

Each of the 8080 system modules is a typical pulse or word generator functional block. Repetition rate generators and output amplifiers are available for either 300 MHz or 1 GHz operation. The 64-bit serial word generator module brings high speed data stream capability to the system, and a 1 GHz delay generator/frequency divider provides interchannel delay in 100 ps increments, as well as half-frequency operation. The full-rack-width mainframe houses and powers the modules.

Using these modules you can configure systems with capabilities covering a broad spectrum of stimulus applications. A basic square wave signal source, for example, consisting of repetition rate generator and output amplifier can provide clocking signals for assemblies of logic circuits. More complex systems, even multi mainframe, can produce single or multichannel data streams optimized for subnanosecond PCM research or IC testing.

The combination of pulse and word generation capability in an integrated system makes possible economical, easy-to-use testing solutions and ensures easy expansion at a later date should test requirements change.

The two systems described as follows are typical of the wide range of systems that can be configured using the fully compatible 8080 modules.

8080 Description.

The Model 8080A Mainframe provides housing and dc power supplies for the 8080 system modules. The modules are built in $\frac{1}{8}$, $\frac{1}{4}$ and $\frac{1}{2}$ mainframe widths and can be accommodated in the mainframe in any position and combination.

The ease with which modules can be exchanged greatly improves serviceability because a defective module can be isolated rapidly and repaired or exchanged. Ease of maintenance is further enhanced by the free access provided to all circuits and assemblies in the system.

The entire system is RFI shielded including a power line filter and sealing gaskets on the modules.

8080A Specifications

Compatibility

Electrical: provides power for all modules in any combination of $\frac{1}{8}$, $\frac{1}{4}$ or $\frac{1}{2}$ -size modules.

Mechanical: mainframe compartments accepts up to two $\frac{1}{2}$ -size, four $\frac{1}{4}$ -size or eight $\frac{1}{8}$ -size modules in any combination.

General

Operating temperature range: 0°C to 55°C.

Power: 115 V or 230 V, +10%, -22%. Frequency 48 Hz to 66 Hz single phase. Up to 200 VA. Power available for modules 55 watts dc.

Weight: net 5 kg (11 lb). Shipping, 8.7 kg (19.1 lb).

Size: 133 mmH x 426 mmW x 422 mmD (5.24" x 16.77" x 16.61").

Options and accessories

907: Front handle kit.

908: rack flange kit.

909: rack flange/front handle kit.

910: additional instrument manual (includes binder and system description)

15400A: blank panel, quarter mainframe width

15401A: blank panel, eighth mainframe width

15402A: Feedthru panel (6x BNC) eighth mainframe width.

Prices

add \$20

add \$15

add \$30

add \$18

\$38

\$38

\$38

8080A Mainframe

\$1330



PULSE GENERATORS

8080 System: 300 MHz word generator example

Models 8081A, 8083A and 8084A

- 300 MHz clock rate
- ≤ 800 ps transition times
- 16, 32 or 64 bit word lengths
- RZ/NRZ formats
- ± 2 V output amplitude (into 50 ohm)
- Selectable preset ECL outputs

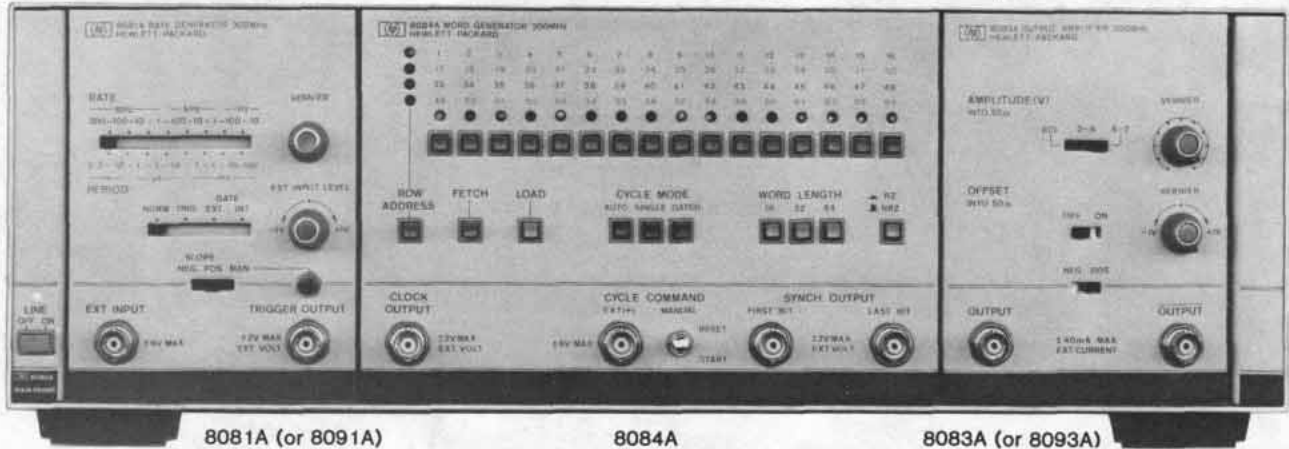

8081A (or 8091A)

8084A

8083A (or 8093A)

300 MHz word generator system

Combining the Model 8084A word generator module with a repetition rate generator and an output amplifier produces a high performance 300 MHz serial data generator. The variable content digital bit stream and synchronizing clock of such a system provide the waveforms necessary for test and development in integrated circuits and telecommunications systems components such as shift registers, modulators and multiplexers.

The Model 8081A repetition rate generator supplies the system clock. It drives the word generator module at rates from 10 Hz to 300 MHz. The Model 8083A output amplifier applies amplitude, rise-time and pulse shape parameters to the word generator output signal and conditions it to provide clean waveforms to an external 50 ohm environment.

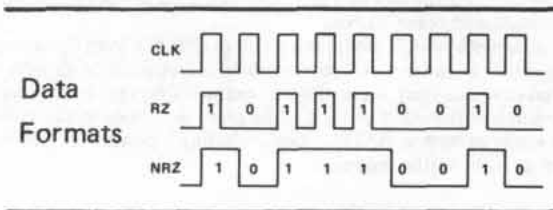

With a single switch you can rapidly select preset ECL-compatible signal levels. When different or more precise levels are required, output pulse amplitude and offset are also separately adjustable. The word generator module gives you a choice of RZ or NRZ data format and provides word framing signals to trigger an oscilloscope. Simultaneously data and data signals, supplied by the complementary output amplifier are particularly useful for testing balanced transmission line systems and line receivers, or for simulating dual-ended IC outputs.

8081 Specifications

Timing

Repetition rate: 10 Hz–300 MHz

Period jitter: $\leq 0.1\%$ ± 50 ps.

External inputs (impedance 50 ohms typical)

Trigger mode: 0–300 MHz repetition rate, ≥ 1.7 ns pulse width.

Gate on/off time: > 1 period/ > 1 period + 10 ns

Trigger level and slope: -1 V to $+1$ V, pos. or neg. edge select.

Sensitivity: 200 mVpp.

Maximum input voltage: ± 6 V.

External trigger output (impedance 50 ohms typical)

High/low signal levels: more pos. than -100 mV/more neg. than -500 mV.

Min. amplitude: 500 mVpp.
Transition times (10–90%): ≤ 1.2 ns
Duty cycle: 50% $\pm 10\%$
Max. external voltage: ± 2 V

8083A Specifications

Output channels. Simultaneous normal and complement outputs.

Source impedance: 50 ohms $\pm 5\%$.

Polarity: neg./pos. selectable

Output pulse

Amplitude (into 50 ohm load): 0.2 V to 2 V in two ranges continuously adjustable, plus ECL range (-0.8 V to -1.6 V adjustable).

Maximum levels: ± 4 V

Offset (into 50 ohm load): ± 1 V common to both channels.

Transition time (10% to 90%): ≤ 800 ps.

Duty cycle (with drive input duty cycle of 50%): 50% $\pm 10\%$

Preshoot, overshoot and ringing: $\leq 10\%$

Output protection: max. applied ext. voltage ± 2 V in pos. mode and 0V to -4 V in neg. mode, or max. ext. current ± 40 mA.

8084 Specifications

Data capacity (1 channel)

Data stream length: 16, 32 or 64 bits selectable.

Cycle command input (impedance 50 ohm $\pm 10\%$, 600 ohm $\pm 10\%$)

Amplitude: ≥ 0.8 V.

Max. input: ± 6 V.

Width: ≥ 3 ns.

Time between cycle comms: word length + $2x$ clk per. + 100 ns

External outputs (Clock, First Bit, Last Bit)

Clock: delivers one pulse per bit. RZ format.

First Bit (FB): coincident with first bit of word. NRZ format.

Last Bit (LB): coincident with last bit of word. NRZ format.

High/low signal levels: more pos. than -100 mV/more neg. than -500 mV or $> +500$ mV/ $< +100$ mV, switch selectable.

Min. Amplitude: > 500 mVpp. Source impedances: 50 ohm $\pm 5\%$.

Transition times (10%–90%): FB and LB ≤ 1.5 ns, Clock ≤ 1.2 ns.

RZ duty cycle (with 50% duty cycle drive input): 50% $\pm 10\%$

General

Size: (8081A) $\frac{1}{4}$ -size; (8083A) $\frac{1}{4}$ -size; (8084A) $\frac{1}{2}$ -size

8081A, 8083A and 8084A option

910: additional operating and service manual

Prices
add \$7.50

Ordering information

8081A 300 MHz Rep. Rate Generator module	\$975
8083A 300 MHz Output Amplifier module	\$870
8084A 300 MHz Word Generator module	\$2705

- 1 GHz repetition rate
- ≤ 300 ps transition times
- High resolution rate controls

- Digital delay/advance in 100 ps steps
- Selectable half frequency operation
- ± 1.2 V output amplitude (into 50 ohm)

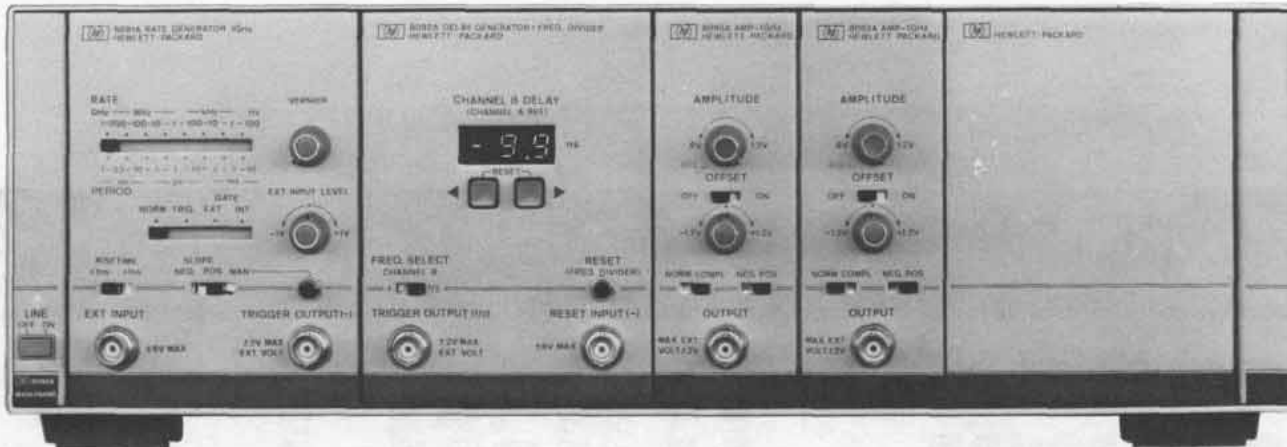

8091A

8092A

8093A

8093A

1 GHz pulse generator system

Models 8091A repetition rate generator, 8092A delay generator/frequency divider, and two 8093A output amplifiers form a versatile 1 GHz pulse generator system. The system includes two output stages with fully independent level controls and the capability to offset the outputs timewise from one another. This system configuration and the waveforms it generates are ideal for testing the fastest integrated circuits and optical components.

Using the delay and half-frequency capability of the Model 8092A, clock and data signals necessary for flip-flop and shift register testing can be generated.

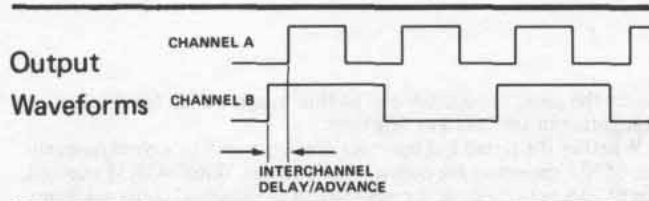

The full frequency output drives the tested device's clock input, and the half-frequency waveform supplies the data input. Setup and hold times are then easily determined by adjusting the interchannel delay, which is variable up to 10 clock periods.

Where formerly two separate, synchronized pulse generators were required to perform the above measurements, the 8080 system provides the necessary capabilities in a single, integrated solution. This together with the testing precision afforded by 300 ps rise and fall time test pulses.

8091A Specifications

Timing

Repetition rate: 100 Hz–1 GHz.
Period jitter: $\leq 0.1\% \pm 20$ ps

External inputs (impedance 50 ohm typical)

Trigger mode: 0–1 GHz rep. rate; ≥ 0.5 ns pulse width.
Gate on/off time: > 1 period/ > 1 period + 10 ns.
Trigger level and slope: -1 V to $+1$ V, pos. or neg. edge select.
Sensitivity: > 300 MHz: pulse/sine 600 mV p-p
 ≤ 300 MHz: pulse 200 mV p-p; sine 1 V p-p.
Max. input voltage: ± 6 V

External trigger output (impedance 50 ohm typical)

Levels: more pos. than -100 mV/more neg. than -500 mV.
Min. amplitude: ≥ 600 mV p-p
Transition time (10–90%): ≤ 500 ps.

Duty Cycle: $50\% \pm 10\%$.

Max. external voltage: ± 2 V.

8092A Specifications

Channel B delay/advance (channel A reference)

Range: ± 9.9 ns in 100 ps steps.

Frequency division: Channel B output frequency can be set by front panel switch to f (channel A) or $1/2 f$ (channel A).

Trigger output ($f/2$): Trigger output is only in $f/2$ mode.

Transition times (10%–90%): < 1 ns.

Reset input (impedance 1 k ohm typical)

Negative-going transition resets ch. B to low level in $f/2$ mode.

Input frequency: 0–2 MHz.

Reset time: ≥ 0.5 μ s.

Maximum external voltage: ± 6 V.

Transition times (10%–90%): ≤ 10 ns.

Manual pushbutton: resets ch. B to low in $f/2$ mode.

8093A Specifications

Output channel

Format: normal or complement selectable.

Source impedance: 50 ohm $\pm 5\%$.

Polarity: neg/pos selectable

Output pulse

Amplitude (into 50 ohm load): 0.6 V to 1.2 V continuously adjustable, plus ECL range (-0.8 V to -1.6 V adjustable).

Maximum levels: ± 4 V offset (into 50 ohm load): ± 1.2 V.

Transition times (10% to 90%): 300 ps.

Duty cycle (with drive input duty cycle of 50%): $50\% \pm 10\%$.

Preshoot, overshoot, ringing: 10% to 500 MHz, $\leq 15\%$ > 500 MHz.

Output protection: max. applied ext. voltage: ± 2 V

General

Size: (8019A) 1/4-size; (8092A) 1/4-size; (8093A) 1/8-size.

Weight: (8091A) net, 1.2 kg (2.6 lb), ship., 2.8 kg (6.2 lb); (8092A) net, 1 kg (2.2 lb), ship., 2.7 kg (5.9 lb); (8093A) net, 0.6 kg (1.3 lb), ship., 2.2 kg (4.8 lb)

8091A, 8092A and 8093A option

910: additional operating and service manual.

Prices
 add \$7.50

Ordering information

8091A 1 GHz Rep. Rate Generator module	\$3145
8092A Delay Generator/Frequency Divider module	\$2805
8093A 1 GHz Output Amplifier module	\$1525



WORD GENERATOR

Logic pattern generator

Model 8170A

- 8 k memory
- 8 bit/16 bit parallel output
- Mini-probe connections to DUT
- Full programmability (HP-IB)
- 2 wire/3 wire handshake capability
- RS 232C serial bus compatibility

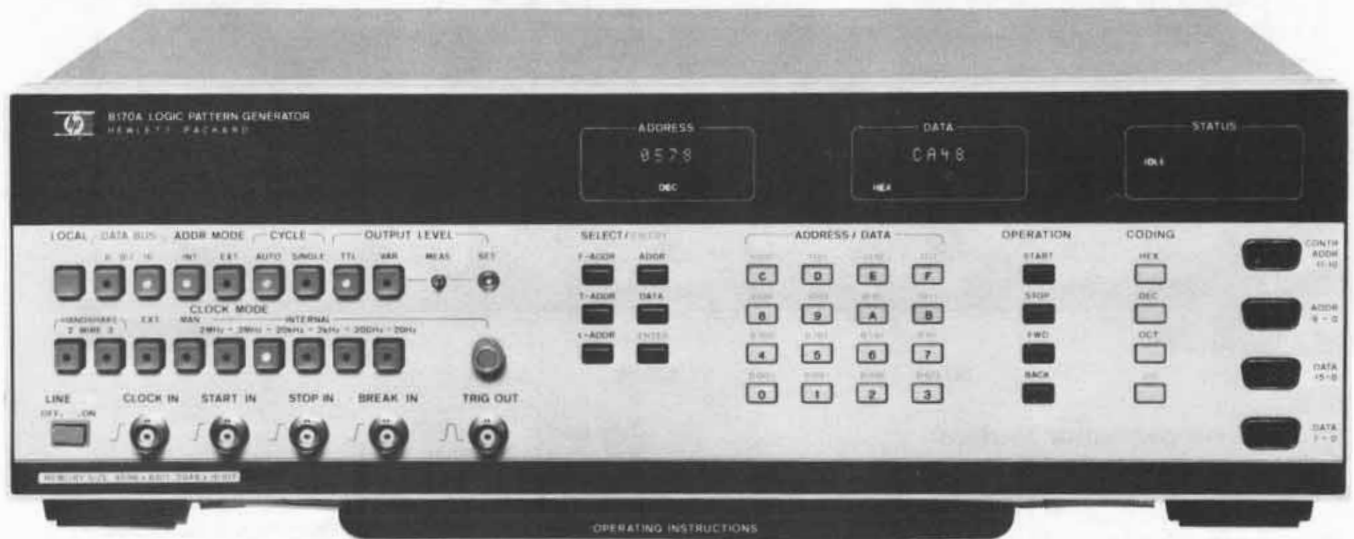

8170A with Option 001



Introduction

The 8170A Logic Pattern Generator is a real-time test stimulus for functional checkout of today's multi-channel logic devices and subassemblies. With data traffic in modern digital systems routed over a shared bus, the 8170A's direct bus driving capability makes design verification at every stage in system development and production a quick, straightforward task.

Data generation by the 8170A is in parallel 8-bit or 16-bit format, to a memory depth of 1024 or 512 words respectively (optionally extendable to four times that capacity). This, combined with a variable clock rate up to 2 MHz permits thorough functional testing at full system operating speed. In addition, output levels of the 8170A ensure a direct match to today's most widely employed logic families—TTL and CMOS, while specially designed mini-probes minimize hook-up problems to the device under test.

Microprocessor control

Designed around the 6800 microprocessor, the 8170A's control scheme permits data, address and operating modes to be entered directly via the instrument keyboard. A sophisticated feature of keyboard programming is the multi-code format available for address and data. Codes include octal, decimal and hexadecimal (see specifications), the microprocessor automatically performing code conversion to the binary base. When fast program check or recall is required, LED's display individual data-address lines in the selected code.

Internal address mode

The 8170A's internal address mode is specifically intended for driving digital busses. Typical bus traffic is simulated by generating data in an ascending address sequence, the first and last address being pre-

set by the user. The 8170A can be thus programmed for detailed investigation of selected bus functions.

Whether the tested bus operates synchronously or asynchronously, the 8170A generates the necessary test signal. With NORM selected, the 8170A outputs data in response to a clock signal (internal, external or manual). Where a bus operates in an asynchronous 2-wire or 3-wire handshake system, the 8170A generates data and data valid signals in accordance with the selected protocol.

External address mode

In external address mode, 8170A operation is analogous to the RE-PROM. Data is output according to the state of externally applied address and enable lines. The main advantage using the 8170A is the ease with which data can be loaded or modified via the keyboard—as opposed to generally complicated processes demanded by RE-PROM's. Where time is a valuable commodity such as in software test and development, the 8170A presents significant savings in this mode.

HP-IB

With full programmability via the HP-IB interface bus, the 8170A's application base extends to automated test systems. Employing microprocessor control over all interface functions, a syntax has been developed to make remote programming of the 8170A as simple as manual operation.

RS 232C-CCITT V24

In many applications, a multi-line readout is necessary for quick program set-ups and checks. For this reason, the 8170A is designed to be compatible with the serial RS 232C/CCITT V24 interface standard. By linking the 8170A to a low cost data terminal over this interface, the multi-line listing of the 8170A memory enables fast program verification.



Specifications

Memory size

Capacity: 8192 bit.

Data bus format: 8 bit x 1024 words or 16 bit x 512 words.

Operating states

IDLE: permits entry of address, data and operating parameters. Data and DAV output in 3-state.

ACTIVE: continuous data output.

BREAK: pause in data output. FWD/BACK enables further data output.

Address modes

Internal: data generation in ascending address sequence from First to Last address.

External: data output follows external address and enable signals. DAV generated at each new address. Data and DAV in 3-state when instrument not enabled. Clock and cycle modes disabled.

Maximum address rate: 2 MHz.

Address to output delay: 400 ns typ., 450 ns max.

Enable to output delay: 100 ns typ., 130 ns max. DAV at min. delay.

Clocking

Internal: 20 Hz to 2 MHz in 5 decade ranges.

Rate jitter: <0.2%

External: dc to 2 MHz. For inp. specs, see "Auxiliary inputs".

Manual: operated by FWD and BACK key.

Handshake: 2-wire/3-wire handshake capability selectable.

Cycle modes

Auto cycle: data is continuously generated between F- and L-ADDR.

Single cycle: data is generated once between F- and L-ADDR. After cycle completion, 8170A returns to IDLE state.

Output signals

Data: pods provide 16 output lines D0-D7 (model 15455A), low byte, and D8-D15 (model 15456A), high byte. Pos./neg. true select on rear panel.

Control: data valid (DAV) generated with each word. Pos./neg. true selectable on rear panel.

DAV delay (adjustable on rear panel)

Non-handshake: 100 ns to 700 ns.

2- or 3-wire handshake: 300 ns to 800 ns.

DAV width: see following table.

INT Clock	MAN Clock	EXT. clock	
		Width 40 ns to 200 ns	> 200 ns
1/2 clk. per ± 50 ns	10 μ s (typ.)	250 ns (typ.)	clk. per ± 50 ns

Status: idle, active and break states indicated on lines ACS and BRS.

Pod output levels

TTL setting

Fan out: 5 standard TTL max.

Levels: high +4.5 V to +5 V, low -0.5 V to +0.4 V.

Signal characteristics (1 standard TTL load)

Transition times (+0.4 V to +2.4 V): 25 ns typ. 50 ns max.

Distorted high level: >+3.5 V

Distorted low level: <+0.8 V.

Variable setting

Maximum load: 50 pF (high impedance)

Levels: high +3 V to +15 V adj., low -0.5 V to +0.4 V.

High level to measurement pin volt. track: ± 0.2 V typ. ± 0.5 V max.

Signal characteristics (50 pF, +15 V)

Transition times (20% to 80%): 35 ns typ. 60 ns max.

Distorted low level: $\leq +1.2$ V.

Distorted high level: $\geq +12.0$ V.

Output protection: all outputs protected against short circuit and ext. voltages from -1.0 V to +18 V.

Auxiliary outputs

TRIGGER: generated at trigger address (T-ADDR).

Format: NRZ.

Levels: standard TTL.

Fan out: 5 standard TTL.

PROBE: +5 V dc.

Address driver outputs (opt. 002): provides 10 address output lines A0 to A9, positive true. 3-state capability in idle state.

Fan out: 10 standard TTL.

Levels: high $\geq +2.4$ V, low $\leq +0.5$ V.

Signal characteristics (into 1 standard TTL)

Transition times (+0.5 V to +2.4 V): ≤ 50 ns.

Distorted high level: $\geq +2.4$ V.

Distorted low level: $\leq +0.8$ V.

Pod input signals

Input RC: 30 k Ω /25 pF.

Levels: high $\geq +2.0$ V; low $\leq +0.8$ V.

Max. external voltage: ± 18 V.

Address input pod (Model 15453A): 10 addressable input lines A0-A9 for operation in external address mode.

Control input pod (Model 15454A): following inp. lines available:

Ready for data (RFD), data accepted (DAC): for handshake mode. In 2-wire handshake RFD level selectable pos./neg. true. In 3-wire handshake, fixed levels for RFD, DAC (see IEE Std. 488-1975)

Enable E1, E2 (E3, E4 at rear panel): for operation in ext. address mode. Selectable levels pos./neg./don't care.

Address A10, A11: for extended memory, option 001.

Auxiliary inputs

Clock in: for external clock signal input.

Start in: external signal starts data generation. Prompts 8170A transition from idle/break to active state.

Stop in: external signal stops data generation. Prompts 8170A transition from active/break state to idle state.

Break in: external signal halts 8170A at current address, outputs remain active. Prompts 8170A transition from active to break state.

Input conditions (all positive edge triggered)

Input RC: 30 k Ω /25 pF.

Levels: high $\geq +2.0$ V, low $\leq +0.8$ V.

Min. width (at +1.3 V): Clock 40 ns; Start/Stop/Break 20 ns.

Max. external voltage: ± 18 V.

HP-IB

Keyboard mode: remote programming of all front panel keys and functions. Coded loading and readout of data.

Data mode: fast binary loading and readout of data only.

RS 232C/CCITT V24.

Remote programming and listing of memory content, and display of current data bus format and address/data coding.

Baud rate: 110, 150, 300, 600, 1200, 2400, 4800, 9600 selectable.

General

Power: 100, 120, 220 or 240 V, +5% - 10%, 48 - 66 Hz, 110 VA max.

Environmental: 0 to 55°C, with relat. humidity to 95% at 40°C.

Weight: net 11 kg (24.3 lbs), shipping 15 kg (33.2 lbs).

Dimensions: 133 H x 426 W x 422 mm D (5.2 x 16.8 x 16.6 in).

Accessories supplied

2 data output pods, 1 address input pod, 1 control pod, a 2 metre power cord and an operating/service manual.

Options and accessories

Option 001: additional 24 k bit memory for output format 8 bit x 4096 words, or 16 bit x 2048 words. add \$545

Option 002: address driver (Model 15452A). add \$280

Option 907: front handle kit (part no. 5061-0089). add \$20

Option 908: rack mount kit (part no. 5061-0077). add \$15

Option 909: combined front handle and rack mount kit. add \$30

Option 910: extra operating and service manual. add \$14

15457A pod connector: easier test connections. add \$48

15263A card reader: rapid memory loading. add \$600

8170A Logic pattern generator \$5430



WORD GENERATORS

Highly flexible word generator, 9 x 32 bit

Model 8016A

- DC to 50 MHz repetition rate
- 2 complementary outputs per channel, RZ/NRZ formats
- Variable RZ width, 4 delay channels
- Channel serializer
- TTL/ECL output levels selectable
- Optional HP-IB programming of bit pattern

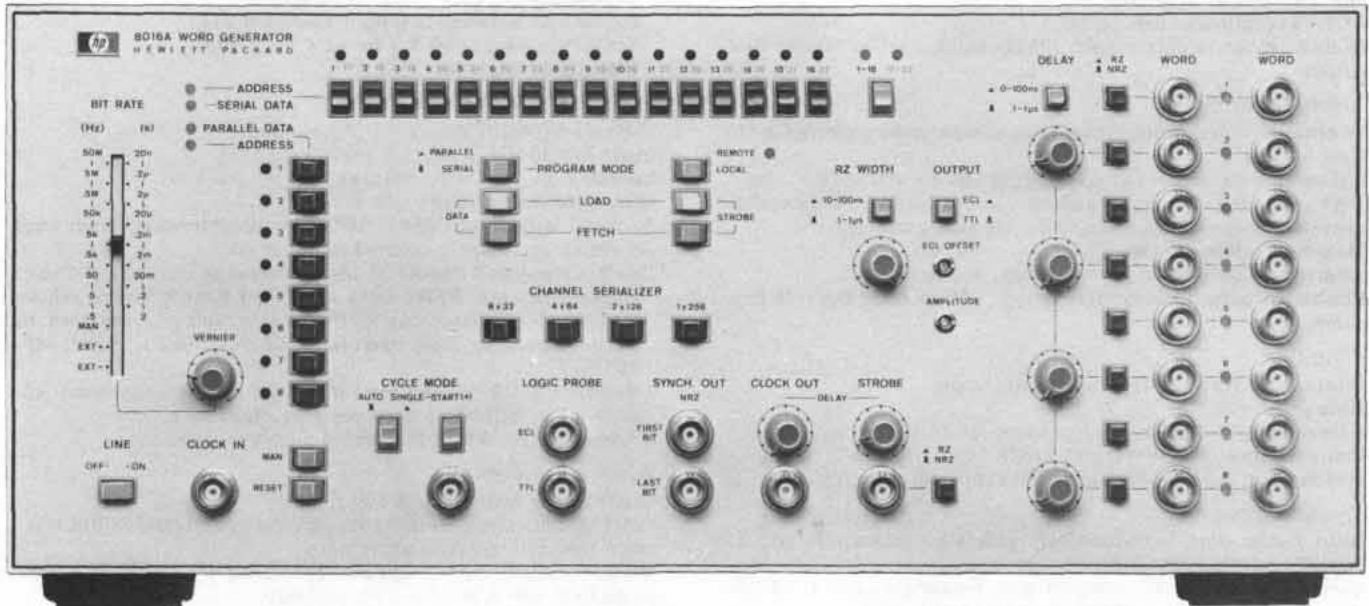

8016A



The 8016A is a parallel and serial data generator that provides digital stimulus for a very wide range of applications. For the digital designer the 8016A is a natural companion to multichannel data display devices such as logic analyzers. It forms an ideal system component for large test systems because it can provide the combination of digital patterns plus adjustable timing parameters necessary for testing IC's and circuit boards. It is also a quite useful time saver for design and test of complex communications systems.

The large memory size and ease with which bit patterns are programmed produce a flexibility of signal output, both in content and in format. Data loading and output can be in either a parallel or serial format. In parallel mode, data is input and output as 32 sequential bytes, each 8 bits wide. In serial mode data is handled as 32 bit serial words, and 8 independent words are available. A built-in channel serializer also permits cascading the channels to produce a word length of up to 256 bits. Maximum use of the memory is thus retained when fewer channels are required.

A strobe output provides additional data formatting capability. The strobe can function either as a ninth data channel 32 bits long, or as a floating 32 bit trigger word assignable to any or all of the 32 bit sections of a serialized data frame. The strobe is thus perfect as a word framing pulse or as a qualifier signal to label address and data information contained in the same data stream. Additional synchronizing signals are provided by the first and last bit outputs and the clock output.

The 8016A's front panel control scheme provides simple control of all of the 8016A's complex waveform generation capabilities. The data entry controls are optimized to a "row of 16, column of 8" arrangement. Each pushbutton and adjacent LED form one bit of a buffer register whose states are displayed on the LED's. Data is loaded either into the row pushbuttons as serial words or into the column pushbuttons as 8 bit parallel bytes. A single press of the load data switch then transfers the data to the high speed memory. If data

needs to be edited, a "fetch" facility returns data to the buffer register, where it is again displayed on the LED's. Bit patterns may also be more rapidly loaded into the 8016A via an optional card reader. The entire memory may thus be loaded in less than 2 seconds.

Complete testing of digital circuits and systems requires not only digital patterns but control of the analog parameters of the pulses as well. Pulse widths, levels, and interchannel delays must all be adjustable both for proper functional testing and, in addition, to measure such dynamic parameters as setup and hold times, clock pulse width sensitivities, and the system sensitivity to propagation delay variations. To meet these testing requirements the 8016A first includes 6 independent delay circuits. Two selectable delay ranges, 0-100 ns or 0.1-1 μ s are provided. Output levels of the 8016A's 50 Ω output amplifiers may also be adjusted to meet either ECL or TTL test specifications. Transition times of <3 ns for TTL and <2.5 ns for ECL pulses are also in line with testing requirements. In addition a choice of RZ or NRZ formats with variable RZ pulse width is provided. This combination of pattern and pulse parameter control means the 8016A can often provide problem solutions which would otherwise require a set-up of separate pulse and word generators.

Its simple but very flexible bit pattern programmability combined with its short cycle time (50 MHz clock) make the 8016A especially effective in simulating worst case conditions in IC testing, e.g. high speed testing of critical areas of memory. Similarly, the 8016A is a time saver in component evaluation environments because test setups can be rapidly built and reconfigured to meet the demands of testing small quantities of a wide variety of IC types. In addition the 8016A is very useful in feeding controlled bit patterns into data buses, data communications systems, and telemetry systems, both for testing and for simulation purposes.

Model 15450A four-channel adapter and model 15451A TTL-CMOS translator can both be used as accessories for the 8016A (see page 343).

Specifications

Data capacity

Data can be loaded in parallel or serial form depending on the position of the PROGRAM MODE switch. The data is loaded via a single row and single column of pushbuttons, each pushbutton controlling a one-bit buffer register.

Number of channels: 8 data channels plus 1 strobe channel.

Number of bits per channel: 32 (fixed).

Total bit capacity: 288.

Serial capacity

One word consists of 32 bits in serial. A front panel switch serializes words to form a frame.

Serial formats:

9 words on 9 channels, including strobe word, each 32 bits long.

4 frames on 4 channels, each consisting of 2 words or 64 bits.

2 frames on 2 channels, each consisting of 4 words or 128 bits.

1 frame on 1 channel consisting of 8 words or 256 bits.

Parallel capacity

Parallel format: 32 words with up to 9 bits in parallel-strobe channel included—will be generated. The number of bits per word depends on the number of output channels serialized.

Data outputs

Two separate outputs per channel, one for normal and one for complement.

Amplitude: TTL or ECL voltage levels, variable by front panel control.

Source impedance: 50 ohms

Delay: four channels can be separately delayed between 0 ns and 1 μ s with reference to the channels 1, 3, 5 or 7.

Two ranges: 0 ns – 100 ns

0.1 μ s – 1 μ s

Ranges are common to all delayable channels. Channels have individual vernier controls.

Delay jitter: $\leq 0.1\% + 5$ ps.

Skewtime: Skewtime of undelayable channels (3, 5, 7) in reference to channel one: ± 1 ns.

Format: RZ or NRZ separately selectable for each data channel and strobe channel.

RZ Width: 10 nsec to 1 μ sec in two ranges. Vernier provides continuous adjustment within ranges. Range switch and vernier common to all channels.

Width jitter: $\pm 0.2\% + 50$ ps

Auxiliary outputs

First bit: corresponds with parallel word one or with the first bit of the serial word. Format is NRZ.

Last bit: corresponds with the last parallel word or with the last bit of the last word of a frame. Format is NRZ.

Clock: delivers one pulse per bit. Format is RZ.

Clock pulse width: controlled by RZ-Width control. Clock pulse may be delayed between 0 ns and 1 μ s in reference to channels 1, 3, 5 or 7.

Strobe word: separate LOAD and FETCH pushbuttons and length 32 bits (can be extended to 256 bits by repetition). The strobe word may be delayed between 0 ns and 1 μ sec in reference to channels 1, 3, 5 or 7.

Amplitude of aux. outputs: TTL or ECL voltage levels variable by front panel control.

Source impedance: 50 ohms.

Probe power

ECL: -5.2 V dc $\pm 10\%$; 80 mA.

TTL: $+5$ V dc $\pm 10\%$; 100 mA.

Bit rate

Internal: 0.5 Hz to 50 MHz in eight ranges. Vernier provides continuous adjustment within ranges.

External: dc up to 50 MHz or manual triggering.

Clock input

Repetition rate: 0 to 50 MHz.

Trigger pulse width: ≥ 10 nsec.

Trigger amplitude: selectable by internal switches on Bit Rate board A5. Max. Amplitude: ± 7 V at 100% duty cycle.

Ext. + (TTL): + amplitude $\geq +2$ V, input impedance ≥ 1 k to GND.

Ext. +: amplitude $\geq +1$ V, input impedance 50 ohms to GND.

Ext. -(ECL): amplitude ≤ -1.6 V, input impedance 50 ohms to -2 V.

Ext. -: Trigger level adjustable at Potentiometer A5R114 from $+1$ V to -1 V.

Input impedance: 50 ohms to GND.

Recycling

Auto mode: data is recycled continuously.

Single cycle (2 modes): a) one word generated for each cycle command. b) words generated as long as the cycle command is active. Last word always completed. If channels are serialized, the serialized word (64 bits, 128 bits, 256 bits) is always completed.

Period between cycle commands: Byte (frame) length plus 200 ns.

Amplitude: $> +2$ V, $\leq +10$ V.

Width: ≥ 12 ns.

Input impedance: 1 k Ω .

Manual reset

Auto cycle: all channel outputs are set to "0". The next clock pulse after RESET generates byte number one.

Single cycle: all channel outputs are reset to word pause. Word pause can either be "ZERO" or "LAST BYTE", controlled by a rear panel switch.

Pulse characteristics

The level of all output signals is controlled by a TTL/ECL switch. Adjusts for amplitude and offset. Source Impedance is 50 ohms.

TTL (across 50 ohms): HIGH LEVEL variable from 2.5 V to 1 V. LOW LEVEL ≤ 0.2 V.

Transition times: ≤ 3.0 ns (First/Last Bit Trigger < 4.0 ns).

ECL (across 50 ohms): HIGH LEVEL OFFSET variable from -0.9 to $+1.1$ V. Amplitude variable from 0.3 V to 1.0 V.

Transition times: ≤ 2.5 ns (First/Last Bit Trigger < 4.0 ns).

General

Operating temperature range: 0°C to $+50^\circ$ C.

Power requirements: 100 V/120 V/220 V or 240 V $+5\%$, -10% , 48 Hz to 66 Hz, 200 VA (maximum).

Weight: net, 14.5 kg (31.96 lb). Shipping, 16 kg (35.27 lb).

Size: 177 H x 426 W x 422 mm D (7" x 16.8" x 16.6").

Options and accessories

001: remote programming. Bit pattern can be programmed by any controller that is compatible with the HP Interface Bus (HP-IB) add \$650

002: Card Reader. This option enables rapid loading of the data and strobe channel bit patterns. The card reader accepts marked or punched cards (HP Part Number 9320-0595) and transmits the data/control information to the 8016A via the HP-IB (Option 001 required) add \$600

907: Front Handle Kit add \$30

908: Rack Flange Kit add \$20

909: Rack Flange & Front Handle Combination Kit add \$45

910: Additional Operating and Service Manual add \$18

15450A: four-channel adapter add \$180

15451A: four-channel TTL-CMOS translator add \$250

8016A 9 x 32 Bit Word Generator

\$7170

WORD GENERATORS

50 MHz serial data/PRBS generator

Model 8018A

- 2048 bit, dual channel memory
- Variable word and pattern length
- TTL, ECL, CMOS compatible

HP-IB

- PRBS generation
- HP-IB interface
- Mixed PRBS/word output for serial data links

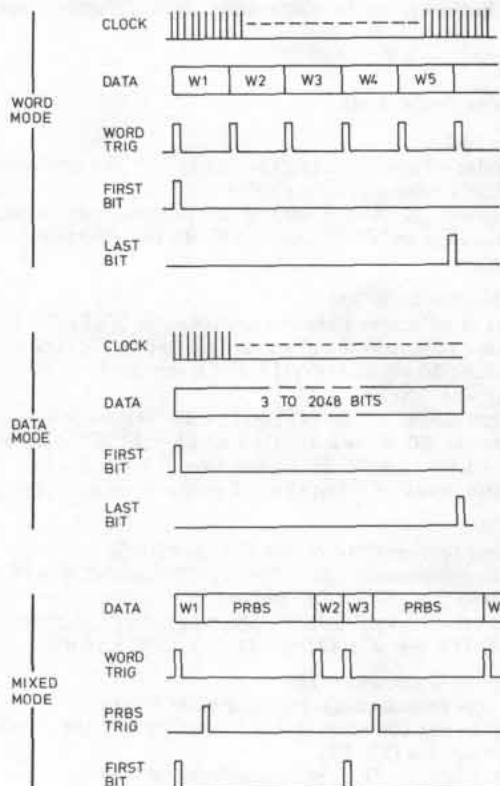
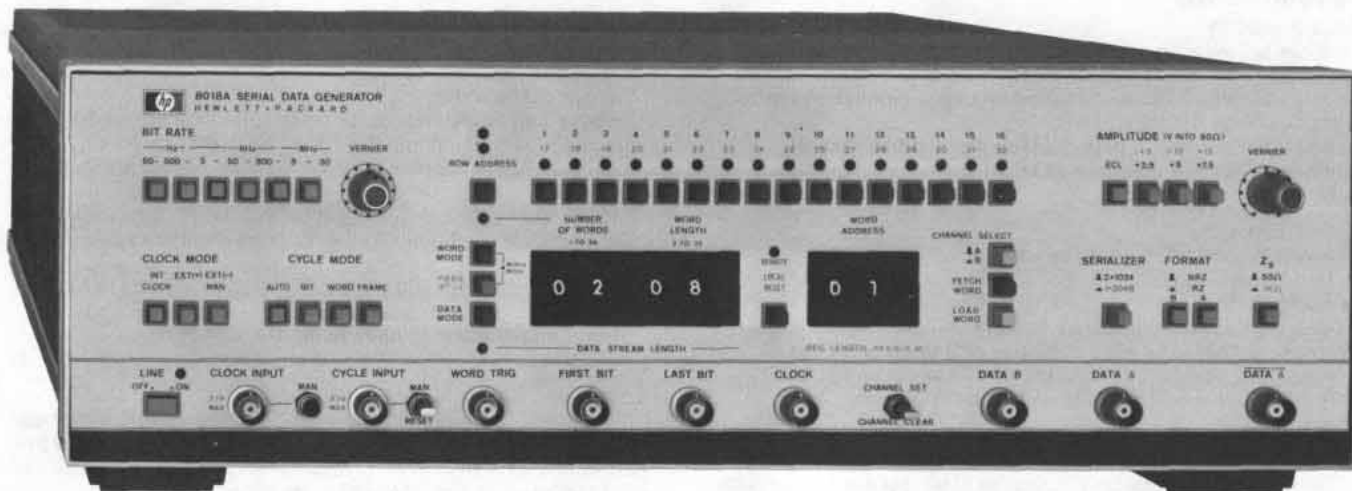

The Hewlett-Packard model 8018A is a high performance data generator designed to meet all of your requirements for serial stimulus up to 50 Mbits/s. Its dual channel memory, for example, contains 2048 individually programmable serial bits, sufficient capacity for the most complex data pattern requirements. Both word and data stream length are variable so you can configure data streams that exactly match your testing applications.

Pattern generating capability is enhanced by a Pseudo-Random Binary Sequence (PRBS) generator. PRBS is a convenient means of generating "worst-case" test patterns and extends pattern length to over 1 million bits. An innovative new technique even lets you mix

PRBS and programmable data words in a single stream, perfect for simulating preamble-data-postamble patterns in serial data link applications.

A high performance output amplifier adds to the 8018A's wide applicability. It delivers clean, 6 ns pulses with repetition rates from dc to 50 Mbits/s. Output amplitude is variable up to 15 volts into 50Ω. This enables you to directly drive logic circuits ranging from TTL to CMOS. Output levels for emitter-coupled-logic (ECL) are also provided.

This wide range of operating modes has been designed to shorten and simplify troubleshooting tasks whenever a serial data source is required. In aerospace, telecommunications, integrated circuits, and in computer and peripheral interfacing, the 8018A provides the stimulus you need for digital design and testing.

For production and other systems environments an HP-IB programming interface (option 001) provides remote control of data generating functions. The interface controller can be anything from a large computer system to a simple card reader. The 15263A card reader (option 002) is especially suited to this purpose. Cards can be marked with instructions or data for rapid and error free memory loading. A 4-channel adaptor (HP15450A) and 4-channel TTL-CMOS translator (15451A) are also available as accessories for the 8018A (see page 343).

Specifications

Word and data generation

Number of channels: 2.

Channel length: 1024 bits (2048 bit total memory capacity).

Word length (M): 3 to 32 bits (to 2048 bits in Data mode).

Number of words (N): variable from 1 to 99.

Channel serialization: channels may be cascaded to extend Channel A length to 2048 bits.

Data content: each bit is individually programmable using front panel switches, or remotely via optional HP-IB interface.

Data formatting: RZ and NRZ formats independently selectable for both output channels. Width in RZ format approximates width of clock output pulse.

Data generation modes

Word mode: data frame consists of N words of length M bits/word.

Data mode: data frame consists of a continuous pattern of length between 3 and 2048 bits. Frame length is determined by 4-digit number set into thumbwheel switches.

PRBS mode: Pseudo-Random Binary Sequence of length $2^n - 1$ bits is produced: $n = 9, 10, 15, 20$.

Mixed mode: Same as WORD mode except with PRBS sequence inserted after every odd number word. Simulates preamble, data message, postamble.

Frame length: 1 to 99 words (WORD mode) or 3 to 2048 bits (DATA mode).

Channel set/clear: fills selected data channel with ones or zeros.

Data outputs

DATA A, DATA A

Output Attenuator Positions	RS	RL	Maximum Amplitude	Minimum Amplitude	tr/ta (10%-90%)	Maximum Repetition Rate
2.5 V	50Ω	50Ω	7.5 V	1.3 V	6 ns	50 MHz
5 V	1 KΩ	50Ω	15 V	2.5 V	8 ns	40 MHz
7.5 V	50Ω	1 KΩ	15 V	2.5 V	8 ns	40 MHz
ECL	50Ω	50Ω	1.0 V	0.5 V	5 ns	50 MHz

Pulse amplitude: variable in three ranges from 1.3 V to 15 V plus fixed ECL position. See table.

Output format: simultaneous Data and $\bar{\text{Data}}$ waveforms are provided. Data output is positive-going with OV baseline. Data is inverted with identical upper and lower level voltages.

ECL position: positive-going pulse with 0.6 to 1.0 V amplitude, and +0.5 to -1.6 V offset. Amplitude and offset internally adjustable. 5 ns maximum transition time. Levels preset for standard ECL. (50Ω source and load resistance).

Maximum transition times (10-90%): 6 ns. See table.

Maximum preshoot, overshoot, pulse top/baseline distortion: 10% of amplitude. 15% in ECL position.

Source resistance: selectable 50Ω or 1 KΩ.

Relation to clock pulse: leading edge of Channel B output coincides with leading edge of clock output ± 3 ns.

Overload protection: cannot be damaged by externally applied voltages between 0 and 16 volts. Protected against open and short circuits.

DATA B

Pulse amplitude: 2.4 V min. into 50Ω, 4.8 V min. into open circuit.

Polarity: positive.

Source resistance: 50Ω.

Relation to clock pulse: leading edge of Channel B output coincides with leading edge of clock output ± 3 ns.

Overload protection: cannot be damaged by externally applied voltages between +5 and -2 volts. Additionally protected against voltages between 0 and 16 volts when current limited to 20 mA. Protected against open circuit and shorts to ground.

Synchronizing outputs

Clock: RZ pulse, occurs with each data bit.

First bit: RZ pulse, identifies first bit of data pattern.

Last bit: RZ pulse, identifies last bit of data pattern.

Word trigger: RZ pulse, identifies first bit of each word.

PRBS trigger: NRZ pulse, identifies beginning of each PRBS pattern.

Amplitude

Clock: 2.4 V min. into 50Ω, 4.8 V min. into open circuit.

FB, LB, WT, PRBS TRIG: 1.2 V min. into 50Ω, 2.4 V min. into open circuit.

Source resistance: 50Ω.

Width:

Clock, FB, LB, WT: 50% ± 20% of period in internal clock mode. Approximates width of externally applied clock pulse in external clock mode.

PRBS trigger: 3 clock cycles.

Overload protection: cannot be damaged by externally applied voltages between +5 and -2 volts. Additionally protected against voltages between 0 and 16 volts when current limited to 20 mA. Protected against open circuits and shorts to ground.

Clocking

Internal

Bit rate: 50 Hz to 50 MHz (40 MHz max. in MIXED mode).

Jitter: 0.2% + 50 ps.

Controls: 5 ranges and 3 turn potentiometer for fine adjust.

External clock input

Bit rate: DC to 50 MHz (40 MHz max. in MIXED mode).

Nominal trigger level: 0.5 V (EXT+), -1.2 V (EXT-).

Minimum pulse amplitude: 1.0 V (EXT+), 0.8 V (EXT-).

Trigger slope: positive.

Minimum pulse width: 10 ns.

Input resistance: 50Ω to ground.

Overload protection: ± 7 V. 0-16 V when current limited to 20 mA. By means of an internal switch, the CLOCK input may be switched to a high impedance mode. The following specifications then apply.

Input resistance: 1 LS-TTL load in series with 300Ω.

Bit rate: DC to 40 MHz.

Trigger pulse: TTL levels. Amplitude may be increased to 16 volts when current limited to 20 mA.

Minimum pulse width: 15 ns.

Manual: pushbutton switch enables single bit output.

Cycle modes

Auto: data frame recycles continuously.

Bit: single bits are triggered by pulses at the CYCLE INPUT. If the input is held high, data bits are continuously generated. Data generation ceases when the input goes low and continues from where it stopped when the input is returned to the high state.

Word: single words are triggered by pulses at the CYCLE INPUT. If the input is held high, words are continuously generated. When the input goes low, data generation ceases after completion of the current word. Data generation continues with the next word when the CYCLE INPUT is returned to the high state.

Frame: single data frames are generated by pulses at the cycle input. If the input is held high, frames are continuously generated. When the input goes low, the current frame is completed and data generation ceases.

Cycle input

Nominal trigger level: 0.5 V.

Trigger slope: positive.

Minimum pulse amplitude: 1.0 V.

Minimum pulse width: 10 ns.

Input resistance: 50Ω to ground.

Overload protection: ± 7 V. 0-16 V when current limited to 20 mA. By means of an internal switch, the CYCLE INPUT can be set to high impedance. The following specifications apply.

Input impedance: 1 LS-TTL load in series with 300Ω.

Trigger pulse: TTL levels.

Minimum pulse width: 15 ns.

Manual: Switch enables outputting single bits, words, or frames.

Reset: Returns generator to bit1.

General

Power requirements: 100 V, 120 V, 220 V, or 240 V; ± 5 to -10%, 48 to 440 Hz. 230 V A max.

Environmental: 0 to 50°C, and with relative humidity to 95% at 40°C.

Weight: net 12 kg (26.5 lbs). Shipping 16 kg (35.3 lbs).

Size: 133 H x 426 W x 422 mm D (5.2" x 16.8" x 16.6").

Options

Opt 001: HP-IB Interface. Permits loading the 8018A memory, word length, and number of words from any HP-IB compatible controller. Starting and stopping of data generation is also remotely controllable. Price add \$650

Opt 002: 15263A Card Reader. Provides fast loading of 8018A. Data stored on punched or marked cards is loaded into the 8018A via its HP-IB interface. Requires Opt 001. Price add \$600

Opt 907: Front Handle Kit add \$20

Opt 908: Rack Mounting Kit add \$15

Opt 910: Extra Operating and Service manual add \$20

8018A Serial Data Generator

Price add \$20

Price add \$15

Price add \$20

\$3475



WORD GENERATORS

2 X 16 bit word & PRBS generator

Model 8006A

- 10 MHz repetition rate
- Selectable PRBS and word length
- Selectable formats RZ/NRZ, normal/complement

- TTL compatible output
- Bit pattern programmable
- Single and continuous cycling

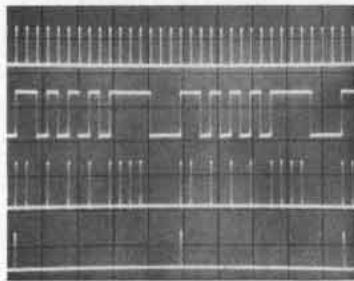

External clock

NRZ Output (16 bit continuous word recycling)

RZ Output signal

First bit synch pulse

The 8006A generates serial digital words of variable length at clock rates up to 10 MHz. An easy selection of two 16 bit words is available. These two words can be serialized to produce a 32 bit word at each output. Selectable operating modes include positive return-to-zero (RZ) format, positive and negative non-return-to-zero (NRZ) format, manual or automatic word cycling, complementary output signals, and remote programming of the data content. The remote programming feature allows conversion of parallel words to serial words. Two outputs provide trigger pulses coincident with the first and the last bit.

Additionally, a pseudo-random binary sequence variable from 7 to 65535 bits can be obtained from channel A output, with the inverted sequence available at channel B.

Specifications

Word generation

One 4 to 32 bit word (even numbers only) or two 2 to 16 bit words. No clock period between words.

Word content: independently set for both words by front panel switches or remote programming (parallel data input). Complement of each word selectable by front panel switches, WORD A—WORD \bar{A} , WORD B—WORD \bar{B} .

Word cycling: continuous or by cycle command (external trigger or manual).

Bit rate: internal, 10 Hz to 10 MHz, four ranges, continuous adjustment within ranges. Manual or external clock 0 to 10 MHz.

Reset: manual reset of word outputs to bit 1 in AUTO CYCLE mode and to word pause in SINGLE CYCLE mode.

Word format: RZ/NRZ/-NRZ selectable for each word output. Positive outputs have current sink capability to drive integrated circuits (TTL/DTL).

Synch outputs: trigger pulses corresponding to the first bit (leading edge) and last bit (trailing edge).

Pseudo-random sequence generation PRN: provides a linear shift register sequence at channel A output and the inverted sequence at channel B output. Maximum bit rate is 9 MHz.

Sequence length: variable from 7 to 65535 bits.

Trigger pulse: selectable for each bit in sequence.

Interface

Clock input

Repetition rate: 0 to 10 MHz, amplitude $\geq \pm 2$ V, $\leq \pm 10$ V.

Width: > 15 ns at +1 V. Input impedance: $> 500\Omega$.

Cycle command input

Minimum period: word length plus 100 ns. Amplitude $> +2$ V, $< +10$ V.

Width: > 15 ns at +1 V. Input impedance: $> 500\Omega$.

External data inputs: no storage capability for programmed data.

Low state: contact closure, TTL low, or voltage source > 0 V, $< +0.8$ V.

High state: open, TTL high or voltage source $> +2.4$ V, $< +5$ V.

Synch outputs

Amplitude: $> +2$ V across 50Ω .

Width: approx. 40 ns. Output impedance: 50Ω .

Clock output (rear panel)

Amplitude: 2 V across 50Ω .

Source impedance: approximately 50Ω .

Pulse width: approximately 30 ns.

Word outputs

Positive NRZ, RZ: high: $+2.5$ V across 50Ω , source impedance 50Ω . Low: ≥ -0.3 V, $\leq +0.3$ V, source impedance approx. 0Ω .

Current sink capability 80 mA maximum.

RZ pulse width: approx. 45 ns.

Negative NRZ: high: 0 V. low: -5 V across 50Ω , source impedance 50Ω .

Transition times: < 10 ns.

General

Operating temperature: 0°C to 50°C .

Power: 115 V or 230 V, $+10\%$, -15% , 48 Hz to 440 Hz, 59 VA.

Weight: net, 6 kg (13 1/4 lb).

Size: 86 H x 426 W x 335 mm D (3.4" x 16.8" x 13.2").

Options

908: Rack Flange Kit

910: additional Operating and Service Manual

8006A 2 x 16 bit Word and PRBS Generator

Price

add \$10

add \$14

\$2180

Accessories for logic signal sources

Models 15263A, 15450A & 15451A

- 15263A card reader for rapid data loading
- 15450A adapter for easy circuit connections
- 15451A translator gives CMOS output levels



15263A

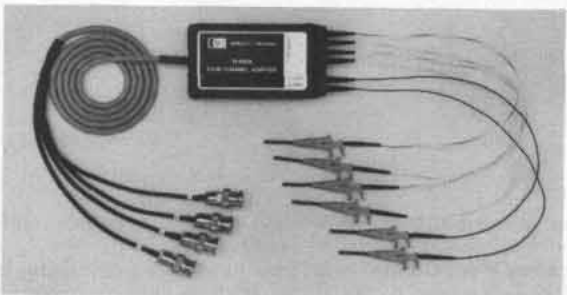

15450A

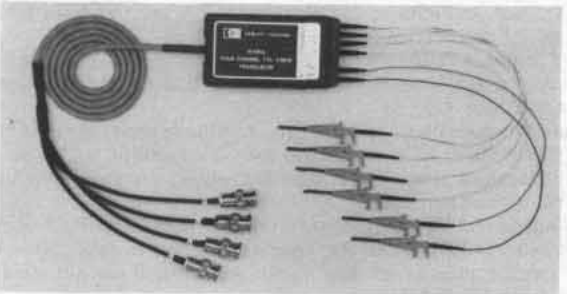

15451A

15263A card reader**Description**

The 15263A is a convenient and easy-to-use remote programming device. It provides parallel instructions or data and is especially suited for the HP 8016A Parallel Word Generator or HP 8018A Serial Data Generator; both provide the power supply voltage necessary for driving the card reader. Rapid and error free memory loading of either generator is obtained. Any bit pattern can easily be programmed by marking cards accordingly. A card is typically read in 1.5 seconds and makes data re-loading or modification a fast and uncomplicated operation.

Specifications

Logic levels (TTL neg.true): HI (0) +2.5 V to +5 V, LO (1) 0 V to +0.4 V.

General

Operating temperature range: 0°C to 55°C.

Power: +5 V, 550 mW.

Weight: 0.6 kg (1.31 lb.) Shipping 1.6 kg (3.5 lb.)

Size: 57H x 115W x 195 mm D (2.2" x 4.5" x 7.6").

Accessories supplied: 50 cards, part number 9320-0595

15450A four-channel adapter**Description**

The Model 15450A Four-Channel Adapter facilitates easy connection from a pulse or data generator to the circuit-under-test, and helps to avoid the distortion problems often encountered in improvised connections. These advantages are of particular significance where multi-channel data and pulse stimulus is required; in such instances,

the Adapter is an ideal companion for the HP 8016A Word Generator.

Inputs to the Adapter are carried by a cable assembly. This consists of four 50 Ohm cables with BNC connectors which plug directly to the signal source. The outputs from the Adapter are carried by 4 short, removable, connecting leads with small hook-type probes which connect easily to the circuit-under-test; even DIP's can be connected reliably. With probes removed, the connecting leads will plug onto back plane pins.

To minimize distortion due to reflections from the circuit-under-test, each channel is terminated by a passive load inside the Adapter body. Two parallel ground leads (also with hook-type probes) are provided to ensure good grounding to the device-under-test.

Specifications

AC/DC characteristics: dependent on signal source.

Internal load: 47.5 ohms in series with 33 pF.

General

Operating temperature: 0°C to 50°C.

Size: body size 95 H x 54 W x 22 mm D (3.7" x 2.1" x 0.9"). Total length including cable 152 cm (60 in).

15451A four-channel TTL-CMOS translator**Description**

The model 15451A is a four channel active signal translator which amplifies TTL signals to CMOS levels. Its capabilities are perfect for adding CMOS compatibility to pulse and word generators with 5 volt outputs such as HP's Model 8016A Word Generator. The 15451A's four inputs conveniently connect to the signal source with BNC connectors. Its four outputs are easily interfaced to the test circuits via small probes which directly attach to circuit nodes. Even adjacent pins of dual-in-line IC packages are reliably and simply contacted using these small hook-type probes. With probes removed, the connecting leads will plug onto back plane pins.

The 15451A is normally powered from the V_{DD} supply of the circuit-under-test and accepts supplies in the range of 5 to 18 volts. The applied power supply voltage is also used to determine the output signal amplitude. This level-tracking capability means that pulse amplitudes need not be reset when the CMOS power-supply voltage is adjusted. It further guarantees that pulse amplitudes never exceed the V_{DD} supply voltage - even when the power supply is switched off (pulse amplitude greater than V_{DD} is a forbidden condition with CMOS logic, violation of which can cause rapid destruction of the tested IC).

Specifications**Inputs**

Number of channels: 4. Fan-in: 2 standard LS TTL loads.

Max. input frequency/transition time: 10 MHz/1 μ s.

Input signal levels: low 0V to +0.8 V, high +2 V to +5 V.

Max./min. input voltage: +7 V/-1 V.

Outputs (source impedance 220 ohms) Following specs. relate to 5 MHz square wave input signal with $V_{DD} = 15$ V and load capacitance = 50 pF per channel

Output signal level: high ($V_{DD} - 1$ V) typ., low +100 mV typ.

Transition times (20%-80%): LO to HI 23 ns typ., HI to LO 16 ns typ.

Propagation delay: LO to HI 45 ns typ., HI to LO 35 ns typ.

Interchannel skew: 2 ns typ.

General

Operating temperature: 0°C to 50°C.

Power: +5 V to +18 V at 250 mA

Size: body size 95 H x 54 W x 22 mm D (3.7" x 0.9" x 2.1").

Total length including cable 152 cm (60").

Options

15263A: opt. 910 extra operating and service manual \$6.38

15450A & 15451A: opt 910 extra operating note \$1.40

Ordering information

15263A Card Reader \$600

15450A four-channel adapter \$180

15451A four-channel TTL-CMOS translator \$250

WORD GENERATORS

PRBS and WORD generation up to 150 Mb/s

Model 3762A

- $2^{23} - 1$ PRBS and 16-bit WORD
- Dual channel generation

- Zero substitution
- Binary NRZ/RZ/CMI interfaces



The 3762A Data Generator is designed primarily for use with the 3763A Error Detector as a 150 Mb/s PCM/TDM error detection system for evaluating high-speed digital transmission equipment. However, sufficient versatility is built into the 3762A to make it ideally suited to many other applications requiring a PRBS/WORD generator.

The generator can be clocked internally or externally. Two internal crystal clocks are provided at standard rates for digital transmission, in the range 30 to 150 Mb/s. These can be offset by up to ± 60 ppm from nominal for, say, testing the tolerance of a system to frequency shift. External clocks can be in the range 1 kHz to 150 MHz, with choice of input termination and trigger level. A clock gating input allows burst mode gating control of pattern generation.

The 3762A is a dual channel generator with the data on one channel delayed relative to that of the other. The patterns available are $2^{10} - 1$, $2^{15} - 1$, and $2^{23} - 1$ bit pseudo-random binary sequences (PRBS), two 10- or 16-bit programmable words, two 1010 repetitive patterns, and two 8-bit programmable words alternated by an external signal. Blocks of zeros may be substituted into PRBS patterns to test pattern sensitive circuits. The position of the zero block within the sequence can be selected via a trigger word, using the WORD switches.

The data outputs are available in both binary and coded format. The binary interfaces have variable amplitude and dc offset to suit different logic families. The coded data outputs are at standard levels and impedances for direct connection to digital transmission equipment.

Specifications

Internal Clock: two crystal clocks in the range 30 to 150 MHz; crystals fitted in standard unit are 139.264 and 141.040 MHz; accuracy better than ± 3 ppm at ambient; offset continuously variable up to ± 60 ppm about crystal frequency.

External Clock Input: 1 kHz to 150 MHz; 75 Ω ; triggering on +ve slope, min pulse width 3 ns, auto, gnd, or ECL threshold switch; sensitivity better than 300 mV pk-pk; 3 V pk-pk max, limits ± 3 V.

Burst Gating Input (rear panel): disables clock for burst mode operation: 50 Ω to -2 V; ECL levels.

Clock Output: CLOCK or $\overline{\text{CLOCK}}$, squarewave; 75 Ω ; amplitude preset in range 1.0 to 2.0 V pk-pk min, or fixed ECL; dc offset preset in range 0 to ± 2 V min, or fixed ECL; transition times < 1.8 ns at 2.0 V pk-pk; overshoot/preshoot $< 10\%$ of pulse amplitude.

Aux Clock Output (rear panel): format as main clock output; impedance, unbalanced, low; ECL levels.

Patterns: $2^{10} - 1$, $2^{15} - 1$, and $2^{23} - 1$ bit PRBS; two 10- or 16-bit programmable words; two 1010 repetitive patterns; two 8-bit programmable words alternated by an external signal; error add

facilities; zero substitution (PRBS only), patterns can be gated off for 1 to 999 clock periods after trigger pulse.

Alternating Word Control Input (rear panel): 1 k Ω ; sensitivity, 250 mV pk-pk squarewave, dc to 100 kHz, 0.5 V pk-pk sine or triangular wave, 200 Hz to 100 kHz; max input 5 V rms.

Data Output A: PRBS or WORD A; DATA or $\overline{\text{DATA}}$, in CMI, NRZ, or RZ format; 75 Ω ;

CMI Format: 139.264 and 141.040 Mb/s, unspecified at other frequencies; ± 0.5 V pk-pk $\pm 10\%$; transition times < 2.0 ns; overshoot/preshoot $< 5\%$ at 1 V pk-pk.

Binary Format: 1 kb/s to 150 Mb/s; amplitude preset in range 1 to 2 V pk-pk min or ECL; dc offset preset in range 0 to ± 2 V min or ECL; transition times < 1.8 ns at 2 V pk-pk; overshoot/preshoot $< 10\%$ of pulse amplitude.

Data Output B: PRBS delayed or WORD B, in NRZ or RZ format; approx delay in PRBS, half sequence with respect to data output A. Other specifications as for data output A; output B not available if output A is CMI coded.

Trigger Output: one pulse every sequence or word; position variable, selected by WORD B, switches; two clock periods wide except with zero substitution when stretched to approx that of zero block; 50 Ω ; 1 V pk min.

Data Monitor 1 (rear panel): data as data output A; format, binary NRZ before coding; impedance, unbalanced, low; ECL levels.

Data Monitor 2 (rear panel): data as data output B; not available when using CMI; format, binary NRZ; other specifications as for data monitor 1.

General

Size: 133 H x 425 W x 440 mm D (5 $\frac{1}{4}$ " x 16 $\frac{3}{4}$ " x 17 $\frac{1}{16}$ ").

Weight: 12 kg (26.5 lb).

Power Supply: 115 V + 10% - 22% or 230 V + 10% - 18%; ac, 48 to 66 Hz; power consumption approx 12 VA.

Options

105: 75 Ω interfaces changed to 50 Ω ; frequencies are 60.032 and 30.016 MHz.

201: data output B changed to read: 30 to 120 Mb/s; DATA or $\overline{\text{DATA}}$, switched at the binary level independent of output A; format RZ coded HDB3 or B3ZS or AMI (internal switch); 75 Ω ; frequencies are 139.264 and 120.000 MHz.

202: as option 201 except frequencies are 139.264 and 34.368 MHz.

330: as option 201 except external clock input, clock output, and data output A changed to 50 Ω , and frequencies are 137.088 and 44.736 MHz.

801: front cover.

3762A Data Generator

Price

-\$70

-\$210

-\$250

-\$280

+\$38

\$8135

Oscillators & function generators

Signal sources have been described by various names—oscillators, test oscillators, audio signal generators, function generators etc. Different names are applied, depending on design and intended use of the source. The name "test oscillator" has been used to describe an oscillator having a calibrated attenuator and output monitor. The term "signal generator" is reserved for an oscillator with modulation capability.

A function generator is a signal generator that delivers a choice of different waveforms with frequencies adjustable over a wide range. Function generators produce sine, triangle, square wave, saw-tooth waves, pulses, sweep, and modulation. Hewlett-Packard's function generators extend from a low frequency of .000001 Hz (HP 3325A) up to a high frequency of 50 MHz (HP 8165A). The HP 3325A also provides synthesizer frequency accuracy up to 20 MHz for sinewaves.

Basic requirements

In selecting an oscillator or function generator, the user will be most interested in its frequency coverage. The question to be answered here is, "Will the instrument supply both the lowest and highest frequencies of interest for anticipated tests?" As shown in Table 1, Hewlett-Packard manufactures a broad range of oscillators and function generators covering the frequency spectrum from .000001 Hz to 50 MHz.

The user's next concern will be with available output power or voltage. Some tests require large amounts of power, while others merely require sufficient voltage output. For almost any application, there is a Hewlett-Packard oscillator capable of delivering desired voltage output into a high impedance load or of supplying desired power into lower impedance loads.

Besides frequency range and power output, the user will be interested in instrument stability, its dial resolution, and the amount of harmonic distortion, hum and noise in the output signal, and functions available. See Table 1 for a comparison of Hewlett-Packard oscillators and function generators.

Frequency stability

Frequency stability of an oscillator determines the ability of the instrument to maintain a selected frequency over a period of time. Component aging, power-supply variations and temperature changes all affect stability. Carefully chosen components, such as precision resistors and variable capacitors in the frequency-determining networks, contribute to long-term stability. The HP 3325A is a synthesized function generator and, therefore, provides considerably better accuracy and stability than conventional oscillators and function generators.

FUNCTIONS				FREQUENCY RANGE												POWER OUTPUT	INST.	PAGE
●																3 W	201C	346
●	●	●	●													560 mW	3310A/B	354
●	●	●	●													250 mW	3312A*	351
●	●	●	●													20 mW	3311A	350
●	●	●	●													250 mW	3325A**	352
●																200 mW	651B/652A 654A	355
●																160 mW	200CD	346
●																160 mW	4204A	349
●	●															40 mW	209A	348
●																17 mW	239A	347
●																10 mW	236A	581
●																10 mW	204C	348
●	●	●	●													1.4 W	8165A	356

*Two Generators, AM, FM, Sweep, Trigger/Gate

**Synthesizer/Function Generator, Opt. 002, 400 mW to 1 MHz, HP-IB

Amplitude stability

Amplitude stability is important in certain oscillator applications. Amplitude stability is inherent in the Hewlett-Packard RC oscillator circuit because of a large negative feedback factor and amplitude stabilizing techniques. "Frequency response," or amplitude variation as frequency is changed, is of special interest when the oscillator is used for response measurements throughout a wide range of frequencies.

Distortion

Distortion in the oscillator's output signal is a measure of the purity of the oscillator's waveform.

Oscillator distortion can be undesirable for harmonic distortion testing of amplifiers, for example. If the amount of distortion contributed by the oscillator is more than 20 dB below the distortion contributed by the amplifier, an error in the harmonic distortion measurement will be less than 10 percent. Total harmonic distortion, as much as 95 dB below the carrier, is available in the audio range with the 239A.

Hum and noise

Hum and noise can be introduced at a variety of points in oscillator circuits; but when the circuit operates at a relatively high level, the amount of hum and noise introduced into the device under test is usually negligible.

Hum and noise introduced by a power amplifier usually remain constant as output signal amplitude is diminished. Hence, even though hum and noise power may be quite small compared to rated output, these spurious signals sometimes become a significant portion of low-level output signals. To overcome such a limitation, many Hewlett-Packard oscillators have their amplitude control on the output side of the power amplifier so that hum and noise are reduced proportionally with the signal when low-level signals are desired for test purposes.

Function generators

The function generator is a versatile, multi-waveform signal source capable of very wide frequency coverage. Available are functions ranging from modulation (3312A), sweep (3312A, 3325A), and trigger/gated waveforms (3310A/B, 3312A) to synthesizer control and HP-IB programmability (3325A). The 3325A not only provides synthesizer frequency accuracy and HP-IB, but very precise waveforms as well. The function generator is an indispensable general purpose signal source for production testing, instrument repair, and the electronics laboratory. Diverse fields of applications in which the function generator is being used include medical research, education, chemical, communications, geophysics, industrial control, military, and aerospace.

OSCILLATORS & FUNCTION GENERATORS

5 Hz to 600 kHz audio oscillators

Models 200CD, 200CD Opt: H20, & 201C



200CD



201C

Description

These Hewlett-Packard oscillators have high stability and accurate, easily resettable tuning circuits. Low-impedance operating levels, together with superior insulation, guarantee peak performance throughout years of trouble-free service. The instruments have a wide frequency range, long dial lengths and feature an improved vernier frequency control.

Accessories available

11000A Cable Assembly	\$17
11001A Cable Assembly	\$17
11004A Line Matching Transformer	\$85
11005A Line Matching Transformer	\$130

Price

Specifications

	200CD	201C
Frequency Range	5 Hz to 600 kHz	20 Hz to 20 kHz
Number of Ranges	5 overlapping	3 overlapping
Dial Accuracy	± 2%	± 1%
Frequency Response	± 1 dB (1 kHz ref)	± 1 dB (1 kHz ref)
Output (into 600Ω load)	> 160 mW (10 V) Opt. H20, 93 mW (7.5 V)	3 W (42.5 V)
Output Impedance	600Ω	600Ω ± 10%, 20, 30 and 40 dB settings < 600Ω, 0 dB and 10 dB settings
Output Balance	Balance and floating better than 0.1% at lower frequencies and approx. 1% at higher frequencies	One terminal at ground potential
Distortion	0.2%, 20 Hz to 200 kHz 0.5%, 5 Hz to 20 Hz and 200 kHz to 600 kHz Opt. H20: 0.06%, 60 Hz to 50 kHz 0.1%, 20 Hz to 60 Hz and 50 kHz to 400 kHz 0.5%, 5 Hz to 20 Hz and 400 kHz to 600 kHz	< 0.5%, 50 Hz to 20 kHz at 1 W < 1%, 20 Hz to 20 kHz at 3 W
Hum and Noise	< 0.1% of rated output	< 0.03% of rated output
Attenuator	Bridged "T"	0 to 40 dB steps, coarse and fine controls
Input Power	115 or 230 V, 50 to 1000 Hz, 90 VA	115 or 230 V, 50 to 400 Hz, 75 VA
Weight kg (lb)	Net: 9.9 kg (22 lb) Shipping: 10.8 kg (24 lb)	Net: 7.2 kg (16 lb) Shipping: 8.6 (19 lb)
W x H x D Dimensions	187 mm x 292 mm x 365 mm (7 3/8" x 11 1/2" x 14 1/2")	191 mm x 292 mm x 318 mm (7 1/2" x 11 1/2" x 12 1/2")
Price	200CD: \$630, Opt. H20: add \$75	201C: \$630

OSCILLATORS & FUNCTION GENERATORS

10 Hz to 110 kHz low distortion oscillator

Model 239A



- < -95 dB THD to 20 kHz
- Calibrated Attenuator
- 10 Hz to 110 kHz

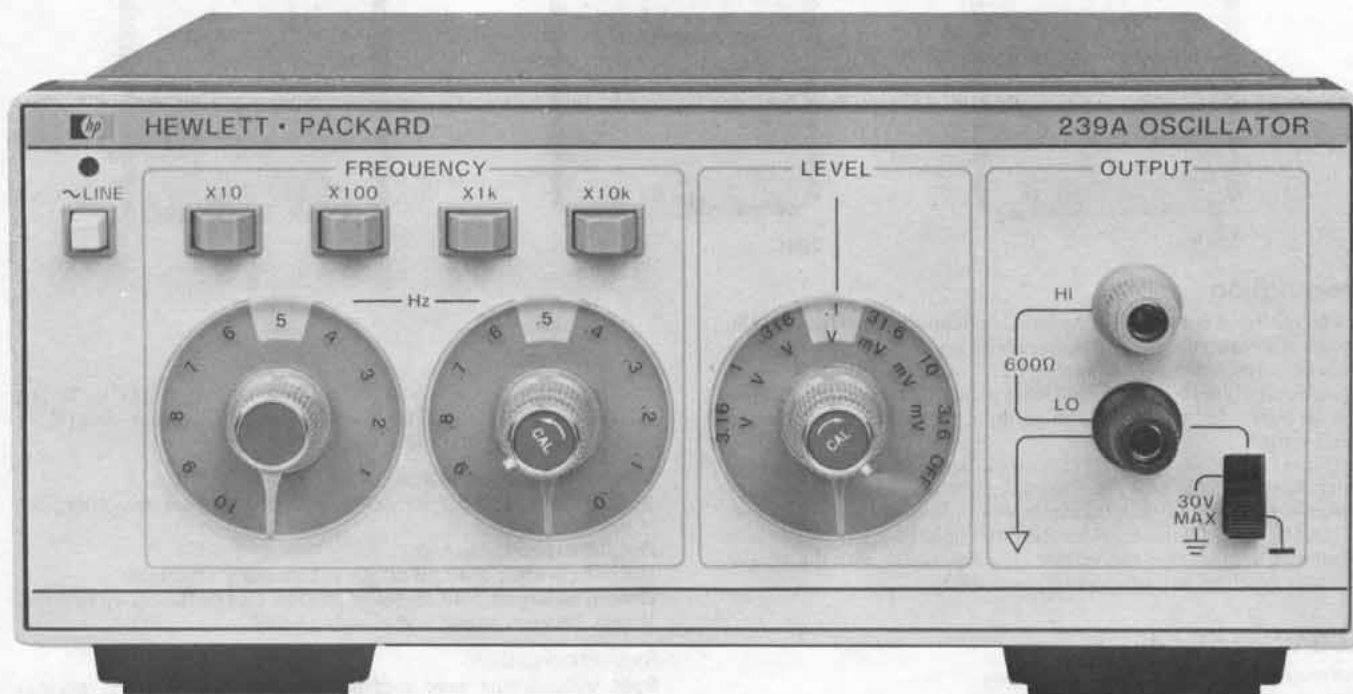

239A

Description

The HP 239A Oscillator provides a low distortion sine-wave output with > 3 Vrms amplitude from 10 Hz to 110 kHz and less than -95 dB (.0018%) total harmonic distortion (THD) to 20 kHz, increasing to -70 dB (.032%) at 110 kHz. Low THD performance combined with a 600Ω output that can be floated to 30 V peak makes the 239A an excellent general purpose audio test source.

Companion Oscillator for distortion measurements

The 239A Oscillator is electrically similar to the built-in oscillator used in the HP 339A Distortion Measurement Set and can be used in conjunction with the 339A where a remote audio source is needed for low distortion measurements such as broadcast studio through transmitter tests. Use of the 239A can improve the range of distortion measurements with earlier model analyzers. Its small size and weight makes the 239A convenient to use on the bench or easy to carry for remote tests.

Calibrated output attenuator

The accurately calibrated output allows measurements to be made without time consuming external calibration. The output level can be changed in 10 dB steps with ± 0.25 dB/step accuracy over a 60 dB range from a maximum calibrated output of +10 dBV (3.16 Vrms). The output is continuously variable between steps down to a level of 1 mV with the amplitude vernier control.

Level flatness is ± 0.1 dB from 20 Hz to 20 kHz and less than ± 0.2 dB over the full frequency range.

Accurate frequency selection

Frequency selection with $\pm 2\%$ accuracy is easily made with 2-digit resolution using rotary knob tuning and the multiplier push-buttons. The frequency vernier control provides continuous frequency coverage between the second digit switch settings.

239A Specifications

Frequency: 10 Hz to 110 kHz in 4 overlapping decade ranges with 2-digit resolution. Frequency vernier provides continuous frequency coverage between second digit switch settings. Frequency accuracy: $\pm 2\%$ of selected frequency (with Frequency Vernier in CAL position).

Output level: Maximum calibrated output (1 kHz, 600Ω load): +10 dBV (3.16 Vrms) $\pm .2$ dB

Output variable from < 1 mV to 3.16 Vrms into 600 ohms.

Output attenuator: Range: 60 dB in 10 dB steps; Accuracy: $\pm .25$ dB/10 dB step. Maximum Cumulative Error ± 1 dB; Output Vernier: > 10 dB range, continuously variable

Level flatness: 20 Hz to 20 kHz: $\leq \pm 0.1$ dB; 10 Hz to 110 kHz: $\leq \pm 0.2$ dB

Distortion ($\geq 600\Omega$ Load, ≤ 3 V Output): 10 Hz to 20 kHz: < -95 dB (0.0018%) THD; 20 kHz to 30 kHz: < -85 dB (0.0056%) THD; 30 kHz to 50 kHz: < -80 dB (0.01%) THD; 50 kHz to 110 kHz: < -70 dB (0.032%) THD

Output impedance: 600Ω $\pm 5\%$

Output terminals may be floated up to 30 V peak.

Operating environment: Temperature: 0°C to 50°C (+32°F to +122°F)

Humidity Range: < 95%, 0°C to 40°C (+32°F to +104°F)

Storage Temperature: -40°C to +75°C (-40°F to +167°F)

Power: 100/120/220/240 V, +5%, -10%, 48 to 66 Hz, 10 VA max.

Weight: Net 2.5 kg (5.5 lbs.); Shipping 3.9 kg (8.5 lbs.)

Dimensions: 106 mm W x 88 mm H x 269 mm D (8.4" x 3.5" x 10.6")

239A Oscillator

\$575

OSCILLATORS & FUNCTION GENERATORS

4 Hz to 2 MHz sine, square wave oscillators

Models 209A, 204C & 204D



209A



204C



204D

Description

The HP 209A is a small, lightweight, sine/square oscillator. Stable, accurate signals can be synchronized with an external source over a frequency range from 4 Hz to 2 MHz. Separately adjustable sine/square outputs are located on the front panel. Distortion and flatness can be minimized at low frequencies by a rear panel low distortion mode switch.

The HP 204C is a small, lightweight capacitive-tuned oscillator. Interchangeable power packs, line, rechargeable batteries or mercury batteries make this instrument ideal for both field and laboratory use.

The HP 204D Oscillator is identical to the 204C with the addition of an 80 dB attenuator and vernier. The attenuator with the vernier provides excellent output amplitude settability.

209A Specifications

Frequency: 4 Hz to 2 MHz in 6 ranges.

Dial accuracy: $\pm 3\%$ of frequency setting.

Flatness at maximum output into 600 Ω load. 1 kHz reference

Low distortion mode	+1%	$\pm 0.5\%$	$\pm 1\%$	$\pm 5\%$
Normal mode	+5%, -1%	$\pm 0.5\%$	$\pm 1\%$	$\pm 5\%$
	4	100	300 k	1 M
				2 M (Hz)

Distortion: 200 Hz to 200 kHz, 0.1% (-60 dB); 4 Hz to 200 Hz, <0.2% (-54 dB); 200 kHz-2 MHz, <1% (-40 dB).

Hum and noise: <0.01% of input.

Output characteristics sine wave

Output voltage: 5 V rms (40 mW) into 600 Ω ; 10 V open circuit.

Output impedance: 600 Ω .

Output control: >26 dB range continuously adjustable.

Output balance: 40 dB below 20 kHz. Output can be floated up to ± 500 V peak between output and chassis ground.

Output characteristics square wave

Output voltage: 20 V p-p open circuit symmetrical about 0 V. Output can be floated up to ± 500 Vp.

Rise and fall time: <50 ns into 600 Ω . Symmetry: $\pm 5\%$.

Output impedance: 600 Ω .

Synchronization

Sync output: sine wave in phase with output; >1.5 V rms, >1 V rms, 50 kHz to 2 MHz into 10 megohm shunted by 100 pF.

Sync input: same as 204C.

204C Specifications

Frequency: 5 Hz to 1.2 MHz in 6 overlapping ranges.

Dial accuracy: $\pm 3\%$ of frequency setting.

Flatness at maximum output into 600 Ω load, 1 kHz reference

Low distortion mode	$\pm 1\%$	$\pm 0.5\%$	$\pm 1\%$
Normal mode	+5%, -1%	$\pm 0.5\%$	$\pm 1\%$
	5	100	300 k
			1.2 M (Hz)

Distortion: 30 Hz to 100 kHz, 0.1% (-60 dB); 5 Hz to 30 Hz, <0.6% (-44 dB); 100 kHz-1.2 MHz, linearly derated to <1%.

Hum and noise: <0.01% of output.

Output characteristics

Output voltage: >2.5 V rms (10 mW or +10 dBm) into 600 Ω ; >5 V rms open circuit.

Output impedance: 600 Ω .

Output control: >40 dB range; continuously adjustable.

Output balance: >40 dB below 20 kHz. Can be floated up to ± 500 V peak between output and chassis ground.

Synchronization

Sync output: sine wave in phase with output; >100 mV rms into <100 pF over entire range; impedance 10 k Ω .

Sync input: oscillator can be synchronized to external signal. Sync range, the difference between sync frequency and set frequency, is a linear function of sync voltage. $\pm 1\%/V$ rms for sine wave with a maximum input of ± 7 V peak (± 5 V rms).

204D Specifications

(Identical to 204C except "output control" is replaced by the following):

Output attenuator

Range: 80 dB in 10 dB steps.

Overall accuracy: ± 0.3 dB, +10 dB through -60 dB ranges; ± 0.5 dB on -70 dB range.

Output vernier: >10 dB range, continuously adjustable.

General

Operating temperature: Specifications are met from 0°C to 55°C.

Power: standard: AC-line 115 V or 230 V $\pm 10\%$, 48 Hz to 66 Hz, <7 VA max. Opt. 001: mercury batteries 300 hours operation. Opt. 002: line/rechargeable batteries 115V or 230V $\pm 10\%$, 48 Hz to 66 Hz, <7 VA max. 22 hours operation per recharge.

Dimensions: 155 mm H (without removable feet) \times 130 mm W \times 203 mm D (6 $\frac{3}{32}$ " \times 5 $\frac{1}{8}$ " \times 8").

Weight: net 2.7 kg (6 lb). Shipping, 3.6 kg (8 lb).

Options and accessories

Option 001, 204C/D (for mercury batteries) add \$90

Option 002, 204 C/D (for rechargeable batt/AC-line) add \$100

11137B Rechargeable battery/AC power pack for \$150

204C/D

11075A Instrument case \$145

5060-8762 Rack adapter frame \$65

Ordering information

209A Sine, square wave oscillator \$550

204C Sine wave oscillator \$475

204D Sine wave oscillator \$525

OSCILLATORS & FUNCTION GENERATORS

10 Hz to 1 MHz digital oscillator

Model 4204A



- 0.2% frequency accuracy
- Accurate 80 dB output attenuator
- 0.01% frequency repeatability
- Excellent stability
- Flat frequency response



Description

Hewlett-Packard's 4204A Digital Oscillator provides accurate, stable test signals for both laboratory and production work. This one instrument does the job of an audio oscillator, an ac voltmeter, and an electronic counter when an accurate frequency source of known amplitude is required.

Any frequency between 10.0 Hz and 999.9 kHz can be digitally selected with an in-line rotary switch to four significant figures. As many as 36,900 discrete frequencies are available. Infinite resolution is provided by one vernier control, which also extends the upper frequency limit to 1 MHz. Frequency accuracy is better than $\pm 0.2\%$ and repeatability is typically better than $\pm 0.01\%$.

A built-in high impedance voltmeter measures output. The meter is calibrated to read volts or dBm into a matched 600 ohm load. (0 dBm = 1 mW into 600 Ohms.) The output attenuator has an 80 dB range, adjustable in 10 dB steps with a 20 dB vernier. Maximum output power can be increased to 10 volts (22 dBm) into 600 Ohms or 20 volts open circuit.

Frequency response is flat with less than $\pm 3\%$ variation over the entire frequency range at any attenuator setting. Frequency stability is better than 10 parts in 10^6 per minute.

Specifications

Frequency range: 10 Hz to 1 MHz, 4 ranges.

Frequency accuracy: $\pm 0.2\%$ or ± 0.1 Hz (at 25°C).

Frequency stability

$\pm 10\%$ line voltage variation: less than $\pm 0.01\%$.

Change of frequency with temperature: $< \pm 100$ ppm/°C.

Drift: < 10 ppm/minute.

Frequency response: flat within $\pm 3\%$, 9,999 kHz ref. (25°C $\pm 5^\circ$ C).

Output: 10 V (22 dBm) into 600 ohms (160 mW). 20 V open circuit.

Output attenuator: 80 dB in 10 dB steps: $< \pm 0.5$ dB error.

Output monitor: voltmeter monitors level at input of attenuator in volts or dB.

Accuracy: $\pm 2\%$ of full scale.

Flatness: $\pm 1\%$ at full scale, 10 Hz to 500 kHz; $\pm 2\%$ at full scale, 500 kHz to 1 MHz.

Distortion: less than 0.3%, 30 Hz to 100 kHz. Less than 1%, 10 Hz to 600 kHz. Less than 1.2%, 10 Hz to 1 MHz.

Hum and noise: less than 0.05% of output.

Temperature range: 0°C to +50°C.

Power: 115 V/230 V switch, $\pm 10\%$, 10 VA, 50 to 60 Hz.

Weight: net, 8.5 kg (19 lb). Shipping, 11 kg (28 lb).

Dimensions: 141 mm H x 426 mm W x 336 mm D (5½" x 16¾" x 13¼").

Accessories available

Accessories available	Price
11000A Cable: dual banana plugs	\$17
11001A Cable: banana plug to BNC male connector	\$17
11004A Line Matching Transformer has a frequency response of 5 kHz to 600 kHz providing fully balanced outputs for 135 or 600 ohms.	\$85
11005A Line Matching Transformer has a frequency response of 20 Hz to 45 kHz providing full balanced output into 600 ohms.	\$130
16252A Matching Transformer has a frequency response of 10 kHz to 1 MHz providing unbalanced 75 ohm output, terminated in UG-657/U female BNC connector.	\$130

Options

001: 4204A Output Monitor top scale calibrated in dBm/600Ω. Bottom scale calibrated in volts add \$25

908: Rack Flange Kit add \$10

910: Extra Manual add \$9

4204A Digital Oscillator \$1885

OSCILLATORS & FUNCTION GENERATORS

0.1 Hz to 1 MHz

Model 3311A

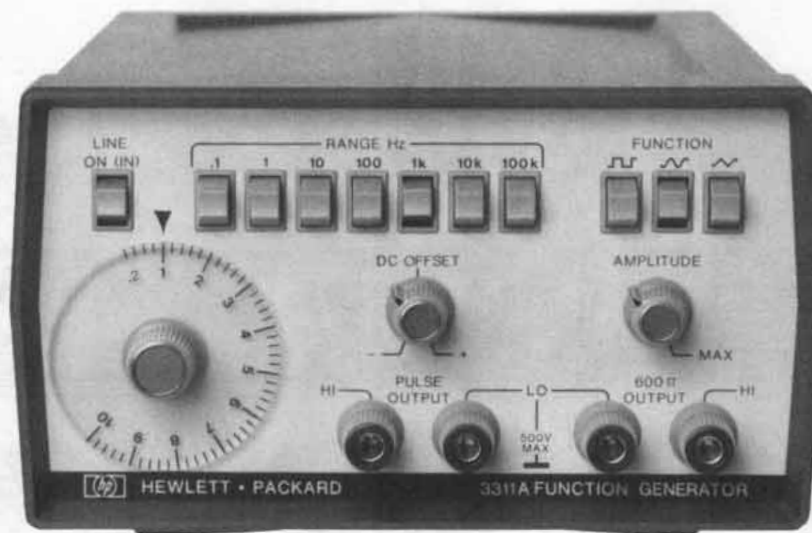

Description

The 3311A Function Generator offers wide functional capability at a modest price. This compact unit has seven decades of range from 0.1 Hz to 1 MHz. Pushbutton range and function selection add convenience to versatility. Added features normally not found on function generators in this price range are 10:1 voltage control and a separate pulse output suitable for synchronization or driving TTL logic circuits.

Output

Ten V p-p into 600 Ω (20 V p-p O.C.). This output may be attenuated by >30 dB by a variable attenuator and offset by ± 5 V. The DC offset allows the sine, square, and triangle functions to be positioned to the most desired level. This feature adds to the usefulness of all three functions.

VCO

The DC coupled voltage control allows the use of an external source to sweep the 3311A > 10:1 in frequency.

Pulse output

A separate TTL compatible pulse output provides current sinking for up to 20 TTL loads. The pulse has a 15/85 aspect ratio with a <25 ns rise time.

Specifications

Waveforms: sinusoid, square, triangle, and positive pulse.

Frequency range: 0.1 Hz to 1 MHz in seven decade ranges.

Dial accuracy: $\pm 5\%$ of full scale.

Isolation: using an external supply, outputs may be floated up to ± 500 V relative to the instrument case (earth ground).

600 Ohm output

Maximum output amplitude: 20 V p-p open circuit; 10 V p-p into 600 Ω .

Amplitude control: continuously variable, >30 dB range. DC off-

set: up to ± 10 V open circuit, ± 5 V into 600 Ω , continuously adjustable and independent of amplitude control. Maximum V_{ac} peak + V_{dc} offset without clipping is ± 10 V open circuit, ± 5 V into 600 Ω .

Output impedance: 600 $\Omega \pm 10\%$.

Sine wave amplitude flatness: within $\pm 3\%$ of 10 kHz reference (maximum output amplitude) to 100 kHz, $\pm 6\%$ to 1 MHz.

Sine wave total harmonic distortion: <3% (maximum output amplitude).

Triangle linearity: deviation <1% from best straight line at 100 Hz (maximum output amplitude).

Square wave transition time: rise time: <100 ns; fall time: <100 ns.

Square wave time axis symmetry error: $\pm 2\%$ maximum to 100 kHz.

Pulse output

Output amplitude: >3 V positive (open circuit) TTL compatible.

Duty cycle: 13.5% to 16.5% of the total period.

Transition times: <25ns.

External frequency control

VCO range: >10:1 on any frequency range.

Input requirement: with frequency dial set to 1.0, a linear ramp of 0.0 V to -10 V ± 2 V will linearly increase frequency >10:1

Input impedance: 10 k $\Omega \pm 10\%$ in parallel with <60 pFd.

General

Operating temperature: 0 $^{\circ}$ C to 55 $^{\circ}$ C; specifications apply from +15 $^{\circ}$ C to +35 $^{\circ}$ C.

Storage temperature: -40 $^{\circ}$ C to +75 $^{\circ}$ C.

Power: 100/120/220/240 V -10%, +5% switchable: 48 Hz to 66 Hz; ≤ 12 VA.

Dimensions: 89 mm H x 159 mm W x 248 mm D (3 $\frac{1}{2}$ " x 6 $\frac{1}{4}$ " x 9 $\frac{3}{4}$ ").

Weight: net, 1.5 kg (3 $\frac{1}{2}$ lb); shipping, 2.5 kg (5 $\frac{1}{2}$ lb).

Rack Mount Kits: 10851A for one 3311A, 10852A for two.

3311A Function Generator

\$295

- AM-FM, sweep, trigger, gate and burst



Description

Hewlett-Packard's 3312 A Function Generator combines two separate, independent function generators with a modulator section in one compact instrument.

The main generator can—via pushbutton control—be triggered by the modulation generator to provide sweep functions, AM, FM or tone burst.

Ten V p-p into 50Ω provides adequate power for most applications. The output attenuator has a range of more than 10,000:1 so clean low-level signals from 10 V to 1 mV p-p into 50Ω can be obtained. The main generator includes dc offset up to 10 volts p-p into 50Ω.

Hewlett-Packard's 3312A is an effective low cost solution for generating a multitude of functions.

3312A Specifications

Output waveforms: sine, square, triangle, \pm ramp, pulse, AM, FM, sweep, triggered and gated.

Frequency characteristics

Range: 0.1 Hz to 13 MHz in 8 decades ranges.

Dial accuracy: $\pm 5\%$ of full scale.

Square wave rise or fall time (10% to 90%): <18 nsec.

Aberrations: <10%.

Triangle linearity error: <1% at 100 Hz.

Variable symmetry: 80:20:80 to 1 MHz.

Sine wave distortion: <0.5% (-46dB) THD from 10 Hz to 50 kHz. >30 dB below fundamental from 50 kHz to 13 MHz.

Output characteristics

Impedance: 50Ω $\pm 10\%$.

Level: 20 V p-p into open circuit, 10 V p-p into 50Ω.

Level flatness (sine wave): < $\pm 3\%$ from 10 Hz to 100 kHz at full rated output (1 kHz reference). < $\pm 10\%$ from 100 kHz to 10 MHz.

Attenuator: 1:1, 10:1, 100:1, 1000:1 and >10:1 continuous control.

Attenuator error: <5%.

Sync output: impedance: 50Ω $\pm 10\%$, >1 V p-p square wave into open circuit. Duty cycle varies with symmetry control.

DC offset: Variable up to ± 10 volts. Instantaneous ac voltage + Vdc offset cannot exceed ± 10 V (open circuit) or ± 5 V (terminated 50 ohm).

Modulation characteristics

Types: internal AM, FM, sweep, trigger, gate or burst; external AM, FM, sweep, trigger, gate or burst.

Waveforms: sine, square, triangle, ramp or pulse variable symmetry.

Frequency range: 0.01 Hz to 10 kHz.

Output level: >1.0 V p-p into 10 kΩ.

Amplitude modulation

Depth: 0 to 100%.

Modulation frequency: 0.01 Hz to 10 kHz (internal). DC to >1 MHz (external).

Carrier 3 dB bandwidth: <100 Hz to >5 MHz.

Carrier envelope distortion: <2% at 70% sine wave modulation with $f_c = 1$ MHz, $f_m = 1$ kHz.

External sensitivity: <10 V p-p for 100% modulation.

Frequency modulation

Deviation: 0 to $\pm 5\%$ (internal).

Modulation frequency: internal: 0.01 Hz to 10 kHz; external: DC to >50 kHz.

Distortion: <-35 dB at $f_c = 10$ MHz, $f_m = 1$ kHz, 10% modulation.

Sweep characteristics

Sweep width: >100:1 on any range.

Sweep rate: 0.01 Hz to 10 kHz, 90:10 ramp, and 0 Hz Range (provides manual setting of "Sweep Start" without modulation generator oscillating).

Sweep mode: repetitive linear sweep between start and stop frequency settings. Retrace time can be increased with symmetry control.

Ramp output: 0 to >-4 p-p into 5 kΩ.

Gate characteristics: start/stop phase range: +90° to -80°.

Frequency range: 0.1 Hz to 1 MHz (useful to 10 MHz).

Gating signal frequency range (external): DC to 1 MHz, TTL compatible.

External frequency control

Range: 1000:1 on any range.

Input requirement: with dial set at 10, 0 to -2 V $\pm 20\%$ will linearly decrease frequency >1000:1. An ac voltage will FM the frequency about a dial setting within the limits (0.1 < f < 10) x range setting.

Linearity: the frequency versus voltage curve will be linear within 0.5% over a 100:1 frequency range.

Input impedance: 2.8 kΩ $\pm 5\%$.

General

Operating temperature: 0°C to +55°C; specifications apply from 0°C to 40°C.

Storage temperature: -40°C to +75°C.

Power: 100 V, 120 V, 220 V, 240 V +5%, -10%, switchable; 48 Hz to 440 Hz; ≤ 25 VA.

Size: 102 mm H x 213 mm W x 377 mm D (4" x 8 $\frac{3}{8}$ " x 14 $\frac{13}{16}$ ").

Weight: net, 3.8 kg (8 lbs, 6 oz). Shipping, 5.9 kg (13 lbs).

OSCILLATORS & FUNCTION GENERATORS

.000001 Hz to 20 MHz Synthesized Function Generator

Model 3325A

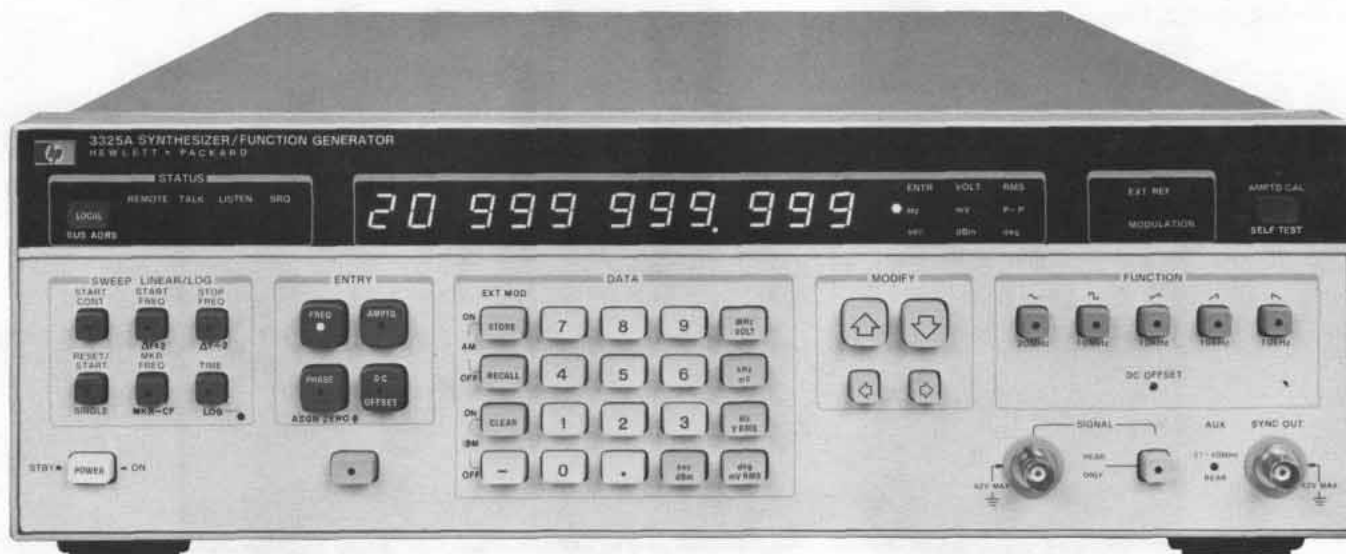

3325A



Description

The HP 3325A Synthesizer/Function Generator provides high precision square, triangle, positive and negative ramps and sinewaves with synthesizer accuracy with up to 11 digit (1 microHertz) resolution. Frequency coverage starts at an unprecedented 1 microHertz (.000001 Hz) and extends to 10.999 999 999 MHz for squarewaves, 10.999 999 999 kHz for triangles and ramps, and to 20.999 999 999 MHz for sinewaves. Output is 1 mV to 10V p-p with 4 digits and full band sweep featured.

Precision waveforms

As a high performance function generator the 3325A provides precision, symmetrical squarewaves to 10.999 999 999 MHz with 20 nsec rise time and .02% + 3 nsec symmetry. Settling time is less than 1 μ sec to within .05% of final value. Use this function for testing amplifier rise time and precision timing and gating.

Ultralinear triangles and both positive and negative ramps provide less than .05% linearity to 10.999 999 999 kHz at full output. The 10 V p-p output can be increased to 40 V p-p to 1 MHz for square and sinewaves with option 002. Use the triangle waves for characterization of audio amplifiers including linearity, gain compression and frequency response. Precision ramps can be used for VCO testing and process control.

More Features

Phase offset

The phase of the output can be changed $\pm 719.9^\circ$ with $.1^\circ$ resolution. The phase is advanced (or retarded) with respect to the starting phase. Zero phase can be assigned as a new reference point. Two 3325A units can be phase locked together for dual phase output applications. Use the Modify function to change the phase $.1^\circ$ at a step.

DC offset

All four functions can be offset up to ± 4.5 VDC. Maximum offset depends on the amplitude range selected. With all functions turned off (DC only), ± 5 VDC is available with a source impedance of 50 Ω . With option 002 DC offset is 4 times the range of the standard instrument.

Storage registers

Ten storage registers can be programmed with ten different combinations of function/parameter settings from the front panel, stored and then recalled. Time is saved when a large number of parameters are changed for each test.

Units conversion

The 3325A can display 11 digits of frequency and 4 digits of volts or millivolts from 1 mV to 10 volts peak to peak. Conversion to RMS or dBm is simple with the touch of a button. Needless calculations and time are saved.

Synthesizer Accuracy

The 3325A not only provides precision square, triangle and ramp waveforms, but also low distortion sinewaves from 1 microhertz to 20.999 999 999 MHz... all with the same synthesizer accuracy, stability and resolution. Sinewave harmonics are 65 dB down below 50 kHz and you can externally modulate with AM and PM.

Fully Programmable

All necessary functions on the 3325A can be controlled from the HP-IB. This not only includes the programming of frequency, amplitude, phase and DC offset, but it also includes function selection, modulation, all sweep parameters, amplitude calibration and self-test. The 3325A also has a Talk mode which allows the instrument to output one ASCII coded parameter at a time when interrogated from the controller.

A Wideband Sweeper

Phase continuous

A major contribution is wideband phase continuous sweep, covering up to the full frequency range of each waveform. Sweep log or linear, single or continuous without the phase discontinuities usually associated with synthesizers. Phase lock loop testing is made easier.

New Technology

The 3325A provides unprecedented performance per dollar thanks to several major contributions from advances in HP technology. A single loop Fractional-N synthesis technique allows synthesizer accuracy with 11 digits of resolution, and as an added bonus... phase continuous frequency sweep. Fewer parts and integrated circuit technology make the difference. A unique method of triangle and ramp waveform generation provides excellent linearity. Add microprocessor control and Hewlett-Packard Interface Bus (HP-IB) operation and the result is more performance, flexibility and versatility on the bench or in automatic test systems than previously available, and at a lower cost.

Specifications

Refer to the 3325A data sheet for complete specifications. Sinewave, synthesizer, and auxiliary specifications are shown in the Synthesizer section, page 364.

Waveforms

Sine, Square, Triangle, negative and positive Ramps

Frequency

Range:

Sine: 1 μ Hz to 20.999 999 999 MHz

Square: 1 μ Hz to 10.999 999 999 MHz

Triangle/Ramps: 1 μ Hz to 10.999 999 999 kHz

Resolution: 1 μ Hz, < 100 kHz

1 mHz \geq 100 kHz

Accuracy: $\pm 5 \times 10^{-6}$ of selected value, 20° to 30° C

Main Signal Output (all waveforms)

Impedance: 50 Ω

Connector: BNC; switchable to front or rear panel, nonswitchable with option 002, except by internal cable change.

Amplitude (All waveforms)

Range: 1 mV to 10 V p-p in 8 amplitude ranges, 1-3-10 sequence (10 dB steps) into 50 Ω load.

Function	Sine		Square		Triangle/Ramps	
	min	max	min	max	min	max
Units Displayed						
peak-peak	1.000 mV	10.00 V	1.000 mV	10.00V	1.000mV	10.00 V
rms	0.354 mV	3.536 V	0.500 mV	5.000 V	0.289 mV	2.887 V
dBm (50 Ω)	-56.02	+23.98	-53.01	+26.99	-57.78	+22.22

Resolution: 0.03% of full range or 0.01 dB (4 digits)

Amplitude Accuracy

Squarewaves/Sinewaves

10 Hz to 10 kHz: $\pm 1\% \geq 3V$; $\pm 2\% < 3V$

10 kHz to 20 MHz: $\pm 3\% \geq 3V$; $\pm 5\% < 3V$

Triangles/Ramps

10 Hz to 2 kHz: $\pm 1\% \geq 3V$; $\pm 2\% < 3V$

2 kHz to 10 kHz: $\pm 6\%$ (Ramps $\pm 11\%$)

Squarewave characteristics

Rise/fall time: ≤ 20 ns 10% to 90% at full output

Overshoot: $\leq 5\%$ of peak to peak amplitude, at full output

Settling time: $< 1 \mu$ s to settle to within .05% of final value, tested at full output with no load

Symmetry: $\leq .02\%$ of period + 3 ns

Triangle/ramp characteristics

Triangle/ramp linearity: (10% to 90%, 10 kHz): $\pm .05\%$ of full p-p output for each range

Ramp retrace time: $\leq 3 \mu$ s, 90% to 10%

DC Offset

Range:

DC only (no ac signal): 0 to ± 5.0 V/50 Ω

DC + AC: Maximum dc offset ± 4.5 V on highest range; decreasing to ± 4.5 mV on lowest range

Resolution: 4 digits

Accuracy

DC only: $\pm .4\%$ of full output for each range

DC + AC to 1 MHz: $\pm 1.2\%$, ramps $\pm 2.4\%$

DC + AC, 1 MHz-20 MHz: $\pm 3\%$

Phase Offset

Range: $\pm 719.9^\circ$ with respect to arbitrary starting phase or assigned zero phase

Resolution: .1°

Increment Accuracy: $\pm .2^\circ$

Phase Modulation

Squarewave range: $\pm 425^\circ$

Triangle range: $\pm 42.5^\circ$

Positive and negative ramps: $\pm 85^\circ$

Modulation frequency range: DC - 5 kHz

Connector: Rear panel BNC

Impedance: 20 k Ω

Frequency Sweep

Sweep time:

Linear: 0.01 s to 99.99 s

Logarithmic: 2 s to 99.99 s single, 0.1 s to 99.99 s continuous

Maximum sweep width: Full frequency range of the main signal output for the waveform in use, except minimum log start frequency is 1 Hz.

Phase continuity: Sweep is phase continuous over the full frequency range of the main output

Auxiliary Inputs and Outputs

Reference input: For phase-locking 3325A to an external frequency reference. Signal from 0 dBm to +20 dBm into 50 Ω . Reference signal must be a subharmonic of 10 MHz from 1 MHz to 10 MHz.

Sync output: Square wave with V (high) $\geq 1.2V$, V (low) $\leq 0.2V$ into 50 Ω

1 MHz reference output: 0 dBm output for phase-locking additional instruments to the 3325A

X-Axis drive: 0 to 10 V dc linear ramp proportional to sweep frequency, .1% linearity, 10 - 90%

Sweep marker output: High to low TTL compatible voltage transition at keyboard selected marker frequency

Option 001 High Stability Frequency Reference

Aging rate: $\pm 5 \times 10^{-8}$ /week, $\pm 1 \times 10^{-7}$ /mo.

Accuracy: $\pm 5 \times 10^{-8}$ (0° to +50°C)

Option 002 High Voltage Output

Frequency range: 1 μ Hz to 1 MHz

Amplitude:

Range: 4.000 mV pp to 40.00V pp (500 Ω , < 500 pf load).

Accuracy: $\pm 2\%$ of full output for each range at 2 kHz.

Flatness: $\pm 10\%$

Squarewave rise/fall time: ≤ 100 ns, 10% to 90% at full output with 500 Ω , 500 pf load.

Squarewave overshoot: $< 10\%$ of peak to peak amplitude with 500 Ω , 500 pf load.

Output impedance: $< 2 \Omega$ at DC, $< 10 \Omega$ at 1 MHz

DC offset:

Range: 4 times the specified range of the standard instrument

Accuracy: $\pm 1\%$ of full output for each range + 25 mV)

Maximum output current: 40 mApp.

General

Operating Environment:

Temperature: 0°C to 55°C

Relative humidity: 95%, 0°C to 40°C

Altitude: $\leq 15,000$ ft.

Storage temperature: -40°C to +75°C

Storage altitude: $\leq 50,000$ ft.

Power: 100/120/220/240V, +5%, -10%; 48 to 66 Hz; 60 VA, 100 VA with all options; 10 VA standby

Weight: 9 kg (20 lbs.) net; 14.5 kg (32 lbs.) shipping

Dimensions: 132.6 mm high \times 425.5 mm wide \times 497.8 mm deep (5 1/4" \times 16 3/4" \times 19 3/4")

Accessories: 11356A Ground Isolator for breaking signal grounds between input/output connectors.

Ordering Information

3325A Synthesized Function Generator

Price

\$3,000

Opt. 001 High Frequency Reference

add \$550

Opt. 002 High Voltage Output

add \$200

Opt. 907 Front Handle Kit (Stand alone orders P/N5061-0089)

\$20

Opt. 908 Rack Flange Kit (Stand alone orders P/N5061-0077)

\$15

Opt. 909 Rack Flange and Handle Combination Kit (Stand alone orders P/N5061-0083)

\$30

11356A Ground Isolator

\$50

OSCILLATORS & FUNCTION GENERATORS

0.0005 Hz to 5 MHz function generators

Model 3310A/B



3310A

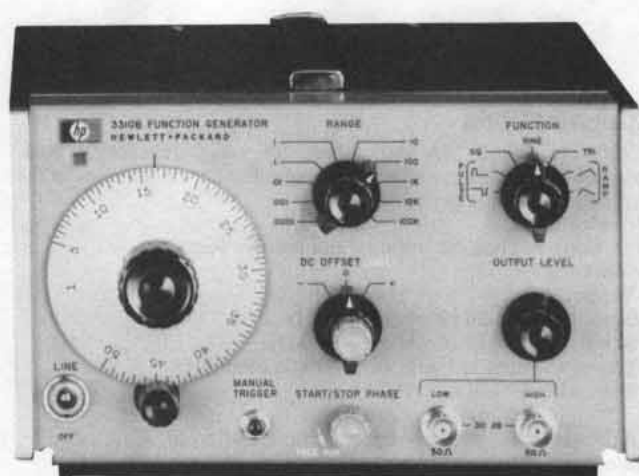

3310B

Description

The 3310A Function Generator is a compact voltage-controlled generator with 10 decades of range. Ramp and pulse functions are available in addition to sine, square and triangle. DC offset and external voltage control provide wide versatility. A fast rise time sync output is provided. Aspect ratio of nonsymmetrical function is 15%/85%.

The 3310B has all the features of the standard 3310A plus single and multiple cycle output capability.

3310A Specifications

Output waveforms: sinusoidal, square, triangle, positive pulse, negative pulse, positive ramp and negative ramp. Pulses and ramps have a fixed 15% or 85% duty cycle.

Frequency range: 0.0005 Hz to 5 MHz in 10 decade ranges.

Sine wave frequency response

0.0005 Hz to 50 kHz: $\pm 1\%$; 50 kHz to 5 MHz: $\pm 4\%$. Reference, 1 kHz at full amplitude into 50 Ω .

Dial accuracy

0.0005 Hz to 500 kHz all functions: $\pm (1\% \text{ of setting} + 1\% \text{ of full scale})$.

500 kHz to 5 MHz sine, square and triangle: $\pm (3\% \text{ of setting} + 3\% \text{ of full scale})$.

500 kHz to 5 MHz pulse and ramps: $\pm (10\% \text{ of setting} + 1\% \text{ of full scale})$.

Maximum output on high: $> 30 \text{ V p-p}$ open circuit; $> 15 \text{ V p-p}$ into 50 Ω (except for pulses at frequency $> 2 \text{ MHz}$).

Pulse (frequency $> 2 \text{ MHz}$): $> 24 \text{ V p-p}$ open circuit; $> 12 \text{ V p-p}$ into 50 Ω .

Minimum output on low: $< 30 \text{ mV p-p}$ open circuit; $< 15 \text{ mV p-p}$ into 50 Ω .

Output level control: range $> 30 \text{ dB}$. High and low outputs overlap for a total range of $> 60 \text{ dB}$; low output is 30 dB down from high output.

Sine wave distortion

0.0005 to 10 Hz: $> 40 \text{ dB}$ (1%).

10 Hz to 50 kHz (on 1 k range): $> 46 \text{ dB}$ (0.5%).

50 kHz to 500 kHz: $> 40 \text{ dB}$ (1%).

500 kHz to 5 MHz: $> 30 \text{ dB}$ (3%).

Square wave and pulse response: $< 30 \text{ ns}$ rise and fall times at full output.

Triangle and ramp linearity: 0.0005 Hz to 50 kHz, $< 1\%$.

Impedance: 50 Ω .

Sync

Amplitude: $> 4 \text{ V p-p}$ open circuit, $> 2 \text{ V p-p}$ into 50 Ω .

DC offset

Amplitude: $\pm 10 \text{ V}$ open circuit, $\pm 5 \text{ V}$ into 50 Ω (adjustable).

Note: max V ac peak + V dc offset is $\pm 15 \text{ V}$ open circuit, $\pm 7.5 \text{ V}$ into 50 Ω .

External frequency control: 50:1 on any range.

Input requirement: with dial set to low end mark, a positive ramp of 0 to $+10 \text{ V} \pm 1 \text{ V}$ will linearly increase frequency 50:1. With dial set at 50, a linear negative ramp of 0 to $-10 \text{ V} \pm 1 \text{ V}$ will linearly decrease frequency 50:1. An ac voltage will FM the frequency about a dial setting within the limits $(1 < f < 50) \times \text{range setting}$.

Linearity: ratio of output frequency to input voltage ($\Delta f / \Delta V$) will be linear within 0.5%.

Sensitivity: approximately 100 mV/minor division.

Input impedance: 10 k Ω .

General

Power: 115 V or 230 V $\pm 10\%$, 48 Hz to 440 Hz, $< 20 \text{ VA}$ max.

Dimensions: 114 mm H (without removable feet), 197 mm W, 203 mm D ($4\frac{1}{2}'' \times 7\frac{3}{4}'' \times 8''$).

Weight: net, 2.7 kg (6 lb); shipping, 4.5 kg (10 lb).

Accessories available

HP Part No. 5060-8750 filler strip for use with HP 1051A Combining Case or HP 5060-8762 Rack Adapter Frame.

3310B Specifications

Same as 3310A with the following additions:

Modes of operation: free run, single cycle, multiple cycle.

Frequency range: 0.0005 Hz to 50 kHz (usable to 5 MHz).

Single cycle^{}:** ext trigger (ac coupled) requires a positive-going square wave or pulse from 1 V p-p to 10 V p-p. The triggering signal can be dc offset, but $(V \text{ ac peak} + V \text{ dc}) \leq \pm 10 \text{ V}$ ext gate (dc coupled) will trigger a single cycle on any positive waveform $\geq 1 \text{ V}$ but $\leq 10 \text{ V}$ which has a period greater than the period of the 3310B output, and a duty cycle less than the period of the 3310B output. The gate signal cannot exceed 10 V.

Multiple cycle^{}:** manual trigger will cause the 3310B to free run when depressed. When the trigger button is released, the waveform will stop on the same phase as it started. Ext. gate will cause the 3310B to free run when the gate is held at between $+1$ and $+10 \text{ V}$. When the gate signal goes to zero, the 3310B will stop on the same phase as it started.

Start-stop phase: the start-stop phase can be adjusted over a range of approximately $\pm 90^\circ$.

Ordering information

3310A Function Generator

3310B Function Generator

Price

\$840

\$950

^{**}This specification applies on the X.0001 to X1 k range only.

OSCILLATORS AND FUNCTION GENERATORS

10 Hz to 10 MHz test oscillators

Models 651B, 652A, 654A



Specifications

MODEL NO.	651B	652A	654A
Description	Amplitude and frequency stability of this solid state capacitance-tuned test oscillator provides high quality signals for general purpose lab or production measurements.	Same as Model 651B, HP's Model 652A offers an expandable output monitor for amplitude control to 0.25% across its entire frequency band for greater output and resettability.	Similar to the 651B Test Oscillator, HP's 654A has balanced outputs of 135Ω, 150Ω, and 600Ω. Automatic leveling over entire frequency range and expanded meter.
Frequency Range	10 Hz to 10 MHz, 6 bands.		
Frequency Accuracy	±2%, 100 Hz to 1 MHz; ±3%, 10 Hz to 100 Hz and 1 MHz to 10 MHz.		±2% 100 Hz to 5 MHz; ±3% 10 Hz to 100 Hz; ±4% 5 MHz to 10 MHz.
Frequency Response (Flatness)	±2%, 100 Hz to 1 MHz; ±3%, 10 Hz to 100 Hz; (±4%, 1 MHz to 10 MHz applies only at 50Ω or 75Ω output and amplitude readjusted to a reference on the output monitor.)	±0.25%, 3 V and 1 V range; ±0.75%, 0.3 V to 0.3 mV range; ±1.75%, 0.1 mV range. (Amplitude readjusted using expanded scale on output monitor).	(±10 dBm and 0 dBm) ±0.5% from 10 Hz to 10 MHz for unbalanced outputs and 10 Hz to 5 MHz for 135Ω and 150Ω outputs, and 10 Hz to 1 MHz for 600Ω output.
Distortion	<1%, 10 Hz to 2 MHz; <2%, 2 MHz to 5 MHz; <4%, 5 MHz to 10 MHz.		10 Hz to 1 MHz, >40 dB below fundamental; 1 MHz to 10 MHz, >34 dB below fundamental.
Output	3.16 V into 50Ω or 600Ω; 6.32 V open circuit. 0.1 mV to 3.16 V full scale, 10 steps in 1, 3, 10 sequence; -70 dBm to +23 dBm (50Ω output) full scale, 10 dBm per step; 20 dB coarse and fine adjustable amplitude control.		+11 dBm to -90 dBm, 10 dB and 1 dB steps with adjustable ±1 dB meter range, calibrated for each impedance of 50Ω and 75Ω unbalanced and 135Ω, 150Ω and 600Ω balanced.
Output Monitor (Monitor's Level at input of attenuator)	Top scale calibrated in volts, bottom scale in dB. Accuracy ±2% of full scale.	Same as 651B plus Expand Scale which expands reference voltage of the normal scale from 0.9 to 1.0 or 2.8 to 3.2	±1 dBm with full scale with 0.02 dB resolution. Accuracy ±0.05 dB.
Output* Connectors	BNC connectors.		
Attenuator	90 dB range in 10 dB steps; ±0.075 dB, -60 dBm to +20 dBm; ±0.2 dB, -70 dBm to -60 dBm.		99 dB range in 10 dB and 1 dB steps; ±1.5% (0.15 dB) except ±10% (1 dB) at output levels below 60 dBm at frequencies >300 kHz.
Temperature Range	0°C to +55°C (32°F to 130°F).		
Power	115V or 230 V ±10%, 48 Hz to 66 Hz, 30 VA max.		115 V or 230 V ±10%, 50 Hz to 66 Hz, 35 VA max.
Weight	Net, 7.6 kg (17 lb). Shipping, 9.90 kg (22 lb).		Net, 9.4 kg (21 lb). Shipping, 11.8 kg (26 lb).
Dimensions	133 mm H x 425 mm W x 286 mm D (5.21" x 16.75" x 11.25").		
PRICE	\$1000	\$1160	\$1370

*Maximum dc voltage that can be applied to output: <±3 V p.



OSCILLATORS & FUNCTION GENERATORS

50 MHz programmable signal source

Model 8165A

- 1 mHz to 50 MHz
- sine, ramp and pulse waveforms
- counted burst
- 20 Vpp amplitude
- Fully programmable
- Storage of operating parameters



8165A with AM + Sweep Opt 002

HP-IB

50%
Symmetry/
duty cycle

Sine

Triangle

Square

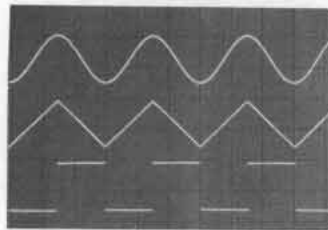

20%
Symmetry/
duty cycle

Ramp

Square

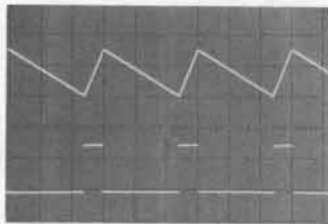

80%
Symmetry/
duty cycle

Ramp

Square

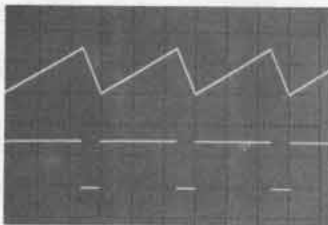

Introduction

The 8165A Programmable Signal Source generates sinewaves, triangles, ramps, square waves and pulses over a frequency range of 1 mHz to 50 MHz. The pushbutton front panel controls and the LED parameter display enable rapid and accurate setting of parameters with no repeatability problems. When you include other features such as microprocessor control, remote programmability of all parameters, and seven operating modes, you have a versatile signal source in just a single instrument that can be used in a wide range of applications.

Microprocessor control

The 8165A contains a microprocessor-controlled interface and keyboard designed to simplify operating and programming. Whether operating the instrument from its keyboard or from a controller via the HP-IB, the microprocessor simplifies parameter and data entry. It

also checks for illegal operations, incompatible settings, and sets up front panel displays. The microprocessor greatly simplifies front panel operation by enabling any parameter to be changed using only 3 steps; a PARAMETER key, DATA keys, and an ENTRY key.

Operating set storage

Up to 10 complete operating sets (functions and parameters) can be stored in the built-in memory. Subsequently you can recall any of the 10 sets instantaneously by pressing only two keys or using one program statement. And you don't have to worry about losing operating sets if the 8165A is accidentally switched off or if the power fails. Internal batteries preserve the current and stored operating sets for up to four weeks.

Stability, accuracy and resolution

The use of phase lock loop techniques, plus a 10 MHz internal or external crystal reference, ensures very stable output frequencies with an accuracy of $\pm 1 \times 10^{-5}$ deviation from programmed value. Resolution is four digits over the frequency range of 1 mHz to 50 MHz. For example, in the frequency range 1-9.999 mHz, this is equivalent to a resolution of 1 μ Hz.

Multiple waveform generation

The multiple waveforms that can be generated by the 8165A suit it to a wide range of digital and analog applications. Sine, triangle or square waves can be generated at frequencies up to 50 MHz. Ramps and rectangular pulses with 20% or 80% duty cycle/symmetry can be generated at frequencies up to 19.99 MHz.

Operating modes

The 8165A can be operated in any of eight different modes; normal, voltage controlled oscillator (VCO), trigger, gate, counted burst, frequency modulation (FM), and optional sweep and amplitude modulation (AM). This wide range of modes enables the 8165A to be used in any operating environment.

Output capability

The 8165A has been designed to fulfil the requirements of analog and digital testing. The source impedance can be set to 50 ohms or 1 k ohms for best termination, i.e. minimum distortion and reflection in each application. The 8165A can also be used as a current source, or supply a variable dc level.

HP-IB programming

The use of a microprocessor makes the 8165A very easy to program across the HP-IB, and ideal in automatic test systems. All operating parameters and functions can be programmed and in learn mode the 8165A can report its status and its current or stored operating sets. Programming is further simplified by the codes on the instrument front panel. The framed mnemonics are the ASCII characters required for programming.

Specifications

Waveforms

Sine, square/pulse (20, 50, 80% duty cycle), triangle/ramp (20, 50, 80% symmetry)

Frequency characteristics

Range: 1.000 MHz to 50.00 MHz (1.000 MHz to 19.99 MHz for 20 and 80% duty cycle/symmetry).

Output characteristics

Range: amplitude and offset independently variable within ± 10 V.
Source impedance: selectable $50\Omega \pm 1\%$ or $1\text{ k}\Omega \pm 10\%$, in parallel with 50 pF.

Amplitude: 10.0 mVpp to 10.0 Vpp (50Ω into 50Ω)
 2.00 Vpp to 20.0 Vpp (1 k Ω into 50Ω)

Accuracy

Frequency	Sine	Square	Triangle (50%)	Triangle (20%, 80%)	Pulse (20%, 80%)
1 kHz	$\pm 2\%$	$\pm 2\%$	$\pm 2\%$	$\pm 2\%$	$\pm 2\%$
1 kHz-5 MHz	$\pm 2\%$	$\pm 2\%$	$\pm 2\%$	$\pm 5\%$	$\pm 2\%$
5 MHz-20 MHz	$\pm 5\%$	$\pm 5\%$	$\pm 5\%$	$\pm 5\%$	$\pm 5\%$
20 MHz-50 MHz	$\pm 5\%$	$\pm 5\%$	$\pm 5\%$ to -20%	—	—

Resolution: 3 digits.

Offset: 0 ± 10 mV to ± 5.00 V (50Ω into 50Ω).

0 ± 20 mV to ± 10.0 V (1 k Ω into 50Ω).

Accuracy: $\pm 1\%$ programmed value $\pm 1\%$ signal Vpp ± 20 mV.

Resolution: 2 digits (10 to 99 mV), 3 digits (≥ 100 mV).

Sine characteristics

Distortion: total harmonic distortion (THD) for fundamental up to 1 MHz: $< \pm 1\%$.

Harmonic signals (fundamental 1-10 MHz): < -36 dB.

Harmonic signals (fundamental above 10 MHz): < -30 dB.

Non-harmonic: < -40 dB.

Square/pulse characteristics

Duty cycle: 20, 50, 80% selectable.

Transition times (10% to 90%): < 5 ns (50Ω into 50Ω), < 7 ns (1 k Ω into 50Ω).

Overshoot/ringing: $< \pm 5\%$ (50Ω into 50Ω), $< \pm 10\%$ (1 k Ω into 50Ω).

Preshoot: $< \pm 5\%$ (50Ω into 50Ω), $< \pm 10\%$ (1 k Ω into 50Ω).

Triangle/ramp characteristics

Symmetry: 20, 50, 80% selectable.

Linearity: (10% to 90%):

$< \pm 1\%$ (up to 5 MHz), $< \pm 5\%$ (above 5 MHz).

Operating modes

Norm: continuous waveform is generated, phase locked to an internal 10 MHz crystal reference.

VCO: external voltage V_{in} ($f_{max} = 100$ kHz) sweeps output frequency over a band. The band is determined by the frequency setting, and the frequency shift by the amplitude of V_{in} .

Trig: each trigger input cycle or manual command generates one output cycle, min trigger pulse width: 10 ns.

Gate: external signal enables oscillator when more positive than threshold. First and last output cycles are always complete, min. pulse width: 10 ns.

Burst: a preprogrammed number of output cycles is generated on receipt of an input trigger signal or manual command, min. time between bursts: 50 ns. Burst length: 1 to 9999 cycles. Min. trigger pulse width: 10 ns.

Frequency modulation: output is frequency modulated by an external voltage applied to a rear panel BNC, 0 to ± 1 V modulates 0 to $\pm 1\%$ deviation.

Modulating frequency: 100 Hz to 20 kHz (Norm mode), dc to 20 kHz (Gate mode with carrier frequency ≥ 1 kHz).

Auxiliary inputs and outputs

Ext. Input: common front panel BNC for external signals used in VCO, Trig, Gate, Burst and (Option 001) Sweep ext./trig.

Signal threshold: $+250$ mV (upper), 0 V (lower).

Max input: ± 20 V.

Input impedance: $10\text{ k}\Omega \pm 10\%$.

Sync output: front panel BNC provides one trigger cycle per main output cycle.

Amplitude: 0.8 V_{pp} into 50Ω (low level zero V, high $+0.8$ V).

Duty cycle: as main output.

Ext. 10 MHz Ref: rear panel BNC for connection of 10 MHz, TTL, system clock, selected by rear panel switch.

HP-IB programming (IEEE Std 488)

Settling times

Frequency: < 200 ms to settle to final value.

Other functions: 20 ms.

Memory

10 addressable locations plus one for current operating state.

Capacity: each location can store a complete set of operating parameters and modes.

Access time: 20 ms each location.

Storage time: internal battery provides memory retention for approx 4 weeks at room temperature.

Options

001 Sweep: provides logarithmic frequency sweep between limits set in on the 8165A. Rear panel BNC provides triangular sweep voltage (V_{sweep}), 0 to 2.99 V amplitude.

Sweep rate: 0.01, 0.1, 1, 10, 100, 1000 seconds per decade selectable.

Trigger: internal for continuous sweep, external produces one up-down sweep per trigger pulse.

General

Power requirements: 100 V, 120 V, 220 V or 240 V; $+5$ to -10% , 48 to 66 Hz, 200 V A max.

Environmental: operates to specifications from 0 to 50°C , and with relative humidity to 95% at 40°C .

Storage: -20 to $+70^\circ\text{C}$.

Weight: net 12 kg (26.5 lbs), Shipping 16 kg (35.3 lbs).

Size: 133 mm H \times 426 mm W \times 422 mm D (5.2" \times 16.8" \times 16.6").

Accessories available

Price

The following cables for interconnecting HP-IB instruments to the bus are available:

10631A	1 m (3.3 ft),	10631B	2 m (6.5 ft)	\$60
10631C	4 m (13 ft),	10631D	0.5 m (1.6 ft)	\$75

Options

002: Sweep + AM add \$710

907: Front Handle Kit add \$20

908: Rack Mounting Kit add \$15

909: Combined Front Handle and Rack Mounting Kit add \$30

910: additional Operating and Service Manual add \$22

8165A Programmable Signal Source

\$6145

FREQUENCY SYNTHESIZERS

General information

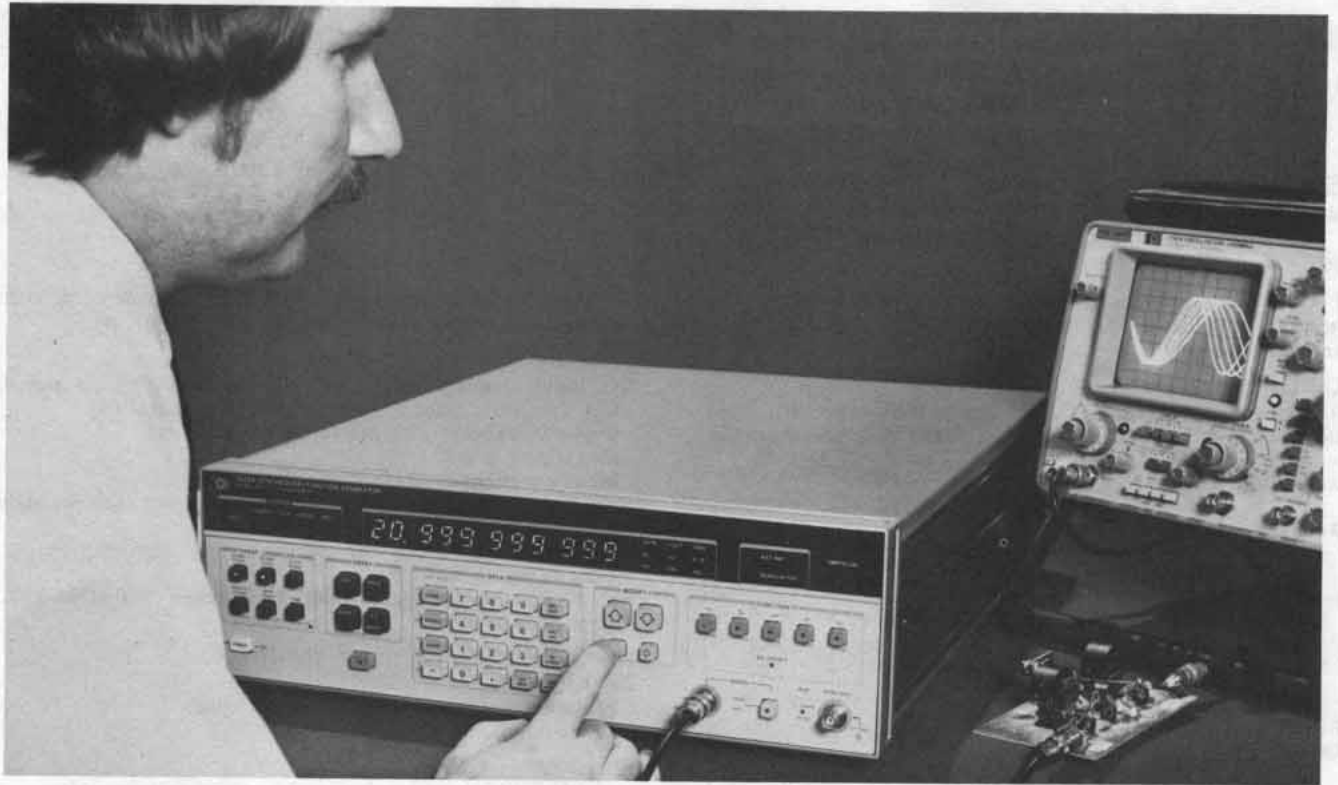

Hewlett-Packard frequency synthesizers translate the stable frequency of a precision frequency standard to a broad spectrum of frequencies that extends from dc to 18 GHz. The table below highlights HP's complete line of frequency synthesizers.

HP Model	Frequency Range	Frequency Resolution	Frequency Stability	Level Range dBm - 50Ω	Level Resolution	Remote Control	Other Features*
3320A (Pg. 360)	DC - 13 MHz 5 ranges	0.01 Hz to 10 kHz (4 digits)	10 ⁻⁷ /day	0 to +13	¼ turn Vernier	Freq.	1
3320B (Pg. 360)	DC - 13 MHz 5 ranges	0.01 Hz to 10 kHz (4 digits)	10 ⁻⁷ /day	-73 to +27	0.01 dB (4 digits)	Freq. & Ampl.	1,8
3320C (Pg. 598)	10 kHz to 17 MHz	10 kHz (20 Hz with Vernier in)	10 ⁻⁷ /day	-79.99 to +11.99	0.01 dB (4 digits)	—	1
3325A*** (Pg. 352 & 364)	DC - 20 MHz (sine)	.000001 Hz or .001 Hz (11 digits)	5 x 10 ⁻⁹ /yr	-56.02 to +23.98 (sine)	.01 dB or .001 mV to .01V (4 digits)	Freq. & Ampl.	8, 11, 12, 13
3330B (Pg. 362)	DC - 13 MHz	0.1 Hz (9 digits)	10 ⁻⁸ /day	-87 to +13	0.01 dB (4 digits)	Freq. & Ampl.	2, 3, 4, 6, 8
3335A (Pg. 366)	200 Hz - 80 MHz	.001 Hz	10 ⁻⁹ /day	-87 to +13	0.01 dB (4 digits)	Freq. & Ampl.	2, 3, 8
8660A/C** (Pg. 374)	10 kHz to 2600 MHz (3 plug-ins)	1 Hz or 2 Hz (10 digits)	3 x 10 ⁻⁸ /day	-146 to +13	Local: 10 dB steps plus Vernier Remote: 1dB Steps	Freq., Ampl. & Modulation	8660A: 5, 2, 8 8660C: 3, 5, 7, 8
8671A (Pg. 380)	2 to 6.2 GHz	1 kHz	5 x 10 ⁻¹⁰ /day	>+ 8	—	Freq., FM Modulation	8, 9
8672A** (Pg. 378)	2 to 18 GHz	1, 2, 3 kHz	5 x 10 ⁻¹⁰ /day	-120 to +3	Local: 10 dB steps plus Vernier Remote: 1 dB Steps	Freq., Ampl. & Modulation	8, 10

*Other features: (1) 10⁻⁹/day freq. stability optional, (2) 5 x 10⁻¹⁰/day, (3) digital freq. sweep, (4) digital ampl. sweep, (5) internal AM/FM, φM, (6) External AM, (7) 3 x 10⁻⁹/day stability Opt. 001 (8) HP-IB, (9) External FM, (10) External AM & FM, (11) 5 X 10⁻⁹/week stability, Opt. 001, (12) external AM & φM, (13) phase continuous sweep.

**The 8660A/C and 8672A are synthesized signal generators. They are discussed in detail in the section labeled "Signal Generators."

***The 3325A Synthesizer/Function Generator includes squarewaves, positive and negative ramps, and triangle waveforms in addition to sinewaves. The waveform capability is discussed in detail in the section marked "Oscillators and Function Generators".

Today's measurement needs are placing increasingly stringent requirements on signal sources for greater frequency resolution and stability. Narrowband component testing, satellite and terrestrial communications, local oscillator and automatic test systems are only a few of the many applications that continually require better and better signal sources.

Increased amplitude accuracy and resolution are also must requirements in many applications. The telecommunication industry's Frequency Division Multiplex (FDM) systems require high amplitude accuracy and resolution (0.01 dB) as well as high frequency resolution and stability. These requirements are also finding their place in to many R & D and production test situations.

With new technology continuing cost reductions in synthesis techniques, the synthesizer is finding use as a precision oscillator and signal generator as well as the more traditional uses as a synthesizer.

Frequency synthesizer definition

A frequency synthesizer is an instrument that translates the frequency stability of a single reference frequency to any one of many other desired frequencies. This definition of a synthesizer distinguishes it from the oscillator or signal generator, which derives its frequency from a tuned circuit or resonant cavity. The stability and resolution of these sources are limited by the oscillator components used. However, the synthesizer's output frequency is synthesized or created by some type of arithmetic operation on the basic frequency reference as shown in the synthesizer model below.

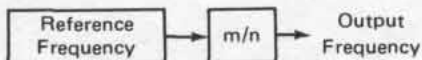

Any desired frequency can be obtained by selecting the appropriate values for m and n. The frequency reference in the above model is in many cases an internal crystal, often oven stabilized, while in other cases the reference is an external standard such as a crystal, rubidium gas cell or cesium beam.

Frequency generation

Most synthesizers employ direct or indirect synthesis techniques for generating the output frequency. In the direct synthesis method, a series of arithmetic operations (multiplying, dividing, mixing) are performed on the reference to achieve the desired output frequency. High switching speed (microseconds) is the primary advantage of direct synthesizers.

Many Hewlett-Packard synthesizers use the indirect synthesis method which derives its output frequency from one or more voltage tuned oscillators, (VTO), phase locked to a reference frequency. The VTO outputs are then combined to achieve the desired output frequency. HP's 3325A and 3335A synthesizers use the new fractional-N technique, allowing more resolution with fewer loops.

Fractional-N allows the $\pm N$ function normally used in the phase locked loop of indirect synthesizers to divide by fractional rather than just integer numbers, resulting in less complexity and lower cost.

Signal quality

The common specifications which describe signal sources include frequency range and resolution, amplitude range and resolution, distortion and stability. The two primary additional specifications pertinent to the synthesizer are phase noise and spurious content.

Phase noise: Phase noise describes the short term frequency stability of a signal source. Internal short-term frequency fluctuations will produce phase modulation sidebands about the nominal frequency. Phase noise is a measure of the magnitude of these sidebands. There are two common methods of specifying phase noise—a sideband plot and integrated phase noise.

The first method expresses phase noise as the ratio of the power in one phase noise sideband per hertz of bandwidth to the total signal power. A sideband plot of the phase noise graphically displays the magnitude and frequency components (spectral density) of the phase noise.

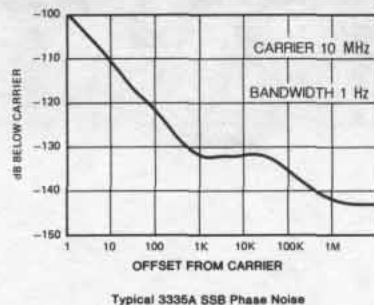

Integrated phase noise is the ratio of the rms value of the total phase noise sidebands in a 30 kHz bandwidth around the carrier (excluding ± 1 Hz) to the power of the carrier.

For a detailed treatment of the subject of phase noise refer to Application Note #207.

Spurious signals: Spurious signals are discrete, non-harmonically related signals appearing in the output. The spurious output specification is the maximum level, in dB below the carrier, of any spurious signal.

Hewlett-Packard synthesizers

Hewlett-Packard offers a wide range of high quality frequency synthesizers covering the frequency range of DC to 18 GHz. In addition to being high performance synthesizers, they incorporate many additional features which allow them to fulfill the needs for either bench or programmable precision signal sources or as versatile programmable signal generators.

Precise level control

Precision amplitude capability consisting of 100 dB amplitude range, 0.05 dB flatness, and 0.01 dB resolution allow the 3320B/C, 3330B and 3335A to perform as precision

level generators as well as synthesizers. Precise level control, using a True-RMS leveling loop, eliminates the need for external leveling and level monitoring.

Synthesizer/function generator

The HP 3325A is both a synthesizer and a function generator providing high purity synthesized sinewaves from .000001 Hz to 20 MHz, precision squarewaves to 10 MHz, linear ramps and triangle waveforms to 10 kHz, 11 digit resolution (1 microhertz <100 kHz), wideband phase continuous sweep, and HP-IB programmability. Additionally, the low price makes the 3325A an excellent choice for low frequency systems or bench applications. For detailed information on the precision waveforms, refer to the Oscillators and Function Generators section.

Synthesized signal generators

The combined frequency ranges of the HP 8660A, 8660C, and 8672A Synthesized Signal Generators span 10 kHz to 18 GHz. These generators couple the frequency accuracy and stability of synthesizers with the modulation capability and precise, calibrated, wide-range level control of high quality signal generators. In addition, each of these generators offer HP-IB remote control of frequency, level, and modulation. Complete details of these and other signal generators are contained in the Signal Generators section of this catalog.

Synthesized level generator

The HP 3335A is a synthesized level generator covering the range of 200 Hz to 80 MHz. Balanced outputs, telecommunication output impedances and special connectors make this instrument ideal for the telecommunications industry as a stand-alone generator with synthesizer stability or as a companion generator for the HP 3745A/B SLMS. For more information on this generator, refer to the Telecommunications section.

Sweep capability

The 3330B, 3335A and 8660C are among the most linear sweepers ever built. Keyboard control of built-in microprocessors gives these instruments digital sweep (a point-by-point sweep with frequency synthesizer accuracy).

The 3325A offers a phase continuous rather than digital sweep over the full frequency range of its output.

The 3330B also offers digital amplitude sweeps. Amplitude can be swept in increments as small as 0.01 dB to test level sensitive circuits like voltage-controlled oscillators and automatic gain control loops.

Programmability (HP-IB)

The 3320B, 3325A, 3335A, 8660A/C, 3330B, 8671A, and 8672A are programmable via the Hewlett-Packard Interface Bus (HP-IB), Hewlett-Packard's implementation of IEEE STD 488-1975. Multiple signal sources interfaced to the same interface bus each may be independently programmed for different functions or frequencies.

FREQUENCY SYNTHESIZERS

.01 Hz to 13 MHz frequency synthesizer

Models 3320A & 3320B

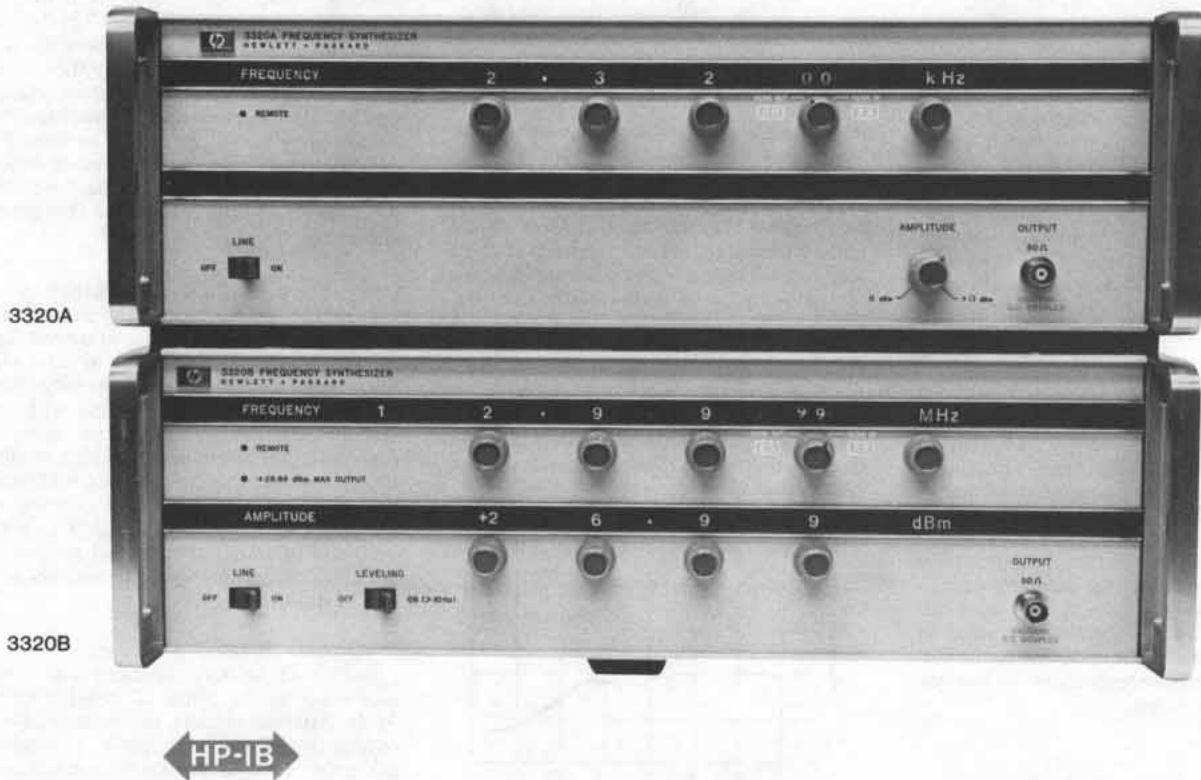

Description

The 3320A/B Frequency Synthesizer has the frequency accuracy, stability, and resolution demanded by many of today's exacting applications. The ease and flexibility of adding greater stability means the 3320A/B can be tailored to your needs as they emerge. Spectral purity and low signal-to-phase noise complement the frequency qualities of the 3320A/B.

The 3320B is more than a synthesizer. It offers precise level control, superior frequency response, low harmonic distortion and high power output.

Two choices of digital remote control afford great flexibility for today's system applications. High precision in both frequency and amplitude means that expensive system monitoring is unnecessary.

Frequency

The 3320A/B Frequency Synthesizer has a broad frequency range of 0.01 Hz to 13 MHz in seven frequency ranges.

Three digits plus a ten-turn two-digit continuous vernier, plus 30% overrange capability, gives the 3320A/B one part in 10^6 frequency resolution across its total frequency range.

Amplitude

The 3320A has a maximum one volt rms into 50 ohms output (+13 dBm) with a continuous +13 dBm to 0 dBm amplitude vernier.

The 3320B features a four-digit leveling loop with a 0.01 dB level

resolution of a calibrated output from +26.99 dBm to -69.99 dBm (-73.00 dBm under remote control).

Frequency response of ± 0.05 dB over range of 10 Hz to 13 MHz, and level accuracy of ± 0.05 dBm absolute at 10 kHz, complement the level capacity of the 3320B.

Programmability/remote control

The 3320A/B is a programmable signal source. Digital remote control capability may be purchased installed in the instrument, or may be added later if the need arises.

The 3320A, with its Option 003, allows parallel BCD remote control of frequency only. The first digit of the frequency vernier, the frequency range, and the main frequency digits may be controlled remotely.

The 3320B has two remote control options. Both options allow full control of all functions except the last vernier digit and the line switch. Option 004 is parallel BCD remote control capability. Option 007 (HP-IB) is a unique bit-parallel/word serial programming option. The Hewlett-Packard Interface Bus (HP-IB) provides a low-cost versatile way to interconnect instruments digitally.

Specifications

Frequency range: 0.01 Hz to 13 MHz in 7 ranges.

Frequency ranges: 10 MHz, 1000 kHz, 100 kHz, 10 kHz, 1000 Hz, 100 Hz and 10 Hz (optional). 30% overrange on all ranges.

Frequency resolution

Range	Vernier Out (local or remote)	Vernier In (local)	Vernier In (remote)
10 MHz	10 kHz	10 Hz	1 kHz
1000 kHz	1 kHz	1 Hz	100 Hz
100 kHz	100 Hz	0.1 Hz	10 Hz
10 kHz	10 Hz	0.01 Hz	1 Hz
1000 Hz	1 Hz	1 mHz	0.1 Hz
100 Hz	0.1 Hz	0.1 mHz	0.01 Hz
10 Hz	0.01 Hz	0.01 mHz	0.001 Hz

Frequency accuracy

Vernier out: ±0.001% of setting for 6 mo, 0°C to 55°C.

Vernier in: ±0.01% of range for 6 mo, 0°C to 55°C.

Frequency stability

Long term: ±10 parts in 10⁶ of setting per year (vernier out) with ambient temperature reference. Optional high stability crystal reference oven available (Option 002).

Signal-to-phase noise (integrated): >40 dB down in 30 kHz band, excluding ±1 Hz, centered on carrier. 10 MHz range, vernier out. Improves on lower frequency ranges.

Harmonic distortion: with output frequencies >0.1% of range at full output amplitude, any harmonically related signal will be less than the following levels: -60 dB with output from 5 Hz to 100 kHz; -50 dB with output from 100 kHz to 1 MHz; -40 dB with output from 1 MHz to 13 MHz.

Spurious: >60 dB down.

Internal frequency standard: 20 MHz crystal.

Phase locking: the 3320A/B may be phase locked with a 200 mV to 2 V rms signal that is any subharmonic of 20 MHz.

Rear panel output: front or rear panel output is standard.

Auxiliary outputs

Tracking outputs: 20 MHz to 33 MHz offset signal. >100 mV rms/50Ω.

1 MHz reference output: 220 mV rms/50Ω (>0 dBm/50Ω).

Low level output: same frequency as main output but remains between 50 mV rms and 158 mV rms (into 50Ω) depending on main output level setting.

3320A Amplitude section

Amplitude: maximum 1 V rms ±10% into 50Ω.

Amplitude range: 0 dBm to +13 dBm range through ¼ turn front panel control (not programmable).

Frequency response: ±2 dB over total range.

Output impedance: 50Ω (75Ω, Opt 001).

3320B Amplitude section

Amplitude range: +26.99 dBm (½ watt) to -69.99 dBm (-73.00 dBm under remote control) into 50Ω. (+26.99 dBm = 5 V rms into 50Ω).

Amplitude resolution: 0.01 dB.

Frequency response (10 kHz reference):

dc	10 Hz	13 MHz	
±0.5 dB	±0.05 dB		+26.99 dBm
	±0.1 dB		-3.00 dBm
	±0.2 dB		-23.00 dBm
	±0.4 dB		-53.00 dBm
			-73.00 dBm

Amplitude accuracy (absolute): +26.99 dBm, ±0.05 dB at 10 kHz and (20°C to 30°C).

Output impedance: 50Ω (75Ω Option 001).

Options

001 (3320A/B) 75 ohm: amplitude range (3320B only) +24.99 dBm to -69.99 dBm (-75.00 dBm under remote control) into 75Ω.

002 (3320A/B) crystal oven*: 5 MHz crystal in temperature stabilized oven. Long term stability: ±1 part in 10⁶/day; ±1 part in

10⁷/mo. Frequency accuracy: ±1 part in 10⁷ of setting per mo. For field installation order accessory kit HP 11237A.

003 (3320A only) BCD remote control*: allows digital remote control of frequency only on 3320A. The most significant digit of the vernier may be programmed, thus giving four digits, plus 30% over-range, control of frequency in seven ranges (two are optional). Frequency switching and settling time: ±0.1% of range, 15 ms, ±0.001% of range, 60 ms. For field installation order accessory kit HP 11238A.

004 (3320B only) BCD remote control*: allows digital remote control of frequency and amplitude. **Four digits of frequency, over-range, frequency range, Vernier In/Out, four digits of amplitude, and leveling loop response times are all controlled digitally. Frequency switching and settling time is ±0.01% of range, 15 ms; ±0.001% of range, 60 ms. Amplitude switching and settling time: <1.5 s to rated accuracy. For field installation, order accessory kit HP 11238C.

006 (3320A/B) 100 Hz, 10 Hz Ranges*: adds two lower frequency ranges, 100.0 Hz and 10.00 Hz, yielding greater resolution for low frequency outputs (see resolution section of specifications). These two ranges are fully programmable if digital remote options are installed. For field installation, order Accessory Kit HP 11240A.

007 (3320B only) HP-IB remote control*: allows bit-parallel word-serial remote control of all functions. **This fully-isolated option allows the 3320B to be interconnected with up to 14 additional HP-IB compatible instruments on a common interface bus. Using a unique addressing scheme, the 3320B can be singled out to receive its individual programming instructions on the bus. This permits several 3320B's to be interconnected to the same interface bus, each programmed to different frequencies and amplitudes. All front panel controls are disabled when in remote control. For field installation, order Accessory Kit, HP 11239C.

Logic Level Requirements for all Digital Remote Control Options.

State	Requirements
"Low" (logical "1")	0 V to 0.4 V (5 mA max.) or contact closure to ground through <80 ohms.
"High" (logical "0")	+2.4 V to +5 V or removal of contact closure to ground.

General

Operating temperature: 0°C to 55°C.

Storage temperature: -40°C to +70°C.

Power requirements: 115 V or 230 V ±10%, 48 Hz to 63 Hz, 110 VA max.

Weight

3320A: net, 14.4 kg (32 lb). Shipping, 18.1 kg (40 lb).

3320B: net, 15.9 kg (35 lb). Shipping, 19.5 kg (43 lb).

Size: 132.6 mm H, 425 mm W, 542.9 mm D (5¹/₂" × 16³/₄" × 21¹/₈").

Options and accessories

	Price
3320A/B Opt 001: 75Ω output	N/C
3320A/B Opt 002: Crystal Oven	\$500
3320A Opt 003: BCD remote control	\$370
3320B Opt 004: BCD remote control	\$450
3320A/B Opt 006: 100 Hz/10 Hz ranges	\$250
3320B Opt 007: HP-IB remote control	\$800
11048C: 50Ω feedthrough termination	\$17
11094B: 75Ω feedthrough termination	\$17
11473-74A: Balancing Transformers. (see page 55)	\$290
11475A: Balancing Transformers. (see page 55)	\$325

Ordering information

3320A Frequency Synthesizer	\$2730
3320B Frequency Synthesizer	\$3850

*Field installable.

**Except last vernier digit and line switch.



FREQUENCY SYNTHESIZERS

0.1 Hz to 13 MHz automatic synthesizer

Model 3330B

- HP-IB
- Digital sweeping of frequency and amplitude

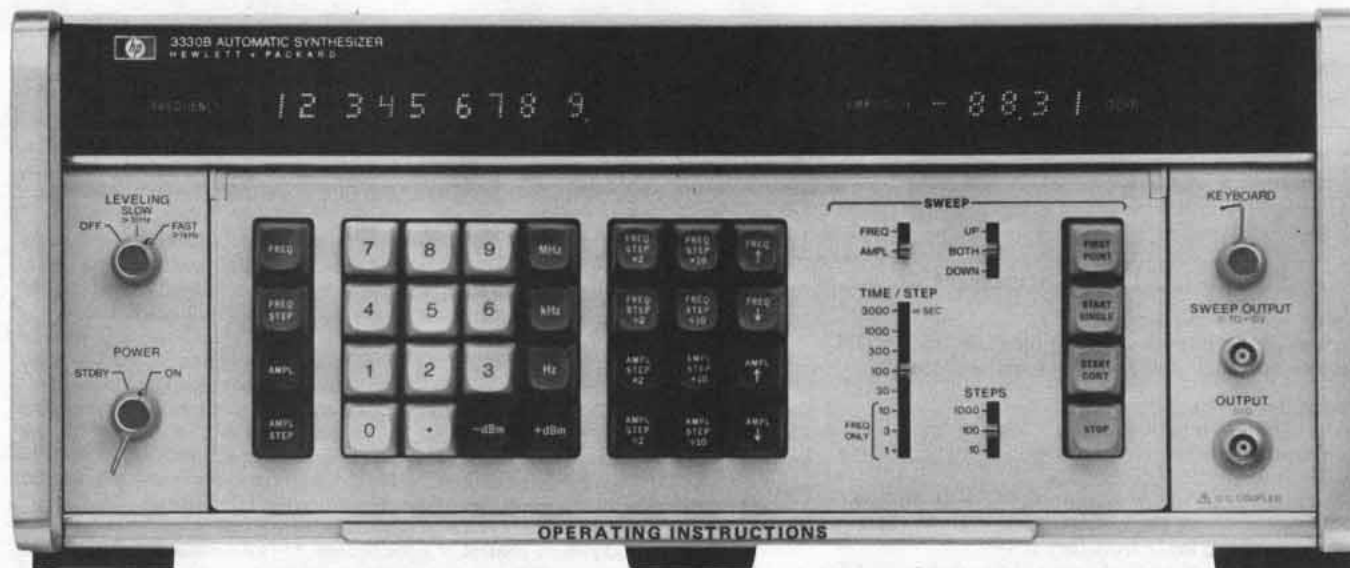

HP-IB

Description

The fully programmable (HP-IB) 3330B Frequency Synthesizer has a frequency stability of $\pm 1 \times 10^{-8}$ per day, -50 dB signal-to-phase noise, with a constant resolution of 0.1 Hz up to 13 MHz. Amplitude can be controlled to a resolution of 0.01 dB over a 100 dB range.

Solid-state displays show frequency and amplitude. Nine digits of frequency and four digits of amplitude are displayed on the Model 3330B.

Spectral purity, not normally associated with frequency synthesizers, is a unique feature of the 3330B. Spurious is >70 dB below the carrier and harmonics are >60 dB to 40 dB below the carrier, depending upon the frequency setting. As a sweeper, the 3330B uses digital sweeping for linearity. Either single or continuous sweeps may be set up. Parameters such as center frequency, frequency step, time per step, and the number of steps go into the memory, then are executed by pressing a single button. The ROM operates the sweep as set up until told to stop. Many of the sweep parameters can be changed while the instrument is sweeping. The instrument sweeps amplitude in steps as small as 0.01 dB. The amplitude can be stepped at the end of each frequency sweep cycle to produce a family of curves.

Specifications

Frequency range: 0.1 Hz to 13,000,999.9 Hz.

Frequency resolution: 0.1 Hz (8 digits + overrange).

Frequency stability

Long term: $\pm 1 \times 10^{-8}$ of frequency per day. $\pm 1 \times 10^{-7}$ of frequency per month.

Temperature: $\pm 1 \times 10^{-8}$ of frequency at $25^\circ\text{C} \pm 10^\circ\text{C}$. $\pm 1 \times 10^{-7}$ of frequency at 0°C to 55°C .

Signal to phase noise (integrated): 50 dB down in a 30 kHz band, excluding ± 1 Hz, centered on carrier.

Harmonic distortion: with full output amplitude, any harmonically related signal will be less than the following specified levels.

5 Hz to 100 kHz: -60 dB.

100 kHz to 1 MHz: -50 dB.

1 MHz to 13 MHz: -40 dB.

Spurious

All nonharmonically related spurious signals will be greater than 70

dB below selected output level or ≤ 110 dBm/50 Ω , whichever is greater.

Frequency switching and settling time: the time required for frequency switching and settling is a function of the largest frequency digit affected by the frequency change in question.

Largest digit changed	0.1 Hz or 1 Hz	10 Hz or 100 Hz	1 kHz or 10 kHz	100 kHz, 1 MHz or 10 MHz
Switching and settling time	<1 ms to within 500 μHz	<1 ms to within 0.05 Hz	<1 ms to within 5 Hz <50 ms to within 0.01 Hz	<1 ms to within 500 Hz; <50 ms to within 1 Hz

Internal frequency reference: 5 MHz crystal oscillator in temperature stabilized oven.

Frequency adjustments

Coarse: internal adjustment adequate for five years of aging.

Fine: one turn pot or ± 5 V dc for 1.2 to 2.5×10^{-7} max control with internal reference or 3×10^{-6} max control with rear panel switch in ext. ref. position without an external reference applied.

External frequency reference: the 3330B may be phase locked with a 200 mV to 2 V rms signal that is any subharmonic of 20 MHz from 1 MHz through 10 MHz.

Rear panel output: front or rear panel output is standard.

Auxiliary outputs

20 - 33 MHz tracking output: >100 mV rms/50 Ω .

1 MHz reference output: >220 mV rms/50 Ω (0 dBm/50 Ω).

Synthesized search or tune: a frequency step (0.1 Hz min) may be entered. This step may be added to or subtracted from the synthesized output signal. Rate of search or tune is selected by the time per step control.

Digital sweeping of frequency: accomplished by entering and setting the center frequency, a frequency step, number of steps, time per step, and sweep direction.

Sweep width: the product of the step size and number of steps.

Step size: continuously adjustable in 0.1 Hz increments.

Step accuracy: $\pm 1 \times 10^{-8}$ per day for standard reference crystal.

Number of steps: 10, 100, or 1000.

Time per step: 1 ms, 3 ms, 10 ms, 30 ms, 100 ms, 300 ms, 1000 ms, and 3000 ms.

Direction of sweep: up, both, down.

Single sweep: initiated by momentary pushbutton.
Continuous sweep: initiated by momentary pushbutton.
Manual sweep: accomplished by holding down the freq ↑ or freq ↓ keys. Display will follow output.
Sweep output: stepped dc voltage proportional to sweep position, 0 to +10V.
Accuracy: ±0.2% of full scale.
Linearity: ±0.1% of full scale.

Digital outputs

Step count: 0 to 1000 count on 12 BCD (1-2-4-8) lines to indicate sweep position.
Sweep status: line to indicate when instrument is sweeping.
Step ready: indicates instrument has spent the selected time per step and is ready to go to the next step.
Sweep modification (continuous): during a continuous sweep, the step size, center frequency, sweep direction, and time per step may be changed without stopping the sweep.
Center frequency modification: accomplished by pressing freq ↑ or freq ↓.
Frequency step: to widen or narrow the sweep width, the frequency step size may be expanded or contracted by factors of 2 or 10. The keys labeled freq step ×2, freq step ÷2, freq step ×10 and freq step ÷10 may be pressed.
Sweep modification (single): during a single sweep, the time per step and direction sweep may be changed without stopping the sweep.

Amplitude section

Amplitude: maximum 2.1 V rms into open circuit; maximum 1.05 V rms into 50Ω.
Amplitude range: +13.44 dBm to -86.55 dBm into 50Ω.
Amplitude resolution: 0.01 dB.
Output impedance: 50Ω (75Ω Opt 001).
Display: four digit readout in dBm with reference to 50Ω.
Leveled frequency response: (10 kHz reference) 10 Hz-13 MHz.*
 +13.44 dBm to -16.55 dBm: ±0.05 dB.
 -16.55 dBm to -36.55 dBm: ±0.1 dB.
 -36.55 dBm to -66.55 dBm: ±0.2 dB.
 -66.65 dBm to -86.55 dBm: ±0.4 dB.

Amplitude attenuator accuracy: ±0.02 dB/10 dB step (at 10 kHz) of attenuation down from maximum output.
Amplitude accuracy (absolute): ±0.05 dB at 10 kHz and +13.44 dBm (15°C ±5°C). (For absolute accuracy at other frequencies and amplitudes, add 0.05 dB to the leveled frequency response specification, plus the attenuator accuracy specification.)

Amplitude modulation: requires external modulation source. Rear panel BNC. ALC switch must be in slow position.

Modulating signal: 100 Hz to 100 kHz.

Modulation depth: 0.95 V rms modulating signal for 95% modulation depth.

Digital sweeping of amplitude: accomplished by entering and setting the center amplitude, an amplitude step, number of steps, time per step and sweep direction.

Type: linear and symmetrical about the center amplitude.

Sweep width: product of the step size and number of steps.

Step size: 0.01 dB to 99.99 dB in 0.01 dB increments.

Number of steps: 10, 100, or 1000.

Time per step: 30 ms, 100 ms, 1000 ms, 3000 ms.

Direction of sweep: up, both, down.

Single sweep: momentary pushbutton. Display follows output.

Continuous sweep: momentary pushbutton. Display of center amplitude or step.

Manual sweep: accomplished by holding down the ampl ↑ or ampl ↓ keys. Display will follow output. Sweep output, digital outputs, sweep

modification (continuous), sweep modification (single), all the same as with frequency sweep.

*Add ±0.5 dB for leveling off.

Digital remote control

Remote control of the 3330B is accomplished via the Hewlett-Packard Interface Bus (HP-IB) which is a standard feature of the instrument. Both the standard non-isolated HP-IB version and an optional isolated HP-IB version (Opt. 004) allow full programming of all frequency, amplitude and sweep functions.

The HP-IB interface allows the 3330B to be interconnected with up to 14 additional HP-IB compatible instruments on a common interface bus. Using an industry-standard addressing scheme, the 3330B can be singled out to receive its individual programming instructions. This permits multiple 3330B's, or other HP-IB sources, to be connected to the same interface bus, each programmed to different frequencies and amplitudes.

Connection of instruments to a system controller is vastly simplified since all HP-IB instruments are interfaced with a common I/O card and driver. Hewlett-Packard Models 9815A, 9825A, 9830A, 9831A and 9845A Calculators, and Models 21MX and 2100 Series computers are all compatible with HP-IB.

Options

001: 75 ohms-1 V rms (factory installation only). Attenuation and output referenced to 75Ω.

Amplitude range: +11.25 dBm to -88.74 dBm.

002: High Stability Crystal Oven.

Long term frequency stability: ±1 × 10⁻⁹ per day. +2 × 10⁻⁸ per month.

Long term temperature: ±1 × 10⁻⁹ total frequency at 25°C, ±10°C. ±1 × 10⁻⁸ total of frequency at 25°C, 0°C to +55°C.

Frequency adjustments: same as standard instrument.

003: deletion of Crystal Oven. 20 MHz ambient temperature crystal reference oscillator.

Frequency stability: ±10 parts in 10⁶/year.

Frequency adjustments: rear panel 1 turn pot or rear panel voltage control input for 30 × 10⁻⁶ maximum control.

004: isolated Digital Input (factory installation only). With this option, the digital input lines are electrically isolated from the signal ground. (HP-IB)

DC isolation: ±250 V.

AC isolation: >30 dB, 0 to 1 MHz.

005: 5 V rms-50 ohm output. This option gives the 3330B a ½ watt output.

Amplitude range: +26.99 dBm to -73 dBm into 50 ohms.

General

Operating temperature: 0°C to +55°C.

Storage temperature: -40°C to +70°C.

Turn on time: application of power to "On": 20 min to within ±1 × 10⁻⁷ of the final frequency.

"Standby" to "On": 15 s to full specifications.

Power requirements: 115 V or 230 V ±10%, 48 Hz to 63 Hz, 20 W standby, 200 W on.

Weight: net, 22.6 kg (53 lb). Shipping, 26.8 kg (63 lb).

Dimensions: 177 mm H × 426 mm W × 547 mm D (7" × 16¾" × 21½").

Options

001: 75Ω-1 V output

002: crystal oven

003: deletion of oven

004: isolated HP-IB

005: 5 V-50Ω output

Price

N/C

add \$610

less \$150

add \$460

add \$310

3330B Automatic Synthesizer

\$7400

FREQUENCY SYNTHESIZERS

1 μ Hz to 21 MHz Automatic Synthesizer

Model 3325A

- Function Generator
- Sweeper
- Programmable

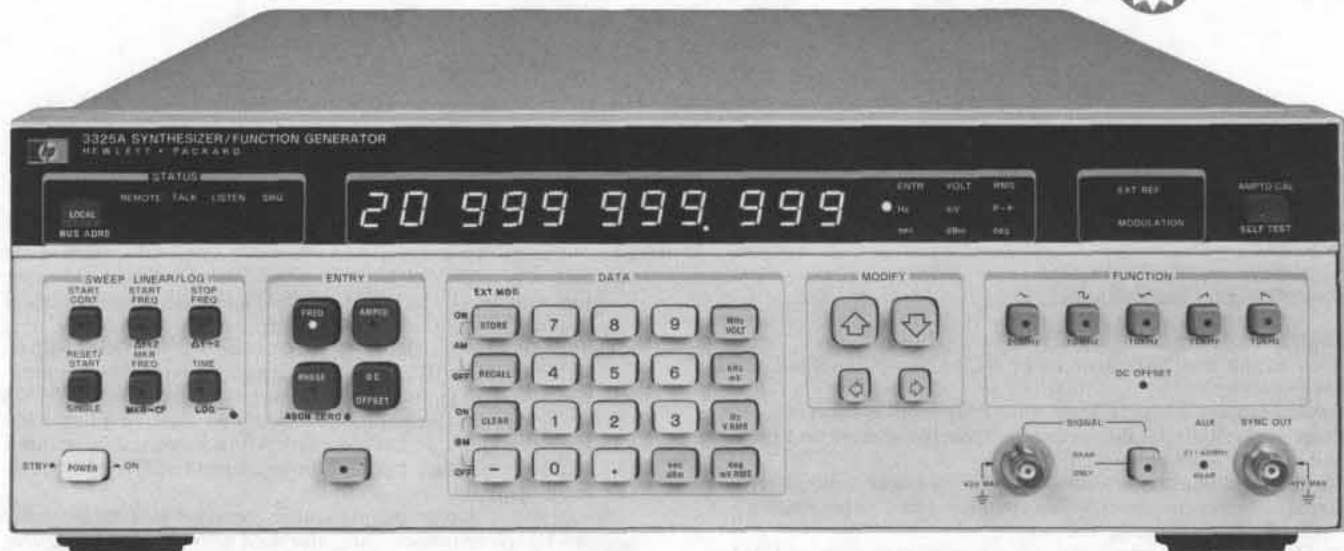

3325A



Description

The 3325A Synthesizer/Function Generator is an uncompromising, high performance synthesizer with 11 digit resolution, a function generator with precision waveforms, a wideband sweeper, and a fully programmable systems instrument.

Synthesizer

The 3325A is first with microhertz resolution below 100 kHz along with frequency coverage from .000001 Hz to 20.999 999 999 MHz. Signal purity, accuracy and stability are as good or better than earlier stand-alone HP synthesizers. Harmonics are 65 dB down below 50 kHz and you can externally modulate with AM and PM.

Function Generator

The 3325A is also a high performance function generator providing precision waveforms with synthesizer accuracy and resolution. Squarewaves to 10.999 999 999 MHz have 20 ns rise and fall times. Triangles and ramps with .05% linearity are available up to 10.999 999 kHz. All waveforms can be DC and phase offset.

A WIDEBAND SWEEPER

A major contribution is wideband phase continuous sweep, covering up to the full frequency range of each waveform. Sweep log or linear, single or continuous without the phase discontinuities usually associated with synthesizers. Phase lock loop testing is made easier.

Make convenient swept frequency network measurement on filters, amplifiers or any passive or active network. Use the TTL marker to check the frequency of points of interest on a swept frequency display desired. Use the convenient "zoom" functions $\Delta F \times 2$ and $\Delta F \div 2$ to quickly change the frequency span for the display desired.

FULLY PROGRAMMABLE

All necessary functions are programmable on the HP-IB, making the 3325A a very versatile and powerful addition to automatic test systems. The isolated interface combined with floating outputs and inputs and talk mode make the 3325A easy to use in Automatic Test Systems.

MORE FEATURES

The phase of the output can be changed $\pm 719.9^\circ$ with $.1^\circ$ resolution. The phase is advanced (or retarded) with respect to the starting

phase. Two 3325A units can be phase locked together for dual phase output applications.

Ten storage registers can be programmed with ten different combinations of function/parameter settings from the front panel, stored and then recalled.

The 3325A can display 11 digits of frequency and 4 digits of volts or millivolts from 1 mV to 10 volts peak to peak. Conversion to RMS or dBm is simple with the touch of a button.

NEW TECHNOLOGY

The 3325A provides unprecedented performance per dollar thanks to several major contributions from advances in HP technology. A single loop Fractional-N synthesis technique allows synthesizer accuracy with 11 digits of resolution, and as an added bonus... phase continuous frequency sweep. Fewer parts and integrated circuit technology make the difference. A unique method of triangle and ramp waveform generation provides excellent linearity. Add microprocessor control and Hewlett-Packard Interface Bus (HP-IB) operation and the result is more performance, flexibility and versatility on the bench, or in automatic test systems than previously available, and at a lower cost.

Specifications

Refer to the 3325A Data Sheet for complete specifications. Waveform specifications are shown in the "Oscillators and Function Generators" section, page 352.

Model 3325A

Waveforms

Sine, Square, Triangle, negative and positive Ramps

Frequency

Range:

Sine: 1 μ Hz to 20.999 999 999 MHz

Square: 1 μ Hz to 10.999 999 999 MHz

Triangle/Ramps: 1 μ Hz to 10.999 999 999 kHz

Resolution: 1 μ Hz, < 100 kHz
1 mHz \geq 100 kHz

Accuracy: $\pm 5 \times 10^{-6}$ of selected value, 20° to 30°C

Stability: $\pm 5 \times 10^{-6}$ /year, 20° to 30°C

Warm-up Time: 20 minutes to within specified accuracy

MAIN SIGNAL OUTPUT (All waveforms)

Impedance: 50 Ω

Connector: BNC; switchable to front or rear panel, nonswitchable with option 002, except by internal cable change. Output may be floated up to 42 V peak (AC + DC)

Amplitude

Range: 1 mV to 10 V p-p in 8 amplitude ranges, 1-3-10 sequence (10 dB steps), into 50 Ω load.

Function Units Displayed	Sine		Square		Triangle/Ramps	
	min	max	min	max	min	max
peak-peak	1.000 mV	10.00 V	1.000 mV	10.00 V	1.000 mV	10.00 V
rms	0.354 mV	3.536 V	0.500 mV	5.000 V	0.289 mV	2.887 V
dBm (50 Ω)	-56.02	+23.98	-53.01	+26.99	-57.78	+22.22

Resolution: 0.03% of full range or 0.01 dB (4 digits).

Amplitude Flatness and Accuracy (Sine):

10 Hz to 10 kHz: ± 0.1 dB ($\pm 1\%$) ≥ 3 V; ± 2 dB ($\pm 2\%$), < 3 V
 10 kHz to 10 MHz: ± 0.3 dB ($\pm 3\%$) ≥ 3 V; ± 5 dB ($\pm 5\%$), < 3 V
 10 MHz to 20 MHz: ± 5 dB ($\pm 5\%$) ≥ 1 V; ± 9 dB ($\pm 10\%$), < 1 V

Sinewave Spectral Purity

Phase Noise: -54 dB for a 30 kHz band centered on a 20 MHz carrier (excluding ± 1 Hz about the carrier).

Spurious: All non-harmonically related output signals will be more than 70 dB below the carrier (60dB with DC offset), or less than -90 dBm, whichever is greater.

Sinewave Harmonic Distortion: Harmonically related signals will be less than the following levels (relative to the fundamental) at full output for each range:

Frequency Range	Harmonic Level
10 Hz to 50 kHz	-65 dB
50 kHz to 200 kHz	-60 dB
200 kHz to 2 MHz	-40 dB
2 MHz to 15 MHz	-30 dB
15 MHz to 20 MHz	-25 dB

Phase Offset

Range: $\pm 719.9^\circ$ with respect to arbitrary starting phase or assigned zero phase

Resolution: $.1^\circ$

Accuracy: $\pm .2^\circ$

DC Offset

Range: DC only (no AC signal): 0 to ± 5.0 V/50 Ω .

DC + AC: Maximum DC offset ± 4.5 V on highest range, decreasing to ± 4.5 mV on lowest range.

Resolution: 4 digits

Sinewave Amplitude Modulation

Modulation depth at full output for each range: 0-100%

Modulation frequency range: DC -50 kHz (0-21 MHz carrier frequency)

Envelope distortion: -30 dB to 80% modulation at 1 kHz, 0 VDC offset

Sensitivity: ± 5 V peak for 100% modulation

Connector: Rear panel BNC

Input impedance: 20 k Ω

Sinewave Phase Modulation

Range: $\pm 850^\circ$, ± 5 V input

Linearity: $\pm 0.5^\circ$, best fit straight line

Modulation frequency range: DC -5 kHz

Connector: Rear panel BNC

Input impedance: 20 k Ω

Frequency Sweep

Sweep time

Linear: 0.01 s to 99.99 s

Logarithmic: 2 s to 99.99 s single, 0.1 s to 99.99 s continuous

Maximum sweep width: Full frequency range of the main signal output for the waveform in use, except minimum log start frequency is 1 Hz.

Phase continuity: Sweep is phase continuous over the full frequency range of the main output.

AUXILIARY INPUTS AND OUTPUTS

Reference input: For phase-locking 3325A to an external frequency

reference signal from 0 dBm to +20 dBm into 50 Ω . Reference signal must be a subharmonic of 10 MHz from 1 MHz to 10 MHz.

Auxiliary frequency output:

Frequency range: 21 MHz to 60.999 999 999 MHz, under range coverage to 19.000 000 001 MHz, frequency selection from front panel.

Amplitude: 0 dBm; output impedance: 50 Ω

Sync output: Square wave with V (high) ≥ 1.2 V, V (low) ≤ 0.2 V into 50 Ω .

X-Axis drive: 0 to +10 V DC linear ramp proportional to sweep frequency, linearity, 10-90%, $\pm .1\%$ of final value.

Sweep marker output: High to low TTL compatible voltage transition at keyboard selected marker frequency.

Z-Axis blank output: TTL compatible voltage levels capable of sinking current from a positive source. Current 200 mA, voltage 45 V, power dissipation 1 watt maximum.

1 MHz reference output: 0 dBm output for phase-locking additional instruments to the 3325A.

10 MHz oven output: 0 dBm internal high stability frequency reference output for phase-locking 3325A. (Opt. 001 only)

HP-IB Control

Frequency switching time to within 1 Hz (exclusive of programming time): ≤ 10 ms for 100 kHz step, ≤ 25 ms for 1 MHz step, ≤ 70 msec for 20 MHz step.

Phase switching time to within 90° of phase lock (exclusive of programming time): ≤ 15 ms.

Amplitude switching and settling time (exclusive of programming time): < 30 ms to within amplitude accuracy specifications.

Option 001 High Stability Frequency Reference

Aging rate: $\pm 5 \times 10^{-8}$ /week, 1×10^{-7} /mo.

Accuracy: $\pm 5 \times 10^{-8}$ (0° to $+50^\circ\text{C}$).

Warm-up time: Reference will be within $\pm 1 \times 10^{-7}$ of final value 15 minutes after turn-on at 25°C for an off time of less than 24 hours.

Option 002 High Voltage Output

Frequency range: 1 μHz to 1 MHz

Amplitude

Range: 4.000 mVpp to 40.00 Vpp (500 Ω , < 500 pf load).

Accuracy and Flatness at Full Output:

Sine and squarewave: ± 2 dB ($\pm 2\%$), 10 Hz - 10 kHz; $\pm .9$ dB ($\pm 10\%$) 10 kHz - 1 MHz

Trianglewave: ± 2 dB ($\pm 2\%$) 10 Hz - 2 kHz; ± 6 dB ($\pm 6\%$) 2 kHz - 10 kHz

Ramps: ± 2 dB ($\pm 2\%$) 10 Hz - 2 kHz; ± 1.0 dB ($\pm 11\%$) 2 kHz - 10 kHz

Sinewave distortion: Harmonically related signals will be less than the following levels (relative to the fundamental full output into 500 Ω , load): 10 Hz - 50 kHz: -65 dB

50 kHz - 200 kHz: -60 dB

200 kHz - 1 MHz: -40 dB

Maximum output current: 40 mApp.

Output impedance: < 2 Ω at DC, < 10 Ω at 1 MHz

DC Offset Range: 4 times the specified range of the standard instrument.

GENERAL

Operating Environment:

Temperature: 0°C to 55°C .

Relative humidity: 95%, 0°C to 40°C .

Altitude: $\leq 15,000$ ft.

Storage temperature: -40°C to $+75^\circ\text{C}$.

Storage altitude: $\leq 50,000$ ft.

Power: 100/120/220/240 V, $+5\%$, -10% , 48 to 66 Hz; 60 VA, 100 VA with all options; 10 VA standby.

Weight: 9 kg (20 lbs.) net; 14.5 kg (32 lbs.) shipping

Dimensions: 132.6 mm high \times 425.5 mm wide \times 497.8 mm deep ($5 \frac{1}{4} \times 16 \frac{3}{4} \times 19 \frac{5}{8}$ ")

Accessories: 11356A Ground Isolator for breaking signal grounds between input/output connectors.

Ordering Information

3325A Frequency Synthesizer

Opt. 001 High Stability Frequency Reference

Opt. 002 High Voltage Output

11356A Ground Isolator

Price
 \$3000
 add \$550
 add \$200
 \$50

FREQUENCY SYNTHESIZERS

200 Hz to 80 MHz automatic synthesizer

Model 3335A



- 1 mHz Resolution
- High Spectral Purity
- Precision Amplitude Control
- Program Storage
- HP-IB

Description

Covering a frequency range of 200 Hz–80 MHz, the 3335A Synthesizer/Level Generator has performance characteristics that make it ideally suited for the telecommunications industry, as well as for traditional synthesizer applications, including testing of Frequency Division Multiplex (FDM) equipment as well as R & D and production testing of communications systems. It features precision level control, milliHertz resolution, high spectral purity, internal frequency sweep, HP-IB programmability and numerous user conveniences.

Internal Storage

Up to 10 different front panel settings (frequency, level, \emptyset incr, etc.) can be stored in internal memory registers for later recall. The DISPLAY key allows viewing of register contents without altering the synthesizer output.

Precision Amplitude

Increasing channel capacity of Frequency Division Multiplex (FDM) systems is continually placing more stringent requirements on the testing of transmission parameters. To meet these performance standards, the 3335A incorporates a state-of-the-art attenuator resulting in attenuator accuracies of up to ± 0.03 dB over the 80 MHz frequency range.

Programmability

The 3335A is fully programmable via the Hewlett-Packard Interface Bus (HP-IB), HP's implementation of IEEE Standard 488–1975. Most Hewlett-Packard 9800 Series Programmable Calculators, as well as Models 21 MX and 2100 series minicomputers, are easily interfaced to the HP-IB.

Frequency Stability

The 3335A synthesizes its output frequency from an internal temperature-controlled crystal oscillator which provides $\pm 1 \times 10^{-9}$ /day frequency stability ($\pm 5 \times 10^{-10}$ is optional). The 3335A can also be phase-locked to any external frequency standards.

Automatic Frequency Sweep

The 3335A combines the precision frequency accuracy and stability of a synthesizer with the time-saving convenience of a digital sweeper.

SLMS - Tracking Generator

The 3335A operates as a tracking generator with the HP 3745A/B Selective Level Measuring Set (SLMS) for automatic or semi-auto-

matic testing of FDM systems. For closed-loop tracking where the 3335A and 3745A/B are in the same location, the frequency of the generator is controlled by the microprocessor in the SLMS.

Abbreviated Specifications

(complete specifications are shown on the 3335A data sheet.)

Frequency

Range: 200 Hz–80.999 999 999 MHz.

Resolution: 0.001 Hz.

Stability (higher stability available with Opt 001): $\pm 1 \times 10^{-9}$ /day; $\pm 1 \times 10^{-7}$ /month.

Frequency switching and settling time: <20 ms to within 90° of final phase.

Spectral purity

Harmonic components (relative to fundamental, full output):

200 Hz – 10 MHz: –45 dB.

10 MHz – 80 MHz: –40 dB.

Spurious: all non-harmonically related outputs will be greater than 75 dB below the carrier or –125 dBm, whichever is greater.

Integrated phase noise (30 kHz band, excluding ± 1 Hz centered on the carrier): 9.9 MHz: –63 dB; 20 MHz: –70 dB; 40 MHz: –64 dB; 80 MHz: –58 dB.

Amplitude

Range

50 Ω : +13.01 dBm to –86.98 dBm; 75 Ω : +11.25 dBm to –88.74 dBm.

Resolution: 0.01 dB.

Absolute accuracy (full amplitude at 100 kHz, 10°C to 35°C): ± 0.05 dB

Note: To determine absolute accuracy tolerances at other frequencies or amplitudes, the flatness and attenuator specifications must be added to the above accuracy specification.

Flatness (relative to 100 kHz, full amplitude): 1 kHz – 25 MHz: ± 0.07 dB; 200 Hz – 80 MHz: ± 0.15 dB.

Attenuator

Range: 98 dB in 2 dB steps.

Accuracy (1 year)

Z ₀	ATTENUATION (dB)	FREQUENCY		
		200 Hz	25 MHz	80 MHz
50 Ω	0 to 18	± 0.03 dB		
75 Ω		± 0.04 dB	± 0.15 dB	
50 Ω	20 to 58	± 0.07 dB		
75 Ω		± 0.09 dB	± 0.25 dB	
50 Ω	60 to 98	± 0.2 dB		
75 Ω		± 0.2 dB	± 0.50 dB	

Amplitude switching time: <500 ms to within ± 0.02 dB of final value.

Sweep characteristics

Sweep Modes:

Single: 10 or 50s single sweep from min. to max. frequency.
Auto: repetitive sweep from min. to max. frequency at a nominal 125 ms rate.
Number of steps: 10 sec., 50 sec., MANUAL: 1000 steps; AUTO (125 ms): 100 steps.
Phase discontinuities: there will be no significant phase discontinuities provided the following breakpoints are not crossed:
 200 Hz - <10 MHz: 1MHz points, e.g. 1 MHz, 2 MHz, etc.
 10 MHz - <20 MHz: 250 kHz points, e.g. 10.25 MHz, 10.5 MHz, etc.
 20 MHz - <40 MHz: 500 kHz points.
 40 MHz - 80 MHz: 1 MHz points.

Opt 001 (high stability frequency reference)

Aging rate: $\pm 5 \times 10^{-10}$ /day; $\pm 2 \times 10^{-8}$ /month; $\pm 1 \times 10^{-7}$ /year.

Opt 002/004

For specifications not listed below, refer to standard instrument specifications, or the 3335A data sheets.

Frequency

Range: 75 Ω : 200 Hz-80.999 999 999 MHz; 124 Ω : 10 kHz-10 MHz; 135 Ω : 10 kHz-2 MHz.
Resolution: .001 Hz.

Amplitude

Range: +11.25 dBm to -88.74 dBm.

Resolution: 0.01 dB.

Flatness (relative to 100 kHz at full amplitude):

75 Ω : 1 kHz - 25 MHz: ± 0.07 dB; 200 Hz - 80 MHz: ± 0.15 dB
 124 Ω : 50 kHz - 10 MHz: ± 0.15 dB; 10 kHz - 10 MHz: ± 0.40 dB
 135 Ω : 10 kHz - 2 MHz: ± 0.18 dB
Accuracy at full output (100 kHz, 10°C to 35°C): 75 Ω : ± 0.05 dB; 124 Ω /135 Ω : ± 0.10 dB

Amplitude accuracy (includes the effects of flatness and attenuator)

75 Ω	200 Hz	1 kHz	25 MHz	80 MHz
+ 11.25				
- 8.74	± 0.25 dB	± 0.15 dB	± 0.35 dB	
-48.74	± 0.30 dB	± 0.20 dB	± 0.45 dB	
-88.74	± 0.40 dB	± 0.30 dB	± 0.70 dB	

124 Ω	10 kHz	50 kHz	10 MHz
+ 11.25			
- 8.74	± 0.60 dB	± 0.35 dB	
-48.74	± 0.65 dB	± 0.40 dB	
-70.0*	± 1.1 dB	± 0.85 dB	

135 Ω	10 kHz	2 MHz
+ 11.25		
- 8.74	± 0.35 dB	
-48.74	± 0.40 dB	
-70.0*	± 0.85 dB	

*Levels down to -88.74 dBm can be selected, however, accuracies are unspecified due to spurious noise floor of -100 dBm.

Outputs

Output Impedances: 75 Ω unbalanced, 124 Ω balanced, 135 Ω balanced
Signal Balance (100 kHz): >60 dB.

Opt 002

75 Ω : commercial equivalent of WECO type 477B (accepts WECO plug 358A).
 124 Ω : commercial equivalent of WECO type 477B at 16 mm (0.625") spacings (accepts WECO plug 372A)
 135 Ω : commercial equivalent of WECO type 223A at 16 mm (0.625") spacings (accepts WECO plug 241A).

Opt 004

75 Ω : commercial equivalent of WECO type 560 A (accepts WECO plug 439A or 440A).
 124 Ω : commercial equivalent of WECO type 560A at 12.7 mm (0.5") spacings (accepts WECO plug 443A).
 135 Ω : commercial equivalent of WECO type 223A at 16 mm (0.625") spacings (accepts WECO plug 241A).

Opt 003

Frequency

Range: 75 Ω : 200 Hz - 80.999 999 999 M Hz; 150 Ω : 10 kHz - 2 M Hz
Resolution: .001 Hz.

Amplitude

Range: + 11.25 to -88.74 dBm.

Resolution: 0.01 dB.

Flatness (relative to 100 kHz at full amplitude): 75 Ω : 1 kHz-25 MHz: ± 0.07 dB, 200 Hz-80 MHz: ± 0.15 dB; 150 Ω : 10 kHz-2 MHz: ± 0.18 dB.

Accuracy at full output (100 kHz, 10°C to 35°C): 75 Ω : ± 0.05 dB; 150 Ω : ± 0.10 dB.

Amplitude accuracy (includes the effects of flatness and attenuator)

75 Ω	200 Hz	1 kHz	25 MHz	80 MHz
+ 11.25				
- 8.75	± 0.25 dB	± 0.15 dB	± 0.35 dB	
-48.74	± 0.30 dB	± 0.20 dB	± 0.45 dB	
-88.74	± 0.40 dB	± 0.30 dB	± 0.70 dB	

150 Ω	10 kHz	2 MHz
+ 11.25		
- 8.74	± 0.35 dB	
-48.74	± 0.40 dB	
-70.0*	± 0.85 dB	

*Levels down to -88.74 dBm can be selected, however accuracies are unspecified due to spurious noise floor of -100 dBm.

Outputs

Output Impedances: 75 Ω Unbalanced, 150 Ω Balanced

Signal Balance (100 kHz): >60 dB

Connectors

75 Ω : BNC; 150 Ω : Pair of BNC's at 20 mm (0.8") spacings

General

Operating environment

Temperature: 0°C to 55°C.

R.H.: <95%, 0°C to +40°C.

Storage temperature: -40°C to +75°C.

Power: 100/120/220/240 V, +5%, -10%; 48 to 66 Hz; 195 VA.

Weight: net: 18.2 kg. (40 lbs). Shipping: 26.8 kg. (59 lb).

Size: 132.6 mm H x 425.5 mm W x 497.8 mm D (5 1/4" x 16 3/4" x 19 3/8").

Ordering information

3335A

Opt 001

Opt 002

Opt 003

Opt 004

Prices effective in U.S.A. only.

Price

\$7000

add \$580

add \$300

add \$200

add \$300

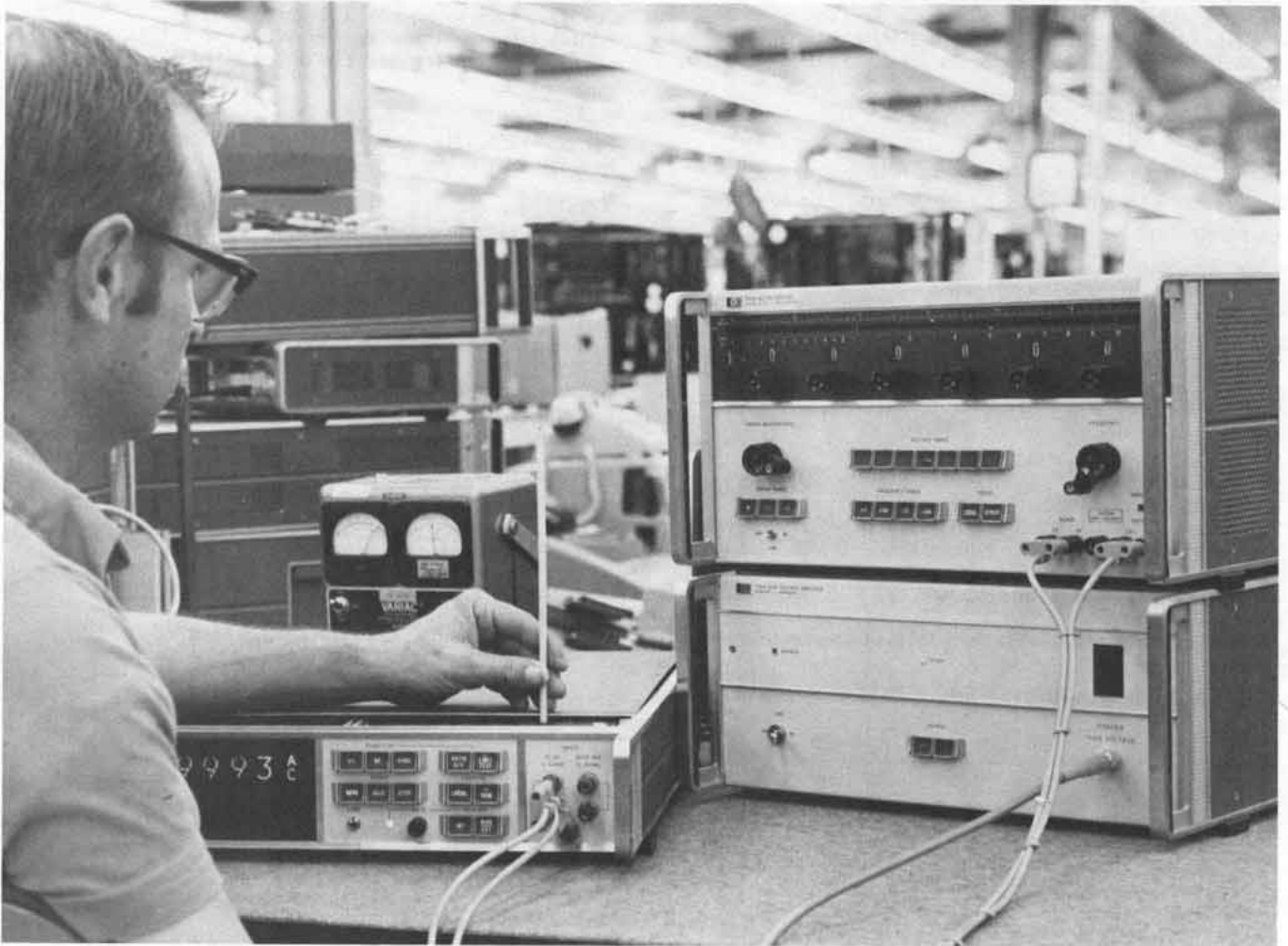

Table 1.

FUNCTION	RANGE	RESOLUTION	MODEL NO.	PAGE
AC volts	1 mV-1000 V*	1 ppm	745A	370
AC volts DC volts AC amps DC amps	0.01V-1000V	3 digits	6920B	369

Hewlett-Packard calibration instruments provide accurate and precise dc and ac stimulus for your calibration needs. Accurate dc voltage measurements capability to 1000 volts is also available for testing dc power supplies and other precision dc sources. See Table 1 for a list of instrument features.

*X10 Amplifier for 745A

CALIBRATORS

AC/DC meter calibrator

Model 6920B



- Calibrate/test DC ammeters up to 4 amps
- Calibrate/test average-reading AC ammeters up to 5 amps

- Calibrate/test DC voltmeters up to 1000 volts
- Calibrate/test average-reading AC voltmeters up to 1000 volts



Specifications

Output voltage ranges

- 0.01-1 V:** current capability 0-5 A.
- 0.1-10 V:** current capability 0-1 A.
- 1-100 V:** current capability 0-100 mA.
- 10-1000 V:** current capability 0-10 mA.

Above output voltage ranges and maximum current capabilities for each range apply for either dc or ac operation.

Output current ranges (5 A maximum output)

- 1-100 μ A:** voltage capability 0-500 V (uncalibrated in AC).
- 0.01-1 mA:** voltage capability 0-500 V.
- 0.1-10 mA:** voltage capability 0-500 V.
- 1-100 mA:** voltage capability 0-50 V.
- 0.1-10 A:** voltage capability 0-5 V.
- 0.1-10A:** (5 A max. output) voltage capability 0-0.5 V.

Above output current ranges and maximum voltage capabilities for each range apply for either dc, 50 Hz or 60 Hz operations.

Output accuracy: DC—0.2% of set value plus 1 digit. AC—0.4% of set value plus 1 digit (when used with average-reading meters). Above accuracy applicable over a temperature range from 15°C to 35°C, over full input voltage range, and after 1-hour warmup.

Controls

Function switch: 3-positions: OFF, AC, and DC. In the OFF position the ac power input is disconnected from the unit. In the AC position the meter calibrator produces an ac output, and in the DC position the calibrator produces a dc output.

Range switch: 10 positions, one for each voltage and current range.

Calibrated output control: digital potentiometer readout control (3 significant digits) determines exact value of output.

Output switch: switch described at left.

Output terminals: two front panel terminals are provided; these are the output terminals for both ac and dc operation. In voltage ranges, the negative terminal is grounded.

Ripple: in dc operation the output ripple is typically less than 1.0% rms/5% p-p of the output range switch setting.

Input: 115 V ac \pm 10%, single-phase, 58-62 Hz, 0.7 A, 65 W max. (See Options 005 and 028 for 50 Hz and 230 V ac operation).

Operating temperature range: 0°C-50°C; convection cooled.

Size: 172 H x 198 W x 279 mm D (6 $\frac{3}{4}$ " x 7 $\frac{9}{16}$ " x 11").

Weight: net, 6.8 kg (15 lb). Shipping 7.71 kg (17 lb).

Options

005: 50 Hz output regulation realignment

028: 230 V ac \pm 10%, single phase input

Price
N/C
N/C

Accessories

5060-8762 Rack kit for mounting one or two 6920B's in a 19" rack

\$65

5060-8760 Filler panel to block unused half of rack adapter

\$17.50

6920B Meter calibrator

\$1045

Description

Model 6920B is a versatile ac/dc meter calibrator, capable of both constant-voltage and constant-current output. Its absolute accuracy makes it suitable for laboratory or production testing of panel meters, multimeters, and other meters having accuracy on the order of 1.0% or higher. This calibrator has been designed for convenience, and combines in one instrument all the outputs needed to test the most commonly used meters.

Output switch

The output switch has two ON positions. The ON TEST position has a momentary contact and output is obtained only while the switch is held ON. This is convenient when several full scale readings are being checked successively and the meter and calibrator are being switched through their ranges. The ON HOLD position is used when continuous output is desired.

AC output waveshape

When the function switch is set on AC, the output wave-shape is sinusoidal (to a first approximation) and has the same frequency as the input line power applied to the instrument (except when an external ac reference is used). The feedback loop, which controls and regulates this ac, is actually monitoring the average value of the ac output although the front panel controls are calibrated in terms of rms. Thus, this calibrator is suitable for use with average-reading ac voltmeters scaled in rms. In addition, the calibrator can be used with true-rms meters, provided allowance is made for the total output distortion. This distortion is approximately equal to the line input waveshape distortion (or distortion of the external ac reference) plus 3%.

CALIBRATORS

AC calibrator, high voltage amplifier

Models 745A & 746A



Description

Hewlett-Packard's Model 745A AC Calibrator combined with Model 746A High Voltage Amplifier is a compact, calibrated AC source with continuously adjustable frequency output from 10 Hz to 110 kHz. Output voltage can be varied from 0.1 mV to 1099.999 V in steps as small as 1 ppm of range over the entire frequency range.

HP's 745A provides the first six voltage ranges, 0.1 mV to 109.9999 V, while the combination of the 745A and 746A permits expansion to 1099.999 V as a seventh range. Model 746A can only be used with the 745A.

Specifications

Ranges

Output voltage ranges: seven ranges with 10% overrange as follows:

Range	Settability and resolution
1 mV	0.100000 mV to 1.099999 mV in 1 nV steps
10 mV	1.00000 mV to 10.99999 mV in 10 nV steps
100 mV	10.0000 mV to 109.9999 mV in 100 nV steps
1 V	0.100000 V to 1.099999 V in 1 μ V steps
10 V	1.00000V to 10.99999 V in 10 μ V steps
100 V	10.0000V to 109.9999 V in 100 μ V steps
1000 V	100.000 V to 1099.999 V in 1 mV steps.

Output voltage from 100 μ V to 110 V are available from 745A output terminals; voltages from 100 V to 1100 V are available from the 746A output cable.

Output frequency ranges: continuously adjustable from 10 Hz to 110 kHz in four decade ranges with 10% overlap.

Error measurement: two ranges with zero center dial; $\pm 0.3\%$, $\pm 3\%$. A zero range is provided to easily switch out the effects of the error measurement system.

Performance rating

Accuracy: accuracy holds for a 90-day period and is met after a one-hour warm-up period at $25^\circ\text{C} \pm 5^\circ\text{C}$ with $<95\%$ RH. This applies only to the 745A. Warm-up time required for HP's 746A is approximately 30 s.

Voltage: specifications are absolute, traceable to National Bureau of Standards.

1 mV to 100 V ranges

Frequency	Accuracy
50 Hz to 20 kHz	$\pm (0.02\%$ of setting + 0.002% of range + $10 \mu\text{V}$)
20 Hz to 50 Hz 20 kHz to 110 kHz	$\pm (0.05\%$ of setting + 0.005% of range + $50 \mu\text{V}$)
10 Hz to 20 Hz	$\pm (0.2\%$ of setting + 0.005% of range + $50 \mu\text{V}$)

1000 V range

Frequency	Accuracy
50 Hz to 20 kHz	±0.04% of setting
20 Hz to 50 Hz 20 kHz to 50 kHz	±0.08% of setting
50 kHz to 110 kHz	±0.15% of setting
10 Hz to 20 Hz	± (0.2% of setting + 0.005% of range)

Frequency: ±(2% of setting +0.2% of end scale).
Error measurement: ±(0.5% of setting +0.5% of range).

Temperature coefficient

Voltage: 1 mV to 100 V ranges: ±0.0003% of setting per °C, 0°C to 55°C. 1000 V range: ±0.0005% of setting per °C, 0°C to 55°C.
Frequency: ±0.05% of end scale per °C, 0°C to 55°C. Derate accuracy specification by this temperature coefficient for operation in temperature range of 0°C to 20°C and 30°C to 50°C.

Voltage stability: stability met after one-hour warm-up period at constant temperature with <95% RH. 1 mV to 100 V ranges:

Long-term: ±0.01% of setting for six months.
Short-term: ±0.005% of setting for 24 hours.

1000 V range

Long-term: 50 Hz to 20 kHz: ±0.01% of setting for six months; 10 Hz to 50 Hz and 20 kHz to 110 kHz: ±0.02% of setting for six months.
Short-term: ±0.005% of setting for 24 hours.

Output characteristics

Total distortion and noise: 0.05% of setting + 10 μV over 100 kHz bandwidth on all ranges.

Total distortion, cycle-to-cycle instability and noise: will cause <±0.005% of error when used to calibrate an average-responding or true rms-responding instrument from 1 mV to 1100 V.

Load regulation (no load to full load)

Output impedance: <1Ω on 1 mV, 10 mV, 100 mV ranges. On the 1 V, 10 V, 100 V, and 1000 V ranges for output current equal to or less than that shown in the diagram below, error is included in the accuracy specification.

Load capability: 1000 pF or 50 mA on 1 mV to 100 V ranges (50 mA allows 800 pF at 100 V, 100 kHz). 1000 pF or 63 mA on 1000 V range (63 mA allows 100 pF at 1000 V, 100 kHz).

Line regulation: ±0.001% of setting change in output voltage for a 10% change in line voltage (included in accuracy specs).

Output terminals: high and low output terminals can be floated ±500 V dc above chassis ground.

Counter output: frequency counter output on 745A rear panel, 2.2 V ± 50%, protected against short circuits.

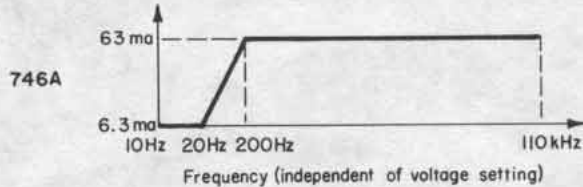

Remote programming

Voltage range, frequency range, error range, and senses	Requirements
Contact closure	Less than 400Ω to ground
NPN transistor	Open circuit voltage 5 V Short circuit current 2 mA Maximum voltage on programming line at closure 0.8 V.
Reed switch through diode	
NPN transistor through diode	
Frequency vernier	Minimum to maximum of range
Analog voltage	+1 V to +10 V DC
Resistance to ground	500Ω—10kΩ

General

Operating temperature: 0°C to 55°C.

Storage temperature: -40°C to +75°C.

RFI: meets MIL-I-6181D when using shielded output connectors.

Power

745A: 115 V or 230 V ± 10%, 50 Hz to 66 Hz, 100 VA max.

746A: 115 V or 230 V ± 10%, 50 Hz to 60 Hz, 850 VA max.

746 aux power rated at 120 VA max.

Weight

745A: net, 29.3 kg (65 lb). Shipping, 36.3 kg (80 lb).

746A: net, 34 kg (75 lb). Shipping, 38.5 kg (85 lb).

Dimensions

745A: 221 mm H x 425 mm W x 467 mm D (8.75" x 16.75" x 18.37").

746A: 177 mm H x 425 mm W x 464 mm D (7" x 16.75" x 18.25").

745A Accessories furnished

Rack mount kit.

HP Part No. 5060-0630, 22-pin printed circuit board extender.

HP Part No. 5060-0043, 15-pin printed circuit board extender.

HP Part No. 5060-0031, 10-pin printed circuit board extender.

HP Part No. 1251-0084 remote programming plug.

746A Accessories furnished

Rack mount kit.

HP Part No. 1251-0485, remote right angle connector.

HP Part No. 1450-0356, incandescent lamp.

HP Part No. 4040-0427, extractor.

HP Part No. 5040-0404, probe holder.

HP Part No. 5060-0216, joining kit bracket.

HP Part No. 5060-0630, 22-pin printed circuit board extender.

HP Part No. 00746-02701, foam filter.

Ordering information

745A AC Calibrator

746A High Voltage Amplifier

Price

\$5775

\$3750

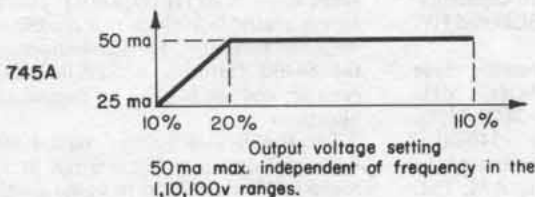



Signal generators

Hewlett-Packard offers a complete line of easy to use HF, VHF, UHF, and SHF signal generators covering frequencies between 10 kHz and 40 GHz. This line includes synthesized signal generators and solid-state generators as well as a complete line of performance-proven vacuum tube signal generators. Each includes the following features: 1) accurate, easy-to-read frequencies, calibrated and variable; 2) accurately calibrated variable output level; 3) wide modulation capability.

Beside these basic features, HP signal generator characteristics ensure the utmost convenience and accuracy for all kinds of measurements and signal simulations, including receiver sensitivity, selectivity or rejection, signal-to-noise ratio, gain bandwidth characteristics, conversion gain, antenna gain, and transmission line characteristics, as well as power to drive bridges, slotted lines, filter networks, etc.

2 to 18 GHz microwave synthesized signal generator

HP's newest signal generator, Model 8672A, provides AM/FM capability and calibrated output usually associated only with signal generators, along with the resolution, spectral purity, stability and programmability of a high quality synthesizer. The HP 8672A covers 2 to 18 GHz with output from +3 to -120 dBm.

A companion unit, the HP 8671A, is a synthesizer only, with a minimum of +8 dBm

from 2 to 6.2 GHz and FM only. Both units are programmable via the HP Interface Bus.

The HP 8672A will find application in several important areas: 1) As a programmable signal simulator in automatic test systems; 2) For satellite receiver testing requiring highly stable (5×10^{-10} /day) signals; 3) for general purpose lab use where its multiband capability can replace a benchful of separate band generators; and, 4) for production use where short runs require different frequency ranges from run to run.

The 8671A will serve in local oscillator applications requiring up-conversion or multiplication for satellite communications or radio astronomy. SSB noise is -89 dB/Hz below the carrier at a 10 kHz offset. Nonharmonic spurious is -70 dB.

10 kHz to 2600 MHz synthesized generator

The HP 8660A/C is a particularly versatile synthesized generator family. Two mainframes are available. The 8660A utilizes thumbwheel switches for frequency selection. The 8660C mainframe has a more versatile keyboard control featuring synthesized digital sweep and frequency-step capability. Programming options for both BCD and HP-IB interfaces are available.

Three plug-in RF sections provide three separate ranges: 10 kHz to 110 MHz, 1 MHz to 1300 MHz, and 1 MHz to 2600 MHz. Output levels are calibrated over >140 dB of range. A wide range of modulations can be configured with plug-in sections. AM, FM,

and phase modulation as well as external pulse modulation are available in various combinations.

Solid-state, high performance generators

This group of signal generators offers all the advantages of solid-state design, such as increased portability, ruggedness, and reliability, while still retaining the outstanding signal quality characteristics of Hewlett-Packard's older vacuum tube signal generators. In addition these generators offer many features not found on the older generators such as digital frequency readout (8640B, 8660C), ability to count external signals (8640B), field portability (8654A/B) and complete remote programming (8660A, 8660C).

HF to UHF

The performance leader of the solid-state family is the 8640 signal generator covering 450 kHz to 550 MHz. Frequency coverage can be extended to 1100 MHz with an internal doubler (Opt 002) and an optional built-in audio oscillator extends the CW output range down to 20 Hz (Opt 001). This generator is available in three models: the 8640A with mechanical slide rule frequency dial; the 8640B featuring a built-in 550 MHz counter; and the 8640M for ruggedized applications.

The 8640B with built-in counter includes two significant new features not previously found on Hewlett-Packard signal generators:

1) the ability to count external signals at frequencies up to 550 MHz and 2) a front panel pushbutton to phase-lock the generator's RF output to the counter time base for frequency stability of better than 5×10^{-8} /hour.

Internally, the heart of the 8640 is a mechanically tuned high-Q cavity oscillator that operates over the range of 230 to 550 MHz. This oscillator has very good inherent stability and exceptionally low noise characteristics. Nine lower frequency ranges are obtained by dividing down the basic oscillator frequency and filtering out the unwanted harmonics.

The 8640M is a ruggedized version of the 8640B featuring phase-locked stability, digital read-out, built-in thermal cutoff and reverse power protection. The 'M' with its aluminum carrying case has been typetested to withstand shock, vibration and humidity extremes, and is specified to operate over a temperature range of -40°C to $+55^{\circ}\text{C}$ for field and flight-line measurements.

Compact, field portable

Compact, portable signal generators form another part of the solid-state family. The 8654 covering 10 to 520 MHz features calibrated output level with a full range attenuator and both AM and FM modulation capability. Small size and light weight make it well suited for field maintenance and operational readiness checks in addition to general purpose signal generator applications. The

8654A is an AM generator with uncalibrated FM capability, while the 8654B has fully calibrated and metered FM and AM.

The 8655A Synchronizer/Counter combines with the 8654A and B to phase lock the generator's RF output to the counter time base for frequency stability of better than 0.1 ppm/hour. In addition the 8655A is an RFI-proof counter with the capability to count external signals up to 520 MHz.

Performance-proven vacuum tube signal generators

HF to UHF

The HP 606B, 608E, and 612A signal generators collectively cover frequencies from 50 kHz to 1.23 GHz. All feature extremely low drift and incidental frequency modulation, and may be amplitude (sine, square, pulse) modulated.

UHF to SHF

A complete line of Hewlett-Packard microwave signal generators provides coverage from 800 MHz to 21 GHz. The 618C, 620B, 626A, and 628A incorporate cavity-tuned klystron oscillators with very low drift and residual FM. They may be pulse, square-wave and frequency modulated, making them useful for microwave receiver testing as well as SWR and transmission line measurements.

The HP 8614A and 8616A signal gener-

ators covering 0.8 to 2.4 GHz and 1.8 to 4.5 GHz feature built-in PIN diode modulators. These modulators allow internal or external output power leveling as well as a wide range of pulse and amplitude modulation.

HP 938A and 940A Frequency Doubler Sets provide low-cost signal generator capability in the 18 to 40 GHz range by doubling the frequency of signal sources in the 9 to 20 GHz range.

Special signal generators/accessories

For Avionics navigation and communications applications, the 8640B option 004 combines digital readout and phase lock features with a demodulated output and special AM circuitry. Combined with suitable external modulation sources, the 8640B provides for testing and calibration of aircraft VOR/ILS and Marker Beacon receivers.

A variety of accessories are available to enhance the operation of HP signal generators. The list includes a spectrum generator, frequency doubler, output terminations, a fuse holder, balanced mixers, filters, and a series of PIN modulators to increase the modulation capability of microwave signal sources. The new HP 11720A Pulse Modulator provides high performance pulse modulation capability over the range of 2 to 18 GHz. The 11710B Down Converter extends the frequency range of the 8640 and 8654 down to 10 kHz.

Signal generator summary

Model	Frequency range	Characteristics	Page
8671A Synthesizer	2 to 6.2 GHz	1 kHz frequency resolution, 5×10^{-10} /day stability, +8 dBm minimum output, completely HP-IB programmable, EXT FM	380
8672A Synthesized Generator	2 to 18.6 GHz	1 to 3 kHz frequency resolution, 5×10^{-10} /day stability. Calibrated output from +3 to -120 dBm. Completely HP-IB programmable, metered, external AM and FM	378
8660A/C Synthesized Generator	0.01 to 110 MHz 1 to 1300 MHz 1 to 2600 MHz	1 Hz frequency resolution, 3×10^{-9} /day stability. Calibrated output from +13 to -146 dBm. HP-IB and TTL programmable. Plug-ins determine frequency range and modulation capability	374
606B Signal Generator	50 kHz to 65 MHz	output +23 to -127 dBm, mod. BW dc to 20 kHz, low drift and noise, low incidental FM, low distortion, auxiliary RF output	388
8640A/B/M Signal Generator	0.5-1024 MHz	output +19 to -145 dBm into 50 Ω ; AM, FM, and ext. pulse modulation, direct calibration, leveled output. 8640B has built-in counter and phase-lock capability. All solid state	381
8640B Opt. 004 Avionics Generator	0.5 to 512 MHz	same as 8640B with phase shift <0.01 $^{\circ}$ at 30 Hz, demodulated AM output, 1 dB step attenuator, for use with external VOR/ILS audio Generators	382
608E Signal Generator	10 to 480 MHz	output +13 to -127 dBm, into 50-ohm load; AM, pulse modulation, direct calibration, leveled power output, aux RF output	389
3200B Oscillator	10-1000MHz	+13 to -107 dBm output into 50 Ω , 120 dB attenuator range 0.002% stability, compact, portable; weight, 15 lb. 13515A Doubler extends frequency to 1000 MHz	394
8654A/B Signal Generator	10-520 MHz	output +10 to -130 dBm into 50 Ω , direct calibration, leveled output, amplitude and frequency modulation, solid-state, compact, weight 17.4 lb	386
8655A Synchronizer/Counter	10-520 MHz	phase lock frequency stabilizer for 8654A and B. 6-digit LED display. Lock resolution, 500 Hz. Low RFI, external count capability to 520 MHz	386
612A Signal Generator	450 to 1230 MHz	output -3 to -127 dBm into 50-ohm load; pulse or square-wave modulation, direct calibration	390
8614A, 8616A Signal Generator	0.8 to 2.4 GHz 1.8 to 4.5 GHz	output +10 (8616: +3 dBm above 3 GHz) to -127 dBm into 50 ohms, leveled below 0 dBm; internal square-wave; external pulse, AM and FM; auxiliary RF output	391
618C, 620B Signal Generators	3.8 to 7.6 GHz 7 to 11 GHz	output 0 to -127 dBm into 50 ohms, pulse, frequency or square-wave modulation, direct calibration, ext FM and pulse modulation, auxiliary RF output	392
626A, 628A Signal Generators	10 to 15.5 GHz 15 to 21 GHz	output +10 dBm to -90 dBm; pulse, frequency or square-wave modulation, direct calibration	393
938A, 940A Frequency Doublers	18 to 26.5 GHz 26.5 to 40 GHz	driven by 9 to 13.25 GHz source, 13.25 to 20 GHz source, HP 626A, 628A, 8690 or 8620 series sweepers or klystrons; 100 dB precision attenuator	393

SIGNAL GENERATORS

Synthesized Signal Generators

Model 8660A and 8660C

- 10 kHz to 2600 MHz
- Synthesizer stability and accuracy
- 1 Hz resolution (2 Hz above 1300 MHz)
- Calibrated output over > 140 dB range
- AM, FM, Φ M, or pulse modulation
- Fully TTL programmable



8660C

HP-IB

8660 A/C Synthesized signal generator

System Concept

The 8660A/C family is a modular solid-state plug-in system. Each system includes: 1) a programmable synthesized signal generator mainframe, 2) at least one RF section plug-in, and 3) at least one modulation section. This modular plug-in construction allows an 8660 system to be configured for any specific application while minimizing the added expense of unnecessary features.

As its name implies, the 8660 is a true frequency synthesizer. Yet it is finding even broader appeal as a high performance signal generator. And being completely programmable, the 8660 is the perfect choice for most automated receiver or component testing situations.

Mainframes

There are two different synthesized signal generator mainframes to choose from. Both feature complete TTL programming of frequency, output levels, and most modulation functions. The standard programming interface is BCD and an optional HP-IB interface is available. Both mainframes can operate from an internal crystal reference or external frequency standard.

The 8660A mainframe uses thumbwheel switches to select CW output frequencies. Frequencies up to 1300 MHz can be entered directly with 1 Hz resolution. (For applications requiring frequencies above 1300 MHz the 8660A must be used with the 86603A Option 003. The frequency selection process involves selecting one-half of the desired RF output frequency and activating the 86603A Option 003 front panel doubler switch).

The 8660C keyboard mainframe provides direct keyboard entry of CW frequencies up to 2600 MHz. Added capabilities of the 8660C include digital sweep, frequency stepping, synthesized search, and a ten-digit numerical display.

Swept testing of very narrowband devices such as crystal filters is made possible by the 8660C's digital sweep. Since the RF output consists of discrete synthesized steps, the result is a very linear sweep with extremely low residual FM. A 0-8 V horizontal sweep output is provided for driving XY plotters, oscilloscopes, etc.

For applications which require frequency to be changed in uniform increments, a frequency stepping capability is provided on the 8660C.

For example, if a receiver with 50 kHz channel spacing is being tested, a 50 kHz step size can be entered and the frequency stepped to the next higher or lower channel with a single key-stroke.

Synthesized search provides the dial tuning convenience of a signal generator while maintaining synthesizer signal quality. As the dial is turned the output frequency is tuned up or down in discrete synthesized steps which may be chosen as small as 1 Hz.

Plug-In RF Sections

There are three RF sections to choose from. The 86601A covers the 10 kHz to 110 MHz frequency range with calibrated output of +13 to -146 dBm. The 86602B (used with the 11661B Frequency Extension Module) covers 1 MHz to 1300 MHz with output of +10 to -146 dBm. The 86603A (also used with the 11661B) covers 1 MHz to 2600 MHz with output of +7 to -136 dBm. All RF sections have 1 Hz frequency resolution except for 2 Hz above 1300 MHz with the 86603A. In the remote mode output level can be programmed in 1 dB steps over the full operating range.

Plug-In Modulation Sections

There are five modulation sections to choose from. The 86632B and 86633B are both AM/FM modulation sections. An accurate modulation meter indicates % AM or FM peak deviation. The 86633B differs from the 86632B in that the carrier is phase locked while FM modulating at rates and deviations up to 100 kHz. The 86632B utilizes a free running VCO during FM but allows rates and deviations up to 1 MHz. Any drift can be removed by depressing the FM CF CAL button.

The 86634A offers only analog phase modulation at rates to 10 MHz and metered deviations to 100° below 1300 MHz and 200° above 1300 MHz. The 86635A Φ M/FM Modulation Section is similar in performance to the 86634A except rates are limited to 1 MHz and FM capability is also included. (The 86634A and 86635A must be used with Option 002 RF sections.)

The 86631B Auxiliary Section provides both external AM and pulse modulation. The 86631B Auxiliary Section must be used when another modulation section is not installed.

All modulation functions of the 86632B, 86633B, and 86635A are fully programmable.

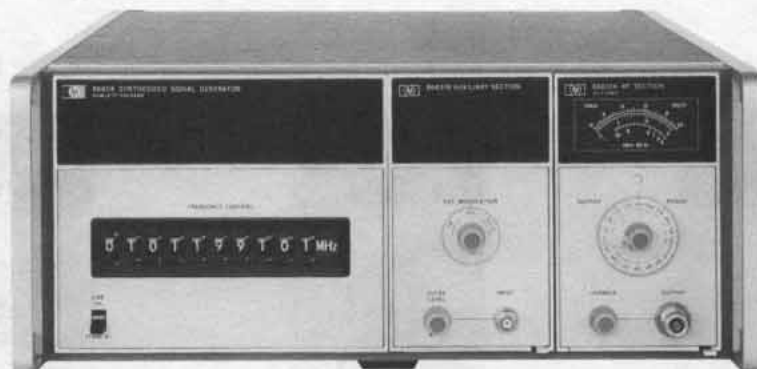

8660A



8660A/C mainframe specifications

Frequency Accuracy and stability: CW frequency accuracy and long term stability are determined by reference oscillator in 8660A/C mainframe (3×10^{-9} /day) or by external reference, if used.

Reference oscillator

Internal: 10 MHz quartz oscillator. Aging rate less than ± 3 parts in 10^6 per 24 hours after 72 hours warm-up. (± 3 parts in 10^9 per 24 hours, Option 001).

External: rear panel switch allows operation from 5 MHz or 10 MHz frequency standard at a level between 0.5 V and 2.5 V rms into 170 ohms.

Reference output: rear panel BNC connector provides output of reference signal selected at level of at least 0.5 V rms into 170 ohms.

Digital sweep (8660C): auto, single or manual. Selectable speeds 0.1, 1, or 50 seconds.

Remote programming

Functions

8660A: all front panel frequency and output level, and most modulation functions are programmable.

8660C: CW frequency, frequency stepping (STEP \uparrow , STEP \downarrow), and output level, and most modulation functions are programmable. Note: digital sweep is NOT programmable.

Programming input

Connector type: 36-pin Cinch type 57 (mating connector supplied). [Optional HP-IB interface; 24-pin Cinch type 57 (mating connector NOT supplied)].

Logic: TTL compatible (negative true).

Switching time: less than 5 ms to be within 100 Hz of any new frequency selected. (Less than 100 ms to be within 10 Hz).

General

Operating temperature range: 0 to +55°C.

Power: 100, 120, 220, or 240 volts +5%, -10%, 48-66 Hz. Approximately 350 watts.

Weight: [Mainframe only] net, 23.8 kg (53 lb). Shipping, 29.6 kg (65 lb).

Options for 8660A/C

001: $\pm 3 \times 10^{-9}$ /day internal reference oscillator.

002: no internal reference oscillator.

003: operation from 50 to 400 Hz line.

004: 100 Hz frequency resolution (200 Hz above 1300 MHz CF).

005: HP-IB programming interface.

100: 11661B factory installed.

009: (8660A only): front panel LED display indicates selected frequency in 1-2-4-8 BCD code.

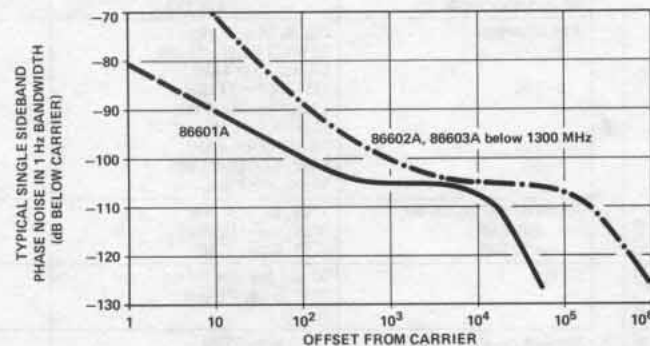

Phase Noise with 86603A above 1300 MHz increases 6 dB.

RF section specifications (Installed in 8660A or 8660C mainframe)

FREQUENCY CHARACTERISTICS	86601A		86602B (with 11661B)		86603A (with 11661B)	
	0.01—110 MHz (109.999999 MHz)		1—1300 MHz (1299.999999 MHz)		1—2600 MHz (2599.999998 MHz)	
					CF < 1300 MHz	CF \geq 1300 MHz
Frequency Range						
Frequency Resolution			1 Hz			2 Hz
Harmonics	< -40 dB		< -30 dB (< -25 dB above +3 dBm)		< -20 dB ¹	
Spurious: Non Harmonically Related	-80 dB		-80 dB below 700 MHz -80 dB above 700 MHz within 45 MHz of carrier -70 dB above 700 MHz > 45 MHz from carrier -50 dB on +10 dBm range		-74 dB within 45 MHz of carrier ¹ -64 dB > 45 MHz from carrier < -64 dB	
Power Line Related (CW, AM, ϕ M only) ²	-70 dB		< -70 dB		< -64 dB	
Signal To Phase Noise Ratio (CW, AM, ϕ M only) ² M	> 50 dB		> 45 dB		> 39 dB	

¹For output levels +3 dBm and below, slightly higher from +3 to +7 dBm.

²Measured in a 30 kHz band centered on the carrier excluding a 1 Hz band centered on the carrier.

• 10 kHz to 110 MHz



86601A

• 1 MHz to 1300 MHz



86602B

• 1 MHz to 2600 MHz



86603A

RF Sections specifications (cont.)

		86601A	86602B (with 11661B)	86603A (with 11661B)		
		0.01–110 MHz	1–1300 MHz	1–1300 MHz	1300–2600 MHz	
OUTPUT CHARACTERISTICS	Output Level (into 50Ω)	+13 dBm to –146 dBm	+10 to –146 dBm	+10 to –136 dBm	+7 to –136 dBm ³	
	Output Accuracy (local and remote)	±1 dB, +13 to –66 dBm ±2 dB, –66 to –146 dBm	±1.5 to –76 dBm ±2.0 to –146 dBm	±2.5 dB, to –76 dBm ³ ±3.5 dB, to –136 dBm		
	Flatness (output level variation with frequency)	< ±0.5 dB	< ±1.0 dB	< ±2.0 dB (1–2600 MHz)		
	Impedance	50Ω				
MODULATION CHARACTERISTICS	AM	AM Modulation Depth	0 to 95%	0 to 90% ⁴		
		3 dB Bandwidth:	200 Hz, CF < 0.4 MHz 10 kHz, 0.4 ≤ CF < 4 MHz 100 kHz, CF ≥ 4 MHz	10 kHz, CF < 10 MHz 10 kHz, CF ≥ 10 MHz	10 kHz	
		0–30%	125 Hz, CF < 0.4 MHz 6 kHz, 0.4 ≤ CF < 4 MHz 60 kHz, CF ≥ 4 MHz	6 kHz, CF < 10 MHz 60 kHz, CF ≥ 10 MHz	N/A	
		0–70%	100 Hz, CF < 0.4 MHz 5 kHz, 0.4 < CF < 4 MHz 50 kHz, CF ≥ 4 MHz	5 kHz, CF < 10 MHz 50 kHz, CF ≥ 10 MHz	N/A	
	0–90%					
	Distortion, ⁵ THD at 30% AM at 70% AM at 90% AM	<1%, 0.4–110 MHz <3%, 0.4–110 MHz <5%, 0.4–110 MHz	<1% <3% <5%	<5% N/A N/A		
	FM	FM Rate	DC to 1 MHz with 86632B 20 Hz to 100 kHz with 86633B	DC to 200 kHz with 86632B and 86635A 20 Hz to 100 kHz with 86633B		
		Maximum Deviation (peak)	1 MHz with 86632B 100 kHz with 86633B	200 kHz with 86632B and 86635A 100 kHz with 86633B	400 kHz w/86632B, 35A 200 kHz w/86633B	
		Distortion, THD (at rates up to 20 kHz)	<1% up to 200 kHz dev. <3% up to 1 MHz dev.	<1% up to 200 kHz dev.		<1% up to 400 kHz dev.
	PULSE	Pulse Rise/Fall Time	200 ns	50 ns		
ON/OFF Ratio (with pulse level control at max.)		> 50 dB	> 40 dB		> 60 dB	
φM ⁶	φM Rate	N/A	DC to 1 MHz with 86635A DC to 1 MHz for CF < 100 MHz DC to 10 MHz for CF > 100 MHz } with 8634A			
	Maximum Peak Deviation	N/A	0 to 100 degrees		0 to 200 degrees	
	Distortion, THD	N/A	<5% up to 1 MHz rates <7% up to 5 MHz rates <15% up to 10 MHz rates			
GENERAL	Weight	Net 5 kg (11 lb) Shipping 6.4 kg (14 lb)	Net 4.1 kg (9 lb) Shipping 5.5 kg (12 lb)	Net 5 kg (11 lb) Shipping 6.4 kg (14 lb)		
		11661B: Net 2.3 kg (5 lb), Shipping 2.7 kg (6 lb)				

3. For +3 to +7 dBm output levels, output accuracy and flatness will be slightly degraded (above 1300 MHz only).

4. For RF output level meter readings from +3 dB to –6 dB and only at +3 dBm and below.

5. Applies only at 400 Hz and 1 kHz rates with output meter set at 0 to +3 dB. AT –6 dB meter setting the distortion approximately doubles.

6. Phase modulation is only possible with Option 002 RF Sections.

• Pulse/AM

• AM/FM

• AM/FM

• ϕ M

• ϕ M/FM



86631B



86632B

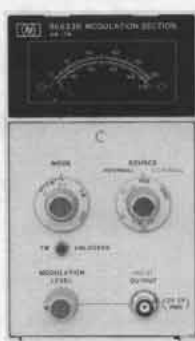

86633B



86634A



86635A

Modulation section specifications

		86631B	86632B	86633B	86634A	86635A
AM	Functions	Ext. Only	Int. and Ext.	Int. and Ext.	—	—
	Indicated Accuracy (at 400 and 1000 Hz rates)	—	$\pm 5\%$ of full scale With 86601A RF Section: $\pm 7\%$, center frequency ≥ 100 MHz With 86603A RF Section: $\pm 10\%$, center frequency ≥ 1300 MHz		—	—
FM	Functions	—	Int. and Ext., FM CF CAL	Int. and Ext.	—	Int. and Ext., FM CF CAL
	Center Frequency Long Term Stability	—	Typically less than 200 Hz/hr.	Same as in CW Mode (3×10^{-8} /day)	—	Typically less than 200 Hz/hr.
	Indicated Accuracy (up to 20 kHz rates)	—	$\pm 5\%$ of full scale		—	$\pm 5\%$ of full scale
PULSE	Functions	Ext. Only	—	—	Int. and Ext.	Int. and Ext.
ϕ M	Indicated Accuracy (15°C to 35°C)	—	—	—	$\pm 5\%$ of full scale up to 100 kHz rates $\pm 8\%$ of full scale up to 2 MHz rates $\pm 15\%$ of full scale up to 10 MHz rates	
Meter		—	0—100% AM 0—10, 100, 1000 kHz FM Pk. Dev. (0—20, 200, 2000 kHz FM for CF ≥ 1300 MHz)	0—100% AM 0—10, 100 kHz FM Pk. dev. (0—20, 200 kHz FM for CF ≥ 1300 MHz)	0—100° Peak ϕ M, (0—200° for CF ≥ 1300 MHz)	0—10, 100, 1000 kHz FM, 0—100° Pk ϕ M (0—20, 200, 2000 kHz FM, 0—200° Pk. ϕ M for CF ≥ 1300 MHz)
Internal Modulation Source Output		None	400 Hz and 1 kHz $\pm 5\%$ 200 mV minimum into 10k Ω . Available on front panel BNC connector			
Input Impedance		50 Ω Pulse 600 Ω AM	600 Ω	600 Ω	50 Ω	600 Ω
Weight		Net, 1.4 kg (3 lb) Shipping, 2.3 kg (5 lb)	Net, 2.7 kg (6 lb) Shipping, 4.1 kg (9 lb)	Net, 2.7 kg (6 lb) Shipping, 4.1 kg (9 lb)	Net, 1.8 kg (4 lb) Shipping, 3.2 kg (7 lb)	Net, 2.7 kg (6 lb) Shipping, 4.1 kg (9 lb)

Ordering information

- 8660A Synthesized Signal Generator Mainframe \$7200
- 8660C Synthesized Signal generator Mainframe \$9600
- Opt 001: $\pm 3 \times 10^{-9}$ /day internal reference oscillator add \$210
- Opt 002: no internal reference oscillator less \$300
- Opt 003: operation from 50 to 400 Hz line add \$155
- Opt 004: 100 Hz frequency resolution (200 Hz above 1300 MHz) less \$350
- Opt 005: HP-IB programming interface \$250
- Opt 009: (8660A only) LED display indicates selected frequency in 1-2-4-8 BCD code add \$210
- Opt 100: 1166B factory installed inside mainframe add \$3800
- 86601A RF Section \$3800

Price

- 86602B RF Section \$4875
- 86603A RF Section \$7100
- Opt 001: no RF output attenuator (all RF Sections) less \$600
- Opt 002: adds phase modulation capability (86602B, 86603A only) add \$1650
- Opt 003: allows operation of 86603A with 8660A mainframe add \$250
- 11661B Frequency Extension Module \$3800
- 86631B Auxiliary Section \$300
- 86632B AM/FM Modulation Section \$2200
- 86633B AM/FM Modulation Section \$2200
- 86634A ϕ M Modulation Section \$1750
- 86635A ϕ M/FM Modulation Section \$2450

SIGNAL GENERATORS

Synthesized signal generators

Model 8672A

- 2 to 18 GHz frequency range
- 1 to 3 kHz frequency resolution
- Low spurious and phase noise
- +3 to -120 dBm calibrated output
- $<5 \times 10^{-10}$ /day stability
- Metered AM/FM

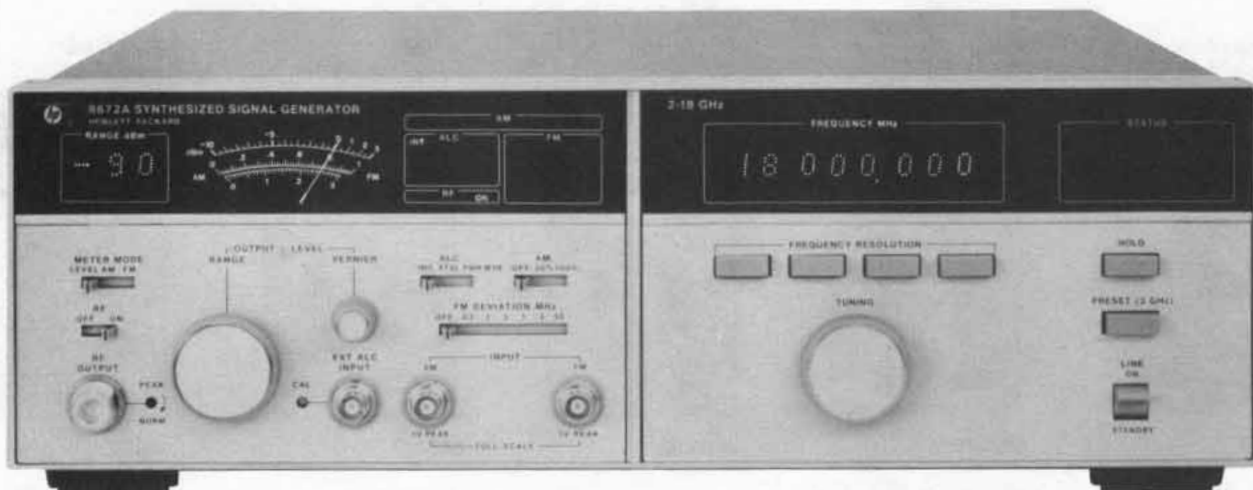

8672A

HP-IB

8672A Synthesized signal generator

The 8672A synthesized signal generator covers the entire 2.0 to 18.0 GHz frequency range in one compact solid-state package (133 mm, 5.25 in. high) while providing calibrated output and complete AM/FM modulation capability. The 8672A can replace two, three, or even four instruments in many applications.

Advanced thin film technology

An indirect synthesis approach is used to phase lock a wideband 2.0 to 6.2 GHz YIG-tuned transistor oscillator (YTO) to the internal (or ext.) time base. The output of the YTO drives a YIG tuned multiplier (YTM), a product made possible by HP's advanced microcircuit technology, to achieve the 2 to 18 GHz coverage. This YTM produces spectrally pure harmonics of the input frequency and selects the proper harmonic automatically.

Excellent spectral purity

The 8672A has been designed for very low single sideband phase noise (see figure 2). This characteristic is very important for L.O. applications and many tests on communication and radar systems. Non-harmonic spurious are also controlled to prevent undesired responses. Such signals are -70 dB from 2 to 6.2 GHz and -60 dB from 12.4 to 18 GHz, excluding power line related frequencies.

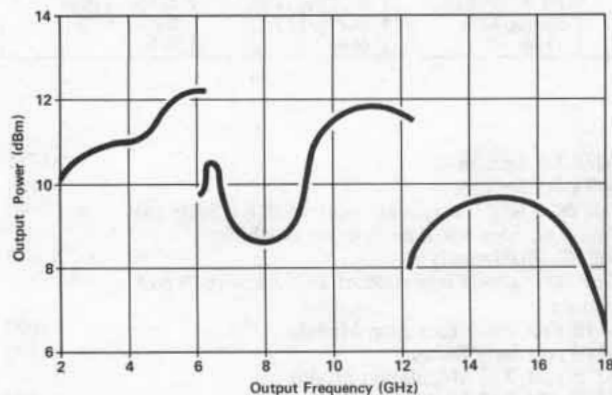

Figure 1. Maximum power typically available on "+10" attenuator setting (Overrange) at 25°C.

Wide dynamic output range

For broadband component and receiver testing applications the 8672A incorporates an exceptionally flat frequency response across the full 2 to 18 GHz range. The addition of a calibrated 110 dB RF step attenuator on the output results in accurate output control from +3 to -120 dBm, enabling very sensitive receiver tests to be made. For LO applications an "overrange" position provides additional power at most frequencies across the full 2 to 18 GHz band. See figure 1.

Calibrated AM/FM modulation

To expand the versatility of the 8672A for accurate receiver testing, AM/FM capability is provided (with externally applied modulation signals). AM depth at rates up to 100 kHz can be accurately set using the front panel meter. FM is allowed up to 10 MHz rates and peak deviations. The meter can also be used to monitor peak deviations on any of six selectable ranges. Both AM depth and FM deviation are linearly controlled by varying the input voltage up to 1 volt maximum. The 8672A remains phase locked in both the AM and FM modes.

Front panel status indicators

For unambiguous operation, a series of annunciators is conveniently located on the front panel to indicate the operational "status" of the instrument. These include:

1. AM/FM modes and selected ranges
2. Output level "overrange" selection
3. RF ON/OFF
4. "Not phase locked" indication.
5. Unleveled condition
6. Remote operation.

All functions fully programmable

The 8672A provides full programmability of all its front panel functions: frequency, output level (in 1 dB steps) and modulation selection. The 8672A has an HP-IB interface (standard on all units) and can be used with any HP 9800 series calculator or minicomputer for automatic systems application.

Fast pulse capability available

High performance pulse modulation of the 8672A is available by the addition of the accessory 11720A Broadband Pulse Modulator. (See page 394). This new Pulse Modulator provides >80 dB ON/OFF ratios with 5 nanosecond (typical) rise and fall times over the 2 to 18 GHz range of the 8672A.

8672A specifications

(See technical data sheet for complete specifications)

Frequency characteristics

Frequency range: 2.0–18.0 GHz (with overrange to 18.599997 GHz).

Frequency resolution: 1 kHz to 6.2 GHz, 2 kHz to 12.4 GHz, 3 kHz to 18.0 GHz.

Time base: internal 10 MHz ($<5 \times 10^{-10}$ /day aging rate) or external 5 or 10 MHz.

Frequency switching time: <15 ms to be within 1 kHz, 2–6.2 GHz; 2kHz, 6.2–12.4 GHz; 3 kHz, 12.4–18 GHz.

Spectral purity

Harmonics, subharmonics and multiples (≤ 18 GHz): <-25 dB.

Single-sideband phase noise (1 Hz BW, CW mode):

Offset from F_c	10Hz	100 Hz	1kHz	10kHz	100kHz
2.0-6.2 GHz	-58 dB	-70 dB	-78 dB	-86 dB	-110 dB
6.2-12.4 GHz	-52 dB	-64 dB	-72 dB	-80 dB	-104 dB
12.4-18.0 GHz	-48 dB	-60 dB	-68 dB	-76 dB	-100 dB

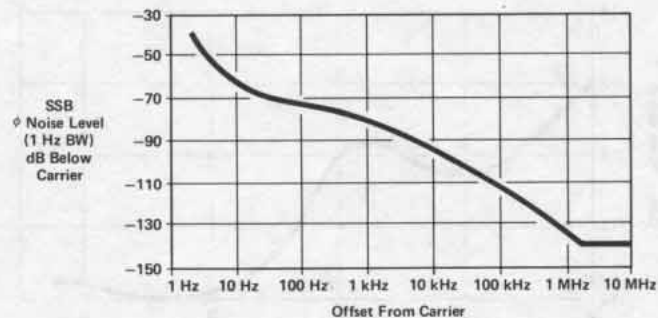

Figure 2. Typical 8672A single-sideband phase noise performance using the internal standard, 2.0-6.2 GHz.

Spurious (CW and AM modes)

Non-harmonically related:

<-70 dB, 2.0-6.2 GHz.

<-64 dB, 6.2-12.4 GHz.

<-60 dB, 12.4-18.0 GHz.

Power line related (CW mode, and within 5 Hz below line frequency, and multiples):

Offset from F_c	<300 Hz	300 Hz to 1 kHz	>1 kHz
2.0-6.2 GHz	-50 dB	-60 dB	-65 dB
6.2-12.4 GHz	-44 dB	-54 dB	-59 dB
12.4-18.0 GHz	-40 dB	-50 dB	-55 dB

Output characteristics

Output level (+15°C to +35°C): +3 to -120 dBm

Total indicated meter accuracy (+15°C to +35°C):

Frequency Range	Output Level Range			
	0 dBm	-10 dBm	-20 dBm	-30 dBm and below
2.0-6.2 GHz	± 1.75 dB	± 2.25 dB	± 2.45 dB	± 1.75 dB ± 0.3 dB/ 10 dB step below 0 dBm range
6.2-12.4 GHz	± 2.0 dB	± 2.5 dB	± 2.7 dB	± 2.0 dB ± 0.3 dB/ 10 dB step below 0 dBm range
12.4-18.0 GHz	± 2.25 dB	± 2.85 dB	± 3.05 dB	± 2.25 dB ± 0.4 dB/ 10 dB step below 0 dBm range

Remote programming accuracy: 0.75 dB better than indicated meter accuracy.

Flatness (+15°C to +35°C): ± 0.75 dB, 2.0-6.2 GHz; ± 1.00 dB, 2.0-12.4 GHz; ± 1.25 dB, 2.0-18.0 GHz.

Output level switching time: <20 ms.

Source impedance: 50 Ω .

Amplitude modulation

AM depth (for RF output meter readings ≤ 0 dB, +15°C to +35°C):

0-75%, 2.0-6.2 GHz.

0-60%, 6.2-12.4 GHz.

0-50%, 12.4-18.0 GHz.

Sensitivity: 30%/V, 100%/V ranges. Max input 1 V peak into 600 Ω .

Rates (3 dB BW): 10 Hz-100 kHz.

Indicated AM meter accuracy (100 Hz – 10 kHz rates): $\pm 5\%$ of range.

Distortion (rates ≤ 10 kHz, RF output ≤ 0 dB, +15°C to +35°C): $<3\%$ at 30% depth.

Frequency modulation

Peak deviation (max): the smaller of

10 MHz or $f_{mod} \times 5$, 2.0–6.2 GHz.

10 MHz or $f_{mod} \times 10$, 6.2–12.4 GHz.

10 MHz or $f_{mod} \times 15$, 12.4–18.0 GHz.

Sensitivity: 30, 100, 300 kHz/V and 1, 3, 10 MHz/V ranges. Max input 1 volt peak into 50 Ω .

Rates (3 dB BW typical): 30, 100 kHz/V ranges: 50 Hz to 10 MHz; 300 kHz/V and 1, 3, 10 MHz/V ranges: 1 kHz to 10 MHz.

Distortion: $<12\%$ for rates <3 kHz decreasing linearly with frequency to 5% at 20 kHz; $<5\%$ for 20 kHz to 100 kHz rates.

Indicated FM meter accuracy (100 kHz rate, +15°C to 35°C): $\pm 10\%$ of full scale.

Residual FM in FM and CW modes (2-6.2 GHz, residual FM doubles for 6.2-12.4 GHz, triples for 12.4-18 GHz):

Range	Post Detection BW	
	20 Hz–1 kHz	20 Hz–3kHz
CW, 30, 100, 300 kHz/V; and 1, 3, MHz/V	6 Hz rms	12 Hz rms
10MHz/V	10 Hz rms	20 Hz rms

Remote programming capability

Frequency: programmable over full range with same resolution as in manual mode.

Output level: programmable over full range in 1 dB steps.

AM modulation: OFF, 30%/V, and 100%/V ranges.

FM modulation: OFF, 30, 100, 300 kHz/V and 1, 3, 10 MHz/V ranges.

Other: RF ON/OFF, ALC INT./EXT. (crystal or power meter).

Programming format: HP-IB (Hewlett-Packard Interface Bus).

General

Operating temperature range: 0 to +55°C.

Power: 100, 120, 220, 240 V +5, -10%, 48-66 Hz. 300 V A max.

Weight: net, 27 kg (60 lb). Shipping, 32.5 kg (72 lb).

Dimensions: 133 mm H x 425 mm W x 603 mm D (5.25" x 16.75" x 23.75").

Options

001: No RF output attenuator

002: No internal reference oscillator

003: Operation at 400 Hz line only

004: Rear panel RF output

005: Rear panel RF output without RF attenuator

006: Chassis slide kit

Price

less \$600

less \$550

add \$250

add \$ 75

less \$525

add \$ 45

8672A Synthesized Signal Generator

\$28,600

SIGNAL GENERATORS

Microwave frequency synthesizer

Model 8671A

- 2-6.2 GHz frequency range
- 1 kHz frequency resolution
- $<5 \times 10^{-10}$ /day stability
- Low spurious and phase noise
- +8 dBm minimum output power
- HP-IB programmability

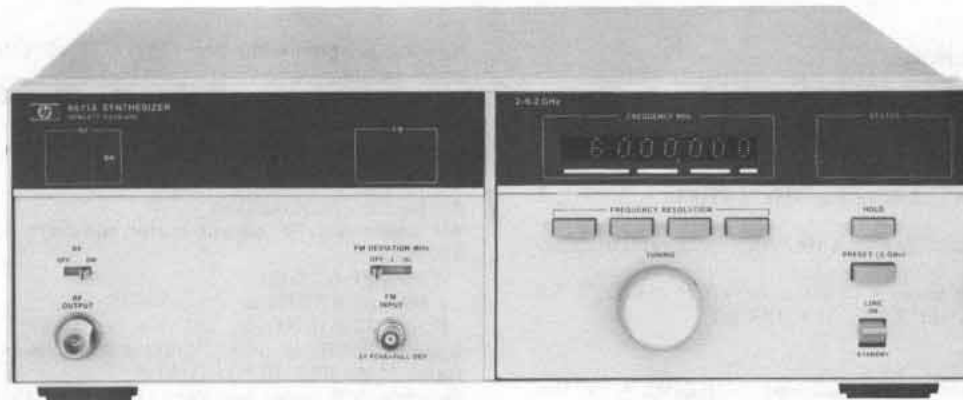

Description

The 8671A microwave frequency synthesizer covers the frequency range 2.0 to 6.2 GHz in 1 kHz steps with excellent stability and spectral purity. It is well suited for most LO applications that require state-of-the-art performance as well as broadband capability.

Spectral purity

Spurious responses (except power line related) are greater than 70 dB below the carrier across the full frequency band. And phase noise, a critical parameter in many applications, is low enough to permit extremely sensitive measurements.

Output power

The 8671A has a guaranteed output of +8 dBm at all frequencies. This is well within the operating range of most commercial mixers. However, for the few applications requiring greater power the 8671A produces clean outputs as high as +10 dBm at many frequencies.

Wideband FM

The 8671A also has frequency modulation capability at rates up to 10 MHz and peak deviations up to 10 MHz (with externally applied signals). Carrier phase-lock is maintained in the FM mode.

HP-IB programmability

The standard programming interface offered with the 8671A is directly compatible with the Hewlett-Packard Interface Bus. Programmable functions include frequency, FM, and RF ON/OFF.

Specifications

(See technical data sheet for complete specifications.)

Frequency characteristics

Frequency range: 2.0-6.2 GHz (6.199999 GHz).

Frequency resolution: 1 kHz.

Time base: internal 10 MHz ($<5 \times 10^{-10}$ /day aging rate) or external 5 or 10 MHz.

Switching time: <15 ms to be within 1 kHz.

Harmonics: <-15 dBc.

Single-sideband phase noise (1 Hz BW, CW mode)

Offset from F_c	10 Hz	100 Hz	1 kHz	10 kHz	100 kHz
SSB level	-58 dB	-70 dB	-78 dB	-86 dB	-110 dB

Spurious

Non-harmonically related: <-70 dB.

Power line related (CW mode, and within 5 Hz below any line related frequency)

Offset from F_c	<300 Hz	300 Hz to 1 kHz	>1 kHz
2.0-6.2 GHz	-50 dB	-60 dB	-65 dB

Output characteristics

Power (uneveled): +8 dBm (min.), +15 to 35°C.

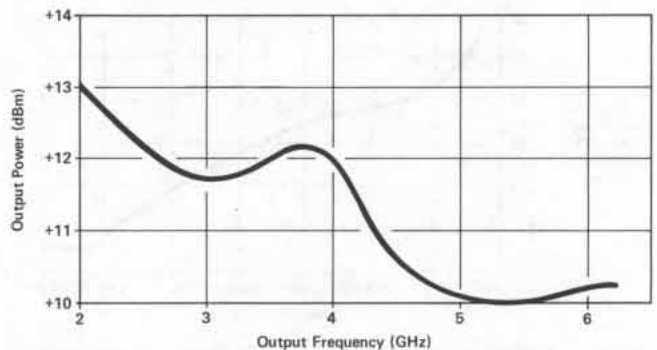

Figure 1. Typical output power available.

Flatness: <6 dB total variation across full frequency band.

Frequency modulation

Peak deviation (max): 10 MHz or $f_{mod} \times 5$, whichever is smaller.

Sensitivity: 50 kHz/V and 5 MHz/V ranges. Max input 2V peak.

Rates (3 dB BW): 50 Hz to 10 MHz typical.

Remote programming

Frequency: programmable over full range with 1 kHz resolution.

FM modulation: OFF, 50 kHz/V, and 5 MHz/V ranges.

Other: RF, ON/OFF.

Programming format: HP-IB (Hewlett-Packard Interface Bus).

General

Operating temperature range: 0 to 55°C.

Power: 100, 120, 220, or 240 V +5, -10%, 48-66 Hz, 300 VA max.

Weight: net, 24 kg (53 lb); shipping, 29.5 kg (65 lb).

Size: 133 H x 425 W x 603 mm D (5.25" x 16.75" x 23.75").

Options

- 002: No internal reference
- 003: Operation at 400 Hz line only
- 005: Rear panel RF output
- 006: Chassis slide kit

Price
 less \$550
 add \$250
 add \$ 75
 add \$ 45
\$17,600

8671A Microwave frequency synthesizer

Precision, high stability, AM-FM, 0.5 to 1024 MHz

Models 8640A, 8640B

- Wide frequency and power range
- Low broadband and close-in noise
- Calibrated, metered AM and FM

- The 8640B also features:
internal phase lock synchronizer
external counter to 550 MHz

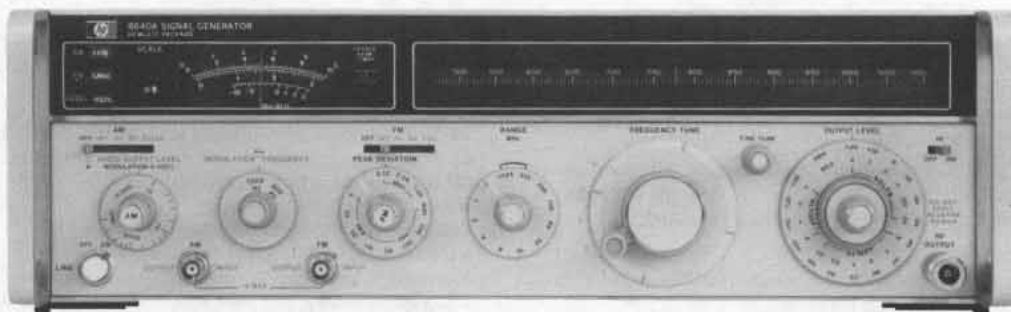

8640A (with option 002)



8640B (with option 001, 002, 003)

8640A/B Signal generator

The 8640 Signal Generator covers the frequency range 500 kHz to 512 MHz (450 kHz to 550 MHz with band overrange) and can be extended to 1100 MHz with an internal doubler (Opt 002). Using the 11710B Down Converter, the 8640 frequency range can be extended down to 10 kHz. An optional audio oscillator (Opt 001) is also available with a frequency range of 20 Hz to 600 kHz. This broad coverage, together with calibrated output and modulation, provides for complete RF and IF performance tests on virtually any type of HF, VHF, or UHF receiver.

Both solid state generators 8640A and B have an output level range of +19 to -145 dBm (2V to 0.013 μ V) which is calibrated, metered, and leveled to within ± 0.5 dB across the full frequency range of the instrument.

The 8640A/B generators provide AM, FM, and pulse modulation for a wide range of receiver test applications. This modulation is calibrated and metered for direct readout under all operating conditions.

A reverse power protection option (Opt 003) is available to eliminate instrument damage due to accidental transmitter keying. This module protects against up to 50 watts of applied power and automatically resets upon removal of the excessive signal.

Spectrally pure output signals

Noise performance of the 8640 is state-of-the-art for a solid-state generator. The high-Q cavity oscillator has been optimized with use of a low-noise microwave transistor for spectrally pure output signals.

At 20 kHz offsets from 230 to 450 MHz, SSB phase noise is > 130 dB/Hz below the carrier level and rises to 122 dB/Hz at 550 MHz. This signal-to-noise ratio increases by approximately 6 dB for each division of the output frequency down to the broadband noise floor of better than 140 dB/Hz. This exceptional noise performance is also preserved during FM modulation and in the phase-locked mode of the 8640B.

Mechanical dial or built-in counter

There are two versions of the 8640 Signal Generators. One, the 8640A, has an easy-to-read slide rule dial with scales for each of the 10 output frequency ranges. There is an additional scale to provide direct readout of the output frequency even in the INTERNAL DOUBLER band, 512-1024 MHz.

The 8640B has the same performance features as the 8640A, but incorporates a built-in 550 MHz frequency counter and phase lock synchronizer.

The built-in 6 digit counter displays the output frequency and can also be used to count external input signals from 20 Hz to 550 MHz. This eliminates the need for a separate frequency counter in many measurement systems.

Internal pushbutton synchronizer

At the push of a button, the 8640B built-in phase lock synchronizer locks the RF output frequency to the crystal time base used in the counter. In this locked mode, the output stability is better than 5×10^{-6} /h and the spectral purity and FM capability of the unlocked mode are preserved. For higher stability, it is possible to lock to an externally applied 5 MHz standard. Two 8640B's can also be locked together for various 2-tone measurements.

In the phase locked mode, increased resolution is available by using the $\frac{1}{2}$ digit increment button. For example, 500 Hz resolution is possible for frequencies between 100 and 1000 MHz.

FM while phase locked

When phase locked, full FM capability is preserved down to modulation rates of 50 Hz. The narrow bandwidth of the phase lock loop (< 5 Hz) provides for FM modulation up to 250 kHz rates and assures no degradation in noise from the unlocked mode. This crystal stability, coupled with the precision modulation and low noise, makes the 8640B ideal for testing narrowband FM or crystal-controlled receivers.

SIGNAL GENERATORS

Precision, high stability, AM-FM, 0.5 to 1024 MHz

Models 8640A, 8640B (cont.)

8640A/B specifications

(See technical data sheet for complete specifications). All specifications apply over the nominal Frequency ranges and over the top 10 dB of the output level vernier range unless otherwise specified.

Frequency

Range: 500 kHz to 512 MHz in 10 octave ranges (to 1024 MHz with option 002 internal frequency doubler).

Ranges and range overlap: ranges extend 10% below and 7% above the nominal frequency ranges shown below.

Frequency ranges (MHz)		
0.5-1	8-16	128-256
1-2	16-32	256-512
2-4	32-64	512-1024
4-8	64-128	(opt 002)

Fine tuning

8640A and 8640B unlocked: >1000 ppm total range.

8640B locked mode: ± 20 ppm by varying internal time base vernier.

Internal counter resolution (8640B unlocked)

Frequency Ranges (MHz)	Normal Mode	Expand X10	Expand X100
0.5-1	10 Hz	1 Hz	0.1 Hz
1-16	100 Hz	10 Hz	1 Hz
16-128	1 kHz	100 Hz	10 Hz
128-1024	10 kHz	1 kHz	100 Hz

Optimum counter resolution when phase-locked (8640B)

Frequency Ranges (MHz)	With 6 Digits	+ $\frac{1}{2}$ Digit
0.5-0.9999995	1 Hz	0.5 Hz
1.0-9.999995	10 Hz	5 Hz
10.0-99.99995	100 Hz	50 Hz
100.0-999.9995	1 kHz	500 Hz
1000-1024	10 kHz	5 kHz

Accuracy

8640A: mechanical dial; accuracy better than $\pm 1.0\%$, resettability better than 0.1%.

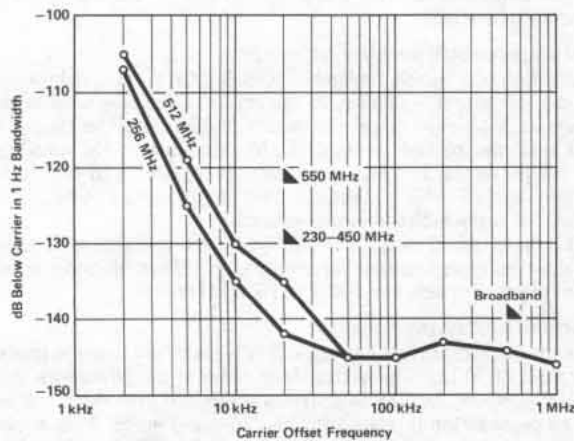

Measured SSB Noise vs. Offset from carrier. Markers indicate specified limits.

8640B: 6½ digit LED display with X10 and X100 expand; accuracy depends on internal or external reference used.

Stability: (after 2 hour warmup)

Normal: <10 ppm/10 min.

Locked: (8640B) <0.05 ppm/hr.

Restabilization time after frequency change

Normal: <15 min.

Locked (8640B): <1 min. after relocking to be within 0.1 ppm of steady state frequency.

Output

Range: 10 dB steps and 18 dB vernier provide the following output power settings into 50Ω.

Frequency Range (MHz)	8640A/B	With Option(s)		
		002	003	002/003
0.5 to 512	+19 to -145 dBm	+18.5 to -145 dBm	+18.5 to -145 dBm	+18 to -145 dBm
512 to 1024 (Option 002)	—	+13 to -145 dBm	—	+12 to -145 dBm

Level flatness (referred to output at 50 MHz and applies to 1 V range and for top 10 dB of vernier range)

Frequency Range (MHz)	8640A/B	With Option(s)		
		002	003	002/003
0.5 to 64	± 0.5 dB	± 0.5 dB	+0.75 dB -1.25 dB	+1.0 dB -2.0 dB
64 to 512	—	± 1.0 dB	—	—
512 to 1024 (Option 002)	—	± 1.5 dB	—	± 2.0 dB

Level accuracy: (worst case as indicated on level meter) ± 1.5 dB to ± 4.5 dB depending on level, frequency, and options installed.

Spectral purity

Harmonics (at 1 volt, +10 dBm output range and below):

>30 dB below fundamental, 0.5 to 512 MHz.

>12 dB below fundamental, 512 to 1024 MHz (option 002).

Spurious output signals (excluding frequencies within 15 kHz of the signal whose effects are specified in residual AM and FM)

Frequency Range (MHz)	Subharmonically Related		Non-harmonically Related	
	8640A	8640B	8640A	8640B
0.5 to 512	none detectable	>100 dBc	none detectable	>100 dBc
512 to 1024 (Option 002)	>20 dBc ¹			

Residual AM (averaged rms): 0.3 to 3 kHz post-detection noise bandwidth >85 dBc.

Residual FM (averaged rms): 0.3 to 3 kHz post-detection noise bandwidth. (CW and up to $\frac{1}{8}$ maximum allowable peak deviation.)

0.5 to 512 MHz <5 Hz.

512 to 1024 MHz <10 Hz.

¹dBc = dB below the carrier.

Modulation

General

Types: Internal AM and FM; External AM, FM and PULSE; simultaneous AM and FM or PULSE and FM.

Internal modulation sources: (independently adjustable output is available at front panel).

Standard: 8640A or 8640B.

Frequency: fixed 400 Hz and 1 kHz, $\pm 3\%$.

Output level: 1 mV to 1 V rms into 600 Ω .

Optional: (internal variable audio oscillator Option 001, 8640A or 8640B).

Frequency: variable 20 Hz to 600 kHz, $\pm 15\%$ plus fixed 400 Hz and 1 kHz $\pm 3\%$.

Output level: 1 mV to 3 V rms into 600 Ω .

Amplitude modulation

Depth

0.5 to 512 MHz: 0 to 100% for output level range from +13 dBm and below.

512 to 1024 MHz: 0 to 100% for output levels of +7 dBm and below, excluding the top 6 dB of output vernier range.

AM Rates: INT and EXT ac; 20 Hz to AM 3 dB bandwidth. EXT dc; dc to AM 3 dB bandwidth.

AM 3 dB bandwidth:

Frequency Ranges	0 to 50% AM	50 to 90% AM
0.5 to 2 MHz	20 kHz	12.5 kHz
2 to 8 MHz	40 kHz	25 kHz
8 to 512 MHz	60 kHz	50 kHz
512 to 1024 MHz	60 kHz	50 kHz

AM distortion (at 400 Hz and 1 kHz rates):

Frequency Ranges	0 to 30% AM	30 to 50% AM	50 to 80% AM
0.5 to 512 MHz	<1%		<3%
512 to 1024 MHz	<10%	<20%	

External AM sensitivity (400 Hz and 1 kHz rates)

0.5 to 512 MHz: (0.1 \pm 0.005)% AM per mV peak into 600 Ω with AM vernier at full clockwise position.

512 to 1024 MHz: nominal 0.1% AM per mV peak into 600 Ω with AM vernier at full clockwise position.

Indicated AM accuracy (400 Hz and 1 kHz rates using internal meter)

0.5 to 512 MHz: $\pm 5.5\%$ of reading $\pm 1.5\%$ of full scale from 0 to 50°C.

512 to 1024 MHz: not specified; each generator can be individually calibrated using operating manual procedure.

Peak incidental phase modulation (at 30% AM)

0.5 to 128 MHz: <0.15 radians.

128 to 512 MHz: <0.3 radians.

512 to 1024 MHz: <0.6 radians.

Peak incidental frequency deviation: equals peak incidental phase modulation x modulation rate.

Pulse modulation

Frequency Ranges (MHz)	0.5-1	1-2	2-8	8-32	32-512	512-1024
Rise and Fall Times	<9 μ s	<4 μ s	<2 μ s	<1 μ s		<1 μ s typical
Pulse Repetition Rate	50 Hz to 50 kHz	50 Hz to 100 kHz	50 Hz to 250 kHz	50 Hz to 500 kHz		
Pulse Width Minimum ¹	10 μ s	5 μ s	2 μ s			
Pulse ON/OFF ratio at max. vernier	>40 dB					>60 dB
Peak Input Required	Nominally +0.5 V (5 V max). Sinewave or Pulse return to zero into 50 Ω					

¹For level accuracy within 1 dB of CW (>0.1% duty cycle).

Frequency modulation

Deviation: maximum allowable deviation equals 1% of lowest frequency in each nominal output frequency range.

Frequency Range (MHz)	Maximum Peak Deviation (kHz)
0.5-1	5
1-2	10
2-4	20
4-8	40
8-16	80
16-32	160
32-64	320
64-128	640
128-256	1280
256-512	2560
512-1024	5120

FM 3 dB Bandwidth: internal and external ac; 20 Hz to 250 kHz External dc; dc to 250 kHz. (8640B locked mode: FM above 50 Hz only.)

FM distortion (at 400 Hz and 1 kHz rates)

<1% for deviations up to 1/4 maximum allowable.

<3% up to maximum allowable deviation.

External FM sensitivity: 1 volt peak into 600 Ω yields maximum deviation indicated on PEAK DEVIATION switch with FM vernier at full clockwise position.

Indicated FM accuracy: (400 Hz and 1 kHz rates from 15°C to 35°C, using internal meter) \pm (7% of reading +1.5% of full scale).

Incidental AM (at 400 Hz and 1 kHz rates)

0.5 to 512 MHz: <0.5% AM for FM up to 1/4 max allowable deviation. <1% AM for FM at maximum allowable deviation.

512 to 1024 MHz (Opt 002): <1% AM for FM up to 1/4 max allowable deviation.

Counter (8640B)

External RF input

Frequency range: 1 Hz to 550 MHz.

Sensitivity: ≥ 100 mV rms into 50 Ω , ac only.

Resolution: 6-digit LED DISPLAY.

Mode	Normal	Expand X10	Expand X100
0-10 MHz	100 Hz	10 Hz	1 Hz
10-550 MHz	10 kHz	1 kHz	100 Hz

External reference input: 5 MHz, nominally >0.5 V p-p (5 V max) into 1 k Ω .

Internal Reference (after 2 h warm-up and calibration at 25°C):

Aging Rate: <0.05 ppm/h; <2 ppm/90 days.

Temperature Drift:

< ± 2 ppm from 15°C to 35°C.

< ± 10 ppm from 0°C to 50°C.

Typical Overall Accuracy (within 3 months of calibration and from 15°C to 35°C): ± 2 ppm.

General

Operating temperature range: 0 to 55°C.

Power Requirements: 100 or 120 volts (+5%, -10%) from 48 to 440 Hz; or 220 or 240 volts (+5%, -10%) from 48 to 66 Hz. 175 VA max (Option 002: 190 VA max).

Weight: 8640A and 8640B: net, 20.8 kg (46 lb). Shipping, 24.1 kg (53 lb).

Dimensions: 140 mm H x 425 mm W x 476 mm D (5.5" x 16.75" x 18.75").

Options

001: (internal variable audio oscillator, 20 Hz to 600 kHz) add \$275

002: (internal doubler 512-1024 MHz) add \$850

003: (reverse power protection) add \$300

004: (avionics option) 8640B only add \$800

Ordering information

8640A Signal Generator

8640B Signal Generator

Price

\$5500

\$6750

SIGNAL GENERATORS

Avionics option

Model 8640B Opt 004

- Demodulated output from RF detector, ac and dc
- Phase shift; less than 0.01° at 30 Hz
- External Count Capability: 1 Hz to 550 MHz

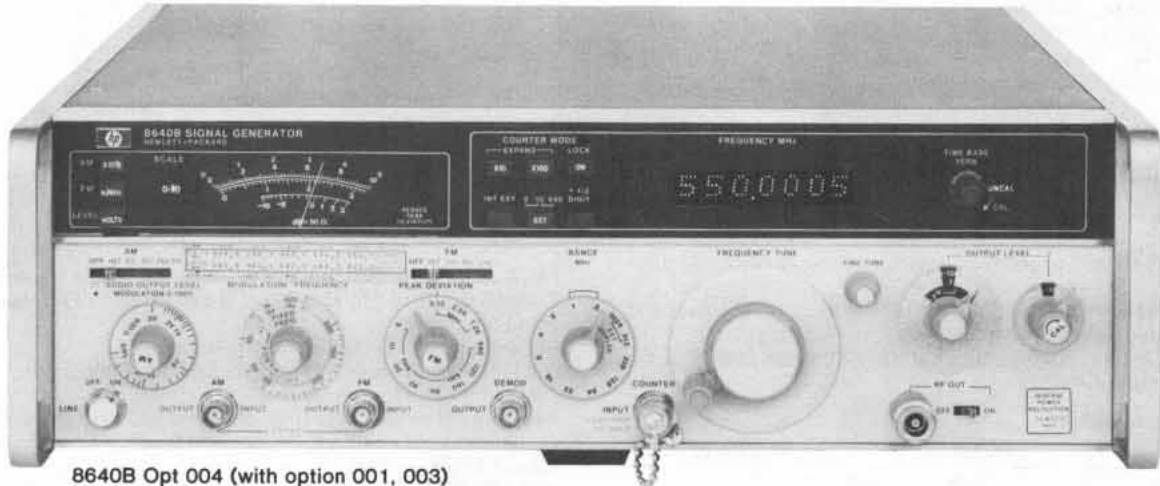

8640B Opt 004 (with option 001, 003)

8640B NAV/COM signal generator

The Hewlett-Packard Model 8640B Option 004 NAV/COM Signal Generator is an 8640B AM/FM Signal Generator specially adapted for testing ILS (Marker Beacon, Localizer and Glide Slope), VOR and VHF communications receivers used throughout the Aviation industry. VOR, LOCALIZER and VHF communications frequencies (108 to 136 MHz) are available on one frequency band for rapid channel selection. GLIDE SLOPE (329 to 335 MHz) and MARKER BEACON (75 MHz) frequencies are also easily set using the 6-digit LED display.

The 8640B Option 004 provides highly stable, spectrally pure RF signals for testing narrow-channel, crystal controlled receivers. For avionics testing, external audio generators are required to provide the composite modulation. Designed with versatile AM and FM modulation, Option 004 features low distortion modulation when used with suitable, external VOR/ILS Audio Generators.

Operation and specifications of the 8640B Option 004 are the same as the Standard 8640B AM/FM Signal Generator with the following additions:

Demodulated output

One front panel BNC connector provides demodulated output from the RF peak detector for precise AM settings. A choice of combined ac/dc at 1 V rms or ac only at 5 V rms is provided.

Output level setting

To ensure the best possible demodulated output linearity, Option 004 combines a 10 dB step attenuator and a 1 dB step attenuator with a vernier. This provides output levels from +15 dBm to -142 dBm (1.3 V to 0.018 μ V). The output level can be read directly from the attenuator dial in dBm or from the front panel meter in dBm or volts.

External AM input impedance

External AM input impedance of 2 k Ω allows compatible operation with old and new generations of external audio generators.

Low distortion modulation

The 8640B Option 004 provides flat AM response and minimum phase shift at 30 Hz and 9960 Hz as well as constant group delay between 9 kHz and 11 kHz for accurate VOR and ILS testing.

Specifications

(These specifications apply to 8640B Option 004 in addition to standard 8640B specifications. See 8640B AM/FM Signal Generator Data Sheet for complete specifications.)

Spectral purity

Noise: SSB Broadband noise floor: greater than 1 MHz offset from carrier, >130 dB down.

Output characteristics

Range: +15 dBm to -142 dBm (1.3 V to 0.018 μ V)

Attenuators: a 10 dB step attenuator plus a 1 dB step attenuator with vernier allow selection of any output level over the full output level range.

Vernier: 2 dB continuously variable from a CAL detent position.

Level flatness: < ± 0.75 dB from 0.5 to 512 MHz referred to output at 190 MHz. < ± 0.5 dB from 108 to 336 MHz referred to output at 190 MHz. (Flatness applies from +10 to -10 dBm.)

Level accuracy

Output Level (dBm)	+15 to -10	-10 to -50	-50 to -142	With Option 003
Total Accuracy as Indicated on Level Meter	± 1.5 dB	± 2.0 dB	± 2.5 dB	Add ± 0.5 dB except from 108 to 336 MHz

Modulation characteristics

Demodulated output (Output vernier in CAL position) (108 to 118 and 329 to 336 MHz): an internal selector switch allows selection of ac only or ac and dc at the demodulated output.

AC only output: directly proportional to AM depth, (90 to 150 Hz modulation frequency).

%AM equals: (20 \pm 0.6)% per V rms, 0 to 55°C; (20 \pm 0.4)% per V rms, 20 to 30°C; (20 \pm 0.2)% per V rms (using calibration sheet provided by factory).

AC and DC output: Ac output voltage is directly proportional to AM depth (90 to 150 Hz modulation frequency).

%AM equals: (100 \pm 3)% per V rms, 0 to 55°C; (100 \pm 2)% per V rms, 20 to 30°C; (100 \pm 1)% per V rms (using calibration sheet provided by factory).

DC output equals (1.414 \pm 0.010) V dc with vernier in CAL position.

Amplitude modulation characteristics (+10 dBm output and below)

External input impedance: nominally 2 k Ω .

Frequency response: <0.1 dB from 90 Hz through 150 Hz (108 to 118 and 329 to 335 MHz.); <0.1 dB from 9 kHz through 11 kHz (108 to 118 MHz); ± 3 dB (0 to 50% AM) from dc through 50 kHz (8 to 512 MHz); ± 3 dB (0 to 70% AM) from dc through 35 kHz (8 to 512 MHz).

Phase shift from audio input to demodulated output (108 to 118 MHz) (AM EXT DC mode, meter function on VOLTS):

30 Hz < $\pm 0.01^\circ$

30 Hz to 10 kHz < $\pm 3^\circ$

9 kHz to 11 kHz < $\pm 2^\circ$ difference.

8640B Avionics Opt 004

\$7550

Ruggedized signal generator, down converter

Models 8640M, 11710B

- 500 kHz to 512 MHz
- -40°C to +55°C operating temperature
- Phase lock stability, external count



8640M

8640M Signal generator

The 8640M is a highly ruggedized version of the 8640B signal generator which adds field useability and retains the excellent stability and signal purity of the 8640B. Six-digit display, phase-lock, and external count capability similar to the 8640B are standard on the 8640M. Internal Pulse modulation capability and 50 W reverse power protection are also standard.

The waterproof combination case, constructed to the requirements of Mil-T-21200J, provides a protective outer shell and cushioned mounts to assure tolerance to the shock and vibration rigors of off-road transportation. All controls on the front panel are drip-proof, and the air ducts are louvered to allow operation in wind, rain, or snow.

Reliability testing to Mil-Std-781 allows prediction of MTBF's in excess of 2200 hours. The testing included vibration, -40°C to +55°C temperature cycling, and power cycling. Maintainability testing to Mil-Std-471 has verified that the mean time to repair the 8640M is less than 2 hours.

8640M Specifications

Frequency

Range: 500 kHz to 512 MHz in 10 Octave ranges (to 1024 MHz with External Frequency Doubler).

Internal counter resolution: same as 8640B (except no Expand X100 range; no extra 1/2 digit).

External counter resolution: from 0 to 10 MHz: 10 Hz; from 10 to 550 MHz: 1 kHz.

Stability

	Normal	Locked
Time (after 3-hr. warm-up)	<15 ppm/10 min	<2 ppm/10 min
Temperature	<50 ppm/°C	<1 ppm/°C

Output range and accuracy

Output (dBm) Range	Using Top 10 dB of Vernier Range		Using Full Vernier Range
	+13 to -7	-7 to -47	-47 to -137
Total Accuracy as Indicated on Level Meter	±2.0 dB	±2.5 dB	±3.0 dB
			Add ±0.5 dB

Modulation

Types: internal AM, FM, and PULSE.
external AM, FM, and PULSE.

Environmental performance

Temperature: MIL-STD-810B, Method 501, 502 Proc. 1.

Operating: continuous operation allowed between -40°C (-40°F) and +55°C (131°F). Intermittent operation (<20 min.) allowed up to +71°C (160°F).

Non-Operating: storage allowed between -60°C (-76°F) and +85°C (185°F).

- Extends frequency range down to 10 kHz on all 8640 and 8654 series generators
- Preserves calibrated output level and modulation



11710B

Humidity: MIL-STD-810B, Method 507 Proc. 1. 10-day test.

Operating: -40°C (-40°F) to +40°C (104°F) at up to 95% RH.

Non-operating: storage allowed between -60°C (-76°F) and +60°C (140°F) up to 95% R.H. Condensation allowed.

Shock: MIL-T-21200J Class II. When mounted in its combination case, the 8640M will withstand 20 g's shock in any of 3 planes without damage.

Vibration: MIL-T-21200J Class II.

Rain: MIL-STD-810B Method 506 Proc. 1. Simulated rain and wind conditions up to 12 in./hour rainfall and up to 40 mph wind. Instrument was in normal operating configuration.

Explosive Atmosphere: MIL-STD-810B Method 511 Proc. 1. Type testing verified successful operation in potentially explosive atmosphere laden with avionic fuel vapor.

Salt Fog: MIL-STD-810B Method 509 Proc. 1. A mechanical mock-up was tested to verify the non-corrosive nature of parts, materials, and processes.

Fungus: non-fungus nutrient material used.

EMI: MIL-STD-461A, Class C1, Test Methods CE 03 and RE 02.

11710B Down converter

The 11710B Down Converter is an accessory for the 8640 and 8654 series signal generators. Frequency inputs from 50.01 to 61 MHz are down converted to the 10 kHz to 11 MHz range respectively. The output level and modulation functions of the 8640 and 8654 remain calibrated. A straight-through selection switch allows the input to pass through unchanged and thus minimizes the necessity to move cables when testing.

11710B Specifications

Input

Down-conversion mode: 50.01 to 61.00 MHz at ≤0 dBm.

Straight-through mode: 0.01 to 1100 MHz (dc coupled).

Down-converted output

Frequency range: 10 kHz to 11 MHz.

Level range: 0 to -107 dBm.

Level flatness: RF source flatness ±0.5 dB (referred to 4.0 MHz).

Total level accuracy: ± (1 dB plus input level accuracy).

Harmonics: >35 dB below the carrier (dBc).

Intermixing spurious: >60 dBc.

Local oscillator feed-through (50 MHz): <-100 dBm.

Internal reference characteristics

Time base output: 1 MHz or 5 MHz selectable, nominally >0.5 V p-p into 500Ω. This will drive an 8640B or 8655A External Time Base Input.

Typical overall accuracy: (within 3 mo. of calibration and from 15°C to 35°C): ±2 ppm.

General

Operating temperature range: 0 to 55°C.

Power requirements: 100, 120, 220, 240 V (+5%, -10%), 48 to 440 Hz; 25 VA maximum.

Weight: net, 3.2 kg (7 lb); shipping 4.5 kg (9 lb).

Dimensions: 102 mm H x 266 mm W x 295 mm D (4" x 10.5" x 11.6").

Ordering Information

8640M Signal generator

11710B Down converter

Price

\$8500

\$1050

SIGNAL GENERATORS

Rugged solid-state generator 10 to 520 MHz; synchronizer/counter

Models 8654A, 8654B, 8655A

- Calibrated output power
- Calibrated AM, FM; internal, external, independent
- 25 Watt reverse power protection (optional)



8654A



8654B

8654A/B Signal generators

The HP 8654A/B Signal Generators are portable, low-cost solid-state generators providing calibrated output and versatile modulation capabilities over the 10 to 520 MHz frequency range. The 8654A provides clean RF signals with harmonics < -20 dBc (dB relative to carrier) and subharmonics and spurious < -100 dBc for testing receivers, amplifiers, antennas, and filter networks. The 8654B has calibrated AM and FM while the 8654A has uncalibrated FM.

Its compactness and small size allow the 8654 to fit easily into production, mobile, airborne, and shipboard test locations. Its rugged, lightweight construction is also suitable for field maintenance and service applications.

Internal oscillators provide both amplitude modulation and frequency modulation at 400 Hz and 1000 Hz, or external modulation can be accomplished using standard audio oscillators.

A front-panel meter accurately indicates amplitude modulation depth from 0 to 90% when the meter mode switch is in the AM position. Additionally, the 8654B provides calibrated and metered FM over four deviation ranges: 0 to 3 kHz, 0 to 10 kHz, 0 to 30 kHz, and 0 to 100 kHz.

Reverse power protection is available (Option 003) to protect against accidental triggering of transceivers of up to 25 watts into the signal generator.

Effective RF shielding and output range permit receiver sensitivity measurements to be made down to power levels of 0.1 μ V.

8654A/B Specifications

Specifications apply from 10 to 520 MHz for output power $\leq +10$ dBm and over the top 10 dB of output level vernier range unless otherwise specified.

Frequency characteristics

Range: 10 to 520 MHz in 6 ranges.

8654A ranges (MHz): 10 to 18.6, 18.6 to 35, 35 to 66, 66 to 130, 130 to 250, 250 to 520.

8654B ranges (MHz): 10 to 19, 19 to 35, 35 to 66, 66 to 130, 130 to 270, 270 to 520.

Accuracy: $\pm 3\%$ after 2-hour warm-up.

Settability: settable to within 5 ppm of the desired frequency with an external indicator after 1-hour warm-up.

Stability (after 2-hour warm-up and 15 min. after frequency change): $< (1 \text{ kHz plus } 20 \text{ ppm})/5 \text{ min.}$

Spectral purity

Harmonic distortion (output power $\leq +3$ dBm): < -20 dBc; with option 003, < -15 dBc.

Subharmonics and non-harmonic spurious (excluding line related): < -100 dBc.

Residual AM (average rms): < -55 dBc in a 50 Hz to 15 kHz post-detection noise bandwidth.

Residual FM on CW (averaged rms deviation): < 0.3 ppm in a 0.3 to 3 kHz post-detection noise bandwidth. < 0.5 ppm in a 50 Hz to 15 kHz post-detection noise bandwidth.

Output characteristics

Range: 10 dB steps and a 13 dB vernier provide power settings from +10 dBm to -130 dBm (0.7 V to 0.07 μ V) into 50 Ω . With Option 003, maximum output power is +8 dBm (0.56 V).

Impedance: 50 Ω ac coupled. SWR < 1.3 on 0.1 V range or lower. With Option 003, SWR < 1.5 on 0.1 V range or lower.

Level accuracy (total as indicated on level meter): +10 to -7 dBm, ± 1.5 dB, -7 to -57 dBm, ± 2.0 dB; -57 to -97 dBm, ± 2.5 dB; -97 to -127 dBm, ± 3 dB.

Level flatness: ± 1 dB referenced to the output at 250 MHz for output levels > -7 dBm.

Auxiliary RF output: > -7 dBm (100 mV) into 50 Ω .

Leakage (with all RF outputs terminated properly): leakage limits are below those specified in MIL-1-6181D. Furthermore, with an output level < 0.01 V, less than 0.5 μ V is induced in a 2-turn, 25 mm diameter loop 25 mm away from any surface and measured into a 50 Ω receiver.

Reverse power protection (Option 003): protects signal generator from accidental applications of up to 25 w (+44 dBm) of RF power (between 10 and 520 MHz) into generator output.

Modulation characteristics

Amplitude modulation: specifications apply for output power $< +3$ dBm.¹

Depth: 0 to 90%.

Modulation rate: internal, 400 and 1000 Hz $\pm 10\%$; external 3 dB bandwidth, dc to > 20 kHz.

External AM sensitivity:² (0.1 ± 0.01)% AM/mV pk into 600 Ω .

Indicated AM accuracy:² $\pm 5\%$ of reading +5% of full scale).

Peak incidental frequency deviation (30% AM):² less than 200 Hz.

Envelope distortion:² $< 3\%$, 0 to 70% modulation; $< 5\%$, 70 to 90% modulation.

Frequency modulation

8654B: fully calibrated.

Peak deviation: 0 to 30 kHz from 10 to 520 MHz.

0 to 100 kHz from 80 to 520 MHz.

Deviation ranges: 0 to 3 kHz, 0 to 10 kHz, 0 to 30 kHz, 0 to 100 kHz.

Modulation rate: internal, 400 and 1000 Hz $\pm 10\%$. External 3 dB bandwidth, dc to > 25 kHz.

FM distortion:² $< 2\%$ for deviations up to 30 kHz, $< 3\%$ for deviations up to 100 kHz.

¹AM is possible above +3 dBm as long as the combination of the AM depth plus carrier output level does not exceed +9 dBm.

²400 and 1000 Hz modulation rates.

- Synchronize 8654A/B, stability 0.1 ppm/hr.
- 500 Hz lock resolution
- Low RFI counter to 520 MHz

External FM sensitivity:² 1 volt peak yields maximum deviation indicated on peak deviation meter with FM LEVEL vernier at fully clockwise position.

Sensitivity accuracy:² ± 12%.

Indicated FM accuracy (15° to 35°C):² ± (12% of reading + 3% of full scale). For 100 kHz deviation above 130 MHz, add 3% of reading.

Incidental AM:² < 1% AM at 30 kHz deviation.

Frequency modulation, 8654A: uncalibrated.

Deviation: > 0.1% of carrier frequency, maximum.

Modulation rate: internal, 400 & 1000 Hz ± 10%. External 3 dB bandwidth, dc coupled to > 25 kHz driven from 600Ω or less.

External FM sensitivity: 10 V_{pk} into 600Ω yields > 0.1% deviation (± 15 volts max).

General characteristics

Power: 100, 120, 220, or 240 volts +5%, -10%, 48 to 440 Hz; 25 VA maximum. 2.3 m (7.5 ft.) power cable furnished with mains plugs to match destination requirements.

Weight: net, 8.0 kg (17.5 lb). Shipping, 9.5 kg (21 lb).

Size: 178 H x 267 W x 306 mm D (7" x 10.5" x 12").

8655A Synchronizer/Counter

The HP 8655A Synchronizer/Counter is a phase-lock frequency stabilizer that provides the HP 8654A and 8654B Signal Generators with crystal-oscillator frequency stability. It is also a frequency counter with very low RFI leakage. When used with an 8654 Signal Generator, the frequency can be phase-locked at any frequency from 10 to 520 MHz. In the locked mode the spectral purity and FM capability of the unlocked 8654 are preserved. This performance allows testing of new state-of-the-art crystal controlled receivers.

Phase locking the 8654 is simple with the 8655A Synchronizer. A push of the LOCK button establishes lock at the frequency shown on the LED display. Maximum lock resolution is 500 Hz. If lock is broken, the LED display flashes. Lock can be re-established by retuning and again pushing the LOCK button.

The 8655A can also be used to count external input signals from 1 kHz to 520 MHz. Input sensitivity is better than 100 mV into 50 ohms. Using the EXPAND button it is possible to achieve a resolution of 1 Hz in the 1 kHz—10 MHz EXT COUNT mode or 100 Hz in both the 10—520 MHz EXT COUNT and SYNCHRONIZE COUNT modes.

RF leakage from an 8654B/8655A system is < 1.5 μV in a 2-turn, 25 mm diameter loop 25 mm away from any surface and measured into a 50 ohm receiver.

8655A Specifications

Counter characteristics

Range: 1 kHz to 520 MHz.

Sensitivity: < 100 mV rms (-7 dBm), ac coupled into 50 ohms. (Typically < -20 dBm, 10 kHz to 200 MHz.)

Maximum input: AC: 707 mV (± 10 dBm) for accurate count. DC: ± 25 V on EXTERNAL COUNT INPUT, 0 V dc (ac only) on rear panel SYNCHRONIZE COUNT INPUT. Both inputs are protected with common fuse.

Count resolution: 6-digit LED display:

Mode	Normal	X10 EXPAND ³
1 kHz to 10 MHz (EXTERNAL)	10 Hz	1 Hz
10 MHz to 520 MHz (EXTERNAL & SYNCHRONIZE COUNT)	1 kHz	100 Hz

Accuracy: ± 1 count ± time base accuracy.

³Will continue to accurately count from 1 to 10 MHz and 100 to 520 MHz with loss of most significant digit (indicated by overflow light). Phase lock is not allowed.



8655A

Time base characteristics

Frequency: 1 MHz temperature-compensated crystal oscillator.

Aging (constant operating temperature): < 0.1 ppm/hr, < 2 ppm/90 days.

Temperature: ± 5 ppm from 0° to 50°C. (Referenced to 25°C).

Typical overall accuracy (after 2 hour warm-up and within 3 months of calibration): better than ± 2 ppm from 15° to 35°C. (Optional higher stability time base available.)

Rear output: 1 MHz, nominally > 0.5 V peak-to-peak into 500 ohms.

External reference input: 1 MHz, nominally > 0.5 V peak-to-peak into 1000 ohms. (Not available with optional high stability time base.)

8654A/B-8655A Synchronization characteristics

Frequency range: 10—520 MHz.

Frequency count resolution: 1 kHz, or 100 Hz in X10 EXPAND.

Frequency lock resolution: 1 kHz. Depressing LOCK + 500 Hz button allows a locked resolution of 500 Hz.

Frequency accuracy: same as time base accuracy.

Lock time duration (after 5 minute warm-up, constant ambient): 45 min. typical.

FM rate while synchronized: 50 Hz to > 25 kHz, (with 8654B only).

FM accuracy (with 8654B only):

$$\left[\begin{array}{c} \text{Total FM} \\ \text{Accuracy} \end{array} \right] = \left[\begin{array}{c} \text{8654B FM} \\ \text{Accuracy} \end{array} \right] \pm \left[\begin{array}{c} \text{Frequency} \\ \text{Correction Error} \end{array} \right]$$

Frequency correction error⁴ is typically < ± 4%.

General

RF leakage (when operated with 8654B using furnished interface cables): less than 1.5 μV in a 2-turn, 25 mm diameter loop 25 mm away from any surface and measured into a 50 ohm receiver.

Power: 100, 120, 220, or 240 volts +5%, -10%, 48 to 400 Hz, 100 VA maximum. 2.9 m (7.5 ft) power cable.

Weight: net, 6 kg (13.0 lb). Shipping 6.5 kg (14 lb).

Size: 102 H x 267 W x 318 mm D (4" x 10.5" x 12.5").

⁴Frequency correction error is a function of the unlocked 8654B frequency drift. For optimum FM accuracy, this error may be eliminated by unlocking, returning to the desired frequency, and relocking.

Ordering information

8654A AM signal generator	Price \$2225
8654B AM/FM signal generator	\$2750
Opt 003: Reverse power protection (for 8654A/B)	add \$300
8655A Synchronizer/Counter	\$2200
Opt 001: High stability time base (for 8655A)	add \$450

SIGNAL GENERATORS

HF signal generator

MODEL 606B

- 50 kHz to 65 MHz
- Excellent signal purity



606B

606B HF signal generator

The Hewlett-Packard 606B Signal Generator provides you with high quality, versatile performance with distinctive ease of operation in the important and widely used 50 kHz to 65 MHz frequency range. Output signals are stable and accurately known, output amplitude can be precisely established over a very wide dynamic range, and versatile modulation capabilities are incorporated to satisfy virtually all measurement requirements. Convenient size and shape, together with a simple, straightforward control panel layout, make the 606B well suited for production line use as well as laboratory or field applications.

Design

The 606B is a master oscillator-power amplifier (MOPA) design with a broadband buffer amplifier stage between the oscillator and power amplifier circuits for isolation. The MOPA design permits optimization of the oscillator circuit for highest stability including low drift, minimum residual FM, low harmonics, etc., without restricting the modulation characteristics. Modulation is applied to the power amplifier circuit with negligible effect on the oscillator frequency (because of the buffer stage). Very fine frequency settability is achieved through incorporation of a ΔF control which provides better than 10 ppm resolution.

606B Specifications

(All specifications apply over top 10 dB of output vernier range.)

Frequency and output characteristics

- Range:** 50 kHz to 65 MHz in 6 bands; accuracy: $\pm 1\%$.
Drift: (1 V output and below) less than 50 ppm (or 5 Hz, whichever is greater) per 10 min period after 2-hr warmup; less than 10 min to restabilize after changing frequency.
 ΔF Control: better than 10 ppm settability; range of ΔF control approximately 0.1%.
Resettability: better than 0.15% after warmup.
Crystal calibrator: provides frequency checkpoints every 100 kHz and 1 MHz; jack provided for audio frequency output; crystal frequency accuracy better than 0.01% from 0° to 50°C.
Residual FM: less than ± 1 ppm or ± 20 Hz peak, whichever is greater.
Output level: continuously adjustable from 0.1 μV to 3 V into 50-ohm resistive load, calibrated in voltage and dBm.

Frequency response and output accuracy: at output below 1 V, output level variation with frequency is less than 2 dB; output accuracy is better than ± 1 dB at any frequency.

Impedance: 50 ohms, SWR less than 1.2 on 0.3 V attenuator range and below.

RFI: meets all conditions specified in MIL-I-6181D; permits receiver sensitivity measurements down to at least 0.1 μV .

Harmonic output: at least 25 dB below the carrier.

Spurious AM: hum and noise sidebands are 70 dB below carrier down to the thermal level of 50-ohm output system.

Auxiliary RF output: (fixed level CW) on front panel: minimum output: 100 mV rms into 50 ohms from 50 kHz to 19.2 MHz, 200 mV rms from 19 to 65 MHz.

Modulation characteristics

Internal AM

Frequency: 400 and 1000 Hz, $\pm 5\%$.

Modulation level: 0 to 95% on 1 V attenuator range and below; 0 to at least 30% on 3 V range.

Incidental FM (attenuator on 1 V range and below, 30% modulation): less than 5×10^{-6} + 100 Hz peak.

Carrier envelope distortion: $< 1\%$ at 30% AM, $< 3\%$ at 70% AM (attenuator on 1 V range and below).

External AM

Frequency: dc to 20 kHz maximum, dependent on carrier frequency (F_c) and percent modulation as tabulated.

Maximum modulation frequency:

30% Mod.	70% Mod.	Square wave Mod.
$0.06 f_c$	$0.02 f_c$	$0.003 f_c$ (3 kHz max.)

Modulation level: 0 to 95% on 1 V attenuator range and below, 0 to at least 30% on 3 V range.

Input required: 4.5 V peak produces 95% modulation (maximum input 50 V peak); input impedance 1000 ohms.

Carrier envelope distortion: $< 3\%$ at 70% AM (≤ 1 V output).

Modulation meter accuracy: $\pm (5\%$ of full scale + 5% of reading) from 0 to 90% for rates to 10 kHz; $\pm 10\%$ of full scale for rates to 20 kHz.

Modulation level constancy (internal or external AM; attenuator on 1 V range and below): modulation level of 70% or less stays constant within ± 0.5 dB regardless of carrier frequency and output level changes.

General

Power: 115 or 230 V $\pm 10\%$, 50 to 400 Hz, 135 VA.

Dimensions: cabinet, 318 mm H x 527 mm W x 375 mm D (12.5" x 20.75" x 14.75"); rack 265.9 mm H x 483 mm W x 371 mm D behind panel, (10.5" x 19" x 14.63").

Weight: cabinet, net, 25 kg (55 lb). Shipping 30 kg (66 lb); rack, net, 22.7 kg (50 lb). Shipping 29.5 kg (65 lb).

Accessories available:

11507A Output Termination, provides 3 positions: 50 ohms, 5 ohms and IEEE Standard Dummy Antenna.

11509A Fuseholder, protection for 606B transceiver tests.

10534A Mixer, for use as a nanosecond pulse modulator.

Ordering information

606B HF Signal Generator (cabinet)

606BR HF Signal Generator (rack)

Price

\$4200

\$4200

- Versatility and value, 10-480 MHz
- Low noise floor
- Master oscillator - power amplifier

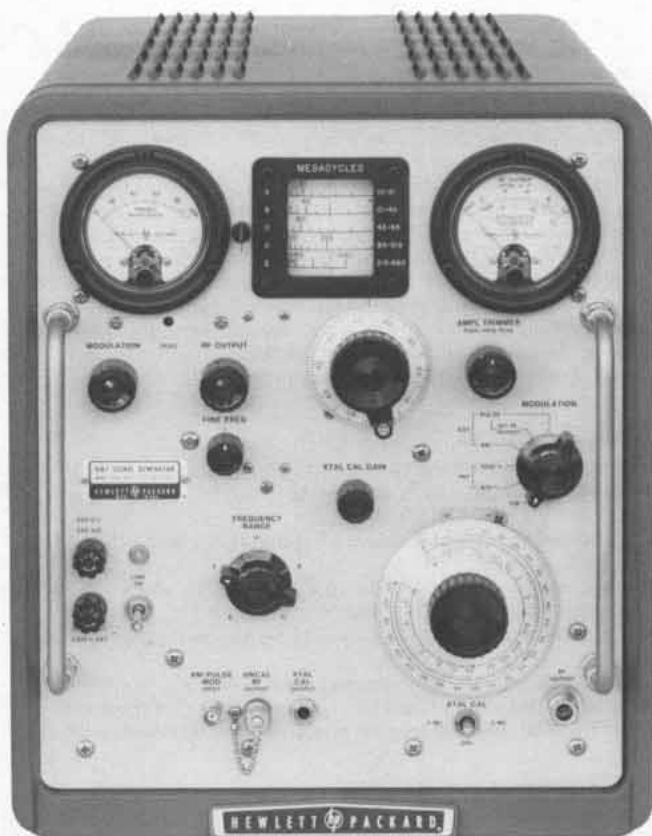

608E

608E VHF signal generator

Model 608E provides high-quality, versatile performance with distinctive ease of operation. The 608E provides an output of up to 1 volt over the range from 10 to 480 MHz.

The 608E is an improved version of the popular and time-proven HP 608C/D Signal Generators. The instrument is a master oscillator-power amplifier (MOPA) type with a broadband buffer amplifier stage between the oscillator and power amplifier circuits for isolation. The MOPA design permits optimization of the oscillator stage for high stability of 0.005% per 10 minutes, minimum residual FM, and low harmonics without restricting the modulation characteristics. Modulation is applied to the power amplifier stage with negligible effect on the oscillator frequency.

608E specifications

Frequency characteristics

Range: 10-480 MHz in five bands.

Accuracy: $\pm 0.5\%$ with cursor adjustment.

Drift: less than $50 \times 10^{-6}/10$ min after one hr. warmup.

Resettability: better than $\pm 0.1\%$ after initial warmup; fine-frequency-adjust provides approximately 25 kHz settability at 480 MHz.

Crystal calibrator: provides frequency check points every 1 MHz up to 270 MHz or every 5 MHz over total range; jack provided for audio frequency output; crystal frequency accuracy better than 0.01% at room temperatures.

Residual FM: less than ± 5 parts in 10^7 in a 10 kHz post-detection bandwidth.

Harmonic output: at least 35 dB below the carrier for harmonic frequencies below 500 MHz.

Output characteristics

Output level: continuously adjustable from 0.1 μV to 1.0 V into a 50-ohm resistive load; output calibrated in volts and dBm.

Accuracy: within ± 1 dB of attenuator dial reading at any frequency when RF output meter indicates "ATTENUATOR CALIBRATED."

Impedance: 50 Ω with a maximum SWR of 1.2 for attenuator setting below -7 dBm.

RFI: meets all conditions specified in MIL-I-6181D; permits receiver sensitivity measurements down to at least 0.1 μV .

Auxiliary RF output: at least 180 mV rms into 50 Ω provided at front panel.

Modulation characteristics

Internal AM

Frequency: 400 and 1000 Hz, $\pm 10\%$.

Modulation level: 0 to 95% modulation at carrier levels 0.5 V and below.

Carrier envelope distortion: less than 2% at 30% AM, less than 5% at 70% AM.

External AM

Frequency: 20 Hz to 20 kHz.

Modulation level: 0 to 95% modulation at carrier levels of 0.5 V and below; continuously adjustable from front panel MOD LEVEL control; input required, 1-10 V rms (1000 Ω input impedance).

Carrier envelope distortion: less than 2% at 30% AM, less than 5% at 70% AM (modulation source distortion less than 0.5%).

Modulation meter accuracy: $\pm 5\%$ of full scale 0 to 80%, $\pm 10\%$ from 80% to 95% (for INT AM or 20 Hz to 20 kHz EXT AM).

Incidental FM (at 400 and 1000 Hz modulation): less than 1000 Hz peak at 50% AM for frequencies above 100 MHz; below 100 MHz; less than 0.001% at 30% AM.

External pulse modulation

Rise and decay time: from 40 MHz to 220 MHz, combined rise and decay $< 4 \mu\text{s}$; above 220 MHz, combined rise and decay time $< 2.5 \mu\text{s}$.

On-off ratio: at least 20 dB for pulsed carrier levels of 0.5 V and above.

Input required: positive pulse, 10-50 V peak, input impedance 2 k Ω .

General

Power: 115 or 230 V $\pm 10\%$, 50 to 400 Hz; approx. 220 VA.

Size: cabinet, 416 H x 337 W x 533 mm D (16.38" x 13.25" x 21"); rack mount: 355.6 H x 483 W x 467 mm D behind panel (14" x 19" x 18.4").

Weight: cabinet mount: net, 28 kg (62 lb); shipping 33.4 kg (74 lb); rack mount: net, 28 kg (62 lb); shipping, 37.4 kg (83 lb).

Accessories available:

11508A Output Cable for high impedance circuits.

11509A Fuse Holder protection for transceiver tests.

10514A Mixer for use as nanosecond pulse modulator.

11690A Doubler for extending frequency range.

11710B Down Converter for low frequency extension.

Ordering information

608E VHF Signal Generator (cabinet)

608ER VHF Signal Generator (rack)

Price

\$5400

\$5400

SIGNAL GENERATORS

UHF signal generator

Model 612A

- 450 to 1230 MHz
- Wide band modulation

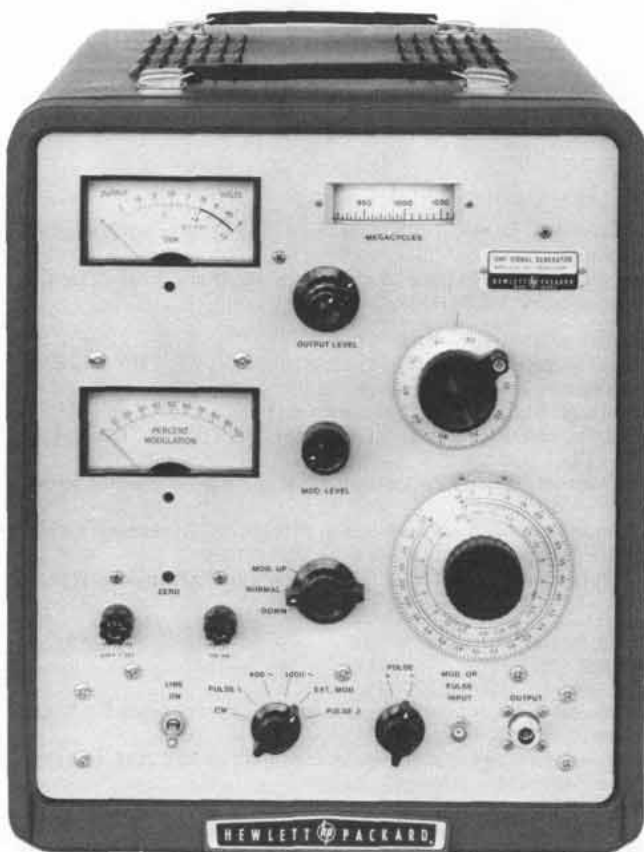

612A

612A UHF signal generator

Here is an all-purpose, precision signal generator particularly designed for utmost convenience and applicability throughout the important UHF-TV frequency band. It is ideally suited for measurements in UHF-television broadcasting, studio-transmitter links, citizen's radio and public service communications systems. The HP 612A also covers the important frequencies used in aircraft navigation aids such as DME, TACAN and airborne transponders. Accessory modulators, available from many of the manufacturers of these navigational aids, enable the 612A to provide the complex modulation patterns required for testing and aligning these systems. In the laboratory, the 612A is a convenient power source for driving bridges, slotted lines, antennas and filter networks. In addition, the HP 8731 PIN Modulators can be used with the 612A to obtain RF pulses with 30 ns rise time and 0.1 μ s minimum duration—with on-off ratios approaching 80 dB.

MOPA circuit

The master oscillator-power amplifier circuit in the HP 612A provides 0.5 volt into 50 ohms over the full frequency range of 450 to 1230 MHz. There is very low incidental FM (less than 0.002% at 30% AM) and excellent amplitude modulation capabilities by all frequencies from 20 Hz to 5 MHz. The degree of modulation is easily read from the large percent modulation meter. The instrument can be amplitude-modulated (either internally or externally), and provision is made for external pulse modulation as well. Pulse modulation can be applied to the amplifier or directly to the oscillator when high on-off signal ratios are required (signal may be completely cut off between pulses). Modulation can be up or down from a preset level to simulate TV modulation characteristics accurately.

Cavity oscillator

The oscillator-amplifier circuit in the 612A employs high frequency pencil triodes in a cavity-tuned circuit for precise tracking over the entire band. Noncontacting cavity plungers are die-cast to precise tolerances, then injection-molded with a plastic filler for optimum Q. The frequency drive is a direct screw-operated mechanism, free from backlash. A waveguide-beyond-cutoff piston attenuator and crystal monitor circuit are used to ensure accurate, reliable output down to 0.1 μ V. The attenuator is calibrated over a range of 131 dB and has been carefully designed to provide a constant impedance-versus-frequency characteristic. The SWR of the 50-ohm output system is less than 1.2 over the complete frequency range.

Specifications

Frequency and output characteristics

Frequency range: 450 to 1230 MHz in one band; scale length approximately 381 mm (15").

Calibration accuracy: within $\pm 1\%$, resettability better than 5 MHz at high frequencies.

Output level: +7 to -127 dBm (0.1 μ V to 0.5 V) into 50-ohm load; calibrated in V and dBm (0 dBm = 1 mW).

Output accuracy: ± 1 dB, 0 to -127 dBm over entire frequency range.

Output impedance: 50 ohms; maximum SWR 1.2.

RFI: conducted and radiated leakage limits are below those specified MIL-I-6181D; permits receiver sensitivity measurements down to 1 μ V.

Modulation characteristics

Amplitude modulation: above 470 MHz, 0 to 90% at audio frequencies, indicated by panel meter; accuracy $\pm 10\%$ of full scale, 30 to 90% modulation.

Incidental FM: less than 0.002% for 30% AM.

Internal modulation: 400 and 1000 Hz $\pm 10\%$; envelope distortion less than 3% at 30% modulation.

External modulation: 20 Hz to 5 MHz; above 470 MHz, 2 V rms produces 85% AM at modulating frequencies up to 500 kHz, at least 40% AM at 5 MHz; modulation may be up or down from the carrier level or symmetrical about the carrier level; positive or negative pulses may be applied to increase or decrease RF output from the carrier level.

Pulse Modulation

Pulse 1 (pulse applied to amplifier): positive or negative pulses, 4 to 40 V peak produce an RF on-off ratio of at least 20 dB; minimum RF output pulse length, 1.0 μ s. Pulse 2 (pulse applied to oscillator) same, but no RF output during off time.

General

Power: 115 or 230 volts $\pm 10\%$, 48 to 440 Hz, 360 VA.

Dimensions: cabinet: 419mm H x 343mm W x 584 mm D (16.5" x 13.5" x 23"); rack mount: 335mm H x 483 mm W x 552 mm D behind panel (14" x 19" x 21.7").

Weight: net, 25.2 kg (56 lb). Shipping, 30.6 kg (68 lb), (cabinet); net, 25.2 kg (56 lb). Shipping, 34.6 kg (77 lb) (rack mount).

Accessories available: 11500A RF Cable Assembly; 360B Low-Pass Filter (may be used where harmonic output must be reduced to a minimum, as in slotted line measurements).

Ordering information

612A UHF Signal Generator (cabinet)

612AR UHF Signal Generator (rack)

Price

\$4300

\$4300

- Stable, easy to use, 800-2400MHz, 1800-4500MHz



HP 8614A, 8616A Signal generators

The HP 8614A and 8616A Signal Generators provide stable, accurate signals from 800 to 2400 MHz (8614A) and from 1800 to 4500 MHz (8616A). Both frequency and attenuation are set on direct-reading digital dials, while selectable functions include CW, leveled output, square-wave modulation, and external AM, FM and pulse modulation. Modulation can be accomplished simultaneously with or without leveling.

Two RF power outputs are simultaneously available from separate front-panel connectors. One provides at least 10 mW (2 mW above 3000 MHz) or a leveled output from 0 to -127 dBm. The other is at least 0.5 mW across the band. This signal can be used for phase-locking the signal generators for extreme stability, or it can be monitored with a frequency counter for extreme frequency resolution without adversely affecting the primary output.

A unique PIN diode modulator permits amplitude modulation from dc to 1 MHz or RF pulses with a 2 μ s rise time. This broad modulation bandwidth permits remote control of output level or precise leveling using external equipment. The internal leveling is also obtained by using a PIN modulator.

The 8614A and 8616A can also be used with companion modulators, HP 8403A modulators and HP 8730-series PIN modulators to provide 80 dB pulse on/off ratio (see page 379). In addition, TWT amplifiers can be used with these generators to provide high power levels.

Specifications

8614A

Frequency range: direct reading within 2 MHz, 800 to 2400 MHz.
Vernier: Δ F control has a minimum range of 1.0 MHz for fine tuning.

Frequency calibration accuracy (0 dBm & below): \pm 5 MHz.

Frequency stability: approximately 50 ppm/ $^{\circ}$ C change in ambient temperature, less than 2500 Hz peak residual FM; 30 ppm change for line voltage variation of \pm 10%.

RF output power: +10 dBm (0.707 V) into 50 Ω load. Output attenuation dial directly calibrated in dBm from 0 to -127 dBm. A second uncalibrated output (approximately -3 dBm) is provided on front panel.

RF output power accuracy (with respect to attenuation dial): \pm 0.75 dB + attenuator accuracy (0 to -127 dBm) including leveled output variations.

Attenuator accuracy: +0, -3 dB from 0 to -10 dBm; \pm 0.2dB \pm 0.06 dB/10 dB from -10 to -127 dBm; direct reading dial, 0.2 dB increments.

Output impedance: 50 Ω ; SWR < 2.0.

Modulation: on-off ratio at least 20 dB for square wave, pulse.

Internal square wave: 950 to 1050 Hz. Square wave can be synchronized with a +1 to +10 V signal at PULSE input.

External pulse: 50 Hz to 50 kHz; 2 μ s rise time, +20 to +100 V peak input.

External AM: DC to 1 MHz.

External FM: a) front panel connector capacity-coupled to repeller of klystron; b) four-terminal rear panel connector (Cinch-Jones type S304AB) is dc-coupled to repeller of klystron.

Power source: 115 or 230 V \pm 10%, 50 to 60 Hz, approximately 130 W.

Size: 141 H x 425 W x 467 mm D (5.5" x 16.75" x 18.4"); rack mount 133 H x 416 W x 483 mm D (5.2" x 16.4" x 19").

Weight: net, 19.5 kg (43 lb). Shipping, 22.7 kg (50 lb).

Option 001: external modulation input connectors on rear panel in parallel with front-panel connectors; RF connectors on rear panel only.

8616A

Frequency range: direct reading within 2MHz, 1800 to 4500 MHz.
Vernier: Δ F control has a minimum range of 1.0 MHz for fine tuning.

Frequency calibration accuracy (0 dBm & below): \pm 10 MHz.

Frequency stability: approximately 50 ppm/ $^{\circ}$ C change in ambient temperature, less than 2500 Hz peak residual FM; 30 ppm change for line voltage variation of \pm 10%.

RF output power: +10 dBm (0.707 V) to -127 dBm into 50 Ω load, 1800 to 3000 MHz; +3 dBm to -127 dBm from 3000 to 4500 MHz into a 50 Ω load. Output attenuation dial directly calibrated in dBm from 0 to -127 dBm. A second uncalibrated output (approximately -3 dBm) is provided on the front panel.

RF output power accuracy (with respect to attenuation dial): \pm 1.0 dB + attenuator accuracy (0 to -127 dBm).

Attenuator accuracy: +1, -2 dB from 0 to -10 dBm, (\pm 0.2 dB \pm 0.06 dB/10 dB) from -10 to -127 dBm.

Output impedance: 50 Ω ; SWR < 2.0.

Modulation: on-off ratio at least 20 dB for square wave, pulse.

Internal square wave: 950 to 1050 Hz. Other frequencies available on special order.

External pulse: 50 Hz to 50 kHz; 2 μ s rise time, +20 to +100 V peak input.

External AM: DC to 1 MHz.

External FM: a) front panel connector capacity-coupled to repeller of klystron; b) four-terminal rear panel connector (Cinch-Jones type S304AB) is dc-coupled to repeller of klystron.

Dimensions: 141 mm H x 425 mm W x 467 mm D (5.5" x 16.75" x 18.4"); rack mount 133 mm H x 416 mm W x 483 mm D (5.2" x 16.4" x 19").

Weight: net, 19.5 kg (43 lb). Shipping, 22.7 kg (50 lb).

Options

001: external modulation input connectors on rear panel in parallel with front-panel connectors; RF connectors on rear panel only.

908: Rack Flange Kit

Price

add \$25

add \$10

Ordering information:

8614A: Signal Generator (800-2400 MHz) \$4750

8616A: Signal Generator (1800-4500 MHz) \$4750

SIGNAL GENERATORS

SHF Signal generators

Models 618C, 620B

- Signal simulations, 3.8-7.6 GHz, 7-11 GHz
- FM, Pulse modulation

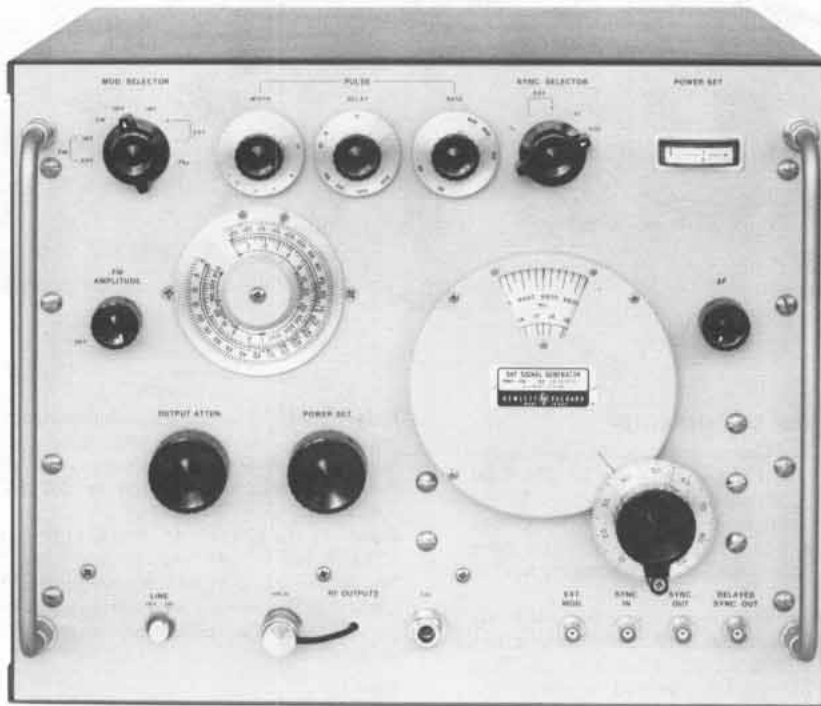

The Models 618C and 620B SHF Signal Generators provide versatility, accuracy, and stability in the range from 3.8 to 11 GHz. Frequency is set on a large, direct-reading dial. A ΔF vernier control provides ultra-fine tuning capability. There is also a provision for remote fine tuning.

A calibrated output from 0 to -127 dBm (0.224 volts to 0.1 microvolt) is also set on a large, direct-reading dial. The dial is calibrated in both dBm and volts. An auxiliary output of at least 0.3 milliwatt is available and is independent of attenuator setting. Thus, it can be used for phase-locking the signal generator when crystal-oscillator stability is required, or it can be monitored with a frequency counter for extreme frequency resolution.

The 618C and 620B Generators both feature oscillators of the reflex klystron type, with external resonant cavity. Oscillator frequency is determined by a movable plunger which varies the length of the cavity. Oscillator output is monitored by a temperature-compensated detector circuit. This circuit operates virtually unaffected by ambient temperature conditions.

Modulation includes internal pulse, square wave, and frequency modulation plus external pulse and frequency modulation.

618C and 620B Specifications

Output

Frequency range

618C: 3.8 to 7.6 GHz covered in a single band.

620B: 7 to 11 GHz covered in a single band; repeller voltage automatically tracked and proper mode automatically selected.

Calibration: direct reading; frequency calibration accuracy better than $\pm 1\%$.

Frequency stability: with temperature: less than 60 ppm/ $^{\circ}$ C change in ambient temperature; with line voltage less than 200 ppm change for line voltage variation of $\pm 10\%$; residual FM: < 15 kHz peak.

Output range: 1 milliwatt or 0.224 volt to 0.1 microvolt (0 dBm to -127 dBm) into 50 ohms; directly calibrated in dBm and volts; coaxial type N connector.

Output accuracy: within ± 2 dB from -7 to -127 dBm, within ± 3 dB from 0 to -7 dBm, terminated in 50-ohm load.

Source impedance: 50 ohms nominal; SWR < 2.0 .

Modulation

Internal pulse modulation: repetition rate variable from 40 to 4,000 pps, pulse width variable 0.5 to 10 microseconds.

Sync out signals: simultaneous with RF pulse, positive; in advance of RF pulse, positive, variable 3 to 300 microseconds (better than 1 microsecond rise time and 25 to 100 volts amplitude into 1,000-ohm load).

External synchronization: sine wave: 40 to 4,000 Hz, 5 to 50 V rms; pulse: 40 to 4,000 pps, 5 to 50 V peak, positive or negative, 0.5 to 5 μ s wide, 0.1 to 1 μ s rise time.

Internal square-wave modulation: variable 40 to 4,000 Hz.

Internal FM: sawtooth sweep rate adjustable 40 to 4,000 Hz; frequency deviation to 5 MHz peak-to-peak over most of the frequency range.

External pulse modulation: pulse requirements: amplitude from 20 to 70 volts positive or negative, width 0.5 to 2,500 microseconds.

External FM: frequency deviation approximately 5 MHz peak-to-peak over most of the band; sensitivity approximately 20 V/MHz at front-panel connector, approximately 10 V/MHz at rear-panel connector (mating connector supplied); front-panel connector is capacitively coupled to klystron repeller; rear-panel connector is dc-coupled to klystron repeller and is suitable for phase-lock control input.

General

RFI: conducted and radiated leakage limits are below those specified in MIL-I-6181D.

Power source: 115 or 230 volts $\pm 10\%$, 50 to 60 Hz 230 W.

Dimensions: cabinet, 353 mm H x 445 mm W x 518 mm D (13.9" x 17.5" x 20.4"); rack mount 355 mm x 483 mm x 483 mm (14" x 19" x 19").

Weight: net, 31.1 kg (69 lb). Shipping, 33.5 (74 lb).

Accessory furnished: 11500A Cable Assembly, 1830 mm (6 ft) of RG-214A/U 50-ohm coax, terminated on each end by type N male connectors.

Ordering information

618C or 620B SHF Signal Generator (cabinet mount)

618CR or 620BR SHF Signal Generator (rack mount)

Price

\$5650

\$5650

- Stable calibrated signals, 10-15.5 GHz, 15-21 GHz

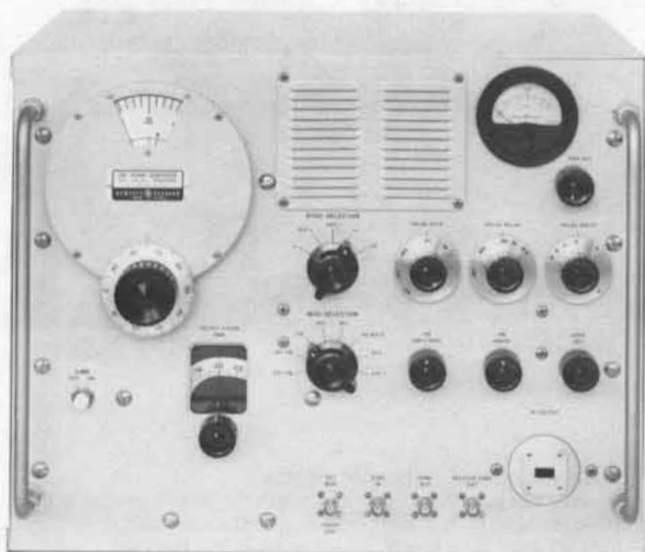

628A

Description

The 626A covers frequencies 10 to 15.5 GHz, and the 628A covers frequencies 15 to 21 GHz. In design and operation, the instruments are similar to Hewlett-Packard generators for lower frequency ranges. Carrier frequency is set and read directly on the large tuning dial. No voltage adjustment is necessary during tuning because repeller voltage is tracked with frequency changes automatically. Oscillator output is also set and read directly, and no frequency correction is necessary throughout operating range. A frequency logging scale permits frequency to be reset within 0.1%.

Both the 626A and 628A offer internal pulse, squarewave and frequency modulation, plus external pulse and frequency modulation. The pulse generators may be synchronized with an external sine wave and positive or negative pulse signals.

The high power output of these signal generators makes them ideally suited for driving HP 938A and 940A Frequency Doubler sets. These doubler sets retain the modulation and stability of the driving source and have accurate power monitors and attenuators.

626A, 628A specifications

Frequency range: 626A, 10 to 15.5 GHz; 628A, 15 to 21 GHz.
Frequency calibration: dial direct-reading in GHz, accuracy better than $\pm 1\%$.
Output range: 10 mW to 1 pW (+10 dBm to -90 dBm. 0 dBm = 1 mW); attenuator dial calibrated in output dBm.
Source SWR: <2.5 at +10 dBm; <1.35 at 0 dBm and below.
Output monitor accuracy: better than ± 1 dB; temperature-compensated thermistor bridge circuit monitors RF oscillator power level.
Output connector: 626A: WR75 waveguide, flat cover flange; 21.6 x 12.0 mm (0.85 x 0.475 in.). 628A: WR51 waveguide, flat cover flange; 15.0 x 8.5 mm (0.59 x 0.335 in.).
Output attenuator accuracy: better than $\pm 2\%$ of attenuation in dB introduced by output attenuator.
Modulation: internal pulse, FM, or square wave; external pulse and FM.
Internal pulse modulation: repetition rate variable from 40 to 4000 pps; pulse width variable 0.5 to 10 μ s.

- Doubler sets for signals 18-26.5 GHz, 26.5-40 GHz

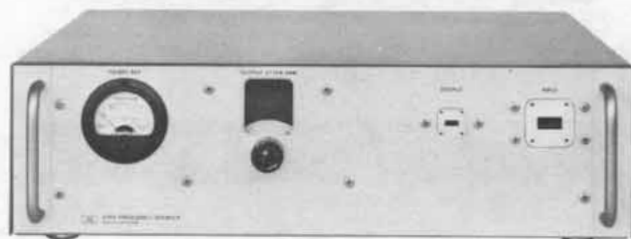

938A

Internal square-wave modulation: variable 40 to 4000 Hz controlled by "pulse-rate" control.

Internal frequency modulation: power line frequency, deviation up to ± 5 MHz.

External pulse modulation: pulse requirements: amplitude 15 to 70 volts peak positive or negative; width 1 to 2500 μ s.

External frequency modulation: provided by capacitive coupling to the klystron repeller; maximum deviation approximately ± 5 MHz.

Sync out signals: positive 20 to 100 V peak into 1000-ohm load; better than 1 μ s rise time; 1) simultaneous with RF pulse, positive; 2) in advance of RF pulse, positive, variable 5 to 300 μ s.

External synchronization: 1) sine wave, 40 to 4000 Hz, amplitude 5 to 50 V rms; 2) pulse signals 40 to 4000 pps, 5 to 50 V amplitude, positive or negative; pulse width 0.5 to 5 μ s; rise time 0.1 to 1 μ s.

Power: 115 or 230 volts $\pm 10\%$, 50 to 60 Hz, approx. 200 watts.

Dimensions: cabinet: 356 mm H x 432 mm W x 381 mm D (14" x 17" x 15"); rack mount: 356 mm H x 483 mm W x 313 mm D (14" x 19" x 12.8").

Weight: net, 26.8 kg (59 lb). Shipping, 29.8 kg (66 lb).

Accessories furnished: 626A, MX 292B and MP 292B Waveguide Adapters; 628A, NP 292A and NK 292A Waveguide Adapters.

Accessories available: M362A low-pass filter.

Frequency doubler sets

Model 938A supplies power from 18 to 26.5 GHz and Model 940A from 26.5 to 40 GHz when driven by 9 to 13.25 GHz and 13.25 to 20 GHz sources respectively. For a swept output, use a swept-frequency source such as Model 8690B or Model 8620A/B series with appropriate RF units.

938A, 940A specifications

Frequency range: 938A, 18 to 26.5 GHz; 940A, 26.5 to 40 GHz.
Conversion loss: less than 18 dB at 10 mW input.
Output power: approximately 0.5-1 mW when used with typical 626A, 628A signal generators; input power: 100 mW maximum.
Output attenuator: accuracy, $\pm 2\%$ of reading or ± 0.2 dB, whichever is greater; range, 100 dB.
Output reflection coefficient: approx. 0.33 at full output; less than 0.2 with attenuator set to 10 dB or greater.
Output flange: 938A K-band flat cover flange for WR-42 waveguide; 940A R-band flat flange for WR-28 waveguide.
Dimensions: 137 mm H x 489 mm W x 457 mm D (5.4" x 19.25" x 18").
Weight: net, 9 kg (20 lb). Shipping, 11.8 kg (26 lb).

Ordering information

626A or 628A SHF signal generator (cabinet)
 626AR or 628AR SHF signal generator (rack)
 938A or 940A frequency doubler

Price
 \$8450
 \$8450
 \$5300

SIGNAL GENERATORS

VHF oscillator, frequency doubler probe, pulse modulator

Models 3200B, 13515A, 11720A

- 10 to 500 MHz
- to 1000 MHz with doubler probe



3200B

3200B VHF oscillator

The VHF oscillator, model 3200B, provides low cost, stable, 10 to 500 MHz RF for testing receivers and amplifiers, and driving bridges, slotted lines, antennas, and filter networks. Good pulse modulation sensitivity allows standard audio oscillators to be used to provide usable square wave modulation; a 2.5-volt sine wave will provide adequate drive for this type application. An optional accessory frequency doubler probe, model 13515A, provides additional frequency coverage from 500 to 1000 MHz.

The 3200B is well suited for bench use and may be adapted for standard 483 mm (19 in.) rack mounting.

Specifications

Frequency range: 10–500 MHz in six bands: 10–18.8 MHz; 18.5–35 MHz; 35–68 MHz; 68–130 MHz; 130–260 MHz; 260–500 MHz.

Frequency accuracy: within $\pm 2\%$ after $\frac{1}{2}$ hour warmup.

Frequency calibration: increments of less than 4%.

Frequency stability (after 4 hour warm-up under 0.2 mW load): short term (5 min) ± 20 ppm; long-term (1 hour) ± 200 ppm; line voltage (5V change) ± 10 ppm.

RF output

Maximum power (across 50 ohm external load): >200 mW (10–130 MHz); >150 mW (130–260 MHz); >25 mW (260–500 MHz).

Range: 0 to >120 dB attenuation from maximum output.

Load impedance: 50 ohms nominal.

RF leakage: sufficiently low to permit measurements at $1 \mu\text{V}$.

RFI: meets requirements of MIL-I-6181D.

Amplitude modulation: externally modulated.

Depth: 0 to 30%

Distortion: $<1\%$ at 30% AM.

External requirements: approximately 32 volts rms into 600 ohms for 30% AM, 200 Hz to 100 kHz.

Pulse modulation: externally modulated.

External requirements: 2.5 volt negative pulse into 2000 ohms.

Power: 105 to 125 V or 210 to 250 V, 50 to 400 Hz, 30 VA.

Dimensions: 167 mm H x 194 mm W x 333 mm D (6.6" x 7.6" x 13.1").

Weight: net, 6.8 kg (15 lb). Shipping 7.7 kg (17 lb).

Accessories available: 13515A frequency doubler probe; 00502-60002 patching cable.

- 2 to 18 GHz
- <10 ns rise and fall times
- >80 dB ON/OFF ratio

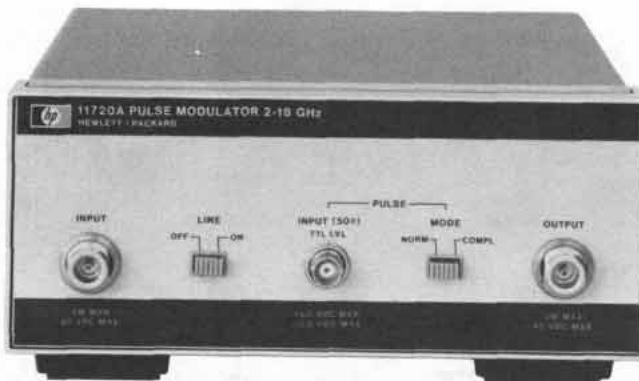

11720A

13515A Frequency doubler probe

Frequency range: 500 to 1000 MHz with the 3200B operating 250 to 260 MHz (130 to 260 MHz range) or 260 to 500 MHz.

RF output: more than 4 mW across external 50 ohm load.

11720A Pulse modulator

The 11720A Pulse Modulator is a high performance state-of-the-art microwave pulse modulator covering the range of 2 to 18 GHz. Because of this wide frequency coverage it can be used to increase the modulation capabilities of many microwave sources (sweepers or Signal Generators) and eliminates the need for several individual modulators in broadband applications.

In addition to wide frequency coverage, the 11720A features extremely short rise and fall times (<10 ns) and a high ON/OFF ratio (>80 dB) making it suitable for almost any pulsed RF application.

Internally the modulator used in the 11720A is a unique series-shunt PIN diode switch offering superior performance to a simple shunt-diode switch which reflects the input power back to the source in the "off" state. In the 11720A the series components reduce this reflection without significantly increasing the insertion loss.

The 11720A contains all the necessary modulator drive circuitry to achieve specified performance so that a standard pulse generator, or any other source that can deliver >3 V peak into 50 ohms, can supply the input. In addition a normal/complement function is provided to adapt the 11720A to positive-true or negative-true logic inputs.

Specifications

Frequency range: 2 to 18 GHz.

ON/OFF ratio: >80 dB.

Rise and fall times: <10 ns.

Insertion loss: <6 dB, 2 to 12.4 GHz; <10 dB, 2 to 18 GHz.

Maximum RF input power: $+20$ dBm.

Maximum repetition rate: >5 MHz.

Minimum RF pulse width: <50 ns.

Pulse input

Normal mode: >3 V (on), <0.5 V (off).

Complement mode: <0.5 V (on), >3 V (off).

Impedance: 50 Ω nominal.

General

Operating temperature: 0°C to 55°C .

Power: 100, 120, 220, 240 V $\pm 5\%$, -10% , 48–400 Hz; 25 VA max.

Weight: net, 2.6 kg (5 lb 12 oz); shipping, 3.6 kg (8 lb).

Size: 101 mm H x 212 mm W x 290 mm D (4.0" x 8.4" x 11.4").

Ordering information

3200B VHF oscillator

13515A Frequency doubler probe

11720A Pulse modulator

Price

\$1400

\$150

\$2500

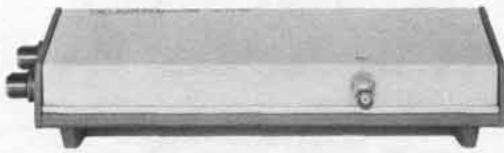

8730B Series

8730 Series PIN modulators

With HP 8730 series PIN Modulators, signal sources, including klystrons, can be pulse-modulated, leveled or amplitude-modulated with sinusoidal and complex waveforms. Fast-rise times, low incidental FM and a nearly constant impedance match to source and load are typical of these absorption-type modulators.

8403A Modulator

The Model 8403A provides complete control of the PIN modulators, supplying the appropriate modulation wave shapes and bias levels for fast rise times, rated on/off ratios and amplitude modulation. An internal square-wave and pulse modulator with PRF of 50 Hz to 50 kHz and adjustable pulse width and delay also provide square wave and pulses for general pulse applications. For applications requiring an absorption-type modulator plus controls in a single unit, a PIN modulator can be installed in the Model 8403A.

8403A specifications

Output characteristics (available separately at front panel).

For driving 8730 PIN modulators: AM and pulse output, pulse output specially shaped for optimum RF rise and decay times.

For general pulse applications: positive dc-coupled pulse 25 to 30 volt in amplitude, approximately symmetrical about 0 volt; no AM signal.

Modulation

Internal square wave

Frequency: variable from 50 Hz to 50 kHz.

Symmetry: better than 45/55%.

Internal pulse

Repetition rate: variable from 50 Hz to 50 kHz.

Delay: variable from 0.1 μ s to 100 μ s, between sync out pulse and RF output pulse.

Width: variable from 0.1 μ s to 100 μ s.

External sync

Signal: 5 to 20 volts peak, + or -, pulse or sine wave.

Input impedance: approximately 2000 ohms, dc-coupled.

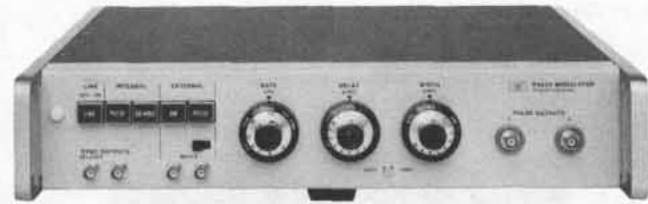

8403A

Trigger out

Sync out: simultaneous with or 0.1 to 100 μ s in advance of RF pulse, as set by delay control.

Delayed sync out: simultaneous with output pulse.

Amplitude: approximately -2 volts.

Source impedance: approximately 330 ohms.

External pulse

Amplitude and polarity: 5 volts to 20 volts peak, + or -.

Repetition rate: maximum average PRF, 500 kHz/sec.

Input impedance: approximately 2000 ohms, dc-coupled.

Width: minimum 0.1 μ s; maximum 1/PRF -0.4 μ s.

Amplitude modulation (with 8730 series)

Frequency response: dc to approximately 10 MHz (3 dB).

Sensitivity: approximately 10 dB/volt with HP 8730A series; approximately 20 dB/volt with HP 8730B series.

Input impedance: approximately 1000 ohms.

General

Power: 115 or 230 volts \pm 10%, 50 to 400 Hz, approximately 10 watts.

Size: 96 mm H x 425 mm W x 467 mm D (3.75" x 16.73" x 18.4"); hardware furnished for rack mount 89 H x 483 W x 416 mm D (3.5" x 19" x 16.4").

Weight: net, 7.4 kg (16.5 lb). Shipping, 9 kg (20 lb).

Options

PIN Modulators installed in 8403A:

001: 8731A

002: 8731B

003: 8732A

004: 8732B

005: 8733A

006: 8733B

007: 8734A

008: 8734B

009: Input and Output Connectors on rear panel

Price

add \$730

add \$925

add \$730

add \$1020

add \$785

add \$1315

add \$900

add \$1185

add \$25

8403A Modulator

\$1700

8730 Series specifications

HP Model	8731A	8731B	8732A	8732B	8733A	8733B	8734A	8734B	8735A	8735B	8731B-H10*
Frequency range (GHz)	0.8-2.4	0.8-2.4	1.8-4.5	1.8-4.5	3.7-8.3	3.7-8.3	7.0-12.4	7.0-12.4	8.2-12.4	8.2-12.4	0.4-1.2
Dynamic range (dB)	35	80	35	80	35	80	35	80	35	80	35
Max. residual atten. (dB) ¹	<1.5	<2.0	<2.0	<3.5 ²	<2.0	<3.0	<4.0	<5.0	<4.0	<5.0	<2.0
Typical rise time (ns) ³	40	30	40	30	30	30	30	30	30	30	40
Typical decay time (ns) ³	30	20	30	20	20	20	20	20	20	20	30
SWR, min. attenuation	1.5	1.6	1.5	1.6 ⁴	1.8	2.0	1.8	2.0	1.7	2.0	1.5 ⁴
SWR, max. attenuation	1.8	2.0	1.8	2.0	2.0	2.2	2.0	2.2	2.0	2.2	2.0 ⁴
Forward bias input resistance (ohms)	300	100	300	100	300	100	300	100	300	100	300
RF connector type	N(f)	N(f)	N(f)	N(f)	N(f)	N(f)	N(f)	N(f)	W/G ⁵	W/G ⁵	N(f)
Weight, net kg (lb)	1.4 (3.0)	2.5 (5.5)	1.4 (3.0)	2.7 (6.0)	1.0 (2.1)	1.4 (3.0)	1.3 (2.8)	1.4 (3.0)	1.4 (3.0)	1.4 (3.0)	2.5 (5.5)
shipping kg (lb)	1.9 (4.2)	3.3 (7.3)	1.9 (4.2)	3.5 (7.8)	1.4 (3.2)	1.9 (4.2)	1.8 (3.9)	1.9 (4.2)	1.9 (4.1)	1.9 (4.2)	3.3 (7.3)
Dimensions											
Height, mm (in)	57 (2.25)	57 (2.25)	57 (2.25)	57 (2.25)	57 (2.25)	57 (2.25)	57 (2.25)	57 (2.25)	57 (2.25)	57 (2.25)	57 (2.25)
Width, mm (in)	83 (3.25)	124 (4.9)	83 (3.25)	124 (4.9)	83 (3.25)	83 (3.25)	83 (3.25)	83 (3.25)	83 (3.25)	83 (3.25)	124 (4.9)
Depth, mm (in)	283 (11.1)	289 (11.4)	283 (11.1)	289 (11.4)	213 (8.4)	311 (12.3)	213 (8.4)	311 (12.3)	171 (6.75)	267 (10.5)	289 (11.4)
Price	\$785	\$1125	\$785	\$1270	\$850	\$1300	\$890	\$1270	\$900	\$1250	\$1125

Maximum ratings: maximum input power, peak or CW: 1 W; bias limits: +20 V, -10 V.

Bias polarity: negative voltage increases attenuation.

RF: radiated leakage limits are below those specified in MIL-I-6181D at input levels <1 mW; at all input levels radiated interference is sufficiently low to obtain rated attenuation.

1. With +5 V bias.

2. 4 dB, 4 to 4.5 GHz.

3. Driven by HP 8403A Modulator.

4. 2.0 SWR, 4 to 4.5 GHz.

5. Fits 1 x 1/2 in. (WR 90) waveguide.

6. External high-pass filters required.

7. Excluding high-pass filters.

SIGNAL GENERATORS

Accessories

Models 10511A, 10514A, 10515A, 10534A, 11507A, 11508A, 11509A, 11687A, 11690A, 11697A/B/C

• Additional Capabilities for Signal Generators



11507A



11509A

10511A Spectrum generator

The 10511A extends the useful frequency range of signal generators, sources, and frequency synthesizers by providing a spectrum of output harmonics up to 1 GHz. It generates a train of 1 nsec-wide pulses when driven by a sinusoid. The input should be a sine-wave between 10 and 75 MHz at +13 to +23 dBm into 50Ω. The harmonic power produced is at least -19 dBm for harmonics 1 through 10. Connectors are BNC.

10514A, 10534A Double balanced mixers

These mixers are excellent in a variety of mixing applications as well as AM, pulse, and square-wave modulation applications. The careful balancing of the hot carrier diodes in the 10514A and 10534A provides excellent output suppression of the local oscillator and input frequencies. Frequency ranges are 0.2-500 MHz for the 10514A and 0.05-150 MHz for the 10534A. Connectors are BNC.

10515A Frequency doubler

The 10515A is an ideal accessory to extend the frequency range of signal generators, sources, and frequency synthesizers such as the HP 606, 608, and 8660 Signal Generators. With input frequencies of 0.5-500 MHz, it provides a doubled output in the range of 1-1000 MHz. Its transformer-coupled full-wave rectifier circuit has a very flat frequency response (typically ± 2 dB over the entire frequency range). It can also be used as a very broadband detector for low level amplitude modulation because it has no internal dc return path. Conversion loss is <14 dB worst case for inputs between +7 and +23 dBm, and connectors are BNC.

11507A Output termination

This multi-purpose termination with BNC connectors enhances the usefulness of any signal generator over a 50 kHz to 65 MHz range by providing:

1. A matched 50Ω termination with <1 dB attenuation to permit use into high impedance circuits.
2. A 20 dB attenuation (10:1) terminated voltage divider which reduces the source impedance to 5Ω for low impedance circuits.
3. A 20 dB attenuation dummy antenna having the IEEE standard characteristics for receiver measurements (driven from a 10:1 divider, operating from 0.54 to 23 MHz).

11508A Output cable

The 11508A provides a 50Ω termination and dual banana plug binding posts at one end of a 610 mm cable (with a Type N connector at the other end). It allows direct connection of a signal generator to high impedance circuits.

11509A Fuseholder

Accidental burnout of attenuators in HP 8640, 8654, 606, and 608 Signal Generators can be prevented by using this fuse element between the signal generator and a transceiver. Otherwise, many watts of RF power can be applied to the signal generator attenuator if the transceiver is accidentally switched to "Transmit." The fuseholder has a frequency range of dc to 480 MHz, insertion loss of ≤ 1 dB,



11687A



11690A



11697B

SWR of ≤ 1.35 (50Ω load), and Type N connectors. Ten extra fuses are furnished.

11687A 50-75Ω Adapter

This 50-75Ω Adapter with Type N connectors is recommended for use with HP 8640, 8654, 8660, 608, and 612 Signal Generators for measurements in 75Ω systems. The voltage calibration on the output level meter is unaffected by use of the adapter, but 1.76 dB must be subtracted from the dB scale on the meter to determine the output in dBm into 75Ω. Frequency range is dc to 1300 MHz.

11690A Frequency doubler

The 11690A extends the frequency range of all HP 8640 series Signal Generators by doubling the 256-512 MHz frequency band up to 1024 MHz (to 1100 MHz with band overrange). All 8640's indicate the correct doubled output frequency on a dial or counter when the 512-1024 MHz range is selected. The 11690A will also perform well with any source meeting the input requirements of 200-550 MHz at +10 to +19 dBm. Conversion loss is <13 dB, output flatness has <4 dB total variation, and the 1st and 3rd input harmonics are suppressed >20 dB. Connectors are BNC.

11697A/B/C Bandpass filters

These filters are specifically designed to reduce any harmonic and subharmonic-related spurious signals present in the output of doubled signal sources (such as the HP 8640 Signal Generator with Option 002 Internal Doubler or 11690A external Frequency Doubler). The 11697A and 11697B cover the USA UHF television band (512-674 MHz and 674-890 MHz respectively). The 11697C covers the 800-1100 MHz range used for navigation aids and mobile radio. Midband attenuation is ≤ 0.6 dB, pass band attenuation is ≤ 1.1 dB, and pass band SWR is ≤ 1.4 . Connectors are Type N.

Rejection band attenuation:

Model	Below Passband		Above Passband	
	Frequency (MHz)	Attenuation	Frequency (MHz)	Attenuation
11697A	≤ 337	≥ 20 dB	768-3000	≥ 20 dB
11697B	≤ 445	≥ 20 dB	1011-3000	≥ 20 dB
11697C	≤ 550	≥ 20 dB	1333-3000	≥ 20 dB

Ordering information

Model	Price
10511A Spectrum Generator	\$350
10514A Double Balanced Mixer (0.2-500 MHz)	\$150
10515A Frequency Doubler (0.5-500 MHz input)	\$170
10534A Double Balanced Mixer (0.05-150 MHz)	\$115
11507A Output Termination	\$175
11508A Output Cable	\$50
11509A Fuseholder	\$80
11687A 50Ω-75Ω Adapter	\$115
11690A Frequency Doubler (230-550 MHz input)	\$180
11697A Bandpass Filter (512-674 MHz)	\$270
11697B Bandpass Filter (674-890 MHz)	\$270
11697C Bandpass Filter (800-1100 MHz)	\$270



Sweep oscillators

Sweep frequency oscillators are used in applications where the characteristics of a device must be determined over a wide, continuous range of frequencies. Combined with a broadband detector and display test set, sweep oscillators provide many benefits compared to CW frequency sources. A sweep measurement provides a dynamic display of the data. The results of any adjustments to the unknown test device are seen immediately (real time) on the display. By replacing laborious point-by-point techniques swept measurements increase the speed and convenience of broadband testing. The continuous frequency characterization of the unknown device also eliminates the chance of missing important information between frequency points. Swept techniques are applicable in all phases of design, manufacture and maintenance.

Hewlett-Packard sweep oscillators

Hewlett-Packard sweepers cover the entire frequency spectrum from dc to 50 GHz. Self-contained, multi-octave sweepers cover the frequency range to 110 MHz. The 8690 series of backward wave and solid state oscillators features plug-ins from 400 kHz to 50

GHz. The 8620 family of solid state oscillators provide a versatile choice of configurations—single band, multiband, or very wide band plug-ins from 10 MHz to 22 GHz. A chart of the individual frequency bands available appears on page 399.

Sweep oscillator features

Sweep flexibility

Every HP sweeper has several different sweep modes available for setting the frequency limits of the instrument. A full band or independently adjustable start/stop frequency sweep can be selected. Alternatively, a marker sweep or a symmetrical ΔF sweep about the desired center frequency can be chosen. Switching from one sweep mode to another is a simple pushbutton operation. In the auto mode the sweep retriggers automatically. Sweep times of 0.01 to more than 100 seconds can be selected. A manual sweep is also available as a front panel control, a real convenience for calibrating displays such as X-Y recorders. An external trigger is provided as well for applications where the sweeper must be synced to other instrumentation or remotely controlled.

On all sweeps a linear voltage proportional to frequency is available on an external connector which is useful for driving the hori-

zontal of the display. Blanking and pen lift signals are also provided at rear output connectors during flyback time when the RF is off.

The 8620 solid state family also features a self-contained multi-band capability in one compact instrument. Different octave range oscillators (up to three in one drawer) can be selected by simply pressing one band select lever. This results in performance, cost, and size benefits compared to externally multiplexed sweeper systems.

Power output and leveling

Power output is continuously adjustable at the front panel over approximately a 10 dB range. Built-in attenuators are also available for greater power control. Internal or external leveling is employed to obtain (1) a constant power output and (2) a good source match (low VSWR). This ensures high accuracy when making swept measurements.

Modulation

Modulation capabilities further extend the sweeper's usefulness both as a sweeper and a signal generator for signal simulations. Wide AM and FM bandwidths are useful for a variety of tests on communication receivers. The flexible FM capability allows remote analog frequency programming which is important for many applications.

MLA compatibility

In communications applications where up-converter simulation is required in conjunction with the HP Microwave Link Analyzer, the 86200 series of plug-ins provides this capability as an option in frequency ranges from 500 MHz to 18 GHz. Group delay of less than 1 nanosecond and linearity of better than 0.5% across 30 MHz across most of the frequency range permit very accurate RF to RF, RF to IF and RF to BB distortion measurements.

Programming

The 8620C solid state sweeper mainframe provides optional BCD or HP-IB programming capability. More than ten thousand frequency points per band permit very fine frequency control. In addition, band selection, sweep mode, RF attenuator, and remote-local can be controlled remotely. This allows the sweeper to be used in a wide variety of automatic systems and sophisticated signal simulation applications.

For example, a 1 MHz to 18.6 GHz frequency synthesizer can be configured using a controller, the 86290B/8620C 2-18.6 GHz sweep oscillator, and the 8660 UHF synthesizer. (See Figure 1). Harmonics of the 8660 are used to phase lock the sweeper to the accuracy and stability of the synthesizer. The desktop computer is then used to control the

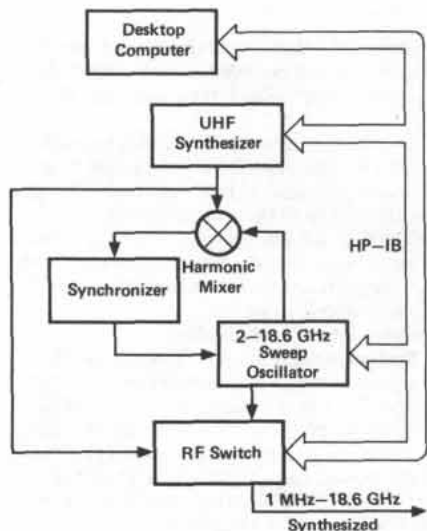

Figure 1.

sweeper, the UHF synthesizer, and RF switches to allow keyboard control of a CW signal or to step the source across a band of interest. Of course, the controller can also be used to assimilate data gathered at each point.

Precision power level control of the sweeper can be obtained by using the desktop computer to drive the sweeper's EXT AM input through a Digital-to-Analog Converter. A calibration array previously stored in the desktop computer would control the D-A voltage producing power level accuracy similar to that of the 436A power meter used in the calibration. (See Figure 2). Level control of the sweeper is important in measuring gain compression and when ratio measurements are not practical. If greater than 10 dB of control range is required, a programmable attenuator with as much as 110 dB of range may be used.

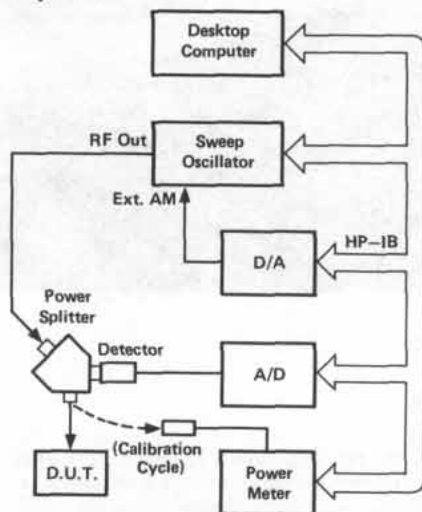

Figure 2.

Digital sweeping synthesizers

The 3325A, 3330B, 3325A and 8660C combine the precision frequency accuracy and stability of a synthesizer with the time saving convenience of a sweeper. Parameters such as start/stop/center frequencies, sweep width, frequency step and sweep time are entered and executed through a convenient keyboard or remote programming. Some additional features are phase continuous linear/log sweep in the 3325A and amplitude sweeping in steps as small as 0.01 dB in the 3330B. This in conjunction with frequency sweeping can provide a comprehensive family of curves.

Sweeper applications

Sweepers are used extensively with swept frequency test sets to characterize the amplitude response of broadband devices or with network analyzers when the phase characteristics of the device (or S-parameters) are needed as well. Two RF measurements—transmission and reflection—are basic to both types of analyzer. Hewlett-Packard of-

fers a complete line of directional couplers, power splitters, and other transducers which together with the analyzers and sweep oscillators provide a total swept measurement solution. Figure 3 shows a complete swept

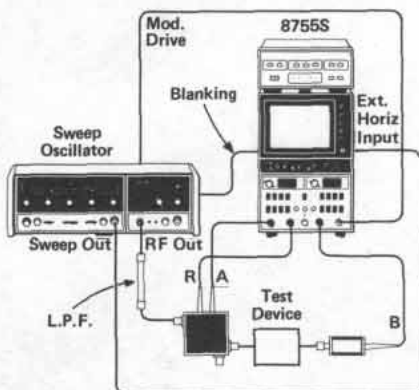

Figure 3.

system that can be used to simultaneously characterize the scalar transmission and reflection properties of devices from 10 MHz to 18 GHz. This system has a sensitivity of better than -50 dBm.

For measurements requiring more sensitivity and/or phase information, sweepers may be used with network analyzers. Now with the HP 8620 family of solid state sweepers and the HP 8410B, these measurements can easily be made across many octaves of frequency. Previously the 8410 had to be retuned every octave. Now, for example, with the 86222A/B and the 8410B, phase-magnitude transmission or reflection coefficients can be measured across the full, 0.11-2.4 GHz range in one continuous sweep at full sweep speed. Since the 8410 is a tuned receiver this means a spurious-free sensitivity of -78 dBm.

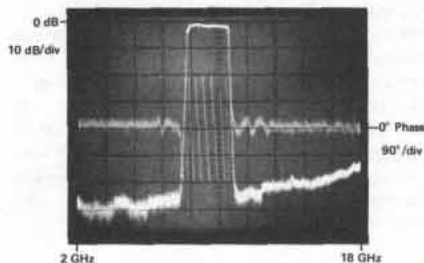

Figure 4

Figure 4 is a CRT photo of simultaneous phase and magnitude transmission characteristics of an 8 to 10 GHz bandpass filter across 2 to 18 GHz using the 86290 Sweep Oscillator Plug-in.

For high power applications such as RFI-susceptibility tests and high attenuation measurements. Hewlett-Packard offers TWT amplifiers which provide better than 1 watt from 1 to 18 GHz.

Synthesizer accuracy and stability can be obtained by phase-locking the Hewlett-Packard sweep oscillators to a harmonic of a very stable source. This high stability is important in many applications including microwave spectroscopy and high-Q swept frequency measurements.

Two-tone sweep testing of devices such as mixers and receiver front ends requires two signals offset from each other by the IF. This is accomplished by phase-locking the difference frequency of two sweep oscillators to a very stable source. The sweepers may then be swept across the band of interest.

The modulation and built-in attenuator features of Hewlett-Packard sweep oscillators make them useful in many traditional

CW signal generator applications.

In addition, accuracy, linearity, and flatness of the broadband 86222A/B and 86290A/B plug-ins make them more than adequate in many applications requiring a general purpose CW generator.

For wideband applications the 86290A/B, 2-18 GHz plug-ins and the 86222A/B 0.01-2.4 GHz plug-ins feature performance that rivals octave band oscillators in the area of frequency purity and accuracy, harmonics, and flatness.

For a complete discussion of swept frequency measurements the following application notes and others are available from your local Hewlett-Packard sales office.

- AN 117-1 "Microwave Network Analysis Applications"
- AN 117-2 "Stripline Component Measurements"
- AN 155-1 "Active Device Measurements

with the 8755 . . ."

- AN 155-2 "100 dB Dynamic Range Measurements, using the 8755 Frequency Response Test Set"
- AN 183 "High Frequency Swept Measurements"
- AN 187-2 "Configuration of A 2-18.6 GHz Synthesized Frequency Source using the 8620C Sweep Oscillator"
- AN 187-3 "Three HP-IB Configurations for Making Microwave Scalar Measurements"
- AN 187-4 "Configuration of a Two-Tone Sweeping Generator"
- AN 187-5 "Calculator Control of the 8620C Sweep Oscillator using the HP-IB"
- AN 187-6 "Frequency Performance of the 8620C Sweep Oscillator Under Remote Programming"
- AN 221 "Semi-Automatic Measurements using the 8410B Microwave Network Analyzer and the 9825A Desk-Top Computer"

Sweep Oscillator—summary chart

Frequency Range*	Model Number			100	1	10	100	1	2	4	8	12	18	26	40
	8620 Series	8690 Series	Other Sweepers	kHz	MHz	MHz	MHz	GHz	GHz	GHz	GHz	GHz	GHz	GHz	GHz
0.1 Hz-13 MHz 0.1 Hz-13 MHz 1 μHz-21 MHz 1 mHz-50 MHz 200 Hz-80 MHz 10 kHz-1280 MHz 10 kHz-2600 MHz			3312A 3330B 3325A 8165A 3335A 8662A 8660C	←	←	←	←	←	←						
100 kHz-110 MHz 400 kHz-110 MHz 10-1300 MHz 10-2400 MHz	86220A 86222A/B	8698B	8601A	←	←	←	←	←	←						
100 MHz-4 GHz 1.0-2.0 GHz 1.4-2.5 GHz 1.7-4.2 GHz	86331C/86320B	8699B 8691A/B 8691A Opt 200 8692B Opt 100						←	←	←					
1.7-4.3 GHz 2-4 GHz 2-8.4 GHz 3.6-8.6 GHz 2-18 GHz 2-22 GHz	86235A or 86331C 86240A/B 86240C 86290A 86290A/B Opt H08	8692A/B						←	←	←	←	←	←		
3.2-6.5 GHz 3.5-6.75 GHz 3.7-8.3 GHz 4-8 GHz	86241A or 86341C	8693A Opt 200 8693B Opt 100 8693A/B						←	←	←	←	←	←		
5.9-9.0 GHz 5.9-12.4 GHz 7-11 GHz 8-12.4 GHz 8-18 GHz	86242D or 86342C 86245A 86250D Opt H08 86250D or 86350C	8694A/B Opt 200 8694A/B 8694A/B Opt 300						←	←	←	←	←	←	←	
10-15 GHz 12.4-18 GHz 17-22 GHz 18-26.5 GHz 26.5-40 GHz 33-50 GHz	86260A Opt H04 86260A 86260A Opt H22	8695A Opt 100 8695A/B 8696A 8697A 8697A Opt H50						←	←	←	←	←	←	←	←

*Other Special Frequency Ranges Can Be Provided Upon Request.

SWEEP OSCILLATORS

Digital marker & generator/sweeper
Models 8600A & 8601A



8600A



8601A

Covering 100 kHz to 110 MHz, the Model 8601A Generator/Sweeper combines the high linearity and flatness of a precision sweeper with a signal generator's frequency accuracy and wide range of calibrated power levels. Though it's small and lightweight, it does the work of two instruments easily and conveniently.

8601A Specifications

Frequency range: low range, 0.1-11 MHz; high range, 1-110 MHz.
Frequency accuracy: approximately $\pm 1\%$ of frequency.

Power output: +20 to -110 dBm; 10-dB steps and 13-dB vernier provide continuous settings over entire range. Meter monitors output in dBm and rms volts into 50 Ω .

Power accuracy: ± 1 dB accuracy for any output level from +13 dBm to -110 dBm.

Flatness: ± 0.25 dB over full range, ± 0.1 dB over any 10 MHz portion (+10 dBm step or below).

Impedance: 50 Ω , SWR <1.2 on 0 dBm step and below.

Harmonics and spurious signals: (CW above 250 kHz, output levels below +10 dBm) harmonics at least 35 dB below carrier. Spurious at least 40 dB below carrier.

Residual FM: noise in a 20 kHz bandwidth including line related components (dominant component of residual FM is noise).

CW: <50 Hz rms, low range; <500 Hz rms high range.

SYM 0, sweep: <100 Hz rms, low range; <1 kHz rms, high range.

Residual AM: AM noise modulation index (rms, 10 kHz bandwidth) is <-50 dB; (typically -60 dB at 25°C).

Crystal calibrator: internal 5 MHz crystal allows frequency calibration to $\pm 0.01\%$ at any multiple of 5 MHz.

Sweep modes: full, video, and symmetrical.

Internal AM: fixed 30% $\pm 5\%$ at 1 kHz.

External AM: 0 to 50%, dc to 400 Hz; 0 to 30%, up to 1 kHz.

Internal FM: 1 kHz rate, fixed 75 kHz $\pm 5\%$, deviation, high range; 7.5 kHz $\pm 5\%$, deviation, low range; <3% distortion.

External FM: sensitivity, 5 MHz per volt $\pm 5\%$, high range, 0.5 MHz per volt $\pm 5\%$, low range; negative polarity; FM rates to 10 kHz.

Weight: net, 9.5 kg (21 lb). Shipping, 12.3 kg (27 lb).

Size: 155 mm H x 190 mm W x 416 mm D (6 $\frac{3}{32}$ " x 7 $\frac{25}{32}$ " x 16 $\frac{3}{8}$ ").

The Model 8600A Digital Marker provides five independent, continuously variable frequency markers over the range 0.1-110 MHz when used with the HP 8601A or 8690B/8698B Generator Sweeper.

The high resolution controls and 6-digit readout permit 0.05% frequency settability. The frequency of any marker may be read while sweeping, simply by pushing a button within the marker control. The marker selected is brighter than the others and points in the opposite direction, ensuring positive marker identification.

8600A Specifications

Marker accuracy: any marker may be placed at a desired frequency $\pm (0.05\%$ of sweep width + sweeper stability).

Weight: net, 5.9 kg (13 lb); shipping 8.2 kg (18 lb).

Size: 99 mm H x 413 mm W x 337 mm L (3 $\frac{7}{8}$ " x 16 $\frac{3}{4}$ " x 13 $\frac{1}{4}$ ").

Ordering information

8600A Digital Marker
Opt 001: Modification kit for 8690B/8698B
8601A Generator/Sweeper
Opt 008: 75 Ω BNC output

Price
\$1700
N/C
\$3000
add \$50

SWEEP OSCILLATORS

Solid state sweeper family, 10 MHz to 22 GHz
Model 8620 System



- Single-band, multi-band, straddle-band and broadband plug-ins
- > 10 mW to 22 GHz



HP-IB

8620 System

The Hewlett-Packard 8620 solid state sweeper system offers the flexibility of the 8620C mainframe in addition to a choice of single-band, multiband, straddle-band, and broadband plug-ins. The 8620 system also offers high output with solid state reliability—greater than 10 mW leveled to 22 GHz.

The fundamental oscillators used in the plug-ins and modules are YIG tuned transistor or bulk effect circuits. YIG tuning results in exceptional tuning linearity, low noise, and low spurious content; it also allows frequency modulation at high rates and wide deviations with low distortion.

Typical unleveled power output

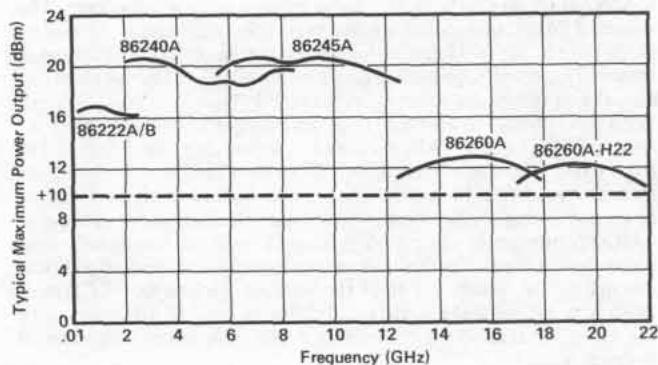

8620C Sweeper mainframe

The 8620C has many features which are highly useful in stringent applications. With convenient functionally grouped controls and lighted pushbutton indicators the mainframe offers extreme ease of operation and flexibility. In addition, it can be a completely programmable source, either HP-IB or BCD, an indispensable feature for automatic systems and signal simulation applications.

86222A/B and 86290A/B broadband plug-ins

Now the 10 MHz to 18.6 GHz frequency range can be covered with just two plug-ins—the 86222A/B and 86290A/B. Besides their broad frequency range these plug-ins offer many special features including unique crystal markers in the 86222B and better than ± 30 MHz frequency accuracy in a 86290A/B even at 18 GHz.

86240A/B straddle-band plug-ins

Covering more than two octaves of frequency the 86240A and B span 2–8.4 GHz with major advances in power output and signal purity. The 86240A offers more than 40 mW leveled output across the full band. The 86240B specifies harmonics of >45 dBc which can be very important when making measurements across more than one octave.

86200 Series single-band plug-ins

The 86200 series of plug-ins covers both ends of the frequency spectrum from 10 MHz to 22 GHz with a choice of more than nine plug-ins.

8621B and 86300 Series multiband plug-ins

The 8621B drawer provides capability for up to two fundamental oscillator modules (86300 series) plus a heterodyne module (86320B). Selecting the band is as simple as pressing a front panel lever.

SWEEP OSCILLATORS

8620 Family: mainframe

Model 8620C

- Optional BCD or HP-IB Programming
- 3 Markers
- 100% ΔF Capability, fully calibrated

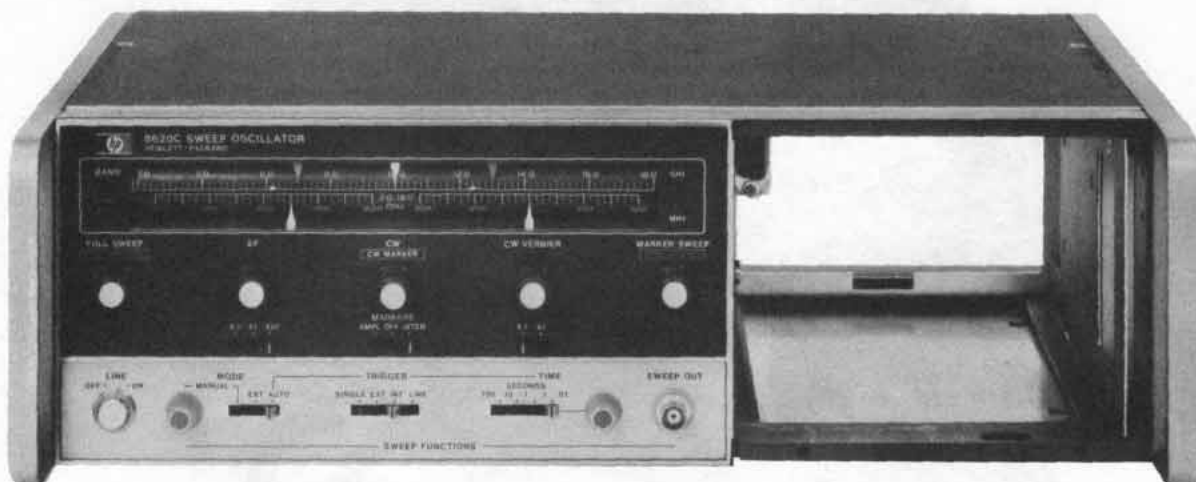

HP-IB

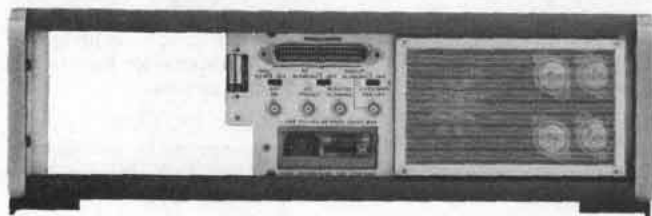

The 8620C offers many features as standard equipment. For example, up to four separate bands and their respective frequency scales can be selected with a touch of the band select lever just to the left of the dial scale. This represents a truly convenient wide-band capacity, one which doesn't necessitate changing plug-ins or the addition of costly, bulky, additional instruments to make wide-band swept measurements. Pushbuttons, concentrically located in the frequency control knobs, light when actuated to indicate the sweep function in use. For example, depressing the FULL SWEEP pushbutton results in a sweep of the total range selected by the band select lever. In this mode three markers are available, controlled by the START MARKER, STOP MARKER, and CW MARKER knobs. The MARKER SWEEP function causes a sweep between START and STOP MARKERS. In MARKER SWEEP, the CW MARKER is still available for further flexibility in identifying specific frequencies.

The 8620C is fully and continuously calibrated for any ΔF sweep width. Having chosen an optimum width, one can read the total sweep width from the calibrated ΔF dial scale. The sweep is symmetrical about the CW MARKER setting and in this function the START and STOP MARKERS are available. Three continuously variable ΔF ranges are available by using the range switch below the ΔF knob. This allows calibrated sweep widths of up to 1%, 10% or 100% of full band at the user's choice.

The CW function is selected by depressing the CW push button. It is possible to also engage the CW VERNIER knob to achieve very accurate settability. With the main dial scale cursor placed on any convenient mark, it is possible to interpolate accurately between dial scale markers by utilizing the CW VERNIER. This vernier makes the effective length of the dial scale $7\frac{1}{2}$ meters (300 inches) and contributes to the increased settability.

Another feature is the capability to fully program the sweeper. The standard 8620C includes inputs for band selection, attenuator setting (with 8621B Opt 010 installed), sweep function selection, and analog frequency control. Option 011 provides, in addition, the capability to digitally program the sweeper with the HP-Interface Bus (HP-IB). With this option, the user can place the sweeper into any sweep function (ΔF , FULL SWEEP, etc.) and it will sweep according to the front panel frequency settings. In this mode a programmable digital marker is available. In addition, an extremely flexible digital frequency programming capability is included with this option. Resolution of 10,000 points per band or 10,000 points across the frequency range set by the front panel controls permit extremely high resolution limited only by the Residual FM of the sweeper. Option 001 BCD programming provides the same capabilities as the HP-IB option with the exception that no digital marker is available in the programmed sweep modes.

8620C Specifications

Frequency

Frequency range: determined by band select lever and RF unit.

Frequency linearity: refer to RF unit specifications.

Sweep functions

FULL sweep: sweeps the full band as determined by the plug-in and the band select lever.

MARKER sweep: sweeps from START MARKER to STOP MARKER frequency settings.

Range: both independent settings are fully calibrated and continuously adjustable over the entire frequency range; can be set to sweep either up or down in frequency.

End-point accuracy: refer to RF unit specifications, same as frequency accuracy.

ΔF Sweep: sweeps symmetrically upward in frequency, centered on CW setting, CW vernier can be activated for fine control of center frequency.

Width: continuously adjustable and calibrated from zero to 1%, zero to 10%, or zero to 100% of usable frequency band as selected with front panel switch. Dial scale calibrated directly in MHz.

Width accuracy: ±1% of maximum ΔF plus ±2% of ΔF being swept.

Center-frequency accuracy: refer to RF unit specifications, same as frequency accuracy.

CW operations: single-frequency RF output controlled by CW MARKER knob selected by depressing pushbutton in CW MARKER control.

Preset frequencies: START MARKER, STOP MARKER, and ΔF end points in manual sweep mode and CW MARKER frequency can be used as preset CW frequencies.

CW vernier: calibrated directly in MHz about CW setting. CW vernier activated by pushbutton in CW vernier control. Zero to ±0.5% or zero to ±5% of full bandwidth, selectable with front panel switch.

Accuracy: Refer to RF unit specifications, same as frequency accuracy.

Frequency markers: three constant width frequency markers are fully calibrated and independently adjustable over the entire range in FULL SWEEP function, controlled by START MARKER, STOP MARKER, and CW MARKER controls. In ΔF sweep START and STOP MARKERS are available, and in MARKER SWEEP the CW MARKER is available. Front panel switch provides for the selection of either amplitude or intensity markers (amplitude modulating the RF output or Z-axis modulating the CRT display).

Resolution: better than 0.25% of RF unit bandwidth.

Marker output: rectangular pulse, typically -5 volts peak available from Z-axis BNC connector on rear panel. Source impedance, approximately 1000 ohms.

Accuracy: refer to RF unit specifications, same as frequency accuracy.

Sweep modes

Auto: sweep recurs automatically.

Line: sweep can be synchronized with the ac power line.

External trigger: sweep is actuated by external trigger signal.

Sweep time: continuously adjustable in four decade ranges typically 0.01 to 100 seconds.

Single sweep: activated by front panel switch.

Manual sweep: front panel control provides continuous manual adjustment of frequency between end frequencies set in any of the above sweep functions.

External sweep: sweep is controlled by external signal applied to programming connector. Zero volts for start of sweep increasing linearly to approximately +10 volts for end of sweep.

Sweep output: direct-coupled sawtooth, zero to approximately +10

volts, at front panel BNC connector, concurrent with swept RF output. Zero at start of sweep, approximately +10 volts at end of sweep regardless of sweep width or direction. In CW mode, dc output is proportional to frequency.

Modulation

Internal AM: square-wave modulation continuously adjustable from 950 to 1050 Hz on all sweep times. On/Off ratio, refer to RF unit specifications.

External AM: refer to RF unit specifications.

External FM: refer to RF unit specifications.

Phase-lock: refer to RF unit specifications.

Remote control

Remote band select: frequency range can be controlled remotely by three binary contact closure lines available at rear panel connector.

Remote attenuation select: 0 to 70 dB attenuation in 10 dB steps can be controlled by 4 binary contact closure lines when used with 8621B Option 010.

Remote frequency programming, Opt 001 (BCD) and 011 (HP-IB)

Functions

Band: manual enable or remote control of four bands.

Mode: seven modes, including digital frequency control in three modes, with a resolution of 10,000 points across FULL band, between START MARKER and STOP MARKER as set by front panel controls, or across ΔF as set by front panel ΔF and CW controls; or selection of any of four analog sweep functions: ΔF or MARKER SWEEP with end points set by appropriate front panel controls, CW as set by CW MARKER control, or FULL SWEEP of band selected.

Marker: with analog sweeps (FULL, ΔF or MARKER SWEEP), a programmable marker is available (Opt 011 only), in either amplitude or intensity as selected with front panel switch.

General

Blanking

RF: with blanking switch enabled, RF automatically turns off during retrace, and remains off until start of next sweep. On automatic sweeps, RF is on long enough before sweep starts to stabilize external circuits and equipment whose response is compatible with the selected sweep rate.

Display (Z-AXIS/MKR/PEN LIFT Output): direct-coupled rectangular pulse approximately +5.0 volts coincident in time with RF blanking is on rear panel.

Negative (Negative blanking output): direct-coupled rectangular pulse approximately -5.0 volts coincident in time with RF blanking, fully compatible with 8410A/B network analyzer.

Pen lift: for use with X-Y recorders having positive power supplies. Transistor-switch signal is available on Z-AXIS/MKR/PEN LIFT connector. This signal is also available on the programming connector.

Furnished: 2.29 m (7½-foot) power cable with NEMA plug; 2 spare 3 amp fuses; extender board for servicing; and calibration scale.

Power: 100, 120, 220, or 240 volts +5 -10%, 50 to 400 Hz. Approximately 140 watts.

Weight: (not including RF unit): Net, 11.1 kg (24 lb). Shipping 13.4 kg (30 lb).

Size: 132.6 mm H x 425 mm W x 337 mm D (5 1/8" x 16 1/4" x 13 1/4").

Ordering information

8620C Sweep Oscillator Mainframe

Opt 001: BCD Frequency Programming

Opt 011: HP-IB Frequency Programming

Opt 908: Rack Flange Kit

Price

\$2350

add \$650

add \$950

add \$10

SWEEP OSCILLATORS

8620 Family: broadband plug-ins

Models 86290A and 86290B

- +10 dBm 2 to 18.6 GHz with 86290B
- +7 dBm 2 to 18 GHz with 86290A

- Advanced technology provides outstanding performance
- 2 to 22GHz with Option H08



86290B

HP 86290B Typical Levelled Power Output

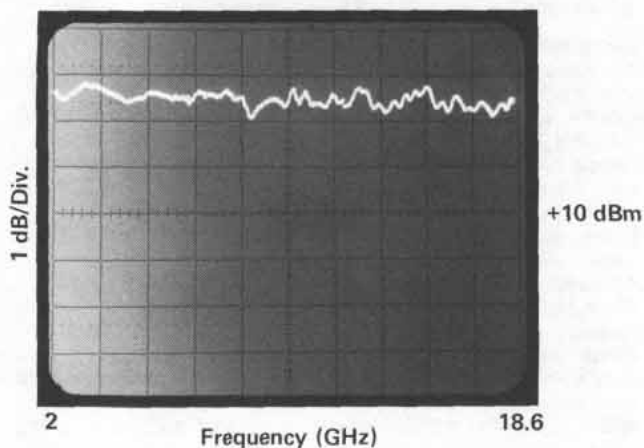

The 86290A and 86290B broadband plug-ins set new standards in wideband sweeper value with versatile frequency coverage and excellent performance characteristics at an attractive size and price. For broadband testing, a continuous sweep from 2 to 18.6 GHz (18 GHz with the 86290A) is provided. In addition, higher frequency resolution is achieved by covering the 2 to 18.6 GHz range in three individual bands of 2 to 6.2 GHz, 6 to 12.4 GHz, and 12 to 18.6 GHz (or 18 GHz). Continuous 2 to 22 GHz sweep operation is available via Option H08 with frequency bands of 2 to 6.2, 6 to 12.4, 12 to 22, and 2 to 22 GHz. Individual bands and corresponding dial scales are selected using the band select lever on the 8620C mainframe. Front panel lights indicate the frequency range selected. In each frequency band, all sweeper mainframe controls are operable.

The 86290A/B plug-ins offer outstanding electrical performance along with small size and simplicity of operation. The key microelectronic elements of the 86290B are a 2 to 6.2 GHz fundamental oscillator, 250 mW GaAs FET amplifier, and high-efficiency multiplier integrated with a tracking YIG filter, which combine to produce > 10 mW swept output over the 2 to 18.6 GHz range. This output is low in harmonic and spurious content and has excellent frequency linearity. On wideband sweeps, the 6.2 GHz and 12.4 GHz switch points can be Z-axis blanked as well as RF blanked, resulting in a spurious-free, clean continuous trace on any display.

The 86290A/B plug-ins have unique advantages as the source for network measurements. For 2 to 18 GHz scalar measurements, the 86290 accepts 27.8 kHz square wave AM modulation directly from the HP 8755 Frequency Response Test Set. Thus the need for an external modulator is eliminated providing convenience and cost savings, and more important, making full sweeper power available at the test device. Phase/amplitude network analysis over the continuous 2 to 18 GHz range becomes a reality using the 86290 and the HP 8410B Network Analyzer. Interfacing between the 8410B and the sweeper permits the 8410B to automatically phase-lock over multi-octave sweeps. Together, the 86290 and the 8410B make possible phase and amplitude measurements from 2 to 18 GHz in one continuous sweep.

As a stand-alone sweeper, the 8620C and 86290 plug-in provide still more features for ease in swept testing. Even at 18 GHz, frequency can be set with ± 30 MHz accuracy. Sweep linearity is 0.05% which means frequencies in the swept mode can be identified to accuracies comparable with wavemeters. Internal leveling is standard. External crystal and power meter leveling circuitry is also provided. A SLOPE control permits the frequency-dependent losses of a test setup to be compensated. The 2 to 6.2 GHz fundamental oscillator signal is always available through a rear output connector. Phase-locking from 2 to 18.6 GHz is accomplished using only 6.2 GHz hardware via this output. Accurate frequency readout is possible by connecting a DVM to the calibrated 1 volt/GHz output located on the rear panel.

With the plug-in flexibility and these exceptional features, the 8620C/86290 sweeper is the ideal source for broadband sweep testing of components, transmission lines, antenna systems and ECM equipment.

General specifications

Switch points: broadband switch points are at 6.2 and 12.4 GHz. Frequency overlap is typically 0 to 20 MHz at switch points.

Auxiliary output: rear panel 2 to 6.2 GHz fundamental oscillator output, nominally -10 dBm.

Slope control: front panel control allowing compensation for frequency dependent losses of a test setup by attenuating power at lower frequencies.

Peak control: front panel control for peaking power over desired frequency range.

Frequency reference output: nom. 1 V/GHz (2-18.6 volts) rear panel BNC output, CW frequency accuracy typically ± 35 MHz.

Mainframe compatibility: the 86290B will operate properly only with the 8620C mainframe. The 86290A will operate directly with 8620A mainframes with serial number prefixes of 1332A and above and with all 8620C mainframes. To use the 86290A with other 8620A mainframes order 86290A Option 060 which includes a mainframe modification kit.

Weight: net, 4.4 kg (9.6 lb). Shipping, 5.9 kg (13 lb).

86290A and 86290B Broadband plug-ins

Specifications with plug-in installed in an 8620C mainframe	BAND 1	BAND 2	BAND 3	BAND 4
Frequency range: (GHz)* 86290A 86290B	2-6.2 2-6.2	6-12.4 6-12.4	12-18 12-18.6	2-18 2-18.6
Frequency accuracy (25°C) CW mode (or >100 ms sweep time with FM switch in FM/PL): (MHz) Remote programming: typically (MHz) All sweep modes: (MHz) Marker: (MHz) Frequency linearity (correlation between frequency and sweep out voltage) typically: (MHz)	± 20 ± 2.5 ± 30 ± 30 ± 8	± 30 ± 3.5 ± 40 ± 40 ± 8	± 30 ± 3.5 ± 40 ± 40 ± 8	± 100 — ± 100 ± 100 ± 30
Frequency stability With temperature: (MHz/°C) With 10% line voltage change: (kHz) With 10 dB power level change: (kHz) With 3:1 load VSWR, all phases: (kHz) Frequency drift (in 10 minute period after 30 minute warm-up): typically (kHz) Residual FM (10 kHz bandwidth; FM switch in norm) CW mode: (kHz peak)	± 0.5 ± 100 ± 200 ± 100 ± 300 <10	± 1.0 ± 100 ± 400 ± 200 ± 600 <20	± 1.5 ± 100 ± 600 ± 300 ± 900 <30	± 2.0 ± 100 ± 600 ± 300 ± 900 <30
Maximum leveled power (25°C): (dBm) 86290A 86290B Power level control range: (dB)	>+7 >+10 >10	>+7 >+10 >10	>+7 >+10 >10	>+7 >+10 >10
Power variation Internally leveled: (dB) Externally leveled (excluding coupler and detector variation) Crystal detector: Power meter: With temperature (typically): (dB/°C)	± 0.7 ± 0.15 ± 0.15 ± 0.1	± 0.7 ± 0.15 ± 0.15 ± 0.1	± 0.8 ± 0.15 ± 0.15 ± 0.1	± 0.9 ± 0.15 ± 0.15 ± 0.1
Spurious signals (below fundamental at specified maximum power) Harmonic related signals: (dB) Nonharmonics: (dB)	>25 >50	>25 >50	>25 >50	>25 >50
Residual AM in 100 kHz bandwidth (below fundamental at specified maximum power): (dB)	>55	>55	>55	>55
Source VSWR internally leveled, 50Ω nominal impedance	<1.9	<1.9	<1.9	<1.9
External FM Maximum deviations for modulation frequencies DC to 100 Hz: (MHz) 100 Hz to 2 MHz: (MHz) Sensitivity (typically) FM mode: (MHz/volt) Phase-lock mode: (MHz/volt)	± 75 ± 5 — -20 -6	± 75 ± 5 — -20 -6	± 75 ± 5 — -20 -6	± 75 ± 5 — -20 -6
AM (At specified maximum power) Specified requirements guaranteeing HP 8755 operation with ±6V, 27.8 kHz square wave MOD DRIVE connected to EXT AM input. On/Off ratio: (dB) Symmetry: Attenuation for +5 volt input: (dB) Internal 1 kHz square wave On/Off ratio: (dB) RF blanking (selected by mainframe switch) On/Off ratio: (dB)	>30 40/60 >30 >25 >30	>30 40/60 >30 >25 >30	>30 40/60 >30 >25 >30	>30 40/60 >30 >25 >30
Minimum sweep time typically: (ms)	10	10	10	60
CW remote programming setting time typical time to settle into CW frequency accuracy specification, 8620C Opt. 001 or 011; FM switch in FM/PL: (ms)	5	5	5	10

*The 2-22 GHz option (H08) differs in some performance areas. Please consult your local HP Field Engineer for complete information.

Ordering information

86290A 2 to 18 GHz +7 dBm (5mW) plug-in (internal leveling standard)

86290B 2 to 18.6 GHz +10 dBm (10 mW) plug-in (internal leveling standard)

Opt 004: rear panel RF output:
(See Data Sheet for specifications)

Price

\$13,250

\$15,250

add \$80

Opt 005: APC-7 RF output connector:

add \$40

Opt 060: 86290A only, kit included for modifying 8620A mainframes with serial prefix 1332A and below. (86290B can only be used with the 8620C):

add \$300

Opt H08: 2 to 22 GHz operation, 86290A/B

add \$3000

SWEEP OSCILLATORS

8620 Family: straddle band plug-ins

Models 86240A, 86240B, and 86240C



86240B



86240C

86240B Low Harmonic Distortion: 2–8.4 GHz

The dynamic range of a swept measurement is often limited by source harmonics. Low pass filtering, either internal or external to the plug-in, is practical only over sweep widths less than an octave. However you can now get narrowband 45 dBc harmonic performance with the convenience of a multi-octave sweep in the 86240B. The dynamic range advantage of the low harmonics when measuring filter rejection, amplifier or mixer distortion is further enhanced by the 86240B's 20 mW of calibrated output power. Internal leveling to ± 0.5 dB is standard as well as a slope control for optimizing the total measurement system flatness. A step attenuator is optionally available if calibrated power control over an 80 dB range is desired.

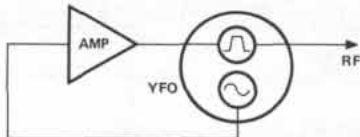

Key to the 45 dBc harmonic performance of the 86240B is the HP designed YIG-FILTER-OSCILLATOR (YFO). The YFO includes two YIG spheres in the same magnet housing. Changing the DC magnetic field strength tunes the resonant frequency of both YIG spheres simultaneously. One YIG tunes the oscillator circuit whose output is amplified by a 100 mW GaAs FET amplifier. This signal is then coupled through the second YIG which filters harmonics down to a level > 45 dB below the carrier over the entire 2 to 8.4 GHz range. Fast rise time pulses are made possible by pulsing the gate bias of a GaAs FET in the amplifier.

86240A High Output Power: 2–8.4 GHz

The use of fixed attenuators to reduce mismatch errors in a swept measurement requires additional source power to maintain the same dynamic range. Similarly, if one wants to take advantage of the excellent flatness and source match of a resistive power splitter, additional power is needed, especially if the test device is a mixer or amplifier with a 10 dBm drive level specification. The 86240A, which contains a non-filtered version of the YFO described above, was designed to meet these needs. It features up to 40 mW of output power, competitive harmonics, at an attractive price. With the internal leveling option, the 86240A also provides calibrated output power and slope control. For radar simulation applications, the 86240A can be externally amplitude modulated with 20 ns rise time pulses.

86240C RF Distortion Analysis of MW Links: 3.6–8.6 GHz

Distortion analysis of microwave radio links frequency requires MLA Upconverter Simulation. The 86240C is designed to fill this need over the important 4, 6, and 8 GHz commercial and military communication bands. The FM circuitry is modified to accept the sweep and test tone signals from the MLA. The oscillator is optimized for group delay of less than 1 ns peak-to-peak over 30 MHz and linearity better than 0.5%. The 86240C is also a very good 40 mW sweeper. It has a 10 MHz FM bandwidth, flat to ± 1.5 dB for noise loading applications plus all the optional leveling and power control features found on the 86240A. Thus, it is two products in one—both general and special purpose—ideal for communications systems applications. For further information on MLA Upconverter Simulation plug-ins, refer to the Telecommunications Test Equipment section on page 607.

86240A/B/C Plug-ins

Specifications with plug-in installed in 8620C mainframe

Frequency characteristics

Linearity: typically $\pm 0.1\%$.

Stability

With temperature: ± 500 kHz/ $^{\circ}$ C.

With 10% line voltage change: ± 40 kHz.

With 10 dB power level change: ± 1.0 MHz.

With 3:1 load SWR, all phases: ± 250 kHz.

With time (after 1 hr. warm-up): typ $< \pm 200$ kHz/10 min.

Residual FM (in 10 kHz bandwidth, CW Mode): < 9 kHz peak.

Reference output: DC-coupled voltage proportional to RF frequency, voltage approximately 1 V/GHz.

Output characteristics

RF power leveling

Internal, option 001: Selected by front panel switch; refer to RF plug-in specifications. (Standard on 86240B)

External

Crystal input: Approximately -10 to -200 mV for specified leveling at rated output; for use with negative polarity detectors.

Power meter input: Switch selects proper compensation for HP Models 432 A/B/C.

Indicator: Front panel indicator lights when RF power level is set too high to permit leveling over entire selected sweep range or when operating in unlevelled mode.

Source SWR: 50 Ω nominal impedance

Internally leveled (Option 001): < 1.6 .

Unleveled: Typically 3.

Residual AM in 100 kHz BW: > 50 dB below carrier at maximum.

RF output connector: Type N female.

Modulation characteristics

External AM

Frequency response: Typically dc to 100 kHz (at maximum leveled power).

Input impedance: Approximately 5000 Ω .

Attenuation for +5V input: > 30 dB.

Internal AM

1 kHz square-wave On/Off ratio: > 40 dB.

External pulse modulation

Rise/Fall time: Typically 20 ns.

Minimum pulse width: Typically 1 μ s leveled, 100 nsec unleveled.

Minimum pulse delay: Typically 30 nsec.

Square wave response: Guarantees HP 8755 Frequency Response Test Set operation with 8755 Modulator Drive connected to PULSE input.

On/Off ratio: > 40 dB.

Symmetry: 40/60.

General specifications

Weight: Net, 2.3 kg (5 lb). Shipping, 3.2 kg (7 lb).

Options

002: 70 dB Step Attenuator

004: Rear Panel RF Output

Price

add \$400

add \$80

	86240A	86240B	86240C
FREQUENCY Frequency Range	2.0-8.4 GHz	2.0-8.4 GHz	3.6-8.6 GHz
Frequency Accuracy: (25 $^{\circ}$ C) CW Mode CW Remote Programming: typically All Sweep Modes (for sweep time > 100 ms)	± 25 MHz ± 3.5 MHz ± 40 MHz	± 25 MHz ± 3.5 MHz ± 50 MHz	± 25 MHz ± 3.5 MHz ± 35 MHz
POWER OUTPUT Maximum Leveled Power: (25 $^{\circ}$) With Option 002:	> 40 mW > 32 mW	> 20 mW > 16 mW	> 40 mW > 32 mW
Power Variation: (At Max. Rated Power) Unleveled (Typically): Internally Leveled (Opt 001) Power Control Range: Power Calibration Accuracy: Add for Option 002: Externally Leveled (Excluding Coupled and Detector Variation) Crystal Detector and Power Meter:	$< \pm 2$ dB $< \pm 1$ dB 10 dB ± 2 dB ± 0.3 dB/10 dB $< \pm 0.1$ dB	$< \pm 0.5$ dB 10 dB ± 1 dB ± 0.3 dB/10 dB $< \pm 0.1$ dB	$< \pm 2$ dB $< \pm 0.8$ dB 10 dB ± 2 dB ± 0.3 dB/10 dB $< \pm 0.1$ dB
Spurious Signals: (below fundamental at specified maximum power): Harmonics Nonharmonics	> 20 dB (20 mW) > 16 dB (40 mW) > 60 dB	> 45 dB > 60 dB	> 20 dB (20 mW) > 16 dB (40 mW) > 60 dB
MODULATION External FM Maximum Deviations for Modulation Frequencies: DC to 100 Hz DC to 1 MHz 90 kHz to 10 MHz Frequency Response: DC to 2 MHz: DC to 10 MHz: Sensitivity: Nominal FM Mode Phase Lock Mode Upconverter Mode	± 75 MHz ± 5 MHz ± 3 dB -20 MHz/V -6 MHz/V	± 75 MHz ± 5 MHz ± 3 dB -20 MHz/V -6 MHz/V	± 150 MHz ± 1.5 MHz ± 1.5 dB ± 1.5 dB $+20$ MHz/V $+20$ MHz/V
PRICE Plug-in: Opt 001 (Internal Leveling)	\$3750 add \$650	\$5200 Included	\$4700 add \$650

SWEEP OSCILLATORS

8620 Family: 10 MHz to 2.4 GHz plug-ins

Models 86222A and 86222B

- 10 MHz to 2.4 GHz in ONE, CONTINUOUS sweep
- Internally leveled FLATNESS ± 0.25 dB over full range
- 1, 10, and 50 MHz crystal marker combs with 86222B
- Marker accuracy even in CW with 86222B



86222A

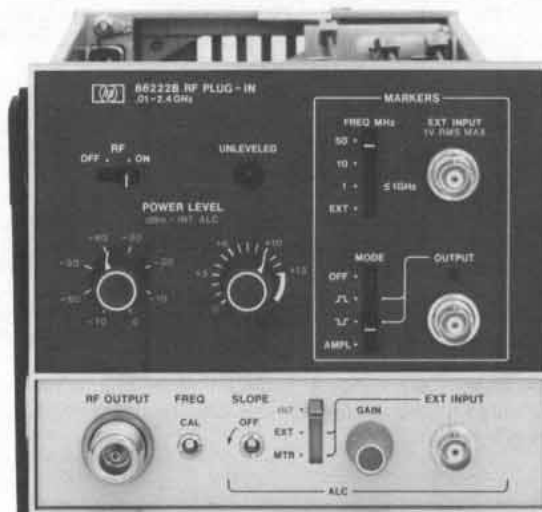

86222B

Description

The HP 86222A/B plug-ins provide uncompromising 10 MHz to 2.4 GHz frequency coverage. The entire range can be swept continuously—no need to break up your measurement into two or more sweeps. Yet narrowband resolution is not sacrificed. This precision is complemented by the 86222's good stability and frequency accuracy to make narrowband measurements truly practical. Both narrowband and wideband linearity is excellent (2 MHz over full band). The RF output characteristics of the 86222 feature similar high performance. Power output is calibrated 0 to +13 dBm in 1 dB increments. The output is internally leveled to ± 0.25 dB flatness over the entire 0.01 to 2.4 GHz range!

For applications demanding precise frequency identification, the 86222B offers an advanced digitally processed birdie marker system which provides the accuracy associated with standard birdie markers without their normal liabilities. The 86222B marker system internally generates a typical birdie marker, then processes it to produce a digital pulse. This pulse can then be used to produce an intensity dot on the CRT which corresponds to a precise frequency. This opens the applications of 86222B "birdie" markers to a wide variety of network analyzers and displays, such as the 8410B and 8755, where previously it was impossible to inject them on either the detected dc or RF signals. Alternately, an amplitude marker, derived from the birdie, can be selected which produces a dip in RF power at each marker frequency. This type of marker is useful for X-Y recordings. In addition, when the output frequency is coincident with a 50, 10, or 1 MHz comb of the internal crystal oscillator, a front-panel LED lights. Thus, independent of the display, an operator can accurately identify a CW frequency of the 86222B—within 75 kHz at 1 GHz! Provision

is also made for injection of an external marker for identification of specific frequencies between 1 MHz markers.

Continuous multi-octave vector measurements to 2.4 GHz are now possible using the HP 86222 together with the HP 8410B Network Analyzer. Previously, measurements could be made only one octave at a time because manual range switching of the HP 8410 was necessary. Now, the HP 86222/8620C combination automatically range switches the network analyzer for one continuous display, even from 0.1 to 2.4 GHz. In addition, with the 86222B crystal marker system the important third dimension, frequency, can be added to the polar display of the HP 8410B.

Increased dynamic range scalar measurements can be made using the HP 86222A/B together with the HP 8755 Swept Frequency Response Test Set. Heterodyne plug-ins in the range of 0.01–2 GHz will typically have a broadband noise output only 45 to 50 dB below the fundamental output signal. This noise is due to the high gain output amplifier used in heterodyne approaches. The noise level will be higher than most broadband detectors' noise level and significantly higher than the noise of the Schottky diode used in the HP 8755. This will limit the dynamic range of measurements such as the transmission loss of high pass, low pass, and notch filters, or return loss of bandpass filters when broadband detectors are used. The HP 8755, which is a 27.8 kHz receiver does not exhibit this problem when used with the HP 86222A/B. By designing an integral modulator in the sweeper, and an ALC loop which will handle the 27.8 kHz, the fundamental oscillator output can be modulated at 27.8 kHz without modulating the noise of the output amplifier. The HP 8755 will therefore not respond to the noise. The typical result is a 10 to 15 dB dynamic range improvement over other heterodyne sweepers and dc diode detection.

Specifications with plug-in installed in an 8620C mainframe

Frequency characteristics

Range: 10 MHz to 2.4 GHz.

Accuracy (25°C)

CW mode: ± 10 MHz.

Remote programming: typically ± 1.5 MHz.

All sweep modes: ± 15 MHz (< 0.1 sec sweep time). Accuracy of 86222B may be enhanced to better than ± 200 kHz through use of crystal markers.

Linearity (correlation between frequency and SWEEP OUT Voltage): typically ± 2 MHz.

Frequency reference output: nominally 1 V/GHz ± 0.01 V.

Frequency cal control: permits fine frequency calibration.

Stability

With temperature: ± 500 kHz/°C.

With 10% line voltage change: ± 20 kHz.

With 3:1 load SWR, all phases: ± 10 kHz.

With 10 dB power level change: ± 20 kHz.

With time (after 1-hour warm-up): typically ± 100 kHz/10 min.

Residual FM: (10 kHz bandwidth; FM switch in NORM; CW Mode): < 5 kHz peak.

Output characteristics

Maximum leveled power (25°C): $> +13$ dBm (20 mW); typically $> +15$ dBm.

Power level accuracy (internal leveling only): ± 1 dB (includes frequency response).

Attenuator Opt 002: add ± 0.2 dB/10 dB step.

Power Variation

Internally leveled

0.01 to 2.4 GHz: ± 0.25 dB.

Across any 50 MHz (0.03 to 2.3 GHz): typically ± 0.05 dB.

Stability with temperature: typically ± 0.02 dB/°C.

Externally leveled (excluding coupler and detector variation)

Crystal detector: (-10 to -100 mV at rated output): ± 0.1 dB.

Power meter (with HP 432A/B/C Series power meters): 0.1 dB.

Unleveled indicator: lights when RF power level is set too high to permit leveling over sweep range selected.

Residual AM in 100 kHz BW: > 50 dB below carrier at maximum power.

Spurious signals: below fundamental.

Harmonics: > 25 dB at $+13$ dBm; typically > 30 dB at $+10$ dBm.

Non-Harmonics

0.01 to 2.3 GHz: > 30 dB at $+13$ dBm; typically > 40 dB at $+10$ dBm.

2.3 to 2.4 GHz: > 25 dB at $+13$ dBm; typically > 35 dB at $+10$ dBm.

Broadband noise in 100 kHz bandwidth: typically < -70 dBm.

Impedance: 50 Ω nominal.

SWR: < 1.5 .

Slope control: allows variable compensation for frequency dependent losses in test set-up.

Output connector: type N female.

Modulation characteristics

External FM

Input impedance: approximately 10 k Ω .

Frequency response: typically 150 kHz.

External AM

Square wave response: guarantees HP 8755 Frequency Response Test Set operation with 8755 Modulator Drive connected to EXT AM input.

On/Off ratio: > 30 dB.

Symmetry: 40/60 at ≥ 10 dBm output power.

Attenuation for +5 V input: > 30 dB.

Internal AM

1 kHz square-wave On/Off ratio: > 30 dB.

RF blanking On/Off ratio: > 30 dB.

External FM

Maximum deviations for modulation frequencies

DC to 100 Hz: ± 75 MHz

100 Hz to 1 MHz: ± 5 MHz.

1 MHz to 2 MHz: ± 2 MHz.

Sensitivity (typically)

FM mode: -20 MHz/V.

Phase-lock mode: -6 MHz/V.

Crystal marker capabilities (86222B Only)

Internal crystal markers: harmonic markers of 10 and 50 MHz usable over full 0.01 to 2.4 GHz range and 1 MHz markers usable 0.01 to 1 GHz. Positive (\nearrow) or negative (\searrow) voltage output pulses can be selected to Z-axis intensify a scope trace; or RF amplitude pips can be selected (at maximum sweep speed pulse width optimized for approximately 10 markers/sweep).

Accuracy of center frequencies (25°C): $\pm 5 \times 10^{-6}$.

Typical marker width around center frequency

1 MHz markers: ± 75 kHz.

10 MHz markers: ± 200 kHz.

50 MHz markers: ± 300 kHz.

Temperature stability: typically $\pm 2 \times 10^{-6}$ /°C.

Marker output \nearrow mode: nominally > 3 V.

\searrow mode: nominally -4 to -9 V, internally adjustable.

Amplitude mode: typically 0.5 dB, internally adjustable.

External marker input: generates amplitude or Z-axis marker when sweep frequency equals external input frequency.

Frequency range: 0.01 to 2.4 GHz.

Marker width: typically ± 300 kHz.

Marker indicator light: green LED lights coincident with crystal or external marker for accurate CW calibration.

General

Improved Network Measurements Capability

8410B Network Analyzer: interfacing through 8620C rear panel connector allows the 8410B to maintain phase lock over multi-octave sweeps at all sweep speeds.

8755 Frequency Response Test Set: direct connection of 8755 mod drive signal to external AM input of the 8620C eliminates the need for an external modulator.

Ordering information

86222A 0.01–2.4 GHz RF Plug-In (Internal Leveling Standard) \$3750

86222B 0.01–2.4 GHz RF Plug-In with Crystal and External Markers (Internal Leveling Standard) \$4350

Opt 002: 70 dB Step Attenuator (10 dB steps) add \$325

Opt 004: Rear Panel RF Output add \$80

SWEEP OSCILLATORS

8620 Family: single band plug-ins

Model 86200 Series

- 10 MHz to 22 GHz coverage
- >50 mW from 5.9 to 12.4 GHz



86245A



86260A

Specifications

86200 Series

The 86200 series plug-ins feature a wide choice of bandwidths and power specifications for covering the 10 MHz to 22 GHz frequency range. The 86222A/B 10 MHz to 2.4 GHz plug-ins and the 86290A/B 2 GHz to 18.6 GHz plug-ins both cover multi-octave frequency ranges with exceptional frequency precision and RF output characteristics. See preceding pages for specifications on these plug-ins. For octave band applications, smaller range plug-ins covering, for instance, 5.9 GHz to 12.4 GHz are available with optional capability to operate as upconverters for MLA measurements.

Frequency linearity: typically $\pm 1\%$.

Frequency reference output: typically 1 V/GHz DC-coupled voltage is available for referencing or phase-locking external equipment to the plug-in or for multi-octave operation with an 8410B.

RF power leveling: internal dc-coupled leveling amplifier and PIN modulator provided.

Internal, Opt 001: selected by front panel switch; refer to RF plug-in specifications (standard on 86220A).

External

Crystal input: approximately -20 to 250 mV for specified leveling at rated output; for use with negative polarity detectors such as 780 Series Directional Detectors, 423A/B and 8470 Series Crystal Detectors.

Power meter input: leveling amplifier with compensation for HP 432A power meter included internally in all plug-ins except the

86230B and 86241A which require the use of an 8404A Leveling Amplifier and the EXT AM input on the 8620 Mainframe.

Indicator: front panel indicator lights when RF power level is set too high to permit leveling over entire selected sweep range or when operating in unleveled mode.

Residual AM in 100 kHz bandwidth: >50 dB below fundamental at specified maximum power.

External AM

Frequency response: typically dc to 100 kHz unleveled, dc to 50 kHz leveled (at maximum leveled power).

Input impedance: approximately 5000 ohms.

RF output connector: type N Female.

Weight: net, 2.3 kg (5 lb). Shipping, 3.2 kg (7 lb).

Options

001: Internal leveling. Refer to RF plug-in specifications.

002: 70 dB attenuator in 10 dB steps, available in 86220A and 86235A

004: rear panel RF output

005: APC-7 RF output connector available on 86260A

Upconverter simulation options: options are available which guarantee compatibility with the HP Microwave Link Analyzer. For further information on these plug-ins refer to the Telecommunications Test Equipment Section beginning on page 607.

Price

See model number

add \$325 or \$400

respectively

add \$80

add \$40

Single band plug-ins

Refer also to broadband models 86222A/B (0.01-2.4 GHz), 86240A/B/C (2-8.6 GHz), and 86290A/B (2-22 GHz)

Specifications with plug-in installed in 8620C	86220A	86230B	86235A	86241A	86242D	86245A	86250D	86260A	86260A Opt H22
Frequency range¹ (GHz):	0.01-1.3	1.8-4.2	1.7-4.3	3.2-6.5	5.9-9.0	5.9-12.4	8.0-12.4	12.4-18.0	17.0-22.0
Frequency accuracy CW mode (MHz):	± 10	± 15	± 20	± 30	± 35	± 40	± 40	± 50	± 50
Remote programming Typically (MHz):	± 7.5	± 2.5	± 2.5	± 10.5	± 5.5	± 10.5	± 8.5	± 5.5	—
All sweep modes (sweep time >100 ms) (MHz):	± 15	± 20	± 30	± 33	± 40	± 50	± 50	± 70	± 70
Residual FM (10 kHz BW) CW mode (kHz) peak:	<5	<7	<7	<7	<15	<15	<15	<25	<25
Maximum leveled power¹ (mW):	10	>10	>40	>6.3	>10	>50	>10	>10	>10
Power variation Internally leveled (dB):	< ± 0.5 Internal leveling cal'd output std.	< ± 1.2	< ± 0.8	< ± 0.8	< ± 0.5	< ± 0.6	< ± 0.5	< ± 0.7	
Externally leveled (dB) (excluding coupler & detector variation):	N/A	< ± 0.1	< ± 0.1	< ± 0.1	< ± 0.1	< ± 0.1	< ± 0.1	< ± 0.1	< ± 0.1
Spurious signals: (dB below fund, at specified max power) Harmonics:	> 25	> 20	> 20	> 16 (3.2-3.8 GHz) > 20 (3.8-6.5 GHz)	> 30	> 17 (5.9-7 GHz) > 30 (7-12.4 GHz)	> 30	> 25	> 25
Nonharmonics:	> 50	> 60	> 60	> 60	> 60	> 60	> 60	> 50	> 50
Source VSWR: (50Ω nom, internally leveled)	< 1.3	< 1.6	< 1.6	< 1.6	< 1.6	< 1.6	< 1.6	< 1.6	
External FM: Max deviations (MHz) for modulation frequencies: DC-100 Hz:	± 15	± 25	± 75	± 25	± 150	± 150	± 150	± 75	± 75
DC-1 MHz:	± 0.5	± 2	± 5	± 2	± 7	± 7	± 7	± 5 (DC-200 kHz)	± 5 (DC-200 kHz)
Sensitivity (nom, MHz/V):	+3.5	-4	-20/-6	-6	-20/-6	-20/-6	-20/-6	-20/-6	-20/-6
AM: Internal 1 kHz square wave On/Off ratio & EXT AM sensitivity To 10 V (dB):	> 35	> 25	> 30	> 25	> 40	> 40	> 40	> 25	> 25
EXT AM Response compatible with 8755 Mod drive signal:	No	No	Yes	No	Yes	Yes	Yes	No	No
Price: Plug-in: Opt 001 (int. lev.):	\$2750 Included	\$2600 +\$390	\$3300 +\$550	\$2500 +\$390	\$2800 +\$450	\$4200 +\$500	\$2900 +\$450	\$3600 +\$550	\$5950

1. Special frequency bands and high power outputs available on request.

SWEEP OSCILLATORS

8620 Family: multiband plug-ins

Models 8621B, 86300 Series

- Modular construction
- >40 mW in S-band

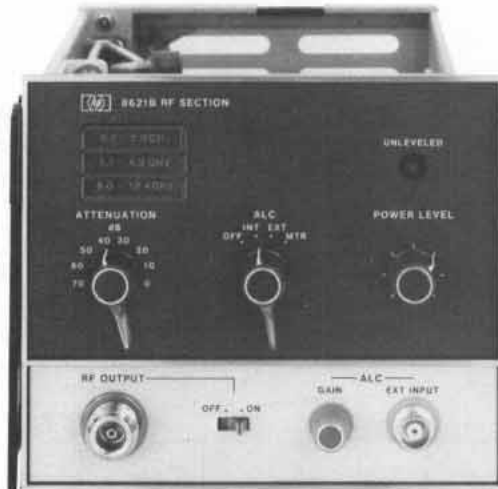

8621B

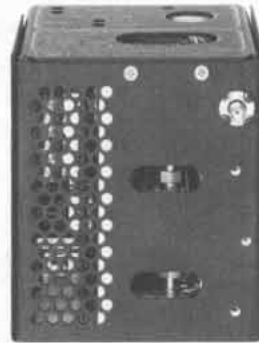

86300 Series



The 8621B RF Drawer houses the 86300 series RF Modules. The standard drawer will accept one fundamental oscillator module. In addition, with the 1.7 to 4.3 GHz fundamental oscillator module, the standard drawer also accepts the 0.1 to 2 GHz heterodyne module to give 0.1 to 4.3 GHz coverage. The 8621B Option 100 will accept two fundamental oscillator modules and the heterodyne module. This will allow, for example, 0.1 to 6.5 GHz coverage in one plug-in.

Specifications

8621B

70 dB step attenuator, opt 010

Range: 70 dB in 10 dB steps set by front panel switch.

Insertion loss: <2.0 dB.

Accuracy: (including frequency response).

For 10 dB: ± 0.6 dB.

For > 10 dB: $\pm 5\%$ of attenuation.

Remote control capability: 4-line binary logic, open or contact closure to ground (8620A/C Mainframe only, input available at rear panel connector).

Weight: net, 0.9 kg (2 lb).

RF power leveling: internal dc-coupled leveling amplifier provided.

Internal: selected by front panel switch; refer to RF module specifications.

External:

Crystal input: approximately ± 20 to ± 250 mV for specified leveling at rated output; for use with positive or negative polarity detectors such as 780 Series Directional Detectors, 423A/B and 424 Series Crystal Detectors; polarity switch provided in RF drawer.

Power meter input: switch in RF drawer selects proper compensation for Models 431B/C or 432A/B/C power meters.

Indicator: front panel indicator lights when RF power level is set too high to permit leveling over entire selected sweep range or when operating in unlevelled mode.

Frequency reference output: DC-coupled voltage nominally 1 V/GHz is available for referencing or phase locking external equipment to the sweeper or for multi-octave operation with the 8410B.

RF output connector: type N Female.

Weight: net, 1.4 kg (3 lb). Shipping, 2.3 kg (5 lb).

Common specifications

86300 series

Frequency linearity: typically $\pm 1\%$.

Residual AM in 100 kHz bandwidth: >50 dB below fundamental at maximum power.

External AM

Frequency response: typically dc to 100 kHz unlevelled, dc to 50 kHz levelled (at maximum levelled power).

Input impedance: approximately 5000 ohms.

Internal leveling: standard on all modules. Refer to RF module specifications.

Weight: net, 1.4 kg (3 lb). Shipping, 1.8 kg (4 lb). Option 010 add 0.9 kg (2 lb).

Ordering information

8621B RF Drawer

Opt 004: Rear panel RF output

Opt 010: 70 dB Attenuator

Opt 100: Multiband capability

Price

\$800

add \$80

add \$950

add \$500

Multiband plug-ins

Specifications with unit installed in 8621B and 8620C	86320B ¹	86331C	86341C	86342C	86350C
Frequency range (GHz):	0.1-2.0	1.7-4.3	3.2-6.5	5.9-9.0	8.0-12.4
Frequency Accuracy: CW mode (MHz): All sweep modes (sweeptimes > 100 ms) MHz:	± 15 ± 20	± 20 ± 25	± 30 ± 33	± 35 ± 40	± 40 ± 50
Residual FM (10 kHz BW) CW mode (kHz Peak):	< 15	< 7	< 7	< 15	< 15
Maximum leveled power (dBm):	> +13	> +16	> +10	> +7	> +6
Power variation: Internally leveled (dB): Externally leveled (dB) (Excluding coupler-detector or thermistor variation):	< ± 0.7 < ± 0.1	< ± 0.8 < ± 0.1	< ± 1 < ± 0.1	< ± 1 < ± 0.1	< ± 1 < ± 0.1
Spurious signals: (dB below fund, at specified max power) Harmonics: Nonharmonics:	> 30 @ 10 dBm > 24 @ 13 dBm > 30 @ 10 dBm > 24 @ 13 dBm	> 20 > 60	> 14 (3.2-3.8 GHz) > 25 (3.8-6.5 GHz) > 60	> 30 > 60	> 30 > 60
Source VSWR: (50Ω nom, internally leveled)	< 1.6	< 1.6	< 1.6	< 1.5	< 1.5
External FM: Max deviations (MHz) for Modulation frequencies: DC-100 Hz: DC-1 MHz: DC-2 MHz: Sensitivity: nominal FM mode (MHz/V): Phase lock mode (MHz/V):	± 75 ± 5 ± 2 -20 -6	± 75 ± 5 ± 2 -20 -6	± 75 ± 5 ± 2 -20 -6	± 75 ± 5 ± 2 -20 -6	± 75 ± 5 ± 2 -20 -6
AM: Internal 1 kHz square wave ON/OFF radio and Ext. AM sensitivity To -10 V (dB)	> 15	> 40	> 25	> 40	> 40
Price	\$2500	\$2800	\$2600	\$3000	\$3000

1. 86320B is a heterodyne unit which must be used with 86331C.

SWEEP OSCILLATORS

8690 Sweeper family, 400 kHz to 50 GHz

Model 8690 System

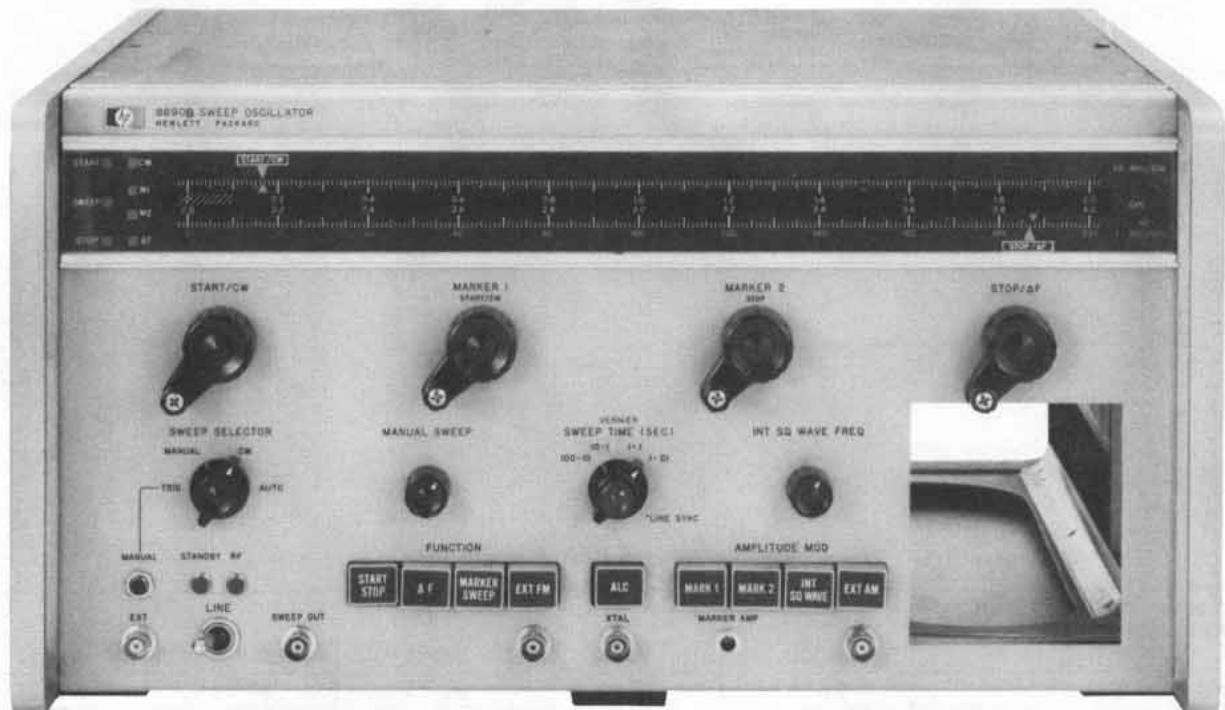

8690 System

The familiar 8690 BWO sweeper family offers exceptional value in performance, operation and versatility. With the ability to accept both BWO and solid state plug-ins, the 8690 mainframe allows BWO coverage where necessary, and more reliable, high performance solid state coverage at lower frequencies.

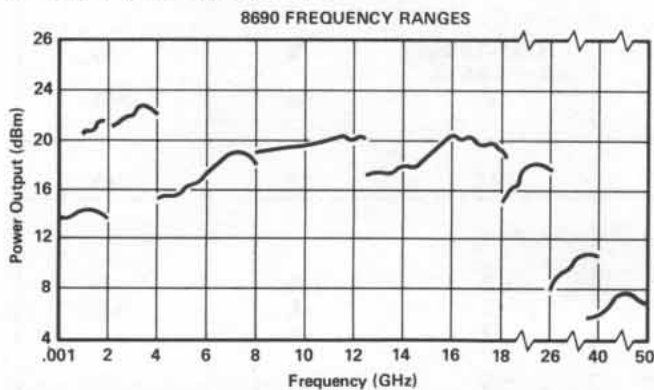

8690B Mainframe specifications

Sweep functions

START/STOP sweep: sweeps from "start" to "stop" frequency setting. Both settings continuously adjustable over entire frequency range.

MARKER sweep: sweeps from "Marker 1" to "Marker 2" frequency setting. Both settings continuously adjustable over entire frequency range and accurate to 1% of full scale for all RF units.

ΔF sweep: sweeps upward in frequency, centered on CW setting. Width is continuously adjustable from zero to 10% of the frequency band and is calibrated in MHz. Accuracy is $\pm 1\%$ of maximum ΔF plus $\pm 10\%$ of ΔF being swept.

CW operation: single-frequency RF output selected by START/CW or MARKER 1 control, depending on sweep function selected.

Sweep modes

Auto, manual, and triggered sweep modes; sweep indicator lights during each sweep.

Sweep time: continuously adjustable in four decade ranges, 0.01 to 100 seconds.

Sweep output: direct-coupled sawtooth, zero to approximately +15 V, concurrent with swept RF output, regardless of sweep width or direction.

General

Frequency markers: two markers independently adjustable over entire frequency range accurate to 1% of full scale. Amplitude is adjustable from front panel. A -5 V triangular pulse is available as an intensity marker on the rear panel.

Internal AM: square wave modulation continuously adjustable from 950 to 1050 Hz.

External AM: frequency response dc to 350 kHz unleveled, dc to 50 kHz leveled.

Blanking: both negative (-4 V) and RF blanking available along with pen lift output.

Weight: net, 23.9 kg (53 lb). Shipping, 32 kg (71 lb).

Size: 222 mm H x 425 mm W x 467 mm D (8 $\frac{3}{4}$ " x 16 $\frac{3}{4}$ " x 18 $\frac{3}{8}$ ").

8690B Sweeper mainframe

\$3100

- Solid state plug-ins
- Both pin and grid leveled BWO plug-ins
- Frequency coverage to 50 GHz

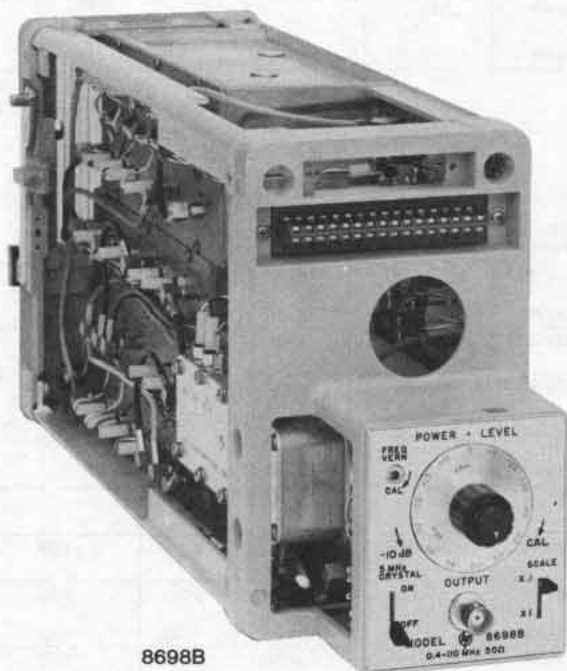

8698B



8693B

Solid state and BWO plug-ins

Solid state plug-ins from 400 kHz to 4 GHz are available for the 8690 mainframe. BWO replacement is both expensive and inconvenient. Solid state plug-ins not only offer high reliability, but also provide low residual FM and good spectral purity. This capability allows one mainframe to cover high frequency, high power BWO applications, yet facilitate high performance, longer life solid state coverage of lower frequencies. There are two solid state plug-ins. The 8698B covers 400 kHz to 110 MHz while the 8699B plug-in has a 100 MHz to 4 GHz range.

Both grid leveled and pin leveled BWO plug-ins are available covering 1 to 50 GHz. Grid leveled BWO oscillators achieve power and leveling control by varying bias on the BWO grid. Although some degradation in frequency performance specifications is seen by this method, grid leveling provides an economical means of power control and delivers higher power output since there are no components (pin modulators) between BWO and front panel output.

PIN leveled BWO plug-ins offer superior frequency stability characteristics. As in all solid state plug-ins, leveling is accomplished through use of a pin diode modulator between oscillator and output. Use of the pin allows the oscillator to work at constant bias and into a

constant impedance load, resulting in very low residual FM and very little frequency pulling. Pin leveling also results in a better source impedance match.

Common specifications: BWO plug-ins

- Warranty:** all BWO's are unconditionally warranted for one year.
- Spurious signals:** harmonics, >20 dB below CW output, nonharmonics, >40 dB below CW output.
- Residual AM:** >40 dB below CW output.
- Magnetic shielding:** all plug-ins except the 8691A/B have shielded BWO's.
- Reference output:** dc voltage proportional to frequency output ≈ 40 V/octave.
- Leveling indicator:** front panel light indicates unlevelled operation.
- Power variation**
 - Unlevelled:** <10 dB over full band.
 - Externally leveled:** ± 0.2 dB for A units.
 ± 0.1 dB for B units.
- Frequency stability with temperature:** $\pm 0.01\%/^{\circ}\text{C}$.
- Weight**
 - 8691-8692: net, 7.7 kg (17 lb). Shipping, 11.3 kg (25 lb).
 - 8693-8697: net, 5.4 kg (12 lb). Shipping, 9 kg (20 lb).
 - 8698-8699: net, 5.0 kg (11 lb). Shipping, 8.6 kg (19 lb).



SWEEP OSCILLATORS

8690 Sweeper family (cont.)

Pin leveled solid state plug-ins

Frequency Range	Model Number	Maximum Leveled Power	Frequency Accuracy	Frequency Stability With		Residual FM ²	Int. Leveling Power Variation	Connector	Price
				Temperature	10 dB Power Level Change				
0.4-11 MHz	8698B	>20 mW	$\pm 1\% \pm 50\text{kHz}$	$\pm 0.05\%/^{\circ}\text{C}$	—	<300 Hz rms	$\pm 0.3\text{ dB}$	BNC ¹	\$2400
11-110 MHz		>20 mW	$\pm 1\% \pm 500\text{kHz}$	$\pm 0.05\%/^{\circ}\text{C}$	—	<500 Hz rms	$\pm 0.3\text{ dB}$		
0.1-2 GHz	8699B	>20mW	$\pm 10\text{ MHz}$	$\pm 750\text{ kHz}/^{\circ}\text{C}$	<100 kHz	<3 kHz rms	—	Type N	\$5100
2-4 GHz		>6 mW	$\pm 10\text{ MHz}$	$\pm 750\text{ kHz}/^{\circ}\text{C}$	<500 kHz	<3 kHz rms	—		

1. 8698B Opt 001: 75Ω BNC output. Add \$55.

2. Residual FM measured with 10 kHz bandwidth.

Grid and pin leveled BWO plug-ins

Frequency	Model Number	Power Control	Maximum Leveled Power	Frequency Accuracy	Freq. Stability With Power Level Change ¹	Residual FM Peak ²	Option 001 Int. Leveling Power Variation	Connector	Price	Option 001 Int. Leveling Price-Add
1.0-2.0 GHz	8691A	GRID	>100 mW	$\pm 1\%$	<20 MHz	<30 kHz	$\pm 0.4\text{ dB}$	Type N	\$3800	\$360
	8691B	PIN	>70 mW	$\pm 10\text{ MHz}$	$\pm 500\text{ kHz}$	<10 kHz	—	Type N	\$4100	—
1.4-2.5 GHz	8691A Opt. 200	GRID	>100 mW	$\pm 1\%$	<30 MHz	<30 kHz	—	Type N	\$4080	—
1.7-4.2 GHz	8692B Opt. 100	PIN	>15 mW	$\pm 25\text{ MHz}$	$\pm 4\text{ MHz}$	<20 kHz	—	Type N	\$4480	—
2.0-4.0 GHz	8692A	GRID	>70 mW	$\pm 1\%$	<40 MHz	<30 kHz	$\pm 0.4\text{ dB}$	Type N	\$3500	\$360
	8692B	PIN	>40 mW	$\pm 20\text{ MHz}$	4 MHz	<15 kHz	—	Type N	\$4050	—
3.5-6.75 GHz	8693A Opt. 200	GRID	>40 mW	$\pm 1\%$	<80 MHz	<50 kHz	—	Type N	\$3900	—
3.7-8.3 GHz	8693B Opt. 100	PIN	>5 mW	$\pm 45\text{ MHz}$	$\pm 1\text{ MHz}$	<20 kHz	$\pm 0.4\text{ dB}$	Type N	\$3950	\$390
4.0-8.0 GHz	8693A	GRID	>30 mW	$\pm 1\%$	<80 MHz	<50 kHz	$\pm 0.5\text{ dB}$	Type N	\$3000	\$390
	8693B	PIN	>15 mW	$\pm 40\text{ MHz}$	$\pm 1\text{ MHz}$	<15 kHz	$\pm 0.4\text{ dB}$	Type N	\$3600	\$390
7.0-11.0 GHz	8694A Opt. 200	GRID	>25 mW	$\pm 1\%$	<160 MHz	<60 kHz	$\pm 0.75\text{ dB}$	Type N	\$3055	\$490
	8694B Opt. 200	PIN	>15 mW	$\pm 40\text{ MHz}$	$\pm 1\text{ MHz}$	<20 kHz	$\pm 0.75\text{ dB}$	Type N	\$4005	\$490
7.0-12.4 GHz	8694A Opt. 100	GRID	>25 mW	$\pm 1\%$	<160 MHz	<60 kHz	$\pm 0.75\text{ dB}$	Type N	\$3360	\$490
	8694B Opt. 100	PIN	>15 mW	$\pm 50\text{ MHz}$	$\pm 1\text{ MHz}$	<20 kHz	$\pm 0.75\text{ dB}$	Type N	\$4310	\$490
8.0-12.4 GHz	8694A	GRID	>50 mW	$\pm 1\%$	<160 MHz	<60 kHz	$\pm 0.75\text{ dB}$	Type N	\$3000	\$490
	8694B	PIN	>30 mW	$\pm 40\text{ MHz}$	$\pm 1\text{ MHz}$	<15 kHz	$\pm 0.75\text{ dB}$	Type N	\$3950	\$490
8.0-18.0 GHz	8694A Opt. 300	GRID	>10 mW	$\pm 1\%$	$\pm 150\text{ MHz}$	<150 kHz	—	Type N	\$6000	—
	8694B Opt. 300	PIN	>5 mW \pm	$\pm 1\%$	$\pm 1\text{ MHz}$	<50 kHz	—	Type N	\$6650	—
10-15.5 GHz	8695A Opt. 100	GRID	>25 mW	$\pm 1\%$	<0.25 GHz	<150 kHz	—	Flat Flange for WR-75WG	\$5050	—
12.4-18.0 GHz	8695A	GRID	>40 mW	$\pm 1\%$	<0.25 GHz	<150 kHz	—	UG-419/U	\$3200	—
	8695B	PIN	>15 mW	$\pm 56\text{ MHz}$	$\pm 1\text{ MHz}$	<25 kHz	—	UG-419/U	\$3900	—
18.0-26.5 GHz	8696A	GRID	>10 mW	$\pm 1\%$	<0.36 GHz	<200 kHz	—	UG-595/U	\$3500	—
26.5-40 GHz	8697A	GRID	>5 mW	$\pm 1\%$	<0.53 GHz	<350 kHz	—	UG-599/U	\$5500	—
33-50 GHz	8697A Opt. H50	GRID	>3 mW	$\pm 1\%$	<0.68 GHz	<450 kHz	—	UG-383/U	\$11,400	—

1. Power level change specification for B units typically 10 dB, A units 6 dB.

2. Residual FM measured with 10 kHz bandwidth.

Opt 004: rear output 8691-8694, 8698-8699

add \$80

Opt 004: rear output 8695-8697

add \$155

Opt J54: phase lock input

add \$350

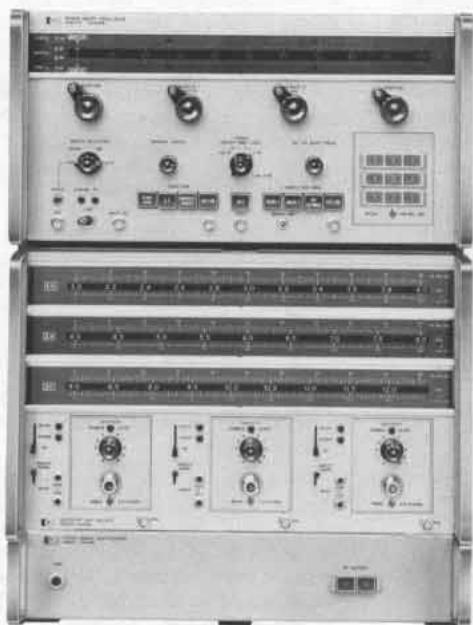

8690B/8706A, 8707A, 8705A



8709A



8404A



11531A

8705A, 8706A, 8707A Multiband System

Multiband systems 400 kHz to 50 GHz are available using the 8706A Control Unit Plug-in and the 8707A RF Unit Holder. The 8706A allows pushbutton control of RF plug-ins installed in the 8707A. The 8705A Multiplexer switches RF signals up to 12.4 GHz from three RF units and provides an ALC signal for the 8690B leveling circuits.

Specifications

8705A Multiplexer

Frequency range: dc to 12.4 GHz. Output port SWR ≤ 1.67 . Input port SWR ≤ 1.35 .

Insertion loss: 3 dB.

Weight: net, 7.8 kg (17 lb). Shipping, 10 kg (22 lb).

8706A Control Plug-in

Compatibility: the 8706A controls up to three 8707A RF unit holders; Option H26 for remote band switching of the 8699B.

Weight: net, 7.3 kg (16 lb). Shipping, 11.4 kg (25 lb).

8707A RF Unit Holder

Capability: accepts up to three 8690 plug-ins.

Sweep functions

Normal: permits all 8690B sweep functions.

Preset: allows screwdriver setting of individual start/stop points.

Weight: net, 13.6 kg (30 lb). Shipping, 16.8 kg (37 lb).

8709A Phase Lock Synchronizer

The 8709A Synchronizer is a phase comparator designed to stabilize the frequency of both HP BWO and solid state sources by phase locking to a reference oscillator. Under these conditions system stability is determined primarily by the stability of the reference oscillator. Phase lock capability is standard on solid state plug-ins from 0.01 to 18 GHz. Order Option J54 for BWO plug-ins. Information on complete phase-locked systems available on request.

Specifications

Input frequency: the locking frequency of the 8709A is 20 MHz. This signal is obtained by multiplying and mixing the reference oscillator with the microwave signal.

Sensitivity: -65 dBm.

Minimum output voltage: high level ± 12.0 V dc; low level ± 8.0 V dc.

Modulation sensitivity: 8690 BWO Option J54 plug-ins, 0.5 to 6.0 MHz/V. 8620 solid state plug-ins 6.0 MHz/V

Weight: net, 4.5 kg (10 lb). Shipping, 5.3 kg (11.6 lb).

8404A Power Meter Leveling Amplifier

The 8404A Leveling Amplifier permits the 431B/C or 432A/B/C power meter to level both the 8620 and 8690 sweeper plug-ins. RF output is leveled to ± 0.5 dB or less when connected to the AM input of the sweeper.

11531A Mainframe Test Plug-in

The 11531A Test Unit Plug-in allows complete calibration of the 8690 mainframe, including sweep modes, markers and BWO. All voltages are selected from a front panel switch.

Ordering Information

	Price
8404A Power Meter Leveling Amplifier	\$650
Opt 001: 4 line BCD level control	add \$210
8705A Signal Multiplexer dc-12.4 GHz	\$3300
8706A Control Unit Plug-in	\$1200
8707A RF Unit Holder	\$2650
8709A Phase-Lock Synchronizer	\$1500
11531A Mainframe Test Unit Plug-in	\$550

POWER & NOISE FIGURE METERS

Power and noise measurements

Average power measurements

At microwave frequencies, power is the best measure of signal amplitude because, unlike voltage and current, power remains constant along a lossless transmission line. For this reason, power meters are almost indispensable for microwave measurement. Typical applications include monitoring transmitter power levels, calibrating signal generators, leveling signal sources, and measuring transmission characteristics of unknown devices.

To satisfy the requirements of this broad range of applications, Hewlett-Packard has developed a family of general purpose microwave power meters. These power meters use either a diode, thermocouple, or thermistor as the power sensing element, and it is important to understand the merits of each of these sensors before choosing a particular power meter.

Power meters and sensors

Hewlett-Packard makes five average-reading power meters. The 435A and the 436A are analog and digital meters, respectively, which are designed to operate with HP's line of thermocouple and diode power sensors. The 432 power meters are designed to operate with HP's line of thermistor mounts. The 432A is an analog power meter. The 432B is digital with BCD output, and the 432C is like the 432B but is fully programmable and auto-ranging.

Thermocouple power sensors use the latest technology and are generally preferred for measuring power because they exhibit lower SWR and wider dynamic range than previously used thermistor elements. Low SWR is directly responsible for superior accuracy since mismatch errors are lower.

HP thermocouple sensors (8481, 8482, 8483) are available from 100 kHz to 18 GHz and range from -30 dBm to +44 dBm. The model 8484A diode sensor operates with the same meters and extends the input level down to -70 dBm. This sensor uses a Low-Barrier Schottky diode to achieve exceptional 100 pW (-70 dBm) sensitivity, and low noise and drift. Because the diode is always operated in its square law region (voltage out \propto power in), the 8484A can be used to measure the true power of complex as well as CW waveforms.

Thermistor power sensors (478A, 486A series) operate with the 432A and 432B power meters. They are used whenever a direct DC-substitution technique is required since these power meters are based on balanced bridge principles. In addition, a full line of waveguide thermistor mounts are available from 3.95 to 40 GHz.

Applications

Information on virtually all aspects of microwave power measurement is contained in Hewlett-Packard application notes. The AN 64 series is intended as the definitive publication for general theory, product orientated how-to descriptions, and a complete treatment of new, innovative automatic systems.

AN64-1, **Fundamentals of RF and Microwave Power Measurements**, deals with the general theory of microwave power measure-

ments. It covers the basic principles of measurement, calculation of measurement uncertainty, traceability, etc.

AN64-2, **Extended Applications of Automatic Power Meters**, discusses an automatic power meter system for measuring attenuation, gain saturation, and the calibration factor of power sensors.

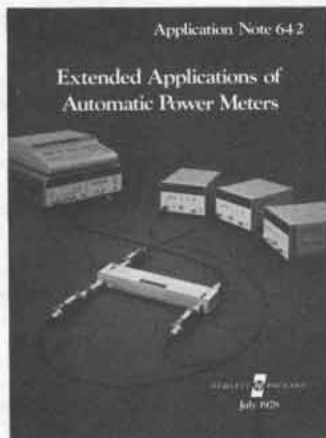

AN196, **Automated Measurements Using the 436A Power Meter**, contains several typical uses of the 436A with the HP-IB Interface bus.

All of these application notes and the **Coaxial & Waveguide Catalog** are available without charge by simply using the request card at the back of this catalog.

Peak power measurement

A frequent requirement in microwave work is the measurement of peak power in a periodic pulse. This may be done by various indirect techniques using thermocouples or thermistors. Hewlett-Packard also produces a versatile instrument that conveniently measures peak power directly in the 50 MHz to 2 GHz frequency range. Model 8900B utilizes

a video comparator technique to bring a known dc voltage, supplied by the instrument in a known impedance, to a level which is equal to the pulse being measured. This allows simple measurement of peak pulse power with a basic accuracy of 1.5 dB even when the waveform is not rectangular. A custom calibration chart increases accuracy to 0.6 dB for critical applications.

Noise figure measurements

In RF microwave communications, radar, etc., the weakest signal that can be detected is usually determined by the amount of noise added by the receiving system. From a performance standpoint, providing an increase in the receiver signal-to-noise ratio by reducing the amount of added noise is more economical than increasing the power of the transmitter.

The quality of a receiver or amplifier (device) is expressed as a figure of merit, or noise figure. Noise figure is the ratio, expressed in dB, of the actual output noise power of the device compared to the noise power which would be available if the device were perfect and merely amplified the thermal noise of the input termination rather than contributing any noise of its own.

The Hewlett-Packard system of automatic noise figure measurement depends upon the periodic insertion of a known excess noise power at the input of the device under test. Subsequent detection of noise power results in a pulse train of two power levels. The power ratio of these two levels contains the desired noise figure information. Hewlett-Packard noise figure meters automatically measure and present this ratio directly in dB of noise figure.

Noise figure is discussed in detail in Hewlett-Packard AN 57, **Noise Figure Primer**. It derives noise figures formulas, describes general noise figure measurements, and discusses accuracy considerations. Use the enclosed request card.

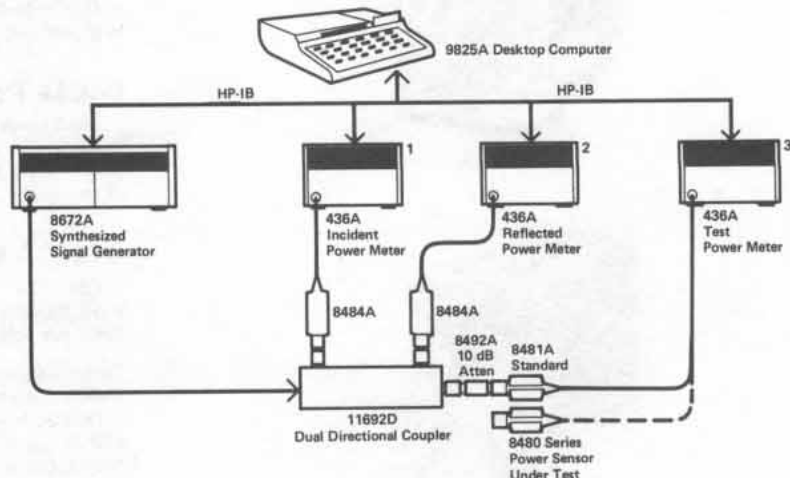

Figure 1. System for measuring calibration factor of power sensors.



Fiber Optic Power Sensor

Model 84801A

- Accurate, repeatable measurements
- Direct reading in watts or dBm
- Battery option for remote operation



84801A

84801A Fiber Optic Power Sensor

The 84801A is an optical power sensor dedicated to fiber optics. Used in conjunction with any of the 432 series power meters, it measures power from -30 dBm to $+10$ dBm ($1 \mu\text{W}$ to 10 mW) over a spectral range of 600 – 1200 nm. The measurement is inherently accurate and repeatable because it is based on a closed-loop electrical substitution method. This method also provides long term stability of the sensor's calibration.

A temperature-compensated thermistor with near black-body characteristics is used as the detector, providing a flat linear response over a broad spectral range. The small changes in coupling efficiency that occur at different wavelengths are expressed in terms of a calibration factor; a typical curve appears below. Absolute calibration is provided at four wavelengths with others (from 500 – 2000 nm) available on request.

Input to the 84801A is made through a large diameter single fiber. Alignment can be made either with or without a user supplied connector. Since its core diameter is larger than that of most high performance optical fibers, coupling loss is inherently low.

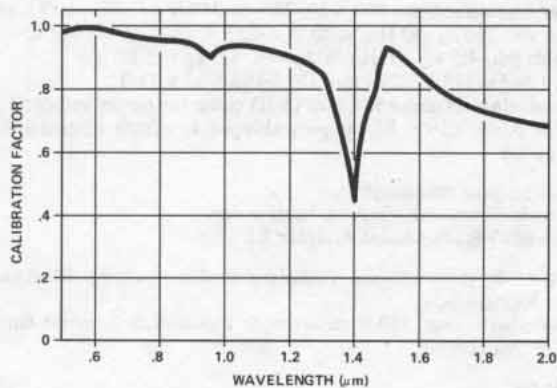

Specifications

Dynamic Range: $10 \mu\text{W}$ (-20 dBm) to 10 mW ($+10$ dBm) full scale.

Spectral Range: 600 nm to 1200 nm.

Cal-Factor Calibration¹: 650 , 800 , 1050 , and 1150 nm. (Other wavelengths available upon request.)

Cal-Factor Accuracy: $\pm 7\%$ at 650 nm; $\pm 8\%$ at 800 , 1050 , and 1150 nm.

Maximum Peak Power²: 200 W .

Maximum Average Power: 30 mW .

Maximum Energy Per Pulse: $10 \text{ W}\mu\text{s}$ (10 microjoules).

¹Calibration referred to power coupled into fiber input.

²Thermistor assembly is field adjustable so that zero set capability can be restored in the event of inadvertent overload.



432A

432B

432C

General

Input Fiber (DuPont PFXS-120) Characteristics:

Nominal Calculated Numerical Aperture: 0.4 .

Nominal Core Diameter: $200 \mu\text{m}$.

Nominal Index of Refraction: 1.456 .

Length Supplied: $\geq 1 \text{ m}$.

Operating Temperature: 0 to 55°C .

Weight: Net 0.2 kg (7 oz). Shipping 0.72 kg ($1 \text{ lb } 10 \text{ oz}$).

Dimensions: Length 76 mm (3 in), height 41 mm (1.65 in), width 36 mm (1.4 in).

Accessories Furnished: Carrying case for protection of fiber pigtail.

Power Meters

The electrical substitution method used by the 84801A is performed automatically by the 432 power meter. In addition, a single knob adjustment will automatically include the 84801A calibration factor in the meter reading. There are three versions in the series of 432 power meters that provide flexibility in the choice of display and capability. The 432A is an economical analog display calibrated in watts and dBm. The 432B provides a $3\frac{1}{2}$ -digit display in milliwatts and a rear panel connector provides a corresponding digital output in an 8421 BCD code. The 432C offers a $3\frac{1}{2}$ -digit readout in milliwatts, automatic ranging, and full BCD programming capability.

Accessories Furnished: 1.5 m (5 ft) electric cable for HP Fiber Optic power sensor; 2.3 m (7.5 ft) power cable. Mains plug shipped to match destination requirements.

Accessories Available: 8477A Power Meter Calibrator, 11076A Carrying Case.

For Further Information: See page 424.

432A/B/C Power Meter Options

Option	Description	Price
001	Rechargeable battery installed, provides up to 24 hours continuous operation (432A only)	add \$105
002	Input connector on rear panel in parallel with front connector	add \$25
003	Input connector on rear panel only	add \$10
100	100 Vac operation	no charge
910	Extra manual	add \$5

Ordering Information

84801A Fiber Optic Power Sensor	\$500
432A Power Meter	\$850
432B Power Meter	\$1475
432C Power Meter	\$2300

POWER & NOISE FIGURE METERS

Thermocouple power meter

Model 436A



436A



436A Power meter

The HP Model 436A Power Meter is a general purpose digital power meter intended for manual and automatic RF and microwave power measurements. It is compatible with the entire series of 8480 power sensors. Depending on which power sensor is used, the 436A can measure power from -70 dBm (100 pW) to $+44$ dBm (25W) at frequencies up to 18 GHz.

The logically organized and uncluttered front panel, and the convenience of push-button operation and digital display make the 436A both easy to interpret and easy to use in any application. The auto ranging capability allows for "hands-off" operation.

The 436A measures either absolute or relative power. It displays absolute power in either watts or dBm, while relative power is displayed in dB.

The 436A Power Meter also features optional programmability; both Hewlett-Packard Interface Bus (HP-IB) and BCD interfaces are available. These interfaces allow full remote control of all power meter functions (CAL function can be programmed to either 100 percent or the CAL factor which has been manually set on the front panel). These options may be added by the user at a later time.

Specifications

Frequency range: 100 kHz to 18 GHz (depending on power sensor used).

Power range (display calibrated in watts, dBm, and dB relative to reference power level).

With 8481A, 8482A, or 8483A sensors: 50 dB with 5 full-scale ranges of -20 , -10 , 0 , 10 , and 20 dBm ($10 \mu\text{W}$ to 100 mW).

With 8481B or 8482B sensors: 44 dB with 5 full-scale ranges of 10 , 20 , 30 , 40 , and 44 dBm (10 mW to 25 W).

With 8481H or 8482H sensors: 45 dB with 5 full-scale range of 0 , 10 , 20 , 30 and 35 dBm (1 mW to 3 W).

With 8484A sensor: 50 dB with 5 full-scale ranges of -60 , -50 , -40 , -30 , and -20 dBm (1 nW to $10 \mu\text{W}$).

Accuracy

Instrumentation

Watt mode: $\pm 0.5\%$.

dBm mode: $\pm 0.02 \text{ dB} \pm 0.001 \text{ dB}/^\circ\text{C}$.

dB (REL) mode¹: $\pm 0.02 \text{ dB} \pm 0.001 \text{ dB}/^\circ\text{C}$.

¹ Specifications are for within range measurements. For range-to-range accuracy add another $\pm 0.02 \text{ dB}$.

Zero: automatic, operated by a front-panel switch.

Zero set: $\pm 0.5\%$ of full scale on most sensitive range, typical. ± 1 count on other ranges.

Zero carry over: $\pm 0.2\%$ of full scale when zeroed on the most sensitive range.

Noise: (typical, at constant temperature, peak change over any one-minute interval); 20 pW (8484A); 40 nW (8481A, 8482A, 8483A); $40 \mu\text{W}$ (8481B, 8482B); $4 \mu\text{W}$ (8481H, 8482H).

Power reference: internal 50 MHz oscillator with Type N female connector on front panel (or rear panel, Option 003 only).

Power output: 1.0 mW . Factory set to $\pm 0.7\%$ traceable to the National Bureau of Standards.

Accuracy: $\pm 1.2\%$ worst case ($\pm 0.9\%$ rss) for one year (0°C to 55°C).

General

Drift: (1 hour, typical, at constant temperature after 24-hour warm-up); 20 pW (8484A); 10 nW (8481A, 8482A, 8483A); $10 \mu\text{W}$ (8481B, 8482B); $1.0 \mu\text{W}$ (8481H, 8482H).

Response time: (0 to 99% of reading):

Range 1 (most sensitive range) <10 seconds

Range 2 <1 second

Ranges 3 through 5 <100 milliseconds

(Typical, measured at recorder output).

Cal factor: 16-position switch normalizes meter reading to account for calibration factor. Range 85% to 100% in 1% steps.

Cal adj: front-panel adjustment provides capability to adjust gain in meter to match power sensor in use.

Recorder output: proportional to indicated power with 1 volt corresponding to full scale and 0.316 volts to -5 dB ; $1 \text{ k}\Omega$ output impedance, BNC connector.

RF blanking: open collector TTL; low corresponds to blanking when auto-zero mode is engaged.

Display: digital display with four digits. 20% over-range capability on all ranges. Analog meter: uncalibrated peaking meter to see fast changes.

Power consumption: 100, 120, 220, or 240 V ($+5\%$, -10%), 48 to 66 Hz, and 360 to 440 Hz: $<20 \text{ W}$ ($<23 \text{ W}$ with option 022 or 024).

Weight: net, 4.5 kg (10 lb). Shipping, 5.5 kg (12 lb).

Size: 134 H, 213 W, 279 mm D ($5\frac{1}{4} \times 8\frac{3}{8} \times 11$ ").

Accessories furnished: 1.5 m (5 ft) cable for power sensor; 2.3 m (7.5 ft) power cable. Mains plug shipped to match destination requirements.

Accessories available

To rack mount one 436A by itself order:

5061-0057 Rack Mount Adapter Kit

Coaxial & Waveguide Catalog & Microwave Measurement Handbook.

84 pages with over 350 measurement accessories. Request card at back of this catalog.

Options	Price
002: Input connector placed on rear panel in parallel with front	add \$25
003: Input connector and reference oscillator output on rear panel only	add \$10
009: 3 m (10 ft) cable for power sensor	add \$30
010: 6.1 m (20 ft) cable for power sensor	add \$55
011: 15.2 m (50 ft) cable for power sensor	add \$105
012: 30.5 m (100 ft) cable for power sensor	add \$155
013: 61 m (200 ft) cable for power sensor	add \$260
022: Digital input/output, fully compatible with HP Interface Bus (HP-IB)	add \$400
024: Digital input/output BCD Interface	add \$300
908: Rack mount kit consisting of 0561-0057	\$25

436A Power meter

\$2050

POWER & NOISE FIGURE METERS

Thermocouple power meter, range calibrator

Model 435A, 11683A



435A



11683A

435A Power meter

The 435A Power Meter is an analog power meter, compatible with the entire series of 8480 power sensors. Depending on which sensor is used, the 435A can measure power from -65 dBm to $+44$ dBm, full scale, at frequencies from 100 kHz to 18 GHz. This versatile instrument also features $<1\%$ instrumentation uncertainty, low noise and drift, auto-zero, recorder output, optional battery operation, and long cable options (up to 200 ft).

11683A Range calibrator

The 11683A calibrator is specifically designed for use with the 435A and 436A power meters. It allows verification of full-scale meter readings on all ranges, as well as meter tracking. Simply connect the cable between the power meter and calibrator. The CAL ADJ control on the power meter is used to set the meter to full scale on the 1 mW range. The calibrator and meter are then stepped through the other ranges verifying accuracy within $\pm 1\%$ plus noise and drift. The 11683A also has a polarity switch which tests the Auto-Zero circuit.

Specifications

435A Power meter

Frequency range: 100 kHz to 18 GHz (depending on power sensor used).

Power range: (435 calibrated in watts and dB in 5 dB steps).

With 8481A, 8482A, or 8483A: -25 dBm ($3 \mu\text{W}$) to $+20$ dBm (100 mW) full scale.

With 8481B or 8482B: $+5$ dBm (3 mW) to $+44$ dBm (25 W) full scale.

With 8481H or 8482H: -5 dBm (0.3 mW) to $+35$ dBm (3 W) full scale.

With 8484A: -65 dBm (300 pW) to -20 dBm ($10 \mu\text{W}$) full scale.

Accuracy

Instrumentation: $\pm 1\%$ of full scale on all ranges.

Zero: Automatic, operated by front-panel switch.

Zero set: $\pm 0.5\%$ of full scale on most sensitive range, typical.

Zero carryover: $\pm 0.5\%$ of full scale when zeroed on the most sensitive range.

Noise: (typical, at constant temperature, peak change over any one-minute interval); 20 pW (8484A); 40 nW (8481A, 8482A, 8483A); 40 μW (8481B, 8482B); 4 μW (8481H, 8482H).

Power reference: Internal 50 MHz oscillator with Type N female connector on front panel (or rear panel, Option 003 only).

Power output: 1.00 mW. Factory set to $\pm 0.7\%$ traceable to the National Bureau of Standards.

Accuracy: $\pm 1.2\%$ worst case ($\pm 0.9\%$ rss) for one year (0°C to 55°C).

General

Drift: (1 hour, typical, at constant temperature after 24-hour warm-

up); 40 pW (8484A); 15 nW (8481A, 8482A, 8483A); 15 μW (8481B, 8482B); 1.5 μW (8481H, 8482H).

Response time: (0 to 99% of reading).

Range 1 (most sensitive range) <10.0 seconds

Range 2 <3.8 seconds

Range 3 <1.3 seconds

Ranges 4 to 10 <500 milliseconds

(Typical, measured at recorder output)

Cal factor: 16-Position switch normalizes meter reading to account for calibration factor. Range 85% to 100% in 1% steps.

Recorder output: proportional to indicated power with 1 volt corresponding to full scale; 1 k Ω output impedance, BNC connector.

RF blanking output: provides a contact closure to ground when auto-zero mode is engaged.

Cal adj: front-panel adjustment provides capability to adjust gain of meter to match power sensor in use.

Power consumption: 110 or 120 V ($+5\%$, -10%), 48 to 66 Hz and 360 to 440 Hz; also 220 or 240 V ($+5\%$, -10%), 48 to 66 Hz only; $<4\text{W}$ ($<10\text{W}$ for option 001 when recharging battery).

Weight: net, 2.6 kg (5 lb, 12 oz). Shipping, 4.2 kg (9 lb, 3 oz).

Size: 155 H x 130 W x 279 mm D (6.1 x 5.1 x 11 in).

Accessories furnished: 1.52 m (5 ft) cable for the power sensor; 2.3 m (7.5 ft) power cable. Mains plug shipped to match destination requirements.

Accessories available

11076A: Carrying case.

5060-8762: Rack adapter frame (holds three instruments the size of the 435A).

Combining cases

1051A: 286 mm (11 $\frac{1}{4}$ " deep.

1052A: 416 mm (16 $\frac{1}{8}$ " deep.

The combining cases accept the $\frac{1}{2}$ -module Hewlett-Packard instruments for bench use or rack mounting. See 1051A data sheet for details.

11683A Range calibrator

Calibration functions: outputs corresponding to meter readings of 3, 10, 30, 100 and 300 μW ; 1, 3, 10, 30, and 100 mW.

Calibration uncertainty: $\pm 0.25\%$ in all ranges.

Power: 115 or 230 V $\pm 10\%$; 50-400 Hz, less than 2 W.

Weight: net, 1.13 kg (2 lb 8 oz). Shipping, 1.9 kg (4 lb 3 oz).

Size: 89 H x 133 W x 216 mm D (3.5 x 5.25 x 8.5 in).

435 Power meter options

001: Rechargeable battery installed provides up to 16 hours of continuous operation Price
add \$100

002: Input connector placed on rear panel in parallel with front add \$25

003: Input connector and reference oscillator output on rear panel only add \$10

009: 3.0 m (10-foot) cable for power sensor add \$30

010: 6.1 m (20-foot) cable for power sensor add \$55

011: 15.2 m (50-foot) cable for power sensor add \$105

012: 30.5 m (100-foot) cable for power sensor add \$155

013: 61 m (200-foot) cable for power sensor add \$260

Ordering information

11683A Range calibrator \$575

435A Power meter \$1000

POWER & NOISE FIGURE METERS

Power Sensors

Models 8481A/B, 8481H, 8482A/B, 8482H, 8483A, 8484A.



8481A

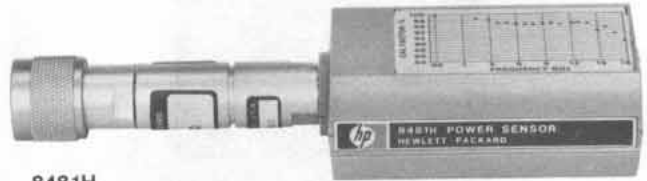

8481H



11708A

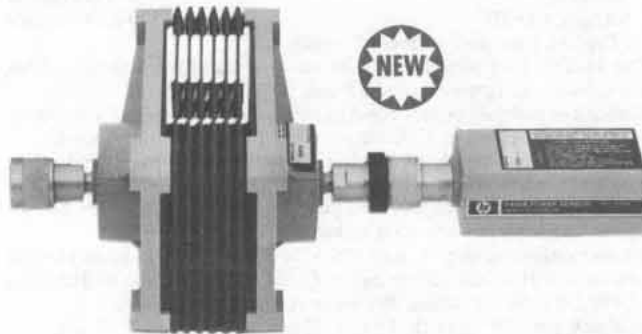

8481B



8484A

The 8480 series of power sensors have been designed for use with the 435A and 436A Power Meters. They feature wide frequency and amplitude ranges in addition to very low SWR.

The power measurement range of these sensors is from 0.1 nW to 30 Watts. With just three sensors a power measurement range of 114 dB can be achieved.

Wide Frequency Range for Many Applications

Power measurements can be made over a frequency range of 100 kHz to 18 GHz. The three frequency ranges covered with these units are 10 MHz to 18 GHz, 100 kHz to 4.2 GHz and a 75-ohm unit from 100 kHz to 2 GHz.

Low SWR for Low Measurement Uncertainty

The 8481/82/83 series of sensors use a silicon monolithic thermocouple as the sensing element. The small physical size of the thermocouple enables the sensors to have a very low SWR even at 18 GHz. A low SWR reduces mismatch uncertainty error, which is one of the largest single sources of error in power measurements. The 8484A sensor uses a crystal detector for higher sensitivity detection without degrading the SWR.

Individually Calibrated for More Confidence in Results

Each sensor is individually calibrated, traceable to the National Bureau of Standards. A Cal Factor control on the meter compensates for power sensor efficiency at any frequency. In addition, a precise Automatic Network Analyzer printout for Cal Factor and reflection coefficient in magnitude and phase is supplied. This means you can significantly reduce mismatch uncertainty by calculating the mismatch error.

High Power Sensors to 30 Watts

The new 8481B and 8482B high power sensors both have a power range of 1 mW to 25 Watts. The 8481B covers a frequency range of 10 MHz to 18 GHz and the 8482B has a frequency range of 100 kHz to 4.2 GHz.

Previous methods of measuring medium power levels usually required adding a separate attenuator in front of a low power sensor. With the 8481/82B power sensors, the attenuator and sensor have been combined into one unit. This reduces mismatch uncertainty error and improves accuracy by including the attenuator in the measured Calibration Factor curves. In addition, the design of the 8481/82B incorporates light-weight, heat-dissipating fins to prevent burns from the attenuator.

Medium Power Sensors to 3 Watts

Model 8481H measures power from 30 μ W to 3 Watts over a frequency range of 10 MHz to 18 GHz. The 8482H measures power from 30 μ W to 3 Watts over a frequency range of 100 kHz to 4.2 GHz.

Standard Sensors to 100 mW

The 8481A, 8482A, and 8483A power sensors all measure power over a range of 0.3 μ W to 100 mW. The 8481A is a 50-ohm sensor with a frequency range of 10 MHz to 18 GHz. The 8482A is a 50-ohm sensor with a frequency range of 100 kHz to 4.2 GHz. The 8483A is a 75-ohm sensor and covers a frequency range of 100 kHz to 2 GHz.

High Sensitivity Sensors

The 8484A measures power from 0.1 nW to 10 μ W over a frequency range of 10 MHz to 18 GHz. It is furnished with the 11708A 50 MHz Reference Attenuator for precise calibration with 1 mW Power Meter Reference Oscillator. Noise and drift have been reduced to less than 5% of full scale on the 300 pW range—only 15 pW when it is used with the 435A Power Meter. Noise and drift are even less with the 436A Power Meter.

8480 Series specifications

Model	Frequency Range (GHz)	Nominal Impedance	SWR Maximum (Reflection Coefficient)	Power Range	Maximum Power	Dimensions mm (in.)	Shipping Weight kg (lb)	Power Linearity ³	RF Connector	Price
8481A	10 MHz-18 GHz	50Ω	1.1 (0.048) 50 MHz-2 GHz 1.18 (0.082) 30 MHz-50 MHz 2-12.4 GHz 1.28 (0.123) 12.4-18 GHz	0.3 μW to 100 mW	300 mW Av. 15 W Peak 30 W μs (per pulse)	30 x 38 x 105 (1 3/16 x 1 1/2 x 4 1/8)	0.5 (1)	+10 to +20 dBm +1.5, -1.0%	N (m)	\$425
Option 001									Add APC-7	\$25
8481B	10 MHz-18 GHz	50Ω	<1.10(0.048) 10 MHz-2GHz <1.18(0.083) 2 GHz-12.4 GHz <1.28(0.123) 12.4-18 GHz	0-35°C 1 mW-25 W 35°C-55°C 1 mW-20 W	0-35°C: 30 W Av. ² 35°C-55°C: 25 W Av. 10 MHz-7 GHz 500 W Peak 7-18 GHz 125 W Peak 500 W μs (per pulse)	83 x 114 x 248 3 3/4 x 4 1/2 x 9 3/4	1.5 (3.2)	+35 to +44 dBm ±8%	N(m)	\$900
8481H ¹	10 MHz-18 GHz	50Ω	1.2 (0.091), 10 MHz-8 GHz 1.3 (0.13), 8-12.4 GHz 1.5 (0.20), 12.4-18 GHz	30 μW to 3 W	3.5 W Av. 100 W Peak 100 W μs (per pulse)	30 x 38 x 149 (1 3/16 x 1 1/2 x 5 7/8)	0.5 (1)	+25 to +35 dBm ±5%	N(m)	\$550
8482A	100 kHz-4.2 GHz	50Ω	1.1 (0.048), 1 MHz-2 GHz 1.2 (0.091), 300 kHz-1 MHz 1.3 (0.13), 2-4.2 GHz 1.6 (0.231), 100-300 Hz	0.3 μW to 100 mW	300 mW Av. 15 W Peak 30 W μs (per pulse)	30 x 38 x 105 (1 3/16 x 1 1/2 x 4 1/8)	0.5 (1)	+10 to +20 dBm +1.5, -1.0%	N(m)	\$425
8482H ¹	100 kHz-4.2 GHz	50Ω	1.2 (0.091) 100 kHz-4.2 GHz	30 μW to 3 W	3.5 W Av. 100 W Peak 100 W μs (per pulse)	30 x 38 x 149 (1 3/16 x 1 1/2 x 5 7/8)	0.5 (1)	+25 to +35 dBm ±5%	N(m)	\$550
8482B	100 kHz-4.2 GHz	50Ω	<1.10(0.048) 100 kHz-2 GHz <1.18(0.083) 2-4.2 GHz	0-35°C 1 mW-25 W 35°C-55°C 1 mW-20 W	0-35°C: 30 W Av. ² 35°C-55°C: 25 W Av. 500 W Peak 500 W μs (per pulse)	83 x 114 x 248 3 3/4 x 4 1/2 x 9 3/4	1.5 (3.2)	+35 to +44 dBm ±8%	N(m)	\$900
8483A	100 kHz-2 GHz	75Ω	1.18 (0.082), 600 kHz-2 GHz 1.8 (0.286), 100-600 Hz	0.3 μW to 100 mW	300 mW Av. 10 W Peak 30 W μs (per pulse)	30 x 38 x 105 (1 3/16 x 1 1/2 x 4 1/8)	0.5 (1)	+10 to +20 dBm +1.5, -1.0%	N(m) 75Ω	\$425
8484A	10 MHz-18 GHz	50Ω	1.15 (0.070) 30 MHz-4 GHz 1.2 (0.091) 4 GHz-10 GHz 1.3 (0.13) 10 GHz-18 GHz 1.4 (0.17) 10 MHz-30 MHz	0.1 nW to 10 μW	200 mW Av. 200 mW Peak	40 x 50 x 170 (1 9/16 x 2 x 6 1/16)	0.5 (1)		N(m)	\$575

1. Only specifications listed in this table apply to 8481H and 8482H. No other specifications are implied.
 2. For pulses greater than 30 W the maximum average power (Pa) is limited by the energy per pulse (E) in W • μs according to Pa = 30-0.02E.
 3. Negligible deviation except for those power ranges noted.

Uncertainty of calibration factor data for 8482A and 8483A

Frequency (MHz)	Sum of Uncertainties (%) ¹			Probable Uncertainties (%) ²		
	8482A	8482B	8483A	8482A	8482B	8483A
0.1	1.85	5.7	3.05	1.33	2.8	1.79
0.3	1.85	5.7	3.05	1.33	2.8	1.79
1.0	1.85	5.7	3.05	1.33	2.8	1.79
3.0	1.85	5.7	3.05	1.33	2.8	1.79
10.0	1.85	5.7	3.05	1.33	2.8	1.79
30.0	1.85	5.7	3.05	1.33	2.8	1.79
50.0	0(ref)	2.7	0(ref)	0(ref)	2.7	0(ref)
100.0	2.95	5.6	3.25	1.58	3.3	1.61
300.0	2.95	5.6	3.25	1.58	3.3	1.61
1000.0	2.95	5.7	3.25	1.58	3.3	1.61
2000.0	3.45	5.5	3.75	1.92	3.1	1.94
4000.0	2.95	5.5	—	1.58	3.1	—

Uncertainty of calibration factor data for 8481A and 8484A

Frequency (GHz)	Sum of Uncertainties (%) ¹			Probable Uncertainties (%) ²		
	8481A	8481B	8484A	8481A	8481B	8484A
1.0	—	5.8	—	—	3.1	—
2.0	3.45	5.8	4.70	1.92	3.1	2.25
4.0	2.95	5.8	4.36	1.58	3.1	1.97
6.0	2.95	5.8	4.55	1.58	3.1	2.00
8.0	2.85	6.0	4.47	1.46	3.1	1.91
10.0	2.85	6.2	4.42	1.46	3.3	1.89
12.4	2.85	7.8	4.71	1.46	4.1	1.98
14.0	5.05	7.9	7.00	2.95	4.1	3.24
16.0	5.45	8.0	7.62	3.07	4.2	3.40
18.0	5.45	8.3	7.15	3.07	4.3	3.30

1. Includes uncertainty of reference standard and transfer uncertainty. Directly traceable to NBS.
 2. Square root of sum of the individual uncertainties squared (RSS).

POWER & NOISE FIGURE METERS

Thermistor power meters

Models 432A/B/C

- Automatic zero
- High accuracy

- Recorded outputs, analog & digital
- Long cable options



432A



432B



432C

432A/B/C Power Meters

High accuracy—no thermoelectric error: High accuracy over a wide temperature range is featured on the 432 Power Meters. By measuring the output voltage of the thermistor bridges, and computing the corresponding power, even higher accuracy $\pm 0.2\% \pm 0.5 \mu\text{W}$ can be obtained.

Accuracy can be maintained on even the most sensitive range because the error due to thermoelectric effect is reduced to a negligible level.

Calibrated mounts: Each thermistor mount is furnished with data stating the Calibration Factor* and Effective Efficiency* at various frequencies across the operating range. For easy and accurate power measurements, the front panel of the 432 contains a calibration factor control, calibrated in 1% steps from 88% to 100%, that compensates for losses in the mount and eliminates the need for calculation.

Instrument type: automatic, self-balancing power meter for use with temperature-compensated thermistor sensor.

* "Calibration Factor" and "Effective Efficiency" are figures of merit expressing the ratio of the substituted signal measured by the power meter to the microwave power incident on and absorbed by the sensor respectively.

Specifications (partial)

Power range

432A: seven ranges with full-scale readings of 10, 30, 100, and 300 μW , 1, 3, and 10 mW; also calibrated in dBm from -20 dBm to $+10$ dBm full scale in 5 dB steps.

432B, 432C: four ranges with full-scale readings of 10 and 100 μW , and 1 and 10 mW.

Noise: Less than 0.25% of full scale (typical).

Response time: At recorder output, 35 ms time constant (typical).

Fine zero: Automatic, operated by front panel switch. Remote fine zero may be accomplished with 432C.

Zero carryover: Less than 0.50% of full scale when zeroed on most sensitive range.

Meter:

432A: taut-band suspension, individually calibrated, mirror-backed scales. Milliwatt scale more than 108 mm ($4\frac{1}{4}$ ") long.

432B, 432C: three digits with one digit overrange. 20% overrange capability on all ranges.

Calibration factor control: 13-position switch normalizes meter

reading to account for thermistor sensor calibration factor. Range 100% to 88% in 1% steps.

Thermistor sensor: Thermistor sensors are required for operation of the 432A/B/C. For microwave sensors HP 478B, 8478B and 486 series see page 425. For Fiber Optic Sensor 84801A see page 419.

Recorder output: Proportional to indicated power with 1 volt corresponding to full-scale. 1 k Ω output impedance.

BCD output: 8, 4, 2, 1 code: "1" positive. TTL compatible logic. Operates with HP 5055A Digital Recorder. "Print" and "Inhibit" lines available. (432B and 432C only.)

Model 432C control lines: Instrument is referenced to +5 V, "Logic 0" is equivalent to 0 V.

Power consumption

432A: 115 or 230 V ac 10%, 50 to 400 Hz, 2½ watts.

432B: 115 or 230 V ac 10%, 50 to 400 Hz, 10 watts.

432C: 115 or 230 V ac 10%, 50 to 400 Hz, 16 watts.

Weight

432A: net, 2.3 kg (5.5 lb); shipping, 4.6 kg (10 lb).

432B: net, 3 kg (6.5 lb); shipping, 4.8 kg (10.5 lb).

432C: net, 3.2 kg (7.2 lb); shipping, 5 kg (11 lb).

Dimensions:

130 mm wide, 155 mm high, 279 mm deep ($5\frac{1}{8}$ " x $6\frac{3}{32}$ " x 11").

Options

001: rechargeable battery installed, provides up to 24 hours continuous operation (432A only)

002: input connector placed on rear panel in parallel with front

003: input connector on rear panel only

009: 3.05 m (10 ft) cable for 110-ohm or 200-ohm sensor

010: 6.10 m (20 ft) cable for 100-ohm or 200-ohm sensor

011: 15.24 m (50 ft) cable for 100-ohm or 200-ohm sensor

012: 30.48 m (100 ft) cable for 100-ohm or 200-ohm sensor

013: 60.96 m (200 ft) cable for 100-ohm or 200-ohm sensor

Ordering information

432A Power meter

432B Power meter

432C Power meter

Price

add \$105

add \$25

add \$10

add \$30

add \$55

add \$105

add \$155

add \$260

\$850

\$1475

\$2300

POWER & NOISE FIGURE METERS

Thermistor, peak power calibrator & power meter calibrator

Models 478A, 8478B, 486 Series, and Models 8900B & 8477A



8900B



8477A



Temperature compensated thermistor mounts

High efficiency and good RF match are characteristic of the HP 478A and 8478B Coaxial and 486 A-Series Waveguide Thermistor mounts which, in conjunction with the 432 Power Meter, provide you with high accuracy even in routine power measurements. These thermistor mounts are temperature-compensated for low drift, even in the presence of thermal shocks, permitting measurement of microwave power as low as one microwatt. Each mount contains data showing Calibration Factor and Effective Efficiency at six frequencies, directly traceable to the National Bureau of Standards at those frequencies where NBS provides calibration service.

Specifications

HP Model	Frequency range, GHz	Maximum SWR	Operating resistance (ohms)	Price
478A	10 MHz to 10 GHz	1.75, 10 to 25 MHz 1.3, 25 MHz to 7 GHz 1.5, 7 to 10 GHz	200	\$225
8478B ¹	10 MHz to 18 GHz	1.75, 10 to 30 MHz 1.35, 30 to 100 MHz 1.1, 0.1 to 1 GHz 1.35, 1 to 12.4 GHz 1.6, 12.4 to 18 GHz	200	\$350
G486A	3.95 to 5.85	1.5	100	\$400
J486A	5.30 to 8.20	1.5	100	\$400
H486A	7.05 to 10.0	1.5	100	\$400
X486A	8.20 to 12.4	1.5	100	\$270
M486A	10.0 to 15.0	1.5	100	\$425
P486A	12.4 to 18.0	1.5	100	\$330
K486A ²	18.0 to 26.5	2.0	200	\$425
R486A ²	26.5 to 40.0	2.0	200	\$475

¹Option Q11: furnished with APC-7 RF connector

add \$25

²Circular flange adapters:

K-band (UG-425/U) HP 11515A

\$120

R-band (UG-381/U) HP 11518A

\$120

8900B Peak power calibrator

The HP 8900B peak power calibrator provides a convenient means for measuring the peak RF power of pulses in the range from 50 to 2000 MHz. The power level is read out directly on the panel meter and is completely independent of repetition rate and pulse width ($>0.25 \mu\text{sec}$).

Specifications

Radio frequency measurement characteristics

Frequency range: 50 to 2000 MHz.

RF power range: 10-200 mW peak full scale (may be readily increased through use of external attenuators or directional couplers).

RF power accuracy: $\pm 1.5 \text{ dB}$ ($\pm 0.6 \text{ dB}$ with custom calibration curve furnished with instrument).

RF power precision: 0.1 dB.

RF pulse width: $>0.25 \mu\text{s}$.

RF repetition rate: 1.5 MHz maximum.

RF impedance: 50 ohms.

RF VSWR: <1.25 .

Monitor output

Level: $>0.2 \text{ volt}$ for 20 mW input (nominal).

Impedance: 150 ohms nominal.

Bandwidth: $>7 \text{ MHz}$.

Physical characteristics

Size: 156 H, 197 W, 279 mm D (6.1" \times 7.75" \times 11").

Weight: net, 4.5 kg (10 lb). Shipping, 5.9 kg (13 lb).

Power consumption: 105 to 125 or 210 to 250 volts, 50 to 60 Hz.

8477A Power meter calibrator

The 8477A Calibrator is specifically designed for use with the 432 Power Meter. It allows you to verify full-scale meter readings on all ranges, and meter tracking. Simply connect three cables between the power meter and calibrator; no charts or additional instruments are required.

Specifications

Calibration points: outputs corresponding to meter readings of: 0.01, 0.03, 0.1, 0.3, 1.0, 2.0, 3.0, and 10 mW (for mount resistance switch settings of both 100 and 200 ohms).

Calibration uncertainty: $\pm 0.2\%$ on the top five ranges, and $\pm 0.5\%$ on the 0.01 and 0.03 mW ranges from $+20^\circ$ to $+30^\circ\text{C}$.

RFI: meets all conditions specified in MIL-I-6181D.

Power: 115 or 230 V $\pm 10\%$, 50-400 Hz, approximately 2 W.

Weight: net, 2.0 kg (4.5 lb). Shipping, 2.9 kg (6.25 lb).

Size: 155 H, 130 W, 203 mm D (6.1" \times 5.1" \times 8").

Ordering information

8900B Peak power calibrator

8477A Power meter calibrator

Price

\$1025

\$575

POWER & NOISE FIGURE METERS

Noise figure meters; sources

Models 340B, 342A, 343A, 345B, 347A, 349A

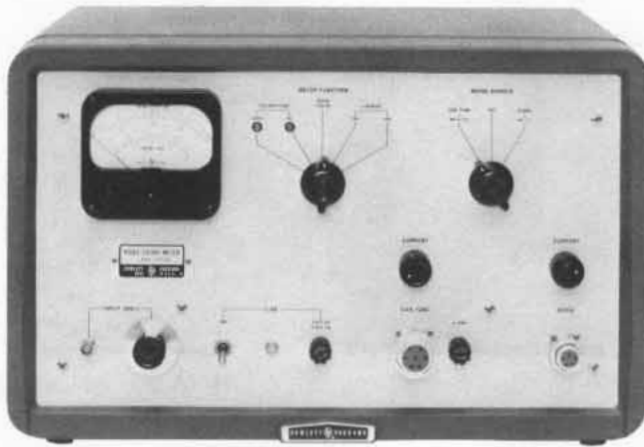

340B

Noise figure meters and noise sources

Model 340B Noise Figure Meter, when used with the appropriate HP noise source, automatically measures and continuously displays noise figure for equipment with IF frequencies of 30 and 60 MHz. Model 342A is similar, and operates on frequencies of 30, 60, 70, 105 and 200 MHz.

HP noise sources provide calibrated noise for measurements on various equipment from IF amplifiers to complete radar systems. Model 343A VHF source operates from 10 to 600 MHz with 50 ohm impedance. 345B IF source is tuned for 30 or 60 MHz with 50, 100, 200, or 400 ohm outputs.

The 347A waveguide sources are argon gas discharge tubes carefully mounted in waveguide sections for frequencies from 3.95 to 18 GHz. Model 349A also uses an argon tube in a coaxial configuration for frequencies from 400 to 4000 MHz.

340B and 342A specifications

Noise figure range: with a 5.2 dB noise source, 0 to 15 dB, indication to infinity; with a 15.2 dB noise source, 3 to 30 dB, indication to infinity.

Accuracy (excluding source accuracy): noise diode scale: ± 0.5 dB, 0 to 15 dB; gas tube scale: ± 0.5 dB, 10 to 25 dB, ± 1 dB, 3 to 10 dB and 25 to 30 dB.

Input frequency: 340B; 30 or 60 MHz, selected by switch; 342A: 30, 60, 70, 105, and 200 MHz, selected by switch. Other frequencies available; prices and details on request.

Bandwidth: 1 MHz minimum.

Input requirements: -60 to -10 dBm (noise source on); corresponds to gain between noise source and input of approximately 50 to 100 dB for 5.2 dB noise source and 40 to 90 dB for 15.2 dB noise source.

Input impedance: 50 ohms nominal.

AGC output: nominal 0 to -6 V from rear binding posts.

Recorder output: 1 mA maximum into 2000 ohms maximum.

Power input: 115 or 230 volts $\pm 10\%$, 50 to 60 Hz, 185 to 435 watts, depending on noise source and line voltage.

Power output: sufficient to operate 343A, 345B, 347A or 349A Noise Sources.

Dimensions: cabinet: 324 mm H, 527 mm W, 368 mm D; (12.8" x 20.3" x 14.5"); rack mount: 266 mm H, 483 mm W, 353 mm D behind panel (10.5" x 19" x 13.9").

Weights: net 19.4 kg (43 lb), shipping 23.9 kg (53 lb) (cabinet); net 16.2 kg (36 lb), shipping 22.5 kg (50 lb) rack mount.

Accessory furnished: one 340A-16A Cable Assembly, connects noise figure meter to 347A or 349A Noise Source.

343A specifications

Frequency range: 10 to 600 MHz.

Excess noise ratio: 10 to 30 MHz, 5.20 dB ± 0.20 dB; 100 MHz, 5.50 dB ± 0.25 dB; 200 MHz, 5.80 dB ± 0.30 dB; 300 MHz, 6.05 dB ± 0.30 dB; 400 MHz, 6.30 dB ± 0.50 dB; 500 MHz, 6.50 dB ± 0.50 dB; 600 MHz, 6.60 dB ± 0.50 dB.



349A



343A



345B



X347A

Source impedance: 50 ohms nominal.

Reflection coefficient: < 0.091 (1.2 SWR), 10 to 400 MHz; < 0.13 (1.3 SWR), 400 to 600 MHz.

Noise generator: temperature-limited diode.

Dimensions: 63 mm H, 70 mm W, 127 mm D (2.5" x 2.75" x 5").

Weight: net 0.34 kg (3/4 lb); shipping 0.9 kg (2 lb).

345B specifications

Spectrum center: 30 or 60 MHz, selected by switch.

Excess noise ratio: 5.2 dB.

Source impedance: 50, 100, 200 or 400 ohms, $\pm 4\%$, as selected by switch; less than 1 pF shunt capacitance.

Noise generator: temperature-limited diode.

Dimensions and weight: same as 343A.

347A specifications

HP Model	Freq. Range (GHz)	Excess Noise Ratio dB	W/G WR	Equiv. Flange UG-()/U	Price
G347A	3.95-5.85	15.2 \pm 0.5	187	407	835
J347A	5.30-8.20	15.2 \pm 0.5	137	441	900
H347A	7.05-10.0	15.6 \pm 0.5	112	138	995
X347A	8.20-12.4	15.7 \pm 0.4	90	39	750
P347A	12.4-18.0	15.8 \pm 0.5	62	419	800

Reflection coefficient for all models, fired or unfired, < 0.091 (SWR 1.2) max.

349A specifications

Frequency range: 400 to 4000 MHz, wider with correction.

Excess noise ratio: 15.6 dB ± 0.6 dB, 400 to 1000 MHz; 15.7 dB ± 0.5 dB, 1000 to 4000 MHz.

Source impedance: 50 ohms nominal.

SWR: < 1.35 (fired), < 1.55 (unfired) up to 2600 MHz; < 1.55 (fired or unfired), 2600 to 3000 MHz; < 2.0 (fired), < 3.0 (unfired) 3000 to 4000 MHz.

Dimensions: 51 mm H, 76 mm W, 381 mm L (2" x 3" x 15").

Weight: net 1.5 kg (3.25 lb). Shipping 2.7 kg (6 lb).

Coaxial & Waveguide Catalog & Microwave Measurement Handbook: 84 pages with over 350 measurement accessories. Request card at back of this catalog.

Ordering information

	Price
340B Noise Figure Meter (cabinet)	\$1950
340BR Noise Figure Meter (rack mount)	\$1925
342A Noise Figure Meter (cabinet)	\$2100
342AR Noise Figure Meter (rack mount)	\$2075
343A Noise Source	\$ 265
345B Noise Source	\$ 425
349A Noise Source	\$ 550



Microwave test equipment product line

Hewlett-Packard offers a complete line of microwave coaxial and waveguide measuring equipment. Measuring systems can be assembled from this equipment to make accurate reflection and transmission measurements on other components such as filters, mixers, cables, etc.

The bulk of microwave measurements made in production test, maintenance, and calibration require amplitude information only. These are sometimes referred to as scalar measurements.

The tables to the right summarize HP capabilities in scalar microwave measurements. More detailed information is available in the following publications:

AN 64-2 Extended Applications of Automatic Power Meters

AN 183 Microwave Swept Measurements

AN 196 Automated Measurements

Using the 436A Power Meter

Coaxial and Waveguide Catalog and Microwave Measurement Handbook

Complimentary copies are available from HP offices or you can use the request card at the back of this catalog.

HP impedance/SWR measuring techniques and capabilities

Measurement Technique	Coaxial Freq. Range	Waveguide Freq. Range	Typical Range	Remarks/Cost/Accuracy/Speed
Manual Slotted Line	500-4000 MHz 1-18 GHz	3.95-18 GHz (4 Bands)	30-35 dB	Lowest cost, high accuracy, slow, point-by-point
Swept Slotted Line	1.8-18 GHz	—	34 dB	Moderate cost, high accuracy, good speed, comprehensive
Reflectometer Square-Law	100-4000 MHz 2-18 GHz	3.95-40 GHz (6 Bands)	35-40 dB	Moderate cost, moderate accuracy, fast, comprehensive
Reflectometer RF-Substitution	100-4000 MHz 2-18 GHz	3.95-40 GHz (6 Bands)	50 dB	Moderate cost, high accuracy, fast, requires display storage
Bridge	1-110 MHz 40 MHz-18 GHz	—	40 dB	Multi-octave, good for coax, best for low SWR, 9 dB insertion loss

HP insertion loss measuring techniques and capabilities

Measurement Technique	Coaxial Freq. Range	Waveguide Freq. Range	Typical Range	Remarks/Cost/Accuracy/Speed
Square-Law	10 MHz-18 GHz	2.6-40 GHz (7 Bands)	50 dB	Low cost, moderate accuracy, simple, fast
RF Substitution	10 MHz-18 GHz	2.6-18 GHz 18-40 GHz	50-100 dB 50-80 dB	Moderate cost, high accuracy, fast, requires display storage
IF Substitution	10 MHz-18 GHz	2.6-18 GHz (5 Bands)	30-120 dB	High cost, very high accuracy, best range, moderate speed
Desktop computer mini-system	100 kHz-4 GHz 10 MHz-18 GHz	—	40-70 dB	Moderate cost, very high accuracy, automated

MICROWAVE TEST EQUIPMENT

Coaxial fixed attenuators

Models 8491A/B, 8492A, 8493A/B, 11581/2/3A

- Flat frequency response
- Low SWR
- Specifications traceable to NBS



11581A

8491A/B, 8492A, 8493A/B fixed attenuators

Hewlett-Packard coaxial fixed attenuators provide precision attenuation, flat frequency response, and low SWR over broad frequency ranges at low prices. Attenuators are available in nominal attenuations of 3-dB and 6-dB and also 10-dB increments from 10 dB to 60 dB. These attenuators are swept-frequency tested to insure meeting specifications at all frequencies. Calibration points are provided on a nameplate chart attached to each unit.

11581A, 11582A, 11583A attenuator sets

A set of four Hewlett-Packard attenuators, 3, 6, 10 and 20 dB are furnished in a handsome walnut accessory case. The 11581A set consists of 8491A attenuators. A set of 8491B attenuators is contained in the 11582A, while the 11583A is comprised of 8492A attenuators. In addition to the calibration stamping on the bodies of the attenuators, the set includes a calibration report. The calibration report is certified traceable to the National Bureau of Standards, and includes both the attenuation and the reflection coefficients for each attenuator at four frequencies for the 11581A (DC, 4, 8, 12.4 GHz) and five frequencies for the 11582A and 11583A (DC, 4, 8, 12.4, 18 GHz). By specifying option 890, calibration data is given at 26 frequencies (11581A) or 42 frequencies (11582A and 11583A), see next page for exact frequency lists.

These sets are ideal for calibration labs or where precise knowledge of attenuation and SWR is desired.

8498A high power attenuator

The 8498A Option 030 is designed to meet the needs of high power attenuation applications in the RF and microwave frequency range. It is specified from DC to 18 GHz at 25 watts average, 500 watts peak from DC to 5.8 GHz, and 125 watts peak from 5.8 to 18 GHz. Available only in a 30 dB model (option 030), the unit offers low SWR (<1.30 at 18 GHz) and good accuracy (± 1 dB at 18 GHz). The unit also features 'human engineered' cooling fins that prevent operator burns even under continuous maximum input power conditions.

HEWLETT PACKARD OPTION 890 CALIBRATION REPORT					
MODEL: 8492A OPT 010			SERIAL NO: 9061		
DATE: 03-22-79			TECHNICIAN: 02387		
CALIBRATION SYSTEM: 8542B SYSTEM 8					
PORT IDENTIFICATION: WITH LABEL FACING THE USER, PORT 1 IS ON THE LEFT AND PORT 2 IS ON THE RIGHT.					
FREQUENCY (MHz)	ATTENUATION (dB)	SWR PORT 1	SWR PORT 2		
100.00	10.01	1.028	1.006		
500.00	10.01	1.025	1.005		
1000.00	10.01	1.028	1.007		
1500.00	10.02	1.027	1.010		
2000.00	10.03	1.027	1.012		
2500.00	10.02	1.027	1.020		
3000.00	10.02	1.025	1.017		
4000.00	10.05	1.109	1.109		
14000.00	10.05	1.103	1.116		
14500.00	10.01	1.110	1.119		
15000.00	10.02	1.105	1.109		
15500.00	10.04	1.094	1.101		
16000.00	10.00	1.092	1.077		
16250.00	9.96	1.092	1.065		
16500.00	9.95	1.095	1.060		
16750.00	9.99	1.106	1.054		
17000.00	9.94	1.095	1.054		
17250.00	9.98	1.093	1.058		
17500.00	9.93	1.090	1.065		
17750.00	9.91	1.075	1.075		
18000.00	9.95	1.074	1.080		

Option 890

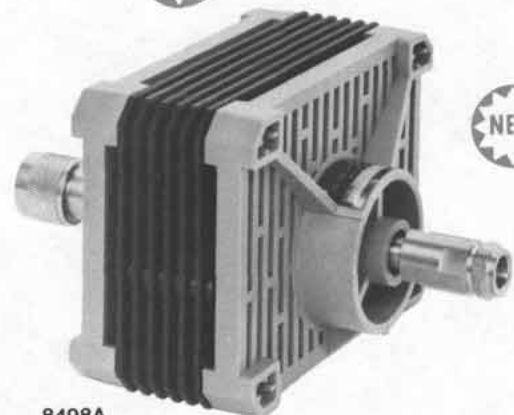

8498A
Option 030



Option 890 calibration data

Extensive calibration data is now available on HP attenuators at low cost. By specifying option 890 on the fixed attenuators or microwave step attenuators, standardized calibration data from 100 MHz to the upper frequency bound of the unit is provided, with frequency steps no larger than 500 MHz. This data is generated from measurements made on an HP 8542 Automatic Network Analyzer and features excellent accuracy (traceable to NBS) and low cost (averages less than \$1 per frequency for three measurements). Data is given for attenuation and the SWR of each port, and provided in a plastic envelope.

Calibration data has important uses in applications such as RF substitution measurements and test system verification. By using the actual calibration data rather than data sheet specifications, the attenuation uncertainty can be reduced 60% or more. Also, the calculated mismatch uncertainty for a test system will be lower if the actual SWR data for the attenuators is used. Similar calibration data is used in HP production areas to verify the performance of manual and automated test systems. For automated system checkout, the calibrated unit is tested and the results are compared to the previously stored calibration data. If the differences are within the measurement uncertainty, proper operation is ensured. For step attenuators, the calibration data can be used in automated test systems to more accurately characterize a device's characteristics. By storing the calibration data for the individual steps, the measurement results can be adjusted by the actual amount of attenuation (for example, when a nominal 10 dB step is actually 9.6 dB).

The calibration data frequencies, prices, and ordering information for fixed attenuators are found on the adjacent page, and the same information for step attenuators is found on page 431.



8491A/B series



8492A series



8493A/B series

Ordering example:

When ordering, the connectors, frequency range, and attenuation value must be specified as shown in the example below.

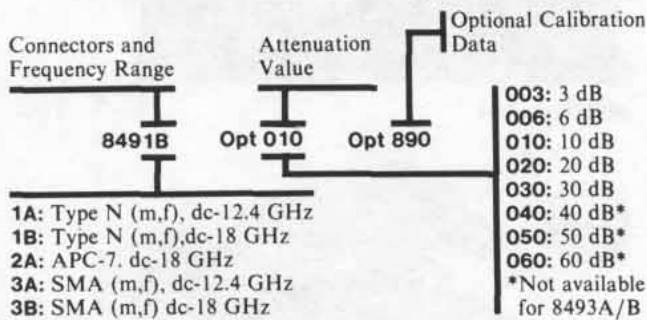

Coaxial & Waveguide Catalog & Microwave Measurement Handbook

84 pages with over 350 measurement accessories. Request card at back of this catalog.

Ordering information

- 11581A 3, 6, 10, 20 dB 8491A set
- OPTION 890 Calibration Data
- 11582A 3, 6, 10, 20 dB 8491B set
- OPTION 890 Calibration Data
- 11583A 3, 6, 10, 20 dB 8492A set
- OPTION 890 Calibration Data

Price

- \$310
- +\$80
- \$420
- +\$100
- \$750
- +\$100

8491A/B, 8492A, 8493A/B, 8498A, option 890 specifications

Model	Frequency Range GHz	SWR Maximum	Maximum input Power	Attenuation Accuracy								Connector	Price (Specify option)
				3 dB (Option 003)	6 dB (Option 006)	10 dB (Option 010)	20 dB (Option 020)	30 dB (Option 030)	40 dB (Option 040)	50 dB (Option 050)	60 dB (Option 060)		
8491A 3-30 dB	dc-12.4	1.2: dc-8 GHz 1.3: 8-12.4 GHz	2 W Av. 100 W Peak	± 0.3 dB	± 0.3 dB	± 0.5 dB	± 0.5 dB	± 1 dB	—	—	—	N(m,f)	\$75
				—	—	—	—	—	± 1.5 dB	± 1.5 dB	± 2 dB		\$100
8491B 3-30 dB	dc-18	1.2: dc-8 GHz 1.3: 8-12.4 GHz 1.5: 12.4-18 GHz	2 W Av. 100 W Peak	± 0.3 dB	± 0.3 dB ± 0.4 dB 12.4-18 GHz	± 0.5 dB	± 0.5 dB ± 1.0 dB 12.4-18 GHz	± 1 dB	—	—	—	N(m,f)	\$95
				—	—	—	—	—	± 1.5 dB	± 1.5 dB	± 2 dB		\$135
8492A 3-30 dB	dc-18	1.15: dc-8 GHz 1.25: dc-12.4 GHz 1.35: 12.4-18 GHz	2 W Av. 100 W Peak	± 0.3 dB	± 0.3 dB ± 0.4 dB 12.4-18 GHz	± 0.5 dB	± 0.5 dB ± 1.0 dB 12.4-18 GHz	± 1 dB	—	—	—	APC-7	\$170
				—	—	—	—	—	± 1.5 dB	± 1.5 dB	± 2 dB		\$205
8493A 3-20 dB	dc-12.4	1.2: dc-8 GHz 1.3: 8-12 GHz	2 W Av. 100 W Peak	± 0.3 dB	± 0.3 dB	± 0.5 dB	± 0.5 dB	—	—	—	—	SMA (m,f)	\$80
				—	—	—	—	± 1 dB	—	—	—		\$85
8493B 3-20 dB	dc-18	1.2: dc-8 GHz 1.3: 8-12.4 GHz 1.5: 12/4-18 GHz	2 W Av. 100 W Peak	± 0.3 dB	± 0.3 dB ± 0.4 dB 12.4-18 GHz	± 0.5 dB	± 0.5 dB ± 1.0 dB 12.4-18 GHz	—	—	—	—	SMA(m,f)	\$95
				—	—	—	—	± 1 dB	—	—	—		\$100
8498A Option 030	DC-18	1.1: DC-2GHz 1.2: 2-12.4GHz 1.35: 12.4-18GHz	25W Avg. 500W Peak (DC-7GHz) 125W Peak (7-18 GHz) 500 Watt-μsec max. per pulse	—	—	—	—	± 1 dB	—	—	—	N(m,f)	Contact HP
Option 890 Calibration Data Information				Models		Calibration Frequencies (MHz)					Option 890 Price		
				8491A, 8493A		100, 500, 1000, every 500 MHz to 12000, 12400. (26 frequencies)					+\$20		
				8491B, 8492A, 8493B, 8498A		Same as above plus 12500 to 16000 in 500 MHz steps, 16000 to 18000 in 250 MHz steps. (42 frequencies)					+\$25		

MICROWAVE TEST EQUIPMENT

Coaxial step attenuators

Models 355C series, 8494/5/6 series, 11713A, 11716A

- Excellent repeatability
- Manual and programmable
- Calibration data available



355C



11713A



355C/D/E/F Manual and programmable step attenuators, dc to 1000 MHz

Precision attenuation from dc to 1000 MHz is available with these Hewlett-Packard attenuators. Models 355C/E provide 0 to 12 dB in 1-dB steps and models 355D/F provide 0 to 120 dB in 10-dB steps. For the 355E and 355F models, attenuation programming is done through a 7-pin connector. All standard models are equipped with BNC connectors.

8494A/B/G/H, 8495A/B/D/G/H/K, 8496A/B/G/H Manual and programmable step attenuators, dc to 26.5 GHz

This family of precision, microwave coaxial step attenuators represents the state-of-the-art in attenuator design. They offer outstanding performance at attractive prices. Three attenuation ranges are available: 0 to 11 dB in 1-dB steps (Model 8494), 0 to 70 dB in 10-dB steps (Model 8495) and 0 to 110 dB in 10-dB steps (Model 8496). There is choice of three connectors Type N (f), SMA (f), and APC-7 (APC-3.5 on 8495D/K only). Manual and programmable versions are available as well as coverage of three frequency ranges (dc-4GHz, dc-18 GHz, and dc-26.5 GHz). Calibration data (SWR and attenuation) is available on the 8494/5/6 models as option 890. The data is generated by an automatic network analyzer test system and is given for each step of the attenuator at 14 frequencies (DC-4 GHz models) or 47 frequencies (DC-18 GHz models); see frequency lists on next page. This data is very useful for improving measurement accuracy in manual and automated test systems.

Each attenuator consists of three or four attenuation sections connected in cascade. Attenuator sections are inserted and removed by cam-actuated "edge line" contacts. These contacts are gold-plated leaf-springs that ensure long life (over a million steps) and high repeatability (typically 0.03 dB).



8495K opt. 004



8495D opt. 004

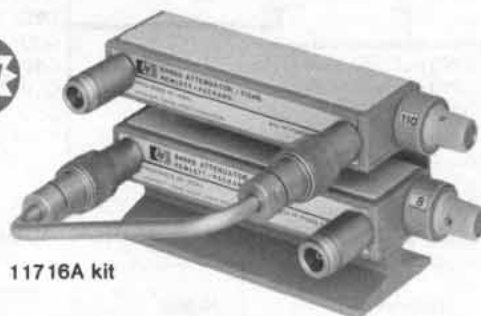

11716A kit

The G, H, and K programmable models offer the same high performance as the manual models with the addition of fast switching solenoids. Attenuation programming is done through a 12-pin connector. For ease of connection to the driving circuit, each attenuator is provided with a five-foot cable assembly that includes the mating connector. By using the HP 11713A Attenuator Driver, the attenuators are easily integrated into a Hewlett-Packard Interface Bus (HP-IB) automated system.

Convenient interconnection of 1 dB and 10 dB models is provided with the 11716A/B. These kits provide a rigid RF cable, mounting bracket, and screws to connect any pair of 8494/5/6 attenuators in series (see picture above). Attenuators must be ordered separately.

Equivalent versions of these attenuators, for incorporation in equipment (i.e., "OEM") are available under HP model numbers 33320, 33321, and 33322. See following pages.

11713A ATTENUATOR/SWITCH DRIVER

This instrument has all of the necessary features to provide HP-IB control of up to two programmable attenuators of the 8494/5/6 or 33320/1/2 series and concurrently up to two electro-mechanical switches (e.g. 8761B or 33311 series). Alternatively, the 11713A can be used to supply +24 V common and ten pairs of current sinking contacts (total current less than 1.25A) to control up to ten relays. The 11713A includes an integral power supply (with short circuit protection) that can simultaneously provide 125 milliamps at 24 volts to all contacts for control of the attenuators and switches, so no external power supply is needed. The unit is provided with two (2) plug-in drive cables for the programmable attenuators which simplifies connection to the driver.

The 11713A also features convenient front panel control so that the user can manually activate the individual attenuation sections and switches when in the 'local' mode. Switching time for the drivers is less than 10 milliseconds.

How to order the 8494/5/6 Series attenuators

To order, basic model number, suffix letter, and connector option must be specified:

Optional Calibration data.

8494 A option 001 Option 890

- 4 (1dB step, 11 dB max)
- 5 (10 dB step, 70 dB max)
- 6 (10dB step, 110 dB max)

- A (Manual, dc—4 GHz)
- B (Manual, dc—18 GHz)
- D (Manual, dc—26.5 GHz)*
- G (Programmable, dc—4 GHz)
- H (Programmable, dc—18 GHz)
- K (Programmable, dc—26.5 GHz)*

- 001 (N-Female)
- 002 (SMA Female)
- 003 (APC-7)
- 004 (APC-3.5 Female)*

* Option 004 is only available on 'D' and 'K' models.

Ordering Information

- 11713A Attenuator/Switch Driver
- 11716A Interconnection Kit (Type N Connectors)
- 11716B Interconnection Kit (APC-7 Connectors)

Price
Contact HP
\$135
\$195

355 Series, 8494/5/6 series specifications

Model and (Switching Mode)	Frequency Range (GHz)	Incremental Attenuation (dB)	SWR Maximum (50Ω Nominal)	Insertion Loss (0 dB setting)	Attenuation Accuracy	Power Rating, Minimum Life	Solenoid Voltage Speed Power	Dimensions, Shipping Weight	Connector Options Available	Price
355C (Manual)	dc—1	0—12 1 dB steps	1.2: dc—0.25 GHz 1.3: dc—0.5 GHz 1.5: dc—1.0 GHz	0.11 dB + 1.39 dB/GHz	±0.1 dB @ 1000 Hz ±0.25 dB: dc—0.5 GHz ±0.35 dB: dc—1.0 GHz	0.5 W avg 350 W peak 0.6 million steps	— 15—18 V <65 ms 3.0 W	152 × 70 × 67 mm (6 × 2.75 × 2.6 in) 1.4 kg (3 lb)	BNC (f) See Note 1	\$240 \$400
355E (Programmable)										
355D (Manual)	dc—1	0—120 10 dB steps	1.2: dc—0.25 GHz 1.3: dc—0.5 GHz 1.5: dc—1.0 GHz	0.11 dB + 1.39 dB/GHz	±0.3 dB @ 1000 Hz ±1.5 dB to 90 dB, and ±3 dB to 120 dB @ 1 GHz	0.5 W avg 350 W peak 0.6 million steps	— 15—18 V <65 ms 3.0 W	152 × 70 × 67 mm (6 × 2.75 × 2.6 in) 1.4 kg (3 lb)	BNC (f) See Note 1	\$240 \$400
355F (Programmable)										
8494A (Manual)	dc—4	0—11 1 dB Steps	1.5	0.6 dB + 0.09 dB/GHz	±0.2 dB: 1—2 dB ±0.3 dB: 3—6 dB ±0.4 dB: 7—10 dB ±0.5 dB: 11 dB	1 W avg 100 W peak 10 μs max. 1 million steps	— 20—30 V <20 ms 2.7 W	159 × 73 × 43 mm (6.2 × 2.9 × 1.7 in) 0.9 kg (2 lb)	001 002 003 See Note 2	\$495 \$785
8494G (Programmable)										
8494B (Manual)	dc—18	0—11 1 dB steps	1.5: dc—8 GHz 1.6: dc—12.4 GHz 1.9: dc—18 GHz	0.6 dB + 0.09 dB/GHz	dc—12.4 GHz ±0.3 dB: 1—2 dB ±0.4 dB: 3—4 dB ±0.5 dB: 5—6 dB ±0.6 dB: 7—10 dB ±0.7 dB: 11 dB dc—18 GHz ±0.7 dB: 1—5 dB ±0.8 dB: 6—9 dB ±0.9 dB: 10—11 dB	1 W avg 100 W peak 10 μs max. 1 million steps	— 20—30 V <20 ms 2.7 W	159 × 73 × 43 mm (6.2 × 2.9 × 1.7 in) 0.9 kg (2 lb)	001 002 003 See Note 2	\$645 \$995
8494H (Programmable)										
8495A (Manual)	dc—4	0—70 10 dB steps	1.3	0.4 dB + 0.07 dB/GHz	±1.6% % in dB from Atten. Setting	1 W avg 100 W peak 10 μs max. 1 million steps	— 20—30 V <20 ms 2.7 W	130 × 73 × 43 mm (5.1 × 2.9 × 1.7 in) 0.9 kg (2 lb)	001 002 003 See Note 2	\$355 \$650
8495G (Programmable)										
8495B (Manual)	dc—18	0—70 10 dB steps	1.35: dc—8 GHz 1.5: dc—12.4 GHz 1.7: dc—18 GHz	0.4 dB + 0.07 dB/GHz	±3%: dc—12.4 GHz ±4%: dc—18 GHz % in dB from Atten. Setting	1 W avg 100 W peak 10 μs max. 1 million steps	— 20—30 V <20 ms 2.7 W	130 × 73 × 43 mm (5.1 × 2.9 × 1.7 in) 0.9 kg (2 lb)	001 002 003 See Note 2	\$470 \$740
8495H (Programmable)										
8495D (Manual)	dc—26.5	0—70 10 dB steps	1.6: dc—12.4 GHz 1.9: 12.4—18 GHz 2.2: 18—26.5 GHz	0.5 dB + 0.13 dB/GHz	±3%: dc—12.4 GHz ±4%: dc—18 GHz ±7%: dc—26.5 GHz % in dB from Atten. Setting	1 W avg 100 W peak 10 μs max. 1 million steps	— 20-30 V <20 ms 2.7 W	159 × 52 × 43 mm (6.2 × 2.1 × 1.7 in) 0.9 kg (2 lb)	004 APC-3.5 See Note 2	\$700 \$1060
8495K (Programmable)										
8496A (Manual)	dc—4	0—110 10 dB steps	1.5	0.6 dB + 0.09 dB/GHz	±1.6% % in dB from Atten. Setting	1 W avg 100 W peak 10 μs max. 1 million steps	— 20—30 V <20 ms 2.7 W	159 × 73 × 43 mm (6.2 × 2.9 × 1.7 in) 0.9 kg (2 lb)	001 002 003 See Note 2	\$495 \$775
8496G (Programmable)										
8496B (Manual)	dc—18	0—110 10 dB steps	1.5: dc—8 GHz 1.6: dc—12.4 GHz 1.9: dc—18 GHz	0.6 dB + 0.09 dB/GHz	±3%: dc—12.4 GHz ±4%: dc—18 GHz % in dB from Atten. Setting	1 W avg 100 W peak 10 μs max. 1 million steps	— 20—30 V <20 ms 2.7 W	159 × 73 × 43 mm (6.2 × 2.9 × 1.7 in) 0.9 kg (2 lb)	01 002 003 See Note 2	\$655 \$1025
8496H (Programmable)										

Option 890	Option 890 Frequency List (MHz)	Models	Option 890 Price
Calibration Data	DC to 4 GHz Models: 100, 300, 500, 700, 900, 1000, 1250, 1500, 1750, 2000, 2500, 3000, 3500, 4000	8494A/G, 8496A/G, 33320A/G, 33322A/G 8495A/G, 33321A/G	+\$130 +\$110
Information	DC to 18 GHz Models: Same as above to 4000 MHz, every 500 MHz to 16000 (plus 12400 MHz), every 250 MHz from 16000 to 18000.	8494B/H, 8496B/H, 33320B/H, 33322B/H 8495B/H, 33321B/H	+\$170 +\$150

Note 1: 355C/D/E/F connector options (BNC (f) standard)		Note 2: 8494/5/6 models must specify connector option. See ordering example on adjacent page.	
Option 001 N(f)	add \$25	Option 001 N(f)	N/C
Option 005 TNC(f)	add \$10	Option 002 SMA(f)	N/C
Option 007 Transistor protection	add \$50	Option 003 APC-7	add \$50
		Option 004 APC-3.5 (8495D/K only)	N/C

MICROWAVE TEST EQUIPMENT

Variable attenuators and OEM step attenuators

Models 375 series, 382 series, 393A, 394A, 33300 series, 33320 series

- High Accuracy
- High Repeatability



394A



P382A



33300A



33321H

393A, 394A Coaxial variable attenuator 33300 series, 33320 series OEM step attenuators

Models 393A and 394A are high power, variable coaxial attenuators for the 0.5 to 2 GHz range. They use the principle of a variable directional coupler to achieve up to 120 dB range with 200 watt power handling capability.

33300 series step attenuators provide wideband programmable signal level control. Magnetic latching solenoids switch individual attenuating elements into and out of contact with a 50-ohm transmission line. C/D models have separate "indicator contacts" and A/B models have "no indicator contacts." Three digit connector options (OXY) must be specified. X is the input connector, Y is output connector, first digit is always 0. See table for option numbers.

33320 series step attenuators are compact versions of the 8494/5/6 bench attenuators on the previous page and are configured for design-

ing into microwave systems and instruments. Manual or electrically-activated versions are available. The manual models take less than 1.5 square inches of panel space. OEM quantity discounts are available for 33300 and 33320 series.

375 Series, 382 series waveguide attenuators

Operation of these 382 series rotary-vane, continuously variable attenuators depends on a mathematical law, rather than on the resistivity of the attenuator card. They are direct-reading and provide accurate attenuation from 0 to 50 dB (60 dB for S382C) regardless of temperature and humidity.

375A series variable flap attenuators consist of a short slotted section of waveguide in which a matched resistive strip is inserted.

Coaxial and Waveguide Catalog & Microwave Measurement Handbook

84 pages with over 350 measurement accessories. Request card at back of this catalog.

393A, 394A, 33300 series, 33320 series specifications

Model	Freq Range (GHz)	Mode	Range	Remarks	Price
393A	0.5-1	Manual	5-120 dB Variable	200 W average	\$1320
394A	1-2	Manual	6-120 dB Variable	200 W average	\$1250
33300 A/B C/D	DC-18	Prog.	0-70 dB 10 dB steps	A&C models 12-15 V	\$ 825 \$ 860
33301 A/B C/D	DC-18	Prog.	0-42 dB 6 dB steps	B&D models 24-30 V	\$ 825 \$ 860
33304 A/B C/D	DC-18	Prog.	0-11 dB 1 dB steps	Connector options available:	\$1100 \$1140
33305 A/B C/D	DC-18	Prog.	0-110 dB 10 dB steps	0: N(f), 1: N(m) 2: 7mm(f), 3: 7mm(m) 5: SMA(f), 6: SMA(m)	\$1100 \$1140
33320A B	DC-4 DC-18	Manual	1-11 dB 1dB steps	Specifications identical to 8494 series previous page	\$ 485 \$ 635
33320G H	DC-4 DC-18	Prog.			\$ 775 \$ 985
33321A B D	DC-4 DC-18 DC-26.5	Manual	0-70 dB 10 dB steps	Specifications identical to 8495 series previous page.	\$ 345 \$ 460 \$ 690
33321G H K	DC-4 DC-18 DC-26.5	Prog.			\$ 640 \$ 730 \$1050
33322A B	DC-4 DC-18	Manual	0-110 dB 10 db steps	Specifications identical to 8496 series previous page	\$ 485 \$ 645
33322G H	DC-4 DC-18	Prog.			\$ 765 \$1015

375A Series 382 series specifications

Model	Frequency Range (GHz)	Accuracy	Attenuation Range (dB)	Waveguide & Equivalent Flange	Price
S382C	2.6-3.95	±1% of reading or 0.1 dB whichever greater ±2% above 50 dB	0-60	WR 284 UG-584/U	\$2800
G382A	3.95-5.85	±2% of reading or 0.1 dB whichever greater	0-50	WR 187 UG-407/U	\$1850
J382A	5.3-8.2	±2% of reading or 0.1 dB whichever greater	0-50	WR 137 UG-441/U	\$1550
H382A	7.05-10.0	±2% of reading or 0.1 dB whichever greater	0-50	WR 112 UG-138/U	\$1550
X382A	8.2-12.4	±2% of reading or 0.1 dB whichever greater	0-50	WR 90 UG-135/U	\$ 930
P382A	12.4-18.0	±2% of reading or 0.1 dB whichever greater	0-50	WR 62 UG-419/U	\$ 930
K382A	18.0-26.5	±2% of reading or 0.1 dB whichever greater	0-50	WR 42 UG-597/U	\$1550
R382A	26.5-40.0	±2% of reading or 0.1 dB whichever greater	0-50	WR 28 UG-599/U	\$1500
X375A	8.2-12.4	±1 dB, ±2 dB	0-20	WR 90 UG-39/U	\$ 450
P375A	12.4-18	±1 dB, ±2 dB	0-20	WR 62 UG-419/U	\$ 450

Slotted lines, carriage, probes

Models 440A, 442B, 444A, 447B, 805C, 809C, 810B series, 816A, 817A

- Precision reflection measurements 0.5 to 18 GHz

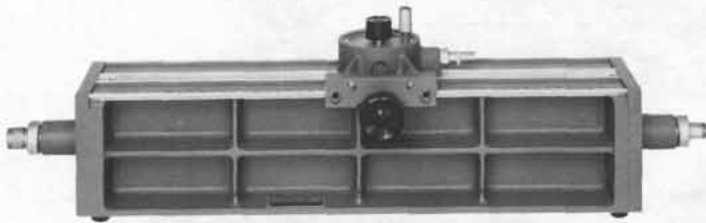

805C



442B



447B



448B

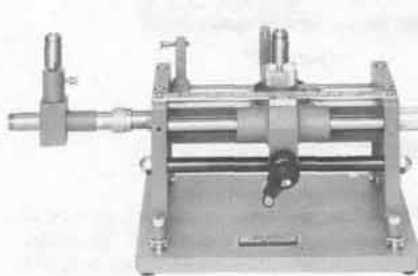

817B

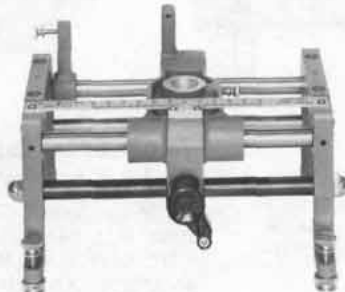

809C



X810B



816A

805C Coaxial slotted line system, 0.5 to 4 GHz

Model 805C is a complete slotted line system, employing 2 parallel ground planes and a rigid center conductor. This configuration has negligible slot radiation and is less sensitive to probe depth. The probe is tunable from 500 to 4000 MHz.

817B coaxial swept slotted line system, 1.8 to 18 GHz

817B fully tested system provides comprehensive swept frequency reflection data with the accuracy inherent in slotted lines. 817B consists of the 816A line, 809C carriage, and the 448B sweep adapter for use with model 11664A detectors and the 8755 frequency response test set.

805C, 817B specifications

Model	Frequency Range (GHz)	SWR Residual	Connectors	Remarks	Price
805C	0.5-4.0	1.04	N(m) N(f)	11512 N(m) short, 11511A N(f) short furnished	\$1750
817B	1.8-18.0	1.06	APC-7 N(f)	11512A N(m) short, 11565A APC-7 short furnished	\$1775
817B Options	001: APC-7 connectors on 448B probes				add \$55
	022: N(m) and N(f) connectors on 816A slotted section				less \$15

809C Slotted line carriage

The 809C Carriage operates with the 816A Coaxial slotted section and four 810B Waveguide slotted sections. It is compatible with the 442B, 444A, 447B, and 448B coaxial probes. The carriage has a centimeter scale with a vernier reading to 0.1 mm, and provision is made also for mounting a dial gauge if more accurate probe position reading is required.

810B Series, 816A slotted sections

810B waveguide and 816A coaxial slotted sections are used with the 809C carriage, 810B waveguide sections accept the 444A untuned probe or the 442B probe plus 440A tuned detector. 816A coaxial line accepts the 447B probe or the 448B adapter sets.

810B Series, 816A specifications

Model	Frequency Range (GHz)	SWR Residual	W/G—Coax Flange/Conn.	Remarks	Price
J810B	5.3-8.2	1.01	WR 137 UG-441/U	Use with 809C Carriage, 444A or 442B + 440A Probes	\$625
H810B	7.05-10.0	1.01	WR 112 UG-138/U		\$450
X810B	8.2-12.4	1.01	WR 90 UG-135/U		\$600
P810B	12.4-18.0	1.01	WR 62 UG-419/U	809C carriage 444A Probe	\$450
816A	1.8-18.0	1.02-1.04	Coaxial APC-7 N(f)	809C Carriage 447B Probe or 448B Sweep Adapter	\$640
Opt 011			Both APC-7		Add \$25
Opt 022			N(m), N(f)		11512A N(m) Short 1156A APC-7 Short furnished

440A, 442B, 444A, 447B, 448B Probes/adapters

440A is a tunable mount (1N21 crystal not supplied) for 2.4-12.4 GHz, to be used on the 442 broadband probe. 442B fits the 809C carriage and provides sampled RF on a Type N jack.

444A is an untuned probe for 2.6-18 GHz for use with the 809C carriage or other 3/8 inch (19 mm) mounting hole and the 810B waveguide sections. 447B is similarly used with the 809C and the 816A coaxial section for 1.8 to 18 GHz.

448B sweep adapter probe has Type N outputs for use with the 11664A detectors of the 8755 test set.

Coaxial & Waveguide Catalog

84 pages with over 350 measurement accessories. Use request card at back of this catalog.

Ordering information

440A Detector mount	\$240
442B RF probe	\$165
444A Untuned probe	\$155
447B Detector probe	\$235
448B Slotted line sweep adapter probes 1.8-18 GHz	\$515
809C Slotted line carriage	\$650

MICROWAVE TEST EQUIPMENT

Coaxial single and dual-directional couplers

Models 770 series, 790 series, 11691D, 11692D

- Broadband coverage
- High directivity
- Close tracking

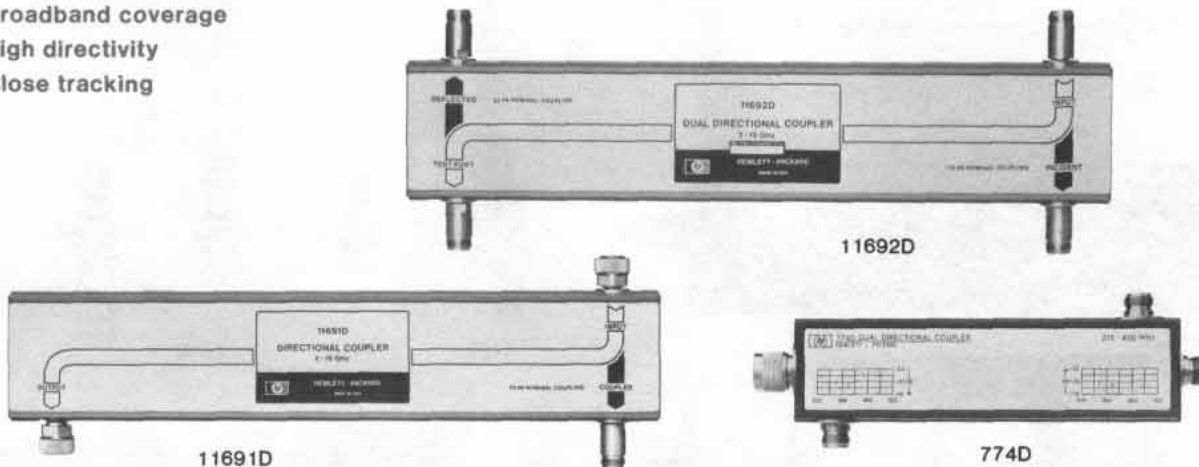

779D Directional coupler

The HP 779D spans more than two octaves from 1.7 to 12.4 GHz with excellent directivity. With increased coupling factor (typically 24 dB), the 779 is useful down to 500 MHz. Upper frequency usefulness extends to 18 GHz with directivity reduced to about 15 dB. Various connector options are available.

790 Series directional couplers (octave bands)

The 790 directional couplers are ultra-flat, high directivity couplers which are ideal for power-monitoring applications in coaxial systems. Output coupling (ratio of output power from main and auxiliary arms) is specified rather than coupling factor. Thus, no correction factor is required to account for insertion losses in the main arm.

11691D Directional coupler

The 11691D is an ultra-wide-band single-directional coupler covering 2 to 18 GHz with high directivity. It is useful as a power monitoring or leveling coupler or used for making reflection measurements. Couplers are preferred over broadband bridges in reflectometer applications in situations where the power level of the source is limited, or where simultaneous measurement of return loss and insertion loss is desired.

779D, 790 Series, 11691D specifications

Model	Frequency Range (GHz)	Mean Output Coupling (dB)	Output Coupling Variation (dB)	Minimum Directivity (dB)	Equivalent ¹ Source Match	Price
779D	1.7-12.4	20 ± 0.5	± 0.75	1.7-4 GHz: 30 4-12.4 GHz: 26	1.2	\$680
796D	0.96-2.11	20 ± 0.5	± 0.2	30	1.13	\$400
797D	1.9-4.1	20 ± 0.5	± 0.2	26	1.16	\$400
798C	3.7-8.3	10 ± 0.3	± 0.3	20	1.25	\$470
11691D	2-18	22 Nominal	± 1.0	2.8 GHz: 30 dB 8-18 GHz: 26 dB	1.2	\$975
796D-798C Standard connectors						
Primary line: N(f), N(m) Auxiliary Arm, N(f)						
779D Standard connectors						
Primary Line: N(f) input, N(f) output; Auxiliary Arm: N(f)						
Option 010: Primary Line N(f) input, N(m) output Other options: APC-7 on any or all ports						N/C Contact HP
11691D Standard connectors						
Primary line: APC-7, APC-7; Auxiliary Arm: N(f)						
Opt 001: All N(f)						less \$30
Opt 005: All APC-7						add \$25
¹ Apparent SWR at the output port of a coupler when used in a closed-loop leveling system.						

774D-777D Dual-directional couplers (octave bands)

The economical 774D-777D couplers cover frequency spreads of more than two-to-one, each centered on one of the important VHF/UHF bands. With their high directivity, and a mean coupling accuracy of ± 0.5 dB these couplers are ideal for reflectometer applications. Furthermore, the close tracking of the auxiliary arms makes these couplers particularly useful for reflectometers driven by externally leveled sweep oscillators such as the HP 8690B and 8620A/B. Power ratings are 50 W average, 500 W peak.

778D, 11692D Dual-directional couplers (multi-octave bands)

These extra wide frequency couplers are ideal for swept-frequency reflectometer testing of broadband coaxial components. 778D covers 100 MHz to 2 GHz and 11692D covers 2 to 18 GHz. High directivity and close tracking of the auxiliary arms are featured. Various connector options are available as shown. Both couplers handle 50 W average power. Peak power; 778D, 500W; 11692D, 250 W.

774D, 775D, 776D, 777D, 778D, 11692D Specifications

Model	Frequency Range (GHz)	Nominal Coupling (dB)	Maximum Coupling Variation (dB)	Minimum Directivity (dB)	SWR Primary Line Maximum (50Ω Nom.)	Price
774D	0.215-0.450	20	± 1	40	1.15	\$495
775D ¹	0.450-0.940	20	± 1	40	1.15	\$515
776D ¹	0.940-1.90	20	± 1	40	1.15	\$495
777D	1.90-4.0	20	± 0.4	30	1.2	\$575
778D	0.10-2.0	20	± 1	0.1-1 GHz: 36 ² 1-2 GHz: 32	1.1	\$590
11692D	2.0-18.0	22	± 1 incident to test port	2-18 GHz: 30 8-18 GHz: 26 ³	2-12.4 GHz: 1.3 12.4-18 GHz: 1.4	\$1700
774D-777D Standard connectors						
Primary Line: N(m), N(f) Auxiliary Arm, N(f), N(f)						
778D Standard connectors						
Primary Line: N(m), N(f); Auxiliary Arms: N(f), N(f)						
Option 011: Primary Line, APC-7, N(f)						N/C
Option 012: Primary Line, N(m), N(f)						N/C
11692D Standard connectors						
Primary line: N(f), APC-7; Auxiliary Arms: N(f), N(f)						
Opt 001: Primary Line, N(f), N(f)						less \$15
Opt 002: Primary Line, N(f), N(m)						less \$15
¹ Maximum auxiliary arm tracking: 0.3 dB for 776D; 0.5 dB for 777D						
² 30 dB, 0.1 to 2 GHz, input port.						
³ 24 dB with Type N connector on the test port.						

- Flat frequency response
- Low equivalent source match
- High directivity to > 40 dB

- Low SWR
- Coverage to 40 GHz



786D

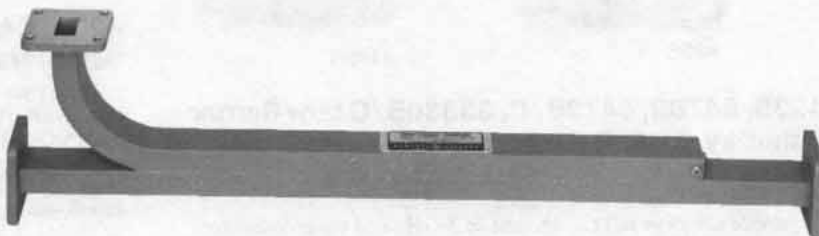

X752A

780 Series directional detectors

The 780 series detectors are directional couplers with built-in crystal detectors. The couplers have flat frequency response and good directivity, while the detectors have good frequency response plus high sensitivity. The configuration of the directional detector reduces the number of ambiguities over the standard system of separate coupler and detector and makes possible tighter correlation between main-arm power and detected signal. The directional detector is well suited for sweep oscillator leveling and can also be used to monitor power with a voltmeter or oscilloscope.

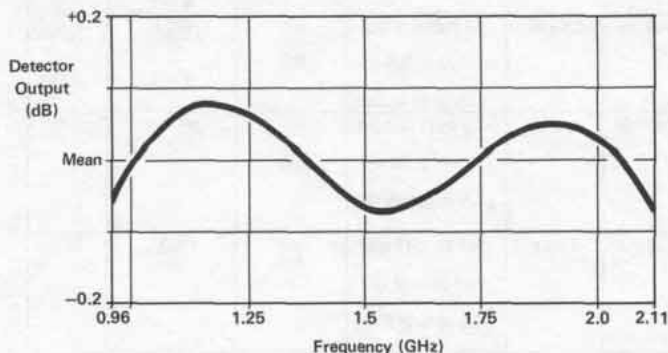

Figure 1. Typical 786D Frequency Response.

780 Series specifications

Model	Frequency Range (GHz)	Frequency Response	Equivalent ² Source Match	Price
786D	0.96-2.11	± 0.2	1.13	\$510
787D	1.9-4.1	± 0.2	1.16	\$510
788C	3.7-8.3	± 0.3	1.25	\$635
789C	8-12.4	± 0.5	1.25	\$750

1. Includes coupler and detector variation with frequency as read on a meter calibrated for square-law detector (e.g., HP 415E).
2. Apparent SWR at the output port of the directional detector when used in a closed-loop leveling system.

Standard connectors

Output: All N (f)

Input: 786D-788C, N (m), 789, N (f)

752 Series waveguide directional couplers

The HP 752 Series couplers are specified to meet a wide variety of microwave applications. Every coupler has a minimum directivity of 40 dB over its entire frequency range. Each coupler is swept-frequency tested to ensure that the main guide SWR and directivity specifications are accurate. Performance characteristics are unaffected by humidity, temperature, and time, making these units especially useful in microwave "standards" measurements.

The 752 couplers are an essential part of many waveguide measurement systems. Attenuation measurements, reflectometer setups, power measurements, source leveling and network analysis are just a few areas in which these couplers are used.

752 Series specifications

Model	Frequency Range (GHz)	Nominal Coupling (dB)	Mean Coupling Accuracy (dB)	Maximum Coupling Variation (dB)	Minimum Directivity (dB)	Waveguide & Flange	Price
J752A	5.85-8.2	3	± 0.4	± 0.5	40	WR137 UG-441/U	\$760
J752C	5.85-8.2	10	± 0.4	± 0.5	40		\$760
J752D	5.85-8.2	20	± 0.4	± 0.5	40		\$760
H752A	7.05-10.0	3	± 0.4	± 0.5	40	WR112 UF-138/U	\$570
H752C	7.05-10.0	10	± 0.4	± 0.5	40		\$570
H752D	7.05-10.0	20	± 0.4	± 0.5	40		\$570
X752A	8.2-12.4	3	± 0.4	± 0.5	40	WR90 UG-135/U	\$430
X752C	8.2-12.4	10	± 0.4	± 0.5	40		\$430
X752D	8.2-12.4	20	± 0.4	± 0.5	40		\$430
P752A	12.4-18.0	3	± 0.4	± 0.5	40	WR62 UG-419/U	\$400
P752C	12.4-18.0	10	± 0.4	± 0.5	40		\$400
P752D	12.4-18.0	20	± 0.4	± 0.5	40		\$400
K752A	18.0-26.5	3	± 0.7	± 0.5	40	WR42 UG-595/U	\$520
K752C	18.0-26.5	10	± 0.7	± 0.5	40		\$520
K752D	18.0-26.5	20	± 0.7	± 0.5	40		\$520
R752A	26.5-40.0	3	± 0.7	± 0.5	40	WR28 UG-599/U	\$600
R752C	26.5-40.0	10	± 0.7	± 0.5	40		\$550
R752D	26.5-40.0	20	± 0.7	± 0.6	40		\$550

MICROWAVE TEST EQUIPMENT

Coaxial crystal detectors

Models 423A/B, 8470A/B, 8471A, 8472A, 8473B/C, 33330B/C

- Flat frequency response
- High burnout protection



33330B



8470B Opt 012



423B



8470B

- Low SWR
- Field replaceable detector elements



423A



8470A



8472B



8471A

423A, 8470A, 8471A, 8472A point-contact detectors

These point-contact detectors have been widely used for many years and provide high performance at an economical price. The 8470A, 8470A Opt 012, and 8472A provide APC-7, Type N, and SMA connector versions to 18 GHz. Matched pairs are available for applications requiring close detector tracking, and all but the 8472A can be supplied with video loads for optimum conformance to square law.

Coaxial & Waveguide Catalog & Microwave Measurement Handbook

84 pages with over 350 measurement accessories. Request card at back of this catalog.

423B, 8470B, 8473B/C, 33330B/C Low Barrier Schottky (LBS) Detectors

The low-barrier Schottky (LBS) detectors are a state-of-the-art addition to the HP family of high performance detectors. Various models provide coverage to 12.4, 18, and 26.5 GHz and input connectors are Type N, APC-7, or APC-3.5 depending on frequency range. Output connector is BNC (f) except for the 33330B/C (SMC).

Matched pairs (Opt 001), square low load (Opt 002), and positive polarity output (Opt 003) are available for most models.

Coaxial crystal detector specifications

Model	Frequency Range (GHz)	Frequency Response (dB)	SWR Maximum (50Ω Norm.)	Low Level Sensitivity	Maximum Input (Peak or Average)	Short-Term Maximum Input (<1 min.)	Opt 001 Matched Pair (order 2 units for each pair)	Options Available	Input Connector	Price
423B	0.01-12.4 LBS	±0.2/octave to 8 GHz ±0.3 overall	<1.15 to 4 GHz <1.3 to 12.4 GHz	>0.5 mV/ μW	200 mW	1 watt	±0.2 dB to 12.4 GHz	001 002 003	N (m)	\$205
423A	0.01-12.4 Point Contact	±0.2/octave to 8 GHz ±0.5 overall	<1.2 to 4.5 GHz <1.35 to 7 GHz 1.5 to 12.4GHz	>0.4 mV/ μW	100 mW	0.1 watt	≥0.2 dB to 8 GHz ±0.3 dB to 12.4GHz	001 002 003	N (m)	\$155
8470B	0.01-18.0 LBS	±0.2/octave to 8 GHz ±0.3 to 12.4 GHz ±0.6 to 18 GHz	<1.15 to 4 GHz <1.3 to 15 GHz <1.4 to 18 GHz	<0.5 mV/ μW	200 mW	1 watt	±0.2 db to 12.4 GHz ±0.3 dB to 18 GHz	001 002 003	APC-7	\$250
8470B Opt 012									N (m)	\$235
8470A	0.01-18.0 Point contact	±0.2/octave to 8 GHz ±0.5 to 12.4 GHz ±1.0 to 18 GHz	<1.2 to 4.5 GHz <1.35 to 7 GHz <1.5 to 12.4 GHz <1.7 to 18 GHz	>0.4 mV/ μW	100 mW	0.1 watt	±0.2 dB to 8 GHz ±0.3 dB to 12.4 GHz ±0.6 dB to 18 GHz	001 002 003	APC-7	\$195
8470A Opt 012									N (m)	\$180
8473B	0.01-18.0 LBS	±0.2 dB/octave to 8 GHz ±0.3 dB to 12.4 GHz ±0.6 dB to 18 GHz	<1.2 to 12.4 GHz <1.5 to 18 GHz	>0.5 mV/ μW	200 mW	1 watt	±0.2 dB to 12.4 GHz ±0.3 dB to 18 GHz ±0.5 dB to 26.5 GHz	001 003	APC-3.5 (m)	\$235
8473C	0.01-26.5 LBS	±0.6 dB to 20 GHz ±1.5 dB w/a -3.5 dB slope, 20 to 26.5 GHz	<1.2 to 4 GHz <1.5 to 18 GHz <2.2 to 26.5 GHz	>0.5 mV/μW to 18 GHz >0.18 mV/μW to 26.5 GHz	200 mW	1 watt	±0.2 dB to 12.4GHz ±0.3 dB to 18 GHz ±0.5 dB to 26.5 GHz	001 003	APC-3.5 (m)	\$275
8472A	0.01-18.0 Point Contact	±0.2/octave to 8 GHz ±0.5 to 12.4 GHz	<1.2 to 4.5 GHz <1.35 to 7 GHz <1.5 to 12.4 GHz ±1.0 to 18 GHz	>0.4 mV/ μW <1.7 to 18 GHz	100 mW	0.1 watt	±0.2 dB to 8 GHz ±0.3 dB to 12.4 GHz ±0.6 dB to 18 GHz	001 003	SMA (m)	\$180
33330B	0.01-18.0 LBS	±0.6 dB	<1.5	>0.5 mV/ μW	200 mW	1 watt	≥0.3 dB	001 003	APC-3.5 (m)	\$225
33330C	0.1-26.5 LBS	±0.6 dB to 20 GHz ±1.5 dB with a -3.5 dB slope 20 to 26.5 GHz	<1.5 to 18 GHz <2.2 to 26.5 GHz	>0.5 mV/μW to 18 GHz Degrades to 0.18 mV/μW at 26.5 GHz	200 mW	1 watt	±0.3 dB to 18 GHz ±0.5 dB to 26.5 GHz	001 003	APC-3.5 (m)	\$260
8471A	100 kHz-1.2 GHz Point Contract	±0.6 dB (typical) ±0.1/100 MHz	1.3 (typical) 50Ω	>0.35 mV/ μW	3 V rms	3 V rms	No	004 005 006	BNC (m)	\$70

Options

All applicable models

001: matched pair

002: square law load

Models 423A, 8470A, 8472A

003: positive output

Price

add \$20/unit

add \$20/unit

N/C

Models 423B/8470B/8473B/C, 33330B/C

003: positive output

Model 8471A

004: positive output

005: 75 ohm negative output

006: 75 ohm positive output

add \$30

N/C

add \$10

add \$10

MICROWAVE TEST EQUIPMENT

Crystal detectors and frequency meters

Models 422A, 424A, 532A, 536A, 537A



K422A



J424A



H532A



537A

422 Series, 424 series crystal detectors

The 422A and 424A family of crystal detectors combine high sensitivity with flat frequency response and low SWR to provide waveguide band coverage from 3.95 to 40 GHz. They deliver between 0.2 and 0.4 mV/ μ W output at low level and handle 100 MW peak input. SWR ranges from 1.35 at G-band to 3 at R-band.

For reflectometer applications in which both flat frequency response and square-law characteristics are important, these models can be supplied as matched pairs (Option 001) and also with an optimum square-law load (Option 002).

422 Series, 424 series waveguide crystal detector specifications

Model	Frequency Range (GHz)	Frequency Response (dB)	Option 001 Matched Pair Tracking (dB)	Option 003 Positive Output	Waveguide & Equivalent Flange	Price
G424A	3.95-5.85	± 0.2	± 0.2 dB	Yes	WR187 UG-407/U	\$250
J424A	5.2-8.2	± 0.2	± 0.2 dB	Yes	WR137 UG-441/U	\$250
H424A	7.05-10.0	± 0.2	± 0.2 dB	Yes	WR112 UG-138/U	\$250
X424A	8.2-12.4	± 0.3	± 0.3 dB	Yes	WR90 UG-135/U	\$210
M424A	10.0-15.0	± 0.5	± 0.5 dB	Yes	WR75 Cover	\$300
P424A	12.4-18.0	± 0.5	± 0.5 dB	Yes	WR62 UG-419/U	\$240
K422A	18.0-26.5	± 2	± 1 dB	No	WR42 UG-595/U	\$575
R422A	26.5-40.0	± 2	± 1 dB	NO	WR28 UG-599/U	\$580
All Models—Option 001 Matched Pair						Add \$20/Unit
All Models—Option 002 Optimum Square-Law Load						Add \$20/Unit
Not All Models—Option 003 Positive Output						N/C

532 Series, 536A, 537A frequency meters

These direct-reading frequency meters measure frequencies from 5.30 to 40 GHz in waveguide and from 960 MHz to 12.4 GHz in coax quickly and accurately. Their long scale length and numerous calibration marks provide high resolution which is particularly useful when measuring frequency differences or small frequency changes. Frequency is read directly in GHz so interpolation or charts are not required.

The instruments comprise a special transmission section with a high-Q resonant cavity which is turned by a choke plunger. A 1 dB or greater dip in output indicates resonance; virtually full power is transmitted off resonance. Overall accuracy of each frequency meter includes allowance for 0 to 100 percent relative humidity and temperature variation from 13 to 33°C. Except for the J532A, there are no spurious modes or resonances.

Coaxial & Waveguide Catalog

And Microwave Measurement Handbook. 84 pages with over 350 measurement accessories. Use request card at back of this catalog.

532 Series, 536A and 537A specifications

Model	Frequency Range (GHz)	Overall Accuracy (%)	Calibration Increment (MHz)	W/G-Coax Equivalent Flange (Connector)	Price
536A	0.96-4.20	0.22-0.96 to 1 GHz 0.17-1 to 4.2 GHz	2	Coax [Type N (f)]	\$990
537A	3.7-12.4	0.170	10	Coax [Type N (f)]	\$730
J532A	5.30-8.20	0.065	2	WR137 UG-441/U	\$1350
H532A	7.05-10.0	0.075	2	WR112 UG-138/U	\$1350
X532B	8.20-12.4	0.080	5	WR90 UG-39/U	\$715
P532A	12.4-18.0	0.100	5	WR62 UG-419/U	\$685
K532A	18.0-26.5	0.110	10	WR42 UG-595/U	\$955
R532A	26.5-40.0	0.120	10	WR28 UG-599/U	\$930

MICROWAVE TEST EQUIPMENT

Coaxial and waveguide terminations

Models 905, 907-911, 914, 920, 930

- Precision loads and shorts for measurements to 40 GHz



905A, 907A, 911A, 911C Coaxial sliding loads

The 905A, 907A and 911A are movable, low reflection 50Ω loads for precision measurements. The 905A and 907A are supplied with three interchangeable connectors, N-male, N-female and APC-7. The 911A is supplied with SMA male and female.

The 911C is a sliding load designed for 3.5 mm coaxial transmission lines and uses the APC-3.5 connector. This permits mode-free operation to 26.5 GHz. The 911C is furnished with interchangeable male and female connectors in a carrying case.

908A, 909A Coaxial fixed terminations

The 908A and 909A terminations are low-reflection loads for terminating 50Ω coaxial systems in their characteristic impedance.

905A, 907A, 911A, 911C specifications

HP Model	Frequency range (GHz)	Load SWR	Power rating	Length in. (mm)	Shipping weight	Price
905A	1.8-18	1.05	1 W avg. 5 kW pk	17.25 (440)	3 lb (1.4 kg)	\$415
907A	1-18	1.1, 1-1.5 GHz; 1.05, 1.5-18 GHz	1 W avg. 5 kW pk	30.62 (778)	9 lb (4.1 kg)	\$750
911A	2-18	1.1, 2-4 GHz; 1.05, 4-18 GHz	1 W avg. 5 kW pk	14.87 (380)	3 lb (1.4 kg)	\$395
911C	2-26.5	1.2, 2-10 GHz; 1.07, 10-26.5 GHz	1 W avg. 5 kW pk	10.5 (266)	3.8 lb (1.7 kg)	\$720

908A, 909A specifications

HP Model	Frequency Range (GHz)	Impedance	SWR	Power Rating	Connector	Price
908A	dc-4	50 ohms	1.05	½ W avg. 1 kW pk	N male	\$55
909A	dc-18	50 ohms	1.05, 0-4 GHz; 1.1, 4-12.4 GHz; 1.25, 12.4-18 GHz	2 W avg. 300 W pk	APC-7	\$110
909A Option 012 and Option 013	dc-18	50 ohms	1.06, 0-4 GHz; 1.11, 4-12.4 GHz; 1.3, 12.4-18 GHz	2 W avg. 300 W pk	Opt. 012 N male Opt. 013 N female	Subtract \$15

11511A, 11512A, 11565A Coaxial shorts

These shorts are used for establishing measurement planes for known reflection phase and magnitude in 50Ω and 75Ω coaxial systems for various connectors.

Coaxial & Waveguide Catalog & Microwave Measurement Handbook

84 pages with over 350 measurement accessories. Request card at back of this catalog.

Ordering information

11511A N-female short (50 ohm)	\$20
1250-1531 N-female short (75 ohm)	\$16
11512A N-male short (50 ohm)	\$15
1250-1530 N-male short (75 ohm)	\$20
11565A APC-7 short (50 ohm)	\$55
0960-0054 SMA-female short (50 ohm)	\$25
0960-0055 SMA-male short (50 ohm)	\$25

910A/B, 914A Waveguide fixed and movable terminations

The 910A/B are fixed terminations for waveguide systems. The 914A/B are similar to the 910A/B, except that its absorptive element is movable and a locking plunger controls the position of the element.

910A/B, 914A/B specifications

Model	Frequency Range (GHz)	SWR	Power Rating	Type	Waveguide Size (EIA)	Price
J910A	5.3-8.2	1.02	1 watt	fixed	WR137	\$215
H910A	7.05-10.0	1.02	1 watt	fixed	WR112	\$140
X910B	8.2-12.4	1.015	1 watt	fixed	WR90	\$150
P910A	12.4-18	1.02	1 watt	fixed	WR62	\$120
J914A	5.3-8.2	1.01	2 watt	sliding	WR137	\$415
H914A	7.05-10.0	1.01	1 watt	sliding	WR112	\$375
X914B	8.2-12.4	1.01	1 watt	sliding	WR90	\$275
P914A	12.4-18	1.01	½ watt	sliding	WR62	\$275
K914B	18-26.5	1.01	½ watt	sliding	WR42	\$450
R914B	26.5-40	1.01	½ watt	sliding	WR28	\$415

920A/B, X923A, X930A Waveguide shorts

The 920A/B are movable shorts, adjustable through at least half a wavelength at the low end of the band. The X923A is also a movable short, but is adjustable through about two wavelengths at 8.2 GHz. The X930A is a shorting switch. SWR is less than 1.02 in the "through" position and greater than 125 in the "short" position.

920A/B, X923A, X930A specifications

Model	Frequency Range (GHz)	Waveguide Size EIA	Price
J920A	5.3-8.2	WR137	\$265
H920A	7.05-10.0	WR112	\$360
X923A	8.2-12.4	WR90	\$335
P920B	12.4-18	WR62	\$330
K920B	18.0-26.5	WR42	\$450
R920B	26.5-40.0	WR28	\$425
X930A	8.2-12.4	WR90	\$500

MICROWAVE TEST EQUIPMENT

Filters, mixers, and tuners

Models 360 series, 362 series, 870A, P932A, 934A



- Effective elimination of undesirable signals
- Low insertion loss through passband

- Correct waveguide discontinuities
- Measure microwave frequencies



X362A



P932A



360D



X870A



934A

360 Series coaxial low pass filters, 362 Series waveguide low pass filters

These Hewlett-Packard low-pass filters facilitate microwave measurements by eliminating undesirable signals (such as harmonics) from the measurement system. Suppression of such signals is particularly important in applications such as broadband reflection and transmission measurements or slotted line measurements, where harmonics generated by the signal source could otherwise impair measurement accuracy.

X870A, P870A Waveguide slide-screw tuners

Waveguide slide-screw tuners are used primarily for correcting discontinuities or for "matching" waveguide systems. X870A covers 8.2-12.4 GHz in WR 90 waveguide and P870A likewise covers 12.4-18.0 GHz in WR 62 waveguide. Both can correct a SWR of 20 to a value of 1.02, with a maximum loss of 2 dB.

934A, P932A Harmonic mixers

These mixers can be used for frequency measurements and phase lock applications from 2 to 18 GHz. Both accept stable VHF signals from 100 to 1000 MHz and provide broadband, high sensitivity mixing with microwave signals. 934A handles coaxial inputs from 2 to 12.4 GHz while P932A mixes signals from 12.4 to 18 GHz in WR 62 waveguide. With 0 dBm input signal 934A provides 1.4 mV p-p output and P932A 0.4 mV p-p.

Coaxial and Waveguide Catalog

84 pages with over 350 measurement accessories. Use request card at back of this catalog.

Ordering information

- X870A Waveguide tuner
- P870A Waveguide tuner
- P932A Waveguide harmonic mixer
- 934A Coaxial harmonic mixer

- Price**
\$490
\$510
\$525
\$340

360 Series coaxial filter specifications

Model	Cut-off Frequency (MHz)	Insertion Loss	Rejection	Impedance	VSWR Maximum	Connectors	Overall Length mm (in)	Shipping Weight kg (lb)	Price
360A	700	Less than 1 dB below 0.9 times cut-off frequency	Greater than 50 dB at 1.25 times cut-off frequency	50Ω	<1.6 to within 100 MHz of cut-off	N (m, f)	276 (10 ⁹ / ₃₂)	0.9 (2)	\$275
360B	1200			50Ω		N (m, f)	183 (7 ¹ / ₃₂)	0.9 (2)	\$240
360C	2200			50Ω	<1.6 to within 200 MHz of cut-off	N (m, f)	274 (10 ⁹ / ₃₂)	0.9 (2)	\$170
360D	4100			50Ω	<1.6 to within 300 MHz of cut-off	N (m, f)	187 (7 ¹ / ₃₂)	0.45 (1)	\$170

362 Series waveguide low pass filter specifications

Model	Passband (GHz)	Stopband (GHz)	Passband Insertion Loss	Stopband Rejection	SWR Maximum	Waveguide Size	Equivalent Flange	Length mm (in)	Shipping Weight kg (lb)	Price
X362A	8.2-12.4	16-37.5	<1 dB	At least 40 dB	1.5	WR 90	UG-39/U	136 (5 ¹ / ₃₂)	0.9 (2)	\$700
M362A	10.0-15.5	19-47			1.5	WR 75	Cover	114 (4 ¹ / ₃₂)	0.9 (2)	\$660
P362A	12.4-18.0	23-54			1.5	WR 62	UG-419/U	94 (3 ¹ / ₁₆)	0.37 (13 oz)	\$720
K362A ¹	18.0-26.5	31-80			1.5	WR 42	UG-595/U	64 (2 ¹ / ₂)	0.15 (5.3 oz)	\$595
R362A ¹	26.5-40.0	47-120	<2 dB	>35 dB	1.8	WR 28	UG-599/U	42 (1 ² / ₃₂)	0.11 (4 oz)	\$525
										\$120

¹Circular Flange Adapters available: For K-Band, Specify 11515A (UG-425/U). For R-Band, Specify 11516A (UG-381/U).

MICROWAVE TEST EQUIPMENT

Coaxial switches

Models 8761A/B, 33311B/C



33311B

HP-IB

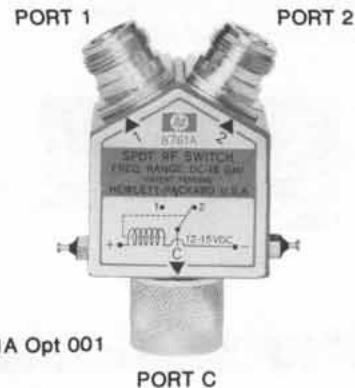

8761A Opt 001

33311B/C Coaxial switch

The 33311B/C are high isolation, single pole, double-throw coaxial switches with excellent characteristics. They are designed for use in 50 ohm systems and the ungated port is automatically terminated internally with 50 ohms, thus eliminating the need for three-switch trees. This feature makes them particularly useful in systems which require low SWR on their lines at all times. The switches are controlled by latching solenoids and switching current is automatically cut off when switching is completed. The 33311C utilizes the new APC-3.5 connector which is SMA compatible and extends the operating frequency range to 26.5 GHz.

8761A/B Coaxial switch

The 8761 is a single-pole, double-throw coaxial switch with low standing-wave ratio, low insertion loss, and excellent isolation from dc to 18 GHz. Mechanically, the switch is a break-before-make type controlled by a latching solenoid. Any of seven coaxial connectors, or a 50-ohm termination, may be specified for each port.

HP-IB Compatible

The 33311B/C and the 8761A/B switches can be remotely controlled by HP-IB with either the 11713A or the 59306A. The 11713A Attenuator Switch Driver is referenced on page 430. The 59306A HP-IB Actuator is referenced on page 26.

33311B/C Specifications

Frequency Range:

33311B: dc to 18 GHz.

33311C: dc to 26.5 GHz.

SWR (50 ohm characteristic impedance)

33311B: <1.25, dc to 12.4 GHz; 1.5, 12.4 to 18 GHz.

33311C: <1.3, dc to 10 GHz; <1.5, 10 to 16 GHz; <2.3, 16 to 26.5 GHz.

Insertion Loss

33311B: <0.25 dB, dc to 2 GHz; <0.5 dB, 2 to 18 GHz.

33311C: <0.25 dB, dc to 2 GHz; <0.5 dB, 2 to 10 GHz; <0.8 dB, 10 to 16 GHz; <1.4 dB, 16 to 26.5 GHz.

Isolation

33311B: >90 dB, dc to 18 GHz.

33311C: >90 dB to 12.4 GHz; >85 dB, 12.4 to 18 GHz; >50 dB, 18 to 26.5 GHz.

RF Connectors

33311B: (3) SMA female.

33311C: (3) APC-3.5 female (SMA compatible).

Power: 1 W average, 100 W peak (10 μ sec duration).

Solenoid voltage (dc or pulsed): 24 volts. Diode protected to reduce voltage transients.

Switching speed: <30 ms (including settling time).

Life: >1,000,000 switchings.

Size: 54" x 53" x 14 mm D (2.13" x 2.13" x 0.56") excluding connectors and solenoid terminals.

Weight: net, 88 gm (3.1 oz). Shipping, 220 gm (8 oz).

Options: 011, 5-volt solenoid voltage (only on 33311B).

8761A/B Specifications

Characteristic impedance: 50 ohms.

Frequency range: dc to 18 GHz.

Standing-wave ratio

Frequency	SWR		
	7-mm	N	SMA
dc-12.4 GHz	1.15 (1.20)	1.20 (1.25)	1.30 (1.30)
dc-18 GHz	1.20 (1.25)	1.25 (1.30)	1.35 (1.35)

SWR in parentheses applies to switch with built-in termination

Insertion loss: <0.5 dB, dc to 12.4 GHz; <0.8 dB, dc to 18 GHz.

Isolation: >50 dB, dc to 12.4 GHz; >45 dB, dc to 18 GHz.

Power: 10 W average, 5 kW peak; built-in termination rated at 2 W average, 100 W peak.

Switching energy: 1.5 W for 20 ms (permanent magnet latching).

Solenoid voltages: (dc or pulsed): 12 to 15 V, 8761A; 24 to 30 V, 8761B.

Switching speed: 35 to 50 ms (including settling time).

Life: >1,000,000 switching.

Dimensions: 41 x 38 x 38 mm (1.6 x 1.5 x 1.5 in.) excluding connectors and solenoid terminals.

Weight: net, 140 to 220 gm (5 to 8 oz). Shipping, 220 to 300 gm (8 to 11 oz).

How to order 8761A/B switches

Specify solenoid voltage and connectors (including built-in 50-ohm termination) by the alphabetic suffix on the switch model number and the appropriate three-digit option number.

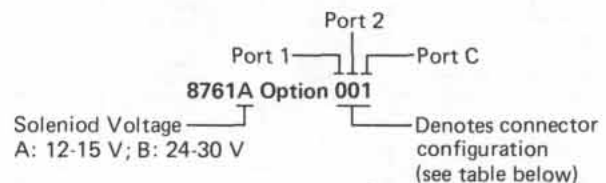

Option Code	Connector Type	Option Code	Connector Type
0	N (f)	4	APC-7 for UT-250 Coax
1	N (m)	5	SMA (f)
2	APC-7	6	SMA (m)
	w/Threaded sleeve		
3	APC-7	7	50 Ω Termination
	w/Coupling nut		

Ordering information

8761A/B order must include option number

8761A/B Coaxial Switch (quantity 1-9)

8761A/B Coaxial Switch (quantity 10-24)

8761A/B Coaxial Switch with 50-ohm termination

33311B Coaxial Switch (quantity 1-9)

33311B Coaxial Switch (quantity 10-24)

33311C Coaxial Switch (quantity 1-9)

33311C Coaxial Switch (quantity 10-24)

Price

\$220

\$210

add \$35

\$395

\$365

\$525

\$485

Adapters, waveguide stands, air lines

Models 281A/B, 292A/B, 11515/6/A, 11524/5/A, 11533/4/A, 11566/7/A, 11588A, 11606A

- Increase versatility of microwave measurements

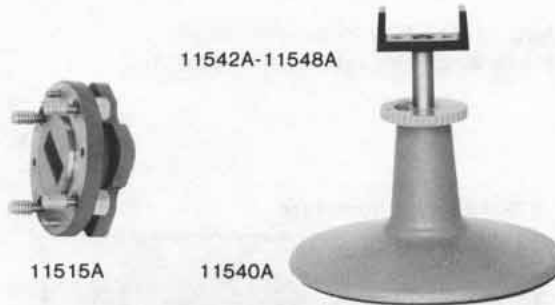

281A/B Specifications

HP Model	SWR	Frequency Range (GHz)	Waveguide Size EIA	Coaxial Connector	W/G Flange UG-() N	Price
S281A	1.25	2.60-3.95	WR284	N Female	53	\$115
G281A	1.25	3.95-5.85	WR187	N Female	149A	\$115
J281A	1.25 ¹	5.30-8.20	WR137	N Female	344	\$95
H281A	1.25	7.05-10.0	WR112	N Female	51	\$85
X281A	1.25	8.20-12.4	WR90	N Female	39	\$75
X281B	12.25	8.20-12.4	WR90	[APC-7] ²	39	\$180
P281B	1.25	12.4-18.0	WR62	[APC-7] ²	419	\$145

1. 1.3 from 5.3 to 5.5 GHz.
2. Option 013. Furnished with stainless steel N-female connector. less \$15

281A/B Coax to waveguide adapters

HP 281A,B adapters transform waveguide transmission line into 50-ohm coaxial line. Power can be transmitted in either direction, and each adapter covers the full frequency range of its waveguide band with SWR less than 1.25.

292A/B, 11515A, 11516A Waveguide to waveguide adapters

Models 292A,B waveguide-to-waveguide adapters connect two different waveguide sizes with overlapping frequency ranges. The 292A consists of a short tapered section of waveguide. The 292B is broached waveguide with a step transition between waveguide sizes.

The 11515A is a square to circular flange adapter for K-band (UG-425 to UG-595). The 11516A is a square to circular flange adapter for R-band (UG-381 to UG-599).

11524A, 11525A, 11533A, 11534A Coax to coax adapters

These coaxial adapters permit easy interconnection of 50-ohm precision 7-mm (APC-7) connectors and 50-ohm Type N or SMA (3-mm type) connectors.

11588A Swivel adapter, 11606A rotary air line

The 11606A rotary air line and the 11588A swivel adapter are capable of a full 360° of rotation. A combination of the air line and the adapter permits rigid coax movement in three dimensions. Even the most awkwardly shaped devices can be easily connected or disconnected in a coax system with the aid of these components. Insertion loss is <0.5dB and uncertainty due to rotation is -57dB.

11566A, 11567A Air line extension

Impedance: 50 ohms.
Frequency: dc-18 GHz.
Reflection coefficient: 0.018 + 0.001 (frequency in GHz).
Connector: APC-7
Length: 11566A: 10.25 cm 11567A: 20.25 cm.
Weight: 0.45 kg (1 lb) net.

11540 Series waveguide stand, waveguide holders

The 11540A waveguide stand locks HP waveguide holders at any height from 70 to 133 mm (2.75" to 5.25"). The stand is 64 mm (2.25") high, and the base measures 121 mm (4.75") in diameter. The waveguide holders are offered in seven sizes to hold waveguide covering frequencies from 3.95 to 40 GHz.

292A/B, 11515A, 11516A Specifications

HP Model	Frequency Range (GHz)	SWR	W/G Size Flange	to	W/G Size Flange	Price
HX292B	8.2-10.0	1.05	WR 112 UG-51/U	to	WR 90 UG-39/U	\$105
MX292B	1.0-12.4	1.05	WR 75 Cover	to	WR 90 UG-39/U	\$150
MP292B	12.4-15.0	1.05	WR 75 Cover	to	WR 62 UG-419/U	\$115
NP292A	15.0-18.0	1.05	WR 51 Cover	to	WR 62 UG-419/U	\$105
NK292A	18.0-22.0	1.05	WR 51 Cover	to	WR 42 UG-595/U	\$115
11515A	18.0-26.5	—	WR 42 UG-425/U	to	WR 42 UG-595/U	\$120
11516A	26.5-40.0	—	WR 28 UG-381/U	to	WR 28 UG-599/U/U	\$120

11524A, 11525A, 11533A, 11534A Specifications

HP Model	Description	Shipping Weight	Price
11524A	[APC-7 to N female]	110 g (4 oz)	\$95
11525A	[APC-7 to N male]	140 g (5 oz)	\$105
11533A	[APC- to SMA male]	140 g (5 oz)	\$135
11534A	[APC-7 to SMA female]	140 g (5 oz)	\$135

11588A, 11606A Specifications

HP Model	Frequency Range 6 Hz	SWR	Connectors	Dimensions mm (in)	Shipping Weight kg (lb)	Price
11588A	DC-12.4	1.1	[7mm, male 7 mm, female]	42 x 59 x 30 (1 3/8 x 2 3/16 x 1 1/16)	0.28 (10 oz.)	\$340
11606A	DC-12.4	1.1	APC-7 7 mm, female	100 x 19 (4 x 3/4)	0.45 (1 lb)	\$275

Ordering Information

Model	Price
11566A Air line extension	\$170
11567A Air line extension	\$195
11540A Waveguide stand	\$30
11542A G-Band	\$25
11543A J-Band	\$15
11544A H-Band	\$15
11545A X-Band	\$15
11546A P-Band	\$20
11547A K-Band	\$15
11548A R-Band	\$15

MICROWAVE TEST EQUIPMENT

Frequency response test sets, 10 MHz to 26.5 GHz

Model 8755 System

- 10 MHz to 26.5 GHz frequency range
- Absolute & ratio measurement capability

- 60 dB dynamic measuring range for each detector
- Excellent stability with time and temperature

8750A Storage-Normalizer



182T Display / 8755B Plug-in
11664A Detectors



8755S SYSTEM

8755S Frequency Response Test System

The 8755S is an economy network measurement system designed to make absolute power and ratio measurements over the 10 MHz to 26.5 GHz frequency range. It is a versatile system capable of solving the majority of scalar (amplitude only) impedance and transmission measurement requirements. The 8755S system consists of the following separate instruments: (1) 8755B Swept Amplitude Analyzer, (1) 182T display unit, (1) 8750A Storage Normalizer, and (3) 11664A Schottky diode detectors.

The 8755B has two independent channels and three detector inputs allowing simultaneous ratio measurement capability. The detectors have a +10 dBm to -50 dBm dynamic range, are interchangeable, and require no calibration. For each channel a resolution of 10, 5, 1, or .25 dB per division is available (also combinations of these, e.g., 15 dB/division) as well as a calibrated offset of ± 59 dB in .25 dB increments. The 8750A Storage-Normalizer connects directly to the 8755B/182T by a single cable to provide digital normalization and storage capability for both channels.

Common measurements made with the 8755 are simultaneous insertion and return loss, amplifier gain and gain compression, and mixer conversion loss and return loss, all on a swept frequency basis. The 8755S system has many features that improve both the accuracy and the versatility compared with other scalar measurement systems.

The 8755B uses an AC detection system which can reject undesired RF signals such as local oscillator feedthrough in mixer measurements and broadband noise in amplifier measurements. The 8755B provides the 27 kHz squarewave drive to AM modulate the RF sweeper output either directly (most HP 8620 RF sweeper plug-ins are directly compatible with the 8755) or by using the 11665B external modulator.

In addition to making absolute or relative power measurements with a single detector, the 8755 will also measure the logarithmic difference in power between two detectors, i.e., ratio measurements. Ratio measurement techniques improve accuracy by providing better equivalent source match and immunity to source power variations. A ratio technique can also allow dynamic range expansion up to 100 dB.

The 8750A Storage-Normalizer improves both the accuracy and convenience of swept frequency measurements. System frequency response error is eliminated by subtracting a digitally stored calibration trace from the measurement trace using the 8750 input minus memory mode. The input minus memory mode also facilitates comparison measurements by providing a single trace display of the difference between two devices. The 8750A has digital storage or flicker-free display so that a complete trace is seen independent of the RF sweep rate. This is a real benefit when device constraints require a slow sweep rate as when making narrow band filter or stepped CW measurements. The 8750A also makes x-y plotting much more convenient by automatically outputting the x, y and penlift signals from digital memory at the push of a single button.

A number of accessories are available for use with the 8755S system to meet most signal separation and filtering requirements. These include the HP 11666A Reflectometer Bridge, the HP 11667A Power Splitter, and the HP 11678 Filter Kits. The HP 11679A and B Extension Cables are also available for use with the 11664 Detectors or the 11666A Bridge to make remote measurements without performance degradation.

Typical applications

Simultaneous insertion and return loss

One common setup for making simultaneous insertion loss and return loss measurements is shown in the diagram following. The R detector in the 11666A measures the incident power while the A detector measures reflected power. The ratio A/R then provides return loss information while the B/R trace displays insertion gain/loss data simultaneously. A display of a bandpass filter measurement using this setup is shown in the photo. The ability to monitor the effects of adjustments on both parameters is especially advantageous. System frequency response error is eliminated using the 8750A *input minus memory* mode. The difference between the measurement and calibration traces is displayed directly, eliminating the frequency response common to both traces. In addition, both the *input minus memory* and the *input* modes of the 8750 provide a flicker-free display independent of the RF sweep rate allowing the complete frequency response to be seen even at very slow sweep rates.

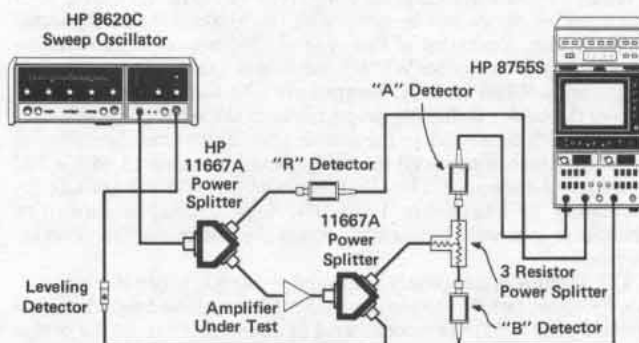
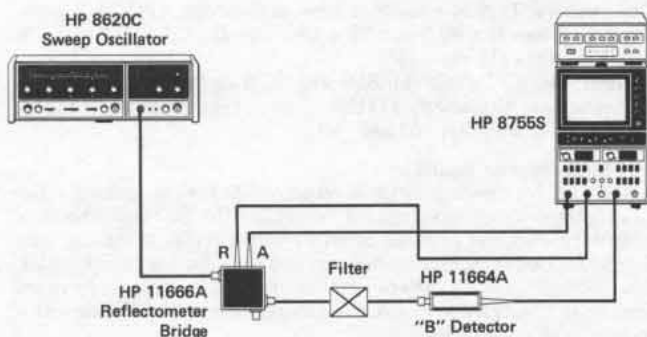
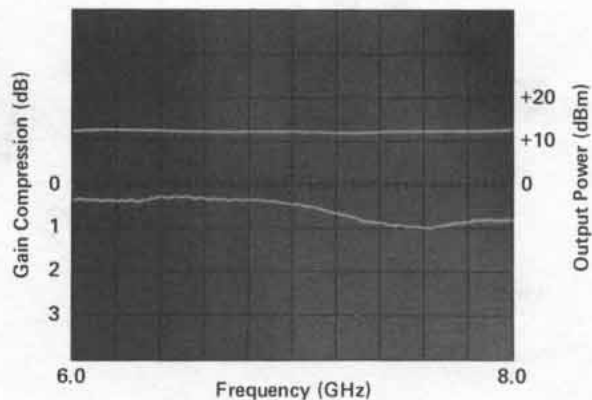
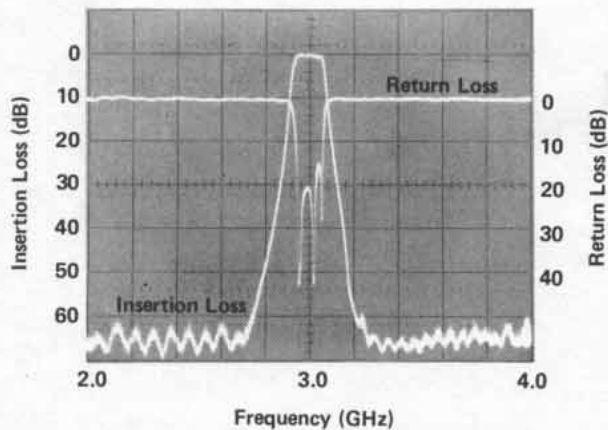

Amplifier gain compression

The ability to make absolute power measurements along with normalized ratio measurements is very useful for amplifier characterization. The top right setup can measure amplifier gain, gain flatness, output power, and gain compression, all on a swept frequency basis. The photo displays the amplifier gain compression and output power over the 6–8 GHz range of the amplifier. The 8750A *input minus memory* mode provides the important ability to compare differences between the small signal gain response with successively compressed gain responses. Once the gain is compressed 1 dB at any frequency the output power indicated by the B detector is the output power for 1 dB gain compression.

Expanded dynamic range

Each detector channel of the 8755 has a 60 dB dynamic range. By using the lower right setup, the dynamic range for each channel is added together to make a 100 dB dynamic range measurement on a lowpass filter. The AC processing of the 8755 allows the detector to reject the broadband noise from the amplifier providing up to 20 dB more dynamic range than would be possible with a DC type detection system. In addition, the full 100 dB dynamic range can be viewed on the CRT display by selecting the 5 and 10 dB per division resolution buttons together, giving 15 dB/division. The amplifier gain variations enter into the measurement as frequency response common to both calibration and measurement traces. The 8750A Storage-Normalizer *input minus memory* mode displays the difference between the calibration and measurement traces thus eliminating the effects of frequency response.

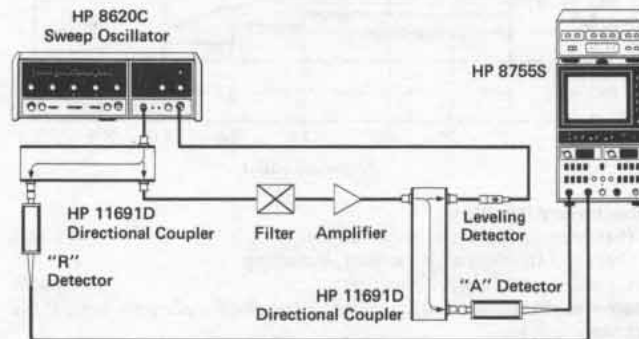
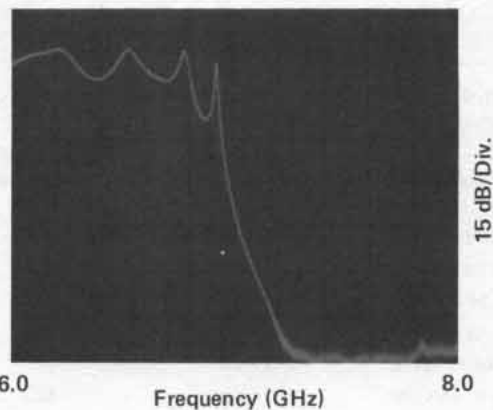



11666A



11665B



11667A

11666A Reflectometer Bridge

Reflection measurements covering from 40 MHz to 18 GHz with one coupling device can be made with the Model 11666A Reflectometer Bridge. Operation of this type of coupling device is based on principles of the resistive Wheatstone Bridge extended to microwave frequencies. When three bridge arms are 50Ω, the voltage across corners of the bridge is directly proportional to the reflection coefficient of the device connected in the fourth arm. Equivalent directivity is then a measure of how well the bridge circuit is balanced with a 50Ω termination connected. (Ideally this would create a voltage null representing infinite return loss.) The high equivalent directivity achievable over wide bandwidths makes the bridge configuration attractive.

The 11666A is completely dedicated to the 8755; two Schottky diode detectors (which sample the incident and reflected signals for ratioing by the 8755) are incorporated as an integral part of the bridge unit. The effective external leveling achieved by ratioing thus isolates the measurement port from source/bridge input mismatch. With the addition of an external 11664A Detector, two simultaneous ratio measurements of insertion and return loss can be made. Small size combined with its wide frequency range and high directivity make the 11666A ideal for production use.

Specifications 11666A (connected to the 8755B Analyzer)

Frequency Range: 40 MHz to 18 GHz.

Frequency Range	Equivalent Directivity	Equivalent Output SWR
40 to 100 MHz	30 dB	1.25
0.1 to 1 GHz	38 dB	1.25
1 to 2 GHz	36 dB	1.25
2 to 4 GHz	33 dB	1.25
4 to 8 GHz	29 dB	1.25
8 to 12 GHz	27 dB	1.27
12 to 18 GHz	26 dB	1.52

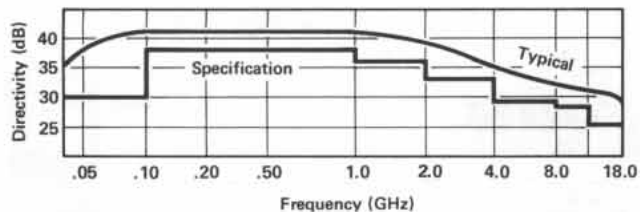

Frequency tracking

(between incident and reflected arms): <3.2dB

(between incident and test port, including 1.1 dB from 11664A Detector): <4.3dB

Nominal coupling: 6-dB incident arm. 9-dB reflected arm. 9-dB transmission loss.

Input SWR: 1.8.

Maximum input power: +15 dBm.

Connectors: Type N-Female on input and output. APC-7 Optional. **Size:** 69.9 mm H x 69.9 mm W x 46.4 mm D (2³/₄" x 2³/₄" x 1⁷/₃₂"). Cable length, 1219 mm (48").

Weight: net, 0.7 kg (1.5 lb). Shipping, 2.26 kg (5.13 lb).

Accessories furnished: 11512A Short, Type N-Male (11565A short, APC-7 with Opt 002 and 003).

11667A Power Splitter

The 11667A Power Splitter is recommended when making wide-band transmission measurements using the 8755 Test Set. This two-resistor type splitter provides excellent output SWR at the auxiliary arm when used for source leveling or ratio measurement applications. The 0.25 dB tracking between output arms over a frequency range from dc to 18 GHz allows wideband measurements to be made with a minimum of uncertainty.

Frequency range: dc to 18 GHz.

Impedance: 50Ω.

	dc-4 GHz	dc-8 GHz	dc-18 GHz
Input SWR:	≤1.15	≤1.25	≤1.45
Equivalent output SWR:	1.10	1.20	1.33
leveling or ratio			
Output tracking: (between output arms)	<0.15 dB	<0.20 dB	<0.25 dB

Insertion loss: 6 dB nominal (input to either output).

Maximum input power: +27 dBm (0.5 watt).

Connectors: Type N female on all ports.

Size: 46 H x 50 W x 19 mm D (1¹³/₁₆" x 2" x 3/4").

Weight: net, 0.06 kg (2 oz). Shipping 0.22 kg (8 oz).

Other signal separation devices

Many other signal separation devices are available from HP for use with the 8755. Coaxial couplers from 0.1 to 18 GHz are available with the 770 series, the 790 series, and the 11692. Higher directivity 752 series waveguide couplers can also be used with the 8755S with the addition of appropriate 281 series waveguide to coax adaptors.

11665B Modulator

Function: absorptive on-off modulator designed for and powered by the 8755B plug-in.

Frequency Range	Return Loss On and Off	Insertion Loss On	Insertion Loss Off
15-40 MHz	≥10 dB	≤7.0 dB	≥35 dB
40 MHz-4 GHz	≥15 dB	≤3.2 dB	≥35 dB
4-8 GHz	≥12 dB	≤3.8 dB	≥40 dB
8-12.4 GHz	≥8 dB	≤4.3 dB	≥45 dB
12.4-18 GHz	≥8 dB	≤5.0 dB	≥45 dB

Modulator drive feedthrough: ≤8 mV (peak) at 27.8 kHz at either port when powered by the 8755B. Reduced to ≤1 mV (peak) using the 11668A. (See 11668A High Pass Filter).

Drive current: nominally +50 mA in ON condition, -50 mA Off condition.

Weight: net, 0.17 kg (6 oz). Shipping, 0.9 kg (2 lb).



11678A



11668A



11679A

11678A Low Pass Filter Kit

The 11678A Low Pass Filter Kit contains five filters conveniently matched to HP 8620 sweeper bands. These filters have <1.1 dB insertion loss at .95 fc with > 40 dB rejection at 1.25 fc. Filter use is recommended to reduce undesirable harmonics causing errors in broadband detector measurements.

Frequency range: low pass filters, cutoff frequency fc: 11688A, 2.8 GHz; 11689A, 4.4 GHz; 11684A, 6.8 GHz; 11685A, 9.5 GHz; 11686A, 13.0 GHz.

Connectors: N-Male, N-Female.

Weight: net 0.44 kg (1 lb). Shipping 1.2 kg (2.9 lb).

11668A High Pass Filter

The 11668A High Pass Filter accessory is recommended when making measurements on active devices which have gain below 50 MHz. Use of the 11668A, placed after the 11665B, reduces the modulator drive feedthrough from 8 mV to 1 mV and prevents possible amplifier saturation. Use of the 11668A filter is not necessary for passive measurements since the feedthrough from the 11665B is -65 dBm and causes no degradation in system performance.

Frequency range: 50 MHz to 18 GHz.

	Insertion Loss	Return Loss
50-100 MHz	≤2.5 dB	≥12 dB
100 MHz-8 GHz	≤1.0 dB	≥16 dB
8-12 GHz	≤1.0 dB	≥14 dB
12-18 GHz	≤1.5 dB	≥14 dB

Maximum input: +27 dBm.

Connectors: N-female, N-male

Weight: 0.13 kg (5 oz). Shipping 0.28 kg (10 oz).

11679A/B Extension Cables

11679A 25-foot Extension Cable and 11679B 200-foot Extension Cable fit directly between 11664A detector and display. Remote detector operation is permitted without performance degradation.

Common System Specifications

Power Measurement Range:

Single Channel: +10 dBm to -50 dBm (noise level).

System Accuracy (Ratio Measurements):

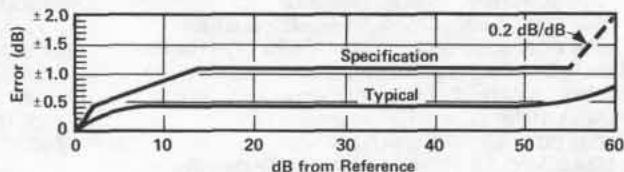

Accuracy curve shows system uncertainty for a relative measurement with +10 dBm incident at the test detector when the 0-dB reference is set. Accuracy when calibration levels below +10 dBm are used remains the same, except the additional 0.2 dB/dB uncertainty should be added for measurements below -45 dBm. This curve includes system noise, offset uncertainty, and crosstalk, and assumes the reference detector power remains fixed between calibration and test. System frequency response is specified separately.

Absolute Measurements:

Absolute power incident on a detector is displayed with respect to the 0 dBm POSITION line when the OFFSET CAL switch is turned

OFF. Accuracy at any power level is typically ±0.5 dB not including detector frequency response or mismatch errors. For applications requiring more precision, increased accuracy can be obtained if the 8755 display is calibrated at a specific power level using a power meter. The stability of the 8755 then permits accurate power measurements repeatable to hundredths of dBs.

General

Resolution: Independent for each channel in steps of 10, 5, 1, or 0.25 dB per division. Combinations of steps can be engaged, e.g. 10 dB/div. and 5 dB/div. to achieve 15 dB/div.

Offset: Independent for each channel. ±59 dB in 1 dB increments.

Graticule: 8755S, 1 Div. ≈1.29 cm. 8755S Option 001, 1 Div. ≈1 cm.

Temperature Range: Operation, 0 to 55°C; storage, -40°C to 75°C.

Power: 48 to 440 Hz, 115/230 V ±10%, typically 100 watts.

8755S Specifications

Consists of:

- 8755B Swept Amplitude Analyzer
- 182T Display
- 11664A Detectors (3 each)
- 8750A Storage Normalizer

Frequency Range: 10 MHz to 18 GHz (determined by the 11664A Detectors)

8755S Option 001 Specifications

Consists of:

- 8755B Swept Amplitude Analyzer
- 180TR Display
- 11664A Detectors (3 each)
- 8750A Storage Normalizer

8755S Option 002 Specifications

Consists of:

- 8755B Swept Amplitude Analyzer
- 182T Display
- 11664A Detector (1 each)
- 11666A Reflectometer Bridge
- 8750A Storage Normalizer

Frequency Range: 40 MHz to 18 GHz (determined by the 11666A bridge).

8755S Option 003 Specifications

Adds 11665B external modulator.

Frequency Range: 15 MHz to 18 GHz (determined by the 11665B modulator).

8755S Option 004 Specifications

Deletes the 8750A Storage Normalizer.

8755S Option 005 Specifications

Consists of:

- 8755B Swept Amplitude Analyzer
- 182T Display
- 11664B Detectors (3 each)
- 8750A Storage Normalizer

Frequency Range: 10 MHz to 26.5 GHz (determined by the 11664B Detectors).

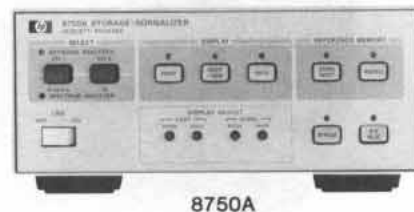

Individual instrument specifications

8755B Plug-in

Function: The 8755B plug-in processes demodulated 27.8 kHz signals from the 11664 Detectors (R,A,B) for logarithmic display on 180 series oscilloscopes.

Resolution: Independent for each channel in steps of 10, 5, 1, or 0.25 dB per division.

Offset: Independent for each channel. ± 59 dB in 1dB increments.

Display units

180 "T" series displays are recommended for use with the 8755B. They provide zero offset recorder outputs, and both positive and negative 5-volt retrace blanking inputs.

Large screen (Model 182T): This display unit is contained in the 8755S standard configuration. It has an 8×10 division internal graticule with 1 div = 1.29 cm. and medium persistence P39 phosphor.

Rack mount (Model 180TR). This display unit is contained in the 8755S Option 001 system configuration. It has an 8×10 division internal graticule with 1 div = 1 cm. and medium persistence P39 phosphor.

The 182T and 180TR are directly compatible with the 8750A Storage-Normalizer. As a result of the 8750A compatibility, the 182T and 180TR cannot be used with time domain plug-ins.

Variable persistence/storage (Model 181T, Cabinet Model 181TR, Rack Mount): These displays can be ordered individually for use with the 8755B. Because they offer CRT storage, they have not been made compatible with the 8750A Storage-Normalizer. They have an 8×10 division internal graticule with 1 div = 0.95 cm. and offer variable persistence phosphor for storing single or multiple traces.

11664A Detectors

Function: Designed specifically for use with the 8755B Swept Amplitude Analyzer, the 11664A detects the envelope of the 27.8 kHz modulated microwave signal. It uses a biased Schottky diode to achieve -50 dBm sensitivity.

Frequency range: 10 MHz to 18 GHz.

Tracking between two 11664A Detectors:

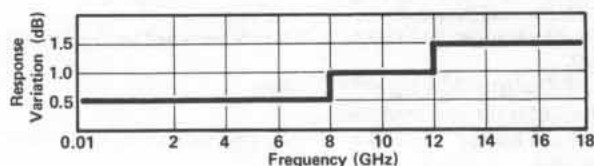

Typical frequency response:

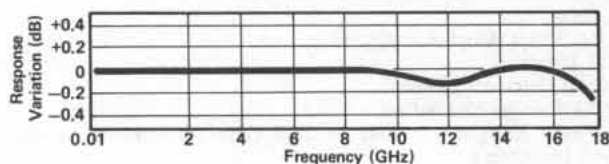

Return loss:

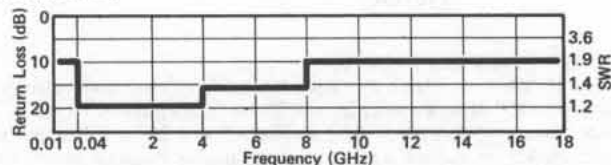

Impedance: 50 ohms nominal

Connector: N-Male.

11664B Detectors

Frequency range: 10 MHz to 26.5 GHz.

Tracking between two 11664B Detectors: Tracking between two detectors at the same power level is typically < 2 dB from 10 MHz to 26.5 GHz.

Return Loss:

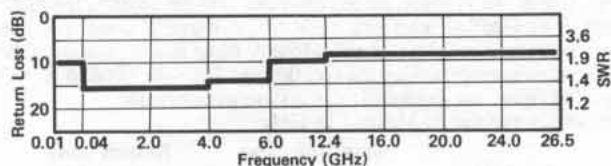

Connector: APC 3.5 Male.

8750A Storage-Normalizer

Function: Provides digital storage display and digital normalization for both channels of the 8755. The 8750A connects directly to the 8755B/182T via a single cable.

Ordering information

The 8755S system and its options are configured of separate instruments and components solely for ordering convenience. If a different display or optional connectors are desired, each part of the system should be listed separately.

	Price
8755S Complete Test Set	\$6050
Opt 001: Rack mount version	no charge
Opt 002: deletes (2) 11664 Detectors, adds	add \$1700
11666A Reflectometer Bridge	
Opt 003: adds 11665B Modulator	add \$500
Opt 004: deletes 8750A Storage-Normalizer	less \$1450
Opt 005: Replaces (3) 11664A with (3) 11664B	add \$600
8755B Test Set Plug-in only	\$1800
11665B 15 MHz 18 GHz Modulator	\$500
11664A 10 MHz 18 GHz Detector	\$300
Opt 001: APC-7 Connector	add \$25
11664B APC 3.5 10 MHz to 26.5 GHz Detector	\$500
182T Large Screen Cabinet Scope Display	\$1900
180TR Standard Screen Rack Display	\$1900
181T Storage, Cabinet Display	\$2600
181TR Storage, Rack Display	\$2700
11666A Reflectometer Bridge	\$2300
11679A 7.6 m (25 ft) Detector Extension Cable	\$55
11679B 61 m (200 ft) Detector Extension Cable	\$225
11668A 50 MHz High Pass Filter	\$250
11667A DC to 18 GHz Power Splitter	\$600
11678A Low Pass Filter Kit	\$650
Individual filters: specify model number	\$130



415E

The Hewlett-Packard Model 415E SWR Meter is a low noise, tuned amplifier-voltmeter calibrated in dB and SWR for use with square law detectors. It is an extremely useful instrument for measuring SWR, attenuation, and gain directly from metered scales, or as a tuned amplifier for driving an X-Y recorder when making RF substitution measurements. The 415E responds to a standard tuned frequency of 1000 Hz. This frequency is front panel adjustable over a range of 7% for exact matching to the internal 1 kHz modulation of the signal source being used. Amplifier bandwidth is also adjustable from 15 to 130 Hz. The narrow bandwidth allows maximum sensitivity at CW frequencies while the wider bandwidths enable swept tests to be displayed on an oscilloscope or X-Y recorder.

A precision 60 dB attenuator with an accuracy of 0.05 dB/10 dB assures high accuracy in making substitution measurements. An expand-offset feature allows any 2 dB range to be expanded to full scale for maximum resolution. Linearity is ± 0.02 dB on expanded ranges and is limited only by meter resolution on normal scales. This performance, together with the inherently low noise figure, allows maximum measurement range with exceptional resolution and linearity.

The Model 415E operates with either crystal or bolometer detectors. Both high and low-impedance inputs are available for crystal detectors. Precise bias currents of 4.5 and 8.7 mA (200 Ω) are available for operation with bolometers as selected at the front panel. This bias is peak limited for positive bolometer protection.

Both ac and dc outputs located on the rear panel allow use of the 415E as a high-gain tuned amplifier or for X-Y recorder operation. In addition, the 415E can be operated with an internally mounted battery pack (option 001) for completely portable use.

Specifications

Sensitivity: 0.15 μ V rms for full-scale deflection at maximum bandwidth (1 μ V rms on high impedance crystal input).

Noise: at least 7.5 dB below full scale at rated sensitivity and 130 Hz bandwidth with input terminated in 100 or 500 Ω ; noise figure less than 4 dB.

Range: 70 dB in 10 and 2-dB steps.

Accuracy: ± 0.05 dB/10 step; maximum cumulative error between

any two 10 dB steps, ± 0.10 dB; maximum cumulative error between any two 2 dB steps, ± 0.05 dB; linearity, ± 0.02 dB on expand scales, determined by inherent meter resolution on normal scales.

Input: unbiased low and high impedance crystal (50-200 and 2500-10,000 Ω optimum source impedance respectively for low noise); biased crystal (1 V into 1 k Ω); low and high current bolometer (4.5 and 8.7 mA $\pm 3\%$ into 200 Ω), positive bolometer protection; input connector, BNC female.

Input frequency: 1000 Hz adjustable 7%; other frequencies between 400 and 2500 Hz available on special order.

Bandwidth: variable, 15-130 Hz; typically less than 0.5 dB change in gain from minimum to maximum bandwidth.

Recorder output: 0-1 V dc into an open circuit from 1000 Ω source impedance for ungrounded recorders; output connector, BNC female.

Amplifier output: 0-0.3 V rms (Norm), 0-0.8 V rms (Expand) into at least 10,000 Ω for ungrounded equipment; output connector, dual banana jacks.

Meter scales: calibrated for square-law detectors; SWR: 1-4, 3.2-10 (Norm); 1-1.25 (Expand). dB: 0-10 (Norm); 0-2.0 (Expand); battery: charge state.

Meter movement: taut-band suspension, individually calibrated mirror-backed scales; expanded dB and SWR scales greater than 108 mm (4 $\frac{1}{4}$ ") long.

RFI: conducted and radiated leakage limits are below those specified in MIL-I-6181D.

Power: 115-230 V $\pm 10\%$, 50-400 Hz, 1 W; optional rechargeable battery provides up to 36 hr continuous operation.

Size: 115 H, 190 W, 279 mmD, (6 $\frac{3}{32}$ " x 7 $\frac{25}{32}$ " x 11").

Weight: net 4 kg (9 lb). Shipping 5.8 kg (13 lb).

Ordering information

415E SWR Meter	Price
Opt 001: rechargeable battery installed	\$800 add \$105
Opt 002: rear panel input connector in parallel with front panel connector	add \$25

NETWORK ANALYZERS

Complete characterization of linear networks



Why network analysis?

Characterizing the behavior of linear networks that will be stimulated by arbitrary signals and interfaced with a variety of other networks is a fundamental problem in both synthesis and test processes. For example, the engineer designing a multicomponent network must predict with some certainty the final network performances from his knowledge of the individual components. Similarly, a production manager must know allowable tolerances on the products he manufactures and whether the final products meet the specified tolerances. Network analysis offers a solution to these problems through complete description of linear network behavior in the frequency domain.

Network analysis accomplishes the description of both active and passive networks by creating a data model of such component parameters as impedances and transfer functions. However, these parameters not only vary as a function of frequency but are also complex variables in that they have both magnitude and phase. Until the advent of the modern network analyzer, phase was difficult to measure at CW frequencies and often involved laborious calculations; these measurements were accomplished by conventional oscilloscopes at lower frequencies and slotted lines at microwave frequencies. However, swept network analyzers now measure magnitude and phase (the total complex quantity) as a function of frequency with less difficulty than conventional CW measurements. Impedance and transfer functions can then be conveniently displayed on a swept CRT, X-Y recorder, or computer controlled

peripherals such as a printer and/or a plotter. HP computers also combine with network analyzers to give new levels of speed and accuracy in swept measurements that could only be attained previously by long calculations at CW frequencies.

Thus, network analysis satisfies the engineering need to characterize the behavior of linear networks quickly, accurately, and completely over broad frequency ranges. In design situations, this minimizes the time required to test new designs and components, allowing more time to be spent on the design itself. Likewise, production test times may be minimized while reducing the uncertainties surrounding the test.

What is network analysis?

Network analysis is the process of creating a data model of transfer and/or impedance characteristics of a linear network through sine wave testing over the frequency range of interest. All network analyzers in the HP product line operate according to this definition.

Creating a data model is important in that actual circuit performance often varies considerably from the performance predicted by calculations. This occurs because the perfect circuit element doesn't exist and because some of the electrical characteristics of a circuit may vary with frequency.

At frequencies above 1 MHz lumped elements actually become "circuits" consisting of the basic elements plus parasitics like stray capacitance, lead inductance, and unknown absorptive losses. Since parasitics depend on

the individual device and its construction they are almost impossible to predict. Above 1 GHz component geometries are comparable to a signal wavelength, intensifying the variance in circuit behavior due to device construction. Further, lumped-element circuit theory is useless at these frequencies and distributed-element (or transmission-line) parameters are required to completely characterize a circuit.

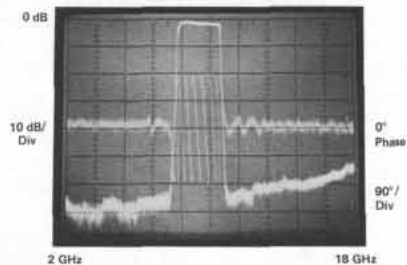

Figure 1. 2 GHz to 18 GHz measurement of magnitude and phase in a single sweep

Data models of both transfer and impedance functions must be obtained to completely describe the linear behavior of a circuit under test. At lower frequencies, h , y , and z -parameters are examples of transfer and/or impedance functions used in network description; at higher frequencies, S -parameters are used to characterize input-output impedances and transfer functions. Therefore, a network analyzer must measure some form of a circuit's transfer and impedance functions to achieve its objective of complete network characterization.

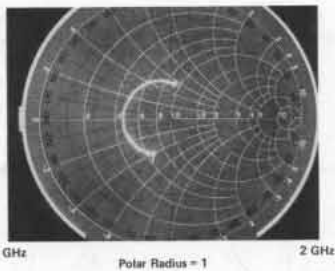

Figure 2. Input impedance of microcircuit amplifier is read directly with Smith Chart Overlay for Polar Display

Network analysis is limited to the definition of linear networks. Since linearity constrains networks stimulated by a sine wave to produce a sine wave output, sine wave testing is an ideal method for characterizing magnitude and phase response as a function of frequency. In non-linear measurements phase is often meaningless and amplitude has to be defined with respect to individual frequency components. For nonlinear measurements see sections on spectrum analyzers and wave analyzers.

Network analyzers

Hewlett-Packard Network Analyzers are instruments that measure transfer and/or impedance functions of linear networks through sine wave testing. A network analyzer system accomplishes these measurements by configuring its various components around the device under test. The first requirement of the measurement system is a sine wave signal source to stimulate the device under test. Since transfer and impedance functions are ratios of various voltages and currents, a means of separating the appropriate signals from the measurement ports of the device under test is required. Finally, the network analyzer itself must detect the separated signals, form the desired signal ratios, and display the results.

Signal sources and signal separation

In the general case, any sine wave source meeting the network analyzer's specifications can be used to stimulate the device under test. For CW measurements a simple oscillator may suffice; for greater CW frequency accuracy a signal generator or synthesizer may also be desirable. If the analyzer is capable of swept measurements, great economies in time can be achieved by stimulating the device under test with a sweep oscillator or sweeping synthesizer. This allows quick and easy characterization of devices over broad frequency ranges. Some network analyzers will operate only with a companion source which both stimulates the device under test and acts as the analyzer's local oscillator.

At low frequencies it is not particularly difficult to separate the appropriate voltages and currents required for transfer and impedance function measurements. Signal separation is merely the process of establishing the proper shorts, opens, and connections at

the measurement ports of the device under test. As frequencies increase, the problem of signal separation usually involves traveling waves on transmission lines and becomes correspondingly more difficult. Hewlett-Packard manufactures test sets (often called "transducers") applicable for separating the appropriate traveling waves in a variety of high frequency measurements.

Broadband and narrowband detection

After the desired signals have been obtained from the test set (or transducer) they must be detected by the network analyzer; HP network analyzers can use one of two detection methods. Broadband detection accepts the full frequency spectrum of the input signal while narrowband detection involves tuned receivers which convert CW or swept RF signals to a constant IF signal. There are certain advantages to each detection scheme.

Broadband detection reduces instrument cost by eliminating the IF section required by narrowband analyzers but sacrifices noise and harmonic rejection. However, noise is not a factor in many applications, and careful measurement techniques, using filters, can eliminate harmonic signals that would otherwise preclude accurate measurements. Broadband systems are generally source independent while some narrowband systems require companion tracking sources. Finally, broadband systems can make measurements where the input and output signals are not of the same frequency, as in the measurement of the insertion loss of mixers and frequency doublers. Narrowband systems cannot make these measurements.

Narrowband detection makes a more sensitive low noise detection of the constant IF possible. This allows increased accuracy and dynamic range for frequency selective measurements (as compared to broadband systems) and high resolution through IF substitution using precision IF attenuators. Source dependent narrowband systems utilize a companion tracking source not only to stimulate the device under test but also to produce a signal offset from the RF by a fixed frequency for tuning the analyzer's constant IF.

Signal processing and display

Once the RF has been detected, the network analyzer must process the detected signals and display the measured quantities. All HP network analyzers are multichannel receivers utilizing a reference channel and at least one test channel; absolute signal levels in the channels, relative signal levels (ratios) between the channels, or relative phase difference between channels can be measured depending on the analyzer. Using these measured quantities, it is possible to either display directly or compute the magnitude and phase of transfer or impedance functions.

Magnitude measurements fall into two categories, relative and absolute; absolute measurements involve the exact signal level in each channel while relative measurements involve the ratios of the two signal channels.

Absolute measurements are usually expressed in voltage (dBV) or in power (dBm). The units dBV are derived by taking the log ratio of an unknown signal in volts to a one volt reference. Similarly, dBm is the log ratio of unknown signal power to a one milliwatt reference.

Relative ratio measurements are usually made in dB which is the log ratio of an unknown signal (Test Channel) with a chosen reference signal (Reference Channel). This allows the full dynamic range of the instrumentation to be used in measuring variations of both high and low level circuit responses. For example, 0 dB implies the two signal levels have a ratio of unity while ± 20 dB implies a 10:1 voltage ratio between two signals.

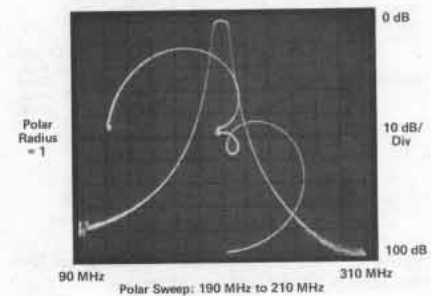

Figure 3. Simultaneous measurement of transmission response and passband reflection coefficient

All network analyzer phase measurements are relative measurements with the reference channel signal considered to have zero phase. The analyzer then measures the phase difference of the test channel with respect to the reference channel.

Measurement results at CW frequencies may be displayed on analog meters, LEDs or computer controlled printers. Swept frequency measurements of amplitude and phase may be displayed versus frequency on CRTs or X-Y plotters. The addition of digital storage and normalization to network analyzer CRT's assures flicker-free traces and removal of frequency response errors for fast, real-time displays of test device responses versus frequency.

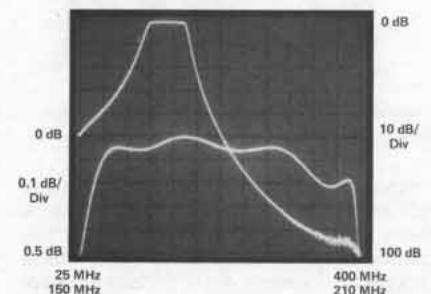

Figure 4. Automatic alternate sweep for coincident measurement of filter passband and skirts

Low frequency network analysis

Networks operating at frequencies below 10 MHz are generally characterized by measuring the gain and phase changes through the network and the associated input and output impedances; h , y , and z -parameters as well as other lumped-component models are typical analytical and computational tools used to represent these measurements. The first derivative of phase with respect to frequency, group delay, is an important measurement of distortion in communication systems. Hewlett-Packard produces a broad line of instrumentation capable of measuring all of these parameters.

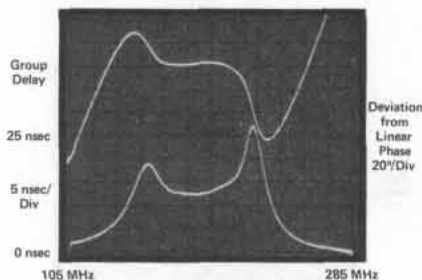

Figure 5. Two independent techniques for measuring filter phase distortion

Phase information complements amplitude data in the measurement of low frequency parameters because it is more sensitive to network behavior and because it is a required component of complex impedance and transfer functions. For instance, phase is more sensitive than amplitude in determining the frequency of network resonances (poles) and anti-resonances (zeroes). This is because the phase shift of a network transfer function is exactly zero at the frequency of resonance. Phase information is also vital in circuit design, particularly loop design, where phase margins are critical.

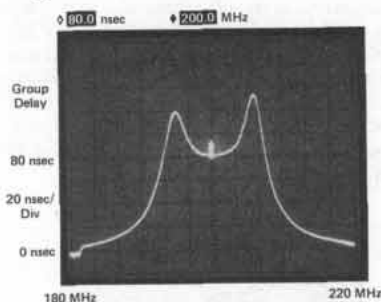

Figure 6. Direct Measurement of Group Delay with digital readout at marker

Phase data are also required to measure delay distortion or group delay of networks. Delay distortion occurs when different frequency components of a complex waveform experience nonlinear phase shifts as they are transmitted through a network. Group delay is a measure of this distortion and is defined as:

$$T_g = \frac{d\theta}{d\omega}$$

There are several techniques for measuring group delay; the most common techniques are phase slope, amplitude modulation, frequency modulation, and frequency deviation. Most HP network analyzers can make measurements with at least one of these techniques while several analyzers measure and display group delay directly. Choice of a group delay measurement technique is dependent on the particular device under test and the resolution required.

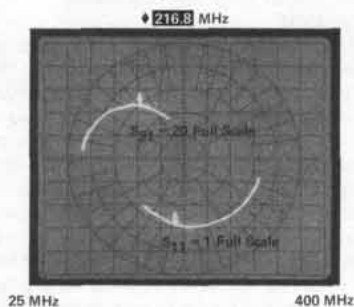

Figure 7. Simultaneous measurement of transistor S-parameters

An alternative method for measuring phase distortion is deviation from linear phase or differential phase. Deviations from linear phase can be measured by introducing enough electrical length in the network analyzer's reference channel to linearize a device's phase shift. Once this has been accomplished it is possible to observe any variations in phase shift linearity at high resolution. Since group delay is the derivative of phase ($\frac{d\theta}{d\omega}$), nonlinearities in phase shift correspond directly to changes in a device's group delay. Introduction of electrical length in the measurement channel may be accomplished by physically adding cable, or it may be accomplished electronically on some network analyzers.

At lower frequency (typically ≤ 50 kHz) digital signal analysis using Fast Fourier Transformations (FFT) can also be used to determine the magnitude and phase of transfer characteristics. This subject is treated in the Signal Analysis section of this catalog.

High frequency network analysis

Total voltage and current along a transmission line begin to vary periodically with distance as frequency increases. Consequently it becomes difficult to establish the required shorts and opens in the correct measurement plane to determine low frequency parameters. Transmission-line theory explains the variations in total voltage and current at high frequencies through forward and reverse traveling waves. Thus, traveling waves are the logical variables to measure at higher frequencies.

Scattering parameters or S-parameters were developed to characterize linear networks at high frequencies. S-parameters de-

fine the ratios of reflected and transmitted traveling waves measured at the network

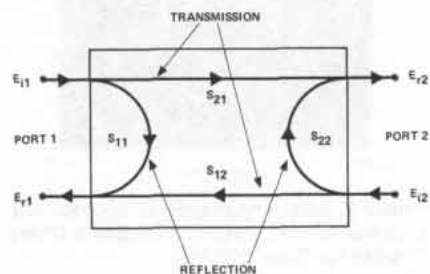

Figure 8. S-parameter model for a two-port linear network

ports. S_{11} is the complex reflection coefficient at port 1 and is the ratio of E_{r1}/E_{i1} , if $E_{i2} = 0$ (port 2 terminated in its characteristic impedance). S_{21} is the complex transmission coefficient from port 1 to port 2, E_{t2}/E_{i1} , if $E_{i2} = 0$. E_i and E_r are normalized voltages (voltage divided by the square root of the characteristic impedance) and represent the amplitude and phase of the incident and emerging or reflected traveling waves. By reversing the ports and terminating port 1 in its characteristic impedance, S_{22} and S_{12} can be similarly defined. From these definitions, the following equations can be derived:

$$E_{r1} = S_{11}E_{i1} + S_{12}E_{i2}$$

$$E_{r2} = S_{21}E_{i1} + S_{22}E_{i2}$$

where incident signals act as independent variables determining the signals leaving the network. The definition of an S-parameter can be easily extended to multiport networks; measurement is also easily accomplished by terminating additional ports in their characteristic impedances. Thus, S-parameters completely describe linear network behavior in the same manner as low frequency parameters.

S-parameters offer numerous advantages to the microwave engineer because they are both easy to use and easy to measure. They are easy to measure because the device is terminated in its characteristic impedance which is accurate at high frequencies, allows swept broadband frequency measurement without tuning, enhances the stability of active devices, and permits a test set up to be used for different devices. The design process is simplified because S-parameters are directly applicable to flow graph analysis. HP network analyzers and the appropriate test sets will measure and directly display S_{21} or S_{12} as gain or attenuation and S_{11} or S_{22} as reflection coefficient, return loss or impedance. Also, S-parameters may be directly related to h , y , and z -parameters through algebraic transformations.

Additional capabilities

The computational capabilities of a digital computer can complement the network analyzer's versatility through simplifying and speeding measurements, data processing, and accuracy enhancement. Hewlett-Packard has integrated network analyzers

into computer systems and now offers some analyzers that may be easily interfaced with HP desktop computers through the Hewlett-Packard Interface Bus.

Precision design work and important manufacturing tolerances demand highly accurate measurements, but most errors in network measurements are complex quantities that vary as a function of frequency, making manual error correction prohibitive. However, the computer can make great contributions to measurement confidence by quickly and easily performing the complex mathematics for sophisticated error correction.

Aside from new levels of accuracy, computer controlled network analyzers can be programmed to set up and make many measurements automatically. The measurement process is further accelerated by the computer's ability to store, transform, summarize, and output data in a variety of formats on a number of peripherals. These capabilities make the computer controlled network analyzer ideal for both computationally aided design or automatic production testing.

Network analyzer product line

Hewlett-Packard offers a complete line of network analyzers capable of measurements through the 1 Hz to 40 GHz frequency range. Further information and detailed specifications on individual network analyzers are available on the following pages (see matrix for specific page numbers).

3575A

The 3575A measures Phase and Amplitude or Gain. With the 3575A, the complete response picture is available at a reasonable cost from a single instrument, over an 80 dB range, from 1 Hz to 13 MHz. The 3575A uses a broadband measurement technique, which is attractive because the measurement is not constrained by internal tracking source or dedicated external device. The 3575A is not dependent on the wave shape, thus measurements can be made on a variety of waveforms such as triangle and square waves.

3040A/3042A

The 3040A is a network analysis system capable of measuring amplitude and phase to 13 MHz. Group delay is an optional capability. The system consists of a synthesizer signal source and a two-channel tracking detector. Measurement applications include filter design and production, amplifier testing, delay measurements on communication devices, and measurements on any linear two-port device.

The 3042A is a fully automatic system which uses the HP 9825A Desktop Computer as a computing controller. The memory, computational power and decision-making power of the computing controller extend the measurement solutions to complex networks in the lab or rapid production line testing. Accuracy can be improved by subtracting system errors from the measurements by using the memory and algebraic powers of the computer and supplied software.

8407A

The 8407A network analyzer tracks the 8601A generator/sweeper (or the 8690B/8698B sweeper) from 100 kHz to 110 MHz. Measurement capabilities include:

- 1) Transmission (gain, loss, phase shift) and reflection (return loss, impedance) measured quickly and easily in either 50Ω or 75Ω by sweeping over the frequency range of interest.
- 2) Complex impedance [Z], θ , or $R \pm jX$ over the wide impedance range 0.1Ω to >10 kΩ.
- 3) Voltage and current transfer functions.
- 4) High impedance in-circuit probing.

A rectangular and polar display and various CRT overlays permit direct readings of parameters of interest as frequency is swept. Applications are detailed in Application Notes 121-1, 121-2.

8405A

The 8405A vector voltmeter is a dual-channel RF millivoltmeter and phasemeter. It reads the absolute voltages on either of two channels and simultaneously determines the phase relationship between them. CW measurements can be made over the frequency range 1 MHz to 1 GHz.

Besides its use as a voltmeter, applications of the 8405A include:

- 1) Transmission measurements (gain, loss, phase shift and return loss) in 50Ω systems.
- 2) Group delay and amplitude modulation index.
- 3) In-circuit probing.
- 4) S-parameters in 50Ω systems.

Application Notes 77-1, 77-3, 77-4, and 91 are available for more detail on the above measurements.

8754A

The 8754A is a completely integrated stimulus/response system for testing a wide variety of networks (like filters, amplifiers, and attenuators) in the 4 to 1300 MHz frequency range. By combining a swept source, three channel tuned receiver, and polar/rectilinear CRT display into a single compact package outstanding performance can be achieved at an economical price. Magnitude, phase, polar reflection coefficient and impedance are all measured directly over 80 dB of spurious free dynamic range. Frequency accuracy is provided by a crystal marker system and since three receiver inputs are available, network transmission and reflection parameters can be measured simultaneously. Additionally, a complete line of 50Ω and 75Ω power splitters, transmission/reflection test sets, and S-parameter test sets, are available. High impedance probe can also be used if necessary and an external signal generator can be used directly to characterize narrow-band devices like crystal filters.

8505A/8507B

The 8505A Network Analyzer provides measurement capability from 500 kHz to 1.3 GHz. Three RF input ports, each with 100 dB of dynamic range, makes possible simultaneous network measurements of reflection

and transmission parameters. Two independent yet identical display channels are each capable of displaying magnitude, phase, deviation from linear phase and group delay of either the transmission or reflection characteristics of an RF network. These parameters can be displayed in rectangular, in polar coordinates or both formats at the same time. The swept source, which is an integral part of the analyzer, offers extreme frequency flexibility through seven different modes of operation.

The 8507B is an Automatic Network Analyzer using the 8505A with HP-1B interface and the HP 9825A Desktop Computer as a controller. The "Learn" mode of operation extends the traditional automatic operation to a new level of operator convenience. Accuracy enhancement, formatting of data, and the speed and ease with which data can be accumulated and summarized are all network measurement contributions made by the 8507B.

8410B/8409A

The 8410B network analyzer system measures the transmission and reflection characteristics of linear networks in the form of gain, attenuation phase shift, reflection coefficient, normalized impedance and S-parameters in the frequency range of 110 MHz to 40 GHz.

Harmonic frequency conversion of the RF to a constant IF is accomplished by the 8411A Harmonic Frequency Converter from 110 MHz to 12.4 GHz; the 8411A option 018 operates from 110 MHz to 18 GHz. In the frequency ranges 18–26.5 GHz (K-band) and 26.5–40 GHz (R-band), the K8747A and R8747A Reflection/Transmission Test units use crystal mixers and a local oscillator to heterodyne the signals down into the range of the 8410B/8411A. In this manner, waveguide components can be measured from 18 to 40 GHz.

The 8410B is a radiometer using both reference and test signal inputs; consequently, the sweeper output must be divided into channels. This is accomplished by a "Test Set" whose other major function can be to provide the switching required for making transmission and reflection measurements with minimum or no changes in the measurement setup. Hewlett-Packard offers a total of twelve different test sets covering various frequency ranges and switching functions.

Another major instrument required in the 8410 measurement system is a unit for the detection and display of the IF amplitude and phase. Three plug-in displays (for the 8410B mainframe) are available for this purpose: a phase-gain indicator with meter readouts for CW measurements; a phase-gain display for displaying log amplitude and phase versus frequency; and a polar display for displaying amplitude and phase in polar coordinates.

The 8410B is capable of swept measurements over multi-octave bands through 18 GHz. Between 18 GHz and 40 GHz, 2 GHz windows may be viewed. Measurements of

NETWORK ANALYZERS

Complete characterization of linear networks (cont.)

more than 60 dB of attenuation and 40 dB of gain are possible.

The HP 8409A Semi-Automatic Network Analyzer System is a practical solution to the need for automatic error-corrected RF and microwave network measurements using a

simple and economical configuration. It is a complete measurement system consisting of the programmable 8620C Sweeper, the 8410B Network Analyzer System, and the 9825A Desktop Computer. It brings the major advantages in accuracy, speed, data col-

lection, and operating convenience at a modest cost increase over the manual network analyzer system. Further information is available in Application Notes 117-1, 117-2 and 221.

NETWORK ANALYZER PRODUCT LINE SUMMARY

Model	Frequency Range	Source	Measurement Capabilities
3575A Gain Phase Meter Page 456	1 Hz-13 MHz	None	Gain, Phase and Amplitude Low Frequency Analysis
3040A Manual Network Analyzer Page 453	50 Hz-13MHz	3320A/B or 3330A/B	Amplitude and Phase Optional Group Delay Gain or Loss Linear Frequency Sweep
3042A Automatic Network Analyzer Page 454	50 Hz-13MHz	3330B Synthesizer	9825A HP-IB System Controller Complex Network Analysis Decision Making Ability Computational Capability
3582A Spectrum Analyzer Page 518	20 mHz to 25.599 kHz	Built-in source that is selectable as either random or pseudorandom. The noise signal is automatically band-limited and band-translated to match the analysis.	Transfer function amplitude and phase. Coherence function. Transient capture and analysis.
5420A Digital Signal Analyzer Page 522	16 mHz-25.6 kHz	Built-in random noise source.	Transfer function, coherence, power spectral density, Histogram, time record average, impulse response.
5451C Fourier Analyzer Page 524	DC to 50 kHz	Optional random pseudo-random or periodic source.	Same as 5420A
8407A Network Analyzer Page 468	100 kHz-110MHz	8601A Generator/Sweeper 8690B/8698B Sweep Oscillator	Transfer Functions, Impedance in 50 Ω , 75 Ω Systems Complex Impedance 0.1 Ω to >10 k Ω High Impedance In-Circuit Probing S-parameters in 50 Ω , 75 Ω systems
8405A Vector Voltmeter Page 470	1 MHz-1GHz (CW)	3200B Oscillator, VHF Signal Generators, 608E (VHF), 612A (UHF) 8654 (UHF), and 8640 A/B	Voltmeter Transfer Functions, Impedance in 50 Ω systems Group Delay, Amplitude Modulation Index S-parameters in 50 Ω systems
8754A Network Analyzer Page 458	4-1300 MHz	Swept source included external source usable.	Magnitude and phase transmission coefficient reflection coefficient and return loss S-parameters, impedance.
8505A RF Network Analyzer Page 460	500 kHz-1.3GHz	Swept Source Included	Complex Transfer functions—Gain/Loss or S-parameters Complex Impedance—T, Return Loss, R \pm jX Distortion—Group Delay, Deviation from Linear Phase Digital Readout of Data while sweeping Frequency Counter included HP-IB with Learn Mode
8507B Automatic RF Network Analyzer Page 466	500 kHz-1.3GHz	Swept Source Included	9825A Desktop Computer with 8505A HP-IB with Learn Mode Automatic Measurements with Data formatting Accuracy Improved Measurements
8410B Network Analyzer Page 471	110 MHz-40GHz	8620 or 8690 Series Sweep Oscillators	Transmission/Reflection Characteristics, S-Parameters 50 Ω Coax Measurements 110 MHz to 18 GHz Waveguide Measurements 8.2 GHz to 40 GHz Continuous Multioctave Measurements with 8620 Series Sweepers DC Bias for Semiconductor Measurements
8409A Semi-Automatic Network Analyzer Page 478	110 MHz-18GHz	8620C Series Sweep Oscillators	Semi-Automatic Transmission/Reflection Measurements Full Error Correction in Reflection Measurements 8410B Network Analyzer System 9825A Desktop Computer

NETWORK ANALYZERS

Network analysis from 50 Hz to 13 MHz

Model 3040A



- High resolution digital amplitude and phase measurements
- 100 dB dynamic range
- Precision digital sweep capability
- Narrow band analysis
- Optional group delay and limit test
- Full digital control via HP-IB



Description

The 3040A Network Analyzer is designed to meet the demand for precise and fast characterization of both active and passive linear two-port devices. The Network Analyzer is a powerful bench system that makes digital amplitude, phase and group delay response measurements over a 50 Hz to 13 MHz frequency range. It uses the 3330B Automatic Synthesizer with leveled output and digital sweep capability to generate the local oscillator signal for the 3570A Tracking Receiver and to provide the stimulus to the device under test.

This system effectively combines the wide dynamic range and the high accuracy of the 3570A Tracking Receiver with the high resolution, and stability of the 3330B Synthesizer, giving the design, production and Q.A. engineers working at audio, video and RF frequencies the precision, convenience, and high information content of swept-frequency response measurements, but with the point by point accuracy of synthesized incremental frequency sweeps.

Residual FM, often a serious limitation to the frequency resolution of swept frequency measurements, is very low ($\ll 1$ Hz) in the 3040A System, allowing accurate narrow band sweeps.

The 3570A Analyzer (Tracking Receiver) has two identical channels for fast, high accuracy "B-A" measurements of gain or insertion loss of two-port devices and to measure the phase shift between input and output ports. It can also function as a limit comparator to determine how closely the gain and phase response of a device matches that of a reference.

Both the passband and the stopband of a device can be examined in detail because the 3570A Analyzer has both a wide amplitude range of 120 dB (1 μ V to 1 V) and a high resolution display (0.01 dB increments). The digital readout also displays phase readings with 0.01° resolution.

Beyond the basic amplitude and phase measurements, the 3040A offers several automatic features not found in more conventional network analyzers.

One is Digital Offset: Values of amplitude and/or phase measured on a reference device are stored in the instrument's memory at the push of a button. Future measurements can then be displayed relative to the stored values. This could be used, for example, to quickly find the -3 dB passband limits of a filter or amplifier.

Another feature is Group Delay: As the synthesizer is stepped in frequency, the analyzer's internal digital processor calculates group delay from two phase shift measurements as $T_d = \Delta\phi/360\Delta f$ sec.

A third one is Limit Test: High and low limits can be entered as digital words from an external controller. The analyzer can be set to stop or output a marker when a limit is reached. This capability is useful, for example, to precisely find the center frequency of a resonant circuit by stopping at the 0° phase reading.

The 3040A Network Analyzer introduces precision, convenience and built-in "intelligence" to the problem of characterizing the behavior of linear networks on the bench.



NETWORK ANALYZERS

Automatic network analysis from 50 Hz to 13 MHz

Model 3042A

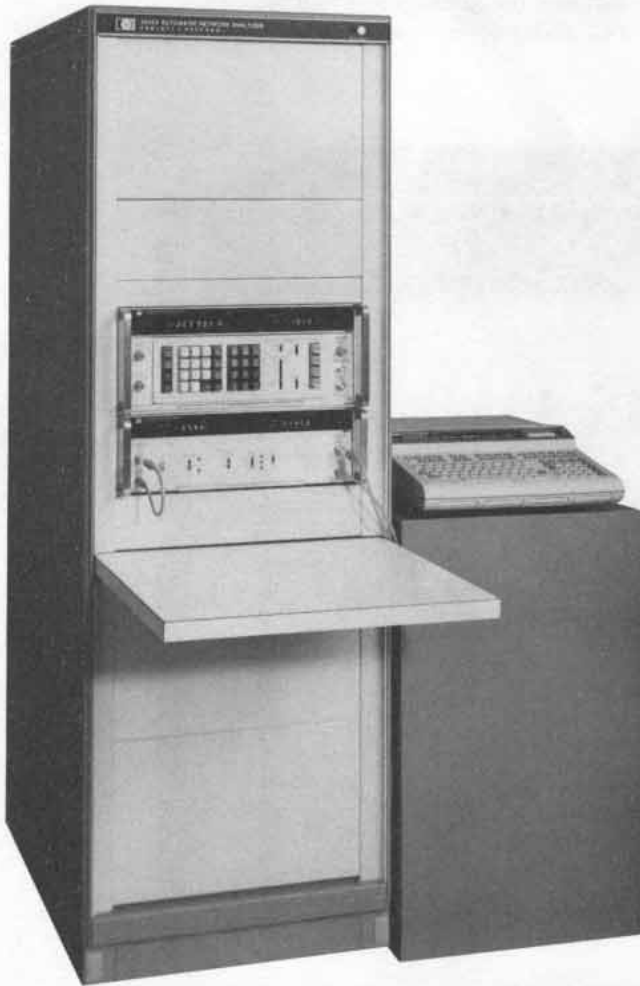

3042A Automatic Network Analyzer

HP-IB

Description

The 3042A Automatic Network Analyzer is a highly powerful, fully automatic system that is designed to meet the demand for precision, speed, automation, simple operation and low cost in the area of fully characterizing active or passive linear two-port devices.

The 3042A system uniquely integrates the:

- wide dynamic range and high resolution of the 3570A Network Analyzer (tracking receiver)
- accuracy and high stability of the 3330B Synthesizer and
- the power computation, data processing and smart peripheral control capabilities of the 9825A System Controller

into a superior systems performance that results in a unique set of contributions to solve the problem of characterizing the behavior of linear two-port over the wide frequency range of 50 Hz to 13 MHz:

- Amplitude, phase and group delay measurement
- Wide amplitude range and high resolution
- Speed and precision in measurements
- Simplicity and flexibility in operation
- Data analysis and presentation of results
- Simple programming and powerful output
- Accuracy enhancement and decision making
- Full automation and substantial reduction in costs

- Full automation and low cost
- Speed and precision in measurements
- Accuracy enhancement of results
- Data analysis and presentation of results
- Simplicity and flexibility in operation
- HP-IB systems interfacing
- 9825A Computing Controller

The 3042A is a fully automatic two-channel Network Analyzer System that provides digital amplitude, phase and group delay measurements, on line data analysis, data reduction and decision making capability plus formatted graphic or tabular representation of results or data storage for further processing at a later time.

Environments such as production, quality assurance and the laboratory are now provided with the capability of extending precision network analysis to applications that were previously impractical because of the length of time it took to make the necessary measurements.

Production applications

In production applications the 3042A substantially reduces the time and cost of making a range of simple or complicated test on all types of components, for example, crystals, amplifiers, filters and other analog devices. The system can run through a long series of tests on a device, checking performance at all specified points and deliver a simple pass/fail answer.

Additionally, automatically compiled test data provides excellent production statistics for improved production control, more precise scheduling and accurate production cost analysis.

Testing programs with built-in operator instructions minimize the requirements for highly trained technicians, as well as training costs. Furthermore, uniform test procedures may easily be established. The 3042A's impact in the production environment can lend directly to a substantial increase in total production throughput while at the same time increasing the number of test parameters, resulting in greater product confidence and lower production cost.

Quality assurance applications

In quality assurance applications the 3042A not only significantly reduces the cost of test equipment necessary to assure a comprehensive product testing job, but the system's inherent flexible HP-IB interface structure allows the system configuration to be easily changed by either simple software modifications or hardware additions. Adapting the 3042A System to an application, which may require a programmable power supply or contact closure to drive the device under test, becomes as simple as connecting the additional instruments via the standard HP-IB connector, loading a different program from the computing controller's cassette and running it. Skilled technicians may be relieved from repetitive yet demanding tasks and placed in positions that maximize the use of their knowledge and skills. The 3042A provides reliable and repeatable results. Various parameters may be tested in greater detail and in less time, resulting in greater product confidence and quality, but lower warranty costs.

Automatically compiled test data provides excellent quality assurance statistics which can easily be presented in any formatted graphic or tabular form by an HP-IB plotter or line printer.

Laboratory applications

In laboratory applications, engineers gain greater insight into their circuit design due to the speed and ease with which data can be accumulated and summarized with the 3042A. The easy-to-use calculator programming format allows easy-to-write, customized programs which solve specialized measurement problems in a fraction of the time required to manually perform and evaluate the same measurements or to write a corresponding computer program. In addition, the accuracy enhancement software furnished with the 3042A System significantly increases the accuracy of the system seven times over that of a single channel measurement (three times over a "B-A" measurement), by judiciously combining the capabilities of the instruments and the controller.

System control and interface

The 3042A Automatic Network Analyzer incorporates the new 9825A Computing Controller as systems controller, operator interface and data processor. The 9825A offers the power and speed of much larger computers but features a high level programming language and editing capabilities that allow nearly instant use of the system with minimal effort.

System-operator interface is greatly simplified through the 9825A's alphanumeric display and typewriter-like keyboard.

The 9825A controller offers easy programmability which requires minimal training. Versatile editing capability for reducing programming time. Immediate feedback on errors made due to improper instructions. Availability of large user memory for lengthy program or data storage. Cartridge convenience for permanent storage of programs or data and flexibility for input and output functions.

Summary

The 3042A Automatic Network Analyzer provides a complete solution to production, quality assurance and laboratory applications at audio, video and RF frequencies with accurate, reliable, repeatable and fast results plus the high information content that automatic gain-phase-delay measurements can give.

Specifications 3040A and 3042A systems

Sources (Channel A & B outputs are isolated and electrically identical)

Frequency

Range: 0.1 to 13,000,999.9 Hz.

Resolution: 0.1 Hz (9 digits).

Amplitude

Range: +13.44 to -86.55 dBm (50Ω).

+11.68 to -88.31 dBm (75Ω option).

Resolution: 0.01 dB.

Accuracy

Leveled frequency response (10 kHz reference)*

10 Hz	13 MHz
±0.05 dB	+13.44 dBm
±0.1 dB	-16.55 dBm
±0.2 dB	-36.55 dBm
±0.4 dB	-66.55 dBm
	-86.55 dBm

*Add 0.5 dB for leveling switch in off position.

Attenuator: (10 kHz reference, 25°C ± 5°C) ±0.2 dB/10 dB step of attenuation down from maximum output.

Absolute: (10 kHz, maximum output, 25°C ± 5°C) ±0.45 dB.

Stability: (24 hr., 25°C ± 1°C): ±0.01 dB.

Impedance: 50 or 75Ω (optional) ±2%.

Receivers (Channel A & B inputs are electrically identical and both tuned precisely to the signal source's frequency)

Frequency

Range: 50 Hz to 13 MHz.

Resolution: 0.1 Hz.

Selectivity: 10 Hz, 100 Hz and 3 kHz bandwidths (60 dB/3 dB bandwidths, 20:1).

Amplitude: (Output is in dB relative to 1 V, 0 dBm or 0.1 V, corresponding to the position of the "Max/Ref Input Voltage" switch.)

Measurement range: 1 V rms to 1 μV rms.

Dynamic range: 0 to -100 dB (using A or B amplitude function), -100 dB to +100 dB (using B-A amplitude function).

Resolution: 0.01 dB.

Accuracy: (25°C ± 5°C): Accuracy of the 3042A is enhanced with software supplied with the system from 50 Hz to 10 MHz and over the top 20 dB of the dynamic range as shown below.

Frequency response: A or B "Amplitude Function" ±0.5 dB; B-A "Amplitude Function" ±0.1 dB; using Accuracy Enhancement Software ±0.03 dB furnished with 3042A system.

Linearity: (A or B amplitude function)

0 to -20 dB	$\left\{ \begin{array}{l} \pm 0.2 \text{ dB} \\ \pm 0.06 \text{ dB with Accuracy Enhancement} \end{array} \right.$
-20 to -80 dB	
-80 to -100 dB	

Stability (8 hr., 25°C ± 1°C after 3 hr. warmup)

100 Hz & 3 kHz BW	Temp. Coefficient (20°C-30°C)			
		±0.05 dB	±0.08 dB	±0.02 dB/°C
10 kHz BW		±0.08 dB	±0.15dB	±0.05 dB/°C
	0 dB			
	-20 dB		-80 dB	

Phase (Phase reference is channel A)

Range: -179.5° to +179.5° (display recycles).

Resolution: 0.01°.

Accuracy: (25°C ± 5°C).

Frequency response (Channel at 0 dB)

±0.8°	±0.2°	±1°
50 Hz	100 Hz	1 MHz
		13 MHz

Amplitude response Channel B within 6 dB of Channel A

0 dB	-20 dB	-70 dB	-80 dB
±0.4°	±0.6°	±1°	

For channels at different levels (specification determination by lowest input).

0 dB	-20 dB	-60 dB	-80 dB*
±1.3°	±1.5°	±3.5°	

*Only specified to -70 dB for frequencies from 50 Hz to 60 kHz.

Linearity: ±0.2° (Channel B within 6 dB of Channel A).

Input impedance: 1 MΩ ±2% shunted by <30 pF.

General

Programmability: all controls, except power switches, are programmable using the HP-IB format.

Ultra-high accuracy: the 3040A/3042A systems can be coupled with an external device such as a calibrated attenuator to provide relative measurements whose amplitude accuracy is limited to the amplitude stability of the receiver and source and the accuracy of the external device.

3040A Options

The basic 3040A system options are listed below. For more information refer to the 3040A/3042A data sheet.

(Order Opt 110 or 111 and Opt 120 or 121)

110: Standard 50Ω 3570A	\$7170
111: Standard 75Ω 3570A	\$7170
112: Delay/Limit Test/Offset (Hardware)	\$490
113: Cable and Load Kit	\$95
120: Standard 50Ω 3330B	\$7860
121: Standard 75Ω 3330B	\$7860

3042A Options

The basic 3042A system options are listed below. For more information refer to the 3040A/3042A data sheet.

200: 50Ω System	N/C
201: 75Ω System	N/C
204: 1201B Oscilloscope	\$2970

The 3042 system is fully integrated, tested, verified and specified as a system. It is supplied with complete software and documentation.

3042A Automatic Network Analyzer \$25,580

Consisting of: 3330B Synthesizer, 3570A Network Analyzer, 9825S which has as standard 24k Bytes of memory, ROMs, Interface and documentation, 56" Rack.

NETWORK ANALYZERS

Gain/phase meter

Model 3575A

- dBV, dB ratio and degrees from 1 Hz to 13 MHz

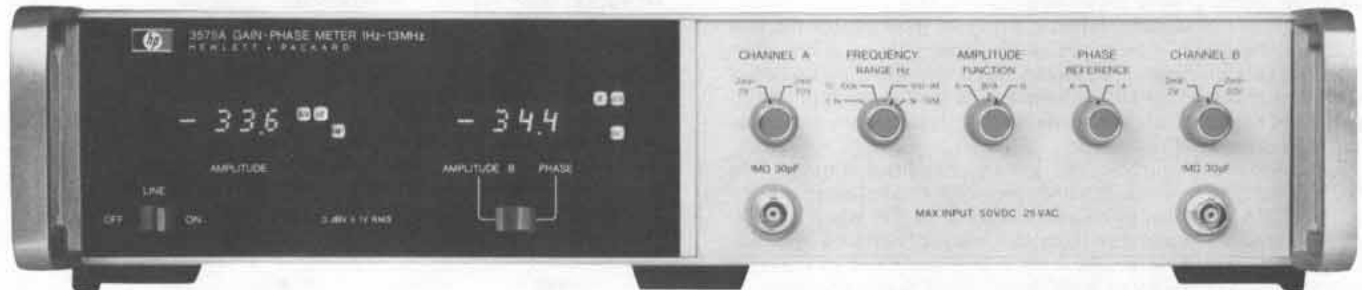

3575A Option 001 dual panel meters

Description

The HP 3575A Gain-Phase Meter is a versatile two-channel analyzer which can measure and display the absolute amplitude level or amplitude ratio of signals present at the inputs. In addition, the 3575A can measure the phase relationship of the two signals. This analyzer is a broadband detector which is easy to use because no frequency tuning is required.

Since a dedicated tracking source is not required to operate with the 3575A, a wide selection of stimuli is possible. This flexibility coupled with a variety of possible amplitude, gain and phase outputs (LED display, analog outputs, and optional BCD) give you a wide choice of cost/results tradeoffs. For example, you may wish to manually plot your network response data on a Bode diagram in which case a low cost sine wave oscillator stimulus may be used. For easier, quicker results you may select a sweeping oscillator and an x-y plotter and let the instruments plot your response. You may use a calculator or computer to control a programmable stimulus source and the 3575A to provide automatic measurements. Here you have a wide range of computation and output possibilities.

Phase

The phase relationship of two signals is indicated over a range of ± 192 degrees with 0.1 degree resolution. A unique logic circuit (patent) design allows the 3575A to make stable phase measurements in the presence of noise. This feature minimizes the error to less than two degrees for a signal-to-noise ratio of 30 dB. One of three band limiting filters may be selected to get further noise rejection.

The 3575A is also capable of measuring the phase relationship of a variety of waveforms, such as square waves and triangle waves. Even harmonic and in-phase odd harmonic components of these signals cause no phase measurement error. For out-of-phase odd harmonic signal-to-harmonic ratios of 40 dB, measurement errors are less than 0.6 degree as shown in Figure 1.

Amplitude

The amplitude of either channel or the ratio of the two can be measured over an 80 dB dynamic range and 100 dB measurement range. Resolution is 0.1 dB. Results are displayed in dBV for channel amplitude and dB for ratio measurements. Digit blanking and channel overload annunciators will turn on if the maximum allowable signal level at either channel input is exceeded.

Readout

The standard three-digit LED display may be selected by the operator to indicate the amplitude of channel A or B, gain or phase. A second three-digit LED display is optionally available for simultaneous display of amplitude and phase readings. Lighted annunciators identify the measurement function, units and remote status.

Programmable

Two programmable options both offer full control of front panel functions and BCD output of information (amplitude, ratio or phase) contained in both digital displays. The two options give the user a choice of negative true or positive true outputs.

Applications

The 3575A can solve network analysis problems in the 1 Hz to 13 MHz frequency range where complex measurements (gain or phase or both) are required. A few of the many measurements it can make are: gain and phase response of feedback systems, envelope delay and return loss of transmission lines, complex impedance of components, and insertion loss of mixers and frequency doublers. Bode plots and Nichols charts are useful graphical tools for analyzing many of these response data.

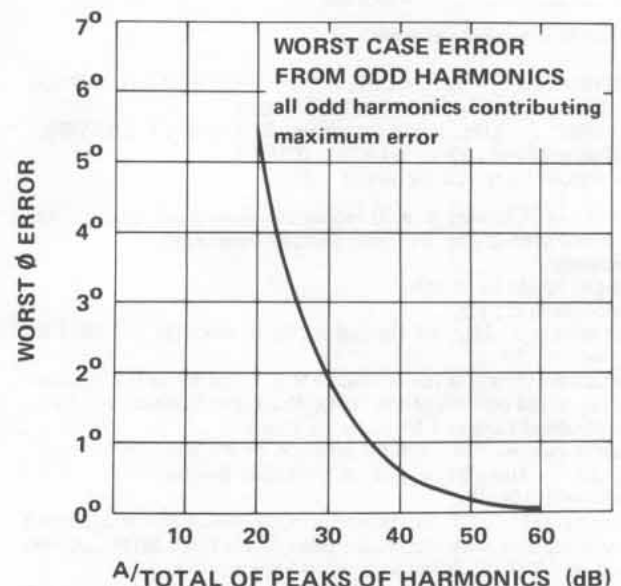
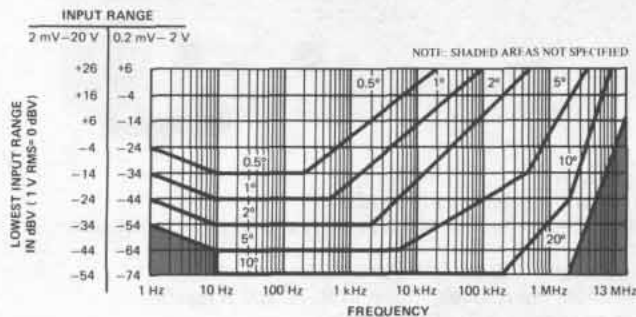

Figure 1. Worst case error from odd harmonics.

Specifications

Phase accuracy*



*Conditions: Temperature: 25°C ± 10°C; Frequency range switch on lowest applicable range; Analog Output accuracy (rear panel).

Input signal range: 200 μV rms to 20 V rms.

Harmonic rejection

Even harmonics: no error.

Odd harmonics: (in phase) no error.

Odd harmonics: (out of phase) 0.57° worst case error when total odd harmonic distortion is 40 dB below the fundamental.

Noise tolerance: 2° error for a 10 kHz, 1 V sine wave on one channel. One volt sine wave added to Gaussian noise (limited to a 1 MHz bandwidth and 30 dB S/N ratio) on the other channel. The 100 Hz to 1 MHz frequency range was used.

Display

Range: ± 180° with 12° of overrange.

Resolution: 0.1°.

Panel meter accuracy: ± 3 counts (0.3 degrees dB/dBV). The panel meter error must be added to the phase and amplitude errors to obtain the display error.

Inputs

Impedance: 1 MΩ 30 pF.

Protection: ± 50 V dc, 25 V rms.

Response time to achieve 90% of final reading

Frequency Range	Time
1 Hz to 1 kHz	20 s
10 Hz to 100 kHz	2 s
100 Hz to 1 MHz	0.2 s
1 kHz to 13 MHz	20 ms

Rear terminal inputs are available as a special (3575A-C09). Digital (Opt. 002). 0, +5 ground true. Twelve lines to fully program all functions.

Outputs

Analog

Phase: 10 mV/degree.

Amplitude: 10 mV/dB or dBV.

Output impedance: 1 kΩ

Digital (Opt 002): 0, +5 V ground true. 31 output lines (1-2-4-8 BCD).

Digital readout: 3½ digits with sign and annunciators. Four readings per second, fixed.

Amplitude accuracy*

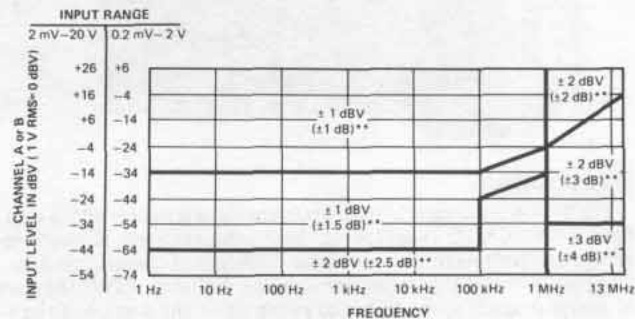

*Conditions: Temperature: 25°C ± 10°C; accuracy applies to dB V and ratio measurements with the same frequency on both channels; for ratio measurements, the lowest level channel determines accuracy; analog output accuracy (rear panel).

**Ratio (B/A) tolerances

Amplitude functions: A dBV, B dBV or B/A dB.

Amplitude reference: (A dBV, B dBV) 1 V rms = 0 dBV.

Display

Range: A dBV, B dBV: -74 dBV to +26 dBV (in two ranges). B/A dB: -100 to +100 dB. (Both input signals must be within the range of 0.2 mV rms to 20 V rms)

Resolution: 0.1 dBV, 0.1 dB.

Options

001 Dual panel meters: HP's 3575A Opt 001 is equipped with two digital readouts and two analog outputs for simultaneous amplitude and phase readings. This option has no additional measurement capability over the standard instrument.

Dual analog outputs: rear panel BNC connectors provide dc output voltages that correspond to the respective panel meter readings.

002/003 Programmable: 3575A Opt 002 and Opt 003 are equipped with dual panel meters and dual analog outputs (same as Opt 001) plus BCD outputs and complete remote control capability. Opt 002 has negative true output levels and Opt 003 has positive true output levels. BCD information from the 3575A (Opt 002) can be read by the 9800 series HP Calculators with appropriate interfacing.

908: Rack Flange Kit.

General

Power: 115 V/230 V ± 10%, 48 Hz to 60 Hz, 40 VA.

Weight: net, 8.3 kg (18.4 lb). Shipping, 11.3 kg (25.8 lb).

Size: 88 mm H x 425 mm W x 337 mm D (3¹⁵/₃₂" x 16³/₄" x 13¹/₄").

Accessories furnished: extender boards, line cable and 50-pin connector (Opt 002 and 003 only).

Options

001: Dual Readout

002: Programmable (negative true output levels)

003: Programmable (positive true output levels)

908: Rack Flange Kit

910: Extra Product Manual

Price

add \$550

add \$980

add \$980

add \$10

add \$23

3575A Gain/Phase Meter

\$3200



Network Analyzers

RF Network Analyzer, 4 MHz to 1300 MHz
Model 8754A

- 4 to 1300 MHz frequency coverage
- Integrated source, receiver, and display
- Three inputs, two measurement channels
- 80 dB dynamic range

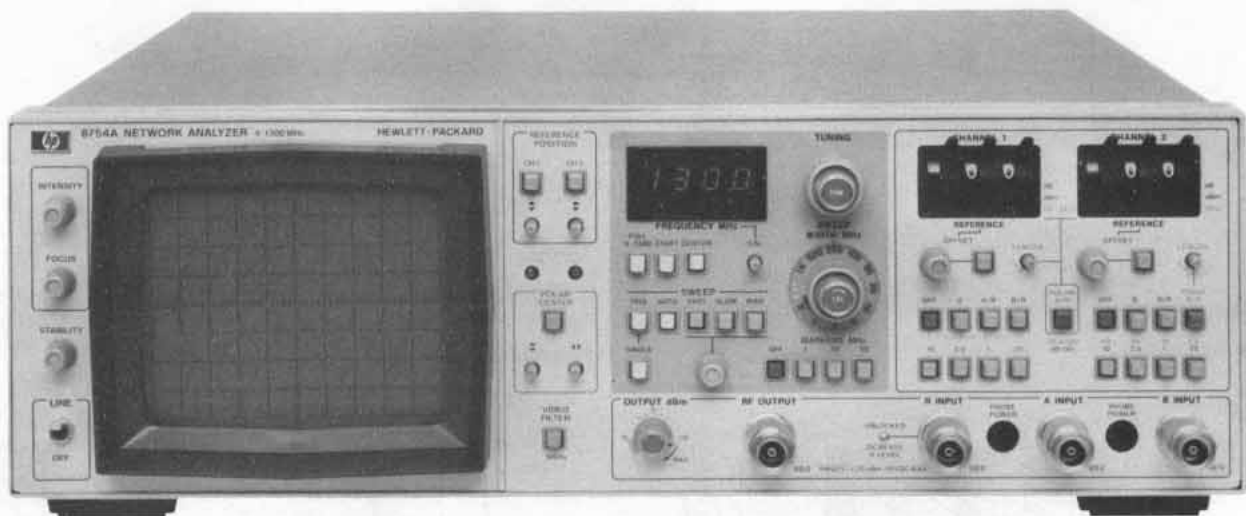

Description

The 8754A is a complete stimulus/response test system which combines a 4-1300 MHz swept source, three-input narrowband, tuned receiver, and both rectilinear and polar displays in a compact package. The convenient built-in source incorporates digital display of the start or center frequency, the ability to sweep all or any portion of the 4-1300 MHz range, and crystal markers at 1, 10, or 50 MHz intervals to enable accurate frequency calibration and measurement. The receiver provides 80 dB dynamic range in two independent measurement channels to allow simultaneous measurement of any two transmission or reflection parameters using a single test setup. Measurements of absolute power, magnitude ratio, phase angle, and reflection coefficient are displayed on the fully calibrated CRT with resolutions up to 0.25 dB and 2.5 degrees per major division. With these features the 8754A offers a new level of operating convenience and technical performance to swept magnitude and phase measurements in laboratory, production, and field testing applications at an economical price.

A comprehensive line of 50Ω and 75Ω test sets allow maximum versatility in a wide range of applications. Matched cable sets, precision adapters, and transistor fixtures provide convenient reliable connections to the test device. Adding the 8750A Storage-Normalizer provides flicker-free rectilinear displays regardless of sweep rate and eliminates the need for grease pencils through automatic normalization of frequency response errors. In applications where the test device response changes rapidly over the 7 kHz residual FM spectrum width, stabilized sources such as the HP 8660 or HP 8640 signal generators can be used directly to provide the necessary signal stability and accuracy.

8754A Network Analyzer Specifications

Source

Frequency range: 4 MHz to 1300 MHz.

Sweep modes: Linear full sweep (4 MHz to 1300 MHz) and calibrated sweep widths with variable start or center frequency.

Sweep widths: Selectable sweep width ranges from 1 to 1000 MHz in a 1, 2, 5 sequence, plus CW. A vernier allows continuous adjustment of sweep width within each range.

Digital frequency readout: Indicates start or center frequency with 1 MHz resolution.

Markers: Internal, crystal-generated harmonic markers at 50, 10, or 1 MHz intervals ($\pm 0.01\%$ accuracy).

Output power range: 0 to typically +13 dBm; ± 0.5 dB flatness.

Spectral purity (+10 dBm RF output level):

Residual FM (swept and CW): ≤ 7 kHz RMS (10 kHz bandwidth).

Harmonics: -28 dBc.

Receiver

Frequency: 4 MHz to 1300 MHz.

Input Channels: Two test inputs (A and B) and one reference (R) input.

Impedance: 50Ω (≤ 1.22 SWR).

Maximum input level: 0 dBm at R, A, and B inputs.

Damage level: +20 dBm (50 Vdc).

Noise level: < -80 dBm, A and B inputs.

Minimum R input level: -40 dBm (≥ -40 dBm required to operate R input phase-locked).

Crosstalk between channels: > 83 dB.

Magnitude frequency response (flatness): Absolute (A, B): $\leq \pm 1$ dB, Ratio (A/R, B/R): $\leq \pm 0.3$ dB.

Magnitude dynamic accuracy (20 - 30°C): ± 0.3 dB from 0 to -50 dBm, ± 0.5 dB from -50 to -60 dBm, ± 1 dB from -60 to -70 dBm, ± 2.5 dB from -70 to -80 dBm.

Magnitude reference offset range: ± 199 dB in 1 dB steps ($\pm 0.1\%$). Vernier provides variable offset for calibration.

Absolute power measurements (A, B, and R): Typically ± 0.5 dBm at 0 dBm, 50 MHz input.

Phase frequency response: $\pm 2.5^\circ$.

Phase range: $\pm 180^\circ$

Phase dynamic accuracy: $\pm 2^\circ$ from 0 to -50 dBm. $\pm 4^\circ$ from -50 to -70 dBm.

Phase reference offset range: $\pm 199^\circ$ in 1° steps ($\pm 1\%$). Vernier provides variable offset for calibration.

Electrical length/Reference plane extension: Typically 0 to 16 cm length for transmission phase; typically 0 to 8 cm reference plane extension adjustment at reflection test port.

Display

Measurement functions: CRT displays either polar trace or Channel 1 and Channel 2 rectilinear traces.

Reference position: Independent reference lines for Channel 1 and Channel 2 and Polar center can be set to any position.

Video filter: Typically 100 Hz (10 kHz without filter).

Graticule size: Rectilinear, 10 cm by 8 cm; polar 8 cm in diameter.

Smith chart overlays: 2, 1, 0.2, and 0.1 full scale.

CRT photography: Tektronix C-5B Oscilloscope Camera is recommended. (UV illumination will not provide graticule exposure.)

Resolution: 10, 2.5, 1, 0.25 dB/major division. 90, 45, 10, 2.5°/major division.

Accuracy: $\pm 2\% \pm 0.05$ divisions for rectilinear trace; within 2.5 mm for polar trace.

General

Input/Outputs

Sweep output: $-5V$ to $+5V$.



8748A



8502A



11850A



11851A

External sweep input: 0 to 10V nominal.
X-Y recorder/External CRT output:
 Horizontal and vertical: 0.1V/div.
 Penlift/Blanking: +5V Blanking and Penlift.
External marker input: Typically -13 dBm RF signal produce a marker at the frequency of the RF signal.
Magnitude/Phase Output: -10 mV/Degree and -100 mV/dB.
Probe power: Two +15 Vdc and -12.6 Vdc.
Storage-Normalizer interfaces: Directly compatible with the HP 8750A Storage-Normalizer. HP 8501A Storage-Normalizer requires a single internal adjustment for compatibility.
Programming connector: Outputs include magnitude/phase and sweep outputs and inputs described above as well as measurement mode selection by TTL levels or contact closures.
External source: The 8754A sweep-out voltage is provided to frequency modulate (sweep) an external signal generator for narrow-band measurement applications. A sweep input is provided to synchronize the CRT display for use with an externally swept source (8620 Series).
Temperature:
 Operating: 0° to 55°C except where noted.
 Storage: -40°C to +75°C.
EMI: VDE 0871/0875 and CISPR publication 11.
Safety: Conforms to the requirements of IEC 348.
Power: Selection of 100, 120, 220 and 240V +5% -10%. 48 to 66 Hz, 20 VA max.
Size: 425.5 mm wide, 133 mm high, 505 mm deep (16 1/4 in x 5 1/4 in x 19 3/4 in).
Weight: Net 16.8 kg (37 lb). Shipping 19 kg (42 lb).

11850A 50Ω Three-Way Power Splitter
11850B 75Ω Three-Way Power Splitter
General: One output port provides the reference output and the other two output ports can be used for independent transmission measurements. Use the 11851A RF Cable Set for interconnections. Detailed specifications on page 464.

8502A 50Ω Transmission/Reflection Test Set
8502B 75Ω Transmission/Reflection Test Set
General: Contains a power splitter and directional bridge to allow simultaneous transmission and reflection measurements. Use the 11851A RF Cable Set for interconnections. Detailed specifications on page 464.

11851A RF Cable Set
General: Three 61 cm (24") 50Ω cables, phase matched to ±4° and one 86 cm (34") 50Ω cable. Used with 8502A/B and 11850A/B. Detailed specifications on page 465.

11857A APC-7 Test Port Extension Cables
General: Two precision 50Ω cables phase matched to ±2° to connect text device between 8748A test ports. Detailed specifications on page 465.

Transistor fixtures
General: Three transistor fixtures can be used with the 8748A. The 11600B and 11602B require use of the 11858A Transistor Fixture Adapter. The 11608A transistor fixture connects directly to the 8748A. Detailed specifications on pages 475 and 476.

Adapter kits
General: The 11853A, 11854A, 11855A, and 11856A accessory kits are available to provide precision Type N and BNC adapters and calibration standards for use with the 11850A/B, 8502A/B, and 8748A test setups. Detailed specifications on page 465.

8748A 50Ω S-parameter Test Set Specifications
Frequency range: 4 MHz to 1.3 GHz
Directivity: ≥40 dB.
Frequency Response:
 Transmission¹(S₂₁, S₁₂): ±1 dB, ±12°
 Reflection¹(S₁₁, S₂₂): ±2 dB, ±15°.
Port match²:
 Test Port 1 and 2: ≥26 dB Return Loss (≤1.11 SWR).
 Test Port 1 and 2 open/short ratio: ≤±0.75 dB and ±6° from 4 to 1000 MHz; ≤0.9 dB and ±7.5° from 1000 MHz to 1300 MHz.
 RF input port: ≥20 dB Return Loss (≤1.22 SWR).
Tracking between reference and test port 1 and 2: S₂₁, S₁₂: ≤±0.5 dB, ≤±4°. S₁₁, S₂₂: ≤±0.75 dB, <±6°. RF input to test port 1 or 2: ≤±1.5 dB.
Maximum operating level: +20 dBm.
RF attenuator range: 0 to 70 dB in 10 dB steps.
Test port connectors: APC-7.
DC bias input range: ±30 Vdc, ±200 mA.
Includes: Cables for connection to 8754A and Reference Plane Extension Cables for standard fixtures.
Recommended accessory: 11857A Test Port Extension Cables, 11608A Transistor Fixture, or 11600B, 11602B Transistor Fixtures.
Power: 20 Vdc, supplied from 8754A via interface cable.
Size: 432 mm wide, 90 mm high, 495 mm deep (17 in. X 3 1/2 in X 19 1/2 in.).
Weight: Net, 9.1 kg (20 lb). Shipping, 11.3 kg (25 lb).

¹ ± degrees, specified as deviation from linear phase.
² Effective port match for ratio measurements.

Ordering Information:	Price
8754A Network Analyzer	\$11,500
Opt 907: Front Handle Kit	add \$20
Opt 908: Rack Flange Kit	add \$15
Opt 909: Rack Mount Flange/Front Handle Kit	add \$30
11850A 50Ω Three-Way Power Splitter	\$525
11850B 75Ω Three-Way Power Splitter	\$525
8502A 50Ω Transmission/Reflection Test Set	\$1,850
8502B 75Ω Transmission/Reflection Test Set	\$1,850
11851A RF Cable Set	\$450
11857A Test Port Extension Cables	\$550
8748A 50Ω S-Parameter Test Set	\$5,400
Opt 907: Front Handle Kit	add \$15
Opt 908: Rack Flange Kit	add \$10
Opt 909: Rack Mount Flange/Front Handle Kit	add \$20

NETWORK ANALYZERS

RF network analyzer, 500 kHz to 1.3 GHz

Model 8505A

- 100 dB of dynamic range
- Digital readout of data with analog display
- Direct group delay and deviation from linear phase
- High performance sweep oscillator
- Complete family of 50Ω and 75Ω test sets
- Digital storage and normalization

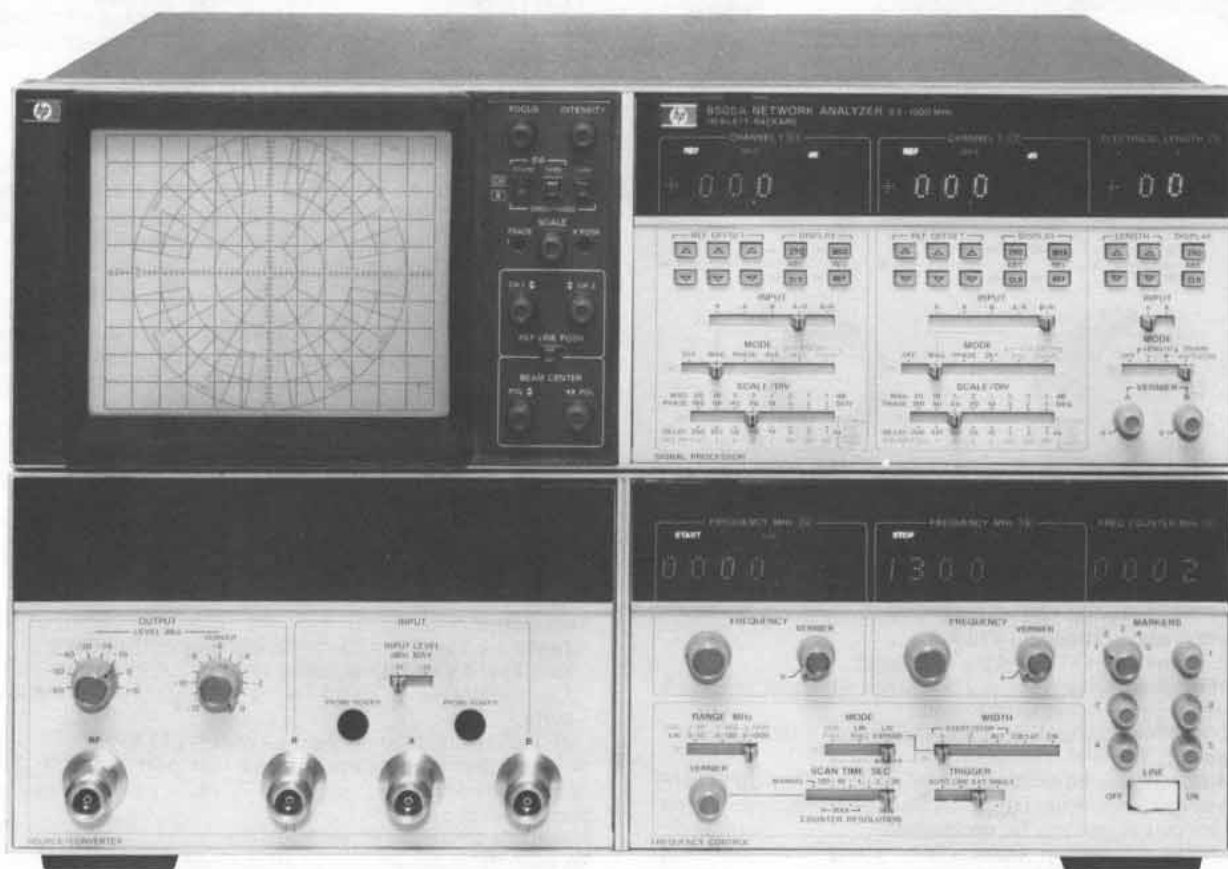

8505A

HP-IB

The HP 8505A is a high performance RF network analyzer operating over the 500 kHz to 1.3 GHz frequency range. It accurately and easily measures complex impedance, transfer functions and group delay of coaxial components and semiconductors. Because both magnitude and phase are measured, it is possible to completely characterize the linear behavior of either active or passive networks.

Since magnitude and phase can be measured and displayed over 100 dB of dynamic range (-10 to -110 dBm), it is a simple process for the 8505A to measure transmission loss of high rejection devices such as filters or gain and return loss of small signal devices like amplifiers. Distortion parameters like group delay, deviation from linear phase, and deviation from constant amplitude are measured in an equally straight-forward manner. Group delay is measured and displayed directly to resolutions of 1 ns per major division using a new linear FM measurement technique. A unique new electrical line stretcher compensates for the linear phase shift of the device under test so that phase non-linearities may be examined at high resolution (1° per major division). Amplitude deviations with frequency can be similarly observed to resolutions 0.1 dB per major division with clear, crisp trace stability. In addition, it is possible to read out swept amplitude, phase and delay digitally at any one of five continuously variable markers with resolutions of 0.01 dB, 0.1°, and 0.1 ns respectively.

Many of the 8505A's high performance features and operating conveniences are derived from the fact that it is a completely integrated system including both the sweep oscillator and receiver. The basic instrument also includes a built-in frequency counter, polar and rectangular displays on the same CRT, the new electronic line stretcher, group delay measurement, and frequency selective digital readings of swept amplitude, phase and delay. The frequency counter with resolutions up to 100 Hz adds further precision to the measurements by allowing frequency as well as amplitude, phase and delay to be read out at any of the five markers. The 8505A is fully programmable in a straight-forward fashion using the Hewlett-Packard Interface Bus (HP-IB operation is standard). A fully configured calculator-based automatic network analyzer system, the 8507B is offered (see page 466).

Companion instruments include the 11850A Three Way Power Splitter for high resolution transmission comparison measurements, the 8502A Transmission/Reflection Bridge for simultaneous transmission and reflection measurements, and the 8503A S-parameter Test Set for complete characterization of two port devices in a single test set-up. The 8501A Storage-Normalizer adds digital storage, normalization, signal averaging, increased resolution, and graphics to 8505A measurements.

8505A Specifications

Source

Frequency characteristics

Frequency range: 500 kHz to 1.3 GHz in three ranges; 500 kHz to 13 MHz, 500 kHz to 130 MHz and 500 kHz to 1.3 GHz.

Swept frequency accuracy: $\pm 1\%$ of range for linear sweep.

CW frequency accuracy: ± 2 counts \pm time-base accuracy.

Frequency stability: better than $\pm 0.01\%$ of reading $\pm 0.01\%$ of frequency range over 10 minutes after warm-up.

Frequency counter characteristics: frequency counter measurements are made at any one of five continuously variable marker positions without interrupting the swept RF signal.

Resolution (least significant digit)

Frequency Range (MHz)	0.5 to 13	0.5 to 130	0.5 to 1300
10 ms Sweep time	10 kHz	100 kHz	1 MHz
100 ms Sweep time	1 kHz	10 kHz	100 kHz
1 second Sweep time	100 Hz	1 kHz	10 kHz

Counter accuracy: ± 2 counts \pm time-base accuracy.

Marker frequency accuracy: $\pm 0.002\%$ of scan width \pm counter accuracy. Measured in CW $\pm \Delta F$

Time-base accuracy: ± 5 ppm ± 1 ppm/ $^{\circ}$ C ± 3 ppm/90 days

Output characteristics

Output power range: +10 dBm to -72 dBm.

Attenuator accuracy: ± 1.5 dBm over 70 dB range.

Vernier accuracy: ± 1 dB.

Leveling: ± 0.5 dB from 500 kHz to 1.3 GHz.

Impedance: 50 Ω ; ≥ 16 dB return loss at -10 dBm output level (<1.38 SWR).

Residual FM

Frequency Range (MHz)	0.5 to 13	0.5 to 130	0.5 to 1300
Residual FM	20 Hz rms	200 Hz rms	2 kHz rms
Bandwidth	20 Hz-1 kHz	20 Hz-1 kHz	20 Hz-10 kHz

Harmonics: >25 dB below main signal at +10 dBm output level.

Sub-harmonics: and spurious signals: below -50 dBm at +10 dBm output level.

General characteristics

Sweep modes: Linear Full, Log Full, Start/Stop 1, Start/Stop 2, Alternate, CW $\pm \Delta F$, and CW.

Sweep times: 10 ms to 100 s in decade ranges.

Trigger modes: auto, line sync., single scan or external sync.

RF Output connector: Type N female

Receiver

Frequency range: 500 kHz to 1.3 GHz

Input characteristics

Input channels: three channels (R, A, and B) with 100 dB dynamic range.

Damage level: +20 dBm or ≥ 50 V dc.

Noise (10 kHz BW): -110 dBm from 10 to 1300 MHz; -100 dBm from 2 to 10 MHz; -95 dBm from 0.5 to 2 MHz.

Impedance: 50 Ω ; ≥ 20 dB return loss (<1.22 SWR). Typically >26 dB return loss (<1.11 SWR).

Magnitude characteristics

Absolute frequency response (A, B, R): ± 1.5 dB

Ratio frequency response (A/R, B/R): ± 0.3 dB from 0.5 MHz to 1.3 GHz.

Dynamic accuracy: ± 0.01 dB/dB from -20 to -40 dBm; ± 0.2 dB from -10 to -50 dBm; ± 0.5 dB from -50 to -70 dBm; ± 1.0 dB from -70 to -90 dBm; ± 2.0 dB from -90 to -100 dBm; ± 4.0 dB from -100 to -110 dBm.

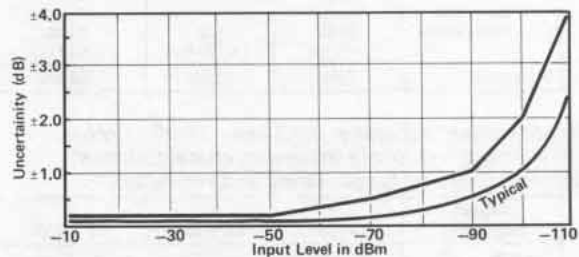

Crosstalk error limits: > 100 dB isolation between inputs.

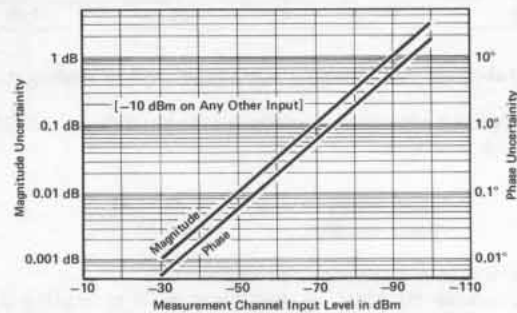

Reference offset accuracy: ± 0.03 dB ± 0.003 dB/dB of offset

Marker measurement resolution: 0.01 dB over any <10 dB range; 0.1 dB over any ≥ 10 dB range.

CRT Display resolution: 0.1 dB to 20 dB/division in 1, 2, 5 sequence.

Phase characteristics

Frequency response: $\pm 3^{\circ}$ from 500 kHz to 750 MHz; $\pm 5^{\circ}$ from 750 MHz to 1.3 GHz.

Range: $\pm 180^{\circ}$.

Accuracy: $\pm 0.01^{\circ}/\text{degree}$ for $\pm 170^{\circ}$; $\pm 0.01^{\circ}/\text{degree} \pm 0.5^{\circ}$ for $\pm 180^{\circ}$.

Dynamic accuracy (in 10 kHz Bandwidth): $\pm 0.02^{\circ}/\text{dB}$ from -20 to -40 dBm; $\pm 0.5^{\circ}$ from -10 to -50 dBm; $\pm 1^{\circ}$ from -50 to -70 dBm; $\pm 3^{\circ}$ from -70 to -90 dBm.

Crosstalk: see amplitude crosstalk specification.

Reference offset accuracy: $\pm 0.3^{\circ} \pm 0.5\%$ of offset.

Marker measurement resolution: $\pm 0.1^{\circ}$ over <100 $^{\circ}$ range and 1° for $\geq 100^{\circ}$ range.

CRT display resolution: 1° to 180° per division in 8 steps.

Polar characteristics: Frequency Response, Dynamic Response, Reference Offset and Marker Measurement specifications are the same as magnitude and phase characteristics.

CRT display accuracy: actual value is within less than 3 mm circle of the displayed value.

Tracking between dB offset controls and polar full switch positions: ≤ 0.2 dB.

Full scale magnitude range: 1 to 0.01 in a 1, 0.5, 0.2 sequence.

Delay characteristics

Frequency response: ± 1 ns from 500 kHz to 1.3 GHz.

Delay accuracy: $\pm 3\%$ of reading ± 3 units (Units = 1 ns for 0.5 to 1300 MHz range, 10 ns for 0.5 to 130 MHz range, and 100 ns for 0.5 to 13 MHz range.)

¹ ± 3 units may be calibrated out with thru connection.

NETWORK ANALYZERS

RF network analyzer, 500 kHz to 1.3 GHz (cont.)

Model 8505A

Range resolution and aperture

Frequency Range (MHz)	0.5 to 13	0.5 to 130	0.5 to 1300
Range	0 to 80 μ s	0 to 8 μ s	0 to 800 ns
Resolution			
CRT:	100 ns	10 ns	1 ns
Marker:	100 ns	10 ns	1 ns
Marker over limited Range:	10 ns	1 ns	0.1 ns
	(<1 μ s)	(\leq 100 ns)	(\leq 10 ns)
Aperture ¹	7 kHz	20 kHz	200 kHz

Reference offset accuracy: ± 0.3 units $\pm 0.3\%$ of offset.

Electrical length/ref. plane extension characteristics

Calibrated electrical length range and resolution:²

Frequency Range (MHz)	0.5 to 13	0.5 to 130	0.5 to 1300
Range	X1		
	X10		
	± 19.9 m	± 1.99 m	± 19.9 cm
	± 100 m	± 10 m	± 1 m
Resolution	X1		
	X10		
	10 cm	1 cm	0.1 cm
	1 m	10 cm	1 cm

Calibrated electrical length accuracy: $\pm 3\%$ of reading $\pm 1\%$ of range.

Linear phase substitution (degrees/scan) Range: $\pm 1700^\circ$ per scan with 0° offset.

$$\frac{\pm 1.4 \text{ km}}{\text{scan width (MHz)}} \quad \text{or} \quad \frac{\pm 4.7 \mu\text{s}}{\text{scan width (MHz)}}$$

Linear phase substitution resolution: 10°

Linear phase substitution accuracy: $\pm 3\%$ of reading $\pm 10^\circ$ / scan

Phase compensation linearity: $<0.2\%$ of phase slope inserted.

General Characteristics

RF input connectors: Type N Female

Display bandwidth: selectable IF bandwidths of 10 kHz and 1 kHz. A video filter position is also provided.

CRT overlays: Smith Charts (2, 1, 0.5, 0.2, 0.1 full scale), Log Charts (10 MHz, 100 MHz and 1000 MHz).

CRT photography: HP 197A Opt 006 camera or HP 197A with 10375A Bezel Adapter required to fit 8505A display. A CRT illumination control is provided.

Auxiliary outputs

Channel 1 and 2 outputs: 0.25 V/display division.

Sweep output: 0.25 V/display division.

Pen lift: DC coupled, 200 mA current sink.

Programming

The 8505A has a remote programming interface using the Hewlett-Packard Interface Bus with Learn Mode.

Power: selection of 100, 120, 200 or 240 V $\pm 5\%$ -10% . 50 to 60 Hz approximately 275 watts.

Size: 279 H x 426 W x 553 mm D (11" x 16 $\frac{3}{4}$ " x 21 $\frac{3}{4}$ ").

8505A Opt 005 Specifications (Phase-Lock Operation)

Source

Frequency characteristics

Modes (8505A): CW and CW $\pm \Delta F$ only.

Range and Resolution (8505A and 8660C/86602B/86632B): the total frequency range is 1 to 1300 MHz with a CW resolution of 1 Hz (set on the 8660C). The maximum $\pm \Delta F$ and $\pm \Delta F$ resolution is 1.3 kHz and 1 Hz from 0.5 to 13 MHz, 13 kHz and 10 Hz from 0.5 to 130 MHz, and 130 kHz and 100 Hz from 0.5 to 1300 MHz.

Range and Resolution (8505A and 8640B Opt 002): (Total Frequency Range: 0.5 to 1024 MHz).

	8640 Frequency Ranges (MHz)	8505A Frequency Range (MHz)		
		0.5-13	0.5-130	0.5-1300
CW Resolution (Set on 8640B)	0.5-1 1-13 16-128 128-1024	0.1 Hz 1 Hz	10 Hz	10 Hz 100 Hz
$\pm \Delta F$ Resolution (Set on 8505A)	All freq. Ranges	1 Hz	10 Hz	100 Hz
Max $\pm \Delta F$	0.5-8 8-16 16-1024	1.3 kHz 1.3 kHz	13 kHz 13 kHz	130 kHz

Typical system residual FM: the Residual FM of a phase-locked 8505A approaches that of the 8660C/86602B/86632B or 8640B.

Output characteristics

Power output, harmonics, spurious outputs, RF noise, etc. are determined by the 8660C with 86602B and 86632B or the 8640B.

Receiver

Magnitude and phase characteristics are unchanged with the exception of the dynamic range specification.

Delay characteristics

Accuracy: $\pm 3\%$ of reading ± 3 units. One unit is equal to the maximum resolution per major division for the frequency range of measurement.

Range, resolution and aperture: (8660C/86602B/86632B or 86640B)

(8505A indicated units x 1000)

	8505 Frequency Range (MHz)		
	0.5-13	0.5-130	0.5-1300
Range	0-80 ms	0-8 ms	0-800 μ s
Resolution:			
CRT & Digital Marker	100 μ s	10 μ s	1 μ s
Digital Marker with	10 μ s	1 μ s	100 ns
Delay Switch Setting	<1 ms	<100 μ s	<10 μ s
Aperture ¹	1.5 kHz	2.0 kHz	4.0 kHz

Electrical length characteristics

Accuracy: $\pm 3\%$ of reading $\pm 3\%$ of range.

Calibrated electrical length, range, and resolution: (8660C/86602B/86632B or 8640): (8505A digital readouts x 1000) give electrical length 1000 times larger and resolution divided by 1000.

General Characteristics

RF Inputs

L.O. drive input level: 10 dBm ± 2 dB (Rear panel BNC).

RF drive input level: 0 dBm ± 2 dB (Rear panel BNC).

Tunable FM output: ± 1.3 V maximum (rear panel BNC with output level controlled by $\pm \Delta F$ control on front panel of 8505A). ± 1.3 V output is obtained independent of the frequency range switch setting.

Capture range of phase-lock loop: 100 kHz (0.5-13 MHz Range); 400 kHz (0.5-130 MHz Range); 4 MHz (0.5-1300 MHz Range).

Standard/phase-lock operation: rear panel switch can disable all phase-lock circuitry when using the instrument in its standard (non phase-lock) operating mode.

¹Typical measurement Aperture using linear FM modulation technique.

²Vernier provides continuous adjustment of electrical length. Calibrated Electrical Length Linearity: $\Delta\phi = 0.7\% \times 1.2 f$ (MHz) x 1 (meters).

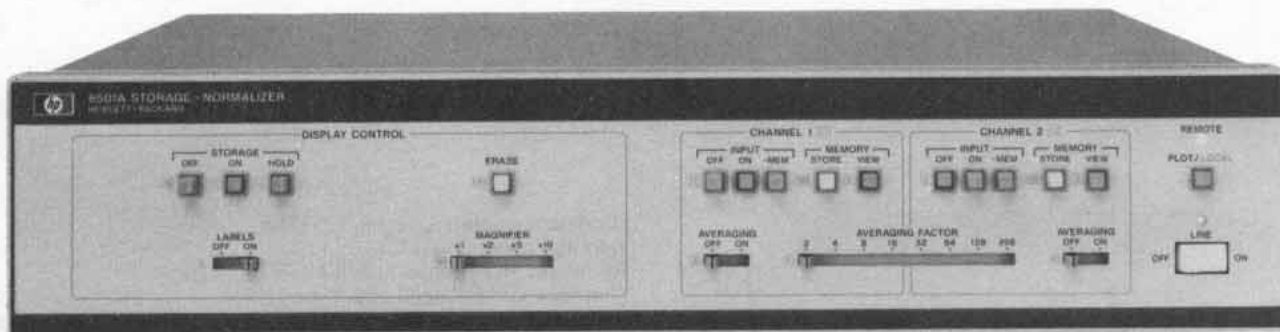

8501A



Description

The 8501A high performance Storage-Normalizer is a dedicated accessory that extends the measurement capability of your HP 8505A RF Network Analyzer (500 kHz to 1.3 GHz). Flicker free displays with digital storage and CRT annotation of major control settings provide convenient easy documentation. Using normalization, frequency response errors are simply removed. In addition the 8501A can digitally average signals to dramatically improve signal-to-noise ratios and magnify the display for high accuracy measurements. With a desktop computing controller, computer graphics capability is added to the 8505A for displaying corrected data, operator messages, or computer programs.

8501A Specifications

Display

Rectangular displays

Horizontal display resolution: two display channels, 500 points per channel (0.2% of full scale, 0.24 mm).

Vertical display resolution: 500 points displayed full scale (0.2% of full scale) plus a 50% overrange (250 points) both above and below full screen.

Polar displays

Display resolution: two display channels, 250 points per polar display (0.2% of full scale, 0.2 mm in X and Y).

Display tracking: visual offsets between direct 8505A and stored displays are approximately $\pm 1/2$ CRT minor division (± 1 mm).

Horizontal input sweep times: 100 sec max/10 ms min.

Conversion time: 10 ms max for 500 ± 2 data points (20 μ s per point).

Display refresh time: nominally 20 ms depending upon information displayed.

Line generator: a line generation technique is used to connect points on a CRT display, yielding a smooth continuous trace.

Markers: all five markers are also available in the digital display mode.

Output

Auxiliary outputs XYZ: (BNC female connectors on rear panel).

X—1 V full screen, 83 mV/div (12 div).

Y—1 V full screen, 100 mV/div (10 div).

Z—1 volt blanks display, +2 volt unblanks display. (Signal compatible for all HP CRT displays such as 1332, 1304, or 1310).

Offsets: The X, Y, and polar display offsets can be adjusted over a $\pm 10\%$ range of screen by means of potentiometers on the rear panel of the 8501A.

Labeling interface: all major control settings of the 8505A and 8503A and phase-lock indication are displayed on the CRT.

HP-IB Interface

HP-IB Interface capabilities

Remote programming

Learn mode: this feature provides the ability to output the current instrument state to a computing controller.

Input data: data for graphics or other purposes can be sent to the 8501A at a rate of:

ASCII mode: 600 points per second.

Binary mode: 10000 points per second.

Output data: data can be read from the 8501A at a rate of:

ASCII mode: 800 points per second.

Binary mode: 9000 points per second.

Graphics: data for graphics can be read into the 8501A and viewed in two types of displays.

Text displays: 22 lines of text with 54 characters per line can be displayed on the CRT.

Vector display: lines can be drawn on the display between any two points with a resolution of 432 points in x and 360 points in y (nominal).

General

Display controls

Storage Off: the 8501A is bypassed so the display returns to normal analog operation.

Storage On: turns on digitally stored display.

Storage Hold: the current display is not updated and is frozen for CRT photography or further analysis.

Erase: display and memory are erased.

Labels: switches all display labeling on or off.

Magnifier: expands the display by a factor of 1, 2, 5, or 10.

Processing functions (Channel 1 and 2)

Input Off: display of channel 1 (2) is blanked.

Input On: channel 1 (2) measurement is displayed.

Input Mem: the difference between the channel 1 (2) measurement and the stored memory content is displayed (normalization).

Memory Store: the current measurement is stored in memory.

Memory View: the stored memory content is displayed.

Averaging: the data averaging function for channel 1 (2) is switched on or off.

Averaging Factor: the degree of averaging is selectable from 2, 4, 8 . . . to 256. The current averaged trace is always displayed and updated at the sweep rate.

Local: returns the 8501A control to the front panel from remote HP-IB control.

Includes: HP-IB cable and the processor interconnect cable.

Accessories: the 11864A Accessory Kit provides the labeling interface boards and connectors for the 8505A. 8505A Opt 007 has these boards and connectors installed.

Power: selection of 100, 120, 220, or 240 V $\pm 5\%$ –10%, 50 to 60 Hz and < 140 VA (< 140 watts).

Size: 90 H x 426 W x 534 mm D (3 1/2" x 16 3/4" x 21").

Weight: net, 12.25 kg (27 lb). Shipping, 14 kg (31 lb).

NETWORK ANALYZERS

RF network analyzer, 500 kHz to 1.3 GHz (cont.)

Model 8505A



8503A



8502A



11850A



11851A

8502A 50Ω Transmission/Reflection Test Set

8502B 75Ω Transmission/Reflection Test Set

Frequency range: 500 kHz to 1.3 GHz.

Impedance: 8502A, 50Ω; 8502B 75Ω.

Directivity: ≥ 40 dB.

Frequency response

Transmission: $\leq \pm 0.8$ dB and $\leq \pm 8^\circ$.

Reflection: $\leq \pm 1.5$ dB and $\leq 15^\circ$ from 0.5–1300 MHz; $\leq \pm 10^\circ$ from 2–1300 MHz.

Port match

Test port: ≥ 26 dB return loss from 2–1300 MHz (≥ 24 dB for 8502B); ≥ 20 dB return loss from 0.5–2 MHz (≥ 18 dB for 8502B).

Test port open/short ratio: ± 0.75 dB and $\pm 6^\circ$ from 2–1000 MHz (± 0.9 dB and $\pm 7.5^\circ$ for 8502B); ± 0.9 dB and $\pm 7.5^\circ$ from 1000–1300 MHz; ± 1.25 dB and $\pm 10^\circ$ from 0.5–2 MHz.

Reference and reflection ports: ≥ 25 dB return loss from 2–1000 MHz; ≥ 23 dB return loss from 0.5–1300 MHz.

Input port: ≥ 23 dB return loss.

Nominal insertion loss:

Input to Test Port: 13 dB (8502A), 19 dB (8502B).

Input to Reference Port: 19 dB (8502A), 19 dB (8502B).

Input to Reflection Port: 19 dB (8502A), 31 dB (8502B).

Maximum operating level: +20 dBm.

Damage level: 1 watt CW.

RF Attenuator range: 0 to 70 dB in 10-dB steps.

Connectors test port: 50Ω Type N Female for 8502A and 75Ω Type N Female for 8502B; all other RF ports 50Ω Type N Female; Bias input, BNC Female.

DC Bias input: ± 30 V dc and ± 200 mA.

Includes: 8502B includes 50Ω/75Ω minimum loss pad.

Recommended accessory: 11851A RF Cable Kit for either 8502A or 8502B.

Size: 61.5 H x 101 W x 204 mm D ($2\frac{1}{16}$ " x $7\frac{1}{2}$ " x 8").

Weight: net, 1.7 kg (3½ lb). Shipping, 3.1 kg (7 lb).

8503A 50Ω S-Parameter Test Set

8503B 75Ω S-Parameter Test Set

Frequency range: 500 kHz to 1.3 GHz.

Impedance: 8503A, 50Ω; 8503B, 75Ω.

Directivity: ≥ 40 dB.

Frequency response

Transmission (S_{12} , S_{21}): ± 1 dB, $\pm 12^\circ$ from 0.5–1300 MHz.

Reflection (S_{11} , S_{22}): ± 2 dB, $\pm 20^\circ$ from 0.5–1300 MHz; $\pm 15^\circ$ from 2–1300 MHz.

Port match

Test ports 1 and 2: ≥ 26 dB return loss from 2–1300 MHz (≥ 24 dB for 8503B), ≥ 20 dB return loss from 0.5–2 MHz (≥ 18 dB for 8503B).

Test port 1 and 2 Open/Short Ratio: $\leq \pm 0.75$ dB and $\pm 6^\circ$ from 2–1000 MHz (± 0.9 dB and $\pm 7.5^\circ$ for 8503B); $\leq \pm 0.9$ dB and 7.5° from 1000–1300 MHz; ± 1.25 dB and $\pm 10^\circ$ from 0.5–2 MHz.

Reference and return ports: ≥ 23 dB return loss from 2–1000 MHz; ≥ 20 dB return loss from 0.5–2 MHz and 1000–1300 MHz.

RF input port: 20 dB return loss from 0.5–1300 MHz.

Maximum operating level: +20 dBm.

Damage level: 1 watt CW.

Connectors: test ports. 50Ω APC-7 for 8503A and 75Ω Type-N Female for 8503B; all other RF connectors, 50Ω Type-N Female; Bias inputs BNC Female.

DC Bias input: 30 V dc, ± 200 mA.

Includes: four 19 cm (7.5") cables for connection to 8505A.

Recommended accessory: 11857A 50Ω Test Port Extension Cables or 11857B/C 75Ω Test Port Extension Cables.

Programming: Opt 001 allows programming via HP-IB.

Power: 100, 120, 220, or 240 V +5%–10%, 50 or 60 Hz. Approx. 10 watts (15 watts for 8503B).

Size: 90 H x 426 W x 553 mm D ($3\frac{1}{2}$ " x $16\frac{3}{4}$ " x 21").

Weight: net, 9.1 kg (20 lb). Shipping, 11.3 kg (25 lb).

Accessories

11850A 50Ω Power Splitter

11850B 75Ω Power Splitter

Frequency range: DC to 1.3 GHz.

Impedance: 11850A, 50Ω; 11850B, 75Ω.

Tracking between any two output ports: ≤ 0.1 dB and $\leq 1.5^\circ$.

Equivalent source match (ratio or leveling): ≥ 32 dB return loss (≤ 1.05 SWR).

Input port match: ≥ 20 dB return loss.

Nominal insertion loss: 9.54 dB for 11850A; 7.78 dB for 11850B.

Frequency response absolute: Input to Output ≤ 0.2 dB.

Maximum operating level: +20 dBm.

Burn-out level: ≥ 1 watt CW.

Connectors: 11850A, 50Ω Type N female; 11850B, three outputs 75Ω Type N female, RF input 50Ω Type N female.

Recommended accessory: 11851A RF Cable Kit.

Includes: 11850B includes three (3) 50Ω/75Ω Minimum Loss Pads

Size: 46 H x 67 W x 67 mm D ($1\frac{7}{8}$ " x $2\frac{5}{8}$ " x $2\frac{5}{8}$ ").

Weight: net, 1.8 kg (4 lb). Shipping, 3.1 kg (7 lb).

11851A RF Cable Kit

General: four 61 cm (24 in.) shielded 50Ω cables, phase matched to 4° at 1.3 GHz. Connectors are Type N Male. Recommended for use with 8502A/B Transmission/Reflection Test Set and 11850A/B Power Splitter.

Weight: net, 0.91 kg (2 lb). Shipping, 1.36 kg (3 lb)

11852A 50Ω/75Ω Minimum Loss Pad

General: the 11852A is a low SWR minimum loss pad required for transmission measurements on 75Ω devices with 8505A receiver (50Ω).

Frequency range: DC to 1.3 GHz.

Insertion loss: 5.7 dB.

Return loss: ≥30 dB (≤1.06 SWR).

Typical Flatness: ≤0.1 dB from DC to 1.3 GHz.

Maximum input power: 250 mW (+24 dBm).

Connectors: 50Ω Type N female and 75Ω Type N male.

Size: 14 mm D x 70 mm L ($\frac{9}{16}$ " x $2\frac{3}{4}$ ").

Weight: net, 0.11 kg (4 oz). Shipping, 0.26 kg (9 oz).

11853A 50Ω Type N Accessory Kit

General: the 11853A furnishes the RF components required for measurement of devices with 50 Type N Connectors using the 11850A, 8502A, or 8503A (8503A also requires the 85032A). Kit contains a Type N Female short, a Type N Male short, two Type N Male barrels, two Type N Female barrels and storage case.

Weight: net, 0.91 kg (2 lb). Shipping, 1.36 kg (3 lb).

11854A 50Ω BNC Accessory Kit

General: the 11854A furnishes the RF components required measurement of devices with 50Ω BNC Connectors using the 11850A, 8502A, or 8503A (8503A also requires the 85032A). Kit contains two Type N Male to BNC Female adapters, two Type N Male to BNC Male adapters, two Type N Female to BNC Female adapters, two Type N Female to BNC Male adapters, a BNC Male short and storage case.

Weight: net, 1.13 kg (2½ lb).

11855A 75Ω Type N Accessory Kit

General: the 11855A provides the RF connecting hardware generally required for measurement of devices with 75Ω Type N connectors using the 8502B, or 8503B. Kit contains two 75Ω Type N Male barrels, two Type N Female barrels, a 75Ω Type N Female short, a 75Ω Type N Male short, a 75Ω Type N Male termination, and storage case.

Weight: net, 0.91 kg (2 lb). Shipping, 1.36 kg (3 lb).

11856A 75Ω BNC Accessory Kit

General: the 11856A provides the RF connecting hardware generally required for measurement of devices with the 75Ω BNC connectors using the 8502B, 11850B, or 8503B. Kit contains two Type N Male to BNC Female adapters, two Type N Male to BNC Male adapters, two Type N Female to BNC Female adapters, two Type N Female to BNC Male adapters, a BNC Male short, a 75Ω BNC Male termination, and storage case.

Weight: net, 0.91 kg (2 lb). Shipping, 1.36 kg (3 lb).

11857A 50Ω APC-7 Test Port Extension Cables

General: two precision 61 cm (24 in.) cables, phase matched to 2° at 1.3 GHz for use with 8503A S-parameter test set. Connectors are 50Ω APC-7.

Weight: net, 0.91 kg (2 lb). Shipping, 2.3 kg (5 lb).

11857B 75Ω Type N Test Port Extension Cables

General: two precision 61 cm (24 in.) cables, phase matched to 2° at 1.3 GHz for use with 8503B S-parameter test set. One cable has a 75Ω Type N Male connectors on both ends; the other has one Type N Male and one Type N Female connector.

Weight: net, 0.91 kg (2 lb). Shipping, 2.3 kg (5 lb).

11857C 75Ω GR 900 Test Port Extension Cables

General: two precision 61 cm (24 in.) cables, phase matched to 2° at 1.3 GHz for use with 8503B S-parameter test set. Connectors are 75Ω Type N Male and 75Ω GR 900.

Weight: net, 0.91 kg (2 lb). Shipping, 2.3 kg (5 lb).

11858A Transistor Fixture Adapter

General: the 11858A adapts the 11600B and 11602B transistor Fixtures (vertical test port configuration) to the 8503A S-parameter test set. Connectors are APC-7.

Weight: net, 0.91 kg (2 lb). Shipping, 1.36 kg (3 lb).

Ordering information

	Price
8505A RF Network Analyzer	\$27,950
Opt 005: Phase Lock	\$1,000
Opt 007: Labeling Interface	\$600
Opt 907: Front Handle Kit	\$40
Opt 908: Rack Flange Kit	\$30
Opt 909: Rack Flange/Front Handle Kit	\$60
Opt 910: Extra Manual	\$50
8503A 50Ω S-Parameter Test Set	\$4,800
Opt 907: Front Handle Kit	\$20
Opt 908: Rack Flange Kit	\$20
Opt 909: Rack Mount Flange/Front Handle Kit	\$20
Opt 910: Extra Manuals	\$10
8503B 75Ω S-Parameter Test Set	\$4,800
Opt 907: Front Handle Kit	\$20
Opt 908: Rack Flange Kit	\$15
Opt 909: Rack Mount Flange/Front Handle Kit	\$20
Opt 910: Extra Manual	\$10
8501A Storage Normalizer	\$5,300
Opt 907: Front Handle Kit	\$20
Opt 908: Rack Mounting Kit	\$15
Opt 909: Rack Mounting/Front Handle Kit	\$20
8502A 50Ω Transmission/Reflection Test Set	\$1,850
Opt 910: Extra Manual	\$6
8502B 75Ω Transmission/Reflection Test Set	\$1,850
Opt 910: Extra Manual	\$6
11850A 50Ω Power Splitter	\$525
11850B 75Ω Power Splitter	\$525
11851A RF Cable Kit	\$450
11852A 50Ω to 75Ω Minimum Loss Pad	\$95
11853A 50Ω Type N Accessory Kit	\$135
11854A 50Ω BNC Accessory Kit	\$135
11855A 75Ω Type N Accessory Kit	\$155
11856A 75Ω BNC Accessory Kit	\$210
11857A 50Ω APC-7 Test Port Extension Cables	\$550
11857B 75Ω Type N Test Port Extension Cables	\$600
11857C 75Ω GR 900 Test Port Extension Cables	\$750
11858A Transistor Fixture Adapter	\$450
11864A Labeling Interface Kit	\$600

NETWORK ANALYZERS

Automatic network analyzer, 500 kHz to 1.3 GHz

Model 8507B

- Improve productivity in lab and factory
- Accuracy enhancement
- Ease of operation via HP-IB
- 9825A Desktop Computer
- Learn mode



Description

The 8507B is a 9825A Desktop Computer system based on the 8505A RF Network Analyzer. The synergism of the easy-to-use desktop computer with the "most programmable network analyzer yet designed" provides a powerful RF network measurement tool for both lab and production uses.

Cost effective solutions

In laboratory applications, engineers gain greater circuit insight due to the speed and ease with which data can be accumulated and summarized with 8507B. With just a few hours training, engineers with no previous programming experience have been able to write customized programs which solve specialized measurement problems. In production applications, the 8507B dramatically reduces the time and cost of making complicated limit tests on all types of components. Testing programs with built-in operator instructions can minimize training cost and assure uniform test procedures.

Simplicity and flexibility of HP-IB

Configuration of the standard 8507B or your own customized system is a simple matter since it is programmed via the Hewlett-Packard Interface Bus (HP-IB). For instance, your RF measurement application may require a programmable power supply for transistor biasing or a digital voltmeter. Merely choose an instrument from the list of HP-IB interfaceable instruments and add it to your 8507B using universal HP-IB cables.

Getting started making measurements is equally easy since the 8507B comes complete with programs for system verification, accuracy enhancement and measurement applications. The system verification programs provide you with a fast operational check of the network analyzer, the desktop computer, and all system interfaces. However, one of the major contributions of the 8507B is its ease of operation and programming using the HP-IB with Learn Mode.

Learn mode operation

The "Learn" mode of operation extends traditional automatic operation to a new level of operator convenience. A single key stroke can cause the desktop computer to accept (learn) a data string from the network analyzer which defines all of the manually set front panel control settings. Once stored in the desktop computer (or permanently recorded) this data string can then be used to automatically return the network analyzer to its exact original test conditions... all without the operator ever writing a single program line!

Programmability features

1) Unique "marker mode" operation provides a real time swept display at the same time data (frequency or displayed parameters) is being logged.

So you can store data at a limited number of frequencies and still be sure you haven't missed a glitch.

2) Human-engineered HP-IB coding does away with complex code tables. To program a function, just type its name (shortened to first letter if you like) and switch position number (numbered 1 to N left to right).

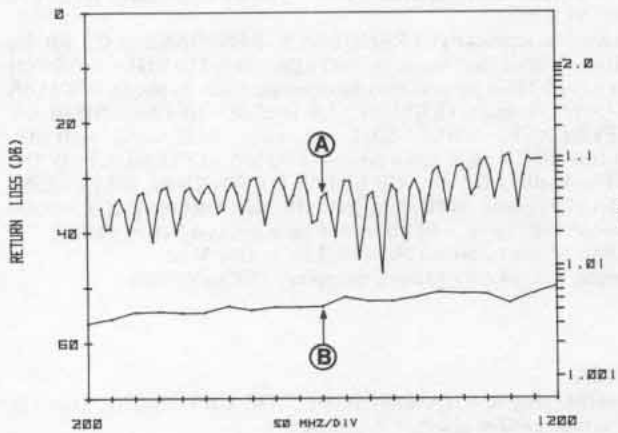

APC-7 to SMA-Female Adapters, 1 SMA-Male Load, 1 SMA-Female Load, 1 SMA-Female Short, and 1 SMA-Male Short.

85036A 75Ω Type N Calibration Kit

For use with the 8507B Opt E75 75Ω Automatic Network Analyzer. Contains 1 Type N Male Termination, 1 Type N Female Termination, 1 Type N Male Short, 1 Type N Female Short, 1 Type N Male Barrel, and 1 Type N Female Barrel.

Accuracy enhancement

Each 8507B system is supplied with a program that permits frequency tracking, mismatch, and directivity errors to be characterized by applying known standards. These stored system errors are then removed from the measurement of the unknown to provide a degree of accuracy exceeding that possible with the standard 8505A.

An example

The plots on the left show the result of software accuracy enhancement. Curve A depicts raw measurements on a 50 dB return loss termination at the end of a six-foot RG 214 cable—a typical application problem in testing in temperature chambers. Curve B shows the results after calibrating at the end of the cable—a 25 dB improvement.

Data in the form you need

With these desktop computers, it is a simple matter to obtain customized printed or plotted outputs. Or you may want to store data on tape for later analysis. Data can be analyzed or statistically summarized directly, bypassing the laborious and error-prone task of manually recording and re-entering data. Data reformatting such as converting return loss to SWR or s-parameters to y-parameters is easily done.

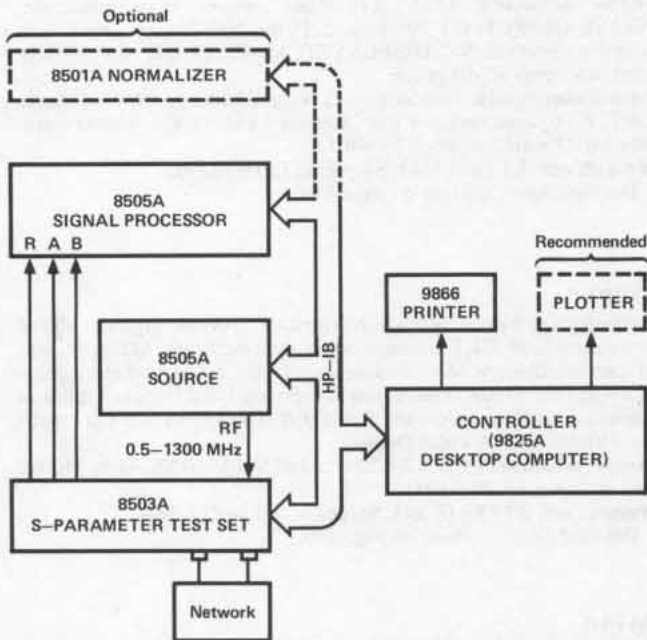

8507B Automatic Network Analyzer

Includes:

- 8505A Network Analyzer
- 8503A S-Parameter Test Set
- APC-7 Calibration Kit (85031A), Systems Table, & Cables
- System Assembly and checkout
- 9825A Desktop Computer (23K byte memory) with String-Advanced Programming and Plotter-General I/O—Extended I/O ROMS and 9866B Printer, cradle and interface, and HP-IB interface.
- 85030B Applications Pac—cartridge with three programs for system verification, accuracy enhancement and basic measurements.

Power: 115 or 230V 50-60 Hz, 750 VA.

Weight: net 227 kg (500 lb). Shipping, 272 kg (600 lb).

Ordering information

	Price
8507B Automatic Network Analyzer	\$51,720
Opt 002: Delete Systems Table	less \$600
Opt 003: Delete 9825A Calculator	less \$14,815
Opt 005: Phase lock	add \$1,000
Opt 006: 8501A Normalizer and 85010B Basic Measurements Program Pac	add \$5,900
85010B Basic Measurements Program Pac for 8501A and 9825A	\$50
85030B Applications Pac software 8507B	\$250
85031A Verification/APC-7 Calibration Kit	\$600
85032A N Calibration Kit	\$775
85033A SMA Calibration Kit	\$400
85036A 75Ω Type N Calibration Kit	\$950

8507B Calibration Kits

85031A Verification and APC-7 Calibration Kits

Included with 8507B. Contains Precision APC-7 Load, APC-7 Short, and two verification standards.

85032A Type N Calibration Kit

For use with 8507B. Contains 2 APC-7 to N-Male Adapters, 2 APC-7 to N-Female Adapters, 1 N-Male Load, 1 N-Female Load, 1 N-Female Short, 1 N-Male Short.

85033A SMA Calibration Kit

For use with 8507B. Contains 2 APC-7 to SMA-Male Adapters, 2

NETWORK ANALYZERS

RF network analyzer system, 100 kHz to 110 MHz

Model 8407 system

- Complete swept characterization of linear networks
- Modular system flexibility
- 50Ω and 75Ω measurements
- Digital storage

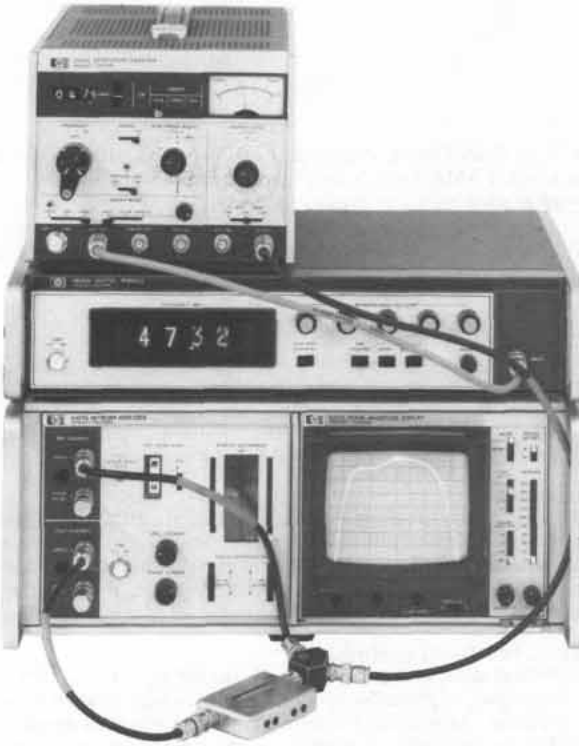

Swept measurements for either designing or testing are made with ease by HP's versatile 8407 Network Analyzer System. Since phase as well as magnitude is measured by a Network Analyzer, the behavior of both active and passive linear networks can be completely characterized from 100 kHz to 110 MHz by swept measurement.

Measurements of gain, loss, phase shift (compute group delay), return loss, and complex reflection coefficient are all possible in either 50Ω or 75Ω systems. These measurements allow the linear behavior of the networks under test to be completely characterized by their complex S-Parameters. Swept complex impedance [Z] and θ (for [Z] from 0.1Ω to >10 kΩ) as well as voltage and current transfer functions are also measured quickly and easily by the 8407 system. Typical linear networks designed and tested with the 8407 are filters, amplifiers, attenuators, antennas, detectors, cables, and recording heads.

Much of the 8407's versatility stems from its modular construction which allows the system to perform a variety of measurements or be economically tailored to one application. The basic instruments of the 8407 system are: The HP 8407A Network Analyzer, one of two REQUIRED sources (HP 8601A Sweeper/Generator or HP 8690B/8698B Sweep Oscillator), choice of two plug-in displays (HP 8412A Phase-Magnitude Display or HP 8414A Polar Display), an optional digital marker (HP 8600A), and one of four transducers (HP 11652A, 11654A, 11655A, or 1121A) depending on the measurement. Because the 8407A is a tracking receiver, the HP 8601A and HP 8690B/8698B are the only sources providing the VTO output required to operate the network analyzer. Thus, an operating system must be configured with one of the required sources, the network analyzer, a display and one or more of the transducers depending on the device under test and the network parameters desired.

Specifications

8407A

General: 8407A is a two input tracking receiver, using both inputs (reference and test channels) to form their magnitude ratio and phase difference before routing to display.

Frequency range: 0.1–110 MHz.

Impedance: 50Ω, Option 008: 75Ω. VSWR < 1.08.

Dynamic range: 80 dB.

Test input: DIRECT –10 to –90 dBm signal range. ATTENUATED, +20 to –50 dBm signal range. Damage level +26 dBm/50 V dc.

Reference input: DIRECT level required, –10 to –60 dBm. ATTENUATED level required +20 to –20 dBm. Damage level +26 dBm/50 V dc.

Amplitude accuracy: FREQUENCY RESPONSE ± 0.2 dB for DIRECT input (test input > –60 dBm), 0.1–110 MHz; ± 0.05 dB over any 10 MHz portion; may be calibrated out. Typically ± 0.05 dB for DIRECT inputs (REFERENCE level of –10 dBm). DISPLAY REFERENCE, <0.05 dB/1 dB step, total error ≤ 0.1 dB; <0.1 dB/10 dB step, total error ≤ 0.25 dB. ATTENUATED INPUTS, 40 dB ± 0.5 dB. REFERENCE CHANNEL GAIN CONTROL, 20 dB and 40 dB steps ± 0.5 dB/step. CROSSTALK, <0.03 dB when test/ref = –40 dB to <4 dB when test/ref = –80 dB.

Power: 65 watts, 50–60 Hz, 115/230 $\pm 10\%$ V ac.

Weight: net, 14.6 kg (32 lb). Shipping, 17.8 kg (39 lb).

8412A

General: plug-in PHASE-MAGNITUDE CRT Display. Displays magnitude and/or phase vs. frequency.

Amplitude accuracy: display, 0.08 dB/dB from midscreen. Rear output: 0.03 dB/dB variation from 0 volt output.

Phase Accuracy: DISPLAY, 0.065°/degree from midscreen. PHASE OFFSET, 0.3°/20° step, $\leq 3^\circ$ for 360° change, positive or negative direction. VS. DISPLAYED AMPLITUDE, <1°/10 dB; total <6° over 80 dB range.

Rear panel inputs: sweeping, ≤ 15 V dc. Blanking, –4 V dc blanks CRT. Z axis (marker), –5 V dc intensifies and +5 V dc blanks trace.

Power: 23 watts, supplied by 8407A.

Weight: net, 7.8 kg (17 lb). Shipping, 10 kg (22 lb).

Detailed Specifications on page 474.

8750A

General: the 8750A Storage-Normalizer provides digitally stored and normalized CRT displays when used with the 8412A Phase-Magnitude Display. Measurements are faster, easier, and more accurate when the 8750A is employed because the CRT is flicker-free and frequency response errors are eliminated. The 8750A is not compatible with the 8414A Polar Display.

Power: selection of 100, 120, 220, or 240 V +5%–10%, 48 to 440 Hz and ≤ 20 VA (≤ 20 watts).

Weight: net, 2.72 kg (6 lbs). Shipping, 5.0 kg (11 lbs).

Detailed Specifications on page 479.

8414A

General: normalized POLAR coordinate display with magnitude calibration in 0.2 of full scale gradations. Full scale is determined by DISPLAY REFERENCE on 8407A; phase calibration is in 10° increments over 360° range. Smith Chart overlays available.

Accuracy: all errors in amplitude and phase due to display are contained within a circle of 3mm about measurement point.

Rear panel inputs: blanking, –4 to –10 V dc blanks CRT. Marker, intensified trace with –4 to –10 V dc.

Rear panel outputs: horizontal and vertical both ± 2.5 V for full scale deflection.

Power: 35 watts, supplied by 8407A.

Weight: net, 5.9 kg (13 lb). Shipping, 8.0 kg (18 lb).

Detailed specifications on page 474.



a pair of six resistive divider probes (1:1, 5:1, 10:1, 20:1, 50:1, 100:1), current probes and a variety of adapters.
Weight: net, 0.9 kg (2 lb). Shipping, 1.4 kg (3 lb).

11655A
General: swept or CW impedance probe mounting directly to 8407A. Mount contains internal calibrator, $100\Omega \pm 5\%$ and $0^\circ \pm 2^\circ$; parasitics capacitances are calibrated out; and simple charts are available for calculating out residual resistances. Contains component adapter, probe to BNC adapter, probe to type N adapter, and various ground assemblies.
Frequency: 0.5–110 MHz (usable to 0.1 MHz).
Measurement range: amplitude, 0.1Ω to $>10\text{ k}\Omega$; phase, $0^\circ \pm 90^\circ$.
CW accuracy: amplitude $\pm 5\%$; $\pm 5^\circ$ for $|Z| > 3.16\Omega$.
Swept accuracy: typically $\pm 5\%$ in amplitude (3–110 MHz), $\pm 5^\circ$ in phase (5–110 MHz); accuracy decreases below 3 MHz. Note all accuracy specs valid only for proper input levels and calibration.
Max external voltage to probe: 50 V dc, 5 V rms.
Weight: net, 0.9 kg (2 lb). Shipping, 2.7 kg (6 lb).

11658A
General: 50 Ω to 75 Ω matching resistor for matching the 50 Ω of the 8407A to a 75 Ω environment. Two 11658A's are very useful for frequent 50 Ω to 75 Ω changes. The 11658A's mount directly on the front pane, of 8407A, FREQUENCY, 0.1–110 MHz. INSERTION LOSS, 3.5 dB. RETURN LOSS, $>40\text{ dB}$. CONNECTORS, 50 Ω BNC male and 75 Ω BNC female.
Net Weight: 28 g (1 oz).

1121A
General: 1:1 active probe for making measurements without disturbing circuitry and measuring voltage transfer functions in systems different from 50 Ω , 10:1 and 100:1 dividers and BNC adapter also furnished.
Frequency response: $\pm 0.5\text{ dB}$ and $\pm 2\%$ from 0.1–110 MHz with a bandwidth (3 dB) of 1 kHz to $>500\text{ MHz}$ and gain $0\text{ dB} \pm 1\text{ dB}$.
Input impedance: 100 k Ω , shunt capacitance of 3 PF at 100 MHz. With 10:1 or 100:1 divider, 1 M Ω , shunt capacitance 1 PF at 100 MHz.
Output impedance: 50 Ω nominal.
Maximum input: 300 mV rms, +80 V dc; with 10:1 divider, 30 V rms, $\pm 350\text{ V dc}$.
Power: supplied by 8407A through PROBE PWR jacks.
Weight: net, 0.7 kg (1.5 lb). Shipping, 1.2 kg (2.5 lb).

85426A
General: bias insertion network providing DC biasing to devices under test on RF transmission lines. Operating frequency range is 0.1–500 MHz with insertion loss $<0.4\text{ dB}$ and return loss $>28\text{ dB}$. Max biasing current of 750 mA and max biasing voltage of 70 V. Connectors are BNC for DC biasing and APC-7 for RF.
Weight: net, 0.5 kg (1 lb). Shipping, 0.8 kg (1.7 lb).

85428B
General: 50 Ω to 75 Ω minimum loss pad. Pad operates from 0.1–110 MHz with an insertion loss of 5.7 dB and VSWR <1.05 . Connectors are 50 Ω BNC male and 75 Ω BNC female.
Weight: net, 0.1 kg (2 oz). Shipping, 0.2 kg (6 oz).

Ordering information	Price
8407A Network Analyzer	\$4900
Opt 008: 75 Ω input	add \$115
8412A Phase Magnitude Display	\$2500
8750A Storage-Normalizer	\$1450
8414A Polar Display	\$2200
8601A Sweeper/Generator	\$3000
Opt 008: 75 Ω output	add \$50
8600A Digital Marker	\$1700
11652A Reflection/Transmission Kit (50 Ω)	\$475
Opt 008: 75 Ω	add \$60
11654A Passive Probe Kit	\$550
11655A Impedance Probe Kit	\$1500
11658A Matching Resistor	\$40
1121A AC Probe Kit	\$650
85426A Bias Insertion Network	\$650
85428B Minimum Loss Pad	\$175
8721A Directional Bridge (50 Ω)	\$200
Opt 008: 75 Ω	add \$20

8601A
General: GENERATOR/SWEEPER operating in either CW or SWEEP modes. Sweep modes are full, variable stop frequency, and symmetrical (up to 10 MHz). Features very low residual FM, spurious, harmonics, and drift. 8601A provides the VTO signal required to operate the 8407A.
Frequency: 0.1–11 MHz in two sweep ranges, 0.1–11 MHz and 1–110 MHz.
Impedance: 50 Ω , Option 008: 75 Ω . VSWR <1.2 .
Accuracy: 1% of frequency, 0.5% linearity, and 2% of sweep width.
Calibrated output: $\pm 0.25\text{ dB}$ flatness over full range, output accuracy $\pm 1\text{ dBm}$ from +10 to -110 dBm.
Auxiliary output: sweep out, blanking (for 8412 and 8414), VTO (required by 8407A), and auxiliary output (0.1–11 MHz both ranges) for 8600 counter/digital marker.
 Detailed specifications on page 400.

8600A
General: DIGITAL MARKER used with 8601A generator/sweeper to provide five continuously variable markers on a display while reading out the frequency of any one marker. Six digit display.
Markers/accuracy: 5 markers accurate at desired frequency $\pm (0.05\%$ sweep width + sweep stability).
Counter frequency range: 0.1–15 MHz (automatically scales up by ten when 8601A on 0.1–110 MHz range).
 Detailed specifications on page 400.

11652A
General: REFLECTION-TRANSMISSION KIT containing power splitter, 8721A DIRECTIONAL BRIDGE, precision termination, calibrating short, three BNC adapters, and four matched, low-leakage cables for both transmission and reflection measurements. All 50 Ω BNC connectors, Option 008 75 Ω .
Directional bridge: 8721A: 6 dB insertion loss and 6 dB coupled to auxiliary arm. Frequency response $\pm 0.5\text{ dB}$ (0.1–110 MHz). Directivity $>40\text{ dB}$ (1 to 110 MHz). Load port return loss $>30\text{ dB}$ ($\rho < 0.03$). Max input power +20 dBm. 50 Ω , Option 008: 75 Ω .
Power splitter: 6 dB through each arm. Max input power +20 dBm. 50 Ω .
50 Ω termination: return loss $>43\text{ dB}$.
Weight: net, 0.7 kg (1.5 lb). Shipping, 1.2 kg (2.5 lb).

11654A
General: passive probe kit for measuring current and voltage transfer functions and accurate complex impedance below 11 MHz. Contains

NETWORK ANALYZERS

Vector voltmeter

Model 8405A

- Accurate voltage and phase measurement
- 1 to 1000 MHz

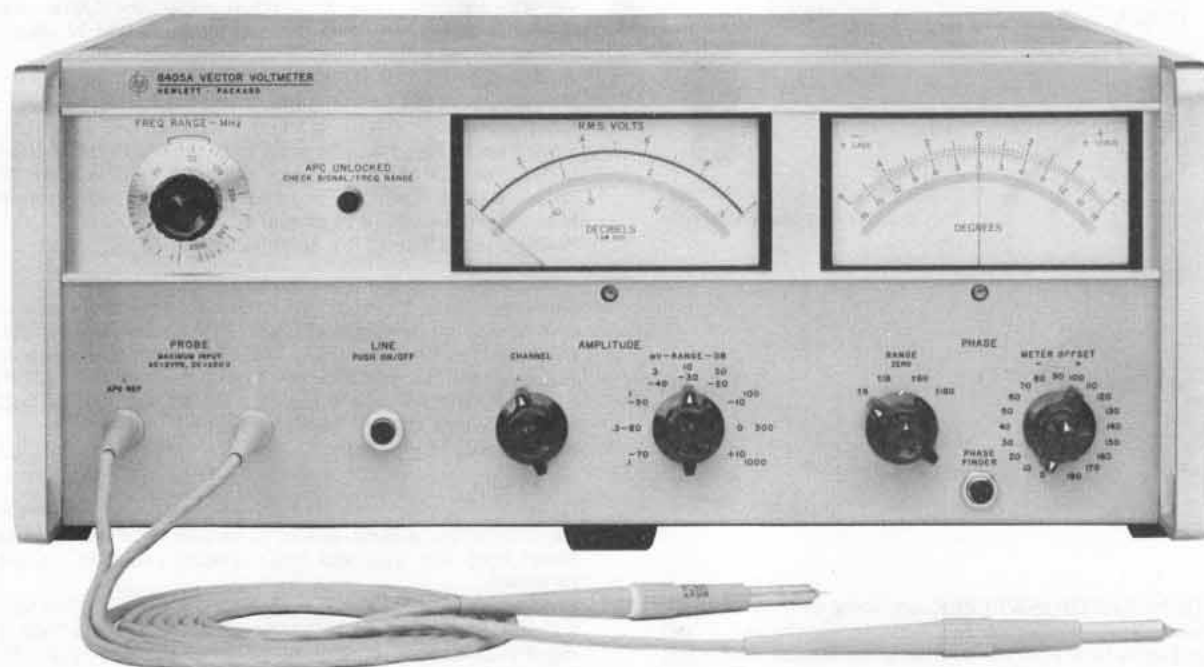

The 8405A Vector Voltmeter measures voltage vectors described by both magnitude and phase. This capability makes the 8405A a unique instrument for about any design and test application in the frequency range 1 to 1000 MHz.

In addition to absolute voltage measurements, capabilities include insertion loss and computed group delay of bandpass filters and other transmission devices, gain and phase margin of amplifiers, complex impedance of mixers, antennas, matching the electrical lengths of cables, s-parameters of transistors, amplitude modulation index, RF distortion measurements and in-circuit probing.

The 8405A achieves this measurement versatility through its two-channel capability enabling voltage magnitude measurements in either channel, thus allowing ratio measurements, and phase difference measurements between the two channels. Gain or loss in excess of 90 dB and phase measurements with 0.1° resolution over a 360° phase range are possible.

Accuracy is achieved through the 1 kHz bandwidth entailing response only to the fundamental frequency of the input signal. Also, phase-locked coherent sampling to translate 1 to 1000 MHz RF signals to 20 kHz IF signals enables accurate detection of voltage magnitude and phase. Automatic phase-locked tuning makes it possible to select the one of 21 overlapping octave ranges which contains the input signal frequency by simply rotating a switch.

Specifications

Frequency range: 1 MHz to 1 GHz in 21 overlapping octave bands; tuning automatic within each band.

Isolation between channels: 1 to 300 MHz, >100 dB; 300 to 1,000 MHz >80 dB.

Maximum input: ac, 2 V peak; dc, ±50 V.

Input impedance (nominal): 0.1 MΩ shunted by 2.5 pF; 1 MΩ shunted by 2 pF when 11576A 10:1 Divider is used; 0.1 MΩ shunted by 5 pF when 10216A Isolator is used. AC coupled.

Voltage range (rms)

Channel	1 - 10 MHz	10 - 500 MHz	500 - 1000 MHz
A	1.5 mV - 1.0 V	300 μV - 1.0 V	500 μV - 1.0 V
B	<20 μV - 1.0 V	<20 μV - 1.0 V	<20 μV - 1.0 V

Voltmeter ranges: 100 μV to 1 V rms full scale in 10 dB steps.

Voltage ratio accuracy: 1-200 MHz, 0.2 dB for -60 to 0 dB ranges and 0.5 dB for -70 dB to +10 dB ranges; 200-1000 MHz, 0.2 dB for -60 to -10 dB ranges, 0.5 dB for -70 dB to 0 dB ranges and 1.5 dB for +10 dB range.

Phase range: 360° indicated on zero-center meter with end-scale ranges of ±180°, ±60°, ±18, and ±6°.

Phase resolution: 0.1° at any phase angle.

Phase meter offset: ±180° in 10° steps.

Phase accuracy: ±1.5° (equal voltage Channel A and B).

Accessories furnished: two 11576A 10:1 Dividers, two 10216A Isolators, two 10218A BNC Adapters, six ground clips for 11576A or 10216A; six replacement probe tips.

Bandwidth: 1 kHz.

Power: 115 or 230 V ±10%, 50 to 400 Hz, 35 W.

Weight: net, 13.9 kg (31 lb). Shipping, 16.3 kg (36 lb).

Size: 177 H x 425 W x 467 mm D (7" x 16 3/4" x 18 3/8").

11570A Accessory kit

50Ω Tee: 11536A: for monitoring signals on 50Ω transmission lines without terminating line. Kit contains two with type N RF fittings.

50Ω Power Splitter: 11549A: all connectors Type N female.

50Ω Termination: 908A: for terminating 50Ω coaxial systems in their characteristic impedance.

Shorting plug: 11512A: Shorting Plug, Type N male.

Ordering information

8405A Vector Voltmeter

Opt 002: linear dB scale

11570A Accessory Kit (measurement in 50Ω systems only)

Price

\$3850

add \$25

\$395

NETWORK ANALYZERS

Microwave network analyzer, 110 MHz to 40 GHz

Model 8410S systems



- Complete microwave measurement systems
- Measures all network parameters

- Multioctave swept frequency measurements
- System accuracy fully specified



8410S Opt 310

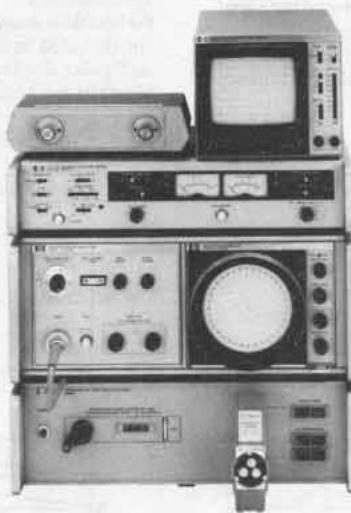

8410S Opt 400



8410S Opt 500

All 8410S Systems measure transmission and reflection parameters of coaxial or semiconductor components in the form of gain, attenuation, phase, reflection coefficient or impedance. Each option has been configured and fully specified for making general measurements on semiconductor devices in a variety of package styles. The 8410S Systems enable the operator to view a real time CRT display over octave or multioctave bands with a dynamic range of 60 dB amplitude and 360° phase. Multioctave, continuous network measurements over

the frequency range of 2 to 18 GHz are possible when the 8410B is used with the HP 8620/86290 Swept Oscillator.

The 8410S Systems' upper frequency limit for coaxial and semiconductor measurements is 12.4 GHz; however, individual instruments may be ordered that will expand coaxial measurement capability to 18 GHz (option 018 instruments) and waveguide measurements from 8.2 GHz to 40 GHz (8747A series).

8410S Network Analyzer Systems Table

GENERAL PURPOSE MEASUREMENTS			All 8410S Systems include the Following Instrument Model Numbers: 8410B, 8410A, 8412A*, 8414A and 11609A										
Frequency Range	Option No.	Measurement Port Configuration	8743A	8745A	8746A	8717B	11600B	11602B	11608A	11604A	11605A	11650	Price
0.11 to 2 GHz	110*	Coaxial (APC-7)		X						X		X	\$20,220
0.11 to 12.4 GHz	310*	Coaxial (APC-7)	X	X						X	X	X	\$25,970
2 to 12.4 GHz	210*	Coaxial (APC-7)	X								X	X	\$18,670
SEMICONDUCTOR CHARACTERIZATION													
0.11 to 2 GHz	400	T018/T072 Packages		X		X	X						\$21,340
0.11 to 2 GHz	401	T05/T012 Packages		X		X		X					\$21,340
0.5 to 12.4 GHz	500	T051 Package			X	X			X				\$23,390
0.5 to 12.4 GHz	501	HPAC-200 Package			X	X			X				\$23,390

*Options 100, 200 and 300 are identical to 110, 210 and 310 respectively except for the 8412A which is replaced by the 8413A.

Specifications

8410S common performance specifications

Function: all systems measure transmission and reflection parameters on a swept-frequency or CW basis with readout of attenuation, gain, phase shift, reflection coefficient, return loss, impedance, depending on display unit.

Transmission measurement (using 8412A): accuracy curves show overall system uncertainty as a function of the amplitude and phase value. Sources of error included are IF gain control, display accuracy, phase offset, system noise and cross-talk. System frequency responses is specified separately and is not included in accuracy curves.

Amplitude accuracy (60 dB dynamic range)

IF gain control: 69 dB in 10 dB and 1 dB steps.

± 0.1 dB/10 dB
 ± 0.05 dB/1 dB

± 0.2 dB maximum cumulative

Display: 0.08 dB/dB from midscreen.

Phase accuracy

Phase offset: $0.3^\circ/20^\circ$ step; maximum 3° for 360° change.

Display: $0.065^\circ/\text{degree}$ from midscreen.

Connectors: RF Input, Type N female stainless steel; Measurement Ports, APC-7 precision 7-mm connectors.

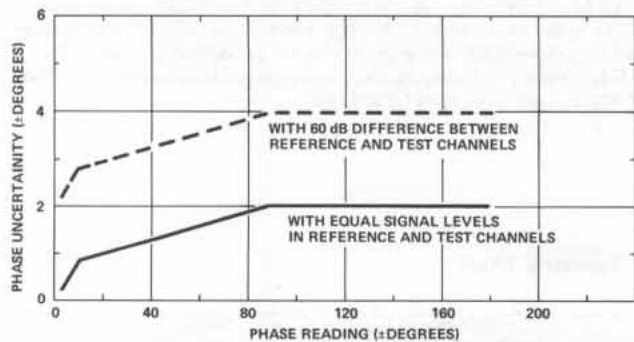
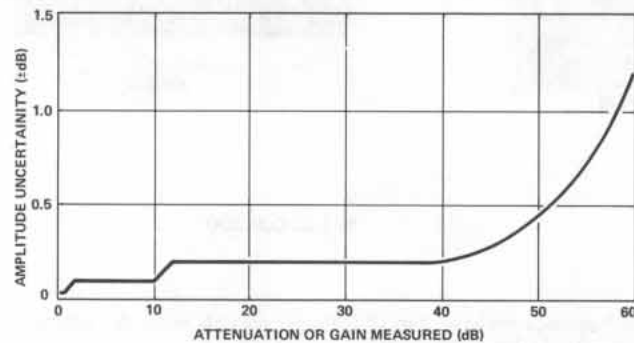

8410S Opt 100/110 specifications

Function: the 8410S option 100/110 measurement systems give all four S-parameters for a two-port network with pushbutton ease over the frequency range of 110 MHz to 2 GHz. A choice in log display units is made by selecting Option 100 (8413A display) or Option 110 (8412A display).

Frequency range: 0.11 to 2.0 GHz.

RF input: 20 dB range between -21 dBm and $+7$ dBm.

Source reflection coefficient: ≤ 0.09 , 0.11–2.0 GHz.

Termination reflection coefficient: ≤ 0.11 , 100–200 MHz; ≤ 0.09 , 200–2000 MHz.

Directivity: > 36 dB 0.11–1.0 GHz; > 32 dB 1.0–2.0 GHz.

Insertion loss, RF input to test port: 4 dB nominal.

Frequency response

Transmission: typically $< \pm 0.35$ dB amplitude and $< \pm 3^\circ$ phase.

Reflection: typically $< \pm 0.09$ magnitude and $\pm 5^\circ$ phase with a short on the test port.

Transmission measurement accuracy: (see common performance specifications).

Reflection measurement accuracy (using 8414A): sources of error included in the accuracy equations are directivity, source match, and polar display accuracy.

Magnitude accuracy:

$\rho_u = \pm (0.015 + 0.03 \rho_L + 0.06 \rho_L^2)$ 0.11–1.0 GHz.

$\rho_u = \pm (0.025 + 0.03 \rho_L + 0.06 \rho_L^2)$ 1.0–2.0 GHz.

ρ_u = magnitude uncertainty.

ρ_L = measured reflection coefficient magnitude.

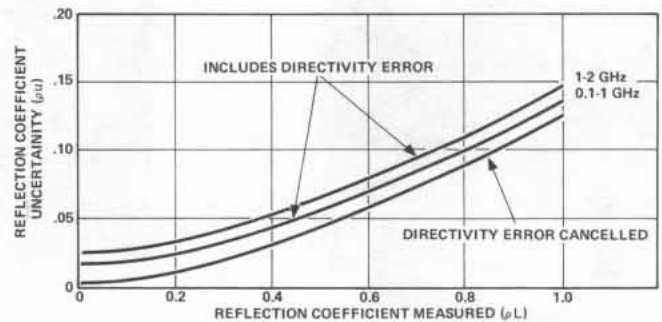

Phase accuracy:

$\Phi_u = \sin^{-1} \rho_u / \rho_L$ for $\Phi_u < 90^\circ$.

Φ_u = phase uncertainty.

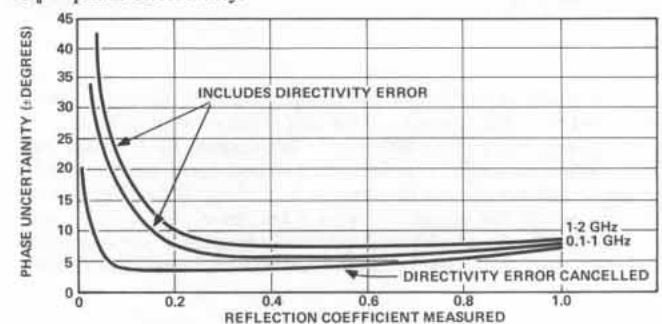

See 8410S Network Analyzer Systems Table for price and instrument breakdown.

8410S Opt 200/210 specifications

Function: The 8410S Option 200/210 measurements systems cover a frequency range of 2 to 12.4 GHz. With just one simple setup and calibration both transmission and reflection measurements are easily made by pushing a button. A choice in log display units is made by selecting Option 200 (8413A display) or Option 210 (8412A display).

Frequency range: 2.0 to 12.4 GHz.

RF input: 20 dB range between -14 dBm and $+14$ dBm.

Source reflection coefficient: ≤ 0.09 , 2–8 GHz; ≤ 0.13 , 8–12.4 GHz.

Termination reflection coefficient: ≤ 0.09 , 2–8 GHz; ≤ 0.13 , 8–12.4 GHz.

Directivity: ≥ 30 dB, 2–12.4 GHz.

Insertion loss, RF input to test port: 20 dB nominal.

Frequency response

Transmission: typically $< \pm 0.5$ dB amplitude and $< \pm 5^\circ$ phase.

Reflection: typically $< \pm 0.09$ magnitude and $< \pm 6^\circ$ phase, with a short on the unknown port.

Transmission measurement accuracy: (see Common Performance Specifications).

Reflection measurement accuracy (using 8414A): sources of error included in the accuracy equations are directivity, source match, and polar display accuracy.

Magnitude accuracy:

$$\rho_u = \pm(0.0316 + 0.03 \rho_L + 0.09 \rho_L^2) \text{ 2-8 GHz.}$$

$$\rho_u = \pm(0.0316 + 0.03 \rho_L + 0.13 \rho_L^2) \text{ 8-12.4 GHz.}$$

ρ_u = magnitude uncertainty.

ρ_L = measured reflection coefficient magnitude.

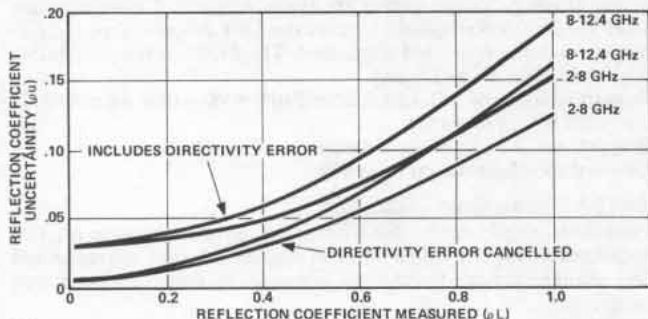

Phase accuracy:

$$\Phi_u = \sin^{-1} \rho_u / \rho_L \text{ for } \Phi_u < \pm 90^\circ.$$

Φ_u = phase uncertainty.

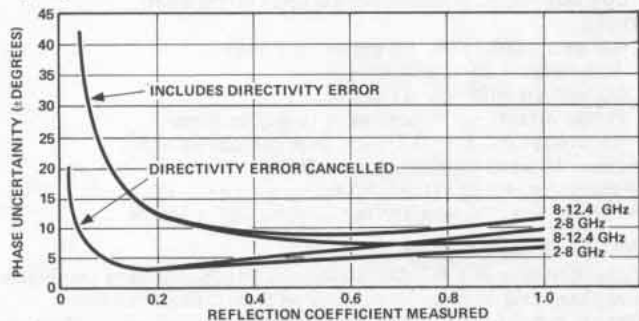

See 8410S Network Analyzer Systems Table for price and instrument breakdown.

8410S Opt 300/310 specifications

Function: The 8410S Option 300/310 measurement systems encompass both the 8410S Option 110 and 210 system specifications and flexibility. The two RF transducer units cover the frequency range of 110 MHz to 12.4 GHz and both offer calibrated line stretchers for extending the reference plan. Coaxial rotary joints and air-lines mounted on the front of the transducer units allow easy connections to the test device. A choice in log display units is made by selecting either Option 300 (8413A display) or Option 310 (8412A display).

See 8410S Network Analyzer System Table for price and instrument breakdown.

8410S Opt 400/401 specifications

Function: The 8410S Option 400/410 S-parameter measurement system provides two port S-parameters for semiconductors in TO-18/TO-72 (Option 400) or TO-5/TO-12 (Option 401) packages. A short circuit Termination and a 50 ohm through section are included with each type fixture for reference plane calibration.

Frequency range: 0.11 to 2.0 GHz.

Transistor dc bias selection: front panel slide switches establish proper dc biasing for both Bi-polar and FET transistors. The voltage and current controls operate independently and are continuously adjustable over a current range of 0 to 500 mA and a voltage range of 0 to 30 Vdc.

RF input: 20 dB range between -21 dBm to +7 dBm.

Incident power at device under test: +3 dBm to -25 dBm.

Source reflection coefficient

Opt 400: typically -0.062.

Opt 401: typically -0.067.

Termination reflection coefficient

Opt 400: typically <0.11, 100 to 200 MHz.
<0.09, 0.2 to 2.0 GHz.

Opt 401: typically <0.14, 100 to 200 MHz.
<0.10, 0.2 to 2.0 GHz.

Directivity

Opt 400: typically <31 dB, 0.11 to 1.0 GHz.
<29 dB, 1.0 to 2.0 GHz.

Opt 401: typically <28 dB, 0.11 to 1.0 GHz.
<27 dB, 1.0 to 2.0 GHz.

Frequency response

Transmission: typically <±0.35 dB, ±3°.

Reflection: typically <±0.5 dB, ±5°.

Transmission measurement accuracy: (see Common Performance Specifications).

Reflection measurement accuracy (using 8414A): sources of error included in the accuracy equations are directivity and source match.

Magnitude accuracy

Opt 400:

$$\rho_u = \pm(0.029 + 0.048 \rho_L + 0.06 \rho_L^2) \text{ 0.11 to 1 GHz.}$$

$$\rho_u = \pm(0.035 + 0.051 \rho_L + 0.062 \rho_L^2) \text{ 1.0 to 2.0 GHz.}$$

Opt 401:

$$\rho_u = \pm(0.038 + 0.054 \rho_L + 0.067 \rho_L^2) \text{ 1.0 to 2.0 GHz.}$$

ρ_u = magnitude uncertainty.

ρ_L = measured reflection coefficient magnitude.

Phase accuracy:

$$\Phi_u = \sin^{-1} \rho_u / \rho_L \text{ for } \Phi_u < 90^\circ.$$

Φ_u = phase uncertainty.

See 8410S Network Analyzer Systems Table for price and instrument breakdown.

8410S Opt 500/501 specifications

Function: The 8410S Option 500/501 S-parameter measurement systems provide the capability of biasing and measuring all four S-parameters of strip-line transistors in the TO-51 (Option 500), HPAC-200 (Option 501) packages. A short circuit termination and a 50-ohm through section are included with each fixture for reference plan calibration.

Frequency range: 0.5 to 12.4 GHz.

Transistor dc bias selection; front panel slide switches establish proper dc biasing for both Bi-polar and FET transistors. The voltage and current controls operation independently and are continuously adjustable over a current range of 0 to 500 mA and a range of 0 to 30 Vdc.

RF input: 20 dB range between -7 and +13 dBm.

Incident power at device under test: -27 dBm to -7 dBm with INCIDENT ATTENUATION set to 0 dB.

Incident attenuation range: 0 to 70 dB in 10 dB steps.

Source reflection coefficient: (typically) <0.13, 0.5 to 8.0 GHz; ±0.14, 8.0 to 12.4 GHz.

Termination reflection coefficient: (typically) <0.13, 0.5 to 8.0 GHz; ±0.14, 8.0 to 12.4 GHz.

Directivity: >28 dB, 0.5 to 4.0 GHz; >23 dB, 4 to 12.4 GHz.

Frequency response: (typically) <1.0 dB, ±5 degrees, 0.05 to 4.0 GHz; <1.5 dB, ±5 degrees, 4.0 to 8.0 GHz; <2.5 dB, ±5 degrees, 8.0 to 12.4 GHz.

Transmission measurement accuracy: (see Common Performance Specifications).

Reflection measurement accuracy: sources of error included in the accuracy equation are directivity and source match.

Magnitude accuracy:

$$\rho_u = \pm(0.04 + 0.08 \rho_L + 0.13 \rho_L^2) \text{ 0.5 to 4.0 GHz.}$$

$$\rho_u = \pm(0.07 + 0.09 \rho_L + 0.135 \rho_L^2) \text{ 4.0 to 8.0 GHz.}$$

$$\rho_u = \pm(0.074 + 0.098 \rho_L + 0.14 \rho_L^2) \text{ 8.0 to 12.4 GHz.}$$

ρ_u = magnitude uncertainty.

ρ_L = measured reflection coefficient magnitude.

Phase accuracy:

$$\Phi_u = \sin^{-1} \rho_u / \rho_L \text{ for } \Phi_u < 90^\circ.$$

Φ_u = phase uncertainty.

See 8410S Network Analyzer Systems Table for price and instrument breakdown.

NETWORK ANALYZERS

Individual instruments

8410 family



8410B



8412A



8411A



8413A



8750A



8418A



8414A

Specifications

8410B/8411A Network Analyzer

Function: 8411A converts RF signals to IF signals for processing in 8410B mainframe. 8410B is the mainframe for display plug-in units. Mainframe includes tuning circuits (octave bands or multioctave bands when used with HP 8620/86290 sweep oscillator), IF amplifiers and precision IF attenuator.

8410B frequency range: 0.11 to 18 GHz.

8411A frequency range: 0.11 to 12.4 GHz.

Opt 018: 0.11 to 18 GHz.

8411A input impedance: 50 ohms nominal. SWR <1.5, 0.11 to 8.0 GHz; <2.0, 8.0 to 12.4 GHz; typically increases to a 10:1 SWR, 12.4 to 18 GHz.

Channel isolation: >65 dB, 0.1 to 6 GHz; >60 dB, 6 to 12.4 GHz; >50 dB, 12.4 to 18 GHz.

Amplitude

Reference channel: -18 to -35 dBm, 0.11 to 12.4 GHz; -18 to -25 dBm from 12.4 to 18.0 GHz.

Test channel: -10 to -75 dBm from 0.11 to 12.4 GHz; -10 to -65 dBm from 12.4 to 18 GHz.

Maximum RF input to either channel: 50 mW.

IF gain control: 69 dB range in 10 dB and 1 dB steps with a maximum cumulative error of ± 0.2 dB.

Phase

Phase range: 0 to 360°

Control: vernier control $\leq 90^\circ$

Connectors (8411A): APC-7.

Power: 115 or 230 V $\pm 10\%$, 50-60 Hz, 70 watts (includes 8411A).

Weight

8410B: net, 14.9 kg (33 lb). Shipping, 18.5 kg (41 lb).

8411A: net, 3.2 kg (7 lb). Shipping, 4.5 kg (10 lb).

Size

8410B: 191 H x 425 W x 467 mm D (7½" x 16¾" x 18¾").

8411A: 67 x 228 W x 143 mm D (2¾" x 9" x 5¾") exclusive of connectors and cable.

8412A Phase-Magnitude Display

Function: plug in CRT display unit for 8410B. Displays relative amplitude in dB and/or relative phase in degrees between reference and test channel inputs versus frequency.

Amplitude

Range: 80 dB display range with selectable resolutions of 10, 2.5, 1 and 0.25 dB/division.

Accuracy: 0.08 dB/dB from midscreen.

Phase

Range: $\pm 180^\circ$ display range with selectable resolutions of 90, 45, 10, and 1°/division.

Accuracy: 0.065°/degree from midscreen.

Phase offset: 0.3°/20° step cumulative <3°.

Power: 23 watts supplied by mainframe.

Weight: net, 7.8 kg (17 lb). Shipping, 10 kg (22 lb).

Size: 152 H x 186 W x 395 mm D (6" x 7½" x 15½") excluding front panel knobs.

8750A Storage-Normalizer

General: the 8750A Storage-Normalizer provides digitally stored and normalized CRT displays when used with the 8412A Phase Magnitude Display. Measurements are faster, easier and more accurate when the 8750A is employed because the CRT is flicker-free and frequency response errors are eliminated. The 8750A is not compatible with the 8414A Polar Display.

Power: selection of 100, 120, 220, or 240V $\pm 5\%$ -10%. 48 to 440 Hz and ≤ 20 VA ≤ 20 watts).

Weight: net, 2.72 kg (6 lbs). Shipping, 5.0 kg (11 lbs).

Detailed specifications on page 479.

8413A Phase-Gain Indicator

Function: plug-in meter display unit for 8410B. Displays relative amplitude in dB or relative phase in degrees between reference and test channel inputs. Pushbutton selection of meter function and range.

Amplitude

Range: ± 30 , ± 10 , and ± 3 dB full scale.

Accuracy: $\pm 3\%$ of end scale.

Log output: 50 millivolts per dB up to 60 dB total.

Phase

Range: ± 180 , ± 60 , ± 6 degrees full scale.

Accuracy: $\pm 2\%$ of end scale.

Output: 10 millivolts per degree.

Phase offset: ± 180 degrees in 10-degree steps.

Accuracy: $\pm 0.2^\circ + 0.3^\circ/10^\circ$ step, cumulative <2°.

Power: 15 watts supplied by mainframe.

Weight: net, 4.9 kg (11 lb). Shipping, 6.7 kg (15 lb).

Size: 152 H x 186 W x 395 mm D (6" x 7½" x 15½").

8414A Polar Display

Function: plug-in CRT display unit for 8410B. Displays amplitude and phase data in polar coordinates on 5-in. cathode ray tube.

Range: normalized polar coordinate display; magnitude calibration 20% of full scale per division. Scale factor is a function of IF setting on 8410B. Phase calibrated in 10-degree increments over 360-degree range.

Accuracy: error circle on CRT ± 3 mm.

Power: 35 watts supplied by mainframe.

Weight: net, 5.8 kg (13 lb). Shipping 8.1 kg (18 lb).

Size: 152 H x 186 W x 395 mm D (6" x 7½" x 15½") excluding front panel knobs.

8418A Auxiliary Power Supply

Function: the 8418A power supply unit provides power for operating of the 8412A, 8413A or the 8414A display units. Used in conjunction with the 8410B Network Analyzer, it provides the capability of viewing amplitude and phase readout in both rectangular and polar coordinates simultaneously. Option H01 adds a remotely programmable 0-70 dB IF attenuator required for autoranging in semi-automatic applications.

Weight: net, 11.2 kg (25 lb). Shipping, 19.7 kg (44 lb).

Size: 177 H x 483 W x 450 mm D (6¾" x 19" x 17½").

Ordering information

	Price
8410B mainframe	\$4000
Opt 908: Rack Flange Kit	add \$10
8411A Frequency Converter	\$3100
Opt 018: 0.11 to 18 GHz	add \$500
8412A Phase-Magnitude Display	\$2500
8413A Phase-Gain Display	\$1900
8414A Polar Display	\$2200
8418A Auxiliary Power Supply	\$1600
Opt H01: Programmable 0-70 dB IF Attenuator	add \$2000
8750A Storage-Normalizer	\$1450



8745A

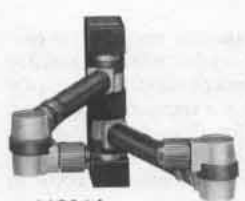

11604A

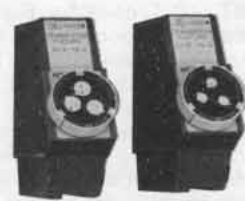

11602B

11600B



8743A

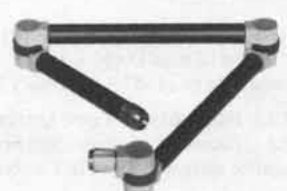

11605A

8745 S-Parameter Test Set

Function wideband RF power splitter and reflectometer with calibrated line stretcher. Pushbutton operated for either forward or reverse transmission or reflection measurements with network analyzer.

Impedance: 50 ohms nominal.
Source reflection coefficient: ≤ 0.057 , 0.11 to 2.0 GHz.
Termination reflection coefficient: < 0.10 , 100, to 200 MHz; < 0.063 , 200 MHz to 2.0 GHz.
Directivity: ≥ 36 dB, below 1 GHz; ≥ 32 dB, 1 to 2 GHz.
Reference plane extension: 0 to 15 cm for reflection; 0 to 30 cm for transmission.
Maximum RF power: 2 watts.
Connectors: RF input type N female; all other connectors APC-7; Option 001, type N female.
Remote programming: ground closure.
Power: 115 or 120 V $\pm 10\%$, 50 to 400 Hz, 40 watts.
Weight: net, 15.4 kg (34 1/4 lb). Shipping, 18.0 kg (40 lb).
Size: 140 H x 425 W x 654 mm D (5 1/2" x 16 3/4" x 25 3/4").

11604A Universal Extension

Function: mounts on front of 8745A; connects to device under test. Rotary air-lines and rotary joints connect to any two port geometry.
Frequency range: dc to 2 GHz.
Impedance: 50 ohms nominal.
Reflection coefficient: 0.035.
Acc. included: semi-rigid coax. cable, HP Part #11604-20021.
Weight: net, 1.8 kg (4 lb). Shipping, 2.2 kg (5 lb).
Size: 127 H x 32 W x 267 mm D (5" x 1 1/4" x 10 1/2").

11600B/11602B Transistor Fixtures

Function: mounts on front of 8745A S-parameter test set; holds devices for S-parameter measurements in a 50 ohm, coax circuit. Both fixtures provide bias for bipolar transistors and FETs. Other devices also fit the fixture (tunnel diodes, etc.).
Transistor base patterns
Model 11600B: accepts TO-18/TO-72 packages.
Model 11602B: accepts TO-5/TO-12 packages.
Calibration references: short circuit termination and a 50 ohm through-section.
Frequency ranges: dc to 2 GHz.
Impedance: 50 ohm nominal.
Reflection coefficient: < 0.05 , 100 MHz to 1.0 GHz: < 0.09 , 1.0 to 2 GHz.
Connectors: hybrid APC-7; Option 001, type N female.
Weight: net 1.1 kg (2 3/8 lb). Shipping, 1.8 kg (4 lb).
Size: 152 H x 44 W x 229 mm D (6" x 1 3/4" x 9").

8743A Reflection/Transmission Test Unit

Function: wideband RF power splitter and reflectometer with calibrated line stretcher. Pushbutton operated for either transmission or reflection measurement with network analyzer.
Frequency range: 2 to 12.4 GHz, (Opt 018: 2 to 18 GHz).
Impedance: 50 ohms nominal.
Source reflection coefficient: ≤ 0.09 , 2.0 to 8.0 GHz; ≤ 0.13 , 8.0 to 12.4 GHz; < 0.2 , 12.4 to 18 GHz.
Termination reflection coefficient: ≤ 0.13 in reflection mode, 2.0 to 12.4 GHz; ≤ 0.2 in transmission mode, 2.0 to 12.4 GHz; typically < 0.2 , 12.4 to 18 GHz.
Directivity: ≥ 30 dB, 2.0 to 12.4 GHz; ≥ 18 dB, 12.4 to 18 GHz.
Reference plane extension: 0 to 15 cm for reflection; 0 to 30 cm for transmission.
Connectors: RF input, type N female; all other connectors APC-7.
Remote programming: ground closure.
Power: 115 or 230 V $\pm 10\%$, 50-400 Hz, 15 W.
Weight: net, 12.1 kg (29 lb). Shipping, 15.3 kg (34 lb).
Size: 140 H x 425 W x 467 mm D (5 1/2" x 16 3/4" x 18 3/8").

11605A Flexible Arm

Function: Mounts on front of 8743A; connects to device under test. Rotary air-lines and rotary joints connect to any two-port geometry.
Frequency range: dc to 12.4 GHz. (Opt 018, 2 to 18 GHz).
Impedance: 50 ohms nominal. Reflection coefficient of ports: ≤ 0.11 , dc to 12.4.
Opt 018: ≤ 0.23 , 2.0 to 12.4 GHz; ≤ 0.31 , 12.4 to 18 GHz.
Connectors: APC-7,
Weight: net, 1.8 kg (4 lb). Shipping, 2.7 kg (6 lb).
Length: 257 mm (10 1/8") closed; 648 mm (25 1/2") extended.

Ordering information

Ordering information	Price
8745A Test Set	\$5500
Opt 001: Type N Test Port Connectors	N/C
Opt 908: Rack Flange Kit	add \$10
11604A Universal Arm	\$1600
11600B/11602B Transistor Fixtures	\$950
Opt 001: Type N Female Connectors	less \$30
8743A Reflection/Transmission Test Unit	\$4500
Opt 018: 0.11 to 18 GHz	add \$800
Opt 908: Rack Flange Kit	add \$10
11605A Flexible Arm	\$1250
Opt 018: 0.11 to 18 GHz	add \$550



8746B



11608A



8717B



8740A



8741A



8742A

8746B S-Parameter Test Set

Function: wideband RF power divider and reflectometer with calibrated stretcher and a selectable 0-70 dB incident signal attenuator. Provides internal bias for completely characterizing two port active devices.

Frequency range: 0.5 to 12.4 GHz.

Source and termination reflection coefficient: ≤ 0.13 .

Directivity: ≥ 30 dB, 0.5 to 4.0 GHz; ≥ 26 dB, 4.0 to 12.4 GHz.

Incident attenuation: 0-70 dB in 10 dB steps $\pm 5\%$.

Reference plane extension: adds 0 to 15 cm for reflection; 0 to 30 cm for transmission.

Remote programming: ground closure.

Transistor biasing: via 36 Pin connector.

Connectors: input type N female, test ports APC-7.

Opt 001: provides 10 dB higher power level at the test port.

Power: 115 or 230 V $\pm 10\%$, 48 to 440 Hz, 110 VA max.

Weight: net, 16.1 kg (35 lb). Shipping, 19.1 kg (42 lb).

Size: 140 H x 425 W x 467 mm D (5½" x 16¾" x 18¾").

11608A Transistor Fixture

Function: provides the capability of completely characterizing stripline transistors in either the TO-51 or HPAC-200 package styles. For special package styles, a through-line microstrip and bolt-in grounding structure machineable by customer is available.

Frequency range: dc to 12.4 GHz.

Reflection coefficient: < 0.05 , dc to 4 GHz; < 0.07 , 4.0 to 8.0 GHz; < 0.11 , 8 to 12.4 GHz.

Package styles

Opt 001: Customer machineable.

Opt 002: TO-51 (0.250" dia.).

Opt 003: HPAC-200 (0.205" dia.).

Calibration references: options 002 and 003 only, short circuit termination and a 50-ohm through-section.

Connectors: APC-7 Hybrid (Option 100 type N female).

Weight: net, 0.9 kg (2 lb). Shipping, 1.4 kg (3 lb).

Size: 25 H x 143 W x 89 mm D (1" x 5½" x 3½").

8717B Transistor Bias Supply

Function: for manual or programmable transistor testing. It is particularly useful with the 11600B, 11602B, and 11608A Transistor Fixtures. The 8717B has two meters for independently monitoring current and voltage on any of the three leads of a transistor under test. Bias connections are conveniently selected for all transistor configurations with a front panel switch. Special circuitry protects sensitive devices from excessive current transients which commonly occur in less sophisticated supplies.

Voltage ranges: 1, 3, 10, 30, 100 V.

Current ranges: 0.1, 0.3, 1, 3, 10, 30, 100, 300, 1000 mA.

Accuracy: 4% of full scale for both current and voltage.

Option 001: programmable D/A converter.

Weight: net, 9.0 kg (20 lb). Shipping, 11.0 kg (25 lb).

Size: 86 H x 425 W x 336 mm D (3¾" x 16¾" x 13½").

8740A Transmission Test Unit

Function: RF power splitter and calibrated line stretcher for transmission measurement with network analyzer.

Frequency range: dc to 12.4 GHz.

Output reflection coefficient: < 0.07 , dc to 7 GHz; < 0.11 , 7.0 to 12.4 GHz.

Connectors: RF input, type N female; output, APC-7.

Reference plane extension: electrical, 0 to 10 cm; mechanical 1-10 cm.

Weight: net, 7.1 kg (16 lb). Shipping, 9.4 kg (21 lb).

Size: 152 H x 186 W x 410 mm D (6" x 7½" x 16¾").

Recommended accessory: 11587A Accessory kit.

8741A and 8742A Reflection Test Units

Function: wideband reflectometer, phase-balanced for swept or single frequency impedance tests with 8410B. Calibrated adjustable reference plane.

Frequency range: 0.11-2.0 GHz (8741A); 2.0-12.4 GHz (8742A).

Directivity: ≥ 36 dB 0.11-1 GHz, ≥ 32 dB 1-2 GHz (8741A); ≥ 30 dB 2-12.4 GHz (8742A).

Connectors: RF input, type N female, all others APC-7.

Reference plane extension: 0-15 cm.

Accessories furnished: 11565A, APC-7 short.

Weight: net, 6.7 kg (15 lb). Shipping, 8.9 kg (20 lb).

Size: 152 H x 186 W x 410 mm D (6" x 7½" x 16¾").

Recommended accessory: 11587A Accessory Kit

Ordering information

	Price
8746B Test Unit	\$7700
Opt 001: Type N Test Port Connectors	N/C
Opt 908: Rack Flange Kit	add \$10
11608A Transistor Fixture (must specify Option 001, 002, or 003)	
Opt 001: Customer Machineable	\$750
Opt 002: TO-51	\$800
Opt 003: HPAC-200	\$800
Opt 100: Type N Female Connectors	less \$30
8717B Transistor Bias Supply	\$2950
Opt 001: Programmable D/A Converter	add \$670
Opt 908: Rack Flange Kit	add \$10
8740A Transmission Test Set	\$3600
8741A Reflection Test Set	\$2750
8742A Reflection Test Set	\$3600

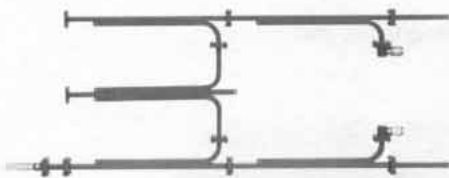

X8747A and P8747A

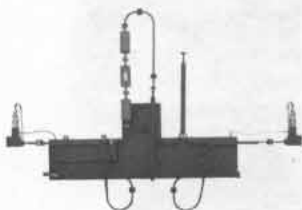

K8747A and R8747A



11587A



11650A



11609A



11589A and 11590A



11599A



11607A

X, P 8747A Reflection/Transmission Test Units

Function: waveguide setup for measuring reflection and transmission parameters of waveguide devices with the network analyzer.

Frequency range: X8747A: 8.2-12.4 GHz; P8747A: 12.4-18 GHz.

K, R 8747A Reflection/Transmission Test Units

Function: waveguide setup for measuring reflection and transmission parameters of waveguide devices with the network analyzer; down-converts with built-in mixers to the frequency range of the 8411A.

Frequency range: K8747A: 18-26.5 GHz; R8747A: 26.5-40 GHz.

11587A Accessory Kit

Function: accessories normally used for transmission and reflection tests with the 8740A, 8741A, and 8742A.

Weight: net, 1.34 kg (3 lb). Shipping, 2.23 kg (5 lb).

11650A Accessory Kit

Function: accessories normally used for transmission and reflection tests with the 8745A and 8743A.

Weight: net, 1.34 kg (3 lb). Shipping, 2.23 kg (5 lb).

11609A Cable Kit

Function: interconnecting cables normally required for network measurements using the 8410 network analyzer.

Weight: net, 0.9 kg (2 lb). Shipping, 1.36 kg (3 lb).

11589A and 11590A Bias Networks

Function: auxiliary units for use with the 11600B, 11602B and 11608A transistor fixtures. These bias networks provide dc bias to the center conductor of a coaxial line while blocking the dc bias from the input RF circuit.

Frequency range: 11589A—0.1 to 3.0 GHz; 11590A—1.0 to 12.4 GHz.

Connectors: BNC for dc biasing; type N female for RF (Option 001; APC-7).

Weight: net, 0.3 kg (9 oz). Shipping, 0.5 kg (1 lb).

Size: 29 H x 76 W x 114 mm D (1 3/8" x 3" x 4 1/2").

11599A Quick Connect Adapter

Function: quickly connects and disconnects the 8745A and the transistor fixtures or 11604A universal extension.

Weight: net, 397 gm (14 oz). Shipping, 652 gm (2 lb).

Size: 127 H x 76 W x 108 mm D (5" x 3" x 4 1/2").

11607A Small Signal Adapter

Function: used with the 8745A S-parameter test set. The incident signal levels to the test device are reduced to the -20 to -40 dBm range.

Weight: net 4.1 kg (4 3/4 lb). Shipping, 4.5 kg (10 lb).

Size: 60 H x 413 W x 244 mm D (2 3/8" x 16 1/4" x 9 5/8").

Ordering information

	Price
X8747A Waveguide Test Set	\$3300
P8747A Waveguide Test Set	\$3450
K8747A Waveguide Test Set	\$9525
R8747A Waveguide Test Set	\$10,050
11587A Accessory Kit	\$1295
11650A Accessory Kit	\$980
11609A Cable Kit	\$140
11589A Bias Network	\$400
Opt 001: APC-7 Connectors	add \$30
11590A Bias Network	\$450
Opt 001: APC-7 Connectors	add \$30
11599A Quick Connect Adapter	\$200
11607A Small Signal Adapter	\$850

NETWORK ANALYZERS

Semi-automatic network analyzer, 110 MHz to 18 GHz

Model 8409A

- Economical automated microwave measurements
- Accuracy enhancement
- 9825A Desktop Computer



Description

The HP 8409A Network Analyzer system is a practical solution to the need for automated error-corrected RF and microwave network measurements using a simple and economical configuration. It's a complete measurement system, comprised of a programmable source, network analyzer, and computing controller. The 8409A brings major advantages in accuracy, speed, and operating convenience at a modest cost increase compared to a manual network analyzer.

The 8409A consists of standard HP instruments and is delivered with accuracy enhancement software, calibration standards, and all necessary cables for hook-up and immediate use. Transmission and reflection characteristics are measured in two ranges, 0.11 to 2 GHz using the 8745A S-Parameter Test Set and 86222B Sweeper Plug-in, and 2 to 18 GHz using the 8743A Reflection/Transmission Test Unit and 86290B Sweeper Plug-in. Switching between the two frequency ranges is easily accomplished by changing both the test set and sweeper plug-in.

Accuracy enhancement software extends measurement capability to tests not possible or extremely difficult and time consuming using a manual system. Vector error terms are measured and stored using a precision sliding load, a short, a shielded open, and a through connection to quantify directivity, source match, and tracking errors at each frequency. These systematic errors are removed during the measurement sequence as the analyzer tunes back to each calibration frequency, measures the device response, and performs the error correction computation.

8409A Automatic Network Analyzer system components

Basic configuration includes:

Network analyzer

8410B Network Analyzer

8411A Opt 018 Harmonic Frequency Converter
8412A Phase-Magnitude Display
8418A Opt H01 Auxiliary Power Supply
8414A Polar Display

Test sets

8745A S-Parameter Test Set (0.11 to 2 GHz)
11857A Test Port Extension Cables
8743A Opt 018 Reflection/Transmission Test Set (2 to 18 GHz)
11611A Test Port Extension Cable

Source

8620C Opt 011 Sweep Oscillator Mainframe with HP-IB Interface
86222B (.01 to 2.4 GHz)
86290B (2 to 18.6 GHz)

HP-IB accessories

59313A Analog-to-Digital Converter
59306A Relay Actuator

Controller

9825A Opt 002 Desk Top Computer (with 23K bytes memory) with String-Advanced Programming ROM, 9872A Plotter-General and Extended I/O ROM and HP-IB Interface.
9866B Thermal Printer with cradle
9872A Digital Plotter

APC-7, Type N, and SMA calibration accessories,
11863B software, interconnect cables and system integration

Ordering information

	Price
8409A Automatic Network Analyzer	\$78,225
Opt 001: (2 to 18 GHz) deletes 0.11 to 2 GHz test set and sweeper plug-in.	less \$10,905
Opt 002: delete controller	less \$19,075



- Digital storage and normalization
- Simple CRT photos and x-y recordings
- Use with HP network and spectrum analyzers



With HP's versatile 8750A Storage-Normalizer, you can make your network analyzer or spectrum analyzer measurements faster, easier, and more accurately through the simple addition of digital storage and normalization. This useful instrument accessory is directly compatible via a single interface cable with the following recently produced or appropriately modified Hewlett-Packard instruments; the 8755 Frequency Response Test Set, the 8407A/8412A, the 8410/8412A, the 8754A and the 8505A Networks Analyzers and 8557A, 8558B, and 8565A Spectrum Analyzers. A special I/O Adapter (opt 001 or opt 002) is available for interfacing instruments (like 140 Series Spectrum Analyzers) that are not directly compatible with the 8750A. An external oscilloscope can then be used for digitally stored and normalized displays. (The 8750A is not compatible with the 8414A Polar Display or the polar mode of the 8505A or the 8754A.)

In network analyzer applications, digital storage always yields a flicker-free display of the complete device response, facilitating easy adjustment of test devices under slow sweep conditions. Measurement accuracy is also improved since frequency response errors can be automatically removed through digital normalization. This effectively eliminates the need to manually record calibration traces on a CRT or x-y recorder and allows high resolution measurements of attenuator, amplifier, or filter passband flatness.

In spectrum analyzer applications, the 8750A's digital storage feature simplifies many difficult tests requiring slow scan times such as high resolution modulation measurements. Drift test are also easy since two traces, a stored reference and the current input, can be displayed simultaneously.

Hard copy documentation can be obtained quickly and easily since data can be frozen on the CRT for straight forward CRT photography or outputted to an x-y recorder at a constant 30 second sweep rate.

Specifications

Display

Horizontal memory resolution: two display channels, 256 points per channel (0.4% of full scale, 8 bit word)

Vertical memory resolution: 512 points displayed full scale (0.2% of full scale, 10 bit word) plus a 50% overrange (256 points) both above and below full screen.

Horizontal input sweep rates: 100 sec max./10 ms. min.

Display refresh rate: 6 ms.

Video detection

Network analyzer: Average Detection (20 kHz).

Spectrum analyzer: Peak Detection.

Input/output

A/D Horizontal input

Network analyzer: 0 to 10 V nominal. Offset ± 0.5 V and Gain Adjust 6 to 15 V.

Spectrum analyzers: ± 5 V nominal. Offset ± 0.5 V and Gain Adjust ± 4.5 to ± 5.5 V.

A/D Vertical input

Network analyzer: ± 0.8 V min. and ± 2.25 V max, with continuous gain adjustment. Offset ± 0.3 V.

Spectrum analyzer: 0 to 0.8 V or 0 to -0.8 V. Offset ± 0.1 V and Gain Adjust $\pm 10\%$.

D/A Horizontal output

Network analyzer: gain adjustment from 1 to 3 V peak. Offset adjustment allows ± 1.5 V or 0 to 3 V sweep output.

Spectrum analyzer: 0 to 3 V nominal. Offset ± 5 V and Gain Adjust from 0.7 to 3.5 V.

D/A Vertical output

Network analyzer: same as Vertical Input with $\pm 10\%$ adjustment range.

Spectrum analyzer: same as Vertical Input with $\pm 10\%$ adjustment range.

X-Y Recorder outputs

Horizontal range and accuracy: 0 ± 20 mV to 1 V nominal, settable within $\pm 3\%$ of full scale. BNC female output (rear panel).

Vertical range and accuracy: ± 4 V $\pm 3\%$ BNC female output (rear panel).

Sweep time: 30 sec per displayed trace.

Penlift output: BNC female (rear panel with open collector driver 20 V maximum.)

Controls

Select: LED display indicates Network or Spectrum Analyzer operation depending on the plug-in interface card.

Display

Input: initiates digital storage.

Input-Mem (Input minus Mem.): Stored Reference trace is subtracted from input data (normalization).

Hold: freezes display for CRT photos or further analysis.

Reference memory

Store input: current input trace is stored as Reference.

Recall: displays stored Reference trace.

Bypass: bypasses 8750A so display is returned to conventional analog operation.

X-Y Plot: initiates X-Y plots.

General

Interface Cards: The 8750A is supplied with two general plug-in interface cards for use with the HP Network and Spectrum Analyzers listed above. When the 8750A is to be used primarily with an 8755B Frequency Response Test Set and 8620C Sweeper, 8410B/8412A Network Analyzer and 8620C Sweeper, or the 8754A Network Analyzer, calibration and adjustment of the 8750A to these instruments can be greatly simplified by ordering one of the plug-in interface cards dedicated to these instruments (Opt. 003 and 004.) All offset and gain adjustments are significantly reduced. When Opt. 003 or 004 are ordered the two general interface cards are also included so you have the flexibility to change your test set up at any time.

Power: selection 100, 120, 220, or 240 V $\pm 5\%$ -10% . 48 to 440 Hz and <20 VA (<20 watts).

Size: 102 H x 212 W x 280 mm D (4" x 8.4" x 11.2").

Weight: net. 2.72 kg (6.1 lbs). Shipping, 5.0 kg (11 lbs).

Ordering information

8750A Storage-Normalizer

Price

\$1450

Opt 001: BNC Interface Adapter (Deletes direct interface cable)

N/C

Opt 002: BNC Interface Adapter (Retains direct interface cable)

add \$125

Opt 003: 8755B or 8412A/8620C Plug-in Interface Card

add \$100

Opt 004: 8754A Plug-in Interface Card

add \$100

SIGNAL ANALYZERS

Wave, distortion, modulation, spectrum and Fourier analyzers

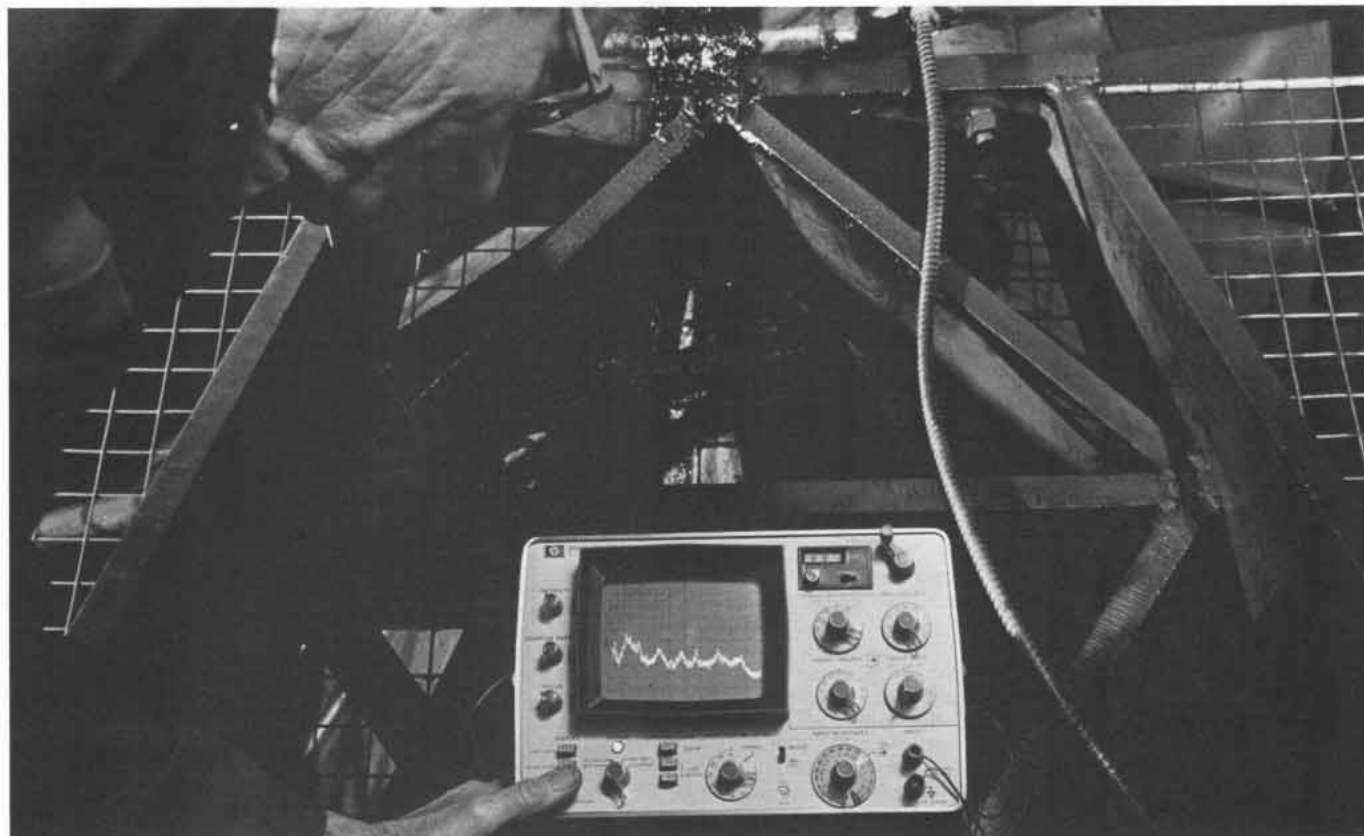

Analysis of signals in the frequency domain is an important measurement concept which is widely used for providing electrical and physical system performance information. Several examples will illustrate some important applications where signal analyzers are useful.

Noise and vibration levels are of major concern to manufacturers and users of mechanical structures such as aircraft, automobiles, and bridges. With an appropriate motion-to-electrical signal transducer the spectrum analyzer or the Fourier analyzer can examine vibration signals in the frequency domain. This makes it possible to monitor and analyze vibration components of rotating machines associated with unbalance, worn bearings or worn gears.

In the fields of telecommunications, the spectrum, modulation and wave analyzers provide vital operational performance verification of transceivers and multiplex systems. Unwanted signals such as carrier leak signals, out-of-band noise, and cross modulated signals must be identified. System gain, loss, and pilot tone measurements must also be made. These measurements are discussed in more detail in the Telecommunications Test Equipment section of this catalog.

Finally, in the general field of electronics, there are four primary uses for the signal analyzer. First, the analyzer is used to identify and measure signals which result from non-linear effects in the process of amplification, filtering, and mixing. Second, the purity of signal sources is commonly observed. Third, the modulation analyzer serves a special purpose in analyzing modulated commu-

nication signals by measuring and displaying RF power, frequency and modulation characteristics. Fourth, the signal analyzer with a companion tracking generator is used as a network analyzer for frequency response measurements of filters, amplifiers, and many other types of networks.

This section discusses the definition and use of several types of instruments for frequency response signal analysis: spectrum analyzers, digital Fourier analyzers, wave analyzers, distortion analyzers and modulation analyzers.

Each of these instruments measure basic properties of a signal in the frequency domain, but each uses a different technique. The spectrum analyzer is a swept receiver that provides a visual display of amplitude versus frequency. It shows on a single display how energy is distributed as a function of frequency, displaying the absolute value of Fourier components of a given waveform. The Fourier analyzer uses digital sampling and transformation techniques to form a Fourier spectrum display that has phase as well as amplitude information. The wave analyzer is the true tuned voltmeter, showing on a meter the amplitude of the energy in a specific frequency window which is tunable over a specific frequency range. The distortion analyzer performs an almost reciprocal function to that of the wave analyzer. It collectively measures the energy outside a specific bandwidth tuning out the fundamental signal and displaying the energy of the harmonics and other distortion products on a meter. The modulation analyzer tunes to the

desired signal and recovers the entire modulation envelope of AM, FM and phase modulation for processing and display.

Figure 1 shows a graphical representation of the way four of the analyzers view a signal and one harmonic. The time domain scan of the signal is presented in Figure 1a. $A(t)$ is the complex voltage waveform as it would be viewed on an oscilloscope. The dashed lines represent the vector components of the signal: $A_1(t)$, the fundamental and $A_2(t)$ the second harmonic. In 1b, the spectrum analyzer displays the frequency spectrum showing both vector components and their amplitude relationship. Spectrum analysis is useful from 5 Hz to over 40 GHz.

The Fourier analyzer uses digital signal processing techniques to extract both the amplitude and phase information about each spectral component. Conceptually the Fourier analyzer can be viewed as measuring a large number (up to 2048) of parallel filters as shown in Figure 1c. These filters are actually very specialized digital filters so that precise, repeatable results can be obtained. With this arrangement of parallel filters the complete display is generated in the time that it takes to analyze the lowest frequency component. HP Fourier analyzers presently cover the range of DC to 100 kHz.

The wave analyzer in Figure 1d, measures the amplitude and frequency of the signal in the frequency window to which it is tuned. This window can be moved to measure the amplitude of the second harmonic, thereby making a precise comparison with the fundamental. This technique is practical from 10 Mz to above 18 MHz.

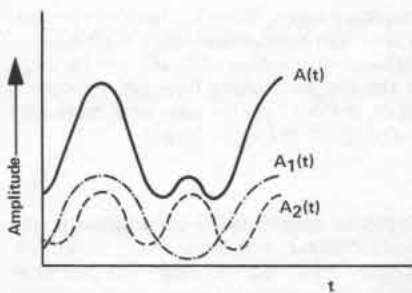

Figure 1a. Waveform

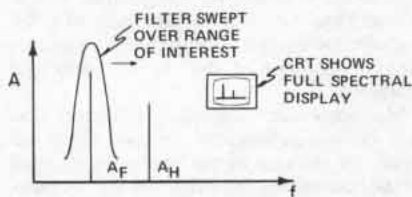

Figure 1b. Spectrum analyzer

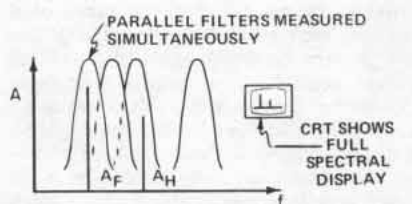

Figure 1c. Fourier analyzer

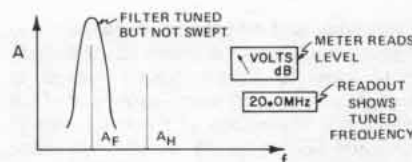

Figure 1d. Wave analyzer

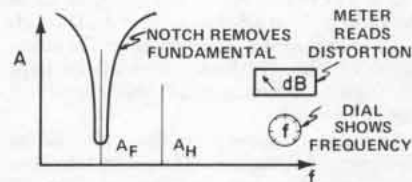

Figure 1e. Distortion analyzer

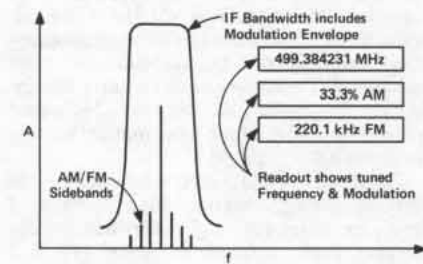

Figure 1f. Modulation analyzer

The distortion analyzer as pictured in Figure 1e. rejects the fundamental to which it has been tuned and measures the energy everywhere else within the instrument's frequency spectrum. Distortion, as a percentage or in dB down from the fundamental, is displayed directly on a meter. Hewlett-Packard distortion analyzers cover 5 Hz to 600 kHz.

The modulation analyzer of Figure 1f. tunes to a desired frequency just as the wave analyzer. Its IF bandwidth and detection system are designed to pass the entire modulation envelope so that percent modulation, distortion, residual and peak deviation measurements can be made. All close-in spectral components, of course, are combined in the measurement.

The following section considers each instrument technique, showing the particular strength and flexibility of each.

Spectrum analyzers

To display useful information about a frequency scan, a spectrum analyzer must be sensitive, frequency stable, free of spurious responses over a wide band, and have calibrated accuracy in the CRT display. The examples which follow best demonstrate the wide variety of information which can be measured on the spectrum analyzer.

Measurements with the spectrum analyzer

CW signal: the most basic spectrum analysis measurement is the single CW signal.

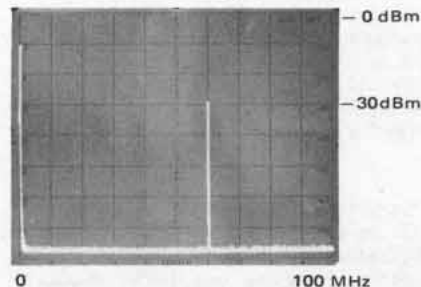

Pictured is a -30 dBm signal at 60 MHz. The zero frequency indicator is at the far left graticule.

Spectral purity of a CW signal: one very important oscillator signal measurement is spectral purity. This 70 MHz carrier has power line related sidebands (± 60 Hz) which are 65 dB down.

Such sidebands may result from power supply ripple. The 50 Hz/division spectrum analyzer scan and the 10 Hz analyzer bandwidth provide the high degree of resolution required to see these sidebands.

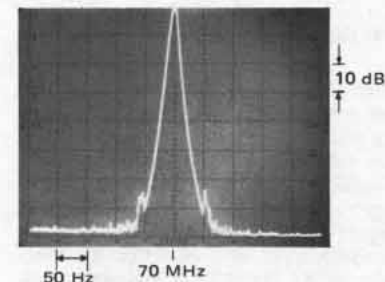

Frequency conversion products: the spectrum analyzer is well suited for frequency conversion measurements such as the output of a balanced mixer as shown.

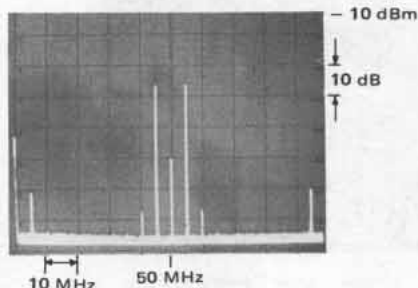

With the 50 MHz local oscillator input at 0 dBm and a 5 MHz, -30 dBm mixer signal, two sidebands at 45 MHz and 55 MHz result. The sidebands are -36 dBm, giving the mixer a 6 dB conversion loss. The local oscillator has 60 dB isolation and the 5 MHz signal has 41 dB isolation. Second order distortion products at 40 and 60 MHz are 40 dB below the desired mixer outputs.

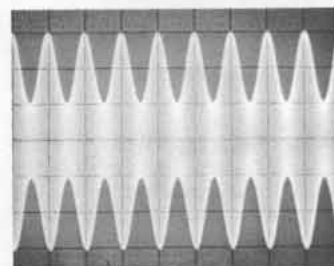

Oscilloscope

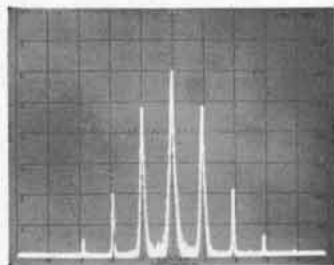

Spectrum Analyzer

Amplitude modulation: percent amplitude modulation is often more easily measured with the spectrum analyzer than it is with the oscilloscope. This is especially true for low level modulation.

With the oscilloscope time display, percent modulation, M , is measured as a ratio of the signal's dimensions: $M = 100(6-2)/(6+2) = 50\%$. In the spectrum analyzer display, whose vertical calibration is 10 dB/division, the carrier and sidebands differ by 12 dB, the voltages in the sidebands are $1/4$ of that of the carrier and again, $M = 50\%$. At the same time the second and third harmonic distortion of the sidebands can be measured at 28 and 44 dB respectively.

Frequency modulation: information transmitted by FM can be thoroughly characterized by the spectrum analyzer.

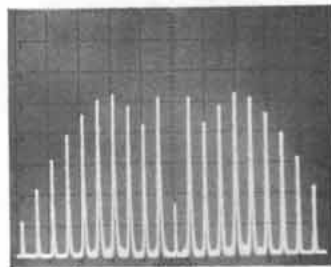

20 kHz Low Deviation FM

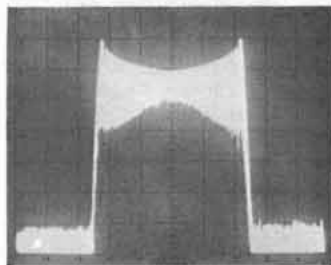

0.5 MHz High Deviation FM

Low deviation FM is applied to a 60 MHz carrier in the first photo. The deviation has been adjusted for the second carrier null ($M = 5.52$). The sideband spacing is 10 kHz, the modulation frequency; therefore, Δf peak = $5.52 \times 10 \text{ kHz} = 55.2 \text{ kHz}$.

The second photo is an example of a high deviation FM. The transmission bandwidth is 2.5 MHz.

Pulsed CW power: by viewing the spectra of a repetitive RF pulse on the spectrum analyzer, pulse width, average and peak power, occupied bandwidth, and duty cycle can be determined.

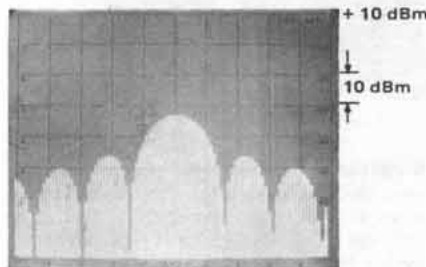

0.5 MHz 6.3 GHz

From the spectral output shown the pulse's complete characteristics are determined: 6.3 GHz RF at 0 dBm, pulsed at 50 kHz rate. The pulse width is 1.3 μs .

Noise: spectrum analysis is effective in measuring impulse noise, random noise, carrier to noise ratio, and amplifier noise figure.

Phase noise: the short term frequency fluctuations of a sine wave source can be measured directly as phase modulation sidebands. Hewlett-Packard spectrum analyzers with narrow resolution and synthesized internal frequency sources can make many phase noise measurements directly. Bandwidth corrections, analyzer corrections, data averaging and setup calibration factors can be accounted for by Hewlett-Packard microprocessor controlled spectrum analyzers. All instrument controls, data transfer and data reduction can be handled by easy-to-write software for Automatic Spectrum Analyzers.

Frequency response: using a tracking signal source and a spectrum analyzer the frequency response of filters can be displayed with ease.

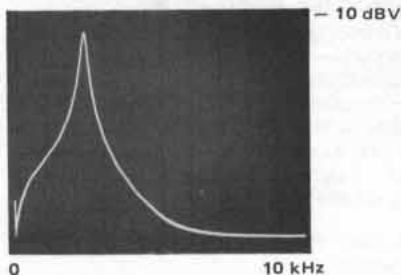

In this case, an audio filter used in a communications system is being measured. Since the input reference level to the filter is -13 dBV, the insertion loss at 2.4 kHz is 4 dB. Extremely high Q devices can be measured with this system.

Spectrum analyzer capabilities

To be useful in making measurements in the frequency domain, the analyzer must be capable of making quantitative measurements. Specifically, an analyzer must:

1. make absolute *frequency* measurements
2. make absolute *amplitude* measurements
3. operate over a *large amplitude dynamic range*
4. have *high resolution* of frequency and amplitude
5. have *high sensitivity*
6. provide means of *observing, preserving, and recording* its output in a convenient and rapid manner by using variable persistence, digital storage and adaptive sweep. Hewlett-Packard spectrum analyzer excel in these six measures of performance. Let us consider each of these performance standards in greater detail.

Absolute frequency measurements: Frequency readout accuracy depends upon the tuning and readout techniques employed, as well as the stability of the spectrum analyzer's frequency reference. The absolute frequency accuracy read off the slide-rule type of frequency dial is approximately 1% of full scale. Synthesized local oscillators allow accuracies to $\pm 4 \text{ Hz}$ at 1500 MHz in narrow

frequency spans. When the spectrum analyzer is used in conjunction with a tracking generator (a source whose frequency is the same as the analyzer tuning frequency) accuracy much better than 1% can be achieved by counting the generator output.

Absolute amplitude measurements: All Hewlett-Packard spectrum analyzers are absolutely calibrated for amplitude measurements. This means the spectrum analyzer indicates to the user what the log/reference level or linear sensitivity is regardless of control settings. Either a warning light or CRT message indicates an uncalibrated condition, making operation of the analyzer easy and foolproof.

Microprocessor controlled analyzers feature built-in calibration routines which account for changes in analyzer controls such as the resolution bandwidth and RF attenuator.

Dynamic range: the dynamic range of a spectrum analyzer is defined as the difference between the input signal level and the average noise level or distortion products whichever is greater. Hence, dynamic range can be either distortion limited, noise limited or display limited. Hewlett-Packard microprocessor controlled analyzers can be set to ensure that distortion products of on-screen signals will be below a certain level.

Frequency and amplitude resolution: frequency resolution is the ability of the analyzer to separate signals closely spaced in frequency. The frequency resolution of an analyzer is a function of three factors: 1) minimum IF bandwidth, 2) IF filter shape factor, 3) spectrum analyzer stability.

The minimum IF bandwidth ranges down to 1 Hz on Hewlett-Packard spectrum analyzers.

One way to define IF filter shape factor is the ratio of 60 dB bandwidth to 3 dB bandwidth. Filter shape factor specifies the selectivity of the IF filter. Hewlett-Packard spectrum analyzers have IF filter shape factors as low as 5:1.

Analyzer frequency stability also limits resolution. The residual FM (short term stability) should be less than the narrowest IF bandwidth. If not, the signal would drift in and out of the IF pass band. Hewlett-Packard analyzers have excellent stability. The residual FM ranges from <1 Hz at low frequency, to <100 Hz at microwave frequencies, enabling the measurement of noise sidebands. The stabilization circuitry is completely automatic and foolproof. No signal recentering, phase-lock loop, manual search, or checking is required.

Amplitude resolution is a function of the vertical scale calibration. Hewlett-Packard analyzers offer both log calibration for observing large amplitude variations (10, 5, 2 and 1 dB/div) and linear calibration for observing small amplitude variations.

Sensitivity: sensitivity is a measure of an analyzer's ability to detect small signals, and is often defined as the point where the signal level is equal to the noise level or $(S+N)/N=2$. Since noise level decreases as the bandwidth is decreased, sensitivity is a function of bandwidth. The maximum attainable sensitivity ranges from -150 dBm to -125 dBm with Hewlett-Packard analyzers.

Variable persistence, digital storage, and adaptive sweep: high resolution and sensitivity both require narrow bandwidths and consequently slow sweep rates. Because of these slow sweeps, both digital display and variable persistence are virtually indispensable in providing a bright, steady flicker-free trace.

The digital storage feature on Hewlett-Packard analyzers covering audio to microwave frequency ranges make measurements and CRT photography simple. It gives the CRT display a dot matrix connected by line generators for an unbroken and uniform intensity scan. In addition, the microprocessor controlled analyzers feature CRT annotation to completely describe the data characteristics displayed.

On low frequency analyzers, adaptive sweep effectively speeds the measurement times. On the very slow sweep times (required when using the 1 Hz bandwidth), adaptive sweep allows the scan to sweep rapidly when no signals occur and slow down when a signal is above a preset level. The measurement time savings can be greater than 20:1

Tracking preselector

The only way to simultaneously avoid spurious, multiple, harmonic and image responses is to filter the RF signal through a tracking preselector. This is an electronically tuned bandpass filter that automatically tracks the analyzer's tuning. A preselector improves the spurious-free range of the analyzer from 70 dB to 100 dB.

Tracking generator

A tracking generator expands the measurement capability of the spectrum analyzer by providing a signal source which tracks the tuning frequency of the analyzer. The source/receiver combination can be used to measure insertion loss, frequency response, return loss and allow precision frequency counting.

It helps make these additional measurements with increased distortion-free dynamic range, sensitivity and selectivity. The tracking generator is also an excellent stable sweeping generator. The residual FM varies from ± 1 Hz for low frequency tracking generators to ± 400 Hz for microwave tracking generators.

Automatic spectrum analyzers

The measurement capability of a spectrum analyzer can be greatly enhanced by allowing a desktop computer to control instrument functions and record frequency and ampli-

tude information. Data can be gathered and processed into a variety of formats at a very rapid rate. Through comprehensive self-calibration, automatic spectrum analysis offers amplitude accuracy of up to ± 0.2 dB with 0.02 dB resolution. User cost savings are realized through faster measurements, lower operator skill requirements, and unattended operation capability.

Further discussion of computer based automatic spectrum analysis can be found on page 497.

Frequency stability analysis

Frequency stability and spectral purity are important parameters when characterizing precision frequency sources. Long term stability or frequency drift due to aging or temperature effects is generally measured with a precision frequency counter such as the HP 5345A; random fluctuations in frequency or phase stability can be measured in the time domain with an electronic counter and the Allan Variance technique.

Another measure of frequency stability is the phase spectral density. The most common method of making this measurement is to mix two signals together and feed the output into a lower frequency wave analyzer or spectrum analyzer. The technique works well for offset frequencies far away enough from the carrier to be compatible with the bandwidths of the analyzer.

For offset frequencies close to the carrier, (e.g. below 100 Hz) the bandwidths of analog analyzers become large in comparison to the frequencies being measured. As 1 Hz is approached, measurements become extremely difficult.

An automatic system for making phase spectral density measurements very close to the carrier is the HP 5390A Frequency Stability Analyzer which is based upon a high performance electronic counter and a programmable calculator. The counter is ideally suited to make measurements in the time domain, and the calculator can transform the data into the frequency domain. This technique allows measurements to be made from 0.01 Hz away from the carrier out to 10 kHz. Sensitivities greater than -150 dBc can typically be obtained at a 1 Hz offset on carriers ranging from 500 kHz to 10 GHz. The standard 5390A requires two sources which can be offset from one another. The 5390A option 010, based on the dual mixer time difference technique, can perform these same measurements on non-offsettable sources. For a more complete description of this automated technique refer to the 5390A Frequency Stability Analyzer on page 538.

Fourier analyzers

The Fourier analyzer uses digital signal processing techniques to provide measurement capability over and above that of a swept spectrum analyzer. Some of these include the precise measurement of random signals obscured by noise, measurement of

the joint properties or relationships of two or more signals, measurements of statistical properties of signals, and measurements of very low frequency (e.g. below 5 Hz) or very closely spaced (e.g. less than 1 Hz) signals.

Fourier analyzers are based on the calculation of the Discrete Fourier Transform using a highly efficient algorithm known as the Fast Fourier Transform. As shown in Figure 2, this algorithm calculates the magnitude and phase of each frequency component from a block of time domain samples of the input signal.

The block diagram that is involved is shown in Figure 3. First, the input signal is filtered to remove out-of-band components. Next, the input is sampled and digitized at regular Δt intervals until a full block of samples called a time record has been collected. The processor then executes the desired series of computations on the time data to produce the frequency domain results. These results, which are stored in memory, can be analyzed on a CRT display, plotted, or processed further to provide the user additional useful information.

$$X(k \Delta f) = \sum x(n \Delta t) e^{-j2\pi(n)k/N}$$

EACH FREQUENCY POINT IS COMPOSED OF A MAGNITUDE AND PHASE VALUE

EACH FREQUENCY POINT CONTAINS INFORMATION FROM ALL TIME DOMAIN SAMPLES

COMPLEX FACTOR

Figure 2

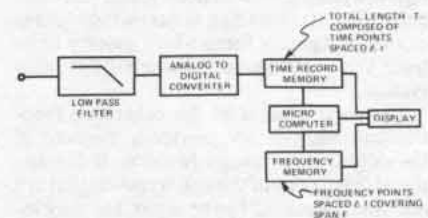

Figure 3

When two or more input channels are provided, signals can be sampled simultaneously. The processor can then additionally compute joint properties of the signals. This is useful for characterizing the transfer function of a linear device and for investigating cause/effect relationships.

The digital nature of Fourier analysis insures *high accuracy, stability* and *repeatability*. In addition, there are several specific advantages that are achieved.

Low frequency coverage

The Fourier transform calculates equally spaced frequency components from DC to the maximum frequency. By simply varying the sample rate it is possible to make measurements down to a few micro Hertz. For such low frequency measurements, the laws of physics dictate a long observation time. Since the Fourier transform simultaneously calculates all frequency points from one set of observation points, a one to two order of magnitude speed improvement over a swept measurement is possible.

High frequency resolution

By digitally translating a band of frequencies down to DC it is possible to provide very high frequency resolution over the entire range. This technique, known as Band Selectable Fourier Analysis, can provide resolution of a few millihertz as shown in Figure 4. Here a 5 Hz band of frequency located at 3 kHz is analyzed showing 0.48 Hz sidebands over 20 dB down.



Figure 4

Direct transfer function measurements

With simultaneous sampling of both the input and output of an electrical, mechanical, or acoustical system, it is possible to directly characterize transfer functions. Since the Fourier analyzer measures the frequency components simultaneously, energy must also be provided at these frequencies. This can be done with a broadband white noise signal, a pseudorandom noise signal or an impulse. Results presented in magnitude/phase or real/imaginary format help quickly illustrate the performance characteristics of a system.

The measurement of the coherence function can additionally provide a measure of the validity of a transfer function. It can distinguish portions of the output power that are not directly caused by the input, but may instead be due to additive noise, distortion products, or unmeasured inputs.

Systems compatibility

Since the Fourier analyzer is basically all digital, interfacing to a computing controller or other digital peripherals is relatively simple. Remote programming and data input/output can considerably expand the range of potential applications.

Fourier analyzer applications

The versatility and performance of the Fourier analyzer make it an ideal tool for a variety of applications as a few specific examples will illustrate.

In the general area of electronics, the Fourier analyzer functions as a very high performance spectrum and network analyzer. It can be very useful for measuring phase noise or for characterizing filters.

In the field of communications, the Fourier analyzer can be very useful for characterizing audio signals, such as modems and touch tone signals.

When combined with a microphone the Fourier analyzer can be useful in character-

izing acoustic devices, such as loud speakers.

With a motion transducer the Fourier analyzer can be used to analyze the vibration signatures of rotating machines. This can be very useful in helping to establish scientific maintenance policies.

The transfer function of a mechanical structure can illustrate how the structure responds to vibration inputs. This is extremely important in optimizing the design of structures that will be subjected to substantial vibration.

Correlator, spectrum display

Correlation analysis may be thought of as the time domain equivalent of spectrum analysis. It is particularly useful for the recovery of periodic signals buried in noise (without requiring a synchronizing signal), the measurement delays in signal transmission path, and the identification of time response of linear systems.

Correlation is the product of two signals expressed as a function of a time delay between them. In computing the cross correlation between two signals, one signal is delayed relative to the other by a known variable amount. For each value of relative delay, the signals are multiplied together and the average product represents the correlation, or similarity for the particular delay. A peak value in cross correlation of random signals indicates that for delay value there is a high degree of similarity between the signals. Such information can be useful in determining propagation times of random phenomena.

Autocorrelation is a special case in which a signal is delayed relative to itself. At zero delay, a signal is of course identical to itself and the correlation value is merely a measure of the mean square voltage of the signal. At increasing values of delay the autocorrelation function can reveal the existence of small periodic components in a large random signal. Such a measurement finds application in acoustics, infrasound analysis, radio astronomy, and many other fields.

Since the correlation function and the power spectrum are Fourier transform pairs, the addition of a spectrum display turns a correlator into a powerful frequency and time domain measuring instrument. An autocorrelation function measured by the correlator can be transformed by the spectrum display into the auto power spectrum of the input signal. Similarly, a crosscorrelation function may be transformed into the corresponding cross power spectrum.

The simultaneous display of time domain functions and their corresponding spectra, coupled with the features of digital signal analysis mentioned above give the correlator and spectrum display some unique advantages as an economical signal analyzer.

Wave analyzers

Wave analyzers are known by several different names: frequency selective voltmeter,

carrier frequency voltmeter, and selective level meter. These names describe the instrument's function rather well.

As mentioned in the introduction to this section a wave analyzer can be thought of as a finite bandwidth window filter which can be tuned throughout a particular frequency range.

Signals will be selectively measured as they are framed by the frequency window. Thus, for a particular signal, the wave analyzer can indicate its frequency (window position) and amplitude. Amplitude is read on an analog meter; frequency is read on either a mechanical or electronic readout.

The uses of wave analyzers can be categorized into three broad areas: 1) amplitude measurement of a single component of a complex frequency system, 2) amplitude measurement in the presence of noise and interfering signals and, 3) measurement of signal energy appearing in a specified, well defined bandwidth.

Wave analyzer considerations

Frequency characteristics

Range: should be selected with the future in mind as well as present requirements.

Accuracy and resolution: should be consistent with available bandwidths. Narrow bandwidths require frequency dial accuracy to place the narrow window in the proper position for measurement. Accuracy of instruments with selectable bandwidths is determined by the basic center frequency accuracy of the IF bandwidth filters in addition to the local oscillator frequency accuracy. Accuracy is usually specified as a fixed frequency error at any point on the dial, thus meaning poorer percentage accuracy at the low frequency settings.

Readout: usually a frequency dial but newer instruments use a frequency counter whose accuracy and ease of use outweighs the increased cost.

Stability: frequency stability is important when using narrow bandwidths and for long term signal monitoring. Stability is best achieved with automatic frequency control (AFC). AFC locks the local oscillator to the incoming signal and eliminates any relative drift between the two. It serves as a tuning aid to pull the signal within the passband, eliminating peaking the frequency control. The AFC always tunes within the passband, improving accuracy on repetitive measurements.

Sweep: some instruments are equipped with sweep to allow use as a spectrum analyzer. Readout is a CRT or X-Y recorder.

Amplitude characteristics

Range: the amplitude range is determined by the input attenuator and the internal noise of the instrument. Sensitivity is defined as the lowest measurable signal equal to the noise level for a unity signal-to-noise ratio (often called tangential sensitivity). Sensitivity will vary with bandwidth and input impedance.

Dynamic Range: defined as the dB ratio of the largest and smallest signals that can be simultaneously accommodated without causing an error in the measurement.

Attenuators: the amplitude range switch is an attenuator in the input and IF stages. Intermodulation distortion is lowest when the input amplifier has the minimum signal applied and the IF gain is greatest. Conversely the internal noise, important when making sensitive measurements, is lowest with maximum input signal and lowest IF gain. The two attenuator instruments allow this transfer of gain between input and IF to be accomplished easily.

Accuracy: amplitude accuracy is a function of frequency, input attenuator response, IF attenuator performance, calibration oscillator stability and accuracy, and meter tracking. Often specifications are expanded to separately describe each contributor.

Readout: amplitude readout is usually a meter calibrated in dB and/or volts. Linear voltage meters are used to allow the user to see down into the noise at the bottom of the scale. Digital readouts are not used because of their slow response and the difficulty of deriving rate-of-change information from a sequence of numbers. This is important since the readout is used as a tuning indicator to show presence of a signal in the passband and when it has reached a peak. Expanded scale meters allowing expansion of any 1 or 2 dB portion of the scale into a full scale presentation allow resolution of input level changes of a few hundredths of a dB. This is useful when the wave analyzer is used as a sensitive indicator in bridge of comparison measurements. The expanded scale meter is included in some instruments and is an optional accessory on others.

Input characteristics

Impedance: may be high impedance bridging input or terminating impedance to match standard transmission lines. High frequency measurements require matched systems to avoid error-producing standing waves on interconnecting cables. The measure of impedance accuracy is usually return loss or reflection coefficient ($RL=20 \log \rho$). In low frequency instruments, percent accuracy is used. High input impedance instruments are usually poorer in high frequency and noise performance and are usually low frequency instruments. High impedance at high frequencies is accomplished by using a bridging probe to place the impedance at the point of measurement. The probe may be active with unity gain or passive with 20-30 dB insertion loss.

Input arrangement: input may be balanced to ground or unbalanced. Communications system usage typically requires balanced input. Standard 600 and 135/150Ω balanced inputs are limited in frequency to less than 1 MHz and 124Ω balanced to less than 10 MHz in most instruments. The impedance may be balanced to ground with the center point grounded or may be completely isolated from ground. Unbalanced inputs do not have frequency range limitations.

Network analysis application

Frequency response testing: with its BFO output, the wave analyzer is particularly useful for measuring filter and amplifier frequency responses. If a notch filter is being measured, for example, a narrow band measurement like that provided by a wave analyzer is essential for obtaining acceptable accuracy. A broadband technique will lead to some misleading results. For example, a notch filter may be driven with a flat oscillator and the response measured with a broadband voltmeter. The notch filter will reject the oscillator's fundamental tone, but pass its harmonics which are in voltmeter's measurement range. Thus, an error results. If the voltmeter were frequency selective, like a wave analyzer, the harmonics would be rejected and the true level of the notch would be measured. Accurate and fast measurements can be made because Hewlett-Packard wave analyzers track and detect on the BFO frequency.

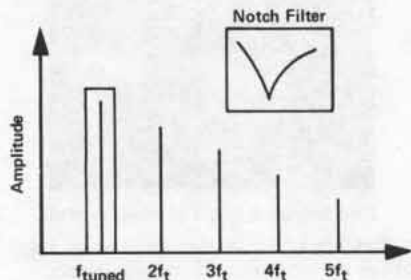

Only signal detected by wave analyzer. For example, the notch of a filter can be accurately measured to its full depth.

Distortion Analyzers

Harmonic distortion is one of many types of distortion created in communications equipment and audio and ultrasonic sound systems. Nonlinear elements in amplifiers cause harmonic related frequencies from a pure tone stimulus to be created at the output. Hence, to a listener, a poor reproduction quality becomes apparent. The total of these frequency components present in a signal, in addition to the fundamental frequency can be measured quickly and easily with Hewlett-Packard distortion analyzers.

The ratio of these frequency components to the amplitude of the fundamental is the total harmonic distortion (THD) as defined by the following equation (1):

$$THD = \frac{\sqrt{\sum(\text{harmonics})^2}}{\text{fundamental}}$$

The Hewlett-Packard distortion analyzer consists of a narrow band rejection filter and broadband detector. Before the fundamental is rejected, the analyzer first measures the amplitude of the fundamental, all the harmonic components, and noise. Then the rejection filter is employed to remove the fundamental. The ratio of the two measurements is an approximation of equation (1)

above and is defined by the following equation (2):

$$THD = \frac{\sqrt{\sum[(\text{harmonics})^2 + (\text{noise})^2]}}{\sqrt{\sum[(\text{fundamental})^2 + (\text{harmonics})^2 + (\text{noise})^2]}}$$

An approximation error of 1/2% can be expected for the THD levels of 10%. However, distortion levels as high as 10% are seldom encountered in most measurement situations. The harmonic content of the stimulus source must not be more than a third of the distortion expected to be caused by the system under test.

True harmonic distortion measurements

The Hewlett-Packard desk-top computer controlled automatic spectrum analyzers provides the user a rapid means of measuring true harmonic distortion levels. The fundamental and its harmonic components are rapidly measured one at a time and the distortion is computed by applying equation (1). In production test situations, distortion calculations can be stored on tape for future reference and/or plotted for hard copy needs. Limit testing can also be applied.

Modulation analyzers

A modulation analyzer is a precision receiver, designed to detect the entire modulation envelope of a signal under test. It can measure and display the carrier characteristics of RF frequency and power as well as AM, FM and phase modulation characteristics such as % AM, peak deviation, residual modulation, and various ratios associated with the above. Faithful recovery of the actual modulation signal for further analysis such as distortion testing is also accomplished.

Applications for modulation analyzers center mostly in transmitter testing and signal generator calibration. The precision receiver capability allows comprehensive testing of the transmitter. All phases of design, production test, and maintenance of transmitters and various modules and subassemblies are applicable. And since signal generator test instruments serve as "precision transmitters", considerable application will be found in metrology and calibration labs for signal generator calibration.

Capabilities

The unique measurement capabilities of modulation analyzers are easily shown on system tests with multiple-mode modulations such as simultaneous AM and FM. For example, if both amplitude and frequency modulation are present on a signal, a rather complex modulation spectrum is produced. To demonstrate this, an HP 8640B Signal Generator was 46.5% amplitude modulated with a 5 kHz triangular wave and 45 kHz peak frequency modulated with a 5 kHz sine wave simultaneously. The spectrum analyzer display of the resulting signal is shown.

SIGNAL ANALYZERS

Wave, distortion, modulation, spectrum and Fourier analyzers (cont'd)

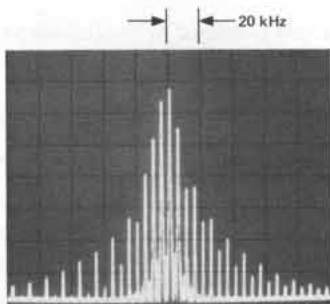

Spectrum Analyzer display of simultaneous AM (46%) and FM (4.5 kHz pk deviation) modulation.

Unequal, complex sidebands result and little data can be deduced. However, since a modulation analyzer faithfully recovers both modulation signals in independent detection systems insensitive to each other, it is easy to separate and read directly the various modu-



Modulation Analyzer displays of RF signal parameters.

lation components involved.

In addition, since the modulation analyzer handles the full complex modulation envelope, it measures and displays peak RF envelope power and average frequency of the entire signal. The following readings are all available at the push of a button.

The independent detection systems demodulate the waveforms and present the resulting signal at the output for viewing on an

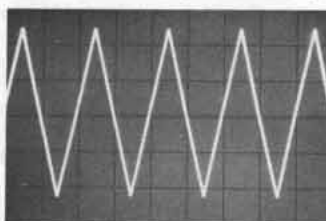

Recovered 5 kHz AM input signal viewed on oscilloscope.

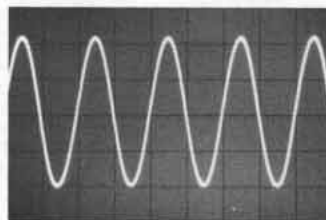

Recovered 5 kHz FM input signal.

oscilloscope or for further analysis by a distortion analyzer or audio wave analyzer.

Since detection systems are independent and highly insensitive to each other, incidental modulation measurements can be made with high precision. For example, even with 90% amplitude modulation, the FM demodulator will indicate incidental FM down to 1 Hz. Such capability is valuable for component design on oscillators, modulators, mixers and so forth. It is very difficult to separate multiple modulation effects on spectrum analyzer displays because both effects are combined.

The HP modulation analyzer contains selectable filters to provide commonly used system characteristics for LP and HP filtering or for FM de-emphasis, etc. Thus measurement of transmitter modulation frequency response performance doesn't require additional equipment.

Finally the modulation analyzer can serve as a high sensitivity, selective frequency counter. Since the superheterodyne design allows high sensitivity amplification of low level modulated signals, frequency counting of signals as low as -65 dBm is possible with good rejection of other signals (even large interfering ones).

Display and computational conveniences speed typical transmitter measurements and improve confidence in results. For example, ratio keys allow any measurement to be expressed as a % or dB relative to any other measured or key-entered value. Such computations are valuable in mobile FM measurements where hum and noise is expressed relative to an industry standard of 60% of maximum allowable deviation.

Signal analyzers selection guide Spectrum analyzers

Frequency Range	Amplitude Calibration Range	Bandwidths		Model Description	Companion Instruments	Page
		Min	Max			
0.02 Hz-25.6 kHz	-120 to +30 dBV	0.02 Hz	363 Hz	3582A Spectrum Analyzer		518
5 Hz-50 kHz	-150 to +30 dBm	1 Hz	300 Hz	3580A Spectrum Analyzer		516
20 Hz-300 kHz	-130 to +10 dBm	10 Hz	10 kHz	8556A Tuning Section Plug-In (See Note 1)		506
10 Hz-13 kHz	-140 to 0 dBm	3 Hz	10 kHz	3044A/45A Spectrum Analyzer		527
20 Hz to 40.1 MHz	-137 dB to +30 dBm	3 Hz	30 kHz	3585A Spectrum Analyzer		488
1 kHz-110 MHz	-130 to +10 dBm	10 Hz	300 kHz	8553B Tuning Section Plug-In (See Note 1)	8443A Tracking Generator (100 kHz-110 MHz)/Counter	508
10 kHz-350 MHz	-120 to +20 dBm	1 kHz	3 MHz	8557A Spectrum Analyzer Plug-In (See Note 2)	8750A Storage-Normalizer	500
100 kHz-1250 MHz	-122 to +10 dBm	100 Hz	300 kHz	8554B Tuning Section Plug-In (See Note 1)	8444A Tracking Generator (500 kHz-1250 MHz)	510
100 kHz-1500 MHz	-115 to +30 dBm	1 kHz	3MHz	8558B Spectrum Analyzer Plug-In (See Note 2)	8750A Storage-Normalizer 8444A Opt. 058 Tracking Generator (500 kHz-1300 MHz)	502
100 Hz-1500 MHz	-137 dBm to 30 dBm	10 Hz	3 MHz	8568A Spectrum Analyzer and 8581A Automatic Spectrum Analyzer	8444A Opt H59 Tracking Generator (500 kHz-1500 MHz)	492 497
10 MHz-40 GHz	-124 dBm to +30 dBm	100 Hz	3 MHz	8565A Spectrum Analyzer	8750A Storage-Normalizer 8444A Opt. 058 Tracking Generator (10-1300 MHz)	498
10 MHz-40 GHz	-130 to +10 dBm	100 Hz	300 kHz	8555A Tuning Section Plug-In (See Note 1)	8444A Tracking Generator (10 MHz-1300 MHz) 8445B Automatic Preselector (10 MHz-18 GHz)	512
0.01 Hz-10 kHz offset from carrier 500 kHz-18 GHz carrier range	-150 dBc min.	<100 μHz	10 kHz	5390A Frequency Stability Analyzer	59309A Digital Clock	538

NOTE 1: For use in oscilloscope mainframes 140T and 141T with IF section plug-ins 8552A or 8552B (page 490).

NOTE 2: For use in oscilloscope mainframes 180TR, 181T/TR and 182T.

Digital Signal Analyzers

Frequency Range	Amplitude Calibration Range	Resolution Points		Model Description	Functions Available	Page
		Min	Max			
DC-100 kHz (See Note 1)	7 steps from ±0.125 to ±8 V	32	2048	5451 Fourier Analyzer	Power spectrum Transfer function Coherence Convolution	524
0.008-25 kHz	7 Steps From ±0.1 to ±10 V	256	32,000 (See Note 2)	5420A Digital Signal Analyzer	Time Average Linear Spectrum Auto Spectrum Transfer Function Coherence Function Histogram Correlation Impulse Response	522
0.1-25 kHz	7 steps from ±0.125 to ±8 V	256 PS 128 TF	1024 PS 512 TF	5427A Digital Vibration Control System (Analysis Mode)	Power Spectrum Transfer Function Transient Capture Shock Response Spectrum	524
0.02 Hz-25.6 kHz	9 steps from 3 mV to 30 V RMS	256	>1.3×10 ⁶ (See note 2)	3582A Spectrum Analyzer	Voltage Spectrum Phase Spectrum Transfer Function Coherence Function Digital Averaging	518
DC-250 kHz	40 mV to 4 V rms	100	100	3721A Correlator	Correlation (Auto and Cross) Probability Density Probability Integral	525
0.005-250 kHz	40 mV to 4 V rms	100	100	3720A Spectrum Display	Real and Complex Fourier Transform of 3721A data	525

NOTE 1: Standard range is DC to 50 kHz, expandable with options to 100 kHz.
NOTE 2: Equivalent number of points using Band Selectable Analysis.

Distortion analyzer

Fundamental Frequency Range	Minimum Distortion	Auto Set Level	Auto Nulling	True RMS	AM Detector	Filters	Model No.	Page
5 Hz to 600 kHz	.03% (-70 dB)		•	•	•	•	331A	532
							333A	532
							334A	532
							334A Opt H05	532
10 Hz-110 kHz	0.0018% (-95 dB)	•	•	•	•	•	339A	531

Wave analyzers

Frequency Range	Selective Bandpass	Dynamic Range		Freq. Readouts	Type of Inputs	Type of Outputs	Modes of Operation	Model Number	Page
		Absolute	Relative						
15 Hz to 50 kHz	3 Hz 10 Hz 30 Hz 100 Hz 300 Hz	0.1 μV-300 V full scale	>85 dB	5-place digital	Banana Jacks	rec: 5 V full scale, with pen lift BFO, Local Oscillator, tuning loudspeaker, and headphone jack	AFC, normal, BFO	3581A/ 3581C	533 576
1 kHz to 18 MHz 18 ranges	50 Hz or Optional 150 Hz 2300 Hz 3100 Hz	-120 to +23 dBm	>72 dB	7 place decade counter	75Ω accepts WECO 358A 124Ω accepts WECO 408A 135Ω accepts WECO 305A External frequency standard	Recorder: 1 V dc full scale 1 kΩ source Aux: 1 MHz (1 V p-p) 30 MHz (40-70 mV) rms LO: (30-48 MHz) 60 to 90 mV rms Audio: +13 dBm into 600Ω	AM, beat LSB, USB	312D/ 3320C	598
1 kHz to 18 MHz 18 ranges or 1 kHz to 22 MHz 18 ranges*	200 Hz 1000 Hz 3100 Hz	200 mV-3.2 V full scale or -120 to +23 dBm -130 to +13 dBm (600Ω only)	>72 dB	7-place decade counter	BNC & probe 11530A bridged/terminated balanced or unbalanced or WE-477B input unbalanced* or BNC input 50Ω unbalanced*	rec: 1 V dc full scale 1 kΩ source aux: 1 MHz (1 V p-p) 30 MHz (40-70 mV) rms LO: (30-48 MHz) 60 to 90 mV rms audio: >0.5 into 10 kΩ 313A: Track or tuned 75Ω unbalanced, -99.9 to +10 dBm (Opt 001, 50Ω unbalanced output)	AFC, AM, beat LSB, USB	312B 313A	534

*312B/313A Opt H01 (WE477B input unbalanced); 312B/313A Opt H05 (BNC input 50Ω unbalanced).

SIGNAL ANALYZERS

20 Hz to 40 MHz spectrum analyzer

Model 3585A

- 80 dB dynamic range
- 3 Hz resolution bandwidth
- ± 0.4 dB amplitude accuracy
- Self-calibrating



Description

The new HP 3585A Spectrum Analyzer has a fully synthesized local oscillator controlled by a microprocessor. The result of this state-of-the-art contribution offers outstanding performance over its frequency range of 20 Hz to 40.1 MHz. Center frequency and span settings have 0.1 Hz resolution and 1×10^{-7} /mo. stability over its entire operating range. The frequency precision and stability enables the 3 Hz resolution bandwidth filter to be used for close-in analysis even at 40 MHz.

An automatic internal calibration routine, administered by the microprocessor, provides up to ± 0.4 dB accuracy over most of the measurement range. Improvements in measurement performance of this magnitude cannot be realized by the user unless the basic limitations of the CRT display are bypassed. This has been accomplished by digitizing the detected video signal, which is then stored in memory. Photographic documentation of the display is greatly simplified by displaying all the essential frequency, amplitude and resolution parameters alpha-numerically around the edge of the CRT.

The power of the microprocessor provides a bonus by making this analyzer easier to use. Several of the usually tedious operations, such as centering a signal, raising it to the reference level, etc., are now simplified with dedicated key operated routines working in conjunction with the display marker. Adjustment of resolution and video bandwidth when modifying span is now an automatic function unless individual manual selection is required. In addition, new functions have been added, such as noise power density measurements and offset capability for both frequency and amplitude.

Measurement power & convenience

The power and convenience of the 3585A's microcomputer-based controls and CRT readout simplify and speed use in so many ways that previously impractical analysis now become routine. Functions such as center frequency and amplitude reference level may be keyboard-set with 0.1 Hz and 0.1 dB precision, varied with an 'analog' knob (actually a rotary pulse-generator), or incrementally key-stepped. The autoranging input attenuator eliminates the error-prone task of adjusting the attenuator to achieve the correct mixer level.

A tunable marker in the 3585A makes basic measurements precise and quick by directly measuring a signal or by speeding the process of magnifying the portion of the spectrum to be analyzed. With the marker set to the signal peak, signal amplitude and frequency (with counter accuracy) are numerically displayed on the CRT. A second marker makes relative measurements instantly available with numerical display of the difference in amplitude and frequency between the two markers. This is useful for modulation, distortion measurements, and bandwidth measurement. For example, in the case of telecommunications applications, the second marker can be set at harmonic or channel spacing from the first so the operator can simply step frequencies to track higher order harmonics or additional channels.

Amplitude and frequency may be offset to normalize values to some reference signal such as a pilot tone or to reflect the relative value of a signal. Other amplitude units, such as dBV or volts, can be chosen. On any occasion all settings can be stored, then later recalled with a short key sequence. As many as three sets of settings may be stored.

Two different traces each of 1001 horizontal points, may be taken, stored in memory, then shown separately or together as desired while comparisons among them may be calculated and displayed digitally on the CRT. A Max Hold key causes the largest amplitude in successive sweeps to be displayed, making it easy to measure residual FM or drift. A built-in tracking generator, with a maximum output of 0 dBm, enables frequency response measurements to be made.

Automatic measurements

Not only are all 3585A functions remotely-programmable via the HP Interface Bus (IEEE Standard 488-1975), the instrument also can be commanded to transfer its measurements out via the bus for interpretation and further interaction by a computing controller. The analyzer can be remotely tuned with the precision of the synthesizer, while retaining analog sweep and exceptional spectral purity. The result is a new and higher level of interaction between the user and the measurement system.

Frequency Accuracy

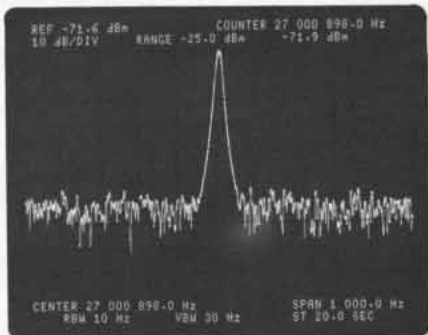

Counter measurements with spectrum analyzer selectivity and sensitivity can be made to 1×10^{-7} /mo. stability while sweeping or manually tuning.

Dynamic Range

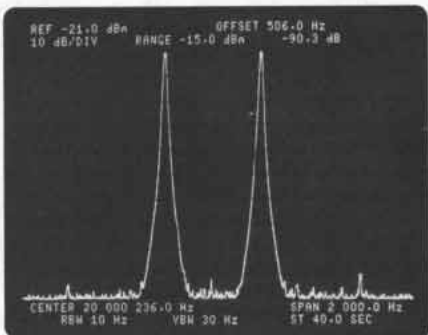

> 80 dB spurious free dynamic range with full scale inputs of -25

dBm to +30 dBm in 5 dB steps. Autoranging input provides full dynamic range with no guesswork.

Internal Calibration

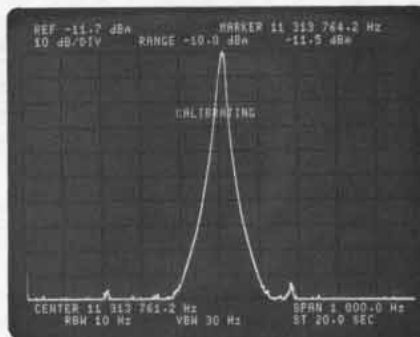

Maximum accuracy is assured at all times by an automatic internal calibration routine which compensates for frequency and amplitude errors in measurements made at the reference level at the center of the screen.

Swept Response Measurements

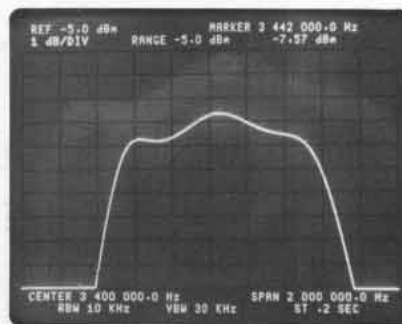

The built-in tracking generator offers superb stability and resolution for crystal filters as well as excellent flatness for wideband devices. The 1 dB/div. amplitude scale is used to expand and resolve small amplitude differences with .01 dB resolution using the marker readout.

SIGNAL ANALYZERS

20 Hz to 40 MHz spectrum analyzer

Model 3585A (cont.)

Marker Aided Measurements

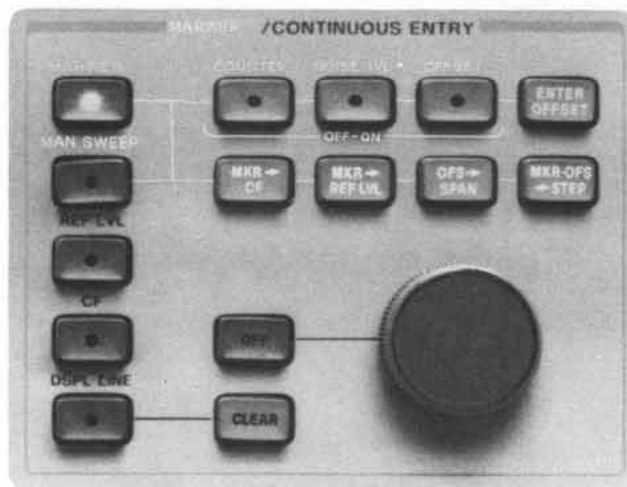

Along with the marker readout capability, there are three additional functions: counter measurements, noise level measurements, and offset (relative) measurements. The four operating aids just above the knob indicate that the marker or offset value can be directly entered into the center frequency, reference level, frequency span, or center frequency step size. These aids save much time in conventional operations by direct transfer of data to another functional control.

Noise Measurement

The noise level key displays RMS noise density normalized to a 1 Hz bandwidth at the marker position. All correction factors are accounted for in the internal measurement routine.

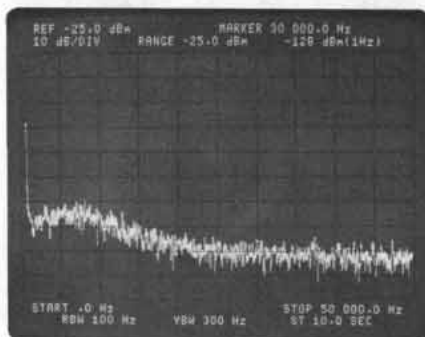

Terminal Interaction

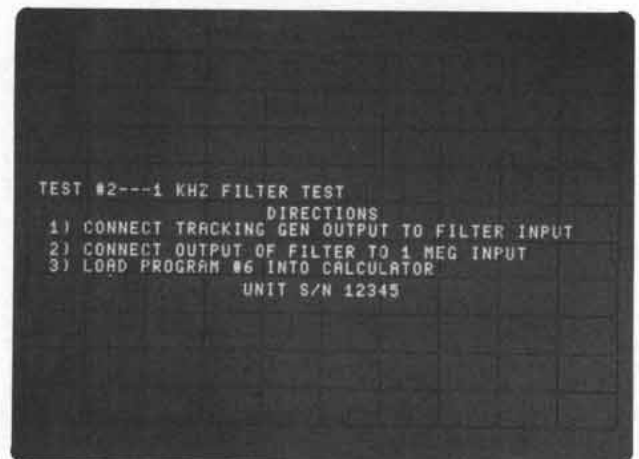

Measurement routines selected from the controller memory via the analyzer keyboard, such as this filter test, can provide instructions to the operator to minimize errors and reduce training time for complex measurements.

Specifications

Frequency

Measurement range: 20 Hz to 40.1 MHz

Displayed Range

Frequency span:

Range: 0 Hz to 40.1 MHz variable with .1 Hz resolution or 10 Hz to 40 MHz in 1, 2, 5 steps

Accuracy: $-0\% + .2\%$ of frequency span setting

Center, Start/Stop, and Manual Frequency

Range: 0 Hz to 40.1 MHz with .1 Hz resolution

Accuracy: 1×10^{-7} /month of frequency

Marker

Readout accuracy: $\pm .2\%$ of frequency span \pm resolution bandwidth

Counter accuracy: $\pm .3$ Hz $\pm 1 \times 10^{-7}$ /month of counted frequency for a signal 20 dB greater than other signals and noise in the resolution bandwidth setting

Resolution

Resolution bandwidths

Range: 3 dB bandwidths of 3 Hz to 30 kHz in a 1, 3, 10 sequence

Accuracy: $\pm 20\%$ at the 3 dB points

Selectivity: 60 dB/3 dB $< 11:1$

Amplitude

Measurement range: -137 dBm to $+30$ dBm (50/75 Ω) or equivalent level in dBV or volts, 31 nV to 22 V (1 M Ω)

Displayed Range

Scale: 10 division CRT vertical axis with Reference Level at the top graticule line

Calibration: 10, 5, 2 and 1 dB/division from the Reference Level

Input range: -25 dBm to $+30$ dBm in 5 dB steps

Reference level (relative to Input Range)

Range: -100 dB to $+10$ dB

Accuracy (using 1 or 2 dB/div., at midscreen with sweep rate reduced by 4 or at the manual frequency): 50/75Ω input:

+10 dB	-50 dB	-70 dB	-90 dB
±.4 dB	±.7 dB	±1.5 dB	

1 MΩ input - add to above

20 Hz	10 MHz	40.1 MHz
±.7 dB	±1.5 dB	

Amplitude Linearity (referred to Reference Level)

0 dB	-20 dB	-50 dB	-80 dB	-95 dB
±.3 dB	±.6 dB	±1.0 dB	±2.0 dB	

Frequency Response (referred to center of span)

50/75Ω input ±.5 dB
1 MΩ input

20 Hz	10 MHz	40.1 MHz
±.7 dB	±1.5 dB	

Marker

Amplitude accuracy

Midscreen at the Reference Level: Use Reference Level accuracy from +30 dBm to -115 dBm, add Amplitude Linearity below -115 dBm.

Anywhere on screen: Add Reference Level Accuracy, Amplitude Linearity and Frequency Response.

Dynamic Range

Spurious responses (image, out of band, and harmonic distortion):

50/75Ω input: <-80 dB referred to a single signal ≤Input Range

1 MΩ input: <-80 dB except second harmonic distortion <-70 dB

Intermodulation distortion:

50/75Ω input: <-80 dB referred to the larger of two signals each ≥6 dB

below Input Range except 2nd order IM from 10 MHz to 40 MHz <-70 dB

1 MΩ input: <-70 dB

Residual responses (no signal at input): <-120 dBm using -25 dBm range

Average noise level

(50/75Ω) input:

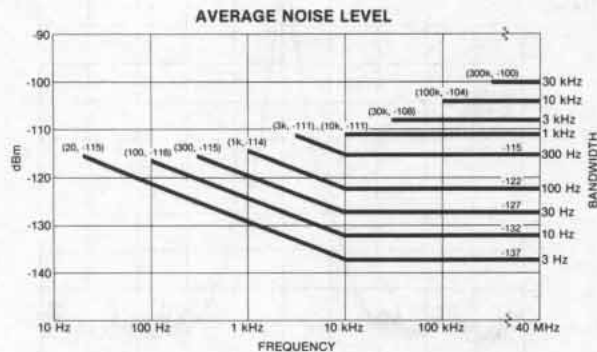

1 MΩ input: Below 500 kHz add 12 dB to above

Sweep

Modes: Continuous, single or manual

Trigger: Free Run, Line, or External

Time: .2 s full sweep to 200 s/Hz of Frequency Span (swept time excluded auto calibration cycles)

Display

Trace: Two memories, A and B each 1001 data points horizontally by 1024 data points vertically are displayed on the CRT at a flicker free rate. Memory A updated at the rate of the analyzer sweep time. Memory B updated by transfer from A (Store A→B).

Max Hold retains in Memory A the largest signal level at each horizontal point over successive sweeps, A-B updates Memory A with sweep data minus Memory B data at each corresponding horizontal point.

Trace detection: A linear envelope detector is used to obtain video information from the IF signal. Peak signal excursions between horizontal sweep data points are retained and displayed at the left-hand data point. This assures that no signal responses are missed.

Input

Signal inputs:

50/75Ω: >26 dB return loss, BNC connector

1 MΩ: ±3% shunted by <30 pf, BNC connector

Maximum input level:

50/75Ω: 13 V peak ac plus dc relay protected against overloads to 42V peak.

External trigger input: Negative going TTL level or contact closure required to initiate sweep.

External reference input: 10MHz (or subharmonic to 1 MHz), 0 dBm minimum level

Output

Tracking generator:

Level: 0 dBm to -11 dBm with a single turn knob

Frequency accuracy: ±1 Hz relative to analyzer tuning

Frequency response: ±.7dB

Impedance: 50Ω; >14 dB return loss

Probe power: +15 Vdc, -12.6 Vdc; 150 ma max.

Suitable for powering HP 1120A Active Probe

External display:

X, Y: 1 volt full deflection; **Z:** <0V to >2.4V

Recorder:

X Axis: 10 V full scale

Y Axis: 10 V full scale

Z — penlift output TTL

IF: 350 kHz, -12 dBV to -14 dBV at the reference level

Video: 10 V at the reference level

Frequency reference: 10.000 MHz ± 1 × 10⁻⁷/mo., +10 dBm into 50Ω

General

Environmental

Temperature: Operating 0°C to 55°C

Humidity: <95% RH except 300 Hz BW 40% RH

Warm-up time: 20 minutes at ambient temperature

Power Requirements: 115V (+11%-25%), 48-440 Hz

230V (+11%-18%), 48-66 Hz

180 Watts 3A max

Weight: 39.9 kg (88 lb.)

Dimensions: 22.9cm (9") H × 42.6cm (16.75") W × 63.5cm (25") D

Ordering Information

Opt. 907: Front Handle Kit

Opt. 908: Rack Flange Kit

Opt. 909: Combined Opt. 907 and 908

Opt. 910: Extra Manual

Model 3585A Signal Analyzer

Price

\$25

\$20

\$45

\$150

\$17,500

SIGNAL ANALYZERS

Spectrum Analyzer, 100Hz to 1500 MHz

Model 8568A

- 100 Hz to 1.5 GHz Frequency Range
- 10 Hz Resolution Bandwidth
- Frequency Counter Accuracy
- Digital Display
- Tunable Marker with Amplitude and Frequency Readout
- Store and Recall Control Settings

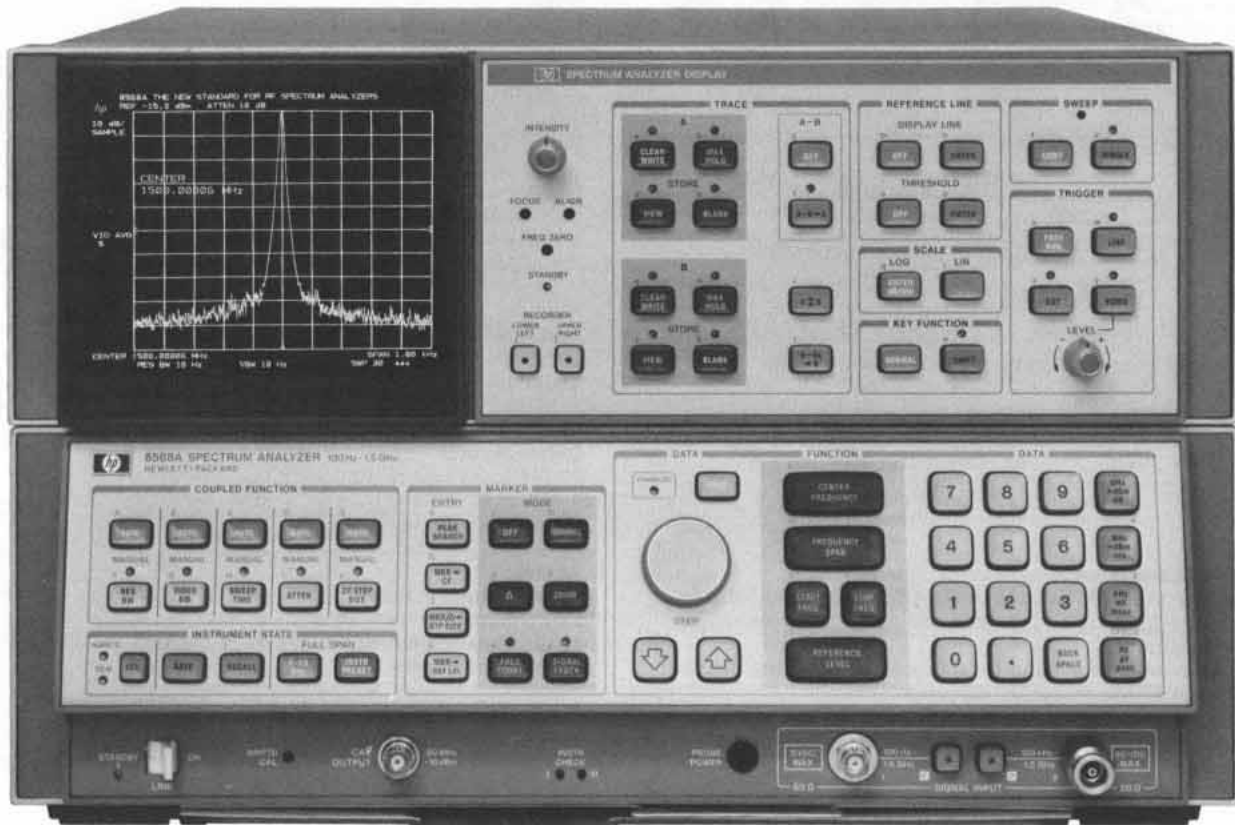

HP-IB

The 8568A is a high performance spectrum analyzer for bench or HP-IB systems use that operates over the 100 Hz to 1500 MHz frequency range. A sophisticated phase lock system combines "synthesizer like" tuning and frequency accuracy with superior local oscillator spectral purity to make narrow resolution bandwidths practical at RF frequencies. The analyzer is designed around its own internal bus and controlled by a microcomputer to yield significant improvements in RF measurement performance, new operational features and unparalleled flexibility under program control.

Performance

Exceptional stability enables the use of a 10 Hz resolution bandwidth over the 100 Hz to 1500 MHz tuning range of the analyzer. Superior spectral purity and narrow resolution make it possible to resolve line related sidebands or measure clean oscillators directly at RF frequencies. 10 Hz resolution also results in -135 dBm sensitivity which makes greater than 85 dB spurious free dynamic range achievable. A frequency reference error of 1×10^{-9} /day together with the analyzer's resolution and sensitivity allow small signals in the presence of large ones to be measured with frequency counter accuracy.

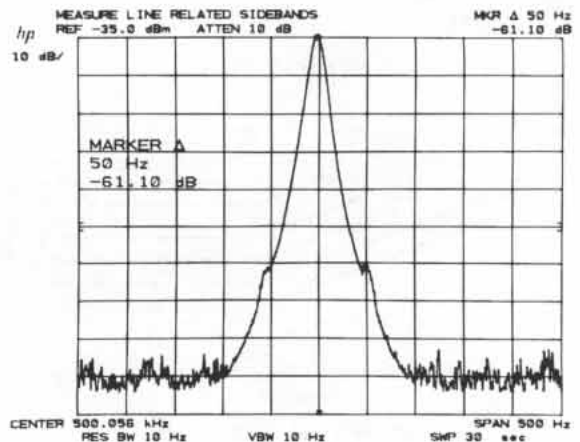

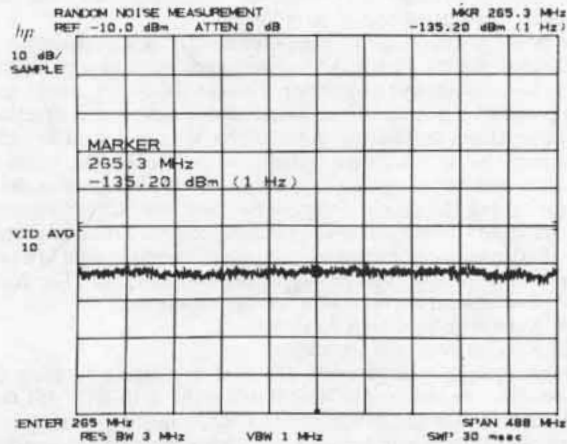
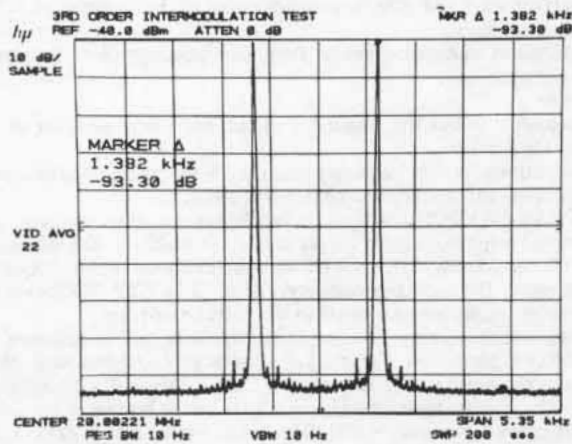
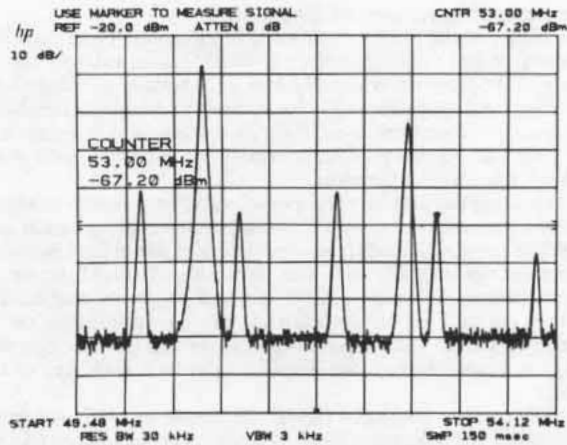
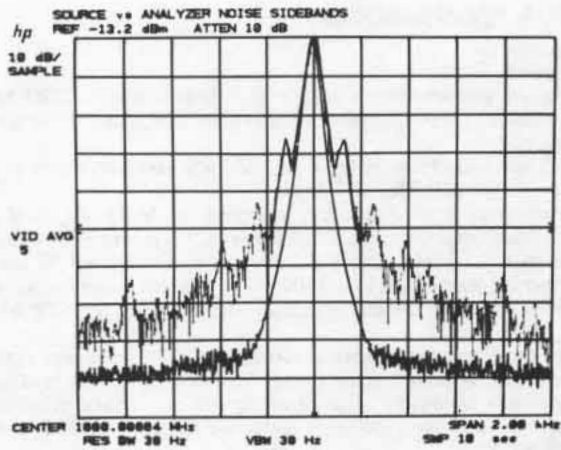

Usability

The front panel concept of the 8568A is new in that the operator reads all the analyzer control settings off the *CRT display* and sets function values through *data controls*. To activate a function the user pushes the appropriate key; he then has the option of setting the function's value using the knob, step keys or numeric/unit keyboard.

Measurements can be made following conventional "zoom" techniques using the center frequency, frequency span and reference level functions, or with the help of certain measurement aids. A preset button sets all analyzer controls to a convenient starting point; coupled functions, such as resolution bandwidth and sweep time change automatically as frequency span is reduced to maintain a calibrated display. A tunable marker is available for directly measuring a signal or speeding the process of magnifying the portion of the spectrum to be analyzed.

With the marker set to the signal peak, the signal's *amplitude* and *frequency*, to counter accuracy, are numerically displayed on the CRT. A second marker, useful for modulation or distortion measurements, makes relative measurements by displaying the difference in amplitude and frequency between the two markers. Marker information enables the operator to step between evenly spaced portions of the frequency spectrum such as communication channels or signal harmonics; the noise level at the marker can be converted to RMS noise density normalized to a 1 Hz bandwidth. The marker may also be positioned at the peak of the largest signal on the screen and used to zoom-in on signals *automatically*.

Once the analyzer's controls have been adjusted, all settings can be *saved* in memory and later *recalled* to repeat the measurements. An internal battery maintains the contents of memory in the event of a power failure.

All displayed information resides in a digital memory from which the CRT is refreshed at a flicker-free rate. Display titles may be added. A trace may be viewed real-time or stored; max hold displays the largest amplitude at 1001 points across the CRT over successive sweeps to aid in the measurement of residual FM or drift. Up to three traces may be observed simultaneously and arithmetic between traces or a trace and reference display line is possible for comparison or frequency response normalization.

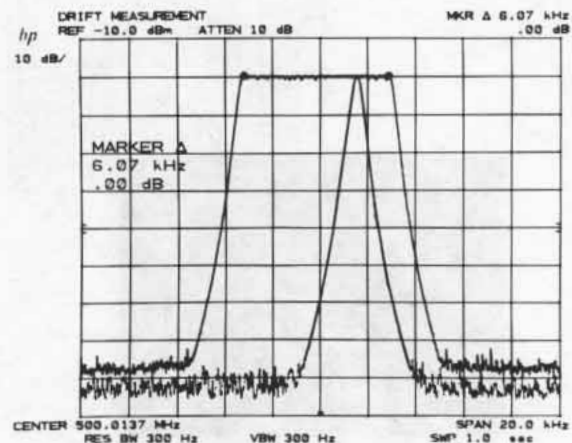



SIGNAL ANALYZERS

Spectrum Analyzer, 100 Hz to 1500 MHz (cont.)

Automatic Measurement Capability

The design of the 8568A lends itself to automatic control via the HP Interface Bus (IEEE Standard 488-1975). The analyzer can be tuned with the precision of a synthesizer while retaining analog sweep and exceptional spectral purity. Its internal architecture facilitates the remote programming of all function settings and the output of CRT trace and marker readout information; the display itself is accessible for annotation purposes.

By exploiting this architecture, a new level of interaction between a user and a measurement system becomes possible under program control. While the user's measurement programs reside in the controller, the operator need interface only with the analyzer (which functions as a "measurement terminal"). A list of these programs may be displayed on the CRT for selection through the appropriate code on the numeric keyboard. The programs themselves can lead the operator through a measurement using graphics to explain each step of the process.

Friendly analyzer codes and HP-IB commands are used to program the analyzer; for example, CF 20 MZ instructs the analyzer to set center frequency to 20 MHz. Built-in firmware features such as instrument preset, peak search and zoom further simplify writing software. Control settings may even be "programmed" from the instrument front panel using "learn" mode.

The primary advantage of computer control is the execution of complicated or time consuming measurement routines with a minimum of involvement by the operator. This capability is especially useful in production line testing or unattended measurement situations such as spectrum monitoring. An analyzer may be joined by other instruments in a distributed system, or be controlled remotely through a data communications network. External control is desirable for setting the proper analyzer function values, reading data, performing any numerical manipulation required (including error correction), analyzing the results, and providing output data in a convenient format on a printer, plotter, or the analyzer CRT. This capability is available in the form of a configured system: 8581A Automatic Spectrum Analyzer.

Consider this measurement example:

Electromagnetic interference: the analyzer begins by using the CRT to show the test set-up. Next it draws the MIL-STD 461 conducted interference test limits on the CRT, adjusting them for the current probe transfer impedance and normalizing for the analyzer impulse bandwidth. The analyzer controls (including resolution bandwidth, video bandwidth, and calibration units) are set to their proper values for the measurement and the results are presented on a semi-log plot together with a printout analyzing compliance.

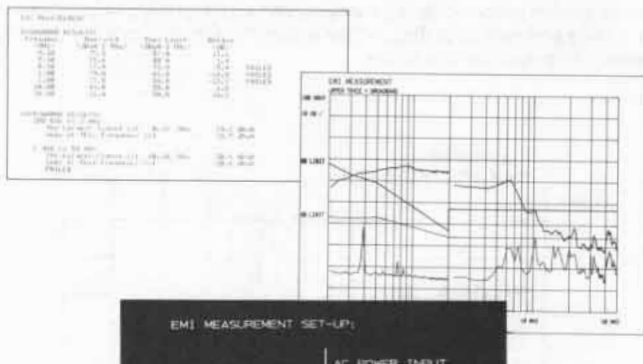

8568A Specifications

Frequency

Displayed range

Frequency span: 100 Hz to 1500 MHz over 10 division CRT horizontal axis. In zero span, the instrument is fixed tuned at the center frequency.

Full span (0-1500 MHz): is immediately executed with a 0-1.5 GHz or INSTR PRESET keys.

Frequency span accuracy: for spans >1 MHz, $\pm(2\%$ of the indicated frequency separation between two points +0.5% span); for span ≤ 1 MHz, $\pm(5\%$ of frequency separation +0.5% span).

Center frequency: 0 Hz to 1500 MHz. Center frequency step size may be set using the numeric keyboard or MKR/ Δ →STP SIZE key.

Readout accuracy: Span ≥ 100 Hz: $\pm(2\%$ of frequency span + frequency reference error x tune frequency +10 Hz) in AUTO resolution bandwidth after adjusting freq zero at stabilized temperature, and using the error correction function, SHIFT W and SHIFT X.

Start-Stop frequency: permissible values must be consistent with those for center frequency and frequency span. SHIFT O sets the analyzer start and stop frequencies equal to the frequencies of the two Δ markers.

Readout accuracy: center frequency accuracy + $\frac{1}{2}$ frequency span accuracy.

Marker

Normal: displays the frequency at the horizontal position of the tunable marker.

Accuracy: center frequency accuracy + frequency span accuracy between the marker and center frequencies.

PEAK SEARCH positions the marker at the center of the largest signal response present on the display to within $\pm 10\%$ of resolution bandwidth. MKR → CF sets the analyzer center frequency equal to the marker frequency; MKR/ Δ → STP SIZE sets the center frequency step equal to the marker frequency.

Freq count: displays the frequency signal on whose response the marker is positioned. The marker must be positioned at least 20 dB above the noise or the intersection of the signal with an adjacent signal and more than four divisions up from the bottom of the CRT.

Accuracy: for span ≤ 100 kHz: frequency reference error x displayed frequency ± 2 counts. For span >100 kHz but ≤ 1 MHz: freq. ref. error x displayed frequency $\pm(10$ Hz +2 counts). For span >1MHz: $\pm(10$ kHz +1 count).

Frequency reference error: aging Rate $< 1 \times 10^{-9}$ /Day; Temp Stability $< 7 \times 10^{-8}$, 0° to 55° C.

Signal track: re-tunes the analyzer to place a signal identified by the marker at the center of the CRT and maintain its position. Useful when reducing frequency span to zoom-in on a signal; also keeps a drifting input signal centered.

Δ : displays the frequency difference between the stationary and tunable markers. Reference frequency need not be displayed.

Accuracy: same as frequency span accuracy; in the FREQ COUNT mode, twice the frequency count uncertainty plus drift during the period of the sweep (typically < 10 Hz/minute). MKR/ Δ → STP SIZE sets the center frequency step size equal to the frequency difference between the markers. SHIFT O sets the analyzer start stop frequencies equal to the frequencies of the two markers.

Zoom: makes it possible to reduce the frequency span about the marker (or signal in the signal track and freq count modes) using the step down key.

Resolution

Resolution bandwidth: 3 dB bandwidths of 10 Hz to 3 MHz in a 1, 3, 10 sequence. Bandwidth may be selected manually or coupled to frequency span.

Bandwidth accuracy: calibrated to: $\pm 20\%$, 3 MHz to 10 Hz; $\pm 10\%$, 1 MHz to 3 kHz.

Bandwidth selectivity: 60 dB/3 dB bandwidth ratio: $< 15:1$, 3 MHz to 100 kHz; $< 13:1$, 30 kHz to 10 kHz; $< 11:1$, 3 kHz to 30 Hz. 60 dB points on 10 Hz bandwidth are separated by < 100 Hz.

Stability

Residual FM: < 3 Hz peak-to-peak ≤ 10 sec; span < 100 kHz, resolution bandwidth ≤ 30 Hz, video bandwidth ≤ 30 Hz.

Drift: <10 Hz/minute of SWEEPTIME after 1 hr. warmup at stabilized temperature, for frequency span ≤ 100 kHz. Spans >100 kHz but ≤ 1 MHz, <100 Hz/minute of SWEEPTIME; >1 MHz, <300 kHz/minute of SWEEPTIME.

Spectral purity

Noise sidebands: >80 dB below the peak of a CW signal at frequency offsets ≥ 30 x resolution bandwidth setting, for resolution bandwidths ≤ 1 kHz.

Line related sidebands: >85 dB below the peak of a CW signal.

Amplitude

Measurement range: -135 dBm to +30 dBm.

Displayed range

Scale: Over a 10 division CRT vertical axis with the Reference Level at the top graticule line.

Calibration

Log:

10 dB/div for 90 dB display from Reference Level.
 5 dB/div for 50 dB display
 2 dB/div for 20 dB display
 1 dB/div for 10 dB display

expanded from Reference Level.

Linear:

10% of Reference Level/div when calibrated in voltage.

Fidelity:

Log:	Incremental	Cumulative
	± 0.1 dB/dB over 0 to 80 dB display	$\leq \pm 1.0$ dB max over 0 to 80 dB display, 20-30°C. $\leq \pm 1.5$ dB max over 0 to 90 dB display.

Linear: $\pm 3\%$ of Reference Level.

Reference level

Range

Log:

+60.0¹ to -139.9 dBm or equivalent in dBmV, dB μ V, volts.

Linear:

228.6¹ volts to 0.22 μ volts full scale.

Accuracy: the sum of the following factors determines the accuracy of the reference level readout. Depending upon the measurement technique followed after calibration, various of these sources of uncertainty may not be applicable.

An internal error correction function calibrates and reduces the uncertainty introduced by analyzer control changes from the error calibration state (-7 dBm reference level, 1 dB/div scale, 10 dB RF attenuation, 1 MHz bandwidth) when SHIFT W is executed just prior to the signal measurement (i.e., at the same temperature) within the 20°-30° range.

Calibrator uncertainty: ± 0.2 dB.

Frequency response (Flatness) uncertainty: input #1: ± 1 dB, 100 Hz to 500 MHz; ± 1.5 dB 100 Hz to 1500 MHz; input #2: ± 1 dB, 100 kHz to 1500 MHz.

Amplitude temperature drift: at -10 dBm reference level with 10 dB input attenuation and 1 MHz resolution bandwidth, ± 0.05 dB/°C (eliminated by recalibration).

Input attenuation switching uncertainty: over 10 dB to 70 dB range.

Resolution bandwidth switching uncertainty: (referenced to 1 MHz bandwidth)—corrected (uncorrected)

Range	20-30°C	0-55°C
3 MHz to 10 Hz	± 0.1 dB (± 1.0 dB)	(± 2.0 dB)
1 MHz to 30 Hz	± 0.1 dB (± 0.5 dB)	(± 1.0 dB)

Log scale switching uncertainty: ± 0.1 dB corrected (± 0.5 dB uncorrected).

IF Gain uncertainty: corrected (uncorrected). Assuming the internal calibration signal is used to calibrate the reference level at -10 dBm and the input attenuator is fixed at 10 dB, any changes in reference level in the following ranges will contribute IF gain uncertainty:

Range	20-30°C	0-55°C
0 dBm to -55.9 dBm	NA ² (± 0.6 dB)	(± 1.0 dB)
-56 dBm to -129.9 dBm	± 1.0 dB ³ (± 1.0 dB)	(± 1.5 dB)

Each 10 dB decrease (or increase) in the amount of input attenuation at the time of calibration and measurement will cause a corresponding 10 dB decrease (or increase) in the absolute reference level settings described above.

RF Gain uncertainty (due to 2nd LO shift): ± 0.1 dB corrected (± 1.0 dB uncorrected)

Error correction accuracy: (applicable when controls are change from the error calibration state if SHIFT W and SHIFT X are used): ± 0.4 dB.

Marker

Normal: displays the amplitude at the vertical position of the tunable marker.

Accuracy: equals the sum of calibrator uncertainty, reference level uncertainty, and scale fidelity between the reference level and marker position.

PEAK SEARCH positions the marker at the peak of the largest signal present on the display. MKR \rightarrow REF LVL set the analyzer reference level equal to the marker amplitude. RMS noise density in a 1 Hz bandwidth is read out using SHIFT M, by sampling the displayed trace and arithmetically correcting for the analyzer envelope detector response, log shaping, and measurement bandwidth.

Δ : displays the amplitude difference between the stationary and tunable markers. Reference frequency need not be displayed.

Accuracy: equals the sum of scale fidelity and frequency between the two markers.

Reference lines

Display line: movable horizontal line with amplitude readout.

Threshold: movable horizontal trace threshold with amplitude readout.

Accuracy: equals the sum of calibrator uncertainty, reference level uncertainty, and scale fidelity between the reference level and reference line.

Dynamic range

Spurious responses: for signal levels ≤ -40 dBm at the input mixer of the analyzer, all image and out-of-band mixing responses, harmonic and intermodulation distortion products are >75 dB below the input signal level.

Second harmonic distortion: for a signal -30 dBm at the mixer and ≥ 10 MHz, second harmonic distortion >70 dB down; 60 dB down for signals <10 MHz.

Third-Order intermodulation distortion: for two signals -30 dBm at the mixer, third-order intermodulation products >70 dB down (+5 dBm T.O.I. for 0 dB input attenuation).

Residual responses (no signal at input): < -105 dBm, with 0 dB input attenuation (typically < -115 dBm).

Average noise level: displayed < -135 dBm for frequencies >1 MHz, < -112 dBm for frequencies ≤ 1 MHz but >500 Hz with 10 Hz resolution bandwidth (0 dB input attenuation, 1 Hz video filter).

Video bandwidth: post detection low pass filter used to average displayed noise: bandwidth variable from 1 Hz to 3 MHz in a 1, 3, 10 sequence. Video bandwidth may be selected manually or coupled to resolution bandwidth.

Digital video averaging: displays the sweep-to-sweep average of the trace over a specifiable number of sweeps with SHIFT G, video averaging is turned off with SHIFT H.

Gain compression: < 0.5 dB for signal levels ≤ -10 dBm at the input mixer.

Sweep

Trigger

Free run: sweep triggered by internal source.

Line: sweep triggered by power line frequency.

Video: sweep triggered by detected waveform of input signal at an adjustable level; signal must be ≥ 0.5 div peak-to-peak.

External: sweep triggered by rising edge of signal input to rear panel BNC connector: trigger source must be >2.4 volt (5 volt max).

¹Maximum input must not exceed +30 dBm (damage level).
²Accounted for under Error Correction Accuracy.
³Correction only applies over the 0 dBm to -55.9 dBm range.



SIGNAL ANALYZERS

Spectrum Analyzer, 100 Hz to 1500 MHz (cont.)

Continuous

Sequential sweeps initiated by the trigger: 20 msec full span to 1500 sec full span in 1, 1.5, 3, 5, 7.5, 10 sequence.

Accuracy: sweep time ≤ 100 sec, $\pm 10\%$; > 100 sec, $\pm 20\%$.

Zero frequency span: 1 μ sec full sweep (10 divisions) to 10 msec full sweep in 1, 2, 5 sequence; 20 msec full sweep to 1500 sec full sweep in 1, 1.5, 2, 3, 5, 7.5, 10 sequence.

Accuracy: same as continuous.

Sweep time may be set manually or automatically for the frequency span, resolution bandwidth and video bandwidth selected.

Single: single sweep armed on activation and initiated by trigger (sweep ≥ 20 msec only).

Display

Trace: A and B are two independent signal response memories each having 1001 horizontal data positions and vertical resolution of 0.1%. Memory contents are displayed on the CRT at a rate independent of the analyzer sweep time. Trace A is displayed brighter than trace B.

Clear/Write: clears memory contents when first activated, then writes the analyzer signal response into the memory each sweep and displays memory.

Max hold: retains in memory and displays the largest signal level occurring at each horizontal data position over the repetitive sweeps beginning at the time the function is activated.

View: stops writing into memory and displays memory without changing its contents.

Blank: stops writing into memory and blanks the trace while retaining the last response in memory.

Arithmetic

A-B: initially subtracts the stored memory contents of B from the current memory contents of A and writes the difference into A; this process continues as the A memory is updated at the sweep rate. To accomplish $A+B-A$ use SHIFT c.

A=B: exchanges A and B display memory contents.

B-DL-B: subtracts the amplitude of the display line from the memory contents of B and writes the difference into B.

A third signal response memory, C (also with a 1001 data positions), can be used for signal response storage. It is accessed indirectly by transferring memory contents between B and C.

B=C: SHIFT l.

B=C: SHIFT i.

View C: SHIFT j.

Blank C: SHIFT k.

Annotation

Title: allows the user to write characters into a specified area on the CRT by pushing SHIFT E and typing the keys next to the blue front panel characters and data numbers desired. Use BACKSPACE for corrections.

Blank: SHIFT o blanks (SHIFT p unblanks) all CRT characters and control setting readouts. SHIFT m blanks (SHIFT n unblanks) the CRT graticule.

Input

RF Inputs

The standard instrument configuration is as follows:

Input # 1: 100 Hz to 1500 MHz, 50 Ω , BNC connector (Fused); dc coupled.

Reflection coefficient: > 0.20 (1.5 SWR) to 500 MHz, < 0.33 (2.0 SWR) 500 MHz to 1500 MHz; ≥ 10 dB input attenuation.

Input # 2: 100 kHz to 1500 MHz, 50 Ω , Type N connector; ac coupled.

Reflection coefficient: < 0.20 (1.5 SWR); ≥ 10 dB input attenuation.

LO emission: typically < -75 dBm (0 dB RF Atten).

Isolation: > 90 dB between inputs.

Also available: Input #1, 100 kHz to 1500 MHz, 75 Ω , BNC connector, ac coupled (Opt 001).

Maximum input level

AC: continuous power, +30 dBm (1 watt); 100 watts, 10 μ sec pulse into ≥ 50 dB attenuation.

DC: Input #1, 0 volts; Input #2, ± 50 volts.

Input attenuator: 70 dB range in 10 dB steps. Zero dB attenuation accessible only through numeric/unit keyboard. Attenuation may be selected manually or coupled to reference level to insure a -10 dBm input mixer drive level for full-screen signals; other mixer levels may be specified using SHIFT ' and entering the desired amplitude through the keyboard.

Accuracy: ± 1.0 dB over 10-70 dB range.

Output

Calibrator: 20 MHz ± 20 MHz x frequency reference error (1×10^{-9} /Day), -10 dBm ± 0.2 dB; 50 Ω .

Probe Power: +15 V, -12.6 V; 150 mA max.

Auxiliary (rear panel; nominal values)

Display: X, Y and Z outputs for auxiliary CRT displays. X, Y: 1 volt full deflection; Z: 0 to 1 V intensity modulation, -1 V blank. BLANK output (TTL level > 2.4 V for blanking) compatible with most oscilloscopes.

Recorder

Horizontal sweep output (x axis): a voltage proportional to the horizontal sweep; 0 V for left edge to +10 V for right edge.

Video output (y axis): detected video output proportional to vertical deflection of CRT trace. Output increases 100 mV/div from 0 to 1 V.

Penlift output (z axis): 15 V blanking output during retrace.

21.4 MHz IF: a 50 Ω , 21.4 MHz output related to RF input to the analyzer. Output nominally -20 dBm for a signal at the reference level. Bandwidth controlled by the analyzer's resolution bandwidth setting.

1st LO: 2-3.7 GHz, $> +4$ dBm; 50 Ω output impedance.

Frequency reference: 10.000 MHz, 0 dBm; 50 Ω output impedance.

Instrument Statement Storage

Up to 6 complete sets of user-defined control settings may be stored and recalled by pressing SAVE or RECALL and the desired register number (1 to 6) from the keyboard. Instrument state information is retained in memory indefinitely in STANDBY and approximately 30 days after line power is terminated.

Remote Operation

The standard 8568A operates on the Hewlett-Packard Interface Bus (HP-IB). All analyzer control settings (with the exception of VIDEO TRIGGER LEVEL, FOCUS, ALIGN, INTENSITY, FREQ ZERO and AMPLD CAL) are remotely programmable. Function values, marker frequency/amplitude, and A/B traces may be output; CRT labels and graphics may be input.

General

Environmental

Temperature: operating 0 $^{\circ}$ C to 55 $^{\circ}$ C, storage -40° C to +75 $^{\circ}$ C.

Humidity: operating $< 95\%$ R.H., 0 $^{\circ}$ C to 40 $^{\circ}$ C except as noted.

EMI: conducted and radiated interference is within the requirements of CE03 and RE02 of MIL STD 461A, VDE 0871, and CISPR pub'n 1, 2 and 4.

Power requirements: 50 to 60 Hz; 100, 120, 220 or 240 volts (+5%, -10%); approximately 450 VA (40 VA in standby). 400 Hz operation is available as Opt 400.

Weight: total net, 45 kg (100 lb); Display/IF Section, 21 kg (47 lb); RF Section, 24 kg (53 lb). Shipping, Display/IF Section 31 kg (69 lb.); RF Section 34 kg (75 lb).

Ordering information

8568A Spectrum Analyzer

Opt 001: 75 Ω (BNC), 100 kHz to 1500 MHz RF

Input #1

Opt 400: 400 Hz Power Line Frequency Operation

Opt 907: Front Handle Kit

Opt 908: Rack Flange Kit

Opt 909: Rack Flange and Front Handle Kit

Opt 910: Extra Manual

Price

\$27,800

\$200

\$400

\$40

\$30

\$60

\$100

SIGNAL ANALYZERS

Automatic Spectrum Analyzer, 100 Hz to 1500 MHz

Model 8581A



- Interactive Front Panel Under Program Control
- Friendly Programming Codes and Powerful Firmware

- 9825A Computing Controller
- Ease of Operation Via HP-IB

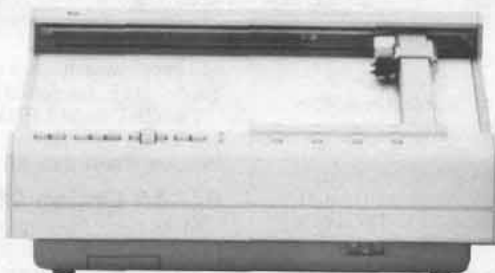
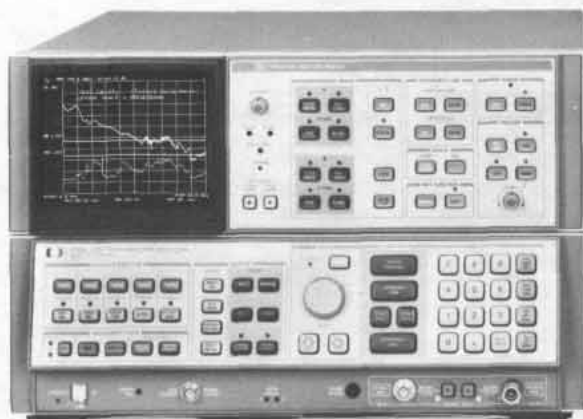

Recommended

The 8581A "Automatic Spectrum Analyzer" includes 8568A Spectrum Analyzer, 9825A Desktop Computer with 23K bytes of memory and all necessary accessories, 9866B Printer with stand, and system table. A sample program PAC contains twenty annotated subprograms which extend the firmware capability of the analyzer. Several useful measurement programs exemplify the use of these subprograms. In addition, utility programs enable CRT plot and system checkout.

Ordering information

8581A Automatic Spectrum Analyzer

Price
\$45,600

System Components

- 8568A** Spectrum Analyzer
- 9825A** Desktop Computer with Option 002, 23K Bytes Memory
- 98210A** String-Advanced Programming Plug-In
- 98216A** Plotter-General I/O-Extended I/O Plug-In
- 9866B** Printer with Option 025, 9825A Interface
- 98034A** HP-IB Interface Card
- 98226A** Computer Cradle
- System Table
- 85860A** Starter-Software PAC for 8568A/9825A
- Factory Assembly and Checkout Prior to Shipment

8581A Options

- Opt 002:** Delete System Table less \$600
- Opt 910:** Extra Manual Set \$150
- 85860A Starter-Software Pac for 8568A/9825A:** PAC includes two 9825 cartridges containing sample measurement programs, subprograms, and utilities. The sample programs demonstrate the application of the subprograms with practical measurements, such as harmonic distortion and spectrum search. Also included is a manual with annotated program listings. Complete compatibility requires 8568A; 9825A, Opt 002; 9866B Opt 025; 98210A; 98216A; and 98034A (plus 9872A Opt 025 and HP-IB cable for plotting). \$250

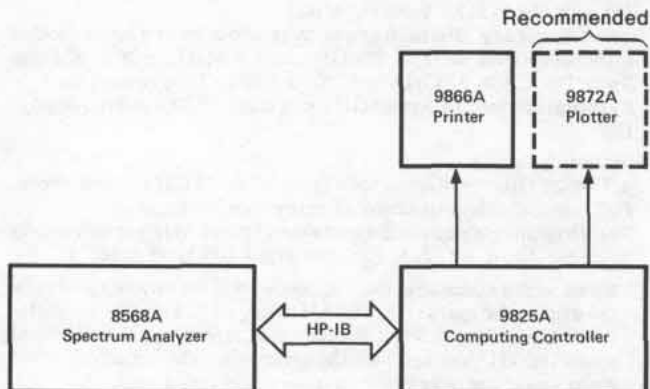

SIGNAL ANALYZERS

Spectrum Analyzer, 10 MHz to 40 GHz

Model 8565A

- 0.01 to 22 GHz coverage with internal mixer
- Internal preselection 1.7 to 22 GHz
- Wide choice of resolution bandwidths
- Simple three knob operation
- Absolute amplitude calibration
- CRT bezel readout displays control settings

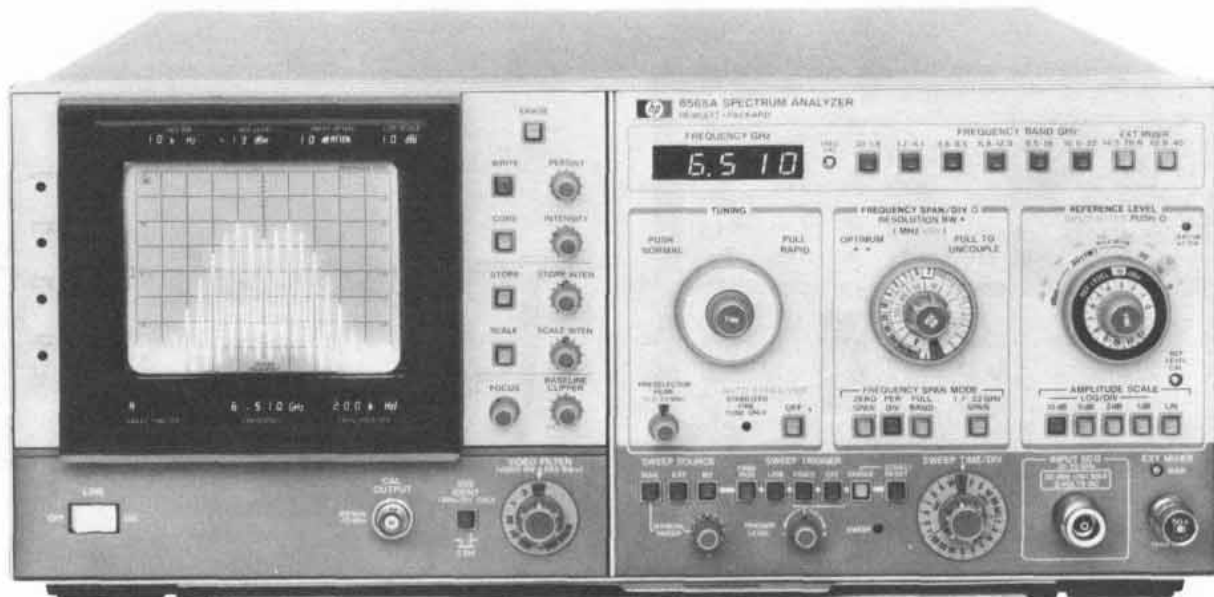

8565A Spectrum Analyzer

Covering from 0.01 to 22 GHz with its internal mixer, the 8565A has built-in preselection and brings accuracy plus convenience to microwave spectrum analysis. The wide range, spurious-free display, compact design and ease of use make it well suited for lab, production, or field applications requiring accurate measurement from IF thru microwave frequencies. The 8565A can cover 0.01 to 22 GHz in just two spans for rapid location of signals prior to close-in analysis in one of six bands. Coverage is easily extended up to 40 GHz with the HP 11517A External Mixer.

High Resolution

Fully automatic stabilization in narrow spans reduces residual FM and drift. Standard resolution bandwidths range from 1 kHz to 3 MHz. The 1 and 3 MHz bandwidths allow fast sweeps in wide spans and increased dynamic range for pulsed RF; narrow bandwidths for measurement of closely spaced signals. Option 100 provides additional 100 Hz and 300 Hz IF bandwidth filters, and residual FM is <100 Hz when stabilized. This 100 Hz resolution is useable up to 8.5 GHz and the 300 Hz resolution bandwidth to 22 GHz. All resolution filters are gaussian-shaped for repeatable measurements, faster non-distorting sweeps and best pulse response.

Absolute Amplitude Calibration

Absolute signal levels from -112 dBm to +30 dBm are easily measured because the HP 8565A always displays the value of the reference line with LED's in the CRT bezel and at the reference level control. Changes in RF, IF gain, and preselector loss are automatically included. In addition, flat frequency response insures accuracy for relative as well as absolute power measurements.

Wide Dynamic Range

Internal preselection (1.7 to 22 GHz) enables you to measure distortion products as much as 100 dB down. Even for closely spaced signals or measurements below 1.7 GHz, all distortion products are greater than 70 dB down. In either case, maximum dynamic range is assured even for 1 watt signals with the 70 dB input attenuator. An input limiter (0.01 to 1.8 GHz) and the internal preselector (1.7 to 22 GHz) enable the 8565A to withstand RF signals up to +30 dBm for all input attenuator settings.

Designed For Convenience

Coupled controls allow you to make most measurements in 3 simple steps. Green color coded keys preset the 8565A for normal operation so a measurement only requires that you tune to a signal, select a desired span, and raise it to the reference level. Automatically select-

ed sweep times insure a calibrated display for all combinations of frequency span, resolution bandwidth and video filtering.

The CRT bezel LED's display all pertinent control settings to give you all the information needed for signal evaluations in one central location. These data are also captured in CRT photos.

8444A Option 058 Tracking Generator

Make swept frequency response measurements to ± 1.7 dB from 10 to 1300 MHz with greater than 90 dB of dynamic range. The output is absolutely calibrated at 0 dBm and continuously variable to <-10 dBm. The frequency of unknown signals as well as the frequency of any point on the frequency response curve can be measured from the external counter output using the low-cost HP 5300/5305B 1300 MHz Counter.

8750A Storage-Normalizer

The analyzer is made even easier to use with the digital storage of the 8750A because there is no need to re-adjust intensity or persistence as the sweep time changes. With the push of a button, a signal can be frozen on the CRT and then compared directly to the current input signal. Traces can also be compared arithmetically (i.e., normalized) to automatically remove frequency response variations. This is especially useful when used with the HP 8444A Opt. 058 Tracking Generator.

8565A Specifications

Frequency Specifications

Frequency range: 0.01 to 22 GHz with internal mixer, 14.5 to 40 GHz with HP 11517A External Mixer.

Tuning accuracy (digital frequency readout in any span mode)

Internal mixing: 0.01 to 2.5 GHz $\leq \pm 5$ MHz, $\pm 20\%$ of Freq. Span/Div; 2.5 to 22 GHz, $\pm 0.2\%$, $\pm 20\%$ of Freq Span/Div.

External mixing: 14.5 to 40 GHz $\leq \pm 0.7\%$, $\pm 20\%$ of Freq Span/Div.

Frequency spans

1.7 to 22 GHz: multiband span from 1.7 to 22 GHz in one sweep.

Full band: displays spectrum of entire band selected.

Per division: eighteen calibrated spans from 1 kHz per div. to 500 MHz per div. in a 1, 2, 5 sequence, plus a full band span, "F".

Span width accuracy: the frequency error for any two points on the display for spans from 500 MHz/div to 20 kHz/div (unstabilized) is less than $\pm 5\%$ of the indicated separation; for stabilized spans 100 kHz/div and less, the error is less than $\pm 15\%$.

Zero span: analyzer becomes a manually tuned receiver.

Spectral resolution and stability

Resolution bandwidths: resolution (3 dB) bandwidths from 1 kHz to 3 MHz in 1, 3, 10 sequence. Bandwidth and span width are independently variable or may be coupled for optimum display when control markers are aligned (▶◀).

Resolution bandwidth accuracy: 3 dB points: $< \pm 15\%$.

Selectivity (60 dB/3 dB bandwidth ratio): $< 15:1$.

Stability: Total residual FM (fundamental mixing 0.01 to 4.1 GHz): stabilized, < 200 Hz p-p in 0.1 sec; unstabilized < 10 kHz p-p in 0.1 sec.

Stabilization range: first LO automatically stabilized for frequency spans 100 kHz/div or less. First LO residual FM typically 30 Hz p-p when stabilized.

Noise sidebands: > 70 dB down, > 30 kHz from center of CW signal in a 1 kHz Res. Bandwidth and a 10 Hz (0.01) Video Filter.

Amplitude Specifications

Amplitude range - internal mixer

Measurement range

Total power: +30 dBm (1 watt).

Damage levels: (50Ω nominal source impedance.)

dc: 0 V with 0 dB input atten, ± 7 V with ≥ 10 dB input atten.

ac: 0 V with 0 dB input atten, 10 V peak with ≥ 10 dB input atten.

RF: (signals above 10 MHz) + 30 dBm for any attenuator setting.

Gain compression: < 1 dB for 0 dBm input level with 0 dB attenuation.

Average noise level: max. avg. noise level with 1 kHz Res. Bandwidth (0 dB atten and 3 Hz video filter) is in the table below:

Frequency Band (GHz)	First IF in MHz	Harmonic Mode	Noise Level (dBm)	Frequency Response* (\pm dB MAX)
0.01-1.8	2050	1-	-112	1.2
1.7-4.1	321.4	1-	-109	1.7
3.8-8.5	321.4	2-	-103	2.5
5.8-12.9	321.4	3-	-94	2.5
8.5-18	321.4	4+	-87	3.0
10.5-22	321.4	5+	-75	4.5

*Frequency response includes input attenuator, preselector and mixer frequency response plus mix mode gain variation (band to band).

Amplitude range - HP 11517A External Mixer

Measurement range: saturation (gain compression < 1 dB), -15 dBm. Damage level > 0 dBm or 0.1 erg.

Sensitivity (Average noise level in a 10 kHz IF bandwidth): 14.5-18 GHz < -80 dBm, 18-26.5 GHz < -70 dBm, 26.5-40 GHz < -60 dBm. Typical sensitivity is 10 dB better for each band.

Reference Level

Reference level range +70 dBm (+30 dBm max. input) to -102 dBm in 10 dB steps and continuous 0 to -12 dB calibrated vernier.

Reference level accuracy: the Auto Sweep setting of the sweep time/div control insures a calibrated display within these limits:

Calibrator output (100 MHz \pm 10 kHz): -10 dBm ± 0.3 dB.

Reference level variation (input attenuator at 0 dB): 10 dB steps $< \pm 0.5$ dB (0 to -70 dBm); $< \pm 1.0$ dB (0 to -90 dBm).

Vernier (0 to -12 dB) continuous: maximum error < 0.5 dB.

Input attenuator: (at preselector input, 0-70 dB in 10 dB steps).

Step size variation: $< \pm 1.0$ dB, 0.01 to 18 GHz; $< \pm 1.5$ dB, 0.01 to 22 GHz.

Maximum cumulative error over the 0 to 70 dB range: $< \pm 2.8$ dB, 0.01 to 18 GHz; $< \pm 4.0$ dB, 0.01 to 22 GHz.

Frequency response: see table above.

Switching between bandwidths: 3 MHz to 1 kHz, ± 1.0 dB

Calibrated display range

Log: (expanded from reference level down). 70 dB @ 10 dB/div, 40 dB @ 5 dB/div, 16 dB @ 2 dB/div and 8 dB @ 1 dB/div.

Linear: full scale from 56 μ V (-102 dBm in 50 Ω to 707 volts (+70 dBm) in 10 dB steps and continuous 0 to -12 dB vernier.

Display accuracy

Log: $< \pm 0.1$ dB/dB, but $< \pm 1.5$ dB over full 70 dB display range.

Linear: $< \pm 0.1$ division over full 8 division deflection.

Residual responses (no signal present at input): with 0 dB input atten, fundamental mixing (0.01 to 4.1 GHz) < -90 dBm.

Signal identifier: available on all bands, used in 1 MHz/div span for signal identification

Signal Input Characteristics

Input 50Ω 0.01 to 22 GHz

Input connector: precision Type N female.

Input impedance

Input attenuator at 0 dB: 50 ohms nominal.

SWR: < 1.5 , 0.01 to 1.8 GHz; < 2.0 , 1.7 to 22 GHz (at analyzer tuned frequency).

Input attenuator at 10 dB or more: 50 ohms nominal.

SWR: < 1.3 , 0.01 to 1.8 GHz; < 2.0 , 1.7 to 22 GHz.

LO Emission (2.00 to 4.46 GHz): -50 dBm, 0.01 to 1.8 GHz; -85 dBm, 1.7 to 22 GHz.

Input protection (for input signals from 0.01 to 22 GHz)

0.01 to 1.8 GHz frequency band: internal diode limiter.

1.7 to 22 GHz frequency bands: saturation of YIG filter (pre-selector) occurs at total input signal power levels below input mixer damage.

External mixer input: BNC female connector is a port for LO power transfer, bias current and IF return.

Sweep Specifications

Sweep time

Auto: sweep time is automatically controlled by Frequency Span/Div, Resolution Bandwidth and Video Filter controls to maintain an absolute amplitude calibrated display.

Calibrated sweep times: 21 internal sweep times from 2 μ sec/div to 10 sec/div in 1, 2, 5, 10 sequence.

Display Characteristics

Cathode Ray Tube (aluminized P31 phosphor, 8 x 10 div internal graticule)

Persistence

Conventional: natural persistence of P31 phosphor.

Write: continuously adjustable from 0.2 sec to full storage.

Storage time: continuously adjustable from 1 minute (full brightness) to > 30 minutes (minimum brightness).

CRT Bezel Readout: bezel LEDs display the following measurement data (included in CRT photographs taken with the HP 197A Opt 001, 006 Oscilloscope Camera): Ampl. Scale Factor, Ref. Level, Input Atten., Res. Bandwidth, Sweptime/Div., Freq., Freq. Span/Div.

General Specifications

Temperature range: operating 0°C to 55°C, storage -40° to +75°C.

Humidity range (Operating): $< 95\%$ R.H. 0°C to 40°C

EMI: conducted and radiated interference is within the requirements of methods CE03 and RE02 of MIL STD 461A, VDE 0871 and CISPR pub'n 1, 2 and 4.

Power requirements: 48-66 Hz, 100, 120, 200 or 240 volts (-10% to +5%) 220 V A max (400 Hz operation available as Opt 400).

Size: 188 H x 426 W x 552 mm D (7 $\frac{3}{8}$ " x 16 $\frac{3}{4}$ " x 21 $\frac{3}{4}$ ").

Weight: net 29.1 kg (64 lbs). Shipping 38.6 kg (85 lbs).

Standard options available

Opt 100, 100 and 300 Hz Resolution Bandwidths: adds 100 Hz and 300 Hz resolution bandwidths with 11:1 shape factor, residual FM < 100 Hz when stabilized and improves sensitivity by 10 dB.

Opt 200—Calibration in dB μ V

Opt 400—400 Hz Power Supply

Ordering information

	Price
8565A Spectrum Analyzer	\$18,900
Opt 100: 100 Hz and 300 Hz Resolution Bandwidths	add \$800
Opt 200: Calibration in dB μ V	add \$100
Opt 400: Internal 50 to 400 Hz Power Supply	add \$250
Opt 907: Front Handle Kit	add \$30
Opt 908: Rack Flange Kit	add \$20
Opt 909: Rack Flange and Front Handle Kit	add \$40
Opt 910: Extra Operating and Service Manual	add \$45
11517A External Mixer (taper section req'd)	\$250
11518A Taper Section, 12.4 to 18 GHz	\$160
11519A Taper Section, 18 to 26.5 GHz	\$160
11520A Taper Section, 26.5 to 40 GHz	\$160
8444A Opt 058 Tracking Generator, 10 to 1300 MHz	\$3,975
8750A Storage-Normalizer	\$1,450

SIGNAL ANALYZERS

Spectrum Analyzer, 0.01 to 350 MHz

Models 8557A/182T & 8750A

- Easy to operate
- Signal level displayed directly in dBm
- ± 2.25 dB amplitude accuracy
- Resolution bandwidths 1 kHz to 3 MHz
- Optional 75 Ω input with dBm or dBmV calibration
- Digital Storage-Normalizer available

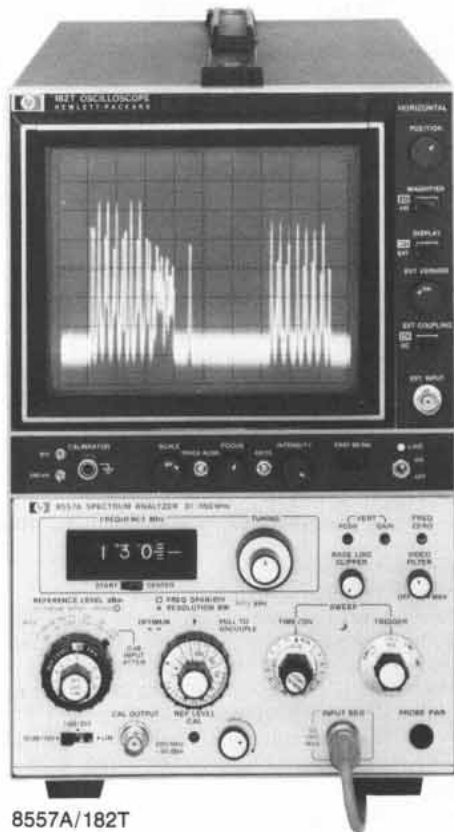

8557A/182T

8557A Spectrum Analyzer

Economy plus performance

The Model 8557A is a 0.01 to 350 MHz spectrum analyzer which plugs into any model 180-series oscilloscope display. This low cost, easy-to-use analyzer provides high accuracy in both amplitude and frequency measurements.

Simple, 3-knob operation

Most measurements consist of three simple steps. Center the inverted marker under the signal to be measured; its frequency is displayed on the digital readout. Zoom-in on the signal by decreasing the frequency span; bandwidth, sweep time, and video filtering are set automatically. Raise the signal to the top of the CRT; read its amplitude (in dBm) from the reference level control.

Absolute amplitude calibration

Signal levels can be read directly from the CRT in dBm (dBmV for Option 002) without the use of external standards or calculations. The signal level represented by the top CRT graticule line is always indicated by the reference level control, and vertical scale factors of 10 dB/div, 1 dB/div, or linear can be selected.

Optional 75 ohm input

Two options are available which allow measurements in 75 ohm systems: Option 001 has 75 ohms impedance and retains the dBm power calibration; Option 002 is also 75 ohms, but the amplitude is calibrated in dBmV for measurements on systems such as CATV.



8750A

8750A Storage-Normalizer

The 8750A is an accessory which provides digital storage, trace comparison and normalization where data in memory is subtracted from current input and then displayed. In conjunction with the 182T display maniframe and either the 8557A or 8558B, the Storage-Normalizer provides flicker-free display of measured signals. High resolution and slow sweep time measurements are easy to observe because of the 8750A's continuous refresh whose rate is independent of the analyzer's sweep rate. Additionally, two traces can be viewed from memory for CRT photography or detailed signal comparison.

Recommended displays

The 8557A/8558B Spectrum Analyzers will function with any 180-series display. However, the following are recommended: for low cost, large screen display, the Model 182T is ideal; the Model 181T offers variable persistence and storage; and the Model 180TR offers a rack mount configuration. Each of these displays provides a long persistence P39 phosphor (except variable persistence displays) and four non-buffered rear panel outputs compatible with most X-Y recorders.

8557A Specifications

Frequency specifications

Frequency range: 10 kHz to 350 MHz.

Frequency display span: (on a 10-division CRT horizontal axis): 12 calibrated spans from 20 MHz/div to 5 kHz/div in a 1, 2, 5 sequence. In "F" or full span the analyzer displays the full 10 kHz to 350 MHz. In "0" or zero span, the analyzer is a fixed-tuned receiver.

Accuracy: frequency error between any two points on the display is less than $\pm 10\%$ of the indicated frequency separation.

Digital frequency readout: indicates center frequency or start frequency of the frequency display span. In full span, the readout indicates center frequency or start frequency of the frequency display span. In full span, the readout indicates the frequency at the marker with 100 kHz resolution.

Accuracy: (after zeroing on the LO feedthrough) ± 3 MHz + 10% of frequency span per division setting.

Stability

Residual FM: less than 1 kHz peak-to-peak for time ≤ 0.1 sec (video filter full clockwise, but not in detent).

Noise sidebands: more than 75 dB below CW signal, 50 kHz or more away from signal with a 1kHz resolution bandwidth and full video filtering.

Resolution

Bandwidth ranges: 3 dB resolution bandwidths of 1kHz to 3 MHz in a 1, 3, 10 sequence. Resolution bandwidth may be coupled to frequency display span at a ratio of two display spans per resolution bandwidth.

Resolution bandwidth accuracy: individual resolution bandwidth 3 dB points calibrated to $\pm 20\%$, ($10^\circ - 40^\circ\text{C}$).

Resolution bandwidth selectivity: 60 dB/3 dB resolution bandwidth ratio $< 15:1$.

Video filter: post-detection low pass filter used to average displayed noise. Bandwidth variable from approximately 3X Resolution Bandwidth to approximately 0.01X Resolution Bandwidth. In the MAX position provides a noise averaging filter with a bandwidth of approximately 1.5Hz.

Amplitude specifications

Absolute amplitude calibration range

Log calibration range: from -117 dBm to $+20$ dBm in 10 dB steps. Reference level vernier, 0 to -12 dB continuously.

Log display ranges: 10 dB/div on a 70 dB display and 1 dB/div on an 8 dB display.

Linear display: from 2.2 microvolts (-100 dBm) full-scale to 2.24 volts ($+20$ dBm) full-scale in 10 dB steps. Full-scale signals in linear translate to approximately full-scale signals in log.

Dynamic range

Average noise level: < -107 dBm with a 10 kHz resolution bandwidth (0 dB input attenuation), 1–350MHz.

Spurious responses: for input signal level \leq Optimum Input Level setting, all image and out of band mixing responses, harmonic and inter-modulation distortion products are more than 70 dB below input signal level, 1 MHz to 350 MHz; 60 dB below, 20 kHz to 1 MHz.

Spurious responses due to 3rd order intermodulation distortion: for two input signals 10 dB above Optimum Input Level setting 3rd Order Intermodulation distortion products are > 70 dB below the input signals, 1–350 MHz; 60 dB below, 10 kHz to 1 MHz (signal separation ≥ 50 kHz).

Residual responses: (no signal present at input): < -100 dBm with 0 dB input attenuation, 0.1–350MHz.

Amplitude accuracy

Frequency response (flatness): ± 0.75 dB.

Switching between bandwidths (at $10^\circ - 40^\circ\text{C}$, 90% relative humidity)

3 MHz to 300 kHz: ± 0.5 dB.

3 MHz to 1 kHz: ± 1.0 dB.

Reference level accuracy (at fixed center frequency, fixed resolution bandwidth): ± 1.5 dB (includes input attenuator and IF gain accuracy. May be improved using IF or RF substitution techniques).

Amplitude log display: ± 0.1 dB/dB but no more than ± 1.5 dB over full 70 dB display range.

Calibrator

Amplitude: -30 dBm ± 1 dB.

Frequency: 250 MHz ± 50 kHz, crystal controlled.

Input specifications

Input connector: Type BNC female.

Input impedance: 50 Ω nominal. Typical reflection coefficient < 0.27 (1.74 SWR) for all Optimum Input Level settings except -40 dBm (0 dB Input Attenuation).

Input attenuator: 50 dB range. Accuracy ± 0.5 dB per 10 dB step, but not more than ± 1.0 dB over full 50 dB range.

Maximum input levels

AC or peak: peak or average power $+20$ dBm (3.16 V ac peak or 0.1 W) incident on analyzer. (MAX input markings on front panel indicate maximum input allowable for < 1 dB gain compression or attenuator overload.)

DC: ± 30 V dc.

Output characteristics

Cal output: -30 dBm, 250 MHz.

Probe power: $+15$ V, -12.6 V; 150 mA max. Powers 1120A, 1121A, 1123A, or 1124A high impedance probes.

Note: oscilloscope display rear panel outputs refer to 180T-series displays and 180-series Option 807 displays only. See below for information on modifying standard displays.

Vertical output: (AUX A on oscilloscope display rear panel): 0 to 0.8 V for 8-division deflection on CRT display; 50 Ω output impedance.

Pen lift/blanking output: (AUX B on oscilloscope display rear panel): 0 to 15 V (0 V, pen down). Approximately 10k Ω impedance when blanked. Compatible with HP 7004B, 7034B, 7005B, and 7035B X-Y RECORDERS.

21.4 MHz IF output: a 21.4 MHz output linearly related to the RF input to the analyzer. Bandwidth controlled by analyzer Resolution Bandwidth setting. Amplitude controlled by input attenuator, IF gain vernier, and first six IF step gain positions (-10 through -60 dBm Ref Level with 0 dB input attenuation). Output is approximately -10 dBm for full-scale signals on the CRT. (AUX C on oscilloscope display rear panel, 50 Ω output impedance.)

Horizontal output (AUX D on oscilloscope display rear panel): -5.0 to $+5.0$ V for 10 div CRT deflection, 5k Ω output impedance.

Sweep characteristics

Sweep time

Auto: sweep time is automatically controlled by Frequency Span, Resolution Bandwidth, and Video Filter.

Manual: sweep determined by front panel control; continuously variable across CRT in either direction.

Calibrated sweep times: 16 internal sweep times from 0.1 ms/div to 10 sec/div in a 1, 2, 5 sequence. For sweep times of 2 ms/div to 10 sec/div, the analyzer is operable in its normal swept-frequency mode. Faster sweeps are useful for analyzing modulation waveforms when the analyzer is being operated as a fixed-tuned receiver with zero Display Span. Sweep times may be reduced to an effective 10 μsec /div by using the 180-series X10 horizontal magnifier.

Accuracy: $\pm 10\%$.

Sweep trigger

Internal: sweep internally triggered by envelope of RF input signal (signal amplitude of 1.0 division peak-to-peak required on CRT display).

Line: sweep triggered by power line frequency.

Free run: sweep triggered repetitively by internally generated ramp.

Single: sweep triggered by front panel sweep trigger switch (spring return position).

Display characteristics

Oscilloscope display sections

180 Series compatibility: the 8557A is compatible with all 180A/180AR, 180C, 180D, 180F, 181A, 181AR, 182A, 184A, and 184B mainframes. It is operable with the 183A, 183B mainframes, but the display is limited to 6 divisions by the 6-division CRT. The following 180-series oscilloscope displays are recommended for use with the 8558B Spectrum Analyzer because they provide 4 nonbuffered rear panel auxiliary outputs (for unattenuated vertical, horizontal, and penlift outputs) and P39 medium-persistence CRT phosphor (except with 181T, 181TR which provide variable persistence):

180TR	P39 phosphor
181T	P31 phosphor with variable persistence
181TR	P31 phosphor with variable persistence
182T	P39 phosphor

See HP Service Notes 180A/AR-10, 180C/D-2, 181A/AR-8 and 182A/C-1 for information needed to modify standard display to provide auxiliary outputs.

Ordering information

	Price
8557A Spectrum Analyzer	\$3950
Opt 001: 75 ohm input (BNC), dBm calibration	add \$100
Opt 002: 75 ohm input (BNC), dBmV calibration	add \$100
182T Display	\$1900
180TR Display	\$1900
181T Display	\$2600
181TR Display	\$2700
8750A Storage-Normalizer	\$1450

SIGNAL ANALYZERS

Spectrum Analyzer, 0.1 to 1500 MHz

Models 8558B/182T & 8444A

- Simple, 3-knob operation
- Display of signal levels directly in dBm
- Resolution bandwidths from 1 kHz to 3 MHz

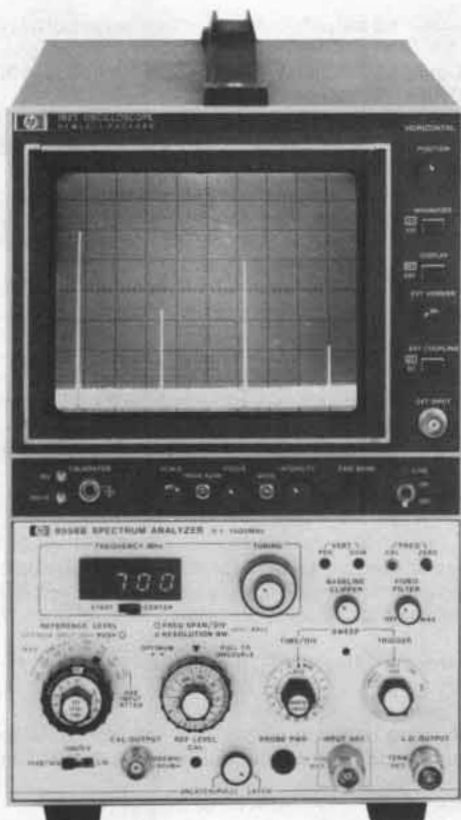

8558B/182T

8558B Spectrum Analyzer

Economical, wide frequency coverage

The Model 8558B is a 0.1 to 1500 MHz spectrum analyzer which plugs into any 180-series oscilloscope display. It is fully calibrated in frequency and amplitude, easy to use, and provides an economical means for making measurements in the RF range.

Simple, 3-knob operation

Most measurements consist of three simple steps. Tune to the signal to be measured; its frequency is displayed on the LED readout. Zoom-in on the signal by decreasing the frequency span; bandwidth, sweep time, and video filtering are set automatically. Raise the signal to the top of the CRT; read its amplitude (in dBm) from the reference level control.

Absolute amplitude calibration

Signal levels can be read directly from the CRT in dBm (dBmV for Option 002) without the use of external standards or calculations. The signal level represented by the top CRT graticule line is always indicated by the reference level control, and scale factors of 10 dB/div, 1 dB/div, and linear can be selected.

Optional 75 ohm input; Internal Limiter

Two options are available which allow measurements in 75 ohm systems: Option 001 has 75 ohms impedance and retains the dBm power calibration; Option 002 is also 75 ohms, but the amplitude is calibrated in dBmV for measurements on systems such as CATV.

Option 003 is an internal limiter that protects the input mixer from application of signal levels in excess of optimum levels.

- 0.5 to 1300 MHz Tracking Generator
- Digital Storage-Normalizer available
- Input protection

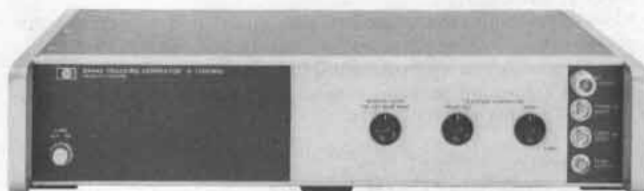

8444A Opt 058 (Compatible with 8558B)

8444A Option 058 Tracking Generator (0.5–1300 MHz)

Make swept frequency response measurements to ± 1.5 dB from 0.5 to 1300 MHz with greater than 90 dB of dynamic range. The output is absolutely calibrated at 0 dBm and continuously variable to -10 dBm. The frequency of unknown signals, as well as the frequency of any point on the frequency response curve, can be measured using the external counter output and Model 5300/5305B Counter.

8750A Storage-Normalizer

The 8750A is an accessory which provides digital storage, trace comparison and swept response normalization. The frequency response variation of a swept measurement system, such as the 8558B and 8444A, can be removed through normalization. In addition, a "real time" signal can be compared with a stored trace or both traces can be viewed from memory for CRT photography or detailed comparison.

Suggested displays

The 8557A/8558B Spectrum Analyzers will function with any 180-series display. However, the following are suggested: for low cost, large screen display, the Model 182T is ideal; the Model 181T offers variable persistence and storage; and the Model 180TR offers a rack mount configuration. Each of these displays provides a long persistence P39 phosphor (except variable persistence displays) and four non-buffered rear panel outputs compatible with most X-Y recorders.

8558B Specifications

Frequency specifications

Frequency range: 100 kHz to 1500 MHz.

Frequency display span: (on a 10-division CRT horizontal axis): 14 calibrated spans from 100 MHz/div to 5 kHz/div in a 1, 2, 5 sequence. In "0" (zero span) the analyzer is a fixed-tuned receiver.

Accuracy: frequency error between any two points on the display is less than $\pm 5\%$ of the indicated frequency separation.

Digital frequency readout: indicates center frequency or start frequency of the frequency display scan. Two ranges: 0 to greater than 195 MHz with 100 kHz resolution; 195 MHz to 1500 MHz with 1 MHz resolution. ZERO control allows frequency readout to be adjusted for accurate calibration anywhere in the frequency range; CAL control removes frequency hysteresis. Resolution 100 kHz.

Accuracy: (after zeroing on the LO feedthrough and operation of the CAL button, $20^\circ - 40^\circ\text{C}$).

0–195 MHz: ± 1 MHz $+20\%$ of frequency span per division setting (≤ 1 MHz per division).

195–1500 MHz: ± 5 MHz $+\%$ of frequency span per division setting.

Stability

Residual FM: less than 1 kHz peak-to-peak for time ≤ 0.1 sec.

Noise sidebands: more than 65 dB below CW signal, 50 kHz or more away from signal with a 1 kHz resolution bandwidth and full video filter.

Resolution

Bandwidth ranges: 3 dB resolution bandwidths of 1 kHz to 3 MHz in a 1, 3, 10 sequence. Resolution bandwidth may be coupled to frequency span at a ratio of two display spans per resolution bandwidth.

Resolution bandwidth accuracy: Individual resolution bandwidth 3 dB points calibrated to $\pm 20\%$.

Resolution bandwidth selectivity: 60 dB/3 dB resolution bandwidth ratio $< 15:1$.

Video filter: post-detection filter used to average displayed noise. Bandwidth variable from approximately 3X Resolution Bandwidth to approximately 0.01X Resolution Bandwidth. In the MAX position provides a noise averaging filter with a bandwidth of approximately 1.5 Hz.

Amplitude specifications

Absolute amplitude calibration range

Log calibration range: from -115 dBm to +30 dBm in 10 dB steps. Reference level vernier, 0 to -12 dB continuously.

Log display ranges: 10 dB/div on a 70 dB display, and 1 dB/div on an 8 dB display.

Linear display: from 2.2 microvolts (-100 dBm) full scale to 7.1 volts (+30 dBm) full-scale in 10 dB steps. Full-scale signals in linear translate to approximately full-scale signals in log.

Dynamic range

Average noise level: < -107 dBm with a 10 kHz resolution bandwidth (0 dB input attenuation).

Spurious responses: for input signal level \leq Optimum Input Level setting, all image and out-of-band mixing responses, harmonic and intermodulation distortion products are more than 70 dB below input signal level, 5 MHz to 1500 MHz; 60 dB below, 100 kHz to 5 MHz.

Spurious responses due to 3rd order intermodulation distortion: for two input signals 10 dB above Optimum Input Level setting 3rd Order Intermodulation distortion products are > 70 dB below the input signals, 5-1500 MHz; 60 dB below, 100 kHz to 5 MHz (signal separation ≥ 50 kHz).

Residual responses: (no signal present at input): < -100 dBm with 0 kB input attenuation.

Amplitude accuracy

Frequency response (flatness): ± 1.0 dB.

Switching between bandwidths (at $10^\circ - 40^\circ$ C).

3 MHz to 300 kHz: ± 0.5 dB.

3 MHz to 1 kHz: ± 1.0 dB.

Reference level accuracy: (at fixed center frequency, fixed resolution bandwidth): ± 1.5 dB (includes input attenuator and IF gain accuracy). May be improved using IF or RF substitution techniques.

Amplitude log display: ± 0.1 dB/dB but not more than ± 1.5 dB over full 70 dB display range.

Calibrator

Amplitude: -30 dBm ± 1.0 dB.

Frequency: 280 MHz ± 50 kHz, crystal controlled.

Input specifications

Input connector: type N female.

Input impedance: 50 Ω nominal. Typical reflection coefficient < 0.20 (1.5 SWR) for all Optimum Input Level settings except -40 dBm (0 dBm input attenuation).

Input attenuator: 70 dB range. Accuracy ± 0.5 dB per 10 dB step but not more than ± 1.0 dB over full 70 dB range.

Maximum

AC or peak: peak or average power +10 dBm (1.0 V ac peak) incident on mixer (0 dB input attenuation), +30 dBm (10 V ac peak or 1 W), incident on input attenuator. (MAX input markings on front panel indicate maximum input allowable for < 1 dB gain compression or attenuator overload).

DC: ± 50 V dc.

Output characteristics

LO output: +10 dBm nominal, 50 ohms; 2.05-3.55 GHz.

Cal output: -30 dBm, 280 MHz.

Probe power: +15 V, -12.6 V; 150 mA max. Powers 1120A, 1121A, 1123A, or 1124A high impedance probes.

Note: the following oscilloscope display rear panel outputs refer to 180T 180TR, 181T, 181TR displays and older 180-series displays with Option 807 only.

Vertical output: (AUX A on oscilloscope display rear panel.) 0 to 0.8 V for 8-division reflection on CRT display; 50 Ω output impedance.

Pen lift-blanking output: (AUX B on oscilloscope display rear panel): 0 to 15 V (0 V, pen down). Approximately 10 k Ω impedance when blanked. Compatible with HP 7004B, 7034B, 7005B, and 7035B X-Y RECORDERS.

21.4 MHz IF output: a 21.4 MHz output linearly related to the RF input to the analyzer. Bandwidth controlled by analyzer Resolution Bandwidth setting. Amplitude controlled by input attenuator, IF gain vernier, and first six IF step gain positions (-10 through -60 dBm Ref Level with 0 dB input attenuation). Output is approximately -10 dBm for full-scale signals on the CRT. (AUX C on oscilloscope display rear panel, 50 Ω output impedance).

Horizontal output: (AUX D on oscilloscope display rear panel): -5.0 to +5.0 V for 10 div CRT deflection, 5k Ω output impedance.

Sweep characteristics

Sweep time

Auto: sweep time is automatically controlled by Frequency Span, Resolution bandwidth, and Video Filter.

Manual: sweep determined by front panel control, continuously variable across CRT in either direction.

Calibrated sweep time: 16 internal sweep times from 0.1 ms/div to 10 sec/div in a 1, 2, 5 sequence. For sweep times of 2 ms/div to 10 sec/div, the analyzer is operable in its normal swept frequency mode. Faster sweeps are useful for analyzing modulation waveforms when the analyzer is being operated as a fixed-tuned receiver with zero Display Span. Sweep times may be reduced to an effective 10 μ sec/div by using the 180-series X10 horizontal magnifier.

Accuracy: $\pm 10\%$.

Sweep trigger

Internal: sweep internally triggered by envelope of RF input signal (signal amplitude of 1.0 division peak-to-peak required on CRT display).

Line: sweep triggered by power line frequency.

Free run: sweep triggered repetitively by internally generated ramp.

Single: sweep triggered by front panel sweep trigger switch (spring return position).

Display characteristics

Oscilloscope display sections

180 Series compatibility: the 8558B is compatible with all 180A, 180AR, 180C, 180D, 180F, 181A, 181AR, 182A, 184A, and 184B mainframes. It is operable with the 183A, 183B mainframes, but the display is limited to 6 divisions by the 6-division CRT. The following 180-series oscilloscope displays are recommended for use with the 8558B Spectrum Analyzer because they provide 4 non-buffered rear panel auxiliary outputs (for unattenuated vertical, horizontal, and penlift outputs) and P39 medium-persistence CRT phosphor (except with 181T, 181TR which provide variable persistence):

180TR	P39 phosphor
181T	P31 phosphor with variable persistence
181TR	P31 phosphor with variable persistence
182T	P39 phosphor

See HP Service Notes 180A/AR-10, 180C/D-2, 181A/AR-8 and 182A/C-1 for information needed to modify standard displays to provide auxiliary outputs.

Ordering information

	Price
8558B Spectrum Analyzer	\$4950
Opt 001: 75 ohm input (BNC), dBm calibration	add \$100
Opt 002: ohm input (BNC), dBmV calibration	add \$100
Opt 003: Internal Limiter	add \$150
182T Display	\$1900
180TR Display	\$1900
181T Display	\$2600
181TR Display	\$2700
8444A Opt 058 Tracking Generator	\$3975
8750A Storage-Normalizer	\$1450

SIGNAL ANALYZERS

Plug-in spectrum analyzer system, 20 Hz to 40 GHz

Model 141T system

- 20 Hz to 40 GHz with just a tuning section change
- Advantages of fully calibrated solid state system
- Add measurement capability to your system as needed
- Tracking generator expands measurement capability
- Increase dynamic range with tracking preselector
- Storage-normalizer adds digital storage

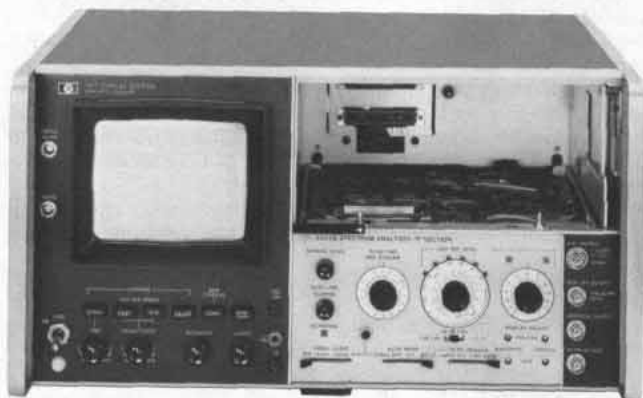

141T, 8552B



8443A



8444A



8445B Opt 002, 003

Hewlett-Packard's high performance plug-in spectrum analyzer family makes frequency domain measurements from 20 Hz to 40 GHz. Because of the system's modularity, the user need purchase only analyzer components necessary to meet immediate production or laboratory measurement requirements. Then, as broader frequency capability is required, additional tuning sections or companion instruments can be added.

The models 8553B, 8554B, 8555A, and 8556A are tuning sections which plug into a 141T display mainframe along with an 8552B IF section to form a member of the Hewlett-Packard high performance spectrum analyzer family. Each tuning section covers a frequency range convenient for equipment design or spectrum surveillance: 8556A, 20 Hz to 300 kHz; 8553B, 1 kHz to 110 MHz; 8554B, 100 kHz to 1250 MHz; and 8555A, 10 MHz to 40 GHz. The IF section plug-in which is used with each tuning section, serves to condition the measurement signal for proper display on the CRT. Two IF sections are available, the 8552B high performance model and the 8552A model for economy. The spectrum analyzer specifications included in this catalog assume the use of the 8552B.

The 8443A and 8444A are tracking generators complementing the basic spectrum analyzer function with an RF source locked to the tuning frequency. The 8445B is an automatic preselector which enhances the dynamic range of the 10 MHz to 40 GHz 8555A tuning section analyzer.



8553B

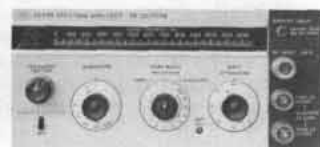

8554B



8555A



8556A

The 141T based spectrum analyzer features absolute calibration of frequency and amplitude, high resolution and sensitivity, wide dynamic range, and simple to interpret display output.

The following pages cover spectrum analyzer performance with each of the tuning sections and companion tracking generator/preselector.

Absolute amplitude calibration

For ease and speed of measurement, full frequency band amplitude calibration allows direct interpretation of signal power or voltage from the CRT display. A choice of logarithmic or linear scaling calibrates the CRT in dBm or μ V respectively. Front panel settings set the top horizontal graticule on the CRT as the reference power in the logarithmic mode; all other CRT measurements can be made relative to this reference. In linear scaling the CRT is calibrated in voltage per division using front panel settings. The bottom graticule is zero voltage.

When a combination of frequency scan, bandwidth, or video filter settings are chosen such that the display becomes uncalibrated, a warning light indicates the condition.

High resolution frequency calibration

The frequency measurement capability of the spectrum analyzer is responsive to user need, making spectrum measurements simply and accurately with three frequency scan modes.

First is the FULL scan mode, which displays the entire tuning section frequency band on the 10 cm horizontal CRT graticule. This mode is effective in viewing broadband effects of circuit adjustments and refinements as they are made. In FULL scan a marker on the CRT corresponds in frequency to the position of the pointer on the tuning section frequency scale, so signals can be readily identified.

The second mode, PER DIVISION scan, centers the display about the frequency indicated by the tuning section pointer. In this mode, narrow, calibrated scan per division and automatic frequency stabilization make high resolution measurements for analysis of signal purity, sidebands, and low deviation FM.

In the third mode, ZERO scan, the analyzer becomes a receiver tuned to the frequency indicated on the scale. Modulation in an input signal at the tuned frequency is displayed on the CRT in the time domain. The scan time control provides a calibrated time base.

High resolution

The ability to resolve close-in signal sidebands, such as line related modulation, is important in frequency domain analysis. The Hewlett-Packard 141T plug-in spectrum analyzers each have narrow bandwidths for such resolution. Up to 110 MHz, the analyzers offer 10 Hz bandwidths and 18 GHz, 100 Hz bandwidths. The frequency stabilization feature already mentioned ensures high resolution by maintaining a jitter-free display.

Wide dynamic range, sensitive

Confidence in signal identification is given by the analyzer's ability to measure wide amplitude differentials without distortion products and to measure very low-level signals. The plug-in spectrum analyzers have typically 70 dB of distortion free dynamic range; that is, the capability of measuring 0.03% signal distortion from the CRT display. With the 8445B preselector the 8555A has a spurious-free range of 100 dB. The CRT displays full dynamic range on a linear, easy to read scale.

Signals at as low a level as -142 dBm (20 nanovolts, 50 ohms) can be detected by the spectrum analyzer with 10 Hz bandwidth. At high frequencies and with 100 Hz bandwidth, -125 dBm signals can be measured.

A parallax free, storable display

The 141T spectrum analyzer mainframe and display features a variable persistence CRT which enables response storage for any measurement. With very narrow bandwidth measurements, extremely slow sweeps are necessary to maintain amplitude calibration (allowing band-pass filters time to respond). A recording CRT is necessary to save this response for viewing. Of course, any response can be stored for a display ready to be photographed. Another display mainframe, the 140T, is available with standard persistence.

Interpretation of response levels on the CRT is free from parallax since the graticule is etched on the inside of the display screen adjacent to the phosphor.

IF section adds convenience features

The high resolution 8552B or the economic 8552A IF section features video filtering, recorder outputs and an internal calibration signal to make the spectrum analyzer easier to use. Video filtering is a low-pass filter which averages noise amplitude response for easier small signal readings. It also makes wide band noise measurements easier.

Recorder outputs, including pen lift, allow hard copy duplication of the CRT display. Manual scan allows setting up of accessories, such as X-Y recorders, adjusting signals on screen during slow scans and measuring frequencies with a counter.

The internal calibration standard is a very stable -30 dBm, 30 MHz signal for quick front panel calibration.

Tracking generators for each frequency band

Either available internally, or as a companion instrument, are leveled signal sources designed to track the swept tuning frequency of the spectrum analyzer. Amplifiers, filters or any circuit which requires an input signal can be characterized to 1300 MHz, with typically wider dynamic range and more precise frequency accuracy than with the spectrum analyzer alone.

The 8556A low frequency tuning section has an internal tracking generator, standard with the instrument. The 8553B and 8554B/8555A use separate generators namely 8443A and 8444A respectively.

8750A Storage-Normalizer

You can add digital storage to the 140-series spectrum analyzer with the 8750A (Opt. 001) and an external oscilloscope. Digital storage provides a flicker-free display regardless of the analyzer sweep speed and facilitates trace comparisons of two traces. If a tracking generator is employed, the normalization feature significantly reduces frequency response variations. The 8750A Storage-Normalizer is a versatile accessory which may be used directly with other HP spectrum and network analyzers. (See Page 24.24).

General specifications

141T spectrum analyzer system

Input impedance: 50Ω nominal. Reflection coefficient <0.30 (1.85 SWR), input attenuator ≥10 dB.

Maximum input level: peak or average power +13 dBm (1.4 V ac peak), ±50 V dc.

Attenuator: 0 to 50 dB in 10 dB steps.

Scan time: 16 internal scan rates from 0.1 ms/div to 10 sec/div in a 1, 2, 5 sequence, and manual scan (8552B only).

Scan time accuracy

0.1 ms/div to 20 ms/div: ±10%.

50 ms/div to 10 s/div: ±20%.

Scan mode

Int: analyzer repetitively scanned by internally generated ramp; synchronization selected by scan trigger

Single: single scan with front panel reset.

Ext: scan determined by 0 to +8 volt external signal.

Manual: scan determined by front panel control.

Scan trigger: for internal scan mode, select between

Auto: scan free-runs.

Line: scan synchronized with power line frequency.

Ext: scan synchronized with >2 volt (20 volt max.) signal.

Video: scan internally synchronized to envelope of RF input.

Auxiliary outputs:

Vertical output: 0 to -0.8 V for full deflection.

Scan output: -5 V to +5 V for 10 div CRT deflection.

Pen lift output: 0 to 14 V (0 V, pen down).

Display characteristics

141T, 140T

Plug-ins: accepts Models 8552A/B, 8553B, 8554B, 8555A and 8556A and Model 1400-series Oscilloscope plug-ins.

Cathode-ray tube type

Model 141T: post-accelerator storage tube, 9000 volt accelerating potential; aluminized P31 phosphor.

Model 140T: post-accelerator, 7300 volt potential medium-short persistence (P7) phosphor.

Cathode-ray tube graticule

Model 141T: 8 x 10 division (approx, 7.1 cm x 8.9 cm parallax-free internal graticule).

Persistence, model 141T only

Normal: natural persistence of P31 phosphor (0.1 second).

Variable

Normal writing rate mode: continuously variable from less than 0.2 second to more than one minute.

Maximum writing rate mode: from 0.2 second to 15 seconds.

Erase: manual; erasure takes approximately 350 ms.

Storage time model 141T only: normal writing rate; more than 2 hours at reduced brightness (typically 4 hours).

Fast writing speed, model 141T only: more than 15 minutes.

Functions used with oscilloscope plug-ins only. Intensity modulation, calibrator; beam finder.

EMI: conducted and radiated interference is within requirements of MIL-I-16910C and MIL-1-6181D and methods CEO3, and REO2 of MIL-STD-461 (except 35 to 40 kHz) when appropriate RF tuning section and 8552A or 8552B are combined in a 140T or 141T Display Section.

Temperature range: operating, 0°C to +55°C; storage, -40°C to +75°C.

Power requirements: 100, 120, 220, or 240V +5%, -10%. 50 to 60 Hz, normally less than 225 watts (includes plug-ins used).

Weight

Model 8552A or 8552B IF section: net, 4.1 kg (9 lb). Shipping 6.4 kg (14 lb).

Model 140T display section: net, 16.8 kg (37 lb). Shipping, 20 kg (45 lb).

Model 141T display section: net, 18 kg (40 lb). Shipping, 23 kg (51 lb).

Tuning section: see following pages.

Size: model 140T or 141T with plug-ins: 221 H x 425 W x 416 mm D (8 3/4" x 16 3/4" x 16 3/8").

Special order: chassis slides and adapter kit.

Ordering information

140T Normal Persistence Display

Opt 908: Rack Flange Kit

141T Variable Persistence Display

Opt 908: Rack Flange Kit

8552A Economy IF Section

8552B High Resolution IF Section

Price

\$1800

add \$15

\$2600

add \$15

\$3175

\$4025

SIGNAL ANALYZERS

141T Spectrum Analyzer System: 20 Hz to 300 kHz

Model 8556A

- Accurate signal level measurements (± 0.95 dB)
- Accurate frequency measurements (± 3 Hz)

- High sensitivity (-152 dBV)
- Built-in tracking generator

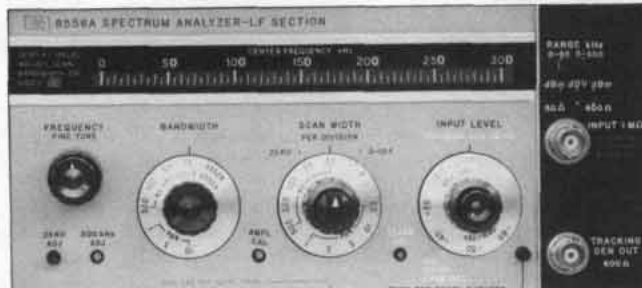

8556A

General purpose measurement flexibility

The 8556A Spectrum Analyzer covers the frequency range from 20 Hz to 300 kHz. It was designed to accommodate the variety of characteristic impedances and amplitude units used in making audio measurements. Balanced or unbalanced inputs are available, and open circuit voltages (dBV or linear) or power (dBm) in several characteristic impedances may be measured. The analyzer is capable of high resolution; frequencies can be measured very accurately. A built-in tracking generator further increases the instrument's utility.

Frequency range

The 8556A has two frequency scales, 0–300 kHz for full coverage and 0–30 kHz for better resolution at low frequencies. The analyzer may be swept symmetrically about a tunable center frequency, swept from 0 Hz to a selectable end point, or operated as a fixed tuned receiver. 20 kHz crystal markers (accurate to 0.01%) can be generated on the CRT to make very accurate frequency measurements.

Absolute amplitude calibration

The 8556A is calibrated for dBm in 600 Ω , dBm in 50 Ω , dBV, and volts. The very accurate reference level control (± 0.2 dB) and vernier (± 0.25 dB) allow the IF substitution technique to be used to improve amplitude measurement accuracy.

Low distortion

Careful design has decreased analyzer distortion to the extent that a full 70 dB dynamic range is achieved. This allows small signals, such as harmonic or intermodulation distortion, to be measured in the presence of large ones.

Resolution—sensitivity

Resolution bandwidths from 10 Hz to 10 kHz are provided on the 8556A. Using the narrow bandwidth, 50 or 60 Hz line related sidebands can be measured. The analyzer's extremely low noise figure together with its narrow bandwidths makes the 8556A very sensitive. Signals as low as -152 dBV (25 nV) can be measured in a 10 Hz bandwidth. The 8556A may be used to measure EMI, such as interference conducted along an AC power line.

Isolated input

The isolated input eliminates the possibility of spurious signal pickup which could be caused by line related ground currents flowing in the ground connections between the analyzer and signal source. The input impedance (1 M Ω) is high enough so that a scope probe may be used with a minimum of loading. An optional balanced input is available which is transformer coupled for isolation and high common mode rejection. The input impedance is 15 k Ω , and the analyzer is calibrated for either dBm-135 Ω or dBm-150 Ω as well as dBm-600 Ω and dBm-900 Ω . Balance (symmetry) is 80 dB at 50 Hz and typically 50 dB at 300 kHz.

Tracking generator

A tracking generator is built into the 8556A. If an external counter is connected to the tracking generator, frequencies can be measured to an accuracy of ± 3 Hz. Swept insertion loss or return loss measure-

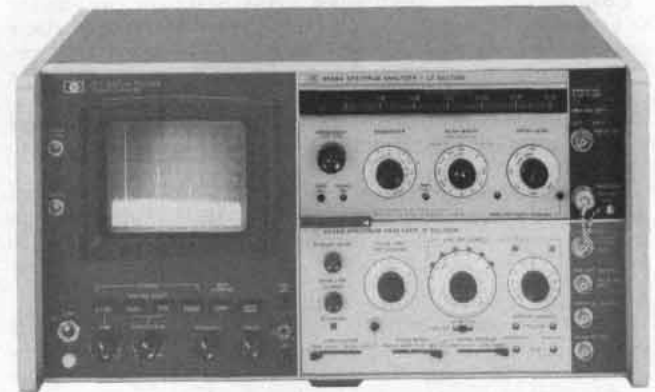

ments can be made on a device such as an amplifier or filter. A 140 dB measurement range is possible using the narrowest resolution bandwidth. The tracking generator also provides a convenient signal for compensating an oscilloscope probe used with the 8556A.

Other applications

The combination of a tracking generator and spectrum analyzer in this frequency range is valuable in applications such as receiver testing and fault location.

Specifications—with 8552B IF Section

Frequency specifications

Frequency range: 20 Hz to 300 kHz. Tuning dial ranges of 0–30 kHz and 0–300 kHz.

Scan width: (on a 10-division CRT horizontal axis)

Per division: 10 calibrated scan widths from 20 Hz/div to 20 kHz/div in a 1, 2, 5 sequence.

0–10 f: 10 calibrated preset scans, from 200 Hz to 200 kHz in a 1, 2, 5 sequence. Analyzer scans from zero frequency to ten times the scan width per division setting.

Zero: analyzer is a fixed tuned receiver.

Frequency accuracy

Center frequency accuracy: 0–30 kHz Range: ± 500 Hz; 0–300 kHz Range: ± 3 kHz.

Marker accuracy: RF markers every 20 kHz accurate to within $\pm 0.01\%$. Markers controlled by front panel on/off switch.

Scan width accuracy: frequency error between any two points on the display is less than $\pm 3\%$ of the indicated frequency separation.

Stability

Residual FM: sidebands >60 dB down 50 Hz or more from CW signal, scan time ≥ 1 sec/div, 10 Hz bandwidth.

Noise sidebands: more than 90 dB below CW signal, 3 kHz away from signal, with a 100 Hz IF bandwidth.

Frequency drift: less than 200 Hz/10 min.

Resolution

Bandwidth ranges: IF bandwidths of 10 Hz to 10 kHz are provided in a 1, 3, 10 sequence.

Bandwidth accuracy: individual IF bandwidth 3 dB points calibrated to $\pm 20\%$ (10 kHz bandwidth $\pm 5\%$).

Bandwidth selectivity: 60 dB/3 dB IF bandwidth ratios, with IF section: $<11:1$ for IF bandwidths from 10 Hz to 3 kHz; $<20:1$ for 10 kHz bandwidth. For 10 Hz bandwidth, 60 dB points are separated by less than 100 Hz.

Amplitude specifications

Absolute amplitude calibration

Log calibration modes

dBV	0 dBV = 1 V rms
dBm-600 Ω	0 dBm = 1 mW-600 Ω
dBm-50 Ω	0 dBm = 1 mW-50 Ω

Input impedance is 1 M Ω . dBm ranges are referenced with input properly terminated externally.

Log calibration range: from -150 dBm/dBV to +10 dBm/dBV.
Log display range: 10 dB/div on a 70 dB display, or 2 dB/div on a 16 dB display.

Linear sensitivity: from 0.1 μ V/div to 1 V/div in a 1, 2, 10 sequence. Linear sensitivity vernier X1 to X0.25 continuously.

Dynamic range

INPUT LEVEL control: -10 to -60 dBm/dBV in 10 dB steps. Accuracy ± 0.2 dB. Marking indicates maximum input levels for 70 dB spurious-free dynamic range.

Average noise level: (specified with a 600 Ω or less source impedance and INPUT LEVEL at -60 dBm/dBV)

Mode	1 kHz IF Bandwidth	10 Hz IF Bandwidth
dBm-50 Ω	<-122 dBm (180 nV)	<-142 dBm (18 nV)
dBm-600 Ω	<-130 dBm (250 nV)	<-150 dBm (25 nV)
dBV	<-132 dBV (250 nV)	<-152 dBV (25 nV)
Linear	<400 nV	<40 nV

Video filter: averages displayed noise; bandwidth of 10 kHz, 100 Hz, and 10 Hz. Bandwidth accuracy $\pm 20\%$.

Spurious responses: input signal level \leq INPUT LEVEL setting; out of band mixing responses, harmonic and intermodulation distortion products are all more than 70 dB below the input signal level 5 kHz to 300 kHz; 60 dB, 20 Hz to 5 kHz. Third order intermodulation products are more than 70 dB below the input signal level, 5 kHz to 300 kHz with signal separation >300 Hz.

Residual responses (no signal present at input): With the INPUT LEVEL at -60 dBm/dBV and the input terminated with 600 Ω or less, all line related residual responses from 0 to 500 Hz are below -120 dBm/dBV. All other residual responses are below 130 dBm/dBV.

Amplitude accuracy:	Log	Linear
Frequency response	± 0.2 dB	$\pm 2.3\%$
Amplitude display	± 0.25 dB/dB but not more than ± 1.5 dB over 70 dB display range	$\pm 2.8\%$ of full 8 div display

Log reference level control: provides 90 dB IF gain control in 10 dB steps. Accurate to ± 0.2 dB ($\pm 2.3\%$).

Log reference level vernier: provides continuous 12dB range. Accurate to ± 0.1 dB ($\pm 1.2\%$) in 0, -6, -12 dB positions; otherwise ± 0.25 dB ($\pm 2.8\%$).

Amplitude measurement accuracy: ± 0.95 dB with proper technique.

General

Scan time: 16 internal scan rates from 0.1 ms/div to 10 sec/div in a 1, 2, 5 sequence.

Scan mode

Int: analyzer repetitively scanned internally.

Ext: scan determined by 0 to +8 volt external signal.

Single: single scan actuated by front panel button.

Manual: scan determined by front panel control.

Input level: provides 50 dB control of input preamplification and attenuation to prevent input overload. INPUT LEVEL markings of

-60 dBm/dBV to -10 dBm/dBV indicate maximum input level for a minimum of 70 dB spurious-free dynamic range. Accuracy ± 0.2 dB (2.3%).

Input impedance: 1 M Ω shunted by ≈ 32 pF.

Maximum input level: 10 V rms, ± 200 V dc. Ground terminals of BNC input connectors are isolated from the analyzer chassis ground to minimize ground loop pickup at low frequencies.

Maximum voltage, isolated ground to chassis ground: ± 100 V dc.

Isolated ground to chassis ground impedance: 100 k Ω shunted by approximately 0.3 μ F.

Gain compression: for input signal level 20 dB above INPUT LEVEL setting, gain compression is less than 1 dB.

Tracking generator specifications

Frequency range: tracks the analyzer tuning, 20 Hz to 300 kHz.
Amplitude range: continuously variable from 100 mV rms to greater than 3 V rms into an open circuit.

Amplitude accuracy: with TRACKING GEN LEVEL in CAL position and 20 kHz markers off, output level at 100 kHz is 100 mV ± 0.3 dB into an open circuit.

Frequency response: ± 0.25 dB 50 Hz to 300 kHz.

Output impedance: 600 Ω .

Residual FM: <1 Hz peak-to-peak.

Power requirements: 100, 120, 200, or 240 V $\pm 5\%$, -10%, 50 to 60 Hz, normally less than 225 watts.

Weight: Model 8556A LF section: net, 3.7 kg (8 lb). Shipping, 5.3 kg (12 lb).

Size: 102 H, 226 W, 344 mm D (4" x 8 7/8" x 13 1/2").

Specifications with 8556A Options 001, 002-balanced input

Amplitude

Log calibration modes-balanced (bridged) input

dBm-135 Ω (Option 001)	0 dBm = 1mW-135 Ω
dBm-150 Ω (Option 002)	0 dBm = 1mW-150 Ω
dBm-600 Ω	0 dBm = 1mW-600 Ω
dBm-900 Ω	0 dBm = 1mW-900 Ω

Input impedance is typically 15 k Ω . dBm ranges are referenced with input properly terminated externally.

Input

Maximum input levels: normal Mode, ± 20 V rms or ± 150 V dc for normal mode (symmetrical) signals between input signal connectors; Common Mode, 200 V rms at 60 Hz or ± 500 V dc for common mode (asymmetrical) voltages between input signal connectors and GUARD or instrument chassis; Guard, ± 100 V dc from GUARD to instrument chassis. (GUARD to chassis impedance is approximately 100 k Ω shunted by 0.3 μ F.)

Balance (Symmetry): 0 -30kHz Range, greater than 80 dB, 50 Hz to 1 kHz; 1 -300 kHz range, greater than 60 dB, 1 kHz to 20 kHz.

Ordering information

- 8556A RF section
- Opt 001: Balanced input
- Opt 002: Balanced input

Price

- \$2525
- add \$220
- add \$220

SIGNAL ANALYZERS

141T Spectrum Analyzer System: 1 kHz to 110 MHz

Models 8553B & 8443A

- Wide frequency range
- 10 Hz resolution bandwidth
- High sensitivity (-140 dBm)

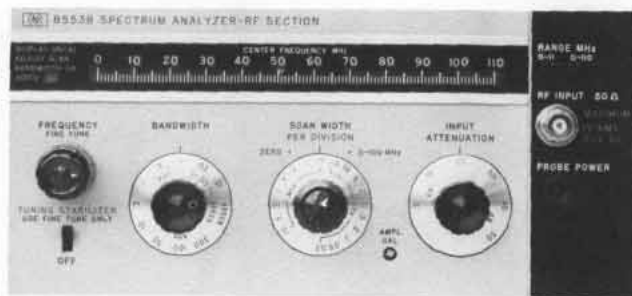

8553B



8443A

- Accurate amplitude measurements (± 1.25 dB)
- 10 Hz frequency accuracy with tracking generator
- 130 dB swept measurement range

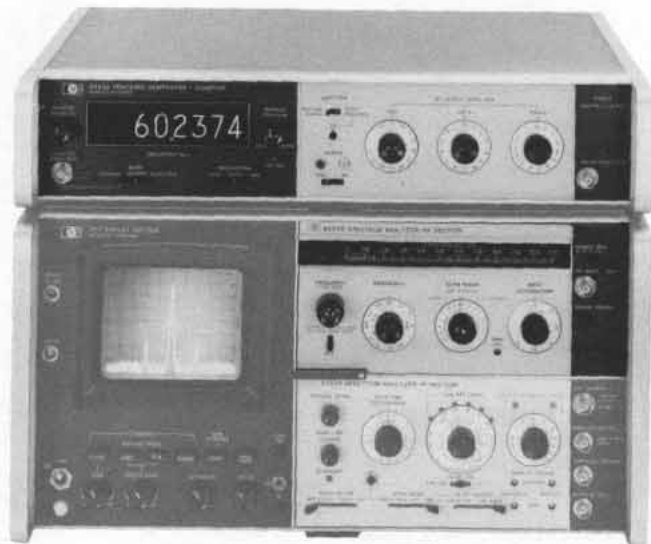

General purpose

The 8553B Spectrum Analyzer makes absolute amplitude and frequency measurements over the 1 kHz to 110 MHz range. This frequency span includes audio, video, navigation aids, telemetry, multiplex communication systems basebands, commercial AM, FM, TV, and land mobile communication. The analyzer features high resolution and stability, low distortion, high sensitivity, and a wide dynamic range. A tracking generator is available which improves the frequency measurement accuracy of the analyzer and can be used to make swept measurements.

Wide frequency range

The broad frequency range of 1 kHz to 110 MHz extends from audio through the FM broadcast band. Scan widths from 200 Hz to 100 MHz allow a user to view all or selected parts of the frequency spectrum while the zero scan mode turns the analyzer into a fixed tuned receiver and displays amplitude variations in the time domain. The analyzer has two dial scales, 0–110 MHz for full coverage and 0–11 MHz for better resolution at low frequencies.

Resolution—stability

The 8553B has resolution bandwidths that range from 300 kHz to 10 Hz. Wide bandwidths are necessary for making measurements on a wideband spectrum such as FM. The extremely high resolution 10 Hz bandwidth allows measurement of 50 Hz sidebands 60 dB down. Such high resolution is made possible by automatic stabilization through phase lock, which reduces residual FM to a negligible level. Good stability is required to measure oscillator residual FM and drift.

Absolute amplitude calibration

The 8553B Spectrum Analyzer is absolutely calibrated in both dBm and volts from -142 dBm (18 nV) to $+10$ dBm (0.7 V). This absolute calibration is derived from a built-in calibrator (-30 dBm at 30 MHz) and extremely flat analyzer frequency response (± 0.5 dB). A display uncal. light warns if the display becomes uncalibrated. The probe power output supplies power to a high impedance probe which can be used to make bridging measurements on circuits terminated at both ends.

High sensitivity

A low analyzer noise figure and narrow bandwidths give the 8553B very high sensitivity. Signal levels as low as -140 dBm can be measured in 10 Hz bandwidth, and a preamplifier is available to further increase sensitivity by 16 dB. Video filtering in 10 kHz, 100 Hz and 10 Hz bandwidths will average the displayed noise. High analyzer

sensitivity is required if distortion in an amplifier or oscillator is to be measured as a function of output level. In EMI studies, field strength can be measured with a calibrated antenna.

70 dB dynamic range

The 8553B has a 70 dB dynamic range when the signal level is properly conditioned at the input mixer. A wide dynamic range is necessary to measure small signals in the presence of large ones, such as harmonic or intermodulation distortion or to monitor signals of widely varying amplitudes, such as in EMC, RFI, and surveillance work.

8443A Tracking Generator

A tracking generator, 8443A, is available which covers the 100 kHz to 110 MHz frequency range of the 8553B. It has a built-in counter, and precision RF attenuators which are useful in making substitution measurements.

Frequency accuracy

In conjunction with an 8443A Tracking Generator, the 8553B Spectrum Analyzer can measure frequencies to an accuracy of ± 10 Hz. When the 8443A is operated in the "track analyzer" mode, the counter will read the frequency at a tunable marker which is generated on the analyzer CRT. The "restore signal" mode is a more convenient way to measure signal frequencies in wide scans because the counter reads the signal frequency automatically without fine tuning. The 8443A Tracking Generator may also be used externally as a 120 MHz direct reading counter.

Swept measurements

The 8443A Tracking Generator can be used with the 8553B to make swept insertion loss and return loss measurements over the 100 kHz to 110 MHz frequency range. Because the signal source tracks the analyzer's tuning, up to 130 dB dynamic measurement range is possible (at 10 Hz bandwidth). Excellent system flatness (± 1.0 dB) insures the accurate determination of swept response characteristics.

Specifications—with 8552B IF Section

Frequency specifications

Frequency range: 1 kHz–110 MHz (0–11 MHz and 0–110 MHz tuning ranges).

Scan width (on 10-division CRT horizontal axis)

Per division: 18 calibrated scan widths from 20 Hz/div to 10 MHz/div in a 1, 2, 5 sequence.

Preset: 0–100 MHz, automatically selects 300 kHz bandwidth IF Filter.

Zero: analyzer is fixed tuned receiver with selectable bandwidth.

Frequency accuracy

Center frequency accuracy: the dial indicates the display center frequency within ± 1 MHz on the 0–110 MHz tuning range; ± 200 kHz on the 0–11 MHz tuning range with FINE TUNE centered, and temperature range of 20°C to 30°C.

Scan width accuracy: scan widths 10 MHz/div to 2 MHz/div and 20 kHz/div to 20 Hz/div: Frequency error between two points on the display is less than $\pm 3\%$ of the indicated frequency separation between the two points. Scan widths 1 MHz/div to 50 kHz/div: Frequency error between two points on the display is less than $\pm 10\%$ of the indicated frequency separation.

Resolution

Bandwidth: IF Bandwidths of 10 Hz to 300 kHz are provided in a 1, 3 sequence.

Bandwidth accuracy: individual IF bandwidths' 3 dB points calibrated $\pm 20\%$ (10 kHz bandwidth $\pm 5\%$).

Bandwidth selectivity: 60 dB/3 dB IF bandwidth ratios: 10 Hz to 3 kHz bandwidths, $<11:1$, 10 kHz to 300 kHz bandwidths, $<20:1$; 60 dB points on 10 Hz bandwidth separated by <100 Hz.

Stability

Residual FM stabilized: sidebands >60 dB down 50 Hz or more from CW signal, scan time ≥ 1 sec/div, 10 Hz bandwidth (typically less than 1 Hz peak-to-peak).

Residual FM unstabilized: <1 kHz peak-to-peak.

Noise sidebands: more than 70 dB below CW signal, 50kHz or more away from signal, with 1 kHz IF bandwidth.

Long term drift (after 1-hour warm-up), stabilized: 50 Hz/min, 500 Hz/10 min; unstabilized: 5 kHz/min, 20 kHz/10 min.

Amplitude specifications

Absolute amplitude calibration range

Log: from -130 to $+10$ dBm, 10 dB/div on a 70 dB display or 2 dB/div on a 16 dB display.

Linear: from 0.1 μ V/div to 100 mV/div in a 1, 2 sequence on an 8-division display.

Dynamic range

Average noise level: <-110 dBm with 10 kHz IF bandwidth.

Video filter: averages displayed noise; 10 kHz, 100 Hz, and 10 Hz bandwidths.

Spurious responses: are below a -40 dBm signal at the input mixer as follows: All image and out-of-band mixing responses, harmonic and intermodulation distortion more than 70 dB down, 2 MHz to 110 MHz; more than 60 dB down, 1 kHz to 2MHz. Third order intermodulation products more than 70 dB down, 1 kHz to 110 MHz (Signal separation >300 Hz).

Residual responses (no signal present at input): with input attenuation at 0 dB: <-110 dBm (200 kHz to 110 MHz); <-95 dBm (20 kHz to 200 kHz).

Amplitude accuracy:	Log	Linear
Frequency response (Flatness: attenuator settings >10 dB):		
1 kHz to 110 MHz	± 0.5 dB	$\pm 5.8\%$
Amplitude Display	± 0.25 dB/dB	$\pm 2.8\%$ of
	but not more than ± 1.5 dB over the full 70 dB display range	full 8 div deflection

Calibrator amplitude: -30 dBm, ± 0.3 dB
Calibrator frequency: 30 MHz, ± 3 kHz.

Log reference level control: provides 70 dB range (60 dB below 200 kHz), in 10 dB steps. Accurate to ± 0.2 dB ($\pm 2.3\%$, Linear Sensitivity).

Log reference level vernier: provides continuous 12 dB range. Accurate to ± 0.1 dB ($\pm 1.2\%$) in 0, -6 , and -12 dB positions; otherwise ± 0.25 dB ($\pm 2.8\%$).

Amplitude measurement accuracy: ± 1.25 dB with proper technique.

General

Input impedance: 50 Ω nominal, BNC connector. Reflection coefficient <0.13 (1.3 SWR), input attenuator ≥ 10 dB. A special 75 Ω 8553B/8552B is available.

Maximum input level: peak or average power $+13$ dBm (1.4 V ac peak), ± 50 V dc, 1 dB compression point, -10 dBm.

Scan time: 16 internal scan rates from 0.1 ms/div to 10 sec/div in a 1, 2, 5 sequence, or manual scan.

Scan mode

Int: analyzer repetitively scanned internally.

Ext: scan determined by 0 to $+8$ -volt external signal.

Manual: scan determined by front panel control.

Attenuator: 0 to 50 dB, in 10 dB increments, coupled to Log Reference Level indicator; automatically maintains absolute calibration. Attenuator accuracy ± 0.2 dB.

Power requirements: 100, 120, 220, or 240 V $+5\%$, -10% , 50 to 60 Hz, normally less than 225 watts.

Weight: Model 8553B RF Section: net, 5.5 kg (12 lb). Shipping, 7.8 kg (17 lb).

Size: 102 mm H x 226 mm W x 334 mm D (4" x 8 $\frac{7}{8}$ " x 13 $\frac{1}{2}$ ").

Tracking generator (8443A)

Frequency range: 100 kHz to 110 MHz.

Amplitude range: <-120 dBm to $+10$ dBm in 10 and 1 dB steps with a continuous 1.2 dB vernier.

Amplitude accuracy

Frequency response (flatness): ± 0.5 dB.

Absolute: 0 dBm at 30 MHz: ± 0.3 dB.

Output impedance: 50 Ω , BNC connector, ac coupled, reflection coefficient ≤ 0.09 (1.2 SWR) with output <0 dBm.

Counter

Display: 7 digits with 1 digit over-range. Reads to ± 10 Hz increments.

Resolution (gate time): 1 kHz (1 ms), 100 Hz (10 ms), 10 Hz (100 ms).

Accuracy: ± 1 count \pm time base accuracy.

Time base aging rate: $<3 \times 10^{-9}$ /day (0.3 Hz/day) after warm-up.

External counter inputs: 10 kHz to 120 MHz, 50 Ω , -10 dBm min.

Power: 100, 120, 220, or 240 V $+5\%$, -10% , 48 to 440 Hz 75 watts.

Weight: Model 8443A: net, 11.04 kg (24 lb, 5 oz). Shipping, 14.47 kg (31 lb, 14 oz).

Size: 88.2 mm H x 425 mm W x 337 mm D (3 $\frac{15}{32}$ " x 16 $\frac{1}{4}$ " x 13 $\frac{1}{4}$ ").

Ordering information
 8553B RF Section
 8443A Tracking Generator

Price
 \$3350
 \$5000

SIGNAL ANALYZERS

141T Spectrum Analyzer System: 100 kHz to 1250 MHz

Models 8554B & 8444A

- High resolution to 100 Hz
- Flat frequency response ± 1 dB
- High sensitivity to -122 dBm (180 nV)
- Variable persistence display
- Companion Tracking Generator
- Optional internal limiter

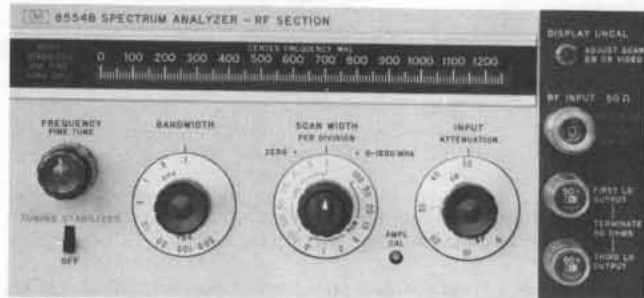

8554B



8444A

8554B Spectrum Analyzer

The 8554B Spectrum Analyzer RF Section covers the frequency range from 100 kHz to 1250 MHz. This broad frequency coverage allows analysis from baseband through UHF navigation bands. Absolute amplitude calibration is maintained over the entire range. Some typical applications include power and frequency measurements on modulation, distortion and spurious outputs, frequency response measurements of filters, amplifiers, modulators and mixers. The analyzer can also be used to make noise measurements such as noise power density over a specified frequency band, carrier-to-noise ratio or swept noise figure measurement of amplifiers. With a calibrated antenna or current probe the analyzer can characterize broadband and narrowband signals encountered in EMI applications.

Absolute amplitude calibration

Absolute amplitude measurements can be made from $+10$ to -122 dBm with ± 2.8 dB accuracy. This accuracy can be improved to ± 1.75 dB using IF substitution. The display is calibrated in log (dBm) to obtain a wide display range and linear (voltage) for measurements requiring maximum resolution. The top graticule line on the CRT is a calibrated reference level which can be changed by the front panel controls from $+10$ to -72 dBm for IF substitution measurements. Amplitude calibration is dependent upon the proper relationship between sweep width, sweep time, resolution bandwidth and video filtering. An uncal warning light is present to indicate an uncalibrated situation.

Flat frequency response

In broadband use, the wide bandwidths allow fast sweeping of the entire spectrum. The analyzer is extremely flat (± 1 dB) over its entire range, allowing direct comparisons of signal amplitudes displayed on the CRT. A 0 to 50 dB input attenuator is provided to prevent overdriving the input mixer.

Resolution

The low residual FM (< 100 Hz peak-to-peak) of the 8554B makes possible resolution bandwidths as narrow as 100 Hz. This enables resolving closely spaced signals such as 1 kHz and 400 Hz sidebands. Bandwidths range from 100 Hz to 300 kHz in a 1, 3, 10 sequence making it easy to select an optimum bandwidth to scan width ratio.

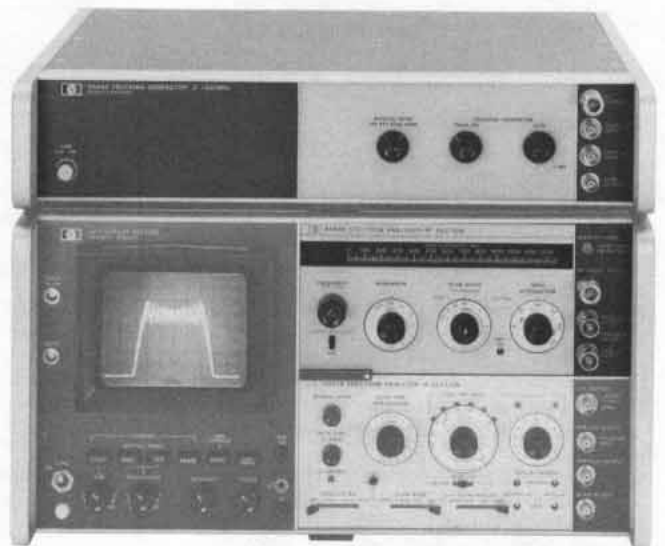

The resolution bandwidths consist of synchronously tuned "gaussian" shaped filters to enable faster sweeping for any given bandwidth. In addition, these filters have narrow shape factors making it possible to measure closely spaced signals differing greatly in amplitude.

Sensitivity

The high sensitivity (-122 dBm in 100 Hz bandwidth) and wide spurious-free measurement range (> 65 dB) of the 8554B means accurate measurements can be made on low level signals and signals varying widely in amplitude. For example, modulation as low as 0.2% can be measured. Low level harmonic and intermodulation distortion, spectrum surveillance and EMI are just a few of the measurements possible. A video filter is provided in the IF section to average displayed noise and simplify the measurement of low level signals.

Automatic tuning stabilization

The 8554B Spectrum Analyzer is automatically stabilized in narrow scans. This gives the stability (< 100 Hz peak-to-peak residual FM) needed for high resolution analysis. Stabilization is accomplished by phase locking the LOs (local oscillators) to a crystal reference in scan widths 200 kHz/div and below. No signal recentering or checking for stabilization is required because the signal remains on screen when phase locked.

8444A Tracking Generator

The 8444A Tracking Generator is a signal source, which, when connected to the 8554B Spectrum Analyzer, has an output whose frequency is the same as the swept frequency of the analyzer. The tracking generator is used as a signal source to measure the frequency response of a device. It can also be used for precision frequency measurements. An external counter output is provided on the 8444A and the frequency of unknown signals as well as the frequency of any point on a frequency response curve can be measured. The use of the 5300/5305B Counter is suggested for frequency measurements to 1300 MHz.

The tracking generator-spectrum analyzer system can be used as a sweeper to provide test signals for other devices. The sweep widths and sweep rates are controlled from the spectrum analyzer and the output level from the tracking generator.

8554B Specifications—with 8552B IF Section

Frequency specifications

Frequency range: 100 kHz to 1250 MHz.

Scan width (on 10-division CRT horizontal axis)

Per division: 15 calibrated scan widths from 100 MHz/div to 2 kHz/div in a 1, 2, 5 sequence.

Preset: 0-1250 MHz, automatically selects 300 kHz bandwidth IF filter.

Zero: analyzer is fixed-tuned receiver.

Frequency accuracy

Center frequency accuracy: The dial indicates the display center frequency with 10 MHz.

Scan width accuracy: frequency error between two points on the display is less than 10% of the indicated separation.

Resolution

Bandwidth: IF bandwidths of 0.1 to 300 kHz provided in a 1, 3, 10 sequence.

Bandwidth accuracy: individual IF bandwidths 3 dB points calibrated to $\pm 20\%$ (10 kHz bandwidth $\pm 5\%$).

Bandwidth selectivity: 60 dB/3 dB IF bandwidth ratio $< 20:1$ for IF bandwidths from 10 kHz to 200 kHz. 60 dB/3 dB bandwidth ratio $< 11:1$ for IF bandwidths 100 Hz to 3 kHz.

Stability (residual FM)

Stabilized: < 100 Hz peak-to-peak.

Unstabilized: < 10 kHz peak-to-peak.

Noise sidebands: more than 70 dB below CW signal, 30 kHz or more away from signal, with 1 kHz IF bandwidth.

Amplitude specifications

Absolute amplitude calibration range

Log: from -122 to $+10$ dBm. 10 dB/div on a 70 dB display, or 2 dB/div on a 16 dB display.

Linear: from $0.1 \mu\text{V/div}$ to 100 mV/div in a 1, 2 sequence on an 8-division display.

Dynamic range

Average noise level: < -102 dBm with 10 kHz IF bandwidth.

Spurious responses: All image and out-of-band mixing responses, harmonic and intermodulation distortion products are more than 65 dB below a -40 dBm signal at the input mixer.

Residual responses (no signal present at input): with input attenuation at 0 dB: < -100 dBm.

Amplitude accuracy

	Log	Linear
Frequency response (flatness)		
100 kHz to 1250 MHz	± 1 dB	$\pm 12\%$
Switching between bandwidths (at 20°C)	± 0.5 dB	$\pm 5.8\%$
Amplitude display	± 0.25 dB/dB but not more than ± 1.5 dB over the full 70 dB display range.	2.8% of full 8 div deflection

Calibrator output

Amplitude: -30 dBm, ± 0.3 dB.

Frequency: 30 MHz, ± 3 kHz.

Log reference level control: provides 70 dB range (60 dB below 200 kHz), in 10 dB steps. Accurate to ± 0.2 dB ($\pm 2.3\%$, Linear Sensitivity).

Log reference level vernier: provides continuous 12 dB range. Accurate to ± 0.1 dB ($\pm 1.2\%$) in 0, -6 , and -12 dB positions; otherwise ± 0.25 dB ($\pm 2.8\%$).

Amplitude measurement accuracy: ± 1.75 dB with proper technique.

RF input specifications

Input impedance: 50Ω nominal. Typical reflection coefficient < 0.30 (1.85 SWR), input attenuator ≥ 10 dB.

Maximum input level: peak or average power $+13$ dBm (1.4 V ac peak), ± 50 V dc.

General

Scan time: 16 internal scan rates from 0.1 ms/div to 10 sec/div in a 1, 2, 5 sequence, and manual scan.

Scan time accuracy

0.1 ms/div to 20 ms/div: $\pm 10\%$.

50 ms/div to 10 s/div: $\pm 20\%$.

Weight

Model 8554B RF section: net, 4.7 kg (10 lb, 4 oz). Shipping 7.8 kg (17 lb).

Size: 102 H, 226 W, 344 mm D (4" x 8 $\frac{7}{8}$ " x 13 $\frac{1}{2}$ ").

8444A Specifications

Specifications for swept frequency response measurements

Dynamic range: > 90 dB from spectrum analyzer 1 dB gain compression point to average noise level (approximately -10 dBm to -100 dBm). Spurious responses not displayed.

Gain compression: for -10 dBm signal level at the input mixer, gain compression < 1 dB.

Absolute amplitude calibration range:

Tracking generator (drive level to test device: 0 to -10 dBm continuously variable. 0 dBm absolutely calibrated to ± 0.5 dB at 30 MHz.

Frequency range: 500 kHz to 1250 MHz.

Frequency resolution: 1 kHz.

Stability

Residual FM (peak-to-peak): stabilized, < 200 Hz; unstabilized, < 10 kHz.

Amplitude accuracy

System frequency response: ± 1.50 dB.

Tracking generator calibration: 0 dBm at 30 MHz to ± 0.5 dB.

Specifications for precision frequency measurements

Frequency accuracy: for unknown signals ± 10 kHz. (Tracking drift typically 50 kHz/10 min after 2-hour warm-up). For points on frequency response curve, counter accuracy \pm Residual FM (200 Hz).

Counter mode of operation

Manual scan: scan determined either by front panel control of 8552B IF Section or by external scan signal provided by the 8444A.

Zero scan: analyzer is fixed-tuned receiver. Counter reads center frequency to accuracy of tracking drift.

Counter output level: typically 0.1 V rms.

Specifications for sweep/CW generator

Frequency: controlled by spectrum analyzer. Range 500 kHz to 1250 MHz with 8554B. Scan widths are as enumerated on this page.

Frequency accuracy: ± 10 MHz using spectrum analyzer tuning dial. Can be substantially improved using external counter output.

Flatness: ± 0.5 dB.

Spectral purity

Residual FM (peak-to-peak): 200 Hz.

Harmonic distortion: 25 dB below output level (typical).

Nonharmonic (spurious) signals: > 35 dB below output level.

Long term stability: drift typically less than 30 kHz/hour when stabilized after 2-hour warm-up.

Sweep width: 20 kHz to 1000 MHz.

Sweep rates: selected by Scan Time per Division on spectrum analyzer.

General

Temperature range: operation, 0°C to 55°C, storage -40 °C to 75°C.

EMI: conducted and radiated energy is within the requirements of MIL-1-6181D.

Power: 115 V and 230 V, 48 to 440 Hz, 12 watts max.

Weight: net, 7.1 kg (15 lb, 10 oz). Shipping, 9.5 kg (21 lb).

Size: 88.2 H, 425 W, 467 mm D (3 $\frac{15}{32}$ " x 16 $\frac{3}{4}$ " x 18 $\frac{3}{8}$ ").

Ordering Information

8554B RF Section

Opt 003: Internal Limiter

8444A Tracking Generator

Price

\$4975

\$170

\$3675

SIGNAL ANALYZERS

141T Spectrum Analyzer System: 10 MHz to 40 GHz

Models 8555A, 8444A & 8445B

- Absolute amplitude calibration
- High sensitivity to -125 dBm (125 nV)
- Resolve signals to 100 Hz

- Scan up to 8 GHz full screen
- 100 dB distortion-free dynamic range with preselector
- Companion tracking generator to 1.3 GHz

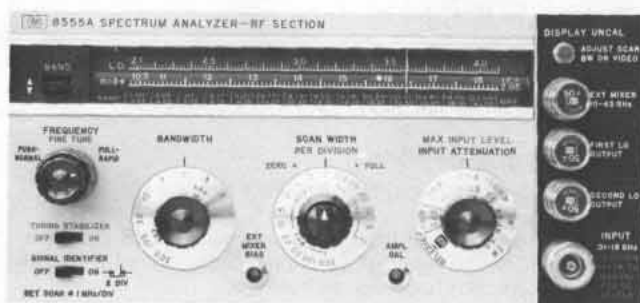

8555A



8444A



8445B Opt 002, 003



8555A Spectrum Analyzer

The 8555A spectrum analyzer covers 10 MHz to 18 GHz with fundamental and harmonic mixing. A single external waveguide mixer can provide 12.4 GHz to 40 GHz coverage. This broad frequency range coupled with its high sensitivity and resolution bandwidth allow a variety of power measurements, frequency measurements, modulation, and noise analysis on almost every type of design module: the frequency response of amplifiers, mixers, and modulators, response and alignment of filters, isolators, couplers and limiters. With wide scan widths and calibrated amplitude the 8555A is ideal for spectrum surveillance and RFI/EMC field strength analysis with a calibrated antenna.

Absolute amplitude calibration

The 8555A offers absolute amplitude calibration from $+10$ dBm to -125 dBm over the 10 MHz to 18 GHz frequency range. This capability makes possible not only absolute signal power measurements, but also the measurement of the power differential between two signals separated by as much as 18 GHz. The parallax-free CRT graticule can read as a log scale (dBm) or a linear scale (volts) with a frequency response accuracy of ± 1.5 dB to 6 GHz and ± 2.0 dB to 18 GHz. The top line of the display is established as the reference level by front panel controls. A light warns of an uncalibrated condition.

High sensitivity

The high sensitivity from -125 dBm (fundamental mixing) to -100 dBm (4th harmonic) in a 100 Hz bandwidth makes it possible to measure large values of attenuation, out of band filter and amplifier response, weak transmitted signals in surveillance work or microvolt signals in EMC applications. A post-detection filter with 10 kHz, 100 Hz and 10 Hz positions averages noise and yields an extremely clean observed trace.

High resolution

Due to low residual FM (<100 Hz peak-to-peak) the 8555A offers outstanding 100 Hz resolution which allows the users to resolve closely spaced signals and low-level sidebands resulting from a 1 kHz modulating signal. The resolution capability makes it possible to analyze spurious low frequency modulation of microwave signals. The high stability of the analyzer results in more accurate measurements of residual FM, long-term drift, phase noise, and spectral purity. Furthermore, the gaussian shape of the IF filters allows fastest sweep for a given resolution bandwidth.

Automatic tuning stabilization

When scanning over a relatively narrow frequency range, the frequency stability of the analyzer's internal local oscillators becomes important for high resolution and frequency measurements. For this reason the 8555A is equipped with a tuning stabilizer circuit which automatically phase locks the analyzer to a crystal oscillator. Display jitter and signal recentering are virtually eliminated.

Added input mixer protection

To prevent an inadvertent 0 dB setting of the input attenuator, a pushbutton lockout is provided on the attenuator knob.

8445B Tracking Preselector, 10 MHz to 18 GHz

The 8445B Tracking Preselector is a YIG tuned filter coupled to the 8555A spectrum analyzer in order to be tuned exactly to the analyzer's reception frequency. The preselector suppresses harmonic mixing image and multiple responses from 1.8 to 18 GHz. The result is a wide spurious free amplitude measurement range. Clean, full band sweeps are possible in scans of 2, 4, 6 or 8 GHz depending upon the band selected.

Below 1.8 GHz the image and multiple responses are eliminated by a low-pass filter in the preselector.

An optional five digit LED display with 1 MHz resolution allows accurate measurement of either the display frequency at the display marker in full scan mode or the center frequency in per division scan.

8444A Tracking Generator 10 to 1300 MHz

The 8444A Tracking Generator provides a level, calibrated RF signal which is exactly the tuned frequency of the spectrum analyzer. This enables swept frequency tests such as frequency response and return loss measurements up to 1300 MHz. With an external counter the frequencies of unknown signals on points along a frequency response curve can be made.

8555A Specifications—with 8552B IF Section

Frequency specifications

Frequency range: 0.01–40 GHz.

Tuning range

With internal mixer: 0.01–18.0 GHz.

With external mixer: 12.4–40 GHz.

Harmonic mixing mode

Signal identification: not normally required with preselector. Signal identifier provided for positive identification of all responses. Rejection of images and multiple responses with preselector is >70 dB.

Scan width

Full scan: the width of the scan depends on mixing mode. Scan width = $n \times 2000$ MHz, where n is the mixing mode; e.g. for $n = 2$, scan width is 4 GHz. Maximum scan width full screen is 8 GHz with coaxial mixer. Preselector necessary to make wide scans usable.

Per division: 16 calibrated scan widths from 2 kHz/div to 200 MHz/div in a 2, 5, 10 sequence.

Zero scan: analyzer becomes fixed-tuned receiver.

Frequency accuracy

Dial accuracy: $n \times (\pm 15 \text{ MHz})$ where n is the mixing mode.

Scan accuracy: frequency error between two points on the display is less than $\pm 10\%$ of the indicated separation.

Stability: residual FM stabilized <100 Hz peak-to-peak (fundamental mixing).

Noise sidebands: for fundamental mixing. More than 70 dB below CW signal 30 kHz or more away from signal, with 1 kHz IF bandwidth and 100 Hz video filter.

Frequency drift

Long term drift: at fixed center frequency after 2-hour warm-up (Typical).

Stabilized: ± 3.0 kHz/10 min.

Unstabilized: ± 25 kHz/10 min.

Stabilization range: first LO can be automatically stabilized to internal crystal reference for scan widths of 100 kHz/div or less.

Resolution

Bandwidth range: selectable 3 dB bandwidths from 100 Hz to 300 kHz in a 1, 3, 10 sequence.

Bandwidth shape: approximately gaussian.

Bandwidth selectivity: 11:1 to 20:1 (60 dB/3 dB).

Bandwidth accuracy: individual IF bandwidth 3 dB points calibrated to $\pm 20\%$ (10 kHz bandwidth, $\pm 5\%$).

Amplitude specifications

Measurement range

Log reference level: from -60 dBm to +10 dBm.

Linear sensitivity: from 0.1 $\mu\text{V/div}$ to 100 mV/div.

Sensitivity and frequency response with internal coaxial mixer noise level: specified for 1 kHz bandwidth.

Frequency response with 10 dB input attenuator setting:

Frequency Range (GHz)	Mixing Mode (n)	Average Noise Level (dBm max.)	Frequency Response* (dB max.)
0.01–2.05	1–	-115	± 1.0
1.50–3.55	1–	-117	± 1.0
2.07–6.15	2–	-108	± 1.3
2.60–4.65	1+	-117	± 1.0
4.11–6.15	1+	-115	± 1.0
4.13–10.25	3–	-103	± 1.5
6.17–10.25	2+	-105	± 1.5
6.19–14.35	4–	-95	± 2.0
8.23–14.35	3+	-100	± 2.0
10.29–18.00	4+	-90	± 2.0

*Includes mixer frequency response, RF attenuator frequency response, mixing mode gain variation, RF input VSWR.

Sensitivity and frequency response with 11517A external waveguide mixer and appropriate waveguide tapers

Average noise level 10 kHz bandwidth (dBm typical):

Frequency Range (GHz)	Mixing Mode (n)	Average Noise Level (dB max.)
12.4–18.0	6–	-85
18.0–26.5	6+	-80
26.5–40.0	10+	-65

Frequency response: typically ± 3 dB over 1 GHz frequency scans.

Residual responses: referred to input on fundamental mixing: <-90 dBm.

Display range

Log: 70 dB, 10 dB/div and 2 dB/div, expanded on a 16 dB display.

Linear: from 0.1 $\mu\text{V/div}$ to 100 mV/div in a 1, 2, sequence on an 8-division display.

Spurious responses due to second harmonic distortion with preselector:

Frequency Range	Power Incident on Input Mixer	2nd Harmonic Distortion
0.01–1.85 GHz	-40 dBm	-63 dB
1.85–18.0 GHz	0 dBm	-100 dB

Spurious responses due to third order intermodulation distortion with preselector

Frequency Range	Signal Separation	Power Incident on Input Mixer	Third Order Intermodulation Distortion
0.01–18.0 GHz	>1 MHz <20 MHz	-30 dBm	-70 dB
0.01–1.85 GHz	>70 MHz	-30 dBm	-70 dB
1.85–18.0 GHz	>70 MHz	0 dBm	-100 dB

Video filter: post detection filter used to average displayed noise. Nominal bandwidths: 10 kHz, 100 Hz, and 10 Hz.

Gain compression: for internal mixer gain compression <1 dB for -10 dBm peak or average signal level to input mixer. 11517A External Mixer (12.4–40 GHz) gain compression <1 dB for -15 dBm peak or average signal level to input mixer.

Amplitude accuracy

IF gain variation with different bandwidth settings: (at 20°C.)

Log: ± 0.5 dB.

Linear: $\pm 5.8\%$



SIGNAL ANALYZERS

141T Spectrum Analyzer System: 10 MHz to 40 GHz

Models 8555A, 8444A & 8445B (cont.)

Amplitude display

Log: ± 0.25 dB/dB, but not more than ± 1.5 dB over the full 70 dB display range.

Linear: $\pm 2.8\%$ of full 8-division deflection.

Log reference level: accurate to ± 0.2 dB ($\pm 2.3\%$ linear sensitivity).

Log reference level vernier: accurate to ± 0.1 dB (1.2%) in 0, -6, and -12 dB positions; otherwise, ± 0.25 dB ($\pm 2.8\%$).

Input attenuator range: 0-50 dB in 10 dB steps, manual safety lock-out for 0 dB position.

Frequency response: typically ± 0.6 dB from 10 MHz to 18 GHz.

Calibrator output: amplitude -30 dBm, ± 0.3 dB. Frequency 30 MHz ± 3 kHz.

Absolute calibration accuracy: overall accuracy is a function of measurement technique. With the appropriate technique, absolute accuracy of ± 1.6 dB (fundamental mixing) and ± 2.6 dB (4th harmonic mixing) is achievable.

Input characteristics

Input impedance: 50 ohms nominal (0.01-18 GHz).

Reflection coefficient: < 0.130 (1.30 SWR) for input RF attenuator settings ≥ 10 dB.

Maximum input level: peak or average power +13 dBm (1.0 V ac rms) incident on mixer (+30 dBm with Opt 002), +33 dBm incident on input attenuator.

RF input connector: type N female.

LO emission: -10 dBm without preselector, -80 dBm with preselector over recommended operating ranges (10 dB input attenuator setting).

General

Scan time: 16 internal scan rates from 0.1 ms/div to 10 sec/div in a 1, 2, 5 sequence.

Power requirements: 100, 120, 220 240 V +5%, -10%, 50-60 Hz, normally less than 225 watts (varies with plug-in units used).

Size: 102 H x 226 W x 344 mm D (4.0" x 8.9" x 13.5").

Weight: net, 16.8 kg (14 lb, 15 oz). Shipping, 8.7 kg (19 lb).

Specifications with option 002; internal limiter installed

All specifications are the same as for the standard unit except the following:

Frequency range: 0.1-12.4 GHz, usable over 0.01-18 GHz range.

Maximum input level

Continuous: 1 W (+30 dBm).

Pulse: 75 watts peak, pulse width ≤ 1 μ s, 0.001 duty cycle.

Reflection coefficient: < 0.33 (2.0 SWR).

Frequency response (flatness): $< \pm 0.5$ dB degradation in response, 0.1-12.4 GHz.

8445B Tracking Preselector

Frequency specifications

Frequency range: DC-1.8 GHz low-pass filter. 1.8-18 GHz tracking filter.

Tracking filter 3 dB bandwidth: typically 20-45 MHz.

Tracking filter skirt roll-off: characteristics of a three-pole filter. (Nominal: 18 dB/octave.)

Insertion loss

	Frequency	Insertion Loss (Except Opt. 004)	Insertion Loss (Opt. 004)
Low-Pass Filter	DC-1.8 GHz	< 2.5 dB	*
	@ 2.05 GHz	> 50 dB	*
Tracking Filter	1.8-12 GHz	< 8 dB	< 7 dB
	12-18 GHz	< 10 dB	< 8 dB

*Low-Pass Filter deleted with Opt 004.

Typical preselector minimum insertion loss at 25°C.

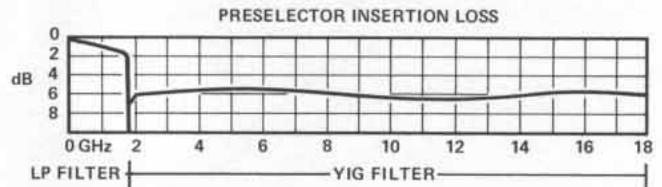

Out-of-band rejection: for YIG filter 1 GHz from center of pass-band > 70 dB.

Digital frequency readout (Option 003):

Function:

Full scan mode: displays frequency at inverted marker.

Per division scan: displays center frequency.

Manual or remote operation of preselector: displays tuned frequency of filter.

Resolution: 1 MHz.

Accuracy: 0.01-1.0 GHz: ± 6 MHz.

1.0-4.0 GHz: ± 8 MHz.

4.0-18 GHz: $\pm 0.2\%$

Input specifications

Input connector: precision Type N female.

Input VSWR: typically < 2.0 (1.8-18 GHz).

Limiting level: (maximum input level for < 1 dB signal compression), $> +5$ dBm.

Damage level: $> +20$ dBm.

General

Remote function: YIG filter frequency can be set by externally supplied voltage.

Power requirements: 100, 120, 220, or 240 V +5%, -10%, 48 to 440 Hz, less than 110 watts.

Size: 88.2 H x 425 W x 467 mm D (3 $\frac{15}{32}$ " x 16 $\frac{1}{4}$ " x 18 $\frac{3}{8}$ ").

Weight: net, 8.8 kg (19 lb 8 oz). Shipping, 11.9 kg (26 lb).

8444A Tracking Generator

Frequency range: 10 MHz to 1300 MHz.

Frequency resolution: 1 kHz.

Residual FM (peak-to-peak): 200 Hz (stabilized).

Amplitude range

Spectrum analyzer display: from -130 dBm to +10 dBm, 10 dB/div on a 70 dB display or 2 dB/div on a 16 dB display (8552B only).

Tracking generator (drive level to test device): 0 to -10 dBm continuously variable.

Amplitude accuracy

System frequency response: ± 1.50 dB.

Tracking generator calibration: 0 dBm at 30 MHz to ± 0.5 dB.

Dynamic range: > 90 dB.

Counter output: typically 0.1 V rms.

General

Power: 115 V and 230 V, 48 to 440 Hz, 12 watts max.

Size: 85.2 H x 425 W x 467 mm D (3 $\frac{15}{32}$ " x 16 $\frac{1}{4}$ " x 18 $\frac{3}{8}$ ").

Weight: net, 7.1 kg (15 lb, 10 oz). Shipping, 9.5 kg (21 lb).

Ordering Information

	Price
8555A Tuning Section	\$8100
Opt 001: APC-7 connectors	add \$40
Opt 002: Internal limiter	add \$210
Opt 005: Video tape	add \$105

8445B Tracking Preselector, dc -18GHz	\$3180
Opt 001: APC-7 connectors	add \$155
Opt 002: Add manual controls	add \$80
Opt 003: Add digital frequency readout	add \$670
Opt 004: Delete low-pass filter	less \$425
Opt 005: Delete interconnect rigid coax	less \$50

8444A Tracking Generator, 10 MHz-1300 MHz	\$3675
11517A External Mixer (taper section req'd)	\$250
11518A Taper Section, 12.4 to 18 GHz	\$160
11519A Taper Section, 18 to 26.5 GHz	\$160
11520A Taper Section, 26.5 to 40 GHz	\$160



11694A



1121A



11517A



11693A



8721A



8406A



197A



8750A



8447 Series

8750A Storage-Normalizer

The 8750A's digital storage allows the user to maintain a flicker-free display, even at slow sweep speeds. Trace comparisons are simplified with the dual memory by simultaneously displaying two traces. When used with a tracking generator, system frequency response variations may be stored in memory and automatically removed from the measurement (normalization).

The 8750A is directly compatible with the HP 8557A, 8558B, and 8565A spectrum analyzers, as well as most HP network analyzers, and requires a conventional low-frequency oscilloscope to be used with the 140 series analyzers. (See page 479).

8447 Series Amplifiers (0.1-1300 MHz)

The 8447 Series amplifiers feature low noise and wide bandwidth. This makes them ideal for improving spectrum analyzer sensitivity and noise figure while providing input isolation. Accurate measurements over a wide frequency range are assured due to the broad frequency coverage, flat frequency response and low distortion of these amplifiers. (See page 33).

11694A 75Ω Matching Transformer (3-500 MHz)

Allows measurement in 75-ohm systems while retaining amplitude calibration. VSWR is less than 1.2, and insertion loss is less than 0.75 dB. Note: Also see Options 001 and 002 for 75Ω versions of 8557A and 8558B.

1121A Active Probe (0.1-500 MHz)

Provides high impedance (>100 kΩ shunted by <3 pF) input to spectrum analyzer for measurements on sensitive circuits. Probe power is supplied by most HP Spectrum Analyzers and flat response with unity gain assures accurate, convenient measurements. (See page 469).

11517A External Mixer

To extend the frequency range of the 8555A and 8565A analyzers to 40 GHz. Taper sections for 12.4-18 GHz (11518A), 18-26.5 GHz (11519A) or 26.5-40 GHz (11520A) bands are required.

11693A Limiter (0.1-12.4 GHz)

The Model 11693A Limiter provides input protection for a variety of instruments in general applications (usable from 0.01 to 18 GHz). For example, the input circuits of spectrum analyzers, samplers, or amplifiers may be protected for inputs up to 75 watts peak or 1 watt average power. Also, signal generators can be protected from application of reverse power.

8721A Directional Bridge

For making return loss measurements from 100 kHz to 110 MHz. (See page 469 under "11652A: Directional bridge").

8406A Frequency Comb Generator

Produces frequency markers at 1, 10, and 100 MHz increments accurate to ±0.01%. External oscillator can be used to generate precision interpolation sidebands. Comb is usable to beyond 5 GHz.

197A Oscilloscope Camera

For a permanent record of your measurements. The 10367A Adapter is required to use the camera with 182-series displays. (See page 189).

Ordering information

Model	Price
11694A 75Ω Matching Transformer	\$75
11517A External Mixer (Mixer only)	\$250
11518A/11519A/11520A Waveguide Taper Sections	\$160
11693A Limiter	\$235
8406A Frequency Comb Generator	\$950
8750A Storage-Normalizer	\$1450

SIGNAL ANALYZERS

5 Hz to 50 kHz spectrum analyzer

Model 3580A

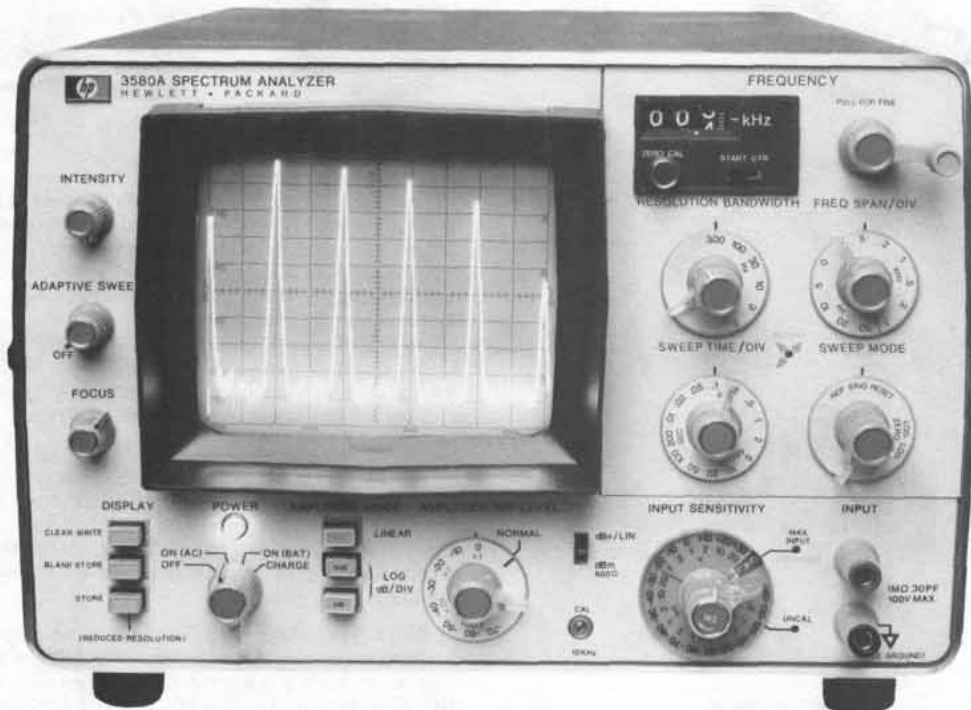

Description

Hewlett Packard's 3580A Spectrum Analyzer is a low frequency high performance analyzer. Its 1 Hz bandwidth allows the user to examine noise and extraneous signal content close in to a signal of interest.

For low frequency applications where sweep speeds can be slow and time-consuming, a special feature, adaptive sweep, allows the user to set a threshold above which only the spectra of interest is observed. In this mode, the CRT is rapidly swept. When a signal is encountered, the sweep slows down to reproduce full response. A factor of ten speed gain is possible.

Digital storage is another important feature which enhances the display for slowly swept low frequency signals. The analyzed signals are digitized and stored in memory. Trace information is then read from memory at a rate appropriate for obtaining an analog-like display.

Digital storage for spectra comparison

Digital storage makes it possible to store one or two traces. When two are stored, both may be simultaneously displayed for easy comparison as shown below.

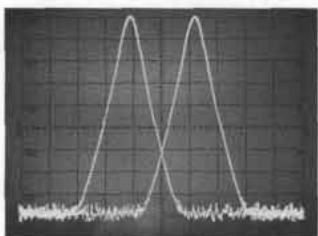

Adaptive sweep

A tremendous savings in sweep time can be achieved by using adaptive sweep. In the left trace below, over 80 dB of dynamic range is used to look at low level signals and noise. Two hundred seconds were required to make the sweep. In the right trace, the baseline is raised to give 50 dB of dynamic range. Noise and other responses are not analyzed so the sweep now takes only 14 seconds.

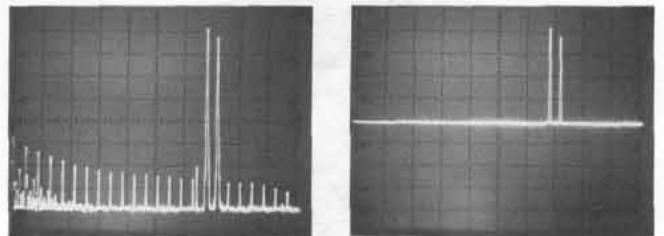

1 Hz bandwidth

When using a 1 Hz bandwidth 60 Hz line related spectra are clearly exposed as shown in the left trace. An analysis of the same signal with a 10 Hz bandwidth will not resolve the line related spectra as shown on the right.

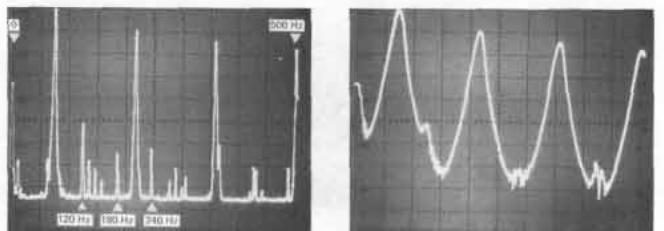

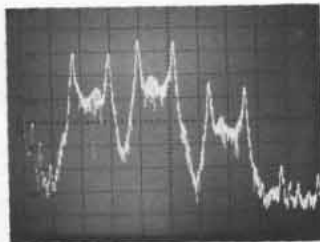

Telecommunications application

Besides analysis of voice spectrum, HP's 3580A gives a clear picture of frequency spectrum for digital transmission. This picture shows a 1200 baud full duplex modem using double sideband suppressed carrier FSK modulation. The "answer" band covers 850 Hz to 1450 Hz while the "transmit" band covers 1950 Hz to 2550 Hz. The higher frequency band at high levels from 3150 Hz to 3750 Hz comes from 3rd order products of the answer band.

Internal calibration signal

A 10 kHz pulse derived from a crystal can be used to compensate for internal errors. A 10 kHz calibration potentiometer is provided so the 10 kHz fundamental can be adjusted to fall on the top line of the display. With this feature, operation and calibration can be verified for most of the instrument.

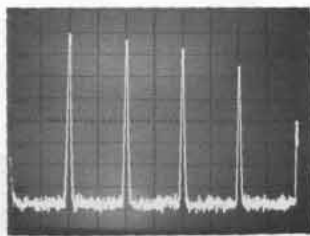

Specifications

Frequency characteristics

Range: 5 Hz to 50 kHz.

Frequency dial accuracy: ±100 Hz, 20°C to 30°C; ±300 Hz, 0°C to 55°C.

Display accuracy: frequency error between any two points is less than ±2% of their indicated separation.

Typical stability: ±10 Hz/hr after 1 hour; ±5Hz/°C.

Frequency dial resolution: 20 Hz on frequency dial.

Bandwidths: (accuracy ±15%)	1 Hz (25°C ±5°C)	3 Hz	10 Hz	30 Hz	100 Hz	300Hz
Shape factor:		10				8

Out of range blank: if controls are set so portions of displayed signal lie below 0 Hz or above 50 kHz, the baseline is displayed.

Amplitude characteristics

Overall instrument range:

Linear: 20 V -100 nV full scale
Log: +30 dBm or dB V;
-150 dBm or dB V

Amplitude accuracy:	Log	Linear
Frequency response:		
20 Hz-20 kHz	±.3 dB	±3%
5 Hz-50 kHz	±.5 dB	±5%
Switching between bandwidths (25°C):		
3 Hz-300 Hz	±.5 dB	±5%
1 Hz-300 Hz	±1 dB	±10%
Amplitude display	±2 dB	±2%
Input attenuator	±.3 dB	±3%
Amplitude reference level: (IF attenuator)		
Most sensitive range	±1 dB	±10%
All other ranges	±1 dB	±3%

Dynamic range: 80 dB

IF feedthru: input level >10V, -60 dB; <10V, -70 dB.

Spurious responses: >80 dB below input reference level.

Smoothing: 3 positions, rolloff is a function of bandwidth.

Overload indicator: this LED indicator warns of possible input amplifier overloading. Without this indication it would be possible to introduce spurious responses without knowing it.

Sweep characteristics

Scan width: 50 Hz to 50 kHz.

Log sweep: 20 Hz to 43 kHz ±20% after 3 sweeps.

Sweep times: .1 sec to 2000 sec.

Rep: In the repetitive mode, sweep will continuously sweep specified band.

Reset: HP's 3580A is set to the start frequency of the sweep.

Manual: in combination with the concentric knob, manual sweep fully duplicates the span of the electronic sweep.

Adaptive sweep: when in adaptive sweep below the threshold level, scan speed is 20 to 25 times faster. Threshold is adjustable to cover 0-60% of screen. Signals greater than about 6 dB above threshold are detected and swept slowly.

Sweep error light: this LED indicates a sweep that is too fast to capture full response. When the light is on, response can be >5% lower than it should.

Zero scan: to look at the time varying signal at the center or start frequency within the bandwidth selected, the zero scan is used.

Output characteristics

Tracking generator output: (also known as BFO or tracking oscillator output).

Range: 0 to 1 V rms into 600Ω.

Frequency response: ±3%, 5 Hz to 50 kHz.

Impedance: 600Ω.

Total harmonic and spurious content: 40 dB below 1 volt signal level.

X-Y recorder analog outputs

Vertical: 0 to +5 V ±2.5%.

Horizontal: 0 to +5 V ±2.5%.

Impedance: 1 kΩ.

Pen lift: contact closure to ground during sweep.

Size: 203.2 mm H x 412.8 mm W x 285.8 mm D (8" x 16 1/4" x 11 1/4").

Weight: net, 12.25 kg (27 lb); 3580A Opt 001: net, 15.88 kg (35 lb).

Temperature range: 0°C to 55°C.

Power: 100 V, 120 V, 220 V, or 240 V +5% -10%. 48 to 440 Hz, 35 VA max.

Opt 001 battery: 5 hours from full charge. 14 hours to fully recharge. The internal battery is protected from deep discharge by an automatic turn off. Useful life of batteries is over 100 cycles.

Ordering information

Opt 001: internal rechargeable battery

Opt 002: balanced input

Price

add \$405

add \$110

3580A Spectrum Analyzer

\$4650

SIGNAL ANALYZERS

Dual-Channel, Real-Time Spectrum Analyzer 0.02 Hz to 25.5 kHz

Model 3582A

- Transfer function magnitude and phase measurements
- Coherence function measurement
- Phase spectrum measurement
- Transient capture and frequency domain analysis
- Internal periodic and random noise source
- Band selectable analysis for 0.02 Hz resolution
- Alphanumeric CRT annotation and marker readout

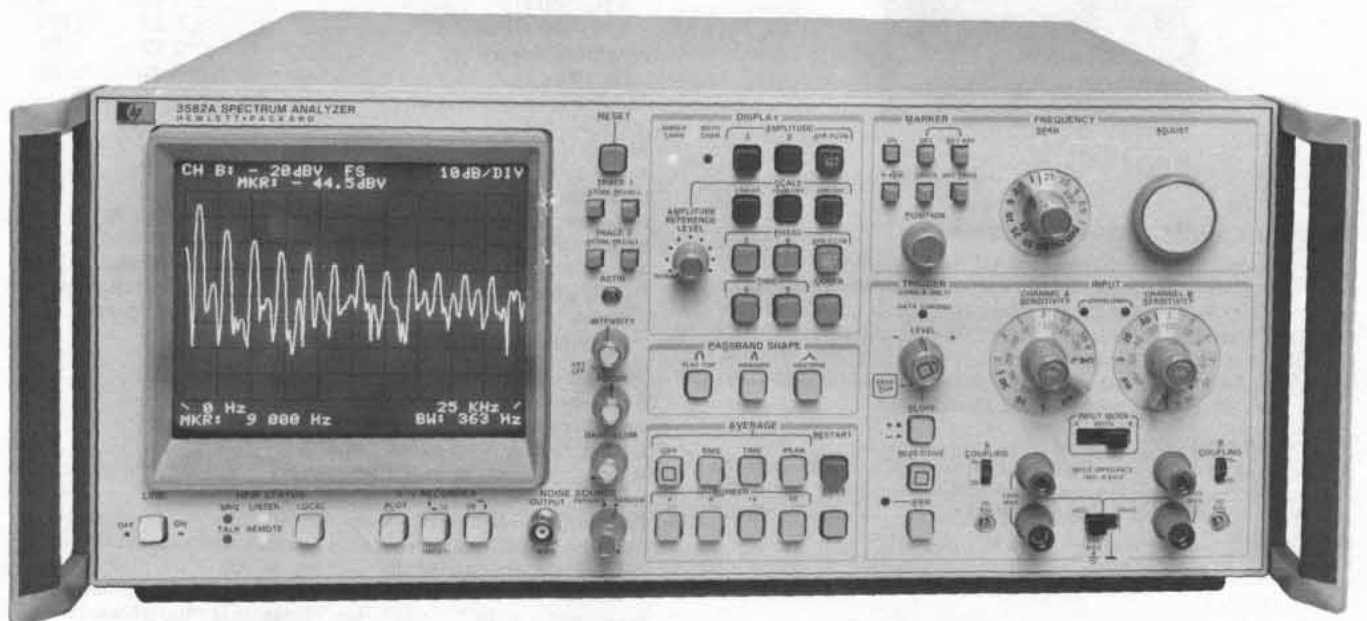

Description

The 3582A is a powerful dual-channel, real-time spectrum analyzer that solves bench or systems measurement problems in the frequency range of 0.02 Hz to 25.599 kHz. Sophisticated LSI digital filtering combined with microcomputer execution of the Fast Fourier Transform (FFT) provides exceptional measurement capability and performance.

Exceptional frequency resolution

The ability to resolve closely spaced spectral components is often critical in the study of subtle phenomena such as structural transfer functions. Unlike conventional digital signal analysis which extends from DC to some maximum frequency, the Model 3582A can "zoom in" to analyze any selected band of frequencies with dramatically improved resolution. The start or center frequency of the 5 Hz to 25 kHz band analysis spans can be adjusted in 1 Hz increments to cover the entire frequency range of the instrument. This provides resolution down to 20 milliHertz across the entire range for spectrum analysis or 40 milliHertz for transfer functions, representing as much as 5000 to 1 improvement over conventional "baseband" analysis.

Excellent low frequency coverage

Many electrical and physical measurements have significant spectral information in the audio and sub-audio range. With frequency ranges from 25 kHz down to 1 Hz full scale, the Model 3582A is extremely well suited to these types of measurements. The display shown in fig. 1 represents the phase noise of a frequency synthesizer over the range of 0 to 1 Hz with a frequency resolution of only 6.00 milliHertz.

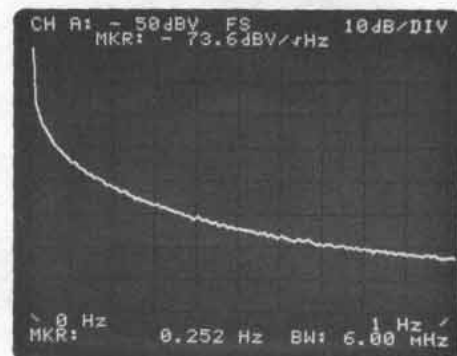

Figure 1

Real time measurement speed

Long measurement times can be a major limitation of swept low frequency spectrum analyzers. In high volume testing or in applications requiring substantial on-line tuning these long measurement times are both expensive and inconvenient. Since the Model 3582A uses an advanced microcomputer to execute the Fast Fourier Transform (FFT), it can perform equivalent measurements as much as one to two orders of magnitude faster than a swept analyzer.

Wide Amplitude Range

When examining the sensitivity of an analyzer, it is important to consider the full range of potential applications. If the analyzer does not directly cover the range of anticipated signals, external amplifiers or attenuators will be required. These devices can add their own noise and can distort the signal being measured. The Model 3582A offers 150 dB of calibrated measurement range covering +30 dBV (31.6 volts) to -120 dBV (1 μ volt) and thus minimizes the need for external signal conditioning. Even with input sensitivities down to -120 dBV the input circuit is fully protected against accidental overloads of 100 Volts DC or 120 Volts RMS for short periods.

Wide dynamic range

In many applications the information of interest is contained not in the high amplitude fundamental, but rather in the low amplitude components. For a spectrum analyzer to provide useful information about these low level components in the presence of a large signal, it must offer wide dynamic range. The Model 3582A dynamic range is specified as 70 dB.

Phase spectrum measurement

Most spectrum analyzers can measure only the amplitude spectrum of a signal, yet complete characterization in the frequency domain also requires phase information. Signals with identical amplitude spectra, but different phase spectra can differ significantly. The advanced digital signal processing techniques incorporated in the Model 3582A provide direct measurement of phase spectra.

Transient capture and analysis

Many signals such as mechanical shocks and electrical transients may occur infrequently and spontaneously and may last only for a brief period of time. Swept spectrum analyzers generally cannot handle these transient signals. By using digital processing techniques, the Model 3582A can capture and analyze transients as short as a few milliseconds. This means that spectrum analysis and transfer function analysis are no longer limited to stable, time invariant signals.

Transfer function measurement with the internal noise source

Many electrical circuits and mechanical systems can be treated as linear networks and can be characterized by the magnitude and phase of their transfer functions.

Most spectrum analyzers can measure only the magnitude portion of the transfer function - and even then only by assuming a flat drive signal. The Model 3582A directly measures the complete transfer function, both magnitude and phase. With dual channels the actual drive signal is measured on Channel A and thus does not have to be totally flat; drive signal variations are taken out in the computation process to give valid results. The major constraint on the input signal is that, unlike a swept source, it must stimulate all frequencies of interest simultaneously. For some applications, true random noise or even impulse signals serve as useful drive signals. In most applications, however, the built-in noise source serves as an ideal input. With this drive signal functioning as a "tracking generator" substitute, the Model 3582A is a low frequency network analyzer with "real-time" measurement speed. As with spectrum measurements, portions of the transfer function as narrow as 5 Hz can be examined anywhere over the 25 kHz frequency range.

Coherence function measurement

The measurement of a device transfer function assumes that the device under test is linear and that no portion of the output is caused by noise or extraneous signal sources. In active electronic circuits or mechanical structures these conditions can easily be violated - yet such violations are very difficult to identify. The Model 3582A considerably simplifies this problem by providing the direct measurement of the coherence function. This is a frequency domain measure of the fraction of the power in one signal (e.g., the output) caused by

the other measured signal (e.g., the input). If this fraction is 1.0, the output at that frequency is caused by the input and the transfer function is valid. If the fraction is near 0.0, the output is caused by something other than the measured input. This cause could be noise, nonlinearities or an unanticipated input, but the result is the same - the transfer function data at that frequency is suspect.

In addition to serving as a valuable check on the validity of transfer functions, the coherence function can be useful when investigating cause/effect relationships particularly in multiple input systems.

Digital averaging capability

Many spectral measurements contain both discrete signals and random noise components. Obtaining proper amplitude readings can be difficult if the random components are really the ones of interest or are of nearly the same amplitude as the discrete signals.

The digital averaging techniques incorporated in the Model 3582A help solve these problems. The RMS averaging mode takes the power average of 4 to 256 successive spectra in order to reduce the uncertainty of the estimate of random spectral components. For measurements where the spectral information is not stable but varies slowly with time, a running exponential form of RMS averaging is provided. By continually reducing the importance of older spectra, this mode prevents old data from completely obscuring new data yet still retains the basic advantages of averaging.

When a synchronizing trigger signal is available, the TIME average can enhance the signal-to-noise ratio by as much as 24 dB. Since it involves the averaging of successive time records before transformation it is also significantly faster than other types of averaging.

Fully annotated, calibrated CRT display

One of the most important features of the Model 3582A is its ease of use. Operator interaction with the instrument is simplified by the combination of intelligent microcomputer control and the alphanumeric display capability. The basic annotation clearly shows the major measurement parameters.

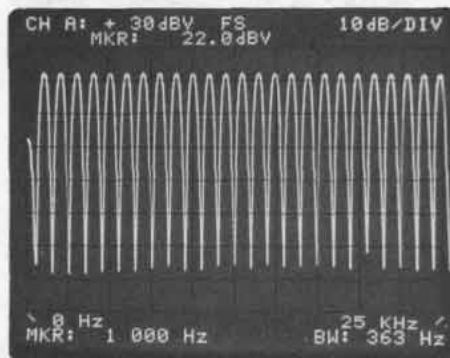

Figure 2

Powerful marker operations

The intensified dot marker is a major operational convenience. When active the frequency and corresponding amplitude, phase or coherence value of the dot are displayed alphanumerically on the display. Since the results are calibrated, there is no need to go through the time consuming, error-prone process of visually interpreting display points.

For operations such as determining frequency separation, the marker can read out in units relative to a previous marker setting which was defined as a reference point.

When making band analysis measurements, the marker can be used in place of the frequency adjust control to define a new start or center analysis frequency.

SIGNAL ANALYZERS

Dual-Channel, Real-Time Spectrum Analyzer 0.02 Hz to 25.5 kHz

Model 3582A (cont.)

Digital trace storage

Two independent information traces can be stored in digital memory for later recall and comparison.

Powerful HP-IB capability

The Hewlett-Packard Interface Bus (HP-IB) is an interface concept that allows two way communication among as many as fifteen different devices. Generally, at least one of these devices is a "computing controller" which exercises overall system control. This controller directs and coordinates the activities of the other devices in the system.

All major front panel controls with the exception of the verniers are fully programmable via the HP-IB. The programming codes are simple and are logically derived from the front panel control labels. The states of the various controls occupy only ten 8-bit bytes of data that can be read and written by the HP-IB. This allows you to manually set up a test from the front panel and store it in a compact form.

From the HP-IB it is a simple matter to command the Model 3582A to output results in a usable form. Not only can the various control settings be retrieved, but numeric marker data can be extracted. More importantly, the full display can be read in ASCII format along with complete annotation.

The flexible HP-IB structure also allows a computing controller to input data other than commands to the Model 3582A. For example, a perfect time record can be synthesized from a mathematical model and input to the instrument for analysis. More importantly, stored display information such as the vibration signatures of a rotating machine can be input to the instrument for review. Also, the controller can mathematically process the stored data and format the results for display on the CRT. Since the controller can also write its own four lines of alphanumeric text, the results can be properly annotated and calibrated. The operator can even be given brief interpretation instructions - all on the CRT of the instrument.

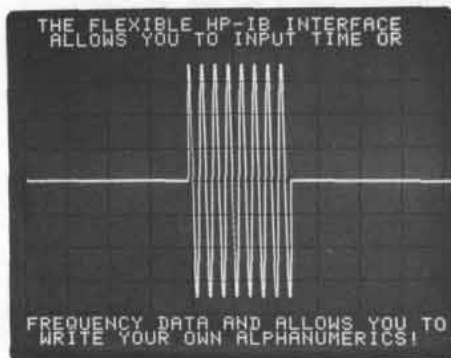

Figure 3

A wide range of applications including:

• Low frequency electronics

Spectrum analyzers have typically been of major value in characterizing the harmonic distortion, spurious outputs, level and frequency of signal sources. The model 3582A not only makes these measurements better and more accurately than before, but it also makes them faster. The additional combination of "real-time" measurement speed and the powerful HP-IB capability make automated testing of these parameters very attractive.

In addition to characterizing low frequency sources, the Model 3582A can help characterize the short term random frequency fluctuations of a precision high frequency source. This is accomplished by mixing the high frequency signal down to DC and measuring the phase noise close-in to the carrier.

With direct transfer function measurements and the built-in driving source, the Model 3582A is well suited to performing a network analysis of low frequency devices such as filters. Figure 4 shows a five section low pass elliptic filter.

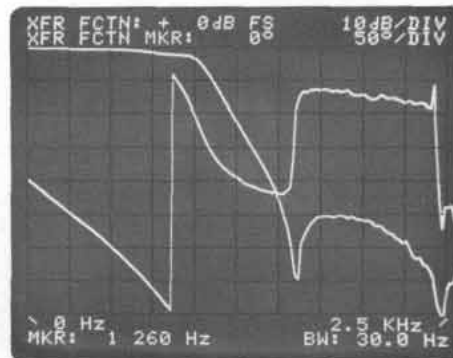

Figure 4

• Telecommunications

The frequency range and performance characteristics of the Model 3582A are well matched to the R&D and production needs of telecommunications. Voice frequency components including analog lines can be easily characterized.

Specialized signal sources such as multifrequency tone sources and modems can pose unusual testing problems. Figure 5 shows the frequency spectrum of a modem transmitting a string of asterisks.

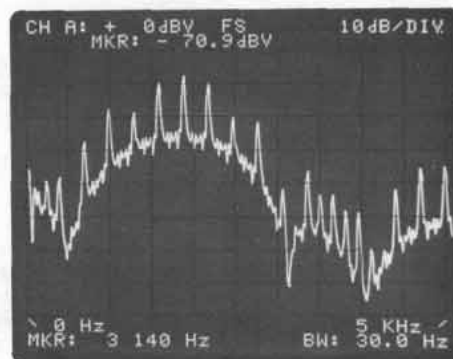

Figure 5

Audio and acoustics

The Model 3582A has a number of features that make it well suited to the analysis of entertainment products. For example, an audio tape recorder is a moderately complex electromechanical system. Any unwanted mechanical speed variations will show up as discrete modulation sidebands on a recorded tone.

With the frequency resolution of the Model 3582A, it is possible to identify the sidebands precisely enough to relate them to actual geometries.

Loudspeakers provide another interesting application example. By combining the built-in noise source with time averaging, it is possible to obtain valid characterizations even in the presence of ambient noise as shown in figure 6 below.

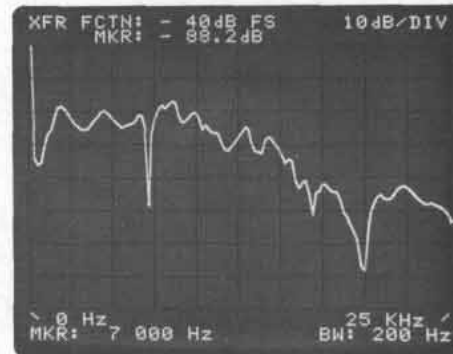

Figure 6

It is also possible to use impulse type signals for this measurement. Since the time record collection time is only a few milliseconds, this can minimize the echo problems.

With a slightly different hook-up the electrical impedance of a loudspeaker can even be measured.

• **Structural analysis**

A broad range of mechanical structures can be adequately described as linear systems and can be characterized by their frequency domain transfer functions. These transfer functions relate applied forces and the resulting motion. This example illustrates the driving point inertance (acceleration/force) transfer function of a small beam.

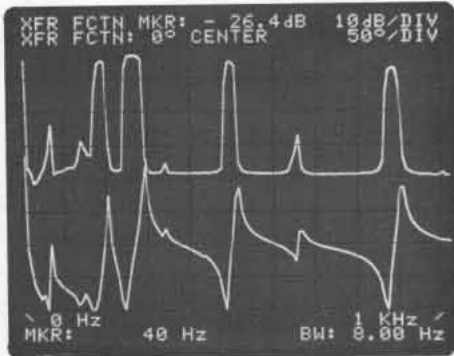

Figure 7

• **Rotating machinery signatures**

Every rotating machine exhibits a unique characteristic vibration pattern determined not only by the basic design and construction of the machine, but also by environmental factors and wear. With the appropriate transducers the Model 3582A can measure and analyze these vibration patterns or "signatures."

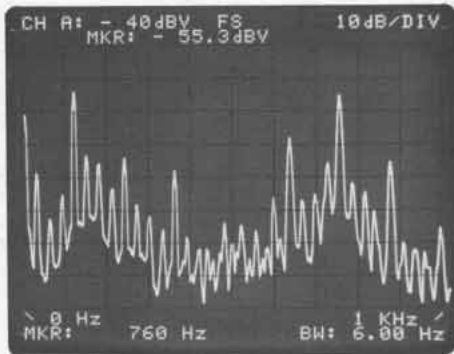

Figure 8

3582A Specifications

Frequency

Range: 0.02 Hz to 25.5 kHz with the low frequency limit the result of DC response.

Spans: 1 Hz to 25 kHz in a 1-2.5-5-10 sequence. The 1 Hz and 2.5 Hz spans are usable only in the 0-start mode.

Accuracy: ±0.003% of display center frequency.

Resolution: 0.4% of the frequency span for single channel or 0.8% of the frequency span for dual channels.

Filter passband shape:

	Flat Top	Hanning	Uniform
3 dB Bandwidth (single channel)	(1.4 ± 0.1% of span)	(0.58 ± 0.05% of span)	(0.35 ± 0.02% of span)
Shape Factor	2.6 ± 0.1	9.1 ± 0.2	7.6 ± 0.2

Amplitude

Display modes:

Log: 10 dB/division or 2 dB/division

Linear: Constant voltage/division

Measurement range:

Log: +30 dBV to -120 dBV noise floor

Linear: +30 V to 1μV noise floor

Dynamic range: 70 dB

DC response: Adjustable to >40 dB below maximum input level

Accuracy:

Accuracy at the Passband Center ±0.5 dB

Flat top filter: +0, -0.1 dB

Hanning filter: +0, -1.5 dB

Uniform filter: +0, -4.0 dB

Note: Overall accuracy is the sum of the accuracy at the passband center plus the selected filter accuracy.

Resolution:

Log: 0.1 dB

Linear: 3 digits

Phase

Display range: +200 degrees to -200 degrees

Accuracy: ±10 degrees

Resolution: 1 degree

Transfer function

Measurement range:

Log: +160 dB full scale to -80 dB full scale

Linear: 4 × 10⁸ full scale to 4 × 10⁻⁸ full scale

Phase display range: +200 degrees to -200 degrees

Accuracy:

Amplitude: ±0.8 dB

Phase: ±5 degrees

Coherence

Measurement range: 0.0 bottom display line to 1.0 top display line

Resolution: 0.01

Input

Impedance: 10⁶Ω ±5% shunted by <60 pF from input high to low (for less than 75% relative humidity)

Isolation: Input low may be floated up to 30V

Coupling: Switch selection of AC or DC coupling. The low frequency 3 dB roll off is <1 Hz.

Common mode rejection:

50 Hz: >60 dB

60 Hz: >58 dB

Crosstalk: <-140 dB between channels with 1 kΩ source impedance driving one channel and the other terminated in 1 kΩ.

Output

X-Y recorder:

Level: 0V to 5.25 V ±5%

Impedance: 1 kΩ

Pen lift: contact closure during sweep

Noise source:

Type: Periodic pseudorandom noise or random noise signal with switch selection. Both are band limited and band translated to match the analysis.

Level: From <10 mV to >500 mV RMS into >50Ω

Impedance: <2Ω

General

Environmental:

Temperature: 0°C to 55°C operating; -40°C to +75°C storage

Humidity: <95% R.H. 0°C to 40°C

Power requirements: 100, 120, 220, or 240 volts (+5%, -10%); 48-66 Hz; less than 150 VA

Dimensions

Size: 425.5 mmW × 552.5 mm D × 188 mmH (16.75" × 21.75" × 7.4")

Weight: 24.5 kg (54 lbs.); shipping weight: 29 kg (63 lbs.)

3582A Spectrum Analyzer

\$10,000

SIGNAL ANALYZERS

Digital Signal Analyzer

Model 5420A

- Dual-Channel Transfer Function
- Band Selectable Analysis
- Fully Calibrated Annotated Display
- Powerful Post-Measurement Processing
- Digital Data Storage
- Random Noise Generator



The 5420A Digital Signal Analyzer is a high performance dual-channel instrument capable of a number of both time domain and frequency domain measurements over a 25 kHz range. It is particularly adapted to solving problems associated with structural vibration and noise, rotating machinery, electro-mechanical control systems, acoustics and a host of similar applications which call for advanced low-frequency analysis.

Among the instrument's important standard features are a fully annotated and calibrated dual-trace display, permanent digital storage for measurement results, band selectable analysis, extensive data processing, advanced triggering capability, external sampling capability, calibration in engineering units and a built-in random noise generator. Capable of both stimulus-response and response only analysis, the 5420's measurement repertoire includes:

- Transfer Function
- Coherence Function
- Impulse Response
- Auto Spectrum
- Cross Spectrum
- Linear Spectrum
- Time Record
- Amplitude Histogram
- Auto Correlation
- Cross Correlation

Important capabilities such as independent pre and post trigger delay on each input channel, overlap processing, and external sampling insure that the instrument's measurement power can be effectively applied to a wide range of problems. Applications which benefit from these capabilities include transient capture and analysis, structural and acoustic transfer function characterization and rotating machinery studies.

A built-in "waveform calculator" is useful for processing measured or synthesized data, as well as real or complex constants, and greatly extends the instrument's basic capabilities. Examples of useful computed functions include:

- Data Comparisons
- Resonant Frequency
- % Critical Damping
- Open Loop Gain
- Calibration in %
- Mechanical Impedance
- Total Harmonic Distortion
- Coherent Output Power
- Signal-to-Noise Ratio
- Transmissibility
- Function Synthesis
- Power



Operation

Operation of a digital signal analyzer has never been easier. A novel "menu" concept replaces the rotary and toggle switches commonly used to control an instrument's operation. The entire current set-up state, including measurement type, bandwidth, input ranges, etc., is displayed on the CRT at the push of a key. Changes to the set-up are made by selection from displayed lists (menus) or by direct numerical input from the control keyboard.

Once set up, measurements are easily executed and may be paused or continued at will. Results are always fully calibrated and annotated. A self-test feature verifies proper operation.

Data Display

The 5420A features a fully annotated and calibrated, dual trace, three-format display which provides for ease of data interpretation. Each display trace is totally independent of the other in terms of the data which the user selects for display, the horizontal and vertical ranges over which it is displayed, and the coordinate system chosen. The user may select from up to 13 available coordinate systems, including complex plots such as Nyquist and Nichols, at the push of a key. Display traces may be viewed one at a time in full format or simultaneously in either an upper/lower or overlaid format.

Dual X and Y axis cursors provide numerical data readout, in either absolute or relative terms, on both axes simultaneously in full format. Any area of the display may be graphically expanded for optimum viewing. Cursors may be either swept or set explicitly, via numerical entry, to desired locations. Harmonic cursors are provided. The X axis cursors may also be used to set the frequency range over which the instrument will operate, thereby concentrating its resolution into the bandwidth of interest.

The display section of the instrument also contains a digital recorder which provides permanent storage of measurement results on small removable tape cartridges and eliminates the need to repeat time consuming and expensive testing. Up to 120 separate measurements may be easily stored and recalled for display, plotting, or further processing on a single cartridge.

SETUP STATE

```
MEASUREMENT : TRANSFER FUNCTION
AVERAGE :      25      , STABLE
SIGNAL :        RANDOM
TRIGGER :       FREE RUN , CHNL 1
```

```
CENT FREQ :     2.00000 KHZ
BANDWIDTH :     800.000 HZ
TIME LENGTH :   320.000 mS
```

```
ΔF : 3.12500 HZ      ΔT : 625.000 μS
```

ADC CHNL	RANGE	AC/DC	DELAY	CAL (C1/C2)
1	5 V	AC	0.0 S	33.3333
* 2	10 V	DC	10.0000 S	20.0000

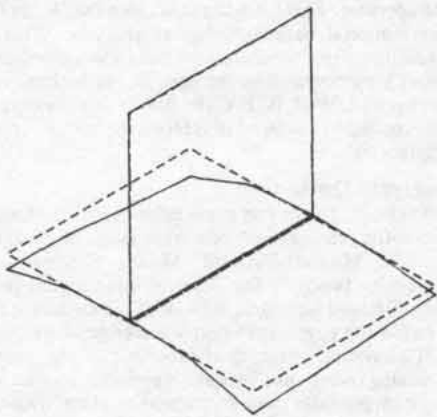
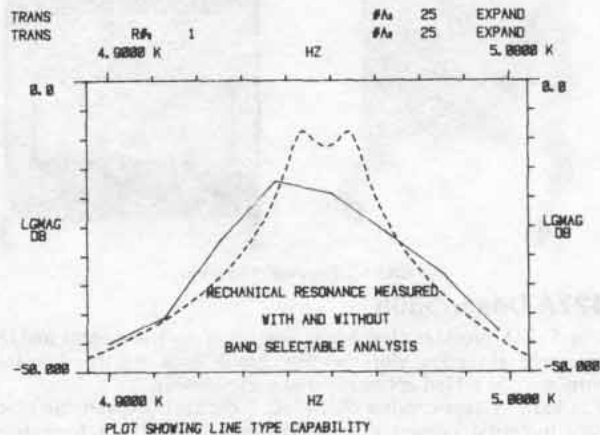
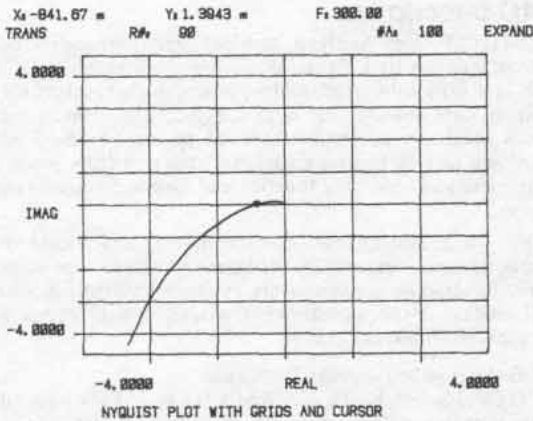
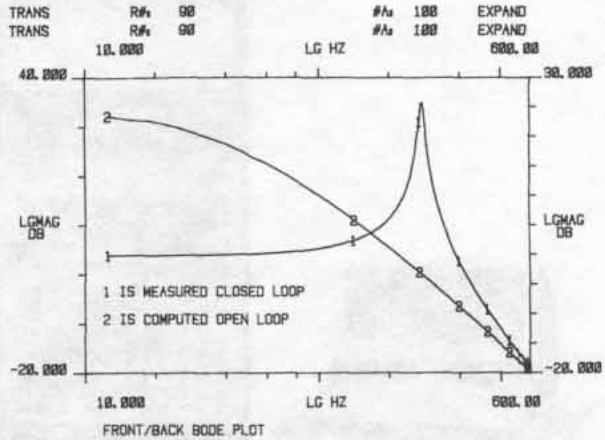
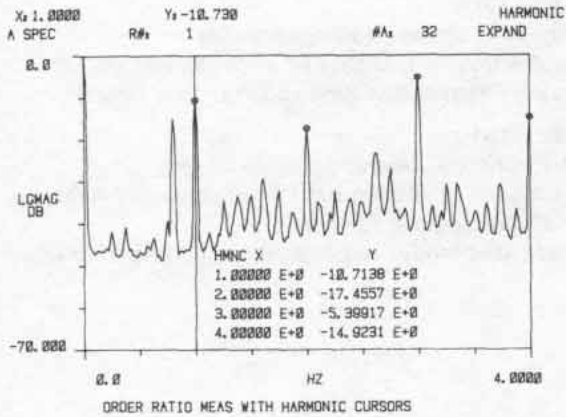

MODE SHAPE PLOT SHOWING DEFORMATION OF T-PLATE

Plotting and Printing

The Hewlett-Packard Interface Bus accessory, 10920A, interfaces the 5420A to other HP-IB compatible instruments, plotters and computing controllers. With this accessory installed, the 5420A will provide both annotated graphic and alpha/numeric data hardcopy on either the HP 9872A or 7245A Digital Plotters. A separate computing controller, with its attendant cost and programming requirements, is not needed although one may be used to provide additional annotation or special plots. The user merely presses the plot or print key and the instrument will reproduce the desired information on the plotter. Cursors are plotted, if displayed, and may be used to select specific data, such as the amplitudes of the rotational orders of a machine, for printing. The user may conveniently scale plots to the desired size. Seven line types and six symbols are available for use in plotting and identifying data.

Control and Data Transfer

Certain applications can benefit substantially from the powerful combination of the 5420A, 10920A and a computing controller. The task of characterizing the dynamic properties of a mechanical structure by identifying its modes of vibration is an example. The transfer function measurements which provide the raw data can be executed rapidly and automatically, over different frequency ranges and at various points on the structure, under the control of a simple program. All the keys on the 5420A's front panel can be remotely "pushed" by a computing controller.

With the measurement complete, the data is easily transferred over the HP-IB from the 5420A to the computing controller where the resonant frequencies, damping factors and mode shape data are extracted. The reduced data can then be transferred back to the 5420A for display in tabular form or as an animated mode shape which depicts structural deformation.

And More

There is much more to the 5420A than can be described here. With all of its power and flexibility, the instrument's operation remains straight-forward and human-oriented. Its performance specifications are impressive and include a 75 dB dynamic range, accuracy to 0.1 dB and 5 degrees, and up to 33 bandwidth selections providing frequency resolutions as fine as 16 μ Hz.

5420A Digital Signal Analyzer \$29,900.00
10920A HP-IB Interface \$2,200.00

SIGNAL ANALYZERS

Digital Fourier Analyzer, Vibration Test Control

Models 5451C, 5427A

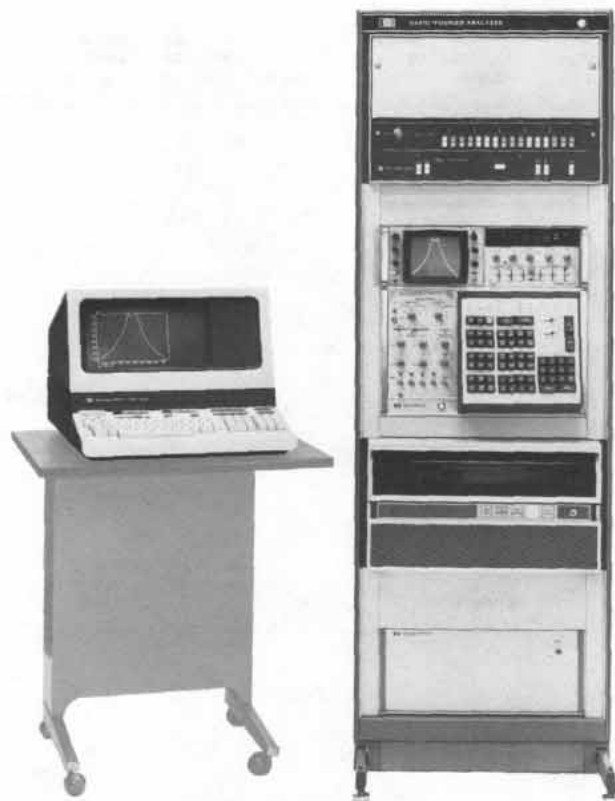

5451C Fourier Analyzer

5427A Description

The 5427A provides closed-loop control of environmental and/or developmental random vibration test stimuli. Sine and transient test control may be added optionally and inexpensively.

The basic system consists of: 5478C 2-channel (expandable to 4) analog-to-digital converter for processing feed-back information; 21MX-E series, microcoded digital processor; 1335A Persistence CRT Display; 2640B operator's terminal; 5477A pushbutton control unit, 9885M flexible disc storage unit; cabinet and programs for random control and a set of analysis routines designed for easy operation by laboratory personnel.

System operation

Random, sine and transient control follow the same logical operational phases. First, the appropriate disc is loaded and the test program or setup (envelope, alarm and abort limits, test time, calibrations, etc.) is loaded from disc storage in response to search codes or names. If a new program or modifications are desired, a friendly question-and-answer sequence is used. Once a new setup has been generated or changes made, it can be assigned a new name and stored for later use.

After a satisfactory setup is obtained, the operate phase allows control of the actual test via pushbuttons on the central control panel. Removable snap-on overlay panels clearly label buttons for the type of test desired. Choices of on-line displays and a 'save' button allows saving of data for later plotting, including auxiliary PSD measurements during random control.

After the test, results and all saved data are available for review or documentation. The digital plotter or graphic terminal options provide fully labeled, report-quality plots of test results.

Specification summary (Random control)

Resolution: 64, 128, 256, 512 lines (1024 lines optional).

Loop Time: ≤ 0.9 second with 2500 Hz bandwidth, 256 lines.

Bandwidth: Δf to 5000 Hz.

Dynamic Range: ≥ 65 dB.

Reference Spectrum: programmable, 32 breakpoints.

5427A Base Price

\$43,000

Model 5427A

- Digital Accuracy and Repeatability
- Pushbutton Operation, Eliminates Programming
- Easily Expanded to Sine and Transient Control

Model 5451C

- Multi-Channel Operation DC to 50 kHz
- Keyboard-Controlled Data Acquisition and Analysis
- > 75 dB Dynamic Range
- Dedicated Model and Signature Analysis Packages

5451C Description

The 5451C Fourier Analyzer provides digital frequency domain analysis of complex time signals in the frequency range of DC to 50 kHz. It is a fully calibrated, multi-purpose digital system for data acquisition, data storage, and data analysis. The primary analysis functions which are controlled from the system keyboard include: Forward and inverse Fourier transform, auto and cross power spectrum, transfer and coherence function and time or frequency domain averaging.

The ability to measure these functions quickly and accurately and with large dynamic range makes the Fourier Analyzer a powerful tool for stimulus-response measurements, system identification, vibration control, modal analysis, signature analysis, underwater sound, acoustics, communications, and more.

Band Selectable Fourier Analysis

5451C Band Selectable Fourier Analysis (BSFA) allows the digital analyzer user to perform digital spectrum analysis over a frequency band whose center frequency and bandwidth are independently selectable by the operator. This frees the user from the DC to F_{max} restrictions of conventional baseband digital analysis. With BSFA the frequency resolution of a measurement can be increased by a factor of 400:1 without a corresponding increase in the amount of computer data space required. With BSFA, the full dynamic range of the analyzer can be applied to the band of interest without interference from outside frequencies.

Modal Analysis Option

Hewlett-Packard offers a comprehensive modal analysis system designed to meet the requirements of a wide range of modal testing applications. The Hewlett-Packard Modal System operates on measured transfer function data to determine modal properties. In addition, an animated isometric display of the structure under test is generated to aid the engineer to better understand its dynamic characteristics. This system offers significant time savings over traditional swept sine analog techniques because it operates on transfer function data. The system provides random, pseudo-random, transient, or periodic random excitation for transfer function measurements.

Signature analysis

Noise, vibration, and failure problems in rotating machinery are quickly analyzed using Hewlett-Packard's powerful Signature Analysis Package. It combines key rotating machinery measurements into a dedicated user-oriented system that's used for preventive maintenance, production quality control, design analysis, and noise and vibration studies.

Six measurements are pushbutton selectable from the operator's control panel: RPM and TIME Spectral Maps, Power Spectrum Analysis, Composite Power Spectrum, Order Ratio, and Order Tracking. This complete range of measurement and analysis features helps the user quickly gain insight into the overall dynamic characteristics of the device, eliminating time-consuming trial-and-error procedures.

5451C System Price

from \$61,500

SIGNAL ANALYZERS

Correlator and spectrum display

Models 3721A, 3720A

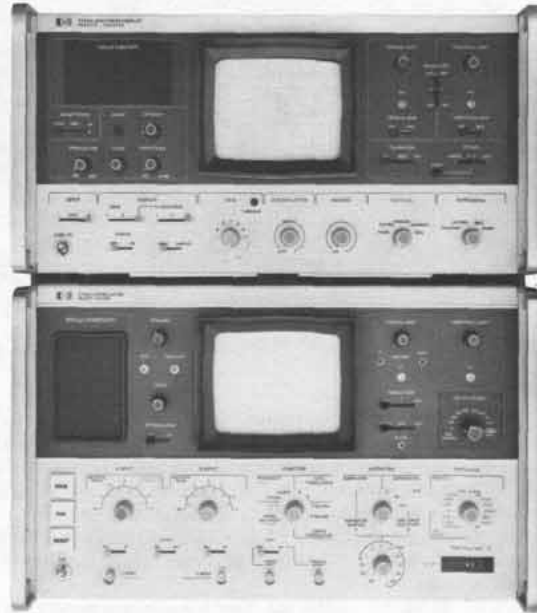

Models 3721A, 3720A

3721A Correlator

The Model 3721A Correlator is a digital statistical signal analyzer covering the range dc to 250 kHz. It computes autocorrelation, cross-correlation, and amplitude probability functions. In addition, a signal recovery facility uses signal averaging to improve the signal-to-noise ratio of a repetitive signal buried in noise. The resultant functions are displayed on a built-in CRT.

The versatile analysis and averaging capabilities combined with portability, automatic calibration, built-in CRT and real-time operation make the 3721A an ideal analyzer for both laboratory and field use.

Major Specifications

Input signal bandwidth: dc to 250 kHz.

Input range: 40 mV rms to 4 V rms.

Functions: Autocorrelation, Crosscorrelation, Probability (Density and Integral), Signal Recovery.

Number of points: 100 points computed and displayed for each function.

Sampling interval: 1 s to 1 μ s (1 Hz to 1 MHz sampling rates). External clock facility allows any interval $\geq 1 \mu$ s to be selected. In Correlation and Signal Recovery the time between displayed points is equal to the sampling interval.

Averaging (two modes are provided).

Summation: computation automatically stopped after a fixed number of samples has been taken. Number of samples selectable from 128 to 128 x 1024.

Exponential: continuous averaging with time constant selectable from 36 ms to over 10⁷ seconds.

Calibration: vertical calibration is automatically displayed on an illuminated panel (except Probability).

Outputs: all computed functions are displayed on the built-in CRT. Analog outputs are provided for use with X-Y recorder and external oscilloscope. Digital outputs allow the transfer of computed data to any HP digital computer or HP paper tape punch (2895A or 8100A). Extra plug-in assemblies are required, type depending on the peripheral used.

3720A Spectrum display

The 3720A Spectrum Display is a unique add-on unit for the Correlator, to complement and extend its capability by Fourier transforming any time display on the 3721A and presenting its equivalent frequency function on a built-in display.

The 3720A performs the Real and/or Complex transformation of autocorrelation and crosscorrelation functions to produce the Power and Cross Spectral Density functions respectively, and converts signal recovered data into frequency information.

Together the 3721A Correlator and 3720A Spectrum Display, each with its own CRT display, form an analysis system giving both time and frequency information simultaneously.

Major Specifications

Input data: digital data is transferred from the Correlator and held in either of two stores, labelled 1 and 2.

Computed transforms: either the Real or Complex transform can be computed of the contents of store 1, the contents of store 2, or the contents of stores 1 and 2 together.

Frequency range: 0.005 Hz to 250kHz using internal 3721A clock. Extendable down to dc with external clock.

Displayed frequency range: two decades of frequency are displayed, the highest frequency being $\frac{1}{2} \Delta t$ Hz (Δt is the 3721A Timescale setting).

Dynamic range: ratio of full scale signal to noise level, for fixed integrator gain, is better than 50 dB.

Gain: continuously variable over a 2-decade, 40 dB, range in seven discrete steps, with intermediate vernier.

Window: two choices are available.

OFF: natural window, nominal bandwidth 1/200 Δt .

ON: triangular window, nominal bandwidth 1/100 Δt .

Interpolation: two modes available.

MANUAL: computes and displays 100 frequency points. Frequencies of all 100 points can be simultaneously and equally varied over a frequency interval, 1/200 Δt .

AUTO: automates the manual interpolation, calculating 10 equispaced points across each frequency interval.

Transform presentation: all combinations of the following axes are available for display.

Vertical axis: Phase, Log Mod, Modulus, Imaginary, Real.

Horizontal axis: Frequency, Log Frequency, Real, Phase.

CRT display: built-in variable persistence CRT with storage facility.

X-Y recorder: separate horizontal and vertical analog outputs corresponding to the CRT display.

Ordering information

3720A Spectrum Display

3721A Correlator

Price

\$8,765

\$11,170

SIGNAL ANALYZERS

Calibrated noise for system stimulation

Model 3722A

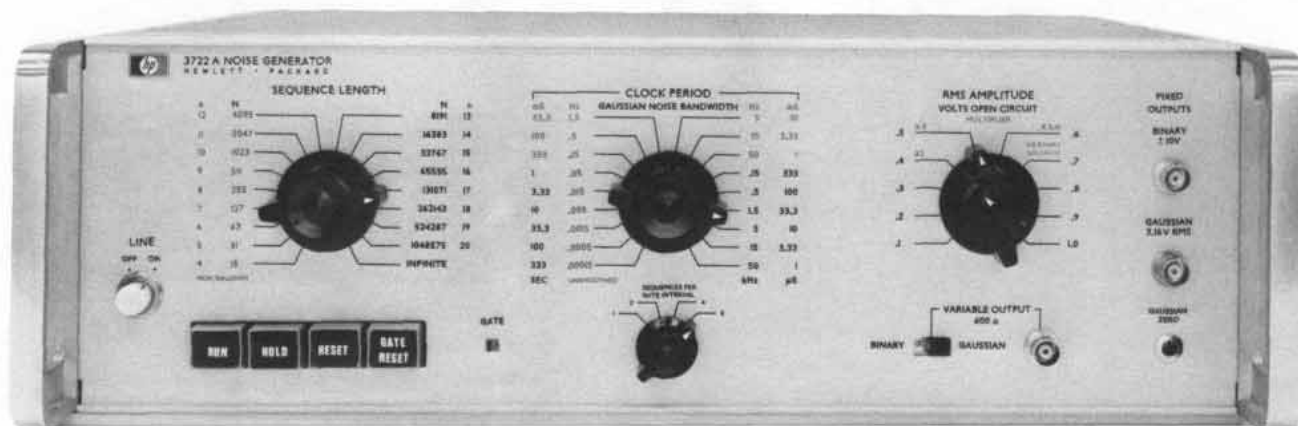

3722A

The Model 3722A Noise Generator uses digital techniques to synthesize binary and Gaussian noise patterns. These 'pseudo-random' patterns, which are of known content and duration, are repeated over and over without interruption. Since one pattern is identical with the next, each pattern has the same effect on the system under test. For this reason, pseudo-random noise signals cause no statistical variance in test results. The Model 3722A also generates truly random binary and Gaussian noise.

The basis of the Model 3722A is a binary waveform generator. The binary output has a $(\sin x/x)^2$ shaped spectrum and the Gaussian output, which is derived from the binary signal by precision low-pass filtering, has an almost rectangular spectrum. Both binary and Gaussian outputs are controllable in bandwidth, but the output power remains constant regardless of selected bandwidth. The frequency of the first null in the binary spectrum is selectable from 0.003 Hz to 1 MHz, and the bandwidth (at -3 dB point) of the Gaussian noise is selectable from 0.00015 Hz to 50 kHz.

Opt H01

Model 3722A Option H01 is a standard Model 3722A Noise Generator modified to provide a second binary output which can be delayed by a selectable number of clock periods with respect to the main binary output. The delayed binary output is available only when the instrument is in the pseudo-random mode. The delay introduced between the two binary outputs is selected by three decade switches on the front panel. These switches are set according to a conversion table supplied with the instrument.

Specifications

Binary output (fixed amplitude)

Amplitude: ± 10 V.**Output impedance:** $< 10 \Omega$.**Load impedance:** 1 k Ω minimum.**Rise time:** < 100 ns.**Power density:** approximately equal to (clock period x 200) V²/Hz at low frequency end of spectrum.**Power spectrum:** $(\sin x/x)^2$ form first null occurs at clock frequency, and -3 dB point occurs at 0.45 x clock frequency.

Gaussian output (fixed amplitude)

Amplitude: 3.16 V rms.**Output impedance:** $< 1 \Omega$.**Load impedance:** 600 Ω minimum.**Zero drift:** < 5 mV change in zero level in any 10°C range from 0° to +55°C.**Power density:** approximately equal to (clock period x 200) V²/Hz at low frequency end of spectrum.**Power spectrum:** rectangular, low-pass: nominal upper frequency f_0 (-3 dB point) equal to 1/20th of clock frequency. Spectrum is flat within ± 0.3 dB up to $1/2 f_0$, and more than 25 dB down at $2f_0$.**Crest factor:** up to 3.75, dependent on sequence length.

Variable output (binary or gaussian)

Amplitude (open circuit)

Binary: 4 ranges: ± 1 V, ± 3 V, ± 3.16 V, and ± 10 V, with ten steps in each range, from X0.1 to X1.0.**Gaussian:** 3 ranges: 1 V rms, 3 V rms, and 3.16 V rms, with ten steps in each range, from X0.1 to X1.0.**Output impedance:** 600 $\Omega \pm 1\%$.

Main controls

Sequence length switch: first 17 positions select different pseudo-random sequence lengths; final position selects random mode of operation (INFINITE sequence length.) $N = 2^n - 1$, where n is the range 4 through 20.**Clock period switch:** selects 18 frequencies from internal clock.

Internal clock

Crystal frequency: 3 MHz nominal.**Frequency stability:** $< \pm 25$ ppm over ambient temperature range 0° to +55°C.**Output:** +12.5 V rectangular wave, period as selected by CLOCK PERIOD switch.

External clock

Input frequency: usable BINARY output (pseudo-random only) with external clock frequencies up to 1 MHz.**Input level:** negative-going signal from +5 V to +3 V initiates clock pulse.**Maximum input:** ± 20 V.

Remote control

Control inputs: remote control inputs for RUN, HOLD, RESET, and GATE RESET functions are connected to 36-way receptacle on rear panel.**Sequence length indication:** 18 pins plus one common pin on the 36-way receptacle are used for remote signaling of selected sequence lengths (contact closure between common pin and any one of the 18 pins).

Delayed binary output (Opt H01)

Typical performance figures for the delayed output are:

Amplitude: switches between +1.5 V and +12 V.**Maximum sink current at 1.5 V level:** 10 mA.**Impedance:** 50 Ω (+1.5 V) and 600 Ω (+12 V).**Rise time:** < 50 ns.**Fall time:** < 20 ns.**Measured with \div probe shunted by 10 pF.

General

Size: 132.6 H x 425 W x 416 mm D (5 $1/32$ " x 16 $3/4$ " x 16 $3/8$ ").**Weight:** net, 10.5 kg (23 lb). Shipping 13.5 kg (30 lb.)

3722A Noise Generator

Opt H01: Delayed Output

\$4185

add \$350

3044A

- High accuracy and resolution digital amplitude measurements
- Synthesizer frequency accuracy and stability
- Wide amplitude range of 150 dB
- Narrow band analysis
- Full digital control via HP-IB

3045A

- Full automation and low cost
- Speed and precision in measurements
- Data analysis and presentation of results
- Simplicity and flexibility in operation
- HP-IB systems interfacing flexibility
- 9825A Computing Controller

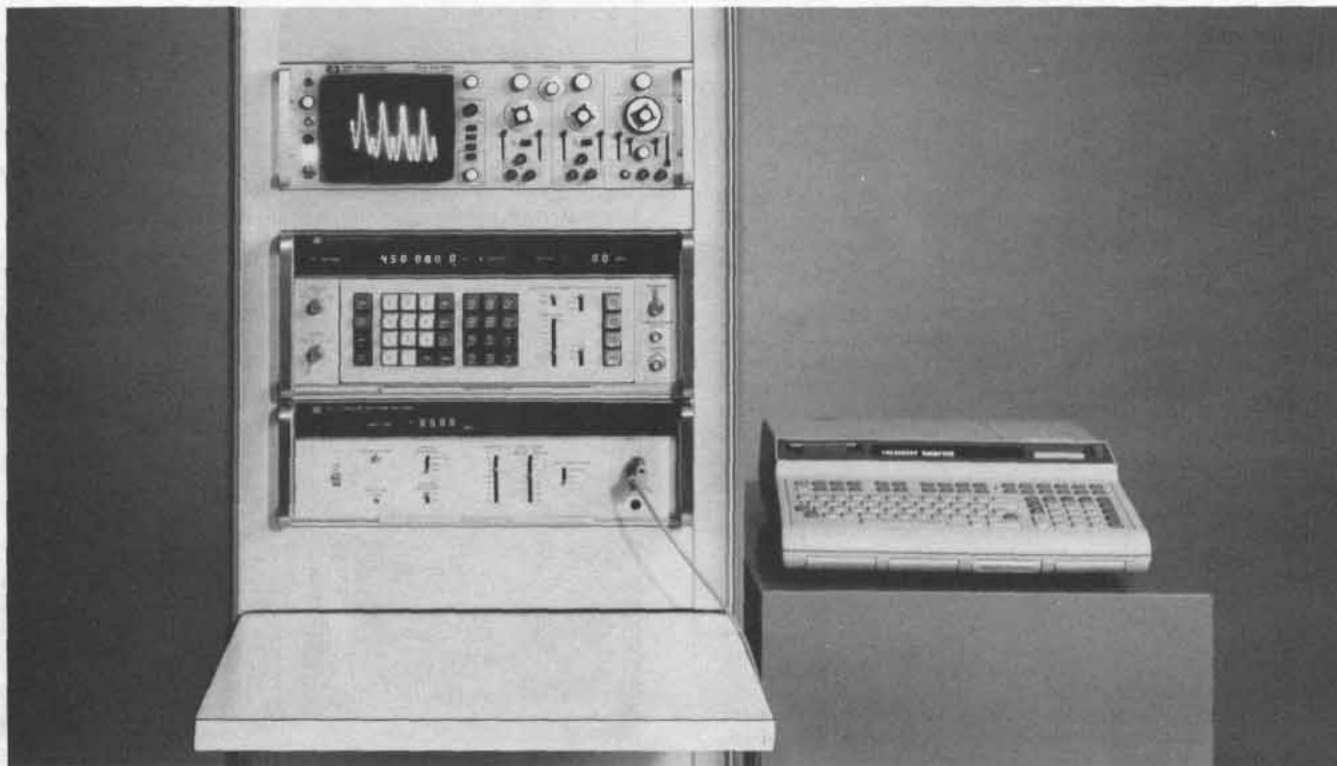

3045 System with Option 204 (HP Model 1201B Oscilloscope)

HP-IB

Description**3044A Spectrum analyzer**

Meeting the demand for precise frequency and amplitude measurements in the 10 Hz to 13 MHz region, the 3044A is a spectrum analyzer with tracking generator. This system uses a synthesizer with leveled output and sweep capability to generate the local oscillator signal for the analyzer and the tracking generator output. This allows fast, extremely accurate "tuning" with the use of frequency up-down keys or keyboard entry of center frequency. The input impedance is front-panel switch selectable to 50 Ω , 75 Ω , and 1 M Ω . The units of the digital display are also front-panel selectable to dBm, dBV and dB relative to a user-entered offset. Digital display of amplitude and frequency gives an unambiguous, high-resolution readout commensurate with the wide dynamic range and high accuracy of this analyzer.

3045 Automatic spectrum analyzer

While the 3044A is an excellent stand-alone spectrum analyzer, the capabilities are greatly improved with the addition of the 9825A Controller, which forms the 3045A system.

The 9825A Controller allows program and data storage on its fast tape cassette. The tape cassette, short calculation times and buffered

input/output speed allow repeated, automated tests which can greatly reduce production and quality-assurance test times. Also the scope of possible measurements greatly increase with the 3045A System. Logarithmic sweeps and limit tests are only two examples. The calculator also allows data manipulation and presentation in units familiar to the system operator in graphic or tabular form.

Because the user may not be familiar with HPL (the language of the 9825A Controller) or even with programming, a compiler is furnished with the 3045A System. The compiler allows the calculator to converse in terms understood by the test engineer, like start and stop frequencies, plot results, and compare with limits. It also accepts and outputs in units of Hz, kHz, MHz, dBm and dBV. The compiler enables the execution of sophisticated tests, like intermodulation distortion measurements, with only a few minutes of initial "programming" time. It can also record the test parameters, which can then be used repeatedly, as in a production environment. The compiler's versatility and ease of use make the full power of the 3045A Spectrum Analyzer readily available to the user.

The 3045 Automatic Spectrum Analyzer system is fully integrated, tested, verified and specified as a system. It is supplied with complete software and documentation.

Applications

Sideband analysis

This is a more traditional spectrum analysis measurement using HP's 3044A and 1201B Oscilloscope. Figure 3 is a picture of the spectrum. The carrier frequency was required to be at 10.7 MHz. Therefore, the synthesizer was set up with a 10.7 MHz center frequency and a ± 500 Hz sweep about the center frequency. From the display, it is apparent that the carrier frequency is approximately where it should be. It is possible to move the center frequency in 0.1 Hz steps with the step keys and look for the peak response to more accurately identify the carrier frequency.

Using the 3 Hz resolution bandwidth, 60 Hz spurious responses are revealed. Noise products also appear very close to the carrier. Here the wide dynamic range of the system exposes the responses that are more than 70 dB below the carrier.

Distortion measurements

The spectrum analyzer system can be very powerful for characterizing the complete response of amplifiers. Gain, noise, spurious distortion and frequency response can all be done with one setup. This example of distortion measurement is one part of the total characterization that can be done.

Distortion of audio frequencies as they pass through amplifiers is measured by several methods. Total harmonic distortion is found by measuring the harmonic output assuming a pure sinewave input. Here again the 3045A offers benefits through calculation power. After the user enters the fundamental frequency, the calculator makes measurements at the appropriate frequencies and calculates the percentage distortion. Figure 2 shows the type of user-oriented printout that is possible using the 9825A Controller and the 9866A Printer.

Intermodulation distortion can similarly be measured as part of the same system provided the sources are available.

Modulation measurements

Both AM and FM modulation show up very well in the frequency domain. Figure 4 shows a typical wide band FM signal. The calculator is used to program the instruments for measurements at the carrier and sideband frequencies. From the data, the modulation index was calculated to be 1.53 with a calculator Bessel algorithm. This is a good example of using the 3045A to make measurements that are not easy with a manual spectrum analyzer.

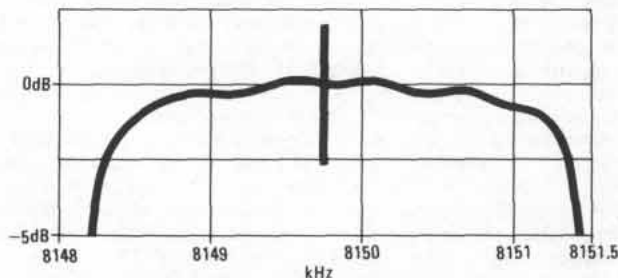

Figure 1. This bandpass filter was characterized using a 3044A system and an x-y recorder. By expanding the Y-axis to cover only 5 dB, the ripple and 3 dB points are very easy to identify.

TOTAL HARMONIC DISTORTION TEST		
FUNDAMENTAL FREQUENCY	ABSOLUTE LEVEL	
1231.0	0.7 DBV	
HARMONIC FREQUENCY	RELATIVE LEVEL	
2	2462.0	-44.20 DB
3	3693.0	-49.20 DB
4	4924.0	-60.70 DB
5	6155.0	-60.40 DB
6	7386.0	-77.50 DB
TOTAL HARMONIC DISTORTION EQUALS -42.85 DB		
OR 0.72 PERCENT		

Figure 2. Using a 3045A system, an amplifier can be completely characterized for total harmonic distortion as well as intermodulation distortion, noise, spurious, frequency response and gain.

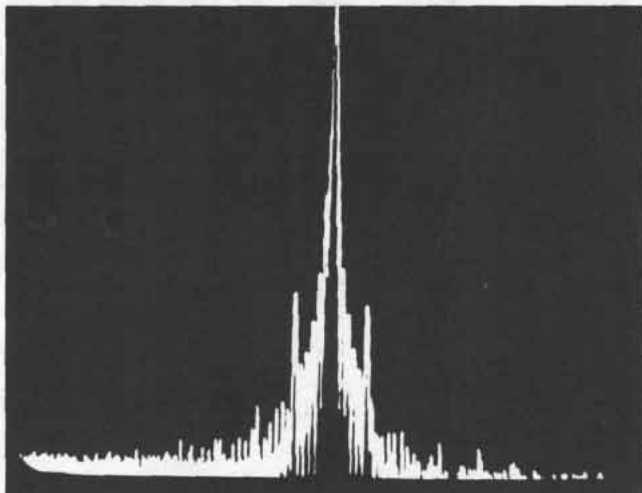

Figure 3. A 3044A was used to analyze close in spurious and noise of a 10.7 MHz carrier. The sweep covers 1 kHz around the carrier.

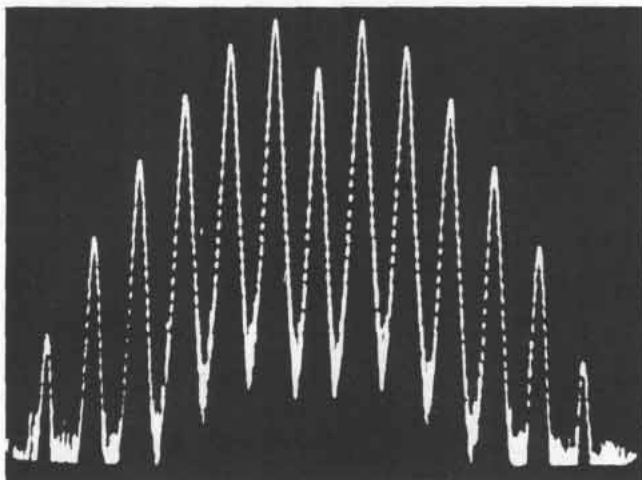

Figure 4. Wideband FM modulation with a 5.3 MHz carrier.

Telemetry

One of the most powerful applications for the spectrum analyzer is in monitoring frequency multiplexed telemetry or alarm systems.

The operating system may have many channels at different levels. When spurious signals appear or channels drop out, it is difficult to see them on a CRT. The 3045A system can be used to show just the problems. This is done by storing the spectrum of the system when it is running properly. Figure 5a shows a part of such a telemetry system. Then subsequent spectrums are subtracted from the normal spectrum. Channels that drop out or lose gain will appear as negative points as shown in Figure 5b. Spurious signals that were not present before will appear as points above the noise level. Rather than looking over the entire spectrum for problems, the system shows them graphically with enough frequency accuracy so the channel with problems can be quickly identified.



Figure 5a. This represents a portion of a frequency multiplexed system operating normally. Notice that not all channels are operating at the same level.

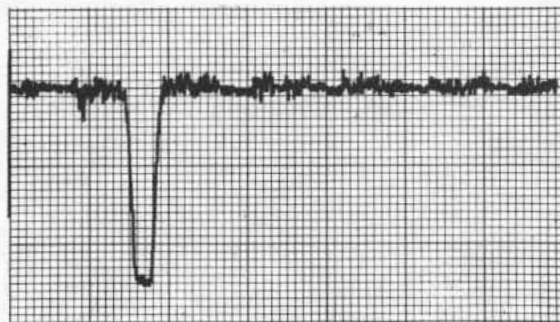

Figure 5b. The difference between a normal system and one that has problems is immediately apparent. One of the channels has dropped out.

3044A/3045A Specifications

Frequency specifications

Frequency range: 10 Hz to 13 MHz.
Scan width: any desired scan is possible in 10, 100 or 1000 steps of frequency increments as small as 0.1 Hz and with 0.1 Hz resolution. The 3045A is additionally capable of taking any number of steps with direct calculator control of the sweep.

Resolution

Bandwidth: 3 Hz to 10 kHz in a 1, 3, 10 sequence.
Bandwidth selectivity: 60 dB/3 dB bandwidth ratios $\leq 11:1$.

Stability

Long term: $\pm 1 \times 10^{-8}$ /day.
 $\pm 1 \times 10^{-7}$ /month.
Phase noise: <50 dB below CW signal in a 30 kHz band around signal.

Amplitude specifications

Absolute amplitude calibration range: -130 dBm to +20 dBm (50 or 75 Ω). -140 dBV to +10 dBV.
Digital amplitude readout: ± 199.99 dB with 0.01 dB resolution.
Dynamic range
Average noise level: -127 dBV in 1 kHz resolution bandwidth.

Smoothing (video filter): provides smoothing with a bandwidth of $\frac{1}{30}$ th the resolution bandwidth on all but the 3 Hz and 10 Hz bandwidths.

Spurious responses: >70 dB below input range setting.

Distortion responses: >80 dB below input signal at input range setting level.

Power-line related responses: 70 dB below input range on +10 dBV through -40 dBV ranges; 60 dB on -50 dBV; 50 dB on -60 dBV ranges.

Amplitude accuracy

Frequency response: ± 0.25 dB (250 kHz reference).

Input range: ± 0.05 dB/step, ± 0.15 dB total accumulation.

Log linearity: 0 to -30 dB ± 0.1 dB.
 -30 to -60 dB ± 0.25 dB.
 -60 to -80 dB ± 0.75 dB.

Stability: (8 hr., 25°C $\pm 1^\circ$ C, after 1 hr. warmup)

10 kHz, 3 kHz, 100 Hz, 30 Hz, 10 Hz, BW's

0 dB	-30 dB	-60 dB	temp. coefficient
± 0.05 dB		± 0.08 dB	± 0.02 dB/ $^\circ$ C

1 kHz, 30 Hz, 3 Hz BW's

0 dB	-30 dB	-60 dB	
± 0.08 dB		± 0.15 dB	± 0.04 dB/ $^\circ$ C

Tracking generator (3330B output)

Frequency range: 0.1 to 13 000 999.9 Hz.

Frequency resolution: 0.1 Hz (9 digits).

Amplitude range: +13.44 to -86.55 dBm (50 Ω).
 +11.68 to -88.31 dBm (75 Ω option).

Amplitude accuracy

Leveled frequency response (10 kHz reference)*

10 Hz	13 MHz	
	± 0.05 dB	+13.44 dBm
	± 0.1 dB	-16.55 dBm
	± 0.2 dB	-36.55 dBm
	± 0.4 dB	-66.55 dBm
		-86.55 dBm

*Add 0.5 dB for leveling switch in off position.

Attenuator (10 kHz reference, 25°C $\pm 5^\circ$ C): ± 0.02 dB/10 dB step of attenuation from maximum output.

Absolute accuracy: ± 0.05 dB at 10 kHz and +13.44 dBm (25°C $\pm 5^\circ$ C).

Amplitude stability (24 hr., 25°C $\pm 1^\circ$ C): ± 0.01 dB.

General

Input impedance: 50 Ω , 75 Ω >30 dB return loss.

1 M Ω $\pm 5\%$ shunted by 30 pF.

Maximum input level: +20 dBm.

Programmability: all controls, except power switches, are programmable using the HP-IB format.

3044A/3045A Options

The basic 3044A and 3045A system options are listed below. For more information refer to the 3044A/3045A data sheet.

3044A Options

110: Standard 3571A	Price
120: Standard 50 Ω 3330B w/Isol. HP-IB	add \$6820
121: Standard 75 Ω 3330B w/Isol. HP-IB	add \$7860
122: 5 V Output	add \$7860
	add \$310

3045A Options

200: 50 Ω System	N/C
201: 75 Ω System	N/C
204: 1201B Oscilloscope	add \$2970

Ordering information

3045A Automatic Spectrum Analyzer consisting of:
 3330B Synthesizer; 3571A Spectrum Analyzer; 9825A Controller, 6.8 k bytes memory; ROMs, Interface, documentation; 56" Rack. \$24,770

SIGNAL ANALYZERS

Distortion Measurement Set

Model 339A

- Ultra low distortion measurements
- Built-in low distortion oscillator
- Automatic
- True RMS detection

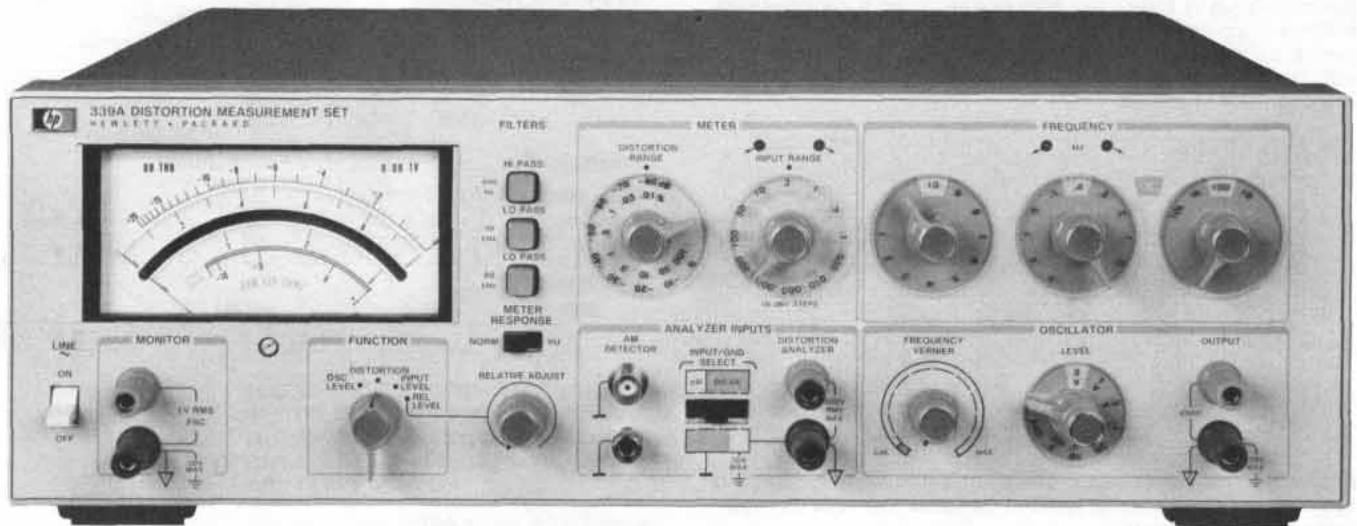

339A

Description

Hewlett-Packard's new Model 339A Distortion Measurement Set is an ultra low distortion measuring system complete with total harmonic distortion (THD) analyzer, true-rms voltmeter, and sine wave oscillator. This small, lightweight bench measurement set allows you to make THD distortion measurements as low as 0.0018% over a 10 Hz to 110 kHz frequency band including harmonics to 330 kHz.

For fast and easy THD measurements the built-in tracking oscillator in HP's 339A saves test time because you tune one instrument instead of two. Frequency and level measurements are easy to do with HP's 339A's voltmeter, which offers you a 1 mV to 300 V measurement range. The Relative Level mode has been included to further simplify frequency response measurements. Just set a 0 dBm reference at any frequency from 10 Hz to 110 kHz. Gain measurements can be read directly from the easy-to-read meter.

Operation simplicity

Automatic frequency tuning and set-level features allow you to make rapid, error free THD measurements. The 339A's built-in tracking oscillator eliminates the need to find the fundamental frequency and tune the analyzer for a null. Just select your oscillator frequency and the rest is automatic. Automatic set-level saves time by automatically setting 0 dB (100%) reference in the distortion measuring mode. Front panel directional indicators light when the input range setting is improper insuring accurate and repeatable measurements. Automatic set-level also greatly simplifies measurements

where distortion as a function of level (SINAD¹ for example) is desired. Without this feature, measurements are very time consuming and tedious.

When an external stimulus is used, analyzer tuning is simplified by directional indicator lights for reaching the fundamental null quickly and easily.

IHF Standards

The ultra low distortion and true rms measuring capabilities of the 339A will be of significant interest to the manufacturers and sales/service companies offering high performance HI-FI equipment. The 339A conforms to portions of a new standard method of measurement for audio amplifiers (IHF-A-202 1978) published by the Institute of High Fidelity, Inc. Particularly noteworthy is the rms measurement of (THD + N) according to sections 1.17 and 2.9.3.1.

SINAD¹ Measurements

Receiver sensitivity and selectivity are two of the most important checks for a transceiver. Since both of these measurements are generally made by the SINAD¹ method, it is very important to use a distortion analyzer that automatically compensates for input variations and provides an accurate indication of noise. Now, with the 339A's auto set level feature and true-rms detection, a more accurate SINAD measurement is possible.

¹SINAD is a sensitivity measurement computed from the ratio of signal plus noise distortion to noise and distortion.

Auto set level eliminates the need for continually checking the 100% set level reference while the receiver input is reduced during the measurement, thus eliminating several tedious operator adjustments with a considerable savings in test time. Also, the true-rms responding 339A more accurately determines the thermal noise and harmonic components in SINAD since it is not subject to the same reading and calibration errors as an average detector.

FCC requirements

The FCC required features for broadcast testing are included in the 339A. They include an AM detector, 30 kHz low pass filter, and switchable VU meter ballistics.

Other features

Hum and noise filters, a high level monitor output for further harmonic analysis, and floating input are standard features on the model 339A.

Specifications

Distortion

Fundamental frequency range: 10 Hz to 110 kHz continuous frequency coverage in 4 decade ranges with 2-digit resolution. Distortion analyzer and oscillator are simultaneously tuned.

Distortion measurement range: 0.01% full scale to 100% full scale (-80 dB to 0 dB) in 9 ranges.

Detection and meter indication: True rms detection for waveforms with crest factor ≤ 3 . Meter reads dB and % THD (Total Harmonic Distortion). Meter response can be changed from NORMAL to VU ballistics with a front panel switch.

Distortion measurement accuracy:

20 Hz to 20 kHz	± 1 dB
10 Hz to 50 kHz	+1, -2 dB
50 kHz to 110 kHz	+1.5, -4 dB

Note: The above specifications apply for harmonics ≤ 330 kHz.

Fundamental rejection:

10 Hz to 20 kHz:	> 100 dB
20 kHz to 50 kHz:	> 90 dB
50 kHz to 110 kHz:	> 86 dB

Distortion introduced by instrument (input > 1V rms):

10 Hz to 20 kHz:	< -95 dB
20 kHz to 30 kHz:	< -90 dB
30 kHz to 50 kHz:	< -85 dB
50 kHz to 110 kHz:	< -70 dB

Residual noise (fundamental frequency settings < 20 kHz, 80 kHz filter IN, source resistance ≤ 1 K Ω shielded): < -92 dB referenced to 1V.

Input level for distortion measurements: 30 mV to 300 V rms (100 mV range minimum).

Input impedance: 100 k Ω \pm 1% shunted by < 100 pF input High to Low.

Monitor: Provides scaled presentation of input signal after fundamental is removed for further analysis using oscilloscope or low frequency spectrum analyzer. Output voltage: 1V rms \pm 5% open circuit for full scale meter indication, proportional to meter deflection. Output resistance: 1k Ω \pm 5%.

Auto set level: No set level adjustment required. Distortion measurements are made directly over 10 dB range selected by input range switch. Two LED annunciators provide a fast visual indication to change input range for valid distortion measurement. Correct range is indicated when both annunciators are extinguished.

Automatic fine tuning: Using internal oscillator: No separate analyzer tuning necessary when using internal oscillator as signal source. Oscillator frequency controls simultaneously tune the analyzer. Using external frequency source: Two LED annunciators provide a quick visual indication for the operator to increase or decrease the frequency. When the analyzer is rough tuned to within one least significant digit of the fundamental frequency, the indicator lights are extinguished and the 339A auto-null circuitry takes over to provide a fast, accurate null without tedious operator tuning.

Input filters (usable on all functions): Low Pass: 30 kHz-3 dB point at 30 kHz, +2.6 kHz, -3 kHz with 60 dB/decade rolloff. Provides band limiting required by FCC for proof-of-performance broadcast testing. 80 kHz-3 dB point at 80 kHz, +7 kHz, -7.9 kHz with 60 dB/decade rolloff. Normally used with fundamental frequencies < 20 kHz to reduce the effect of higher frequency noise present in the measured signal. High Pass: 400 Hz -3 dB point at 400 Hz, +35

Hz, -40 Hz with 60 dB/decade rolloff. Normally used with fundamental frequencies > 1 kHz to reduce the effect of hum components in the input signal.

DC isolation: Input low may be connected to chassis ground or floated to 30 V to reduce the effects of ground loops on the measurement.

Relative input level mode

Provides a ratio measurement relative to an operator selected reference level with readout directly in dBV or dBm (600 Ω). Voltage range, frequency range, accuracy specifications, and monitor are the same as in Voltmeter mode. (Accuracy is relative to 0 dB set level input.)

Oscillator

Frequency range: 10 Hz to 110 kHz in 4 overlapping decade ranges with 2 digit resolution. Frequency vernier provides continuous frequency tuning between 2nd digit switch settings.

Output level: Variable from < 1 mV to > 3 V rms into 600 Ω with 10 dB/step Level control and > 10 dB Vernier adjustment. OSC Level position on function switch allows a quick check of oscillator level without disconnecting leads to device under test. Off position on Oscillator Level control provides fast signal-to-noise measurement capability. Oscillator output terminals remain terminated in 600 Ω .

Frequency accuracy: \pm 2% selected frequency (with Frequency Vernier in Cal position).

Level flatness: 20 Hz to 20 kHz: $\leq \pm 0.1$ dB
10 Hz to 110 kHz: $\leq \pm 0.2$ dB

Distortion ($\geq 600\Omega$ Load, $\leq 3V$ Output):

10 Hz to 20 kHz:	< -95 dB (0.0018%) THD
20 kHz to 30 kHz:	< -85 dB (0.0056%) THD
30 kHz to 50 kHz:	< -80 dB (0.01%) THD
50 kHz to 110 kHz:	< -70 dB (0.032%) THD

Output resistance: 600 Ω \pm 5%

Voltmeter

Voltage range: 1 mV rms full scale to 300 V rms full scale (-60 dB to +50 dB full scale, meter calibrated in dBV and dBm into 600 Ω).

Detection and meter indication: True rms detection for waveforms with crest factor ≤ 3 . Meter reads true rms volts, dBm into 600 Ω , and dBV.

Accuracy (% of range setting):

20 Hz to 20 kHz:	$\pm 2\%$
10 Hz to 110 kHz:	$\pm 4\%$

Frequency range: 10 Hz to 110 kHz.

Input impedance: 100 k Ω \pm 1% shunted by < 100 pF input High to Low.

Monitor: Provides scaled presentation of input signal for further analysis using oscilloscope or low frequency spectrum analyzer. Output voltage: 1V rms \pm 5% open circuit for full scale meter indication, proportional to meter deflection. Output resistance: 1 k Ω \pm 5%.

AM Detector

Frequency range: Carrier frequencies: 550 kHz to 1.6 MHz. Modulation frequencies: 20 Hz to 20 kHz.

Distortion introduced by AM Detector (with 30 kHz filter switched IN): Up to 85% Modulation: < -36 dB (1.6%) THD
85% to 95% Modulation: < -30 dB (3%) THD

Input level: Maximum: 60V peak. Modulation signal level: 2V rms minimum; 10V rms maximum.

Monitor (with modulated RF carrier applied to AM Detector input).

Distortion mode: Provides scaled presentation of demodulated input signal after fundamental is removed.

Voltmeter and relative input mode: Provides scaled presentation of demodulated input signal. Output Voltage and Output Resistance are the same as in Distortion mode.

General

Power: 100/120/220/240 V + 5%, -10% 48 Hz to 66 Hz line operation, 200 mA maximum.

Dimensions: 146 mm H x 426 mm W x 375 mm D (5.75" x 16.75" x 14.75").

Weight: net 8.2 kg (18 lbs). Shipping 11.3 kg (25 lbs).

Ordering information

339A Distortion Measurement Set

\$1900

SIGNAL ANALYZERS

Distortion analyzers

Models 331A, 333A, 334A



333A

Description

Hewlett-Packard's models 331A, 333A and 334A Distortion Analyzers measure total distortion down to 0.1% full scale at any frequency between 5 Hz to 600 kHz; harmonics are indicated up to 3 MHz. These instruments measure noise as low as 50 microvolts and measure voltages over a wide range of level and frequency. Refer to table below for available models and features.

Model No.	Auto Nulling	Hi-Pass Filter	Lo-Pass Filter	AM Detector
331A				
333A	X	X		
334A	X	X		X
334A Opt. H05	X		X	X

Option 001 for each model features VU meter characteristics conforming to FCC requirements.

331A Specifications

Distortion measurement range: any fundamental frequency, 5 Hz to 600 kHz. Distortion levels of 0.1%–100% are measured full scale in 7 ranges.

Distortion measurement accuracy

Harmonic measurement accuracy (full scale)
Fundamental Input Less Than 30 V

Range	± 3%	± 6%	± 12%
100%–0.3%	10 Hz–1 MHz	10 Hz–3 MHz	
0.1%	30 Hz–300 kHz	20 Hz–500 kHz	10 Hz–1.2 MHz

Fundamental Input Greater Than 30 V

Range	± 3%	± 6%	± 12%
100%–0.3%	10 Hz–300 kHz	10 Hz–500 kHz	10 Hz–3 MHz
0.1%	30 Hz–300 kHz	20 Hz–500 kHz	10 Hz–1.2 MHz

Elimination characteristics: fundamental rejection >80 dB. Second harmonic accuracy for a fundamental of 5 to 20 Hz; better than +1 dB; 20 Hz to 20 kHz; better than ±0.6 dB; 20 kHz to 100 kHz; better than –1 dB; 100 kHz to 300 kHz; better than –2 dB; 300 kHz to 600 kHz; better than –3 dB.

Distortion introduced by instrument: > –70 dB (0.03%) from 5 Hz to 200 kHz. > –64 dB (0.06%) from 200 kHz to 600 kHz. Meter indication is proportional to average value of a sine wave.

Frequency calibration accuracy: better than ±5% from 5 Hz to 300 kHz. Better than ±10% from 300 to 600 kHz.

Input impedance: distortion mode; 1 MΩ ±5% shunted by <70 pF (10 MΩ shunted by <10 pF with HP 10001A 10:1 divider probe).

Voltmeter mode: 1 MΩ ±5% shunted by <35 pF, 1 to 300 V rms; 1 MΩ ±5% shunted by <70 pF, 300 μV to 0.3 V rms.

Input level for distortion measurements: 0.3 V rms for 100% set level or 0.245 V for 0 dB set level (up to 300 V may be attenuated to set level reference).

DC isolation: signal ground may be ±400 V dc from external chassis.

Voltmeter range: 300 μV to 300 V rms full scale (13 ranges) 10 dB per range.

Voltmeter accuracy: (using front panel input terminals)

Range	± 2%	± 5%
300 μV	30 Hz–300 kHz	20 Hz–500 kHz
1 mV–30 V	10 Hz–1 MHz	5 Hz–3 MHz
100 V–300 V	10 Hz–300 kHz	5 Hz–500 kHz

Noise measurements: voltmeter residual noise on the 300 μV range: <25 μV rms, when terminated in 600 (shielded) ohms, <30 μV rms terminated with a shielded 100 kΩ resistor.

Output: 0.1 ±0.01 V rms open circuit and 0.05 ±0.005 V rms into 2 kΩ for full scale meter deflection.

Output impedance: 2 kΩ.

Power supply: 115 or 230 V ±10%, 50 to 66 Hz, approximately 4 VA.

333A Specifications

Same as Model 331A except as indicated below:

Automatic nulling mode: set level: at least 0.2 V rms

Frequency ranges: X1, manual null tuned to less than 3% set level; total frequency hold-in ±0.5% about true manual null. X10 through X10 k, manual null tuned to less than 10% of set level; total frequency hold-in ±1% about true manual null.

Automatic null accuracy: 5 Hz to 100 Hz: meter reading within 0 to +3 dB of manual null. 100 Hz to 600 kHz: meter reading within 0 to +1.5 dB of manual null.

High-pass filter: 3 dB point at 400 Hz with 18 dB per octave roll off. 60 Hz rejection: 40 dB. Normally used with fundamental frequencies greater than 1 kHz.

Power supply: same as Model 331A.

334A Specifications

Same as Model 333A except as indicated below:

AM detector: high impedance DC restoring peak detector with semiconductor diode operates from 550 kHz to greater than 65 MHz. Broadband input, no tuning is required.

Maximum input: 40 V p-p AC or 40 V peak transient.

Distortion introduced by detector: carrier frequency: 550 kHz–1.6 MHz: <50 dB (0.3%) for 3–8 V rms carriers modulated 30%. 1.6 MHz–65 MHz: <40 dB (1%) for 3–8 V rms carriers modulated 30%.

Note: Distortion introduced at carrier levels as low as 1 Volt is normally <40 dB (1%) 550 kHz to 65 MHz for carriers modulated 30%.

General

Dimensions: 426 mm W x 126 mm H x 337 mm D (16.75" x 5" x 13.25").

Weight: net, 7.98 kg (17.75 lb). Shipping, 10.35 kg (23 lb).

Ordering information

Option 001, indicating meter has VU characteristics conforming to FCC requirements for AM/FM and TV broadcasting

H05-332A (meets FCC requirements)

H05-334A (meets FCC requirements)

331A Distortion Analyzer

333A Distortion Analyzer

334A Distortion Analyzer

Price

add \$25

add \$129

add \$105

\$1160

\$1300

\$1370



Description

Hewlett-Packard's 3581A Wave Analyzer resolves and measures the amplitude and frequency of spectral components. This instrument offers accurate amplitude and good frequency resolution in the form of a portable, easy to use measuring tool. Since not all signals originate from a stable frequency source, the 3581A incorporates an AFC circuit which locks to a drifting signal for stable, accurate measurements.

HP's 3581A has other important features that are necessary when making measurements of small voltages from transducers and harmonic signals. Its 30 nV sensitivity becomes important for these measurements. Battery operation or balanced input option can be used to reduce the line related interference common in low level measurements so only the real spectrum is measured.

Digital readout of tuned frequency is located above the analog meter. It has been grouped with the meter for ease of reading. Resolution of the digital readout is 1 Hz for any frequency between 15 Hz and 50 kHz. Readout is updated five times per second so delay between tuning and reading is minimized.

Four meter scales are used to provide a wide range of displays. Two scales are used for linear voltage readings. Two log scales provide either a 90 dB or 10 dB display. In any case, the large meter with its mirror backing can present readings in dBV, dBm or volts. A meter was specifically chosen for amplitude display rather than digital readout because it is easier to peak a meter reading and because it's much easier to get a feel for noise or other amplitude variations by watching the meter. The same voltage used to drive the meter is also available on the rear panel for driving X-Y recorders.

Specifications*

Frequency characteristics

Range: 15 Hz to 50 kHz.

Display: 5 digit LED readout.

Resolution: 1 Hz.

Accuracy: ± 3 Hz.

Typical stability: ± 10 Hz/hr after 1 hour and ± 5 Hz/ $^{\circ}$ C.

Automatic frequency control (AFC) hold-in range: ± 800 Hz.

Amplitude characteristics

Instrument range

Linear: 30 V to 100 nV full scale.

Log: +30 dBm or dBV to -150 dBm or dBV.

Amplitude accuracy:	Log	Linear
Frequency response,	± 0.4 dB	$\pm 4\%$
15 Hz-50 kHz		

Dynamic range: >80 dB.

Noise sidebands: greater than 70 dB below CW signal. 10 bandwidths away from signal.

Spurious responses: >80 dB below input reference level.

Sweep characteristics

Scan width: 50 Hz to 50 kHz. These scans can be adjusted to cover a group of frequencies within the overall instrument range.

Sweep error light: this LED indicates a sweep that is too fast to capture full response. When the light is on, response will be lower than it should be.

External trigger: a short to ground stops the normal sweep. Opening the short then enables a sweep.

Input characteristics

Impedance: 1 M Ω , 30 pF.

Maximum input level: 100 V rms, ± 100 V dc.

Output characteristics

Tracking generator output: (also known as BFO or tracking oscillator output).

Range: 0 to 2 V rms.

Frequency response: $\pm 3\%$ 15 Hz to 50 kHz.

X-Y recorder analog outputs

Vertical: 0 to +5 V $\pm 2.5\%$.

Horizontal: 0 to +5 V $\pm 2.5\%$.

Impedance: 1 k Ω .

Pen lift: contact closure to ground during sweep.

Restored output: acts as a narrow band amplifier.

General

Power requirements: 100 V, 120 V, 220 V, or 240 V $\pm 5\%$ -10%, 48 Hz to 440 Hz, 10 VA typical.

Dimensions: 412.8 mm H x 203.2 mm W x 285.8 mm D (16 $\frac{1}{4}$ " x 8" x 11 $\frac{1}{4}$ ").

Weight: 11.5 kg (23 lb). Opt 001: 13.5 kg (30 lb).

Options

001: Internal battery 12 hours from full charge. Internal battery is protected from deep discharge by an automatic turnoff. Useful life of this battery is over 100 cycles.

910: Extra set manuals

Price

add \$405

add \$20

3581A Wave Analyzer

\$3400

*Note: for complete specifications, refer to page 576 (HP 3581C selective voltmeter) which is a dedicated telecommunication version of the HP 3581A wave analyzer.

SIGNAL ANALYZERS

1 kHz to 18 MHz selective voltmeter/tracking oscillator

Models 312B & 313A



312B (top), 313A

Description

Hewlett-Packard Model 312B/313A is a frequency selective voltmeter/tracking oscillator operating in the frequency range of commercially available carrier and radio systems. The set is capable of making transmission and noise measurements. A 312D is available with special features for telecommunications applications. See page 598.

HP's 312B uses a frequency synthesizer for tuning that is automatically phase locked in 1 MHz steps. Tuning between lock points is indicated on a 7-place digital readout with 10 Hz plus time-base accuracy. Coupled with this digital indication of unambiguous frequency is an automatic tuning aid known as automatic frequency control (AFC). The AFC will automatically fine tune frequency to the center of the set's passband, and automatically correct any relative frequency drift between the set and the signal being measured. Long term monitoring of signals is possible without periodic readjustment. High frequency accuracy coupled with AFC gives clear, instantaneous tuning and eliminates the need to search for signals.

Input and IF attenuators allow a maximum of dynamic range without concern for overloading the set. Attenuators can be easily set for minimum distortion or noise performance. Attenuator settings are in-

dicated clearly on a lighted annunciator which, when added to meter indication, gives a fast indication of input level. An accessory expanded scale meter allows 0.02 dB resolution of input level for high resolution readings.

The instrument is equipped with both balanced and unbalanced inputs to fit measuring situations without the need for external accessory transformers. A wide selection of input impedances, either bridging or terminated, is provided along with provisions for an accessory high impedance, balanced bridging probe to reduce measurement errors. The set always indicates directly in dBm or volts at any impedance, eliminating time consuming calculations or conversion charts.

Three selectable bandwidths are provided for all measurement situations. A narrow 200 Hz bandwidth is used for highly selective measurements, a 1000 Hz bandwidth for general measurements, and a 3100 Hz bandwidth for noise measurements.

Demodulation of upper or lower sideband channels with an audio output is provided for monitoring noise, traffic, or tones in any channel. The accurate digital frequency readout requires only a quick reference to the line frequency charts to determine frequency for perfect demodulation. In this respect, Model 312B can be thought of as a single-channel, tuneable, multiplex, receive terminal.

HP's Model 313A Tracking Oscillator provides an accurate, flat output at the frequency to which the 312B is tuned for frequency response measurements. Output frequency is quickly and easily set by the digital tuning indicator on the selective voltmeter.

Output level is easily set by a 3-digit presentation with 0.1 dB resolution. Output level is also easily read and remains constant with changes in frequency requiring no time consuming resetting of level at each new frequency.

A built-in meter provides an expanded scale display of the 312B's meter indication with 0.02 dB resolution of input level.

312B Specifications

Tuning characteristics

Frequency range: 1 kHz to 18 MHz in 18 overlapping bands, 200 kHz overlap between bands.

Frequency accuracy: ± 10 Hz + time base accuracy. Frequency indicated on in-line digital readout with ± 10 Hz resolution.

Selectivity

Bandwidth Hz	3 dB BW	60 dB BW
200 Hz	200Hz $\pm 10\%$	426 Hz $\pm 10\%$
1000Hz	1kHz $\pm 10\%$	2135 Hz $\pm 10\%$
3100 Hz	3100 Hz $\pm 10\%$	6200 Hz $\pm 10\%$

Amplitude characteristics

Amplitude measurement range

50 Ω to 150 Ω : -120 dBm to +23 dBm.

600 Ω : -130 dBm to +13 dBm.

Voltage: 200 mV full scale to 3.2 V (50 Ω reference).

Amplitude accuracy

Frequency response (bridging input with external termination of 50 Ω $\pm 1\%$).

1 kHz to 10 kHz: ± 0.5 dB (5% of reading).

10 kHz to 10 MHz: ± 0.2 dB (2% of reading).

10 MHz to 18 MHz: ± 0.5 dB (5% of reading).

Matching impedance: 50 Ω , 60 Ω , 75 Ω , 124 Ω , 135 Ω , 150 Ω or 600 Ω , balanced or unbalanced on 312B.

Distortion

Harmonically related, 1 kHz to 1 MHz: >55 dB below zero reference. 1 MHz to 18 MHz; >65 dB below zero reference. Residual response.

Noise Floor: <-120 dBm in 1 kHz Bandwidth and 75 Ω input.

Receiver characteristics

Receiver mode outputs

AM: diode-demodulated audio.

Beat: beat frequency audio centered at f_0 .

LSB: product-demodulated audio, carrier reinserted at $f_0 + 1.8$ kHz.

USB: product-demodulated audio, carrier reinserted at $f_0 - 1.8$ kHz.

Audio output level: >0.5 V rms into 10k Ω with full-scale meter deflection.

Recorder output level: 1 V ± 0.1 V with full-scale deflection across open circuit.

Power: 115 V or 230 V $\pm 10\%$, 48 Hz to 66 Hz, <100 VA.

Size: 266 mm H x 425 mm W x 467 mm D (10 $\frac{15}{32}$ " x 16 $\frac{3}{4}$ " x 18 $\frac{3}{4}$ ").

Weight: net, 20.7 kg (46 lb).

313A Specifications

Frequency range

As tracking oscillator: 10 kHz to 18 MHz.

As signal source: 10 kHz to 18 MHz in one band, continuous tuning.

Frequency accuracy

As tracking oscillator: 35 Hz ± 4 Hz above 312B tuning.

As signal source

10 kHz to 2 MHz: $\pm 1\%$ of max dial setting.

2 MHz to 8 MHz: $\pm 3\%$ of max dial setting.

8 MHz to 22 MHz: $\pm 5\%$ of max dial setting.

Frequency stability

As signal source: short-term (5 min) drift <1 kHz in stable environment after warmup.

Frequency response: ± 0.1 dB, 10 kHz to 18 MHz.

Amplitude stability: ± 0.1 dB for 90 days (0 $^\circ$ to 55 $^\circ$ C).

Maximum output: 0 dBm or +10 dBm ± 0.1 dB, selectable at front panel.

Output attenuator: 3-section attenuator provides 0 dB to 99.9 dB attenuation in 0.1 dB steps.

Attenuator accuracy

0.9 dB section (0.1 dB steps): ± 0.02 dB.

9 dB section (1 dB steps): ± 0.1 dB.

90 dB section (10dB steps): ± 0.1 dB to 50 dB, ± 0.2 dB to 90 dB.

Output impedance: 75 Ω unbalanced. (50 Ω option: 01)

Harmonic distortion: more than 34 dB below fundamental.

Recorder output: ± 0.3 V for full-scale deflection. Output impedance 1 k Ω , BNC female connector.

Power: 115 V or 230 V $\pm 10\%$, 48 Hz to 66 Hz, <35 VA.

Size: 132.6 mm H x 425 mm W x 467 mm D (5 $\frac{1}{32}$ " x 16 $\frac{3}{4}$ " x 18 $\frac{3}{4}$ ").

Weight: net, 11.3 kg (25 lb).

312B Options

001: carrier rejection notches inserted at $f_0 \pm 2$ kHz Price add \$120

Ordering information

312B Selective Voltmeter \$5600

313A Tracking Oscillator \$2255

SIGNAL ANALYZERS

Modulation Analyzer, 150 kHz to 1300 MHz

Model 8901A

- Measures AM and FM to 1% accuracy
- Measures RF frequency
- Measures peak envelope power
- Low internal noise
- Completely automatic
- Optional built-in AM & FM calibrators



8901A

8901A Modulation analyzer

The 8901A Modulation Analyzer combines the capabilities of several instruments to give a complete, accurate characterization of modulated signals in the 150 kHz to 1300 MHz frequency range. It very accurately measures modulation and recovers the modulation signal. It determines RF frequency with 10 or 100 Hz resolution. It also measures RF peak power and in many instances eliminates the need for a power meter. The analyzer is ideally suited for characterization of transceivers and for metrology applications in calibrating precision signal generators. The fully automatic 8901A makes all major measurements with the push of a single key or under HP-IB control. Hewlett-Packard Interface Bus (HP-IB) control is included in the standard instrument.

Modulation Measurement Accuracy

Very accurate modulation measurements along with very low internal noise enable the 8901A to characterize even high performance signal sources. Its detection system is configured for wideband recovery of the entire modulation spectrum so that highly precise measurements such as signal to noise or distortion can be made on the modulation signal. Modulation depth and deviation accuracy is generally <1% of reading. Residual AM noise in a 50 Hz to 3 kHz bandwidth is 0.02% while FM noise is <10 Hz for 1300 MHz carrier frequencies, decreasing to <1 Hz below 100 MHz. Since AM and FM demodulators are independent and highly insensitive to each other, measurements of incidental AM and FM can be made with high precision.

Three detectors are available for depth and deviation measurements, positive peak, negative peak, and an average-responding detector with RMS (sinewave) calibration. This allows for the determination of residual noise on a signal. The PEAK HOLD function captures and displays the maximum peak modulation of a signal and is ideal for making transient measurements such as modulation limiting on mobile radios. It can capture even very short transients and hold their peak indefinitely.

For measuring convenience, two high-pass and three low-pass post-detection filters for filtering the recovered modulation are included. The 20 kHz Bessel filter was chosen to give minimum overshoot for square wave modulation. This allows accurate measurement of signals which are digitally modulated such as FSK.

Four de-emphasis networks commonly used in FM systems, 25, 50, 75, and 750 μ s, are provided. When chosen, the de-emphasis networks always affect the demodulated output but the user can select whether or not the de-emphasis network affects the deviation measured and indicated by the display.

Option 010 provides precision modulation standards. One standard is an amplitude modulated signal whose depth is calibrated to <0.1% accuracy. The second standard is a frequency modulated signal with peak deviation calibrated to <0.1% accuracy. Because the modulation standard can be included in the analyzer, metrology laboratories are not required to purchase a separate standard for calibration.

Complete Signal Characterization

The 8901A Modulation Analyzer is more than just a high quality modulation meter. It also performs as a frequency counter and RF power meter. Resolution for the 150 kHz to 1300 MHz frequency counter is 10 Hz below 1000 MHz and 100 Hz above 1000 MHz. Sensitivity is -25 dBm (12 mV rms) below 650 MHz and -20 dBm (22 mV rms) above 650 MHz. The standard instrument's time base stability is <1x10⁻⁶/month or an optional time base is available with <1x10⁻⁹/day stability.

With a wide dynamic range, >50 dB (<22 mV rms to 7 V rms), the Modulation Analyzer automatically adjusts the internal level of the signal for optimum measurement. It can also selectively measure signals other than the largest with the approximate frequency entered via the keyboard. This is done with an unprecedented sensitivity of 0.22 mV rms, and dynamic range of >90 dB. Input protection from damage is provided for signals up to 25 W.

The 8901A uses a diode detection circuit to measure RF input power. This technique measures peak voltage and is calibrated from 1 mW to 1W for sine wave inputs.

Another function, TUNED RF LEVEL, configures the modulation analyzer as a selective RF power meter, allowing measurement of only signal levels in the tuned IF filter passband prior to automatic leveling.

Ease of Operation

The 8901A Modulation Analyzer provides unexcelled accuracy while remaining extremely easy to use. Under control of an internal microprocessor the 8901A is fully automatic and autoranging. Most measurements require only a single keystroke. There is no need to tune the analyzer, adjust levels, or select the appropriate range. Data processing routines of the microprocessor permit the user to make measurements relative to a measured value or to one entered from the keyboard by using the ratio keys.

Special functions entered using the numerical keys and the special function key give the operator manual control of instrument functions, instrument operation, and service aids. For example, one special function configures the instrument to track input signals without losing frequency lock. This simplifies measurement routines which require data at various frequencies across a band.

8901A Specifications

RF input

Frequency Range: 150 kHz to 1300 MHz
Operating Level: 150 kHz–650 MHz: 12 mV_{rms} to 7 V_{rms}
 650 MHz–1300 MHz: 22 mV_{rms} to 7 V_{rms}
Input Impedance: 50Ω nominal

Frequency Modulation

Rates: 150 kHz–10 MHz: 20 Hz to 10 kHz
 10 MHz–1300 MHz: 20 Hz to 200 kHz
Deviations: 150 kHz–10 MHz: 40 kHz_{peak} maximum
 10 MHz–1300 MHz: 400 kHz_{peak} maximum

Accuracy¹:

150 kHz–10 MHz: +1%, -2% of reading ± 1 digit, 20 Hz to 10 kHz rates
 10 MHz–1300 MHz: ± 1% of reading ± 1 digit, 30 Hz to 150 kHz rates
 ± 5% of reading ± 1 digit, 20 Hz to 200 kHz rates

Demodulated Output Distortion:

250 kHz–10 MHz: <0.1% THD, deviations <10 kHz
 10 MHz–1300 MHz: <0.1% THD, rates and deviations <100 kHz
AM Rejection (for 50% AM at 400 Hz and 1 kHz rates): <20 Hz deviation measured in a 50 Hz to 3 kHz BW.

Residual FM (50 Hz to 3 kHz BW): <10 Hz_{rms} @ 1300 MHz, decreases linearly with frequency to <1 Hz_{rms} for 100 MHz and below.

Deviation Resolution:

1 Hz, <4 kHz deviation
 10 Hz, 4 kHz to 40 kHz deviation
 100 Hz, 40 kHz to 400 kHz deviation

Phase Modulation

Carrier Frequency: 10 MHz to 1300 MHz

Rates: 200 Hz to 20 kHz.

Deviation and Resolution¹:

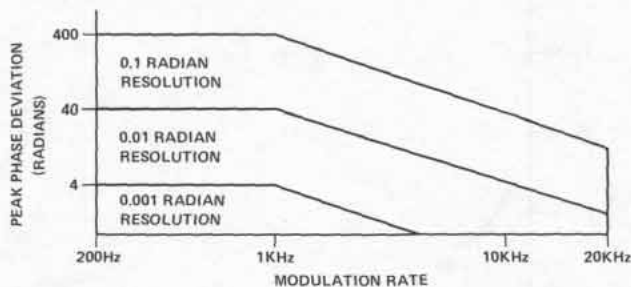

Accuracy: ± 3% of reading ± 1 digit

Demodulated Output Distortion: <0.1% THD

AM Rejection (for 50% AM at 1 kHz rate): ≤ 0.02 radians

Amplitude Modulation

Rates:

150 kHz–10 MHz: 20 Hz to 10 kHz
 10 MHz–1300 MHz: 20 Hz to 100 kHz

Depth: to 99%

Accuracy¹:

150 kHz–10 MHz: +1%, -2% of reading ± 1 digit, 50 Hz to 10 kHz rates, >5% depth
 ± 3% of reading ± 1 digit, 20 Hz to 10 kHz rates
 10 MHz–1300 MHz: ± 1% of reading ± 1 digit, 50 Hz to 50 kHz rates, >5% depth
 ± 3% of reading ± 1 digit, 20 Hz to 100 kHz rates

Demodulated Output Distortion: 0.3% THD for ≤ 50% depth
 0.5% THD for ≤ 95% depth

FM Rejection (at 400 Hz and 1 kHz rates, 50 Hz to 3 kHz BW):

250 kHz to 10 MHz: <0.1% AM for <5 kHz_{peak} deviation

10 MHz to 1300 MHz: <0.1% AM for <50 kHz_{peak} deviation

Residual AM (50 Hz to 3 kHz BW): <0.02%_{rms}

Depth Resolution: 0.01% for depths ≤ 39.99%

0.1% for depths ≥ 40%

Frequency Counter

Range: 150 kHz–1300 MHz

Accuracy: Reference accuracy ± 3 digits.

Internal Reference: Frequency: 10 MHz

Aging rate: <1 × 10⁻⁹/month (Optional: 1 × 10⁻⁹/day²)

Maximum Resolution: 10 Hz for frequencies <1 GHz

100 Hz for frequencies ≥ 1 GHz

RF Level (peak voltage responding, rms sine wave power calibrated)

Range: 1 mW to 1W

Instrumentation Accuracy: ± 2 dB

SWR: <1.5 in a 50Ω system

Resolution: 0.1 mW for levels 0.1 to 1W

0.01 mW for levels 0.01 to 0.1W

0.001 mW for levels <0.01W

Audio Filters

(High-pass: 50 Hz and 300 Hz. Low-pass: 3 kHz, 15 kHz, > 20 kHz.)

De-emphasis filters: 25 μs, 50 μs, 75 μs, and 750 μs.)

Fiatness:

50 Hz High Pass: <1% at rates ≥ 200 Hz

300 Hz High Pass: <1% at rates ≥ 1 kHz

3 kHz Low Pass: <1% at rates ≤ 2 kHz

15 kHz Low Pass: <1% at rates ≤ 10 kHz

>20 kHz Low Pass: <1% at rates ≤ 10 kHz

¹Peak residuals must be accounted for in peak readings.

²After 30 day warm-up.

Calibrators (Option 010)

AM Calibrator Depth and Accuracy: 33.33% depth nominal, internally calibrated to an accuracy of ± 0.1%

FM Calibrator Deviation and Accuracy: 33 kHz_{peak} deviation nominal, internally calibrated to an accuracy of ± 0.1%

General Characteristics

Operating Temperature Range: 0° to 55°C

Power Requirements: 100, 120, 220, or 240V (+5, -10%); 48-66 Hz; 200 VA max.

Weight: Net 19.7 kg (44 lb); shipping 25.2 kg (56 lb).

Dimensions: 465 mm D × 425 mm W × 187 mm H (18.3 in × 16.8 in × 7.4 in.).

Options

001: Rear panel instead of front panel connectors \$100

002: 3 × 10⁻⁹/day internal reference oscillator 600

003: Rear panel connections for external local oscillator 200

004: Operation from 48 to 440 Hz power line 150

010: AM and FM calibrators 500

Ordering Information

8901A Modulation Analyzer

\$7500

SIGNAL ANALYZERS

Frequency Stability Analyzer

Model 5390A

- Phase noise measurements close to carrier
- Offsets from 0.01 Hz to 10 kHz
- Sensitivity as high as -140 dBc at 1 Hz offset
- Measures sources to 18 GHz
- Automatic Operation



5390A Frequency Stability Analyzer

GENERAL

The 5390A Frequency Stability Analyzer will characterize oscillator stability in either the time domain or the frequency domain. For time domain characterization, the 5390A measures fractional frequency deviation which represents the RMS deviation of the signal from the nominal carrier frequency measured over a given time interval. For characterization in the frequency domain, the 5390A presents results in terms of the spectral density of phase fluctuations. The 5390A specializes in high resolution phase noise measurements close to the carrier where other techniques are difficult to use or are unable to make the measurements at all.

The system can accommodate a wide frequency range of input signals from 500 kHz to 18 GHz. Provision is also made for external mixers for broader frequency coverage or direct input in the range of DC-100 kHz. With this amount of flexibility, almost any oscillator can be measured with the 5390A. All the signal processing capabilities needed to make measurements are built into the system, including down-conversion, low-noise amplification, and bandwidth control.

The 5390A is a complete hardware and software measurement capability, fully assembled and tested at the factory. Making measurements only requires connecting the test and reference oscillators and specifying a few measurement parameters. Thereafter, the system runs unattended to the completion of the specified group of measurements. Access to the interactive application programs is provided through specially defined keys on the computing controller's keyboard.

Measurement Technique

The basic system configuration uses a heterodyne down-conversion technique to produce a measurable signal. Two oscillators, the test oscillator at a carrier frequency ν_0 and a reference oscillator at a frequency $\nu_0 \pm \nu_b$, are connected to a double balanced mixer through one of the sets of inputs on the 10830A Mixer/IF Amplifier. (Usually two identical oscillators, one slightly offset, are used. In this case, the noise measured is twice the contribution of either oscillator. The 5390A's software can compensate for this factor of two to produce the correct result). The resultant difference frequency (or "beat" frequency), ν_b , is filtered and amplified by a low noise limiting amplifier and applied to the input of the 5345A Electronic Counter. The 5345A makes frequency measurements of the beat frequency under the control of the 5358A Measurement/Storage Plug-in at measurement intervals also determined by the 5358A. The measurement results are stored locally in the 5358A facilitating the taking of a large number of measurements very rapidly and reducing "dead time" between measurements to less than 17 μ s.

Fractional Frequency Deviation Measurements

The 5390A system measures fractional frequency deviation over an exceptionally wide range of averaging times (τ values). τ values as small as 10 μ s and as large as 999×10^3 s can be accommodated by the system. The measurement bandwidth is another parameter critical to the validity of fractional frequency measurements. The 5390A provides the choice of several bandwidths: 100 kHz, 25 kHz, 6.3 kHz, 1.6 kHz, 400 Hz, 100 Hz and 25 Hz. There is also provision for an external filter.

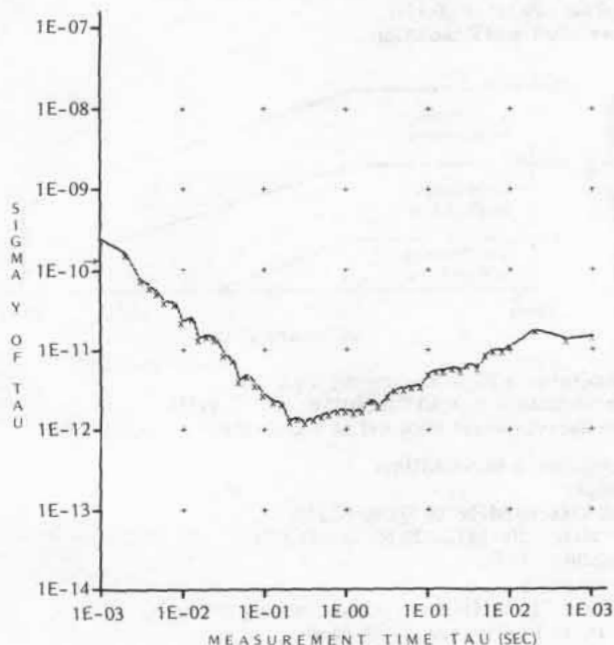

Sample σ_y vs τ plot generated by 5390A.



5390 opt 010 instrument cluster (shown with Digital Clock opt 004)

Phase Spectral Density Measurements

The measurement of close-in phase noise (spectral density of phase fluctuations) at offset frequencies from the carrier below 10 to 100 Hz has traditionally been difficult or impossible. Now, with the 5390A, it is possible to make these measurements rapidly and easily. The measurement technique is based on an N sample variance computed by the 9825A from frequency measurements made by the 5345A. Phase noise spectral density is then determined from the measured N sample variance. The 5358A Measurement Storage Plug-In controls gate time and dead time between frequency measurements. This makes the 5345A look like a digital filter in the frequency domain whose center frequency and bandwidth are determined by gate time, dead time, and number of measurements in the sample.

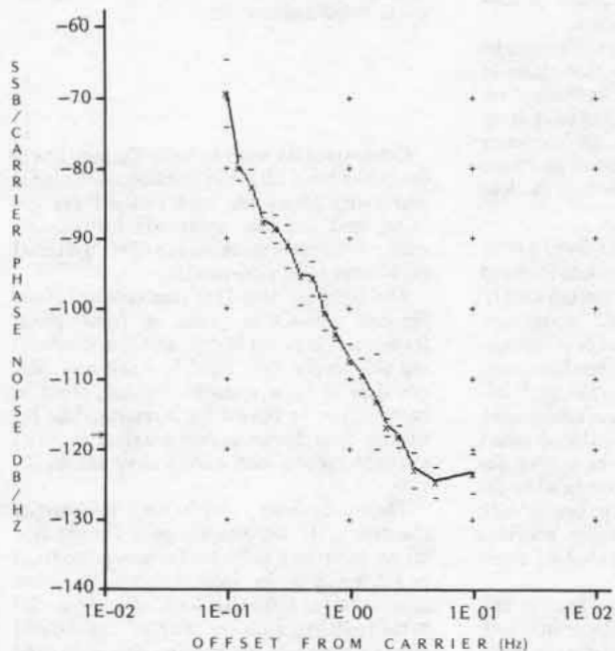

Sample phase noise plot generated by 5390A.

Option 010 Dual Mixer Time Difference

Measurements can be made with the 5390A using either the standard single heterodyne configuration or the dual mixer time difference configuration (Option 010). The primary application of the single heterodyne method is where an offsettable reference oscillator is available, whose noise over the range of interest is equal to or better than the test oscillator. The primary application of the Option 010 configuration is for measuring non-offsettable sources.

In the Dual Mixer Time Difference configuration of the system (Option 010) a second 10830A Mixer-IF Amplifier is added. A third difference oscillator is used in this set-up to produce two measurable signals. The test oscillator at a frequency ν_0 and the reference oscillator at essentially the same frequency are each applied to the 10830A's. The difference oscillator's signal ($\nu_0 + \nu_b$) is split and applied to both 10830A's. The resultant two difference signals (ν_b) are applied to the 5345A's inputs and time interval measurements are made between the two at intervals τ .

Systems Options

	Price
001 Expands 5358A memory in 2K increments. Up to 3 Opt. 001's may be added.	add \$300 each
004 Adds 59309A Digital Clock and HP-IB cable.	add \$1085
010 Adds second 10830A, 59308A, power splitter, system cabinet, and expands 5358A memory to 6K bytes.	add \$5900
102 Expands 9825A memory from 15,036 bytes to 23,228 bytes.	add \$800
325 Deletes 9825A	less \$7950
371 Deletes 9871 Printer/Plotter	less \$3600

Ordering Information

- 5390A Basic System includes:
- 5345A Option 011 Electronic Counter
 - 5358A Measurement Storage Plug-In
 - 10830A Mixer/IF Amplifier
 - 10831A Test Tone Generator
 - 9825A Option 001 Computing Controller
 - 98210A Advanced Programming, String ROM
 - 98213A General I/O, Extended I/O ROM
 - 98034A HP-IB Interface
 - 9871A Option 001 Printer/Plotter
 - System Cabinet
 - System Software

5390A Basic System

\$26,100

CABINETS & MEASUREMENT ACCESSORIES

Modular enclosure system for individual HP products

System-II

- Truly modular, fits standard heights and widths
- Broad range of accessories for bench or rack use
- Strong frame, yet easy service access to interior

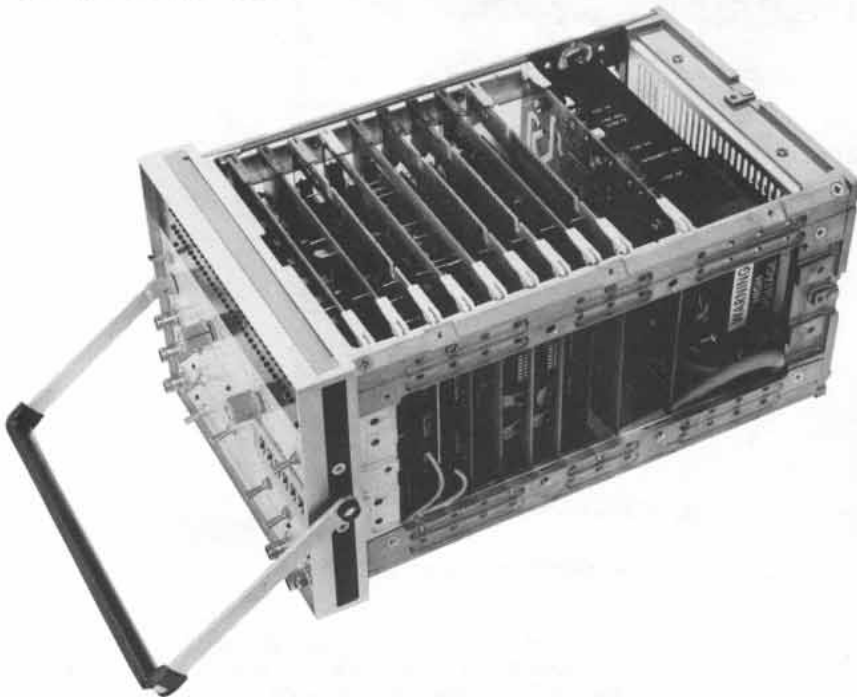

Look inside newer HP instruments housed in System-II cabinets, and you will find an extremely strong frame allowing maximum use of interior space. Yet, there's excellent service access from top, bottom and sides. (Optional bail handle is shown on this particular instrument.)

In 1961, Hewlett-Packard introduced a new universal enclosure system for instruments. That system (called "System I" within HP) made it practical to stack instruments neatly for bench use, while at the same time providing a convenient means for mounting the instruments directly in a rack. It was also esthetically more appealing than the simple boxes of various sizes that had been the norm—and it provided more convenient access to internal parts and more efficient use of space than the conventional chassis-slipped-into-a-box approach commonly in use at that time.

Need for a new enclosure system

Continuing changes in the nature of electronic instrumentation have created new needs in enclosure systems. Foremost among these is the need for even better accessibility to internal parts, as circuits become more densely packed. Ideally, this not only means access from top and bottom, as provided by the 1961 system, but also from the sides, front and back as well.

Today's miniaturized circuits also lead to two other types of problems. First, the enclosures tend to be smaller than in the past—meaning that costly combining cases or space-consuming rack adapter frames are often required for grouping smaller products together on the bench or in the rack. Second,

there's the need to optimize utilization of smaller front panel areas—and it becomes increasingly difficult to arrange displays, nomenclature and the growing number of controls for convenient user operation.

Radiated electrical interference can also be a significant problem, as transition times of digital signals shorten to the nanosecond region. This means that instruments tend to radiate a greater amount of high-frequency energy, thereby creating potential problems for users operating sensitive devices in close proximity.

New standard enclosure: System-II

With the above in mind, Hewlett-Packard has developed a new enclosure system for HP products, using an "inside-out" design approach. That is, design priorities first concentrated on all servicing, manufacturing, electrical, mechanical, and thermal needs before turning to the esthetic considerations. The resulting enclosure has greater strength but is lighter in weight than the earlier design. Also, it provides better accessibility for servicing, has more versatility in bench/rack configurations, and it inherently provides significant attenuation of unwanted RF energy.

This new enclosure is called "System II", and it is now the standard package in which new HP cabinet-enclosed products are being introduced.

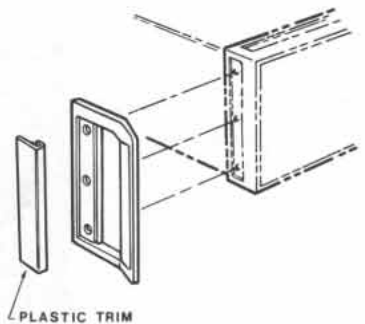

PLASTIC TRIM

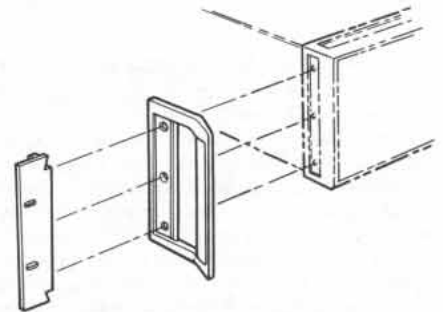
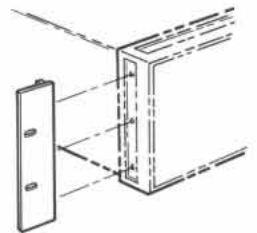

Three front handle and/or rack flange kits are available as standard options on full-width instruments—or, the kits may be purchased separately.

Compatibility with current System-I products has been carefully considered. Cabinet and panel colors for both systems are the same, and the new System-II instruments will conveniently stack on the older System-I enclosures (and vice-versa).

The basic System-II frame consists of six die-cast aluminum parts: a front panel frame, a rear panel frame, and four connecting side struts. It is rigid by itself and does not depend upon internal decking, front or rear panels, or covers for strength. The resulting open design makes maximum use of available space, and allows easy access inside.

The sturdy front panel frame is the heart of the design. It has integral pads for the side struts, mounting holes for fastening the front panel, recesses for front handles and rack flanges or for links that lock adjacent enclosures together, slots for plug-in latches, and narrow channels for holding top, side, and bottom covers.

Heights

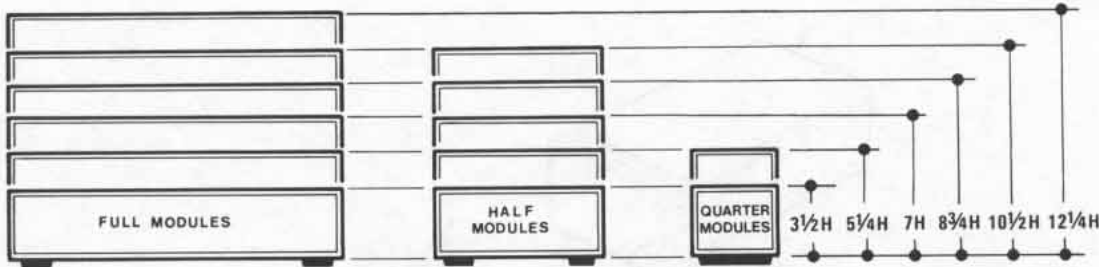

Widths

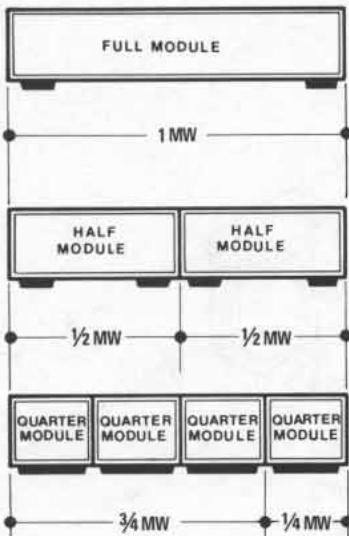

The narrow U-shaped channels serve as wave traps that reduce the radiation of (or susceptibility to) unwanted RF energy. As a further precaution, small ridges aligned in the direction of cover insertion provide high-pressure points for establishing good electrical contact. Only RF energy at wavelengths much shorter than those of concern can move between these contact points. Trim detail on the side covers provide the same kind of RF seal along the sides, as does a similar arrangement under the lip of the covers at the rear. The covers, however, are each retained by a single captive screw, enabling quick removal for servicing.

The sizes of holes such as those needed for mounting cabinet feet have been reduced to practical minimums.

Maximized panel area

Unlike the earlier design, the System-II front panel frame uses all the available area in full multiples of vertical EIA/IEC increments. Also, the front panel frame overhangs lower side members, completely filling the allotted rack space while still allowing room for the optional use of System-II rack support shelves.

The front panel mounts to the framework with screws accessible from the outside, and because it does not serve as a structural member, there is an increase in the amount of usable panel space. This reduces the crowding of controls so instruments become easier to operate.

All screws used in cabinet assembly are of the self-locking type with an inserted plastic patch on the threads, preventing the screws from working loose when subject to vibration.

Easier carrying

Front-panel handles (now optional) have been designed with an outward tilt. The angled handle is comfortable for the hand, while presenting a minimal visual obstruction of controls located along the edges of the front panel. (Optional rack-mounting flanges may be installed with or without the front handles in place.)

Summary of System-II dimension descriptors

Dimension Descriptor	Equivalent to: "U"	mm	
		mm	inches
Height	2U	88.1	3.469
	3U	132.6	5.219
	4U	177.0	6.969
	5U	221.5	8.719
	6U	265.9	10.469
	7U	310.4	12.219
Width	1/4 MW ¹	105.7	4.160
	1/2 MW	212.3	8.360
	3/4 MW ²	318.9	12.550
	1 MW ²	425.5	16.750
Depth ⁴	11D	269.2	10.600
	14D	345.4	13.600
	17D	421.6	16.600
	20D	497.8	19.600
	23D	574.0	22.600

¹ See ANSI C83.9-1972 or IEC 297-1975.

² HP products are not available in S-II cabinets 3/4 MW, but this is a useful dimension to indicate filler panel widths.

³ Adding S-II rack flanges extends the 1 MW dimension for mounting in standard 482.6 mm (19.00 inch) rack.

⁴ Depth dimension includes basic cabinet only; does not include protrusions such as controls, front handles, etc.

Full width products have a handle on each side. Each side handle is in the form of a long strap, which provides more freedom in finding a balance point. The strap handle recess in each side panel also provides a place for mounting rack slides.

An optional front bail handle is available for smaller products, and some products are equipped with a strap handle on top.

Modular small enclosures

The smaller enclosures in System-II are dimensioned to be exact submultiples of the standard rack width design. Rack mounting frames are therefore not required; a simple extender to reach full rack width is all that is needed.

It is easy to group instruments together horizontally or vertically by using simple lock links. The links can be installed by using threaded holes already provided in the framework, allowing quick assemble and separation of instruments.

Depths

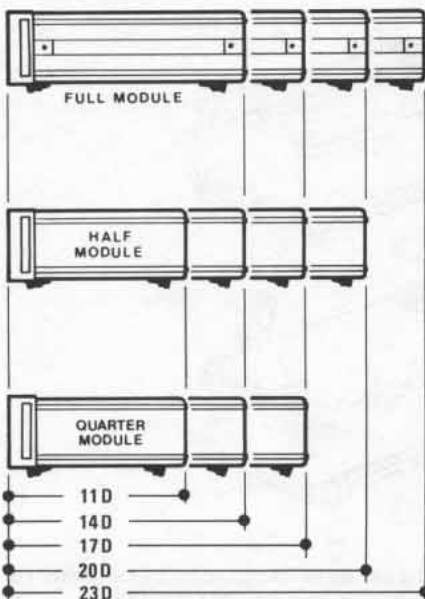

CABINETS & MEASUREMENT ACCESSORIES

Modular enclosure system for individual HP products

System-II general accessories and parts

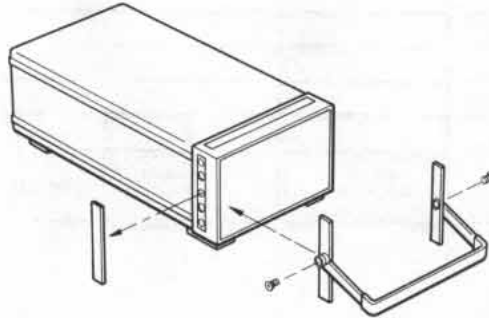

Bail-type carrying handles are available for ½ MW products having heights of 3 ½ H, 5 ¼ H or 7 H.

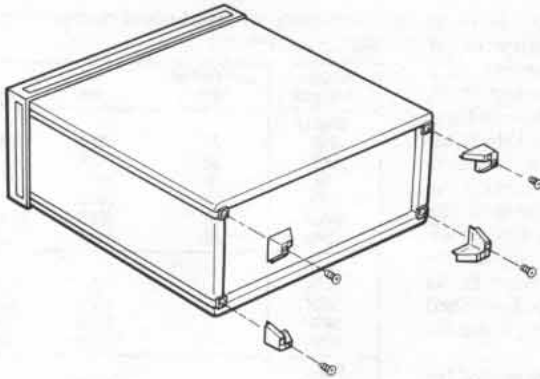

Standoff feet in Kit 5061-2009 provide rear panel protection for instruments operated, transported or stored vertically.

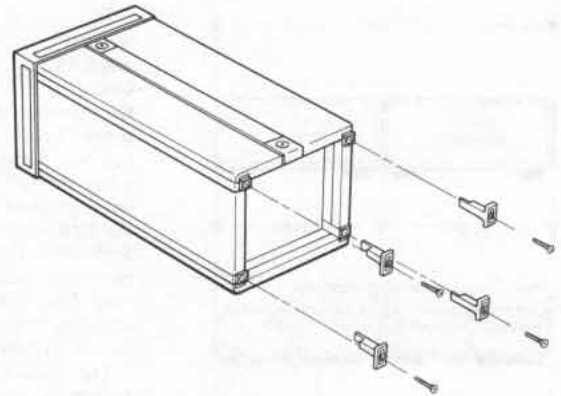

Kit 5061-0095 provides flanged cord wrap posts as a convenient way to keep power cords and signal cables with an instrument.

Locking cabinets together

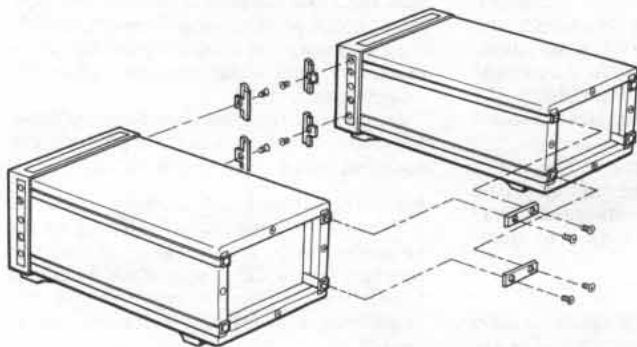

Sub-module cabinets (¼ MW & ½ MW) of equal depths lock side-by-side, using horizontal lock links from Kit 5061-0094.

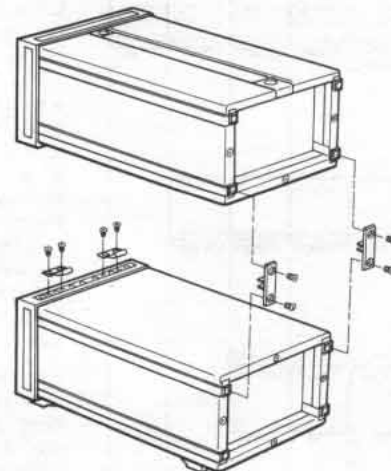

Cabinets of equal depths can be stacked and locked together securely, using vertical lock links from Kit 5061-0094



General accessories and parts for System-II cabinets

Item ¹	Fits these System-II Cabinets	Description	Part Number	Price	
Front handle kit (Will be shipped with instrument, if ordered as Option 907 at same time. Otherwise available separately per Part Numbers listed at right.)	All cabinets—but principle use is on 1 MW (Full Module) cabinets, or on sub-Module cabinets locked together to form width of 1 MW	Includes two front handles; fit on each side of front panel frames, for cabinets this high:	3½ H	5061-0088	\$20
			5¼ H	5061-0089	\$20
			7 H	5061-0090	\$30
			8¾ H	5061-0091	\$30
			10¼ H	5061-0092	\$45
			12¼ H	5061-0093	\$45
Bail handle kit	½ MW (Half Module)	Convenient carrying handle for lightweight cabinets this high:	3½ H	5061-2001	\$15
			5¼ H	5061-2002	\$20
			7 H	5061-2003	\$25
Cabinet lock-together kit	All cabinets, provided they are of equal depth.	Kit of lock link hardware and screws for joining instrument cabinets in several different configurations. Enough horizontal links (12 front, 6 rear) for three side-by-side joints (up to 4 instruments), and enough vertical links (4 front, 4 rear) to form two over under joints (up to 3 instruments). ²	5061-0094	\$15	
Cabinet feet	1 MW (Full Module) and ½ MW (Half Module)	Standard foot (1): fits bottom of 1 MW and ½ MW cabinets (requires 2 front, 2 rear).	5040-7201	\$2 ea.	
			Tilt stand (1): fits onto standard foot and is used in pairs (front or rear).	1460-1345	\$2 ea.
			Non-skid foot (1): used (in pairs) in lieu of standard rear or front foot, to minimize bench-top creeping instrument. (Some lighter-weight products are supplied with this type foot on rear.)	5040-7222	\$3 ea.
	¼ MW (Quarter Module)	Standard foot (1): fits bottom of ¼ MW cabinet (requires 1 in front, 1 in rear).	5040-7205	\$2.50 ea.	
			Tilt stand (1): fits onto ¼ MW standard foot (only 1 used, for front or rear).	1460-1369	\$2.50 ea.
			Kit of four special feet which provide 25.4mm (1 in.) standoff protection to rear panel. Used when instrument is operated in vertical position, or when it is transported/stored on its rear panel.	5061-2009	\$5 ea.
Feet, rear panel standoff	All cabinets—except does not normally fit cabinets which are ¼ MW and 3½ H.	Kit of four special feet which provide 25.4mm (1 in.) standoff protection to rear panel. Used when instrument is operated in vertical position, or when it is transported/stored on its rear panel.	5061-2009	\$5 ea.	
Cord-wrap kit, rear panel	Recommended for products only ¼ MW and ½ MW weighing less than 11 kg (24 lbs.)	Kit of four flanged posts around which power cords or signal cables may be wrapped for transport/storage. (not designed for heavy duty support; use kit 5061-2009 for such applications.)	5061-0095	\$5	

¹ All kits and rear panel standoff feet are supplied with appropriate mounting screws.
² Locking cabinets together horizontally in a configuration wider than 1 MW (Full Module) is not recommended.

CABINETS & MEASUREMENT ACCESSORIES

Modular enclosure system for individual HP products

System-II rack mounting accessories

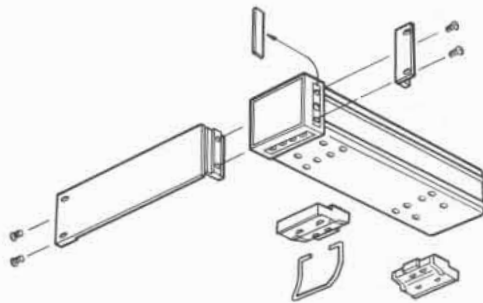

Cabinets $\frac{1}{4}$ MW utilize one broad foot each at front and rear (either accept tilt stand). Note how rack mounting adapter and rack flange fit onto front frame, after trim strip is removed.

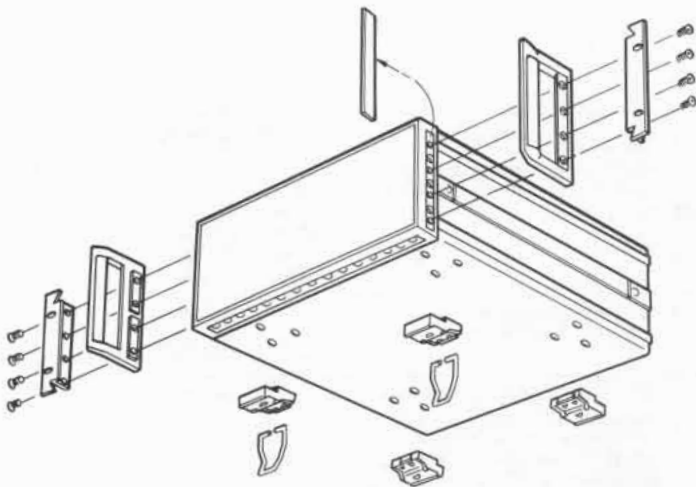

Cabinets $\frac{1}{2}$ MW and 1 MW utilize two feet each at both front and rear (all accept tilt stand). Note how front handle and/or rack flange fit onto front frame.

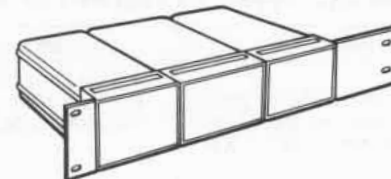
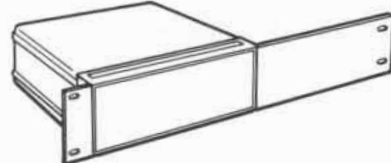
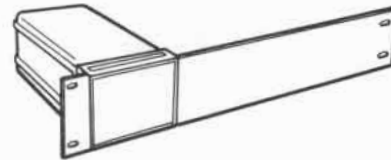

Sub-module cabinets ($\frac{1}{4}$ MW & $\frac{1}{2}$ MW) may be extended to full rack width by using rack mounting adapters as shown above.

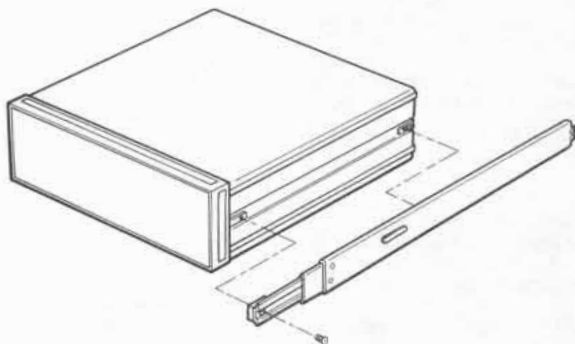

Standard slides fit full module cabinets (MW) for installation in HP rack enclosures. Adapter brackets for using slides in non-HP rack enclosures are also available.

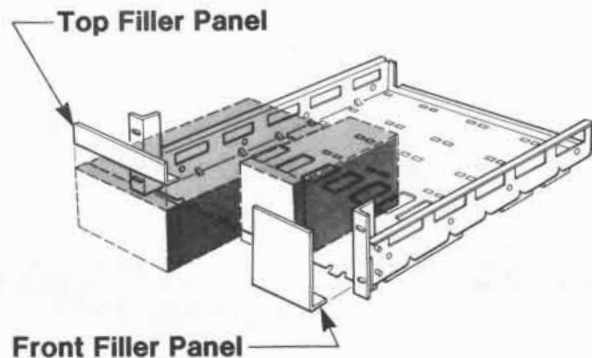

Sub-module cabinets ($\frac{1}{4}$ MW & $\frac{1}{2}$ MW) in any combination of heights (up to 7 inches) and depths (up to 20 inches) may be rack mounted by using the support shelf and optional filler panels.

Rack mounting accessories for System-II cabinets

S-II Cabinet Width	Item ¹	Description	Module Size	Part Number	Price	
1 MW (Full Module)	Rack flange kit (Will be shipped with instrument, if ordered as Option 908 at same time. Otherwise available separately per Part Numbers listed at right.)	Includes two rack flanges; fit on each side of front panel frames, for cabinets this high:	3½ H	5061-0074	\$15	
			5¼ H	5061-0077	\$15	
			7 H	5061-0078	\$20	
			8¾ H	5061-0079	\$20	
			10½ H	5061-0080	\$25	
			12¼ H	5061-0081	\$25	
1 MW (Full Module)	Rack flange & front handle combination kit (Will be shipped with instrument, if ordered as Option 909 at same time. Otherwise available separately per Part Numbers listed at right.)	Includes two rack flange/front handle combinations; fit one each side of front panel frame, for cabinets this high:	3½ H	5061-0075	\$20	
			5¼ H	5061-0083	\$30	
			7 H	5061-0084	\$45	
			8¾ H	5061-0085	\$45	
			10½ H	5061-0086	\$60	
			12¼ H	5061-0087	\$60	
1 MW (Full Module)	Standard slide kit for HP rack enclosures	Includes two standard slides for installing instrument weighing no more than 38.6 kg (85 lb.) into HP rack enclosures. Fit side handle recess on S-II cabinets this deep:	14D & 17D	1494-0018	\$45	
			20D & 23D	1494-0017	\$45	
	Standard tilt slide for HP rack enclosures	Same as standard slide above, plus permits tilting instruments up or down 90° Fit:	14D & 17D	1494-0025	\$95	
			20D & 23D	1494-0026	\$95	
	Slide adapter bracket kit	Includes brackets for adapting the standard slides above for use in non-HP rack system enclosures of adequate depth.		1494-0023	\$20	
	Heavy-duty slide kit for HP rack enclosures.	Includes two heavy-duty slides for installing instrument weighing no more than 79.6 kg (175 lb.) into HP rack enclosures. Fit S-II cabinets this deep:	20D & 23D	1494-0016	\$115	
¼ MW (Quarter Module) and ½ MW (Half Module)	Rack mounting adapter kit ²	Includes one rack flange and one extension adapter ¼ MW. For mounting one S-II cabinet ¼ MW, having a height 3½ H. Includes one rack flange and one extension adapter ½ MW. For mounting one S-II cabinet ½ MW or two cabinets ¼ MW, having these heights: Includes one rack flange and one extension adapter ¾ MW. For mounting one S-II cabinet ¾ MW together with one cabinet ¼ MW, or for mounting three cabinets ¼ MW together, having a height of 3½ H.	3½ H	5061-0073	\$25	
			5¼ H	5061-0072	\$25	
			7 H	5061-0057	\$25	
			8¾ H	5061-0060	\$35	
			10½ H	5061-0066	\$45	
	Rack flange kit ²	May be used whenever S-II cabinets ¼ MW and/or ½ MW are combined to a full width of 1 MW (Full Module)			See 1MW above	
					See 1MW above	
					See 1MW above	
					See 1MW above	
					See 1MW above	
Support shelf	For mounting one or more S-II cabinets which are ¼ MW or ½ MW, and up to 20D. Cabinet depths need not be equal, but heights must match support shelf height, except where top filler panels are used. Maximum shelf projection behind front mounting panel is 534 mm (21 in.). Maximum instrument weight is 50 lb.	3½ H	5061-0096	\$100		
		5¼ H	5061-0097	\$110		
		7 H	5061-0098	\$125		
Slide kit for support shelf	Includes two slides for slide-mounting any of the above three support shelves in HP rack enclosures.		1494-0015	\$45		
Front filler panels for support shelf	For 3½ H support shelf partially filled with S-II instruments, and having the following front panel space to fill:	¼ MW to fill	5061-2021	\$15		
		½ MW to fill	5061-2022	\$20		
		¾ MW to fill	5061-2023	\$25		
		For 5¼ H support shelf, and having the following front panel space to fill:	¼ MW to fill	5061-2024	\$30	
	½ MW to fill	5061-2025	\$35			
	¾ MW to fill	5061-2026	\$40			
	For 7 H support shelf, and having ½ MW front panel space to fill.		5061-2027	\$30		
Top filler panels for support shelf	For ¼ MW and having the following vertical space to fill:	1¼ H	5061-2035	\$15		
		3½ H	5061-2036	\$15		
	For ½ MW and having the following vertical space to fill:	1¼ H	5061-2037	\$20		
3½ H		5061-2038	\$25			

¹ All kits and support shelf items are supplied with appropriate mounting screws and hardware.
² Cabinet lock-together kit (5061-0094) is also required whenever two, three or four sub-modules (¼ MW and/or ½ MW) are to be joined in a configuration using Rack mounting adapters or Rack flanges.

Also, submodules cabinets must be of equal depth.
³ Requires two 5061-0071 kits if one cabinet ¼ MW is to be center-mounted.

CABINETS AND MEASUREMENT ACCESSORIES

Combining cases, rack adapters, panel covers, carrying cases

1051A, 1052A, 11046A, 11075A, 5060 Series

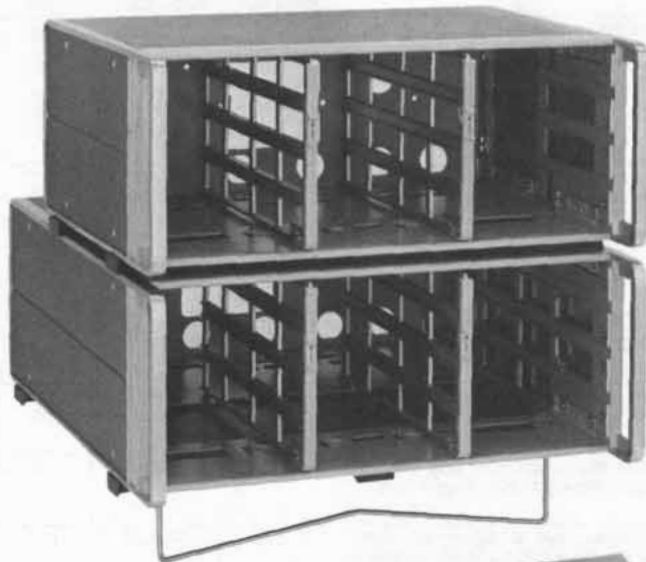

1051A

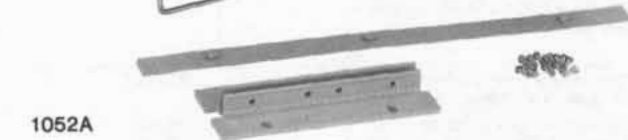

1052A

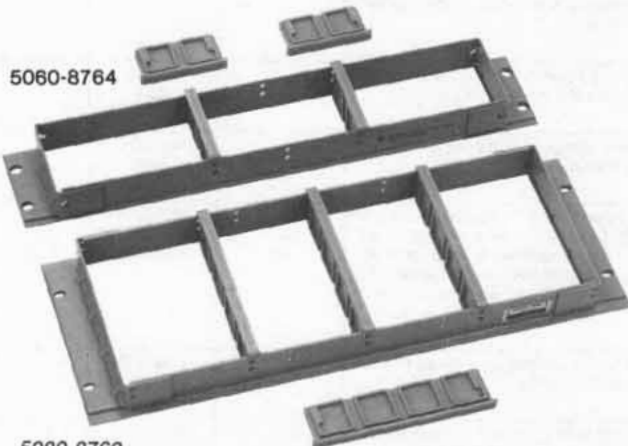

5060-8764



5080-8762

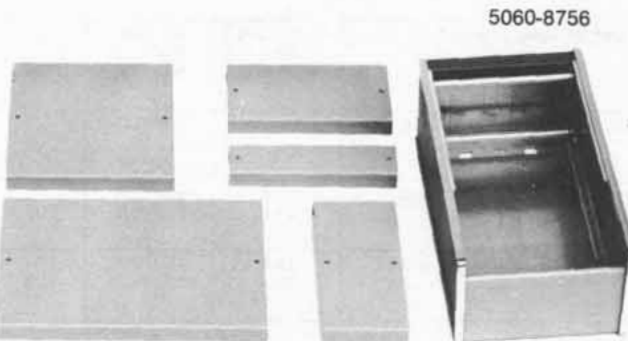

5060-8756

5060-8757 to 5060-8761

1051A, 1052A Combining cases

Models 1051A and 1052A combining cases conveniently rack or bench mount combinations of small modular Hewlett-Packard instruments. In addition, these cases can be stacked on each other or on any full module instrument. Both cases accept $\frac{1}{2}$ or $\frac{1}{4}$ instrument modules, 130 mm or 198 mm wide ($5\frac{1}{8}$ or $7\frac{7}{32}$ inches). The basic difference is that the 1052A is 130 mm ($5\frac{1}{4}$ ") deeper, and will accept modules up to 416 mm deep ($16\frac{3}{8}$ "). The extra length provides more space in the rear for wiring. The 1051A accepts instruments up to 286 mm deep ($11\frac{1}{4}$ "). Each case is furnished with two dividers.

1051A, 1052A Specifications

Dimensions

1051A: 178 H \times 482.6 W \times 337 mm D ($7'' \times 19'' \times 13\frac{1}{4}''$).

1052A: 178 H \times 482.6 W \times 467 mm D ($7'' \times 19'' \times 18\frac{3}{8}''$).

Weight

1051A: net, 4.5 kg (10 lb). Shipping, 6.7 kg (15 lb)

1052A: net, 5.4 kg (12 lb). Shipping, 8.1 kg (18 lb)

Opt 910: extra manual

Price

\$350

\$375

add \$1

Rack adapter frames 5060-8762, 5060-8764

These frames can be used to hold combinations of $\frac{1}{2}$ and $\frac{1}{4}$ width module HP instruments. Each frame is furnished with mounting hardware and divider panels. Two models are available for different instrument heights. Adapter frames are for permanent or semipermanent rack mounting. Where quick removal and reinstallation of instruments is desirable, the 1051A and 1052A combining cases should be used.

5060-8762: equivalent to IEC 4U (7" H), accepts instrument heights of 38, 77, or 155 mm ($1\frac{1}{2}''$, $3\frac{1}{2}''$, or $6\frac{1}{2}''$)

\$60

5060-8764: accepts only instrument heights of 38 or 77 mm ($1\frac{1}{2}''$ or $3\frac{1}{2}''$)

\$55

Filler panels, 5060-8757 to 5060-8761

Filler panels can be used to close off any leftover space after instruments are mounted in combining cases or adapter frames. Panels are made in a variety of widths and heights. Available widths are $\frac{1}{6}$, $\frac{1}{4}$, and $\frac{1}{2}$ modules; heights are $\frac{1}{4}$, $\frac{1}{2}$ and the full 155 mm ($6\frac{1}{2}''$).

Specifications, filler panels

Part No.	Module Case Height \times Width	Dimensions		Price
		mm	in	
5060-8757	$\frac{1}{4} \times \frac{1}{2}$	38 x 130	$1\frac{1}{2} \times 5\frac{1}{4}$	\$12
5060-8758	$\frac{1}{2} \times \frac{1}{2}$	77 x 130	$3\frac{1}{2} \times 5\frac{1}{4}$	\$15
5060-8759	full $\times \frac{1}{2}$	155 x 130	$6\frac{1}{2} \times 5\frac{1}{4}$	\$15
5060-8760	full $\times \frac{1}{2}$	155 x 198	$6\frac{1}{2} \times 7\frac{7}{32}$	\$16
5060-8761	full $\times \frac{1}{6}$	155 x 63	$6\frac{1}{2} \times 2\frac{3}{64}$	\$12

Accessory drawer 5060-8756

\$85

The accessory drawer can be used in place of a filler panel to finish off unused space in the combining cases. The drawer is $\frac{1}{2}$ width and $\frac{1}{2}$ height.

Dimensions: 77 H \times 130.2 W \times 279.4 mm D ($3\frac{1}{2}'' \times 5\frac{1}{8}'' \times 11''$)



5060-0789

Cooling kits, 5060-0789 and 5060-0796

These cooling kits are designed to be easily installed in the 1052A combining case. They can be installed in the 1051A, at the factory upon special request, but installation in the shorter case limits the depth of instruments the case can accept, and makes it impossible to use the accessory drawer.

5060-0789: 115 V, 50 to 60 Hz \$200
5060-0796: 230 V, 50 to 60 Hz Quote

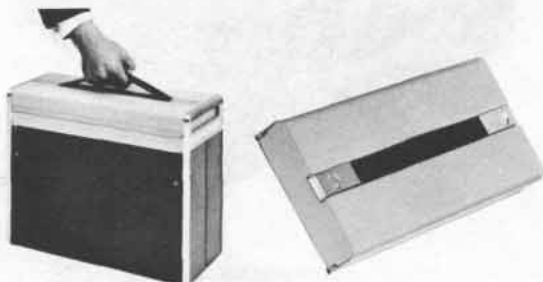

5060-8768

Control panel covers, 5060-8766 to 5060-8771

A series of control panel covers equipped with carrying handles are available for full rack width instruments. These covers protect instrument front panels and make rack mounted instruments tamper-proof.

One of these covers, the 5060-8768, fits either the 1051A or 1052A. Other covers are available to fit the six modular enclosures with front panel heights ranging from 88.1 to 310.4 mm (3½ to 12¼").

5060-8766: 88.1 mm (3½") EIA panel height \$87.50
5060-8767: 132.6 mm (5¼") EIA panel height \$92.50
5060-8768: 177 mm (7") EIA panel height \$100
5060-8769: 221.5 mm (8¾") EIA panel height \$105
5060-8770: 265.9 mm (10½") EIA panel height \$110
5060-8771: 310.4 mm (12¼") EIA panel height \$120



11046A

11046A Carrying case

This rugged, splashproof carrying case accepts ½ width module instruments (maximum depth 203.2 mm or 8"). The case includes a shoulder carrying strap. Weight 5.4 kg (12 lb). \$275

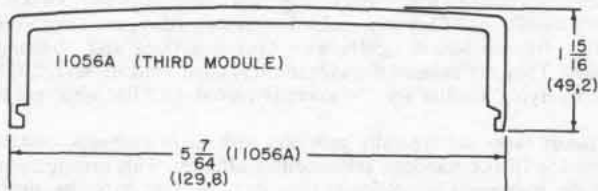

11056A

11056A Handle kit

A handle for carrying HP instrument modules of ½ width. \$20



11075A

11075A, 11076A Module instrument case

A rugged, high impact plastic instrument case for HP ½ module instruments. Instruments can be operated, stored or carried in this splashproof case. Storage compartment for power cord in rear of case is accessible through a removable hatch. Front lid contains adequate storage space for cables, test leads, etc. The dual purpose tilt stand also serves as a carrying handle. 11075A is 203 mm D (8"); 11076A is 279 mm (11") D.

11075A: Module Instrument Case \$145
11076A: Module Instrument Case \$135

CABINETS & MEASUREMENT ACCESSORIES

Rugged protection for instruments

Modular instrument transit cases

Typical cushion
full size (425.5 mm) module

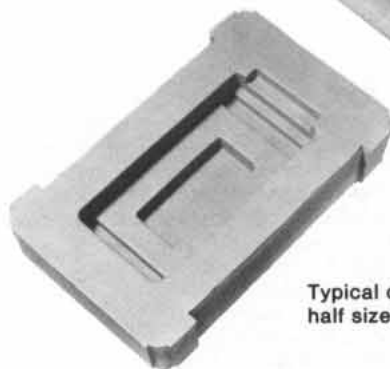
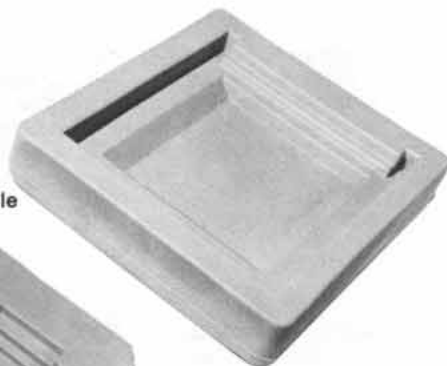

Typical cushion
half size module (197.6 mm wide)



V = Valise Style



Typical System I transit case



S = Split Style

Transit Case Styles

The HP transit cases are rugged protective outer shells for use when instruments must be frequently transported and used away from laboratory conditions. They are molded of strong fiberglass-reinforced plastic. All are sealed tightly with O-ring gaskets and clamping latches. They are rainproof under the test conditions of MIL-STD-108. Carrying handles are conveniently placed, fold flat when not in use.

Transit cases are typically provided with foam cushions, custom formed to fit the standard HP modular cabinets. This arrangement provides maximum protection against damage from handling, dropping, or crushing. A selection of case sizes is available to accommodate nearly any instrument and combination of accessories.

Transit cases - System I

Instrument Size (inches)			Instrument Size (mm)			Case Size* (inches) Not including hardware			Case size (mm) Not including hardware			Style	Shipping Weight		HP Part Number	Price
H	W	D	H	W	D	L	W	D	L	W	D		Lbs.	kg		
3½	16½	13¼	88.1	425.5	336.6	20½	17½	9	520.7	444.5	228.6	V	15	68	9211-1288	\$180
5¼	16½	13¼	132.6	425.5	336.6	20½	17½	10½	520.7	444.5	273.1	V	16	73	9211-1289	\$260
7	16½	13¼	177.0	425.5	336.6	20½	17½	12½	520.7	444.5	317.5	V	17	77	9211-1290	\$260
8½	16½	13¼	221.5	425.5	336.6	20½	17½	14¼	520.7	444.5	362.0	S	18	82	9211-1291	\$260
3½	16½	18½	88.1	425.5	466.7	23	21	9	584.2	533.4	228.6	V	18	82	9211-1292	\$280
5¼	16½	18½	132.6	425.5	466.7	23	21	10½	584.2	533.4	273.1	V	19	86	9211-0839	\$280
7	16½	18½	177.0	425.5	466.7	23	21	12½	584.2	533.4	317.5	V	20	91	9211-1293	\$280
8½	16½	18½	221.5	425.5	466.7	23	21	14¼	584.2	533.4	362.0	V	21	95	9211-1294	\$280
10½	16½	18½	265.9	425.5	466.7	23	21	16	584.2	533.4	406.4	S	22	100	9211-1295	\$280
12¼	16½	18½	310.4	425.5	466.7	23	21	17½	584.2	533.4	450.9	S	22	100	9211-1313	\$290
5¼	16½	21¼	132.6	425.5	542.9	25½	23½	10½	647.7	596.9	273.1	V	24	110	9211-1296	\$320
7	16½	21¼	177.0	425.5	542.9	25½	23½	12½	647.7	596.9	317.5	V	24	110	9211-1735	\$320
12¼	16½	24¼	310.4	425.5	542.9	24	19	29½	609.6	482.6	755.7	S	32	150	9211-1297	\$280
6½	5¼	8	165.1	130.2	203.2	14½	10½	11¼	362.0	228.6	285.8	V	8	36	9211-1317	\$190
6½	5¼	11	165.1	130.2	279.4	16½	10½	11¼	428.6	263.5	285.8	V	11	50	9211-1318	\$150
6½	7¼	8	165.1	196.9	203.2	16½	10½	11¼	428.6	263.5	285.8	V	11	50	9211-1316	\$160
6½	7¼	11	165.1	196.9	279.4	16½	10½	11¼	428.6	263.5	285.8	V	11	50	9211-1315	\$190
6½	7¼	16	165.1	196.9	406.4	20½	12½	11¼	520.7	317.5	285.8	V	15	68	9211-1734	\$215
6½	10½	11	165.1	266.7	279.4	16½	14½	8½	419.1	368.3	215.9	V	12	55	9211-1895	\$225

Full-module width instruments

Transit cases-System II:

Appropriate Front Handle Kit (HP Part Number 5061-0088 to -0093) must be installed on instruments for adequate protection.

Dimensions in inches and mm

Instrument size						Case size* (not including hardware)						Style	HP Part Number	Price			
in	H	mm	in	W	mm	in	D	mm	in	L	mm				in	W	mm
3½	88.1	16%	425.5	13%	349.3	23	584.2	21	533.4	8%	222.3	V	9211-2642	\$300			
5¼	132.6	16%	425.5	13%	349.3	23	584.2	21	533.4	10%	266.7	V	9211-2643	\$300			
7	177.0	16%	425.5	13%	349.3	23	584.2	21	533.4	12%	311.2	V	9211-2644	\$300			
8%	221.5	16%	425.5	13%	349.3	23	584.2	21	533.4	14	355.6	V	9211-2645	\$300			
10½	265.9	16%	425.5	13%	349.3	23	584.2	21	533.4	15%	400.1	S	9211-2646	\$300			
12%	310.4	16%	425.5	13%	349.3	23	584.2	21	533.4	17%	444.5	S	9211-2647	\$300			
3½	88.1	16%	425.5	16%	425.5	24%	622.3	24%	622.3	8%	222.3	V	9211-2648	\$340			
5¼	132.6	16%	425.5	16%	425.5	24%	622.3	24%	622.3	10%	266.7	V	9211-2649	\$340			
7	177.0	16%	425.5	16%	425.5	24%	622.3	24%	622.3	12%	311.2	V	9211-2650	\$340			
8%	221.5	16%	425.5	16%	425.5	24%	622.3	24%	622.3	14	355.6	S	9211-2651	\$340			
10½	265.9	16%	425.5	16%	425.5	24%	622.3	24%	622.3	15%	400.1	S	9211-2652	\$340			
12%	310.4	16%	425.5	16%	425.5	28	711.2	24	609.6	17%	444.5	S	9211-2653	\$360			
3½	88.1	16%	425.5	19%	501.7	28	711.2	24	609.6	8%	222.3	V	9211-2654	\$360			
5¼	132.6	16%	425.5	19%	501.7	28	711.2	24	609.6	10%	266.7	V	9211-2655	\$360			
7	177.0	16%	425.5	19%	501.7	28	711.2	24	609.6	12%	311.2	V	9211-2656	\$360			
8%	221.5	16%	425.5	19%	501.7	28	711.2	24	609.6	14	355.6	S	9211-2657	\$360			
10½	265.9	16%	425.5	19%	501.7	28	711.2	24	609.6	15%	400.1	S	9211-2658	\$360			
12%	310.4	16%	425.5	19%	501.7	28	711.2	24	609.6	17%	444.5	S	9211-2659	\$360			
3½	88.1	16%	425.5	22%	577.9	30%	774.7	24%	622.3	8%	222.3	V	9211-2660	\$360			
5¼	132.6	16%	425.5	22%	577.9	30%	774.7	24%	622.3	10%	266.7	V	9211-2661	\$360			
7	177.0	16%	425.5	22%	577.9	30%	774.7	24%	622.3	12%	311.2	S	9211-2662	\$380			
8%	221.5	16%	425.5	22%	577.9	30%	774.7	26%	666.8	14	355.6	S	9211-2663	\$380			
10½	265.9	16%	425.5	22%	577.9	30%	774.7	26%	666.8	15%	400.1	S	9211-2664	\$380			
12%	310.4	16%	425.5	22%	577.9	30%	774.7	26%	666.8	17%	444.5	S	9211-2665	\$390			

*For overpack size to hold case add 1¼", 31.8 mm, to L & W and 1¼", 6.4 mm to D.

Half-and quarter-module width instruments

Transit cases-System II:

Dimensions in inches and mm

Instrument size						Case size* (not including hardware)						Style	HP Part Number	Price			
in	H	mm	in	W	mm	in	D	mm	in	L	mm				in	W	mm
3½	88.1	8%	204.2	10%	273.1	14%	377.8	13%	349.3	7%	190.5	v	9211-2666	\$225			
5¼	132.6	8%	204.2	10%	273.1	14%	377.8	13%	349.3	9%	235.0	v	9211-2667	\$225			
7	177.0	8%	204.2	10%	273.1	14%	377.8	13%	349.3	11	279.4	v	9211-2668	\$225			
8%	221.5	8%	204.2	10%	273.1	14%	377.8	13%	349.3	12%	323.9	v	9211-2669	\$225			
10½	265.9	8%	204.2	10%	273.1	14%	377.8	13%	349.3	14%	368.3	v	9211-2670	\$225			
3½	88.1	8%	204.2	13%	349.3	20	508.0	13%	342.9	7%	190.5	v	9211-2671	\$290			
5¼	132.6	8%	204.2	13%	349.3	20	508.0	13%	342.9	9%	235.0	v	9211-2672	\$290			
7	177.0	8%	204.2	13%	349.3	20	508.0	13%	342.9	9%	235.0	v	9211-2673	\$290			
8%	221.5	8%	204.2	13%	349.3	20	508.0	13%	342.9	12%	323.9	v	9211-2674	\$290			
10½	265.9	8%	204.2	13%	349.3	20	508.0	13%	342.9	14%	368.3	v	9211-2675	\$290			
3½	88.1	8%	204.2	16%	425.5	20	508.0	13%	342.9	7%	190.5	v	9211-2676	\$290			
5¼	132.6	8%	204.2	16%	425.5	20	508.0	13%	342.9	9%	235.0	v	9211-2677	\$290			
7	177.0	8%	204.2	16%	425.5	20	508.0	13%	342.9	11	279.4	v	9211-2678	\$290			
8%	221.5	8%	204.2	16%	425.5	20	508.0	13%	342.9	12%	323.9	v	9211-2679	\$290			
10½	265.9	8%	204.2	16%	425.5	20	508.0	13%	342.9	14%	368.3	v	9211-2680	\$290			
3½	88.1	8%	204.2	19%	501.7	24%	616.0	13	330.2	7%	190.5	v	9211-2681	\$250			
5¼	132.6	8%	204.2	19%	501.7	24%	616.0	13	330.2	9%	235.0	v	9211-2682	\$250			
7	177.0	8%	204.2	19%	501.7	24%	616.0	13	330.2	11	279.4	v	9211-2683	\$250			
8%	221.5	8%	204.2	19%	501.7	24%	616.0	13	330.2	12%	323.9	v	9211-2684	\$250			
10½	265.9	8%	204.2	19%	501.7	24%	616.0	13	330.2	14%	368.3	v	9211-2685	\$250			
3½	88.1	4%	104.8	10%	273.1	14	355.6	10	254.0	6%	165.1	v	9211-2686	\$210			
5¼	132.6	4%	104.8	10%	273.1	14	355.6	10	254.0	8%	209.6	v	9211-2687	\$210			
7	177.0	4%	104.8	10%	273.1	14	355.6	10	254.0	10	254.0	v	9211-2688	\$210			
3½	88.1	4%	104.8	13%	349.3	16%	428.6	10%	266.7	6%	165.1	v	9211-2689	\$220			
5¼	132.6	4%	104.8	13%	349.3	16%	428.6	10%	266.7	8%	209.6	v	9211-2690	\$220			
7	177.0	4%	104.8	13%	349.3	16%	428.6	10%	266.7	10	254.0	v	9211-2691	\$220			
3½	88.1	4%	104.8	16%	425.5	20%	514.4	11%	298.5	6%	165.1	v	9211-2692	\$220			
5¼	132.6	4%	104.8	16%	425.5	20%	514.4	11%	298.5	8%	209.6	v	9211-2693	\$220			
7	177.0	4%	104.8	16%	425.5	20%	514.4	11%	298.5	10	254.0	v	9211-2694	\$220			

*For overpack size to hold case add 1¼", 31.8 mm, to L & W and ¼", 6.4 mm to D.



Cases for other size instruments or special applications are available through HP Service Center

Caster kit 1490-0913 can be field installed to provide (4) 3¼" diameter swivel casters mounted with quarter turn fasteners



CABINETS & MEASUREMENT ACCESSORIES

Operating Cases: rugged protection for instruments



Operating Case with instrument and drawer.

HP cases are rugged protective outer shells for use when instruments must be frequently transported and used away from laboratory conditions. They are molded of strong fiberglass and have conveniently placed carrying handles that fold flat when not in use. All are sealed tightly with O-ring gaskets and clamping latches and are rain-proof under the test conditions of MIL-STD-108.

Operating cases are equipped internally with shock-mounted frames that accept any standard 19-inch rack-mounting instruments up to the maximum height of the frames. This arrangement offers the convenience of operation without removing the instrument from its carrying case. At the same time, environmental protection is afforded.

More than one instrument may be combined in a single operating case for convenience in setting up and operating. Patch-cable interconnections may then be left in place within the case, so that when the unit has been transported to its place of use the covers are removed and the instruments inside are ready to put into use with a minimum of delay.

Drawers are available in three different heights so that small accessories, tools, etc., can be kept inside the case with the instruments. Fitted foam cushions can be made up to accommodate nearly any shape articles.



A caster kit is available to fit the operating case allowing it to become a mobile rack. Once the kit is installed, the casters themselves may be attached or removed in seconds. With casters removed, the attaching hardware adds nothing to the overall dimensions of the case.



Fitted foam drawer cushions to accommodate various HP accessory combinations are available.

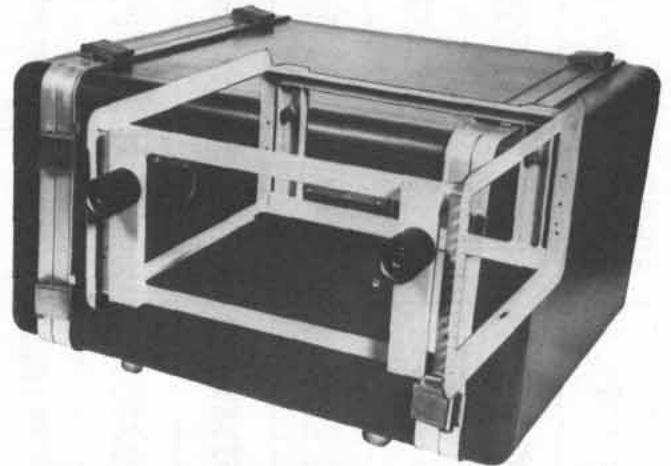

Equipped with elastomeric shock mounts, these enclosures provide outstanding shock and vibration attenuation. A set of standard shock mounts can be provided for any equipment weight and fragility.

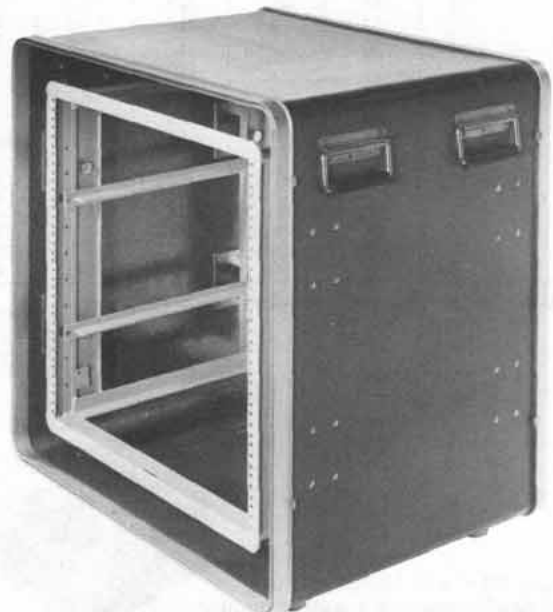

Operating Case showing T-Bars installed.



Nominal rack ht. in	ISO	Instrument Weight				Case Size (inches) Not including hardware			Case Size (mm) Not including hardware			Weight				HP Part Number	Price
		Maximum		Minimum		W	H	D	W	H	D	Case		Shipping			
		lb	kg	lb	kg							lb	kg	lb	kg		
5 1/4	3U	75	34.0	20	9.1	24.0	10.8	28.5	609.6	274.3	723.9	40	18.1	50	28.7	9211-1302	\$800
8 1/4	5U	75	34.0	20	9.1	24.0	15.0	27.0	609.6	381.0	685.8	46	20.9	56	25.4	9211-1303	\$900
10 1/4	6U	130	59.0	30	13.6	24.0	17.0	28.5	609.6	431.8	723.9	53	24.0	64	29.0	9211-2635	\$925
12 1/4	7U	100	45.4	25	11.3	24.0	18.9	28.5	609.6	480.1	723.9	55	24.9	65	29.5	9211-1163 ^a	\$925
14	8U	130	59.0	30	13.6	24.0	20.6	28.5	609.6	523.2	723.9	57	25.9	70	31.8	9211-1241	\$1200
15 1/4	9U	130	59.0	30	13.6	24.0	22.4	28.5	609.6	569.0	723.9	60	27.2	75	34.0	9211-1242	\$1250
17 1/4	10U	130	59.0	30	13.6	24.0	24.1	28.5	609.6	612.1	723.9	64	29.0	80	36.3	9211-1243	\$1200
19 1/4	11U	130	59.0	30	13.6	24.0	25.9	28.5	609.6	657.9	723.9	69	31.3	85	38.6	9211-1244	\$1250
21	13U	250	113.4	50	22.7	24.0	28.0	28	609.6	711.2	723.9	75	34.0	90	40.8	9211-1245	\$1250
22 1/4	14U	250	113.4	50	22.7	24.0	29.5	28.5	609.6	749.3	723.9	77	34.9	95	43.1	9211-2636	\$1500
24 1/4	15U	250	113.4	50	22.7	24.0	31.0	28.5	609.6	787.4	723.9	80	36.3	100	45.4	9211-1911	\$1500
26 1/4	16U	250	113.4	50	22.7	24.0	30.8	28.5	609.6	782.3	723.9	83	37.6	105	47.6	9211-2637	\$1500
28	17U	250	113.4	50	22.7	24.0	34.5	28.5	609.6	876.3	723.9	87	39.5	110	49.9	9211-2638	\$1600
29 1/4	18U	250	113.4	50	22.7	24.0	36.4	28.5	609.6	924.6	723.9	90	40.8	115	52.2	9211-2639	\$1500
31 1/4	19U	250	113.4	50	22.7	24.0	38.0	28.5	609.6	965.2	723.9	94	42.6	120	54.4	9211-2640	\$1500
33 1/4	20U	250	113.4	50	22.7	24.0	39.9	28.5	609.6	995.7	723.9	97	44.0	125	56.7	9211-1713 ^a	\$1500
47 1/2	21U	320	145.2	70	31.8	24.0	53.9	28.5	609.6	1369.1	723.9	140	63.5	175	79.4	9211-2641	\$2400

1. Each Operating Case is supplied with one T-bar set for supporting sides of instruments.
2. Has interlocking feet for stacking.
3. For rack mounts no deeper than 533.4 mm (21 in.); uses 431.8 mm (17 in.) T-bar sets.

Standard & special order features

- Inner rack frame with provision for infinitely adjustable T-bar instrument support brackets. Supplied
- Inner rack frame with RETMA hold pattern drilled in rear rails. Supplied
- Mating feet for stacking one case on top of another. Special color other than tan. Please specify. Supplied
- Modified inner rack frame depth. Standard depth 20" from front panel mounting surface to rear surface of frame. This option includes an appropriate change in the overall depth of the enclosure. Please specify desired inner frame depth. Maximum 23", minimum 12". N/C
- Chassis trak C-300 instrument slide pair to mount on either side of inner frame using RETMA hole pattern drilled in front and rear rails. \$60
- Special shock mounts for unusual instrument weights. Please specify weights. \$20
- Increased front cover depth. Maximum depth 6". Please specify. \$10
- Increased rear cover depth. Maximum depth 6". Please specify. \$40
- Latches recessed into the surface of the case. \$20
- Handles recessed into the surface of the case. \$75
- Hermetically sealed case tested by the hot water method. \$20
- MIL-C-4150 certification with the exception of design and preproduction testing. Case will have increased wall thickness, hardware anodized to military \$35

specification, and will be hermetically tested using the hot water method.

- Addition of an automatic pressure relief valve. \$20
- Addition of a manual pressure relief valve. \$10
- Addition of four permanently mounted, 3/2" diameter swivel casters. \$40
- Addition of four removable, 3/2" diameter swivel casters. Also available in kit form P/N 1490-0913. \$55
- Addition of two aluminum hat-section skids to the case bottom. \$30
- Addition of lift rings to either side of the case. \$15

Accessories

- 9211-1164** 3 1/2 H (88.1 mm) Drawer with ball bearing slides. \$195
- 9211-1165** 5 1/4 H (132.6 mm) Drawer with ball bearing slides. \$180
- 9211-1166** 7 H (177 mm) Drawer with ball bearing slides. \$230
- 0950-0122** AC power receptacle strip with four outlets mounted on bottom rear of inner rack frame. Power cord 1 m (3.3') long, NEMA connectors. \$25
- 9211-1173** Pair T-Bar instrument support brackets. \$26
- 1490-0913** Caster kit, four removable 3/2" (88.9 mm) swivel casters. \$55

On special order, complete transportable field instrument groups can be assembled to suit individual requirements. On request, cases can be fabricated that meet the environmental requirements of Military Specifications.

CABINETS AND MEASUREMENT ACCESSORIES

Accessories

Cables

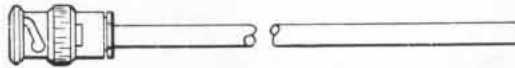

10501A: 110 cm (44 in)

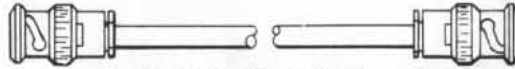

10502A L=20 cm (9 in)
11086A L=60 cm (24 in)
10503A L=120 cm (48 in)
10519A L=180 cm (48 in)

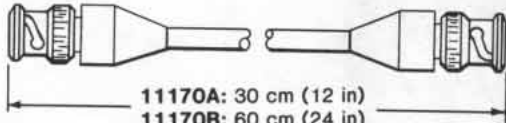

11170A: 30 cm (12 in)
11170B: 60 cm (24 in)
11170C: 120 cm (48 in)

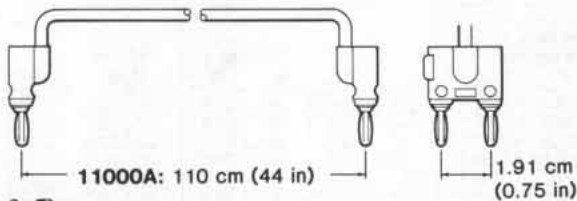

11000A: 110 cm (44 in)

1.91 cm
(0.75 in)

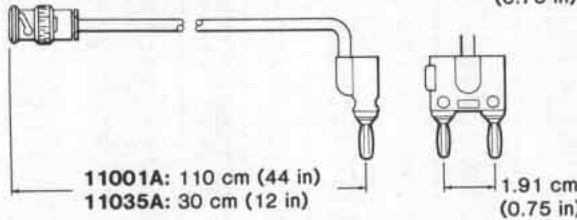

11001A: 110 cm (44 in)
11035A: 30 cm (12 in)

1.91 cm
(0.75 in)

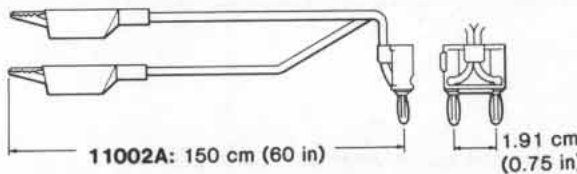

11002A: 150 cm (60 in)

1.91 cm
(0.75 in)

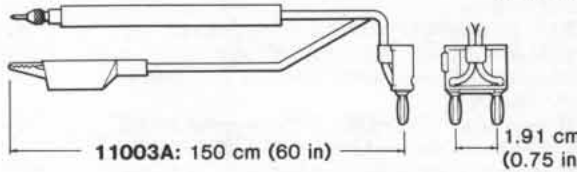

11003A: 150 cm (60 in)

1.91 cm
(0.75 in)

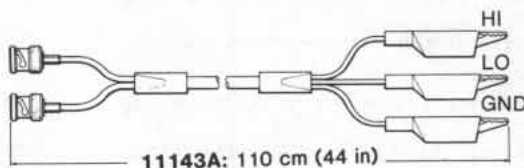

11143A: 110 cm (44 in)

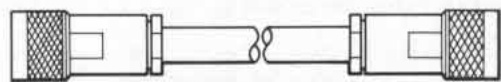

11500A: 180 cm (72 in)
11500B: 60 cm (24 in)

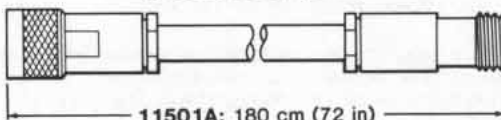

11501A: 180 cm (72 in)

Cable assemblies

Price

10501A Cable assembly

111.76 cm (44 in.) of 50-ohm coaxial cable terminated on one end only with UG-88C/U BNC (m) connector.

\$10

10502A Cable assembly

22.86 cm (9 in.) of 50-ohm coaxial cable terminated on both ends with UG-88C/U BNC (m) connectors.

\$15

10503A Cable assembly

121.96 cm (48 in.) of 50-ohm coaxial cable terminated on both ends with UG-88C/U BNC (m) connectors.

\$15

10519A Cable assembly

182.88 cm (72 in.) of 50-ohm coaxial cable terminated on both ends with UG-88C/U BNC (m) connectors.

\$30

11170A Cable assembly

30 cm (12 in.) of 50-ohm coaxial cable terminated on both ends with BNC (m) connectors.

\$17

11170B Cable assembly

61 cm (24 in.) of 50-ohm coaxial cable terminated on both ends with BNC (m) connectors.

\$17

11170C Cable assembly

122 cm (48 in.) of 50-ohm coaxial cable terminated on both ends with BNC (m) connectors.

\$17

11000A Cable assembly

112 cm (44 in.) of 50-ohm coaxial cable terminated on both ends with a dual banana plug, for (3/4 in.) binding posts.

\$17

11001A Cable assembly

112 cm (44 in.) of 50-ohm coaxial cable terminated on one end with a dual banana plug and on the other end with a UG-88C/U BNC (m) connector.

\$17

11002A Test leads

152 cm (60 in.) test leads alligator clips to dual banana plug.

\$12

11003A Test leads

152 cm (60 in.) test leads, probe and alligator clip to dual banana plug.

\$12

11035A Cable assembly

30 cm (12 in.) of 50-ohm coaxial cable terminated on one end with a dual banana plug and on the other end with a UG-88C/U BNC (m) connector.

\$17

11143A Cable assembly

112 cm (44 in.) test leads, dual BNC to alligator clips.

\$45

11500A Cable assembly

183 cm (72 in.) of 50-ohm coaxial cable terminated on both ends with UG-21D/U Type N (m) connectors.

\$55

11500B Cable assembly

Identical with 11500A except 61 cm (24 in.) long.

\$50

11501A Cable assembly

183 cm (72 in.) of 50-ohm coaxial cable terminated with UG-21D/U Type N (m) and UG-23D Type N (f) connectors.

\$60



1250-0076
1250-1286



1250-0077
1250-1534
1250-1477

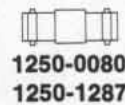

1250-0080
1250-1287



1250-0082
1250-1533
1250-1473



1250-0176

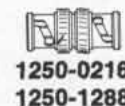

1250-0216
1250-1288

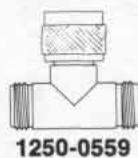

1250-0559



1250-0777
1250-1529
1250-1472

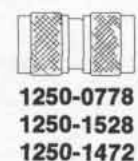

1250-0778
1250-1528
1250-1472

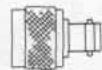

1250-0780
1250-1535
1250-1476



1250-0781

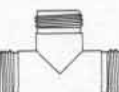

1250-0846



1250-1158



1250-1159

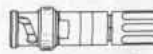

1250-1263

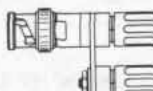

1250-1264



1250-1474
1250-1536

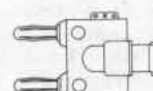

1250-2277

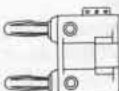

1251-2816

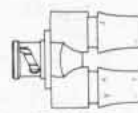

10110B

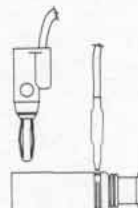

10111A



10113A



11524A



11525A



11533A



11534A

Adapters type N, Standard 50Ω

Part no.	Price
1250-0077 N (f) to BNC (m)	\$7.90
1250-0082 N (m) to BNC (m)	\$17.50
1250-0176 N (m) to Type N (f) right angle	\$28
1250-0559 N tee, (m) (f) (f)	\$21
1250-0777 N (f) to Type N (f)	\$7
1250-0778 N (m) to Type N (m)	\$10
1250-0780 N (m) to BNC (f)	\$5.25
1250-0846 N tee (f) (f) (f)	\$12

Adapters type N, Precision¹ 50Ω

Part no.	Price
1250-1472 N (f) to N (f)	\$20.50
1250-1473 N (m) to BNC (m)	\$20.50
1250-1474 N (f) to BNC (f)	\$16.50
1250-1475 N (m) to N (m)	\$28
1250B 476 N (m) to BNC (f)	\$21
1250-1477 N (f) to BNC (m)	\$18

Adapters type N, Standard 75Ω²

Part no.	Price
1250-1528 N (m) to N (m)	\$25
1250-1529 N (f) to N (f)	\$25
1250-1533 N (m) to BNC (m)	\$30
1250-1534 N (f) to BNC (m)	\$26
1250-1535 N (m) to BNC (f)	\$29
1250-1536 N (f) to BNC (f)	\$23

Adapters SMA

Part no.	Price
1250-1158 SMA (f) to SMA (f)	\$9.50
1250-1159 SMA (m) to SMA (m)	\$11

Adapters APC-7

Part no.	Price
11524A APC-7 to Type N (f)	\$95
11525A APC-7 to Type N (m)	\$105
11533A APC-7 to SMA (m)	\$135
11534A APC-7 to SMA (f)	\$135

Adapter banana plug

Part no.	Price
1251-2816 Dual Banana plug	\$2.40

Adapters BNC, Standard 50Ω

Part no.	Price
1250-0076 Right angle BNC (UG-306/D)	\$5.75
1250-0080 BNC (f) to BNC (f) (UG-914/U)	\$4.90
1250-0216 BNC (m) to BNC (m)	\$5.25
1250-0781 BNC Tee (m) (f) (f)	\$6.20
1250-1263 BNC (m) to single banana plug	\$11.50
1250-1264 BNC (m) to dual banana plug	\$3.60
1250-2277 BNC (f) to dual banana plug	\$10
10110B BNC (m) to dual banana plug	\$25
10111A BNC (f) to shielded banana plug	\$17
10113A Dual BNC (f) to triple banana plug	\$20

Adapters BNC, Standard 75Ω

Part no.	Price
1250-1286 Right Angle BNC	\$12
1250-1287 BNC (f) to BNC (f)	\$10.50
1250-1288 BNC (m) to BNC (m)	\$11.50

¹ "Precision": typically ≥36 dB. Return Loss to 1.3 GHz.

² Type N outer conductor; center pin sized for 75 Ω characteristic.

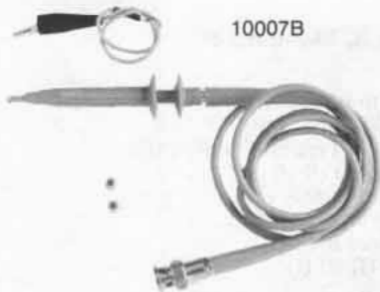

10007B

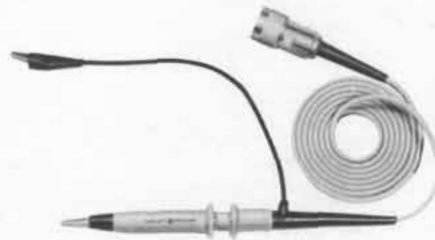

11021A



11036A



11040A



11045A



11047A

10007B, 10008B Probe

The 10007B and 10008B are straight-thru BNC probes with a retractable hook tip, and 20 cm (8 in.) ground lead with alligator tip included

	Peak Voltage	Shunt Capacitance	Length
10007B	600 V	40 pF	1.1m (3.5ft.)
10008B	600 V	60 pF	1.8m (6 ft.)

Price
\$40

11021A Divider probe

1000: 1 divider probe increases range of HP 425A dc Microvolt-Ammeter to 1000 volts

\$135

11028A Current divider

100: 1 divider for extended range measurements for 456A AC Current Probe

\$85

11036A AC probe

Peak responding for use with 410C

\$180

11040A Capacitive voltage divider

For 410 series voltmeters. Increases range so transmitter voltages can be measured quickly and easily. Accuracy $\pm 1\%$. Division ratio 100:1. Input capacity approximately 2 pF. Maximum voltage 2000 V at 50 MHz, decreasing to 100 V at 400 MHz. Frequency range 10 kHz to 400 MHz

\$130

11045A DC voltage divider

For 410C voltmeter. Gives maximum safety and conveniences for measuring high voltages as in television receivers, etc. Accuracy $\pm 5\%$. Division ratio 100: 1. Input impedance 1 G Ω . Maximum voltage 30 kV. Maximum current drain 2.5 μ A

\$100

11047A Output voltage divider

Input 600 Ω . Output 600 $\Omega \pm 1\%$. 6 $\Omega \pm 1\%$. Voltage rating $\frac{1}{2}$ watt

\$35



456A (with ac VM)

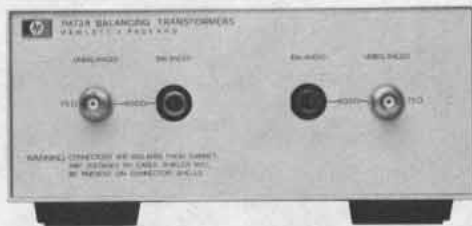

11473A

(Each module contains two transformers with the following specifications)

Model No.		11473A	11473B	11474A	11475A	11476A
Impedance*	Unbal	75Ω	75Ω	75Ω	75Ω	75Ω
	Bal	600Ω	600Ω	135Ω	150Ω	124Ω
Mating connectors	Unbal	BNC	BNC	BNC	BNC	BNC
	Bal	WECO 310	Siemens 9 REL STP-6AC	WECO 241	Siemens 9 REL STP-6AC	WECO 408A
Frequency range:		20 Hz—50 kHz	20 Hz—50 kHz	2 kHz—2 MHz	2 kHz—2 MHz	5 kHz—5 MHz
Frequency response:		±0.5 dB	±0.5 dB	±0.5 dB	±0.5 dB	±0.5 dB
Insertion loss:		<0.75 dB at 1 kHz	<0.75 dB at 1 kHz	<0.25 dB at 50 kHz	<0.25 dB at 50 kHz	<0.25 dB at 50 kHz
Longitudinal balance:		>40 dB	>40 dB	>40 dB	>40 dB	>35 dB
Max input power:		+13 dBm	+13 dBm	+27 dBm	+27 dBm	+27 dBm

*50Ω unbalanced to balanced transformer available on special basis. Above specifications apply.

456A Description

Conventional voltmeters or oscilloscopes can measure current quickly and dependably—without direct connection to the circuit under test or any appreciable loading to test circuit. HP's 456A AC Current Probe clamps around the current-carrying wire, and provides a voltage output read on voltmeter or scope. Model 456A's 1 mA to 1 mV conversion permits direct reading up to 1 A rms.

456A Specifications

- Sensitivity:** 1 mV/mA ±1% at 1 kHz.
- Frequency response:** ±2%, 100 Hz to 3 MHz; ±5%, 60 Hz to 4 MHz; -3 dB at <25 Hz and >20 MHz.
- Pulse response:** rise time is <20 ns, sag <16%/ms.
- Maximum input:** 1 A rms, 1.5 A peak; 100 mA above 5 MHz.
- Effect of dc current:** no appreciable effect on sensitivity and distortion from dc current up to 0.5 A.
- Input impedance:** (impedance added in series with measured wire by probe) <50 mΩ in series with 0.05 μH (this is approximately the inductance of 1½ in. of hookup wire).
- Probe aperture:** 4 mm (5/32") diameter.
- Probe shunt capacity:** approx. 4 pF added from wire to ground.
- Distortion at 1 kHz:** for 0.5 A input at least 50 dB down; for 10 mA input at least 70 dB down.
- Equivalent input noise:** <50 μA rms (100 μA when AC powered).
- Output impedance:** 220Ω at 1 kHz; approximately +1 V dc component; should work into load of not less than 100,000Ω shunted by approximately 25 pF.
- Power:** battery life (two), approximately 400 hours; ac power supply; Option 001, 115 or 230 V ±10%, 50 to 1000 Hz approx. 1 W.

11473A-11476A Description

Balancing transformers provide a balanced output from a single-ended input, or a single-ended output from a balanced input. Impedances available are 75 ohms unbalanced to 124Ω, 135Ω, 150Ω, and 600Ω balanced. Frequency response is ±0.5 dB.

Ordering instructions
456A AC Current Probe
Opt 001: AC Power Supply
11473A Balancing Transformer

Price
\$525
add \$50
\$290

11473B Balancing Transformer \$290
11474A Balancing Transformer \$290
11475A Balancing Transformer \$325
11476A Balancing Transformer \$290

TRANSCIVER TEST EQUIPMENT

Automatic RF test system

Model 8950B

- Designed for AM, FM and 0M transceivers from 2 to 1000 MHz



- Ideal for testing FM mobile, aircraft communication, tactical and citizen's band radios.
- Component stimulus/response testing from DC to 1000 MHz.



Varied applications

The HP 8950B Transceiver Test System automatically tests AM and FM communications transceivers over the frequency range of 2 to 1000 MHz. It is ideal for production line testing, R & D evaluation, quality assurance testing, incoming inspection, and user maintenance of many transceivers. The HP 9825A desk top computer controls the stimulus and measurement capabilities of the system via the HP Interface Bus (HP-IB).

Speed

Using the 8950B system, transceiver testing time can typically be reduced by a factor of 10 or more, resulting in greatly increased productivity. For example, the system performs a typical set of tests on a mobile radio in about 2 minutes, while a manually operated setup would require about 20 minutes.

Accuracy

Operation of the 8950B under computer control offers better accuracy than a manual system. By automatically applying previously

measured calibration factors, repeatable system errors such as frequency response and insertion loss are virtually eliminated.

Data presentation

The 9825A contains a 16 character wide thermal printer adequate for writing software or for short message printouts. For more sophisticated printouts several peripherals are system compatible including the HP 7245A plotter-printer, 9866B thermal printer, and the 9871A character impact printer.

A flexible HP-IB system

HP-IB interconnection insures that your 8950B will not become obsolete in the near future: as new and more advanced instrumentation is offered, your system can easily be updated to include added measurement capability. The 8950B employs general purpose, off-the-shelf instruments except for the 8951B System Interface. This means you may already be using nearly identical instruments in your measurements; therefore, test results will be directly comparable and operation and maintenance simplified.

Varied applications

The system interface provides access, under program control, to all instruments in the system. This hardware switching combined with the modular instrument driver subroutines provides powerful general purpose automatic stimulus/response testing from DC to 1000 MHz of components, audio and RF amplifiers, modules, and subassemblies.

8951B System interface

The 8951B System interface contains all the signal switching and conditioning needed to route signals to and from the proper instruments and the radio under test. All radio connections are made at a single working panel and no manual switching or cable reconnection is necessary during a typical series of tests.

In addition to switches, the 8951B includes a 100 watt RF attenuator, a high quality FM discriminator, and a diode detector for AM measurements. Three band-reject filters with provision for an external filter are used for distortion and SINAD measurements.

Positive and negative peak detectors provide true FM peak deviation measurement. Extra switching is provided to add spectrum analysis capability to the system.

9825A Computer controller

The flexible and powerful 9825A is an ideal controller for this system. It employs HPL, a high-level programming language which offers power and efficiency for handling equations and controlling instruments, yet is easy to learn and use. The controller and HPL allow easy storage and review of programs and data on a built-in, high speed, 250,000 byte tape cartridge.

System software

The 8950B is furnished with a tape cartridge containing a comprehensive library of system programs: 1) the *verification program* is a short system self-test to assure the user that the system is operational, 2) the *calibration program* generates calibration factors to correct repeatable errors in the system, 3) the *measurement subroutines* allow complex measurements to be made by writing only a single statement, 4) and the *instrument drivers* facilitate information transfer between the calculator and the instruments.

Writing programs

To perform a series of tests on a transceiver, a program must be written which accesses the appropriate measurement and instrument driver subroutines. Additional program statements will provide a printed copy of the results which can include the chosen test limits or a Pass-Fail indication of total test performance. Because of the software flexibility, special tests can easily be written using the instrument drivers provided with the system.

Typical system tests

Receiver

SINAD sensitivity	Hum and noise
Quieting sensitivity	AGC response
Squelch threshold	Modulation acceptance bandwidth
Audio power	Power supply sensitivity
Audio distortion	Current drain
Audio response	DC and AC voltage

Transmitter

Carrier power	Audio sensitivity
Carrier frequency and stability	Squelch tone frequency
AM depth	Limited spurious measurement
FM deviation	Power supply sensitivity
Audio distortion	Current drain
Audio response	Modulation limiting

General Purpose Automatic Tests

DC voltage	Resistance
AC voltage	Frequency
Amplifier gain	Flatness

8950B System specifications (includes software calibration)

General

System frequency range: 1-1000 MHz.

System power range: 0.5 - 100 watts.

Calculator controlled power supply voltages: 0 to 30 V, 50 mV resolution.

Current drain measurement range: 50 mA to 10 A.

Transmitter tests

Power measurement range (Antenna port): 1 mW to 100 watts.

Power measurement range (AUX RF input): 10 μW to 1 watt.

Power measurement accuracy (Antenna port): expected ±0.3 dB ±7.2%.

Frequency measurement range: 0 to 1300 MHz.

AM measurement

Frequency range: 2-400 MHz.

AM depth range: 0.5 to 95%.

AM accuracy (1 kHz rate 10% to 80%): ±2% AM DEPTH ±5% of reading.

AM rate range (3 dB): 50 Hz - 25 kHz.

AM residual distortion (at 30% AM): (at 400 Hz, 1 kHz, 3 kHz rates): ≤2%

FM measurement (positive and negative peak detection)

Frequency range: 4-1000 MHz.

Peak deviation range: 300 Hz - 20 kHz.

System residual: <10 Hz in 1 kHz BW.

FM accuracy (1 kHz rate): ±3% ±30 Hz.

FM rate range (3 dB): 50 Hz - 20 kHz.

FM residual distortion (at ≥3 kHz peak deviation at 400 Hz, 1 kHz, 3 kHz rates): ≤1.0%.

0M measurement

Frequency range: 4 - 1000 MHz.

Deviation: Δθ_{max} = 20/mod. rate (kHz).

0M rate range: 50 Hz - 20 kHz.

0M accuracy (1 kHz rate): ±3%.

Spurious measurements (> 1 MHz away from carrier): 0 to -40 dBc.

Receiver tests

Minimum measurable sensitivity (typical): 0.2 μV.

Output level range (Antenna port, into 50 ohms): -145 to -19 dBm (~0.013 μV to 25 mV).

Output level accuracy (1 to 1000 MHz, at Antenna port): ±1.5 dB.

Audio power measurement accuracy: 0.5% ± speaker load tolerance.

Audio distortion measurement: At 400, 1000, and 3000 Hz rates.

Residual distortion: RF generator distortion +0.3%.

Audio frequency range:

AM: 50 Hz to 50 kHz (RF freq >10 MHz)

FM: 50 Hz to 100 kHz.

Modulation acceptance bandwidth measurement range: 1 to 100 kHz.

General characteristics

Operating temperature range: 15° to 35°C.

Power requirements: 115 volts ±10%, 60 Hz.

Net weight (less calculator): 186 kg (410 lb).

Options

	Price
002: Additional Power Supply capability (Substitute 6268B, #026, J80 and 59501A for 6002A)	add \$650
003: Reduced frequency (110 MHz)	less \$4300
004: 230 V, 50 Hz operation	N/C
005: Delete 9825A Controller, ROM's and HP-IB interface	less \$10750

8950B Transceiver Test System (including controller and programs) \$63000

PCM/TDM transmission techniques

Pulse code modulation (PCM) developed because of a need for greater capacity over local telephone circuits between exchanges. In its basic form, it replaces a system of one pair of wires per subscriber with a system of two pairs of wires for 24 or 30 subscribers.

The basic PCM process converts the analog signal into digital pulses. The 4 kHz voice channel is sampled at an 8 kHz rate, each sample quantized to one of 256 possible levels and then each sample allocated an 8-bit binary code dependent on its quantized level. The result is a two-level (unipolar) digital stream clocked at 64 kb/s.

Time division multiplexing (TDM) is a means of transmitting several sources of information over one medium by allocating time slots to each source. Primary level multiplexing (usually of 4 kHz voice channels) is achieved, either by sampling each source sequentially prior to quantizing and encoding or by time interleaving the 8-bit encoded samples at the 64 kb/s level. A 24 voice channel assembly will then produce a digital stream at 1544 kb/s comprising 24×64 kb/s encoded voice plus 8 kb/s (1 bit per frame) of framing information to allow separation of the individual channels at the receive terminal equipment. Signalling infor-

mation is carried by "bit stealing" the least significant bit of each speech time slot one frame in every six. This is the standard system used in North America. In Europe, 30 voice channels are combined in a digital stream at 2048 kb/s comprising 30×64 kb/s encoded voice plus 64 kb/s (8 bits per frame) of framing information and 64 kb/s (8 bits per frame) of signalling information.

Higher level multiplexing is achieved by further interleaving of digital streams, either synchronously or asynchronously using pulse stuffing or pulse justification. There are three standard digital transmission "hierarchies" which have been developed (North American, European, and Japanese) and some of the interfaces have been standardised internationally by the International Telegraph and Telephone Consultative Committee (CCITT). However, to suit various local needs other transmission rates exist locally within national boundaries.

The basic concept of digital transmission is to send data so that it can be regenerated at frequent intervals without producing errors. Transmission impairments are then largely dependent on terminal performance. The unipolar digital stream generated in the multiplex is not ideal for cable transmission because of its dc content, significant energy

spectrum up to high frequencies and pattern-dependent timing content. Therefore, a line code is usually employed which has zero dc content, energy concentrated at frequencies lower than the bit rate, and regular timing content. The simplest form of line code is alternate mark inversion (AMI) where each data mark or "one" is given a polarity opposite to the preceding mark. This results in a bipolar signal meeting the first two criteria. A further development of AMI is to insert a specific pattern whenever long runs of zeros occur to maintain the timing content. Various patterns are in use; for example, B6ZS and B3ZS (bipolar with six or three zero substitution) and HDB3 (high density bipolar with a maximum of three consecutive zeros). All are recognizable in that they produce a known sequence of bipolar errors (ie violate the AMI rule) and so can be removed at the receive terminal. These simple line codes are also used on interface connections between digital equipment.

The primary multiplex digital output signal in line code is transmitted over existing audio cable by replacing loading coils with digital regenerators (see Fig.1). Higher order multiplex signals are transmitted over coaxial cable using more complex line codes or over radio systems using phase shift keying of an IF or RF carrier or over optical fibre using further binary coding.

PCM/TDM measurements

Measurements on PCM/TDM equipment can be divided into those on the terminal and those on the transmission link.

Traditionally the primary PCM multiplex terminals have been characterised in terms of their voice channel performance by either connecting two terminals back-to-back or looping a single terminal at the digital side. The measurements made have been standard voice channel tests of level, frequency response, noise, crosstalk, intermodulation, etc, plus measurements unique to PCM such as quantizing distortion. The measurement methods have been agreed and standardized by CCITT. While this approach to terminal testing has been adequate for local junction PCM systems, the increasing use of PCM in the trunk network and the introduction of digital TDM switching now makes it necessary to measure the performance of the transmit half of a terminal separately from the receive half. This requires analog-to-digital (A-D) and digital-to-analog (D-A) tests of the voice channel parameters plus checks of digital functions such as frame alignment or synchronization. These types of measurements are also required on digital switching equipment which contains PCM coder/de-

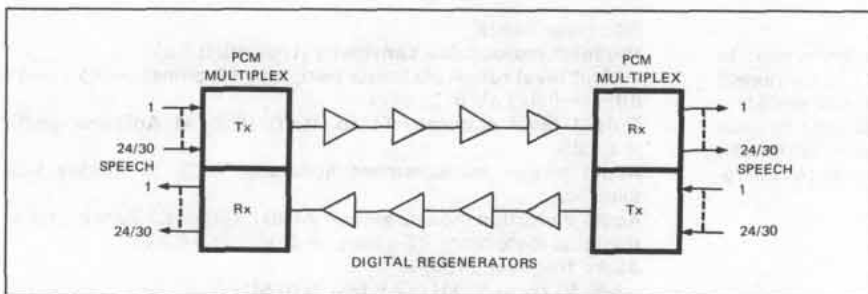

Figure 1. Basic PCM/TDM transmission system

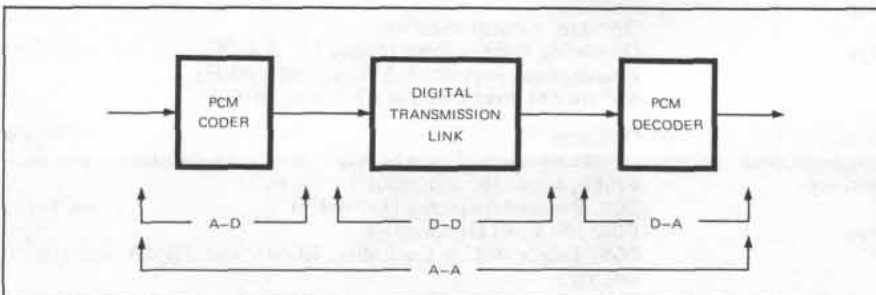

Figure 2. PCM/TDM measurements

coders (codecs) to interface with the existing analog environment, for example, a PABX. Increasing use of single channel PCM codec "chips" in this type of equipment also requires A-D and D-A testing of integrated circuit devices.

Measurements on digital transmission systems (including the higher level TDM multiplexes) are aimed at establishing data transparency (ie how truthfully the data is transmitted). The principal measure of quality is bit error rate (BER) which is defined as the total number of errors in the received signal divided by the total number of transmitted bits. As such, it represents the probability of any received bit being in error. The standard technique of measuring BER is to stimulate the transmission system with a pseudorandom binary data stream. The sequence length should be chosen to simulate a normal traffic signal and vary sufficiently in pattern content to adequately test pattern-sensitive parts of the equipment (eg clock recovery circuits). For measurements at 1.5/2.0 Mb/s and 6.3/8.4 Mb/s a $2^{15}-1$ bit pattern has been standardized by CCITT, while for higher speed systems, a $2^{23}-1$ bit pattern has been proposed. At the transmission system output, the data stream is synchronized with a locally generated, error-free pattern and then a bit-by-bit comparison carried out. Any differences are bit errors, and if counted over a

known number of clock periods, can be displayed as BER.

BER measurements are made under a number of differing conditions, including:

- a) normal conditions of bit rate, signal level, noise, and crosstalk
- b) tests with added timing jitter (phase variations of the clock timing instants)
- c) tests with the data bit rate offset from the normal clock rate
- d) tests with noise added to the data signal.

BER measurements are made on the unipolar data stream (i.e., after any interface code has been removed). This is especially important for systems where the interface code is not transmitted through the system (e.g., digital multiplex, digital radio, and optical fibre systems). However, binary access is not always available and it is necessary for test equipment to supply and accept both unipolar and bipolar patterns. It is also useful to measure code violation errors on cable transmission systems where the line code is the same as the interface code. Detection of code errors is relatively simple and can be done without taking the system out of service. For AMI line coding, two consecutive marks having the same polarity constitute a code error or bipolar violation. For HDB3, B6ZS, and B3ZS, combinations of "ones" and "zeros", including bipolar violations which do not obey the coding rule, constitute code errors.

PCM/TDM test equipment

For testing primary multiplex terminal equipment, the 3779A/B Primary Multiplex Analyzer provides A-A, A-D, and D-A measurement capability in an integrated test set. The instrument can be programmed to execute a complete measurement sequence to stored test limits and print out results on an external printer. Automatic testing of all the voice channels in a multiplex can be carried out via the 3777A Channel Selector controlled by the 3779A/B.

For testing digital transmission equipment up to 50 Mb/s, the 3780A Pattern Generator/Error Detector provides binary and code error measurement in a single portable instrument. Frequency offset generation and measurement are also included. BER measurements on higher speed systems up to 150 Mb/s can be made with the 3762A Data Generator and 3763A Error Detector. This system includes the new interface code called Coded Mark Inversion (CMI). Also provided is BER measurement on patterns with zero substitution for checking the pattern dependence of a system or for testing the effectiveness of scramblers. The 3762A/3763A have also been designed to operate in burst mode for Time Division Multiple Access (TDMA) satellite applications.

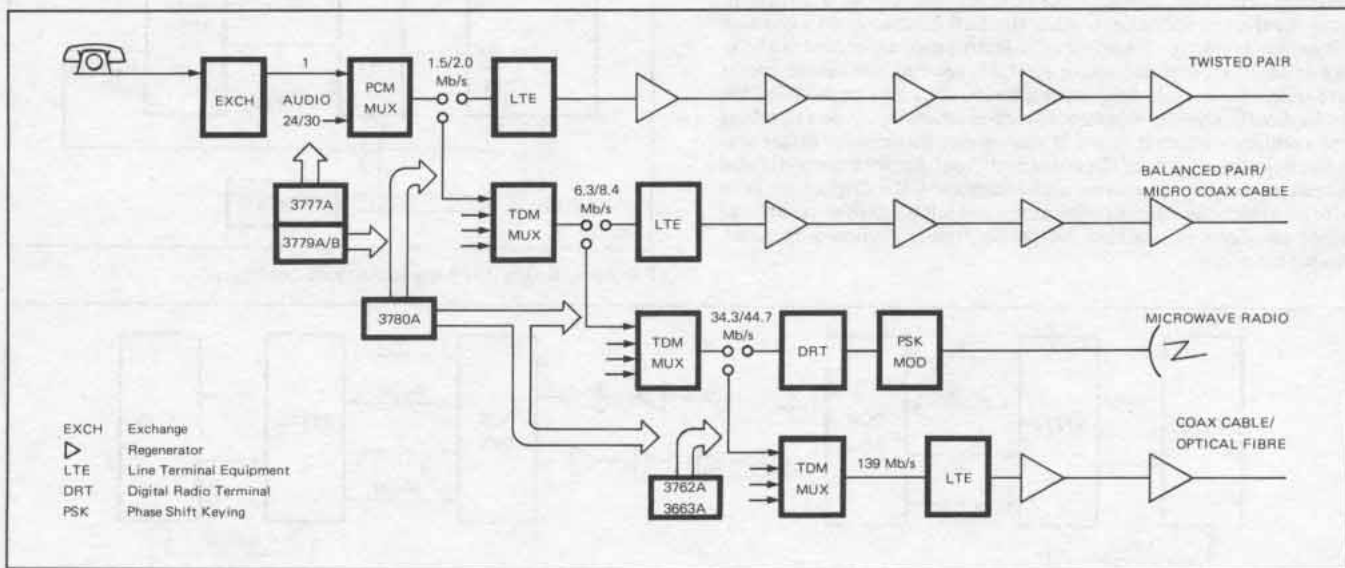

Figure 3. PCM/TDM test equipment applications

TELECOMMUNICATIONS TEST EQUIPMENT

Primary Multiplex Analyzer

Models 3779A and 3779B

- A-A, A-D, and D-A measurements
- Automatic measurement sequencing
- User-level keyboard programming

- Non-volatile program storage
- Built-in data modem
- CCITT, CEPT, and Bell compatible

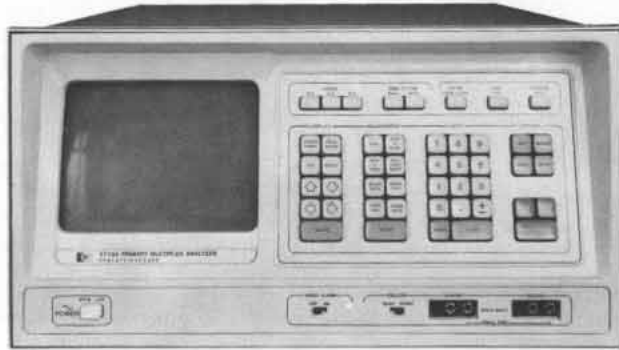

3779A

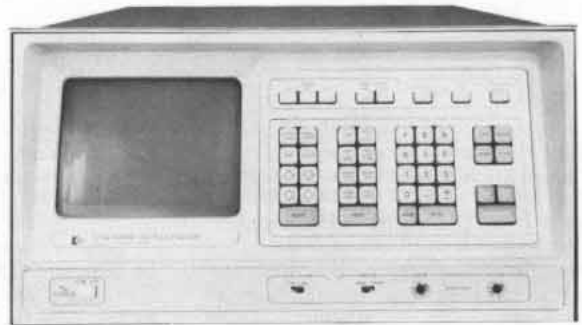

3779B



Model 3779A provides voice channel measurements to CEPT recommendations. The digital option is designed to test PCM equipment conforming to CCITT Recommendations G.711 and G.732, ie 30 voice channels/32 time slots encoded using the A-law and time division multiplexed into a 2048 kb/s digital stream.

Concept

The 3779A/B Primary Multiplex Analyzer (PMA) is a totally new concept in automated measurements of voice channel equipment including PCM, FDM, TDM terminals, and switching. It has been designed specifically to measure to CCITT, CEPT, and Bell recommendations and makes significant contributions in new measurement hardware and software. Separate tests of analog-digital (A-D) and digital-analog (D-A) performance of PCM terminals can be made in addition to characterizing the analog-analog (A-A) performance of voice channels.

Organized around a microprocessor, the instrument can automatically sequence through a number of measurements to programmed limits, calculate, and display results. Control over the PMA is via a keyboard orientated towards voice channel measurements. Programming requires no special expertise, since all measurement execution software is pre-programmed into the instrument. Operation is therefore at measurement parameter level. If required, the measurement parameters (test levels, frequencies, limits, etc.) may be modified via the keyboard. Once programmed, measurements may be assembled into a sequence which is stored in non-volatile memory for future use. Indication of the status of the instrument, together with measurement parameters/results, are on an alpha-numeric CRT display. Built-in self-test greatly facilitates calibration and fault diagnosis. Security of stored programs is provided via an electronic, keyboard-operated, combination lock.

Model 3779B provides voice channel measurements to Bell recommendations. The digital option is designed to test PCM equipment conforming to CCITT Recommendations G.711 and G.733, ie 24 voice channels/24 time slots encoded using the μ -law and time division multiplexed into a 1544 kb/s digital stream.

The PMA itself can control a number of 3777A Channel Selectors to provide multi-channel access for voice and signalling measurements. The PMA can also format results and print them out via a 2631A or 9871A printer equipped with HP-IB. A built-in modem in the PMA allows one instrument to control another remotely over the voice channel under test, enabling automatic end-end testing of the analog parameters of a voice channel circuit without recourse to external modems and common carrier interfaces.

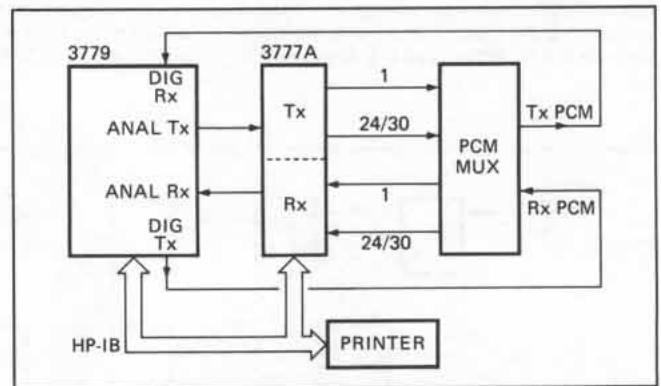

Figure 1. Basic 3779 measurement configuration.

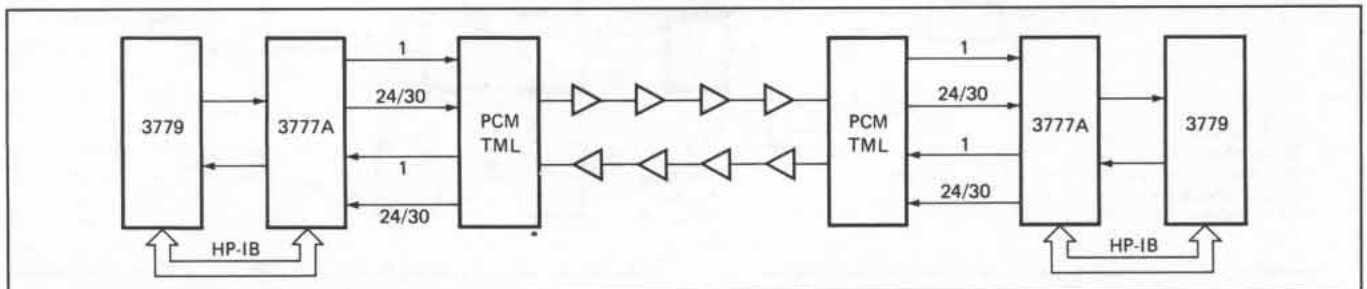

Figure 2. End-end measurement configuration.

Analog-Analog Measurements

Conventional analog hardware controlled by the processor is used to provide up to 21 different A-A measurements (see Table 1). A digital frequency synthesizer provides sinusoidal tones from 40 Hz to 40 kHz in 10 Hz steps, plus auxiliary output for two-tone intermodulation measurements and local oscillator for the analog receiver. A noise source for linearity and quantization distortion measurements in accordance with CCITT Recommendation 0.131 is also provided in the 3779A. A four-tone source for intermodulation measurements in accordance with Bell System Technical Reference (BSTR) Publication 41009 is also provided in the 3779B. The maximum level of a tone output is +13 dBm and for noise is +5 dBm. This level can be attenuated by 0 to 89.9 dB in 0.1 dB steps.

Table 1. 3779A/B Measurement Capability

Measurements	A-A	A-D	D-A	E-E
Gain	•	•	•	•
High accuracy gain	•			
Gain using peak codes		•		
Digital mW gain			•	
Gain vs frequency	•	•	•	•
Gain vs level using noise (3779A only)	•			•
Gain vs level using tone	•		•	•
Gain vs level using peak codes		•		
Gain vs level using sync 2 kHz			•	
Pedestal (coder offset)		•		
Idle channel noise psophometric (3779A only)	•	•	•	•
Idle channel noise C-message (3779B only)	•	•	•	•
Idle channel noise 3 kHz flat	•	•	•	•
Idle channel noise selective	•	•	•	•
Noise-with-tone	•			•
Quantizing distortion using tone	•		•	•
Quantizing distortion using noise (3779A only)	•			•
Intelligible crosstalk	•	•	•	•
Intermodulation using two tones	•			•
Intermodulation using four tones (3779B only)	•			•
Discrimination against out-of-band inputs	•			•
Spurious out-of-band outputs	•			•
Spurious in-band outputs	•		•	•
Return loss (Tx and Rx)	•			•
Impedance balance (TX and Rx)	•			•
Signal balance	•			•
E & M signalling distortion	•			•
Analog level	•			
Digital level		•		
Remote alarms (3779A only)			•	
Multi-frame alignment (3779A only)			•	
Frame alignment (3779A only)			•	
Local alarms (3779A only)			•	

The analog receiver contains a range of selectable filters and a choice of ac averaging or rms detectors. The particular configuration used for each measurement is fixed in ROM and controlled by the processor. The 3779A includes two quantization distortion measurement filters for the noise method, an 810 Hz quantization distortion measurement notch filter for the tone method, and a psophometric filter in accordance with CCITT Recommendation P.53A. The 3779B includes four-tone intermodulation measurement filters, a 1010 Hz quantization distortion measurement notch filter, and a C-message filter in accordance with BSTR Pub 41009. Both models also include selective filters with 3 dB bandwidths of 40 Hz and 12 Hz, and 3 kHz flat filter.

The analog interfaces (including relative test levels) can be programmed on a per channel basis to be 600Ω or 900Ω, balanced or unbalanced, with or without facilities for accepting exchange battery. The looping of the digital signal can be provided by the PMA internally.

Analog-Digital Measurements

Three types of A-D measurements are provided via a digital receiver which accepts the 2048 kb/s or 1544 kb/s serial PCM stream and extracts the desired time slot for measurement. Any failures of the digital signal are detected and flagged.

The first measurement method calculates the rms power in the time slot using 800 samples of the 8-bit PCM word. From a measurement of the analog signal applied to the channel under test, parameters such as gain can be calculated.

The second method uses a peak code detector and displays the positive and negative peak codes in decimal equivalent. It can be used to check the gain, overload point (T_{max}), symmetry, and offset of the coder.

The third method returns the digital signal to the analog domain using a very accurate reference decoder which operates over the lower segments of the coding law. Conventional selective or weighted filtering can be used to measure crosstalk or noise.

Digital-Analog Measurements

A digital test signal can be inserted into any time slot of the PCM frame. The frame can be internally generated by the PMA, or accepted from the multiplex under test by the digital receiver in the PMA and passed through the digital transmitter. When the frame is internally generated, the voice channels not under test are normally loaded with a zero-level code to simulate quiet conditions. For alignment tests, the idle code is replaced by a PRBS to simulate traffic conditions.

Test patterns are derived from two sources. The digital samples of a variable frequency sine wave from 40 Hz to 3990 Hz in 10 Hz steps are available from the synthesizer in the analog transmitter. These samples can be attenuated from +3 dBm0 to -64 dBm0 in 1 dB steps before compression to 8-bit PCM words. This source is therefore both variable in frequency (not harmonically related to the 8 kHz sampling rate) and level, and is used for frequency response and level response measurements. Alternatively, test signals can be supplied as 8-bit samples, synchronous with the sampling rate, directly from the processor. These include the CCITT 1 kHz digital sine wave as specified in Recommendation G.711 (commonly referred to as a "digital mW") and a variable level 2kHz digital sine wave for decoder linearity checks. The processor also supplies test patterns for checking alarm, frame alignment, and multi-frame alignment circuits in the multiplex (3779A only).

The digital transmitter and receiver in the PMA can be set for channel associated signalling where the signalling information for each channel is assigned via a multi-frame structure, or common channel signalling may be used.

Single Channel Interface

In order to perform A-D and D-A measurements on TDM switching equipment, single channel PCM codecs and PCM codec integrated circuits, a single channel digital interface is provided in the PMA at TTL levels. This is arranged as an 8-bit serial or parallel signal, together with a synchronisation signal at an 8 kHz rate. A 2048 kb/s or 1544 kb/s clock is also provided. This interface enables simple external circuitry to be built for the specific application.

Signalling

The A-A measurement repertoire includes a measurement of "E" and "M" signalling distortion over a PCM or FDM transmission system. A variable frequency (5 Hz to 20 Hz), variable mark/period ratio square wave signal between gnd or battery and open circuit is provided on two "M" outputs separately from the voice analog output. The received signalling information on either of two "E" inputs is analyzed for mark/period ratio distortion.

Two-Wire Measurements

Measurements on two-wire PCM voice channels can be performed with a single PMA connected as in Figure 1 using internal time slot translation on the digital signal. In the 3779A, time slot "n" in the 2048 kb/s signal is translated to time slot "(n+16)". In the 3779B, time slot "n" in the 1544 kb/s signal is interchanged with time slot "(n+1)" for odd values of "n". Thus, A-A two-wire measurements can be performed from one channel to its translated equivalent.

Multi-Channel Operation

For-A-A testing, the PMA can control a number of 3777A Channel Selectors in cascade to provide access to up to 256 voice channels. The PMA can be programmed to change the format of its analog interfaces automatically as it scans the channels.

For tests on a PCM multiplex terminal, analog signals can be applied to or accepted from up to 30 voice channels using a single 3777A Channel Selector controlled by the PMA. Scanning at the digital time slot level is integral to the PMA.

End-End Measurements

Two further measurement modes in addition to the local A-A, A-D, and D-A modes are provided. These are "master-to-slave" (M→S) and "slave-to-master" (M←S) measurements. Remote control of one PMA by another is possible using the built-in modem to transmit control and result information over the voice channel under test. Thus, separate M→S and M←S measurements over a link can be controlled from one end of the link with all the results appearing at that end also. This capability is available for A-A measurements only and can be used to check out the analog performance of voice channels (PCM or FDM) automatically, including channel scanning using two PMA's (see Figure 2), without recourse to external modems, common carrier interfaces, etc.

Controller

The processor, keyboard, and display together control the operation of the instrument. External control is also possible via the HP-IB interface.

An HP microprocessor is used together with a large amount of memory. The processor is a 16-bit machine produced on the HP silicon-on sapphire (SOS) process. Read-only-memory (ROM) provides storage of the main measurement configuration and execution software plus "default" sets of measurement parameters (levels, frequencies, and mask limits) and self-test routines. Random-access-memory (RAM) is used for measurement programming and work-space. In addition, non-volatile-memory (NVM) is used for storing system, channel, and measurement parameters (including limit masks) and measurement sequences developed by an operator. The NVM is truly non-volatile magnetic core storage and can accommodate up to 68 different measurements of average size. These can be arranged as four independent measurement sequences or as one long sequence.

Programming and execution of the measurements are via keyboard control at a measurement level as opposed to a functional level (see Figure 3). Five mode keys select the measurement mode. Each of the seven most common measurements is selected by a key which brings up the "default" measurement parameters in the alpha-numeric CRT display. These parameters can be changed by the operator simply by

manipulating the display cursor and numeric entry keys. The modified set of parameters can then be run as a single measurement by pressing the RUN key, or stored in NVM for future use by pressing the INSERT key. This process can be repeated for other desired measurements such that a measurement sequence is built up. Less common measurements are accessed via a "menu" OTHER MEAS key which brings up in the display a numbered list of measurements available in that mode.

Each measurement can be executed automatically. For example, a measurement of quantization distortion can be performed over a range of levels against the pre-programmed limits without manual intervention. The instrument can also automatically sequence through a programmed series of measurements and, dependent on whether the channel under test passes or fails, the instrument can halt, repeat, or branch to another part of the test sequence in addition to printing the result on an external printer. Entry of these "pass/fail" conditions is done during the programming phase using the editing keys (WAIT, REPEAT, GO-TO-N, PRINT). However, the WAIT, REPEAT, PRINT keys can be used as commands like RUN, STOP, SINGLE STEP to manually override the program during a "run".

The PROGRAM LOCK key allows locking of measurement sequences or the majority of the keyboard for program security simply by entering a numeric code.

The SELF TEST key allows access to built-in self-test routines which check the hardware and locate faults to a functional block or a circuit board. This includes self-calibration of filters, etc.

HP-IB Control

The PMA can control a number of 3777A Channel Selectors and a Printer. More complex instrument system configurations require an external controller. If the external controller has the capability of "passing control", then the PMA can be programmed to control its own subsystem directly, without external controller intervention. Otherwise, the external controller can be used to extend the PMA's capabilities as follows:

- Different algorithms for setting up scanner configurations can be programmed in the external controller.
- Measurement results can be directed to a large external memory and processed further (eg. statistical analysis, graphical display).
- The measurements to be performed can be held in the back-up memory of the external controller (eg. cassettes or discs) and used as an external measurement sequence of virtually infinite length as a replacement for the internal sequencing capability of the PMA.
- A PMA internal sequence with associated system parameters can be held in the external controller memory and distributed to any other PMA's.
- Remote control of the PMA becomes possible using HP-IB commands from the external controller.

Specifications

The standard 3779A/B provides analog-analog and end-end measurement capability. Analog-digital and digital-analog capabilities are optional. The measurements are summarized in Table 1.

Options (3779A)

001: provides A-D and D-A hardware and software; digital interfaces are bipolar rectangular via 75Ω unbalanced BNC connectors.

002: same as Opt 001 but with Siemens 1.6 mm connectors. add \$2285

Options (3779B)

001: provides A-D and D-A hardware and software; digital interfaces are bipolar rectangular via 100Ω balanced WECO connectors. add \$2285

Ordering Information

3779A Primary Multiplex Analyzer (CEPT) \$20530
3779B Primary Multiplex Analyzer (Bell) \$20530

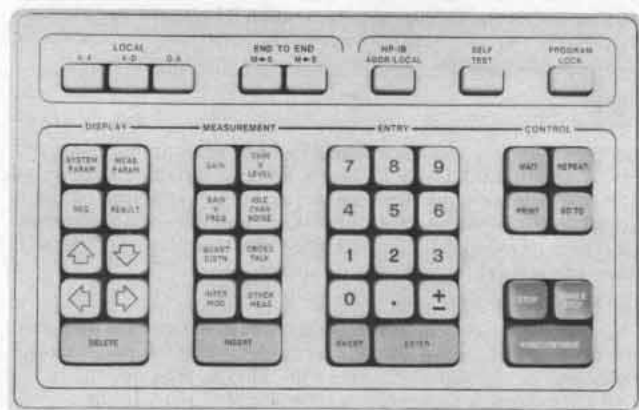

Figure 3. Primary Multiplex Analyzer keyboard.

TELECOMMUNICATIONS TEST EQUIPMENT

HP-IB controlled Channel Selector

Model 3777A



- DC to 110 kHz
- 2-wire / 4-wire balanced switching

- Modular construction
- Up to 30 4-wire channels

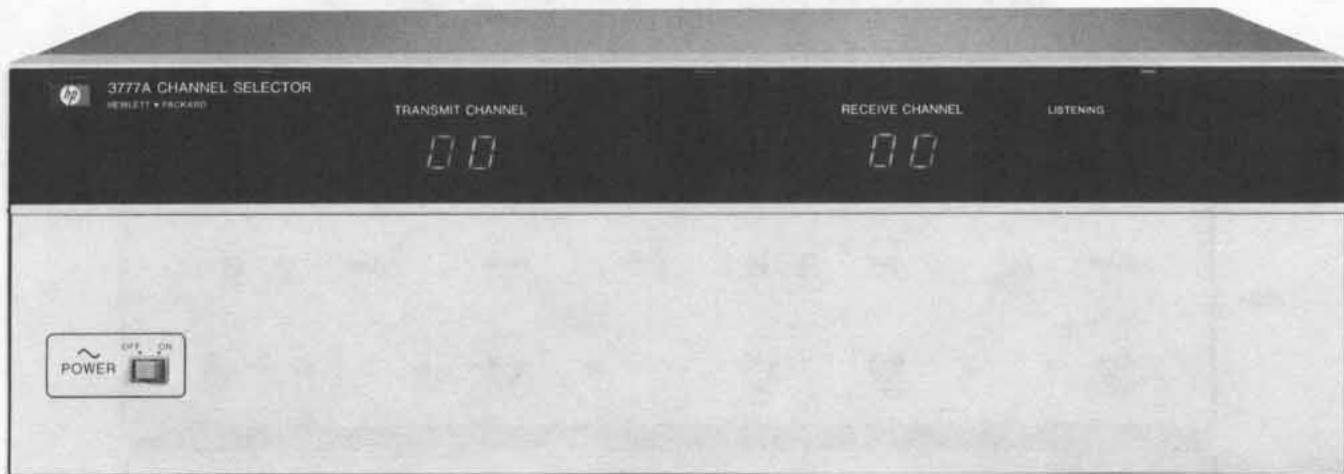

Description

The 3777A is an HP-IB controlled Channel Selector. It provides test point access for maintenance and production testing of PCM and FDM telecommunications systems.

The instrument contains two identical banks of relays, termed 'Transmit' and 'Receive.' Each bank comprises up to 30 balanced, bi-directional, two-pole changeover switches. The Transmit bank enables switching of a single source to any one of up to 30 outputs. In the Receive bank, any one of up to 30 inputs can be switched to a common output. To provide a quiet termination for telecommunications equipment, all unselected channels are terminated in 600Ω in series with 2.2 μF.

The two switch banks are controlled independently via the HP-IB from the 3779A/B Primary Multiplex Analyzer, a computer or a programmable calculator. For automatic test systems, the 3777A can scan, under external program control, through a number of channels in any desired sequence.

Construction of the 3777A is modular, with the 30 channels in both Transmit and Receive banks arranged in 5 blocks, each block having 6 Transmit and 6 Receive channels. 12 and 24 channel versions with only 2 or 4 blocks are available as options.

Principal applications are in testing telecommunications equipment where the 3777A may be used to switch PCM primary multiplex channels, FDM voice channels or groups, and voice frequency telegraph circuits, for measurements during production, installation, or maintenance. The high quality relays employed in the 3777A also make it suitable for many other general purpose applications requiring an HP-IB controlled channel selector.

Specifications

Insertion loss: <0.05 dB at 110 kHz.

Resistance of through path: <500 mΩ each leg.

Return loss of terminated port: >20 dB against 600Ω (800 Hz to 110 kHz).

Crosstalk (Isolation): >100 dB (dc to 4 kHz).
>80 dB (dc to 40 kHz).
>70 dB (dc to 110 kHz).

Changeover time: <20 ms (including bounce).

DC isolation to ground: 130 V max.

Max DC differential voltage: 60 V.

AC proof voltage to ground: 184 V peak.

Max AC differential proof voltage: 84 V pk.

Max current capability

DC (Through): 120 mA.

AC (Terminated): 20 mA rms.

Connectors: Siemens audio connectors for transmit I/P and receive O/P. A 37-way D-type connector is associated with each group of 6 receive I/P's and transmit O/P's.

General

Weight: 7 kg (15.4 lb).

Size: 145 H × 425 W × 350 mm D (16.8" × 3.5" × 13.9").

Power supply: 100/120/220/240 V, +6 —13%; ac, 48 to 66 Hz; consumption 10 VA.

Options

001: 24 channels in transmit and receive banks. less \$295

WECO 310 connectors used for transmit I/P and receive O/P

002: 12 channels in transmit and receive banks. less \$865

Siemens audio connectors used for transmit I/P and receive O/P

003: 12 channels in transmit and receive banks. less \$865

WECO 310 connectors used for transmit I/P and receive O/P.

Model 3777A Channel Selector

\$4015

Specifications

3762A Data Generator

Internal clock: two crystal clocks in the range 30 to 150 MHz; crystals fitted in standard unit are 139.264 and 141.040 MHz; offset continuously variable up to ±60 ppm.

External clock input: 1 kHz to 150 MHz; 75Ω; 300 mV pk-pk sensitivity, with choice of input termination and trigger level.

Burst gating input (rear panel): disables clock for burst mode operation; 50Ω; ECL levels.

Clock output: CLOCK or $\overline{\text{CLOCK}}$; 75Ω; preset amplitude and offset or fixed ECL levels.

Patterns: $2^{10} - 1$, $2^{15} - 1$, and $2^{20} - 1$ PRBS; two 10- or 16-bit programmable words; two 1010...repetitive patterns; two 8-bit words alternated by an external signal; PRBS patterns can be gated off for 1 to 999 clock periods after trigger pulse (zero substitution); error add facilities.

Alternating word control input (rear panel): dc to 100 kHz; 250 mV pk-pk sensitivity.

Data output A: PRBS or WORD A; DATA or $\overline{\text{DATA}}$, in CMI, NRZ or RZ format; 75Ω; preset amplitude and offset or fixed ECL levels.

Data output B: PRBS delayed, or WORD B, in NRZ or RZ format; other specifications as for Data output A.

Trigger output: one pulse every sequence or word; variable in position, selected by word switches; two clock periods wide, but stretched in zero substitution mode; 50Ω; 1 V.

Auxiliary outputs (rear panel): clock and data (both A and B) outputs in binary ECL levels.

3763A Error Detector

Data input: CMI, NRZ, or RZ formats; 75Ω DATA or $\overline{\text{DATA}}$; 300 mV pk-pk sensitivity on binary inputs, with choice of termination and trigger level; 12 dB fixed equalization at 70 MHz on CMI inputs with clock recovery.

External clock: as 3762A.

Burst gating input: (rear panel): as 3762A.

Clock output: monitor output; 50Ω; ECL levels.

Patterns: all the patterns of the 3762A, including zero substitution, but excluding alternating words.

Synchronization: automatic, manual, or external (ECL); sync loss > 10000 errors in 90000 bits; resync time typically < 800 bits.

Trigger output: as 3762A.

Error measurements: closed loop bit-by-bit comparison at the binary level with an independent, error-free local reference.

BER: looks for 10 or 100 errors and takes reciprocal of clock counter; result displayed on LED's as $X \cdot Y \times 10^{-n}$ where $n = 1$ to 9, with automatic scaling.

COUNT: totalizes errors over a selected gating period; internal period can be 10^6 , 10^8 , 10^{10} clock periods or 1 min to 24 h, repetitive

or single shot; manual start/stop or external (ECL) control; result displayed on LED's as ABCD.

Measurement gating input: gates error and clock inputs to error counter, providing a measurement "window"; 50Ω; ECL levels.

Frequency offset measurement: measures deviation of received bit rate from nominal rate; result displayed on LED's as $\pm \text{BCD} \times 10^{-6}$.

Flags: gating; error; overflow; sync loss.

24 hour clock: provides local time of result on printer output.

Interval timer: controls gating period in COUNT and print rate when periodic printing of results is required.

Printer output (rear panel): 8-4-2-1 BCD, 10-columns output of result, plus local time, if required, and flags; TTL print command pulse.

Recorder output (rear panel): constant current drive output of BER or COUNT result, with flags.

Display output (rear panel): overflow digits of error count available; 50Ω; 1 V.

Error output (rear panel): one transition per error; or one pulse per error below 75 Mb/s; 50Ω; 1 V.

Counter gate output: error counter gating period brought out to enable simultaneous gating of external counter; TTL levels.

General (3762A & 3763A)

Size: 3762A: 133 H × 425 W × 440 mm D ($5\frac{1}{4}'' \times 16\frac{3}{4}'' \times 17\frac{5}{16}''$).
3763A: 178 H × 425 W × 440 mm D ($7'' \times 16\frac{3}{4}'' \times 17\frac{5}{16}''$).

Weight: 3762A: 12 kg (26.5 lb). 3763A: 14 kg (31 lb).

Power supply: 115 V + 10%–22% or 230 V + 10%–18%; ac, 48 to 66 Hz; power consumption approx 12 VA, each.

Options (3762A/3763A)

105: 75Ω interfaces changed to 50Ω. Frequencies are 60.032 and 30.016 MHz.

201: Data output B not delayed; HDB3/B3ZS/AMI; 75Ω; ±1 V. Second data input (B) on 3763A; 75Ω; HDB3/B3ZS/AMI; automatic equalization for up to 12 dB cable loss at $\frac{1}{2}$ bit rate relative to a ±1 V signal; clock recovery at installed crystal frequencies. Channel B cannot be used simultaneously with A. Frequencies are 139.264 and 120.000 MHz.

202: as for Option 201 except frequencies are 139.264 and 34.368 MHz.

330: as for Option 201 except frequencies are 137.088 and 44.736 MHz. In addition, clock and binary data interfaces changed to 50Ω.

801: front cover.

Prices

–\$70/–\$70

–\$210/+\$305

–\$250/+\$260

–\$280/+\$180

+\$38/+\$48

Ordering information

3762A Data Generator \$8135
3763A Error Detector \$8480

TELECOMMUNICATIONS TEST EQUIPMENT

1 kb/s-50 Mb/s PCM/TDM error measuring set for field use

Model 3780A

- Binary and code error measurements
- Internal crystal clocks and clock recovery
- Clock frequency offset generation and measurement
- Ternary coded and binary interfaces
- PRBS and WORD pattern generation and detection
- Printer and recorder outputs

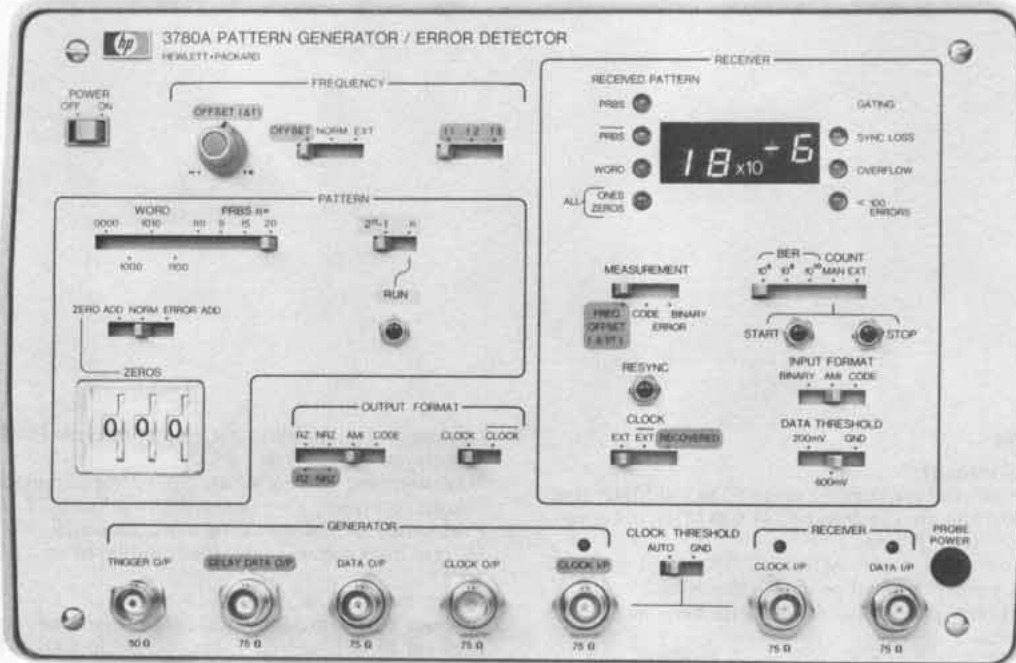

The 3780A Pattern Generator/Error Detector is a comprehensive error measuring set in one portable package. The instrument measures Binary Errors and Code Errors in digital transmission equipment operating at bit rates between 1 kb/s and 50 Mb/s. Frequency offset generation and measurement are also provided at the standard bit rates used in PCM/TDM transmission.

Binary errors are detected by stimulating the system with a test pattern and comparing the output bit-by-bit with a separate internally generated, error-free pattern. Code errors on interface or line coded information are detected during decoding into binary data. The errors can be counted over a chosen gating period and displayed directly as bit error rate (BER) or total error count (COUNT).

Error measurements can be made with PRBS or WORD patterns and the receiver has automatic pattern recognition and synchronization. Zero add facilities allow investigation of regenerator clock recovery performance. This capability can be extended by the optional addition of programmable word and alternating word generation.

The clock frequency in the pattern generator can be offset and measured in the receiver. The offset is displayed as a fraction of the nominal crystal centre frequency. In addition, the offset of external clocks applied to the generator can be measured provided that the frequency is within 25 kHz of one of the installed crystal frequencies.

BER or COUNT results can be displayed directly by LED's on the front panel or monitored via a BCD printer and strip chart recorder. This makes the 3780A ideally suited for unattended long-term measurements.

The 3780A has been designed principally for use in field trials, commissioning, and maintenance of digital transmission terminal and link equipment. It is particularly suited for testing digital multiplex, radio, and line systems but will also find application in development of more advanced systems such as optical fibre transmission and time division switching.

Specifications

Measurements

Binary errors: closed loop bit-by-bit detection on any pattern produced by generator, excluding added zeros or alternating words.

Code errors: violations of coding rule detected on any pattern with AMI, HDB3, or HDB2 coding (optionally AMI, B6ZS, or B3ZS).

Frequency offset: measurement of fractional offset of generator clock output from installed crystal rates.

Options

Word/connector options

001: all words replaced by a 16-bit front panel programmable word	add \$255
002: Siemens 1.6 mm connectors	add \$65
003: combination of 001 and 002	add \$315

Frequency offset option

099: frequency offset capability—measurement only, generation facility deleted	less \$430
---	------------

Frequency/codec options

Std: internal clock frequencies of 2048, 8448, and 1536 kHz; HDB3/HDB2 codec.	
100: internal clock frequencies of 2048, 8448, and 34368 kHz; HDB3/HDB2 codec.	N/C
101: internal clock frequencies of 1544, 6312, and 44736 kHz; B6ZS/B3ZS codec.	N/C
102: internal clock frequencies of 1544, 6312, and 3152 kHz; B6ZS/B3ZS codec.	N/C

3780A Pattern Generator/Error Detector **\$7565**

Data and Voice Testing

There are a wide variety of tests which can be made on a data communications system. Depending on the point in the system at which the tests are made, quite different philosophies and techniques apply. These group conveniently into three areas; data domain, time domain and frequency domain (Fig. 1) Data domain tests are concerned with protocol and flow of data characters within the data com-

change with time. Intermittent problems are very difficult and time consuming to troubleshoot in any system. The size and complexity of a data communication system aggravates the problems.

Even private leased lines are in a constant state of flux. When a trunk goes down for testing or repair, a new trunk will be patched in with different parameters. This constant change requires more frequent testing.

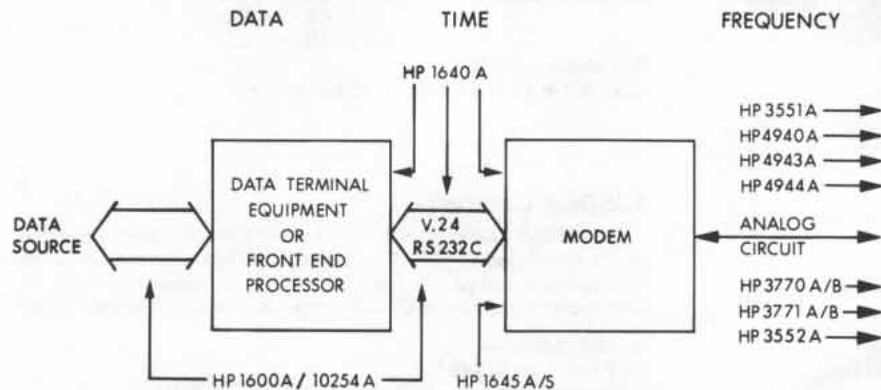

Figure 1. The three domains of data communication instrumentation.

munication systems. Time domain includes common digital tests such as bit error rate. Frequency domain tests describe the analog transmission line, for example, loss and noise.

Data communications troubleshooting involves some unique testing problems that are different from the testing done on traditional equipment. The individual tests and parameters are simple because of the low bandwidths (about 3 kHz) and modest signal-to-noise ratios (about 24 dB). The difficulty comes from the complex interrelationships of these simple parameters. For example, how does envelope delay distortion of the line (Figure 2) affect the digital error rate of a modem (Figure 3), and how does that affect the throughput of the computing system? The mathematical relationship between these simple parameters is very difficult to understand for terrestrial data links. Generally, specific limits for each parameter are tariffed for different classes of channel service.

Data communication systems require extensive handshaking between machines and across the different domains. Handshake problems are difficult to locate because they are transient and because each machine alone usually will test good. It is very difficult to isolate the handshake problem to one interface.

The geographic size and multitude of subsystems in a telecommunication system make it vulnerable to intermittent and transient impairments as well as degradation and

Data Domain

A new serial analyzer, the HP 1640A, captures and displays the serial data at the RS 232C (V24) interface. Data is displayed in binary form using hexadecimal notation, or in the actual high level code being transmitted, such as ASCII or EBCDIC. In addition, the analyzer makes time interval measurements between events occurring at the interface. The 1640A can trap on invalid character sequences, time interval violations, or data error, enabling the user to identify problems quickly when troubleshooting a computer communications network.

The 1640A is also capable of simulating a computer, terminal, or the digital side of a modem by generating specific messages and interface handshake signals—capability useful not only during network troubleshooting but also for developing and debugging systems software during systems integration and installation phases.

The HP 1600S Logic State Analyzer, when combined with the 10254A Serial-To-Parallel Converter, extends HP's data analysis capability to the parallel busses within the CPU or terminal. Comparative analysis can be made across I/O interfaces to verify performance of serial formatters for terminals and disc drives. The 1600S/10254A system operates to 10 MHz and displays data in its natural binary format. Its application is intended primarily for synchronous interfaces or asynchronous interfaces where a bit clock is available.

Digital Measurements—Time Domain

Data Error Analyzers are used to monitor the quality of both the modem and transmission facility. They provide more information about the modem and transmission line than Logic State Analyzers, but no information about the Data Terminal Equipment which they replace.

The overall quality of the link is indicated by its Bit Error Rate. A good link will have an error rate better than 1×10^{-6} errors per bit. This measurement will include the effect of both transmission line impairments and the modem's ability to overcome them. Modems vary widely in their sensitivity to line impairments. Low speed (less than 300 bps) and adaptively equalized modems are less sensitive than high speed (more than 4800 bps) and nonadaptively equalized modems.

Since data communications systems transmit data and control errors in blocks, these instruments also measure Block Error Rate. Bit Error Rate and Block Error Rate can be used together to examine the statistics of the error mechanism. If the Bit Error Rate and Block Error Rate are both high, the impairment is random and probably due to noise. If the Bit Error Rate is high but the Block Error Rate is low, the impairment is more sporadic. This happens when lines are switched, sync is temporarily lost or impulse noise is too high.

Error rates are qualitative checks of the data communication system which can be made in a few minutes. If the system is bad, diagnostic measurements are provided to help isolate the problem. Dropouts, clock slips, error skew, jitter and total peak distortion indicate some of the problems that can occur on a link. These measurements are made simultaneously with the error rate measurements and can be printed out in automatic, unattended mode if desired.

Catastrophic failures can usually be found with self tests and loop back switches built into the Data Terminal Equipment and Modem. A Transmission Test Set can find catastrophic failures of the transmission line. Logic Analyzers and Data Error Analyzers can find catastrophic failures that are not illuminated by internal self tests.

Degradations of the modem or transmission line are more difficult to find and require more extensive test equipment. The most common degradation is an excessive error rate due to line impairments or a faulty modem.

The transmission line will have a set of steady state impairments (e.g., amplitude distortion, envelope delay distortion, non-linear distortion, and frequency offset which smear the modem's symbols and make them harder to separate in the modem receiver). The line will also have random impairments (e.g., message circuit noise, impulse noise, phase jitter, phase and gain hits which can temporarily push the symbols into the wrong slot, causing a digital error).

Line impairments—frequency domain

Transmission Line Analyzers and Transmission Impairment Measuring Sets (TIMS) are used to measure the transmission distortion parameters that cause the modems to have a high bit error rate. These distortion parameters fall into two main types: steady-state and transient. These transmission parameter measurements are made on the telephone plant facilities. Because they are frequency domain measurements, they do not provide information about the data or time domain. In most cases, these transmission parameter measurements conform to CCITT or Bell standards . . . both in their results and in the methods used.

Typically, a telephone line is conditioned for a given data rate, thereby limiting the distortion allowed. The total line capability can be assessed if three line characteristics are established:

- (a) effective channel bandwidth as given by the attenuation and delay distortion
- (b) net-circuit loss
- (c) noise

The attenuation and delay distortions impose an upper limit to data transmission speed and reduce the noise margin to errors generated. The net circuit loss and noise affect the signal-to-noise margin. Noise includes both steady-state background noise and transient noise which includes impulse noise, gain and phase hits and drop-outs.

Measurements

There is a major difference in testing above and below 2000 bps. Below 2000 bps, modems are asynchronous and usually frequency shift keyed (FSK). These modems are not as sensitive to line impairments and can be maintained most of the time with simple test equipment like HP 3551A and 3555B. The digital measurements all can be made by the HP 1645S which is capable of either asynchronous or synchronous testing.

Data rates higher than 2000 bps are accomplished by transmitting more bits per symbol. This requires a synchronous modem of more sophisticated design. These modems, especially at 7200 and 9600 bps, are sensitive to channel impairments. Bell modems usually are phase shift keying (PSK) or quadrature amplitude modulation (QAM). Also used are pulse amplitude modulation (PAM) and AM single sideband (SSB) modems.

Only the Logic State Analyzers are capable of on-line testing with data traffic. The Data Error Analyzers and Transmission Test Sets generally require that the line be taken out of service and tested at each end with a compatible test set. These test sets require a known stimulus for all measurements except signal level and message circuit noise.

The majority of data networks are duplex (two way) because of the necessity for error control schemes that require a reply (ACK or

NAK) from the nominal receiver. Because of this, the testing must be done near to far and far to near to verify that both directions of the line are working.

There usually must be an identical or equivalent test set on each end of the line (4940/4940 or 1645/1645) and a technician to operate the set in each direction. The 4942A and 3770B use a microprocessor to achieve master-slave operation so that only one technician is required.

Sometimes lines can be looped around at the far end to eliminate the extra technician and test set. In the laboratory, this is always true for half duplex testing of experimental equipment. In the field, however, the loop around causes twice the length of line to be tested, so the parameters are relative . . . not absolute, and not tariffed. Some modems are capable of gain restoration in loop around to avoid an unrealistic extra 16 dB loss. Digital loop around can be accomplished at the terminal interface or in software in the DTE.

The 4940A is capable of measuring all the tariffed impairments in the U.S. The 3770B measures in one combined unit all of the maintenance parameters laid down in CCITT recommendation M. 1060, P53A, and V55. The 1645A is capable of synchronous measurements according to both Bell and CCITT specifications. There is some overlapping of the frequency domain measurements. A 3551A might be used to make simple measurements on a synchronous circuit and a 4940A might be used to investigate difficult problems on a low speed asynchronous circuit.

The choice between digital and frequency measurements depends on the application. A telephone company may not have access to or responsibility for the digital side of the modem, so frequency measurements would be best. A data communication end-user interested in go/no-go testing can make them fastest with a digital measurement of bit error rate or data characters. Since malfunctions know no boundaries, it is important that the test equipment fit the problem.

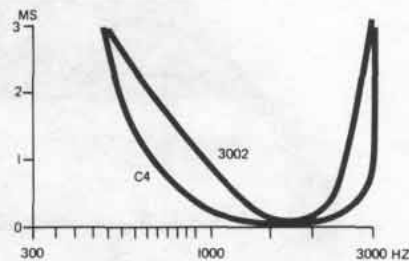

Figure 2. Advanced test sets like the 4940A, 4942A, and 3770A/B can measure envelope delay distortion.

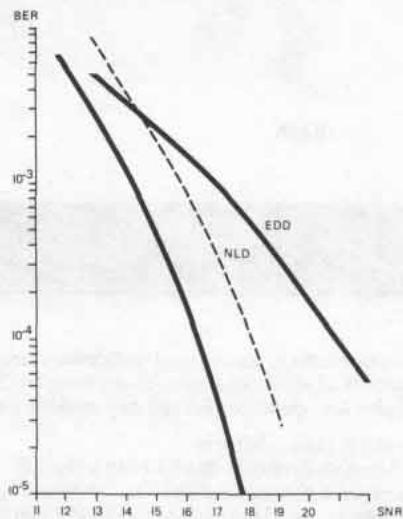

Figure 3. This classical performance characteristic of a modem shows where three types of equipment can contribute. Data error analyzers, like the 1645A, can measure bit-error-rate (BER) in the time domain. Simple transmission test sets, like the 3551A, can measure signal-to-noise ratio in the frequency domain. Advanced test sets like the 3770A/B, 4940A, and 4942A can measure important envelope delay distortion (EDD). Further the 4940A measures non-linear distortion (NLD).

MODEM TYPE	FREQUENCY		TIME	DATA
	US	CCITT		
ASYNCH < 2000 bps	3551A	3552A		
SYNCH > 2000 bps	4940A 4943A 4944A 3771B	3770A 3770B 3771A	1645A 1645S	1640A
DDS				

Figure 4. Where to use the various HP instruments in a data communication system.

TELECOMMUNICATIONS TEST EQUIPMENT

Six simultaneous, automatic data measurements

Models 1645A & 10235A



1645A



Direct reading, autoranged indications are displayed on an LED readout. Handshake signals conforming to CCITT convention are included for operation through any modern system.

1645A Description

Hewlett-Packard's Model 1645A Data Error Analyzer quickly isolates data communications link problems through six simultaneous measurements. During tests, the 1645A can be left totally unattended because it automatically maintains synchronization even in the presence of dropouts. And for added convenience, the 1645A can be equipped with a printer for hard-copy, permanent recordings of long tests.

Bit-error and block-error rate tests are autoranged and displayed directly on an LED readout, there is no need to perform any calculation. Additionally, the 1645A measures jitter or total peak distortion (the sum effect of jitter and bias), counts the number of times carrier loss or dropouts occur, measures data-error skew and counts the number of clock slips resulting from phase hits on the link or modem sync problems.

With all these measurements made during the same test interval, you'll know precisely what is causing your problems in modems, data channels, complete communications systems.

10235A Interface cover

The 10235A Interface Cover is designed for troubleshooting problems on the RS-232C interface bus. The most common problems such as wrong voltages and excessive turnaround times, which most commonly occur during installation, are easily pinpointed with the measurement capability of the interface cover.

Measurements include time interval, voltage measurements, audio monitoring, data set control signal monitoring, and the ability to send control signals to the data sets. This measurement capability can be easily patched through the 25 x 25 pin matrix to every pin of the RS232C interface for complete testing.

The programmable matrix has the 25 pins of the RS-232C interface (modem and business machine) connected to the columns along with most of the RS-232C conductors from the 1645A to the modem. Several important signals, send data, receive data, transmit clock and receive clock, are separated and applied to the matrix rows for manual manipulation by the technician.

The most important row outputs are TP1 and TP2 which are connected to the time interval circuits for measuring the interval between signals occurring on two different leads in the matrix. The interval timer measures the time while a visual indication of which lead changed state first is supplied by LED's connected to TP1 and TP2. This permits accurate timing measurements of important signals such as turnaround time between Request to Send and Clear to Send responses. Test points 1 and 2 may also be monitored with the built-in loudspeaker. For maximum flexibility the voltmeter can be connected through jumper leads to TP1, TP2, or TP3 of the matrix to any of the 25 input leads. The external inputs also allow external voltage measurements such as telephone line signal levels.

Control information can also be exchanged between the 10235A and the data set by using any of the eight data set control switches. In addition control signals from the data set can be monitored through the matrix on the eight control signal indicators.

Interfaces

For versatility in design and troubleshooting, both CCITT V24 (RS-232C) levels and TTL levels are available in the 1645A. TTL levels are through front panel BNC connectors. Interfacing with standard RS-232C systems is through a rear panel 25 pin connector. The system interface, including connector, is contained on one circuit card which is easily replaced for other interfaces. The Model 10388A interface card and cable is for modems conforming to CCITT V35 (W.E. Type 306) high speed modems. The Model 10387A interface is for type 303 wideband modems. Interfacing with modems conforming to MIL-188C standards is available with Model 18062A. A breakout box, Model 10389A for RS-232C systems, is available as a convenient method of opening interconnecting lines. Test points on each side of the switch permits monitoring of signal levels, or with jumper leads offer a convenient method of matching different system installations.

For communications companies that need to test both low and high speed systems the 1645S offers a complete data transmission test set. The test set includes a 1645A Data Error Analyzer with RS-232C interface; 10235A Interface Cover; CCITT V 35 and Type 303 interface with matching cables; Model 10389A RS-232C breakout box with cable; and two accessory pouches. The 1645A in this system incorporates a wider phase lock loop capture range which allows receiver lock-on to PRBS signals of other units that do not have crystal controlled transmitters for end-to-end testing. The 1645S includes two diode and two resistor pins for the 10235A matrix. This complete test system offers eight basic data communication measurements plus audio which is capable of detecting malfunctions ranging from crossed wires to intersymbol interference in a wide range of data communications systems.

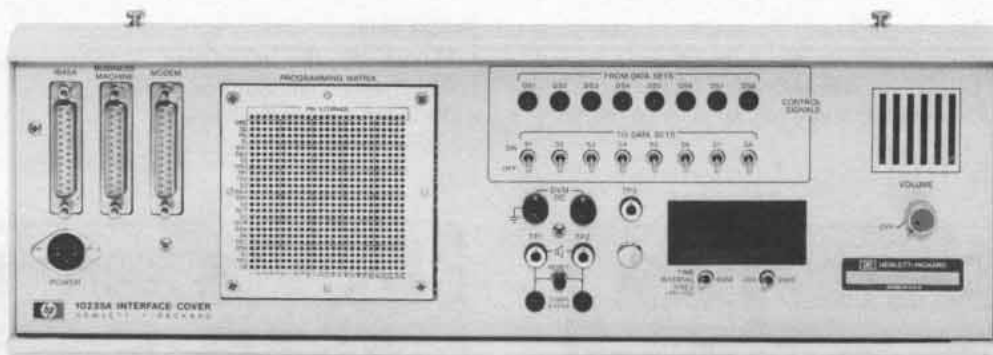

10235A

1645A Specifications

Bit rate

Internal

Transmitter bits per second: selectable 75, 150, 200, 300, 600, 1200, 1800, 2400, 3600, 4800, 7200, 9600.

Crystal frequency: 5.75 MHz \pm 0.03%, <0.01% jitter.

Receiver with bit synchronizer: same as internal transmitter.

External: transmitter and receiver, to 5 MHz.

Data outputs/inputs

Front panel

Input: data input required TTL levels; max input 5.5 V.

Outputs: receiver sync, transmitter sync, and event at TTL levels; data output is >2 V into 50 ohms; jitter/total peak is 1 V p-p for each 10% of p-p distortion from waveform causing distortion.

Rear panel

Inputs: backward channel data, external transmitter and receiver clock require TTL levels; max input 5.5 V.

Outputs: bits lost at TTL levels; internal transmitter clock is >2 V into 50 ohms.

Multipin connectors: 25 pin female connector for interfacing with standard RS-232C communications systems. 36 pin female printer output at TTL levels in BCD 8421 code.

General

Power: 115 or 230 V ac, 48 to 440 Hz, 150 VA max.

Operating environment: temperature, 0 to +55°C (+32°F to +130°F); humidity, to 95% relative humidity at +40°C (+104°F); altitude, to 4600 m (15 000 ft); vibration, vibrated in three planes for 15 min. each with 0.254 mm (0.010 in.) excursion, 10 to 55 Hz.

Dimensions: 133 H x 425 W x 286 mm D (5¼" x 16¾" x 11¼").

Weight: net, 8.2 kg (18 lb). Shipping, 10.9 kg (24 lb).

Accessories supplied: one 3 m (10 ft) RS-232C interconnecting cable to connect the 1645A to the modem, connects to 10235A when used in the 1645S configuration (HP P/N 01645/61605), one 2.3 m (7.5 ft) 3 wire power cord (HP P/N 8120-1378); one Operating and Service Manual.

1645A Indicators and controls

Indicators

Out of lock; received data inverted; bit error; carrier loss; clock slip; block error; data set ready (DSR); clear to send (CTS); loss of data; test on.

Selector switches

Clock; pattern; data/data; exponent range; single/cycle (printer); DTR/RTS/backward channel; start/stop; off/look; off/xmit errors; off/filter; event, bit error, carrier loss, clock slip, block error, skew, jitter/total peak.

10235A Specifications

Time interval

Range: 999 ms full scale.

Resolution: 1 ms.

Accuracy: \pm 2% of measured interval \pm 1 count.

Start-Stop: TP1 & TP2 input, LED indicates event start at TP1 or TP2.

Trigger slope: positive edge.

Trigger amplitude: \pm 3 V.

Input resistance: approx. 4 k Ω .

DC digital voltmeter

Ranges: 19.99 V, 199.9 V full scale.

Accuracy: \pm 1% of reading, \pm 1 count.

Digital units: 3½ digits.

Input resistance: 1 M Ω .

Overload protection: to 1000 V.

General

Interface connectors: three 25 pin female connectors for connecting the 10235A to the 1645A, modem, and business machine. Interface conforms to RS-232C standard.

Power requirements: +15 V to 25 V and -15 V to -25 V supplied by the 1645A.

Dimensions: 132 H x 399 W x 48 mm D (5.2" x 15.7" x 1.9").

Weight: net, 1.8 kg (4 lb). Shipping, 3.2 kg (7 lb).

Accessories supplied: one 46 cm (18") RS-232C interconnecting cable connects 10235A to 1645A (HP P/N 10235-61606); one accessory pouch, attaches to side of 1645A (HP P/N 1540-0385); one Operating Note.

Indicator and control functions

Indicators: eight light emitting diodes (LED) provide logic HI or LO indications for corresponding patch pins in the programming matrix, +3 V lights LED.

Audio: built-in loudspeaker and volume control.

Control switches: eight switches supply control signals through the program matrix to business machine/modem connectors. ON is +5 V, OFF is -5 V.

Interfaces

Model	Price
Model 10387A for Type 303 modems (with cable)	\$390
Model 10388A for CCITT V35 (with cable)	\$290
Model 10389A Breakout Box (RS-232C)(with cable)	\$165
Model 18062A MIL-STD-188C Interface	\$190

Accessories

Printer interconnecting cable: Model 10233A cable connects the 1645A to HP Model 5055A or 5150A printers; 36 pin male connector on one end and 50 pin male connector on the other \$50

Front panel cover: protects 1645A front panel during transit and provides convenient carrying handle (HP P/N 5060-8767). This cover is not needed when a 10235A Interface Cover is ordered with a 1645A, or with a 1645S Data Transmission Test Set. \$80

Ordering information

1645A Data Error Analyzer	\$2500
Opt 908: includes rack mounting kit	add \$10
Opt 910: additional set of manuals	add \$15.50
10235A Interface Cover	\$1000
1645S Data Communications Test Set*	\$4500
Opt 910: additional set of manuals	add \$25

*Includes 10387A, 10388A 10389A, and interconnecting cables.

TELECOMMUNICATIONS TEST EQUIPMENT

Amplitude/delay distortion analyzer; Telephone line analyzer

Models 3770A, 3770B

3770A & 3770B

- Delay and Attenuation Distortion measurements
- Compatible with CCITT Recommendation 0.81
- Rugged, portable, and really easy to use



3770A

3770B only

- Makes all the maintenance measurements listed in CCITT Recommendation M.1060
- Optional slaving facilities

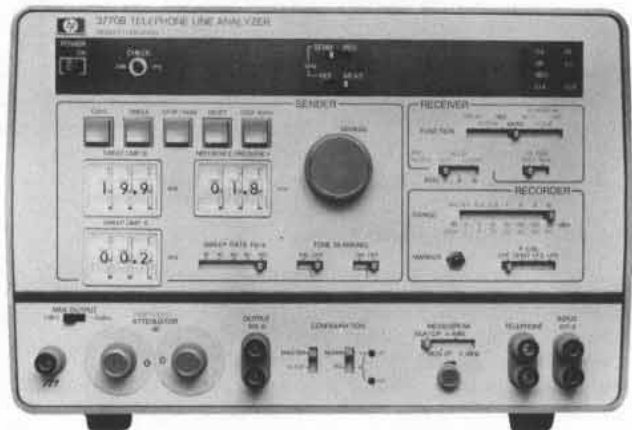

3770B

Description

The HP 3770A and 3770B are designed for audio data line characterization to CCITT standards. The 3770A measures the basic parameters affecting data lines. The 3770B makes, in one combined unit, all of the routine maintenance measurements listed in CCITT Recommendation M.1060 for high speed data lines. This includes the measurements performed by the 3770A.

The 3770A measures group delay, attenuation distortion, and absolute level in the frequency range 200 Hz to 20 kHz. It has automatic ranging, zeroing, and synchronization, with simultaneous LED read-out of measurement result and frequency. The sender and receiver are combined in a single, rugged, portable unit.

The 3770B, in addition, measures weighted noise, noise-with-tone, and impulse noise. Further, an optional slave facility for group delay and attenuation distortion measurements allows the measurement results for both directions of transmission on a 4-wire circuit to be displayed at one end of the circuit. Also, the measurements in both directions can be controlled from one end of the circuit, leaving the slave unit unattended.

The 3770A and 3770B both have X-Y recorder outputs to enable a permanent swept record of the measurements to be made. A suitable portable X-Y recorder can be supplied as an option. Pre-printed graph paper showing CCITT limits for group delay and attenuation distortion measurements can also be supplied.

Both instruments also have a built-in telephone facility to allow voice communication in a 2- or 4-wire mode over the line or lines under test. An integral loudspeaker allows the operator to monitor either the receiver input or sender output.

Measurement principles

For group delay and attenuation distortion measurements, the operation of the 3770A and 3770B is compatible with CCITT Recommendation 0.81. With this method, the sender generates a carrier signal which switches between the reference and measuring frequencies at a rate of 4.166 Hz. The composite signal is amplitude modulated by a 41.66 Hz sine wave and transmitted through the channel to be analyzed. The relative group delay of the channel at the two frequencies is measured by comparing the delay of the envelope recovered during the measuring period with that recovered during the reference period. The relative attenuation measurement is made by comparing the amplitude of the two envelopes.

The receiver can measure the absolute level of either the measuring or reference carrier within the range -50 to +10 dBm. As the sender

output is calibrated in dBm, this measurement allows the absolute loss of the transmission path to be calculated. In addition to normal operation, absolute level measurements can be made using a pure tone.

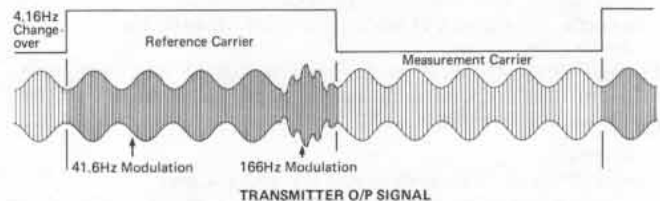

Background noise can be measured in two ways with the 3770B: weighted noise measurements, and weighted noise-with-tone measurements. Weighted noise measurements are made in accordance with CCITT Recommendation P.53A. The input is applied to a psophometric (or telephone) weighting filter and then the power is measured using a true rms detector. The filter simulates the combined characteristics of a telephone handset and a human ear, and is used to make the noise reading correspond to the subjective effect of the noise on the human ear. Also available with the 3770B is a 3 kHz flat filter which gives the noise power in the channel without psophometric weighting. In the weighted noise-with-tone mode, the 3770B measures the background noise while a 1004 Hz tone is applied to the channel. This is particularly important with, for example, PCM channels where the noise measurement would be inaccurate unless the channel is loaded. At the receiver, the 1004 Hz tone is filtered out before the noise power is measured.

The impulse noise measurement is compatible with CCITT Recommendation V.55. Impulse noise can be caused by switching, lightning, etc., and is characterized by large spikes exceeding the normal background noise level. It is measured by counting the number of spikes which exceed a given threshold level. In the 3770B, the threshold level is adjustable in 1 dB steps over the range 0 to -49 dB, where 0 dB corresponds to 1.1 V (the peak voltage of a 0 dBm sine wave into 600Ω is 1.1 V). Pulses exceeding the threshold and of greater than 50μs duration are counted; pulses of less than 20μs duration are not. Also, there is a dead time of approximately 125 ms during which further impulses are not counted.

The specifications which follow apply to both the 3770A and 3770B, unless otherwise stated.

Specifications

Sender

Reference carrier: 0.4 to 19.9 kHz in 100 Hz steps.
Measuring carrier: 0.20 to 20.00 kHz in 10 Hz steps.
Modulation envelope frequency: 41.66 Hz. (Mod. Index 0.4 ± 0.05).
Identification-burst frequency: 166 Hz* (Mod. Index 0.2 ± 0.05).
Carrier changeover frequency: 4.166 Hz.*
Accuracy of above frequencies: ± 0.1%.
 * Locked to envelope frequency
Measuring frequency sweep rates: 10, 20, 40, 80, 160 Hz/s, nominal.
Measuring frequency sweep limits: settable in range 0.2 to 19.9 kHz (100 Hz steps). Accuracy as for measurement frequency.
Carrier level: 0 to -49 dBm in 1 dB steps.
Carrier harmonic distortion: <1% (40 dB) total.

Receiver

Operating level range: <-50 dBm to >+10 dBm.
Frequency measurement accuracy: 0.1% (with sender other than 3770A/B: 0.1% ± 5 Hz).

Recorder

X-axis output: 0 to +5 V for 0 to 20 kHz or 0 to 5 kHz.
Y-axis output: ± 5 V for ± FS of the recorder range selected: available for group delay, attenuation distortion, noise and noise-with-tone measurements.

Output/input circuits

Impedance: 600Ω balanced.
Return loss: > 40 dB.
Degree of balance: > 50 dB. (Receiver 200 Hz to 6 kHz: > 60dB).
Maximum operating common mode voltage: (having regard to balance): 10 V ac rms, 100 V dc.
Maximum safe common mode voltage: 150 V ac rms, 50 Hz to 20 kHz, or 100 V dc.

Combined sender and receiver

Frequency range: 0.2 to 20 kHz.
Group delay distortion
Delay range: 0 to ± 10 ms.
Inherent group delay error of sender (rms): 0.2 to 0.4 kHz, < 5 μs; 0.4 to 0.6 kHz, < 2 μs; 0.6 to 20 kHz, < 1 μs.
Receiver measuring accuracy (rms): (5°C to 40°C) 0.2 to 0.4 kHz, < 15μs ± 1% of reading; 0.4 to 0.6 kHz, < 8μs ± 1% of reading; 0.6 to 20 kHz, < 5 μs ± 1% of reading. For 0°C to 50°C, ± 1% of reading becomes ± 2%. For additional group delay specifications, see Data Sheet.

Attenuation distortion

Receive Level Range within which both Measurement and Reference carrier levels are contained	Receiver Maximum Error of Attenuation in the range 0 to +40 dB		Sender Max. Error
	5 to 40°C	0 to 50°C	
+ 5 to -5 dBm	0.15 dB ± 1%	0.15 dB ± 1%	0.1 dB
+ 5 to -20 dBm	0.15 dB ± 1%	0.15 dB ± 1.5%	0.1 dB
+10 to -30 dBm	0.2 dB ± 1%	0.2 dB ± 2%	0.1 dB
+10 to -40 dBm	0.2 dB ± 1.5%	0.3 dB ± 2.5%	0.1 dB
+10 to -50 dBm	0.6 dB ± 2.5%	0.7 dB ± 3%	0.1 dB

Level measurement (without changeover and unmodulated)

Receive range: + 10 dBm to -50 dBm.
Accuracy

	5 to 40°C		0 to 50°C	
	Sender	Receiver	Sender	Receiver
+10 to -20 dBm	± 0.2 dB	± 0.2 dB	± 0.2 dB	± 0.3 dB
-20 to -30 dBm	± 0.2 dB	± 0.4 dB	± 0.3 dB	± 0.5 dB
-30 to -40 dBm	± 0.3 dB	± 0.7 dB	± 0.4 dB	± 0.8 dB
-40 to -50 dBm	± 0.5 dB	± 1.2 dB	± 0.5 dB	± 1.6 dB

Level measurements can also be made with modulation and change-over.

Weighted noise (3770B only)

Measurement range: 0 to -85 dBm.
Detector type: true rms.
Weighting filters: CCITT telephone, and 3 kHz flat.
Method: compatible with CCITT Recommendation P.53A.

Noise-with-tone (3770B only) as for weighted noise, except:

Measurement range: 0 to -80 dBm.
Tone frequency: 1004 Hz.
Impulse noise (3770B only)
Threshold: single level, adjustable in 1 dB steps from 0 to -49 dB (0 dB is equivalent to 1.1V).
Deadtime: 125 ± 25 ms.
Method: compatible with CCITT Recommendation V.55.

Slave facility (optional—3770B only)

Modes: remote control, and remote retransmission. Slaving applies to group delay and attenuation distortion measurements only.
Remote control: the master unit controls the measurement and reference frequencies of the slave unit.
Remote retransmission: the slave returns the group delay and attenuation distortion information to the master for display and recording.

General

Size: 200 H x 330 W x 560 mm D (7⁷/₁₀" x 13" x 22").
Weight: 3770A, 12 kg (26.5 lb); 3770B, 14 kg (30.9 lb).
Temperature ranges: operating: 0°C to 50°C, unless otherwise specified; storage: -40°C to 75°C.
Supply voltages: 115 V ac + 10-22% or 230 V ac + 10-18%; 48 to 66 Hz.
Power consumption: 3770A, 75 VA; 3770B, 100 VA.

3770A Options

Opt 001: send level range extended to -49 to +10 dBm.
Opt 002: loop holding provided for sender output and receiver input.
Maximum dc loop holding current: 100 mA.
Voltage drop at maximum current: approximately 12 V.
Dynamic output impedance: approximately 50 kΩ.
Opt 005: tone blanking.
Range: two bands in the range 0.2 to 9.9 kHz.
Range limits: any multiple of 100 Hz.

Frequency range blanked (kHz): Option number specifies range:

kHz	Opt	kHz	Opt	kHz	Opt
0.4 to 0.6	117	2.0 to 2.4	104	2.8 to 3.2	110
0.5 to 0.7	101	2.1 to 2.5	105	3.0 to 3.4	111
0.6 to 0.9	102	2.2 to 2.6	106	3.2 to 3.6	112
0.8 to 1.2	115	2.3 to 2.7	107	3.4 to 3.8	113
1.4 to 1.8	116	2.4 to 2.8	108	3.6 to 4.0	114
1.9 to 2.2	103	2.6 to 3.0	109		

Other ranges available on request. Quote Option 100 instead of the above numbers, and specify the required frequency ranges.

In-ld operating instructions: English—std; German—Option 031; French—Option 032; Italian—Option 033; Spanish—Option 034.

Opt 040: suitable portable X-Y Recorder in carrying case. Pre-printed graph paper showing CCITT limits also available—Amplitude Distortion (9280-0403), Delay Distortion (9280-0402).

Opt 061: rack mount version.

Opt 910: additional set of manuals.

3770B Options

When ordering a 3770B, select ONE option from the table below (i.e. select the standard instrument OR one option). This completely specifies the measurements selected. Note that group delay, attenuation distortion and absolute level measurement facilities are provided with ALL instruments.

Measurement facilities	Option											
	STD	001	002	003	004	005	006	007	008	009	010	011
Noise	•		•	•	•	•				•	•	•
Slaving		•	•							•	•	•
+10 dBm output				•		•	•			•	•	•
Tone blanking					•	•		•	•		•	•

Opt 012: loop holding—see 3770A Options for specifications.

Tone Blanking: ranges and range limits as for 3770A. Other options (In-ld instructions, X-Y recorder, rack mount version, and additional manuals) as for 3770A.

Ordering information

3770A Amplitude/Delay Distortion Analyzer
3770B Telephone Line Analyzer

Price
 \$7220
 \$8540

TELECOMMUNICATIONS TEST EQUIPMENT

Data Line Analyzer

Models 3771A, 3771B

- CCITT and Bell versions
- Simultaneous measurement of transients

- HP-IB option
- Optional printer output

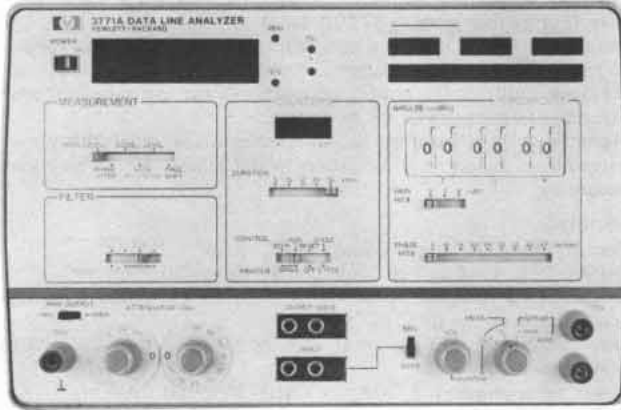

3771A

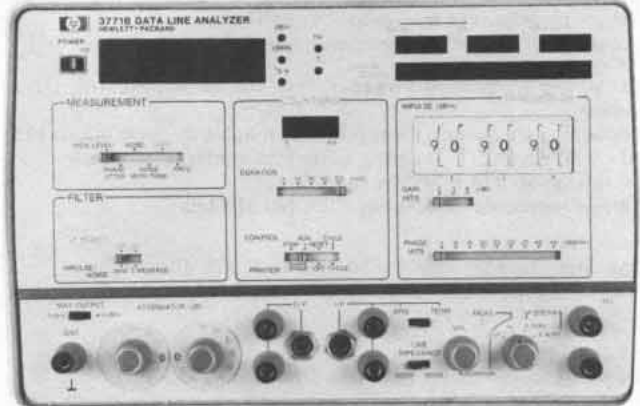

3771B



Description

The 3771A and 3771B Data Line Analyzers have been designed for making installation and troubleshooting measurements on telephone lines used for carrying high-speed data. Two versions are available—the 3771A is compatible with CCITT standards, the 3771B with Bell Publication 41009 (May 1975).

The 3771A is a companion instrument to hp 3770A Amplitude/Delay Distortion Analyzer and 3770B Telephone Line Analyzer. When either is used with the 3771A, they provide a complete portable easy-to-use CCITT data line testing facility. Routine data line maintenance measurements can be performed using the 3770A/B, and troubleshooting measurements using the 3771A. The 3771B can be used with the hp 4943A/4A Transmission Impairment Measuring Set for complete data line characterization and testing where Bell measurement standards are required.

The 3771A/B measures two basic types of parameter affecting data lines—steady state and transient.

The steady state parameters measured are:

- Level
- Phase Jitter
- Weighted Noise
- Noise-with-Tone
- Frequency Shift

The transients measured are (all measured simultaneously):

- 3-Level Impulse Noise
- Phase Hits
- Gain Hits
- Dropouts

Transient parameters are normally measured over 15-minute intervals and by measuring all of them simultaneously, the 3771A/B saves considerable operator time. Also, any comparison of results is statistically valid.

The 3771A/B can be used as a stand alone test instrument or as part of an automatic test system. An option allows the 3771A/B to be controlled externally via the Hewlett-Packard Interface Bus (HP-IB). Other optional features available are a printer output for recording the results of unattended long-term transient measurements, and dc loopholding for sender output and receiver input. In-lid operating instructions are provided for the 3771A/B, in addition to the normal detailed operating booklet. In the 3771A, the in-lid instructions can be supplied in English, French, German, Italian, or Spanish.

Measurement principles

Absolute level, in the frequency range 20 Hz to 4 kHz, can be measured from +10 to -80 dBm. To measure the loss of a line, a fixed frequency tone with a calibrated output level is provided from the transmitter. In the 3771A, the fixed frequency is 800 Hz; in the 3771B, it is 1004 Hz. The signal level is measured using a full wave averaging detector.

In the phase jitter measurement, a fixed frequency tone (1020 Hz in the 3771A, 1004 Hz in the 3771B) is transmitted over the line under test and the peak-to-peak jitter is measured and displayed in the receiver.

For weighted noise measurements, two weighting filters are provided—CCITT Telephone and 3 kHz Flat in the 3771A and C-Message and 3 kHz Flat in the 3771B. In both instruments, a true rms detector is used. Noise-with-tone measurement is also available, in which a tone is transmitted through the line under test. The tone is removed at the receiver, leaving only the noise. This allows measurements to be made when the noise level is dependent on the signal level, eg in a PCM communications system.

All the transients are measured simultaneously. A holding tone is transmitted and phase/gain hits and dropouts are measured using this tone. The tone frequencies used are 1020 Hz for the 3771A and 1004 Hz for the 3771B. Note that these are the same test tone frequencies used for noise-with-tone measurements. Variable thresholds are provided for phase and gain hits while for dropouts the threshold is fixed at -12 dB (the definition of a dropout is a negative gain hit of at least 12 dB, lasting for 4 ms or longer). For impulse noise measurements a blocking filter removes the holding tone. Three independently variable thresholds are provided. In the 3771A, there is an impulse noise only mode and both CCITT Recommendation 0.71 filters are available.

A counting hierarchy is built into the 3771A/B to prevent "double counting" of hits. When a dropout occurs, the detection and counting of phase and gain hits, and impulse noise is blocked. Also, when a phase or gain hit occurs, the detection and counting of impulse noise is blocked.

Frequency shift measurement is optional in the 3771A. Two tones at 1020 and 2040 Hz—in an exact harmonic relationship—are transmitted. Frequency shift is measured by detecting the loss in the harmonic relationship, as detailed in CCITT Recommendation 0.111.

In the 3771B, frequency is measured directly from 20 Hz to 4 kHz. For frequency shift measurement a stable 1004 Hz tone is transmitted over the line under test and measured by the receiver.

Specifications

3771A—CCITT

Transmitter

Output Level: 0 to -49 dBm, in 1 dB steps.

Frequency: automatically fixed at appropriate value for measurement selected.

Level

Transmitter Tone Frequency: 800 ± 0.05 Hz.

Range: +10 to -80 dBm.

Frequency Range: 20 Hz to 4 kHz.

Phase Jitter

Range: 0 to 30° pk-pk.

Transmitter Tone Frequency: 1020 ± 0.05 Hz.

Technique: compatible with CCITT Recommendation 0.91.

Weighted Noise

Dynamic Range: 0 to -80 dBm.

Detector Type: true rms.

Weighting Filters: 3 kHz Flat; CCITT Telephone.

Technique: compatible with CCITT Recommendation P.53.

Noise-with-Tone

As for Weighted Noise, plus:

Tone Frequency: 1020 ± 0.05 Hz.

Transient Measurements—General

Dead Time: 125 ± 25 ms.

Transmitter Tone Frequency: 1020 ± 0.05 Hz.

Timer Ranges: 5, 15, 30, 60 minutes, and manual start/stop/reset/cycle control.

Timer Capacity: 99 hours 59 minutes.

Max Count Capacity of Transient Registers: 9999.

Counting Hierarchy: as Bell Publication 41009 (May 1975).

Impulse Noise

Threshold: three, independently variable in 1 dB steps from 0 to -49 dBm.

Impulse Noise—FLAT: compatible with CCITT Recommendation 0.71.

Impulse Noise—NOTCH: measurement simultaneous with other transients.

Gain Hits

Threshold: 2, 3, and 6 dB.

Technique: compatible with Bell Publication 41009 (May 1975).

Phase Hits

Threshold: adjustable in 5° steps from 5° to 45° .

Technique: compatible with Bell Publication 41009 (May 1975).

Dropouts

Threshold: 12 dB below carrier signal level.

Technique: compatible with Bell Publication 41009 (May 1975).

Output/Input Circuits

Input Impedance: 600 Ω .

Output Impedance: 600 Ω .

Return Loss: ≥ 40 dB.

Degree of Balance (Input circuits only):

50 Hz: ≥ 80 dB.

500 Hz: ≥ 70 dB.

500 Hz to 4 kHz: ≥ 60 dB.

General

Max Operating Longitudinal Voltage: 30 V ac rms, or 125 V dc.

Size: 200 H x 300 W x 560 mm D ($7\frac{7}{8}$ " x $11\frac{1}{2}$ " x 22").

Weight: 12 kg (26.5 lb) net.

Operating Temperature Range: 0 to 50° C.

Storage Temperature Range: -40 to $+75^\circ$ C.

Power Supply: 100, 120, 220, 240 V ac, +5 -10%; 48 to 66 Hz; power consumption 30 VA, max.

3771B—North America

Transmitter

Output Level: +10 to -49 dBm, in 1 dB steps.

Frequency: automatically fixed at appropriate value for measurement selected.

Level

Transmitter Tone Frequency: 1004 ± 0.05 Hz.

Range: +10 to -80 dBm.

Frequency Range: 20 Hz to 4 kHz.

Phase Jitter

Range: 0 to 30° pk-pk.

Transmitter Tone Frequency: 1004 ± 0.05 Hz.

Technique: compatible with Bell Publication 41009 (May 1975).

Weighted Noise

Dynamic Range: 0 to 90 dBm.

Detector Type: true rms.

Weighting Filters: 3 kHz Flat, C-Message.

Technique: compatible with Bell Publication 41009 (May 1975).

Noise-with-Tone

As for Weighted Noise, plus:

Tone Frequency: 1004 ± 0.05 Hz.

Frequency

Range: 20 Hz to 4 kHz.

Accuracy: ± 0.1 Hz, 20 Hz to 1.8 kHz; ± 1 Hz, 1.8 to 4 kHz.

Transmitter Tone Frequency: 1004 ± 0.05 Hz.

Transient Measurements—General

Blanking Period: 143 ms $\pm 5\%$.

Transmitter Tone Frequency: 1004 ± 0.05 Hz.

Timer Ranges: 5, 15, 30, 60 minutes, and manual start/stop/reset/cycle control.

Timer Capacity: 99 hours 59 minutes.

Max Count Capacity of Transient Registers: 9999.

Counting Hierarchy: as Bell Publication 41009 (May 1975).

Impulse Noise

Threshold: three, independently variable in 1 dB steps from 30 to 109 dBm.

Technique: compatible with Bell Publication 41009 (May 1975).

Gain Hits, Phase Hits, Dropouts

As for 3771A.

Output/Input Circuits

Input Impedance: 600 Ω , 900 Ω , and bridged.

Output Impedance: 600 Ω and 900 Ω .

Return Loss: ≥ 40 dB.

Degree of Balance (Input circuits only):

60 Hz: ≥ 80 dB.

540 Hz: ≥ 70 dB.

540 Hz to 4 kHz: ≥ 60 dB.

General

As for 3771A.

Options (3771A and 3771B)

Option 001—+ 10 dBm Output (3771A only) add \$58

Output Level: maximum sender output level 0 or +10 dBm, selected by switch.

Option 002—Loopholding

3771A add \$140

Voltage Drop: 12 ± 2 V at 100 mA.

AC Impedance of Loopholding Circuit: 20 Hz to 4 kHz: ≥ 100 k Ω .

3771B add \$140

Technique: compatible with Bell Publication 41009 (May 1975).

Option 003—Frequency Shift (3771A only) add \$320

Range: 0 to 10 Hz.

Tone Frequencies: 1020 and 2040 Hz, in harmonic relationship.

Technique: compatible with CCITT Recommendation 0.111.

Option 004—Printer Output add \$220

Format: 8421 BCD.

Compatibility: hp 5150A, 5055A, 5050B.

Information: all transient data at end of each timer interval.

Option 005—HP-IB add \$590

In-ld Operating Instructions: English—std; German—Option 031; French—Option 032; Italian—Option 033; Spanish—Option 034. N/C

Ordering Information

3771A Data Line Analyzer—CCITT \$7150

3771B Data Line Analyzer—North America \$7150

TELECOMMUNICATIONS TEST EQUIPMENT

15 Hz to 50 kHz selective voltmeter

Model 3581C

- Voice grade testing
- Wideband data circuit testing
- Single frequency interference
- Spectrum analysis



Description

The 3581C Selective Voltmeter has found wide application in testing special service circuits in both inside and outside plant maintenance. The 3581C is used to do spectrum analysis, measure non-linear distortion (harmonic distortion) and to locate and measure unwanted spurious and induced tones. The unit can be operated from ac line or from optional internal batteries.

Specifications

Frequency range: 15 Hz to 50 kHz.

Display: 5 digit LED readout. Resolution: 1 Hz. Accuracy: ± 3 Hz.

Typical stability: ± 10 Hz/hr. after 1 hour. ± 5 Hz/ $^{\circ}$ C.

Automatic frequency control (AFC), hold-in range: ± 800 Hz.

Pull-in range: > 5 x bandwidth for 3 Hz to 100 Hz bandwidth; > 800 Hz for 300 Hz bandwidth for full-scale signal.

Lock frequency: center of passband ± 1 Hz.

Amplitude

Instrument range

Linear: 30 V to 100 nV full scale.

Log: +30 dBm or dBV to -150 dBm or dBV.

Amplitude accuracy:

	Log	Linear
15 Hz-50 kHz, frequency response	± 0.4 dB	$\pm 4\%$
Switching between bandwidths	± 0.5 dB	$\pm 5\%$
Amplitude display	± 2 dB	$\pm 2\%$
Input attenuator	± 0.3 dB	$\pm 3\%$
Amplitude reference level (IF Attenuator)		
Most sensitive range	± 1 dB	$\pm 10\%$
All other ranges	± 1 dB	$\pm 3\%$

Note: these specifications cover the full temperature frequency and amplitude range, and represent worst case. Accuracy is significantly better for measurements not at the extremes.

Dynamic range > 80 dB.

Noise level

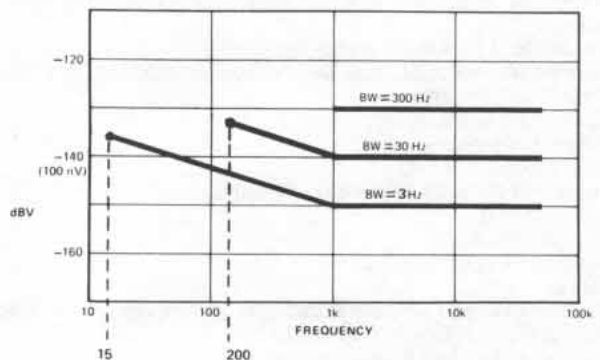

Noise sidebands: greater than 70 dB below CW signal. 10 bandwidths away from signal.

IF feedthrough: input level > 10 V: -60 dB; input level < 10 V: -70 dB.

Spurious responses: > 80 dB below input reference level.

Line related spurious: > 80 dB below input reference level or -140 dBV (0.1 μ V) or -90 dBm on 3581C in balanced terminated mode.

Zero beat response: > 30 dB below full scale at 25° C $\pm 5^{\circ}$ C. > 15 dB for 0° C to 55° C.

Smoothing: 3 position, rolloff is a function of BW.

Overload indicator: this LED warns of possible input amplifier overloading.

Uncal indicator: the variable input attenuator may be set to positions between steps. This is useful for scaling signals. When this feature is being used, the Uncal indicator clearly shows the instrument is not on a standard setting.

Meter scales taut band with mirror backing:

0 dB to -90 dB	Log
0 dB to -10 dB	
0 to 1	Linear
0 to 3.2	

Calibrator: the 10 kHz fundamental of the calibrator may be used along with the 10 kHz cal adjustment to set the meter to full scale. This calibrates the circuitry that follows the input attenuator to an accuracy of $\pm 1.5\%$ at full scale, 10 kHz and same bandwidth.

Sweep

Scan width: 50 Hz to 50 kHz. These scans can be adjusted to cover a group of frequencies within the overall instrument range.

Sweep times: 0.1 s to 2000 s.

REP: in the repetitive mode, sweep will continuously sweep the specified band.

Single scan: after triggering a single sweep, HP's 3581C will remain at upper end of sweep. A sweep may also be triggered externally through a BNC connector on the rear panel labeled "external trigger." Grounding inhibits internal trigger.

Reset: HP's 3581C is set to the start frequency of sweep.

Manual: in combination with concentric knob, manual sweep fully duplicates span of electronic sweep.

Off: sweep circuits and associated controls are turned off.

Sweep error light: this LED indicates a sweep that is too fast to capture full response. When the light is on, response will be lower than it should.

Zero scan: to look at the time varying signal at center or start frequency within bandwidth selected.

External trigger: a short to ground stops normal sweep. Opening the short then enables a sweep.

Input

Meter Scale Buttons	Terminated	Bridging	Unbalanced
Volts 900 Ω dBm/LIN	Input impedance 900 Ω . Reads volts on volt scales of meter. 1 V rms input gives 1 V rms on meter.	Input impedance 10 k Ω . Reads volts on volt scales of meter. 1 V rms input gives 1 V rms on meter.	Input impedance 1 M Ω . Reads volts on volt scales of meter. 1 V rms input gives 1 V rms on meter.
dB 900 Ω dBm/LIN	Input impedance 900 Ω . Reads dBm 900 Ω on dB scales of meter. 0.949 V rms input gives 0 dB reading on meter.	Input impedance 10 k Ω . 900 Ω termination necessary to be calibrated with a source that has 900 Ω output impedance. 0.949 V rms input gives 0 dB reading on meter.	Input impedance 1 M Ω . 900 Ω termination necessary to be calibrated with a source that has 900 Ω output impedance. 0.949 V rms input gives 0 dB reading on meter.
Volts 600 Ω /dBm		Not a valid combination.	
dB 600 Ω /dBm	Input impedance 600 Ω . Reads dBm 600 Ω on dB scales of meter. 0.775 V rms input gives 0 dB reading on meter.	Input impedance 10 k Ω . Termination necessary to be calibrated with a source that has 600 Ω output impedance. 0.775 V rms input gives 0 dB reading on meter.	Input impedance 1 M Ω . Termination necessary to be calibrated with a source that has 600 Ω output impedance. 0.775 V rms input gives 0 dB reading on meter.

Unbalanced (UNBAL)

Impedance: 1 m Ω /40 pF.

Max. input level:

+ 30 dBm to -10 dBm sensitivity: 100 V rms or ± 100 V DC.

-20 dBm to -70 dBm sensitivity: 50 V rms or ± 100 V DC.

Balanced/bridged (BRDG)

Impedance: 10 k Ω .

Max. input level: +20 dBm; ± 100 V DC.

Frequency response: 40 Hz-20 kHz, ± 0.5 dBm for signals < 20 dBm.

Dynamic range: 80 dB for signals < 0 dBm and > 100 Hz.

Common mode rejection: > 70 dB at 60 Hz.

Balanced/terminated (TERM)

Impedance: 600 Ω /900 Ω balanced.

Max. input level: +20 dBm; ± 100 V DC.

Frequency response: same as balanced/bridging.

Dynamic range: same as balanced/bridging.

Common mode rejection: > 64 dB at 60 Hz.

Input connector: accepts WECO 310 plug—input is transformer coupled.

Output

Tracking generator output (also known as BFO or tracking oscillator output).

Restored output

Range: 0 to 2 V rms.

Frequency response: $\pm 3\%$ 15 Hz to 50 kHz.

Frequency accuracy: ± 1 Hz relative to center of filter.

Impedance: 600 Ω .

Total harmonic and spurious content: (for tracking generator output) > 40 dB below 1 V rms signal level.

LO output: 100 mV signal from 1 MHz to 1.5 MHz as input is tuned from 0 to 50 kHz.

Output connector: WECO 310, for connection to tracking generator output or restored output. In addition to monitoring restored output with headphones, an internal speaker also provides an audio indication of signal content.

Restored and tracking generator

Output impedance: 600 Ω balanced.

Frequency response: ± 0.5 dB 100 Hz to 20 kHz.

X-Y recorder analog outputs

Vertical: 0 to +5 V $\pm 2.5\%$.

Horizontal: 0 to +5 V $\pm 2.5\%$.

Impedance: 1 k Ω .

Pen lift: contact closure to ground during sweep.

General

Operating temperature range: 0°C to 55°C.

Humidity: 95% relative, maximum at 40°C.

Power requirements: 100 V, 120 V, 220 V, 240 V +5% -10%, 10 VA typical, 48 Hz to 440 Hz.

Size: 412.8 mm H x 203.2 mm W x 285.8 mm D (16 1/4" x 8" x 11 1/4").

Weight: 11.5 kg (23 lb); Option 001, 13.5 kg (30 lb).

Accessory available: 7035B Option 20, X-Y recorder.

Option 001 battery: used to make floating measurements or to break ground loops; 12 hours from full charge; 12 hours to fully charge. The internal battery is protected from deep discharge by an automatic turn-off.

Ordering Information

3581C Selective Voltmeter

Opt 001: Battery Pack

7035B Opt 020: X-Y Recorder

Price

\$3680

add \$405

add \$1770

Transmission test sets

Models 3551A & 3552A

- Voice grade testing
- Data circuit testing



3551A
(North American)

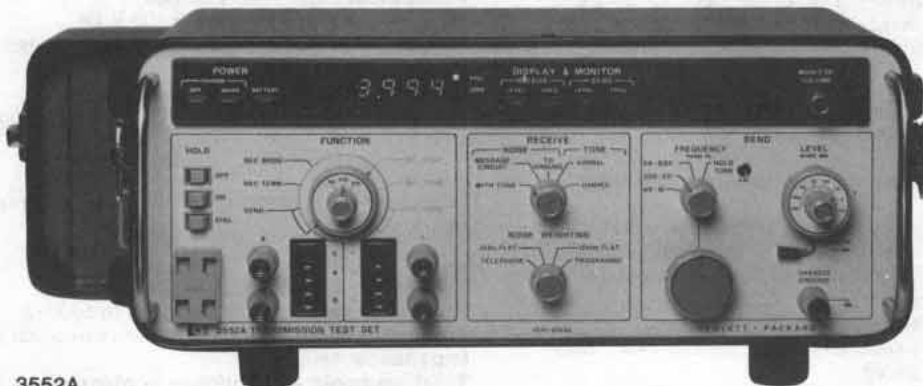

3552A
(CCITT)

Description

Hewlett-Packard's 3551A (North American Measurement Standard) and 3552A (CCITT) Transmission Test Sets are rugged, portable and ideally suited for measurements on voice, program and data circuits up to 50 kb/s.

These four-function test sets are capable of measuring tone level, noise level, and frequency, while simultaneously sending tone. Both level and frequency are fully autoranging.

A normal sampling of 10/second in tone level and frequency allows a "direct feel" between an adjustment and the ensuing reading. In addition, a damped sample rate of 2/second is useful when reading noisy signals. The digital LED (Light Emitting Diode) readout displays either the level or frequency of the input or output regardless of terminal function selected.

Appropriate resolution, time constant and sample rate are automatically provided to simplify operation for the user.

These test sets can measure both two-wire and four-wire balanced circuits. Impedances of 135, 600, and 900 ohms can be selected on the 3551A; impedances of 150, 600, and 900 ohms are available on the 3552A. In addition, the receiver may be either terminated or bridged.

The test sets may be powered by either ac line or internal rechargeable batteries and are suited for both inside and outside plant maintenance.

A full wave average detector is used for tone level measurements. Automatic ranging eliminates the need to set attenuators and thus reduces the possibility of errors due to faulty calculations. Direct digi-

tal readout gives a 0.1 dB resolution over the entire 85 dB dynamic range.

For frequency measurements, a four-digit autoranging frequency counter is provided. The readout is calibrated in kHz and features 1 Hz resolution from 40 Hz to 10 kHz and 10 Hz resolution from 10 kHz to 60 kHz. The decimal point is automatically positioned to avoid the possibility of errors due to overflow of the four digits.

Noise measurements are made with a QUASI RMS detector and displayed in dBm on the 3551A and dBm on the 3552A, with 1.0 dB resolution. Display rate is slowed to 2 per second to provide analog feel of slowly changing noise levels. Both test sets have the capability of measuring noise-with-tone, message circuit noise, and noise-to-ground. Four switch selectable weighting networks are provided; C-message, Program, 3 kHz, and 15 kHz Flat in the 3551A; and Telephone (Psophometric), Programme, 3 kHz Flat and 15 kHz Flat in the 3552A. In the noise-with-tone position, a notch is inserted before the selected weighting network.

Send oscillator covers a frequency range of 40 Hz to 60 kHz in three bands; 40 Hz to 1 kHz, 200 Hz to 6 kHz and 2 kHz to 60 kHz. The output level is continuously variable from +10 dBm to -60 dBm.

In addition, a fixed position is provided to be used as the holding tone when making a noise-with-tone measurement.

A convenient set of clip-on dial terminals for connecting a lineman's handset is provided. This allows a line connection to be dialed up and then held in an off-hook (busy) condition while making either receive or send measurements on a two-wire wet line.

Specifications, Model 3551A & 3552A

Receiver

Level Measurements

Frequency range: 40 Hz to 60 kHz.
Dynamic range: +15 dBm to -70 dBm.
Resolution: 0.1 dB.
Sample rate: 10/second normal, 2/second damped.
Detector type: average responding.
Accuracy: at 25°C ± 10°C, temperature coefficient: ± 0.005 dB/°C beyond this range.

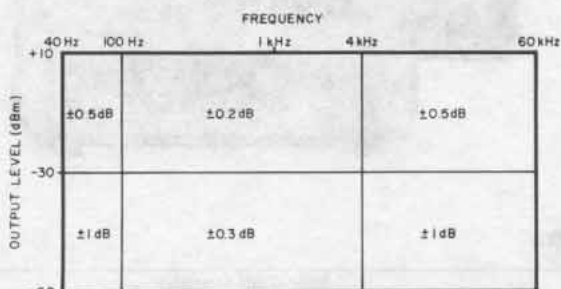

TRANSMITTER ACCURACY NOT SPECIFIED BELOW 500Hz ON 135Ω OR 150Ω OUTPUT.

Frequency measurements

Frequency range: 40 Hz to 60 kHz.
Dynamic range: +15 dBm to -70 dBm.
Resolution: 1 Hz (40 Hz to 10 kHz), 10 Hz (10 kHz to 60 kHz).
Sample rate: 10 second normal, 2/second damped.
Accuracy: ± 1 count.

Transmitter 3551A & 3552A

Frequency range: 40 Hz to 60 kHz.
Ranges: 40 Hz to 1 kHz, 200 Hz to 6 kHz, 2 kHz to 60 kHz, 800 Hz fixed. (Other frequencies available 3552A.) 1004 Hz fixed, 3551A.
Resolution: 1 Hz (40 Hz to 10 kHz), 10 Hz (10 kHz to 60 kHz).
Sample rate: 10/second.
Harmonic distortion: < -50 dB (THD 100 Hz to 4 kHz); < -40 dB (THD 40 Hz to 100 Hz and 4 kHz to 20 kHz); < -30 dB (THD 20 kHz to 60 kHz); < -55 dB (all harmonics 100 Hz to 4 kHz); < -60 dB (THD 1004 Hz fixed).
Accuracy: ± 1 count.
Level range: +10 dBm to -60 dBm (40 Hz to 60 kHz), +6 dBm to -60 dBm. (1004 Hz fixed—3551A; 800 Hz fixed—3552A).
Resolution: 0.1 dB.
Sample rate: 10/second.
Accuracy: at 25°C ± 10°C, temperature coefficient: ± 0.005 dB/°C beyond this range.

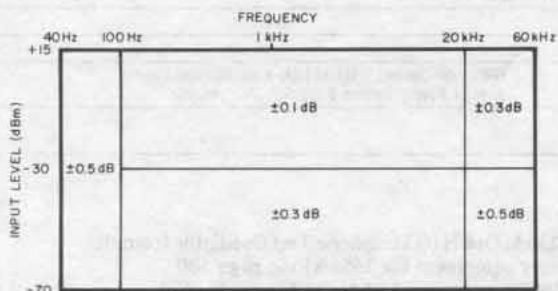

RECEIVER ACCURACY NOT SPECIFIED BELOW 500Hz OR BELOW -65dBm WHEN USING 135Ω OR 150Ω INPUT.

3551A Noise measurements

Dynamic range
Message circuit noise: 0 dBm to +85 dBm.
Noise-with-tone: 10 dBm to +85 dBm.
Noise-to-ground: 40 dBm to +125 dBm.
Resolution: 1 dB.
Sample rate: 2/second.
Detector type: Quasi-RMS responding.

Accuracy

Message circuit noise: ± 1 dB (+20 dBm to +85 dBm), ± 2 dB (0 dBm to +20 dBm).
Noise-with-tone: ± 1 dB (+20 dBm to +85 dBm), ± 2 dB (+10 dBm to +20 dBm).
Noise-to-ground: ± 1 dB (+60 dBm to +125 dBm), ± 2 dB (+40 dBm to +60 dBm).
Weighting filters: C-message, 3 kHz flat, 15 kHz flat, program.

3552A Noise measurements

Dynamic range
Message circuit noise: -90 dBm to -5 dBm.
Noise-with-tone: -80 dBm to -5 dBm.
Noise-to-ground: -50 dBm to +35 dBm.
Resolution: 1 dB.
Sample rate: 2/second.
Detector type: Quasi-RMS responding.

Accuracy

Message circuit noise: ± 1 dB (-70 dBm to -5 dBm), ± 2 dB (-90 dBm to -70 dBm).
Noise-with-tone: ± 1 dB (-70 dBm to -5 dBm), ± 2 dB (-80 dBm to -70 dBm).
Noise-to-ground: ± 1 dB (-30 dBm to +35 dBm), ± 2 dB (-50 dBm to -30 dBm).
Weighting filters: Telephone (CCITT Psophometric), 3 kHz flat, 15 kHz flat, Programme.

General

Monitor: built-in speaker, monitors received or transmitted signal.
Balanced impedances: 135Ω, 600Ω, 900Ω (3551A).
Balanced impedances: 150Ω, 600Ω, 900Ω (3552A).
Bridging loss: < 0.2 dB.
Return loss: > 30 dB.
Longitudinal balance: > 60 dB at 6 kHz, > 126 dB at 50 Hz.
Hold circuit: 20 milliamps constant current, < 0.2 dB holding loss, resistive fuse protection.
Input/output protection: blocks 300 V dc.
Maximum longitudinal voltage: 200 V rms.
Battery supply: > 4 hours continuous operation on internal rechargeable batteries at 25°C. Battery drain is automatically turned off when discharged below proper operating level. Complete recharge in 12 hours.
Power requirements: 100 V, 120 V, 220 V, 240 V ± 10%; 48 Hz to 440 Hz; 4 VA.
Temperature range: 0°C to 55°C, operating; -20°C to +66°C storage.
Relative humidity: 0 to 95% (< 40°C).
Dimensions: 133 mm H × 343 mm W × 254 mm D (5¼" × 13½" × 10").
Weight: net, 6.6 kg (14.5 lb). Shipping, 7.3 kg (16 lb).

Options

C01-3551A, C01-3552A: 19 inch rack mount, ac power only (no batteries) **Price N/C**
H10-3551A: Extends frequency range to 85 kHz **add \$300**

Ordering information

3551A Transmission test set **\$2000**
3552A Transmission set (CCITT) **\$2345**

TELECOMMUNICATIONS TEST EQUIPMENT

Transmission & noise measuring set

Models 3555B & 3556A

- Voice and carrier testing

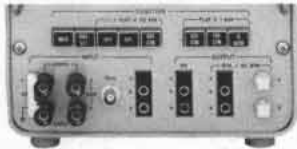

Description

Hewlett-Packard's 3555B Transmission and Noise Measuring Set is designed especially for telephone plant maintenance. It measures attenuation, distortion, cross-talk coupling and noise. Weighting networks comply with Bell System Technical Reference Publication number 41009, and include C-message, 3 kHz, 15 kHz flat and program.

HP's 3556A performs the same tasks as the 3555B. It also has built-in weighting networks that comply with 1960 CCITT requirements, which include telephone (psophometric) 3 kHz flat, and 15 kHz flat, Programme (P53) weighting filters.

Operating instructions printed in the protective cover are available in different languages at no extra charge.

Complementary equipment for the 3555B is HP 236A Telephone Test Oscillator (236A Opt. H10 for the 3556A). When used together, they make a complete transmission test set for accurate, convenient voice and carrier measurements.



Specifications

	3555B (North American Standards)	3556A (CCITT Standards)
VOICE FREQUENCY LEVEL MEASUREMENTS: 20 Hz to 20 kHz		
dB/volt range	-91 dBm to +31 dBm	-78 dBm to +32 dBm/0.1 mV to 30 V F.S.
Level accuracy**	±0.5 dB; ±0.2 dB, 40 Hz to 15 kHz, level >60 dBm	100 Hz to 5 kHz: ±0.2 dB; 20 Hz to 20 kHz: ±0.5 dB
Input	Terminated or bridged 600Ω or 900Ω balanced. Bridging loss: <0.3 dB at 1 kHz. Balance: >80 dB at 60 Hz >70 dB at 6 kHz, >50 dB to 20 kHz. Return loss: 30 dB min (50 Hz to 20 kHz)	Terminated: 600Ω symmetrical. Non-terminated: 10 kΩ symmetrical. Non-terminated error: <0.4 dB at 800 Hz. Symmetry: >80 dB at 50 Hz, >70 dB at 6 kHz, >50 dB to 20 kHz. Return loss: 30 dB min (50 Hz to 20 kHz)
Holding circuit	700Ω dc resistance, 60 mA max. loop line current at 300 Hz. With holding circuit in, above specs apply from 300 Hz to 4 kHz	
NOISE MEASUREMENTS:		
dB/volt range	-1 dBm to +121 dBm	-78 dBm to +32 dBm/0.1 mV to 30 V F.S.
Weighting filters	3 & 15 kHz flat, C-message, and program (Bell system technical reference pub #41009)	3 & 15 kHz flat, Telephone and Programme (P53, CCITT)
Input	Same as for voice frequency measurements	
CARRIER FREQUENCY LEVEL MEASUREMENTS:		
dB/volt range	-61 dBm to +11 dBm	-48 dBm to +12 dBm/3 mV to 3 V.F.S.
Level accuracy	600Ω balanced (symmetrical): 1 kHz to 150 kHz ±0.5 dB; 10 kHz to 100 kHz, ±0.2 dB. 135Ω balanced (or 150Ω balanced)†: 1 kHz to 600 kHz, ±0.5 dB; 10 kHz to 300 kHz, ±0.2 dB. 75Ω unbalanced (asymmetrical): 100 Hz to 600 kHz, ±0.2 dB; 30 Hz to 1 MHz, ±0.5 dB; 1 MHz to 3 MHz, ±0.5 dB ±10% of meter reading	4 rechargeable batteries (25 V total) or power line from 90 V to 250 V ac, 48 Hz to 440 Hz, <10 VA. Option 001 uses same battery as 3555B
Input	Terminated or bridged 135Ω† or 600Ω balanced (symmetrical) and 75Ω unbalanced (asymmetrical)	
Return loss	600Ω: 26 dB min., 3 kHz to 150 kHz; 135Ω†: 26 dB min. 1 kHz to 600 kHz; 75Ω: 30 dB min. to 3 MHz	
Bal/symmetry	>70 dB to 10 kHz, >60 dB to 100 kHz, >40 dB to 600 kHz	
GENERAL:		
Meter	Linear dB scale	Linear dBm scale
External battery	24 V or 48 V office battery, <15 mA	
Internal battery	Single NEDA 202, 45 V "B" battery Option H03 uses rechargeable batteries and similar to 3556A	
AC	115 or 230 V (specify for 3555B) (switch for 3556A) 48 Hz to 440 Hz, <10 VA	
Dimensions	299 mm H × 197 mm W × 207 mm D (11¾" × 7¾" × 8¼")	
Weight	Net, 6.8 kg (15 lb). Shipping, 7.5 kg (17 lb).	
Jacks	Will accept Western Electric 241, 309, 310, 358, 289 and 347 plugs; 1011B hand-set or 52 type headset	Will accept Siemens 9 REL KL1-6A, 4 mm diameter banana plugs or 3-prong Siemens 9 REL STP-6AC connector
**For levels >1 dBm accuracy spec applies only for freq. above 100 Hz. †150Ω for 3556A.		

Ordering information

HP 236A Telephone Test Oscillator (complementary equipment for 3555B) see page 580

HP 236A, Opt H10 Telephone Test Oscillator (complementary equipment for 3556A) see page 580
3555B Transmission and Noise Measuring Set
3556A Psophometer

Price

\$1250
 \$1290

TELECOMMUNICATIONS TEST EQUIPMENT

Telephone test oscillators

Model 236A (Bell) Model 236A Opt H10 (CCITT)



- Voice and carrier testing



HP 236A

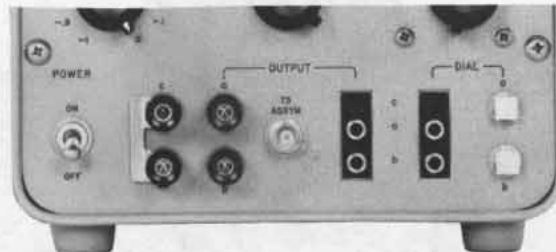

HP 236A Option H10

General

Hewlett-Packard's Models 236A and 236A Option H10/H20 Telephone Test Oscillators are particularly useful for lineup and maintenance of telephone voice and carrier systems when used with their companion instruments 3555B and 3556A Transmission Noise Meters. CCITT requirements are met with the HP 236A Option H10 and HP 3556A when used together.

Ordering information

HP236A Option H10, CCITT (ac line and dry battery)	add \$235
HP 236A Option H20, CCITT (ac line and rechargeable batteries)	add \$340
HP 236A Telephone Test Oscillator (North American)	\$800

Specifications

	236A (Bell)	236A Option H10 (CCITT)
Frequency range	50 Hz to 560 kHz	
Frequency dial accuracy	± 3% of setting	
Frequency response		
600Ω output	± 0.3 dB from 50 Hz to 20 kHz	
900Ω output	± 0.3 dB from 50 Hz to 20 kHz	
135Ω output	± 0.5 dB from 5 kHz to 560 kHz	
150 and 75Ω outputs		± 0.5 dB from 5 kHz to 560 kHz
Output level/accuracy	-31 to +10 dBm in 0.1 dBm steps/ ± 0.2 dBm from -31 to +10 dBm (1 kHz ref., Opt H10, 800 Hz ref.).	
Noise	At least 65 dB below total output or -90 dBm—whichever noise is greater. 3 kHz bandwidth	
Distortion	At least 40 dB below fundamental output.	
Output circuit	Balanced (symmetrical) and floating. Can be operated up to ± 500 V dc above (earth) ground.	
Output impedance	600 and 900Ω ± 5% from 50 Hz to 20 kHz 135Ω ± 10% from 5 kHz to 560 kHz	600 and 150Ω symmetrical 75Ω asymmetrical
Output balance (output symmetry)	600 and 900Ω outputs: 70 dB at 100 Hz, 55 dB at 3 kHz 135 and 150Ω outputs: 50 dB at 5 kHz, 30 dB at 560 kHz	
Output jacks	Accepts Western Electric 241, 309, and 310 plugs.	Accepts 3-prong Siemens 9 REL, STP 6 AC or 4 mm diameter banana plugs.
Dial jacks	Accepts Western Electric 309 and 310 plugs. Clip posts accept Western Electric 1011B lineman's hand-set clips.	Accepts 3-prong Siemens 9 REL, STP 6 AC or 4 mm diameter plugs. Clip posts accept lineman's hand-set clips as alligator clips.
DC holding coil	600 and 900Ω outputs only. 700Ω ± 10% dc resistance; 60 mA maximum loop current at 100 Hz.	
Power requirements	Line: 115 or 230 V (switch) ± 10% ac, 48 Hz to 440 Hz, < 2 VA. Internal battery: single NEDA 202 45 V "B" battery. 236A Option H20: (same as 236A Option H10 except) five 6.25 V rechargeable batteries; 90 V ac—250 V ac, 48 Hz—440 Hz, < 10 VA during battery charge.	
Weight	Net, 6.1 kg (13.5 lb). Shipping, 7.7 kg (17 lb)	
Complementary equipment	HP 3555B Transmission and Noise Measuring Set	HP 3556A Psophometer

TELECOMMUNICATIONS TEST EQUIPMENT

Transmission impairment measuring sets (TIMS)

Models 4940A

- Complete analog testing of voice/data channels
- Compatible with North American Standard
- Low frequency phase jitter

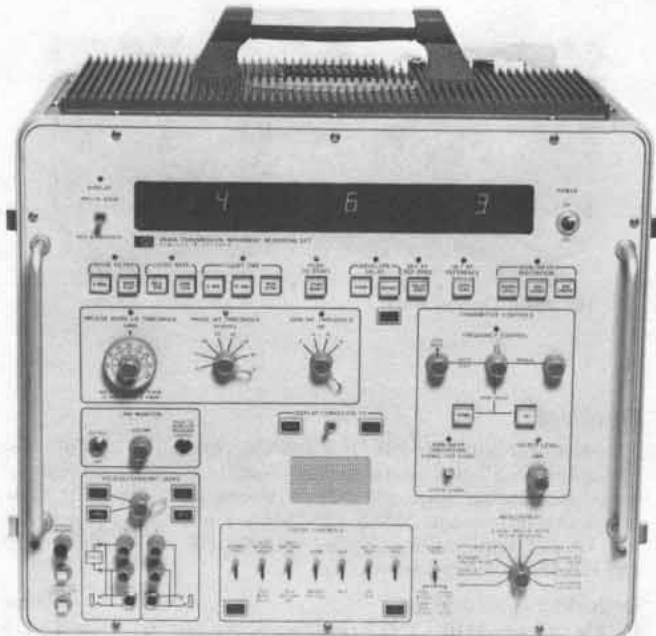

4940A

TIMS—Transmission impairment measuring set

Most of the important analog parameters can be measured by a combined assortment of analog test sets which measure only a few parameters. However, TIMS are "stand alone" combination test sets that measure 7 to 15 parameters depending on the model and options selected. Thus TIMS can replace a large number of analog test sets. The major advantages of TIMS are that they cost significantly less and are more compact and more portable than a combination of test sets required to do the same measurements.

In addition to its cost savings and portability, TIMS are easy to operate. The switches on the front panel are logically arranged in functional groups. Simple straight-forward operating procedures allow the craftsman or engineer to quickly and easily analyze voice band data channel.

4940A TIMS—complete analog testing

The HP 4940A measures all the necessary parameters to completely describe the ability of a voiceband channel to carry medium and high speed data. The 4940A is the ideal tool for analyzing and troubleshooting C and D-1 conditioned lines.

With the HP 4940A it is possible simultaneously to observe all of the transients that cause data errors. By counting phase hits, gain hits, dropouts and three levels of impulse noise at the same time, a more accurate analysis can be made of error causes and channel quality. All of these transients are totalled by TIMS during the selected count time and stored in memory. The pushbutton-selectable count times are 5, 15 minutes and continuous. During the test and at the end of the count time, either the impulse noise totals or the hits and dropout totals may be displayed from memory.

The 4940A TIMS measures the peak-to-peak phase jitter in two separate bands. Bell standard phase jitter is measured in the frequency band of 20 Hz to 300 Hz, and Bell low frequency phase jitter is measured in the frequency band of 4 Hz to 20 Hz. By measuring the peak-to-peak phase jitter in each band, you can identify positively the existence of low frequency phase jitter from standard phase jitter.

4940A Specifications

For detailed specifications ask your local HP sales office for a 4940A TIMS data brochure.

General

Power: 105 volts to 129 volts AC, 60 Hz, 130 watts.

Dimensions: 46.4 cm H x 47.0 cm: W x 32.4 cm D (18¼" x 18½" x 12¾").

Weight: net, 18 kg (39 lb). Shipping, 25 kg (54 lb).

Options

Options	Price
001: adds P/AR measurement	add \$300
002: adds nonlinear distortion measurement	add \$800
003: adds P/AR and nonlinear distortion measurements	add \$975
004: adds P/AR, nonlinear distortion and low frequency phase jitter	add \$1770
010: Field carrying case	add \$300
019: 19" Rack Mount Adapter	N/C
023: 23" Rack Mount Adapter	N/C

The nonlinear distortion technique is licensed under Hekimian Laboratories, Inc., USA Patent No. 3862380.

4940A Transmission Impairment Measuring Set

\$9000

Measures level and frequency, message circuit noise (C-message and 3 kHz flat), noise-with-tone, 3-level impulse noise, phase hits, gain hits, dropouts, phase jitter, envelope delay, noise-to-ground.

4940A, 4943A and 4944A Comparison

Measurement	4940A	4943A	4944A
Message Circuit Noise-C-Message	•	•	•
3 kHz Flat	•	•	•
Noise with Tone	•	•	•
Attenuation Distortion	•	•	•
Envelope Delay Distortion	•	•	•
Impulse Noise	•	•	•
1 Level	•	•	•
3 Levels	•	•	•
Phase Hits	•	•	•
Gain Hits	•	•	•
Dropouts	•	•	•
Phase Jitter	•	•	•
Low Frequency Phase Jitter	•	•	•
Non-Linear Distortion	•	•	•
Peak to Average Ratio	•	•	•
Noise to Ground	•	•	•
Signal to Noise Ratio	•	•	•

TELECOMMUNICATIONS TEST EQUIPMENT

Transmission impairment measuring set (TIMS)

Models 4943A and 4944A



- Portable for field service tests
- Analog testing of voice/data channels

- Master-slave for remote end-to-end testing
- Automatic self check



4943A



4944A



4943A TIMS

Gives you a permanent record of your measurements

The analog output circuit allows you to display the measured signal on a CRT display or record it on an X-Y recorder or strip chart recorder. Built-in storage and internally generated graticule lines allow you to use non-storage oscilloscopes or uncalibrated CRT display.

Customers who want to have analog output capability and nonlinear distortion should order a 4943A option 012. Option 012 removes phase jitter and adds nonlinear distortion. Customers who want to have nonlinear distortion and no analog output capability should order a 4944A TIMS.

4943A Specifications

For detailed specifications ask your local HP Sales Office for a 4943A TIMS Data Brochure.

General

Power: 100, 120, 220, 240 V ac 48 to 66 Hz.

Size: 196 H x 338 W x 591 mm D (7.7" x 13.3" x 23.3").

Weight: 12.2 kg (27 lb).

Options

Options	Price
010: HP-IB Interface	add \$500
012: Nonlinear distortion replaces phase jitter	add \$450
015: 18055A Transit Case	add \$300
019: 10491B 19" Rack Mount	add \$100
910: Extra set manuals	add \$50

4943A Transmission Impairment Measuring Set \$7400

Measures level and frequency, message circuit noise (C-message and 3 KHz Flat), 1 level impulse noise, signal-to-noise ratio, envelope delay, phase jitter. Analog outputs with internal storage and internally generated graticules, two holding coils, MASTER-SLAVE feature, and portable mainframe.

4944A TIMS

Measures all parameters for C & D conditioned channels

The 4944A TIMS measures all parameters including nonlinear distortion, tariffed for C- and D-conditioned leased data lines. Non-linear distortion is measured using the four tone intermodulation distortion technique. This technique is licensed under Hekimian Laboratories, Inc. USA Patent No. 3862380. The 4944A TIMS computes the 2nd and 3rd order products and automatically corrects the readings for noise.

Applications for the 4944A TIMS include circuit routining, circuit troubleshooting and installation testing. The portable 4944A is designed for both field service use and test center use.

4944A Specifications

For detailed specifications ask your local HP Sales Office for a 4944A TIMS Data Brochure.

General

Power: 120 V or 240 V/50 Hz/60 Hz Power Operation

Size: 196 H x 338 W x 591 mm D (7.7" x 13.3" x 23.3").

Weight: 12.2 kg (27 lb).

Options

Options	Price
001: Deletes nonlinear distortion	subtract \$1050
010: HP-IB Interface	add \$500
019: 10491B 19" Rack Mount	add \$100
910: Extra set of manuals	add \$50

4944A Transmission Impairment Measuring Set \$7200

Measures level and frequency, message circuit noise (C-message and 3 KHz Flat), signal-to-noise ratio, 1 level impulse noise, envelope delay, non-linear distortion, two holding coils, MASTER-SLAVE feature, and portable mainframe.

TELECOMMUNICATIONS TEST EQUIPMENT

Portable test set

Model 3550B

- Voice and carrier measurements



Description

Hewlett-Packard's Model 3550B Portable Test Set is designed specifically to measure transmission line and system characteristics such as continuity and attenuation distortion. It is particularly useful for lineup and maintenance of multi-channel communication systems. Model 3550B contains a wide range oscillator, a voltmeter, and a patch panel to match both oscillator and voltmeter to 135, 600, and 900 ohm lines. These instruments are mounted in a combining case that is equipped with a splash-proof cover. In addition, the oscillator, voltmeter, and patch panel may be used separately whether they are in or removed from the combining case.

Both the oscillator and voltmeter are transistorized and operate from their internal rechargeable batteries or from the ac line. Batteries provide 40 hours of operation between charges and are recharged automatically during operation from the ac line.

Specifications

Oscillator HP 204C Opt H20

(Refer to Page 348)

Voltmeter, HP 403B Opt 001

(Refer to Page 41)

Patch panel, HP 353A

(Specifications apply with oscillator and voltmeter)

Input (receiver)

Frequency range: 50 Hz to 560 kHz.**Frequency response:** ± 0.5 dB, 50 Hz to 560 kHz.**Impedance:** 135 Ω , 600 Ω , and 900 Ω and bridging (10 k Ω center tapped).**Balance:** better than 70 dB at 60 Hz for 600 Ω and 900 Ω ; better than 60 dB at 1 kHz for 600 Ω and 900 Ω ; better than 40 dB over entire frequency range for 135 Ω , 600 Ω , and 900 Ω .**Insertion loss:** less than 0.75 dB at 1 kHz.**Maximum level:** +10 dBm (2.5 V rms at 600 ohms).

Output (send)

Frequency range: 50 Hz to 560 kHz.**Frequency response:** ± 0.5 dB, 50 Hz to 560 kHz.**Impedance:** 135 Ω , 600 Ω , and 900 Ω center tapped.**Balance:** better than 70 dB at 60 Hz for 600 Ω and 900 Ω ; better than 60 dB at 1 kHz for 600 Ω and 900 Ω ; better than 40 dB over entire frequency range for 135 Ω , 600 Ω , and 900 Ω .**Insertion loss:** less than 0.75 dB at 1 kHz.**Distortion:** less than 1%, 50 Hz to 560 kHz.**Maximum level:** +10 dBm (2.5 V rms into 600 ohms).**Attenuation:** 110 dB in 10 and 1 dB steps.**Accuracy, 10 dB section:** error is less than ± 0.25 dB at any step.**Accuracy, 100 dB section:** error is less than ± 0.5 dB at any step.**Connectors:** two 3-terminal binding posts for external circuit connection and two BNC female connectors for oscillator and voltmeter connection.

Patch panel, Opt H02-353A

(Same as Model 353A except as indicated below)

Attenuator: 23 dB ± 0.5 dB (1-step slide switch).

Hold circuit (rec terminals)

***Frequency response:** 300 Hz to 3 kHz ± 0.5 dB, 1 kHz reference.**DC resistance:** 240 ohms nominal.**Maximum DC current:** 100 mA.**Maximum DC voltage:** 150 volts.**Attenuation:** 23 dB ± 0.5 dB (1-step slide switch).

Hold circuit (send terminals)

***Frequency response:** 300 Hz to 3 kHz ± 0.5 dB, 1 kHz reference.**DC resistance:** 240 ohms nominal.**Maximum DC current:** 100 mA.**Maximum DC voltage:** 150 volts.**Connectors:** special telephone jacks to accept Western Electric No. 309 and 310 plugs. Sleeve jack is connected to sleeve of jacks 309 and 310. Two 3-terminal binding posts for external circuit connection.

Two terminals (Tel Set) connector for Hand Set, two BNC female connectors for oscillator and voltmeter connection.

Patch panel, Opt H03-353A

(Same as Model 353A except as indicated below)

Hold circuit (rec terminals)

***Frequency response:** 300 Hz to 3 kHz ± 0.5 dB, 1 kHz reference.**DC resistance:** 240 ohms nominal.**Maximum DC current:** 100 mA.**Maximum DC voltage:** 150 volts.**Attenuation:** 23 dB ± 0.5 dB (1-step slide switch).

Hold circuit (send terminals)

***Frequency response:** 300 Hz to 3 kHz ± 0.5 dB, 1 kHz reference.**DC resistance:** 240 ohms nominal.**Maximum DC current:** 100 mA.**Maximum DC voltage:** 150 volts.**Connectors:** special telephone jacks to accept Western Electric No. 309, 310 and 241 at send and receive terminals. Sleeve jack is connected to sleeve of jacks 309 and 310.

Two terminal (Tel Set) connector available for Hand Set. Two BNC female connectors for oscillator and voltmeter connection.

General

Size: 489 H x 213 W x 337 mm D (19 $\frac{1}{4}$ " x 8 $\frac{3}{8}$ " x 13 $\frac{1}{4}$ ") with cover installed.**Weight:** net, 13.5 kg (30 $\frac{1}{2}$ lb). Shipping, 18 kg (40 lb).

Ordering information

	Price
3550B Portable Test Set (with 353A Patch Panel)	\$1850
H02-3550B (with H02-353A substituted for standard 353A)	add \$150
H03-3550B (with H03-353A substituted for standard 353A)	add \$150

*This is the frequency response with the holding coil across the line. Refer to Model 353A Specifications for response in "non holding" condition.



Analysis—The Key to Success

Trying to locate a short, ground, cross, (short between to conductors) and open in buried plant means you are literally working blind. Analysis provides the clues to help you visualize what's going on in the cable and, therefore, a pretty good idea of what caused the fault.

To locate a fault in buried plant the first problem we must solve is to locate the cable. With the Hewlett-Packard Cable Fault Locator Model 4904A this problem is easily solved. The 4904A is a tone set that has a very stable transmitter output signal, and a sharply tuned receiver unit to allow you to locate cable path and depth under the most adverse conditions. This instrument is designed to reject the normal noise interference from power lines. As the cable path is being located the depth of the cable can be measured and sheath damage can be pinpointed.

Now that the path and depth of the cable are known the exact location of the fault may be determined. If the fault is resistive, (short, cross, grounded conductor, battery cross) we

will use the Hewlett-Packard Model 4930A Conductor Fault Locator. In plastic insulated conductor (PIC) cable the resistive faults can range in severity from a few ohms to many thousands of ohms. The 4930A will locate the exact distance (in feet or meters) to the fault regardless of the fault resistance. The operator need only follow the easy to understand diagrams and instruction in the lid of the instrument to locate the most complex resistive fault.

The third instrument required for fault locating is the Hewlett-Packard Model 4910G Open and Split Locator. The open conductor is located as quickly and easily as the resistive faults using the 4910G. The instrument uses the latest in electronic technology, which allows you to make very accurate measurements without the need of repetitive operation. This microprocessor based instrument performs several measurements automatically and digitally displays the distance to the open. In many cases an open conductor is not open but split with another pair. The 4910G will locate the split to within one

manhole. The 4904A Cable Fault Locator can now be used to verify the split location before the splice case is removed. As you can see the 4910G Open and Split Locator will save you many hours in locating both opens and splits.

In order to be able to effectively and efficiently find faults in multi-pair cable the craftsman must be equipped with a Cable Fault Locator (4904A), Conductor Fault Locator (4930A), and the Open/Split Locator (4910G). With this family of instruments all cable faults can be located quickly. This will therefore keep down time, and customer complaints to a minimum.

When several pair have high resistance faults in the same cable, water in the cable is a good possibility. With the ease of operation and speed at which the operator can determine the fault locations, the size and location of the wet section of cable can be quickly measured and the decision to repair or replace that section can be made with confidence.

TELECOMMUNICATIONS TEST EQUIPMENT

Telephone outside plant instruments

Models 4960A, 4961A, 4910G, 4930A, 4904A, 4905A, 18043A



4961A

4960A



4930A



4910G

Telephone cable construction

Telephone cable construction involves installing, splicing and then testing new cables as well as rearranging and testing old cables. Such telephone cables, containing many hundreds of conductor pairs, provide the most effective method of transmitting voice band information signals from a distribution point to the communications terminal at the subscriber's location. Most of the larger cables use noncolor-coded paper and pulp insulation for the pairs. Prior to termination in the field, the new pairs must be identified by pair number. Traditional methods of pair identification were time consuming and later semi-automatic methods often proved unreliable. An increasing need to rearrange telephone cables and pairs as well as a higher labor content associated with such activities has resulted in a need for fast, reliable pair identification equipment.

New 4960A/4961A automatic pair identifier system

The 4960A/4961A System reliably identifies and tests working and nonworking telephone cable pairs in loaded or nonloaded telephone cables up to 40,000 feet in length. The system has two parts... the 4960A Office Unit and the 4961A Field Unit. The office mainframe using standard test connectors (shoes). The Field Unit is operated by the craftsman at the field location. A pushbutton starts the operation of testing, identifying and determining the status of each pair.

There are four operating modes: Self Check, Shoe Check, Scan Mode and Select Mode. Self Check tests the operation of the units. Shoe Check determines if all the pairs in the shoe are making good contact to the mainframe. Scan Mode determines the pair number of a randomly chosen pair within the hundred pair count. Select Mode instructs the Office Unit to apply an audible tone to any selected pair in the count. The Select Mode is useful for identifying pairs that do not identify in the Scan Mode and for determining the problem on a faulted pair.

The system is noninterfering to voice and most data circuits. No control pair is required for communication between the Office and

Field Units. Other features include bad, busy and reversed pair indications as well as large, lighted digital displays.

Cable fault locating

Of prime interest in telephone cable maintenance is the location of physical damage to the cables. Telephone cable fault location has become an especially acute problem in recent years as more cable is placed underground. Although better protected from the environment, the cable is subject to new dangers and the telephone craftsman is faced with locating damage hidden by several feet of earth. In addition, higher traffic density on cables and demands for higher quality transmission have placed more emphasis on cable reliability and quality.

Direct reading fault locators

Field instruments that provide a direct distance-to-fault reading in feet (or metres) have the benefit of relieving the craftsman of the drudgery of performing manual calculations. Locating faults becomes faster, requires less training and is less error prone than with manual bridge techniques.

4930A conductor fault locator

The 4930A is an automatic, digital, direct reading test set operating on the Wheatson Bridge principle. It is designed to locate extremely high resistance shorts, crosses and grounds, such as might occur from minute amounts of moisture in plastic insulated cable (PIC). The 4930A is connected to the cable pairs at an access point and the far-end of the cable is strapped to form a bridge configuration. Two nulling operations are performed and then either the distance to the fault, distance strap to fault or the distance to the far-end is obtained on the autoranging digital display. The 4930A includes pushbutton checks of the fault resistance, the condition of the strap as well as of its 12 V battery. A self check circuit is built into the set. The 4930A is housed in a rugged polycarbonate case. 50 Hz noise rejection and metric options are available.



New 4910G open and split fault locator

The 4910G is designed to provide direct distance readings to both opens and splits. An open is a discontinuity in one or both of the wires of a cable pair. Opens can be the result of bad splices as well as the result of damage caused by shotgun pellets, squirrels, gophers or shovels. A split is a splicing error in which one side of a pair is inadvertently cross-connected with one side of a second pair while the remaining sides are spliced correctly. The split is the only cable fault that is virtually always man-made. The 4910G operates on a capacitance charge sampling principle which relates the charge placed on a length of wire to its capacitance and hence its length. A built-in microprocessor performs automatically the measurements and calculations necessary to locate opens and splits. The test set averages out the effect of noise on the line by automatically taking several readings on the pair prior to displaying the fault distance on its autoranging digital display. The 4910G is set automatically for standard .083mf/mile exchange cable but can be reset to other types of cable by means of the D Factor control. 50 Hz noise rejection and metric options are available.

Tone type fault locators

The tone type locator, such as the Model 4904A, places a pulsed tone on the faulted circuit which is traced by an inductive pick-up coil and a sensitive tuned receiver. At the point of the fault, the signal drops in level, thereby pinpointing the exact physical location of the fault. The tone locator also has the advantage of being able to precisely trace the path of the cable and, by triangulation, determine its depth at any point. This information is necessary for use in accurately locating the fault. It is also necessary for accurately marking the cable location to protect it from construction and excavation work being performed in the vicinity of the cable. The tone locator system is designed so that only the transmitted signal is detected, and interfering signals (such as power line harmonics) do not interfere with the measurement. Output power of the transmitter is kept low to prevent interference with other working circuits in the cable and to prevent "carry-by" of the signal beyond the fault.

4904A cable fault locator

The 4904A is a pulsed tone system for locating shorts, crosses and grounds in direct buried, underground (ducted) and aerial utilities

cable. It also accurately locates path and depth of buried cables and pipes. The sensitive narrow bandwidth receiver rejects ac hum and permits locating high resistance faults. It produces a pulsed 990 Hz tone for buried cable fault locating and a pulsed 150 Hz tone for aerial cable. The tone transmitter unit also has a built-in ohmmeter for analyzing faults. The accessory earth contact frame is especially useful for locating high resistance pinhole faults in the cable sheathing. It comes complete with transmitter, receiver, search wand, earth contact frame, cables and ground rod.

Ultrasonic leak detection

As pressurized gas escapes through an aperture, it creates considerable noise in the ultrasonic region of 36 to 44 kHz. The HP Ultrasonic Translator Detectors (such as Model 4905A) detect this characteristic sound with a sensitive, directional Barium Titanate microphone and translates the signal to audio by mixing it with a 40 kHz local oscillator signal. The audio signal is then amplified and monitored on a speaker and level meter.

The most common causes of pressure leaks in cable plant are corrosion (particularly in coastal areas), electrolysis, squirrels, boring beetles, abrasion from wind and weather, hunters, and outside workmen. Abrasion (during installation) and corrosion are the most frequent causes of cable sheath trouble in cable installed underground in ducted passages.

To detect leaks in aerial cables, the craftsman merely scans the cable from the ground with the flashlight-size microphone, listening for the characteristic hissing sounds of a leak. By simultaneously observing the level meter, he can "peak in" on the leak and determine its exact location. Pole mounted accessories are available for closer scanning of the cable and the 18043A Ultrasonic Reflector accessory is a parabolic type dish allowing exact aerial leak locating from ground level.

Leaks in ducted underground systems are located with a unique "Duct Probe" accessory.

4905A ultrasonic translator detector

The 4905A is a lightweight, portable ultrasonic detector which includes a directional probe, a 6-ft. coil cord and a leather utility case. It has a self-contained speaker, a logging meter, and provision for headphones.

TELECOMMUNICATIONS TEST EQUIPMENT

General Information: FDM/Carrier Systems Testing

FDM/Carrier Systems

FDM/carrier systems are used to transmit large numbers of communications channels simultaneously over a single transmission medium, each channel being allocated a unique part of the frequency spectrum. The transmission media are generally microwave radio networks, which typically carry up to 1800 channels on each RF carrier, and coaxial cable systems, which typically carry up to 3600 channels on each coaxial 'tube'. Higher capacity systems also exist (for example, 60 MHz coaxial cable) which can carry 13,200 channels on each tube.

Each transmission spectrum is complex, containing—in addition to the communications channels—residual carriers, pilot tones, signalling and test tones which may be used to monitor the working of the system while it is actually carrying traffic.

Measurement Requirements

In the design, manufacture, installation and maintenance of FDM/carrier systems several types of measurement are necessary. Some measurements use general-purpose instruments such as network analyzers, power meters and frequency standards, but the majority of measurements require a dedicated communications selective level meter and a level generator.

HP offers a wide range of instrumentation to satisfy your measurement needs.

FDM/Carrier System Measurements

Of the many FDM measurements made, the most common are:

- Reference pilots
- Line pilots
- Channel power
- Channel noise
- Group power
- Carrier leak
- Signalling tone
- Test tone
- Supervisory tones
- Inter-supergroup noise
- Spectrum analysis
- Broadband power
- Frequency response
- Gain/loss
- Return loss
- Crosstalk

Selective Level Meter Requirements

When choosing a selective level meter (SLM), there are several criteria to consider in balancing cost and performance.

1. **Frequency Accuracy:** Ideally, tuning should be accurate and stable, using a synthesized local oscillator. This allows precise tuning to the frequency at which the measurement is to be made and, if required, remote control of the tuning.

Cost savings can be made using a free-running local oscillator, with reduced frequency accuracy and stability. This approach needs manual searching in the region of the signal and peaking the meter on the signal of interest.

2. **Sensitivity:** An SLM as well as being able to measure high level signals accurately needs enough sensitivity to measure, for example, channel noise at a low level test point. In defining measurement range, noise floor is typically the limiting factor and generally -115 dBm in 3.1 kHz is acceptable. Where greater sensitivity is required, external low-noise amplifiers are available.

3. **Measurement Filters:** It is useful to have a selection of filters for measuring pilots and other single-frequency tones, channel power, channel noise and group power. The pilot filter should have sufficient out-of-band rejection to reject adjacent signals, for example, when measuring a channel virtual carrier leak in the presence of a group pilot. If the SLM is synthesizer-tuned and the need for "peaking" is to be avoided, then a flat top is necessary to allow for drift in the station master oscillator and the SLM between calibrations.

The channel filter should ideally have a flat top and a bandwidth equal to the voice-channel (generally 3.1 kHz). At the same time, it should have sufficient out-of-band rejection to reject adjacent channels, residual carriers and pilots, thereby ensuring an accurate measurement of all signals within the voice-channel. To make accurate noise measurements on all types of signals, a true psophometric or "C"-message weighting filter should be used with an RMS detector. Account should be taken of inverted channels, since weighting filters are asymmetric.

Cost savings can be made using the conventional 1.74 kHz effective noise bandwidth filters. The sacrifice with these is that they give the correct result only if the signals being measured are single tones or white noise. If the channel contains, for instance, VF signalling tones or data then the measurement may be in error.

The group filter is useful both in measuring the power in a group and in speeding up the search for high level users in the multiplex. In the majority of cases it is found that a high level user in one channel of a group has a sufficiently large effect on the group power to enable reliable detection with the group filter. Thus by measuring blocks of 12 channels the search is greatly speeded up.

4. **RMS versus Average Detector:** A true RMS detector always gives the correct result regardless of the composition of the signal being measured, but it is more expensive than an averaging detector. Usually the averaging detector is calibrated to give correct power measurements with sinusoidal signals and it will be in error when signals with a different spectral composition are measured. In order to overcome this, in the case of the nominal 1.74 kHz bandwidth channel filter, this bandwidth is increased to give the correct results when measuring white-noise signals.

5. **Ease of Use:** When making measurements on an FDM signal with a conventional manually-tuned SLM, the frequency of the desired pilot or channel to be measured must first be determined from the line frequency chart, a table containing several hundred frequencies. The SLM is then tuned to that frequency, its input and IF attenuators adjusted and the meter read, probably after fine tuning to peak the signal. The meter reading must be added to the attenuator settings to complete the measurement. The process is a familiar one, but time consuming and prone to error.

An alternative approach, made possible by developments in microprocessors and semiconductor memories, is to store the tables of FDM frequencies in the SLM so that, with the aid of a synthesized local oscillator, measurements may be made, with speed and confidence, directly in terms of the FDM description.

Manual Testing

The 312B SLM and the 313A Tracking Oscillator are widely used in all FDM applications from R&D to system maintenance. These units provide a relatively low-cost solution when an SLM and a tracking source is adequate.

The 312D SLM and the 3320C stand-alone Level Generator are specifically designed for FDM system installation and

maintenance. The SLM and Level Generator are among the lowest priced units designed for this purpose.

The 3040A Network Analyzer provides a synthesized tracking generator and selective level meter. It can be used for stimulus-response testing up to 13MHz (2700 channels). The 3044A Megahertz Spectrum Analyzer provides a precise tracking generator and SLM. It has 0.1 Hz frequency resolution and 0.01 dB level resolution plus digital readout and keyboard control. It can readily be automated by adding HP-IB control hardware and a system controller such as the 9825A Desk-top Computer. In this configuration (HP3045A) the system offers an ideal solution for production test and Q.A. requirements.

The 3745A & B and the 3747A & B Selective Level Measuring Sets and the 3335A Synthesizer/Level Generator provide an optimum solution to the problems of measurements on FDM systems for manufacture, installation and field maintenance. These selective level measuring sets each have a synthesized local oscillator, wide sensitivity range of +15 dBm to -120 dBm (which is adjusted automatically), and absolute measurement accuracy of ± 0.25 dB including typical flatness of 0.1 dB. The measurement filters are purpose designed for FDM systems: a 22 Hz flat-topped pilot filter, a 3.1 kHz channel filter with an optional

true psophometric or "C"-message weighted noise filter and a 48 kHz group filter. The detector is a true RMS thermopile detector.

The sensitivity is automatically adjusted and the measurement results displayed on a digital LED display. CCITT and Bell frequency plans are stored in memory thus tuning is effected simply by keying in Channel, Group, Supergroup number, etc.

Several automatic routines are also accessible from the simple keyboard. Examples are scans of pilots, channel power, group power, carrier leak and inter-supergroup noise. These sets can also measure broadband power and, optionally, phase jitter, weighted noise and noise-with-tone.

Automatic Testing

Hewlett-Packard manufactures a wide range of HP-IB automatic system components. These make the implementation of automatic system ideas relatively straight forward from both the hardware and software standpoints. HP-IB systems make automatic testing more economically justifiable.

The 3042A Network Analyzer offers automatic stimulus-response testing of level, phase and group delay. It is ideal for use in the design and manufacture of FDM equipment to 13 MHz (2700 channels.)

The 3045A Automatic Spectrum Analyzer is also used primarily in FDM design and manufacture. The system consists of a precision source and tracking detector under the

control of a desk-top computer such as the 9825A. Manufacturers of FDM equipment have found that the 3045A has helped reduce test time on radio equipment by a factor of 10. Equally important is that manufacturers have found that 3045A programming can be handled in-house without needing software specialists.

The 3745A & B and the 3747A & B can be remotely controlled through the HP-IB from a suitable controller such as the 9825A or 9845A Desk-top Computers or the HP 1000 Computer System. This facilitates building a range of measurement systems from, for example, a single-instrument automatic, production test system to a fully automatic, multi-station, remote surveillance system. 3745A & B and 3747A & B SLMS systems are already providing comprehensive automatic measurement capability on FDM networks in many countries throughout the world.

An integral part of both large and small surveillance systems is a means of both connecting test points to the measuring set and connecting test signals to appropriate test inputs. This access switching is provided by the 3754A, 3756A and 3757A Switches which are controlled by a 3755A Switch Controller. For small systems, manual control is available by means of a keyboard on the 3755A and for large systems an HP-IB input is provided.

Summary of Selective Level Meters

	312B	312D	3745A 3745B	3747A 3747B	3591A 3594A
Frequency Range	1kHz to 18MHz	1kHz to 18MHz	50Hz to 25MHz	10kHz to 90MHz	20Hz to 620kHz
Level Range	+23 to -120dBm	+23 to -120dBm	+15 to -120dBm	+15 to -120dBm	+50 to -100dBm
Detector	Average	Average	RMS	RMS	Average
Filters	200Hz 1kHz 3.1kHz	50/150Hz 1.74/2.3kHz 3.1kHz	22Hz 3.1kHz 48kHz Psophometric or "C"-Message weighted* 2.5kHz* Notch filters*	22Hz 3.1kHz 48kHz Psophometric or "C"-Message weighted* 2.5kHz* Notch filters*	10Hz 100Hz 1kHz 3.1kHz
Broadband	No	No	Yes	Yes	No
Phase Jitter	Ext Meter	Ext Meter	Internal*	Internal*	Ext Meter
Scanning	Manual	Manual	Automatic	Automatic	Automatic
Companion Level Generator	313A	3320C	3335A	3335A	3320C

*Optional—refer to specifications

TELECOMMUNICATIONS TEST EQUIPMENT

25 MHz and 90 MHz Selective Level Measuring Sets

Models 3745A, 3745B and 3747A, 3747B

- Frequency range 50 Hz to 25 MHz (3745A/B), 10 kHz to 90 MHz (3747A/B)
- Selective filters for pilot, channel and group power measurements
- Autoranging attenuators and automatic tuning to stored frequency plans
- Out-of-limit alarm with hardcopy record on separate printer
- Automatic routines for unattended measurements
- HP-IB compatible



3745B



3747B

HP-IB

Description

The 3745A & B and 3747A & B Selective Level Measuring Sets (SLMS's) are designed to make fast, accurate selective level measurements. A built-in frequency synthesizer gives accurate, stable tuning to the precise frequency at which the measurement is to be made. This simplifies the tuning of the SLMS. The 3745A/B and 3747A/B can be tuned over their frequency ranges (50 Hz to 25 MHz and 10 kHz to 90 MHz respectively) with a resolution of 10 Hz.

The SLMS's measure true rms power between +15 dBm and -120 dBm with 0.1 dB or 0.01 dB resolution. Fully autoranging attenuators and amplifiers simplify operation further by eliminating the need to set attenuators and add meter readings. Measurement results are automatically displayed to the selected resolution, in dBm or dB relative terms, on an LED display. The absolute accuracy of the measurement over wide level and temperature ranges is $< \pm 0.25$ dB including a flatness variation of typically $< \pm 0.1$ dB.

Many benefits are derived from the purpose-designed filters contained in the SLMS's. The pilot filter has a flat-top, necessary for automatic tuning, and achieves high out-of-band rejection so that, for example, carrier leak and adjacent pilots can be measured on active systems. The channel filter is a flat-topped 3.1 kHz filter which measures all signals in the voice-channel with high out-of-band rejection—ensuring that pilots, residual carriers, signalling tones, etc., do not interfere with measurements. Optional weighted filters are available to make either true 'C'-message or CCITT psophometrically weighted noise measurements. With these options, phase jitter on a voice-channel can also be measured. A 48 kHz filter for group power measurements is also provided, to facilitate fast location of high level signals on a multiplex.

The SLMS is internally-controlled by a microprocessor which provides several ease-of-use and time-saving features. As well as tuning exactly to an entered frequency, the SLMS can refer to BELL or CCITT multiplex frequency plans in its memory and automatically tune to the correct frequency at any level in the multiplex. Other frequency plans can be installed to special order. This eliminates the need for FDM Plan Charts and Tables. The SLMS's can automatically step through pilots, channels, group powers, carrier leaks, etc., across the baseband of a multiplex—comparing levels with pre-determined alarm limits and providing a print-out of out-of-limit signals on a separate Thermal Printer. 250 pilot measurements can be made in about 2 minutes or, 2700 channel powers or carrier leaks can be measured in about 15 minutes. Spectrum analysis measurements of a voice-channel, group, supergroup or even the whole baseband can also

be made. Measurements can be made unattended, for example, overnight.

The SLMS's are fully programmable via the Hewlett-Packard Interface Bus (HP-IB) and so can form the basis of a powerful, fully-automatic surveillance system.

Specifications (Unless otherwise stated, all specifications are for 0°C to 55°C after 30 minute warm-up)

Frequency range

75Ω Unbalanced input

(3745A/B): 50 Hz* to 25 MHz.

(3747A/B): 10 kHz to 90 MHz.

124Ω Balanced input (3745B/3747B): 10 kHz to 10 MHz.

135Ω Balanced input (3745B/3747B): 10 kHz to 10 MHz.

150Ω Balanced input (3745A/3747A): 10 kHz to 10 MHz.

Minimum frequency step size: 10 Hz.

*When fitted with Option 050

Frequency tuning accuracy

With INTERNAL REFERENCE OSCILLATOR

Initial setting accuracy: $< \pm 2 \times 10^{-8}$ parts, ± 1 Hz

Ageing rate: $< 1.5 \times 10^{-8}$ parts/month.

Measurement ranges

75Ω Unbalanced input

Filter	Range (dBm)	Noise Floor (dBm) (with open-circuit input)	
		50 kHz to 300 kHz	300 kHz to 25 MHz (3745A/B) 300 kHz to 90 MHz (3747A/B)
22 Hz—Pilot	+15 to -120	<-110	<-115
3.1 kHz—Channel	+15 to -115	3745A/B <-100 3747A/B <-95	<-113
48 kHz—Group	+15 to -75	—	<-100
Input Power— Broadband	+15 to -35 (3745A/B) +15 to -55 (3747A/B)	—	—

Input circuits

Impedance: 75Ω.

Return loss: >32 dB (50 kHz to 25 MHz-3745A/B).
>30 dB (50 kHz to 70 MHz-3747A/B).
>22 dB (70 MHz to 90 MHz-3747A/B).

Maximum ac input power: +25 dBm.

Measurement accuracy

75Ω Unbalanced input—selective measurement

Frequency Range	Level Accuracy (dB) over the temperature range 10°C to 35°C, after autocalibration (see Notes 1 and 2)	
	+15 to -60 dBm	-60 to -80 dBm
1 kHz to 10 kHz (3745A/B)	< ±1.0 (nominal)	—
10 kHz to 50 kHz (3745A/B & 3747A/B)	< ±0.35	< ±1.0 (nominal)
50 kHz to 20 MHz (3745A/B) } 50 kHz to 70 MHz (3747A/B) }	< ±0.25	< ±0.35
20 MHz to 25 MHz (3745A/B) } 70 MHz to 90 MHz (3747A/B) }	< ±0.35	< ±0.45

75Ω Unbalanced input—broadband measurement

Frequency Range	Level Accuracy (dB) over the temperature range 0°C to 55°C, after autocalibration—(see Note 2)
10 kHz to 25 MHz (3745A/B)	< ±1.0
50 kHz to 70 MHz (3747A/B)	< ±1.0
70 MHz to 90 MHz (3747A/B)	< ±1.5 (nominal)

Note 1: For all selective measurements in the frequency range 10 kHz to 90 MHz, to extend the temperature range to 0°C to 55°C, add 0.1 dB.

Note 2: The following errors are eliminated by autocalibration.
Temperature Coefficient: 0.01 dB/°C.
Stability: 0.1 dB/24 hours (at constant temperature).

Measurement display

Resolution: 0.01 dB (with long averaging).
0.1 dB (with normal averaging).

Filters

Pilot filter—22 Hz

Ripple over 22 Hz bandwidth: <0.1 dB pk-pk.
3 dB bandwidth: 38 Hz, ±10%.
Adjacent pilot rejection (±60 Hz): >38 dB.
Rejection at > ±110 Hz: >60 dB.

Channel filter—3.1 kHz

Ripple over 2.6 kHz bandwidth: <0.5 dB pk-pk.
3 dB bandwidth: 3.1 kHz, ±10%.
Virtual carrier rejection at ±1.85 kHz: >55 dB.
Adjacent channel rejection (±4 kHz): >70 dB (3745A/B).
>65 dB (300 kHz to 70 MHz) (3747A/B).
>63 dB (70 MHz to 90 MHz) (3747A/B).

Equivalent noise bandwidth: 3.1 kHz (nominal)

Group filter—48 kHz

3 dB bandwidth: 48 kHz, ±15%.
Adjacent group rejection (±48 kHz): >25 dB.
Rejection at > ±80 kHz: >40 dB.

Intermodulation

Second order intermodulation rejection: >70 dB (3745A/B)
>65 dB (3747A/B).

In-band image and IF signals: >80 dB.

Typical measurement times

Pilot filter: 450 ms (for pilots in a typical multiplex system).
Channel filter: 300 ms (for channels in a typical multiplex system).
Group filter: 260 ms (for groups in a typical multiplex system).

Additional output

Audio output

Frequency response: ±1 dB (600 Hz to 3.1 kHz).

General

Size: 268 H x 425 W x 505 mm D (10.6" x 16.8" x 19.9").

Weight: net, 40 kg (88 lb); shipping, 54 kg (120 lb).

Power:

Voltages: 100/120/220/240 V (+10% -13%), 48 to 66 Hz.

Consumption: 200 VA.

Options

Connectors: A range of connector options is available (see Data Sheet for information).

Opt 021: phase jitter + psophometric weighted filter.

Phase jitter

Ranges: 3° and 30° FSD.

Residual phase jitter: <0.5°.

Accuracy: ±15% of reading + residual phase jitter.

Bandwidth: 20 to 300 Hz.

Measurements are made on a tone after the input signal has been demodulated. The demodulated test-tone must be within the range 950 Hz to 1050 Hz.

Weighting filter

Weighting curve: CCITT recommendation P.53 superimposed on 3.1 kHz channel filter, as specified.

Opt 022: phase jitter + C-message weighted filter.

Phase jitter

Ranges: 3° and 30° FSD.

Residual phase jitter: <0.5°.

Accuracy: ±15% of reading + residual phase jitter.

Bandwidth: 20 to 300 Hz.

Measurements are made on a tone after the input signal has been demodulated. The demodulated test-tone must be within the range 950 Hz to 1050 Hz.

Weighting filter

Weighting curve: C-message weighting superimposed on 3.1 kHz channel filter, as specified.

Opt 023: 800 Hz notched filter.

Allows the SLMS to make notched psophometrically-weighted measurements (to CCITT standard).

Opt 024: 1010 Hz notch filter.

Allows the SLMS to make notched 'C'-message weighted measurements (to BELL standard).

Opt 025: 2.5 kHz channel filter.

Ripple over 2.3 kHz bandwidth: <0.8 dB.

3 dB bandwidth: 2.5 kHz, ±5%.

Adjacent channel rejection (±3 kHz): >60 dB.

Equivalent noise bandwidth: 2.5 kHz (nominal).

Opt 040: X-Y recorder/X-Y display driver.

Allows SLMS to drive an X-Y recorder or X-Y display.

Opt 050: extended frequency range (3745A/B only). Extends frequency range of 3745A/B down to 50 Hz.

Flatness (50 Hz to 1 kHz) referred to 1 MHz and at 0 dBm: < ±0.4 dB.

Typical Measurement Uncertainty: (75 Ω input) 200 Hz to 10 kHz (with 22 Hz filter) for level range 0 dBm to 60 dBm: < ±0.6 dB.

Typical Noise Floor (with 3.1 kHz filter centered at 1.85 kHz): < -85 dBm.

Miscellaneous options

	3745A/B	3747A/B
908: rack flange kit	+\$53	+\$53
910: extra set manuals	+\$63	+\$73

Ordering information

	Price
3745A/B Selective Level Measuring Set	\$19,470
3747A/B Selective Level Measuring Set	\$24,050
Opt 021: phase jitter + psophometric weighted filter.	+\$295
Opt 022: phase jitter + C-message weighted filter.	+\$295
Opt 023: 800 Hz notched filter.	+\$320
Opt 024: 1010 Hz notched filter.	+\$320
Opt 025: 2.5 kHz channel filter.	+\$590
Opt 040: X-Y recorder/X-Y display driver.	+\$1150
Opt 050: 3745A/B extended frequency range.	+\$170

TELECOMMUNICATIONS TEST EQUIPMENT

Access/distribution switches and controller (8.5 MHz, 25 MHz, 90 MHz)

Models 3754A, 3755A, 3756A, 3757A

- Select 1 from a possible 10 RF Inputs/Outputs
- Cascade several Switches to allow selection from 1000 Inputs/Outputs
- Mix different Switches for the most cost-effective solution

- Single 3755A can control 111 Switches from a simple keyboard
- Remote input selection using HP-IB
- 75 Ω termination of unselected ports



3754A



3756A



3757A



3755A

Description

Applications

The 3754A, 3756A and 3757A Switches and the 3755A Controller have been developed to meet the requirements of three main areas.

1. Frequency Division Multiplex (FDM) System surveillance and maintenance—the Controller/Switch combination is used in conjunction with a Selective Level Measuring Set (SLMS), such as the 3745A/B (25 MHz) or 3747A/B (90 MHz), to monitor pilot and traffic levels at various points in the multiplex without manually connecting the SLMS to each point.
2. Production testing—where automatic selection of several RF signals is required.
3. Data logging—where large numbers of RF signals need to be accumulated at one control point.

Model 3754A 25 MHz Access Switch

The Model 3754A 25 MHz Access Switch is an ac-coupled, uni-directional, ten-input switch with a frequency range from 10 kHz to 25 MHz. The 3754A incorporates a virtual-ground amplifier—giving an insertion loss of $< \pm 0.1$ dB from 50 kHz to 20 MHz and high isolation across the whole frequency range. The isolation between any unselected input and the output is > 85 dB and the isolation between any two inputs is > 90 dB. In addition, pre-set gains of 1, 2 and 3 dB are internally selectable to compensate for losses in cables and equalizers. (The 3754A can be powered from the ac mains or from a dc supply.)

Model 3756A 90 MHz Bi-directional Switch

The Model 3756A 90 MHz Switch is a dc-coupled, bi-directional, ten-way switch with a frequency range from dc to 90 MHz. The 3756A offers isolation of > 80 dB between Channels, and > 75 dB between unselected input and output ports. It has an insertion loss of 1 dB with a flatness of $< \pm 0.2$ dB and > 28 dB return loss. (The 3756A can be powered from the ac mains or from a dc supply.)

Model 3757A 8.5 MHz Access Switch

The Model 3757A 8.5 MHz Access Switch is a low-cost, ac-coupled, uni-directional, ten-input switch with a frequency range of 10 kHz to 8.5 MHz. An option provides expanded frequency range from 200 Hz to 8.5 MHz. The 3757A has an insertion loss < 0.1 dB from 10 kHz to 4 MHz and isolation of > 95 dB between Channels. In addition, pre-set gains of 1, 2 and 3 dB are internally selectable to compensate for losses in cables and equalizers. (The 3757A is powered from a ± 15 V dc supply.)

Model 3755A Switch Controller

The Model 3755A Switch Controller has a small, easy-to-operate keyboard with a 3-digit LED display to denote the input or output selected. Each Switch (3754A, 3756A or 3757A) is given a 1-digit code, to select the required port. In a large Switch network, involving 3 levels of cascaded Switches, selection from up to 1000 inputs or outputs is possible. This requires a 3-digit code (000 to 999) where each digit represents the input or output of the appropriate Switch at each of the 3 levels.

Because the 3755A is a self-contained unit, separate from the Switches, it is possible to locate the Switches remotely from the Controller. In the case of the 3754A and 3757A, the control signal can be transmitted over the same cable as the RF signal. This eliminates the need for separate control cables and makes inter-connection changes easier. Sending control signals over the RF path has no effect on the RF signal source. (The 3755A is powered from the ac mains.)

The control signals can also be sent along a separate two-wire path. This is necessary for the 3756A or when the continuous dc path between the Switches and Controller is interrupted, for example, by an ac-coupled equalizer inserted to compensate the line-frequency response.

A combination of both methods of control signaling can be employed in the same Switch system. Also, if necessary, high and low frequency Switches can be incorporated into the same system.

HP-IB Control

The 3755A Switch Controller can be remotely controlled over the Hewlett-Packard Interface Bus (HP-IB) by a desk-top computer. Selection of the RF input/output to be accessed is achieved using a 3-digit code that defines the particular input/output required. Since it is the 3755A which is controlled via the HP-IB, only one bus address is used for up to 111 Switches.

Ordering Information

Model 3754A 25 MHz Access Switch
 Model 3755A Switch Controller
 Model 3756A 90 MHz Bi-directional Switch
 Model 3757A 8.5 MHz Access Switch

Price
 \$1975
 \$1655
 \$2585
 \$625

TELECOMMUNICATIONS TEST EQUIPMENT

Access/Distribution Switches and Controller (8.5 MHz, 25 MHz and 90 MHz) (Cont'd)

Models 3754A, 3755A 3756A and 3757A



Specifications

Parameter	3754A 25 MHz Access Switch	3755A Switch Controller	3756A 90 MHz Bi-directional Switch	3757A 8.5 MHz Access Switch
Frequency Range	10 kHz to 25 MHz	-	dc to 90 MHz	10 kHz to 8.5 MHz 200 Hz to 8.5 MHz (Opt 200)
Insertion Loss	< ±0.1 dB (50 kHz to 20 MHz) < ±0.3 dB (10 kHz to 25 MHz)	<0.1 dB (I/P & O/P on rear) <0.2 dB (I/P & O/P on front)	1 dB ±0.2 dB	0 dB ±0.1 dB (10 kHz to 4 MHz) 0 dB ±0.2 dB (10 kHz to 8.5 MHz) 0 dB ±0.5 dB (200 Hz to 10 kHz — Opt 200)
Pre-set Gain	0 dB 1 dB ±0.1 dB 2 dB ±0.1 dB 3 dB ±0.1 dB (75Ω only)	-	-	1 dB ±0.03 dB 2 dB ±0.03 dB 3 dB ±0.03 dB
Isolation	>85 dB (between I/P & O/P) >90 dB (any two inputs)	-	>77 dB (between I/P & COMMON) >80 dB (any two unselected inputs)	>70 dB (any I/P & O/P over 10 kHz to 8.5 MHz) >75 dB (any I/P & O/P over 10 kHz to 4 MHz or -20 Hz to 10 kHz - Opt 200) >95 dB (any two adjacent inputs 10 kHz to 8 MHz) >105 dB (any two adjacent inputs 10 kHz to 4 MHz or 200 Hz to 10 kHz - Opt 200)
Return Loss	>30 dB (selected I/P from 60 kHz to 25 MHz) >23 dB (unselected I/P from 60 kHz to 25 MHz) >30 dB (output from 60 kHz to 25 MHz)	>30 dB (rear panel from 60 kHz to 25 MHz)	>28 dB (dc to 80 MHz) >20 dB (80 MHz to 90 MHz)	>35 dB (selected I/P from 10 kHz to 8 MHz) >35 dB (unselected I/P from 10 kHz to 8 MHz) >35 dB (output from 10 kHz to 8 MHz)
Overload Level	0 dBm (control over signal path) +10 dBm (control over separate path) +8 dBm (50Ω version only)	-	-	0 dBm
Maximum Ac Input Power	+25 dBm (at each input)	-	+25 dBm (at each input)	+25 dBm (at each input)
Noise Power Ratio (Typical)	>70 dB (-10 dBm over any 8 MHz band)	>70 dB (-10 dBm over any 8 MHz band)	-	>50 dB (-10 dBm Input from 60 kHz to 8 MHz) >58 dB (-10 dBm Input from 60 kHz to 4.1 MHz)
Thermal Noise (in 3.1 kHz bandwidth)	<-115 dBm (from 60 kHz to 300 kHz) <-120 dBm (from 300 kHz to 25 MHz)	-	-	<-119 dBm (60 kHz to 4.1 MHz) <-117 dBm (60 kHz to 8.5 MHz) <-100 dBm (300 Hz to 3.4 kHz — Opt 200)

General

Power	3754A	3755A	3756A	3757A
Input Voltages (ac)	100, 120, 220, 240 V	100,120,220,240 V	100,120,220,240 V	-
Tolerance	±10%	±10%	±10%,-15%	-
Consumption	<20 VA	<20 VA	<20 VA	-
Frequency	48 to 66 Hz	48 to 66 Hz	48 to 66 Hz	-
OR				
Input Voltages (dc)	±15 V	-	+15 V	20 V
Tolerance	±2%	-	±2%	±0.5 V
Nominal Current	150 mA (-15 V) 300 mA (+15 V)	-	200 mA	100 mA
Ripple	<5 mV pk-pk	-	5 mV pk-pk	<5 mV pk-pk
Weights				
Net	6 kg (13 lb)	5 kg (11 lb)	6 kg (13 lb)	1.7kg (3.75 lb)
Shipping	11 kg (24 lb)	12 kg (26 lb)	11 kg (24 lb)	4 kg (7.5 lb)
Dimensions				
Width	425 mm (16.8 in)	425 mm (16.8 in)	425 mm (16.8 in)	483 mm (19 in)
Height	89 mm (3.5 in)	89 mm (3.5 in)	89 mm (3.5 in)	44 mm (2 in)
Depth	350 mm (13.9 in)	350 mm (13.9 in)	350 mm (13.9 in)	260 mm (10 in)
Options	Front Rear	Front Rear	Front Rear	Front Rear
BNC (75Ω)	STD 010	STD 010	STD 010	STD -
Siemens Series				
2.5/6 mm (75Ω)	001 011	001 011	001 011	- -
Siemens Series				
1.6/5.6 mm (75Ω)	002 012	002 012	002 012	- -
BPO Type IE (75Ω)	003 013	003 013	- -	- -
Commercial equivalent of WECO Type 560 A (75Ω)	004 014	004 014	004 014	- -
Commercial equivalent of WECO Type 477B (75Ω)	005 015	005 015	005 015	005 -
BNC (50Ω)	006 016	006 016	- -	- -
Suhner J-Type (75Ω)	- -	- -	007 017	- -

TELECOMMUNICATIONS TEST EQUIPMENT

Synthesizer/level generator

Model 3335A



3335A

Description

The 3335A is a 200 Hz-80 MHz Synthesizer/Level Generator with performance characteristics that make it ideally suited for testing low-density carrier, radio baseband and high-density cable carrier systems as well as for R&D and production testing. It features precision level control, high frequency resolution (0.001 Hz from 200 Hz to 80 MHz), optional frequency stability of $\pm 5 \times 10^{-10}$ /day and high spectral purity. The 3335A is fully HP-IB programmable.

Precision amplitude control

High capacity FDM systems are placing more stringent requirements on testing transmission parameters. One such area where new standards of performance are required is amplitude control. The 3335A incorporates a state-of-the-art attenuator structure resulting in attenuator accuracies of up to ± 0.035 dB over the 80 MHz frequency range. A true rms leveling loop provides ± 0.15 dB flatness over the entire frequency range (± 0.10 dB from 1 kHz to 25 MHz) and 0.01 dB resolution over a 100 dB amplitude range. The 3335A can be externally leveled.

Digital frequency selection

Frequency is controlled via the front panel or by remote control with up to 0.001 Hz resolution. Frequency can also be changed by incrementing or decrementing the frequency by any arbitrary amount. FDM testing is simplified by stepping from channel to channel with a single keystroke.

Amplitude blanking

The 3335A has switch selectable amplitude blanking to prevent disturbing a pilot tone when testing FDM systems. The output is blanked while the synthesizer tunes to the new frequency. This allows response testing of FDM systems while in service.

Internal storage for repetitive testing

The 3335A's internal microprocessor-controlled memory can store any combination of parameters (frequency, level, etc.) of the instrument in 10 separate memory registers. The contents of these registers can then be recalled for fast and repeatable testing.

SLMS tracking generator

The 3335A operates as a tracking generator with the HP 3745A/B Selective Level Measuring Set (SLMS) for automatic or semi-automatic testing of FDM systems. For closed-loop tracking, (3335A and 3745A/B in the same location), the frequency is controlled by the SLMS. The 3745A/B and 3335A can sweep through any selectable frequency spectrum or cycle through the channels of a multiplex system by calling up the FDM frequency plans stored in the SLMS memory. The 3335A and 3745A/B can also operate in an open loop tracking mode separated by the system under test or they can be interfaced via the HP Interface Bus (compatible with IEEE STD 488-1975) to a programmable calculator or computer for a completely automatic test system.

Options

Standard: Equipped with switch-selectable 50 Ω and 75 Ω outputs (BNC connectors).

001: High-stability frequency reference

002/004: Equipped with 75 Ω unbalanced and 124 Ω and 135 Ω balanced connectors per table.

Option	Fits WECO Type	Spacing	Accepts WECO Type
75 Ω 002 004	477B 560A	N/A	358A 439A/440A
124 Ω 002 004	477B 560A	16 mm (.625") 12.7 mm (0.5")	372A 443A
135 Ω 002/004	223A	16 mm (.625")	241A

003: 75 Ω unbalanced BNC output and 150 Ω balanced output using a pair of BNC connectors at 20 mm (0.80 in.) spacings.

Abbreviated specifications

(For complete specifications, refer to page 364 and the 3335A data sheet.)

Frequency range:

Standard: 200 Hz-80 MHz;

Opt. 002/004: 75 Ω , 200 Hz-80 MHz; 124 Ω , 10 kHz-10 MHz; 135/150 Ω , 10 kHz - 2 MHz.

Opt. 003: 75 Ω , 200 Hz-80 MHz; 150 Ω , 10 kHz - 2 MHz

Frequency resolution: .001 Hz.

Stability, long term: $\pm 1 \times 10^{-8}$ /day; $\pm 1 \times 10^{-7}$ /month.

Opt. 001 (high stability frequency reference):

Aging rate: $\pm 5 \times 10^{-10}$ /day; $\pm 2 \times 10^{-8}$ /month; $\pm 1 \times 10^{-7}$ /year

Warmup: Within 5×10^{-9} of final value 20 minutes after turn-on at 25°C.

Spectral purity

Harmonic distortion: 200 Hz-10 MHz: < -45 dB; 10 MHz-80 MHz: < -40 dB

Phase noise (30 kHz band, excluding ± 1 Hz, centered on the carrier): 9.9 MHz: < -63 dB; 20 MHz: < -70 dB; 40 MHz: < -64 dB; 80 MHz: < -58 dB

Spurious: Nonharmonically related signals 75 dB below the carrier or -110 dBm, whichever is greater

Amplitude range:

Standard: 50 Ω : +13.01 dBm to -86.98 dBm; 75 Ω : +11.25 dBm to -88.74 dBm.

Opt. 002/004: 75/124/135 Ω : +11.25 dBm to -88.74 dBm

Opt. 003: 75/150 Ω : +11.25 dBm to -88.74 dBm

Resolution: 0.01 dB

Absolute level accuracy (max. output at 100 kHz, 20°C to 30°C): ± 0.05 dB

Signal balance (124 Ω , 135 Ω , 150 Ω balanced outputs): > 40 dB

Flatness (relative to 100 kHz, full amplitude): 50/75 Ω : 1 kHz - 25 MHz: ± 0.07 dB; 200 Hz - 80 MHz: ± 0.15 dB. 124 Ω : 10 kHz - 10 MHz: ± 0.15 dB, 10 kHz - 10 MHz ± 0.4 dB; 135/150 Ω : 10 kHz - 2 MHz: ± 0.18 dB

Attenuator accuracy (relative to 100 kHz, full amplitude)

Impedance	Amplitude (dBm)	Frequency		
		200 Hz	40 MHz	80 MHz
50 Ω	+13.01 to -6.98	± 0.04 dB		
	-6.99 to -46.98	± 0.09 dB		
	-46.99 to 86.98	± 0.20 dB		
75 Ω	+11.25 to -8.74	± 0.04 dB	± 0.15 dB	
	-8.75 to -48.74	± 0.09 dB	± 0.25 dB	
	-48.75 to -88.74	± 0.20 dB	± 0.50 dB	

NOTE: For 124 Ω , 135 Ω , and 150 Ω , refer to data sheet.

Options

001: Hi-stability reference

Price

add \$580

002: Connector option (75/124/135 Ω)

add \$300

003: Connector option (75/150 Ω)

add \$200

004: Connector option (75 Ω , miniature WECO on 124/135 Ω)

add \$300

3335A Synthesizer/Level Generator

\$7000

TELECOMMUNICATIONS TEST EQUIPMENT

SLMS Accessories



15575A-H, 15578A, 15580A, 15581B, 15582A, 15584A, 15585A, 15587A, 15588A, 15589A



15578A



15580A



15581B



15582A



15587A



15588A



15575A-H



15584A



15585A



15589A

Active and Passive Probes

Models 15578A, 15580A, 15581B high-impedance probes are used with the SLMS for bridging measurements. The 15578A and 15580A are "active" devices having an insertion loss of 0 dB. Model 15581B is a passive probe having an insertion loss of 20 dB. The 15581B can also inject signals from a Level Generator at points where a high impedance source is required. See Data Sheet (5952-3218) for options.

Specifications

Parameter	15578A	15580A	15581B
Frequency Range	50 kHz to 90 MHz	20 kHz to 25 MHz	10 kHz to 25 MHz
Insertion Loss	0 dB \pm 0.3 dB (300 kHz to 70 MHz)	0 dB \pm 0.2 dB (50 kHz to 20 MHz)	20 dB \pm 0.2 dB (50 kHz to 20 MHz)
Tapping Loss (in 75 Ω system)	<0.3 dB (50 kHz to 50 MHz) <0.5 dB (50 kHz to 70 MHz)	<0.15 dB (50 kHz to 20 MHz)	<0.25 dB (50 kHz to 20 MHz)
Max Input Power	+25 dBm	+10 dBm	+25 dBm
Power Supply	+15 V (25 mA)	+15 V (25 mA)	—
Prices	\$425	\$350	\$190

Low-Noise Amplifiers

Models 15587A and 15588A are 20 dB low-noise amplifiers designed to increase the sensitivity of the SLMS. They are particularly useful for extending the range of the 3745A/B or 3747A/B for low level Group Power and Broadband Power measurements. See Data Sheet (5952-3218) for options.

Specifications

Parameter	15587A	15588A
Frequency Range	60 kHz to 25 MHz	300 kHz to 90 MHz
Gain	20 dB \pm 0.2 dB (300 kHz to 18 MHz) 20 dB \pm 1 dB (60 kHz to 25 MHz)	20 dB \pm 0.2 dB (4 MHz to 70 MHz) 20 dB \pm 1 dB (300 kHz to 90 MHz)
Input Return Loss	>20 dB (300 kHz to 18 MHz)	>20 dB (1 MHz to 70 MHz)
Noise Figure	<5 dB (60 kHz to 12 MHz) <10 dB (12 MHz to 20 MHz)	<7 dB (1 MHz to 90 MHz)
Max Input Power	-10 dBm	-10 dBm
Power Supply	+15 V (45 mA)	+15 V (20 mA)
Price	\$595	\$780

Return Loss Kit

\$550

Model 15582A Return Loss Kit, with a suitable Level Generator, allows the SLMS to make return loss measurements from 10 kHz to 25 MHz. Extended coverage from 100 kHz to 90 MHz is possible with Model 8721A Opt 008 Directional Bridge.

Cable Equalizers

\$270 ea

Models 15575A-H constitute a range of eight Cable Equalizers, designed to equalize the Loss/Frequency characteristics of different lengths of 75 Ohm coaxial cable.

Transit Case

\$550

Model 15584A is a fibre-glass transit case with custom-moulded foam inserts to suit the 3745A/B or 3747A/B SLMS.

Diagnostic Kit

\$980

Model 15585A consists of several troubleshooting aids which assist in servicing the SLMS.

Instrument Cart

\$560

Model 15589A is suitable for transporting the SLMS and its auxiliary equipment.

TELECOMMUNICATIONS TEST EQUIPMENT

Remote Automatic Surveillance Systems

Models 3745A/B, 3747A/B, 3754A, 3755A, 3756A, 3757A, 3335A, 9825A, 1000 System

Introduction

Hewlett-Packard offer a range of remote-surveillance systems for Frequency Division Multiplex (FDM)/Carrier Networks. The HP Systems are selected to suit the size and management requirements of the FDM Network.

HP surveillance systems are based upon the 3745A/B and 3747A/B Selective Level Measuring Sets (SLMS's). These instruments are semi-automatic when used 'stand-alone' but, with the addition of a controller such as a 9825A Desk-top Computer or an HP 1000 Computer System (interfaced via the HP-IB), they become the basis of a powerful, automatic measurement system.

Switching between test points is achieved with the 3754A, 3756A and 3757A Switches controlled (via the HP-IB) by the 3755A Switch Controller. Test signals are generated by the HP-IB compatible 3335A Synthesizer/Level Generator.

Interfacing between locations is achieved over full duplex, dedicated telephone lines. Therefore, it is necessary to translate the parallel form HP-IB information to an RS232-compatible serial data form, suitable for transmission through standard broadband modems. This is achieved with a device such as the 59403A Common Carrier Interface. Figure 1 shows the application of an HP system to a remote station.

There are two basic applications using either a Desk-top Computer (such as the 9825A) or a Computer System (such as the HP1000 System) as the controller of the Surveillance system. The choice is made according to the size of the FDM/Carrier network and the network management requirements.

The Desk-top Computer based system is suited to controlling several remote measurement locations INDIVIDUALLY. In this way, up to 10 remote stations can be handled with ease. In the absence of controller activity, the full semi-automatic capabilities of the 3745A/B and 3747A/B SLMS's may be utilized in each location (see Figure 2).

The HP1000 Computer System allows full automatic control of up to 16 remote locations SIMULTANEOUSLY. By adding the 263X or 264X Series terminals to remote locations, the full automatic system capabilities can be made available from any point in the network (see Figure 3).

For networks requiring the co-ordination of greater numbers of measurement locations, the power of the HP1000 Distributed System concept can be used to expand the measurement system to meet increased network requirements with ease (see Figure 4).

Further details of any of the computers and instrumentation mentioned can be obtained from your local Hewlett-Packard representative.

Applications

Remote Station

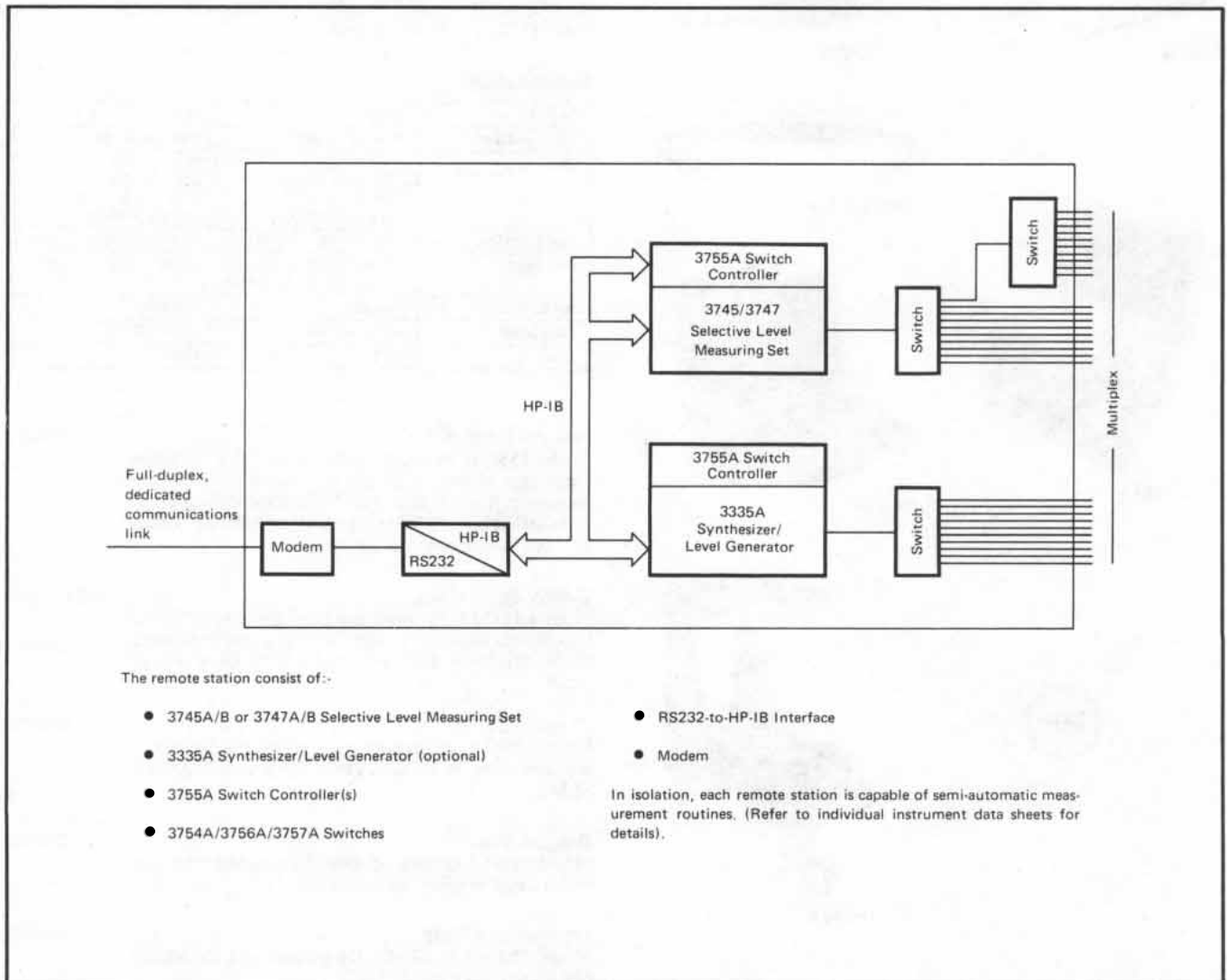

Desk-top Computer System

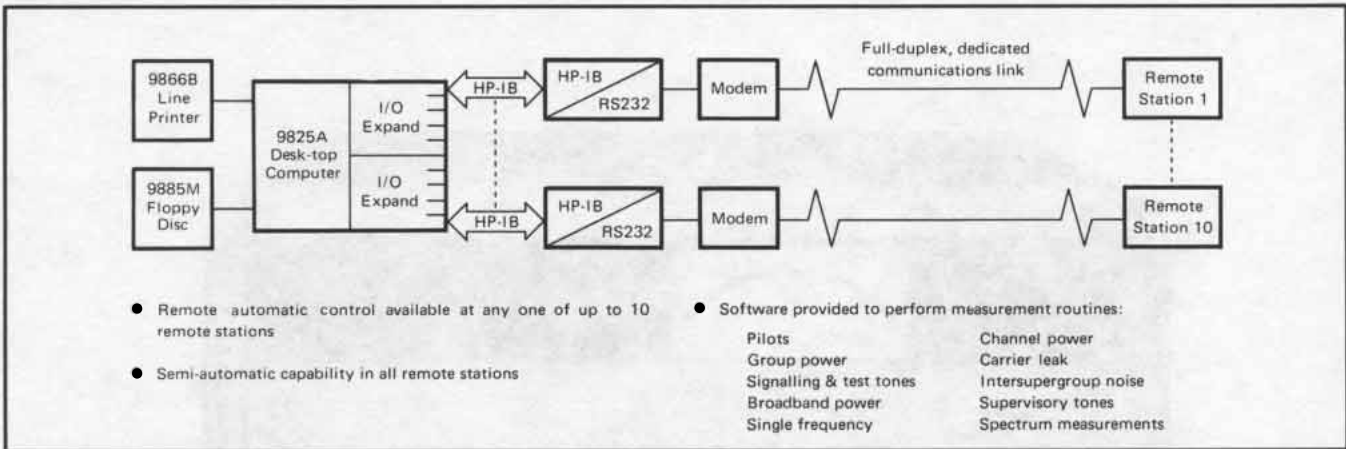

HP 1000 Computer System

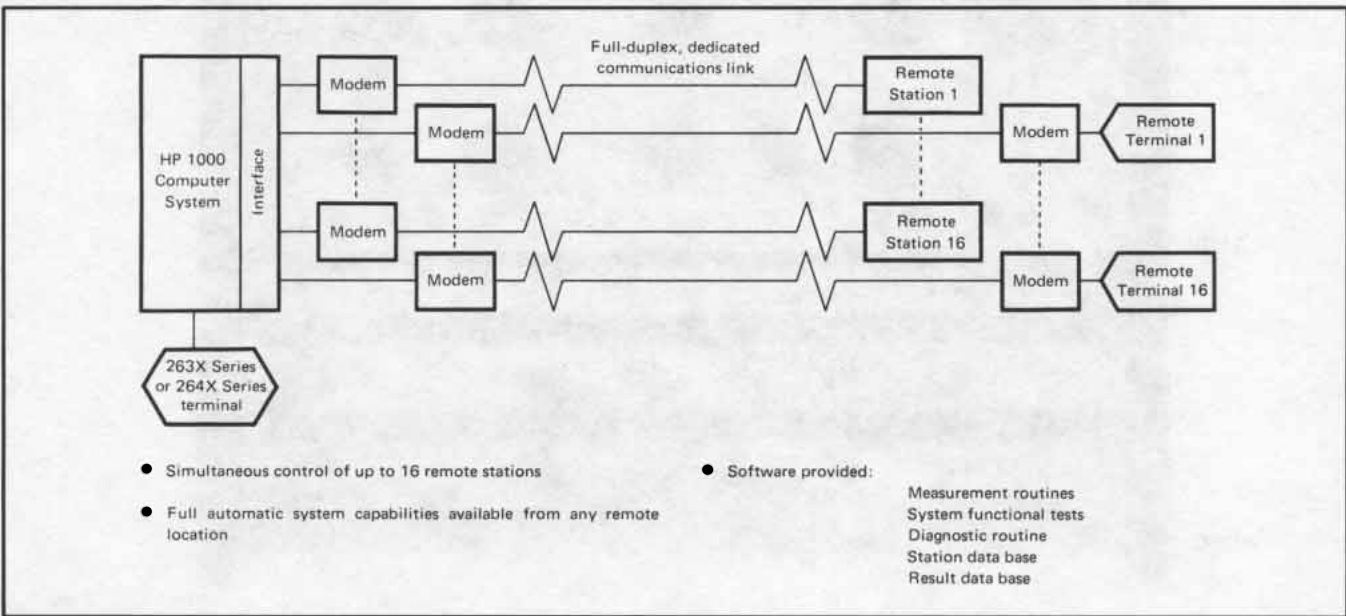

HP 1000 Distributed Computer System

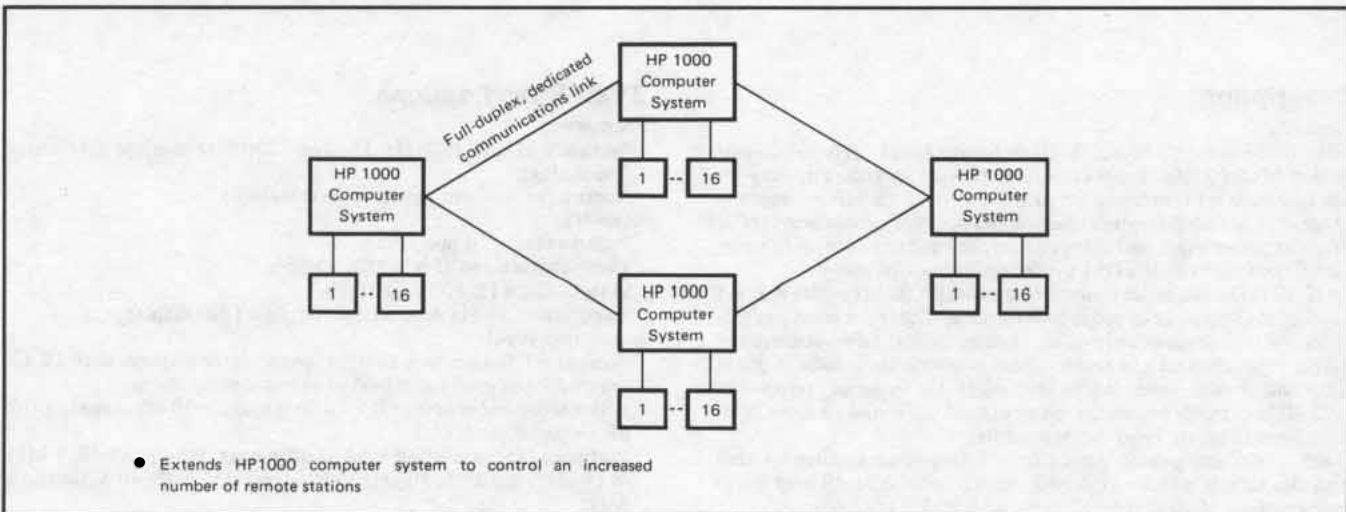

TELECOMMUNICATIONS TEST EQUIPMENT

Selective level meter/generator

Models 312D & 3320C

- FDM Multiplex carrier testing

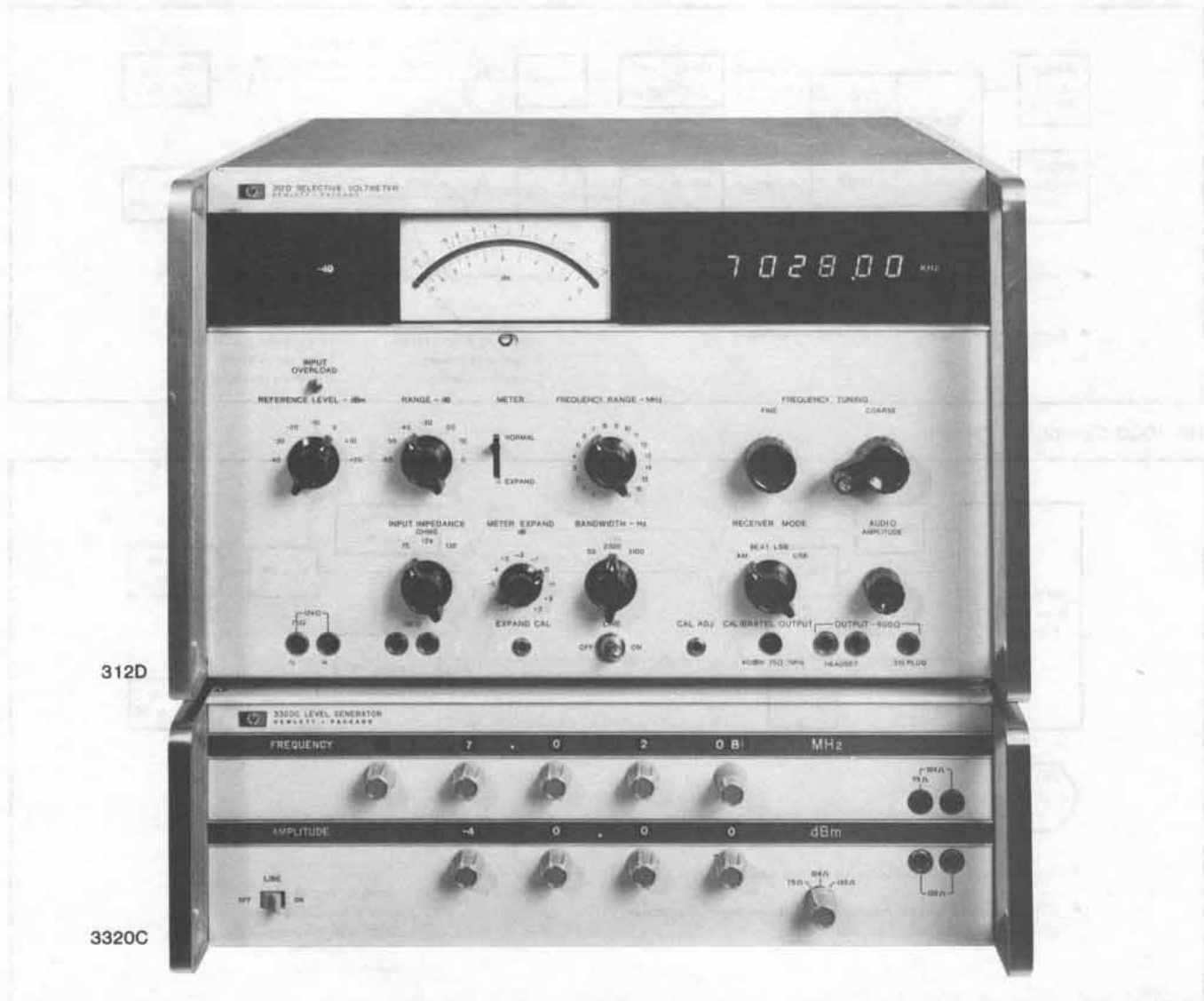

Description

General

Hewlett-Packard's Model 312D Selective Level Meter and companion Model 3320C Level Generator provide an accurate, easy-to-use transmission measuring set in the 1 kHz to 18 MHz frequency range ideally suited for maintenance and operations requirements. It provides proper input and output connectors and impedances to interface directly into most FDM carrier multiplex equipment.

HP's 312D has a noise equivalent bandwidth that provides a direct reading of C-message or psophometric noise. The instrument has sufficient fidelity to act as an invisible channel bank to down-convert any 4 kHz voice channel and make typical measurements such as phase jitter and impulse noise. It also features 10 Hz frequency resolution, 0.02 dB level resolution on the meter expand scale, and an input overload lamp to assure valid measurements.

HP 3320C companion generator is a frequency synthesizer that provides signals with an amplitude resolution of 0.01 dB over a frequency range of 10 kHz to 17 MHz with 20 Hz resolution.

312D Specifications

Frequency

Range: 1 kHz to 18 MHz; 18 bands; 200 kHz overlap; coarse and fine tuning.

Accuracy: ± 10 Hz plus time base stability.

Stability

Aging rate: ± 20 ppm/year.

Temperature ($25^{\circ}\text{C} \pm 10^{\circ}\text{C}$): 20 ppm.

Line voltage ($\pm 10\%$): 0.1 ppm.

Resolution: 10 Hz read on a seven digit LED display.

Amplitude level

Range: -120 dBm to $+23$ dBm, annunciator displays each 10 dB selected input level regardless of switch combinations.

Attenuator accuracy: ± 0.1 dB (0 through -50 dB range); ± 0.2 dB (-60 dB range).

Flatness (75Ω matched load; 0 dBm max. level): 0.5 dB, 1 kHz to 10 kHz; ± 0.2 dB, 10 kHz to 10 MHz; ± 0.5 dB, 10 MHz to 18 MHz.

Stability: 0.1 dB, 90 days.

Overload: lamp indicates incorrect range selection.

Selectivity: the exact midband of the selected filter is identified by a 3 Hz rejection notch.

Bandwidth	3 dB Rejection	60 dB Rejection
*50 Hz	50 Hz \pm 10%	106 \pm 10%
*150 Hz	150 Hz \pm 10%	320 \pm 10%
**1740/2300 Hz	2300 Hz \pm 10%	4800 \pm 10%
*3100 Hz	3100 Hz \pm 10%	6200 \pm 10%

* Select one bandwidth only; 50 Hz standard, 150 Hz Opt 001.

** Carrier notches inserted at $f_c \pm 2$ kHz. Notch filter down >55 dB at $f \pm 2$ kHz; down >45 dB at ± 7.5 Hz from center of rejection notch.

Passband flatness: <0.2 dB.

Meter: (backlighted scale shows whether normal or expand mode is selected).

Meter range:

Normal: -20 dB to $+3$ dB.

Expand: -1 dB to $+1$ dB.

The expand meter will expand any two dB portions of the meter from -7 dB to $+3$ dB in 1 dB step.

Tracking: ± 0.05 dB expand; ± 0.1 dB normal (to -10 dB indication).

Input impedance: 75Ω unbalanced, accepts WECO 358A plug; 124Ω balanced, accepts WECO 408A plug; 135Ω balanced, accepts WECO 241A plug.

Receiver

Modes

AM: average responding diode demodulated audio.

Beat: beat frequency, carrier reinserted at f_c .

LSB: product demodulated audio, carrier reinserted at $f_c + 1.8$ kHz.

USB: product demodulated audio, carrier reinserted at $f_c - 1.8$ kHz.

Distortion

1 kHz to 1 MHz: >55 dB below zero reference.

1 MHz to 18 MHz: >65 dB below zero reference.

Residual response: 72 dB below zero reference with no input.

Noise level: < -117 dB in 2300 Hz bandwidth.

Internal calibrator output: 1 MHz square wave; -40 dBm ± 0.1 dB into 75Ω termination; accepts WECO 358A plug.

Common mode rejection: >40 dB, 1 kHz to 5 MHz; >30 dB, 5 MHz to 18 MHz.

Output level (front panel):

$+14$ dBm into 600Ω with full scale meter deflection.

Accepts WECO 464A plug for operator head set.

Accepts WECO 310A plug for 600Ω output.

Speaker is normally in the output circuit unless a plug is inserted, then speaker is disconnected.

Auxiliary outputs (rear panel)

1 MHz: >0.5 volt p-p sine wave into 1 k Ω , BNC female.

30 MHz: 40 mV to 70 mV rms into 50Ω , BNC female.

Local oscillator: 30 MHz to 48 MHz, 60 mV to 90 mV rms into 50Ω , BNC female.

Auxiliary input (rear panel)

External reference frequency: 1 MHz, 0 dBm ± 10 dBm into 50Ω .

General

Size: 266mmH x 425mmW x 467 mm D ($10\frac{5}{32}$ " x $16\frac{3}{4}$ " x $18\frac{3}{8}$ ").

Weight: net, 20.7 kg (46 lb). Shipping 26.6 kg (59 lb).

Power: 115 or 230 V $\pm 10\%$, 48 to 66 Hz, <100 VA.

Specifications, 3320C

Frequency

Range: 10 kHz to 17 MHz in one range (75 Ω).

Resolution

Vernier out: 10 kHz.

Vernier in: 20 Hz.

The frequency counter in the 312D can be used to count the output frequency of the 3320C to within 10 Hz.

Accuracy

Vernier out: ± 10 ppm of setting.

Vernier in: 10 kHz to 12.5 MHz; ± 600 Hz.

12.5 MHz to 17 MHz; ± 750 Hz.

Stability: ± 10 ppm/year.

TC: 20°C to 30°C: ± 5 ppm.

Line variations of 10%: 0.1 ppm.

High stability crystal reference oven available (Option 001).

Phase noise: < -40 dB in to 30 kHz band, excluding ± 1 Hz.

Harmonics and spurious: >50 dB down.

Internal frequency standard: 20 MHz.

Amplitude level

Range: $+11.99$ dBm to -79.99 dBm.

Resolution: 0.01 dB.

Accuracy: $+11.99$ dBm to -60 dBm: ± 0.25 dB. -60 dBm to -79.99 dBm; ± 0.4 dB.

Output impedance (front panel switch selectable)

75 Ω unbalanced: accepts WECO 358A Plugs.

124 Ω balanced: accepts WECO 408A Plugs.

135 Ω balanced: accepts WECO 241A Plugs.

Auxiliary outputs (rear panel)

—Tracking output: Tracks main output with 20 MHz offset. >100 mV rms into 50Ω , Female BNC.

—Low level output: same frequency as main output but remains between 50 mV rms and 158 mV rms into 50Ω Female BNC.

—1 MHz output: Reference output, 0 dBm ± 10 dBm into 50Ω , Female BNC.

Can be used as external frequency source for the 312B or 312D.

Auxiliary input (rear panel)

External frequency reference input: may be phase locked with an external signal which is within 200 mV rms and 2 V rms and which is any subharmonic of 20 MHz from 1 MHz through 10 MHz (e.g., 1 MHz, 2 MHz, 2.5 MHz, 5 MHz, 10 MHz), Female BNC.

High stability crystal oven (Option 001)

5 MHz reference in temperature stabilized oven.

Stability: ± 1 part in 10^8 /day or 1 part in 10^7 /month.

Accuracy: ± 1 part in 10^7 of setting/month.

For field installation order Accessory Kit 11237A.

General

Operating temperature: 25°C $\pm 5^\circ$

Power: 115 V or 230 V $\pm 10\%$, 48 Hz to 66 Hz, 110 VA.

Weight: net, 15.4 kg (34 lb). Shipping, 22.2 kg (49 lb).

312D Selective Level Meter

Opt 001: 150 Hz bandwidth

Opt 908: Rack Flange Kit

Opt H03: CCITT Version

\$6300

N/C

add \$15

add \$320

3320C Level Generator

Opt 001: Crystal Oven

Opt 908: Rack Flange Kit

Opt H02: CCITT Version

\$4200

add \$525

add \$10

add \$430

TELECOMMUNICATIONS TEST EQUIPMENT

Selective voltmeter, 20 Hz to 620 kHz

Models 3591A/3594A

- Voice grade testing
- FDM Carrier testing



Description

Hewlett-Packard's 3591A Mainframe and 3594A Plug-in combine to form a general purpose 20 Hz to 620 kHz frequency selective level meter. The 3591A/3594A features automatic level ranging, wide dynamic range, log and linear x-y outputs as well as several input impedances and AM/SSB demodulation capability.

The 3591A/3594A has found wide acceptance in communications laboratories, manufacturing and field maintenance.

Specifications

Frequency range: 20 Hz to 620 kHz.

Amplitude ranges: 3 μ V to 30 V full scale in 15 ranges.

Amplitude accuracy with input terminated

Meter switch in normal position: overall accuracy: ± 0.43 dB to ± 0.67 dB of reading depending on frequency, including

Frequency response flatness, total deviation: 600 Ω : 20 Hz to 100 Hz ± 0.53 dB ($\pm 5\%$); 100 Hz to 620 kHz ± 0.26 dB ($\pm 3\%$).

All other terminations: 5 kHz to 620 kHz ± 0.26 dB ($\pm 3\%$).

Meter tracking: ± 0.1 dB or $\pm 1\%$ of reading, 0 dB to -10 dB.

Meter switch in linear dB position: overall accuracy: ± 1 dB.

Internal calibrator: frequency, 100 kHz ± 10 Hz; amplitude, full scale on 0 dB range in CAL mode: accuracy, ± 0.1 dB.

Dynamic range: (IM and harmonic distortion products) > 85 dB below zero dB reference level when absolute measurements are being made (> 70 dB for 20 Hz to 50 Hz). > 80 dB below zero dB reference level when relative adjustment is used (> 70 dB for 20 Hz to 50 Hz).

Residual responses

> 80 dB below zero reference (> 70 dB for 20 Hz to 50 Hz).

Return loss: 100 Hz to 620 kHz, 600 Ω > 30 dB; 5 kHz to 620 kHz, 150 Ω , 135 Ω , 75 Ω , > 35 dB.

Noise level

Bandwidths	Input noise level (600 Ω input impedance)
10 Hz and 100 Hz	< -125 dBm or 0.44 μ V
1 kHz and 3.1 kHz	< -115 dBm or 1.38 μ V

Selectivity

Rejection	Bandwidths			
	10 Hz	100 Hz	1 kHz	3.1 kHz
3 dB	10 Hz	100 Hz	1 kHz	3.1 kHz
60 dB	35 Hz	320 Hz	3.1 kHz	9.6 kHz

(Frequency accuracy $\pm 10\%$)

Inputs: balanced or single-ended, not floating, terminating, or bridging.

Automatic frequency control

Capture threshold: 75 dB below 0 dB reference.

Dynamic hold-in range: > 3 bandwidths. Tracking rate proportional to bandwidth.

Input functions

dBm: levels calibrated in dBm for impedances selected.

Abs Vm: level calibrated in volts.

Rel: input level can be set arbitrarily to 0 dB Ref. (10 dB set level range).

Input impedances*

Resistances: 75 Ω , 135 Ω , 150 Ω , 600 Ω terminated; 50 k Ω (single ended bridging) and 100 k Ω (balanced bridging).

Capacitance (each terminal to ground): 10 mV, 30 mV ranges < 55 pF; 100 mV to 30 V ranges < 40 pF.

Common mode rejection: 20 Hz to 620 kHz, > 40 dB.

Automatic ranging: 8 ranges, 0 dB to -70 dB. Ranging rate proportional to bandwidth.

Output: amplitude: adjustable 0 to 1 V rms open circuit.

BFO frequency response flatness: ± 0.2 dB or $\pm 2\%$.

Resistance: 600 Ω .

L.O. output: frequency, 1.28 MHz to 1.90 MHz (1.28 MHz + tuned frequency); amplitude, 0.65 V rms $\pm 20\%$ open circuit; resistance, 250 Ω .

Recorder outputs

X-axis	Plug-in frequency ranges	
	62 kHz	620 kHz
X-axis linear output: (1 k Ω source resistance)	0 to -12.4 V (200 mV/kHz $\pm 5\%$)	0 to -12.4 V (20 mV/kHz $\pm 5\%$)
X-axis log output: (1 k Ω source resistance)	5V/decade $\pm 5\%$ (50 Hz—62 kHz)	5 V/decade $\pm 5\%$ (500 Hz—620 kHz)

Y-Axis

Linear Y axis output: + 10 V dc $\pm 2\%$ for full scale meter indication, 1 k Ω source resistance.

Log Y axis output: + 1 V to + 10 V dc, proportional to linear dB meter indication (-90 to 0 dB, 0.1 V/dB) 1k Ω source resistance.

Power: 115 V or 230 V $\pm 10\%$, 50 Hz to 400 Hz, < 70 VA.

Size: 221 H x 425 W x 467 mm D (8 $\frac{3}{4}$ " x 16 $\frac{3}{4}$ " x 18 $\frac{3}{8}$ ").

Weight: net, 17.2 kg (38 lb). Shipping, 24.9 kg (55 lb).

Options

908: Rack Flange Kit

Price

add \$15

3591A Selective Voltmeter

\$5465

3594A Sweeping Local Oscillator Plug-in

\$2850

*Other terminations on special order.

In many countries the main communication system consists of a network of FM microwave radio links. Typically, these links can carry up to 1800 FDM telephone channels, using a 70 MHz IF carrier and an RF band in the range 600 MHz to 18 GHz. However, some countries are now installing 140 MHz IF microwave links which can carry up to 2700 FDM telephony channels.

All information signals (speech, television, or data) carried by these links have a common objective—to convey the information with maximum fidelity. Failure to keep distortion in a link within specified limits results in an unacceptably high level of intermodulation noise. This prevents the link from carrying the designated channel capacity and the link operator incurs a severe financial penalty due to loss of revenue-earning channels. The qualitative tests shown in Table 1 are particularly relevant as indicators of overall system performance.

The use of noise-loading measurements to establish the intermodulation performance of

FDM telephony links is well known and they provide 'go/no-go' criteria for the transmission quality of a system between baseband (BB) terminals. Although such measurements can separate the basic and intermodulation noise components, they do not localize the noise sources.

The main contributors to distortion in FM microwave radio links are the modulators, demodulators and carrier circuits at IF such as amplifiers, and carrier circuits at RF such as non-linear amplifiers. The distortion parameters of these circuits can be measured in terms of nonlinearity, amplitude variations and group delay variations. To do this, test equipment must interface with the links at BB, IF and RF. Commissioning microwave link equipment involves minimizing these circuit distortion parameters by adjustment or equalization.

On lower capacity systems, these adjustments are normally enough to reduce intermodulation distortion to an acceptable level. With increased traffic capacity, the toler-

ances imposed on the circuit parameters become more and more strict and normal commissioning methods often do not produce satisfactory results. Consequently, relating the circuit parameters to the intermodulation noise (measured by a noise-loading test set) becomes increasingly more difficult.

The main source of discrepancy is the result of amplitude modulation to phase modulation (AM/PM) conversion in the transmission carrier path. This AM/PM conversion occurring in non-linear networks introduces additional intermodulation from the signal deviations arising in preceding networks. These 'coupled' responses can be assessed only by differential gain/differential phase (DG/DP) measurements with high-frequency test tones.

DG/DP measurements have the advantage of characterizing a link more completely and they yield valuable diagnostic information. Furthermore, these two measurements are mathematically related to the BB measurement of noise power ratio. This information allows microwave link manufacturers to design link parameters with much more certainty and it allows microwave link operators to optimize performance in a more cost effective way. HP Application Note AN 175-1 'Differential Phase and Gain at Work' covers this subject in considerable detail.

HP microwave link analyzers (MLA's), at 70 MHz IF and 140 MHz IF, were developed specifically for the purpose of measuring various forms of distortion on terrestrial and satellite microwave radio links. The measurement capabilities of HP link analyzers, as shown in Table 2, were established in close cooperation with the telecommunications industry.

A valuable extension of the MLA measurement capability can be obtained using RF up and down converters. The circuit distortions at RF have identical effects to the IF circuit distortions when the carrier signal is eventually demodulated. Hence, the RF distortions can be analyzed using an MLA, provided a transparent RF-to-IF interface is available. A down converter provides such an interface and allows independent measurements on microwave transmitters. A so-called 'up-converter' in fact provides a transparent BB-to-RF interface, allowing independent measurements on microwave receivers. Both converters used with an MLA provide an RF-to-RF measurement capability.

Table 1. Qualitative tests to verify radio system performance

Test	FDM	Video	Digital
1. Insertion Gain	•	•	•
2. Frequency Response	•	•	•
3. Envelope Delay Distortion		•	•
4. Spurious Interference Tones	•	•	•
5. Thermal Noise	•	•	•
6. White Noise Loading	•		
7. Video Waveform Tests		•	
8. Video System Program Channel (Subcarrier) Tests		•	
9. Bit Error Rate Tests			•

Table 2. Diagnostic tests to maintain radio system performance

Measurement	BB	IF	RF
1. Module Power Levels, Gains and Losses	•	•	•
2. Modem Centre Frequencies		•	•
3. TX and RX Local Oscillator Frequencies			•
4. Transmitter RF Output Frequency			•
5. Spurious Tones	•	•	•
6. FM Mod + Demod Deviation Sensitivity	•	•	•
7. FM Mod + Demod Linearity	•	•	•
8. Return Loss	•	•	•
9. Amplitude Flatness	•	•	•
10. Group Delay		•	•
11. Differential Gain and Phase		•	•

TELECOMMUNICATIONS TEST EQUIPMENT

Microwave Link Analyzers

Models 3710A and 3790A MLA systems

- Isolate and characterize causes of intermodulation distortion in wideband microwave radios
- Baseband and IF interfaces
- 70 MHz or 140 MHz IF capability
- Test analog and digital radios



3710A
(70 MHz IF)
MLA System

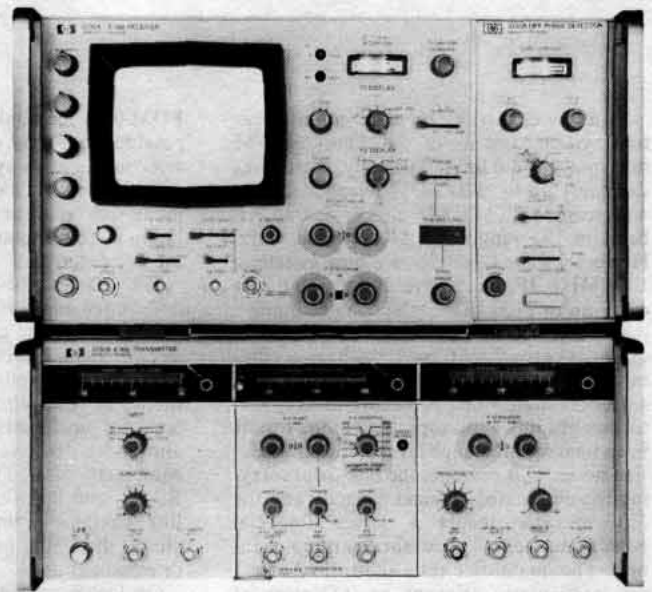

3790A
(140 MHz IF)
MLA System

Description

The 3710A and 3790A Microwave Link Analyzer (MLA) Systems are diagnostic instruments. They isolate and characterize causes of intermodulation distortion in wideband microwave radios. The MLA's have applications in both analog and digital radio systems. Both MLA's have baseband and IF interface capabilities. The 3710A system interfaces with 70 MHz IF radios and the 3790A MLA system interfaces with 140 MHz IF radios.

Primary measurements provided by the HP MLA systems are:

- baseband power, gain and loss.
- IF power, gain and loss.
- IF centre frequency.
- modulator/demodulator deviation sensitivity.
- modulator/demodulator linearity.
- modulator/demodulator group delay.
- swept IF amplitude response.
- swept IF group delay.
- swept IF return loss.
- baseband and IF differential gain (HF linearity).
- baseband and IF differential phase (HF group delay).
- baseband return loss.

When used with the 8620C/86200 Series RF Sweeper system (equipped with the MLA interface option) and the 3730A RF Down Converter, the swept measurements of the basic MLA can be extended to RF. Pages 606 and 607 give further details about this RF instrumentation (3730A and 8620C).

Because HP MLA's have low inherent distortions they provide extremely accurate and rapid radio measurements. The specifications of HP MLA's are conservatively defined to assure adequate performance over wide operating ranges and long-time periods. The system specifications and oscillograms on the following page illustrate performance capabilities of HP MLA's.

A series of options are also provided with the MLA's. The options include:

- test-tone frequencies.
- connectors.
- balanced 124Ω baseband impedance.
- sweep frequencies.
- variable phase output of sweep signal.

With this performance capability and range of options, a highly-accurate and flexible measurement system is available from HP. Therefore, the HP MLA's provide for improved design, production, commissioning and maintenance of wideband analog and digital Microwave Radio Systems.

Ordering information

	Price
140 MHz system (3790A/3791A/3792A/3793A)	\$19830
70 MHz system with high frequency test tones (3710A/3702B/3705A/3716A)	\$19840
70 MHz system with low frequency test tones (3710A/3702B/3703B/3715A)	\$18255

Typical HP MLA Performance

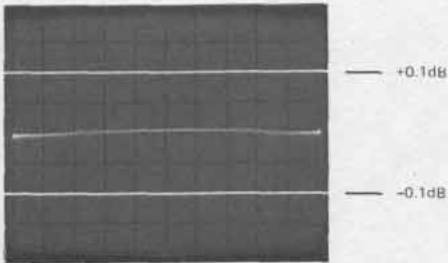

3710A MLA system: Amplitude flatness performance at 0 dBm input level.

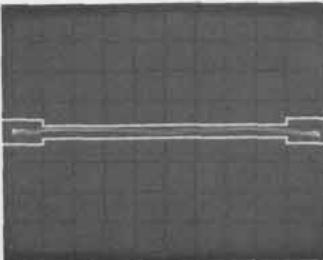

3710A MLA system: Group delay (mask includes inherent slope and noise specifications using 250kHz test-tone).

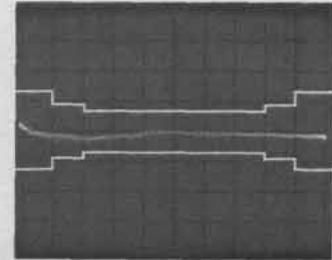
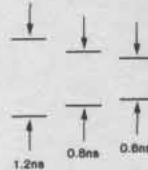

3710A MLA system: Differential gain (using 2.4 MHz test-tone).

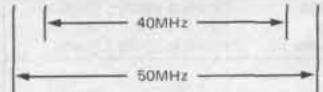
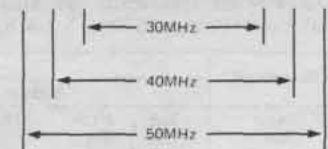

MLA IF-IF System specifications

3710A (70 MHz IF) MLA System

Measurement Capability	IF Range (MHz)	Calibrated Display Range	Maximum Sensitivity	Maximum Inherent Slope	Maximum Inherent Noise (rms)	
					BB Frequency	IF-IF
IF Response	45 to 95	0 to ± 1 dB	0.1dB/cm	± 0.05 dB at +5dBm ± 0.1 dB from +5 to +21dBm	—	
BB Linearity & Differential Gain	50 to 90 45 to 95	0 to 50%	0.25%/cm	0.2% 0.4%	—	
Group Delay	55 to 85 50 to 90 45 to 95	200 ns	0.25ns/cm	0.4ns 0.6ns 1.0ns	83.333kHz 250kHz 500kHz	0.6ns 0.2ns 0.1ns } with 200kHz rms dev
Differential Phase	55 to 85 50 to 90 45 to 95	18° or 31.4° rad	0.5°/cm	0.4° at 2.4 MHz 0.4° at 2.4 MHz 0.6° at >2.4 MHz 0.8° at >2.4 MHz	2.4 MHz 4.43MHz 5.6MHz 8.2MHz	0.1° 0.1° 0.1° } with 500 kHz rms. dev
IF Return Loss	45 to 95	10 to 49dB (accuracy depends on Hybrid used)	1dB/cm	1dB	—	

3790A (140 MHz IF) MLA System

Measurement Capability	IF Range (MHz)	Calibrated Display Range	Maximum Sensitivity	Maximum Inherent Slope	Maximum Inherent Noise (rms)	
					BB Frequency	IF-IF
IF Response	115 to 165	0 to ± 1 dB	0.025dB/cm	± 0.05 dB at +5dBm ± 0.1 dB from +5 to ± 10 dBm at input to 3792A	—	
BB Linearity & Differential Gain	125 to 155 115 to 165	0 to 50%	0.25%/cm	0.2% 0.4%	—	
Group Delay	125 to 155 115 to 165	200ns	0.25ns/cm	0.2ns 0.5ns	83.333kHz 250kHz 500kHz	0.6ns 0.2ns 0.1ns } 200kHz rms dev
Differential Gain	125 to 155 115 to 165	18° or 31.4° rad	0.5°/cm	0.2° 0.5°	2.4MHz 4.43MHz 5.6MHz 8.2MHz 12.39MHz	0.1° 0.1° 0.1° } 500kHz rms dev
IF Return Loss	115 to 165	10 to 49dB (accuracy depends on Hybrid used)	1dB/cm	1dB	—	



TELECOMMUNICATIONS TEST EQUIPMENT

Microwave Link Analyzers (Cont'd)

Models 3710A and 3790A MLA Systems

Fixed Frequency Specifications

Except where specifically indicated, these specifications apply for both the 3710A and 3790A MLA Systems.

Measurement	Range		Accuracy	Frequency						
	Maximum	Minimum								
IF *Power Gain Loss	+21dB } 72dB } 20dB }	3710A } MLA } System }	+19dB } 90dB } 20dB }	3790A } MLA } System }	-10dBm } 0dB } 0dB }	±0.5dB } ±1dB } ±1dB }	45 to 95MHz } 45 to 95MHz } 45 to 95MHz }	3710A } MLA } System }	115 to 165MHz } 115 to 165MHz } 115 to 165MHz }	3790A } MLA } System }
BB *Power Gain Loss	-10dBm } 39dB } 59dB }		-49dBm } 0dB } 0dB }		±0.5dB } ±1dB } ±1dB }	†80kHz to 10MHz } †80kHz to 10MHz } †80kHz to 10MHz }	3710A } MLA } System }	†80kHz to 15MHz } †80kHz to 15MHz } †80kHz to 15MHz }	3790A } MLA } System }	
Modulator Sensitivity	141kHz RMS/-49dBm		141kHz RMS/0dBm		1kHz } (using 83.333kHz } BB test-tone } and first Bessel } Zero 2.405)	70 ± 3MHz } (at IF Output) }	3710A } MLA } System }	140 ± 3MHz } (at IF Output) }	3790A } MLA } System }	
Demodulator Sensitivity	-10dBm/10 to 500kHz RMS } (using calibrated deviation control and measuring the BB output power from the demodulator)		-49dBm/10 to 500kHz RMS		—	45 to 95MHz (at IF INPUT)				
Notes:	* Receiver only † Using the 3715A or 3791A Ext Input facility, at BB frequencies other than indicated on front panel. Also requires removal of 3705A/3703B from 3702B, to avoid built-in low-pass filter at frequencies other than indicated on front panels.									

Options

To compile a suitable MLA System for your application, select **one** of the following combinations:

(70 MHz IF with low-frequency test-tones only)—3710A/3702B/3715A/3703B

(70 MHz IF with low- and high-frequency test-tones)—3710A/3702B/3716A/3705A

(140 MHz IF with low- and high-frequency test-tones)—3790A/3792A/3793A/3791A

Connector Options

STD BNC	002 Siemens (large)	003 Siemens (small)	004 Commercial equivalent of WECCO Type 477B

NOTE: It is not necessary to specify connector options on the Phase Detector plug-ins (3703B, 3705A, 3793A).

Sweep Options (Generator only)

STD 70 Hz	006 50 Hz	007 100 Hz	015* 18 Hz and 70 Hz

* 18 Hz is in addition to the 70 Hz internal sweep on the Generator and must be used with associated bandwidths of 90 Hz and 180 Hz (available only on Phase Detector plug-in 3705A Opt 015).

Bandwidth Options (3705A only)

STD — 1 kHz, 5 kHz, 10 kHz

015 — 90 Hz, 180 Hz, 1 kHz, 5 kHz, 10 kHz

Test-tone (BB) Options

The low-frequency test-tones have been classified into two groups:
CCIR — 83.333, 250 and 500 kHz

BELL — 92.593, 277.778, 555.556 kHz

Note: Only one of these groups can be specified.

Various combinations of low- and high-frequency test-tones can be ordered. Selection can be made from the following table.

IF	Test-tone Selection (CCR or BELL + high frequency)									BB Transmitter and Phase Detector Plug-ins	
	Low frequency		High frequency (MHz)								
	CCR	BELL	2.4	3.50	3.58	4.43	4.50	5.60	8.20		12.39
70 MHz	STD	012	●			●		●	●		3716A/ 3705A
	013	010	●			●		●	●		
	019	011	●			●		●	●		
	014		●	●		●		●	●		
	016		●			●		●	●		
	018		●			●		●	●		
	STD	009									3715A/3703B
140 MHz	STD		●			●		●	●	●	3791A/ 3793A
	013		●			●		●	●	●	

Other Options

008 provides a variable-phase sweep output on the 3710A or 3790A IF/BB Transmitters.

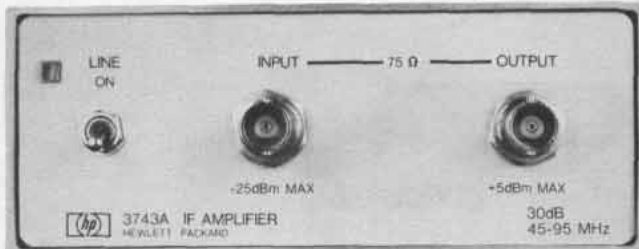

3743A IF Amplifier

3743A IF Amplifier

- Improve MLA IF input sensitivity to -40 dBm.
- Frequency range, 45 to 95 MHz.
- Group delay, <0.3 ns.
- Amplitude flatness, <0.2 dB.
- Return loss, >26 dB (75Ω).
- Noise figure, ≤ 8 dB.

3744A BB Sweeper

- Operates with 70 MHz or 140 MHz IF MLA's to provide swept baseband stimulus and amplitude detection.
- Frequency range, 100 kHz to 15 MHz.
- Flatness, <0.1 dB (from 100 kHz to 8.5 MHz).

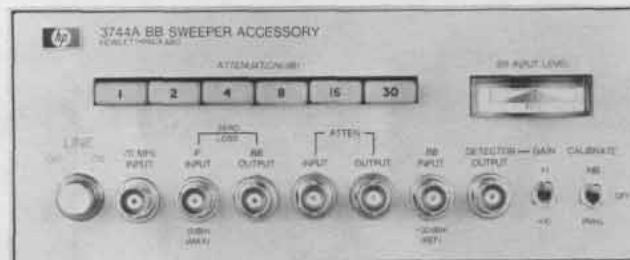

3744A BB Sweeper

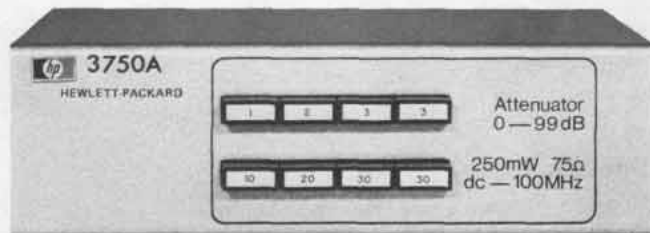

3750A Attenuator

3750A Attenuator

- Impedance, 75Ω .
- Attenuation range, 0 to 99 dB in 1 dB steps.
- Frequency range, dc to 100 MHz.

For detailed performance specifications on the 3743A, 3744A and 3750A, refer to the appropriate data sheet.

For details on additional MLA accessories, refer to the MLA data sheets. These additional accessories include:

- 75Ω cables.
- Test hybrids, loads and calibrated mismatch.
- Transit cases.

For accessories which support the 3730A RF Down Converter and 8620C RF Sweeper, refer to the appropriate data sheets and sections of this catalog.

Ordering Information

3743A IF Amplifier
3744A BB Sweeper
3750A Attenuator

Price
\$970
\$1860
\$410

TELECOMMUNICATIONS TEST EQUIPMENT

RF Down Converter

Model 3730A

- RF to IF frequency conversion
- 1 to 12 GHz frequency range
- Extends test capability of microwave link analyzers to RF

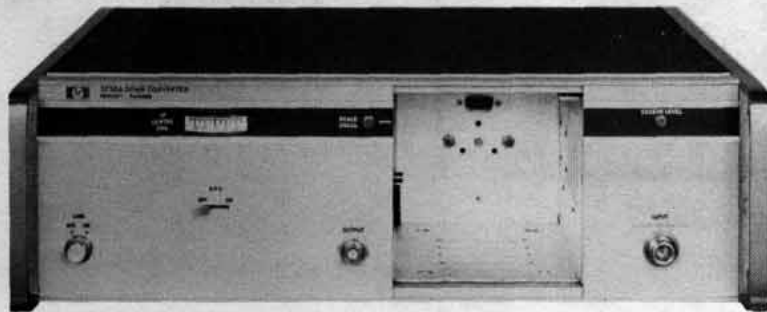

3730A
RF Down Converter
Mainframe



3736A
Plug-in
1.7 to 4.2 GHz



3737A
Plug-in
3.3 to 6.5 GHz



3738A
Plug-in
6.3 to 8.5 GHz

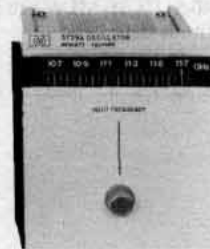

3739A
Plug-in
10.7 to 11.7 GHz



37301A
Dummy
Plug-in

Description

The 3730A RF Down Converter and plug-ins provide RF to IF conversion and RF test capabilities for Microwave Link Analyzers (MLA's). The RF range (1 to 12 GHz) is accommodated by a series of local-oscillator plug-ins, allowing easy tuning to the desired operating frequency and convenient change of RF operating bands. A dummy plug-in (37301A) allows the user to connect his own local oscillator source to the Down Converter mainframe.

The Down Converter mainframe features an IF centre frequency meter (to facilitate RF tuning), an AFC (to maintain centre frequency), an input-overload warning light and an optional 1 dB step variable gain control. Special options are available to extend the RF range up to 18 GHz and down to 0.5 GHz. A special 140 MHz IF output is also available. (Contact your local HP representative for details on these options).

Using the 3730A RF Down Converter, RF Transmitter performance can be verified and the performance adjusted locally in-station. This minimizes the amount of compensation required in the Receiver for Transmitter distortion. Thus it provides a more rapid System trouble-shooting/alignment procedure and improves System performance by minimizing Transmitter distortions at their source. The 3730A can also be used at the RF Receiver pre-selector output to isolate path/antenna/feeder problems.

Specifications

3730A RF Down converter mainframe

Frequency range: 1.0 GHz to 12.0 GHz (0.5 GHz to 12.0 GHz and 1.0 GHz to 18.0 GHz are available as special options*).

RF Input level range: 0 to -16 dBm (standard) (0 to -40 dBm with 25 dB/1 dB step variable gain control—Opt 010).

Maximum input level: 0 dBm.

RF Input impedance: 50Ω.

RF Input VSWR: <1.4.

IF Output frequency: 70 MHz ± 25 MHz (140 MHz ± 25 MHz available as special option*).

IF Output impedance: 75Ω.

IF Output return loss: >28 dB.

†RF-IF Amplitude flatness: <0.5 dB over any 50 MHz band (<0.7 dB over any 50 MHz band with Opt 010).

†RF-IF Group delay: <1.0 ns over any 50 MHz band

*Contact your HP representative for details on special options.

† These specifications include 3710A system residuals.

(Refer to MLA Data Sheet for detailed specifications.)

3730A RF Down Converter

3736A 1.7-4.2 GHz

3737A 3.3-6.5 GHz

3738A 6.3-8.5 GHz

3739A 10.7-11.7 GHz

\$4460

\$2605

\$2895

\$4095

\$3590

TELECOMMUNICATIONS TEST EQUIPMENT

RF Sweeper MLA Upconverter Simulator

Models 8620C, 86200 Series RF Plug-ins



- MLA Upconverter Simulator Options 0.5 to 18.0 GHz
- Use with MLA or as a general purpose sweeper

- Swept and CW RF Source
- Test Digital & Analog Microwave Radio Systems & Components

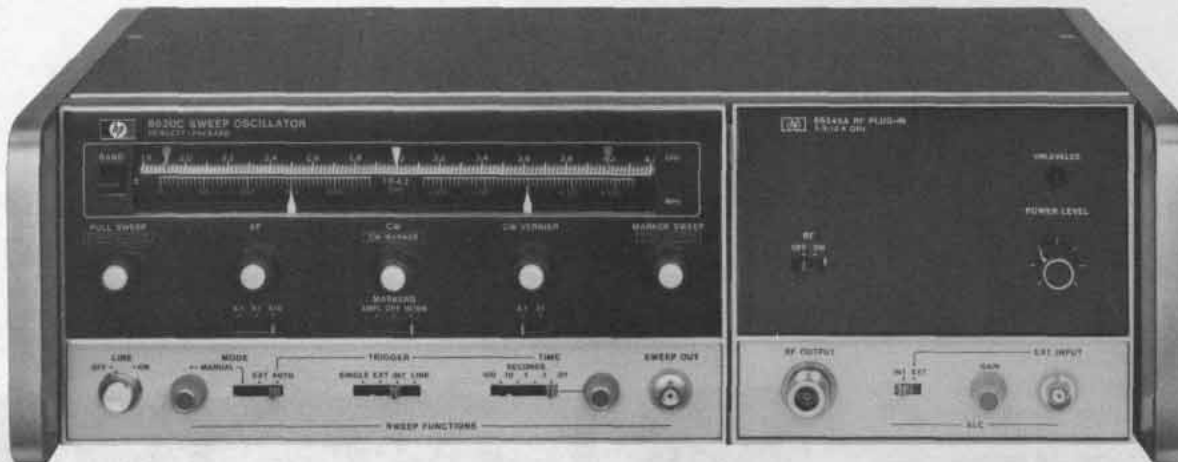

8620C/86245A

Description

The 8620C Sweep Oscillator and 86200 Series of RF plug-ins provide a high performance, solid state source for Microwave Radio System tests via MLA Upconverter Simulation Options. These permit accurate RF-to-BB, RF-to-IF and RF-to-RF distortion measurements to be made with the 3700 Series MLA System. Also the plug-ins can be used as standard sweeper plug-ins, with the only basic difference being modified FM circuitry. The RF-to-RF measurements must be made in conjunction with the 3730A RF Down Converter. This allows group delay, linearity, differential gain and phase measurements to be made on RF devices and components within the Microwave Radio System.

Specifications

The 8620C/86200 Series MLA Upconverter Simulation Plug-ins are optimized for group delay, linearity, and differential gain and

phase over the specified frequency range. The following specifications supplement the standard plug-in specifications (covered on pages 401-411).

Complementary Equipment	Price
8620C Sweeper Mainframe (required)	\$2350
To properly interface the 8620C/86200 Series plug-in to the item under test, the following are recommended for optimal performance:	
784B Directional Detector (1.6 - 12.4 GHz)	\$800
Flatness over any 30 MHz: <math>\leq \pm 0.1 \text{ dB}</math>	
Equivalent Source Match: typically ≤ 1.5	
11675B Leveling Cable Assembly (1.7 - 12.4 GHz)	\$350
Group Delay: $\leq 0.25 \text{ ns p-p}$ (with 1.25 SWR at each end)	

MLA Upconverter Simulation Plug-in Specifications (25°C)

Model Number	MLA Option Number	MLA Freq. Range (GHz)	Group Delay (ns) p-p	Linearity (%)	Diff. Gain (%)	Diff. Phase (°)	FM Sens. (MHz/V)	Price W/MLA Option
			@277.7 kHz		@5.6 MHz ¹			
			Across Any 30 MHz BW					
86222A/B	H80	0.5-2.4	<3	<2.5	<2.5	<3	N/S	\$4650/5250
86235A	008	1.7-4.3	<2	<2.0	<2.0	<2	+20	\$3850
86240C		3.6-8.6	<1	<0.5	<0.5	<1	+20	\$4700
86242D	008	5.9-9.0	<1	<0.5	<0.5	<1	+20	\$3350
86245A	008	5.9-12.4	<1	<0.5	<0.5	<1	+20	\$4850
86250D	008	8.0-12.4	<1	<0.5	<0.5	<1	+20	\$3450
86260A	H82	12.0-18.0	<3	<2.5	<2.5	<3	N/S	\$4600

¹Except 86222A/B & 86260A which are tested @ 2.4 MHz.

For applications requiring better distortion specifications, HP also offers plug-in systems which include a leveling cable and directional coupler. These systems are available in the following bands: 1.7-2.4 GHz, 3.6-4.3 GHz, 5.8-6.5 GHz, 7.0-8.6 GHz, 10.7-11.7 GHz, and 12.2-12.7 GHz. The system specifications are as follows:
Group Delay @ 500 kHz: $\leq 0.5 \text{ ns p-p}$

Linearity @ 500 kHz: $\leq 0.25\%$

Flatness: $\leq \pm 0.1 \text{ dB}$

For more information consult your local HP Field Engineer.

The options shown after each plug-in provide the special MLA interface capability. Refer to pages 404 to 411 for details on other RF Sweeper plug-in specifications and options.

Personal Calculators

Pocket and Personal Printing Calculators

General Information

Hewlett-Packard introduced the world's first pocket scientific calculator in 1972. Since then, Hewlett-Packard has introduced numerous other pocket and personal printing calculators with technologically advanced features; each with different capabilities for different levels of problem sophistication. To properly select a calculator, you must consider not only the problems you're facing today, but those you're likely to face tomorrow.

Personal Calculators

If your problems are fairly straight forward but still include coordinate conversions, log and trig functions, the new HP-31E may be the model for you. The new HP-31E is the lowest priced scientific pocket calculator Hewlett-Packard offers, yet it has all the functions and features you'd expect to find in a quality scientific pocket calculator. For advanced calculations, the new HP-32E may be ideal for you. It contains all the features and functions of the HP-31E plus advanced statistics to handle even the toughest of problems.

For repetitive or iterative problems the new HP-33E keystroke programmable has the problem-solving power to meet your need. The HP-33E remembers a series of keystrokes as you press them, then executes the sequence later at your command.

If you require keystroke programmability plus the advantages of Continuous Memory, pick up either the HP-19C or HP-29C. The Continuous Memory feature of these calculators makes it possible to retain programs—even with the calculator switched off. And the HP-19C gives you a printed record of your scientific and engineering problems.

If your problems are more business oriented, take a look at the HP-37E or HP-38E. These calculators provide the desirable combination of financial, mathematical, and statistical capabilities frequently used in business transactions. And for the businessperson that must evaluate large numbers of investment alternatives, the HP-92 provides solutions quickly, easily, and accurately. The thermal printing feature gives you an indispensable record of time and money solutions.

For the ultimate in problem-solving power, Hewlett-Packard offers the fully program-

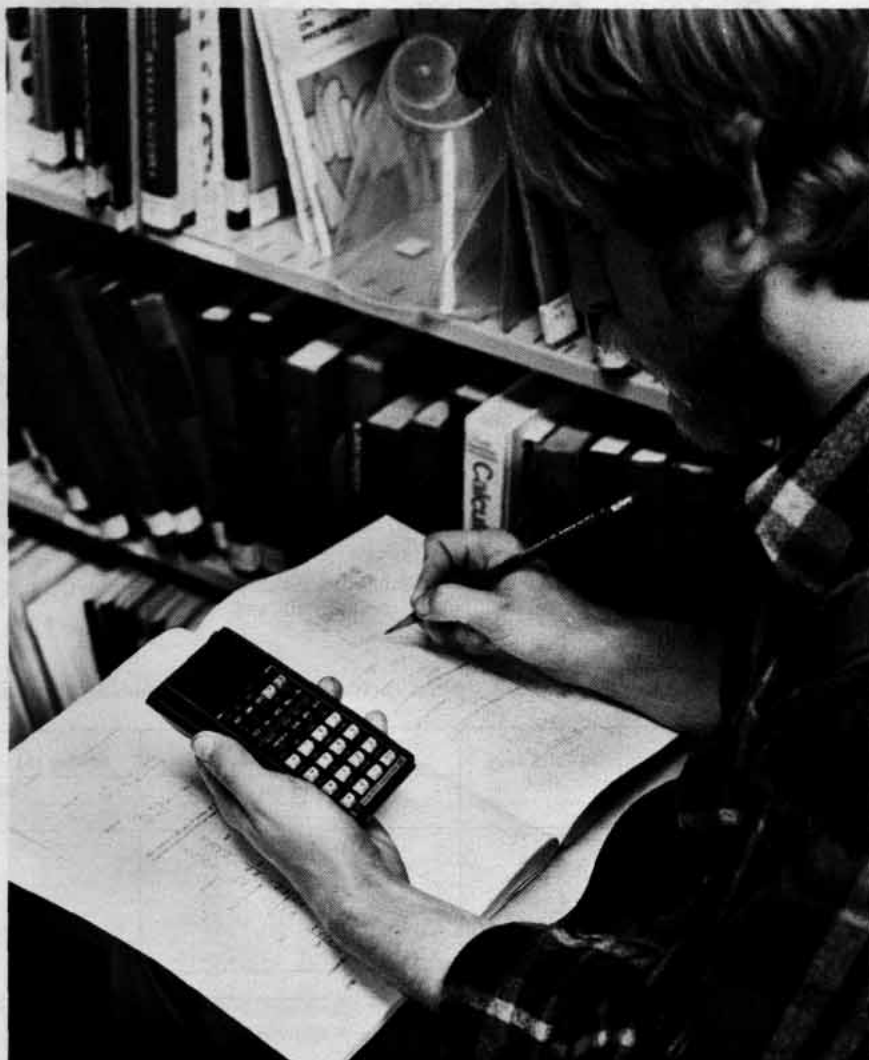

mable HP-97 Printing Calculator. The HP-97 is the most powerful personal calculator ever made by Hewlett-Packard. The HP-97 combines exceptional programming power with a battery-operated printer, all in one self-contained unit. The HP-67 provides the

identical power of the HP-97 in the classic pocket size.

Whichever HP calculator you select, you can be assured that it is the finest in its class...the standard of HP quality permits nothing less.

PERSONAL CALCULATORS

Scientific Pocket Calculators

Model HP-19C/29C



- Advanced programming features
- Merged keystrokes provide greater memory efficiency

- A complete range of preprogrammed functions and features
- Fast and easy editing



The HP-19C and HP-29C are a pair of advanced programmable calculators with Continuous Memory. Continuous Memory retains a user's programs or data, even with the power turned off. The HP-19C combines a full range of scientific functions, advanced programming features and RPN number entry with a battery powered printer in a convenient hand-held size. The HP-29C offers the same features and functions in an even smaller "pocket size." These functionally identical calculators provide exceptional utility to professionals and students in science or engineering fields.

Specifications

Pre-Programmed Functions

Angular: Sin, Cos, Tan, \sin^{-1} , \cos^{-1} , \tan^{-1} ; Hours - Minutes - Seconds Conversion to decimal hours; polar/rectangular conversion; degrees, radians, grads angular modes.

Logarithmic: Log, 10^x , Ln, e^x .

Statistics: Summations Σx , Σy , Σx^2 , Σy^2 , Σxy ; deletion of unwanted data; mean, standard deviation.

Other: +, -, \div , \times , y^x , x^2 , π , \sqrt{x} , $1/x$, %. Integer truncation; fraction truncation; absolute value.

Programming features: 98 steps of Continuous Memory (all functions merged); 16 Continuous Memory data storage registers; 14 volatile data storage registers; four-register stack; last-X register; $x \neq y$, $x = y$, $x > y$, $x \leq y$; $x \neq 0$, $x = 0$, $x > 0$, $x < 0$ conditional tests;

Increment/decrement storage register and skip on zero.

Addressing

Label addressing: indirect addressing of labels and data storage; relative addressing; three levels of subroutines.

Editing: single step execution; single step and back step inspection of a program; insert/delete editing; position the calculator at any step in program memory. Pause—review intermediate results.

General

Display: fixed decimal, scientific and engineering notation.

Print select switch: print only when you desire; print digit entries and functions automatically; or trace an executing program.

HP-19C Physical specifications

Power: 115 Vac (or 230 Vac) $\pm 10\%$, 50 to 60 hz.

Size: 40mm H x 88mm W x 165 mm L (1.6" x 3.45" x 6.5").

HP-29C Physical specifications

Power: AC 115 (or 230 V) $\pm 10\%$, 50 to 60 hz.

Size: 30.2mm H x 68.3mm W x 130.2 mm L (1.2" x 2.7" x 5.1").

Ordering information

HP-19C Printing Programmable with Continuous Memory

Price

\$275

HP-29C Programmable with Continuous Memory

\$175



PERSONAL CALCULATORS

Scientific Pocket Calculators HP-31E, HP-32E, HP-33E

- New easy-to-read display
- Self-check capacity
- Error codes
- Improved accuracy



HP-31E

The new HP-31E is a no-nonsense machine that provides an excellent blend of mathematical and scientific functions at the lowest price ever for a Hewlett-Packard calculator.

The HP-31E has the functions you need for science or engineering. Exponentials, reciprocals, square roots, pi and per cent at the touch of a key.

Computes sine, cosine, or tangent, arc sine, arc cosine, and arc tangent—all with a choice of degrees, radians, or grads mode.

The HP-31E gives you Rectangular/Polar Conversions, Logarithms, Metric Conversions, Four Addressable Registers and LAST X, Two Display Modes, Stack Review, Selective Clearing Options. The HP-31E is designed to help cut through the toughest scientific and mathematical problems.

HP-31E Specifications

Preprogrammed functions

Trigonometric/Mathematical: DEG, RAD, GRD modes, SIN, COS, TAN and inverses, R = P, DEG = RAD, LOG, 10^x, LN, e^x, y^x, √x, 1/x, π, +, -, ÷, x, %.

General

Clearing options: CLX, STK, REG, ALL, PREFIX

Memory: 4 storage registers, LAST X.

Recharger Power Requirements: 90 to 120 VAC, 50 to 60 Hz, or 198-242 VAC, 50 to 60 Hz.

Size: 30 mm H (1.2") x 75 mm W (3.0") x 140 mm L (5.6")

Ordering information
HP-31E Scientific Calculator

Price
\$60



HP-32E

The new HP-32E is the most powerful scientific preprogrammed calculator ever built by HP. The HP-32E is packed with dozens of invaluable mathematical and scientific functions to help solve even the toughest of problems.

The HP-32E has extensive statistical capabilities; normal distribution, linear regression and estimate, correlation coefficient, and two variable means and standard deviations. 15 addressable storage registers. The HP-32E provides exceptional utility for managers, statisticians or anyone who must reduce and interpret data.

HP-32E Specifications

Preprogrammed functions

Trigonometric/Mathematical: DEG, RAD, GRD Modes, SIN, COS, TAN and inverses. R = P, DEG = RAD, H = H.MS, LOG, 10^x, LN, e^x, y^x, √x, 1/x, x², π, +, -, ×, ÷, %, Δ%, %Σ.

Statistical: \bar{x} , s, r, L.R., \hat{x} , \hat{y} , Σ+, Σ- (n, Σx, Σx², Σy, Σy², Σxy), Q, Q⁻¹, n!

General

Clearing options: CLX, REG, Σ, ALL, PREFIX

Memory: 15 Storage Registers, LAST X

Recharger Power Requirements: 90 to 120 VAC, 50 to 60 Hz, or 198-242 VAC, 50 to 60 Hz.

Size: 30 mm H (1.2") x 75 mm W (3.0") x 140 mm L (5.6").

Ordering information
HP-32E Advanced Scientific
Calculator with Statistics

Price
\$ 80



HP-33E

The new HP-33E provides extraordinary problem-solving power plus versatile keystroke programmability to solve repetitive problems quickly and easily. The HP-33E remembers a series of keystrokes as you press them, then executes the sequence later at your command. Programming removes the drudgery of lengthy or repetitive calculations saving time for decision making. The HP-33E features 49 lines of Program Memory. An instruction occupies only a single line of memory whether a keyboard operation has one, two, or three keystrokes. In addition to the 49 lines of fully merged program memory, the HP-33E has a variety of specialized functions to make programming more useful and powerful.

HP-33E Specifications

Preprogrammed functions

Trigonometric/Mathematical: DEG, RAD, GRD modes, SIN, COS, TAN and inverses, R = P, DEG = RAD, H = H.MS, LOG, 10^x, LN, e^x, y^x, √x, 1/x, x², π, +, -, x, ÷, %, ABS, INT, FRAC.

Statistics: \bar{x} , s, r, L.R., \hat{x} , \hat{y} , Σ+, Σ- (n, Σx, Σx², Σy, Σy², Σxy).

Programming: SST, BST, GTO, GSB, RTN, R/S, PAUSE, NOP. 3 levels of Sub-routines, 8 Conditional tests.

General

Clearing options: CLX, STK, REG, PRGM, PREFIX

Memory: 8 Storage Registers, LAST X, 49 Program Lines

Recharger Power Requirements: 90 to 120 VAC, 50 to 60 Hz, or 198-242 VAC, 50 to 60 Hz.

Size: 30 mm H (1.2") x 75 mm W (3.0") x 140 mm L (5.6").

Ordering information
HP-33E Programmable Scientific
Calculator

Price
\$100

PERSONAL CALCULATORS

Financial Pocket Calculators
HP-37E, HP-38E



HP-37E



HP-38E

HP-37E

The new HP-37E is the basic calculator you need for answers to most business and financial problems such as pricing, compound interest, trend lines and more. The HP-37E can solve for the fifth variable given four-n (number of compounding periods), i (interest rate), PV (present value), PMT (payment) and FV (future value). Key the elements of the problem in any order. The HP-37E's ability to modify the variables in a problem continuously make it ideal for solving problems in complex or changing business situations.

HP-37E Specifications

Preprogrammed functions

Financial: Number of periods, Interest rate per period, Present value, Payment, Future value. Accumulated interest, Payment to principal, Remaining balance. Ordinary and Annuity due switch.

Percent: Percent, Percent of total, Percent change, Price.

Mathematical: Four arithmetic functions, Reciprocal, Square root, Exponentiation, Factorial, Natural logarithm and antilogarithm.

Statistical: Two variable mean and standard deviation, Linear estimate and correlation coefficient. Summations (n , Σx , Σx^2 , Σy , Σy^2 , Σxy) and error correction.

General

Clearing options: CLX, Clear finance, Clear all.

Control: Enter, $x-y$ exchange, Roll down, Change sign. Store and Recall. Shift key. On-off switch.

Registers: 7 user's, 5 financial, 4 operational.

Recharger Power Requirements: 90 to 120 VAC, 50 to 60 Hz, or 198-242 VAC, 50 to 60 Hz.

Size: 30 mm H (1.2") \times 75 mm W (3.0") \times 140 mm L (5.6").

Ordering information

HP-37E Business Management Calculator

Price
\$75

HP-38E

With all the capabilities of the HP-37E, the new HP-38E is a powerful financial calculator that includes programming. The HP-38E combines a wide array of financial functions with the ability to remember all the keystrokes in a calculation and repeats them with the touch of a key. The HP-38E calculates net present value (NPV) and

internal rate of return (IRR) for up to 20 groups of uneven cash flows with up to 99 cash flows in each group. The HP-38E provides capabilities that are invaluable to business managers and business students alike.

HP-38E Specifications

Financial: Number of periods, Interest rate per period, Present value, Payment, Future value. Accumulated interest, Payment to principal, Remaining balance. Ordinary and Annuity due switch. Simple interest. Net present value, Internal rate of return. Automatic entry for grouped or individual cash flows.

Percent: Percent, Percent of total, Percent change.

Mathematical: Four arithmetic functions, Reciprocal, Square root, Exponentiation, Natural logarithm and antilogarithm, Factorial.

Statistical: Two variable mean and standard deviation. Weighted average. Linear estimate of x and y values, Correlation coefficient. Summations (n , Σx , Σx^2 , Σy , Σy^2 , Σxy) and error correction.

General

Clearing options: CLX, Clear all, Clear finance, Clear statistics, Clear prefix, Clear program.

Control functions: Enter, $x-y$ exchange, Roll down, Change sign. Store and Recall. Enter exponent. Round, Integer, Fraction. Two shift keys. On-off switch.

Programming Functions: Program/run, Go to, Tests ($x \leq y$, $x = 0$). Single-step, Back step. Pause, Run/stop. Memory Map.

Calendar Functions: Date with day of week, Number of days, Date Format switch (month-day-year or day-month-year).

Display: 10 digits, Low-level battery indicator.

Registers: 20 user's, 5 financial, 4 operational, Last x register. 8 program lines (expandable to 99).

Recharger Power Requirements: 90 to 120 VAC, 50 to 60 Hz, or 198-242 VAC, 50 to 60 Hz.

Size: 30 mm H (1.2") \times 75 mm W (3.0") \times 140 mm L (5.6").

Ordering information

HP-38E Advanced Financial Calculator with Program-
mability

Price
\$120

PERSONAL CALCULATORS

Desktop Printing Calculators

HP-92A, HP-97A



HP-97A



HP-92A

HP-92

The HP-92 Investor is a portable printing financial calculator for the person who must evaluate a large number of investment alternatives quickly, easily, and accurately. The HP-92 solves problems involving time and money; compound interest, balloons, discounted cash flow, bonds and notes, depreciation, net present value, internal rate of return. The flick of a switch engages the quiet thermal printer that provides an indispensable record of your calculations. 30 storage registers. Printing and clearing functions. And with all its powerful computational capability, the HP-92 fits into a standard-sized briefcase—an invaluable feature for the person on the go.

HP-92 Specifications

Compound Interest: [n], [12X], [i], [12+], [PV], [FV], [PMT]
Discounted Cash Flow Analysis: [NPV], [IRR]
Bonds and Notes: [PRICE], [YIELD], [IS, ST], [MT], [CALL], [CPN]
Depreciation: [STL], [SOYD], [DB], [BOOK], [LIFE], [SAL], [N1], [N2]
Percentage: [%], [$\Delta\%$], [% Σ]
Calendar: 2000 Year Calendar, [Date + Days], [Δ Days], [g] [PRINT X]
Statistics: [$\Sigma+$], [$\Sigma-$], [\bar{x}], [s], [L.R.], [\hat{y}], [r]
Storage: [STO], [RCL]
Printing and Clearing: [AMORT], LIST: [FINANCE], [PRINT X], LIST: [STACK], LIST: [REG], [Σ], [CLX], [CL FIN], [CL REG] [CL Σ], [CLEAR]
Number Entry and Manipulation: [ENTER], [CHS], [x $\bar{=}$ y] [R] [R], [EEX], [RND], [LAST X]
Mathematics: [y^x], [e^x], [LN], [\sqrt{x}], [1/x], [+], [-] [x] [+]
Power: AC: 115 or 230 V + 10%, 50 to 60 Hz.
Size: 63.5 mm H (2.5") x 229 mm W (9") x 203 mm L (8").

Ordering information
 HP-92 Investor

Price
 \$495

HP-97

This is the most powerful personal calculator Hewlett-Packard has ever made. The HP-97 combines exceptional programming power—

plus a battery-operated printer, all in one self-contained unit. An extra-large display provides easy readability and a buffered keyboard allows data to be keyed in at high speed. The HP-97 solves your problems faster and with less chance for error.

HP-97 Specifications

Preprogrammed functions

Mathematical: Sin, Cos, Tan, Sin⁻¹, Cos⁻¹, Tan⁻¹; Degrees, radians, grads angular modes; Coordinate conversion; Degree/radian conversion; Hours/minutes/seconds addition and conversion to decimal hours; Log, 10^x, Ln, e^x; Integer truncation; Fraction truncation; Absolute value; Rounding; +, -, x, \div , y^x, x², 1/x, \sqrt{x} , N!, %, %CH, π .

Statistical: Summations n, Σx , Σx^2 , Σy , Σy^2 , Σxy ; Deletion of unwanted data; Mean, Standard deviations.

Programming features

Card Reader features: Record/Load all data registers; Load selected data registers; Record/Load entire program memory; Merge program subsections; Angular mode, flag settings, and display status are recorded with program recording and reset with program loading.

Addressing: Label addressing; Indirect addressing of labels and data storage; Relative addressing; 10 user-definable keys or 20 user-definable labels; Three levels of subroutines (GSB).

Conditionals: x = y, x \neq y, x > y, x \leq y, x \neq 0, x = 0, x < 0, x > 0; Four flags; Increment, decrement storage registers and skip on zero.

Editing: Single step execution; Single step and back step inspection of a program; Insert/Delete editing. Position the calculator at any step in program memory (GTO-*nnn*).

General

Memory: 224 steps of program memory.

Display: Up to 10 significant digits with selective round-off to desired number of places in fixed decimal notation.

Power: 90–127 VAC or 200–254 VAC, 50 to 60 Hz. 5.0 V dc for nickel cadmium rechargeable battery pack.

Size: 63.5 mm H (2.5") x 228.6 mm W (9") x 203.2 mm L (8").

Ordering information

HP-97 Fully Programmable Printing Calculator

Price

\$750



• Increase versatility of your calculator

• Customize your HP calculator to your need

In keeping pace with the growing number of HP personal calculator owners, Hewlett-Packard offers solutions to most imaginable needs in the form of accessories. HP software, hardware and supplies will significantly increase the versatility and usefulness of your calculator. As your problem-solving capabilities grow, HP grows with you. By putting the "Application Pacs" and "Solutions Books" to work for you, you may find that the solutions you require already exist.

Application Pac topic areas include:

- Stat Pac
- Math Pac
- EE Pac
- Business Decisions Pac
- Civil Engineering Pac
- Clinical Lab & Nuclear Medicine Pac
- Games Pac
- ME Pac
- Surveying Pac
- Navigation Pac

Solutions Books, 40 total, cover numerous topic areas. Included are: Statistics, Math, Business, Surveying, Mechanical & Electrical Engi-

neering as well as Medicine, Navigation, Real Estate, Taxes and Games.

To keep your HP calculator operating at peak efficiency, several different models of rechargeable battery packs, reserve power pacs, and DC rechargers are available to counter untimely power losses; at home or in the field.

To complement the software, HP provides a full line of personal calculator accessories to keep your HP calculator safe and sound. To protect against a "mysterious disappearance" of your calculator, there is a ruggedly-designed, key-operated security cradle available to protect your investment. For printing models, a six-foot security cable is available. For some models, HP offers a hard leather case to guard against normal environment conditions in the field, as well as a stylish, black, soft leather case. From battery pacs to blank program cards, HP has the accessories for your needs.

COMPUTATION

HP 3000 Computer Systems

Series II, Series III



The HP 3000 computer systems, designed specifically for terminal-oriented business data processing, are virtual memory computers with true multiprogramming and multilingual capabilities. They can simultaneously handle many transaction processing, time-sharing, and batch operations in any of six high level programming languages (COBOL, RPG, BASIC, FORTRAN, SPL - the HP 3000 Systems Programming Language, and APL). The result of an integrated hardware-software design effort, the HP 3000 systems are based on the specific demands of people who want to use a business data processing system in a multiprogramming environment, including a complete data base management and inquiry facility, interactive program development, and an advanced communications/networking capability.

A powerful disc-based operating system, Multiprogramming Executive III (MPE III), optimizes the processing of the large number of users who concurrently communicate with the system through both interactive terminals and batch devices. Since transaction processing, in particular, presents the computer with an uneven processing load, large amounts of terminal and disc I/O, and a high degree of code and data sharing, MPE is designed to dynamically allocate such system resources as main memory, the central processor, and peripheral devices to each program as needed. At the same time, each user operates in an environment of complete security, without interference or illegal access from unauthorized users.

A wide choice of data management facilities is also available, with both sequential and random access methods included as part of the MPE file system itself. The award winning IMAGE/3000 data base management system allows information to be related logically between data sets (files), minimizing

data redundancy and facilitating information retrieval. Complemented by QUERY/3000, an English-like interactive inquiry language, IMAGE handles multiple files and makes it easy to define and create a data base tailored to your specific needs. The Keyed Sequential Access Method (KSAM/3000) subsystem also extends the file system by providing files which may have one primary and up to 15 alternate keys, with retrieval based upon the value of the data. To simplify data entry procedures, the Data Entry Library (DEL/3000) subsystem facilitates the design and maintenance of CRT terminal data entry screens and provides edit checking of entered data.

Data communications subsystems extend the basic asynchronous terminal communications under MPE to include synchronous multidrop terminal communications (MTS/3000), IBM 2780/3780 emulation (RJE/3000), IBM HASP II and JES2 emulation (MRJE/3000), and Distributed Systems software (DS/3000). Designed to be both easy to use and versatile enough to adapt to a broad spectrum of commercial/industrial applications, DS/3000 provides the capability to establish interactive communications links between different types of Hewlett-Packard computer systems in geographically dispersed locations.

Manufacturing applications software (MFG/3000), a new offering in the HP 3000 product line, is currently offered for sale in the United States and Canada. Designed for the discrete manufacturer who assembles standard, multi-piece products in lots, MFG provides an integrated on-line system for managing the materials planning and control function of the manufacturing operation.

Applications for HP 3000 computer systems encompass the full range of data pro-

cessing tasks. For many small-to-medium companies an HP 3000 handles the entire data processing load, from inventory control to engineering design, sales order entry, payroll, and personnel records. Larger, multi-divisional corporations distribute computing power throughout the company by linking a number of HP 3000s to each other and, optionally, by allowing the HP 3000s in this network to communicate with a larger mainframe computer.

The HP 3000 family of computers is comprised of both Series II and Series III systems, each of which offers a full range of peripheral options, access to all system software, and expandable hardware configurations.

The HP 3000 Series III standard configuration features 256 kilobytes of fault control memory, with capacity for 2 megabytes, 10 spare I/O slots, and room for 31 terminals. Supported memory sizes are 256kb, 512kb, 768kb, 1024kb, 1536kb, and 2048kb. Options are available to expand the I/O capacity to 23 slots and support an additional 32 interactive terminals.

Series III prices from \$115,000

Series II systems are available in two configurations, Model 6 and Model 8. The Model 6 standard configuration features 256 kilobytes of fault control memory, 10 spare I/O slots, and room for 31 terminals. The Model 8 standard configuration includes 320 kilobytes of fault control memory, 23 spare I/O slots, and space for 63 terminals. Both Series II systems are expandable to 512 kilobytes of memory. All system software is completely compatible on the Model 6, the expanded I/O capacity Model 8, and the larger memory capacity series III.

Series II prices from \$99,000



HP 250 Business Computer

The HP 250 is specifically designed to meet the business management needs of small to medium sized companies. User convenience and human engineering combine with excellent computing power to allow simplified operation—even for the first-time user. It achieves big-system performance at small-system prices.

With the HP 250, smaller businesses can take advantage of the improved efficiency computers offer. Powerful programming tools make it easier for independent applications specialists to tailor solutions to the user's business. Installing an HP 250 computer can lead to better return on investment and improved operating efficiency.

Ease of Use

The flexible-disc based HP 250 is equally at home in the office or in the computer room. It operates on either standard 110 or 220-volt power and normally requires no special operating environment. Built-in quality and excellent maintainability help assure excellent service.

The following are some of the features that make the HP 250 easy to use:

Simple turn-on. A simple twist of the key turns the HP 250 on and starts an automatic self-test of the system. The key also helps control access to the machine for data security.

Adjustable display screen. The display screen provides a means of viewing information or displaying results and reports. The display screen itself tilts, swivels and slides—at the push of a hand—to reach the most comfortable and efficient position for the user.

Softkeys. These unique keys, located along the bottom of the display screen, can be programmed to guide the user through application routines. Video labels, describing the present function of each key, appear on the screen directly above the softkeys.

Keyboard. The keyboard includes an office typewriter-like layout, 10-key numeric entry pad, and control and editing keys. These features and other design considerations—such as a feel that encourages touch typing and positioning at a comfortable height—combine to make data entry and system operation easier.

Documentation. System reference manuals provide detailed operating instructions for beginner through professional. A quick-reference manual, stored in the console drawer, gives answers to frequently asked questions.

Accent panels. To help key the HP 250 to individual office decors, customers can select from accent panels of several colors.

Programming Tools

The HP 250 incorporates several features that make the applications specialist's job of tailoring individual solutions simpler and less costly. Tools for data base management, forms and report generation provide capabilities previously available only on more expensive business computers—and not on all of them. These programming tools are designed to take advantage of HP Business BASIC. This language takes standard industry BASIC—with conversational-style instructions—and enhances it for business applications.

Data Base Management. IMAGE/250 is a subset of an award winning Hewlett-Packard data base management package. A collection of programs and commands, it provides the power to create, control and maintain a complex information management system. As a programmer's tool, it enables easier, less costly application development.

QUERY. QUERY/250 uses the Data Base Management capabilities in allowing unprogrammed access to stored information. It can provide the user with reports unique to changing requirements and is an excellent development and debugging tool for the programmer.

FORMS. The FORMS/250 feature allows the programmer to easily recreate existing forms on the display screen, letting the system adapt to the user's way of doing things. Users can display and complete a form right on the screen. When blanks are filled on a displayed form (i.e., when processing an order), pressing a button logs the transaction.

REPORT WRITER. REPORT WRITER/250 gives the applications specialist a versatile set of commands with which to format reports without writing complicated programs. Thus computer generated reports can be designed to highlight important information.

Computational Power

At the heart of the HP 250 is a processor that uses proven Hewlett-Packard integrated-circuit technology. It handles computations (with 12 digit precision), performs sorts, controls information flow and directs peripheral operation.

The standard system contains 32K bytes of user memory (expandable to 64K bytes), 128K bytes of system memory, two 1.2 megabyte flexible disc drives and a 180 cps line printer.

Ordering Information

HP 250 - Standard (dual flexible-disc based)
System with 2631A Printer

Price
\$24,525

COMPUTATION

Business Oriented Computer System



Chair available from
Herman Miller, Inc.

Full Capability Business System

- Exceptionally FRIENDLY user interface
- Operates in normal office environment
- Unique Integrated Display System
- Multiterminal processing
- Multiprogramming, multitasking, virtual memory operating system
- IMAGE/300 Data Base Management System
- RPG II and Business Basic Languages
- Character sets for 10 European Languages
- Expandable to grow with your needs
- Designed for reliability

The HP 300 is a full capability, low cost computer system designed for dedicated, on-line business applications. It can answer the specialized needs of a department in a large organization or the overall requirements of a smaller organization. In either case, the HP 300 can be tailored to optimize each dedicated application environment.

The basic unit includes the Integrated Display System, built-in disc storage for over 12 million characters, drive for one million character flexible discs, 256 thousand characters of error correcting, solid-state memory

and the HP 300's powerful processor. Available software includes the AMIGO/300 Operating System, the Typist/300 text editor, Sort/Merge Utilities, the HELP online reference manual, the Diagnostic/Utility System, the Business Basic/300 and the RPG

II/300 languages, and the IMAGE/300 Data Base Management System including the Data Base Inquiry feature.

The HP 300 can be expanded to include additional applications terminals, multiple printers, various increments of removable disc storage to a total of over 250 million characters, and over a million characters of built-in, error correcting, solid state main memory.

Because of its expandability, prices span a broad range. For general product information, as well as detailed price and configuration information, please return an inquiry card or contact your local Hewlett-Packard sales office.

Breaking Down the Barriers.

The HP 300's unique Integrated Display System (see photo below) gives the application designer the flexibility to implement tailored applications that are truly easy to use. "Push-button" softkeys along the right side of the screen can be used to select computer operations. These softkeys can be dynamically labeled and relabeled on the display using the language of your business.

The IDS screen can be divided into multiple "windows". Each window has the full function of an independent display. This allows complex information to be displayed in easily understood ways.

Information displayed, though it may be wider and much longer than the screen, can be "scrolled" both vertically and horizontally to be viewed in its entirety.





HP 1000 computers provide a performance range from the economical M-Series to the fast floating-point capability of the new F-Series Computer. Based on an architecture proven successful in over 16,000 installations, all HP 1000 computers use the same instruction set and interfacing logic. Hence, the user can change models with minimal effect on software, peripherals, service, training, and spares provisioning.

HP 1000 M-Series

The economical M-Series, designed for cost-critical applications, includes the HP 2105A, 2108M, and 2112M computers. Memory capacity ranges from 64k to 2M bytes, and I/O capability is 4 to 14 channels, expandable to 46 channels. Standard features include memory parity, extended arithmetic, and floating point instructions. A board-computer version, the 2108MK, is available for OEM and high-volume applications. The 2108MK processor board is a capable 24-bit microprocessor with 211 instructions and 325-ns cycle time.

HP 1000 E-Series

The E-Series computer is nearly twice as powerful as the M-Series, and provides variable microcycle timing, microprogrammable block I/O, a microprocessor port, asynchronous memory, and much larger control store address space. E-Series computers are available in two models, HP 2109E and 2113E, with a choice of maximum mainframe memory capacities from 640k to 1280k bytes and 9 or 14 I/O channels, expandable to 46 channels. (Also available as a board computer, the HP 2109EK.)

HP 1000 F-Series

For users who need speed, precision and larger memory capacity, HP offers two F-Series computers, 2111F and 2117F. Both feature a new hardware Floating Point Processor that speeds calculations (2.5 to 6 times faster than E-Series or M-Series) and a new Scientific Instruction Set for rapid execution of trigonometric and logarithmic functions (compute sine in less than 48 μ s). A Fast FORTRAN Processor, also standard in F-Series computers, provides firmware microcode for more than a dozen instructions—e.g., array address calculations, parameter passing, and other routines—that run 2 to 20 times faster than conventional software execution speed. F-Series computers feature high-performance 350-ns memory and are fully user-microprogrammable.

Type	M-Series			E-Series		F-Series	
Computer model	2105A	2108M	2112M	2109E	2113E	2111F	2117F
Panel height (inches)	5.25	8.75	12.25	8.75	12.25	12.25	17.50
Memory speed	650 ns	650 ns	650 ns	595 ns 350 ns	595 ns 350 ns	350 ns	350 ns
Max. mainframe memory	64kb	640kb	1280kb	640kb	1280kb	640kb	1280kb
Memory extender capacity	N.A.	1152kb	768kb	1152kb	768kb	1.8Mb	1.8Mb
Mainframe I/O channels	4	9	14	9	14	9	14
I/O Chan	36	41	46	41	46	46	46

Alternate Memory Systems

For configuration flexibility, the standard memory in any HP 1000 computer may be deleted at the time of the order, and you can select an alternative memory system of equal or greater size. High-performance 350-ns memory is available as an option for the E-Series.

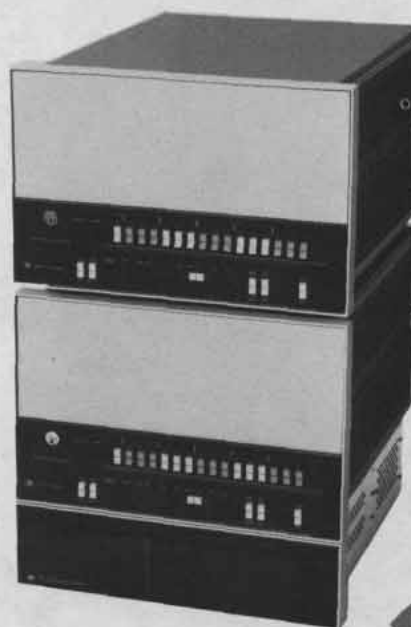

HP-IB

HP 2111F and 2117F F-Series computers

Fault-control memory, optionally available for all HP 1000 computers, detects and corrects single-bit errors and detects all double-bit errors, thereby improving memory MTBF three times or more.

For compatibility and prices of alternative memory packages, consult your HP field engineer.

Ordering information	Price*
2108MK M-Series Board Computer w/32kb memory	\$2,950
2105A M-Series Computer	\$4,150
2108M M-Series Computer w/64kb memory	\$7,950
2112M M-Series Computer w/128kb memory	\$10,450
2109EK E-Series Board Computer w/32kb memory	\$3,450
2109E E-Series Computer w/64kb memory	\$9,250
2113E E-Series Computer w/128kb memory	\$11,750
2111F F-Series Computer w/64kb high-perf. memory	\$12,250
2117F F-Series Computer w/128kb high-perf. memory	\$16,000
12539C Time Base Generator	\$350
12897B Dual Channel Port Controller	\$750
12944B/12991B Power Fail Recovery System	\$600
12977B M-Series Fast FORTRAN Processor	\$900
12979B I/O Extender	\$4,500
12990B Memory Extender	\$3,500
13047A User Control Store	\$550
13197A Writable Control Store	\$2,000
13306A E-Series Fast FORTRAN Processor	\$650

*Quantity discounts are available.

A complete list of computer accessories is available from your HP Sales Office.



COMPUTATION

Dedicated real-time computer systems

HP 1000 Systems

- Computation
- Instrumentation
- Operations management



HP 1000 Model 45
(cabinet and desk versions)



HP 1000 Model 25

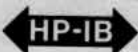

© 1984 Hewlett-Packard Company. All rights reserved. HP, the HP logo, and the HP-IB logo are registered trademarks of Hewlett-Packard Company. Model 45 and Model 25 are trademarks of Hewlett-Packard Company. The information in this advertisement is subject to change without notice. For more information, contact your local Hewlett-Packard representative or call 1-800-541-4411.

HP 1000 Computer Systems

The HP 1000 system family consists of two memory-based systems (Models 20 and 25) and three disc-based systems (Models 30, 40 and 45) for powerful computation and measurement/control applications.

Models 20, 30 and 40 utilize an E-series computer while the odd-numbered systems (Models 25 and 45) feature the fast new F-series computer with hardware Floating Point Processor and Scientific Instruction Set which speed calculations. (A floating point add, for example, executes in only 630 ns; a multiply, in 1.78 μ s.)

High-performance memory with 350-ns cycle time is included with Models 25 and 45 and increases performance by up to 30% over the standard 595-ns memory. Available as an option, fault-control memory detects and corrects any bit failure, thereby improving MTBF three times or more. And optional high-speed disc drives with 33.3 ns access time (average) allow up to 400M bytes of on-line disc storage.

HP 1000 systems feature a Real-Time Executive (RTE) operating system and are programmable in FORTRAN, BASIC, Assembly Language, and Micro-assembly Language.

Computation

Model 45 combines the fast F-series computer with powerful new RTE-IV software to provide processing speed and power unique for this price range. The system can process data arrays as large as 2.048M bytes directly in physical memory, without time-consuming disc swaps. Average execution time for square root is only 30.9 μ s; sine and cosine, less than 48 μ s. New GRAPHICS/1000 software formats output in plots and pictures that are easier to interpret.

Instrumentation

HP 1000 systems are also designed for control and interaction with HP-IB instruments. Up to 14 HP-IB devices connect to the system via a single interface card, so that the system can control multiple test or measurement stations. For small analog input needs, the 91000A plug-in card adds a capacity of 16 single-ended or 8 differential ± 10 V fs analog inputs. For larger jobs, use the 2240 A Measurement and Control Subsystem that handles 128 channels of analog and digital I/O, expandable to 256 channels.

Operations Management

Two optional software packages, DATACAP/1000 and IMAGE/1000, aid operations management. DATACAP/1000 is designed for automatic factory data capture from multiple terminals (e.g., test records, order entry, or inventory control). IMAGE/1000, data base management software, simplifies building and maintaining a large data base.

Distributed Systems Network

An important feature of HP real-time systems is their ability to be linked together to form a large multi-system network. DS/1000 software/firmware interfaces multiple HP 1000 systems to each other or to a larger HP 3000 system. RJE/1000 provides direct communication between HP 1000 systems and most IBM 360/370 installations.

Five models to choose from

Model 20 includes an E-series computer with 64k of memory, RTE-M software, a system console with CRT display, and your choice of desk or upright cabinet configuration.

Model 21 is physically identical to the Model 20 but includes high-performance memory and an F-series processor.

Model 30 includes an E-series computer, RTE-II software, system console with CRT, choice of desk or upright configuration, and a 4.9M byte or 19.6M byte disc.

Model 40 includes an E-series computer with 128k bytes of memory, new RTE-IV software, system console with CRT, a 14.7M byte disc. **Model 45** features the fast F-series computer with 128k bytes of high performance memory, RTE-IV and GRAPHICS/1000 software, system console with graphics display terminal, 19.6M byte disc.

Ordering information

HP 1000/20 Computer System	\$22,000
HP 1000/25 Computer System	\$27,500
HP 1000/30 Computer system	\$31,500—\$36,500
HP 1000/40 Computer System	\$40,000
HP 1000/45 Computer System	\$46,500

Prices

HP 1000 SYSTEM COMPATIBILITY SUMMARY

	MODEL 20		MODEL 25		MODEL 40		MODEL 45		MODEL 30		
	2174A	2174B	2175A	2175B	2176A	2176B	2177A	2177B	2170A	2171A	2172A
Base system computer type	E-Series		F-Series		E-Series		F-Series		E-Series		
Type of memory	Std performance		High performance		Std performance		High performance		Standard performance		
Memory cycle time	595 ns		350 ns		665 ns		420 ns		595 ns		
Operating system	RTE-M		RTE-M		RTE-IV		RTE-IV		RTE-II		
System console	2645A		2645A		2645A		2648A		2645A		
Memory: Base (bytes) Maximum	64k 2048k	64k 1280k	64k 1280k	64k 1280k	128k 2048k	128k 1280k	128k 1280k	128k 1280k	64k 64k	64k 64k	64k 64k
Standard system disc	None		None		7906 (19.6Mb)		7906 (19.6Mb)		7900 (4.9Mb)	7906 (19.6Mb)	
Optional alternate system discs	None		None		7920 (50Mb) or 7900 (4.9Mb)	7920 (50Mb)	7920 (50Mb)	7920 (50Mb)	None		
Flexible disc available?	Yes	Yes	Yes	Yes	Yes	Yes	Yes	Yes	Yes	Yes	Yes
RJE/1000 available?	No	No	No	No	Yes	Yes	Yes	Yes	Yes	Yes	Yes
DS/1000 available?	Yes	Yes	Yes	Yes	Yes	Yes	Yes	Yes	No	No	No
IMAGE/1000 available?	No	No	No	No	Yes	Yes	Yes	Yes	Yes	Yes	Yes
91000A/2313A Analog-digital Subsystem available?	Yes	Yes	Yes	Yes	Yes	Yes	Yes	Yes	Yes	Yes	Yes
2240A Meas. & Control Processor available?	Yes	Yes	Yes	Yes	Yes	Yes	Yes	Yes	Yes	Yes	Yes
92840A GRAPHICS/1000 available?	Yes	Yes	Yes	Yes	Yes	Yes	Incl.	Incl.	No	No	No
12790A Multipoint interface available?	Yes	Yes	Yes	Yes	Yes	Yes	Yes	Yes	No	No	No
12979B Dual-Port I/O Extender available?	Yes	No	Yes	No	Yes	No	Yes	No	Yes	Yes	No
12990B Memory Extender available?	Yes	No	No	No	Yes	No	No	No	Not applicable		

COMPUTATION

Desktop Computers

Models 9815A, 9815S, 9825A



9815A/S

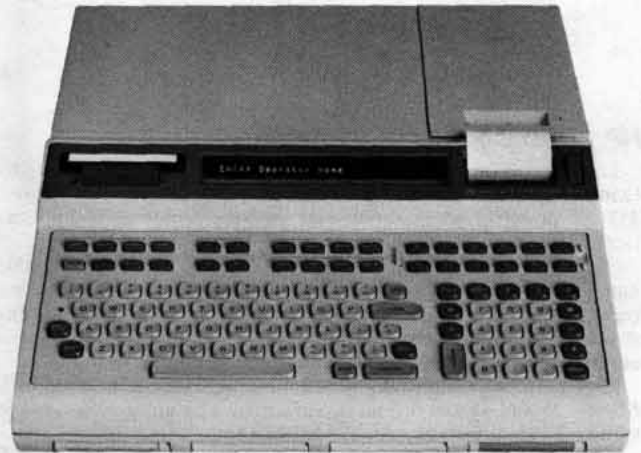
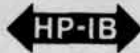

9825A



9815A/S

Both the 9815A and the 9815S feature a built-in high-speed data cartridge, a 16-character alphanumeric thermal printer, an auto-start switch and programming keys that double as Special Function keys. The 9815S has two I/O channels and a larger memory. Both machines can be used in four basic ways:

1. Interfacing: The 9815 has seven interface cards. The HP 98310A is for the 9872 Plotter, the HP 98131A is for the 9871A Character Impact Printer and the HP 98132A is for the 9862A Plotter. The HP 98133A BCD I/O accommodates 9-digit BCD input with high-speed mode and 8-bit parallel output. The HP 98134A General I/O is a bidirectional 8-bit parallel interface which enables you to connect the 9815 to other equipment. The 98135A HP-IB I/O will accept up to 14 HP-IB interconnected instruments. The 9815 can be used to control the data flow to and from the instruments, gathering and processing the data simultaneously. The HP 98134A Serial I/O provides RS-232-C compatibility as well as 20 mA and 60 mA current-loop, receive-only options.

2. Programmable Problem Solving: The 9815S has 3800 program steps; the 9815A has 472. Each has ten data registers at power up. You can reallocate the memory for any combination of program steps and data registers you wish. The programming language includes such sophisticated features as FOR-NEXT loops; symbolic, absolute or calculated addresses; automatic address updating during editing; descriptive error messages; and subroutines nested to seven deep.

3. Dedicated Problem Solving: Hewlett-Packard offers several software packages with a prerecorded cartridge, Special Function key overlay, and easy-to-follow instructions for each program. Set the switch to auto-start, slip in the cartridge, put the overlay in place, and turn on the 9815. The first file will be automatically loaded and the program executed. The tedious set-up work is done for you.

4. Quick Keystroke Calculations: 28 built-in scientific functions, the powerful Reverse Polish Notation Logic System also used by HP pocket calculators, a buffered keyboard, large display and hardcopy printout provide you with advanced problem solving at your fingertips.

9825A

The 9825A Desktop Computer has many features previously found only on minicomputers. It is particularly suited to controller applications and is a powerful stand-alone device.

Significant contributions include two-level priority interrupt, live keyboard, direct memory access with input speeds up to 400k 16-bit words per second, high-performance bidirectional tape drive, multidimensional arrays, automatic memory record and load, and extended internal calculation range ($\pm 10^{511}$ to $\pm 10^{-511}$). Some of these are standard features and others are available in optional plug-in read-only memories (ROMS).

HPL, a high-level, formula-oriented language, is easy to learn and is designed for controller applications as well as for data processing. HPL provides for subroutine nesting and flags and allows 26 simple variables and 26 multidimensional array variables, limited only by the size of 9825A's memory. Editing of lines and characters is simple, and error locations are identified by a flashing cursor in the display. Fixed- and floating-point formats can be set from the typewriter-like keyboard.

The keyboard has twelve Special Function keys that, combined with the shift key, can handle 24 different operations. These keys help in program writing and in peripheral and instrument control. They can serve as immediate execute keys, as call keys for subroutines and as typing aids.

With the live keyboard, the user can examine and change program variables, perform complex calculations, call subroutines, and record and list programs while the 9825A is performing other operations.

Interrupt capability, available in the Extended I/O ROM, permits the 9825A to act as a controller for several instruments or peripherals requiring attention at unpredictable rates or times. It can also be used as an asynchronous terminal by adding the Systems Programming ROM.

A 32-character LED display and a built-in 16-character thermal printer provide alphanumeric readout including both capital and lowercase letters. Some European and Greek characters are also available in an optional ROM.

The high-speed bidirectional data cartridge holds 250k bytes of information and has an average access time of 6 seconds to any place on the tape. Bidirectional search speed is 2286 mm/s (90 in./s), and read/write speed is 559 mm/s (22 in./s). The entire memory can be recorded on the cartridge for reloading at a later time. Verification of files is automatic on recording.

Ordering information

9815A Desktop Computer	\$2900
9815S Desktop Computer	\$3950
9825A Desktop Computer	\$5900



Series 9800 System 35A

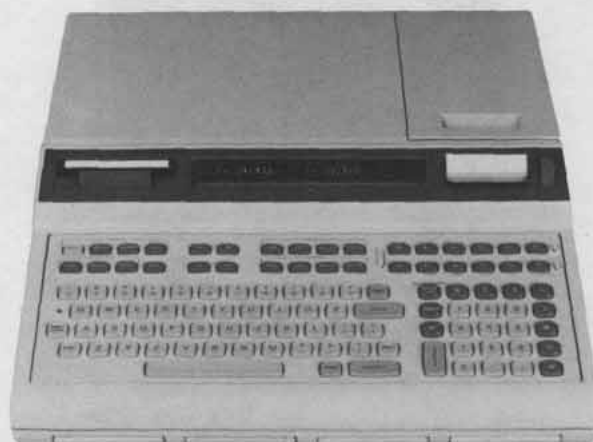

Series 9800 System 35B



Series 9800 System 35

This powerful, integrated desktop computer is ideal for many scientific and engineering applications involving computation, data acquisition and control, or both. It offers large memory (64K to 256K bytes), optional CRT and an impressive range of interfacing capabilities.

System 35A has a 12-inch diagonal CRT that can display 20 lines of program or data at a time. Four additional lines are reserved for keyboard entries and system comments. The CRT can display 80 characters per line. If a CRT is not required, System 35B has a 32-character single-line LED display.

Language **BASIC**

System 35's enhanced BASIC language is easy to use, yet much more powerful than ANSI BASIC. System 35 can run ANSI Standard BASIC programs, and, in addition, offers many of the powerful and convenient features of FORTRAN and APL, including subprograms, multidimensional numeric arrays, string arrays and multi-character identifiers.

Assembly

System 35 can also be programmed in assembly language by experienced assembly programmers. For certain specialized computational and I/O operations, assembly programming can increase speeds by a factor of 100 or more. For more general applications, assembly language may be of no benefit. The assembly language programming capability is intended for experienced users only and is available in a set of optional ROMs.

I/O

The optional I/O ROM provides buffered I/O, Direct Memory Access (DMA), fast read/write, 15 levels of priority interrupt and built-in I/O drivers. A time-out feature avoids deadlocks, and auto-start can get the System 35 going after a power failure without an operator's help.

Ready-made, plug-in interface cards are available to simplify interfacing. They are the HP-IB (IEEE Specification 488-1975), Bit Parallel, Bit Serial and BCD cards. The System 35 has three I/O slots to accept these cards, and with I/O expanders it can interface to 14 peripherals and instruments at one time.

A complete line of peripherals is available to augment System 35. It includes printers, plotters, paper tape punch, paper tape reader, card reader, digitizer, cartridge tape drive, and a flexible disk drive.

Features

- Read/Write memory from 64K to 256K bytes
- Enhanced BASIC language
- Optional assembly language capability
- Optional I/O ROM
- Optional CRT
- Optional 16-character thermal strip printer
- Cartridge tape drive (217K bytes/tape)
- Interactive keyboard
- User-definable Special Function keys

Ordering information

- 9835A Desktop Computer
- 9835B Desktop Computer

Price
 \$9900
 \$8700

COMPUTATION**Desktop Computers****Series 9800 System 45**

Series 9800 System 45

HP-IB

Series 9800 System 45

Hewlett-Packard's System 45 is a powerful, integrated desktop computer, ideal for such applications as design analysis, management science, mathematical modeling, statistical analysis and linear programming.

This system features a 13k byte user memory expandable to 62k bytes, CRT (Cathode Ray Tube) with graphics option, built-in thermal line printer (optional), enhanced HP BASIC language, and dual tape drives (second drive optional).

CRT

System 45's 12-inch diagonal CRT is an integral part of this desktop computer. Its alphanumeric mode with 24 lines of 80 characters each lets you view data, list programs, and display keyboard inputs, messages and system commands. Special high-lighting features—underlining, blinking, and inverse video—are provided for visual impact.

The CRT also has an optional raster scan graphics mode. This allows high-speed interactive plotting within a 560 x 455 dot matrix, presenting clear, well-defined lines and curves. System 45 also features a unified graphics command set that enables the same graphic image to be output to a variety of peripherals simply by changing one line of program. By giving the DUMP GRAPHICS command, you can also transfer on-screen graphics to the optional built-in thermal printer for precise hard-copy output.

Enhanced HP BASIC Language

System 45's enhanced BASIC language is easy to use, yet much more powerful than ANSI BASIC. System 45 can run ANSI Standard BASIC programs, and, in addition, offers many of the powerful and convenient features of FORTRAN and APL, including subprograms, multidimensional numeric arrays, string arrays, matrix operations and multicharacter identifiers.

Enhanced HP BASIC provides for unified mass storage operations. No matter which storage device you choose, you use the same set of statements to address the media, which can be the HP 9885M/S Flexible Disk Drive, the HP 7906 and 7920 Disc Drives, or the built-in 217k byte tape cartridges. Language consistency saves you time and money by eliminating the need for program changes when addressing different storage devices.

Built-In Thermal Printer

The optional built-in thermal printer prints up to 80 characters per line at up to 480 lines per minute, and plots at about 25.4 mm/s (1 in./s). The printer provides quality printing with standard ASCII upper and lowercase characters. It uses both black perforated and blue continuous-roll papers in English and metric sizes.

Interface Capability

Should your applications require peripheral/instrument control, the System 45 has a wide range of interfacing capabilities. It features 15 levels of programmable priority interrupt, DMA (Direct Memory Access), buffered I/O and overlapped processing. Interface types include BCD, bit-parallel, bit-serial (Specification RS-232-C), HP-IB (IEEE Specification 488-1975), real time clock and incremental plotter.

Computer Features

- Enhanced HP BASIC
- Graphics package (optional)
- Quality alphanumeric and graphics CRT display
- Two built-in tape cartridges (one standard, one optional)
- Overlapped processing
- Typewriter-like keyboard
- Built-in unified mass storage operations
- User read/write memory of 13k bytes, expandable to 62k bytes
- Interface capability
- Built-in thermal printer (optional)
- Optional character sets in English, German, Spanish and French

Ordering Information

When ordering the System 45, be sure to specify either the 9845S or 9845A.

The **9845S** desktop computer system includes 62 650 bytes read/write memory; CRT with graphics package; two 217k byte tape cartridge drives; built-in thermal line printer; ASCII, German, French or Spanish keyboard option.

Price \$20 000

The **9845A** desktop computer includes 13 488 bytes of read/write memory; 24-line CRT display; one 217k byte tape cartridge drive; ASCII, German, French or Spanish keyboard option.

Price \$11 500

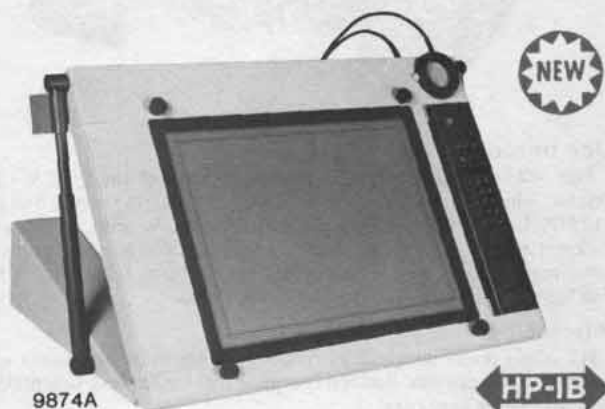

9874A Digitizer

The 9874A Digitizer provides a convenient method of entering graphic information into the HP 9815A/S, 9825A, 9830A/B, System 35A/B and System 45A/S desktop computers and other computers using the HP-IB interface cable.

The 9874 features an adjustable glass platen that can accommodate the digitizing of a wide variety of projectable media such as X rays, movies and 35 mm slides. By tilting the platen to full vertical position and setting a projector behind the digitizer, exact images can be reproduced without distortion, then digitized.

To take advantage of the adjustable platen, HP developed a vacuum cursor which can adhere to any portion of the platen. Regardless of the platen's position, the cursor will not slip—even if bumped.

The lighted cursor has an open-circle target, 0.250 mm in diameter, giving the pinpoint precision to accurately position and then move the cursor on a line thinner than a human hair.

In addition, the 9874 has microprocessor intelligence and its own built-in memory (16K bytes). It also has a control pad with digitizer control, Special Function and numeric entry keys. Points may be digitized one at a time or continuously (based on time or distance increments) by simply pressing the appropriate key. An axis align key automatically aligns the x and y axes of the digitizer with those of the document—immediately establishing a new coordinate system.

Used in numerous applications—strip chart analysis, mapping and resource management, PC board layout, and destructive and non-destructive test analysis—the 9874's advanced features make it easy to control your entire application.

Although especially designed for use with the Series 9800 Desktop Computers, all HP-IB compatible computers and peripherals can realize the full power and benefits of the 9874A Digitizer.

9875A Cartridge Tape Unit

The 9875A is the first HP-IB compatible storage peripheral to be produced by HP. As such, it can be used by virtually any device that can function as a controller.

The tape unit interfaces to HP Series 9800 Desktop Computers via the Hewlett-Packard Interface Bus. Any desktop computer in the series can store data on the 9875 tape unit, which can then read the data into any other desktop computer in the series.

The 9875 tape unit stores data in HP's Standard Interchange Format (SIF). While HP-IB compatibility requires that the tape unit be interfaced to the desktop computer receiving the data, an SIF-compatible machine can read a 9875 tape on its own internal tape drive without being connected to the 9875. Similarly, tapes produced by SIF machines can be read by the 9875.

Twenty-three built-in commands provide exceptional flexibility in formatting each 225K byte tape cartridge. The tape is partitioned into files and records, much like the structure of many disk memories. Two physical tracks on the tape are treated as a single logical track. Data can be organized in a serial access format (access by file) or in a random access format (access by record). Physical record sizes from 2 to 256 bytes can be selected. Records and files can be marked on the tape before any data is written, or they can be created automatically as the data are stored. The 9875 is available as either a single or double tape drive unit, and each cartridge has a 256K byte capacity, providing large mass storage for far less than the cost of a disc drive.

Ordering information
9874A Digitizer
9875A Cartridge Tape Unit

Price
\$6200
\$2600

COMPUTATION

Desktop Computer Peripherals

Models 9862A, 9872A, 9881A

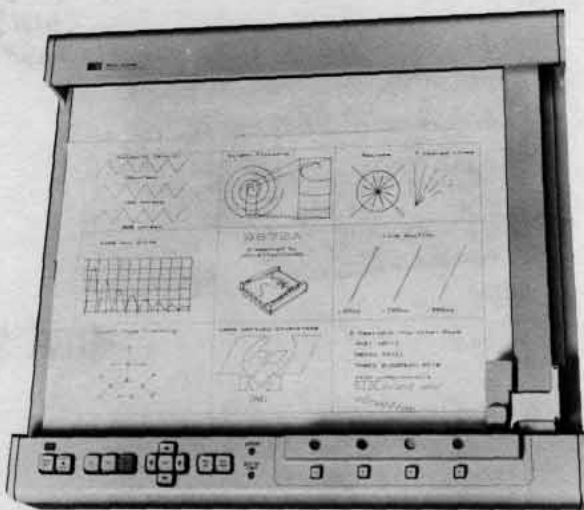

9872A

HP-IB

X-Y plotters

The 9862A X-Y Plotter with a peripheral control function block automatically scales your data, generates words as well as numbers and sets up both axes, complete with labels and tick marks—all in your designated units.

The 9872A X-Y Plotter provides permanent four-color (blue, green, red and black) graphic output. This microprocessor-based plotter (A3 size) has automatic or manual pen selection and gives high-resolution line and character quality via addressable moves in lengths as small as 0.025 mm (0.001 in.). Seven different dashed-line fonts are also available for trace differentiation and easy interpretation. In program mode, pen speed may be adjusted to any of 36 rates from 10 mm/s to 360 mm/s in 10 mm increments. The 9872 has five built-in character sets including Spanish, Scandinavian and French/German. You can also change character size, slant and direction or even design your own characters.

The microprocessor-based operating system accepts HPGL (Hewlett-Packard Graphics Language) commands to control all the plotting functions. The HP-IB (IEEE 488-1975) interface bus and HPGL language allow the plotter to be interfaced to a variety of computers. High-level graphics languages are available in most computers to make plotting even easier.

9872A Features

- Programmable selection of four pens
- Selectable pen speed
- Five character sets
- User-defined characters
- Window plotting
- HP-IB compatibility



9881A

Line printer

The 9881A Line Printer Subsystem consists of the 2607A Line Printer, which is a reliable, low-cost 5 x 5 dot matrix printer, and the 11287A Line Printer Interface Card. Its unique print mechanism makes it quiet enough for business environment and provides up to six consistent, clean copies. It prints at 200 lines/min. regardless of the line length and has full 132-column line width.

Interfacing

HP offers many interface cards designed for those customers who desire to build custom, desktop computer-controlled instrumentation systems. These cards are:

9815A interface cards

- 98133A BCD Interface—8 digit BCD input with high-speed mode, 8-bit parallel output.
- 98134A General Interface—bidirectional 8-bit parallel interface.
- 98135A HP-IB Interface—general connection for HP-IB compatible instruments (in conformance with IEEE Std. 488-1975).
- 98136A RS-232-C Serial Interface—conforms to EIA RS-232-C recommended specifications.

9825A and System 35 and 45 interface cards

- 98032A 16-bit Parallel Interface—latched 16-bit input/output for bidirectional transfer of information.
- 98033A BCD Input Interface—connects the 9825A with bit-parallel, digit-parallel BCD devices.
- 98034A HP-IB Interface—allows communication with as many as 14 HP-IB compatible instruments per interface.
- 98035A Real Time Clock—adds real time reference and time-related control capabilities to the 9825A, 9835A and 9845A desktop computers.
- 98036A Serial Interface—provides bit serial communication between the desktop computers and asynchronous EIA RS-232-C devices such as data terminals and modems.
- 98040A Incremental Plotter Interface—allows the System 45 to access large flatbed and drum incremental plotters.
- 98041A Disc Interface—provides the System 45 access to large capacity, high-speed disc peripherals.

Ordering information

	Price
9862A X-Y Plotter	\$3200
9872A Four-Color Plotter	\$4200
9881A Line Printer Subsystem	\$7990
98133A BCD Interface	\$ 600
98134A General 8-bit Parallel Interface	\$ 300
98135A HP-IB (IEEE Std. 488-1975) Interface	\$ 600
98136A RS-232-C Serial Interface	\$ 600
98032A 16-bit Parallel Interface	\$ 400
98033A BCD Input Interface	\$ 400
98034A HP-IB (IEEE Std. 488-1975) Interface	\$ 400
98035A Real Time Clock Interface	\$ 600
98036A Serial Interface	\$ 600
98040A Incremental Plotter Interface	\$ 600
98041A Disc Interface	\$2100

Desktop Computer Peripherals

Models 9866B, 9877A, 9880B, 9883A, 9884A

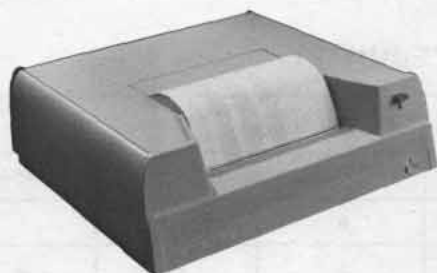

9866B



9877A



9884A

Thermal printer

The 9866B Thermal Printer is a general purpose, 80-column printer. The 9866B produces page-width, fully formatted, alphanumeric text, tables or simple plots at 240 lines/min. and is capable of unidirectional plotting.

High speed tape reader subsystem

The 9883A tape reader features speed and quiet operation. Optically it reads tapes at 500 char./s.

Tape punch subsystem

The 9884A provides a fast and reliable method of directly transferring output onto punched tape at 75 char./s.

Card readers

The high-speed 9869A Hopper Card Reader handles 80-column punched cards as well as mark-sense cards.

The hand-fed 9870A Card Reader can read 35 columns of mark-sense or punched cards in less than two seconds.

Mass memory subsystem

The 9880B Mass Memory Subsystem supplies the HP 9830A/B with substantial data storage. The memory media of this peripheral are a permanently installed memory platter and an interchangeable cartridge (HP 12869A), each having a capacity of 2.4 million bytes; this is the equivalent of more than 600 000 total items of data of twelve digits each.

Disc interface

The 98041A Disc Interface allows the System 45 to access the 20 megabyte 7906 fixed/removable disc and the 50 megabyte 7920 removable disc. For more information, see individual product descriptions for 7906 and 7920.

Tape cartridges and cassettes

The 9865A Tape Cassette lets you easily store, update and retrieve data and programs. A fast, bidirectional search feature lets you find any file on the tape without rewinding. The 9865A has a minimum capacity of 48K bytes.

Interfaced with the 9825A, the 9877A External Tape Memory provides an inexpensive method of storing up to 1M bytes of information. In addition, it offers fast duplication of up to four tapes in less than 60 min. The 9877 uses the same type of tape cartridges as that designated for the 9825A desktop computer. The 9875A HP-IB Tape Cartridge is the most recent tape peripheral. See individual product description for more complete information.

I/O expanders

The 9868A I/O Expander allows you to plug up to 13 peripherals or test instruments into your 9810A, 9821A and 9830A/B. The 9878A provides six additional I/O slots for the 9825A, 9835A/B and 9845A/S.

Ordering information

	Price
9865A Tape Cassette	\$1885
9866B Thermal Printer	\$3350
9868A I/O Expander	\$1060
9869A Hopper Card Reader	\$4075
9870A Card Reader	\$580
9877A External Tape Memory	\$2340
9878A I/O Expander	\$1200
9880B Mass Memory Subsystem	\$10,950
9883A Tape Reader Subsystem	\$2510
9884A Tape Punch Subsystem	\$3080

COMPUTATION**Desktop Computer Peripherals****Interfacing Summary****Desktop Computer Interfacing Summary**

Interface ports located in the back of each of the Series 9800 Computers provide plug-to-plug compatibility with a variety of HP peripherals listed in the following table. HP's ready-made interface cards and preprogrammed Read Only Memories (ROMs) complete

the communication link between the peripherals and computers of your choice.

A selection of additional HP peripherals and computers listed in the catalog assure you maximum flexibility when configuring a system to your exact requirements as well as providing an upward growth path to the future.

HP SERIES 9800 DESKTOP INTERFACING SUMMARY

Peripherals	Desktop Computers				
	9815A/S	9825A	9830A/B	9835A/B	9845A/S
9865A Tape Cassette			•		
9866B Thermal Printer	•	•	•	•	•
9868A I/O Expander			•		
9869A Hopper Card Reader		•	•	•	•
9870A Card Reader			•		
9871A Character Impact Printer	•	•	•	•	•
9872A Four-Color Plotter	•	•		•	•
9874A Digitizer	•	•	•	•	•
9875A Cartridge Tape Unit	•	•	•	•	•
9877A External Tape Memory		•			
9878A I/O Expander		•		•	•
9880B Mass Memory Subsystem			•		
9883A High Speed Tape Reader Subsystem	•	•	•	•	•
9884A Tape Punch Subsystem	•	•	•	•	•
9885M/S Flexible Disk Drive		•		•	•
2631 Dot Matrix Impact Character Printer	•	•	•	•	•
7225 Mini Plotter	•	•	•	•	•
7245 Printer/Plotter	•	•	•	•	•
7906 Hard Disc Drive					•
7920 Hard Disc Drive					•

Character Impact Printer; Flexible Disk Drive

9871A; 9885M/S

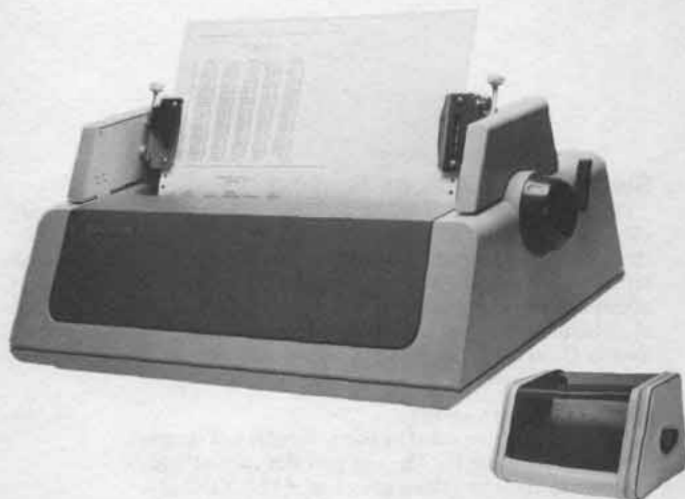
**9871A**

The HP 9871A is a full-character serial impact printer for use with 9800 Series desktop computing systems. The platen accommodates paper up to 381 mm (15 in.) wide. The 9871 prints a standard 132 columns at 10 characters/in.; however, character and line spacing can be defined to increase or decrease the number of characters per line. Any of six different interchangeable print disks (96 characters each) provides full-character quality impact printing.

Plotting and form filling

Bidirectional motions of the platen and print mechanism provide plotting capabilities for charts and graphs. Programmable tabulation, both horizontal and vertical, simplifies plotting and form-filling on this printer. The optional 98020A Soft Sound Enclosure allows locating the 9871 in quiet office environments. Additionally, an optional form-feed mechanism, HP 98021A, feeds continuous Z-fold paper in one direction and aids in producing clear multiple copies. The 98021A option includes a basket for stacking the paper printout.

The 9871 is fully self-contained and can be easily interfaced with any 9800 Series desktop computer for use in scientific, industrial and commercial applications.

Features

- Full-character quality serial impact printing
- Bidirectional carrier and platen
- 96-character interchangeable print disk
- 335,3 mm (13.2 in.) writing line
- User-defined character and line spacing
- Programmable page formatting
- Plotting

Specifications

Speed: average text line at 10 characters/in.; 30 characters/sec
Paper: single sheet; continuous feed (form-feed mechanism recommended for continuous feed); single-part or multi-part, 2 to 6 parts—0.46 mm (0.018 in.) total maximum thickness. Maximum width 381 mm (15").

Options and accessories

- Standard print disk
- ASCII print disk
- European print disk
- Katakana print disk
- Cyrillic print disk
- APL print disk

Ordering information

	Price
9871A Character Impact Printer	\$3600
98020A Soft Sound Enclosure	\$125
98021A Form-feed Mechanism with Paper Stack Basket	\$275

9885M/S

Low cost, high speed, large capacity, reliability and ease of operation in data management make the HP 9885 Flexible Disk Drive a valuable addition to the desktop computer system. Mass storage on the 9885 provides random access to approximately 500,000 bytes of data per removable disk.

The flexible disk drive comes in two versions, the 9885M (master) with a built-in controller, and the 9885S (slave). Up to three slaves can connect to one master. This expandability provides a means of ensuring easy "backup" of critical information or providing random access to nearly 2 million bytes of data.

Average transfer rate between computer and disk drive is 23k bytes/s. Double-density read/write on the flexible disk further enhances access rate and increases total storage capacity. Average access time to any location on the disk is 267 ms.

Special features and benefits include:

- Random access
 - Store or retrieve any file(s) on the disk in less than 1/4 sec.
- Smart directory
 - Files referenced by "name;" user designates the file "name" (i.e., get "Jones").
 - Quick access to catalog (index) of stored files (available anytime). The disk directory tells the drive when and where a file exists—the drive does not waste time searching for files not on that disk.
 - Catalog update occurs "automatically" as system operations are executed.
- Dynamic size allocations
 - Provides the most efficient packing of data on the disk.
 - A deleted file will be automatically replaced by another file equal to or smaller in size than the old.
 - User may "repack" files so that all unused or available space is collected together on the disk.
- Write—verify feature
 - Ensures that the information recorded on the flexible disk is identical to the source information in the computer memory.

Sample Commands

get "Test 1"	Loads program from the disk to the computer.
save "T Test"	Stores program or specified parts of it in a specified file.
chain	Loads a program from the disk to the computer, retaining variable values.
copy	Duplicates contents of one file into another file or drive.

Ordering information

	Price
9885M Flexible Disk Drive Master and Opt 025: for operation with 9825A	\$3900
9885M Flexible Disk Drive Master and Opt 031: for operation with 9831A	\$4100
9885M Flexible Disk Drive Master and Opt 045: for operation with 9845A (mass memory ROM not included)	\$3750
9885S Flexible Disk Drive Slave	\$2500



**Consolidation, installation,
and configuration/testing for automatic test systems**

HP-ATS Integration Services

Previously, when building an automatic test system, users had only two choices: purchase an already-assembled "turn-key" system or purchase computer and instruments separately and assemble them on your own. As a result of our experience with more than 1000 HP automatic test system installations worldwide, HP now offers three categories of system-building assistance, called HP-ATS Integration Services.

An automatic test system can be purchased at various levels of completion, depending on how much help the user desires. At the lowest level, Consolidation, Hewlett-Packard consolidates all products ordered and ships them on a specific date in a single delivery, simplifying scheduling and materials management for the user.

At the next level, Racking and Cabling Service, HP consolidates the equipment, designs cabinet layout and power distribution, then installs the equipment in cabinets. The user assumes responsibility for software configuration and testing.

With the highest level of service, Configuration/System Test, the user receives a fully-installed, fully-integrated system, ready to solve problems. HP consolidates the equipment, installs it in cabinets, configures the operating software, and checks out the system on-site.

Integration service prices vary depending on the complexity and size of the system. A typical system that contains \$100,000 of instrumentation would require \$20,000 to \$30,000 of integration services to be fully configured and tested (all three services).

Ordering Information

93282A ATS Consolidation Service
93283A ATS Racking and Cabling Service
93284A ATS Configuration/System Test Service

Switches for Automatic Test

HP-IB switch products used in HP automatic test systems are available individually for those who manufacture their systems in-house or those who have complex switching requirements in their automated test setups. These switches provide a commercially-available solution to connecting the system to the unit-under-test (UUT). Three types of switching units are available, all controlled by a single 9411A Switch Controller that provides micro-processor control of up to 8 switch mainframes.

- **9411A Switch Controller** \$2,350
The 9411A is controlled by the automatic test system computer via the HP-IB, and provides control logic for up to eight switching units and +12.5 VDC (4A maximum) relay power for up to four switching units. Performs comprehensive self-test and fault isolation of all signal relays in the 9412A and 9414A switching units.
- **9412A Modular Switch** \$10,000 to \$35,000
Provides high-density, multi-function switching of signals up to 10 MHz. A built-in 1768-pin (34 x 52) matrix interface panel improves signal performance and eliminates "spider web" cabling. The 9412A accommodates five types of switchcards in any combination up to a total of 25 cards.
- **9413A VHF Switch** \$2000 to \$7000
Provides modular, flexible high-frequency switching of pulse and video signals up to 500 MHz. The 9413A accommodates up to 12 coaxial switch modules.
- **9414A Matrix Switch** \$5000 to \$30,000
Provides maximum flexibility in switching signals up to 10 MHz. Designed for high-density, high-performance switching, the 9414A allows any UUT pin to be switched to any instrument in the system. The 16-input matrix can be configured in 30-pin increments (UUT pins) up to 120 pins. A distribution bus allows several instruments to share four of the 16 matrix inputs, thus minimizing switching requirements.

HP 9411A
Switch
Controller

HP 9413A
VHF
Switch

HP 9412A
Modular
Switch

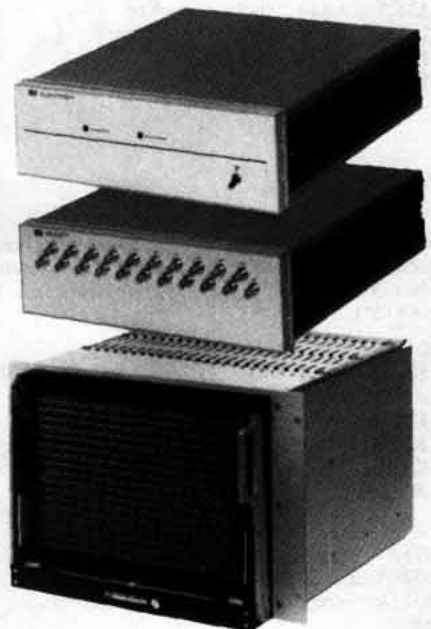

Measurement and Control Computer Interface

Models 2240A and 91000 Series



2240A Measurement and Control Processor

**2240/2241A Measurement and Control Processor**

The microprocessor-based HP 2240A Measurement and Control Processor provides 128 channels of both analog and digital input/output signals, with interrupt handling for complete measurement and control capability in one unit. The HP 2241A Extender adds up to 128 channels to extend the capability to a total of 256 I/O points. The 2240A executes computer-independent, real-time tasks delegated from the controller. A powerful command set, tailored for measurement and control applications, is built into the 2240A to simplify and reduce programming. Programming can be done in BASIC, FORTRAN, HP Assembly or HPL languages via the HP-IB.

The 2240A can be used with a HP 9825, 9830A, or 9845A Desktop Computer or with the HP 1000 Computer System. Multiple 2240A test stands can be added via the HP-IB as part of a distributed measurement and control network. You can remote the 2240A up to 1000 meters over a single twisted pair of wires, or delegate tasks over phone lines with the HP 59403A HP-IB/Common Carrier Interface and industry standard modems.

The 2240A option 001, Extended Throughput ROM, increases the speed of continuous data acquisition severalfold by providing additional commands, larger buffer size, and binary data transmission instead of ASCII data transmission.

A variety of measurement and control function cards is available for the 2240A/2241A:

- **22900A** Analog Input Card \$1,600
32 single-ended or 16 differential channels, ± 10 V, 12 bits including sign, 20 kHz sample/scan rate. Auto correction for gain and offset temperature drift.
- **22901A** Analog Output Card \$900
4 channels, 0 to 10 V or -10 V to $+10$ V output, 10 bits with dual level storage. Auto readback from first level, 4-lead remote sense (Kelvin) connections.
- **22901B** Analog Output Card \$1,200
4 channels, 4 to 20 mA current output, 0 to 10 V, or -10 V to $+10$ V output, 12 bits resolution with dual level storage. Four-lead remote sense (Kelvin) connections.
- **22902A** Digital Input Card \$310
32 channels, TTL or CMOS levels.
- **22903A** Common Interrupt Card \$450
16 channels, TTL or CMOS levels, individual channel enable and transition direction, interrupt test.
- **22904A** Digital Output Card \$480
32 channels, TTL or CMOS, open-collector output, dual level storage, auto readback, level or pulse outputs.
- **22905A** Counter/Stepper Motor Card \$800
4 channels for event counting, frequency or period measurement, or stepper drive output. Internal self-test clock, TTL compatible.

22920A Signal Conditioning Tray

The HP 22920A Signal Conditioning Tray provides maximum isolation for the 2240A Measurement and Control Processor from high voltage inputs and electrical noise. Each 22920A holds one signal conditioning card, with provision for field wiring (14-22 AWG) connection to 56 screw terminal connectors. Signal conditioning cards available for the 22920A are:

- **22912A** Relay Output Card \$290
16 channels, 2 amperes, 125 VAC/DC, 60 VA rating, Form-C (SPDT) hermetically sealed relays.
- **22913A** Isolated Digital Input Card \$430
16 channels, 5 to 120 VDC and 16 to 230 VAC with selectable response times and overload fuses.
- **22914A** General Purpose Breadboard Card \$130
16 channels for analog/digital, input/output signal conditioning. Pad layouts for user-installed signal conditioning components such as amplifiers, relays, filters, fuses, resistors and voltage regulators.
- **22915A** Low Level Analog Input Card \$1,250
16 differential channels, amplifier-per-channel, jumper selectable gains ± 20 mV, ± 50 mV, ± 100 mV, ± 500 mV, ± 10 V. Pads for filters, current loop and open thermocouple detection resistors.

2313B Analog I/O Subsystem

The HP 2313B Analog I/O Subsystem consists of control, sampling, and analog-to-digital conversion modules in a mainframe designed for rack-mounted operations with HP 2100S or HP 1000 series Computer Systems. The subsystem I/O capacity is expandable to 528 differential analog inputs or 44 analog outputs, or combinations of inputs and outputs.

- **12751A** High Level Multiplexer \$800
 ± 10 V, 45 kHz, 32 S.E., 16 differential inputs
- **12760A** Low Level Relay Multiplexer \$1,000
16 ch. differential, ± 10 mV to 200 mV, 200 V CMV
- **12761A** Low Level Solid State Multiplexer \$1,150
16 ch. differential, ± 10 mV to ± 800 mV, 10 V CMV

Plug-In Subassemblies

Individual measurement and control interfaces are contained on plug-in assembly cards for HP 2100 and HP 1000 computers:

- **91000A** Analog-to-Digital Interface Subsystem \$1,600
A complete ± 10.24 V fs analog input subsystem, including interface and control logic, sample and hold amplifier, ADC, and input multiplexer.
- **12551B** 16-Bit Relay Output Register \$550
Provides 16 floating contact closures for controlling 1 to 16 devices and optional readback circuitry for data verification.
- **12930A** Dual-Channel Universal Interface \$850
16-bit input/16-bit output plus control and status data. Choice of differential or TTL logic. Up to 1 million 16-bit words.
- **12555B** Digital-to-Analog Converter \$600
Provides two analog outputs ranging between 0 and $+10$ volts, 8-bit resolution.
- **12556B** 40-Bit Register \$650
40-Bit (10 BCD digit) capacity for driving program input lines, choice of ASCII or binary output modes.
- **12604B** Data Source Interface \$600
32-Bit (8 BCD digit) capacity, accommodates logic levels between -100 V and $+100$ V.

Ordering information

	Price
2240A Measurement and Control Processor	\$2,750
2240A-001 Extended Throughput ROM	\$250
2241A Extender	\$1,500
22920A Signal Conditioning Tray	\$165
2313B Analog I/O Subsystem	\$6,200

COMPUTATION

Interactive display terminal family

Models 2647A, 2648A



2647A



2647A

Introduction

Hewlett-Packard has a growing family of general-purpose display terminals which include: the new 2647A Intelligent Graphics Terminal, 2648A Graphics Terminal, 2649A Microprogrammable Terminal, 13290B Development Terminal, 2640B Display Terminal, the high performance 2645A Display Station, the 2640C and 2645K/N/R/S International Terminals, the 2641A APL Display Terminal and a number of accessories for filling the needs of a variety of applications. Hewlett-Packard display terminals are in wide use today in manufacturing, service organizations, government and education performing in such applications as:

- data entry
- inquiry/response
- editing text
- file updating
- transaction processing
- programming
- off-line operation
- data storage
- printing
- order entry
- batch operation
- time-sharing
- graphics

2647A Intelligent Graphics Terminal

The second in the expanding line of graphics terminals from Hewlett-Packard is the 2647A Intelligent Graphics Terminal. The 2647A offers a new horizon of flexibility and power for activities requiring a computer and for those that do not.

Microprocessor intelligence allows user programmability in BASIC. Data from a computer can be reformatted by the 2647A with a Basic program in the terminal. The 2647A is the solution to applications that require both on-line capability and local intelligence.

In addition to offering user programmability, the 2647A provides full interactive alphanumeric capability. This makes the 2647A a

most effective solution in other areas such as program preparation, text entry or editing and data entry.

The 2647A shares all the features of the 2648A Graphics Terminal and provides the following additional capabilities:

User Programmability: The 2647A can be programmed in Basic with graphics extensions to control plotting functions. Used as a pre-processor, the 2647A can prepare and format data for transmission to a computer. All terminal facilities are available to the local Basic program.

Simple User Interface: Terminal operations are controlled by English-like commands. After the user specifies a type of command to be performed, the terminal automatically presents the user with the logical alternatives to complete the intended operation. This eliminates the need to memorize complicated keystroke sequences, thus reducing operator errors.

High-Level Graphics Commands: English-like commands control the graphics features of the 2647A, such as set up functions, axis generation, plotting and interactive functions. These commands can be in a local Basic program or transmitted from a host computer.

Multiple Automatic Plotting: Sophisticated graphs and charts can be generated while requiring little or no programming experience. A menu is provided to lead the user through a question and answer session about the data. By completing the form and a few keystrokes, the user can display his data by using bar charts, pie charts, semi-log and log-log charts or regular linear charts. Automatic data labels, legends and titles are also provided. This feature makes chart generation friendly and easy to use with or without a computer.

Dual-Cartridge Tape: The 2647A offers as standard equipment dual mini-cartridges, each of which can store up to 110k bytes of data. Use them to store alphanumeric data, graphic pictures or both.



2648A



2648A

Model 2648A Graphics Terminal

The 2648A graphics terminal was the first CRT terminal from Hewlett-Packard that was designed specifically for graphics. More importantly, it offers high performance graphics capabilities to users requiring low cost graphic terminals; capabilities normally found only in larger computer systems. Being microprocessor driven, it has localized intelligence that offers users the opportunity to explore new areas and to try out new ideas in graphics not before available in a terminal.

Raster scan technology: the 2648A can be used in high ambient light environments since raster scan provides a bright, easy-to-read display. This helps to minimize eye fatigue when extended sessions at the terminal become necessary.

With refreshed raster scan technology, the ability to modify selected portions of a picture is a natural feature.

Modification of pictures does not require that the complete display be erased and redrawn. This helps to minimize the computer overhead requirements and the user wait time.

Independent alphanumeric and graphic memories: the alphanumeric memory can store up to 37 lines of 80 characters (less enhancements). Independent of the alphanumeric memory is the graphics memory, consisting of 16 each 16K RAM integrated packets providing a 360 by 720 dot resolution. Now, computer dialogue and the final picture reside in separate memories. Since either memory can be inhibited without disturbing the other, readability of the display is enhanced.

Hardware zoom and pan: the graphic memory of the 2648A can be magnified up to sixteen (16) times, facilitating investigations and/or modifications of dense areas of the display. Panning is available to view any area of the magnified display not in the viewing window. The complete display can be panned through without reinitializing the display data. This capability is available to the user whether on or off-line from the computer.

Sophisticated users as well as users having little or no programming skills can take advantage of the 2648A's capability to plot column-wise tabular data automatically.

Automatic plotting: a simple menu is provided to lead the user through a question and answer session about the data. With a few

simple keystrokes, a fully labeled plot of the specified data can then be presented on the display. This feature makes graphics friendly, easy to use, and can be done with or without a supporting computer.

Rubber band line: trial graphics can be performed with or without computer support using the Rubber Band Line mode. Quick, user-initiated picture generation and/or modification before final commitment to design is now possible.

Pattern generation with rectangular area shading: user-specified patterns can be generated for use in shading defined rectangular areas of the display. This enhances the shading of parts assemblies or facilitates differentiation of bar graphs where color would normally be used.

Compatibility mode: when in compatibility mode, the 2648A can be used with most terminals that have a 780 by 1024 dot displayable area. Data is mapped on a 1 to 1 basis into the 2648A's display space, or it may be scaled to fit in the 360 by 720 dot data space. This capability will help to minimize user conversion time and loss of the initial software investment.

Additionally, since the 2648A and 2647A are members of the 2640 Series Family of Terminals, they have many features that make it an outstanding alphanumeric terminal.

Some of these features are:

- Choice of Communications Environments:
 - RS232C Asynchronous ASCII; Full or Half Duplex
 - Optional 20 mA Current Loop
 - Optional Asynchronous or Synchronous
 - Multipoint/Polled
 - Wide Selection of Modems
 - 8 User Definable Soft Keys
 - Fully Integrated Mass Storage Option
 - Two Cartridge Tape Drives
 - 110 Kilobytes of Storage per Cartridge Tape
 - Alpha/Numeric Field Checking
 - Automatic Data Logging
 - Character Wraparound
 - Adjustable Margins
 - Full Editing
 - Insert or Delete Lines or Characters
- And much more!

COMPUTATION

Interactive display terminal family (cont.)

Models 2649A, 2640B



2649A



13290B

Model 2649A Microprogrammable Terminal/Controller

The Hewlett-Packard Model 2649A Microprogrammable Terminal/Controller represents an innovative approach to satisfying the need for an intelligent terminal or controller with a set of capabilities which has been tailored to meet the requirements of a particular application. By combining applications specific hardware and firmware with the wide selection of standard hardware and firmware which is available with the 2649A, the OEM or sophisticated end user can develop a reliable, cost-effective solution to business, industrial and research problems spanning the applications spectrum.

Complete system in a single package: the 2649A combines a processor, memory I/O and peripherals in a single, attractive package. This means that the 2649A is ideal for use in applications where space is a limiting factor or where the esthetics of the package are of concern.

Modular architecture: modular architecture allows the OEM or end user to optimize both hardware and firmware configurations to match each specific application. Thus, unnecessary hardware and firmware is avoided with a resulting cost savings. Modular architecture also means greater flexibility so that as the application grows, the capability of the terminal or controller may be enhanced by adding more memory, peripherals or firmware.

Graphics capability: the optional graphics capability of the 2649A adds a new dimension to the solution of application problems. This unique capability allows large quantities of data to be displayed in graphical form for easy interpretation and manipulation by the user. The overhead imposed by the addition of the graphics capability is minimized by the use of a hardware vector generator and a separate graphics memory.

Choice of interface and memory options: interfacing is made easier because there is a wide selection of general purpose, peripheral HP-IB, and data communications interfaces to choose from. A variety of memory options, including RAM, ROM and PROM modules, is available to meet program and data storage requirements in a highly efficient manner. Memory options may be configured to support up to 120 k bytes of combined RAM, ROM and PROM.

Simplified hardware/firmware development: development of hardware and firmware is simplified by the extensive development tools which are available. The HP 13290B Development Terminal, for example, provides the user with source program generation, resident assembly, program execution and debug capabilities. The comprehensive documentation package and training course which are offered provide the knowledge necessary to adapt the 2649A to meet various application requirements. A firmware support package including a microprocessor assembly language cross-assembler which executes on a Hewlett-Packard 1000 Computer System is also available.

Model 2640B display terminal**Easy to read display:**

the large 5 inch by 10 inch display of the 2640B presents up to 1,920 characters in a 24 line by 80 column format. A 9 x 15 dot character cell allows large characters to be represented accurately. Wide character and line separation, inverse video, and optional plug-in character sets with underlining, half-bright, and blinking are enhancements designed to increase clarity and easy sessions at the terminal.

Full editing capability: the 2640B transmits character-by-character as an interactive terminal or is capable of operating on variable length blocks of information. Local editing allows the user to modify data before transmission to the computer. Editing and computer connect times can be significantly reduced by such standard features as:

- character or line insertion and deletion
- cursor addressability and positioning (up, down, left, right, home)
- programmable protected fields in any combination of display positions
- off-screen storage with scrolling (scroll up, scroll down, next page, previous page)
- standard horizontal tabs and protected field tabulation
- eight special function keys for user-defined routines, such as forms entry or on-line error detection
- positional memory lock



2640B



2645A

Plug-in character sets: there is the capacity to use up to four 128-character sets concurrently (switch selectable on a character-by-character basis): the Roman set including displayable control codes for program debugging; the line drawing set for forms drawing and limited graphics capability; the math set with frequently used math symbols and Greek characters; the large character set for enlarged character presentation; or user-defined character set.

Choice of communications capabilities: the standard 2640B operates at up to 2400 baud and offers both full and half duplex asynchronous communication using an EIA RS232C interface. It is Bell 103A and 202C/D/S/T modem compatible with a choice of main channel and reverse channel protocols. Options include 20 mA DC current loop, split input/output speed and custom baud rates.

Versatile keyboard: the detached, expanded ASCII keyboard is easy to use and flexible enough to fill a wide variety of applications. It contains a ten key numeric pad, cursor control, tab and page control pad, editing and special function keys.

Multi-page display memory: because of efficient memory allocation, the standard 2640B with its 1024 bytes of memory can display from 8 to 50 lines dependent on line length. With memory expansion to 8 k bytes, over three pages of data can be stored. Information can be viewed 24 lines at a time by scrolling forward or backward a line or a page at a time.

Hard-copy interface: a wide variety of hard-copy devices can be accommodated via an optional RS232C serial interface or HP printer compatible parallel interface. Commands to print data can be initiated either locally from the terminal keyboard or remotely from a computer.

Self-test: every element of the 2640B has been engineered for high reliability and ease of service. For example, the Self-Test feature gives the user an instant diagnostic test that the terminal is operating properly.

Modular architecture, microprocessor controlled: microprocessor implementation and modular architecture produce a terminal with a wide range of capabilities; and, as needs grow, the potential for

flexibly adding such features as additional display memory, printer interfaces and other character sets.

Model 2645A display station

All 2640B features: the high performance 2645A Display Station offers a superset of the capabilities of the 2640B. It has the same features and benefits as the 2640B (see 2640B features description) and has many significant additional features described below.

High speed: the 2645A can operate at speeds up to 9600 bits per second and, like the 2640B, transmits either character-by-character as a fully interactive terminal or can operate on variable length blocks of information.

Choice of communications capabilities: the standard 2645A is a teletypewriter compatible (EIA RS232C serial asynchronous, ASCII, half or full duplex). Optional capabilities include 20 mA current loop; and either asynchronous or synchronous polling for multipoint communications networks. Polling offers the cost saving benefits of shared communications resources — modems, data lines and computer I/O channels; as well as improved transmission error checking and communications compatibility with a wide range of computer systems. The 2645A operates as a single unit or can be daisy-chained to other 2645A's on a single communication line. Synchronous multipoint and asynchronous multipoint can optionally be used for polled communications networks. Also, the 2645A can be used with a wide selection of modems over dialed or leased lines.

User-defined soft keys: each of 8 special function keys can be easily set to issue a user-defined string of up to 80 data characters or several control sequences stored in the 2645A. This feature allows the keyboard to be more specialized to each application, and can considerably simplify use of the keyboard and result in greater efficiency—each soft key performs the operations of several key sequences. For example, the soft keys can issue frequently used programming sequences; search for files; aid forms construction for data entry; dynamically configure the terminal; or issue instructions to the user, computer or both.

COMPUTATION

Interactive display terminal family

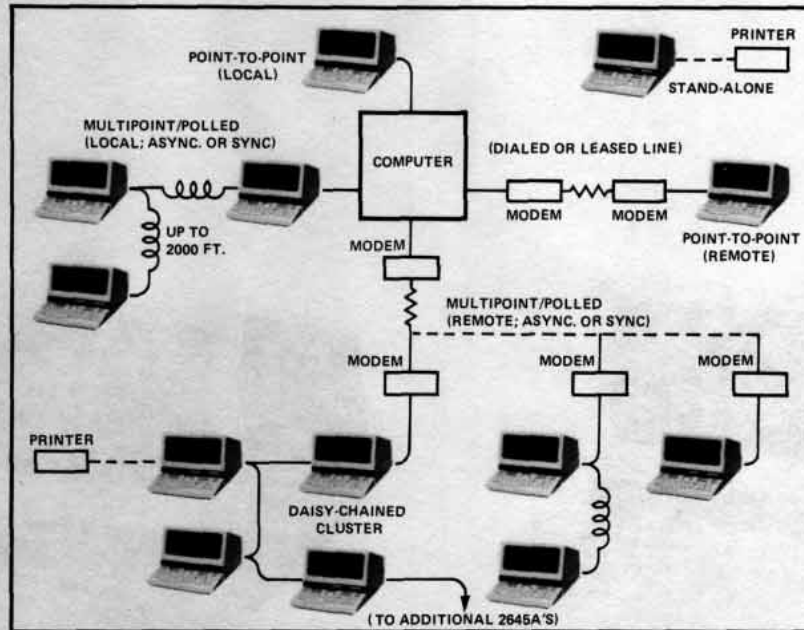

Figure 1. Data communications capabilities of the Hewlett-Packard family to terminals.

considerably simplify use of the keyboard and result in greater efficiency—each soft key performs the operations of several key sequences. For example, the soft keys can issue frequently used programming sequences; search for files; aid forms construction for data entry; dynamically configure the terminal; or issue instructions to the user, computer or both.

Fully integrated mass storage: many operations normally requiring connection to a computer system can now be done off-line with the 2645A. Optional, dual cartridge tape units allow batching of significantly reduce user time; conserve both computer and communications resources; provide a tape backup; and very importantly, allow the terminal to keep on working even when a computer is unavailable. Single keys for the most frequently performed functions, and color-coded prefix keys to exercise the 2645A's full capabilities suit the 2645A to a wide variety of users and applications. Gold and green prefix keys provide full access to the 2645A's multiple data paths to allow information to be moved between any of the functional units of the display station—cartridge, display, keyboard, printer, and data communications interface. Also, the tapes are fully controlled from either keyboard or computer. The highly reliable, interchangeable MiniCartridge tapes each provide the capacity of up to 110,000 characters of storage formatted in variable length records and files. The tape units feature rapid data transfer and bi-directional high-speed search to access any file in seconds. The MiniCartridge is ideally suited for storing data, forms, programs, or text, and is an excellent substitute for paper tape.

Additional capabilities

- Numeric/Alpha field checking
- Display memory expandable to 12 k bytes
- Automatic data logging—stores data as it leaves the display memory automatically on the optional tape cartridges
- Line wraparound—when inserted text requires more than 80 columns per line.
- Adjustable margins—for variable column width/multiple columns/split screen

International terminals

The 2640C is an international version of the 2640B Display Terminal. It has basically the same features and benefits as the 2640B (see 2640B features description). The 2645K/N/R/S are international versions of the 2645A.

Model 2640C—Cyrillic (Russian): the 2640C is capable of displaying the full 128-Cyrillic-character set. Cyrillic and Roman characters can be generated from a single keyboard with all keys labeled and located in the accepted positions for Cyrillic keyboards. Pressing a single key switches between standard Roman and Cyrillic. Adjacent

characters on the display can be from the Roman, Cyrillic, or optional plug-in character sets.

Model 2645K—Katakana (Japanese): the 2645K is capable of displaying 128 character Roman set and a 64 character Katakana set. Katakana and Roman characters can be generated from the keyboard which is labeled with both Katakana and Roman characters.

Model 2645N—Danish/Norwegian: the 2645N is a unilingual terminal in which the Danish/Norwegian character sets are displayed and present on the keyboard.

Model 2645S—Swedish/Finnish: the 2645S is a unilingual terminal in which the Swedish/Finnish character sets are displayed and present on the keyboard.

Model 2645R—Arabic: the 2645R is a dual character terminal in which Arabic and upper case Roman characters are displayed and present on the keyboard.

Model 2641A APL Display Station

The 2641A APL Display Station retains all features and capabilities of the 2645A. An additional APL character set, including overstrike characters, is standard. Keyboard layout conforms to industry conventions. Integrated cartridge tape storage optional.

Family enhancements and accessories

13231A Display enhancement: with the 13231A individual characters or fields of characters can be displayed in any of the sixteen possible combinations of blinking, underline, half-bright or standard inverse video. The 13231A also provides the capacity for adding up to three 128-character sets. A line drawing set, math symbol set and large character set are currently available.

13245A Character set generation kit: the high resolution display and 9 x 15 dot character cell are available for special character set design with the 13245A. An included manual documents the steps necessary to design individual characters, assign the desired ASCII code equivalent, and generate the information to purchase Programmable Read Only Memories (PROM) which store the user-defined character sets.

13238A Duplex register: the 13238A provides a parallel output interface which supports the HP 9866 thermal line printer and 9871 character-serial impact printer.

13250B Serial printer interface: the versatile 13250B supports a wide variety of RS232C serial interface compatible printers at speeds up to 9600 bits per second.

13254A Video output interface: the 13254A provides the capability of generating video output which can be used by compatible television monitors and video hardcopy to duplicate whatever is being displayed by one of the Hewlett-Packard family of display terminals.



Family specifications

General

Screen size: 127 mm (5") x 254 mm (10").
Screen capacity: 24 lines x 80 columns (1,920 characters).
Character generation: 7 x 9 enhanced dot matrix; 9 x 15 dot character cell; non-interlaced raster scan.
Character size: 2.46 mm (0.097") x 3.175 mm (0.125").
Character set: 64 upper-case Roman; 128 character APL set with 2641A; 128 character Roman set with 2645A; 128 Danish/Norwegian set with 2645N; 128 character Swedish/Finnish set with 2645S; 128 character Roman/Arabic set with 2645R.
Cursor: blinking-underline.
Display modes: white on black; black on white (inverse video).
Refresh rate: 60 Hz (50 Hz optional).
Tube phosphor: P4.
Implosion protection: bonded implosion panel.
Keyboard: detachable. Full ASCII/APL keyboard for 2641A. Full ASCII code keyboard; 2640B 20 control/editing keys, 2645 8 user-defined soft keys and 16 additional control/editing keys; ten-key numeric pad; cursor pad; multi-speed auto-repeat, n-key roll-over; 1.22 m (4 ft.) cable.
Cartridge tape: two mechanisms, 10 ips read/write speed, 60 ips search rewind speed, 800 bpi recording, max 110 k bytes of storage per MiniCartridge. Optionally available for 2641A, 2645 series 2648A, and 2649A.

Data communications

Data rate: 110, 150, 300, 1200, 2400 (4800 on 2641A & 2645R, 9600 also on 2645A, 2648A, and 2649) and external-switch selectable (110 selects two stop bits). Operation above 1200 baud may require nulls or handshake protocol to insure data integrity. Basic language control in the 2647A requires handshaking protocol to a host CPU.

Std. asynchronous communications: EIA RS232C; compatible with Bell 103A modems; compatible with Bell 202C/D/S/T modems.

Transmission modes: full or half duplex, asynchronous.

Optional communications interfaces:

Current loop, split speed, custom baud rates.

Asynchronous multipoint (2645A/N/S).

Synchronous multipoint (2645A/N/S).

Operating modes: on-line; character, block.

Parity: switch selectable (even/odd/none).

Environmental conditions

Ambient temperature

Non-operating: -40° to 75°C (-40° to 167°F); -10° to 60°C (-15° to 140°F) with tape.

Operating: 0° to 55°C (32° to 131°F); 5° to 40°C (41° to 104°F) with tape.

Humidity (non-condensing): 5 to 95% (20 to 80% with tape).

Altitude

Non-operating: sea level to 7620 metres (25,000 ft).

Operating: sea level to 4572 metres (15,000 ft).

Vibration and shock: (type tested to qualify for normal shipping and handling in original shipping container.)

Vibration: 0.25 mm (0.010") pp, 10 to 55 Hz, 3 axes.

Shock: 30 g, 11 ms, 1/2 sine.

Physical specifications

Display monitor weight: 19.6 kg (43 lb).

Keyboard weight: 3.2 kg (7 lb).

Display monitor dimensions: 342 mm H x 444 mm W x 457 mm D (13.5" x 17.5" x 18"), 648 mm D (25.5") including keyboard.

Keyboard dimensions: 90 mm H x 444 mm W x 216 mm D (3.5" x 17.5" x 8.5").

Power requirements

Input voltage: 115 (+10%, -23%) at 60 Hz ±0.2%.
 230 (+10%, -23%) at 60 Hz ±0.2%.

Power consumption: 85 W to 150 W max.

Ordering information

2640B Interactive Display Terminal	\$2600
2640C Cyrillic Display Terminal	\$4250
2641A APL Display Terminal	\$4100
2645A Display Station with tape	\$3500 \$5100
2645K Katakana Display Station	\$4000
2645N Danish/Norwegian Display Station	\$3750
2645R Arabic Display Station	\$4350
2645S Swedish/Finnish Display Station	\$3750
2647A Intelligent Graphics Terminal	\$8300
2648A Graphic Terminal with tape	\$5500 \$7100
2649A Microprogrammable Terminal	\$2150
13290B Development Terminal	\$6950

Short-term lease and quantity discounts available.

COMPUTATION

Optical mark reader for data collection and entry

Model 7260A

- Immediate off-line data preparation at source
- Reads marks made by ordinary pencil
- Reads standard punched cards
- Off-line operation with terminals
- Easy local/remote connection to computer via RS232C/CCITT V24 interface.



7260A

A typical mark sense form

PRODUCTION			PRODUCTION CARD			QUALITY CONTROL			
Operator No.	Job No.	Quantity Produced	USE ONLY PRE-PRINTED SOFT PENCIL	Control No.	Quantity Passed	2 of 25,000, 0000			
0	0	0		0	0	0			
1	0	0		0	0	0			
2	0	0		0	0	0			
3	0	0		0	0	0			
4	0	0		0	0	0			
5	0	0		0	0	0			
6	0	0		0	0	0			
7	0	0		0	0	0			
8	0	0		0	0	0			
9	0	0		0	0	0			
			PRODUCTION SUPERVISOR SIGNATURE				QUALITY CONTROL SUPERVISOR SIGNATURE		

The 7260A Optical Mark Reader saves data preparation time and prevents errors by using one functional card for both source document and data entry. The data may be marked with an ordinary soft lead pencil, eliminating the need for special marking pencils or keypunch operations. Also, errors can easily be erased. Each form may contain any combination of pencil marks/prepunched holes/preprinted marks.

The 7260A can be operated remotely from the computer via an RS232C/CCITT V24 interface and modems. This enables it to be sited exactly where it is needed, e.g. production line, quality control, warehouse. All source documents can then be conveniently batched for transmission to the computer at one time. A Select Hopper (option 002) is available which allows card selection under program control.

Specifications

Code capacity: recognizes 128 characters Hollerith code.
Translation: to bit-serial 7-level ASCII, selectable parity.
Operational modes: demand and continuous feed.
Parity: generates and transmits selectable parity.
Data rates: 110, 150, 300, 600, 1050, 1200, 2400 baud, selectable.
Tab cards dimensions: standard tab card size 82.6 x 187.3 mm (3.3 x 7.4") up to 82.6 x 282.6 mm (3.3 x 11.1")

Hopper capacity: 450 cards input, 450 cards output.

Interface: RS-232C and CCITT V24

Interface Connectors: 2 Cinch/Cannon DBM-25S-rear panel.

Invalid Code: transmits a selectable character when data outside 128 character set is marked.

Mute and Line-Local Operation: allows operation with local terminal, and allows muting of terminal Printer.

Mnemonic Control: allows 3 letter mnemonics to control Reader when control codes would interfere with system operation.

Image: transmits Binary card image as two typing characters with selectable parity, activated by control codes from computer.

Size: 305 mm H x 368 mm W x 610 mm D (12 x 14.5 x 24")

Weight: net, 24.6 kg (54 lb). Shipping, 33.2 kg (73 lb).

Environment (exclusive of tab cards):

Storage temperature: -40°C to +75°C

Exposure power on: -20°C to +65°C

Meets specifications: 0°C to +55°C

Humidity: 5%-95% at 25°C to 40°C.

Vibration: 10-55 Hz, 0.25mm (0.01") peak-to-peak excursions.

Environment (tab cards): from 20% to 75% RH at 23°C.

AC Power: (see Option 005 for 220/240 V ac operation) 100 or 120 V. ac, +5%-10%, switch selected 47.5 Hz, 66 Hz; 300 VA.

Fuses: line 4ASB, transformer 2ASB.

U.L. approval: U.L. approved and meets IEC specs.

Options

002: Select Hopper

003: Encoder

004: Bell

005: 220/240V ac +5% -10% (line fuse 2ASB, Transformer 1ASB.)

006: 50 Hz operation

007: Wider input hopper (+0.5 mm/0.2 inch) for use with forms of nominal standard burst from continuous line printer stationery.

300: Operating manual for 3000 series II system

Price

add \$230

add \$230

add \$60

NC

NC

add \$52

add \$10

7260A Optical Mark Reader

\$4295



- User defined prompting lights/keys for ease of use
- Alphanumeric multifunction reader
- Alphanumeric thermal printer



- Multidrop through SERIAL LINK
- Control of distributed HP-IB devices
- Built-in self test

Specifications

General

Display: 15 position with character set: 0 through 9, decimal point, space, E, □ (for each Special Function Key pressed).

Keyboard: buffered. Keys: 0 through 9, decimal point, minus, Enter and Delete. Ten special function keys (SFK's). Gold SRQ key.

Communications

Serial Link: shielded, twisted-pair cable

Signal levels: 5V differential. Optocoupler isolation

Length: max. 2 km from the computer.

Transmission speeds: from 15 transfers/second/terminal (56 terminals) to 280 transfers/second/terminal (1 terminal).

HP-IB: standard HP-IB cables to the terminal's HP-IB connector.

Loading: 2 HP-IB loads.

Printer

Type and speed: thermal, 50 lines per minute.

Characters & format: 64 ASCII character set with 20 char./line.

Programming: on/off and End of Paper status.

Multifunction Reader

Input Media:

-perforated plastic badges, non embossed (Industry type III)

-standard punched cards

-mark sense forms up to 80 column density and 40 cm (16") long.

Reading rate: up to 1 badge or form per second.

Buffer size: one form (up to 160 characters).

Programming: reader can be configured as follows

-clock/no clock marks

-clock on data/clock after data mark position

-Hollerith/Image reading mode

-40 column/80 column fixed density

-punched holes/holes and marks

-card insertion error detection enable/disable

-power on configuration can be preset using switches.

Software: supported software available for use with HP 1000.

Environmental

Temperature: Free space ambient. Non operating -40° to $+70^{\circ}$ C (-40° to $+158^{\circ}$ F). Operating 0° to $+55^{\circ}$ C (32° to 131° F).

Humidity: 5 % to 95 % (non condensing).

Heat dissipation: 25 watts maximum.

Vibration and shock: Type tested for normal shipping/handling.

Physical

Weight: net 5.9 kg (13 lbs.), shipping 8.3 kg (18.26 lbs.)

Size: 157 mm H x 277 mm W x 400 mm D (6.2 x 10.9 x 15.7 in.)

Power requirements

Input voltage: 115V (+10 %, -25 %), 230V (+10 %, -15 %)

Input frequency: 47.5 to 66 Hz.

Power consumption: 50 watts maximum.

Approvals: UL, CSA and VDE approved.

Options and Accessories

Opt. 002: terminal without reader Price
less \$600

Opt. 003: terminal without reader/printer less \$1200

92900B Subsystem: (includes HP 40280A interface \$4400

kit, 3070B terminal, test cable, manuals)

92900B opt. 002: incl. 3070B without reader less \$600

92900B opt. 003: incl. 3070B without reader/printer less \$1200

40280A Computer Interface kit: (includes serial link \$1200

controller board, interface-to-serial link cable, termina-
tion set, manual).

3070B Data Capture/Data Retrieval Terminal **\$3200**

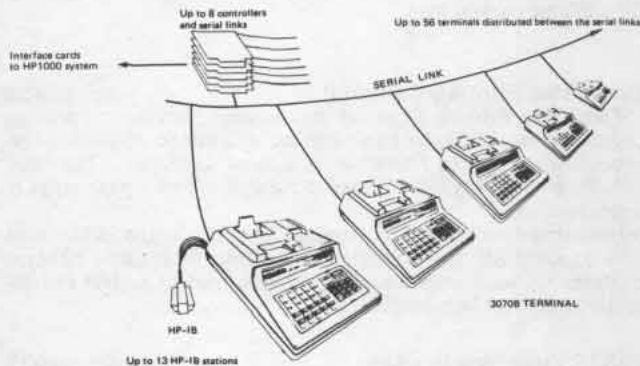

Multidrop through the SERIAL LINK

Ease of Use

The HP 3070B Data Capture/Data Retrieval Terminal can be used in a wide variety of everyday situations whenever you need to communicate with a computing system (stock control, point-of-sale, goods shipping). A set of 10 special function keys and 15 prompting lights can be defined by you to customize your own terminal. Thus the terminal guides you through a transaction, making it very easy to use.

Reader and printer features

A multifunction reader and alphanumeric printer further enhance the 3070B's capabilities. The reader will accept badges and punched or mark sense forms for accurate, rapid data collection. The printer gives you written proof of transactions completed.

Multidrop and HP-IB

Terminals widely spread out through your plant can be connected to an HP 1000 System via a Serial Link. You simply plug in the terminals (up to 56 per System 1000) anywhere along the link up to 2 km (1.25 miles) from the computer. Alternatively you can control the 3070B, via its HP-IB interface, from a desktop computer. This interface also enables the 3070B to connect distributed clusters of HP-IB devices to the Serial Link for remote control.

COMPUTATION

Peripherals: printer/printer terminal

Models 2631A, 2631G, 2635A



Hewlett-Packard's 2630 family of hard-copy printers and terminals sets new standards in flexibility and user convenience while maintaining traditional high reliability and low cost of ownership.

Members of the family are the HP 2631A Printer, the HP 2635A Printing Terminal, and the new HP 2631G Graphics Printer.

2630 Family features

- Smart bidirectional printing
- Multiple print modes
- 128-character set standard
- Optional secondary character sets
- Long-life print head
- Easy-loading ribbon cartridge
- High throughput
- Simple mechanical design
- Self test
- Interfacing flexibility
- Easy installation

HP 2631A Printer **from \$3100**

The 2631A Printer is a smart bidirectional character serial printer. Under microprocessor control, this printer constantly evaluates incoming data to determine the most efficient print direction based on line length and current position on the print head. Ten or more embedded space characters cause the print head to skip at high speed. Lines without printable characters result in a high-speed paper slew to the next printable line. The result is maximum throughput for any given input.

The 2631A prints serially at 180 characters per second. Using smart bidirectional printing, this translates to a line per minute speed in normal mode ranging from 70 lines per minute for full 136-character lines to 500 lines per minute for 10-character lines.

128-Character set: The standard 2631A provides a full 128 character USASCII character set. A 7 x 9 dot character cell allows high resolution printing of true lower case characters and, with display function enabled, representation of ASCII control codes. An optional secondary character set can be selected by control codes when required for the output.

Long Life Print Head: The durable print head used in the 2631A is conservatively rated at 100-million characters and, to keep the cost of ownership low, has been designed to be easily cleaned and replaced when required by the operator.

Easy Loading Cartridge Ribbon: The print ribbon is contained in a unique plastic cartridge and is easily removed and installed without touching the ribbon itself. Drive for the ribbon is provided by print head motion. This eliminates the need for a separate ribbon drive motor.

Three Print Densities: Normal, expanded, and compressed print can be selected by control panel switches or by control codes embedded in the data. Normal provides 10 characters per inch (136 characters per line); expanded prints at 5 characters per inch (68 characters per line) for headings and emphasis; compressed prints at 16.7 characters per inch (227 characters per line) for maximum output per page.

Interfacing Flexibility: A variety of interfaces are available for the 2631A Printer. The standard interface is a general purpose differential parallel interface; options include TTL interface for use with the HP 2640 series of CRT terminals, Hewlett-Packard Interface Bus (HP-IB), RS232C/CCITT V.24 with or without modem control, and 20 milliamp current loop.

HP 2635A Printing Terminal **from \$3450**

The 2635A Printing Terminal has the same features and printing capabilities as the 2631A plus additional advantages to meet the responsibilities required for full-scale terminal operations. The functionally grouped keyboard is easy to use and will fill a wide range of applications.

Interfacing Flexibility: The standard interface for the 2635A is an EIA standard RS232C asynchronous interface for use with 103-type modems. Optional interfaces add 202-type modem control and 20-milliamp current loop interface.

2631G Graphics Printer **from \$4025**

The 2631G, a new member of the 2630 family, combines the capabilities of a high-performance serial character printer with the ability to print raster data format graphics.

Graphics Printing: The 2631G offers 72-dot per inch vertical and horizontal resolution graphics printing, ideal for medium resolution graphics such as business, general scientific, and engineering data. The 2631G will print a graphics image as wide as 13.56 inches (976 dots) and of unlimited length all on standard line printer paper.

The 2631G is an outstanding companion for the 2648A or the new 2647A Intelligent Graphics CRT Terminal. With a simple key sequence, the 2631G provides a hard-copy reproduction dot-for-dot of the CRT graphics display.

Alphanumeric Printing: In the alphanumeric printing mode, the 2631G offers the printing capabilities of the 2631A with additional flexibility in print modes and forms handling.

The 2631G offers control panel or program selection of four print densities. Five and 7.2 characters per inch expanded print densities for titles and headings; 10 characters per inch for standard "typewriter sized" text; and 14.4 characters per inch for line or 120 characters per line on 8.5 inch wide paper.

The forms length can be selected via control codes for any length up to 256 lines. The text length can be selected for any value less than the forms length. This provides automatic perforation stepover capability with both standard and non-standard length forms.

COMPUTATION
Line Printer
Model 2608A



2608A

Performance is the watchword for the new HP 2608A line printer. It is a low cost, very reliable, medium speed printer which has been designed for use in most computer applications. With crisp, clear dot matrix printing, the HP 2608A will print at speeds up to 400 lines per minute.

Special user features include graphics capability, multiple character sets, double size characters, and 16-channel vertical format control.

The HP 2608A is rugged enough for EDP applications yet quiet enough to be compatible with office environments.

High Reliability: The HP 2608A printing mechanism has few moving parts, operates virtually without friction, and requires minimum maintenance. The basis of the printing mechanism is a hammer and coil set for each of the 132 print positions. With this hammer and coil arrangement, dots are placed precisely in any of 924 dot positions on a print line.

In addition, the printer is microprocessor controlled for flexibility and increased functional capabilities as well as added reliability. Microprocessor control also provides an internal self test mode.

High Throughput: The HP 2608A will print upper case ASCII characters at a speed of 400 lines per minute. This print speed in conjunction with a vertical slew rate of 14 milliseconds increases the throughput. In graphics mode, a full page of data is plotted in less than 18 seconds.

High Quality Print: The dot matrix character cell provides crisp, clear character formation and is especially well suited for the printing of multipart forms. Each dot is formed with equal force; thus, impact variations, which cause embossing, smearing, and light or partially formed letters, do not occur.

Up to six-part forms may be used with the HP 2608A. To maintain print quality when changing pack thickness, the platen-to-hammer

gap can be easily adjusted by the operator. Paper is loaded through the bottom, and eight-pin paper tractors are standard.

Printing Versatility: The HP 2608A can be programmatically controlled to print double size characters (the 5X7 matrix is increased to 10X14). When double size characters are printed, line spacing becomes either three or four lines per inch instead of six or eight lines per inch, and characters occupy two print columns instead of one. Up to 13 different character sets can reside within the printer and any two can be used interchangeably in the same line.

When the printer's ability to precisely position dots on the page is combined with user written applications software, the HP 2608A provides the potential for a virtually unlimited array of graphics output.

Forms control is provided through a 16-channel electronic vertical format control unit which may be operated with either the standard channel assignments or with programmatically assigned channel definitions. An optional 12-inch form VFC is available.

User Convenience Features: The HP 2608A is a quiet printer. Special acoustical materials have been used in the construction of the printer, and the enclosed stand, which provides an out-of-the-way paper location, also contributes to quiet operation.

An extended life, easy-to-install cartridge ribbon will print an average of 30-million characters. When a ribbon change is required, it is a quick, clean task.

A self-test routine tests the HP 2608A to verify its operational status. This self-test function may either be initiated with the control panel switch or performed under program control. If a self-test failure occurs, the printer has been designed to provide a binary display which will identify the specific portion of the self-test routine which has failed.

Model 2608A

\$9,250

COMPUTATION

Multi-access controller disc drive family

Models 7906, 7920, 7925

- Configuration Flexibility from 20 to 960 M bytes
- High Performance
- Reliability and Serviceability

- Systems Engineered
- World-Wide Service and Support

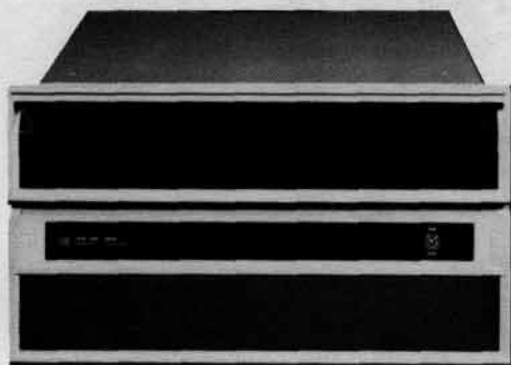

7906MR/SR



The Hewlett-Packard controller-compatible family of disc drives, commonly referred to as the Multi-Access Controller (MAC) Disc Drive Family, represents a truly unique philosophy for mass storage devices. The MAC design emphasizes total system flexibility through the "multi-spindle" concept: Any number from one to eight MAC drives may be accessed through a single controller, resulting in unparalleled freedom of system design. This flexibility allows the user to tailor the most economic storage system to his current needs and budget, while providing the option for future expansion as mass storage requirements increase.

The MAC disc drives utilize fast-access, track follower servo-feedback head positioning to provide exceptional performance over a wide temperature range. Each drive has self-contained fault indicators to aid in isolating and identifying malfunctions that may occur within the system. This feature, together with HP's proven reliability, results in a minimum of expensive down-time. Each master drive (7906M, 7920M, and 7925M) includes enclosure, Controller, Disc Pack or Cartridge, and Cabling.

MAC Drive Family Features

- Configuration flexibility from 20 Mbytes up to 960 Mbytes of HP-formatted useable storage.
- High performance disc drives, with 25 ms average seek time (5 ms, track-to-track).
- Multi-spindle concept for distributing storage among several drives to increase system reliability through backup and redundancy.
- Sophisticated microprocessor-based disc controller, which will support up to eight family drives in any combination.
- Self-contained fault indicators for improved serviceability.
- Systems-engineered for optimum performance with computing systems.
- Designed, manufactured, and individually inspected for superb performance and reliability over a wide environmental range.
- World-wide service and support.



7906M/S



7906 Disc Drive

19.6 Mbytes formatted capacity: The 7906 disc drive uses a cartridge storage with two 9.8 Mbyte discs, one fixed and one removable. This feature makes creation of backup files a simple matter for the single-drive user.

Temperature Compensation Circuitry: Included in the 7906 electronics is a temperature compensation system, allowing less than 60-second start-up time from the time drive power is switched on.

7920 Disc Drive

50 Mbytes Formatted Capacity: Each 7920 drive provides 50 Mbytes of mass storage on interchangeable disc packs. The maximum of eight 7920 drives per controller would yield 400 Mbytes of HP-formatted storage capacity.

Rock-Solid Reliability: Over six thousand 7920 disc drives have been manufactured since its introduction in early 1977. A proven performer, it is a recognized leader with demonstrated reliability considerably better than the industry norm.

7925 Disc Drive

120 Mbytes Storage Capacity: Each 7925 drive provides 120 Mbytes of formatted storage capacity, which means a total of 960 Mbytes (0.960 gigabytes) would be available using eight 7925 drives on a single controller.

Manufacturing Excellence: The top-of-the-line 7925 is backed by manufacturing expertise gained from producing over 20,000 disc drives for minicomputer and desktop calculating systems. Like each MAC family disc drive, the 7925 is subjected to exhaustive testing before it leaves the factory floor. Critical components and printed circuit assemblies are baked in ovens for at least 48 hours—the equivalent of 500 operational hours—to identify and correct early failures. Fully assembled disc drives are then operated continuously for at least two days under the control of special diagnostic software.



7920



7925



Specifications

Seek Time (All Models)
Track-to-Track: 5 ms
Average Random: 25 ms
Full Stroke (typical): 45 ms

Rotation

Speed: 7906/7920 - 3,600 rpm
 7925 - 2,700 rpm

Average Rotational Delay: 7906/7920 - 8.33 ms
 7925 - 11.1 ms

Capacity (Maximum Per Drive)-Formatted

7906: 19,660,800 bytes
7920: 50,073,600 bytes
7925: 120,176,640 bytes

Data Transfer Rate

All Models: 937.5 Kilobytes/second

Power Requirements

AC Voltages: 100V, 120V, 220V, 240V, all +5%, -10%
Frequency: Single Phase, 47.5 to 66 Hz

Power: 7906M - 720W/7.6A max at 120V, 60 Hz
 7906S - 510W/5.4A max at 120V, 60 Hz
 7906MR - 690W/7.3A max at 120V, 60 Hz
 7906SR - 480W/5.2A max at 120V, 60 Hz
 7920M - 782W/7.9A max at 120V, 60 Hz
 7920S - 530W/5.8A max at 120V, 60 Hz
 7925M - 600W/4.6A max at 120V, 60 Hz
 7925S - 400W/4.4A max at 120V, 60 Hz

Environmental

Temperature: 10° to 40°C (50° to 104°F) operating
Relative Humidity: 8% to 80%
Altitude: Sea level to 4 572 m (15,000 ft) operating, -304.8 m (-1,000 ft) to 15 240 m (50,000 ft) non-operating
Tilt: 7920/7925 - Up to ± 10 degrees about either horizontal axis
 7906 - Up to ± 30 degrees about either horizontal axis

Ordering Information

7906M Master Drive and Cabinet \$14,000
7906S Add-on Drive and Cabinet \$10,000
7906MR Master Drive, Rack Mountable \$13,000
7906SR Add-on Drive, Rack Mountable \$ 9,000
7920M Master Drive \$17,000
7920S Add-on Drive \$13,000
7925M Master Drive \$21,000
7925S Add-on Drive \$17,000

Price

\$14,000
 \$10,000
 \$13,000
 \$ 9,000
 \$17,000
 \$13,000
 \$21,000
 \$17,000

COMPUTATION

Certified disc media products

Models 12940A, 13356A, 13394A

- 100% Tested
- Greater Dependability
- Full Warranty



13394A



13356A

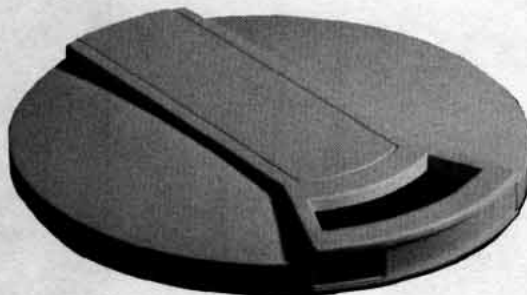

12940A

A certified Hewlett-Packard cartridge or pack is provided with each family disc drive. Each HP disc media product is uniquely selected and individually tested to meet our rigid requirements for total disc drive performance.

Features

- 100 percent testing and certification of each disc pack and cartridge.
- Dynamic mechanical testing dramatically increases reliability through detection of surface imperfections or imbalances.
- Exhaustive worst-case data transfer testing to ensure optimum error rate and interchangeability.
- Maximum security through greater media dependability.
- Full warranty protection for HP disc drives when using HP media products.

Disc Inspection and Testing

Although the technology for producing magnetically coated discs is well established, a significant quantity prove to be unacceptable to meet HP's stringent reliability requirements. Critical dimensions, cleanliness, and oxide coating irregularities are closely monitored resulting in out-of-tolerance components being rejected.

Dynamic Mechanical Testing

Each disc is tested dynamically to insure head flyability over its entire surface. This means each disc surface must be both flat and smooth within very small tolerances, since the head typically "flies" at less than 50 microinches above the surface.

Iterative Data Transfer Testing

If a disc meets the mechanical requirements, it is tested for data transfer capability under "worst case" conditions. Each disc is subjected to the worst written data patterns and track following information it could ever expect to see under normal operating conditions. Data is then read back with the head offset to simulate mis-aligned heads. All data is then shifted one bit and again read with offset. This is done iteratively, after which defective tracks are flagged and cataloged.

Specifications

Environmental

Temperature

Operating: 4.5° to 55°C (40° to 130°F)

Non-Operating: -40° to 75°C (-40° to 167°F)

Relative Humidity

Operating: 8% to 80%

Non-Operating: 8% to 80%

Dimensions

12940A - Disc Cartridge for 7906

Diameter: 38.1 cm (15.0 in.)

Height: 3.6 cm (1.4 in.)

13356A - Disc Pack for 7925 (includes protective cover set)

13394A - Disc Pack for 7920 (includes protective cover set)

Diameter: 37.9 cm (14.9 in.)

Height: 11.2 cm (4.4 in.)

Ordering Information

12940A Disc Cartridge for 7906

13356A Disc Pack for 7925

13394A Disc Pack for 7920

Price

\$180

\$850

\$600

Multiprogrammer: versatile I/O expander & converter

Model 6940B

- Build Your Own Automatic System

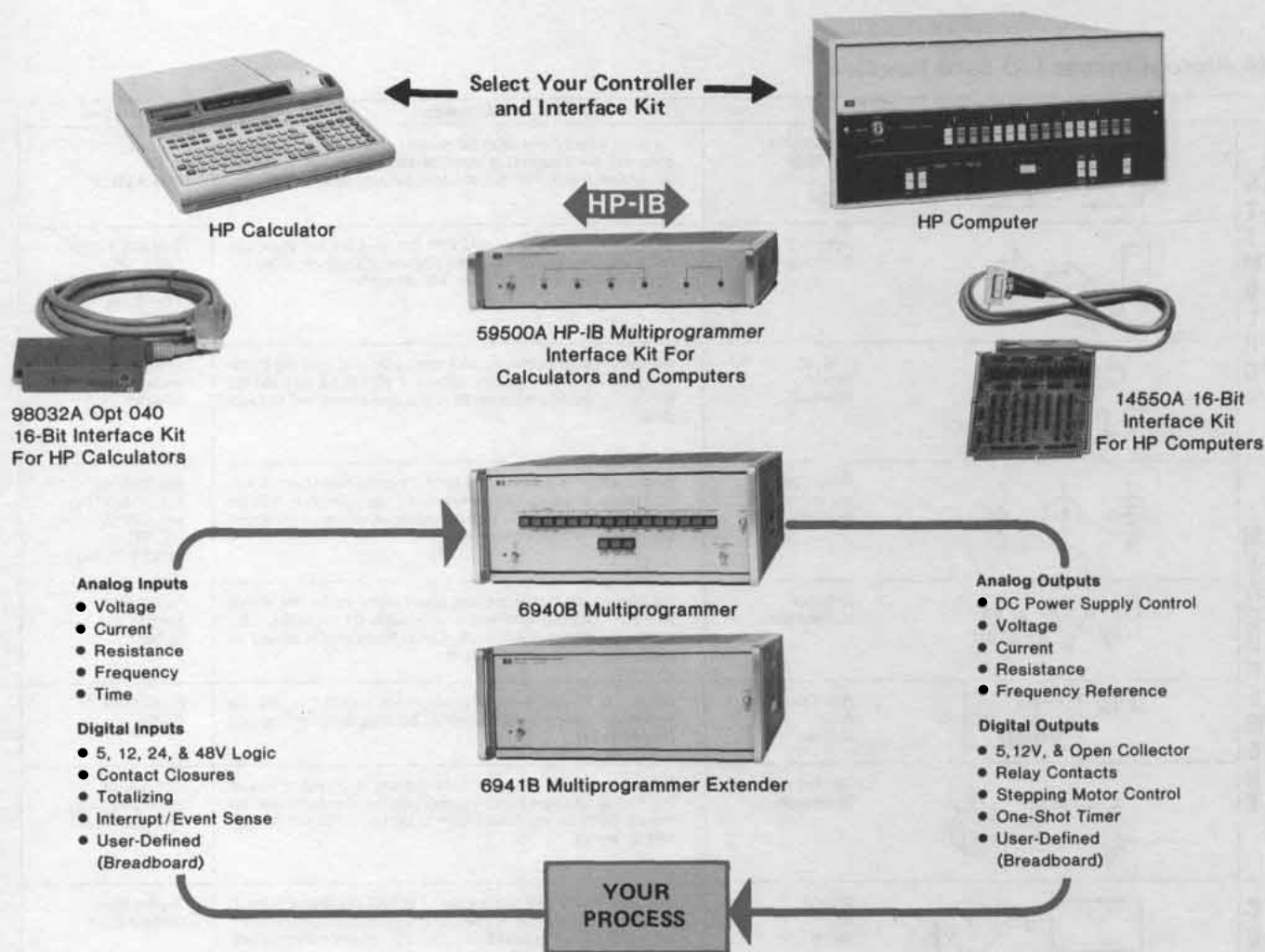

Description

The multiprogrammer is the vital link between a Hewlett-Packard desktop computer or minicomputer and your test or control process. As shown above, multiprogrammer products include interface kits, 6940B and 6941B mainframes, and a family of plug-in cards that provide the I/O capabilities shown above and on the next page.

Each 6940B Multiprogrammer mainframe holds up to fifteen plug-in cards. For additional I/O capability, a chain of up to fifteen 6941B Multiprogrammer Extenders may be cabled to the 6940B Multiprogrammer expanding the maximum capacity of the system to 240 plug-in cards.

Thousands of Multiprogrammers are in use now as part of user-defined-and-assembled systems for production testing and control,

data acquisition, process monitoring, life testing, quality control, and component evaluation. Production engineers find that the Multiprogrammer is a versatile and convenient instrument for industrial measurement and control applications.

Additional information for all multiprogrammer products is available in a free, 48-page brochure. Included are detailed specifications as well as applications, programming, and interfacing information. Ask your HP Sales Engineer for publication number 5952-3982, or use the card at rear of catalog.



COMPUTATION







Multiprogrammer: versatile I/O expander & converter

Model 6940B (cont.)

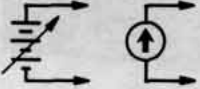
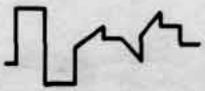
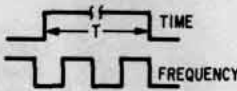
- Stimulus
- Measurement

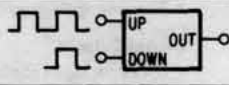
- Control
- Data acquisition

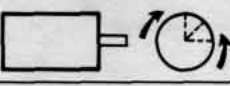
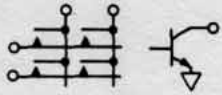
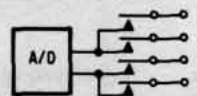
Multiprogrammer I/O card function

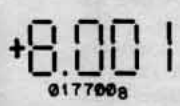
	Functions	Applications	Cards Used
STIMULUS	 <p>Programmable DC Voltage and Current</p>	The output voltage (up to 100V) and current (up to 1000A) of thirty-seven different HP power supplies can be programmed to provide bias in automatic test systems or control of electromechanical process equipment.	Resistance Output 69501A-69513A
	 <p>Digital-to-Analog Conversion</p>	Twelve bit voltage and current DAC's for strip chart, x-y, and analog tape recordings as well as control of analog programmable instruments and process control devices with 0-5 volt or 4-20 mA inputs.	Quad DAC, 69322A; Voltage DAC 69321B; Current DAC, 69370A; Regulator 69351B
	 <p>Time and Frequency Reference</p>	One-shot timing pulses, programmable from 1 μ sec to 40 days, and crystal-controlled pulse trains in fixed frequencies of 1, 10, 100, 1 K, 10 K, and 100 kHz serve as time base references for control, measurement, and data acquisition.	Timer, 69600B; Frequency Ref. 69601B.
MEASUREMENT	 <p>Voltage, Current and Resistance Measurements</p>	Measure voltages in the presence of 100 V of common mode noise. Connecting a resistor across the input permits current measurements for 4-20 mA current loops used in process control. Combine voltage monitor and current DAC cards for resistance measurements.	High Speed A/D, 69422A; Low Level A/D, 69423A; Current DAC, 69370A; Regulator 69351B
	 <p>Frequency Measurements</p>	The pulse counter card accumulates counts over a precise time interval when a programmable timer card is connected to the enable line of the counter. The program divides the count by the time interval to measure the frequencies from 200 kHz to 0.001 Hz.	Pulse Counter, 69435A, Timer, 69600B.
	 <p>Pulse Counting Preset Up/Down</p>	Counter may be preset to any value within count range of 0 to 4095. The program can examine the counter without disturbing the counting process (read-on-the-fly).	Pulse Counter, 69435A.
	 <p>Time Interval Measurement</p>	Elapsed time between two events can be measured in the range of 10 μ sec to 1 hour by counting a known frequency over the unknown interval. The program divides the accumulated count by the known frequency to determine the interval.	Pulse Counter, 69435A; Frequency Reference, 69601B.
CONTROL	 <p>Stepping Motor Control</p>	One output word to card produces from 1 to 2047 square-wave pulses at either of two outputs (CW or CCW) to control motor translators. Output pulses are also used for pulse train update of supervisory control stations.	Stepping Motor Control, 69335A.
	 <p>Digital Output and Switching</p>	Twelve bits of data in TTL, open collector, or SPST relay-contact form provide digital control of instruments, indicators, and solid-state AC relays.	TTL, 69331A; Open Collector, 69332A; Relay Out, 69330A; Relay Out/Readback, 69434A.
ACQUISITION	 <p>Scanning and Input Multiplexing</p>	Simple single-ended switches or multi-wire scanner matrices are formed by interconnecting relays on a Relay Output or a Relay Output/Readback card. The relay output card scanners act as input multiplexers for Voltage Monitor, Pulse Counter, and Digital Input Cards.	Relay Output, 69330A; Relay Output/Readback, 69433A.
	 <p>Event Sensing</p>	It is often necessary for a system to respond quickly to alarm conditions, operator intervention or other requests for immediate service. This service request is made via a program interrupt generated by either an event sense or a process interrupt card.	Event Sense, 69434A; Process Interrupt, 69436A.
	 <p>Digital Input</p>	Digital input cards accept 12 bits of data from digital measuring instruments, push buttons, switches, relays, and other digital devices in the form of logic levels or contact closures. Digital data sources with more than 12 bits of data use several digital input cards.	Digital Input, 69431A; Isolated Digital Input, 69430A.

New Multiprogrammer plug-in cards are being developed. Ask your HP Field Sales Engineer for the latest technical data describing all Multiprogrammer products.

Desktop Computer-Based Multiprogrammers

Unless your automatic system requires the high-speed execution of a computer, there's a good chance you can take advantage of the economy, flexibility, and ease-of-programming offered by a desktop computer-based Multiprogrammer. The heart of the Multiprogrammer approach to real-time system design is the HP Desktop Computing Controller.

9825A HPL language computing controller: a powerful programmable calculator that features a high-level language particularly suited to test and control applications. Designed principally for engineering, research, and statistics use, it has many features previously found only in minicomputers.

A basic system includes an HP desktop computing controller, a 6940B Multiprogrammer, from one to fifteen plug-in I/O cards, and the interfacing accessories of your choice. Model 6941B Extender mainframes and additional I/O cards can be used to further expand the system.

HP-IB Interfacing Accessories

For HP-IB systems, a 59500A Multiprogrammer Interface unit is required, together with the HP-IB interface card associated with your computing controller (98034A card for 9825A controllers).

HP-IB Multiprogrammer Cabling

Computing controller-to-59500A Interface Unit: One HP-IB cable No. 10631 supplied with the controller interface card. Additional 10631 cables can be ordered separately in 1, 2, or 4 metre length.

59500A-to-6940B: Standard 18-inch (0.46 m) chaining cable No. 14541A, supplied with 59500A.

6940B-to-6941B: Standard 18-inch (0.46 m) chaining cable No. 14541A, purchased separately. Lengths up to 100 ft (30 m) are available on special order.

Plug-in card-to-users device: 14555A connector provided with most Multiprogrammer plug-in cards for user to fabricate own cable.

16-Bit Duplex Interface

The multiprogrammer can also be interfaced directly to a 9825A computing controller using the 98032A Option 040 controller interface card. The 98032A Option 040 includes the basic interface card, a boot, and a cable that comes ready to connect to the 6940B mainframe.

Documentation Package

A complete documentation package is supplied with each purchase, including a User's Guide for the selected desktop computer, a Multiprogrammer User's Guide, and Operating and Service Manuals for the various Multiprogrammer mainframes, plug-in cards, and accessories.

Minicomputer-Based Multiprogrammers

Hewlett-Packard computers are interfaced to most Multiprogrammers with HP Interface Kit 14550A. The kit contains the HP computer-to-6940B cable, verification and driver software, and plug-in cards and cable.

14550A Interface Kit for HP Minicomputers

This kit provides all the equipment necessary to install, verify, and operate a Multiprogrammer with HP 1000 series computers. This kit includes:

1. A specially modified 12566B card. 16-bit duplex register card that plugs into the HP computer. Hardware manuals, a test connector

and a software verification routine for the microcircuit card are provided in the kit.

2. 14540A Multiprogrammer-to-12556B 12-ft (3 M) cable.
3. A 69431A Digital Input Card with Option 095, 69331A Digital Output Card, 14550-60001 Slot Verification Cable, and 14910A Complete Diagnostic tape. This equipment is used to completely test the digital paths between the computer and the Microcircuit card, 14540A cable, Multiprogrammer Mainframe, 14541A Chaining Cables, 6491B Multiprogrammer Extenders and each Multiprogrammer plug-in I/O slot. The diagnostic also tests the front panel lamps and proximity switches by interfacing with the operator.
4. Binary object tapes and software operating manuals for BCS, (DOS/DOS-M), and RTE Multiprogrammer Drivers. Also included is a tape and manual for the BCS Multiprogrammer Library that allows the Multiprogrammer BCS Driver to be used with FORTRAN or ALGOL.
5. Instructions that allow you to completely test the Interface Kit and Mainframes. On-site installation by HP is not included with the kit. The kit is designed to help you become familiar with the Multiprogrammer as you install it and verify its operation.

14540A Main input cable: This 12-ft (3 m) cable connects the Multiprogrammer to the specially Modified Ground True 12566B Microcircuit Card. This cable is included in the 14550A Interface Kit.

Common Accessories

The following multiprogrammer accessories are common to all types of interfaces:

14541A chaining cable: This cable connects 6940B to 6941B Mainframes and 6941B to other 6941Bs. Cable is 18" long (.46 m).

14533B pocket programmer: The pocket programmer is used to check digital input/output connector J1 of the 6940B. Changes in the switch positions on the pocket programmer are visible on the front panel of the 6940B, and the outputs of the 6940B proximity switches are available at test points on the pocket programmer.

14534A pocket programmer cable: The pocket programmer plugs directly into the 6940B. The 3-foot extender cable allows you to operate the pocket programmer in front of the 6940B.

14551A multiprogrammer service kit: This kit allows rapid troubleshooting of a Multiprogrammer system to the plug-in board level to minimize system downtime. The basic kit includes: spare components for 6940B/6941B mainframes and plug-in I/O cards, spare plug-in boards for mainframes, software and hardware necessary to run diagnostic tests on a desktop computer or minicomputer-based Multiprogrammer, an extender card, and complete service documentation. If desired, the kit can be expanded in accordance with specific needs of the user.

Condensed Specifications

6940B/6941B Common Specifications

Input/output card positions: Maximum of 15 plug-in input or output cards per mainframe. Hinged front panel provides access.

Mainframe data connectors: Two 50-contact, ribbon connectors.

Data transfer rate: up to 20,000 words/second.

Maximum data resolution: 12 bits per plug-in card.

Accessories furnished: Data Input Plug, PC Board Extender Card.

Cooling: Natural convection.

Temperature: 0°C to 55°C operating, -40°C to +75°C storage.

Size: 172.2 H x 425.4 W x 539.8 mm D (6.78" x 16.75" x 21.25").

Power: 100/120/220/240 V ac selectable, 48-440 Hz, 230 watts.

COMPUTATION

Multiprogrammer: versatile I/O expander & converter

Model 6940B (cont).

6940B Specifications

Front panel controls: Power ON/OFF switch and indicator lamp, REMOTE/LOCAL switch for selecting computer or manual control, 19 proximity switches for manual data entry and control.

Weight: net, 15.9 kg (35 lb). Shipping, 19.5 kg (43 lb).

6941B Specifications

Front panel controls: Power ON/OFF switch and indicator lamp.

Weight: net, 15.2 kg (33.5 lb). Shipping, 18.3 kg (40.3 lb).

Programmable Plug-In Cards**Output Cards**

69500A-69506A Resistance Output Cards: Provides a single 12-bit resistance programming channel. The programming coefficients of these models are compatible with HP programmable power supplies equipped with Option 040. Model 69500A is supplied without resistors allowing the user to install his own.

69510A-69513A Resistance Output Cards: Provides two 6-bit resistance programming channels; these models program the current limit of HP power supplies equipped with Option 040.

69321B Voltage D/A Converter Card: Provides a high speed, bipolar output voltage. Output range is from -10.240 to +10.235 V, at 0-5 mA. Conversion speed is 30 μ sec maximum to within 5 mV of final value. (69351B voltage regulator also required.)

69322A Quad D/A Voltage Converter Card: Provides four high speed, bipolar output voltages. Output ranges from -10.24 to +10.22 volts, at 0-5 mA. Updates of any output can typically occur every 100 μ sec. Output resolution is 20 mV. (69351B voltage regulator also required.)

69330A Relay Output Card: Provides 12 separate form A (SPST, normally open) mercury-wetted contact outputs that reflect the status of 12 programmed data bits. Includes gate/flag circuits for exchange of control signals with user's device.

69433A Relay Output/Readback Card: Provides 12 separate form A (SPST, normally open) mercury-wetted contact outputs. Also supplies 12 input data lines that can be read by the controller and which indicate the relay coil voltage status.

69331A Digital Output Card: Provides programmed microcircuit logic level outputs on 12 separate output lines. Card includes gate/flag circuits for exchange of control signals with user's device.

69332A Open Collector Output Card: Provides 12 open-collector driver outputs. IC buffers on the card act as switches for voltages up to 30 volts dc and currents up to 40 mA.

69335A Stepping Motor Control Card: Used to drive stepper motor and pulse-update type controls. Can be programmed to generate from 1 to 2047 pulse outputs to either of two terminals.

69600B Programmable Timer Card: Can be programmed to generate crystal controlled, one-shot timing pulses. Time increment is variable from 1 μ s to 40 days.

69380A Breadboard Output Card: This card allows user to design and build a custom analog of digital output card. Card includes basic address, storage and control signal buffer circuits.

69601B Frequency Reference Card: Provides six fixed square wave outputs derived from a MHz crystal at frequencies from 1 Hz to 100 kHz.

\$1500

\$1200

\$250-\$300

\$300

\$300

\$600

\$250

\$250

\$210

\$130

\$200

\$300

\$125

\$250

Input Cards

69422A High Speed A/D Converter Card: Using a fully isolated, guarded input circuit, this card monitors bipolar dc voltages on any of the following switch selectable ranges: ± 100 mV, ± 1 V, ± 10 V, ± 100 V. The 12 bit, two's complement digital word returned to the controller indicates the magnitude and sign of the measured voltage. Up to 33,000 conversions per second can be performed as commanded by the program or an external trigger input.

69423A Low Level A/D Converter Card: This card measures up to 6 inputs from thermocouples, pressure transmitters or other low-level transducers. The dual-slope integrating A/D and 6-channel reed relay scanner take up to 10 readings per second on either of two programmable ranges, ± 20 mv with 10 uv resolution or 0-20mv with 5 uv resolution. A thermistor built into the isothermal block on the 69423A allows the controller to compensate thermocouple readings.

69431A Digital Input Card: This card monitors 12 bits of TTL, DTL, or contact closure data from user's device. Card includes gate/flag circuits for exchange of control signals with user's device. Return bits to controller reflect the status of 12 input bits.

69430A Isolated Digital Input Card: This card monitors 12 bits of input data from user's device. All input lines are isolated from one another and from the Multiprogrammer power supply. Eight options of the card are available to accommodate either ground-true or positive-true logic sense inputs and various input levels.

69434A Event Sense Card: This card compares the magnitude of an external 12-bit input word with a stored reference word and generates a service request for any of four conditions, depending on the placement of a jumper on the card. The four possible conditions are: In = Ref, In \neq Ref, In > Ref, In < Ref. The reference word is loaded from the controller. Both the input and reference words can be read back to the controller.

69435A Pulse Counter Card: This card counts pulses, up or down, in the range of 0 to 4095. A carry or borrow pulse is generated as the count goes above 4095 or below 0. These pulses allow multiple counter cards to be cascaded for greater counting capability or they can serve as alarm signals. The card can also be used as a pre-set counter.

69436A Process Interrupt Card: This card provides TTL and open collector compatible edge detectors; one positive and one negative for each of 12 storage latches. Logic transitions lasting 100 ns or longer are detected, stored, and used to generate a service request to the controller.

69480A Breadboard Input Card: Allows user to design and build a custom analog or digital input card. Card includes basic address and control circuits.

59500A Interface Unit Specifications

\$700

Converts the serial ASCII alphanumerics of the HP-IB to the 16-bit parallel format required by the 6940B/6941B Multiprogrammer. The 59500A design is optimized for ease of programming the 6940B/6941B.

Front panel controls: Power ON/OFF switch and indicator. LED's indicate mode and gate/flag status between HP-IB and the Multiprogrammer for system check-out and maintenance.

Cooling: Natural convection.

Temperature: 0°C to 55°C operating; -40°C to +75°C storage.

Size: 82.6 H x 425.4 W x 463.6 mm D (3.25" x 16.75" x 18.25").

Weight: 5.4 kg (12 lb).

Power: 100/120/220/240 V ac (selectable) 48-440 Hz, 15 W.

\$600

\$800

\$210

\$250

\$400

\$250

\$400

\$125



Faxitron® cabinet systems

Radiography, the art and science of making pictures with X-rays, has an important place in modern technology. It is one of the major nondestructive test methods available to industry, provides an indispensable tool in scientific investigations and is a valuable aid to law enforcement agencies. Hewlett-Packard makes a major contribution to these activities with X-ray equipment that offers a "better way" through advanced technology and design. This equipment makes radiographs easier and safer to take, provides portability for field use or offers stop-motion capability for the study of dynamic events.

Industrial inspection

Industrial quality control and inspection procedures, especially in the field of electronics, benefit from nondestructive testing by radiography. The advantages of a testing method which does not harm the test objects are obvious. Radiography, therefore, offers benefits in design engineering, incoming inspection, production quality control, product reliability and failure analysis. X-rays are used to detect misregistration or plate-thru problems in multi-layer P.C. boards; porosity, poor substrate bonding and wiring or lead location in transistors and integrated circuits; voids and other encapsulation problems in potted components; and solder balls or other defects in sealed relays.

Die casting is another industry that benefits from the nondestructive aspects and ability to "see inside" provided by radiography. Porosity, gas voids, tramp metal inclusion and other common defects can be easily detected and the cause determined. Expensive machining time can be avoided for castings found to be defective through X-ray inspection. The integrity of welds, alignment of

connectors, inspection for proper assembly and mechanical defects are further examples of tests which radiography performs for industry. The benefits of X-ray testing are reduced production costs, better quality assurance and product safety. The results are increased profits.

Scientific applications

Oceanography, geology, marine biology, paleontology, pathology, botany, forestry and agricultural research are a few examples of

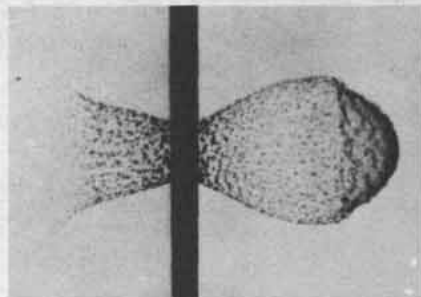

scientific disciplines that use X-rays. Applications range from the study of the interior anatomy of fossils to determining the viability of seeds.

Law enforcement applications

Radiography aids many law enforcement groups. Crime labs use X-rays to visualize certain types of latent fingerprints, for powder and lead splatter patterns in ballistics and for questioned-document examination. Medical examiners use X-rays for cause-of-death investigations and identification of remains. X-rays aid in examining parcels or mail to identify dangerous devices and to verify bomb circuitry.

These are among the many applications served by HP Faxitron® Cabinet X-ray Systems. They offer a unique combination of high quality radiographic capability, simplicity of operation and convenience of use which is expanding the capabilities of scientific and industrial concerns throughout the world.

Portable X-ray systems

Portable systems of lightweight and small size are made possible by the field emission type tube. Hewlett-Packard markets several portable systems including the Model 43501, a self-contained battery-operated portable system specifically designed for the unique field use requirements of explosive ordnance demolition squads. Integral power capability and small, remotely operated X-ray tubes make possible X-ray examination of suspected bombs.

X-ray inspection of otherwise inaccessible components in complex structures is also facilitated by the 43501.

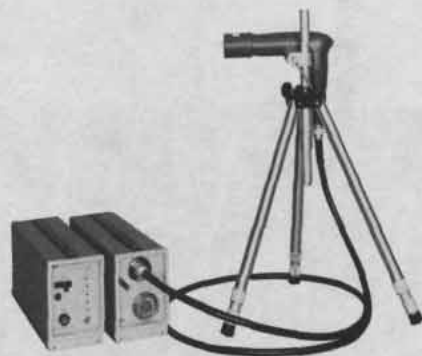

Model 43501B Portable X-ray

Pulsed radiation sources

Hewlett-Packard has pioneered in the design and manufacture of cold-cathode, flash X-ray tubes and systems. Cold-cathode tubes, based on the field emission principle, are combined with a pulse generator and appropriate control units. The systems produce nanosecond bursts of X-rays, electrons or super radiant light (SRL). Output voltage and energy are provided by Marx-surge type energy storage modules charged in parallel and discharged in series through a pressurized spark gap switch mechanism.

A number of channels can often be operated from common controls enabling a series of stop motion radiographs at desired intervals.

Other capabilities include slow and fast cine-systems providing a series of motion picture-like radiographs at rates from 1 to 1000 frames/sec. These systems are custom designed from standard units.

HP pulse radiation systems yield a reproducible 5-10,000 ampere electron beam in air at energies of 400-2300 keV and pulse widths of 3-40 nanoseconds. Current densities of 12,500 amperes per cm² and dose rates up to 10¹⁵ Rads/second can be obtained.

Their reproducibility, high dose-rate output, ease of operation and instrumentation and small space requirement make them ideal for radiation chemistry or pulsed radiolysis studies as well as radiation effects studies, radiation biology and laser pumping.

For specific information and consultation regarding HP X-ray systems, contact Hewlett-Packard, 1700 S. Baker Street, McMinnville, Oregon 97128, telephone: (503) 472-5101.

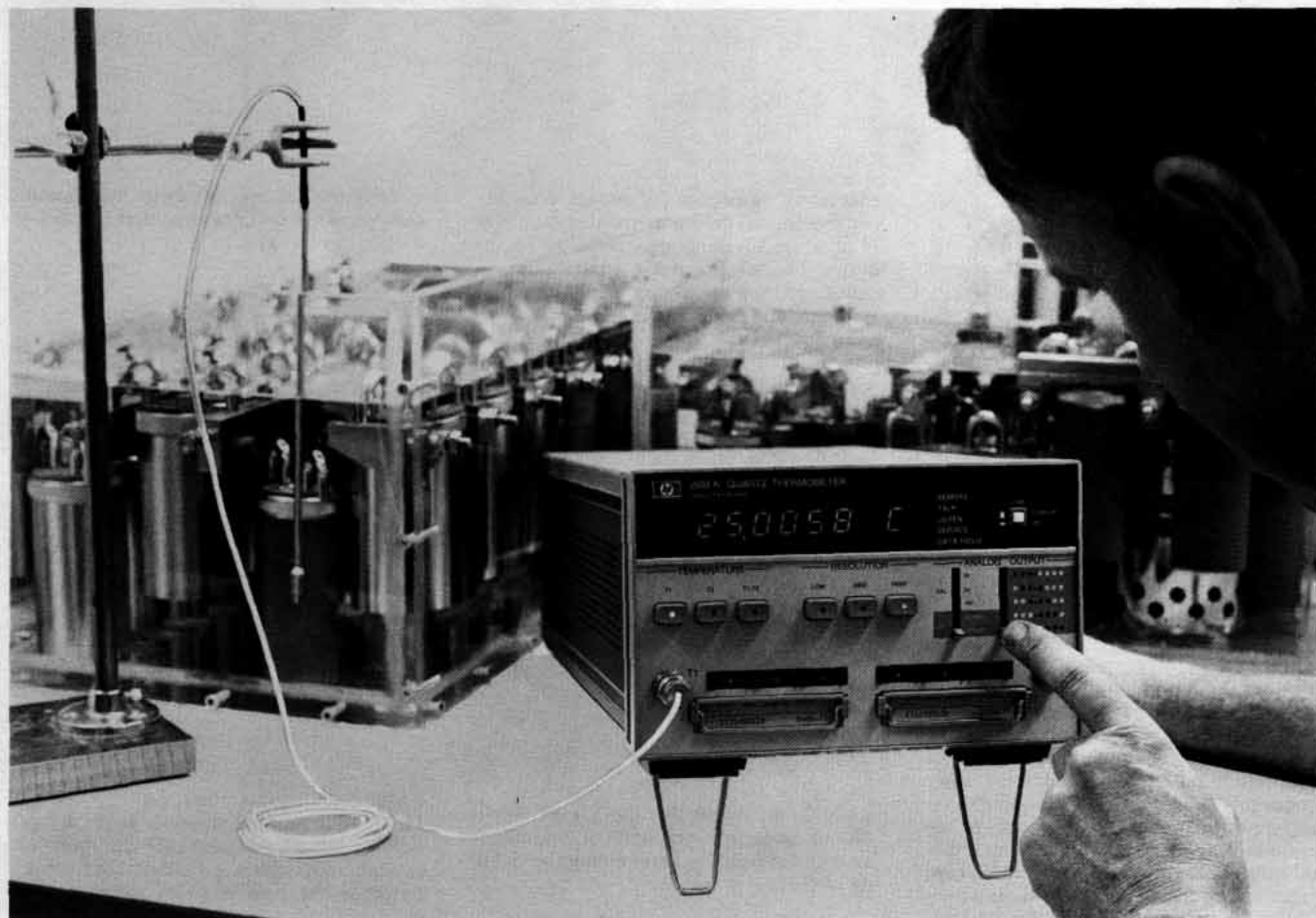

Laser Measurement

The Hewlett-Packard 5526A Laser Calibration System utilizes a precisely-known wavelength of light to provide a portable, easily used dimensional measurement tool for such parameters as length, angle, straightness, squareness and flatness.

The 5526A Laser Calibration System is used in a wide variety of applications where very accurate physical measurements are required, such as characterizing the positioning accuracy and geometry of machine tools and measuring machines.

A wide variety of output devices are available to record the measurement data including digital printers and X-Y recorders. The Option X55 Laser/Calculator System allows the measurement data to be transferred directly from the Laser Calibration System to the 9815A Programmable Calculator and immediately processed by prewritten metrology programs. The reduced data is then presented in either printed format or plotted to provide report quality graphs of the measurements.

Quartz Crystal Technology

Hewlett-Packard laboratories have developed quartz crystals which respond to temperature or pressure with amazing linearity,

stability, accuracy, and sensitivity. Quartz crystals resonate in electronic oscillator circuitry at a very precise frequency. Hewlett-Packard has discovered a way to produce quartz crystals whose resonate frequencies vary extremely linearly with temperature or pressure. For example, the resonate frequency of a 2804A temperature sensing crystal varies 1000 Hz (nominal) per °C. These resonate frequencies are conditioned by electronic circuitry to produce exceptionally high resolution temperature or pressure measurements.

Digital Thermometer

HP's 2804A Quartz Thermometer provides extremely precise, reliable measurements with standard resolution of 0.0001°C over the range -80 to +250°C. The excellent sensing characteristics of the quartz thermometer are enhanced by the advantages of *direct digital readout* (no bridge balancing, or reference to resistance- or voltage-temperature tables or curves), immunity to noise and cable resistance effects, and no requirement for external equipment such as reference junction. Temperature can be measured up to 4500 feet from the 2804A with optional amplifiers.

Nearly all intermediate range digital thermometers use resistance, thermistor, or thermocouple sensors. Because of its good sensing characteristics, Hewlett-Packard uses a platinum resistance sensor in its general purpose 2802A thermometer. Platinum resistance sensors have very good accuracy, stability, linearity and reproducibility. The 2802A features two ranges: -200°C to +600°C with 0.1°C resolution and -100°C to +200°C with 0.01°C resolution. The display unit may be used with other HP snap-in modules to make a voltmeter, a multimeter as well as other instruments.

Quartz Pressure Gauge

The Hewlett Packard 2811B Quartz Pressure Gauge can detect pressure changes as small as 0.01 psi in 10,000 psia. Precision pressure measuring capability and rugged construction make the HP 2811B Quartz Pressure Gauge (Probe and Signal Processor) ideal for applications requiring surface readout such as oil well logging, oceanographic research, and studies of subterranean hydrodynamics. The 2811B recording options can be connected directly to the pressure gauge output for direct readout, strip chart recording or digital printout of pressure data.

Laser system for dimensional measurements Model 5526A

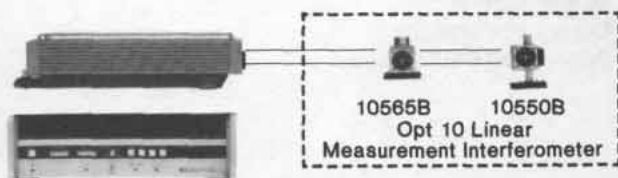

Laser transducer for "build-in" applications

Model 5501A



Configuration

The 5526A Laser Measurement System is a major advance in economical dimensional metrology. A choice of options allows the measurement of length, angle, flatness, straightness, squareness, and parallelism. In addition, output options are available to reduce the data to printed or plotted format.

General Capabilities

The system is a highly accurate displacement measuring tool with a resolution of one millionth of an inch (0.01 μm) for linear measurements and 0.1 arc-second for angular measurements. Fully automatic tuning, instant warm-up and remote interferometric measurement techniques assure drift-free accuracy from the moment of switch-on.

Brief specification

5526A Laser/display

Laser: Helium-Neon type. Fully automatic tuning. Instant warmup. Accuracy (for all linear displacement measurement): ± 0.5 parts per million ± 1 count (Metric ± 0.5 parts per million ± 2 counts.)

Resolution: normal and smooth modes.

Normal 0.000,01 in. Metric: 0.1 μm . Angular: 1 arc-sec $\times 10$: 0.000,001 in. Metric 0.01 μm . Angular: 0.1 arc-sec.

Maximum allowable signal loss: 95% (-13 dB).

Maximum measuring velocity: 720 in/min (182 m/min.)

Atmospheric and material compensation: manual input from tables. 5510A Automatic compensator optional.

Opt 10 linear interferometer

Accuracy: as for 5526A Laser Display.

Maximum measuring range: up to 200 feet (60 m) depending on conditions.

Opt 20 linear + angular/flatness interferometer

Linear specifications are as for Opt 10.

Accuracy: ± 0.1 arc-second (± 1 count in last digit) up to ± 100 arc-seconds. ± 1 arc-seconds (± 1 count in last digit) up to ± 1000 arc-seconds. ± 4 arc-seconds per degree (± 1 count in last digit) up to ± 10 degrees using correction table.

Opt 30 short range straightness interferometer

Accuracy

Inch: ± 5 microinches/foot ± 1 count in last digit.

Metric: ± 0.4 micrometer/meter ± 2 counts in last digit.

Calibration: $\pm 3\%$ of reading.

Resolution: as for 5526A Laser Display.

Lateral range: ± 0.1 inch (+2.5 mm).

Axial range: 10 feet (3 m).

5510A automatic compensator

5526A/5510A System accuracy (worse case):

- For air temperature within range 68-85°F (20-30°C) 1.3 ppm ± 1 count (metric 1.3 ppm ± 2 counts.)
- For air temperature within range 55-105°F (13-40°C) 1.5 ppm \pm count (metric 1.3 ppm ± 2 counts.)

5526A Options

Option	Price
010: Linear Interferometer	\$4520
020: Linear + Angular/Flatness Interferometer	\$7140
030: Straightness Interferometer	\$4375
908: Rack Flange Kit	\$10
X55: Laser Measurement/Calculator System	\$35,905

Ordering Information

5510A Automatic Compensator	\$5150
5526A Laser/Display	\$11,795

Systems description

The 5501A Laser Transducer is the basis of a linear displacement measurement system which brings the many advantages of interfero-

metry to builders and users of accurate positioning equipment at a cost comparable with conventional devices. Using a single laser source, up to 6 axes of motion may be monitored simultaneously. This feature plus numerous other design innovations, significantly lowers the cost of laser interferometer feedback. A range of output devices offers the choice of feedback control or digital display. Although the Laser Transducer is designed for original equipment manufacturers (OEM), simple installation techniques make it attractive for retrofit by end-users as well.

Specifications

Resolution: 0.16 μm (6 microinches) or 0.08 μm (3 microinches) using Plane Mirror Interferometer. Resolution Extension can increase measurement resolution up to a factor of 10.

Accuracy: ± 0.5 parts per million.

Range: Up to 60 meters (200 feet) depending upon conditions (sum of axes for multi-axis configurations).

Number of axes: Up to six, depending on system configuration and environmental conditions. Maximum allowable measurement velocity: 18.3 meters/min (720 inches/min.)

Optional accessories

A wide variety of Interferometers, Retroreflectors, Beam Splitters, and Beam Benders allow application of the 5501A Laser Transducer to the most complex measurement problems.

Linear interferometer: Most economical and widely used for linear displacement measurements.

Plane mirror interferometer: Used for precision measurement and control of X-Y stage motion.

Single beam interferometer: Extremely small linear measurement interferometer for applications where size and weight are critical.

Beam splitters and benders: Optional components to divide and direct the laser beam to the individual measurement axes.

Electronic outputs

A range of output formats are available for the 5501A Laser Transducer which provide compatibility with a wide variety of measurement applications.

Computer interface electronics: Interface the 5501A Laser Transducer to virtually any digital processor or controller. This universal binary interface is ideal for position control systems with the most demanding response requirements.

Calculator interface electronics: Based on Hewlett-Packard Programmable Calculators and the Hewlett-Packard Interface Bus provide completely integrated measurement packages. Designed for acquiring, reducing and displaying measurement data, this interface allows simple application of the 5501A Laser Transducer to a wide variety of measurement oriented machines.

English/metric pulse output electronics: Provide a universal interface to almost all numerical controls for machine tools. Designed primarily to facilitate installation of the 5501A Laser Transducer on machine tools by Original Equipment Manufacturers, this interface provides inch or metric value pulses over a wide range of resolutions.

Ordering information

Model	Price
5501A Laser Transducer	\$5585
10780A Receiver	\$450
10700A 33% Beam Splitter	\$350
10702A Linear Interferometer	\$1350
10703A Retroreflector	\$550
10707A Beam Bender	\$250

5501A Options

251: Hewlett-Packard Interface Bus Electronics	\$5760
450: English/Metric Pulse Output	\$7130

Other optical and electronic interface options available; please request 5501A data packet.

PHYSICAL & OPTICAL MEASUREMENTS

Quartz pressure gauge

Model 2811B

- 0.01 psi resolution (69 Pa)
- 0.025% Full Scale Accuracy
- Direct Surface Readout

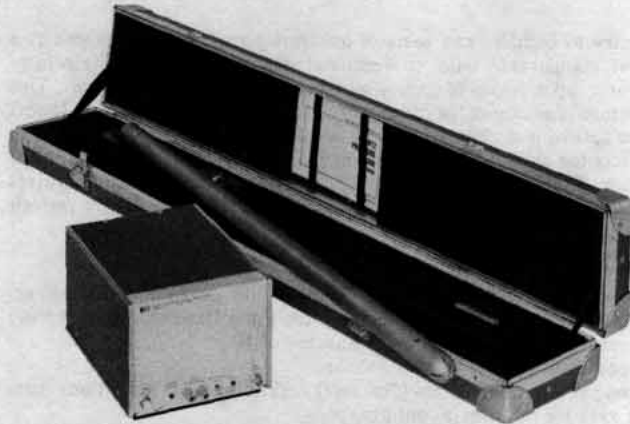

2811B Quartz Pressure Gauge

0.01 psi Resolution at 11,000 psi (69 PA @ 69 MPa)

The HP 2811B Quartz Pressure Gauge measures wellbore pressure with a resolution of 0.01 psi over a dynamic range in excess of 11,000 psi. This capability makes it possible to measure pressure changes that cannot be detected with conventional gauges using bourdon tube transducers.

This ability to detect and record small pressure changes allows sophisticated test techniques to be used economically. For example, since the super-sensitive HP Quartz Pressure Gauge can detect small pressure transients at observation wells, pulse tests can be conducted with extremely short pulse cycle times at the stimulus well. Because the shut-in time is reduced, the permeability and formation thickness between wells can be determined at a substantially lower cost.

With the 2811B recording options, pressure transients can be observed and recorded on the surface while the test is in progress. When the surface readout indicates the test is completed, the gauge can be retrieved immediately. Pressure data can be read directly without intermediate scaling or other calculations.

The 2811B Quartz Pressure Gauge was specifically designed for pressure measurement in oil and gas wells and it is used by many oil companies and well service companies. However, its high resolution pressure measuring capability and rugged construction also make it ideally suited for oceanographic research and subterranean hydrodynamic studies.

Description

The 2811B consists of a 2813B Quartz Pressure Probe and a 2816A Pressure Signal Processor. A frequency signal proportional to pressure is transmitted from the bottom-hole pressure probe to the signal processor on the surface. It travels through a single-conductor, armored electric line. The processor conditions the pressure-related signal to drive a separate electronic frequency counter for direct readout. If a preset counter is used (included in 2811B recording options), wellbore pressure will be displayed in psi. No scaling or intermediate calculations are necessary.

For field use, the 2811B Analog & Digital Recording Option is available. It provides a convenient method of obtaining direct visual

- Simple Operation
- Long Term Stability
- 200-11000 PSIA Range

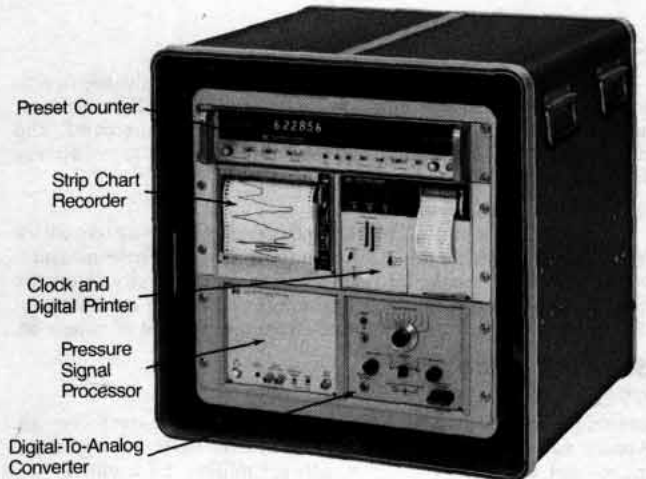

HP 2811 Analog & Digital Recording Option 026/027 Mounted in Field Case

display and a permanent record of pressure data. Pressure transients are recorded on a strip chart recorder and a digital printer. All instruments are shock mounted in a rugged field case to withstand rough handling.

System specifications

Sensitivity: 105 Hz/psi nominal (105 Hz/6.9 kPa) output of signal processor.

Probe operating pressure range: 0-12,000 psi (0-82.7 MPa).

Probe operating temperature range: 32° to 302°F (0 to 150°C).

Signal processor operating temperature range: 32° to 131°F (0° to 55°C).

Calibrated pressure range: 200-11,000 psia (1.4-75.8 MPa).

Resolution: 0.01 psi (69 Pa) when sampling for a 1-second period.

Repeatability: ±0.4 psi (±2.76 kPa) over entire range.

Accuracy (at thermal equilibrium) if operating temperature is known

within 1.8°F (1°C): ±0.5 psi or ±0.025% of reading (±3.45 kPa or ±0.025% of reading).

within 18°F (10°C): ±1 psi or ±0.1% of reading (±6.89 kPa or ±0.1% of reading).

within 36°F (20°C): ±5 psi or ±0.25% of reading (±34.5 kPa or ±0.25% of reading).

Dimensions and weights

2813B Probe: 1 1/16" (36.5 mm) OD by 39 3/8" (1000 mm) long.

Weight: 11 lb (5.0 kg).

2816A Signal Processor: 154 mm H x 197 mm W x 279 mm D (6 1/16" x 7 3/4" x 11")

2811B options

026: Analog & Digital Recording, 60 Hz, and English units

027: Analog & Digital Recording, 50 Hz, and Metric units

Price

add \$11,750

add \$11,750

2811B Quartz Pressure Gauge

\$17,325

Includes HP 2813B Quartz Pressure Probe and carrying case, calibration tables, manual and HP 2816A Pressure Signal Processor. Output of HP 2816A Pressure Signal Processor connects directly to recording options.



- 0.04°C Absolute Accuracy
- 0.0001°C or 0.001°F Resolution
- -80° to +250°C Range
- Display of Absolute or Differential Temperature
- Flexible HP-IB Systems Interface
- Variable Resolution Analog Output
- Easy Ice Point or Triple Point Adjustment

The 2804A Quartz Thermometer allows you to easily measure temperature with exceptionally high accuracy and resolution. Absolute accuracy is 40 millidegrees Celsius over the range of -50°C to 150°C, NBS traceable to IPTS-68. The useable resolution of 0.0001°C allows you to measure temperature changes that could not be detected by other digital thermometers.

The 2804A can be used with one or two temperature sensing probes. The temperature of either probe, or their difference, can be measured and displayed under pushbutton control. Display resolution is selectable from 0.01 to 0.0001°C (0.1 to 0.001°F) by pushbuttons. An internal switch allows you to easily select measurement in the Celsius or Fahrenheit temperature scale.

Temperature is measured and displayed automatically with the microprocessor and electronics provided in the 2804A package. There is no need to balance a bridge, perform calculations using resistance- or voltage-temperature tables or curves, or to use calibration correction tables. The only adjustment necessary to remove effects of thermal history on the sensor is a simple ice point or triple point calibration adjustment using the front panel thumbwheel switches.

How It Works

The 2804A temperature sensor is a quartz crystal whose precise angle of cut gives a stable and repeatable relationship between resonant frequency and temperature. Each quartz sensor is individually calibrated at the factory over the full temperature range. The calibration data for each sensor is processed and stored in a calibration module which is supplied with the probe.

In operation, a microprocessor in the thermometer performs the complex control and calculation operations to accurately measure temperature from the quartz sensor frequency and probe calibration information in the calibration module. The microprocessor also performs self-checks to detect fault conditions. If a problem occurs that would give an improper measurement, an error message is displayed to indicate the source of the problem.

System Oriented Design

The HP-IB option offers you a simple, yet flexible, way to connect the Quartz Thermometer to either an HP computing controller or printer. Temperature data can easily be sent to a calculator or computer for processing and recording. All front panel controls can be operated automatically by commands sent on the bus.

The optional analog output converts any three consecutive digits to a voltage between 0 and +10 volts to drive a chart recorder. Front panel controls allow easy adjustment of pen zero and full scale as well as normal or offset (center-zero) operation. Any three digits can be

selected for conversion allowing you to change the full scale value on the recorder.

2804A Specifications

Performance

Range: -80 to 250°C.

Absolute Accuracy: 2804A with 18110A, 18111A, 18112A or 18117A Quartz Probe —

±0.040°C from -50 to 150°C

±0.075°C from -80 to 250°C

NBS traceable to IPTS-68

Resolution: Three levels can be selected —

Level of selection	Resolution		Nominal time between readings in seconds	
	°C	°F	T1 or T2	T1 - T2
Low	0.01	0.1	0.1	0.2
Medium	0.001	0.01	1	2
High	0.0001	0.001	10	20

General

Display: 7 digit LED with polarity, decimal, and degree C or F annunciator.

Probes: a variety of probes are available for use with the 2804A. Refer to the data sheet for specifications and sheath configurations.

Power Required

100, 120, 220, or 240 VAC, +5%–10%, 48 to 66 Hz, <30 VA.

Options

006: Analog Output \$450
010: HP-IB Interface \$350

Accessories and probes

18107A External Oscillator \$150
18108A Line Amplifier \$150
18109A Diagnostic Kit \$350
18110A Laboratory Probe and cal module, 25 mm (1") \$950
18111A Laboratory Probe and cal module, 230 mm (9.1") \$950
18112A Laboratory Probe and cal module, 460 mm (18.1") \$1000
18115A Heavy Duty Probe and cal module, 30 mm (1.2") \$1050
18116A Heavy Duty Probe and cal module, 100 mm (3.9") \$1050
18117A Heavy Duty Probe and cal module, 180 mm (7.1") \$1050

2804A Quartz Thermometer \$2600

SOLID STATE COMPONENTS

Optoelectronics

Optocouplers, displays



To insure product quality, HP manufactures its own semiconductor materials such as Gallium Arsenide.

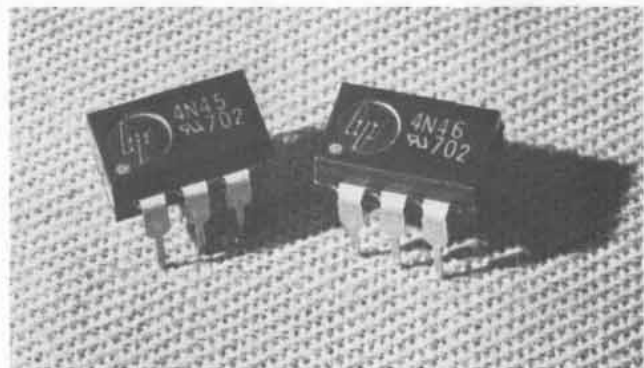

6-PIN Optocoupler.

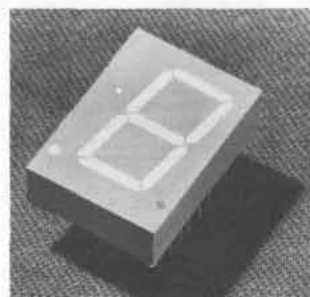

20.32mm (0.8") LED display.

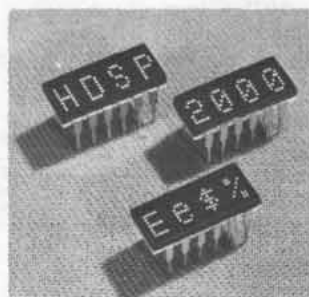

Alphanumeric LED displays.

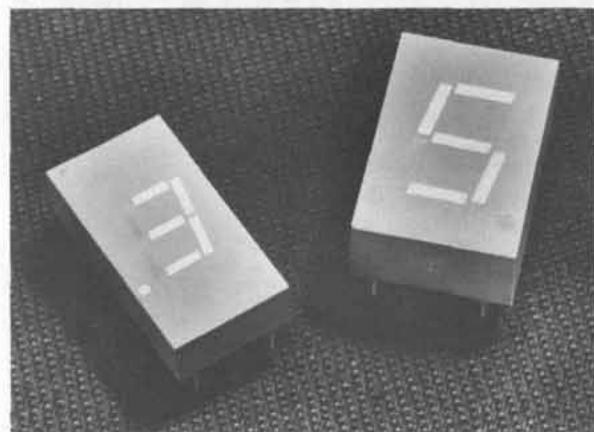

Sunlight viewable red and yellow LED displays.

Low cost components, available from Hewlett-Packard, offer exceptional performance in consumer, industrial, military, and other OEM equipment. With sophisticated semiconductor processing equipment, and the industry's most extensive hybrid thin-film microcircuit manufacturing facilities, Hewlett-Packard applies newly developed technologies to component manufacturing, offering high performance solid state numeric and alphanumeric readouts plus LED lamps, optocouplers, emitters, and PIN photodiodes. In addition, Hewlett-Packard is expanding its technology to include fiber optic capabilities. Fiber optics is just beginning to emerge as a practical medium for data communications.

All Hewlett-Packard components are available in quantity and at economically attractive prices.

Optoelectronics

Hewlett-Packard's Optoelectronic Division offers a complete line of GaAsP and GaP discrete light emitting diodes (LED's), numeric, hexadecimal, and alphanumeric displays. These components provide solid state reliability to any visible readout. As status indicators, arrays, multi-digit or multi-character displays, these compact LED's are electrically compatible with monolithic integrated circuits, with a useful life greater than 100,000 hours.

Optocouplers

Hewlett-Packard's family of optocouplers provides economical, high performance solutions to problems caused by ground loops and induced common mode noise in both analog and digital applications in commercial, industrial, and military products. Hewlett-Packard's original approach toward integrated output detectors provides performance not found in conventional phototransistor output optocouplers. With 3000 VDC isolation, the types of optocouplers available include high speed devices capable of 10 M bits and high gain devices which are specified at 400% CTR at input currents as low as 0.5 mA. In addition, highly linear optocouplers are useful in analog applications, and a new integrated input optically coupled line receiver can be connected directly to twisted pair wires without additional circuitry. Most of these devices are available in dual versions, as well as hermetic DIP packages. For military users, Hewlett-Packard's established hi-rel capability facilitates economical, hi-rel purchases.

Displays

Low cost numeric displays, packaged single or clustered, are available in character heights from 0.11" to 0.8". Low power small character displays have been designed for portable instrumentation and calculator applications. Other seven-segment display units are available in red, yellow, and green colors for use in instrumentation, point-of-sales terminals, and TV indicator applications. High power, sunlight viewable, large character displays are readily adapted to outdoor terminals, gas pumps and agricultural instrumentation. For these displays, Hewlett-Packard has successfully integrated a gray package design with untinted segments. This results in excellent bright ambient contrast enhancement.

Integrated numeric and hexadecimal displays (with on-board IC's), available in plastic and hermetic packages, solve the designer's decoding/driving problem. These displays have been designed for low cost and ease of application in a wide range of environments.

Alphanumeric displays are available in two attractive configurations. Small alphanumeric displays feature four 5 x 7 dot matrix characters and on-board shift registers for data storage. They are contained in 16-pin DIPs which are end-stackable for unlimited possibilities in alphanumeric display formatting.

Hewlett-Packard's 16-segment solid state LED alphanumeric displays are available in four- and eight- character end-stackable modules. They are designed for use in computer peripheral products, automotive instrument panels, calculators, and electronic instruments and systems requiring low power consumption in an easy-to-read display. Magnification of the LED by an integral lens results in a character size of 3.8mm (0.150 in.). Drawing as little as 1.0 to 1.5 mA average current per segment, this enhances character intensity while keeping power use at a minimum.

Solid State Lamps

LED lamps are available in a wide variety of plastic and hermetic packages to satisfy almost any application. Many styles can be mounted on a front panel using clips and all are suitable for P.C. board mounting. Hewlett-Packard military screened hermetic lamps are very popular in applications demanding hi-reliability.

Products with wide or narrow viewing angles, and a range of brightnesses, are available in red, high efficiency red, yellow and green. Package styles include the traditional T-1-3/4, T-1, and TO-18 packages, as well as our own subminiature (stackable on 2.54mm [0.100 in.] centers), rectangular, and panel mountable hermetic packages.

Emitters

Hewlett-Packard offers high radiant intensity emitters near-IR in both floodlight and spotlight configurations. Emitters are ideally suited for use in optical transducers and encoders, smoke-detectors, bar code scanners, paper-tape readers, and fiber optic drivers.

PIN Photodiodes

Hewlett-Packard PIN photodiodes are excellent light detectors with an exceptionally fast response of 1 ns, wide spectral response from near infrared to ultra-violet, and wide range linearity (constant efficiency over 6 decades of amplitude). With dark current as low as 250 pA at 10 V, these detectors are especially well-suited for operation at low light levels. The device construction allows high speed operation at reverse voltages of 5 volts.

Applications include fiber optic receivers, laser scanners, range-finders, and power monitors, radiometers and photometers, process control systems, and medical diagnostic equipment.

High reliability test programs are available.

Fiber Optics

One of the pioneers in fiber optic technology, Hewlett-Packard is currently developing fiber optic systems for digital applications. The systems are ideal for point-to-point, processor-to-processor, and processor-to-peripheral interconnection in noisy environments or at distances/bandwidths difficult to achieve with wire or coax systems.

Elements of the HP System will include modular optical transmitters and receivers, single fiber optical connectors, and compatible optical fiber cables. Transmission capabilities will include distances to 1 kilometer and data rates to 20M bits NRZ (10 MHz clock rate).

Several cable alternatives are planned, including single and dual channel versions. All types will be reinforced and jacketed for industrial use. Compatible field installable connectors will be available for module-to-cable and cable-to-cable interconnections.

Write for more information

Hewlett-Packard Optoelectronic capabilities are described in individual data sheets, application notes, application bulletins, a complete catalog, and an applications manual.

Solid State Displays and Optoelectronics Designer's Catalog:

This contains detailed, up-to-date information on our complete optoelectronic product line. It is divided into five major product sections: solid state lamps, solid state displays, optocouplers, emitters, and PIN photodiodes. A special introductory section on fiber optics is also included, previewing the soon-available capabilities. Included in the 240 pages are product photographs, specifications, operating characteristics and performance graphs.

Optoelectronics Applications Manual: This newly published manual is intended to serve as an engineering guide about the application of and designing with LED products. Each of the generalized LED product types are covered, with additional chapters on contrast enhancement techniques, photometry and radiometry, LED reliability, mechanical consideration of LED devices, photodiodes and LED theory. This book is available from a Hewlett-Packard Distributor or from the McGraw-Hill Book Company.

All literature, including prices, are as near as your phone. Call any Hewlett-Packard Sales Office or contact any of our franchised distributors for product availability and information.

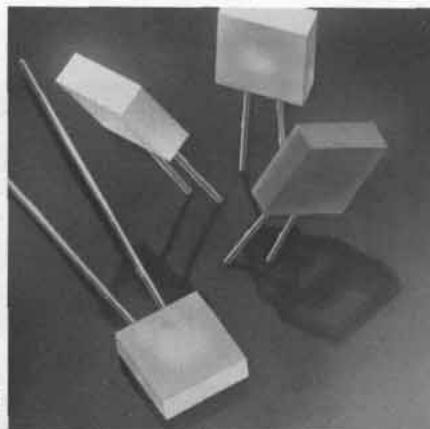

Rectangular solid state lamps.

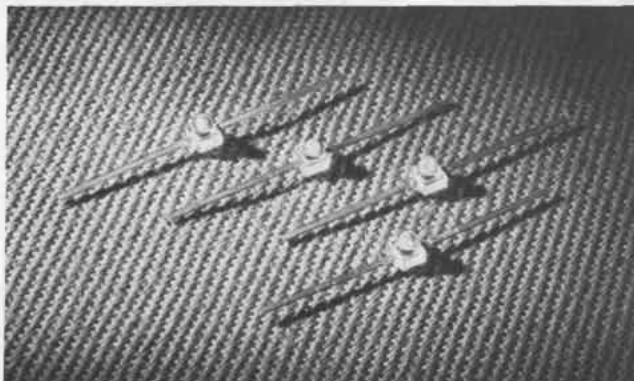

High-intensity subminiature emitters.

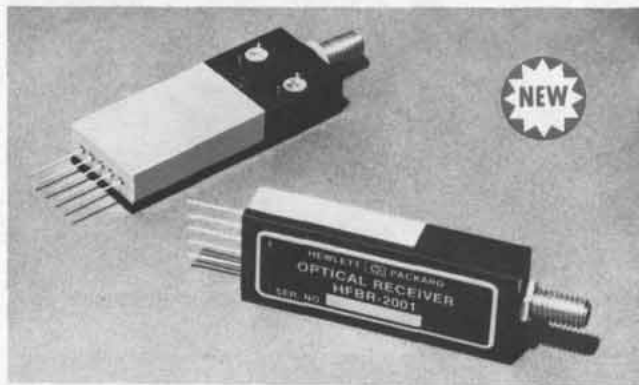

Fiber optic transmitter and receiver.



HPBK-1000.

- Transistors and diodes

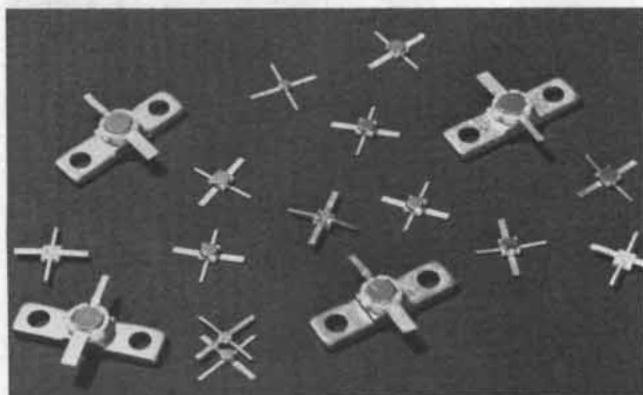

HP low noise, general purpose and linear power microwave transistors are supplied in a wide variety of stripline and microstrip packages.

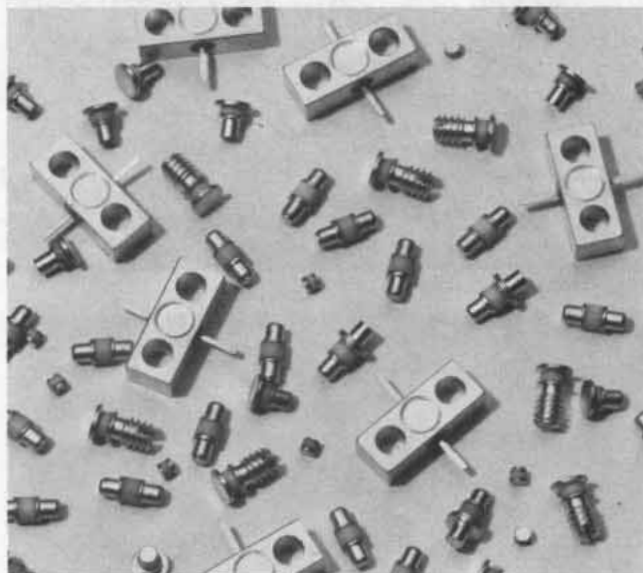

Various stripline and coaxial packages are used for Schottky, PIN, IMPATT and Step Recovery Diodes.

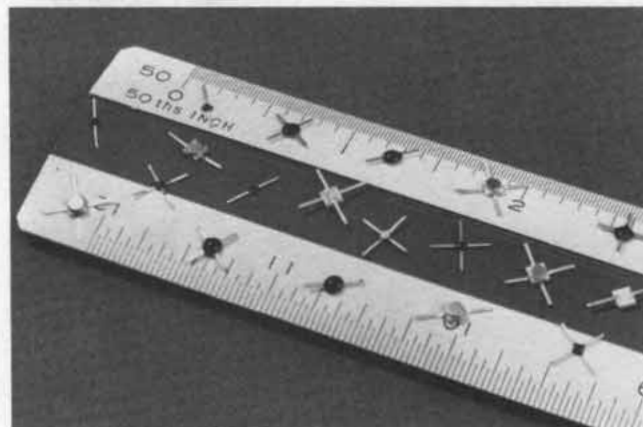

Schottky diode singles and matched quads are available in 3 types of microstrip packages; hermetic, high frequency plastic, and low cost plastic.

Hewlett-Packard components, utilized in consumer, industrial, military and other OEM equipment, assure optimum performance. Advanced machinery and processing techniques are employed to produce highly sophisticated Silicon and Gallium Arsenide devices. The product lines consist of Si bipolar and GaAs field effect transistors; Schottky, PIN, IMPATT and Step Recovery Diodes; and Integrated Products.

Transistors

HP silicon bipolar and GaAs field effect transistors fill most requirements for multistage amplifiers from the VHF region through 12 GHz. Devices are available for the low noise input stage, the high gain intermediate stage and the power output stages.

Silicon Bipolar Transistors: Device-to-device uniformity and superior microwave performance are combined in the new HXTR series of devices which have been individually designed for low noise (HXTR-6000 series), high gain (HXTR-2000 series), or low distortion linear power (HXTR-5000 series). With guaranteed RF performance specifications from 1.5 GHz to 4 GHz, these devices are well suited for high reliability space, military, and industrial applications at frequencies up to 5 GHz. Examples of products in this series of devices include the low noise HXTR-6104, which typically offers 1.4 dB NF with 14 dB associated gain at 1.5 GHz, and the HXTR-5102 linear power transistor, featuring 27.5 dBm P_{1dB} typical linear power with 7 dB associated gain at 4 GHz.

GaAs Field Effect Transistors (GaAs FETS): HP offers rugged devices using this exciting new technology both in package and in chip form. Extensive application support in the form of bulletins and application notes help users design with these new devices. The present family includes the packaged HFET-1102 with 1.7 dB maximum NF and 11 dB minimum associated gain at 4 GHz, and the HFET-1000 chip which at 12 GHz can produce either 20 mW of linear output power or 4.2 dB noise figure with 6 dB gain, depending upon bias conditions. Packaged products including the 2N6680 and the HFET-1102 are available in high reliability versions.

Hewlett-Packard silicon bipolar and GaAs field effect transistors are supplied in chip form, or in various stripline packages. Complete data sheet characterization and excellent processing uniformity make it possible to design your circuit by calculation instead of by trial-and-error.

Diodes

Schottky Barrier Diodes: Schottky diodes combine extremely high rectification efficiency with pico-second switching speeds, low series resistance, and low noise characteristics. This combination makes the Schottky an excellent mixer/detector diode.

At HF, VHF, and UHF frequencies, HP delivers glass-packaged devices in million piece quantities at economical prices. These same diodes have many digital circuit applications such as clipping and clamping where switching speed is important.

At microwave frequencies, their low noise and repeatable RF impedance lead to outstanding performance either as mixers or detectors. A new series of zero bias Schottky detector diodes offers improved detection efficiency without the DC bias requirements of conventional detector diodes. Package configurations for mixer/detector diodes include beam lead devices as well as conventional ceramic, stripline and axial-leaded packages.

PIN Diodes: PIN diodes function as variable resistors at microwave frequencies. By controlling the DC bias, the RF resistance of a PIN diode can be varied from 1Ω to about $10k\Omega$. This unique property of the PIN diode makes it extremely useful as a switch, attenuator, modulator, phase shifter, limiter or AGC element at all frequencies from 1 MHz to 18 GHz and above. Package configurations include beam-leaded devices as well as conventional microstrip, ceramic and axial-leaded packages.

Diodes And Integrated Products

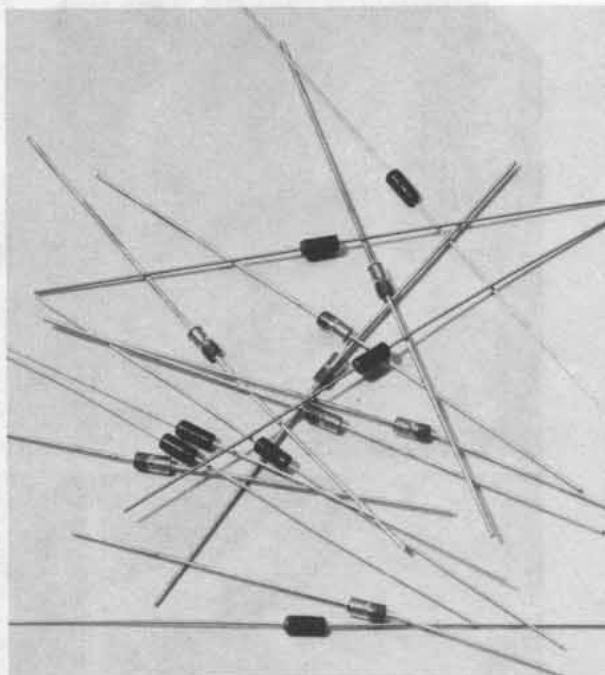

Glass package, PIN and Schottky diodes are used for high volume price sensitive applications in the HF-UHF range and for general purpose switching.

IMPATT Diodes: IMPATT diodes are a fundamental source of RF power at frequencies above 4 GHz. CW devices can supply 3.5W at 6 GHz with 10% efficiency, while pulse-optimized devices operating at 10 GHz offer 14W at 800ns pulse width and 25% duty cycle.

Step Recovery Diodes: SRD's are intended for use as comb generators and harmonic frequency multipliers. When used as a comb generator, the abrupt termination of the diode's reverse recovery current generates voltage pulses up to tens of volts with pulse widths as narrow as 100ps giving useful power at frequencies in excess of 20 GHz. By optimizing the circuit around any specific harmonic, high efficiency multiplication can be accomplished.

Integrated Products

Hewlett-Packard manufactures a broad line of components for the control, conversion, and generation of RF and microwave signals. This line of integrated products (combinations of chip and beam lead diodes with hybrid thin film circuit technology) includes SPST switches, absorptive modulators, attenuators, limiters, comb generators, double balanced mixers, and mixer/detectors.

The HXMR-5001 is a double balanced mixer which provides excellent broadband performance and reliability. This rugged mixer has low conversion loss and high isolation across the full 2-12.4 GHz RF/LO band, while retaining a wideband IF of 0.01-1.0 GHz. For the HF-UHF range, both double balanced and low cost single balanced mixers are available.

Recently the Microwave Semiconductor Division has developed a line of X-band, narrow band GaAs FET amplifiers. These low noise, front end amplifiers have exhibited state-of-the-art performance. These units, which offer greater reliability and lower costs compared to devices such as paramps, utilize HP's half micron and one micron GaAs FETS.

High Reliability Testing

Many Hewlett-Packard components are space qualified. The reliability of these devices is established by one of the finest high reliability testing facilities in the microwave component industry. Hewlett-Packard's High Reliability Test Group maintains military approved JAN and JANTX parts in stock and can recommend HP standard screening programs, patterned after MIL-S-19500, for any HP component. Those who wish to design their own screening specifications can consult with and obtain quotations from Hewlett-Packard's staff of Hi Rel Test Engineers.

Write for More Information

Hewlett-Packard RF and microwave component capabilities are described in individual data sheets and application bulletins.

Diode and Transistor Designer's Catalog: This catalog contains detailed, up-to-date specifications on our complete product line. It is divided into the following major sections: Schottky Barrier Diodes, PIN Diodes for Signal Control, Microwave Source Diodes, Devices for Hybrid Integrated Circuits, Military Approved Devices, Microwave Transistors and Integrated Products.

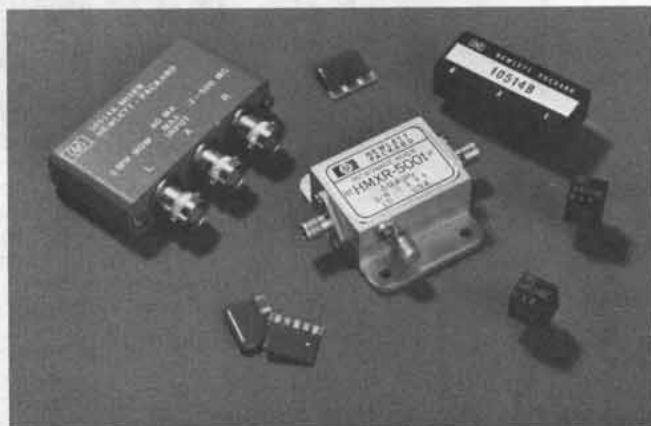

Hewlett-Packard's mixer product line includes low cost single balanced mixers for use to 1 GHz and double balanced mixers for both RF and microwave frequency ranges.

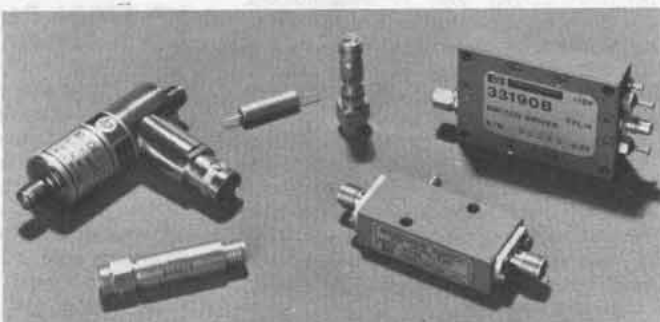

Solid state switches cover the frequency range from 0.1 to 18 GHz. An add-on switch driver features TTL compatible input. Other components include Limiters, Comb Generators and Absorptive Modulators.



Gas Chromatographs

HP 5800A Series

Reporting Gas Chromatographs

The HP 5800A Series provides the complete GC analytical system. It has an integral digital processor that operates the gas chromatograph and its accessories throughout the analytical run, following precisely the instructions that you give it *before the run*, on an easy-to-use keyboard or magnetic card reader.

The intelligent control center of an HP 5800A, the built-in digital processor, controls all aspects of the GC analysis: all temperatures, carrier flow rate measurement, detector operation, integration of peak areas, identification of components, calculation of concentrations, plotting of chromatogram and analysis report. After you set the analysis parameters on the keyboard and inject a standard sample, a single keyboard entry causes an HP 5800A to initiate a simple dialog which calibrates for the method; thereafter, it will analyze your samples, make the calculations by whatever method you specify—normalization, internal standard or external standard—and report the results . . . all automatically.

Other HP 5800A Series features include: Choice of universal injection port with glass or metal liners and on-column injection capability.

Multi-purpose glass capillary inlet system.

Complete detector selection including nitrogen/phosphorus selective FID.

Time programming allowing changes throughout an analysis at precise, preset retention times.

Run programming to preset analysis parameters for a series of samples before injecting the first one.

Operation with a variety of glass, metal, packed or capillary columns.

All these features are present in a high performance oven that can be controlled and programmed from -60° to 400°C to meet separation requirements for almost any type of sample!

HP 5700A Series GC's . . . Digital, Compact, Modular Capable of Full Automation

The HP 5700A Series breaks the traditional barrier between versatile but expensive "research" instruments and dedicated, more cost-conscious "routine" instruments. This series embraces the HP 5710A and HP 5730A Dual Column/Multiple Detector GC's which serve every research or routine laboratory need.

To meet special requirements, 5700 options include: specific detectors, including Nitrogen/Phosphorous FID, EC and Flame Photometric; multi-detector capability; dual input/dual output electrometer; electronic baseline compensation; inlet system for glass capillaries.

Liquid Chromatographs

New HP 1084B

Processor-controlled LC

Using a concept pioneered by Hewlett-Packard, the HP 1084B, High Performance Liquid Chromatograph is controlled by a built-in central processor. It gives the user full control over separation parameters, minimizes quantitative errors and is simpler to use than conventional instruments both in routine chemical analysis and in developing new analytical methods.

Solvent preparation capability, a semi-automatic variable volume injection system, feedback flow control, a readily accessible temperature-controlled column compartment, gradient elution capability and a choice of high-performance detectors are features of this system.

Two-way communication with the HP 1084B is made through a keyboard in terms that are simple and familiar to the chromatographer. Once instructed, the instrument injects the desired sample size (from 10 to 200 microliters) at full column pressure without interrupting solvent flow, controls solvent composition, generates flow gradients, then collects and computes chromatographic data and reports them on heat-sensitive, smudgeless paper—all automatically.

An important new feature of the HP 1084B is its ability to change separation parameters, detector wavelength sequences,

calibration factors and calculation procedures between analytical runs, automatically. This feature, together with pre-programmed variable wavelength detection and automatic batch sampling, provides new modes of operation which enable HPLC method development, routine analysis and trace analysis to be performed with far greater precision and efficiency.

Isocratic, Economical HPLC

The HP 1082B, an economical isocratic version of the HP 1084B, can be upgraded to full gradient capability when the need arises.

Pre-Programmed Variable Wavelength Detection

The new HP 79875A Variable Wavelength UV/Visible Detector is time-programmable. Commands entered into the HP 1084B Liquid Chromatograph change the wavelength setting at specified times so that each sample component can be detected at its maximum absorbance. The detector changes to any wavelength within its 190 to 600 nm range in less than 4 seconds and includes an automatic baseline reset. Set up for analysis, and compound identification, is assisted by a scan mode. On pressing a key, the solvent flow is stopped and the detector rapidly scans the range from 190 to 540 nm. By doing this for each component of interest, the most effective wavelength setting can be determined, or its identity confirmed. The expanded programming capability of the HP 1084B not only enables the wavelength setting to be changed during an analysis but also enables complete wavelength sequences to be changed between analytical runs, automatically.

Fixed Wavelength UV Detection

The high performance Hewlett-Packard fixed wavelength UV Detector (254 nm) makes subnanogram detection levels possible for a wide range of substances. This detector features excellent linearity, repeatability and low drift characteristics and is easy to operate. It is a standard component of the HP 1084B, but is also available as a standalone unit (HP 1036A) which is fully compatible with HP 3380 Integrators.

Automatic Sampling System

The HP 79842A Automatic Sampling System enables batches of up to 60 samples and calibration standards to be analyzed automatically in sequence, and then repeated if desired, by the HP 1084B Liquid Chromatograph. Only the injected sample amount is consumed by the system, making it possible to use micro-vials for applications where only small sample quantities are available. A detachable unit containing 60 glass vials is mounted on top of the Liquid Chromatograph. The variable-volume injector, which is a standard part of the chromatograph, then samples each vial in a pre-programmed sequence. The injection volume can be preset manually to any point between 10 and 200 microliters.

GC/Mass Spectrometer Systems

HP 5985B GC/MS Includes Dual CI/EI Source, Powerful Data System

To collect, store and process the vast amount of data produced from GC/MS measurements, the HP 5985B GC/MS/Data System provides the ideal answer. This system lets you solve routine or complex analytical problems quickly and accurately without any of the tedium usually associated with mass spectrometry. Mass range is 10 to 1000 amu and sensitivity is to picogram levels, essential for analysis of samples encountered in typical pesticide, pollution, drug, and biological problems.

HP 5985B software programs, its vast libraries (one has over 60,000 spectra), and its all-digital electronics combine to make it a powerful GC/MS system. Programs provided include those for simultaneous data acquisition and reduction, automatic tuning, BASIC (an easily-learned language for user-created programs), and BATCH PROCESSOR which allows completely automatic operation of the system.

The new HP 5985B is complete with: HP 5840A microprocessor-controlled gas chromatograph; dual chemical/electron ionization source; jet, direct, and capillary GC/MS interfaces; hyperbolic quadrupole mass filter; vacuum system; dual disc data system with its 10 million words of disc storage; all integrated and mounted in a single console unit.

New HP 5993B

Desktop GC/MS with Disc-based Data System

This new middle-price system combines the compact GC/MS of the HP 5992B with a powerful data system. Versatile software includes BATCH processing and much more. Mass range is 10 to 800 amu.

New HP 5992B . . .

Computer-controlled, Benchtop Size, Automatic Tuning

The compact HP 5992B offers excellent performance at an economical price. Its features include a microprocessor-controlled gas chromatograph as an integral part of the system, an efficient hyperbolic rod quadrupole mass analyzer, and automatic tuning of the mass spectrometer components. It has none of the usual knobs or switches to set, but is controlled by HP 9825A Desktop Computer which uses a combination of keystroke instructions and stored programs for efficient operation of the entire system.

The HP 5992B's quadrupole mass filter uses hyperbolic rods, the theoretically ideal shape for this type of filter. Improved peak shapes and higher sensitivity, compared to round-rod filters, are direct consequences of this geometry. For 1 nanogram of methyl stearate scanned at 190 atomic mass units (amu) per second, the system produces a signal-to-noise ratio of 10:1. Total mass range is 10 to 800 amu.

Standard data acquisition and display software provides normal spectrum generation, total ion chromatograms, tape cartridge storage and later display of individual spectra, library search, and selected ion monitoring.

Accessories include an X-Y plotter, flexible disc storage device, phone modem interface, and capillary GC injection system.

Laboratory Automation Systems

HP 3350 Series Laboratory Automation Systems can increase your sample throughput, provide easy-to-use, yet sophisticated data reduction, perform record keeping tasks and automate your analytical procedures. The 3350 Series provides ascending levels of laboratory automation. As a result, it gives you the freedom to configure an affordable system to meet your present needs and provides the flexibility to grow easily and economically to meet future requirements.

Upward compatibility of hardware and software lets you expand at your discretion in steps to fit your laboratory's needs.

System growth occurs in two areas. Software capability can grow from the "turnkey" chromatographic package to include liquid sampler control, simulated distillation and lab BASIC.

Lab BASIC offers you the flexibility to tailor data handling and report generation to meet your specific requirements without sacrificing any of the security and friendliness of the "turnkey" operation. Hardware can grow to include additional instruments, system terminals and expanded data storage on tape cartridges or disc.

The 3351, smallest member of the family, is a low-cost solution to your data acquisition and data analysis requirements which can be expanded to 30 instruments. The 3352 and 3353 members of the family offer larger processors, CRT terminals with data storage capability and line printers.

The top-of-the-line 3354 Lab Automation System with a 20M byte disc offers reintegration of raw data, control of sampling devices, simulated distillation and Lab BASIC II. In addition to capability of 45 instrument interfaces, the system can have 15 terminals and 4 industry standard 9-track mag tapes.

Reporting Integrators

HP 3380 Series Reporting Integrators provide an excellent data handling function for existing gas or liquid chromatographs. All three integrators in this series provide the unique printer/plotter that draws an annotated chromatogram and prints a complete analysis report, all on a single piece of paper.

The Model 3380S includes these features in a simple to use, inexpensive design. The Model 3380A adds all the standard chromatographic methods. In addition to methods, the Model 3385A adds integrator timed events, a magnetic card reader and external timed events. It also supports automatic liquid sampler and data communications options.

Patient Monitoring and Resuscitation

- Stand-alone monitors
 - Modular instruments
 - ECG Telemetry
 - Complete monitoring systems
 - Arrhythmia detection, storage and recall
 - Patient Data Management
 - Mobile Resuscitation System with batt./AC operating Defibrillator
- Request Catalog #5952-5254.*

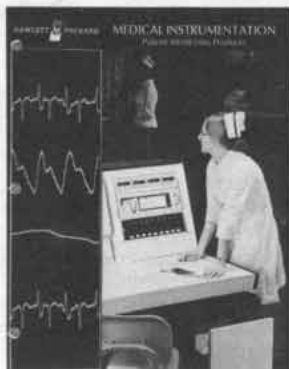

Respiratory Instrumentation

- Pulmonary Calculator System
 - Ear Oximeter
 - Single-Breath Diffusion System
 - Respiratory Recording Systems (6)
 - Modular Pulmonary Function Testing Instruments
 - CO₂ Analyzer
 - Exercise Testing System
- Request Catalog #5952-5257*



Perinatal Instrumentation

- Fetal/Maternal and Neonatal monitoring includes bedside fetal monitors, a Calculator-based System, and Central Stations
- Telemetry for birthing centers
- Neonatal monitoring uses heart rate, respiration, temperature, ambient oxygen measuring instruments, and a Cardiorespirograph. *Request Catalog #5952-5258.*





Cardiography Instrumentation

- Single- and 3-channel Electrocardiographs
- ECG Data Management Systems for computer-aided interpretation of ECGs.
- ECG Stress Testing Systems.
- ECG/Heart Sound/Pulse Recording Systems.
- ECG Computer Terminals for phone transmission or tape recording ECG data. *Request Catalog #5952-5255.*

Cardiovascular Instrumentation

- Multi-channel heated stylus or optical recording systems for clinical or research use
- Complete choice of transducers, scopes, magnetic tape recorders, meter and numerical displays
- More than 12 plug-in signal conditioners
- Computerized catheterization data analysis system automates on-line data collection and analysis
Request Catalog #5952-5256.



Consumables

Wide choice for use with H-P and other medical electronic instruments includes:

- Disposable ECG monitoring electrodes (adult and infant)
- Disposable transducer domes
- Disposable scalp electrodes
- Chemical thermal medical chart papers
- Permapaper® chart papers
- Disposable pressure kits
- Redux® electrolytes
Request Catalog #5952-5260

Radiology

HP offers a group of high performance medical X-ray machines with automatic exposure control. They include a Mobile X-ray System (shown at left) designed especially for handling difficult radiographic requirements in the Intensive Care area; a Dedicated High kV Chest X-ray System for rapid, consistent and low dose chest procedures; and Faxitron Cabinet X-ray Systems for specimen radiography and for laboratory training of radiological technicians.





Hewlett-Packard, long recognized as the leading supplier of electronic measuring and computing instruments for the engineer, has developed a similar position in electronic distance/angle measurement and computation instrumentation for the surveyor. These instruments are briefly described on this page.

HP 3805A DISTANCE METER

The HP 3805A Distance Meter is a low cost, short range, automatic readout, infrared light source instrument. The range of the HP 3805A is 1.6 km (1 mile) with the measured distance displayed in metres or feet at the flip of a switch. The HP 3805A features a built-in computer that controls the instrument's internal functions and communicates the quality of the measurement to the operator through the communicative display. A minimum of 3,000 readings are taken for each measurement and displayed in as little as 6 seconds. The instrument also has an internal self-check capable of verifying electronic performance in the field or office; and automatic atmospheric correction. The optional battery snaps into the bottom of the instrument providing cable free operation for a lightweight, portable field system.

HP 3808A MEDIUM RANGE DISTANCE METER

The HP 3808A Distance Meter is a medium range, "one push-button", slope distance instrument with a range of 10 km (6.25 miles) to two triple prism retro-reflector assemblies. This increased range capability permits measurement with fewer prisms (reducing logistic problems and accessory costs)



and also permits surveying in marginal atmospheric conditions. Measured distance may be displayed in either metres or feet (switch-selectable). The tracking mode permits continuous updating of distances or can be used to monitor return signal strength, permitting fast target acquisition. Measurement confidence can be increased by use of the "sigma" mode which displays a statistical value related to prevailing measurement conditions. The HP 3808A also features an internal self-check capable of verifying performance in the field or office; digital output, which allows data to be recorded automatically; and automatic atmospheric correction. An optional horizontal angle base graduated in degrees or grads is also available.

HP 3810A TOTAL STATION

The HP 3810A Total Station is a short range, automatic, direct reading, electro-optical distance and angle measuring instrument utilizing an infrared light source. The range of the HP 3810A is 1.6 km (1 mile) with the measured distance displayed in metres or feet and angles displayed in degrees or grads. The key to the Total Station's power is a built-in micro-computer and a vertical angle sensing device. The instrument has the ability to measure the slope distance, zenith angle, correct for curvature and refraction and automatically compute and display the horizontal distance. Four parameters are selectable for display: zenith angle, slope distance, horizontal distance and vertical distance. The communicative display indicates the quality of the measurement, on target indication, and notifies the operator of a low battery. Horizontal angle measure-



ments are made with the 20 second least count horizontal angle base with estimation to 5 seconds or 10^{cc} on the micrometer scale. The HP 3810A also features a built-in atmospheric correction to 1 part per million, a snap-in battery, and a "tracking" mode for rapid point setting to one-tenth of a foot with updated measurements every three seconds. Precise measurements to one-thousandth of a foot can be made in approximately six seconds.

Hewlett-Packard's versatile Distance Meters and Total Stations are suited for such applications as layout, location, boundary, hydrographic, topographic, control, and mine surveys. A short demonstration is all that is necessary for operator training on these instruments.

SURVEYING CALCULATORS

The Civil Engineering Division also markets Hewlett-Packard's line of desk-top programmable calculators and peripherals. Application and programming specialists have developed libraries of surveying programs for these systems.

For detailed specifications and prices on these instruments and optional accessories, contact the Civil Engineering Division, P.O. Box 301, Loveland, Colorado, 80537.

Note: Photographs and descriptive texts describe complete Distance Meter and Total Station systems. Accessories such as Prisms, Tripods, and Adaptors are optional equipment. Please contact your local Hewlett-Packard Sales Office for a complete list of standard equipment supplied with Distance Meters and Total Stations.



With Hewlett-Packard's extensive product line and worldwide customer mix there are two main avenues for technical customer training. These are live training sessions and video tapes. Live training sessions fall into three subcategories: applications, service and tutorial. Application seminars aimed at increasing your utilization of general purpose test instrumentation are often available at no charge. On the other hand, seminars on the operation of dedicated systems are more specific in nature and are generally charged for. Service seminars are available on a supply-and-demand basis and, as such, there is usually a charge. For detailed information on all HP seminars, contact your Hewlett-Packard field engineer or call the Hewlett-Packard office nearest you—see the inside back cover.

HP video tapes

A better way to learn

Part of the "extra value" which comes with each Hewlett-Packard product is our continuing commitment to provide Hewlett-Packard customers with useful training information in the areas of applications and service. In the past, this information has often been in the form of classroom seminars, either at your nearby Hewlett-Packard sales office or at one of our training facilities in California.

Now our capability is expanding by offering you both service and applications training via video tape. Video tape training is

exceptionally convenient and readily available, ready for your own use at any time or any place, including within your own facilities.

Effective: Hewlett-Packard has found that video tape is a highly effective training medium. Video tapes can convey more information in less time, and with higher retention, than even the best live instruction. Hewlett-Packard programs are professionally produced and are based on measurable instructional objectives. They consider what the student already knows, emphasize what he needs to know, and omit what he does not need to know. Many video tapes utilize split-screen techniques, allowing students to watch a procedure on one part of the screen while observing its effect on another part. Most Hewlett-Packard video tapes are 100% visualized, as opposed to conventional, partially visualized video tape "lectures."

Flexible: With video tapes, you can tailor your training program to suit the many needs of your organization. You may select training programs for individuals with different backgrounds and specific needs, present effective programs to audiences of just one or hundreds, and offer a library of technical programs your staff members can easily consult on their own . . . for new information or for refresher purposes.

Faster: It has been our experience that Hewlett-Packard video programs compress learning time by a factor of up to 6-to-1. A video tape library also reduces the time needed to

organize and schedule your training. You can schedule highly professional presentations anytime and anywhere, without arranging for outside instructors or juggling the detailed logistics that are often required for live training sessions. More effective training in one-sixth the time!

Convenient: Video tape programs come on small, easy-to-file magnetic tape reels or cassettes. Inexpensive playback equipment is easily operated by unskilled personnel. Programs may be viewed on small portable monitors or on full-screen TV sets. Video tapes can be quickly searched for specific information using "fast forward" or "fast rewind," and many recorders can stop on a single frame for more detailed study.

Time-tested: All the video tapes offered in the Hewlett-Packard Videotape Catalog were developed to serve Hewlett-Packard's needs for a practical, low cost source of up-to-date training in a wide variety of subjects. Now, after having been tested in Hewlett-Packard training activities throughout the world, many of these video programs are available to help meet your training objectives.

Digital troubleshooting 90420D

Developed to train HP's own technicians, this course is especially useful in showing how to approach real problems in real equipment.

- Practical demonstrations
- Proven teaching techniques

- Flexibility of use for classroom or individual study
- Latest in digital troubleshooting tools
- Most recent logic symbology
- Useful troubleshooting tips

Digital troubleshooting was made for technicians. It is an appropriate transition from transistors to digital electronics. It also can be used as a refresher course. Equivalent in coverage to a college term of 13 weeks, the course is presented in color on 14 videocassettes having a total running time of 5 hours and 31 minutes. The lab demonstrations shown in video are from the workbook included with the series. Also included is a 180 page text and a study guide.

There is ample use of reinforcement in the presentation and in the self-scoring quizzes at the end of most of the modules.

Digital troubleshooting videotapes

**Introduction to digital electronics/
90421D Lesson 1 12 Mins.**
Digital products and techniques are becoming more popular and widely used. This lesson looks at some of the areas where digital techniques are used—areas such as computers, communications, telemetry, test equipment, industrial control, and consumer electronics. It also points out how the integrated circuit (IC) has caused a virtual explosion in the use of digital techniques. Widely used terms and concepts such as binary, digital, analog, gates, and memory are explained. The lesson concludes with a comparison of digital and analog techniques, a summary, and a short, self-scoring quiz.

**Binary nature of digital circuits
90422D Lesson 2 18 Mins.**
Digital circuits operate using the binary or two-digit number system. Binary digits (bits) are introduced in this lesson covering the operation of the pure binary and Binary Coded Decimal (BCD) systems. Mechanical or transistor switches can be used to control the two logic levels used to represent binary data. Either positive or negative logic systems can be used to represent binary numbers, and they can be transmitted in either serial or parallel fashion. This lesson concludes with a summary and a short, self-scoring quiz.

**Basics of transistors and IC's
90423D Lesson 3 18 Mins.**
Integrated Circuits have revolutionized digital electronics. An IC contains many transistorized circuits switch between two voltage levels that represent binary 1's and 0's. Because of their importance, this lesson reviews the basics of transistors and diodes. PN junction diodes are covered first, then PNP and NPN junction transistors are reviewed. The lesson then discusses how transistors can be operated as either saturated or non-saturated switches. Metal Oxide Semiconductor (MOS) transistor switches are also covered. Packaging and classification of Integrated Circuits are the final topic in this lesson followed by a summary and a short, self-scoring quiz.

**Logic gates and symbols
9042D Lesson 4 25 Mins.**
Logic gates and flip-flops are the two main



digital building blocks. This program covers six basic logic gates and their symbols. The logic circuits covered are the AND, NAND, OR, NOR, Exclusive OR, and Inverter. After the operation of each logic element is explained using logic symbols, the operation of a circuit is demonstrated. Next, troubleshooting of gate circuits is covered, then the use of logic troubleshooting tools is demonstrated. The lesson ends with a summary and a short, self-scoring quiz.

Note: The logic symbols included in this series are based on ANSI Y32.14/IEEE 91-193. This industry standard document supersedes MIL-STD-806 B/C and is approved for use by the U.S. Department of Defense.

**Introduction to digital IC families
90425D Lesson 5 29 Mins.**
This is the first of two lessons dealing with digital IC families. In this section DCTL, RTL, and DTL are covered.

This videotape begins with a review of logic gates consisting of the circuit diagram, truth table, logic diagram, and Boolean expression. Several schematics from an actual instrument are explained. Equivalent gates, shown on these schematics, are discussed according to function. This is followed by a discussion of the history of gate design as it applies to the digital troubleshooter, so that bad troubleshooting practices can be avoided. The lesson concludes with a short, self-scoring test.

**Modern digital IC families
90426D Lesson 6 27 Mins.**
This is the second of two lessons dealing with digital IC families. In this section TTL, HTL, ECL and CMOS are covered.

This videotape begins with a review of the principles introduced in Lesson 5, then explains how the five subfamilies of TTL work (Standard TTL, Low Power TTL, High Speed TTL, Schottky TTL, and Lower Power Schottky TTL). Also explained are open-collector TTL and three-state logic. Similar

discussion occurs about HTL, ECL, and CMOS families. The lesson concludes with troubleshooting as applied only to families.

**Simple troubleshooting techniques
90427D Lesson 7 18 Mins.**
Experienced service technicians use a number of simple troubleshooting tools and techniques to help reduce repair time and eliminate the need for electrical measurement, when servicing integrated circuit assemblies.

This program focuses attention on logical approach to troubleshooting, highlighting simple techniques of isolating and replacing defective components on integrated circuit assemblies.

**Troubleshooting digital IC's
90428D Lesson 8 27 Mins.**
Fundamental differences between analog and digital circuits make traditional troubleshooting tools inefficient. Products designed especially for testing digital circuits include: The Logic Clip, Logic Probe, Logic Pulser, Current Tracer, and Logic Comparator. This program takes a close look at these IC Troubleshooters. Also covered are the types of failures found in digital integrated circuits and how to troubleshoot them.

**Flip-flops
90429D Lesson 9 31 Mins.**
Flip-flops are one of the main building blocks of digital circuits. This program covers both the NAND and NOR RS, closed RS, D, T, and JK flip-flops. The theory of operation of each flip-flop is covered using ANSI Y32.14/IEEE 91-1973 logic symbology. Then, the flip-flop is demonstrated and its operation summarized. Clocked logic, edge and level triggering, direct set and reset inputs, and troubleshooting flip-flops are also covered.



theory of operation of each flip-flop is covered using ANSI Y32.14/IEEE 91-1973 logic symbology. Then, the flip-flop is demonstrated and its operation summarized. Clocked logic, edge and level triggering, direct set and reset inputs, and troubleshooting flip-flops are also covered.

Counters and shift registers
90430D Lesson 10 30 Mins.

Counters and Shift Registers are the two most popular uses of flip-flops. This program covers binary and decade counters, both ripple and synchronous types. Also covered are up and down counters, presettable counters, frequency dividers, circular shift registers and strobed displays. The operation of each circuit is first explained using logic symbols, then demonstrated. Troubleshooting is the final topic in this program. The lesson ends with a short, self-scoring quiz.

Combinational logic circuits
90431D Lesson 11 30 Mins.

The basic building blocks of combinational logic circuits are gates. In this videotape we see how gates are combined to form line drivers, three-state drivers, one-shot multivibrators, multiplexers, adders, and code converters.

After an overview of the operation of these devices, they're shown in actual use in a production.

The program concludes with a section on troubleshooting, which deals with typical problems which may arise in combinational logic circuits.

Display technologies
90432D Lesson 12 30 Mins.

A large variety of display technologies is used with digital circuits. This program looks at the types and configurations of displays,

then discusses typical troubleshooting problems specific to them. Some of the types covered are neons, gaseous discharge tubes, and light emitting diodes (both segmented and dot matrix forms). Included is a discussion on planar tubes, incandescent displays, and liquid crystals.

In the troubleshooting section typical faults the technicians might encounter are discussed. Each of these faults is demonstrated and solutions are suggested.

IC manufacturing
90433D Lesson 13 11 Mins.

A basic knowledge of IC manufacturing should prove helpful to anyone involved in servicing digital equipment.

Manufacturing IC's involves a photographic process, and a series of masks is used to control the areas where impurities are allowed to diffuse; forming semiconductors. This program shows the steps in the manufacture of IC's, starting with an actual wafer and following it through to a completed IC package.

Memories
90434D Lesson 14 25 Mins.

Due to the many unique demands of today's users of computers and calculating devices, many different configurations for different types of memory. This lesson considers six types of memory-punched paper tape, punched cards, magnetic (reel-to-reel and cartridge), magnetic disks (hard and floppy), ferrite core, and semiconductor.

This lesson defines and describes the use of sequential access and Random Access Memory (RAM), volatile and nonvolatile memory, Read/Write Memory, Read-Only Memory (ROM) and Programmable Read-Only Memory (PROM). Tips on handling the various types of memory conclude the program.

Practical Transistors 90100D

The widely used Practical Transistor Series is a definitive, 15-tape excursion into the exceedingly important (and mysterious) world of transistors. As outlined below, each highly informative program in the wide-ranging series is primarily concerned with examining the many practical aspects of transistors rather than just dwelling on theory and math. The end result, after viewing this popular series, will be a deeper working understanding of transistors which will make maintenance and troubleshooting problems far easier and more efficient. The series is therefore highly recommended for electronics students, service personnel and engineers.

A supplementary textbook by transistor authority George Stanley Jr. (who also hosts the series), plus a complete set of homework problems and answers, is included with the nearly nine hours of video taped material*

Transistors vs. tubes
90030D330 Lesson 1 30 Mins.

The first program in the 15-part series introduces author George C. Stanley Jr., who defines the objectives of the course, describes the text upon which the course is based and explains the use of the homework problems. The rest of the program then reviews and builds upon the student's prior knowledge to make comparisons between vacuum tubes and transistors.

Temperature effects
90030D316 Lesson 2 30 Mins.

Part 2 develops the various common techniques of biasing transistors, and emphasizes the effects of heat on transistor circuits with demonstrations.

Current/voltage drive
90030D317 Lesson 3 41 Mins.

Part 3 is concerned with the comparison between voltage drive and current drive in transistor circuits. During this program, several concepts are developed which become important building blocks for the rest of the course.

Answers by inspection
90030D318 Lesson 4 43 Mins.

Part 4 develops the first of several valuable timesaving rule-of-thumb formulas: a simplified expression for voltage gain. Demonstrations serve to illustrate the usefulness and effectiveness of this formula.

Answers by inspection
90030D319 Lesson 5 40 Mins.

Part 5 develops additional rule-of-thumb formulas for the calculation of voltage gain with feedback, input impedance, output impedance, and distortion in common emitter circuits.

Answers by inspection
90030D331 Lesson 6 37 Mins.

Part 6 concentrates on the emitter follower circuit and develops expressions for its voltage gain, and input and output impedance.

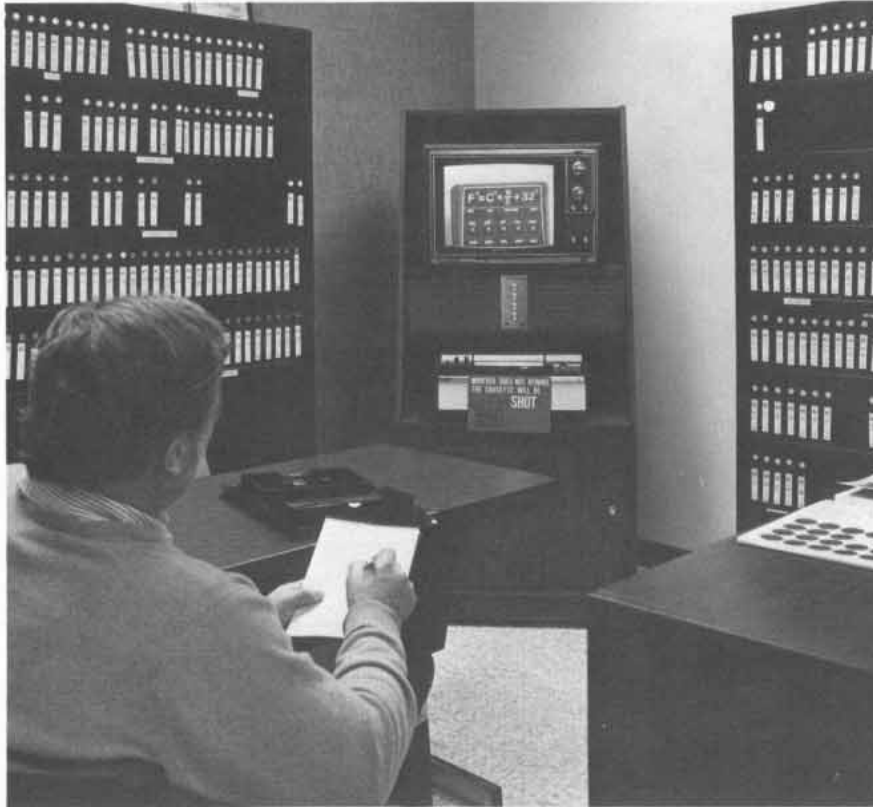
**Answers by inspection**

90030D319 Lesson 5 40 Mins.
Part 5 develops additional rule-of-thumb formulas for the calculation of voltage gain with feedback, input impedance, output impedance, and distortion in common emitter circuits.

Answers by inspection

90030D331 Lesson 6 37 Mins.
Part 6 concentrates on the emitter follower circuit and develops expressions for its voltage gain, and input and output impedance.

Multistage amplifiers

90030D322 Lesson 7 44 Mins.
Part 7 is devoted to applying the knowledge gained in Parts 4, 5, and 6 to an analysis of a three-stage transistor amplifier. Demonstrations on a actual circuit illustrate the accuracy of the approximations involved.

Troubleshooting

90030D323 Lesson 8 43 Mins.
The information obtained in preceding programs is further clarified in Part 8, which covers troubleshooting on both single-stage and multi-stage transistor circuits. Class problems are presented and solved using actual circuits.

Feedback amplifiers

90030D324 Lesson 9 27 Mins.
Part 9 first reviews single-stage and multi-stage circuits with feedback. Valuable troubleshooting tips for feedback circuits are then illustrated with demonstrations.

Why a transistor amplifies

90030D325 Lesson 10 27 Mins.
Part 10 illustrates how and why transistors amplify electrical signals. Discussion of the

roles of majority and minority carriers leads to an intriguing example of the effect of nuclear radiation on transistor performance.

Troubleshooting

90030D326 Lesson 11 33 Mins.
Part 11 is devoted to more practical applications of what has been learned so far. Demonstrations of troubleshooting are given on an actual multistage transistor amplifier to illustrate common failure patterns.

Fets and unijunctions

90030D327 Lesson 12 34 Mins.
Part 12 provides explanations of the operation of both junction and MOS field-effect transistors. Troubleshooting tips and the effects of nuclear radiation on these devices are given. The program concludes with the operation of the Unijunction transistor.

Breakdown diodes

90030D328 Lesson 13 37 Mins.
Part 13 compares Zener and avalanche diodes in terms of their temperature coefficient of voltage. This leads to a discussion of the use of various kinds of diodes for temperature compensation networks.

SCR's and tunnel diodes

90030D329 Lesson 14 28 Mins.
Part 14 covers the operation and the uses for silicon controlled rectifiers and tunnel diodes. Special video effects help to explain the complexities of tunnel diode operation. Comparisons are then drawn to other semiconductor devices.

PIN, SRD, and HC diodes

90030D332 Lesson 15 28 Mins.
Part 15 explains step recovery diodes, hot carrier diodes, and PIN diodes, and outlines

their typical applications. The series concludes with a short presentation on how the many special video effects were created for the various tapes in the series.

Ordering information

To order video programs, books, or the Logic Lab, please contact your local Hewlett-Packard field engineer. As a convenience, regional Hewlett-Packard Sales and Service offices are listed inside back cover.

HP Product Number	Price
90420D Digital Troubleshooting (14 videocassettes, plus a textbook, lab workbook, and study guide)	\$3,600
Individual videocassettes	
90421 Introduction to Digital Electronics	\$275
90422D Binary Nature of Digital Circuits	\$300
90423D Basics of Transistors and IC's	\$325
90424D Logic Gates and Symbols	\$375
90425D Introduction to Digital IC Families	\$375
90426D Modern Digital IC Families	\$375
90427D Simple Troubleshooting Techniques	\$375
90428D Troubleshooting Digital IC's	\$375
90429D Flip-Flops	\$375
90430D Counters and Shift Registers	\$375
90431D Combination Logic Circuits	\$375
90432D Display Technologies	\$375
90433D IC Manufacturing	\$250
90434D Memories	\$375

Books

90500E Digital Troubleshooting Textbook	\$9.95
90500F Digital Experiments (Lab Workbooks)	\$8.95
90500G Digital Troubleshooting Study Guide	\$2.50

Lab experiments are used to reinforce learning. They require access to a digital experimenter's kit such as the HP 5035T Logic Lab.

90100D Practical Transistors

(15 monochrome videocassettes plus a textbook, workbook problem sets) \$1,687.50

90100M Transistor Basics textbook \$5.95

90100N Practical Transistors Student workbook \$5.50

Local taxes, shipping and handling will be added to all orders.

Midterm examinations, final examination, examination solutions and certificates of completion are supplied with the purchase of 90100D and 90420D, but are shipped separately. See your local HP field engineer for details.

Video programs are supplied in NTSC Standard only.

Formats other than 1/4" videocassette can be quoted on request.

Domestic U.S. Prices only.

Designed to help you obtain maximum use from Your HP equipment



Hewlett-Packard Application Notes are a compilation of applications research and experience which have been written in collaboration with HP engineers and our customers. Some are tutorial, while others describe specific "how to" procedures. Listed below are the application notes that are currently available from your local sales office. Or, you may write directly to Application Notes, Hewlett-Packard, 1820 Embarcadero Road, Palo Alto, California 94303, U.S.A.

- | | | | | | |
|---------------|---|---------------|--|---------------|--|
| 52-1 | Fundamentals Of Time And Frequency Standards | 80-004 | Annual Percentage Rate For Loans With A Balloon Payment | | |
| 52-2 | Timekeeping And Frequency Calibration | 80-005 | Price And Yield Calculations For Mortgages Traded At A Discount/Premium | 117-1 | Tubes, Phosphors, And High-Speed Oscillography |
| 57 | Noise Figure Primer | 80-006 | Annuity Due And Present Value Calculating Logs, Anti-Logs, And Roots Of Numbers | 117-2 | Microwave Network Analyzer Applications |
| 63E | Modern EMI Measurement | 80-007 | Yield And Periodic Payment Amount Calculations For Leases With A Balloon Payment Or Residual Value | 121-1 | Stripline Component Measurements With The 8410A Network Analyzer |
| 63E-1 | Quasi-Peak Measurements Using A Spectrum Analyzer | 80-008 | Internal Rate Of Return (IRR) For Uneven Cash Flows | 121-2 | Network Analysis With The HP 8407A 0.1-110 MHz Swept Impedance With The 8407A Network Analyzer 0.1-110 MHz |
| 64-1 | Fundamentals Of RF And Microwave Power Measurement | 80-009 | Linear Regression Calculations Using The Vector Impedance Meters | 123 | Floating Measurements And Guarding |
| 64-2 | Extended Applications Of Automatic Power Meters. | 80-010 | Magnetic Tape Recording Handbook | 124 | True RMS Measurements |
| 70 | Precise DC Measurements | 86 | How Vector Measurements Expand Design Capabilities—1 To 1,000 MHz | 126 | Theory And Applications Of Wave Analyzers |
| 77-1 | Transistor Parameter Measurements | 89 | S-Parameter Techniques For Faster, More Accurate Network Design | 128 | Applications Of A DC Constant Current Source |
| 77-3 | Complex Impedance Measurements | 91 | A2A Video Transmission System Alignment | 133-1 | Low Frequency Pulse Amplitude Measurements |
| 77-4 | Swept-Frequency Group Delay Measurements | 95-1 | Principles Of Cathode-Ray Tubes, Phosphors, And High-Speed Oscillography | 134 | Audio Frequency Measurements With The 8556A-8552B Spectrum Analyzer |
| HP-80 | Financial Pocket Calculator | 114 | | 135-2 | High-Volume Production Testing |
| 80-001 | Direct Reduction Loan Amortization Calculations | 115 | | 135-12 | Depot Testing Of Avionic Modules |
| 80-002 | Annuity Due Calculations For Savings Funds | | | | |
| 80-003 | Annuity Due Calculations For Savings Plans When Compounding Periods Differ From Payment Periods | | | | |

- | | | | |
|--------|---|---------|---|
| 135-16 | Minicomputer Systems Aid Military Vehicle Testing | | |
| 135-21 | Viggen Avionic Support | 150-2 | FM Spectrum Analysis...Pulsed RF |
| 135-23 | Television Set Production Revolutionized By Automatic Alignment And Test | 150-3 | Spectrum Analysis...Tracking Generators |
| 135-25 | Automation In Production Testing | 150-4 | Spectrum Analysis...Noise Measurements |
| 136 | Understanding And Operating The 8555A Spectrum Analyzer And 8445B Automatic Preselector | 150-5 | Spectrum Analysis...CRT Photography And X-Y Recording Techniques |
| 140 | Fourier Analyzer Training Manual | 150-7 | Spectrum Analysis...Signal Enhancement |
| 140-3 | Dynamic Testing Of Mechanical Systems Using Impulse Testing Techniques | 150-8 | Spectrum Analysis...Accuracy Improvement |
| 140-4 | Digital Auto-Power Spectrum Measurements | 150-9 | Spectrum Analysis...Noise Figure Measurement |
| 140-6 | Measurement Of Machine Tool Vibration | 150-10 | Spectrum Analysis...Field Strength |
| 140-7 | Nuclear Power Plant Diagnostics Using Fourier Analysis Techniques | 150-11 | Spectrum Analysis...Distortion Measurements |
| 141 | AM, FM Measurements With The Transfer Oscillator | 150-12 | Spectrum Analysis...Using The HP 11517A External Mixer To 40 GHz |
| 142 | EMI Measurement Procedure | 152 | Probing In Perspective |
| 145-5 | Computer System Helps Graduate Business School Teach Management Technology | 154 | S-Parameter Design |
| 145-11 | Time-Shared Systems Expand Scope Of Education | 155-1 | Active Device Measurements With The HP 8755 Frequency Response Test Set |
| 145-13 | Computer Systems Raise Student Achievement Levels | 155-2 | 100 dB Dynamic Range Measurements Using The HP 8577 Frequency Response Test Set |
| 145-21 | Minicomputer Systems Modernize Administration, Expand Instruction | 156-1 | Remote Laser Interferometry Calibration Of A Surface Plate |
| 145-23 | Minicomputer System Provides Broad Administrative Support | 156-2 | Principles Of Automatic Compensation |
| 145-24 | Time-Sharing System Provides Administrative Capabilities, Expands Instruction | 156-4 | Calibration Of A Machine Tool Measurement Of Straightness Of Travel |
| 150 | Spectrum Analysis...Spectrum Analyzer Basics | 156-5 | Low Frequency Gain Phase Measurements |
| 150B | Spectrum Analysis...Using The 8557A And 8558B Spectrum Analyzers | 157 | Selecting The Right DVM |
| 150-1 | Spectrum Analysis...AM And | 161-1 | Hewlett-Packard Series 9800: The Name And Number That Saves Time And Money |
| | | 161-5 | Computing Calculators...A Competitive Edge For Real Estate Investment Analysis |
| | | 161-7 | Low-Cost Calculator System |
| | | 161-11 | Saves Time, Improves Accuracy For Radiation Therapists and Physicists |
| | | 162-1 | King and King Architects And The Business Information Management System |
| | | 163-1 | Time Interval Averaging |
| | | 164-2 | Techniques Of Digital Troubleshooting |
| | | 164-3 | Calculator Control Of The 8660A/C Synthesized Signal Generator |
| | | 164-4 | New Techniques For Analyzing Phase Lock Loops |
| | | 166 | Digital Phase Modulation (PSK) And Wideband FM |
| | | 166-2 | Large Screen Display Applications And Interfacing |
| | | 167-4 | 1304A Large Screen Display Applications And Interfacing Engineering In The Data Domain Calls For A New King Of Digital Instrument |
| | | 167-5 | Troubleshooting In The Data Domain Is Simplified By Logic Analyzers |
| | | 167-6 | Mapping, A Dynamic Display Of Digital System Operation |
| | | 167-7 | Supplementary Data From Map Displays Without Changing Probes |
| | | 167-8 | Stable Displays Of Disc System Waveforms Synchronized To Record Address |
| | | 167-9 | Functional Analysis Of The Motorola M6800 Microprocessor System |
| | | 167-10 | Using The 1620A For Serial Pattern Recognition |
| | | 167-11 | Functional Analysis Of INTEL 8008 Microprocessor System |
| | | 167-12 | Functional Analysis Of Fairchild F8 Microprocessor Systems |
| | | 167-12A | Functional Analysis Of MOS-TEK F8 Microprocessor Systems |
| | | 167-13 | The Role Of Logic State Ana- |

- lyzers In Microprocessor Based Designs
- 167-14** Functional Analysis Of 8080 Microprocessor Systems
- 167-15** Functional Analysis Of INTEL 4004 Microprocessor Systems
- 167-16** Functional Analysis Of INTEL 4040 Microprocessor Systems
- 167-17** Functional Analysis Of National IMP Microprocessor Systems
- 167-18** Functional Analysis Of National Semiconductor SC/MP Microprocessor System
- 167-19** Systematic "Turn-On" Of Microprocessor Systems Using Logic State Analyzers
- 170-1** HP 8640A/B Signal Generator Output Level Accuracy
- 170-2** The 8640A/B Third Order Intermodulation Product Characteristics
- 171-1** Crystal Testing With The 8640A/B And 8405
- 171-2** Extending The 8640B Frequency Down To DC
- 173** Recent Advances In Pulsed RF And Microwave Frequency Measurements
- 173-1** Dynamic Measurement Of Microwave Voltage Controlled Oscillators With The 5345A Electronic Counter
- 174-0** Index To The AN-174 Application Note Series
- 174-1** Measuring The Transfer Characteristic Of A Voltage Controlled Oscillator
- 174-2** Measuring Differential Nonlinearity Of A Voltage Controlled Oscillator
- 174-3** Measuring Integral Nonlinearity Of A Voltage Controlled Oscillator
- 174-4** Measuring Dual VCO Tracking Error
- 174-5** Determining Probability Densities (Histograms) With The 5345A Electronic Counter
- 174-6** Measuring The Stability Of A Frequency Source
- 174-7** Measuring Fractional Frequency Standard Deviation (SIGMA) Versus Averaging Time (TAU)
- 174-8** Measuring FM Peak-to-Peak Deviation
- 174-9** Making Automatic Phase Measurements With The 5345A Electronic Counter
- 174-10** Measuring Electrical Length Delay Of Cables
- 174-11** Measuring Warm-Up Characteristics And Aging Rates Of Oscillators
- 174-12** Measuring Frequency Sweep Linearity Of Sweep Generators
- 174-13** Measuring The Tuning Step Transient Response Of VCO's To 18 GHz
- 175-1** Differential Phase And Gain At Work
- 176-1** Line Shape And High Mass Sensitivity Of The Dodecapole
- 176-3** 500-FEMTOGRAM Detection Of DDT By GC/MS
- 176-4** Analysis Of Commercial Alpha-Olefin: Open Tubular Column GC/MS
- 176-5** A Comparison Of Magnetic Sector And Dodecapole Spectra Column Technology In GC/MS
- 176-6** Doubly-Charged Ions
- 176-7** Explosives: Analysis Using Dual Chemical/Electron Ionization GC/MS
- 176-8** Methane: Its Usefulness As Both Carrier And Reactant Gas In Chemical Ionization GC/MS
- 176-10** Femtomole Analysis Of A Biogenic Amine By GC/MS
- 176-11** Picogram Detection Of Tetrachlorodibenzodioxin
- 176-12** Reactant Gas Selection In Chemical Ionization Mass Spectrometry Part I (See 176-18 For Part II)
- 176-13** Reactant Gas Selection In Chemical Ionization Mass Spectrometry Part II (See 176-18 For Part I)
- 176-14** Picogram Detection Of An Anticonvulsant By Chemical Ionization GC/MS
- 176-15** Analysis Of Pollutants In Urban Air By GC/MS
- 176-16** Analysis Of Derivatized Amino Acids By Chemical Ionization GC/MS
- 176-17** Effect Of A Membrane Separator On GC/MS Peak Shape And Retention Characteristics
- 176-18** Reactant Gas Selection In Chemical Ionization Mass Spectrometry: Part II. (See 176-13 For Part I)
- 176-19** Use Of A Mixed Reagent Gas For Chemical Ionization GC/MS
- 176-21** Automatic Data Reduction And Analysis Using Batch Processor GC/MS
- 176-22** Analysis Of Chloropesticides And PCB's In Cheese By Glass Capillary GC/MS Using The Selected Ion Monitoring Technique
- 176-23** Capillary Column GC/MS Analysis Of Essential Oils
- 176-24** GC/MS Analysis Of Volatile Organic In Water
- 176-25** Ensuring Reproducible Mass Spectral Patterns With Automatically Tuned GC/MS Systems
- 181-1** Measuring Linearity Of VCO's From 10Hz To 23 GHz
- 181-2** Data Acquisition With The 5300B Measuring System
- 183** High Frequency Swept Measurements
- 185** Waveform Parameter Measurements Using The Microprocessor Controlled Oscilloscope (1722)
- 185-2** Transmission Line Matching And Length Measurements Using Dual-Delayed Sweep
- 185-3** Percent Amplitude Modulation

- 185-4 Measurements In The Time Domain
Elimination Of Computation Of Analog Measurements By Using The Direct Reading Oscilloscope 1722
- 186 Dual-Delayed Sweep For Precise Time Interval Measurements
- 187-2 Configuration Of A 2-18 GHz Synthesized Frequency Source Using The 8620C Sweep Oscillator
- 187-3 Three HP-IB Configurations For Making Microwave Scalar Measurements
- 187-4 Configuration Of A Two-Tone Sweeping Generator
- 187-5 Calculator Control Of The 8620C Sweep Oscillator Using The HP-IB
- 188 Thermocouple Measurements With The 3050B
- 190 40 GHz Frequency Measurement With Standard Instruments
- 191 Time Interval Measurement Using An Electronic Counter
- 191-1 Automatic Zero Calibration Of The 5359A Time Synthesizer At A Designated Remote Location
- 191-2 Determining Digital Circuit Timing Tolerance To Optimize Adjustment Or Design
- 191-3 Precision Time Interval Measurements In Radar Applications
- 191-4 Using The 5370A Universal Time Interval Counter To Characterize Pulse Width, Repetition Rate And Jitter
- 192 Using A Narrow Band Analyzer For Characterizing Audio Products
- 195 Pulse Generator Techniques In CMOS Applications
- 196 Automatic Measurements Using HP 436A Power Meter
- 197-1 Laser Interferometers For Position Feedback
- 197-2 Laser And Optics
- 198 Event-Related Triggering... A Clear Solution For Digital Signals
- 199 Small Screen Displays—Medical Diagnostic System Applications And Interfacing
- 200 New Fundamentals Of The Electronic Counters
- 200-1 Fundamentals Of Microwave Frequency Counters
- 200-2 Fundamentals Of Quartz Oscillators
- 201-1 Routine QA Measurements Of Precision Resistors
- 201-2 Measuring Differential Non-Linearity Of A Voltage Controlled Oscillator
- 201-3 A Multiple Station Electronic Test System
- 201-4 Performance Evaluation Of HP-IB Using RTE Operating Systems
- 201-5 The HP-IB Link: Control Of Distributed HP-IB Devices
- 201-6 Computer Interconnections: A Choice Of Ways To Link HP 1000 System To HP 9825AS Desktop
- 201-7 High-Performance Software For The HP 3455A/3495A Subsystem
- 202-1 Optical Mark Readers Substantially Increase Productivity
- 202-2 Optical Mark Readers Provide Low Cost Data Entry Into An HP 3000 Computer System
- 202-3 Distributed HP Optical Mark Readers Provide Easy Remote Data Collection
- 204-1 Automatic Accelerometer Calibration
- 204-2 Energy Conservation In A Restaurant
- 205-1 Low Frequency Amplitude Considerations Of The 3042A System
- 206-1 Measuring Wide-Band Noise With The HP-3045A Automatic Spectrum Analyzer
- 207 Understanding And Using Phase Noise In The Frequency Domain
- 212-1 Building An Inventory Control Data Base
- 212-2 Building An Order Processing Data Base
- 214-1 Recording With Input Noise Present
- 214-2 X-Y Recorder Dynamic Response
- 214-3 X-Y Recorder Input Connection Configuration And Input Noise
- 214-4 High Sensitivity X-Y Recorder Has Few Restrictions
- 215-1 A More Rugged, Cleaner Writing Oscillographic Ink Recorder
- 216 A Guide To The Use Of The HP 3570A/3571A Analyzers
- 218-1 Applications And Performance Of The 8671A/8672A Microwave Synthesizers
- 218-2 Obtaining Millihertz Resolution From The 8671A And 8672A
- 218-3 A 1 MHz-18 GHz Signal Generator With 1, 2, Or 3 Hz Resolution
- 219 HP 8595A R.F. Network Analyzer Basic Measurements
- 220 Operating The HP 8565A Spectrum Analyzer
- 221 Semi-Automatic Measurements Using The 8410B Microwave Network Analyzer And The 9825A Desktop Computer
- 222 A Designer's Guide To Signature Analysis
- 223 Oscilloscope Measurements In Digital Systems
- 224-2 Signal Conditioning: HP 22914A Breadboard Card
- 225-2 Measuring Phase Spectral Density Of Synthesized Signal Sources Exhibiting f^0 and f^1 Noise Characteristics With The

	5390A Frequency Stability Analyzer				
226	Automatic Transceiver Testing With the 8950A	240-1	Feedback Control System Measurements	742	A Compendium On Automated Arrhythmia Detection
227	Word Generator Techniques In Multi-Channel Applications	245-1	Signal Averaging With The HP 3582A Spectrum Analyzer	743	Electrosurgery Interference—Minimize Its Effects On ECG Monitors
228-3	Determination Of Benzene And Toluene In Gasoline	245-2	Measuring The Coherence Function With The HP 3582A Spectrum Analyzer	922	Application Of PIN Diodes
228-4	Applications And Operation Of The Nitrogen-Phosphorus Detector	246	Using The HP 3585A Spectrum Analyzer With The HP 9825A Computing Controller	923	Hot Carrier Diode Video Detectors
228-5	Optimizing Analysis Using Splitless Injection On Capillary Columns	260-1	Understanding Hewlett-Packard's Model 1615A Logic Analyzer	928	Ku-Band Step Recovery Multipliers
228-6	Automated Determination Of Benzene Adsorbed On Charcoal Tubes	270-1	An Example Of Automatic Measurement Of Conducted EMI With The HP 8568A Spectrum Analyzer	929	Fast-Switching PIN Diodes
229-1	HP-Plot/2l Software Conversion Guide	280-1	Making Complex Measurements With The HP Model 1602A Logic State Analyzer	931	Solid State Alphanumeric Display Decoders/Driver Circuitry Selection And Use Of Microwave Diode Switches And Limiters
232-1	HPLC Of Pharmaceutical Products Analgesic Tables	280-2	Monitoring the IEEE-488 Bus With The 1602A Logic State Analyzer	932	5082-7300 Series Solid-State Display Installation Techniques
232-2	HPLC Method Development On The HP 1084A	710	8800 Medical Systems—Pressure Measurement	935	Microwave Power Generation And Amplification Using IMPATT Diodes
232-3	Theophylline Assay By High Performance Liquid Chromatography	711	8800 Medical Systems—ECG Measurement	936	High Performance PIN Attenuator For Low-Cost AGC Applications
233-1	Functional Analysis Of Signetics 2650 Microprocessor Systems Using the 1610A	712	8800 Medical Systems—Heart Sound Measurement	937	Monolithic Seven Segment LED Display Installation Techniques
233-2	Functional Analysis Of TMS 9900 Microprocessor Systems Using The 1610A	715	Model 1513A Automatic Cardiograph Model 1514A ECG/Phono System	939	High Speed Optically Coupled Isolators
233-3	Functional Analysis Of ZILOG Z80 Microprocessor Systems Using The 1610A	718	Patient Safety	940	Diodes For Hybrid Integrated Circuits
233-4	Functional Analysis Of 8080 Microprocessor Systems Using The 1610A	721	ECG Application Note for Nurses	941	5082-7700 Series Seven-Segment LED Display Applications
233-5	Functional Analysis Of Motorola M6800 Microprocessors Systems Using the 1610A	725-1	Esophageal Motility	942	Schottky Diodes For High Volume Low Cost Applications
235	An Introduction To Balanced Circuits And Impedance Matching	729	Pulmonary Function Analyzer	944-1	Microwave Transistor Bias Considerations
236-1	A "Make" or "Buy" Analysis For Power Supplies	732	Recording Phonocardiography And External Pulse Wave Recording	945	Photometry Of Red LEDs
240-0	Time And Frequency Domain Measurements	733	Physicians Guide To The HP Cath Lab Computer System	946	5082-7030 Series Monolithic Seven-Segment Displays
		735	Using Electrically Operated Equipment Safely With The Monitored Cardiac Patient Pulmonary Testing System	947	Digital Data Transmission Using Optically Coupled Isolators
		737	Guide To Physiological Pressure Monitoring	948	Performance Of The 5082-4350/51/60 Isolators In Short To Moderate Length Digital Data Transmission Systems
		739		949-1	Linear Power Amplification Using HP 35830 Transistors
				949-2	HP 35826E 1.5 GHz Lumped

- 951-1 Element Amplified Applications For Low Input Current, High Gain Optically Coupled Isolators
- 951-2 Linear Applications Of Optically Coupled Isolators
- 956-1 The Criterion For The Tangential Sensitivity Measurement
- 956-2 The E-2 Mixer Equivalent Circuit
- 956-3 Flicker Noise In Schottky Diodes
- 956-4 Schottky Diode Voltage Doubler
- 956-5 Dynamic Range Extension Of Schottky Detectors
- 956-6 Temperature Dependence Of Schottky Detector Voltage Sensitivity
- 957-1 Broadbanding The Shunt Pin Diode SPDT Switch
- 957-2 Reducing The Insertion Loss Of A Shunt Pin Diode
- 957-3 Rectification Effects In Pin Attenuators
- 959-1 Factors Affecting Silicon IMPATT Diode Reliability And Safe Operation
- 959-2 Reliability Of Silicon IMPATT Diodes
- 961 Silicon Double-Drift IMPATT Diodes For Pulse Applications
- 962 Silicon Double-Drift IMPATT Diodes For High-Power CW Microwave Applications
- 963 Impedance Matching Techniques For Mixers And Detectors
- 964 Contrast Enhancement Techniques
- 965 Printed Circuit Balanced Mixer Design And Applications
- 966 Applications Of The HP HDSP-2000 Alphanumeric Display
- 967 A Low Noise 4 GHz Amplifier Using The HXTR-6101 Silicon Bipolar Transistor
- 968 IMPATT Amplifier
- 969 An Optimum Zero Bias Schottky Detector Diode
- 970 A 6 GHz Amplifier Using The HFET-1101 GaAs FET
- 1000 Digital Data Transmission With The HP Fiber Optic System
- AB 1 Construction and Performance of High Efficiency Red, Yellow, And Green LED Materials
- AB 3 Soldering Hewlett-Packard Silver Plated Lead Frame LED Devices
- AB 4 Detection And Indication Of Segmented Failures In 7-Segment LED Displays
- AB 5 Current Source For Diode Testing
- AB 6 Pin Diode RF Resistance Measurement
- AB 7 Mixer Distortion Measurements
- AB 9 Derivation, Definition And Application Of Noise Measure
- AB 10 Transistor Noise Measurements
- AB 12 Chip Parameters For HXTR-2001
- AB 13 Transistor Speed Up Using Schottky Diodes
- AB 14 Waveform Clipping With Schottky Diodes
- AB 15 Waveform Clamping With Schottky Diodes
- AB 16 Waveform Sampling With Schottky Diodes
- AB 17 Noise Parameters And Noise Circles For The HXTR-6101,-6102,-6104 And -6105 Low Noise Transistors
- AB 18 The Performance Of The HXTR-6101 At Submilliampere Bias Levels
- AB 19 Noise And Power Parameters For The HFET-1101
- AB 20 Amplitude To Phase Conversion In IMPATT Amplifiers
- AB 22 Equivalent Circuits For Double Drift CW IMPATT Diodes
- AB 50 Hewlett-Packard Watch Chip Drawings
- AB 51 Interfacing The HDSP-2000 Display To A Microprocessor
- AB 52 Large Monolithic LED Displays
- AB 53 Interfacing The HDSP-6504/6508 16-Segment Alphanumeric Display
- AB 54 Mechanical Handling Of Subminiature LED Lamps And Arrays
- AB 55 Low Cost Interface For A 32-Character HDSP-2000 Alphanumeric Display
- GC 1-73 Analysis Of Polychlorinated Biphenyls
- GC 2-73 Operating Conditions For Optimum Performance Of The 5711A Flame Ionization Detector
- GC 3-73 Heroin Assay Using Gas Chromatography
- GC 4-73 Automatic Flame Photometric Analysis Without Solvent Flame-out
- GC 6-74 Determination Of Acetaldehyde, Ethyl Acetate And Fusel Oils In Alcoholic Beverages
- GC 7-74 The Determination Of Chromium By Gas Chromatography Using A Flame Photometric Detector
- GC 9-74 Classification Of Anaerobic Bacteria By Gas Chromatography
- GC 1-75 The Gas Chromatographic Determination Of Vinyl Chloride Monomer
- GC 2-75 Analysis Of Essential Oils By Gas Chromatography
- GC 3-75 The Automatic Determination Of CO, CH₄, And Total Hydrocarbons
- GC 4-75 Automated Analysis Of Essential Oils
- GC 5-75 The Rapid Determination Of H₂S, COS And SO₂ By Gas Chromatography
- GC 1-76 Constant Current Electron Capture Detection With Nitrogen Carrier Gas
- GC 3-76 The Analysis Of Gas In Transformer Oils By Gas Chromatography
- GC 4-76 Splitless Injection On Open Tubular Columns
- GC 6-76 Trace Organic Constituents In Water
- GC 7-76 Quantitative Analysis Using A "Purged Splitless" Injection Technique
- GC 8-76 The Gas Chromatographic Determination Of Residual Acrylonitrile Monomer
- GC 9-76 Analysis Of Ammonia Plant Gases
- L-1 Linearity Testing of VCO's
- L-3 Logic Amplifier Transfer Function Testing
- L-5 3050B Turbine Measurements
- L-6 Monitoring And Controlling The pH Of Industrial Chemical Waste

When you purchase a Hewlett-Packard product, you also receive the assurance that it will continue to perform to its published specifications today, tomorrow, next week—and for a reasonable number of months and years in the future.

We firmly believe that our obligation to you as a customer goes much beyond just the delivery of your new HP product. This philosophy is implemented by Hewlett-Packard in two basic ways: (1) by designing and building excellent products with good serviceability, and (2) by backing up those products with a customer service program which can respond to your needs with speed and completeness.

The HP customer service program is one of the most important facets of our worldwide operations, providing a local service capability in many of our field offices (listed inside the back cover of this catalog.) Indeed, this customer service program is one of the major factors in Hewlett-Packard's reputation for integrity and responsibility towards its customers.

Warranty

As an expression of confidence in our products to continue meeting the high standards of reliability and performance that customers have come to expect, Hewlett-Packard's products carry the following warranty:

Warranty statement

Hewlett-Packard (HP) products are warranted against defects in materials and workmanship. The warranty period for each product will be provided on request at the time of sale and is specified in documentation supplied with the product. During the warranty period, HP will, at its option, either repair or replace products which prove to be defective.

Within HP service travel areas, warranty service for products installed by HP and certain other products designated by HP will be performed at Buyer's facility at no charge. Outside HP service travel areas, warranty service will be performed at Buyer's facility only upon HP's prior agreement and Buyer shall pay HP's round trip travel expenses. In all other cases, products must be returned to a service facility designated by HP.

Buyer shall prepay shipping charges for products returned to HP for warranty service and HP shall pay for return of the products to Buyer. However, Buyer shall pay all shipping charges, duties and taxes for products returned to HP from another country.

Limitation of warranty

The foregoing warranty shall not apply to defects resulting from:

1. Improper or inadequate maintenance by Buyer;
2. Buyer-supplied software or interfacing;
3. Unauthorized modification or misuse;
4. Operation outside of the environmental specifications for the product; or
5. Improper site preparation or maintenance.

No other warranty is expressed or implied. HP specifically disclaims the implied warranties of merchantability and fitness for a particular purpose.



With Hewlett-Packard you get excellent products backed by a responsive customer service program.

Exclusive remedies

The remedies provided herein are Buyer's sole and exclusive remedies. HP shall not be liable for any direct, indirect, special incidental, or consequential damages, whether based on contract, tort or any other legal theory.

Certification

Some customers are especially interested in the test and quality assurance programs that HP applies to its products. These Hewlett-Packard programs are documented in a Certificate of Conformance which is available upon request at the time of purchase. This certificate states:

Products, materials, parts, and services furnished on this order have been provided in accordance with all applicable Hewlett-Packard specifications. Actual inspection and test data pertaining to this order is on file and available for examination.

Hewlett-Packard's calibration measurements are traceable to the National Bureau of Standards to the extent allowed by the Bureau's calibration facilities.

The Hewlett-Packard Quality Program satisfies the requirements of MIL-Q-9558A, MIL-I-45208A, and MIL-C-45662A.

Repair service

Help in maintaining your Hewlett-Packard equipment in first-rate operating condition is as close as a telephone call to the nearest Hewlett-Packard field office. Whether you want to repair an instrument yourself, or send it to a Hewlett-Packard facility for repair, recalibration, or overhaul, your local Hewlett-Packard field office can offer a complete range of technical assistance.

Local repair facilities are backed up by Regional Repair Centers that are located in major industrial areas. The Regional Repair centers have more sophisticated test equipment, factory-trained specialists, and a full line of replacement parts.

If your equipment installation is fixed, and if justified by the type of service required, Hewlett-Packard will perform service at your facility.

You have access to all of Hewlett-Packard's extensive service network through your local Hewlett-Packard field office.

Replacement parts

Replacement parts play a key role in Hewlett-Packard's customer service program. Prompt product maintenance, whether it's

performed in your shop or ours, depends on the ready availability of replacement parts. Your replacement parts orders are transmitted via high speed communications systems to Parts Centers strategically located. Most orders are shipped the same day received at the Parts Centers.

When ordering a replacement part, please specify the Hewlett-Packard part number listed in the table and give the complete name. If circumstances require your ordering a part without specifying the part number, please include in your order the instrument model number, its serial number, a complete description of the part, its function, and its location in the equipment.

Customer service agreements

Your instrument maintenance requirements in many cases may be handled most economically by entering into a Hewlett-Packard Customer Service Agreement. When you have a customer service agreement, HP assumes our maintenance responsibilities for a basic annual fee. This relieves you of having to hire your own trained maintenance specialists, of having to maintain replacement parts inventories, and of having to set up the administrative procedures needed for proper maintenance scheduling. Please contact your nearest HP office for details.

Service publications

The Operating and Service Manual supplied with each Hewlett-Packard test and measuring product contains maintenance, calibration, diagnostic and repair procedures, with troubleshooting charts and circuit diagrams. All replaceable parts are listed. Extra manuals are available at reasonable cost from your nearby Hewlett-Packard field office. Most operating and service manuals with changes and service notes are now available on COSATI standard, positive microfiche.

New or special calibration procedures, instrument modifications, and special repair procedures are described in detail in Hewlett-Packard Service Notes. This series of publications serves as a convenient means of updating operating and service manuals.

Bench Briefs, a periodic newsletter, has servicing tips, new modifications and other suggestions to help repair and maintenance personnel get maximum performance from Hewlett-Packard instruments. It describes new service notes and other company publications as they become available. To become a regular subscriber, ask your local HP field office to place your name on the mailing list.

ORDERING INFORMATION

Shipping, prices, and terms of sale



Communicating with HP

Hewlett-Packard is committed to providing convenient local support and the best possible attention to customer needs on a worldwide basis. There are more than 172 sales and service offices located in 65 countries; A listing of offices appears on the inside back cover of this catalog.

Your entry point to the resources of Hewlett-Packard is through the local HP office nearest you. Our field engineers and order support specialists there are well-equipped to provide you with pre-sale assistance in product selection, as well as related business information such as current product availability and price delivered to your location.

Many HP field offices are tied into a sophisticated intra-company communications system. This not only means prompt transmission of orders to any of the 30 HP product responsible divisions—it also speeds the flow of regular messages among all HP field offices and factories. The objective, of course, is to provide the fastest possible response to your product interests.

Placing our order

Hewlett-Packard people at the field office nearest you will be pleased to provide assistance in selecting the HP equipment most appropriate to your needs, and to help you prepare your order.

The information in this catalog will, in many cases, be sufficient for you to decide to buy a particular HP product. In those instances, a telephone call to the nearest HP office will provide you with (1) information on product availability, and (2) the product's price, delivered to your location (since any budgetary prices provided with this catalog are FOB appropriate HP factory or warehouse facility).

HP wants to be sure the product delivered to you is exactly the one you want. Therefore, when placing your order, please specify the product's catalog (model, accessory, or part) number, as well as the product's name. Be as complete as possible in specifying exactly what you'd like, including standard options.

In the event you want special features or capabilities such as different color or a non-standard power line voltage, ask your HP field engineer about availability and cost of these "specials" first—and then, to prevent misunderstandings, include special instructions and specification details with your order.

Shipping methods

Inside the USA: Shipments to destinations in the USA are made directly from factories or local warehouses. Unless specifically requested otherwise, express or truck transportation is used, whichever is less expensive and most serviceable to you. Small items are sent parcel post. If fast delivery is needed, we gladly ship by air freight, air express, or air parcel post, when specified on your order, at prevailing rates. In many parts of the USA, a consolidated air freight service provides the speed of air transport at surface rates. Ask your HP field engineer for details.

Outside the USA: Shipments to destinations outside the USA are made from the appropriate Hewlett-Packard facility by either surface or air, as requested. Sea shipments usually require commercial export packaging at a nominal extra charge.

Budgetary prices

Price information which may be supplied with this catalog provides you with helpful budgetary guidance.

Prices appearing in this catalog, unless otherwise specified, are F.O.B. USA factory or shipping point and apply only to domestic U.S.A. customers.

Please call your nearby Hewlett-Packard field office to determine a product's delivered price outside of the U.S.A.

Prices furnished with this catalog are net prices prevailing at the time of printing. Hewlett-Packard reserves the right to change prices, and those prices prevailing at the time an order is received will apply.

Quotations and pro forma invoices

Destination prices and other details you may need to know before ordering can be quickly obtained via telephone. Just call your nearest HP office.

If you are an international customer requiring formal paperwork such as pro forma invoices or FAX, CIF, or C&F quotations, please contact the Hewlett-Packard office or representative serving your area. Exportation or importation assistance is also available.

Terms of sale

Inside the USA: Terms are net 30 days from invoice date. Unless credit with Hewlett-Packard has already been established, shipments will be made COD or on receipt of cash in advance.

Leasing and extended financial terms are available. However, the associated costs are not included in any product prices furnished with this catalog. Your nearby HP office will be pleased to discuss your requirements, and work with you in setting up an appropriate program.

Outside the USA: Terms for orders from customers outside the United States of America which are placed with the Hewlett-Packard Company, are irrevocable letters of credit or cash in advance—unless other terms have been previously arranged. Terms for orders placed with authorized Hewlett-Packard international subsidiaries or representatives/distributors are mutually determined.

U.S. government sales

Most products in this catalog are covered on GSA federal supply schedule multi-award contracts.

Product changes

Although product information and illustrations in this catalog were current at the time it was approved for printing, Hewlett-Packard, in a continuing effort to offer excellent products at a fair value, reserves the right to change specifications, designs, and models without notice.