

THE HP 8510B AS A HIGH PERFORMANCE ANTENNA AND RADAR CROSS-SECTION ANALYZER

John W. Boyles
Network Measurements Division
1400 Fountaingrove Parkway
Santa Rosa, California 95403

RF & Microwave
Measurement
Symposium
and
Exhibition

 HEWLETT
PACKARD

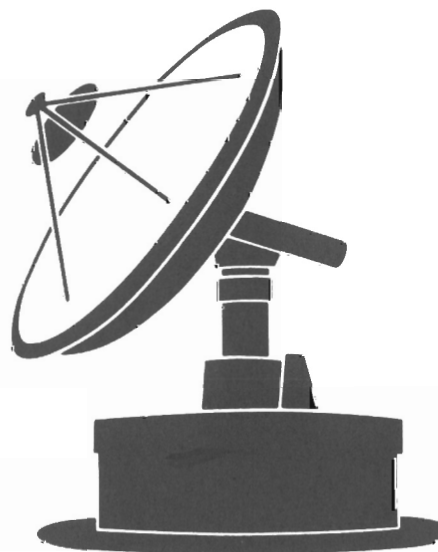

ANTENNA AND RCS TESTING WITH THE HP 8510B NETWORK ANALYZER

John W. Boyles
Network Measurements Division
1400 Fountaingrove Parkway
Santa Rosa, CA 95401

ABSTRACT:

The HP 8510B Network Analyzer contains enhancements and new features that expand its scope beyond network analysis to include new capability for high performance Antenna and Radar Cross-Section (RCS) Testing.

This paper describes different measurement techniques used for Antenna and RCS testing including the use of Far-Field, Near-Field, and Compact Antenna and RCS test ranges. The unique requirements that these measurement techniques place on the instrumentation and how they are satisfied by the appropriate HP 8510B configuration are discussed. Other topics include descriptions of the harmonic sampler (HP 8511A) and external mixer based front ends for the HP 8510B and the use of software (time domain) and hardware gating techniques to remove RCS range clutter.

Author:

John W. Boyles is a development engineer at the Network Measurements Division of Hewlett-Packard located in Santa Rosa, CA. He has a BS degree received from North Carolina State University in 1978 and a MSEE degree received from the Georgia Institute of Technology in 1979, both in electrical engineering. With HP since 1979, he has performed both microwave oscillator and analog circuit design and has developed training materials on time domain network analysis. Since 1984, he has been involved in application and system development for Antenna and Radar-Cross Section Measurements with High Performance Vector Analyzers.

THE HP 8510B
AS A HIGH PERFORMANCE
ANTENNA AND RCS ANALYZER

6751

HP 8510B PRODUCT DESCRIPTION

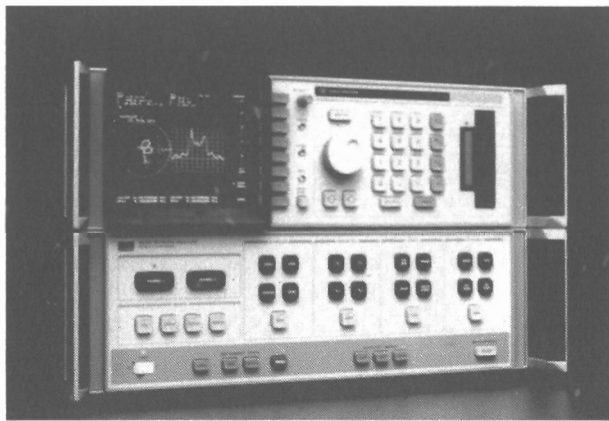

6752

HP 8510B ANTENNA TEST
CAPABILITIES

- ❑ 4-Input Phaselocked Receiver
- ❑ Magnitude and Phase Measurement
- ❑ Broad Frequency Coverage
- ❑ High Measurement Sensitivity
- ❑ Extremely Fast Measurement Speed
- ❑ Precise Triggering
- ❑ Frequency List Mode
- ❑ HP-IB & Analog Outputs
- ❑ Proven Reliability (>3000 hr MTBF)

6753

Antenna and Radar Cross Section (RCS) measurements are performed in a variety of ways, each of which presents unique challenges to the test instrumentation and measurement system. While there are several different kinds of antenna and RCS test ranges, the required test equipment does not change significantly between them. This paper describes how to configure the HP 8510B Network Analyzer to make high performance Antenna and RCS measurements.

The HP 8510 Network Analyzer is a high performance stimulus/ response measurement system that consists of a microwave source, receiver front end, and the HP 8510B as IF receiver and system controller. Its modularity and general flexibility have made the HP 8510 useful for a variety of antenna and RCS applications (Reference 1). Recent HP 8510B enhancements have greatly expanded the analyzer's antenna and RCS capability. [This paper lists many features found only in the HP 8510B. To upgrade an HP 8510A to an HP 8510B, order the HP 85103A Performance Upgrade Package (Reference 2).]

The HP 8510B can be configured as a multi-input, phaselocked antenna test receiver that offers very broad frequency coverage, wide dynamic range and high measurement sensitivity. Its hardware triggering and fast internal processing combine to give precise CW Pattern measurements at a data rate fast enough even for near-field antenna testing. The frequency list mode allows testing at multiple frequencies. Both HP-IB and Analog outputs are provided for automated measurements or direct interface with antenna pattern recorders. These capabilities, coupled with its proven reliability (>3000 hours mean time between failures (MTBF)), make the HP 8510B a very attractive choice for antenna test.

HP 8510B RCS CAPABILITIES

- ❑ High Speed Measurements
- ❑ Broad Frequency Coverage
- ❑ RCS Error Correction
- ❑ Time Domain Imaging
- ❑ Software Gating
- ❑ Pulsed-RF Operation
- ❑ Antenna, RCS, and Network Analysis

6754

OUTLINE

- I. HP 8510B FRONT ENDS
- II. ANTENNA TESTING
- III. RCS TESTING
- IV. SUMMARY/ RECOMMENDATIONS

6756

I. HP 8510B FRONT ENDS

- A. HP 8511A CONFIGURATION
- B. EXTERNAL MIXER CONFIGURATION
- C. COMPARISON OF FRONT ENDS

6757

For RCS test, the HP 8510B provides an extremely fast RAMP sweep mode for broadband measurements at up to 801 frequencies. The built-in calibration models can be used to automatically correct the RCS data for systematic measurement errors. Time domain processing then provides RCS down-range imaging and software gating capability. For more advanced RCS systems, the analyzer can also be operated under pulsed-RF test conditions.

In addition to its antenna and RCS test capabilities, the HP 8510B also makes high performance network measurements.

We will begin with a description of the HP 8510B configurations that are most appropriate for Antenna and RCS testing, focusing on both HP 8511A and external mixer front-ends. Next, several antenna and RCS test categories will be described to show how the HP 8510B can be configured and applied to meet the unique requirements of each application. Far-field, compact range, and near-field antenna measurements and far-field, compact range, and pulsed-RF RCS measurements will be covered. This will be followed by a short summary.

We will begin with a description of the HP 8510B antenna and RCS test configurations, their features, and the performance that can be achieved. The two basic receiver configurations use either the HP 8511A or external mixer front ends. This will be followed by a performance comparison of each configuration.

HP 8511A CONFIGURATION

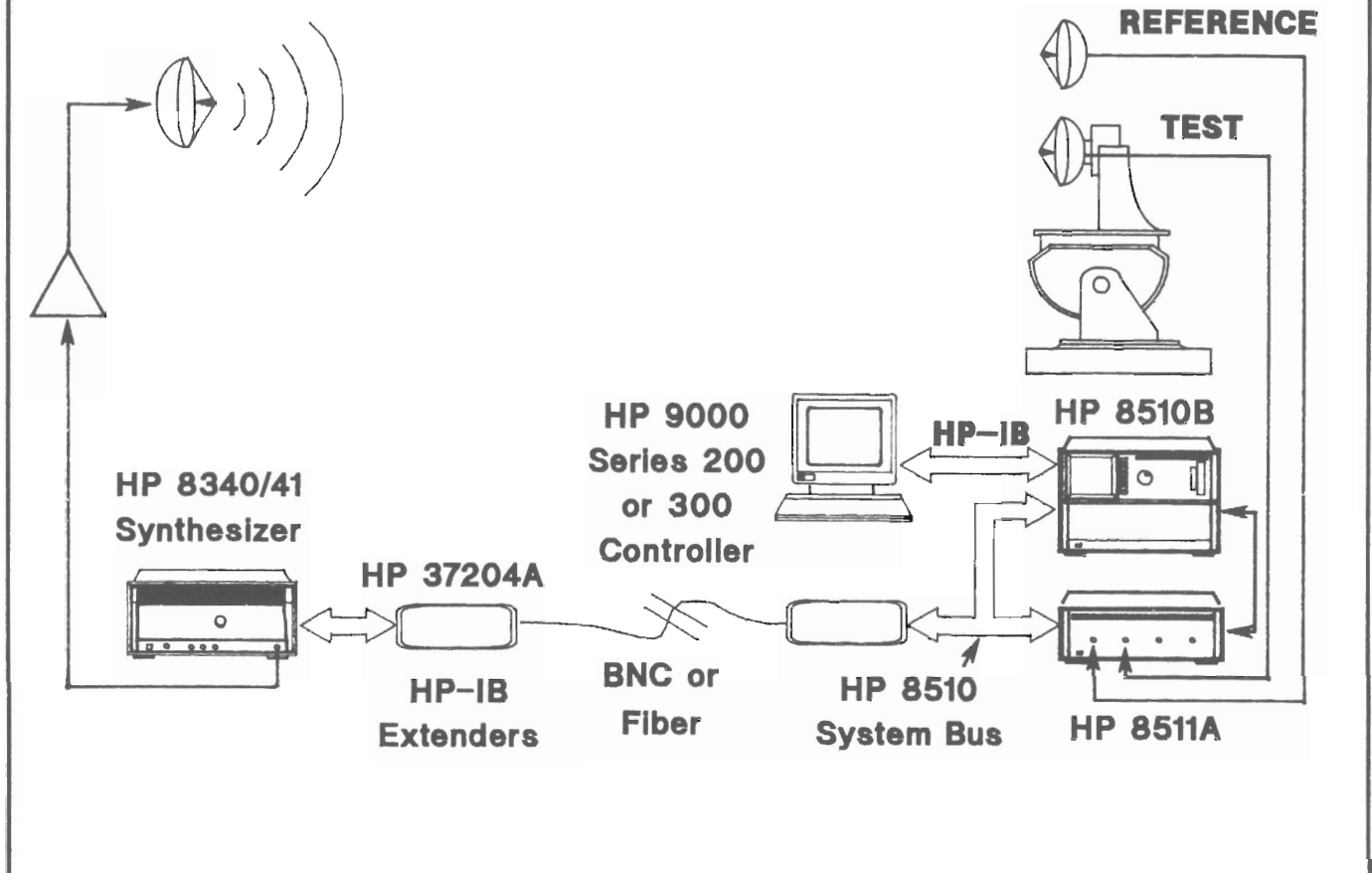

6758

HP 8511A CONFIGURATION

The HP 8510B Analyzer consists of a microwave source (HP 8340B/ 8341B), a receiver front end for RF to IF conversion, and the HP 8510B as the IF receiver and system controller. This configuration shows the HP 8511A Frequency Converter as the receiver front end.

The HP 8511A uses a Harmonic Sampling technique to convert the RF at each of its four inputs to 20 MHz IF signals that are processed by the HP 8510B. The RF source is provided by the HP 8340B/ 8341B Synthesized Sweeper (the HP 8350B Sweep Oscillator family is also compatible). The source and test set are controlled by the HP 8510B over a private (HP-IB) system bus, with an additional IF interconnect cable to the test set. Because the Voltage Controlled Oscillator (VCO) inside the HP 8511A phaselocks to the incoming RF signal (instead phaselocking the RF to a synthesized LO), the RF source can be separated a great distance from the receiver and operated under remote control using HP-IB extenders.

To measure amplitude and phase, the HP 8510B must have a Reference signal that remains constant during the measurement. This signal provides the denominator of the measured parameter (Test/Reference). Usually, this amplitude and phase signal also serves as the phaselock reference signal as well, although this is not always the case (for example, for pulsed-CW RCS as described later). The phaselock reference signal is obtained using a separate reference antenna or else a cable to route to the test set a signal coupled off from the RF source.

ADVANTAGES OF HP 8511A

- ❑ Compact, Low Cost Front End
- ❑ Broad Bandwidth (45 MHz-26.5 GHz)
- ❑ Wide Dynamic Range (75-105 dB)
- ❑ Extremely Fast RAMP Sweep

TRADEOFFS

- ❑ Limited Sensitivity
- ❑ Susceptible to RFI
- ❑ RF Cable Losses

6759

The HP 8511A provides a compact, low cost microwave front end with an extremely broad bandwidth (45 MHz to 26.5 GHz) and wide dynamic range (75-105 dB, depending on averaging). Operating in the RAMP Sweep mode, the HP 8511A provides extremely fast broadband RCS measurements.

The HP 8511A tradeoffs come from its use of a harmonic sampler, a technology with a relatively high noise figure that limits its input sensitivity. Although not affected by RF harmonics or subharmonics, the HP 8511A is susceptible to RF Interference (RFI) at other frequencies (more on this topic later). And because the RF signals are routed from the antenna to the test set, RF cable losses are encountered.

HP 8511A PERFORMANCE

	Frequency Range	
	0.045 - 20 GHz	20 - 26.5 GHz
Dynamic Range 0 Averages	75 dB (-10 to -85 dBm)	68 dB (-15 to -83 dBm)
Dynamic Range 1024 Averages	105 dB (-10 to -115 dBm)	98 dB (-15 to -113 dBm)

* Signal to Noise Ratio of 13 dB.

6760

This slide lists the dynamic range, maximum input, and sensitivity (for signal to noise ratio of 13 dB) of the HP 8510B/ HP 8511A configuration for the cases of 0 and 1024 averages (the noise reduction effects of averaging will be covered in more detail later). These numbers will be helpful in determining the best configuration for a particular antenna/ RCS range.

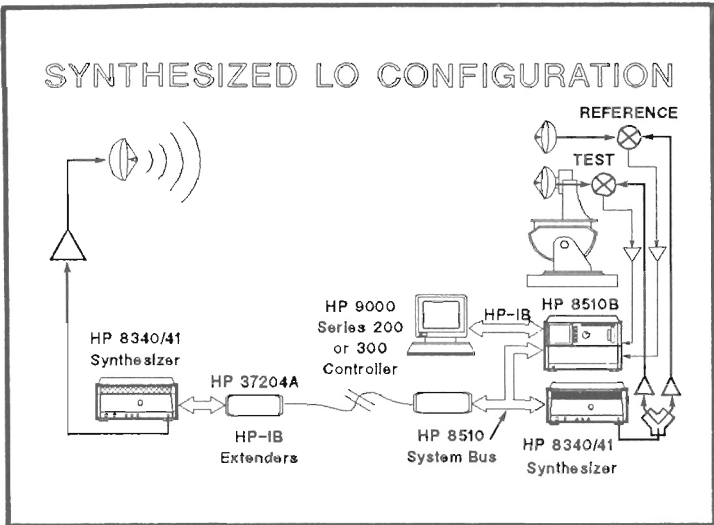

6762

It is also possible to use an HP 8340B/ 8341B Synthesized Sweeper as the LO source for a non-phaselocked (fully synthesized) test configuration. With the synthesized LO, there are no restrictions on the remotability of the reference mixer (unlike the phaselocked LO, described later). In addition, it also allows (magnitude-only) pattern testing with no reference signal.



6763

A receiver front end with external mixers allows RF to IF (20 MHz) conversion to take place very close to the antenna under test. Advantages of the HP 8510B external mixer configuration include improved measurement sensitivity, minimized RF cable (and rotary joint) losses between the antenna and receiver, and reduced susceptibility to spurious RFI signals. The external mixer configuration is also capable of full millimeter wave coverage to 100 GHz (no holes).

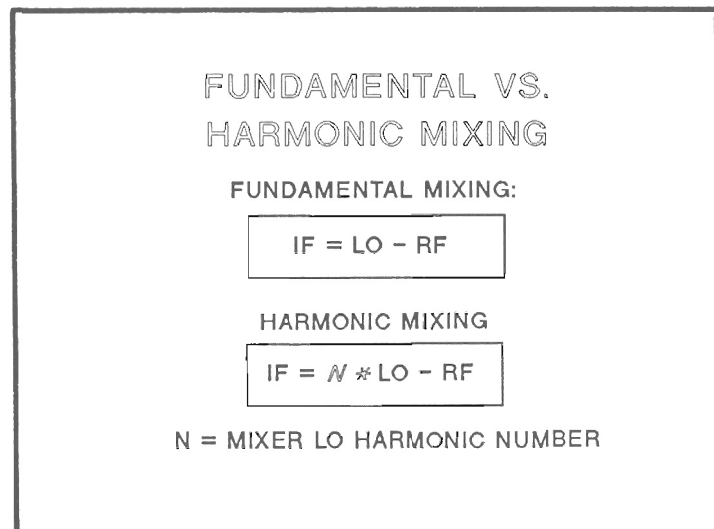

6764

The external mixer configuration can be operated with either Fundamental or Harmonic Mixing. With fundamental mixing, the IF frequency equals the LO frequency minus the RF frequency. The "harmonic" mixer is one that is designed to use a harmonic of the LO signal in the conversion process. The harmonic mixer output is $IF = (N * LO) - RF$, where N is the LO harmonic number. Each mixing technique offers certain advantages and tradeoffs.

ADVANTAGES OF HARMONIC MIXING

- ▣ Lower Frequency LO Source
- ▣ Lower Cost of LO Source, Amplifiers Cabling, and Rotary Joints
- ▣ Better Mixer RF/ LO Isolation

6765

HARMONIC MIXING TRADEOFFS

- ▣ Higher Conversion Loss Reduces Sensitivity (by $> 20 \times \text{LOG}_{10}[N]$)
- ▣ Susceptible to RFI at Each LO Harmonic

RFI EXAMPLE:

$$\text{RF} = 14 \text{ GHz}, \quad \text{LO} = \text{RF} / 7 = 2 \text{ GHz}$$

The Mixer Will Also Convert Signals at 2, 4, 6, 8, 10, and 12 GHz With Lower Loss, and at 16, 18, 20,... GHz With Higher Loss.

6766

FUNDAMENTAL MIXING

ADVANTAGES

- ▣ Highest Sensitivity Because of Low Mixer Conversion Loss
- ▣ Highest RFI Immunity Because of Fundamental LO Frequency

TRADEOFF

- ▣ Increased Cost of LO Source, Cables, Amplifiers, and Rotary Joint

6767

The use of harmonic mixing lowers the required LO source frequency by the mixer harmonic number, N. For example, a x4 harmonic mixer operating at an RF frequency of 16 GHz requires a LO frequency of only 4 GHz. This reduces the cost of the LO source, isolation amplifiers, cabling, and antenna rotary joints. Harmonic mixers also usually have much better RF to LO isolation than fundamental mixers, which reduces the need for LO isolation amplifiers. For low mixer harmonic numbers, these improvements are achieved with little sacrifice in measurement performance.

The major tradeoff with harmonic mixing is the increased mixer conversion loss (of roughly $20 \times \log(N)$ dB), which reduces measurement sensitivity. And because a harmonic mixer front end can also downconvert signals at each LO harmonic, it is susceptible to interference from spurious RF signals, particularly at lower LO harmonics where the mixer has less conversion loss. For example, if a x5 harmonic mixer is used to measure a 15 GHz RF signal, it will also convert any signals at 3, 6, 9, and 12 GHz with lower conversion loss, and at 18, 21, 24,... GHz with higher conversion loss. See Reference 3 for more information.

The fundamental mixer front end provides the highest measurement sensitivity of the HP 8510B antenna test configurations because of the low mixer conversion loss (typically 6-8 dB). Because only one LO signal is present in the mixer, it also provides the highest immunity to RFI signals. The tradeoff with using fundamental mixing is the increased cost of the LO source, isolation amplifiers, cables, and rotary joints, which must operate at a higher frequency than with harmonic mixing.

SENSITIVITY COMPARISON

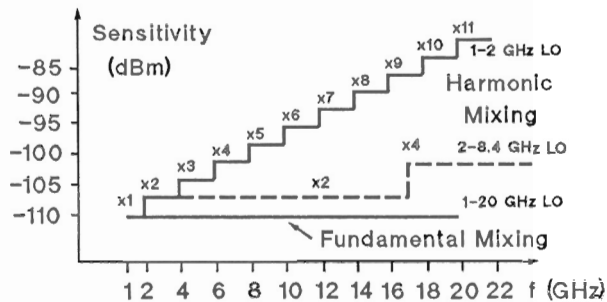

6768

This slide gives a graphical comparison of the difference in sensitivity that can be achieved with different mixing approaches. Fundamental mixing offers the highest sensitivity that stays essentially constant over the full mixer frequency range. The use of a low numbered harmonic mixer with a 2-8.4 GHz LO has only slightly worse sensitivity, which makes it attractive for many applications. The high numbered harmonic mixer with a 1-2 GHz LO starts out with high sensitivity, but it degrades in a stairstep fashion as the frequency in increased (by greater than 30 dB at the high end).

RFI COMPARISON

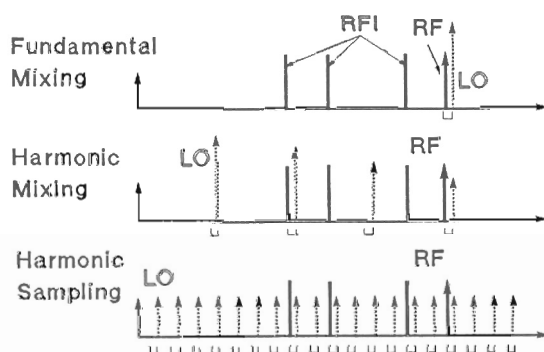

6769

This slide illustrates the RFI susceptibility of the fundamental mixing, harmonic mixing, and HP 8511A harmonic sampler configurations. With fundamental mixing, only RFI signals that are very close to the test (RF) frequency will cause interference. For harmonic mixing, several LO harmonics are present, which increases the likelihood that RFI will be detected. This is compounded by the mixer conversion loss being better at lower LO harmonics, and is why the lowest practical harmonic mixing number should be used. With the harmonic sampler, there are very many LO harmonics present, but with approximately equal conversion loss, making it much more susceptible to RFI.

EXTERNAL MIXER CONSIDERATIONS

- Reference Mixer Phaselocked Loop can Have up to 300 Ft. Total Delay (Unlimited with Synthesized LO)
- Supports Single Point, Fast CW, and Step Sweep Modes

6770

When using the phaselocked HP 8350B as LO in the external mixer configuration, the total electrical delay of the phaselocked loop is restricted to 300 feet (requires option H15). This limits the separation between the HP 8510B and the reference mixer (but not the test mixer) to a maximum of 150 feet (45.5 m). The external mixer configuration supports all instrument features and data modes except for Ramp sweep operation.

EXTERNAL MIXER PERFORMANCE

NOISE FLOOR CALCULATIONS

$$P_n = kTFB/A$$

- K = Boltzman's Constant
- T = Front End Temperature
- F = Front End Noise Figure
- B = Receiver Noise Bandwidth
- A = Averaging Factor

$$P_n(\text{dBm}) = -134 \text{ dBm} + F(\text{dB}) - 10 \log_{10}(A)$$

6771

COMPUTING NOISE FIGURE

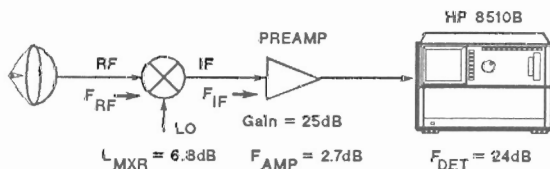

$$F_{IF} = F_{AMP} + (F_{DET} - 1) / G_{AMP} \quad (\text{linear})$$

$$F_{RF}(\text{dB}) = L_{MXR}(\text{dB}) + F_{IF}(\text{dB}) = 11 \text{ dB}$$

6772

MEASUREMENT SENSITIVITY

AVERAGE NOISE FLOOR

$$P_n = -134 \text{ dBm} + F_{RF}(\text{dB})$$

$$= -123 \text{ dBm}$$

SENSITIVITY = *PEAK* Noise Floor

$$S_{MIN} = P_n + 13 \text{ dB}$$

$$= -110 \text{ dBm, (no averages)}$$

6773

The following example shows how to calculate the performance of the HP 8510B external mixer configuration. The receiver average noise floor is described by the equation $P_n = kTFB/A$, where k = Boltzman's constant ($1.379 \text{ E-20 mW/Kelvin-Hz}$), T = the receiver front end temperature (Kelvin), F = the receiver front end noise figure, B = the noise bandwidth (approximately 10 kHz for the HP 8510B), and A = the averaging factor. Expressed in decibels (assuming $T=290\text{K}$ and $B=10 \text{ kHz}$), $P_n(\text{dBm}) = -134 \text{ dBm} + F(\text{dB}) - 10 \log_{10}(A)$.

The HP 8510B IF detector (20 MHz inputs) has a average noise floor of -110 dBm, measured in a 10 kHz IF bandwidth, for a noise figure (F_{DET}) of 24 dB. Adding an IF preamp with a 2.7 dB noise figure and 25 dB gain (Avantek ACT5-200) will reduce the IF noise figure (F_{IF}) to 4.2 dB, according to the equation $F_{IF} = F_{AMP} + (F_{DET} - 1) / G_{AMP}$. The RF noise figure (F_{RF}) is approximately equal to F_{IF} plus the mixer conversion loss. Using a fundamental mixer with 6.8 dB loss gives an RF noise figure of 11 dB. RF cable losses add directly to F_{RF} . Further improvement is possible with a low noise RF preamp.

The HP 8510B noise floor can now be calculated: $P_n = -123 \text{ dBm}$ ($-134 \text{ dBm} + 11 \text{ dB } F_{RF}$). While P_n represents the average noise level, the peak noise levels are much higher. It can be shown that the peaks of white thermal noise do not exceed a value of $P_n + 10 \text{ dB}$ with very high certainty (>99.96%). In addition, the effect of noise is increased by 3 dB when a calibration that involves background subtraction (RCS cal) is used. Therefore, 13 dB is added to the average noise level to obtain the useful RF measurement sensitivity, or $S_{min} = P_n + 13 \text{ dB}$. For the previous example, $S_{min} = -110 \text{ dBm}$.

EFFECT OF AVERAGING

- ❑ Similar to IF Bandwidth Reduction
- ❑ Improves Sensitivity by $10 \log_{10}(A)$
- ❑ Increases Measurement Time by 200 Microseconds/ Average

EXAMPLE: 1024 Averages

- ❑ Improves Sensitivity 30 dB ($S_{MIN} = -140$ dBm)
- ❑ Adds 205 msec to Measurement Time

6774

Averaging improves measurement sensitivity by $10 \cdot \log_{10}(\text{averages})$, similar to the effect of reducing the IF bandwidth by the averaging factor. Each average adds an additional 200 microseconds per point to the measurement time. An averaging factor of 128 improves the IF sensitivity by 21 dB, to -134 dBm (equivalent to an IF bandwidth reduction from 10 kHz to approximately 78 Hz) while adding approximately 205 msec per point to the measurement time.

DYNAMIC RANGE

UPPER LIMIT

$$S_{MAX} = \text{MAX IF INPUT} - G_{AMP} + L_{MXR}$$

$$= -10 \text{ dBm} - 25 + 6.8 = -28 \text{ dBm}$$

DYNAMIC RANGE (DR)

$$DR = S_{MAX} - S_{MIN}$$

$$DR = -28 - (-110) = 82 \text{ dB}$$

$$= -28 - (-140) = 112 \text{ dB (1024 avgs)}$$

6775

The upper limit (S_{max}) of the measurement dynamic range can be determined by adding to the HP 8510B maximum IF input level (-10 dBm) the losses that are encountered and subtracting the gains. Therefore, $S_{max} = -10$ dBm (max IF input) + 7 dB (RF/IF conversion loss) - 25 dB (IF preamp gain) = -28 dBm. The measurement dynamic range, $DR = S_{max}$ (-28 dBm) - S_{min} (-113 dBm), or $DR = 82$ dB with no averaging or 112 dB with 1024 averages.

SUMMARY: FRONT END FORMULAS

- ❑ IF Noise Figure: $F_{IF} = F_{AMP} + (F_{DET} - 1) / G_{AMP}$
- ❑ RF Noise Figure: $F_{RF} = L_{MXR}(\text{dB}) + F_{IF}(\text{dB})$
- ❑ Average Noise Floor: $P_n = K T F B / A$
 $P_n(\text{dBm}) = -134 \text{ dBm} + F_{RF}(\text{dB}) - 10 \log_{10}(A)$
- ❑ RF Sensitivity: $S_{MAX} = P_n + 13 \text{ dB}$
 $S_{MIN}(\text{dBm}) = -121 \text{ dBm} + F_{RF}(\text{dB}) - 10 \log_{10}(A)$
- ❑ Max RF Input:
 $S_{MAX}(\text{dBm}) = -10 \text{ dBm} + L_{MXR}(\text{dB}) - G_{AMP}(\text{dB})$
- ❑ Dynamic Range:
 $DR = 111 \text{ dBm} - F_{IF}(\text{dB}) - G_{AMP}(\text{dB}) - 10 \log_{10}(A)$

6776

This slide summarizes the formulas used to calculate the performance of the external mixer front end.

EXTERNAL MIXER PERFORMANCE

Parameter	Avg.	Mixing Type	
		Fundamental (7 dB Loss)	Harmonic (x4) (18 dB Loss)
Max Input:		-28 dBm	-17 dBm
Sensitivity:	0	-110 dBm	-99 dBm
	1024	-140 dBm	-129 dBm
Dynamic Range:	0	82 dB	82 dB
	1024	112 dB	112 dB

6777

This table lists the measurement performance achievable with the external mixer front end with fundamental and x4 harmonic mixing for the cases of 0 and 1024 averages. Averaging improves sensitivity by $10 \cdot \log_{10}[\text{averages}]$ and increases the measurement time by $200 \cdot (\text{number of averages}) \cdot (\text{number of points})$ (except in the RAMP sweep mode, where the averaging factor multiplies the sweep time).

COMPARISON OF FRONT ENDS

Parameter	Ranking		
	Fundamental Mixers	Harmonic Mixing	HP 8511A
Sensitivity	1	2	3
RFI Immunity	1	2	3
Dynamic Range	1	1	2
Cost	3	2	1

6778

This table ranks the HP 8511A, fundamental mixer, and a harmonic mixer front ends with regard to sensitivity, RFI immunity, dynamic range, and cost. With an understanding of these considerations, we will now address antenna and RCS measurements.

II. ANTENNA TESTING

- A. ANTENNA BASICS
- B. CONVENTIONAL RANGES
- C. FAR-FIELD REQUIREMENTS
- D. OTHER ANTENNA TEST TECHNIQUES

6779

Before discussing specific antenna test configurations, it is useful to briefly review some antenna basics. This will be followed by a look at conventional antenna test ranges, a review of the requirements of farfield testing, and then other antenna test techniques.

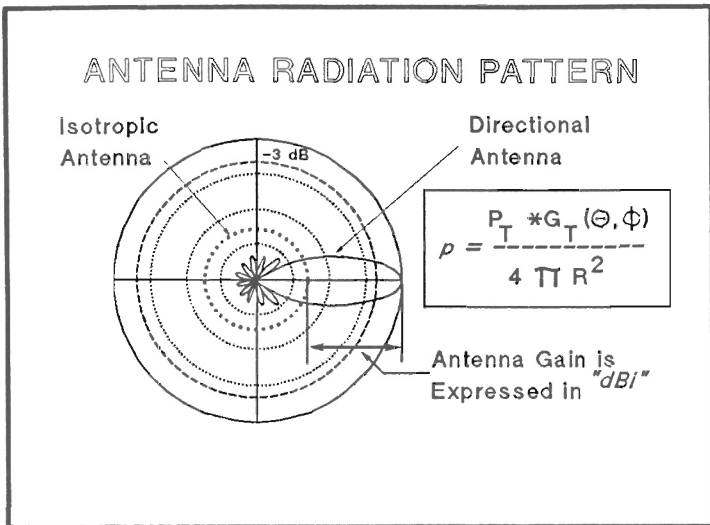

6780

The antenna radiation pattern describes energy is directed as a function of azimuth and elevation angle. Important antenna pattern characteristics include the main beam location, -3 dB (half-power) beamwidth, and the relative sidelobe levels. The radiated field intensity is described by its power density equation (power per unit area). Antenna gain describes the antenna's energy focusing capability and is expressed in terms of dB relative to an isotropic radiator (dBi), an antenna that radiates equally in all directions.

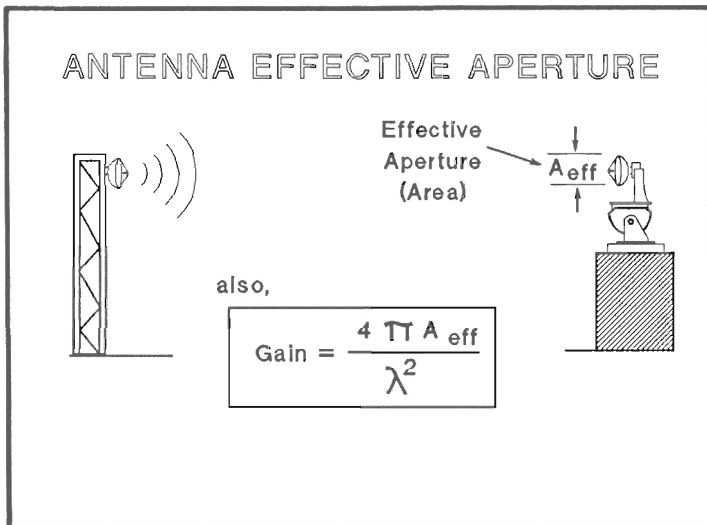

6781

The radiated wavefront is spherical shaped with regard to phase, but with most energy concentrated in the direction of the highest gain. At the other end of the range, the receive antenna encounters part of this radiated wavefront proportional to its effective aperture (area), which describes how electrically large the antenna looks to the incident field. The effective aperture is related to antenna gain by the formula listed.

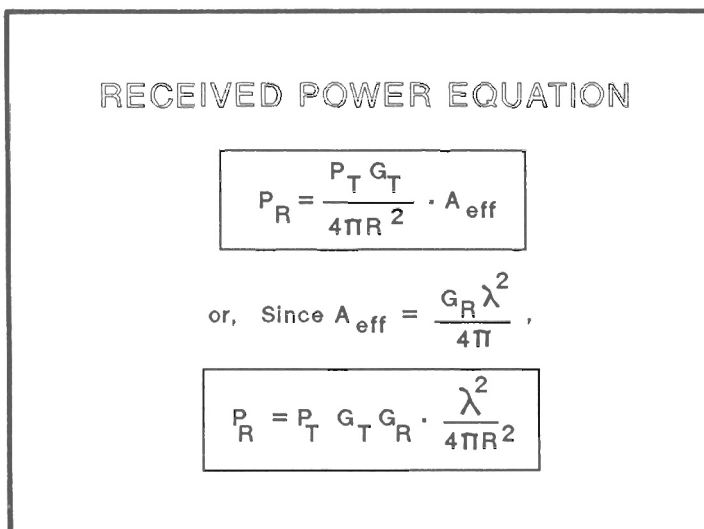

6782

The received power equation is the product of the transmitted power density and the effective aperture of the receive antenna. Using the relationship between antenna aperture and gain, this equation can be rewritten to show that received power is proportional to the transmitted power and antenna gains and is inversely proportional to the square of the distance expressed in wavelengths. Because the received power decreases by the square of the distance between the antennas (R^2), it is desirable to keep this distance as short as possible without violating the requirements of far-field testing.

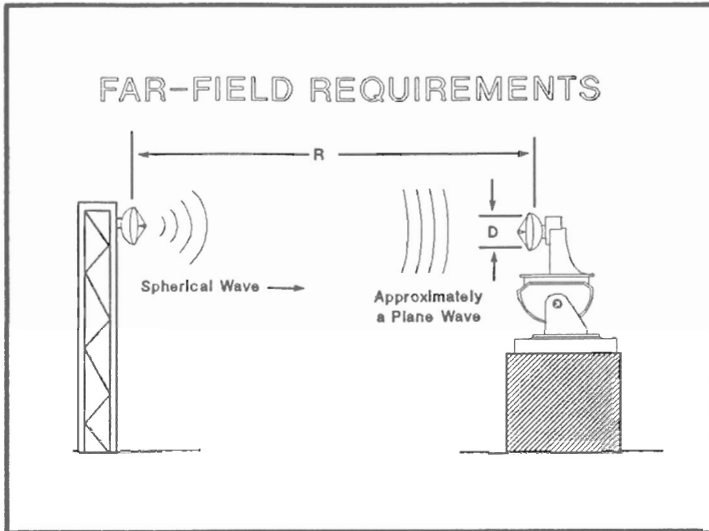

Although an antenna radiates a spherical shaped wavefront, in most applications the receive antenna is far removed from the transmit antenna so that the portion of the wavefront it receives is approximately planar over its aperture. For this reason, planewave illumination is usually desired for antenna pattern testing, and most test ranges have the transmit and receive antennas separated by a large distance to insure that the incident field looks "planar" over the receive antenna aperture. This is referred to as "far-field" testing.

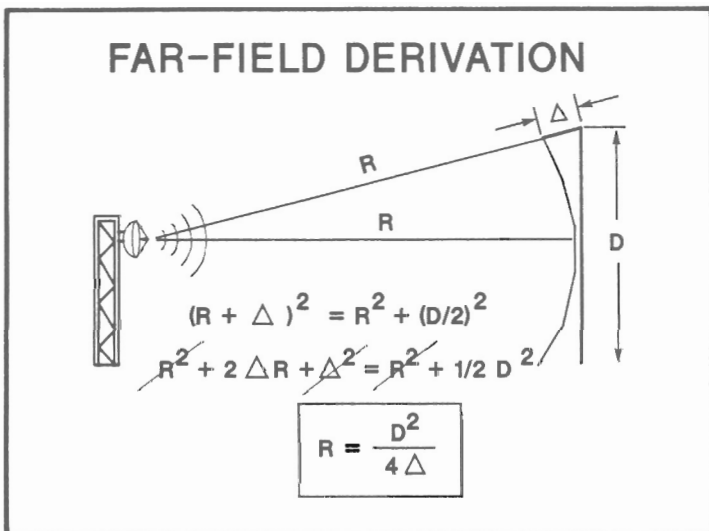

The separation required for far-field testing depends on the amount of phase curvature (delta) that is considered acceptable for a particular antenna under test. From the range geometry, using the Pythagorean Theorem, and ignoring the insignificant Δ^2 term, R is found to be proportional to the largest antenna dimension (D) and inversely proportional to delta.

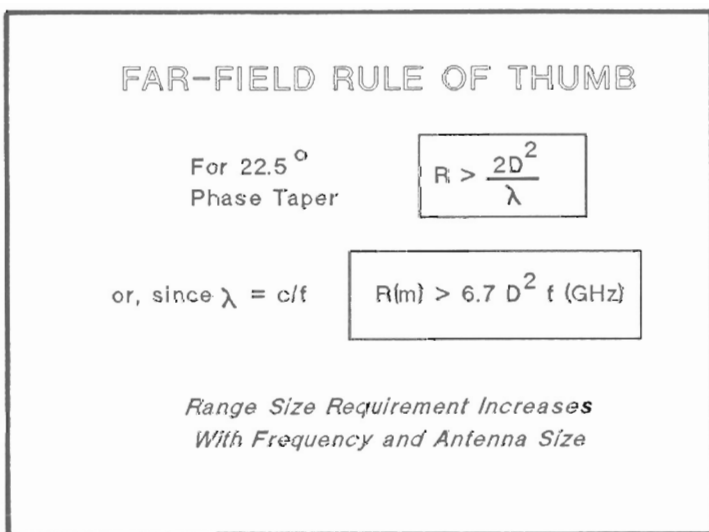

Letting delta equal 1/8 wavelength (22.5°) gives a commonly used rule of thumb for the Far-field separation distance of $R = 2 \cdot D^2 / \text{wavelength}$, where D is the largest dimension of the antenna aperture. It can also be rewritten as $6.7 \cdot D^2 \cdot \text{Frequency}$, which shows that the far-field distance increases with antenna size and operating frequency. This formula is an approximation that still allows 22.5 degrees (1/8 wavelength) of phase curvature across the antenna aperture.

CONVENTIONAL OUTDOOR RANGE

External Mixer Configuration

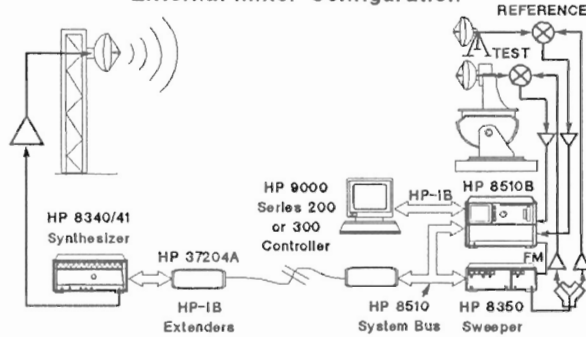

6785

The HP 8510B configuration that is best suited to the long range antenna test application uses the external mixer front-end using fundamental or low numbered harmonic mixing. This configuration provides the high sensitivity and RFI immunity that are important for very long, outdoor ranges. The phaselock reference signal is obtained using a separate reference antenna that picks up a constant signal from the radiating source antenna. This configuration applies to most outdoor test applications.

CONVENTIONAL INDOOR RANGE

HP 8511A Configuration

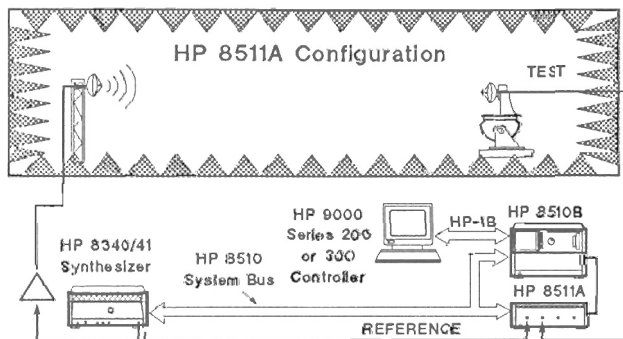

6786

For indoor antenna testing, RF sensitivity is often less of an issue, and a high degree of RFI immunity is not required. Therefore, the HP 8511A configuration is often the best solution. The phaselock reference signal in this case can often be provided using a RF cable if the distances are not too great (otherwise, use a reference antenna). For good phase measurement stability, it is important to electrically balance the cable portions of the reference and test signal paths. The harmonic mixer configuration can be used when higher sensitivity and dynamic range are required.

POSITIONER INTERFACE FOR AUTOMATIC ANTENNA TEST

- ❑ Requires Programmable Positioner Controller
- ❑ Use Computer to Read Position and Output HP-IB Triggers to HP 8510B
- ❑ Have Positioner Controller Output "Record Increment Pulse" (TTL) to Trigger HP 8510B

6788

For automated pattern measurements, data acquisition control can be done using either HP-IB or hardware triggering. With HP-IB triggers, the Frequency List, Single Point, Step Sweep, and Ramp sweep modes can be used. For hardware triggering, many programmable positioner controllers can supply a "record increment pulse" at desired antenna positions to directly trigger the HP 8510B in its FastCW mode. At each TTL trigger, a data point is taken and immediately output to the computer, with a total cycle time of less than 1 millisecond.

INTERFACE FOR MANUAL ANTENNA TEST

- ❑ HP 8510B Analog Output and Single Point Mode
- ❑ Displayed Parameter is Converted to DC Voltage Compatible with Antenna Pattern Recorder Input
- ❑ Can Output Any Parameter/ Rectangular Format
- ❑ Analog Output Updates Every 30 msec (Firmware Rev. 4.0)

6789

Most antenna pattern recorders operate with analog inputs, and the HP 8510B has an analog output to directly interface with them. With the analog output enabled, the displayed parameter is converted to a DC voltage and output on a BNC connector to provide the measurement input to the pattern recorder. Any measured parameter and any of the rectangular formats (including magnitude and phase) can be selected as the analog output. The HP 8510B is operated in the Single Point mode, which continuously updates the measured parameter approximately every 30 msec. See Reference 5.

EFFECTS OF VIOLATING THE FAR-FIELD RULE

- ❑ The $\frac{2D^2}{\lambda}$ Rule is Still an Approximation
- ❑ Non-Planewave Illumination Distorts Measured Sidelobes, Nulls, Beamwidth, and Gain
- ❑ Effect is Worse for Low Sidelobe Antennas

6790

For large/ high frequency antennas, it is increasingly difficult to obtain adequate planewave illumination on a conventional test range. The effects of violating the far-field test condition can be considered by determining the effect of non-planewave illumination on the test antenna pattern. In general, this causes distortion of the measured antenna sidelobes, nulls, beamwidth, and gain, and the effects are more severe for low sidelobe antennas.

EFFECTS OF PHASE TAPER

$$R = \frac{2D^2}{\lambda} \quad (22.5^\circ \text{ Taper})$$

5 dB/ div Slight Distortion 10 dB/ div Noticeable Distortion

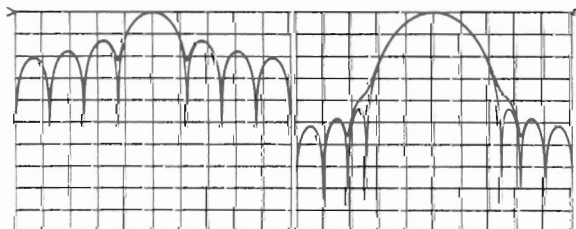

13 dB Sidelobe
Antenna

44 dB Sidelobe
Antenna

6791

This slide illustrates how different amounts of phase curvature affect a high sidelobe (13 dBc) and a low sidelobe (-44 dBc) antenna pattern. The most significant effect is a masking of the close-in sidelobes. For the -13 dB sidelobe antenna, the effects of phase curvature are not significant until it exceeds $1/8$ wavelength, which is the amount allowed by the $2D^2/\text{wavelength}$ formula. However, the distortion is more severe for the low sidelobe antenna, which indicates that much further reduction in phase taper is required for acceptable characterization (which increases the far-field distance).

OTHER TECHNIQUES FOR ANTENNA TEST

- ❑ COMPACT ANTENNA TEST RANGE (CATR)
- ❑ NEAR-FIELD ANTENNA TEST RANGE

6792

Therefore, to perform plane-wave testing of high performance antennas, the conventional test range has to be much larger than distance given by the familiar $2D^2/\lambda$ far-field rule of thumb. However, there are other measurement techniques available to test such high performance antennas in smaller geometries. The following section will describe the compact antenna test range, and the near-field antenna test range.

COMPACT ANTENNA TEST RANGE

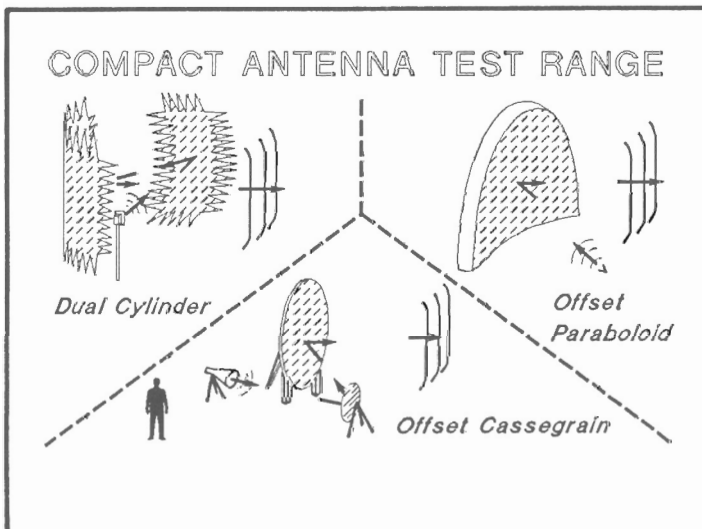

6793

The Compact Antenna Test Range (CATR) allows planewave testing of large antennas in relatively short distances. The CATR technique involves using large curved metal reflectors (approximately parabolic) to change the antenna's spherical wavefront into a plane wave. Because it is an indoor range, it has the advantages of insensitivity to weather and increased security. The three dominant CATR designs today use an offset Cassegrain (Harris Corporation), a dual cylindrical surface (March Microwave), or an offset paraboloid (Scientific Atlanta) reflector design.

CATR REQUIREMENTS

- ❑ Required Sensitivity Depends on CATR "Transfer Function"
- ❑ Frequency Range Depends on Reflector Size and Surface Finish
- ❑ The HP 8510B Has Versatility to Meet Broad Range of Requirements

6794

The many CATR performance issues are beyond the scope of this paper, but two that influence the test equipment are the frequency range, which is determined by the size and surface finish of the reflectors, and the CATR "transfer function", which describes the ratio of the power received over the power transmitted for a given RCS target size. A higher CATR transfer function requires lower receiver sensitivity. In general, proper selection of HP 8510B front end will satisfy the many CATR requirements.

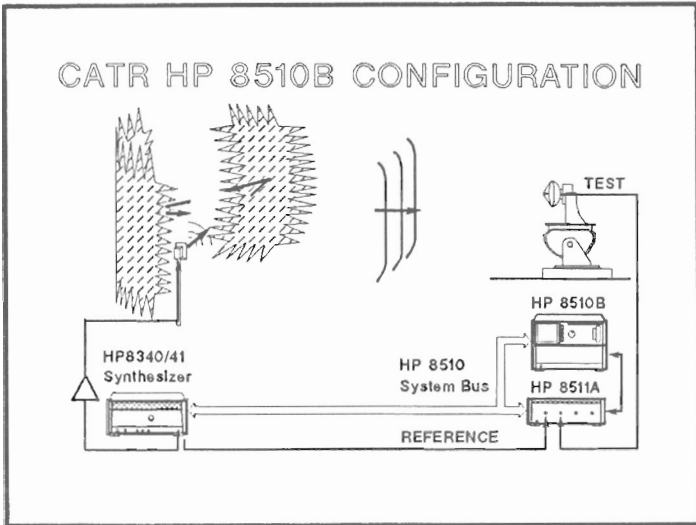

6795

For the compact range antenna testing, either the HP 8511A and the external mixer configuration can be used, and the choice becomes one of frequency range and measurement sensitivity. This slide shows the HP 8511A configuration. (Further discussion of CATR considerations will be made in the section on CATR RCS measurements.)

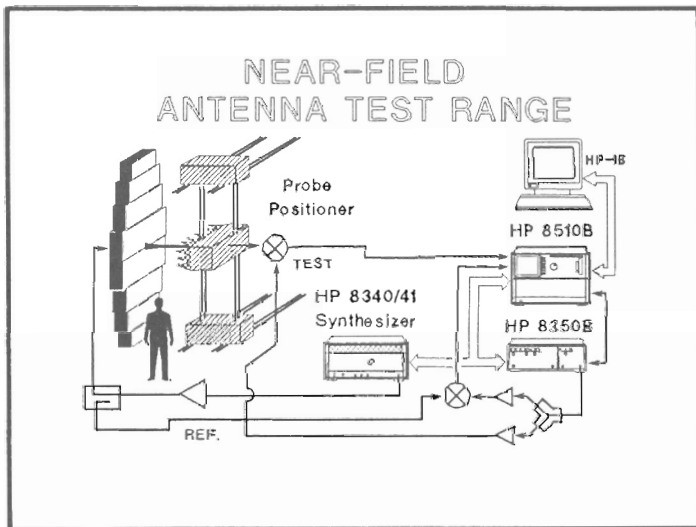

6796

The Near-Field measurement technique offers another approach for testing large antennas indoors. Taking advantage of the mathematical relationship (through the 2-dimensional Fourier Transform) between the near-field distribution and the far-field radiation pattern, this technique involves characterizing the magnitude and phase response of the antenna in the radiating near-field and then computing the far-field pattern. This requires collecting often millions of data points at precise locations and then processing the data offline in large computers.

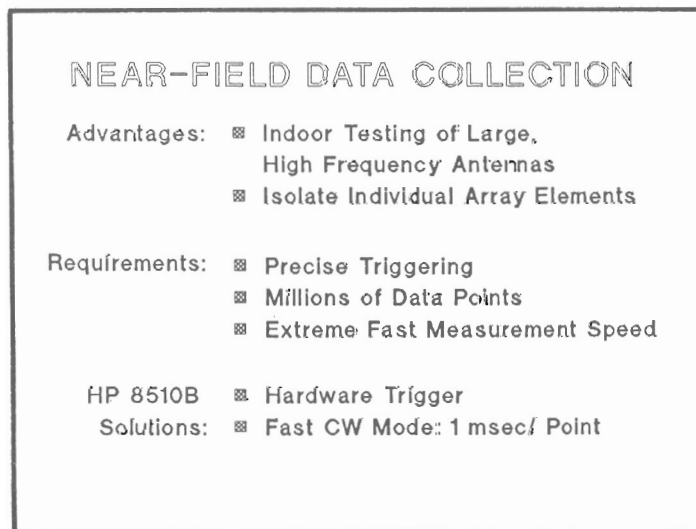

6797

The near-field technique allows testing very large and/or high frequency antennas in small, indoor ranges. For phased-array antenna test, the near-field data can also be used to isolate bad array elements. The vast amount of data collection requires an extremely fast receiver with precise data triggering. The HP 8510B FastCW mode (designed for compatibility with near-field testing) operates with (TTL) hardware triggering to provide precise data acquisition at a continuous, uninterrupted rate of 1 millisecond per point, which includes data acquisition and output to a computer.

III. RADAR CROSS-SECTION

"How Large an Object Looks to a Radar Signal"

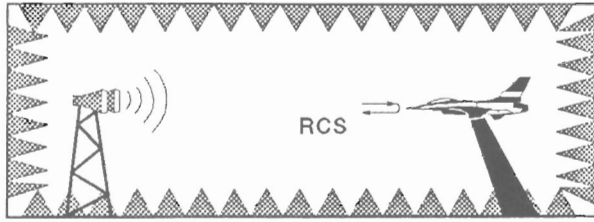

6798

Radar Cross Section (RCS) testing is a rapidly growing measurement category. Simply defined, RCS is a measure of how large an object looks to a radar signal or, more technically, a measure of the echo characteristics of a radar target. Important RCS targets include air, land, and sea vehicles and the objects that are placed on them (including antennas, radomes, materials, etc.). For RCS measurements, the transmit and receive antennas are located on the same side of the range and pointed towards the target on the other end.

RCS RANGE TERMINOLOGY

- ☒ Radar Equation
- ☒ RCS Range Types
- ☒ Range Clutter
- ☒ Target Zone/ Mount
- ☒ RCS Reference Target

6799

Before examining the different test configurations and techniques for RCS measurements, it is useful to review some terminology found in RCS ranges.

THE RADAR EQUATION

$$P_R = \frac{P_T G_T}{4\pi R^2} \cdot \frac{RCS}{4\pi R^2} \cdot A_R$$

Transmitted
Reflected
Received

or since $A_R = G_r \lambda^2 / 4\pi$

$$P_R = P_t G_t G_r \cdot \frac{\lambda^2}{(4\pi)^3 R^4} \cdot RCS$$

System Parameters
Spread Factor
Target RCS

6800

The power received on an RCS range can be determined from the Radar Equation, which can be written as shown. The radar target can be considered as a secondary (reflective) radiating source where the RCS has replaced the P*G term. Substituting the relationship between antenna aperture and gain gives an equivalent form of the radar equation that is divided into system parameters (P_t , G_t , and G_r), a spread factor (center term), and the target RCS. Note that the received power is proportional to the fourth power of the distance to the target (R^4).

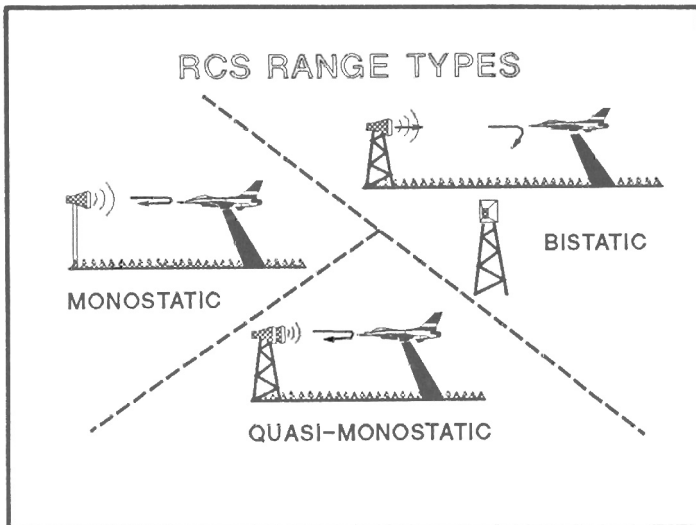

6801

The terms "monostatic", "bistatic", and "quasi-monostatic" describe the arrangement of the RCS transmit and receive antennas. A monostatic RCS configuration uses a single horn for transmitting and receiving, with a coupler or isolator used to separate the transmit and receive signals. A bistatic configuration uses separate antennas for transmit and receive, with the reflected energy measured at the bistatic angle. The "quasi-monostatic" configuration uses two antennas placed side-by-side to provide greater isolation between transmit and receive signals than most monostatic arrangements.

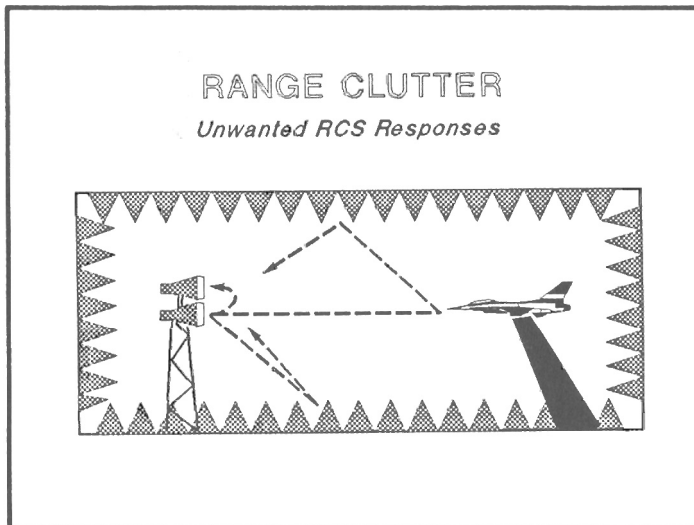

6802

Range Clutter refers to unwanted RCS responses that are caused by imperfect absorption of RF absorber materials and coupling between the transmit and receive antennas. These unwanted RCS responses are spread out in time proportional to the path lengths involved. Range clutter inside the target zone can prevent small RCS responses from being viewed. (The HP 8510 time domain capability is very useful in locating sources of anechoic chamber range clutter.)

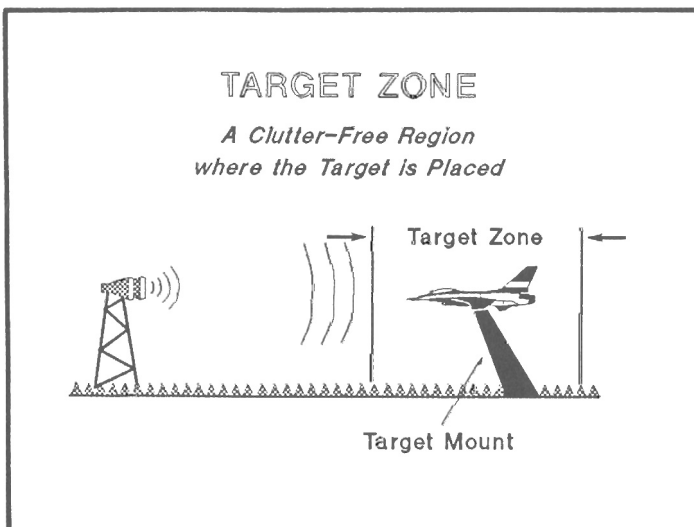

6803

The RCS "Target Zone" refers to the region in the chamber where the target is placed. This is also referred to as the "Test Zone" or "Quiet Zone."

The term "Target Mount" refers to the structure used to hold the RCS target in place during the measurement. Target mount support techniques include the use of non-metallic support lines, low-density styrofoam columns, and RF absorber covered structures.

RCS REFERENCE TARGET

- Simple Shape
- Known RCS
- Used to Calibrate Range



Sphere



Trihedral
Corner
Reflector



Cylinder

6804

A reference target is an object with a known calculable response that is used to calibrate the RCS range. Simple shapes are normally used as reference targets, the most common being a metal sphere (which has a RCS that is independent of orientation). Other useful reference targets include flat-plate reflectors, corner reflectors, and cylinders, although many other RCS targets can be used.

OUTDOOR RCS CONFIGURATION

External Mixer Front End

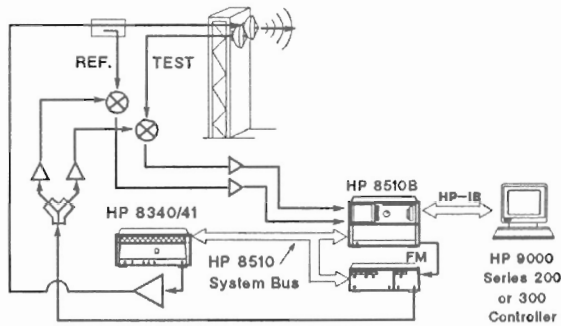

6805

We will now focus our attention on RCS test range types. Outdoor RCS ranges usually require high measurement sensitivity and RFI immunity. Therefore, the HP 8510B external mixer configuration with fundamental mixers is recommended. This slide shows the quasi-monostatic configuration. For good phase measurement stability with each configuration, it is important to electrically balance the reference and test cable lengths.

INDOOR RCS CONFIGURATION

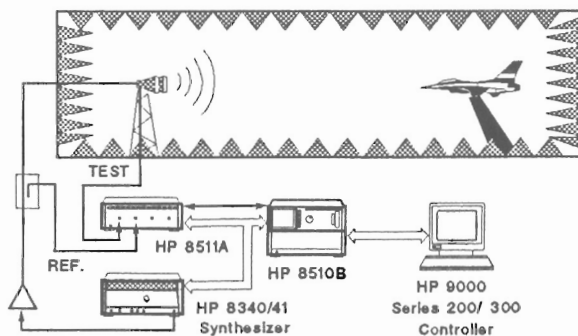

6806

For short-range/ indoor RCS ranges, the sensitivity requirement is less severe, and there are no RFI signals to contend with. Therefore, the HP 8511A configuration is recommended, which offers an extremely wide bandwidth (26.5 GHz) and dynamic range and has the added benefit of the extremely fast RAMP sweep mode for broadband measurements.

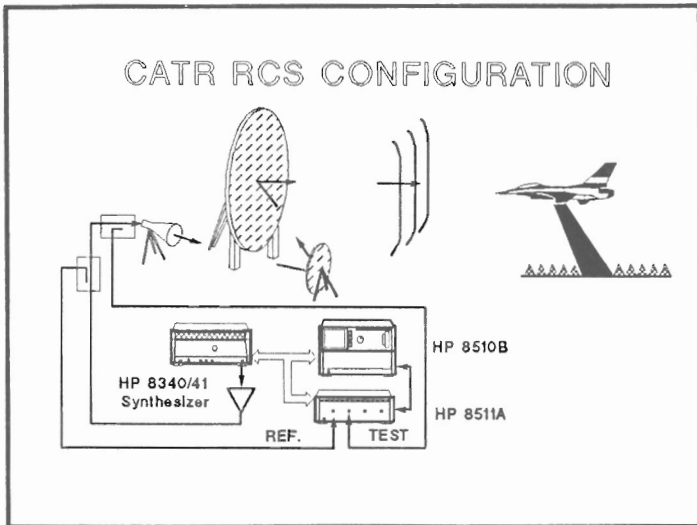

6807

The Compact Range allows indoor, planewave testing of large RCS targets and at high frequencies. This slide shows the HP 8511A front end in the CATR RCS configuration. The external mixer configuration will be shown in a later slide.

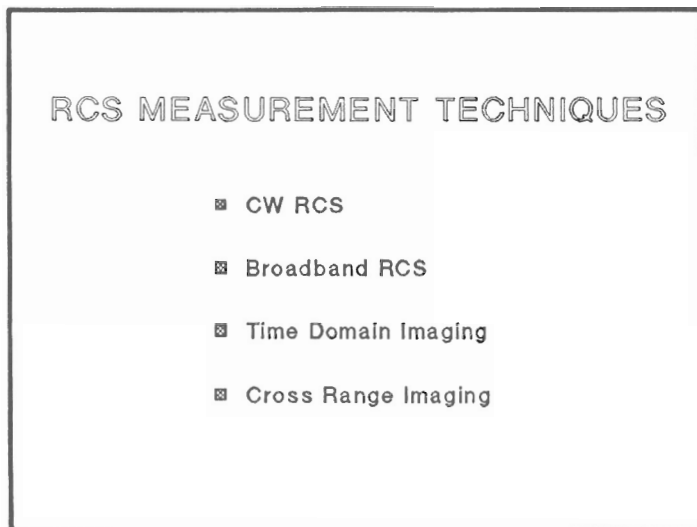

6808

The next section will describe several of the different RCS measurement techniques that are available with the HP 8510B.

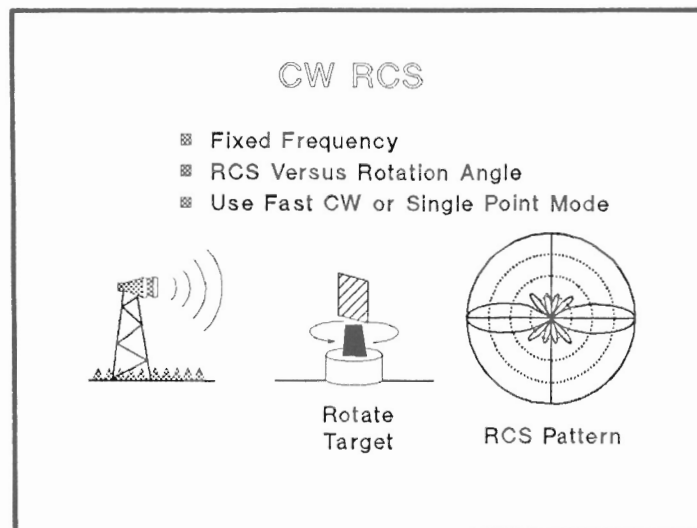

6809

Often RCS measurements are made at a single CW frequency and plotted versus position of target rotation. The resulting RCS "pattern" can look very similar to an antenna radiation pattern. This slide shows the RCS pattern of a flat plate reflector for a full 360 degree rotation. As with antenna pattern measurements, the HP 8510B FastCW mode offers the fastest measurement capability (1000 points per second) for automated measurements, and the Single Point mode with the analog output provides the means for a manual (pattern recorder) measurement.

BROADBAND RCS WITH TIME DOMAIN IMAGING

- ❑ Measure RCS Versus Frequency at Fixed Aspect Angles
- ❑ The HP 8510B Computes the Time Domain Response to Display RCS vs. Down-Range

6810

Another method for RCS characterization involves making broadband measurements at fixed aspect angles. Along with the additional frequency domain information obtained with each measured trace, this makes possible the transformation of the data to the time domain (using the inverse Fourier Transform) to display RCS versus range (down-range imaging).

BROADBAND RCS EXAMPLE

RCS of Brass Cylinder with Rounded Ends

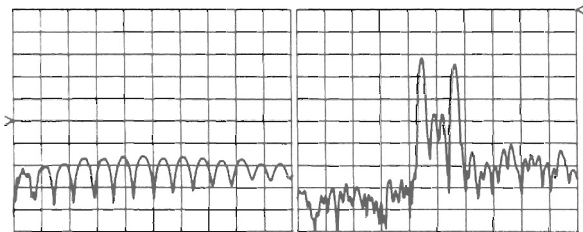

6811

In the time domain (Bandpass mode), the HP 8510B displays the target response to a pulsed-RF signal with an impulse shaped envelope, which shows how the target RCS varies with time/ distance. In this example, the time domain response of a metal cylinder with rounded ends shows a significant reflection from the front and back ends of the target.

CROSS-RANGE IMAGING

8747 BORESIGHT
07470201, RPI HH (sm)

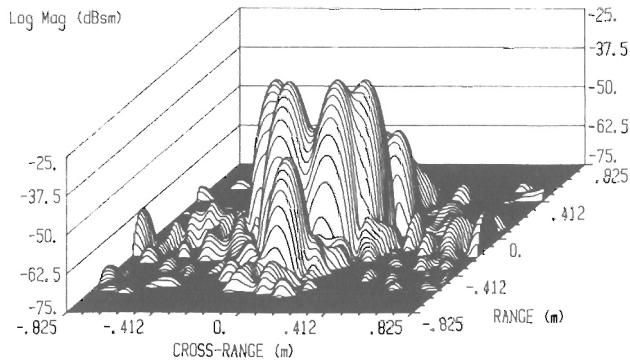

6812

In addition to the down range (time domain) imaging built into the HP 8510B, it is also possible to take additional measurements and compute the cross-range imaging response. This slide shows the cross-range image of a scale model of a commercial airplane as measured with the HP 8510 and computed using the ARCS software package available from March Microwave (plot courtesy of March Microwave).

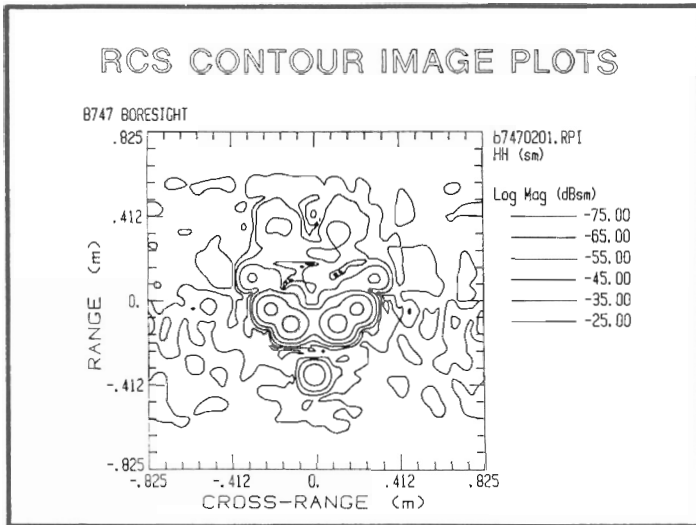

6813

In addition to the "waterfall" plots in the previous slide, the cross-range imaging data can be used to make contour plots that show added detail of the target response (plot courtesy of March Microwave).

RCS CONCEPTS AND TERMINOLOGY

- ❑ RCS Units
- ❑ RCS Resolution
- ❑ RCS Waveforms
- ❑ Alias-Free Range
- ❑ RCS Calibration

6814

In the next section, we will cover some concepts and terminology used in RCS measurements.

RCS UNITS: THE "dBsm"

AREA DEFINITION:

"dB Below a Square Meter"

$$\text{RCS (dBsm)} = 10 \log_{10} [\text{RCS (m}^2\text{)}]$$

SIGNAL LEVEL DEFINITION:

"Difference in Levels Received from Test Target and a 1 Square Meter (RCS) Reference Target"

6815

RCS is defined in units of area expressed in square meters. Another RCS unit is the "dBsm," which is read "dB below a square meter" and defined as $10 \cdot \log_{10}[\text{RCS(m}^2\text{)}]$. An equivalent definition of dBsm is the difference in RF signal level received when the test target is measured to the level received when a 1.0 meter² reference target is measured, expressed in dB. For example, suppose that the RCS return from a 1.0 square-meter reference target is -30 dBm. If the test target measures at -45 dBm, then it has an RCS of -15 dBsm (15 dB below the return from a square meter target), for a RCS area of 0.0316 square meters.

RCS (DOWN-RANGE) RESOLUTION

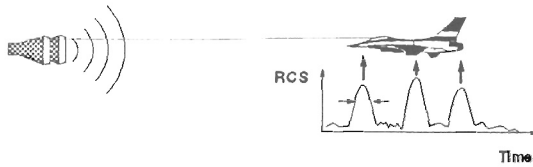

- ❑ The Minimum Resolvable Separation Between Target Scatterers
- ❑ Determined by 1/2 Impulse Width
- ❑ Inversely Proportional to Frequency Span

6816

RCS response resolution refers to the minimum separation between target scatterers that can be resolved by the time domain response. With the HP 8510B, this is determined solely by the time domain impulse width (actually, 1/2 of the impulse width since it is a reflection measurement), which is inversely proportional to the measurement frequency span. Therefore, very short duration time domain impulses can be used by taking data over wide frequency spans.

RCS W/ WAVEFORMS

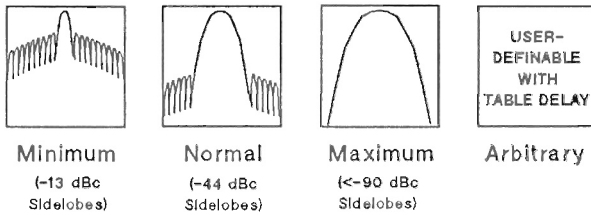

$$\text{Resolution} = \frac{1/2 \times 1.2}{\text{FSPAN}} \times \begin{cases} 1.0 & \text{Minimum} \\ 1.6 & \text{Normal} \\ 2.4 & \text{Maximum} \end{cases}$$

6817

The HP 8510B can provide a number of different time domain waveforms as the RCS stimulus. Three built-in impulse waveforms can be selected. In addition, it is also possible to enter the (user-defined) frequency domain Fourier Coefficients of other time domain waveforms (using the HP 8510B "Table Delay" feature) to provide arbitrary waveform capability. This slide shows the formulas for RCS resolution and the relative impulse sidelobe level for the three different impulse shapes provided by the HP 8510B.

RCS ALIAS-FREE RANGE

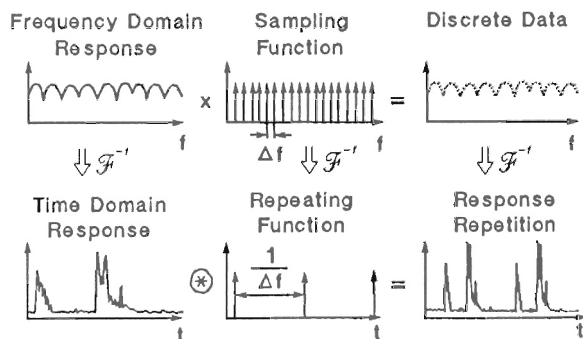

6818

With the frequency to time domain approach used with the HP 8510, a repetition of the time domain response occurs at periodic intervals equal to the reciprocal of the spacing between frequency data points. The separation between these response repetitions is called the time domain "range." The term "aliasing" refers to the undesirable condition of overlap of the time domain repetitions. To prevent aliasing with RCS measurements, the time domain range must be greater than roughly twice the RCS chamber length.

RCS FORMULAS

RCS RANGE and RESOLUTION

$\text{RCS Range (m)} = \frac{(\# \text{Pts} - 1) \cdot c}{\text{FSPAN}} > \sim 3L$ <p>(L = Chamber Length in meters)</p>
$\text{FSPAN}_{\text{MAX}} \text{ (GHz)} = 80 / L, \text{ (for 801 Points)}$
$\text{Best Resolution (m) (801 Points)} = L \cdot \begin{cases} 0.0023 & \text{Minimum} \\ 0.0036 & \text{Normal} \\ 0.0054 & \text{Maximum} \end{cases}$

6819

The time domain range is inversely proportional to the frequency span and therefore directly proportional the impulse width. Thus, for a given chamber size (which determines the minimum allowable time domain range) there is a minimum impulse width that can be used and therefore a minimum response resolution that can be achieved. These formulas list the relationships between best response resolution and RCS range size (assuming 801 points). Refer to Reference 4 for more detailed information on HP 8510 time domain concepts and terminology.

RCS CALIBRATION

- ▣ Characterize Systematic RCS Errors
- ▣ Mathematically Correct the Measured Data
- ▣ Two Term (Isolation-Response) Error Model

6820

RCS calibration refers to the technique used by the HP 8510B of characterizing RCS systematic measurement errors and mathematically removing them from the measured data (see References 6 and 7). The HP 8510B Response-Isolation error model is used to remove the two most significant RCS systematic errors.

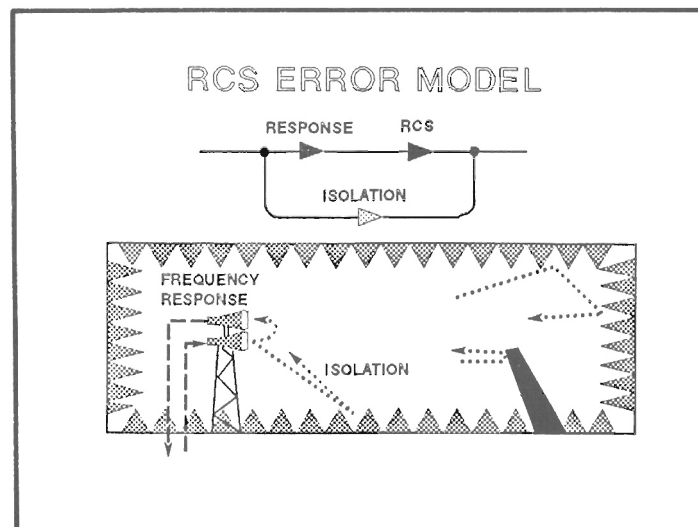

6821

The RCS Isolation error is due to the range clutter caused by leakage between the transmit and receive antennas and by spurious reflections in the anechoic chamber. These signals arrive in parallel with the target responses, and they limit the ability to measure small RCS targets. The Frequency Response error is caused by the non-ideal frequency response of the cables, connectors, coupler, and antennas in the system. To the extent that these measurement errors are repeatable, they can be characterized and their effects removed from the measured data.

RCS CALIBRATION PROCEDURE

1. Measure Reference Target
2. Remove Target, Measure Empty Chamber
3. Subtract Trace [2] from Trace [1] to Obtain the Frequency Response Error Trace
4. Use Trace [2] as the Isolation Error Trace
5. When Changing Target Mounts, Re-measure Chamber to Obtain new Isolation Error Trace

6822

RCS Calibration is performed in a 2-step process. First, the reference target response is measured, followed by the response of the empty chamber. Subtracting the chamber response (background) from the reference target response gives the frequency response error trace. If the reference target mount is also to be used for the test target, then the background response already measured provides the isolation error trace. Otherwise, the new target mount is installed and the chamber response re-measured to provide the isolation error trace.

EFFECTS OF RCS CALIBRATION

FREQUENCY DOMAIN

- ⊗ Subtracts Out Range Clutter
- ⊗ Normalizes Out Frequency Response Error
- ⊗ Reference Target Response has Zero dB Amplitude and Zero Degrees Phase

TIME DOMAIN

- ⊗ Reference Target Response is Impulse with Zero dB Amplitude at Time = Zero Seconds
- ⊗ Target Zone Shifts to Zero Seconds

6823

RCS error correction performs a background subtraction and normalization to the reference trace to remove the isolation and response errors from the measured data. The error corrected frequency domain response of the reference target has zero dB amplitude and zero degrees phase, and its time domain response is a unity height impulse at time $t=0$ seconds (note that the target zone is also shifted to zero seconds).

CALIBRATION EXAMPLE

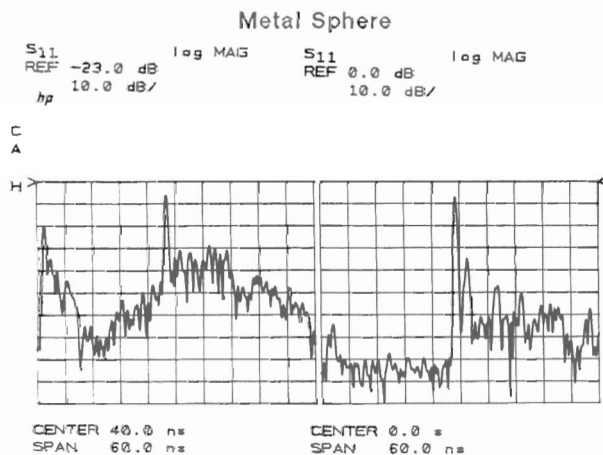

6787

This slide shows the time domain RCS responses of a (12 inch diameter) metal sphere both before and after calibration is applied. With error correction turned off, the response of the sphere is about 30 dB above the background clutter level. With error correction applied, however, the range clutter is greatly reduced, particularly in the region in front of the target. Note that the background the secondary "creeping wave" response of the sphere can be clearly seen,

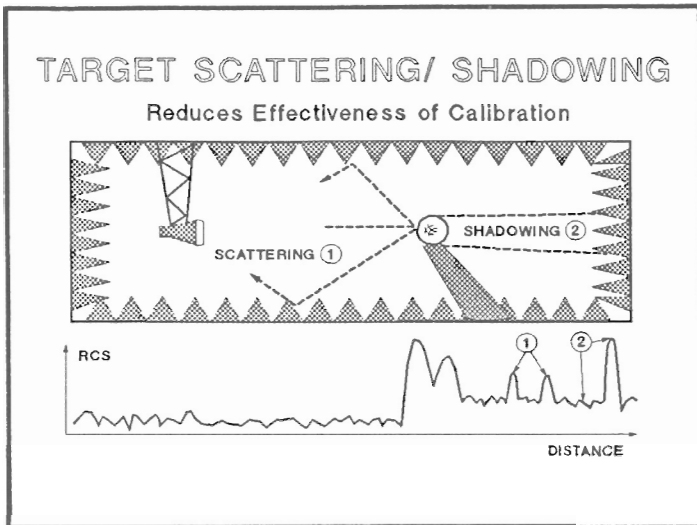

6824

The effectiveness of RCS calibration in removing range clutter can be reduced in the region behind the target zone because of the target "shadowing" the region behind it. For example, a large back wall reflection will be subtracted out by the error correction, but it can reappear when a large target is measured because the presence of the target lowers the energy that strikes the back wall, which makes the subtraction less valid. In addition, the target can scatter energy toward the walls and ceiling, which can cause spurious responses that arrive in time after the target zone responses. Shadowing and target scattering reduce the ability to observe small RCS responses when large target responses are also present.

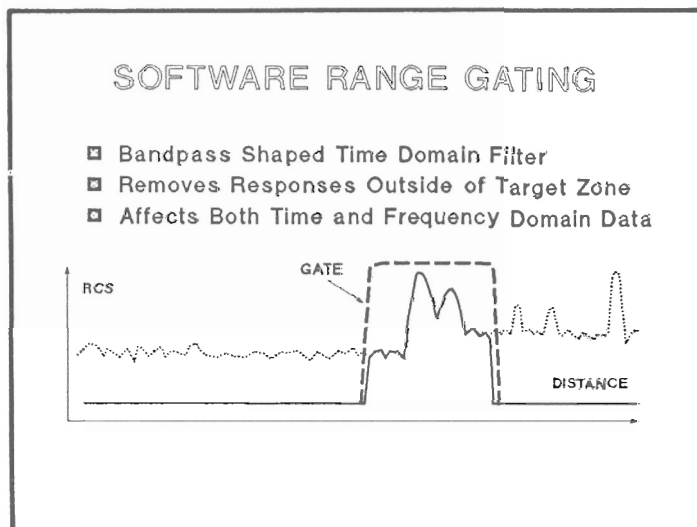

6825

However, many of these residual spurious responses can be removed using gating. The HP 8510B has the ability to mathematically gate out unwanted RCS responses that are located outside the target zone, removing their effects from both time and frequency domain data. The user has direct control of the gate width and location, and there are several gate (filter) shapes from which to choose.

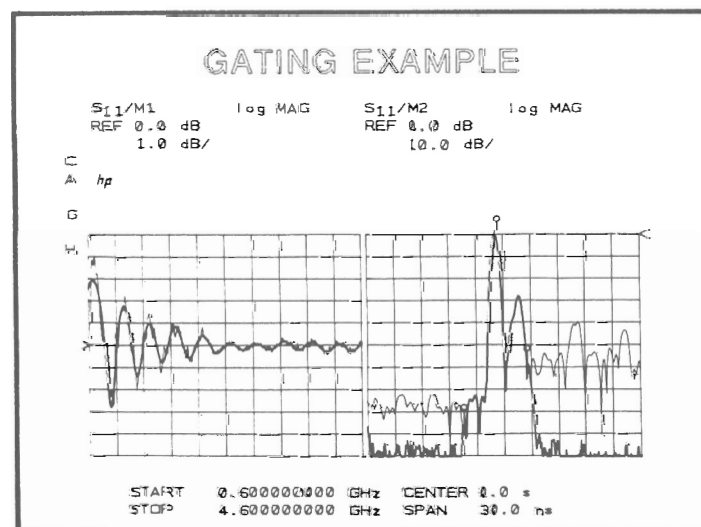

6827

This example demonstrates the use of gating to reduce the effects of unwanted RCS responses in this measurement of a metal sphere. The gate is centered around the target zone and, with the gate applied, the effects of the responses outside the gate are removed. In the frequency domain, this removes the high frequency ripple from the response.

EFFECT OF LARGE SPURIOUS RCS RESPONSES

- ❑ Can Saturate the Receiver Front End
- ❑ Caused by Spurious Energy From:

CATR
"Big Bang"

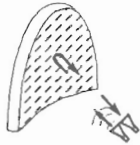

Bistatic
Coupling

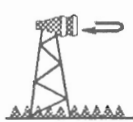

Monostatic
Return Loss

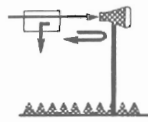

6826

Background subtraction (calibration) and software gating are very effective in removing spurious RCS responses and range clutter. However, if very large spurious RCS responses occur, they can saturate the receiver front end if high transmit power is used. The CATR "Big Bang" refers to energy that reflects directly back from the CATR reflector(s). A bistatic range can have significant coupling between the transmit and receive antennas. For a monostatic range, large reflections can occur from the finite antenna return loss. If these spurious reflections are larger than the target signal, they will limit the ability to amplify the transmit signal level to increase the target responses.

NOISE-LIMITED VS. CLUTTER-LIMITED RANGE

- ❑ Increasing Transmit Power Does not Benefit a Clutter-Limited Measurement
- ❑ With the Wide Dynamic Range of the HP 8510B, the Measurement Floor is Often Clutter-Limited
- ❑ Background Subtraction Lowers Clutter Level
- ❑ Time Domain Processing Gain Lowers Noise by the Number of Points (29 dB for 801 Points)

6828

However, increasing the transmit power level will cause no benefit if the measurement floor is limited by range clutter instead of receiver noise, which often occurs with the wide dynamic range of the HP 8510B. RCS calibration will reduce range clutter, and receiver noise is reduced by averaging and also by processing gain in the frequency to time domain transformation (by up to 29 dB for 801 points). If, after calibration, the noise floor is caused by clutter then increasing the transmit power will also increase the clutter level and produce no net gain detecting small targets.

PULSED-RF RCS MEASUREMENTS

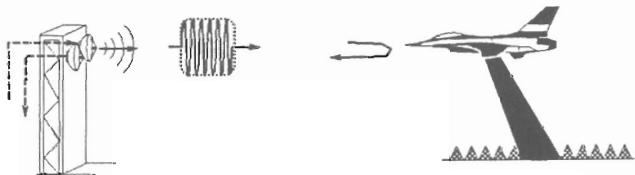

6829

In cases where the RCS measurement is receiver-noise limited (which can occur if the CATR has a low transfer function and a large "big bang" or else on long distance RCS ranges), then a Pulsed-CW/ hardware gating technique can be used (see References 8, 9, and 10). This technique involves pulsing the transmit signal and using RF switches to channel the signal into resistive loads during the time that large spurious signals are present at the receive antenna.

UNDERSTANDING PULSED-RF

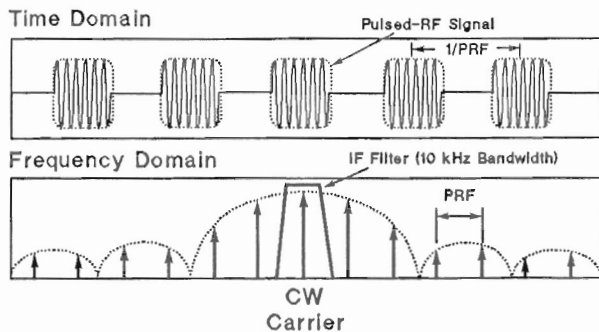

6830

This slide shows the time and frequency domain responses of a pulsed RF signal. In the frequency domain, the spectral lines are separated by the Pulse Repetition Frequency (PRF), and the envelope is determined by the shape of the pulse waveform - a rectangular pulse would give a $\text{sin}(x)/x$ envelope. Only the portion of the waveform within the HP 8510B IF 10 kHz detection bandwidth is measured, so for a $PRF > 30 \text{ kHz}$, only the carrier frequency is measured - the HP 8510B will not even know the signal has been pulsed.

PULSED-RF RCS CONFIGURATION

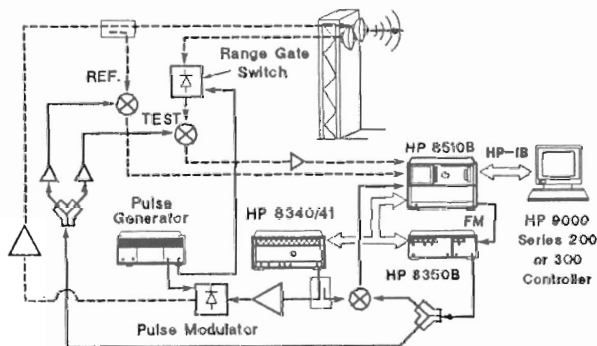

6831

In this typical HP 8510B pulsed-RF RCS configuration, part of the RF signal is coupled off before modulation to provide the phaselock reference signal. The modulated signal is amplified and sent to the transmit antenna, with a portion coupled off and measured to provide the pulsed reference signal. The RCS responses enter an RF network that switches the input between the receiver and a resistive load to blank the receiver when large spurious signals are present. The signals that are passed are then measured by the HP 8510B, and test/reference is displayed.

ADVANTAGES OF PULSED-RF OPERATION

- ❑ Allows Hardware Gating (Receiver Blanking) of Large Spurious RCS Responses
- ❑ Permits Higher Transmit Power Levels
- ❑ Reduces Absorber Requirements
- ❑ Provides Gating Method for CW Measurements
- ❑ Decreases Alias-free Range Requirements for Broadband Measurements
- ❑ Makes RCS Resolution Independent of Chamber Size

6832

Pulsed-RF RCS test with hardware gating can remove large spurious responses and allow transmit power levels that would otherwise saturate the receiver. This can help reduce absorber requirements for an RCS range, resulting in significant cost savings. For CW test, it provides a method for range gating without requiring broadband data and time domain processing. For broadband measurements with time domain processing, hardware gating can lower the alias-free range requirement from twice the chamber length to equal twice the range gate width. For a given chamber size and number points, this increases the minimum frequency span and thus the available RCS resolution.

TRADEOFFS OF PULSED-RF OPERATION

- ⊠ Increased Cost and Complexity of System by Additional Hardware and Timing Circuitry
- ⊠ Lowers Average Power by $10 \cdot \log_{10} [\text{Duty Cycle}]$

6833

The pulsed-CW technique is not without tradeoffs. It increases the cost and complexity of the measurement system by the addition of pulse modulation, RF switching, and timing circuitry. Pulsing also lowers the average signal level proportional to the duty cycle. For example, a 50% duty cycle lowers the average power by 6 dB, so that at least 6 dB higher transmit power must be used to break even.

PERFORMANCE LIMITATIONS

- ⊠ Pulse Repetition Frequency (PRF) > 30 kHz
- ⊠ Switch Rise-Time Determines the Hardware Gate Width and Cutoff Time
- ⊠ The Chamber Size Determines the Maximum PRF

$$\text{Max PRF} < \frac{c \text{ (m/s)}}{\sim 3 \times \text{Chamber Length (m)}}$$
- ⊠ Average Power Lowered by $10 \log_{10} [\text{Duty Cycle}]$

6834

This table lists several performance limitations of pulsed-RF operation. With this CW-carrier detection technique, the PRF must be greater than 30 kHz. The hardware gating and receiver blanking performance is determined by the precision of the timing circuitry and rise time of the RF switches. The maximum PRF is determined by the chamber size (to prevent aliasing), given by the formula shown. Also, the average power is lowered by the duty cycle (by 6 dB for a 50% duty cycle).

SUMMARY

- ⊠ Discussed HP 8510B Front Ends and Their Performance and Tradeoffs
- ⊠ Reviewed Far-Field, CATR, and Near-Field Antenna Measurements and Test Configurations
- ⊠ Reviewed RCS Terminology and Concepts
- ⊠ Illustrated RCS Error Correction, Time Domain Analysis, and Software Range Gating
- ⊠ Described Far-Field and CATR RCS Configurations
- ⊠ Discussed Pulsed-RF RCS Application, Configuration, and Limitations

6845

In this paper, we have shown how the HP 8510B can perform a variety of high performance antenna and RCS measurements. The HP 8511A harmonic sampler and the external mixer front ends were described along with their performance and tradeoffs. Far-field, near-field, and Compact Range antenna measurements were reviewed and HP 8510B configurations shown for both manual and automated measurements. We reviewed some RCS terminology and showed how to apply the built-in error correction and time domain features to perform RCS measurements for both conventional and Compact RCS ranges. We then discussed pulsed-RF operation of the HP 8510B for RCS measurement applications with unique requirements.

With its high performance and versatility, the HP 8510B can satisfy your requirements for antenna and RCS testing.

REFERENCES:

1. Hewlett-Packard Co., "HP 8510B Network Analyzer Technical Data Sheet," May 1, 1987 (HP Literature Number 5954-8361).
2. Hewlett-Packard Co., "HP 85103A Performance Upgrade Package for the HP 8510A Network Analyzer Technical Data Sheet," May 1, 1987 (HP Literature Number 5954-8365).
3. John W. Boyles, "Choosing the Proper Mixing Technique for Antenna Testing," *Microwaves & RF*, vol. 27, no. 3, March 1988.
4. Hewlett-Packard Co., "HP 8510B Network Analyzer Operating and Programming Manual: Section 2, Time Domain Measurements."
5. Hewlett-Packard Co., "Antenna Measurements: Manual Pattern Measurements Using the HP 8510B," Product Note No. 8510-11, December 1, 1987 (HP Literature Number 5954-8391).
6. John W. Boyles, "Recruit an ANA for RCS Tests," *Microwaves & RF*, vol. 24, no. 3, March 1985, pp. 87-92.
7. Hewlett-Packard Co., "Radar Cross-Section Measurements With the HP 5810 Network Analyzer," Product Note No. 8510-2, April 1985 (HP Literature Number 5954-1522).
8. P.S. Kao, Jose A. Munoz, Gregg L. Sandy, "A Pulsed/CW RCS Measurement System Using the HP8510 Network Analyzer," *1987 Antenna Measurement Techniques Association Proceedings*, September 1987, pp. 151-155.
9. Marcel Boumans, Steve Brumley, "Hardware Gating Improves HP8510 Based RCS Measurement Systems," *1987 Antenna Measurement Techniques Association Proceedings*, September 1987, pp. 212-216.
10. Allen L. Lindsay, "Making Precision RCS Measurements on a Compact Range Using an HP8510 and an RF Switching Network," *1987 Antenna Measurement Techniques Association Proceedings*, September 1987, pp. 319-323.



March 1, 1988

Printed in U.S.A.
5956-4355