

Pulsed Phase Noise Measurements

Ray Fried
YHP/Spokane

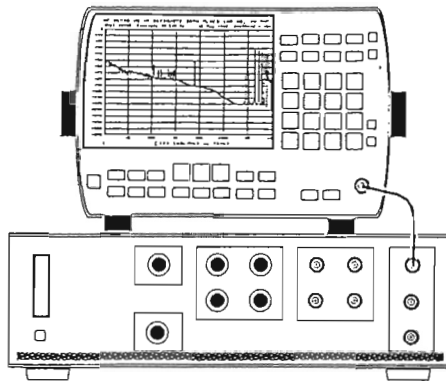

**RF & Microwave
Measurement
Symposium
and
Exhibition**



 **HEWLETT
PACKARD**

Pulsed Phase Noise Measurements

YHP T&M 90

Tokyo/Osaka

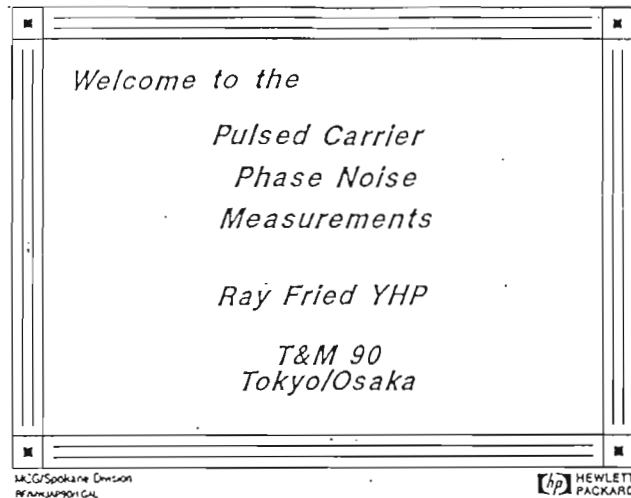

This paper discusses Pulsed Phase Noise Measurements. Many of the concepts and solutions presented in this paper were developed and compiled as a result of helping customers make these demanding measurements on state of the art radar systems.

Pulsed noise measurements have traditionally been made with custom test sets. With the introduction of the HP 3048, a general purpose measurement tool now exists.

There is an HP Application Note that covers this topic in more detail. It is Application Note 386. You may find it as useful reference material if you have further interest in this topic. If you have questions after the paper is given, there will be time for questions. We would also like to invite you to the Phase Noise Measurement booth space for a demonstration of the hardware after this presentation.

Pulsed Carrier Phase Noise Measurement

Agenda

- *Applications*
- Basics of pulsed carriers
- Limitations with making pulsed measurements
- Recommended hardware configurations
- 3048A and 11729C capabilities
- Summary

This is the agenda we will be following.

- * First a few comments about applications of pulsed RF carriers
- * Some brief basics
- * Limitations with making pulsed measurements
- * Recommended hardware configurations
- * The HP3048 and HP11729C capabilities
- * Then we will conclude with a summary

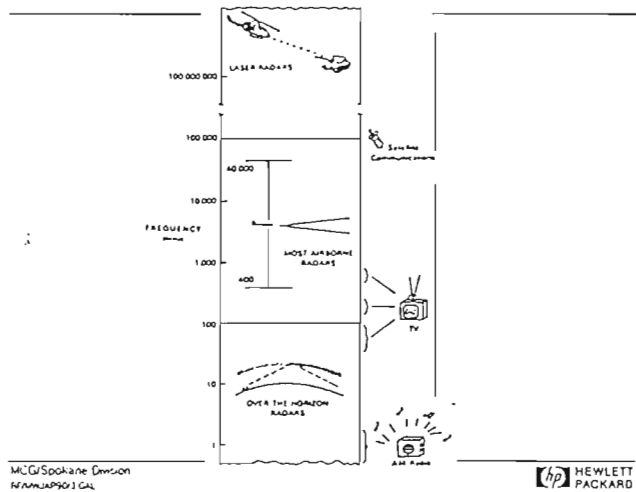

Many radar systems use pulsed technology.

Types such as Range Radars, Coherent, Frequency Agile, Chirp, and Phase Coded to name a few.

These may be ground based or airborne radars.

They may be used for many different applications.

And they cover a wide range of frequencies.

Stepped-Frequency Radar (Imaging Applications)

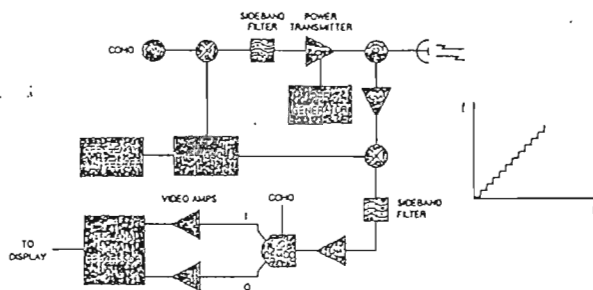

Here is a block diagram of a Radar used for imaging applications. It, like many other radars, uses pulsed technology.

The quality of a pulsed radar systems is often directly related to the noise of the pulsed L.O. In this case, you can see the L.O. chain here. The L.O. phase noise can affect the radars sensitivity & resolution.

Since signal processing components such as amplifiers and pulse modulators can add multiplicative and additive noise to the CW oscillator, it is necessary to measure the noise of the pulsed signal.

Pulsed Carrier Phase Noise Measurement

Agenda

- Applications
- *Basics of pulsed carriers*
- Limitations with making pulsed measurements
- Recommended hardware configurations
- 3048A and 11729C capabilities
- Summary

Basic Characteristics of a Pulsed Waveform

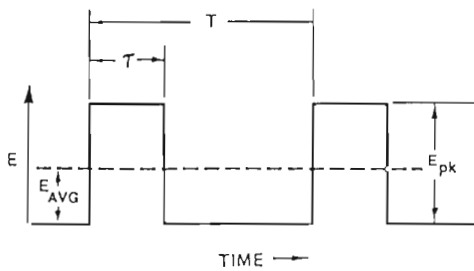

MJG/Spokane Division
RFANW4P908.GAL

HEWLETT
PACKARD

I will use this slide to establish some terms we will be using. Here we have a repetitive rectangular wave shape.

We will use T to denote the period of the repetitive rectangular waveform and τ to denote the pulse duration.

Addition of a Fundamental Cosine Wave and its Harmonics to Form Rectangular Pulses

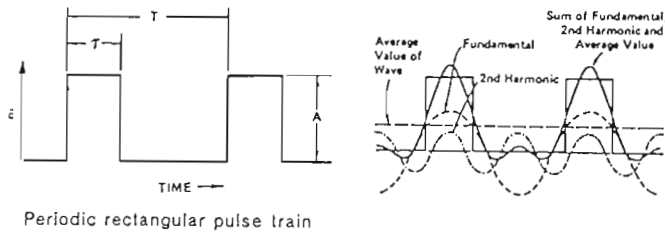

Periodic rectangular pulse train

MJG/Spokane Division
RFANW4P907.GAL

HEWLETT
PACKARD

This slide should remind you of the harmonic content of a periodic rectangular waveform.

As you know, any repetitive wave shape can be represented by a fundamental signal of frequency $1/T$, its harmonics and possibly a DC term. Of course, relative phase and magnitude and harmonic number are important parameters as one attempts to describe a repetitive waveform by its harmonics.

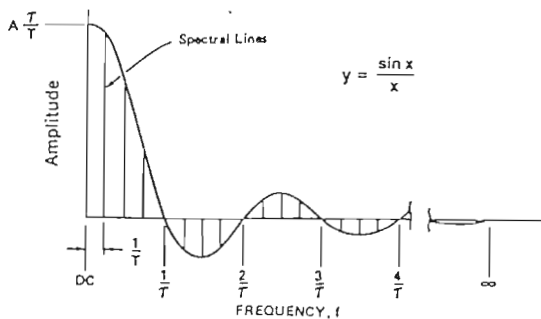

MJG/Spokane Division
RFANW4P907.GAL

HEWLETT
PACKARD

If we observe a repetitive rectangular signal in the frequency domain we would note spectral lines spaced in frequency at harmonics of $1/T$. The amplitude of the successive harmonics follow the $\text{Sin}X/X$ function which is the Fourier transform of this rectangular function. The envelope of the harmonics go through zero magnitude points at frequencies that are multiples of the reciprocal of the pulse width.

Of course we are assuming a perfect rectangular waveform, that is, one that has zero rise and fall time and no ringing.

Multiplication of a CW Carrier by a Pulsed Waveform Results in a Pulsed Carrier

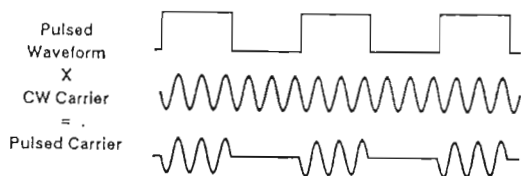

MCG/Spokane Division
HPANWJAPR86 CAL

 HEWLETT
PACKARD

In reality the pulsed carrier output is generated by multiplying a CW carrier signal by a rectangular base band signal.

It is important to note the pulse to pulse phase continuity resulting from this configuration. This phase continuity is important.

If it were not for this continuity, there would be large pulse to pulse phase steps or phase jitter. This jitter would likely mask the noise spectra we are attempting to measure.

Also from a baseband noise measurement point of view, we will find it necessary to maintain phase quadrature in the phase noise measuring system. This steady state phase quadrature condition would not exist if there was not pulse to pulse phase continuity.

Basic Characteristics of a Pulsed Carrier

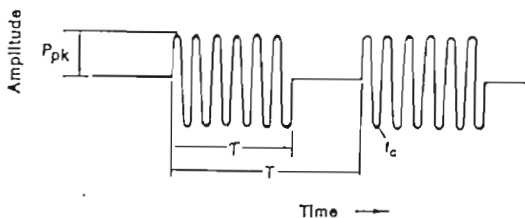

MCG/Spokane Division
HPANWJAPR86 CAL

 HEWLETT
PACKARD

At this point we must introduce additional terms,

- Carrier Frequency
- PRF (Pulse Repetition Frequency)
- Duty cycle (ratio of τ to the Interpulse period) expressed in %
- Peak power
- Average power = peak power X duty cycle

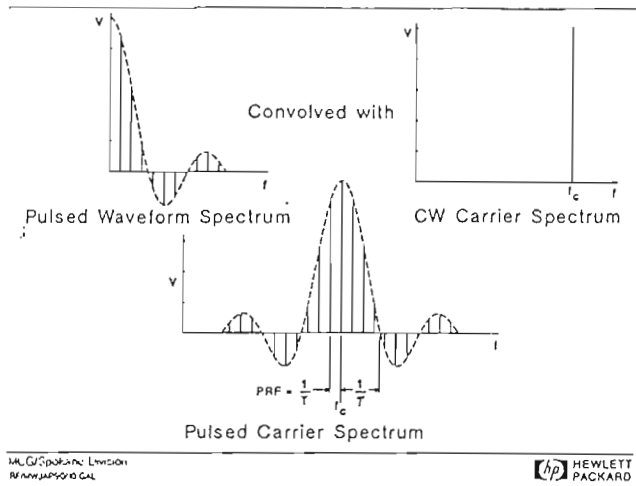

Now lets look in the frequency domain at this pulsed carrier signal.

Note the Pulsed Carrier spectrum is that of the base band wave shape convolved with the CW carrier spectrum.

Also note the PRF spaced components and the signal null at $1/\tau$.

Lets now focus our attention on how pulse modulation affects the phase noise of the carrier.

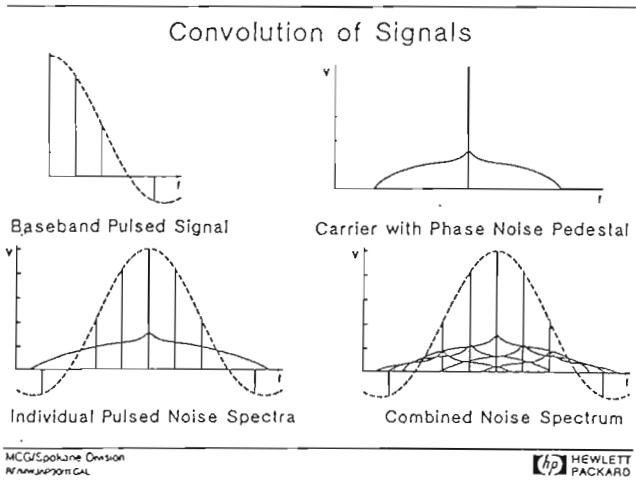

When the CW carrier is pulse modulated, each spectral component carries the information or noise modulation that was present in the original CW frequency. This then effectively lays the spectrum over itself with a frequency offset which effectively adds noise around the carrier. In effect, noise at any offset from the original CW carrier will re appear within $\pm PRF/2$ of the original CW signal.

Note that these noise components will be reduced in amplitude by the SinX/X relationship of the pulse modulating signal. This added noise component will be significant if the spectrum of the CW signal does not roll off with increasing offset and if the pulse width is relatively short (null occurs at large offsets). If the pulse width is short, there will be many spectral lines that add to the fundamental component.

Pulsed Carrier Phase Noise Measurement

Agenda

- Applications
- Basics of pulsed carriers
- *Limitations with making pulsed measurements*
- Recommended hardware configurations
- 3048A and 11729C capabilities
- Summary

Now lets look at some of the measurement limitations when making pulsed noise measurements.

Using a Double Balanced Mixer as a Phase Detector

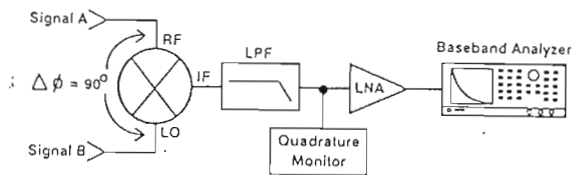

MCG/Spokane Division
RFANWJAP9013 CAL

hp HEWLETT
PACKARD

This is a very common phase noise measurement configuration. It uses a phase detector to convert phase fluctuations to voltage fluctuations. These voltage fluctuations are then displayed on a baseband spectrum analyzer. Typically, a diode balanced mixer is used as the phase detector as it has low residuals, rejects amplitude modulation components and works with relatively high power. Furthermore wideband units are readily available.

However the use of a mixer for a phase detector does require the filtering off of the mixer input frequencies and sum frequency at the output. Therefore a LPF is used. Because baseband analyzers do not have low noise figure front ends, a LNA is typically used.

One necessary condition of this approach is that the mixer must be held in phase quadrature. This can be accomplished by feedback to one of the sources (A or B). A phase quadrature condition results in a maximum phase detector coefficient, and minimum amplitude detection coefficient.

In reality, if we were to feed the mixer (phase detector) output to one of the VCOs, we would have a phase locked loop using one of the sources as the VCO, and the mixer as a phase detector. This locked loop would then maintain phase quadrature even though there is a tendency for the sources to drift in frequency.

In this measurement setup, the system sensitivity is determined by the "phase detector coefficient" and the LNA noise figure. A high phase detector sensitivity results in greater system sensitivity and improved dynamic range.

PHASE DETECTOR OUTPUT FOR A CW SIGNAL

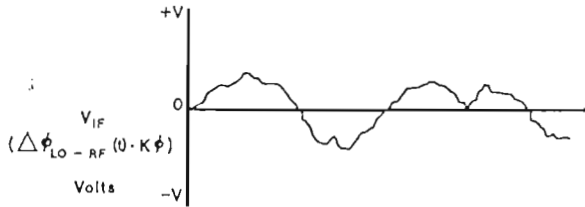

The phase detector output voltage looks like this after low pass filtering. The detector output voltage magnitude is a function of the instantaneous delta phase and the phase detector coefficient. The phase detector output is a continuous signal. In a pulsed carrier measurement however, things are different.

MCG/Spokane Division
RF/MWJAP90/14.GAL



Phase Detector Output for a Pulsed Carrier

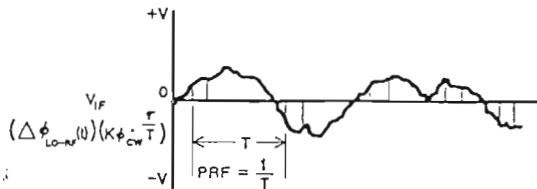

In this case, the detector output is "sampled". It is not continuous. The output is present only over a portion of the time, that is only when the carrier is present.

- * Phase Detector Output is Sampled Versions of CW Phase Noise
- * Effective Sensitivity of Phase Detector Scaled by Duty Cycle
- * Noise above $\frac{PRF}{2}$ Aliased below $\frac{PRF}{2}$
- * PRF Filter may be Required

MCG/Spokane Division
RF/MWJAP90/15.GAL



Effects of Measuring Noise On Pulsed Carriers

- ⊗ Reduced Measurement Dynamic Range
- ⊗ Limited Measurement Offset Range
- * Folding of Noise at Large Offsets to the Carrier
- * PRF Feedthrough
- * Mixer DC Offset - Lack of Quadrature
- * Limited Tuning Range

YHP
1T&M90VRF_1



This produces a number of effects. We will discuss several of them.

- a) Reduced measurement dynamic range. This will result because the phase detector sensitivity is effectively scaled, or reduced by the duty cycle. This reduction in phase detector sensitivity directly reduces the measurement sensitivity thereby increases the measurement noise floor and ultimately reduces the measurement dynamic range. A 10 % duty cycle increases the noise floor by 20 dB which in turn reduces the dynamic range by 20 dB as compared to a CW measurement.

Another cause of dynamic range reduction is self demodulation of the L.O. This can be a significant problem at small duty cycles since the desired signal is present for only a small portion of the time and the L.O. can demodulate itself during the entire period thus becoming a major factor in noise contribution.

- b) The second effect of this sampled measurement is described by sampling theory. If a band limited signal is sampled with equal spaced time samples, it can be recovered by low-pass filtering if the fundamental frequency of the sampling process is greater than twice the highest frequency present in the band limited signal. Since the phase noise of a CW carrier is not band-limited, it is being undersampled. Therefore measurements made at large frequency offsets are redundant with lower offsets.

Measurement Offset Range

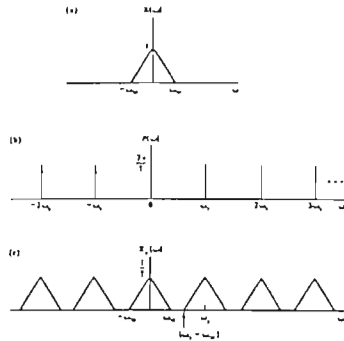

MCC/Spectrum Division
 HP 43400/RF Calc

HP HEWLETT
 PACKARD

The limitation of measurement offset range has been graphically illustrated in this slide. Notice a signal $X(\omega)$ with its sidebands. Also notice the sample rate. Notice that if we attempt to make measurements at offsets greater than $(\omega_s)/2$ we simply are measuring the same noise as we did slightly below $(\omega_s)/2$. In other words we effectively cannot learn more about the noise profile by measuring at offsets greater than $PRF/2$.

Effects of Measuring Noise On Pulsed Carriers

- * Reduced Measurement Dynamic Range
- * Limited Measurement Offset Range
- ⊕ Folding of Noise at Large Offsets to the Carrier
- ⊕ PRF Feedthrough
- ⊕ Mixer DC Offset - Lack of Quadrature
- * Limited Tuning Range

YHP
 1T&M300/RF_1

HP HEWLETT
 PACKARD

Noise at larger offsets is folded near the carrier - into the measurement range. As we mentioned before, the contribution of this effect depends on the duty cycle and the noise spectra. In general we can estimate the noise will be degraded by $10 \log$ base 10 of the number of spectral lines within the first null.

PRF feedthrough will be present. This can overload the LNA which would result in useless measurements. In any case, PRF energy will be apparent on the measurement output plot.

Mixer DC Offset may be a problem.

Mixer DC Offset

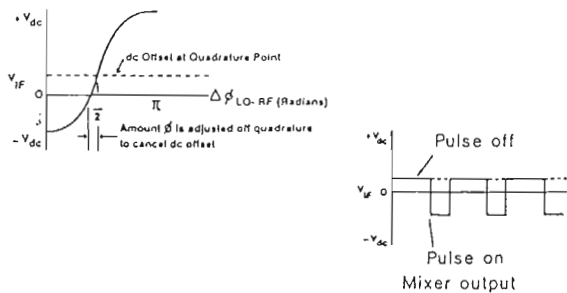

MCC/Sputnik Division
16-AN-1409017-GAL

hp HEWLETT
PACKARD

Theoretically when signals of identical frequency and a constant phase offset of 90 degrees are applied to a mixer, the mixer will produce a zero volt output. In practice, real mixers often exhibit a dc offset at this phase quadrature point. This can result from reflections and insufficient mixer balance.

The dc offset is the deviation from 0 volts when the RF and L.O. inputs are at quadrature.

This mixer DC offset can generate several problems. It can overload the LNA. On the other hand, frequently we adjust the relative phase of the mixer input signals to force the mixer output to a zero volt condition. This is often done as an indication of quadrature and to reduce the LNA input bias voltage. This can be a problem however when the DC zero output condition does not correspond to a quadrature condition. Three problems are:

- a) one, the phase detector coefficient is reduced. This reduces sensitivity, increases noise the floor, and ultimately degrades the dynamic range of the measurement system. As you can see, the phase slope is maximum at the true quadrature condition.
- b) And the second problem is increased amplitude demodulation. This occurs when quadrature is not achieved.
- c) Increased PRF feedthrough.

Effects of Measuring Noise On Pulsed Carriers

- * Reduced Measurement Dynamic Range
- * Limited Measurement Offset Range
- * Folding of Noise at Large Offsets to the Carrier
- * PRF Feedthrough
- * Mixer DC Offset - Lack of Quadrature
- ⊗ Limited Tuning Range

YHP
1T4M90ARF_1



The final problem that I would like to talk about is limited tuning range. Two factors must be considered:

- a) The phase detector coefficient is reduced by the pulse duty cycle. This reduces the loop bandwidth of the control loop that holds the mixer in a phase quadrature condition. To compensate for this, the Peak Tuning Range (PTR) can be adjusted by inserting gain in the feedback loop.
- b) The control loop bandwidth must be smaller than the PRF rate in order to maintain stability and a linear condition.

Tuning Range

vs.

PRF (Absolute Measurements)

Peak Tuning Range < PRF/2

The resulting effect is that the Peak Tuning Range must be less than the PRF/2.

YHP
1T4M90ARF_3



Pulsed Absolute Measurements

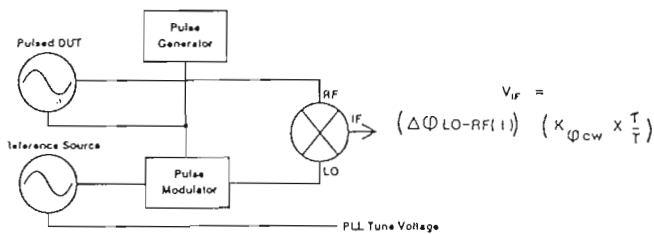

MCG/Spokane Division
REF:HPJAP909 CAL

HP HEWLETT
PACKARD

This slide shows a PARTIAL SOLUTION to some of the previously mentioned problems. This is an "absolute" noise measurement configuration. We use the term "absolute" to imply a noise measurement on a one port device. We refer to two port noise measurements as residual, in other words, the noise of the input signal is canceled and not measured in that case.

Here we have a pulsed Device Under Test. Notice in this one port absolute measurement the pulse modulator on the L.O. input. It is pulsed on at the same time as the DUT. This has several benefits.

- By turning off the L.O. when the input pulse is not present, the generation of a DC offset voltage during the off time will not take place. Therefore a more accurate phase quadrature condition is maintained.
- Furthermore the amount of PRF feedthrough will be reduced.
- The self demodulation of the L.O. AM noise will be eliminated during the period when the incoming signal (and L.O.) is pulsed off. This will reduce one component of the system residual noise.

Pulsed Residual Measurements

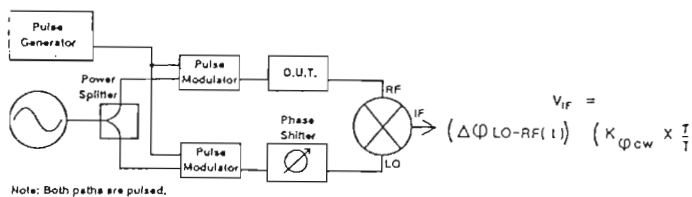

Note: Both paths are pulsed.

MCG/Spokane Division
REF:HPJAP909 CAL

HP HEWLETT
PACKARD

The concept of pulse modulating the L.O. is also applicable to Pulsed Residual Measurements. Notice the 2 port DUT and the common signal source and the pulse modulators. Again the benefit of pulsing both ports is reduced L.O. noise contribution, reduced PRF feedthrough problems and a smaller DC offset situation.

By using these techniques it is possible to make absolute measurements down to duty cycles of 5 % and residual measurements to 1 % duty cycle.

HP3048A ブロック・ダイアグラム

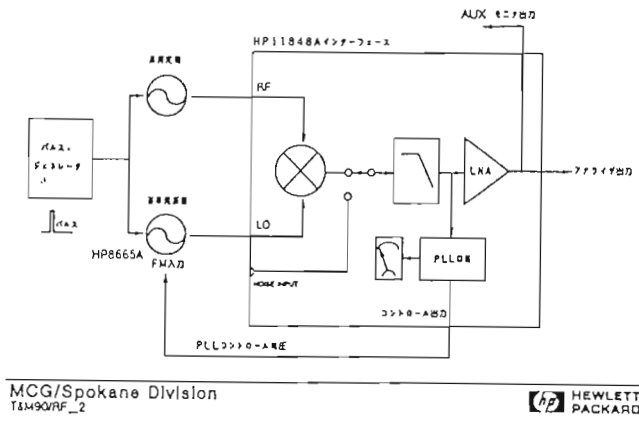

Lets examine PRF feedthrough for a moment. As was mentioned before, excessive PRF transients or feedthrough will overload the LNA. This feedthrough may be the result of sampling in the presence of excessive mixer DC offset. Or it may be the result of actual phase transients occurring on either the measured signal or the L.O. near the times of amplitude transitions. PRF feedthrough can also result from insufficient port-to-port mixer isolation.

This HP3048 block diagram will be helpful in the PRF feedthrough discussion. Notice the inputs, mixer, low pass filter, and phase locking circuitry. Also notice the AUX Monitor output. This, along with a wideband oscilloscope can be used to observe the phase detector output and determine if the LNA is overloaded. If the LNA is overloaded, it can be bypassed with internal switches.

The HP 3048 phase noise measurement system also includes a phase transient detector at the LNA output. It is used to automatically bypass the LNA if predetermined PRF levels are detected. When the LNA is bypassed, system sensitivity and dynamic range is reduced.

Since the "AUX Monitor" port follows the LNA one can also determine if the LNA is saturating. When making measurements in the PULSED MODE, it is possible to override the effect of the PRF detector and manually switch the LNA "IN" or "OUT". If the saturation is not occurring during a significant portion of the ON period it may be advisable to use the LNA.

PRF Feedthrough

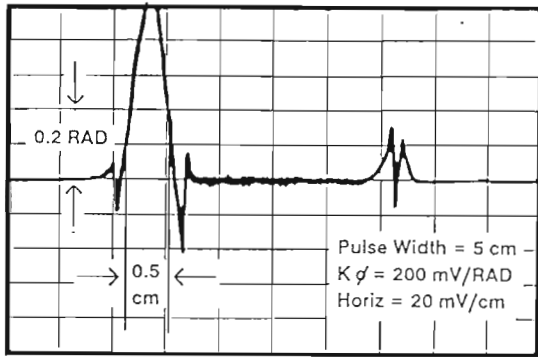

MCG/Spokane Division
 HPAN/AP920/GAL

hp HEWLETT
 PACKARD

This slide shows the maximum limit of phase transients for acceptable measurements. If phase transients exceed .2 radians for more than 10% of the pulse, the measurement accuracy may be degraded.

PRF Filtering

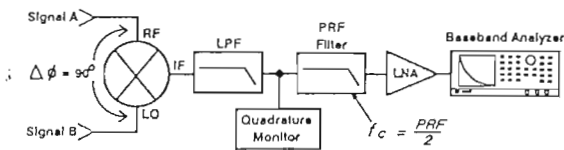

MCG/Spokane Division
 HPAN/AP920/GAL

hp HEWLETT
 PACKARD

A PRF filter can be used to reduce PRF feedthrough. In this case it is placed between the mixer output and the LNA input. If a filter is required, choose one that has a 3 dB cutoff frequency approximately equal to PRF/2 and has at least 60 dB of attenuation at 2 times the PRF.

HP3048A ブロック・ダイアグラム

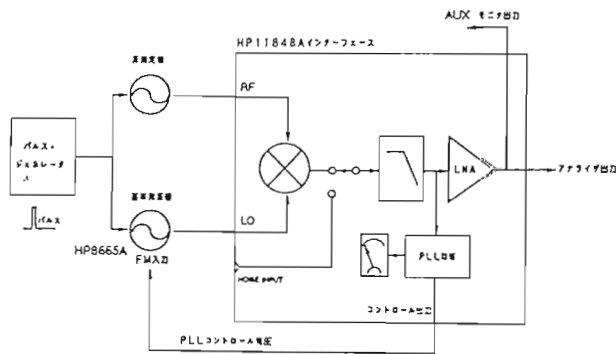

MCG/Spokane Division
 T&M90/RF_2

hp HEWLETT
 PACKARD

When a PRF filter is required, an external phase detector must be used since there is no direct access to the output of the internal phase detector.

Notice the "Noise Input" port. It is used when an external mixer and PRF filter are required.

Experience has shown that for many pulsed measurements, the measurement can be made without a PRF filter.

Pulsed Carrier Phase Noise Measurement

Agenda

- Applications
- Basics of pulsed carriers
- Limitations with making pulsed measurements
- *Recommended hardware configurations*
- 3048A and 11729C capabilities
- Summary

MCG/Spokane Division
 97ANW14P90722.GAL



Now lets look at the recommended hardware configurations for a number of measurements.

Recommended Configuration for Absolute Measurements If PRF Filter is Required

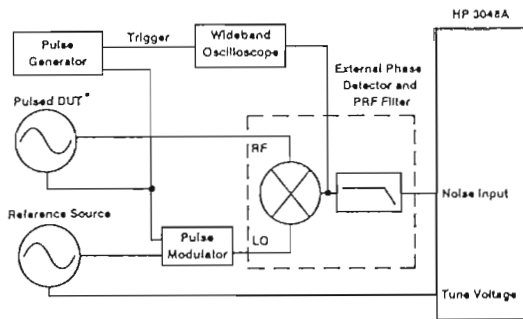

MCG/Spokane Division
 97ANW14P90722.GAL



For absolute measurements that require a PRF filter, this configuration is recommended.

Recommended Configuration for Residual Measurements If PRF Filter is Required

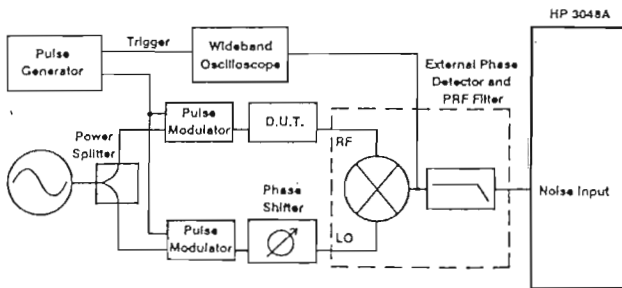

MCG/Spokane Division
 97ANW14P90722.GAL



For residual measurements that require a PRF filter, use this configuration.

Recommended Configuration for Residual Measurements

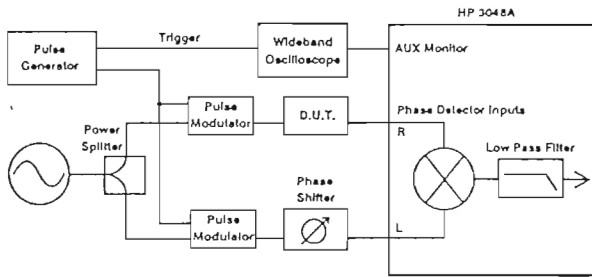

MCG/Spokane Division
RF/MW/90276.GAL

HP HEWLETT
PACKARD

If no PRF filter is required, use this configuration for residual measurements.

Pulsed Carrier Phase Noise Measurement

Agenda

- Applications
- Basics of pulsed carriers
- Limitations with making pulsed measurements
- Recommended hardware configurations
- *3048A and 11729C capabilities*
- Summary

MCG/Spokane Division
RF/MW/90276.GAL

HP HEWLETT
PACKARD

Now we will look at the HP3048A and HP11729C capabilities.

Noise Floor Using an HP 8663A as the Source

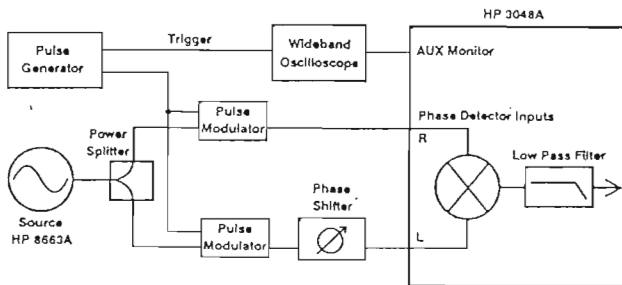

MCG/Spokane Division
RF/MW/90276.GAL

HP HEWLETT
PACKARD

The measurement system noise floor can be evaluated with this measurement set up.

Residual Noise Floor

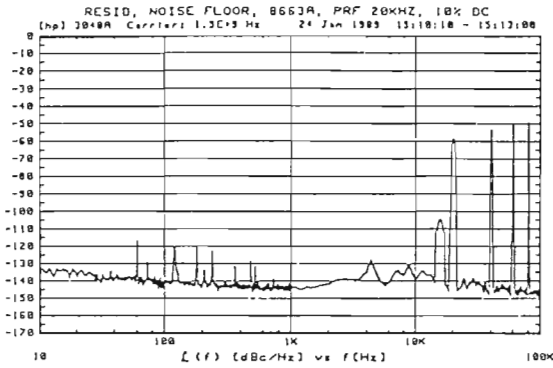

MCG/Spokane Division
RFA#HP9027 CAL

HP HEWLETT
PACKARD

Notice the -140 dBc floor, even with a 10% duty cycle. The PRF is 20kHz. Useful measurements can only be made to offsets < 10kHz.

Residual Noise of HP 8447D Amplifier

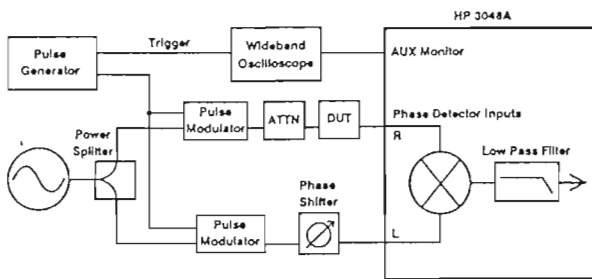

MCG/Spokane Division
RFA#HP9028 CAL

HP HEWLETT
PACKARD

This configuration is being used to measure the pulsed residual noise of an HP 8447D amplifier.

Residual Noise of HP 8447D Amplifier

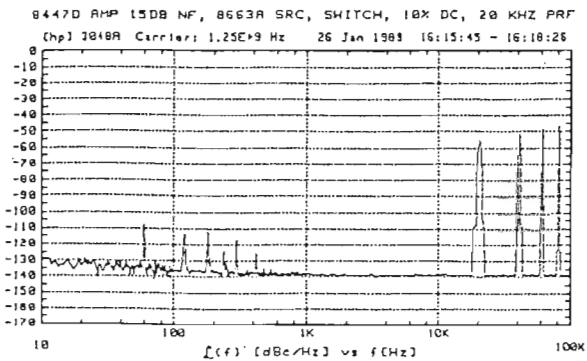

MCG/Spokane Division
RFA#HP9027 CAL

HP HEWLETT
PACKARD

Here are the results of the measurement.

HP 8663A versus HP 8663A Pulsed Source Measurement

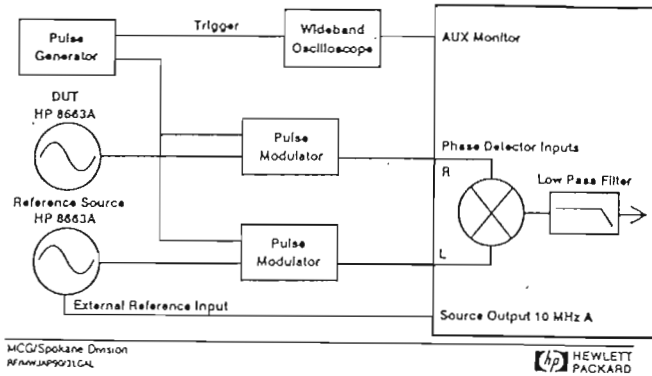

This is the recommended configuration for absolute measurements of pulsed sources.

This configuration was used to measure the noise quality of a pulsed HP 8663A signal generator.

HP 8663A versus HP 8663A Pulsed Source Measurement

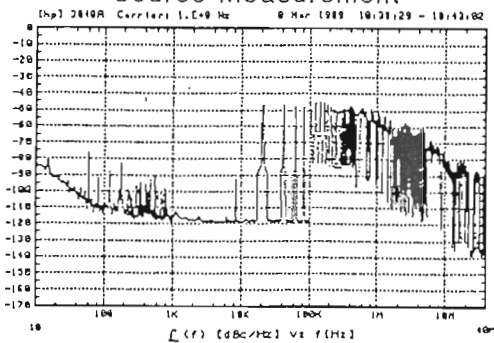

Here are the results of the measurement. Notice the noise floor at 1 to 10 KHz offset is about 10 dB higher than in a non pulsed application. For offsets < 100 Hz the performance is about the same as non-pulsed measurements.

Absolute Measurements with the HP 3048/11729C

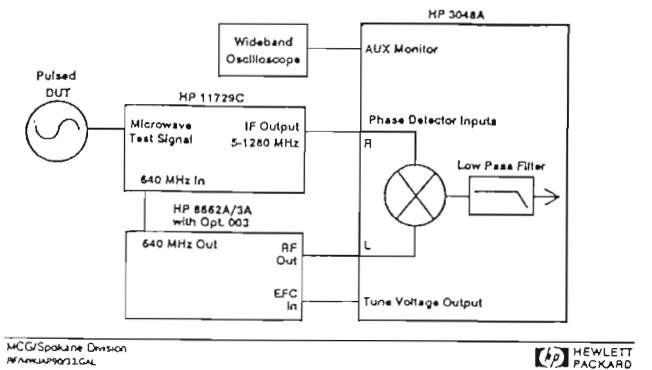

The HP11729C is a low noise down converter that can be used for making absolute measurements. It uses a 640 MHz reference to convert incoming microwaves down to a frequency range of 5 to 1280 MHz. The 8662 is used for the L.O.

Pulsed Carrier Phase Noise Measurement

Agenda

- Applications
- Basics of pulsed carriers
- Limitations with making pulsed measurements
- Recommended hardware configurations
- 3048A and 11729C capabilities
- *Summary*

ICG/Spokane Division
FAMWAP9031.GAL



In summary then we have covered some of the basics and several limitations in making pulsed noise measurements. We presented several solutions to these limitations and made some hardware recommendations. Finally the HP3048 and HP11729C capabilities were presented

Limitations

- Measurement Offset Range
- Mixer DC Offset
- LO AM Noise
- PRF Feedthrough
- Duty Cycle

Here are some of the limitations we discussed.

ICG/Spokane Division
FAMWAP9031.GAL



Summary Continued

	Capabilities	
	Absolute	Residual
HP 3048A:	Determined by phase detector (Internal or External)	
Frequency range		
Minimum duty cycle	5%	1%
Minimum PRF	2 X PTR	No Minimum
Noise Floor	Phase detector noise scaled by duty cycle	
Accuracy	± 2 dB .01 Hz to 1 MHz offsets ± 4 dB 1 MHz to 40 MHz offsets	
HP 3048A/11729:		
Frequency range	10 MHz to 18 GHz, to run with specials	N/A
Minimum duty cycle	5%	N/A
Minimum PRF	2 X PTR	N/A
Noise Floor	HP 8662/11729 CW noise folded by pulse spectrum	N/A
Accuracy	± 2 dB .01 Hz to 1 MHz offsets ± 4 dB 1 MHz to 40 MHz offsets	

ICG/Spokane Division
FAMWAP9031.GAL



I would like to conclude with this slide that summarizes capabilities of configurations for absolute and residual measurements. The HP3048 is guaranteed to operate correctly at these recommended minimums. If a measurement is made below these minimums, and the system operates correctly, then the accuracy of the measurement is not in question. You can see the duty cycle limitations listed here. It may be possible to make measurements with a lower duty cycle if a locked PLL condition can be maintained.