



APPLICATION NOTES

APPLICATION NOTE 37

MONITORING A RADIO TRANSMITTER SIGNAL WITH A

Ⓜ 120A OR 130B OSCILLOSCOPE

A high frequency radio transmitter signal can be monitored for observation and for modulation measurements quickly and easily with the low frequency, Ⓜ 120A or 130B Oscilloscope. Since no internal change in the oscilloscope is necessary, it is still useful for other purposes.

GENERAL

A schematic of the actual vertical plate circuit of the Ⓜ Model 130B Oscilloscope is shown in Figure 1 and the equivalent circuit in Figure 2. The terminal board is found at the rear of the oscilloscope.

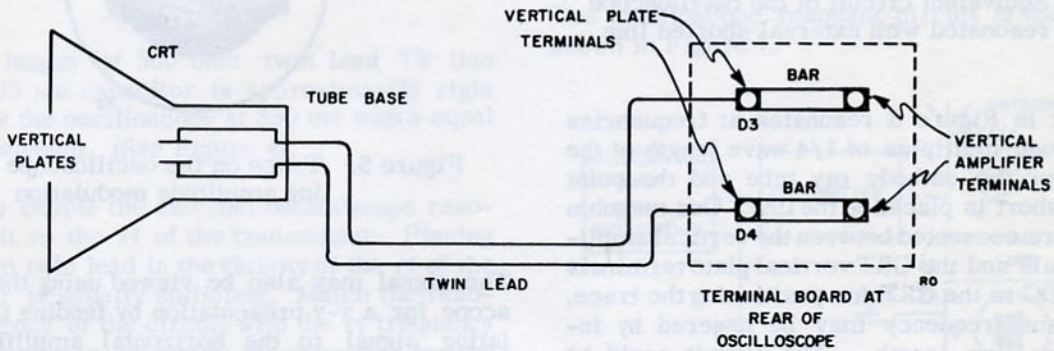

Figure 1. Wiring Diagram of the 120A or 130B Oscilloscope Vertical Plate Deflection Circuit

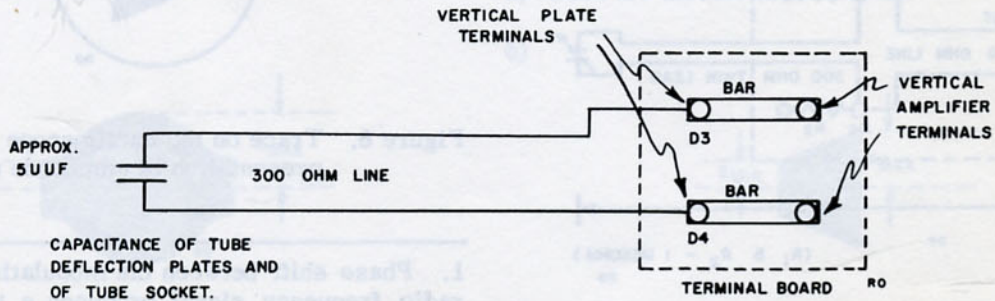

Figure 2. Equivalent plate deflection circuit of the Oscilloscope

11/2/59

Ordinarily, bars connect the vertical plate amplifier terminals to the CRT vertical plate terminals. However, a low frequency oscilloscope can be made to resonate and thus display frequencies in the hundred of megacycles by removing these bars and connecting it as shown in Figure 3.

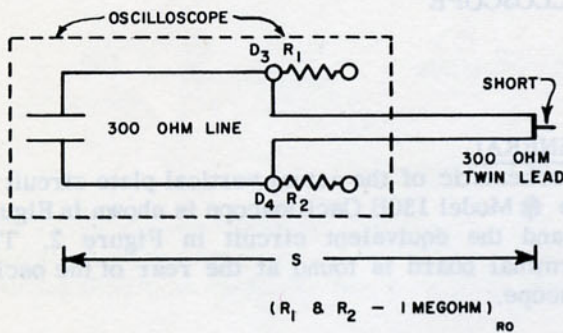

Figure 3. Equivalent circuit of the oscilloscope resonated with external shorted line

The circuit in Figure 3 resonates at frequencies which are odd multiples of 1/4 wave length of the line between the cathode ray tube and the point at which a short is placed on the line. One megohm resistors are connected between the vertical amplifier terminals and the CRT vertical plate terminals to provide DC to the CRT for positioning the trace. The resonant frequency may be lowered by increasing the line length. The circuit could be resonated at any frequency by providing a sliding short. However, in practice it is probably easier to tune the line by using a variable capacitor in place of a short at the end of the line as shown in Figure 4.

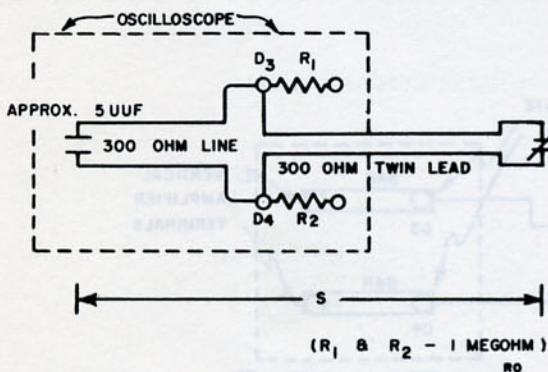

Figure 4. Equivalent circuit of the oscilloscope resonated with external line and variable capacitor

The modulation performance of the transmitter can be viewed after the oscilloscope is resonated on the center frequency of the transmitter. Since the Q of this resonant circuit is not too high and therefore has a broad resonance, the transmitter should remain centered on the resonance peak. The amplitude of the signal on the oscilloscope plates will therefore be directly proportional to the amplitude of the transmitter signal. Any amplitude modulation of the transmitter will cause a corresponding amplitude modulation in the oscilloscope plate signal. The modulation as shown in Figure 5 may be viewed by synchronizing the oscilloscope to the modulating waveform and sweeping in the usual manner.

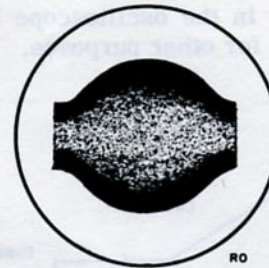

Figure 5. Trace on the oscilloscope showing amplitude modulation

The signal may also be viewed using the oscilloscope for a x-y presentation by feeding the modulating signal to the horizontal amplifier while applying the radio frequency signal to the vertical plates. A trapezoidal pattern will be viewed on the oscilloscope face as shown in Figure 6.¹

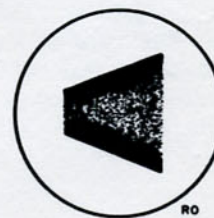

Figure 6. Trace on the oscilloscope showing x-y presentation of amplitude modulation

1. Phase shift between the modulating signal and radio frequency signal produces a three dimensional trapezoidal pattern. Phase shift, however, does not usually prevent the modulation measurement.

PROCEDURE

For Y Presentation

- 1) Connect the oscilloscope as shown in Figure 7.

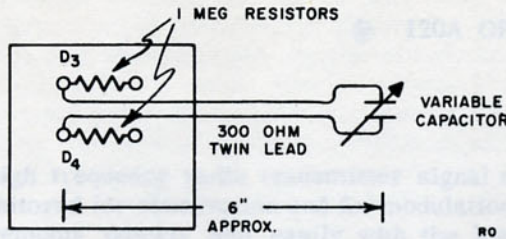

Figure 7. Rear view of 120A or 130B Oscilloscope showing connections for monitoring a transmitter signal

A 6 inch length of 300 ohm twin lead TV line with a 5-20 μf capacitor is approximately right to resonate the oscilloscope at 350 mc with equal to 3/4 wavelength. (See Figure 4).

2) Loosely couple the external oscilloscope resonant circuit to the rf of the transmitter. Placing the 300 ohm twin lead in the vicinity of the rf of the transmitter is usually sufficient. Match the resonant frequency of the circuit with the rf frequency of the transmitter by tuning the capacitor for the maximum amplitude on the cathode ray tube face. Decreasing the capacitance setting of the variable capacitor will raise the resonant frequency. The variable capacitor should be set at a capacitance value several times larger than the 5 μf capacitance of the cathode ray tube so that most of the voltage will be developed across the deflection plate of the tube. If resonance cannot be obtained, change the line length.

- 3)

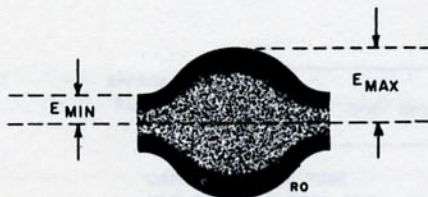

Figure 8. Trace on oscilloscope showing Y presentation of amplitude modulation

The percentage modulation can be found from the oscilloscope trace in Figure 8. The percentage modulation is shown below where E_o is the average amplitude of the signal.

$$E_o = \frac{E_{\min} + E_{\max}}{2}$$

$$\% \text{ modulation} = \frac{E_{\max} - E_o}{E_o} \times 100$$

For X-Y Presentation

The x-y presentation is sometimes preferred because its trapizoidal pattern presents more clearly defined maximum and minimum amplitude points.

- 1) Connect the oscilloscope as shown in Figure 9. The oscilloscope resonant circuit is the same as shown in Figure 7.

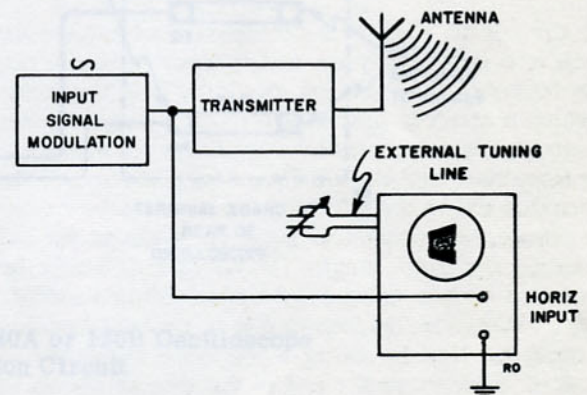

Figure 9. Setup for X-Y Presentation of Signals

- 5) Tune the circuit as in step 2..
- 6)

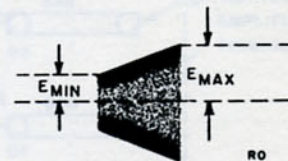

Figure 10. Trace on oscilloscope showing X-Y presentation of amplitude modulation