

How vector measurements expand design capabilities

1 to 1000 Mhz

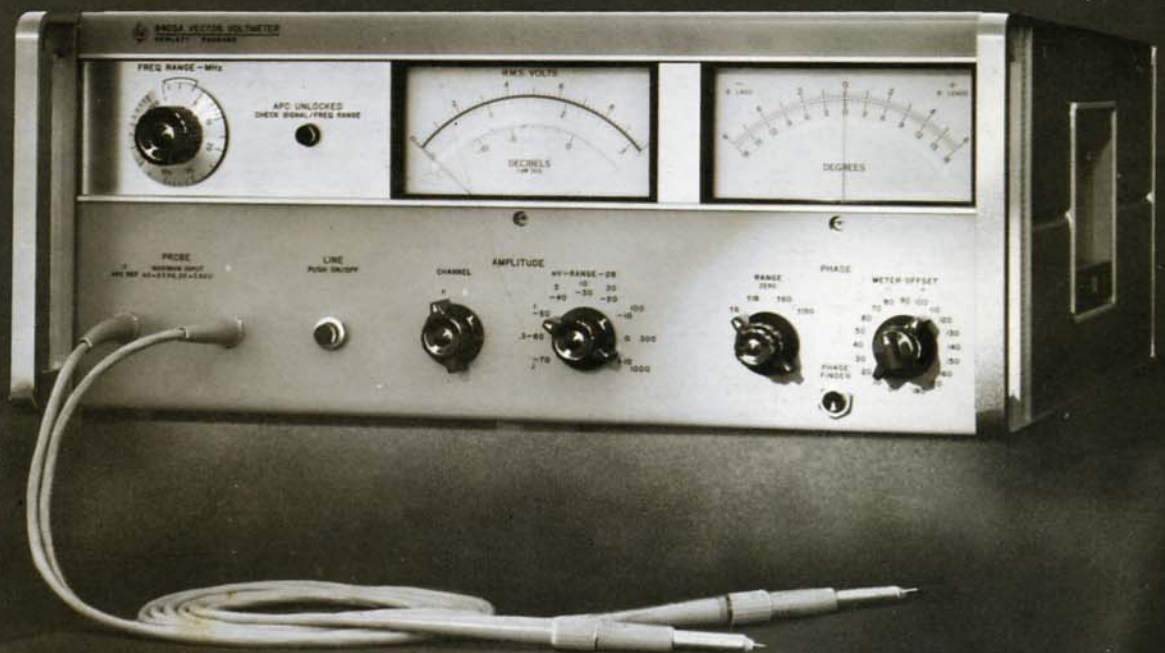

application note 91

HEWLETT  PACKARD



MODEL 8405A VECTOR VOLTMETER

APPLICATION NOTE 91

HOW VECTOR MEASUREMENTS EXPAND DESIGN CAPABILITIES — 1 to 1,000 MHz

JANUARY 1968

TABLE OF CONTENTS

	PAGE
Introduction	1
Feedback Amplifiers	2
Transmission Line Electrical Length	4
Matching Cable Electrical Length	6
Group Delay	8
Resonance	12
Automatically Tuned Voltmeter	14
Amplitude Modulation Measurement 1 to 1000 MHz	15
Appendix I	17
Appendix II	18

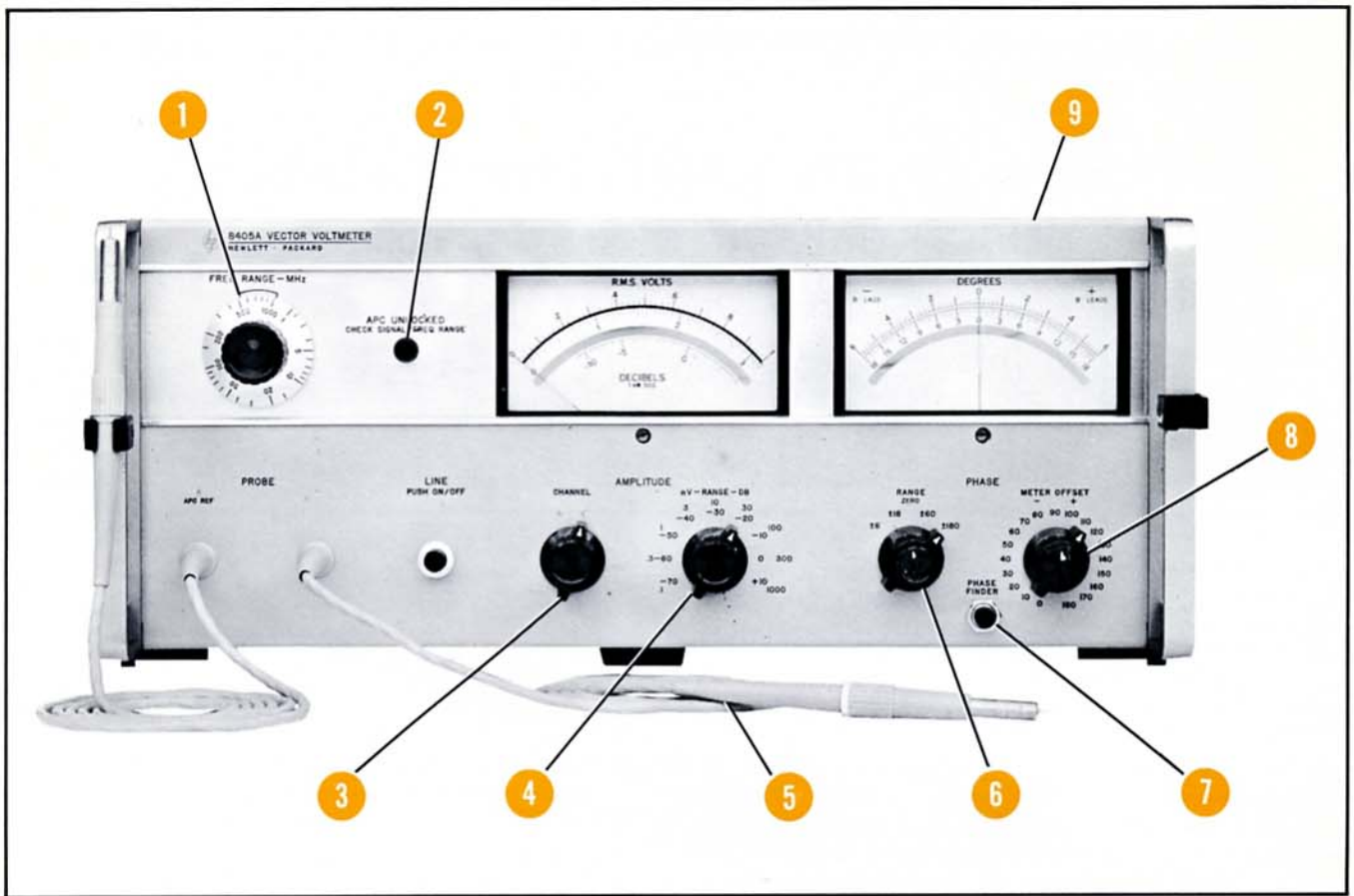

MODEL 8405A VECTOR VOLTMETER

1. **FREQ RANGE**
Tunes over octave bands automatically.
2. **APC UNLOCKED**
Light goes out when 8405A is "locked".
3. **CHANNEL SELECTOR SWITCH**
4. **AMPLITUDE RANGE SWITCH**
100 μ volts full scale sensitivity
90 dB range
5. **HIGH IMPEDANCE PROBES**
6. **PHASE RANGE SWITCH**
 $\pm 6^\circ$ full scale
7. **PHASE FINDER**
Returns **PHASE RANGE** to $\pm 180^\circ$ and **METER OFFSET** to 0° for direct readout of phase regardless of the position of these controls.
8. **PHASE METER OFFSET**
 $\pm 180^\circ$ in 10° steps
9. **IF OUTPUT**
Reconstructs RF to 20 kHz for analysis with low-frequency instruments.

Introduction

Vector measurements can add a new dimension to design information. "Vector" refers to the capability of defining two voltages not only by their magnitude but by the **phase** difference between them. Presented in simple graphical form (Figure 1), these parameters are magnitudes "A" and "B" and the angle " θ_{AB} " between them.

This note presents a variety of commonly encountered situations where vector measurements can provide important insight into device and circuit behavior.

The techniques for making these vector measurements involve the use of the Hewlett-Packard 8405A Vector Voltmeter, a two-channel RF millivoltmeter/phasermeter covering the 1- to 1,000-MHz frequency range. The instrument uses phase-locked coherent sampling to translate the RF signals to 20-kHz signals that retain the same wave shapes and the same amplitude and phase relationships as the original RF. Thus, the vector voltmeter can be considered much like an RF receiver, and the resultant performance characteristics are related to those you might find in a precision laboratory receiver. The various applications presented in this note draw upon the receiver-like properties of the vector voltmeter; for this reason, the salient characteristics of the instrument will be discussed briefly.

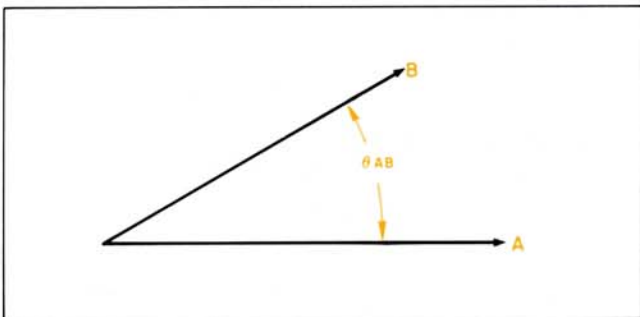

Figure 1. Measurement of voltage ratios are, in reality, "vector" measurements since a phase angle always exists in addition to magnitude information.

Wide Frequency Coverage. The frequency range of the vector voltmeter is 1 to 1,000 MHz, a part of the spectrum where vector information is often required yet historically has been difficult to obtain. Signal tuning of the instrument is simple and noncritical because the 8405A phase-locks itself to the fundamental of the incoming signal with only a coarse front-panel adjustment covering octave or greater spans. It can then follow slowly drifting signals automatically.

High Sensitivity. Like a receiver, the vector voltmeter is a sensitive instrument, measuring down to 100 μV full scale (residual noise is less than 10 μV), and maximum input is 10 V full scale with a 10:1 divider. Thus, readings can be taken over a 90- to 100-dB range — useful for measuring filters in both pass and rejection bands as well as other high loss or high gain devices.

High Selectivity. Although the sampling system employed in the 8405A results in wide frequency coverage, the actual measurement bandwidth in the 20-kHz IF preceding the voltage and phase measuring sections is only about 1 kHz, affording high selectivity. As a result, measurements are free from errors that might be encountered with a wideband system if signal harmonics or other spurious outputs were present. The illustration opposite page 1 shows the 8405A Vector Voltmeter with the major operating controls described.

In addition to the applications presented in this note, the vector voltmeter has proven to be immensely useful for measuring variables such as transistor parameters¹, frequency drift², complex impedance³, RF leakage, antenna characteristics⁴, and many other applications.

¹ HP Application Note 77-1, *Transistor Parameter Measurements*.

² HP Application Note 77-2, *Precision Frequency Comparison*.

³ HP Application Note 77-3, *Complex Impedance Measurements, 1 to 1,000 MHz*.

⁴ "The RF Vector Voltmeter — An Important New Instrument For Amplitude and Phase Measurements from 1 MHz to 1,000 MHz." *HP Journal*, May 1966, pages 2-12. (Copies of these are available, at no charge, from your local HP Sales Office or from Hewlett-Packard, Palo Alto.)

Feedback Amplifiers

Feedback has considerable effect on the characteristics of an amplifier. For example, when β times the output of an amplifier is fed-back into the input of an amplifier with gain G , the overall amplifier gain, K , becomes $K = G/(1 + \beta G)$. See Figure 2a.

The open-loop gain, βG , however, is frequency-sensitive and varies in both phase and magnitude with changes in frequency. When βG has unity magnitude (0 dB) and a phase angle of -180 degrees, the amplifier becomes unstable and starts to oscillate.

GAIN AND PHASE MARGIN

An indication of the stability of a feedback amplifier is given by the phase margin and gain margin. **Phase margin** is the difference between 180 degrees and the phase of βG at the frequency for which the open-loop gain is 0 dB. **Gain margin** is the open-loop gain at the frequency where the phase of βG is -180 degrees. Typical gain and phase margins are 10 to 40 dB and 20 to 50 degrees, respectively, for stable amplifier operation.

MEASUREMENT

The vector voltmeter is ideally suited for high-frequency feedback amplifier analysis. The open-loop gain and phase can be read simultaneously over the frequency range from 1 to 1,000 MHz and over a 90-dB dynamic range. The configuration for making open-loop gain measurements is given in Figure 2b.

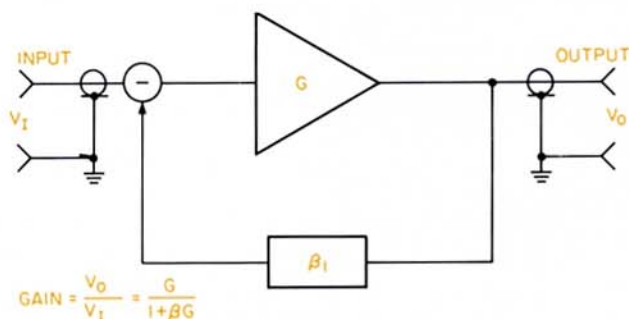

Figure 2a. Schematic Diagram of Typical Feedback Circuit.

A procedure for making open-loop gain measurements is as follows:

1. Break the circuit at the summing junction (point where the output is fed back into the input as indicated in Figure 2a for an ideal feedback amplifier).
2. Terminate the open-loop with impedances equal to the closed-loop impedances seen at the summing junction of the closed-loop amplifier. See Figure 2b.
3. Set the signal generator at frequency of interest and secure probe A of the vector voltmeter near the input of the circuit. Probe A is used to keep the vector voltmeter in phase-lock and must have an input of at least 1.5 mV, 1–10 MHz; 300 μ V, 10–500 MHz; 500 μ V, 500–1,000 MHz.
4. Measurements are made with channel B of the vector voltmeter. Either the HP 11576A 10:1 Divider or the HP 10216A Isolator should be used on the 8405A probes to prevent errors due

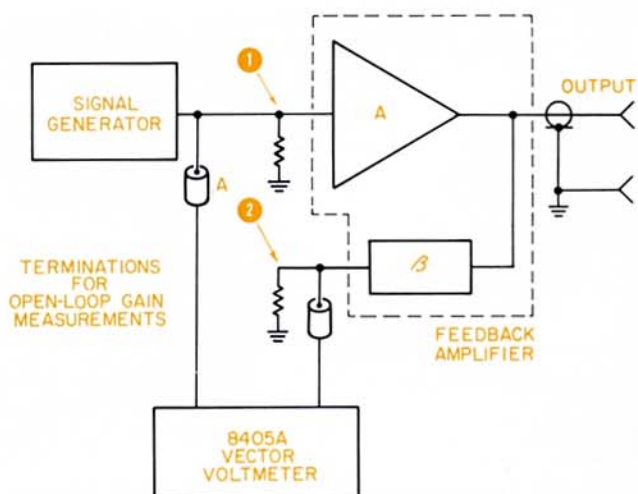

Figure 2b. Test Setup for Making Open-Loop Gain and Phase Margin Measurements.

to variations in test point impedances. Place probe B at test point 1 as indicated in Figure 2b. Using the phase zero control, adjust the 8405A for a convenient phasemeter reference (preferably 0 degrees). Note phase and amplitude readings.

5. Place probe B at test point 2 as indicated in Figure 2b. Note amplitude and phasemeter readings. The difference between these readings and those of step 4 will give the open-loop gain of the feedback amplifier.
6. Increase the frequency of the signal generator until the phase difference indicated by the vector voltmeter is ± 180 degrees. The gain indicated at this frequency is the open-loop **gain margin**.
7. Increase signal generator frequency until the gain indicated by the vector voltmeter is 0 dB. Subtract 180 degrees from the phase indicated at this frequency for the open-loop **phase-margin**.

EXAMPLE

Figure 3 shows the open-loop phase and gain for a transistor amplifier circuit as measured with the vector voltmeter. The amplifier was unstable, as gain and phase margins indicate.

ACCURACY

There are three accuracy considerations when making open-loop gain measurements with the 8405A; 1) basic

instrument accuracy, 2) test point impedance variation, and 3) open-loop gain terminations.

The procedure described above makes voltage ratio and phase difference measurements. The accuracy of the 8405A is best for this type of measurement. Since both input and output measurements are made with channel B, the absolute voltage and phase errors tend to cancel out. Voltage ratio can be measured within ± 0.2 dB and phase difference within ± 1.5 to ± 6 degrees over a 0- to 70-dB dynamic range.

Test point impedance is another source of error. For instance, amplitude and phase measurement errors are about 2 percent and 10 degrees, respectively, with a test point impedance variation of 25 to 1,000 ohms. These errors, however, are eliminated by using the HP 10216A Isolators or 11576A 10:1 Dividers on the probes for measurements up to approximately 100 MHz. Above 100 MHz, where circuits behave more like transmission lines (and impedance levels are more related to the transmission line characteristic impedance), use of the HP 11536A 50 Ω Probe Tee is especially desirable.

If terminations for the open-loop amplifier do not duplicate the closed-loop summing junction impedance, the amplifier characteristics will change, thus causing incorrect measurements. If the necessary impedance cannot be determined by inspection or simple calculation, it can be measured with the HP 4815A RF Impedance Meter (500 kHz—108 MHz) to ensure accurate impedance duplication.

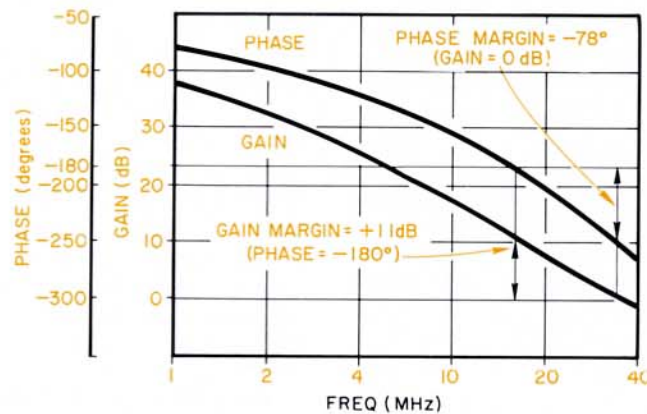

Figure 3. Phase and gain responses are plotted for a transistor feedback amplifier from 1 to 40 MHz. Note that data indicates amplifier is unstable.

Transmission Line Electrical Length

Transmission lines have a vital role in all RF and pulse systems. Although they are designed primarily for minimum SWR and attenuation, it is becoming more and more important to determine their electrical length. The electrical length of a transmission line is critical in many applications. Some of these are:

- Feed lines for phased-array antennas
- Cable for pulsed RF systems
- Pulse compression radars
- Computers

It is also convenient to know the electrical length of a device which has considerable phase shift, particularly when the device is relatively narrow band in nature. Typical examples of such devices are cascaded IF amplifiers, distributed amplifiers, or crystal filters.

Time domain reflectometry⁵ is one way to measure electrical length. However, in cases where both ends of the transmission line are available, a method employing phase measurements with the 8405A Vector Voltmeter offers an important advantage—the ability to measure electrical length **as a function of frequency** with high accuracy and resolution.

Electrical length, l , is given by ⁶

$$l = \frac{10^8 \Delta\phi}{1.2 \Delta f} \text{ (cm)} \quad (1)$$

where $\Delta f = f_2 - f_1$

f_1 (Hz) = an arbitrary frequency

f_2 (Hz) = a frequency above f_1

$\Delta\phi$ (degrees) = phase shift when the frequency is changed from f_1 to f_2

Determining electrical length using this equation becomes easy because the unknowns, $\Delta\phi$ and Δf , can readily be measured with the vector voltmeter and a frequency

counter, respectively. The electrical length is simply the constant, $10^8/1.2$, times the **slope** of phase versus frequency, $\Delta\phi/\Delta f$. Thus, changes of electrical length with frequency are indicated by nonlinearities in the phase-versus-frequency plot. See Figure 4.

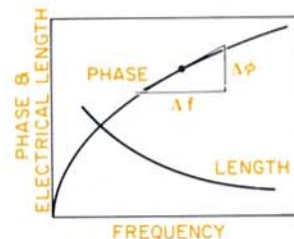

Figure 4. Nonlinearity of phase versus frequency indicates that electrical length is a function of frequency according

to the relationship $l = \frac{10^8}{1.2} \cdot \frac{\Delta\phi}{\Delta f}$ (cm).

MEASUREMENT

The measurement setup for such a length determination is shown in Figure 5. When the frequency range of interest is narrow with respect to the center frequency, accurate measurement of the frequency change requires high stability in the source and good resolution in the frequency measurements. Therefore, the use of a phase-locked signal source and a high-stability frequency counter is recommended.

The procedure is as follows:

1. To calibrate, zero the phase with the range switch in the $\pm 6^\circ$ position over the frequency range of interest. In Figure 5, the electrical lengths from the signal source to channels A and B are practically identical. Change the frequency from f_1 to f_2 and note the net phase shift, if any, to check this.
2. Insert the unknown as shown.

⁵ Hewlett-Packard Application Notes 62, 67 and 75 cover time domain reflectometry in a comprehensive manner. Copies of these notes are available without charge from your nearest HP Sales Office, or from Hewlett-Packard Co., Palo Alto, Calif.

⁶ See Appendix I for derivation.

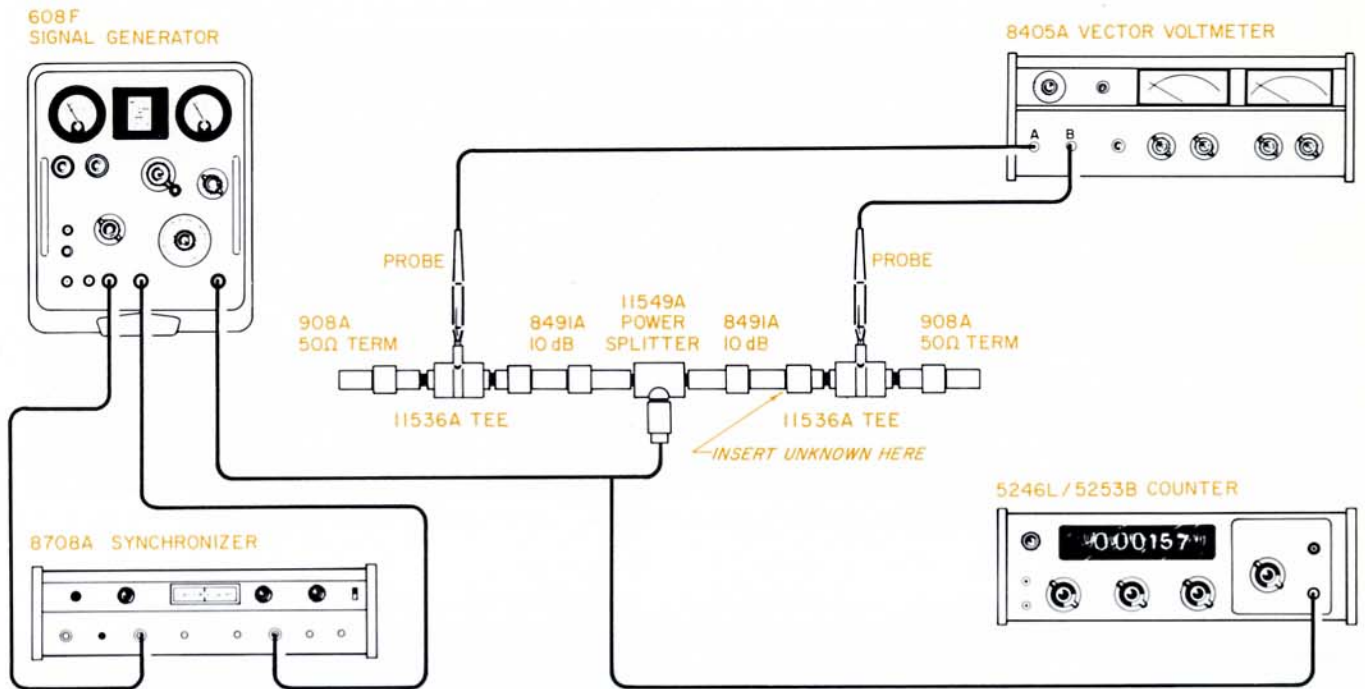

Figure 5. Test Setup for Measuring Electrical Length by Determining Phase Shift versus Frequency of Test Device.

3. Note the phase shift at f_1 and measure this frequency. Use the phase offset and the $\pm 6^\circ$ scale for highest phase resolution.
4. Change to frequency f_2 and measure it. The frequency increment should be small, or consistent with the accuracy of measuring $f_2 - f_1$, in order to obtain a good approximation of the phase slope at a given frequency. Again, use the phase offset and the $\pm 6^\circ$ range to read phase. Calculate $\Delta\phi$ and Δf from steps 3 and 4 after subtracting any phase shift noted in step 1 from $\Delta\phi$.

ACCURACY

Equation (1) shows that the accuracy in measuring electrical length is a function of the error in measuring the quantities $\Delta\phi$ and Δf . The error in $\Delta\phi$ is ≈ 0.2 degree for $\Delta\phi = 10$ degrees or about 2 percent when the phase shift is within the 12 degree single-phase range of the 8405A Vector Voltmeter. If the phase shift is greater than 12

degrees, the error in phase is typically no greater than 1.5 degrees over a 360 degree range for low loss (< 20 dB) devices. Thus, the error, in this case, is a function of the measured phase shift.

Frequency increments should be small to keep $\Delta\phi$ less than 12 degrees. In addition, accurate measurements of electrical length at a given frequency point are possible with small frequency increments. It is assumed that a synchronized or stabilized signal source is used to eliminate frequency drift errors. Accuracy of Δf depends upon the resolution and accuracy of the frequency counter used. The resolution and accuracy required will depend upon the phase-versus-frequency slope, or electrical length, of the device. Counters are available that provide resolutions and accuracies to a few cycles. Consequently, the error in electrical length is usually limited to the vector voltmeter phase error of about ± 0.2 degree for $\Delta\phi < 12$ degrees, or approximately ± 2 percent.

Matching Cable Electrical Length

A common measurement requirement is matching two devices, such as cables, to have the same electrical length. It is not sufficient for the device to have the exact mechanical length. Small variations in propagation velocity between the two will result in different **electrical** lengths even though the **mechanical** dimensions are the same.

A difficulty arises in the fabrication of matched cables for electrical length. Once the connectors have been attached, it is time consuming to remove the connector and re-trim the cables if the electrical lengths are not the same. The method described here matches the cables **before** the connectors are attached.

The 8405A Vector Voltmeter measures the phase shift between the incident wave on a cable and the wave reflected from the open-circuited end of the cable. When the electrical length of two cables is the same, the phase shift will be the same. The lengths could differ by an integral number of wavelengths, but in the 1- to 1,000-MHz frequency range of the vector voltmeter this difference is usually apparent by inspection.

MEASUREMENT

The test configuration appears in Figure 6. Note the use of the dual directional coupler for separating the incident and reflected waves. The test frequency is not

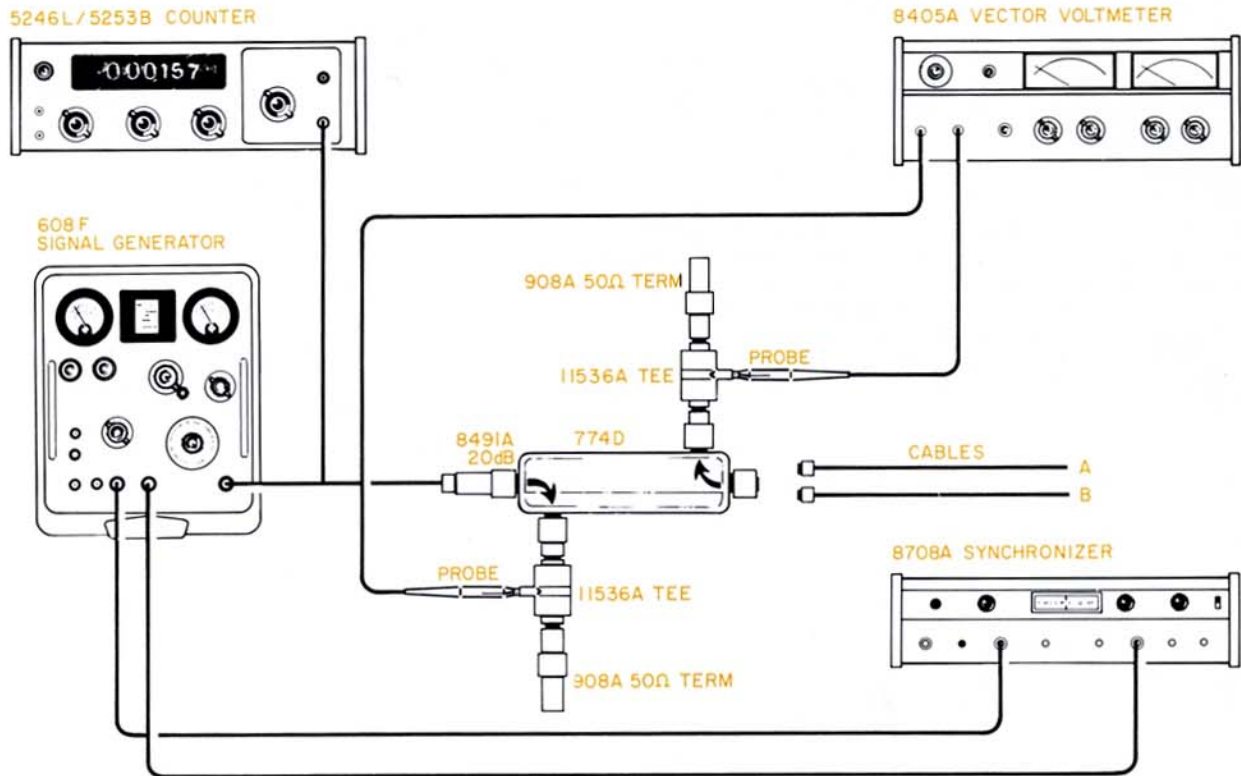

Figure 6. Test Setup using Directional Couplers to Measure Phase Shift and, thus, Match Electrical Length of Two Cables Very Precisely.

necessarily limited by the range of the dual directional coupler, for it will operate well below the stated frequency range. Coupling factor increases as frequency is lowered (at a 6 dB/octave rate), and signal levels become smaller. This seldom limits measurement range because the vector voltmeter has high sensitivity and wide dynamic range.

By stabilizing the signal generator with the synchronizer, the measurement is more precise. Stabilization is not usually required except at the higher frequencies and where the length of the cable is an appreciable part of a wavelength.

The procedure for matching electrical lengths is as follows:

1. Set up the instrument as shown in Figure 6.
2. Cut the cables to the approximate length desired. You can use time domain reflectometry for this purpose (see HP Application Note 67).
3. Connect the shorter cable to the coupler and set an arbitrary phase reference.
4. Replace the shorter cable with the longer and trim the longer cable until the phase readings are the same. Install the connectors with care to preserve the equality of the electrical length.

EXAMPLE

Two pieces of RG214/U cable about 2½ feet long are to be made equal in electrical length. The first cable is connected to the coupler. Using the phase offset and ±6° scale, the phase is zeroed. The first cable is replaced

by the second and a + 4.5-degree phase shift is noted. (Note the phase will always be leading for the longer line.) The longer cable is carefully trimmed until the phase shift is zero, i.e., matches the reference phase shift. The two cables are now matched with about ±0.2 mm precision.

ACCURACY

The conditions of this test allow maximum phase accuracy. The signal amplitude is approximately the same in both channels and the 8405A probes are both in 50Ω line. Furthermore, in the final stages of trimming the longer cables, the phase range and the phase offset switches will remain in the same position for both cables. Under these conditions, the accuracy depends upon the resolution, repeatability, and short-term drift of the system, which is approximately ±0.2-degree. With the above phase resolution and repeatability, the accuracy to which lengths can be matched is about

$$\pm \frac{0.2^\circ}{360^\circ} \lambda = 5.56 \cdot 10^{-4} \lambda$$

At a frequency of 1,000 MHz, the signal wavelength will be ≈30 cm and so accuracy will be about 0.2 mm.

The frequency drift of the source must be kept within ±0.1 percent. The HP 606, 608, and 612 Signal Generators all have less than this amount of drift after a 10-minute warmup. The drift can be monitored with a counter. The 8708A Synchronizer, available for both the 606B and 608F Signal Generators, provides for frequency stability of a few parts in 10⁷.

Group Delay

A device may introduce two types of distortion. The first type is due to a frequency-sensitive **amplitude** response. The second type occurs from nonlinear **phase** variations and may be a significant source of distortion even when the amplitude response is flat.

Related to the second type is a phenomenon called "group delay," which is the transit time of signals through a device. Group delay is defined as

$$\text{Group Delay} = t_D = \frac{d\phi}{d\omega} \text{ (s)} \quad (2)$$

It is proportional to the slope of phase versus frequency. When the transit time or group delay is not constant with frequency (phase versus frequency is nonlinear), phase relationships of the signal components change, and distortion results.

Group delay measurements are important in audio- and video-frequency amplifiers and networks. In transmission systems with complex waveforms, such as TV or carrier systems, a linear phase characteristic is necessary to prevent waveshape degradation.⁷

The 8405A Vector Voltmeter is well suited for group delay measurements. The frequency range of the vector voltmeter is 1 to 1,000 MHz, which includes many of the communications systems frequency allocations. The phase offset control of the instrument permits a $\pm 6^\circ$ full-scale phase reading for high resolution measurements.

MEASUREMENT

To measure the group delay of an amplifier or other network, first set up the test equipment as in Figure 7. The 8708A Synchronizer will help achieve greater precision by stabilizing the signal generator. The procedure is as follows:

1. With the test equipment in the configuration of Figure 7, zero the phase shift with the range switch on $\pm 6^\circ$.
2. Insert the test network as in Figure 8.

⁷ S. Goldman, *Frequency Analysis, Modulation and Noise*, McGraw-Hill, 1948. P. 117-123.

3. Vary the frequency over the frequencies of interest and note the phase shift.
4. Calculate the group delay.

$$t_D = \frac{d\phi}{d\omega} = \frac{\Delta\phi \text{ (rad)}}{\Delta\omega} = \frac{\Delta\phi \text{ (deg)}}{360 \Delta f \text{ (Hz)}} \quad (3)$$

For convenience, choose Δf to be some power of 10 times 2.778 Hz. (The number, 2.778 is related to the reciprocal of 360 which, therefore, converts phase in degrees directly into time units.)

For example, if Δf is 2.778 MHz,

$$t_D = \frac{\Delta\phi \text{ (deg)}}{360 \cdot 2.778 \cdot 10^6} = \Delta\phi \cdot 10^{-9} \text{ (s)} \quad \text{or} \\ t_D \text{ (ns)} = \Delta\phi.$$

Thus, when $\Delta f = 2.778$ MHz, the phase meter units are nanoseconds instead of degrees. In general, group delay can be determined by changing input frequency in increments of $2.78 \cdot 10^n$ kHz and determining delay from corresponding phase meter changes with scale factor of 10^{-n} $\mu\text{s/deg}$, where $n = 0, \pm 1, \pm 2, \dots$

EXAMPLE

The device under test in this example was a broadband amplifier. The test equipment was set up in the configuration of Figure 8. The frequency was varied in 2.778-MHz steps. Thus, the phase change in degrees represented the group delay in nanoseconds for that frequency increment. The results of this test are plotted in Figure 9.

REFERENCE DELAY LINE

It is much easier to evaluate a device for phase non-linearity, or changes in group delay, if the mean slope of the phase-versus-frequency curve is as close to zero as possible so that the changes in slope become deviations from a near 0-degree phase reference. This can be done by inserting into the reference channel a line with

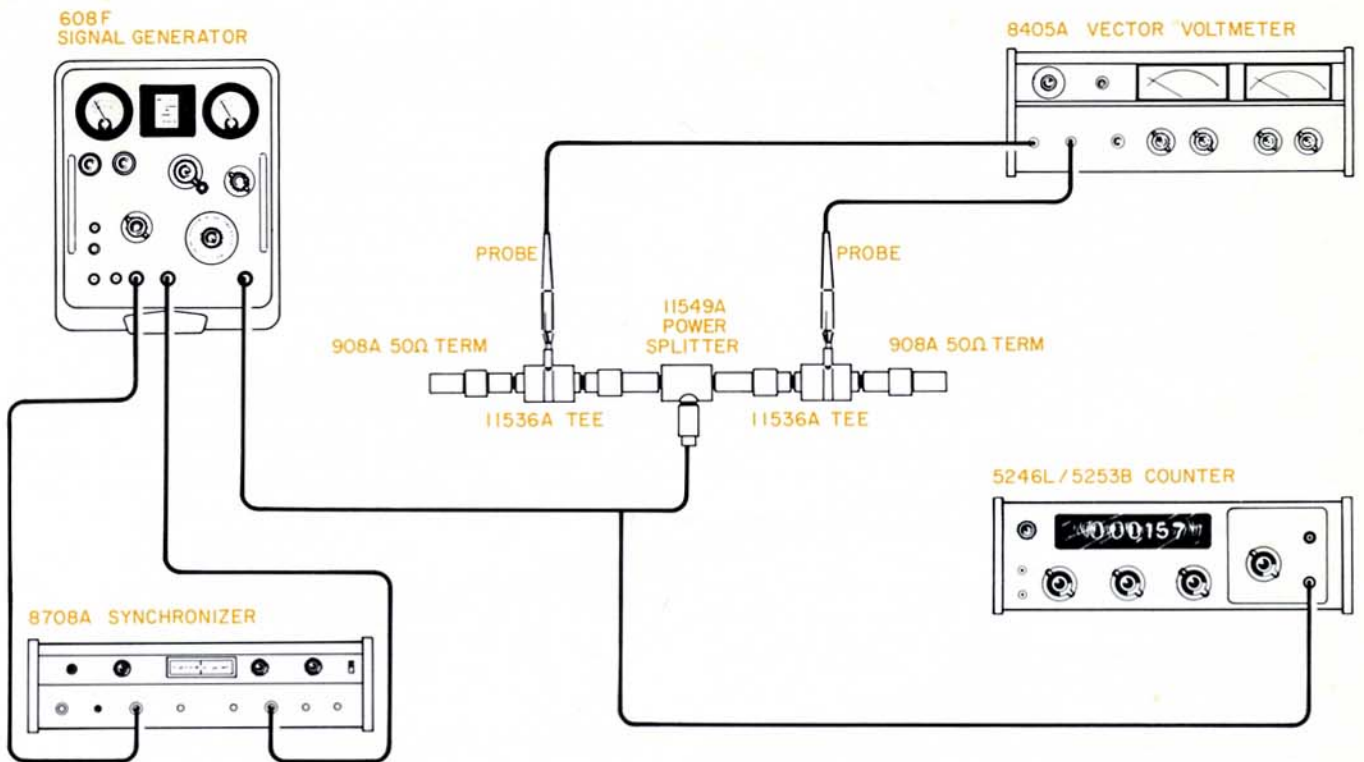

Figure 7. Equipment Connections for Calibrating Vector Voltmeter for Group Delay Measurements.

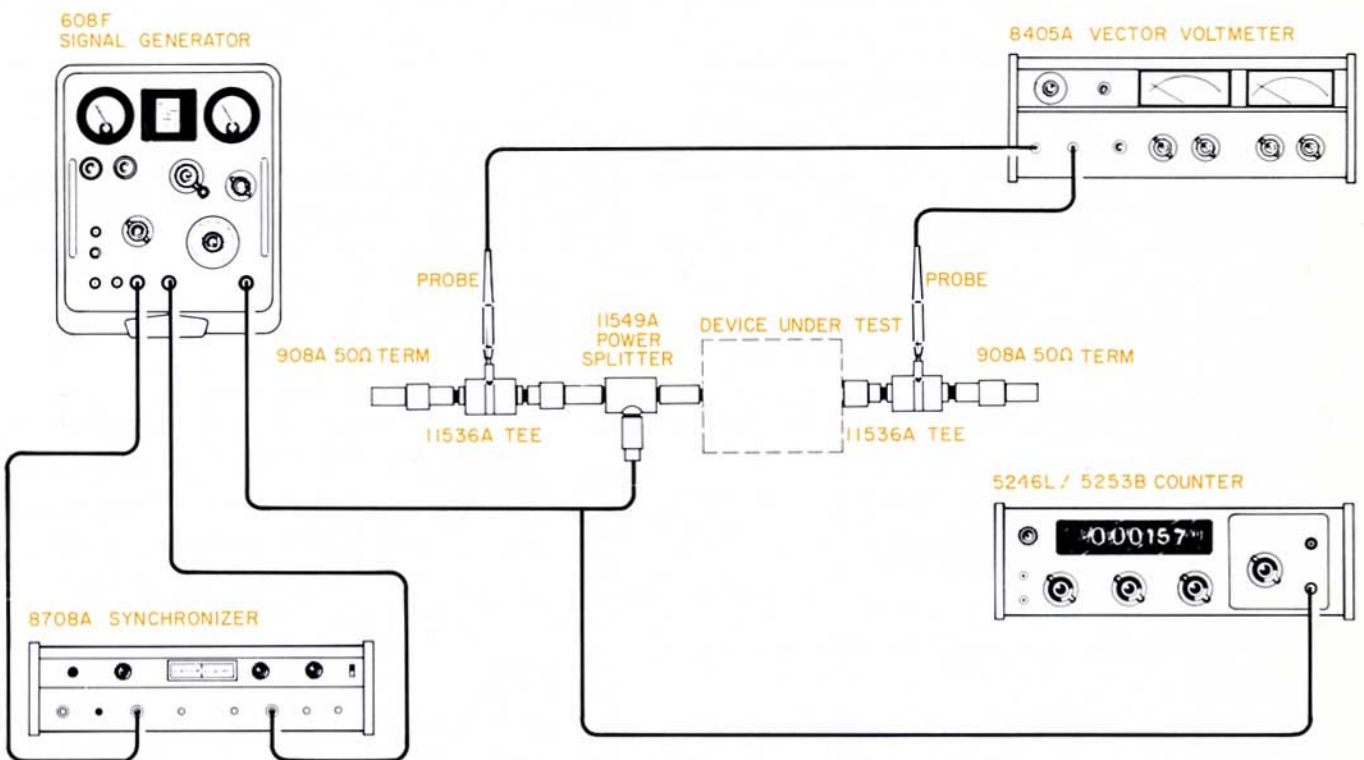

Figure 8. Measurement of Group Delay on Device Inserted in Setup of Figure 7.

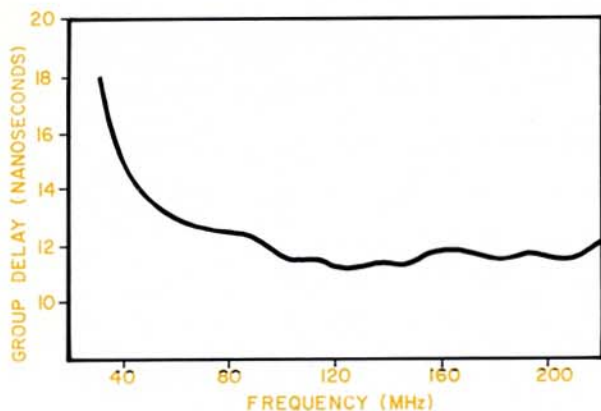

Figure 9. Group delay of a CATV amplifier is plotted directly from measurements of phase shift in degrees with frequency in 2.778-MHz steps. Group delay in nano-seconds is thus read directly from phase meter scale in degrees.

an equivalent delay equal to the mean slope of phase versus frequency. Figures 10 and 11 show phase-versus-frequency curves before and after a delay line is inserted in the A or reference channel between the power splitter and the probe tee. With the delay line in the reference channel, any phase change with frequency indicates the difference between the delay of the reference line and the delay of the device under test.

You can determine the electrical length of the reference delay line by using the method described in the section on measuring electrical length. The length can also be approximated by noting that 1 foot of delay line ($\epsilon=1.0$) is roughly equivalent to 1 nanosecond of delay. Including a line stretcher as part of the delay line is convenient for fine tuning.

Higher accuracy for making relative delay measurements is possible by using a reference delay line because it is

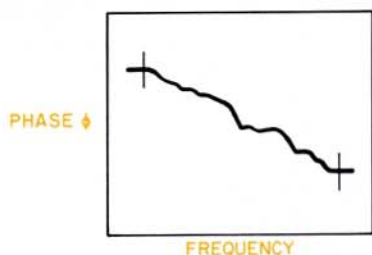

Figure 10. Phase Response versus Frequency for Device with Large Electrical Length.

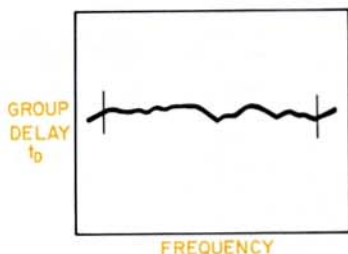

Figure 11. Phase response of device tested in Figure 10 has delay line or line stretcher inserted in reference channel. This allows higher phase resolution and accuracy in making relative group delay measurements.

not necessary to change the phase range setting on the vector voltmeter. In fact, when the setting is not changed, the phase accuracy of the vector voltmeter will be better than ± 0.2 -degree or ± 0.2 nanosecond in the case of 2.778-MHz steps. Absolute group delay accuracy will depend, of course, on the accuracy of measuring the electrical length of the reference delay line.

SWEPT-FREQUENCY DISPLAY OF GROUP DELAY

Many group delay measurements require a swept-frequency display to observe instantaneous changes in group delay over a frequency band while adjustments are being made on the device being tested. For example, devices such as filters and equalizers must be adjusted for constant group delay or linear phase response over given pass bands to minimize distortion. A unique method for making this kind of qualitative measurement with the vector voltmeter has been devised that requires only a slight modification to the instrument.

An additional benefit to this technique is the ability to use the vector voltmeter phase offset control as a delay line to set the display for a phase reference anywhere in the band of interest. This is particularly advantageous when adjusting multi-order pole filters where the group delay may be as long as 1 microsecond. A delay line ($\epsilon=1$) about 1000 feet long would be necessary to cancel out the linear phase component of devices with this order of group delay.

THEORY OF OPERATION

The test setup for this measurement is shown in Figure 12. Because the RF circuitry of the 8405A cannot follow fast sweeps and stay "locked" or tuned to the signal frequency, the RF section of the instrument is bypassed and only the 20-kHz IF section of the vector voltmeter is used in this application. Thus the need for the signal source frequency to be amplitude-modulated at a 20-kHz frequency through the double balanced mixer. The power supply provides the dc necessary to bias the mixer properly.

The modulated, swept RF is fed through an attenuator to the device to be tested, then detected, amplified, and fed to the 20-kHz section of the vector voltmeter. This

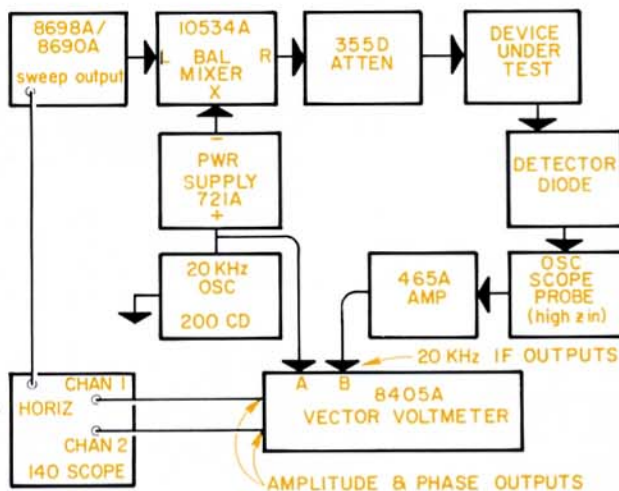

Figure 12. Test Setup for Making Swept-frequency Displays for Group Delay Adjustments.

section measures the phase difference between the detected 20-kHz signal and the 20-kHz modulating or reference signal. In this case, the demodulated 20-kHz signal has the same phase relationship to the reference 20-kHz signal as the phase-shifted carrier frequency has to the reference RF signal applied to the device. The $\pm 180^\circ$ phase offset switch of the 8405A is conveniently used as a variable phase shifter, or delay line, to present an easily readable display on an oscilloscope. It is usually desirable to balance out the linear phase component of the phase-versus-frequency response so that the nonlinear effects can be displayed against the horizontal graticule lines of the oscilloscope. This allows for expansion of the display with the oscilloscope sensitivity controls and for calibration, if desired, of the display in units of group delay per centimeter.

The **inputs** to the vector voltmeter are to the rear panel terminals labeled "20 kHz IF output." Circuit boards A3, A4, A10 must be removed to disable certain circuitry when using this method. The phase and amplitude outputs of the vector voltmeter are fed into the vertical

inputs of a dual-trace oscilloscope, which is horizontally swept by the sweep generator. The phase range switch of the Vector Voltmeter is then adjusted so that the group delay trace is flat at center frequency. Effects of filter adjustments on the phase response can then be monitored continuously on the oscilloscope.

EXAMPLE

The device under test in this case was a 5th order Bessel function filter in the 10.7-MHz IF section of an FM tuner. Oscilloscope traces for three different degrees of alignment are shown in Figures 13, 14, and 15. The upper curve in each case is amplitude. In Figure 13, both the amplitude and group delay curves show that the filter is improperly aligned. Figure 14 shows the case where amplitude response would indicate proper alignment, although the group delay is still slightly nonlinear in the mid-frequency range. When the IF strip has been properly tuned, the group delay appears flat as in Figure 15.

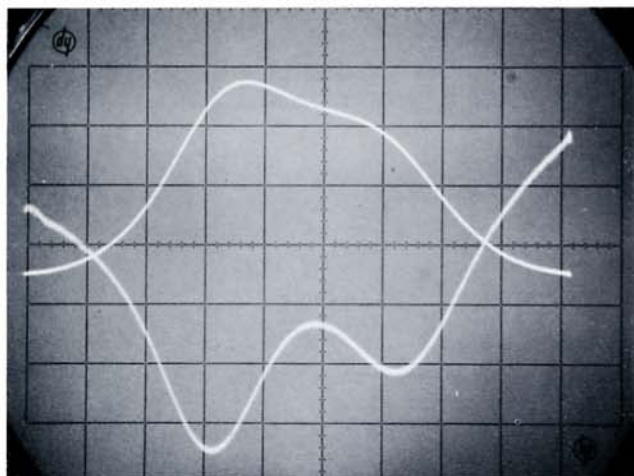

Figure 13. Top Trace: Amplitude Response of IF Passband of FM Receiver. Bottom Trace: Group Delay. Note that filter in receiver is out of alignment.

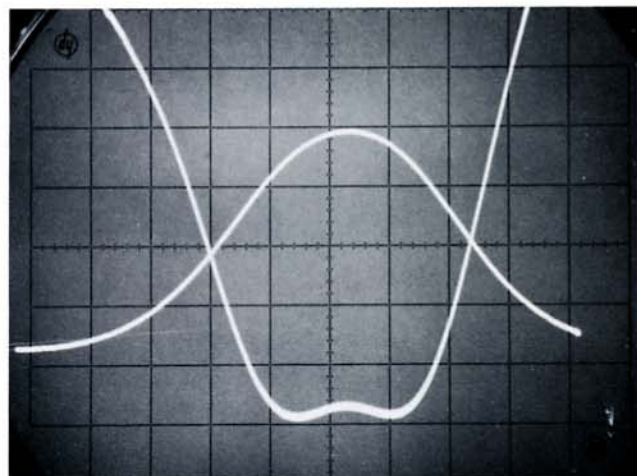

Figure 14. Same as Figure 13 but filter is adjusted for optimum amplitude response, although phase, or group delay, is still slightly nonlinear.

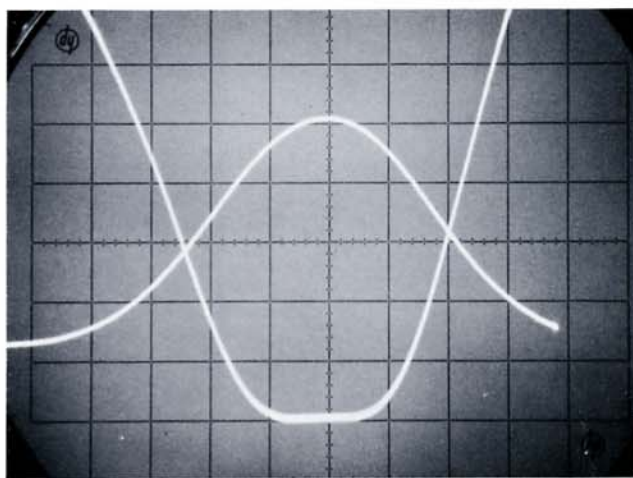

Figure 15. Same as Figure 13 and 14 with IF strip properly adjusted for flat group delay over passband.

Resonance

The 8405A Vector Voltmeter can be used to determine the resonant frequency of tuned circuits, filters, oscillators and other circuits in the frequency range from 1 to 1,000 MHz. With the 8405A, one can locate the resonant frequency by detecting the zero-degree phase crossover. Historically, the technique has been to locate a maximum or minimum of the amplitude response. The phase detection method is a much more accurate and sensitive method because phase is usually changing very rapidly near resonance, while the amplitude response curve in this region is often essentially flat.

MEASUREMENT

A typical measurement setup is shown in Figure 5. (The 8708A Synchronizer is used to phase-lock the signal generator for greater stability.) The measurement procedure is as follows:

1. Set up the test configuration as in Figure 5, leaving out the test device and connecting the B channel 11536A Probe Tee directly to the power splitter.
2. Zero the phase meter.
3. Insert the test device.
4. Read phase shift versus frequency.

Resonance is defined as the frequency at which the phase shift through the device equals the 0-degree phase reference set during Step 2. The circuit is purely resistive at the 0-degree phase crossover point, the reactive components having canceled out, and is thus resonant. To distinguish between a series or parallel-type resonance, note whether the amplitude response has peaked to a maximum or minimum.

EXAMPLE

The test device for this example was an HP 8442A 20-MHz narrow band Crystal Filter. Its amplitude and phase characteristics are plotted in Figure 16. The expanded scale of Figure 17 shows the curves in greater detail near resonance. Note that as the phase varies from $+6^\circ$ to -6° (full scale on the most sensitive phase

range), the amplitude variation is imperceptible. It is the extreme phase sensitivity that allows the resonant frequency to be determined with very high resolution.

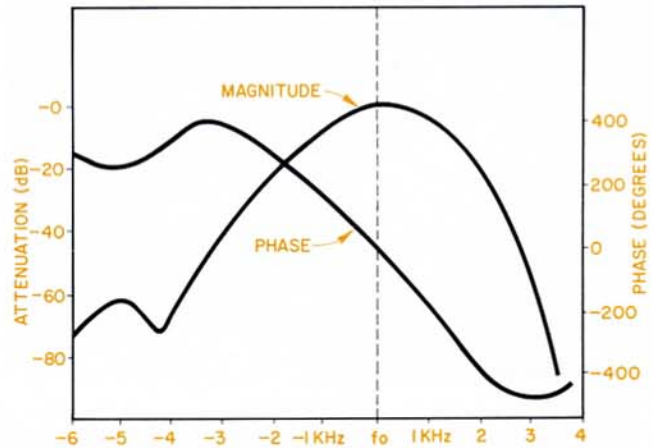

Figure 16. Amplitude and Phase Response of Narrow Band 20-MHz Crystal Filter.

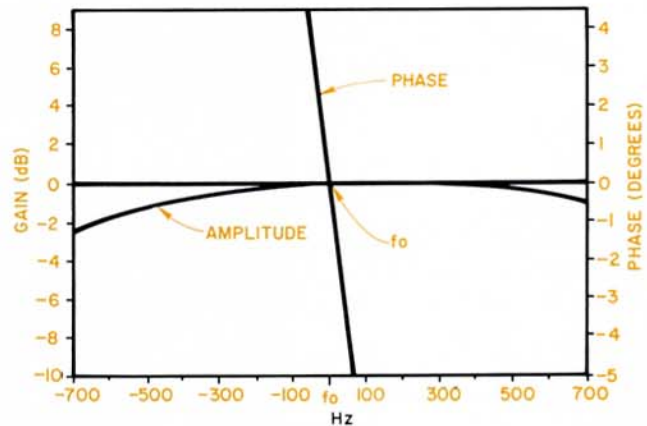

Figure 17. Plot of crystal filter of Figure 16 is greatly expanded near resonant frequency. Note the high phase versus frequency sensitivity which allows determination of resonant frequency with exceptional resolution.

The Q of the filter can also be obtained from this test. The Q is equal to the resonant frequency divided by the 3-dB bandwidth. The Q was about 9100 for the HP 8442A Filter.

ACCURACY

This technique assumes that the electrical length at resonance of the device under test is negligible. A possible source of error, however, is the shift in phase from the 0-degree resonance phase point due to the electrical length added by the physical length of the device. The device is assumed to resonate at the center plane of its physical configuration. The physical length is composed of transmission lines carrying the signal to the resonant structure. This effect upon accuracy will depend upon (1) the resonant frequency wavelength (2) the slope of the phase-versus-frequency curve of the network near resonance (3) and the physical length of the device. You can estimate the effect of the electrical length phase

shift on the resonant frequency determination by measuring the physical length of the device, converting this to phase shift at the resonant frequency, and by noting how much this phase shift would affect frequency accuracy.

In this example, the wavelength is about 1500 cm at 20 MHz, the electrical length is approximately 15 cm, and the phase slope is about 15 Hz/deg. This results in a frequency accuracy of

$$\frac{15 \cdot 360 \text{ deg}}{1500} \cdot 15 \text{ Hz/deg} = \pm 54 \text{ Hz}$$

$$\text{or } \frac{54}{2 \cdot 10^7} = 0.0003\%$$

Note that the very high sensitivity of the phase response (≈ 15 Hz/deg) as compared to the amplitude response accounts for the capability to determine the resonant frequency accurately.

Automatically Tuned Voltmeter

Several of the 8405A Vector Voltmeter design features combine to make it an exceptionally easy-to-use *tuned* voltmeter over its frequency range from 1 to 1,000 MHz. Channel A locks on the largest input signal to the vector voltmeter. Channel B responds to signals only at the frequency to which channel A is locked. The 3-dB bandwidth is 1 kHz. The vector voltmeter also has a broad three-decade frequency range and greater than 90 dB dynamic range. With the combination of automatic signal tuning and high measurement selectivity, measurements are made easily and accurately. An example of its use to measure a notch filter is discussed below. Measurement with the vector voltmeter is then compared with a broadband voltmeter. The comparison shows the erroneous results that can be obtained because the broadband voltmeter responds to harmonics of the signal source output.

EXAMPLE

The filter used in this example is a notch filter designed to reject a 21.6-MHz signal. It is used to suppress the second harmonic of a signal generator. Its precise frequency response, especially at the rejection frequency, must be known in this application.

For a comparison, the frequency response of the filter was plotted using both a broadband voltmeter and the vector voltmeter. Since the broadband voltmeter would respond to signal source frequencies other than the fundamental, it was expected to show an incorrect picture of the rejection of the filter. This was found to be the case.

The two frequency response curves are plotted in Figure 18. The lower curve is the data plotted using the vector voltmeter; the upper, the broadband voltmeter. At the maximum rejection frequency of about 21.6 MHz, the amplitude response as measured by the broadband voltmeter was approximately 17 dB in error. The broadband voltmeter was also measuring the response of the filter at 43.2 and 64.8 MHz, i. e., the 2nd and 3rd harmonics of the signal source. Most signal generators have enough

harmonic content to cause considerable error in measurements of this type unless a **tuned** voltmeter such as the 8405A is used. The vector voltmeter shows that the true rejection is approximately -50 dB. The test configuration for this example is the same as Figure 8.

The operation of the vector voltmeter to obtain this data was extremely simple. It was only necessary to set the frequency range switch to the proper octave setting, tune the signal source through the band, and change the amplitude range switch as necessary. The vector voltmeter automatically locked to the signal source and measured the response at that frequency only.

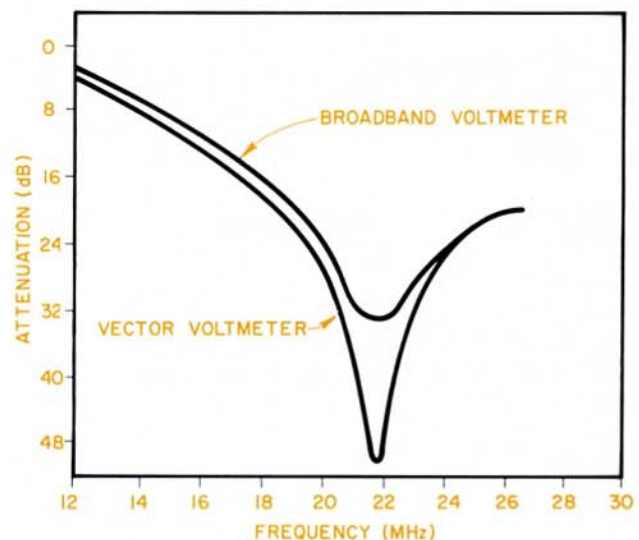

Figure 18. Plot of magnitude response of filter using 1 kHz bandwidth vector voltmeter and general purpose broadband voltmeter. Difference is due to response of broadband voltmeter to harmonics of insufficiently filtered signal source.

Amplitude Modulation

The 8405A Vector Voltmeter allows convenient, direct measurement of peak amplitude modulation on signals from 1 to 1,000 MHz on a low frequency (20 kHz), high input impedance oscilloscope. It translates signals in this 3-decade RF range down to 20 kHz. In translation, the relation of the sidebands to the carrier is preserved for sideband frequencies up to about 10 kHz.

This method of measuring AM offers several advantages over other methods in this frequency range. It is quickly and easily made. AM is displayed on a low-frequency oscilloscope even at frequencies as high as 1,000 MHz. Other methods, such as using crystal detectors to demodulate, require working in the square-law range, (requiring mathematical conversions), or in the linear range where selection of crystals with wide dynamic range is difficult.

The vector voltmeter is, in essence, a broadband receiver with wide dynamic range that can display AM on any carrier from 1 to 1,000 MHz through its 20-kHz output.

Amplitude modulation on weak carrier signals ($100 \mu\text{V}$) can be measured with it because of its high sensitivity. In addition, as a receiver, the vector voltmeter automatically tunes to the signal source through a phase-lock feedback circuit and, thus, does not require manual retuning to follow any drift in the signal source.

EXAMPLE

Percent modulation can be conveniently determined as follows:

1. Connect the instruments as in Figure 19.
2. Calibrate the oscilloscope trace with the unmodulated carrier. The peak magnitude corresponds to 100 percent AM. For example, if the peak carrier voltage were 10 cm, the percent modulation would be 10%/cm.

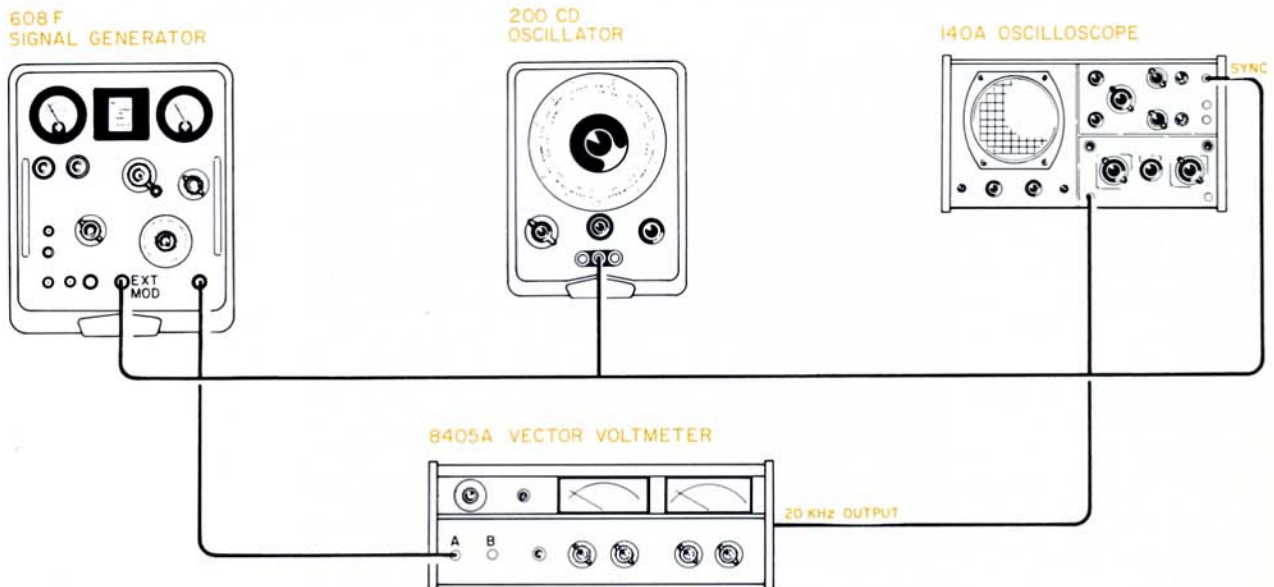

Figure 19. Test setup is used to check percent AM modulation of signal generators from 1 to 1,000 MHz by displaying 20-kHz IF signal of vector voltmeter on oscilloscope.

3. Offset the peak of the unmodulated carrier to the lowest graticule line of the oscilloscope. The offset capabilities of most oscilloscopes will limit the full scale amplitude to 100 percent AM full scale.
4. Modulate the carrier and read percent modulation from the oscilloscope trace.

By this procedure, the percent modulation of the trace in Figure 20 can be read directly as 50 percent in Figure 21.

LOW LEVEL MODULATION

For very low levels of modulation it is possible to increase the resolution to a few percent. This requires the use of the Hewlett-Packard 1406A Differential Amplifier plug-in for the 140 HP/or 141 Oscilloscope. This plug-in has the dc offset capability required to position the expanded modulating signal on the oscilloscope. It also has dc stabilization, which eliminates any dc drift of the trace.

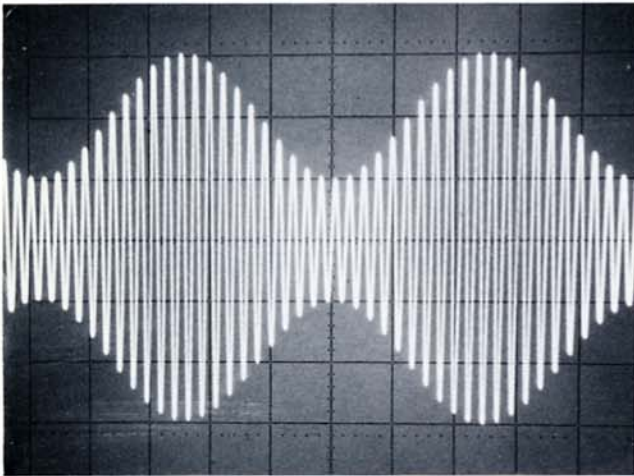

Figure 20. 50% AM on 400-MHz carrier is observed on line frequency oscilloscope. 400-MHz carrier is reconstructed to 20-kHz output signal.

The following steps briefly outline the method.

1. Set up the instruments as shown in Figure 19 using the 1406A Differential Amplifier.
2. Set the peak magnitude of the CW signal to full scale on the oscilloscope.
3. Increase the vertical sensitivity of the oscilloscope by the desired multiple (e. g., if the calibration was 10% AM per cm, a sensitivity change from 10 mV/cm to 1 mV/cm on the oscilloscope would result in 1% AM/cm.)
4. Using the positioning adjustment, offset the trace until the peak of the unmodulated carrier is at the center graticule line.
5. Modulate the carrier and note the percent modulation.

Figure 22 shows about 1 percent modulation, illustrating the sensitivity of the method.

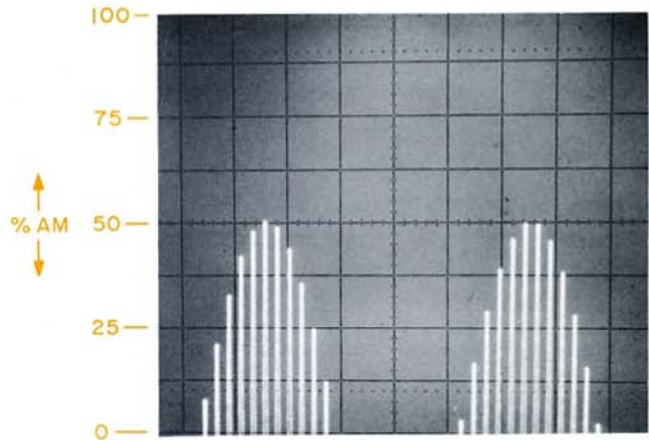

Figure 21. Oscilloscope offset technique allows percent AM to be read directly off oscilloscope graticule.

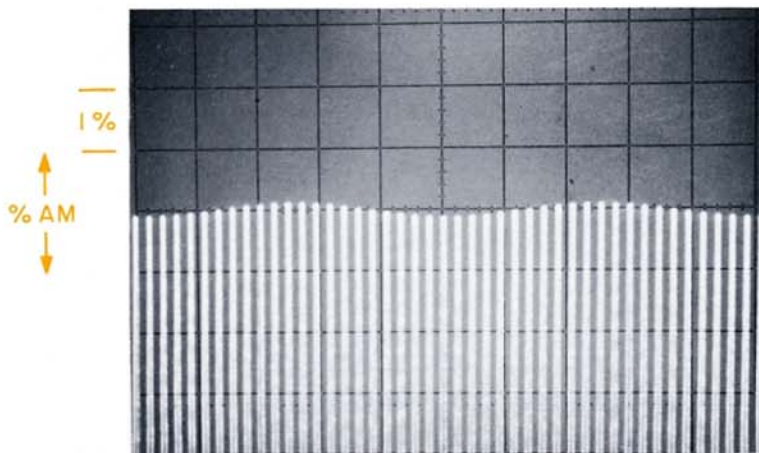

Figure 22. Low levels of AM modulation are observed with use of sensitive differential amplifier scope plug-in with dc offset capability.

Appendix I

Derivation of the formula for determining electrical length.

$$n_1 = \text{number of wavelengths at frequency } f_1 \quad (1)$$

and

$$\lambda_1 = \frac{300 \cdot 10^6}{f_1} \text{ (meters);} \quad (2)$$

then

$$l = n_1 \lambda_1 = \text{electrical length} \quad (3)$$

But

$$l = \left(n_1 + \frac{\Delta\phi}{360} \right) \lambda_2 \quad (4)$$

where

$$\lambda_2 = \frac{300 \cdot 10^6}{f_2} \text{ (meters)} \quad (5)$$

f_2 being the next higher frequency above f_1 which causes a phase change of $\Delta\phi$.

From (3) and (4)

$$n_1 \lambda_1 = \left(n_1 + \frac{\Delta\phi}{360} \right) \lambda_2 \quad (6)$$

$$\frac{n_1 + \frac{\Delta\phi}{360}}{n_1} = \frac{\lambda_1}{\lambda_2} = \frac{f_2}{f_1} \quad (7)$$

$$1 + \frac{\frac{\Delta\phi}{360}}{n_1} = \frac{f_2}{f_1} \quad (8)$$

Solving for n_1

$$n_1 = \frac{\frac{\Delta\phi}{360}}{\frac{f_2}{f_1} - 1} \quad (9)$$

Since $l = n_1 \lambda_1$

$$l = \frac{\frac{\Delta\phi}{360}}{\frac{f_2}{f_1} - 1} \lambda_1 \quad (10)$$

Substituting (2) into (10)

$$l = \frac{\frac{\Delta\phi}{360}}{\frac{f_2}{f_1} - 1} \cdot \frac{300 \cdot 10^6}{f_1} = \frac{300 \cdot 10^6}{f_2 - f_1} \cdot \frac{\Delta\phi}{360} \quad (11)$$

$$l = \frac{10^8}{1.2} \cdot \frac{\Delta\phi}{f_2 - f_1} = \frac{10^8}{1.2} \cdot \frac{\Delta\phi}{\Delta f} \text{ (cm).} \quad (12)$$

Appendix II

SPECIFICATIONS

INPUT CHARACTERISTICS

Instrument Type: Two-channel sampling RF millivoltmeter-phasemeter which measures voltage of two signals and simultaneously displays the phase angle between the two signals.

Frequency Range: 1 MHz to 1 GHz in 21 overlapping octave bands (lowest band covers two octaves).

Tuning: Automatic within each band. Automatic phase control (APC) circuit responds to the Channel A input signal. Search and lock time, approximately 10 millisecond.

Voltage Range

Channel A:

1 to 10 MHz: 1.5 mV to 1 V rms.
10 to 500 MHz: 300 μ V to 1 V rms.
500 to 1,000 MHz: 500 μ V to 1 V rms.
Can be extended by a factor of 10 with 11576A 10:1 Divider.

Channel B: 100 μ V to 1 V rms full scale (input to Channel A required); can be extended by a factor of 10 with 11576A 10:1 Divider.

Input Impedance (nominal): 0.1 megohm shunted by approximately 2.5 pF; 1 megohm shunted by approximately 2 pF when 11576A 10:1 Divider is used; 0.1 megohm shunted by approximately 5 pF when 10216A Isolator is used. AC coupled.

Isolation Between Channels:

1 to 300 MHz: greater than 100 dB.
300 to 1,000 MHz: greater than 80 dB.

Maximum AC Input: 2 V peak.

Maximum DC Input: \pm 50 V.

GENERAL

20 kHz IF Output (each channel): Reconstructed signals, with 20 kHz fundamental components, having the same amplitude, waveform, and phase relationship as the input signals. Output impedance, 1,000 ohms in series with 2,000 pF; BNC female connectors.

Recorder Output:

Amplitude: 0 to +1 V dc \pm 6% open circuit, proportional to voltmeter reading in volts. Output tracks voltage reading within \pm 0.5% of full scale. Output impedance, 1,000 ohms; BNC female connector.

Phase: 0 to \pm 0.5 V dc \pm 6%, proportional to phasemeter reading. External load greater than 10,000 ohms affects recorder output and meter reading less than 1%. Output tracks meter reading within \pm 1.5% of end scale; BNC female connector.

RFI: Conducted and radiated leakage limits are below those specified in MIL-I-6181D and MIL-I-16910C except for pulses emitted from probes. Spectral intensity of these pulses is approximately 60 μ V/MHz; spectrum extends to approximately 2 GHz. Pulse rate varies from 1 to 2 MHz.

Power: 115 or 230 V \pm 10%, 50 to 400 Hz, 35 watts.



Weight: Net, 30 lb (13.5 kg). Shipping, 35 lb (15.8 kg).

Dimensions: 18 $\frac{3}{8}$ x 7 x 16 $\frac{3}{4}$ in. (467 x 177 x 425 mm).

VOLTMETER CHARACTERISTICS

Meter Ranges: 100 μV to 1 V rms full scale in 10-dB steps. Meter indicates amplitude of the fundamental component of the input signal.

Voltage Accuracy: When accessories are used on one or both probes.

Accessory	Impedance		Frequency	Accuracy
HP 11536A 50 Ω Feed-through Tee	50 Ω		1-100 MHz	$\pm 2\%$ of full scale
	Freq.	SWR	100-300 MHz	$\pm 6\%$ of f.s.
	1-750 MHz 1-1000 MHz	< 1.15 < 1.20	300-1000 MHz	$\pm 12\%$ of f.s.*
HP 11576A 10:1 Divider	$1\text{ M}\Omega$  2 pF equiv. to $Z = \frac{80}{f(\text{MHz})}$ k Ω from 5-100 MHz		1-100 MHz	$\pm 6\%$ of f.s.
HP 10216A Isolator	$100\text{ k}\Omega$  5 pF equiv. to $Z = \frac{32}{f(\text{MHz})}$ k Ω from 15-200 MHz		1-200 MHz	$\pm 6\%$ of f.s.

* Above 300 mV and 800 MHz add +5%.

Voltage Ratio Accuracy: 0.2 dB.

Residual Noise: Less than 10 μV as indicated on the meter.

Bandwidth: 1 kHz.

PHASEMETER CHARACTERISTICS

Phase Range: 360°, indicated on zero-center meter with end-scale ranges of ± 180 , ± 60 , ± 18 , and $\pm 6^\circ$. Meter indicates phase difference between the fundamental components of the input signals.

Resolution: 0.1° at any phase angle.

Meter Offset: $\pm 180^\circ$ in 10° steps.

Phase Accuracy: At single frequency 1.5° (equal signal levels at Channel A and B).

Phase accuracy vs. frequency and signal level.

Accessory	Frequency	Voltage Range Channel A or B	Phase Accuracy
HP 11536A 50 Ω Feed-through Tee	1-500 MHz	100 μV to 300 mV	$\pm 3^\circ$
	500-1000 MHz	100 μV to 100 mV	$\pm 3^\circ$
HP 11576A 10:1 Divider	1-100 MHz	1 mV to 3 V	$\pm 4^\circ$
HP 10216A Isolator	1-200 MHz	100 μV to 300 mV	$\pm 6^\circ$

Phase Jitter vs. Channel B Input Level

Greater than 700 μV : Typically less than 0.1° p-p.

125 to 700 μV : Typically less than 0.5° p-p.

20 to 125 μV : Typically less than 2° p-p.

