

## Errata

**Title & Document Type:** Application Note 150-4  
Spectrum Analysis - Noise Measurements

**Manual Part Number:** 5952-1147

**Revision Date:** April 1974

---

### HP References in this Manual

This manual may contain references to HP or Hewlett-Packard. Please note that Hewlett-Packard's former test and measurement, semiconductor products and chemical analysis businesses are now part of Agilent Technologies. We have made no changes to this manual copy. The HP XXXX referred to in this document is now the Agilent XXXX. For example, model number HP8648A is now model number Agilent 8648A.

### About this Manual

We've added this manual to the Agilent website in an effort to help you support your product. This manual provides the best information we could find. It may be incomplete or contain dated information, and the scan quality may not be ideal. If we find a better copy in the future, we will add it to the Agilent website.

### Support for Your Product

Agilent no longer sells or supports this product. You will find any other available product information on the Agilent Test & Measurement website:

[www.tm.agilent.com](http://www.tm.agilent.com)

Search for the model number of this product, and the resulting product page will guide you to any available information. Our service centers may be able to perform calibration if no repair parts are needed, but no other support from Agilent is available.

**APPLICATION NOTE 150-4**

**SPECTRUM ANALYSIS . . .**  
**Noise Measurements**

Printed April 1974



**HEWLETT  
PACKARD**

## CONTENTS

	Page
INTRODUCTION .....	1
Review of Spectrum Analyzer Basics .....	2
CHAPTER 1. Impulse Noise Measurements .....	3
Dynamic Range Considerations .....	5
Summary .....	6
CHAPTER 2. Random Noise Measurement .....	7
Detector Characteristics .....	8
Logarithmic Shaping .....	8
Averaging .....	8
Random Noise Measurement—Summary .....	9
Dynamic Range Considerations .....	10
Narrow Video Bandwidths .....	11
CHAPTER 3. Carrier-to-Noise Ratio .....	12
CHAPTER 4. Amplifier Noise Figure Measurements .....	13
Measurement Procedure .....	14
Sensitivity Calculations .....	15
Example Measurements .....	15
CHAPTER 5. White Noise Loading .....	17
Dynamic Range .....	17
CHAPTER 6. Oscillator Spectral Purity .....	19
Residual AM .....	19
Measurement .....	20
Sensitivity .....	20
Residual Phase Modulation (PM) .....	21
Voltage-tuned Oscillators .....	21
Phase-lock Oscillators .....	22
Fixed Oscillators .....	23
Microwave Fixed Oscillators .....	23
Measurement Notes .....	24
Alternate Technique for Residual AM .....	24
Alternate PM Techniques .....	25
Examples .....	25
APPENDIX .....	26
Determination of Maximum Input Noise Power .....	26
Response to Noise of the Spectrum Analyzer in the Log Mode.....	26
Typical Noise Sidebands for Model 8553B	
1 kHz - 110 MHz Spectrum Analyzer .....	28
Typical Low Frequency Sensitivity for Model 8556A	
20 Hz - 300 kHz Spectrum Analyzer .....	28
Correction Factors (Impulse Noise) .....	29
Correction Factors (Random Noise) .....	29

## INTRODUCTION

This Application Note deals with the measurement of noise with the spectrum analyzer. In order to organize our discussion, some working definition of the term "noise" is required.

When we think of noise, we usually think in terms of the effects of the noise. For example, receiver designers may think of audible noise in a received signal; computer designers may think of spurious "bits" caused by transients in the system.

For the purpose of this note, we shall define noise as any signal which has its energy present over a frequency band significantly wider than the spectrum analyzer's resolution bandwidth, i.e., any signal where individual spectral components are not resolved. This includes both desired and undesired signals. For example, white noise may be used in audio testing as a desired signal.

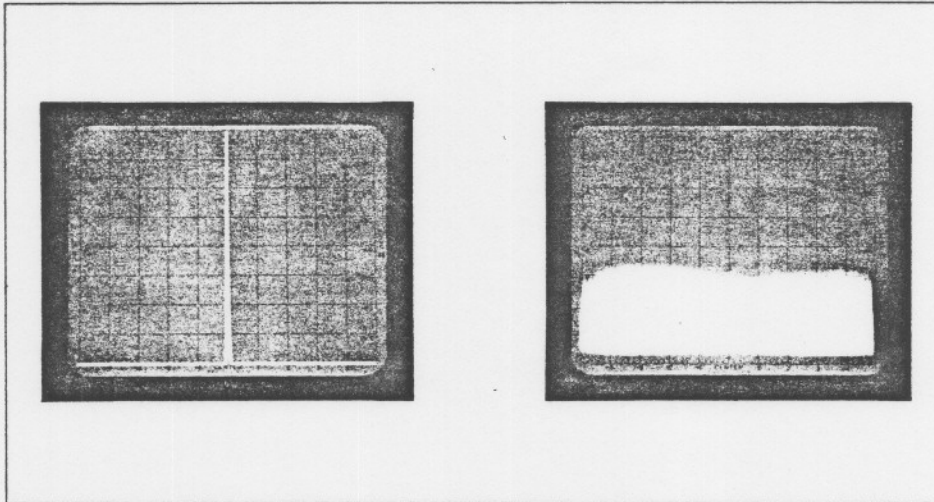

**Figure 1.** The left photo represents a response to a CW signal present at the spectrum analyzer input. The right photo shows a display of random noise. Signals of this type will be analyzed by the methods of this Application Note.

Since noise is present over a wide band of frequencies, the total voltage or power measured by the spectrum analyzer will depend on the resolution bandwidth used. For this reason, any noise measurement must include the bandwidth in which the measurement was made, e.g., dBm/Hz, volts/MHz, etc.

Two basic types of noise will be discussed in this note, random noise and impulse noise. Random noise is generated by heat in resistors and other continuous processes. Impulse noise is generated by switching and transient phenomena and is characterized by the launching of discrete impulses in time.

### REVIEW OF SPECTRUM ANALYZER BASICS

A few points about the operation of a spectrum analyzer are pertinent to the later discussion. Let's look at the basic block diagram:

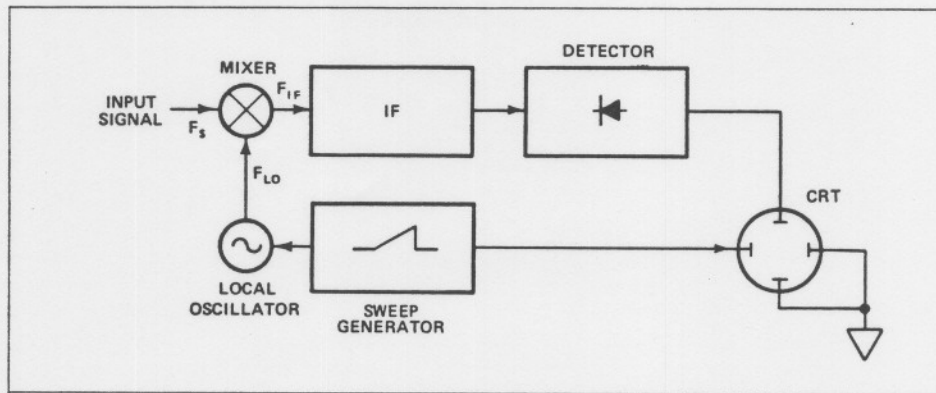
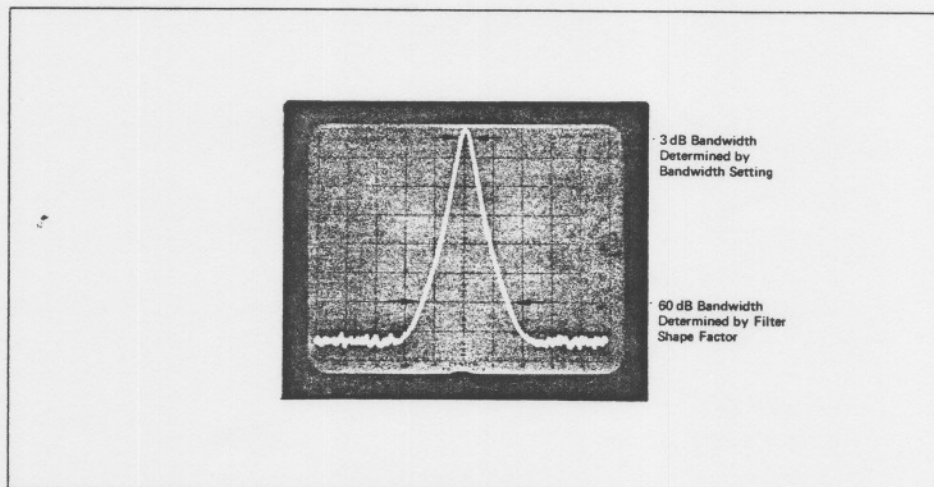

**Figure 2.** A response appears on the CRT whenever  $F_s \pm F_{LO} = F_{IF}$ . Example: For the 8553B 110 MHz Spectrum Analyzer,  $F_{IF} = 200$  MHz;  $F_s = 0$ -110 MHz; and  $F_{LO} = 200$ -310 MHz. Then, for an input signal at 50 MHz, the local oscillator would be tuned to 250 MHz to get a 200 MHz difference frequency and a response on the CRT.

An input signal is mixed with a swept local oscillator in the input mixer. This mixing product passes through the IF filters and amplifiers, and the detected output is displayed on the vertical axis of the CRT.

If a CW signal is present at the input, and the local oscillator is swept over the range necessary to display this signal ( $F_s = F_{LO} \pm F_{IF}$ ), then the resultant display will be the IF bandpass filter shape of the spectrum analyzer. Therefore, the shape and bandwidth of these filters determine both the resolution of the spectrum analyzer and the measurement bandwidth for noise measurements.

The spectrum analyzer will accurately reproduce the amplitude of signals which are  $\leq -10$  dBm at the input mixer. An input attenuator ahead of the mixer allows adjusting the input level to the proper range. Broadband signals may have considerable total energy, while the energy at any single frequency is small. This will result in a decreased dynamic range. This effect is discussed in more detail later in the note.



**Figure 3.** The IF filter shape of the spectrum analyzer is traced out whenever a CW signal is displayed. The 3 dB bandwidth is determined by the setting of the bandwidth control; the 60 dB bandwidth is a property of the IF filter.

## CHAPTER 1

### IMPULSE NOISE MEASUREMENTS

As was mentioned earlier, impulse noise is phase coherent. That is, each spectral component at any instant is coherent in phase to all other spectral components. For this reason, as the measurement bandwidth is doubled, the measured noise voltage doubles.

An impulse generates a voltage across the spectrum analyzer IF which is dependent upon bandwidth. The peak voltage displayed will be dependent on the bandwidth chosen. Therefore an impulse noise measurement must be normalized to the instrument's impulse bandwidth, which is defined as the ideal rectangular filter bandwidth with the same voltage response as the actual instrument IF filter. (See Figure 4.)

The units of measurement, then, will be in volts/Hz or voltage per unit bandwidth. For example, measurements of electromagnetic interference (EMI) are usually made in decibels referred to one microvolt per megahertz ( $\text{dB}\mu\text{V}/\text{MHz}$ ).

To measure the spectrum analyzer impulse bandwidths, use the following procedure:

1. Connect a signal generator to the spectrum analyzer input.
2. Tune to the signal on the spectrum analyzer, and display the signal generator output in the linear display mode.
3. Adjust the output amplitude of the signal generator for an 8-division deflection at the peak of the response.
4. Reduce the scan width until the display almost fills the CRT. (See Figure 5.)
5. Measure the area under the curve by counting squares or integrating from a photo of the display. Divide the area by 8 to obtain the impulse bandwidth. The calibration of the horizontal axis is given by the setting of the scan width control.

Additional methods are discussed in some detail, and a theory of measurement is given in Application Note 142, "EMI Measurement Procedure."

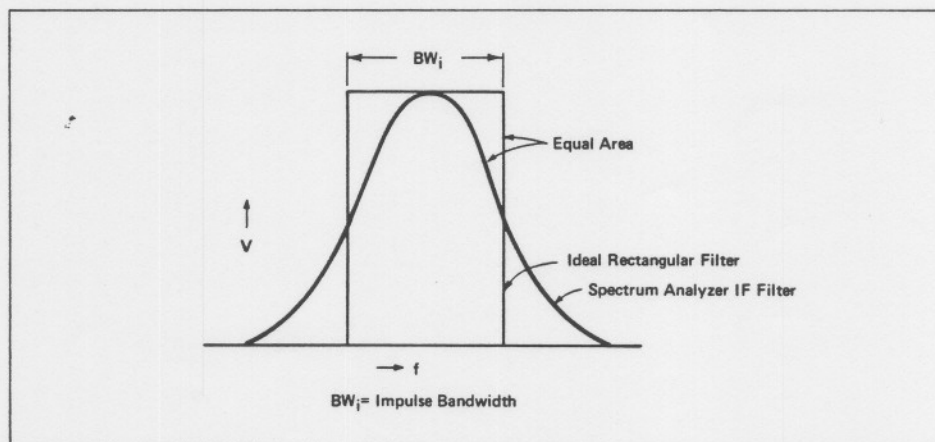

Figure 4. The impulse bandwidth is defined by an ideal filter with identical voltage response.

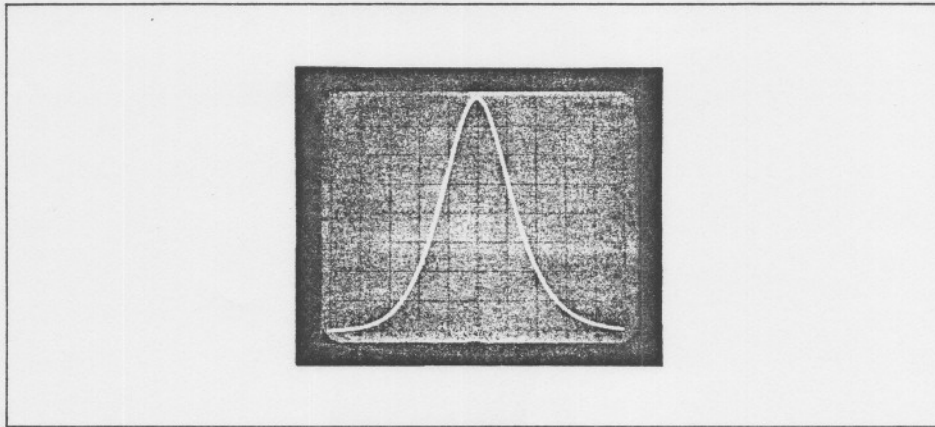

Figure 5. Display adjusted so that the filter response almost fills the CRT.

The detector in the spectrum analyzer is an envelope detector. For impulse measurements, this is the type of detection which is needed. The detector responds to the peaks of the transient signals, and the CRT acts as a "peak hold" to display the resultant output.

**Note:** The video filter must not be used since this peak reading capability would be destroyed.

So, in order to measure impulse noise, we need to determine the response on the CRT, convert to units of voltage, and normalize to some impulse bandwidth.

Although voltage can be read directly from the analyzer in the linear display mode, the log mode is preferred to allow a wider measurement range. The calibration in dBm can readily be converted to voltage from the following relationship:

$$0 \text{ dBm (50 } \Omega) = +107 \text{ dB}_{\mu\text{V}} \text{ (50 } \Omega)$$

To normalize to a given bandwidth, we can use a correction factor in decibels to be subtracted from any reading. This is arrived at from the expression:

$$S(\text{dB}_{\mu\text{V}}/\text{BW}_1) = V(\text{dB}_{\mu\text{V}}) - B(\text{dB}[\text{BW}_1])$$

Where:

- S = Broadband spectral intensity normalized to bandwidth,  $\text{BW}_1$
- V = Voltage measured on the CRT in bandwidth,  $\text{BW}_1$
- B = Correction factor

When we double the bandwidth we double the impulse noise voltage, so the difference in dB between signals observed in two bandwidths is  $\Delta\text{dB} = 20 \log \text{BW}_A/\text{BW}_B$ . Therefore, B can be determined from the following relationship:

$$B = 20 \log \frac{\text{BW}_1}{\text{BW}_1}$$

Where:

- $\text{BW}_1$  = Spectrum Analyzer impulse bandwidth
- $\text{BW}_1$  = Bandwidth to be normalized to

Example:

Let's normalize to a 1 MHz bandwidth with an analyzer which has a 140 kHz impulse bandwidth.

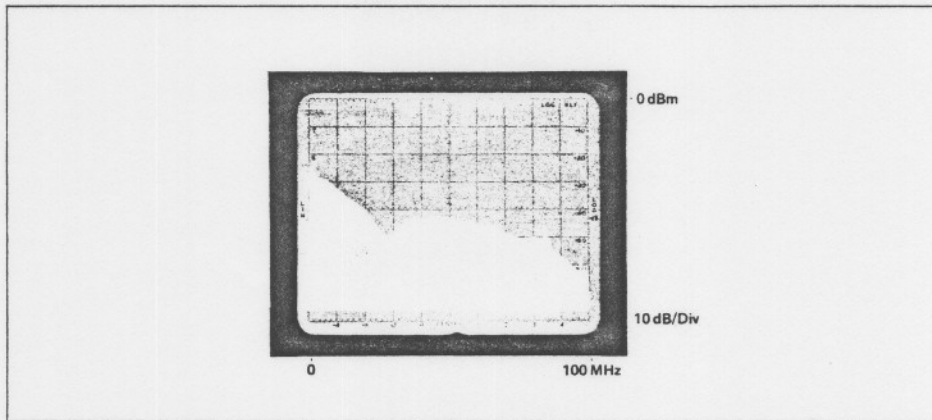

Figure 6. Example: Impulse noise level at 70 MHz is  $-47$  dBm. We add 107 dB to get  $+60$  dB $\mu$ V. Subtracting the bandwidth correction factor, we get 77.1 dB $\mu$ V/MHz.

$$B = 20 \log \frac{140 \text{ kHz}}{1 \text{ MHz}} = -17.1 \text{ dBMHz}$$

and  $S = V - (-17.1 \text{ dBMHz})$

Therefore, if we measure a signal at  $-47$  dBm on the CRT in a 140 kHz impulse bandwidth, and we desire the spectral intensity in dB $\mu$ V/MHz, we proceed as follows:

1.  $-47 \text{ dBm} / 140 \text{ kHz} + 107 \text{ dB}\mu\text{V/dBm} = +60 \text{ dB}\mu\text{V}/140 \text{ kHz}$
2.  $60 \text{ dB}\mu\text{V}/140 \text{ kHz} - (-17.1 \text{ dBMHz}) = +77.1 \text{ dB}\mu\text{V}/\text{MHz}$

#### DYNAMIC RANGE CONSIDERATIONS

First, let's look at the means for obtaining maximum sensitivity. If we change the bandwidth setting on the spectrum analyzer, we change the total noise voltage measured by the analyzer. Furthermore, since making the bandwidth 10 times wider gives 10 times the noise voltage, the signal level displayed on the CRT will increase by 20 dB.

A 10 times increase in bandwidth causes the spectrum analyzer internal noise to increase by 10 dB. (This will be discussed in the section on random noise.) Therefore, 10 dB improvement in signal-to-noise ratio can be obtained by increasing the bandwidth by a factor of 10. Wide bandwidths should be used for impulse noise measurements.

To determine the available dynamic range, let's take some typical numbers. For this example, we will use the 110 MHz Spectrum Analyzer, Model 8553B.

In the 100 kHz bandwidth, the analyzer's average noise level is  $-100$  dBm or  $+7$  dB $\mu$ V. The overload, or gain compression, point is  $-10$  dBm or  $+97$  dB $\mu$ V.

If a signal is inserted in the input of the analyzer which has a total energy of  $+97$  dB $\mu$ V across the frequency range from 0 to 120 MHz (the cutoff frequency of the input filter), we can calculate the worst case dynamic range. We will use a typical number of 140 kHz impulse bandwidth in the 100 kHz IF bandwidth position.

$$B = 20 \log \frac{120 \text{ MHz}}{140 \text{ kHz}} = 58.7 \text{ dB}$$



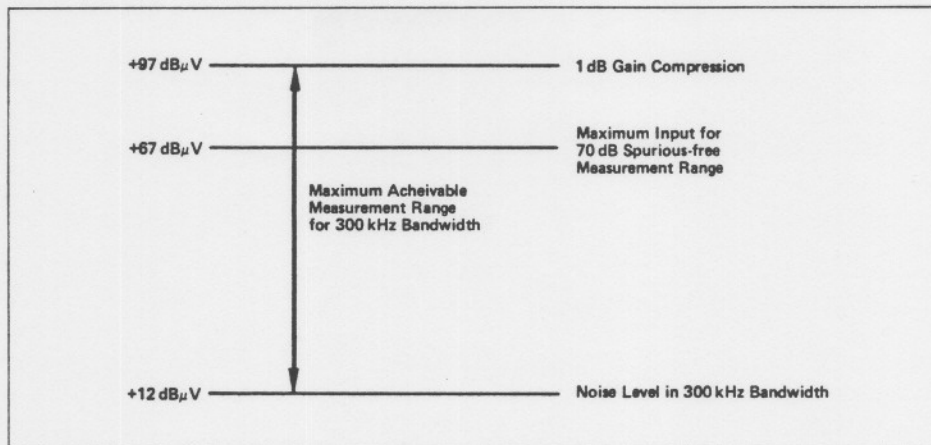

Figure 7. Maximum achievable measurement range would be realized by limiting input noise to 300 kHz bandwidth before the input mixer of the spectrum analyzer. For actual analyzer without accessories, input bandwidth equals 120 MHz.

$$+97 \text{ dB}\mu\text{V}/120 \text{ MHz} \approx +47 \text{ dB}\mu\text{V}/300 \text{ kHz}$$

$$\text{Measurement Range} = +47 \text{ dB}\mu\text{V} - 12 \text{ dB}\mu\text{V} = 35 \text{ dB (worst case)}$$

Then:

$$+97 \text{ dB}\mu\text{V} - (58.7 \text{ dB [140 kHz]}) = 38.3 \text{ dB}\mu\text{V}/140 \text{ kHz}$$

The signal-to-noise ratio would then be  $38.3 \text{ dB}\mu\text{V} - 7 \text{ dB}\mu\text{V}$  equals 31.3 dB.

If broadband noise exists over a wide enough band, it becomes impossible to detect the level on the CRT, and the dynamic range becomes effectively zero. For example, if the  $+97 \text{ dB}\mu\text{V}$  signal existed over a 3600 MHz band, the signal level would be less than  $7 \text{ dB}\mu\text{V}/140 \text{ kHz}$ , and no signal would be detected.

#### SUMMARY

Measure the signal level in dBm.

Add 107 dB to get dB $\mu$ V.

Normalize to the proper impulse bandwidth.

## CHAPTER 2

### RANDOM NOISE MEASUREMENT

Random noise consists of frequency components which, as the name implies, are random in amplitude and phase. Measurement of random noise, then, depends on some statistical basis. Normally, the process consists of integration or averaging and taking the rms value of this averaged result.

Since the spectral components are random in phase, doubling the measurement bandwidth will not double the measured voltage, but instead doubles the measured power. Therefore, random noise is usually specified as some noise power per unit bandwidth, e.g., dBm/Hz. The normalizing bandwidth is called the random noise bandwidth or noise power bandwidth. For HP analyzers, this is approximately 1.2 times the 3 dB bandwidth.

The definition of the noise power bandwidth is similar to the impulse bandwidth. It is the ideal rectangular filter bandwidth with the same power response as the actual instrument IF filter.

The best way to measure the noise power bandwidth is by the method previously described for the impulse bandwidth, except that all vertical coordinates should be squared to give a power display. This would necessitate graphing the curve by hand to get the desired results or doing a numerical integration.

A simpler method which gives adequate results is to measure the 3 dB bandwidth, and multiply by 1.2. To measure the 3 dB bandwidth, use the following procedure:

1. Connect a signal generator to the spectrum analyzer input, and connect the auxiliary output of the generator to a frequency counter.
2. Tune to the signal on the spectrum analyzer, and display the signal generator output in the linear mode.

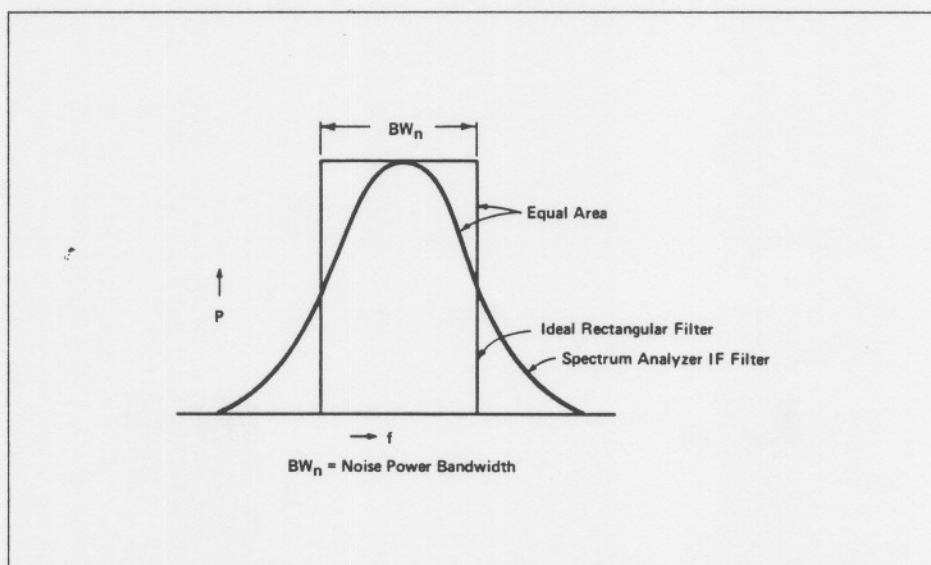

Figure 8. The noise power bandwidth is defined by an ideal filter with identical power response.

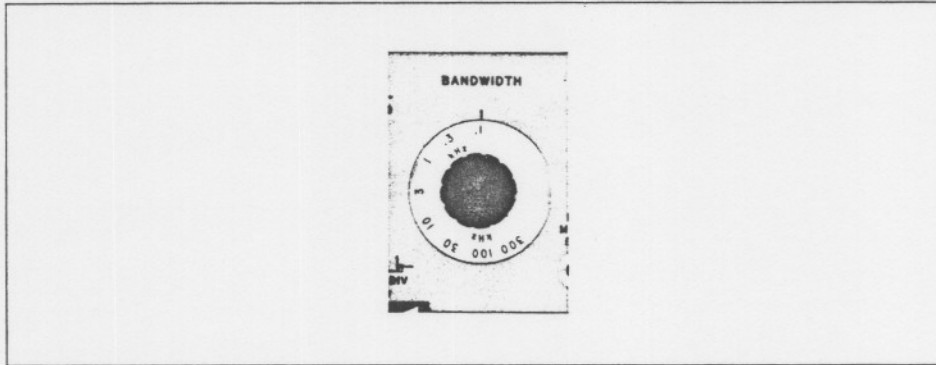

Figure 9. The setting of the bandwidth control is the nominal 3 dB bandwidth of the spectrum analyzer.

3. Adjust the output of the signal generator for a deflection of 7.1 divisions at the peak of the display.
4. Center the display on the CRT, and switch to zero scan.
5. Carefully tune the signal generator until the vertical deflection is 5 divisions, and record the frequency on the counter.
6. Carefully tune the signal generator through the peak response until the deflection is again 5 divisions. Read and record the counter frequency.
7. Subtract the frequencies in steps 5 and 6 to get the 3 dB bandwidth.

Nominal values for the 3 dB bandwidth are engraved on the bandwidth knob. This is accurate to  $\pm 5\%$  for the 10 kHz bandwidth only. For this reason, the 10 kHz bandwidth can be used without further calibration in a number of cases.

#### DETECTOR CHARACTERISTICS

Some consideration of detector characteristics is now in order. We noted in our previous discussion that the spectrum analyzer uses an envelope detector. When used with random noise, this creates a reading which is lower than the true rms value of the average noise. This difference is 12.8% or 1.05 dB. (See Appendix A.)

#### LOGARITHMIC SHAPING

Since log shaping tends to amplify noise peaks less than the rest of the noise signal, the detected signal is smaller than its true rms value. This correction for the log display mode combined with the detector characteristics gives a total correction of 2.5 dB, which should be added to any random noise measured in the log display mode.

#### AVERAGING

A further consideration is the integration or averaging of the random noise. In the spectrum analyzer, this is accomplished with the video filter. A video bandwidth much narrower than the IF bandwidth should be used. A video filter setting about 100 times narrower than the IF bandwidth will give effective averaging. (See Figure 10.)

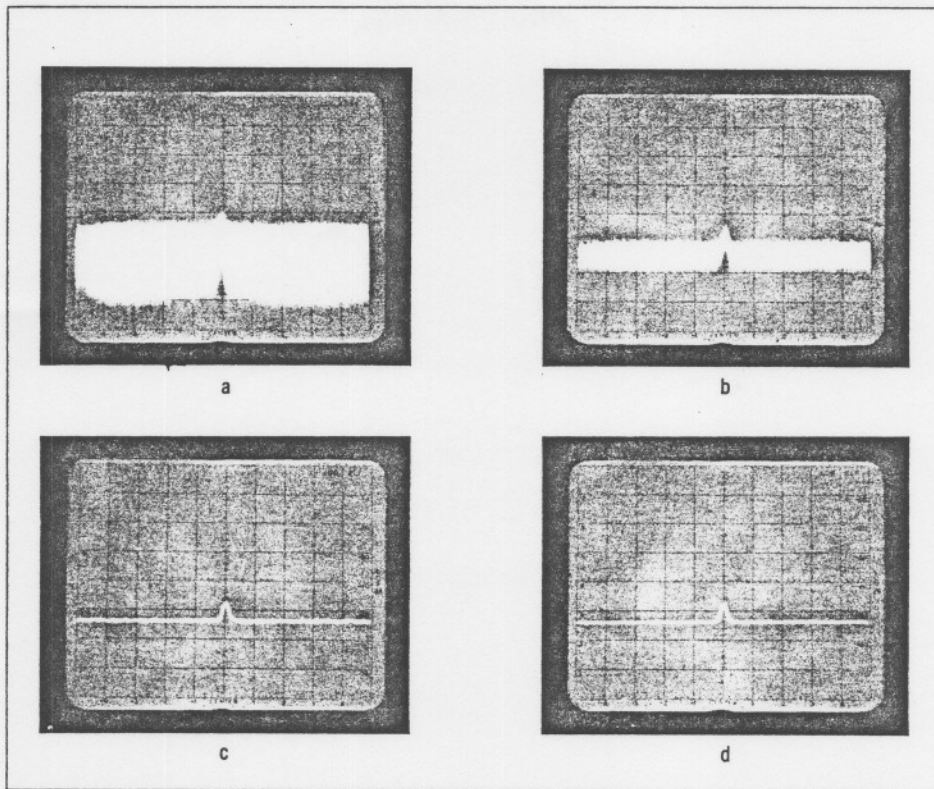

Figure 10. The video filter effectively averages random noise. All four photos are taken with the 100 kHz IF bandwidth, and the video filter is progressively switched through its four positions: OFF, 10 kHz, 100 Hz, and 10 Hz.

#### RANDOM NOISE MEASUREMENT—SUMMARY

The measurement consists of the following steps:

Measure the signal level in dBm.

Add 2.5 dB.

Normalize to the proper noise power bandwidth.

Example:

A signal is measured at  $-35$  dBm in a 10 kHz bandwidth. The level in dBm/Hz is desired.

First, we add 2.5 dB to get  $-32.5$  dBm. If the 10 kHz bandwidth is used, the noise power bandwidth is 12 kHz. So, to normalize to 1 Hz bandwidth, we compute the correction factor from:

$$10 \log \frac{12 \text{ kHz}}{1 \text{ Hz}} = 40.8 \text{ dB}$$

This is similar to the correction used in normalizing for impulse measurements except the calculations reflect the power addition of random signals. The final answer, then, is:

$$-32.5 \text{ dBm}/12 \text{ kHz} - 40.8 \text{ dB} = -73.3 \text{ dBm/Hz}$$

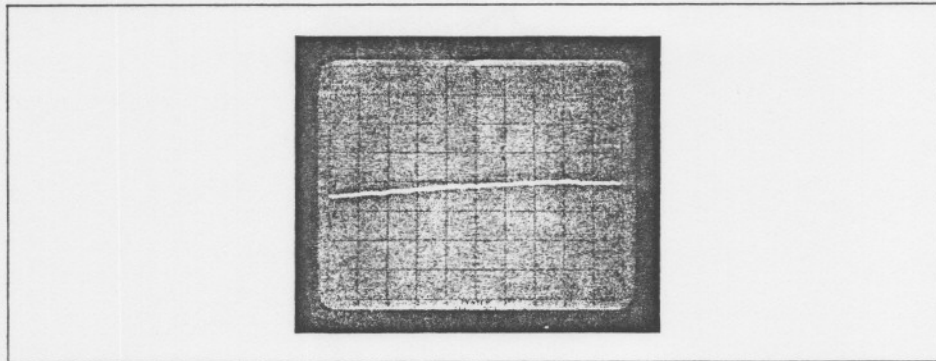

Figure 11. With a 10 kHz bandwidth setting, the noise at 10 MHz is  $-35$  dBm. Applying the 2.5 dB correction, we get  $-32.5$  dBm. Then, normalizing to a 1 Hz bandwidth, we get  $-73.3$  dBm/Hz.

### DYNAMIC RANGE CONSIDERATIONS

If we examine what happens as the spectrum analyzer bandwidth is changed, we will see that the sensitivity for random noise measurements is independent of bandwidth. For example, we narrow the bandwidth by a factor of 10. The analyzer's internal noise (which is, itself, random noise) is decreased by a factor of 10, or 10 dB. At the same time, the random noise we are measuring also decreases by 10 dB, so the signal-to-noise ratio remains constant.

If a white noise source is applied to the spectrum analyzer with total power of  $-10$  dBm over the 120 MHz input range of the 0-110 MHz spectrum analyzer, we can calculate the available dynamic range. We can pick any bandwidth, so let's use the 10 kHz bandwidth for simplicity. The noise power bandwidth is 12 kHz and the spectrum analyzer sensitivity is  $-110$  dBm. To normalize to the 12 kHz bandwidth, we compute the correction factor from:

$$10 \log \frac{120 \text{ MHz}}{12 \text{ kHz}} = 40 \text{ dB}$$

Then,  $-10 \text{ dBm}/120 \text{ MHz} - 40 \text{ dB} = -50 \text{ dBm}/12 \text{ kHz}$ . We can measure from  $-50$  dBm to  $-110$  dBm, or a 60 dB total range.

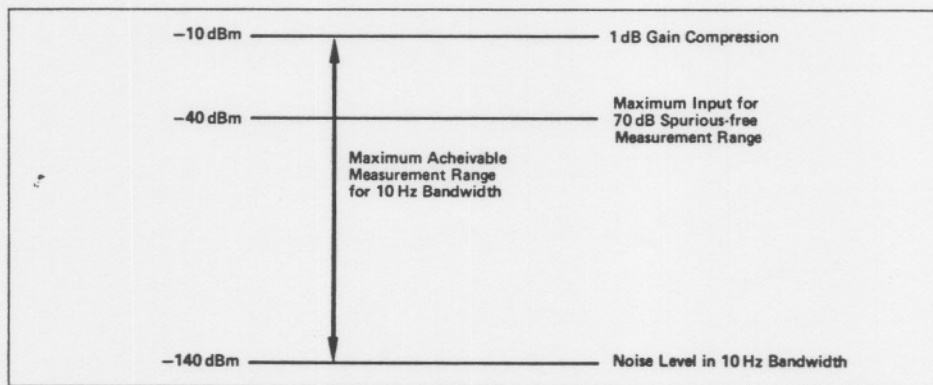

Figure 12. Maximum achievable measurement range would be realized by limiting input noise to 10 Hz bandwidth before input mixer of the spectrum analyzer. For actual analyzer without accessories, input bandwidth equals 120 MHz.

$$\begin{aligned} -10 \text{ dBm}/120 \text{ MHz} &\approx -80 \text{ dBm}/10 \text{ Hz} \\ \text{Measurement Range} &= -80 \text{ dBm} - (-140 \text{ dBm}) = 60 \text{ dB (worst case)} \end{aligned}$$

#### NARROWER VIDEO BANDWIDTHS

The video filter in the spectrum analyzer can be modified for better averaging when narrow IF bandwidths are used. When this is done, the "display uncal" light will not function properly. The proper scan time can be calculated, though, from the following formula:

$$BW_{\text{video}} (BW_{\text{IF}}) \geq 0.35 \frac{\text{Scan Width per Division}}{\text{Scan Time per Division}}$$

**Note:** This is an empirical relationship which is useful for most cases, but it will not provide an exact answer.

## CHAPTER 3

### CARRIER-TO-NOISE RATIO

Measurement of carrier-to-noise ratio is quite similar to measurement of random noise power density. The measurement basically consists of:

1. Measure the carrier or desired signal level.
2. Measure the random noise and apply corrections.
3. Normalize to the desired bandwidth.

For example, it is desired to measure the video carrier-to-noise ratio of a composite TV signal. The effective bandwidth of the received signal, then, is 6 MHz. So we will normalize to this bandwidth to get the C/N ratio which will be seen by the TV receiver.

So, if the carrier appears at  $-25$  dBm, and the noise is measured as  $-95$  dBm in a 10 kHz bandwidth, we can make the following calculations:

1. Add 2.5 dB to the noise level.
2. Normalize to 6 MHz bandwidth.

$$N(6 \text{ MHz}) = N(10 \text{ kHz}) + 10 \log \frac{6 \text{ MHz}}{1.2(10 \text{ kHz})}$$

$$N = -92.5 \text{ dBm}/10 \text{ kHz} + 27 \text{ dB} = -65.5 \text{ dBm}/6 \text{ MHz}$$

Then, the carrier-to-noise ratio is  $-25$  dBm to  $-65.5$  dBm, or 40.5 dB. This method can be applied to any input signal if the bandwidth of the intended receiver is known. That is, if we want to know the signal-to-noise ratio seen by a 0-12.4 GHz crystal detector, we must normalize to a 12.4 GHz bandwidth, etc.

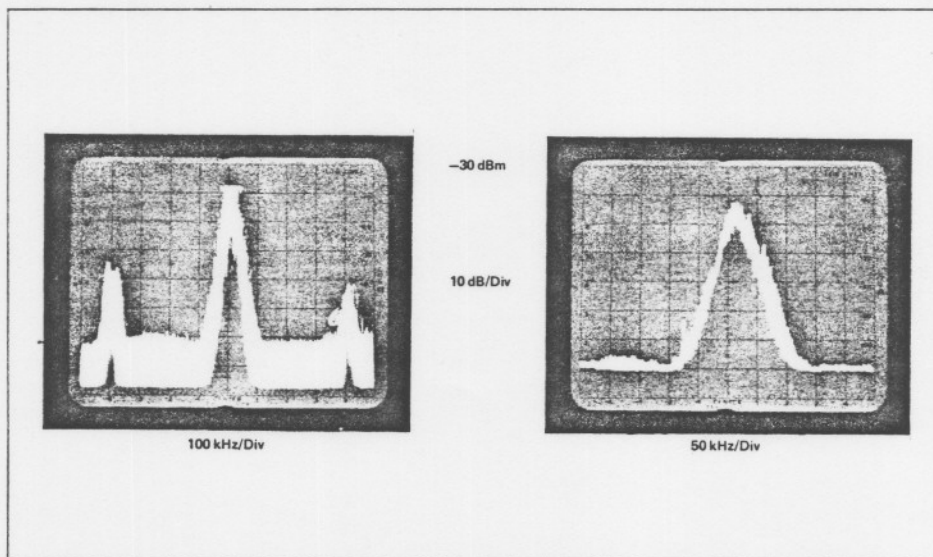

**Figure 13.** In the left photo, we measure the level of an FM broadcast station as received at the spectrum analyzer at  $-38$  dBm. In the right photo, we add video filtering to average the noise (the modulation looks like noise, so the carrier level must be measured with the video filter OFF) at  $-100$  dBm in a 10 kHz bandwidth. Applying the corrections and normalizing to a 200 kHz transmission bandwidth, we get about a 47 dB signal-to-noise ratio for an FM receiver.

## CHAPTER 4

### AMPLIFIER NOISE FIGURE MEASUREMENTS

The noise figure of an amplifier is defined by the expression:

$$NF = \frac{P}{K T B G}$$

Where  $P$  = Noise power at the output with the input terminated  
 $K$  = Boltzmann's constant ( $1.38 \times 10^{-23}$  joule/°K)  
 $T$  = Absolute temperature (°K)  
 $B$  = Amplifier bandwidth  
 $G$  = Amplifier gain

An amplifier which contributed no noise would have a noise figure of one, i.e., all noise appearing at the output is due to noise generated by the input termination. More often, noise figures are expressed in dB.

$$NF \text{ (dB)} = 10 \log NF$$

$$\text{and, } NF \text{ (dB)} = 10 \log \left( \frac{P}{K T B G} \right)$$

Inspecting this expression, we can see that we don't need to measure the total noise power output of the amplifier. We can, instead, measure the power in some unit bandwidth and use that bandwidth in place of  $B$  in the equation. This also saves having to measure the actual amplifier bandwidth.

The terms which need to be evaluated, then, are: noise power output per unit bandwidth, amplifier gain, and temperature. Practically, we can take room temperature to be 290°K.

Then,

$$NF \text{ (dB)} = 10 \log \frac{P}{K T B G} = 10 \log \frac{P}{B G} - 10 \log K T$$

And,

$$NF \text{ (dB)} = 10 \log \frac{P}{B} - 10 \log G - 10 \log K T$$

As a practical consideration, the noise power output will be small, and some pre-amplification will be necessary to improve the spectrum analyzer sensitivity. The effect of the added amplifier will be to increase the system gain, and it can be included in the equation. The effect on accuracy, which depends on both the preamplifier noise figure and on the gain of the amplifier under test, will be discussed in the section on sensitivity.

The actual measurement will be made on the linear scale to gain resolution, so the noise level will be read in voltage.

The equation for the amplifier noise figure then becomes:

$$NF \text{ (dB)} = 10 \log \frac{V^2}{R} - 10 \log B - 10 \log (G_A \cdot G_T) - 10 \log k T$$



Where:

- V = Noise voltage read from spectrum analyzer
- B = Spectrum analyzer noise power bandwidth
- $G_A$  = Gain of preamplifier
- $G_T$  = Gain of amplifier under test

For a 50 ohm system impedance, a Gaussian filter shape, and a room temperature of 290°K (17°C), the above formula becomes:

$$NF(\text{dB}) = 20 \log V - 10 \log BW - 10 \log (G_A \cdot G_T) + 187.27 \text{ dB}$$

where BW = Spectrum analyzer 3 dB bandwidth

The 187.27 dB in the above formula results from the sum of four numbers:  $-10 \log 50$  ohms;  $-10 \log kT$ ;  $-10 \log 1.2$  (an approximate correction factor to go from noise power bandwidth to Gaussian 3 dB bandwidth); and +1.05 dB (detector correction factor).

#### MEASUREMENT PROCEDURE

A signal generator will be used as a substitution device to measure the gain of the preamp and test amp, and the total output noise voltage will be measured on the spectrum analyzer.

Make the following test setup:

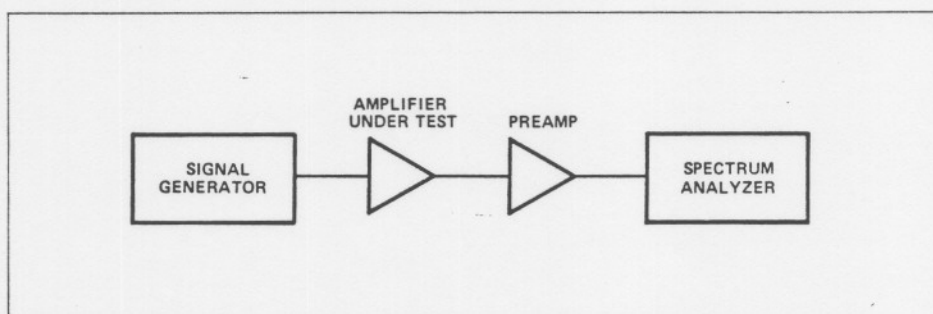

Figure 14. Test setup to calibrate the gain of the two amplifiers.

Set the spectrum analyzer for a convenient display of the signal generator output, using the 2 dB per division or linear display mode. With 10 dB of input attenuation, use the spectrum analyzer log reference level controls to set a convenient reference. Be sure the input level to the spectrum analyzer is less than 0 dBm, or serious errors will result due to gain compression. Record the attenuator setting on the signal generator.

Remove both amplifiers and connect the signal generator directly to the spectrum analyzer input. Increase the power output from the generator until the reference previously established is reached. Record the attenuator setting. The difference between these two settings is  $G_T + G_A$  in dB.

Disconnect the signal generator, and connect the amplifiers as shown:

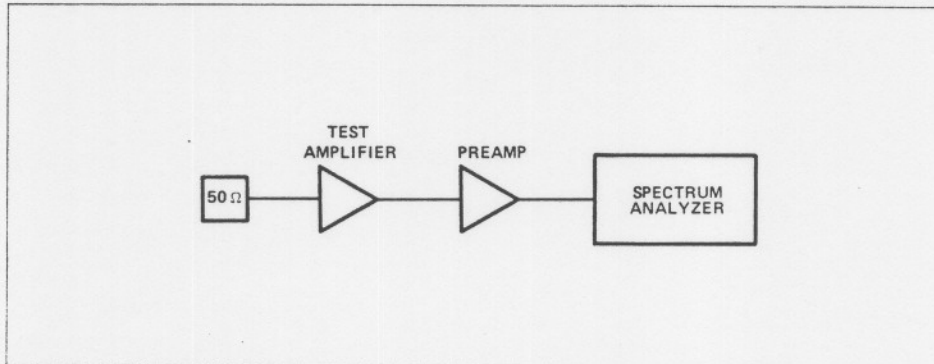

Figure 15. Noise figure test setup.

Measure the noise voltage on the linear scale, and measure the analyzer 3 dB bandwidth (if it has not been previously done). Compute the noise figure.

$$NF \text{ (dB)} = 10 \log \frac{V^2}{BW} - (G_A + G_T) + 187.27 \text{ dB}$$

#### SENSITIVITY CALCULATIONS

The smallest noise figure measurable depends on the spectrum analyzer sensitivity and the gain of the amplifier under test. First, let's compute the sensitivity with the preamp by using the expression for system noise figure:

$$NF_s = NF_1 + \frac{NF_2 - 1}{G_1}$$

**Note:** Noise figures and gain are power ratios, not in dB.

**Example:**

Spectrum analyzer noise figure is 24 dB, and a 20 dB gain, 5 dB noise figure preamp is used.

$$NF_s = 3.17 + \frac{250}{100} = 5.67 \approx 7.5 \text{ dB}$$

Then, a 10 dB gain, 7.5 dB noise figure amplifier under test would give a noise output 10 dB above the spectrum analyzer noise level.

We assume that the noise measured on the spectrum analyzer is contributed only by the amplifier under test. To test this assumption, let's calculate the actual system noise figure for a known amplifier.

We shall use a 20 dB gain, 5 dB noise figure amplifier as an example. The measured noise figure will be:

$$NF_s = 3.17 + \frac{5.67 - 1}{100} = 3.175 = 5.02 \text{ dB}$$

or 0.02 dB error introduced

If we take the spectrum analyzer noise figure to be degraded by setting the input attenuator to 10 dB, the error is 0.38 dB.

Using higher gain in either the preamp or test amplifier reduces the error contributed by the measurement system. The approximate error can be calculated from the measured data, if desired.

#### EXAMPLE MEASUREMENT

Figure 16 shows the results of measurements over the range from 10 to 110 MHz on a CATV amplifier. Measurements were made at 30, 60, and 90 MHz. The spectrum analyzer 3 dB bandwidth was 10.5 kHz, and the vertical scale on the photo is  $5 \mu\text{V}/\text{div}$ .

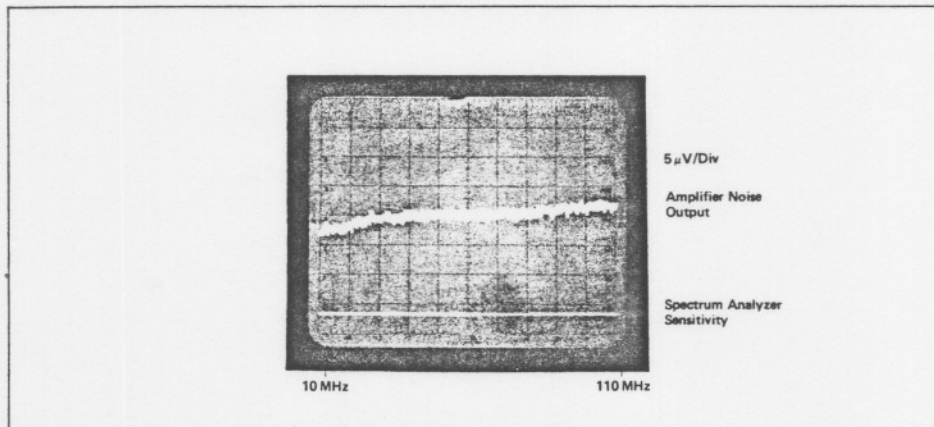

Figure 16. Example for noise figure measurement.

#### 30 MHz

$$\begin{aligned} \text{The gain, } G_A + G_T &= 48.5 \text{ dB} \\ V &= 19 \mu\text{V} \end{aligned}$$

$$\text{NF (dB)} = 10 \log \frac{(19 \times 10^{-6})^2}{10.5 \times 10^3} - 48.5 + 187.27 = 4.13 \text{ dB}$$

#### 60 MHz

$$\begin{aligned} \text{The gain, } G_A + G_T &= 49 \text{ dB} \\ V &= 20 \mu\text{V} \end{aligned}$$

$$\text{NF (dB)} = 10 \log \frac{(20 \times 10^{-6})^2}{10.5 \times 10^3} - 49 + 187.27 = 4.08 \text{ dB}$$

#### 90 MHz

$$\begin{aligned} \text{The gain, } G_A + G_T &= 49.3 \text{ dB} \\ V &= 21 \mu\text{V} \end{aligned}$$

$$\text{NF (dB)} = 10 \log \frac{(21 \times 10^{-6})^2}{10.5 \times 10^3} - 49.3 + 187.27 = 4.20 \text{ dB}$$

## CHAPTER 5

### WHITE NOISE LOADING

One application of a white noise source is to simulate random modulation of a carrier. This will often give more meaningful evaluation of a system under operating condition. One simplified example might be the following:

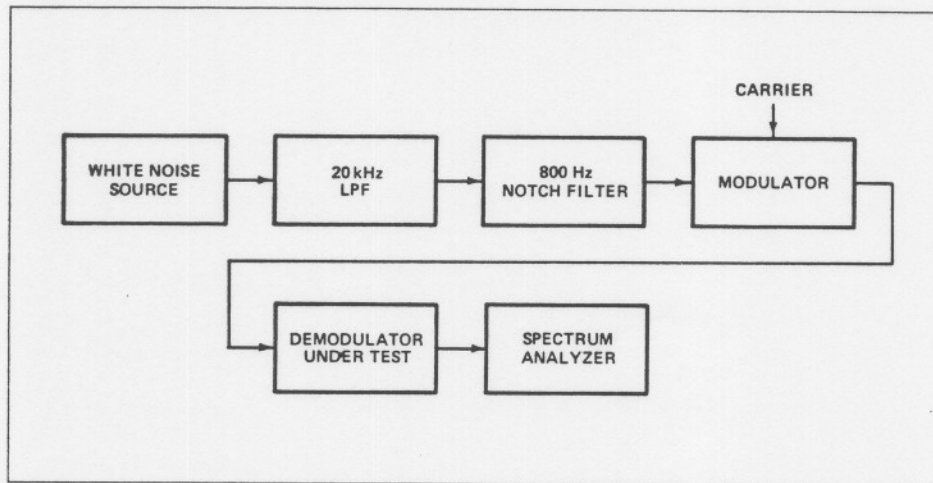

Figure 17. Basic white noise loading test.

The white noise is shaped to provide a 20 kHz bandwidth and a 60 - 80 dB notch at 800 Hz. This modulates an RF carrier, and the demodulator recovers the noise signal. If the signal is recovered without distortion, the 800 Hz notch will be the same depth as when it was created, i.e., 60 - 80 dB. If any distortion is introduced in the modulation-demodulation process, the notch will not be as deep.

Measurement techniques on the spectrum analyzer are quite simple. There are two considerations: the bandwidth must be narrow enough to resolve the notch, and the dynamic range must be wide enough to avoid having distortion created by the spectrum analyzer.

The bandwidth requirements are readily determined, but the dynamic range may be a complicated matter.

#### DYNAMIC RANGE

Let's look at our dynamic range. The spectrum analyzer is specified for all distortion products to be down 70 dB for  $-40$  dBm to the input mixer.

Suppose we look at a noise signal from 0 to 20 kHz with a 30 Hz bandwidth. The total noise energy must not exceed  $-40$  dBm over the 20 kHz bandwidth. This amounts to  $-67$  dBm in a 30 Hz bandwidth. Since distortion appears 70 dB below  $-40$  dBm, or  $-110$  dBm, the dynamic range is from  $-67$  dBm to  $-110$  dBm, or 43 dB. This is the deepest notch which can be recovered.

However, using an 800 Hz bandpass filter ahead of the spectrum analyzer to limit the bandwidth of the input noise, we can achieve 60 to 65 dB of dynamic range.

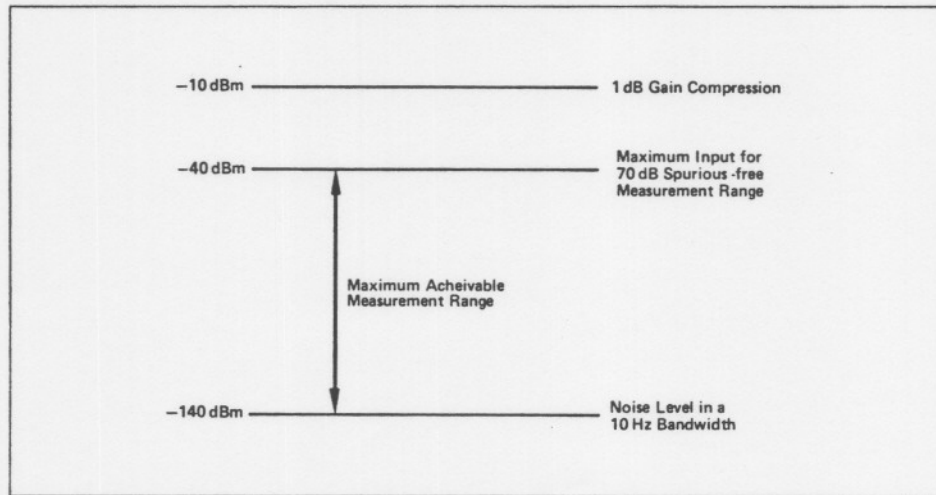

Figure 18. Maximum achievable measurement range and 70 dB distortion-free range would be realized by limiting input noise to 10 Hz bandwidth ahead of the input mixer. For audio frequency analyzer without accessories, input bandwidth equals 1.2 MHz.

$$-40 \text{ dBm}/1.2 \text{ MHz} \approx -90 \text{ dBm}/10 \text{ Hz}$$

$$\text{Dynamic Range} = -90 \text{ dBm} - (-140 \text{ dBm}) = 50 \text{ dB}$$

With 5 kHz low pass filter installed at input,

$$-40 \text{ dBm}/5 \text{ kHz} \approx -67 \text{ dBm}/10 \text{ Hz}$$

$$\text{Dynamic Range} = -67 \text{ dBm} - (-140 \text{ dBm}) \approx 70 \text{ dB}$$

## CHAPTER 6

### OSCILLATOR SPECTRAL PURITY

It is often desirable to characterize the stability of an oscillator by measuring noise sidebands on the carrier. This is especially true for high stability oscillators where traditional terms like "residual FM" or "residual AM" have little meaning.

The sidebands present may represent either amplitude jitter or phase (frequency) jitter on the oscillator output. Therefore, it may be desired to measure both independently rather than to just measure the total noise sideband level.

In many cases, the noise sidebands will be high enough to be measured directly, using the techniques described for random noise. Some oscillators will have discrete, line-related sidebands which can be readily measured. However, any "clean" oscillator will require special techniques to establish the sideband levels which may be 150 dB/Hz below the carrier. Application Note 270-2 describes an automatic system for measuring sideband noise down to 130 dBc/Hz with the 8568A Spectrum Analyzer.

#### RESIDUAL AM

The method of measurement for residual AM will consist of using an envelope detector to recover the AM sidebands while ignoring FM or phase modulation (PM) sidebands. The basic block diagram is as shown below.

The calibration source is used to create an accurately known modulation level to calibrate the system. This is accomplished by essentially using the detector as a mixer.

The source under test is set for a level of +15 to +17 dBm (when the HP 423A Crystal Detector is used), and the calibration source is set for a small frequency offset

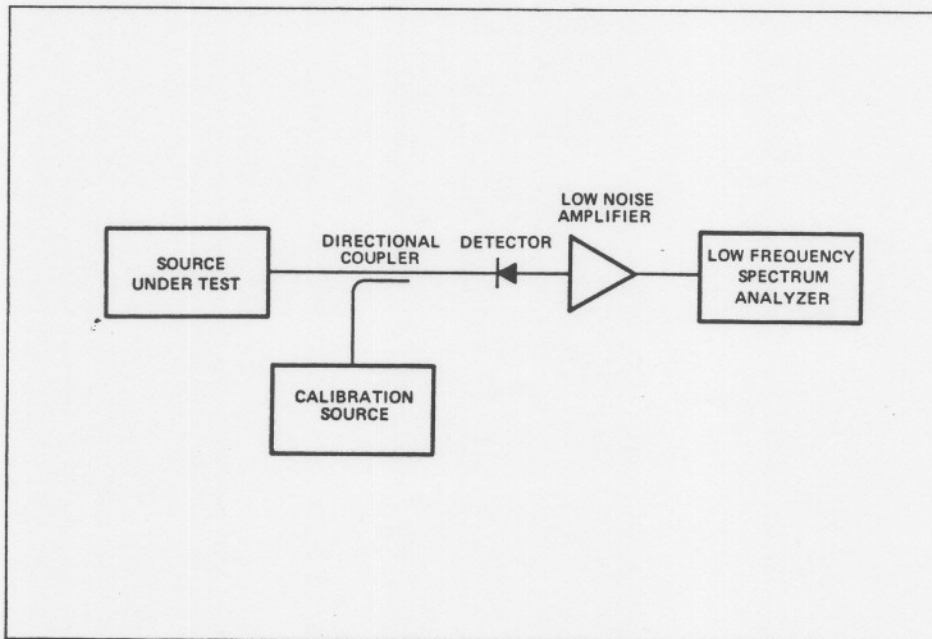

Figure 19. Block diagram for residual AM measurements.

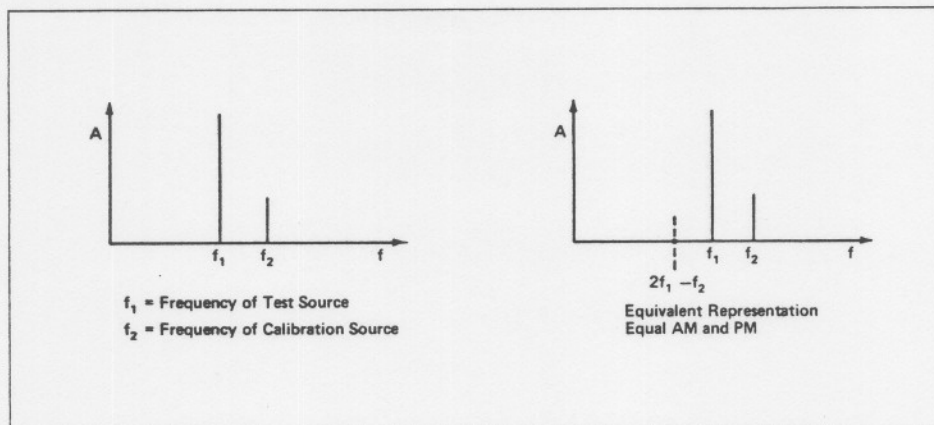

Figure 20. Input to crystal detector during calibration for residual AM. The equivalent input is as shown in the diagram to the right and corresponds to equal AM and PM.

with a level 50 to 100 dB below the source under test. The output of the directional coupler looks like the above in the frequency domain.

When  $f_2$  is more than 26 dB below  $f_1$ , the output represents an equal amount of AM and PM adding in phase. Thus, the lower sidebands cancel, and the upper sidebands add. The actual level of the upper AM sideband is 6 dB below the calibration generator output. So if we set the calibration source 84 dB below the test source, the equivalent output from the detector at  $f_2 - f_1$  will represent AM 90 dB below the carrier. (Remember, the detector ignores any PM which is present.) (See Application Note 150-1 for further information on AM and PM.)

The high level of the source under test is sufficient to drive the detector into its linear region. We can check the operation of the detector circuit by changing the calibration source's frequency and amplitude. As the amplitude is changed in 10 dB steps, the output should change in 10 dB steps. Also, as the frequency is changed, the output frequency should change, but the amplitude should remain constant.

The amplifier should have a high impedance input to avoid loading the detector, and the output impedance should be 50 ohms to interface to the spectrum analyzer without loss.

## MEASUREMENT

The measurement technique is quite simple. We first calibrate for a known carrier-to-sideband ratio. This is accomplished as outlined before. That is, the calibration source is set for a frequency slightly higher than the test source and a level 50 to 100 dB lower. The output from the amplifier is adjusted to a convenient reference on the CRT. For example, a calibration signal 74 dB below the test source is used, and the reference signal out represents AM 80 dB below the carrier.

Then, turn off the calibration source, and read the noise sideband level. Remember to add the 2.5 dB correction factor and normalize to some bandwidth as for any random noise measurement. Discrete sidebands can be measured directly without corrections.

## SENSITIVITY

The overall sensitivity will depend on the detector noise figure, the amplifier noise figure and gain, and the spectrum analyzer characteristics.

For discrete (narrowband) sidebands, the sensitivity will be related to the spectrum analyzer bandwidth. For noise sidebands, sensitivity close to the carrier will also be related to the bandwidth. Of course, as narrower bandwidths are used, narrower video filter settings are required. Further smoothing may be accomplished by using an X-Y recorder to display the output.

### Note

Care must be taken to shield the low frequency portion of the system from radiated signals such as the AM broadcast band. Also, if you are working in an RF range where radiated signals may be present, these may radiate into the detector. Any such signal would appear as a spurious sideband. For maximum sensitivity measurements such as this, it may be desirable to operate in a shielded room.

## RESIDUAL PHASE MODULATION (PM)

In this method, we will use a double-balanced mixer as a phase detector. Whenever two signals of equal frequency and in phase quadrature are applied to the local oscillator and RF ports of a double-balanced mixer, the output at the mixed port is the detected phase relationship between the two signals.

The basic method, then, deals with obtaining this phase quadrature between two signals. We will classify the technique for getting phase quadrature by oscillator type. Basically, there are four types: voltage-tuned oscillators, phase-lock oscillators, fixed oscillators, and microwave fixed oscillators.

## VOLTAGE-TUNED OSCILLATORS

To measure a voltage-tuned oscillator, we will phase-lock it to a stable reference. The block diagram is shown below:

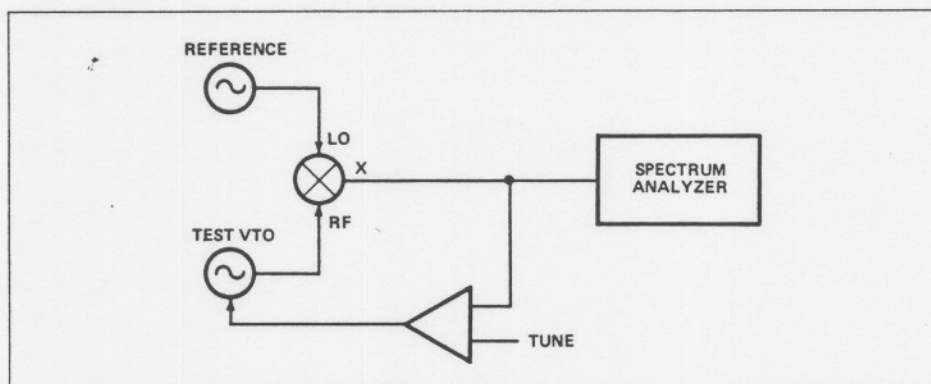

Figure 21. Test setup for phase modulation measurements on a VTO.



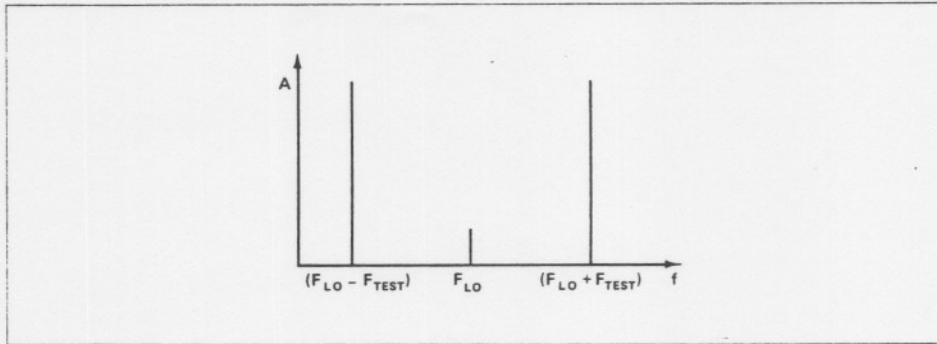

Figure 22. Output of the mixer when local oscillator and test oscillator are unlocked.

The gain crossover frequency of the lock loop must be at a frequency lower than any to be measured. Calibration of the system is readily accomplished by tuning the VTO off frequency so that no lock occurs. The output of the mixer will then be as shown above.

The signals at  $F_{LO} + F_{TEST}$  and  $F_{LO} - F_{TEST}$  represent sidebands 6 dB below the fundamental. The  $F_{LO} - F_{TEST}$  signal will appear in the range of measurement and should be set to the -6 dB graticule line on the spectrum analyzer. The log reference level will now read the equivalent carrier level.

The VTO is then tuned until lock occurs. At this point, we need to establish phase quadrature. The loop is adjusted so that the dc component of the error voltage is at a minimum to assure quadrature and true phase detection.

Now, applying the usual corrections, you can measure the phase noise sidebands.

#### PHASE-LOCK OSCILLATORS

The measurement technique is quite similar to voltage-tuned oscillators except the lock loop is built in to the oscillator unit. For this case, we will lock a spectrally pure synthesizer and the oscillator under test to the same reference to obtain a constant phase relationship.

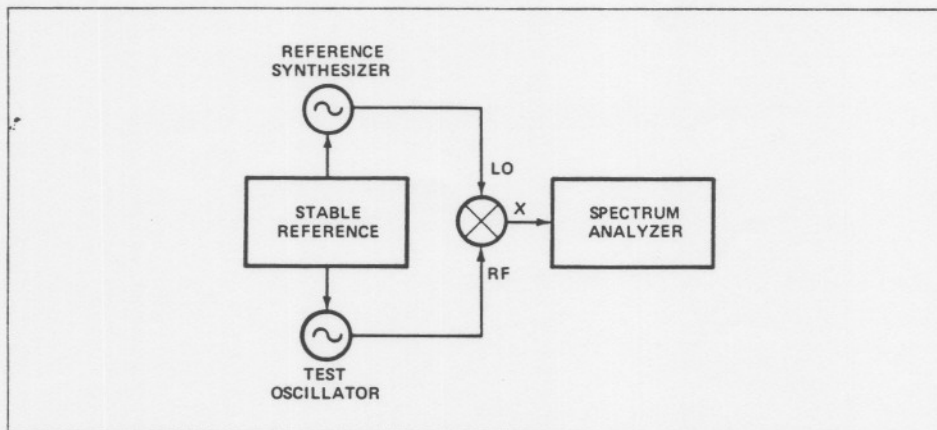

Figure 23. Block diagram for phase modulation tests on a phase-lock oscillator.

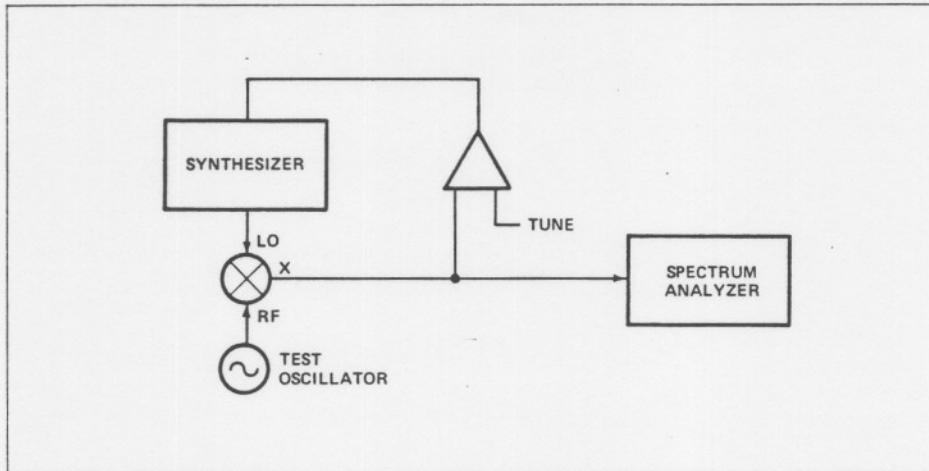

Figure 24. Test setup for a fixed oscillator. Synthesizer is locked to oscillator output.

First, the test oscillator and the synthesizer are offset in frequency by a small amount, and the display is calibrated as for the case of the VTO, i.e., the output from the mixer represents a sideband 6 dB below the carrier.

Next, the mixer output is monitored on a dc-coupled oscilloscope, and phase-lock is broken by opening one loop. As the phase error crosses zero, the lock loop is closed. This may need to be done several times until the lock occurs with zero phase error. If some adjustment within the lock loop is available on the test oscillator, it may be possible to achieve phase quadrature in this manner without locking and unlocking the oscillators.

The resultant display will now be phase noise versus frequency, and the usual corrections can be applied.

#### FIXED OSCILLATORS

The fixed oscillator presents a slightly different problem. In this case, a stable reference which can be slightly tuned by an input voltage is required. A synthesizer such as the HP 5100/5110 solves this problem, since a search input is provided. See Figure 24.

Calibration is still performed in the same manner as before. With the two oscillators offset, the difference frequency represents a sideband 6 dB down from the carrier.

The synthesizer is then tuned until lock occurs, and the phase error signal (dc component from mixer) is adjusted to zero. This assures phase quadrature.

The display on the spectrum analyzer will be phase noise versus frequency from the carrier, and the usual corrections apply.

#### MICROWAVE FIXED OSCILLATORS

For microwave oscillators, a delay line and phase shifter often provide the best technique for obtaining phase quadrature between the LO and RF ports of the mixer.

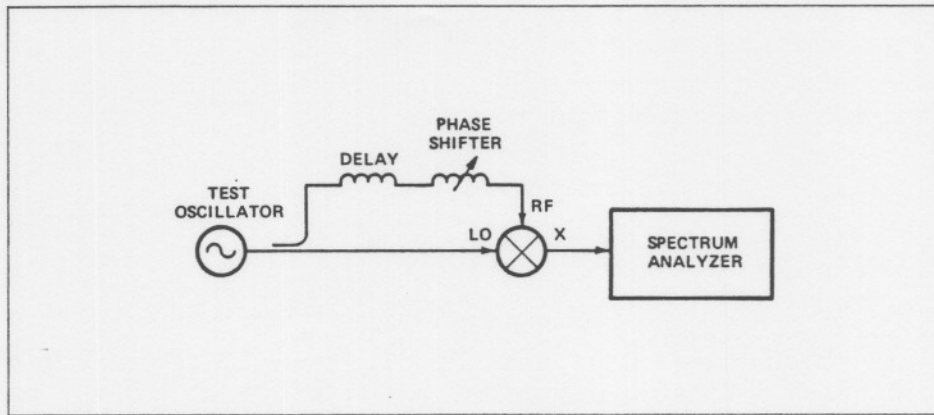

Figure 25. Block diagram for testing a microwave fixed oscillator.

The delay line assures that the random noise appearing at the two ports of the mixer does not cancel. (This would occur if identical length lines were used.) The delay line must be sufficiently long to provide at least 360 degrees of delay at the lowest measurement offset frequency (i.e., 1 ms for a 1 kHz minimum offset). The phase shifter allows adjustment to phase quadrature by obtaining a zero dc component out of the mixer.

To calibrate, a second oscillator, slightly different in frequency and at the same level, is inserted into the mixer at the LO port in place of the oscillator under test. (The directional coupler should be left in the circuit and its through arm terminated in 50 ohms.) Here, too, the mixer output will represent a sideband 6 dB below the carrier.

To measure, reconnect as shown in the diagram, and adjust for zero dc output to obtain quadrature. The display will now be phase noise versus frequency from carrier. Again, apply the usual corrections.

#### MEASUREMENT NOTES

A low noise amplifier may be used to increase the spectrum analyzer sensitivity, if required. Be sure to account for its gain after calibration. (Do not attempt to calibrate with the amplifier in the circuit, since it will probably be overloaded.)

The spectrum analyzer bandwidth determines the sensitivity for discrete sidebands, and it also affects sensitivity for close-in noise sidebands.

In the case of the VTO and the fixed oscillator, the lock loop bandwidth must be lower in frequency than the lowest frequency of interest.

For the case of the microwave fixed oscillator, the delay must be long enough to allow a random relationship between the two ports of the mixer. Normally this should be about the reciprocal of the lowest frequency offset to be measured.

#### ALTERNATE TECHNIQUE FOR RESIDUAL AM

In each of the methods under residual PM, we adjusted the two mixer inputs for phase quadrature. If, instead, we adjusted for phase coherence (maximum dc output), the mixer output would be detected AM. The rest of the technique would be similar.

## ALTERNATE PM TECHNIQUES

Residual phase modulation can be measured on low frequency oscillators by multiplying their output frequency. This multiplies the FM deviation (and therefore the PM) while the AM remains constant. Thus it is possible to multiply to a high harmonic where the oscillator noise sidebands appear above the spectrum analyzer noise sidebands. For example, a multiplication of 1000 brings the sideband level up 60 dB.

In addition, an FM discriminator, such as the HP 5210A, can be used to obtain the residual frequency noise sidebands. This method offers less sensitivity than the methods shown, and the output must be converted from FM noise to PM noise by some mathematical technique.

## EXAMPLES

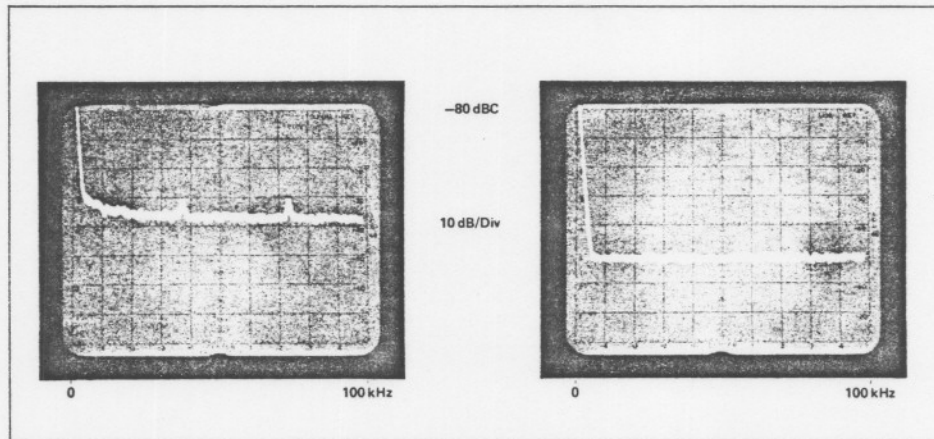

Figure 26. Residual AM measurement. The spectrum analyzer was calibrated such that the log reference level represents 80 dB down from the carrier in the left photo. Discrete sidebands appear 110 dB below the carrier. The IF bandwidth was 1 kHz, so the noise level 50 kHz from the carrier is  $-145.3 \text{ dB/Hz}$  ( $-117 \text{ dB} + 2.5 \text{ dB} - 30.8$ ). The photo to the right shows the spectrum analyzer sensitivity.

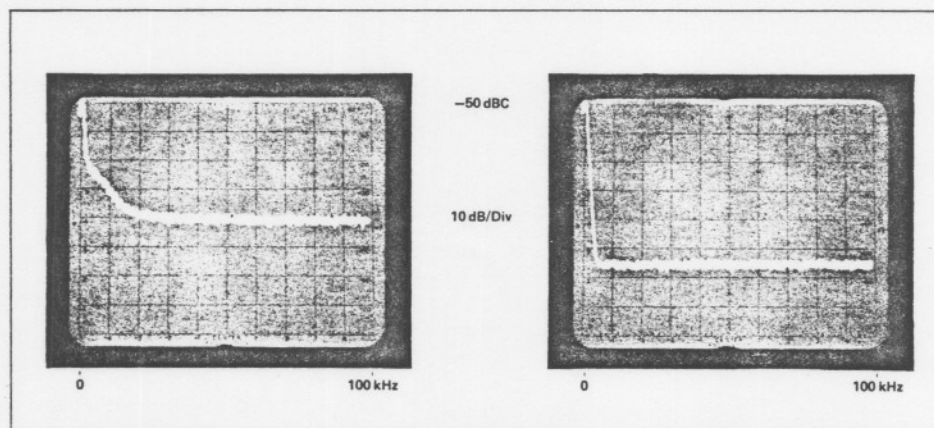

Figure 27. Residual phase modulation on a synthesized signal generator. In the left photo, the log reference level was calibrated at  $-50 \text{ dB}$  referred to the carrier. The IF bandwidth was 1 kHz. Then, the noise level is  $-118.3 \text{ dB/Hz}$  at 50 kHz ( $-90 \text{ dB} + 2.5 \text{ dB} - 30.8 \text{ dB}$ ). The rise in the noise response below 20 kHz is caused by the synthesizer's phase-lock loop. The photo to the right shows the spectrum analyzer sensitivity.

## APPENDIX

### DETERMINATION OF MAXIMUM INPUT NOISE POWER

The maximum input power used to calculate the values in Table 1 was determined as follows. A  $-10$  dBm CW signal will cause 1 dB gain compression in the mixer. This is 70 mV rms or 100 mV peak in a 50-ohm system. With narrowband gaussian noise such as we are considering, the maximum value of the envelope will be less than  $3/\sqrt{2}$  times the rms value of the envelope with a 99% probability or 99% of the time.<sup>1</sup> Thus, the rms value of the noise envelope is

$$\frac{\sqrt{2}}{3} (100 \text{ mV}) = 47 \text{ mV or } -13.5 \text{ dBm}$$

Since 99% is quite conservative,<sup>2</sup> we can safely say that the maximum input to the mixer is  $-13$  dBm or  $50.0 \mu\text{W}$ . This, then, is the maximum total power allowable at the mixer input.

### RESPONSE TO NOISE OF THE SPECTRUM ANALYZER IN THE LOG MODE

Narrowband white noise consists of random bursts of energy which have an envelope,  $R$ , described adequately by the "Rayleigh distribution."<sup>1</sup> See Figure A.

$$P(R) = \frac{R}{\sigma^2} e^{-R^2/2\sigma^2}$$

which we normalize, by setting the scale factor  $\sigma = 1$ , to

$$P(R) = R e^{-R^2/2}$$

The rms value of this function is  $\sqrt{2}$ .

<sup>1</sup> Reference Data for Radio Engineers, ITT, 4 Ed., p. 991.

<sup>2</sup> If signals causing 1 dB gain compression occur only 1% of the time, they will have only 1% effect.

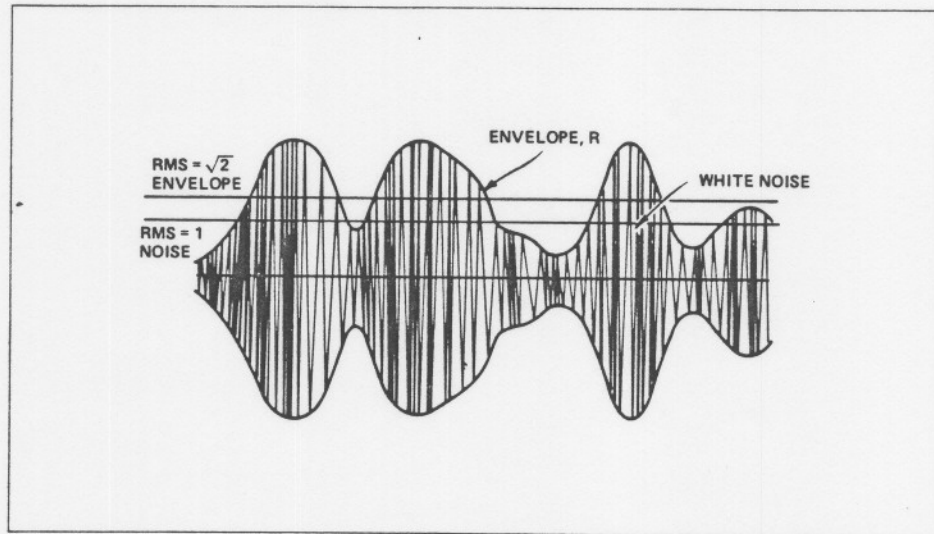

Figure A.

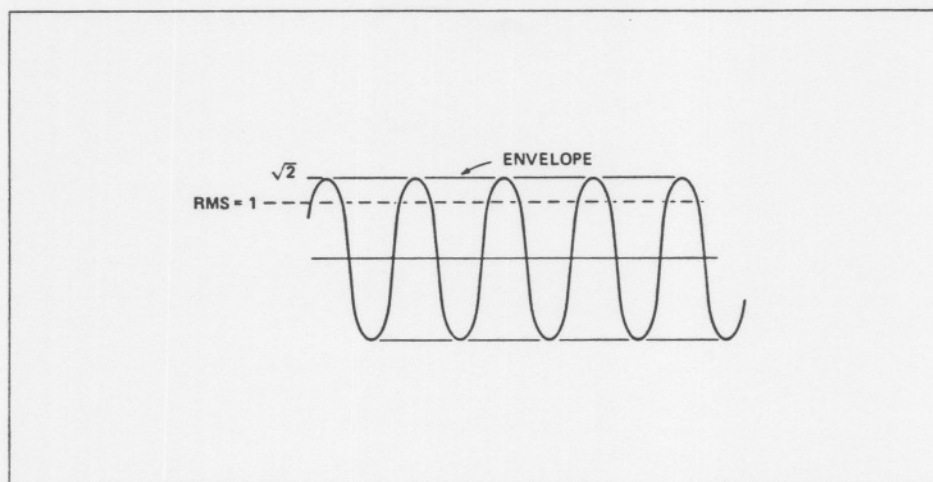

Figure B.

In the spectrum analyzer, this noise is processed by peak detection (envelope detection), logging, and averaging. Thus, with  $V(R) = \log_{10} R$ , the average of  $V_n$ , the noise voltage, is

$$\begin{aligned}\bar{V}_n &= \int_0^\infty [V(R)] [P(R)] dR \\ &= \int_0^\infty (\log R) [R e^{-R/2}] dR \\ &= 0.0580\end{aligned}$$

by numerical integration.

A sine wave of the same heating power (envelope =  $\sqrt{2}$ , see Figure B) processed in the same way yields

$$\bar{V}_s = \log \sqrt{2} = 0.346$$

Taking the difference and translating it from nepers to dB,

$$\text{Difference} = 8.68 (0.346 - 0.058) = 2.50 \text{ dB}$$

This is the desired correction factor by which the signal generator power must be reduced to become a reference for noise power density.

Table 1

Noise Spectrum Width	Maximum Input Power Density (Input Atten. at 0 dB)
1 MHz	50.0 $\mu\text{W}/\text{MHz}$
10 MHz	5.0 $\mu\text{W}/\text{MHz}$
100 MHz	0.5 $\mu\text{W}/\text{MHz}$
1 GHz	0.05 $\mu\text{W}/\text{MHz}$

TYPICAL NOISE SIDEBANDS FOR MODEL 8553B  
 1 kHz - 110 MHz SPECTRUM ANALYZER

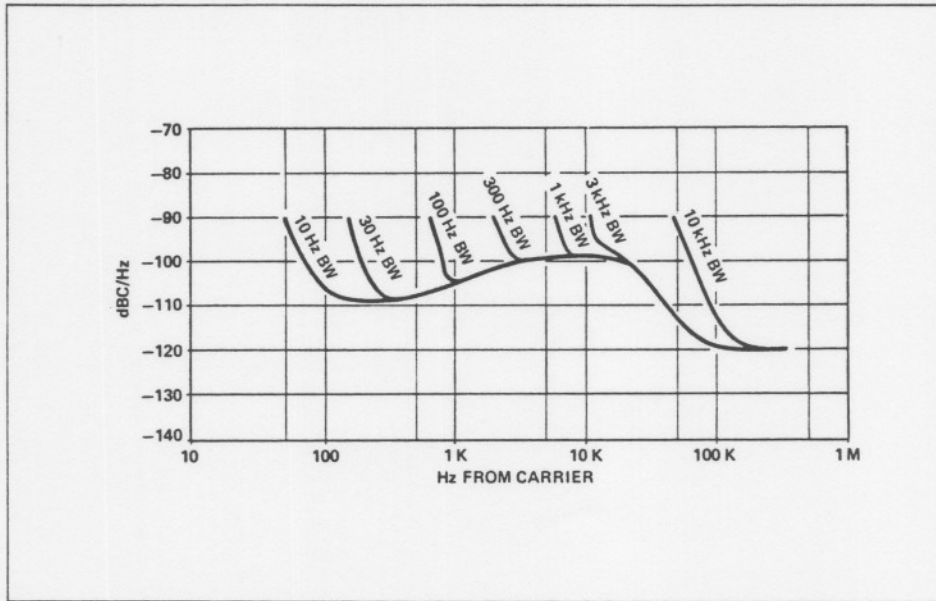

Figure C.

TYPICAL LOW FREQUENCY SENSITIVITY FOR MODEL 8556A  
 20 Hz - 300 kHz SPECTRUM ANALYZER

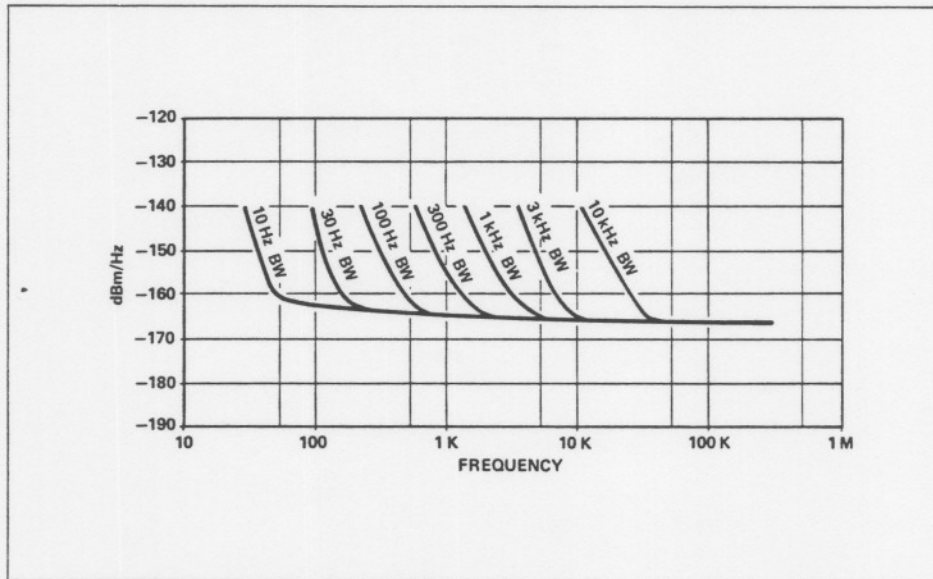

Figure D.

#### CORRECTION FACTORS (IMPULSE NOISE)

Convert dBm to dB $\mu$ V/MHz using the following corrections. (Nominal figures only. Use measured data for greater accuracy.)

Bandwidth	Correction (Add to dBm Reading)
300 kHz	116 dB
100 kHz	124 dB
30 kHz	134 dB
10 kHz	144 dB
3 kHz	154 dB
1 kHz	164 dB
300 Hz	174 dB
100 Hz	184 dB

#### CORRECTION FACTORS (RANDOM NOISE)

Convert dBm measurements to dBm/Hz using the following corrections. (Nominal figures only. Use measured data for greater accuracy.)

Bandwidth	Correction (Subtract from dBm Reading)
10 Hz	8.3 dB
30 Hz	13.1 dB
100 Hz	18.3 dB
300 Hz	23.1 dB
1 kHz	28.3 dB
3 kHz	33.1 dB
10 kHz	38.3 dB
30 kHz	43.1 dB
100 kHz	48.3 dB
300 kHz	53.1 dB





**HEWLETT  
PACKARD**