

## Errata

**Title & Document Type:** Application Note 150-4: Spectrum Analysis Signal Enhancement

**Manual Part Number:** unknown

**Revision Date:** June 1975

---

### HP References in this Manual

This manual may contain references to HP or Hewlett-Packard. Please note that Hewlett-Packard's former test and measurement, semiconductor products and chemical analysis businesses are now part of Agilent Technologies. We have made no changes to this manual copy. The HP XXXX referred to in this document is now the Agilent XXXX. For example, model number HP8648A is now model number Agilent 8648A.

### About this Manual

We've added this manual to the Agilent website in an effort to help you support your product. This manual provides the best information we could find. It may be incomplete or contain dated information, and the scan quality may not be ideal. If we find a better copy in the future, we will add it to the Agilent website.

### Support for Your Product

Agilent no longer sells or supports this product. You will find any other available product information on the Agilent Test & Measurement website:

[www.tm.agilent.com](http://www.tm.agilent.com)

Search for the model number of this product, and the resulting product page will guide you to any available information. Our service centers may be able to perform calibration if no repair parts are needed, but no other support from Agilent is available.

**APPLICATION NOTE 150-7**

**SPECTRUM ANALYSIS . . .**

**Signal Enhancement**

Printed June 1975



## CHAPTER 1

### Basic Considerations

#### Definition of Sensitivity

Sensitivity, to be useful, needs to relate to how small a signal can be measured on the analyzer. The CRT deflection is always proportional to the total power which includes the signal and the noise. A signal can be seen when it is equal to the noise power.

$$S = N \text{ or } \frac{S + N}{N} = 2 \quad (1), \text{ where}$$

S = power of the signal

N = power of the noise

In this case, S + N will be twice the noise power or deflected 3 dB above the noise.

#### Available Noise Power

The input termination of a network (an amplifier, receiver, or spectrum analyzer) has a certain amount of available noise power which is, in most cases, thermal noise. An impedance  $Z = R + jX$  at temperature T generates across its open circuit terminals a voltage resulting from the random motion of free electrons thermally agitated. This "noise voltage",  $e_n$ , can be defined by the equation:

$$e_n^2 = 4kTBR, \text{ where}$$

k = Boltzmann's constant  $1.374 \times 10^{-23}$  joule/°K

T = absolute temperature °K

R = resistive component of impedance

B = Bandwidth

If the impedance  $Z = R + jX$  is connected to a matched load with input impedance  $Z = Z^*$  as shown in Figure 1, maximum transfer of the noise power will occur. Noise power  $P_n$  will be dissipated in the load resistance  $R_L$  due to the noise voltage generated in the original resistance R. The noise power will be:

$$P_n = \frac{(e_n/2)^2}{R_L} = \frac{e_n^2}{4R_L} = \frac{4KTBR}{4R_L}$$

Since there is equal noise voltage across source and load when  $R = R_L$

$$P_n = KTB \quad (2).$$

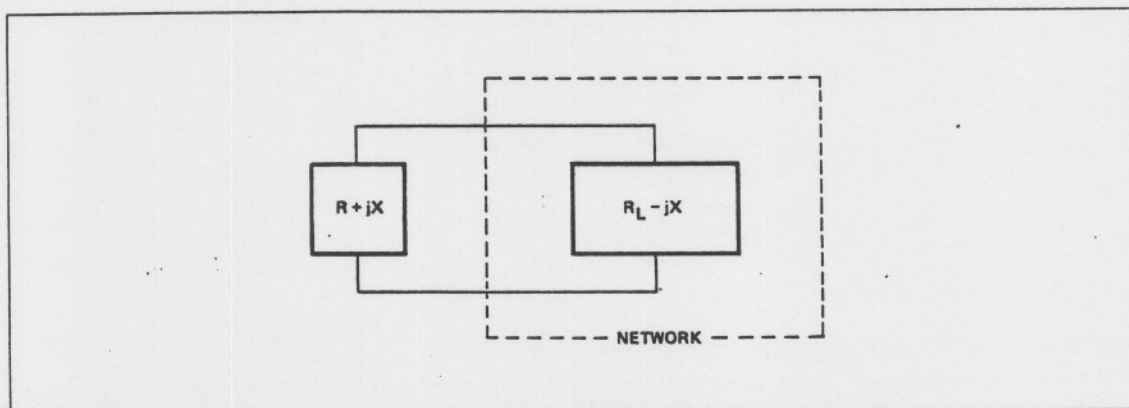


Figure 1. Available noise power  $P_n$  is equal to  $KTB$ .

Equation (2) defines the available noise power from the source. In systems operating at frequencies where voltages and resistances cannot be clearly defined, this equation becomes the usable expression, containing terms that can be measured.

#### Noise Figure

Let us consider the network in Figure 2 with a power gain  $G$  which can be more or less than 1. In practice a network is never noiseless and decreases the signal-to-noise ratio.

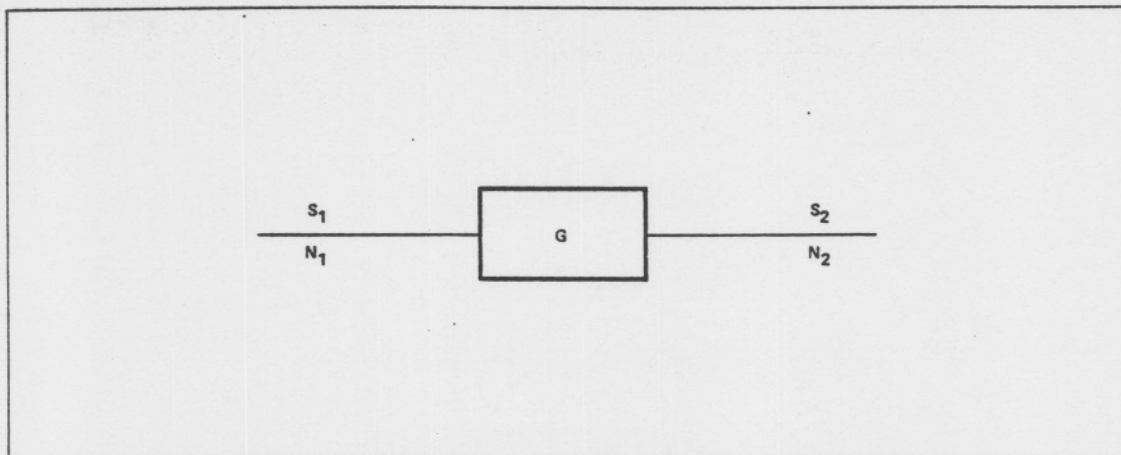


Figure 2.

The noise figure of the network may be defined as the ratio of input signal-to-noise power ratio to the output signal-to-noise power ratio.

$$\text{Noise figure } F = \frac{S_1/N_1}{S_2/N_2} = \frac{S_1}{N_1} \cdot \frac{N_2}{S_2}, \text{ where}$$

$S_1$  = input signal power

$N_1$  = input noise power

$S_2$  = output signal power

$N_2$  = output noise power

$$\text{Since } S_2 = S_1 G \quad F = \frac{N_2}{N_1 G}$$

If the network is noiseless, the output noise will just be equal to the amplified input noise. In other words,  $N_2 = N_1 G$  and  $F = 1$ . When  $F > 1$ , there is degradation of the input signal-to-noise ratio. The output noise power  $N_2$ , from a noisy network is made up of two terms:

- The first due to the amplification of the input noise power  $N_1 G$
- The second is the amount of noise power generated by the noisy network and is equal to  $(F - 1) N_1 G$ . So that  $N_2 = N_1 G + (F - 1) N_1 G = F N_1 G$

We have seen  $N_1$  is the input noise power or the available noise power; that is,  $N_1 = KTB$ . It follows then that

$$N_2 = FkTBG \quad (3).$$

#### Sensitivity of a Spectrum Analyzer

We can use equation (3) to figure out the output noise power or sensitivity of a spectrum analyzer. Unfortunately, the gain is unknown and we prefer to define the total input noise power which is the output noise power divided by the gain.

Equation (3) becomes

$$N = F_{SA} kTB \quad (4) \text{ with } F_{SA} = \text{Spectrum analyzer noise figure.}$$

It's more convenient to express the formula in dB

$$10 \log N = 10 \log F_{SA} + 10 \log kT + 10 \log B$$

At room temperature,  $T = 290^\circ\text{K}$  and  $10 \log kT = -204 \text{ dB}$ , a value which is constant in normal utilization. (We have an error of 0.4 dB for  $t = 23^\circ\text{C} \pm 30^\circ\text{C}$ .) Units are usually expressed in dBm, that is dB referred to a mW. Since  $0 \text{ dBm} = 1 \text{ mW}$ , we get

$$(N)_{\text{dBm}} = (F_{SA})_{\text{dB}} + (B)_{\text{dB}} - 174 \text{ dBm} \quad (5), \text{ where}$$

$(F_{SA})_{\text{dB}}$  is the noise figure of the spectrum analyzer in dB,  $(B)_{\text{dB}} = 10 \log B$  where B is the equivalent noise power bandwidth in Hz (in gaussian filters this is 1.2 times the resolution bandwidth). For simplicity this applications note will use the analyzers bandwidth setting for B. Thus if  $B = 1 \text{ Hz}$ , then  $10 \log B = 0$  or if  $B = 10 \text{ kHz}$ , then  $10 \log B = 40 \text{ dB}$ .

A 10 times increase in the bandwidth causes the spectrum analyzer internal noise to increase by 10 dB. For instance, if the internal noise power is  $-110 \text{ dBm}$  with  $10 \text{ kHz}$  BW;

at  $1 \text{ kHz}$  IF, we get  $-120 \text{ dBm}$ ;  
at  $100 \text{ Hz}$  IF,  $-130 \text{ dBm}$ ;  
and so on.

Obviously the sensitivity will be the best when the bandwidth is the narrowest.

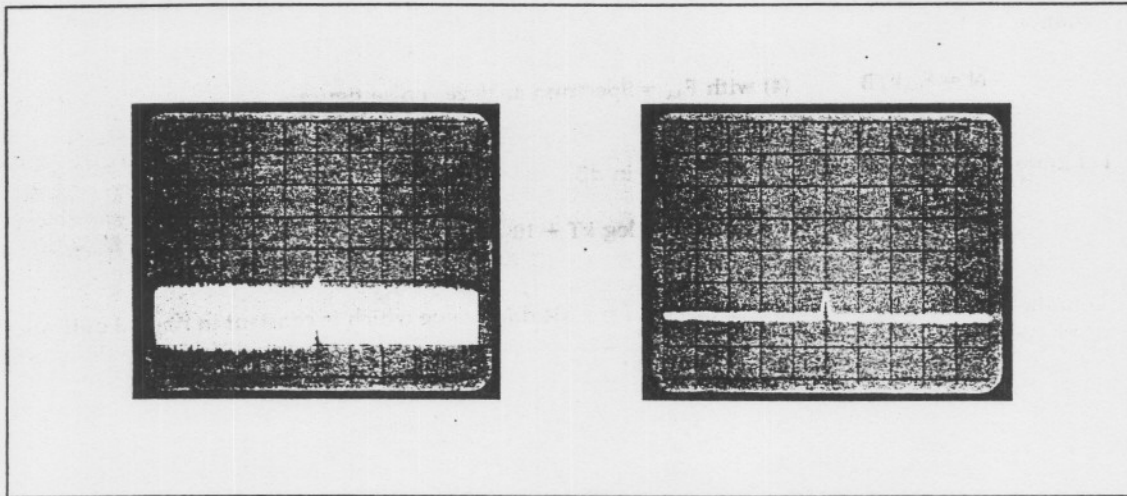
There is a restriction to this general comment for impulse noise measurements. In this particular case, the maximum achievable measurement range is for the largest bandwidth. For more information, refer to HP Application Note 150-4: "SPECTRUM ANALYSIS . . . Noise Measurements."

#### Average Noise Level

We have seen that the sensitivity of a spectrum analyzer is a function of its internal noise which in turn is related to its bandwidth. When the signal is equal to the noise power, the signal is deflected 3 dB above the noise level since the analyzer always displays  $S + N$ . So one way to measure sensitivity would be to insert a signal and decrease its level until it is 3 dB above the noise.

However, by using the video filter (see Figure 3), some of the noise can be averaged and the signal now appears 7 dB above the noise. The reason for that is the measurement of the noise power related to the IF bandwidth is misleading without a video filter since peak detection is used instead of RMS detection. A noise signal can only be measured if it is averaged. One technique,\* is to use the video filter. For good integration choose a video bandwidth one hundredth or less of the IF bandwidth. In other words, if the video filter is on and if the signal is deflected up 3 dB, we can assume that the signal is really equal to the averaged noise level. This is our sensitivity definition;  $\frac{S + N_{\text{avg}}}{N_{\text{avg}}} = 2$ . Therefore, sensitivity can be easily checked without any signal; turn on the video filter, select the  $10 \text{ kHz}$  IF bandwidth and read the average noise level in dBm directly off the CRT. When doing this, remember the noise is always related to IF bandwidth.

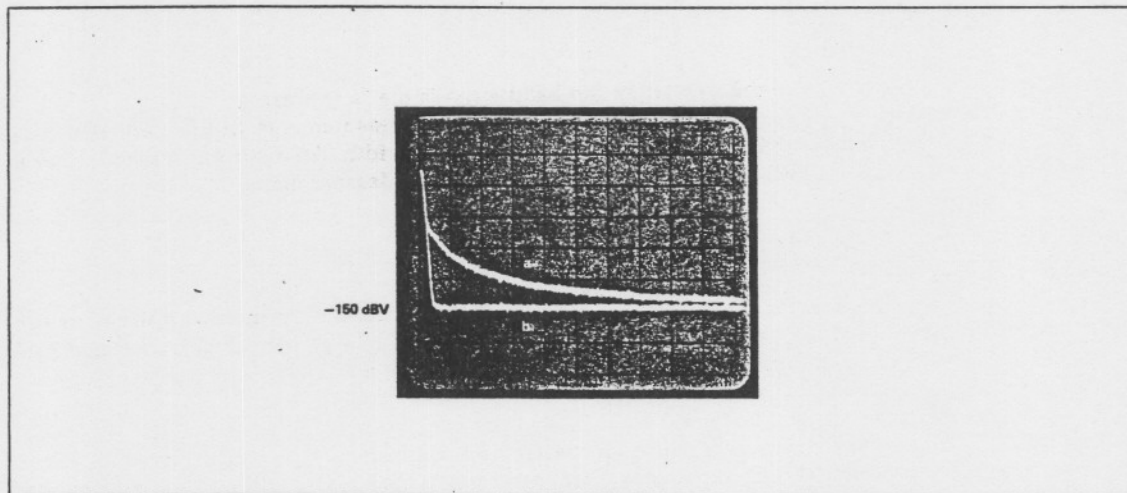
\*See, AN 150-4 Noise Measurements



**Figure 3.** The same signal power is displayed without video filter in left photo and after averaging (10 Hz video filter) in right photo.

#### Spectrum Analyzers, with High Impedance

So far the spectrum analyzer's noise figure has been determined from the available noise power since the input impedance is equal to the characteristic impedance of the circuit, which is generally  $50\ \Omega$ . Low frequency spectrum analyzers (such as the HP 3580A or HP 8556A) have high input impedance ( $1\ \text{M}\Omega$ ) which generates a large noise voltage. But due to the low input capacitance ( $\approx 30\ \text{pf}$ ), at higher frequencies the noise voltage is lower.



**Figure 4.** Reduction of average noise level of a high input impedance Spectrum Analyzer into an open circuit trace (a); and with a  $50\ \Omega$  feedthrough trace (b).

Trace (a) of Figure 4 shows the HP 8556A average noise level versus frequency (0 to 200 kHz) in a 3 kHz bandwidth. An easy way to reduce this noise is to connect a low impedance feedthrough (e.g.,  $50\ \Omega$  or  $600\ \Omega$ ). The effect of a  $50\ \Omega$  feedthrough termination is shown by trace (b) in figure 4 (note how the difference is greater in low range). Another advantage to using a feedthrough is to get calibrated power measurements. The standard HP 8556A can make power measurements calibrated for  $50$  or  $600\ \Omega$ ;  $135$ ,  $150$  and  $900\ \Omega$  inputs are available as options.

### Noise Figure of the Spectrum Analyzer

It is easy to figure out the noise figure from equation (5) when you know the average noise. For example, the HP 8553B (1 KHz - 110 MHz) has an average noise level  $< -110$  dBm with 10 KHz IF bandwidth. So  $(B)_{dB} = 10 \log 10^4 = 40$  dB and since  $(N)_{dBm} = -110$  dBm we get  $(F_{SA})_{dB} = -110$  dBm + 174 dB - 40 dB = 24 dB. Noise figure is more general than the average noise because it is independent of bandwidth.

In table 1 we find the noise figure for some HP Spectrum Analyzers.

	HP 8553B 1 KHz - 110 MHz	HP 8554B 0.1 - 1250 MHz	HP 8558B 0.1 - 1500 MHz	HP 8555A 0.01 - 18 GHz
Noise Figure F	F = 24 dB	F = 32 dB	F = 29 dB	depends on mixing mode n = 1 F = 27 dB

Table 1. Noise figure for some HP Spectrum Analyzers

### Enhancement of Sensitivity

From equation (5) we can see N will decrease with either a decrease in noise figure, F or IF bandwidth, B. Thus sensitivity can be enhanced by:

- Using one or several amplifiers in cascade to achieve a low system noise figure, F.
- Using the narrowest possible IF bandwidth.
- Using video filtering to average the detected noise and enhance signals.

## CHAPTER 2

### Amplifiers and Sensitivity

The simplest method to handle weak signals is to connect a broadband amplifier at the input of the spectrum analyzer. In this chapter we are going to define how much we can improve the sensitivity and determine the number of amplifiers we can connect in cascade for a maximum enhancement.

#### Sensitivity

Let's consider the set up in Figure 5 with two broadband amplifiers in cascade, connected to the input of the spectrum analyzer.

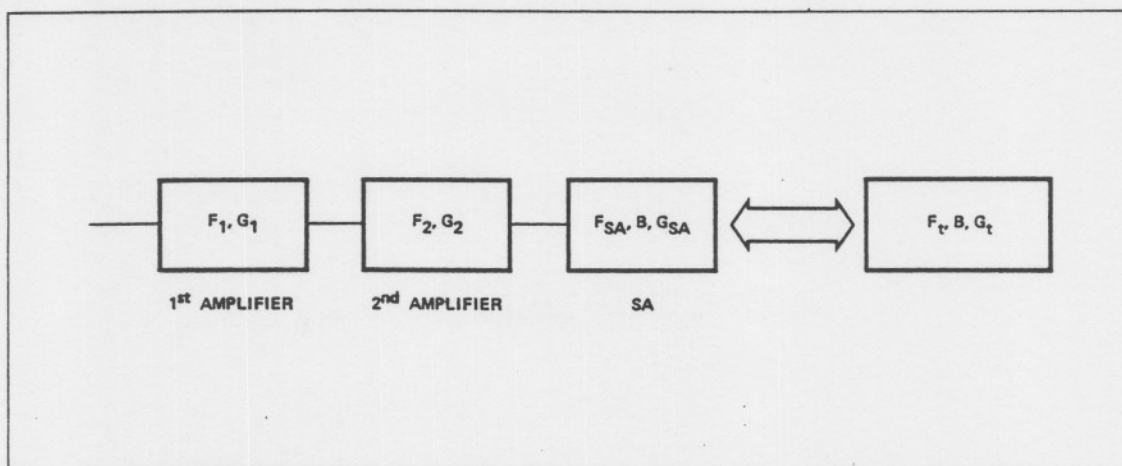


Figure 5. The two amplifiers and the Spectrum Analyzer put together can be considered as a single instrument with a new noise figure  $F_t$ .

Let's assume that the power bandwidth of the amplifiers is compatible with the frequency range being measured. Note that  $F_1$ ,  $F_2$  are the noise figures and  $G_1$ ,  $G_2$  are the gain of the 1st and 2nd amplifier, respectively.

The spectrum analyzer is defined with its noise figure  $F_{SA}$ , with the bandwidth of the IF section  $B$ , and its gain  $G_{SA}$ . These three instruments put together may be considered as a single one defined by a total noise figure  $F_t$ , with the same bandwidth  $B$  and a total gain  $G_1 G_2 G_{SA} = G_t$ . Therefore, the total noise power at the input is:

$$N = F_t KTB \text{ (see first chapter), or}$$

$$(N)_{dBm} = (F_t)_{dB} + (B)_{dB} - 174 \text{ dBm, where}$$

$$(B)_{dB} = 10 \log B, B \text{ is the spectrum analyzer's bandwidth.}$$

The knowledge of  $F_t$  will allow us to determine the sensitivity of the whole system and sensitivity will be improved if  $F_t < F_{SA}$ .

#### Noise Figure

The effects of the noise contribution of the two amplifiers, and of the spectrum analyzer can be seen in Figure 6. We know (first chapter) the contribution to noise power of a network with a gain  $G$  and noise figure  $F$  is  $(F - 1)NG$ ,  $N$  being the input noise power. The input termination supplies a noise power  $kTB$  which is amplified and appears at the output of the spectrum analyzer as  $kTB G_1 G_2 G_{SA}$ . The contribution of the first amplifier is  $(F_1 - 1)kTB G_1$ , which is amplified by the following networks and becomes



$(F_1 - 1)kTBG_1G_2G_{SA}$ . Similarly the contribution of the second amplifier appears at the output of the system as  $(F_2 - 1)kTBG_2G_{SA}$ . The noise contribution of the spectrum analyzer is  $(F_{SA} - 1)kTBG_{SA}$ . The system noise figure  $F_t$  is the ratio of actual noise power output to noise power output contributed by the input termination.

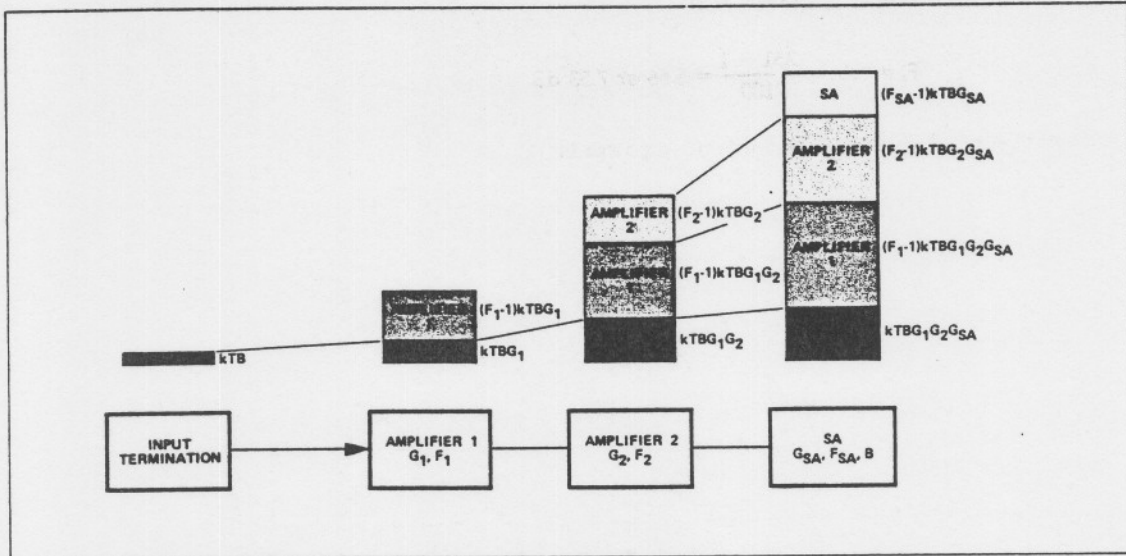


Figure 6. The effects of noise contribution of two amplifiers and Spectrum Analyzer in cascade.

$$F_t = \frac{\text{total noise output}}{kTBG_1G_2G_{SA}}$$

$$= \frac{kTBG_1G_2G_{SA} + (F_1 - 1)kTBG_1G_2G_{SA} + (F_2 - 1)kTBG_2G_{SA} + (F_{SA} - 1)kTBG_{SA}}{kTBG_1G_2G_{SA}}$$

$$F_t = F_1 + \frac{F_2 - 1}{G_1} + \frac{F_{SA} - 1}{G_1G_2} \quad (6)$$

The general equation for the noise figure of several cascaded stages would then be:

$$F_t = F_1 + \frac{F_2 - 1}{G_1} + \dots + \frac{F_n - 1}{G_1G_2 \dots G_{n-1}}$$

In general each gain  $G \gg 1$ . Hence the overall noise figure depends primarily on the noise figure of the first stage. The effects of the following stages are reduced by the product of the gain terms up to that point. If we choose a broadband amplifier with a low noise figure we shall improve the sensitivity.

#### Set Up with One Amplifier

With one amplifier, the total noise figure is reduced to  $F_t = F_1 + \frac{F_{SA} - 1}{G}$  and the total noise power at the input of the amplifier will be

$$(N)_{dBm} = 10 \log \left( F_1 + \frac{F_{SA} - 1}{G} \right) + (B)_{dB} - 174 \text{ dBm} \quad (7)$$

Since the noise figure and gain are expressed in dB, we have to convert these parameters to a linear power form to figure out the total noise figure.

**EXAMPLE**

With the HP 8553B (1 kHz – 110 MHz and  $F = 24$  dB) we can use a broadband amplifier 8447A ( $F = 5$  dB;  $G = 20$  dB).

$F = 24$  dB is equivalent to  $F$  (linear) = 251,  
 $F = 5$  dB is equivalent to  $F$  (linear) = 3.16,  
and  $G = 20$  dB becomes  $G$  (linear) = 100.

$$F_t = 3.16 + \frac{251 - 1}{100} = 5.66 \text{ or } 7.53 \text{ dB}$$

and with a bandwidth of 10 Hz the noise power is

$$(N)_{\text{dBm}} = 7.53 \text{ dB} + 10 \text{ dB} - 174 \text{ dBm} = -156.47 \text{ dBm}$$

At the same bandwidth the HP 8553B alone has an internal noise power of  $-140$  dBm so we enhance the sensitivity by about  $+16$  dB with an amplifier which has a gain of  $20$  dB. This is due to the noise contribution of the amplifier. It would have been a mistake to believe that the sensitivity would increase by  $20$  dB.

In Figure 7 the reference level of the spectrum analyzer is  $-70$  dBm, but due to the fact we have connected an amplifier with a gain of  $20$  dB, the actual reference level is  $-90$  dBm. We can easily measure a signal at  $-140$  dBm; the average noise is at  $-155$  dBm.

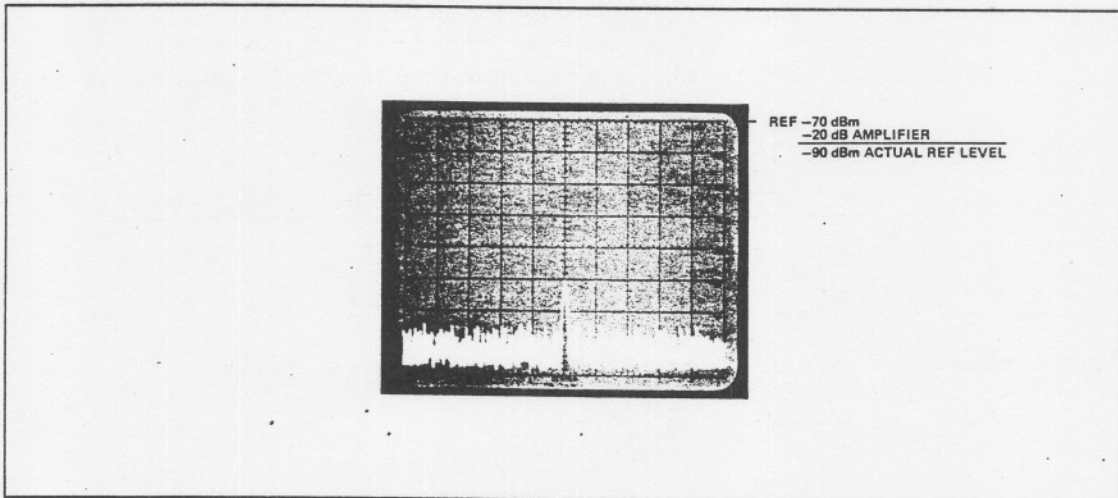


Figure 7. HP 8553B with HP 8447A Preamplifier. With a  $+20$  dB gain preamplifier, the new reference is  $-70$  dBm  $-20$  dB =  $-90$  dBm. Average noise is at  $-160$  dBm.

**GRAPHIC DETERMINATION OF THE TOTAL NOISE FIGURE OR NOISE POWER**

As we can see with this example, the computation of the total noise figure is tedious.

Assuming that  $F_{SA} \gg 1$ , or  $(F_{SA})_{\text{dB}} > 10$  dB, the general equation becomes, with  $10$  KHz bandwidth,

$$(N)_{dBm} = 10 \log \left( F_1 + \frac{F_{SA}}{G_{AMP}} \right) - 134 \text{ dBm.}$$

If  $F_1$  is constant,  $(N)_{dBm}$  is a function of  $\frac{F_{SA}}{G_{AMP}}$  or  $(F_{SA} - G_{AMP})_{dB}$ . For each  $F_1$ , there is a corresponding curve as shown in Figure 8. The curves are approximate, but accurate for  $(F_{SA})_{dB} \geq 10 \text{ dB}$ .

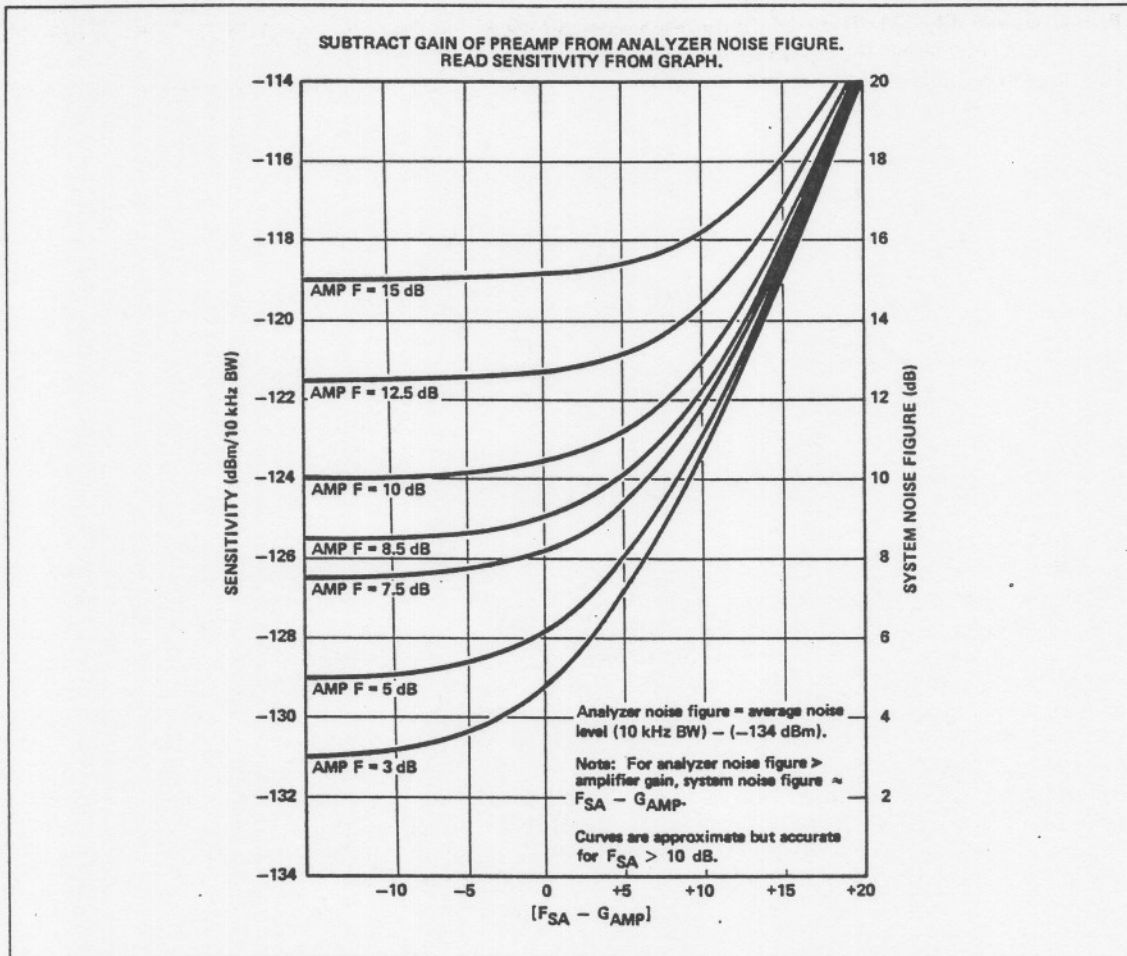


Figure 8. Graphic determination of the noise figure or sensitivity (dBm/10 kHz BW) of the system.

From the preceding example we know that  $(F_{SA} - G_{AMP})_{dB} = 24 \text{ dB} - 20 \text{ dB} = +4 \text{ dB}$ . By the curve  $F = 5 \text{ dB}$ , we can determine that the total noise figure is 7.6 dB or the noise power is  $-126.4 \text{ dBm}$  for a bandwidth of 10 KHz. With 10 Hz bandwidth we again obtain the values computed previously  $-126.4 \text{ dBm} - 30 \text{ dB} = -156.4 \text{ dBm}$ .

#### Using Two Amplifiers

The general expression of the input noise power is

$$(N)_{dBm} = 10 \log \left( F_1 + \frac{F_2 - 1}{G_1} + \frac{F_{SA} - 1}{G_1 G_2} \right) + (B)_{dB} - 174 \text{ dBm}$$

where  $F_1, F_2$  are the linear noise figures and  $G_1, G_2$  are the linear power gains of the 1st and 2nd amplifiers.

Calculation is always possible, but tedious. As a matter of fact, to enhance the sensitivity we have to choose amplifiers with the largest gain and the lowest noise figure. If  $\frac{F_{SA} - 1}{G_1 G_2} \ll 1$  or  $(G_1 + G_2)_{dB}$

$\gg (F_{SA})_{dB}$  the noise power is  $(N)_{dBm} \approx 10 \log\left(F_1 + \frac{F_2 - 1}{G_1}\right) - 134$  dBm with 10 KHz bandwidth, and the curves of Figure 8 are helpful. On the X axis we will have  $(F_2 - G_1)_{dB}$  and each curve is for  $(F_1)_{dB}$  constant. For example, with two amplifiers in cascade with 20 dB gain and 5 dB noise figure each, we have  $(F_2 - G_1)_{dB} = 5 \text{ dB} - 20 \text{ dB} = -15 \text{ dB}$  on the X axis and we get on the curve  $F_1 = 5 \text{ dB}$  a sensitivity of  $-129$  dBm, i.e., 2.6 dB better than with a single amplifier.

So the contribution of the second amplifier is poor; as a matter of fact, the total noise figure is 5 dB with two amplifiers and 7.50 dB with a single amplifier. In practice with two amplifiers with low noise figure and large gain ( $\geq 20$  dB) the total noise figure is the noise figure of the first amplifier, and the connection of a third one will contribute nothing since the total noise figure remains constant.

#### Maximum Input Power

Broadband amplifiers are specified for an output power with 1 dB gain compression. The HP 8447A preamplifiers have  $< 1$  dB compression for an output power of +7 dBm; that means if the gain is +20 dB, we cannot feed in a signal more than  $7 \text{ dBm} - 20 \text{ dB} = -13 \text{ dBm}$  in order to not compress the signal.

This may happen when you want to measure a weak signal present with a strong signal. Whenever the highest signal is compressed, the weak signal will be too. So before "zooming" in on the low signal, be sure that any strong signals won't overload the preamplifier.

On the other hand, if after preamplification, the signal fed to the spectrum analyzer is higher than the optimum input level, we have to adjust the input attenuator as we would if the spectrum analyzer were used alone, since the output signal of the preamplifier may cause internal distortion.

#### Distortion

Amplifiers are never perfectly linear and we may have to worry about their harmonic distortion. For example, let's compute the amplifier's contribution to an input signal's harmonic content. The HP 8447A (+20 dB gain) has a typical harmonic distortion  $< -60$  dB for  $< -30$  dBm power output. Assume a signal whose fundamental is at  $-50$  dBm and second harmonic at  $-90$  dBm. In theory, after amplification, the fundamental and the second harmonic would be respectively  $-30$  dBm and  $-70$  dBm. As a matter of fact, the actual amplitude of the 2nd harmonic is the result of two components, one due to the amplification of the signal harmonic and the other due to the amplifier distortion. We know for an output power at  $-30$  dBm the amplifier generates a second harmonic at  $-30 \text{ dBm} - 60 \text{ dB} = -90 \text{ dBm}$ . Since the components of the 2nd harmonic are coherent in phase we have to add the voltages;  $-70$  dBm and  $-90$  dBm correspond respectively to  $70.7 \mu\text{V}$  and  $7.07 \mu\text{V}$  in  $50 \Omega$ . Then the total voltage is  $77.78 \mu\text{V}$  and the power becomes  $-69.17$  dBm. So the second harmonic which was initially at  $-90$  dBm is measured at  $-69.17 \text{ dBm} - 20 \text{ dB} = 89.17 \text{ dBm}$ . So, due to the amplifier distortion we get an error of 0.83 dB.

#### Amplitude Accuracy and Adjustment of the New Reference Level

When you connect an amplifier to the spectrum analyzer the amplitude accuracy is degraded due to the gain accuracy and the gain flatness of the amplifier. The total degradation of the accuracy is merely the sum of the gain accuracy and gain flatness of the amplifier.

For example, with the HP 8447D Preamplifier the gain is  $+26 \text{ dB} \pm 1.5 \text{ dB}$  and with a gain flatness across full frequency range at  $\pm 1.5 \text{ dB}$ . Thus, the amplitude accuracy is degraded by  $\pm 3 \text{ dB}$ .

To cancel the amplifier gain accuracy, we can calibrate the Spectrum Analyzer and amplifier connected together, using the Spectrum Analyzer's internal calibrator. In our example, the degradation of the amplitude accuracy will decrease to  $\pm 1.5 \text{ dB}$ .

As shown below this calibration will allow us to set the new reference level at an integral multiple of 10.

Let us consider the HP 8447D Preamplifier connected to the HP 8554B. After setting the input attenuator (20 dB) to not overload the input mixer, connect the internal calibrator (30 MHz;  $-30 \text{ dBm}$ ) and set the log reference of the IF section to 0 dBm.

Let's assume the actual amplifier gain is +25 dB instead of the nominal +26 dB. To set the top of the displayed spectral line on a main division, we adjust the gain vernier to -5 dB. So the actual reference becomes  $0 \text{ dBm} - 25 \text{ dB} - 5 \text{ dB} = -30 \text{ dBm}$ . To figure out the new reference it will be sufficient to subtract -30 dB from the reference level read from the knob. For example,

- 0 dBm corresponds to -30 dBm
- +10 dBm corresponds to -20 dBm
- 10 dBm corresponds to -40 dBm and so on.

#### Typical Enhancement with Broadband HP Amplifiers

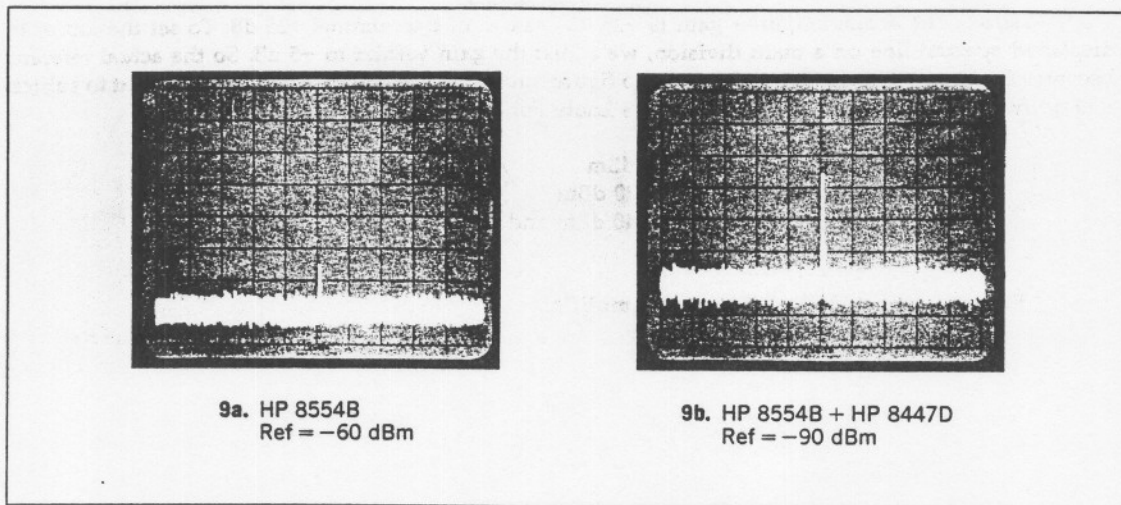
The choice of the preamplifier depends upon the frequency range of the analyzer. The following table (2) gives the main features of some preamplifiers and the enhancement of HP analyzers in terms of total noise figure and noise power with the minimum possible bandwidth.

	HP 8553B -140 dBm (10 Hz) F = 24 dB	HP 8554B -122 dBm (100 Hz) F = 32 dB	HP 8558B -117 dBm (1 KHz) F = 27 dB
1 × HP 8447A 0.1 - 400 MHz G = 20 dB; F = 5 dB	-156.5 dBm F <sub>t</sub> = 7.50 dB	≈ -141 dBm F <sub>t</sub> = 12.78 dB	≈ -135 dBm F <sub>t</sub> = 9.20 dB
2 × HP 8447A	-159 dBm F <sub>t</sub> = 5 dB	≈ -148.5 dBm F <sub>t</sub> = 5.24 dB	≈ -139 dBm F <sub>t</sub> = 5.14 dB
1 × HP 8447D 100 KHz - 1.3 GHz G = 26 dB; F = 8.5 dB		-143.5 dBm F <sub>t</sub> = 10.5 dB	≈ -135.5 dBm F <sub>t</sub> = 9.1 dB
2 × HP 8447D		-145.5 dBm F <sub>t</sub> = 8.5 dB	≈ -136 dBm F <sub>t</sub> = 8.5 dB

**Table 2.** Sensitivity and noise figure of some HP Spectrum Analyzers connected to one or two HP 8447 serial preamplifiers.

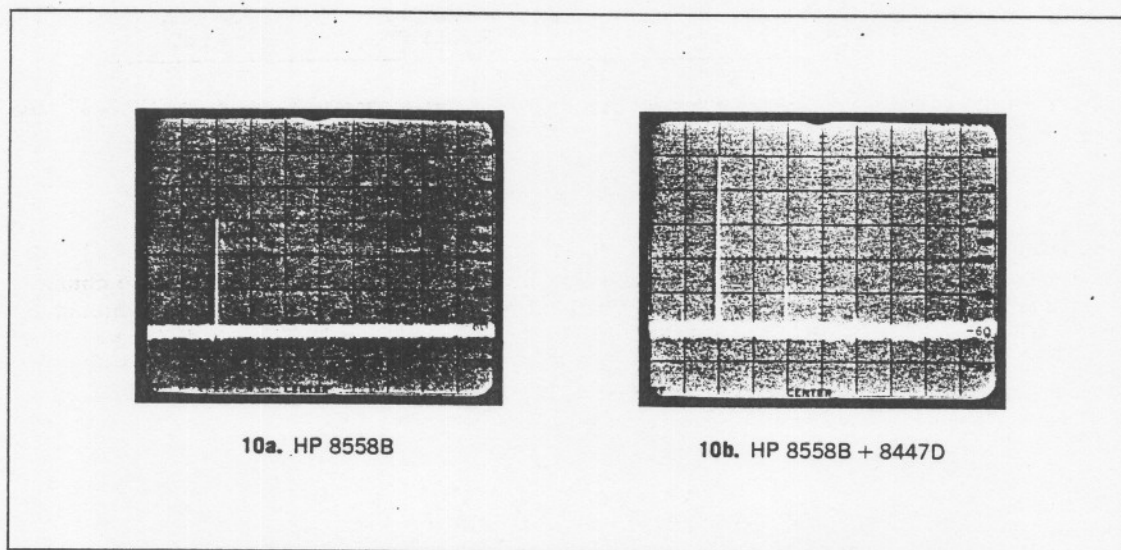
#### Applications

Whenever you need more sensitivity, the use of a broadband amplifier is an easy way to obtain it. A small signal is directly analyzed by the HP 8554B (0.1 to 1250 MHz) in Figure 9a or fed in through the HP 8447D Preamplifier (26 dB, 0.1 to 1300 MHz) before analysis in Figure 9b. Since 26 dB is an awkward gain level, it's convenient to choose the log reference level as -64 dBm (-60 dBm; -4 dBm vernier). Since the amplifier has a gain of +26 dB the actual reference is  $-64 \text{ dBm} - 26 \text{ dBm} = -90 \text{ dBm}$ . The noise level in Figure 9a is -124 dBm and in Figure 9b is -144 dBm; thus the amplifier improved the sensitivity by 20 dB.



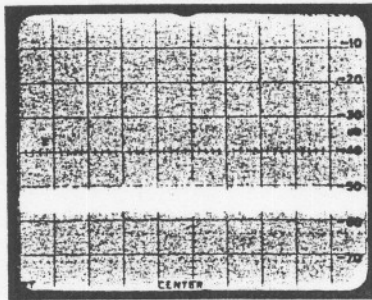
**Figure 9.** Enhancement of the sensitivity of the HP 8554B Spectrum Analyzer (0.1 to 1250 MHz) with the HP 8447D Preamplifier (Gain = 26 dB; 0.1 to 1300 MHz). The same power signal is displayed in both photos. The sensitivity is improved by 20 dB in Figure 9b.

In broadband analysis, using an amplifier can improve the dynamic range. Such a case occurs when you want to measure the harmonics of a weak signal or small nonharmonic signals. For example, in Figures 10a and 10b an RF signal (200 MHz; -60 dBm) is analyzed with the HP 8558B. Only the use of the HP 8447D Preamplifier allows the measurement of second and third harmonics.

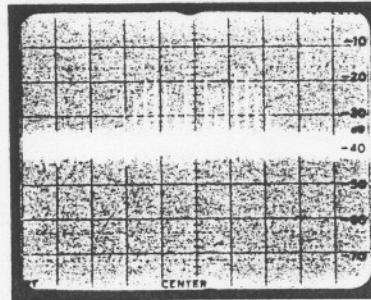


**Figure 10.** Measurement of Harmonics of a Weak Signal

Whenever you want high sensitivity but without using a narrow resolution bandwidth, use of a broadband amplifier can be helpful. Figures 11a and 11b show the analysis of a 90 MHz signal modulated in frequency;  $\Delta F$  peak = 75 KHz and  $f$  modulation = 13.59 KHz. In Figure 11b we get enough sensitivity to use the Bessel null technique, that is  $\Delta F$  can be adjusted for the 2nd carrier zero. In this case,  $m = 5.52$  and since  $\Delta F = m \times f_{\text{mod}}$ , we get  $\Delta F = 5.52 \times 13.59 \text{ KHz} = 75 \text{ KHz}$ .



11a. HP 8558B



11b. HP 8558B + 8447D

Figure 11. Measurement of a Frequency Modulated Signal. Carrier frequency = 90 MHz.  $\Delta f$  peak = 75 kHz.  $f$  modulation = 13.59 kHz. In Figure 11b we can adjust  $\Delta f$  with accuracy (second carrier null).

## CHAPTER 3

### Signal Enhancement in AM Measurements

The spectrum analyzer is a very powerful tool for measuring the sidebands of an amplitude modulated signal. However, in some cases, it may not have enough resolution, dynamic range or sensitivity to measure:

- the intermodulation products resulting from two closely spaced tones
- the ripple from the power line
- the modulation of weak signals in radio navigation application (localizer and glide slope)

In this chapter we will explain a method which improves the spectrum analyzer's capability of analyzing such amplitude modulated signals.

#### Set up

Let us consider the set up in Figure 12. We connect a low frequency spectrum analyzer at the video output of a high frequency spectrum analyzer.

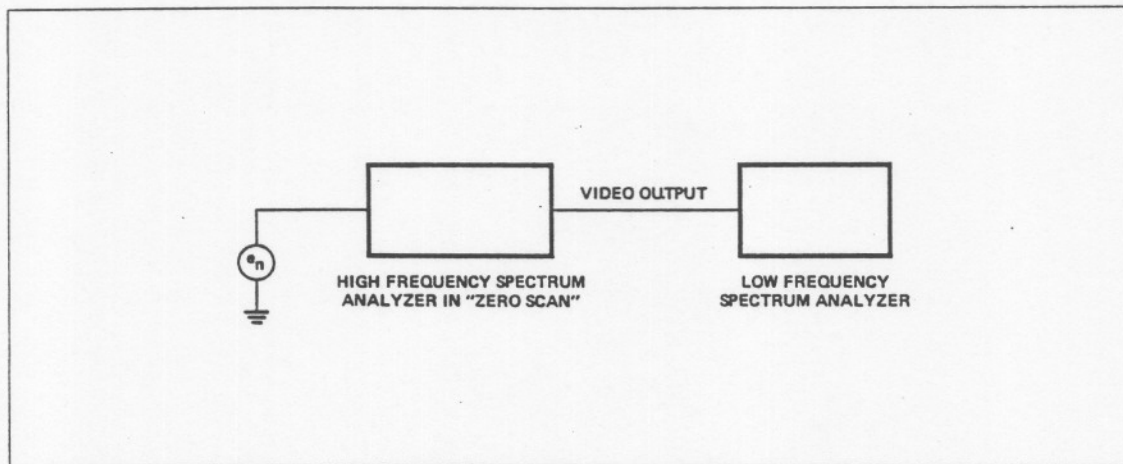


Figure 12.

The first spectrum analyzer is in "zero scan" which means it works as a fixed tuned receiver and simply acts as a down converter; if we apply an amplitude modulated signal at its input, the demodulated signal appears at the video output. This low frequency signal can then be analyzed with more resolution by the low frequency spectrum analyzer. Figures 13a and 13b show time and frequency domain pictures of a signal as it goes through the system.



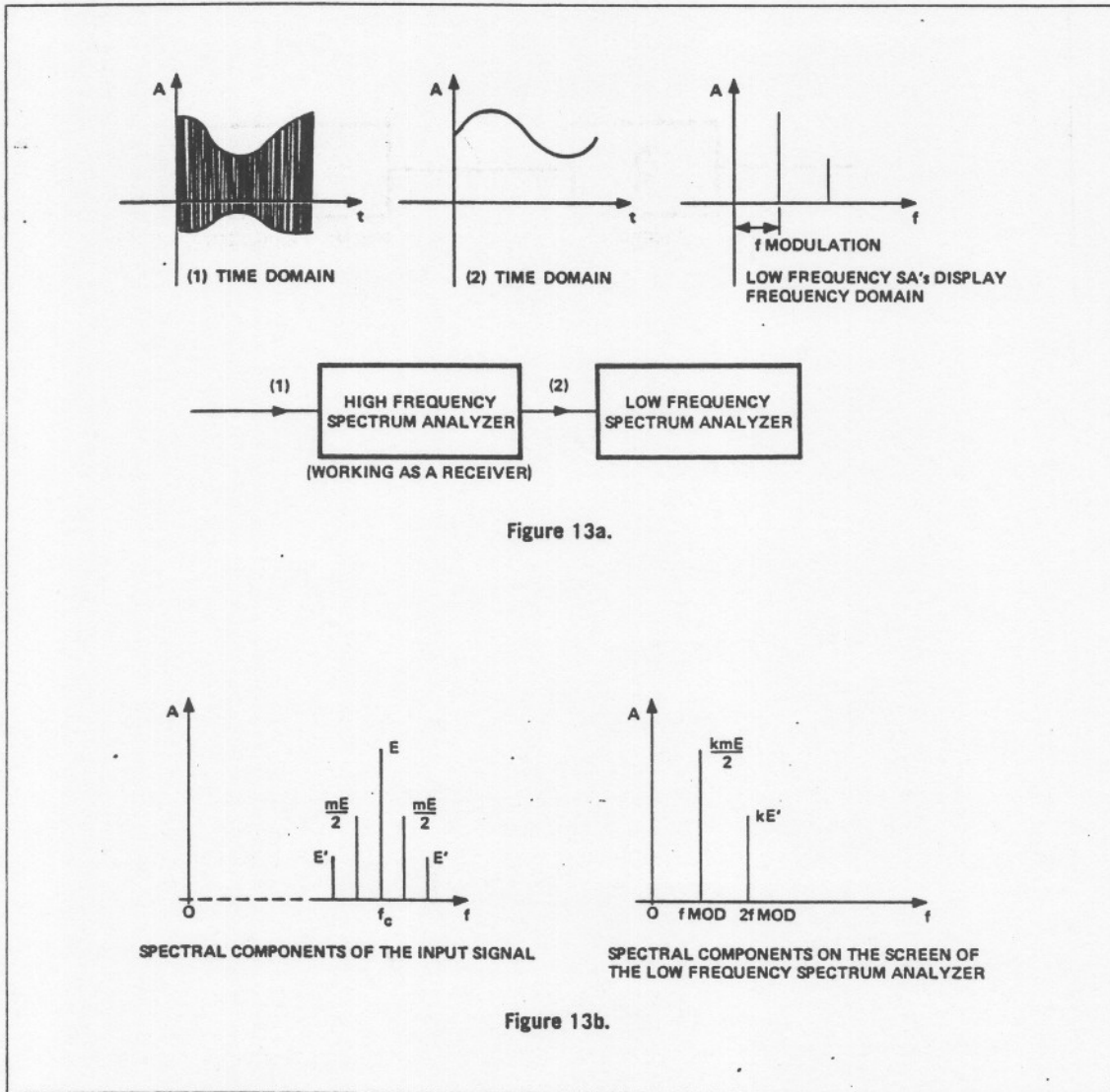


Figure 13a.

Figure 13b.

Figure 13a shows the processing of the input signal, an amplitude modulated signal described in time domain (picture 1) is fed into a receiver which is a high frequency spectrum analyzer in "0 scan." The demodulated signal (picture 2) is analyzed by a low frequency spectrum analyzer which yields its spectral components.

Figure 13b shows the spectral components of the input signal and those displayed on the low frequency spectrum analyzer's screen. The frequency of the first spectral line is the modulation frequency, and its amplitude is proportional to the percentage of modulation. The other components characterize the distortion of the demodulated signal.

#### Sensitivity

As Figure 13b shows, the low frequency spectrum analyzer displays the spectrum of the *modulating* signal, and we can only consider the sensitivity for this modulating signal. The theoretical formula of the gain is described in the following section.

#### THEORETICAL GAIN

The whole system is made of a receiver (high frequency spectrum analyzer) and a low frequency spectrum analyzer Figure 14.

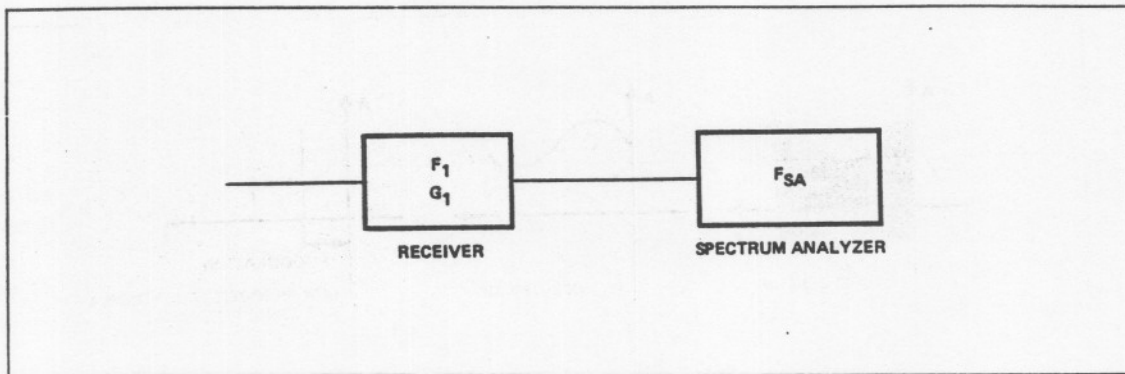


Figure 14.

The receiver has a constant noise figure  $F_1$  and a gain  $G_1$  for the demodulated signal. The spectrum analyzer has a noise figure  $F_{SA}$ . We know the total noise power at the input of the system is:

$$N = kTB F_t, \text{ with } F_t = F_1 + \frac{F_{SA} - 1}{G_1}$$

so the general formula becomes

$$N = kTB \left( F_1 + \frac{F_{SA} - 1}{G_1} \right) \quad (8)$$

The lower the noise, the greater the sensitivity will be. Therefore, we have to get the lowest bandwidth, the lowest  $F_1$  and make  $\frac{F_{SA} - 1}{G_1}$  negligible relative to  $F_1$ .

Getting the lowest bandwidth is very simple since we use a low frequency spectrum analyzer which is one of the main features of this kind of instrument. For example, with the HP 3580A we can select a 1 Hz resolution bandwidth.  $F_1$  characterizes the sensitivity of the receiver. To reduce the influence of the term  $\frac{F_{SA} - 1}{G_1}$  we obviously have to choose a low frequency spectrum analyzer with a high sensitivity ( $F_{SA}$  as low as possible) and to set the gain of the IF of the receiver as high as possible but without distorting the signal.

#### COMMENT

An easy method to further improve the sensitivity is to connect a broadband amplifier with a low noise figure to the input of the receiver as shown in Figure 15.

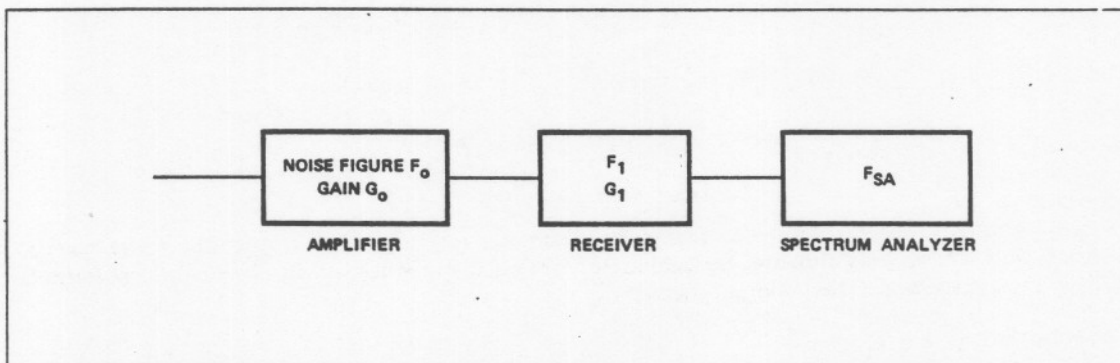


Figure 15.

The total noise figure is

$$F_T = F_0 + \frac{F_1 - 1}{G_1} + \frac{F_{SA} - 1}{G_1 G_0}$$

and the noise power is

$$N = kTB \left( F_0 + \frac{F_1 - 1}{G_0} + \frac{F_{SA} - 1}{G_1 G_0} \right) \quad (9)$$

#### ACTUAL GAIN

In practice, the gain of the receiver,  $G_1$  is not known. However,  $G_1$  is large enough so that equation (8) becomes

$$N = kTB F_1 \quad (10)$$

which is the expression for the noise of the first spectrum analyzer, but with the bandwidth of the low frequency spectrum analyzer. For the same reason, equation (9) becomes:

$$N = kTB \left( F_0 + \frac{F_1 - 1}{G_0} \right) \quad (11)$$

which is the noise of the amplifier and high frequency spectrum analyzer put together but with the bandwidth of the low frequency spectrum analyzer.

#### Calibration and Measurements

What is the information given by the first spectral line on the screen of the spectrum analyzer shown in Figure 13b?

- 1) its frequency is the frequency of modulation
- 2) its amplitude allows us to know the percentage of modulation

We know (Application Note 150-1) that

$$(E_{SB})_{dB} - (E_C)_{dB} + 6 \text{ dB} = 20 \log m \quad (12), \text{ where}$$

$E_{SB}$  = amplitude of the side band

$E_C$  = amplitude of the carrier

$m$  = percentage of modulation

When the spectrum analyzer is calibrated in dBV (0 dBV = 1 V), the voltage of the spectral line is proportional to  $E_{SB}$  or, as in equation (12), to  $m$ , whenever  $E_C$  is constant. The other lines we could see at  $2f$ ,  $3f$ , etc., characterize the distortion of the demodulated signal.

#### CALIBRATION

The conversion from dBV to percentage of modulation will be possible in a semilog graph in which a straight conversion line will be drawn for each given carrier power as we will see later.

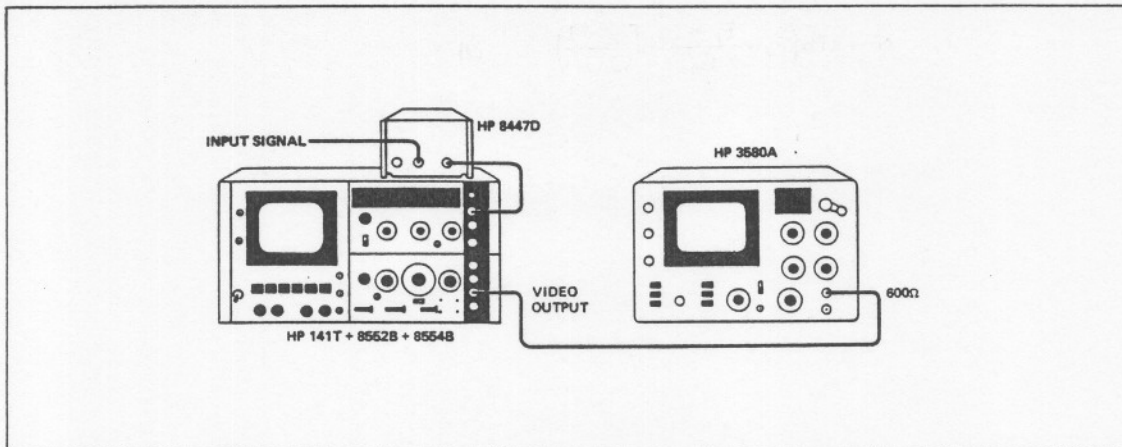
#### MEASUREMENT PROCEDURE

- 1) Measure the carrier power with the high frequency spectrum analyzer.
- 2) Switch the high frequency spectrum analyzer to zero scan.
- 3) Measure with the low frequency spectrum analyzer the amplitude in dBV of the demodulated signal and use the graph to determine the percentage of modulation.

#### CALIBRATION AND MEASUREMENT PROCEDURE

Let's consider the set up in Figure 16 to show how enhancement is applied. To calibrate the set up we

use a signal generator with internal or external capability of amplitude modulation. We have to draw the graph of conversion from dBV to percentage of modulation for different carrier powers. If you don't have a generator with calibrated amplitude modulation, use the high frequency spectrum analyzer to set it. With a carrier at  $-30$  dBm, the high dynamic range of the spectrum analyzer allows an accurate adjustment, even for a low percentage of modulation. Then, adjust the attenuator on the signal generator for the desired power output.



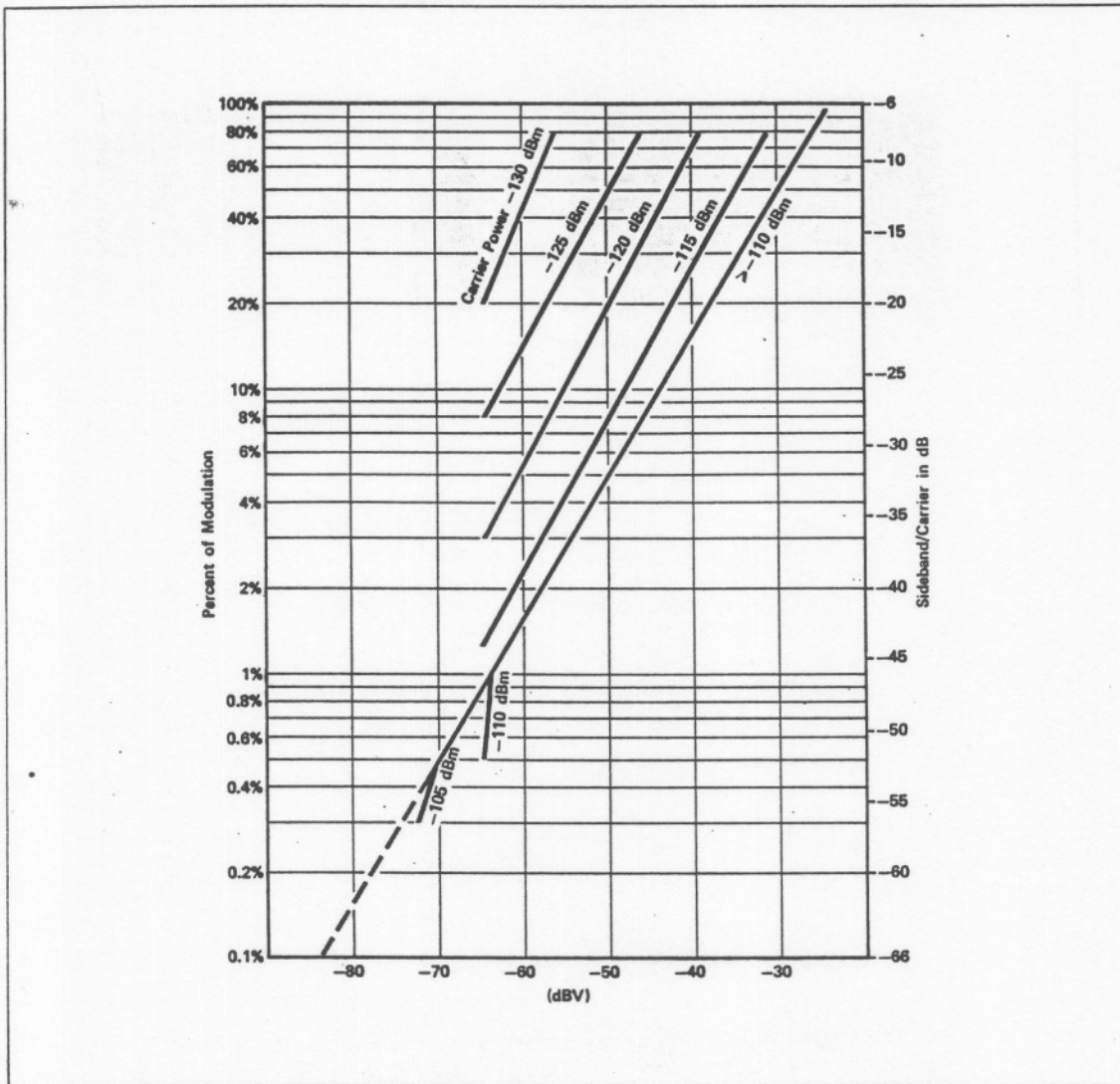
**Figure 16.** Set up for amplitude modulation measurements. HP 8447D Preamplifier, gain 26 dB, frequency range 100 kHz to 1.3 GHz; noise figure of 8.5 dB. HP Spectrum Analyzer 141T, 8552B, 8554B (100 kHz to 1250 MHz) HP Low Frequency Spectrum Analyzer 3580A (5 Hz to 50 kHz, Resolution: 1 Hz).

The following operations will be used for both calibration and measurement:

- 1) First of all, center the signal on the display of the high frequency spectrum analyzer while in the per-division scan mode. Proper choice of the bandwidth and scan width controls will enable display of weak signals. Record the carrier power.
- 2) Change bandwidth setting to 1 KHz, scan time to 1 ms/div and switch to zero scan. Peak trace on display with fine tune control. Then increase bandwidth to 300 KHz.
- 3) Set receiver in linear display mode and adjust linear sensitivity (log reference) controls to maximize the amplitude of the displayed waveform within display limits. Retain this setting throughout calibration and measurement; the receiver is now properly tuned.
- 4) The video output of the receiver is connected to the low frequency spectrum analyzer thru a low impedance (e.g. 600 $\Omega$ ) shunt at the input. Use the dBv (10 dB/div) display mode and select bandwidths which give a sufficient signal-to-noise ratio.
- 5) For each carrier power and modulation setting record the level of the modulation frequency component displayed on the low frequency spectrum analyzer.

#### CALIBRATION :

By following the calibration procedure, a set of lines like those shown in Figure 17 can be plotted. These then can be used in future measurements using the same instrument system.



**Figure 17.** Percentage of modulation versus dBV for one system based on the instruments listed in Figure 16. The curves of conversion of dBV to percentage of modulation must be drawn for each system. The conversion depends on the carrier power. For example, for a signal at  $-125$  dBm, a spectral line at  $-63$  dBV on the display of the low frequency Spectrum Analyzer corresponds to 10% of modulation or the side bands are at  $-26$  dB relative to the carrier or at  $-125$  dBm  $-26$  dB =  $-151$  dBm.

It's best to plot at least three points for each carrier power so the best straight conversion line may be drawn. We can see that the conversion is identical for any carrier  $\geq -110$  dBm because the gain of the IF section is sufficient to achieve the same demodulated output. For a carrier  $< -110$  dBm, the slope of conversion is slightly different. The gain of the IF section is maximum (Ref:  $-70$  dBm) and for the same percentage of modulation as we decrease the power of the carrier, we decrease the amplitude of the demodulated signal. In Figures 18a and 18b, the same 1 KHz demodulated signal is displayed on the screen of the HP 3580A. For the same percentage of modulation (50%) the amplitude of the line is different. In Figure 18a the line is at  $-30$  dBV while in Figure 18b, it is at  $-40$  dBV.

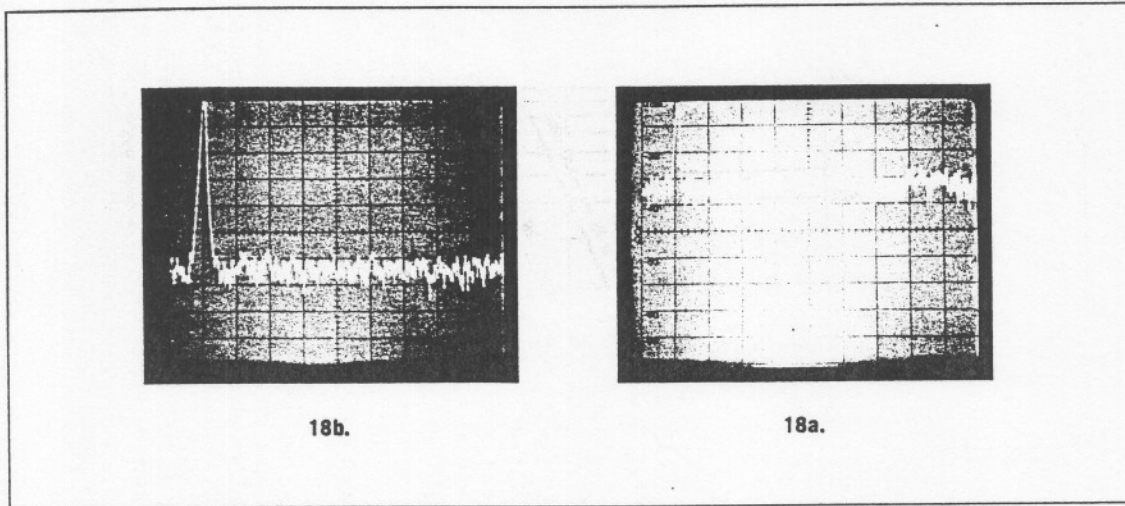


Figure 18. The spectral component amplitude of the demodulated signal may depend on the carrier power. For the same percentage of modulation, the spectral line is at -30 dB in Figure 18a and -40 dB in Figure 18b.

#### MEASUREMENTS

Follow the procedure as we have described to measure the carrier power and the amplitude in dBV of the demodulated signal. Then use the calibration curves to determine the percentage of modulation. For example, if the carrier power is -125 dBm, a line of -63 dBV on the HP 3580's screen corresponds to 10% modulation.

#### Sensitivity

We can use the equation (11) to determine the sensitivity for the side band

$$N = kTB \left( F_0 + \frac{F_1 - 1}{G_0} \right), \text{ with } B = 3 \text{ Hz}$$

$$(F_0)_{\text{dB}} \text{ noise figure of the amplifier} = 8.5 \text{ dB} = 7.05 \text{ in linear}$$

$$(F_1)_{\text{dB}} \text{ noise figure of the spectrum analyzer} = 32 \text{ dB} = 1585 \text{ in linear}$$

$$(G_0)_{\text{dB}} \text{ gain of the amplifier} = 26 \text{ dB} = 398 \text{ in linear}$$

$$F_0 + \frac{F_1 - 1}{G_0} = 7.05 + \frac{1585}{398} = 11.02 \text{ or } 10.4 \text{ dB,}$$

$$\text{and since } 10 \log 3 = 4.77 \text{ dB}$$

$$\text{We get } N = -174 \text{ dBm} + 4.77 \text{ dB} + 10.4 \text{ dB} = -159 \text{ dBm}$$

If we look at the graph, the lowest percentage of modulation for a carrier at -110 dBm is 0.6% or the side bands are at -110 dBm - 50 dB = -160 dBm. But for a -120 dBm carrier we can only measure 3% modulation or the side bands are at -120 dBm - 36 dB = -156 dBm. For carrier power < -110 dBm, equation (11) is no longer useful. The desensitization for a low power carrier is due to the additional noise at the video output and therefore equation (11) does not hold. Table 3 gives sensitivity for the side bands with pre-amplification and a high resolution spectrum analyzer.

	HP 8447D Preamp HP 8554B	HP 8447D Preamp HP 8554B HP 3580A	Improvement (dB)
Carrier power = -120 dBm	-143 dBm	-156 dBm	+13 dB
Carrier power ≥ -110 dBm	-143 dBm	-160 dBm	+17 dB

Table 3. Sensitivity for the side bands (amplitude modulation)

#### COMMENT

Without the preamplifier we will obtain in first approximation the same curve Figure 17 but with a shift to account for the different carrier power to be measured at the receiver:

At -130 dBm we will substitute  $-130 \text{ dBm} + 26 \text{ dB} = -104 \text{ dBm}$   
 $\geq -110 \text{ dBm}$  becomes  $\geq -84 \text{ dBm}$ .

#### Applications

The main features are

- high sensitivity for the side bands
- high resolution—bandwidth as low as 1 Hz (HP 3580A)
- frequency range is the low spectrum analyzer's frequency range

#### INTERMODULATION PRODUCTS

To check and to measure the intermodulation products of a transmitter, two tones which are very close to each other are used. The transmitter operates at a sufficient level (-30 dBm) to get the maximum dynamic range for the demodulated signals (typically 70 dB).

#### MEASUREMENT OF AMPLITUDE MODULATION NOISE

Whenever you want to measure the ripple of the power lines in HF equipment this technique can be used. Figure 19 shows the 60 Hz ripple of a transmitter at 200 MHz. The noisy side band is at -57 dB from the carrier.

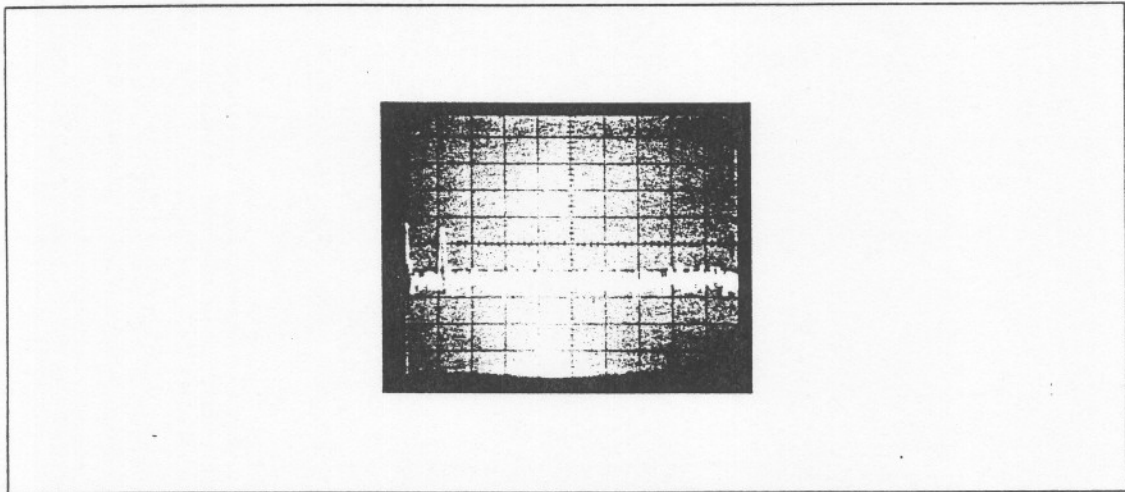


Figure 19. 60 Hz ripple of a transmitter measured at -57 dB from the carrier.

#### RADIO/NAVIGATION

To facilitate landing of aircraft at airports in bad weather, the Instrument Landing System is used. The localizer (108 MHz to 112 MHz) and the glide slope (329.3 to 335 MHz) both use amplitude modulation

at 90 Hz and 150 Hz. Figure 20 displays the two modulating signals at 40% modulation with a signal generator at -130 dBm. The HP 8558B used with the HP 3580A will handle both glide and localizer signals.

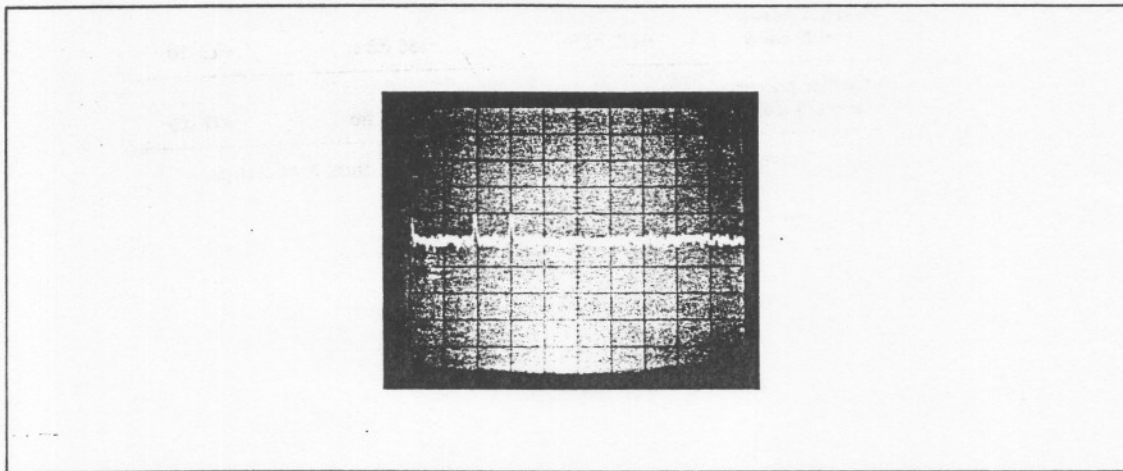


Figure 20. 90 Hz and 150 Hz demodulated signals of a localizer signal at -130 dBm. 40% amplitude modulation.

## APPENDIX

### Amplitude Modulation

Modulation	SB/Carrier
100%	-6 dB
90%	-6.9 dB
80%	-7.9 dB
70%	-9 dB
60%	-10.4 dB
50%	-12 dB
40%	-14 dB
30%	-16.5 dB
20%	-20 dB
10%	-26 dB
9%	-26.9 dB
8%	-27.9 dB
7%	-29 dB
6%	-30.4 dB
5%	-32 dB
4%	-34 dB
3%	-36.5 dB
2%	-40 dB
1%	-46 dB
0.8%	-48 dB
0.5%	-52 dB
0.3%	-56.5 dB
0.2%	-60 dB
0.1%	-66 dB