

HEATHKIT[®] MANUAL

for the

FET/TRANSISTOR TESTER

Model IT-3120

595-1989-04



HEATH COMPANY • BENTON HARBOR, MICHIGAN

HEATH COMPANY PHONE DIRECTORY

The following telephone numbers are direct lines to the departments listed:

Kit orders and delivery information (616) 982-3411
Credit (616) 982-3561
Replacement Parts (616) 982-3571

Technical Assistance Phone Numbers

8:00 A.M. to 12 P.M. and 1:00 P.M. to 4:30 P.M., EST, Weekdays Only
R/C, Audio, and Electronic Organs (616) 982-3310
Amateur Radio (616) 982-3296
Test Equipment, Weather Instruments and
Home Clocks (616) 982-3315
Television (616) 982-3307
Aircraft, Marine, Security, Scanners, Automotive,
Appliances and General Products (616) 982-3496
Computers — Hardware (616) 982-3309
Computers — Software:
Operating Systems, Languages, Utilities (616) 982-3860
Application Programs (616) 982-3884
Heath Craft Wood Works (616) 982-3423



YOUR HEATHKIT 90-DAY LIMITED WARRANTY

Consumer Protection Plan for Heathkit Consumer Products

Welcome to the Heath family. We believe you will enjoy assembling your kit and will be pleased with its performance. Please read this Consumer Protection Plan carefully. It is a "LIMITED WARRANTY" as defined in the U.S. Consumer Product Warranty and Federal Trade Commission Improvement Act. This warranty gives you specific legal rights, and you may also have other rights which vary from state to state.

Heath's Responsibility

PARTS — Replacements for factory defective parts will be supplied free for 90 days from date of purchase. Replacement parts are warranted for the remaining portion of the original warranty period. You can obtain warranty parts direct from Heath Company by writing or telephoning us at (616) 982-3571. And we will pay shipping charges to get those parts to you . . . anywhere in the world.

SERVICE LABOR — For a period of 90 days from the date of purchase, any malfunction caused by defective parts or error in design will be corrected at no charge to you. You must deliver the unit at your expense to the Heath factory, any Heathkit Electronic Center (units of Veritechnology Electronics Corporation), or any of our authorized overseas distributors.

TECHNICAL CONSULTATION — You will receive free consultation on any problem you might encounter in the assembly or use of your Heathkit product. Just drop us a line or give us a call. Sorry, we cannot accept collect calls.

NOT COVERED — The correction of assembly errors, adjustments, calibration, and damage due to misuse, abuse, or negligence are not covered by the warranty. Use of corrosive solder and/or the unauthorized modification of the product or of any furnished component will void this warranty in its entirety. This warranty does not include reimbursement for inconvenience, loss of use, customer assembly, set-up time, or unauthorized service.

This warranty covers only Heath products and is not extended to other equipment or components that a customer uses in conjunction with our products.

SUCH REPAIR AND REPLACEMENT SHALL BE THE SOLE REMEDY OF THE CUSTOMER AND THERE SHALL BE NO LIABILITY ON THE PART OF HEATH FOR ANY SPECIAL, INDIRECT, INCIDENTAL OR CONSEQUENTIAL DAMAGES, INCLUDING BUT NOT LIMITED TO ANY LOSS OF BUSINESS OR PROFITS, WHETHER OR NOT FORSEEABLE.

Some states do not allow the exclusion or limitation of incidental or consequential damages, so the above limitation or exclusion may not apply to you.

Owner's Responsibility

EFFECTIVE WARRANTY DATE — Warranty begins on the date of first consumer purchase. You must supply a copy of your proof of purchase when you request warranty service or parts.

ASSEMBLY — Before seeking warranty service, you should complete the assembly by carefully following the manual instructions. Heathkit service agencies cannot complete assembly and adjustments that are customer's responsibility.

ACCESSORY EQUIPMENT — Performance malfunctions involving other non-Heath accessory equipment, (antennas, audio components, computer peripherals and software, etc.) are not covered by this warranty and are the owner's responsibility.

SHIPPING UNITS — Follow the packing instructions published in the assembly manuals. Damage due to inadequate packing cannot be repaired under warranty.

If you are not satisfied with our service (warranty or otherwise) or our products, write directly to our Director of Customer Service, Heath Company, Benton Harbor MI 49022. He will make certain your problems receive immediate, personal attention.

Heathkit® Manual

for the

FET/TRANSISTOR TESTER

Model IT-3120

595-1989-04

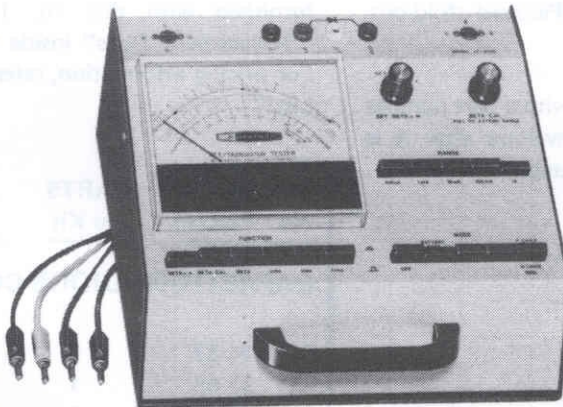

TABLE OF CONTENTS

Introduction	2	Operation	20
Parts List	2	In Case of Difficulty	29
Assembly Notes	4	Troubleshooting	30
Step-by-Step Assembly	5	Specifications	31
Subpanel Assembly and Wiring	8	Circuit Description	32
Front Panel Assembly and Wiring	13	Chassis Photograph	38
Subpanel Installation	15	Circuit Board X-Ray Views	39
Final Wiring	17	Schematic. . .(Fold-out from page)	41
Test and Adjustment	19	Warranty	Inside Front Cover
Final Assembly	20	Customer Service	Inside Rear Cover

HEATH COMPANY
BENTON HARBOR, MICHIGAN 49022

Copyright © 1976
Heath Company
All Rights Reserved
Printed in the United States of America

INTRODUCTION

The Heathkit Model IT-3120 FET/Transistor Tester is a quality instrument for quick, accurate tests of conventional (bipolar) transistors, diodes, FET's, SCR's, triacs, and unijunction transistors. Gain (DC Beta), transconductance (Gm), and leakage values are read directly on the large easy-to-read meter.

You can quickly and easily test devices either in-circuit or out-of-circuit. The Tester provides special circuitry to balance out in-circuit impedances. Use either the color coded leads for in-circuit tests or the built-in transistor and FET sockets for out-of-circuit tests.

Five current ranges permit leakage measurements as low as 1 microampere and collector currents as high as 1 ampere.

Pushbutton type range, mode, and function switches assure easy, consistent operation.

A special battery testing circuit provides a meter indication of the condition of the self-contained power supply. Another convenience of this portable instrument is the two-color front panel design, black lettering for conventional (bipolar) transistors and red lettering for FET's. Also, separate, brief operating instructions are printed on the rear panel.

Refer to the "Kit Builders Guide" for information on tools, wiring, soldering, resistors, and capacitors.

PARTS LIST

Check each part against the following list. The key numbers correspond to the numbers on the Parts Pictorial (fold-out from Page 5).

Any part that is packaged in an envelope with a part number on it should be placed back in its envelope after it is identified until that part is called for in a step.

To order a replacement part, use the Parts Order Form furnished with this kit. If one is not available, see "Replacement Parts" inside the rear cover of the Manual. For pricing information, refer to separate "Heath Parts Price List."

KEY HEATH No.	Part No.	PARTS Per Kit	DESCRIPTION
RESISTORS			
1/2-Watt			
A1	1-129	3	4.7 Ω , 10% (yellow-violet-gold)
A1	1-105	1	10 k Ω , 5% (brown-black-orange)
A1	6-1509	1	15 Ω , 1% (brown green-black-gold)
1/4-Watt, 1% Precision			
A2	6-1660-12	2	166 Ω (brown-blue-blue-black)
A2	6-3600-12	1	360 Ω (orange-blue black-black)
A2	6-1501-12	1	1500 Ω (brown-green-black-brown)
Other			
A3	2-11-2	1	1.5 Ω , <u>2-watt</u> , precision
A4	3-13-3	1	.15 Ω , <u>3-watt</u> ,

KEY HEATH No.	Part No.	PARTS Per Kit	DESCRIPTION
------------------	----------	------------------	-------------

CAPACITORS-DIODE-CONTROLS

B1	21-57	2	.005 μ F disc capacitor
B2	57-65	1	1N4002 silicon diode
B3	10-934	1	750 Ω control
B4	10-926	1	15 k Ω control
B5	14-11	1	250 k Ω /5000 Ω (5 k) control

HARDWARE

#2 Hardware

C1	250-175	10	2-56 x 3/8" screw
C2	252-51	10	2-56 nut
C3	254-7	10	#2 lockwasher

#4 Hardware

C4	250-52	8	4-40 x 1/4" screw
C5	252-2	8	4-40 nut
C6	254-9	8	#4 lockwasher

KEY HEATH No.	PARTS Part No.	PER KIT	DESCRIPTION
------------------	-------------------	---------	-------------

#6 Hardware

C7	250-155	6	#6 × 3/8" sheet metal screw
C8	255-49	3	#6 spacer

#10 Hardware

C9	250-83	2	#10 × 1/2" hex head self-tapping screw
----	--------	---	--

Control Hardware

C10	252-7	2	Control nut
C11	253-10	2	Control flat washer
C12	254-4	2	Control lockwasher

SOCKETS — JACKS — PLUGS

D1	434-342	2	Transistor socket
D2	434-343	9	Socket pin
D3	436-11	1	Red banana jack
D3	436-22	1	Black banana jack
D3	436-24	1	White banana jack
D3	436-29	1	Green banana jack
D4	438-47	4	Banana plug
D5	260-53	4	Alligator clip

FEET-KNOBS-INSULATORS

E1	261-49	8	Rubber foot
E2	462-362	2	Knob
E3	70-10	1	Black banana plug insulator
E3	70-11	1	Red banana plug insulator
E3	70-12	1	Green banana plug insulator
E3	70-13	1	White banana plug insulator
E4	73-34	4	Rubber insulator

WIRE

341-1	1	Black <u>stranded</u>
341-2	1	Red <u>stranded</u>
341-5	1	White <u>stranded</u>
341-6	1	Green <u>stranded</u>
344-50	1	Black
344-51	1	Brown
344-52	1	Red
344-54	1	Yellow
344-55	1	Green
344-59	1	White

KEY HEATH No.	PARTS Part No.	PER KIT	DESCRIPTION
------------------	-------------------	---------	-------------

Wire (cont'd.)

344-70	1	White-black
344-71	1	White-brown
344-72	1	White-red
344-73	1	White-orange
344-74	1	White-yellow
344-75	1	White-green
344-77	1	White-violet
344-78	1	White-gray

MISCELLANEOUS

	85-1167-1	1	Circuit board
F1	203-1412-2	1	Front panel
F2	90-561-3	1	Cabinet shell
F3	204-1837	1	Subpanel
F4	207-82	5	Clamp
F5	211-15	1	Handle
F6	214-76	2	Battery holder
F7	407-173	1	Meter
F8	455-50	2	Knob bushing
F9	64-97	1	Mode switch
F10	64-98	1	Range switch
F11	64-99	1	Function switch
F12	490-5	1	Nut starter
	597-260	1	Parts Order Form
	597-308	1	Kit Builders Guide
	391-34	1	Blue and white label
		1	Manual (See front cover for part number.)
			Solder

The following batteries should be purchased at this time for use in the completed Kit:

2 D-cell flashlight batteries (alkaline type preferred for longer life).

ASSEMBLY NOTES

1. Before starting to assemble this kit, be sure you have read the wiring and soldering information in the "Kit Builders Guide."
2. Resistors will be called out by their respective value in Ω , or $k\Omega$, and color code. Use 1/2-watt resistors unless directed otherwise.
3. Capacitors will be called out by their capacitance value (in μF) and type (disc).

SAFETY WARNING: Avoid eye injury when you clip off excess leads. We suggest that you wear glasses, or at least clip the leads so the ends will not fly toward your eyes.



STEP-BY-STEP ASSEMBLY

CONTINUE

START

Position the circuit board as shown. Then complete each step on the Pictorial.

NOTE: When wiring this kit, you will be instructed to prepare lengths of wire ahead of time, as in the next step. To prepare a wire, cut it to the indicated length and remove 1/4" of insulation from each end. The wires are listed in the order in which they will be used. Do not use stranded wire until you are specifically instructed to do so in a step.

() Prepare the following lengths of white wire:

- | | |
|--------|--------|
| 2-1/4" | 5-1/2" |
| 1" | 4" |
| 5" | 3-1/4" |

As you install each wire in the following steps, turn the circuit board over, solder the wire to the foil, and cut off the excess lead lengths.

(✓) 2-1/4" white wire.

() 1" white wire.

(✓) 5" white wire.

(✓) 5-1/2" white wire.

() 4" white wire.

() 3-1/4" white wire.

FOR GOOD SOLDER CONNECTIONS, YOU MUST KEEP THE SOLDERING IRON TIP CLEAN... WIPE IT OFTEN WITH A DAMP SPONGE OR CLOTH.

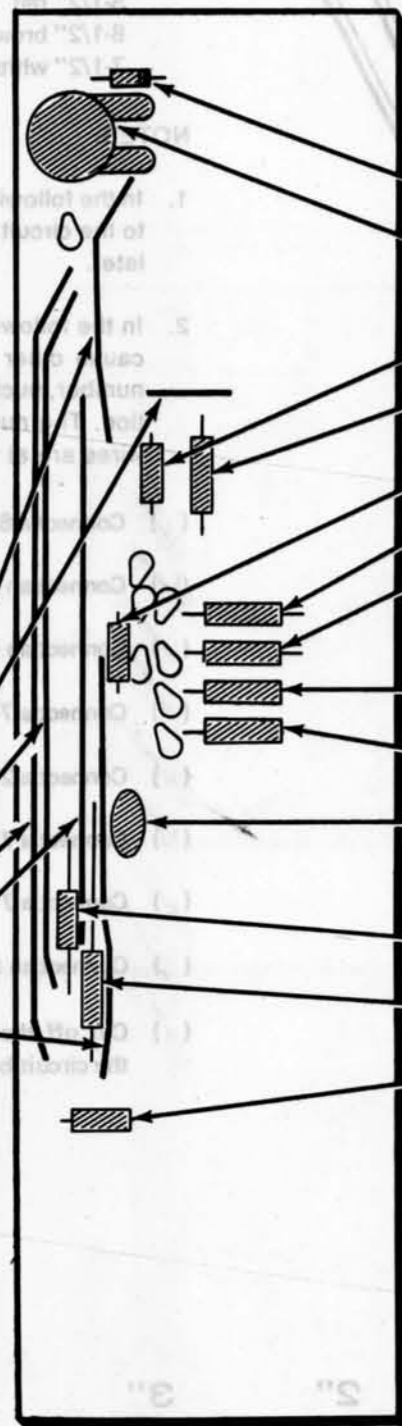

PICTORIAL 1

NOTE: DIODES MAY BE SUPPLIED IN ANY OF THE FOLLOWING SHAPES. ALWAYS POSITION THE BANDED END AS SHOWN ON THE CIRCUIT BOARD.



BANDED END

- () 1N4002 silicon diode (#57-65).
- () 750 Ω control.
- () 10 kΩ (brown-black-orange).
- (✓) 360 Ω, 1% precision (orange-blue-black-black).
- () 4.7 Ω (yellow-violet-gold).
- () .15 Ω, 3-watt precision.
- () 1.5 Ω, 2-watt precision.
- () Solder the leads to the foil and cut off the excess lead lengths.
- () 15 Ω, 1% precision (brown-green-black-gold).
- () 166 Ω, 1% precision (brown-blue-blue-black).
- () .005 μF disc.
- NOTE: Position the next two resistors over the outlines on the circuit board.
- (✓) 4.7 Ω (yellow-violet-gold).
- () 1500 Ω, 1% precision (brown-green-black-brown).
- (✓) 4.7 Ω (yellow-violet-gold).
- () Solder the leads to the foil and cut off the excess lead lengths.

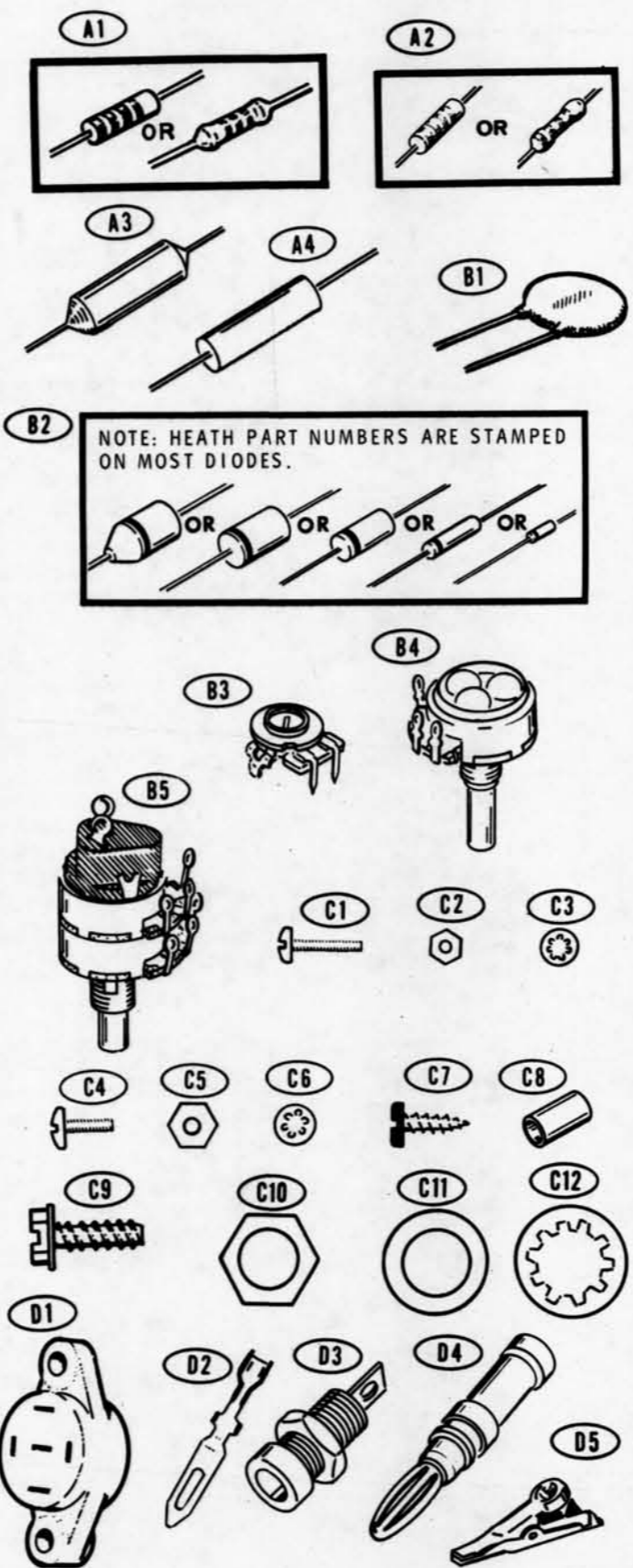

NOTE: HEATH PART NUMBERS ARE STAMPED ON MOST DIODES.

PARTS PICTORIAL

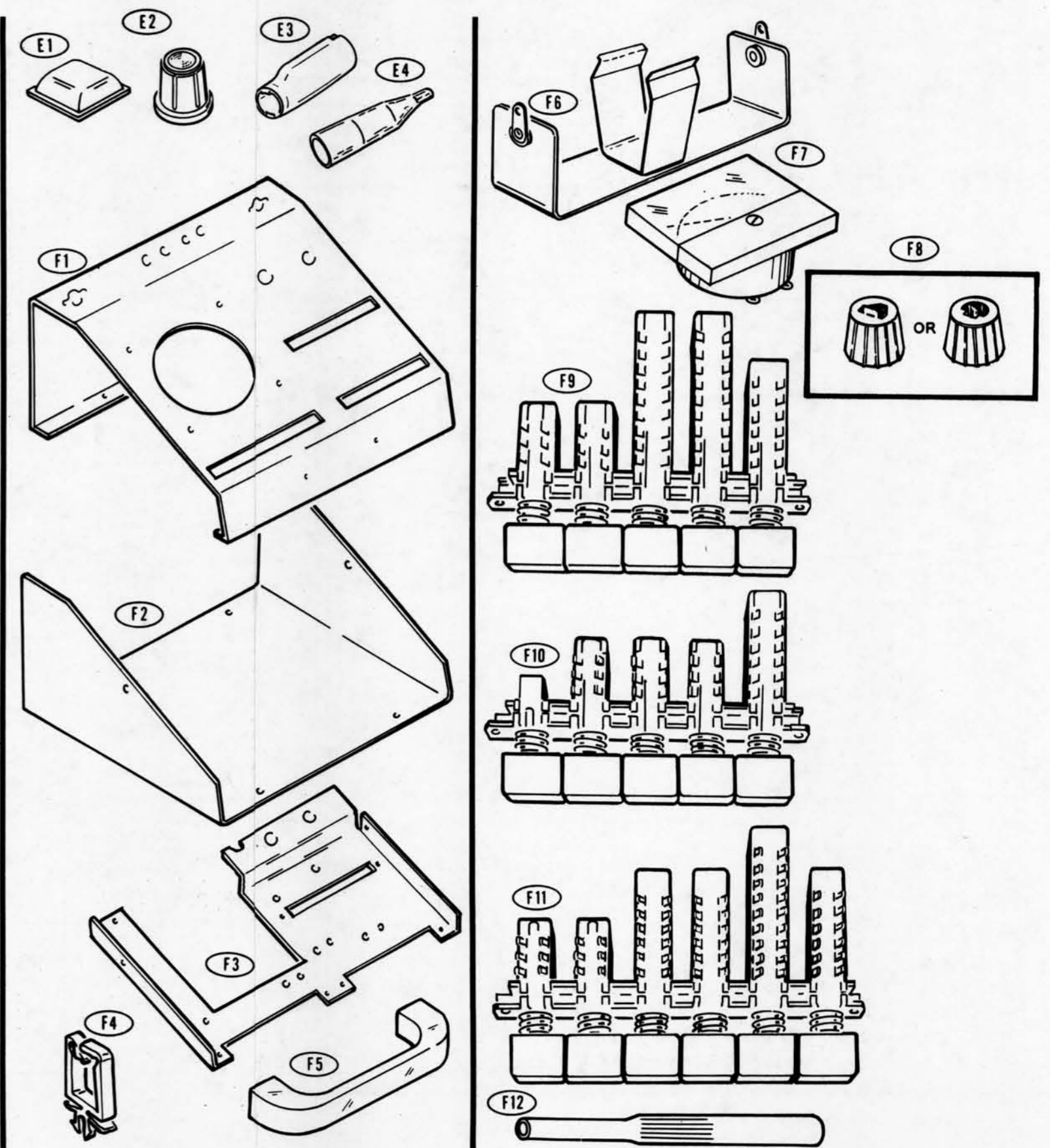

PARTS PICTORIAL

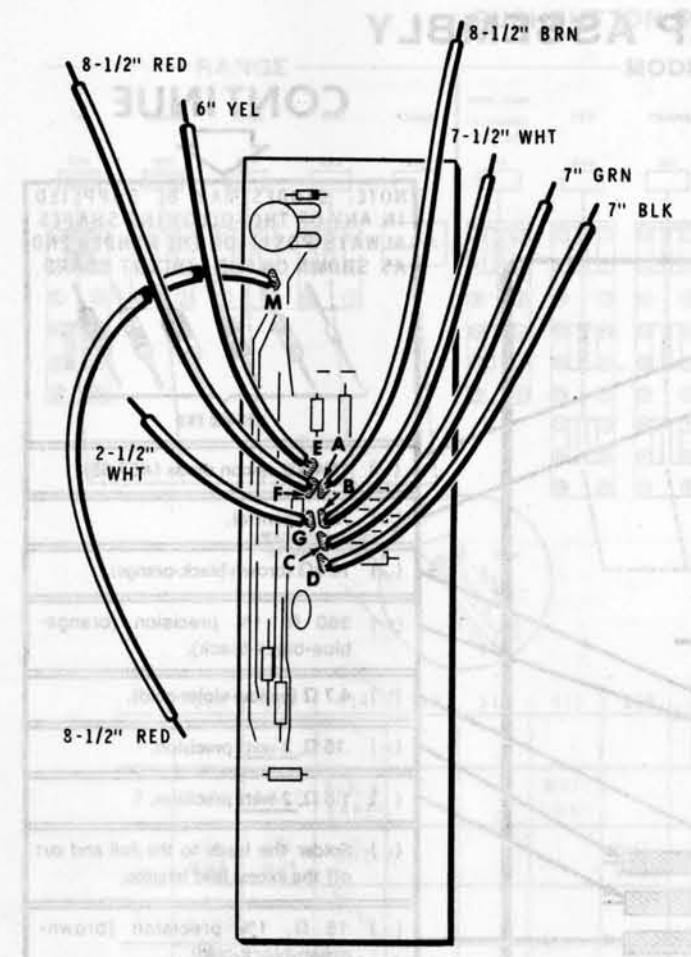
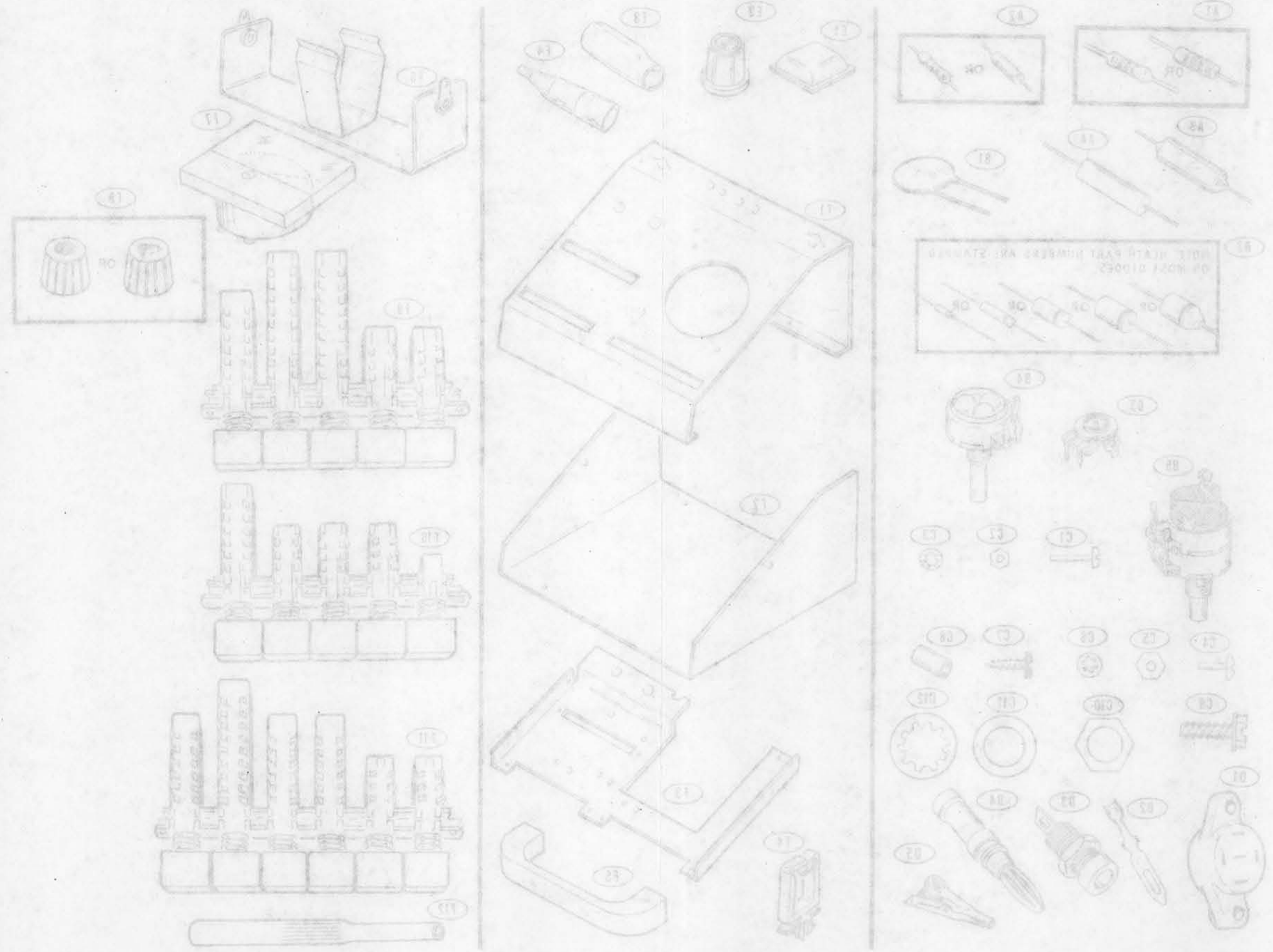

Refer to Pictorial 2 for the following steps.

() Prepare the following lengths of hookup wire:

- 6" yellow
- 8-1/2" red
- 8-1/2" brown
- 7-1/2" white
- 2-1/2" white
- 7" green
- 7" black
- 8-1/2" red

NOTES:

1. In the following steps, connect only one end of a wire to the circuit board. The other end will be connected later.
2. In the following steps, (NS) means not to solder because other wires will be added later. "S" with a number, such as (S-3), means to solder the connection. The number following the "S" tells how many wires are at the connection.

- () Connect a 6" yellow wire to hole E (S-1).
- () Connect an 8-1/2" red wire to hole F (S-1).
- () Connect an 8-1/2" brown wire to hole A (S-1).
- () Connect a 7-1/2" white wire to hole B (S-1).
- () Connect a 2-1/2" white wire to hole G (S-1).
- () Connect a 7" green wire to hole C (S-1).
- () Connect a 7" black wire to hole D (S-1).
- () Connect an 8-1/2" red wire to hole M (S-1).
- () Cut off the excess lead lengths from the foil side of the circuit board.

PICTORIAL 2



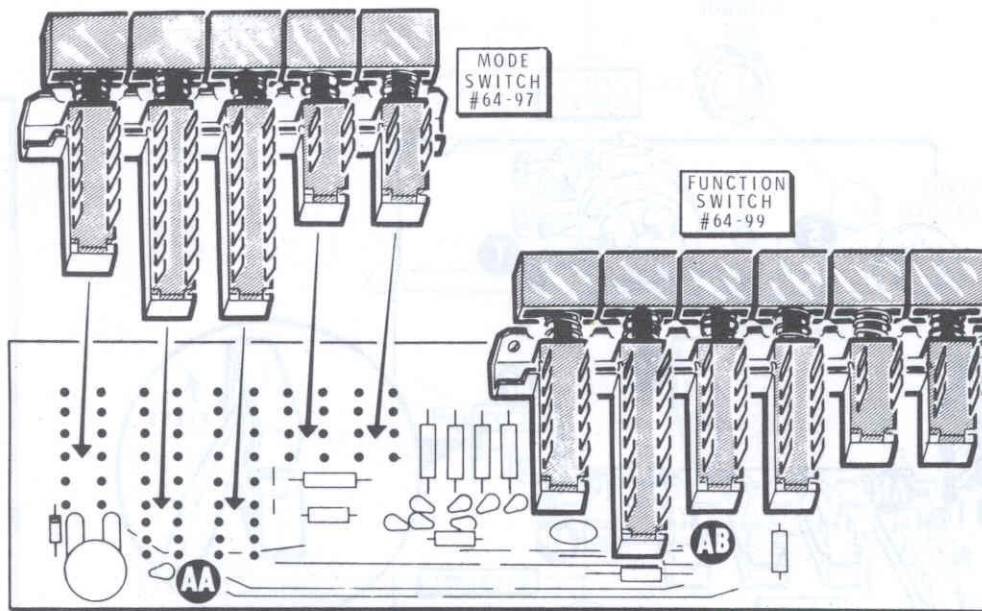

PICTORIAL 3

Refer to Pictorial 3 for the following steps.

NOTE: In the following steps, install the mode and function switches as follows:

1. Align the switch over the holes on the circuit board. Then insert the switch lugs into the circuit board holes.
2. Press the switch against the circuit board; then turn the circuit board over and solder one lug at each end of the switch to the foil.
3. Re-examine the switch to make sure it is still seated against the circuit board.
4. Make sure the jumper wires on the component side of the circuit board do not touch the lugs of the switch.

5. Then solder the remaining lugs (those surrounded with foil) to the circuit board foil.

- () Install the mode switch (#64-97) on the circuit board at AA. NOTE: To make sure you use the correct switch, compare it to the one shown at location AA on Pictorial 3.
- () Install the function switch (#64-99) on the circuit board at AB.
- () Carefully examine the circuit board foil to make sure all leads are soldered to the foil. Then cut off any excess lead lengths.

NOTE: You should have a 166 Ω precision resistor left. Set it aside; it will be used later.

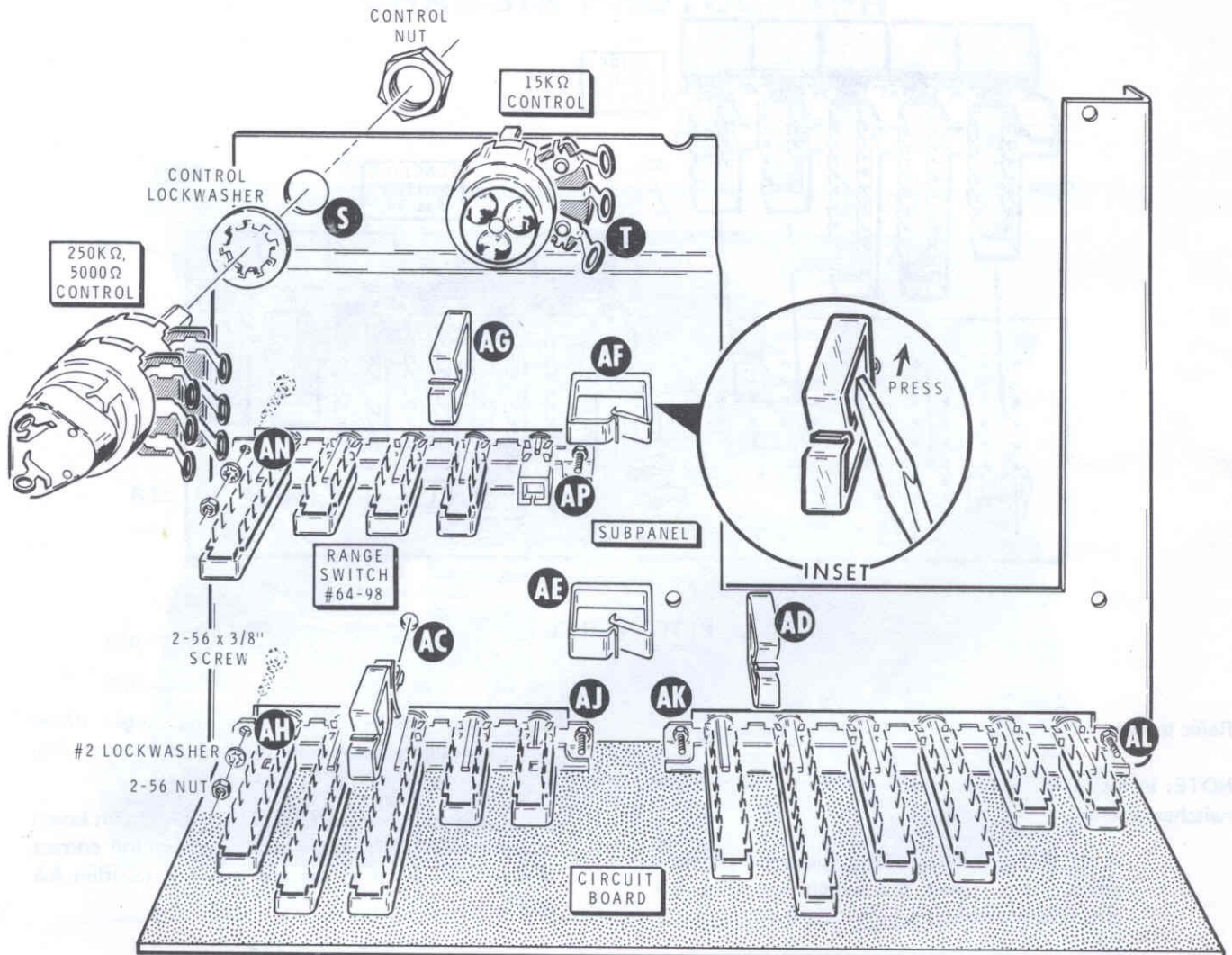

PICTORIAL 4

SUBPANEL ASSEMBLY AND WIRING

Refer to Pictorial 4 for the following steps.

NOTE: The plastic clamps you will install in the next two steps are quite brittle. Place them in warm water for a few minutes to make them more flexible before you install them.

- () Refer to the inset drawing and install a clamp on the subpanel at AC. Support the back of the subpanel; then use a screwdriver to press the clamp into the hole. Position the clamp as shown in the Pictorial.
- () Likewise, install the clamps at AD, AE, AF, and AG.

NOTES:

1. The term "hardware" will be used to refer to the screws, nuts, and lockwashers when parts are being

mounted in some of the following steps. The phrase "Use 2-56 x 3/8" hardware," for example, means to use a 2-56 x 3/8" screw, one or more #2 lockwashers, and a 2-56 nut. Refer to the Pictorial called out in a step for the correct number of lockwashers and the correct way to install the hardware.

2. Use the plastic nut starter supplied with this kit to hold and start 2-56 and 6-32 nuts on screws.
- () Mount the assembled circuit board on the subpanel. Use 2-56 x 3/8" hardware at AH, AJ, AK, and AL.
- () Install the range switch (#64-98) on the subpanel as shown. Use 2-56 x 3/8" hardware at AN and AP. NOTE: The pushbuttons of this switch are larger than the cutout in the subpanel. Therefore, you must tilt the switch and insert one end at a time into the cutout.

- () Temporarily install a 250 kΩ/5000 Ω (5 k) control on the subpanel at S. Use a control lockwasher and a control nut.
- () Temporarily install a 15 kΩ control on the subpanel at T. Use a control lockwasher and a control nut.

Refer to Pictorial 5 (fold-out from this page) for the following steps.

- () Position the free ends of the wires coming from the circuit board out of the way as shown.

NOTE: When bare wire is called for in the following steps, cut the white wire to the indicated length; then remove all of the insulation.

- () Prepare the following lengths of hookup wire:

1" bare	3/4" bare
1-1/2" white	1" bare
3/4" bare	1-1/4" white
3/4" bare	1-1/4" white

- () Connect a 1" bare wire between lugs 3 (NS) and 6 (S-1) of control S.
- () Connect a 1-1/2" white wire between lugs 5 (S-1) and 7 (S-1) of control S.

NOTE: Use the switch lug numbering drawing of Pictorial 5 for help in identifying the pushbutton switch lugs in the following steps.

- () Connect a 3/4" bare wire from lug 2 of switch M (S-1) to lug 5 of switch N (NS).
- () Connect a 3/4" bare wire from lug 2 of switch N (S-1) to lug 5 of switch P (NS).
- () Connect a 3/4" bare wire from lug 2 of switch P (NS) to lug 5 of switch R (S-1).

NOTE: Where a wire passes through a connection and then goes to another point, as in the next step, it will count as two wires in the solder instructions (S-2) one entering and one leaving the connection. Be especially careful, when soldering these connections, to apply enough solder and heat to solder these "through wires."

- () Connect a 1" bare wire from lug 9 (NS) through lug 4 (S-2) of switch M to lug 6 of switch N (NS).

- () Connect a 1-1/4" white wire from lug 6 of switch N (S-2) to lug 6 of switch P (NS).

- () Connect a 1-1/4" white wire from lug 6 of switch P (S-2) to lug 6 of switch R (NS).

- () Prepare the following lengths of wire:

8" white-red	12" white-gray
9" brown	8" yellow
6" white-violet	7" white-green
3" white	

NOTE: Most wire lengths are longer than needed to reach their terminating points. Therefore, use square corners (bent 90 degrees) when you position the wires to make the kit as neat as possible when it is completed.

- () Connect an 8" white-red wire from lug 10 of switch B (S-1), through clamps AC and AD, to lug 5 of switch K (S-1).

- () Connect a 9" brown wire from lug 11 of switch B (S-1), through clamps AC, AE, AF, and AG, to lug 3 of control S (S-2).

- () Connect a 6" white-violet wire from lug 3 of switch B (S-1), through clamps AC and AD, to lug 2 of switch G (S-1).

- () Connect a 3" white wire from lug 5 of switch B (S-1), through clamp AC, to lug 2 of switch D (S-1).

- () Connect one end of a 12" white-gray wire to lug 2 of switch A (S-1). Insert the other end through clamps AC, AE, and AF. It will be connected later.

- () Connect an 8" yellow wire from lug 7 of switch A (S-1), through clamps AC, AE, and AF, to lug 2 of control T (S-1).

- () Connect a 7" white-green wire from lug 18 of switch B (S-1), through clamps AC and AD, to lug 11 of switch G (S-1).

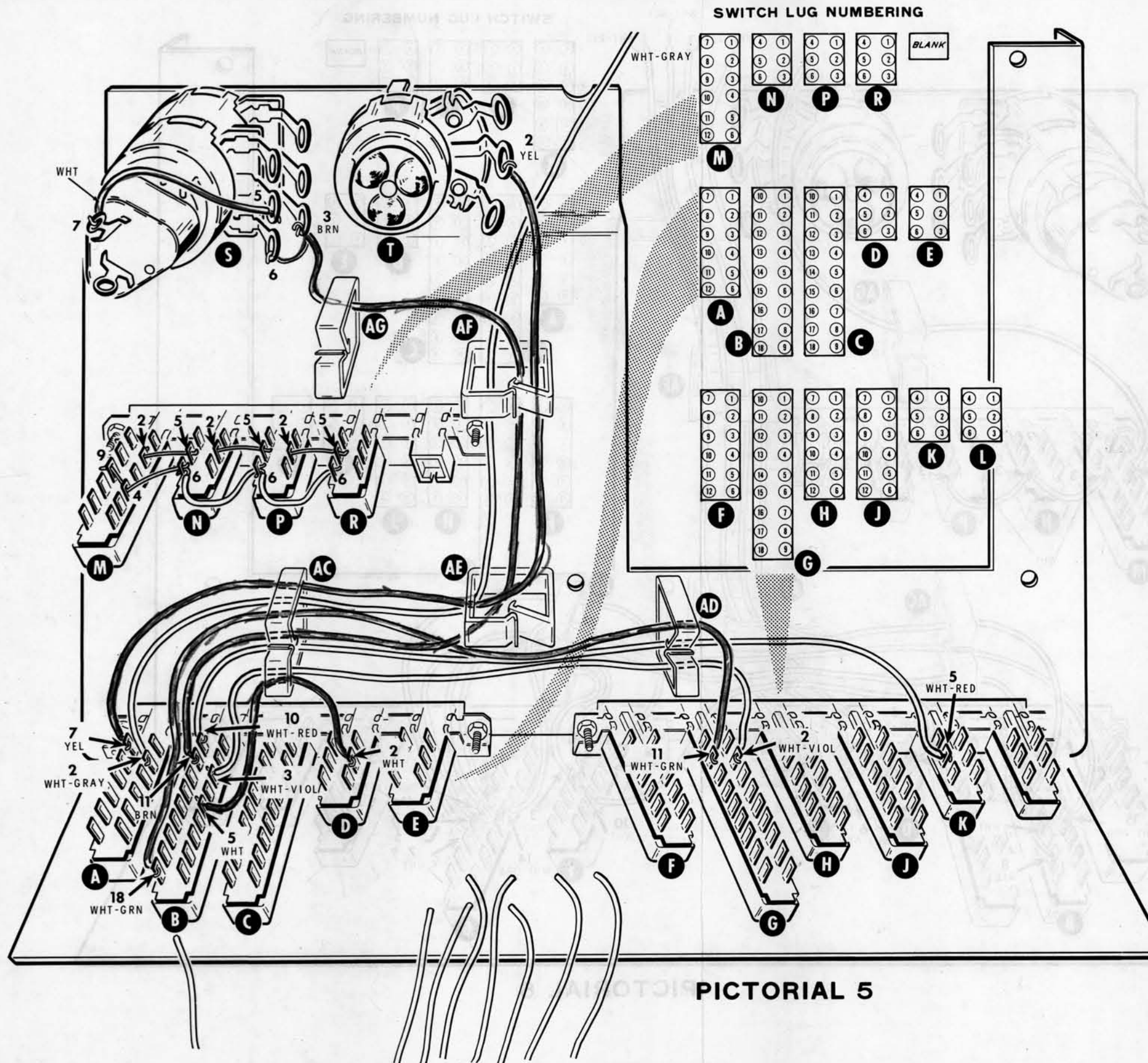

PICTORIAL 5

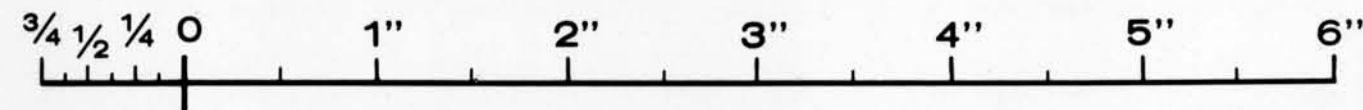

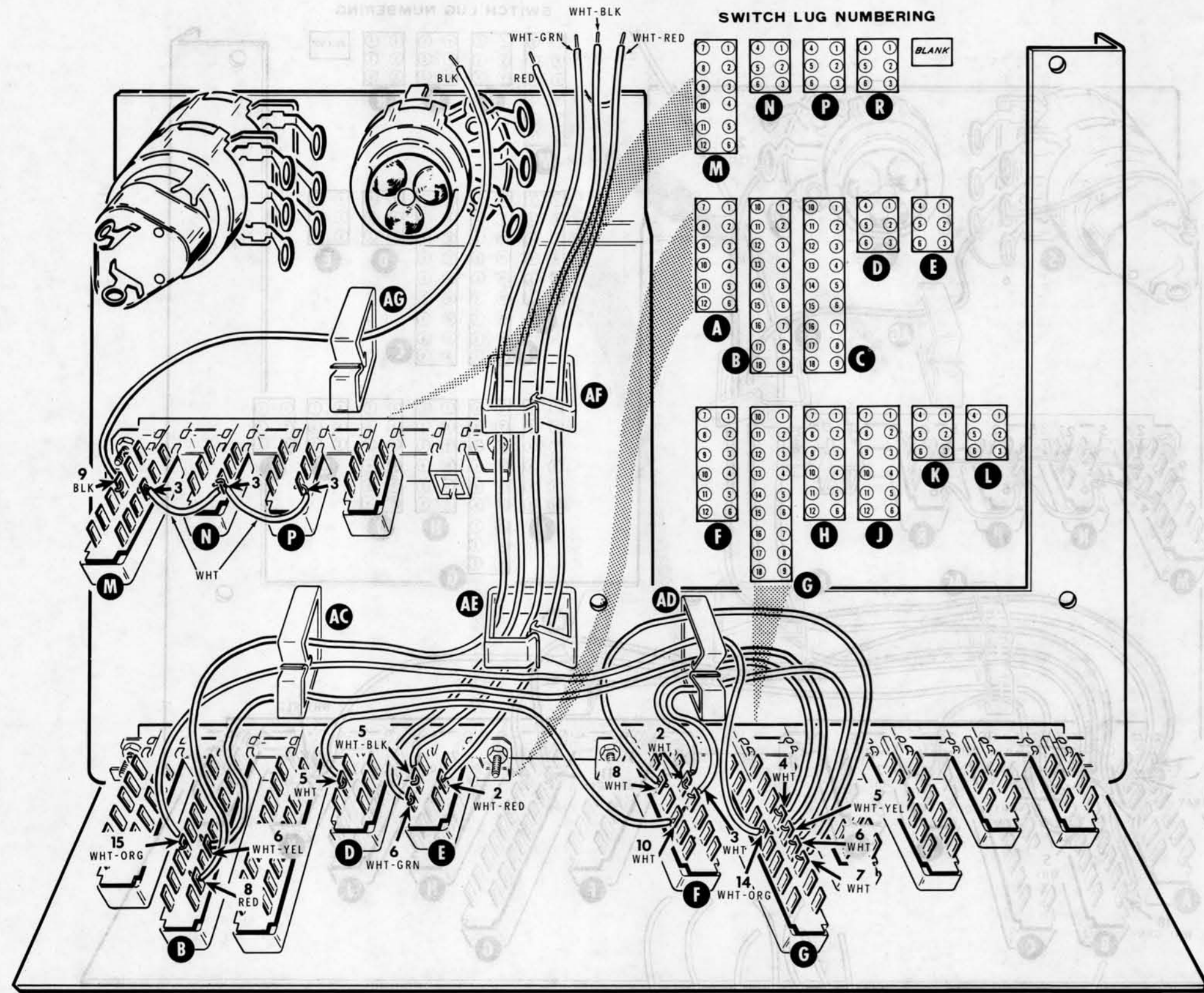

SWITCH LUG NUMBERING

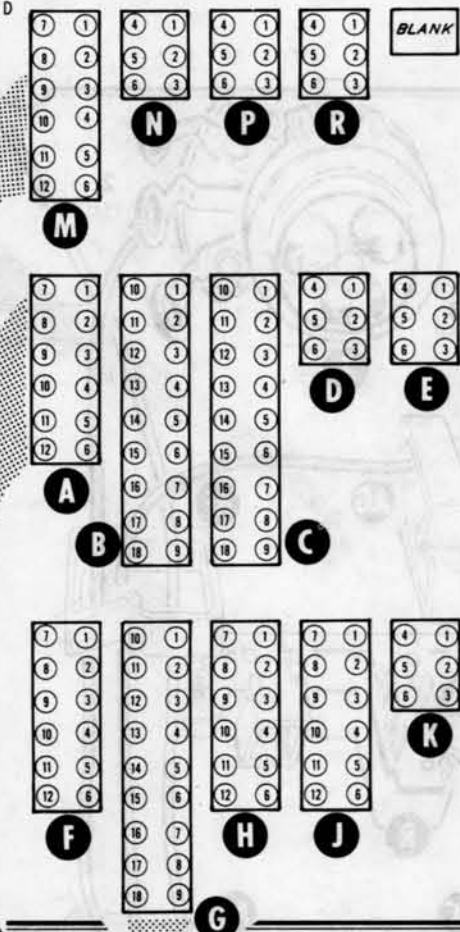

PICTORIAL 6

Refer to Pictorial 6 for the following steps.

Prepare the following lengths of wire:

- 7" white-orange
- 2" white
- 6-1/2" white-yellow
- 2" white
- 2-1/2" white
- 4" white

Connect a 7" white-orange wire from lug 15 of switch B (S-1), through clamps AC and AD, to lug 14 of switch G (S-1).

Connect a 2" white wire from lug 2 of switch F (S-1), through clamp AD, to lug 4 of switch G (S-1).

Connect a 6-1/2" white-yellow wire from lug 6 of switch B (S-1), through clamps AC and AD, to lug 5 of switch G (S-1).

Connect a 2" white wire from lug 3 of switch F (S-1), through clamp AD, to lug 6 of switch G (S-1).

Connect a 2-1/2" white wire from lug 8 of switch F (S-1) through clamp AD to lug 7 of switch G (S-1).

Connect a 4" white wire from lug 5 of switch D (S-1) to lug 10 of switch F (S-1).

Prepare the following lengths of wire:

- 1-1/4" white
- 1-1/4" white
- 9" white-black
- 9" white-green
- 9" white-red
- 10" red
- 7-1/4" black

Connect a 1-1/4" white wire from lug 3 of switch M (NS) to lug 3 of switch N (NS).

Connect a 1-1/4" white wire from lug 3 of switch N (S-2) to lug 3 of switch P (S-1).

NOTE: In each of the following five steps, you will connect only one end of a wire. The other end will be connected later.

Connect one end of a 9" white-black wire to lug 5 of switch E (S-1). Insert the other end of this wire through clamps AE and AF.

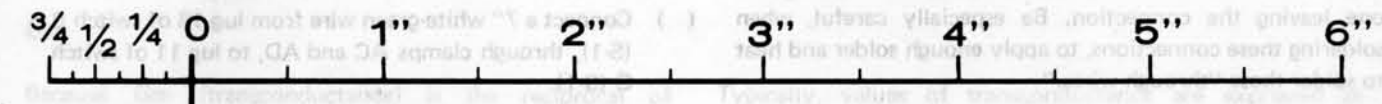

✓ Connect one end of a 9" white-green wire to lug 6 of switch E (S-1). Insert the other end of this wire through clamps AE and AF.

✓ Connect one end of a 9" white-red wire to lug 2 of switch E (S-1). Insert the other end of this wire through clamps AE and AF.

✓ Connect one end of a 10" red wire to lug 8 of switch B (S-1). Insert the other end of this wire through clamps AC, AE, and AF.

✓ Connect a 7-1/4" black wire from lug 9 of switch M (S-2). Insert the other end of this wire through clamp AG.

Refer to Pictorial 7 (fold-out from this page) for the following steps.

✓ Prepare the following lengths of wire:

- 4-1/2" white-brown 10" white-violet
- 7-1/2" white-black 10" brown
- 7-1/2" white-gray 2" white
- 9-1/2" green 7-1/2" white
- 10" white

✓ Connect a 4-1/2" white-brown wire from lug 8 of switch A (S-1), through clamp AC, to lug 3 of switch E (S-1).

✓ Connect a 7-1/2" white-black wire from lug 16 of switch B (S-1), through clamps AC and AD, to lug 6 of switch F (S-1).

✓ Connect a 7-1/2" white-gray wire from lug 8 of switch H (S-1), through clamps AD, AE, AF, and AG, to lug 6 of switch R (S-2).

✓ Connect one end of a 9-1/2" green wire to lug 5 of switch H (S-1). Insert the other end of this wire through clamps AD, AE, and AF. It will be connected later.

✓ Connect a 10" white wire from lug 7 of switch J (S-1), through clamps AD, AE, AF, and AG, to lug 3 of switch M (S-2).

✓ Connect a 10" white-violet wire from lug 10 of switch J (S-1), through clamps AD, AE, AF, and AG, to lug 5 of switch M (S-1).

✓ Connect a 10" brown wire from lug 2 of switch J (S-1), through clamps AD, AE, AF, and AG, to lug 2 of control S (NS).

✓ Connect a 2" white wire between lugs 2 (S-2) and 8 (NS) of switch S.

✓ Connect one end of a 7-1/2" white wire to lug 8 of control S (S-2). Insert the other end of this wire through clamp AG. It will be connected later.

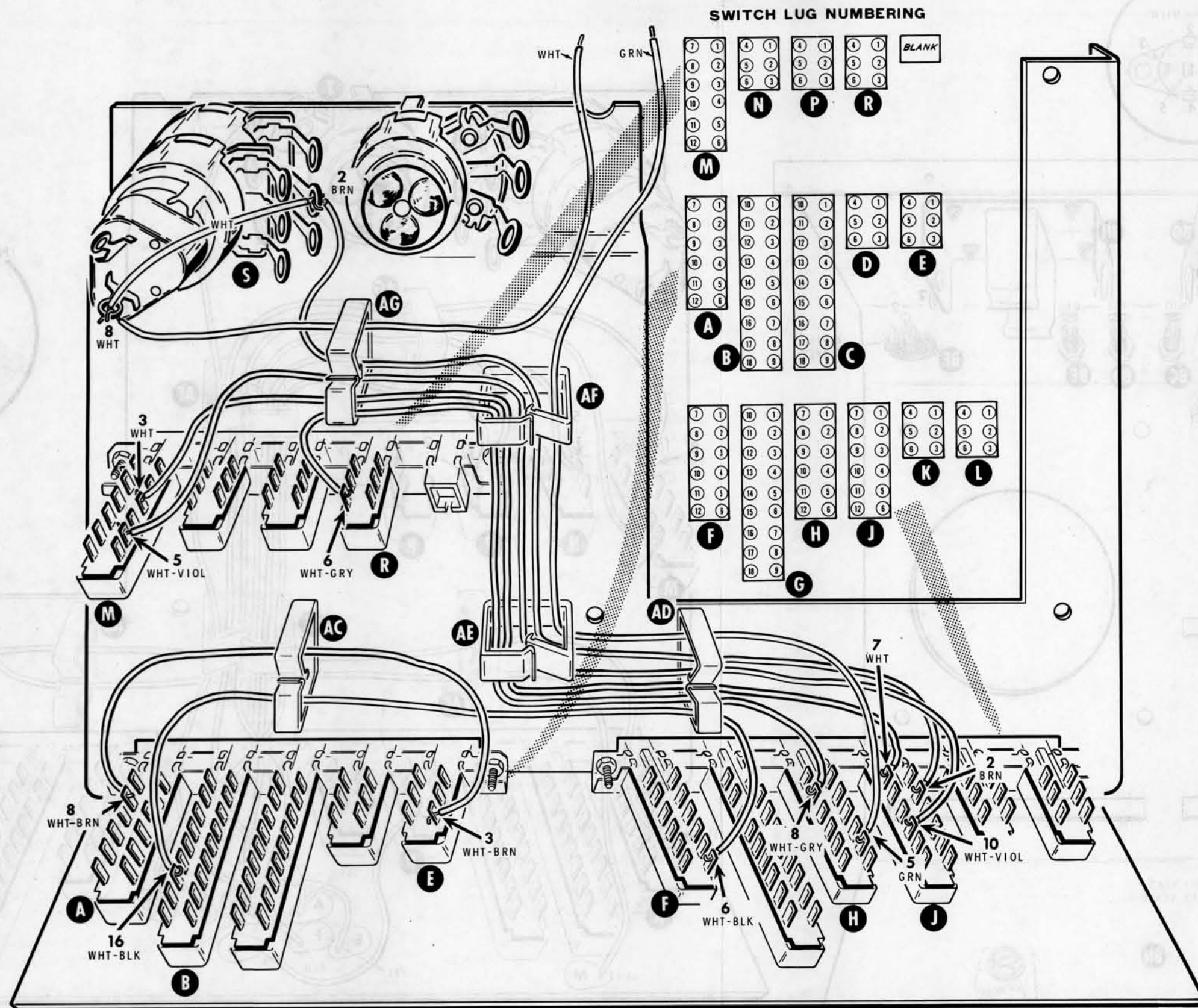

PICTORIAL 7

Refer to Pictorial 8 for the following steps.

- (✓) Prepare a 10" length of black solid wire.
- (✓) Connect one end of a 10" black wire to lug 11 of switch A (S-1). Insert the other end of this wire through clamps AC and AD. It will be connected later.
- (✓) Route the red wire coming from circuit board hole M through clamps AC and AD. It will be connected later.
- (✓) Connect the yellow wire coming from circuit board hole E, through clamps AE and AF, to lug 1 of control T (S-1).
- (✓) Connect the black wire coming from circuit board hole D, through clamps AE, AF, and AG, to lug 2 of switch P (S-2).
- (✓) Connect the green wire coming from circuit board hole C, through clamps AE, AF, and AG, to lug 5 of switch P (S-2).
- (✓) Connect the white wire coming from circuit board hole B, through clamps AE, AF, and AG, to lug 5 of switch N (S-2).
- (✓) Connect the brown wire coming from circuit board hole A, through clamps AE, AF, and AG, to lug 8 of switch M (S-1).
- (✓) Connect the red wire coming from circuit board hole F, through clamps AE, AF, and AG, to lug 6 of switch M (S-1).
- (✓) Connect the white wire coming from circuit board hole G to lug 3 of switch D (S-1).
- (✓) Refer to the inset drawing on Pictorial 8 and close each clamp. To do this, push inward on the flexible arm until it locks to the stationary arm.

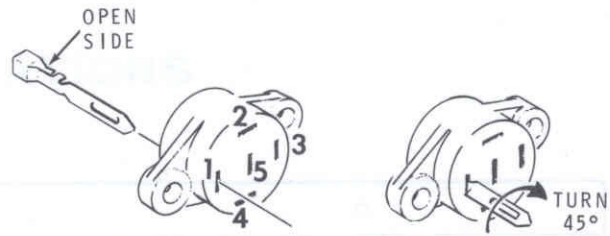

Detail 9A

- () 2. Start a socket pin down through socket hole 1. Be sure the open side of the top of the pin faces the center of the socket.
- () 3. Push the pin as far as you can into the socket. Then pull it with long-nose pliers until it is fully seated.
- () 4. On the underside of the socket, grasp the full length of the pin with pliers and twist the pin about 45 degrees to hold it into the socket.
- () 5. In the same manner, install four more pins into the socket.
- () 6. Similarly, prepare a 4-pin socket; do not install a pin in hole 5.
- () Install a prepared 5-pin transistor socket at BA with 2-56 x 3/8" hardware.
- () Install the prepared 4-pin socket at BF with 2-56 x 3/8" hardware. Be sure to position the socket with lug 2 as shown.
- () Install a black banana jack at BB. Use the nut supplied with the jack. Do not overtighten the nut.
- () Install a white banana jack at BC. Use the nut supplied with the jack. Do not overtighten the nut.
- () Install a red banana jack at BD. Use the nut supplied with the jack. Do not overtighten the nut.
- () Install a green banana jack at BE. Use the nut supplied with the jack. Do not overtighten the nut.
- (✓) Mount a battery holder at BG with 4-40 x 1/4" hardware. Be sure to position the positive (+) end as shown.
- (✓) Mount a battery holder at BH with 4-40 x 1/4" hardware. Be sure to position the positive (+) end as shown.
- (✓) Mount the handle at BN with #10 x 1/2" hex head self-tapping screws.

This completes the assembly and wiring of the subpanel. Set it aside temporarily.

FRONT PANEL ASSEMBLY AND WIRING

Refer to Pictorial 9 for the following steps.

- () Place a soft cloth on your work surface to protect the front panel from becoming scratched.
- () Locate the front panel and position it as shown.

Refer to Detail 9A for the following six steps.

- () 1. Position a transistor socket as shown.

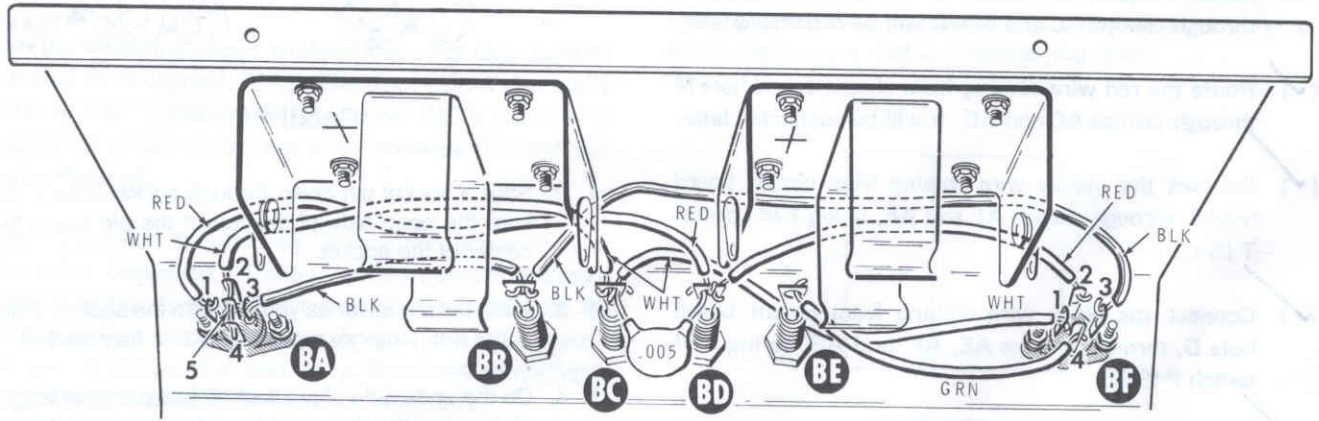

PICTORIAL 10

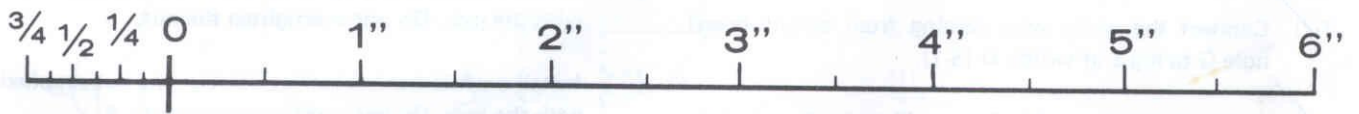

Refer to Pictorial 10 for the following steps.

() Prepare the following lengths of wire:

3-1/2" green

6" black

5" white

4" red

5" white

5-1/2" red

4" black

- (✓) Connect a 3-1/2" green wire from lug 4 of socket BF (S-1) to the lug of jack BE (NS).
- (✓) Remove an additional 1/4" of insulation from one end of a 5" white wire. Connect this end of the wire through lugs 2 (S-2) and 5 (S-2) to lug 4 (S-1) of socket BA. Connect the other end to the lug of jack BC (NS).
- (✓) Connect a 5" white wire from lug 1 of socket BF (S-1) to the lug of jack BC (NS).
- (✓) Connect a 4" black wire from lug 3 of socket BA (S-1) to the lug of jack BB (NS).
- (✓) Connect a 6" black wire from lug 3 of socket BF (S-1) to the lug of jack BB (NS).
- (✓) Connect a 4" red wire from lug 2 of socket BF (S-1) to the lug of jack BD (NS).
- (✓) Connect a 5-1/2" red wire from lug 1 of socket BA (S-1) to the lug of jack BD (NS).

- (✓) Cut both leads of a .005 μ F disc capacitor to 3/4". Then connect this capacitor from the lug of jack BC (NS) to the lug of jack BD (NS).

SUBPANEL INSTALLATION

Refer to Pictorial 11 (fold-out from Page 17) for the following steps.

- (✓) Mount the meter on the front panel. Position the meter with the positive (+) terminal as shown. Install only a lockwasher and nut at BJ. Use the hardware included with the meter.
- (✓) Place a #6 spacer on meter mounting bolts BK, BL, and BM.
- (✓) Locate the assembled subpanel and remove the control nuts from controls S and T.
- (✓) Install the assembled subpanel on the inside of the front panel.
- (✓) Install lockwashers and nuts at BK, BL, and BM. Use the hardware included with the meter. Be sure pushbutton switches do not bind against the front panel. If necessary, reposition the subpanel.
- (✓) Install control flat washers and control nuts on controls S and T.
- (✓) Remove and discard the shorting wire from between the meter terminals.

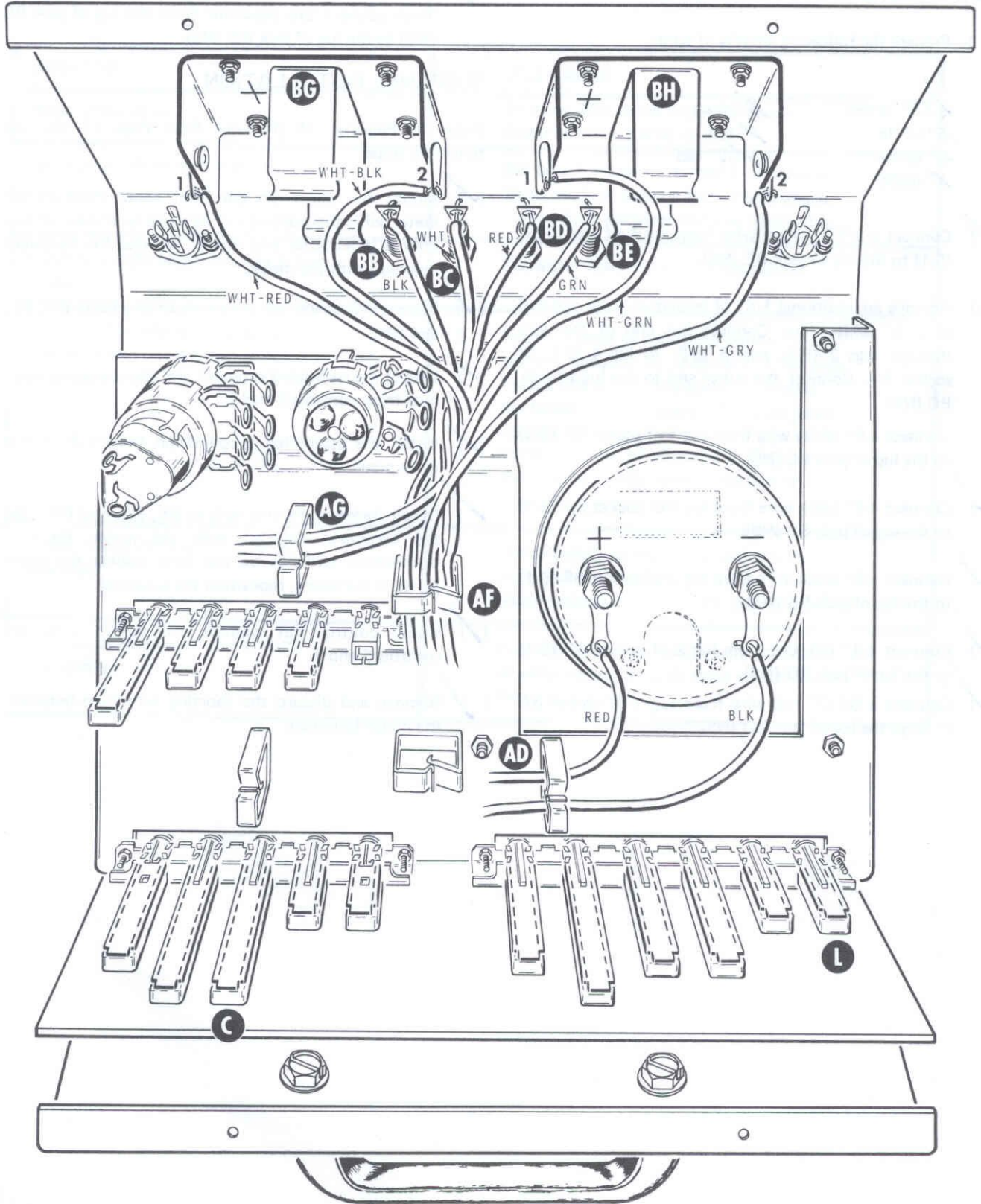

PICTORIAL 12

FINAL WIRING

Refer to Pictorial 12 (on Page 16) for the following steps.

- (✓) Connect the red wire coming from clamp AD to the positive (+) terminal of the meter (S-1).
- (✓) Connect the black wire coming from clamp AD to the negative (-) terminal of the meter (S-1).
- (✓) Connect the black wire coming from clamp AG to the lug of jack BB (S-3).
- (✓) Connect the white wire coming from clamp AG to the lug of jack BC (S-4).

Connect the wires coming from clamp AF as follows:

- (✓) Red wire to the lug of jack BD (S-4).
- (✓) Green wire to the lug of jack BE (S-2).
- (✓) White-red wire to lug 1 of battery holder BG (S-1).
- (✓) White-black wire to lug 2 of battery holder BG (S-1).
- (✓) White-green wire to lug 1 of battery holder BH (S-1).
- (✓) White-gray wire to lug 2 of battery holder BH (S-1).
- (✓) This completes the wiring of your Transistor Tester. Check to see that all connections are soldered. Switches C and L should not have any wires connected to the switch lugs.

Refer to Pictorial 13 for the following steps.

- () Prepare the red test lead from red stranded wire as shown in Part A of Pictorial 13. Then install a banana

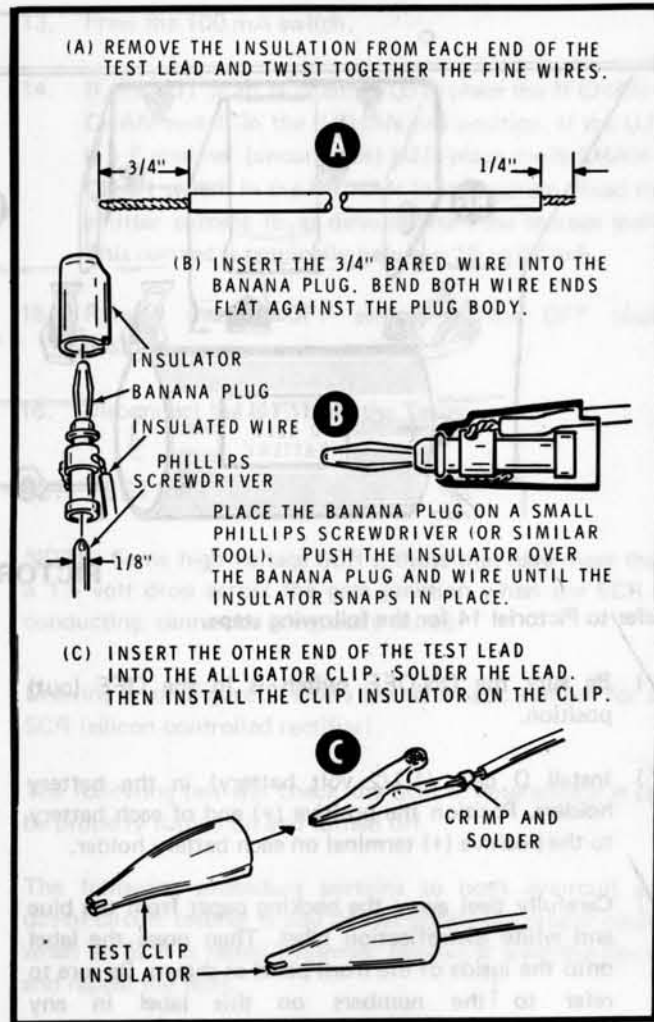

PICTORIAL 13

plug with a red insulator on one end and an alligator clip and rubber insulator on the other end of the test lead as shown in Parts B and C of the Pictorial.

- () In a similar manner, use stranded wire and prepare the black, white, and green test leads.

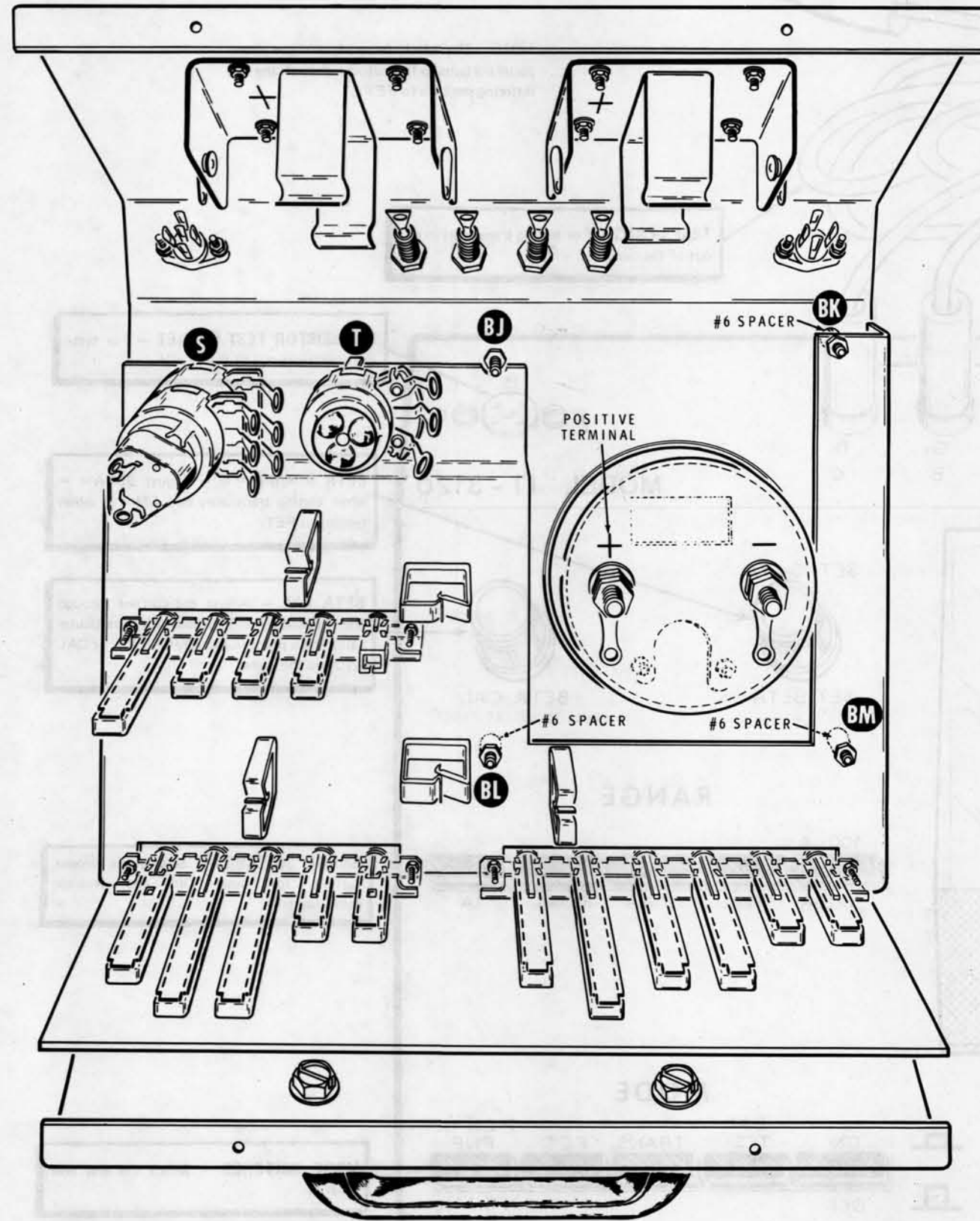

PICTORIAL 11

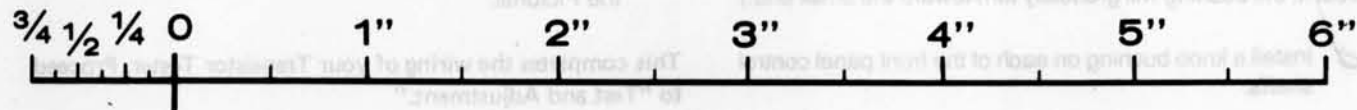

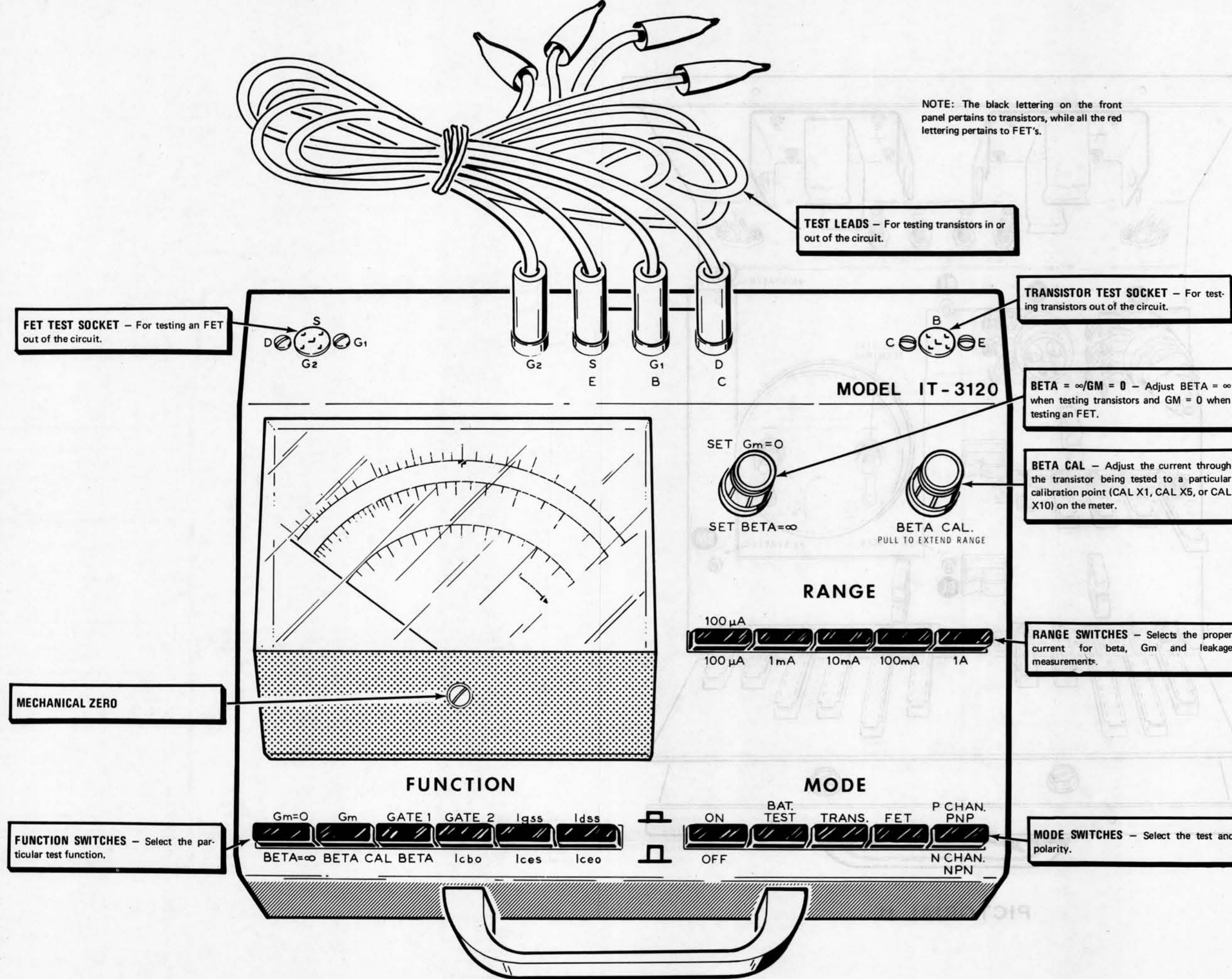
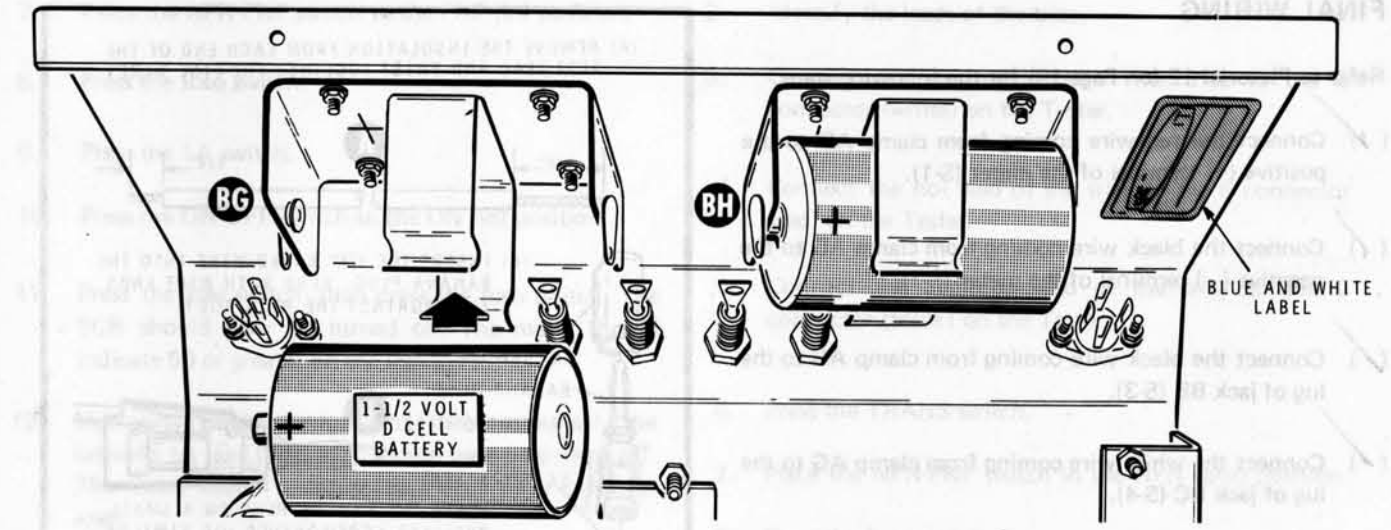
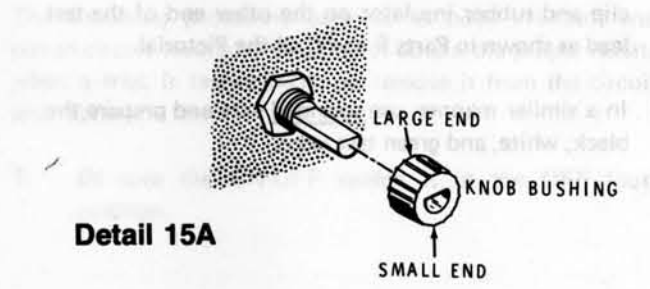

Figure 1



- Refer to Pictorial 14 for the following steps.
- (✓) Be sure the ON-OFF switch is in the OFF (out) position.
 - (✓) Install D cells (1-1/2 volt battery) in the battery holders. Position the positive (+) end of each battery to the positive (+) terminal on each battery holder.
 - (✓) Carefully peel away the backing paper from the blue and white identification label. Then press the label onto the inside of the front panel as shown. Be sure to refer to the numbers on this label in any communications you have with the Heath Company about this kit.



- Refer to Pictorial 15 for the following steps.
- Refer to Detail 15A and notice that the knob bushing is tapered. Be sure, in the next step, to place this bushing on the shaft with the small end facing out, or the knob will not slide onto it. (Roll the bushing on a flat surface if you are unsure about it; the bushing will gradually turn toward the small end.)
- (✓) Install a knob bushing on each of the front panel control shafts.

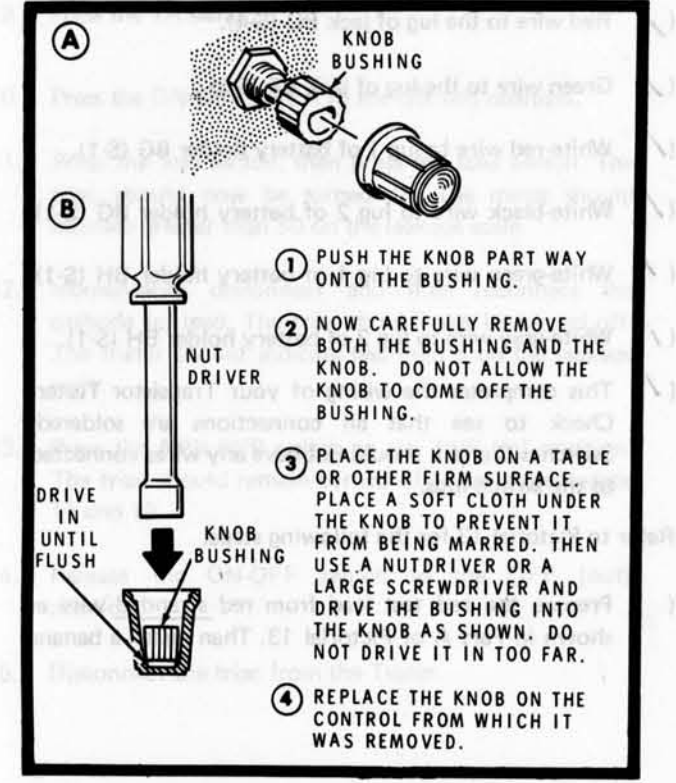

- In the following step you will install knobs on the two control shafts. Perform this step carefully, since it is difficult to remove a bushing from a knob once it is fully inserted.
- (✓) Install knobs on each of the control shafts as shown in the Pictorial.
- This completes the wiring of your Transistor Tester. Proceed to "Test and Adjustment."

TEST AND ADJUSTMENT

Figure 1 shows the front panel of the Transistor Tester. Study the figure carefully to identify the function of each switch, control, jack, and socket.

If any trouble is encountered in the following steps, refer to the "In Case of Difficulty" section on Page 29.

- (✓) Be sure the ON-OFF switch is in the OFF (out) position.
- (✓) The meter needle should be on the extreme left mark on the scale as shown in Figure 1. If the pointer is not over this mark, slowly turn the Mechanical Zero screw, while you lightly tap the meter face with your finger to properly position the pointer.

BATTERY TEST

- (✓) Press the following front panel pushbutton switches:

10 mA
BETA = ∞
BAT. TEST

- (✓) Be sure the PNP-NPN switch is in the NPN (out) position.
- (✓) Press the ON-OFF switch to the ON (in) position. The meter pointer should be within the BAT OK area on the meter. A new battery will cause the pointer to deflect off scale on the right side of the meter. This is normal.
- (✓) Press the PNP-NPN switch to the PNP (in) position. The meter pointer should be within the BAT OK area on the meter. A new battery will cause the pointer to deflect off scale on the right side of the meter.
- (✓) Release the ON-OFF switch to the OFF (out) position.

ADJUSTMENT

- (✓) Connect the test leads to the appropriate front panel jacks.
- (✓) Connect the 166 Ω, 1%, precision resistor (brown-blue-blue-black) between the collector (black) test lead and the emitter (red) test lead.

- (✓) Press the following front panel pushbutton switches:

TRANS
Iceo
10 mA

- (✓) Press the PNP-NPN switch to the PNP (in) position.
- (✓) Press the ON-OFF switch to the ON (in) position.
- (✓) Adjust the control on the circuit board to position the meter pointer at the 85 mark on the leakage scale.
- (✓) Release the PNP-NPN switch to the NPN (out) position. The meter reading should not change. If the reading is different, note the position of the pointer. (If the meter indication is greater than 90, or less than 80, replace the batteries.) Then readjust the control on the circuit board to place the pointer half way between the noted point and the 85 mark.

- (✓) Remove the resistor from the test leads. Tape this resistor to the inside of the front panel for future use.

- (✓) Release the ON-OFF switch to the OFF (out) position.

- (✓) Press the following front panel pushbutton switches:

FET
GM = 0
100 μA

- (✓) Press the P CHAN-N CHAN switch to the P CHAN (in) position.
- (✓) Press the ON-OFF switch to the ON (in) position.
- (✓) Rotate the SET Gm = 0 control. If the meter pointer can be positioned above and below the 0 mark (full scale) on the Gm scale, the FET circuitry is operating properly.
- (✓) Release the P CHAN-N CHAN switch to the IN CHAN (out) position and repeat the previous step.
- (✓) Release the ON-OFF switch to the OFF (out) position.

This completes the "Test and Adjustment" of your Transistor Tester. Proceed to "Final Assembly."

FINAL ASSEMBLY

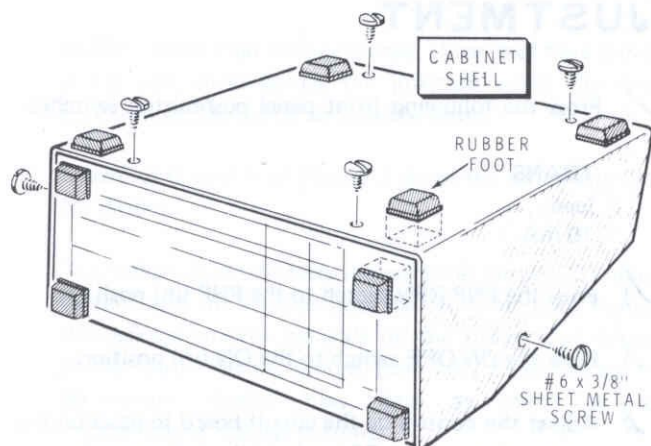

Refer to Pictorial 16 for the following steps.

- () Install the cabinet shell on the front panel with #6 x 3/8" sheet metal screws.
- () Remove the backing paper from the rubber feet and install them on the cabinet shell and the rear of the front panel as shown.

This completes the assembly of your Transistor Tester. Proceed to the "Operation" section.

PICTORIAL 16

OPERATION

GENERAL INFORMATION

The Transistor Tester measures the DC beta (gain) characteristics of transistors and the Gm (transconductance) characteristics of FET's (field effect transistors), characteristics that will even vary between transistors of the same type. These tests give you actual operating characteristics of a transistor and not merely a "bad" or "good" rating. Also, unijunction transistors, diodes, silicon controlled rectifiers, and triode AC switches can be easily tested.

Refer to Figure 1 for the locations and descriptions of the controls, switches, and connections on the Tester.

Transistors may either be plugged into the test sockets on the Transistor Tester or the test leads may be used. To use the test leads, connect the black test lead to the collector (C), the white test lead to the base (B), and the red test lead to the emitter (E) of the transistor being tested. When you test FET's (field effect transistors) or UJT's (unijunction transistors), connect the black test lead to the drain (D), the red test lead to the source (S), and the white test lead to the gate (G) of the device. If the transistor has two gates, connect the green test lead to the second gate (G).

Some transistors have a fourth lead connected to an internal shield. Leave this lead disconnected in the test procedure (bend it out of the way when you plug transistors into the transistor test socket).

CAUTION: Never connect the Transistor Tester, or test a device, while power is applied to the circuit. The Tester and/or the circuit could be damaged.

When devices are tested in-circuit, you may sometimes find it difficult to connect the test leads to the device because its leads are either too short or inaccessible. In such cases, you can usually connect each test lead to the lead of another component that is connected to the desired terminal on the device. To determine where you can connect the test leads on the circuit board, shine a light through the circuit board; this will let you trace each foil from the device to the other components. In cases where this is impractical, solder a short piece of wire to the printed circuit foil that is connected to the lead of the device; then connect the test lead to this wire.

The front panel lettering is in two colors, black and red. The black lettering calls out the controls used primarily when transistors are tested, while the red lettering calls out the controls relating to FET testing. Remember, when performing any of the following tests, if the TRANS switch is pressed in, refer to the black lettering; if the FET switch is pressed in, refer to the red lettering.

Proceed to the particular test procedure you wish to perform. Remember, it is a good idea to occasionally test the batteries before you use the Tester, especially if the Tester has not been used for some time.

BATTERY TEST

Test the batteries as follows:

1. Release the NPN-PNP switch to the NPN (out) position to check one battery.

2. Press the BAT TEST switch.
3. Press the ON-OFF to the ON (in) position. The meter pointer should fall within the BAT OK mark.
4. Press the NPN-PNP switch to the PNP (in) position to check the other battery. The meter pointer should fall within the BAT OK mark.
5. Release the ON-OFF switch to the OFF (out) position.

Before you test a transistor, it is helpful, but not necessary, to determine its class (signal, intermediate power, or power), and its type (NPN or PNP).

The current capability of a transistor is what determines its class. Both the specific application and the physical size can be used to estimate the amount of current that passes through a transistor. A schematic diagram is helpful in identifying the particular application. Transistors with small metal cases or plastic cases will usually be classed as signal devices. Medium size metal cases and transistors with small heat sinks fall in the intermediate power class. Power transistors are usually large and most generally used with large heat sinks. Figure 2 shows examples of each class.

Figure 2 shows several lead configurations for transistors. However, since there are other configurations, be sure you know the lead configuration of your transistor before you test it.

The schematic diagram can also be used to identify the transistor type (NPN or PNP). Drawings A and B of Figure 3 show the symbols for both an NPN and PNP transistor. Notice that the arrow on the emitter lead points away from the base in the NPN transistor and points toward the base in a PNP transistor. Also, an NPN transistor will have a positive collector-to-emitter voltage while the PNP transistor has a negative collector-to-emitter voltage. If you are unable to determine the transistor type, proceed with the test. Special steps are provided to identify the type.

TRANSISTOR TESTING

General

Out-of-circuit beta (gain) tests are always quite accurate, but the accuracy of an in-circuit test depends on the shunting resistances of the circuit in which the transistor is being used. If the transistor indicates gain when tested in-circuit, you may consider the transistor to be good. Leakage tests must always be made with the transistor out of the circuit, since the resistance in the circuit could cause an erroneous reading. To make a quick good or bad test, perform only the beta test.

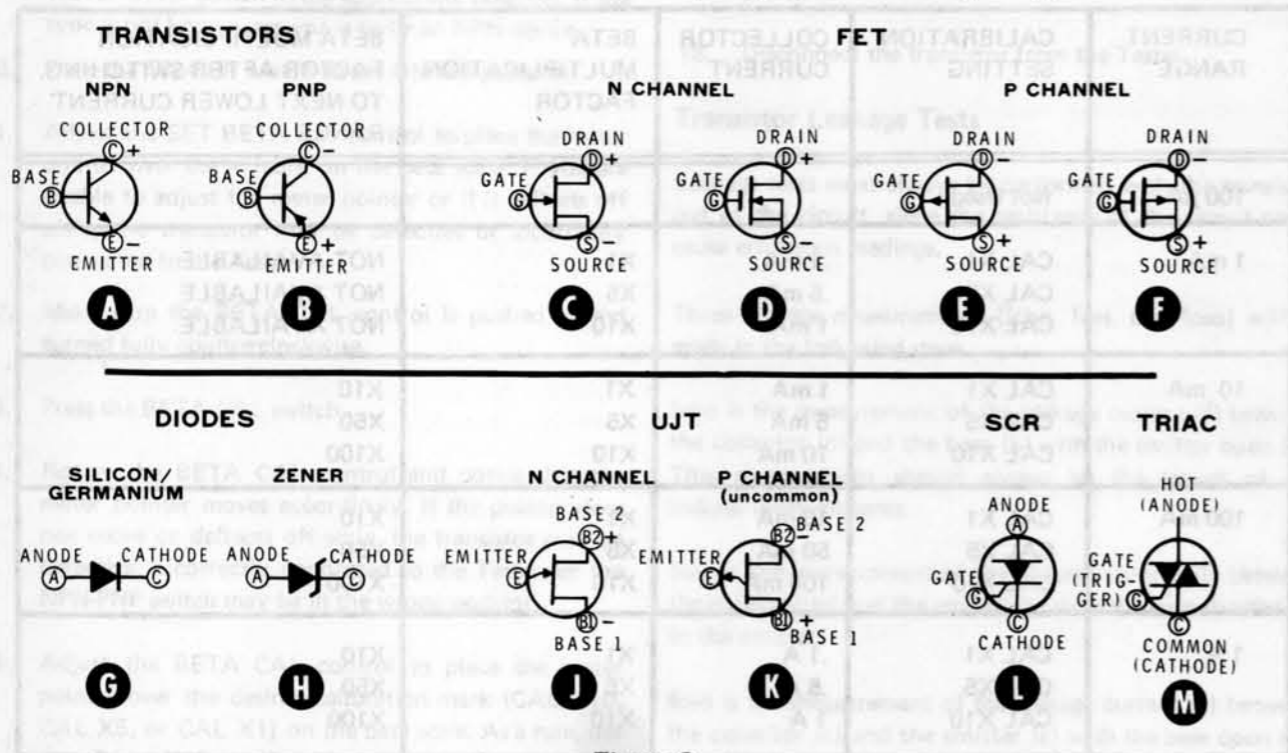
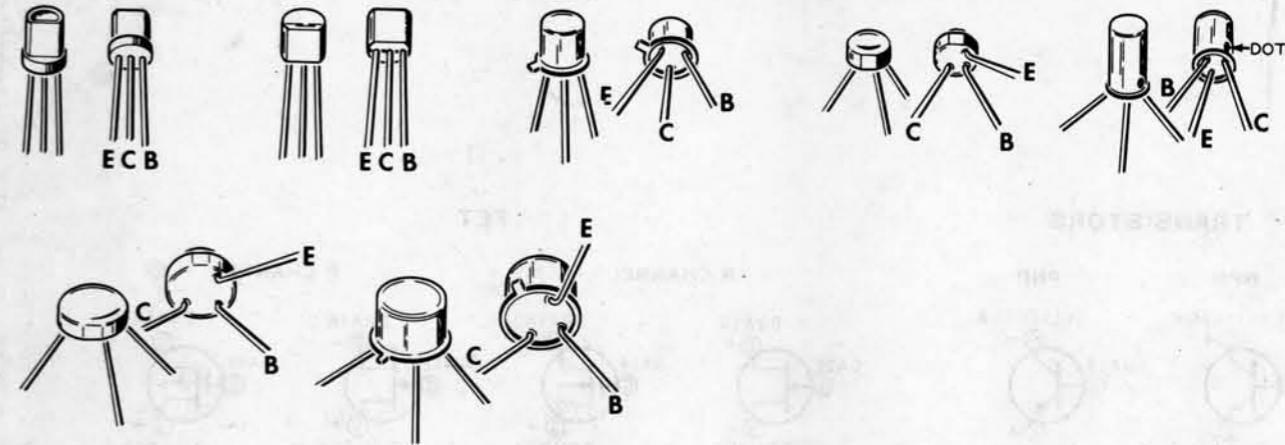
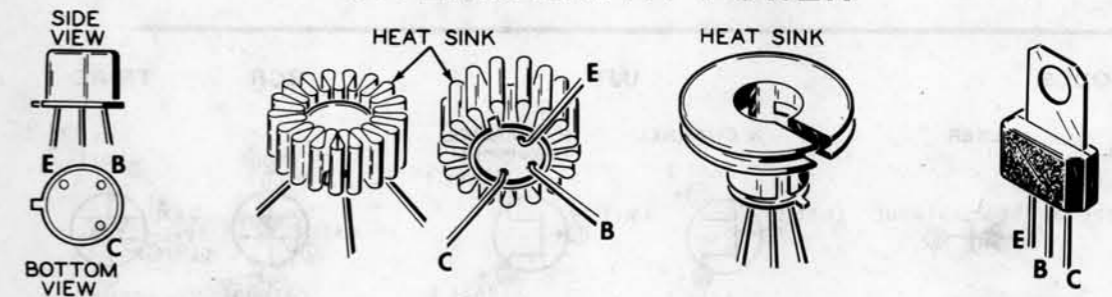

Figure 3

SIGNAL TRANSISTORS



INTERMEDIATE POWER



POWER

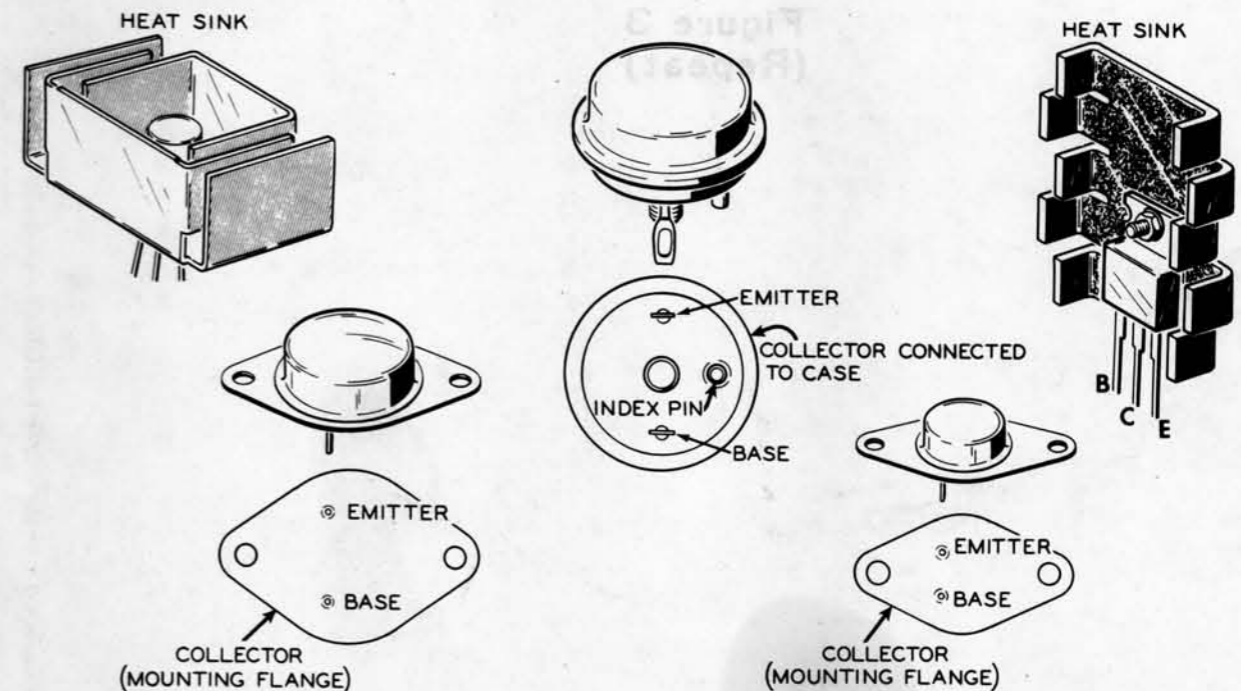

Figure 2

SIGNAL TRANSISTORS

TRANSISTORS

FET

NPN

PNP

N CHANNEL

P CHANNEL

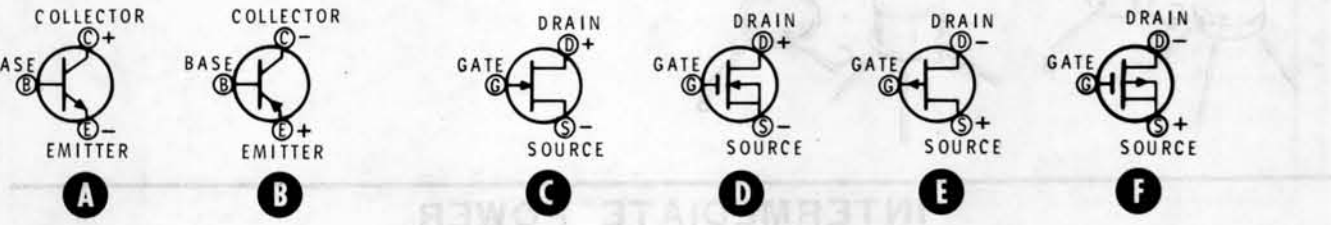

DIODES

UJT

SCR

TRIAC

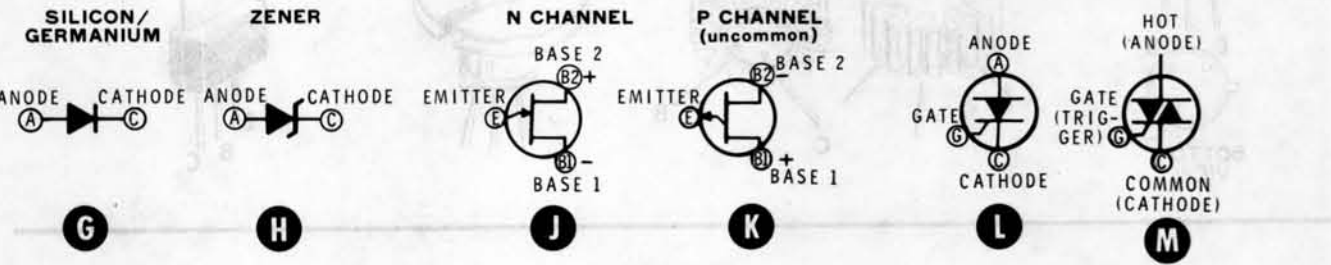

Figure 3 (Repeat)

The following chart shows the three classes of transistors, possible applications, and the approximate operating current for each class. Use the figures in the current capability column when you select the current range for a test.

For example:

Meter indication = 3.5
 Calibration Setting = CAL X10
 BETA = 3.5 x 10 = 35

CLASS	APPLICATION	CURRENT CAPABILITY
SIGNAL	AUDIO, RF, IF	1 mA – 10 mA
INTERMEDIATE POWER	AUDIO, SWITCHING	10 mA – 100 mA
POWER	AUDIO, REGULATOR, OUTPUT	100 mA – 1 A

However, if the meter indication is greater than 50, press the next lower current range switch (in this case, 10 mA) and multiply the new meter indication by 100. Notice that this new current range provides an additional multiplication factor of 10.

EXAMPLE:

Meter indication = greater than 50
 Select next lower current range (additional factor of 10)
 New meter indication = 6.5
 Calibration setting = CAL X10
 BETA = 6.5 x 10 x 10 = 650

The beta scale of the meter has three calibration points CAL X10, CAL X5, and CAL X1. The CAL X10 setting is used most often when transistors are tested out of the circuit. The chart in Figure 4 shows the relationships of the various current ranges and the calibration settings. The 100 mA current range, for instance, supplies a maximum of 100 mA collector current when the CAL X10 setting is used. In this case and as a general rule, the beta of a transistor is the meter indication multiplied by the calibration setting.

Keep in mind that the next lower current range can be used only when the meter indication is greater than 50 and only for the 1 A, 100 mA, and 10 mA current ranges.

CURRENT RANGE	CALIBRATION SETTING	COLLECTOR CURRENT	BETA MULTIPLICATION FACTOR	BETA MULTIPLICATION FACTOR AFTER SWITCHING TO NEXT LOWER CURRENT RANGE
100 μ A	Not Used			
1 mA	CAL X1 CAL X5 CAL X10	.1 mA .5 mA 1 mA	X1 X5 X10	NOT AVAILABLE NOT AVAILABLE NOT AVAILABLE
10 mA	CAL X1 CAL X5 CAL X10	1 mA 5 mA 10 mA	X1 X5 X10	X10 X50 X100
100 mA	CAL X1 CAL X5 CAL X10	10 mA 50 mA 100 mA	X1 X5 X10	X10 X50 X100
1 A	CAL X1 CAL X5 CAL X10	.1 A .5 A 1 A	X1 X5 X10	X10 X50 X100

Figure 4

The following procedure pertains to both in-circuit and out-of-circuit testing. If you do not obtain the proper results when the transistor is tested in-circuit, remove it from the circuit and repeat the tests.

Beta (Gain) Test

1. Be sure the ON-OFF switch is in the OFF (out) position.
2. Identify each lead of the transistor.
3. Connect the base (b) lead of the transistor to the B connector (white) on the Tester.
4. Connect the emitter (e) lead of the transistor to the E connector (red) on the Tester.
5. Connect the collector (c) lead of the transistor to the C connector (black) on the Tester.
6. Press the TRANS switch.
7. Press the BETA = ∞ switch.
8. Determine the transistor class (signal, intermediate power or power). Then press the appropriate range switch to select the proper current.
9. Identify the transistor type (NPN or PNP). Then place the NPN-PNP switch in the appropriate position. If the type is not known, assume it to be an NPN device.
10. Press the ON-OFF switch to the ON (in) position.
11. Adjust the SET BETA = ∞ control to place the meter pointer over the ∞ mark on the beta scale. If you are unable to adjust the meter pointer or if it deflects off scale, the transistor may be defective or incorrectly connected to the Tester.
12. Make sure the BETA CAL control is pushed in and turned fully counterclockwise.
13. Press the BETA CAL switch.
14. Rotate the BETA CAL control and notice that the meter pointer moves accordingly. If the pointer does not move or deflects off scale, the transistor may be defective, incorrectly connected to the Tester, or the NPN-PNP switch may be in the wrong position.
15. Adjust the BETA CAL control to place the meter pointer over the desired calibration mark (CAL X10, CAL X5, or CAL X1) on the beta scale. As a rule, use the CAL X10 mark. Lower settings reduce the collector current accordingly as shown in Figure 4.

NOTE: If you cannot position the meter pointer at the desired calibration mark when testing power transistors, pull out on the BETA CAL control to extend its range. If you are still unable to calibrate the Tester at the desired mark, especially when the transistor being tested is in-circuit, use the next lower calibration mark (CAL X5 or CAL X1).

16. Press the BETA switch. Note the meter indication. Multiply this indication by the calibration setting (CAL X10, CAL X5, or CAL X1) to obtain the actual transistor beta. NOTE: If the meter indication is greater than 50, a lower current range may be selected to provide an additional multiplication factor of 10 as explained previously (only on ranges 10 mA or higher).

A transistor that is tested in-circuit and that has a beta of less than 10 should be removed from the circuit and retested. As a rule, any transistor that has a gain less than 10 when tested out-of-circuit should be considered defective.

The previous steps have explained the beta testing procedure. If the device is out of the circuit, the following leakage tests will further test the transistor. Disregard the next two steps if you are going to perform the leakage tests.

17. Release the ON-OFF switch to the OFF (out) position.
18. Disconnect the transistor from the Tester.

Transistor Leakage Tests

Leakage tests must always be performed with the transistor out of the circuit, since the resistance of the circuit could cause erroneous readings.

Three leakage measurements (I_{cbo} , I_{ces} , and I_{ceo}) will be made in the following steps.

I_{cbo} is the measurement of the leakage current (I) between the collector (c) and the base (b) with the emitter open (o). This measurement should always be the lowest of the leakage measurements.

I_{ces} is the measurement of the leakage current (I) between the collector (c) and the emitter (e) with the base shorted (s) to the emitter.

I_{ceo} is the measurement of the leakage current (I) between the collector (c) and the emitter (e) with the base open (o). This measurement should always be the highest of the three leakage measurements.

In other words, for good transistors, I_{cbo} will always be less than I_{ces} and I_{ces} will always be less than I_{ceo} .

Generally, you will not obtain any measurable leakage when testing silicon transistors. Most low-power silicon transistors have very low leakage with the collector to base leakage current (I_{cbo}) usually less than $1 \mu A$ (one microampere). High-power silicon transistors may indicate an I_{ceo} up to $50 \mu A$.

Germanium transistors have an I_{cbo} that ranges from several microamperes to as high as 5 mA. The following chart is a guide to help you determine if the leakage is too high for a germanium transistor. If in doubt, refer to a transistor manual.

GERMANIUM TRANSISTOR	TYPICAL LEAKAGE CURRENT		
	I_{cbo}	I_{ces}	I_{ceo}
RF-IF-AUDIO	0 – 5 μA	0 – 50 μA	1 μA – 500 μA
AUDIO-SWITCHING	0 – 10 μA	1 μA – 100 μA	5 μA – 1 mA
POWER	5 μA – 100 μA	5 μA – 1 mA	50 μA – 5 mA

NOTES:

1. Be sure the "BETA TEST" has been completed before you perform the following leakage tests.
2. If the leakage current is greater than $100 \mu A$, causing the meter pointer to deflect off scale, select a higher current range.

3. Leakage current will increase in temperature. Even body heat from holding the transistor in your hand can increase the leakage current.

As you perform the leakage tests, analyze the result and determine if the leakages are within acceptable limits.

1. Press the I_{cbo} switch.
2. Press the $100 \mu A$ switch. Read the leakage current directly from the leakage scale.
3. Press the I_{ces} switch. Read the leakage current directly from the leakage scale.
4. Press the I_{ceo} switch. Read the leakage current directly from the leakage scale.
5. Release the ON-OFF switch to the OFF (out) position.
6. Disconnect the transistor from the Tester.

FET TESTING

Drawings C and D of Figure 3 (fold-out from Page 22) show the schematic symbols for N channel FET's (field effect transistors). Notice that N channel FET's have a positive drain-to-source voltage. Drawings E and F show the schematic symbols for P channel FET's. These FET's have a negative drain-to-source voltage.

The following steps measure the G_m (transconductance) of FET's. G_m usually ranges between 500 to 10,000 $\mu mhos$. This characteristic, like beta, can even vary between FET's of the same type. It is also useful when selecting devices (matching) that have the same characteristics.

The following procedure pertains to both in-circuit and out-of-circuit testing. If you do not obtain the proper results when the FET is tested in-circuit, remove it from the circuit and repeat the tests.

Gm (transconductance) Test

1. Be sure the ON-OFF switch is in the OFF (out) position.
2. Identify each lead of the FET to be tested; then connect the FET to the Tester.
3. Press the FET switch.
4. Press the Gm = 0 switch.
5. Press the 100 μ A switch.
6. Identify the FET type (N channel or P channel). Then place the P CHAN - N CHAN switch in the appropriate position.
7. Press the ON-OFF switch to the ON (in) position.
8. Adjust the SET Gm = 0 control to place the meter pointer over the 0 mark on the Gm scale.
9. Press the Gm switch. Read the Gm directly from the Gm scale. Multiply this reading by 1000 to obtain Gm. If the Gm is ∞ or 0, the FET is defective.
10. Press the GATE 1 switch. The Gm should decrease. If the Gm does not change or increases, first check to make sure the FET is correctly connected to the Tester and the P CHAN - N CHAN switch is in the proper position. If the Gm still does not change, or if it increases, the FET is defective.
11. If the FET being tested has two gates, press the GATE 2 switch. The Gm should decrease. If the Gm does not change, or if it increases, the FET is defective.

The previous steps have explained the Gm testing procedure. If the device is out of the circuit, the following leakage test will further test the FET. Disregard the next two steps if you are going to perform the leakage tests.

12. Release the ON-OFF switch to the OFF (out) position.
13. Disconnect the FET from the Tester.

FET Leakage Tests

Leakage tests must always be performed with the FET out of the circuit, since the resistances of the circuit could cause erroneous readings.

Two leakage measurements (I_{gss} and I_{dss}) will be made in the following steps.

I_{gss} is the measurement of the leakage current (I) between the gate (g) and the source (s) with the drain shorted (s) to the source. Since this leakage current is nominally in the nanoampere range, any measurable leakage indicates the FET is defective.

I_{dss} is the measurement of the current (I) between the drain (d) and the source (s) with the gate shorted (s) to the source. This measurement is not an actual leakage current, but more of a forward current between 100 μ A and 10 mA to indicate that the FET is conducting. The I_{dss} measurement is often helpful when selecting FET's (matching) that have similar characteristics.

NOTE: Be sure the "Gm Test" has been completed before you perform the following leakage tests.

1. Press the I_{gss} switch.
2. Be sure the 100 μ A switch is pressed. Read the leakage current directly from the leakage scale. Any measurable leakage indicates that the FET is defective.
3. Press the 10 mA switch.
4. Press the I_{dss} switch. Read the current directly from the leakage scale. If necessary, select a lower current range to obtain a meter indication.
5. Release the ON-OFF switch to the OFF (out) position.
6. Disconnect the FET from the Tester.

DIODE TESTING

NOTE: Some high voltage diodes, those that have more than a 1.5 volt drop across the junction when the diode is conducting, cannot be adequately tested.

Drawings G and H of Figure 3 show the schematic symbols for diodes.

The following diode tests measure the forward (conducting) current and the reverse (leakage) current. Like transistors, the leakage current depends on the diode type (silicon or germanium). Silicon diodes have very little leakage, while germanium diodes may have as much as several microamperes leakage current.

A good signal diode will have a forward current greater than 0.8 mA, while a good power diode (rectifier) will have a forward current greater than 0.8 A.

The actual zener voltage of a zener diode cannot be tested. However, if a zener diode tests good as a conventional diode, you can assume that it is good. Always test zener diodes and varactor diodes in the same manner as signal diodes. Some temperature compensated zener diodes cannot be tested.

The following procedure pertains to both in-circuit and out-of-circuit testing. If you do not obtain the proper results when a diode is tested in-circuit, remove it from the circuit and repeat the tests.

1. Be sure the ON-OFF switch is in the OFF (out) position.
2. Identify the diode leads.
3. Connect the cathode lead of the diode to the C connector (black) of the Tester.
4. Connect the anode lead of the diode to the E connector (red) of the Tester.
5. Press the TRANS switch.
6. Press the 100 μ A switch.
7. Press the Iceo switch.
8. Be sure the NPN-PNP switch is in the NPN (out) position.

9. Press the ON-OFF switch to the ON (in) position. Read the leakage current directly from the leakage scale. This leakage should be less than a few microamperes.

10. Press the NPN-PNP switch to the PNP (in) position.

CAUTION: In the following steps, do not select a current range that exceeds the current rating of the diode.

11. If a signal diode is being tested, press the 1 mA switch. If a power diode (rectifier) is being tested, press the 1A switch. The meter indication should be greater than 80 on the leakage scale for both types of diodes.
12. Release the ON-OFF switch to the OFF (out) position.
13. Disconnect the diode from the Tester.

UJT TESTING

Drawings J and K of Figure 3 show the schematic symbols for both the N channel and the P channel (uncommon) UJT's (unijunction transistors).

Three measurements (I_{eb_2s} , $I_{b_2b_1s}$, and I_{b_2es}) will be made in the following steps.

I_{eb_2s} is the measurement of leakage current (I) between the emitter (e) and base 2 (b_2) with base 1 shorted (s) to base 2.

$I_{b_2b_1s}$ is the measurement of forward current (I) through base 2 (b_2) and base 1 (b_1) with the emitter shorted (s) to base 1. This current can be converted to R_{bb} (the resistance between base 1 and base 2) as follows:

$$\frac{1.5 \text{ V (battery voltage)}}{I_{b_2b_1s}} = R_{bb}$$

I_{b_2es} is the measurement of emitter current (I) between base 2 (b_2) and the emitter (e) with base 1 shorted (s) to the emitter.

Because only leakages are measured, unijunction transistors must be tested out-of-circuit. This will eliminate erroneous leakage indications caused by circuit resistances.

1. Be sure the ON-OFF switch is in the OFF (out) position.

2. Identify the leads of the UJT.
3. Connect the emitter (e) lead of the UJT to the G₁ connector (white) on the Tester.
4. Connect the base 1 (b₁) lead of the UJT to the S connector (red) of the Tester.
5. Connect the base 2 (b₂) lead of the UJT to the D connector (black) of the Tester.
6. Press the FET switch.
7. Press the Igss switch.
8. Press the 100 μA switch.
9. Identify the UJT type (N channel or P channel). Then place the P CHAN-N CHAN switch in the appropriate position.
10. Press the ON-OFF switch to the ON (in) position. Read the I_{b2s} leakage current directly from the leakage scale. This leakage should be less than 1 μA.
11. Press the 1 mA switch.
12. Press the Idss switch. Read the I_{b2b1s} current directly from the leakage scale. This current is normally between 150 μA and 400 μA. R_{bb} (the resistance between base 1 and base 2) can be obtained by dividing 1.5 volts (battery voltage) by the current (I). For example:

$$\frac{1.5 \text{ V}}{I_{b_2 b_1 s}} = R_{bb}$$

$$I_{b_2 b_1 s} = 250 \mu\text{A} = .000250\text{A}$$

$$\frac{1.5 \text{ V}}{.00025\text{A}} = 6000 \Omega$$

$$R_{bb} = 6000 \Omega$$

13. Press the 100 mA switch.
14. If the UJT is an N channel UJT, place the N CHAN-P CHAN switch in the P CHAN (in) position. If the UJT is a P channel (uncommon) UJT, place the N CHAN-P CHAN switch in the N CHAN (out) position. Read the emitter current I_{b2es} directly from the leakage scale. This current is nominally between 15 to 60 mA.
15. Release the ON-OFF switch to the OFF (out) position.
16. Disconnect the UJT from the Tester.

SCR TESTING

NOTE: Some high voltage SCR's, those that have more than a 1.5 volt drop across the gate junction when the SCR is conducting, cannot be adequately tested.

Drawing L of Figure 3 shows the schematic symbol for an SCR (silicon controlled rectifier).

The following test will check the SCR to determine if it can be properly turned on and turned off.

The following procedure pertains to both in-circuit and out-of-circuit testing. If you do not obtain the proper results when an SCR is tested in-circuit, remove it from the circuit and repeat the tests.

1. Be sure the ON-OFF switch is in the OFF (out) position.
2. Identify the leads of the SCR.
3. Connect the gate (g) lead of the SCR to the B connector (white) on the Tester.
4. Connect the anode (a) lead of the SCR to the E connector (red) on the Tester.
5. Connect the cathode (c) lead of the SCR to the C connector (black) on the Tester.
6. Press the TRANS switch.

7. Place the NPN-PNP switch to the PNP (in) position.
8. Press the I_{ceo} switch.
9. Press the 1A switch.
10. Press the ON-OFF switch to the ON (in) position.
11. Press the I_{ces} switch; then press the I_{ceo} switch. The SCR should now be turned on. The meter should indicate 50 or greater on the leakage scale.
12. Momentarily disconnect and then reconnect the cathode (c) lead. The SCR should now be turned off. The meter should indicate less than 5 on the leakage scale.
13. Release the ON-OFF switch to the OFF (out) position.
14. Disconnect the SCR from the Tester.

TRIAC TESTING

NOTE: Some high voltage triacs, those that have more than a 1.5 volt drop across the gate junction when the triac is conducting, cannot be adequately tested.

Drawing M Figure 3 shows the schematic symbol for a Triac (triode AC switch).

The following tests will check the triac to determine if it can be properly turned on and turned off.

The following procedure pertains to both in-circuit and out-of-circuit testing. If you do not obtain the proper results when a triac is tested in-circuit, remove it from the circuit and repeat the tests.

1. Be sure the ON-OFF switch is in the OFF (out) position.

2. Identify the leads of the triac.
3. Connect the gate (g) lead of the triac to the B connector (white) on the Tester.
4. Connect the hot lead of the triac to the E connector (red) on the Tester.
5. Connect the common lead of the triac to the C connector (black) on the Tester.
6. Press the TRANS switch.
7. Place the NPN-PNP switch in the NPN (out) position.
8. Press the I_{ceo} switch.
9. Press the 1A switch.
10. Press the ON-OFF switch to the ON (in) position.
11. Press the I_{ces} switch; then press the I_{ceo} switch. The triac should now be turned on. The meter should indicate greater than 50 on the leakage scale.
12. Momentarily disconnect and then reconnect the cathode (c) lead. The triac should now be turned off. The meter should indicate less than 5 on the leakage scale.
13. Press the NPN-PNP switch to the PNP (in) position. The triac should remain turned off. Now, repeat steps 11 and 12.
14. Release the ON-OFF switch to the OFF (out) position.
15. Disconnect the triac from the Tester.

IN CASE OF DIFFICULTY

This section of the Manual is divided into two parts. The first part, titled "General Troubleshooting Information," describes what to do about the difficulties that may occur right after your Tester is assembled.

The second part, titled "Troubleshooting Chart," is provided to assist you in servicing the Tester if the "General Troubleshooting Information" fails to clear up the problem, or if difficulties occur after your Tester has been in use for some time. The "Troubleshooting Chart" lists possible difficulties that could raise along with several possible solutions to those difficulties.

Try to analyze the symptoms of any problem you might have before starting any troubleshooting procedure. This can usually be accomplished by trying the various functions of your Tester to determine abnormal operations. A review of the "Operation" section may help.

GENERAL TROUBLESHOOTING INFORMATION

NOTE: The following checks will be most effective if you apply them to one part of the kit at a time.

1. Recheck the wiring. Trace each lead in colored pencil on the Pictorial as it is checked. It is frequently helpful to have a friend check your work. Someone who is not familiar with the unit may notice something you have consistently overlooked.
2. About 90% of the kits that are returned for repair do not function properly due to poor connections and soldering. Therefore, many troubles can be eliminated by a careful inspection of connections to

make sure they are soldered as described in the "Kit Builders Guide." Reheat any doubtful connections. Be sure all wires are soldered at places where several wires are connected.

3. Check each circuit board foil to be sure there are no solder bridges between adjacent connections. Remove any solder bridges by holding a clean soldering iron tip between the two points that are bridged until the excess solder flows down onto the tip of the soldering iron.
4. Check each resistor value carefully. A resistor that is discolored, or cracked, or shows any sign of bulging would indicate that it is faulty and should be replaced.
5. Be sure the diode is installed with the banded end positioned correctly.
6. Check all component leads connected to the circuit boards. Make sure the leads do not extend through the circuit board and come in contact with other connections or parts.
7. Check all wires that are connected to the circuit board switches. Make sure the wires do not touch the other lugs. Make sure all wires are properly soldered.

NOTE: In an extreme case where you are unable to resolve a difficulty, refer to the "Customer Service" information inside the rear cover of the Manual. Your Warranty is located inside the front cover.

TROUBLESHOOTING CHART

SYMPTOM	POSSIBLE CAUSE
Meter inoperative.	<ol style="list-style-type: none"> 1. Shorting wire across meter terminals. 2. Batteries not installed or weak.
Meter pegs left when turned on.	<ol style="list-style-type: none"> 1. Set Beta = ∞ control turned fully counterclockwise. 2. Meter leads or battery leads interchanged. 3. One or both batteries installed backwards.
Meter pegs right when Beta Cal switch is pressed in.	<ol style="list-style-type: none"> 1. Transistor leads incorrectly connected.
No full scale deflection; Beta Cal control pulled out and turned fully clockwise.	<ol style="list-style-type: none"> 1. Batteries weak or have poor connection. Remove batteries, bend battery holder ends inward and replace the batteries. Rotate the batteries in the holders to insure good contact. 2. Control R1 out of adjustment. Refer to the "Test and Adjustment" section on Page 19.
Current range different than label indicates.	<ol style="list-style-type: none"> 1. Range switch wiring. Trace wiring from switch to circuit board. 2. Shunt resistances. Check R1, R2, R3, and R4.
Function or mode switches operate improperly.	<ol style="list-style-type: none"> 1. Function and mode switch jumper wires. Trace all wires associated with these switches and the circuit board.

SPECIFICATIONS

DC Beta	1 to 5000 with the following ranges available: 1 to 50, 5 to 250, 10 to 500, 50 to 2500, 100 to 5000.
Collector Currents Available	1 mA, 5 mA, 10 mA, 50 mA, 100 mA, 500 mA, and 1 A.
G_m	0 to 50,000 μ hos.
Leakage Measurements (Iceo, Ices, Icbo, Idss, Igss)	Five current ranges, $\pm 5\%$. 0-100 μ A, 0-1 mA, 0-10 mA, 0-100 mA, 0-1 A
Out-of-Circuit Accuracy	$\pm 2\%$, $\pm 2\%$ arc for DC beta and leakage.
In-Circuit Accuracy	Indicates good or bad transistor, FET, diode, SCR, or triac.
Diode Test	Tests for forward conduction and reverse leakage (out-of-circuit).
SCR and Triac Tests	Tests for proper conduction and blocking.
Unijunction Transistor Test	Measures I_{eb_2s} , $I_{b_2b_1s}$, and Emitter Current (out-of-circuit).
Power	Two 1-1/2 volt D cells.
Dimensions (overall)	9-9/16" wide x 8-5/8" deep x 5-1/4" high.
Net Weight (Less batteries)	3-1/2 lbs.

The Heath Company reserves the right to discontinue products and to change specifications at any time without incurring any obligation to incorporate new features in products previously sold.

CIRCUIT DESCRIPTION

Refer to the Schematic Diagram (fold-out from Page 41) while you read this "Circuit Description."

General Consideration

All of the following circuit explanations refer only to NPN transistors or N channel FET's. The descriptions also apply equally to PNP transistors and P channel FET's except that the polarity of the meter and both batteries (B1 and B2) must be reversed.

Diode D1 protects the meter by limiting the voltage across it to 0.6 volts. Capacitors C1 and C2 prevent oscillations from occurring in the device being tested. Resistors R5 and R6 limit the current to protect controls R11 and R12 in case a short circuit occurs. For simplicity, the above components are not shown in the following partial schematics.

All switches are shown on the Schematic in the released (out) position even though this configuration does not represent a particular test. This enables you to easily trace a particular test circuit by pressing (mentally) only the switch related to that test.

BATTERY TEST

Each battery is tested separately. The NPN position of the NPN-PNP switch connects battery B2 into the battery

testing circuit. The PNP position of the NPN-PNP switch connects battery B1 into the battery testing circuit. A load, simulating operating conditions, is connected across each battery while the battery voltage is being measured. This assures that the battery is capable of supplying adequate current and voltage for the tests.

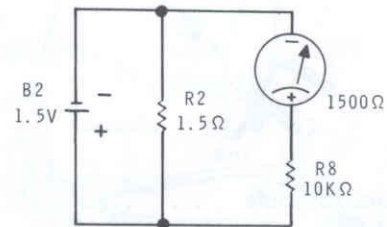

BAT TEST

Figure 5

When the Bat Test switch is pressed, resistor R2 is placed across the battery terminals to load the battery. See Figure 5. The meter, now functioning as a voltmeter, measures the battery voltage. If the battery is serviceable (0.9 volt or more), the meter pointer will fall within the Bat OK mark on the meter.

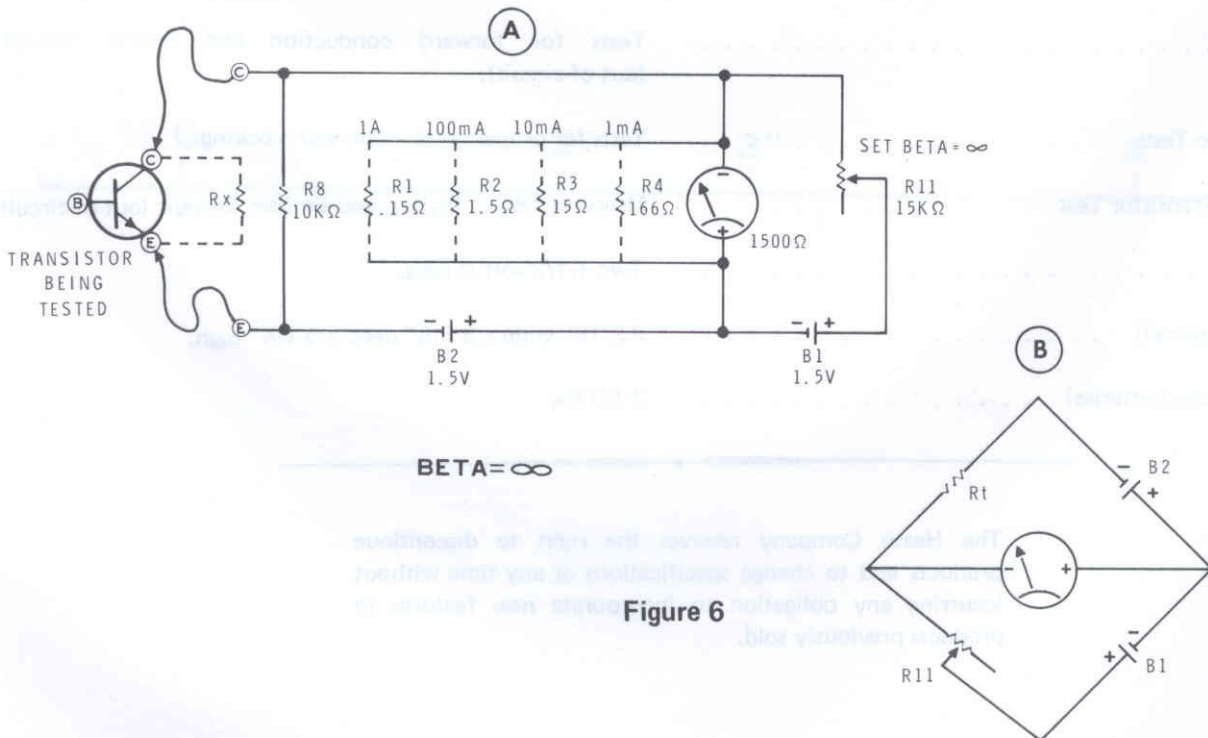

Figure 6

BETA = ∞

The "beta = ∞" circuit, as shown in Part A of Figure 6, primarily compensates for the transistor collector load resistance, R8, and in-circuit resistances, Rx.

This circuit is basically a bridge circuit as shown in Part B of Figure 6. Resistor Rt represents load resistor R8 plus any in-circuit resistance, Rx. Because Rx varies widely from one circuit to another, control R11 (Set Beta = ∞) provides a means of balancing the bridge circuit. A true representation of beta can now be achieved since any unbalance that occurs in subsequent tests will be directly associated with the transistor collector current.

Resistors R1 through R4 are meter shunt resistances for the 1 A through 1 mA ranges respectively. The 100 μA range does not use a meter shunt resistor.

BETA CAL

The base of the transistor is now connected into the circuit through control R12 (Beta Cal) and resistor R10. See Figure 7. Control R12 adjusts the base current of the transistor until sufficient collector current flows through the meter to place the pointer over the CAL X10 mark (full scale). The collector current is now equal to the particular current range you selected.

Because resistor R10 is the same value as the meter resistance, the meter and resistor R10 can be interchanged in the following tests to measure base current without changing the collector current.

Notice that a shunt resistor is in parallel with resistor R10. This total resistance (R10 and its shunt) is ten times larger than the resistance of the meter and its shunt for the same range. Thus, when the meter is placed in the base circuit, it will read 1/10 the current measured in the collector circuit.

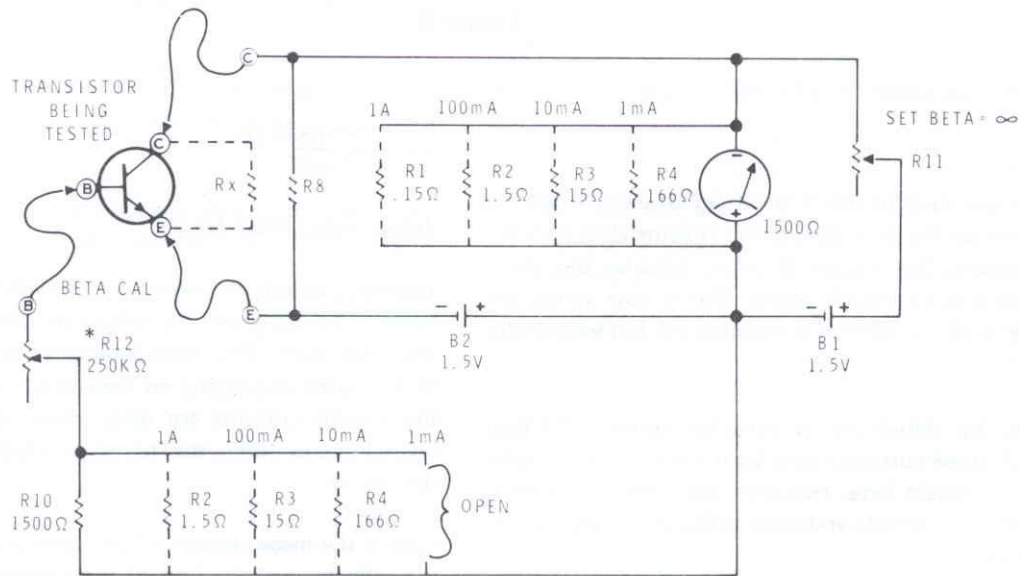

* R13 (5000Ω)
IF CONTROL IS PULLED
OUT (1A RANGE ONLY).

BETA CAL

Figure 7

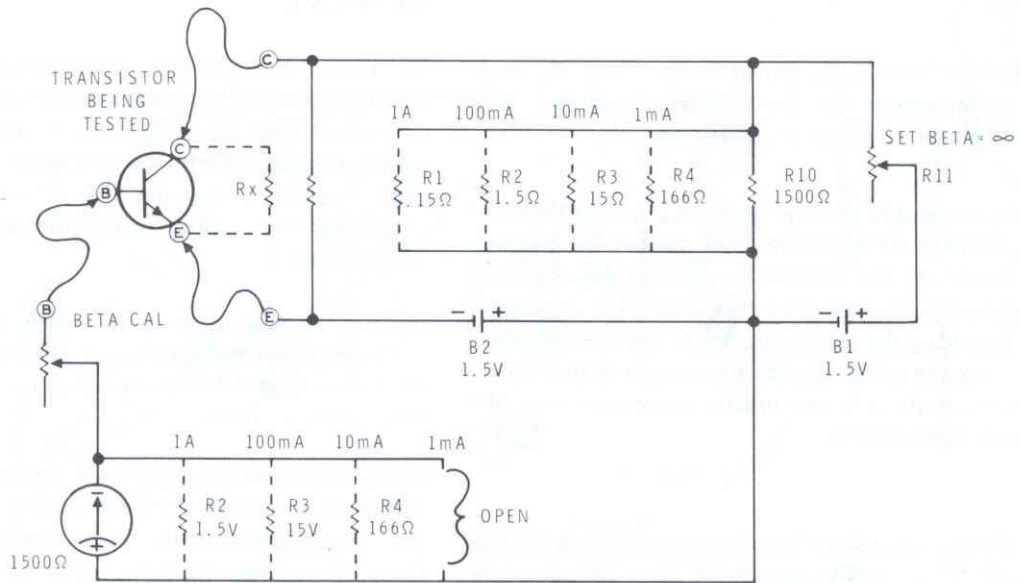

BETA

Figure 8

BETA

This circuit is similar to the beta cal circuit except that the meter is now in the base circuit and resistor R10 is in the collector circuit. See Figure 8. Also, because the shunt resistor that was previously across R10 is now across the meter, only 1/10 the current is required for full-scale meter deflection.

Since beta, by definition, is collector current (Ic)/base current (Ib), these currents could be measured and the ratio computed to obtain beta. However, the meter scale takes into account the currents and their ratio, and reads directly in terms of beta.

For example, when the 10 mA current range is selected, and the Beta Cal control is adjusted to place the meter pointer over the CAL X10 mark (full scale), a collector current of 10 mA flows through the device. Now, when the meter is in the base circuit, assume that a 1 mA current flows. The meter pointer will deflect full scale (1 mA) and indicate a beta of 1 times a multiplier of 10 (CAL X10). Thus, beta = 10. The same result can be obtained from the formula:

$$\frac{I_C}{I_B} = \frac{10 \text{ mA}}{1 \text{ mA}} = 10$$

Icbo, Ices, AND Iceo

Leakage currents are measured by placing a battery and the meter (and its shunt resistance) in series with two of the transistor leads. The meter indicates leakage current from 0 to 1 ampere, depending on the current range selected. Since the leakage currents are quite small, usually measured in microamperes (μA), the transistor must be removed from the circuit.

Icbo is the measurement of the current that flows between the collector and the base of the transistor with the emitter open (unconnected). See Figure 9.

Ices is the measurement of the current that flows between the collector and the emitter of the transistor with the base connected to the emitter. See Figure 10.

Iceo is the measurement of the current that flows between the collector and the emitter of the transistor with the base open (unconnected). See Figure 11.

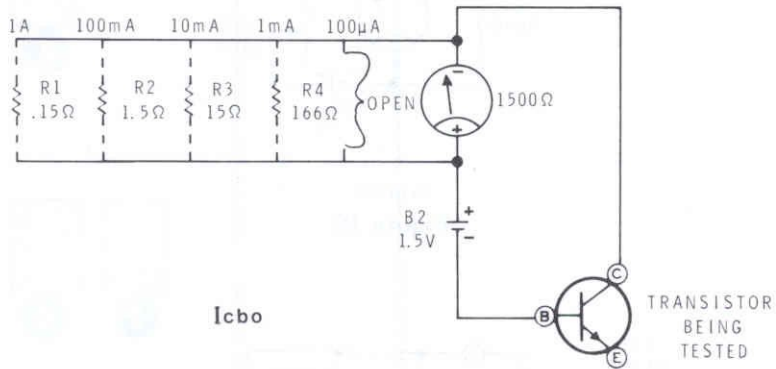

Figure 9

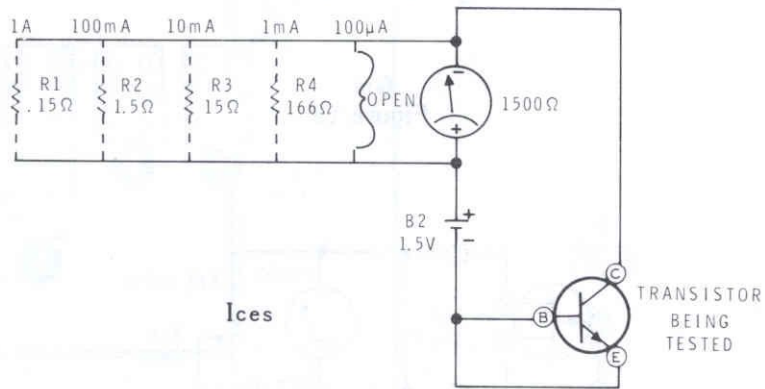

Figure 10

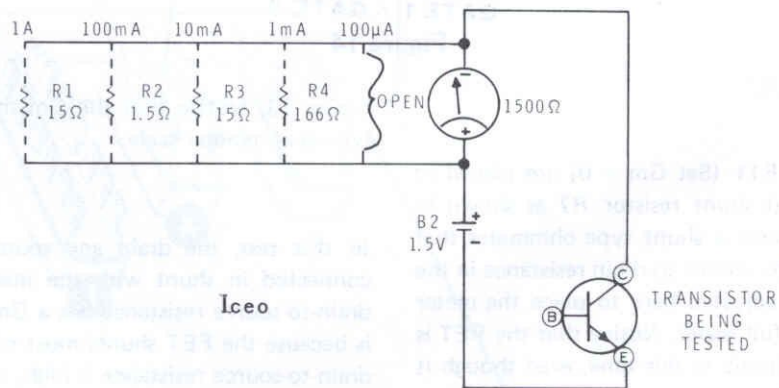
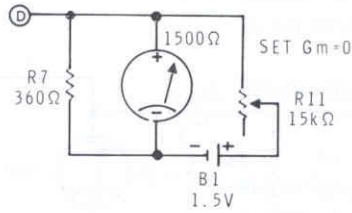
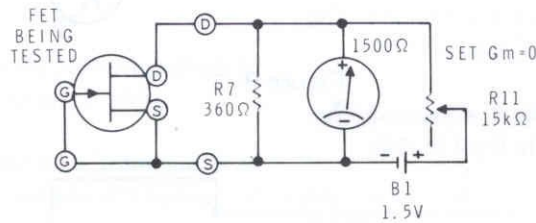

Figure 11



G_m=0
Figure 12



G_m
Figure 13

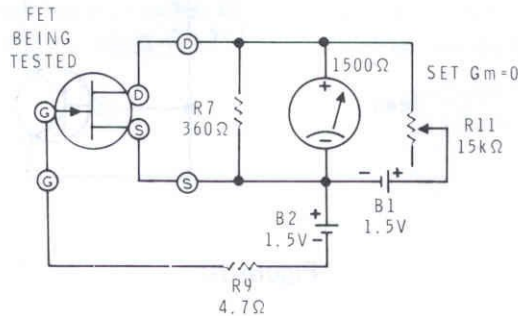

GATE 1 / GATE 2
Figure 14

G_m = 0

Battery B1 and control R11 (Set G_m = 0) are placed in series with the meter and shunt resistor R7 as shown in Figure 12. This circuit forms a shunt type ohmmeter that will be used to measure the source-to-drain resistance in the G_m test. Control R11 is adjusted here to place the meter pointer over the 0 mark (full scale). Notice that the FET is not connected into the circuit at this time, even though it may be connected to the Tester.

G_m

Because G_m (transconductance) is the reciprocal of resistance, an ohmmeter type circuit can measure G_m. See

Figure 13. Notice that the G_m meter scale is similar to a typical ohmmeter scale.

In this test, the drain and source leads of the FET are connected in shunt with the meter. An FET with a low drain-to-source resistance has a G_m that approaches ∞. This is because the FET shunts most of the meter current. If the drain-to-source resistance is high, the G_m approaches 0. This is because the FET shunts very little meter current.

Typically, values of transconductance are expressed in μmhos (the meter indication multiplied by 1000).

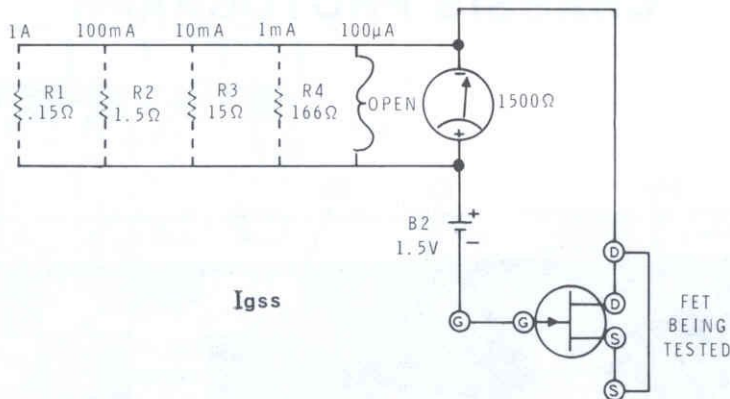

Figure 15

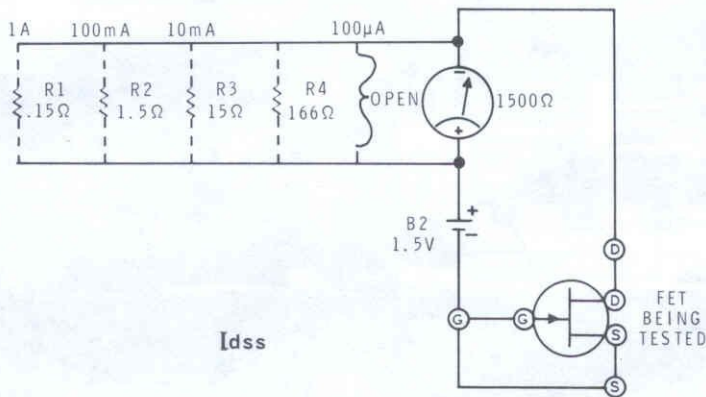

Figure 16

GATE 1 AND GATE 2

The "Gate 1" circuit is similar to the G_m circuit. See Figure 14. However, the Gate 1 test places a reverse bias on the gate of the FET through resistor R9. This causes the channel of the FET to become electrically narrower, increasing its resistance, decreasing its G_m . A noticeable decrease in G_m should be apparent when the Gate 1 switch is pressed.

If the FET is a dual gate device, the Gate 2 switch will reverse bias the second gate. A noticeable decrease in G_m should also be apparent when the Gate 2 switch is pressed.

I_{gss} AND I_{dss}

Leakage currents are measured by placing a battery and the meter (and its shunt resistance) in series with two of the

FET leads. The meter indicates leakage current from 0 to 1 ampere, depending on the current range selected. Since the leakage currents are quite small, usually measured in microamperes (μA), the FET must be removed from the circuit.

I_{gss} is the measurement of the current that flows between the gate and the source of the FET with the drain connected to the source. See Figure 15.

I_{dss} is the measurement of the current that flows between the drain and the source of the FET with the gate connected to the source. See Figure 16.

CHASSIS PHOTOGRAPH

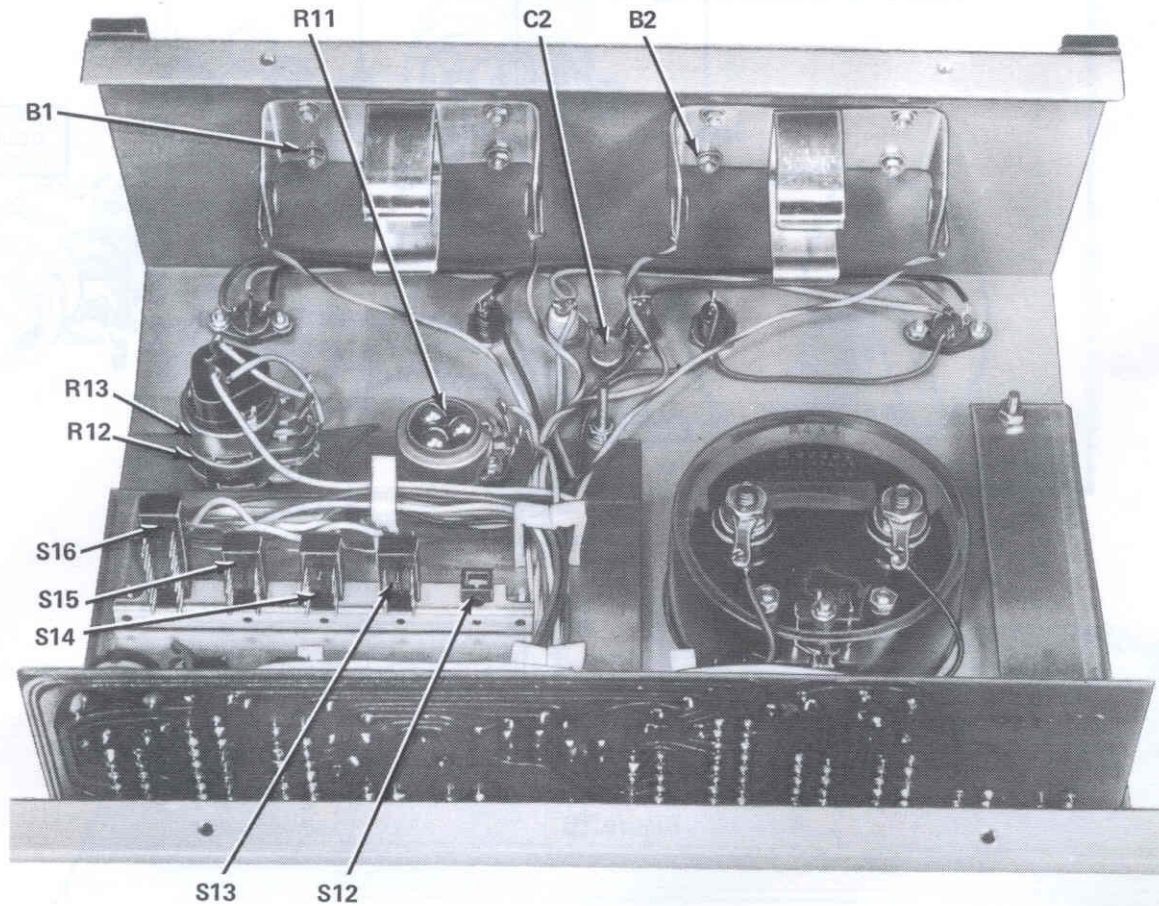

CIRCUIT BOARD X-RAY VIEWS

NOTE: To identify a part shown in one of these Views, so you can order a replacement, proceed in either of the following ways:

1. A. Refer to the place where the part is installed in the Step-by-Step instructions and note the "Description" of the part (for example: 1500 Ω or .005 μ F).
 - B. Look up this Description in the "Parts List."
2. A. Note the identification number of the part (R-number, C-number, etc.).
 - B. Locate the same identification number (next to the part) on the Schematic. The "Description" of the part will also appear near the part.
 - C. Look up this Description in the "Parts List."

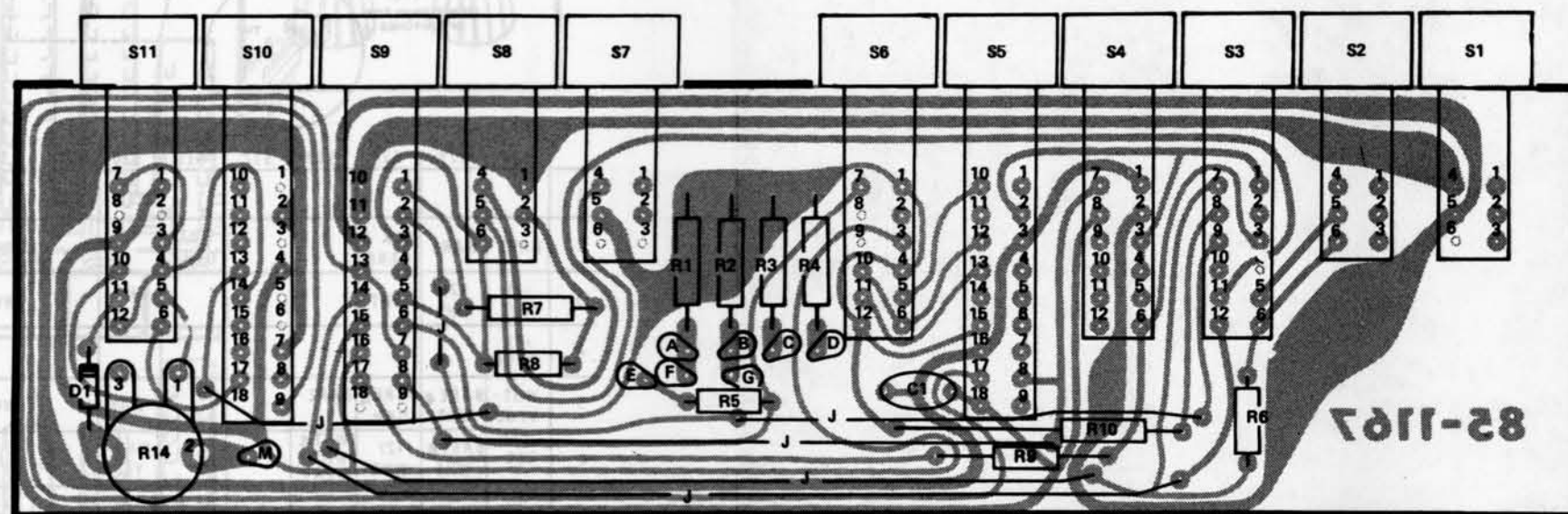

(VIEWED FROM COMPONENT SIDE)

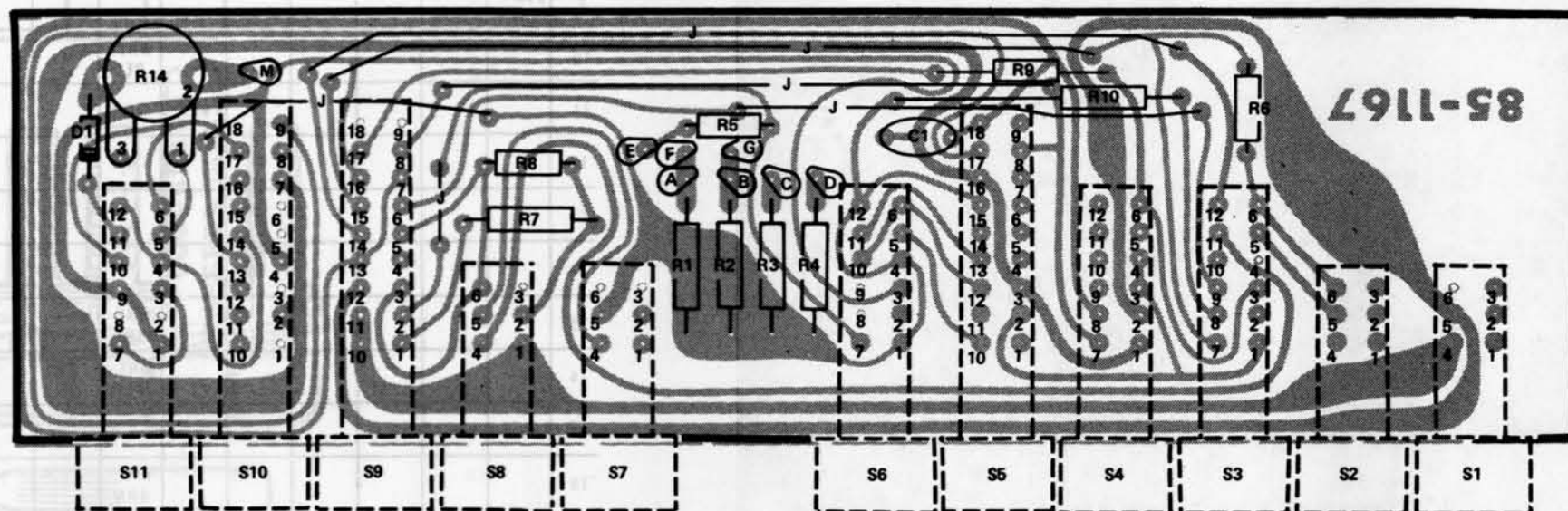

(VIEWED FROM FOIL SIDE)

KEY HEATH No.	PARTS Part No.	DESCRIPTION Part No.
#5 Hardware		
27	250-105	#6 #10 x 1/8" sheet metal screw
28	250-01	#5 spacer
#10 Hardware		
29	250-03	#10 x 1/2" hex head self tapping screw
Control Hardware		
30	252-7	Control knob
31	253-10	Control knob washer
32	254-4	Control knob washer
SOCKETS — JACKS — PLUGS		
33	434-342	Transistor socket
34	434-043	Socket pin
35	435-11	Red banana jack
36	435-24	Black banana jack
37	435-24	White banana jack
38	435-25	Green banana jack
39	435-47	Banana plug
40	255-59	Alligator clip
FEET-KNIBS-INSULATORS		
41	261-48	Rubber foot
42	462-362	Knob
43	70-10	Black banana plug insulator
44	70-11	Red banana plug insulator
45	70-12	Green banana plug insulator
46	70-13	White banana plug insulator
47	70-24	Rubber insulator
WIRE		
341-1		Black (enamel)
341-2		Brown (enamel)
341-3		White (enamel)
341-4		Green (enamel)
344-00		Black
344-01		Brown
344-02		Red
344-04		Yellow
344-05		Green
344-06		White

KEY HEATH No.	PARTS Part No.	DESCRIPTION Part No.
Wire (enamel)		
	344-70	White/black
	344-71	White/brown
	344-72	White/red
	344-73	White/orange
	344-74	White/yellow
	344-75	White/green
	344-77	White/violet
	344-78	White/gray
MISCELLANEOUS		
	18-1127-1	Circuit board
F1	305-3412-0	Front panel
F2	305-361-0	Cabinet shell
F3	304-1027	Suspension
F4	257-82	Clamp
F5	251-15	Handle
F6	254-26	Battery holder
F7	425-03	Slider
F8	425-02	Knob bushing
F9	46-37	Mode switch
F10	84-95	Range potentiometer
F11	84-93	Function switch
F12	100-5	Nut stander
	581-262	Parts Order Form
	581-278	Kit Success Guide
	581-34	Blue waterproof tape
		Manual (see front cover for part number)
		Solder

The following batteries should be purchased at this time for use in the completed kit:
 2 D-cell flashlight batteries (alkaline type preferred for longer life)

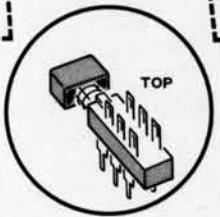
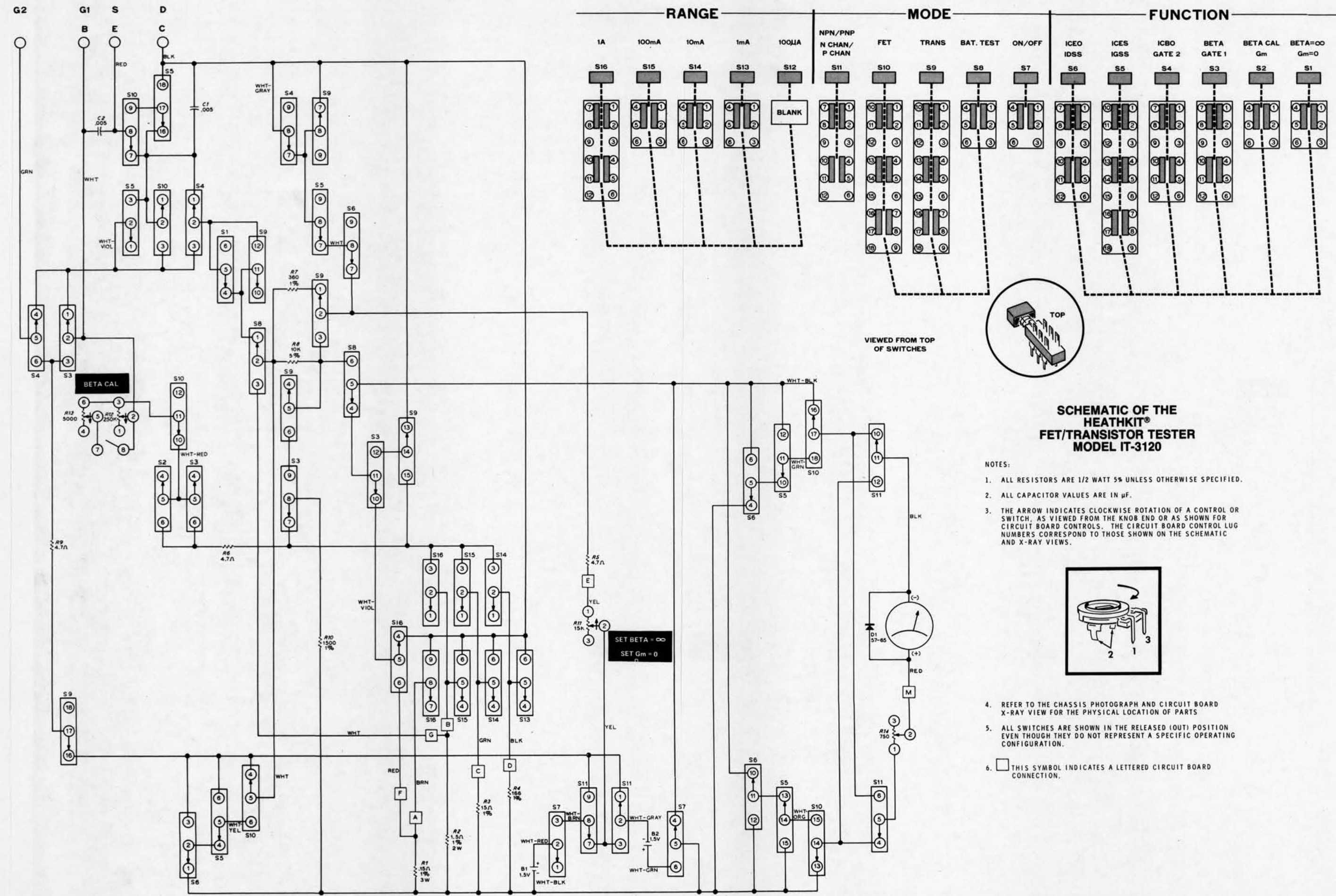

SCHEMATIC OF THE HEATHKIT® FET/TRANSISTOR TESTER MODEL IT-3120

- NOTES:
1. ALL RESISTORS ARE 1/2 WATT 5% UNLESS OTHERWISE SPECIFIED.
 2. ALL CAPACITOR VALUES ARE IN μF .
 3. THE ARROW INDICATES CLOCKWISE ROTATION OF A CONTROL OR SWITCH, AS VIEWED FROM THE KNOB END OR AS SHOWN FOR CIRCUIT BOARD CONTROLS. THE CIRCUIT BOARD CONTROL LUG NUMBERS CORRESPOND TO THOSE SHOWN ON THE SCHEMATIC AND X-RAY VIEWS.

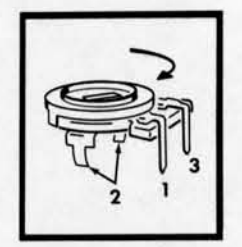

4. REFER TO THE CHASSIS PHOTOGRAPH AND CIRCUIT BOARD X-RAY VIEW FOR THE PHYSICAL LOCATION OF PARTS
5. ALL SWITCHES ARE SHOWN IN THE RELEASED (OUT) POSITION EVEN THOUGH THEY DO NOT REPRESENT A SPECIFIC OPERATING CONFIGURATION.
6. THIS SYMBOL INDICATES A LETTERED CIRCUIT BOARD CONNECTION.

FOR PARTS REQUESTS ONLY

- Be sure to follow instructions carefully.
- Use a separate letter for all correspondence.
- Please allow 10 - 14 days for mail delivery time.

DO NOT WRITE IN THIS SPACE

INSTRUCTIONS

- Please print all information requested.
- Be sure you list the correct **HEATH** part number exactly as it appears in the parts list.
- If you wish to prepay your order, mail this card and your payment in an envelope. Be sure to include 10% (25¢ minimum, \$3.50 maximum) for insurance, shipping and handling. Michigan residents add 4% tax.
Total enclosed \$ _____
- If you prefer COD shipment, check the COD box and mail this form. COD

NAME _____
 ADDRESS _____
 CITY _____
 STATE _____ ZIP _____

The information requested in the next two lines is not required when purchasing nonwarranty replacement parts, but it can help us provide you with better products in the future.

Model # _____ Invoice # _____
 Date _____ Location _____
 Purchased _____ Purchased _____

LIST HEATH PART NUMBER	QTY.	PRICE EACH	TOTAL PRICE
TOTAL FOR PARTS			
HANDLING AND SHIPPING			
MICHIGAN RESIDENTS ADD 4% TAX			
TOTAL AMOUNT OF ORDER			

SEND TO: **HEATH COMPANY**
 BENTON HARBOR
 MICHIGAN 49022
ATTN: PARTS REPLACEMENT

Phone (Replacement parts only): 616 982-3571

CUT ALONG DOTTED LINE

FOR PARTS REQUESTS ONLY

- Be sure to follow instructions carefully.
- Use a separate letter for all correspondence.
- Please allow 10 - 14 days for mail delivery time.

DO NOT WRITE IN THIS SPACE

INSTRUCTIONS

- Please print all information requested.
- Be sure you list the correct **HEATH** part number exactly as it appears in the parts list.
- If you wish to prepay your order, mail this card and your payment in an envelope. Be sure to include 10% (25¢ minimum, \$3.50 maximum) for insurance, shipping and handling. Michigan residents add 4% tax.
Total enclosed \$ _____
- If you prefer COD shipment, check the COD box and mail this form. COD

NAME _____
 ADDRESS _____
 CITY _____
 STATE _____ ZIP _____

The information requested in the next two lines is not required when purchasing nonwarranty replacement parts, but it can help us provide you with better products in the future.

Model # _____ Invoice # _____
 Date _____ Location _____
 Purchased _____ Purchased _____

LIST HEATH PART NUMBER	QTY.	PRICE EACH	TOTAL PRICE
TOTAL FOR PARTS			
HANDLING AND SHIPPING			
MICHIGAN RESIDENTS ADD 4% TAX			
TOTAL AMOUNT OF ORDER			

SEND TO: **HEATH COMPANY**
 BENTON HARBOR
 MICHIGAN 49022
ATTN: PARTS REPLACEMENT

Phone (Replacement parts only): 616 982-3571

CUSTOMER SERVICE

REPLACEMENT PARTS

Please provide complete information when you request replacements from either the factory or Heath Electronic Centers. Be certain to include the **HEATH** part number exactly as it appears in the parts list.

ORDERING FROM THE FACTORY

Print all of the information requested on the parts order form furnished with this product and mail it to Heath. For telephone orders (parts only) dial 616 982-3571. If you are unable to locate an order form, write us a letter or card including:

- Heath part number.
- Model number.
- Date of purchase.
- Location purchased or invoice number.
- Nature of the defect.
- Your payment or authorization for COD shipment of parts not covered by warranty.

Mail letters to: Heath Company
Benton Harbor
MI 49022
Attn: Parts Replacement

Retain original parts until you receive replacements. Parts that should be returned to the factory will be listed on your packing slip.

OBTAINING REPLACEMENTS FROM HEATH ELECTRONIC CENTERS

For your convenience, "over the counter" replacement parts are available from the Heath Electronic Centers listed in your catalog. Be sure to bring in the original part and purchase invoice when you request a warranty replacement from a Heath Electronic Center.

TECHNICAL CONSULTATION

Need help with your kit? — Self-Service? — Construction? — Operation? — Call or write for assistance. you'll find our Technical Consultants eager to help with just about any technical problem except "customizing" for unique applications.

The effectiveness of our consultation service depends on the information you furnish. Be sure to tell us:

- The Model number and Series number from the blue and white label.
- The date of purchase.
- An exact description of the difficulty.
- Everything you have done in attempting to correct the problem.

Also include switch positions, connections to other units, operating procedures, voltage readings, and any other information you think might be helpful.

Please do not send parts for testing, unless this is specifically requested by our Consultants.

Hints: Telephone traffic is lightest at midweek — please be sure your Manual and notes are on hand when you call.

Heathkit Electronic Center facilities are also available for telephone or "walk-in" personal assistance.

REPAIR SERVICE

Service facilities are available, if they are needed, to repair your completed kit. (Kits that have been modified, soldered with paste flux or acid core solder, cannot be accepted for repair.)

If it is convenient, personally deliver your kit to a Heathkit Electronic Center. For warranty parts replacement, supply a copy of the invoice or sales slip.

If you prefer to ship your kit to the factory, attach a letter containing the following information directly to the unit:

- Your name and address.
- Date of purchase and invoice number.
- Copies of all correspondence relevant to the service of the kit.
- A brief description of the difficulty.
- Authorization to return your kit COD for the service and shipping charges. (This will reduce the possibility of delay.)

Check the equipment to see that all screws and parts are secured. (Do not include any wooden cabinets or color television picture tubes, as these are easily damaged in shipment. Do not include the kit Manual.) Place the equipment in a strong carton with at least **THREE INCHES** of *resilient* packing material (shredded paper, excelsior, etc.) on all sides. Use additional packing material where there are protrusions (control sticks, large knobs, etc.). If the unit weighs over 15 lbs., place this carton in another one with 3/4" of packing material between the two.

Seal the carton with reinforced gummed tape, tie it with a strong cord, and mark it "Fragile" on at least two sides. Remember, the carrier will not accept liability for shipping damage if the unit is insufficiently packed. Ship by prepaid express, United Parcel Service, or insured Parcel Post to:

Heath Company
Service Department
Benton Harbor, Michigan 49022



HEATH COMPANY • BENTON HARBOR, MICHIGAN
THE WORLD'S FINEST ELECTRONIC EQUIPMENT IN KIT FORM

LITHO IN U.S.A.