

HEATH COMPANY
BENTON HARBOR, MICHIGAN

THE WORLD'S
Finest
TEST EQUIPMENT
IN KIT FORM

ASSEMBLING
AND USING
YOUR

Heathkit

GRID DIP
METER
MODEL GD-1B

595-67

HEATH COMPANY
BENTON HARBOR,
MICHIGAN

PRICE 50¢

THE WORLD'S *Finest* TEST EQUIPMENT IN KIT FORM

6/1/54

Downloaded by
RadioAmateur.EU

STANDARD COLOR CODE — RESISTORS AND CAPACITORS

<p>AXIAL LEAD RESISTOR</p> <p>Brown — Insulated Black — Non-insulated</p> <p>Tolerance Multiplier 1st and 2nd Significant Figures</p> <p>Wire wound resistors have 1st digit band double width</p>	<p>UNINSULATED</p> <p>Color</p> <p>BLACK BROWN RED ORANGE YELLOW GREEN BLUE VIOLET GRAY WHITE</p>	<p>FIRST RING</p> <p>BODY COLOR</p> <p>First Figure</p> <p>0 1 2 3 4 5 6 7 8 9</p>	<p>SECOND RING</p> <p>END COLOR</p> <p>Second Figure</p> <p>0 1 2 3 4 5 6 7 8 9</p>	<p>THIRD RING</p> <p>DOT COLOR</p> <p>Multiplier</p> <p>None 0 .00 .000 .0000 00,000 000,000 0,000,000 00,000,000 000,000,000</p>	<p>RADIAL LEAD DOT RESISTOR</p> <p>Multiplier 1st Figure 2nd Figure Tolerance</p>	<p>5-DOT RADIAL LEAD CERAMIC CAPACITOR</p> <p>Temp. Coeff. Capacity Multiplier Tolerance</p>	<p>EXTENDED RANGE TC CERAMIC HICAP</p> <p>Temp. Coeff. Capacity Multiplier Tolerance</p>	<p>AXIAL LEAD CERAMIC CAPACITOR</p> <p>Temp. Coeff. Capacity Multiplier Tolerance</p>	<p>DISC CERAMIC RMA CODE</p> <p>5-Dot Capacity Multiplier Tolerance Temp. Coeff.</p>
---	--	---	--	--	--	---	---	--	---

The standard color code provides all necessary information required to properly identify color coded resistors and capacitors. Refer to the color code for numerical values and the zeroes or multipliers assigned to the colors used. A fourth color band on resistors determines tolerance rating as follows: Gold = 5%, silver = 10%. Absence of the fourth band indicates a 20% tolerance rating.

The physical size of carbon resistors is determined by their wattage rating. Carbon resistors most commonly used in Heath-kits are 1/2 watt. Higher wattage rated resistors when specified are progressively larger in physical size. Small wire wound resistors 1/2 watt, 1 or 2 watt may be color coded but the first band will be double width.

for free by
RadioAmateur.eu

ASSEMBLY AND OPERATION OF THE HEATHKIT GRID DIP METER MODEL GD-1B



SPECIFICATIONS

Frequency Range.....	2 to 250 mc using five coils. Additional coils available; extending frequency to 350 kc.
Meter Movement.....	500 microampere
Power Requirements.....	117 volt, 5 watts, 50/60 cycle
Power Supply.....	Transformer operated selenium rectifier
Dimensions.....	7" long x 2 1/2" wide x 3 1/4" deep
Shipping Weight.....	4 lbs.
Net Weight.....	2 lbs.

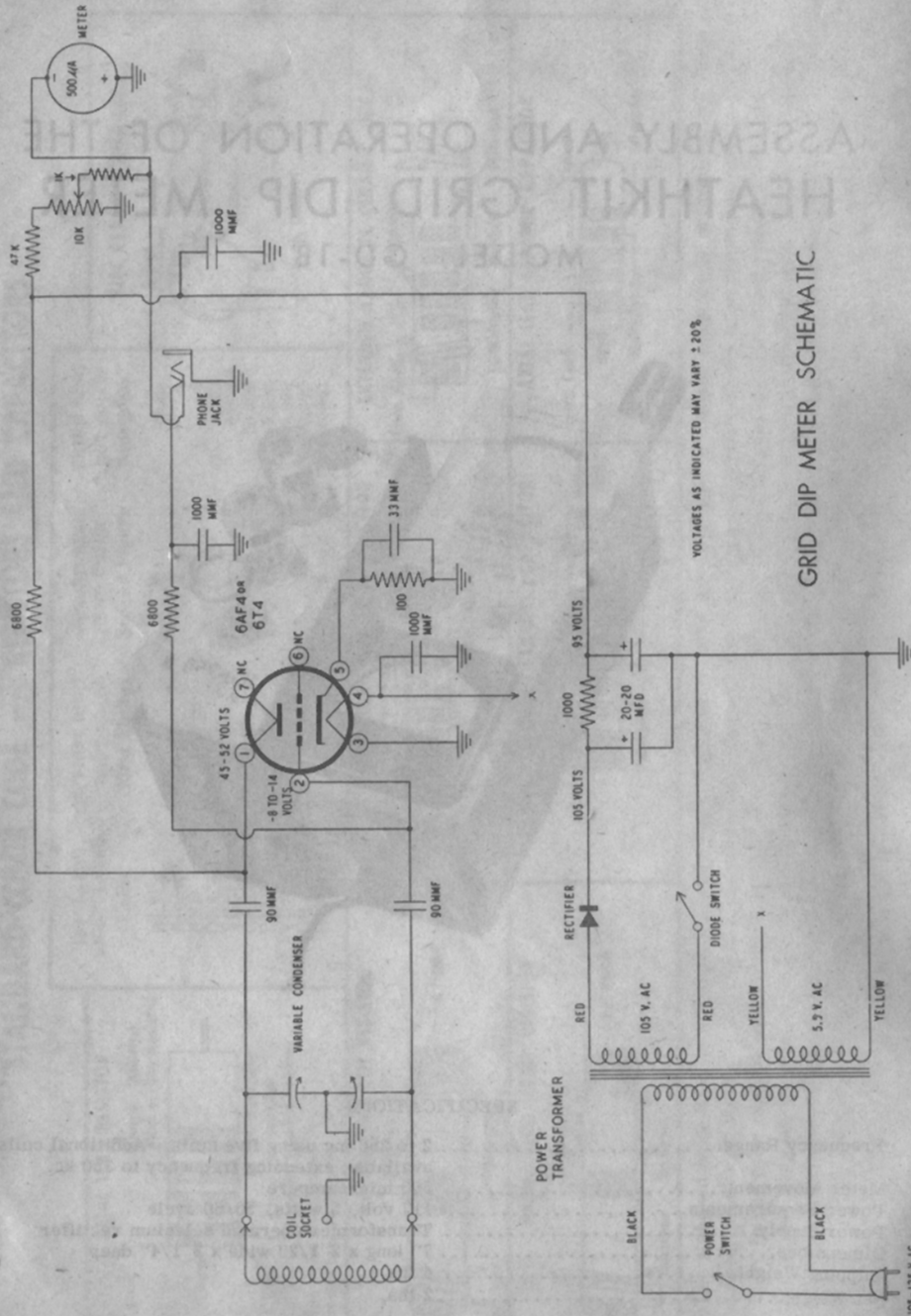

ASSEMBLY AND USE OF THE HEATHKIT MODEL GD-1B GRID DIP METER

The Heathkit Grid Dip Meter model GD-1B is a very useful instrument. As well as determining resonant frequencies, it is also capable of performing the various tests required in the design, adjustment, and operation of high frequency radio and television equipment. Being basically a variable high frequency oscillator, it can be used as a signal generator or marker generator. As a grid dip meter, it can be used to determine the resonant frequency of tuned circuits or the resonant frequency of individual parts, such as coils or condensers. Because it will indicate the resonant frequency of a circuit, methods are outlined for using this information to determine unknown values of inductance, capacity, or Q. When used as a diode detector, it checks the frequency of other high frequency RF sources (providing the RF energy is at least 500,000 microvolts). Switched to an oscillating detector, used in conjunction with a pair of headphones, it is even more sensitive for checking the frequency of other oscillators.

To begin construction turn to the section entitled, "Step-By-Step Construction" starting on Page 8.

OPERATION OF THE GRID DIP METER

A good understanding of the operation of the grid dip meter will aid materially in the proper use of the instrument.

The grid dip meter is a high frequency oscillator operating in the range from 2 mc to over 250 mc. Useful range may be extended down to 350 kc with additional coil set #341-A. A microammeter is inserted in the grid circuit of the oscillator tube. Whenever the oscillator is coupled to a load or resonant frequency, a noticeable reduction in grid current takes place. This reduction in grid current is termed the "grid dip."

The most common load which will absorb energy from the oscillator is a resonant circuit tuned to the same frequency as the oscillator. The grid dip meter can be changed to a wave meter by setting the bottom switch to the "diode" position. When used as a wave meter, the tube acts as a diode detector. As the instrument is tuned to the frequency of nearby RF sources, the diode current reading on the meter will increase. (The sensitivity control must be advanced to maximum, initially.) Thus the GD-1B can be used to determine the frequency of other oscillating circuits providing there is sufficient RF energy within the oscillator circuit under test.

Plugging a pair of headphones into the phone jack and setting the DIODE-OSC. switch to OSCILLATOR position, converts the GD-1B to an oscillating detector. This arrangement can also be used to determine the frequency of other oscillating currents. As the GD-1B is tuned to the frequency of another nearby RF source, a whistle or beat note is heard in the phones. When the GD-1B is adjusted to the lowest beat note (zero beat), the frequency read on the dial scale is the same as the frequency of the other oscillating circuit. (At high frequencies, only a "click" will be heard.)

USING THE GRID DIP METER

The basic use of the Grid Dip Meter is the coupling of the instrument to the test circuit. It is possible to couple the test circuit either inductively or capacitively. Inductive coupling is usually most convenient. Capacity coupling is necessary in some instances, such as in the case of coaxial lines where shielding complicates the situation. For the most accurate reading the coupling between the grid dip meter and the test circuit should be as loose as possible (wide spacing between the two units), while yet being able to obtain a readable dip.

The relative Q of a circuit can be quickly determined by noting the sharpness of the dip. A broad dip is indicative of a low Q circuit. Assembling a few different resonant circuits and determining their resonant frequency will familiarize the builder with the operation of the grid dip meter.

It will be found that as the dial is rotated from one end of the band to the other, that the meter reading also changes. If the sensitivity control is set for a mid-scale meter reading when the

dial is at approximately the middle of the band, the adjustment will probably be sufficient for any frequency setting within the band.

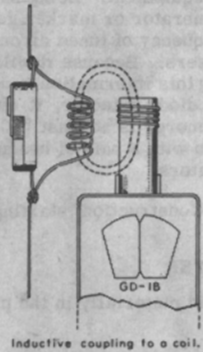

A

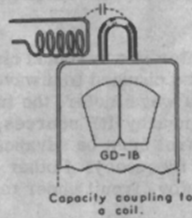

B

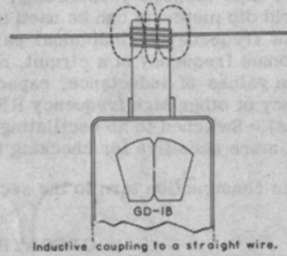

C

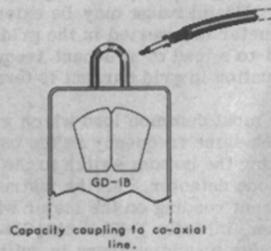

D

DETERMINING AN UNKNOWN CAPACITY

Unknown values of capacity between 70 and 2,000 $\mu\mu\text{f}$ can readily be measured with the grid dip meter. The unknown condenser should be placed parallel with the 14-37 mc coil, designated as coil C on Page 19 of this manual, the coil thus forming a parallel circuit.

Depending upon the suspected value of the unknown condenser (see graph on Page 5), the 2-5 or 5-14 mc coil, designated as A or B, should be plugged into the instrument. Set the DIODE-OSC. switch to OSCILLATOR position. Couple quite closely the coil of the parallel resonant circuit containing the unknown condenser and tune the GD-1B through the frequency range. When the dip has been detected, reduce the coupling so that the dip shows up over a very narrow frequency band. At maximum dip, read the frequency indicated on the dial and from the graph, read the value of the unknown condenser. A glance at the graph will reveal that condensers under 65 $\mu\mu\text{f}$ are not covered. To determine values in this range, an extra capacitor of about 100 $\mu\mu\text{f}$ should be used. If it is not a precision capacitor, its value can be determined by the method outlined above. Once its value is known, it should be connected in parallel with the unknown condenser and the 14-37 mc coil "C". Using this method, the total capacity of this test circuit is determined. The value of the unknown condenser is the difference between the total capacity in the test circuit and the value of the known added condenser.

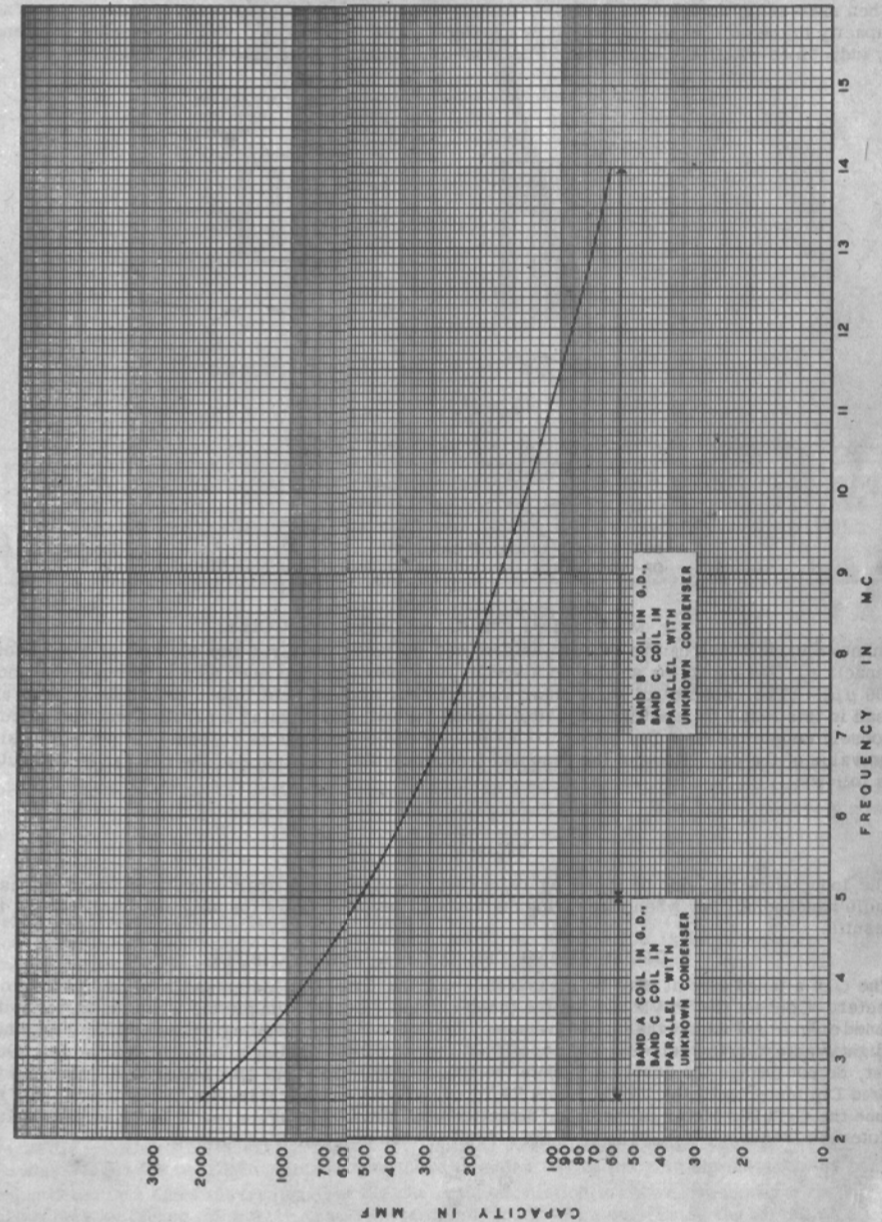

When measuring an unknown capacity, certain errors must be considered. Among these are capacity in the coil, capacity caused by nearby metallic objects, and shift of resonant frequency by inductance within the capacitor. For most applications these may be neglected.

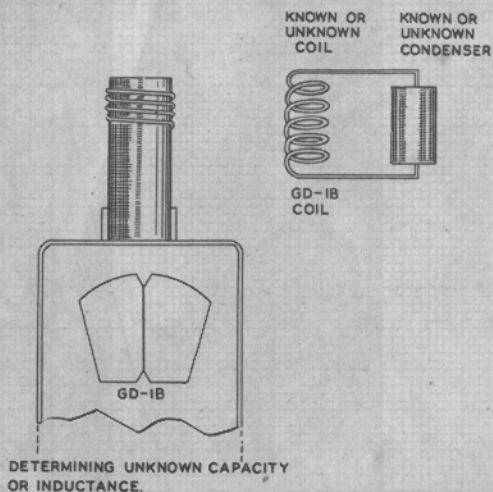

MEASURING INDUCTANCE OF RF COILS

Unknown inductances can be readily determined by using the Grid Dip Meter and some known capacitor. The capacitor should be a small, low tolerance unit such as a silver mica of about 100 μmf . (The capacity of some unknown condenser may be determined as outlined above and used in this test.) Connect the capacitor across the inductor forming a parallel resonant circuit. Loosely couple the Grid Dip Meter to this circuit and determine its resonant frequency. Using the value of the capacitor and the resonant frequency, the inductance of the coil can be computed as follows:

$$L_x = \frac{1}{39.48f^2C}$$

The inductance can also be found by referring to a reactance chart such as is found in many radio handbooks. As when measuring capacities, certain errors (usually negligible) affect the results.

DETERMINING THE Q OF A TUNED CIRCUIT

The Q of a tuned circuit may be measured using the Grid Dip Meter and a vacuum tube voltmeter. Connect the VTVM across the tuned circuit. Loosely couple the Grid Dip Meter to the tuned circuit and adjust the output frequency until a maximum reading on the VTVM is obtained. Slightly adjusting the coupling will permit setting the VTVM reading to a convenient value. (Once set, do not change the coupling.) Note the frequency of the Grid Dip Meter, f_c . Retune the Grid Dip Meter until the VTVM reads 70.7% of the peak value. Note this frequency (f_1) and retune the Grid Dip Meter in the other direction until the VTVM again reads 70.7% of peak value. Note this frequency (f_2). The Q of the circuit is then calculated as follows:

$$Q = \frac{f_c}{\Delta f}$$

where Δf equals the difference between f_1 and f_2 .

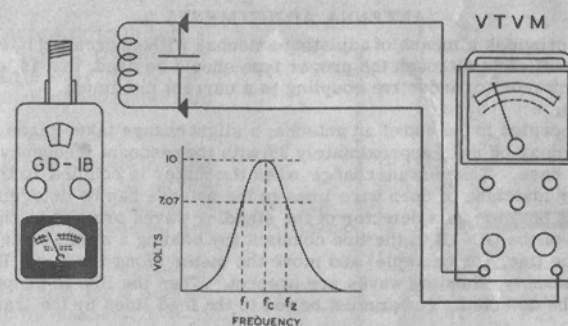

Measuring "Q" of a tuned circuit.

CAUTION: BE VERY CAREFUL WHEN USING THE GRID DIP METER NEAR HIGH VOLTAGE CIRCUITS. IT IS POSSIBLE FOR THE OPERATOR TO RECEIVE A SEVERE OR DEADLY SHOCK IF THE METER OR COIL SHOULD TOUCH A HIGH VOLTAGE CIRCUIT.

PRETUNING A TRANSMITTER

The GD-1B provides an excellent means of preadjusting a transmitter prior to applying voltage. Each of the various tuning circuits throughout the transmitter can be set to its approximate operating frequency. Thus, when the power is applied, only a slight adjustment is needed to finish the job.

NEUTRALIZATION

The grid dip meter is very useful when neutralizing a transmitter. Set the bottom switch to the DIODE position so that the instrument can be used as a tuned detector. Remove the plate voltage (filament should be on) from the stage of the transmitter to be neutralized and apply power to the driver stage.

Using the GD-1B as a detector, couple its coil to the output of the stage being adjusted. Adjust the GD-1B for maximum meter indication and then adjust the neutralizing control for a minimum meter reading. It will probably be necessary to readjust the output circuit to proper frequency and then repeat the neutralizing adjustment. As the neutralization is being accomplished, it may be necessary to couple the GD-1B more closely to the output circuit.

Another method is to couple the grid dip meter to the input of the stage to be neutralized and adjust to the maximum dip. (All plate voltages in the transmitter should be turned off.) Set the neutralizing control so that no deflection of the GD-1B meter is seen when the output circuit of the stage is rotated through the operating frequency.

LOCATING PARASITIC OSCILLATIONS

Parasitic oscillations are easily located by applying power to the transmitter and checking the various stages for oscillations other than those intended. (Use the grid dip meter as an oscillating detector.) Once the frequency of the parasitic oscillation is known, the power to the transmitter may be turned off and the unwanted resonant circuits located. (Using the GD-1B as a grid dip meter, check circuit wiring, chokes, etc. for unwanted resonant frequencies.)

ANTENNA ADJUSTMENTS

The Grid Dip Meter provides a means of adjusting antennas without creating interference. Loose coupling is usually sufficient although the proper type should be used, that is, capacity coupling to a voltage maximum point or inductive coupling to a current maximum.

When the GD-1B is coupled to the end of an antenna, a slight change takes place in its "effective" length. This change may be up to approximately 3% with the resonant frequency appearing lower than is actually the case. There is no change when the meter is coupled to the middle part of the antenna. Proper matching of open wire lines to the antenna can be determined by using the GD-1B in the DIODE position as a detector of the standing waves present on the line. Arrange to hold the coupling of the GD-1B to the line constant (by holding a small piece of insulator between the coil and the line, for example) and move the meter along the line. If the meter indication varies considerably, standing waves are present. When the line is properly matched, no standing waves can be detected. Power must be fed to the feed lines by the transmitter or other RF source.

The check for proper matching of a coaxial line is noting the amount of power delivered to the antenna. The GD-1B is used as a field strength meter (set in DIODE position and placed near the antenna where the change in output can be noted). Proper matching is denoted by maximum output from the antenna.

STEP-BY-STEP CONSTRUCTION

Begin by checking the parts against the parts list. In this way, you will become familiar with the various parts and also you will avoid throwing away any small parts with the packing.

Should inspection reveal the necessity for replacement of a component, write to the Heath Company immediately. The following information should be supplied in all cases:

- A. Clearly identify the part in question by using the part number and description found in the manual parts list.
- B. Identify the type and model number of the kit in which it is used.
- C. Mention the order number and date of kit purchase.
- D. Describe the nature of defect or reason for requesting replacement.

The Heath Company will promptly supply the necessary replacement. Please do not return the defective component until specifically requested to do so. Do not under any circumstances dismantle the component in question as this will void the guarantee. If tubes are to be replaced, please pack them carefully to prevent breakage in shipment as broken tubes are not eligible for replacement.

STEP-BY-STEP ASSEMBLY

Before starting actual mechanical and electrical assembly, study all pictorials, as parts placement and lead dress are extremely important in high frequency equipment such as the grid dip meter. If all wires and components are placed exactly as pictured, no difficulty should be encountered upon completion of the instrument.

MOUNTING OF PARTS ON BOTTOM PLATE

- () Mount a 2-lug terminal strip in location A with a 6-32 screw, lockwasher and nut.
- () Mount the rectifier in location B with aid of #6 speed nut. The speed nut may be screwed or pushed on the rectifier stud. Be sure the positive side is as indicated in pictorial.
- () Mount the 1-lug right hand terminal strip in location J. Position exactly as shown in Pictorial 1.

(Note the color coding of the power transformer leads. The transformer should be mounted so that the red leads are nearest location A. Be sure the transformer is not mounted backwards.)

- () Slide a 6-32 screw through hole in location C1. Slip the transformer mounting flange over the screw. Slide on a solder lug and fasten with a 6-32 nut.

- () Slide a 6-32 screw through the hole in location C2. Pass the screw through the transformer mounting flange, slide on a lockwasher and fasten with a nut.

- () In location D, fasten angle bracket to the chassis by means of a 6-32 screw, solder lug positioned as shown in Pictorial 1, and fasten with a nut.

- () In location E, slide a 6-32 screw through the hole in the bottom plate. Pass it through the hole in the angle bracket, slide a 1-lug terminal strip over the screw and fasten with a lockwasher and nut.

- () In location M, temporarily mount the sensitivity control (with ON-OFF switch on the back) using a control nut. See Pictorial 3 for proper placement of the lugs.

- () Mount the DIODE-OSC. switch in location F by means of two 6-32 screws, lockwashers and nuts. Pictorial 1 shows proper position of the switch. Be sure mounting is not reversed. Pictorial 1 clearly shows the mounting of this switch.

- () Place the tube socket, face down, on a table in front of you with the widest spacing toward you. Locate pins 6 and 7. These pins must be entirely removed from the tube socket base.

- () Upon locating pins 6 and 7, use a pair of side cutters to clip the solder lugs 6 and 7 as close to the ceramic tube base as possible. Insert the sharpened end of a pencil into the hole of the lug to be clipped. A slight pressure on the pencil will make it easier to clip the lug. After clipping the solder lug as described, use a small screwdriver to press the remainder of the socket pin through the top of the tube socket. For greatest accuracy at high frequency, it is imperative that tube socket pins 6 and 7 be removed in the described manner.

- () Mount the small solder lug and the tube socket on the tube mounting bracket by means of the 3-48 screws, lockwashers and nuts. See Figures 1 and 2. Make certain that the widest spacing between pin holes is as shown in Pictorial 1.

- () Bend the small solder lug as shown in Figure 1.

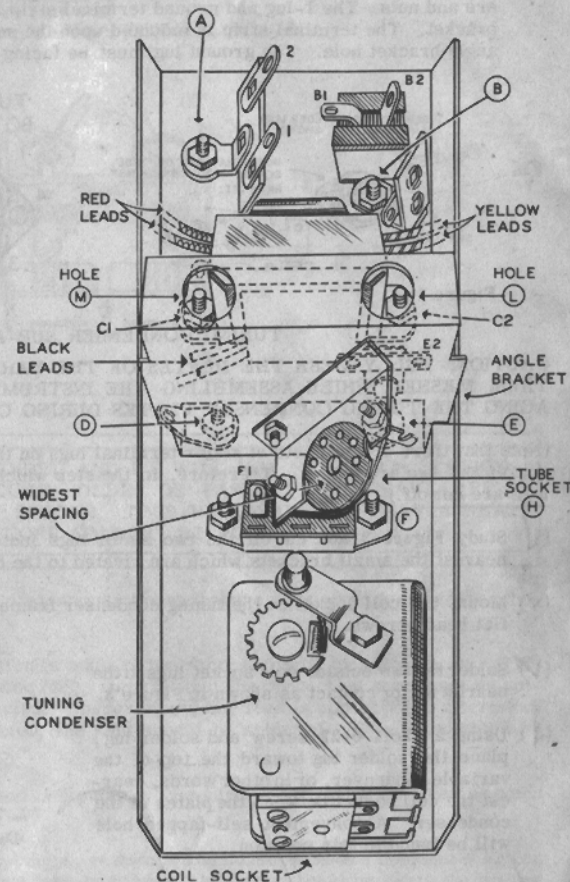

PICTORIAL 1
MOUNTING OF PARTS ON
BOTTOM PLATE

- () Fasten the tube mounting bracket to the angel bracket by means of 6-32 screws, lockwashers and nuts. The 1-lug and ground terminal strip must be mounted behind the tube socket bracket. The terminal strip is mounted upon the screw protruding through the uppermost angle bracket hole. The ground lug must be facing toward the top as pictured in Pictorial 3.

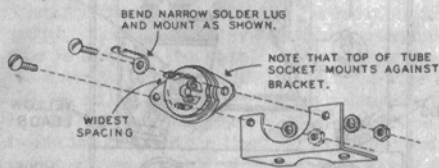

Figure 1

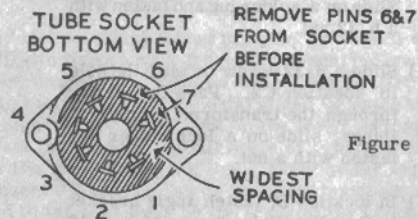

Figure 2

TUNING CONDENSER SUB-ASSEMBLY

CAUTION: FULLY MESH THE PLATES OF THE VARIABLE TUNING CONDENSER. KEEP THEM MESHD WHILE ASSEMBLING THE INSTRUMENT. THIS WILL PREVENT DAMAGING THE TUNING CONDENSER PLATES DURING CONSTRUCTION.

(Note that there are two sets of stator terminal lugs on the tuning condenser. Two of these are cut off and two are left on. Therefore, in the step which follows, make sure that the correct lugs are cut off.)

- () Study Figure 3 and cut off the two stator lugs indicated. These lugs (shown dotted) are nearest the small brackets which are riveted to the condenser frame.

- () Mount the coil socket on the tuning condenser frame as shown in Figure 3. Use two 6-32 flat head screws.

- () Solder the two outside coil socket lugs to the nearby stator contact as shown in Figure 3.

- () Using a short 6-32 screw and solder lug, place the solder lug toward the top of the variable condenser, or in other words, nearest the coil socket between the plates of the condenser. A convenient self-tapped hole will be found in this position.

- () Place a length of bare wire between solder lug and unused coil socket prong (S).

- () Mount another solder lug on the tuning condenser frame as shown in Figure 3. Use a short 6-32 screw.

- () Bend the remaining two stator lugs as shown in Figure 4, side view.

- () Mount a disc condenser on each of these lugs with a 3-48 screw and nut. Note the angle of the disc condenser leads.

- () Mount the tuning condenser on the bottom plate with three short screws. Use a #6 lockwasher between the screw head and bottom plate of these three screws.

(The 3-prong coil socket supplied with the GD-1B is designed for use with the accessory 341-A Coil Kit.)

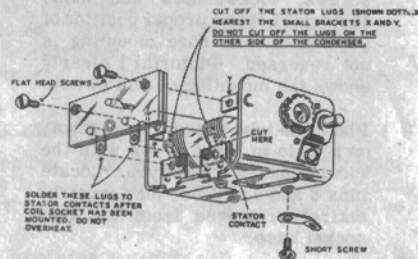
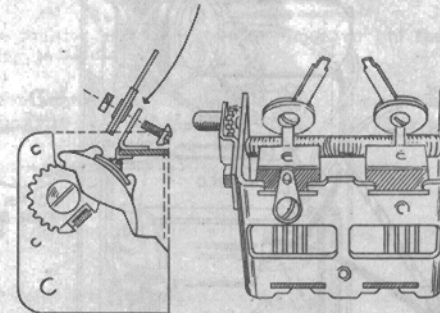

Figure 3

BEND BACK STATOR TERMINAL LUGS AS SHOWN HERE. MOUNT EACH DISC CONDENSER WITH A 3-48 SCREW AND NUT.



SIDE VIEW

Fig. 4

NOTE: ALL GUARANTEES ARE VOIDED AND WE WILL NOT REPAIR OR SERVICE INSTRUMENTS IN WHICH ACID CORE SOLDER OR PASTE FLUXES HAVE BEEN USED. WHEN IN DOUBT ABOUT SOLDER, IT IS RECOMMENDED THAT A NEW ROLL PLAINLY MARKED "ROSN CORE SOLDER" BE PURCHASED.

It is helpful to place the large pictorial diagrams on the wall above your work space so that they may be readily referred to.

In some cases, more than one connection is made to the same terminal or solder point. This condition is designated by the abbreviation (NS), meaning that the connection should not be soldered until other leads have been connected. Wherever only one lead is connected to a terminal or where the last lead has been connected, the joint should be soldered. This is indicated by the abbreviation (S).

Unless otherwise indicated, all wire used is insulated. Be sure to use insulated sleeving when called for.

The leads on components such as transformers, resistors and condensers are frequently longer than necessary. When wiring these parts into the circuit, the leads should be cut to the proper length. This will result in a neater looking instrument, and in most instances proper OPERATION is IMPOSSIBLE with long, untrimmed leads in critical parts of the circuit.

WIRING

- () Connect one black lead of the power transformer to A2 (NS).
- () Connect the other black lead to either lug of the OFF-ON switch located to the rear of the sensitivity control (S).
- () Connect one red lead of the power transformer to F2 (S). Run this lead along the edge of the bottom plate, making sure it is pressed firmly against the bottom plate.
- () Run a length of hook-up wire from F1 (S) to solder lug C1 (NS). Run this lead along the edge of the bottom plate.
- () Connect the other red lead to B2 (S).

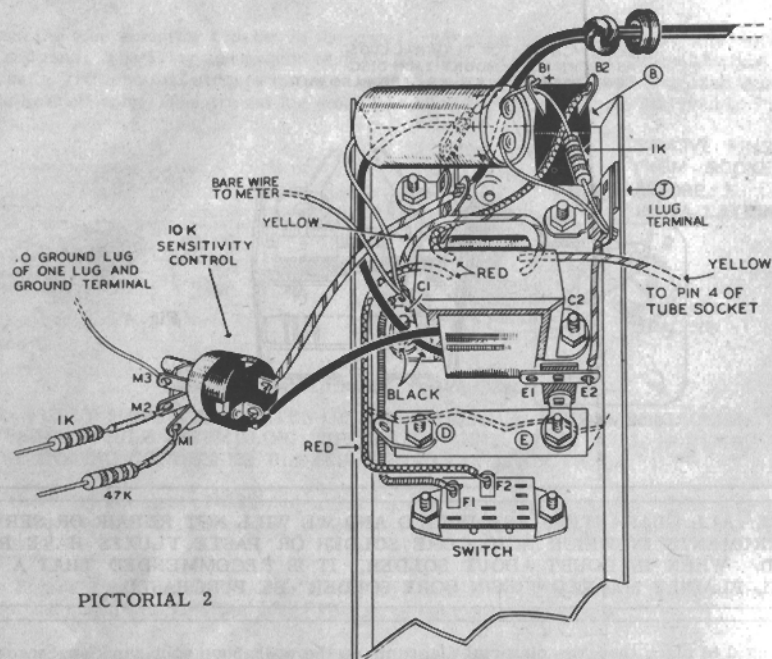

PICTORIAL 2

(✓) Connect one yellow lead of the power transformer to pin 4 of the tube socket (NS). See Pictorial 3.

When soldering to miniature tube socket terminals, use care to prevent solder from flowing into the socket pin holes. This could prevent insertion of the tube pins and cause possible damage to the tube.

(✓) Connect the other yellow lead to solder lug C1 (NS).

NOTE: There will be several wires connected to solder lug C1. Use care to keep all connections neat. The purpose of using a central ground point is to eliminate oscillation and feedback in high frequency instruments.

(✓) Run a wire from A1 (NS) to the lug on the OFF-ON switch (on the back of the sensitivity control) which does not have a black transformer lead connected to it (S).

(✓) Slide a rubber grommet over the line cord.

(✓) Split and knot the line cord as shown. Connect one lead of the cord to A2 (S). The knot provides strain relief, should the cord be accidentally jerked.

(✓) Connect the other lead of the line cord to A1 (S).

(✓) Connect a 1000 Ω 1/2 watt resistor (brown-black-red) between B1 (NS) and the right hand 1-lug terminal strip located directly behind the rectifier (NS).

(✓) Connect one positive lead (marked + or "positive") of the dual 20 μ fd condenser to B1 (S). (Use sleeving.)

(✓) Connect the other positive lead of the dual 20 μ fd condenser to the right hand terminal strip located directly to the rear of the rectifier (NS). (Use sleeving.)

(✓) The negative lead of the dual 20 μ fd condenser connects to solder lug C1 (NS). (Use sleeving.)

(✓) Connect a 2 1/2" length of bare wire to solder lug C1 (S). Leave the other end free at this time.

(✓) Remove the sensitivity control from the angle bracket. Leave the wires to the OFF-ON switch connected.

To facilitate wiring, several connections are made to this control before final mounting.

(✓) Cut a length of hook-up wire to 1 1/2". Strip both ends and connect one end to M3 on the sensitivity control (S).

(✓) Locate a 1000 Ω resistor (brown-black-red). Cut each lead to 1" in length. Slip a 3/4" piece of insulated sleeving over each of the leads.

(✓) Connect one end of the resistor to M2 (S).

(✓) Clip the leads of a 47 K Ω resistor (yellow-violet-orange) to approximately 1".

(✓) Slip sleeving over each of these leads, leaving approximately 1/4" of bare wire at the end of each lead. Now attach one lead of this resistor to M1 (S).

This completes the wiring shown in Pictorial 2.

CUT OFF THIS SMALL TONGUE AT THE END OF THE CONDENSER LEAD.

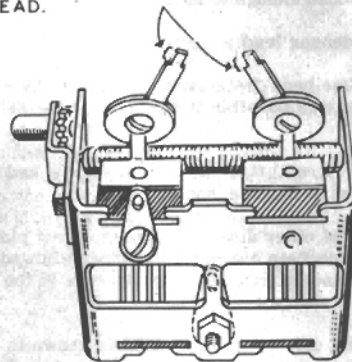

Figure 5

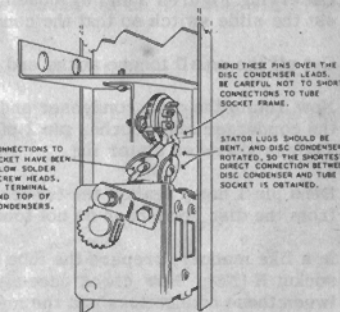
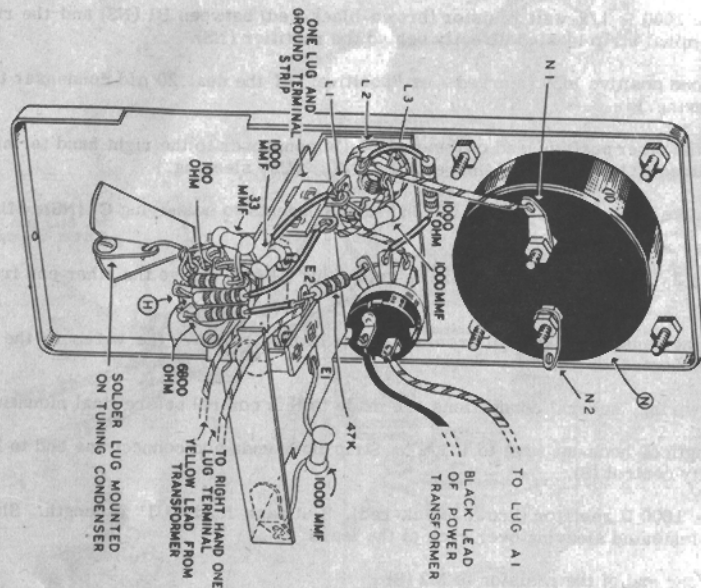

Figure 6



PICTORIAL 3

DISC CONDENSER CONNECTIONS

IMPORTANT: The connections described in the following steps are extremely critical, since they have a direct bearing on the calibration of the instrument.

- () Observing Figures 5 and 6, loosen the nut holding the disc condenser on the stator lug nearest the slide switch so that the condenser is just loose enough to be rotated.
- () Cut off the small tongue at the end of the disc condenser lead.
- () Now rotate the disc condenser and at the same time bend the stator lug so that the end of the condenser lead touches pin 1 of socket H as near as possible to the body of the socket. Tighten screw on stator lug.
- () Bend pin 1 down against the condenser lead, being careful that the pin socket lug and lead from the disc condenser do not touch the metal part of the tube socket (NS).
- () In a like manner, prepare the tube socket pin and the other disc condenser to meet pin 2 of socket H (NS). Now check once again to see that adequate clearance has been allowed between these connections and the metal part of the tube socket. Line up the hole in the tube socket pin with the hole in the flat disc condenser lead.
- () Flow solder over the screw head, condenser lug and disc condenser plate as shown in Figure 6. Use a minimum of solder to prevent possible short circuit.

PREPARATION OF TUNING DRUM



Figure 7

Figure 8

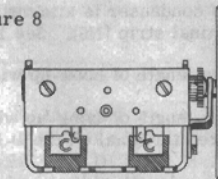

- () Assemble the frequency dial scale and tuning drum so that the calibration markings are visible through the face of the drum. Fasten the dial scale to the drum with four pieces of adhesive-backed material from the label set. The adhesive strips should cover a portion of the drum rim and the paper scale. Blank extra dial plates have been printed on the large drawings. These are for the kit builder who wishes to calibrate the instrument himself. Details are given under "Calibration." (See Figure 7.)
- () Start a 6-32 set screw in the hub of the tuning drum. Place the drum on the tuning condenser shaft and tighten the set screw just enough to hold the drum on the shaft. See Figure 8.
- () Remove the meter from its box and install in the control panel being sure it is properly oriented, i. e., bottom of meter nearest edge of control panel. Use the hardware supplied with the meter for mounting. Loosen the two meter terminal nuts and set the solder lugs at right angles to their original location.
- () Place the front panel against the angle bracket and line up the holes for the phone jack and sensitivity control.
- () Mount the sensitivity control in location M. See Figure 9 for details of hardware assembly. Keep the lugs exactly as indicated in Pictorial 3. On some controls, a small locating lug protrudes from the front of the control housing. If this interferes with the mounting, cut it off or bend it over.
- () Mount the phone jack (see Figure 9 and Pictorial 3) in location L. Keep all lugs oriented exactly as indicated.
- () Attach the free end of the 1 1/2" lead from M3 to the ground lug of the 1-lug and ground terminal strip (NS).
- () Attach the free end of the 47 KΩ resistor (yellow-violet-orange) to terminal strip E2 (NS).
- () Attach the free end of the 1 KΩ resistor (brown-black-red) to lug L2 (NS) on the phone jack. Be sure to use the previously prepared insulated sleeving.
- () Cut the leads of one of the 1000 μμf ceramic condensers (bearing the color code black-red-black-brown dots) to 1/2" length.

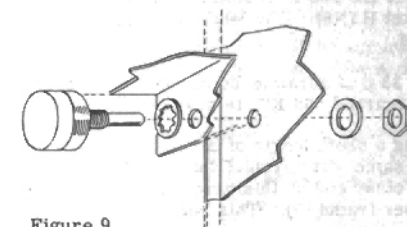

Figure 9

- () This condenser is attached between lug L3 (NS) and the ground lug of the 1-lug and ground terminal strip (NS). See Pictorials 2 and 3.
- () Run a length of hook-up wire between lug L2 (S) and lug N1 (S) on the meter.
- () Run a length of hook-up wire between terminal L3 (S) located on the phone jack and the insulated terminal on the 1-lug and ground terminal strip (NS).
- () Place a length of hook-up wire between the right hand terminal strip (S) (located behind the rectifier) and lug E2 of the 1-lug terminal strip (NS). Be sure the hook-up wire follows the contour of the bottom plate.
- () Select one of the 6800 Ω resistors (blue-gray-red) and cut one wire to a length of 1/4" from the body of the resistor. The other lead from this resistor is cut to a length of approximately 1".
- () Prepare a length of insulated sleeving 3/4" long.
- () Place the short lead of the resistor through the slot of pin 1 of the tube socket. The body of the resistor must be placed as close as physically possible to the tube socket pin (S). (See Pictorial 3.) Use care when making this connection so that excessive heat will not be conducted to the resistor.
- () Slip the previously prepared insulated sleeving over the other lead of this resistor. This lead may now be placed in terminal E2 (S).
- () Select one of the 1000 $\mu\mu\text{f}$ ceramic condensers and place between lug E1 (S) located on the 1-lug terminal strip, and the ground lug located adjacent to E1 (S).
- () Select the other 6800 Ω resistor (blue-gray-red) and clip one lead to a length of 1/4". Prepare a length of insulated sleeving 3/4" long.
- () Place the short lead of this resistor through the slot in the tube socket pin 2 (S) in exactly the same manner as described for pin 1. Once again, be careful of excessive heat.
- () Slip the 3/4" length of insulated sleeving over the remaining resistor lead and bend the protruding resistor lead at a right angle so it will fall into the insulated terminal of the 1-lug and ground terminal strip (S).
- () Using the third and last 1000 $\mu\mu\text{f}$ ceramic condenser, clip one lead to a length of 1/4". This lead is now placed through tube socket pin 4 (S). Dress the body of the condenser on top or near the two previously installed 6800 Ω resistors.
- () Cut a length of insulated sleeving to fit over the untrimmed lead of the 1000 $\mu\mu\text{f}$ condenser. Place the free end to the ground lug of the 1-lug and ground terminal strip (S).
- () Select the 100 Ω resistor (brown-black-brown) and place between pin 5 and pin 3 of tube socket H (NS). The leads of this resistor should be just long enough to allow clearance of pin 4.
- () The 33 $\mu\mu\text{f}$ ceramic condenser (bearing the color code orange-orange-black-white), some are marked "33 K", is now installed between pin 5 (S) and pin 3 (NS) of tube socket H.
- () Using a short length of bare wire, attach one end to pin 3 (S) of socket H. Wrap one turn of this same wire around the narrow solder lug located on the tube socket angle bracket (S). The other end of this bare wire is drawn through the solder lug located on the tuning condenser frame (S). This solder lug must be bent flat before completing connection.

- () Connect the free end of the bare wire from solder lug C1 to the positive terminal on the meter (S).

IMPORTANT NOTICE

A MINIATURE TUBE CAN EASILY BE DAMAGED WHEN PLUGGING IT INTO ITS SOCKET. USE EXTREME CARE WHEN INSTALLING THE 6AF4 OR 6T4 TUBE. WE DO NOT GUARANTEE OR REPLACE MINIATURE TUBES BROKEN DURING INSTALLATION.

- () Insert the miniature tube in socket H.
- () Fasten the knob on the sensitivity control by tightening the set screw.

The instrument is now ready to calibrate. See instructions for this procedure below. Once the calibration is completed, the final steps of assembly should be performed.

SPECIAL NOTE: When the instrument is first turned on (set to OSC. position) the meter will indicate below zero. Upon warming up, the meter will read correctly. This fact is mentioned because the builder might conclude that the meter is connected backwards when he first turns the instrument on and sees the meter reading below zero.

ACCURACY

It should be remembered that the grid dip meter is neither designed nor intended to be used for applications requiring a high degree of accuracy. The grid dip meter is not in the same class as accurate signal generators, many of which can be used as secondary frequency standards. Calibration errors up to 5% can be expected. However, except for the specialized uses involving high accuracy, this instrument is invaluable in applications such as outlined in the manual as well as others too numerous to mention.

One factor concerning the accuracy of the highest band (100-250 mc) must be considered. At high frequencies such as these, the actual wiring of the kit comes into the picture. Such things as proper placement of components, correct lead dress, short lead lengths, good solder connections, etc. are all important. The manual shows how the kit should be constructed for best results, but the actual mechanics of construction are beyond the control of the Heath Company. Therefore, if the high band frequency seems greatly different from that of the other bands, check the actual construction of the kit for proper wiring and parts location as outlined in the pictorials and step-by-step instructions.

CALIBRATION

The Grid Dip Meter is provided with a ready-calibrated dial. This dial will be sufficiently accurate for most applications. If no means of checking frequency is available, the dial may be set so that the calibration end markings coincide with the line (on the window) when the tuning condenser is completely meshed.

A more accurate adjustment of the ready-calibrated dial is possible if a short wave receiver or high frequency signal generator is available.

USING A RECEIVER: If the frequency settings on the receiver are known to be accurate, it is only necessary to tune in the Grid Dip Meter (set to OSC. position) on the receiver and set the GD-1B dial to the same frequency reading as the receiver dial.

If the dial calibrations on the receiver are not accurate, tune the receiver to some station whose frequency is known (WWV for example) and then tune the Grid Dip Meter to this same frequency (set in OSC. position). Adjust the tuning dial on the GD-1B to read this same frequency.

COMPLETE CALIBRATION OF THE GD-1B

Extra dial plates have been prepared for the builder who has the equipment available to completely calibrate his own instrument. In doing so, differences in wiring technique and positioning which will shift frequency settings slightly can be corrected. The dial window must first be removed from the front panel. The blank dial plate may be temporarily fastened to the outside of the tuning drum while making the calibration marks. After the calibration is completed, the dial plate should be fastened under the tuning dial for protection. If the GD-1B is calibrated with a receiver (the receiver should be accurately calibrated), first set the receiver to the frequency and then adjust the GD-1B (used as an oscillator) to the same frequency and mark the dial. Repeat the procedure for each frequency mark desired.

If the GD-1B is calibrated with a signal generator, first set the signal generator to the frequency and then adjust the GD-1B (used as a diode detector) to the same frequency, and then mark the dial. Repeat for each frequency point. After hand calibration has been completed, replace the dial window, using rubber cement.

- () Install the four rubber feet in the bottom panel.

Figure 10



- () Pass the line cord through the cabinet so that it comes out the back. The back of the cabinet has a large U notch in one end.
- () Fit the front panel to the cabinet assembly by sliding the flanges inside the panel rim. Make sure that the dimple in the end of the panel rim mates with the hole in the cabinet flange. (Be sure that the knot in the line cord is inside the cabinet. The grommet which is on the line cord should then be slipped into the large U notch.)
- () The assembly may now be completed by adding the back panel to the cabinet and securing it with two #6 sheet metal screws.
- () Check the clearances between the tuning drum and cabinet. See that the drum operates without binding or rubbing. If necessary, adjust the position of the drum on the tuning condenser shaft. Be careful not to disturb the calibration during this adjustment.

This completes the construction of the instrument.

IN CASE OF DIFFICULTY

1. Recheck the wiring very carefully. Tracing the leads on the pictorial wiring diagrams in colored pencil as they are checked in the instrument will prevent overlooking some connections.
2. Compare tube socket voltages with those shown on the schematic diagram. Readings given were made using a vacuum tube voltmeter. Other type meters will give lower readings.
3. Test tube to be certain it is operating properly.
4. Write to the Heath Company describing operating characteristics and listing the voltages measured at the various socket connections. (See "Service" information.)

TROUBLE SHOOTING

METER FAILS TO MOVE UPSCALE: Check position of DIODE-OSC. switch. Check solder joints between coil socket and variable condenser lugs. Re-heat solder previously applied to disc condensers. Examine connections on pins 1 and 2 of tube socket H for possible ground.

CALIBRATION NOT LINEAR: Shorten all leads. Be sure that two 6800 Ω resistors are coupled close to pins 1 and 2 of the tube socket H. Remove excessive solder from all connections. Check value of all resistors in circuit, these resistors should remain within $\pm 10\%$ tolerance of their indicated value. Examine the variable condenser for possible warped plates.

NO METER INDICATION WHEN IN DIODE POSITION: Insufficient source of RF signal: The average RF signal generator, radio receiver, or television set will give little or no indication when the GD-1B is in DIODE position.

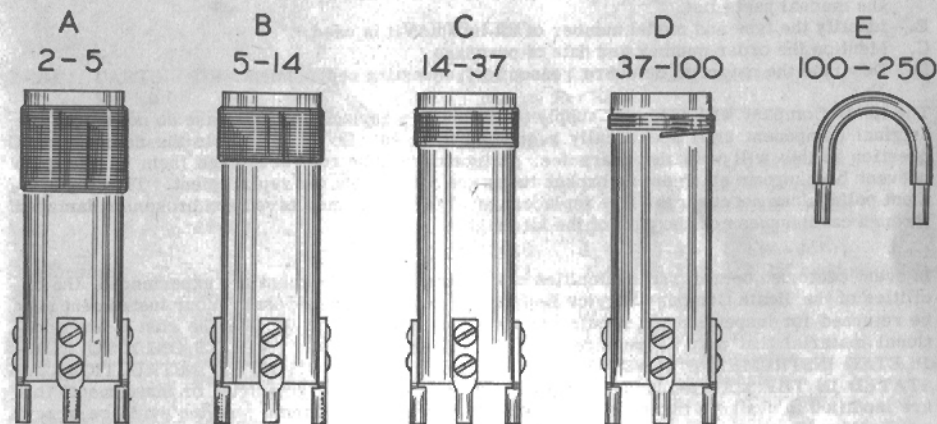

IDENTIFYING CHARACTERISTICS OF COILS

COILS MAY BE SUPPLIED WITH EITHER TWO OR THREE MOUNTING PRONGS. THE ELECTRICAL CHARACTERISTICS WILL REMAIN UNCHANGED.

OPERATION OF THE SENSITIVITY CONTROL VERY CRITICAL: This indication is normal, due to the extremely high "Q" circuit, and sensitivity of the instrument.

METER FALLS BELOW ZERO: This is normal during warm-up period, or when the coil is removed while the instrument is in operation. Advance sensitivity control to maximum during warm-up.

REPLACEMENTS

Material supplied with Heathkits has been carefully selected to meet design requirements and ordinarily will fulfill its function without difficulty. Occasionally improper instrument operation can be traced to a faulty tube or component. Should inspection reveal the necessity for replacement, write to the Heath Company and supply all of the following information:

- Thoroughly identify the part in question by using the part number and description found in the manual parts list.
- Identify the type and model number of kit in which it is used.
- Mention the order number and date of purchase.
- Describe the nature of defect or reason for requesting replacement.

The Heath Company will promptly supply the necessary replacement. Please do not return the original component until specifically requested to do so. Do not dismantle the component in question as this will void the guarantee. If tubes are to be returned, pack them carefully to prevent breakage in shipment as broken tubes are not eligible for replacement. This replacement policy does not cover the free replacement of parts that may have been broken or damaged through carelessness on the part of the kit builder.

SERVICE

In event continued operational difficulties of the completed instrument are experienced, the facilities of the Heath Company Service Department are at your disposal. Your instrument may be returned for inspection and repair for a service charge of \$3.00 plus the cost of any additional material that may be required. **THIS SERVICE POLICY APPLIES ONLY TO COMPLETED INSTRUMENTS CONSTRUCTED IN ACCORDANCE WITH THE INSTRUCTIONS AS STATED IN THE MANUAL.** Instruments that are not entirely completed or instruments that are modified in design will not be accepted for repair. Instruments showing evidence of acid core solder or paste fluxes will be returned not repaired.

The Heath Company is willing to offer its full cooperation to assist you in obtaining the proper operation of your instrument and therefore this factory repair service is available for a period of one year from the date of purchase.

SHIPPING INSTRUCTIONS

Before returning a unit for service, be sure that all parts are securely mounted. Attach a tag to the instrument giving name, address and trouble experienced. Pack in a rugged container, preferably wood, using at least three inches of shredded newspaper or excelsior on all sides. **DO NOT SHIP IN THE ORIGINAL KIT CARTON AS THIS CARTON IS NOT CONSIDERED ADEQUATE FOR SAFE SHIPMENT OF THE COMPLETED INSTRUMENT.** Ship by prepaid express if possible. Return shipment will be made by express collect. Note that a carrier cannot be held liable for damage in transit if packing, in HIS OPINION, is insufficient.

SPECIFICATIONS

All prices are subject to change without notice. The Heath Company reserves the right to discontinue instruments and to change specifications at any time without incurring any obligation to incorporate new features in instruments previously sold.

WARRANTY

The Heath Company limits its warranty of parts supplied with any kit (except tubes, meters and rectifiers, where the original manufacturer's guarantee only applies) to a period of three (3) months from the date of purchase. Replacement will be made only when said part is returned postpaid, with prior permission and in the judgment of the Heath Company was defective at the time of sale. This warranty does not extend to any Heathkits which have been subjected to mis-

use, neglect, accident and improper installation or applications. Material supplied with a kit shall not be considered as defective, even though not in exact accordance with specifications, if it substantially fulfills performance requirements. This warranty is not transferrable and applies only to the original purchaser. This warranty is in lieu of all other warranties and the Heath Company neither assumes nor authorizes any other person to assume for them any other liability in connection with the sale of Heathkits.

The assembler is urged to follow the instructions exactly as provided. The Heath Company assumes no responsibility or liability for any damages or injuries sustained in the assembly of the device or in the operation of the completed instrument.

HEATH COMPANY
Benton Harbor, Michigan

PARTS LIST

PART No.	PARTS Per Kit	DESCRIPTION	PART No.	PARTS Per Kit	DESCRIPTION
Composition Resistors			Hardware		
1-3	1	100 Ω	250-2	4	3-48 x 1/4 screw
1-9	2	1 K Ω	250-7	5	6-32 x 3/16 screw
1-51	2	6800 Ω	250-8	2	#6 sheet metal screw
1-25	1	47 K Ω	250-9	10	6-32 x 3/8 screw
Condensers			250-28	1	6-32 x 1/4 set screw
20-25	2	90 μ f disc	250-32	2	6-32 x 3/8 flat head screw
21-7	1	33 μ f ceramic	252-1	4	3-48 nut
21-14	3	1000 μ f ceramic	252-3	10	6-32 nut
25-24	1	20-20 μ f electrolytic	252-7	2	Control nut
26-10	1	variable condenser	253-10	2	Control washer
Controls-Switches-Sockets			254-1	13	#6 lockwasher
19-15	1	10K sensitivity control	254-4	2	Control lockwasher
60-1	1	Slide Switch	254-7	2	#3 lockwasher
434-34	1	Tube socket	259-1	4	#6 solder lug
434-40	1	Coil socket	259-6	1	Solder lug
Coils			252-10	1	#6 speed nut
40-46A	1	2-5 mc	Miscellaneous		
40-46B	1	5-14 mc	54-17	1	Power Transformer
40-46C	1	14-37 mc	57M14	1	Rectifier
40-46D	1	37-100 mc	73-1	1	Rubber grommet
40-M25	1	100-250 mc	89-1	1	Line cord
Sheet Metal Parts			261-1	4	Rubber feet
90-19	1	Cabinet Assembly*	340-2	1	length Bare wire
100-M33	1	Front panel assembly	344-1	1	length Hook-up wire
204-M40	1	Tube bracket	346-1	1	length Insulated sleeving
204-M41	1	Angle bracket	390-1	1	Label set
205-15	1	Bottom plate	407-12	1	Meter
			411-44	1	6AF4 (or 6T4) tube
			431-1	1	1-lug terminal strip
			431-14	1	1-lug and ground terminal strip
			431-2	1	2-lug terminal strip
			431-15	1	1-lug terminal strip (RH)
			436-4	1	Phone jack
			445-3	1	Calibration scale
			462-12	1	Tuning drum
			462-13	1	Knob
			388-7	1	Coil box
			595-67	1	Manual

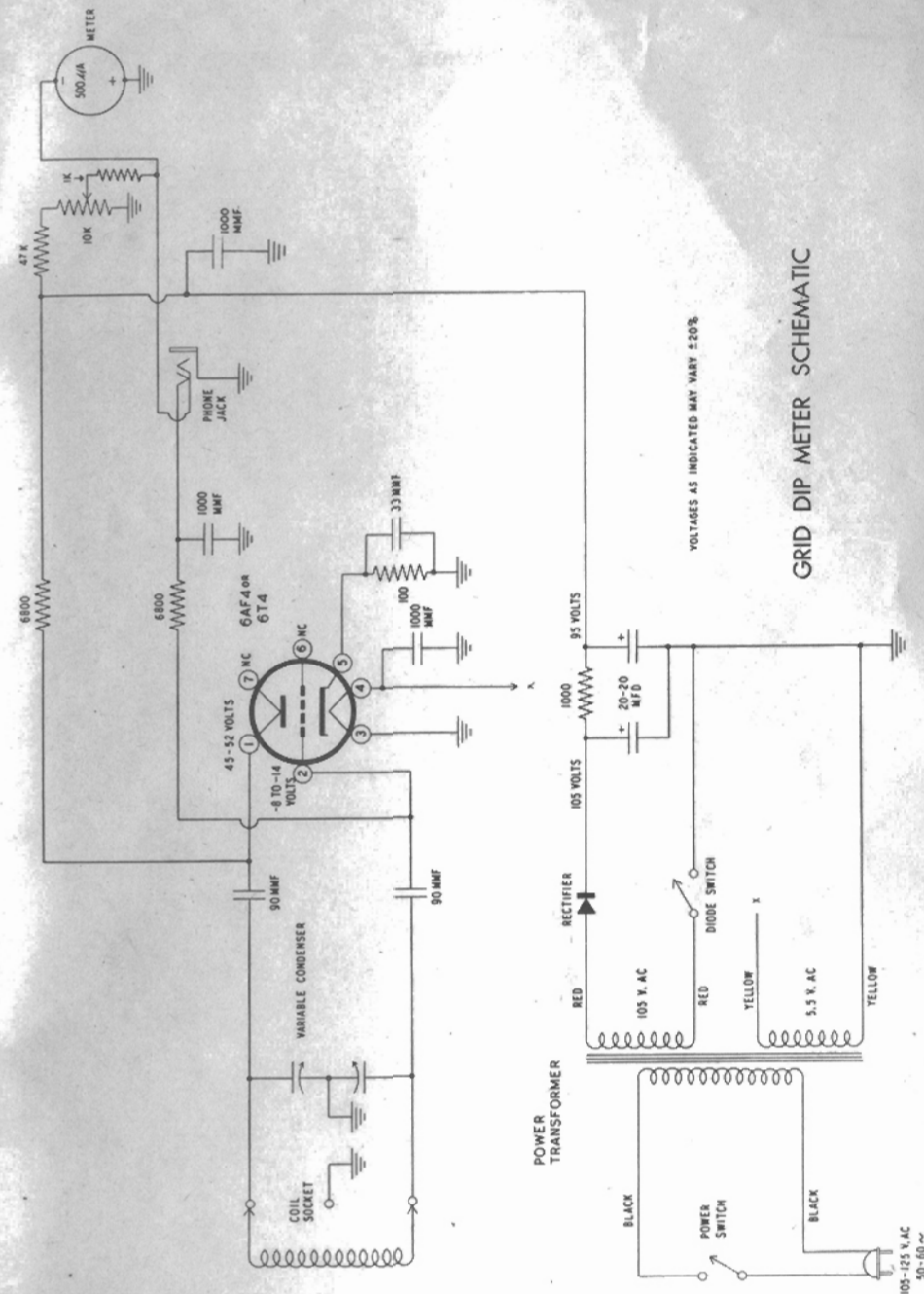
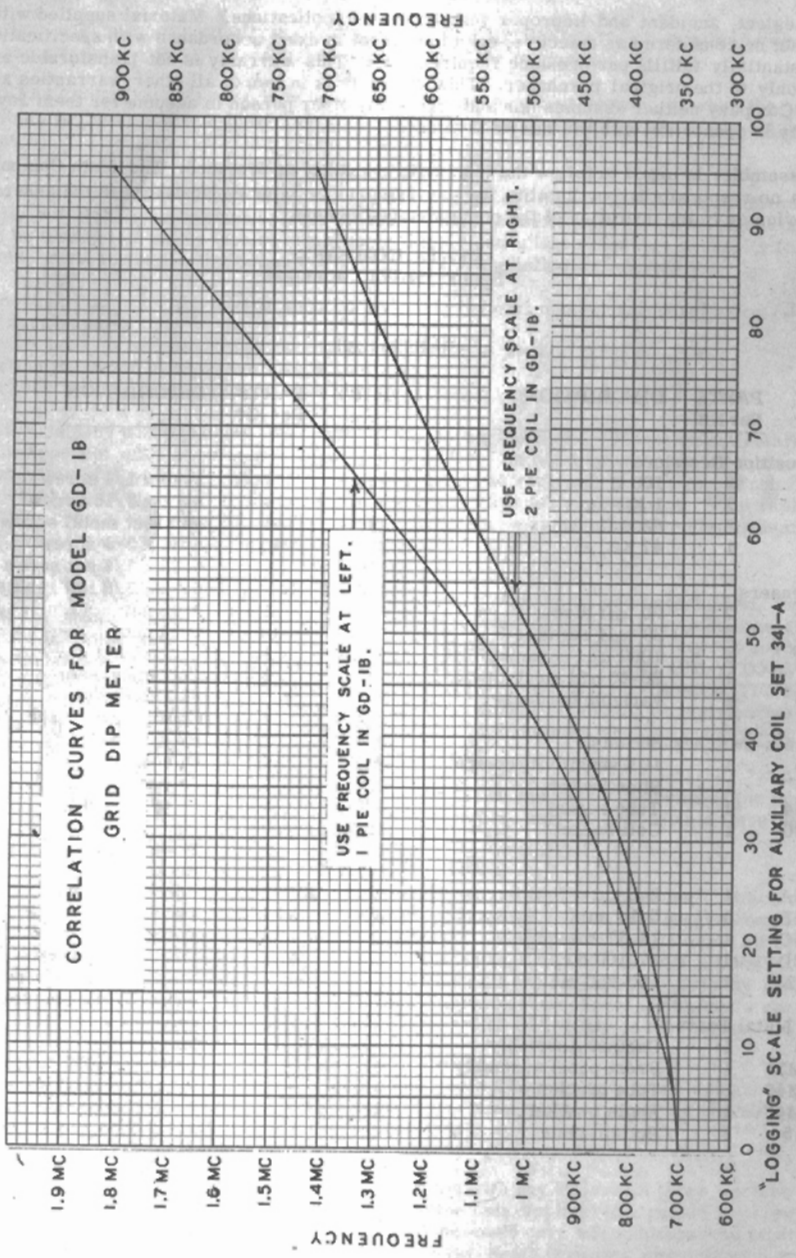

HEATHKIT GRID DIP METER

MODEL GD-1B



SPECIFICATIONS

Frequency Range.....	2 to 250 mc using five coils. Additional coils available; extending frequency to 350 kc.
Meter Movement.....	500 microampere
Power Requirements.....	117 volt, 5 watts, 50/60 cycle
Power Supply.....	Transformer operated selenium rectifier
Dimensions.....	7" long x 2 1/2" wide x 3 1/4" deep
Shipping Weight.....	4 lbs.
Net Weight.....	2 lbs.

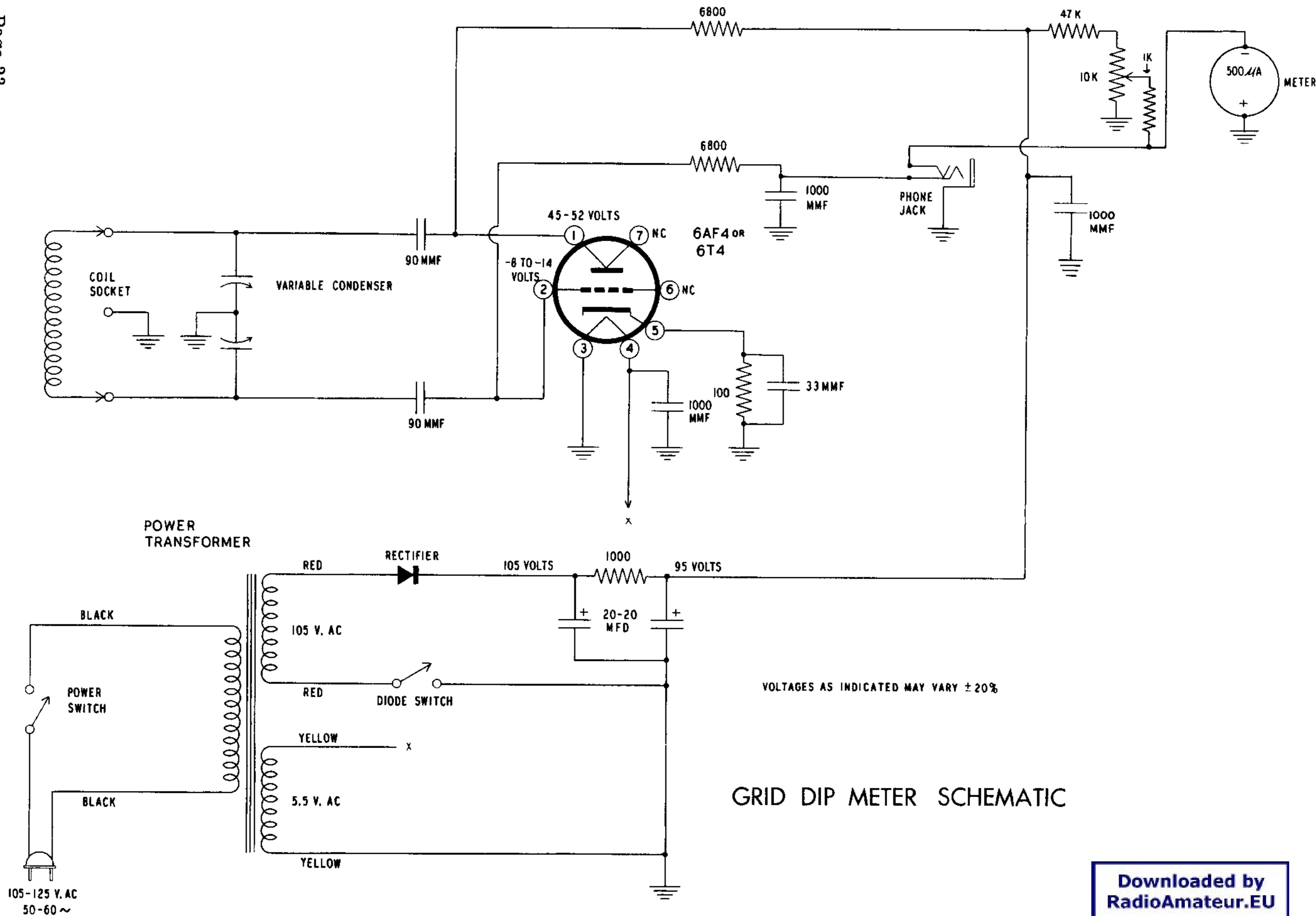

VOLTAGES AS INDICATED MAY VARY ± 20%

GRID DIP METER SCHEMATIC