

PERSONNEL. THIS UNIT CONTAINS NO OPERATOR SERVICEABLE PARTS.

WARNING: USING THIS EQUIPMENT IN A MANNER NOT SPECIFIED BY THE ACCOMPANYING DOCUMENTATION MAY IMPAIR THE SAFETY PROTECTION PROVIDED BY THIS EQUIPMENT.

CASE, COVER OR PANEL REMOVAL

Removing protective covers from the Test Set exposes the operator to electrical hazards that can result in electrical shock or equipment damage. Do not operate this Test Set with the case, cover or panels removed.

SAFETY IDENTIFICATION IN TECHNICAL MANUAL

The following terms draw attention to possible safety hazards, that may exist when operating or servicing this equipment.

CAUTION: IDENTIFIES CONDITIONS OR ACTIVITIES THAT, IF IGNORED, CAN RESULT IN EQUIPMENT OR PROPERTY DAMAGE (E.G., FIRE).

WARNING: IDENTIFIES CONDITIONS OR ACTIVITIES THAT, IF IGNORED, CAN RESULT IN PERSONAL INJURY OR DEATH.

SAFETY SYMBOLS IN MANUALS AND ON UNITS



CAUTION: Refer to accompanying documents.



AC OR DC TERMINAL: Terminal that may supply or be supplied with ac or dc voltage.



DC TERMINAL: Terminal that may supply or be supplied with dc voltage.



AC TERMINAL: Terminal that may supply or be supplied with ac or alternating voltage.



device is connected ON or disconnected OFF.

EQUIPMENT GROUNDING PRECAUTION

Improper equipment grounding can result in electrical shock.

USE OF PROBES

Check specifications for maximum voltage, current and power ratings of any connector on the Test Set before connecting a probe from a terminal device. Verify terminal device performs within these specifications before using it for measurement, to prevent electrical shock or damage to the equipment.

POWER CORDS

Power cords must not be frayed, broken nor expose bare wiring when operating this equipment.

USE RECOMMENDED FUSES ONLY

Use only fuses specifically recommended for the equipment at the specified current and voltage ratings.

INTERNAL BATTERY

This unit contains a lead-acid battery, serviceable only by a qualified technician.

CAUTION:

SIGNAL GENERATORS FOR MAINTENANCE AND OTHER ACTIVITIES CAN BE A SOURCE OF ELECTROMAGNETIC INTERFERENCE (EMI) TO COMMUNICATION RECEIVERS. SOME TRANSMITTED SIGNALS CAN CAUSE DISRUPTION AND INTERFERENCE TO COMMUNICATION SERVICES OUT TO A DISTANCE OF SEVERAL MILES. USERS OF THIS EQUIPMENT SHOULD SCRUTINIZE ANY OPERATION THAT RESULTS IN RADIATION OF A SIGNAL (DIRECTLY OR INDIRECTLY) AND SHOULD TAKE NECESSARY PRECAUTIONS TO AVOID POTENTIAL COMMUNICATION INTERFERENCE PROBLEMS.

<u>TITLE</u>	<u>PAGE</u>
INTRODUCTION	6
HOW TO USE THIS BOOK	6
INSTALLATION	7
Cable Statement, Power Up Procedures	7
Applying AC Power, Battery Power Operation, Applying External DC Power	7
CONTROLS, CONNECTORS AND INDICATORS	8
RECEIVER TESTING	16
Measuring Receiver Center Frequency, et al	17
Receiver Center Frequency	17, 18
12 dB SINAD Sensitivity	17, 19
Modulation Acceptance Bandwidth	17, 20
Measuring Receiver Audio Output Level	21
Measuring Receiver IF Bandwidth	23
Monitoring Paging Receivers	26
TRANSMITTER TESTING	30
Measuring Transmitter Harmonics	31
	4

TABLE OF CONTENTS (Cont'd)

<u>TITLE</u>	<u>PAGE</u>
TRANSMITTER TESTING (Cont'd)	
Measuring Transmitter Frequency Error	34
Measuring Transmitter Distortion	37
Analyzing Intermod Distortion	40
Isolation and Insertion Loss	42
Monitoring DCS & CTCSS	43
DCS or CTCSS Generate	44
DCS or CTCSS Receive	45
How To Find An Unknown Transmitter Frequency	46
FILE SYSTEM OPERATION	48
How To Create A File	49
File Management.....	51
How To Retrieve A File	53
BATTERY FUSE REPLACEMENT	54
EXTERNAL CLEANING	55
SPECIFICATIONS	56

This publication was developed to aid the communication service technician in using the COM-120B Communications Service Monitor to analyze certain common transmitter and receiver performance parameters and should be used in conjunction with the COM-120B Operation and TMAC Manuals. Tests included were selected because of appropriateness, application to as wide a spectrum of equipment as possible and minimum amount of auxiliary equipment required to perform the test.

The scope of this publication does not allow the inclusion of specific troubleshooting techniques, nor guarantee that the included tests are suitable for all applications. Consult material from the UUT manufacturer for specific test requirements or other appropriate tests.

This Application Guide contains actual field applications of the COM-120B Communications Service Monitor.

The Application Guide is divided into three categories: Receiver Testing, Transmitter Testing and File System Operation.

Each Application is preceded by the name of the test and is comprised of a brief overview with highlights of the application.

There is a detailed test setup illustration following each Application.

Refer to the front and rear panel illustrations to identify the controls, connectors and indicators referenced in the Application Guide.

INSTALLATION

CABLE STATEMENT

For continued EMC compliance, double shielded and properly terminated external interface cables must be used with this equipment when interfacing with the RS-232, IEEE-488 GPIB and Reference Connectors.

POWER UP PROCEDURES

The Internal Battery, if installed, charges automatically whenever the COM-120B is connected to a power source and the Main Power Switch is ON. The Power Supply is designed to sense applied voltage and automatically compensate with no further actions required.

APPLYING AC POWER

1. Insure proper fuse is installed in AC FUSE Holder.
2. Connect power cord to AC Input Connector.
3. Plug cord into power source. Insure proper grounding.
4. Set Main Power Switch to ON ("I" on switch). Power APPLIED Indicator lights when power is available.

5. Press COM-120B Front Panel Power ON Key to activate unit. Power ON Indicator lights.

BATTERY POWER OPERATION

1. Press COM-120B Front Panel Power ON Key.
2. Power ON Indicator lights.
Option 01 required for battery operation.
Power cycles off after approximately 10 minutes of operation.
Flashing Power ON Indicator denotes low battery charge.

APPLYING EXTERNAL DC POWER

1. Insure proper fuse is installed in DC FUSE Holder.
2. Connect power cord to DC Input Connector.
3. Plug cord into power source. Power APPLIED Indicator lights when power is available.
4. Press COM-120B Front Panel Power ON Key to activate unit. Power ON Indicator lights.

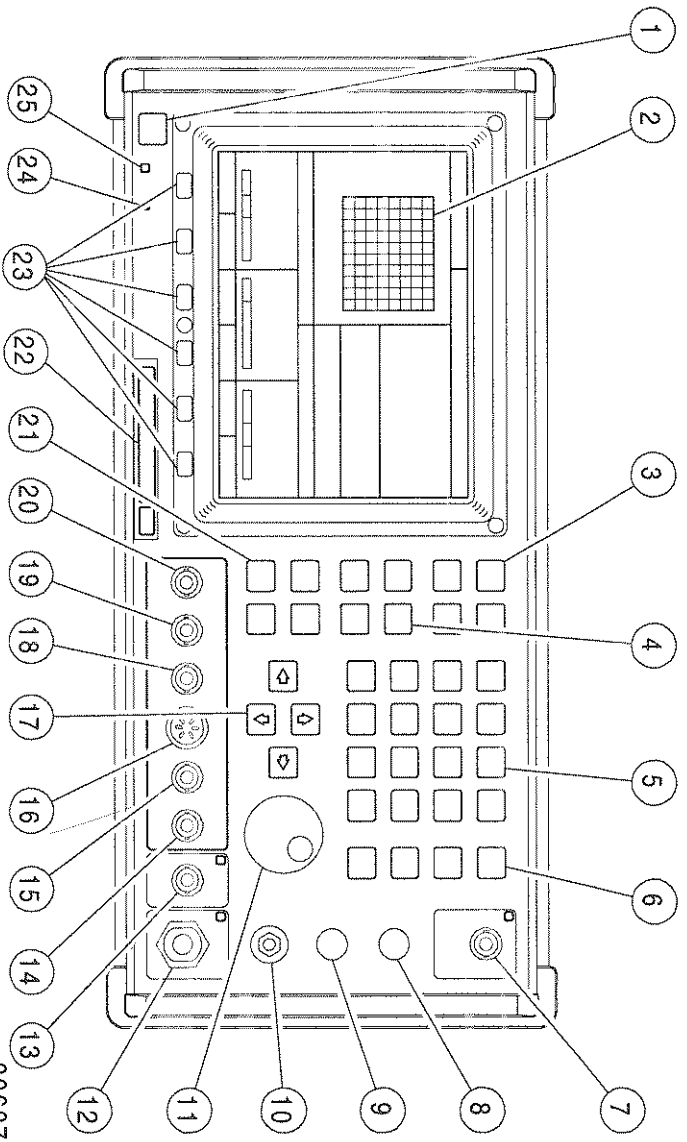

COM-120B Front Panel

00607131

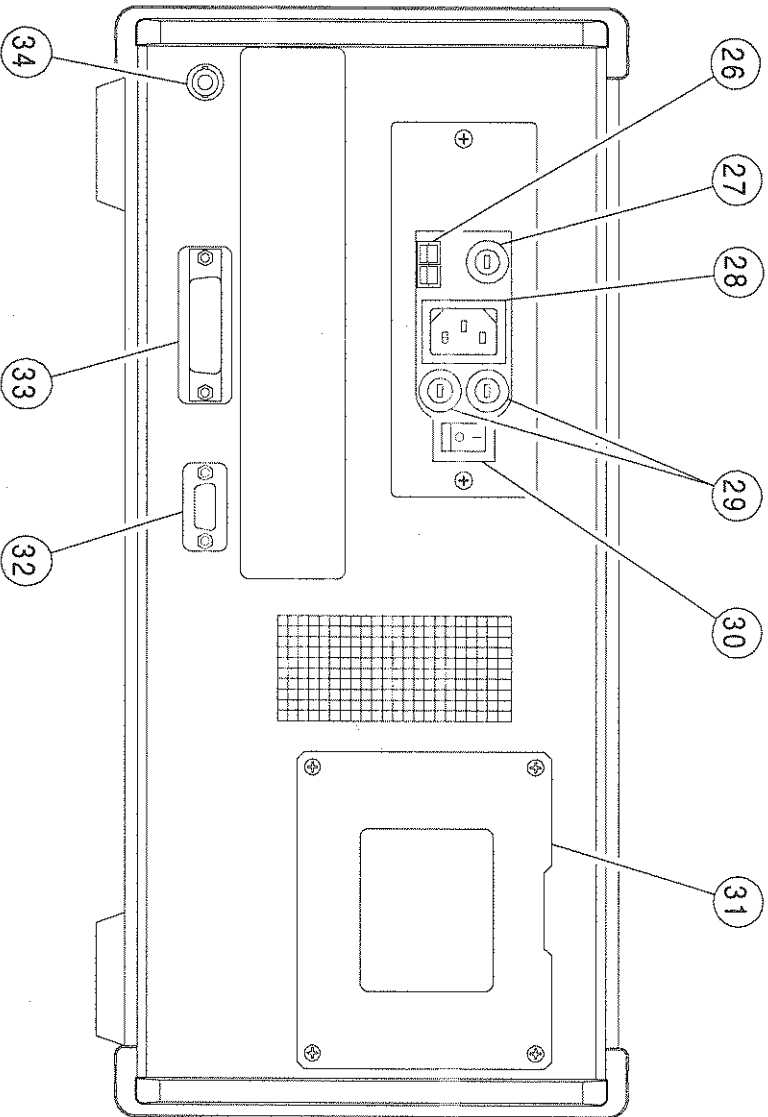

COM-120B Rear Panel

00607132

③ Test Mode Keys

GEN Test Mode Key, accesses Generate Test Mode Operation Screen.
REC Test Mode Key, accesses Receive Test Mode Operation Screen.
DPLX Test Mode Key, accesses Duplex Test Mode Operation Screen.
SPCL Test Mode Key, accesses Optional Operation Modes.

④ Instruments Keys

SCOPE Key, accesses Oscilloscope Operation Screen.
ANLYZ Key, accesses Spectrum Analyzer Operation Screen.
MTRS Key, accesses Independent Meters Functions.
AUDIO Key, accesses Audio/Data Generators Functions.

⑤ DATA ENTRY Keys

Numeric Keys, use to enter numeric (0-9) values.
* Key, use for DTMF functions.
Key, use for DTMF functions.
+/- Key, use to set sign of entered value.
• Key, use to enter decimal point in numeric values.
SHIFT Key, use for alphabetic function of Front Panel Keys (see table).
ENTER Key, selects data field for edit or completes an editing action.

KEY	SHIFT	KEY	SHIFT	KEY	SHIFT
GEN	A	5	J	AUDIO GEN	S
REC	B	6	K	*	T
1	C	●	L	0	U
2	D	SCOPE	M	#	V
3	E	ANLYZ	N	STORE	W
+/-	F	7	O	RCL	X
DPLX	G	8	P	SHOW LIST	Y
SPCL	H	9	Q	SETUP	Z
4	I	MTRS	R	TAB	[space]

6 CONTROL Keys

ESC Key, use to escape an editing action without change to parameters.
 HOLD SCRNL Key, use to freeze current screen. Press any key to return to normal operation.
 START/STOP Key, use to start or stop the following operating functions:
 Reset One Shot in Oscilloscope Operation
 Bit Error Rate Meter (Option 07)
 LTR® Trunking (Option 14)

Input connector to monitor "off-the-air" signals. Also used as a connection for low power (10 W maximum) signals.

7 ANTENNA Connector 

CAUTION: DO NOT EXCEED 0.25 W MAXIMUM CONTINUOUS INPUT OR DAMAGE TO THE COM-120B MAY RESULT.

⑩ PHONES Connector

Provides access for using Headphones when audio signal is present.

⑪ SCROLL SPINNER

Allows operator to scroll through current test mode operation screen, scroll through lists of parameter selections and actively increase and decrease one digit of numeric parameters.

⑫ T/R Connector 

50Ω Connector for high power input or output signals.

CAUTION: DO NOT EXCEED 200 MAXIMUM CONTINUOUS INPUT OR DAMAGE TO THE COM-120B MAY RESULT.

⑬ AUX RF OUT 

50Ω Auxiliary output connector for RF signals.

CAUTION: DO NOT EXCEED 0.25 W MAXIMUM CONTINUOUS INPUT OR DAMAGE TO THE COM-120B MAY RESULT.

⑭ AUDIO/DATA GEN 

600Ω connector for output of audio and data generators. Access is selectable from individual generator setup screens.

CAUTION: DO NOT EXCEED 20 V MAXIMUM CONTINUOUS INPUT OR DAMAGE TO THE COM-120B MAY RESULT.

selectable from individual generator setup screens.

CAUTION: DO NOT EXCEED 20 V MAXIMUM CONTINUOUS INPUT OR DAMAGE TO THE COM-120B MAY RESULT.

⑩ MIC/ACC 

Provides access for microphone or accessory equipment. Both generate and receive lines are available.

CAUTION: DO NOT EXCEED 20 V MAXIMUM CONTINUOUS INPUT OR DAMAGE TO THE COM-120B MAY RESULT.

⑪ DATA SCROLL

Allows operator to scroll through current test mode operation screen, scroll through list of parameter selections and actively increase and decrease one digit of numeric parameters.

⑫ EXT MOD 

100 k Ω connector allows input for external modulation source.

CAUTION: DO NOT EXCEED 20 V MAXIMUM CONTINUOUS INPUT OR DAMAGE TO THE COM-120B MAY RESULT.

⑬ AUDIO/DATA IN 

100 k Ω connector allows input of external audio and data signals.

CAUTION: DO NOT EXCEED 30 V MAXIMUM CONTINUOUS INPUT OR DAMAGE TO THE COM-120B MAY RESULT.

21 MEMORY Keys

STORE Key, selection allows operator to store current Operation Screen and all current parameters for future.
RECALL Key, selection allows operator to recall previously stored Operation Screens.
SHOW LIST Key, provides access to menu of all storage lists.
SETUP Key, provides access to setup menu for system information and system configuration.

22 PCMCIA Card Slot

Provides access to enhance software capability.

23 Soft Function Keys

Provides access to defined function.

24 Power ON LED

Denotes unit is ON when lit.

25 Power APPLIED

Denotes power is provided to the unit when lit.

26 DC Input 

Accepts dc power cord to supply dc power (12 to 30 Vdc) to COM-120B.

CAUTION: DO NOT EXCEED 12 TO 30 Vdc OR DAMAGE TO THE COM-120B MAY RESULT.

27 DC Fuse 

10 A, 32V Slo-Blo Fuse is provided for dc operation.

120B MAY RESULT.

②8 AC Input  Accepts ac power cord to supply ac power (90 to 265 VAC) to COM-120B.

CAUTION: DO NOT EXCEED 90 TO 265 VAC OR DAMAGE TO THE COM-120B MAY RESULT.

②9 AC Fuse  Two 2 A fuses are provided for ac operation.

CAUTION: ONLY USE A 2 A FUSE OR DAMAGE TO THE COM-120B MAY RESULT.

③0 Main Power Switch Switches power applied ON and OFF.

③1 Battery Access Panel Provides access to battery.

③2 RS-232 Connector Provides serial interface for remote operations with COM-120B.

③3 GPIB Connector IEEE-488 connector provides parallel interface for remote operation with COM-120B.

③4 Reference Connector Provides connection for input of external 10 MHz Reference Signal.

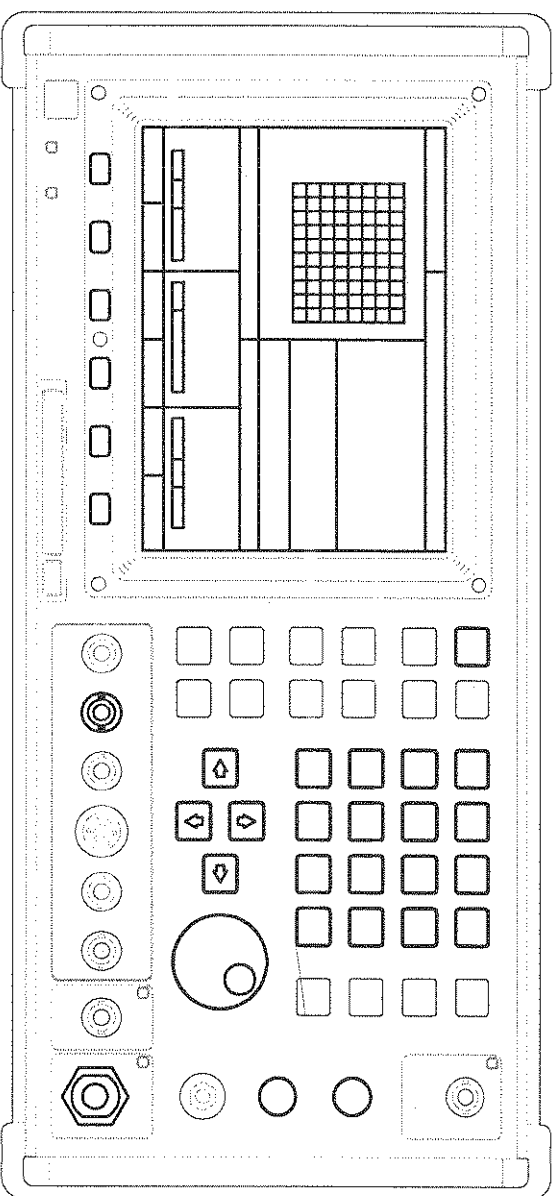

00607138

Controls, Connectors and Indicators shown here in bold are used during Receiver Testing.

MEASURING RECEIVER CENTER FREQUENCY, et al

This procedure configures the COM-120B RF Generate Operation Screen to measure Receiver Center Frequency, Modulation Acceptance Bandwidth and 12 dB SINAD Sensitivity (Receiver Sensitivity).

Why are these measurements important?

The *Receiver Center Frequency* test determines if the local oscillators are close to the design frequency and if the IF is aligned properly. Measurement of *Modulation Acceptance Bandwidth*, while set up to do the normal *12 dB SINAD Sensitivity* test, quickly determines the radio's overall low level signal performance.

Bandwidth and 12 dB SINAD Sensitivity all contribute to a receiver's performance at low signal levels.

RECEIVER CENTER FREQUENCY

The receiver center frequency is the frequency that produces the best SINAD reading.

MODULATION ACCEPTANCE BANDWIDTH

Modulation acceptance bandwidth is measured by increasing the deviation until distortion occurs in the 1 KHz tone due to bandwidth limitations.

12 DB SINAD SENSITIVITY

SINAD is the acronym for **Signal + Noise And Distortion**. SINAD is the voltage ratio of signal, noise and distortion to noise and distortion and is expressed in dB. 12 dB is the most common SINAD specification point. SINAD is a more accurate method of measuring the readability of a signal because distortion is measured in the 1 kHz signal in addition to quieting. A badly distorted audio signal fails a SINAD test.

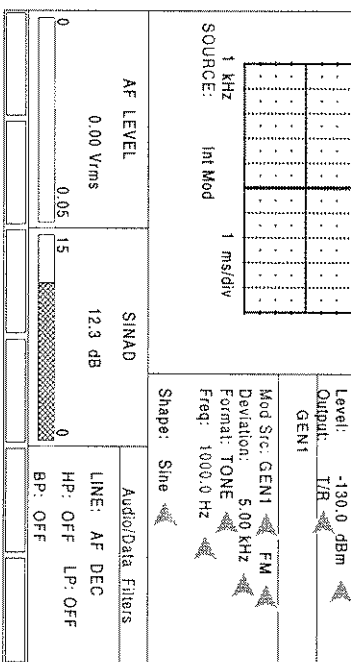
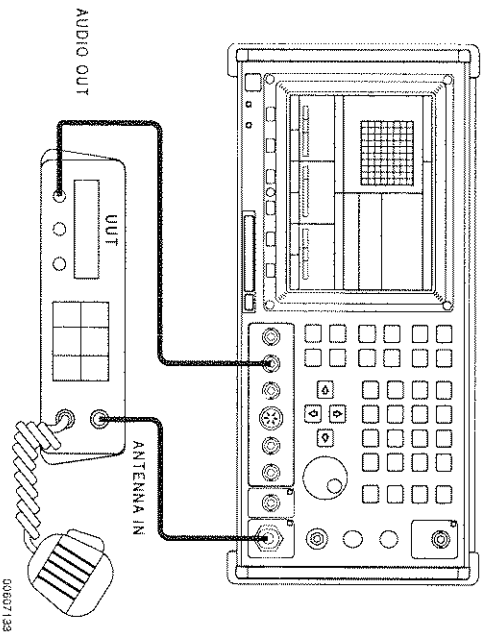

00607134

Use the Data Entry Keys, Data Scroll Spinner and Data Scroll Keys to edit the appropriate fields.

Connect the COM-120B T/R RF IN/OUT to the Unit Under Test (UUT) ANTENNA IN via a coaxial cable.

Connect the UUT AUDIO OUT to the COM-120B AUDIO/DATA/SINAD IN via a coaxial cable.

HF GEN AUDIO/DATA FILTERS SETUP MENU				
LINE	BAND PASS FILTER	HIGH PASS FILTER	LOW PASS FILTER	WIDE-BAND
DATE / SINAD	OFF	300 HZ	4 KHZ	ON
*** PRESS *EXEC* TO ACTIVATE SELECTION ***				
SPEAKER / PHONES	INT - MOD			

00607135

To start, cursor to the Audio/Data Filter LINE field.

Press F1 .

Press F6 . Make the appropriate edits to the RF Gen Audio/Data Filters Setup Menu.

Don't forget to press F5 to activate the selection.

F6 exits to the previous screen.

Cursoring to the Level field gains access to F5 and F6 .

Press F6 and the COM-120B goes to work in pursuit of the 12 dB target. Deactivate the SINAD search function when 12 dB is reached on the SINAD Meter.

Adjust the RF field for the highest SINAD Meter reading to reveal the actual *UUT* Center Frequency.

12 dB SINAD SENSITIVITY

Measure Receiver Center Frequency first to ensure accurate test results.

Cursor to the Level field and press F5 .

Set the SINAD= field to 10 dB or 12 dB (as specified by the Receiver Manufacturer) and press F6 .

Press F6 to activate the SINAD search function.

Press F6 to deactivate the SINAD search function *after* the Level settles.

This Level is the Receiver Sensitivity Level.

Output: T/R		Mod Src: GEN1	
GEN1		FM	
Deviation: 5.00 KHz		Format: TONE	
Freq: 1000.0 Hz		Shape: Sine	
SOURCE: 1 KHz Int Mod 1 ms/div		Audio/Data Filters	
AF LEVEL	SINAD	LINE: AF DEC	
0.00 Vrms	12.0 dB	HP: OFF LP: OFF	
0.05 15	0	BP: OFF	

00807139

Measure Receiver Center Frequency first to ensure accurate test results.

Cursor to the Level field and press F5 **SINAD=**

Set **SINAD=** to 12 dB and press F6 **RETURN**

Press F6 **S=ON/OFF** to activate the SINAD search function.

Press F6 **S=ON/OFF** to deactivate the SINAD search function after the Level settles.

Now, increase the COM-120B Level 6 dB.

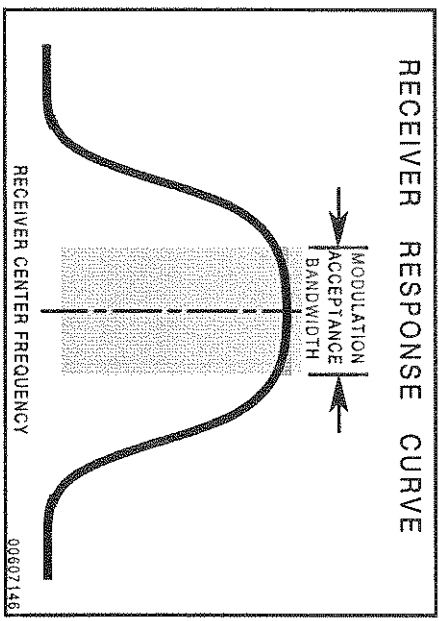

NOTES

MEASURING RECEIVER AUDIO OUTPUT LEVEL

This procedure configures the RF Generate Operation Screen to measure Receiver Audio Output Level.

Why measure the receiver audio output level?

The audio output level of a receiver is dependent on internal audio amplifier circuitry. The inherent audio amplifier circuitry increases the energy level of the audio frequency output signal which must have enough drive to effectively reproduce the original input. This test provides a visual representation of the audio output level. What goes in, must come out!

TEST SETUP

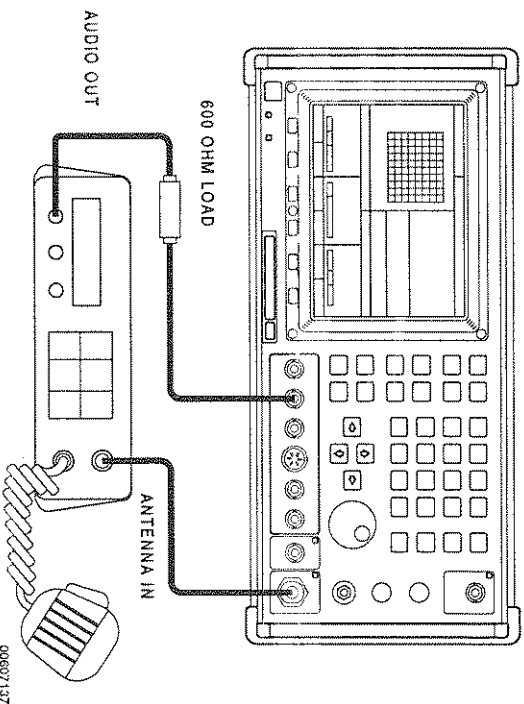

00607137

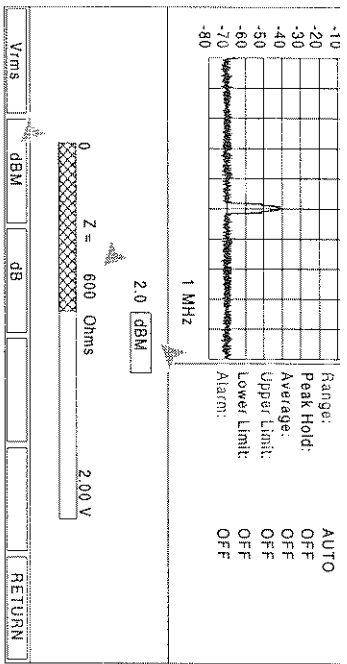

00607136

Use the Data Entry Keys, Data Scroll Spinner and Data Scroll Keys to edit the appropriate fields.

Connect the COM-120B T/R RF IN/OUT to the Unit Under Test (UUT) ANTENNA IN via a coaxial cable.

Measure Receiver Center Frequency first to ensure accurate test results.

to press F5 to activate the selection.
 F6 exits to the previous screen.

Now, adjust the UUT Audio Output for the desired output.

Cursor to the AF LEVEL field and press F1 .

Press F2 to reveal impedance for dBm reading.

The COM-120B uses a standard 600 Ohms default. The 'Z = field is editable from 0 to 1000 Ohms.

Attach an external load between the UUT Audio Output and the COM-120B AUDIO/DATA/SINAD IN input.

The illustration uses a 600 Ohm load.

The Audio Frequency Level Meter reading that results is the Audio Output Level of the UUT.

MEASURING RECEIVER IF BANDWIDTH

This procedure configures the RF Generate Operation Screen to measure Receiver IF Bandwidth.

Why check the receiver IF Bandwidth?

The IF filtering network determines the receiver's selectivity. If too narrow, audio distortion is produced. If too wide, there may be adjacent channel interference. Symmetry of the IF filter is important for recovering audio with the lowest distortion.

TEST SETUP

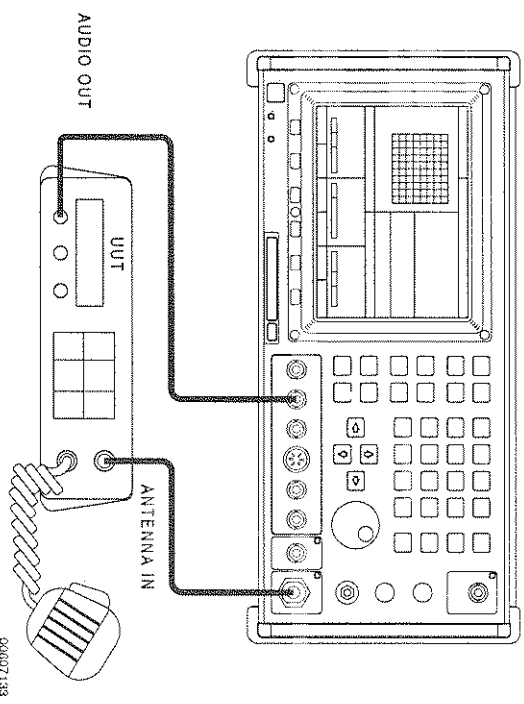

00007133

Level:	-130.0 dBm
Output:	T/R
GEN1	
Mod Src: GEN1	FM
Deviation:	5.00 KHz
Format: TONE	
Freq:	1000.0 Hz
Shape:	Sine
AF LEVEL	0.00 Vrms
SINAD	12.3 dB
0	0.05
15	
0	
Audio/Data Filters	
LINE:	AF DEC
HP:	OFF
LP:	OFF
BP:	OFF

00607134

Use the Data Entry Keys, Data Scroll Spinner and Data Scroll Keys to edit the appropriate fields.

Connect the COM-120B T/R RF IN/OUT to the Unit Under Test (UUT) ANTENNA IN via a coaxial cable.

Measure Receiver Center Frequency first to ensure accurate test results.

LINE	BAND PASS FILTER	HIGH PASS FILTER	LOW PASS FILTER	WIDE BAND
DTMF / SINAD	OFF	300 Hz	4 KHz	ON
*** PRESS EXEC TO ACTIVATE SELECTION ***				
SPEAKER / PHONES	INT . MOD			

00607135

To gain access to the RF Gen Audio/Data Filters Setup Menu, press F6 **CONFIG** after setting the Audio/Data Filter Line field to **AF DEC**. Make the appropriate edits.

Don't forget to press F5 **EXEC** to activate the selection.

F6 **RETURN** exits to the previous screen.

Cursoring to the Level field gains access to F5 **SINAD=** and F6 **S=ON/OFF**.

Activate the SINAD search function and the COM-120B goes to work in pursuit of the 12 dB target.

Press F6 S=ON/OFF to deactivate the SINAD search function when 12 dB is reached on the SINAD Meter.

This Level is the Reference Sensitivity.

Increase this COM-120B Level 60 dB.

Now, increase the COM-120B RF field until the SINAD Meter reads 12 dB.

Note the resulting frequency as the Upper Frequency.

Now, decrease the COM-120B RF field past the UUT Center Frequency until the SINAD Meter reads 12 dB.

Note the resulting frequency as the Lower Frequency.

Mathematically, subtract the Lower Frequency from the Upper Frequency to obtain the Receiver IF Bandwidth.

IF Response Curve

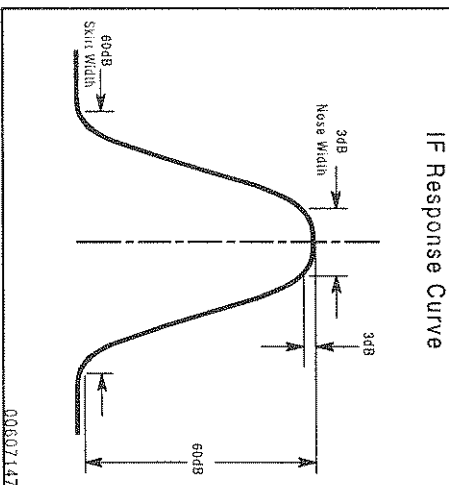

NOTES

This procedure configures the RF Generate Operation Screen to monitor Paging Receivers.

Why test pagers?

Propagation, fading, shading and off-frequency conditions are some of the things that affect a paging system.

Individual pagers react differently to variations in signal level, modulation and frequency. The objective is to determine pager reaction.

The key to successful pager testing requires the simulation of real-world conditions that affect pager operation.

“Flaky” pagers are a source of frustration and may cause a loss of revenue and customers.

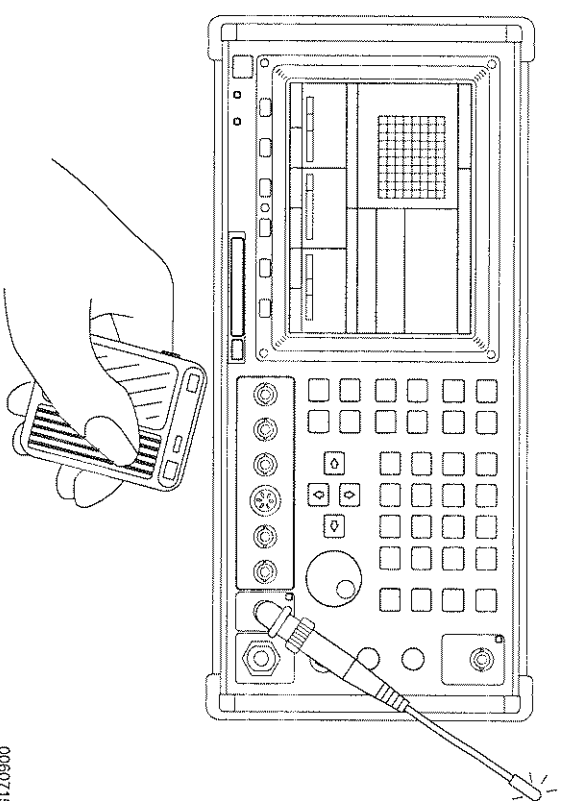

006071:

GENERATE		SCOPE		RF: 158.1000 MHz	
				FL: OFF	
				Level: 0.0 dBm	
				Output: AUX	
				DATA	
				Mod Src: DATA	
				Deviation: 4.00 KHz	
				Format: POCSSAG	
SOURCE: 1 KHz Int Mod		20 ms/div			
AF LEVEL		SINAD		Audio/Data Filters	
0.00 Vrms		... dB		LINE: AF DEC	
0.05		15 dB		HP: OFF LP: OFF	
				BP: OFF	

00607159

Use the Data Entry Keys, Data Scroll Spinner and Data Scroll Keys to edit the appropriate fields.

Connect an antenna to the COM-120B AUX RF OUT connector.

To start, press Mode Hardkey .

The following settings are intended as an example. Actual settings for this test may vary depending on the paging transmitter.

RF field to **Pager Assigned Center Frequency**.

Output field to **AUX**.

Level field to **0.0 dB**.

Mod Src field to **DATA** and **FM**.

Deviation field to **4.00 KHz**.

Now, cursor to the Format field and press F1 .

Select POCSSAG and press F6 .

Menu selections depend on installed options.

Press F6 .

Set the appropriate DATA RATE, CAPCODE RANGE and FUNCTION for the pager under test.

Press F6 .

Power ON the pager under test to an idle state.

Press F5 to simulate a page.

If the pager fails to respond, there is a problem. Review the field settings. Observe the burst transmission on the COM-120B scope or analyzer display. If these are satisfactory, the pager is the problem.

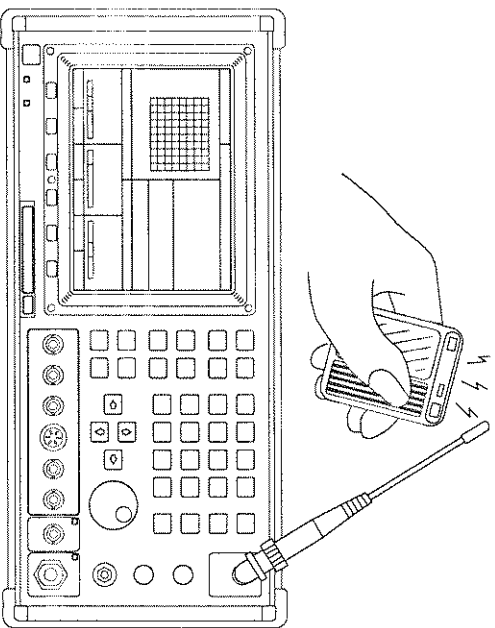

00607156

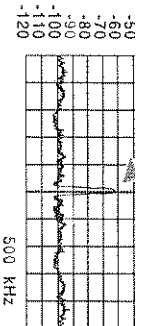

Input: ANI Atten: 0 dB
 Demod: FM IF BW: 15. KHz
 AE GEN OUT DATA DEC
 LINE: DATA DEC
 HPF: OFF LPF: OFF
 BPF: OFF
 Tone/Data Code: POCSAG

AF FREQUENCY:	2749 Hz	DISTORTION:	93.7 %
RF ERROR	RECL LEVEL	DEVIATION	
159.536996 MHz	-75.8 dBm 36.2 uV	± 0.21 KHz	
-1 KHz	-110 dBm	-30 dBm	0 KHz
1 KHz			2 KHz

00607160

Use the Data Entry Keys, Data Scroll Spinner and Data Scroll Keys to edit the appropriate fields.

Connect an antenna to the COM-120B Antenna connector.

To start, press Mode Hardkey



The following settings are intended as an example. Actual settings for this test may vary depending on the paging transmitter.

RF field to *Pager 1st LF Frequency*.

Input field to *ANT*.

Attenu field to *0 dB*.

Now, cursor to the Tone/Data Code field and press
F1 . Select a format and press F6

Usable selections depend on installed options.

Power ON the pager under test to an idle state.

Position the pager close to the antenna to allow the COM-120B to "sniff" the Pager's 1st LO frequency.

Observe the sniffed LO frequency on the analyzer display.

Adjust the Pager LO frequency to the analyzer center graticule.

Absence of a Pager signal may indicate the Pager's 1st LO isn't running.

Reference the COM-120B RF ERROR Meter. Pager Frequency may be in error.

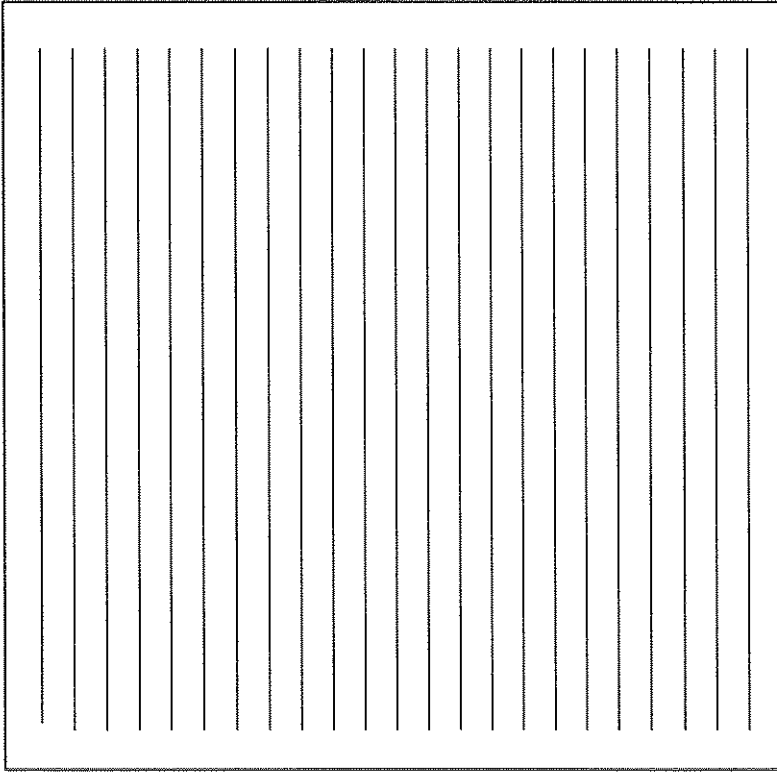

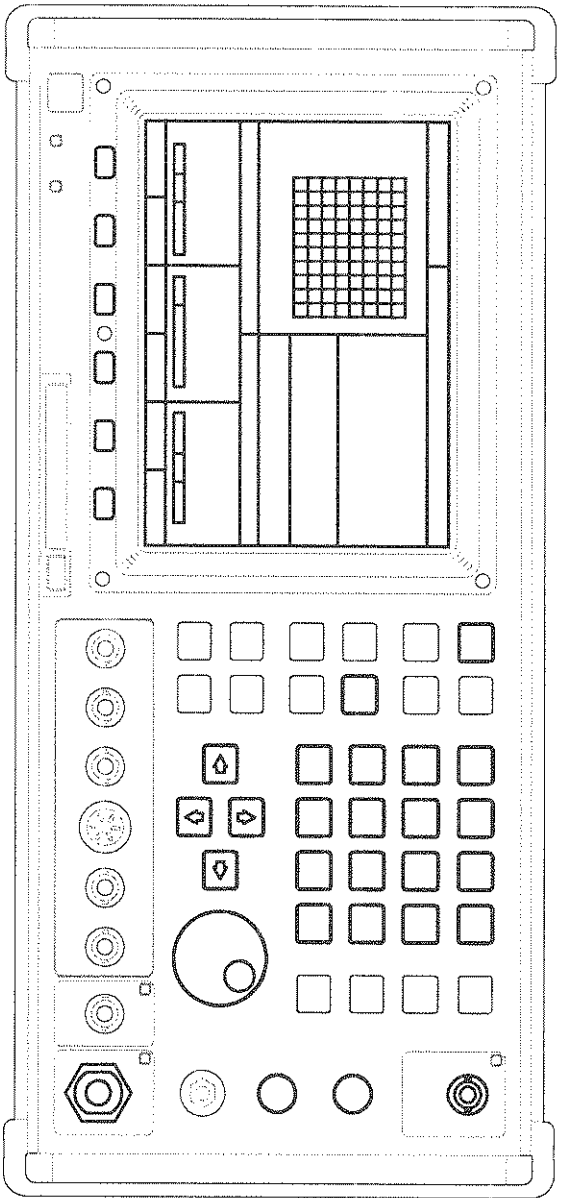

00607140

Connectors, Controls and Indicators shown here in **bold** are used during Transmitter Testing.

HARMONICS

This procedure configures the Analyzer Operation Screen to measure Transmitter Harmonics.

Is transmitter harmonics a major concern?

Yes. The F.C.C. harmonic specification requires that all emissions beyond a certain percentage of the authorized bandwidth be attenuated. Check F.C.C. Regulations for proper harmonic specifications.

Minimum attenuation for signals 2250% of authorized bandwidth. (harmonics & spurious)

Xmtr power in watts	Min. atten. dB below cw	Xmtr power in watts	Min. atten. dB below cw
1	43	100	63
5	50	150	65
10	53	200	66
25	57	250	67
50	60	300	68
75	62	500	70

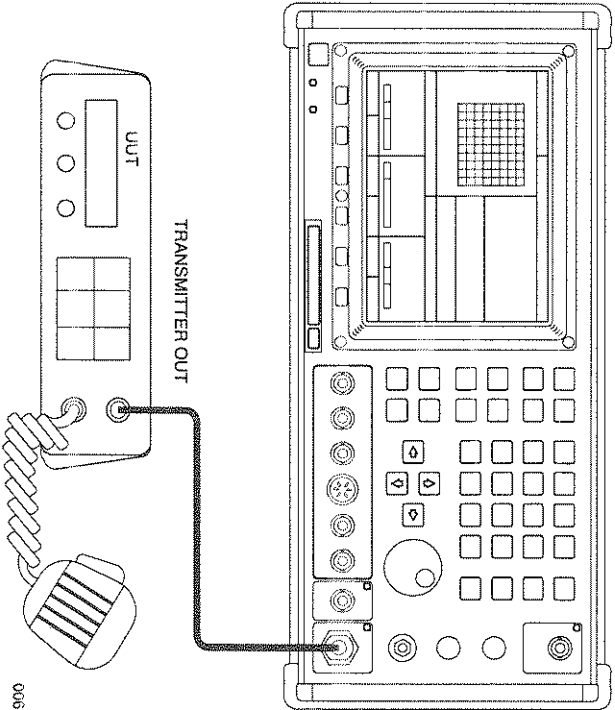

00607149

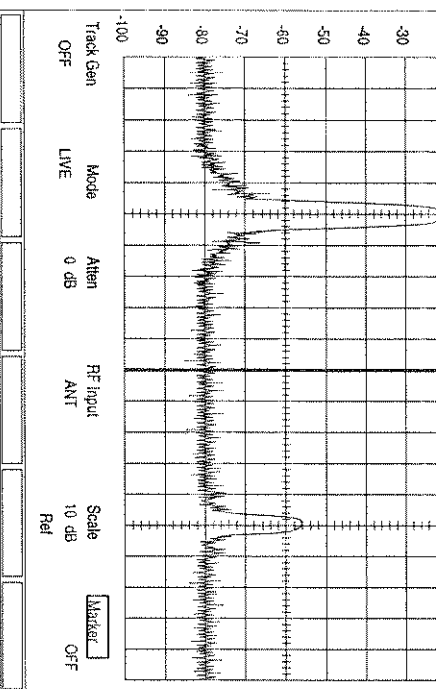

Use the Data Entry Keys, Data Scroll Spinner and Data Scroll Keys to edit the appropriate fields.

Connect the COM-120B T/R RF IN/OUT to the Unit Under Test (UUT) TRANSMIT OUT via a coaxial cable.

Measure Receiver Center Frequency first to ensure accurate test results.

vertical scale and set to **dBm**.

Cursor clockwise and set the Scan Width field to **500 kHz**. Cursor to these fields and set the:

Sweep field to **5 ms/div**.

Analyzer Center Frequency field to **UUT**

Transmitter Frequency.

Resolution Bandwidth field to **300 kHz**.

Track Gen field to **OFF**.

Mode field to **LIVE**.

Atten field to **0 dB**.

RF Input field to **T/R**.

Scale field to **10 dB**.

Marker field to **OFF**.

Ref field to **-20 dBm at top of the vertical scale**.

Now, make the following connections

Connect **UUT** Transmitter output to COM-120B T/R connector.

Key the transmitter to view the **UUT Transmitter Frequency** signal.

Adjust the transmitter fundamental signal level as near the top graticule as possible *without* exceeding the graticule to obtain the maximum dynamic range.

This procedure configures the RF Receive Operation Screen to measure the Frequency Error of a 100 MHz RF Signal at the T/R connector.

Why measure transmitter frequency error?

If a radio was set to transmit on a particular frequency and a significant internal transmitter frequency error existed, the transmission might never be received.

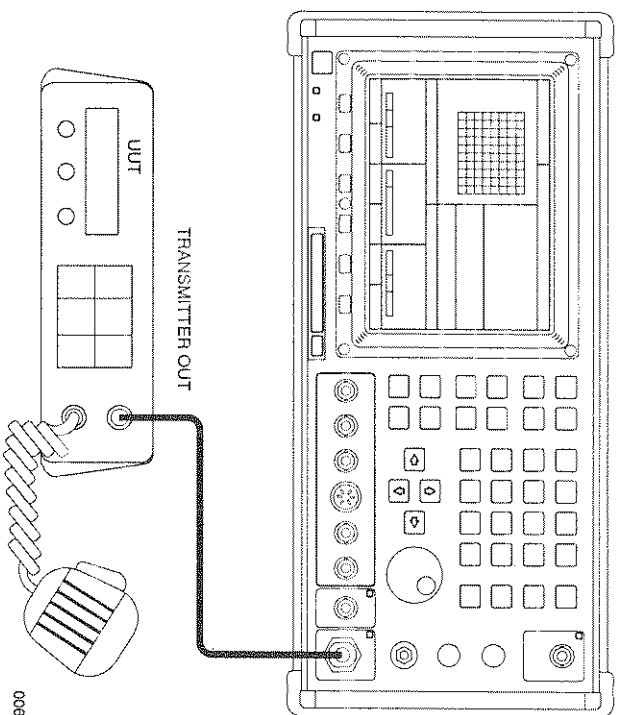

00607149

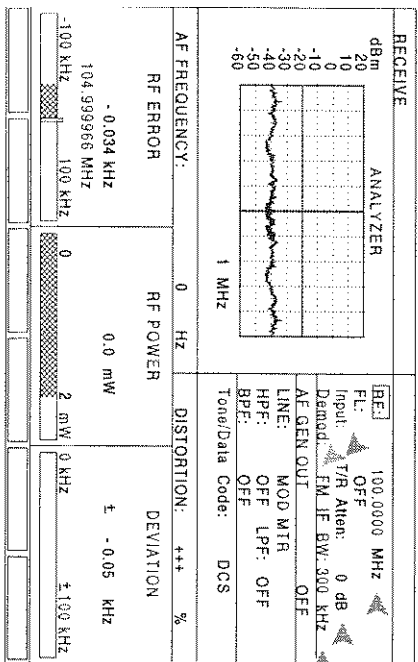

00807143

Use the Data Entry Keys, Data Scroll Spinner and Data Scroll Keys to edit the appropriate fields.

Connect the COM-120B T/R RF IN/OUT to the Unit Under Test (UUT) TRANSMIT OUT via a coaxial cable.

Measure Receiver Center Frequency first to insure accurate test results.

To start, press Mode Hardkey



RF field to *Transmitter Center Frequency*.
 Input field to *T/R*.
 Atten field to *0 dB*.
 Demod field to *FM*.
 BW field to *300 kHz*.

Now, cursor to the RF ERROR Meter and press F1
ZOOM

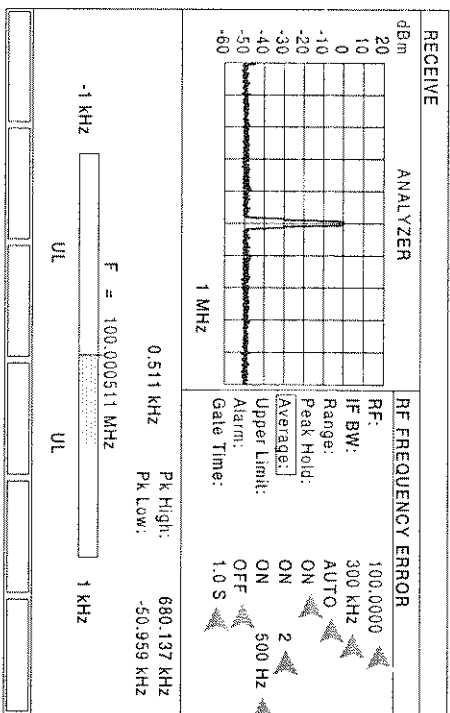

00807142

Set the Average field to *ON* and select the number of samples to be averaged before a reading is reported. Range is 2 to 10.

Set the Upper Limit field to *ON* and select an Upper Limit value. Range is 0 to 100000 Hz.

If desired, set the Alarm field to *ON* and an audible alarm sounds when the signal exceeds the Upper Limit.

Set the Gate Time field to *1.0 S*.

Press F6 .

Now, using a coaxial cable, apply the Transmitter Center Frequency Signal to the COM-120B T/R connector.

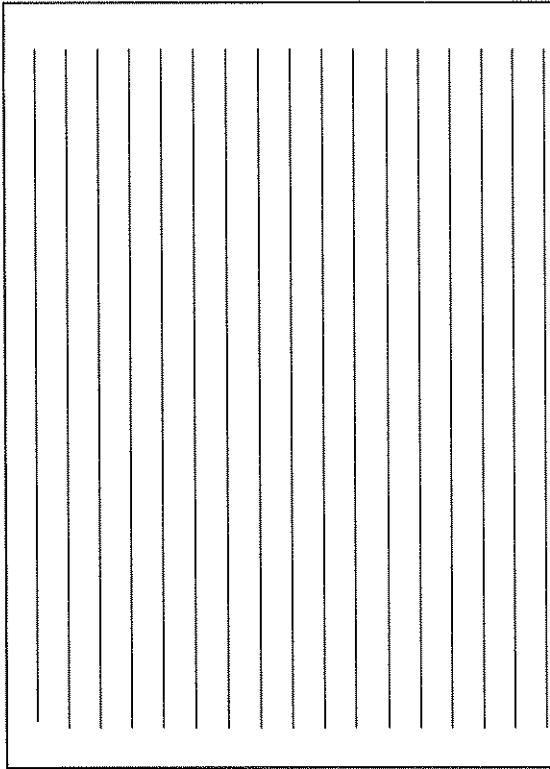

MEASURING TRANSMITTER DISTORTION

This procedure configures the RF Receive Operation Screen to measure the Distortion of a 100 MHz RF Signal at the T/R connector. The signal is FM Modulated and has a 1 kHz sine wave as audio.

Why measure transmitter distortion?

The audio stages of a transmitter produce measurable distortion. Also, a phase modulator that is improperly adjusted can produce distortion which is detectable using this measurement.

If the transmitter uses a phase modulator, tune the phase modulator stage for minimum distortion. A compromise may be necessary between the best distortion and deviation level.

TEST SETUP

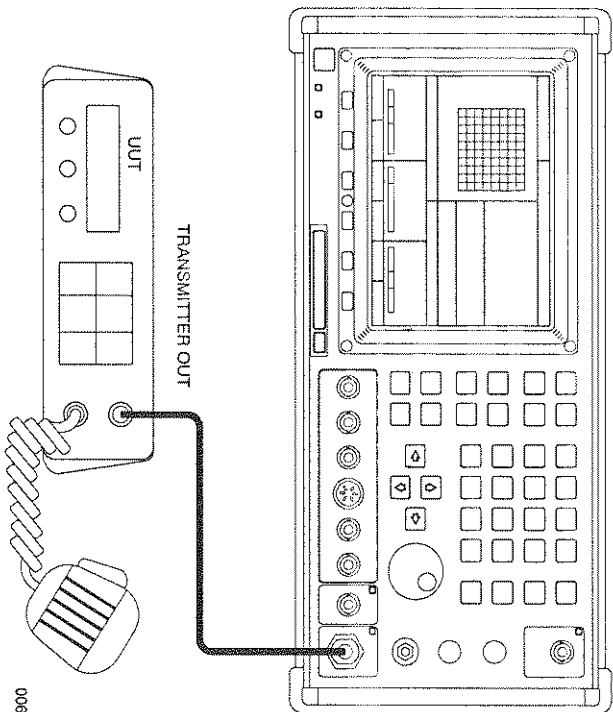

00607149

LINE	F PASS FILTER	F PASS FILTER	F PASS FILTER	DATA
MOD METERS	OFF	OFF	OFF	ON
DTMF/SINAD	OFF	300 Hz	4 KHz	ON
AF ENTR/DECODE	LOEF <input type="checkbox"/>	OFF	OFF	OFF
DATA DECODER	OFF	OFF	OFF	ON
*** PRESS EXEC TO ACTIVATE SELECTION ***				
SPEAKER / PHONES	OFF			
DEMOP OUT	AF CNT			

00007150

RECEIVE	ANALYZER	DISTORTION METER	FILTERS
		Source: DEMOD Range: AUTO Peak Hold: OFF Average: 2 Upper Limit: ON Lower Limit: ON Alarm: OFF	HPF: 300 Hz LPF: 4 KHz BPF: OFF
0 dBm 2.5% 20%			

00007151

Measure Receiver Center Frequency first to ensure accurate test results.

To start, press Mode Hardkey

REC

Cursor to these fields and set the:

RF field to *Transmitter Center Frequency*.

Input field to *T/R*.

Atten field to *0 dB*.

Demod field to *FM*.

BW field to *300 KHz*.

Now, cursor to the LINE field and press F1 **MENU**.

Select DTMF/SINAD and press F6 **RETURN**.

To gain access to the Receiver Audio/Data Filters Setup Menu, press F6 **CONFIG**.

Cursor to DTMF/SINAD and set the High Pass Filter to 300 Hz and Low Pass Filter to 4 KHz.

Don't forget to press F5 **EXEC** to activate the selection.

OK, cursor to the DISTORTION Meter and press
F1 **ZOOM**.

Cursor to these fields and set the...

Range field to **AUTO**. Peak Hold remains OFF
in AUTO range.

Average field to **ON** and select the number of
samples to be averaged before a reading is
reported. Range is 2 to 10.

Upper Limit field to **ON** and select an Upper
Limit value. Range is 0.0% to 100%.

Lower Limit field to **ON** and select a Lower
Limit value. Range is 0.0% to 100%.

Alarm field to **ON** if desired. An audible alarm
sounds when the signal exceeds the Upper
Limit.

Press F6 **RETURN**.

The COM-120B is capable of generating a 1 KHz
signal to modulate the transmitter carrier signal.

Set the AF GEN OUT field to ON. Press F1

ZOOM.

Source field to **GEN2**.
State field to **ON**
Freq field to **1000.0 KHZ**.
Shape field to **SINE**.
Level field to **1 V**.

Press F6 **RETURN**.

Now, using a coaxial cable, apply the Transmitter Center
Frequency signal to the COM-120B T/R connector.

Key the transmitter and hold the mic over the COM-120B
speaker vent located on the left side of the case near the
back.

Rotate the COM-120B Volume Control Knob clockwise and
note the meter readings.

For a more accurate reading, connect the COM-120B
AUDIO/DATA GEN OUT to the radio mic. Set the Level to
the lowest value that provides adequate deviation. Some
radios may require a 10 dB pad to lower the audio level.

NOTES

This procedure configures the RF Receive Operation Screen to analyze Intermod Distortion.

When intermodulation problems occur, first determine if the problems are generated within the receiver by mixing products or are produced by mixing in an external non-linear device such as corroded antenna connections or in a nearby transmitter.

Externally or internally produced?

Eliminate the receiver first by splitting the signal from the antenna and feeding both the receiver in question and the COM-120B's receiver. Listen to the receiver for the intermod and look on the analyzer display at the receive frequency. If noise is heard from the receiver and not seen on the analyzer, this *only* determines that *on channel* intermod is not produced externally. A mixing product generated externally and interfering on a spurious response frequency within the receiver or a mix within the receiver may be the problem.

constant. When the interfering signal is heard, set the top of the signal to the top of the screen.

Install a 3 dB attenuator in the outside antenna line. If the analyzer signal level drops *appreciably* more than 3 dB, the intermod is produced within the receiver. If the drop is only 3 dB, the source is external, probably in a nearby transmitter or antenna system.

To determine if the mix is within the suspected transmitter:

A tuned isolator is needed in the suspected transmitter's output line to provide different forward and reverse loss factors.

Measure the forward and reverse loss at the intermod frequency.

Connect the RF Coupler's output to the COM-120B Antenna input.

Adjust the coupler to establish an intermod reference level the intermod appears again.

intermod.

If the intermod signal drops by the forward attenuation of the isolator, the intermod is not being caused by this transmitter.

If the intermod signal drops by the reverse attenuation of the isolator, this is the offender.

SNIFFER LOOP diagram
(EXTREMELY UN-CRITICAL DIMENSIONS)

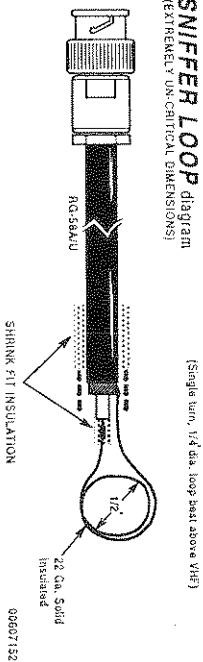

***SNIFFER LOOP** is nothing more than one of two turns of insulated wire on one end of a convenient length of coaxial cable. Install a male BNC connector on the other end to connect to the COM-120B Antenna Input.

TEST SETUP

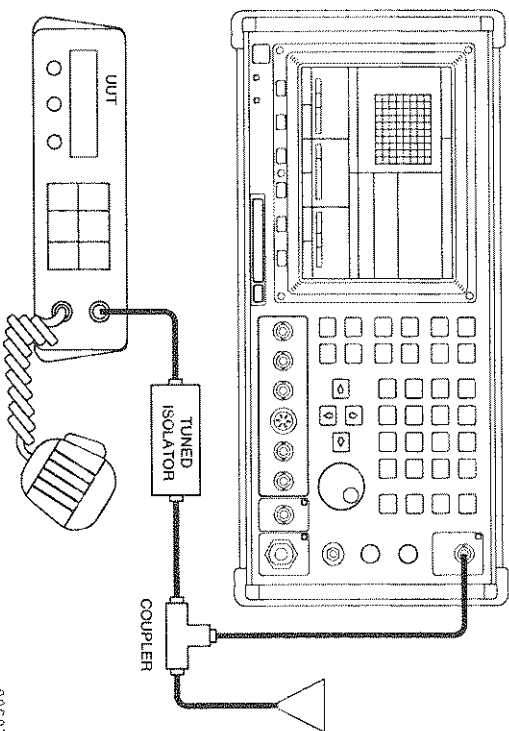

00607153

This procedure configures the RF Receive Operation Screen to measure Isolation and Insertion Loss.

T-R relays can be a source of several problems. Low transmitter power, poor receiver sensitivity and even intermod interference problems.

Transmitter Power Loss

Transmit Power loss caused by the relay is easily isolated by measuring output power with and without the relay.

Receiver Sensitivity Loss

Receiver sensitivity loss is isolated by measuring the transmission loss at the receiver frequency. Sensitivity loss is more likely to be an intermittent problem due to the lack of power to punch through the thin corrosion layer on the receive contacts.

T-R Relay May Be An Intermod Source

Corrosion on contacts may act as a diode, creating an unwanted mixer when excited by strong RF signals from the antenna.

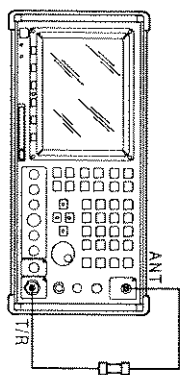

Set reference level with cables on 1 dB/DIV to compensate for cable & connector losses.

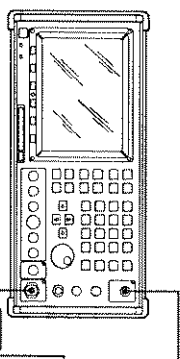

Transmission loss in receive mode: Use 1 dB/DIV for highest resolution

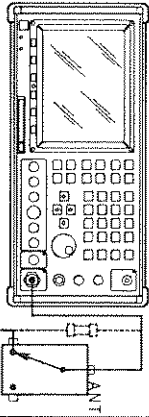

Power Loss: Determine wattage loss by eliminating relay.

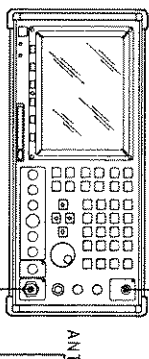

Receiver isolation during transmit.

MONITORING DCS & CTCSS

This procedure configures the RF Receive Operation Screen to monitor DCS and CTCSS.

What is DCS?

DCS, or Digitally Coded Squelch, uses subaudible frequencies and a 23-bit digital "word" to mute radio receiver background noise and unwanted communications. The DCS 83 codeword capacity may all be used on the same channel. The codeword is repeated cyclically every 171 ms and ends with a 180 ms burst of turn-off code—a 134 Hz tone. The DCS codeword's 1s and 0s are converted into an analog signal to continuously modulate the FM carrier.

What is CTCSS?

CTCSS, or Continuous-Tone Coded Squelch, uses subaudible frequencies below 300 Hz. One tone is assigned to a user. The decoding device in the radio switches on the speaker when the proper tone is received. Tones are below the 300 Hz to 3000 Hz audio speech band. A low-level subaudible tone is superimposed continuously with the voice on the FM carrier.

TEST SETUP

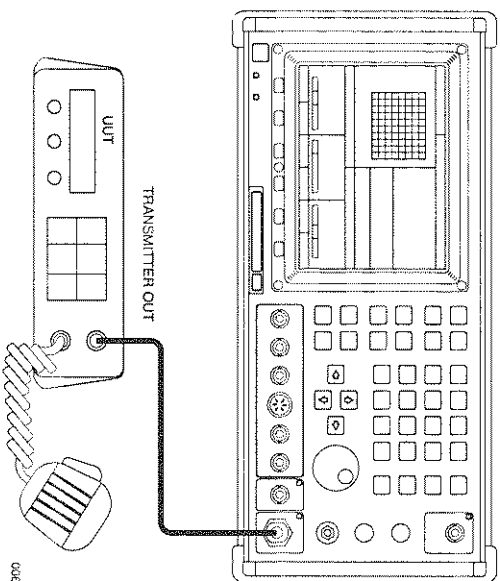

Connect the COM-120B T/R connector to the Unit Under Test (UUT) TRANSMIT OUT via a coaxial cable.

Option: Connect antenna to COM-120B ANT connector to sniff off the air.

Use the Data Entry Keys, Data Scroll Spinner and Data Scroll Keys to edit the appropriate fields.

Cursor to these fields and set the:

Scope/Analyzer field to **Scope**.
RF field to **Transmitter Center Frequency**.

Input field to **T/R**.

Atten field to **0 dB**.

Demod field to **FM**.

IF BW field **as appropriate**.

If using FM, cursor to the Deviation Meter and perform an FM-Zero.

Key the transmitter to verify the COM-120B receives the signal.

DCS Generate.

Cursor to the LINE field. Press F1 MENU .

Press F6 CONFIG . Set the DATA DECODER

Low Pass Filter to **300 Hz**. Press F5 EXEC .

Press F6 RETURN .

Cursor to these scope fields and set the:

SOURCE field to **Data Decoder**.

Vertical Scale to **1 KHz**.

Sweep to **20 ms/div**.

Key the transmitter. Verify the proper DCS value is displayed.

Examine waveform on scope. It should appear like a slightly rounded square wave.

CTCSS Generate.

Cursor to the LINE field. Press F1 MENU .

Select AF CNTR. Press F6 RETURN .

Press F6 CONFIG . Set the AF CNTR/DECODE Low Pass Filter to **300 Hz**. Press F5 EXEC . Press F6 RETURN .

Cursor to these scope fields and set the:

SOURCE field to **AF Cntr**.

Vertical Scale to **0.40 KHz**.

Sweep to **20 ms/div**.

Key the transmitter. Verify the proper CTCSS frequency value is displayed on the AF Frequency field. If not...

Examine waveform on the scope. There should be a sine wave.

This Section is especially helpful when a radio transmit frequency is unknown. The COM-120B has an internal function that eliminates the mystery.

How does it work?

A radio needs testing, but, the transmit frequency is unknown. What to do? The COM-120B has a solution.

A general idea of the transmitter frequency is helpful, but not necessary.

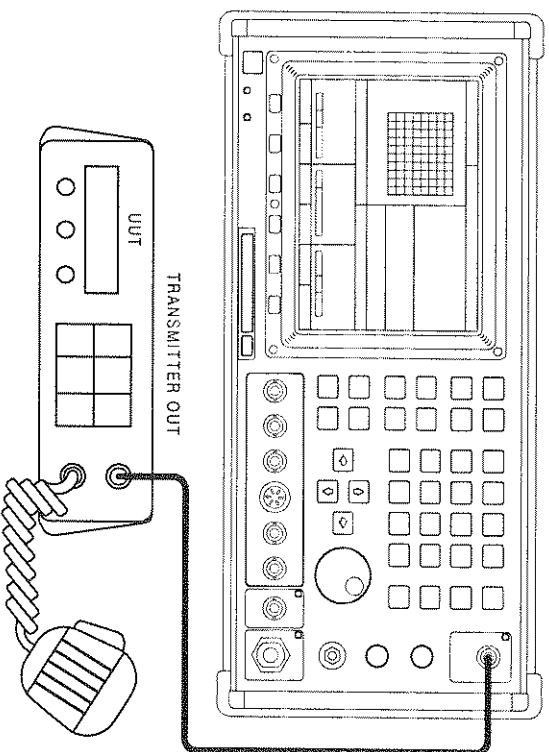

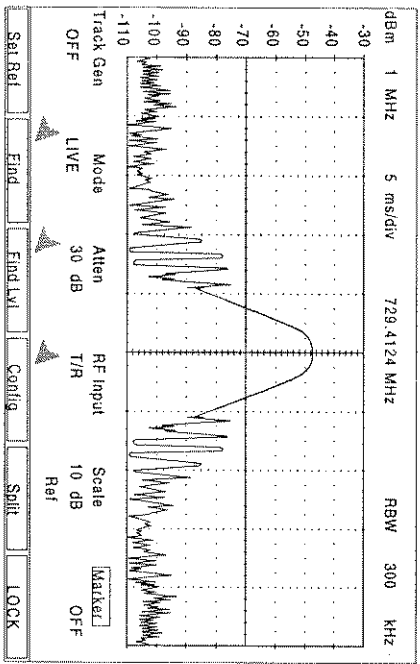

Use the Data Entry Keys, Data Scroll Spinner and Data Scroll Keys to edit the appropriate fields.

Connect the COM-120B T/R connector to the Unit Under Test (UUT) TRANSMIT OUT via a coaxial cable.

This example configures the COM-120B to locate and display an unknown transmitter frequency.

First, press Instruments Hardkey



Set the COM-120B Analyzer Center Frequency to 500.0000 MHz.

Set the RF Input field to T/R.

Press F4 and set the sweep width to 500.0000 MHz. This causes the COM-120B to sweep the entire spectrum from 0 to 1000 MHz. Press F4 again.

Press F3 . Use the Data Scroll to adjust the level marker a few dB lower than the expected signal.

Example: For a 5 Watt signal, set the marker at 30 dB.

Press F3 again.

Press F2 . The COM-120B locates and displays the transmitter frequency signal.

NOTES

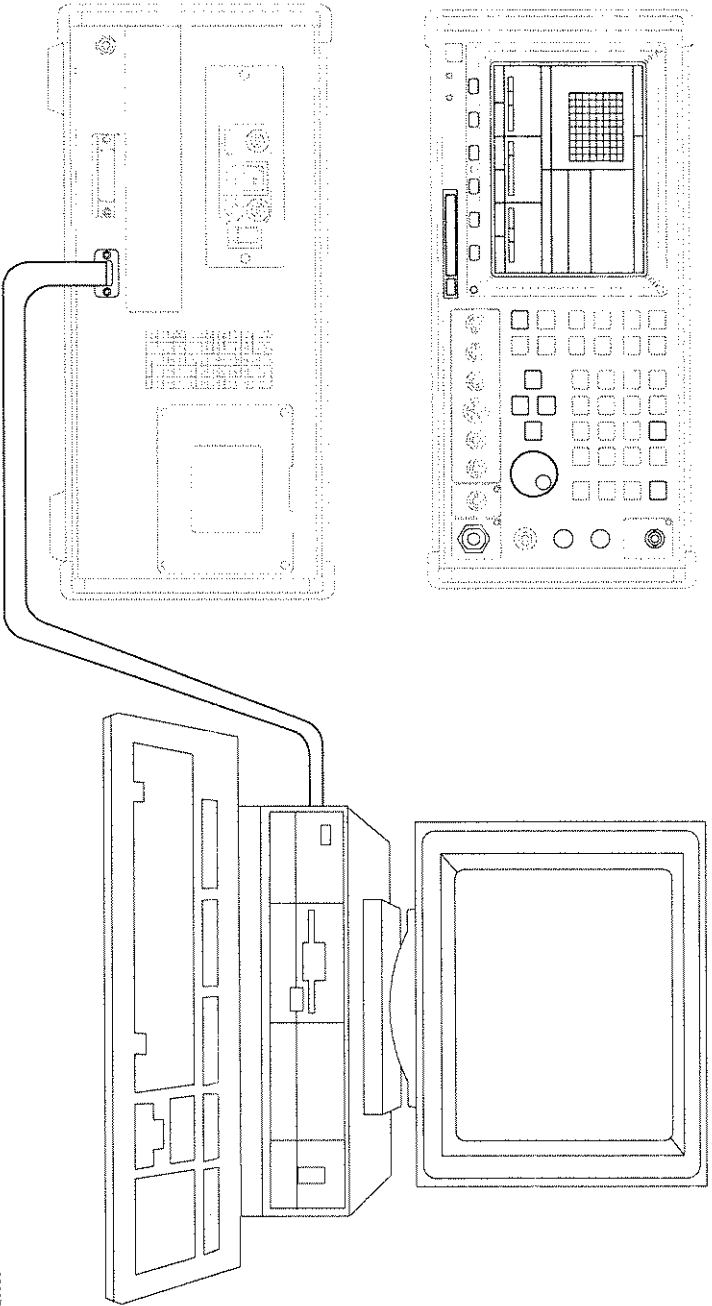

00567162

Controls, Connectors and Indicators shown here in **bold** are used during File System Operation.

HOW TO CREATE A FILE

This Section is to help clear up some COM-120B File System Operation confusion. A little patience reveals the file system is really very simple to operate.

How to start.

The COM-120B Communications Service Monitor requires a direct RS-232 connection. To successfully copy or move files to the PC (Personal Computer), the COM-120B RS-232 settings must match the Baud Rate, Data Bits, Stop Bits, Parity and Handshake settings used in the RF software terminal program.

To start, press Memory Hardkey

the RS-232 SETTINGS screen.

Complete the RS-232 SETUP and press F6

the PCMCIA SETUP screen.

The COM-120B prints to a file, printer or PCMCIA Modem or Serial Card.

The PCMCIA Card Slot is not for Memory, Flash or FAX cards! The following setup is an example.

PRINT SCREEN SETUP

PRINT SCREEN SETUP			
<input type="button" value="PRINT TO:"/>	FILE	▶	
DRIVE:	INTERNAL	▶	
FILE NAME:			
FILE TYPE:	PRINTER	▶	
PRINT MODE:	UNIDIRECTIONAL	▶	
FORMAT:	EPSON 9 PIN	▶	
FILE	RS-232	PCMCIA	RETURN

To start, press Memory Hardkey

the PRINT SCREEN SETUP.

FILE

Other Options: RS-232, PCMCIA or GPIB.

Cursor to the DRIVE field. Press F1 **INTERNAL**.

Other Option: EXTERNAL.

Cursor to the FILE NAME field. Press F3

FILE

Other Options: CLEAR, ...

Enter a file name. For this example, press this key sequence to create the file "SCREEN":

PRESS

SHIFT	AUDIO GEN	1	RTN	3	3	N
SHIFT	GEN		RTN			ANLYZ

PRESS

SHIFT	F	*	ENTER
-------	---	---	-------

The COM-120B automatically generates unique file names when wildcards * or ? are used. Wildcard ** allows multiple screen captures.

Cursor to the FILE TYPE field. Press F5 **PRINTER**. The file outputs to a printer.

Print Mode only available with File Type **PRINTER** selected. Other Option: BIDIR (Bidirectional).

Cursor to the **FORMAT** field. Press F1 **9 PIN** to format the printer output.

Other Options: 24 PIN (EPSON), HP LJ (HP LASERJET).

Select a COM-120B mode of operation.

Press Control Hardkey **HOLD SCRN** to 'freeze' the screen.

Following a short pause, special softkeys F1 **PRINT**

F2 **ABORT** and F6 **RESUME** appear.

F2 **ABORT** is accessible only for a current print job. This softkey is not available once all print jobs are finished.

Press F1 **PRINT**.

See, **FILE MANAGEMENT**.

FILE MANAGEMENT

This Section is here to provide some insight into how to manage the file system. The clue is: DOS (Disk Operated System) experience is extremely beneficial, but not necessary.

How to access and manipulate stored files.

The COM-120B Directory Structure example:

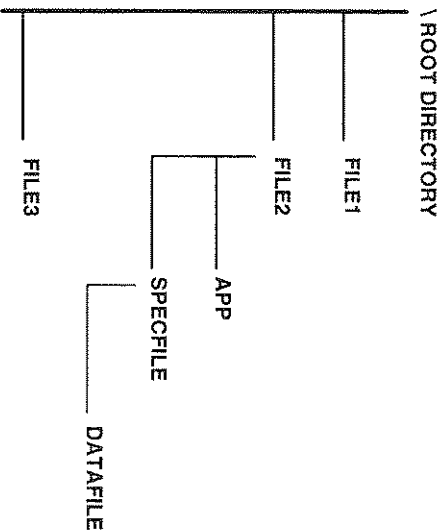

storage capacity. Use subdirectories.

To start, press Memory Hardkey

SHOW LIST

Press F3 FILES

F4 APP appears and executes when an Application Software Option is loaded into the COM-120B.

STORED FILES SCREEN

FILE LIST	810 Kbytes free	1017 Kbytes total			
DRIVE: INTERNAL COM120FLASH					
PATH: ▲					
NAME	TYPE	SIZE	DATE	TIME	ATTR
SCREEN	DIR	549	03/16/1995	10:10:18	D
SCOPE	TRACE	564	03/16/1995	10:10:26	A
ANALY	.TRC	1443	02/23/1996	16:17:32	A
FM RADIO	SET	393	03/16/1996	10:09:34	A
MACROS	.MAC	393	12/20/1996	07:48:26	A
FILE1	DIR	693	01/12/1997	17:08:44	D
FILE2	DIR	458	01/18/1997	14:32:01	D
FILES3	DIR	1272	01/20/1997	09:15:57	D
INTERNAL	PCMCIA	FIX	PACK	RETURN	

00607164

To select drive where desired files are located:

Press F1 for Internal Flash Memory.

Options: FIX, repairs damage to the file system (CHKDSK operation). PACK, performs any needed packing on the file system.

Press F2 for external PCMCIA card.

Options: FIX, repairs damage to the file system (CHKDSK operation). FORMAT, an audible alarm and window warning, prompts for a confirmation. *ALL data is lost if formatted!* PACK, performs any needed packing on the file system.

Cursor to the PATH field.

Options: CLEAR, .. or \.

Enter a path (i.e., \FILE\SPECFILE) or cursor to desired subdirectory. Press F1 .

Cursor to desired file. Press F1 .

This action automatically runs a macro file.

Press F1 to set or clear a Read Only attribute.

Press F2 to set or clear an Archive attribute. Press F6 .

How to Move, Copy, Delete or Rename a file.

Cursor to desired file. Press F2 . Cursor to the ACTIONS field.

To Move the file, press F1 . Enter the new path and drive destination. Press F1 .

To Copy the file, press F2 . Enter the new path and drive destination. Press F1 .

To Delete the file, press F3 . An audible alarm and query accompany this action. *There is no recovery process for a deleted file.* Press F6 to quit or press F1 .

To Rename the file, press F4 . Enter the new name. Press F1 .

Simple, huh.

HOW TO RETRIEVE A FILE

This Section instructs how to download files from the COM-120B file system via a software terminal program package on the PC.

How to talk the talk.

First, make sure there is a good physical RS-232 connection between the COM-120B and PC.

The COM-120B Communications Service Monitor requires a direct RS-232 connection. To successfully copy or move files to the PC (Personal Computer), it is imperative the COM-120B RS-232 settings match the Baud Rate, Data Bits, Stop Bits, Parity and Handshake settings used in the RF software terminal program.

This writing assumes a PROCOMM PLUS® software terminal program package.

Configure PROCOMM PLUS®. Setup Protocol and General Options.

look for carrier detect. Carrier detect is *not* generated by the COM-120B.

Be sure to set "Abort xfer if CD lost" to: NO

Hit [ENTER] on the keyboard. PROCOMM PLUS® returns an I. Congratulations! The COM-120B and PC are talking.

Now, type in the remote command line and file parameter.

Example:

Download the files in a directory called "screens"

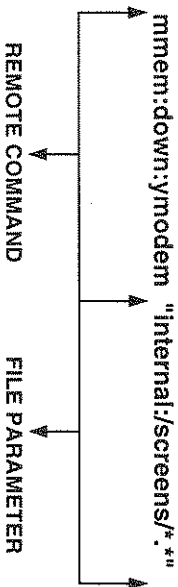

Hit [Page Down] on the keyboard to view download protocols. Hit [Y] for Ymodem (Batch).

Xmodem only retrieves one file at a time and no wildcards. The file must be specified.

The download process begins.

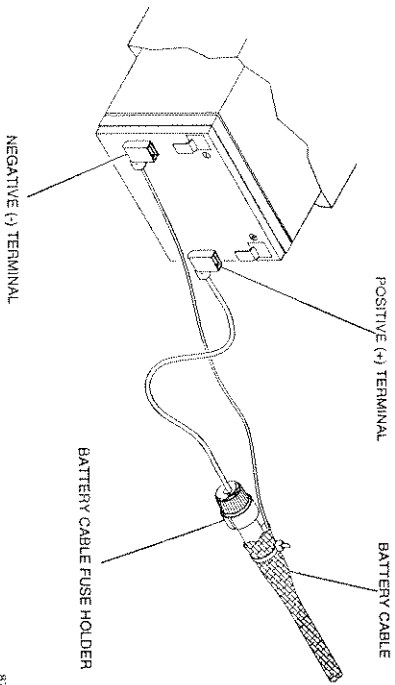

8707005

REPLACEMENT INSTRUCTIONS

1. Set COM-120B Main Power Switch to OFF.
2. Remove all power sources from COM-120B.
3. Loosen 4 Screws on Battery Access Panel and remove.
4. Disconnect Positive (+) and Negative (-) Terminals from Battery.
5. Remove Battery from cavity.
6. Pull Battery Cable out of COM-120B until Battery Fuseholder is exposed.
7. Unscrew Battery Cable Fuseholder Cap.
8. Replace Fuse with 10 A Fast-Blo Fuse.
9. Feed Battery Cable into Chassis.
10. Install Battery in cavity.
11. Connect Positive (+) and Negative (-) Terminals to Battery.
12. Install Battery Access Panel.

COM-120B PRODUCT SPECIFICATIONS

A warm-up time of 5 minutes is required for the following performance requirements.

RF measurements are referenced to 50 Ω .

Accuracy and Resolution stated in percent are referenced to measured or selected value unless otherwise stated.

Where resolution exceeds accuracy, resolution takes precedence.

Specifications and features are subject to change without notice.

RF SIGNAL GENERATOR

Frequency

Range: 250 KHz to 999.9999 MHz

Resolution: 100 Hz

Accuracy: Same as Master Oscillator

Supplemental Characteristic

Tunable Range: Tunable from 100 Hz to

999.9999 MHz (characteristic below 250 kHz are not specified)

Output (T/R and AUX RF Connectors)

Range (T/R):

-130 to -20 dBm (Simplex Mode)
-130 to -40 dBm (Duplex Mode)

Range (AUX):

-130 to -13 dBm

Resolution:

0.1 dB

Accuracy:

± 2 dB (> -90.0 dBm, < 400 MHz)
 ± 2.5 dB otherwise

VSWR:

$< 1.15:1$ (0.25 to ≤ 100 MHz)
 $< 1.23:1$ (> 100 to ≤ 400 MHz)
 $< 1.38:1$ (> 400 MHz)

Spectral Purity

Residual FM:

< 20 Hz (rms, 0.3 to 3 KHz BW)

Residual AM:

$< 0.5\%$ (rms, 0.3 to 3 KHz BW)

Harmonics:

< -26 dBc

Non Harmonics:

< -50 dBc (≤ 1000 MHz)
 < -40 dBc (> 1000 MHz)

Input Protection (T/R):

50 W CW continuous
100 W CW (90 sec/3 min)
150 W CW (30 sec/3 min)
200 W CW (15 sec/3 min)

(AUX):

Up to 0.25 W

Frequency Modulation

Range: 100 Hz to 100 KHz

Resolution: 10 Hz (0.01 to 2.55 KHz)
50 Hz (2.60 to 12.75 KHz)

Accuracy: $\pm 5\%$ + residual FM, (1 KHz rate,
GEN1, GEN2, EXT MOD)

$\pm 10\%$ + residual FM (DATA
GEN)

$\pm 15\%$ + residual (DTMF GEN)

Distortion: $< 2\%$ (1 KHz sine wave, 10 KHz
deviation, 0.3 to 3 KHz BW)

Supplemental Characteristic

Rate: 10 Hz to 20 KHz-FSK rates up to
40 kbps

EXT MOD Sensitivity 2 kHz/Vpk $\pm 10\%$ (FM Narrow)
10 kHz/Vpk $\pm 10\%$ (FM Wide)

Amplitude Modulation:

Range: 30% to 90%

Resolution 1%

Accuracy: $\pm 5\%$ + residual AM (1 KHz rate,
GEN1, GEN2, EXT MOD,

≤ 400 MHz and $< +7$ dBm or

> 400 MHz and < 0 dBm)

$\pm 15\%$ + residual AM (DTMF

GEN, ≤ 400 MHz and $< +7$ dBm or

> 400 MHz, < 0 dBm)

EXT MOD Sensitivity: 9% to 11% Vpk

Supplemental Characteristic

Rate: 100 Hz to 10 KHz

Phase Modulation

Range: 0.1 to 10 radians peak

Resolution: 0.1 radians

Accuracy: $\pm 5\%$ + residual PM (1 KHz rate,
GEN1, GEN2, EXT MOD)

$\pm 15\%$ + residual PM (DTMF
GEN)

EXT MOD Sensitivity: 2 rad/Vpk $\pm 10\%$

Supplemental Characteristic

Rate: 100 Hz to 6 KHz

AUDIO/DATA GENERATORS

A.F. Generator #1

Frequency Range: 5 Hz to 20 KHz (sine wave
only) 5 Hz to 10 KHz (other
wave shapes)

Frequency Resolution: 0.1 Hz

Frequency Accuracy: Same as Master Oscillator

± 0.1 Hz

Output Range (High Lvl): 0.01 to 2.5 Vpk (into 150 Ω)

Output Resolution

(High Lvl): 0.01 Vpk

Output Rang (Low Lvl): 0.1 to 250 mVpk (into 150 Ω)

Output Resolution (Low Lvl): 0.1 mV

Output Accuracy (Low Lvl): $\pm 4\%$ full range ± 0.25 mVpk (≤ 10 KHz, 0.03 Vpk) <level ≥ 1 mVpk)
 $\pm 7\%$ full range ± 0.25 mVpk (>10 KHz, 0.03 Vpk <level ≥ 1 mVpk)

THD: <0.7% (1 KHz sine wave, 2.5 Vpk, 150 Ω Load)
 <1% (all other frequencies and levels)

Wave Shape: Sine, Ramp, Square, Triangle

A.F. Generator #2

Frequency Range: 1 KHz (sine wave)

Frequency Accuracy: ± 0.2 Hz

Output Range (High Lvl): 0.01 to 2.5 Vpk (into 150 Ω)

Output Resolution (High Lvl): 0.01 Vpk

Output Accuracy (High Lvl): $\pm 3\%$ full range ± 5 mVpk (≥ 0.03 Vpk)

Output Accuracy (Low Lvl): $\pm 4\%$ full range ± 0.25 mVpk (0.03 Vpk) <level ≥ 1 mVpk)

DTMF Generator

Output Range (High Lvl): 0.01 to 2.5 Vpk (into 150 Ω)

Output Resolution (High Lvl): 0.01 Vpk

Output Accuracy (High Lvl): $\pm 10\%$ full range ± 5 mVpk (≥ 0.03 Vpk)

Output Range (Low Lvl): 0.1 to 25 mVpk (into 150 Ω)

Output Resolution (Low Lvl): 0.1 mV

Output Accuracy (Low Lvl): $\pm 10\%$ full range ± 0.25 mVpk (0.03 Vpk) <level ≥ 1 mVpk)

Modes: Continuous, Single Shot

Supplemental Characteristics

Digits: 16 (0-9, *, #, A, B, C, D)

Mark/Space Timing: 25 to 999 ms

Mark/Space Timing Resolution: 1 ms

Mark/Space Accuracy: $\pm 20\%$

Frequency

Range: 250 KHz to 999.9999 MHz

Resolution: 100 Hz

Supplemental Characteristic

Tunable Range: Tunable from 100 Hz to 999.9999 MHz (characteristics below 250 KHz are not specified)

Sensitivity:

2 μ V (10 dB SINAD, >2 MHz, 1 kHz tone, 3.3 KHz deviation, 15 KHz IF BW, C-Message weighted filter, 10 KHz FM deviation meter range, 15°C \leq to \leq 35°C) \leq 2.5 μ V otherwise

Antenna Input Protection:

10 W CW (5 sec with alarm)

Selectivity:

300 KHz, 15 KHz

Supplemental Characteristic

Adjacent Channel Rejection:

RX BW (3.0 dB) >30.0 dB Down
300 KHz \pm 485 KHz
15 KHz \pm 15 KHz

Demodulation Output

FM: 0.20 Vpk/KHz \pm 10% (10 KHz range)

0.10 Vpk/KHz \pm 10% (20 KHz range)

range)

0.02 Vpk/KHz \pm 10% (100 KHz range)

AM: 1.13 \pm 0.06 Vrms (80% modulation)

\emptyset M: 0.2 Vpk/Rad \pm 10%

SELECTIVE RF COUNTER

Frequency Range:

250 KHz to 999.9999 MHz (The received frequency must be within the IF bandpass of the COM-120B.)

Supplemental Characteristic

Tunable Range:

100 Hz to 999.9999 MHz (characteristics below 250 KHz are not specified)

Resolution:

1 Hz

Accuracy:

Same as Master Oscillator \pm 2 Hz

RF Level:

0 to 53 dBm (T/R Connector) -60 to 0 dBm (Antenna Connector)

RF FREQUENCY ERROR METER

Meter Range:

0 Hz to 100 KHz

Meter Accuracy:

Same as Master Oscillator \pm 2 counts

Meter Resolution:

1 Hz (10 sec gate time)
10 Hz (1 sec gate time)

RF Level: 0 to 53 dBm (T/R Connector)

-60 to 0 dBm (Antenna Connector)

AF FREQUENCY COUNTER

Frequency

10 Hz to 20 KHz

Accuracy: Same as Master Oscillator ± 1 counts

Resolution

(1 sec gate time): 0.1 Hz (1 sec gate time, 10 to 500 Hz)

1 Hz (1 sec gate time, >500 Hz to 20 KHz)

0.1 Hz (10 sec gate time)

Supplemental Characteristic

Input Signal Level

SCOPE/DVM Input: 90 mVpp (50 mV range, any waveform)

450 mVpp (any waveform)

FREQUENCY MODULATION METER

Range:

10 KHz, 20 KHz, 50 KHz, 100 KHz full scale

Resolution:

10 Hz (10 KHz range)
100 Hz (20 KHz, 50 KHz, 100 KHz ranges)

Modulation Rate:

0 to 20 KHz

Carrier Range:

250 KHz to 999.9999 MHz (The received frequency must be within the IF bandpass of the COM-120B.)

Carrier Level:

0 to 53 dBm (T/R Connector)
-60 to 0 dBm (Antenna Connector)

Ø MODULATION METER

Range:

1, 2, 5, 10 rad peak full scale

Resolution:

0.01 rad (1 and 2 radian ranges)
0.1 rad (5 and 10 radian ranges)

Accuracy:

$\pm 5\%$ of full scale ± 0.1 rad ± 1 count + source residual PM (300 KHz IF BW, 1 KHz tone, 1 rad deviation, C-message weighted filter)

Modulation Rate:

100 Hz to 6 KHz

Carrier Range:

250 KHz to 999.9999 MHz (The received frequency must be within the IF bandpass of the COM-120B.)

Carrier Level:

0 to 53 dBm (T/R Connector)
-60 to 0 dBm (Antenna Connector)

Range:

1% to 100%

Resolution:

0.1%

Accuracy:

±5% of full scale ±1 count + source residual AM (300 KHz IF BW, 1 kHz tone, 50% AM depth, C-Message weighted filter)

Modulation Rate:

50 Hz to 10 KHz

Carrier Range:

250 KHz to 999.9999 MHz (The received frequency must be within the IF bandpass of the COM-120B.)

Carrier Level:

0 to 53 dBm (T/R Connector)
-60 to 0 dBm (Antenna Connector)

Supplemental Characteristic

AGC Attack Time: 50 ms

RF POWER METER

Meter Ranges:

2 mW to 200 W in a 1-2-5 sequence

Resolution:

1% of full scale or 0.1 mW whichever is greater

Accuracy:

±10% ±0.1 mW ±1 count (>200 mW or temperature 15°C to 3°C)
±15% ±0.1 mW ±1 count (<200 mW or 15°C < temperature ≤35°C)

HF Level Range:

2 mW to 200 W average power

Supplemental Characteristic

Usable Level:

0.2 mW to 200 W average power (characteristics below 2 mW not specified)

Operating Conditions:

50 W CW continuous (50°C)
100 W CW (90 sec/3 min, 50°C)
150 W CW (30 sec/3 min, 50°C)
200 W CW (15 sec/3 min, 50°C)

VSWR:

1.15:1 (0.25 to 100 MHz)
1.23:1 (100 to 400 MHz)
1.38:1 (>400 MHz to 999.9999 MHz)

Alarms:

Audible and visual (if applied power exceeds 200 W in the 200 W range or temperature exceeds 105°C)

RECEIVE LEVEL METER

Range:

-101 to -30 dBm (15 KHz IF BW)
-80 to -30 dBm (300 KHz IF BW)

Supplemental Characteristic

Accuracy: ±3 dB

Frequency Range

250 KHz to 999.9999 MHz (The received frequency must be within the IF bandpass of the COM-120B.)

Accuracy: $\pm 0.5\%$ distortion ± 1 count (1% to 10%)
 $\pm 2\%$ distortion ± 1 count (>10 to 20%)

Signal Frequency: 1 KHz

Supplemental Characteristic

Signal Level: 0.03 to 200 Vrms (SCOPE/DVM input)
0.15 to 15 Vrms (AUDIO/DATA input)

SINAD METER

Range: 3 to 30 dB

Resolution: 0.1 dB

Accuracy: ± 1 dB ± 1 count (at 12 dB)

Signal Frequency: 1 KHz

Supplemental Characteristic

Signal Level: 0.03 to 200 Vrms (SCOPE/DVM input)
0.15 to 15 Vrms (AUDIO/DATA input)

DIGITAL VOLTMETER

Ranges: 50 mV to 200 V in a 1-2-5 sequence

Range (DC): 10 mV to 200 Vdc (SCOPE/DVM input)
(AC): 10 mV to 200 Vrms (SCOPE/DVM input)
150 mV to 15 Vrms (AUDIO/DATA input)

Meter Ranges: 50 mV to 200 V (1-2-5 sequence)

Resolution: 3.5 digit

OSCILLOSCOPE

Bandwidth (3 dB): 50 KHz

Vertical

Ranges: 10 mV to 200 V per division
(1-2-5 sequence)

Max Input Voltage: 200 Vpk

Accuracy: 5% full scale

Resolution: 1% full scale

Coupling: DC, AC and GND

Supplemental Characteristic

Resolution: 256 data points, 8 major divisions

Horizontal

Ranges: 100 μ sec to 100 ms per division
(1-2-5 sequence)

Resolution: 1% full scale

Accuracy: 1% full scale

Supplemental Characteristic

Resolution: 500 data points, 10 major divisions
Impedance: 1 M Ω , unbalanced

Center Frequency: 250 KHz to 999.9999 MHz
Supplemental Characteristic

Tunable Range: 100 Hz to 999.9999 MHz
(characteristics below 250 kHz are not specified)

Resolution: 100 Hz

Frequency Span Ranges: 1 kHz to 100 MHz per division in a 1-2-5 sequence + zero span

Accuracy: $\pm 5\%$ of span width
Normal, Split Screen

Operation Modes:
Frequency Span Modes:

Scan Width	Resolution Bandwidth
100 MHz	3 MHz
50 MHz	3 MHz
20 MHz	3 MHz
10 MHz	3 MHz
5 MHz	300 kHz
2 MHz	300 kHz
1 MHz	300 kHz
500 kHz	30 kHz
200 kHz	30 kHz
100 kHz	30 kHz
50 kHz	30 kHz
20 kHz	3 kHz
10 kHz	3 kHz
5 kHz	3 kHz
2 kHz	300 Hz
1 kHz	300 Hz
0 kHz	30 kHz

Display: Log, 2 and 10 dB per division

Vertical Resolution: 1 dB
Range (Dynamic): 60 dB
Bandwidth Switching Error: <3 dB

Log Linearity: ± 2 dB (referenced to -40 dBm)
 ± 3 dB ($\leq 15^\circ\text{C}$, $\geq 35^\circ\text{C}$)

Input Attenuator: 0, 30 dB (Antenna Connector)

INPUT/OUTPUT CONNECTORS

RS-232 Connector

Operations Mode: Off, PC (Input/Output)

Baud Rates: 100, 150, 300, 600, 1200, 2400, 4800, 9600, 19200, 38400

Stop Bits: 1, 2

Parity: Odd, Even, None

Handshake: None, Xon/Xoff, CTS/RTS

MASTER OSCILLATOR

TCXO

Frequency: 10 MHz

Uncertainty: ± 0.1 PPM

Temperature Stability: ± 0.2 PPM (0°C to 50°C)

Aging: ± 0.5 PPM/year

DC Input:	12 to 30 Vdc
Power Consumption	
AC:	180 W maximum
DC:	150 W maximum
Supplemental Characteristic	
Power Consumption	
(AC):	110 W typical
(DC):	90 W typical

GENERAL CHARACTERISTICS

Operating Temperatures	0° to 50°C
Dimensions:	40.0 cm (15.75") wide, 19.0 cm (7.5") high, 42.9 cm (16.875") deep (without bail handle and front panel cover)
	44.0 cm (17.32") wide, 19.0 cm (7.5") high, 53.7 cm (21.125") deep (with bail handle and front panel cover)
Weight:	17.3 kg (38.5 lbs) (without options, lid, accessories)

WHEN OPERATING THE EQUIPMENT IN THE NORMAL HORIZONTAL POSITION, MAINTAIN AT LEAST TWO INCHES (FIVE CENTIMETERS) OF CLEARANCE BETWEEN THE EQUIPMENT SIDE WITH EXHAUST FAN AND OBJECTS OR WALLS. IF OPERATING IN A RACK, MAXIMUM AMBIENT TEMPERATURE MUST BE AT OR BELOW 40°C.

OPTIONS

- 01 Internal Battery. Provides self-contained power.
- 02 0.01 PPM Oven Time Base. The oven time base replaces the standard TCXO and is recommended for customers maintaining 800/900 MHz systems.
- 03 30 KHz IF Filter. The 30 KHz filter is required when ordering Option 15.
- 04 #2 Variable Function Generator. The generator replaces the standard fixed 1 kHz generator.
- 05 Generate Amplifier. An internal 26 dB amplifier for those requiring additional RF output level.
- 07 Data Generator/BER Meter. The Data Generator/Bit Error Rate Meter is available for testing digital characteristics of transceivers.
- 08 SSB Receive Filter. The SSB filter is available for customers requiring the capability to monitor SSB signals.
- 09 RCC Signaling. Provides MTS, IMTS and Tone Remote Control signaling.

CCIR EURO
 DZVEI NATEL
 EEA CCIRH
 5/6 Tone DDZVEI
 ZVEI EIA
 POCSAG

12 Tracking Generator. Tracking Generator and Spectrum Analyzer provide amplitude vs. frequency display when sweeping cavities, duplexors, etc.

repeater and mobiles.

15 AMPS Mobile Station Test. Auto and manual test facilities to verify proper operation of AMPS mobiles, transportables and portables.

16 EDACS*. Provides test capability for EDACS repeaters and mobiles.

NOTES
