

Thank you very much for your shopping on us, if you need any other manual, email me at ebay@micromanuals.com , I will do my best to help you.

Our Website will be available soon, please check later at www.micromanuals.com

If you find any others selling the manual made by me, please email me also.

Attention Please:

The listing of this manual is to help those who need this manual to repair and maintain their equipment.

If you want to buy this manual, you must agree that this manual is only charged for Labeling, Service (List Price), Shipping and Handling Fee;

Thanks and enjoy reading.

MicroManuals or Micromanuals.COM on Ebay

OPERATION MANUAL

DUAL MODE/TRI-BAND CELLULAR SYSTEM ANALYZER

IFR-1900

**PUBLISHED BY
IFR AMERICAS, INC.**

COPYRIGHT © IFR Americas, Inc. 1999

All rights reserved. No part of this publication may be reproduced, stored in a retrieval system, or transmitted in any form or by any means, electronic, mechanical, photocopying, recording or otherwise without the prior permission of the publisher.

NT400 is COPYRIGHTED © by Northern Telecom, Inc.

10200 West York / Wichita, Kansas 67215 U.S.A. / (316) 522-4981 / FAX (316) 524-2623

THIS PAGE INTENTIONALLY LEFT BLANK.

SAFETY FIRST: TO ALL OPERATIONS PERSONNEL

REFER ALL SERVICING OF UNIT TO QUALIFIED TECHNICAL PERSONNEL. This unit contains no operator serviceable parts.

CASE, COVER OR PANEL REMOVAL

Removing the Test Set from the case exposes the operator to electrical hazards that can result in electrical shock or equipment damage. Do not operate this Test Set with the Chassis Assembly removed from the Case Assembly.

SAFETY IDENTIFICATION IN TECHNICAL MANUAL

This manual uses the following terms to draw attention to possible safety hazards, that may exist when operating this equipment.

CAUTION: THIS TERM IDENTIFIES CONDITIONS OR ACTIVITIES THAT, IF IGNORED, CAN RESULT IN EQUIPMENT OR PROPERTY DAMAGE (e.g., FIRE).

WARNING: THIS TERM IDENTIFIES CONDITIONS OR ACTIVITIES THAT, IF IGNORED, CAN RESULT IN PERSONAL INJURY OR DEATH.

SAFETY SYMBOLS IN MANUALS AND ON UNITS



CAUTION: Refer to accompanying documents. (This symbol refers to specific CAUTIONS represented on the unit and clarified in the text.)



AC OR DC TERMINAL: Terminal that may supply or be supplied with ac or dc voltage.



DC TERMINAL: Terminal that may supply or be supplied with dc voltage.



AC TERMINAL: Terminal that may supply or be supplied with ac or alternating voltage.



SWITCH ON/OFF (Push-Push): AC line power to the device is connected ON or disconnected OFF.

EQUIPMENT GROUNDING PRECAUTION

Improper grounding of equipment can result in electrical shock.

USE OF PROBES

Check the specifications for the maximum voltage, current and power ratings of any connector on the Test Set before connecting it with a probe from a terminal device. Be sure the terminal device performs within these specifications before using it for measurement, to prevent electrical shock or damage to the equipment.

POWER CORDS

Power cords must not be frayed, broken nor expose bare wiring when operating this equipment.

USE RECOMMENDED FUSES ONLY

Use only fuses specifically recommended for the equipment at the specified current and voltage ratings.

INTERNAL BATTERY

This unit contains a Lithium Battery, serviceable only by a qualified technician.

CAUTION: SIGNAL GENERATORS CAN BE A SOURCE OF ELECTROMAGNETIC INTERFERENCE (EMI) TO COMMUNICATION RECEIVERS. SOME TRANSMITTED SIGNALS CAN CAUSE DISRUPTION AND INTERFERENCE TO COMMUNICATION SERVICES OUT TO A DISTANCE OF SEVERAL MILES. USERS OF THIS EQUIPMENT SHOULD SCRUTINIZE ANY OPERATION THAT RESULTS IN RADIATION OF A SIGNAL (DIRECTLY OR INDIRECTLY) AND SHOULD TAKE NECESSARY PRECAUTIONS TO AVOID POTENTIAL COMMUNICATION INTERFERENCE PROBLEMS.

THIS PAGE INTENTIONALLY LEFT BLANK.

LIST OF EFFECTIVE PAGES

The manual pages listed below that are affected by a current change or revision are so identified by a revision number.

Date of Issue for original and changed pages are:

Original 0 March 1999

TOTAL NUMBER OF PAGES IN THIS MANUAL IS 158 CONSISTING OF THE FOLLOWING:

Pg. No.	Rev. No.	Pg. No.	Rev. No.
Title/Copyright	0	5-1 through 5-16.....	0
Safety	0	6-1 through 6-46.....	0
A through B	0	A-1 through A-2.....	0
i through iv	0	B-1 through B-4.....	0
1-1 through 1-4	0	C-1 through C-2	0
2-1 through 2-2	0	D-1 through D-4	0
3-1 through 3-48	0	E-1 through E-4.....	0
4-1 through 4-10	0	Index-1 through Index-6 .	0

THIS PAGE INTENTIONALLY LEFT BLANK.

TABLE OF CONTENTS

SECTION 1 - OVERVIEW

1.1	Overview of the CSA Option.....	1-1
1.2	Cellular Band Operation.....	1-2
1.3	Cellular Channel Definition.....	1-2
1.4	Operating Basics	1-3
	To access the Dual Mode/Tri-Band functions of the CSA	1-3
	To access operation screens and setup menus.....	1-3
	To move the cursor and enter values.....	1-3
	To use the Scrolling Window on Selected Data Monitor Screens	1-3
	To use the Soft Function Keys.....	1-4
	To print any screen on the color display	1-4

SECTION 2 - CONNECTORS

2.1	General	2-1
2.2	IFR-1900 CSA Front Panel Connectors.....	2-1
2.3	IFR-1900 CSA Rear Panel Connectors.....	2-2

SECTION 3 - OPERATION

3.1	TIA/EIA-136 Cellular Data Monitor.....	3-1
	To access the TIA/EIA-136 Cellular Data Monitor	3-1
	To connect the Test Set for Cell Site Monitoring	3-3
	To view the spectrum of the currently monitored channel.....	3-3
	To adjust input attenuation using Analyzer feature.....	3-3
	To select the data fields displayed on the operation screens	3-4
	To monitor selected data fields received on the Broadcast Channel (F-BCCH, E-BCCH, S-BCCH)	3-4
	To follow a call from the Broadcast Control Channel to the assigned Digital Traffic or Analog Voice Channel	3-5
	To monitor messages and selected data fields received on the SPACH* Channel ...	3-5
	To follow a call from the SPACH* Channel to the assigned Digital Traffic or Analog Voice Channel	3-6
	To monitor data fields received on the Neighbors List screen	3-6
	To monitor RACH messages and selected data fields received on the RDCCH Channel screen	3-7
	To monitor selected data fields received on the Forward Analog Control Channel .	3-7
	To send received FOCC data out the RS-232 Connector	3-8
	To follow a call from the Forward Analog Control Channel to the assigned Digital Traffic or Analog Voice Channel.....	3-8
	To capture selected data fields received on the Forward Analog Control Channel..	3-8
	To capture the raw data words received on the Forward Analog Control Channel...	3-9
	To capture selected data fields received on the Forward Digital Traffic Channel...	3-9
	To capture the raw data words received on the Forward Digital Traffic Channel ...	3-10

SECTION 3 - OPERATION (CONT)

3.1	TIA/EIA-136 Cellular Data Monitor (cont)	
	To capture the raw interleaved data received on the Forward Digital Traffic Channel.....	3-10
	To monitor selected data fields received on the Forward Analog Voice Channel	3-11
	To capture the raw data words received on the Forward Analog Voice Channel.....	3-11
	To capture selected data fields received on the Reverse Analog Control Channel ...	3-12
	To capture the raw data words received on the Reverse Analog Control Channel....	3-12
	To monitor selected data fields received on the Reverse Digital Traffic Channel ...	3-13
	To capture selected data fields received on the Reverse Digital Traffic Channel....	3-13
	To send received RDTC VSELP data out the RS-232 Connector.....	3-14
	To monitor selected data fields received on the Reverse Analog Voice Channel.....	3-15
	To display DTMF received on the Reverse Analog Voice Channel.....	3-15
3.2	Analog Control Channel (ACC) Cell Site Simulation	3-16
	To connect the Test Set to the Mobile Station	3-16
	To access the ACC Cell Site Simulation screens.....	3-16
	To select data fields displayed by the RECC and RDTC screens	3-18
	To start sending the overhead message train	3-18
	To perform a Registration	3-19
	To place a call to the Mobile Station	3-19
	To accept an origination, complete a call and monitor.....	3-20
	To input and monitor audio on the DTC (VSELP or ACELP operation) from the Test Set.....	3-20
	To perform Mobile Assisted BER measurement and call handoff from the RDTC ...	3-21
	To send Digital Traffic Channel messages	3-21
	To send Analog Voice Channel messages.....	3-22
	To Monitor Reverse Analog Control Channel messages from the Mobile Station....	3-22
	To send a Page order (call not completed)	3-22
	To send Global Action Overhead messages	3-22
	To send the DCCH Pointer (Control Channel Information Message)	3-23
	To send a Mobile Station Control Message	3-24
	To perform modulation accuracy and power testing on a mobile station	3-24
	To plot $\pi/4$ DQPSK I/Q pattern with constellation (mobile station).....	3-25
	To plot constellation alone (mobile station).....	3-26
	To display power meter alone (mobile station)	3-26
	To perform adjacent channels power measurements (mobile station)	3-27

SECTION 3 - OPERATION (CONT)

3.3	Digital Control Channel (DCCH) Cell Site Simulation	3-28
	To connect the Test Set to the Mobile Station	3-29
	To access the DCCH Cell Site Simulation Screens	3-29
	To set up the FDCCH Broadcast Channel Messages	3-30
	To perform a Registration	3-31
	To place a call to the Mobile Station.....	3-32
	To accept an origination, complete a call and monitor	3-33
	To send Digital Traffic Channel messages.....	3-34
	To send Analog Voice Channel messages	3-35
	To send a SPACH Message.....	3-35
	To perform modulation accuracy and power testing on a mobile station	3-36
	To plot $\pi/4$ DQPSK I/Q pattern with constellation (mobile station)	3-37
	To plot constellation alone (mobile station)	3-37
	To display power meter alone (mobile station).....	3-38
	To perform adjacent channels power measurements (mobile station).....	3-38
3.4	DCCH Mobile Simulation	3-39
	To access the DCCH Mobile Simulation Screens	3-39
	To send repetitive random or user-defined data words	3-39
	To send RACH (Random Access Channel) messages on the RDCCH.....	3-40
3.5	Bit Error Rate.....	3-41
	BER Test Modes	3-41
	Loopback Modes (Base Station only).....	3-41
	To connect the Test Set to the Mobile or Base Station	3-41
	To perform a BER test.....	3-43
3.6	Modulation Accuracy and Power.....	3-44
	To perform a modulation accuracy and power test	3-44
	To plot $\pi/4$ DQPSK I/Q pattern with constellation	3-45
	To plot constellation alone.....	3-46
	To display power meter alone.....	3-46
3.7	TDMA Power	3-47
	To perform a power test.....	3-47
3.8	Adjacent Channel Power Measurement	3-48
	To perform an Adjacent Channel Power Measurement test.....	3-48

SECTION 4 - APPLICATIONS

4.1	Monitoring a Base Station off the Air (ACC).....	4-1
4.2	Following a Call from the Analog Control Channel	4-2
4.3	Monitoring Raw Data on Forward Analog Control Channel	4-3
4.4	Placing a Digital Call to a Mobile Station (ACC).....	4-4
4.5	Performing a Handoff on a Call Made to a Mobile Station (ACC).....	4-6
4.6	Performing a Mobile Station Authentication (DCCH).....	4-7
4.7	Performing a Mobile Station Unique Challenge (DCCH)	4-8
4.8	Placing a DCCH Digital (ACELP) Call to a Hyperband Channel.....	4-9
4.9	Performing a DTC Handoff to Another Band (ACC or DCCH).....	4-10

SECTION 5 - CELLULAR MESSAGES

5.1	Broadcast Channel Messages	5-1
5.2	SPACH Channel Messages	5-4
5.3	Reverse Digital Control Channel Messages.....	5-5
5.4	Global Action Overhead Messages	5-8
5.5	Mobile Station Control Messages	5-10
5.6	Forward Digital Traffic Channel Messages.....	5-13
5.7	Forward Analog Voice Channel Messages	5-15

SECTION 6 - CELLULAR FIELDS

APPENDICES

Appendix A	Specifications	A-1
Appendix B	Broadcast Channel Default Configuration.....	B-1
Appendix C	Auxiliary Functions	C-1
Appendix D	Remote Configuration.....	D-1
Appendix E	Abbreviations and Acronyms	E-1

INDEX

OVERVIEW

1.1 OVERVIEW OF THE CSA

This manual contains instructions for operating the Dual Mode/Tri-Band Cellular System Analyzer (CSA) section of the IFR-1900 and is intended to be used in conjunction with the IFR-1900 Communications Service Monitor Operation Manual (1002-3402-200). The CSA provides the ability to monitor, simulate and test Base and Mobile Stations utilizing EIA/TIA-553, TIA/EIA-627 (formerly IS-54B), TIA/EIA-136 and NT400© protocols.

The CSA is controlled from the IFR-1900 front panel and color display as the special test functions. The CSA also operates remotely through the rear panel connectors.

The CSA provides the following functions and tests:

Protocol Testing

- Cellular Data Monitor
- Analog Control Channel Cell Site Simulation
- Digital Control Channel Cell Site Simulation
- Digital Control Channel Mobile Simulation

Parameter Testing

- Digital Traffic Bit-Error Rate test for Mobile and Base Station
- Modulation Accuracy and Power Measurements
- TDMA Power Meter
- Adjacent Channel Power Measurement

Miscellaneous

- Self Test, Diagnostics, Configuration Info, External I/O Setup and a User File System.

The CSA operates remotely through the rear panel of the IFR-1900 by means of the following:

- Dedicated RS-232 Connector (OPT. RS-232 Connector).
- Additional address using the GPIB (IEEE-488) Connector.
- Additional Test MACro (TMAC) commands for TIA/EIA-136 protocol and control.

1.2 CELLULAR BAND OPERATION

The CSA operates within the three following frequency bands, supporting the channels of each cellular band and the protocols discussed in Section 1.1:

BAND	CSA NAME	CHANNEL NO.
800 MHz Cellular	U8	1 to 1023
1900 MHz PCS*	HY	1 to 1999
400 MHz	U4	1 to 333

*Personal Communications Service.

When preparing to operate within a specific cellular band, the user must specify both the channel and band.

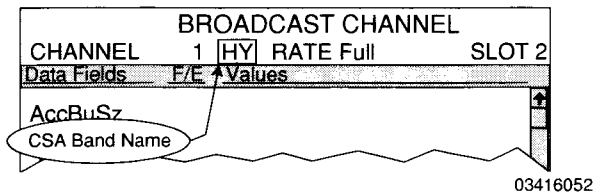

1.3 CELLULAR CHANNEL DEFINITION

The CSA monitors and simulates the following channels:

	CELLULAR CHANNEL	ACRONYM
Control Channels	Forward Digital Control Channel	FDCCH
	Broadcast Channel (includes F-BCCH, E-BCCH and S-BCCH)	BCCH
	SMSCH, PCH and ARCH	SPACH
	Reverse Digital Control Channel	RDCCH
	Forward Analog Control Channel	FOCC
	Reverse Analog Control Channel*	RECC
Voice Channels	Forward Digital Traffic Channel	FDTC
	Reverse Digital Traffic Channel*	RDTC
	Forward Analog Voice Channel	FVC
	Reverse Analog Voice Channel*	RVC

* Monitored only, not simulated.

Each item in this operation manual that specifically discusses TIA/EIA-136 is marked with the following symbol: **DCCH**.

The Cellular Channel names and acronyms listed above are used interchangeably in this manual.

1.4 OPERATING BASICS

To access the Dual Mode/Tri-Band functions of the CSA

Screens and menus of the CSA appear on the color display of the IFR-1900. The front panel keys are used to operate the CSA.

Pressing **DPLX** and **Sp Tst F5** displays the Dual Mode TIA/EIA-136 Cellular menu. All CSA functions and tests are accessed from this screen. Pressing the DATA ENTRY Key or Soft Function Key associated with an item selects the desired function.

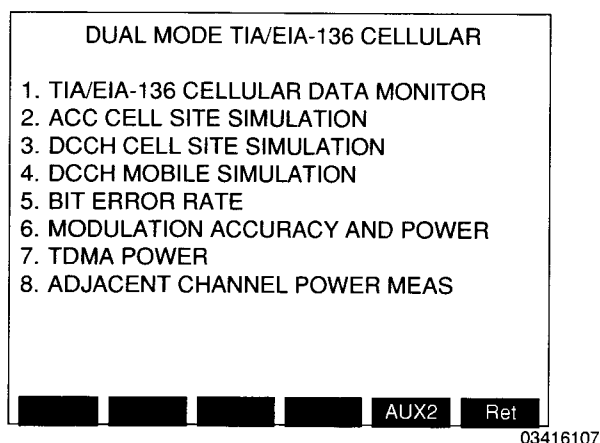

To access operation screens and setup menus

Once a selection is made from the Dual Mode TIA/EIA-136 Cellular menu and the starting screen of the function appears, the Soft Function Keys are used to access the rest of the screens. The **Ret** Soft Function Key returns operation to the previous screen. (See Appendix C, Auxiliary Functions, for a description of AUX2 F5 Soft Function Key.)

Many of the screens have a setup menu used to select the data fields displayed or to enter other settings. Press **SETUP SPECIAL FUNCTION** Key to access the menu of the current screen. Some menus are two or three pages in length, with Soft Function Keys **Page 1**, **Page 2** or **Page 3** used to display other pages. Press **Ret F6** to return to the operation screen.

To move the cursor and enter values

The FIELD SELECT Keys move the cursor to selectable fields on each screen or menu. For most fields with fixed selections, press **ENTER** to toggle between the selections. If the field contains alpha-numeric data, use the DATA ENTRY Keypad to enter a value (press **SHIFT** to access the alphabetic characters). For all displayable characters including symbols, use the DATA SCROLL **↑** and **↓** Keys or DATA SCROLL Spinner to scroll the possible selections until the desired selection appears. For address character fields, other selections include the Soft Function Keys, +/- Key, the M/μ Key and K/m Key. For the M/μ Key, M is a left parenthesis and μ is a right parenthesis. For the K/m Key, K is a colon and m is a semicolon. Press **ENTER** to finalize the edit.

To use the Scrolling Window on Selected Data Monitor Screens

The BCCH, SPACH, RDCCH, FDTC and RDTTC data monitor screens provide a display window that can be scrolled to view when the number of data fields to be displayed extends beyond the maximum display area. When this happens, the non-scrolling window automatically changes to one that may be scrolled.

Activate the scrolling window by positioning the cursor on the top bar of the scrolling window. Once activated, the data fields may be scrolled up or down through the window with the DATA SCROLL **↑** and **↓** Keys (use DATA SCROLL **←** and **→** Keys to “page” through data fields).

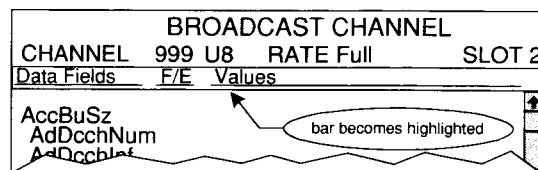

03416053

To use the Soft Function Keys

Screens and menus contain at least one set of Soft Function Key definitions across the bottom. Each definition corresponds to a specific Soft Function (F#) Key located under the color display. If a screen or menu has more than one set of Soft Function Keys, **More** appears as the **F6** definition. Pressing **More F6** alternates the sets of Soft Function Keys that are displayed.

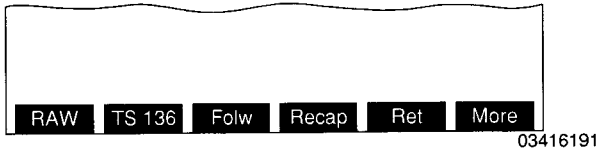

To print any screen on the color display

Press **PRINT SCRN** to print any screen.

The IFR-1900 printing parameters must be set before plotting. (See *IFR-1900 Communications Service Monitor Operation Manual*.)

CONNECTORS

2.1 GENERAL

See the IFR-1900 Communications Service Monitor Operation Manual for explanation of all of the IFR-1900 controls, connectors and indicators.

2.2 IFR-1900 CSA FRONT PANEL CONNECTORS

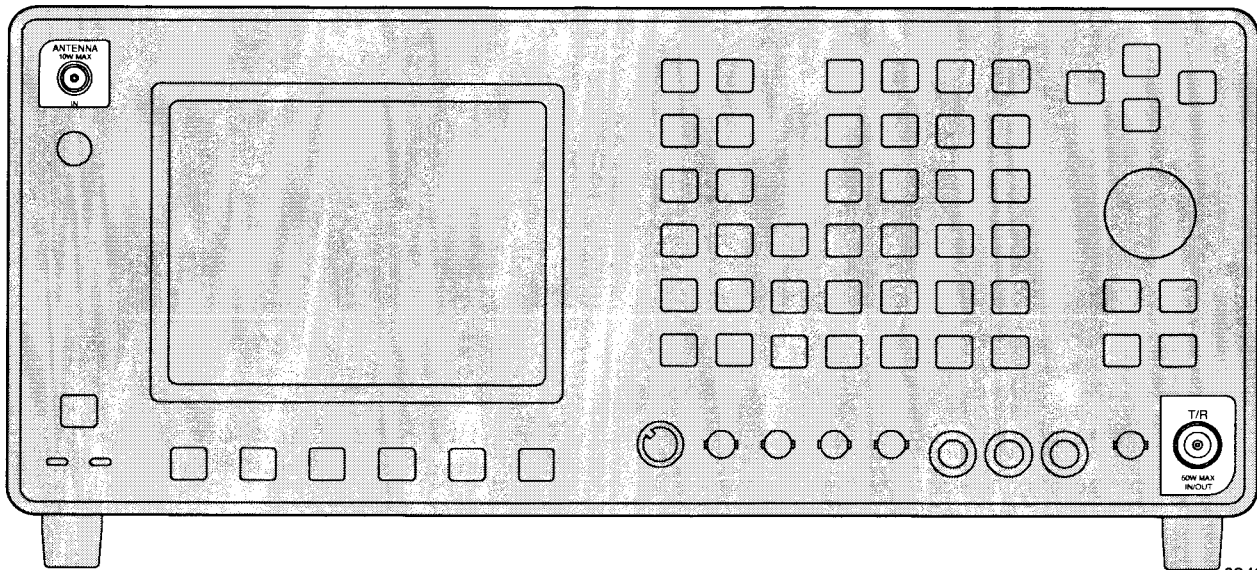

03420010

ANTENNA IN Connector

Monitors low level "off the air" signals. **THE MAXIMUM CONTINUOUS INPUT FOR THE ANTENNA IN CONNECTOR IS 10 W.**

T/R Connector

Sends and receives RF signals from the Base Station or Mobile Phone. Connect T/R Connector to RF Input/Output of device to be tested. **THE MAXIMUM CONTINUOUS INPUT FOR THE T/R CONNECTOR IS 50 W.**

OPERATIONAL INPUT SIGNAL POWER RANGES

ANTENNA IN Connector	-80 to 0 dBm
T/R Connector	-5 to +47 dBm

To compensate for higher power levels into the ANTENNA IN or T/R Connectors, use the Analyzer feature provided with each monitor screen to adjust input attenuation. (See "*To adjust input attenuation using Analyzer feature*" in Section 3.)

There is 60 dB attenuation difference between the T/R and ANTENNA IN Connectors.

2.3 IFR-1900 CSA REAR PANEL CONNECTORS

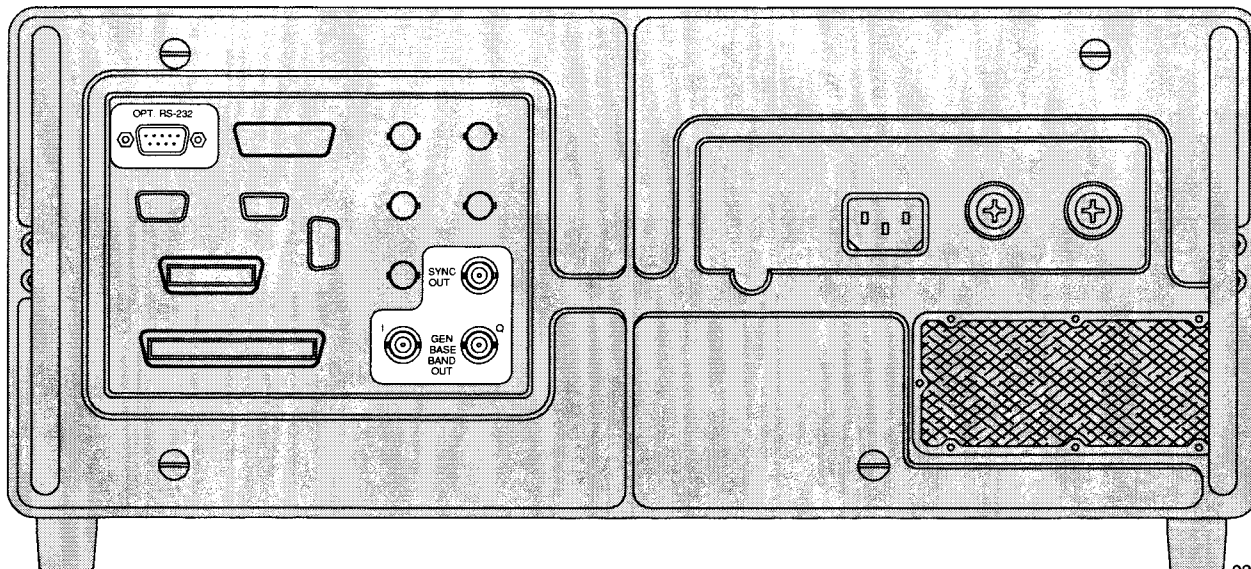

03420011

OPT. RS-232 Connector

Provides for serial remote operation of the CSA.

SYNC OUT Connector

BNC output (TTL) representing the beginning of the designated TDMA timeslot of the Mobile Station being tested. Active during Cell Site Simulation only. Signal goes low for 6.7 ms starting at the beginning of the Mobile Station TDMA burst.

GENERATOR BASEBAND OUT I and Q Connectors

BNC outputs (analog) represent the baseband drive signals for the DQPSK modulation for the CSA generator. The ± 1 volt signals represent the absolute I/Q values that can be routed to an RF signal generator accepting complex RF signals.

GPIB (IEEE-488) Connector (See IFR-1900 Communication Service Monitor Operation Manual.)

The IFR-1900 Communications Service Monitor and CSA internally share the GPIB (IEEE-488) Connector, as shown below:

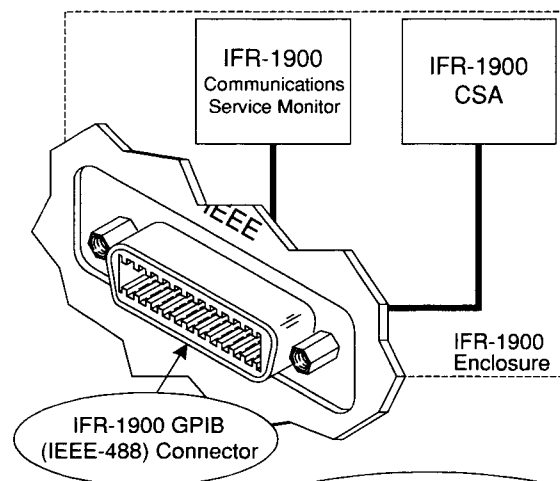

User must specify different GPIB addresses for the Communications Service Monitor and CSA. See Appendix D, Remote Configuration.

Depending on the IFR-1900 printer output setup, the following IFR-1900 Connectors can be used for printing screens:

- HOST RS-232
 - PRINTER
 - GPIB (IEEE-488)
- } See IFR-1900 Communications Service Monitor Operation Manual.

03401008

OPERATION

3.1 TIA/EIA-136 CELLULAR DATA MONITOR

The TIA/EIA-136 Cellular Data Monitor receives and displays messages and data fields received from the Base Station and Mobile Station. The ANTENNA IN Connector receives the cellular input and becomes active as soon as the screen is accessed.

Operation screens have setup menus allowing the selection of the data fields that are displayed. The user can select up to 10 or 16 data fields in any order.

A Capture feature holds or "captures" the current data on the screen associated with a specified order or MIN received. Prior to receiving a specified order or MIN or with Capture off, data fields are updated as new data is received. A "Recap" Soft Function Key is provided to return the operation screen to live monitoring until the capture criteria is, again, met.

A Follow feature allows the operation to follow a call to the Digital Traffic or Analog Voice Channel when a channel designation is made. This feature also follows the call when a handoff is made and returns operation to the Forward Digital Control Channel (FDCCH) screens or Forward Analog Control Channel (FOCC) screen once the call is terminated.

An Analyzer feature displays the frequency spectrum centered on the current channel. The selection of a new channel or band (U8, U4 or HY) from the Analyzer display is maintained when returning to the previous cellular data monitor screen from which the Analyzer display was originally called. The Analyzer feature utilizes the Spectrum Analyzer display on the Duplex Transmitter operation screen of the IFR-1900. (See *"To view the spectrum of the currently monitored channel"* for additional instructions for using the Analyzer feature.) Press *Sp Tst* Soft Function Key to return to monitor screen.

To access the TIA/EIA-136 Cellular Data Monitor

Press *DPLX* and *Sp Tst F5* to activate the CSA. The Dual Mode TIA/EIA-136 Cellular main menu appears. Press *I* to select the TIA/EIA-136 Cellular Data Monitor. The Broadcast Control Channel (BCCH) screen appears:

BROADCAST CHANNEL			
CHANNEL	U8	RATE Full	SLOT 2
Data Fields	F/E	Values	
AccBuSz			
AdDcchNum			
AdDcchInf			
02	"		
03	"		
AlphSID			
ARQMap			
AUTH			
BC	F	O	
BI	F	O	
BSMC			
CAP			

FDC FVC Follow FOCC Ret More

03416054

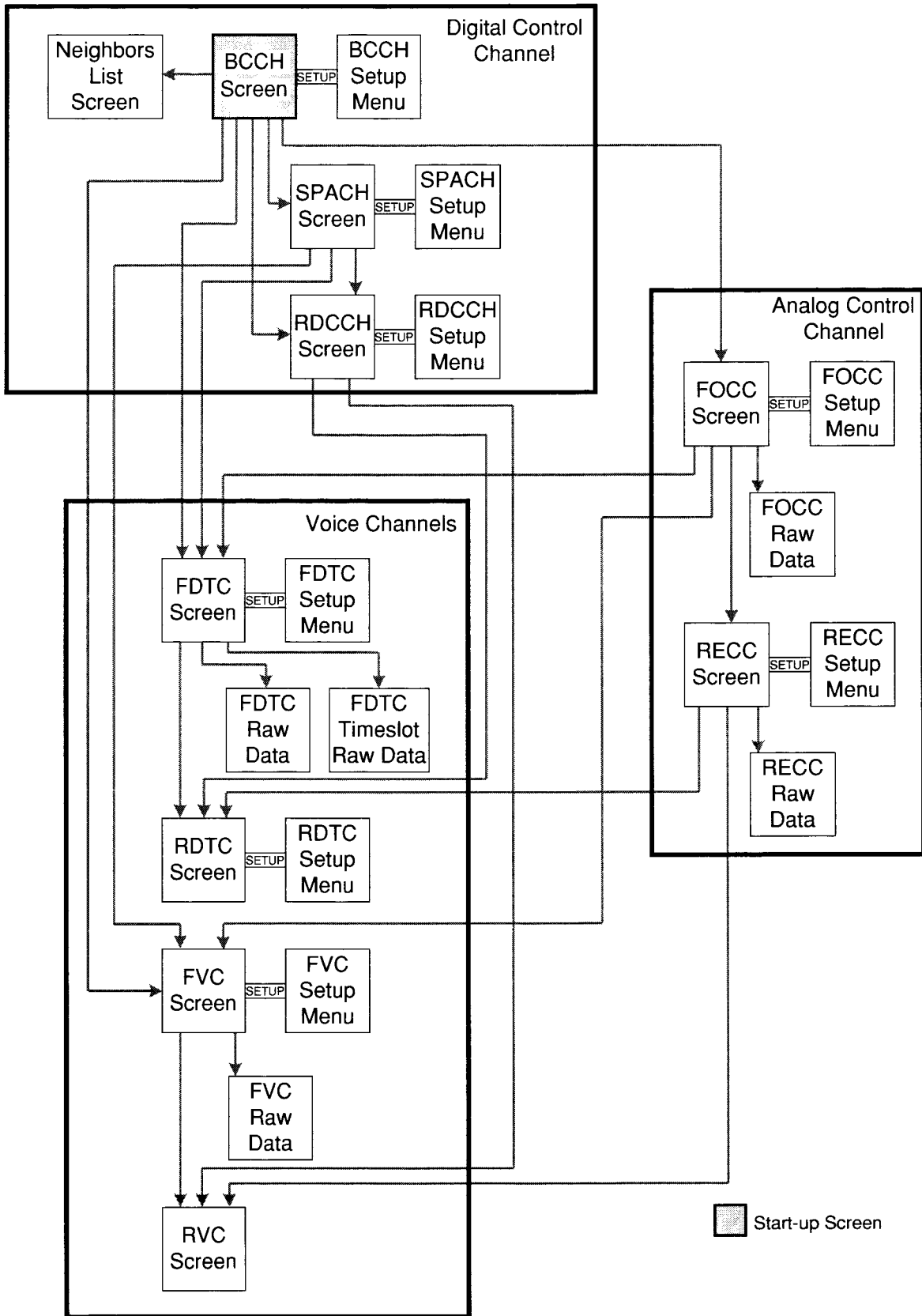

TIA/EIA-136 Cellular Data Monitor Screen Hierarchy

03401009

To connect the IFR-1900 CSA for Cell Site Monitoring

For Cell Site monitoring, the ANTENNA IN Connector is used for receiving signals from the Base Station and Mobile Station. No signals are transmitted during Cell Site monitoring.

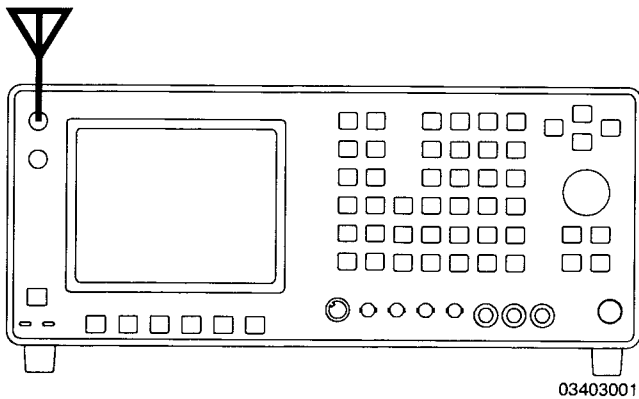

To view the spectrum of the currently monitored channel

Each channel screen of the TIA/EIA-136 Cellular Data Monitor has the Analyzer feature. This feature provides access to the IFR-1900 Analyzer for displaying the current spectrum. Press **ANLZ** Soft Function Key to activate the Analyzer feature and enter the Duplex Transmitter Operation screen. (To view the full Analyzer, press **Disp F1** and **2**.) For other Duplex Transmitter Operation screen adjustments, see the IFR-1900 Communications Service Monitor Operation Manual. The following is a sample Analyzer display for cellular operation:

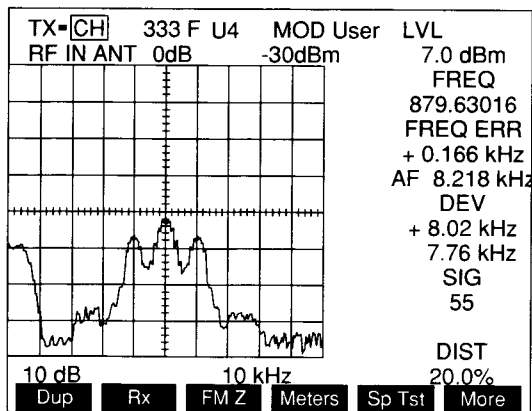

03416055

Utilizing the Analyzer feature, the user can determine if the incoming signal is within the operational range of the CSA Option (see Section 2). See below to compensate for input power levels.

Selecting a different RF frequency or channel/band with the Analyzer displayed also changes the channel or band monitored by the current cellular screen. To return to the previous TIA/EIA-136 Cellular Data Monitor screen, press **Sp Tst F5**.

To adjust input attenuation using Analyzer feature

Move cursor to Input Attenuation field and Press **DATA SCROLL** ↑ to select desired level of attenuation.

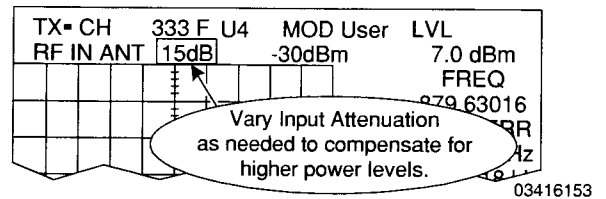

See IFR-1900 Communications Service Monitor Operation Manual for more details.

To select the data fields displayed on the operation screens

Screens display numerous data fields. With the exception of the Neighbors List, Raw Data and RVC screens, data fields displayed are selected from the respective setup menu.

Press **SETUP** to display the setup menu for the current screen:

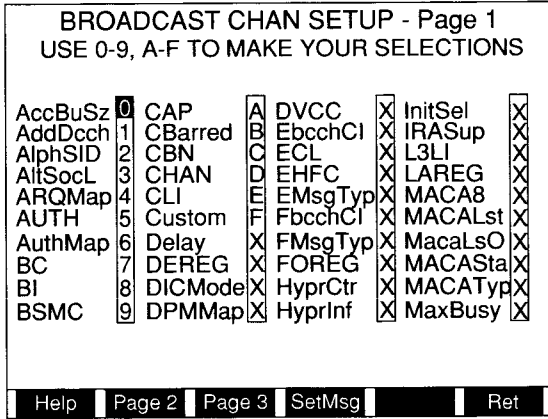

03416174

Move the cursor to the desired fields and press a DATA ENTRY Key (0 to 9, A to F). The number used determines the order the selected field is displayed on the current screen. Pressing any other DATA ENTRY Key deselects the field. Some setup menus have 2 or 3 pages and **Page 1**, **Page 2** or **Page 3** Soft Function Keys. Pressing the **Page** Soft Function Keys toggles operation from one page to the other. For field descriptions, see Section 6. Press **Ret F5** when desired data fields are selected.

To monitor selected data fields received on the Broadcast Channel (F-BCCH, E-BCCH, S-BCCH) DCCH

From any screen, press **DPLX**, **Sp Tst F5** and **1** to access the Broadcast Channel Screen. Move cursor to the CHANNEL, BAND and SLOT fields and select the cellular channel (1 to 1999, depending on band), band (U8, U4 or HY) and TDMA slot (1 to 3) to monitor. Move cursor to the RATE field and, pressing **ENTER**, toggle the rate to Full or Half.

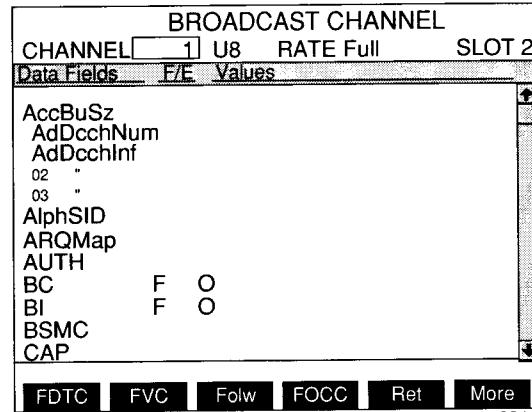

03416054

Press **SETUP** to display the setup menu, and select the data fields to be displayed.

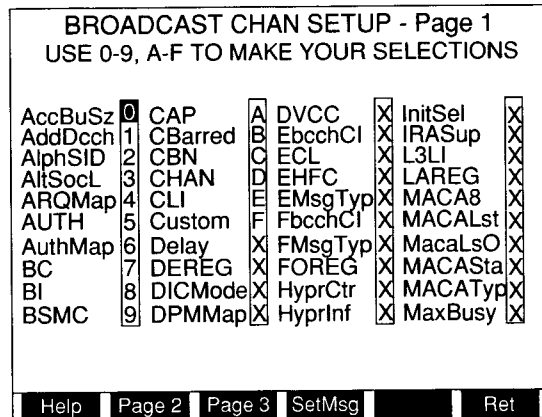

03416174

Pressing **Help F1** toggles a field containing the full name listing of the abbreviated display name currently selected by the cursor. Dots following the name indicate the field contains multiple subfields.

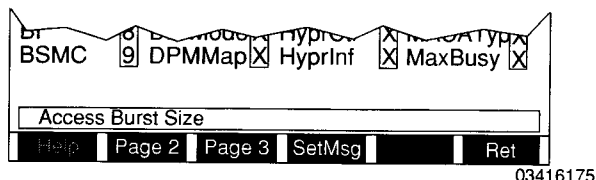

Pressing **SetMsg F4** provides preset data field selections by message type. Press **DATA SCROLL** ↑ until desired message type appears in the shaded field. Press **ENTER** to accept the current message type presets; otherwise, press **ESC F6**. All data field selections made prior to using the SetMsg function are not retained; however, manual changes afterward are allowed.

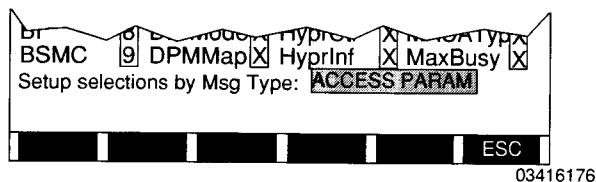

The contents of data fields are updated as they are received. F-BCCH (Fast Broadcast Control Channel) information is indicated by an “F;” while E-BCCH (Extended Broadcast Control Channel) information is indicated by an “E.”

To follow a call from the Broadcast Control Channel to the assigned Digital Traffic or Analog Voice Channel **DCCH**

Press **Folw F3** to activate Follow. A call assigned a Digital Traffic or Analog Voice channel displays the appropriate screen and monitors the call.

If a handoff occurs, the new channel is monitored (if in range). When the call is terminated or travels out of range, operation returns to the Broadcast Control Channel (BCCH) screen. To turn Follow off, press **Folw F3**, again. Follow can be initiated from the Broadcast Channel, SPACH* Channel, FOCC (Forward Analog Control Channel), FDTC (Forward Digital Traffic Channel) or the FVC (Forward Analog Voice Channel) screen.

To monitor messages and selected data fields received on the SPACH* Channel **DCCH**

From the Broadcast Channel screen, press **More F6** and **Spach F3** to display the SPACH Channel screen.

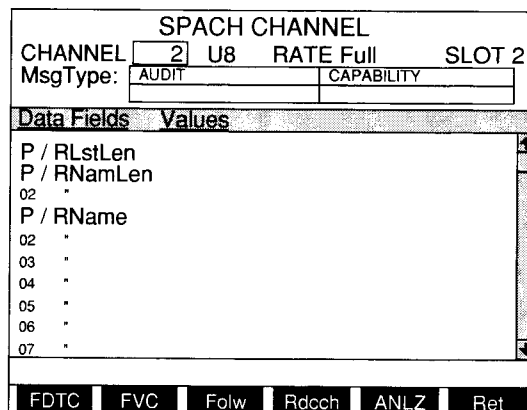

Select the cellular channel, band and TDMA slot to monitor. Move cursor to the RATE field and, pressing **ENTER**, toggle the rate to Full or Half.

* SMSCH, PCH and ARCH.

Press **SETUP** to display the setup menu, and select the data fields to be displayed in the scrolling window.

```

SPACH CHAN SETUP - Page 1
USE 0-9, A-F TO MAKE YOUR SELECTIONS

AlphP/R 0 CdParty   A DirSub   X IDT       X
AlphSID 1 CdPSub    B Display X L2MEA    X
ARM      2 CgPNUM   C DMAC    X L2MEK    X
ATS      3 CgNumPI  D DTXSup  X L3LI     X
AUTHBS   4 CgPSub    E DVCC    X LastTry  X
BCN      5 CHAN     F EHI     X MACALst  X
BSMC     6 Custom  X FoRereg X MACAOth X
BT       7 BdgDsp   X FRNO   X MEM      X
BU       8 DICMode X GA     X MEMode  X
Cause    9 DirAddr X Hyprinf X MIN     X

Help Page 2 Page 3 SetMsg Ret
  
```

03416177

To monitor data fields received on the Neighbors List screen **DCCH**

From the Broadcast Channel screen, press **More F6** and **Neigh F1** to display the Neighbors List data monitor screen.

```

NEIGHBORS LIST
CHANNEL 2 U8 RATE Full SLOT 2
Neighbors List: TDMA
Neighbor Cell: 1 of

CHAN          CELL TYPE
Prot Ver      Network Type
DVCC          Dir Retry Chan
RESEL_OFF    MS_ACC_PWR
SS_SUFF      RSS_ACC_MIN
DELAY        PSID/RSID Ind
HL_FREQ      PSID/RSID SL
CELL_SYNC    PSID/RSID Support:

Cell ++ Cell -- Ret
  
```

03416057

Press **Help F1** to toggle a field containing the full name listing of the abbreviated display name currently selected by the cursor. Pressing **Page 2 F2** or **Page 3 F3** displays the remaining data fields. Pressing **SetMsg F4** provides preset data field selections by message type.

The SPACH Channel screen displays from one to four message types being transmitted at any one time in the SPACH Channel. The selected data fields are updated as new information is received and decoded.

To follow a call from the SPACH* Channel to the assigned Digital Traffic or Analog Voice Channel **DCCH**

Press **Folw F3** to activate Follow. A call assigned to a Digital Traffic or Analog Voice channel displays the appropriate screen and monitors the call.

If a handoff occurs, the new channel is monitored (if in range). When the call is terminated or travels out of range, operation returns to the SPACH Channel screen. To turn Follow off, press **Folw F3**, again.

* SMSCH, PCH and ARCH.

Select the cellular channel, band and TDMA slot to monitor. Move cursor to the RATE field and, pressing **ENTER**, toggle the rate to Full or Half. Move cursor to the Neighbors List field and press **DATA SCROLL** ↑ to select one of the following types of Neighbors List:

- TDMA
- Analog
- TDMA - Multi Hyperband
- Analog - Multi Hyperband
- Other Hyperband

Although only one Neighbor Cell can be displayed at any one time, the Neighbors List consists of up to 24 Neighbor Cells. Pressing **Cell++ F3** displays the Neighbors List information of next higher Neighbor Cell; likewise, pressing **Cell-- F4** displays the Neighbors List information of next lower Neighbor Cell.

The selected data fields are updated as new information is received and decoded.

To monitor RACH messages and selected data fields received on the RDCCH Channel screen **DCCH**

From the Broadcast Channel screen, press **More F6** and **Rdcch F4** to display the RDCCH (Reverse Digital Control Channel) data monitor screen.

RDCCH CHANNEL	
CHANNEL	2 U8 RATE Full SLOT 2
LENGTH:	ABBREV DVCC 1
MsgType:	AUDITCON AUTHENTICATION
	SERIAL NUMBER
Data Fields	Values
Ana800	
AsyncSp	
AUTHR	
AUTHU	
BndWdth	
BSMC	
BSMCSup	
BT	
RDC	RVC
	ANLZ
	Ret

03416058

Select the cellular channel, band and TDMA slot to monitor. Move cursor to the RATE field and, pressing **ENTER**, toggle the rate to Full or Half. Move cursor to the LENGTH field and, pressing **ENTER**, toggle the LENGTH to normal or abbreviated. Select the DVCC (0 to 255).

The correct length and DVCC must be selected to decode the RACH messages.

Press **SETUP** to display the setup menu, and select the data fields to be displayed in the scrolling window.

RDCCH SETUP - Page 1					
USE 0-9, A-F TO MAKE YOUR SELECTIONS					
AltSocS	0	CdPNum	A	DRateSp	X L2MEA X
Ana800	1	CdPSub	B	EHI	X L2MEK X
AsyncSp	2	CgNumPI	C	Emrgncy	X L3LI X
AUTHR	3	CgPNum	D	ESN	X LastTry X
AUTHU	4	CgPSub	E	FRNOMap	X LTM X
BndWdth	5	CrfMsgT	F	FWVint	X MaxPFC X
BSMC	6	COUNT	X	G3FxFxSup	X MEMode X
BSMCSup	7	Custom	X	HRateSp	X MfrCode X
BT	8	DatMode	X	IDT	X MIN-L2 X
C-Num	9	Display	X	IRASup	X Model X
Help	Page 2	SetMsg		Ret	

03416178

Press **Help F1** to toggle a field containing the full name listing of the abbreviated display name currently selected by the cursor. Pressing **Page 2 F2** displays the remaining data fields. Pressing **SetMsg F4** provides preset data field selections by message type.

The RDCCH Channel screen displays from one to six RACH message types being transmitted at any one time in the RDCCH Channel. The selected data fields are updated as new information is received and decoded.

To monitor selected data fields received on the Forward Analog Control Channel

Press **DPLX**, **Sp Tst F5** and **FOCC F4** to display the FOCC screen:

FWD CNTL CHANNEL			
CHANNEL	327 U8	WORD	A & B
CAPTURE	OFF	PAGE	316 / 522 - 4981
MESSAGE	OVERHEAD	ORDER	
SCC			0
DCC	1		
SID	164		
MIN			316 / 522 - 4981
ORDER			PAGE
VMAC			0
CHAN			190
CMAX - 1	20		
N - 1	20		
CMAC	0		
			B / 11
FDC	FVC	Folw	Recap
		Ret	More

03416154

Press **SETUP** to display setup menu, and select the data fields to be displayed. Select the cellular channel and band to monitor. Move cursor to Capture field and select OFF. The FOCC for the selected channel and band is continuously monitored; the displayed data fields are updated as new information is received and decoded.

To send received FOCC data out the RS-232 Connector

From the FOCC screen, press *Remote* Soft Function Key to stop decoding data and start sending received FOCC data (10 kbit) as ASCII characters out the RS-232 Connector. Each character represents one nibble (four bits) of data. Data is sent out at a 38400 baud rate. Press *STOP* Soft Function Key to stop sending data out the RS-232 Connector and resume normal decoding.

To follow a call from the Forward Analog Control Channel to the assigned Digital Traffic or Analog Voice Channel

Press *Folw F3* to activate Follow. A call assigned to a Digital Traffic or Analog Voice channel displays the appropriate screen and monitors the call. Although Capture is disabled with Follow activated, the MIN setting is used for Follow. With a MIN specified, only calls to that MIN are followed. With no MIN specified, any call initiated on the selected Forward Analog Control Channel is followed.

If a handoff occurs, the new channel is monitored (if in range). When the call is terminated or travels out of range, operation returns to the FOCC screen. To turn Follow off, press *Folw F3* again. Follow can be initiated from the FOCC, FDTC (Forward Digital Traffic Channel) or the FVC (Forward Analog Voice Channel) screen.

To capture selected data fields received on the Forward Analog Control Channel

Select the data fields to be displayed from the setup menu. Move cursor to the CAPTURE field and press *DATA SCROLL* ↑ to select a capture condition. Press *ENTER*. If ORDER or BOTH is selected, move cursor to the Order field and press *DATA SCROLL* ↑ until the desired order appears. Press *ENTER*. If MIN or BOTH is selected, move cursor to the MIN field and enter the desired MIN. Press *ENTER*. Pressing a non-digit DATA ENTRY Key enters a wildcard character. Each wildcard character accepts any value for that digit. If OFF is selected, the Capture feature is disabled. Press *CE* to clear an entry.

FWD CNTL CHANNEL			
CHANNEL	327 U8	WORD	A & B
CAPTURE	BOTH	PAGE	316 / 522 - 4981
MESSAGE		OVERHEAD	ORDER
SCC			0
DCC	1		
SID	164		
MIN			316 / 522 - 4981
ORDER			PAGE
VMAC			0
CHAN			190
CMAx - 1	20		
N - 1	20		
CMAC	0		
			B / I 1

03416059

Prior to receiving the Capture condition, the data fields of the Forward Analog Control Channel are updated as new information is received and decoded. Once the Capture condition is received, the screen displays and holds the current data for each of the applicable fields. The "captured" data remains on the screen until a "recapture" is initiated. To restart the capture, press *Recap F4*. If OFF is selected for CAPTURE, the data fields are updated as new information is received and decoded.

To capture the raw data words received on the Forward Analog Control Channel

From the FOCC screen, press *More F6* and *RAW F2* to display the RAW FOCC screen:

RAW FWD CNTL CHANNEL					
CHANNEL	327 U8	WORD A & B		POSITION <input type="checkbox"/>	
CAPTURE	PAGE				
TS1	0	TS2	4398		
Wd	Data	Parity	Check	B/I	TS (mS)
A:	D5C19F9	F8C	GOOD	1	0
B:	D5C19F9	F8C	GOOD	1	0
A:	D5C19F9	F8C	GOOD	1	46
B:	D5C19F9	F8C	GOOD	1	46
A:	D01480E	368	GOOD	1	92
B:	D01480E	368	GOOD	1	92
A:	DC2994F	526	GOOD	1	138
B:	DC2994F	526	GOOD	1	138
A:	D5C19F9	F8C	GOOD	1	185
B:	D5C19F9	F8C	GOOD	1	185

03416060

This screen fills and displays a 100 data word buffer. Received data errors are corrected.

If an order is selected, the POSITION setting determines the position of the captured order in the data buffer. If NONE is selected for CAPTURE, the data buffer is filled with the first data words received on the Forward Analog Control Channel.

Select the cellular channel, band and word selection (A, B or A&B) to monitor. Select an order to capture on or select NONE. Move the position cursor to the location the captured order is to occupy in the data buffer. Press *START F5* to start capture. "Wait" appears in the top left corner of the screen. Once the data buffer is full, the data is displayed. Press *Stop F5* to stop data accumulation prematurely and display the data that is received.

Each received word is time stamped (in ms) with the captured order receiving a time stamp of 0. Pressing *UP F1* or *DOWN F2* scrolls the data buffer. Setting TS1 or TS2 data fields and pressing *TS1 F3* or *TS2 F4* displays that part of the data buffer.

To capture selected data fields received on the Forward Digital Traffic Channel

From the FOCC screen, press *FDTC F1* to display the FDTC screen. This screen displays the DVCC, Energy(r0) (Frame Energy parameter code received from each 20 ms Speech frame) (VSELP only) and the selected data fields.

FWD DGTL TRAFFIC CHAN			
CHANNEL	<input type="checkbox"/> 2 U8	DVCC 128	SLOT 2
CAPTURE	NONE	Energy(r0) 25	
Msg Type - S:	F:		
Data Fields	S/F	Values	
AMT			
ARQMap			
ATS			
AUTHBS			
BSMC			
BSMCci			
Cause			
02			
CgNamRes			
CgNamPl			
CgNamSl			

03416195

Select the data fields to be displayed from the setup menu. Select cellular channel, band and TDMA slot to monitor. Move cursor to the CAPTURE field and press *DATA SCROLL* ↑ to select the desired order. Press *ENTER*.

Prior to receiving the Capture condition, the data fields of the Forward Digital Traffic Channel are updated as new information is received and decoded. Once the Capture condition is received, the screen displays and holds the current data for each of the applicable fields. The "captured" data remains on the screen until a "recapture" is initiated. To restart the capture, press *Recap F4*. If NONE is selected for CAPTURE, the data fields are updated as new information is received and decoded.

To capture the raw data words received on the Forward Digital Traffic Channel

From the FDTC screen, press **More F6** and **RAW F1** to display the RAW FDTC screen:

```

RAW FWD DGLT TRAFFIC CHAN
CHANNEL [ 8 ] U8 SLOT 1 ACCH FAST
DEPTH 20 POSITION [ ]
CAPTURE NONE
TS1 0 TS2 4300
CF RSVD MESSAGE DVCC TS (mS)
1 47F7A2C4D7F3 3A -1200
0 48B39AE39C17 3A -0300
0 76F5C43A8E33 3A 0000
1 29472C8E2A17 3A 0020
0 27E3C81E6A4B 3A 1260
1 F8A52F9C3722 3A 1260
0 17C38E74D8F5 3A 3860
1 4F57D8C2E7A2 3A 3880
    
```

UP DOWN TS1 TS2 START Ret

03416062

This screen displays up to 100 data words captured in a buffer. The data received is de-interleaved and error correction is performed. If an order is selected, the POSITION setting determines the captured order's position in the data buffer. If NONE is selected for ORDER, the data buffer is filled with the first data words received on the Forward Digital Traffic Channel.

Select the cellular channel, band and TDMA slot to monitor. Select SACCH or FACCH messages to monitor. Select an order to capture on or select NONE. Set the DEPTH setting to the desired size of the data buffer (number of data words). Move the position cursor to the location the captured order is to occupy in the data buffer. Press **START F5** to start capture. "Wait" appears in the top left corner of the screen. If NONE is selected for CAPTURE, new data is displayed as information is received; otherwise, the capture condition must be met prior to displaying any new data. Press **Stop F5** to stop data accumulation prematurely and display the data that has been received.

Each received word is time stamped (in ms) with the captured order receiving a time stamp of 0. Pressing **UP F1** or **DOWN F2** scrolls the data buffer. Setting TS1 or TS2 data fields or pressing **TS1 F3** or **TS2 F4** displays that part of the data buffer.

To capture the raw interleaved data received on the Forward Digital Traffic Channel

From the FDTC screen, press **TS 136 F2** to display the FDTC Timeslot Raw Data screen:

```

FDTC TIMESLOT RAW DATA
CHANNEL [ 55 ] U8 SLOT 1
TS1 0140 TS2 0400
SYNC A91DE4A TS (mS) 0140
SACCH 4AC
CDVCC 0F2
DATA 0 C 7 3 1 C C 2 8 9 F 4 B
      3 1 6 5 2 8 9 A 4 B D 6 2
      3 B C 0 8 8 3 6 5 C 8 8 A
      C 7 9 1 A B 2 6 9 3 6 5 C
      0 8 3 3 5 C 3 8 A 5 2 0 9
CDL 0 0 0
    
```

UP DOWN TS1 TS2 START Ret

03416190

This screen displays up to 100 data words stored in a buffer as they are received. No de-interleaving or error correction is performed.

Select the cellular channel, band and TDMA slot to monitor. Press **START F5**. After the buffer is filled or **STOP F5** is pressed, a data word appears on the screen displaying the SYNC, SACCH, CDVCC and DATA (both 130 bit fields together). One data word is displayed at a time.

Each data word is time stamped (in ms) starting with 0. TS(mS) displays the current time stamp position. Pressing **UP F1** or **DOWN F2** scrolls the data buffer one data word at a time. Setting TS1 or TS2 data fields and pressing **TS1 F3** or **TS2 F4** displays the data word closest to the time stamp setting.

To monitor selected data fields received on the Forward Analog Voice Channel

From the FOCC screen, press **FVC F2** to display the FVC screen:

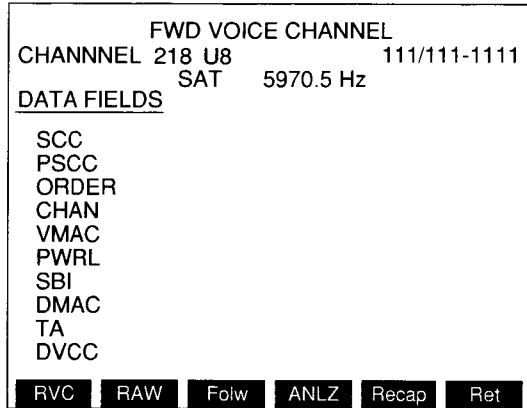

03416064

Select the data fields to be displayed from the setup menu. Select the cellular channel and band to monitor. The Analog Voice Channel is monitored displaying the MIN, SAT and the selected data fields received.

To capture the raw data words received on the Forward Analog Voice Channel

From the FVC screen, press **RAW F2** to display the FVC Data screen:

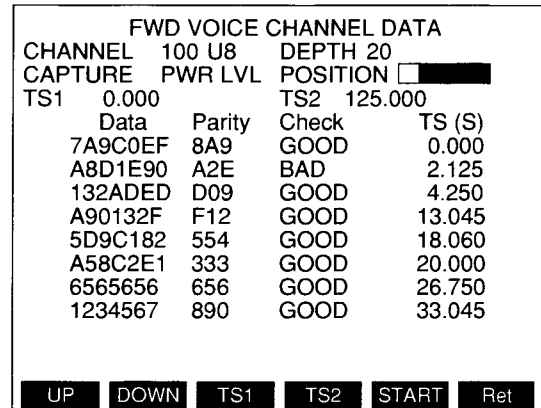

03416065

This screen displays up to 100 data words captured in a buffer. Received data errors are corrected. If an order is selected, the POSITION setting determines the position of the captured order in the data buffer. If NONE is selected for CAPTURE, the data buffer is filled with the first data words received on the Forward Analog Voice Channel.

Select the cellular channel and band to monitor. Select an order to capture on or select NONE. Set the DEPTH setting to the desired size of the data buffer (number of data words). Move the position cursor to the location the captured order is to occupy in the data buffer. Press **START F5** to start capture. "Wait" appears in the top left corner of the screen until the data buffer is full. If NONE is selected for CAPTURE, new data is displayed as information is received; otherwise, the capture condition must be met prior to displaying any new data.

Each received word is time stamped (in ms) with the captured order receiving a time stamp of 0. Pressing **UP F1** or **DOWN F2** scrolls the data buffer. Setting TS1 or TS2 data fields and pressing **TS1 F3** or **TS2 F4** displays that part of the data buffer.

To capture selected data fields received on the Reverse Analog Control Channel

From the FOCC screen, press *More F6* and *RECC F3* to display the RECC screen:

```

REVERSE CNTL CHANNEL
CHANNNEL 218 U8
CAPTURE BOTH PAGE RESP 316/522-4981

DATA FIELDS
T/ORDER
ORDER CD
ORDQ
LOCAL/MT
MIN
ESN
SCM
E
S
DIGITS1

RDC  RVC  Clear  Recap  Ret  More
    
```

03416066

Select the data fields to be displayed from the setup menu. Move cursor to the CAPTURE field and press *DATA SCROLL* ↑ to select a capture condition. Press *ENTER*. If ORDER or BOTH is selected, move cursor to the Order field and press *DATA SCROLL* ↑ until the desired order appears. Press *ENTER*. If MIN or BOTH is selected, move cursor to the MIN field and enter the desired MIN. Press *ENTER*. Wildcard characters can be entered by pressing a non-digit DATA ENTRY Key. If OFF is selected, the data fields are displayed when received.

Prior to receiving the Capture condition, the data fields of the Reverse Analog Control Channel are updated as new information is received and decoded. Once the Capture condition is received, the screen displays and holds the current data for each of the applicable fields. The "captured" data remains on the screen until a "recapture" is initiated. To restart the capture, press *Recap F4*. If OFF is selected for CAPTURE, the data fields are updated as new information is received and decoded.

To capture the raw data words received on the Reverse Analog Control Channel

From the RECC screen, press *More F6* and *RAW F3* to display the Raw RECC screen:

```

RAW REV CNTL CHANNEL
CHANNEL 100 U8 POSITION
CAPTURE BOTH PAGE RESP 316/522-4981
TS1 0 TS2 4398
Data Parity Check TS (ms)

UP DOWN TS1 TS2 START Ret
    
```

03416067

This screen displays 100 data words captured in a buffer. Received data errors are corrected. If an order is selected, the POSITION setting determines the position of the captured order in the data buffer. Selecting NONE for CAPTURE fills the data buffer with the first data words received on the RECC. Selecting MIN for CAPTURE fills the data buffer with the first data words received from the designated Mobile Station.

Select cellular channel and band. Select an ORDER, MIN or BOTH to capture on or select NONE. Move the POSITION cursor to select desired location of captured word in the data buffer (enables viewing data before and/or after captured word). Press *START F5* to start capture. Wait appears in the top left corner of the screen. If NONE is selected for CAPTURE, new data is displayed as information is received; otherwise, the capture condition must be met prior to displaying any new data. Press *Stop F5* to stop data accumulation prematurely and display the received data.

Each received word is time stamped (in ms) with the captured order receiving a time stamp of 0. Pressing *UP F1* or *DOWN F2* scrolls the data buffer. Setting TS1 or TS2 data fields and pressing *TS1 F3* or *TS2 F4* displays that part of the data buffer.

To monitor selected data fields received on the Reverse Digital Traffic Channel

From the RECC screen, press **RDTC F1** to display the RDTC screen. This screen displays the DVCC, Energy(r0) (Frame Energy) (VSELP only) and the selected data fields.

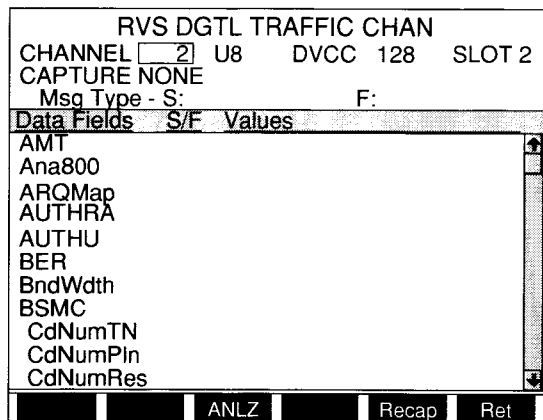

03416197

Select the data fields to be displayed from the setup menu. Select the cellular channel, band and TDMA slot to monitor. Move cursor to the CAPTURE field and select OFF. The RDTC for the selected channel and band is continuously monitored; the displayed data fields are updated as new information is received and decoded.

To capture selected data fields received on the Reverse Digital Traffic Channel

With the RDTC monitor screen displayed, select the data fields to be displayed from the setup menu. Select the cellular channel, band and TDMA slot to monitor.

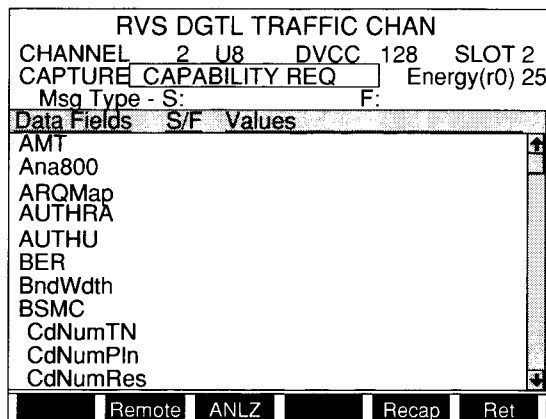

03416198

Move cursor to the CAPTURE field and press **DATA SCROLL** ↑ to select the order to capture.

Prior to receiving the Capture condition, the data fields of the Reverse Digital Traffic Channel are updated as new information is received and decoded. Once the Capture condition is received, the screen displays and holds the current data for each of the applicable fields. The "captured" data remains on the screen until a "recapture" is initiated. To restart the capture, press **Recap F5**. If NONE is selected for CAPTURE, the data fields are updated as new information is received and decoded.

To send received RDTC VSELP data out the RS-232 Connector

From the RDTC screen, press *Remote* Soft Function Key to stop decoding data and start sending VSELP data as ASCII characters out the RS-232 Connector. Each character represents one nibble (four bits) of data. Data is sent out at a 38400 baud rate. Press *STOP* Soft Function Key to stop sending data out the RS-232 Connector and resume normal decoding.

The VSELP data transmitted from the RS-232 Connector, when in the RDTC screen, consists of a repeating 20 ms speech frame. Each speech frame is composed of 27 sets of 2 ASCII characters terminated by a newline character. Each set of ASCII characters contains the value of a corresponding VSELP Parameter Code listed below:

VSELP PARAMETER CODE	LENGTH (BITS)	DESCRIPTION
r0	5	Frame Energy
lpc1	6	1st Reflection Coefficient
lpc2	5	2nd Reflection Coefficient
lpc3	5	3rd Reflection Coefficient
lpc4	4	4th Reflection Coefficient
lpc5	4	5th Reflection Coefficient
lpc6	3	6th Reflection Coefficient
lpc7	3	7th Reflection Coefficient
lpc8	3	8th Reflection Coefficient
lpc9	3	9th Reflection Coefficient
lpc10	2	10th Reflection Coefficient
lag_1	7	Lag for 1st sub frame
lag_2	7	Lag for 2nd sub frame
lag_3	7	Lag for 3rd sub frame
lag_4	7	Lag for 4th sub frame
code1_1	7	1st code (L) for 1st sub frame
code1_2	7	1st code (L) for 2nd sub frame
code1_3	7	1st code (L) for 3rd sub frame
code1_4	7	1st code (L) for 4th sub frame
code2_1	7	1st code (H) for 1st sub frame
code2_2	7	1st code (H) for 2nd sub frame
code2_3	7	1st code (H) for 3rd sub frame
code2_4	7	1st code (H) for 4th sub frame
gsp0_1	8	{GS, P0, P1} code for 1st sub frame
gsp0_2	8	{GS, P0, P1} code for 2nd sub frame
gsp0_3	8	{GS, P0, P1} code for 3rd sub frame
gsp0_4	8	{GS, P0, P1} code for 4th sub frame

The following is an example of 8 speech frames as received from the RS-232 Connector:

The VSELP parameter code is in hexadecimal and right-justified within each set of 2 ASCII characters.

```
02170F100505040605060174120B675D60766E35304C785D5282A4
03140F1206070406060501256C1A382C0815721B7E30475E8AC188
02170D13050504060506024373430D2560026D1F096F55984DA798
021909160307040606060206262C2E3C445D470F59585E9F595D4F
01160D12050604050405003C542C1724601400742A3201A1E4A88E
02170F1305040407050501150B05080D7B30045B573C6D8F92525C
0314101203040507050402180F07461A06254C4E4C0D158A895D56
0E16160C07090204030501695B5D453844161552742915350E000E
```

To monitor selected data fields received on the Reverse Analog Voice Channel

From the RECC screen, press *RVC F2* to display the RVC screen:

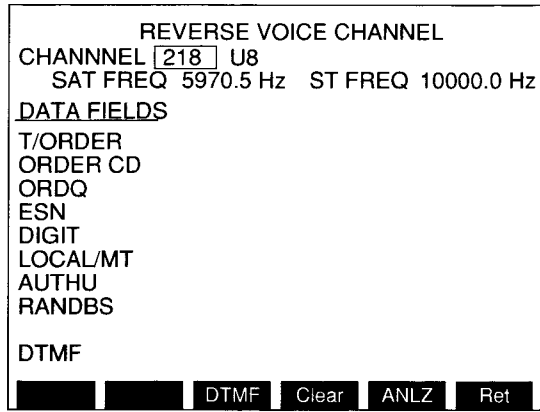

03416069

Select the cellular channel and band to monitor. The channel selected is monitored and the SAT, signal tone (ST FREQ) and active data fields are displayed, holding the last received data until new data is received.

To display DTMF received on the Reverse Analog Voice Channel

From the RVC screen, select the cellular channel and band to monitor. Press *DTMF F3*. Press the digit keys on the Mobile Station. The IFR-1900 displays the DTMF received from the Mobile Station.

3.2 ANALOG CONTROL CHANNEL (ACC) CELL SITE SIMULATION

The ACC Cell Site Simulation is used to test EIA/TIA-553 and TIA/EIA-627 capable Mobile Stations. To access the ACC Cell Site Simulation, press 2 from the Dual Mode TIA/EIA-136 Cellular main menu. The System Parameter screen appears.

The System Parameter screen is used to send the 16 word overhead message train which consists of the System Parameter Overhead message (2 words: A and B) and 14 Control-Filler words. The overhead message train is used by the Global Action screen to send Global Action overhead messages and by the Call screen to initiate a call. The Mobile Station Control screen is also accessed from the System Parameter screen.

The Call screen is used to establish a call to the Mobile Station or accept a call from the Mobile Station, transferring the call to a Digital or Analog channel. Once the call is established, messages can be sent on the Digital or Analog forward channel, having the response from the Mobile Station automatically monitored on the corresponding reverse channel screen.

The Global Action screen is used to send Global Action Overhead messages. The Global Action Overhead messages are appended to the System Parameter Overhead message in the overhead message train selected from the System Parameter screen. The overhead message train is maintained at 16 words in length by reducing the number of Control-Filler words sent.

The Mobile Station Control screen is used to send Mobile Station Control messages (each 2 to 5 words in length). A Mobile Station Control message, when sent once or repeatedly, follows the System Parameter Overhead message in the overhead message train by replacing an equal number of Control-Filler words.

To connect the Test Set to the Mobile Station

For ACC Cell Site Operation, the T/R Connector is used for transmitting to the Mobile Station and for receiving signals from the Mobile Station. The T/R Connector connects to the RF input/output connector of the Mobile Station.

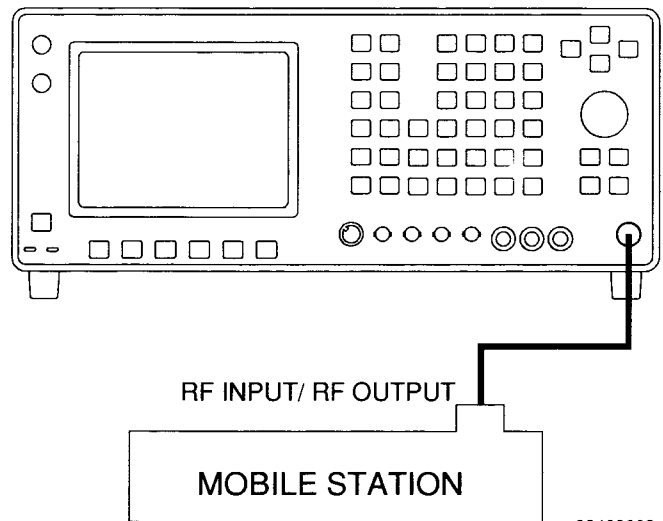

03403002

To access the ACC Cell Site Simulation screens

Pressing **DPLX**, **Sp Tst F5** and **2** displays the System Parameter screen. All other ACC Cell Site Simulation screens are accessed from this screen. Pressing **Start F1** starts the transmission of the System Parameter message and displays the following Soft Function Keys:

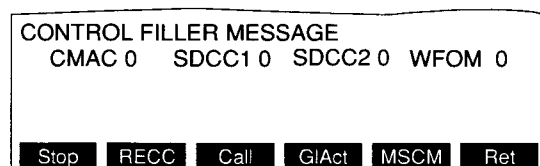

9157026

Call F3 displays the Call Screen. **GIAct F4** displays the Global Action screen. **MSCM F5** displays the Mobile Station Control screen.

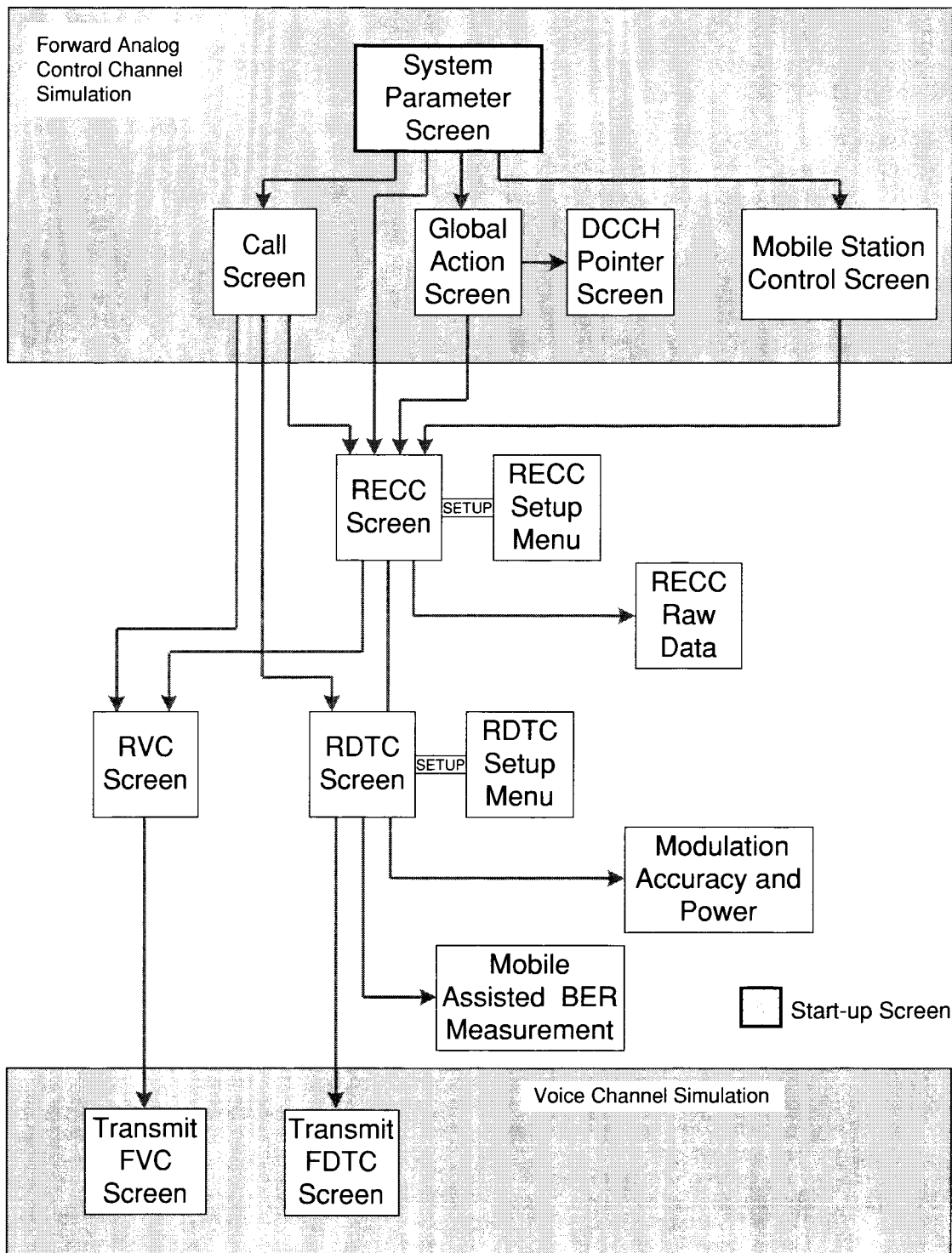

Analog Control Channel Cell Site Simulation Screen Hierarchy

03401002

To select data fields displayed by the RECC and RDTC screens

From the System Parameter screen, press **RECC F2** display the RECC screen.

The RECC screen allows access to the RDTC and RVC screens. These screens are used to monitor the Mobile Station's responses to the messages sent to it. The RECC and RDTC screens have setup menus used to select the data fields monitored. To select the data fields, press **SETUP** with the screen displayed. The setup menu for the current screen appears:

```

REVERSE CNTL CHAN SETUP
USE 0-9 TO MAKE YOUR SELECTIONS

T/ORDER 0 SDCC1 X RANDBS X
ORDER CD 1 SDCC2 X SERVICE CD X
ORDQ 2 LT X PM_D X
LOCAL/MT 3 AUTHR X SAP X
MIN 4 COUNT X ACKED DATA X
ESN 5 RANDC X CRC X
SCM 6 DCC X DATA PART X
E 7 EP X RLP X
S 8 ER X
DIGITS1 9 MPC1 X
DIGITS2 X AUTHU X
    
```

Ret

9150005

Move the cursor to the desired fields and press a DATA ENTRY Key (0 to 9). The number used determines the order the selected field is displayed on the current screen. Pressing a non-numeric DATA ENTRY Key deselects the field. The RDTC setup menu has two pages.

Press **Page 2** or **Page 1 F2** to toggle operation from one page to the other. Press **Help F1** to toggle a field providing the full name of the abbreviated display name currently selected by the cursor.

Press **Ret F6** after selecting the desired data fields.

To start sending the overhead message train

From the System Parameter screen, select the channel, band and RF level to use.

```

CELL SITE SIMULATION
FWD CNTL CHANNEL
CHANNEL 333 U8 RFLVL -70.0

SYSTEM PARAMETER OVERHEAD MESSAGE
DCC 1 PCI 1 RCF 1 SID 166
S 1 E 1 REGH 1 REGR 1
N 20 CMAX 20 AUTH 1 EP 0

CONTROL FILLER MESSAGE
CMAC 2 SDCC10 SDCC20 WFOM 1
    
```

Start RECC Ret

03416192

Select the System Parameter Overhead message and the Control-Filler fields. For field definitions, see Section 6. Press **Start F1** to start transmitting the overhead message train. (The System Parameter screen is now considered "active.")

The overhead message train is sent to the Mobile Station repeatedly until **Stop F1** is pressed. The overhead message train consists of 2 System Parameter words followed by 14 Control-Filler words.

To perform a Registration

From the active System Parameter screen, press **Call F3** to display the Call screen:

```

CELL SITE SIMULATION
  FWD CNTL CHANNEL
CHANNEL 333 U8 RFLVL -70.0

CALLING SETUP
  TYPE ANALOG
  MIN 316/522-4981
  CHAN 1 VMAC 5
  SAT FREQ 5970 Hz DEV 2.0

ALERT SETUP
  TYPE ALERT W/INFO
  SIGNAL PITCH MED   CADENCE 000011
  EF 0 PI 00 SI 00
  CALLING NUMBER 3165224981
  
```

Page AutoRg Folw RECC Ret

03416193

Press **AutoRg F2** from the Call screen (the label turns red). If Follow is off, the RECC screen appears displaying the Mobile Station registration.

If Follow is on, the Call screen remains and uses the registration from the Mobile Station to update the MIN field (AutoRg F2 label returns to the original white color).

The CSA increments the REGID in the System Parameter Overhead message prompting the Mobile Station to register. The CSA continues to increment the REGID by 512 every 3 seconds until the Mobile Station registers. After receiving the registration from the Mobile Station, the CSA sends a Registration Confirmation message.

REGH or REGR on the System Parameter screen must be set to 1 prior to attempting an Autonomous registration of the Mobile Station.

For a Home registration, REGH must be set to 1; for a Roam registration, REGR must be set to 1.

To place a call to the Mobile Station

From the Call screen, select the Forward Analog Control Channel, band and RF level.

```

CELL SITE SIMULATION
  FWD CNTL CHANNEL
CHANNEL 333 U8 RFLVL -30.0

CALLING SETUP
  TYPE DIGITAL TIA/EIA-136
  MIN 316/522-4981
  CHAN 1 SLOT 1 DMAC 0 DVCC 1
  PM 0 MEM 0 EF 0 VC ACELP

ALERT SETUP
  SIGNAL PITCH MED   CADENCE 000011
  CALLING NUMBER 4445556666

  TYPE 000 PLAN 0000
  PI 00 SI 00
  
```

Page AutoRg Folw RECC Ret More

03416194

Select the TYPE of channel to assign the call to (DIGITAL TIA/EIA-136, DIGITAL TIA/EIA-627 or ANALOG). Activate Follow. Select the remaining call fields. For field definitions, see Section 6.

For DIGITAL calls, a PLC message is sent before the Alert message. Only the fields for the Alert message or the PLC message appear at one time. To select the fields of both messages, edit the fields that appear. Then press **More F6** and **PLC** or **Alert F1** to display the other fields. Some message fields can be omitted by pressing **off F2**. For field definitions, see Section 6.

Press **Page F1**. A Page message is sent to the Mobile Station. Upon receiving the Page Response, a Slot or Voice Designation message is sent, assigning the Mobile Station to the Digital Traffic or Analog Voice Channel selected. If a Digital Traffic Channel is assigned, a PLC message is sent. On either channel, an Alert message is sent to ring the Mobile Station.

If Folw F3 is selected, the RDTTC or RVC screen appears displaying the response of the Mobile Station; otherwise, the RECC screen appears displaying the response of the Mobile Station. Pressing **Ret F6** terminates the call and returns operation to the Call screen.

To accept an origination, complete a call and monitor

From the Call screen, select the Forward Analog Control Channel, band and RF level to use.

```
CELL SITE SIMULATION
FWD CNTL CHANNEL
CHANNEL 333 U8 RFLVL -70.0
CALLING SETUP
TYPE ANALOG
MIN 316/522-4981
CHAN 1 VMAC 5
SAT FREQ 5970 Hz DEV 2.0
ALERT SETUP
TYPE ALERT W/INFO
SIGNAL PITCH MED CADENCE 000011
EF 0 PI 00 SI 00
CALLING NUMBER 3165224981
```

Page AutoRg Folw RECC Ret

03416193

Select the TYPE of channel to assign the call to. Press **Folw F3** to activate Follow. Select the remaining call fields. For field definitions, see Section 6.

For DIGITAL calls, a PLC message is sent. If the Alert message fields are displayed, press **More F6** and **PLC F1** and select the PLC fields as desired. Some message fields can be omitted by pressing **off F2**. For field definitions, see Section 6.

Place a call using the Mobile Station under test. When the Origination message is received, a Slot or Voice Designation message is sent. If a Digital Traffic Channel is assigned, a PLC message is sent.

The RDTC or RVC screen appears to monitor the response from the Mobile Station.

To input and monitor audio on the DTC (VSELP or ACELP operation) from the Test Set

Using a POTS (Plain Old Telephone System) telephone handset with a electret microphone, connect the handset to the MIC/ACC Connector on the front panel of the IFR-1900 (see *IFR-1900 Communications Service Monitor Operation Manual*) in the following manner:

Red to pin 3, yellow to pin 2 and green and black to pin 8.

MIC/ACC

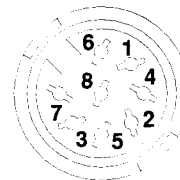

IN/OUT

03418009

To perform Mobile Assisted BER measurement and call handoff from the RDTC

From an active RDTC screen, press **MBER F5** to display the Mobile Assisted BER Measurement screen:

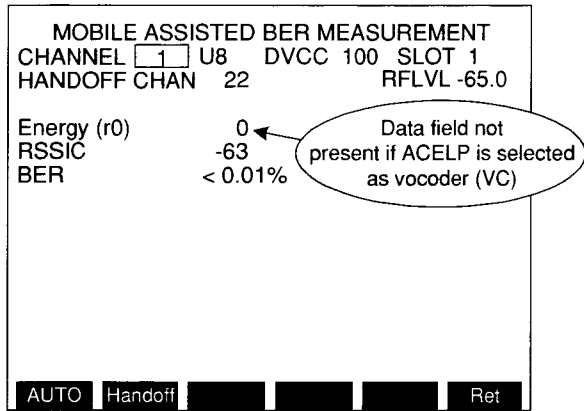

03416073

The Energy (r0) field displays the VSELP frame energy value. The RSSIC field displays the Received Signal Strength in dBm according to the received RSSIC data field. The BER field displays the Bit Error Rate percentage reported by the Mobile Station.

Press **AUTO F1** to automatically set RF level. The Auto function adjusts the RF level until the Mobile Station reports (Channel Quality message) a BER of 2% to 4%. When the Mobile Station reports a BER of 2% to 4%, the Auto function increases the adjusted RF level 10 dB. The AUTO label remains red until the procedure is complete.

Manually adjust the RFLVL field to find exact Mobile Station sensitivity.

Perform a handoff by selecting Handoff Channel (HANDOFF CHAN field) and pressing **Handoff F2**.

Press **Ret F6** to return to RDTC screen. Press **Ret F6** again (or press END on the Mobile Station) to terminate the call and return operation to the Call screen.

To send Digital Traffic Channel messages

Place a call to the Mobile Station as previously described. Set TYPE to the applicable DIGITAL selection. Once the call is completed, the RDTC screen appears. Press **FDTC F1**. The FDTC screen appears:

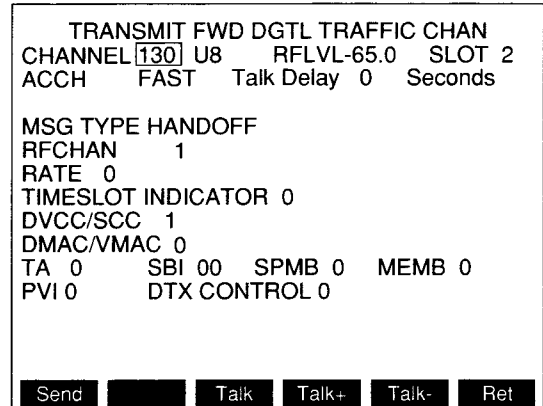

03416074

The current channel, band and slot of the call are displayed. Select the SLOW or FAST Associated Control Channel used for transmitting. Select the RF level to use. Move cursor to MSG TYPE and select the message to be sent. Once the message is selected, the appropriate fields appear. Set the fields to the desired settings and press **Send F1**. The message is sent on the Forward Digital Traffic Channel. The RDTC screen is displayed to monitor the response from the Mobile Station.

Press **Talk F3** to activate Talkback function (puts data received on RDTC in applicable FDTC fields and transmits data, with VSELP or ACELP, back to the Mobile Station). Use **Talk+ F4** and **Talk- F5** to set 0 to 5 second delay between receiving and transmitting.

Press **FDTC F1** to send another message or press **Ret F6** to terminate the call and return operation to the Call screen.

The Forward Digital Traffic Channel messages that can be sent to the Mobile Station are defined in Section 5. For definitions of the fields used with the Forward Digital Traffic Channel messages, see Section 6.

To send Analog Voice Channel messages

Place a call to the Mobile Station under test as previously described. Set TYPE to ANALOG. Once the call is completed, press **FVC F1** from the RVC screen. The FVC screen appears:

```
TRANSMIT FWD VOICE CHANNEL
CHANNEL 133 U8      RFLVL -65.0

MT/ORDER HANDOFF

RFCHAN 212
PSCC 00
EF 0
SCC 00
VMAC 0
PVI 0
MEM 0
```

Send [] [] [] [] [] Ret

03416075

The current channel and band of the call is displayed. Set the RF level as desired. Move cursor to MT/ORDER and select the message to be sent. Once the message is selected, the appropriate fields appear. Set the fields to the desired settings and press **Send F1**. The message is sent on the Forward Analog Voice Channel. The RVC screen is displayed monitoring the Mobile Stations response.

Press **FVC F1** to send another message or press **Ret F6** to drop the call and return operation to the Call screen.

The Forward Analog Voice Channel messages that can be sent to the Mobile Station are defined in Section 5. For definitions of the fields used with the Forward Analog Voice Channel messages, see Section 6.

To Monitor Reverse Analog Control Channel messages from the Mobile Station

From the Call screen, deactivate Follow. When a message is received from the Mobile Station, the RECC screen is displayed. Press **Ret F5** to return to the Call screen.

To send a Page order (call not completed)

From the Call screen, deactivate Follow. Select the channel, band and RF level to use. Press **Page F1**. A Page message is sent to the Mobile Station. With Follow off, no other messages (Slot or Voice designation) are sent. The RECC screen appears monitoring the Mobile Stations response. Press **Ret F5** to return to the Call screen.

To send Global Action Overhead messages

From the active System Parameter screen, press **GIAct F4**. The Global Action screen appears:

```
CELL SITE SIMULATION
FWD CNTL CHANNEL
CHANNEL 333 U8 RFLVL -30.0 REPEAT OFF

GLOBAL ACTION OVERHEAD MESSAGE
REGINCR 0
PUREG 0 PDREG 0 LREG 0
LOCAID 0 NEWACC 0
OLC 0000000000000000 BIS 0
MAXBUSY-PGR 0 MAXSZTR-PGR 0
MAXBUSY-OTHER 0 MAXSZTR-OTHER 0
LOCAL CNTL 0000000000000000
RAND1_A 0000 RAND1_B 0000
CDMA FREQ 1 CDMA AVAIL 0
```

Send Action RECC [] [] [] [] [] DochPtr Ret

03416076

To send the DCCH Pointer (Control Channel Information Message)

Select the channel, band and RF level to use. Press **Action F2** to display the Global Action Overhead messages. Any number of Global Action Overhead messages may be sent. Move cursor to each message and press **ON F1** to activate or **OFF F2** to deactivate. Press **Ret F6** to return to the Global Action screen. Set the relevant fields for the messages selected.

Press **Send** to send the messages selected. The Global Action Overhead messages sent are appended to the System Parameter Overhead message initiated from the System Parameter screen. Control-Filler messages complete the 16 word overhead message train transmitted.

If REPEAT is on, the overhead message train containing the Global Action Overhead messages selected is sent until **Stop F1** is pressed (even after exiting the screen). If REPEAT is off, the Global Action Overhead messages are sent once. Once the Global Action Overhead message is stopped, the System Parameter Overhead message continues to be sent in the overhead message train as selected from the System Parameter screen.

To view the Mobile Stations response, press **RECC F3**. The RECC screen is displayed monitoring the current Reverse Analog Control Channel.

The Global Action Overhead messages are defined in Section 5. For definitions of the fields used with the Global Action Overhead messages, see Section 6.

The DCCH Pointer, operating separately from the Global Actions, informs the mobile station where to find the Digital Control Channel associated with the current Analog Control Channel.

From the Global Action screen, press **DcchPtr F5**. The DCCH Pointer screen appears displaying the Control Channel Information Message data fields:

CELL SITE SIMULATION	
FWD CNTL CHANNEL	
CHANNEL	333 U8 RFLVL -30.0 REPEAT OFF
CNTL CHANNEL INFORMATION MESSAGE	
CHAN	1
ASYNC DATA	0
G3 FAX	0
DATA PRIVACY	0
HDVCC	0
HYPERBAND	0
Send	Ret

03416077

The channel, band, RFLvl and repeat fields operate the same as in the Global Action screen; select values as desired. Using the cursor, enter values for each of the Control Channel Information message data fields.

Press **Send F1** to append the Control Channel Information message to the System Parameter Overhead message in the overhead message train. If REPEAT is on, the Control Channel Information message is sent in the overhead message train until **Stop F1** is pressed (even after exiting the screen). If REPEAT is off, the Control Channel Information message is sent once. Once the Control Channel Information message is stopped, as with the Global Action Overhead message, the System Parameter Overhead message is continued as selected from the System Parameter screen. Press **Ret F6** to return to the Global Action screen. For definitions of the fields used with the Control Channel Information message, see Section 6.

To send a Mobile Station Control Message

From the active System Parameter screen, press **MSCM F5**. The Mobile Station Control screen appears:

```

CELL SITE SIMULATION
  FWD CNTL CHANNEL
CHANNEL 333 U8 RFLVL-30.0 REPEAT OFF
MOBILE STATION CONTROL MESSAGE
MT/ORDER VC DES      ORDQ 000
MIN 316/522-4981    CHAN 1
SCC 11      DVCC 0
VMAC 1      DMAC 1  LOCAL 00000
CHANPOS 1   2   3
CHANPOS 4   5   6
EF 0       PM 0   MEM 0
RANDU 000000 AUTHBS 00000
RANDSSD_1 0000000 RANDSSD_2 0000000
RANDSSD_3 00      PVI 0
    
```

Send RECC Ret

03416078

Select the channel, band and RF level to use. Move cursor to MT/ORDER and select the message to send. Enter the MIN of the Mobile Station and select the remaining fields that are relevant to the message chosen.

Press **Send F1**. The Mobile Station Control message is sent following the System Parameter Overhead message in the overhead message train. The Mobile Station Control message (2 to 5 words in length) replaces an equal number of Control-Filler words.

If REPEAT is off, the RECC screen is displayed monitoring the Mobile Stations response. To return to the Mobile Station Control screen, press **Ret F6**. If REPEAT is on, the Mobile Station Control message is sent repeatedly until **Stop F1** is pressed. The overhead message train with the System Parameter Overhead message continues as before, but without the Mobile Station Control message.

The Mobile Station Control messages are defined in Section 5. For definitions of the fields used with the Mobile Station Control messages, see Section 6.

To perform modulation accuracy and power testing on a mobile station

Place a call to the Mobile Station as previously described. Set TYPE to the applicable DIGITAL selection. Once the call is completed, the RDTDC screen appears:

```

RVS DGTL TRAFFIC CHANNEL
CHANNEL [ 2 ] U8 DVCC 128 SLOT 2
Data Fields S/F Values
AMT
Ana800
ARQMap
AUTHRA
AUTHU
BER
BndWdth
BSMC
CdNumTN
CdNumPln
CdNumRes
FDTC ANLZ ModAcc MBER Ret
    
```

03416112

Press **ModAcc F4** to display the Mobile Station Modulation Accuracy and Power screen:

MODULATION ACCURACY AND POWER		
	156 Symbols	First 10 Symbols
EVM	7.16%	7.71%
Mag Error	3.52%	4.58%
Phase Error	3.42 Deg	3.41 Deg
Freq Error	5.4 Hz	
I/Q Offset	-29.4 dB	
Droop	-0.0008 dB	
Power	21.83 dBm	152.66 mW

Stop I/Q Const Power Ret More

03416106

When screen appears, the CSA begins measuring the RMS values of modulation accuracy and output power of the Mobile Station transmit burst on the RDTDC. Two methods of measurement are displayed:

1. The full "maximum-effect" portion of the Mobile Station transmit burst consisting of 156 symbols (312 bits).

2. The first 10 symbols (20 bits) of a Mobile Station transmit burst (following the ramp-up) averaged over 10 bursts.

The measurements displayed are divided into the same categories as discussed in Section 3.4 for Base Station modulation accuracy with the following exceptions:

- **Droop**
Change in amplitude over the portion of the Mobile Station transmit burst being measured.
- **Mobile Station Power**
Channel power represented in dBm and mW in the portion of the Mobile Station transmit burst being measured.
- **The first 10 Symbols modulation accuracy is measured in RMS Error Vector Magnitude (EVM), RMS Magnitude Error and RMS Phase Error.**

Press **Stop F1** to stop measurements.

Press **More F6** and **ANLZ F3** to observe the spectrum of the received signal. Press **Sp Tst F5** to return to Modulation Accuracy screen.

Press **More F6** and **Zero F2**, to zero power meter. A message appears informing the user to, first, disconnect RF and DC signal from the T/R Connector, then press **ENTER** to begin.

To plot $\pi/4$ DQPSK I/Q pattern with constellation (mobile station)

From the Modulation Accuracy and Power screen, press **I/Q F2** to display the Pi/4 DQPSK I-Q Pattern screen:

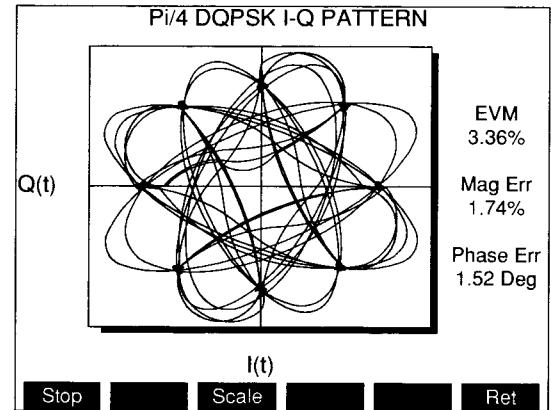

03416108

When the Pi/4 DQPSK I-Q Pattern screen appears, the CSA begins to continually sample the signal from the Mobile Station. The I/Q pattern and constellation is repeatedly plotted from each sample, clearing the pattern display area at the end of each plot sequence. In addition, the values of RMS Error Vector Magnitude (EVM), RMS Magnitude Error and RMS Phase Error are repeatedly updated from each sample.

For each sample, the values are updated first, followed by the plotting of the I/Q Pattern.

Press **Stop F1** to stop sampling and freeze display.

When the plotting first begins, the pattern is automatically scaled to extend to 90% of pattern display area. Pressing **Scale F3** scales the next incoming data pattern to extend to 90% of pattern display area.

To plot constellation alone (mobile station)

From the Modulation Accuracy and Power screen, press **Const F3** to display the Pi/4 DQPSK Constellation screen:

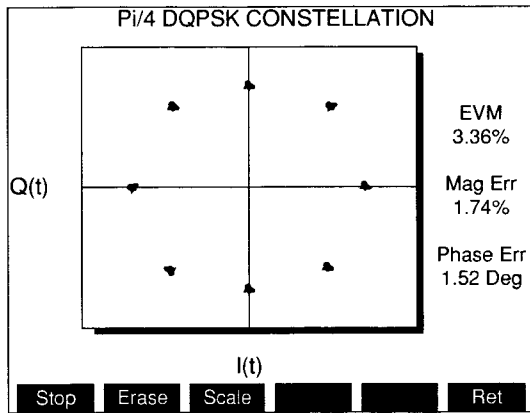

03416110

When the Pi/4 DQPSK Constellation screen appears, the CSA begins to continually sample the signal from the Mobile Station. The constellation of decision points is repeatedly plotted from each sample. In addition, the values of RMS Error Vector Magnitude (EVM), RMS Magnitude Error and RMS Phase Error are repeatedly updated.

For each sample, the values are updated first, followed by the plotting of the constellation.

Press **Stop F1** to stop sampling and freeze display.

Pressing **Erase F2** turns the label red and clears the display area at the end of the plotting sequence for each sample. Pressing **Erase F2**, again, turns off the Erase feature.

As with the Pi/4 DQPSK I-Q Pattern screen, the constellation can be rescaled in reference to the display area by pressing **Scale F3**.

To display power meter alone (mobile station)

From the Modulation Accuracy and Power screen, press **Power F4** to graphically display channel power:

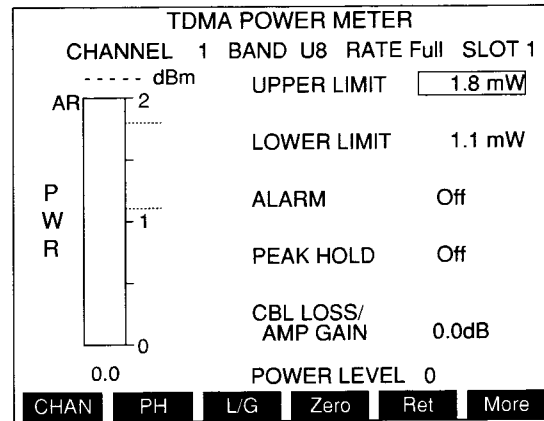

03416182

When the TDMA Power Meter screen appears, the CSA begins to continually sample the signal from the Mobile Station. The values and graphical representation of power are repeatedly updated from each sample. Press **Stop F1** to stop sampling and freeze display.

Press **Zero F4**, to zero power meter. A message appears informing the user to, first, disconnect RF and DC signal from the T/R Connector, then press **ENTER** to begin.

With cursor in the Power Level field, use the keypad of the IFR-1900 to enter the TDMA power level of the Mobile Station from 0 to 10. Press **ENTER**. The CSA sends a Physical Layer Control (PLC) message to the Mobile Station to change output power, accordingly.

The following ranges (in mW) are utilized by the power meter screen:

- | | | |
|---------|----------|-----------|
| 0 to 2 | 0 to 50 | 0 to 1000 |
| 0 to 10 | 0 to 250 | 0 to 4000 |

The TDMA Power Meter screen operates similar to the Power Meter Operation screen. See the IFR-1900 Communications Service Monitor Operation Manual.

To perform adjacent channels power measurements (mobile station)

From the Modulation Accuracy and Power screen, press *More F6* and *ACPM F4* to display the Adjacent Channel Power Measurement screen.

Press *NORM F2* to normalize or flatten out level differences between the tested frequencies due to the signal filter (takes approximately 30 seconds).

Press Start *F1* to measure signals from the mobile station.

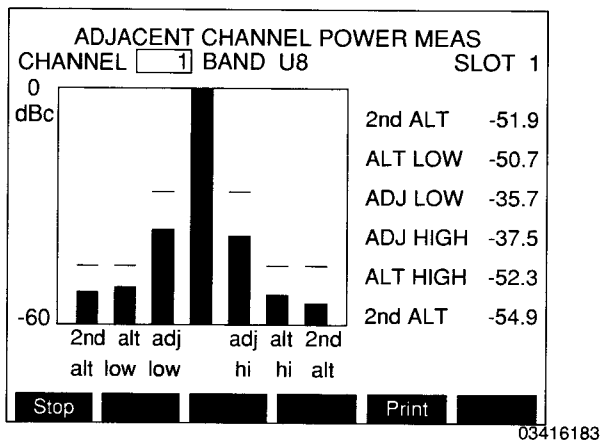

The screen indicates the level of adjacent channels, shown in dB, relative to the selected center channel level. The adjacent channels (ADJ LOW/alt low and ADJ HIGH/adj hi) are, of course, 30 kHz from the center channel. The alternate channels (ALT LOW/alt low and ALT HIGH/alt hi) are 60 kHz from the center channel and the second alternate channels (2nd ALT/2nd alt) are 90 kHz from the center channel. Red signal bars indicate signals exceeding set level limits (lines shown on screen).

Press *Print F5* to send the formatted measurement data out the OPT. RS-232 Connector to a pc or RS-232 serial printer. Measurement data includes the time and date the measurements were taken.

Press *Stop F1* to stop measurements.

3.3 DIGITAL CONTROL CHANNEL (DCCH) CELL SITE SIMULATION

DCCH

The DCCH Cell Site Simulation is used to test TIA/EIA-136 capable Mobile Stations.

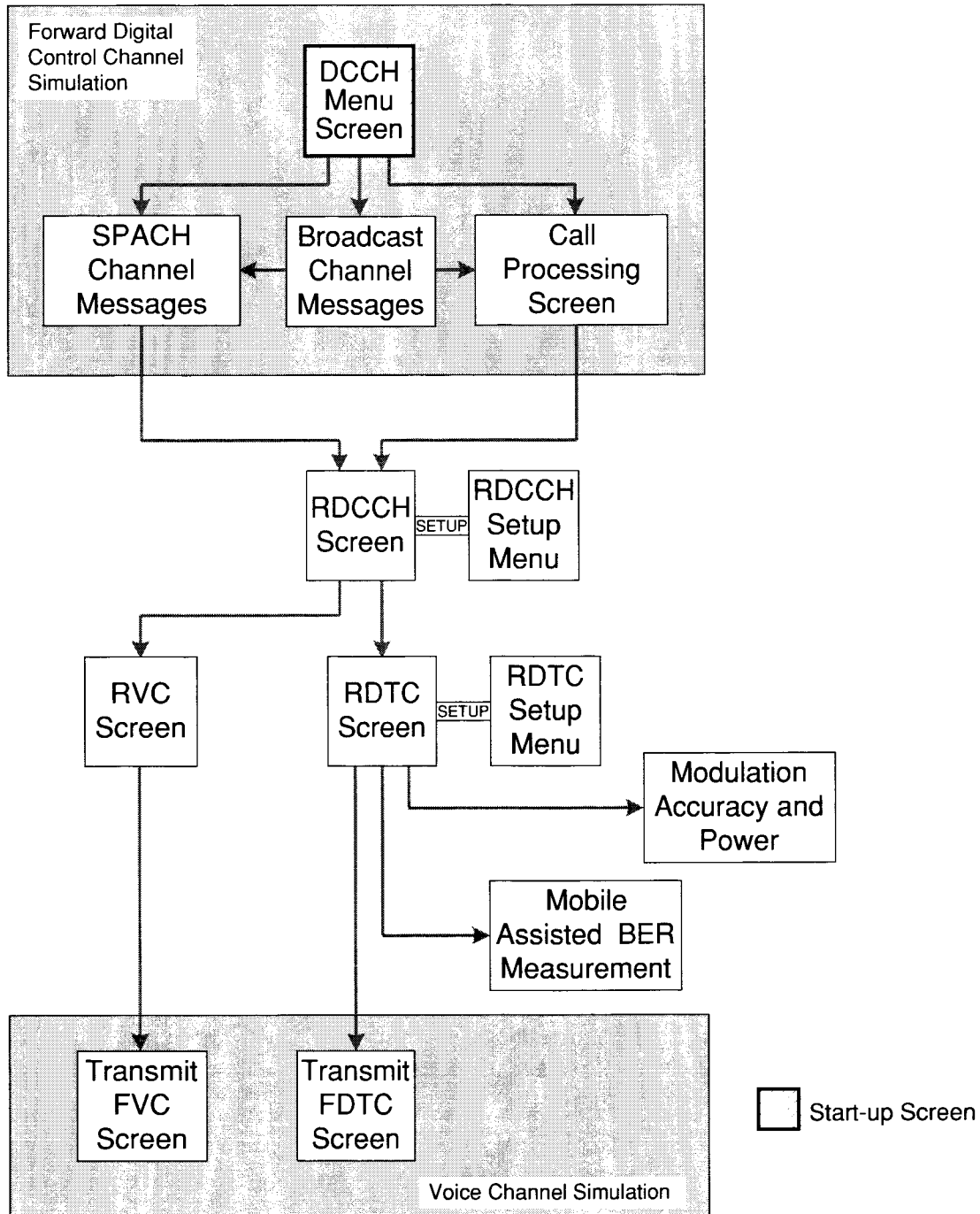

DCCH Cell Site Simulation Screen Hierarchy

03401003

To connect the Test Set to the Mobile Station DCCH

For DCCH Cell Site Simulation, the T/R Connector is used for transmitting to the Mobile Station and for receiving signals from the Mobile Station. The T/R Connector is connected to the RF input/output connector of the Mobile Station.

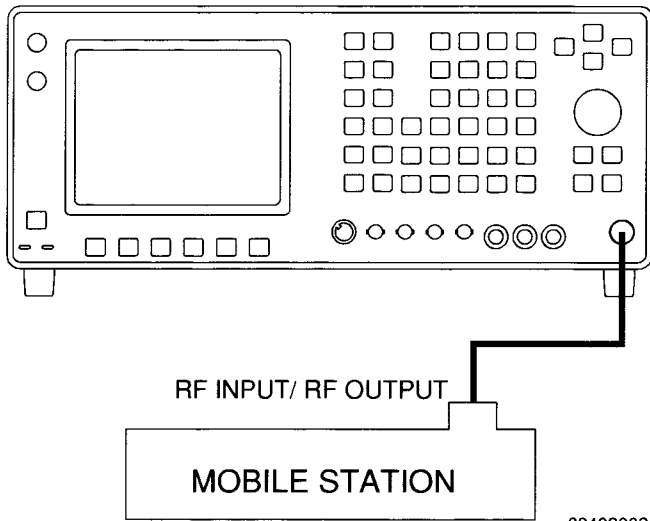

To access the DCCH Cell Site Simulation Screens DCCH

Press *DPLX*, *Sp Tst F5* and *3* to display the FDCCH Cell Site Simulation menu screen.

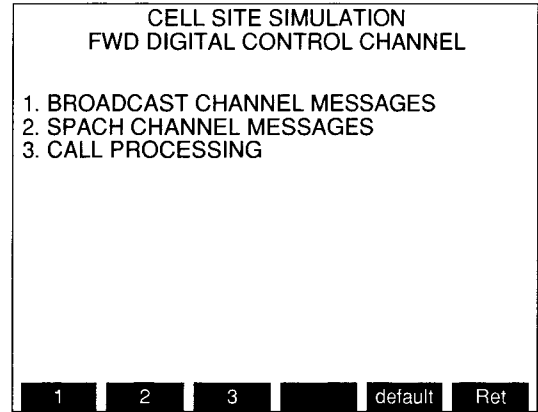

Pressing the associated Soft Function Key or DATA ENTRY key displays the related FDCCH simulation screen.

When any one of the three items on the menu screen are selected, the CSA begins transmitting the FDCCH signal out the T/R connector on the front panel. The CSA continues to transmit the FDCCH signal when returning to the FDCCH Cell Site Simulation menu screen, but stops when exiting the menu or the Special Test operation of the CSA.

To set up the FDCCH Broadcast Channel Messages DCCH

The Broadcast Channel (F-BCCH, E-BCCH and S-BCCH logical channels) carries generic, system-related information.

Pressing *default F5* configures the CSA to transmit the Broadcast Channel Messages in a preset manner. See Appendix B for details on Broadcast Channel default configuration. When selected, "default" changes to red and the "1. BROADCAST CHANNEL MESSAGES" line becomes gray and cannot be selected.

The Broadcast Channel messages may be customized to fit specific applications or needs. Pressing *F1* displays the Broadcast Channel Messages Screen.

Some Broadcast Channel messages are optional and must be turned "on" to be included in the FDCCH transmission.

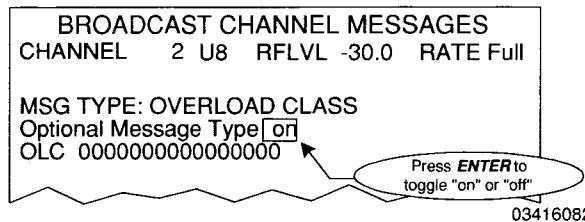

03416082

All Optional Message Types are broadcast on the E-BCCH.

The DCCH Call Processing or the SPACH* Channel messages screen are accessible by pressing Soft Function Keys F2 or F3, respectively.

* SMSCH, PCH and ARCH.

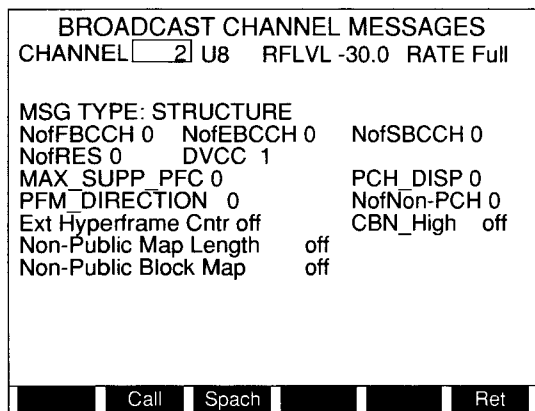

03416081

Select the channel, band, RF level, and rate to use. Move cursor to MSG TYPE and select the message to be sent. Once the message is selected, the appropriate data fields appear. Set the fields to the desired settings. Any change made to any of the data fields is reflected immediately in the data stream in the FDCCH signal.

Section 5 defines the available Broadcast Channel messages that can be sent to the Mobile Station. Section 6 defines the data fields (information elements) used with the Broadcast Channel messages.

To perform a Registration **DCCH**

The Broadcast Channel must be configured manually or set to default prior to performing a mobile station registration to ensure predictable results.

After power-up, the mobile station attempts to locate and camp on the best control channel signal (DCCH or ACC) available. While performing Control Channel Scanning and Locking, an active phone may lock and begin camping on an actual cell site control channel instead of the DCCH being broadcast from the Test Set. Judicious channel selection is recommended to provide predictable results. In certain environments the use of a RF screen room may be required.

Registration may occur rapidly. Operator must be alert to observe the actions of the mobile station.

Press **F3** from the DCCH Cell Site Simulation Menu or **F2** from the Broadcast Channel Messages screen to display the Call Processing screen.

```
FWD DIGITAL CONTROL CHANNEL
CALL PROCESSING

CHANNEL [ 2 ] U8  RFLVL -30.0  RATE Full
CALLING SETUP
TYPE ANALOG
IDT 2  MIN 316/522-4981
CHAN 130  VMAC 1  MEM 0  PV  1
SAT FREQ 5970  Hz  DEV 2.0
ALERT SETUP
TYPE ALERT W/INFO
SIGNAL PITCH MED  CADENCE 000011
EF 0  PI 00  SI 00
CALLING NUMBER 123/456-7890

PAGE  REG  Folw  Rdcch  Ret
```

03416083

After power-up and the Mobile Station begins to camp on the channel specified, the mobile station performs a power up registration if the Broadcast Channel messages have been set to default. Otherwise, press **REG F2** to perform a registration. If Follow is off, when the Mobile Station registers, the RDCCH Data Monitor screen appears displaying the Mobile Station response. If Follow is on, when the Mobile Station registers, the Call Processing screen remains displayed and the Mobile Station Registration message is used to update the MIN data field.

The MIN data field identifies the Mobile Station for further action.

To place a call to the Mobile Station DCCH

The Broadcast Channel must be configured manually or set to default prior to placing a call to a mobile station to ensure predictable results.

Press **F3** from the DCCH Cell Site Simulation Menu or **F2** from the Broadcast Channel Messages screen to display the Call Processing screen.

FWD DIGITAL CONTROL CHANNEL
CALL PROCESSING

CHANNEL 2 U8 RFLVL -30.0 RATE Full
 CALLING SETUP
 TYPE DIGITAL
 IDT 2 MIN 316/522-4981
 CHAN 130 SLOT 1 DMAC 0 DVCC 1
 SB 0 TA 0 PV 0 DIC 1 VC 1 VSELP
 ALERT SETUP
 SIGNAL PITCH MED CADENCE 000011
 CALLING NUMBER 123/456-7890

TYPE 000 PLAN 0000
 PI 00 SI 00

PAGE REG Folw Rdcch Ret More

03416084

Select the channel, band, RF level and rate to use.

Select the TYPE of channel to assign the call to (DIGITAL or ANALOG). Ensure that Follow is activated. Select the remaining call fields. For data field definitions, see Section 6.

For DIGITAL calls, a PLC message is sent before the Alert message. Only the fields for the Alert message or the PLC message appear at any one time. To select the fields of both messages, press **More F6** to display the second set of Soft Function Keys.

CALLING NUMBER 123/456-7890

TYPE 000 PLAN 0000
 PI 00 SI 00

PLC Ret More

09116019

Edit the fields that appear and press **PLC** or **ALERT F1** to display the other fields. Some message fields can be omitted by pressing **off F2**. To assign a call to a Digital Traffic Channel, Time Alignment (TA) in the PLC SETUP must be set to a value and not turned off. For data field definitions, see Section 6.

CHANNEL 2 U8 RFLVL -30.0 RATE Full
 CALLING SETUP
 TYPE DIGITAL
 IDT 2 MIN 316/522-4981
 CHAN 130 SLOT 1 DMAC 0 DVCC 1
 SB 0 TA 0 PV 0 DIC 1 VC 2 ACELP
 PLC SETUP
 DMAC 0
 TA 31
 DTX 0
 DIC 1

ALERT Ret More

03416187

Press **Page F1**. A Page message is sent to the Mobile Station. Upon receiving the Page Response from the mobile station, an Analog Voice or Digital Traffic Channel Designation message is sent, assigning the Mobile Station to the Digital Traffic or Analog Voice Channel selected. If a Digital Traffic Channel is assigned, a PLC message is sent. On either channel, an Alert message is sent to ring the Mobile Station.

The RDTTC or RVC screen appears for monitoring the response from the Mobile Station. Ending the call from the Mobile Station or pressing **Ret F6** terminates the call and returns operation to the Call screen.

To accept an origination, complete a call and monitor DCCH

The Broadcast Channel must be configured manually or set to default prior to placing a call to a mobile station to ensure predictable results.

Press **F3** from the DCCH Cell Site Simulation Menu or **F2** from the Broadcast Channel Messages screen to display the Call Processing screen.

```

FWD DIGITAL CONTROL CHANNEL
CALL PROCESSING

CHANNEL 2 U8 RFLVL -30.0 RATE Full
CALLING SETUP
TYPE DIGITAL
IDT 2 MIN 316/522-4981
CHAN 130 SLOT 1 DMAC 0 DVCC 1
SB 0 TA 0 PV 0 DIC 1 VC 1 VSELP
ALERT SETUP
SIGNAL PITCH MED CADENCE 000011
CALLING NUMBER 123/456-7890

TYPE 000 PLAN 0000
PI 00 SI 00
    
```

03416084

Select the channel, band, RF level and rate to use.

Select the TYPE of channel to assign the call to (DIGITAL or ANALOG). Ensure that Follow is activated. Select the remaining call fields. For data field definitions, see Section 6.

For DIGITAL calls, a PLC message is sent. If the Alert message fields are displayed, press **More F6** to display the second set of Soft Function Keys and press **PLC F1** and select the PLC fields as desired. Some message fields can be omitted by pressing **off F2**. To assign a call to a Digital Traffic Channel, Time Alignment (TA) in the PLC SETUP must be set to a value and not turned off.

The VC field selects the active vocoder (0 for none, 1 for VSELP or 2 for ACELP [3 to 7 are reserved for future use).

For data field definitions, see Section 6.

Place a call using the Mobile Station under test. When the Origination message is received, an Analog Voice or Digital Traffic Channel Designation message is sent. If a Digital Traffic Channel is assigned, a PLC message is sent on the FDTC.

The RDTC or RVC screen appears to monitor the response from the Mobile Station.

From RDTC screen, press **MBER F5** to display Mobile Assisted BER Measurement screen:

```

MOBILE ASSISTED BER MEASUREMENT
CHANNEL 1 U8 DVCC 100 SLOT 1
HANDOFF CHAN 22 RFLVL -65.0

Energy (r0) 0
RSSIC -63
BER < 0.01%
    
```

03416073

Data field not present if ACELP is selected as vocoder (VC)

The Energy (r0) field displays the VSELP frame energy value. The RSSIC field displays the Received Signal Strength in dBm according to the received RSSIC data field. The BER field displays the Bit Error Rate percentage reported by the Mobile Station.

Press **AUTO F1** to automatically set RF level. The Auto function adjusts the RF level until the Mobile Station reports (Channel Quality message) a BER of 2% to 4%. When the Mobile Station reports a BER of 2% to 4%, the Auto function increases the adjusted RF level 10 dB. The AUTO label remains red until the procedure is complete.

Audio is sent to DEMOD OUT and MIC/ACC Connectors. Input audio to the VSELP is routed through the MIC/ACC Connector only. (See *To input and monitor audio on the DTC (VSELP or ACELP operation) from the Test Set* in Section 3.2.)

Manually adjust the RFLVL field to find exact Mobile Station sensitivity.

Perform a handoff by selecting Handoff Channel (HANDOFF CHAN field) and pressing *Handoff F2*.

Press *Ret F6* to return to RDTc screen. Press *Ret F6* again to terminate the call and return operation to the Call screen.

To send Digital Traffic Channel messages

DCCH

Place a call to the Mobile Station as previously described. Set TYPE to DIGITAL. Once the call is completed, the RDTc screen appears. Press *FDTC F1*. The Transmit FDTC screen appears:

```

TRANSMIT FWD DGTL TRAFFIC CHAN
CHANNEL 130 U8 RFLVL-65.0 SLOT 2
ACCH FAST Talk Delay 0 Seconds

MSG TYPE HANDOFF
RFCHAN 1
RATE 0
TIMESLOT INDICATOR 0
DVCC/SCC 1
DMAC/VMAC 0
TA 0 SBI 00 SPMB 0 MEMB 0
PVI 0 DTX CONTROL 0

Send Talk Talk+ Talk- Ret

```

03416074

The current channel, band and slot of the call are displayed. Select the SLOW or FAST Associated Control Channel used for transmitting. Select the RF level to use. Move cursor to MSG TYPE and select the message to be sent. Once the message is selected, the appropriate fields appear. Set the fields to the desired settings and press *Send F1*. The message is sent on the Forward Digital Traffic Channel. The RDTc screen is displayed to monitor the response from the Mobile Station.

Press *Talk F3* to activate Talkback function (puts data received on RDTc in applicable FDTC fields and transmits data, with VSELP or ACELP, back to the Mobile Station). Use *Talk+ F4* and *Talk- F5* to select 0 to 5 second delay between receiving and transmitting.

Press *FDTC F1* to send another message or press *Ret F6* to terminate the call and return operation to the Call screen.

Section 5 defines the available Forward Digital Traffic Channel messages that can be sent to the Mobile Station. Section 6 defines the fields used with the Forward Digital Traffic Channel messages.

To send Analog Voice Channel messages

DCCH

Place a call to the Mobile Station under test as previously described. Set TYPE to ANALOG. Once the call is completed, press **FVC F1** from the RVC screen. The FVC screen appears:

```
TRANSMIT FWD VOICE CHANNEL
CHANNEL 133 U8      RFLVL -65.0

MT/ORDER HANDOFF

RFCHAN 212
PSCC   00
EF     0
SCC    00
VMAC   0
PVI    0
MEM    0

Send [ ] [ ] [ ] [ ] [ ] Ret
```

03416075

The current channel and band of the call is displayed. Set the RF level as desired. Move cursor to MT/ORDER and select the message to be sent. Once the message is selected, the appropriate fields appear. Set the fields to the desired settings and press **Send F1**. The message is sent on the Forward Analog Voice Channel. The RVC screen is displayed monitoring the Mobile Stations response.

Press **FVC F1** to send another message or press **Ret F6** to drop the call and return operation to the Call screen.

The Forward Analog Voice Channel messages that can be sent to the Mobile Station are defined in Section 5. For definitions of the fields used with the Forward Analog Voice Channel messages, see Section 6.

To send a SPACH Message **DCCH**

The Broadcast Channel must be configured manually or set to default prior to sending SPACH Channel Messages to ensure predictable results.

The SPACH Channel Messages screen is accessible from the DCCH Cell Site Simulation menu or Broadcast Channel Messages screen. Press **F2** from the DCCH Cell Site Simulation menu screen to display the SPACH Channel Messages screen.

```
SPACH CHANNEL MESSAGES
CHANNEL [2] U8  RFLVL -30.0  RATE Full

MSG TYPE: AUDIT
IDT 2      MIN 316/522-4981
Forced Re-reg 0
Debug Disp Allowed 0
Subaddress: Length off  Odd/Even off
              Type off   Index off  Character off

Send Rdcch off [ ] [ ] [ ] Ret
```

03416086

Select the channel, band, RF level and rate to use.

Move cursor to MSG TYPE and press **DATA SCROLL** ↑ to select the SPACH message to send; press **ENTER**. Section 5 defines the available SPACH Channel messages that can be sent to the Mobile Station. Select the remaining data fields. Some message fields can be omitted by pressing **off F3**. For data field definitions, see Section 6.

Press **Send F1** to send the SPACH message to the mobile station. The Reverse Digital Control Channel Data Monitor (RDCCH) (see Section 3.1) appears to display the response from the mobile station.

Tip: For quick data field selection in the RDCCH Data Monitor, use the SetMsg feature (Soft Function Key F4) in the RDCCH Setup screen. Select the corresponding message type sent from the mobile station.

To perform modulation accuracy and power testing on a mobile station DCCH

Place a call to the Mobile Station as previously described. Set TYPE to DIGITAL. Once the call is completed, the RDTC screen appears:

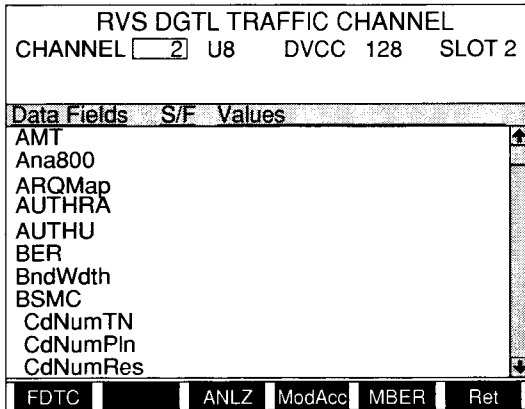

03416112

Press **ModAcc F4** to display the Mobile Station Modulation Accuracy and Power screen:

MODULATION ACCURACY AND POWER		
	156 Symbols	First 10 Symbols
EVM	7.16%	7.71%
Mag Error	3.52%	4.58%
Phase Error	3.42 Deg	3.41 Deg
Freq Error	5.4 Hz	
I/Q Offset	-29.4 dB	
Droop	-0.0008 dB	
Power	21.83 dBm	152.66 mW

Stop I/Q Const Power Ret More

03416106

When screen appears, the CSA begins measuring the RMS values of modulation accuracy and output power of the Mobile Station transmit burst on the RDTC. Two methods of measurement are displayed:

1. The full "maximum-effect" portion of the Mobile Station transmit burst consisting of 156 symbols (312 bits).

2. The first 10 symbols (20 bits) of a Mobile Station transmit burst (following the ramp-up) averaged over 10 bursts.

The measurements displayed are divided into the same categories as discussed in Section 3.4 for Base Station modulation accuracy with the following exceptions:

- **Droop**
Change in amplitude over the portion of the Mobile Station transmit burst being measured.
- **Mobile Station Power**
Channel power represented in dBm and mW in the portion of the Mobile Station transmit burst being measured.
- **The first 10 Symbols modulation accuracy is measured in RMS Error Vector Magnitude (EVM), RMS Magnitude Error and RMS Phase Error.**

Press **Stop F1** to stop measurements.

Press **More F6** and **ANLZ F3** to observe the spectrum of the received signal. Press **Sp Tst F5** to return to Modulation Accuracy screen.

Press **More F6** and **Zero F2**, to zero power meter. A message appears informing the user to, first, disconnect RF and DC signal from the T/R Connector, then press **ENTER** to begin.

To plot $\pi/4$ DQPSK I/Q pattern with constellation (mobile station) **DCCH**

From the Modulation Accuracy and Power screen, press **I/Q F2** to display the Pi/4 DQPSK I-Q Pattern screen:

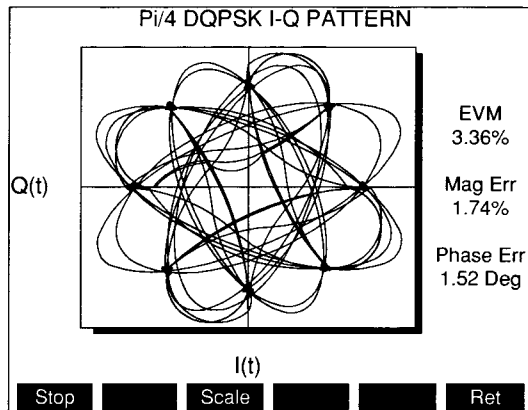

03416108

When the Pi/4 DQPSK I-Q Pattern screen appears, the CSA begins to continually sample the signal from the Mobile Station. The I/Q pattern and constellation is repeatedly plotted from each sample, clearing the pattern display area at the end of each plot sequence. In addition, the values of RMS Error Vector Magnitude (EVM), RMS Magnitude Error and RMS Phase Error are repeatedly updated from each sample.

For each sample, the values are updated first, followed by the plotting of the I/Q Pattern.

Press **Stop F1** to stop sampling and freeze display.

When the plotting first begins, the pattern is automatically scaled to extend to 90% of pattern display area. Pressing **Scale F3** scales the next incoming data pattern to extend to 90% of pattern display area.

To plot constellation alone (mobile station) **DCCH**

From the Modulation Accuracy and Power screen, press **Const F3** to display the Pi/4 DQPSK Constellation screen:

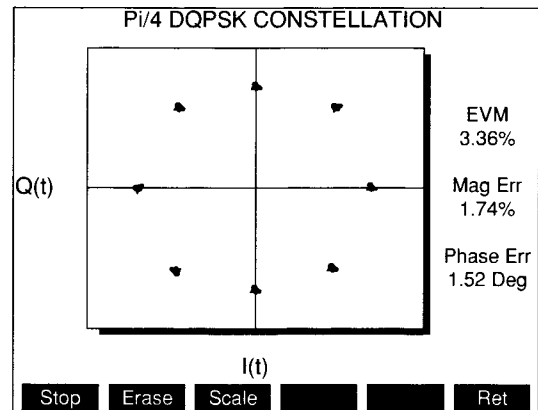

03416110

When the Pi/4 DQPSK Constellation screen appears, the CSA begins to continually sample the signal from the Mobile Station. The constellation of decision points is repeatedly plotted from each sample. In addition, the values of RMS Error Vector Magnitude (EVM), RMS Magnitude Error and RMS Phase Error are repeatedly updated.

For each sample, the values are updated first, followed by the plotting of the constellation.

Press **Stop F1** to stop sampling and freeze display.

Pressing **Erase F2** turns the label red and clears the display area at the end of the plotting sequence for each sample. Pressing **Erase F2**, again, turns off the Erase feature.

As with the Pi/4 DQPSK I-Q Pattern screen, the constellation can be rescaled in reference to the display area by pressing **Scale F3**.

To display power meter alone (mobile station) DCCH

From the Modulation Accuracy and Power screen, press **Power F4** to graphically display channel power:

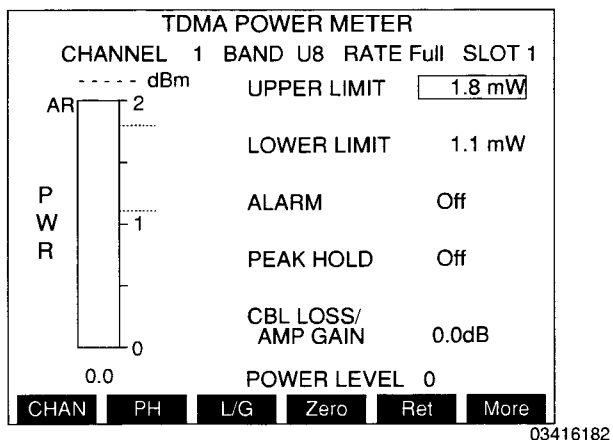

When the TDMA Power Meter screen appears, the CSA begins to continually sample the signal from the Mobile Station. The values and graphical representation of power is repeatedly updated from each sample. Press **Stop F1** to stop sampling and freeze display.

Press **Zero F4**, to zero power meter. A message appears informing the user to, first, disconnect RF and DC signal from the T/R Connector, then press **ENTER** to begin.

With cursor in the Power Level field, use the keypad of the IFR-1900, enter the TDMA power level of the Mobile Station from 0 to 10. Press **ENTER**. The CSA sends a Physical Layer Control (PLC) message to the Mobile Station to change output power, accordingly.

The following ranges (in mW) are utilized by the power meter screen:

0 to 2	0 to 50	0 to 1000
0 to 10	0 to 250	0 to 4000

The TDMA Power Meter screen operates similar to the Power Meter Operation screen. See the IFR-1900 Communications Service Monitor Operation Manual.

To perform adjacent channels power measurements (mobile station)

From the Modulation Accuracy and Power screen, press **More F6** and **ACPM F4** to display the Adjacent Channel Power Measurement screen.

Press Start F1 to measure signals from the mobile station.

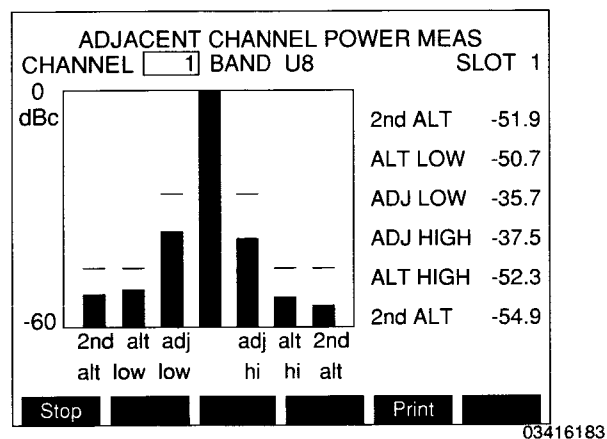

The screen indicates the level of adjacent channels, shown in dB, relative to the selected center channel level. The adjacent channels (ADJ LOW/alt low and ADJ HIGH/adj hi) are, of course, 30 kHz from the center channel. The alternate channels (ALT LOW/alt low and ALT HIGH/alt hi) are 60 kHz from the center channel and the second alternate channels (2nd ALT/2nd alt) are 90 kHz from the center channel.

If desired, press **Print F5** to send the formatted measurement data out the OPT. RS-232 Connector. Measurement data includes the time and date the measurements were taken.

Press **Stop F1** to stop measurements.

3.4 DCCH MOBILE SIMULATION DCCH

The DCCH Mobile Simulation is used to test Base Stations on the Reverse Digital Control Channel (RDCCH). The Test Set can transmit specific RACH (Random Access Channel) message types. Also, the Test Set can continuously transmit pseudo-random or a user-defined data words to aid in performing RF testing.

The CSA must be receiving an FDCCH signal to transmit on the RDCCH.

To access the DCCH Mobile Simulation Screens DCCH

Pressing **DPLX**, **Sp Tst** and **4** displays the Reverse (RVS) Digital Control Channel screen.

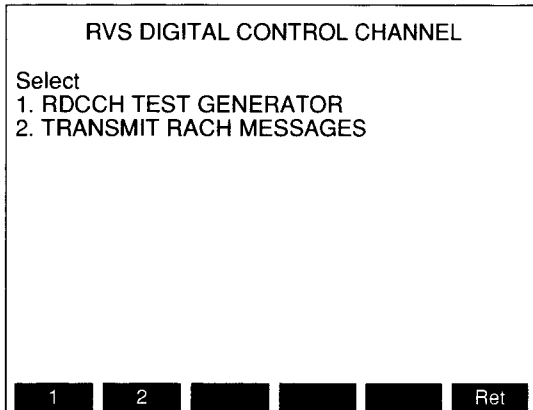

09116013

To send repetitive random or user-defined data words DCCH

Pressing **1** from the RVS Digital Control Channel screen displays the RDCCH Test Generator.

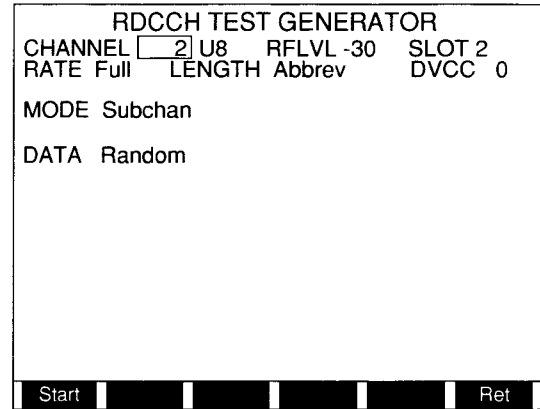

03416087

Select the RF level, cellular channel, band and TDMA slot in which to transmit. Move cursor to the RATE field and, pressing **ENTER**, toggle the rate to Full or Half. Move cursor to the LENGTH field and, pressing **ENTER**, toggle the LENGTH to normal or abbreviated. Select the DVCC (0 to 255). Move cursor to the MODE field and, pressing **DATA SCROLL** \uparrow , select Contiguous (every TDMA block or 1/2 frame) or Subchannel (every 6th TDMA block) transmission; press **ENTER**.

To send RACH (Random Access Channel) messages on the RDCCH DCCH

Pressing **2** from the RVS Digital Control Channel screen displays the TRANSMIT RVS DGTL CONTROL CHAN screen.

```

TRANSMIT RVS DGTL CONTROL CHAN
CHANNEL 130 U8 RFLVL -65.0 SLOT 2
RATE Full LENGTH Abbrev

MSG TYPE AUDIT CONFIRMATION
IDT 2 MIN 316/522-4981
PFC(-1) 0
Selected PSID/RSID 0
User Group: Type 0 Status 0
ID FFFF
Subaddress: Length 1 Odd/Even 0
Type 3 Index 0 Character 0
Display: Length 0 Index 0 Char 0
    
```

Send Fdch Next Prev Ret

03416196

Select the RF Level, cellular channel and band and TDMA slot in which to transmit. Move cursor to the RATE field and, pressing **ENTER**, toggle the rate to Full or Half. Move cursor to the LENGTH field and, pressing **ENTER**, toggle the LENGTH to normal or abbreviated.

Position cursor on MSG TYPE and press **DATA SCROLL** ↑ until desired RACH message type appears in the activated field; press **ENTER** to select. Section 5 defines the available RACH messages that can be sent on the RDCCH. Once the message is selected, the appropriate fields appear. Set the fields to the desired settings. Some message fields can be omitted by pressing **off F3**. For data field definitions, see Section 6.

Pressing **Next F4** or **Prev F5** steps the operation through each message type, some of which consist of more than one screen.

Pressing **Send F1** transmits the selected RACH message once. The operator may press **Fdch F2** to transfer operation to the Broadcast Channel data monitor screen to view the response on the FDCCH; then return to send the next message.

Move cursor to DATA field and press **DATA SCROLL** ↑ to select **Random** for pseudo-random data words or **User** for User-defined data words; press **ENTER**. When User-defined data is selected, seven additional 16 bit data field appear for editing. These data fields constitute the user-defined data words.

Move cursor to DATA field and press **DATA SCROLL** ↑ to select **Random** for pseudo-random data words or **User** for User-defined data words; press **ENTER**. When User-defined data is selected, seven additional 16 bit data field appear for editing. These data fields constitute the user-defined data words.

```

MODE Subchan
DATA User
 3AC5 1234 14FD FFFD
 ABCD EFEF F800
    
```

Start Ret

09116037

Press **Start F1** to begin sending the repetitive data words on the RDCCH. Press **Stop F1** to stop transmitting on the RDCCH.

3.5 BIT ERROR RATE

The Digital Traffic Bit Error Rate screen performs Bit Error Rate tests on signals received from the Base or Mobile Station. In addition, Loopback functions are available for Base Stations with self BER Test capabilities.

The following modes are available:

- Pseudo-Random
- User Defined
- Loopback (Base Station only)
- Loop 45 MHz Offset (Base Station only)

BER Test Modes

In the PSEUDO-RANDOM or USER DEFINED modes, the CSA transmits data words containing Pseudo-random or user-defined data on the Reverse Digital Traffic Channel. The Base Station is required to transmit the data as it is received (with no error correction) on the Forward Digital Traffic Channel (FDTC).

Loopback Modes (Base Station only)

In the LOOPBACK mode, the CSA takes the data contained in each TDMA slot on the FDTC and reformats and retransmits the data in TDMA timeslots on the Reverse Digital Traffic Channel.

In the LOOP 45MHz OFFSET mode, the CSA demodulates the FDTC signal and, again, modulates the data, as received, with a carrier at 45 MHz below the received signal.

To connect the Test Set to the Mobile or Base Station

The T/R Connector transmits and receives the test signal to and from the Mobile Station.

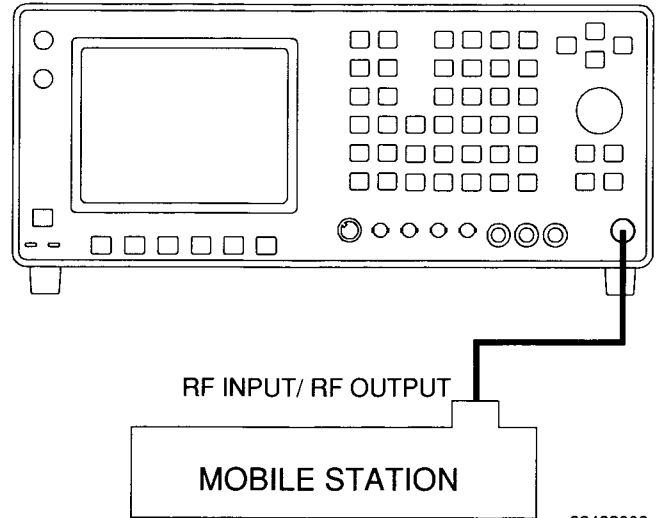

The T/R Connector receives the test signal from the Base Station. The DUPLEX OUT Connector transmits the test signal to the Base Station. The ANTENNA IN Connector can also be used for receiving Base Station signals, provided signals are less than 10 mW.

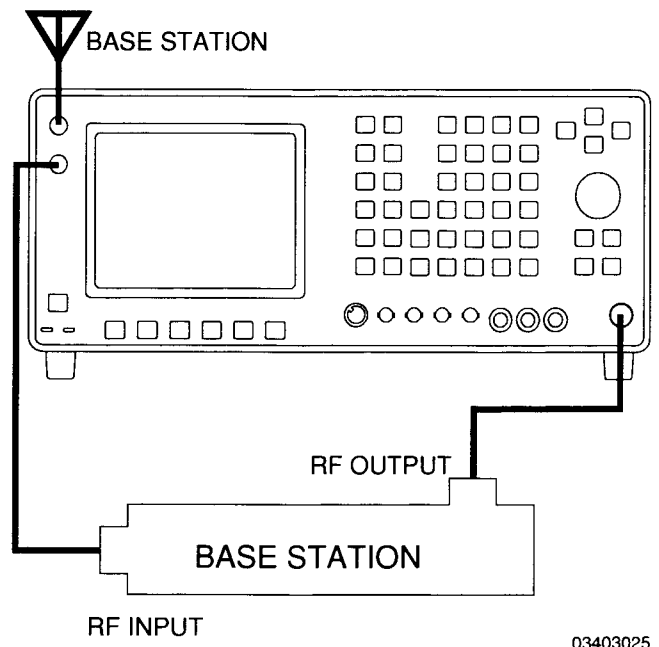

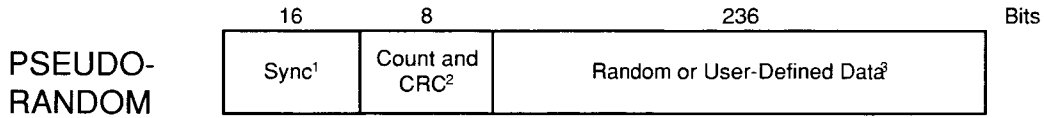

NOTES:

1. The value of the 16 bit Sync word is 0xA712.
2. The 8 bit Count and CRC word consists of a 3 bit count and a 4 bit CRC for correcting the count. The remaining bit is the MSB and is always zero.
3. There are eight 236 Random bit patterns - a different pattern for each Count (see NOTE 2).

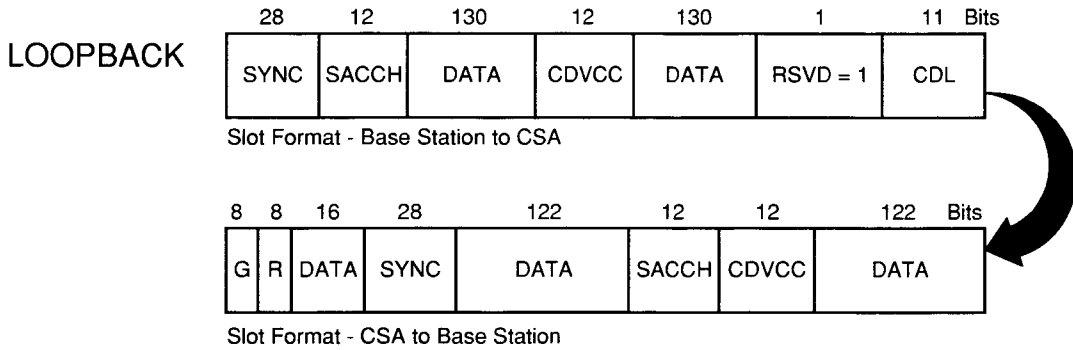
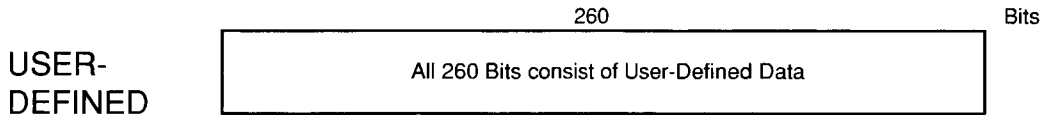

LOOP 45 MHz OFFSET

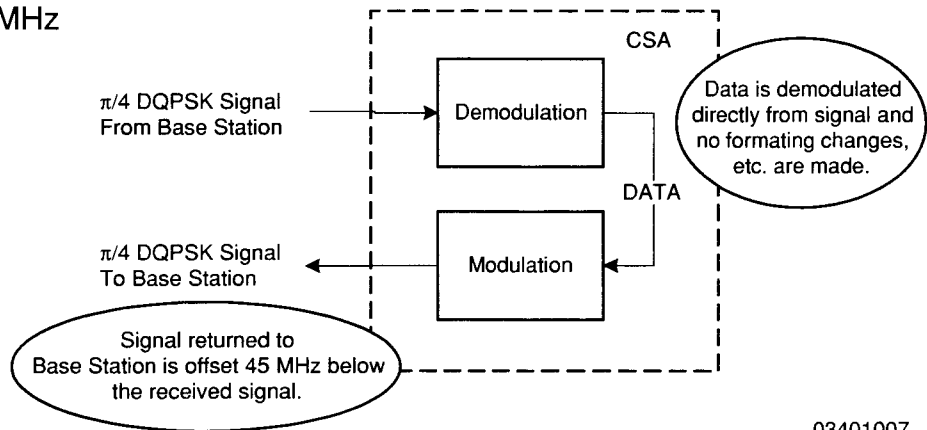

03401007

Digital Traffic BER Test Modes

To perform a BER test

From the Dual Mode TIA/EIA-136 Cellular main menu, press **5** to display the Bit Error Rate screen:

```

          BIT ERROR RATE
CHANNEL  123 U8
SLOT     1      DVCC 100
RF LVL   -30.0  STEP  1.0
MODE     MOBILE STATION

DATA     USER DEFINED

TOTAL BITS      9325
TOTAL ERRORS    47
BER             0.5 %

GO  Edit  ANLZ  Clear  Ret

```

03416180

Select Mode, Digital Traffic Channel, band, slot and DVCC to use. Select RF level used to transmit. (Editing with **DATA SCROLL** ↑ and ↓ adjusts the RF level by the STEP amount.) Set the STEP setting as desired.

The CSA begins transmitting on the RDTC when the Bit Error Rate screen appears.

Select the DATA type. If USER DEFINED is selected, press **Edit F2** to display the user defined data:

```

          USER DEFINED DATA FIELD SETUP

DATA:  A5 A5 A5 A5 A5 A5 A
       5 A5 A5 A5 A5 A5 A5
       A5 A5 A5 A5 A5 A5 A
       5 A5 A5 A5 A5 A5 A5
       A5 A5 A5 A5 A5 A5 A

Ret

```

03416109

Press **ENTER** and enter desired data. Press **ENTER** and **Ret F6**.

Press **ANLZ F4** to observe spectrum of the received signal.

Press **GO F1** to start test. Press **Clear F5** to clear the current results.

If the Base or Mobile Station under test does not immediately return the test data, a large BER percentage is displayed and needs to be cleared.

3.6 MODULATION ACCURACY AND POWER

The Modulation Accuracy and Power screen measures the $\pi/4$ DQPSK modulation and Power level of signals received from the Base Station. The T/R Connector receives the signals and connects to the RF output of the Base Station.

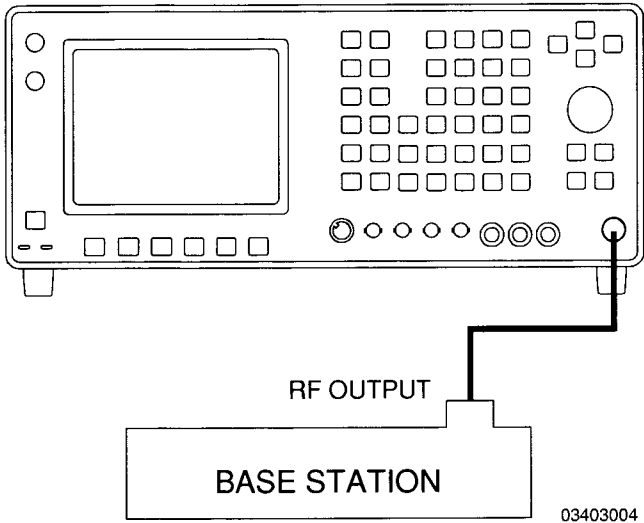

To perform a modulation accuracy and power test

From the Dual Mode TIA/EIA-136 Cellular main menu, press **6** to display the Modulation Accuracy screen:

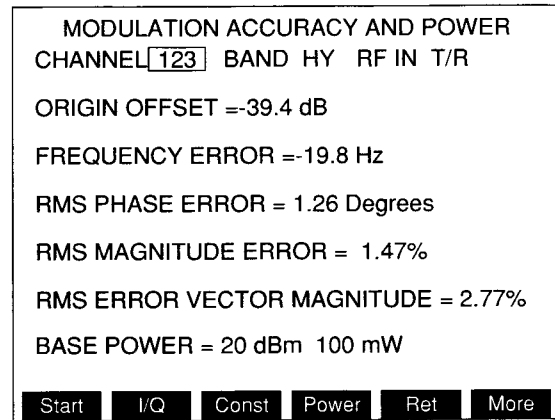

03416181

Select the Forward Digital Traffic channel and the Base Station signal band to receive.

Use ANTENNA IN Connector and set RF IN to ANT for low power measurements (as low as -40 dBm) or set RF IN to T/R.

Press **More F6** to display 2nd set of Soft Function Keys:



03416179

Press **ANLZ F3** to observe the spectrum of the received signal. Press **Sp Tst F5** to return to Modulation Accuracy screen.

Press **Zero F2**, to zero power meter. A message appears informing the user to, first, disconnect RF and DC signal from the T/R Connector, then press **ENTER** to begin.

Press **Print F5** to send the formatted modulation accuracy and power data out the OPT. RS-232 Connector to a pc or RS-232 serial printer. The data includes the time and date the modulation accuracy and power measurements were taken.

Press **START F1**. When the test is complete, the following results are displayed:

- **ORIGIN OFFSET**
20×LOG of the I/Q origin offset magnitude. Indicates the amount of carrier feedthrough. An offset <-30 dBc satisfies current requirements.
- **FREQUENCY ERROR**
Difference between the received carrier frequency and the ideal carrier frequency. A frequency error $\leq \pm 200$ Hz satisfies current requirements.
- **RMS PHASE ERROR**
RMS value of the absolute phase errors.
- **RMS MAGNITUDE ERROR**
RMS value of the differences between the ideal magnitudes and the received magnitudes.
- **RMS ERROR VECTOR MAGNITUDE**
RMS value of the magnitude of the error vectors. A value <12.5% satisfies current requirements.
- **BASE POWER**
Channel power represented in dBm and mW.

To plot $\pi/4$ DQPSK I/Q pattern with constellation

From the Modulation Accuracy and Power screen, press **I/Q F2** to display the Pi/4 DQPSK I-Q Pattern screen:

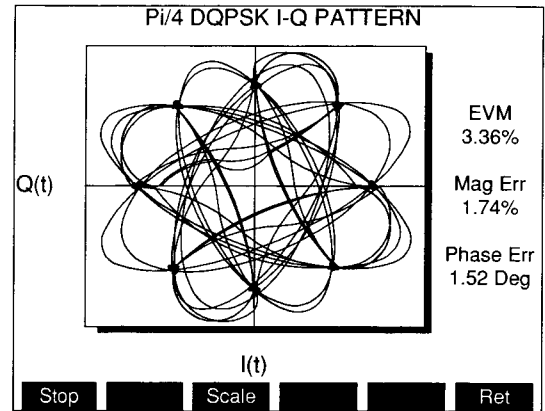

03416108

When the Pi/4 DQPSK I-Q Pattern screen appears, the CSA begins to continually sample the signal from the Base Station. The I/Q pattern and constellation is repeatedly plotted from each sample, clearing the pattern display area at the end of each plot sequence. In addition, the values of RMS Error Vector Magnitude (EVM), RMS Magnitude Error and RMS Phase Error are repeatedly updated from each sample.

For each sample, the values are updated first, followed by the plotting of the I/Q Pattern.

Press **Stop F1** to stop sampling and freeze display.

When the plotting first begins, the pattern is automatically scaled to extend to 90% of pattern display area. Pressing **Scale F3** scales the next incoming data pattern to extend to 90% of pattern display area.

To plot constellation alone

From the Modulation Accuracy and Power screen, press **Const F3** to display the Pi/4 DQPSK Constellation screen:

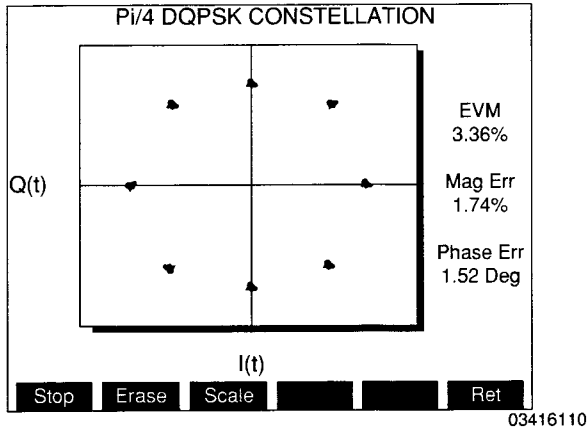

When the Pi/4 DQPSK Constellation screen appears, the CSA begins to continually sample the signal from the Base Station. The constellation of decision points is repeatedly plotted from each sample. In addition, the values of RMS Error Vector Magnitude (EVM), RMS Magnitude Error and RMS Phase Error are repeatedly updated.

For each sample, the values are updated first, followed by the plotting of the constellation.

Press **Stop F1** to stop sampling and freeze display.

Pressing **Erase F2** turns the label red and clears the display area at the end of the plotting sequence for each sample. Pressing **Erase F2**, again, turns off the Erase feature.

As with the Pi/4 DQPSK I-Q Pattern screen, the constellation can be rescaled in reference to the display area by pressing **Scale F3**.

To display power meter alone

From the Modulation Accuracy and Power screen, press **Power F4** to graphically display channel power:

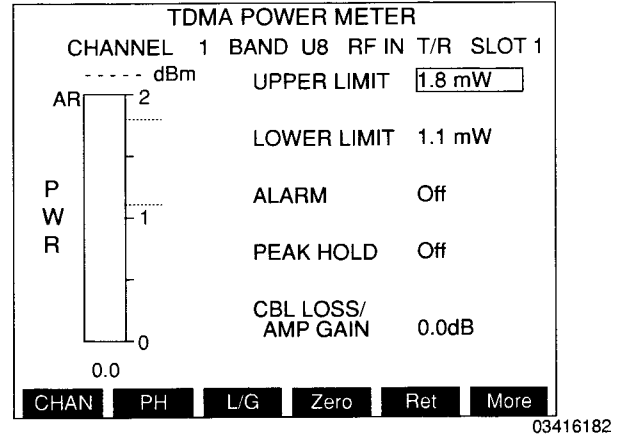

When the TDMA Power Meter screen appears, the CSA begins to continually sample the signal from the Base Station. The values and graphical representation of power is repeatedly updated from each sample. Press **Stop F1** to stop sampling and freeze display.

Press **Zero F4**, to zero power meter. A message appears informing the user to, first, disconnect RF and DC signal from the T/R Connector, then press **ENTER** to begin.

The following ranges (in mW) are utilized by the power meter screen:

0 to 2	0 to 250	0 to 20000
0 to 10	0 to 1000	0 to 80000
0 to 50	0 to 4000	

The TDMA Power Meter screen operates similar to the Power Meter Operation screen. See the IFR-1900 Communications Service Monitor Operation Manual.

3.7 TDMA POWER

The TDMA Power Meter screen measures Base Station output power. This is the same meter accessed from the Modulation Accuracy and Power screen. The T/R Connector receives the signals and connects to the RF output of the Base Station.

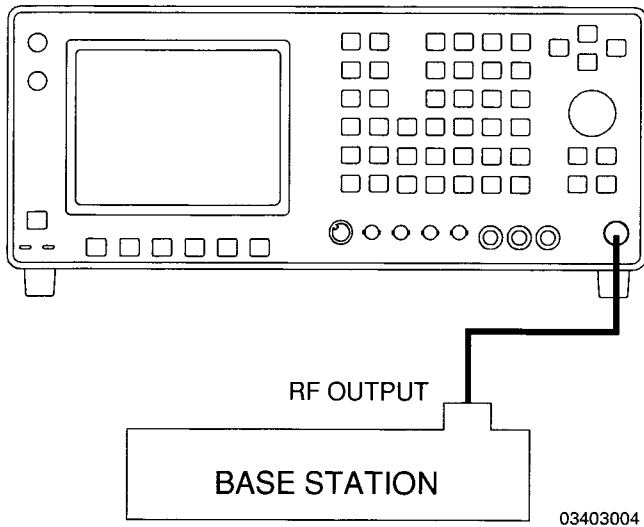

When the TDMA Power Meter screen appears, the CSA begins to continually sample the signal from the Base Station. The values and graphical representation of power is repeatedly updated from each sample. Press **Stop F1** to stop sampling and freeze display.

Press **Zero F4**, to zero power meter. A message appears informing the user to, first, disconnect RF and DC signal from the T/R Connector, then press **ENTER** to begin.

The following ranges (in mW) are utilized by the power meter screen:

0 to 2	0 to 250	0 to 20000
0 to 10	0 to 1000	0 to 80000
0 to 50	0 to 4000	

The TDMA Power Meter screen operates similar to the Power Meter Operation screen. See the IFR-1900 Communications Service Monitor Operation Manual.

To perform a power test

From the Dual Mode TIA/EIA-136 Cellular main menu, press 7 to display the TDMA Power Meter screen:

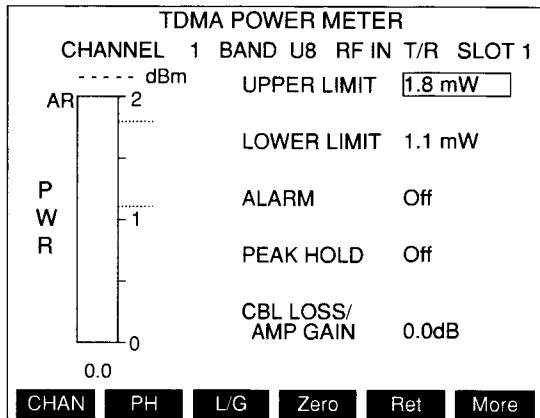

3.8 ADJACENT CHANNEL POWER MEASUREMENT

The Adjacent Channel Power Measurement screen measures the ratio of the power in the adjacent channels to the power in the center channel for Base Stations or Mobile Stations. The T/R Connector receives the signals and connects to the RF output of the Base or Mobile Station. The ANTENNA IN Connector can also be used for receiving Base Station signals, provided signals are less than 10 mW.

To perform an Adjacent Channel Power Measurement test

From the Dual Mode TIA/EIA-136 Cellular main menu, press 8 to display the Adjacent Channel Power Measurement screen:

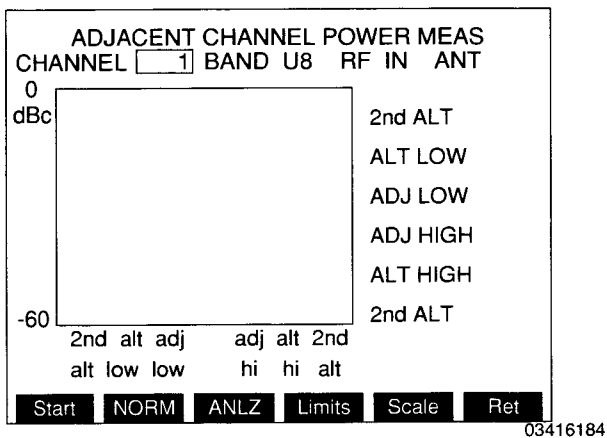

Press **NORM F2** to normalize or flatten out level differences between the tested frequencies due to the signal filter (takes approximately 30 seconds). Repeat normalize function after any CHANNEL change.

Press **Scale F5** to scale input to be as close as possible without going over the top of scale for best level accuracy (takes <2 minutes with RF IN set to T/R or <10 seconds with RF IN set to ANT). Repeat scale function after any significant signal level change.

Press **Limits F4** to set level limits (lines shown on screen during measurement) for the frequencies tested (30 kHz from center-adjacent channels, 60 kHz from center-1st alternate channels and 90 kHz from center-2nd alternate channels). Press **Default F1** to set limits to default values (shown below). Press **Off F3** to deactivate selected limits. Press **Ret F6** to return to Adjacent Channel Power Measurement screen.

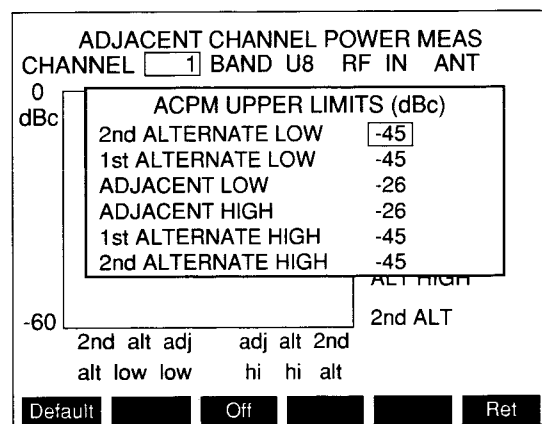

Press **Start F1** to measure signals from the base station.

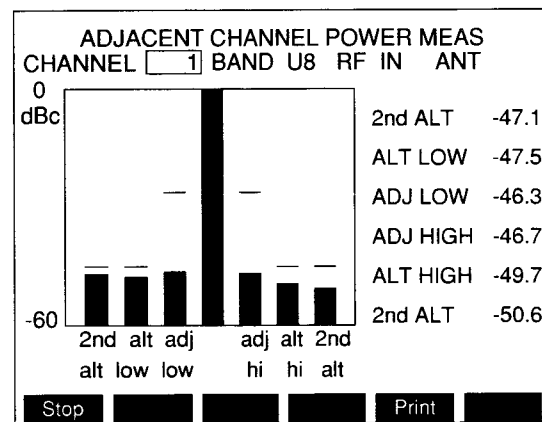

Press **Print F5** to send the formatted measurement data out the OPT. RS-232 Connector to a pc or RS-232 serial printer. Measurement data includes the time and date the measurements were taken.

Press **Stop F1** to stop measurements.

APPLICATIONS

4.1 MONITORING A BASE STATION OFF THE AIR (ACC)

This procedure captures and displays selected data fields on the Forward Analog Control Channel when a Page message is received.

1. Connect Antenna to the ANTENNA IN Connector.

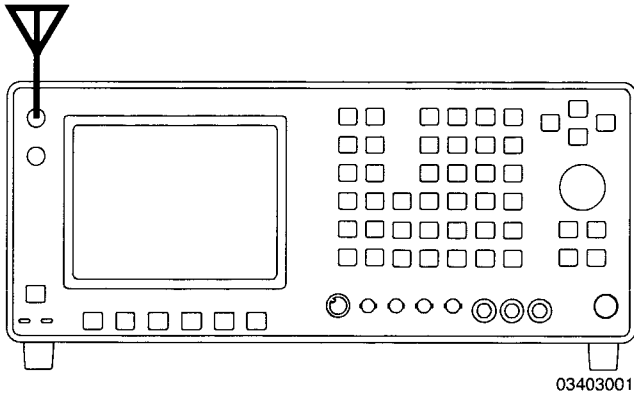

2. Press **DPLX** and **Sp Tst F5** to display the Dual Mode TIA/EIA-136 Cellular menu.
3. Press **1** and **FOCC F4** to display FOCC screen.
4. Press **SETUP** to enter FOCC setup menu:

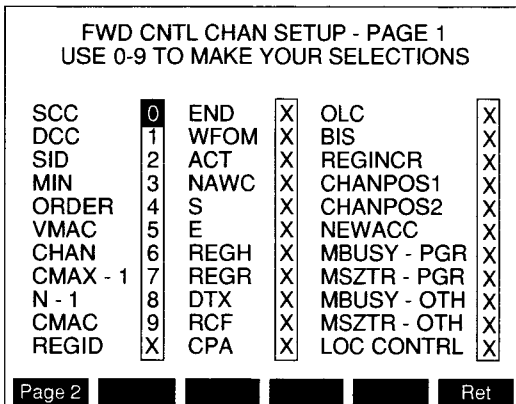

03416189

ACC - Analog Control Channel
DCCH - Digital Control Channel

5. Select the data fields to display on the FOCC screen from this menu. Use the FIELD SELECT Keys to move the cursor and use the DATA ENTRY Keys to select the data fields as shown.
- 6.. When the data fields are selected, press **Ret F6** to return to the FOCC screen:

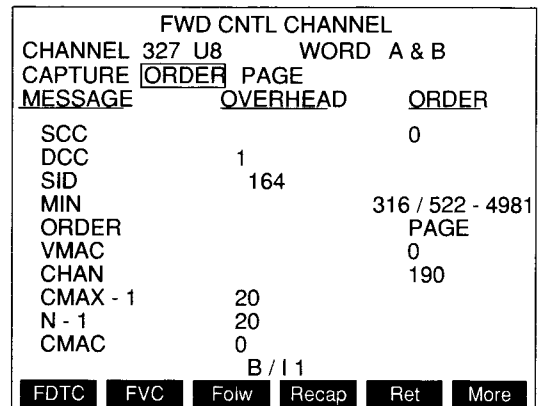

03416089

7. Move cursor to CHANNEL and use DATA ENTRY Keys to enter a Control Channel and associated cellular band. Press **ENTER**.
8. Move cursor to WORD and press **DATA SCROLL** ↑ until desired word selection appears.
9. Move cursor to CAPTURE and press **DATA SCROLL** ↑ until ORDER appears. Press **ENTER**.
10. Move cursor to the ORDER field and press **DATA SCROLL** ↑ until PAGE appears. Press **ENTER**.

When a Page message is received on the selected Analog Control Channel, the screen freezes, displaying the data fields selected from the FOCC setup menu.

11. Press **Recap F4** to restart the Capture function.

4.2 FOLLOWING A CALL FROM THE ANALOG CONTROL CHANNEL

This procedure follows a call from the Forward Analog Control Channel to the assigned Digital Traffic Channel.

1. Connect Antenna to the ANTENNA IN Connector.

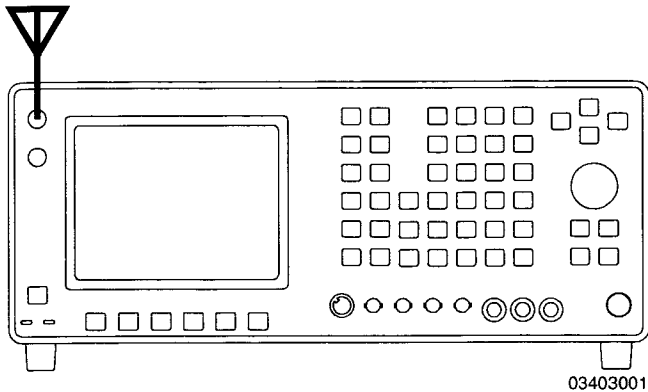

2. Press **DPLX** and **Sp Tst F5** to display the Dual Mode TIA/EIA-136 Cellular menu.
3. Press **I** and **FOCC F4** to display FOCC screen. Press **FDTC F1** to display FDTC screen.
4. Press **SETUP** to enter FDTC setup menu:

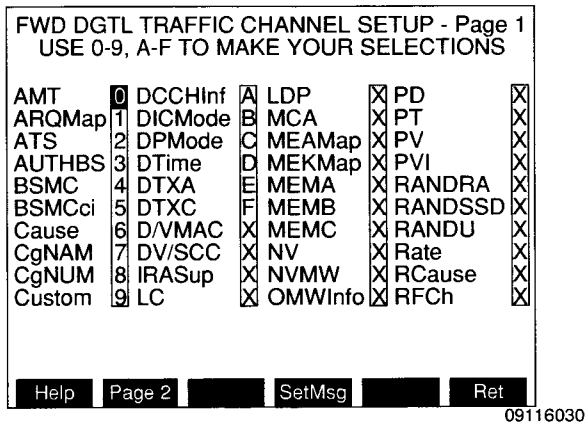

5. Select the data fields to display on the FDTC screen from this menu. Use the **FIELD SELECT** Keys to move the cursor and use the **DATA ENTRY** Keys to select the fields as shown.
6. Press **Page2 F1** to display page 2 of the FDTC setup menu:

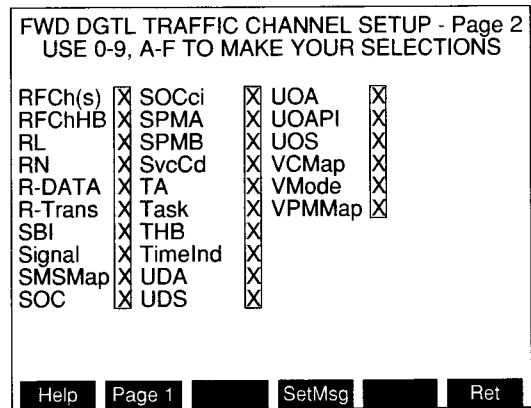

7. Use the **FIELD SELECT** Keys to move the cursor and use the **DATA ENTRY** Keys to select the additional fields shown.
8. When the data fields are selected, press **Ret F5** to return to the FDTC screen. Press **Ret F5**, again to return to the FOCC screen.

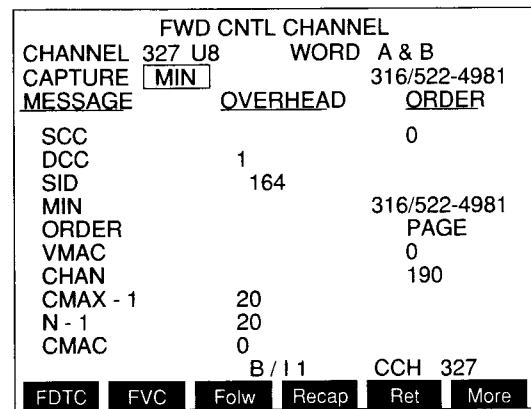

9. Move cursor to CHANNEL and use DATA ENTRY Keys to enter an Analog Control Channel and associated cellular band. Press **ENTER**.
10. Move cursor to WORD and press **DATA SCROLL** ↑ until desired word selection appears.
11. Move cursor to CAPTURE and press **DATA SCROLL** ↑ until MIN appears. Press **ENTER**.
12. Move cursor to the MIN field and use DATA ENTRY Keys to enter the MIN of the Mobile Station called. Press **ENTER**.
13. Press **Folw F3** until label appears red.

When a Slot message is received for the selected MIN, the CSA displays the FDTC screen to monitor the assigned channel and slot.

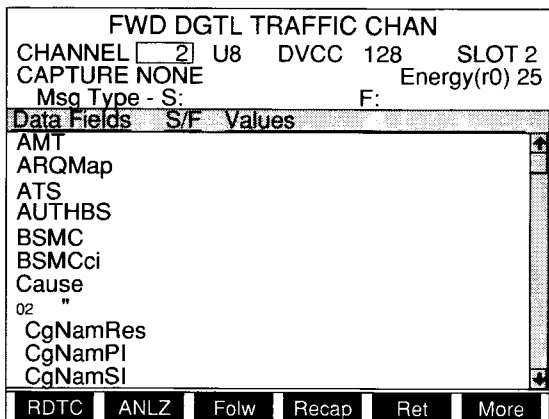

03416195

If there is a handoff, the CSA monitors the new assigned channel (Forward Digital Traffic Channel or Forward Analog Voice Channel). When the call is terminated, operation returns to the FOCC screen.

4.3 MONITORING RAW DATA ON FORWARD ANALOG CONTROL CHANNEL

This procedure captures a Page message and the surrounding raw data received on the Forward Analog Control Channel.

1. Connect Antenna to the ANTENNA IN Connector.

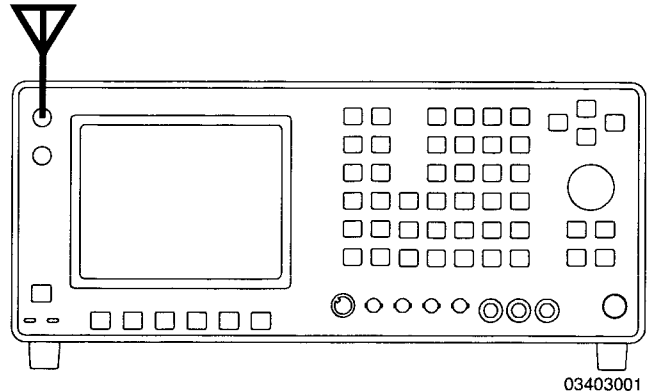

03403001

2. Press **DPLX** and **Sp Tst F5** to display the Dual Mode TIA/EIA-136 Cellular menu.
3. Press **1** and **FOCC F4** to display the FOCC screen.
4. Press **More F6** and **RAW F2** to display the RAW FOCC screen.

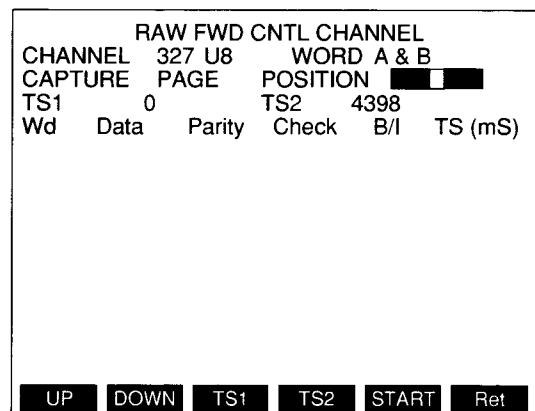

03416091

- Move cursor to CHANNEL and use DATA ENTRY Keys to enter an Analog Control Channel and associated cellular band. Press ENTER.
- Move cursor to WORD and press DATA SCROLL ↑ until desired word selection appears.
- Move cursor to CAPTURE and press DATA SCROLL ↑ until PAGE appears. Press ENTER.
- Move cursor to the POSITION field and press DATA SCROLL ← and → to move POSITION setting to the middle.
- Press START F5. (Wait appears in the top left corner until the 100 word buffer is full.)

Once the buffer is full or STOP F5 is pressed, the data words are displayed.

- Press UP F1 or DOWN F2 to scroll the displayed data words.

Setting a TS field (TS1 or TS2) to a time stamp value and pressing the corresponding Soft Function Key displays that part of the data buffer.

RAW FWD CNTL CHANNEL					
CHANNEL 327 U8		WORD A & B			
CAPTURE	PAGE	POSITION		█	
TS1	0	TS2		4398	
Wd	Data	Parity	Check	B/I	TS (mS)
A:	D5C19F9	F8C	GOOD	1	0
B:	D5C19F9	F8C	GOOD	1	0
A:	D5C19F9	F8C	GOOD	1	46
B:	D5C19F9	F8C	GOOD	1	46
A:	D01480E	368	GOOD	1	92
B:	D01480E	368	GOOD	1	92
A:	DC2994F	526	GOOD	1	138
B:	DC2994F	526	GOOD	1	138
A:	D5C19F9	F8C	GOOD	1	185
B:	D5C19F9	F8C	GOOD	1	185

UP DOWN TS1 TS2 START Ret

03416092

4.4 PLACING A DIGITAL CALL TO A MOBILE STATION (ACC)

This procedure places a DIGITAL call to the Mobile Station under test.

- Connect the RF input/RF output connector of the Mobile Station to the T/R Connector.

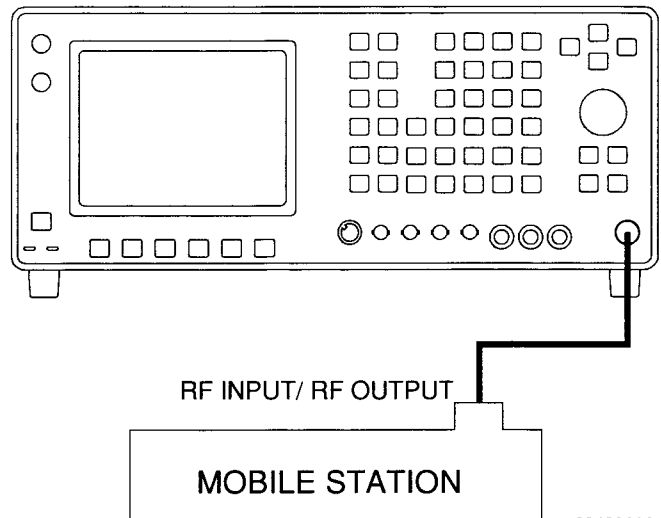

03403002

- Press DPLX and Sp Tst F5 to display the Dual Mode TIA/EIA-136 Cellular menu.
- Press 2 to display the System Parameter screen of the Cell Site Simulator:

CELL SITE SIMULATION			
FWD CNTL CHANNEL			
CHANNEL	333 U8	RFLVL	-65.0
SYSTEM PARAMETER OVERHEAD MESSAGE			
DCC	0	PCI	1
RCF	1	SID1	83
S	1	E	1
REGH	0	REGR	0
N	21	CMAx	21
AUTH	0	EP	0
CONTROL FILLER MESSAGE			
CMAC	0	SDCC1	0
SDCC2	0	WFOM	1

Start RECC Ret

03416093

4. Move cursor to CHANNEL and use DATA ENTRY Keys to enter an Analog Control Channel and associated cellular band. Press **ENTER**.
5. Move cursor to RF LVL and use DATA ENTRY Keys to enter the RF level used when transmitting to the Mobile Station. Press **ENTER**.
6. Move cursor to each System Parameter and Control-Filler field and set as shown.
7. Press **Start F1** to start transmitting the System Parameter Overhead message.
8. Press **Call F3** to display the Call screen:

```

CELL SITE SIMULATION
  FWD CNTL CHANNEL
CHANNEL 333 U8 RFLVL -65.0

CALLING SETUP
TYPE DIGITAL TIA/EIA-136
MIN 316/522-4981
CHAN 130 SLOT 2 DMAC 0 DVCC 1
PM 0 MEM 0 EF 0 VC VSELP
ALERT SETUP
SIGNAL PITCH MED CADENCE 000001
CALLING NUMBER 4445556666

TYPE 000 PLAN 0000
PI 00 SI 00

```

Page AutoRg Folw RECC Ret More

03416199

9. Press **Folw F3** until label appears red.
10. Press **AutoRg F2**. to allow the registration of the Mobile Station to update the MIN field.
11. Move cursor to the CALLING SETUP TYPE and press **ENTER** until DIGITAL appears. Set the remaining parameters as shown.

12. Press **More F6** and **PLC F1** to display the PLC message fields. Set these fields as shown:

```

CELL SITE SIMULATION
  FWD CNTL CHANNEL
CHANNEL 333 U8 RFLVL -65.0

CALLING SETUP
TYPE DIGITAL
IDT 2 MIN 316/522-4981
CHAN 130 SLOT 1 DMAC 0 DVCC 1
SB 0 TA 0 PV 0 DIC 1 VC VSELP
PLC SETUP
DMAC 0
TA 0
DTX 0
DIC 1

```

Alert Ret More

03416200

13. Press **More F6** and **Page F1** to send the Page message.

The CSA monitors the Mobile Station and displays the RDTC screen. When the call is terminated, operation returns to the call screen.

4.5 PERFORMING A HANDOFF ON A CALL MADE TO A MOBILE STATION (ACC)

This procedure sends a handoff message to the Mobile Station once a call is made.

1. Connect the RF input/RF output connector of the Mobile Station to the T/R Connector.

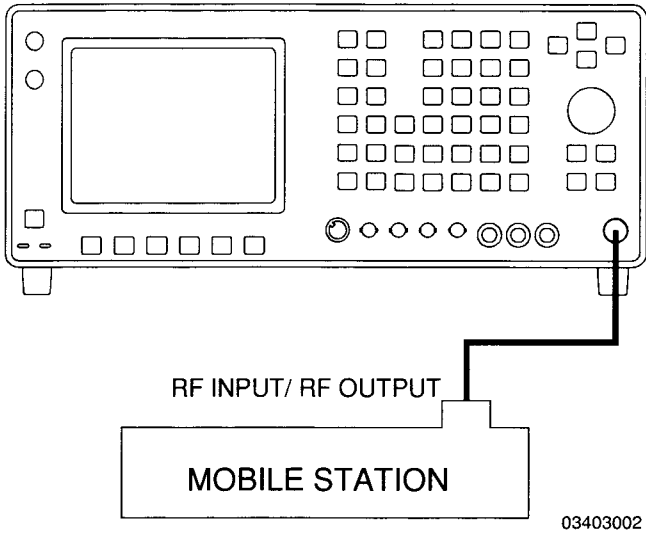

2. Place a DIGITAL call to the Mobile Station (see Section 4.4).

Once a call is made to the Mobile Station, the CSA displays the RDTC screen.

3. Press **FDTC F1** to display the FDTC screen:

```

TRANSMIT FWD DGTL TRAFFIC CHAN
CHANNEL 130 U8 RFLVL-65.0 SLOT 2
ACCH FAST Talk Delay 0 Seconds

MSG TYPE HANDOFF
RFCHAN 1
RATE 0
TIMESLOT INDICATOR 0
DVCC/SCC 1
DMAC/VMAC 0
TA 0 SBI 00 SPMB 0 MEMB 0
PVI 0 DTX CONTROL 0

Send Talk Talk+ Talk- Ret
    
```

03416074

4. Move cursor to ACCH and press **ENTER** until FAST appears.
5. Move cursor to MSG TYPE and press **DATA SCROLL** ↑ until HANDOFF appears. Press **ENTER**.
6. Set Handoff fields as shown.
7. Press **Send F1** to send the Handoff message.

The CSA displays the RDTC screen to monitor the response of the Mobile Station. When the call is terminated, operation returns to the Call screen.

4.6 PERFORMING A MOBILE STATION AUTHENTICATION (DCCH)

This procedure uses the SPACH Channel of the DCCH Cell Site Simulator to authenticate the TIA/EIA-136 capable Mobile Station under test.

1. Connect the RF input/RF output connector of the Mobile Station to the T/R Connector.

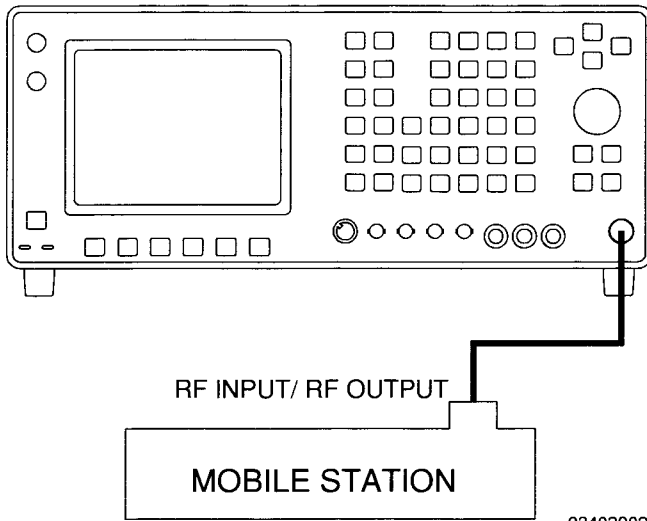

2. Press **DPLX** and **Sp Tst F5** to display the Dual Mode TIA/EIA-136 Cellular menu.
3. Press **3** to display the FDCCH Cell Site Simulation menu.
4. Press **default F5** (default label appears red).
5. Press **2 F2.** to display the SPACH Channel Messages screen.
6. Move cursor to CHANNEL and use DATA ENTRY Keys to enter a Digital Control Channel and associated cellular band. Press **ENTER**.
7. Move cursor to RF LVL and use DATA ENTRY Keys to enter the RF level used when transmitting to the Mobile Station. Press **ENTER**.

8. Move cursor to RATE and press **ENTER** to toggle transmission rate to Full or Half.
9. Move cursor to MSG TYPE and press **DATA SCROLL** ↑ until “SSDUP/BSCHALCON” appears. Press **ENTER**. The following data fields appear:

```

SPACH CHANNEL MESSAGES
CHANNEL  U8 RFLVL -30.0 RATE Full

MSG TYPE: SSDUP/BSCHALCON
IDT 2 MIN 316/522-4981
A-KEY 12345678900987654321
ESN 255 02765412
RANDSSD 3AC49DFA0981DA
Subaddress: Length off Odd/Even off
              Type off Index off Character off

A-KEY Checksum 132561
Received RANDBS 3AC2467F
Calculated AUTHBS 3AC24
SSD Update Status Successful
    
```

03416096

10. Move cursor to IDT and press **2** to select MIN for Identity Type. Press **ENTER**.
11. Power up Mobile Station.
12. Verify the MIN and ESN on the SPACH Channel Messages screen update when the Mobile Station performs power up registration.
13. Move cursor to A-Key. Using DATA ENTRY keys enter an A-Key value. Press **ENTER**. Observe new value calculated in the A-KEY Checksum data field.
14. Enter new A-Key and Checksum values observed in Step 13 into Mobile Station.
15. Press **Send F1**. Verify “Received RANDBS” and “Calculated AUTHBS” values as displayed.
16. Verify SSD Update Status (“Successful” or “Unsuccessful”).

4.7 PERFORMING A MOBILE STATION UNIQUE CHALLENGE (DCCH)

This procedure uses the SPACH Channel of the DCCH Cell Site Simulator to challenge the TIA/EIA-136 capable Mobile Station under test.

1. Perform a Mobile Station Authentication according to application 4.6.
2. Move cursor to MSG TYPE and press **DATA SCROLL** ↑ until “UNIQUE CHALLENGE” appears. Press **ENTER** to display the following data fields:

```
SPACH CHANNEL MESSAGES
CHANNEL [ 2 ] U8 RFLVL -30.0 RATE Full

MSG TYPE: UNIQUE CHALLENGE
IDT 2 MIN 316/522-4981
RANDU 1234DC
Subaddress: Length off Odd/Even off
             Type off  Index off  Character off

Calculated AUTHU 24454
Received AUTHU 24454

Send Rdcch Ret
```

03416097

3. Press **Send F1**. Verify “Calculated AUTHU” and “Received AUTHU” values as displayed.

The Mobile Station successfully passes being challenged if the displayed values of “Calculated AUTHU” and “Received AUTHU” are identical.

4.8 PLACING A DCCH DIGITAL (ACELP) CALL TO A HYPERBAND CHANNEL

This procedure uses the Call Processing screen and specific settings of the Broadcast Channel of the DCCH Cell Site Simulation to place a DCCH Digital (ACELP) call to a Hyperband channel.

1. Connect the RF input/RF output connector of the Mobile Station to the T/R Connector.

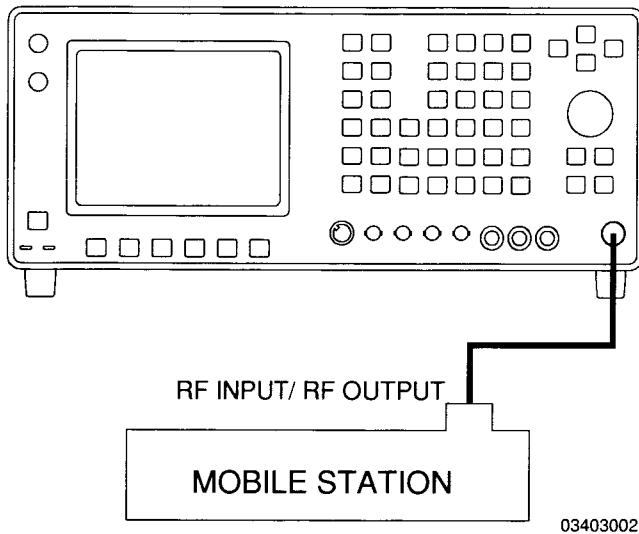

03403002

2. Press **DPLX** and **Sp Tst F5** to display the Dual Mode TIA/EIA-136 Cellular menu.
3. Press **3** to display the FDCCH Cell Site Simulation menu.
4. Press **1 F1** to access the Broadcast Channel Messages screen.
5. Move cursor to MSG TYPE and press **DATA SCROLL** ↑ until "SYSTEM IDENTITY" appears. Press **ENTER**.
6. Move cursor to Protocol Version. Press **4** to indicate "IS-136, Rev. A" protocol. Press **ENTER**.
7. Move cursor to MSG TYPE, again, and press **DATA SCROLL** ↑ until "SERVICE MENU-Fbcch" or "SERVICE MENU-Ebcch" appears. Press **ENTER**.

8. Move cursor to VC Map. Enter **00010** to indicate that the Base Station (CSA) supports IS-641 ACELP. Press **ENTER**.
9. Press **CALL F2**. The Call Processing screen appears. Move cursor to TYPE and press **ENTER** until DIGITAL appears.

```

FWD DIGITAL CONTROL CHANNEL
CALL PROCESSING

CHANNEL 25 HY RFLVL -55.0 RATE Full
CALLING SETUP
TYPE DIGITAL
IDT 2 MIN 123/456-7890
CHAN 15 SLOT 1 DMAC 5 DVCC 220
SB 0 TA 0 PV 4 DIC 0 VC 2 ACELP
ALERT SETUP
SIGNAL PITCH MED CADENCE 000011
CALLING NUMBER 3165224981

TYPE 000 PLAN 0000
PI 00 SI 00
    
```

PAGE REG Folw Rdcch Ret More

03416155

10. Ensure that each of the fields are set as shown in the screen above.

According to TIA/EIA-136, Hyperband channels 1 and 1999 are defined as "Not Used." However, the CSA operates with Hyperband channels 1 through 1999.

11. Press **Folw F3** until the label turns red.
12. Press **REG F2**, and power up Mobile Station. Allow Mobile Station time to register.

Label goes red until Mobile Station registers, then returns to the normal white color.

13. Press **PAGE F1** to ring the Mobile Station.
14. Answer call at Mobile Station.

The RDTC screen appears to monitor the response from the Mobile Station.

4.9 PERFORMING A DTC HANDOFF TO ANOTHER BAND (ACC OR DCCH)

This procedure uses the DTC Handoff message in either the ACC or DCCH Cell Site Simulation to allocate the Mobile Station to another band.

1. Connect the RF input/RF output connector of the Mobile Station to the T/R Connector.

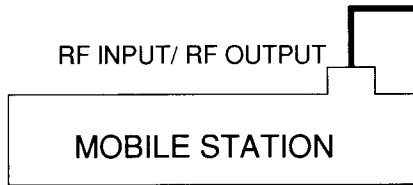
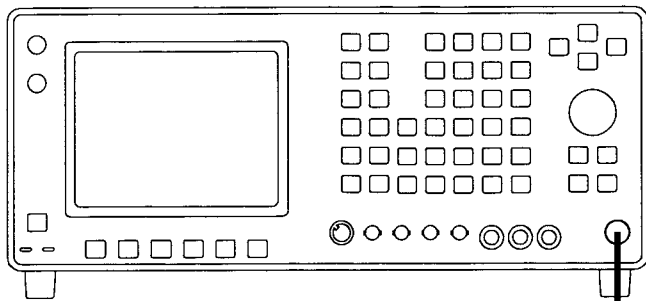

03403002

2. Place a DIGITAL call to the Mobile Station (see Section 4.4).

Once a call is made to the Mobile Station, the CSA displays the RDTC screen.

3. Press **FDTC F1** to display the FDTC screen.

4. With cursor at MSG TYPE, press **DATA SCROLL** ↑ until “DTC HANDOFF” appears. Press **ENTER** to display the following data fields:

```

TRANSMIT FWD DGTL TRAFFIC CHAN
CHANNEL [130] U8 RFLVL-65.0 SLOT 2
ACCH FAST Talk Delay 0 Seconds

MSG TYPE [DTC HANDOFF]
RFCHAN 333
ATS 1 DVCC 1
DMAC 0 TA 0
SBI 00 PV 0
SOC CHANGE 0 BSMC CHANGE 0
DTX CONTROL 0 DELTA TIME off
VC off PM_V off DPM off
MEA off MED off MEK off
TARGET HYPERBAND 1
    
```

03416098

5. Move cursor to RFCHAN. Enter channel number of desired band from keypad. Press **ENTER**.
6. Move cursor to TARGET HYPERBAND. Press **DATA SCROLL** ↑ until desired value specified below appears:

TARGET HYPERBAND	VALUE
800 MHz	0
1900 MHz	1
Reserved	2
Reserved	3

7. Press **ENTER**.
8. Press **SEND F1**.

The RDTC monitor screen appears to monitor the response of the Mobile Station on the new band and channel. When the call is terminated, operation returns to the Call screen (ACC) or Call Processing screen (DCCH).

CELLULAR MESSAGES

5.1 BROADCAST CHANNEL MESSAGES

Following are the Broadcast Channel messages that can be sent to the Mobile Station. These messages are sent on a continual basis on the Forward Digital Control Channel (FDCCH). The Broadcast Channel (BCCH) is used, in general, to carry generic, system-related information and is broken down into three logical channels: the F-BCCH, E-BCCH and S-BCCH. For definitions of the fields used with the Broadcast Channel messages, see Section 6.

Each Broadcast Channel message is defined as either mandatory or optional.

ACCESS PARAMETERS

The Access Parameters message defines the requirements for Mobile Station access on a DCCH. This mandatory message is sent on the F-BCCH.

ALTERNATE RCI INFO

The Alternate RCI Info message provides information regarding a DCCH associated with a regulatory configuration different from that of the current DCCH and optional mobile country code and Hyperband info related to current DCCH. This optional message is sent on the E-BCCH.

BSMC MSG DELIVERY

The Base Station Manufacture Code Message Delivery message consists of BSMC signaling information beyond the scope of the IS-136 specification and binary data as specified by the SOC/BSMC protocol currently in use. This optional message is sent on the F-BCCH or E-BCCH.

CNTL CHAN SELECTION

The Control Channel Selection Parameters message defines the criteria for Mobile Station selection of a DCCH and, optionally, provides information regarding additional DCCH frequencies in the current cell and their relationship to the current DCCH. This mandatory message is sent on the F-BCCH.

EMERGENCY

The Emergency Information Broadcast message provides emergency information and optional alerting instructions to all Mobile Stations. This optional message is sent on the E-BCCH.

MACA

The Mobile Assisted Channel Allocation message orders the Mobile Station to report radio measurements on certain channels. MACA contains information regarding the channels the Mobile Station is to measure and when to report the measurements for mobile assisted channel allocation. This optional message is sent on the F-BCCH or E-BCCH.

MACA (MULTI)

The Mobile Assisted Channel Allocation (Multi Hyperband) message orders multi hyperband capable Mobile Stations to report radio measurements on certain channels. MACA (MULTI) takes precedence over and contains information same as the MACA message. This optional message is sent on the F-BCCH or E-BCCH.

NEIGHBOR CELL

The Neighbor Cell message provides the service signal strength used in the control channel reselection process. Additionally this message provides optional information indicating what probability blocks within a band contain a DCCH for a non-public system in the current DCCH service area. This mandatory message is sent on the E-BCCH.

NEIGHBOR CELL (MULTI)

The Neighbor Cell (Multi Hyperband) message provides the neighbor cell information to multi hyperband capable Mobile Stations. This optional message is sent on the E-BCCH.

NEIGH SERVICE INFO

The Neighbor Service Info message provides information regarding the services supported by a TDMA neighbor Cell Site. This optional message is sent on the E-BCCH.

NEIGH SVC INFO (MULTI)

The Neighbor Service Info (Multi Hyperband) message provides information same as the NEIGH SERVICE INFO message to multi hyperband capable Mobile Stations. This optional message is sent on the E-BCCH.

OVERLOAD CLASS

The Overload Class message is used to regulate Mobile Station originations and registrations on the RACH. The Mobile Station must examine the value of the OLC bit map corresponding to an internally stored access overload class assignment. The Mobile Station continues with the access attempt only if the Mobile Station's bit in the OLC bit map is enabled. This optional message is sent in the F-BCCH.

REG PARAMETERS

The Registration Parameters Message defines the requirements for Mobile Station registration on a DCCH. This mandatory message is sent on the F-BCCH.

REGULATORY CONFIGURATION

The Regulatory Configuration message identifies a particular radio frequency system allocation and recommended DCCH allocation. An optional RF channel allocation for system configurations not specified in IS-136 may also be included. This mandatory message is sent on the E-BCCH.

SERVICE MENU

The Service Menu message provides a list of services supported by the current cell site. This optional message is sent on the E-BCCH.

SOC/BSMC ID

The System Operator Code/Base Station Manufacture Code Identification message is used to identify the SOC and BSMC values associated with the current cell site. This optional message is sent on the F-BCCH or E-BCCH.

SOC MSG DELIVERY

The SOC Message Delivery message carries SOC-specific signaling information with content beyond the scope of TIA/EIA-136. This optional message is sent on the F-BCCH or E-BCCH.

SYSTEM IDENTITY

The System Identity Message defines the identification information of a DCCH with optional private/residential system, mobile country code and alphanumeric system ID information. This mandatory message is sent on the F-BCCH.

TIME AND DATE

The Time and Date message provides the time from Jan 1, 1980 and Time Zone Offset. This optional message is sent on the E-BCCH.

STRUCTURE

The DCCH Structure message defines the setup of a Forward Digital Control Channel. This mandatory message is sent on the F-BCCH.

Slot arrangement allowed in the FDCCH:

FDCCH Channel	DCCH Full-Rate (Half Rate)	
	Min	Max
F-BCCH (F)	3 (3)	10 (10)
E-BCCH (E)	1 (1)	8 (8)
S-BCCH (S)	0 (0)	15 (11)
Reserved (R)	0 (0)	7 (7)
SPACH	2 (2)	*

* The maximum for the SPACH Channel for Full Rate is 32 - (F+E+S+R) and for Half Rate is 16 - (F+E+S+R).

DCCH Structure message data field values versus actual slot values:

NofFBCCH (NofEBCCH) [NofSBCCH] {NofRES}	Actual Number of F-BCCH (E-BCCH) [S-BCCH] {Reserved} Slots in Superframe
0 (0) [0] {0}	3 (1) [0] {0}
1 (1) [1] {1}	4 (2) [1] {1}
2 (2) [2] {2}	5 (3) [2] {2}
3 (3) [3] {3}	6 (4) [3] {3}
4 (4) [4] {4}	7 (5) [4] {4}
5 (5) [5] {5}	8 (6) [5] {5}
6 (6) [6] {6}	9 (7) [6] {6}
7 (7) [7] {7}	10 (8) [7] {7}
•	
•	
•	
[15]	[15]

If the actual number of F-BCCH slots required in the superframe to hold the built F-BCCH is greater than that specified in the DCCH Structure message, the value is changed to the minimum required.

The Slot Configuration field is not included in the DCCH Structure message screen, because Slot Configuration is based on the setting on RATE (i.e. if RATE is set to FULL, then Slot Configuration is set to 1; if RATE is set to HALF, then Slot Configuration is set to 0).

The Extended Hyperframe Counter (Ext Hyperframe Cntr) and CBN_High are automatically programmed when enabled by pressing *ENTER*.

5.2 SPACH CHANNEL MESSAGES

Following are the SPACH Channel messages that can be sent to the Mobile Station. These messages are sent as required on the FDCCH. The SPACH is a logical channel used to broadcast information to specific Mobile Stations regarding SMS Point-to-Point (SMSCH), paging (PCH) and to provide an access response channel (ARCH). For definitions of the fields used with the SPACH Channel messages, see Section 6.

AUDIT

The Audit Order message is used to solicit an audit confirmation from the Mobile Station. This message is sent on the PCH.

CAPABILITY REQUEST

The Capability Request message is used to query the capabilities of a specific Mobile Station. This message is sent on the PCH.

MESSAGE WAITING

The Message Waiting message is used to inform the Mobile Station of waiting messages. This message is sent on the PCH.

PARAMETER UPDATE

The Parameter Update message is used to inform the Mobile Station to update the internal call history parameter that is used in the authentication process. This message is sent on the PCH.

R-DATA

The R(elay)-Data message is used to carry SMS messages from the Cell Site to the Mobile Station. This message is sent on the SMSCH after first sending a SPACH Notification of R-DATA on the PCH.

SSDUP/BSCHALCON

The Shared Secret Data Update and Base Station Challenge Confirmation message performs five steps:

- Sends an SSD Update Order.
- Waits for a Base Station Challenge message.
- Calculates AUTHBS.
- Sends a Base Station Challenge confirmation.
- Waits for a SSD Update Confirmation indicating success or failure.

This message is sent on the PCH and the ARCH.

UNIQUE CHALLENGE

The Unique Challenge Order message instructs the Mobile Station to execute the authentication algorithm while utilizing the RANDU information element. This message is sent on the PCH.

USER ALERT

The User Alert message is used to activate user alerting at a Mobile Station. This message is sent on the PCH.

5.3 REVERSE DIGITAL CONTROL CHANNEL MESSAGES

Following are the Reverse Digital Control Channel messages that can be sent to the Cell Site. These messages are sent on the RDCCH in the logical channel referred to as the Random Access Channel (RACH). In general, the RACH is used to request access to the system. Data on the RACH is sent in TDMA bursts. For definitions of the data fields used with the Reverse Digital Control Channel messages, see Section 6.

AUDIT CONFIRMATION

The Audit Confirmation message is sent in response to Audit message on the SPACH and provides the PFC of the Mobile Station and other optional information elements.

AUTHENTICATION

The Authentication message provides the information elements: COUNT, RANDC and AUTHR. These information elements are used by the cell site to authenticate the Mobile Station

If the information element, AUTH, in the mandatory Access Parameters message on the F-BCCH is set to 1, the Authentication message is concatenated to the following RACH messages: Origination, Page Response, Registration, R-DATA or a SPACH Notification indicating R-DATA.

BSCHAL/SSD UPDATE

A combination of two messages: the Base Station Challenge Order message is sent in response to an SSD Update message, and the SSD Update Order Confirmation message is sent after receiving a Base Station Challenge Confirmation.

The Base Station Challenge Order message provides RANDBS.

The SSD Update Order Confirmation message provides the SSD Update Status (indicates the success or reason for failure of an SSD Update Order from the perspective of Mobile Station).

The A-Key checksum is computed based on the A-KEY and ESN of the Mobile Station. The RANDSSD is received on the SPACH channel in a SSD Update Order message. The AUTHBS is received on the SPACH channel in the Base Station Challenge Order Confirmation message. The SSD Update Status is computed and sent as part of the SSD Update Order Confirmation message.

CAPABILITY REPORT

The Capability Report message provides information regarding subscriber terminal operational and physical layer characteristics and protocol feature support.

If Capability Request in the mandatory Registration Parameters message on the F-BCCH is set to 1, the Capability Report message is concatenated to a Registration message for the following registration types: new system, forced and power-up

MACA REPORT

The Mobile Assisted Channel Allocation Report message optionally provides channel quality and signal strength information regarding the current DCCH or signal strength information for other DCCHs specified in MACA_LIST in the optional MACA message on the F-BCCH.

If the information element MACA_TYPE in the optional MACA message on the F-BCCH is set to 1XXX, the MACA Report is concatenated to the following RACH messages: Audit Confirmation, Origination, Page Response and Registration.

ORIGINATION

The Origination message is sent when a call is initiated from the Mobile Station. The Origination message provides information regarding the physical layer characteristics of the Mobile Station, requested service and call details.

PAGE RESPONSE

The Page Response message is sent in response to a Page message from the cell site addressed to the MIN or MSID of the Mobile Station. The Page Response message provides physical layer characteristics of the Mobile Station and requested service.

QUEUE DISCONNECT

The Queue Disconnect message to the Base Station requests disconnection of the queued originated call in the Mobile Station.

R-DATA ACCEPT

The R-DATA Accept message responds to an R-DATA message on the SPACH channel addressed to the MIN or MSID the Mobile Station and provides an I.D. to associate the R-DATA Accept message with the R-DATA message being acknowledged.

R-DATA MESSAGE

The R-DATA message is sent when the Mobile Station originates point-to-point teleservice. The R-DATA message provides the message being delivered, user text, an I.D. to associate an R-DATA Accept or R-DATA Reject message with the R-DATA message being acknowledged and additional teleservice information.

R-DATA REJECT

The R-DATA Reject message provides the qualifying reason the Mobile Station rejected the R-DATA message and an I.D. to associate the R-DATA Reject message with the R-DATA message being rejected.

The CSA always accepts R-DATA messages sent on the SPACH channel unless the RACH R-DATA Reject message is sent, when in this screen, in response to an R-DATA message.

REGISTRATION

The Registration message provides the type of registration attempted, protocol supported by and physical layer characteristics of Mobile Station and optional network and call information.

SERIAL NUMBER

The Serial Number message provides the ESN consisting of the manufacture code and serial number of Mobile Station:

If the information element S in the mandatory Access Parameters message on the F-BCCH is set to 1, the Serial Number message is concatenated to the following RACH messages: Registration, Origination, Page Response SPACH Confirmation due to a SPACH Notification indicating R-DATA, R-DATA, Base Station Challenge Order and Unique Challenge Order Confirmation.

SPACH CONFIRMATION

The SPACH Confirmation message is sent in response to a message sent on the SPACH channel. The SPACH Confirmation message echoes the confirmed message type*.

* The Confirmed Msg Type data field can be set to Automatic or any of the following SPACH message types: Msg Waiting, Parameter Update, SPACH Notif or User Alert. If set to Automatic, the Confirmed Msg Type matches the SPACH message being confirmed.

TEST REGISTRATION

The Test Registration message is sent by the Mobile Station to inquire regarding the probability of receiving service should the Mobile Station attempt to register on any given PSID/RSID. The Test Registration message provides the PSID/RSID Map information element to indicate which private/residential systems have been queried by the Mobile Station. (This information element is included to indicate the private/residential systems on which the Mobile Station may receive service. The ordering of the PSID/RSID Map reflects the ordering of the PSID/RSID Set sent in the System Identity message on the F-BCCH.)

UNIQUE CHAL CONFIRM

The Unique Challenge Order Confirmation message is sent in response to a Unique Challenge Order message on the SPACH channel addressed to the MIN of the Mobile Station. The Unique Challenge Order Confirmation message provides AUTHU.

5.4 GLOBAL ACTION OVERHEAD MESSAGES

Following are the Global Action message definitions and relevant fields. Global Action Overhead messages are sent to the Mobile Station from the Global Action screen of the ACC Cell Site Simulation.

The relevant fields are those fields edited from the Global Action screen used with the message. Fields that must be set to a certain value are not selectable and not listed. For more information on a field, see Section 6.

ACCESS ATTEMPT

The Access Attempt Parameters message updates the maximum busy occurrences and number of seizure tries allowed. If this access is a Page response, the MAXBUSY-PGR and MAXSZTR-PGR fields are updated, otherwise, the MAXBUSY-OTHER and MAXSZTR- OTHER fields are updated.

FIELD	DESCRIPTION
MAXBUSY-PGR	Maximum number of busy occurrences allowed for Page responses.
MAXSZTR-PGR	Maximum number of seizure tries allowed for Page responses.
MAXBUSY-OTHER	Maximum number of busy occurrences allowed for other responses.
MAXSZTR-OTHER	Maximum number of seizure tries allowed for other responses.

ACCESS TYPE

The Access Type Parameter message updates the BIS field of the Mobile Station.

FIELD	DESCRIPTION
BIS	BIS is set to 1 if the Mobile Station must monitor the Reverse Control channel status when originating a call.

CDMA

The CDMA Capability message informs the Mobile Station that the Analog Control Channel has CDMA capability.

LOCAL CNTL 1

The Local Control 1 message allows customized messages to be sent to the Mobile Station.

FIELD	DESCRIPTION
LOCAL CNTL	16 bit local control message.

LOCAL CNTL 2

The Local Control 2 message allows customized messages to be sent to the Mobile Station.

FIELD	DESCRIPTION
LOCAL CNTL	16 bit local control message.

LOC AREA

The Location Area message requires the Mobile Station to accept PUREG, PDREG, LREG and LOCAID values.

FIELD	DESCRIPTION
PUREG	Set to 1 if power up registration is enabled; 0 otherwise.
PDREG	Set to 1 if power down registration is enabled; 0 otherwise.
LREG	Set to 1 if local area ID registration is enabled; 0 otherwise.
LOCAID	Indicates change in location area.

NEW ACCESS

The New Access Channel Set message provides the Mobile Station with a new first access channel. This channel is used by the Mobile Station to determine a new set of access channels.

FIELD	DESCRIPTION
NEWACC	The first access channel.

OVERLOAD

The Overload Control message informs selected Mobile Stations that the current control channel can not be accessed. Each Mobile Station monitors one OLC bit when receiving an Overload message. If the Mobile Station's OLC bit is set to 0, the Mobile Station is not allowed to access the current control channel of the sending Base Station.

FIELD	DESCRIPTION
OLC 0	Overload Class bit 0.
OLC 1	Overload Class bit 1.
OLC 2	Overload Class bit 2.
OLC 3	Overload Class bit 3.
OLC 4	Overload Class bit 4.
OLC 5	Overload Class bit 5.
OLC 6	Overload Class bit 6.
OLC 7	Overload Class bit 7.
OLC 8	Overload Class bit 8.
OLC 9	Overload Class bit 9.
OLC 10	Overload Class bit 10.
OLC 11	Overload Class bit 11.
OLC 12	Overload Class bit 12.
OLC 13	Overload Class bit 13.
OLC 14	Overload Class bit 14.
OLC 15	Overload Class bit 15.

RAND CHAL A

The Random Challenge A message provides the RAND1_A value (most significant half of RAND). RAND is used in the authentication process.

FIELD	DESCRIPTION
RAND1_A	Most significant 16 bits of the RAND value.

RAND CHAL B

The Random Challenge B message provides the RAND1_B value (least significant half of RAND). RAND is used in the authentication process.

FIELD	DESCRIPTION
RAND1_B	Least significant 16 bits of the RAND value.

REG INC

The Registration Increment message updates the Mobile Station's REGINCR value.

FIELD	DESCRIPTION
REGINCR	The increment for the Mobile Station to add to the registration ID when performing autonomous registrations.

RESCAN

The Rescan message instructs the Mobile Station to stop the present task and rescan the dedicated Control Channels. This message has no selectable fields.

5.5 MOBILE STATION CONTROL MESSAGES

Following are the Mobile Station Control message definitions and their relevant fields. Mobile Station Control messages are sent to the Mobile Station from the Mobile Station Control screen of the ACC Cell Site Simulation.

The relevant fields are those fields edited from the Mobile Station Control screen that are used with the message. Some fields that must be set to a certain value are not selectable and are not listed. For more information on a field, see Section 6.

The EF field, contained in many of the following messages, should be set to 0.

A ALERT

The Abbreviated Alert message alerts the Mobile Station using the Forward Control Channel.

ASYNCR PAGE

The Asynchronous Data Page message requires the Mobile Station to send a Page Response message.

AUDIT

The Audit message is used by the Base Station to determine if a Mobile Station is active in the system.

AVC ASSIGN

The Analog Voice Channel Assignment message assigns the mobile to the specified Analog Voice Channel.

FIELD	DESCRIPTION
PVI	Set to 1 if TIA/EIA 136 is supported; 0 if TIA/EIA 627 (IS-54).
MEM	Set to 1 to indicate encrypted signaling is enabled.
SCC	SAT Color Code. 00 - 5970 Hz 01 - 6000 Hz 10 - 6030 Hz 11 - Indicates that word 2 of Mobile Station Control message includes EF, LOCAL/MSG Type, ORDQ, ORDER fields
VMAC	Sets the initial Mobile Station power level.
CHAN	Analog Voice Channel assigned

BSCHALCON

The Base Station Challenge Order Confirmation processes the RANDBS received and sends the resulting AUTHBS back to the Mobile Station.

FIELD	DESCRIPTION
AUTHBS	Output of the authentication algorithm compared to the Mobile Station's own AUTHBS.

DIR RTRY

The Directed Retry message instructs the Mobile Station to select a new access channel.

FIELD	DESCRIPTION
ORDQ	Determines Last Try value. If ORDQ is 000, set LT to 0. If ORDQ is 001, set LT to 1.
CHANPOS	Indicates position of a Control Channel relative to the first access channel.

G3 PAGE

The Group 3 Fax Page message requires the Mobile Station to send a Page Response message.

G3FAX WTG

The Group 3 Fax Message Waiting message indicates the number of G3-Fax messages waiting.

FIELD	DESCRIPTION
LOCAL	Set to the number of messages waiting.

INTRCPT

The Intercept message informs the Mobile Station of a procedural error made in placing a call.

LC

The Local Control is used to send customized orders to the Mobile Station.

FIELD	DESCRIPTION
LOCAL	Message field allowing customized messages to be sent. Field is displayed in binary.

MSG WTG

The Message Waiting message informs the Mobile Station user that one or more messages are impending.

FIELD	DESCRIPTION
LOCAL	Set to the number of messages waiting.

PAGE

A Page order requires the Mobile Station to send a Page Response message.

REG CNF

The Registration Confirmation message confirms the Mobile Station's registration. Order Code is set to 01101 and Message Type is set to 00000.

FIELD	DESCRIPTION
ORDQ	Set to confirm desired registration: 000; Non-autonomous, do not make whereabouts known 001; Non-autonomous, make whereabouts known 010; Autonomous, do not make whereabouts known 011; Autonomous, make whereabouts known

REG W/AUTH

The Registration with Authentication requires the Mobile Station to send Authentication Word C.

RELEASE

The Release message requires the Mobile Station to stop transmitting (terminate the call).

REORDER

The Reorder message informs the Mobile Station to attempt to place a call again.

SLOT 1, SLOT 2 and SLOT 3

The Slot message assigns a Digital Traffic Channel and Timeslot for TIA/EIA 627 (IS-54) VSELP operation.

FIELD	DESCRIPTION
MEM	Set to 1 to indicate encrypted signaling is enabled.
PM	Privacy Mode is set to 1 if Voice Privacy is activated
DMAC	Requires the Mobile Station to use the specified power level. Set from 000 to 1010 (0 to 10).
CHAN	Digital Traffic Channel assigned.
PVI	Set to 1 if IS-136 is supported; 0 if TIA/EIA 627 (IS-54).
DVCC	Digital Verification Color Code.

SLOT1-136, SLOT2-136, SLOT3-136

The Slot message assigns a Digital Traffic Channel and Timeslot for IS-136 VSELP operation.

SLOT1-641, SLOT2-641, SLOT3-641

The Slot message assigns a Digital Traffic Channel and Timeslot for IS-136 ACELP operation.

SLOT1-FAX, SLOT2-FAX, SLOT3-FAX

The Slot message assigns a Digital Traffic Channel and Timeslot for IS-136 Fax/Data operation.

SLOT12-FAX

The Slot message assigns a Digital Traffic Channel and Timeslots 1 and 2 for IS-136 double rate Fax/Data operation.

SLOT13-FAX

The Slot message assigns a Digital Traffic Channel and Timeslots 1 and 3 for IS-136 double rate Fax/Data operation.

SLOT23-FAX

The Slot message assigns a Digital Traffic Channel and Timeslots 2 and 3 for IS-136 double rate Fax/Data operation.

SLOT123-FAX

The Slot message assigns a Digital Traffic Channel and Timeslots 1, 2 and 3 for IS-136 triple rate Fax/Data operation.

SMS WTG

The SMS Message Waiting message indicates the number of Short Message Service messages waiting.

FIELD	DESCRIPTION
LOCAL	Set to the number of messages waiting.

SSD UP

The Shared Secret Data Update sends a RANDSSD value to the Mobile Station. The Mobile Station should respond with a Base Station Challenge message.

FIELD	DESCRIPTION
RANDSSD_1	Most significant 24 bits of the RANDSSD value.
RANDSSD_2	Second most significant 24 bits of the RANDSSD value.
RANDSSD_3	Least significant 8 bits of the RANDSSD value.

UCHAL

The Unique Challenge message provides the Mobile Station with a RANDU value and requests the Mobile Station to respond with the output of the authentication process (AUTHU).

FIELD	DESCRIPTION
RANDU	Value used in the authentication process started with a Unique Challenge message.

VC DES

The Voice Channel Designation message assigns a call to a Voice Channel.

FIELD	DESCRIPTION
CHAN	Voice Channel assigned.
VMAC	Sets the initial Mobile Station power level.

5.6 FORWARD DIGITAL TRAFFIC CHANNEL MESSAGES

Following are the Forward Digital Traffic Channel messages that can be sent to the Mobile Station. These messages are sent from the Transmit FDTM screen after a call is established from the Call or Call Processing screen of the ACC or DCCH Cell Site Simulation. For definitions of the fields used with the Forward Digital Traffic Channel messages, see Section 6.

ALERT

The Alert message is used to ring the Mobile Station.

AUDIT

The Audit message is used to determine if a Mobile Station is active in the system.

BS ACK

The Base Station Acknowledgment messages confirm messages sent by the Mobile Station. The type of acknowledgment (Connect, Release or Status) is selected by the user.

BS CHALL CONF

The Base Station Challenge Confirmation message provides an AUTHBS value for the Mobile Station to use to compare with an internal value of AUTHBS.

BURST DTMF ACK

The Send Burst DTMF Acknowledge message confirms the Base Station received the Send Burst DTMF request.

CAPABILITY REQ

The Capability Update Request to solicit the protocol and service capability of the Mobile Station.

CONT DTMF ACK

The Send Continuous DTMF Acknowledge messages confirms the Base Station received the Send Continuous DTMF request.

DTC HANDOFF

The Dedicated Digital Traffic Channel (DTC) Handoff message is sent to order the Mobile Station from one DTC to another DTC.

FLASH

The Flash with info message is used to send information and/or ring the Mobile Station.

FLASH ACK

The Flash with info Acknowledgment message confirms receiving a Flash message from the Mobile Station.

HANDOFF

A Handoff message transfers the call from the present Digital Traffic Channel to a new Digital Traffic or Analog Channel.

HYPER MEAS

The Hyperband Measurement Order is sent to instruct the Mobile Station to begin channel quality measurements and to report on the specified hyperband and channel.

LOCAL CNTL

The Local Control message is used for customized messages.

MAINT

The maintenance message is used to select the maintenance mode of the Mobile Station.

MEASUREMENT

The Measurement Order message instructs the Mobile Station to begin channel quality measurements and transmit them to the Base Station. The signal strength (RSSIC) and BER measurements are also taken on the current Forward Digital Traffic Channel.

PARAMETER UPDATE

The Parameter Update message instructs the Mobile Station to increment the COUNT parameter (Call History parameter).

PLC

The Physical Layer Control message determines the Mobile Station's value of the following parameters: DMAC, TA, DTX and DIC.

R-DATA

The R(elay)-Data message is used to carry SMS messages to the Mobile Station.

RELEASE

A Release message terminates the current call.

SSD UPDATE

The Shared Secret Data Update message sends a RANDSSD value to the Mobile Station. The Mobile Station should execute the authentication algorithm and return a Base Station Challenge message.

STATUS REQ

The Status Request message informs the Mobile Station to change status and/or provide a status message to the Base Station.

STOP MEAS

The Stop Measurement message instructs the Mobile Station to stop channel quality measurements and reporting.

UNIQUE CHALLENGE

The Unique Challenge message provides the Mobile Station with a RANDU value and requests the Mobile Station to respond with the output of the authentication algorithm (AUTHU).

5.7 FORWARD ANALOG VOICE CHANNEL MESSAGES

Following are the Forward Analog Voice Channel (FVC) messages that can be sent to the Mobile Station. These messages are sent from the Transmit FVC screen after a call is established from the Call or Call Processing screen of the ACC or DCCH Cell Site Simulation. For definitions of the fields used with the Forward Analog Voice Channel messages, see Section 6.

ALERT

The Alert message is used to ring the Mobile Station.

ALERT W/INFO

The Alert with Information message includes information with the Alert for the user.

ASYNC PAGE

The Asynchronous Data Page message requires the Mobile Station to send a Page Response message.

AUDIT

The Audit message is used to determine if a Mobile Station is active in the system.

BSCHALCON

The Base Station Challenge Order Confirmation message provides AUTHBS to Mobile Station.

CALL MODE ACK

The Call Mode Acknowledgment message is used by the Base Station to confirm either a change in the call mode or indicate the privacy mode to be used.

DIS DTMF

The Disable DTMF message requires the Mobile Station to disable its DTMF tone generator. DTMF may be enabled again after the next Called Address message is sent to the Base Station (in response to a Send Called Address message).

DIS MEM

The Disable Message Encryption Mode message disables the message encryption mode.

ENA MEM

The Enable Message Encryption Mode message enables the message encryption mode.

FLASH W/INFO

The Flash with Information message informs the Mobile Station of the flash digits sent.

G3 PAGE

The Group 3 Fax Page message requires the Mobile Station to send a Page Response message.

G3 FAX WTG

The Group 3 Fax Message Waiting message indicates the number of G3-Fax messages waiting.

HANDOFF

A Handoff message transfers the call from the present Channel to a new Analog Channel.

LC

The Local Control message is used for customized messages.

MAINTNC

The maintenance message is used to select the maintenance mode of the Mobile Station.

MSG WTG

The Message Waiting message informs the Mobile Station user that one or more messages are pending.

PAGE

A Page order requires the Mobile Station to send a Page Response message.

PU

The Parameter Update message instructs the Mobile Station to increment the COUNT parameter (Call History parameter).

PWR LVL

The Power Level message requires the Mobile Station to change power level.

RELEASE

The Release message terminates the current call.

RELEASE COMPLETE

The Release Complete message causes the Mobile Station to turn off the transmitter and enter the Serving-System Determination task

RELEASE W/INFO

The Release with DCCH Information message causes the Mobile Station to send a Release Complete message, turn off the transmitter and enter the Serving-System Determination task.

S ALERT

The Stop Alert message instructs the Mobile Station to stop transmitting the Signal Tone.

SLOT 1, SLOT 2 and SLOT 3

A Slot message transfers the call to a Digital Traffic Channel and Timeslot for TIA/EIA 627 (IS-54) VSELP operation.

SLOT1-136, SLOT2-136 and SLOT3-136

A Slot message transfers the call to a Digital Traffic Channel and Timeslot for TIA/EIA 136 VSELP or ACELP operation.

SMS WTG

The SMS Message Waiting message indicates the number of Short Message Service messages waiting.

SND ADDR

The Send Called Address message requires the Mobile Station to send the Called Address.

SNR REQ

The Serial Number Request message requires the Mobile Station to send a Serial Number Response message, providing the Mobile Station serial number to the Base Station.

SSD UP

The Shared Secret Data Update message sends a RANDSSD value to the Mobile Station. The Mobile Station should respond with a Base Station Challenge message.

UCHAL

The Unique Challenge message provides the Mobile Station with a RANDU value and requests the Mobile Station to respond with the output of the authentication process (AUTHU).

CELLULAR FIELDS

Many of the Cell Site Monitor and Cell Site Simulation screens display data fields. These data fields are defined in this Section.

The DCCH Data Monitor and Simulation screens sometimes represent fields with the same function with a slightly different name due to size restrictions in the Data Monitor setup screens; therefore, some of the following fields have an additional name(s) in parentheses (). These fields are represented in the following way: Data Monitor (Simulation).

In addition, some fields listed may be followed by an acronym in brackets [] to help differentiate field names that are identical but have different functions or are used in a different way.

AccBuSz (Access Burst Size)

Access Burst Size is 1 if Mobile Station must use Abbreviated length bursts on the RACH; 0 if Normal length is to be used.

ACKED DATA [RECC]

See Acked Data subfield of *DatMode*.

ACT

ACT (Global Action) value indicates the type of Global Action Overhead Message as follows:

GLOBAL ACTION MESSAGE	ACT
Rescan	0001
Registration Increment	0010
Location Area	0011
New Access Channel Set	0110
Overload Control	1000
Access Type Parameters	1001
Access Attempt Parameters	1010
Random Challenge A	0111
Random Challenge B	1011
Local Control 1	1110
Local Control 2	1111

AddDcch (Additional DCCH Info)

Additional DCCH Information provides information regarding additional DCCH frequencies in the current cell and their relation to the current DCCH.

Subfields:

AdDcchNum is the number of additional DCCH channels in this cell minus one.

AdDcchInf consist of two other subfields DCCH Channel and Slot Configuration. **DCCH Channel** is the encoded value of a channel in current cell on which at least one DCCH resides. **Slot Configuration** is the encoded value of a number of slots assigned to DCCHs on the channel in the DCCH Channel field.

Address Info

Address Info is used in the definition of the C-Number, Called Party, Called Party number, Calling Party Number, Message Center Address, User Destination Address and User Originating address.

Subfields:

Length of Address Info content in octets.

Type of Number is coded as follows:

Code	Description
000	Unknown
001	International Number
010	National Number
011	Network Specific Number
100	Subscriber Number
110	Abbreviated Number
111	Reserved for Extension
All other codes are reserved	

Numbering Plan Identification is coded as follows:

Code	Description
0000	Unknown
0001	ISDN/telephony numbering plan (ITU Recommendations E.164 and E.163)
0011	Data numbering plan (ITU Recommendation X.121)
0100	Telex numbering plan (ITU Recommendation F.69)
0110	Land Mobile numbering plan (ITU Recommendation E.212)
1001	Private numbering plan
1100	Destination Point Code and Subsystem Number
1110	Internet Address
1111	Reserved for extension
All other codes are reserved	

Address Encoding is 1 if the address field is to be encoded as TBCD; 0 if IRA.

Address contains the address.

AlphP/R

Alphanumeric PSID/RSID List reflects the ordering of the PSID/RSID Set sent on the System Identity message.

AlphSID (Alpha System ID)

Alphanumeric System ID supplies an alphanumeric system ID to each user.

AltSocL

Alternate System Operator Codes List contains information on the optional alternate SOC's supported by the Base Station.

AltSocS

Alternate System Operator Code Support indicates what alternate SOC the Mobile Station supports.

AMT

Acknowledge Message Type displays the Message Type acknowledged.

Ana800 (800 Analog Speech Sup)

800 MHz Analog Speech Support is 1 if 800 MHz Analog Speech is supported; 0 otherwise.

ARM

ARQ Response Mode is 1 if Mobile Station is to send SPACH ARQ Status frame on a reservation basis and PI (Polling Indicator) is set to 1; 0 if Mobile Station to send SPACH ARQ Status frame on a contention basis (PI = 1). A Layer 2 field.

ARQMap

FACCH/SACCH ARQ Map is 1 if Cell Site supports FACCH/SACCH ARQ mode on the TIA/EIA-136 digital traffic channels; 0 otherwise.

ASYN [ACC]

Async Data is 1 if current Analog Control Channel supports Async Data; 0 otherwise.

AsyncSp (Async Sup) [DCCH]

Async Data Support is 1 if Mobile Station supports Async Data operation; 0 otherwise.

ATS

ATS specifies the assigned time slot.

Value	Function
0001	Full-rate DTC on time slots 1, 4
0010	Full-rate DTC on time slots 2, 5
0011	Full-rate DTC on time slots 3, 6
1001	Half-rate DTC on time slot 1
1010	Half-rate DTC on time slot 2
1011	Half-rate DTC on time slot 3
1100	Half-rate DTC on time slot 4
1101	Half-rate DTC on time slot 5
1110	Half-rate DTC on time slot 6
0100	Double full-rate DTC on time slots 1, 4 and 2, 5
0101	Double full-rate DTC on time slots 1, 4 and 3, 6
0110	Double full-rate DTC on time slots 2, 5 and 3, 6
1111	Triple full-rate DTC on time slots 1, 2, 3, 4, 5, 6
All other values are reserved	

AUTH [DCCH]

Authentication bit is 1 if Mobile Station is to send the Authentication message along with a Registration, Origination, Page Response, R-DATA or SPACH Confirmation message due to a SPACH Notification indicating R-DATA; 0 otherwise.

AUTH [ACC]

Authentication bit is 1 if the Base Station supports the authentication procedure.

AUTHBS

Output response of the authentication algorithm initiated by the Base Station Challenge Order. Base Station calculated AUTHBS is sent to the Mobile Station and compared to the Mobile Station calculated AUTHBS.

AuthMap

AuthMap determines if a Mobile Station should include the Authentication message as part of the access attempt.

Value	Function
000000	Authentication message not required
XXXXX1	Authentication message for Registration required
XXXX1X	Authentication message for Originations required
XXX1XX	Authentication message for Page Responses and SPACH Confirmations required (Authentication message included only when sending a SPACH Confirmation in response to a SPACH Notification including R-DATA.
XX1XXX	Authentication message for R-DATA messages required
All other values are reserved.	

AUTHR

Output of the CAVE algorithm sent to the Base Station for a Mobile Station initiated authentication procedure. AUTHR (along with RANDC and COUNT) authenticates registrations, originations and page responses by the Mobile Station.

AUTHRA

The Mobile Station sets this 18-bit information element to the output of the Auth_Signature Procedure in the response to a Re-Authentication Order,

AUTHU

Output of the CAVE algorithm during a Base Station initiated authentication procedure (Unique Challenge message). The Mobile Station generated AUTHU is sent to the Base Station and compared to the AUTHU generated there.

BAND

See 1.2, Cellular Band Operation.

BC

Begin/Continue, a Layer 2 Field, is 0 when indicating an FBCCH or EBCCH Begin Frame; 1 indicates a Continue Frame.

BCN

BCCH Change Notification flag, a Layer 2 field, toggles to indicate a change in F-BCCH or E-BCCH information.

BER

During a Mobile Assisted Handoff (Measurement order), the Mobile Station measures the BER of the current Digital Traffic Channel. This BER reading is sent to the Base Station along with received Signal Strength readings on specified RF channels.

BI

Begin Indicator, a Layer 2 Field, is 1 when indicating a new Layer 3 message is started in a FBCCH or EBCCH Continue Frame; 0 indicates the rest of the Begin or Continue frame is padded with Filler.

BIS

Busy-Idle Status bit is 1 if the Mobile Station must check for an idle-to-busy transition on the Reverse Control Channel when accessing the system.

BndWdth (Bandwidth)

Bandwidth, displayed in decimal, specifies the digital traffic channel bandwidth requirements for the requested call.

Value	Function
000	Half-Rate Digital Traffic Channel Only
001	Full-Rate Digital Traffic Channel Only
010	Half-Rate or Full-Rate Digital Traffic Channel - Full-Rate Preferred
011	Half-Rate or Full-Rate Digital Traffic Channel - Half-Rate Preferred
100	Double Full-Rate Digital Traffic Channel Only
101	Triple Full-Rate Digital Traffic Channel Only
All other values are reserved	

BSMC

Base Station Manufacturer Code identifies the assigned manufacturer's code.

BSMCCI

BSMC Change Indicator is 1 if the BSMC associated with the current DTC is different than the BSMC associated with the DTC being assigned.

BSMCSup (BSMC Sup)

BSMC Support is 1 if Mobile Station supports the BSMC sent on the SOC/BSMC identification message sent on the BCCH; 0 otherwise.

BT

Burst Type, a Layer 2 field, specifies the Burst Type when BU (Burst Usage) indicates a burst usage of type PCH, ARCH or SMSCH and if Layer 3 data is sent to more than one Mobile Station.

Value	Function
000	Single MSID Frame
001	Double MSID Frame
010	Triple MSID Frame
011	Quadruple MSID
100	CONTINUE Frame
101	ARQ Mode BEGIN
110	ARQ Mode CONTINUE
111	User Group Frame

BU

Burst Usage, a Layer 2 field, is used to discriminate between hard (no Layer 3 data provided) page burst, PCH bursts, ARCH bursts and SMSCH bursts.

Value	Function
000	Null
001	Hard Penta Page (20-bit MSID)
010	Reserved
011	ARCH Burst
100	SMSCH Burst
101	Hard Triple Page (34-bit MSID)
110	Hard Quadruple Page (20 or 24-bit MSID)
111	PCH Burst

CADENCE

CADENCE (the on, off pattern of the Alert tone) is the 6 least significant bits of the Signal field. The Signal field is used for Alert messages. The repeating pattern for each CADENCE is determined as follows:

DESCRIPTION	CADENCE
No tone	000000
Long: 2 sec on and 4 sec off	000001
Short-short: 0.8 sec on, 0.4 sec off, 0.8 sec on and 4 sec off	000010
Short-short-long: 0.4 sec on, 0.2 sec off, 0.4 sec on, 0.2 off, 0.8 sec on and 4 sec off	000011
Short-short-2: 1 sec on, 1 sec off, 1 sec on and 3 sec off	000100
Short-long-short: 0.5 sec on, 0.5 sec off, 1 sec on, 0.5 sec off, 0.5 sec on and 3 sec off	000101
Short-short-short-short: 0.5 sec on, 0.5 sec off, 0.5 sec on, 0.5 sec off, 0.5 sec on, 0.5 sec off 0.5 sec on and 2.5 sec off	000110
PBX long: 1 sec on and 2 sec off	000111
PBX short-short: 0.4 sec on, 0.2 sec off, 0.4 sec on and 2 sec off	001000
PBX short-short-long: 0.4 sec on, 0.2 off, 0.4 sec on, 0.2 sec off, 0.8 sec on and 1 sec off	001001
PBX short-long-short: 0.4 sec on, 0.2 sec off, 0.8 sec on, 0.2 sec off, 0.4 sec on and 1 sec off	001010
PBX short-short-short-short: 0.4 sec on, 0.2 sec off, 0.4 sec on, 0.2 off, 0.4 sec on, 0.2 sec off, 0.4 sec on and 0.8 sec off	001011
Pip-Pip-Pip-Pip: 0.1 sec on, 0.1 sec off, 0.1 sec on, 0.1 sec off, 0.1 sec on, 0.1 sec off, 0.1 sec on, 0.1 sec off	001100
Reserved	001101 to 111111

CALLD N1

Called Party Number digits 1 to 10 are displayed.

CALLD N2

Called Party Number digits 11 to 20 are displayed.

CALLD N3

Called Party Number digits 21 to 30 are displayed.

CALLD PL

Called Party Numbering Plan Identification is displayed as follows:

DESCRIPTION	CALLD PL
Unknown	0000
ISDN/Telephony numbering plan (CCITT E. 164 and E. 163)	0001
Data numbering plan (CCITT X. 121)	0011
Telex numbering plan (CCITT F. 69)	0100
Private numbering plan	1001
Reserved for extension	1111
Reserved for future use	all other values

CALLD SP

Called Party Number Spare is reserved for future use.

CALLD TY

Called Party Number Type is displayed as follows:

DESCRIPTION	CALLD TY
Unknown	000
International number	001
National number	010
Network specific number	011
Subscriber number	100
Reserved for future use	101
Abbreviated number	110
Reserved for extension	111

CALLG N1

Calling Party Number Digits 1 to 10 are displayed.

CALLG N2

Calling Party Number Digits 11 to 20 are displayed.

CALLG N3

Calling Party Number Digits 21 to 30 are displayed.

CALLG PI

Calling Party Number Presentation Indicator indicates if the calling number is displayed as follows:

DESCRIPTION	CALLG PI
Presentation allowed	00
Presentation restricted	01
Number not available	10
Reserved	11

CALLG PL

Calling Party Numbering Plan Identification is displayed as follows:

DESCRIPTION	CALLG PL
Unknown	0000
ISDN/Telephony numbering plan (CCITT E. 164 and E. 163)	0001
Data numbering plan (CCITT X. 121)	0011
Telex numbering plan (CCITT F. 69)	0100
Private numbering plan	1001
Reserved for extension	1111
Reserved for future use	all other values

CALLG SI

Calling Party Screening Indicator identifies how the calling number was screened as follows:

DESCRIPTION	CALLG SI
User provided, not screened	00
User provided, verified and passed	01
User provided, verified and failed	10
Network provided	11

CALLG SP

Calling Party Number Spare is reserved for future use.

CALLG TY

Calling Party Number Type is displayed as follows:

DESCRIPTION	CALLG TY
Unknown	000
International number	001
National number	010
Network specific number	011
Subscriber number	100
Reserved for future use	101
Abbreviated number	110
Reserved for extension	111

CALLING NUMBER (CALLING NUM)

The number identifying the source of the call to the Mobile Station.

CAP

Capability Request is 1 if Mobile Station must include a Capability Report message when sending a New System registration, Forced registration or Power-Up registration; 0 otherwise.

Cause

Cause for Registration Reject, Release or Reorder/Intercept.

Code	Cause
0000	Unknown MSID
0001	Congestion
0010	RSS too low
0011	Unknown
0100	Operator Determined Barring
0101	User Group Release
0110	User Group Barred
0111	Requested Service Code Not Supported
1000	Requested Service Code Not Available
1001	Authentication Failure
1010	Addressing Information Not Supported
1011	Requested Message Encryption Mode Temporarily Denied
1100	Unknown UGID
1101	PSID/RSID Removal
1110	Reserved
1111	Reserved

CBarred (Cell Barred)

Cell Barred indicates if a specific cell is barred for access and the Number of

100 SFs (Superframes) the cell can be considered barred. The Cell Barred status is displayed as 1 or 0, and Number of

100 SFs is a decimal value.

CBN (CBN_High)

CBN_High supports message encryption on the Forward and Reverse DCCH and DTC. CBN_High is incremented every 192 SFs when the Extended Hyperframe Counter cycles to 0.

CdNum

See *CdPNum*.

CdParty (Called Party)

Called Party specifies the called party associated with a call terminated by the Mobile Station.

CdPNum (Called Party Number)

Called Party Number specifies the called party associated with a call originated by the Mobile Station.

CdPSub

Called Party Subaddress specifies the subaddress of the called party.

CELL_SYNC

CELL_SYNC is 1 if the candidate DCCH is superframe synchronized with the current DCCH; 0 otherwise.

CELLTYPE

CELLTYPE provides for operator bias of Mobile Station control channel reselection decisions.

Value	Function
00	REGULAR
01	PREFERRED
10	NON-PREFERRED
11	Reserved

CgNAM

Calling Party Name indicates the name of the calling party.

CgNUM

Calling Party Number indicates the number of the calling party.

CgNumPI

Calling Party Number Presentation Indicator specifies the presentation restrictions and screening related to the Calling Party Number field.

CgPNUM

Calling Party Number specifies the network address of the calling party.

CgPsub

Calling Party Subaddress specifies the subaddress of the calling party.

CHAN

Cellular Channel in the 800 MHz Hyperband (1 to 1023).

CHANPOS1

Channel Position 1, used with Directed Retry Message, is the channel position of access channel 1, 2 and 3 relative to the first access channel.

CHANPOS2

Channel Position 2, used with Directed Retry Message, is the channel position of access channel 4, 5 and 6 relative to the first access channel.

CHAR1 and 2

Displays characters received during Called Party Number or Calling Party Number messages. Each CHAR field displays 1 to 16 characters.

CLI

Continuation Length Indicator, a Layer 2 field, indicates the number of bits in the current FBCCH or E-BCCH Layer 2 frame used to carry information from a previously initiated Layer 3 message. CLI is displayed in binary.

CM

Call Mode of the current call indicating the following:

FUNCTION	CM
Analog Voice Channel acceptable	----0
Analog Voice Channel not acceptable	----1
Full rate Digital Traffic Channel not acceptable	---0-
Full rate Digital Traffic Channel acceptable	---1-
Half rate Digital Traffic Channel not acceptable	--0--
Half rate Digital Traffic Channel acceptable	--1--
Other DQPSK channel not acceptable	-0---
Other DQPSK channel acceptable	-1---
Other voice coding not acceptable	0----
Other voice coding acceptable	1----

CMAC

Control Mobile Attenuation Code specifies the maximum power level allowed for Mobile Station transmitting on the Reverse Control Channel as follows:

DESCRIPTION	CMAC
Power level 0	000
Power level 1	001
Power level 2	010
Power level 3	011
Power level 4	100
Power level 5	101
Power level 6	110
Power level 7	111

CMAX-1

CMAX is the maximum number of Access Channels to be scanned when accessing the system.

CMode

The 5-bit Call Mode field has the same code as the MSG TYPE field for Mobile Station initiated messages only – Origination and Page Response Messages.

CnfMsgT (Confirmed Msg Type)

Confirmed Message Type, displayed as text, is always set to the value of the SPACH Notification Type field included in the SPACH Notification message used to solicit a SPACH Confirmation response from a Mobile Station.

CNPC

Displays the Calling Number Presentation Code as follows:

DESCRIPTION	CNPC
Calling number follows	0001
Calling number not available from network	0010
Calling number presently restricted	0011
Reserved	all other values

C-Num (C-Number)

C-Number allows the Mobile Station to provide the Base Station with network address information in conjunction with a registration of type De-registration.

Subfields:

CNumLen - Length of Address Info contents (See *Address Info*). Displayed as decimal.

CNumTyp - Type of Number (See *Address Info*). Displayed as decimal.

CNumPln - Numbering Plan Identification (See *Address Info*). Displayed as decimal.

CNumEnc - Address Encoding (See *Address Info*). Displayed as binary.

CNumADR - Address (See *Address Info*). Displayed as text.

COUNT

Call History Parameter sent to the Base Station for a Mobile Station initiated authentication procedure. COUNT (along with AUTHR and RANDC) are used in the authentication procedure which validates registrations, originations and page responses by the Mobile Station.

CPA

Combined Paging and Access bit is 1 if access functions and paging functions are on the same Control Channel.

CPN_RL

Calling Party Number Remaining Length indicates the number of characters in the first instance of the Calling Party Number.

CRC [RECC]

See CRC subfield of DatMode

Custom (Custom Control)

Custom Control consists of binary data as specified by the SOC/BSMC protocol currently in use. Custom is displayed in hex values.

DATA PART [RECC]

See Data Part subfield of DatMode

DatMode (Data Mode)

Data Mode identifies the mode to be used for the requested Data/Fax Call.

Subfields:

PM_D

Value	Function
000	No Data Privacy
001	Data Privacy Algorithm A
All other values are reserved	

SAP is 0 if SAP 0 only; 1 if SAP 0 and 1.

Acked Data is 0 if data is acknowledged, unacknowledged or both; 1 if data is unacknowledged only.

CRC

Value	Function
00	16-bit Cyclic Redundancy Check
01	24-bit Cyclic Redundancy Check
10	No Cyclic Redundancy Check
11	Reserved

Data Part

Value	Function
000	See IS-135
001	STU-III
All other values are reserved.	

RLP

Value	Function
00	RLP1
01	RLP2
All other values are reserved.	

DbgDsp (Debug Disp Allowed)

Debug Display Allowed is 1 if the Mobile Station is allowed to include a Display field in the Audit Confirmation message; 0 otherwise.

DCC

Digital Color Code is sent to the Mobile Station and is retransmitted to identify which Base Station the Mobile Station is receiving.

DCCHInf

Digital Control Channel Information specifies where the Mobile Station can find a digital control channel.

DCCHAN

CHAN in the Control Channel Information Message, displayed in decimal, indicates the RF channel used by the Digital Control Channel.

DELAY

DELAY specifies delay in Superframes in the E-BCCH Neighbor Cell message used for Control Channel Reselection purposes. DELAY is displayed as a decimal value.

CODE	VALUE (SUPERFRAMES)
0000	0
0001	15
0010	30
0011	45
0100	60
0101	75
0110	90
0111	105
1000	150
1001	195
1010	240
1011	285
1100	330
1101	375
1110	420
1111	Reserved

DEREG

DEREG bit is 1 if De-registration is enabled; 0 otherwise. DEREG is sent with the Registration Parameters message on the F-BCCH.

DIC

Delay Interval Compensation Mode bit is 1 if the Mobile Station activates DIC function; 0 if deactivated.

DICMode (DIC Mode)

Delay Interval Compensation Mode bit is used to control the application of the DIC mode in the Mobile Station. When received in the Access Parameters message, the domain of DIC application is set to DCCH. When received in the Digital Traffic Channel Designation message, the domain of DIC application is set to the DTC.

Digits (DIGITS1, DIGITS2)

Displays digits received during Called Address, Send Continuous DTMF and other messages. Each DIGITS field displays 1 to 11 digits.

Dir Retry Chan

Directed Retry Channel is 1 if the associated Neighbor List channel is considered for Directed Retry purposes; 0 otherwise.

DirAddr

Directory Address is the assigned directory address for a Mobile Station when the Mobile Station is served by a system not networked to the home system.

DirSub

Directory Subaddress specifies the assigned directory subaddress (extension number) for the Mobile Station. Transmit DirSub in conjunction with the Directory Address.

Display

Display is used to supply display information that may be displayed to the Mobile Station user.

Subfields:

DisplLen - Length of Display info in octets is displayed in decimal.

Display - Display Character (IRA) with up to three instances is displayed as text.

DMAC

Digital Mobile Attenuation Code indicates the Mobile Station power level to be used on the Digital Traffic Channel assigned as follows:

DESCRIPTION	DMAC
Power level 0	0000
Power level 1	0001
Power level 2	0010
Power level 3	0011
Power level 4	0100
Power level 5	0101
Power level 6	0110
Power level 7	0111
Power level 8	1000
Power level 9	1001
Power level 10	1010
Reserved	1011 to 1111

Dmode

Data Mode indicates the mode to be used for the requested data service. See *DatMode*.

DPMap (DPM Map)

Data Privacy Mode Map identifies the forms of data privacy supported by the Base Station.

Value	Function
0000	No Data Privacy Supported
XXX1	Data Privacy Algorithm A Supported
1XXX	Reserved for SOC/BSMC Specific Signaling
All other bit map positions are reserved	

DPMODE

Data Privacy Mode provides data privacy mode operation information for the assigned digital traffic channel.

DRateSp (Double-Rate Sup)

Double Rate DTC Support is 1 if Double Rate digital traffic channels are supported by the Mobile Station; 0 otherwise.

DTime

Delta Time specifies timing advance in half symbols to apply, relative to the current Mobile Station transmit time, on the assigned digital traffic channel.

DTMF

Displays decoded DTMF received from the Mobile Station.

DTX

Discontinuous Transmission bits identify how the Mobile Station is allowed to use discontinuous transmission. DTX is two bits on the Forward Voice Channel and is displayed as follows:

DTX	DTX USE ALLOWED
10	Low level ≥ 8 dB below high level
11	No minimum for low level
00	DTX not allowed

DTX is 1 bit with the PLC message on the Forward Digital Traffic Channel and is set to 1 if allowed; 0 otherwise.

DTXA

DTX Allowed specifies whether the Mobile Station can use Discontinuous-Transmission.

DTXC

DTX Control specifies the DTX mode supported on the current handoff channel and is set to 1 to maintain current DTX mode or 0 for disabled DTX.

DTXSup

DTX (Discontinuous-Transmission) Support, displayed in decimal, is used to indicate DTX capabilities supported on the analog voice channel.

Values	Function
00	DTX Not Supported
01	Reserved
10	DTX Supported - up to 8 dB attenuation
11	DTX Supported - no limit on attenuation

DVCC [DCCH]

Digital Verification Color Code is used to calculate the Layer 2 CRC. DVCC is displayed as a decimal value.

DVCC [ACC]

The Digital Verification Color Code is an 8-bit parameter used to identify the correct Digital Traffic Channel. The DVCC is sent on the Forward and Reverse Channels.

D/VMAC

DMAC/VMAC specifies the Mobile Station power level to use on the new traffic or voice channel (*see DMAC*). For handoff from a digital traffic channel to an analog voice channel, the Mobile Station interprets the last three significant bits of codes 0000 through 0111 as VMAC (*see VMAC*).

DV/SCC

Digital Verification/SAT Color Code defines the color code to use. Interpretation of the DV/SCC information depends on the value of the Timeslot Indicator (see TimeInd). If the Timeslot Indicator = 0, the two least significant bits of DV/SCC are coded as the SAT Color Code (see SCC) and the other six bits are 0. If the Timeslot Indicator ≠ 0, interpret the DV/SCC as the 8-bit DVCC of the new traffic channel.

E

Extended Address bit is 1 if the Mobile Station must send MIN1 and MIN2; 0 if the Mobile Station can send only MIN1. MIN1 is the 24 bits corresponding to the 7-digit telephone number. MIN2 is the 10 bits corresponding to the 3-digit area code.

EbcchCI

E-BCCH Change Indicator, a Layer 2 bit in an F-BCCH frame, is 1 if a change in the E-BCCH is indicated; 0 otherwise.

ECL

E-BCCH Cycle Length, a Layer 2 field, indicates the total number of Layer 2 frames required for the current E-BCCH cycle. ECL is displayed as a decimal value.

EF

Extended Protocol Forward Channel indicator is set to 0.

EHFC (Ext Hyperframe Cntr)

Extended Hyperframe Counter supports Paging Frame Classes higher than 5. EHFC counts modulo 8 and is displayed as a decimal value.

EHI

Extension Header Indicator is 1 if the Extension Header is present in a Layer 2 Begin frame (except the SPACH ARQ STATUS Frame); 0 otherwise. The Extension Header contains supplementary header information used to identify the Message Encryption Mode used. EHI is a Layer 2 field.

Emrgncy (Emergency)

Emergency Call is 1 if origination is an emergency call; 0 otherwise.

EMsgTyp

E-BCCH Message Type identifies the function of a E-BCCH message. EMsgTyp is displayed as text.

END

End indication bit is 1 in the last word of the Overhead Message; 0 otherwise.

EP

Extended Protocol bit is 1 indicating the Base Station is capable of using the Extended Protocol.

ER

Extended Protocol Reverse Channel indicator is 1 when the current message is using the Extended Protocol message format.

ESN

Electronic Serial Number of the Mobile Station contains the following fields:

ESN FIELDS	BITS
Serial Number	1 to 18
Reserved for future use	19 to 24
Manufacturer Code	25 to 32

FbcchCI

F-BCCH Change Indicator, a Layer 2 bit in an F-BCCH frame, is 1 if a change in the F-BCCH is indicated; 0 otherwise.

FI

Feature Indicator is used to allow the user to activate supplementary features available from the Base Station.

FMsgTyp

F-BCCH Message Type identifies the function of an F-BCCH message. FMsgTyp is displayed as text.

FOREG

Forced Registration bit is 1 if forced registration is enabled; 0 otherwise. FOREG is sent with the Registration Parameters message on the F-BCCH.

FoRereg (Forced Re-reg)

Forced Re-registration is 1 if Mobile Station is required to initiate a Registration attempt with Registration Type set to Forced; 0 otherwise.

FRNO

Frame Number, a Layer 2 field, uniquely identifies specific frames sent in support of an ARQ mode transaction.

FRNOMap

Frame Number Map, a Layer 2 field, is a partial or complete bit map representation of the receive status of an ARCH or SMSCH ARQ mode transaction. This field is 32 bits long. A bit set to 1 represents a corresponding frame was received and 0, not received.

FWVint (Firmware)

Firmware Vintage, displayed in hexadecimal, identifies the firmware vintage (specific to a Mobile Station vendor) of the Mobile Station.

G3FAX [ACC]

G3 Fax is 1 if G3 Fax is supported; 0 otherwise.

G3FxDup (G3 Sup) [DCCH]

G3-Fax Support is 1 if the Mobile Station supports G3-Fax operation; 0 otherwise.

GA

Go Away is 1 if the candidate DCCH is barred; 0 if not barred. A Layer 2 field.

HDVCC

Half Digital Verification Color Code, displayed in decimal, provides the 4 least significant bits of the DVCC associated with the Digital Control Channel specified by the CHAN field.

HL_FREQ

HL_FREQ is 1 if channel measurements frequency is High; 0 if the frequency is Low.

HRateSp (Half-Rate Sup)

Half-Rate DTC Support is 1 if the Mobile Station supports Half-Rate digital traffic channels; 0 otherwise.

HyprCtr

Hyperframe Counter used to identify which hyperframe is currently being broadcast. HyprCtr counts modulo 12 and is utilized to determine Paging Frame Class. HyprCtr is displayed as a decimal value.

HyprInf (Hyperband Info)

Hyperband Info indicates the Hyperband associated with the specified DCCH. HyprInf is displayed as a decimal value.

IDT

Identity Type, a Layer 2 field, defines the MSID format.

INFO

Information passed with a Flash with Information message on the Forward Voice Channel.

InitSel (Initial Sel Cntl)

Initial Selection Control, if set, discourages a Mobile Station executing the Control Channel Selection procedure (initial selection) from selecting a DCCH for camping purposes.

IRASup (IRA Support, IRA Sup)

IRA Support indicates if a Mobile Station or cell site supports IRA address encoding in the Address Info information element.

KeyFac

Keypad Facility allows the user to convey characters entered via a keyboard or similar terminal.

KF1

Keypad Facility 1 displays digits 1 to 11 of characters entered using a keypad or terminal.

KF2

Keypad Facility 2 displays digits 12 to 22 of characters entered using a keypad or terminal.

KF3

Keypad Facility 3 displays digits 23 to 32 of characters entered using a keypad or terminal.

L2MEA

Message Encryption Algorithm, a Layer 2 field, has two bits where values 00 through 10 are reserved and 11 (3) is reserved for SOC/BSMC specific signaling.

L2MEK

Message Encryption Key is the same as L2MEA.

L3LI

Layer 3 Length Indicator, a Layer 2 field displayed in decimal, specifies the length in octets of the L3DATA field.

LAREG

LAREG (Location Area Registration) is used to indicate if the Mobile Station is to register when the present RNUM of the current DCCH is not part of the Mobile Station's RNUM list used to define the location area.

LastTry

See *LT*.

LC

Local Control indicates a customized operation for the Mobile Station to perform.

LDP

Last Decoded Parameter displays the last decoded Parameter Type value.

LOC CONTRL (LOCAL CNTL)

Local Control message is used to customize the operation of the Mobile Station.

LOCAL/MT

Displays the Message Type received.

LREG

LREG bit is 1 if location area ID registration is enabled; 0 otherwise.

LT

Last Try indicates if the next access attempt is required to be the last attempt.

LTM

LTM Measurement provides the Channel Quality and LT_RSS of the current channel in the MACA Report.

Subfields:

LTM-WER – Word Error Rate is displayed in decimal.

Code	Estimated WER
000	0 %
001	> 0 - 2%
010	> 2 - 4%
011	> 4 - 8%
100	> 8 - 16%
101	> 16 - 32%
110	> 32 - 64%
111	> 64%

LTM-BER – Bit Error Rate is displayed in decimal.

Bit pattern	AVE_BER interval (%)
000	< 0.01
001	0.01 to less than 0.1
010	0.1 to less than 0.5
011	0.5 to less than 1.0
100	1.0 to less than 2.0
101	2.0 to less than 4.0
110	4.0 to less than 8.0
111	≥ 8.0

LTM –Continued–

LTM-ltrss - Long Term Received Signal Strength is displayed in decimal.

Bit Pattern	RSS Value
00000	-113 dBm or less
00001	-111 dBm
00010	-109 dBm
00011	-107 dBm
...	...
11110	-53 dBm
11111	-51 dBm or greater

LTM-FMI - Full Measurement Indicator is 1 if the measurement is based on a full measurement; 0 otherwise.

LOCAID

Location Area Identity is used to identify changes in location area.

MACA8 (MACA_8_CNTL)

MACA 8 CONTROL is used with MACA_TYPE and MACA_STATUS to determine the number channels reported.

MacaLsO

MACA_LIST (Other Hyperband) contains information on the channels other than the current DCCH.

Mobile Stations incapable of performing measurements on a channel specified in the MACA_LIST (Other Hyperband) reports an RSS value of 00000 for that channel.

MACALst (MACA_LIST)

MACA_LIST provides DCCH channel numbers (other than the current DCCH) for Mobile Assisted Channel Allocation measurements.

Subfields:

MACANum (Number of MACA Channels)

MACAChan (CHAN) is a concatenated list of channels (each 11 bits long) in the 800 MHz hyperband.

MACAOth

See MacaLsO.

MACASta (MACA_STATUS)

MACA_STATUS specifies which MACA function combinations are enabled.

Value	Function
00	MACA Disabled
01	MACA LTM Enabled
10	MACA STM Enabled
11	MACA LTM and STM Both Enabled

MACATyp (MACA_TYPE)

MACA_TYPE specifies when MACA reporting is to commence.

Value	Function
1XXX	Report MACA at Audit Confirmation
X1XX	Report MACA at Page Response
XX1X	Report MACA at Origination
XXX1	Report MACA at Registration

Man Code

See MfrCode.

MaxBusy (Max Busy/Res)

Max Busy/Reserved specifies the maximum number of times BRI≠Idle can be detected during any given access attempt before Layer 2 declares an access attempt failure.

Value	Function
0	1 BRI ≠ Idle Allowed
1	10 BRI ≠ Idle Allowed

MaxPFC (Max PFC, MAX_SUPP_PFC)

MAX_SUPPORTED_PFC specifies the maximum paging frame class supported by a DCCH or a Mobile Station.

Value	Function
000	PFC ₁ is the only PFC supported
001	PFC ₂ is the maximum supported PFC
010	PFC ₃ is the maximum supported PFC
011	PFC ₄ is the maximum supported PFC
100	PFC ₅ is the maximum supported PFC
101	PFC ₆ is the maximum supported PFC
110	PFC ₇ is the maximum supported PFC
111	PFC ₈ is the maximum supported PFC

MaxRep (Max Rep)

Max Repetitions specifies the maximum number of times a specific burst within any given access attempt may be sent on the RACH before Layer 2 declares an access attempt failure.

Value	Function
00	0 Repetition Allowed
01	1 Repetition Allowed
10	2 Repetitions Allowed
11	3 Repetitions Allowed

MaxRet (Max Retries)

Max Retries specifies the maximum number of Layer 2 access attempts before declaring an access failure.

Value	Function
000	1 Access Attempt Allowed
001	2 Access Attempts Allowed
010	3 Access Attempts Allowed
011	4 Access Attempts Allowed
100	5 Access Attempts Allowed
101	6 Access Attempts Allowed
110	7 Access Attempts Allowed
111	8 Access Attempts Allowed

MaxStop (Max Stop)

Max Stop Counter specifies the maximum number of times that either of the following conditions can be detected for any given access attempt before Layer 2 declares an access attempt failure:

- BRI set to Reserved or Idle after sending an intermediate burst of an access attempt.
- R/N set to Not Received along with BRI set to Reserved or Idle after sending the last burst of an access attempt.

Value	Function
0	1 Occurrence Allowed
1	2 Occurrences Allowed

MBUSY-OTH

Maximum number of busy occurrences allowed for non-Page accesses on the Reverse Control Channel.

MBUSY-PGR

Maximum number of busy occurrences allowed for Page accesses on the Reverse Control Channel.

MCA

Message Center Address identifies the Teleservice Server Address associated with the message being sent.

MCC (Mobile Country Code)

Mobile Country Code of the current DCCH.

MEAMap (MEA Map)

Message Encryption Algorithm Map identifies the message encryption algorithms, domains and keys supported by a DCCH or a DTC.

Subfields:

MEAMDom specifies the number of instances and ordering of the Encryption Algorithms subfield.

Code	Function
0000 0000	No Domains Supported
XXXX XXX1	Domain A Supported
All other bit map positions are reserved	

MEAMAlg (Encryption Algorithms)

Code	Function
0000	No Message Encryption Algorithms Supported
XXX1	Algorithm A Supported
1XXX	Reserved for SOC/BSMC Specific Signaling
All other bit map positions are reserved	

MEKMap (MEK Map)

Message Encryption Key Map specifies the message encryption keys supported by the cell site.

Value	Function
0000	No Message Encryption Keys Supported
XXX1	Message Encryption Key A Supported
1XXX	Reserved for SOC/BSMC Specific Signaling
All other bit map positions are reserved	

MEM

Message Encryption Mode is 1 to indicate that message encryption algorithm A and message encryption domain A are enabled on the assigned voice channel; 0 if disabled.

MEMA

Message Encryption Mode A provides message encryption mode information including the MEM and NV fields.

MEMB

Message Encryption Mode B provides message encryption mode status of a Mobile Station (1 if on or 0 if off).

MEMC

Message Encryption Mode C provides message encryption mode information including the MEMC and NV fields.

MEMode

Message Encryption Mode identifies the selected message encryption algorithm, key and domain.

Subfields:

MEA (message encryption algorithm)

Value	Function
000	No Message Encryption
001	Message Encryption Algorithm A
All other values are reserved	

MED (message encryption domain)

Value	Function
001	Message Encryption Domain A
All other values are reserved	

MEK (message encryption key)

Value	Function
001	Message Encryption Key A
All other values are reserved	

MenuMap (Menu Map)

Menu Map specifies the services supported by the cell site.

Value	Function
00000 00000	No Services Supported
XXXXX XXXX1	30kHz Analog Speech Supported
XXXXX XXX1X	Half-Rate Digital Speech Supported
XXXXX XX1XX	Full-Rate Digital Speech Supported
XXXXX X1XXX	Half-Rate Data Supported
XXXXX 1XXXX	Full-Rate Data Supported
XXXX1 XXXXX	Double Rate Data Supported
XXX1X XXXXX	Triple Rate Data Supported
XX1XX XXXXX	STU-III Supported
All other bit map positions are reserved	

MfrCode (Man Code)

Manufacture Code, displayed in hexadecimal, specifies the manufacturer of the Mobile Station.

MIN

Mobile Identification Number is the telephone number identifying the Mobile Station.

MIN-L2

Mobile Identification Number (Layer 2) is the 34-bit MIN type of MSID.

MM

Message Mapping, a Layer 2 field, is 0 if there is one instance of L3LI and L3DATA per instance of MSID; 1 if there is one instance of L3LI and L3DATA for multiple MSIDs.

Model

Model Number, displayed in hexadecimal, identifies the Mobile Station number (specific to a Mobile Station vendor).

MPCI

Mobile Protocol Capability Indicator indicates the Mobile Station capabilities as follows:

DESCRIPTION	MPCI
EIA 553 and IS-54-A	00
EIA/TIA IS-54-B	01
Reserved	all other values

Mobile Country Code

See MCC.

MSID-L2

Mobile Station Identity (Layer 2), displayed in binary; is a 20, 24, 34 or 50-bit field as determined by the IDT field.

MS-Pwr (MS_ACC_PWR)

MS_ACC_PWR specifies the maximum nominal output power the Mobile Station uses when accessing the cell site. MS_ACC_PWR is also used as a portion of the criteria for control channel selection and reselection.

MsgWtg (Message Waiting Info)

Message Waiting Info indicates the type and number of messages waiting

Subfields:

MsgWtgNV specifies Number of Values.

MsgWtgTy indicates the type of message associated with the Number of Message Waiting subfield (Number of Values + 1).

Value	Function
0000	Voice Messages
0001	SMS Messages
0010	G3-Fax Messages
0100 to 0111	User Specific Messages
All other values are reserved	

MsgWtgNm indicates the number of messages waiting associated with Message Waiting Type subfield.

Value	Function
000000	No Message
000001	1 Message
...	...
111110	62 Messages
111111	Unknown Number of Messages (One or More)

MSID

Mobile Station Identity is used to identify all Mobile Stations. One of the following MSID formats are used:

- IMSI (International Mobile Station Identity) - Encoded as a 50-bit MSID.
- TMSI (Temporary Mobile Station Identity) - a 20 or 24-bit MSID.
- MIN (Mobile Station Identification Number) - a 34-bit MSID.

MSIDA_{sn}

MSID Assignment specifies the MSID the Mobile Station is to use.

Subfields:

MSID_{idt} specifies MSID identity type.

Code	Value
00	20-bit TMSI
01	24-bit TMSI
10	Reserved
11	Reserved

MSIDA_{sgn} - Assigned MSID.

MSG TYPE

Displays the Message Type transmitted or received.

MSZTR-OTH

Maximum number of seizure attempts allowed for non-Page accesses on the Reverse Control Channel.

MSZTR-PGR

Maximum number of seizure attempts allowed for page accesses on the Reverse Control Channel.

MT

Displays the Message Type received on the Voice Channel.

N-1

N is the number of paging channels the Mobile Station must scan. N-1 (not N) is displayed.

NAWC

Number of Additional Words Coming is 1 less than the total number of words in the System Parameter Overhead Message (not counting inserted control-filler messages).

Network, Network Type

Network Type specifies which are supported on a control channel.

Network Type	Code
Public	1XX
Private	X1X
Residential	XX1

NEWACC

The new first access channel sent in a New Access Channel Global Access message.

NL3M

Number of Layer 3 Messages, a Layer 2 field displayed in decimal, specifies from 1 to 8 Layer 3 messages with a range of values from 0 to 7.

NmEbcch (NofEBCCH)

Number of E-BCCH specifies the number of contiguous dedicated E-BCCH slots per superframe.

Value	Function
000	1 E-BCCH slot per superframe
001	2 E-BCCH slots per superframe
010	3 E-BCCH slots per superframe
011	4 E-BCCH slots per superframe
100	5 E-BCCH slots per superframe
101	6 E-BCCH slots per superframe
110	7 E-BCCH slots per superframe
111	8 E-BCCH slots per superframe

NmFbcch (NofFBCCH)

Number of F-BCCH specifies the number of contiguous dedicated F-BCCH slots per superframe.

Value	Function
000	3 F-BCCH slots per superframe
001	4 F-BCCH slots per superframe
010	5 F-BCCH slots per superframe
011	6 F-BCCH slots per superframe
100	7 F-BCCH slots per superframe
101	8 F-BCCH slots per superframe
110	9 F-BCCH slots per superframe
111	10 F-BCCH slots per superframe

NmSbcch (NofSBCCH)

Number of S-BCCH specifies the number of contiguous dedicated S-BCCH slots per superframe.

NOMW

Number of Messages Waiting (0 to 63) at the Base Station to be sent to the Mobile Station.

NonPub (Non-Public Block Map)

Non-Public Probability Blocks indicates if each probability block for a given system configuration contains a DCCH for a non-public system in the current service area.

NPRgCtl (Non-Public Reg Cntl)

Non-Public Registration Control informs the Mobile Station if a Registration attempt is allowed independent of having a PSID or RSID match and if the Test Registration is allowed.

Value	Function
X1	PSID/RSID match independent registration allowed
1X	Test Registration allowed
00	PSID/RSID match independent registration and Test Registration not allowed (Default case if information element not sent)

NUM PLAN ID

Calling Party Numbering Plan Identification is displayed as follows:

DESCRIPTION	CALLG PL
Unknown	0000
ISDN/Telephony numbering plan (CCITT E. 164 and E. 163)	0001
Data numbering plan (CCITT X. 121)	0011
Telex numbering plan (CCITT F. 69)	0100
Private numbering plan	1001
Reserved for extension	1111
Reserved for future use	all other values

NumNON (NofNon-PCH)

Number of Non-PCH Subchannel specifies the number of SPACH slots that may not be allocated to Mobile Stations as PCH subchannels.

- For a half-rate DCCH, the following values apply:

Value	Function
00	All SPACH slots are eligible to be allocated as PCH Subchannels
01	The last SPACH slot cannot be allocated as a PCH Subchannel
10	The last two SPACH slots cannot be allocated as PCH Subchannels
11	The last three SPACH slots cannot be allocated as PCH Subchannels

- For a full-rate DCCH, the following values apply:

Value	Function
00	All SPACH slots are eligible to be allocated as PCH Subchannels
01	The last two SPACH slots cannot be allocated as a PCH Subchannel
10	The last four SPACH slots cannot be allocated as PCH Subchannels
11	The last six SPACH slots cannot be allocated as PCH Subchannels

NumRes (Nof RES)

Number of Reserved Slots specifies the number of dedicated Reserved slots per superframe.

NV

Number of Values indicates the number of values in the variable length parameter field (0 to 63).

NVMW

Number of Voice Messages Waiting specifies the number of voice messages waiting at the Base Station. All six bits set to 1 indicates an unknown number of messages (≥ 1).

OatsSup

Over-the-Air-Activation Teleservice Support indicates support when set to 1 or no support when set to 0.

OLC

OLC (Overload Class) specifies if a Mobile Station can make an Origination, Registration or Originated Point-to-Point Teleservice. The Mobile Station compares the value of the OLC bit map with an internally stored access overload class assignment.

Value	Function
XXXXXXXXXXXXXXXXX1	See NOTE.
XXXXXXXXXXXXXXXXX1X	See NOTE.
XXXXXXXXXXXXXXXXX1XX	See NOTE.
XXXXXXXXXXXXXXXXX1XXX	See NOTE.
XXXXXXXXXXXXXXXXX1XXXX	See NOTE.
XXXXXXXXXXXXXXXXX1XXXXX	See NOTE.
XXXXXXXXXXXXX1XXXXXXX	See NOTE.
XXXXXXXXXX1XXXXXXXXXX	See NOTE.
XXXXXXXXX1XXXXXXXXXX	See NOTE.
XXXXXX1XXXXXXXXXX	See NOTE.
XXXXXX1XXXXXXXXXX	See NOTE.
XXXXX1XXXXXXXXXX	Test Mobile Stations
XXXX1XXXXXXXXXX	Emergency Mobile Stations
XXX1XXXXXXXXXX	Reserved
XX1XXXXXXXXXX	Reserved
X1XXXXXXXXXX	Reserved
1XXXXXXXXXX	Reserved
NOTE: Uniform distribution assigned to normal subscribers	

OMWInfo

Other Messages Waiting Info provides the type and number of messages waiting.

ORDER

Displays the order or message transmitted to the Mobile Station.

ORDER CD

Order Code determines the order type.

ORDQ

Order Qualifier qualifies the order to a specific action.

P/RAv1

PSID/RSID Available specifies the PSID/RSIDs for which a Mobile Station may receive service in the current SID area.

Subfields:

NumP/R (Number of PSID/RSID).

P/RAvail (PSID/RSID) consists of the subfields PSID/RSID Type Indicator and PSID/RSID Value. **PSID/RSID Type Indicator** is 1 if system is residential; 0 if public. For a public system, **PSID/RSID Value** is as follows:

Value (hex)	Function
0000	Unused
0001-2FFF	SID Specific PSIDs
3000-CFFF	SOC Specific PSIDs
D000-DFFF	Nationwide PSIDs
E000-EFFF	International PSIDs
F000 - FFFF	Reserved

For a residential system, **PSID/RSID Value** is as follows:

Value (hex)	Function
0000	Unused
0001-FFFF	SOC Specific RSID

P/RMap

PSID/RSID Map indicates which private/residential systems have been queried by the Mobile Station. This information element is included in the Test Registration Response message to indicate the private/residential systems on which the Mobile Station may receive service. The ordering of the PSID/RSID Map reflects the ordering of the PSID/RSID Set sent on the System Identity message.

Value	Function
XXXX XXXX XXXX XXX1	1st PSID/RSID Selected/Accepted
XXXX XXXX XXXX XXX0	1st PSID/RSID Not Selected/Not Accepted
...	...
1XXX XXXX XXXX XXXX	16th PSID/RSID Selected/Accepted
0XXX XXXX XXXX XXXX	16th PSID/RSID Not Selected/Not Accepted

P/RSID

PSID/RSID Set specifies the PSID/RSID of each private/residential system being served by a DCCH (which is serving one or more private/residential systems).

Subfields:

P/R-SOC (SOC) see SOC.

P/R-Num (Number of PSID/RSID).

P/R SID (PSID/RSID) consists of the subfields PSID/RSID Type Indicator and PSID/RSID Value. PSID/RSID Type Indicator is 1 if system is residential; 0 if public. These are displayed as R or P followed by the hex value. For a public system, PSID/RSID Value is as follows:

Value (hex)	Function
0000	Unused
0001-2FFF	SID Specific PSIDs
3000-CFFF	SOC Specific PSIDs
D000-DFFF	Nationwide PSIDs
E000-EFFF	International PSIDs
F000 - FFFF	Reserved

For a residential system, **PSID/RSID Value** is as follows:

Value (hex)	Function
0000	Unused
0001-FFFF	SOC Specific RSID

PCH (PCH_DISP)

PCH_DISPLACEMENT specifies the number of additional SPACH slots the Mobile Station reads when PCON (page continuation) is set.

Value	Function
000	0 additional SPACH slots read
001	1 additional SPACH slot read
010	2 additional SPACH slots read
...	...
111	7 additional SPACH slots read

PCI

Protocol Capability Indicator is 1 if the Base Station is capable of Dual Mode operation.

PCON

Page Continuation, a Layer 2 field, is 1 for the Mobile Station to read additional SPACH slots, determined by PCH_DISPLACEMENT after reading the assigned PCH subchannel. PCON is 0 if the Mobile Station may sleep until the next occurrence of the assigned PCH subchannel.

PD

Protocol Discriminator specifies the Layer 3 protocol used for the message being sent.

Value	Function
00	TIA/EIA-136
All other values reserved.	

PDREG

PDREG (Power Down Registration) is 1 if the Mobile Station must register at power down; 0 otherwise.

PEA

Partial Echo Assigned, a Layer 2 field, is the 7-bit partial echo value used by a Mobile Station during an ARQ mode transaction.

PFC

Paging Frame Class is the specified frequency of paging frames the Mobile Station skips prior to waking up and reading the assigned PCH Subchannel.

A paging frame is defined as the number of hyperframes over which a Mobile Station has single instance of PCH allocation.

PFC	PFN (Paging Frame Number) (Periodicity In HF)
1	1
2	2
3	3
4	6
5	12
6	24
7	48
8	96

PFC-1 (PFC(-1))

PFC Minus One specifies the current paging frame class (1 to 8) of a Mobile Station. Range of values is 0 to 7. Displayed as decimal.

PFCReq (PFC Request)

PFC Request uses PFC-1 to specify the paging frame class requested by a Mobile Station. Displayed as decimal.

PFM

Paging Frame Modifier is 1 if the Current PFC (Paging Frame Class) may modified as directed by the PFM_DIRECTION flag; 0 if the Current PFC is remain as the Assigned PFC. A Layer 2 field.

PFMdir (PFM_DIRECTION)

PFM_DIRECTION, a Layer 2 field, is 1 if the Current PFC (Paging Frame Class) is to be incremented by one (push out) and the required conditions are met; 0 if the Current PFC is to be decremented by one (pull in) and the required conditions are met.

PI

Calling Party Number Presentation Indicator indicates if the calling number is displayed as follows:

DESCRIPTION	CALLG PI
Presentation allowed	00
Presentation restricted	01
Number not available	10
Reserved	11

PLAN

Calling Party Numbering Plan Identification is displayed as follows:

DESCRIPTION	CALLG PL
Unknown	0000
ISDN/Telephony numbering plan (CCITT E. 164 and E. 163)	0001
Data numbering plan (CCITT X. 121)	0011
Telex numbering plan (CCITT F. 69)	0100
Private numbering plan	1001
Reserved for extension	1111
Reserved for future use	all other values

PM

Privacy Mode bit is 1 if voice privacy is activated on the assigned Digital Traffic Channel; 0 if not activated.

PM_D [RECC]

See *PM_D* subfield of *DatMode*

Present RNUM

See *RNUM*.

Primary

Primary Superframe Indicator is 0 if the current superframe is the primary superframe within a hyperframe; if 1 the current superframe is the secondary superframe.

PRIVACY

Data Privacy is 1 if Data Privacy is supported; 0 otherwise.

Prot Ver (Protocol Version, Protocol)

Protocol Version supported.

Value	Function
0000	EIA-553 or IS-54-A
0001	TIA/EIA 627
0010	IS-136 Rev 0
0011	Permanently Reserved
0100	IS-136 Rev A
All other values are reserved	

PSCC

Present SAT Color Code displays Color Code received in the last message.

PSID/RSID

See *P/R*.

PSID/RSID Map

See *P/RMap*.

PSID/RSID Ind

PSID/RSID Indicator is 1 if the PSID/RSID Support Length and PSID/RSID Support fields are present; 0 otherwise.

PSID/RSID SL

PSID/RSID Support Length specifies the length of the PSID/RSID Support field minus one.

PSID/RSID Support

The PSID/RSID Support field indicates which PSID/RSID values identified in the PSID/RSID Set information element of the System Identity message of the current DCCH are supported by the DCCH neighbor under consideration. The ordering of the bits in this field reflects the ordering of the PSID/RSID Set sent in the System Identity message in that the least significant bit is associated with the first PSID/RSID listed in the PSID/RSID Set. If a bit in this field is set to 1, then the associated PSID/RSID entry in the PSID/RSID Set is supported by the neighbor cell under consideration. If a bit in this field is set to 0, then the opposite is true.

PUREG

PUREG (Power-Up Registration) is 1 if the Mobile Station is to register at power up; 0 otherwise.

PT

Parameter Type indicates type of optional parameter included with the message.

PV

See Prot Ver.

PVI

Protocol Version Indicator is 1 if TIA/EIA-136 protocol is supported on the assigned channel; 0 if TIA/EIA 627 (IS-54) is supported.

PWRL

PWRL is the Power Level Class (0 to 7) of the Change Power message.

Qpos

Queue position provides queue position information.

RAND

RAND contains the random number stored by a Mobile Station for use in selected authentication processes.

RAND1_A

The 16 most significant bits of the 32-bit RAND value sent to the Mobile Station. The Mobile Station uses the RAND value in the authentication process.

RAND1_B

The 16 least significant bits of the 32-bit RAND value sent to the Mobile Station. The Mobile Station uses the RAND value in the authentication process.

RANDBS

The 32-bit random number generated by the Mobile Station during a SSD Update procedure is sent to the Base Station and both the Base Station and the Mobile Station use RANDBS to generate the SSD Update output (AUTHBS).

RANDC

Eight most significant bits of RAND are sent to the Base Station for a Mobile Station initiated authentication procedure. RANDC (along with AUTHR and COUNT) are used in the authentication procedure which validates registrations, originations and releases by the Mobile Station.

RANDRA

A 32-bit random number (typically RAND), generated by the Base Station in the Re-Authentication Order.

RANDSSD (RANDssid)

A 64-bit random number generated by the Mobile Stations Home system. RANDSSD is sent to the Mobile Station and both the Mobile Station and the Base Station use RANDSSD to generate the SSD-A_NEW value. This initiates the SSD Update procedure.

RANDSSD1

The most significant 24 bits of RANDSSD sent to the Mobile Station with a SSD Update message.

RANDSSD2

Bits 8 to 31 of RANDSSD sent to the Mobile Station with a SSD Update message.

RANDSSD3

The least significant 8 bits of RANDSSD sent to the Mobile Station with a SSD Update message.

RANDU

The 24-bit random number sent to the Mobile Station in the Unique Challenge Order and used to generate the authentication output (AUTHU).

RATE

Displays the Channel Rate. 0 signifies a full rate channel and 1 signifies a half rate channel.

RCause (R-Cause)

R-Cause is used to qualify an R-DATA REJECT message.

RCF

Read Control-Filler bit is 1 if Mobile Station must read the Control-Filler message before accessing the system; 0 otherwise.

RcfAuth

RCF and AUTH specifies if the Mobile Station is to read Control Filler information and send Authentication information when making an access on a ACC as a result of a Directed Retry received on the DCCH. Two bit field. 1st, RCF and 2nd, AUTH. RCF, is 1 if Mobile Station is to read Control Filler; 0 otherwise. AUTH is 1 if Authentication is enabled; 0 otherwise.

RCI

RCI identifies a particular radio frequency system allocation, together with recommended DCCH allocation, as defined in TIA/EIA-136.

R-Data (R-DATA, R-Data Unit)

R-Data Unit

Subfields:

RDatlen - Length indicator in octets

RDatHLPid - Higher Layer Protocol Identifier

Value	Function
0000 0000	Network Specific
0000 0001	Point-to-Point SMS
0000 0010	OATS
All other values are reserved	

RDatHLPda - Higher Layer Protocol Data Unit. The Higher Layer Protocol Data Unit field in the R-Data Unit subfield is used to carry the SMS CMT messages when the Higher Layer Protocol Identifier indicates Point-to-Point SMS.

OATS transports messages between the MS and the CSC/OTAF when the Higher Layer Protocol Identifier indicates OATS.

RDatDly

R-Data Delay controls the period between R-DATA message transmissions on the RACH and uses a DELAY subfield (*see DELAY*).

REGH

REGH (Registration for Home Mobile Stations) is 1 to allow the Mobile Station to perform a registration in the home system of the Mobile Station; 0 otherwise.

REGID

REGID Parameters consists of REGID and REGID_PER. REGID is a system clock ranging from 0 to 1048575. REGID_PER indicates how often REGID is incremented (0 to 15 superframes).

REGINCR

Registration Increment field is the new increment for the Mobile Station to add to the registration ID when performing autonomous registrations.

REGPer (REG Period)

REG Period specifies the registration periodicity in number of 94 superframes. Values are coded from 0 to 511 indicating 94 to 48128 superframes (approximately 1 minute to 8.5 hours).

REGPER	Value
00000 0000	94 Superframes
00000 0001	188 Superframes
00000 0010	282 Superframes
...	...
11111 1110	48034 Superframes
11111 1111	48128 Superframes

REGR

REGR (Registration for Roaming Mobile Stations) is 1 to allow a roaming Mobile Station to perform registration; 0 otherwise.

RegType

Registration Type specifies the type of registration the Mobile Station is attempting.

Value	Function
0000	Power down
0001	Power up
0010	Location Area
0011	Forced
0100	Periodic
0101	Deregistration
0110	New System
0111	ACC to DCCH
1000	TMSI Timeout
1001	User Group
1010	New Hyperband
All other values are reserved.	

RejTime

Reject Time is used by the system to indicate to a Mobile Station the interval of time when the Mobile Station is allowed to register again.

RESEL_OFF

RESEL_OFFSET is used to increase/decrease the preference of a new candidate cell being considered for control channel reselection.

Code	Value (dB)
0000000	-128
0000001	-126
...	...
0111110	-4
0111111	-2
1000000	0
1000001	2
...	...
1111110	124
1111111	126

Request Number

See RN.

RFCh

RF Channel for Handoff includes the CHAN subfield to indicate the RF channel number.

RFChAlc (RF Channel Allocation)

RF Channel Allocation specifies an RF channel allocation for system configurations that are not described in TIA/EIA-136.

Subfields:

RFChNum (Number of Channel Groups) number of channel groups minus one.

RFChGrp (Channel Group) consists of two subfields: First Channel and Last Channel. Channel Group is an ordered pair indicating the first/last RF channel numbers assigned to the Channel Group.

RFCHAN (1-4)

Each RFCHAN field displays 1 to 4 RF Channels. By selecting the 3 RFCHAN fields, all RF Channels in the Measurement order are displayed.

RFChHB

RF Channel and Hyperband provides a list of RF Channels with the associated Hyperbands.

RFCh(s)

RF Channels for Measurement, sent by the Base Station in the Measurement Order, provides the list of channels for the Mobile Station to take measurements on.

RgInfMp

Reg-Info Map provides additional information used in the registration process. The Reg-Info Map subfield is coded as follows:

Value	Function
XXX1	IS-41 Based Intersystem Communications Supported.
XX1X	SID Report Requested
X1XX	Reserved
1XXX	Reserved

RL

Remaining Length is the number of octets to follow (0 to 63).

RL_W

Remaining Length in Words is the number of words left in the Alert with Information or Flash with Information message.

RLP [RECC]

See RLP subfield of DatMode

RML

R-DATA Message Length specifies the maximum length of an R-DATA message that a Mobile Station may send on the RACH.

Value	Function
000	No R-DATA message on RACH
001	31 octet R-DATA message on RACH allowed
010	63 octet R-DATA message on RACH allowed
011	127 octet R-DATA message on RACH allowed
100	Reserved
101	Reserved
110	Reserved
111	Limited only by layer 2 format

RN (Request Number)

Request Number indicates the number of requests for retransmission due to a lack of acknowledgment.

RNUM (Present RNUM)

Present RNUM contains the registration number used to define the Virtual Mobile Location Area (VMLA) for a particular Mobile Station.

RNumLst

RNUM List contains the registration number that are used to define the Virtual Mobile Location Area (VMLA) for a particular Mobile Station.

Subfields:

NumRNUM - Number of RNUMs.

RNUMLst List of up to ten RNUMs.

RR

Release Reason indicates why a release occurred as follows:

DESCRIPTION	RR
Normal release	0000
Power down release	1111
Reserved	all other values

RSS-Min, RSS_ACC_MIN

RSS_ACC_MIN specifies the minimum received signal strength required to access a cell. Used for the cell (re)selection process.

Code	Value (dBm)
00000	-113 or less
00001	-111
...	...
11110	-53
11111	-51 or greater

RSSI1

Received Signal Strength of RF channels 1, 2 and 3 specified by the Measurement order. The Mobile Station reports the signal strength measurements used for a Mobile Assisted Handoff.

RSSI2

Received Signal Strength of RF channels 4, 5 and 6 specified by the Measurement order. The Mobile Station reports the signal strength measurements used for a Mobile Assisted Handoff.

RSSI3

Received Signal Strength of RF channels 7, 8 and 9 specified by the Measurement order. The Mobile Station reports the signal strength measurements used for a Mobile Assisted Handoff.

RSSI4

Received Signal Strength of RF channels 10, 11 and 12 specified by the Measurement order. The Mobile Station reports the signal strength measurements used for a Mobile Assisted Handoff.

RSSIC

Received Signal Strength of the Current Digital Traffic Channel measured by the Mobile Station. This value and Signal Strength readings of other RF Channels are sent to the Base Station during a Mobile Assisted Handoff (Measurement order).

RSVD

Reserved for future use.

R-Trans (R-Transaction ID)

R-Transaction Identifier is used to associate a R-DATA ACCEPT or a R-DATA REJECT message to the R-DATA message being acknowledged.

RtryCh

Retry Channel indicates a channel to be considered for directed retry purposes.

S

S is 1 if the Mobile Station is to send the Serial Number message along with a Registration, Origination, Page Response, R-DATA, SPACH Confirmation due to a SPACH Notification indicating R-DATA or Base Station Challenge Order; 0 otherwise.

SAP [RECC]

See SAP subfield of *DatMode*.

SAT

Supervisory Audio Tone is transmitted from the Base Station to the Mobile Station and repeated back to the Base Station.

SB

Shortened Burst is 1 if Mobile Station is to send shortened burst initially on the assigned digital traffic channel; 0 otherwise.

SBcchSp (S-BCCH Sup)

SMS Broadcast Support is 1 if Mobile Station supports SMS Broadcast operation; 0 otherwise.

SBI

Shortened Burst Indicator is used with a handoff and indicates if the Mobile Station uses shortened bursts initially on the new Digital Traffic Channel. SBI also indicates if a handoff is made inside the same cell. SBI is defined as follows:

DESCRIPTION	SBI
Transmit normal burst after cell to cell handoff.	00
Transmit normal burst after same cell handoff.	01
Transmit shortened burst after cell to cell handoff.	10
Reserved	11

SCC

Supervisory Audio Tone Color Code indicates the SAT frequency the Base Station is transmitting according to the following table:

SAT FREQ Hz	SCC
5970	00
6000	01
6030	10
Not used	11

ScanInt (SCANINTERVAL)

SCANINTERVAL specifies the basic interval, in hyperframes, between consecutive signal strength measurements.

Value	Function
0000	1 Hyperframe interval
0001	2 Hyperframes interval
...	...
1110	15 Hyperframes interval
1111	16 Hyperframes interval

ScanOpt (Scan Opt Ind)

Scanning Option Indicator is 1 if a Mobile Station can apply the optional enhancements to the signal strength measurement interval applicable to neighbor list entries; 0 otherwise.

SCM

Station Class Mark indicates Power Class, Discontinuous Transmission abilities and Bandwidth of the Mobile Station.

The 5-bit value is defined as follows:

POWER CLASS	SCM
Class I	0--00
Class II	0--01
Class III	0--10
Class IV	0--11
Class V	1--00
Class VI	1--01
Class VII	1--10
Class VIII	1--11

BANDWIDTH	SCM
20 MHz	-0---
25 MHz	-1---

TRANSMISSION	SCM
Continuous	--0--
Discontinuous	--1--

SDCC1

Supplementary Digital Color Code 1 is two additional bits supplementing the DCC. SDCC1 and SDCC2 together increase the number of color codes from 4 to 64.

SDCC2

Supplementary Digital Color Code 2 is two additional bits supplementing the DCC. SDCC1 and SDCC2 together increase the number of color codes from 4 to 64.

SELPR (Selected PSID/RSID)

Selected PSID/RSID, displayed in decimal, specifies on which private/residential system (1 to 16) in the PSID/RSID Set the Mobile Station is registered or attempting to register. Range of value is 0 to 15.

SERV-SS (SERV_SS)

SERV_SS (Service Signal Strength) is used in the control channel reselection process.

Code	Value (in dB)
0000	Service Offering Reselection Trigger Condition not allowed.
0001	2
...	...
1110	28
1111	30

SERVICE CD (Service)

Service Code (RECC), displayed in decimal, is used to indicate if an Async Data or G3 Fax call is being attempted. SERVICE CD is coded as follows:

0100 indicates Async Data

0101 indicates G3 Fax

All other values reserved.

SFBs (Bands)

Supported Frequency Bands, displayed in binary, specifies the frequency bands supported by the Mobile Station with Digital Traffic Channels.

Value	Function
XXXX XXX1	800 MHz A & B Bands Supported
XXXX XX1X	1900 MHz A Band Supported
XXXX X1XX	1900 MHz B Band Supported
XXXX 1XXX	1900 MHz C Band Supported
XXX1 XXXX	1900 MHz D Band Supported
XX1X XXXX	1900 MHz E Band Supported
X1XX XXXX	1900 MHz F Band Supported
1XXX XXXX	Reserved

SI

Calling Party Screening Indicator identifies how the calling number was screened as follows:

DESCRIPTION	CALLG SI
User provided, not screened	00
User provided, verified and passed	01
User provided, verified and failed	10
Network provided	11

SID

SID is the System Identification Number of the Base Station. This parameter identifies the Base Station.

SIDRpt

System Identification Report indicates the last SID the Mobile Station successfully registered on.

SIGNAL

SIGNAL is used for Alert messages, to ring the Mobile Station.

SIGNAL –Continued–

Subfields:

Pitch

Value	Function
00	Medium Pitch (standard)
01	High Pitch
10	Low Pitch
11	Reserved

Cadence is the on, off pattern of the tone.

Value	Function
000000	No tone: Off
000001	Long: 2 sec on and 4 sec off (std)
000010	Short-short: 0.8 sec on, 0.4 sec off, 0.8 sec on and 4.0 sec off
000011	Short-short-long: 0.4 sec on, 0.2 sec off, 0.4 sec on, 0.2 off, 0.8 sec on and 4 sec off
000100	Short-short-2: 1 sec on, 1 sec off, 1 sec on and 3 sec off
000101	Short-long-short: 0.5 sec on, 0.5 sec off, 1 sec on, 0.5 sec off, 0.5 sec on and 3 sec off
000110	Short-short-short-short: 0.5 sec on, 0.5 sec off, 0.5 sec on, 0.5 sec off, 0.5 sec on, 0.5 sec off and 2.5 sec off
000111	PBX long: 1 sec on and 2 sec off
001000	PBX short-short: 0.4 sec on, 0.2 sec on, 0.4 sec on and 2 sec off
001001	PBX short-short-long: 0.4 sec on, 0.2 off, 0.4 sec on, 0.2 sec off, 0.8 sec on and 1 sec off
001010	PBX short-long-short: 0.4 sec on, 0.2 sec off, 0.8 sec on, 0.2 sec off, 0.4 sec on and 1 sec off
001011	PBX short-short-short-short: 0.4 sec on, 0.2 sec off, 0.4 sec on, 0.2 off, 0.4 sec on, 0.2 sec off, 0.4 sec on and 0.8 off

All other values are reserved.

SIGNAL –Continued–

Duration specifies from 1 to 15 cycles of cadence with a range of 0 to 14, and the value of 15 specifies a continuous repeating of cadence.

SIGNAL PITCH

SIGNAL PITCH is the 2 most significant bits of the Signal field. The Signal field is used for Alert messages.

SLOT

The Timeslot used when a call is assigned to a Digital Traffic Channel.

SlotCnf

Slot Configuration specifies the number of slots dedicated to a DCCH for the current frequency.

Value	Function
00	One half-rate DCCH on slot 1
01	One full-rate DCCH on slots 1 and 4
10	One full-rate DCCH on slots 1 and 4, and One full-rate DCCH on slots 2 and 5
11	One full-rate DCCH on slots 1 and 4; One full-rate DCCH on slots 2 and 5, and One full-rate DCCH on slots 3 and 6

SMSMap (SMS Map)

SMS Map specifies the extent to which the cell site supports the CMT teleservice.

Value	Function
00	CMT Teleservice Not Supported
X1	SMS SUBMIT Supported
1X	SMS DELIVER Supported

SNT

Spach Notification Type specifies the message type the Base Station intends to deliver to the Mobile Station: Page, SSD Update, R-DATA, Queue Update, Queue Disconnect and Mobile Assisted Channel Allocation (MAHO).

SOC

SOC (System Operator Code) identifies the operator providing service.

Value (hex)	Function
000	Reserved / Unknown
001 - 7FF	National SOC
800	Reserved / Unknown
801 - FFF	International SOC

SOCci

System Operator Code Change Indicator specifies, if set to 1, the SOC associated with the current digital traffic channel differs from the SOC associated with the digital traffic channel being assigned. A 0 setting indicates no SOC change.

SOCSup SOC Sup

SOC support is 1 if Mobile Station supports a SOC sent on the SOC/BSMC Identification message on the BCCH; 0 otherwise.

Software

See SWVint.

SpchSFP

SFP (Superframe Phase) of Received SPACH is displayed as a decimal value.

SPMA

Service Privacy Mode A indicates the privacy mode status of the Mobile Phone including the PM subfield.

SPMB

Service Privacy Mode B indicates the privacy mode status of the Mobile Phone (1 is on, 0 is off).

SRM

SPACH Response Mode is 0 if the Mobile Station is to make the next access attempt on the RACH contention-based once the Mobile Station has received all frames associated with a given SPACH message; 1 if the next access attempt is to be reservation-based under the same circumstances.

SS-SUF (SS_SUFF)

SS_SUFF (signal strength sufficient) specifies the minimum signal strength deemed sufficient for a candidate control channel to be considered for control channel reselection.

Code	Value (dBm)
00000	- 113 or less
00001	-111
...	...
11110	-53
11111	-51 or greater

SSD UP, SSD_UPDATE

Secret Shared Data Update bit is set to 1 if SSD Update message succeeds; 0 if the message fails.

SSDStat (SSD Update Status)

SSD Update Status, displayed in decimal, is used to indicate the success or Mobile Station's reason for failure of an SSD Update Order.

Value	Function
00	SSD Update Successful
01	SSD Update Failed due to AUTHBS mismatch
10	Reserved
11	Reserved

ST

Signal Tone is a 10 kHz tone transmitted by the Mobile Station to confirm orders and to indicate flash and release requests.

STM

STM Measurement is used to send the measured signal strength of the MACA channels.

Subfields:

STM-NV - Number of values is displayed in decimal.

STM-strss - Short Term Received Signal Strength is displayed in decimal and encoded as the subfield *LTM-ltrss* of the field LTM.

STMOth

STM Measurement (Other Hyperband) provides the measurement status of MACA channels not included in the STM Measurement.

STU3Sup

STU-III Support indicates the Mobile Station supports STU-III operation if set to 1 or does not support STU-III operation if set to 0.

SubAddr (SubAddress)

Subaddress identifies the subaddress of a called or calling party.

Subfields:

SubAdrLen - Length of Subaddress Info content in octets.

SubAdrO-E - Odd/Even Indicator is 1 if there are an odd number of address signals; 0 for an even number.

SubAdrTyp - Type of Subaddress.

Code	Description
000	NSAP (ITU Recommendation X.213 or ISO 8348 AD2)
010	User-specified
All other values are reserved	

SubAdrRes - Reserved.

SubAddr - Subaddressing. Two instances of this field may be used.

SubSup (Subaddr Supp, Subaddr Sup)

Subaddressing Support is 1 if Base Station or Mobile Station supports subaddressing; 0 otherwise.

SvcCd

Service Code specifies the requested service.

Code	Function
0000	Analog Speech Only
0001	Digital Speech Only
0010	Analog or Digital Speech - Analog Preferred
0011	Analog or Digital Speech - Digital Preferred
0100	Async Data
0101	G3 Fax
0110	Service Rejected
0111	STU-III
All other codes are reserved	

SWVint (Software)

Software Vintage, displayed in hexadecimal, is used to identify the Mobile Station software vintage (specific to a Mobile Station vendor).

SYREG

SYREG is 1 if Mobile Station is to register when having entered a new system identification area; 0 otherwise.

T/ORDER

Identifies orders or messages and acknowledgments received.

TA

Displays the Time Alignment (number of units from SOR). 31 instructs the Mobile Station to maintain current timing offset.

Task

Task Status provides the current Mobile or Base Station task. The Task subfield indicates the task as follows:

DESCRIPTION	Task
Waiting for Order	000
Waiting for Answer	001
Conversation	010
Reserved	all other values

TDMA Service Info

See TSI.

TERM INF

Terminal Information contains the following subfields:

TERM INF SUBFIELD	LENGTH (bits)
IS-54 Version (IS-54A 0000), (IS-54B 0001)	4
Manufacturer code	8
Mobile Station model number	8
Mobile Station firmware	6
Access Overload Class	4
Mobile Station local control status (1 enabled, 0 disabled)	1
Registration bit	1

TextMes (Text Message Data Unit)

Text Message Data Unit contains the message to be broadcast.

Subfields:

TextMesLen (Length Indicator) number of octets of short message characters.

TextMesEnc (Encoding Identifier):

00001 IRA, as specified by Tables 5 and A-1 of ITU Recommendation T.50 (1992)

00010 User specific.

All other values are reserved.

TextMesRes (Reserved).

TextMsg (Short Message Character) is encoded as specified by the Encoding Identifier and displayed as a string.

THB

Target Hyperband indicates the hyperband for the occurring handoff channel.

TI

Timeslot Indicator displays the assigned Timeslot; 0 signifies an Analog Voice Channel, 1 to 6 signifies the 6 Timeslots.

Tim1180 (Time from Jan 1, 1980)

Time from Jan 1, 1980. This information element is a sequential time counter in seconds elapsed since January 1, 1980, 00:00 hour, 0 seconds using Greenwich Mean Time as the reference point.

TimeInd

Timeslot Indicator specifies the timeslot of the designated traffic channel.

DESCRIPTION	TimeInd
Analog Channel (target hyperband defaults to 800 MHz.)	000
Timeslot 1	001
Timeslot 2	010
Timeslot 3	011
Timeslot 4	100
Timeslot 5	101
Timeslot 6	110
Reserved	111

For Timeslot indications, the target hyperband defaults to the current hyperband.

Time Zone Offset

See *TZOff*.

ToneInd

Tone Indicator specifies the type of tone to be generated by the Mobile Station.

Value	Function
00	Reorder
01	Intercept
All other values are reserved	

TRateSp (Triple-Rate Sup)

Triple Rate DTC Support is 1 if Mobile Station supports triple rate digital traffic channels; 0 otherwise.

TSA

Teleservice Server Address.

Subfields:

TSALen - Length of Address Info content in octets.

TSATyp - Type of Number.

TSAPln - Numbering Plan Identification.

TSAEnc - Address Encoding.

TSAddr - Address. Up to six instances allowed.

TSI (TDMA Service Info)

TDMA Service Info provides service attribute information for Other Hyperband TDMA neighbors.

Subfields:

TDMANcnt (TDMA Neighbor Count) number of TDMA Neighbors.

TDMAMap (TDMA Service Map) consists of the two subfields: Service Map Indicator and Service Map. **Service Map Indicator** is 1 if the Service Map subfield is present; 0 otherwise. The **Service Map** subfield, when present, provides service information and is coded as follows:

Value	Function
00 0000 0000	No Services Supported
XX XXXX XXX1	Analog Speech
XX XXXX XX1X	Digital Speech
XX XXXX X1XX	G3 Fax
XX XXXX 1XXX	Async Data
XX XXX1 XXXX	Voice Privacy
XX XX1X XXXX	Data Privacy
XX X1XX XXXX	Message Encryption
XX 1XXX XXXX	User Group
X1 XXXX XXXX	Point-to-Point SMS
1X XXXX XXXX	Reserved

TSIOth

TDMA Service Info (Other Hyperband) provides service attribute information for Other Hyperband TDMA neighbors.

TYPE OF NUM (TYPE)

Calling Party Number Type is displayed as follows:

DESCRIPTION	CALLD TY
Unknown	000
International number	001
National number	010
Network specific number	011
Subscriber number	100
Reserved for future use	101
Abbreviated number	110
Reserved for extension	111

TZOff (Time Zone Offset)

Time Zone Offset is used to identify the time zone offset in minutes relative to Greenwich Mean Time.

UDA

User Destination Address of a short message is used to identify the user destination address of a short message.

Subfields:

UDALen - Length of Address Info content in octets. Displayed as decimal. (See *Address Info*.)

UDATyp - Type of Number. Displayed as decimal. (See *Address Info*.)

UDAPln - Numbering Plan Identification. Displayed as decimal. (See *Address Info*.)

UDAEnc - Address Encoding. Displayed as binary. (See *Address Info*.)

UDAddr - Address. Up to six instances allowed. Displayed as text. (See *Address Info*.)

UDS

User Destination Subaddress is used to identify the subaddress of the destination user of a short message.

Subfields:

UDSLen - Length of Subaddress Info content in octets. Displayed as decimal. (See *SubAddr*.)

UDSO-E - Odd/Even Indicator. Displayed as binary. (See *SubAddr*.)

UDSTyp - Type of Subaddress. Displayed as decimal. (See *SubAddr*.)

UDSRes - Reserved. Displayed as binary. (See *SubAddr*.)

UDSAddr - Subaddressing. Displayed as hexadecimal. Up to two instances allowed. (See *SubAddr*.)

UG (User Group)

User Group identifies the User Group I.D. that a Mobile Station has requested or has been allocated.

Subfield:

UGStat - User Group Status is displayed in decimal.

Value	Function
00	Preferred User Group ID allocation request/Allocated User Group ID
01	Unspecified User Group ID allocation request
10	De-allocate MS from currently allocated User Group ID
11	Reserved

UGType - User Group Type is displayed in decimal.

Value	Function
00	20-bit Local UGID
01	24-bit SOC UGID
10	34-bit National UGID
11	50-bit International UGID

UGID - User Group I.D with length specified by *UGType*, is displayed in hexadecimal.

UGID-L2

User Group Identity consist of one of the following: 20-bit Local UGID, 24-bit SOC UGID, 34-bit National UGID or 50-bit International UGID.

UGMap (User Group Map)

User Group Map is 1 if cell site supports User Group operation; 0 otherwise.

UGSup (UG Sup)

User Group Support is 1 if Mobile Station supports user group operation; 0 otherwise.

UOA

User Originating Address is used to identify the user originating address of a short message.

Subfield:

UOALen - Length of Address Info content in octets. Displayed as decimal. (*See Address Info.*)

UOATyp - Type of Number is displayed in decimal. (*See Address Info.*)

UOAPln - Numbering Plan Identification is displayed in decimal. (*See Address Info.*)

UOAEnc - Address Encoding is displayed in binary. (*See Address Info.*)

UOAddr - Address. Up to six instances allowed is displayed as text. (*See Address Info.*)

UOAPI

User Originating Address Presentation Indicator specifies the presentation restrictions and screening related to User Originating Address or the originating MSID.

UOS

User Originating Subaddress is used to identify the subaddress of the originating user of a short message.

Subfields:

UOSLen - Length of Subaddress Info content in octets is displayed in decimal. (See *SubAddr*.)

UOSO-E - Odd/Even Indicator is displayed in binary. (See *SubAddr*.)

UOSTyp - Type of Subaddress is displayed in decimal. (See *SubAddr*.)

UOSRes - Reserved and displayed in binary. (See *SubAddr*.)

UOSAddr - Subaddressing has up to two instances allowed and is displayed in hexadecimal. (See *SubAddr*.)

User Group Map

See *UGMap*.

VC

See *Vmode*.

VCMap (VC Map)

Voice Coder Map, displayed in binary, specifies the types of voice coders supported by the Mobile Station.

Value	Function
00 0000	No Voice Coders Supported
XX XXX1	VSELP Voice Coder Supported
XX XX1X	Alternate Voice Coder Supported (see IS-641.)
1X XXXX	Reserved for SOC/BSMC Specific Signaling
All other bit map positions are reserved	

VMAC

Voice Mobile Attenuation Code sets initial Mobile Station power level when assigning the Mobile Station to a Digital Traffic or Voice channel. VMAC is displayed as follows:

DESCRIPTION	VMAC
Power level 0	000
Power level 1	001
Power level 2	010
Power level 3	011
Power level 4	100
Power level 5	101
Power level 6	110
Power level 7	111

VMode (Voice Mode)

Voice Mode specifies the mode to be used for the requested Voice Call.

Subfields:

VMvc - VC field

Value	Function
000	No Voice Coder
001	VSELP Voice Coder
010	Alternate Voice Coder
110	Reserved for SOC/BSMC Specific Signaling
All other values are reserved	

VMpmv - PM_V field

Value	Function
000	No Voice Privacy
001	Voice Privacy Algorithm A
100	Reserved for SOC/BSMC Specific Signaling
All other values are reserved	

VPM

Voice Privacy Mode bit is 1 if voice privacy is activated on the assigned Digital Traffic Channel; 0 if not activated.

VPMap (VPM Map)

Voice Privacy Mode Map specifies the forms of voice privacy supported by the cell site. Display in binary.

Value	Function
0000	No Voice Privacy Supported
XXX1	Voice Privacy Algorithm A Supported
1XXX	Reserved for SOC/BSMC Specific Signaling
All other bit map positions are reserved	

WFOM

Wait For Overhead Message bit is 1 if the Mobile Station must wait for an Overhead Message before transmitting on the Reverse Control Channel.

THIS PAGE INTENTIONALLY LEFT BLANK.

APPENDICES

APPENDIX A - SPECIFICATIONS

See IFR-1900 Operation Manual (1002-3402-200) for specifications.

THIS PAGE INTENTIONALLY LEFT BLANK.

APPENDIX B - BROADCAST CHANNEL DEFAULT CONFIGURATION

When the "default" Softkey on the Broadcast Channel Messages screen (see Section 3.5) is selected, the CSA is configured to transmit the Broadcast Channel Messages in a preset manner. The Broadcast Channel default configuration consists of only the following mandatory Broadcast Channel messages:

BCCH Messages	Subchannels		
	F-BCCH	E-BCCH	S-BCCH
DCCH Structure	√		
Access Parameters	√		
Control Channel Selection Parameter	√		
Registration Parameters	√		
System Identity	√		
Neighbor Cell		√	
Regulatory Configuration		√	

These message are set up according to the following tables:

DCCH Structure

The format of the DCCH Structure message is as follows:

Information Element	Type	Length	Value (Binary)
Protocol Discriminator	M	2	00
Message Type	M	6	00 0100
Number of F-BCCH	M	3	000
Number of E-BCCH	M	3	000
Number of S-BCCH	M	4	0000
Number of Reserved Slots	M	3	000
Hyperframe Counter	M	4	Automatic
Primary Superframe Indicator	M	1	Automatic
Slot Configuration	M	2	01
DVCC	M	8	00000001
MAX_SUPPORTED_PFC	M	3	000
PCH_DISPLACEMENT	M	3	000
PFM_DIRECTION	M	1	0
Number of Non-PCH Subchannel Slots	M	2	00
Extended Hyperframe Counter	O	7	Not Sent
CBN_High	O	20	Not Sent
Non-Public Probability Blocks	O	9 ~ 24	Not Sent

Access Parameters

The format of the Access Parameters message is as follows:

Information Element	Type	Length	Value (Binary)
Protocol Discriminator	M	2	00
Message Type	M	6	00 0001
AUTH	M	1	0
S	M	1	0
RAND	M	32	0 (Dec)
MS_ACC_PWR	M	4	0000
Access Burst Size	M	1	1
Max Retries	M	3	111
Max Busy/Reserved	M	1	1
Max Repetitions	M	2	11
Max Stop Counter	M	1	1
R-DATA Message Length	M	3	000
Cell Barred	M	5	00000
Subaddressing Support	M	1	0
Delay Interval Compensation Mode	M	1	0

Control Channel Selection Parameters

The format of the Control Channel Selection Parameters message is as follows:

Information Element	Type	Length	Value (Binary)
Protocol Discriminator	M	2	00
Message Type	M	6	00 0011
SS_SUFF	M	5	00000
RSS_ACC_MIN	M	5	00000
SCANINTERVAL	M	4	0000
Initial Selection Control	M	1	0
DELAY	M	4	0000
Scanning Option Indicator	M	1	0
Additional DCCH Information	O	20 ~ 111	Not Sent

Registration Parameters

The format of the Registration Parameters message is as follows:

Information Element	Type	Length	Value (Binary)
Protocol Discriminator	M	2	00
Message Type	M	6	00 0111
REGH	M	1	1
REGR	M	1	1
PUREG	M	1	1
PDREG	M	1	1
SYREG	M	1	1
LAREG	M	1	0
DEREG	M	1	1
FOREG	M	1	1
Capability Request	M	1	1
Present RNUM	O	14	Not Sent
REG Period	O	13	Not Sent
REGID Parameters	O	28	Not Sent
Non-Public Registration Control	O	6	Not Sent

System Identity

The format of the System Identity message is as follows:

Information Element	Type	Length	Value (Binary)
Protocol Discriminator	M	2	00
Message Type	M	6	00 1011
SID	M	15	0 (Dec)
Network Type	M	3	100
Protocol Version	M	4	0010
PSID/RSID Set	O	37 + 17 * N	Not Sent
Mobile Country Code	O	14	Not Sent
Alphanumeric SID	O	12-132	Not Sent

Neighbor Cell

The format of the Neighbor Cell message is as follows:

Information Element	Type	Length	Value (Binary)
Protocol Discriminator	M	2	00
Message Type	M	6	00 1110
SERV_SS	M	4	0000
Non-Public Probability Blocks	O	9 ~ 24	Not Sent
Neighbor Cell List (TDMA)	O	(9 + 57 * N)- (9 + 77 * N)	Not Sent
Neighbor Cell List (Analog)	O	9 + 49 * M	Not Sent

Regulatory Configuration

The format of the Regulatory Configuration message is as follows:

Information Element	Type	Length	Value (Binary)
Protocol Discriminator	M	2	00
Message Type	M	6	00 1111
RCI	M	2	01
RF Channel Allocation	O	32 ~ 1418	Not Sent

APPENDIX C - AUXILIARY FUNCTIONS

C.1 AUXILIARY FUNCTIONS MENU

The CSA Auxiliary Functions menu screen is accessed in the following manner:

1. Power up the IFR-1900 (see IFR-1900 Operation Manual).
2. Press **DPLX**. Press **Sp Tst F5** to display the Dual Mode TIA/EIA-136 Cellular menu.
3. Press **AUX2 F5** to display the CSA Auxiliary Functions menu.

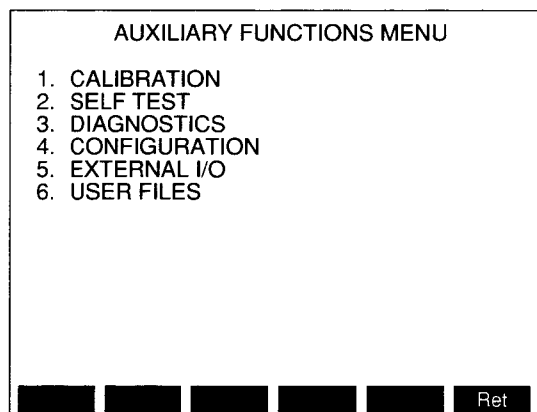

03416103

C.2 CALIBRATION

Factory use only.

C.3 SELF TEST

The CSA Self Test reasonably assures the user the CSA is operating properly. Each of the tests in the Self Test can be performed individually if desired.

To Perform Self Test

1. From the CSA Auxiliary Functions menu, press **2** to display the Self Test menu:

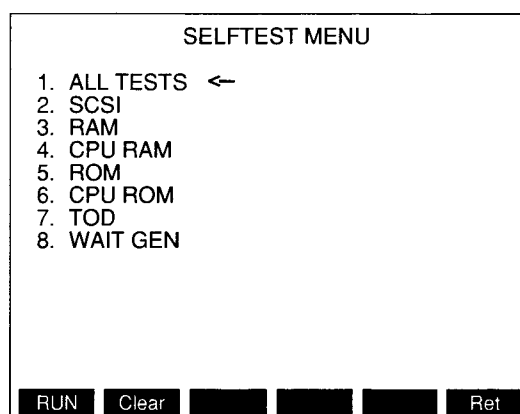

03416104

2. Using Field Select keys, move arrow to "1. ALL TESTS" and press **RUN F1** to automatically execute each test in sequence, starting with "2. SCSI". P or F appears beside each test indicating a pass or fail. Press **Abort F5** at anytime to abort the automatic running of the self tests. (The Abort Soft Function Key appears only when running "ALL TESTS.")
3. To run an individual test, move arrow to desired self test and press **RUN F1**. P or F appears beside the test indicating the test passed or failed.
4. Press **Clear F2** to clear previous test results.
5. Press **Ret F6** to return to the CSA Auxiliary Functions menu.

C.4 DIAGNOSTICS

Factory use only.

C.5 CONFIGURATION

From the Auxiliary Functions menu, press **4** to display the configuration of the CSA. The version, date and time of the system firmware is displayed.

C.6 EXTERNAL I/O PARAMETERS

External I/O Parameters configure the CSA for remote operation through the CSA OPT. RS-232 Connector or the IFR-1900 GPIB (IEEE-488) Connector.

External I/O Parameters Procedure:

1. From the Auxiliary Functions menu, press **5** to display the External I/O Parameters screen:

EXTERNAL I/O PARAMETERS	
RS-232 BAUDRATE	19200
RS-232 PARITY	NONE
RS-232 BIT LENGTH	8
RS-232 STOP BITS	1
RS-232 PACE	XON
GPIB ADDRESS	30

Ret

9150016

2. Use **FIELD SELECT** \uparrow and \downarrow to select parameter. Use **DATA SCROLL Spinner** or **DATA SCROLL** \uparrow and \downarrow to edit parameter. Set parameters as desired.

User must select a CSA GPIB address different from the Communication Service Monitor GPIB address.

3. Press **DPLX** to escape Special Test (Sp Tst).

The IFR-1900 must be in an operation screen for remote operation.

C.7 USER FILES

User files are created and loaded using remote commands through the CSA OPT. RS-232 Connector. Refer to the TMAC Users Manual for programming and loading user files.

To Execute Macro Type Files

1. From the Auxiliary Functions menu, press **6** to display the 1900CSA Flash Files directory:

1900CSA FLASH FILES		
Bytes Used: 103168	Bytes Free: 1448960	
NAME	TYPE	SIZE
S_TEST	MACRo	9477 ←
MINIT1	MACRo	6822
STATE1	STATE	65536

EXEC Delete Init Pack RET

03416105

2. Use **FIELD SELECT** \uparrow and \downarrow to select desired file.
3. Press **EXEC F1**.

To Delete a File

1. Use **FIELD SELECT** \uparrow and \downarrow to select desired file. Press **Delete F2**. Use **FIELD SELECT** \uparrow and \downarrow to verify and press **ENTER**.
2. Press **Pack F4** to Perform Pack operation (releases Flash Memory space after deleting file[s]),. Use **FIELD SELECT** \uparrow and \downarrow to verify and press **ENTER**.

To Delete All Files and Initialize Flash Memory

Press **Init F3**.

APPENDIX D - REMOTE CONFIGURATION

D.1 GENERAL

This section provides general configuration procedures for remote operation for the CSA section of the IFR-1900. Remote operation depends on having CSA settings match user equipment and interface settings. Settings in configuration procedures may require variation depending on user equipment.

D.2 CONFIGURING FOR RS-232 OPERATION

Remote operation using Host system

The CSA can be remotely operated from a host system. The host system can be a PC using terminal emulation software or an RS-232 terminal.

Host system setup and operation

1. Connect Host system to CSA OPT. RS-232 on rear panel of IFR-1900 using standard 9-pin to 9-pin RS-232 cable:

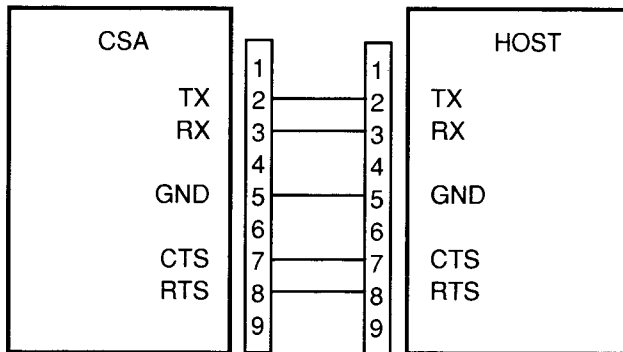

03403005

2. Press **DPLX**, **Sp Tst F5**, **AUX2 F5** and **5** to access the External I/O Parameters screen:

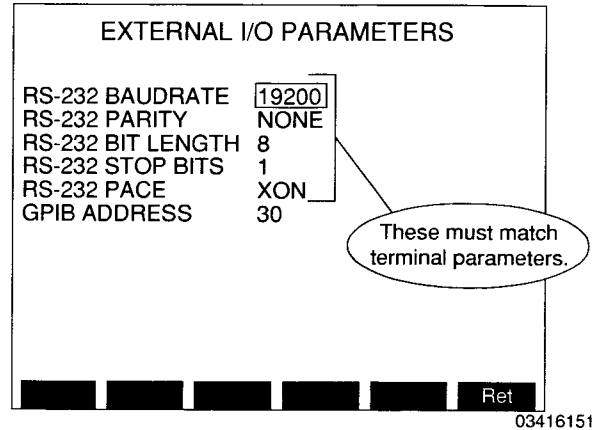

03416151

3. Using cursor, set RS-232 parameters as desired.
4. Press **DPLX** to exit the Dual Mode TIA/EIA-136 Cellular operation.
5. Set terminal emulator software or RS-232 terminal parameters to match CSA settings (or vice versa).
6. Send desired CSA commands from host terminal to CSA. Write and save macros, as desired, using host system text editor. Transfer macros and programs, as desired, to CSA using host system.

D.3 REMOTE OPERATION USING MODEM

The CSA can be connected to a Modem and operated remotely over telephone line.

Host system setup and operation

1. Connect Modem to CSA OPT. RS-232 on rear panel of IFR-1900 as shown below:

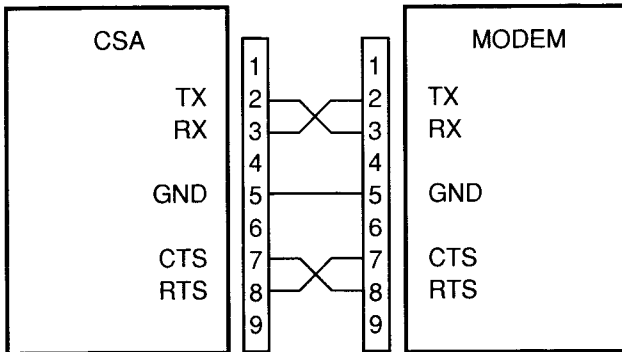

03403006

2. Perform Steps 2 through 4 of Section C.2.
3. From remote telephone location, call Modem and operate CSA.

D.4 CONFIGURING FOR GPIB OPERATION

The CSA can be remotely operated using GPIB protocol via the GPIB (IEEE-488) Connector on the rear panel of the IFR-1900.

In the IFR-1900, the CSA and Communications Service Monitor share the GPIB (IEEE-488) Connector on the rear panel. Both sections function by the user designating separate GPIB addresses for the Communications Service Monitor and the CSA.

GPIB setup and operation

1. Press **DPLX**, **Sp Tst F5**, **AUX2 F5** and **5** to access the External I/O Parameters screen:

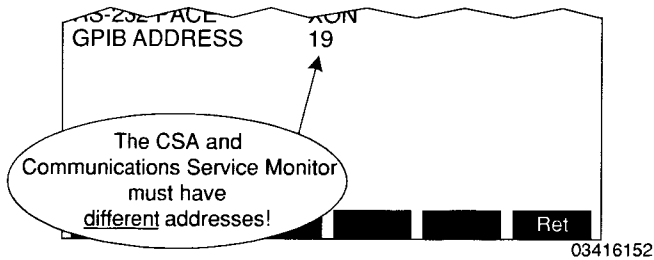

2. Using cursor and specify GPIB address for the CSA.

Specify address not conflicting with any device connected to the GPIB.

3. Press **DPLX** to exit the Dual Mode TIA/EIA-136 Cellular operation.
4. Connect GPIB cable connector to GPIB (IEEE-488) Connector on the rear panel of the IFR-1900.
5. Initiate parallel remote operation from GPIB controller.

THIS PAGE INTENTIONALLY LEFT BLANK.

APPENDIX E - ABBREVIATIONS AND ACRONYMS

A		D	
A	Ampere	dB	Decibels
ac	Alternating Current	dBc	Decibels relative to carrier
ACC	Analog Control Channel	dBm	Decibels relative to 1 milliwatt
AF	Audio Frequency	dc	Direct Current
ANLZ	Analyzer	DCCH	Digital Control Channel
ANSI	American National Standards Institute	DGTL	Digital
ARCH	Access Response Channel	Disp	Display
ASCI	American National Standard Code for Information Interchange	DMM	Digital Multimeter
AUX	Auxiliary	DPLX	Duplex Operation Mode (See IFR-1900 Communications Service Monitor Operation Manual)
AVC	Analog Voice Channel	DQPSK	Differential Quadrature Phase Shift Keying
B		DTC	Digital Traffic Channel
BCCH	Broadcast Control Channel (or Broadcast Channel)	DTMF	Dual Tone Multi-Frequency
BER	Bit Error Rate	DTX	Discontinuous Transmission
B/I	Busy/Idle	DVCC	Digital Verification Color Code
bps	Bits per second	E	
C		E- BCCH	Extended Broadcast Control Channel
CCH	Control Channel	ESC	Escape
CCITT	International Consultative Committee for Telephone and Telegraph	ESD	Electrostatic discharge
ccw	Counterclockwise	EXT MOD	External
CDL	Coded DCCH Locator		
CDVCC	Coded Digital Verification Color Code		
CHAN, Chan	Channel		
CNTL	Control		

F

F- BCCH	Fast Broadcast Control Channel
FACCH	Fast Associated Control Channel
FDCCH, Fdcch	Forward Digital Control Channel
FDTC	Forward Digital Traffic Channel
FOCC	Forward Analog Control Channel
Folw	Follow
FREQ, freq	Frequency
FSK	Frequency shift keying
FVC	Forward Analog Voice Channel
FWD	Forward

G

GIAct	Global Action
GND	Ground
GPIB	General Purpose Interface Bus

H

Hz	Hertz
Hex	Hexadecimal

I

Id	Identification
ISDN	Integrated Services Digital Network
IEEE	Institute of Electrical and Electronic Engineers
I/O	Input/Output

K

kbit	kilobit
kbps	Kilobits per second
kHz	Kilohertz (1000 Hertz)

L

lvl	Level
L.O.	Local Oscillator

M

MBER	Mobile Assisted BER Measurement
MHz	Megahertz (1000000 Hertz)
MIC	Microphone Source
min	minute
MIN	Mobile Identification Number
ms	Millisecond
MSCM	Mobile Station Control Message
mV	Millivolt
mVp-p	Millivolt peak to peak
mW	Milliwatt

P

PC	Personal Computer
PCH	Paging Channel
PCS	Personal Communications Service/System
PLC	Physical Layer Control
ppm	part per million
Prev	Previous

R

RACH	Random Access Channel
RDCCH, Rdcch	Reverse Digital Control Channel
RDTCC	Reverse Digital Traffic Channel
Recap	Recapture
RECC	Reverse Analog Control Channel
REG	Register, registration
Ret	Return
RF	Radio Frequency
RFLVL	RF Level
RF Pwr Lvl	RF Power Level
RMS, rms	Root Mean Square
RVC	Reverse Analog Voice Channel
RVS	Reverse

S

S- BCCH	Short Message Service - Broadcast Control Channel
SACCH	Slow Associated Control Channel
sec	Second
SMS	Short Message Service
SMSCH	Short Message Service Point-to-Point Channel
Sp Tst	Special Test
SPACH, Spach	SMSCH, PCH and ARCH
SQLCH	Squelch
SSB	Single Sideband
ST	Signal(ing) Tone

T

TDMA	Time Division Multiple Access
TS	Time Stamp

U

UHF	Ultra High Frequency
-----	----------------------

V

V	Volt
VAC	Alternating current voltage
VCH	Voice Channel
Vdc	Direct current voltage
VOL	Volume
Vp-p	Volt peak to peak
VSELP	Vector Sum Excited Linear Predictive
VSWR	Voltage standing wave ratio

W

W	Watt
---	------

THIS PAGE INTENTIONALLY LEFT BLANK.

INDEX

$\pi/4$ DQPSK I/Q pattern with constellation, To plot
 ACC (mobile station) 3-25
 Base Station 3-45
 DCCH (mobile station) 3-37

A

Abbreviations and Acronyms E-1
 ACC Cell Site Simulation 3-16
 Accept an origination, complete a call and monitor, To
 ACC 3-20
 DCCH 3-33
 Access the
 ACC Cell Site Simulation screens, To 3-16
 DCCH Cell Site Simulation Screens, To 3-29
 DCCH Mobile Simulation Screens, To 3-39
 Dual Mode/Tri-Band Functions of the CSA, To 1-3
 TIA/EIA-136 Cellular Data Monitor, To 3-1
 TIA/EIA-136 Cellular Data Monitor Operation screens and setup menus, To 3-1
 Accuracy and Power Test, Modulation
 ACC 3-24
 DCCH 3-36
 ACELP Vocoder 3-20, 3-33, 3-34, 4-9
 Adjacent Channel Power Measurement 3-48
 Adjacent channels power measurements (mobile station), To perform
 ACC 3-27
 DCCH 3-38
 Adjust input attenuation using Analyzer feature, To 3-3
 Analog Control Channel Cell Site Simulation Screen Hierarchy 3-17
 Analog Voice Channel messages, To send
 ACC 3-22
 DCCH 3-35
 Analyzer feature, To adjust input attenuation using 3-3
 ANTENNA IN Connector 2-1
 Applications 4-1
 Following a Call from the ACC 4-2
 Monitoring
 a Base Station off the Air (ACC) 4-1
 Raw Data on FOCC 4-3
 Performing a
 DTC Handoff to Another Band 4-10
 Handoff on a Call Made to a Mobile Station (ACC) 4-6
 Mobile Station
 Authentication (DCCH) 4-7
 Unique Challenge (DCCH) 4-8
 Placing a Call
 DCCH Digital (ACELP) Call to a Hyperband Channel 4-9
 Digital Call to a Mobile Station (ACC) 4-4
 Attenuation
 Between Antenna In and T/R Connectors 2-1
 To adjust, using Analyzer feature 3-3
 Audio on the DTC from the Test Set, To input and Monitor 3-20
 Authentication (DCCH), Performing a Mobile Station 4-7
 Auxiliary Functions C-1

B

Band
 Operation, Cellular 1-2
 Performing a DTC Handoff to Another 4-10
 Base Station, To connect the Test Set to the Mobile or 3-41
 BER test, To perform a 3-43
 Bit Error Rate
 BER Test Modes 3-41
 Mobile Assisted Measurement 3-21
 Broadcast Channel
 Default Configuration B-1
 (F-BCCH, E-BCCH, S-BCCH), To monitor selected data fields received on the 3-4
 Messages 5-1
 Broadcast Control Channel to the assigned Digital Traffic or Analog Voice Channel, To follow a call from the 3-5

C

Capture selected data fields received on the
 Forward Analog Control Channel, To 3-8
 Forward Digital Traffic Channel, To 3-9
 Reverse Analog Control Channel, To 3-12
 Reverse Digital Traffic Channel, To 3-13
 Capture the raw data words received on the
 Forward Analog Control Channel, To 3-9
 Forward Analog Voice Channel, To 3-11
 Forward Digital Traffic Channel, To 3-10
 Reverse Analog Control Channel, To 3-12
 Capture the raw interleaved data received on the
 Forward Digital Traffic Channel, To 3-10
 Cell Site Monitoring, To connect the Test Set for Cell Site Simulation
 ACC 3-16
 DCCH 3-28
 Cellular
 Band Operation 1-2
 Channel Definition 1-2
 Data Monitor Screen Hierarchy, TIA/EIA-136 3-2
 Data Monitor, To access the TIA/EIA-136 Fields 6-1
 Messages 5-1
 Channel Power Measurement, Adjacent 3-48
 Channel Definition, Cellular 1-2
 Codes, VSELP Parameter 3-14
 Configuration
 Broadcast Channel Default B-1
 CSA C-2
 Remote D-1
 Connectors 2-1
 Connect the Test Set
 for Cell Site Monitoring, To 3-3
 to the Mobile or Base Station, To 3-41
 to the Mobile Station, To
 ACC 3-16
 DCCH 3-29
 Constellation, To Plot
 Base Station 3-45, 3-46
 Mobile Station (ACC) 3-25, 3-26
 Mobile Station (DCCH) 3-37

D

Data fields displayed	
by the RECC and RDTC screens, To select	3-18
on the operation screens, To select the	3-4
Data Monitor, TIA/EIA-136 Cellular	3-1
Data Out RS-232 Connector	
FOCC	3-8
RDTC	3-14
Data words, To send repetitive random or user-defined	3-39
DCCH Cell Site Simulation Screen Hierarchy	3-28
DCCH Cell Site Simulation Screens, To access the	3-29
DCCH Mobile Simulation Screens, To access the	3-39
DCCH Pointer (Control Channel Information Message), To send the	3-23
Default Configuration, Broadcast Channel	B-1
Delete Files, To	C-2
Digital Traffic BER Test Modes	3-42
Digital Traffic Channel messages, To send	
ACC	3-21
DCCH	3-34
Digital Traffic or Analog Voice Channel, To follow a call from the	
Broadcast Control Channel to the assigned	3-5
Forward Analog Control Channel to the assigned	3-8
SPACH* Channel to the assigned	3-6
Display DTMF received on the Reverse Analog Voice Channel, To	3-15
Display power meter alone, To	3-46
Display power meter alone (mobile station), To	
ACC	3-26
DCCH	3-38
DTC (VSELP or ACELP operation) from the Test Set, To input and monitor audio on the	3-20
DTMF received on the Reverse Analog Voice Channel, To display	3-15

E

Execute Macro Type Files, To	C-2
External I/O Parameters	C-2

F

FDCCH Broadcast Channel Messages, To set up the	3-30
FDTC Messages	5-13
Fields, Cellular	6-1
Files, To Delete	C-2
Flash Memory, To Initialize	C-2
FOCC data out the RS-232 Connector, To send received	3-8
Follow a call from the	
Broadcast Control Channel to the assigned	
Digital Traffic or Analog Voice Channel, To	3-5
Forward Analog Control Channel to the assigned	
Digital Traffic or Analog Voice Channel, To	3-8
SPACH* Channel to the assigned Digital Traffic or Analog Voice Channel, To	3-6
Following a Call from the	
ACC	3-8, 4-2
BCCH	3-5
SPACH	3-6
Forward Analog Control Channel, To capture selected data fields received on the	3-8
capture the raw data words received on the	3-9
monitor selected data fields received on the	3-7
Forward Analog Voice Channel, To capture the raw data words received on the	3-11
monitor selected data fields received on the	3-11
Forward Digital Traffic Channel, To capture selected data fields received on the	3-9
the raw data words received on the	3-10
the raw interleaved data received on the	3-10
Frame, Speech	3-14
Front Panel	2-1
FVC Messages	5-15

G

GENERATOR BASEBAND OUT I and Q Connectors	2-2
Global Action Overhead Messages	5-8
To send	3-22
GPB (IEEE-488) Connector	2-2, C-2, D-2

H

Handset, Telephone	
Using, To input and monitor audio on the DTC	3-20
Hook-up, Remote	D-1, D-2

I

I and Q Connectors, GENERATOR BASEBAND OUT	2-2
Initialize Flash Memory, To	C-2
I/Q Pattern, To Plot	
Base Station	3-45
Mobile Station	
ACC	3-25
DCCH	3-37
Input attenuation using Analyzer feature, To adjust	3-3
Input and monitor audio on the DTC (VSELP or ACELP operation) from the Test Set	3-20

M

Macro Type Files, To Execute	C-2
Maximum Input Power	2-1
Measurement, Adjacent Channel Power	3-48
Memory, To Initialize Flash	C-2
Messages, Cellular	5-1
BCCH	5-1
FDTC	5-13
FVC	5-15
Global Action Overhead	5-8
Mobile Station Control (MSCM)	5-10
RDCCH	5-5
SPACH	5-4
Mobile Assisted BER Measurement	3-20
Mobile Assisted BER measurement and call handoff from the RDTC, To perform	3-21
Mobile or Base Station, To connect the Test Set to the	3-41
Mobile Simulation, DCCH	3-39
Mobile Station Control Messages	5-10
Mobile Station Control Message, To send a	3-24
Mobile Station, To connect the Test Set to the	
ACC	3-16
DCCH	3-29
Mobile Station, To place a call to the	
ACC	3-19
DCCH	3-32
Modulation Accuracy and Power	3-44
ACC	3-24
DCCH	3-36
Monitor data fields received on the Neighbors List screen, To	3-6
Monitoring a Base Station off the Air (ACC)	4-1
Monitoring Raw Data on FOCC	4-3
Monitor messages and selected data fields received on the SPACH* Channel, To	3-5
Monitor RACH messages and selected data fields received on the RDCCH Channel screen, To	3-7
Monitor Reverse Analog Control Channel messages from the Mobile Station, To	3-22
Monitor selected data fields received on the Broadcast Channel, To	3-4
Monitor selected data fields received on the Forward Analog Control Channel, To	3-7
Monitor selected data fields received on the Forward Analog Voice Channel, To	3-11
Monitor selected data fields received on the Reverse Analog Voice Channel, To	3-15
Monitor selected data fields received on the Reverse Digital Traffic Channel, To	3-13
Move the cursor and enter values, To	1-3

N

Neighbors List screen, To monitor data fields received on the	3-6
--	-----

O

Operating Basics	1-3
Operation	3-1
Operation, Cellular Band	1-2
Operational Input Signal Power Ranges	2-1
Origination, complete a call and monitor;	
To accept an	
ACC	3-20
DCCH	3-33
Overhead Message Train	3-16, 3-18, 3-22, 3-23

P

Page order (call not completed), To send a Panel	3-22
Front	2-1
Rear	2-2
Parameter Codes, VSELP	3-14
Perform a BER test, To	3-43
Perform a modulation accuracy and power test, To	3-44
Perform a power test, To	3-47
Perform a Registration, To	
ACC	3-19
DCCH	3-31
Perform adjacent channels power measurements (mobile station), To (ACC)	3-27
(mobile station), To (DCCH)	3-38
Perform an Adjacent Channel Power Measurement test, To (base station)	3-48
Performing a	
DTC Handoff to Another Band	4-10
Handoff on a Call Made to a Mobile Station (ACC)	4-6
Mobile Station Authentication (DCCH)	4-7
Mobile Station Unique Challenge	4-8
Perform Mobile Assisted BER measurement and call handoff from the RDTTC, To	3-21
Perform modulation accuracy and power testing on a mobile station, To	
ACC	3-24
DCCH	3-36
Perform Self Test, To	C-1
Place a call to the Mobile Station, To	
ACC	3-19
DCCH	3-32
Placing a Call	
DCCH Digital (ACELP) Call to a Hyperband Channel	4-9
Digital Call to a Mobile Station (ACC)	4-4
Plot $\pi/4$ DQPSK I/Q pattern with constellation, To (mobile station), To (ACC)	3-37
(mobile station), To (DCCH)	3-25
Plot constellation alone, To (mobile station), To (ACC)	3-26
(mobile station), To (DCCH)	3-37
Power	
Maximum Input	2-1
Measurement, Adjacent Channel	3-48
Meter, To Display Alone	
Base Station	3-46
Mobile Station	
ACC	3-26
DCCH	3-38
Meter, To Zero	3-25, 3-26, 3-36, 3-38 3-44, 3-46, 3-47
Ranges, Operational Input Signal	2-1
TDMA	3-47
Test, Modulation Accuracy and	3-44
ACC	3-24
DCCH	3-36
Print any screen on color display, To	1-4

Q

Q Connectors, GENERATOR BASEBAND OUT I and	2-2
--	-----

R

RACH (Random Access Channel) messages on the RDCCH, To send	3-40
RACH messages and selected data fields received on the RDCCH Channel screen, To monitor	3-7
RDCCH Messages	5-5
RDTTC VSELP data out the RS-232 Connector, To send received	3-14
Rear Panel	2-2
Registration, To perform a	
ACC	3-19
DCCH	3-31
Remote	
Configuration	D-1
Hook-up	D-1, D-2
Reverse Analog Control Channel	
messages from the Mobile Station, To Monitor	3-22
To capture selected data fields received on the	3-12
To capture the raw data words received on the	3-12
Reverse Analog Voice Channel, To	
display DTMF received on the	3-15
monitor selected data fields received on the	3-15
Reverse Digital Traffic Channel, To	
capture selected data fields received on the	3-13
monitor selected data fields received on the	3-13
RS-232 Connector	2-2, C-2, D-1, D-2
Data out	
FOCC	3-8
RDTTC	3-14

S

Select data fields displayed	
By the RECC and RDTC screens, To	3-18
On the operation screens, To	3-4
Self Test	C-1
Send a	
Mobile Station Control Message, To	3-24
Page order (call not completed), To	3-22
SPACH Message, To	3-35
Send Analog Voice Channel messages, To	
ACC	3-22
DCCH	3-35
Send Digital Traffic Channel messages, To	
ACC	3-21
DCCH	3-34
Send Global Action Overhead messages, To	3-22
Send RACH (Random Access Channel) messages on the RDCCH, To	3-40
Send received FOCC data out the RS-232 Connector, To	3-8
Send received RDTC VSELP data out the RS-232 Connector, To	3-14
Send repetitive random or user-defined data words, To	3-39
Send the DCCH Pointer (Control Channel Information Message), To	3-23
Set up the FDCCH Broadcast Channel Messages, To Simulation	3-30
ACC Cell Site	3-16
DCCH Cell Site	3-28
DCCH Mobile	3-39
SPACH Channel Messages	5-4
SPACH* Channel, To monitor messages and selected data fields received on the	3-5
SPACH* Channel to the assigned Digital Traffic or Analog Voice Channel, To follow a call from the	3-6
SPACH Message, To send a	3-35
Specifications	A-1
Speech Frame	3-14
Start sending the overhead message train, To	3-18
SYNC OUT Connector	2-2

T

TDMA Power	3-47
Telephone handset	
Using To input and monitor audio on the DTC	3-20
TIA/EIA-136 Cellular Data Monitor	3-1
T/R Connector	2-1

U

Unique Challenge, Performing a Mobile Station	4-8
User Files	C-2
Use the Scrolling Window on Selected Data Monitor Screens, To	1-3

V

View the spectrum of the currently monitored channel, To	3-3
Vocoder	
ACELP	3-20, 3-33, 3-34, 4-9
VSELP	3-14, 3-20, 3-21, 3-33, 3-34
VSELP Parameter Codes	3-14

Z

Zero Power Meter, To	3-25, 3-26, 3-36, 3-38 3-44, 3-46, 3-47
----------------------	--

THIS PAGE INTENTIONALLY LEFT BLANK.