

INSTRUCTION MANUAL

OSCILLOSCOPE

SS-5711

岩崎通信機株式会社



IWATSU ELECTRIC CO., LTD.

Main Office: 7-41, 1-chome Kugayama Sugihara-ku, Tokyo 168 Japan,
Telephone Tokyo (334) 1111

Overseas Operation Department: Asahiseimei-Building 1-3, 2-chome Nihonbashi Chuo-ku,
Tokyo, 103 Japan, Telephone Tokyo (272) 0461, Telex J24225
(TELEIWA) Cable Address TELEPHIWATSU

TABLE OF CONTENTS

SECTION 1	SPECIFICATIONS	1-1			
1-1	GENERAL	1-1	2-5-4	Operation for Enlarging Waveforms on the CRT Screen	2-17
1-2	ELECTRICAL SPECIFICATIONS	1-1	2-5-5	Operation for ALT Sweep	2-18
1-2-1	Cathode-Ray Tube (CRT)	1-1	2-5-6	Operation for Observing Television Composite Video Signal Waveforms	2-19
1-2-2	Vertical Deflection System	1-1		Operation for Single Sweep	2-20
1-2-3	Triggering	1-2	2-5-7	Operation for Use as an X-Y Scope	2-21
1-2-4	Horizontal Deflection System	1-3	2-5-8	Z Axis System	2-21
1-2-5	X-Y Operation	1-4			
1-2-6	Z-Axis System	1-4			
1-2-7	Signal Output	1-4	2-5-9		
1-2-8	Power Supply	1-5			
1-3	PHASICAL CHARACTERISTICS	1-5	SECTION 3	MEASURING PROCEDURES	3-1
1-4	ENVIRONMENTAL CHARACTERISTICS	1-5	3-1	ADJUSTMENTS NECESSARY BEFORE MEASUREMENTS	3-1
1-5	ACCESSORIS	1-5	3-1-1	TRACE ROTATION Adjustment	3-1
			3-1-2	GAIN Adjustment	3-1
SECTION 2	OPERATING INFORMATION	2-1	3-1-3	x5 BAL Adjustment	3-1
2-1	OPERATING PRECAUTIONS	2-1	3-1-4	VARIABLE BAL Adjustment	3-1
2-2	OPERATION OF THE HANDLE	2-2	3-1-5	Probe Phase Adjustment	3-1
2-3	CONTROLS AND SWITCHES	2-2	3-2	MEASURING METHODS	3-2
2-3-1	Front Panel	2-3	3-2-1	Voltage Measurement	3-2
2-3-2	Rear Panel	2-8	3-2-2	Current Measurement	3-3
2-3-3	Bottom Cover	2-8	3-2-3	Time Measurement	3-4
2-4	OPERATIONG INSTRUCTIONS	2-10	3-2-4	Frequency Measurement	3-5
2-4-1	Basic Operation for Signal Observation	2-10	3-2-5	Phase Difference Measurement	3-5
2-4-2	Applying Signals	2-11	SECTION 4	THEORY OF OPERATION	4-1
2-4-3	Signal Input Coupling Section	2-11	4-1	GENERAL	4-1
2-4-4	Vertical Defection Factor Setting	2-12	4-1-1	Pre-amplifiers for Channels 1, 2, 3, and 4	4-1
2-4-5	Triggering	2-12	4-1-2	Delay Cable Driver Circuit	4-1
2-4-6	Sweep Rate Setting	2-15	4-1-3	Vertical Main Amplifier	4-1
2-5	APPLIED OPERATIONS FOR SIGNAL OBSERVATION	2-15	4-1-4	Trigger Signal Circuit	4-1
2-5-1	Operation for Dual-Trace Observation	2-15	4-1-5	TV Trigger Signal Separator Circuit	4-1
2-5-2	Operation for Observation of the Sum of Two Signals or Their Difference	2-16	4-1-6	A and B Trigger Amplifier Circuits	4-3
2-5-3	Operation for Quadruple-Trace Observation	2-16	4-1-7	A and B Sawtooth Generator Circuits	4-3
			4-1-8	Horizontal Amplifier	4-3
			4-1-9	Z-Axis Amplifier	4-3
			4-1-10	CRT Circuit	4-4
			4-1-11	Low-Voltage Circuit	4-4

4-1-12	Calibration Voltage and Current Generator Circuit	4-4	6-7-8	The parallel of the Horizontal Trace and the Horizontal Scale (TRACE ROTATION)6-13
SECTION 5	MAINTENANCE.	5-1	6-7-9	The Parallel of the Vertical Trace and the Vertical Scale (ORTHOgonARITY)6-14
5-1	PREVENTIVE MAINTENANCE.	5-1	6-7-10	Pattern Distortion6-15
5-1-1	Cleaning	5-1	6-8	CALIBRATOR OUTPUT6-16
5-1-2	If Unused for a Long Time	5-1	6-8-1	Output Voltage6-16
5-1-3	Checking	5-2	6-8-2	Repetition Rate6-17
5-1-4	Periodic Adjustment	5-2	6-9	VERTICAL DEFLECTION SYSTEM	6-18
5-2	PARTS REPLACEMENT	5-2	6-9-1	ADD Balance6-18
5-2-1	Cover Removal	5-2	6-9-2	X 5 Balance6-19
5-2-2	Printed Circuit Board Removal.	5-2	6-9-3	mV Balance6-20
5-2-3	Printed Circuit Board Parts Replacement.	5-3	6-9-4	Variable Balance6-20
5-2-4	Replacing Resistors, Diodes or IC's.	5-3	6-9-5	Pulse Response I (CH1, CH2 sag at 10mV/DIV)6-21
5-2-5	Power Transistor Replacement.	5-3	6-9-6	Deflection Factor I (CH1, CH2)6-22
5-2-6	CRT Replacement	5-4	6-9-7	Pulse Response I (CH1, CH2 sag at 10mV/div)6-24
5-2-7	High-Voltage Power Transformer Replacement.	5-5	6-9-8	Position Center (CH3, CH4)6-25
5-2-8	Replacing Control Knobs and Rotary Switches	5-5	6-9-9	Attenuator Compensation I (CH1, CH2)6-26
5-2-9	Replacing Pushbutton Switches	5-5	6-9-10	Attenuator Compensation II (CH3, CH4)6-28
SECTION 6	CHECK AND ADJUSTMENT	6-1	6-9-11	Deflection Factor II (CH3, CH4)6-30
6-1	GENERAL.	6-1	6-9-12	Pulse Response III (overshoot and others)6-31
6-2	PERIOD OF CHECK AND ADJUSTMENT	6-1	6-9-13	Pulse Response IV (CH3, CH4 sag)6-33
6-3	PRECAUTIONS FOR CHECK AND ADJUSTMENT.	6-1	6-9-14	Bandwidth6-34
6-4	EQUIPMENT REQUIRED.	6-1	6-9-15	Linearity6-35
6-5	CHECK AND ADJUSTMENT ITEMS	6-4	6-10	TRIGGERING SYSTEM.6-36
6-6	PREPARATION	6-6	6-10-1	FIX triggering level6-36
6-7	POWER SUPPLY AND CRT CHECK AND ADJUSTMENT	6-6	6-10-2	Triggering Level I (CH1, CH2)6-38
6-7-1	Power Supply DC Level I (Voltage Range)	6-6	6-10-3	Triggering Level II (CH3, CH4)6-40
6-7-2	Power Supply DC Level II (Ripple Voltage)	6-7	6-11	HORIZONTAL DEFLECTION SYSTEM6-42
6-7-3	AC Line Voltage Range	6-8	6-11-1	Average Voltage Horizontal Amplifier6-42
6-7-4	Limiter Level	6-9	6-11-2	Magnification Center6-42
6-7-5	High-Voltage Power Supply.6-10	6-11-3	A.B Sweep Start6-43
6-7-6	Intensity6-11			
6-7-7	Focus6-12			

6-11-4 Sweep Rate6-44
 6-11-5 Magnified Sweep Rate6-46
 6-11-6 Start and Stop of Delay6-47
 6-11-7 Jitter.6-49
 6-12 X-Y OPERATION6-50
 6-12-1 Deflection Factor6-50
 6-12-2 Spot Location.6-50
 6-12-3 Phase Difference6-51

SECTION 7 SCHEMATIC DIAGRAMS 7-1

SECTION 8 ELECTRICAL PARTS LIST 8-1

CH1 ATTENUATOR &
 PRE- AMPLIFIER (1) 8-2
 CH2 ATTENUATOR &
 PRE- AMPLIFIER (1) 8-4
 CH1 PRE-AMPLIFIER (2) 8-6
 CH2 PRE-AMPLIFIER (2) 8-8
 DELAY CABLE DRIVER8-10
 VERTICAL PANEL SWITCHES . . .8-12
 VERTICAL CONTROL8-13
 VERTICAL OUTPUT AMPLIFIER .8-14
 CH3 & CH4 PRE-AMPLIFIER &
 SOURCE8-16
 A TRIGGER AMPLIFIER8-18
 B TRIGGER AMPLIFIER.8-20
 TV SYNC SEPARATOR.8-21
 A SWEEP GENERATOR8-22
 B SWEEP GENERATOR8-24
 TIMING SWITCHES8-26
 HORIZONTAL SWITCHES.8-27
 HORIZONTAL CONTROL.8-28
 HORIZONTAL AMPLIFIER.8-30
 Z-AXIS CIRCUIT8-32
 CRT CIRCUIT8-34
 POWER SUPPLY &
 CALIBRATOR8-36
 PRINTED CIRCUIT BOARDS. . . .8-38

**SECTION 9 MECHANICAL PARTS LIST
 AND ILLUSTRATION. 9-1**

1
2
3
4
5
6
7
8
9
10
11
12
13
14
15
16
17
18
19
20
21
22
23
24
25

Specifications

1-1 GENERAL

The SS-5711 is an oscilloscope with a frequency bandwidth of DC to 100 MHz that can display 8 traces on 4 channels.

The SS-5711 is useful in a wide range of applications for not only production lines and maintenance and service purposes but also for the research and development of a variety of electronic devices. The features of the SS-5711 are as follows:

- In addition to display of 8 traces on 4 channels, the SS-5711 has an ADD function for measuring the sum of two signals and CH 2 POLAR for measurement of the difference between two signals.
- Both CH 1 and CH 2 have a high deflection factor of 1 mV/div (in the x5 MAG function), which permits accurate measurement of voltages.
- The horizontal deflection system has sweep rates up to 2 nsec/div (in the x10 MAG function) so that even high-speed phenomena can be measured with accuracy.
- The SS-5711 has delayed sweep, single sweep, ALT sweep, and X-Y operation functions, and a TV synchronizing signal separator circuit so that television and other composite video signal waveforms can be observed.

1-2 ELECTRICAL SPECIFICATIONS

1-2-1 Cathode-Ray Tube (CRT)

Shape	Rectangular, 6 inches
Display Area	8 div x 10 div (1 div = 10 mm), with internal illuminated graticule of parallax-free type
Phosphor	B31 (Standard)
Accelerating Voltage	Approximately 20 kV

1-2-2 Vertical Deflection System

Modes	CH 1, CH 2, ALT, CHOP, ADD, QUAD (Quadruple) CHOP switching rate: 500 kHz \pm 40%
-------	--

Channels 1 and 2

Deflection Factor	5 mV/div to 5 V/div, in 10 calibrated steps in a 1-2-5 sequence Accuracy: \pm 2% (at 10°C to 35°C) \pm 5% (at -10°C to +50°C)
	5 mV/div to 12.5 V/div continuously variable with the VARIABLE control x5 MAG: 1 mV/div to 1 V/div, in 10 calibrated steps Accuracy: \pm 4% (at 10°C to 35°C) \pm 8% (at -10°C to +50°C)

Frequency Response	DC to 100 MHz, -3 dB (5 mV/div to 2 V/div) DC to 50 MHz, -3 dB (1 mV/div, 2 mV/div; x5 MAG) DC to 100 MHz, -3.5 dB (5 V/div)
--------------------	--

Notes

- 10°C to 35°C
- Bandwidth : The highest usable frequency is 20 MHz.
- AC coupling: The lowest usable frequency is 4 Hz.

Rise Time	3.5 nsec (at 10 mV/div) or less
-----------	---------------------------------

Pulse Response Overshoot: 3%
 Sag (at 1 kHz): 1%
 Other distortion: 2%
 (10 mV/div, 10°C to 35°C)

Signal Delay Delay cable supplied

Input Coupling AC, DC, GND

Input RC Direct
 1 MΩ±1.5%/25 pF ± 2 pF
 With probe
 10 MΩ±2%/14 pF ±2 pF

Maximum Input Voltage
 Direct:
 250 V (DC +peak AC)
 With probe:
 600V (DC + peak AC)
 (Refer to the instruction
 manual for the probe for the
 maximum input voltage
 where the probe is used.)

Drift 0.1 div/hour or 2 mV/hour,
 whichever is larger, 30 minutes
 after power is turned on
 (Standard)

Common Mode Rejection Ratio
 At 10 mV/div
 50 : 1 (1 kHz sine wave)
 15 :1 (20 MHz sine wave)

Polarity Inversion CH 2 only

Channels 3 and 4

Deflection Factor 0.1 V/div, 1V/div, selectable
 Accuracy: ±4%
 (at 10°C to 35°C)
 ±8%
 (at -10°C to +50°C)

Frequency Response DC to 100 MHz -3 dB
 (0.1 V/div)
 DC to 100 MHz -3.5 dB
 (1V/div)

Notes
 • 10°C to 35°C
 • Bandwidth: The highest
 usable frequency is 20 MHz.
 AC coupling: The lowest usable
 frequency is 4 Hz.

Pulse Response As shown in table 1-1.
Table 1-1 (at 10°C to 35°C)

Waveform Distortion	0.1 V/div	1 V/div
Overshoot	7%	10%
Sag (at 1 kHz)	2%	2%
Other distortion	5%	5%

Input Coupling AC, DC

Input RC Direct:
 1 MΩ±1.5%/27 pF ± 3 pF
 With probe
 10 MΩ±2%/14 pF ±2pF

Maximum Input Voltage
 Direct:
 250 V (DC +peak AC)
 With probe:
 600 V (DC +peak AC)

1-2-3 Triggering

A-Triggering

Triggering Mode AUTO, NORM SINGLE/
 RESET

Signal Sources CH 1, CH 2, CH 3, LINE,
 NORM
 (External trigger can be used
 by selecting CH 3 with
 SOURCE switch)

Coupling AC, DC, HF REJ, LF REJ,
 FIX,TV-H, TV-V

Slope Positive-going (+),
 negative-going (-)

Minimum Trigger Sensitivity

As shown in table 1-2

Table 1-2 (at -10°C to 35°C)

Frequency	Sensitivity of CH 1, CH 2, CH 3, CH 4
DC to 10 MHz	0.3 div
10 MHz to 50 MHz	1 div
50 MHz to 100 MHz	1.5 div

Notes

- FIX:
1 div at 100 Hz to 10 MHz
2 div at 10 MHz to 50 MHz
Sine waves only
- TV-V, TV-H synchronizing signal level: 1 div or more on screen amplitude for a composite video signal composed of 7 parts video signal and 3 parts synchronizing signal
- Trigger signals are attenuated in the following frequency ranges depending on coupling
AC: 30 Hz or lower
HF REJ: 10 kHz or higher
LF REJ: 10 kHz or lower
- AUTO sweep mode: The lowest usable frequency is 50 Hz)

B-Triggering

Signal Sources RUNS AFTER DELAY, CH 1, CH 2, CH 4
(External trigger can be used by selecting CH 4 with SOURCE switch.)

Coupling AC, DC, HF REJ, FIX (AC)

Slope Positive-going (+), negative-going (-)

Minimum Trigger Sensitivity
As shown in table 1-2

1-2-4 Horizontal Deflection System

Modes A, A INTEN, ALT, B (DLY'D), X-Y

A-Sweep
Sweep Rates 20 nsec/div to 0.5 sec/div in 23 calibrated steps in a 1-2-5 sequence
20 nsec/div to 1.25 sec/div, continuously variable with the VARIABLE control
Accuracy I (Over center 8 divisions):
± 2% (at 10°C to 35°C)
± 4% (at -10°C to +50°C)
Accuracy II (Over 2 of the center 8 divisions):
± 5% (at -10°C to +50°C)

Hold-Off Time Variable with the HOLD OFF control

B-Sweep
Delay Continuous delay (RUNS AFTER DELAY,) triggered delay

Sweep Rates 20 nsec/div to 50 msec/div, in 20 calibrated steps in a 1-2-5 sequence
Accuracy I (Over center 8 divisions):
± 2% (at 10°C to 35°C)
± 4% (at -10°C to +50°C)
Accuracy II (Over any 2 of the center 8 divisions):
± 5%
(-10°C to +50°C)

Time Difference Measurement
0.2 μ sec/div to 5 sec/div
Accuracy: ± 1% of reading ± 0.01 graduation (Minimum graduation of DELAY TIME MULT dial)

Delay Jitter 1/20,000 or less

Sweep Magnification 10 times
(Maximum sweep rate: 2 nsec/div)
Accuracy I of magnified sweep rate (Over center 8 divisions):
±5%
at 20 nsec/div, 50 nsec/div
±3%
at 0.1 μsec/div to 0.5 sec/div
(at 10 °C to 35 °C)
Accuracy II of magnified sweep rate (Over any 2 of the center 8 divisions):
±10%
at 20 nsec/div, 50 nsec/div
±6%
at 0.1 μsec/div to 0.5 μsec/div
±5%
at 1 μsec/div to 0.5 sec/div
(at 10 °C to 35 °C)
(Except 30 nsec from sweep start point and 40 nsec from sweep end point)

1-2-5 X-Y Operation

X Axis (Same as CH 1 except for the following)

Deflection Factor Same as that of CH 1
Accuracy: ±3%
(at 10 °C to 35 °C)
±5%
(at -10 °C to +50 °C)

Frequency Response DC to 2 MHz, -3 dB

Y Axis Same as CH 2

X-Y Phase Defference 3° or less (at DC to 100 kHz)

1-2-6 Z-Axis System

Sensitivity 0.5 Vp-p
Polarity Positive (deceases intensity),
negative (increase intensity)
Frequency Range DC to 5 MHz
Input Resistance 4.6 k Ω ± 10%
Maximum Input Voltage 50 V (DC + peak AC)

1-2-7 Signal Outputs

Calibrator

Waveform Square wave
Repetition Frequency 1 kHz
Accuracy: ±1%
(at 10 °C to 35 °C)
±2%
(at -10 °C to +50 °C)

Duty Ratio 40% to 60%
Output Voltage 0.6 V
Accuracy: ±1%
(at 10 °C to 35 °C)
± 1.5%
(at -10 °C to +50 °C)

Output Current 10 mA
Accuracy: ±1%
(at 10 °C to 35 °C)
±2%
(at -10 °C to +50 °C)

CH 1 OUT

Output Voltage 40 mV ± 20% per div of amplitude on the CRT screen
(at 50 Ω terminated)
Frequency Response DC to 50 MHz, -3 dB
Output Resistance 50 Ω ± 20%

A Gate Out

Output Voltage Approximately +5 V (Base line: Approximately 0 V)
Output Resistance Approximately 2.7 k Ω

B Gate Out

Same as A gate Out

1-2-8 Power Supply

Voltage Range	100 V (90 to 110 V)/ 115 V (103 to 128 V)/ 220 V (195 to 242 V)/ 230 V, 240 V (207 to 264 V) AC One of these voltage ranges can be selected with voltage selector plug.
Frequency Range	50 to 400 Hz
Power Consumption	Approximately 62 W (at 100 V AC)

1-3 PHYSICAL CHARACTERISTICS

Weight	Approximately 9.5 kg (Without panel cover and accessories bag)
Dimensions	320 ± 2 (W) x160 ± 2 (H) x400 ± 2 (L) (mm) See Figure 1-1.

1-4 ENVIRONMENTAL CHARACTERISTICS

Operating Temperature	-10°C to +50°C
Operating Humidity	40°C, 90% Relative Humidity
Storage Temperature	-20°C to +70°C
Storage Humidity	70°C, 80% Relative Humidity

Altitude	Operating: 5,000 m maximum (atmospheric pressure 428 mmHg) Non-operating: 15,000 m maximum (atmospheric pressure 87 mmHg)
Vibration	From 10 Hz to 55 Hz and back in 1 minute; double amplitude 0.63 mm; for 15 minutes each in vertical, hori- zontal, and longitudinal direc- tions for a total of 45 minutes
Impact	One side is raised to an elevation angle of 45° (10 cm maximum), and let fall on a piece of hard wood. Each side is put to this test 3 times.
Drop	A package ready for trans- portation is dropped from a height of 60 cm.

1-5 ACCESSORIES

Power Cord	1
Probe (SS-0012)	2
Fuse (FSA-2)	2
Panel Cover	1
Dust Cover	1
Instruction Manual	1
Accessories Bag	1

For the method of removing the accessories bag,
refer to Figure 1-2.

Figure 1-1. Dimensional Diagram

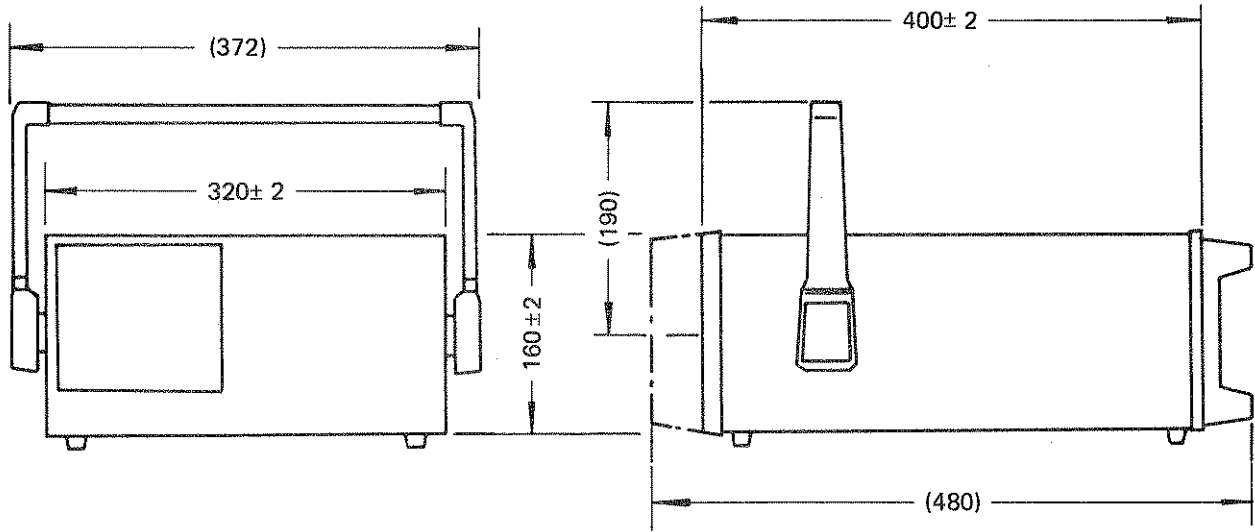
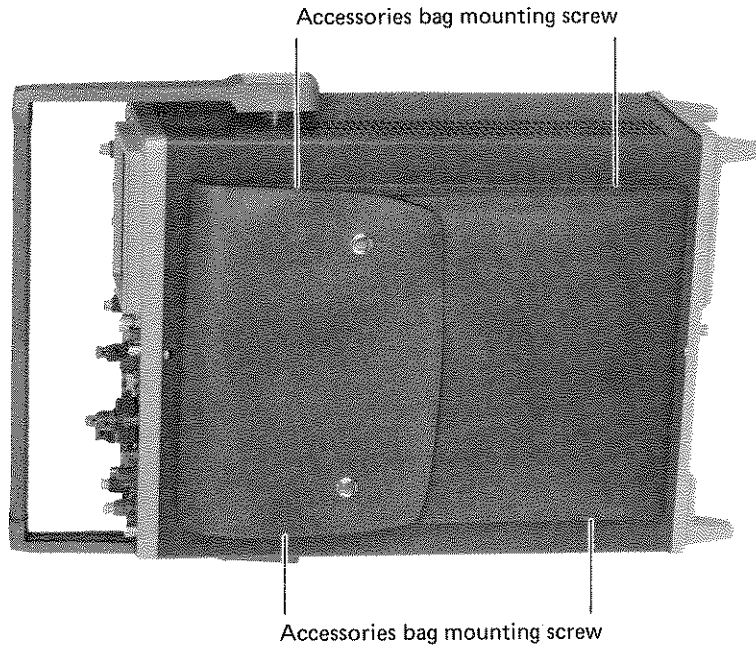

Figure 1-2. Accessories Bag



When removing the accessories bag from the upper cover of the SS-5711, remove the four accessories bag mounting screws shown in Figure 1-2.

Use the same screws for mounting the accessories bag on the upper cover again.

Notes

Operating Information

2-1 OPERATING PRECAUTIONS

Observe the following precautions in operating the SS-5711.

Ambient temperature and ventilation

The SS-5711 operates normally in the ambient temperature range of -10°C to $+50^{\circ}\text{C}$. Be sure to use the SS-5711 within this range. Use of it outrange can result in some trouble. Do not place anything near the ventilating hole in the cover to block heat dissipation.

Line voltage check

Before plugging the power cord to an electrical output, be sure to check its voltage. The SS-5711 can be used on the line voltage shown in Table 2-1, which can be selected with the voltage selector plug on the rear panel. Also check the fuse in the rear panel as shown in Table 2-1. Operating the SS-5711 on other than the specified voltages can result in breakdown.

Before changing the voltage selector plug, or replacing the fuse, be sure to unplug the power cord from the electrical outlet.

Table 2-1

Set Position	Center Voltage	Voltage Range	Fuse
A	100 V	90 to 110 V	2 A slow-blow
B	115 V	103 to 128 V	
C	220 V	195 to 242 V	1 A slow-blow
D	230/240 V	207 to 264 V	

Be sure to replace the fuses with the correct ones.

The SS-5711 uses the fuses shown in Table 2-2 to protect the circuits from damage by overcurrent.

If any of these fuses is burnt out, carefully determine the cause, repair a defect if any, and replace it with the

correct one. Never use fuses other than specified because it can cause not only troubles but danger.

Table 2-2

Circuit No.	Fuse Spec.	Function	Position
21F1	2 A slow-blow	Voltage selector plug A or B	Rear panel see Figure 2-4.
	1 A slow-blow	Voltage selector plug C or D	
20F10	1 A slow-blow	CRT circuit protection	See Figure 2-1.

Use the supplied power cord.

Use the supplied 3-core power cord.

When operating the SS-5711 on the line voltage form a 2-core electrical outlet with the supplied 3-core power cord and a conversion adaptor, be sure to ground the ground terminal on the rear panel to prevent danger.

Signal applies to the probes and input connectors

Be sure to connect the probe ground leads and input

Figure 2-1. Fuse Locations

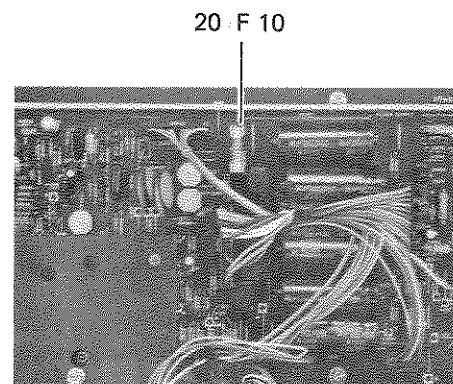

connector ground terminals to the ground voltage part of the object to be measured. If they are connected to other point, the ground leads or terminals will be shorted through the SS-5711, resulting in breakage of the measuring object or the SS-5711 (including its probes). This must be absolutely avoided.

Do not increase light intensity excessively

Do not increase the light intensity of traces or spot more than necessary. Excessive light intensity can not only result in eyes fatigue but, if left for a long time, burn the CRT phosphor surface.

Using the SS-5711 with the CRT screen up

The SS-5711 can be used with the CRT screen up as shown in Figure 2-2 (a). Be careful not to bring the SS-5711 down by pulling hard the probes connected to the signal input connector.

2-2 OPERATION OF THE HANDLE

The carrying-handle of the SS-5711 can be unlocked if the rotary part (root) the handle is pushed inwards (in the arrow direction) as shown in Figure 2-2 (d).

If both the right and left ends are pushed, they can be unlocked together, and the handle can be turned as it is.

If the rotary part is released, the handle is automatically locked.

The handle can be positioned as desired for carrying (as shown in Figure 2-2 (d)) or as a stand for signal observation (as shown in Figure 2-2 (c)).

Fold the handle back as shown in Figure 2-2 (b), if possible, when storing the SS-5711.

2-3 CONTROLS AND SWITCHES

The functions of the switches and controls on the front and rear panels are explained. Refer to Figure 2-3, 2-4, and 2-5.

The front panel is color-coded. The power supply, CRT, and vertical deflection controls are dark-olive; trigger and horizontal deflection controls are light-olive.

If the VARIABLE controls for vertical deflection factor and sweep rate are set to other than the CAL position, the indicator lamp lights to indicate non-calibration.



In the description of the switches, the word IN indicate their pushed position () and the word OUT their released position ().

Figure 2-2. How to Place the SS-5711 and Use the Handle



2-3-1 Front Panel

Power, CRT and Calibration controls

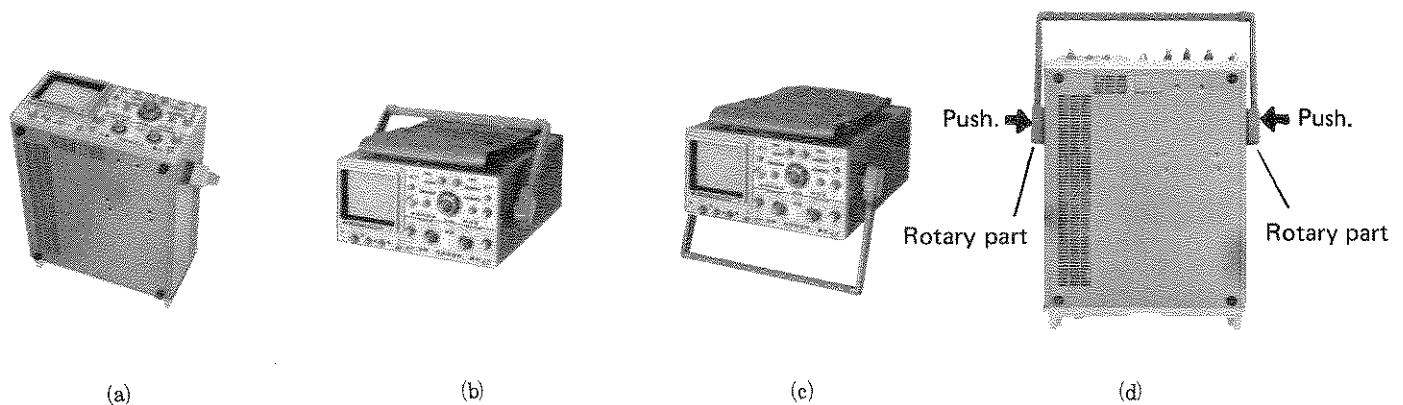
POWER ON/OFF

Power switch

A INTEN (Slate-grey)

Adjust the brightness of traces or spot. Turning the control clockwise increases intensity, and turning it counterclockwise decreases intensity.

B INTEN (PUSH ENHANCE) (Warm-grey)

This has B INTEN control function and A-sweep enhancing control function.

B INTEN control adjusts the brightness of B-sweep (magnified waveform) when HORIZ DISPLAY is in the ALT or B (DLY'D). Turning the control clockwise increases the brightness in the range from 2 nsec/div to 20 nsec/div of TIME/DIV switch when the control is IN. The lamp on the left lights at this time. When the button is OUT position, brightness returns to normal and the lamp goes out.

BEAM FIND

Search the trace or spot positions. If the button is pushed when a trace or spot is outside the screen, it appears on the CRT screen.

FOCUS

Focus traces or spot.

ASTIG

Use this control when traces or spots cannot be focus with the FOCUS control.

SCALE

Adjust the brightness scale. Turning it clockwise brightens the scale, and turning it counterclockwise darkens the scale.

TRACE ROTATION

Adjust traces parallel to the horizontal graticule lines.

CAL 0.6 V

Signal output terminal of a square wave with a calib-

ration voltage of 0.6 V and a repetition frequency of 1 kHz. The output signal is used for adjusting vertical axis deflection factor, probe phase, and sweep rate.

⊥ (Ground terminal for measurement)

Signal ground terminal for measurement. Connect it to the ground terminal of the circuit to be measured.

Vertical Deflection System

POSITION GND REF (PUSH) (CH 1, CH 2)

This control has a position adjusting function and a ground level search (push) function.

As a position adjuster, it adjusts the vertical location of a trace or spot. Turning the control clockwise moves a trace or spot upward, and turning the control counterclockwise moves it downward.

If the control is pushed for ground level search, input signal is not connected to the vertical amplifier, but the input of the vertical amplifier is grounded. The ground voltage, level can be easily measured.

INPUT (CH 1, CH 2)

Connector for connecting a probe or cable to apply input signal to be measured.

The maximum input voltage is 250 V (DC + peak AC) where input signals are directly applied; or 600 V (DC + peak AC) where a probe is used.

(For the maximum input voltage where a probe is used, refer to the instruction manual for probe.)

AC-DC (CH 1, CH 2, CH 3, CH 4)

Switch for selecting a signal input coupling.

AC: The vertical deflection input is AC-coupled. Even if AC input signal is superimposed on DC signal, the DC component is blocked so only the AC component is allowed to pass.

DC: The vertical deflection input is DC-coupled. All the frequency components, including DC, are allowed to pass through.

GND (CH 1, CH 2)

When the GND position is selected, input signal is not connected to the vertical amplifier, but the input circuit of the vertical amplifier is grounded. (Input signal is not

Figure 2-3. Front Panel

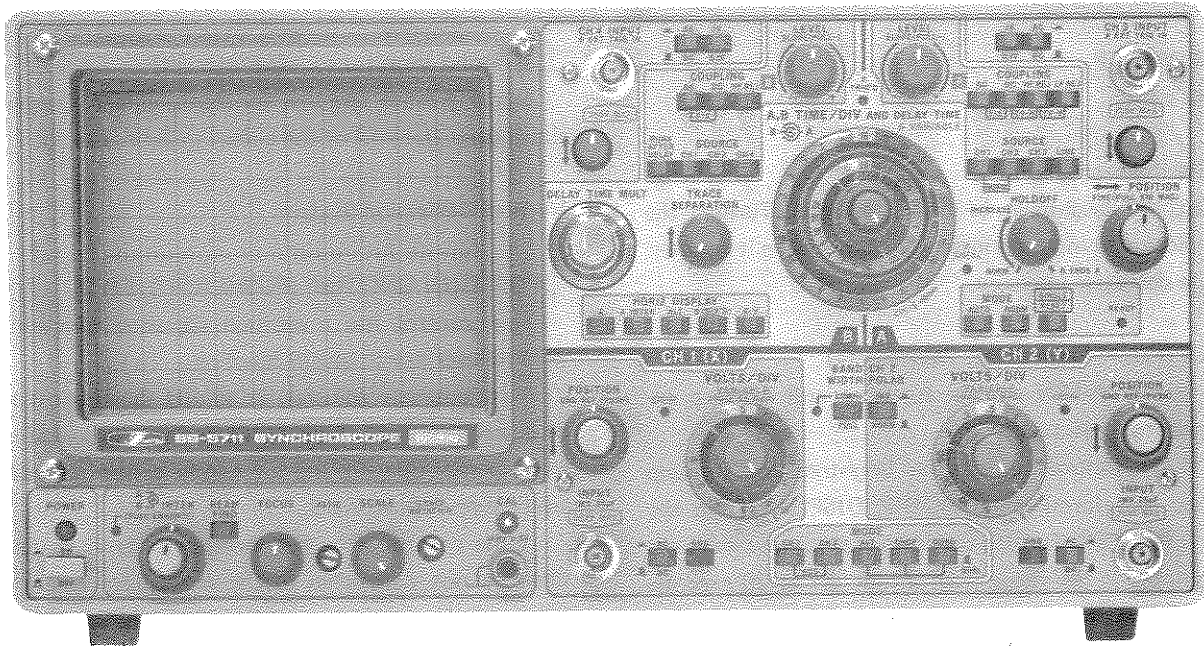
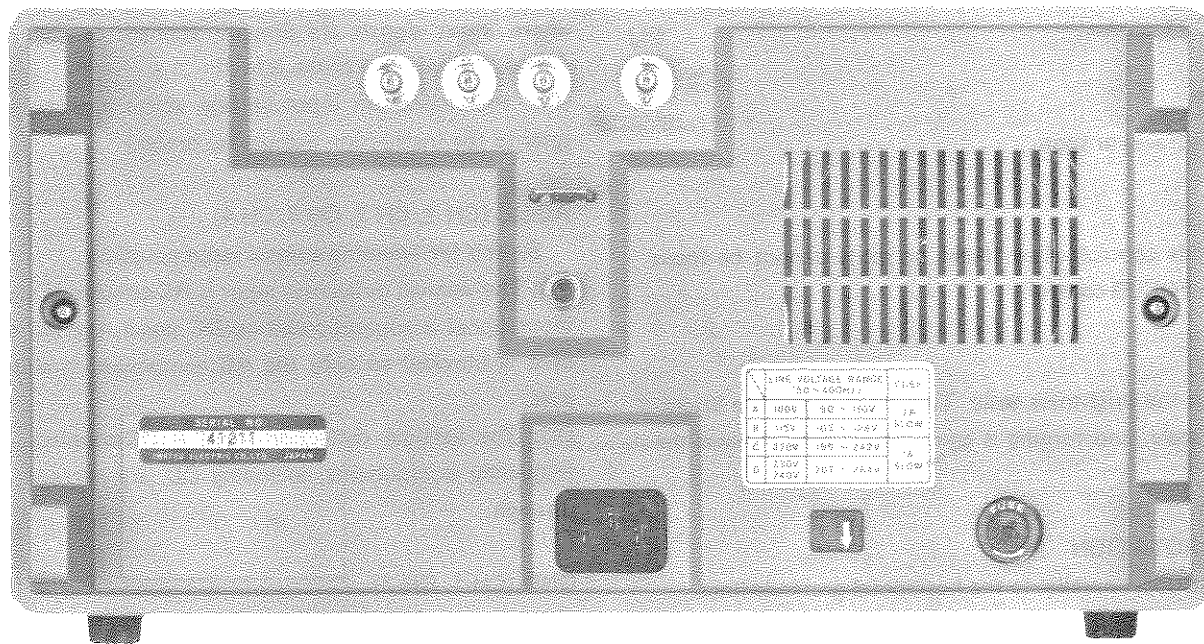

Figure 2-4. Rear Panel



grounded.) Thus, the ground voltage (normally serving as a reference level for measurement) can be easily confirmed.

<For reference>

Difference between GND REF and GND

The GND REF and GND switches are both used for ground level confirmation.

The GND REF switch is pushbutton, which can be pushed with the index finger while the \downarrow POSITION control is turned with the thumb and middle finger to shift ground level. If the GND REF button is IN, free-running sweep takes place so that ground level can be checked even if the NORM trigger mode is selected.

The GND switch is a spring-return push button, which may be in the GND position while other switches or controls are being operated. If the AUTO trigger mode is selected in this case, ground reference can be confirmed. If the NORM trigger mode is selected, however, ground reference cannot be checked because sweep stops.

UNCAL (CH 1, CH 2)

If the VARIABLE control is set to other than the CAL position, this lamp lights to indicate non-calibration.

VOLTS/DIV (CH 1, CH 2)

Set the vertical deflection factor to select one of 10 positions from 5 mV/div to 5 V/div to suit input signal level. If the x5 MAG function is used (by pulling the VARIABLE control) at 5 mV/div or 10 mV/div, a high deflection factor of 1 mV/div or 2 mV/div can be obtained.

The VOLTS/DIV switches represent the voltage (of an input signal) per division of the scale on the CRT screen where the VARIABLE control is set to the CAL position.

VARIABLE (PULL x5 MAG) (CH1, CH 2)

The VARIABLE control has the deflection factor adjusting function and waveform magnifying function.

As the deflection factor adjusting it provides continuously variable the uncalibrated deflection factor. The deflection factor is 2.5 times or more when the control is turned fully counterclockwise.

As a waveform magnifying (PULL x5 MAG), it may be pushed to give the same deflection factor as indicated by the VOLTS/DIV switch, or pulled to multiply it by 5.

BANDWIDTH 20 MHz/FULL

Push-push switch for selecting a vertical deflection bandwidth for CH 1, CH 2, CH 3, and CH 4. When the button is OUT position, the bandwidth is as described in the section on Specifications. When the button is IN, a bandwidth of 20 MHz is selected so that the high-frequency noise component of input signals are cut out to make the trace sharp. At this time, the indicator lamp on the left lights.

When observing a signal with a small amplitude, for example, the deflection factor is increased, which increases noise to possibly make it difficult to observe the signal.

CH 2 POLAR INV/NORM

Select the polarity of signal applied to CH 2. NORM when the button is OUT; and INV when the button is IN where the polarity is inverted.

MODE

These MODE button are used for switching vertical deflection operation. The following modes can be selected.
CH 1: Only signal which is applied to CH 1 (x) INPUT is displayed on the CRT screen.

CH 2: Only signal which is applied to CH 2 (Y) INPUT is displayed on the CRT screen.

ALT: The two signals applied to CH 1 and CH 2 INPUT connectors are displayed on the CRT screen. This mode is suitable for observing waveforms where TIME/DIV is set to a position faster than 1 msec/div.

CHOP: The two signals applied to CH 1 and CH 2 INPUT connectors are displayed on the CRT screen. This mode is suitable for observing waveforms where TIME/DIV is set to a position slower than 1 msec/div.

ADD: The ADD mode is selected when both CH 1 and CH 2 buttons are simultaneously pushed in. This mode is used for observing the algebraic sum of the signals applied to CH 1 and CH 2 INPUT connectors or their difference. CH 1 \pm CH 2 can be selected with CH 2 POLAR.

QUAD: If the QUAD button is IN when the ALT or CHOP button is IN position, quadruple traces are displayed on the CRT screen. This mode is used for simultaneously displaying the signals applied to CH 1, CH 2, CH 3, and CH 4 INPUT connectors on the CRT screen. Either of the two following quad modes can be selected.

Quad-trace display in the ALT mode: If the ALT and QUAD buttons are pushed in, ALT operation takes place to display 4 signals on the CRT screen.

Quad-trace display in the CHOP mode: If the CHOP and QUAD button are pushed in, CHOP operation takes place to display 4 signals on the CRT screen.

If the HORIZ DISPLAY ALT button is IN during the above operations, the 4 signals are displayed on the CRT screen. If the QUAD button is pushed again to the out (DUAL) position, the SS-5711 operates in the ALT or CHOP mode as indicated on the panel.

CH 3 INPUT (A EXT TRIG IN)

Connect a probe or cable for applying a signal input to be measured or an external trigger signal input for A-sweep. The maximum input voltage is 250 V (DC + peak AC) where the input signal is directly applied; or 600 V (DC + peak AC) where a probe (10 : 1) is used. (For the maximum input voltage where a probe is used, refer to the instruction manual for probe.)

⤴ (CH 3, CH 4)

Select a trace vertical position for CH 3 (CH 4) with this control. Turning it clockwise moves a trace upward, and turning it counterclockwise moves it downward.

1 V - 0.1 V (CH 3, CH 4)

Select CH 3 (CH 4) deflection factor with this control. The value indicated represents a voltage per division of the graticule on the CRT screen.

CH 4 INPUT (B EXT TRIG IN)

Connect a probe or cable for applying a signal input to be measured or an external trigger signal input for B-sweep.

The maximum input voltage is 250 V (DC + peak AC) where the input is directly applied, or 600 V (DC + peak AC) where a probe (10 : 1) is used.

(For the maximum input voltage where a probe is used, refer to the instruction manual for probe.)

Horizontal Deflection Controls

HORIZ DISPLAY

The following modes can be selected with the horizontal deflection control buttons.

A: A sweep mode for normal waveform observation. Sweep time can be selected with the A TIME/DIV switch and A VARIABLE control.

A INTEN: A delayed sweep mode (in which a part of the input signal waveform is magnified for observation)

ALT: Alternate A INTEN sweep and B sweep

B (DLY'D): A sweep delay mode (in which the part selected by delayed sweep is magnified)

X-Y: A mode in which the SS-5711 is used as an X-Y scope, CH 1 serving as X axis and CH 2 as Y axis.

MODE

This button selects either of the following trigger modes. AUTO: In the AUTO mode, a sweep is started if trigger condition is readied; or a free-running sweep takes place otherwise.

NORM: In the NORM mode, a sweep is started if trigger condition is readied; or no sweep take place otherwise.

SINGLE/RESET: The single trigger mode. This button also has a RESET function so, no trigger signal, it puts the SS-5711 into a ready condition, which is indicated by the lighting of the READY lamp on the right.

READY

This lamp lights when the SS-5711 is in a ready state in the single sweep mode.

← POSITION FINE (PULL x10 MAG)

This control has position adjusting and waveform magnifying functions.

It has two kinds of knobs for position adjustment: The large grey knob for coarse horizontal position adjustment, and the small red knob for fine horizontal position adjustment. Turning the knobs clockwise moves the waveform to the right-hand, and turning them counterclockwise moves it to the left-hand.

When the small red knob is pulled, the x10 MAG function is set to magnify the waveform 10 times in the horizontal direction.

COUPLING (A-Sweep)

For selecting an A-sweep trigger coupling (trigger circuit input coupling).

AC: AC coupling is selected. Trigger signal DC component is blocked. AC signal only is used for triggering.

DC: DC coupling is selected. DC can be used for triggering.
HF REJ: Frequencies over approximately 10 kHz are attenuated by a lowpass filter. Suitable for observing signals cleared of high-frequency noise.

LF REJ: Highpass filter coupling to attenuate low frequencies under approximately 10 kHz.

Suitable for observing signals cleared a low-frequency noise.

FIX: If both the AC and DC buttons are simultaneously pushed in, the trigger level is fixed nearly at the zero point.

Thus, it is not necessary to operate the LEVEL control.

TV-H: If both the DC and HF REJ buttons are simultaneously pushed in, TV-H coupling is selected. This trigger coupling is used for observing a composite video signal waveform over a period of 1 H by triggering with a television horizontal trigger pulse.

TV-V: If both the HF REJ and LF REJ buttons are simultaneously pushed in, TV-V coupling is selected. This trigger coupling is used for observing a composite video signal waveform over a period of 1 V by triggering with a television vertical trigger pulse.

SOURCE (A-sweep)

Select the SOURCE of A-sweep trigger signal.

CH 1: The input signal applied to CH 1 INPUT is branched out as internal trigger signal.

CH 2: The input signal applied to CH 2 INPUT is branched out as internal trigger signal.

CH 3: The input signal applied to CH 3 INPUT is branched out as internal /external trigger signal.

LINE: The SS-5711's power line signal is used as trigger signal. This mode is used for observing line signal and line harmonics.

NORM: If both the CH 1 and CH 2 buttons are simultaneously pushed in, the NORM mode is selected, in which the signal for the waveform displayed on the CRT screen in connection with a vertical mode is used as a trigger signal. (For a detailed description of trigger signal selection, refer to the subsequent paragraph on triggering.)

HOLDOFF

This control is used for stabilized synchronization of complex (composite) pulse waveforms. Turning the control fully counterclockwise to NORM minimizes the holdoff period, and turning it clockwise continuously increases the

holdoff period.

When the control is turned fully clockwise to B ENDS A, A-sweep ends simultaneously with B-sweep, provided that the HORIZ DISPLAY button A INTEN, ALT or B (DLY'D) is pushed in. This prevents intensity decrease for delayed sweeps with a high magnification ratio.

LEVEL SLOPE (PULL-) (A-Trigger, B-Trigger)

This control has trigger level setting and trigger slope selecting functions.

Push it for positive-going slope trigger level selection; or pull it for negative-going slope trigger level selection.

A TRIG'D

This lamp lights to indicate a triggering state.

A, B TIME/DIV and DELAY TIME

The outer knob is for A TIME/DIV and DELAY TIME, and the inner knob for B TIME/DIV.

The A TIME/DIV AND DELAY TIME control has 23 A-sweep positions from 20 nsec/div to 0.5 sec/div, and selects delays in A INTEN sweep or B (DLY'D) sweep. The value of each position of the control represents a sweep rate and delay time per division on the CRT screen where the A VARIABLE control is turned fully clockwise to the CAL position.

The B TIME/DIV control has 20-sweep positions from 20 nsec/div to 50 msec/div, but no VARIABLE control.

A VARIABLE

Provides continuously the varies A-sweep rate. If the control is turned fully counterclockwise, the value of where the TIME/DIV switch is set at least 2.5 times or more.

A UNCAL

This lamp lights to indicate that A sweep rate is uncalibrating state when A VARIABLE control is out of CAL position.

DELAY TIME MULT

This potentiometer selects the amount of delay time between the start of A sweep and the start of B sweep.

COUPLING (B-Sweep)

For selecting a B-sweep trigger coupling (trigger circuit coupling).

All functions are the same as those of A-sweep except for LF REJ, TV-H and TV-V.

SOURCE (B-Sweep)

The SOURCE buttons are used for selecting B-sweep trigger signals and a type of delay (continuous delay or triggered delay).

RUNS AFTER DELAY: When the button is IN, RUNS AFTER DELAY is selected for continuous delay.

CH 1: Function is the same as that of A-sweep.

CH 2: Function is the same as that of A-sweep.

CH 4: The input signal applied to CH 4 INPUT is branched out as trigger signal. This function corresponds to the external trigger function of a dual-trace oscilloscope.

(If the CH 1, CH 2, or CH 4 button is pushed in, the triggered delay mode is selected.)

TRACE SEPARATION

This control is used for moving the B-sweep waveform above the A INTEN sweep waveform on the CRT screen when the HORIZ DELAY button ALT is IN. If the control is turned fully counterclockwise, the A INTEN sweep and B-sweep waveforms overlap, and when the control is turned fully clockwise, the B-sweep waveform moves 4 divisions or more.

2-3-2 Rear Panel**CH 1 OUT**

The input signal of CH 1 is provided. The output signal is used as an input signal source for a frequency counter or others. The output voltage is 40 mV \pm 20% per division of the graticule on the CRT screen in case of 50-ohm termination.

A GATE OUT

Provides the positive output voltage of approximately 5 V synchronized with A-sweep during its period.

B GATE OUT

Provides the positive output voltage of approximately 5 V synchronized with B-sweep during its period.

Z AXIS INPUT

Apply a signal for external intensity modulation to this input terminal. The maximum input voltage is 50 V (DC + peak AC).

CAL 10 mA

A square wave current of 1 kHz, 10 mA flows through the current loop terminal in the arrow direction (from right to left). Use its current output for checking and calibrating the current probe.

 (Ground terminal for protection)

Ground terminal for protecting the oscilloscope. When supplying a line voltage from a 2-core electrical outlet, be sure to connect this terminal to the ground for preventing danger.

AC LINE INPUT

AC voltage is supplied to this connector. Connect the supplied power cord to it.

A.B.C.D (Voltage Selector plug)

Set the voltage selector plug's arrow mark to one of the A, B, C or D position to suit the AC line voltage. Refer to the table of line voltage ranges.

FUSE

Fuse holder

2-3-3 Bottom Cover**GAIN**

This is for adjusting vertical deflection factor.

x5 BAL

This is for adjusting vertical deflection position when the PULL x5 MAG is pushed or pulled.

VARIABLE BAL

This is for adjusting the movement of vertical trace position when the vertical deflection VARIABLE control is turned.

Figure 2-5. Bottom cover

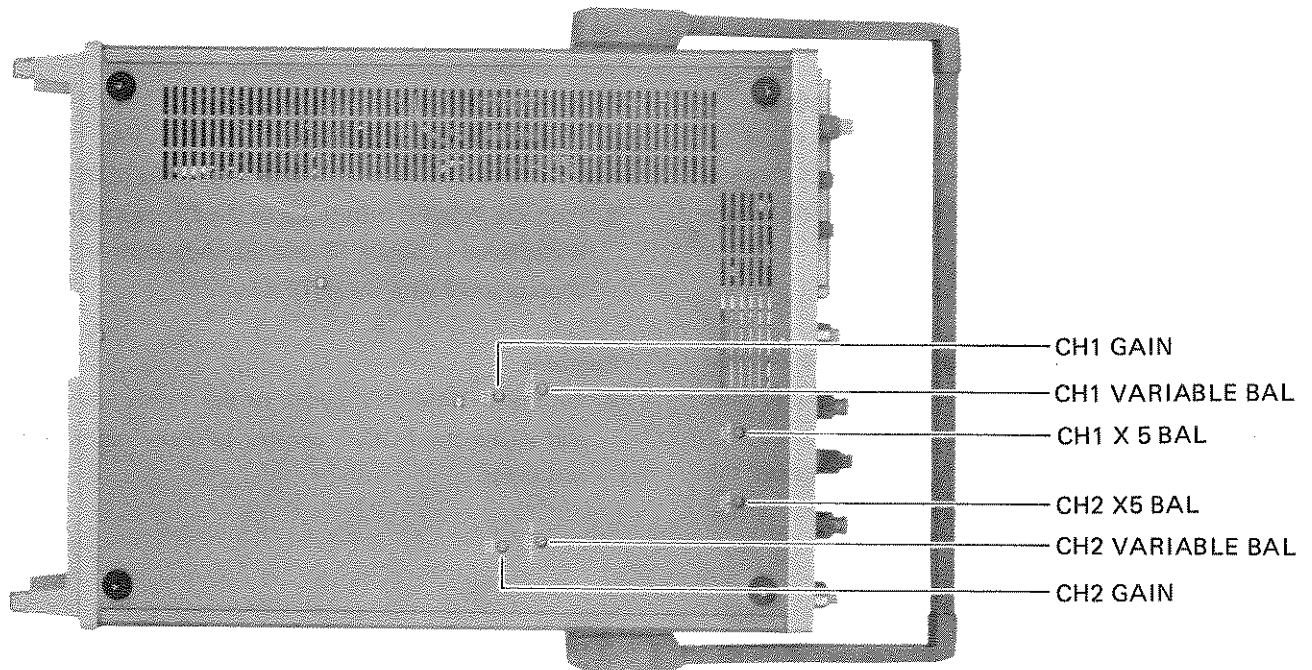

2-4 OPERATING INSTRUCTIONS

The basic operating instructions for the SS-5711 used for observing voltage waveforms are explained below.

2-4-1 Basic Operation for Signal Observation

The following procedure applies where a CAL 0.6 V signal is applied to CH 1 INPUT with the supplied probe for observation.

Turning POWER On

Before connecting the power cord, check the AC line voltage with a voltmeter, and set the voltage selector plug to the proper position to suit the line voltage.

1. Set the POWER to OFF position, and connect the power cord to the AC LINE INPUT connector on the rear panel and an electrical outlet.

2. Set the controls as follows. See Figure 2-6 and 2-7.

A INTEN	Midrange
MODE (Vertical)	CH 1
AC-DC (CH 1)	AC
⬇ POSITION (CH 1)	Midrange
HORIZ DISPLAY	A
MODE (Horizontal)	AUTO
↔ POSITION	Midrange
FINE (PULL x10 MAG)	Midrange (button IN)

3. Push the POWER button up to the ON position. A trace is displayed in about 15 seconds. Adjust its intensity as appropriately with the INTEN control.

Focusing

4. Set the A TIME/DIV switch to the 1 msec/div position, and adjust the FOCUS control to make the trace clear and sharp.

Figure 2-6. Power, CRT and Calibration controls

Figure 2-7. Vertical Deflection and Horizontal Deflection Controls

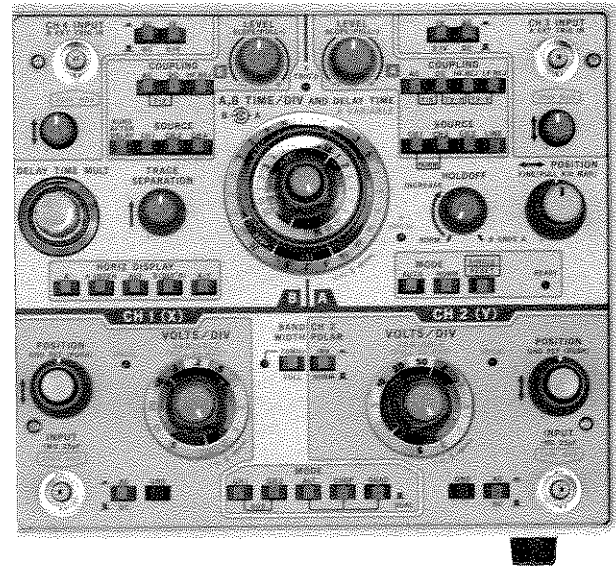
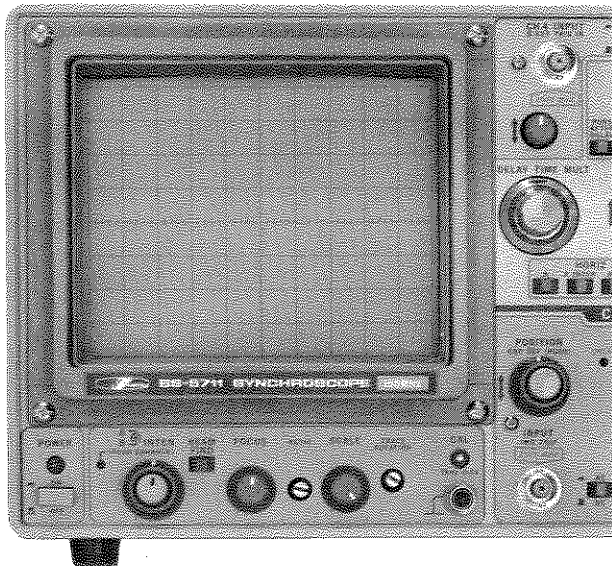

Applying signals and triggering

5. Set the controls as follows.
 - COUPLING (A-Sweep) AC
 - SOURCE (A-Sweep) CH 1
 - VOLTS/DIV (CH 1) 10 mV
 - VARIABLE (CH 1) CAL
6. Using the supplied probe, connect CH 1 INPUT to the CAL. 0.6 V terminal.
7. Turn the LEVEL (A-Sweep) control to nearly the mid-range, and a 6-division calibration voltage waveform is displayed on the CRT screen. It is triggered by internal trigger (AC coupling) in the AUTO mode.
 - For a detailed description of triggering, refer to Triggering in a subsequent paragraph.

Deflection Factor Setting

8. As VOLTS/DIV switch is turned from 20 mV, 50 mV, and on to 5 V, the deflection factor decreases so that the waveform amplitude on the CRT screen becomes small. The amplitude also decreases when the VARIABLE control is turned counterclockwise. Adjust the input deflection factor with the VOLTS/DIV switch and VARIABLE control so that the input signal has an amplitude easy to be observed on the CRT screen.

Sweep Rate Setting (A-Sweep)

9. As the A TIME/DIV switch is turned from 0.5 msec,

Figure 2-8. Calibrator waveform

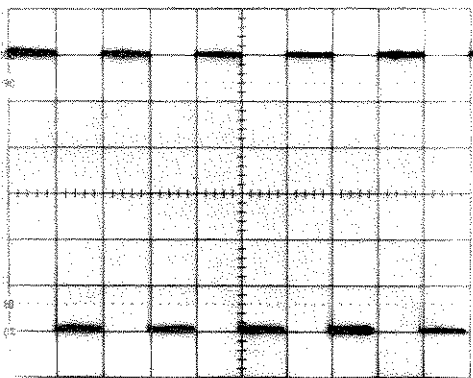

0.2 msec and on the 20 nsec, the displayed waveform that can be observed decreases. There are kinds of signals to be measured. To observe various signals on a suitable cycle, set an appropriate sweep rate with the A TIME/DIV switch and A VARIABLE control. For the sweep rate setting procedure, refer to the subsequent paragraph on sweep rate setting.

The basic operation procedures for observing signal waveforms have been described above.

2-4-2 Applying Signal

Apply the signals to be observed to CH 1, CH 2, CH 3, and/or CH 4 INPUT connectors.

Generally a passive probe is used for applying a signal to the oscilloscope.

The use of a probe prevents the waveforms on the CRT screen from being adversely affected by the induction of an external electric field. If a 10 : 1 probe is used, the input impedance is higher than where a 1:1 probe is used, and thus the load effect on the signal source is lessened. This permits accurate waveform observation in spite of a high signal source impedance.

The 10:1 probe, however, attenuates the input signal to 1/10 so the VOLTS/DIV readings of input signal amplitude must be multiplied by 10.

The 1:1 probe is suitable for observing low-frequency low-level signals because a large load effect is produced on high-frequency signals.

(For a detailed description of the probe, refer to Section 3 MEASURING PROCEDURES and the instruction manual for probe.)

2-4-3 Signal Input Coupling Selection

Kinds of signals, including DC, AC, and AC superimposed on DC, may be applied for observation. For accurate observation of these kinds of signals, select the proper signal input coupling with the AC-DC switch.

(See Figure 2-9 and 2-10.)

AC Coupling:

In AC coupling, a DC signal is blocked by a capacitor so that only the AC signal passes it. Thus, the AC signal

waveform will be out of the screen by the DC voltage so it can be observed with its amplitude increased on the screen. If a signal with a low repetition frequency is observed in the AC coupling mode, a sag appears in the waveform if the signal is a square wave; or if it is a sine wave, the amplitude on the screen is attenuated about -3 dB per 4 Hz from the actual one.

DC Coupling:

DC coupling is selected for observing all the frequency components of a signal input.

Ground Coupling:

The input of the vertical amplifier circuit is grounded so a ground level trace is displayed on the screen. The ground level normally serves as reference level in measurements.

2-4-4 Vertical Deflection Factor Setting

To observe a signal waveform, it must be displayed with an appropriate amplitude on the CRT screen.

The CH 1 and CH 2 VOLTS/DIV switches are deflection factor select switches, and their VARIABLE controls are for fine adjustment of deflection factor. (See Figure 2-9.)

If the VARIABLE controls are turned fully clockwise to the CAL position, the positions of the VOLTS/DIV switches directly indicate the selected deflection factors, which represent the voltage per division of the screen scale for the signal waveforms displayed.

Figure 2-9. CH 1 input section

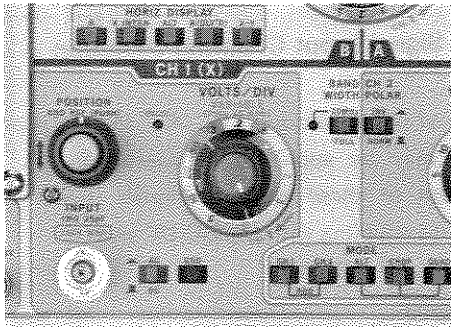

The deflection factor select switches for CH 3 and CH 4 have two position, 0.1 V/div and 1 V/div, but no VARIABLE controls. (See Figure 2-10.)

2-4-5 Triggering

It is necessary to have a correct understanding of the triggering procedure in using an oscilloscope.

The triggering procedure for A-sweep (where the HORIZ DISPLAY button A is IN) is described below. The triggering procedure for B-sweep that is necessary in delayed sweep operation is described in the subsequent paragraph on Waveform Magnification Operation.

The following must be set for A-sweep triggering.

- Trigger Signal
Selects CH 1, CH 2, CH 3, NORM, or LINE with the SOURCE button.
- Trigger Coupling
Selects AC, DC, HF REJ, LF REJ, FIX, TV-H, or TV-V with the COUPLING button.
- Trigger system
Selects AUTO, NORM, or SINGLE-RESET with the MODE switch.
- Slope
Selects either positive-going (+) or negative-going (-).
- Level
Selects a suitable trigger level.

Figure 2-10. CH 3 input section

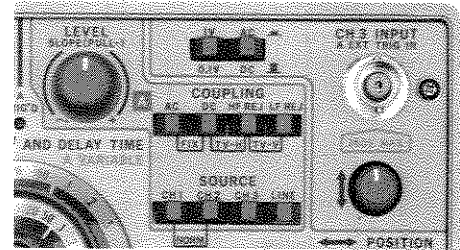

- Hold off

Selects a suitable HOLD OFF time.

A detailed description of the above 6 items is given below.

Trigger Signal

To observe an input signal waveform, it is necessary to apply an input signal, or a signal which has a constant time relationship with the input signal (called a trigger signal), to the trigger circuit to drive it.

Select internal trigger (CH 1, CH 2, CH 3, NORM), external trigger (CH 3), or line trigger (LINE) with the SOURCE button.

Input signal applied to input connector is brached off from vertical deflection system and method that applies it to the trigger circuit is called internal trigger.

The input signal is also used as internal trigger circuit. Thus, operation is simple.

The method of applying an external input signal, or a signal which has a constant time relationship with the input signal, to the trigger circuit is called external trigger.

External trigger has the following advantages.

- External trigger is unaffected by the channel to which an input signal is applied. In the internal trigger mode, the trigger signal amplitude changes whenever the deflection factor is changed, and thus the trigger level must be adjusted accordingly. In the external trigger mode, once trigger condition is established, the signals remain synchronized even if the signal to be measured changes in amplitude.
- If desired a specific time before, or after, an input signal waveform, apply this signal as trigger to EXT TRIG IN (CH 3) so that the desired waveform can be observed.

The method of applying a line waveform from the built-in power transformer to the trigger circuit is called line trigger, which is used for observing line waveforms and line high frequencies.

Internal Trigger (CH 1, CH 2, CH 3, NORM)

If SOURCE CH 1 is selected, the input signal that is applied to CH 1 is used as trigger signal.

If SOURCE CH 2 or CH 3 is selected, the input signal that is applied to CH 2 or CH 3 is used as trigger signal.

If SOURCE NORM (CH 1 and CH 2 pushed in simultaneously) is selected, the input signal applied to CH 1 is used as trigger signal in the CH 1 vertical mode, or the input signal applied to CH 2 is used as trigger signal in the

CH 2 vertical mode. In the ALT vertical mode, the input signal applied to CH 1 triggers CH 1, and that applied to CH 2 triggers CH 2. Alternate use of trigger signals to suit the display on the screen is convenient for comparison of waveforms. In the CHOP or ADD mode, use CH 1, CH 2, or CH 3 instead of NORM because trigger is generally unstable.

External Trigger (CH 3)

If SOURCE CH 3 is selected, the input signal that is applied to CH 3 INPUT (A EXT TRIG IN) is used as external trigger signal.

Line Trigger (LINE)

If SOURCE LINE is selected, line trigger is available.

Trigger Coupling

The COUPLING button is used for selecting a coupling for the trigger circuit input. AC, DC, HF REJ, LF REJ, FIX, TV-H, or TV-V can be selected. Select one of them steady triggering according to the kind of trigger signal (AC, DC, composite video signal, etc.).

AC: The trigger circuit input is AC-coupled so the DC component of the trigger signal is blocked. Thus, only the AC component of the trigger signal is used for triggering. Generally, AC coupling is convenient, but triggering is difficult if the trigger frequency is below 10 Hz.

DC: The trigger circuit input is DC-coupled for DC triggering. If a AC trigger signal is superimposed on DC, whose voltage is outside the trigger level range, trigger is ineffective.

HF REJ: The trigger circuit input comprises a lowpass filter which rejects high-frequency trigger signals (over about 10kHz) and high-frequency noises mixed with high-frequency signals and passes only low-frequency components.

LF REJ: The trigger circuit input comprises a high pass filter which rejects low-frequency trigger signals (over about 10 kHz) and low-frequency noises mixed with the trigger signals, and passes only high-frequency components.

FIX: The trigger circuit input is AC-coupled and the trigger level is fixed nearly at 0 V, so trigger takes place without operating the LEVEL control.

TV-H: Uses a television horizontal synchronization pulse for triggering in observing signals over a period of 1H.

TV-V: Uses a television vertical synchronization pulse for triggering in observing composite video signals over a period of 1 V.

Trigger System

The SS-5711 offers selection of the trigger mode of AUTO, NORM, or SINGLE/RESET.

AUTO: Auto trigger is selected. If a trigger signal with the proper frequency and level is applied to the trigger circuit, trigger condition can be readied by turning the LEVEL control to an appropriate trigger level. In the following cases, however, free-running sweeps occur due to the absence of trigger condition.

1. No trigger signal.
2. A trigger signal too small.
3. The LEVEL control set out of the trigger signal used.
4. A trigger signal with a frequency below 50 Hz.

NORM: Normal trigger is selected. If a trigger signal with the proper frequency level is applied to the trigger circuit, trigger condition can be readied by turning the LEVEL control to an appropriate trigger level.

In the following cases, however, sweeps stop and the instrument gets into a ready condition due to the absence of trigger condition.

1. No trigger signal.
 2. A trigger signal too small for the LEVEL control to match its level.
 3. The LEVEL control set out of the trigger signal used.
- SINGLE-RESET:** Single sweep mode. For details, refer to the subsequent description of the single sweep mode.

SLOPE

Push the LEVEL control for triggering from a positive-going slope, or pull it for triggering from negative-going slope.

LEVEL

If the LEVEL control is nearly at the midrange trigger level is set place at neary 0 V.

The trigger level moves in the positive (+) direction as the LEVEL control is turned clockwise, or in the negative (-) direction as the control is turned counterclockwise. (See Figure 2-11.)

In the coupling mode FIX, the trigger level is fixed nearly at 0 V. Thus, it is not necessary to operate the LEVEL control for triggering.

Figure 2-11. SLOPE versus LEVEL

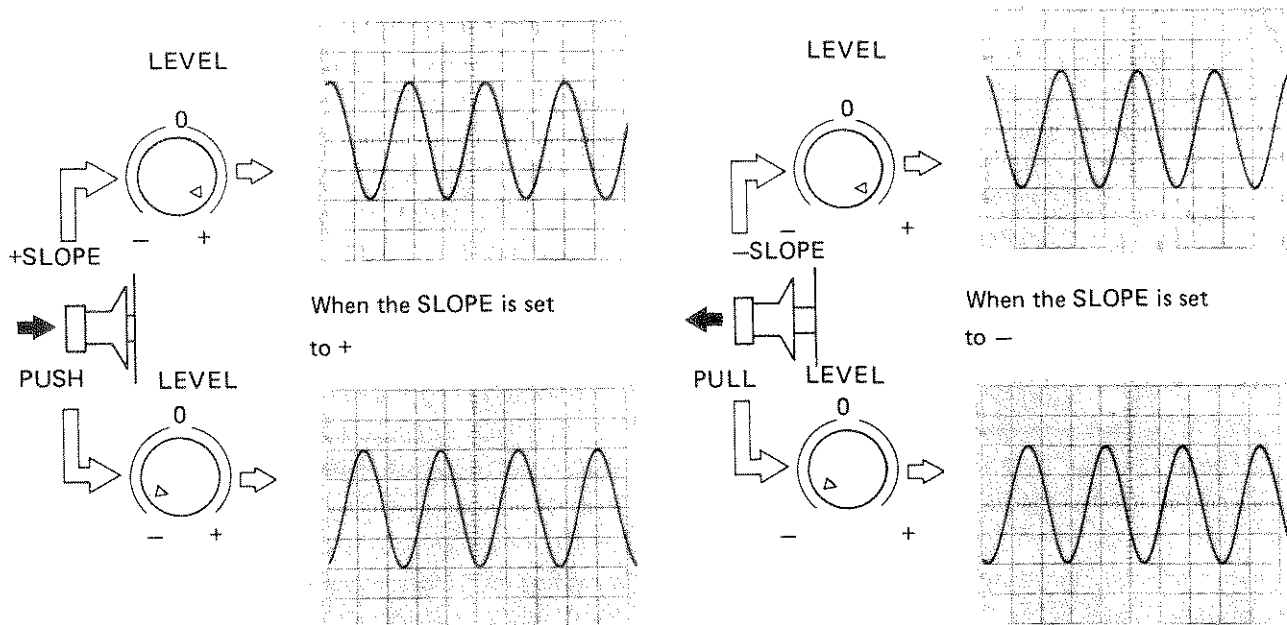

HOLDOFF

Complex waveforms of a pulse train may appear overlapped despite synchronization depending on sweep rate setting.

If that occurs, turn the HOLDOFF control from the NORM position (fully counterclockwise) toward INCREASE to change the holdoff time. If the HOLDOFF control is adjusted to start a sweep at the basic input signal cycle, the wave-forms are displayed in a way easy to observed.

2-4-6 Sweep Rate Setting

Many kinds of signals, some with a low repetition frequency and some with a high one, and some pulses with a fast rise and some with a low rise, may be measured. To measure these kinds of signals, it is necessary to select a suitable sweep rate.

When measuring signals with a low repetition frequency or slow rise pulses, for example, select a low sweep rate; and when measuring signal with a high repetition frequency or fast rise pulses, select a high sweep rate.

If the HORIZ DISPLAY mode A is selected, A-sweep (normal sweep) takes place. In this case, operate the A-sweep controls.

The sweep rate control used in the A-sweep mode is A TIME/DIV, and its VARIABLE control is for sweep rate

fine adjustment. (see Figure 2-12.)

If the A VARIABLE control is turned fully clockwise to the CAL position, each position of the A TIME/DIV switch directly represents the sweep rate it indicates. If the A VARIABLE control is turned fully counterclockwise, the sweep rate pointed by the A TIME/DIV switch is 2.5 times the indicated value or less.

The sweep rate control used in the B-sweep mode is B TIME/DIV switch, which has no VARIABLE control.

2-5 APPLIED OPERATIONS FOR SIGNAL OBSERVATION

The Oscilloscope SS-5711 has various convenient functions for signal observation. The following operating instructions for observing signals by use of its various functions are based on the assumption that you have sufficiently understood the basic operation procedures.

2-5-1 Operation for Dual-trace Observation

As described in the section on basic operations, the SS-5711 used as a dual-trace oscilloscope can display two signals to be measured on the CRT screen. Either ALT (alternate sweep) or CHOP (chopped sweep) can be selected for dual-trace observation. By using the ALT or CHOP mode as appropriate, dual-trace observation can be made at rates ranging from low to high speed.

Dual-Trace observation in the ALT mode

The ALT mode is suitable for observing two signals that have a high frequency. In this mode, a sweep occurs alternately between CH 1 and CH 2 so dual traces can be observed by applying two signals to CH 1 and CH 2 INPUT connectors.

The alternate sweep mode covers the full TIME/DIV range so a slow sweep rate makes dual-trace observation difficult.

Select the CHOP mode mentioned below when observing low-frequency signals.

Figure 2-12. TIME/DIV and VARIABLE controls

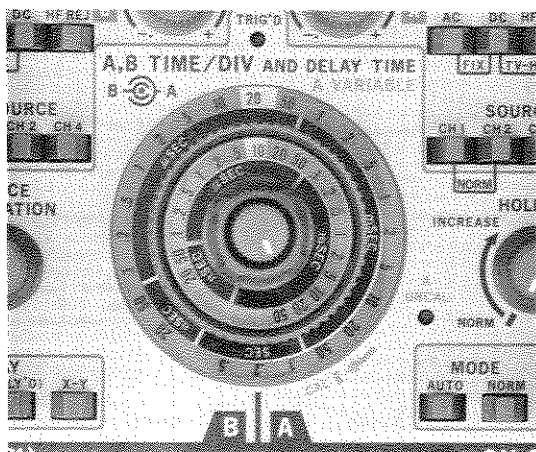

Dual-Trace observation in the CHOP mode

The CHOP mode is suitable for dual-trace observation of low-frequency signals. CH 1 and CH 2 sweep are switched from one to the other about every 500 kHz so that, contrary to the ALT mode, it is difficult to observe high-frequency signals because their traces turn into dotted lines. Use the ALT mode for high-frequency signals.

2-5-2 Operation for Observation of the Sum of Two Signals or Their Difference

Observation in the ADD Mode

The ADD mode is selected if the vertical MODE buttons CH 1 and CH 2 are simultaneously pushed in. If signals are applied then to CH 1 and CH 2 INPUT connectors, the sum

of the two signals (CH 1 + CH 2) can be observed. If the CH 2 POLAR button is pushed in to the INV position then, the difference between the two signals [(CH 1) + (-CH 2)] can be observed.

The deflection factor can be independently adjusted for CH 1 and CH 2 in the ADD mode so select a range to suit the purpose.

In the ADD mode, the POSITION controls for CH 1 and CH 2 may be used for adjusting trace positions, but for accurate measurement, the two POSITION controls should be kept nearly at the center.

2-5-3 Operation for Quadruple-Trace Observation

The SS-5711 can simultaneously display up to four

Figure 2-13. Dual-trace observation in the ALT mode

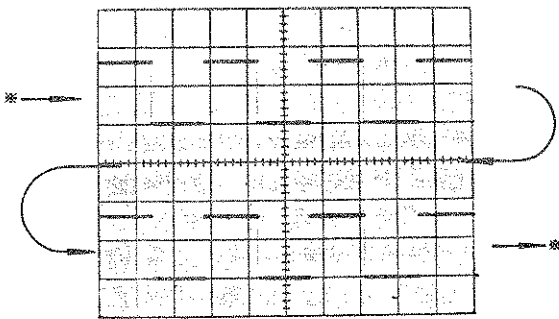

Figure 2-14. Dual-trace observation in the CHOP mode

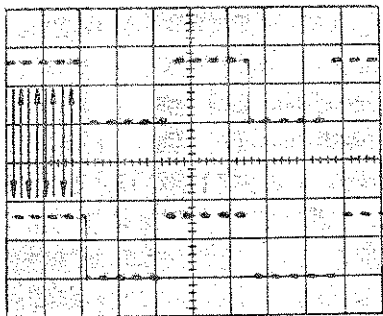

Figure 2-15. Quadruple-trace observation

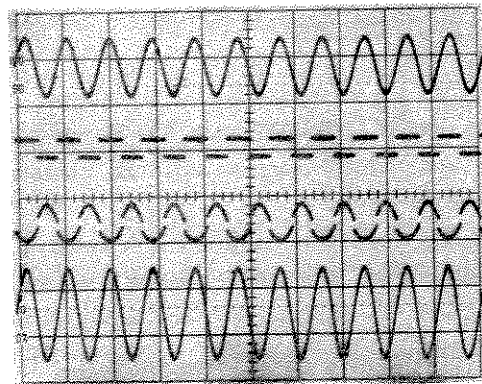
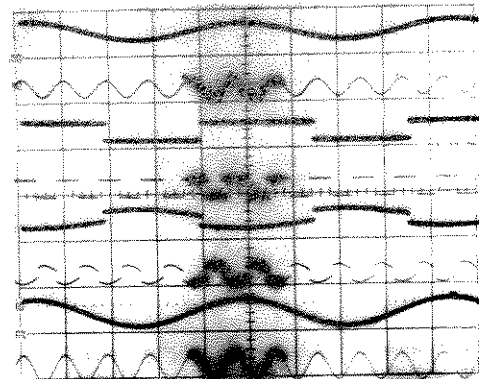

Figure 2-16. Quadruple-trace observation in the ALT mode



signals on the CRT screen aside from the dual-trace capability.

If the vertical MODE buttons ALT and QUAD, or CHOP and QUAD are simultaneously pushed in, traces for CH 1, CH 2, CH 3, and CH 4 are displayed on the CRT screen. Thus, by applying the four signals to be measured to the respective input connectors, the four signals can be simultaneously observed.

If the HORIZ DISPLAY mode ALT is selected under this condition, 8 traces are displayed on the screen as shown in Figure 2-16, giving A INTEN and B sweeps for the respective channels.

The vertical axis of quadruple traces is displayed by chopped operation if the vertical MODE buttons CHOP and QUAD are pushed in, or by alternate operation if the vertical MODE buttons ALT and QUAD are pushed in. When observing signal faster than 1 msec/div, push the vertical MODE buttons CHOP and QUAD IN. When observing signal slower than 1 msec/div, push the vertical MODE buttons ALT and QUAD IN.

2-5-4 Operation for Enlarging Waveform on the CRT Screen

Waveforms on the CRT screen can be partially magnified timewise (in the horizontal axis direction) for detailed observation by any of the following three methods.

- To use a fast sweep rate
- To use the x10 MAG function to magnify.
- To use the delayed sweep function to magnify.

These are explained in detailed below.

Using a fast sweep rate

Use a fast sweep rate to magnify the leading end of the waveform on the screen timewise. If the center part or tailing end of the waveform is magnified by using a fast sweep rate, those parts will go out of the CRT screen. In such a case, use the x10 MAG function to magnify the waveform.

Magnifying waveforms by x10 MAG

This method is mainly used to magnify the center part or tailing end of waveforms timewise.

Move the desired part to the center of the CRT screen with the horizontal POSITION control, and pull the FINE

(PULL x10 MAG) knob so the desired part is magnified 10 times in the horizontal direction. The trace length at this time is approximately 10 divisions on the CRT screen, but is actually increased to approximately 100 divisions, and can be observed from end to end with the horizontal POSITION and FINE controls.

This method is simple, but magnification is limited to 10 times. The sweep rate to be used for extended observation is the value indicated by the TIME/DIV switch multiplied by 1/10.

Thus, the fastest sweep rate can be extended to 5 nsec/div.

Extending waveform by delayed sweep

The method of magnifying waveform in above paragraph is simple. It can increase the displayed sweep speed by 10 times, but it is limited to 10 times.

The method of magnifying waveform by delayed sweep can magnify every part of the waveform displayed magnifier ratio between A sweep and B sweep is determined by

$$\frac{A \text{ TIME/DIV (sec/div)}}{B \text{ TIME/DIV (sec/div)}}$$

but this method is limited frequency of input signal. If an input signal has a high frequency and if the A TIME/DIV switch is at the fastest speed before magnification, the waveform cannot be magnified any more.

Therefore, delayed sweep magnified is suitable for enlarging the desired part of an input signal that has a relatively low frequency.

Delayed sweep magnification comes in continuous delay and trigger delay as described below.

Continuous Delay: Operation for continuous delay is as follows:

1. Select the HORIZ DISPLAY mode A, apply an input signal, and triggering.
2. Turn the B TIME/DIV switch to a position faster than the A TIME/DIV switch.
3. Select the B-sweep SOURCE mode RUNS AFTER DELAY.
4. Select the HORIZ DISPLAY mode A INTEN

If the DELAY TIME MULT dial is turned clockwise after taking the above steps, a particularly intensity modulation part appears as shown in the upper waveform of Figure 2-17, and moves continuously from left to right. If this intensity modulation part is moved to a position where is measured, and if the HORIZ DISPLAY mode B (DLY'D)

is selected, that part can be magnified fully on the CRT screen as shown in the lower waveform of Figure 2-17.

Use the B TIME/DIV switch for selecting a B (DLY'D) sweep rate. The magnification ratio increases as the sweep rate is increased. If the magnification ratio is raised so much delay jitter shows, making waveform observation difficult. Thus, there are limitations on magnified waveform observation by continuous delay due to delay jitter. In such a case, use the trigger delay described below if a higher magnification ratio is desired.

The delay time of the magnified part can be calculated by multiplying the indicated value of A TIME/DIV switch by the indicated value of the DELAY TIME MULT dial.

Trigger Delay: Trigger delay can be selected if the B-sweep SOURCE switch is set to CH 1, CH 2 or CH 4 (if a trigger signal is applied to CH 4). Delayed magnification can be made by B-sweep triggering and performing the same steps of operation as those of continuous delay.

The magnified part (B-sweep) in trigger delay starts at a trigger point subsequent to the delay time selected with

the DELAY TIME MULT dial. The trigger point moves as DELAY TIME MULT is turned.

If DELAY TIME MULT is turned during a B (DLY'D) sweep, the waveform may appear still, but actually you are watching the part selected in the A INTEN sweep mode.

B-Sweep Trigger

The B-sweep trigger controls include B-sweep COUPLING SOURCE, and LEVEL.

The LEVEL and COUPLING (except for LF REJ, TV-H, TV-V) functions and operations are the same as the A-sweep LEVEL and COUPLING functions and operations. The SOURCE button is used for selecting a trigger signal. RUNS AFTER DELAY is for continuous delay; and CH 1, CH 2 and CH 4 (external trigger function of the conventional oscilloscope) are for trigger delay. If CH 4 is selected, apply a trigger signal to CH 4 INPUT. If CH 1, CH 2 is selected, the same function as in the A-sweep mode is performed.

Figure 2-17. Magnification by Continuous Delay

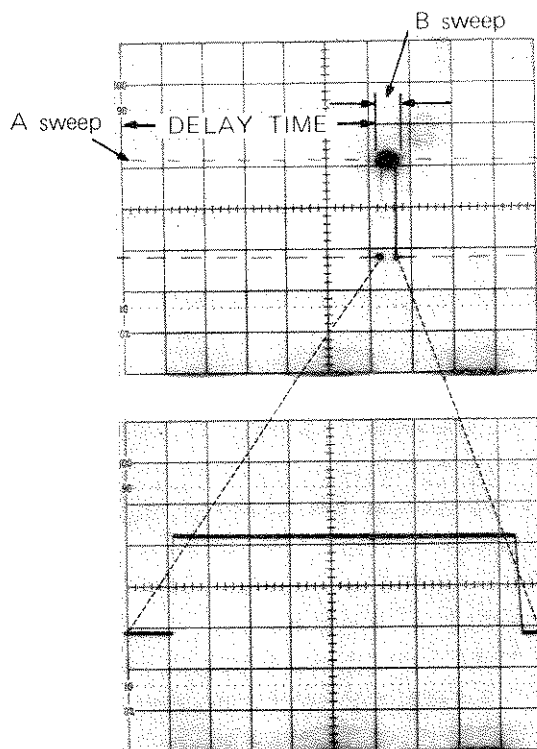

2-5-5 Operation for ALT Sweep

In the ALT sweep mode, an A INTEN sweep and a delayed B-sweep occur alternately. Thus, a non-magnified part and a magnified part can be simultaneously observed. The operation procedure is as follows:

1. Select the HORIZ DISPLAY mode A, apply an input signal, and synchronize.
2. Set B TIME/DIV switch to a position faster than that of A TIME/DIV switch.
3. Set the B-sweep SOURCE switch to RUNS AFTER DELAY.
4. Set the HORIZ DISPLAY switch to ALT.
5. Move the B-sweep waveform to the position where the A-sweep waveform is measured, using the DELAY TIME MULT dial.
6. Turn the B TIME/DIV switch, and magnify.
7. Move the B-sweep waveform (magnified waveform) to a point where it is easy to observe as shown in Figure 2-18, using TRACE SEPARATION.

Note: If TRACE SEPARATION is turned fully counter-clockwise, the A-sweep waveform and B-sweep (magnified) waveform are completely double. When it is turned fully clockwise, the B-waveform moves about 4 divisions

or more above the A-sweep waveform.

The delay time of the magnified part can be easily obtained in the same sweep by the formula shown in the above paragraph on waveform magnification by delay. If the magnification ratio is increased, jitter shows on the CRT screen. In that case, set the SOURCE button to other than RUNS AFTER DELAY for trigger delay as in B (DLY'D) sweep.

2-5-6 Operation for Observing Television Composite Video Signal Waveforms

The SS-5711 has a television synchronizing separator circuit so that television and other composite video signal waveforms can be displayed. The operation procedure is as follows.

Figure 2-18. TRACE SEPARATION Adjustment

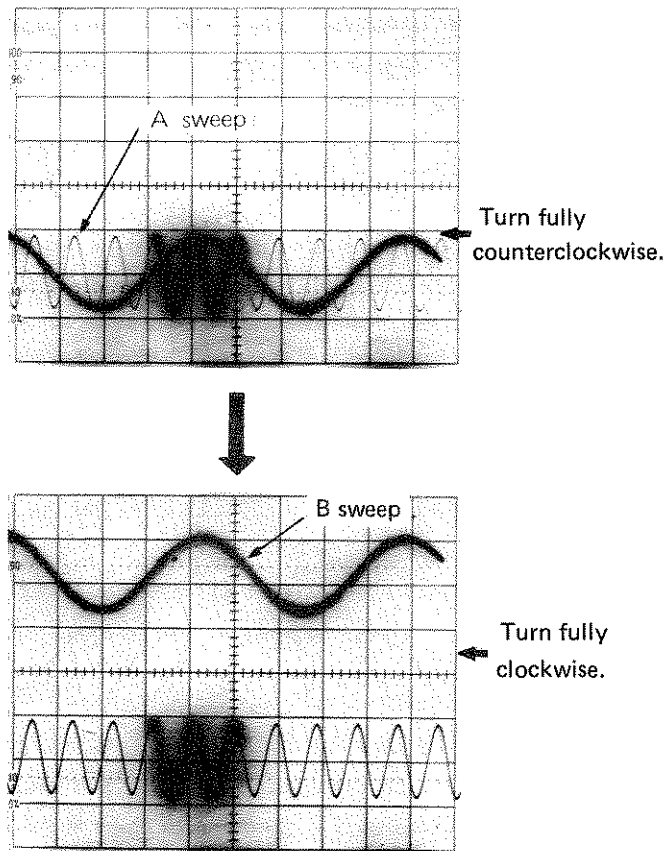

Observation by Normal Sweep

1. Set the controls as follows:

- | | |
|------------------------------|---|
| HORIZ DISPLAY | A |
| Vertical MODE | CH 1 or CH 2 (whichever a signal is applied to) |
| COUPLING | TV-V (when observing a V signal), or
TV-H (when observing an H signal) |
| SOURCE
(internal trigger) | CH 1 or CH 2 (whichever a signal is applied to) or
NORM |

Figure 2-19. Where H Trigger Signal is Positive

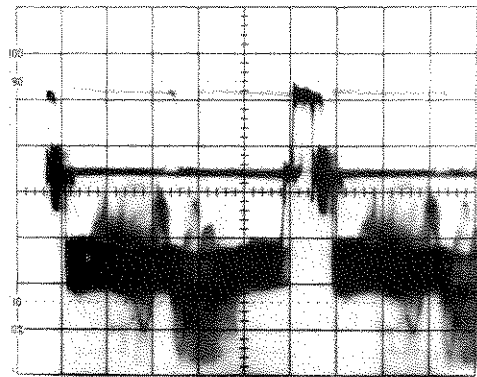
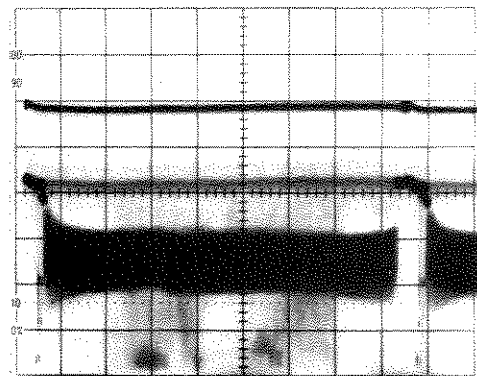

Figure 2-20. Where V Trigger Signal is Positive



(external trigger) CH 3 (Apply a signal to CH 3 INPUT.)

2. Apply the composite signal to be measured to CH 1, CH 2, or CH 3.
3. Adjust so that the composite video signal waveform has an amplitude of 1 division or more (30% of the trigger signal component) on the screen.
4. Selects the horizontal mode AUTO or NORM.
5. Turns the SLOPE control to the + position if the trigger signal component of the composite video signal measured is positive-going; or to the - position if it is negative-going, (Refer to Figure 2-19, and 2-20.
6. Turn the TIME/DIV switch to display the desired part of the signal on the screen.

Magnified Observation by Delayed Sweep

1. In continuation of the above steps, set the HORIZ DISPLAY switch to A INTEN.
2. Turn A TIME/DIV switch to 2 msec/div.
3. When observing by continuous delay, set the B-sweep SOURCE button to RUNS AFTER DELAY; or when trigger delay is desired, set it to CH 1 or CH 2 or CH 4. (Apply the trigger signal to CH 4 INPUT if CH 4 is selected.)
4. Select the desired part to be magnified, using DELAY TIME MULT.
5. Set the HORIZ DISPLAY switch to B (DLY'D), and select the desired magnification ratio with B TIME/DIV switch.
6. The SS-5711 has no 1st-2nd field switching function, but it can be accomplished with an accuracy of about

50% by shifting the AC-DC button or by pushing or pulling the SLOPE control.

2-5-7 Operation for Single Sweep

In observing discharge waveforms or fast-speed transient phenomena, such as the chattering of an operating relay, the waveforms are displayed one upon another. If waveform is displayed at a slower sweep rate, transient phenomena can not be observed in detail. If the single sweep function is used for observing such phenomena, the transient phenomena can be observed without being double and photographed. (See Figure 2-21.)

The basic operation procedure for single sweep using a calibrator voltage is described below.

1. Select the HORIZ DISPLAY mode A and the horizontal mode NORM.
2. Using one of the supplied probes, apply a CAL 0.6 V to INPUT, set VOLTS/DIV to 10 mV and synchronize.
3. Select the horizontal mode SINGLE, and push the SINGLE/RESET button, and confirm that only a single sweep takes place.
4. Disconnect the input signal, and push the SINGLE/RESET button. Confirm that the READY lamp on the right lights.

If the READY lamp lights after these steps, the oscilloscope is in a sweep standby state, ready to make a single sweep if a trigger signal is applied. (The oscilloscope may not be in a standby state if the LEVEL control is at some point near the center. If so, turn the LEVEL control

Figure 2-21. Example of Repeated Sweep and Single Sweep Waveforms

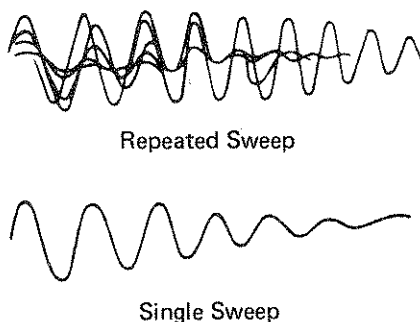
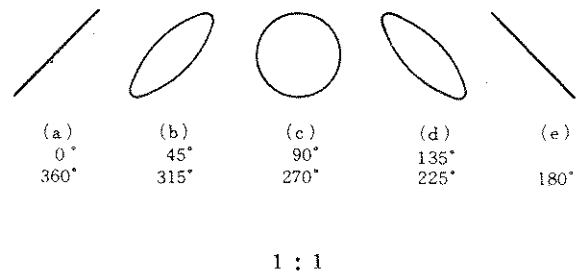

Figure 2-22. Lissajou's Figure of Sine Wave



slightly counterclockwise or clockwise.) If a transient signal is applied to the oscilloscope, it sweeps only once, display the correct waveform.

The single sweep function is effective also in the A INTEN and B (DLY'D) sweep modes. If an external trigger signal is applied and the same operations as in the internal trigger mode are taken, a single sweep is also available. A dual-trace simultaneous single sweep can be made in the CHOP mode, but not in the ALT mode.

2-5-8 Operation for Use as X-Y Scope

By performing operations for use as an X-Y scope, phase differences, Lissajours' figures of various frequency ratios, and hysteresis curves can be observed.

The SS-5711 operates as an X-Y scope, and a spot appear nearly at the center of the screen when the HORIZ DISPLAY mode X-Y is selected.

If signals are applied to CH 1 and CH 2 INPUTs, the signal applied to CH 1 drives the horizontal axis (X) and the signal applied to CH 2 drives the vertical (Y) axis, thus describing a Lissajou's figure.

The X-axis deflection factor is adjusted with the CH 1 VOLTS/DIV switch and its VARIABLE control; and the Y-axis deflection factor with the CH 2 VOLTS/DIV switch control and its VARIABLE control. If the VARIABLE controls are set to the CAL position, the deflection factors are as indicated by the VOLTS/DIV switches. Vertical

Figure 2-23. Lissajou's Figures of Various Frequency Ratios

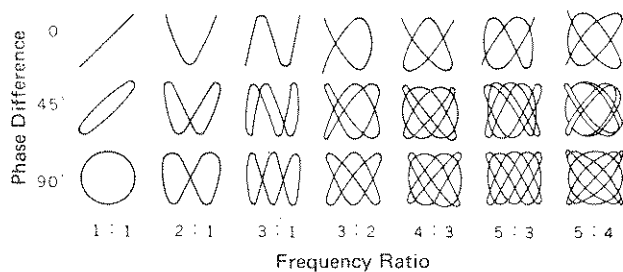

position can be adjusted with the CH 2 POSITION control, and horizontal position with the POSITION control and its FINE control.

Figure 2-22 and a-23 show Lissajou's figures of measuring sine waves and different frequencies. As shown in these figures, varied waveforms are displayed depending on phase difference and frequency ratio. These waveforms are observed still.

Figure 2-24 shows examples of Lissajou's figure of different waveforms.

2-5-9 Z Axis System

In addition to the vertical (Y) axis and horizontal (X) axis, there is also a Z axis (which modulates intensity but does not affect the waveform displayed) for displaying electrical phenomena. The SS-5711 has Z AXIS INPUT on the rear panel which is fed to the CRT circuit to modulate the intensity of waveform displayed on the CRT screen.

If an input voltage of 0.5 Vp-p or more is applied, the intensity is modulated. A negative input signal increases the intensity, and a positive input signal decreases it. The frequency range is from DC to 5 MHz, and the maximum input it voltage is 50 V (DC + peak AC.)

A time reference for the waveform displayed can be obtained by applying a time marker to Z AXIS INPUT. Sweep rate can be calibrated by use of the time marker, even if observing input signal at uncalibrated sweep rate.

Figure 2-24. Lissajou's Figure of Different Waveforms (Frequency ratio 1 : 1)

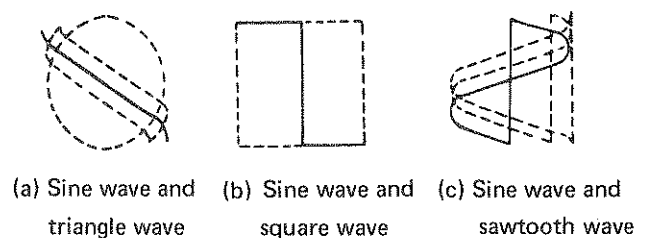

Notes



Measuring Instructions

3-1 ADJUSTMENTS NECESSARY BEFORE MEASUREMENT

It may be necessary to adjust the adjusters on the front panel and bottom before attempting measurements in order to assure accuracy of measurements. In case of measuring with a probe, its phase adjustment is necessary. Whichever the case, the adjusting screwdriver (supplied as an accessory to the probes) may be used for adjustment purposes.

About 30 minutes of warmup is recommended for stabilizing operation before adjusting the controls and probe phase.

3-1-1 TRACE ROTATION Adjustment

Traces may become not parallel to the graticule lines on the CRT screen due to geomagnetic effect or other cause.

If that occurs, display a trace on the CRT screen, move it to the center of the screen with \updownarrow POSITION, and adjust the trace parallel to the graticule lines with TRACE ROTATION. Before making this adjustment, install the SS-5711 in the normal place of use for measurements.

3-1-2 GAIN adjustment (CH 1, CH 2)

Vertical deflection check and adjustment are necessary to assure accuracy of voltage measurements.

The check and adjustment method is as follows. Set VOLTS/DIV switch to 10 mV, and connect INPUT to the CAL 0.6 V output terminal with an accessory probe. Check that the amplitude of the waveform displayed on the CRT screen is 6 divisions. If it is not rating adjust it with the GAIN. (See Figure 2-5.)

3-1-3 X5 BAL Adjustment (CH 1, CH 2)

If ambient temperature fluctuations are variable, the vertical position of a trace may shift when \updownarrow POSITION is pushed or pulled.

If that occurs, adjust the X5 BAL while pushing and pulling \updownarrow POSITION so that the trace will not deviate from its vertical position. (See Figure 2-5.)

3-1-4 VARIABLE BAL Adjustment (CH 1, CH 2)

If ambient temperature fluctuations are variable, the vertical position of a trace may shift when the vertical deflection VARIABLE control is turned.

If that occurs, adjust the VARIABLE BAL while turning the VARIABLE control so that the trace will not deviate from its vertical position. (See figure 2-5.)

3-1-5 Probe Phase Adjustment

10 : 1 passive probe phase adjustment

The following probes can be used for the SS-5711: Type SS-0012 (1.5 m long) with an attenuation ratio of 10 : 1; SS-0001 (1 m long), SS-0002 (1.5 m long), and SS-0003 (2 m long), the later three with an attenuation ratio of 1 : 1. (Those probes with an attenuation ratio of 1 : 1 are optional.)

A mismatched probe phase can result in measuring the wrong waveform. Be sure to correctly adjust the probe before use.

First, set VOLTS/DIV to 10 mV, connect the probe to INPUT and the CAL 0.6 V output terminal so that a calibration voltage waveform with an amplitude of 6 divisions is displayed on the CRT screen.

Next turn the variable capacitor of the probe. The waveform changes as shown in figure 3-1 b or c. Adjust the variable capacitor correctly until the waveform is as shown in Figure 3-1 a.

Section 3 Measuring Instructions

Current probe sensitivity check

When using a current probe for measurement, check its sensitivity beforehand.

Read the instruction manual for the current probe for the checking procedure. The SS-5711 has the CAL 10 mA current loop terminal on the rear panel, where a square wave current of 10 mA flows in the arrow direction.

3-2 MEASURING METHODES

3-2-1 Voltage Measurement

Quantitative Measurement

The quantitative measurement of voltage can be made by setting the VOLTS/DIV VARIABLE control to the CAL position. The measured value can be calculated by Equation (3-1) or (3-2).

- a. Measurement with the x1 position of the probe:

$$\text{Voltage (V)} = \text{VOLTS/DIV setting value (V/div)} \times \text{Displayed amplitude of input signal (div)} \dots (3-1)$$
- b. Measurement with the x10 position of the probe:

$$\text{Voltage (V)} = \text{VOLTS/DIV setting value (V/div)} \times \text{Displayed amplitude of input signal (div)} \times 10 \dots (3-2)$$

Figure 3-1. Probe phase waveforms

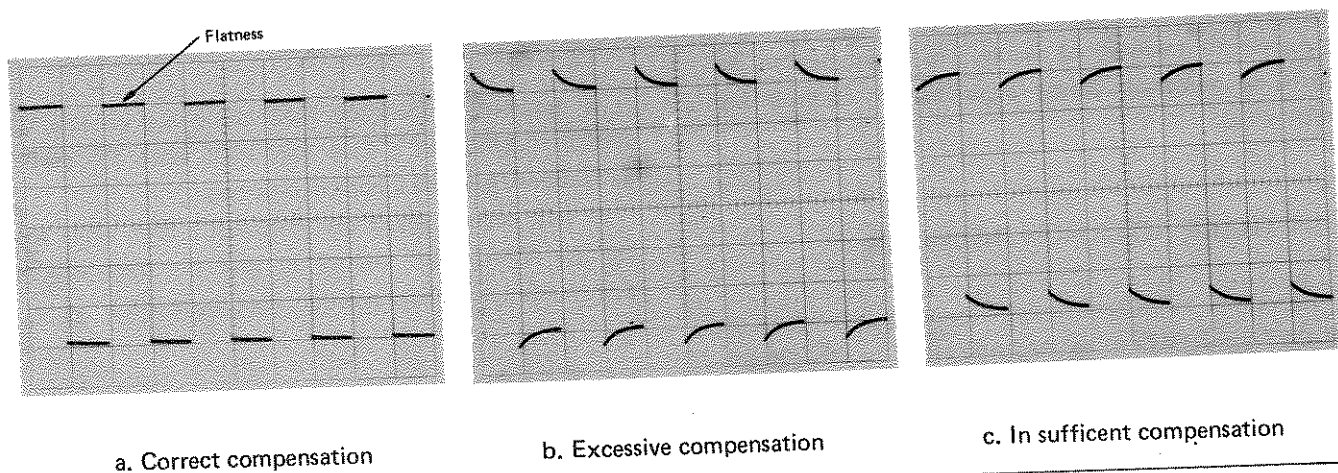

Figure 3-2. DC voltage measurement

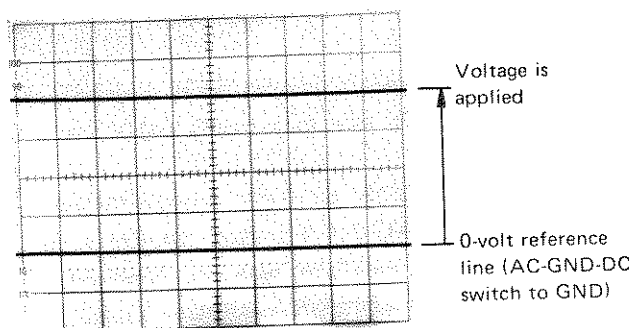
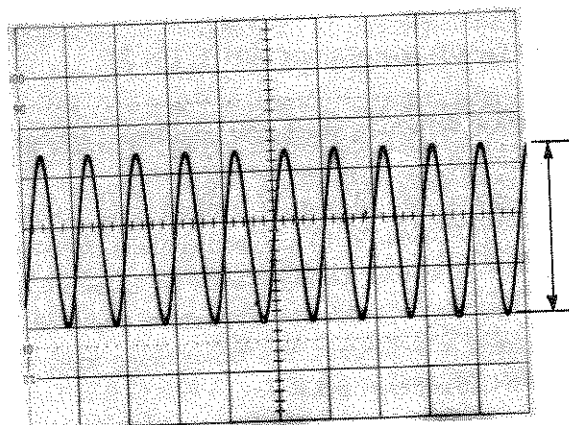

Figure 3-3. AC voltage measurement



DC Voltage Measurement

This instrument functions as a high input resistance, high sensitivity, quick response DC volt meter in order to measure DC voltage. Measurement procedure is as follows:

1. Set the sweep MODE switch to AUTO, and select a sweep rate so that the trace may not flicker.
2. Set the AC-GND-DC switch to GND. The vertical position of the trace in this case is used as 0-volt reference line as shown in Figure. 3-2. Adjust the vertical POSITION control in order to place the trace exactly on a horizontal graticule, which facilitates the reading of signal voltage.
3. Set the AC-GND-DC switch to DC, and apply the voltage to be measured to the input connector. The vertical displacement of the trace gives the voltage amplitude of the signal. When the trace shifts upward, the measured voltage is positive with regard to the ground potential. When the trace shifts downward, the voltage is negative. The voltage can be obtained by Equation (3-1) or (3-2).

AC Voltage Measurement

The measurement of the voltage waveform is performed as follows; Set the VOLTS/DIV switch in order to obtain the amplitude for easy reading, read the amplitude as shown in Figure 3-3 and calculate by Equation (3-1) or (3-2).

When the waveform superimposed on DC current is measured, set the AC-GND-DC switch to DC in order to measure the value including DC component, or set this switch to AC in order to measure AC component only.

The measured value by means of this procedure is peak value (Vp-p). Effective value (Vrms) of a sine wave signal can be given by Equation (3-3).

$$\text{Effective voltage (V rms)} = \frac{\text{Peak voltage (Vp-p)}}{2\sqrt{2}} \dots (3-3)$$

3-2-2 Current Measurement

Phenomena that can be observed by direct input application to the oscilloscope are voltage phenomena. All electrical phenomena other than voltage phenomena, such as mechanical vibrations and all others, require conversion

into voltages for applying to INPUT.

In current measurements, a resistor of a known value is added to the circuit to be measured, and voltage variations at both ends of the resistor are observed on the CRT screen of the oscilloscope. The current value is calculated from the relationship $V = IR$. The resistor to be added to the circuit must have a resistance within a range in which the circuit will not change in operating condition. In case a resistor cannot be added to the circuit to be measured for reasons of operation, a current probe may be used for measuring currents without disconnecting the circuit. As shown in Figure 3-4, the current at the measuring point is detected by the core and secondary winding, and is applied to the vertical deflection system of the oscilloscope.

When measuring a small current, the output of the secondary winding is amplified and then applied. When measuring a large current, a shunt is inserted to apply a divided current. Otherwise, the core will be saturated. This method, however, is subject to limitation in frequency bandwidth. That is, it is unusable for high-frequency signals. if the circuit is ungrounded, a signal input cannot assure accurate current measurement. That is, a differential input amplifier is necessary in that case. As mentioned in the paragraph on Operation for observation of the Sum of Two Signals or their Difference, the SS-5711 can be used for differential observation. This capability may be used in the following way. Select the vertical mode ADD, and CH 2 POLAR INV. Connect a probe to CH 1 and CH 2

Figure 3-4. Current waveform measurement with current probe

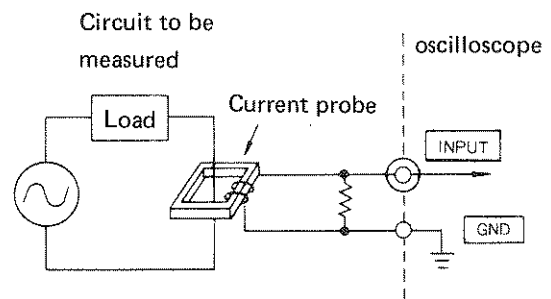

INPUTs, and its tips to both ends of the resistor inserted. Turn the VOLTS/DIV switches for CH 1 and CH 2 to the same position. The waveforms for both ends of the resistor, i. e., current waveforms, can now be observed.

3-2-3 Time Measurement

The time interval of two points on a signal waveform can be calculated as follows: Set the TIME/DIV VARIABLE control to CAL, read the setting values of the TIME/DIV and x5 MAG switches and calculate the time by Equation (3-4).

$$\begin{aligned} \text{Time (s)} &= \text{TIME/DIV setting value (s/div)} \\ &\times \text{Length corresponding to the time to be} \\ &\text{measured (div)} \\ &\times \text{Reciprocal number of x5 MAG setting} \\ &\text{value. (3-4)} \end{aligned}$$

Where, the reciprocal number of the x5 MAG setting value is 1 when the sweep is not magnified, and 1/5 when the sweep is magnified.

Pulsewidth Measurement

The basic pulsewidth measurement procedure is as follows:

1. Display the pulse waveform vertically so that the distance between the top part of the pulse waveform and the horizontal center line of the graticule may be equal

- to the distance between the bottom part of the pulse and the horizontal center line as shown in Figure 3-4.
2. Set the TIME/DIV switch in order to make the easy observation of the signal.
3. Read the distance between centers of rising and falling edges, i.e., the distance between two points at which pulse edges cross the horizontal center line of the graticule. Calculate the pulsewidth by Equation (3-4).

Rise (or Fall) Time Measurement

The rise (or fall) time measurement of the pulses is obtained as follows.

1. Display the pulse waveform vertically and horizontally in the same manner as for the pulsewidth measurement procedure.
2. Turn the horizontal POSITION control in order to set the upper 10% point of the waveform on the vertical center line of the graticule. (In Figure 3-5, the upper 10% point is 0.4 division below the top of the pulse since the displayed amplitude is 4 divisions.) Read the distance T₁ between the vertical center line and the point at which the rising (or falling) edge crosses the horizontal center line.
3. Shift and set the lower 10% point of the waveform to the vertical center line of the graticule as shown by the dotted line in Figure 3-5. Read the distance T₂ between the vertical center line and the point at which the rising (or falling) edge crosses the horizontal center line.

Figure 3-5. Pulse width measurement

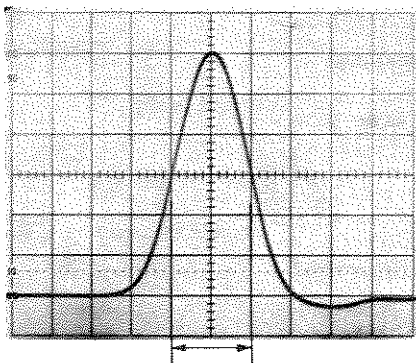
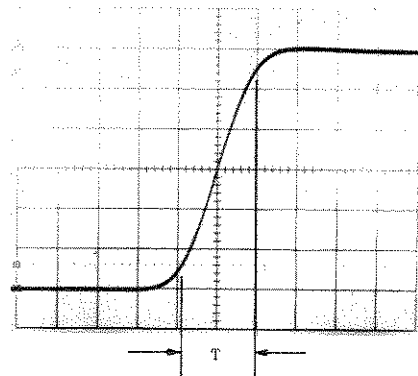

Figure 3-6. Rise (or fall) time measurement



- Calculate the rise (or fall) time by substituting the sum of T₁ and T₂ for Equation (3-4).

3-2-4 Frequency Measurement

Of the frequency measurement procedure, there are the following methods.

The first method: Calculate the one-cycle time (interval) of the input signal by Equation (3-4) as shown in Figure 3-6, and obtain the frequency by Equation (3-5).

$$\text{Frequency (Hz)} = \frac{1 \text{ (c)}}{\text{Period (s)}} \dots\dots\dots (3-5)$$

The second method: Count the repetition number N per 10 divisions in the viewing area, and calculate the frequency by Equation (3-6).

$$\text{Frequency (Hz)} = \frac{N \text{ (c)}}{\text{TIME/DIV setting value (s/div)} \times 10 \text{ (div)}} \dots\dots\dots (3-6)$$

When N is large (30 to 50), the second method can give a higher accuracy level than that obtained with the first method. This accuracy is approximately equal to the rated accuracy of sweep rate. However, when N is small, the count below decimal point becomes very ambiguous, which results in considerable error.

Figure 3-7. Frequency measurement (1)

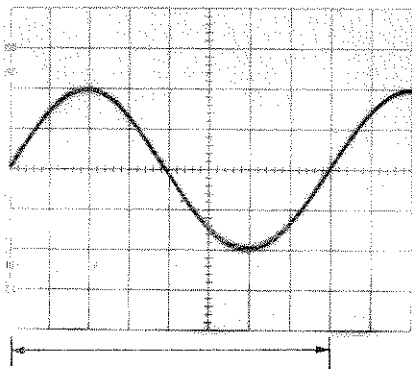

For the measurement of comparatively low frequencies having a simple pattern such as sine wave, square wave, triangle wave, and sawtooth wave, measurement with high accuracy can be effected by the following method: Operate the oscilloscope as an X-Y scope, make the Lissajou's pattern by applying the signal of which frequency is known, and read the necessary value.

3-2-5 Phase Defference Measurement

Of the measurement of phase difference between two signals, there are the following two methods:

The first one is the Lissajou's pattern method by using the instrument as an X-Y scope. The phase difference of signals can be calculated from the amplitudes A and B of the pattern shown in Figure 3-8 and by Equation (3-7).

$$\text{Phase difference (deg)} = \sin^{-1} \frac{A}{B} \dots\dots\dots (3-7)$$

The second method is an application of dual-trace function. Figure 3-9 shows an example of dual-trace display of leading and lagging sine wave signals having the same frequency. In this case, the SOURCE switch must be set to a channel which is connected to the leading signal, and set the TIME/DIV switch so that the length of 1-cycle of the displayed sine wave may be 9 divisions.

Figure 3-8. Frequency measurement (2)

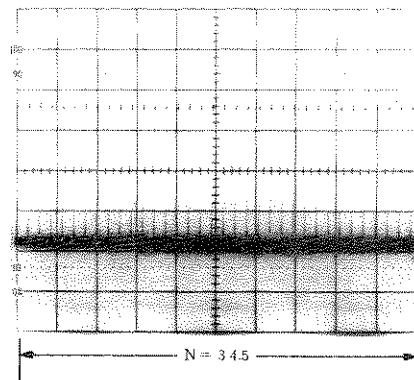

Then, 1-division graticule represents a waveform phase of 40° (1 cycle = $2\pi = 360^\circ$). The phase difference between the two signals can be easily calculated by Equation (3-8).

Figure 3-9. Phase difference measurement using Lissajou's pattern

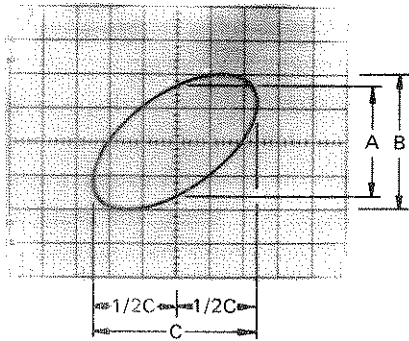

Phase difference (deg) = $T \text{ (div)} \times 40^\circ$ (3-8)
 Where, T is the distance between two points at which the leading and lagging signals cross the horizontal center line of the graticule.

Figure 3-10. Phase difference measurement by dual-trace display

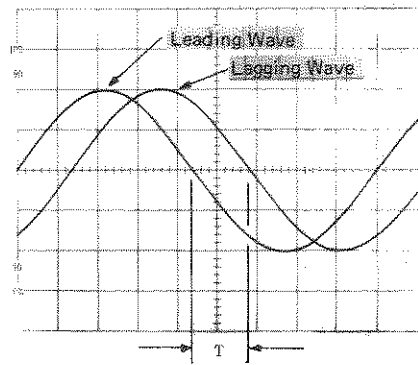

Theory of Operation

This section describes the function and operation of each circuit in reference to the SS-5711 block diagram shown in figure 4-1-1.

display by time division, four-channel (CH 1 through CH 4) display by time division.

Multi-channel display by time division comes in two modes of operation: ALT and CHOP. ALT is the mode for changing display channels every sweep or horizontal axis, and CHOP is the mode for changing display channels every 500 kHz by the pulse from the built-in chop pulse generator. In the CHOP mode, a chop blanking pulse is applied to the Z-axis amplifier to erase the transient phenomenon during channel switching.

4-1 GENERAL

The circuit construction of the SS-5711 is shown in figure 4-1-1. Each block is used for driving the CRT's electron beams finally.

4-1-1 Preamplifiers for Channels 1, 2, 3, and 4

The vertical deflection system has four independent preamplifiers. The preamplifiers for CH 1 and CH 2 combine an attenuator (VOLTS/DIV switch), variable (VARIABLE control), and magnifier (PULL X 5 MAG switch) to permit input deflection factor setting from 1 mV to 12.5 V per division of the graticule scale. The simplified attenuator provided for CH 3 and CH 4 permits input deflection factor setting to 0.1 V or 1 V. As an input signal is applied to the INPUT connector for each channel, it is converted to a balanced signal, which is amplified and led to the delay cable driver circuit.

4-1-2 Delay Cable Driver Circuit

The delay cable driver circuit leads the balanced signal from each preamplifier to the vertical main amplifier individually or by time division through diode gate opening and closing.

Modes of leading the balanced signal can be selected by setting the vertical MODE switch: CH 1 or CH independent, display of the sum of CH 1 and CH 2 or the difference between them, two-channel (CH 1 and CH 2)

4-1-3 Vertical Main Amplifier

The vertical main amplifier is used for driving the electron beams which scan the fluorescent face of the CRT screen in the vertical axis (Y-axis) direction, and amplifies input signals up to the inherent deflection factor of the CRT to make the vertical input deflection factor correspondent to the CRT scale.

4-1-4 Trigger Signal Circuit

The signals branched out from the vertical preamplifiers are led to the trigger signal amplifier circuits via trigger signal switching circuits for CH 1, CH 2, CH 3, CH 4, LINE (from the power circuit) and NORM (from the main amplifier from electronic switching) signals.

4-1-5 TV Trigger Signal Separator Circuit

Suppose that a television composite signal is applied to the vertical preamplifier. If the input is directly applied to the trigger signal amplifier circuit as it is, stabilized synchronization cannot be expected because the video signal component changes. Thus, the video signal component is removed by feeding the input through the TV trigger signal

Figure 4-1. SS-5711 Overall block diagram

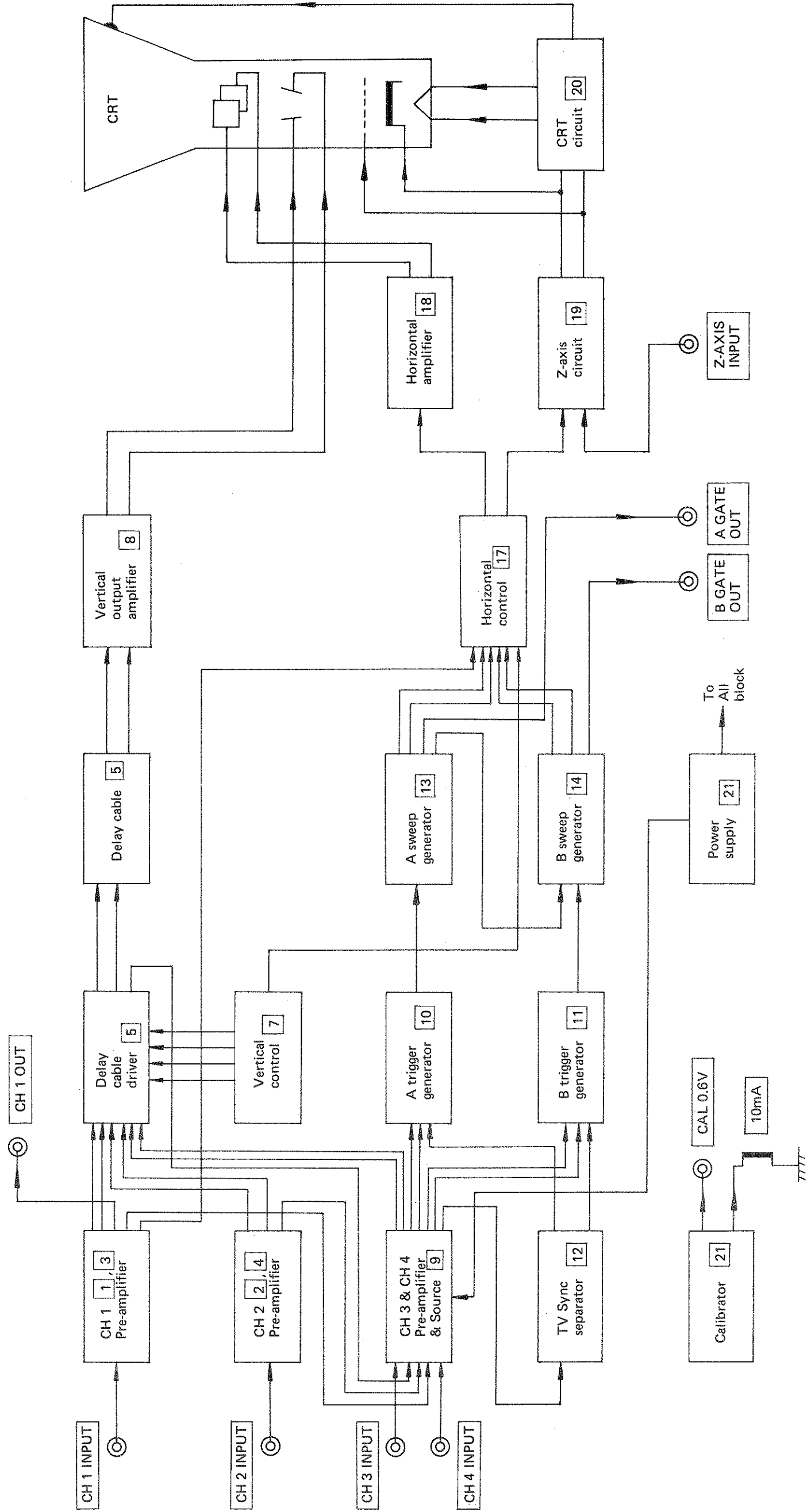

separator circuit, and the vertical trigger signal (TV-V) and horizontal trigger signal (TV-H) are separated by the time constant circuit composed of a resistor and capacitor. And after it, the stabilized synchronization is assured.

In TV trigger delay sweep, a horizontal trigger component is applied to the B trigger amplifier circuit.

4-1-6 A and B Trigger Amplifier Circuits

The signals applied to the vertical preamplifiers are branched out and led to the A and B trigger amplifier circuits. Before reaching these amplifier circuits, however, the lowpass filter or highpass filter can be selected.

These trigger signals are applied to the A or B trigger amplifier circuit, where the signals are amplified to the proper sensitivity. The amplified signals are led to the sweep circuit via the pulse shaping circuit, which converts them to trigger pulses having a constant rise time and voltage.

4-1-7 A and B Sawtooth Generator Circuits

The pulse generated by the A trigger pulse shaping circuit is applied to the A sawtooth generator circuit, and a sawtooth signal for horizontal axis sweep is generated when the sweep gate opens.

The B sawtooth generator circuit generates a sweep signal at a preset time after the operation of the A sawtooth generator circuit. The sweep by sawtooth B is called delayed sweep, which may be classified by the start timing of the B sawtooth generator circuit as follows:

Continuous Delay Sweep

Sawtooth B is generated when a pulse signal is generated by comparison of the voltage set with the delay multi-dial with sawtooth A.

Trigger Delay Sweep

Sawtooth B is generated by the first trigger signal B that reached after generation of a pulse signal by comparison of the voltage set with the delay multi-dial with sawtooth A.

As described above, sawtooth waves are generated by opening and closing the sweep gate, and sweep gate signals A and B generated at that time are led to the Z axis amplifier.

4-1-8 Horizontal Amplifier

The horizontal amplifier drives the electron beams which scan the fluorescent face of the CRT in the horizontal axis (X-axis) direction, and amplifies the input signals up to the inherent deflection factor to the CRT so that the trigger signals from the A and B sawtooth generator circuits will correspond to the time axis scale on the CRT screen.

Sweep signal A or B may be selected for the horizontal amplifier with the HORIZ DISPLAY switch A or A INTEN and B (DLY'D) input sweep signal A and sweep signal B respectively to the horizontal amplifier.

In ALT operation, sweep signals A and B are alternately selected by electronic switching every sweep, and input to the horizontal amplifier.

In X-Y operation, the signal input to the vertical preamplifier for CH 1 INPUT is led to the horizontal amplifier via the trigger amplifier and the signal applied to CH 2 INPUT is led to the horizontal amplifier. Thus, a Lissajous' figure can be displayed on the screen, by the signal applied to CH 1 INPUT (X-axis display) and the signal applied to CH 2 INPUT (Y-axis display).

4-1-9 Z-Axis Amplifier

The Z-axis amplifier selects gate pulses from the A and B sawtooth generator circuits, amplifies the selected pulse, and generates a CRT intensity modulation signal. These gate pulses are called unblanking pulses because they eliminate horizontal sweepback.

The unblanking pulses vary in waveform according to HORIZ DISPLAY switch position. An unblanking pulse is generated from an A-gate waveform in the A sweep mode, from a combination of A-gate and B-gate waveforms in the A INTEN mode, and from a B-gate waveform in the B (DLY'D) sweep mode. In ALT sweep, unblanking pulses with the A INTEN waveform and B-sweep waveform are alternately provided to the HORIZ DISPLAY switch by

electronic switching every sweep, and input to the Z axis amplifier.

In addition, the aforementioned chop blanking signal for erasing the transient phenomenon during chopping, and the signal applied to Z AXIS INPUT for intensity modulation from the outside are also provided to the Z axis amplifier input.

If a positive signal of 0.5 V or more is applied to Z AXIS INPUT, the CRT luminance lowers to permit intensity modulation. The INTEN control for adjusting overall intensity is also connected to the Z-axis amplifier input.

4-1-10 CRT Circuit

The CRT circuit consists of a circuit which generates heater voltages and high voltages for generating and accelerating electron beams, and grid circuits around the CRT for proper focusing.

4-1-11 Low-Voltage Circuit

The low-voltage circuit generates stabilized low voltage from commercial AC power to drive each circuit, and also supplies a line trigger signal to synchronize with the CRT scale illuminating power and commercial AC power.

4-1-12 Calibration Voltage and Current Generator Circuit

This is a constant-voltage constant-current square wave generator, and is set to a repetition frequency of about 1 kHz. Using the signal generated by this circuit, probe phases can be adjusted and oscilloscope input sensitivity can be calibrated. Current probe phases can also be adjusted by means of the current loop in the rear panel.

1
2
3
4
5
6
7
8
9
10
11
12
13
14
15
16
17
18
19
20
21
22
23
24
25
26
27
28
29
30
31
32
33
34
35
36
37
38
39
40
41
42
43
44
45
46
47
48
49
50
51
52
53
54
55
56
57
58
59
60
61
62
63
64
65
66
67
68
69
70
71
72
73
74
75
76
77
78
79
80
81
82
83
84
85
86
87
88
89
90
91
92
93
94
95
96
97
98
99
100

Maintenance

This section describes the maintenance procedures for keeping the SS-5711 in good condition over a long period of time. If it becomes necessary to check and replace the circuit parts, refer to the Circuit Arrangement Diagrams.

Apart from the instructions given in this section, the proper operation procedures described in section 2 must also be observed to assure long satisfactory operation.

5-1 PREVENTIVE MAINTENANCE

These are the preventive maintenance procedure for preventing troubles and keeping your oscilloscope clean and well for a long period of time.

5-1-1 Cleaning

The extent of dirt varies according to the ambient condition in which the instrument is used. The instrument should be cleaned as required. Dirt accumulated in the instrument causes overheating because it interrupts effective heat dissipation. It also damages the parts under high-humidity condition. A dirty switch contact or connector can cause faulty contact, and dirt accumulated on the inner circuit part can cause spark during the wet season. The fluids suitable or unsuitable for cleaning the instrument are shown in table 5-1.

Table 5-1

Suitable fluids	Alcohol, water, neutral detergent
Unsuitable fluids	Acetone gasoline, ether, lacquer thinner, methylethyl ketone, chemicals containing ketone detergent

Cover Cleaning

Remove the covers, and clean them with detergent. Remove stains of grease using a soft cloth dampened with one of the suitable fluids shown in Table 5-1.

Front Panel Cleaning

Wet a soft cloth with one of the suitable fluids shown in table 5-1, and clean the front panel with it. If alcohol is used, some traces might be left. The front panel can also be cleaned with detergent. In this case, it is necessary to wipe off the detergent left on the panel and the control knobs with a cloth dampened with water.

Inside Cleaning

The best way of cleaning the dirt accumulated in the instrument is to use an air compressor. Dirt which remains after blowing with air compressor can be removed by using a soft paint brush and blowing again with air compressor.

CRT and Filter Cleaning

The CRT screen and the filter can become dirty if they are used for a long time. Ordinary stains and fingerprints can be removed by wiping with a soft cloth. If they are terribly dirty, use a soft cloth dampened with alcohol.

5-1-2 If Unused for a Long Time

If you don't use the instrument for a long time, remove the probe, adaptor, etc. From it and put them in the supplied bag. Attach the supplied panel cover to it, put the dust cover on the device, and store it in a place as dry as possible.

This can keep the instrument clean.

5-1-3 Checking

Inspect the inside of the instrument periodically for burnt resistors, faulty contacts, or damaged printed circuit boards. Major troubles can be prevented by repairing them immediately.

5-1-4 Periodic Adjustment

Periodic inspection and adjustments are necessary for keeping the instrument in accurate operating condition at all times. If the instrument is continuously used, inspect and adjust it about every 1000 hours. If it is not used so much, it may be inspected and adjusted about every six months.

5-2 PARTS REPLACEMENT

The replacement procedures for faulty parts detected by circuit inspection are described here. Be sure to disconnect the power cord from the electrical outlet before replacing any faulty parts.

5-2-1 Cover Removal

The covers must be removed before inspecting the inside or replacing faulty parts.

Be sure to remove the rear panel first in removing the covers. The rear panel can be removed by removing the two each screws on the right and left of the panel. Then, remove the six screws from the top, left, and right sides of the top cover in its front and rear parts, and remove the cover by pulling it rearward. (The front end of the top cover is inserted behind the front panel.)

Remove one each screw in the front and rear parts of the bottom cover and the two screw near the center of it, and remove the bottom cover by pulling rearward. (The front end of the bottom cover is inserted behind the front panel).

5-2-2 Printed Circuit Board Removal

To replace a faulty printed circuit board or a faulty parts on a printed circuit board, remove the printed circuit board.

The instrument has separate printed circuit boards for the V-unit, H-unit, and others.

The printed circuit board for the V-unit consists of the following circuits.

- CH 1 preamplifiers (1), (2)
- CH 2 preamplifiers (1), (2)
- Delay cable driver
- Vertical control
- Vertical panel switches

The V-unit removal procedure is as follows.

1. Remove the control knobs VOLTS/DIV, VARIABLE, POSITION and GND REF for CH 1 and CH 2.
2. Remove the two screws on the bottom of the sub panel and the screw from the right side of it.
3. Remove the two screws over the CH 1 and CH 2 INPUT connectors on the front panel.
4. Remove the four screws that fasten the printed circuit board.
5. Remove the V-unit by sliding it rearward.

Figure 5-1. External View of the V-Unit

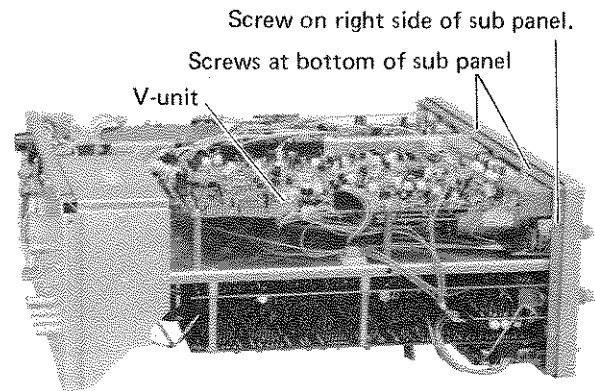

(This photo shows the instrument upside down.)

The printed circuit board for H-unit consists of the following.

- CH 3 and CH 4 attenuators and preamplifiers
- TV sync separator
- A trigger generator
- B trigger generator
- B sweep generator

The H-unit removal procedure is as follows.

1. Remove the two screws on top of the sub panel and the screw on the right side of it.
2. Remove the two screws over the CH 3 and CH 4 INPUT connectors on the front panel.
3. Disconnect the connectors for the leads that are connected to other printed circuit boards.
4. Remove the four screw that fasten the printed circuit board.
5. Remove the H-unit by sliding it rearward.

To remove the individual printed circuit boards, remove the pin connectors and multi-connectors that are connected to them first and then the control knobs and rotary switches from the front panel and the screws that fasten the printed circuit boards.

5-2-3 Printed Circuit Board Parts Replacement

In replacing diodes, transistors, IC's, resistors, or capacitors, on a printed circuit board, use your soldering iron carefully so that neither the copper foil of the printed circuit board will be peeled off nor any parts on the circuit board will be damaged.

Because the semiconductors, such as transistors and diodes, are not thermal-resistant, pinch the leads with tweezers and solder them quickly component so that the heat of the soldering iron will not be directly conveyed to the semiconductor. Diodes and transistors used for replacement must have good performance.

The resistors, capacitors, and other passive elements used in the instrument are carefully selected so any replacement parts to be used in their place must have good ones. (See the parts list in section 8.)

Electrode contact of transistor or diode and serious variation of their characteristics may incidentally make a resistor burn or a capacitor short-circuit. If such a trouble should occur, eliminate the cause of it before replacing the faulty part.

5-2-4 Replacing Resistors, Diodes or IC's

In replacing a transistor, diode, or IC, make sure of the electrodes. (See tables 5-4, 5-5, and 5-6.)

Particularly, transistors must be replaced with ones that have good performance. The transistors that have been specially selected are noted in the schematic diagrams.

5-2-5 Power Transistor Replacement

The power transistors for the instrument are mounted on the rear sub panel. In replacing any of them, remove the rear panel, and remove the screw that fastens the transistor. The power transistors are connected with a connector.

In installing a new transistor, first wind heat dissipating silicon rubber (TC-30) around the transistor to assure satisfactory heat dissipation between the transistor and sub panel, and install the transistor. Be sure to insert it into the connector in the correct direction. (Connect the brown lead of the connector to pin 1 of the transistor, and the orange lead one to pin 2 of the transistor.)

Figure 5-2. External View of H-Unit

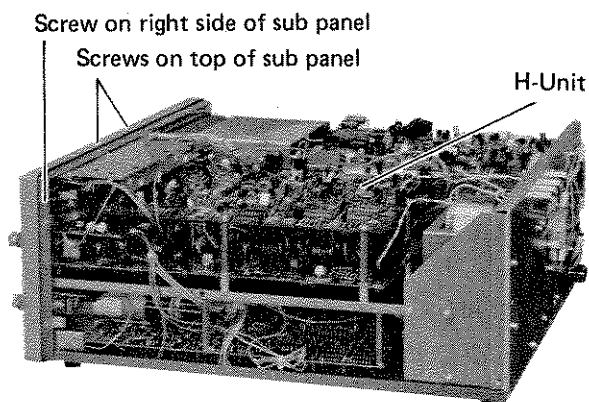

5-2-6 CRT Replacement

Handle the CRT carefully in replacing it because it will be damaged easily by dropping or shock. Care must be also taken not to apply too much strain to the deflection pin to prevent the glass from cracking.

The CRT removal procedure is as follows:

1. Remove the rear panel and the top cover.
2. Disconnect the CRT socket.
3. Remove the anode cap after discharging it because it might retain a high voltage charge.
4. Disconnect the wires from the deflection pin.

The blue and yellow leads are for vertical deflection, the white and black leads for horizontal deflection, and the red lead is for the negative electrode of Q3 of V1 (CRT).

Disconnect the leads with care so that they will not be rewired to the deflection pin in the wrong way.

5. Disengage the connector at the tip for the trace rotation coil leads (white, black).
6. Pull out the ORTHO leads (green blue).

7. Remove the four screws that fasten the printed circuit board (V main amplifier) over the CRT, and lift it slightly.
8. Remove the two screws that fasten the CRT clamps to the rear sub panel.
9. Loosen the long screws for the CRT clamps that fasten the CRT.
10. Slightly pull the CRT and shield case rearward, lift the front end of the CRT and pull it forward until it comes out.
11. Pull the CRT carefully from the shield case.

Reverse the above procedure for installing the CRT. If the CRT has been replaced, readjustments must be made by referring to section 6 Performance (Check) and Adjustment.

Figure 5-3. CRT and its Peripheral Parts

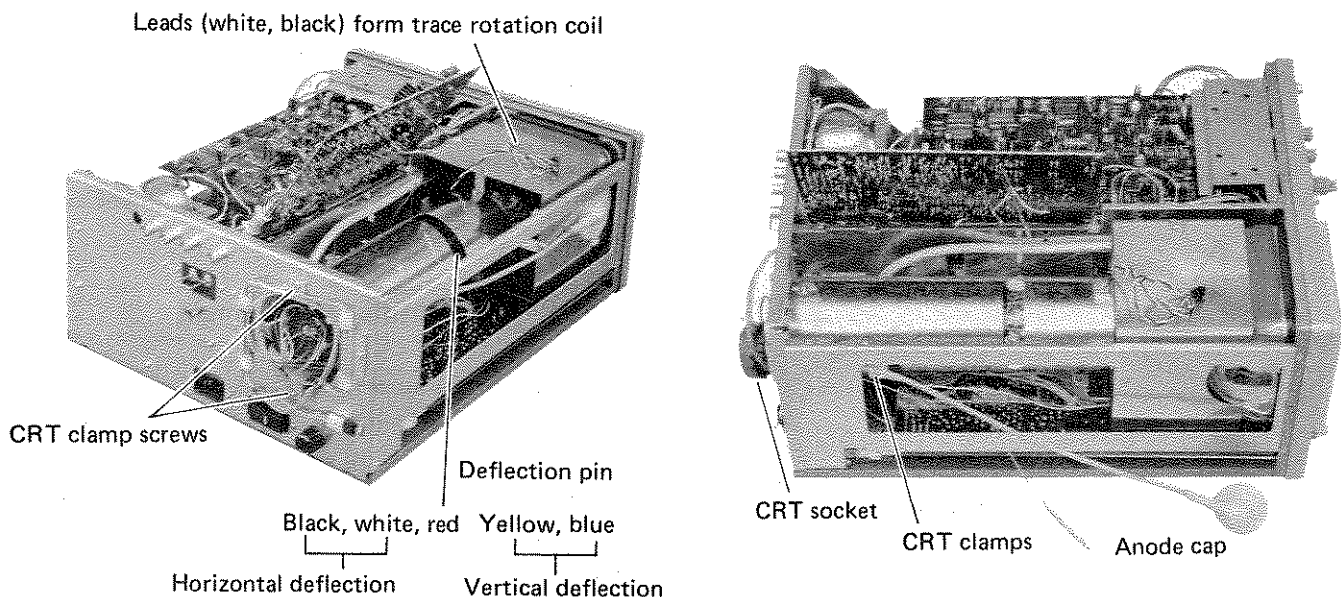

5-2-7 High-Voltage Power Transformer Replacement

Care must be taken in replacing the high-voltage power transformer which supplies high voltage to the CRT because the CRT circuit may be live with high voltage. The removal procedure is as follows:

1. Remove the rear panel, and top and bottom covers.
2. Remove the two screws that fasten the high-voltage case, and remove the case.
3. Remove the three screws that fasten the printed circuit board for the high-voltage circuit, disengage the printed circuit board connector and transistor connector, and remove the printed circuit board.
4. The high-voltage power transformer is soldered on the printed circuit board. It must be unsoldered by using a soldering iron. When the high-voltage power transformer has been replaced, readjustment is necessary.

5-2-8 Replacing Control Knobs and Rotary Switches

The control knobs and rotary switches are mounted on the printed circuit boards and the front sub panel. Their replacement procedure is as follows:

1. Remove the screw from the printed circuit board on which the control knob or rotary switch to be replaced is mounted.
2. Disengage the connector that is connected to the printed circuit board.
3. Remove the control knob or rotary switch.
4. Remove the nut which fastens the control or rotary switch, and remove it together with the printed circuit board. (Refer to the Hand V-unit removal procedures mentioned before.)
5. Melt the solder that fastens the control or rotary switch, using a soldering iron. Reverse the above procedure for installing them.

5-2-9 Replacing Pushbutton Switches

Pushbutton Switches for the H— and V—Units

After following the removal procedure of the H—/V—unit removal procedure mentioned before, remove the pushbutton switch from the printed circuit board, using a soldering iron. The replacement procedure for the HORIZ DISPLAY and horizontal MODE pushbuttons is as follows:

HORIZ DISPLAY and Horizontal MODE Pushbuttons

Follow the removal procedure of the H—/V—unit, remove the front panel, and proceed as follows:

1. Remove the nuts that fasten the A and B TIME/DIV switches, horizontal POSITION control, HOLDOFF control, and TRACE SEPARATION control from the sub panel.
2. Remove the A-sweep printed circuit board.
3. Remove the two each screws that fasten the HORIZ DISPLAY and horizontal MODE switches from the sub panel, and remove them together with the printed circuit board.
4. Melt the solder that fastens the printed circuit board by using a soldering iron, and remove the switches.

Check and Adjustment

6-1 GENERAL

Correct measurement requires the normal operation of each circuit in SS-5711 and satisfactory maintenance of their performance.

With the regular performance check and adjustment, SS-5711 can develop its functions in a reliable manner for a long period of service. This section describes the appropriate method of check and adjustment.

6-2 PERIOD OF CHECK AND ADJUSTMENT

The regular and periodical check and adjustment of performance is necessary for correct measurement. The proper check intervals for SS-5711 are six months.

6-3 PRECAUTIONS FOR CHECK AND ADJUSTMENT

For the performance check and adjustment, pay attention to the following:

- a. In each check and adjustment items, the description for the control knob manipulation presupposes the setting completed for item 6-6 Preparation. Whether the check and adjustment are carried out for all items or for limited items, make sure to start the operation from the point where the setting has been made according to the preparation for check and adjustment.
- b. Some signal generator outputs at a 50Ω termination; so using a coaxial cable with characteristic impedance of 50Ω (e.g. BB-120 by Iwatsu), terminate the cable end at the scope side with a 50Ω terminator (e.g. BB-50M1 by Iwatsu).
- c. The low-voltage power is supplied to all circuits. If its voltage or ripple goes outside the specified values, the other performance will be affected. If check and adjustment, therefore, check the low-voltage power supply first.
- d. The CRT has a high-voltage. For its check and adjustment, be careful not to catch an electric shock.
- e. The adjuster has the circuit numbers. To make the circuit clear, the number in the boxes of the circuit diagrams are described before the circuit number.

6-4 EQUIPMENT REQUIRED

The check and adjustment requires the equipment and accessories as described in table 6-4-1. The equipment must have the performance equal to or greater than those described in the table. The signal connector of SS-5711 is BNC. If the terminator or signal output terminal is other than BNC, prepare a converter connector.

Table 6-4-1 List of equipment required

Equipment	Minimum Specifications	Purpose	Recommended Model
Scope calibrator • Standard-amplitude signal level • Time-mark generator • Sine wave generator • Square wave generator • Fast rise signal generator	: 6mV to 60V ±0.5% or less : 10nsec to 2 sec ±0.05% or less : 1kHz ±20% Frequency range : 50Hz to 250kHz Rise time : 5nsec or less Repetition : 50kHz to 200kHz Rise time : 0.35nsec or less	Vertical, triggering and horizontal checks and adjustments	Iwatsu SC-340 TEKTRONIX PG506 Calibration Generator TG501 Time-Mark Generator (TM500-series power module mainframe is needed)
Standard signal generator	Frequency : 50kHz to 100 MHz Output level : 60mV or more	Pattern distortion, bandwidth and phase difference checks and adjustments	HP 8654A/B TEKTRONIX SG503 Leveled Sine-Wave Generator
Digital volt-meter	Range : DC to 200VDC ±0.05% + 1dgt : 0 to 300VAC	Power supply checks and adjustments	Iwatsu VOAC747 HP 3465A/B
High-voltage probe (For digital volt-meter)	Range : DC to 20k VDC ±3% + 1dgt	High-voltage power supply check and adjustment	Iwatsu High-voltage probe HP 34111A

Table 6-4-1 List of equipment required (cont.)

Equipment	Minimum Specifications	Purpose	Recommended Model
Test Oscilloscope and x1 probe (x1 probe is optional accessory)	Bandwidth : DC to 1MHz Minimum deflection factor: 1mv/dv	Power supply ripple check and general troubleshooting	a. Iwatsu SS-5212 TEKTRONIX 213 Oscilloscope b. Iwatsu SS-0001/0002 TEKTRONIX P6101 Probe (x1)
Frequency counter	Range: 10Hz to 1.5MHz Resolution: 1Hz	Repetition rate of calibrator check	Iwatsu FC-8841 HP 5300/5301A
Voltage regulator		AC line voltage range check	
Termination (2 required)	Impedance: 50 Ω	Signal termination	Iwatsu BB-50M1
Divider		Signal interconnection	Iwatsu B-50D3
Cable (2 required)	Impedance: 50 Ω Length: 120mm	Signal interconnection	Iwatsu BB-120C
Supplied x10 probe		Signal interconnection	Iwatsu SS-0011
Screwdriver		Adjust variable resistors and capacitors	Iwatsu Probe accessory

6-5 CHECK AND ADJUSTMENT ITEMS

The check and adjustment items are shown in table 6-5-1.

The right column indicates items that may be affected by adjustment.

Together with one item, also check and adjust other items that may be affected by that item.

In check and adjustment of all items, do them in the following sequence

Table 6-5-1 Items and interactions

order	Checks and adjustments items	Page	Checks and adjustments affected
	Power supply and CRT		
1	6-7-1 Power supply DC level I (voltage range)	6-6	All items
2	6-7-2 Power supply DC level II (ripple voltage)	6-7	All items
3	6-7-3 AC line voltage range	6-8	
4	6-7-4 Limit level	6-9	6-7-5
5	6-7-5 High-voltage power supply	6-10	6-7-6, 6-7-10, 6-9-6, 6-9-11, 6-9-15, 6-11-4 6-11-5, 6-12-1
6	6-7-6 Intensity	6-11	6-7-7
7	6-7-7 Focus	6-12	
8	6-7-8 The parallel of the horizontal trace and horizontal scale (TRACE ROTATION)	6-13	
9	6-7-9 The parallel of the vertical trace and vertical scale (ORTHOGONALITY)	6-14	
10	6-7-10 Pattern distortion	6-15	6-9-6, 6-11-4, 6-11-5
	Calibrator output		
11	6-8-1 Repetition rate	6-16	
12	6-8-2 Output voltage	6-17	
	Vertical deflection system		
13	6-9-1 ADD balance	6-18	6-9-8
14	6-9-2 X5 balance	6-18	6-9-4, 6-10-2, 6-12-2
15	6-9-3 5mV balance	6-19	
16	6-9-4 VARIABLE balance	6-19	6-10-2, 6-12-2
17	6-9-5 Pulse response I (CH1•CH2 sag at 10mV/div)	6-20	
18	6-9-6 Deflection factor I (CH1•CH2)	6-21	6-12-1
19	6-9-7 Pulse response II (CH1•CH2 sag at 1mV/div)	6-23	
20	6-9-8 Position center (CH3 CH4)	6-24	

Order	Check and adjustment items	Page	Checks and adjustments affected
21	6-9-9 Attenuator compensation I (CH1 • CH2)	6-26	
22	6-9-10 Attenuator compensation II (CH3 • CH4)	6-28	
23	6-9-11 Deflection factor II (CH3 • CH4)	6-30	
24	6-9-12 Pulse response III (overshoot and others)	6-31	6-9-6, 6-9-13, 6-10-1 to 6-10-3
25	6-9-13 Pulse response IV (CH3 • CH4 sag)	6-33	
26	6-9-14 Bandwidth	6-34	
27	6-9-15 Linearity	6-35	
	Trigger system		
28	6-10-1 FIX Triggering level	6-36	
29	6-10-2 Triggering level I (CH1 • CH2)	6-38	
30	6-10-3 Triggering level II (CH3 • CH4)	6-40	6-9-8
	Horizontal deflection system		
31	6-11-1 Average voltage of horizontal amplifier	6-42	
32	6-11-2 Magnification Center	6-42	6-12-2
33	6-11-3 A • B sweep start	6-43	
34	6-11-4 Sweep rate	6-44	
35	6-11-5 Magnified sweep rate	6-46	
36	6-11-6 Start and stop of delay	6-47	
37	6-11-7 Jitter X-Y operate	6-49	
	X - Y operation		
38	6-12-1 Deflection factor	6-50	
39	6-12-2 Spot location	6-50	
40	6-12-3 Phase difference	6-51	

6-6 PREPARATION

Before making check and adjustment, prepare the following:

1. Set the ambient temperature at 23°C ± 5°C.
2. Before turning the power on, set the switches and control knobs as shown in the table at the left.

Precaution

Open the page to the left and refer to the contents when making check and adjustment of each item.

Switches and controls	Setting
POWER	OFF
A INTEN	Slightly right of the midrange
B INTEN	Midrange
FOCUS	Midrange
SCALE	Full clockwise turn
VERTICAL MODE	CH 1
↑ POSITION (CH 1 • CH 2)	Midrange
VOLTS/DIV (CH 1.2)	10 mV
VARIABLE (CH 1 • 2)	CAL (Push)
AC-DC (CH 1 • CH 2)	DC
BAND WIDTH	FULL
CH 2 POLAR	NORM
↔ POSITION	Midrange
FINE (PULL X 10 MAG)	Midrange (Push)
COUPLING (A • B)	AC
SOURCE (A • B)	CH 1
HOLDOFF	NORM
HORIZONTAL MODE	AUTO
LEVEL (A • B)	Midrange (push)
A TIME/DIV	1m SEC
A VARIABLE	CAL
HORIZ DISPLAY	A
DELAY TIME MULT	Full counter-clockwise turn

6-7 POWER SUPPLY AND CRT CHECK AND ADJUSTMENT

6-7-1 Power Supply DC Level I (Voltage Range)

Item	Description												
Rating	<table border="1" style="width: 100%; border-collapse: collapse;"> <thead> <tr> <th style="width: 30%;">DC power voltage</th> <th style="width: 70%;">Output voltage range</th> </tr> </thead> <tbody> <tr> <td>- 12 V</td> <td>Within ± 0.12 V</td> </tr> <tr> <td>+ 5 V</td> <td>Within ± 0.2 V</td> </tr> <tr> <td>+ 12 V</td> <td>Within ± 0.3 V</td> </tr> <tr> <td>+ 39 V</td> <td>Within ± 1.2 V</td> </tr> <tr> <td>+ 129 V</td> <td>Within ± 3.9 V</td> </tr> </tbody> </table>	DC power voltage	Output voltage range	- 12 V	Within ± 0.12 V	+ 5 V	Within ± 0.2 V	+ 12 V	Within ± 0.3 V	+ 39 V	Within ± 1.2 V	+ 129 V	Within ± 3.9 V
DC power voltage	Output voltage range												
- 12 V	Within ± 0.12 V												
+ 5 V	Within ± 0.2 V												
+ 12 V	Within ± 0.3 V												
+ 39 V	Within ± 1.2 V												
+ 129 V	Within ± 3.9 V												

Check and Adjustment Measure the voltage across the measurement position (see Figure 6-7-3) and the ground and check that the values are within the rated values. If the voltage is outside the rated value, adjust " -12V" with 21R 77 -12V ADJ (see Figure 6-7-3). Check voltages at other locations again.

Note: The design is such that by adjusting -12V, other voltages can be set within the specification range.

Related Items	All items
---------------	-----------

3. Set the voltage switch on the rear panel to meet the line voltage. Connect the power cord to the plug socket of the line. If the line voltage is outside the operating range of SS-5711, set the voltage within the range using a voltage regulator.
4. Turn POWER switch on to supply power, adjust A INTEN to provide the proper intensity and trace, and keep the condition for about 30 minutes to warm up the machine.

6-7-2 Power Supply DC Level II (Ripple Voltage)

Item	Description	
Rating	DC power voltage	Ripple voltage
	- 12 V	0.5 mVp-p or less
	+ 5 V	1 mVp-p or less
	+ 12 V	
	+ 39 V	2 mVp-p or less
	+ 129 V	
Setting	Stop the sweep by setting HORIZ mode to SINGLE.	
Check	Connect a X 1 probe the oscilloscope and check the ripple voltages of each power supply.	
Related Items	All items	

6-7-3 AC Line Voltage Range

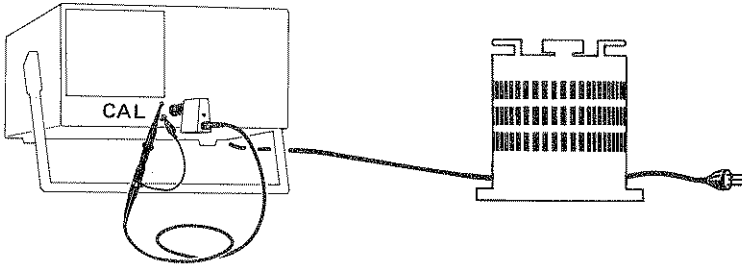
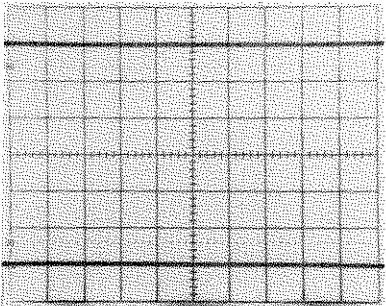
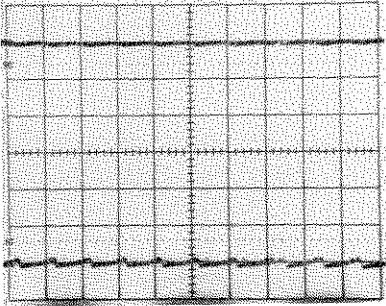
Item	Description				
Rating	The CRT waveform must be sufficiently stable within the voltage range shown in the right table.	Set position	Center voltage	Voltage range	Fuse used
		A	100 V	90 to 110 V	2 A slow-blown fuse
		B	115 V	103 to 128 V	
		C	220 V	195 to 242 V	1A slow-blown fuse
		D	230/240 V	207 to 264 V	
Connection	<p style="text-align: center;">SS-5711 Voltage regulator</p> 				
Setting	With A TIME/DIV switch being set to 10 ms, swing the amplitude 6 div.				
Check	<div style="border: 1px solid black; padding: 10px; text-align: center;"> <p><i>Precaution</i></p> <p><i>In exchange of the power switching plug or replacing fuses, remove the power cord from the line plug socket. When exchanging the voltage plug, remove the rear panel.</i></p> </div> <p>Using a voltage regulator, change the AC supply voltage continuously in the rated range, and check that ripple or intensity modulation does not appear on the CRT waveform.</p>				
CRT waveform	<p>Normal waveform</p> 	<p>Abnormal waveform</p> 			

6-7-4 Limiter Level

Item	Description
Rating	The CRT circuit oscillates and stops intermittently when the CRT cathode voltage (−2.45 kV) reaches −2.6 kV to −3.0 kV. In this condition, brightness is increased intermittently and returns to normal when the CRT cathode voltage is restored to −2.45 kV.
Setting	Set A INTEN to fully counter-clockwise.
Check and adjustment	<div style="border: 1px solid black; padding: 10px; margin-bottom: 10px;"> <p style="text-align: center;"><i>Precaution</i></p> <ul style="list-style-type: none"> • <i>The limiter protects the CRT should the high-voltage reach an abnormally high level. The limiter level is checked by altering the CRT cathode voltage (the CRT deflection factor changes when this voltage is altered). This check should only be performed to check limiter operation or adjust CRT cathode voltage.</i> • <i>As high-voltage is measured when the limiter level and CRT cathode voltage (described later) are checked, particular care should be taken to guard against electric shock. These checks should be performed only after A INTEN is turned fully to the left to extinguish the trace.</i> </div> <p>Measure the voltage between the CRT cathode (see Figure. 6-7-1) and GND with a digital multimeter (use a high voltage probe) and gradually raise the voltage with 20R13 HV ADJ (see Figure. 6-7-3). Check that the limiter operates (as evidenced by the intermittent increases in brightness) when the voltage indicated on the multimeter is between −2.6 kV and −3.0 kV.</p> <p>When the above checks have been completed, check the CRT cathode voltage as described in "CRT Cathode Voltage" and set it to −2.45 kV.</p>

6-7-5 High-Voltage Power Supply

Item	Description
Rating	-2.45 kV \pm 5% (between the CRT cathode and ground)
Check and Adjustment	<div style="border: 1px solid black; padding: 10px; margin: 10px auto; width: 80%;"> <p style="text-align: center;"><i>Precaution</i></p> <p style="text-align: center;"><i>If the error of the CRT cathode voltage is within \pm 5%, do not made adustment, except when all items or deflection factor and sweep rate are adjusted.</i></p> </div> <p>Using a digital multimeter (with a high-voltage probe), measure the voltage between the CRT cathode and the ground (see Figure 6-7-1), and check that the voltage is within -2.45 kV \pm 5%. If the result is outside the rated value, adjust the voltage with 20 R13 HV ADJ (see Figure 6-7-2).</p>
Related Items	6-7-6, 6-7-10, 6-9-6, 6-9-11, 6-9-15, 6-11-4, 6-11-5, 6-12-1

Figure 6-7-1. Testpoint Location (CATHODE of CRT)

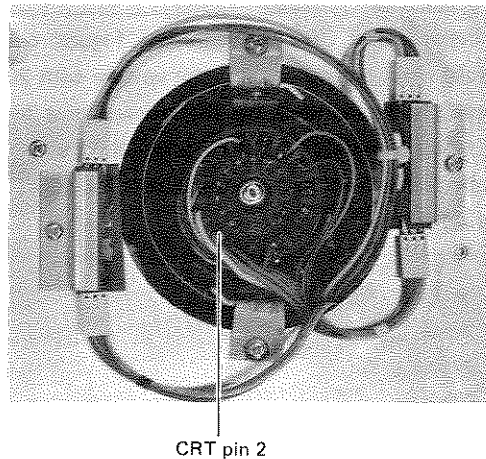

6-7-6 Intensity

Item	Description
Rating	The trace is extinguished when A INTEN control is turned fully counter-clockwise.
Setting	Measure the voltage of 19R54 (see Figure 6-7-2) and the ground using the test oscilloscope.
Check and adjustment	Check that the maximum value of the Z AMP output waveform is +80 V when A INTEN control is turned fully clockwise. If it is not +80 V, adjust with 19R31 LEVEL (see Figure 6-7-2). Adjust with A INTEN control so that the maximum value of the Z AMP output is +40 V. The trace should appear faintly at this setting, if it does not, adjust with 20R44 INTEN ADJ (see Figure 6-7-2).
Related Items	6-7-7

6-7-7 Focus

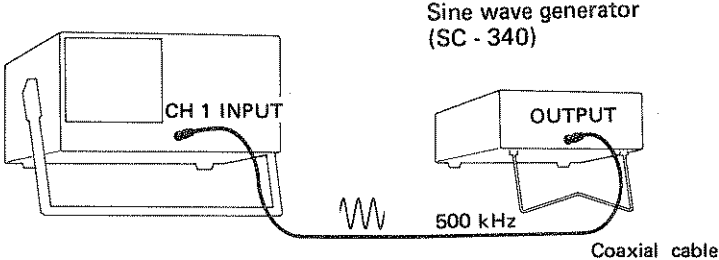
Item	Description
Rating	Using FOCUS control, adjust focus to a suitable setting within $\pm 45^\circ$ of midrange.
Connection	<p data-bbox="475 453 565 480">SS-5711</p> 
Setting	Set A INTEN control so that the trace is slightly visible, apply a 500 Hz sine wave signal to CH 1 INPUT, and adjust output voltage so that amplitude is 6 divisions.
Check and adjustment	<p data-bbox="342 970 1469 1070">While viewing the waveform, adjust so that the optimum focus is obtained. If optimum focus cannot be obtained, set FOCUS control to the midrange and adjust with ASTIG (on front panel), 20R57 FOCUS 1, and 19R71 FOCUS 2 (see Figure 6-7-2).</p> <p data-bbox="342 1081 1469 1144">Adjust with 19R62 AUTO FOCUS (see Figure 6-7-2) to minimize the effect on focus when intensity is adjusted by turning A INTEN control to the right.</p>

6-7-8 The parallel of the Horizontal Trace and the Horizontal Scale (TRACE ROTATION)

Item	Description
Rating	The horizontal trace and the horizontal scale lines should be parallel at the center of the screen.
Check	<div style="border: 1px solid black; padding: 10px; margin: 10px 0;"> <p style="text-align: center;"><i>Precaution</i></p> <p style="text-align: center;"><i>As the angle of the trace is affected to some degree by the earth's magnetism, check and adjust after the SS-5711 is set in position for measurement.</i></p> </div> <p>Superimpose the trace on the horizontal center line of the scale (use POSITION control) and check that both are parallel. If they are not parallel, adjust with TRACE ROTATION (on the front panel).</p>

6-7-9 The Parallel of the Vertical Trace and the Vertical Scale (ORTHOGONALITY)

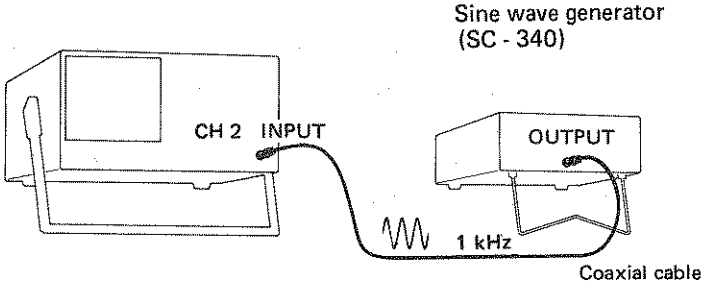
Item	Description
Rating	The vertical trace and vertical scale lines should be parallel at the center of the screen.
Connection	<p style="text-align: center;">SS-5711</p> 
Setting	Set HORIZONTAL DISPLAY switch to X – Y and adjust to an amplitude of 8 divisions.
Check and adjustment	<div style="border: 1px solid black; padding: 10px; text-align: center;"> <p><i>Precaution</i></p> <p><i>As the angle of the trace is affected to some degree by the earth's magnetism, check and adjust after the SS-5711 is set in position for measurement.</i></p> </div> <p>Superimpose the trace on the vertical center line of the scale (use POSITION control and FINE control) and check that both are parallel. If they are not parallel, adjust with 18R102 ORTHOGONALITY (see Figure 6-7-2).</p> <p>Note: As the adjustments in 6-7-8 and 6-7-9 affect each other, they should be repeated a number of times.</p>

6-7-10 Pattern Distortion

Item	Description																					
Rating	<p>Produce raster in the range of 8 div X 10 div on the CRT screen , and check that the vertical and horizontal deflection of raster is within the range shown in the figure at the right.</p> 																					
Connection	<p>SS-5711</p> 																					
Setting	<table border="1" data-bbox="1237 1783 1346 2759"> <thead> <tr> <th colspan="4">SS-5711</th> <th>Input</th> <th>Signal</th> <th>Amplitude on CRT screen</th> </tr> <tr> <th>HORIZ DISPLAY</th> <th>A TIME/DIV</th> <th>B TIME/DIV</th> <th>HOLD OFF</th> <th>Waveform</th> <th>Frequency</th> <th></th> </tr> </thead> <tbody> <tr> <td>A INTEN</td> <td>1 mS</td> <td>20 nS</td> <td>B ENDS A</td> <td>Sine</td> <td>10 MHz</td> <td>8 div</td> </tr> </tbody> </table>	SS-5711				Input	Signal	Amplitude on CRT screen	HORIZ DISPLAY	A TIME/DIV	B TIME/DIV	HOLD OFF	Waveform	Frequency		A INTEN	1 mS	20 nS	B ENDS A	Sine	10 MHz	8 div
SS-5711				Input	Signal	Amplitude on CRT screen																
HORIZ DISPLAY	A TIME/DIV	B TIME/DIV	HOLD OFF	Waveform	Frequency																	
A INTEN	1 mS	20 nS	B ENDS A	Sine	10 MHz	8 div																
Check and adjustment	<ol style="list-style-type: none"> 1. Check the horizontal deflection of raster on the top and bottom of scale. 2. Set the raster to the right and left ends of scale and check the vertical deflection of the raster. <p>If the check result shows a great distortion, adjust it with 20R61 PATTERN (see Figure 6-7-2).</p>																					
Related Items	6-9-6, 6-11-4, 6-11-5																					

Figure 6-7-2 Adjustment and testpoint Locations (POWER SUPPLY and CRT)



6-8 CALIBRATOR OUTPUT

6-8-1 Output Voltage

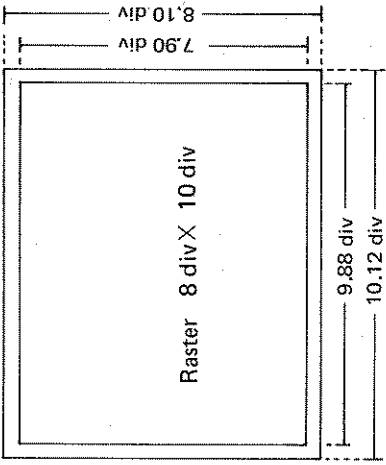
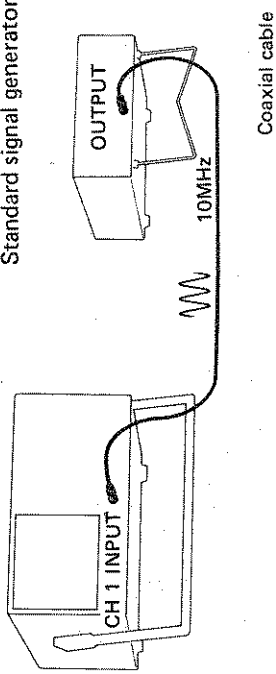
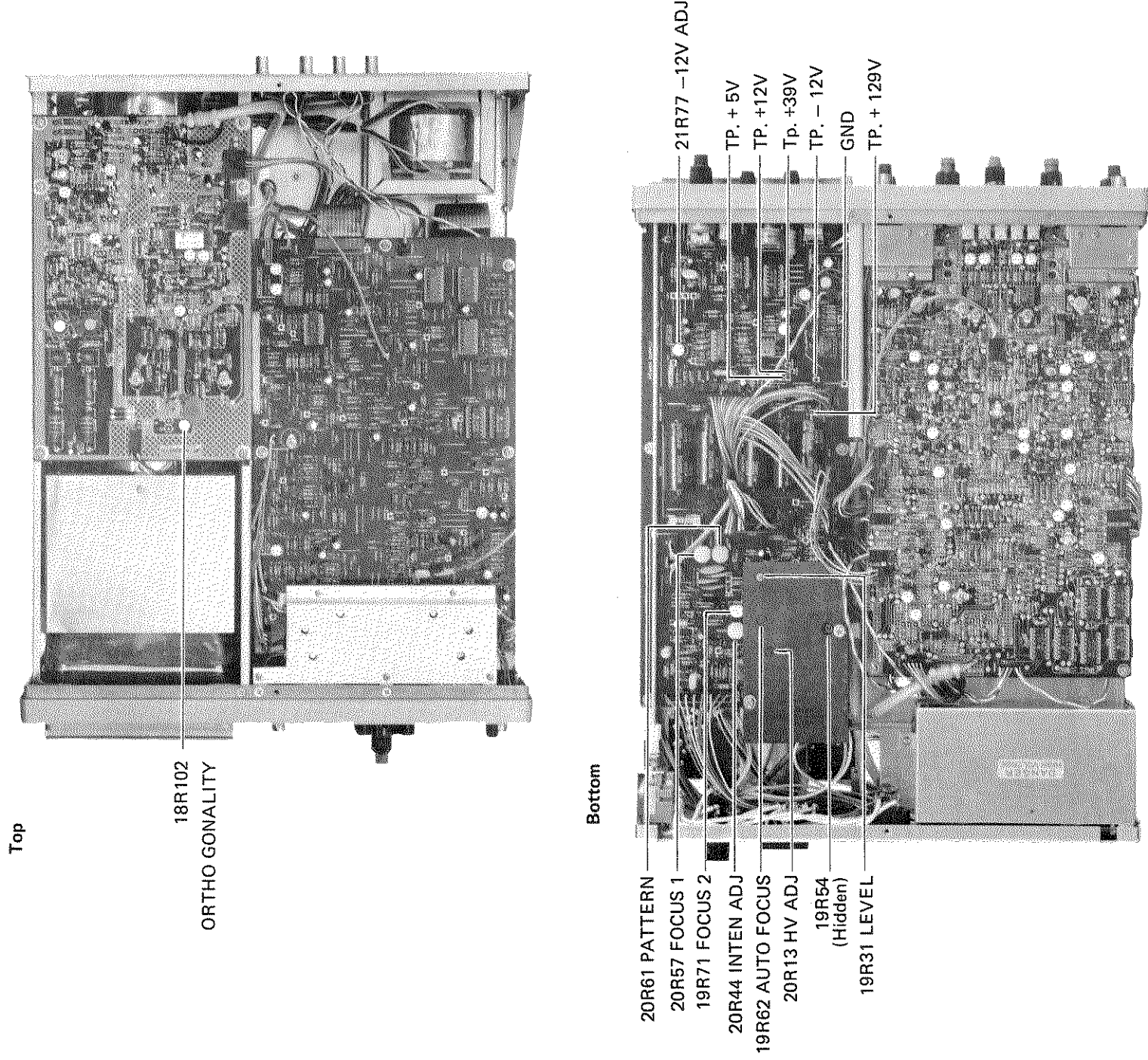
Item	Description
Rating	0.6 V \pm 1%
Setting	Short test terminals 21 P 31 (see Figure 6-8-1) to stop oscillation.
Check and adjustment	Use a digital multimeter to measure the voltage between the CAL 0.6 V terminal and GND. Check that this voltage is between 0.594 V and 0.606 V and adjust with 21R 14 LEVEL (see 6-8-1), if out of the rating.

Figure 6-8-1 Adjustment Location (CALIBRATOR OUTPUT)

Bottom

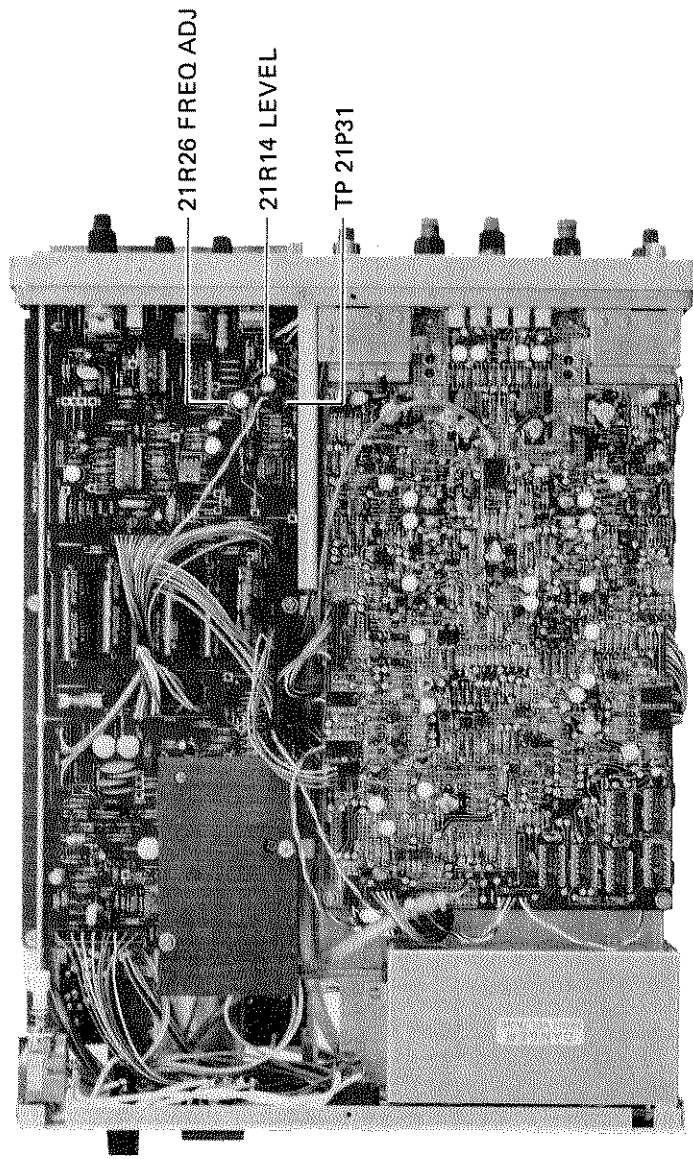

6-8-2 Repetition Rate

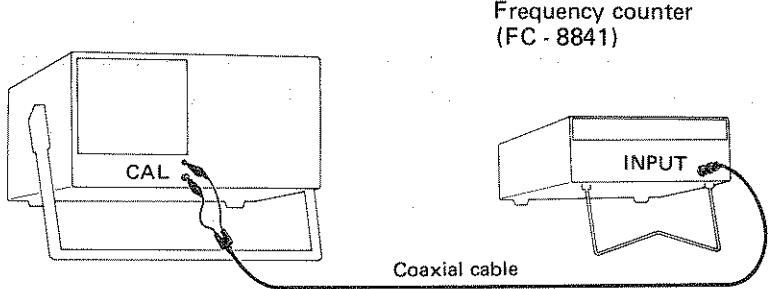
Item	Description
Rating	1 kHz \pm 1%
Connection	<p data-bbox="461 480 553 506">SS-5711</p>  <p data-bbox="951 527 1149 576">Frequency counter (FC - 8841)</p> <p data-bbox="850 783 976 808">Coaxial cable</p>
Check	Check that the calculated value is within 1 kHz \pm 1%. If it is not, adjust with 21R26 FREQ ADJ (see Figure 6-8-1).

6-9 VERTICAL DEFLECTION SYSTEM**6-9-1 ADD Balance**

Item	Description
Setting	Set the vertical MODE switch to ALT and set the horizontal traces to the center of the screen with CH1 and CH2 POSITION control.
Check and adjustment	Turn the vertical MODE switch to ADD and check that the trace does not move. Adjust with 8R31 ADD BAL (see Figure 6-9-1), if it does move.
Related Items	6-9-8

6-9-2 X 5 Balance

Item	Description
Setting	Set the CH1 and CH2 VOLTS/DIV switches to 5 mV.
Check and adjustment	Check that the trace does not move when PULL X 5 MAG switch is replaced by push-pull. If CH1 moves, adjust with 1R46 X 5 BAL (see Figure 6-9-1), and if CH2 moves, adjust with 2R46 X 5 BAL (see Figure 6-9-1).
Related Items	6-9-4, 6-10-2, 6-12-2

6-9-3 5 mV Balance

Item	Description
Check and adjustment	Check that the trace does not move when the VOLTS/DIV switch setting turned from 10 mV/DIV to 5 mV/DIV. If CH1 moves, adjust with 1R77 5 mV BAL (see Figure 6-9-1), and if CH2 moves, adjust with 2R77 5mV BAL (see Figure 6-9-1).

6-9-4 Variable Balance

Item	Description
Check and adjustment	Check that the trace does not move when VARIABLE control is turned. If CH1 moves, adjust with 3R47 VAR BAL (see Figure 6-9-1), and if CH2 moves, adjust with 4R47 VAR BAL (see Figure 6-9-1). Perform the same check with VOLTS/DIV switch set to 5 mV, 2 mV and 1 mV.
Related Items	6-10-2, 6-12-2

6-9-5 Pulse Response I (CH1 · CH2 sag at 10 mV/DIV)

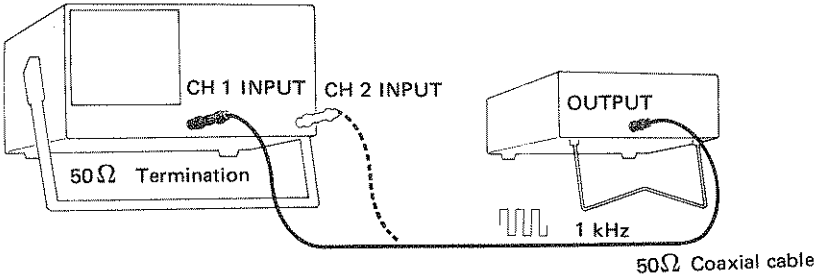
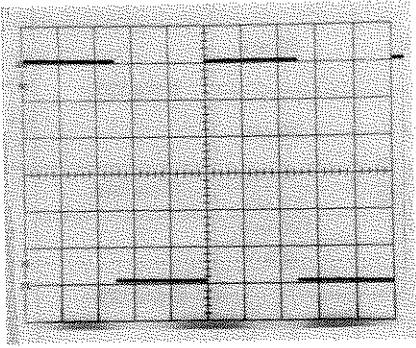
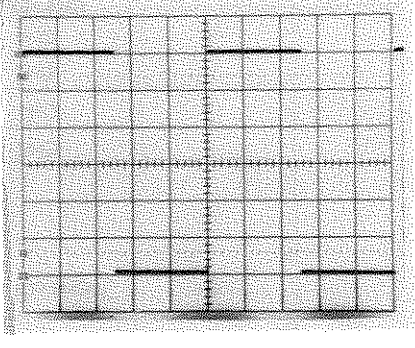
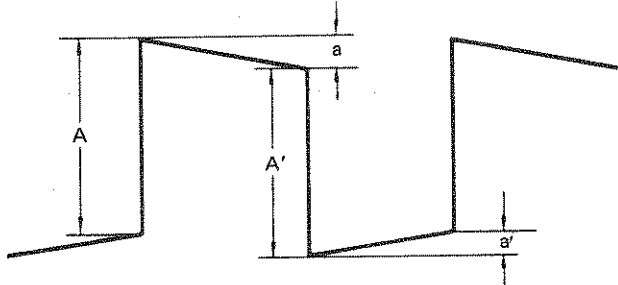
Item	Description
Rating	1%
Connection	<p>SS-5711</p> <p>Square wave generator (SC - 340)</p>  <p>50Ω Termination</p> <p>CH 1 INPUT CH 2 INPUT</p> <p>OUTPUT</p> <p>1 kHz</p> <p>50Ω Coaxial cable</p>
Setting	Set to an amplitude of 8 divisions on the CRT screen.
Check and Adjustment	Check flatness of the square wave. If CH1 is out of the rating adjust with 1R63 X 1 LF COMP (see Figure 6-9-1), and if CH2 is not within the rated value, adjust with 2R63 X1 LF COMP (see Figure 6-9-1).
CRT waveform	<p>60Hz</p>  <p>1kHz</p> 
Reference	 <p>A: Basic amplitude</p> <p>a: Sag</p> $\text{Sag} = \frac{a}{A} \text{ (or } \frac{a'}{A'}) \times 100\%$ <p>The larger or $\frac{a}{A}$ or $\frac{a'}{A'}$ is taken.</p> <p>(Electronic Machinery Industry Association MEA - 27)</p>

6-9-6 Deflection Factor I (CH1·CH2)

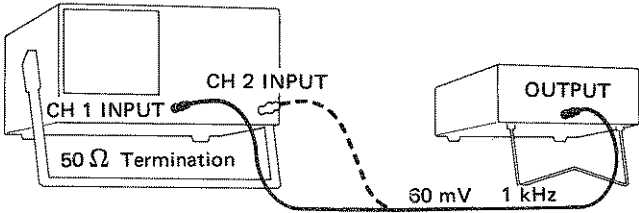
Item	Description																																																																		
Rating	X 1: ±2% X 5: ±4%																																																																		
Connection	<p style="text-align: center;">SS-5711</p> <p style="text-align: right;">Standard-amplitude signal level (SC - 340)</p> 																																																																		
Setting	<table border="1" style="width: 100%; border-collapse: collapse;"> <thead> <tr> <th rowspan="2" style="width: 10%;">Sequence</th> <th colspan="2" style="width: 20%;">SS-5711</th> <th rowspan="2" style="width: 10%;">Input voltage</th> <th rowspan="2" style="width: 10%;">Amplitude on CRT screen</th> <th colspan="2" style="width: 20%;">Calibrator</th> </tr> <tr> <th style="width: 10%;">Channel</th> <th style="width: 10%;">VOLTS/DIV</th> <th style="width: 10%;">Circuit No.</th> <th style="width: 10%;">Name</th> </tr> </thead> <tbody> <tr> <td rowspan="3" style="text-align: center;">1</td> <td style="text-align: center;">CH1·CH2</td> <td rowspan="3" style="text-align: center;">10 mV</td> <td rowspan="3" style="text-align: center;">60 mV</td> <td style="text-align: center;">—</td> <td style="text-align: center;">8R64 *1</td> <td style="text-align: center;">MAIN GAIN</td> </tr> <tr> <td style="text-align: center;">CH1</td> <td rowspan="2" style="text-align: center;">6 div ±2%</td> <td style="text-align: center;">3R56</td> <td style="text-align: center;">CH1 GAIN</td> </tr> <tr> <td style="text-align: center;">CH2</td> <td style="text-align: center;">4R56</td> <td style="text-align: center;">CH2 GAIN</td> </tr> <tr> <td rowspan="2" style="text-align: center;">2</td> <td style="text-align: center;">CH1</td> <td rowspan="2" style="text-align: center;">5 mV</td> <td rowspan="2" style="text-align: center;">30 mV</td> <td rowspan="2" style="text-align: center;">6 div ±2%</td> <td style="text-align: center;">3R32</td> <td style="text-align: center;">CH1 5 mV GAIN</td> </tr> <tr> <td style="text-align: center;">CH2</td> <td style="text-align: center;">4R32</td> <td style="text-align: center;">CH2 5 mV GAIN</td> </tr> <tr> <td rowspan="8" style="text-align: center;">3</td> <td rowspan="8" style="text-align: center;">CH1·CH2</td> <td style="text-align: center;">5 mV *2</td> <td style="text-align: center;">6 mV</td> <td rowspan="3" style="text-align: center;">6 div ±4%</td> <td rowspan="8" style="text-align: center;">—</td> <td rowspan="8" style="text-align: center;">—</td> </tr> <tr> <td style="text-align: center;">10 mV *2</td> <td style="text-align: center;">12 mV</td> </tr> <tr> <td style="text-align: center;">20 mV</td> <td style="text-align: center;">120 mV</td> </tr> <tr> <td style="text-align: center;">50 mV</td> <td style="text-align: center;">0.3 V</td> <td rowspan="5" style="text-align: center;">6 div ±2%</td> </tr> <tr> <td style="text-align: center;">0.1 V</td> <td style="text-align: center;">0.6 V</td> </tr> <tr> <td style="text-align: center;">0.2 V</td> <td style="text-align: center;">1.2 V</td> </tr> <tr> <td style="text-align: center;">0.5 V</td> <td style="text-align: center;">3 V</td> </tr> <tr> <td style="text-align: center;">1 V</td> <td style="text-align: center;">6 V</td> </tr> <tr> <td style="text-align: center;">2 V</td> <td style="text-align: center;">12 V</td> </tr> <tr> <td style="text-align: center;">5 V</td> <td style="text-align: center;">30 V</td> </tr> </tbody> </table> <p style="margin-top: 10px;">*1 Coarse adjustment for CH1 and CH2, used with large errors in the same direction. *2 (PULL X5 MAG) pulled out</p>						Sequence	SS-5711		Input voltage	Amplitude on CRT screen	Calibrator		Channel	VOLTS/DIV	Circuit No.	Name	1	CH1·CH2	10 mV	60 mV	—	8R64 *1	MAIN GAIN	CH1	6 div ±2%	3R56	CH1 GAIN	CH2	4R56	CH2 GAIN	2	CH1	5 mV	30 mV	6 div ±2%	3R32	CH1 5 mV GAIN	CH2	4R32	CH2 5 mV GAIN	3	CH1·CH2	5 mV *2	6 mV	6 div ±4%	—	—	10 mV *2	12 mV	20 mV	120 mV	50 mV	0.3 V	6 div ±2%	0.1 V	0.6 V	0.2 V	1.2 V	0.5 V	3 V	1 V	6 V	2 V	12 V	5 V	30 V
Sequence	SS-5711		Input voltage	Amplitude on CRT screen	Calibrator																																																														
	Channel	VOLTS/DIV			Circuit No.	Name																																																													
1	CH1·CH2	10 mV	60 mV	—	8R64 *1	MAIN GAIN																																																													
	CH1			6 div ±2%	3R56	CH1 GAIN																																																													
	CH2				4R56	CH2 GAIN																																																													
2	CH1	5 mV	30 mV	6 div ±2%	3R32	CH1 5 mV GAIN																																																													
	CH2				4R32	CH2 5 mV GAIN																																																													
3	CH1·CH2	5 mV *2	6 mV	6 div ±4%	—	—																																																													
		10 mV *2	12 mV																																																																
		20 mV	120 mV																																																																
		50 mV	0.3 V	6 div ±2%																																																															
		0.1 V	0.6 V																																																																
		0.2 V	1.2 V																																																																
		0.5 V	3 V																																																																
		1 V	6 V																																																																
2 V	12 V																																																																		
5 V	30 V																																																																		

6-9-8 Position Center (CH3-CH4)

Item	Description
Setting	Set ALT and QUAD of vert MODE to IN (push).
Check and adjustment	<div style="border: 1px solid black; padding: 5px; margin-bottom: 5px;"> <p style="text-align: center;"><i>Precaution</i></p> <p style="text-align: center;"><i>Adjust following "Check and Adjustment of triggering" (described later).</i></p> </div> <p>Set CH3 and CH4 to their center positions and check that the CH3 and CH4 traces are one division below the horizontal centerline. If the CH3 trace is not one division below the horizontal centerline, adjust with 5R36 CH3 POS (see Figure 6-9-1), and if the CH4 trace is not one division below the horizontal centerline, adjust with 5R56 CH4 POS (see Figure 6-9-1).</p>

Figure 6-9-1. Adjustment locations (VERTICAL DEFLECTION SYSTEM 1)

Top

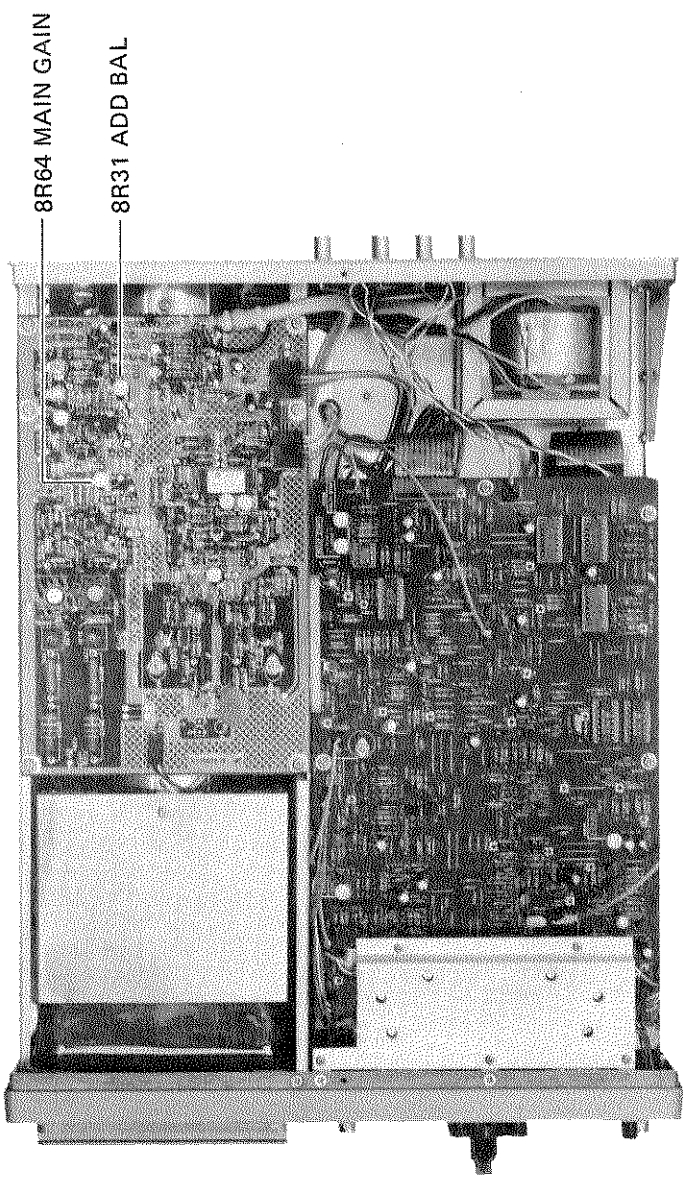

Bottom

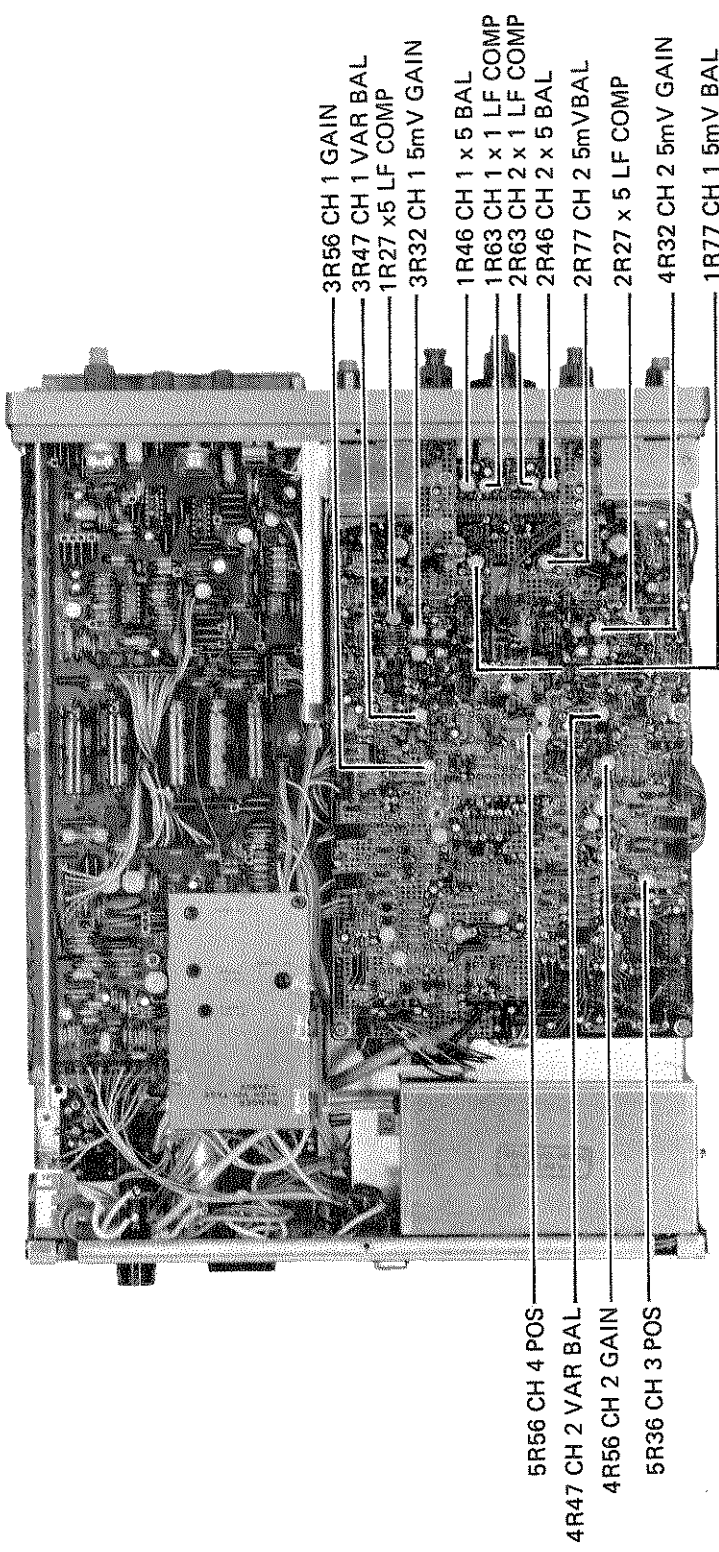

6-9-9 Attenuator Compensation I (CH1·CH2)

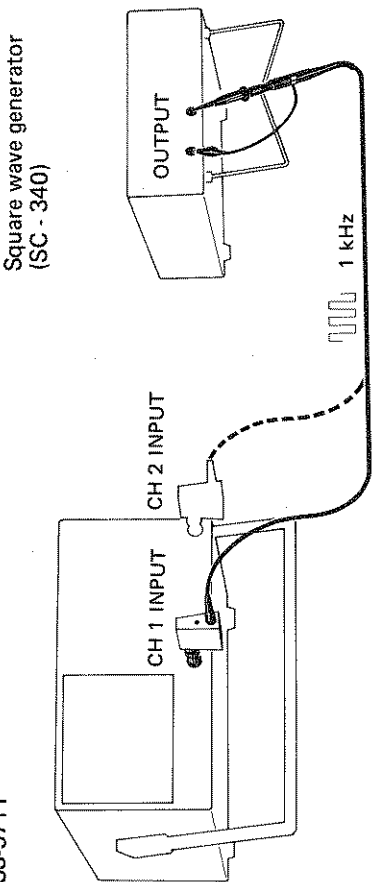
Item	Description																														
Rating	1% or less																														
Connection	<p>SS-5711</p>  <p>Square wave generator (SC - 340)</p> <p>CH 1 INPUT</p> <p>CH 2 INPUT</p> <p>OUTPUT</p> <p>1 kHz</p>																														
Setting	<table border="1"> <thead> <tr> <th data-bbox="883 1258 917 1414">Sequence</th> <th data-bbox="883 1081 917 1258">SS-5711</th> <th colspan="2" data-bbox="883 916 917 1081">Input signal</th> <th data-bbox="883 553 917 916">Amplitude on screen</th> <th data-bbox="883 419 917 553">Calibrator</th> </tr> <tr> <th data-bbox="923 1258 957 1414"></th> <th data-bbox="923 1081 957 1258">Channel</th> <th data-bbox="923 916 957 1081">Voltage</th> <th data-bbox="923 770 957 916">Waveform</th> <th data-bbox="923 553 957 770">Frequency</th> <th data-bbox="923 419 957 553">Circuit No.</th> </tr> </thead> <tbody> <tr> <td data-bbox="963 1258 997 1414">1</td> <td data-bbox="963 1081 997 1258">CH 2</td> <td data-bbox="963 916 997 1081">0.6 V</td> <td data-bbox="963 770 997 916">Square wave</td> <td data-bbox="963 553 997 770">6 div</td> <td data-bbox="963 419 997 553">* 1</td> </tr> <tr> <td data-bbox="1003 1258 1038 1414">2</td> <td data-bbox="1003 1081 1038 1258">CH 2</td> <td data-bbox="1003 916 1038 1081">Adjust to required VOLTS/DIV value</td> <td data-bbox="1003 770 1038 916">Square wave</td> <td data-bbox="1003 553 1038 770">1 kHz</td> <td data-bbox="1003 419 1038 553">1C11</td> </tr> <tr> <td data-bbox="1044 1258 1078 1414">3</td> <td data-bbox="1044 1081 1078 1258">CH 1 · CH 2</td> <td data-bbox="1044 916 1078 1081"></td> <td data-bbox="1044 770 1078 916"></td> <td data-bbox="1044 553 1078 770">Easily observable amplitude</td> <td data-bbox="1044 419 1078 553">* 2</td> </tr> </tbody> </table> <p>*1. Adjust the phase of the X 10 probe. *2. The attenuator compensator capacitor is incorporated in the VOLTS/DIV switch. Only the capacitor used to adjust the set VOLTS/DIV switch is visible externally (see Figure 6-9-2).</p>	Sequence	SS-5711	Input signal		Amplitude on screen	Calibrator		Channel	Voltage	Waveform	Frequency	Circuit No.	1	CH 2	0.6 V	Square wave	6 div	* 1	2	CH 2	Adjust to required VOLTS/DIV value	Square wave	1 kHz	1C11	3	CH 1 · CH 2			Easily observable amplitude	* 2
Sequence	SS-5711	Input signal		Amplitude on screen	Calibrator																										
	Channel	Voltage	Waveform	Frequency	Circuit No.																										
1	CH 2	0.6 V	Square wave	6 div	* 1																										
2	CH 2	Adjust to required VOLTS/DIV value	Square wave	1 kHz	1C11																										
3	CH 1 · CH 2			Easily observable amplitude	* 2																										
Check and adjustment	<ol style="list-style-type: none"> 1. Check the flatness of the CH2 square wave and adjust the compensation of the X 10 probe as required. 2. Check the flatness of the CH1 square wave and adjust 1C11 (see Figure 6-9-2) as required. 3. Turn VOLTS/DIV switch and input voltage and check and adjust the compensation of attenuator (see Figure 6-9-2). <p>Note: The 5 mV range is for checking only, not for adjustment.</p>																														

6-9-9 Attenuator Compensation I (CH1 · CH2) (Cont.)

Item	Description
CRT waveform	<p>Through compensation</p> <div style="display: flex; justify-content: space-around;"> <div style="text-align: center;">  <p>(a) Proper</p> </div> <div style="text-align: center;">  <p>(b) Improper (overcompensation)</p> </div> <div style="text-align: center;">  <p>(c) Improper (undercompensation)</p> </div> </div>
	<p>Probe compensation</p> <div style="display: flex; justify-content: space-around;"> <div style="text-align: center;">  <p>(a) Proper</p> </div> <div style="text-align: center;">  <p>(b) Improper (overcompensation)</p> </div> <div style="text-align: center;">  <p>(c) Improper (undercompensation)</p> </div> </div>

Figure 6-9-2. Adjustment locations (CH1 · CH2 attenuator compensation)

Bottom

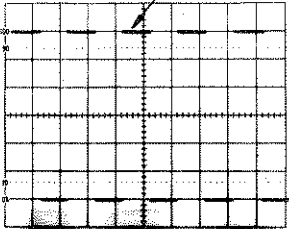
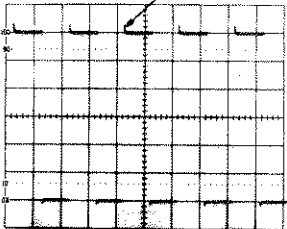
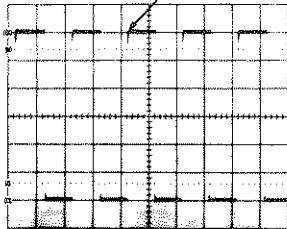
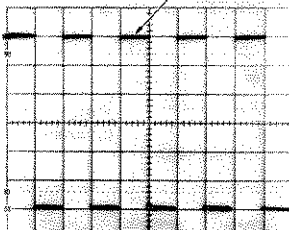
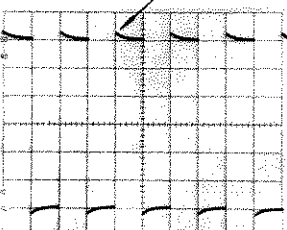
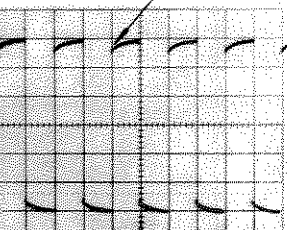
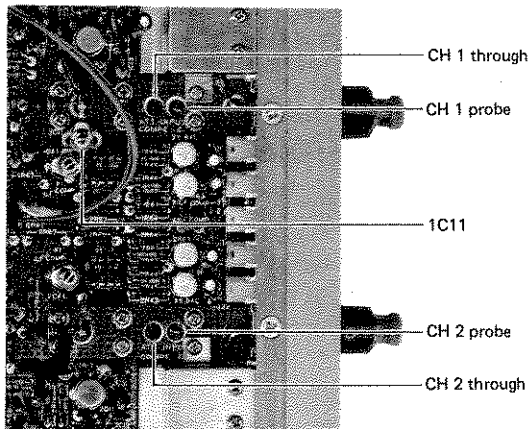

6-9-10 Attenuator Compensation II (CH3.CH4)

Item	Description																																																																
Rating	2% or less																																																																
Connection																																																																	
Setting	<table border="1"> <thead> <tr> <th rowspan="2">Fre- quency</th> <th colspan="3">SS-5711</th> <th colspan="3">Input Signal</th> <th rowspan="2">Amplitude on screen</th> <th>Calibrator</th> <th rowspan="2">Remark</th> </tr> <tr> <th>Chan- nel</th> <th>Vert MODE</th> <th>0.1 V- 1 V</th> <th>Voltage</th> <th>Waveform</th> <th>Frequency</th> <th>Circuit No.</th> </tr> </thead> <tbody> <tr> <td>1</td> <td rowspan="2">CH 3</td> <td rowspan="4">ALT and QUAD IN push</td> <td>0.1 V</td> <td>6 V</td> <td rowspan="4">Square wave</td> <td rowspan="4">1 kHz</td> <td rowspan="4">6 div ±2%</td> <td>9 C8 and probe</td> <td>—</td> </tr> <tr> <td>2</td> <td>1 V</td> <td>60 V</td> <td>9 C2</td> <td>Probe</td> </tr> <tr> <td></td> <td></td> <td></td> <td></td> <td>9 C3</td> <td>Through</td> </tr> <tr> <td>3</td> <td rowspan="2">CH 4</td> <td>0.1 V</td> <td>6 V</td> <td>9 C28 and probe</td> <td>—</td> </tr> <tr> <td>4</td> <td>1 V</td> <td>60 V</td> <td>9 C22</td> <td>Probe</td> </tr> <tr> <td></td> <td></td> <td></td> <td></td> <td>9 C21</td> <td>Through</td> </tr> </tbody> </table>										Fre- quency	SS-5711			Input Signal			Amplitude on screen	Calibrator	Remark	Chan- nel	Vert MODE	0.1 V- 1 V	Voltage	Waveform	Frequency	Circuit No.	1	CH 3	ALT and QUAD IN push	0.1 V	6 V	Square wave	1 kHz	6 div ±2%	9 C8 and probe	—	2	1 V	60 V	9 C2	Probe					9 C3	Through	3	CH 4	0.1 V	6 V	9 C28 and probe	—	4	1 V	60 V	9 C22	Probe					9 C21	Through
Fre- quency	SS-5711			Input Signal			Amplitude on screen	Calibrator	Remark																																																								
	Chan- nel	Vert MODE	0.1 V- 1 V	Voltage	Waveform	Frequency		Circuit No.																																																									
1	CH 3	ALT and QUAD IN push	0.1 V	6 V	Square wave	1 kHz	6 div ±2%	9 C8 and probe	—																																																								
2			1 V	60 V				9 C2	Probe																																																								
								9 C3	Through																																																								
3	CH 4		0.1 V	6 V				9 C28 and probe	—																																																								
4		1 V	60 V	9 C22	Probe																																																												
				9 C21	Through																																																												
Check and adjustment	<ol style="list-style-type: none"> 1. Check flatness of the CH3 square wave. Adjust with 9C8 (see Figure 6-9-3) and the probe compensation adjustment variable capacitor as required. 2. Set 0.1V – 1V switch to 1 V, set the input signal to 60 V, and check the attenuator compensation. Adjust with 9C3 and 9C2 (see Figure 6-9-3) as required. 3. Check flatness of the CH4 square wave. Adjust with 9C28 (see Figure 6-9-3) and the probe compensation adjustment variable capacitor as required. 4. Set 0.1 – 1 V switch to 1 V, set the input signal to 60 V, and check the attenuator compensation. Adjust with 9C21 and 9C23 (see Figure 6-9-3) as required. 																																																																

Figure 6-9-3. Adjustment locations (CH3 · CH4 attenuator compensation)



6-9-11 Deflection Factor II (CH3 · CH4)

Item	Description																																															
Rating	±4% or less																																															
Connection	<p style="text-align: center;">SS-5711 CH 4 INPUT CH 3 INPUT Standard-amplitude signal level</p> <p style="text-align: center;">50Ω Termination (SC - 340)</p> 																																															
Setting	<table border="1" style="width: 100%; border-collapse: collapse;"> <thead> <tr> <th colspan="3" data-bbox="321 895 727 938">SS-5711</th> <th colspan="3" data-bbox="727 895 1040 938">Input signal</th> <th data-bbox="1040 895 1170 938" rowspan="2">Amplitude on screen</th> <th colspan="2" data-bbox="1170 895 1446 938">Calibrator</th> </tr> <tr> <th data-bbox="321 938 448 1002">Channel</th> <th data-bbox="448 938 581 1002">Vert MODE</th> <th data-bbox="581 938 727 1002">0.1 V – 1 V</th> <th data-bbox="727 938 833 1002">Voltage</th> <th data-bbox="833 938 935 1002">Wave-form</th> <th data-bbox="935 938 1040 1002">Fre-quency</th> <th data-bbox="1170 938 1295 1002">Circuit No.</th> <th data-bbox="1295 938 1446 1002">Name</th> </tr> </thead> <tbody> <tr> <td data-bbox="321 1002 448 1108" rowspan="2">CH3</td> <td data-bbox="448 1002 581 1208" rowspan="4" style="text-align: center; vertical-align: middle;">ALT and QUAD IN (push)</td> <td data-bbox="581 1002 727 1066" style="text-align: center;">0.1 V</td> <td data-bbox="727 1002 833 1066" style="text-align: center;">0.6 V</td> <td data-bbox="833 1002 935 1208" rowspan="4" style="text-align: center; vertical-align: middle;">sine</td> <td data-bbox="935 1002 1040 1208" rowspan="4" style="text-align: center; vertical-align: middle;">1 kHz</td> <td data-bbox="1170 1002 1295 1208" rowspan="4" style="text-align: center; vertical-align: middle;">6 div ±4%</td> <td data-bbox="1295 1002 1446 1066" style="text-align: center;">5R33</td> <td data-bbox="1446 1002 1468 1066" style="text-align: center;">CH3 GAIN</td> </tr> <tr> <td data-bbox="581 1066 727 1108" style="text-align: center;">1 V</td> <td data-bbox="727 1066 833 1108" style="text-align: center;">6 V</td> <td data-bbox="1295 1066 1446 1108" style="text-align: center;">—</td> <td data-bbox="1446 1066 1468 1108" style="text-align: center;">—</td> </tr> <tr> <td data-bbox="321 1108 448 1172" rowspan="2">CH4</td> <td data-bbox="581 1108 727 1172" style="text-align: center;">0.1 V</td> <td data-bbox="727 1108 833 1172" style="text-align: center;">0.6 V</td> <td data-bbox="1295 1108 1446 1172" style="text-align: center;">5R53</td> <td data-bbox="1446 1108 1468 1172" style="text-align: center;">CH4 GAIN</td> </tr> <tr> <td data-bbox="581 1172 727 1208" style="text-align: center;">1 V</td> <td data-bbox="727 1172 833 1208" style="text-align: center;">6 V</td> <td data-bbox="1295 1172 1446 1208" style="text-align: center;">—</td> <td data-bbox="1446 1172 1468 1208" style="text-align: center;">—</td> </tr> </tbody> </table>									SS-5711			Input signal			Amplitude on screen	Calibrator		Channel	Vert MODE	0.1 V – 1 V	Voltage	Wave-form	Fre-quency	Circuit No.	Name	CH3	ALT and QUAD IN (push)	0.1 V	0.6 V	sine	1 kHz	6 div ±4%	5R33	CH3 GAIN	1 V	6 V	—	—	CH4	0.1 V	0.6 V	5R53	CH4 GAIN	1 V	6 V	—	—
SS-5711			Input signal			Amplitude on screen	Calibrator																																									
Channel	Vert MODE	0.1 V – 1 V	Voltage	Wave-form	Fre-quency		Circuit No.	Name																																								
CH3	ALT and QUAD IN (push)	0.1 V	0.6 V	sine	1 kHz	6 div ±4%	5R33	CH3 GAIN																																								
		1 V	6 V				—	—																																								
CH4		0.1 V	0.6 V				5R53	CH4 GAIN																																								
		1 V	6 V				—	—																																								
Check and adjustment	<p>Check that the amplitude on the CRT screen is within 6 div. ±4%. If the CH3 is out of the rating adjust with 5R33 CH3 GAIN (see Figure. 6-9-4), and if the CH4 is out the rating, adjust with 5R53 CH4 GAIN (see Figure. 6-9-4).</p>																																															

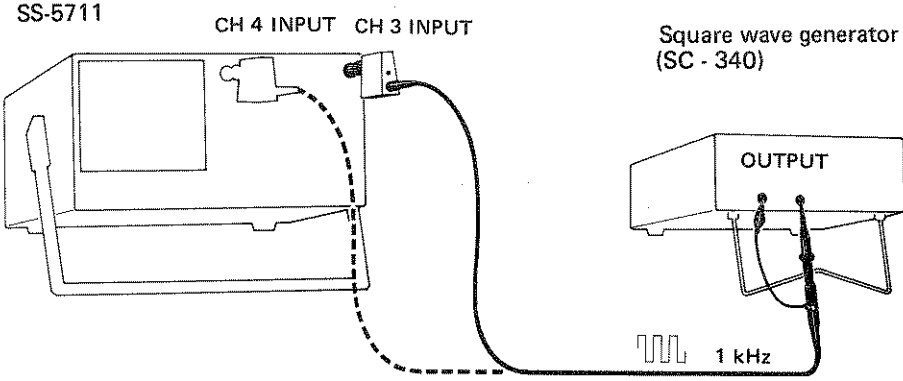
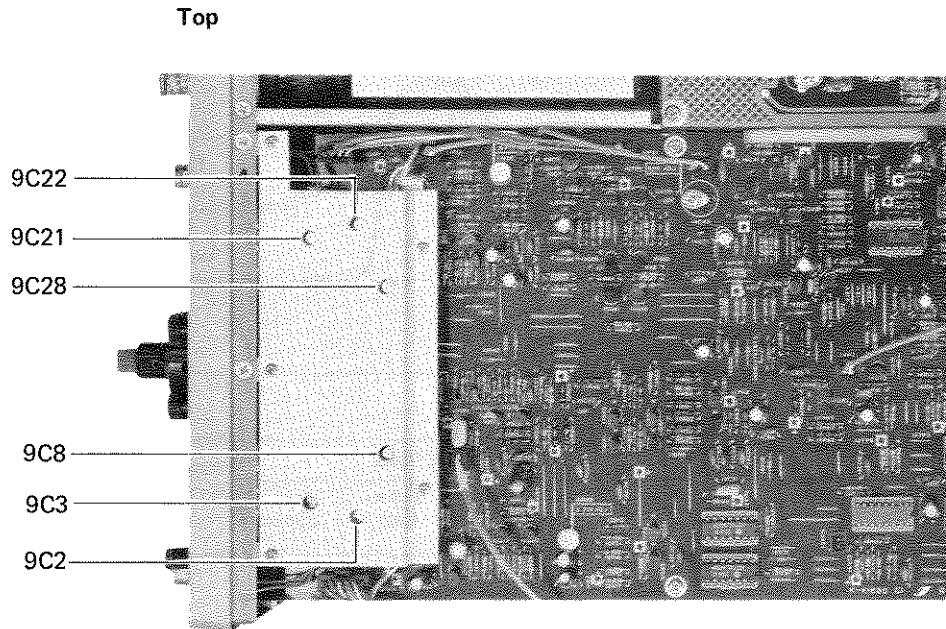
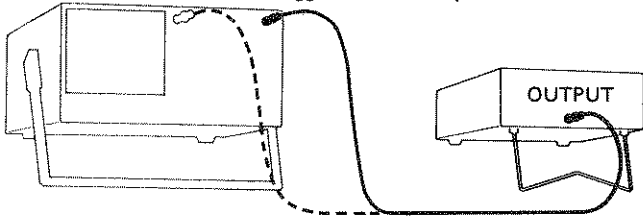
6-9-12 Pulse Response III (overshoot and others)

Item	Description		
Rating	CH1 CH2	Overshoot	3% or less
		Other waveform distortion	3% or less
	CH3 CH4	Overshoot	7% or less
		Other waveform distortion	5% or less

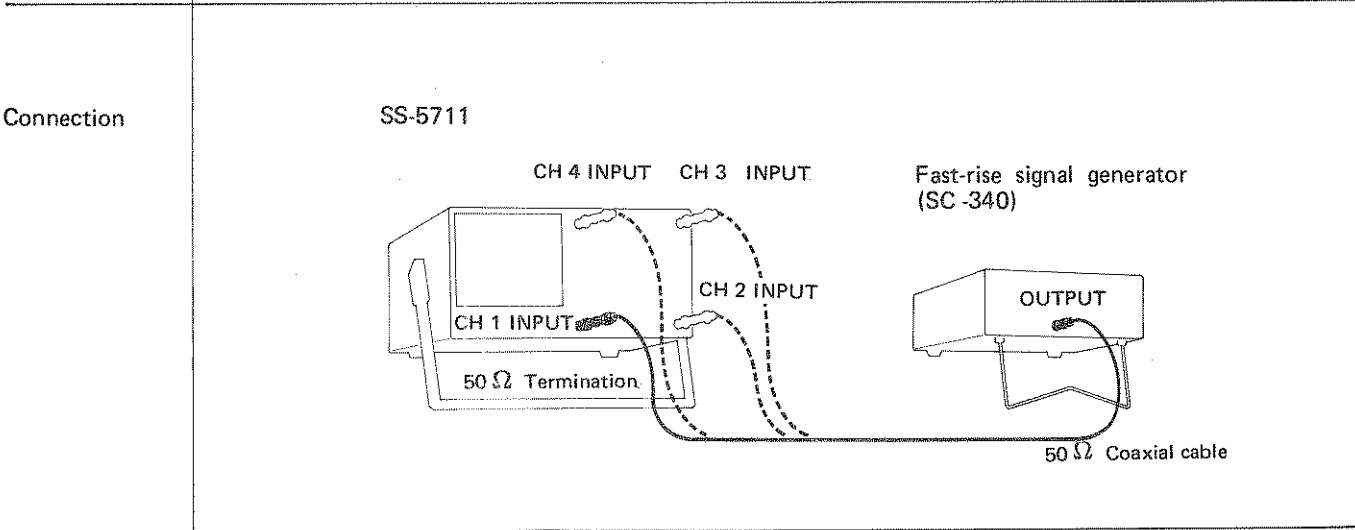

Setting

Se-quence	SS-5711		Input signal		Ampli-tude on screen	Calibrator circuit No.	
	Channel	VOLTS/DIV	Voltage	Fre-quency		Sparate	Common
1	CH1	10 mV	60 mV	100 KHz	6 div	3R24, 3C23, 3C24	
	CH2					4R24, 4C23, 4C24	
2	CH1	5 mV	30 mV	100 KHz	6 div	3C32	
	CH2					4C32	
3	CH3	0.1V	0.6V	100 KHz	6 div	5C32	
	CH4					5C52	

Check and adjustment

1. Check CH1 and CH2 overshoot and other distortion. If CH1 is out of the rating, adjust with 3R24, 3C23, 3C24 (see Figure. 6-9-4) and the common calibrators (see Figure.6-9-4), if CH2 is out of the rating, adjust with 4R24, 4C23, 4C24 (see Figure 6-9-4) and the common calibrators (see Figure 6-9-4).
2. Turn VOLTS/DIV switch to 5 mV and check as above. If CH1 is out of the rating, adjust with 3C32 (see Figure. 6-9-4) and the common calibrators, if CH2 is out of the rating, adjust with 4C32 (see Figure. 6-9-4) and the common calibrators.

6-9-12 Pulse Response III (Cont)

Item	Description
	<p>3. Check CH3 and CH4 overshoot and other distortion. If CH3 is out of the rating, adjust with 5C32 (see Figure 6-9-4) and the common calibrators, if CH4 is out of the rating, adjust with 5C52 (see Figure 6-9-4) and the common calibrators.</p> <div style="border: 1px solid black; padding: 10px; margin: 10px auto; width: fit-content;"> <p style="text-align: center;"><i>Precaution</i></p> <p style="text-align: center;"><i>When adjusting, check as in "Bandwidth" (described later).</i></p> </div>

Related Items	6-9-6, 6-9-13, 6-10-1 to 6-10-3
---------------	---------------------------------

CRT waveform	
--------------	--

Reference	<div style="display: flex; justify-content: space-between; margin-top: 10px;"> <div style="width: 45%;"> <p>A: Basic amplitude</p> <p>b/A: Overshoot</p> <p>c/A: Ringing</p> <p>W: Pulsewidth</p> </div> <div style="width: 45%;"> <p>Tr: Rise time</p> <p>Tf: Fall time</p> <p>d/A: Rounding</p> <p>Td: Signal delay time</p> </div> </div>
-----------	--

6-9-13 Pulse Response IV (CH3· CH4 sag)

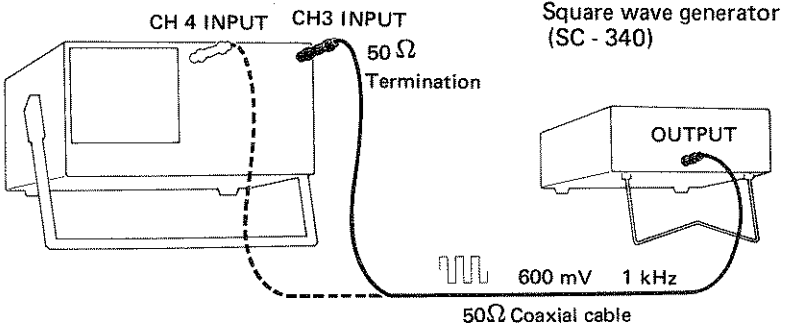
Item	Description											
Rating	2%											
Connection	 <p>SS-5711</p> <p>CH 4 INPUT CH3 INPUT</p> <p>50Ω Termination</p> <p>Square wave generator (SC - 340)</p> <p>OUTPUT</p> <p>600 mV 1 kHz</p> <p>50Ω Coaxial cable</p>											
Setting	<table border="1" data-bbox="409 895 1026 1098"> <thead> <tr> <th colspan="3" data-bbox="409 895 850 959">Input signal</th> <th data-bbox="850 895 1026 959" rowspan="2">Amplitude on CRT screen</th> </tr> <tr> <th data-bbox="409 959 539 1017">Voltage</th> <th data-bbox="539 959 678 1017">Waveform</th> <th data-bbox="678 959 850 1017">Frequency</th> </tr> </thead> <tbody> <tr> <td data-bbox="409 1017 539 1098">600 mV</td> <td data-bbox="539 1017 678 1098">Square wave</td> <td data-bbox="678 1017 850 1098">1 KHz</td> <td data-bbox="850 1017 1026 1098">6 div</td> </tr> </tbody> </table>	Input signal			Amplitude on CRT screen	Voltage	Waveform	Frequency	600 mV	Square wave	1 KHz	6 div
Input signal			Amplitude on CRT screen									
Voltage	Waveform	Frequency										
600 mV	Square wave	1 KHz	6 div									
Check	Set the waveform at the center of the screen and check sags of CH3 and CH4											
CRT waveform	See 6-9-5 (page 6-21)											

6-9-14 Bandwidth

Item	Description				
Rating	CH1 CH2	5 mV/div to 2V/div	DC to 100MHz	-3dB	
		1mV/div, 2mV/div	DC to 50MHz	-3dB	
	CH3 CH4	5V/div	DC to 100MHz	-3.5dB	
		0.1V/div	DC to 100MHz	-3dB	
		1V/div	DC to 100MHz	-3.5dB	

Connection

SS-5711

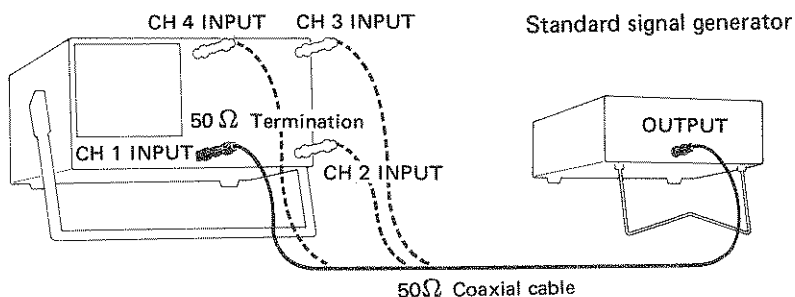

Setting

Se- quence	SS-5711		Input signal			Amplitude on CRT screen
	Channel	VOLTS/DIV	Voltage	Wave- form	Frequency	
1	CH1*CH2	5 mV	30 mV	sine	50 kHz	6 div
2					100 MHz	4.25 div or more
1		1 mV	6 mV		50 kHz	6 div
2					50 MHz	4.25 div or more
1		5 V	30 V		50 kHz	6 div
2					100 MHz	4.01 div or more
1	CH3*CH4	0.1 V	0.6 V	50 kHz	6 div	
2				100 MHz	4.25 div or more	
1		1 V	6 V	50 kHz	6 div	
2				100 MHz	4.01 div or more	

Check

1. Set the reference frequency to 50 kHz and adjust the signal generator so that the amplitude swings 6 div.
 2. Then, change the frequency corresponding to each rating, and read the amplitude.
- If the bandwidth is outside the rated values, readjust the items of "Square Wave Response" described previously. In this case, rise the tip of waveform sharply in order to have a good bandwidth.

6-9-15 Linearity

Figure 6-9-4. Adjustment locations (VERTICAL DEFLECTION SYSTEM II)

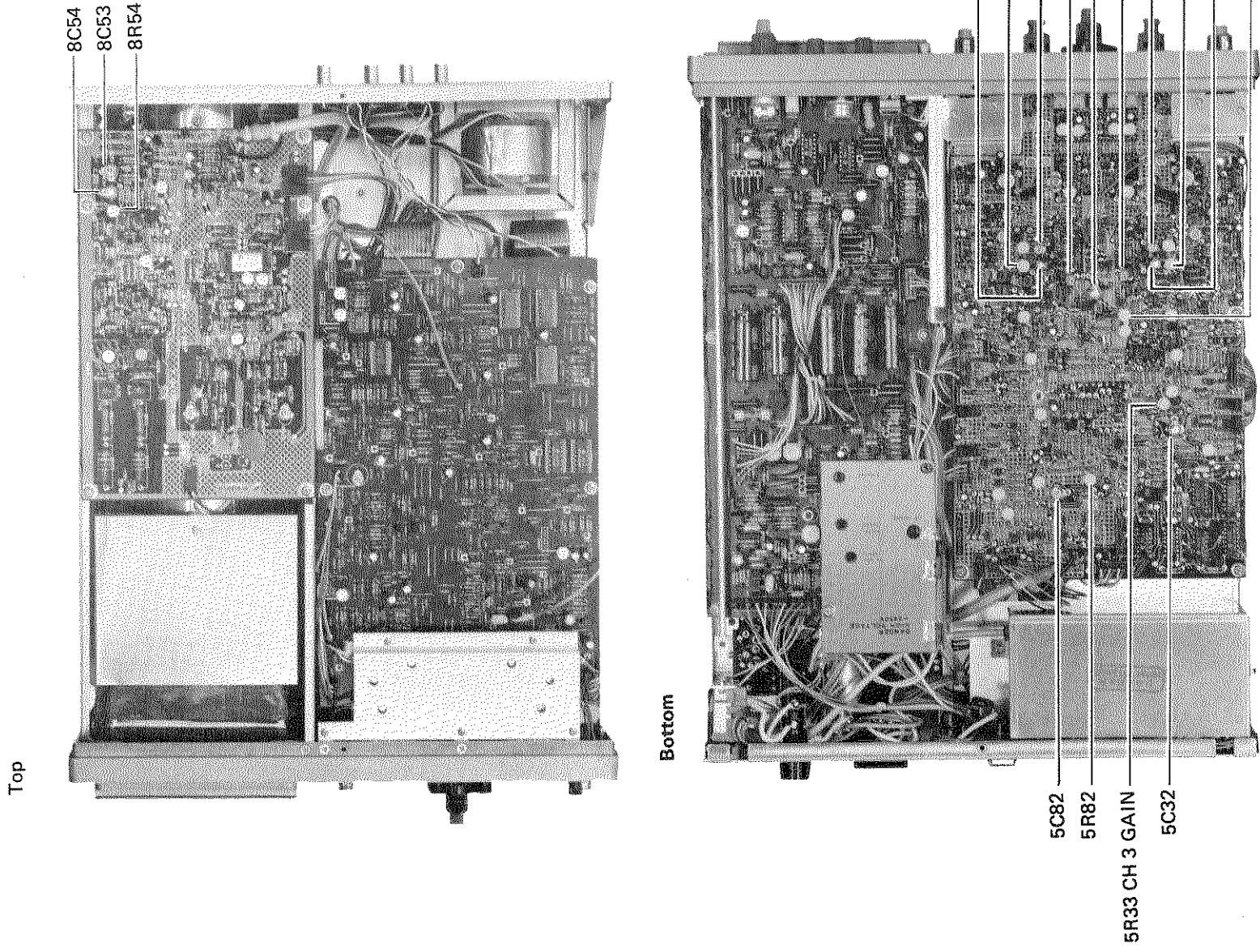

Item	Description											
Rating	Within $\pm 3\%$ (at 1 kHz)											
Connection	<p>SS-5711</p> <p>Sine wave generator (SC-340)</p> <p>CH1 INPUT</p> <p>OUTPUT</p> <p>20mV</p>											
Setting	<table border="1"> <thead> <tr> <th rowspan="2">SS-5711 Channel</th> <th colspan="2">Input signal</th> <th rowspan="2">Amplitude on CRT screen</th> </tr> <tr> <th>Voltage</th> <th>Waveform</th> <th>Frequency</th> </tr> </thead> <tbody> <tr> <td>CH1 - CH2</td> <td>20 mV</td> <td>Sine</td> <td>1 kHz 2 div</td> </tr> </tbody> </table>	SS-5711 Channel	Input signal		Amplitude on CRT screen	Voltage	Waveform	Frequency	CH1 - CH2	20 mV	Sine	1 kHz 2 div
SS-5711 Channel	Input signal		Amplitude on CRT screen									
	Voltage	Waveform		Frequency								
CH1 - CH2	20 mV	Sine	1 kHz 2 div									
Check	Swing amplitude by 2 div at the screen center. Then using POSITION control, move the waveform within 2 div at the top and bottom of the scale, and check that the amplitude change is within $\pm 3\%$.											
CRT Waveform	<p>The top line</p> <p>The center line</p> <p>The bottom line</p> <p>2 div</p>											

6-10 TRIGGERING SYSTEM

6-10-1 FIX triggering level

Item	Description																																											
Connection	<p>SS-5711</p>  <p>Sine wave generator (SC - 340)</p>																																											
Setting	<table border="1"> <thead> <tr> <th rowspan="2">Sequ- ence</th> <th colspan="4">SS-5711</th> <th colspan="2">Input signal</th> <th colspan="2">Ampli- tude on screen</th> <th colspan="2">Calibrator</th> </tr> <tr> <th>Vert MODE</th> <th>VOLTS/ DIV</th> <th>A coupling</th> <th>B coupling</th> <th>HORIZ DISPLAY</th> <th>Wave- form</th> <th>Vol- tage</th> <th>Fre- quency</th> <th>Circuit No.</th> <th>Name</th> </tr> </thead> <tbody> <tr> <td>1</td> <td>CH1</td> <td>0.1 V</td> <td>FIX</td> <td>—</td> <td>A</td> <td>sine</td> <td>0.4 V</td> <td>1 kHz</td> <td>10R25</td> <td>FIX ADJ</td> </tr> <tr> <td>2</td> <td></td> <td></td> <td>—</td> <td>FIX</td> <td>B (DLY'D)</td> <td></td> <td></td> <td>4 div</td> <td>11R25</td> <td>FIX ADJ</td> </tr> </tbody> </table>	Sequ- ence	SS-5711				Input signal		Ampli- tude on screen		Calibrator		Vert MODE	VOLTS/ DIV	A coupling	B coupling	HORIZ DISPLAY	Wave- form	Vol- tage	Fre- quency	Circuit No.	Name	1	CH1	0.1 V	FIX	—	A	sine	0.4 V	1 kHz	10R25	FIX ADJ	2			—	FIX	B (DLY'D)			4 div	11R25	FIX ADJ
Sequ- ence	SS-5711				Input signal		Ampli- tude on screen		Calibrator																																			
	Vert MODE	VOLTS/ DIV	A coupling	B coupling	HORIZ DISPLAY	Wave- form	Vol- tage	Fre- quency	Circuit No.	Name																																		
1	CH1	0.1 V	FIX	—	A	sine	0.4 V	1 kHz	10R25	FIX ADJ																																		
2			—	FIX	B (DLY'D)			4 div	11R25	FIX ADJ																																		
Check and adjustment	<ol style="list-style-type: none"> 1. Check that the waveform on the CRT screen is synchronized and that it does not change when A sweep LEVEL control is turned. If the waveform is not synchronized, or is noticeably distant from the horizontal line through the start point, adjust with 10R25 A FIX ADJ (see Figure 6-11-1). 2. Set HORIZ DISPLAY to B (DLY'D) and check that the waveform on the CRT screen is synchronized and that it does not change when B sweep LEVEL is turned. If the waveform is not synchronized, or is noticeably distant from the horizontal line through the start point, adjust with 11R25 B FIX ADJ (see Figure. 6-10-1). 																																											

Figure 6-10-1. Adjustment locations (FIX TRIGGERING LEVEL)



6-10-2 Triggering Level I (CH1·CH2)

Item	Description																																																																						
Connection	<p style="text-align: center;">SS-5711</p> 																																																																						
Setting	<table border="1" style="width: 100%; border-collapse: collapse;"> <thead> <tr> <th rowspan="2">Frequency</th> <th rowspan="2">Item</th> <th colspan="4">SS-5711</th> <th colspan="3">Input voltage</th> <th rowspan="2">Amplitude on screen</th> <th colspan="2">Calibrator</th> </tr> <tr> <th>Vert MODE</th> <th>VOLTS/DIV</th> <th>A·B coupling</th> <th>A·B source</th> <th>Voltage</th> <th>Waveform</th> <th>Frequency</th> <th>Circuit No.</th> <th>Name</th> </tr> </thead> <tbody> <tr> <td rowspan="2">1</td> <td>A triggering</td> <td rowspan="2">CH1</td> <td rowspan="6">0.1V</td> <td>A DC</td> <td>A CH1</td> <td rowspan="6">0.4 V</td> <td rowspan="6">sine</td> <td rowspan="6">1 kHz</td> <td rowspan="6">4 div</td> <td>3R83</td> <td>CH1 TRIG LEVEL</td> </tr> <tr> <td>B triggering</td> <td>B DC</td> <td>B CH1</td> <td>—</td> <td>—</td> </tr> <tr> <td rowspan="2">2</td> <td>A triggering</td> <td rowspan="4">CH2</td> <td>A DC</td> <td>A NORM</td> <td>5R111</td> <td>NORM TRIG DC BAL</td> </tr> <tr> <td>B triggering</td> <td>B DC</td> <td>B CH2</td> <td>—</td> <td>—</td> </tr> <tr> <td rowspan="2">3</td> <td>A triggering</td> <td>A CH2</td> <td>4R87</td> <td>CH2 TRIG LEVEL</td> </tr> <tr> <td>B triggering</td> <td>B CH2</td> <td>—</td> <td>—</td> </tr> </tbody> </table>												Frequency	Item	SS-5711				Input voltage			Amplitude on screen	Calibrator		Vert MODE	VOLTS/DIV	A·B coupling	A·B source	Voltage	Waveform	Frequency	Circuit No.	Name	1	A triggering	CH1	0.1V	A DC	A CH1	0.4 V	sine	1 kHz	4 div	3R83	CH1 TRIG LEVEL	B triggering	B DC	B CH1	—	—	2	A triggering	CH2	A DC	A NORM	5R111	NORM TRIG DC BAL	B triggering	B DC	B CH2	—	—	3	A triggering	A CH2	4R87	CH2 TRIG LEVEL	B triggering	B CH2	—	—
Frequency	Item	SS-5711				Input voltage			Amplitude on screen	Calibrator																																																													
		Vert MODE	VOLTS/DIV	A·B coupling	A·B source	Voltage	Waveform	Frequency		Circuit No.	Name																																																												
1	A triggering	CH1	0.1V	A DC	A CH1	0.4 V	sine	1 kHz	4 div	3R83	CH1 TRIG LEVEL																																																												
	B triggering			B DC	B CH1					—	—																																																												
2	A triggering	CH2		A DC	A NORM					5R111	NORM TRIG DC BAL																																																												
	B triggering			B DC	B CH2					—	—																																																												
3	A triggering			A CH2	4R87					CH2 TRIG LEVEL																																																													
	B triggering			B CH2	—					—																																																													
Check and adjustment	<ol style="list-style-type: none"> 1. Check that the triggering level is the middle of the input signal amplitude when A LEVEL control is set to the midrange. If not the middle, adjust with 3R83 CH1 TRIG LEVEL (see Figure. 6-10-2). Perform the same check with B triggering as well. 2. Turn A SOURCE switch to NORM and perform the same check as above. If not the middle, adjust with 5R111 NORM TRIG DC BAL (see Figure. 6-10-2). 3. Turn A SOURCE switch to CH2 and perform the same check as above. If not the middle, adjust with 4R87 CH2 TRIG LEVEL (see Figure 6-10-2). Perform the same check with B triggering as well. 																																																																						

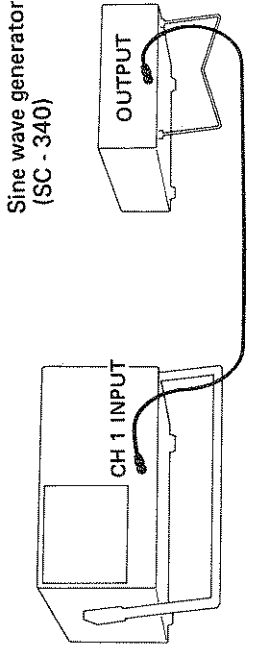
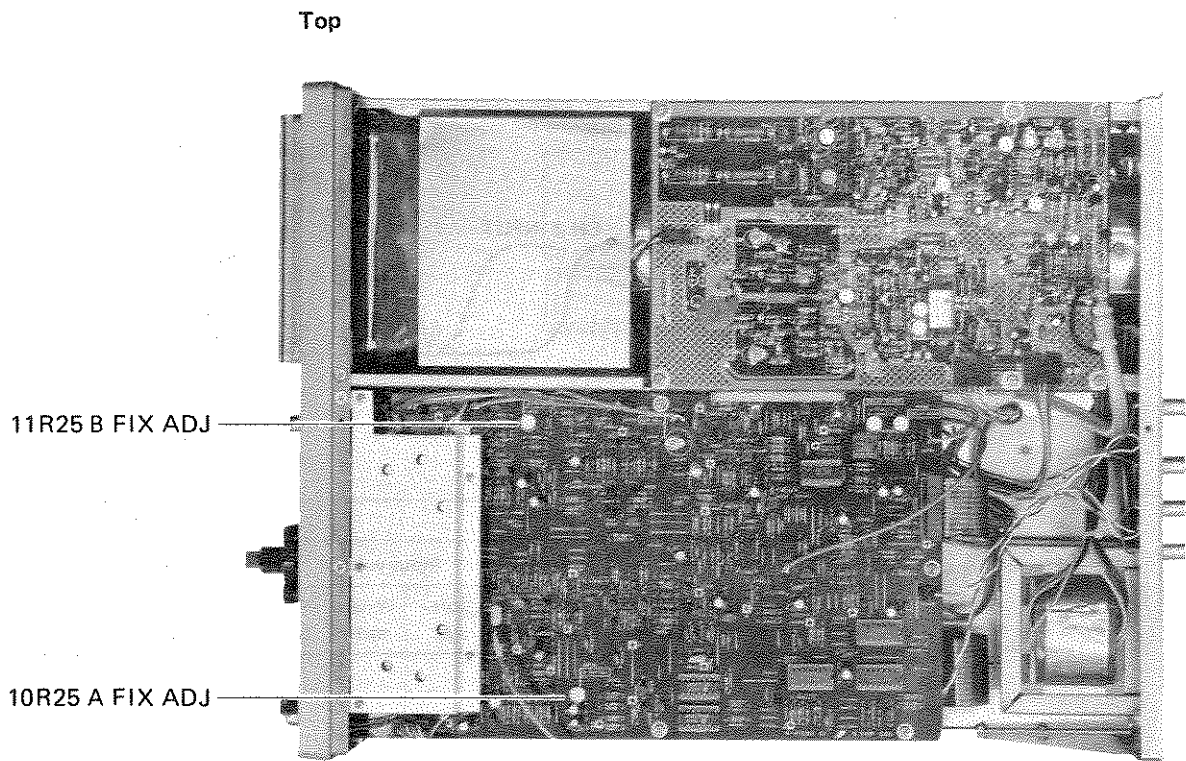
Figure 6-10-2. Adjustment locations (CH1 • CH2 TRIGGERING LEVEL)



6-10-3 Triggering Level II (CH3· CH4)

Item	Description																																																			
Connection	<p style="text-align: center;">SS-5711</p> <p style="text-align: center;">CH 4 INPUT CH 3 INPUT</p>  <p style="text-align: right;">Sine wave generator (SC 340)</p> <p style="text-align: center;">OUTPUT</p> <p style="text-align: center;">0.4 V 1 kHz</p>																																																			
Setting	<table border="1" style="width: 100%; border-collapse: collapse;"> <thead> <tr> <th rowspan="2">Sequ- ence</th> <th rowspan="2">Item</th> <th colspan="4">SS-5711</th> <th colspan="3">Input signal</th> <th rowspan="2">Ampli- tude on screen</th> <th colspan="2">Calibrator</th> </tr> <tr> <th>Vert MODE</th> <th>VOLTS/ DIV</th> <th>A · B coupling</th> <th>A · B source</th> <th>Volt- age</th> <th>Wave- form</th> <th>Fre- quency</th> <th>Circuit No.</th> <th>Name</th> </tr> </thead> <tbody> <tr> <td style="text-align: center;">1</td> <td style="text-align: center;">A triggering</td> <td>QUAD CHOP IN (PUSH)</td> <td rowspan="2" style="text-align: center;">0.1 V</td> <td style="text-align: center;">A DC</td> <td style="text-align: center;">A CH3</td> <td rowspan="2" style="text-align: center;">0.4 V</td> <td rowspan="2" style="text-align: center;">sine</td> <td rowspan="2" style="text-align: center;">1 kHz</td> <td rowspan="2" style="text-align: center;">4 div</td> <td style="text-align: center;">9R45</td> <td style="text-align: center;">CH3 LEVEL ADJ</td> </tr> <tr> <td style="text-align: center;">2</td> <td style="text-align: center;">B triggering</td> <td></td> <td style="text-align: center;">B DC</td> <td style="text-align: center;">B CH4</td> <td style="text-align: center;">9R46</td> <td style="text-align: center;">CH4 LEVEL ADJ</td> </tr> </tbody> </table>												Sequ- ence	Item	SS-5711				Input signal			Ampli- tude on screen	Calibrator		Vert MODE	VOLTS/ DIV	A · B coupling	A · B source	Volt- age	Wave- form	Fre- quency	Circuit No.	Name	1	A triggering	QUAD CHOP IN (PUSH)	0.1 V	A DC	A CH3	0.4 V	sine	1 kHz	4 div	9R45	CH3 LEVEL ADJ	2	B triggering		B DC	B CH4	9R46	CH4 LEVEL ADJ
Sequ- ence	Item	SS-5711				Input signal			Ampli- tude on screen	Calibrator																																										
		Vert MODE	VOLTS/ DIV	A · B coupling	A · B source	Volt- age	Wave- form	Fre- quency		Circuit No.	Name																																									
1	A triggering	QUAD CHOP IN (PUSH)	0.1 V	A DC	A CH3	0.4 V	sine	1 kHz	4 div	9R45	CH3 LEVEL ADJ																																									
2	B triggering			B DC	B CH4					9R46	CH4 LEVEL ADJ																																									
Check and adjustment	<ol style="list-style-type: none"> 1. Check that the triggering level is the middle of the input signal amplitude when A SOURCE switch is set to CH3 and A LEVEL control is set to the midrange. If not the middle, adjust with 9R45 CH3 LEVEL ADJ. 2. Turn B SOURCE switch to CH4 and perform the same check as above. If not the middle, adjust with 9R46 CH4 LEVEL ADJ <div style="border: 1px solid black; padding: 10px; margin-top: 10px; text-align: center;"> <p><i>Precaution</i></p> <p><i>As the CH3 POSITION (previously described) is altered when 9R45 is used for adjustment and the CH4 POSITION altered when 9R46 is used for adjustment, the "CH3· CH4 Center position" item should be checked again.</i></p> </div>																																																			
Related Items	6-9-8																																																			

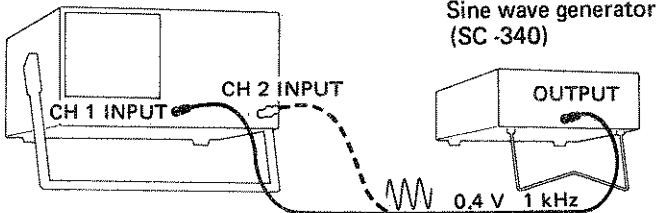
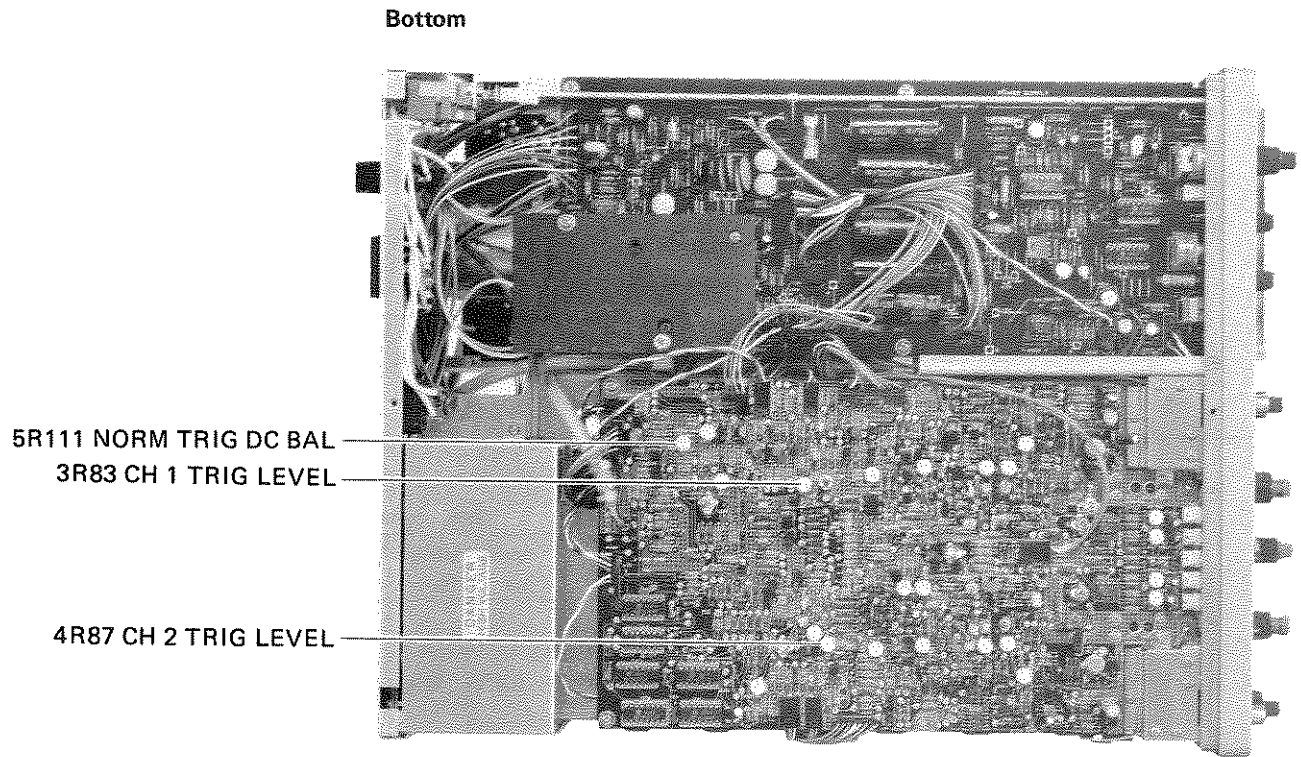
Figure 6-10-3. Adjustment locations (CH3 • CH4 TRIGGERING LEVEL)



6-11 HORIZONTAL DEFLECTION SYSTEM

6-11-1 Average Voltage Horizontal Amplifier

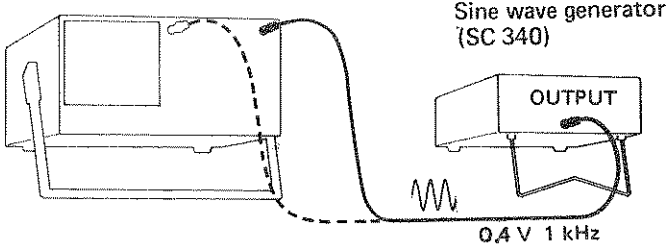
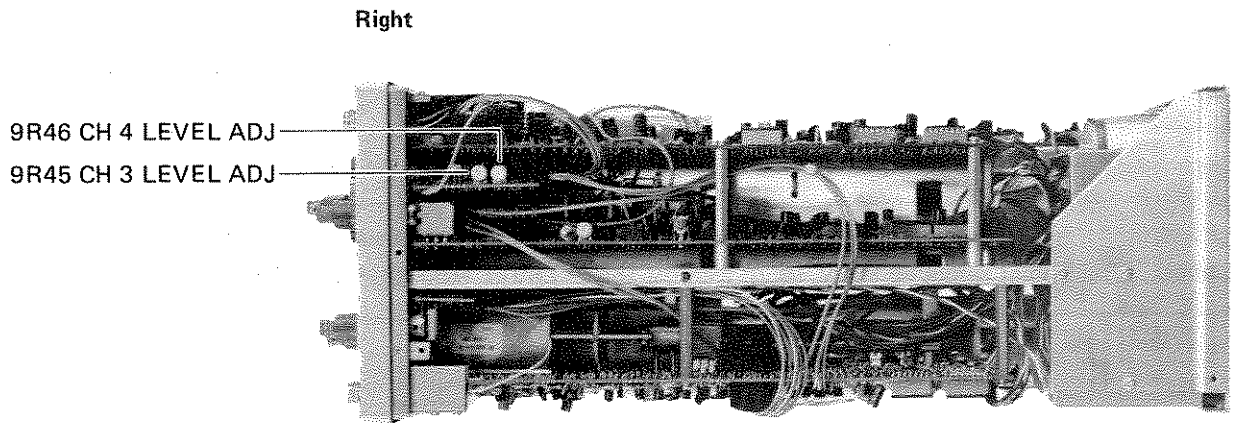
Item	Description
Rating	+65 V \pm 5V
Setting	Set HORIZ DISPLAY switch to X-Y and move the bright spot to the center of the screen.
Check and adjustment	Use a digital multimeter to measure the voltage between the collector of 18Q32 and GND. If this voltage is not within 65 V \pm 5V, adjust with the 18R59 LEVEL ADJ (see Figure. 6-11-1).

6-11-2 Magnification Center

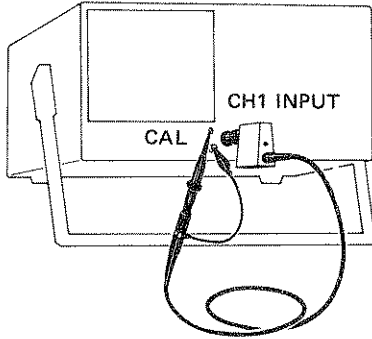
Item	Description
Connection	<p data-bbox="699 1034 781 1059">SS-5711</p>  <p>The diagram shows the front panel of the SS-5711 oscilloscope. A probe is connected to the CH1 INPUT terminal. Another terminal labeled CAL is also visible on the panel.</p>
Setting	Swing CRT amplitude by 6 div.
Check and adjustment	<p>With the horizontal POSITION, set the sweep start point (rise of CAL waveform) to the vertical center line of scale, pull FINE (PULL X 10 MAG), and check the motion of the sweep start point.</p> <p>If the motion width is great, adjust with 18 R56 MAG CENT (see figure 6-11-1).</p>
Related Item	6-12-2

6-11-2 Magnification (Cont)

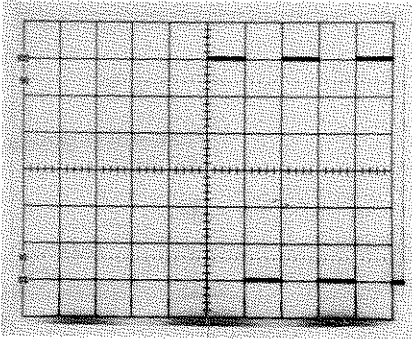
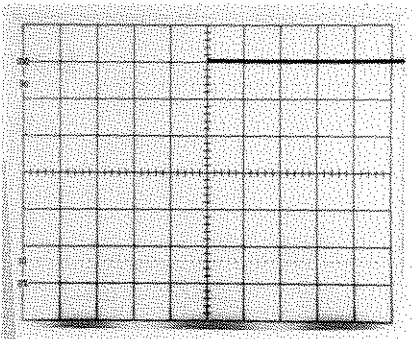
Item	Description
CRT waveform	<div style="display: flex; justify-content: space-around; align-items: center;"> <div style="text-align: center;"> <p>X 1</p>  </div> <div style="text-align: center;"> <p>X 10 MAG</p>  </div> </div>

6-11-3 A · B Sweep Start

Item	Description						
Setting	<table style="width: 100%; border: none;"> <tr> <td style="width: 50%; border: none;">HORIZ DISPLAY</td> <td style="width: 50%; border: none;">ALT</td> </tr> <tr> <td style="border: none;">B TIME/DIV</td> <td style="border: none;">1mS</td> </tr> <tr> <td style="border: none;">B sweep source</td> <td style="border: none;">RUNS AFTER DELAY</td> </tr> </table>	HORIZ DISPLAY	ALT	B TIME/DIV	1mS	B sweep source	RUNS AFTER DELAY
HORIZ DISPLAY	ALT						
B TIME/DIV	1mS						
B sweep source	RUNS AFTER DELAY						
Check and adjustment	<p>Turn TRACE SEPARATION and move B sweep trace to a little above A INTEN sweep trace. Check at this time both start points of A INTEN sweep trace and B sweep trace are at the same position on the vertical line of the scale.</p> <p>If the check result shows a separation, adjust it with 17R11 A · B START ADJ (see figure 6-11-1).</p>						

6-11-4 Sweep Rate

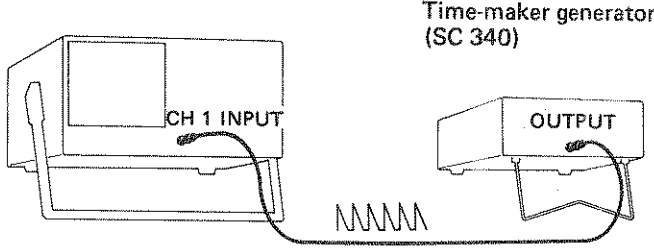
Item	Description																																																	
Rating	I. $\pm 2\%$ at 8 div at center of screen. II. $\pm 5\%$ within any 8 div on screen.																																																	
Connection	<p style="text-align: center;">SS-5711</p>  <p style="text-align: right;">Time-maker generator (SC 340)</p>																																																	
Setting	<table border="1" style="width: 100%; border-collapse: collapse;"> <thead> <tr> <th rowspan="2">Sequ- ence</th> <th rowspan="2">Item</th> <th colspan="2">SS-5711</th> <th>Input signal</th> <th colspan="2">Calibrator</th> </tr> <tr> <th colspan="2">TIME/DIV</th> <th>REPETITION</th> <th>Circuit No.</th> <th>Name</th> </tr> </thead> <tbody> <tr> <td>1</td> <td rowspan="3">A sweep</td> <td colspan="2">1 mS</td> <td>1 mS</td> <td rowspan="2">18R36</td> <td rowspan="2">A SWP CAL</td> </tr> <tr> <td>2</td> <td>0.5 S</td> <td>to 0.1 mS</td> <td rowspan="2">Adjust to required TIME/DIV value</td> </tr> <tr> <td>3</td> <td>50 μS</td> <td>to 20 nS</td> <td>13C43</td> <td>—</td> </tr> <tr> <td>4</td> <td rowspan="3">B sweep</td> <td colspan="2">1 mS</td> <td>1 mS</td> <td rowspan="2">15R73</td> <td rowspan="2">B SWP CAL</td> </tr> <tr> <td>5</td> <td>50 mS</td> <td>to 0.1 mS</td> <td rowspan="2">Adjust to required TIME/DIV value</td> </tr> <tr> <td>6</td> <td>50 μS</td> <td>to 20nS</td> <td>14C43</td> <td>—</td> </tr> </tbody> </table>						Sequ- ence	Item	SS-5711		Input signal	Calibrator		TIME/DIV		REPETITION	Circuit No.	Name	1	A sweep	1 mS		1 mS	18R36	A SWP CAL	2	0.5 S	to 0.1 mS	Adjust to required TIME/DIV value	3	50 μ S	to 20 nS	13C43	—	4	B sweep	1 mS		1 mS	15R73	B SWP CAL	5	50 mS	to 0.1 mS	Adjust to required TIME/DIV value	6	50 μ S	to 20nS	14C43	—
Sequ- ence	Item	SS-5711		Input signal	Calibrator																																													
		TIME/DIV		REPETITION	Circuit No.	Name																																												
1	A sweep	1 mS		1 mS	18R36	A SWP CAL																																												
2		0.5 S	to 0.1 mS	Adjust to required TIME/DIV value																																														
3		50 μ S	to 20 nS		13C43	—																																												
4	B sweep	1 mS		1 mS	15R73	B SWP CAL																																												
5		50 mS	to 0.1 mS	Adjust to required TIME/DIV value																																														
6		50 μ S	to 20nS		14C43	—																																												
Check and adjustment	<ol style="list-style-type: none"> 1. Adjust the start pulse to 1 div to the right of the left edge of the scale and check errors I and II. If out of the rating, adjust with 18R36 A SWP CAL (see Fig. 6-11-1). 2. Adjust input signal repetition to A TIME/DIV and check errors I and II for 0.5 S to 0.1 mS. 3. Adjust input signal repetition to A TIME/DIV switch and check errors I and II for 50 μS to 20 nS. If out of the rating, adjust with 13C43 (see Figure. 6-11-1). 4. Select B sweep and perform the same check as in 1 step. If out of the rating, adjust with 15R73 B SWP CAL (see Figure. 6-11-1). 5. Adjust input signal repetition to B TIME/DIV switch and check errors I and II for 50 mS to 0.1 mS. 6. Adjust input signal repetition to B TIME/DIV switch and check errors I and II for 50 μS to 20 nS. If out of the rating, adjust with 14C43 (see Figure. 6-11-1). 																																																	

6-11-4 Sweep Rate (Cont.)

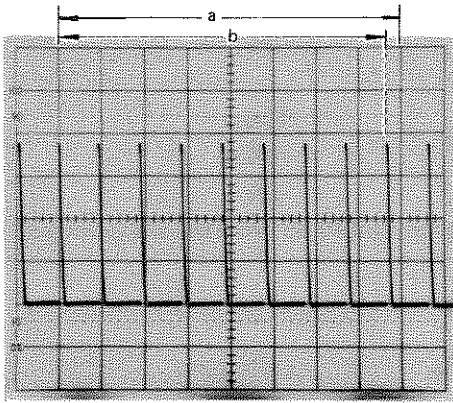
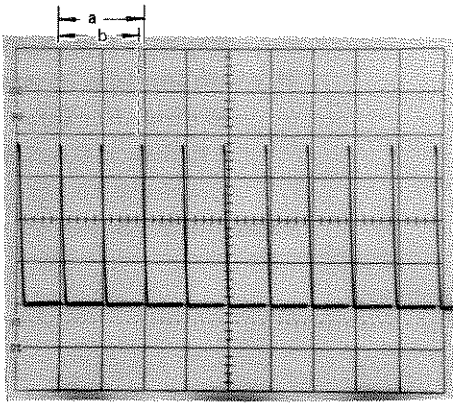
Item	Description
<p>CRT waveform</p>	<div style="display: flex; justify-content: space-around;"> <div style="text-align: center;"> <p>Sweep time error I</p>  <p>Sweep time error ratio = $\frac{a - b}{a} \times 100$</p> <p>Sweep time error ratio = where a: effective horizontal surface total scale length (8 div) b: marker corresponding to "a"</p> </div> <div style="text-align: center;"> <p>Sweep time error II</p>  <p>Sweep time error ratio = $\frac{a - b}{a} \times 100$</p> <p>Sweep time error ratio = where a: any 2 div in effective horizontal surface b: measured value of time marker corresponding to "a"</p> </div> </div>

6-11-5 Magnified Sweep Rate (Cont)

Item	Description
	3. Adjust input signal repetition to a TIME/DIV switch and check errors I and II for $0.5\mu\text{ S}$ to 20 nS . If out of the rating, adjust with 18C75 and 18C94 (see Figure. 6-11-1). 4. Select B sweep and perform the same check as in 1 step.
CRT waveform	See Figure. 6-11-5.

6-11-6 Start and Stop of Delay

Item	Description																										
Rating	$\pm 1\%$ of reading ± 0.01 scale (DELAY TIME MULT dial minimum scale)																										
Connection	<p style="text-align: center;">SS-5711</p> <p style="text-align: right;">Time-marker generator (SC - 340)</p>																										
Setting	<table border="1"> <thead> <tr> <th rowspan="2">Sequ- ence</th> <th colspan="4">SS-5711</th> <th rowspan="2">Input Signal</th> <th colspan="2">Calibrator</th> </tr> <tr> <th>B HORIZ DISPLAY</th> <th>B TIME/ DIV</th> <th>B SOURCE</th> <th>DELAY TIME MULT dial</th> <th>Circuit No.</th> <th>Name</th> </tr> </thead> <tbody> <tr> <td rowspan="2">1</td> <td rowspan="2">A INTEN</td> <td rowspan="2">$5\ \mu\text{S}$</td> <td rowspan="2">RUNS AFTER DELAY</td> <td>0.40</td> <td rowspan="2">0.2 mS</td> <td rowspan="2">14R92</td> <td>DLY START</td> </tr> <tr> <td>10.00</td> <td>1 mS</td> <td>14R96</td> <td>DLY STOP</td> </tr> </tbody> </table>	Sequ- ence	SS-5711				Input Signal	Calibrator		B HORIZ DISPLAY	B TIME/ DIV	B SOURCE	DELAY TIME MULT dial	Circuit No.	Name	1	A INTEN	$5\ \mu\text{S}$	RUNS AFTER DELAY	0.40	0.2 mS	14R92	DLY START	10.00	1 mS	14R96	DLY STOP
Sequ- ence	SS-5711				Input Signal	Calibrator																					
	B HORIZ DISPLAY	B TIME/ DIV	B SOURCE	DELAY TIME MULT dial		Circuit No.	Name																				
1	A INTEN	$5\ \mu\text{S}$	RUNS AFTER DELAY	0.40	0.2 mS	14R92	DLY START																				
				10.00			1 mS	14R96	DLY STOP																		

6-11-6 Start and Stop of Delay (Cont)

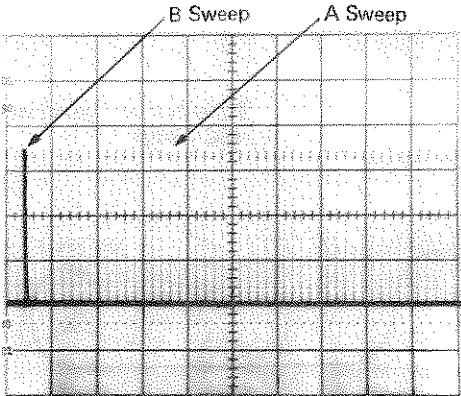
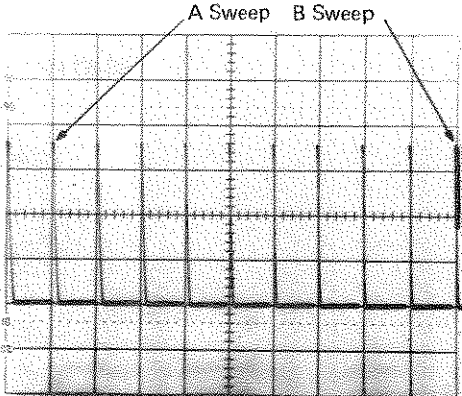
Item	Description
Check and adjustment	<p>1. Set the DELAY TIME MULT dial to 0.40 and check that the B sweep is at the 3rd, pulse from sweep start (as shown in CRT waveform). If out of the rating, adjust with 14R92 DLY START (see Figure 6-11-1).</p> <p>2. Turn the DELAY TIME MULT dial to the right and set it to 10.000 and check that the B sweep is at the 11th pulse (as shown in CRT waveform). If out of the rating, adjust with 14R96 DLY STOP (see Figure. 6-11-1).</p> <div style="border: 1px solid black; padding: 10px; margin: 10px 0;"> <p style="text-align: center;"><i>Precaution</i></p> <p style="text-align: center;"><i>As items 1 and 2 effect each other, the adjustments should be repeated a number of times.</i></p> </div>
CRT waveform	<div style="display: flex; justify-content: space-around;"> <div style="text-align: center;"> <p>DELAY TIME MULT start location</p>  <p>A TIME/DIV 1 mSEC, B TIME/DIV 5 μS Input signal: 0.2 mS pulse wave DELAY TIME MULT dial: scale 0.40</p> </div> <div style="text-align: center;"> <p>DELAY TIME MULT stop location</p>  <p>A TIME/DIV 1 mSEC, B TIME/DIV 5 μS Input signal: 1 mS pulse wave DELAY TIME MULT dial: scale 10.00</p> </div> </div>

6-12-3 Phase Difference

Item	Description																
Rating	Within 3° (DC to 100 kHz sine wave)																
Connection	<p>SS-5711</p>  <p>Cable must be same electrical length</p> <p>Standard signal generator</p> <p>OUTPUT</p> <p>CH 1 (X) INPUT</p> <p>CH 2 (Y) INPUT</p> <p>600 mV 100 kHz</p> <p>Coaxial cable</p>																
Setting	<table border="1"> <thead> <tr> <th rowspan="2">SS-5711</th> <th colspan="3">Input signal</th> <th rowspan="2">Amplitude on CRT screen (vertical and horizontal)</th> <th rowspan="2">Remark</th> </tr> <tr> <th>HORIZ DISPLAY</th> <th>Voltage</th> <th>Waveform</th> </tr> </thead> <tbody> <tr> <td>X (CH1) and Y (CH2)</td> <td>X - Y</td> <td>60 mV</td> <td>sine</td> <td>6 div</td> <td>Divider B-50D3 used</td> </tr> </tbody> </table>	SS-5711	Input signal			Amplitude on CRT screen (vertical and horizontal)	Remark	HORIZ DISPLAY	Voltage	Waveform	X (CH1) and Y (CH2)	X - Y	60 mV	sine	6 div	Divider B-50D3 used	
SS-5711	Input signal			Amplitude on CRT screen (vertical and horizontal)	Remark												
	HORIZ DISPLAY	Voltage	Waveform														
X (CH1) and Y (CH2)	X - Y	60 mV	sine	6 div	Divider B-50D3 used												
Check	Read "a" on the screen and check the reading is less than 0.3 div.																
CRT waveform	 <p>a : Opening at horizontal center line</p>																

Figure 6-12-1. Adjustment locations (X - Y operation)



NOTES

Schematic Diagrams

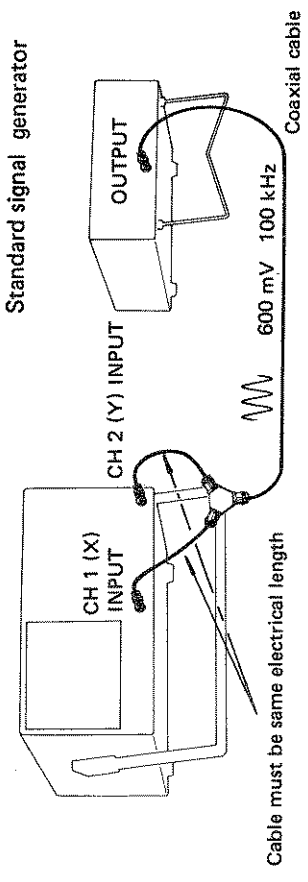
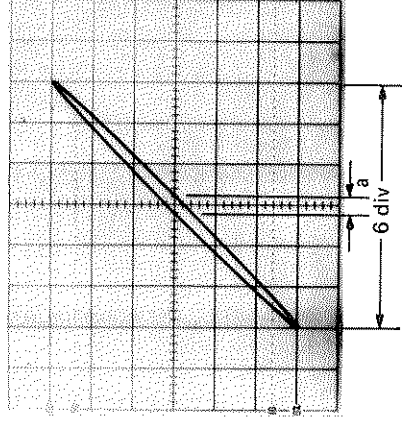
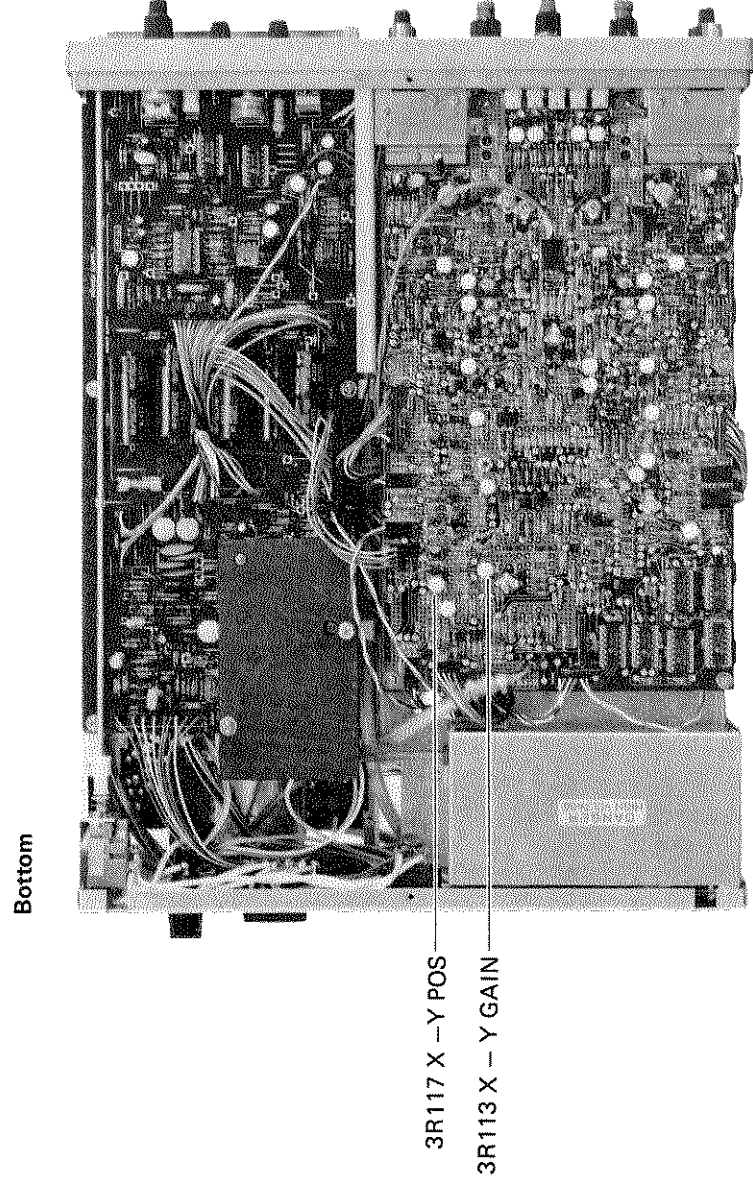
Voltages and Waveforms

In the schematic diagrams, the voltages and waveforms in the normal operation of the instrument are as shown.

They are useful for troubleshooting.

These voltages and waveforms are measured according to the following conditions:

1. The CAL 1kHz 0.6V connector is connected to the INPUT connector by 10 : 1 passive probe as the test signal.
2. Exceptions in the controls setting are shown by "VOLTAGE & WAVEFORM READING CONDITIONS" noted on the schematic diagram. Beside, the asterisks maked on the diagram show the point measured by the exceptional settings.
3. The waveforms starting from the negative slope are measured by setting the SLOPE switch of a test oscilloscope to (-).
4. The switches and controls of this instrument is set as follows:

—Power supply & CRT circuit—

POWER	ON
SCALE	Arbitrary position
INTEN	Best desired
FOCUS	Best focused display

—Vertical deflection system—

AC-GND-DC (CH1-2)	DC
VOLTS/DIV	10mV/div
VARIABLE (CH1-2)	CAL
AC-DC (CH3)	DC
0.1V-1V	0.1V
POSITION (CH1,2,3,4)	Mid position
MODE	CH1
CH2 POLAR	NORM (■)
BANDWIDTH	FULL (■)

—Horizontal deflection system—

HORIZONTAL	A
MODE	AUTO
A TIME/DIV	1mS/div
A VARIABLE	CAL
B TIME/DIV	1mS/div
DELAY TIME MULT	Counter-clockwise
	Set the start portion of the trace to the left-end of vertical graticule.
FINE (Pull x 10 MAG)	Push Mid position
HOLD OFF	NORM
	(Counter-clockwise)

—Trigger system—

SOURCE	CH1
COUPLING	AC
LEVEL-SLOPE (pull-)	Push, Trigger

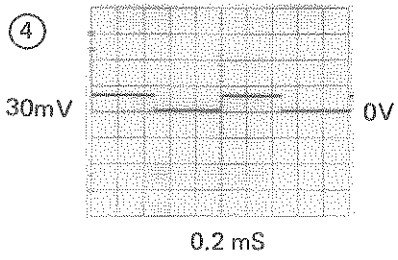
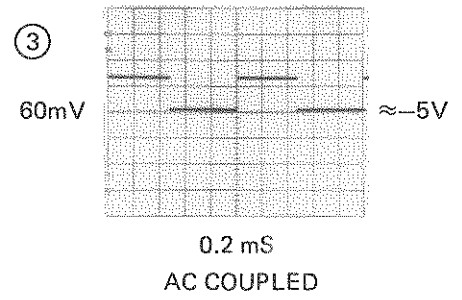
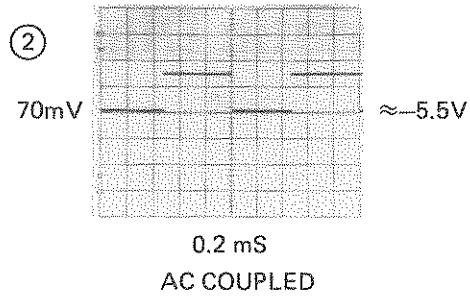
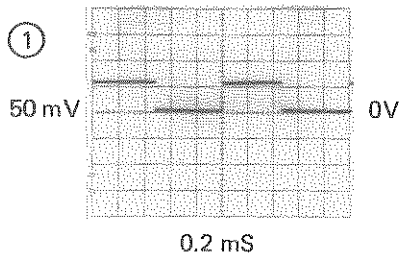

WAVEFORMS

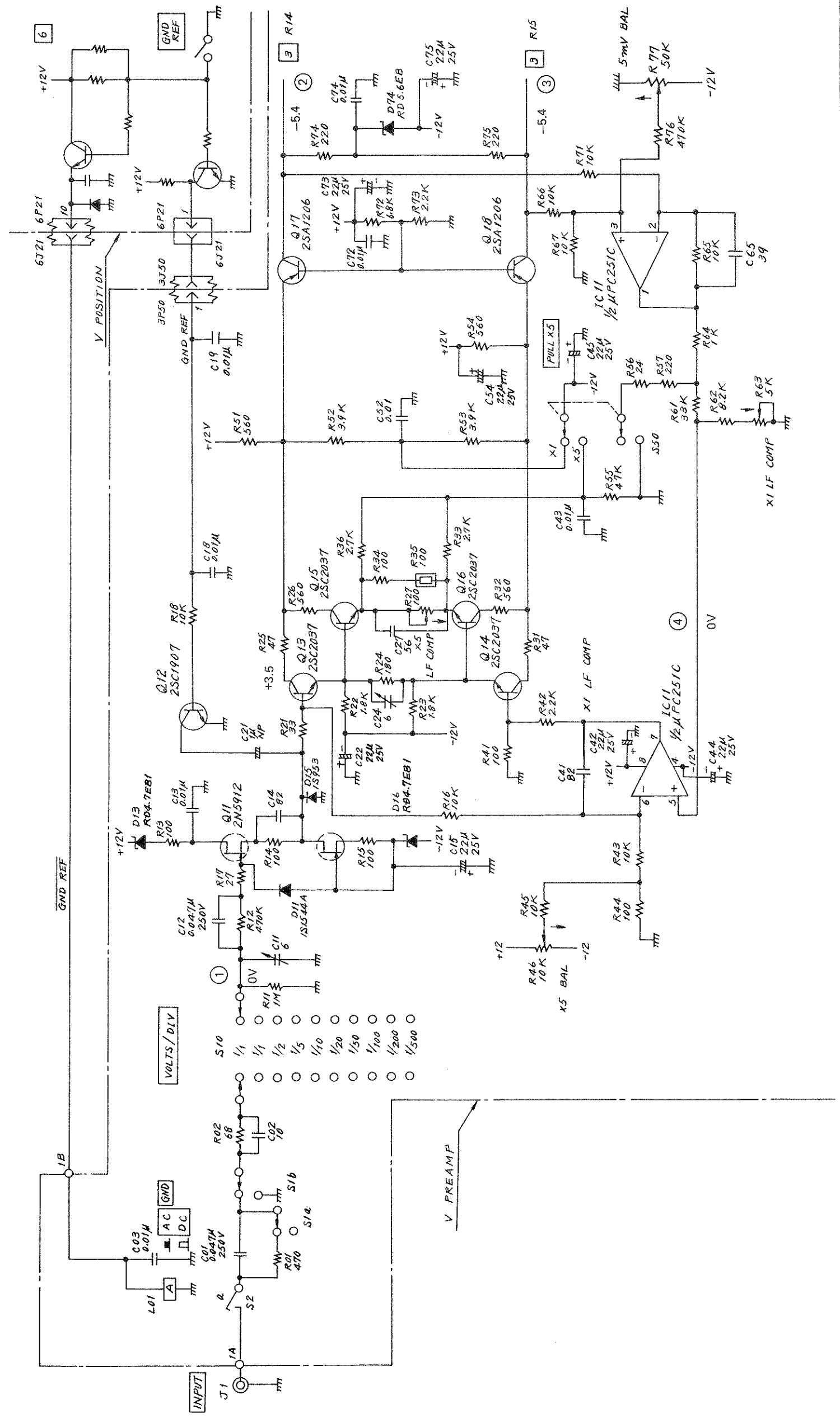

SS-5711 / SS-5711C / SS-5711D
 CH 1 ATTENUATOR & PRE-AMPLIFIER (1) 1
 BBWSS24009102 4



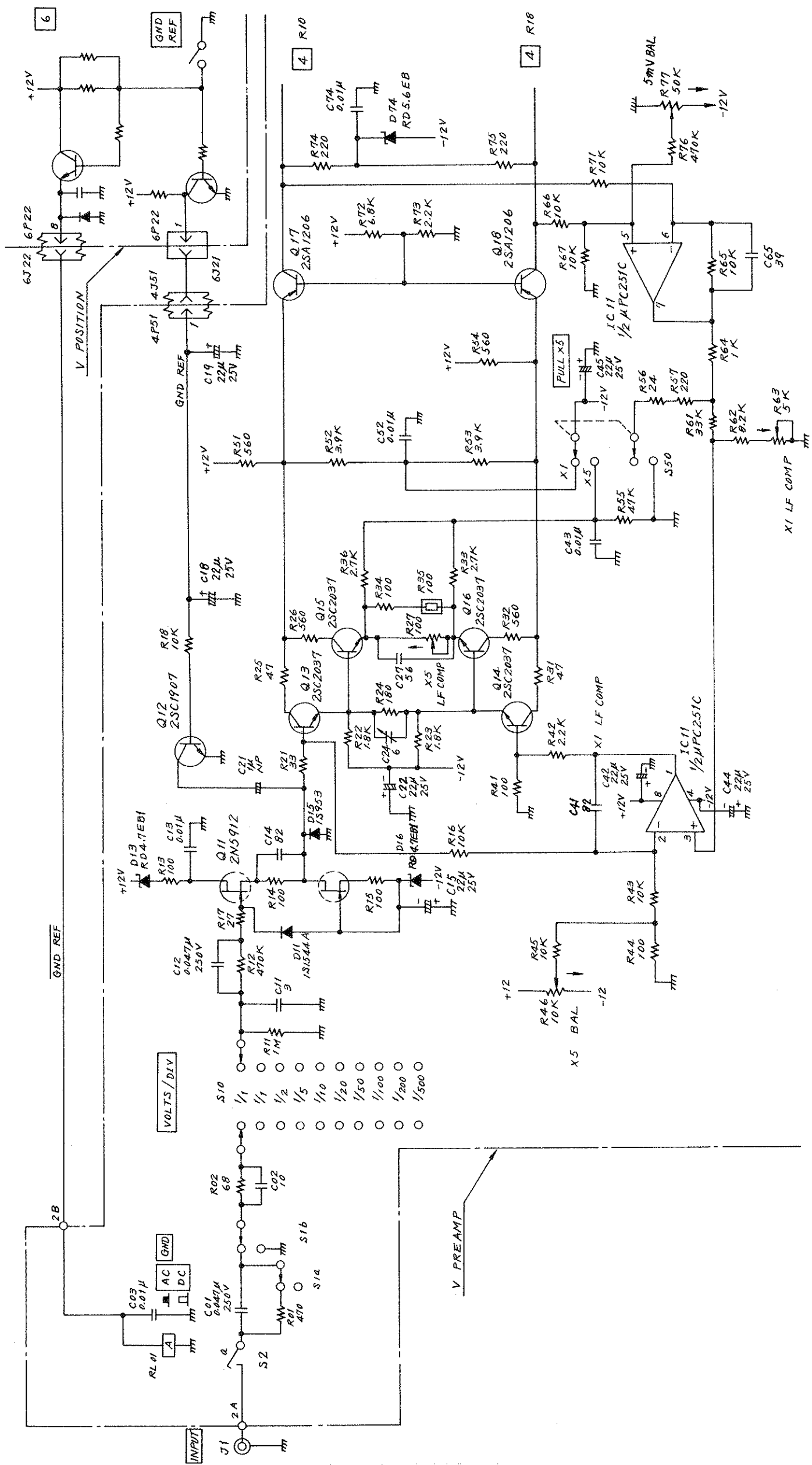

SS-5711/SS-5711C/SS-5711D
 CH2 ATTENUATOR
 & PRE-AMPLIFIER (1) 2
 BWSS24010102 4

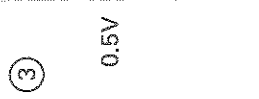

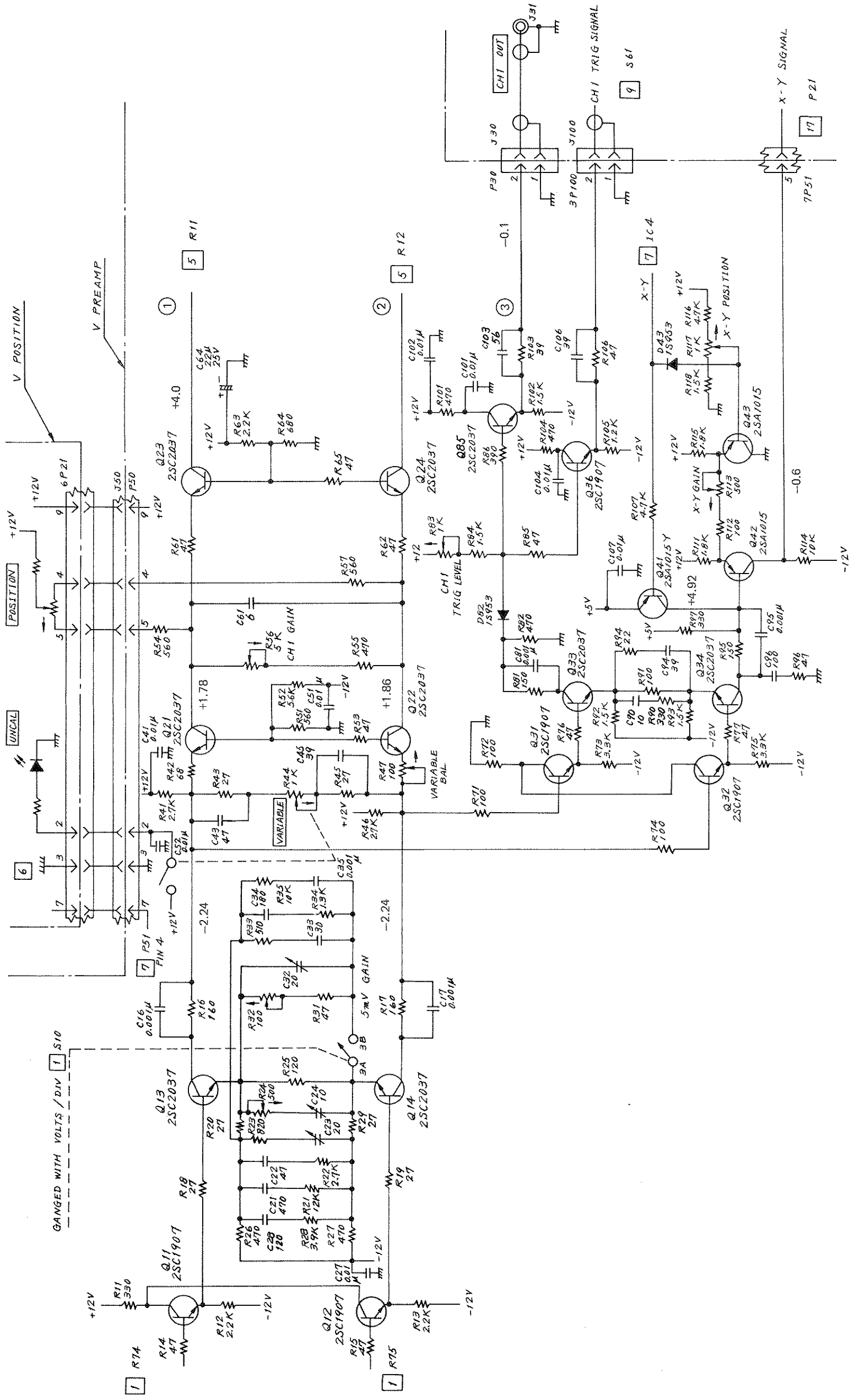

SS-5711 / SS-5711C / SS-5711D
 CH1 PRE-AMPLIFIER(2) 3
 BBWSS24011102 4



[The main body of the page contains extremely faint and illegible text, likely bleed-through from the reverse side of the paper. The text is too light to be transcribed accurately.]

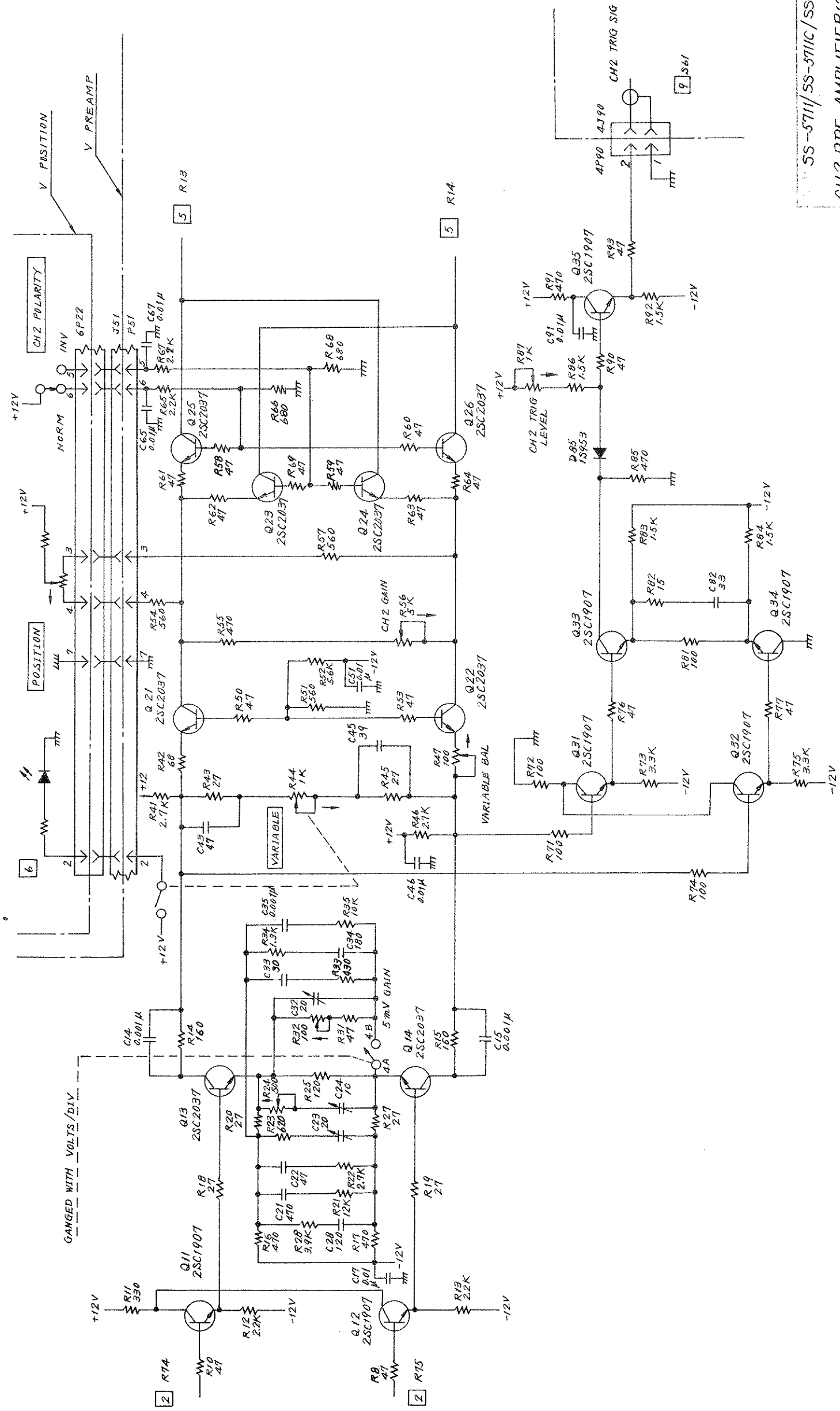

SS-5711/SS-5711C/SS-5711D
 CH2 PRE-AMPLIFIER(2) 4
 BBWSS24012102 4

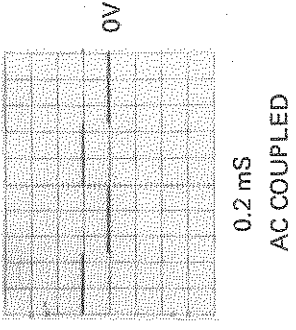
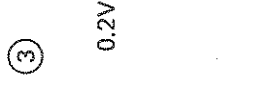
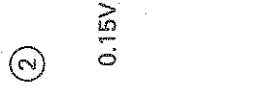
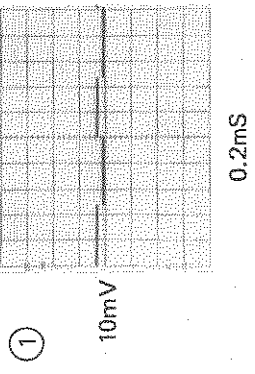

WAVEFORMS

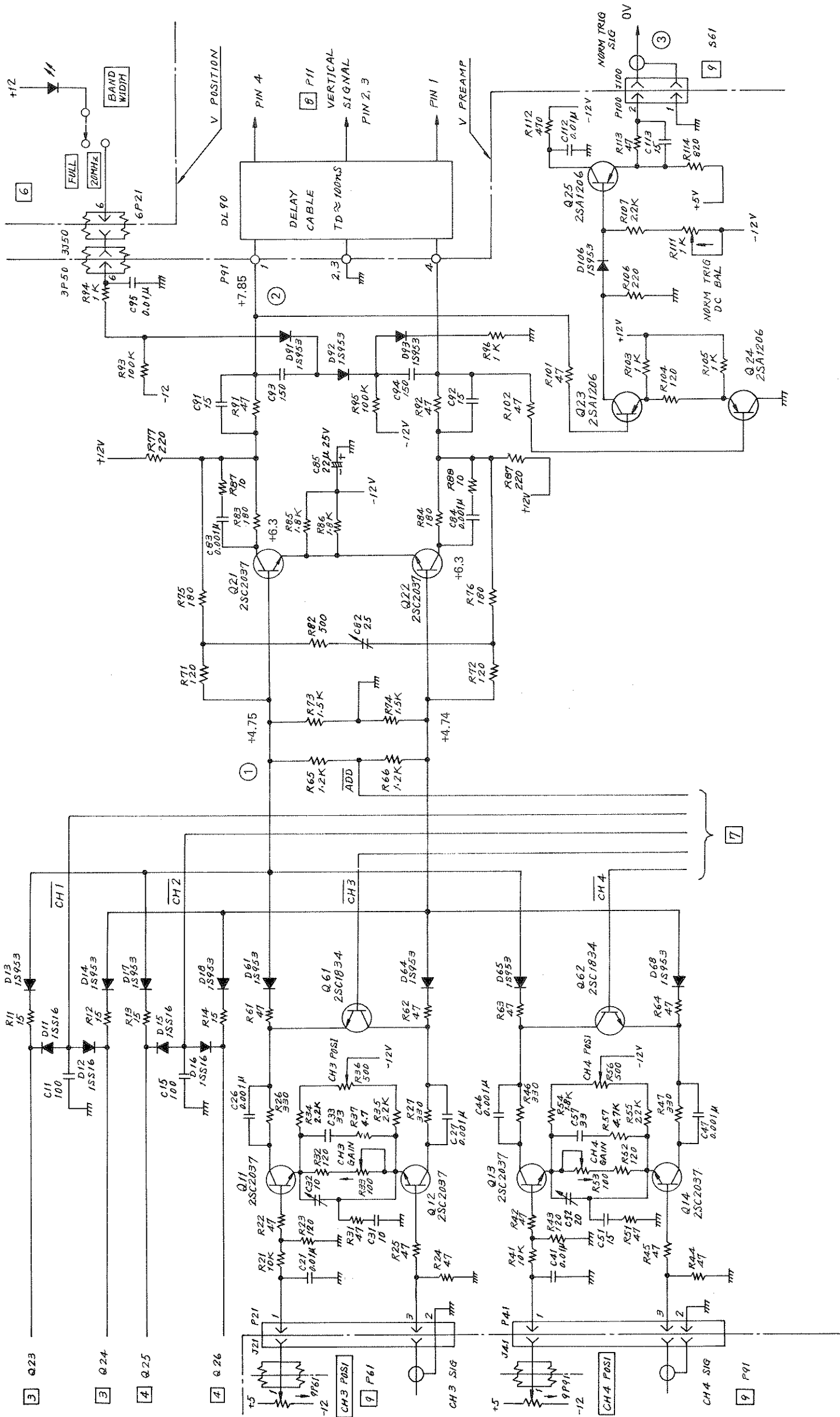

SS-57111 / SS-5711C / SS-5711D
 DELAY CABLE DRIVER 5
 BBWSS 24013102 4

1 2 3 4 5 6 7 8 9 10 11 12 13 14 15 16 17 18 19 20 21 22 23 24 25 26 27 28 29 30 31 32 33 34 35 36 37 38 39 40 41 42 43 44 45 46 47 48 49 50 51 52 53 54 55 56 57 58 59 60 61 62 63 64 65 66 67 68 69 70 71 72 73 74 75 76 77 78 79 80 81 82 83 84 85 86 87 88 89 90 91 92 93 94 95 96 97 98 99 100

Section 7 Schematic Diagrams

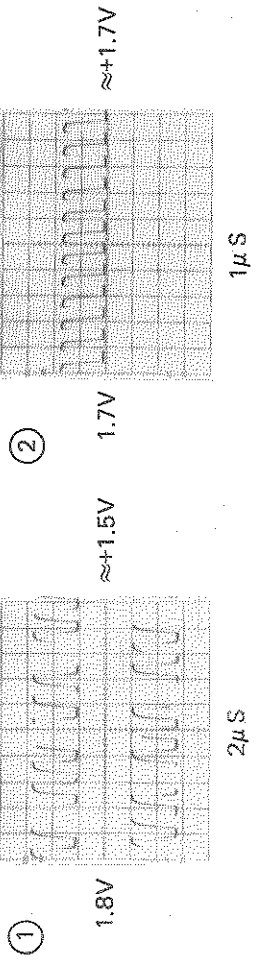

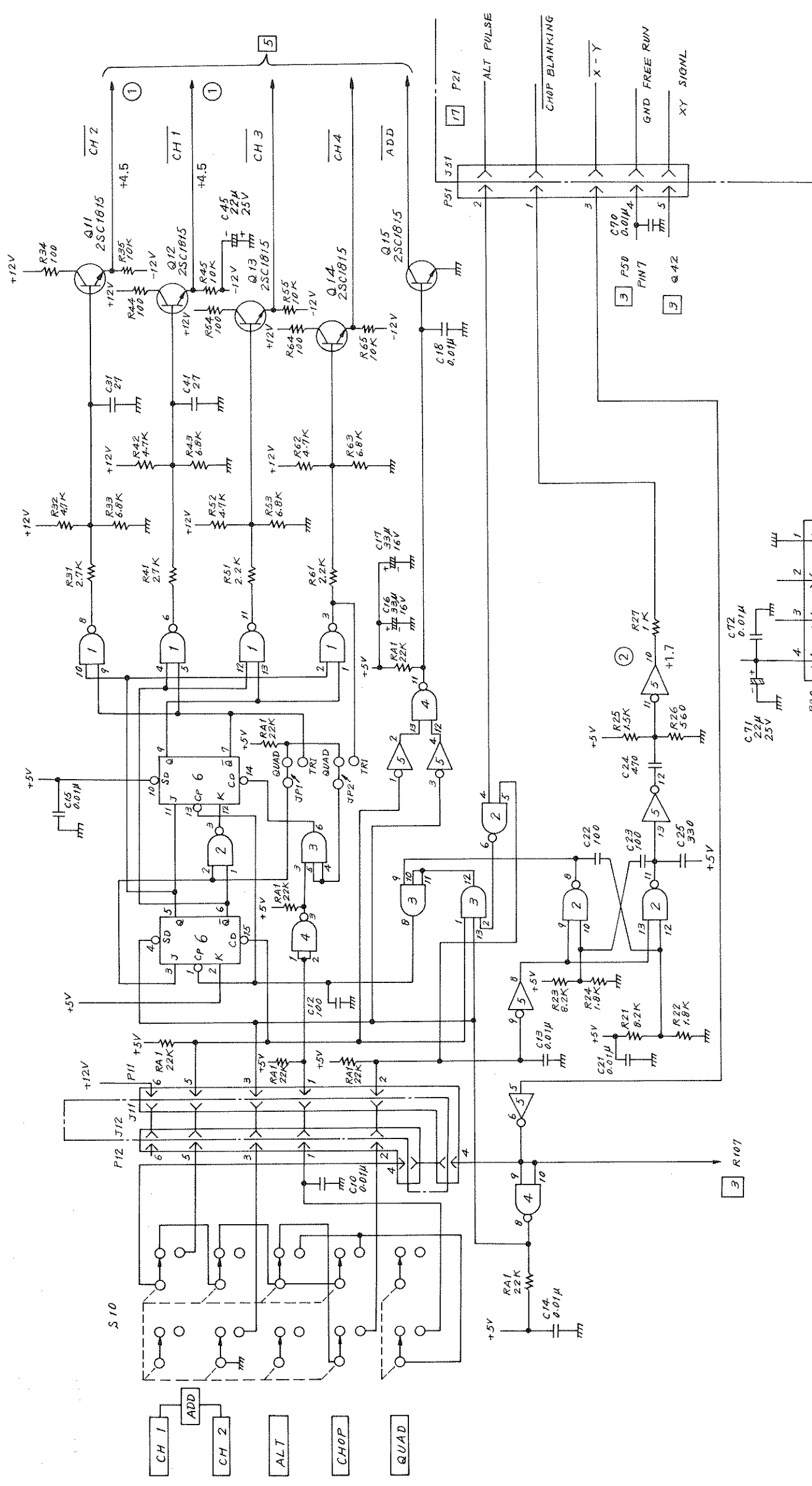

IC 2	74LS00	7	GND	+5V
IC 5	74LS04	7	14	14
IC 3	74LS11	7	14	14
IC 4	74LS26	7	14	14
IC 1	74LS26	7	14	14
IC 6	74LS112	8	16	16

VOLTAGE & WAVEFORM READING CONDITIONS
MODE CHOP

SS-5711 / SS-5711C / SS-5711D
VERTICAL CONTROL 7
BBWSS10002102 3

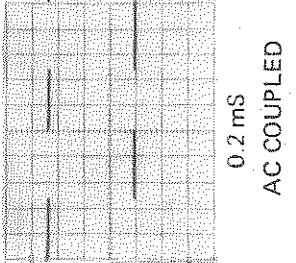
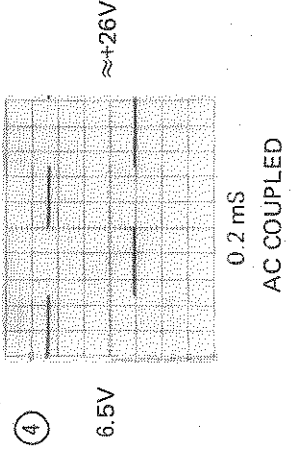
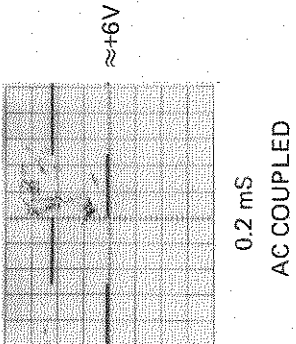
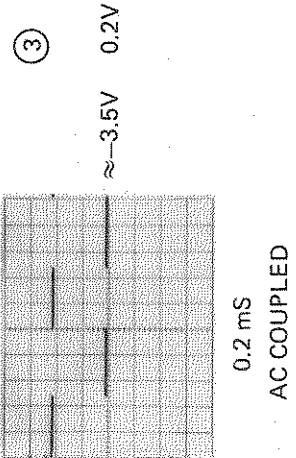
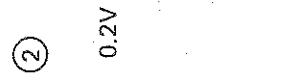
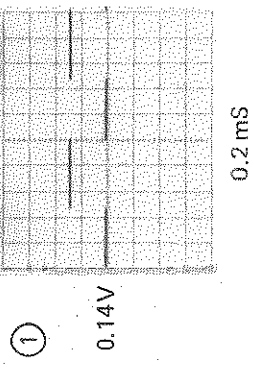

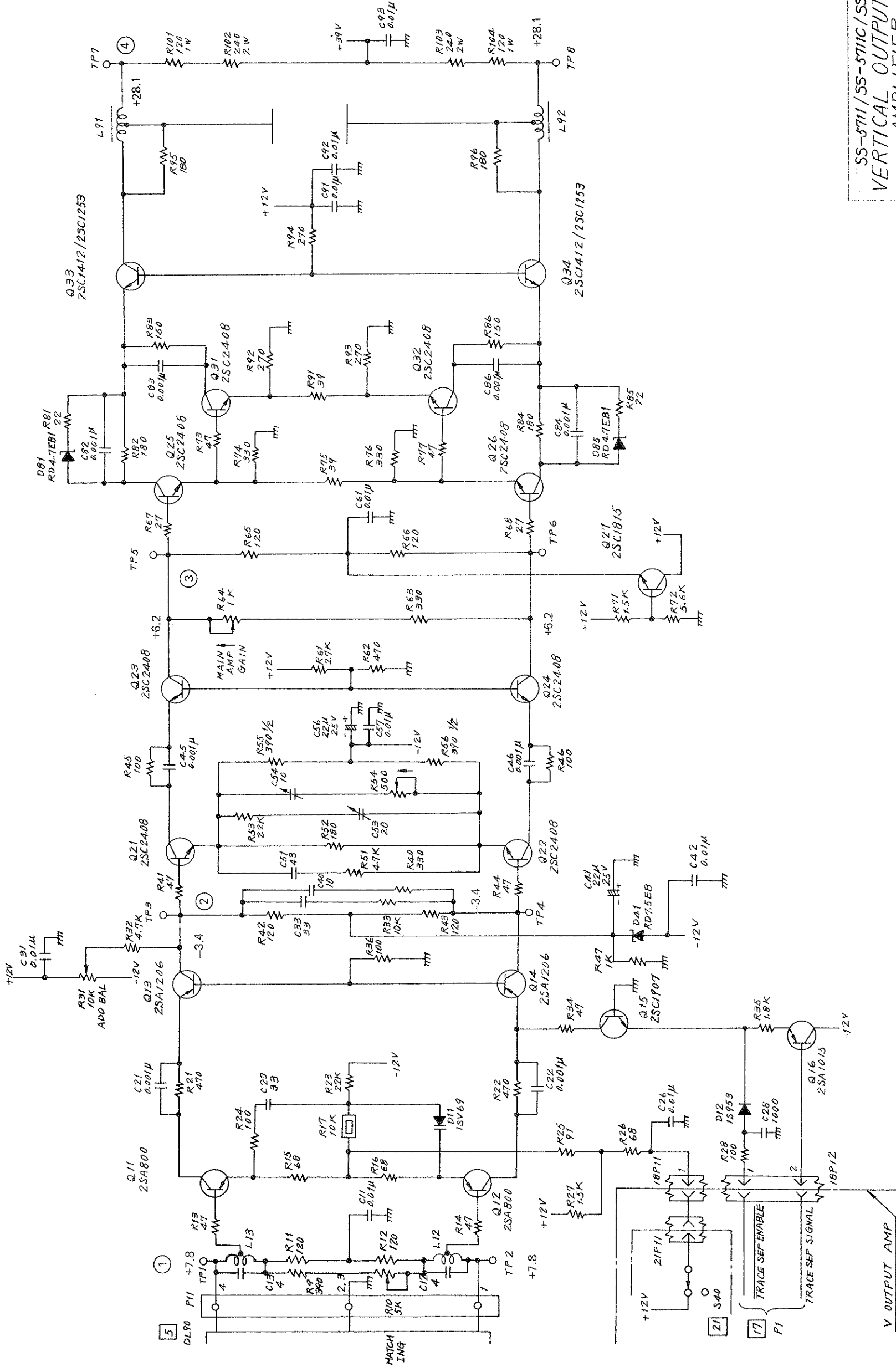

SS-5711 / SS-5711C / SS-5711D
 VERTICAL OUTPUT
 AMPLIFIER

BBWSS24014102 4

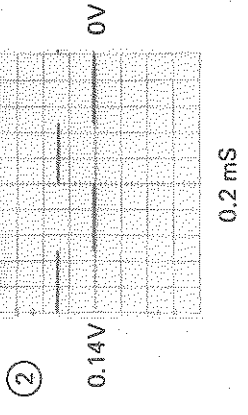
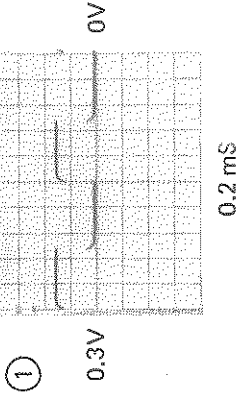

WAVEFORMS

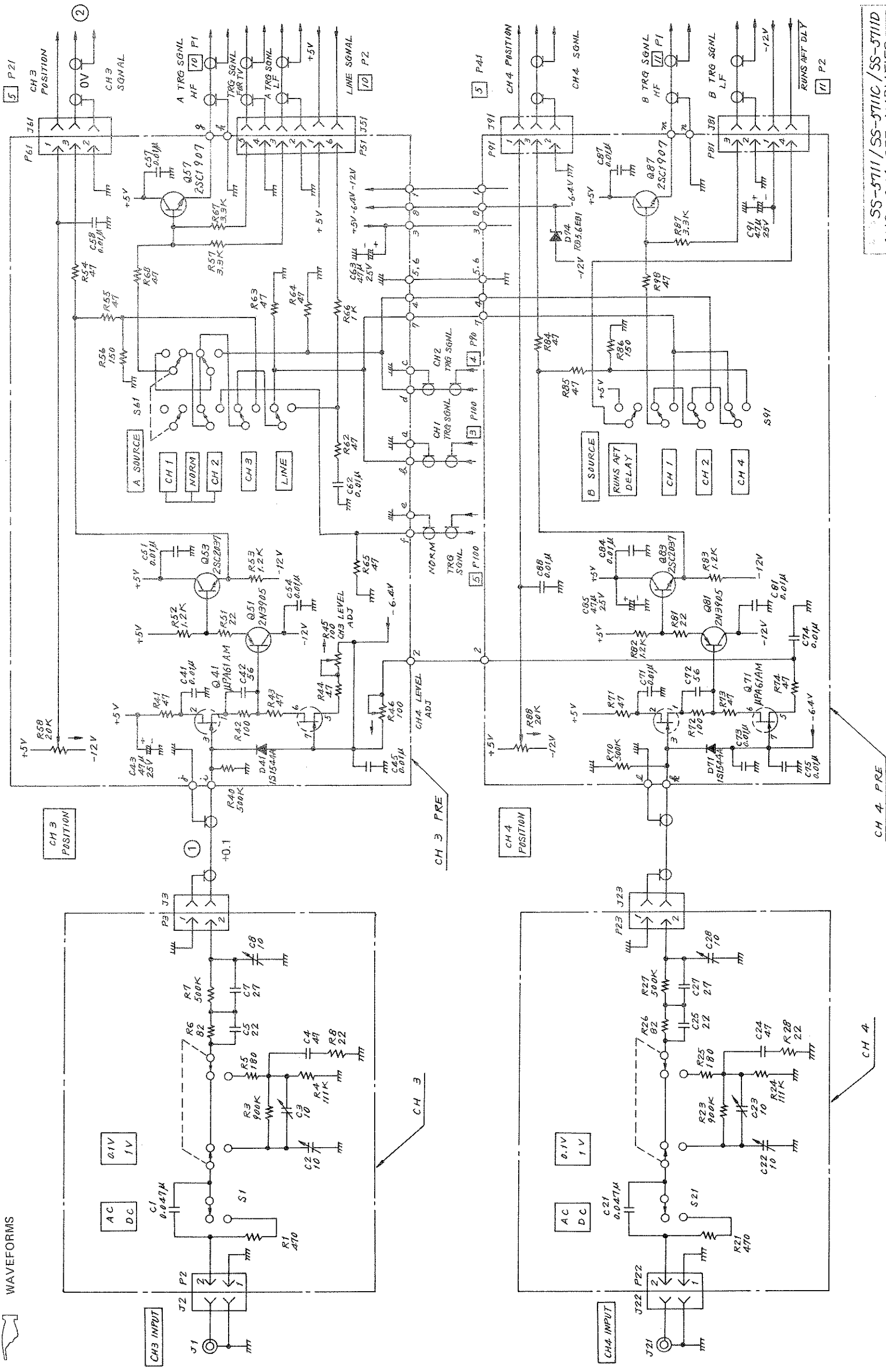

SS-5711 / SS-5711C / SS-5711D
 CH3 & CH4 PRE-AMPLIFIER & SOURCE
 BWSS24015102 3

VOLTAGE & WAVEFORM READING CONDITIONS
 MODE CHOP & QUAD
 A SOURCE CH 3

①
0.2V

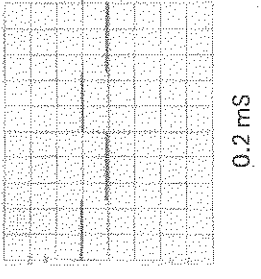

②
0.2V

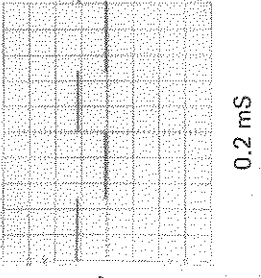

③
1.3V

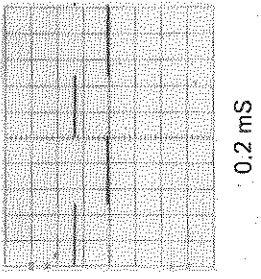

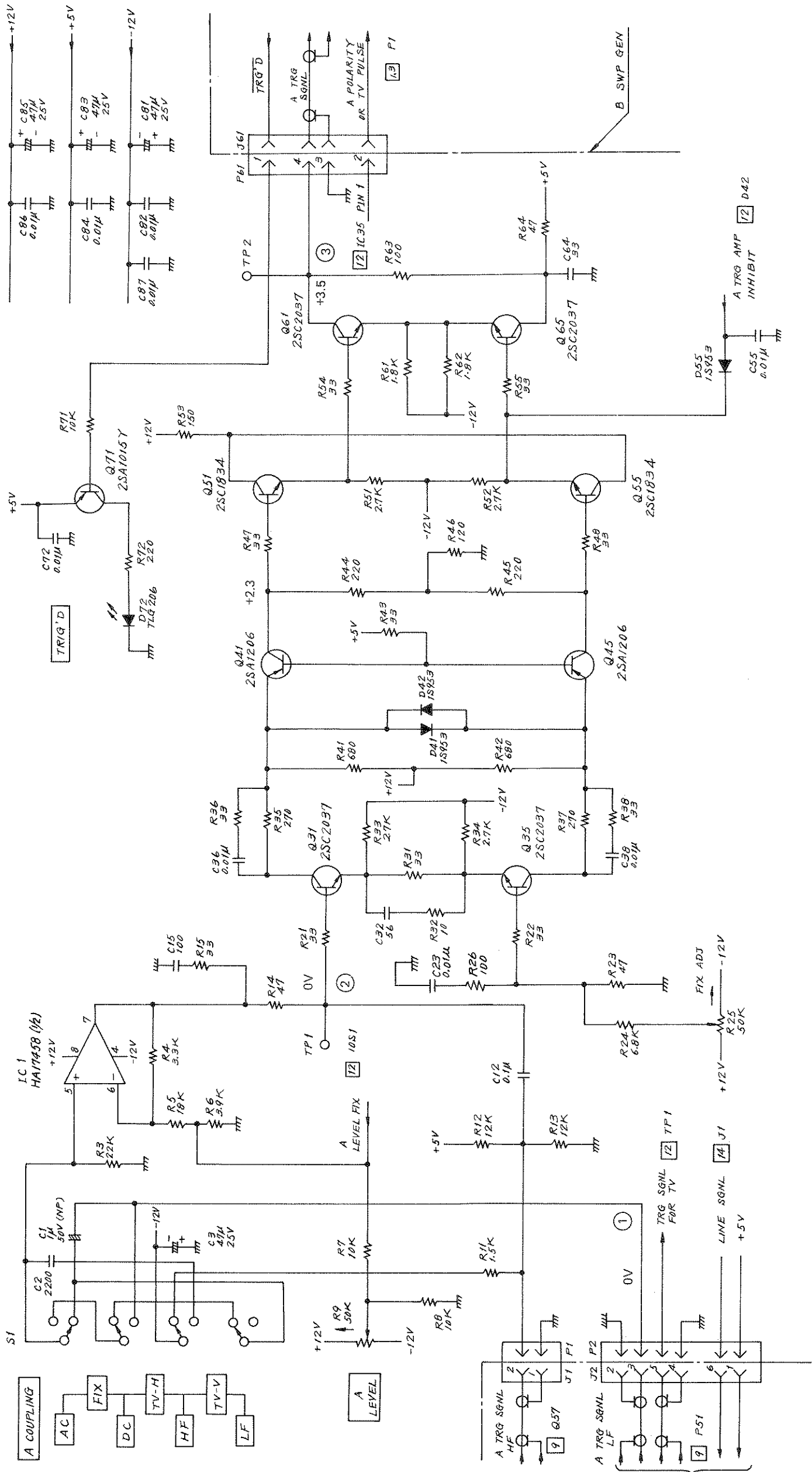

SS-5711 / SS-5711C / SS-5711D
 A TRIGGER AMPLIFIER 10
 BBWSS34001102 4



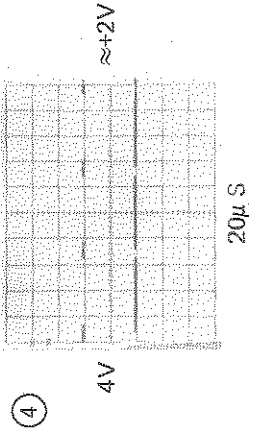
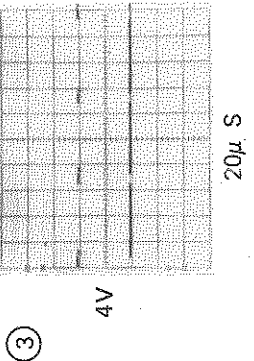
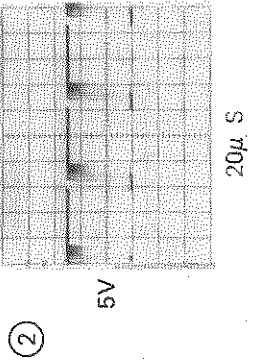
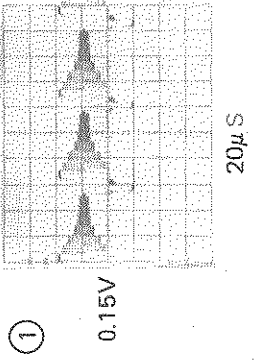

WAVEFORMS

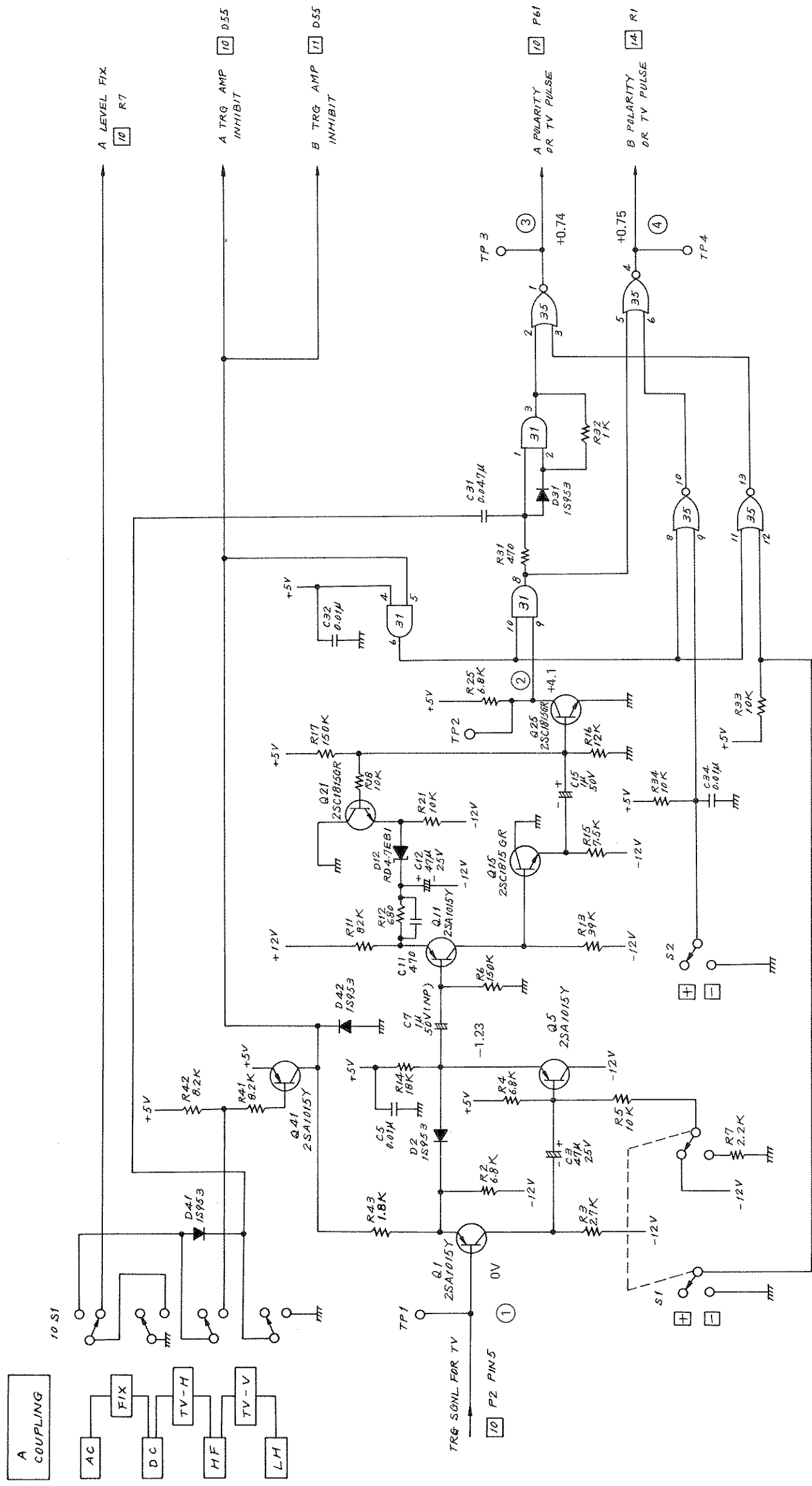

SS-5711/SS-5711C/SS-5711D
TV SYNC SEPARATOR 12
BBWSS34003102 4

VOLTAGE & WAVEFORM READING CONDITIONS
COUPLING TV-H

IC 31	SN 74LS08N	14	7
IC 35	SN 74LS02N	14	7

B SWP GEN

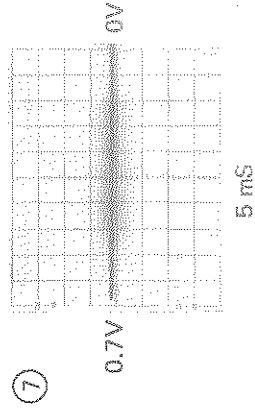
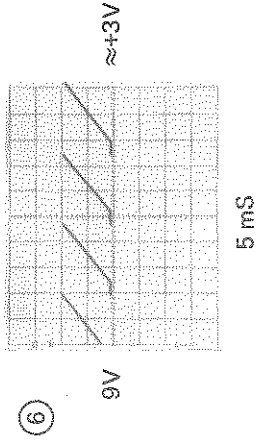
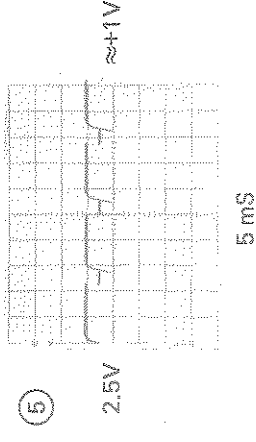
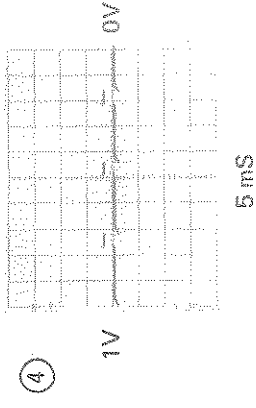
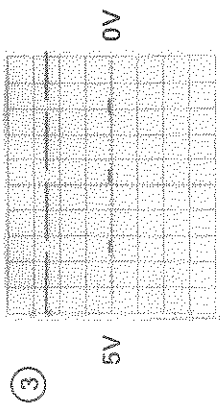
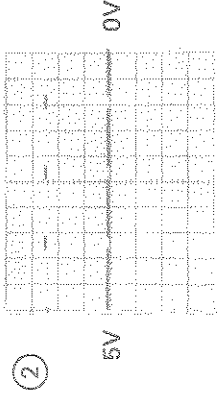
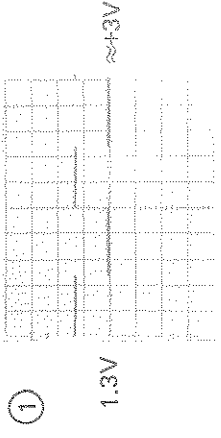

WAVEFORMS



IC 1	F10107 DC	+5V	GND
IC 5	F10131 DC	1-16	8
		1-16	8
IC 11	SN74LS123N	16	8
IC 15	SN74LS08N	14	7
IC 21	SN74LS00N	14	7
IC 26	SN74LS02N	14	7
IC 71, 91	SN74LS74AAN	14	7
IC 75	CD 4066 BE		
IC 81	μPC272 C		

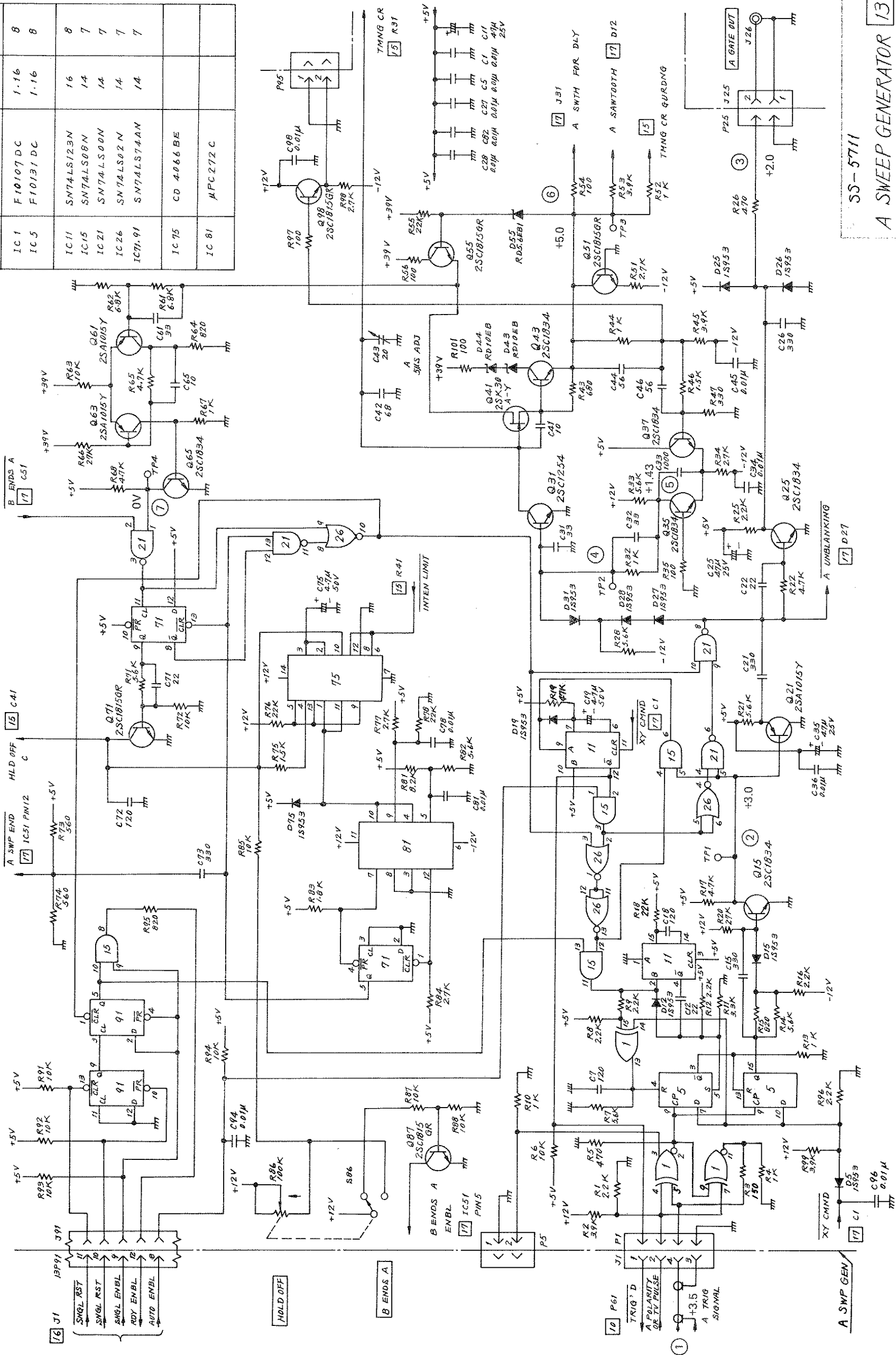

SS-5711
 A SWEEP GENERATOR 13
 BBWSS20004102 4

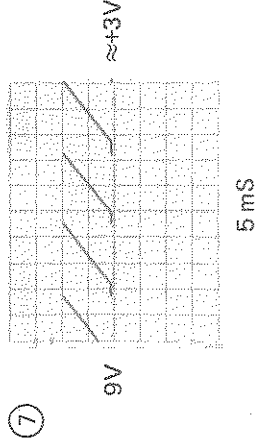
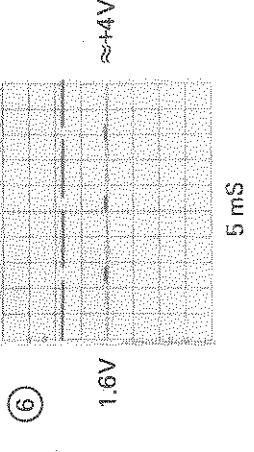
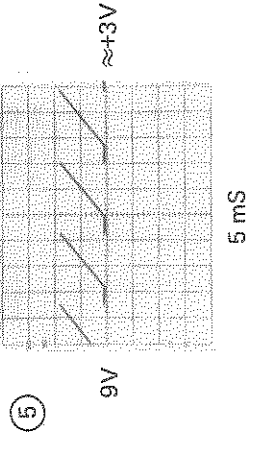
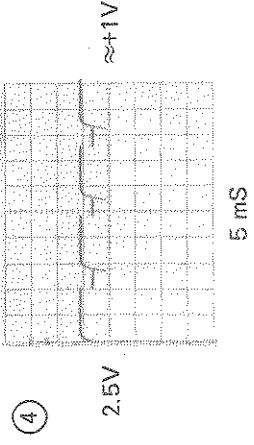
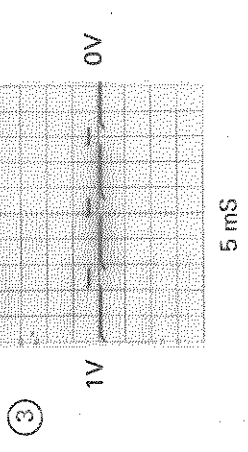
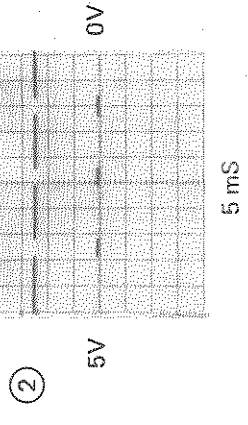
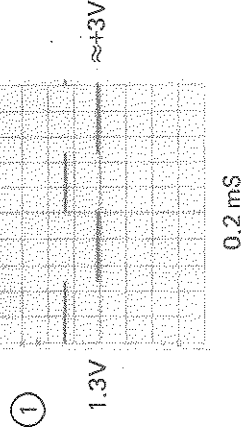





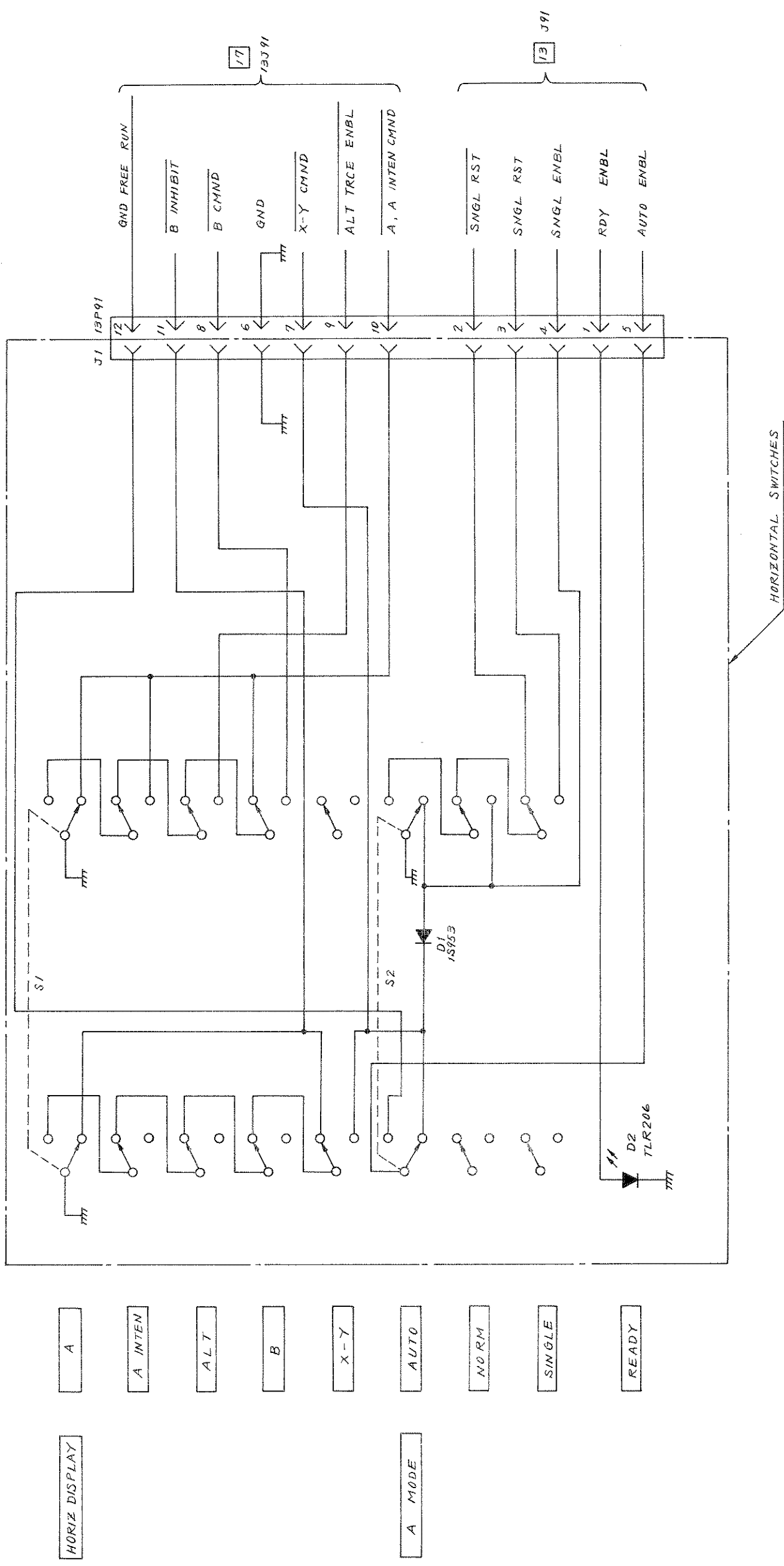

SS-5711 / SS-5711C / SS-5711D
 HORIZONTAL SWITCHES 16
 BBWSS40002102 3



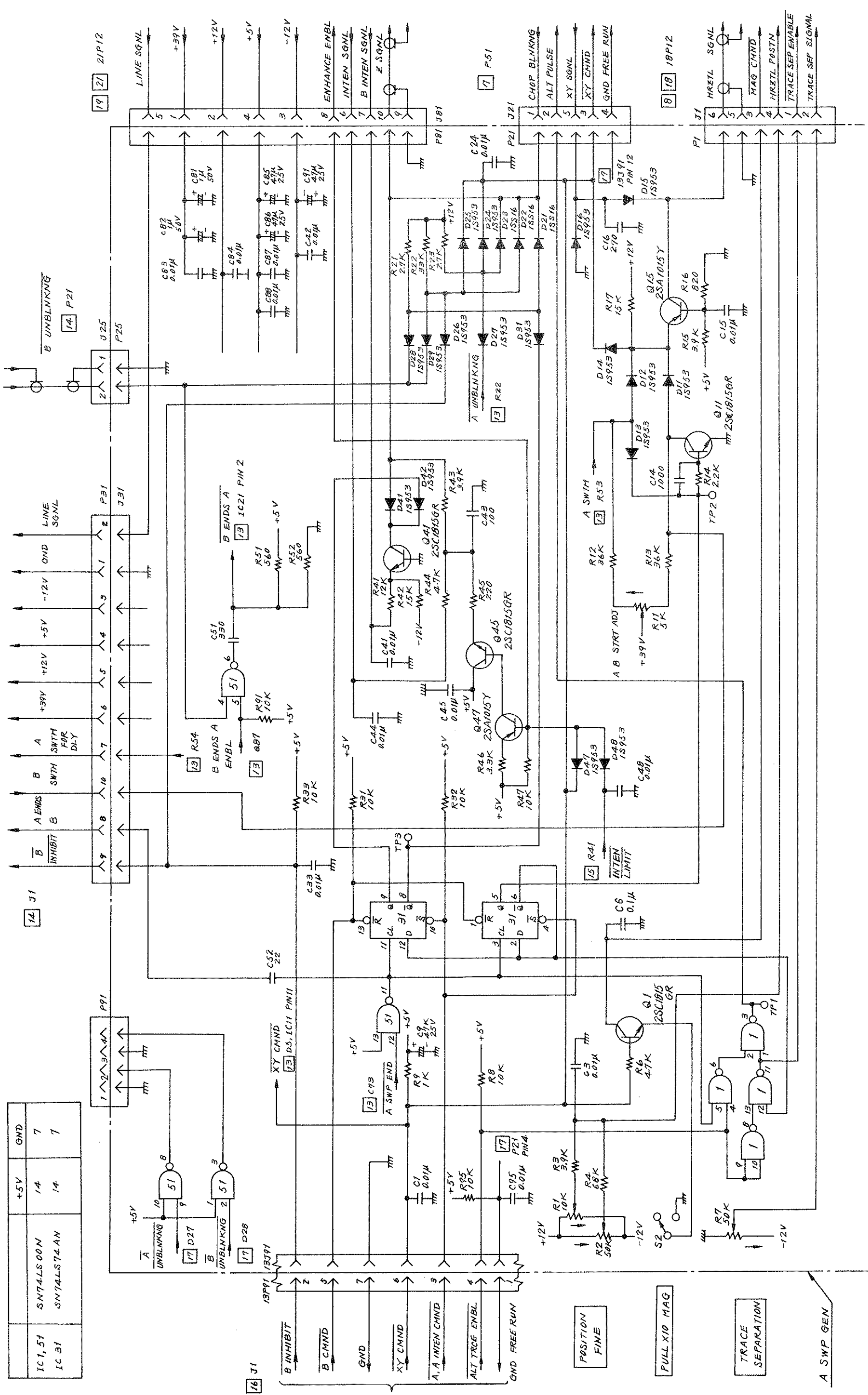

IC 1, 51	SW74LS00N	+5V	GND
IC 31	SW74LS74AN	14	7
		14	7

SS-5711/SS-5711C/SS-5711D
 HORIZONTAL CONTROL 17
 BBWSS10003102 4

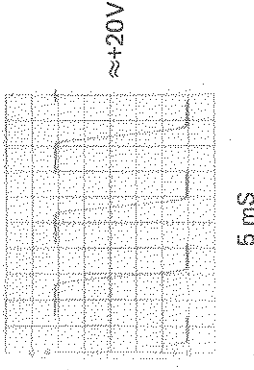
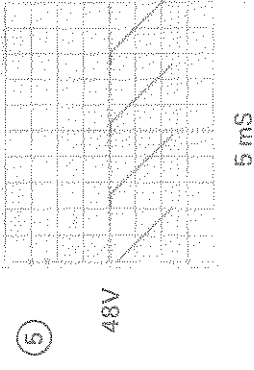
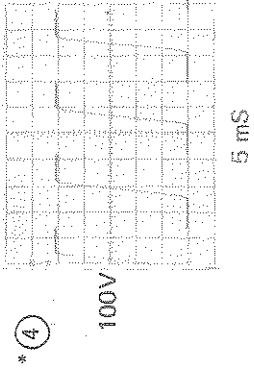
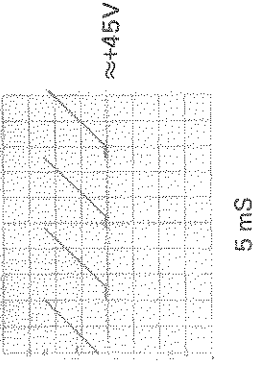
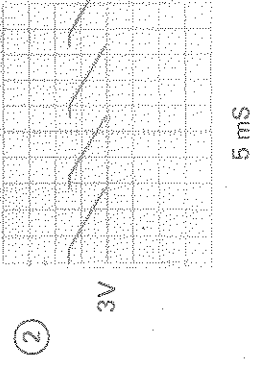
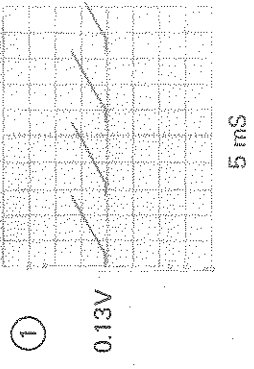

WAVEFORMS

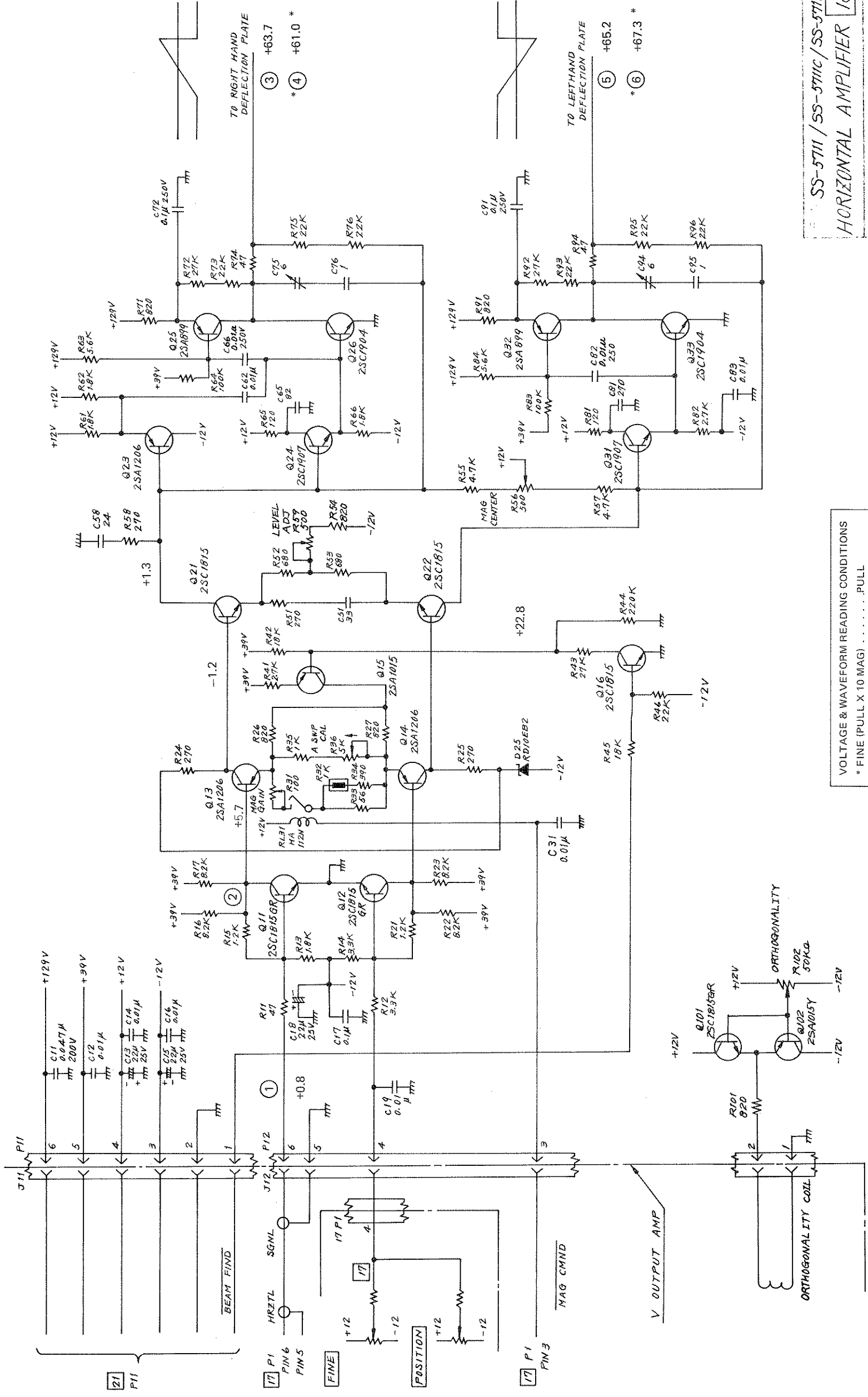

VOLTAGE & WAVEFORM READING CONDITIONS
 * FINE (PULL X 10 MAG) PULL

SS-5711 / SS-5711C / SS-5711D
 HORIZONTAL AMPLIFIER 18
 BBWSS24016102 4

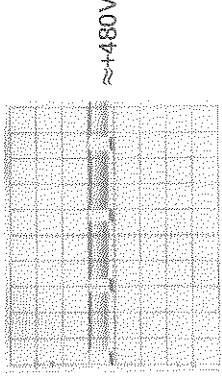
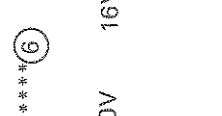
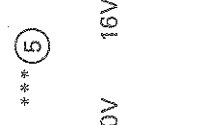
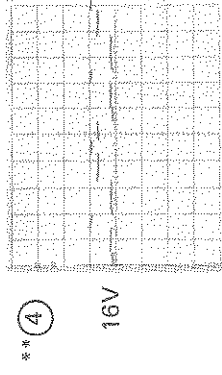
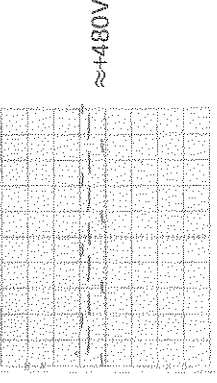
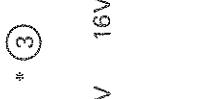
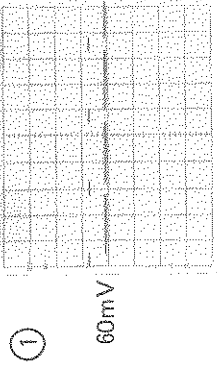

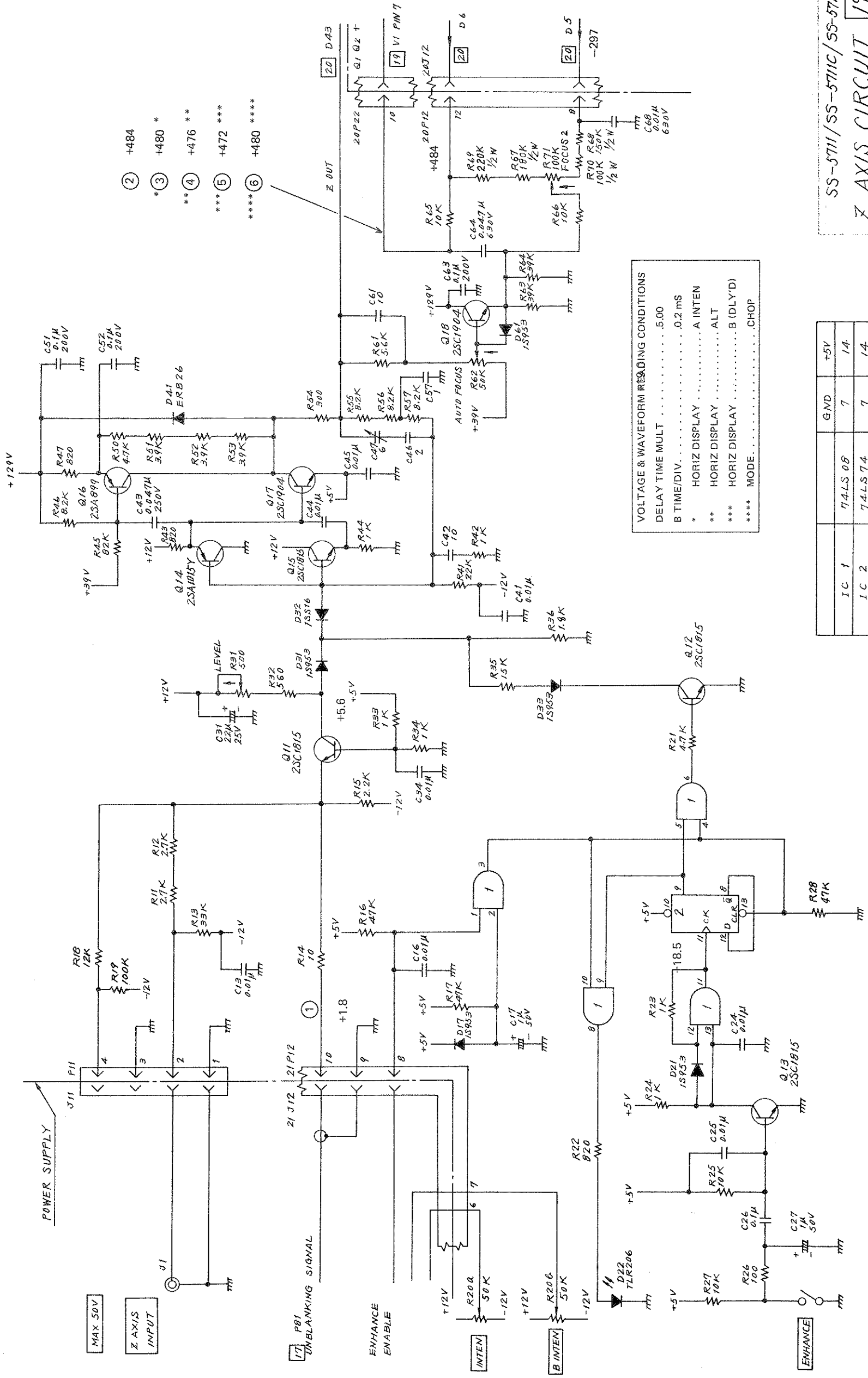

SS-5711/SS-5711C/SS-5711D
Z AXIS CIRCUIT 19
BBWSS 24008102 4

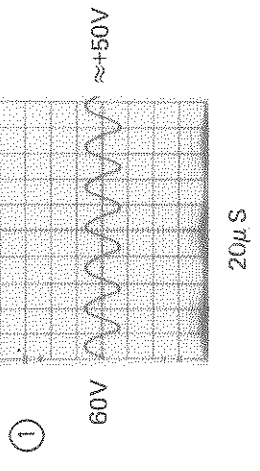

WAVEFORMS

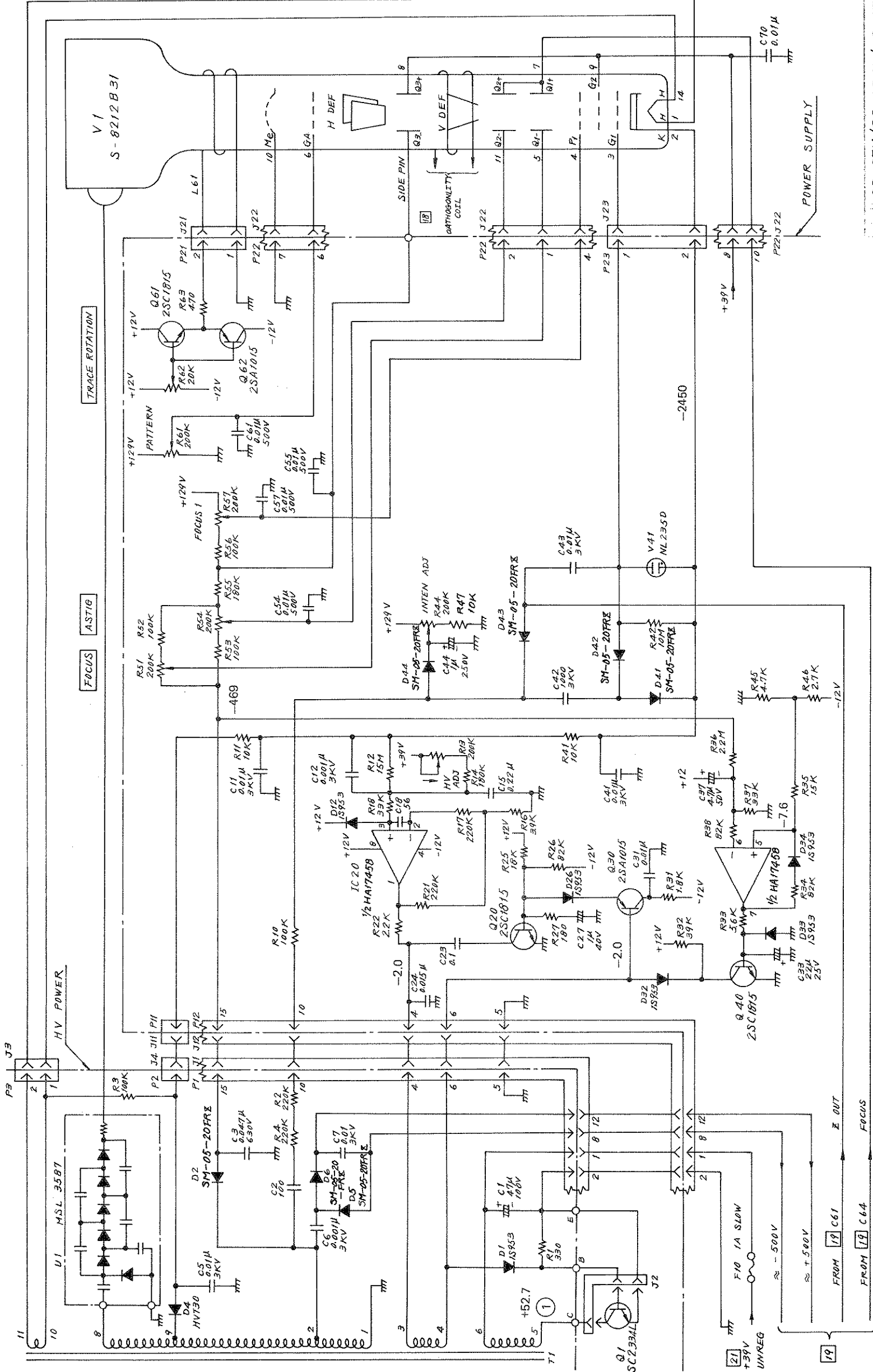

SS-5711/SS-5711C/SS-5711D
 CRT CIRCUIT 20
 BBWSS08002102 4

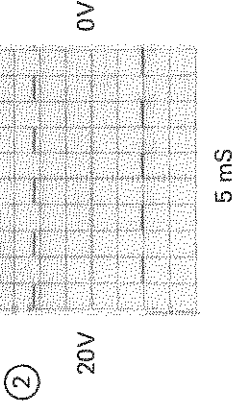
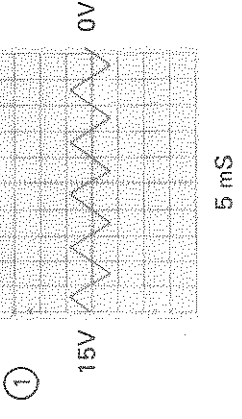

WAVEFORMS

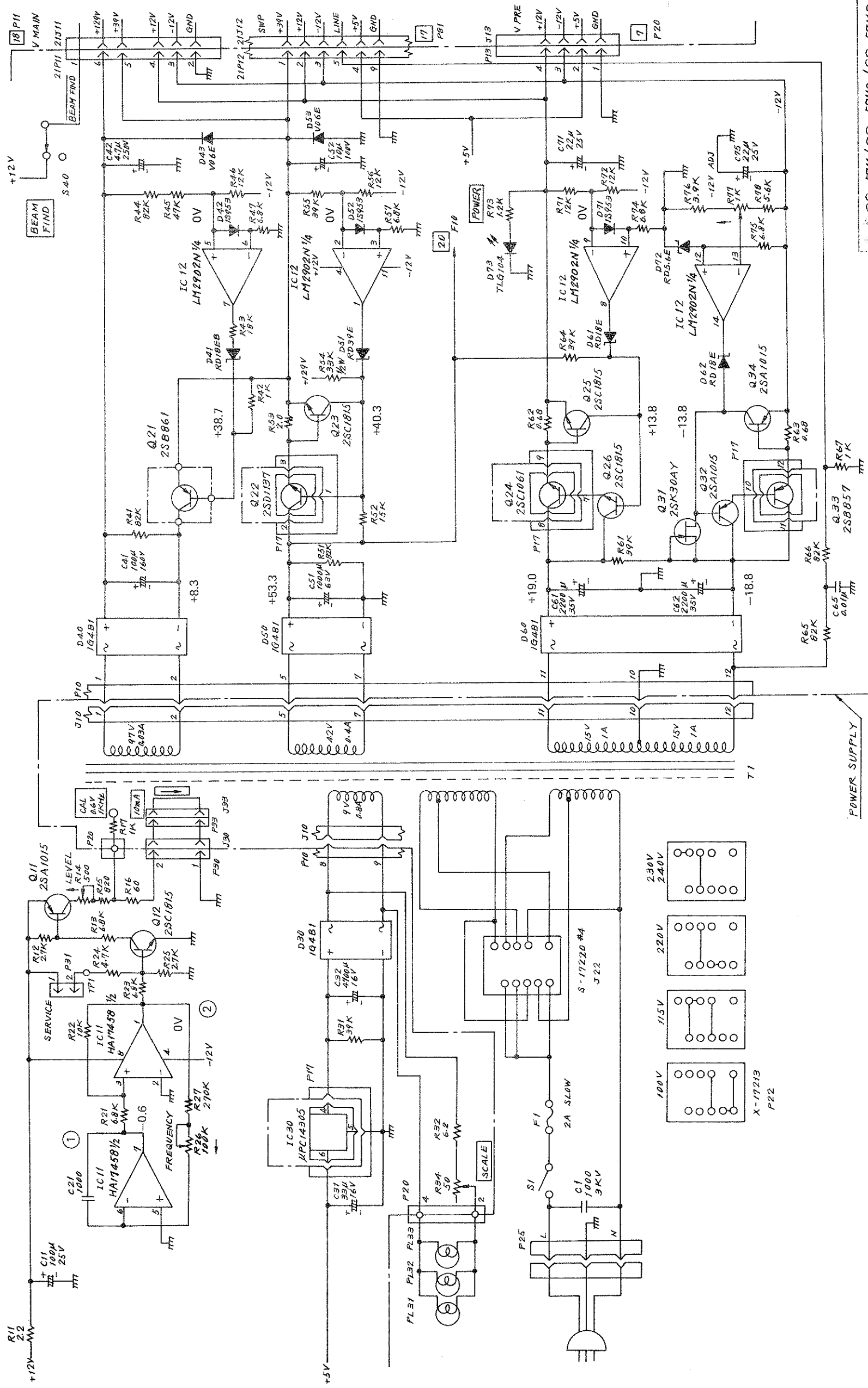

SS-5711 / SS-5710C / SS-5711D
POWER SUPPLY & CALIBRATOR
 21
 BWSS08003102 4

Electrical Parts List

Ordering Information

Replacement parts may be ordered through an IWATSU Representative of directly from the factory. To be certain of receiving the proper parts, a ways include the following information with the order:

- Model Number and serial number of the instrument on which the parts will be installed.
- Circuit reference number and subassembly name, if applicable, for which the part is intended. If the part does not have a circuit reference, the description from the parts list should be used.
- Iwatsu part number.

For factory repair, contact the IWATSU agent and include the following information:

- Model number and serial number of the instrument on which the work is to be performed.
- Details concerning the nature of the malfunction, or, type of repair desired.
Shipping instructions will be sent to you promptly.

How to Use This Parts List

The part list is divided into subsections corresponding to the schematic diagrams such as CH1, CH2 ATTENUATOR & PRE-AMPLIFIER (1), CH1, CH2, PRE-AMPLIFIER (2), DELAY CABLE DRIVER, VERTICAL PANEL SWITCHES, VERTICAL CONTROL, VERTICAL OUTPUT AMPLIFIER, CH3, CH4 PRE-AMPLIFIERS & SOURCE, A, B TRIGGER AMPLIFIER, TV SYNC SEPARATOR, A, B SWEEP GENERATOR, TIMING SWITCHES, HORIZONTAL SWITCHES, HORIZONTAL CONTROL, HORIZONTAL AMPLIFIER, Z AXIS CIRCUIT, CRT CIRCUIT and POWER SUPPLY & CALIBRATOR.

Component locations can be determined from the schematic diagrams, each component appears only once in the parts list. At the beginning of each subsection are listed part numbers for any complete subassemblies in that category that are available as replacement parts. These subassemblies may include individually-listed components; care should be taken to pinpoint malfunctions to the exact replacement parts actually needed and thus avoid the time and cost involved in "over-repair".

Abbreviations

Cap	Capacitor
Cer	Ceramic
Poly	Polyethyltel film
Elect.	Aluminum electrolytic chemical
Elect. tan.	Tan-talum electrolytic chemical condenser
		[The symbol F (farad) is omitted]
Res.	Resistor
W.W.	Wire wound
Comp	Composition
		[The symbol Ω (ohm) is omitted]
FET	Field Effect Transistor
Diode	
T. diode.	Tunnel diode
Z. diode.	Zenner diode
S.B. diode	Schottky barrier diode
V.C. diode	Variable capacitance diode
L.E.D.	Light emission diode
IC.	Integrated Circuit
Var.	Variable

CIRCUIT REFERENCE	DESCRIPTION	IWATSU PART NO.	CIRCUIT REFERENCE	DESCRIPTION	IWATSU PART NO.
CH1 ATTENUATOR & PRE-AMPREFIER (1)			1R21	Res., 33k, $\pm 1\%$, $\frac{1}{4}W$, Carbon	DRD139911
			1R22	Res., 1.8k, $\pm 1\%$, $\frac{1}{4}W$, Metal	DRE939171
1C01	Cap., 0.047 μ , $\pm 20\%$, 200V, Poly.	DCF160291	1R23	Same as 1R22	
1C02	Cap., 10p, $\pm 0.5p$, 50V, Cer.	DCC231701	1R24	Res., 180., $\pm 1\%$, $\frac{1}{4}W$, Metal	DRE535311
1C03	Cap., 0.01 μ , +80% \sim -20%, 50V, Cer.	DCC139501	1R25	Res., 47k, $\pm 1\%$, $\frac{1}{4}W$, Carbon	DRD139261
1C11	Cap., 2 \sim 8p, Var., 250V, Cer.	DCV019561	1R26	Res., 560k, $\pm 1\%$, $\frac{1}{4}W$, Carbon	DRD139131
1C12	Same as 1C01		1R27	Res., 100, Var, 0.3W, Cermet	DRV412001
1C13	Same as 1C03		1R31	Same as 1R25	
1C14	Cap., 82p, $\pm 5\%$, 50V, Cer.	DCC239141	1R32	Same as 1R26	
1C15	Cap., 22 μ , $\pm 20\%$, 250V, Elect.	DCE229041	1R33	Res., 2.7k, $\pm 1\%$, $\frac{1}{4}W$, Metal	DRE939651
1C18	Same as 1C03		1R34	Same as 1R13	
1C19	Same as 1C03		1R35	Res., 10k, $\pm 15\%$, Thermistor	DDD080331
1C21	Cap., 1p, 0.25p, 50V, Cer.	DCE244711	1R36	Same as 1R33	
1C22	Same as 1C15		1R41	Same as 1R14	
1C24	Cap., 2 \sim 8p, Var., 250V, Cer.	DCV019612	1R42	Res., 2.2k, $\pm 1\%$, $\frac{1}{4}W$, Metal	DRE939021
1C27	Cap., 56p, $\pm 5\%$, 50V, Cer.	DCC239251	1R43	Same as 1R16	
1C41	Same as 1C14		1R44	Same as 1R14	
1C42	Same as 1C15		1R45	Same as 1R18	
1C43	Same as 1C03		1R46	Res., 10k, Var., 0.3W, Cermet	DRV411991
1C44	Same as 1C15		1R51	Res., 560, $\pm 1\%$, $\frac{1}{4}W$, Metal	DRE939141
1C45	Same as 1C15		1R52	Res., 3.9k, $\pm 1\%$, $\frac{1}{4}W$, Metal	DRE939421
1C52	Same as 1C03		1R53	Same as 1R52	
1C54	Same as 1C15		1R54	Same as 1R51	
1C65	Cap., 39p, $\pm 5\%$, 50V, Cer.	DCC239131	1R55	Res., 47k, $\pm 5\%$, $\frac{1}{4}W$, Carbon	DRD139171
1C72	Same as 1C03		1R56	Res., 24, $\pm 1\%$, $\frac{1}{4}W$, Metal	DRE939481
1C73	Same as 1C15		1R57	Res., 220, $\pm 1\%$, $\frac{1}{4}W$, Metal	DRE939601
1C74	Same as 1C03		1R62	Res., 8.2k, $\pm 5\%$, $\frac{1}{4}W$, Carbon	DRD139581
1C75	Same as 1C15		1R63	Res., 5k, Var., 0.3W, Cermet	DRV412051
			1R64	Res., 1k, $\pm 1\%$, $\frac{1}{4}W$, Metal	DRE939072
			1R65	Same as 1R16	
1L01	Magnet Coil, S1283-12V	DCL110531	1R66	Same as 1R16	
			1R67	Same as 1R16	
1R01	Res., 470, $\pm 5\%$, $\frac{1}{4}W$, Carbon	DRD139371	1R71	Same as 1R16	
1R02	Res., 68, $\pm 5\%$, $\frac{1}{4}W$, Carbon	DRD134551	1R72	Res., 6.8k, $\pm 1\%$, $\frac{1}{4}W$, Metal	DRE939331
1R11	Res., 1M, $\pm 0.5\%$, $\frac{1}{4}W$, Metal	DRE249041	1R73	Same as 1R42	
1R12	Res., 470k, $\pm 5\%$, $\frac{1}{4}W$, Carbon	DRD135471	1R74	Same as 1R57	
1R13	Res., 100, $\pm 1\%$, $\frac{1}{4}W$, Metal	DRE535251	1R75	Same as 1R57	
1R14	Resl 100, $\pm 1\%$, $\frac{1}{4}W$, Metal	DRE939561	1R76	Res., 470k, $\pm 5\%$, $\frac{1}{4}W$, Carbon	DRD139931
1R15	Same as 1R13		1R77	Res., 50k, Var., 0.3W, Cermet	DRV412061
1R16	Res., 10k, $\pm 1\%$, $\frac{1}{4}W$, Metal	DRE939301			
1R17	Res., 27k, $\pm 1\%$, $\frac{1}{4}W$, Carbon	DRD134451			
1R18	Res., 10k, $\pm 5\%$, $\frac{1}{4}W$, Carbon	DRD139161			

CIRCUIT REFERENCE	DESCRIPTION	IWATSU PART NO.	CIRCUIT REFERENCE	DESCRIPTION	IWATSU PART NO.
1D11	Diode, 1S1544A	DDD010801	11C11	IC, μ PC251C	DIC610091
1D13	Z.Diode, RD4.7EB1	DDD033131			
1D15	Diode, 1S953	DDD010821	1S1	Push switch, SUJ20A	DSW014851
1D16	Same as 1D13		1S2	Reed switch, ORD229 (2030)	DKD065891
1D74	Z. Diode, RD5.6EB1	DDD031141	1S10	Rotary switch, (ADR353-1)	DFB020161
1Q11	FET, 2N5912	DTR250011	1J1	Connector, BNC 080	DCN040711
1Q12	Transistor, 2SC1907	DTR137611			
1Q13	Transistor, 2SC2037	DTR137591			
1Q14	Same as 1Q13				
1Q15	Same as 1Q13				
1Q16	Same as 1Q13				
1Q17	Transistor, 2SA1206	DTR119041			
1Q18	Same as 1Q17				

CIRCUIT REFERENCE	DESCRIPTION	IWATSU PART NO.	CIRCUIT REFERENCE	DESCRIPTION	IWATSU PART NO.
CH2 ATTENUATOR & PRE-AMPLIFIER (1)			2R26	Res., 560, $\pm 1\%$, $\frac{1}{4}W$, Carbon	DRD139121
			2R27	Res., 100, Var, 0.3W, Cermet	DRV412001
2C01	Cap., 0.047 μ , $\pm 20\%$, 200V, Poly.	DCF160291	2R31	Same as 2R25	
2C02	Cap., 10p, $\pm 0.5p$, 50V, Cer.	DCC231701	2R32	Same as 2R26	
2C03	Cap., 0.01 μ , $+80\% \sim -20\%$, 50V, Cer.	DCC139501	2R33	Res., 2.7k, $\pm 1\%$, $\frac{1}{4}W$, Metal	DRE939651
			2R34	Same as 2R13	
2C11	Cap., 3p, $\pm 0.25p$, 500V, Cer.	DCC250701	2R35	Res., 10k, $\pm 15\%$, Thermistor	DDD080331
2C12	Same as 2C01		2R36	Same as 2R33	
2C13	Same as 2C03		2R41	Same as 2R14	
2C14	Cap., 82p, $\pm 5\%$, 50V, Cer.	DCC239141	2R42	Res., 2.2k, $\pm 1\%$, $\frac{1}{4}W$, Metal	DRE939021
2C15	Cap., 22 μ , $\pm 20\%$, 250V, Elect.	DCE229041	2R43	Same as 2R16	
2C18	Same as 2C15		2R44	Same as 2R14	
2C19	Same as 2C15		2R45	Same as 2R18	
2C22	Same as 2C15		2R46	Res., 10k, Var., 0.3W, Cermet	DRV411991
2C24	Cap., 2 $\sim 8p$, Var., 250V, Cer.	DCV019612	2R51	Res., 560, $\pm 1\%$, $\frac{1}{4}W$, Metal	DRE939141
2C27	Cap., 56p, $\pm 5\%$, 50V, Cer.	DCC239251	2R52	Res., 3.9k, $\pm 1\%$, $\frac{1}{4}W$, Metal	DRE939421
2C41	Same as 2C14		2R53	Same as 2R52	
2C42	Same as 2C15		2R54	Same as 2R51	
2C43	Same as 2C03		2R55	Res., 47k, $\pm 5\%$, $\frac{1}{4}W$, Carbon	DRD139171
2C44	Same as 2C15		2R56	Res., 24, $\pm 1\%$, $\frac{1}{4}W$, Metal	DRE939481
2C45	Same as 2C15		2R57	Res., 220, $\pm 1\%$, $\frac{1}{4}W$, Metal	DRE939601
2C52	Same as 2C03		2R61	Res., 33k, $\pm 1\%$, $\frac{1}{4}W$, Metal	DRE939091
2C65	Cap., 39p, $\pm 5\%$, 50V, Cer.	DCC239131	2R62	Res., 8.2, $\pm 5\%$, $\frac{1}{4}W$, Carbon	DRD139581
2C74	Same as 2C03		2R63	Res., 5k, Var., 0.3W, Cermet	DRV412051
			2R64	Res., 1k, $\pm 1\%$, $\frac{1}{4}W$, Metal	DRE939071
2L01	Magnet coil, S1283-12V	DCL110531	2R65	Same as 2R16	
			2R66	Same as 2R16	
2R01	Res., 470, $\pm 5\%$, $\frac{1}{4}W$, Carbon	DRD139371	2R67	Same as 2R16	
2R02	Res., 68, $\pm 5\%$, $\frac{1}{4}W$, Carbon	DRD134551	2R71	Same as 2R16	
2R11	Res., 1M, $\pm 0.5\%$, $\frac{1}{2}W$, Metal	DRE249041	2R72	Res., 6.8k, $\pm 1\%$, $\frac{1}{4}W$, Metal	DRE939331
2R12	Res., 470k, $\pm 5\%$, $\frac{1}{4}W$, Carbon	DRD135471	2R73	Same as 2R42	
2R13	Res., 100, $\pm 1\%$, $\frac{1}{4}W$, Metal	DRE535251	2R74	Same as 2R57	
2R14	Res., 100, $\pm 1\%$, $\frac{1}{4}W$, Metal	DRE939561	2R75	Same as 2R57	
2R15	Same as 2R13		2R76	Res., 470k, $\pm 5\%$, $\frac{1}{4}W$, Carbon	DRD139931
2R16	Res., 10k, $\pm 1\%$, $\frac{1}{4}W$, Metal	DRE939301	2R77	Res., 50k, Var., 0.3W, Cermet	DRV412061
2R17	Res., 27k, $\pm 1\%$, $\frac{1}{4}W$, Carbon	DRD134451			
2R18	Res., 10k, $\pm 5\%$, $\frac{1}{4}W$, Carbon	DRD139161	2D11	Diode, 1S1544A	DDD010801
2R21	Res., 33, $\pm 1\%$, $\frac{1}{4}W$, Carbon	DRD139911	2D13	Z. Diode, RD4.7EB1	DDD033131
2R22	Res., 1.8k, $\pm 1\%$, $\frac{1}{4}W$, Metal	DRE939171	2D15	Diode, 1S953	DDD010821
2R23	Same as 2R22		2D16	Same as 2D13	
2R24	Res., 180, $\pm 1\%$, $\frac{1}{4}W$, Metal	DRE535311	2D74	Z. Diode, RD5.6EB1	DDD031141
2R25	Res., 47, $\pm 1\%$, $\frac{1}{4}W$, Carbon	DRD139261			

CIRCUIT REFERENCE	DESCRIPTION	IWATSU PART NO.	CIRCUIT REFERENCE	DESCRIPTION	IWATSU PART NO.
2Q11	FET, 2N5912	DTR250011	2IC11	IC, μ PC251C	DIC510091
2Q13	Transistor, 2SC2037	DTR250011			
2Q14	Same as 2Q13		2S1	Push switch, SUJ20A	DSW014851
2Q15	Same as 2Q13		2S2	Reed switch, ORD229(2030)	DKD065891
2Q16	Same as 2Q13		2S10	Rotary switch (ADR353-3)	DFB020161
2Q17	Transistor, 2SA1206	DTR119041			
2Q18	Same as 2Q17		2J1	Connector, BNC 080	DCN040711

Section 8 Electrical Parts List

CIRCUIT REFERENCE	DESCRIPTION	IWATSU PART NO.	CIRCUIT REFERENCE	DESCRIPTION	IWATSU PART NO.
CH1 PRE-AMPLIFIER (2)			3R19	Same as 3R18	
			3R20	Same as 3R18	
3C16	Cap., 1000p, $\pm 10\%$, 50V, Poly.	DCF129071	3R21	Res., 12k, $\pm 5\%$, $\frac{1}{4}W$, Carbon	DRD139601
3C17	Same as 3C16		3R22	Res., 2.7k, $\pm 5\%$, $\frac{1}{4}W$, Carbon	DRD139481
3C21	Cap., 470p, $\pm 5\%$, 50V, Cer.	DCC239151	3R23	Res., 820, $\pm 5\%$, $\frac{1}{4}W$, Carbon	DRD139941
3C22	Cap., 47p, $\pm 5\%$, 50V, Cer.	DCC239031	3R24	Res., 500, Var., 0.3W, Cermet	DRV412021
3C23	Cap., 2.5 ~ 22.5p, 250V, Cer.	DCV019592	3R25	Res., 120, $\pm 1\%$, $\frac{1}{4}W$, Metal	DRE535271
3C24	Cap., 2 ~ 12p, 250V, Cer.	DCV019602	3R26	Res., 470, $\pm 1\%$, $\frac{1}{4}W$, Metal	DRE535411
3C27	Cap., 0.01 μ , +80%, ~ -20%, 50V, Cer.	DCC139501	3R27	Same as 3R26	
			3R28	Res., 3.9k, $\pm 5\%$, $\frac{1}{4}W$, Carbon	DRD139521
3C28	Cap., 120p, $\pm 5\%$, 50V, Cer.	DCC239261	3R29	Same as 3R18	
3C32	Same as 3C23		3R31	Res., 47, $\pm 1\%$, $\frac{1}{4}W$, Metal	DRE939511
3C33	Cap., 30p, $\pm 5\%$, 50V, Cer.	DCC232701	3R32	Res., 100, Var., 0.3W, Cermet	DRV412001
3C34	Cap., 180p, $\pm 5\%$, 50V, Cer.	DCC239371	3R33	Res., 510, $\pm 5\%$, $\frac{1}{4}W$, Carbon	DRD139381
3C35	Same as 3C16		3R34	Res., 1.3k, $\pm 5\%$, $\frac{1}{4}W$, Carbon	DRD138751
3C41	Same as 3C27		3R35	Res., 10k, $\pm 5\%$, $\frac{1}{4}W$, Carbon	DRD139161
3C43	Same as 3C22		3R41	Res., 2.7k, $\pm 1\%$, $\frac{1}{4}W$, Metal	DRE939651
3C45	Cap., 39p, $\pm 5\%$, 50V, Cer.	DCC239131	3R42	Res., 68, $\pm 5\%$, $\frac{1}{4}W$, Carbon	DRD139841
3C51	Same as 3C27		3R43	Same as 3R18	
3C52	Same as 3C27		3R45	Same as 3R18	
3C61	Cap., 6p, $\pm 0.5p$, 50V, Cer.	DCC239091	3R46	Same as 3R41	
3C64	Cap., 22 μ , $\pm 30\%$, 25V, Elect.	DCE229041	3R47	Same as 3R32	
3C81	Same as 3C16		3R51	Res., 560, $\pm 1\%$, $\frac{1}{4}W$, Metal	DRE939141
3C90	Cap., 10p, $\pm 0.5p$, 50V, Cer.	DCC239041	3R52	Res., 5.6k, $\pm 1\%$, $\frac{1}{4}W$, Metal	DRE939671
3C94	Cap., 39p, $\pm 5\%$, 50V, Cer.	DCC239131	3R53	Res., 47, $\pm 5\%$, $\frac{1}{4}W$, Carbon	DRD139261
3C95	Same as 3C16		3R54	Res., 560, $\pm 5\%$, $\frac{1}{4}W$, Carbon	DRD139121
3C96	Cap., 100p, $\pm 5\%$, 50V, Cer.	DCC239051	3R55	Res., 470, $\pm 5\%$, $\frac{1}{4}W$, Carbon	DRD139371
3C101	Same as 3C27		3R56	Res., 5k, Var., 0.3W, Cermet	DRV412051
3C102	Same as 3C27		3R57	Same as 3R54	
3C103	Cap., 56p, $\pm 5\%$, 50V, Cer	DCC239251	3R61	Res., 47, $\pm 1\%$, $\frac{1}{4}W$, Metal	DRE939511
3C104	Same as 3C27		3R62	Same as 3R61	
3C106	Same as 3C45		3R63	Res., 2.2k, $\pm 1\%$, $\frac{1}{4}W$, Metal	DRE939021
3C107	Same as 3C27		3R64	Res., 680, $\pm 1\%$, $\frac{1}{4}W$, Metal	DRE939631
			3R65	Res., 47k, $\pm 1\%$, $\frac{1}{4}W$, Metal	DRE535171
3R11	Res., 330, $\pm 5\%$, $\frac{1}{4}W$, Carbon	DRD139351	3R71	Res., 100, $\pm 5\%$, $\frac{1}{4}W$, Carbon	DRD139291
3R12	Res., 2.2k, $\pm 1\%$, $\frac{1}{4}W$, Metal	DRE535571	3R72	Res., 100, $\pm 1\%$, $\frac{1}{4}W$, Metal	DRE535251
3R13	Same as 3R12		3R73	Res., 3.3k, $\pm 5\%$, $\frac{1}{4}W$, Carbon	DRD139501
3R14	Res., 22, $\pm 5\%$, $\frac{1}{4}W$, Carbon	DRD139261	3R74	Same as 3R71	
3R15	Same as 3R14		3R75	Same as 3R73	
3R16	Res., 160, $\pm 5\%$, $\frac{1}{4}W$, Carbon	DRD139111	3R76	Same as 3R65	
3R17	Same as 3R17		3R77	Same as 3R65	
3R18	Res., 27k, $\pm 1\%$, $\frac{1}{4}W$, Metal	DRE535111	3R81	Res., 150, $\pm 5\%$, $\frac{1}{4}W$, Carbon	DRD139101

CIRCUIT REFERENCE	DESCRIPTION	IWATSU PART NO.	CIRCUIT REFERENCE	DESCRIPTION	IWATSU PART NO.
3R82	Res., 470, $\pm 1\%$, $\frac{1}{4}W$, Metal	DRE939121	3D43	Diode, 1S953,	DDD010821
3R83	Res., 1k, Var., 0.3W, Cermet	DRV412031	3D82	Same as 3D43	
3R84	Res., 1.5k, $\pm 5\%$, $\frac{1}{4}W$, Carbon	DRD139431			
3R85	Same as 3R14		3Q 11	Transistor, 2SC1907	DTR139061
3R86	Res., 390, $\pm 5\%$, $\frac{1}{4}W$, Carbon	DRD139361	3Q12	Same as 3Q11	
3R90	Same as 3R11		3Q13	Transistor, 2SC2037	DTR137591
3R91	Res., 100, $\pm 1\%$, $\frac{1}{4}W$, Metal	DRE939561	3Q14	Same as 3Q13	
3R92	Same as 3R84		3Q21	Same as 3Q13	
3R93	Same as 3R92		3Q22	Same as 3Q13	
3R94	Res., 22, $\pm 5\%$, $\frac{1}{4}W$, Carbon	DRD139231	3Q23	Same as 3Q13	
3R95	Same as 3R81		3Q31	Same as 3Q11	
3R96	Same as 3R65		3Q32	Same as 3Q11	
3R97	Res., 330, $\pm 1\%$, $\frac{1}{4}W$, Metal	DRE939621	3Q33	Same as 3Q13	
3R101	Same as 3R55		3Q34	Same as 3Q13	
3R102	Same as 3R84		3Q35	Same as 3Q13	
3R103	Res., 39, $\pm 1\%$, $\frac{1}{4}W$, Metal	DRE939501	3Q36	Same as 3Q11	
3R104	Same as 3R55		3Q41	Transistor, 2SA1015Y	DTR119011
3R105	Res., 1.2k, $\pm 5\%$, $\frac{1}{4}W$, Carbon	DRD139421	3Q42	Same as 3Q41	
3R106	Res., 47, $\pm 5\%$, $\frac{1}{4}W$, Carbon	DRD139261	3Q43	Same as 3Q41	
3R107	Res., 4.7k, $\pm 5\%$, Carbon	DRD139151			
3R111	Res., 11.8k, $\pm 5\%$, $\frac{1}{4}W$, Carbon	DRD139441	3J30	Connector, M36-M87-02	DCN034601
3R112	Same as 3R91		3J31	Connector, BNC CH1 OUT	DCN040711
3R113	Same as 3R24		3J50	Connector, M31-M87-10	DCN034531
3R114	Same as 3R35		3J100	Same as 3J30	
3R115	Same as 3R111				
3R116	Same as 3R107		3P30	Connector, M36-02-30-1349	DCN034901
3R117	Same as 3R83		3P50	Connector, M33-10-30-114P	DCN034721
3R118	Same as 3R84		3P100	Same as 3P30	

CIRCUIT REFERENCE	DESCRIPTION	IWATSU PART NO.	CIRCUIT REFERENCE	DESCRIPTION	IWATSU PART NO.
CH2 PRE-AMPLIFIER (2)			4R28	Res., 3.9k, $\pm 5\%$, $\frac{1}{4}W$, Carbon	DRD139521
4C14	Cap., 1000p, $\pm 10\%$, 50V, Poly.	DCF129071	4R31	Res., 47, $\pm 1\%$, $\frac{1}{4}W$, Metal	DRE939511
4C15	Same as 4C14		4R32	Res., 100, Var., 0.3W, Cermet	DRV412001
4C17	Cap., 0.01 μ , +80% -20%, 50V, Cer.	DCC139501	4R33	Res., 430, $\pm 5\%$, $\frac{1}{4}W$, Carbon	DRD138741
4C21	Cap., 470p, $\pm 5\%$, 50V, Cer.	DCC239151	4R34	Res., 1.3k, $\pm 5\%$, $\frac{1}{4}W$, Carbon	DRD139751
4C22	Cap., 47p, $\pm 5\%$, 50V, Cer.	DCC239031	4R35	Res., 10k, $\pm 5\%$, $\frac{1}{4}W$, Carbon	DRD193161
4C23	Cap., 2.5 ~22.5p, Var., 250V, Cer.	DCV019592	4R41	Res., 2.7k, $\pm 1\%$, $\frac{1}{4}W$, Metal	DRE939651
4C24	Cap., 2 ~12p, Var., 250V, Cer.	DCV019602	4R42	Res., 68, $\pm 5\%$, $\frac{1}{4}W$, Carbon	DRD139841
4C28	Cap., 120p, $\pm 5\%$, 50V Cer.	DCC239261	4R43	Same as 4R18	
4C32	Same as 4C23		4R45	Same as 4R18	
4C33	Cap., 30p, $\pm 5\%$, 50V, Cer.	DCC232701	4R46	Same as 4R41	
4C34	Cap., 180p, $\pm 5\%$, 50V, Cer.	DCC239271	4R47	Same as 4R32	
4C35	Same as 4C14		4R50	Res., 47, $\pm 1\%$, $\frac{1}{4}W$, Metal	DRE535171
4C43	Cap., 47p, $\pm 5\%$, 50V, Cer.	DCC239031	4R51	Res., 560, $\pm 1\%$, $\frac{1}{4}W$, Metal	DRE939141
4C45	Cap., 39p, $\pm 5\%$, 50V, Cer.	DCC239131	4R52	Res., 5.6k, $\pm 1\%$, $\frac{1}{4}W$, Metal	DRE939671
4C46	Same as 4C17		4R53	Same as 4R50	
4C51	Same as 4C17		4R54	Res., 560, $\pm 5\%$, $\frac{1}{4}W$, Carbon	DRD139121
4C65	Same as 4C17		4R55	Res., 470, $\pm 5\%$, $\frac{1}{4}W$, Carbon	DRD139371
4C67	Same as 4C17		4R56	Res., 5k, Var., 0.3W, Cermet	DRV412051
4C82	Same as 4C33		4R57	Same as 4R54	
4C91	Same as 4C17		4R58	Res., 47, $\pm 5\%$, $\frac{1}{4}W$, carbon	DRD134511
4R8	Res., 47, $\pm 5\%$, $\frac{1}{4}W$, Carbon	DRD139261	4R59	Same as 4R58	
4R10	Same as 4R8		4R60	Same as 4R50	
4R11	Res., 330, $\pm 5\%$, $\frac{1}{4}W$, Carbon	DRD139351	4R61	Same as 4R50	
4R12	Res., 2.2k, $\pm 1\%$, $\frac{1}{4}W$, Metal	DRE535571	4R62	Same as 4R50	
4R13	Same as 4R12		4R64	Same as 4R50	
4R14	Res., 160, $\pm 5\%$, $\frac{1}{4}W$, Carbon	DRD139111	4R65	Res., 2.2k, $\pm 1\%$, $\frac{1}{4}W$, Metal	DRE939021
4R15	Same as 4R14		4R66	Res., 680, $\pm 1\%$, $\frac{1}{4}W$, Metal	DRE939631
4R16	Res., 470, $\pm 1\%$, $\frac{1}{4}W$, Metal	DRE535411	4R67	Same as 4R65	
4R17	Same as 4R16		4R68	Same as 4R66	
4R18	Res., 27, $\pm 1\%$, $\frac{1}{4}W$, Metal	DRE535111	4R69	Same as 4R50	
4R19	Same as 4R18		4R71	Res., 100, $\pm 5\%$, $\frac{1}{4}W$, Carbon	DRD139291
4R20	Same as 4R18		4R72	Same as 4R71	
4R21	Res., 12k, $\pm 5\%$, $\frac{1}{4}W$, Carbon	DRD139601	4R73	Res., 3.3k, $\pm 5\%$, $\frac{1}{4}W$, Carbon	DRD139501
4R22	Res., 2.7k, $\pm 5\%$, $\frac{1}{4}W$, Carbon	DRD139481	4R74	Same as 4R71	
4R23	Res., 620, $\pm 5\%$, $\frac{1}{4}W$, Carbon	DRD139131	4R75	Same as 4R73	
4R24	Res., 500, Var., 0.3W, Cermet	DRV412021	4R76	Same as 4R8	
4R25	Res., 120, $\pm 1\%$, $\frac{1}{4}W$, Metal	DRE535271	4R77	Same as 4R8	
4R27	Same as 4R18		4R81	Res., 100, $\pm 1\%$, $\frac{1}{4}W$, Metal	DRE939561
			4R82	Res., 15, $\pm 5\%$, $\frac{1}{4}W$, Carbon	DRD139221
			4R83	Res., 1.5k, $\pm 5\%$, $\frac{1}{4}W$, Carbon	DRD139431
			4R84	Same as 4R83	

CIRCUIT REFERENCE	DESCRIPTION	IWATSU PART NO.	CIRCUIT REFERENCE	DESCRIPTION	IWATSU PART NO.
4R85	Res., 470k, $\pm 1\%$, $\frac{1}{4}W$, Metal	DRE939121	4Q11	Transistor, 2SC1970	DTR139061
4R86	Same as 4R83		4Q12	Same as 4Q11	
4R87	Res., 1k, Var., 0.3k, Cermet	DRV412031	4Q13	Transistor, 2SC2037	DTR137591
4R90	Same as 4R50		4Q14	Same as 4Q13	
4R91	Same as 4R55		4Q21	Same as 4Q13	
4R92	Same as 4R83		4Q22	Same as 4Q13	
4R93	Same as 4R50		4Q23	Transistor, 2SC2073	DTR137631
4D85	Diode, 1S953	DDD010821	4Q24	Same as 4Q23	
			4Q25	Same as 4Q23	
			4Q26	Same as 4Q23	
			4Q31	Same as 4Q11	
			4Q32	Same as 4Q11	
			4Q33	Same as 4Q11	
			4Q34	Same as 4Q11	
			4Q35	Same as 4Q11	
			4J51	Connector, M31-M87-07	DCN034501
			4J90	Connector, M36-M87-02	DCN034601
			4P51	Connector, M33-07-30-114P	DCN034691
			4P90	Connector, M36-02-30-1349	DCN034901

CIRCUIT REFERENCE	DESCRIPTION	IWATSU PART NO.	CIRCUIT REFERENCE	DESCRIPTION	IWATSU PART NO.
DELAY CABLE DRIVER			5R31	Same as 5R25	
5C11	Cap., 100p, $\pm 5\%$, 50V, Cer.	DCC239051	5R32	Res., 120, $\pm 5\%$, $\frac{1}{4}W$, Carbon	DRD139301
5C13	Cap., 14p, $\pm 5\%$, 50V, Cer.	DCC239221	5R33	Res., 100, Var., 0.3W, Cermet	DRV412001
5C15	Same as 5C11		5R34	Res., 2.2k, $\pm 5\%$, $\frac{1}{4}W$, Carbon	DRD139461
5C21	Cap., 0.01 μ , +80% -20%, 50V, Cer.	DCC139501	5R35	Same as 5R34,	
5C26	Cap., 1000p, $\pm 10\%$, 50V, Poly.	DCF129071	5R36	Res., 500, Var., 0.3W, Cermet	DRV412021
5C27	Same as 5C26		5R37	Res., 4.7k, $\pm 5\%$, $\frac{1}{4}W$, Cermet	DRD139151
5C31	Cap., 10p, $\pm 0.5\%$, 50V, Cer.	DCC239041	5R41	Same as 5R21	
5C32	Cap., 2 ~42p, Var., 250V, Cer.	DCV019581	5R42	Same as 5R22	
5C37	Cap., 33p, $\pm 5\%$, 50V, Cer.	DCC239011	5R43	Res., 120, $\pm 1\%$, $\frac{1}{4}W$, Metal	DRE535271
5C41	Same as 5C21		5R44	Same as 5R22	
5C46	Same as 5C26		5R45	Same as 5R22	
5C47	Same as 5C26		5R46	Same as 5R26	
5C51	Cap., 150p, $\pm 5\%$, 50V, Cer.	DCC239221	5R47	Same as 5R26	
5C52	Cap., 2.5 ~22.5p, Var., 250V, Cer.	DCV019531	5R51	Same as 5R22	
5C57	Same as 5C37		5R52	Same as 5R43	
5C82	Cap., 4 ~34p, Var., 250V, Cer.	DCV019541	5R53	Same as 5R33	
5C83	Same as 5C26		5R54	Same as 5R34	
5C84	Same as 5C26		5R55	Same as 5R35	
5C85	Cap., 22 μ , $\pm 30\%$, 250V, Elect.	DCE229041	5R56	Same as 5R36	
5C91	Same as 5C13		5R57	Same as 5R37	
5C92	Same as 5C13		5R61	Same as 5R22	
5C93	Cap., 150p, $\pm 5\%$, 50V, Cer.	DCC239011	5R62	Same as 5R22	
5C94	Same as 5C93		5R63	Same as 5R25	
5C95	Same as 5C21		5R64	Same as 5R25	
5C112	Same as 5C21		5R65	Res., 1.2k, $\pm 1\%$, $\frac{1}{4}W$, Metal	DRE939291
5DL90	Delay cable, CD -3, 80cm	KHB048111	5R66	Same as 5R65	
5R11	Res., 15, $\pm 5\%$, $\frac{1}{4}W$, Carbon	DRD139221	5R71	Res., 120, $\pm 1\%$, $\frac{1}{4}W$, Metal	DRE939571
5R12	Same as 5R11		5R72	Same as 5R71	
5R13	Same as 5R11		5R73	Res., 1.5k, $\pm 1\%$, $\frac{1}{4}W$, Metal	DRE939641
5R14	Same as 5R11		5R74	Same as 5R73	
5R21	Res., 10k, $\pm 5\%$, $\frac{1}{4}W$, Carbon	DRD139161	5R75	Res., 180, $\pm 1\%$, $\frac{1}{4}W$, Metal	DRE939591
5R22	Res., 47, $\pm 1\%$, $\frac{1}{4}W$, Metal	DRE535171	5R76	Same as 5R75	
5R23	Res., 120, $\pm 5\%$, $\frac{1}{4}W$, Carbon	DRD139301	5R77	Res., 220, $\pm 1\%$, $\frac{1}{4}W$, Metal	DRE939601
5R24	Same as 5R22		5R82	Res., 500, Var., 0.3W, Cermet	DRV412021
5R25	Res., 47, $\pm 5\%$, $\frac{1}{4}W$, Carbon	DRD139261	5R83	Res., 180, $\pm 5\%$, $\frac{1}{4}W$, Carbon	DRD139961
5R26	Res., 330, $\pm 5\%$, $\frac{1}{4}W$, Carbon	DRD139351	5R84	Same as 5R83	
5R27	Same as 5R26		5R85	Res., 1.8k, $\pm 1\%$, $\frac{1}{4}W$, Metal	DRE939171
			5R86	Same as 5R85	
			5R87A	Res., 10, $\pm 5\%$, $\frac{1}{4}W$, Carbon	DRD139211
			5R87B	Same as 5R77	
			5R88	Same as 5R87A	

CIRCUIT REFERENCE	DESCRIPTION	IWATSU PART NO.	CIRCUIT REFERENCE	DESCRIPTION	IWATSU PART NO.
5R91	Same as 5R63		5Q11	Transistor, 2SC2037	DTR137591
5R92	Same as 5R63		5Q12	Same as 5Q11	
5R93	Res., 100k, $\pm 5\%$, $\frac{1}{4}W$, Carbon	DRD139751	5Q13	Same as 5Q11	
5R94	Res., 1k, $\pm 5\%$, $\frac{1}{4}W$, Carbon	DRD139141	5Q14	Same as 5Q11	
5R95	Same as 5R93		5Q21	Same as 5Q11	
5R96	Same as 5R94		5Q22	Same as 5Q11	
5R101	Same as 5R25		5Q23	Transistor, 2SA1206	DTR119041
5R102	Same as 5R25		5Q24	Same as 5Q23	
5R103	Same as 5R94		5Q25	Same as 5Q23	
5R104	Same as 5R32		5Q61	Transistor, 2SC1834	DTR131031
5R105	Same as 5R94		5Q62	Same as 5Q61	
5R106	Res., 220, $\pm 5\%$, $\frac{1}{4}W$, Carbon	DRD139321			
5R107	Res., 2.2k, $\pm 5\%$, $\frac{1}{4}W$, Carbon	DRD139461	5J21	Connector, M36-M87-03	DCN034611
5R111	Res., 1k, Var., 0.3W, Cermet	DRV412031	5J41	Same as 5J21	
5R112	Res., 470, $\pm 5\%$, $\frac{1}{4}W$, Carbon	DRD139371	5J100	Connector, M36-M87-02	DCN034601
5R113	Same as 5R25				
5R114	Res., 820, $\pm 5\%$, $\frac{1}{4}W$, Carbon	DRD139941	5P21	Connector, M36-03-30-134P	DCN034911
			5P41	Same as 5P21	
5D11	Diode, 1SS16	DDD010411	5P91	Connector, M33-04-30-114P	DCN034661
5D12	Same as 5D11		5P100	Connector, M36-02-30-134P	DCN034901
5D13	Diode, 1S953	DDD010821			
5D14	Same as 5D13				
5D15	Same as 5D11				
5D16	Same as 5D11				
5D17	Same as 5D13				
5D18	Same as 5D13				
5D61	Same as 5D13				
5D64	Same as 5D13				
5D65	Same as 5D13				
5D68	Same as 5D13				
5D91	Same as 5D13				
5D92	Same as 5D13				
5D93	Same as 5D13				
5D106	Same as 5D13				

CIRCUIT REFERENCE	DESCRIPTION	IWATSU PART NO.	CIRCUIT REFERENCE	DESCRIPTION	IWATSU PART NO.
VERTICAL PANEL SWITCHES			6D11	L.E.D., TLR206	DDD070101
6C11	Cap., 0.01 μ , +80%, ~ -20%, 50V, Cer.	DCC139501	6D12	Same as 6D11	
6C31	Same as 6C11		6D13	Same as 6D11	
6C41	Same as 6C11		6D14	Diode, 1S953	DDD010821
6R11	Res., 10k, \pm 5%, $\frac{1}{4}$ W, Carbon	DRD139161	6D31	Same as 6D14	
6R12	Res., 1k, \pm 5%, $\frac{1}{4}$ W, Carbon	DRD139141	6D41	Same as 6D14	
6R13	Same as 6R12		6D42	Same as 6D14	
6R14	Same as 6R11		6Q11	Transistor, 2SC1815GR	DTR139011
6R15	Same as 6R11		6Q12	Same as 6Q11	
6R21	Res., 3.3k, \pm 5%, $\frac{1}{4}$ W, Carbon	DRD139501	6Q31	Same as 6Q11	
6R22	Res., B5k, Var., 0.05W, Carbon	DRV147381	6Q32	Same as 6Q11	
6R23	Res., 1.8k, \pm 5%, $\frac{1}{4}$ W, Carbon	DRD139441	6Q41	Same as 6Q11	
6R24	Same as 6R21		6S12	Push switch, SVJ12A,	DSW014831
6R25	Same as 6R22		6S20	Same as 6S12	
6R26	Same as 6R23		6J21	Connector, M31-M87-10	DCN034531
6R31	Same as 6R11		6J22	Connector, M31-M87-08	DCN034511
6R32	Same as 6R12		6P21	Connector, M33-10-30-134P	DCN034821
6R33	Same as 6R12		6P22	Connector, M33-08-30-134P	DCN034801
6R34	Same as 6R11				
6R35	Same as 6R11				
6R41	Res., 4.7k, \pm 5%, $\frac{1}{4}$ W, Carbon	DRD139151			
6R42	Same as 6R41				
6R43	Same as 6R23				

CIRCUIT REFERENCE	DESCRIPTION	IWATSU PART NO.	CIRCUIT REFERENCE	DESCRIPTION	IWATSU PART NO.
VERTICAL CONTROL			7R51	Res., 2.2k, $\pm 1\%$, $\frac{1}{4}W$, Metal	DRE939021
7C10	Cap., 0.01 μ , $+80\% \sim -20\%$, 50V, Cer.	DCC139501	7R52	Same as 7R32	
7C12	Cap., 100 p, $\pm 5\%$, 50V, Cer.	DCC239051	7R53	Same as 7R33	
7C13	Same as 7C10		7R54	Same as 7R34	
7C14	Same as 7C10		7R55	Same as 7R35	
7C15	Same as 7C10		7R61	Same as 7R51	
7C16	Cap., 33 μ , $\pm 20\%$, 16V, Elect.	DCE229011	7R62	Same as 7R32	
7C17	Same as 7C16		7R63	Same as 7R33	
7C18	Same as 7C10		7R64	Same as 7R34	
7C21	Same as 7C10		7R65	Same as 7R35	
7C22	Same as 7C12		7RA1	Resistor, Array, 8-22-k Ω J	DFB015641
7C23	Same as 7C12		7Q11	Transistor, 2SC1815GR	DTR139011
7C24	Cap., 570P, $\pm 5\%$, 50V, Cer.	DCC239151	7Q12	Same as 7Q11	
7C25	Cap., 330P, $\pm 5\%$, 50V, Cer.	DCC239181	7Q13	Same as 7Q11	
7C31	Cap., 27P, $\pm 5\%$, 50V, Cer.	DCC239241	7Q14	Same as 7Q11	
7C41	Same as 7C31		7Q15	Same as 7Q11	
7C45	Cap., 22 μ , $\pm 20\%$, 25V, Elect.	DCE229041	7IC1	IC, SN74LS26N	DIC140271
7C70	Same as 7C10		7IC2	IC, SN74LS00N	DIC140041
7C71	Same as 7C45		7IC3	IC, SN74LS11N	DIC140121
7C72	Same as 7C10		7IC4	Same as 7IC1	
7R21	Res., 8.2k, $\pm 5\%$, $\frac{1}{4}W$, Carbon	DRD139581	7IC5	IC, SN74LS04N	DIC140051
7R22	Res., 1.8k, $\pm 5\%$, $\frac{1}{4}W$, Carbon	DRD139441	7IC6	IC, SN74LS112N	DIC141111
7R23	Same as 7R21		7S10	Push switch, SUJ50A	DSW014921
7R24	Same as 7R22		7J11	Connector, M36-M87-06	DCN034641
7R25	Res., 1.5k, $\pm 5\%$, $\frac{1}{4}W$, Carbon	DRD193431	7J12	Same as 7J11	
7R26	Res., 560, $\pm 5\%$, $\frac{1}{4}W$, Carbon	DRD139121	7J20	Connector, M36-M87-04	DCN034621
7R27	Res., 1k, $\pm 5\%$, $\frac{1}{4}W$, Carbon	DRD139141	7J51	Connector, M36-M87-05	DCN035631
7R31	Res., 2.7k, $\pm 1\%$, $\frac{1}{4}W$, Metal	DRE939651	7P11	Connector, M36-06-30-114P	DCN034891
7R32	Res., 4.7k, $\pm 1\%$, $\frac{1}{4}W$, Metal	DRE939471	7P12	Same as 7P11	
7R33	Res., 6.8k, $\pm 1\%$, $\frac{1}{4}W$, Metal	DRE939331	7P20	Connector, M36-04-30-114P	DCN034871
7R34	Res., 100, $\pm 5\%$, $\frac{1}{4}W$, Carbon	DRD139291	7P51	Connector, M36-05-30-114P	DCN034881
7R35	Res., 10k, $\pm 5\%$, $\frac{1}{4}W$, Carbon	DRD139161			
7R41	Same as 7R31				
7R42	Same as 7R32				
7R43	Same as 7R33				
7R44	Same as 7R34				
7R45	Same as 7R35				

CIRCUIT REFERENCE	DESCRIPTION	IWATSU PART NO.	CIRCUIT REFERENCE	DESCRIPTION	IWATSU PART NO.
VERTICAL OUTPUT AMPLIFIER			8R9	Res., 390, $\pm 5\%$, $\frac{1}{4}W$, Carbon	DRD134731
8C11	Cap., 0.01 μ , $+80\% \sim -20\%$, 50V, Cer.	DCC139501	8R10	Res., 5k, Var., 0.3W, Cermet	DRV412051
8C12	Cap., 4p, $+80\% \sim -20\%$, 50V, Cer.	DCC239201	8R11	Res., 120, $\pm 1\%$, $\frac{1}{4}W$, Metal	DRE130611
8C13	Same as 8C12		8R12	Same as 8R11	
8C21	Cap., 1000p, $\pm 10\%$, 50V, Poly.	DCF129071	8R13	Res., 47, $\pm 5\%$, $\frac{1}{4}W$, Carbon	DRD139261
8C22	Same as 8C21		8R14	Same as 8R13	
8C23	Cap., 33p, $+80\% \sim -20\%$, 50V, Cer.	DCC239011	8R15	Res., 68, $\pm 1\%$, $\frac{1}{4}W$, Metal	DRE939531
8C26	Same as 8C11		8R16	Same as 8R15	
8C28	Same as 8C21		8R17	Res., 10k, $\pm 15\%$, Thermistor	DDD080431
8C31	Same as 8C11		8R21	Res., 470, $\pm 5\%$, $\frac{1}{4}W$, Carbon	DRD139371
8C33	Same as 8C23		8R22	Same as 8R21	
8C40	Cap., 10p, $+80\% \sim -20\%$, 50V, Cer.	DCC239041	8R23	Res., 22k, $\pm 5\%$, $\frac{1}{4}W$, Carbon	DRD139641
8C41	Cap., 22 μ , $+100\% \sim -10\%$, 25V, Elect.	DCE229041	8R24	Res., 100, $\pm 5\%$, Carbon	DRD139291
8C42	Same as 8C11		8R25	Res., 91, $\pm 1\%$, $\frac{1}{4}W$, Metal	DRE939551
8C45	Same as 8C21		8R26	Same as 8R15	
8C46	Same as 8C21		8R27	Res., 1.5k, $\pm 5\%$, $\frac{1}{4}W$, Carbon	DRD139431
8C51	Cap., 43P, $+80\% \sim -20\%$, 50V, Cer.	DCC239291	8R28	Same as 8R24	
8C53	Cap., 2.5 \sim 20.5P, Var., 250V, Cer.	DCV019531	8R31	Res., 10k, Var., 0.3W, Cermet	DRV411991
8C54	Cap., 2 \sim 12p, Var., 250V, Cer.	DCV019581	8R32	Res., 4.7k, $\pm 5\%$, $\frac{1}{4}W$, Carbon	DRD193151
8C56	Same as 8C41		8R33	Res., 10k, $\pm 5\%$, $\frac{1}{4}W$, Carbon	DRD193161
8C57	Same as 8C11		8R34	Same as 8R13	
8C61	Same as 8C11		8R35	Res., 1.8k, $\pm 5\%$, $\frac{1}{4}W$, Carbon	DRD139441
8C82	Same as 8C21		8R36	Same as 8R24	
8C83	Same as 8C21		8R40	Res., 330, $\pm 5\%$, $\frac{1}{4}W$, Carbon	DRD139351
8C84	Same as 8C21		8R41	Same as 8R13	
8C86	Same as 8C21		8R42	Res., 120, $\pm 1\%$, $\frac{1}{4}W$, Metal	DRE939571
8C91	Same as 8C11		8R43	Same as 8R42	
8C92	Same as 8C11		8R44	Same as 8R13	
8C93	Same as 8C11		8R45	Same as 8R24	
8L11	Matching coil	DCL150381	8R46	Same as 8R24	
8L12	Same as 8L11		8R47	Res., 1k, $\pm 5\%$, $\frac{1}{4}W$, Carbon	DRD134831
8L91	Peaking coil	DCL151301	8R51	Same as 8R32	
8L92	Same as 8L91		8R52	Res., 180, $\pm 5\%$, $\frac{1}{4}W$, Metal	DRE939591
			8R53	Res., 2.2k, $\pm 5\%$, $\frac{1}{4}W$, Carbon	DRD139461
			8R54	Res., 500, Var., 0.3W, Cermet	DRV412021
			8R55	Res., 390, $\pm 1\%$, $\frac{1}{2}W$, Metal	DRE949011
			8R56	Same as 8R55	
			8R61	Res., 2.7k, $\pm 1\%$, $\frac{1}{4}W$, Metal	DRE939651
			8R62	Res., 470, $\pm 1\%$, $\frac{1}{4}W$, Metal	DRE939121
			8R63	Res., 330, $\pm 1\%$, $\frac{1}{4}W$, Metal	DRE939621
			8R64	Res., 1k, Var., 0.3V, Cermet	DRV412031
			8R65	Same as 8R42	

CIRCUIT REFERENCE	DESCRIPTION	IWATSU PART NO.	CIRCUIT REFERENCE	DESCRIPTION	IWATSU PART NO.
8R66	Same as 8R42		8D11	Diode, 1SV69	DDD019011
8R67	Res., 27, $\pm 5\%$, $\frac{1}{4}W$, Carbon	DRD139071	8D12	Diode, 1S953	DDD010821
8R68	Same as 8R67		8D41	Z.Diode, RD7.5EB	DDD031811
8R71	Res., 1.5k, $\pm 1\%$, $\frac{1}{4}W$, Metal	DRE939641	8D81	Z. Diode, RD4.7EB1	DDD033131
8R72	Res., 5.6k, $\pm 1\%$, $\frac{1}{4}W$, Metal	DRE939671	8D85	Same as 8D81	
8R73	Res., 47, $\pm 5\%$, $\frac{1}{4}W$, Carbon	DRD139261	8Q11	Transistor, 2SA800	DTR115701
8R74	Res., 330, $\pm 1\%$, $\frac{1}{4}W$, Metal	DRE939621	8Q12	Same as 8R11	
8R75	Res., 39, $\pm 1\%$, $\frac{1}{4}W$, Metal	DRE939501	8Q13	Transistor, 2SA1206	DTR119041
8R76	Same as 8R74		8Q14	Same as 8Q13	
8R77	Same as 8R73		8Q15	Transistor, 2SC1907	DTR139061
8R81	Res., 22, $\pm 5\%$, $\frac{1}{4}W$, Carbon	DRD139231	8Q16	Transistor, 2SA1015Y	DTR119011
8R82	Same as 8R52		8Q21	Transistor, 2SC2408	MHN000481
8R83	Res., 150, $\pm 1\%$, $\frac{1}{4}W$, Metal	DRE939581	8Q22	Same as 8Q21	
8R84	Same as 8R52		8Q23	Same as 8Q21	
8R85	Same as 8R81		8Q24	Same as 8Q21	
8R86	Same as 8R83		8Q25	Same as 8Q21	
8R91	Same as 8R75		8Q26	Same as 8Q21	
8R92	Res., 270, $\pm 1\%$, $\frac{1}{4}W$, Metal	DRE939611	8Q27	Transistor, 2SC1815GR	DTR139011
8R93	Same as 8R92		8Q31	Same as 8Q21	
8R94	Res., 270, $\pm 5\%$, $\frac{1}{4}W$, Carbon	DRD139331	8Q32	Same as 8Q21	
8R95	Res., 180, $\pm 5\%$, $\frac{1}{4}W$, Carbon	DRD139961	8Q33	Transistor, 2SC1412	DTR130901
8R96	Same as 8R95		8Q34	Same as 8Q33	
8R101	Res., 120, $\pm 2\%$, 1W, Metal	DRE153511	8P11	Connector, M33-04-30-114P	DCN034661
8R102	Res., 240, $\pm 2\%$, 2W, Metal	DRE163581			
8R103	Same as 8R102				
8R104	Same as 8R101				

CIRCUIT REFERENCE	DESCRIPTION	IWATSU PART NO.	CIRCUIT REFERENCE	DESCRIPTION	IWATSU PART NO.
CH3 & CH4PRE—AMPLIFIER & SOURCE			9R1	Res., 470, $\pm 5\%$, $\frac{1}{4}W$, Carbon	DRD139371
9C1	Cap., 0.47 μ , $\pm 20\%$, 200V, Poly.	DCF160291	9R3	Res., 900k, $\pm 0.5\%$, $\frac{1}{2}W$, Metal	DRE249031
9C2	Cap., 2 \sim 12p, Var., 250V, Cer.	DCV019581	9R4	Res., 111k, $\pm 0.5\%$, $\frac{1}{4}W$, Metal	DRE239011
9C3	Same as 9C2		9R5	Res., 180, $\pm 5\%$, $\frac{1}{4}W$, Carbon	DRD139961
9C4	Cap., 47p, $\pm 5\%$, 100V, Cer.	DCC249511	9R6	Res., 82, $\pm 5\%$, $\frac{1}{4}W$, Carbon	DRD139981
9C5	Cap., 22p, $\pm 5\%$, 50V, Cer.	DCC239121	9R7	Res., 500k, $\pm 0.5\%$, $\frac{1}{2}W$, Metal	DRE249021
9C7	Cap., 27p, $\pm 5\%$, 300V, Mica	DCM252311	9R8	Res., 22, $\pm 1\%$, $\frac{1}{4}W$, Metal	DRE535091
9C8	Same as 9C2		9R21	Same as 9R1	
9C21	Same as 9C1		9R23	Same as 9R3	
9C22	Cap., 2 \sim 12p, Var., 250V, Cer.	DCV019581	9R24	Same as 9R4	
9C23	Same as 9C22		9R25	Same as 9R5	
9C24	Same as 9C4		9R26	Same as 9R6	
9C25	Same as 9C5		9R27	Same as 9R7	
9C27	Same as 9C7		9R28	Same as 9R8	
9C28	Same as 9C22		9R40	Res., 500k, $\pm 0.5\%$, $\frac{1}{2}W$, Metal	DRE249021
9C41	Cap., 0.01 μ , $+80\% \sim -20\%$, 50V, Cer.	DCC139501	9R41	Res., 47, $\pm 5\%$, $\frac{1}{4}W$, Carbon	DRD139261
9C42	Cap., 56p, $+80\% \sim -20\%$, 50V, Cer.	DCC239251	9R42	Res., 100, $\pm 1\%$, $\frac{1}{4}W$, Metal	DRE939561
9C43	Cap., 57p, $\pm 20\%$, 25V, Elect.	DCE229061	9R43	Same as 9R41	
9C45	Same as 9C41		9R44	Res., 47, $\pm 1\%$, $\frac{1}{4}W$, Metal	DRE939511
9C51	Same as 9C41		9R45	Res., 100, Var., 0.3W, Cermet	DRV412121
9C54	Same as 9C41		9R46	Same as 9R45	
9C57	Same as 9C41		9R51	Res., 22, $\pm 5\%$, $\frac{1}{4}W$, Carbon	DRD139231
9C58	Same as 9C41		9R52	Res., 1.2k, $\pm 1\%$, $\frac{1}{4}W$, Metal	DRE939291
9C62	Same as 9C41		9R53	Same as 9R52	
9C63	Same as 9C43		9R54	Same as 9R44	
9C71	Same as 9C41		9R55	Same as 9R44	
9C72	Same as 9C42		9R56	Res., 150, $\pm 1\%$, $\frac{1}{4}W$, Metal	DRE939581
9C73	Same as 9C41		9R57	Res., 3.3k, $\pm 1\%$, $\frac{1}{4}W$, Metal	DRE939661
9C74	Same as 9C41		9R58	Res., 20k, Var., 0.05W, Carbon	DRV131411
9C75	Same as 9C41		9R62	Same as 9R41	
9C81	Same as 9C41		9R63	Same as 9R44	
9C84	Same as 9C41		9R64	Same as 9R44	
9C85	Same as 9C43		9R67	Same as 9R57	
9C87	Same as 9C41		9R68	Same as 9R41	
9C88	Same as 9C41		9R70	Same as 9R40	
9C91	Same as 9C43		9R71	Same as 9R41	
			9R72	Same as 9R42	
			9R73	Same as 9R41	
			9R81	Same as 9R51	

CIRCUIT REFERENCE	DESCRIPTION	IWATSU PART NO.	CIRCUIT REFERENCE	DESCRIPTION	IWATSU PART NO.
9R82	Same as 9R52		9J1	Connector, BNC	DCN040711
9R83	Same as 9R52		9J2	Connector, M31C8-4	DCN034501
9R85	Res., 47, $\pm 1\%$, $\frac{1}{4}W$, Metal	DRE939511	9J3	Same as 9J2	
9R86	Same as 9R56		9J21	Same as 9J1	
9R87	Same as 9R57		9J22	Same as 9J2	
9R88	Same as 9R58		9J23	Same as 9J2	
9R98	Same as 9R41		9J51	Connector, M36-M87-06	DCN034641
			9J61	Connector, M36-M87-03	DCN034611
9D41	Diode 1S1544A	DDD010801	9J81	Connector, M36-M87-04	DCN034621
9D71	Same as 9Q51		9J91	Same as 9J61	
9D74	Diode, RD5.6EBI	DDD031141			
			9P2	Connector, M36-02-30-134P	DCN034901
9Q41	Twin-transistor, μ PA61AM	DTR295281	9P3	Same as 9P2	
9Q51	Transistor, 2N3905	DTR150011	9P22	Same as 9P2	
9Q53	Transistor, 2SC2037	DTR137591	9P23	Same as 9P2	
9Q57	Transistor, 2SC1907	DTR137611	9P51	Connector, M36-06-30-134P	DCN034941
9Q71	Same as 9Q41		9P61	Connector, M36-03-134P	DCN034911
9Q81	Same as 9Q51		9P81	Connector M36-06-30-134P	DCN034921
9Q83	Same as 9Q53		9P91	Same as 9P61	
9Q87	Same as 9Q57				
9S1	Coupling switch, SUJ25A	DSW014861			
9S22	Same as 9S1				
9S61	Push switch, SUJ45A	DSW014901			
9S91	Same as 9S61				

CIRCUIT REFERENCE	DESCRIPTION	IWATSU PART NO	CIRCUIT REFERENCE	DESCRIPTION	IWATSU PART NO.
A TRIGGER AMPLIFIER			10R31	Res., 33, $\pm 1\%$, $\frac{1}{4}W$, Metal	DRE939491
10C1	Cap., 1μ , $+150\% \sim -10\%$, 50V, Elect.	DCE244711	10R32	Res., 10, $\pm 5\%$, $\frac{1}{4}W$, Carbon	DRD139211
10C3	Cap., 47μ , $+150\% \sim -10\%$, 25V, Elect	DCE229061	10R33	Res., 2.7k, $\pm 1\%$, $\frac{1}{4}W$, Metal	DRE939651
10C2	Cap., 2200p, $\pm 10\%$, 50V, Poly	DCF129061	10R34	Same as 10R33	
10C12	Cap., 0.1μ , $\pm 10\%$, 50V, Poly	DCF129601	10R35	Res., 270, $\pm 5\%$, $\frac{1}{4}W$, Carbon	DRD139331
10C15	Cap., 56p, $\pm 5\%$, 50V, Cer.	DCC239051	10R36	Same as 10R15	
10C23	Cap., 0.01μ , $\pm 10\%$, 50V, Cer.	DCC133571	10R37	Same as 10R35	
10C32	Cap., 56p, $\pm 5\%$, 50V, Cer.	DCC239251	10R38	Same as 10R15	
10C36	Cap., 0.01μ , $\pm 10\%$, 500V, Cer.	DCC139501	10R41	Res., 680, $\pm 1\%$, $\frac{1}{4}W$, Metal	DRE939631
10C38	Same as 10C36		10R42	Same as 10R41	
10C55	Same as 10C36		10R43	Same as 10R15	
10C64	Cap., 33p, $\pm 5\%$, 50V, Cer.	DCC239011	10R44	Res., 220, $\pm 1\%$, $\frac{1}{4}W$, Metal	DRE939601
10C72	Same as 10C36		10R45	Same as 10R44	
10C81	Same as 10C3		10R46	Res., 120, $\pm 1\%$, $\frac{1}{4}W$, Metal	DRE939571
10C82	Same as 10C36		10R47	Same as 10R15	
10C83	Same as 10C3		10R48	Same as 10R15	
10C84	Same as 10C36		10R51	Same as 10R33	
10C85	Same as 10C3		10R52	Same as 10R33	
10C86	Same as 10C36		10R53	Res., 150, $\pm 5\%$, $\frac{1}{4}W$, Carbon	DRD139101
10C87	Same as 10C36		10R54	Same as 10R15	
10R3	Res., 22k, $\pm 1\%$, $\frac{1}{4}W$, Metal	DRE939061	10R55	Same as 10R15	
10R4	Res., 3.3k, $\pm 1\%$, $\frac{1}{4}W$, Metal	DRE939661	10R61	Res., 1.8k, $\pm 1\%$, $\frac{1}{4}W$, Metal	DRE939171
10R5	Res., 18k, $\pm 1\%$, $\frac{1}{4}W$, Metal	DRE939351	10R62	Same as 10R61	
10R6	Res., 3.9k, $\pm 1\%$, $\frac{1}{4}W$, Metal	DRE939421	10R63	Res., 100, $\pm 1\%$, $\frac{1}{4}W$, Metal	DRE939561
10R7	Res., 10k, $\pm 1\%$, $\frac{1}{4}W$, Metal	DRE939301	10R64	Same as 10R14	
10R8	Same as 10R7		10R71	Res., 10k, $\pm 5\%$, $\frac{1}{4}W$, Carbon	DRD139161
10R9	Res., 50k, Var., 0.2W, Carbon	DRV146811	10R72	Res., 220k, $\pm 5\%$, $\frac{1}{4}W$, Carbon	DRD139321
10R11	Res., 1.5k, $\pm 5\%$, $\frac{1}{4}W$, Carbon	DRD139431	10D41	Diode, 1S953	DDD010821
10R12	Res., 12k, $\pm 5\%$, $\frac{1}{4}W$, Carbon	DRD139601	10D42	Same as 10D41	
10R13	Same as 10R12		10D55	Same as 10D41	
10R14	Res., 47, $\pm 1\%$, $\frac{1}{4}W$, Metal	DRE939511	10D72	Diode, TLG206	DDD071121
10R15	Res., 33, $\pm 5\%$, $\frac{1}{4}W$, Carbon	DRD139911	10Q31	Transistor, 2SC2037	DTR137591
10R21	Same as 10R15		10Q35	Same as 10Q31	
10R22	Same as 10R15		10Q41	Transistor, 2SA1206	DTR119041
10R23	Same as 10R14		10Q45	Same as 10Q41	
10R24	Res., 6.8k, $\pm 1\%$, $\frac{1}{4}W$, Metal	DRE939331	10Q51	Transistor, 2SC1834	DTR131031
10R25	Res., 50k, Var., $\frac{1}{2}W$, Carbon	DRV412061	10Q55	Same as 10Q51	
10R26	Res., 100, $\pm 5\%$, $\frac{1}{4}W$, Carbon	DRD134591	10Q61	Same as 10Q31	
			10Q62	Same as 10Q31	

CIRCUIT REFERENCE	DESCRIPTION	IWATSU PART NO.	CIRCUIT REFERENCE	DESCRIPTION	IWATSU PART NO.
10IC1	IC, HA17458	DIC613511	10J1	Connector, M36-M87-02	DCN034601
			10J2	Connector, M36-M87-06	DCN034641
10S1	Coupling switch, SUJ45A	DSW014901	10J61	Connector, M36-M87-04	DCN034621
10P1	Connector, M36-02-30-114P	DCN034851			
10P2	Same as 10P1				
10P61	Same as 10P1				

CIRCUIT REFERENCE	DESCRIPTION	IWATSU PART NO.	CIRCUIT REFERENCE	DESCRIPTION	IWATSU PART NO.
B TRIGGER AMPLIFIER			11R34	Same as 11R33	
11C1	Cap., 1μ , +75%~ -10%, 50V, Elect.	DCE244711	11R35	Res., 270, $\pm 5\%$, $\frac{1}{4}W$, Carbon	DRD139331
11C2	Cap., 2200p, $\pm 10\%$, 50V, Poly.	DCF129061	11R36	Same as 11R15	
11C3	Cap., 47μ , $\pm 20\%$, 25V, Elect.	DCE229061	11R37	Same as 11R35	
11C12	Cap., 0.1μ , $\pm 10\%$, 50V, Poly.	DCF129601	11R38	Same as 11R15	
11C15	Cap., 100p, $\pm 5\%$, 50V, Cer.	DCC239051	11R41	Res., 680, $\pm 1\%$, $\frac{1}{4}W$, Metal	DRE939631
11C23	Cap., 0.01μ , $\pm 10\%$, 50V, Cer.	DCC133571	11R42	Same as 11R41	
11C32	Cap., 56p, $\pm 5\%$, 50V, Cer.	DCC239251	11R43	Same as 11R15	
11C36	Cap., 0.01μ , $\pm 10\%$, 50V, Cer.	DCC139501	11R44	Res., 220, $\pm 1\%$, $\frac{1}{4}W$, Metal	DRE939601
11C38	Same as 11C36		11R45	Same as 11R44	
11C53	Same as 11C36		11R46	Res., 120, $\pm 1\%$, $\frac{1}{4}W$, Metal	DRE939571
11C55	Same as 11C36		11R47	Same as 11R15	
11C64	Same as 11C15		11R48	Same as 11R15	
11C65	Same as 11C3		11R51	Same as 11R33	
11C81	Same as 11C3		11R52	Same as 11R33	
11C82	Same as 11C36		11R53	Res., 150, $\pm 5\%$, $\frac{1}{4}W$, Carbon	DRD139101
11C84	Same as 11C36		11R54	Same as 11R15	
11C85	Same as 11C3		11R55	Same as 11R15	
11C86	Same as 11C36		11R61	Res., 1.8k, $\pm 1\%$, $\frac{1}{4}W$, Metal	DRE939171
11R3	Res., 22k, $\pm 1\%$, $\frac{1}{4}W$, Metal	DRE939061	11R62	Same as 11R61	
11R4	Res., 3.3k, $\pm 1\%$, $\frac{1}{4}W$, Metal	DRE939661	11R63	Res., 100, $\pm 1\%$, $\frac{1}{4}W$, Metal	DRE939561
11R5	Res., 18k, $\pm 1\%$, $\frac{1}{4}W$, Metal	DRE939351	11R64	Same as 11R14	
11R6	Res., 3.9k, $\pm 1\%$, $\frac{1}{4}W$, Metal	DRE939421	11D21	Diode, 1S953	DDD010821
11R7	Res., 10k, $\pm 1\%$, $\frac{1}{4}W$, Metal	DRE939301	11D41	Same as 11D21	
11R8	Same as 11R7		11D55	Same as 11D21	
11R9	Res., 50k, Var., 0.2W, Carbon	DRV146811	11Q31	Transistor, 2SC1907	DTR137611
11R11	Res., 1.5k, $\pm 5\%$, $\frac{1}{4}W$, Carbon	DRD139431	11Q35	Same as 11Q31	
11R12	Res., 39k, $\pm 5\%$, $\frac{1}{4}W$, Carbon	DRD139701	11Q41	Transistor, 2SA1206	DTR119041
11R13	Res., 12k, $\pm 5\%$, $\frac{1}{4}W$, Carbon	DRD139601	11Q45	Same as 11Q41	
11R14	Res., 47, $\pm 1\%$, $\frac{1}{4}W$, Metal	DRE939511	11Q51	Transistor, 2SC1834	DTR131031
11R15	Res., 33, $\pm 5\%$, $\frac{1}{4}W$, Carbon	DRD139911	11Q55	Same as 11Q51	
11R21	Same as 11R15		11Q61	Transistor, 2SC2037	DTR137591
11R22	Same as 11R15		11Q65	Same as 11Q61	
11R23	Same as 11R14		11S1	Push switch, SUJ35A	DSW014881
11R24	Res., 6.8k, $\pm 1\%$, $\frac{1}{4}W$, Metal	DRE939331	11J1	Connector, M36-M87-02	DCN034601
11R25	50k, Var., $\frac{1}{2}W$, Cermet	DRV412061	11J2	Connector, M36-M87-04	DCN034621
11R26	Res., 100, $\pm 5\%$, $\frac{1}{4}W$, Carbon	DRD134591	11P1	Connector, M36-02-30-114P	DCN034851
11R31	Res., 33, $\pm 1\%$, $\frac{1}{4}W$, Metal	DRE939491	11P2	Same as 11P1	
11R32	Res., 10, $\pm 5\%$, $\frac{1}{4}W$, Carbon	DRD139211			
11R33	Res., 2.7k, $\pm 1\%$, $\frac{1}{4}W$, Metal	DRE939651			

CIRCUIT REFERENCE	DESCRIPTION	IWATSU PART NO.	CIRCUIT REFERENCE	DESCRIPTION	IWATSU PART NO.
TV SYNC SEPARATOR			12R21	Same as 12R5	
12C2	Cap., 47 μ , \pm 20%, 25V, Elect.	DCE229061	12R25	Same as 12R2	
12C5	Cap., 0.01 μ , +80% ~ -20%, 50V, Cer.	DCC139501	12R31	Res., 470k, \pm 5%, 1/4W, Carbon	DRD139371
12C7	Cap., 1 μ , \pm 30%, 50V, Elect.	DCE244711	12R32	Res., 1k, \pm 5%, 1/4W, Carbon	DRD139141
12C11	Cap., 470p, \pm 5%, 50V, Cer.	DCC239151	12R33	Same as 12R5	
12C12	Same as 12C2		12R34	Same as 12R5	
12C15	Cap., 1 μ , \pm 20%, 50V, Elect.	DCE249121	12R41	Res., 8.2k, \pm 5%, 1/4W, Carbon	DRD139581
12C31	Cap., 0.047 μ , \pm 10%, 50V, Elect.	DCF129581	12R42	Same as 12R41	
12C32	Same as 12C5		12R43	Same as 12R7	
12C34	Same as 12C5		12D2	Diode, 1S953	DDD010821
12R2	Res., 6.8k, \pm 5%, 1/4W, Carbon	DRD139561	12D12	Diode, RD4.7EB1	DDD033131
12R3	Res., 2.7k, \pm 5%, 1/4W, Carbon	DRD139481	12D31	Same as 12D2	
12R4	Same as 12R2		12D41	Same as 12D2	
12R5	Res., 10k, \pm 5%, 1/4W, Carbon	DRD139161	12D42	Same as 12D2	
12R6	Res., 150k, \pm 5%, 1/4W, Carbon	DRD139771	12Q1	Transistor, 2SA1015Y	DTR119011
12R7	Res., 2.2k, \pm 5%, 1/4W, Carbon	DRD139461	12Q5	Same as 12Q1	
12R11	Res., 82k, \pm 5%, 1/4W, Carbon	DRD139741	12Q11	Same as 12Q1	
12R12	Res., 680, \pm 5%, 1/4W, Carbon	DRD139391	12Q15	Transistor, 2S1815GR	DTR139011
12R13	Res., 39k, \pm 5%, 1/4W, Carbon	DRD139701	12Q21	Same as 12Q15	
12R14	Res., 18k, \pm 5%, 1/4W, Carbon	DRD139631	12Q25	Same as 12Q15	
12R15	Res., 7.5k, \pm 5%, 1/4W, Carbon	DRD139571	12Q41	Same as 12Q1	
12R16	Res., 12k, \pm 5%, 1/4W, Carbon	DRD139601	12IC31	IC, SN74LS08N	DIC140091
12R17	Same as 12R6		12IC35	IC, SN74LS02N	DIC140031
12R18	Same as 12R5				

CIRCUIT REFERENCE	DESCRIPTION	IWATSU PART NO.	CIRCUIT REFERENCE	DESCRIPTION	IWATSU PART NO.
A SWEEP GENERATOR			13R1	Res., 2.2k, $\pm 5\%$, $\frac{1}{4}W$, Carbon	DRD139461
13C1	Cap., 0.01μ , $+80\% \sim -20\%$, 50V, Cer.	DCC139501	13R2	Res., 3.9k, $\pm 5\%$, $\frac{1}{4}W$, Carbon	DRD139531
13C5	Same as 13C1		13R3	Res., 150, $\pm 1\%$, $\frac{1}{4}W$, Metal	DRE130631
13C7	Cap., 120p, $\pm 5\%$, 50V, Cer.	DCC239261	13R4	Res., 1k, $\pm 5\%$, $\frac{1}{4}W$, Carbon	DRD139141
13C11	Cap., 47μ , $\pm 20\%$, 25V, Elect.	DCE229061	13R5	Res., 470, $\pm 5\%$, $\frac{1}{4}W$, Carbon	DRD139371
13C12	Cap., 22p, $\pm 5\%$, 50V, Cer.	DCC239121	13R6	Res., 10k, $\pm 5\%$, $\frac{1}{4}W$, Carbon	DRD139161
13C15	Cap., 220p, $\pm 5\%$, 50V, Cer.	DCC239181	13R7	Res., 5.6k, $\pm 5\%$, $\frac{1}{4}W$, Carbon	DRD139541
13C18	Same as 13C7		13R8	Same as 13R1	
13C19	Cap., 4.7μ , $\pm 20\%$, 50V, Elect.	DCE249151	13R9	Same as 13R1	
13C21	Same as 13C15		13R10	Same as 13R4	
13C22	Same as 13C12		13R11	Res., 3.3k, $\pm 5\%$, $\frac{1}{4}W$, Carbon	DRD139501
13C25	Same as 13C11		13R12	Same as 13R1	
13C26	Same as 13C15		13R13	Same as 13R4	
13C27	Same as 13C1		13R14	Res., 5.6k, $\pm 1\%$, $\frac{1}{4}W$, Metal	DRE939671
13C28	Same as 13C1		13R15	Res., 820, $\pm 1\%$, $\frac{1}{4}W$, Metal	DRE939151
13C31	Cap., 33p, $\pm 5\%$, 50V, Cer.	DCC239011	13R16	Res., 2.2k, $\pm 1\%$, $\frac{1}{4}W$, Metal	DRE939021
13C32	Same as 13C31		13R17	Res., 4.7k, $\pm 5\%$, $\frac{1}{4}W$, Carbon	DRD139151
13C33	Cap., 1000p, $\pm 10\%$, 50V, Poly.	DCF129071	13R18	Res., 18k, $\pm 5\%$, $\frac{1}{4}W$, Carbon	DRD135131
13C34	Same as 13C1		13R19	Res., 100k, $\pm 5\%$, $\frac{1}{4}W$, Carbon	DRD135311
13C35	Same as 13C11		13R20	Res., 1.2k, $\pm 5\%$, $\frac{1}{4}W$, Carbon	DRD139661
13C36	Same as 13C1		13R21	Same as 13R7	
13C41	Cap., 10p, $\pm 0.5\%$, 50V, Cer.	DCC239041	13R22	Same as 13R17	
13C42	Cap., 68p, $\pm 5\%$, 100V, Cer.	DCC249531	13R25	Same as 13R1	
13C43	Cap., 2.5~22.5p, Var., 250V, Cer.	DCV019641	13R26	Same as 13R5	
13C44	Cap., 56p, $\pm 5\%$, 50V, Cer.	DCC239251	13R28	Same as 13R7	
13C45	Same as 13C1		13R32	Same as 13R4	
13C46	Same as 13C44		13R33	Same as 13R7	
13C61	Same as 13C31		13R34	Res., 2.7k, $\pm 5\%$, $\frac{1}{4}W$, Carbon	DRD139481
13C65	Same as 13C41		13R35	Res., 100, $\pm 5\%$, $\frac{1}{4}W$, Carbon	DRD139291
13C71	Same as 13C12		13R43	Res., 680, $\pm 5\%$, $\frac{1}{4}W$, Carbon	DRD139391
13C72	Same as 13C7		13R44	Res., 1k, $\pm 1\%$, $\frac{1}{4}W$, Metal	DRE939071
13C73	Same as 13C15		13R45	Res., 3.9k, $\pm 1\%$, $\frac{1}{4}W$, Metal	DRE939421
13C75	Same as 13C19		13R46	Res., 1.5k, $\pm 1\%$, $\frac{1}{4}W$, Metal	DRE939641
13C78	Same as 13C1		13R47	Res., 330k, $\pm 1\%$, $\frac{1}{4}W$, Metal	DRE939621
13C81	Same as 13C1		13R51	Same as 13R34	
13C82	Same as 13C1		13R52	Same as 13R4	
13C94	Same as 13C34		13R53	Same as 13R45	
13C96	Same as 13C34		13R54	Same as 13R35	
13C98	Same as 13C1		13R55	Same as 13R18	
			13R56	Same as 13R35	
			13R61	Res., 6.8k, $\pm 1\%$, $\frac{1}{4}W$, Metal	DRE939331
			13R62	Same as 13R61	

CIRCUIT REFERENCE	DESCRIPTION	IWATSU PART NO.	CIRCUIT REFERENCE	DESCRIPTION	IWATSU PART NO.
13R63	Res., 10k, $\pm 1\%$, $\frac{1}{4}W$, Metal	DRE939301	13D31	Same as 13D5	
13R64	Same as 13R15		13D43	Diode, RD 10FB	DDD032251
13R65	Res., 4.7k, $\pm 1\%$, $\frac{1}{4}W$, Metal	DRE939471	13D44	Same as 13D43	
13R66	Res., 27k, $\pm 1\%$, $\frac{1}{4}W$, Metal	DRE939361	13D55	Diode, RD 5.6E	DDD031141
13R67	Same as 13R4		13D75	Same as 13D5	
13R68	Same as 13R17				
13R71	Same as 13R7		13Q15	Transistor, 2SC1834	DTR131031
13R72	Same as 13R6		13Q21	Transistor, 2SA1015Y	DTR119011
13R73	Res., 560, $\pm 5\%$, $\frac{1}{4}W$, Carbon	DRD139121	13Q25	Same as 13Q15	
13R74	Same as 13R73		13Q31	Transistor, 2SC1254	DTR130861
13R75	Res., 1.5k, $\pm 5\%$, $\frac{1}{4}W$, Carbon	DRD139431	13Q35	Same as 13Q15	
13R76	Same as 13R18		13Q37	Same as 13Q15	
13R77	Same as 13R34		13Q41	FET. 2SD30A-Y	DTR210141
13R78	Same as 13R18		13Q43	Transistor, 2SC1834	DTR131031
13R81	Res., 8.5k, $\pm 5\%$, $\frac{1}{4}W$, Carbon	DRD139581	13Q51	Transistor, 2SC1815GR	DTR139011
13R82	Same as 13R7		13Q55	Same as 13Q51	
13R83	Res., 1.8k, $\pm 5\%$, $\frac{1}{4}W$, Carbon	DRD139441	13Q61	Same as 13Q21	
13R84	Same as 13R34		13Q63	Same as 13Q21	
13R85	Same as 13R6		13Q65	Same as 13Q15	
13R86	Res., 100k, Var., $\frac{1}{8}W$, Carbon	DRV146831	13Q71	Same as 13Q51	
13R87	Same as 13R6		13Q87	Same as 13Q51	
13R88	Same as 13R6		13Q98	Same as 13Q51	
13R91	Res., 10k, $\pm 5\%$, $\frac{1}{4}W$, Carbon	DRD139161			
13R92	Same as 13R91		13IC1	IC, F10107DC	DIC310051
13R93	Same as 13R91		13IC5	IC, F10131DC	DIC310081
13R94	Same as 13R91		13IC11	IC, SN74LS123N	DIC141181
13R95	Res., 820, $\pm 5\%$, $\frac{1}{4}W$, Carbon	DRD139941	13IC15	IC, SN74LS08N	DIC140091
13R96	Same as 13R1		13IC21	IC, SN74LS00N	DIC140011
13R97	Same as 13R35		13IC26	IC, SN74LS02N	DIC140031
13R98	Same as 13R34		13IC71	IC, SN74LS74AN	DIC140751
13R99	Same as 13R2		13IC75	IC, CD4066BE	DIC410591
13R101	Same as 13R35		13IC81	IC, μ PC272C	DIC630741
			13IC91	Same as 13IC71	
13D5	Diode, 1S953	DDD010821			
13D12	Same as 13D5		13J1	Connector, BNC	DCN034621
13D15	Same as 13D5		13J25	Connector, BNC	DCN034601
13D19	Same as 13D5		13J26	Connector, BNC	DCN040711
13D25	Same as 13D5		13J91	Connector, BNC	DCN030691
13D26	Same as 13D5				
13D27	Same as 13D5		13P1	Connector, BNC	DCN034871
13D28	Same as 13D5		13P5	Connector, BNC	DNC034851
			13P25	Same as 13P5	
			13P95	Same as 13P5	

CIRCUIT REFERENCE	DESCRIPTION	IWATSU PART NO.	CIRCUIT REFERENCE	DESCRIPTION	IWATSU PART NO.
B SWEEP GENERATOR			14R1	Res., 3.9k, $\pm 5\%$, $\frac{1}{4}W$, Carbon	DRD139521
			14R2	Res., 2.2k, $\pm 5\%$, $\frac{1}{4}W$, Carbon	DRD139461
14C1	Cap., 47 μ , $\pm 20\%$, 25V, Elect.	DCE229061	14R3	Res., 270, $\pm 1\%$, $\frac{1}{4}W$, Metal	DRE939611
14C2	Cap., 0.01 μ , +80% \sim -20%, 50V, Cer.	DCC139501	14R4	Res., 1k, $\pm 5\%$, $\frac{1}{4}W$, Carbon	DRD139141
			14R5	Same as 14R4	
14C3	Same as 14C1		14R6	Same as 14R2	
14C4	Same as 14C2		14R7	Res., 6.8k, $\pm 1\%$, $\frac{1}{4}W$, Metal	DRE939331
14C5	Same as 14C2		14R8	Res., 680, $\pm 1\%$, $\frac{1}{4}W$, Metal	DRE939631
14C6	Same as 14C2		14R9	Res., 1.8k, $\pm 1\%$, $\frac{1}{4}W$, Metal	DRE939171
14C7	Same as 14C2		14R10	Same as 14R4	
14C8	Same as 14C2		14R11	Same as 14R2	
14C11	Same as 14C2		14R12	Same as 14R2	
14C12	Same as 14C1		14R13	Res., 820, $\pm 1\%$, $\frac{1}{4}W$, Metal	DRE939151
14C13	Cap., 330p, $\pm 5\%$, 50V, Cer.	DCC239181	14R14	Res., 5.8k, $\pm 1\%$, $\frac{1}{4}W$, Metal	DRE939671
14C14	Same as 14C2		14R15	Res., 2.2k, $\pm 1\%$, $\frac{1}{4}W$, Metal	DRE939021
14C15	Cap., 22p, $\pm 5\%$, 50V, Cer.	DCC239121	14R16	Res., 27k, $\pm 5\%$, $\frac{1}{4}W$, Carbon	DRD139661
14C16	Same as 14C2		14R17	Res., 3.3k, $\pm 5\%$, $\frac{1}{4}W$, Carbon	DRD139501
14C17	Same as 14C1		14R18	Same as 14R4	
14C18	Same as 14C2		14R22	Res., 4.7k, $\pm 5\%$, $\frac{1}{4}W$, Carbon	DRD139151
14C19	Same as 14C1		14R25	Same as 14R2	
14C22	Same as 14C15		14R26	Res., 470, $\pm 5\%$, $\frac{1}{4}W$, Carbon	DRD139371
14C26	Same as 14C13		14R28	Res., 5.6k, $\pm 5\%$, $\frac{1}{4}W$, Carbon	DRD139541
14C31	Cap., 33p, $\pm 5\%$, 50V, Cer.	DCC239011	14R32	Same as 14R4	
14C32	Same as 14C31		14R33	Same as 14R28	
14C33	Cap., 1000p, $\pm 10\%$, 50V, Poly	DCF129071	14R34	Res., 2.7k, $\pm 5\%$, $\frac{1}{4}W$, Carbon	DRD139481
14C35	Same as 14C1		14R35	Res., 100, $\pm 5\%$, $\frac{1}{4}W$, Carbon	DRD139291
14C36	Same as 14C2		14R36	Same as 14R26	
14C41	Cap., 10p, $\pm 0.5p$, 50V, Cer.	DCC239041	14R43	Res., 680, $\pm 5\%$, $\frac{1}{4}W$, Carbon.	DRD139391
14C42	Cap., 56p, $\pm 5\%$, 100V, Cer.	DCC249521	14R44	Res., 1k, $\pm 1\%$, $\frac{1}{4}W$, Metal	DRE939071
14C43	Cap., 2.5 \sim 2.5p, Var., 250V, Cer.	DCV019531	14R45	Res., 3.9k, $\pm 1\%$, $\frac{1}{4}W$, Metal	DRE939421
14C44	Cap., 56p, $\pm 5\%$, 50V, Cer.	DCC239251	14R46	Res., 1.5k, $\pm 1\%$, $\frac{1}{4}W$, Metal	DRE939641
14C46	Same as 14C44		14R47	Res., 330, $\pm 1\%$, $\frac{1}{4}W$, Metal	DRE939621
14C55	Cap., 1 μ , $\pm 20\%$, 50V, Elect.	DCE249121	14R48	Res., 10k, $\pm 5\%$, $\frac{1}{4}W$, Carbon	DRD139161
14C61	Same as 14C15		14R51	Same as 14R35	
14C63	Cap., 100p, $\pm 5\%$, 50V, Cer.	DCC239051	14R52	Same as 14R4	
14C64	Same as 14C1		14R53	Same as 14R45	
14C75	Same as 14C2		14R55	Res., 22k, $\pm 5\%$, $\frac{1}{4}W$, Carbon	DRD139641
14C83	Same as 14C44		14R56	Same as 14R35	
14C98	Same as 14C2		14R61	Same as 14R45	

CIRCUIT REFERENCE	DESCRIPTION	IWATSU PART NO.	CIRCUIT REFERENCE	DESCRIPTION	IWATSU PART NO.
14R62	Res., 4.7i, $\pm 1\%$, $\frac{1}{4}W$, Metal	DRE939471	14D9	Diode, 1S953	DDD018
14R63	Res., 180 k, $\pm 1\%$, $\frac{1}{4}W$, Metal	DRE939711	14D15	Same as 14D9	
14R64	Same as 14R22		14D25	Same as 14D9	
14R65	Same as 14R2		14D26	Same as 14D9	
14R66	Same as 14R2		14D27	Same as 14D9	
14R67	Same as 14R7		14D28	Same as 14D9	
14R68	Same as 14R1		14D31	Same as 14D9	
14R69	Same as 14R2		14D43	Z. Diode, RD10FB	DDD032251
14R71	Same as 14R56		14D44	Same as 14D43	
14R72	Same as 14R56		14D55	Z.Diode, RD6.6ED1	DDD031141
14R73	Same as 14R44		14D61	Same as 14D9	
14R74	Res., 8.2k, $\pm 1\%$, $\frac{1}{4}W$, Metal	DCE939051	14D62	Same as 14D9	
14R75	Res., 2.7k, $\pm 1\%$, $\frac{1}{4}W$, Metal	DCE939651	14Q15	Transistor, 2SC1834	DTR131031
14R76	Res., 12k, $\pm 1\%$, $\frac{1}{4}W$, Metal	DCE939681	14Q25	Same as 14Q15	
14R77	Same as 14R56		14Q31	Transistor, 2SC1254	DTR130861
14R81	Res., 27k, $\pm 1\%$, $\frac{1}{4}W$, Metal	DCE939361	14Q35	Same as 14Q15	
14R82	Same as 14R13		14Q37	Same as 14Q15	
14R83	Same as 14R76		14Q41	FET, 2SK30A-Y	DTR210141
14R84	Same as 14R81		14Q43	Same as 14Q15	
14R85	Same as 14R1		14Q45	Transistor, 2SA1015Y	DTR119011
14R86	Same as 14R17		14Q51	Transistor, 2SC1815GR	DTR139011
14R91	Same as 14R74 Cermet		14Q55	Same as 14Q51	
14R92	Res., 1k, Var., 0.3W, Cermet	DRV412031	14Q81	Same as 14Q45	
14R93	Same as 14R75		14Q83	Same as 14Q45	
14R94	Same as 14R34		14IC1	IC, F10107DC	DIC310051
14R95	Res., 10k, Var., 1.5W, W.W.	DRV770351	14IC5	IC, F10131DC	DIC310081
14R96	Same as 14R92		14IC11	IC, F10116DC	DIC310201
14R97	Same as 14R34		14IC71	IC, CA3086	DIC190381
14R98	Same as 14R4		14IC91	IC, HA17458	DIC613511
14R99	Res., 560, $\pm 1\%$, $\frac{1}{4}W$, Metal	DRE939141	14J1	Connector, FF-10-002	DCN030711
			14J21	Connector, M36-M87-02	DCN034601
			14J25	Same as 14J21	
			14J26	Connector, BNC	DCN040711
			14J41	Connector, M36-M87-03	DCN034611
			14J91	Same as 14J41	
			14P5	Connector, M36-02-30- 114P	DCN034851
			14P21	Same as 14P5	
			14P25	Same as 14P5	
			14P41	Connector, M36-03-30-114P	DCN034861
			14P91	Same as 14P41	

CIRCUIT REFERENCE	DESCRIPTION	IWATSU PART NO.	CIRCUIT REFERENCE	DESCRIPTION	IWATSU PART NO.
TIMING SWITCHES			15R26	Res., 3.9k, $\pm 5\%$, $\frac{1}{4}W$, Carbon	DRD139521
15C23	Cap., 0.01 μ , +80% \sim -20%, 50V, Cer.	DCC139501	15R31	Res., 47, $\pm 5\%$, $\frac{1}{4}W$, Carbon	DRD139261
15C31	Cap., 1 μ , $\pm 1\%$, 50V, Poly.	DCF420281	15R32	Res., 220, $\pm 5\%$, $\frac{1}{4}W$, Carbon	DRD139321
15C32	Cap., 0.1 μ , $\pm 1\%$, 50V, Poly.	DCF420271	15R41	Res., 22k, $\pm 5\%$, $\frac{1}{4}W$, Carbon	DRD139641
15C33	Cap., 9900P, $\pm 0.25\%$, 50V, Poly.	DCF125791	15R51	Same as 15R1	
15C34	Cap., 900P, $\pm 0.25\%$, 50V, Poly.	DCF125801	15R53	Same as 15R3	
15C35	Cap., 56p, $\pm 5\%$, 50V, Cer.	DCC239251	15R56	Same as 15R6	
15C41	Cap., 1 μ , $\pm 20\%$, 50V, Elect.	DCE249121	15R57	Same as 15R7	
15C42	Cap., 0.1 μ , $\pm 10\%$, 50V, Poly.	DCF129601	15R58	Same as 15R8	
15C43	Cap., 6800P, $\pm 10\%$, 50V, Poly.	DCF129201	15R59	Same as 15R8	
15C71	Same as 15C23		15R61	Same as 15R11	
15C73	Same as 15C23		15R62	Same as 15R12	
15C82	Same as 15C32		15R63	Same as 15R13	
15C83	Same as 15C33		15R64	Same as 15R14	
15C84	Same as 15C34		15R65	Same as 15R15	
15C85	Same as 15C35		15R71	Same as 15R21	
15R1	Res., 7.5M, $\pm 1\%$, $\frac{1}{2}W$, Metal	DRE560141	15R72	Res., 22k, $\pm 1\%$, $\frac{1}{4}W$, Metal	DRE939061
15R3	Res., 2.5M, $\pm 1\%$, $\frac{1}{2}W$, Metal	DRE560131	15R73	Res., 5k, Var., 0.3W, Cermet	DRV412091
15R6	Res., 1.25M, $\pm 1\%$, $\frac{1}{2}W$, Metal	DRE560121	15R74	Res., 6.8k, $\pm 1\%$, $\frac{1}{4}W$, Metal	DRE939331
15R7	Res., 750k, $\pm 0.5\%$, 1/8W, Metal	DRE249121	15R81	Same as 15R31	
15R8	Res., 250k, $\pm 0.5\%$, $\frac{1}{2}W$, Metal	DRE249111	15R82	Same as 15R32	
15R9	Same as 15R8		15D26	L.E. D, TLR206	DDD070181
15R11	Res., 126.2k, $\pm 0.5\%$, 1/8W, Metal	DRE229141	15Q21	Transistor, 2SA578	DTR110331
15R12	Res., 55.6k, $\pm 0.5\%$, 1/8W, Metal	DRE229131	15Q23	Transistor, 2SC1815GR	DTR139011
15R13	Res., 25k, $\pm 0.5\%$, 1/8W, Metal	DRE229121	15Q71	Same as 15Q21	
15R14	Res., 12.5k, $\pm 0.5\%$, 1/8W, Metal	DRE229111	15Q73	Same as 15Q23	
15R15	Res., 5k, $\pm 0.5\%$, $\frac{1}{4}W$, Metal	DRE239121	15S1	Rotary switch,	DSW034632
15R21	Res., 8.2k, $\pm 1\%$, $\frac{1}{4}W$, Metal	DRE939051	15J81	Connector, M36-M87-03	DCN034611
15R22	Res., 3.9k, $\pm 1\%$, $\frac{1}{4}W$, Metal	DRE939421	15P81	Connector, M36-03-30-114P	DCN034861
15R23	Res., 50k, Var., 0.1W, Carbon	DRV147401			
15R24	Same as 15R21				
15R25	Same as 15R22				

CIRCUIT REFERENCE	DESCRIPTION	IWATSU PART NO.	CIRCUIT REFERENCE	DESCRIPTION	IWATSU PART NO.
HORIZONTAL SWITCHES			16S1	Push switch, SUJ50A	DSW014911
			16S2	Push switch, SUJ30A	DSW014871
16D1	Diode, 1S953	DDD010821	16J1	Connector, FF-12-002	DCN030701
16D2	L.E.D., TLR206	DDD070181			

CIRCUIT REFERENCE	DESCRIPTION	IWATSU PART NO.	CIRCUIT REFERENCE	DESCRIPTION	IWATSU PART NO.
HORIZONTAL CONTROL			17R11	Res., 5k, 0.3W, Carbon	DRV412091
			17R12	Res., 36k, $\pm 1\%$, $\frac{1}{4}W$, Metal	DRE939691
			17R13	Same as 17R12	
17C1	Cap., 0.01μ , $+80\% \sim -20\%$, 50V, Cer.	DCC139501	17R14	Res., 2.2k, $\pm 5\%$, $\frac{1}{4}W$, Carbon	DRD139461
17C3	Same as 17C1		17R15	Same as 17R3	
17C6	Cap., 0.1μ , $+80\% \sim -20\%$, 50V, Cer.	DCC939011	17R16	Res., 820, $\pm 1\%$, $\frac{1}{4}W$, Metal	DRE939151
17C9	Cap., 47μ , $\pm 20\%$, 25V, Elect.	DCE229061	17R17	Res., 15k, $\pm 1\%$, $\frac{1}{4}W$, Metal	DRE939341
17C14	Cap., 0.001μ , $+80\% \sim -20\%$, 50V, Poly.	DCF129071	17R21	Res., 2.7k, $\pm 1\%$, $\frac{1}{4}W$, Metal	DRE939651
17C15	Same as 17C1		17R22	Res., 33k, $\pm 5\%$, $\frac{1}{4}W$, Carbon	DRD139681
17C16	Cap., 270p, $\pm 5\%$, 50V, Cer.	DCC239281	17R23	Same as 17R21	
17C24	Same as 17C1		17R31	Same as 17R8	
17C33	Same as 17C1		17R32	Same as 17R8	
17C41	Same as 17C1		17R33	Same as 17R8	
17C43	Cap., 100p, $\pm 5\%$, 50V, Cer.	DCC239051	17R41	Res., 12k, $\pm 5\%$, $\frac{1}{4}W$, Carbon	DRD139601
17C44	Same as 17C1		17R42	Res., 15k, $\pm 5\%$, $\frac{1}{4}W$, Carbon	DRD139611
17C45	Same as 17C1		17R43	Same as 17R3	
17C48	Same as 17C1		17R44	Res., 4.7k, $\pm 1\%$, $\frac{1}{4}W$, Metal	DRE939471
17C51	Cap., 330p, $\pm 5\%$, 50V, Cer.	DCC239181	17R45	Res., 220, $\pm 1\%$, $\frac{1}{4}W$, Metal	DRE939601
17C52	Cap., 22p, $\pm 5\%$, 50V, Cer.	DCC239121	17R46	Res., 3.3k, $\pm 5\%$, $\frac{1}{4}W$, Carbon	DRD139501
17C81	Cap., 1μ , $\pm 20\%$, 50V, Elect.	DCE249121	17R47	Same as 17R8	
17C82	Same as 17C81		17R51	Res., 560, $\pm 5\%$, $\frac{1}{4}W$, Carbon	DRD139121
17C83	Same as 17C1		17R52	Same as 17R51	
17C84	Same as 17C1		17R91	Same as 17R8	
17C85	Same as 17C9		17R95	Same as 17R8	
17C86	Same as 17C9		17D11	Diode, 1S953	DDD010821
17C87	Same as 17C1		17D12	Same as 17D11	
17C88	Same as 17C1		17D13	Same as 17D11	
17C91	Same as 17C9		17D14	Same as 17D11	
17C92	Same as 17C1		17D15	Same as 17D11	
17C95	Same as 17C1		17D16	Same as 17D11	
			17D21	Diode, 1SS16	DDD010411
17R1.2	Res., (10k, 50k,) Var., $\frac{1}{8}W$, Carbon	DRV146841	17D22	Same as 17D21	
(17S2)	With switch		17D23	Same as 17D21	
17R3	Res., 3.9k, $\pm 1\%$, $\frac{1}{4}W$, Metal	DRE939421	17D24	Same as 17D11	
17R4	Res., 68k, $\pm 5\%$, $\frac{1}{4}W$, Carbon	DRD139731	17D25	Same as 17D11	
17R6	Res., 4.7k, $\pm 5\%$, $\frac{1}{4}W$, Carbon	DRD139151	17D26	Same as 17D11	
17R7	Res., 50k, Var., $\frac{1}{8}W$, Carbon	DRV146821	17D27	Same as 17D11	
17R8	Res., 10k, $\pm 5\%$, $\frac{1}{4}W$, Carbon	DRD139161	17D28	Same as 17D11	
17R9	Res., 1k, $\pm 5\%$, $\frac{1}{4}W$, Carbon	DRD139141	17D29	Same as 17D11	
			17D31	Same as 17D11	
			17D41	Same as 17D11	

CIRCUIT REFERENCE	DESCRIPTION	IWATSU PART NO.	CIRCUIT REFERENCE	DESCRIPTION	IWATSU PART NO.
17D42	Same as 17D11		17J1	Connector, M36-M87-06	DCN034641
17D47	Same as 17D11		17J21	Connector, M36-M87-05	DCN034631
17D48	Same as 17D11		17J25	Connector, M36-M87-02	DCN034601
17Q1	Transistor, 2SC1815GR	DTR139011	17J31	Connector, FF-10-001	DCN030681
17Q11	Same as 17Q1		17J81	Connector, M31-M87-10	DCN034531
17Q15	Transistor, 2SA1015Y	DTR119011	17P1	Connector, M36-06-30-114P	DCN034891
17Q41	Same as 17Q1		17P21	Connector, M36-05-30-114P	DCN034881
17Q45	Same as 17Q1		17P25	Connector, M36-02-30-114P	DCN034851
17Q47	Same as 17Q15		17P81	Connector, M36-10-30-114P	DCN034721
17IC1	IC, SN74LS00N	DIC140011	17P91	Connector, M36-04-30-114P	DCN034871
17IC31	IC, SN74LS74AN	DIC140751			
17IC51	Same as 17IC1				

CIRCUIT REFERENCE	DESCRIPTION	IWATSU PART NO.	CIRCUIT REFERENCE	DESCRIPTION	IWATSU PART NO.
HORIZONTAL AMPLIFIER			18R27	Same as 18R26	
18C11	Cap., 0.047 μ , $\pm 20\%$, 250V, Poly.	DCF160291	18R31	Res., 100, Var., 0.3W, Cermet.	DRV412001
18C12	Cap., 0.01 μ , +80% ~ -20%, 50V, Cer.	DCC139501	18R32	Res., 1k, $\pm 15\%$, Thermistor,	DDD080421
18C13	Cap., 22 μ , 20%, 25V, Elect.	DCE229041	18R33	Res., 56, $\pm 1\%$, $\frac{1}{4}W$, Metal	DRE939521
18C14	Same as 18C12		18R34	Res., 390, $\pm 5\%$, $\frac{1}{4}W$, Carbon	DRD139361
18C15	Same as 18C13		18R35	Res., 1k, $\pm 1\%$, $\frac{1}{4}W$, Metal	DRE939071
18C16	Same as 18C12		18R36	Res., 5k, Var., 0.3W, Cermet	DRV412051
18C17	Cap., 0.1 μ , +80% ~ -20%, 50V, Cer.	DCC939011	18R41	Res., 2.7k, $\pm 1\%$, $\frac{1}{4}W$, Metal	DRE939651
18C18	Same as 18C13		18R42	Res., 18k, $\pm 1\%$, $\frac{1}{4}W$, Metal	DRE939351
18C19	Same as 18C12		18R43	Res., 27k, $\pm 1\%$, $\frac{1}{4}W$, Metal	DRE939361
18C31	Same as 18C12		18R44	Res., 220k, $\pm 5\%$, $\frac{1}{4}W$, Carbon	DRD139791
18C51	Cap., 33p, $\pm 5\%$, 50V, Cer.	DCC239011	18R45	Same as 18R42	
18C58	Cap., 27p, $\pm 0.25p$, 500V, Cer.	DCC239241	18R46	Res., 22k, $\pm 1\%$, $\frac{1}{4}W$, Metal	DRE939061
18C62	Same as 18C12		18R51	Res., 270, $\pm 5\%$, $\frac{1}{4}W$, Carbon	DRD139331
18C65	Cap., 82p, $\pm 5\%$, 50V, Cer.	DCC239141	18R52	Res., 680, $\pm 1\%$, $\frac{1}{4}W$, Metal	DRE939631
18C66	Cap., 0.01 μ , $\pm 10\%$, 200V, Poly.	DCF159501	18R53	Same as 18R52	
18C72	Cap., 0.1 μ , $\pm 20\%$, 250V, Poly.	DCF158021	18R54	Res., 820, $\pm 1\%$, $\frac{1}{4}W$, Metal	DRE939151
18C75	Cap., 2 ~ 8p, Var., 250V, Cer.	DCV019561	18R55	Res., 4.7k, $\pm 1\%$, $\frac{1}{4}W$, Metal	DRE939471
18C76	Cap., 1p, $\pm 0.25p$, 500V, Cer.	DCC259101	18R56	Res., 500, Var., 0.3W, Cermet	DRV412021
18C81	Cap., 270p, $\pm 5\%$, 50V, Cer.	DCC239281	18R57	Same as 18R55	
18C82	Same as 1866		18R58	Same as 18R51	
18C83	Same as 18C12		18R59	Same as 18R56	
18C91	Same as 18C72		18R61	Res., 1.8k, $\pm 5\%$, $\frac{1}{4}W$, Carbon	DRD139441
18C94	Same as 18C75		18R62	Same as 18R61	
18C95	Same as 18C76		18R63	Res., 5.6k, $\pm 1\%$, $\frac{1}{4}W$, Metal	DRE939671
18R11	Res., 47, $\pm 5\%$, $\frac{1}{4}W$, Carbon	DCD139261	18R64	Res., 100k, $\pm 1\%$, $\frac{1}{4}W$, Metal	DRE939191
18R12	Res., 3.3k, $\pm 5\%$, $\frac{1}{4}W$, Carbon	DCD139501	18R65	Res., 120, $\pm 5\%$, $\frac{1}{4}W$, Carbon	DRD139301
18R13	Res., 1.8k, $\pm 1\%$, $\frac{1}{4}W$, Metal	DRE939651	18R66	Same as 18R61	
18R14	Res., 3.3k, $\pm 1\%$, $\frac{1}{4}W$, Metal	DRE939661	18R71	Same as 18R54	
18R15	Res., 1.2k, $\pm 1\%$, $\frac{1}{4}W$, Metal	DRE939291	18R72	Res., 27k, $\pm 5\%$, $\frac{1}{4}W$, Carbon	DRD139661
18R16	Res., 8.2k, $\pm 1\%$, $\frac{1}{4}W$, Metal	DRE939051	18R73	Res., 22k, $\pm 5\%$, $\frac{1}{4}W$, Carbon	DRD139641
18R17	Same as 18R16		18R74	Same as 18R11	
18R21	Same as 18R15		18R75	Res., 22k, $\pm 1\%$, $\frac{1}{4}W$, Metal	DRE939061
18R22	Same as 18R16		18R76	Same as 18R75	
18R23	Same as 18R16		18R81	Same as 18R65	
18R24	Res., 270, $\pm 1\%$, $\frac{1}{4}W$, Metal	DRE939611	18R82	Res., 2.7k, $\pm 5\%$, $\frac{1}{4}W$, Carbon	DRD139481
18R25	Same as 18R24		18R83	Same as 18R64	
18R26	Res., 820, $\pm 5\%$, $\frac{1}{4}W$, Carbon	DRD139941	18R84	Same as 18R63	
			18R91	Same as 18R54	
			18R92	Same as 18R72	
			18R93	Same as 18R73	
			18R94	Same as 18R11	

CIRCUIT REFERENCE	DESCRIPTION	IWATSU PART NO.	CIRCUIT REFERENCE	DESCRIPTION	IWATSU PART NO.
18R95	Same as 18R75		18Q11	Transistor, 2SC1815GR	DTR139011
18R96	Same as 18R75		18Q12	Same as 18Q11	
18R101	Same as 18R26		18Q13	Transistor, 2SA1206	DTR119041
18R102	Res., 50k, Var., 0.3W, Cermet	DRV412061	18Q14	Same as 18Q13	
			18Q15	Transistor, 2SA1015Y	DTR119011
18RL31	Reed Relay, HA-112H	DKD062041	18Q16	Same as 18Q11	
			18Q21	Same as 18Q11	
18D25	Diode, RD10FB	DDD032251	18Q22	Same as 18Q11	
			18Q23	Same as 18Q13	
			18Q24	Transistor, 2SC1907	DTR137611
			18Q25	Transistor, 2SA899G/B	DTR115691
			18Q26	Transistor, 2SC1904G/B	DTR137051
			18Q31	Same as 18Q24	
			18Q32	Same as 18Q25	
			18Q33	Same as 18Q26	
			18Q101	Same as 18Q21	
			18Q102	Same as 18Q15	
			18J11	Connector, M36-M87-06	DCN034641
			18J12	Same as 18J11	
			18P11	Connector, M36-06-30-134P	DCN034946
			18P12	Same as 18P11	

CIRCUIT REFERENCE	DESCRIPTION	IWATSU PART NO.	CIRCUIT REFERENCE	DESCRIPTION	IWATSU PART NO.
Z AXIS CIRCUIT			19R25	Res., 10k, $\pm 5\%$, $\frac{1}{4}W$, Carbon	DRD139161
			19R26	Res., 100, $\pm 5\%$, $\frac{1}{4}W$, Carbon	DRD139291
19C13	Cap., 0.01 μ , +80% \sim -20%, 50V, Cer.	DCC139501	19R27	Same as 19R25	
19C16	Same as 19C13		19R28	Res., 47k, 5%, $\frac{1}{4}W$, Carbon	DRD135231
19C17	Cap., 1 μ , $\pm 20\%$, 25V, Elect.	DCE249121	19R31	Res., 500, Var., 0.3W, Cer.	DRV412021
19C24	Same as 19C16		19R32	Res., 560, $\pm 5\%$, $\frac{1}{4}W$, Carbon	DRD139121
19C25	Same as 19C16		19R33	Res., 1k, $\pm 1\%$, $\frac{1}{4}W$, Metal	DRE939071
19C26	Cap., 0.1 μ , $\pm 2\%$, 50V, Poly.	DCF129601	19R34	Same as 19R33	
19C27	Same as 19C17		19R35	Res., 15k, $\pm 1\%$, $\frac{1}{4}W$, Metal	DRE939341
19C31	Cap., 22 μ , $\pm 20\%$, 25V, Elect.	DCE229041	19R36	Res., 1.8k, $\pm 1\%$, $\frac{1}{4}W$, Metal	DRE939171
19C34	Same as 19C16		19R41	Res., 22k, $\pm 5\%$, $\frac{1}{4}W$, Carbon	DRD139641
19C41	Same as 19C16		19R42	Same as 19R23	
19C42	Cap., 10p, $\pm 0.5\%$, 50V, Cer.	DCC239041	19R43	Same as 19R22	
19C43	Cap., 0.047 μ , $\pm 20\%$, 250V, Poly.	DCF160291	19R44	Same as 19R23	
19C44	Same as 19C16		19R45	Res., 82k, $\pm 5\%$, $\frac{1}{4}W$, Carbon	DRD139741
19C45	Same as 19C16		19R46	Res., 8.2k, $\pm 5\%$, $\frac{1}{4}W$, Carbon	DRD139581
19C46	Cap., 12p, $\sim 0.25p$, 500V, Cer.	DCC259111	19R47	Same as 19R22	
19C47	Cap., 2 \sim 8p, Var., 250V, Cer.	DCV019561	19R50	Same as 19R21	
19C51	Cap., 0.1 μ , 20%, 250V, Poly.	DCF158021	19R51	Res., 3.9k, $\pm 5\%$, $\frac{1}{4}W$, Carbon	DRD139521
19C52	Same as 19C51		19R52	Same as 19R51	
19C57	Cap., 1p, $\pm 0.25p$, 50V, Cer.	DCC239191	19R53	Same as 19R51	
19C61	Same as 19C42		19R54	Res., 300, $\pm 5\%$, $\frac{1}{4}W$, Carbon	DRD139341
19C63	Same as 19C51		19R55	Same as 19R46	
19C64	Cap., 0.047 μ , $\pm 20\%$, 630V, Poly.	DCF171131	19R57	Same as 19R46	
19C68	Cap., 0.01 μ , $\pm 20\%$, 630V, Poly.	DCF170201	19R61	Res., 5.6k, $\pm 5\%$, $\frac{1}{4}W$, Carbon	DRD139541
19R11	Res., 2.7k, $\pm 5\%$, $\frac{1}{4}W$, Carbon	DRD139481	19R62	Res., 50k, Var., 0.5W, Cermet	DRV420221
19R12	Same as 19R11		19R63	Res., 39k, $\pm 5\%$, $\frac{1}{4}W$, Carbon	DRD139701
19R13	Res., 33k, $\pm 5\%$, $\frac{1}{4}W$, Carbon	DRD139681	19R64	Same as 19R63	
19R14	Res., 10, $\pm 5\%$, $\frac{1}{4}W$, Carbon	DRD139211	19R65	Same as 19R25	
19R15	Res., 2.2k, $\pm 1\%$, $\frac{1}{4}W$, Metal	DRE939021	19R66	Same as 19R25	
19R16	Res., 47k, $\pm 5\%$, $\frac{1}{4}W$, Carbon	DRD139171	19R67	Res., 180k, $\pm 1\%$, $\frac{1}{4}W$, Metal	DRE949041
19R17	Same as 19R16		19R68	Res., 150k, $\pm 1\%$, $\frac{1}{4}W$, Metal	DRE949021
19R18	Res., 12k, $\pm 5\%$, $\frac{1}{4}W$, Carbon	DRD139601	19R69	Res., 220k, $\pm 1\%$, $\frac{1}{4}W$, Metal	DRE949031
19R19	Res., 100k, $\pm 5\%$, $\frac{1}{4}W$, Carbon	DRD139751	19R70	Res., 100k, $\pm 1\%$, $\frac{1}{4}W$, Metal	DRE939191
19R20	Res., (50k, 50k), Var., 0.1W, Carbon with switch	DRV147391	19R71	Res., 100k, Var., 0.5W, Cermet	DRV411111
19R21	Res., 4.7k, $\pm 5\%$, $\frac{1}{4}W$, Carbon	DRD139151	19D17	Diode, 1S953/TA21R	DDD010821
19R22	Res., 820, $\pm 5\%$, $\frac{1}{4}W$, Carbon	DRD139941	19D21	Same as 19D17	
19R23	Res., 1k, $\pm 5\%$, $\frac{1}{4}W$, Carbon	DRD139141	19D22	L.E D, TLR206	DDD070181
19R24	Same as 19R23		19D31	Same as 19D17	
			19D32	Diode, 1SS16	DDD010411
			19D33	Same as 19D17	
			19D41	Diode, ERB26-20	DDD023571
			19D61	Same as 19D17	

CIRCUIT REFERENCE	DESCRIPTION	IWATSU PART NO.	CIRCUIT REFERENCE	DESCRIPTION	IWATSU PART NO.
19Q11	Transistor, 2SC1815GR	DTR139011	19J1	BNC Connector, BNC080	DCN040711
19Q12	Same as 19Q11		19J11	Connector, M36-M87-04	DCN034621
19Q13	Same as 19Q11				
19Q14	Transistor, 2SA1015Y	DTR119011	19P11	Connector, M36-04-30-114P	DCN034871
19Q15	Same as 19Q11				
19Q16	Transistor, 2SA899G/B	DTR115691			
19Q17	Transistor, 2SC1904G/B	DTR137051			
19Q18	Same as 19Q17				
19IC1	IC, SN74LS08N	DIC140091			
19IC2	IC, SN74LS74AN	DIC140751			

CIRCUIT REFERENCE	DESCRIPTION	IWATSU PART NO.	CIRCUIT REFERENCE	DESCRIPTION	IWATSU PART NO.
CRT CIRCUIT			20R12	Res., 15k, $\pm 5\%$, 2W, Metal	DRG950121
			20R13	Res., 180k, $\pm 1\%$, $\frac{1}{4}W$, Metal	DRE939711
20C1	Cap., 47 μ , $\pm 20\%$, 100V, Elect.	DCE255091	20R16	Res., 3.9k, $\pm 5\%$, $\frac{1}{4}W$, Carbon	DRD139521
20C2	Cap., 100p, $\pm 10\%$, 500V, Cer.	DCC259141	20R17	Res., 220k, $\pm 5\%$, $\frac{1}{4}W$, Carbon	DRD139791
20C3	Cap., 0.047 μ , $\pm 20\%$, 600V, Poly.	DCF171131	20R18	Res., 33k, $\pm 5\%$, $\frac{1}{4}W$, Carbon	DRD139681
20C5	Cap., 0.01 μ , +80% ~ -20%, 3kV, Cer.	DCC173501	20R21	Same as 20R17	
			20R22	Res., 2.2k, $\pm 5\%$, $\frac{1}{4}W$, Carbon	DRD139461
20C6	Cap., 1000p, $\pm 20\%$, 3kV, Cer.	DCC171831	20R25	Res., 18k, $\pm 5\%$, $\frac{1}{4}W$, Carbon	DRD139631
20C7	Same as 20C5		20R26	Res., 82k, $\pm 5\%$, $\frac{1}{4}W$, Carbon	DRD139741
20C11	Cap., 0.01 μ , $\pm 20\%$, 3kV, Cer.	DCC173501	20R27	Res., 180, $\pm 5\%$, $\frac{1}{4}W$, Carbon	DRD139961
20C15	Cap., 0.22 μ , $\pm 10\%$, 50V, Poly.	DCF129711	20R31	Res., 1.8k, $\pm 5\%$, $\frac{1}{4}W$, Carbon	DRD139441
20C18	Cap., 56p, $\pm 5\%$, 50V, Cer.	DCC239251	20R32	Res., 39k, $\pm 5\%$, $\frac{1}{4}W$, Carbon	DRD139701
20C23	Cap., 0.1 μ , $\pm 10\%$, 50V, Poly.	DCF129601	20R33	Res., 5.6k, $\pm 5\%$, $\frac{1}{4}W$, Carbon	DRD139541
20C24	Cap., 0.015 μ , $\pm 10\%$, 50V, Poly.	DCF129031	20R34	Res., 82k, $\pm 1\%$, $\frac{1}{4}W$, Metal	DRE939701
20C27	Cap., 1 μ , +75% ~ -10%, 50V, Elect.	DCE244711	20R35	Res., 15k, $\pm 1\%$, $\frac{1}{4}W$, Metal	DRE939341
			20R36	Res., 2.2 μ , $\pm 5\%$, 1W, Metal	DRG940311
20C31	Cap., 0.01 μ , +80% ~ -20%, 50V, Cer.	DCC139501	20R37	Res., 33k, $\pm 1\%$, $\frac{1}{4}W$, Metal	DRE939091
			20R38	Same as 20R34	
20C33	Cap., 22 μ , $\pm 20\%$, 25V, Elect.	DCE229041	20R41	Same as 20R11	
20C37	Cap., 4.7 μ , $\pm 20\%$, 50V, Elect.	DCE249151	20R42	Res., 10 μ , $\pm 5\%$, 1W, Metal	DRG940321
20C41	Same as 20C11		20R44	Same as 20R13	
20C42	Same as 20C6		20R45	Res., 4.7k, $\pm 1\%$, $\frac{1}{4}W$, Metal	DRE939471
20C43	Same as 20C11		20R46	Res., 2.7k, $\pm 1\%$, $\frac{1}{4}W$, Metal	DRE939651
20C44	Cap., 1 μ , +75% ~ -10%, 250V, Elect.	DCE270251	20R47	Res., 10k, $\pm 5\%$, $\frac{1}{4}W$, Carbon	DRD135071
			20R51	Res., 200k, Var., 1.5W, Cermet	DRV350211
20C54	Cap., 0.01 μ , +80% ~ -20%, 50V, Cer.	DCC163511	20R52	Res., 100k, $\pm 1\%$, $\frac{1}{4}W$, Metal	DRE939191
			20R53	Same as 20R52	
20C55	Same as 20C54		20R54	Res., 200k, Var., 0.2W, Carbon	DRV146851
20C57	Same as 20C54		20R55	Same as 20R14	
20C61	Same as 20C54		20R56	Same as 20R52	
20C70	Cap., 0.01 μ , +80% ~ -20%, 50V, Cer.	DCC133571	20R57	Same as 20R13	
			20R61	Same as 20R13	
20L61	Inductor, Lotation Coil	DCL140111	20R62	Res., (20k, 20k), 0.05W, Carbon	DRV131421
20L62	Inductor, Orthogonality Coil	DCL140251	20R63	Res., 470, $\pm 5\%$, $\frac{1}{4}W$, Carbon	DRD139371
20R1	Res., 330, $\pm 5\%$, $\frac{1}{4}W$, Carbon	DRD139351			
20R2	Res., 220k, $\pm 5\%$, $\frac{1}{4}W$, Carbon	DRD139791			
20R3	Res., 100k, $\pm 5\%$, $\frac{1}{4}W$, Carbon	DRD139751			
20R4	Same as 20R2				
20R10	Res., 100k, $\pm 5\%$, $\frac{1}{4}W$, Carbon	DRD139751			
20R11	Res., 10k, $\pm 5\%$, $\frac{1}{4}W$, Carbon	DRD139161			

CIRCUIT REFERENCE	DESCRIPTION	IWATSU PART NO.	CIRCUIT REFERENCE	DESCRIPTION	IWATSU PART NO.
20D1	Diode, 1S953	DDD010821	20J1	Connector, M31-M87-15	DCN034551
20D2	Diode, SM-05-20FRZ	DDD021721	20J3	Connector, M36-M87-02	DCN034601
20D4	Diode, HVT-30S	DDD021421	20J4	Same as 20J3	
20D5	Same as 20D2		20J11	Same as 20J3	
20D6	Same as 20D2		20J12	Same as 20J1	
20D12	Same as 20D1		20J21	Same as 20J3	
20D26	Same as 20D1		20J22	Connector, M31-M87-10	DCN034531
20D32	Same as 20D1		20J23	Same as 20J3	
20D33	Same as 20D1				
20D34	Same as 20D1		20P1	Connector, M33-15-30-114P	DCN034741
20D41	Same as 20D2		20P3	Connector, M36-02-30-114P	DCN034851
20D42	Same as 20D2		20P4	Same as 20P3	
20D43	Same as 20D2		20P11	Same as 20P3	
20D44	Same as 20D2		20P12	Same as 20P1	
			10P21	Same as 20P3	
20Q1	Transistor, 2SC2334L	DTR137621	20P22	Connector, M33-10-30-114P	DCN034721
20Q20	Transistor, 2SC1815GR	DTR139011	20P23	Same as 20P3	
20Q30	Transistor, 2SA1015Y	DTR119011			
20Q40	Same as 20Q20		20T1	High Voltage Transformer, FS-34442	DCL220351
20Q61	Same as 20Q20				
20Q62	Same as 20Q30		20U1	High Voltage Unit, MSL3587A	DES050563
20IC20	IC, HA17458	DIC613511	20V41	Neon Bracket Lamp, NL235	DLP025171
			20F10	Fuse, FSA-1 Fuse Holder, FSA-1	DFU020141 DSK060141

CIRCUIT REFERENCE	DESCRIPTION	IWATSU PART NO.	CIRCUIT REFERENCE	DESCRIPTION	IWATSU PART NO.
POWER SUPPLY & CALIBRATOR			21R46	Res., 12k, $\pm 1\%$, $\frac{1}{4}W$, Metal	DRE939681
			21R47	Same as 21R13	
21C1	Cap., 1000p, $\pm 20\%$, 3kV, Cer.	DCC171831	21R51	Same as 21R41	
21C11	Cap., 100 μ , $\pm 20\%$, 25V, Elect.	DCE229071	21R52	Res., 15k, $\pm 5\%$, $\frac{1}{4}W$, Carbon	DRD139611
21C21	Cap., 1000p, $\pm 10\%$, 150V, Poly.	DCF241311	21R53	Res., 2, $\pm 5\%$, 1W, Metal	DRS229051
21C31	Cap., 33 μ , $\pm 20\%$, 16V, Elect.	DCE229011	21R54	Res., 33k, $\pm 5\%$, $\frac{1}{2}W$, Carbon	DRD149321
21C32	Cap., 4700 μ , $\pm 20\%$, 16V, Elect.	DCE920711	21R56	Same as 21R46	
21C41	Cap., 100 μ , $\pm 20\%$, 160V, Elect.	DCE960161	21R57	Same as 21R13	
21C42	Cap., 4.7 μ , $\pm 20\%$, 250V, Elect.	DCE270401	21R61	Same as 21R31	
21C51	Cap., 1000 μ , $\pm 20\%$, 63V, Elect.	DCE945121	21R62	Res., 0.68, $\pm 5\%$, 1W, Metal	DRS229041
21C52	Cap., 10 μ , $\pm 20\%$, 100V, Elect.	DCE259011	21R63	Same as 21R62	
21C61	Cap., 2200 μ , $\pm 20\%$, 35V, Elect.	DCE930321	21R64	Same as 21R31	
21C62	Same as 21C61		21R65	Same as 21R41	
21C65	Cap., 0.01 μ , $+80\% \sim -20\%$, 50V, Cer.	DCC139501	21R66	Same as 21R41	
			21R67	Same as 21R42	
21C71	Cap., 22 μ , $\pm 20\%$, 25V, Elect.	DCE229041	21R71	Same as 21R46	
21C75	Same as 21C71		21R72	Same as 21R46	
			21R73	Res., 1.2k $\pm 5\%$, $\frac{1}{4}W$, Carbon	DRD139421
21R11	Res., 2.2, $\pm 5\%$, $\frac{1}{4}W$, Carbon	DRD138881	21R74	Same as 21R13	
21R12	Res., 2.7k, $\pm 5\%$, $\frac{1}{4}W$, Carbon	DRD139481	21R75	Same as 21R21	
21R13	Res., 6.8k, $\pm 5\%$, $\frac{1}{4}W$, Carbon	DRD139561	21R76	Res., 3.9k, $\pm 1\%$, $\frac{1}{4}W$, Metal	DRE939421
21R14	Res., 500, Var., 0.3W, Cermet	DRV412021	21R77	Res., 1k, Var., 0.3W, Cermet	DRV412031
21R15	Res., 820, $\pm 5\%$, $\frac{1}{4}W$, Carbon	DRD139941	21R78	Res., 5.5k, $\pm 1\%$, $\frac{1}{4}W$, Metal	DRE939671
21R16	Res., 60, $\pm 0.5\%$, $\frac{1}{4}W$, Metal	DRE239111			
21R17	Res., 1k, $\pm 5\%$, $\frac{1}{4}W$, Carbon	DRD134831	21D30	Diode, 1G4B1	DDD021031
21R21	Res., 6.8k, $\pm 1\%$, $\frac{1}{4}W$, Metal	DRE939331	21D40	Same as 21D30	
21R22	Res., 10k, $\pm 1\%$, $\frac{1}{4}W$, Metal	DRE939301	21D41	Diode, RD18EB	DDD031701
21R23	Same as 21R13		21D42	Diode, 1S953	DDD010821
21R24	Res., 4.7k, $\pm 5\%$, $\frac{1}{4}W$, Carbon	DRD139151	21D43	Diode, SM-1M-02	DDD010771
21R25	Same as 21R12		21D50	Same as 21D30	
21R26	Res., 100k, Var., 0.3W, Cermet	DRV412131	21D51	Diode, RD39EB	DDD031151
21R27	Res., 270k, $\pm 1\%$, $\frac{1}{4}W$, Metal	DRE939311	21D52	Same as 21D42	
21R31	Res., 39k, $\pm 5\%$, $\frac{1}{4}W$, Carbon	DRD139701	21D53	Same as 21D43	
21R32	Res., 6.2, $\pm 5\%$, 2W, Metal	DRS231081	21D60	Same as 21D30	
21R34	Res., 50, Var., 0.5W, Cermet	DRV350201	21D61	Same as 21D41	
21R41	Res., 82k, $\pm 5\%$, $\frac{1}{4}W$, Carbon	DRD139741	21D62	Same as 21D41	
21R42	Res., 1k, $\pm 5\%$, $\frac{1}{4}W$, Carbon	DRD139141	21D71	Same as 21D42	
21R43	Res., 18k, $\pm 5\%$, $\frac{1}{4}W$, Carbon	DRD139631	21D72	Diode, RD5.6EB1	DDD031141
21R44	Res., 82k, $\pm 1\%$, $\frac{1}{4}W$, Metal	DRE939701	21D73	L.E.D., TLG-104	DDD071111
21R45	Res., 47k, $\pm 1\%$, $\frac{1}{4}W$, Metal	DRE939371			

CIRCUIT REFERENCE	DESCRIPTION	IWATSU PART NO.	CIRCUIT REFERENCE	DESCRIPTION	IWATSU PART NO.
20D1	Diode, 1S953	DDD010821	20J1	Connector, M31-M87-15	DCN034551
20D2	Diode, SM-05-20FRZ	DDD021721	20J3	Connector, M36-M87-02	DCN034601
20D4	Diode, HVT-30S	DDD021421	20J4	Same as 20J3	
20D5	Same as 20D2		20J11	Same as 20J3	
20D6	Same as 20D2		20J12	Same as 20J1	
20D12	Same as 20D1		20J21	Same as 20J3	
20D26	Same as 20D1		20J22	Connector, M31-M87-10	DCN034531
20D32	Same as 20D1		20J23	Same as 20J3	
20D33	Same as 20D1				
20D34	Same as 20D1		20P1	Connector, M33-15-30-114P	DCN034741
20D41	Same as 20D2		20P3	Connector, M36-02-30-114P	DCN034851
20D42	Same as 20D2		20P4	Same as 20P3	
20D43	Same as 20D2		20P11	Same as 20P3	
20D44	Same as 20D2		20P12	Same as 20P1	
			10P21	Same as 20P3	
20Q1	Transistor, 2SC2334L	DTR137621	20P22	Connector, M33-10-30-114P	DCN034721
20Q20	Transistor, 2SC1815GR	DTR139011	20P23	Same as 20P3	
20Q30	Transistor, 2SA1015Y	DTR119011			
20Q40	Same as 20Q20		20T1	High Voltage Transformer, FS-34442	DCL220351
20Q61	Same as 20Q20				
20Q62	Same as 20Q30		20U1	High Voltage Unit, MSL3587A	DES050563
20IC20	IC, HA17458	DIC613511	20V41	Neon Bracket Lamp, NL235	DLP025171
			20F10	Fuse, FSA-1 Fuse Holder, FSA-1	DFU020141 DSK060141

CIRCUIT REFERENCE	DESCRIPTION	IWATSU PART NO.	CIRCUIT REFERENCE	DESCRIPTION	IWATSU PART NO.
POWER SUPPLY & CALIBRATOR			21R46	Res., 12k, $\pm 1\%$, $\frac{1}{4}W$, Metal	DRE939681
			21R47	Same as 21R13	
21C1	Cap., 1000p, $\pm 20\%$, 3kV, Cer.	DCC171831	21R51	Same as 21R41	
21C11	Cap., 100 μ , $\pm 20\%$, 25V, Elect.	DCE229071	21R52	Res., 15k, $\pm 5\%$, $\frac{1}{4}W$, Carbon	DRD139611
21C21	Cap., 1000p, $\pm 10\%$, 150V, Poly.	DCF241311	21R53	Res., 2, $\pm 5\%$, 1W, Metal	DRS229051
21C31	Cap., 33 μ , $\pm 20\%$, 16V, Elect.	DCE229011	21R54	Res., 33k, $\pm 5\%$, $\frac{1}{2}W$, Carbon	DRD149321
21C32	Cap., 4700 μ , $\pm 20\%$, 16V, Elect.	DCE920711	21R56	Same as 21R46	
21C41	Cap., 100 μ , $\pm 20\%$, 160V, Elect.	DCE960161	21R57	Same as 21R13	
21C42	Cap., 4.7 μ , $\pm 20\%$, 250V, Elect.	DCE270401	21R61	Same as 21R31	
21C51	Cap., 1000 μ , $\pm 20\%$, 63V, Elect.	DCE945121	21R62	Res., 0.68, $\pm 5\%$, 1W, Metal	DRS229041
21C52	Cap., 10 μ , $\pm 20\%$, 100V, Elect.	DCE259011	21R63	Same as 21R62	
21C61	Cap., 2200 μ , $\pm 20\%$, 35V, Elect.	DCE930321	21R64	Same as 21R31	
21C62	Same as 21C61		21R65	Same as 21R41	
21C65	Cap., 0.01 μ , +80% \sim -20%, 50V, Cer.	DCC139501	21R66	Same as 21R41	
			21R67	Same as 21R42	
21C71	Cap., 22 μ , $\pm 20\%$, 25V, Elect.	DCE229041	21R71	Same as 21R46	
21C75	Same as 21C71		21R72	Same as 21R46	
			21R73	Res., 1.2k $\pm 5\%$, $\frac{1}{4}W$, Carbon	DRD139421
21R11	Res., 2.2, $\pm 5\%$, $\frac{1}{4}W$, Carbon	DRD138881	21R74	Same as 21R13	
21R12	Res., 2.7k, $\pm 5\%$, $\frac{1}{4}W$, Carbon	DRD139481	21R75	Same as 21R21	
21R13	Res., 6.8k, $\pm 5\%$, $\frac{1}{4}W$, Carbon	DRD139561	21R76	Res., 3.9k, $\pm 1\%$, $\frac{1}{4}W$, Metal	DRE939421
21R14	Res., 500, Var., 0.3W, Cermet	DRV412021	21R77	Res., 1k, Var., 0.3W, Cermet	DRV412031
21R15	Res., 820, $\pm 5\%$, $\frac{1}{4}W$, Carbon	DRD139941	21R78	Res., 5.5k, $\pm 1\%$, $\frac{1}{4}W$, Metal	DRE939671
21R16	Res., 60, $\pm 0.5\%$, $\frac{1}{4}W$, Metal	DRE239111			
21R17	Res., 1k, $\pm 5\%$, $\frac{1}{4}W$, Carbon	DRD134831	21D30	Diode, 1G4B1	DDD021031
21R21	Res., 6.8k, $\pm 1\%$, $\frac{1}{4}W$, Metal	DRE939331	21D40	Same as 21D30	
21R22	Res., 10k, $\pm 1\%$, $\frac{1}{4}W$, Metal	DRE939301	21D41	Diode, RD18EB	DDD031701
21R23	Same as 21R13		21D42	Diode, 1S953	DDD010821
21R24	Res., 4.7k, $\pm 5\%$, $\frac{1}{4}W$, Carbon	DRD139151	21D43	Diode, SM-1M-02	DDD010771
21R25	Same as 21R12		21D50	Same as 21D30	
21R26	Res., 100k, Var., 0.3W, Cermet	DRV412131	21D51	Diode, RD39EB	DDD031151
21R27	Res., 270k, $\pm 1\%$, $\frac{1}{4}W$, Metal	DRE939311	21D52	Same as 21D42	
21R31	Res., 39k, $\pm 5\%$, $\frac{1}{4}W$, Carbon	DRD139701	21D53	Same as 21D43	
21R32	Res., 6.2, $\pm 5\%$, 2W, Metal	DRS231081	21D60	Same as 21D30	
21R34	Res., 50, Var., 0.5W, Cermet	DRV350201	21D61	Same as 21D41	
21R41	Res., 82k, $\pm 5\%$, $\frac{1}{4}W$, Carbon	DRD139741	21D62	Same as 21D41	
21R42	Res., 1k, $\pm 5\%$, $\frac{1}{4}W$, Carbon	DRD139141	21D71	Same as 21D42	
21R43	Res., 18k, $\pm 5\%$, $\frac{1}{4}W$, Carbon	DRD139631	21D72	Diode, RD5.6EB1	DDD031141
21R44	Res., 82k, $\pm 1\%$, $\frac{1}{4}W$, Metal	DRE939701	21D73	L.E.D., TLG-104	DDD071111
21R45	Res., 47k, $\pm 1\%$, $\frac{1}{4}W$, Metal	DRE939371			

CIRCUIT REFERENCE	DESCRIPTION	IWATSU PART NO.	CIRCUIT REFERENCE	DESCRIPTION	IWATSU PART NO.
21Q11	Transistor, 2SA1015Y	DTR119011	21T1	Power Transformer, C546888	DCL210992
21Q12	Transistor, 2SC1815GR	DTR139011	21F1	Fuse, FSA-2	DFU020151
21Q21	Transistor, 2SB861B	DTR125181		Fuse Holder, FH033	DSK065361
21Q22	Transistor, 2SD1137	DTR145711			
21Q23	Same as 21Q12		21J10	Connector, M31-M87-12	DCN034541
21Q24	Transistor, 2SC1061C	DTR130661	21J11	Connector, M36-M87-06	DCN034641
21Q25	Same as 21Q12		21J12	Connector, M31-M87-10	DCN034531
21Q26	Same as 21Q12		21J13	Connector, M36-M87-04	DCN034621
21Q31	FET, 2SK30A-Y	DTR210141	21J17	Same as 21J10	
21Q32	Transistor, 2SA1015Y	DTR119011	21J21	Connector, S-17220 # 04	DCN093521
21Q33	Transistor, 2SB857C	DTR125231	21J30	Connector, M36-M87-02	DCN034601
21Q34	Same as 21Q11		21J33	Same as 21J30	
21IC11	IC, HA17458	DIC613511	21P10	Connector, M33-12-30-114P	DCN034731
21IC12	IC, LM2902N	DIC613451	21P11	Connector, M36-06-30-114P	DCN034891
21IC30	IC, μ PC14305H	DIC650021	21P12	Connector, M33-10-30-114P	DCN034721
21S1	Switch, SDG5P-E	DSW016531	21P13	Connector, M36-04-30-114P	DCN034891
21S40	Switch, SUJ12A	DSW014841	21P17	Same as 21P10	
21PL31	Scale Illumination Lamp	DLP016092	21P20	Connector, M33-04-30-114P	DCN034661
21PL32	Same as 21PL31		21P22	Connector, X-17213	DCN093511
21PL33	Same as 21PL31		21P25	Connector, CM-3	DCN013361
			21P30	Connector, M36-02-30	DCN034871
			21P31	Same as 21P30	
			21P33	Same as 21P30	

CIRCUIT REFERENCE	DESCRIPTION	IWATSU PART NO.
PRINTED CIRCUIT BOARDS		
VERTICAL MAIN AMPLIFIER		KPN187841
VERTICAL PRE-AMPLIFIER		KPN187941
	(Composed with Vertical pre-Amplifier, Vertical Positions and CH3 & CH4 Amplifiers)	
A SWEEP GENERATOR		KPN188131
B SWEEP GENERATOR		KPN188051
POWER SUPPLY		KPN188251
	(Composed with Power Supply, Horizontal Switches and Calibrator)	
H.V.POWER		KPN188341
	(Composed with CRT Circuit, CH3 & CH4 Attenuator and High-voltage Protector)	

Mechanical Parts List and Illustration

INDEX NO	NAME & DESCRIPTION	Q'ty	IWATSU PART NO
1	COVER, upper	1	KBA512931
2	COVER, lower	1	KBA513051
3	PANEL A, front	1	KPA141121
4	PANEL B, front	1	KPA141311
5	PANEL, rear		KCM059821
6	ACCESSORY BAG	1	KLT021721
7	HANDLE, arm	2	KCM059431
8	HANDLE, bar	1	KMM198011
9	COVER, handle	1	KCM059731
10	COVER, handle arm	2	KCM059521
11	GEAR, stater	2	KCM059611
12	SPRING, handle arm	2	KSR012611
13	STOPPER, handle arm spring	2	KBA508121
14	FIXED METAL PLATE, stater gear	2	KBA512521
15	NAME PLATE B, serial number	1	ARA002711
16	NAME PLATE, line voltage range	1	KRA103621
17	FOOT, rubber, 16 ϕ	4	KGM007931
18	RH-3 x 10A	4	MSQ930223
19	N101220SR	1	KCM060811
20	A301540DGA	1	KCM060611
21	A471560DGA	1	KCM060521
22	TIMING PANEL	1	KPA142121
23	TIMING PANEL SUPPORT	1	KCM061811
24	N111230SRP	2	KCM060911
25	A301760DGA	2	KCM060711
26	PS KNOB	1	KCM066211
27	S181580DGA	4	KCM061001
28	PUSH BUTTON	2	KCM061611
29	MULTI-DIAL (electric part)		
30	K141360SGP	2	KCM061511
31	K141360SG	4	KCM061411
32	K101160	1	KCM061111
33	K101160SG	2	KCM061211
102	KD(+) $3 \times 18S$	8	MKD130181
103	KP - $3 \times 12S$		MKP130121
105	KT - $2 \times 4B$		MKT220042
106	KT - $3 \times 8B$		MKT230082
108	KT - $3 \times 12B$		MKT230122
115	HL - 3×3		MHL130039
120	SW-3S		MSW130001
121	W-3S		MWW130001
122	NYLON W-2 (DM-7100)	6	KPL102411

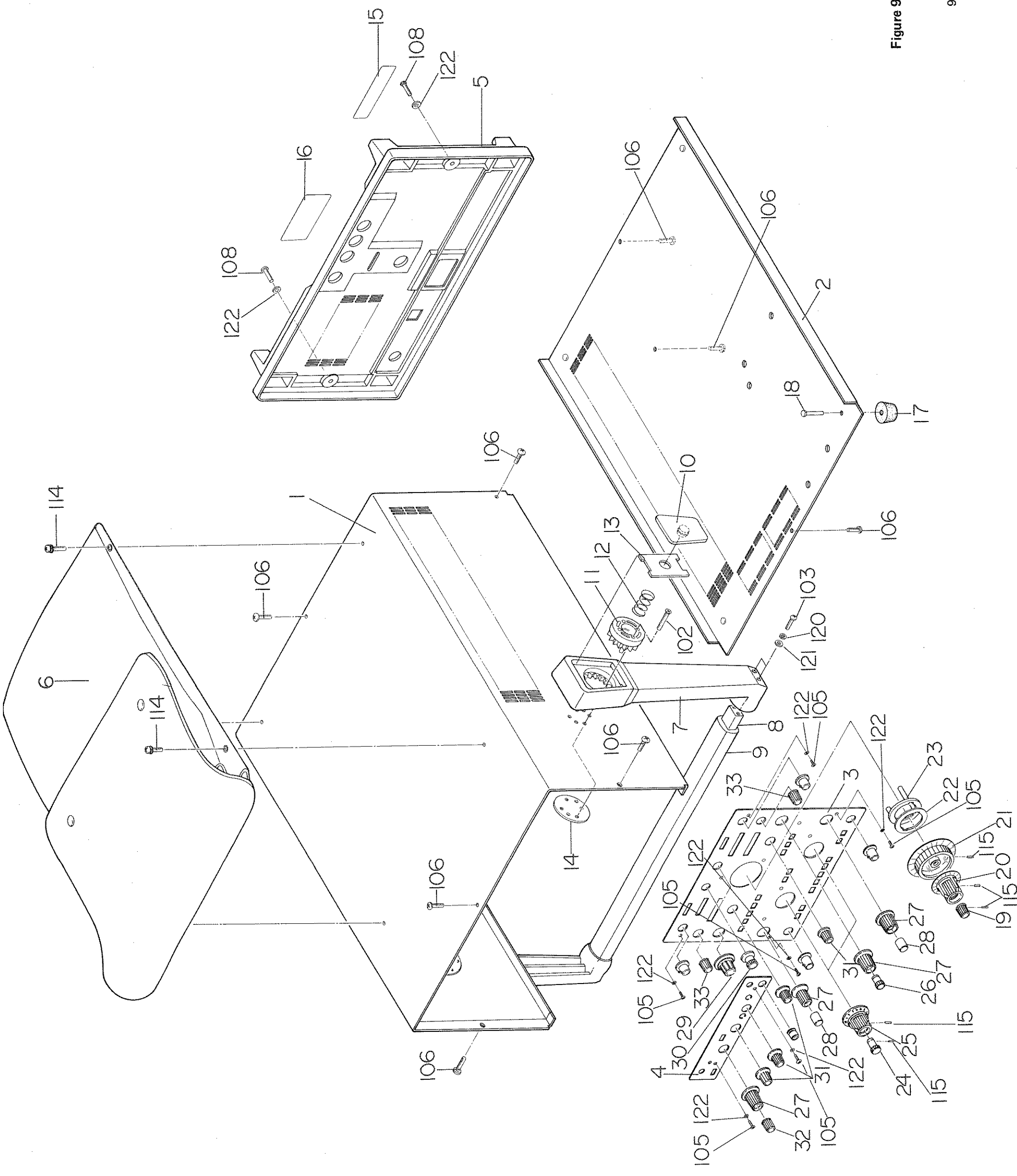

Figure 9-1

Section 9 Mechanical Parts List
Fig 9-2

SS-5711

INDEX NO	NAME & DESCRIPTION	Q'ty	IWATSU PART NO
34	COVER, panel	1	KCM059921
35	SUB PANEL, front	1	KPA141841
36	CHASSIS	(1)	KBA516061
37	FRAME	1	KBA513751
38	SUB PANEL, rear	1	KPA142251
39	CRT SHIELD PLATE	1	KBA516831
40	CASE, high voltage	1	KBA516921
41	SEAT PLATE, transformer	1	KBA516721
42	STOPPER, transistor	2	KBA516411
43	SILICON RUBBER, heat-dissipater		
44	SEAT PLATE, CP	1	KBA526711
45	SEAT PLATE, line voltage selector	1	KBA526611
46	SEAT PLATE, INLET	1	KBA526511
47	PS KNOB CI, POWER		KCM061911
48	JOINT	1	KCM006621
49	ROD, power switch	1	KMM198311
50	INSULATE COUPLING	1	KCM006521
51	SPRING		
52	GUIDE, printed circuit board	3	MZT900381
53	BAND		MHK000961
55	CLAMP, DKN-05	1	MHK001331
69	BUSHING KG-024	1	KBU000501
82	TERMINAL, CAL	1	DTA010871
85	CP OUTPUT TERMINAL	1	KPS009511
86			
100	KD - 3 x 6S		MKD130061
101	KD - 3 x 8S		MKD130081
110	SM1 - 3 x 6	20	MSM130061
111	SM1 - 3 x 8CT		MSM130081
114	SM5 - 3 x 8		MSM530081
116	HL - 3 x 4		MHL130049
117	KP - 3 x 10		MKP130101
120	SW - 3S		MSW130001
121	W - 3S		MWW130001
125	WS09(1.5)62B0	1	KMM199611
126	STAY RB1.6 08 09 30A0	3	AMM627811
127	STAY		KMM198211

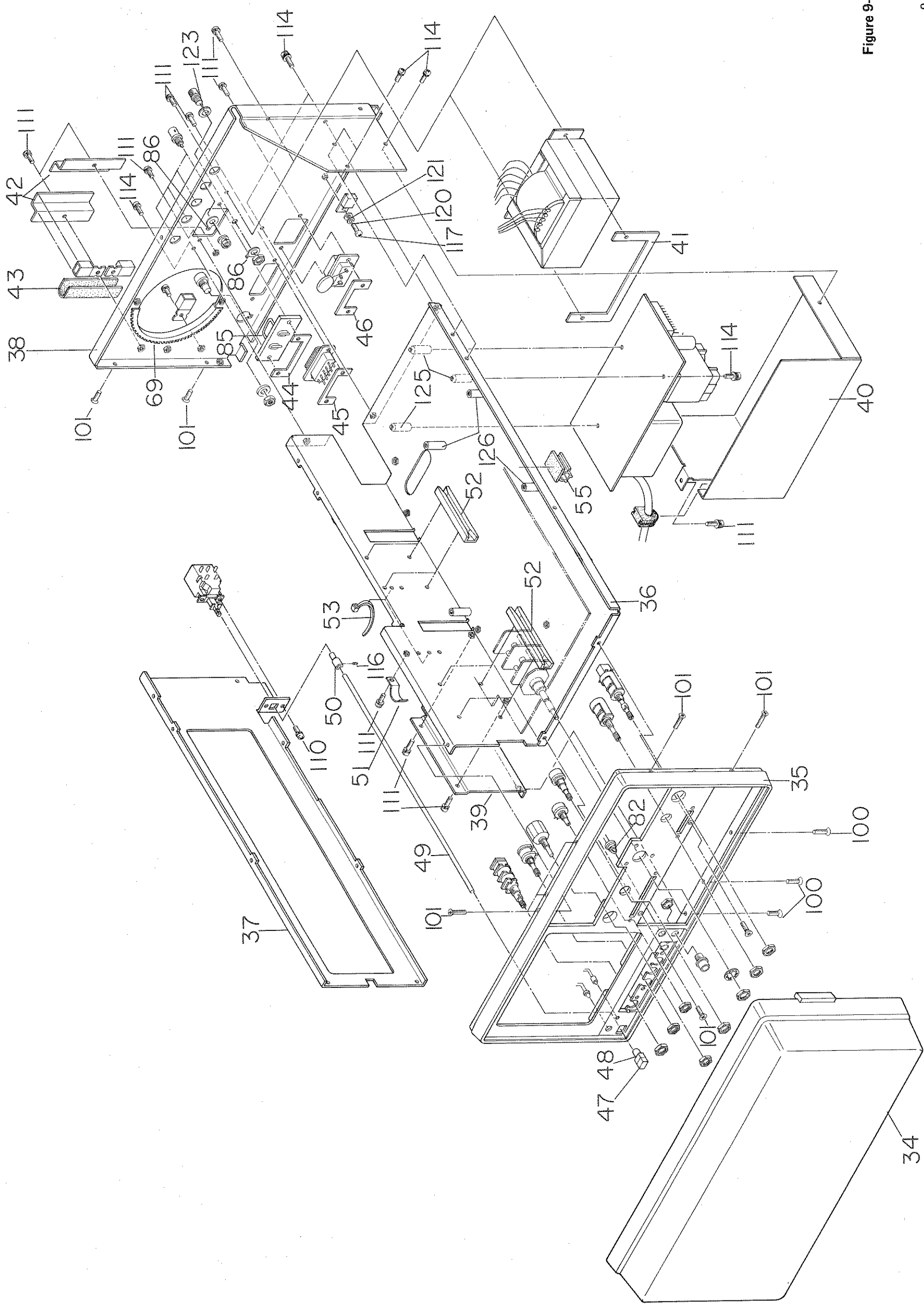

Figure 9-2

Fig 9-3

INDEX NO.	NAME & DESCRIPTION	Q'ty	IWATSU PART NO
51	SPRING, ground	2	KBA520821
56	SUB PANEL, H	1	KPA141931
57	SUB PANEL, V	1	KPA142021
58	ATT SHIELD PLATE F	1	KBA513831
59	ATT SHIELD PLATE E	2	KBA514031
60	ATT SHIELD PLATE A	1	KBA516631
61	ATT SHIELD PLATE C	1	KBA516331
62	ATT SHIELD PLATE B	1	KBA516531
63	ATT SHIELD PLATE D	1	KBA516231
64	ATTACHMENT, PCB of power supply	1	KBA529711
65	STAY A, screw	1	KMM198611
66	STAY B, screw	1	KMM198721
67	STAY C, screw	8	KMM198811
68	SBH (5.5) (18.5) 30B0	1	KMM107511
83	PS KNOB D1	37	KCM062011
84	PS KNOB D2		
86	Lug 10.2 ϕ	4	KPS004311
100	KD - 3 x 6S		MKD130061
101	KD - 3 x 8S		MKD130081
109	SM1 - 2.6 x 6CT	30	MSM126061
111	SM1 - 3 x 8CT		MSM130081
112	SM1 - 3 x 12CT	10	MSM130121
113	SM5 - 3 x 6	50	MSM530061
114	SM5 - 3 x 8		MSM530081
118	KD - 2.6 x 4S		MKD126041
120	SW - 2.6S		MSW126001
	SW - 3S		MSW130001

Fig 9-4

INDEX NO	NAME & DESCRIPTION	Q.ty	IWATSU PART NO
53	BAND		MHK000961
70	BEZEL B2,	1	KCM060321
71	BEZEL B2,	1	KCM060411
72	FILTER FRAME B2	1	KPL014811
73	CUSHION, CRT	1	KGM009631
74	SCALE ILLUM PLATE	1	KCM056111
75	STOPPER, Filter	1	KPL013411
76	NAME PLATE, title, SS-5711	1	KRA103221
77	SHIELD CASE A	1	KBA513221
78	SHIELD CASE B	1	KBA513311
79	SUSPENSION A, <small>CRT shielded case A and B</small>	2	KBA513421
80	SUSPENSION B, <small>CRT shielded case A and B</small>	1	KBA513521
81	CRT FIX BAND	1	KBA513621
82	CRT FIXED RUBBER	1	KGM009511
104	KP (+) 3 x 25S	1	MKP130251
107	KT - 3 x 10		MKT230102
113	SM5 - 3 x 6	50	MSM530061
114	SM5 - 3 x 8		MSM530081
120	SW - 3S		MSW130001

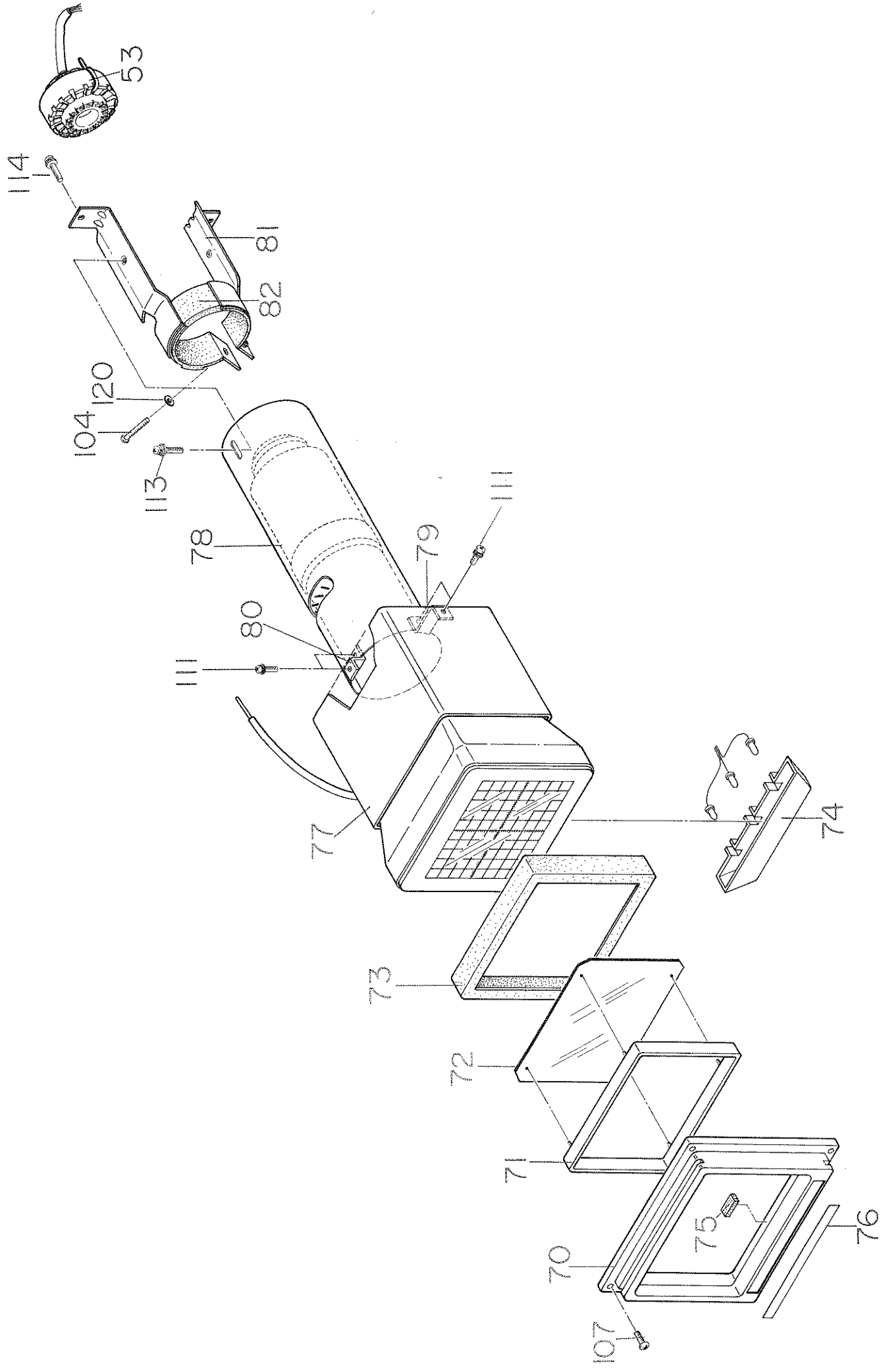

Figure 9-4

