

INSTRUCTION MANUAL
MODEL 604
DIFFERENTIAL ELECTROMETER AMPLIFIER

KEITHLEY INSTRUMENTS, INC.
PRINTED JANUARY 1977, CLEVELAND, OHIO U.S.A.

CONTENTS

Section	Page
SPECIFICATIONS	iv
1. GENERAL DISCRIPTION.	1
2. OPERATION.	3
3. CIRCUIT DESCRIPTION.	11
4. MAINTENANCE.	13
5. ACCESSORIES.	25
6. REPLACEABLE PARTS.	27
SCHEMATICS	36

ILLUSTRATIONS

Fig. No.	Title	Page
1	Model 604 Front Panel Controls.	3
2	Model 604 Rear Panel Controls	3
3	Model 6041 Front Panel.	4
4	Typical Experiment.	5
5	Error Due to Ammeter Resistance	8
6	Internal View of Model 301 Amplifier.	9
7	Model 604 Block Diagram	11
8	Ripple Obtained for the 26 Volt Supply.	14
9	Ripple Obtained for the 15 Volt Supply.	15
10	Ripple Obtained for the 21 Volt Supply.	15
11	Location of Voltage Supplies Test Points.	15
12	Null Obtained with the Signal Generator at 5Hz.	17
13	Null Obtained with the Signal Generator at 1kHz	17
14	Top View Model 604.	21
15	Bottom View Model 604	22
16	Component Layout of PC-165.	23
17	Resistor Locations on PC-165.	24
18	Top Cover Assembly.	35
19	Bottom Cover Assembly	35

SPECIFICATIONS

AS AN AMPLIFIER:

INPUT: Single ended or differential.
GAIN: 10 to 10⁶ in 1x and 3.33x steps.
GAIN ACCURACY: Better than ±1% at dc exclusive of noise and drift.
GAIN STABILITY: Better than ±0.1% per 6 months exclusive of noise and drift.
ZERO STABILITY: Within 4 millivolts per week and 300 microvolts/°C referred to input after a 1-hour warm-up.
LINEARITY: Better than ±0.1% of full output at dc exclusive of noise and drift.
FREQUENCY RESPONSE: ±1% dc to 10 kHz on all gains, from 1000-ohm source resistance or less, ±3 dB to 200 kHz at minimum gain for small signals, decreasing to 50 kHz on maximum gain. Maximum linear output swing decreases above 10 kHz to 10% of full output at 75 kHz.
HIGH FREQUENCY ATTENUATOR: 6 dB per octave with -3 dB points at 100 Hz to 30 kHz in six 1x and 3x steps. Seventh step gives rated frequency response.
NOISE: Less than 20 microvolts rms, 3 to 100 Hz; less than 80 microvolts rms, 3 Hz to 50 kHz with maximum gain (approximately triple with minimum gain). Noise increases approximately in proportion to rise time decrease when guarding.
INPUT IMPEDANCE: Greater than 10¹⁴ ohms shunted by less than 5 picofarads in unguarded position, greater than 10¹⁴ ohms shunted by less than 1 picofarad in guarded position. Inner shield of triaxial cable is driven in guarded position.
COMMON MODE REJECTION: Greater than 90 dB, dc to 120 Hz, decreasing to 80 dB at 1 kHz.
COMMON MODE VOLTAGE: Up to ±11 volts, dc to 1 kHz, decreasing to ±50 millivolts maximum at 75 kHz.
OUTPUT: ±10 volts single ended for full scale at up to 5 milliamperes.
 Unity Gain: Two outputs provide signals equal to each input-to-ground voltage ±0.005% at dc (exclusive of up to 5 millivolts zero offset referred to output).
 All outputs are short-circuit proof.

AS AN AMMETER (with accessory shunts):

Less than 2 x 10⁻¹⁴ ampere.

TYPICAL RISE TIMES AND NOISE (with Model 6041 Differential Current Shunt*):

Shunt Resistor (ohms)	Current Span (full scale)	Guarded		Unguarded	
		Rise Time (10%-90%)	Noise (p-p)	Rise Time (10%-90%)	Noise (p-p)
10 ⁴	10 ⁻⁶ to 10 ⁻⁴ A	0.00005 s	2x10 ⁻¹⁴ A	0.0005 s	2x10 ⁻¹³ A
10 ⁶	10 ⁻⁸ to 10 ⁻¹¹ A	0.0005 s	2x10 ⁻¹⁶ A	0.05 s	2x10 ⁻¹⁵ A
10 ¹⁰	10 ⁻¹⁰ to 10 ⁻¹³ A	0.05 s	2x10 ⁻¹⁸ A	5.0 s	2x10 ⁻¹⁷ A
10 ¹⁴	10 ⁻¹¹ to 10 ⁻¹⁴ A	0.5 s	2x10 ⁻¹⁹ A	50.0 s	2x10 ⁻¹⁸ A

* with three feet of triaxial input cable and no other shunt capacitance. When measuring current with the internally mounted 6033 Shunt Resistor, the Model 604 has slightly shorter rise times and lower noise for corresponding Model 6041 ranges.

Model 6041 Differential Current Shunt

Model 6041 Specifications:

Resistor Accuracy: ±2% 10⁴ to 10¹⁴ ohms in decade steps.
Connectors: Input: Triaxial. Output: Cable and connectors mate with Model 604 input.
Dimensions, Weight: 7" high x 8 1/4" wide x 10" deep; net weight, 6 pounds.

AS A DC VOLTMETER:

RANGE: ±1 millivolt full scale to ±1 volt in seven 1x and 3x steps.
METER ACCURACY: ±2% of full scale exclusive of noise and drift.
METER NOISE: ±40 microvolts with inputs shorted.
POLARITY: Meter switch selects left-zero (positive or negative) or center-zero scales. Meter switch does not reverse polarity of outputs.

GENERAL:

ZERO SUPPRESSION: Up to ±1 volt dc between inputs.
MAXIMUM INPUT OVERLOAD: ±400 volts, dc - 100 kHz either input to ground or between inputs.
CONNECTORS: Input: Special Teflon-insulated Triaxial Dage 33050-1. Amplifier output: 80 PC2F. Unity-gain output: BNC.
POWER: 105-125 or 210-250 volts (switch selected); 50-60 Hz; 10 watts.
DIMENSIONS, WEIGHT: 7" high x 8 1/4" wide x 10" deep; net weight, 12 pounds.
ACCESSORIES FURNISHED: Two 6011 Input Cables; mating amplifier output connector.

SECTION 1. GENERAL DESCRIPTION

1-1. GENERAL.

a. The Keithley Model 604 Differential Electrometer Amplifier is a completely solid-state instrument that can be used by itself single-endedly or differentially either as an amplifier or a millivoltmeter. The Amplifier has selectable gains of 10 to 10^6 in $1x$ and $3.33x$ steps corresponding to the VOLTS Switch settings of 1 to $.001$.

b. When used in conjunction with the Model 6041 Differential Current Shunt the Model 604 becomes a single-ended or differential picoammeter. Single-ended and differential current measurements from 10^{-8} to 10^{-14} ampere can be made with this setup. Also, high megohm resistors may be installed within the Model 604 to allow shunt picoammeter operation.

1-2. MODEL 604 FEATURES.

a. As an amplifier, the Model 604 will operate over a bandwidth from dc to 50 kHz or greater with six selectable 3-dB points from 30 kHz to 100 Hz. Thus, the signal-to-noise ratio may be optimized for a particular application. The amplifier output furnishes ± 10 volts at 5 milliamperes single-ended.

b. The Electrometer Amplifier has an input resistance of greater than 10^{14} ohms shunted by less than 5 picofarads in the unguarded position, that allows high impedance measurement to be made easily. When in the guarded position the input impedance is shunted by less than 1 picofarad.

c. Low offset current - less than 2×10^{-14} ampere - minimizes zero offset with high source resistance and permits maximum resolution when measuring current.

d. A choice of outputs which can be used simultaneously or singly is available. Each input of the Model 604 has a unity gain output, which has ± 50 ppm accuracy. This allows the Model 604 to be used as a preamplifier with differential or digital voltmeters for precise measurements. Also, these outputs can be fed into an X-Y recorder for recording data from high impedance sources. When desired, the unity-gain outputs can be monitored for absolute values while recordings are made from the amplifier output.

e. All outputs are short-circuit proof, and output noise referred to the input is nearly constant regardless of the gain.

f. The guarding capability of the Model 604 allows fast measurements from high resistance sources, by eliminating the effects of cable capacitance and leakage. To conveniently facilitate these measurements, the Model 6301 Guarded Probe can be used to connect the source to the Model 604 in the guarded mode. The guard feature is switch selectable.

g. Another outstanding feature of the Keithley Model 604 is its zero stability. Signals can be monitored over weeks without constant rezeroing. Zero drift of the Amplifier is less than 4 millivolts per week; zero offset due to temperature changes is less than 300 microvolts per $^{\circ}\text{C}$. Zero shift due to mechanical shock or vibration is negligible.

h. Overloads up to ± 400 volts will not damage the 604 Amplifier, and recovery is almost immediate. A unique circuit provides protection while maintaining the favorable features of the MOS FET input.

i. As another convenience feature, the Model 604 provides a very stable ± 1 volt suppression on any range. Variations as small as 1 millivolt in a 1 -volt signal can be displayed full scale.

j. Variations in line voltages from 105 to 125 volts cause no apparent change even on the most sensitive range. Line frequency noise is practically eliminated from the Model 604 output.

1-3. MODEL 6041. The Model 6041 Differential Current Shunt is an accessory specifically designed to convert the Model 604 Amplifier into a single-ended or differential multi-range picoammeter.

a. The driven guard enables the Model 604 Amplifier and the Model 6041 Shunt combination to obtain fast response in current measurements. Input capacitance at the end of a 10 -foot cable is maintained at 1 picofarad in the guarded mode. As a result, rise times of 0.5 millisecond are possible with 10^{-11} ampere input signals. Guarding is maintained through the Model 6041 by the use of triaxial input connectors and total guarding within the Shunt itself.

b. For those applications where maximum signal-to-noise ratio is more desirable than fast response, the Model 604 can be used in its unguarded mode. Noise will be as low as 2×10^{-15} ampere using a 10^{11} ohm resistor. However, rise times are much longer than when the Model 604 is in its guarded mode. Regardless of mode, the high frequency cutoff can be used to reduce noise at the higher frequencies.

c. For those cases where a limited current span is to be monitored, a pair of high megohm resistors, available as the Model 6033, can be mounted internally within the Model 604. Although this method limits the current span to only four decades, it does slightly improve both the noise and the rise time characteristics over that obtainable with the multi-range Model 6041 Current Shunt. The compromise between noise and rise time still must be made by choosing the guarded or unguarded mode.

d. Low offset current minimizes zero offset with high source resistance, permitting maximum resolution when measuring current.

TABLE 2. Model 604 Front Panel Controls (Figure 1).

Control	Functional Description	Paragraph
VOLTS Switch	Selects full scale range Model 604 is to measure, or gain instrument is to amplify.	2-6
HIGH CUT HZ Switch	Varies the high frequency rolloff of the Model 604 and selects the maximum bandwidth to be measured. When the Switch is in the OFF Position the full bandwidth of the Model 604 is available.	2-5
METER Switch	Turns instrument off and on; disconnects meter; selects meter polarity; sets instrument for center zero operation.	2-2
Meter Pilot Light	Indicates instrument is on.	2-8
SUPPRESS Controls: FINE ADJ., MEDIUM, COARSE	Zeros amplifier output and determines the amount of zero suppression; up to 1 volt dc between inputs.	2-6
ZERO CHECK Buttons	Shunts respective INPUT Receptacle. Locking either one allows single ended use. Locking both zeroes the meter. Opening both allows differential measurements.	2-2
GUARD-OFF Switch	Allows guarding for high speed measurements from high resistance sources when in GUARD Position.	2-2
(+) and (-) INPUT Receptacles.	Connect inputs to sources. May be used either singularly or conjointly for single ended or differential measurements respectively. Receptacles are Teflon-insulated triaxial connectors.	2-1

TABLE 3. Model 604 Rear Panel Controls (Figure 2).

Control	Functional Description	Paragraph
UNITY GAIN OUTPUTS: FROM (-) INPUT; FROM (+) INPUT	For use as an extremely linear preamplifier. Outputs are equal to respective inputs within $\pm 0.005\%$ at dc, exclusive of offset, noise and drift.	2-11
GROUND Post	Connected to ground of all the outputs and the ground wire of the power cord.	---
AMPLIFIER OUTPUT	For monitoring output.	2-11
LINE VOLTAGE Switch	Sets instrument for 117 volt or 234 volt operation.	2-2
FUSE	3AG Slow Blow. 117 volt operation: -1/8 ampere. 234 volt operation: -1/16 ampere.	2-8

TABLE 4. Model 6041 Differential Current Shunt Front Panel Controls (Figure 3).

Control	Functional Description	Paragraph
+INPUT Switch	Switches shunt resistor at input of the amplifier for the Model 604 +INPUT Receptacle, thus determining full scale current range Model 604 is to measure.	2-2
-INPUT Switch	Switches shunt resistor at input of the amplifier for the Model 604 -INPUT Receptacle, thus determining full scale current range Model 604 is to measure. Both switches are used in differential current measurements.	2-2
INPUT: + and -	Connects Model 6041 inputs to sources. May be used either singularly or conjointly for single-ended or differential measurements respectively. Receptacles are Teflon-insulated triaxial connectors.	2-2
TO 604 INPUTS: + and -	Connects Model 6041 to respective Model 604 Input Receptacles.	2-2
GND	Connected to ground of Models 604 and 6041.	

SECTION 2. OPERATION

2-1. INPUT CONNECTIONS. The Model 604 has two input connectors, the +INPUT Receptacle and the -INPUT Receptacle, for use either single-endedly or for measuring the difference between two input signals.

a. The Model 604 INPUT Receptacles are Teflon-insulated triaxial connectors. The center terminal is the high impedance terminal; the inner shield is either guard or ground; the outer shield is ground. The inner shield of the INPUT Receptacle may be used as a driven guard with the GUARD-OFF Switch in the GUARD Position.

b. There are Keithley Accessories available which are designed to increase accuracy and convenience of input connections.

c. The Model 6011 Input Cable facilitates input connections. Table 5 indicates the color coding of the alligator clips. The center terminal is shielded by the inner braid of the triaxial cable up to the miniature alligator clip. If the unshielded clip causes pickup from nearby electric fields, remove it and connect the shielded lead directly to the source.

TABLE 5. Color Coding of Alligator Clips for Model 6011 Input Cable.

Lead	Circuit	Terminal
heavy wire with red clip cover	high	Center
thin wire with black clip cover	guard	Inner Shield
thin wire with green clip cover		Outer Shield

d. When working with a high impedance source carefully shield the input connection and the source since any variation in the electrostatic field near the input may cause definite meter disturbances.

e. Use high resistance, low-loss materials -- such as Teflon (recommended), polyethylene or polystyrene -- for insulation. The insulation leakage resistance of test fixtures and leads should be several orders of magnitude higher than the internal resistance of the source. Excessive leakage reduces the accuracy of reading from high impedance sources. Triaxial or coaxial cables used should be a low noise type which employs a graphite or other conductive coating between the dielectric and the surrounding shield braid. Amphenol-Borg Electronics Corporation, Microdot, Inc., and Simplex Wire and Cable Company make satisfactory types. Use of the Model 6011 Input Cable insures good input connections.

NOTE

Clean, dry connections and cables are very important to maintain the value of all insulation materials. Even the best insulation will be compromised by dust, dirt, solder flux, films of oil or water vapor. A good cleaning agent is methyl alcohol, which dissolves most common dirt without chemically attacking the insulation. Air dry the cables or connections after washing with alcohol or use dry nitrogen if available. Or, if it is available, Freon is an excellent cleaning agent.

f. With the GUARD-OFF Switch in GUARD Position the Model 604 may have at least ten feet of triaxial cable on its input without adding capacitance to the

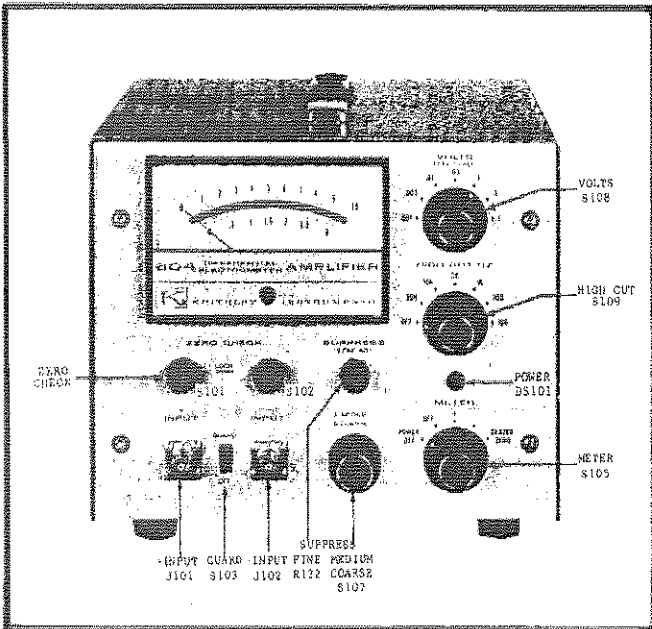

FIGURE 1. Model 604 Front Panel Controls

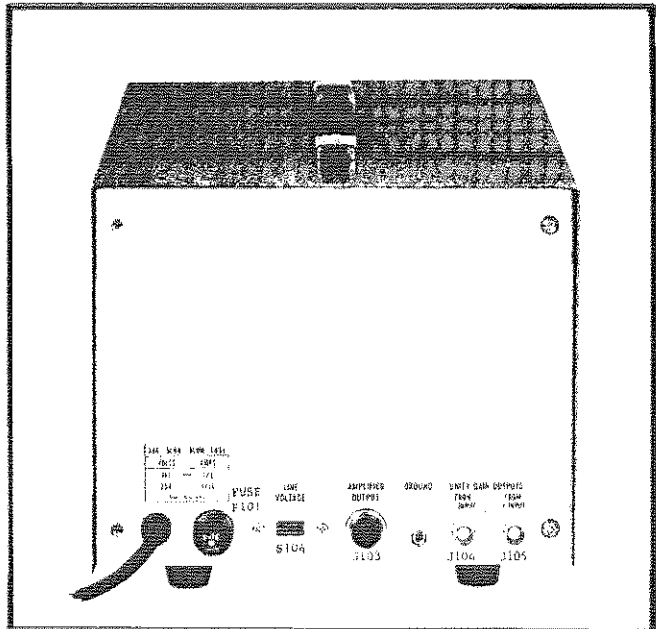

FIGURE 2. Model 604 Rear Panel Controls

input (input capacitance is specified at 1 pF). Note, however, that guarding can only eliminate input cable capacitance effects. Except in one special case, see subparagraph 2-1i, guarding cannot be used to eliminate effects due to source capacitance. Do not connect the guard circuit to the source.

NOTE

For a complete discussion on guarding with the Model 604 refer to paragraphs 2-3 and 2-4.

g. When working with a high impedance source any change in the shunt capacitance of the input circuit will cause disturbances in the reading. Make the measuring setup as rigid as possible, and tie down connecting cables to prevent their movement. A continuous vibration may appear at the output as a sinusoidal signal, and other precautions may be necessary to isolate the instrument and the connecting cable from the vibration.

h. For low impedance measurements -- measurements that are above 10^{-8} amperes -- unshielded leads may be used.

i. The Model 6012 Triaxial-to-Coaxial Adapter enables using coaxial cables and accessories with the Model 604 by adapting the triaxial INPUT Receptacles to the UHF coaxial type.

1. The Adapter connects the Model 604 inner shield to ground defeating the guard capability that the triaxial receptacles make possible. Except for the special case spelled out in the following subparagraph 2, the GUARD-OFF Switch must be in the OFF position for the instrument to function.

2. If the Model 6012 Adapter is used with the Model 6041 Shunt in front of the Model 604 and the current source can be floated off ground, then a feedback picoammeter connection is possible. In this situation the coaxial shield is guard with the GUARD-OFF Switch in the GUARD position. To make possible a guarded circuit, connect guard, the coaxial shield, to the low of the current source. Remember, however, if the current source low is grounded, the GUARD-OFF Switch must be in the OFF position for the instrument to operate, and no guarded circuit is possible this way.

2-2. INPUT CONSIDERATIONS.

a. The Model 604 + INPUT Receptacle is the input to the non-inverting amplifier. This means that for a single-ended positive input to this Receptacle the output is positive and for a negative input the output is negative. The polarity can also be interpreted with the METER Switch and displayed on the meter.

b. The Model 604 - INPUT Receptacle is the input to the inverting amplifier. Thus for a single-ended positive input signal to this Receptacle the output is negative and for a negative input the output is positive.

c. For single-ended measurements just lock the ZERO CHECK Button for the Input Receptacle that you do not intend to use, and apply the signal to the other Receptacle. When locked, the ZERO CHECK Button will connect its Input Receptacle to ground presenting an open circuit to the respective amplifier. The Model 604 always measures the signal differentially. In the single-ended mode it measures the difference between the applied signal and the reference signal (ground).

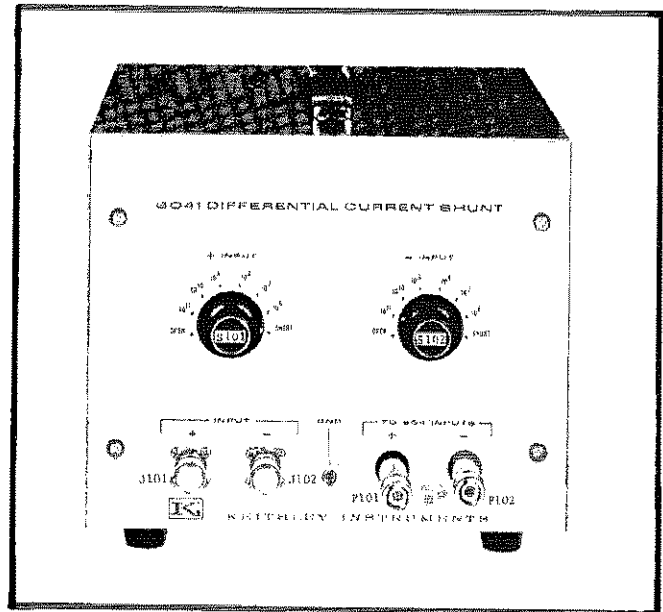

FIGURE 3. Model 6041 Front Panel Controls and Terminals.

d. For differential measurements unlock both ZERO CHECK Buttons and apply one signal to one of the Input Receptacles and the other signal to the other Receptacle. It does not matter which Receptacle accepts the high or low signal. If the signal to the -INPUT Receptacle is positive with respect to the signal to the +INPUT Receptacle, then the output, and the meter, will read negative. If the signal to the +INPUT Receptacle is positive with respect to the signal to the -INPUT Receptacle, then the output will be positive.

e. The Model 6041 is a Differential Current Shunt which, when used in conjunction with the Model 604, enables the Model 604 to become either a single-ended or differential shunt ammeter. The INPUT Receptacles on the Model 6041 are nominally labeled. That is, it is not essential that, single-endedly, a positive signal be applied to the (+) Receptacle and a negative to the (-) Receptacle or, differentially, the high signal to the (+) and the low to the (-).

1. The Model 6041 outputs (labeled: TO 604 INPUTS; + and -), which connect the Model 6041 to the Model 604, are directly tied to their corresponding Input Receptacle. That is, a signal to the +INPUT Receptacle will be accepted at the + output and a signal to the -INPUT Receptacle will be accepted at the - output.

2. Though it is not absolutely necessary, it is recommended that upon connecting the Model 6041 to the Model 604, the corresponding output receptacle of the Model 6041 be connected to the corresponding Input Receptacle on the Model 604. Otherwise, the user may become utterly confused at what the polarity at the Model 604 output corresponds to.

3. Note that the +INPUT Switch on the Model 6041 applies to the Model 6041 +INPUT Receptacle only and the -INPUT Switch applies to the -INPUT Receptacle only, regardless of the relative or absolute polarities of the signals at the inputs.

2-3. GUARDING.

a. There are several factors which contribute to the bandwidth of an experiment.

1. The amplifier bandwidth;
2. The source resistance and capacitance;
3. The capacitance of the cable connecting the amplifier to the source.

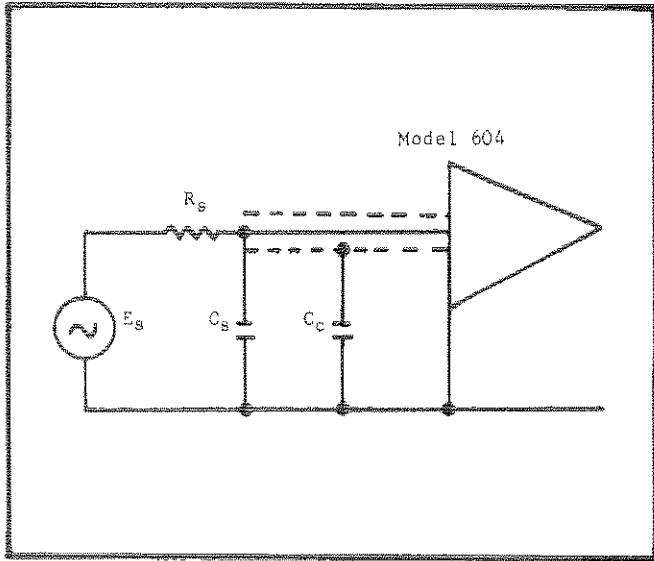

FIGURE 4. Figure Depicts a Typical Experiment Showing the Amplifier, Cable and Source. In the figure C_c is the capacitance due to the connecting cable, C_s is the source capacitance, R_s is the source resistance and E_s is the source voltage.

b. In the typical setup shown in Figure 4, if a perfect amplifier were placed at the source, the 3 dB frequency of the source would be

$$f_{3dB} = \frac{1}{2\pi R_s C_s} = .16/R_s C_s \quad \text{equation 1.}$$

where f_{3dB} is the 3dB bandwidth of the source in Hz;
 R_s is the source resistance in ohms.
 and C_s is the source capacitance in farads.

1. If, to take an example, R_s is equal to 10^9 ohms and C_s is equal to 10 picofarads, then

$$f_{3dB} = \frac{.16}{(10^9)(10^{-11})} = \frac{.16}{(10^{-2})} = 16 \text{ Hz.}$$

2. Now, if a cable is used to connect the source to the amplifier, a new bandwidth is encountered because of the addition of the cable capacitance and equation 1 becomes

$$f_{3dB} = \frac{.16}{R_s (C_s + C_c)} \quad \text{equation 2.}$$

where f_{3dB} is the 3dB bandwidth of the system in Hz;
 R_s is the source resistance in ohms;
 C_s is the source capacitance in farads;
 and C_c is the cable capacitance in farads.

An average cable adds approximately 30 picofarads per foot to the circuit. Thus, a 3-foot cable would add 90 picofarads and

$$f_{3dB} = \frac{.16}{10^9(10+90)(10^{-12})} = 1.6 \text{ Hz.}$$

So, in this example, connecting the source to the amplifier with a 3 foot cable, without guarding, would cause a 10:1 reduction in bandwidth.

c. The Model 604 is designed to eliminate (guard) the cable capacitance when used in the guard mode. The Model 604 will reduce the apparent capacity at the end of an up to 10 foot long triaxial cable to approximately 1 picofarad by driving the inner shield of the cable.

NOTE

The capacity from the center conductor of a triaxial cable to the inner shield is about 30 picofarads per foot. From the inner shield to the outer shield it is about 70 picofarads per foot. The signal source, however, only sees the capacity from the center conductor to the inner shield. The guard circuit, though, drives the entire capacity, about 100 picofarads per foot. The Model 604 guard circuit effectively drives up to 1000 picofarads; thus the 10 foot cable limitation.

1. In the above example, then, the guard feature of the Model 604 allows the user to achieve almost the entire bandwidth of the source circuit.

$$f_{3dB} = \frac{.16}{10^9(10+1)(10^{-12})} = 14.5 \text{ Hz.}$$

2. Notice that, in the above case, guarding does not increase the bandwidth of the source, but practically eliminates the effect of cable capacity.

d. The guard feature does, however, have several limitations.

1. It is effective driving only up to 1000 picofarads. Thus, no more than 1000 picofarads should be guarded from either input for optimum response.
2. The guard voltage swing is limited by the common mode voltage swing (± 1 volts dc to 1 kHz and approximately ± 2 volts at 5 kHz).
3. The guard feature is not effective beyond 5 kHz because of internal phase shifts. These shifts cause peaking to occur above 5 kHz, but the system still remains stable.

e. Note that each input of the Model 604 has its own separate guard circuit which is completely independent of the other. Note, also, that guard and the unity-gain outputs are electronically identical (see schematic diagram 22820E in Section 5).

2-4. GUARD-OFF SWITCH.

a. This Switch when in the GUARD Position reduces the effect of input cable capacity and provides high speed measurements from high resistance sources at the end of a cable by driving the cable capacitance and the inner shield of the INPUT Receptacle(s) (refer to paragraph 2-3). A guarded circuit is possible in this way.

b. With the Switch in the GUARD Position input capacity is decreased (to approximately 1 pF even with up to 10 feet of cable on the input) and rise time is decreased. Note, however, that the noise is increased.

c. With the GUARD-OFF Switch in the OFF position the input capacity is increased to 5 pF with no cable the input and 100 pF with 3 feet of cable on the input. The speed of response and the noise are decreased.

NOTE

When using the Model 6041 with the GUARD-OFF Switch in the GUARD position the total system is guarded. Also, less than 3 pF will be present at the Model 6041 input with 3 feet of cable on the input.

d. Therefore, although guarding increases speed, it also increases noise as well and a compromise between speed and noise will have to be made.

2-5. HIGH CUT HZ SWITCH.

a. This Switch allows the user to select the most amenable bandwidth to achieve optimum rise time and noise. The amplifier rolls off at 6 dB/octave and the Switch determines the measured bandwidth of the amplifier and cuts off higher frequencies at the 3 dB point. For example, if the Switch is set to 1 kHz the bandwidth of the Model 604 is 1 kHz and all higher frequencies are cut off. Setting the Switch to OFF gives the rated frequency response.

b. The user can use the HIGH CUT HZ Switch to select the optimum bandwidth for his measurement by cutting off higher frequency noise components, ringing and overshoot. Note, however, the lower the bandwidth the longer the rise time. So the user will have to use the requirements of his experiment and the method of trial and error to select the proper setting of the Switch for optimum achievement.

2-6. SUPPRESS CONTROLS.

a. There are three SUPPRESS Controls: FINE ADJ., MEDIUM and COARSE. The COARSE and MEDIUM SUPPRESS Controls are eight position switches. The MEDIUM Control interpolates between the setting of the COARSE Control. The FINE ADJ. Control is a ten-turn potentiometer that interpolates between the settings of the MEDIUM Control. These controls may either be used for suppression or for zeroing the Model 604.

b. The zero suppress circuit cancels any constant dc voltage in order to use a more sensitive range to observe a superimposed signal. There is up to ± 1 volt available for zero suppression. This means that on the most sensitive ranges up to 1000 times full scale may be suppressed. For example, the Model 604 can measure changes of 1 millivolt full scale in a 1 volt steady signal on its .001 volt range.

c. Operation.

1. Adjust the VOLTS Switch to the range that gives the closest to a full scale meter deflection.
2. Turn the SUPPRESS Controls completely in the direction opposite meter deflection (counterclockwise for positive deflections and clockwise for negative deflections).
3. Turn the COARSE Control setting until the meter needle passes through zero. Turn the MEDIUM Control until the needle passes back through zero and then adjust the FINE ADJ. Control for zero deflection.

4. Set the VOLTS Switch to a more sensitive range and readjust for zero, if necessary.

2-7. COMMON MODE REJECTION.

a. A good differential amplifier is characterized by its common mode rejection and also its common mode voltage range. The Model 604 rates relatively well in both these areas.

b. The specifications in Table 1 read greater than 90 dB from dc to 120 Hz decreasing to 80 dB at 1 kHz. Actually, the common mode rejection is greater than this. The specification is based on the nonlinear distortion caused by swinging the amplifier between ± 1 volts common mode. The fundamental is almost completely removed and all that appears at the output is predominately second harmonic of the common mode input signal. This distortion increases with frequency and the specification is degraded accordingly. At lower common mode levels, lets say 2 volts peak-to-peak, it is practically impossible to see any output change due to the common mode signal up to 1 kHz at any gain setting on the Model 604.

2-8. PRELIMINARY PROCEDURES.

a. Check the Fuse and the LINE VOLTAGE Switch for the proper line voltage. Connect the power cord to the power source.

b. Set the Model 604 front panel controls as follows:

ZERO CHECK Button (+)	LOCK
ZERO CHECK Button (-)	LOCK
VOLTS Switch	1
HIGH CUT HZ Switch	OFF
GUARD-OFF Switch	OFF
METER Switch	POWER OFF.

c. Turn the METER Switch to CENTER ZERO. The Meter Pilot Light should turn on. Within a few seconds the meter needle should come to the center position. If not, adjust the meter zero with the FINE ADJ. and MEDIUM SUPPRESS Controls. Normally, there is no need to use the COARSE Control.

NOTE

Using the center zero scales decreases accuracy because the scale span is reduced.

d. After a few moments increase the voltage sensitivity by advancing the VOLTS Switch to .3, .1, etc. Continue zeroing with the FINE ADJ. Control.

e. After long periods of storage or after an overload, the Model 604 may drift excessively. The input transistors are insensitive to mechanical shock; however, a severe input overload may cause a zero offset. This is corrected with the SUPPRESS Controls. Drifting, though, can occur for several hours.

2-9. VOLTAGE MEASUREMENTS.

a. The Model 604 can be used to measure voltages two ways. Both ways may be used in either the guarded or the unguarded mode (refer to paragraphs 2-3 and 2-4),

1. In the single-ended method the unknown voltage is connected to one of the Input Receptacles. The other Receptacle is locked in Zero Check Position (refer to paragraph 2-2).

NOTE

The ZERO CHECK Buttons are true transfer type switches. When they are depressed, the input will be briefly connected to 10^9 ohms to ground. Then as the Buttons are further depressed toward LOCK position the input is open circuited and will remain so until the Button is released. In the LOCK position the Model 604 input is internally connected to ground. Please note that for certain very high impedance sources it may be necessary to never connect the input to ground, even through 10^9 ohms. If this is the case, depress and release the ZERO CHECK Button as fast as possible and the source will see 10^9 ohms for only a few milliseconds.

2. In the differential method one unknown voltage is connected to one of the Input Receptacles and the other voltage is connected to the other Input Receptacle. In this mode both ZERO CHECK Buttons are unlocked. (Refer to paragraph 2-2).

3. Accessory probes extend the Model 604's range to 10 kilovolts. (Use either single-endedly or differentially only with the GUARD-OFF Switch in the OFF position).

b. Single-Ended Method Voltage Measurements. This method should be used when an unknown voltage from a single source is to be measured. (Refer to paragraph 2-2 also).

1. Set the Model 604 front panel controls as follows:

ZERO CHECK Button (+)	LOCK
ZERO CHECK Button (-)	LOCK
VOLTS Switch	1
HIGH CUT HZ Switch	OFF
GUARD-OFF Switch	OFF
METER Switch	CENTER ZERO.

2. Connect the unknown voltage to one of the Input Receptacles. Zero the meter (paragraph 2-6) and unlock the ZERO CHECK Button pertaining to the used Input Receptacle. Keep the other ZERO CHECK Button in the LOCK position. Set the METER Switch to + or -, as necessary. Increase sensitivity with the VOLTS switch until the greatest on-scale meter deflection is obtained. Recheck zero setting after increasing sensitivity. (Refer to paragraph 2-2 also).

3. For guarded, fast measurements, set the GUARD-OFF Switch to GUARD. This method reduces the effects of input cable capacity with very high impedance sources and allows guarded voltage measurements (Refer to paragraphs 2-3 and 2-4).

4. Set the HIGH CUT HZ Switch to the desired position to obtain optimum response. (Refer to paragraph 2-3).

c. Differential Method Voltage Measurements. This method should be used to measure the difference between two unknown voltages neither of which has to be at ground potential, and either of which may be as much as 11 volts off ground. (Refer to paragraph 2-2).

1. Set the Model 604 front panel controls as shown in subparagraph b1 above.

2. Connect one unknown voltage to one of the Input Receptacles and the other voltage to the other Input Receptacle. Zero the meter and then

unlock both ZERO CHECK Buttons. Set the METER Switch to + or -, as necessary. Increase sensitivity with the VOLTS Switch until the greatest on scale meter deflection is obtained. Recheck zero setting after increasing sensitivity. The difference signal is equal to the percentage of full scale that the meter reads times the VOLTS Switch setting. (Refer to paragraph 2-2 also).

3. For guarded, fast measurements, set the GUARD-OFF Switch to GUARD. (Refer to paragraphs 2-3 and 2-4).

4. Set the HIGH CUT HZ Switch to the desired position to obtain optimum response. (Refer to paragraph 2-5).

d. To measure sources greater than 1 volt, use one of two divider probes. The Model 6102A 10:1 Divider Probe extends the Model 604's range to 10 volts; overall accuracy is $\pm 4\%$ and input resistance is 10^{10} ohms. The Model 6103A 1000:1 Divider Probe extends the Model 604's range to 1 kilovolt; overall accuracy is $\pm 6\%$ and input resistance is 10^{12} ohms. Follow the same operating procedures with the dividers as in subparagraph b. The Model 6012 Triaxial-to-Coaxial Adapter must be used with the Models 6102A and 6103A Divider Probes. Note, however, using the Adapter connects the inner shield to ground, defeating the guarding capability of the Model 604. Therefore, the GUARD-OFF Switch must be in the OFF position for the instrument to operate. The full-scale voltage range is the divider ratio times the VOLTS Switch setting.

NOTE

If the Models 6102A and 6103A Divider Probes are used with the Model 604 in the differential mode, the common mode rejection is limited by the probe matching and typically would be about 30 dB. Thus, 30 volts of common mode voltage would cause a full scale indication.

2-10. CURRENT MEASUREMENTS. The Model 604 becomes an ammeter when used in conjunction with the Model 6041 Differential Current Shunt or when resistors are installed within the cases of the Model 301 (see Figure 6). When using the Model 6041, resistors are switched across the inputs of the Model 301 Amplifiers in the Model 604 with the + and - INPUT Switches on the Model 6041. The full scale current range is equal to reciprocal of the INPUT Switch setting on the Model 6041 times the setting of the VOLTS Switch on the Model 604. For example, if the INPUT Switch is set to 10^8 and the VOLTS Switch is set to .01, then the full scale current range is equal to $1/10^8 \times .01 = 10^{-8} \times .01 = 10^{-10}$ amperes.

NOTE

The Model 301 Instruction Manual, supplied with the Model 604, gives complete information on Model 301 operation, circuit description, troubleshooting, calibration, parts lists and schematic diagrams. There are two Model 301 Operational Amplifiers used as plug-in units in the Model 604.

a. The Model 604 can measure currents several ways, each of which may be used either in the guarded or unguarded mode.

1. In the single-ended method the unknown current is connected to one of the Input Receptacles on the Model 6041. The other Input Receptacle on the Model 6041 is locked in Zero Check position

by its corresponding ZERO CHECK Button on the Model 604 front panel. (Refer to paragraph 2-2).

2. In the differential method one unknown current is connected to one of the Input Receptacles on the Model 6041 and the other current is connected to the other Input Receptacle. In this mode both ZERO CHECK Buttons are unlocked. (Refer to paragraph 2-2).

3. With the shunt resistors mounted inside the cases of the Model 301 Amplifiers in the Model 604 the Model 604 may be used as an ammeter either single-endedly or differentially. This method, however, limits versatility and gives only four decades of response. The same input considerations apply with this method as spelled out in paragraph 2-2.

CAUTION

When resistors are mounted internally, the input is open circuited when in zero check. This presents an open circuit to the current source, stopping current flow. In some cases this could be harmful to the current source and possibly to the Model 604 itself when high compliance voltages are encountered.

NOTE

When making measurements from high impedance sources or low current sources using the guarding feature, it may be desirable to set the HIGH CUT HZ Switch to the lowest setting, 100 Hz, to limit the noise bandwidth in some cases. The noise increase, when guarding, increases linearly with the bandwidth increase and the noise may eventually overload the amplifier. This would cause an error in a meter reading, but the error would go undetected unless the output was monitored on an oscilloscope.

b. Rise time varies primarily with the current

range, the input capacity and the method used (guarded or unguarded). See specifications, Table 1, page ii. On all ranges, the rise time in the guarded method is less than one second with the specified capacity across the input. Even with much larger capacities on the input the negative feedback maintains a relatively short rise time. Given a choice, it is better to place the Model 6041 nearer to the current source than to the data reading instrument. Transmitting the input signal through long cables decreases the responses speed and increases noise.

c. Single-Ended Method Current Measurements with Model 6041. This method is used to measure an unknown current from a single source (Refer to paragraph 2-2).

1. Connect the Model 6041 outputs, labeled TO 604 INPUT + and -, to the corresponding Input Receptacles on the Model 604 with the supplied mating cable. Set the Model 604 and 6041 front panel controls as follows:

ZERO CHECK Button (+)	LOCK
ZERO CHECK Button (-)	LOCK
VOLTS Switch	1
HIGH CUT HZ Switch	OFF
GUARD-OFF Switch	OFF
METER Switch	CENTER ZERO
+INPUT Switch	SHORT
-INPUT Switch	SHORT.

2. Connect the unknown current to one of the Input Receptacles on the Model 6041. Zero the meter and unlock the ZERO CHECK Button that corresponds to the Input Receptacle being used. Set the METER Switch to + or -, as necessary. Increase sensitivity with the VOLTS Switch and the Input Switch that corresponds to the Input Receptacle being used until the greatest on-scale meter deflection is obtained. Recheck zero setting after increasing sensitivity. (Refer to paragraph 2-2 also).

3. The full-scale current range is the VOLTS

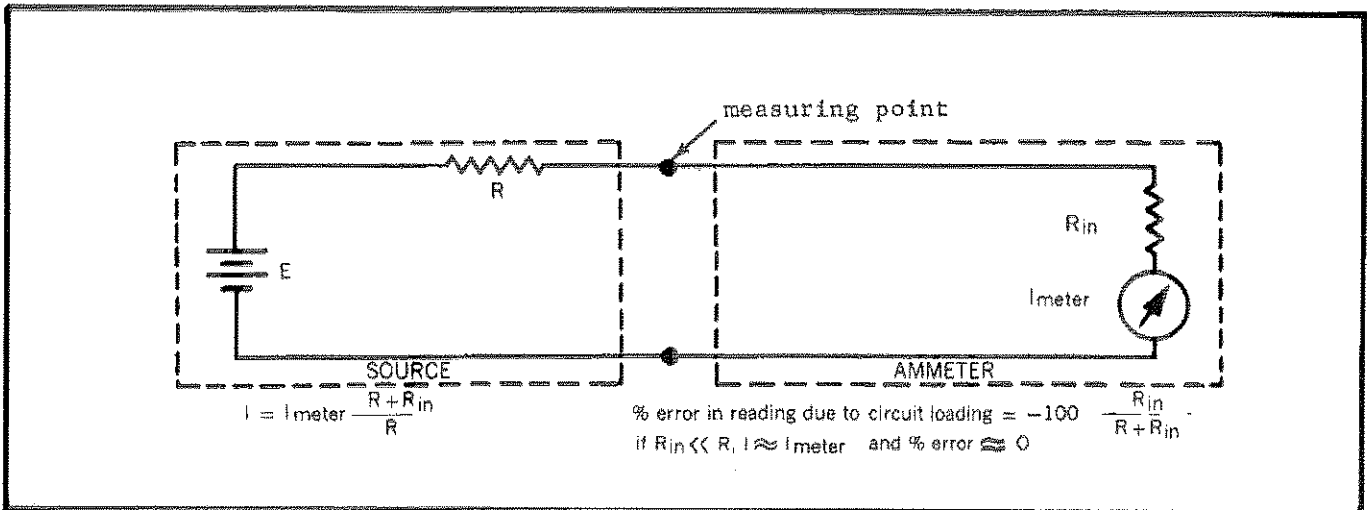

FIGURE 5. Error due to Ammeter Resistance. Current sources may be considered a voltage (E) in series with a resistance (R). The current with the ammeter short circuited is $I = E/R$. With the short circuit removed, the effective input resistance of the ammeter (R_{in}) is in series with the source resistance (R). The current of the complete circuit is reduced and $I_{meter} = E/(R+R_{in})$. If the effective ammeter input resistance is small compared to R , $I_{meter} \approx I$ and the error introduced by circuit loading is negligible.

Switch setting times the reciprocal of the Input Switch setting. Use the smallest VOLTS Switch setting possible to minimize input voltage drop and thus obtain the best accuracy. The full scale input voltage drop is equal to the VOLTS Switch setting.

NOTE

If the source has very high compliance voltage and large source resistance, the signal-to-noise ratio can be improved, without appreciably degrading the accuracy, by using a larger shunt resistor and a less sensitive voltage range. (For example: If a current source has a 300 volt compliance and 10^{12} ohms output resistance, then $I = 300/10^{12} = 3 \times 10^{-10}$ amperes. Using a 10^9 ohms shunt resistor and a 300 millivolt full scale voltage range would display this current full scale. The loading error would be only 0.1%, which is 40 times less than the accuracy of the system. The signal-to-noise ratio would be 100 times better than if a 10^7 ohms shunt resistor and a 3 millivolt full scale range were used).

d. Differential Method Current Measurements with the Model 6041. This method is used to measure the difference between two unknown currents neither of which has to be at ground. (Refer to paragraph 2-2 also).

1. Connect the model 6041 outputs, labeled TO 604 INPUTS + and -, to the respective Input Receptacles on the Model 604 with the supplied mat-

ing cable. Set the Models 604 and 6041 front panel controls as follows:

ZERO CHECK Button (+)	LOCK
ZERO CHECK Button (-)	LOCK
VOLTS Switch	1
HIGH CUT HZ Switch	OFF
GUARD-OFF Switch	OFF
METER Switch	CENTER ZERO
+INPUT Switch	SHORT
-INPUT Switch	SHORT.

2. Connect one unknown current to one of the Input Receptacles on the Model 6041 and the other current to the other Input Receptacle. Zero the meter and unlock both ZERO CHECK Buttons. Set the METER Switch to + or -, as necessary. Increase sensitivity with the VOLTS Switch and both of the Input Switches until the greatest on-scale meter deflection is obtained. (Increase the settings of both Input Switches in unison). Recheck zero setting after increasing sensitivity. (Refer to paragraph 2-2).

3. The difference signal is equal to the percentage of full scale that the meter reads times the VOLTS Switch setting times the reciprocal of the setting of the Input Switches. Use the smallest VOLTS Switch setting possible to minimize input voltage drop and thus obtain the best accuracy. The full scale input voltage drop is equal to the VOLTS Switch setting.

e. Each Model 604 Input Receptacle is connected to a Model 301 Operational Amplifier hooked up in single-ended configuration. The Amplifier corresponding to the +INPUT Receptacle is in a non-inverting mode and the Amplifier corresponding to the -INPUT Receptacle is in an inverting mode. If so

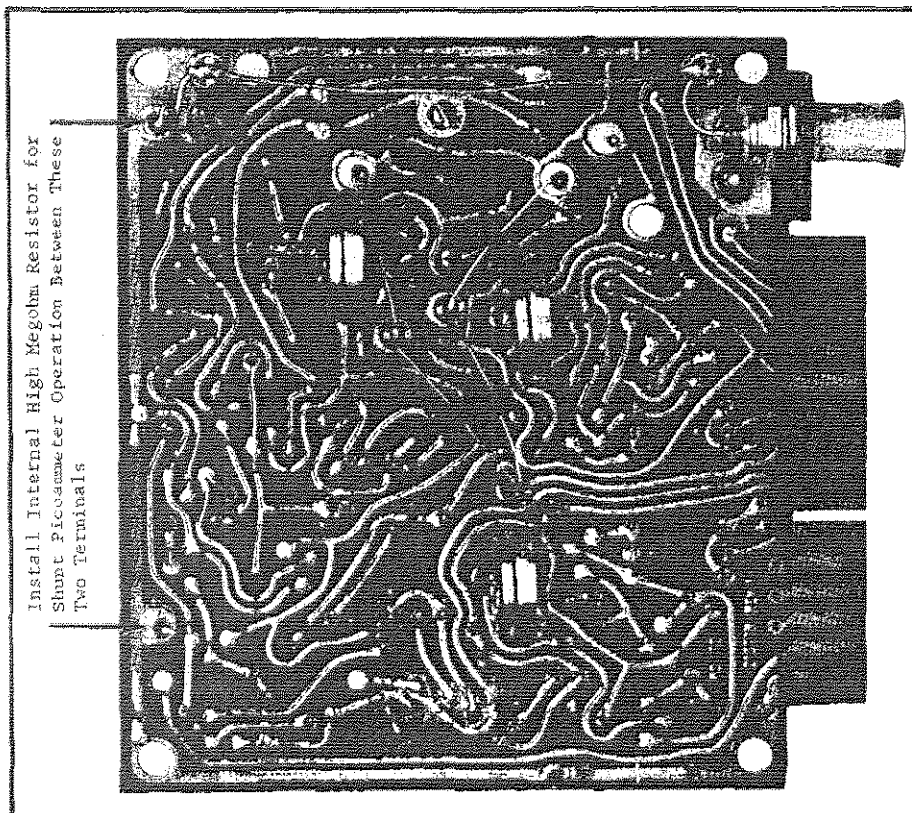

FIGURE 6. Internal View of Model 301 Amplifier Showing Location for Installing Internal Resistor. For complete and comprehensive information on the Model 301, refer to the supplied Model 301 Instruction Manual.

TABLE 6. Typical Rise Times and Noise of the Model 604 As An Ammeter With a Single Pair of Model 6033 Shunt Resistors Internally Mounted. This table was compiled using the smallest HIGH CUT HZ Switch setting permissible to obtain the rise times. Thus, the noise bandwidth of the system is kept as close as possible to the signal bandwidth.

Shunt Resistor (ohms)	Current Span (full scale)	100 pF Guarded		100 pF Unguarded	
		Rise Time 10%-90%	Noise p-p	Rise Time 10%-90%	Noise P-P
106	10 ⁻⁶ to 10 ⁻⁹ A	0.00003 sec	10 ⁻⁹ A	0.0003 sec	10 ⁻¹⁰ A
108	10 ⁻⁸ to 10 ⁻¹¹ A	0.0003 sec	10 ⁻¹⁰ A	0.03 sec	10 ⁻¹² A
1010	10 ⁻¹⁰ to 10 ⁻¹³ A	0.03 sec	10 ⁻¹² A	3.0 sec	2x10 ⁻¹⁴ A
1011	10 ⁻¹¹ to 10 ⁻¹⁴ A	0.3 sec	10 ⁻¹³ A	30.0 sec	2x10 ⁻¹⁵ A

desired, the Model 604 may be used as an ammeter by installing shunt resistors within the cases of either or both Model 301 Amplifiers. Figure 6 shows the positions in which the internal resistors may be mounted.

NOTE

When measuring current with the internally mounted Keithley Model 6033 Shunt Resistors, the Model 604 has slightly shorter rise times and lower noise for corresponding Model 6041 ranges. Please refer to Table 6.

1. In this configuration, therefore, the Model 6041 Current Shunt does not have to be used with the Model 604 to make current measurements. Note, however, that installing the resistors within the Model 301 cases is a time consuming operation. Note, also that using the Model 604 in such a manner severely limits the versatility and capability of the Model 604. Also, using it as an ammeter in such a way allows only four decades of current measuring capability.

NOTE

The Model 604 may be used to measure voltages with the resistors installed within the Amplifiers. Note, however, that the magnitude of the input impedance would then be equal to the value of the installed resistor. This could lead to significant errors in voltage measurements if the source resistance is on the order of magnitude of the installed resistor.

2. The Model 604 may be used as either a single-ended or differential current measuring device in this configuration. The same instructions given in paragraph c and d above, less the Model 6041 instructions, apply here for the single-ended and differential modes respectively. The full scale current range, or difference signal, is equal to the reciprocal of the shunt resistor times the setting of the VOLTS Switch. (Refer to paragraph 2-2 also).

CAUTION

Pay special attention to the caution of paragraph 2-10a, sub-paragraph 3.

f. Use the GUARD-OFF Switch for Guarded or Unguarded Measurements. Guarded or unguarded measurements can be made in each of the preceding modes. (Refer to paragraphs 2-3 and 2-4 also)

g. Use the HIGH CUT HZ Switch in each of the current modes as desired to obtain optimum response. (Refer to paragraph 2-5).

2-11. OUTPUTS. The Model 604 has three outputs:

two UNITY GAIN OUTPUTS each corresponding to its respective Input Receptacle, providing signals equal to each input-to-ground voltage to within $\pm 0.005\%$ at dc; an AMPLIFIER OUTPUT for recording the amplified or difference signal. These outputs may be used to drive recorders, oscilloscopes and X and Y recorders to record amplified signals, difference signals and absolute signals.

NOTE

The front panel SUPPRESS Controls will zero only the FROM +INPUT GAIN OUTPUT; that is the output for the non-inverting input. Also, the ± 1 volt suppression may only be applied at this output. The FROM -INPUT UNITY GAIN OUTPUT may be zeroed internally by adjusting the zero control in the Amplifier for the -INPUT. (Refer to the supplied Model 301 Instruction Manual). Thus, when the AMPLIFIER OUTPUT is zeroed, it is highly unlikely that both UNITY GAIN OUTPUTS will be zeroed and several millivolts offset may be present. Also, it is very improbable that both the UNITY GAIN OUTPUTS and the AMPLIFIER OUTPUT will all be exactly zero at the same time, but any two of the three can be.

a. The AMPLIFIER OUTPUT is ± 10 volts at 5 milli-amperes to amplify signals within 1% for recorders, oscilloscopes and similar instruments. This output can be used for recording single-ended signals or differential, relative signals. The AMPLIFIER OUTPUT Receptacle is a microphone receptacle Amphenol type 80MC2F and mates with an Amphenol type 80MC2M. Pin No. 1 of the output terminal is the output and pin number 2 is ground when the GUARD-OFF Switch is in the OFF position.

b. The AMPLIFIER OUTPUT Receptacle and the UNITY GAIN Receptacles may be used in conjunction; the AMPLIFIER OUTPUT for recording the relative difference signal and a UNITY GAIN for recording the absolute signal of its input.

NOTE

All outputs of the Model 604 are short circuit proof.

c. The UNITY GAIN Outputs provide signals to each input-to-ground voltage within $\pm 0.005\%$ at dc. They can be used for impedance matching to minimize circuit loading errors or convenient connections to a recorder when the GUARD-OFF Switch is in the GUARD position. Also, these two outputs may be used to record with an XY recorder; 1 output to drive the X channel and one the Y.

SECTION 3. CIRCUIT DESCRIPTION

3-1. GENERAL.

a. The Model 604 is an entirely solid-state instrument that uses as its basic circuit components two Keithley Model 301 Operational Amplifiers. These two amplifiers, hooked-up in unity-gain configuration, are the input amplifiers for the Model 604. Three other major blocks of the Model 604 circuit are composed of three integrated circuit amplifiers that serve the functions of differential amplifier, auxiliary amplifier and an output amplifier, respectively. The 1st major block to be considered is the power supplies. Peripheral circuits result in zero suppression, frequency attenuation and amplifier gain through switched in resistors and capacitors.

b. The block diagram in Figure 7 illustrates the basic sections of the circuit of the Model 604. The schematic diagram, 22820E, is a detailed diagram showing the complete circuit of the Model 604 and the circuit designations. Refer to these to better understand the description given in the following paragraphs.

NOTE

The circuit description of the Model 301 Amplifiers, circuit designations AR101 and AR102, are not given in this particular section. However, the complete circuit description of these Amplifiers is in the supplied Model 301 Instruction Manual.

3-2. INPUT AMPLIFIERS.

a. Two standard Keithley Model 301 Solid-State Electrometer Operational Amplifiers, designated AR101 and AR102, are used in the input; one for

each input. They are connected for unity gain in such a fashion that an input resistance of greater than 10^{14} ohms for the Model 604 is achieved. This is done by using the inverting input of the Model 301 as the input, connecting its output to ground and using the common as the output with the non-inverting input connected to common. In this configuration the gain accuracy is the reciprocal of the open loop gain of the Model 301 Amplifier.

b. Zero suppression is added between the non-inverting input and the common in the Model 301 Amplifier which is used in the Model 604 + input. Front panel controls S106 and S107 switch in resistors R122 through R144 to achieve this suppression.

NOTE

Refer to Table 7 for the gains of each amplifier in the Model 604 corresponding to each total gain of the Model 604.

3-3. DIFFERENTIAL AMPLIFIER. Circuit designation QA101 is a linear integrated circuit connected as a differential amplifier. The common mode rejection of the Model 604 is obtained by adjusting this amplifier, through capacitor C114 and resistor R148, both at low and high frequency.

3-4. AUXILIARY AMPLIFIER. Circuit designation QA102 is a linear integrated circuit connected for a non-inverting gain of 30. It is used only on the highest three gains, 1000 to 10,000 (refer to Table 7).

3-5. OUTPUT AMPLIFIER. Circuit designation QA103 is a linear integrated circuit connected as an inverting amplifier. Gain is adjustable between 1 and 33.3 (See Table 7). The high frequency rolloff

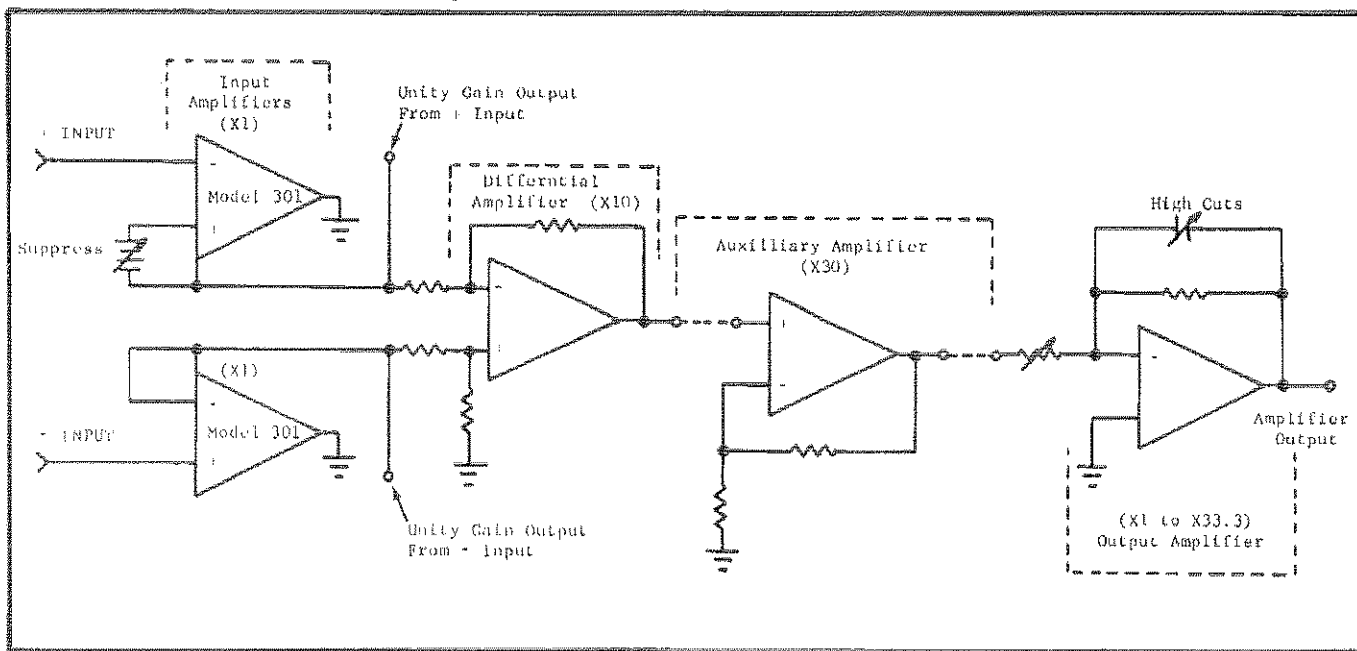

FIGURE 7. Model 604 Block Diagram.

TABLE 7. Model 604 Gain Chart

The Table gives the total gain of the Model 604 Electrometer Amplifier in one column, and the gain of each component amplifier within the Model 604 corresponding to each total gain. Refer also to Figure 7 which shows the basic amplifiers composing the Model 604 circuit.

Total Model 604 Gain	Input Amplifier Gain	Differential Amplifier Gain	Auxiliary Amplifier Gain	Output Amplifier Gain
10	1	10	-	1
33.3	1	10	-	3.33
100	1	10	-	10
333	1	10	-	33.3
1000	1	10	30	3.33
3333	1	10	30	11.11
10,000	1	10	30	33.3

of this amplifier is adjusted between 100 Hz and wideband with the HIGH CUT HZ Switch, S108, by switching capacitors C121 through C126 across the feedback resistor, R153 through R157. The rolloff of these high cuts is 6 dB per octave. The output of QA103 goes to output connector J103 and drives the meter, M101. By putting the HIGH CUT HZ Switch in the output amplifier, the noise bandwidth is always the same as the signal bandwidth.

3-6. POWER SUPPLIES. There are three sets of ± 15 volt power supplies in the Model 604. One set is located on the main board and drives the three linear integrated circuit amplifiers, QA101, QA102 and QA103. There is one set of supplies for each of the Model 301 Amplifiers located inside the Model 301s, with pre-regulators on the main board. (Refer to

supplied Model 301 Instruction Manual for a detailed description of Model 301 power supply regulator circuits). With the exception of the pre-regulators, the power supplies are all short circuit proof.

3-7. MODEL 6041 DIFFERENTIAL CURRENT SHUNT. The Model 6041 basically consists of two differentially connected, shielded, high megohm switches. Using either or both switches, high megohm resistors are shunted across the inputs of the respective Model 301 Amplifiers to make the Model 604 a differential or single-ended ammeter.

NOTE

Refer to schematic diagram 23458C for the Model 6041.

TABLE 8.

Equipment Recommended for Models 604 and 6041 Maintenance. Use these instruments or their equivalent.

Instruments	Refer to Paragraph
Ballantine Model 340 True RMS Voltmeter	4-8
Fairchild Model 7050 Digital Voltmeter	4-2, 4-6, 4-12, 4-15, 4-16
Hewlett-Packard Model 200CD Signal Generator	4-7, 4-13, 4-14
Hewlett-Packard Model 400 AC Voltmeter	4-13, 4-14
Keithley Instruments Model 241 Voltage Supply	4-5
Keithley Instruments Model 260 Nanovolt Source	4-12, 4-15, 4-16
Keithley Instruments Model 261 Picoampere Source	4-16
Keithley Instruments Model 370 Recorder	4-11
Keithley Instruments Model 5155 High Megohm Resistor Standards	4-15
Keithley Instruments Model 6012 Triaxial-to-Coaxial Adapter	4-16
Keithley Instruments Model 610C Electrometer	4-2
Keithley Instruments Model 662 Differential Voltmeter	4-4, 4-5
Keithley Instruments Type CS-178 Connector	4-2
Tektronix Model 561 Oscilloscope	4-3, 4-4, 4-7, 4-13
Offset Current Fixture (composed of a 10^{12} ohm resistor and a Keithley Type CS-141 Connector)	4-9
100:1 Divider	4-7, 4-13
1:1 and 1000:1 Dividers	4-13
10:1 Divider	4-13, 4-14

SECTION 4. MAINTENANCE

4-1. GENERAL.

a. The function of the maintenance section is to provide a method of checking the Models 604 and 6041 to make sure that they operate properly and within the specifications given in Table 1 on page ii.

b. The following procedures are recommended for adjusting and calibrating the Models 604 and 6041. Use the equipment recommended in Table 8. If proper facilities are not available or if difficulty is encountered, contact Keithley Instruments, Inc., or its representatives to arrange for factory calibration.

c. If returning the instrument to Keithley Instruments for repair or calibration, use the Repair and Calibration form at the rear of this manual. Use of this form will clarify difficulties that may ensue and will result in continued good service. When using this form, please detach along dotted line.

d. The figures at the end of this section show the component layouts for the Model 604. Refer to them to find desired components for adjusting the instrument. Refer also to the circuit description in Section 3 and the schematic diagram at the back of the manual to identify the more critical components.

NOTE

The supplied Model 301 Instruction Manual contains the troubleshooting, calibration procedures, component layouts and schematic diagrams for the AR101 and AR102 amplifiers.

TABLE 9.

Model 604 Internal Controls. (See Figures at end of this section for control locations).

Control	Circuit Designation	Paragraph
Zero Adjust (Model 301)	R106	4-4
+15V Adj.	R112	4-2, 4-3
-15V Adj.	R120	4-2, 4-3
Common Mode Adj.	R148	4-7
Common Mode Adj.	C114	4-7
Zero Center Adj.	R158	4-6
Full Scale Adj.	R161	4-6

4-2. INITIAL CHECKS AND ADJUSTMENTS.

a. Make sure the Model 604 is not connected to an ac power line. Set rear panel LINE VOLTAGE Switch properly and the front panel controls as follows:

ZERO CHECK Button (+)	LOCK
" " (-)	LOCK
VOLTS Switch	1
HIGH CUT Hz Switch	OFF
GUARD-OFF Switch	OFF
METER Switch	POWER OFF

b. Remove both Model 301 Amplifiers, circuit designation AR101 and AR102 (Figure 14), from the Model 604 chassis. Do not reinstall these ampli-

fiers until so specified in subparagraph 4-2i.

c. Adjust mechanical meter zero for zero indication on the meter.

d. Check for proper operation of both ZERO CHECK Buttons as delineated in subparagraphs 1 through 7 below.

NOTE

The ZERO CHECK Buttons are break-before-make transfer switches with a 10^9 ohm resistor built into the shaft of the switch. This resistor places 10^9 ohms resistance to ground across the corresponding Model 301 Amplifier input (AR101 or AR102) during transfer between contacts. The 10^9 ohm resistance eliminates large transients during break.

1. Set the ZERO CHECK Button for the + INPUT Receptacle to LOCK.

2. Connect the AR101 Model 301 Amplifier input (Figure 8) to a Model 610C Electrometer. Use an adapter or cable with a Keithley Type CS-178 jack on the end for connection to the AR101 Input. Operate the Model 610C in Normal mode on the 10×10^9 ohms range. With the + INPUT ZERO CHECK Button fully depressed or in LOCK, the Electrometer meter should indicate zero.

3. Release the ZERO CHECK Button slowly. As it is released the Model 610C should indicate approximately 1×10^9 ohms when the Button is about 1/16 to 1/64 of an inch from full depression. This point is the break from the ground contact.

4. The 1×10^9 ohms reading should continue until the ZERO CHECK Button nears the fully released position, at which time the reading should increase to greater than 10×10^9 ohms. This point is the make with the input contact when the 10^9 ohms resistance shaft moves away from the wiper.

5. Set the Model 610C for 10×10^{10} ohms range to slow the reading. Depress the ZERO CHECK Button until a 1×10^9 ohms reading is achieved. This is the position at which the shaft of the Button touches the wiper. Note the distance that the shaft must be depressed to reach this point. The distance should be approximately 1/16 of an inch. This will ensure that the shaft will not readily touch the wiper and place 10^9 ohms across the input when the ZERO CHECK Button is in the unlocked position.

6. Release the ZERO CHECK Button and short the center pin of the + INPUT Receptacle to ground. The meter reading should go to zero.

7. Repeat steps 1 through 6 using the ZERO CHECK Button for the - INPUT Receptacle and the input jack for the AR102 Model 301 Amplifier.

e. Connect the Fairchild Model 7050 DVM between ground and the inter-shield of the Model 604 + INPUT Receptacle. Use the Model 7050 as an ohmmeter on the 150 kilohm range.

1. With the Model 604 GUARD-OFF Switch in the OFF position the Model 7050 should read zero.

With the Switch in the GUARD position the ohm-meter should read greater than 30 kilohms and typically from 50 to 70 kilohms.

2. Repeat the above tests with the Model 7050 connected between ground and inter-shield of the - INPUT Receptacle.

3. When completed set the Differential Amplifier METER Switch to OFF.

f. Plug the Model 604 into a 117 or 234 volt ac power source and turn the METER Switch to +, - or CENTER ZERO. (Make sure that the Model 301 Amplifiers, AR101 and AR102, are removed).

1. If the Differential Amplifier is operative, the meter reading will remain at or near zero.

2. If the instrument is inoperative, that is, if the meter pegs or indicates a large positive or negative up-scale reading, then set the +15 and -15 volt supplies per subparagraph g below. Do this before troubleshooting for other than an obvious problem.

g. Set the +15 volt regulated supply to approximately 15 volts with the +15V Adj. Potentiometer R112. In like manner set the -15 volt regulated supply to -15 volts with the -15V Adj. Potentiometer R120. (Figure 17 shows the locations of R112, and R120 and the layout of PC-195 in general).

h. Use a Model 610C to check for approximately 30 to 36 volts across capacitors C102(+), C103(-), C104(+) and C105(-); the unregulated positive and negative supply voltages Model 301 Amplifiers AR101 and AR102. Since the common for these supplies has no reference to ground, these voltages can be checked by connecting the Electrometer directly across each capacitor. Figure 16 shows the location of the capacitors.

NOTE

The voltage across these capacitors with the Model 301s installed will be approximately 29 volts. Hence, they are referred to as unregulated 29 volt supplies.

1. Set the Model 604 METER Switch to POWER OFF and install the Model 301 Amplifiers.

1. Set the Model 604 GUARD-OFF Switch to GUARD. Check for continuity between the inter-shield of the + INPUT Receptacle and the center pin of the UNITY GAIN OUTPUT, FROM + INPUT. In like manner check for continuity between the inter-shield of the - INPUT Receptacle and the center pin of the UNITY GAIN OUTPUT, FROM - INPUT.

2. If there is no continuity, check the respective Model 301 Amplifier for continuity between pin 2 and pin 15.

j. Set the Model 604 front panel controls as follows:

ZERO CHECK Button (+)	LOCK
" " " (-)	LOCK
VOLTS Switch	1
HIGH CUT HZ Switch	OFF
GUARD-OFF Switch	OFF
METER Switch	ON

If it is not possible to bring the meter on scale or to zero it, then one of the following problems may be the cause.

1. The Model 301 Amplifiers may be defective. If this is so, then either they should be repaired or a new operational set must be substituted.

2. The Model 604 suppression may be defective. Check this out per paragraph 4-6.

3. The 21 volt regulated supplies may be defective. Refer to paragraph 4-3 to check the supplies.

4. If none of the above localizes the problem, then perform the Zero Balance and Unity Gain checks as shown in paragraphs 4-4 and 4-5.

4-3. POWER SUPPLY ADJUSTMENTS.

a. Connect the Tektronix Model 561 Oscilloscope between the Model 604 chassis and the proper test points shown in Figure 11 for performing the power supply checks.

b. Check the plus and minus 26 volt supplies. (During this check, the Model 604 should be connected to a 117 or 234 volt ac power source).

1. The voltage for this check should be 26 volts \pm 3 volts.

2. The ripple must be less than 3 volts peak-to-peak.

3. Figure 8 shows a typical ripple obtained for the 26 volt supply.

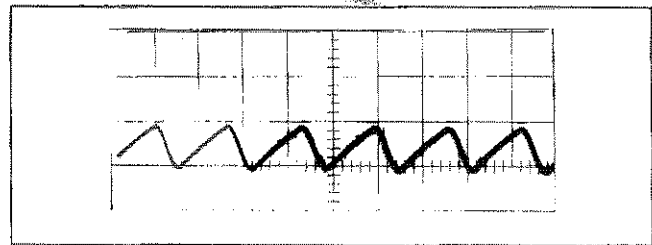

FIGURE 8. Typical Ripple Obtained for the 26 Volt Supply. The scale is 1 volt per division vertical, and 5 milliseconds per division horizontal.

c. Check the plus and minus 15 volt supplies with the Model 604 connected to a 117 or 234 volt ac power line.

1. Adjust +15V Adj. Potentiometer, R112, for +15 volts \pm 30 millivolts. (Figure 17 shows R112).

2. Adjust -15V Adj. Potentiometer, R120, for -15 volts \pm 30 millivolts. (Figure 17 shows R120).

3. The ripple in each case must be less than 2 millivolts peak-to-peak. Figure 9 shows typical ripple for the 15 volt supplies.

4. Monitor the plus and minus 15 volt supplies as the line voltage is changed from 105 to 125 volts ac for a 117 volt line or 210 to 250 volts for a 234 volt line. The voltage change in the 15 volt supplies should be less than 100 millivolts.

5. Return the line to 117 or 234 volts ac.

d. Check the regulated plus and minus 21 volt supplies of both Model 301s. Pin 6 and pin 10 of the Model 301s on the underside of the PC board are

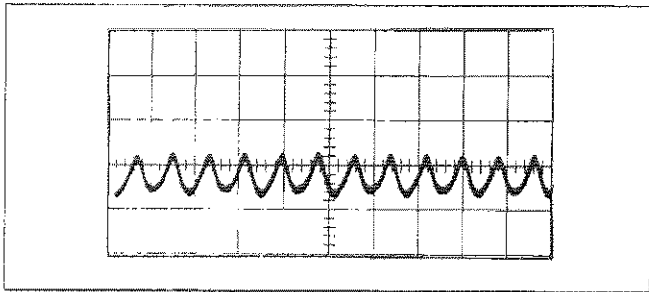

FIGURE 9. Typical Ripple Obtained for the 15 Volt Supply. The scale is 1 millivolt per division vertical, and 10 milliseconds per division horizontal.

the test points for the -21 volt supply and +21 volt supply respectively. Figure 15 shows the location of these test points.

1. The voltage at the positive and negative test points should be +21 and -21 volts ± 2 volts respectively.

2. The ripple in each case should be less than 40 millivolts peak-to-peak and is typically less than 30 millivolts peak-to-peak. Figure 10 shows a typical ripple for the 21 volt supplies.

NOTE

The Model 301 supply voltages are referenced to ground only when the 301s are installed. Use the common of capacitors C102 and C103 or C104 and C105 if the Model 301s are removed. Ripple measurements are meaningless with the Model 301s removed.

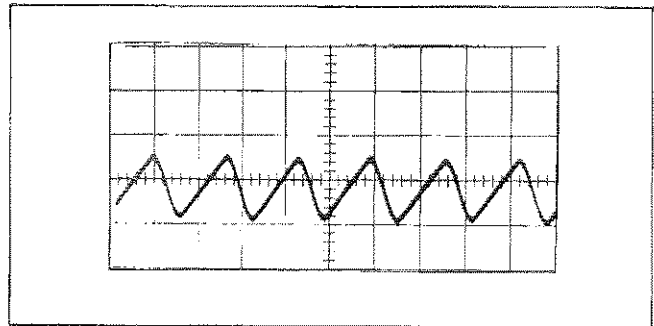

FIGURE 10. Typical Ripple Obtained for the 21 Volt Supply. The scale is 10 millivolts per division vertical, and 5 milliseconds per division horizontal.

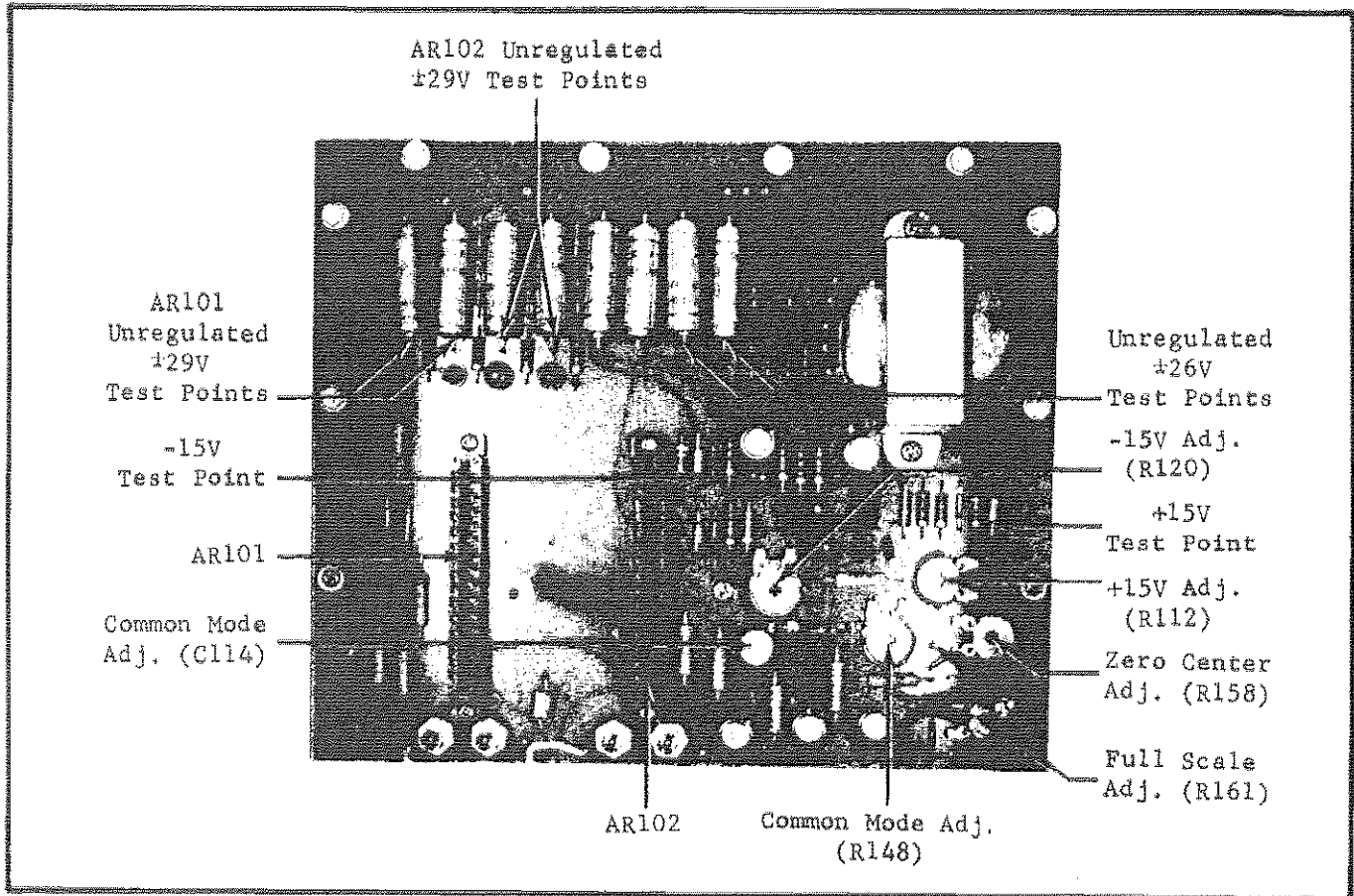

FIGURE 11. Location of Voltage Supplies Test Points (see paragraph 4-3).

4-4. MODEL 301 ZERO BALANCE ADJUSTMENT AND OSCILLATION CHECK.

a. Set the Model 604 front panel controls as follows:

ZERO CHECK Button (+)	LOCK
" " " (-)	LOCK
VOLTS Switch	1
HIGH CUT HZ Switch	OFF
GUARD-OFF Switch	OFF
METER Switch	OFF

b. On the underside of PC-195, jumper the suppression voltage to low as shown in Figure 14. The suppression voltage is available at one input of the AR101 Model 301.

1. Connect a Keithley Model 662 Differential Voltmeter to the Model 604 UNITY GAIN OUTPUT, FROM + INPUT. Adjust the AR101 Model 301 Zero Control, available through the Model 301 cover, for zero volts ±1 millivolt.

2. Repeat the procedures in subparagraph 1 above using the UNITY GAIN OUTPUT, FROM - INPUT and the AR102 Model 301.

3. Remove the jumper attached in subparagraph 4-4b above. Set the Model 604 VOLTS Switch to .001 and zero the Meter with the Model 604 SUPPRESS Controls. When completed return the VOLTS Switch Setting to 1.

c. Connect the UNITY GAIN OUTPUT, FROM + INPUT to an ac coupled Model 561 Oscilloscope and set it on the 1 millivolt per division vertical scale. Observe the Oscilloscope for high frequency oscillations as the Model 604 VOLTS Switch is stepped from 1 through .001 settings. If oscillations are observed, it can be corrected by replacing the 1.2 microfarad capacitor C103 in the Model 301.

NOTE

Do not mistake normal output noise for oscillation. Normal output noise is approximately 1 millivolt of grass and 120 cycle ripple.

d. Connect the UNITY GAIN OUTPUT, FROM - INPUT to the Oscilloscope and repeat the procedures of paragraph 4-4c above.

4-5. UNITY GAIN CHECK.

a. Set the Model 604 front panel controls as follows:

ZERO CHECK Button (+)	LOCK
" " " (-)	LOCK
VOLTS Switch	1
HIGH CUT HZ Switch	OFF
GUARD-OFF Switch	OFF
METER Switch	OFF

1. Connect a Keithley Model 241 Voltage Supply to the Model 604 + INPUT Receptacle and to the low terminal of the Keithley Model 662 Differential Voltmeter. Make sure, upon connection, that the Model 241 is dialed for zero volts and that the output is on. Ensure, also, that the link on the Model 662 is not attached between low and ground of the Differential Voltmeter.

2. Connect the Model 604 UNITY GAIN OUTPUT, FROM + INPUT Terminal to the high terminal of the Model 662.

3. Set the Model 662 dials to zero and the null switch to 10 millivolts. The Model 662 should indicate at or near zero.

NOTE

A large transient generated when the Model 241 output switch is changed from stand-by to on causes a zero shift which results in erroneous readings. The correct method to use is to dial out zero volts then turn the output switch to on.

b. With the Model 241 at zero volts, release the Model 604 ZERO CHECK Button for the + INPUT Receptacle and note that the Model 662 null remains the same.

1. Apply a positive 10 volts with the Model 241. The Model 662 null indication should not change more than 0.5 millivolts and typically is less than 0.2 millivolts. A change of 0.5 millivolts indicates a unity gain of 50 ppm.

2. Return the Model 241 to zero volts. The Model 662 null should return to the original reading.

c. Repeat the procedures in above paragraphs a and b with the Model 241 connected to the Model 604 - INPUT Receptacle and the Model 604 UNITY GAIN OUTPUT, FROM - INPUT Terminal connected to the high terminal of the Model 662.

4-6. SUPPRESSION AND METER CALIBRATION.

a. Set the Model 604 front panel controls as follows:

ZERO CHECK Button (+)	LOCK
" " " (-)	LOCK
VOLTS Switch	1
HIGH CUT HZ Switch	OFF
GUARD-OFF Switch	OFF
METER Switch	OFF

b. Connect the Model 604 AMPLIFIER OUTPUT to the Model 7050 Digital Voltmeter.

c. Check to make sure that the Model 604 SUPPRESS Controls are able to adjust the output for greater than plus and minus 10 volts. Then set the output for exactly 10.000 volts (10.000 volts is achieved when the Model 7050 alternates between 9.99 and 10.00).

d. Adjust the Full Scale Potentiometer, R161 (Figure 17), for full scale meter indication.

e. Set the VOLTS Switch to .001 and zero the Model 604 output and meter.

1. Set the VOLTS Switch to 1 and adjust the FINE ADJ SUPPRESS Control for exactly 0.000 volts at the output, if necessary.

2. Set the METER Switch to CENTER ZERO and adjust the Zero Center Potentiometer, R158 (Figure 17), to obtain a zero meter reading on the center zero scale.

4-7. COMMON MODE REJECTION CALIBRATION.

a. Set the Model 604 front panel controls as follows:

ZERO CHECK BUTTON (+)	LOCK
" " " (-)	LOCK

VOLTS Switch	.001
HIGH CUT HZ Switch	100
GUARD-OFF Switch	OFF
METER Switch	OFF

b. Zero the Model 604 meter with the SUPPRESS Controls.

c. Connect the Hewlett-Packard Model 200CD Signal Generator to both the + INPUT Receptacle and - INPUT Receptacle of the Model 604 and apply 5 Hz at 20 volts peak-to-peak. Connect the Model 604 AMPLIFIER OUTPUT to a dc coupled Model 561 Oscilloscope.

1. Release both ZERO CHECK Buttons simultaneously and adjust the Common Mode Adj. Potentiometer, R148 (Figure 17) for minimum output. Minimum output should occur at a null (a null is achieved where the voltage increases when the potentiometer is adjusted either side of minimum output).

2. The output voltage must be less than 6 volts peak-to-peak (this is 90 dB of rejection at the amplifier gain of 10^4). Typically the minimum output will be less than 3 volts peak-to-peak and will be composed basically of second harmonic.

3. When completed with the above tests, zero check both Model 604 INPUT Receptacles.

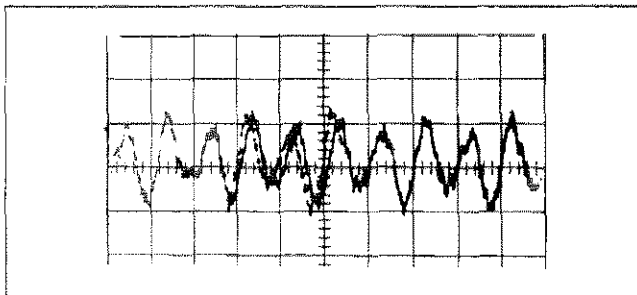

FIGURE 12. Null Obtained with the Signal Generator at 5 Hz. The scale is 1 volt per division vertical, and 0.1 second per division horizontal.

d. Set the Model 604 HIGH CUT HZ Switch to 10K and apply 1 kilohertz at 20 volts peak-to-peak to the Model 604 with the Model 200CD Signal Generator. Zero the meter with the SUPPRESS Controls.

1. Release both ZERO CHECK Buttons simultaneously and adjust the Common Mode Adj. Trimmer capacitor, C114 (Figure 16), for minimum output null. If null is unattainable, increase or decrease the value of capacitor C127 (Figure 16) as needed.

2. The output voltage must be less than 20 volts peak-to-peak (this is 80 dB of rejection at the amplifier gain of 10^4). Typically the minimum output will be less than 8 volts peak-to-peak and will be composed basically of second harmonic.

3. When completed with the above tests, zero check both Model 604 INPUT Receptacles.

e. If, in either or both of the preceding checks of paragraphs c and d, the minimum output exceeds the stated limits, then the probable cause is high second harmonic generated by integrated circuit amplifier QA101 (Figure 14). If this is so, re-

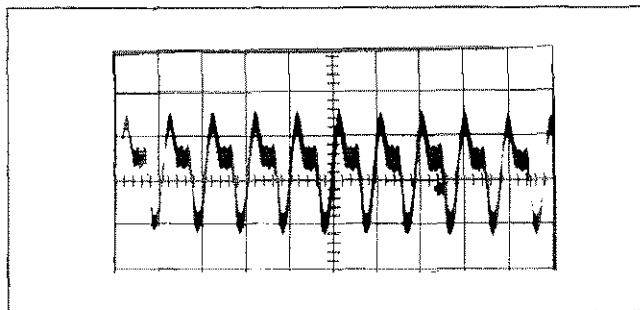

FIGURE 13. Null Obtained with the Signal Generator at 1 kHz. The scale is 2 volts per division vertical, and 1 millisecond per division horizontal.

place QA101 with a new component.

f. Set the HIGH CUT HZ Switch to OFF and set the Signal Generator to 75 kilohertz at minimum output. Connect a 100:1 divider between the Signal Generator and the + and - INPUT Receptacles of the Model 604. Connect an ac coupled Model 561 Oscilloscope to both Model 604 UNITY GAIN OUTPUT Receptacles. Set the Oscilloscope to 50 millivolts per division vertical. It may be necessary to float the Oscilloscope to eliminate 60 cycle ground loops.

NOTE

Monitoring the UNITY GAIN OUTPUT Terminals is effectively the same as monitoring the input.

1. Set the METER Switch to on (+, - or CENTER ZERO). Zero the Model 604 meter with the SUPPRESS Controls and release both ZERO CHECK Buttons simultaneously.

2. Observe the meter and slowly increase the Signal Generator output until a dc shift is observed.

3. Decrease the signal to the point where the dc shift just starts to occur.

4. The signal at the input, monitored at the UNITY GAIN OUTPUT Terminals with the Oscilloscope, should be 100 millivolts peak-to-peak or greater.

NOTE

For the calibration procedures in paragraph 4-8 through 4-15, it is imperative that the Model 604 cover be on the unit.

4-8. NOISE CHECK.

a. Set the Model 604 front panel controls as follows:

ZERO CHECK Button (+)	LOCK
" " " (-)	LOCK
VOLTS Switch	.001
HIGH CUT HZ Switch	100
GUARD-OFF Switch	OFF
METER Switch	CENTER ZERO

b. Attach the Ballantine Model 340 True RMS Voltmeter to the Model 604 AMPLIFIER OUTPUT Receptacle.

1. Zero the Model 604 with the SUPPRESS Controls.

2. Observe the output noise and meter noise.

a) The meter noise, excluding drift, should be less than 80 millivolts peak-to-peak.

b) The output noise, excluding drift, must be less than 200 millivolts RMS.

3. Set the GUARD-OFF Switch to the GUARD position and check the noise. There should be no appreciable change in noise. Return the Switch to OFF.

c. Set the HIGH CUT HZ Switch to OFF and observe the output noise. It should be less than 600 millivolts RMS.

4-9. OFFSET CURRENT CHECK. This check requires a special, easy-to-construct, fixture. The fixture consists of a triaxial connector, Keithley part number CS-141, and a shielded 10^{12} ohm resistor that connects the center pin of CS-141 to ground. The fixture must be shielded to eliminate excessive noise pickup.

a. Set the Model 604 front panel controls as follows:

ZERO CHECK Button (+)	LOCK
" " " (-)	LOCK
VOLTS Switch	.001
HIGH CUT HZ Switch	OFF
GUARD-OFF Switch	OFF
METER Switch	CENTER ZERO

b. Connect the Current Offset Fixture to the Model 604 + INPUT Receptacle and zero the meter.

1. Set the VOLTS Switch to .1. In conjunction with the 10^{12} ohm resistor in the Fixture, this results in 10^{-13} ampere full scale.

2. Release the + ZERO CHECK Button and note the offset current. It should be less than 2×10^{-14} ampere (this is within 2 major divisions of zero). The offset may be positive or negative.

c. Repeat the procedure of above paragraph b with the Fixture on the - INPUT Receptacle.

4-10. 234 VOLT AC OPERATION CHECK. (For 117V units).

a. Set the LINE VOLTAGE Switch on the rear panel of the Model 604 to 234V and plug the unit into a 234 volt ac 50 or 60 Hz power source.

b. Set the VOLTS Switch to .001 and Zero the meter with the SUPPRESS Controls. Being able to zero on this range is sufficient indication that the instrument is operative at 234 volts ac.

c. Unplug the instrument from the 234 volt ac power source and return the LINE VOLTAGE Switch to 117.

4-11. DRIFT VERIFICATION.

a. Set the Model 604 front panel controls as follows:

ZERO CHECK Button (+)	LOCK
" " " (-)	LOCK
VOLTS Switch	.01
HIGH CUT HZ Switch	OFF
GUARD-OFF Switch	OFF
METER Switch	OFF

b. Connect the Model 604 AMPLIFIER OUTPUT Receptacle to the Keithley Model 370 Recorder. Set the Recorder attenuator to 10 volts. Recorder calibra-

tion is now 10 millivolts full scale either side of zero.

c. After a one hour warm-up, the Model 604 must not drift more than 4 millivolts per week or more than 0.3 millivolts per °C.

d. While the drift specifications is in terms of a week, it may be possible to determine the drift within 24, 48 or 72 hours rather than run the full week. After the one hour warm-up and excluding drift due to temperature, the drift may be calculated as shown in the subparagraphs below.

1. After 24 hours, if the drift is less than 0.55 millivolt, the instrument meets specifications.

2. After 48 hours, if the drift during the last 24 hours is multiplied by six and is added to the drift during the first 24 hours and the total is 4 millivolts or less, then the Model 604 meets specifications.

3. After 72 hours, if the drift during the last 24 hours multiplied by 5 is added to the drift of the first and second 24 hours and the total is 4 millivolts or less, then the unit meets the week's drift specifications.

e. Since temperature can be a major contributor to drift (up to 0.3 millivolt per °C allowable), the temperature should be recorded along with the drift.

f. If the drift of the Model 604 is excessive, age the instrument and redrift. If it is still excessive, then a probable cause of poor Model 604 drift is excessive Model 301 Amplifier drift. One or both of the Model 301s may have excessive drift. Or, it may be that the drift of that particular pair of Model 301s is additive, in which case replacing one Model 301 might solve the problem.

4-12. VOLTAGE ACCURACY VERIFICATION.

a. Set the Model 604 front panel controls as follows:

ZERO CHECK Button (+)	Unlock
" " " (-)	LOCK
VOLTS Switch	1
HIGH CUT HZ Switch	OFF
GUARD-OFF Switch	OFF
METER Switch	OFF

b. Connect the Keithley Model 260 Nanovolt Source to the Model 604 + INPUT Receptacle. Monitor the Model 604 AMPLIFIER OUTPUT Receptacle with the Model 7050 DVM.

c. Starting with setting of 1, check all the settings of the VOLTS Switch down to .001 for 10 volts ±1% at the output. This is an indication of from 9.90 volts to 10.10 volts on the Model 7050.

4-13. FREQUENCY RESPONSE CHECK.

a. Set the Model 604 front panel controls as follows:

ZERO CHECK Button (+)	LOCK
" " " (-)	LOCK
VOLTS Switch	1
HIGH CUT HZ Switch	OFF
GUARD-OFF Switch	OFF
METER Switch	OFF

b. Connect a Signal Generator through a 1:1 divider to both the + INPUT and - INPUT Receptacles of the Model 604. Monitor the AMPLIFIER OUTPUT Receptacle with both a Hewlett-Packard Model 400 AC Voltmeter and an ac coupled Model 561 Oscilloscope. Use the Voltmeter on the 10 volt range and the Oscilloscope should be at 5 volts per division vertical.

NOTE

If other than a constant amplitude signal generator is used, it will be necessary to monitor the output of the signal generator with another voltmeter in order to maintain the same signal level at the various frequencies. Do not use the Model 604 UNITY GAIN OUTPUT Terminals for monitoring.

c. Set the Signal Generator for 100 Hz.

1. Unlock the + ZERO CHECK Button and adjust the Signal Generator amplitude to obtain 7 volts RMS at the output of the Model 604. The signal observed on the Oscilloscope should be approximately 20 volts peak-to-peak with no discernible distortion.

2. Sweep the frequency from 100 Hz to 10 kilohertz. The output must remain within 1% of the 100 Hz 7 volt RMS reference (6.9 volts to 7.1 volts RMS) and the signal observed on the Oscilloscope should have no discernible distortion.

3. Set the + ZERO CHECK Button to LOCK and unlock the - ZERO CHECK Button. The output signal at 10 kHz must be 7 volts RMS $\pm 1\%$ and the signal observed on the Oscilloscope should have no discernible distortion.

4. Set both ZERO CHECK Buttons to LOCK.

d. Replace the 1:1 divider with a 10:1 divider. Set the Signal Generator to 75 kHz and the Oscilloscope to 1 volt per division. Ignore the Voltmeter for this test.

1. Open the + INPUT Receptacle and note that the output will swing at least 2 volts peak-to-peak without discernible distortion.

2. Zero check the + INPUT Receptacle and repeat the procedure of subparagraph 1 above with the - INPUT Receptacle open.

3. Set both ZERO CHECK Buttons to LOCK.

e. Replace the 10:1 divider with a 100:1 divider. Set the Signal Generator to 10 kHz and the Voltmeter to the 100 millivolts range. Ignore the Oscilloscope for this test.

1. Unlock the + ZERO CHECK Button and adjust the Signal Generator amplitude to obtain 70 millivolts at the Model 604 AMPLIFIER OUTPUT.

2. Sweep the frequency from 10 kHz to 200 kHz. The output must remain within ± 3 dB of the 10 kHz 70 millivolts reference.

3. Set the + ZERO CHECK Button to LOCK position and unlock the - ZERO CHECK Button. Again, the 200 kHz output signal must be within ± 3 dB of the 10 kHz 70 millivolts reference.

4. Set both ZERO CHECK Buttons to LOCK.

f. Set the Model 604 VOLTS Switch to .001 and

zero the meter. The meter must be maintained at or near zero during the checks in the following subparagraphs g and h or the output signal will be clipped.

g. Set the Voltmeter to the 10 volt range and the Oscilloscope to 5 volts per division vertical. Use a 1000:1 divider and check the .001 setting of the Model 604 VOLTS Switch per above paragraph 4-13c. (Note that there will be noise riding on the signal observed on the Oscilloscope).

h. Use a 1000:1 divider and set the Signal Generator to 10 kHz, the Voltmeter to the 3 volt range and the Oscilloscope to 2 volts per division.

1. Unlock the + ZERO CHECK Button and adjust the Signal Generator amplitude to obtain 2 volts RMS at the output of the Model 604. The signal observed on the Oscilloscope should be approximately 6 volts peak-to-peak and noisy.

2. Sweep the frequency from 10 kHz to 50 kHz. The output should remain within ± 3 dB of the 10 kHz 2 volts RMS reference.

3. Set the + ZERO CHECK Button to LOCK and unlock the - ZERO CHECK Button. Again, the 50 kHz output signal must be within ± 3 dB of the 10 kHz 2 volts RMS reference.

4. Zero check both inputs of the Model 604.

4-14. HIGH CUTS CHECK.

a. Set the Model 604 front panel controls as follows:

ZERO CHECK Button (+)	Unlock
" " " (-)	LOCK
VOLTS Switch	1
HIGH CUT HZ Switch	OFF
GUARD-OFF Switch	OFF
METER Switch	OFF

b. Connect the Signal Generator through a 10:1 divider to the Model 604 + INPUT Receptacle. Connect the Model 604 AMPLIFIER OUTPUT Receptacle to the Model 400 AC Voltmeter and set the Voltmeter to the 3 volt range.

c. With the HIGH CUT HZ Switch at OFF, set the Signal Generator to 100 kHz and adjust the amplitude to obtain 2 volts RMS at the output of the Model 604. This level will be used as a reference throughout the High Cuts checks (paragraphs d and e below).

NOTE

Refer to note of paragraph 4-13b concerning the use of a constant amplitude signal generator.

TABLE 10.
High Cut Hz Settings for Frequency Check.

HIGH CUT Hz Switch Setting	3 dB Down Frequency Limits
100	80 to 120 Hz
300	240 to 360 Hz
1K	800 to 1200 Hz
3K	2.4 to 3.6 kHz
10K	8 to 12 kHz
30K	24 to 36 kHz

d. Set the HIGH CUT HZ Switch to the settings indicated in Table 10. Check that the output is 3 dB down from the 2 volts RMS reference at some frequency within the frequency limits listed for each setting.

e. If the output does not roll off at 3 dB within the frequency limits listed, the applicable high cut capacitor is out of tolerance.

4-15. INPUT IMPEDANCE CHECK.

a. Set the Model 604 front panel controls as follows:

ZERO CHECK Button (+)	Unlock
" " " (-)	LOCK
VOLTS Switch	1
HIGH CUT HZ Switch	OFF
GUARD-OFF Switch	OFF
METER Switch	OFF

b. Connect the Model 260 Nanovolt Source to the Model 604 + INPUT Receptacle and the Model 7050 DVM to the AMPLIFIER OUTPUT Receptacle.

1. Apply + 1 volt to the + INPUT Receptacle. The output voltage should be 10 volts $\pm 1\%$ (9.90 to 10.10 volts).

2. Connect a Keithley Model 5155 High Megohm Standard 10^{12} ohms resistor in series between the Model 260 and the + INPUT Receptacle.

3. Apply + 1 volt to the + INPUT Receptacle. The output voltage must come to within 100 millivolts of the voltage noted in subparagraph 1 above. This indicates an input impedance of 10^{14} ohms or greater. Note, however, that it may require a few minutes for the reading to come in and stabilize.

c. Repeat the procedure in paragraph b using -1 volt and the - INPUT Receptacle.

4-16. MODEL 6041 DIFFERENTIAL CURRENT SHUNT CALIBRATION.

a. Check the full scale accuracy of the Model 604 on the 1 volt range per paragraph 4-12. Note the actual output voltage and use this as a reference to determine the accuracy of the Model 6041 ranges.

b. Set the equipment up in feedback picoammeter configuration as specified in the following subparagraphs.

1. Set the Model 6041 + INPUT and - INPUT Switches to the 10^6 position. Attach the TO 604 INPUTS + and - Connectors to their respective Model 604 INPUT Receptacles.

2. Set the Model 604 front panel controls as follows:

ZERO CHECK Button (+)	Unlock
" " " (-)	LOCK
VOLTS Switch	1
HIGH CUT HZ Switch	OFF
GUARD-OFF Switch	GUARD
METER Switch	OFF

3. Connect a Model 7050 DVM to the Model 604 AMPLIFIER OUTPUT Receptacle.

4. Remove the link from between Low and ground on the rear of the Keithley Model 261 Picoampere Source. Connect the Model 261 to the Model 6041 + INPUT Receptacle through a Keithley Model 6012 Coaxial-to-Triaial Adapter.

c. Check the full scale accuracy of the 10^6 through 10^{11} settings of the + INPUT Switch with the Model 261 set for 1×10^{-6} through 1×10^{-11} amperes. All ranges must be within $\pm 2\%$ of the Model 604 full scale accuracy (actual output voltage ± 0.20 volt).

1. After checking the accuracy set the Model 6041 + INPUT Switch to 10^{11} and the Model 604 + ZERO CHECK Button to LOCK and the GUARD-OFF Switch to OFF. This places the equipment in shunt picoammeter configuration.

2. Release the + ZERO CHECK Button and note that the meter reading climbs slowly to approximately 1/2 scale indication.

3. When completed, set the + ZERO CHECK Button to LOCK and the GUARD-OFF Switch to GUARD.

d. Repeat the procedure of paragraph c above with the Model 261 connected to the Model 6041 - INPUT Receptacle.

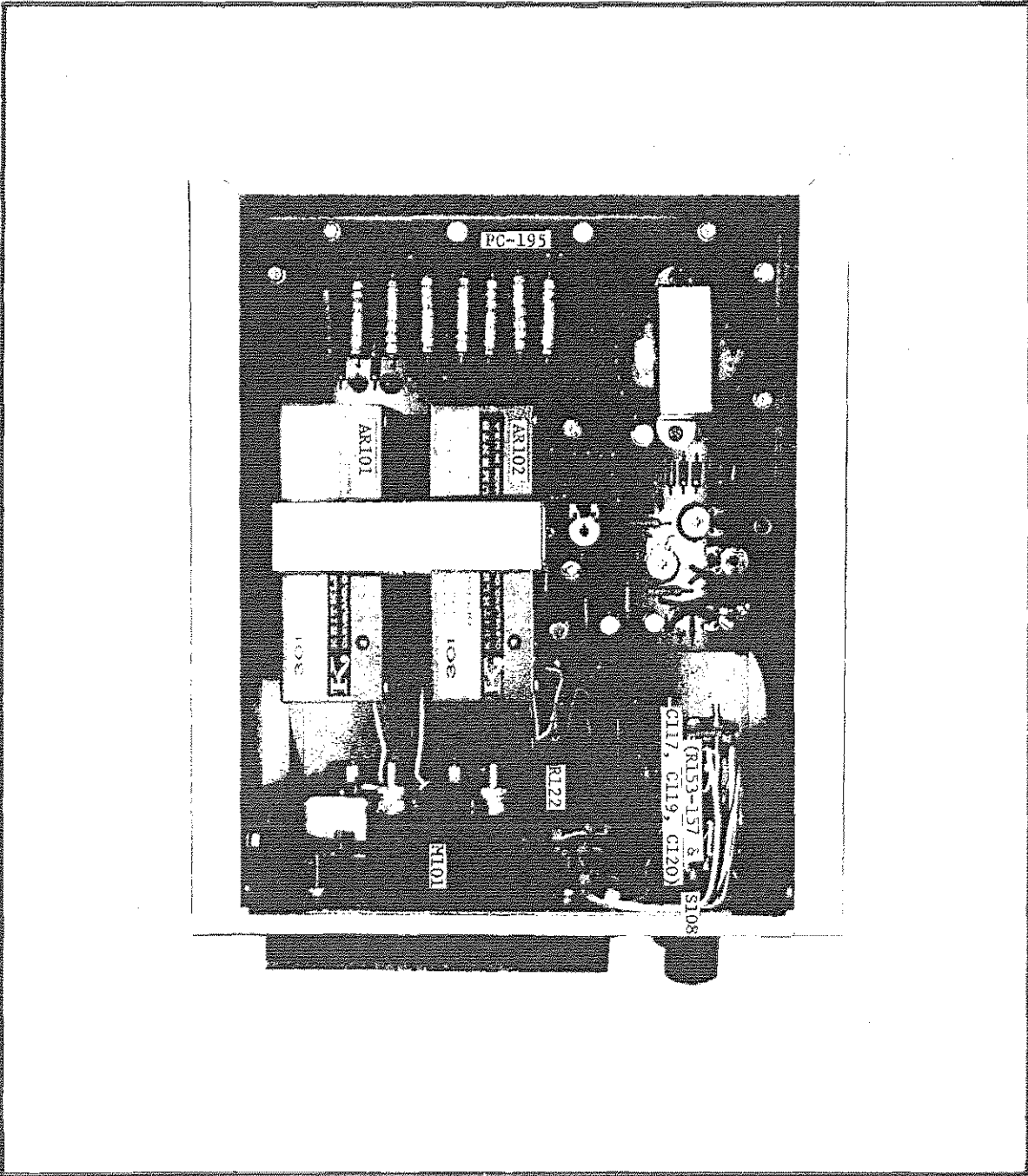
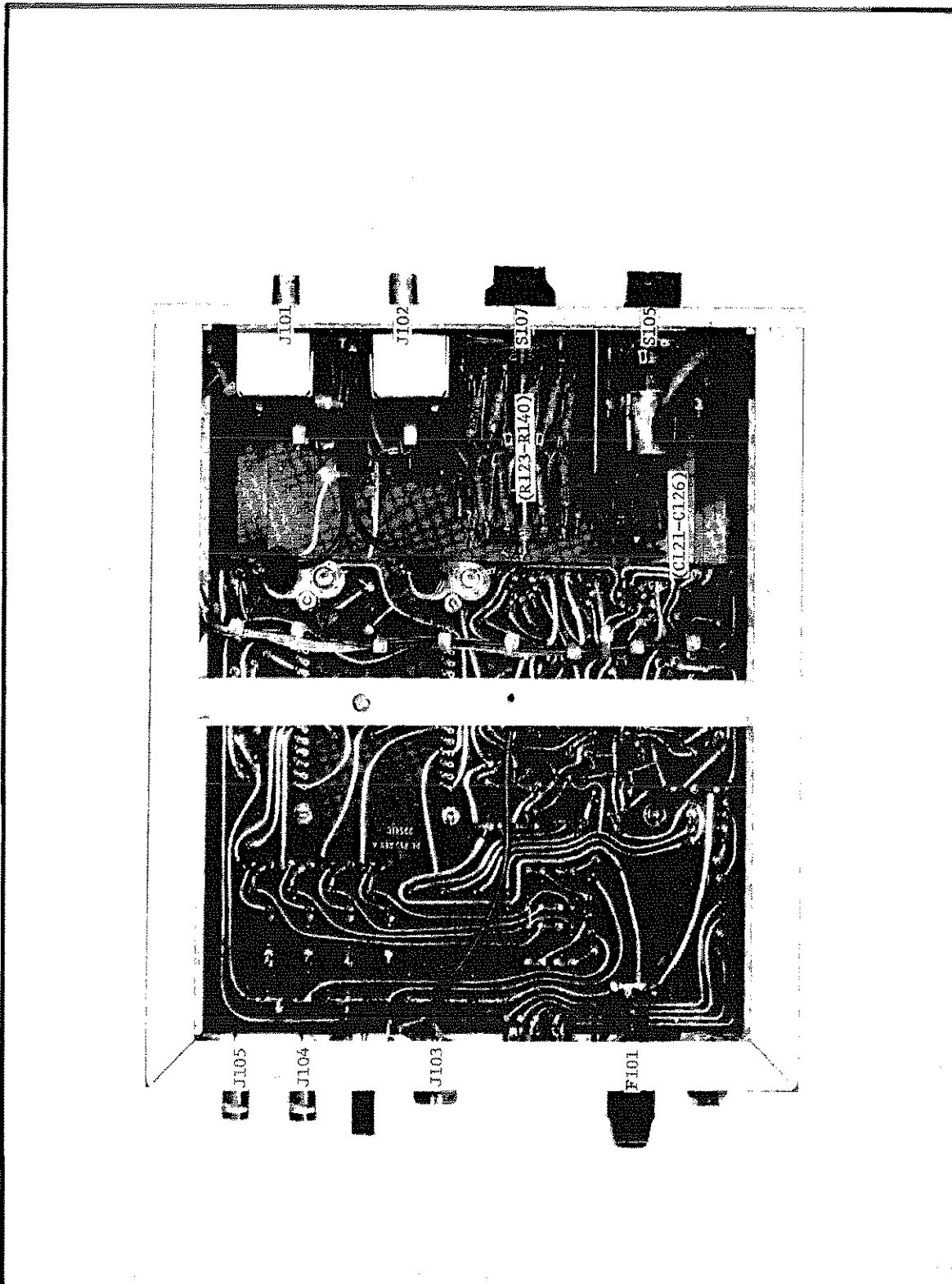

FIGURE 14. Top View Model 604 Chassis. Front panel faces up. Figure shows location of components, pc boards, and switches. For Bottom View, see Figure 15.



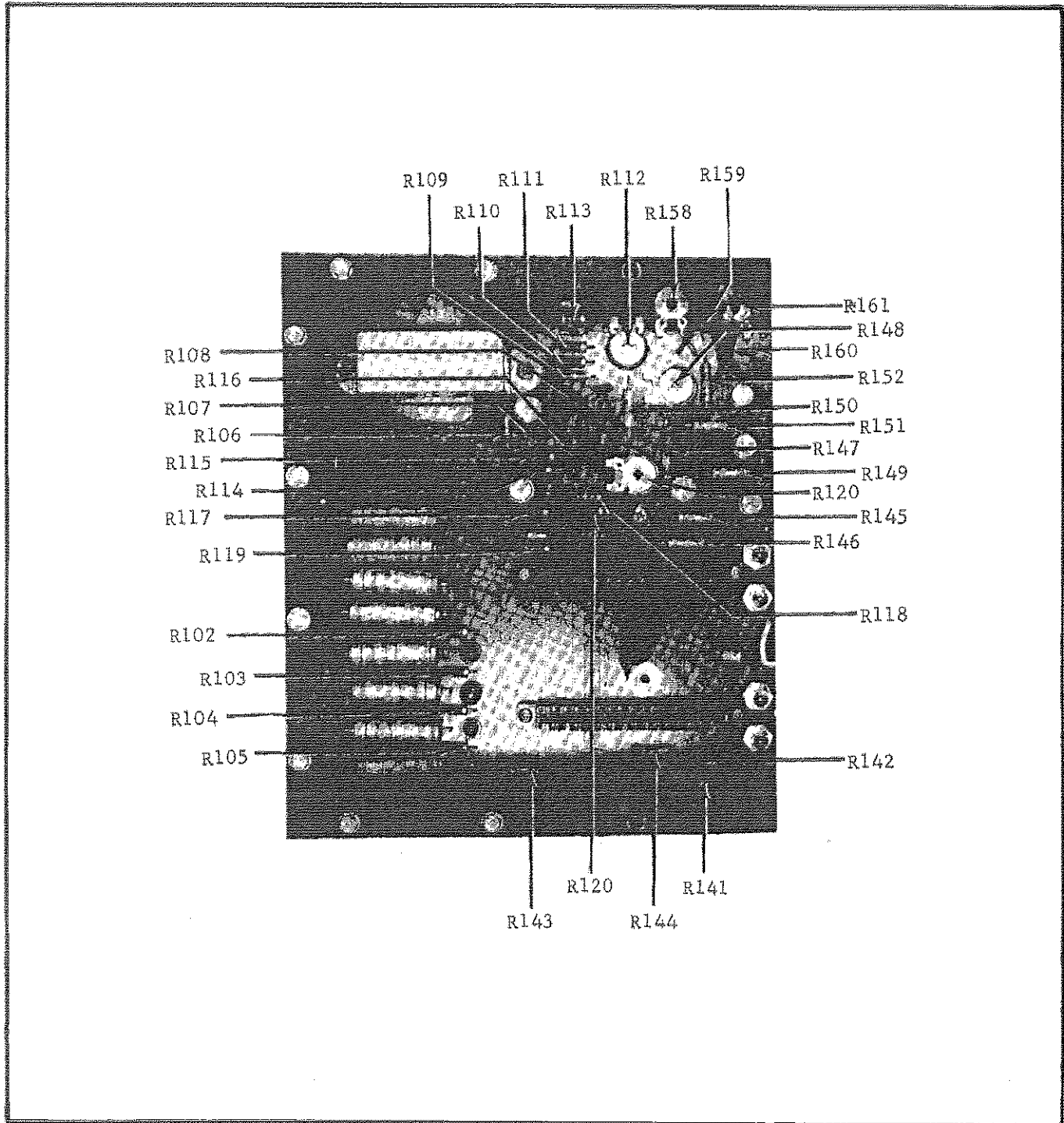

FIGURE 17. Resistor Locations on PC-195. For other component locations, see Figure 16.

SECTION 5. ACCESSORIES

Model 6011 Input Cable

Description: The 6011 is a low-noise triaxial cable, 30" long, terminated by three color-coded alligator clips. This cable mates directly with the triaxial input. The cable is fabricated using a Keithley part no. CS-141 connector and part no. SC-22 low-noise cable.

Application: The 6011 may be used for measurements which require a triaxial connection, especially when the input LO is floated above CASE ground. The cable permits full use of the Model 615 capabilities.

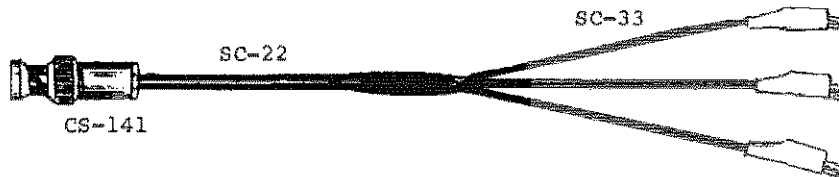

Model 6301 Guarded Probe

Description: The 6301 is a guarded triaxial cable, 3 ft. long, terminated by a probe for making point-to-point measurements.

Application: The 6301 may be used for measurements which require a triaxial cable with a guarded probe having an insulation resistance greater than 10^{14} ohms.



Model 1531 Gripping Probe

Description: The 1531 is a triaxial cable, 3 ft. long, terminated by a special gripping-type probe. The 1531 insulation resistance is greater than 10^{10} ohms. The probe is rated for off ground measurements up to 500 v

Application: The 1531 may be used for measurements which require a triaxial cable. The probe permits convenient connections to the circuit under test due to the gripping feature.

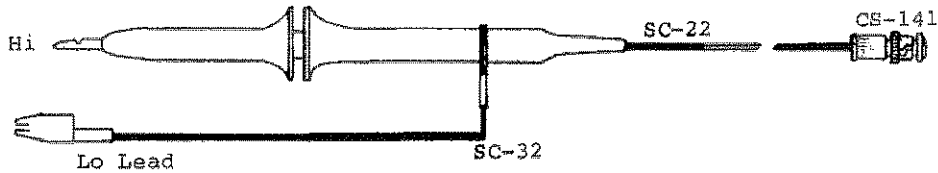

Model 6012 Triax-to-Coax Adapter

Description: The 6012 is an adapter for mating the triaxial input and UHF (coax) type connectors. This adapter can be used with Models 6101A, 6101B, 6103A, 6102A, etc.

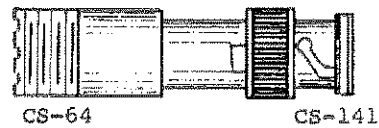

Model 4006 Rack Mounting Kit

Description:

The Model 4006 is a rack mounting kit with overall dimensions, 7 inches high x 19 inches wide. Two top covers are provided for use with either 10 inch or 13 inch deep instruments.

Application:

The Model 4006 converts the instrument from bench mounting to rack mounting. It is suitable for mounting one instrument in one-half of a standard 19-inch rack.

Parts List:

Item No.	Description	Qty. Per Assembly	Keithley Part No.
1	Top Cover, 10"	1	20016B
2	Panel Adapter Plate	1	19158A
3	Angle Support	1	19157A
4	Screw, #10 x 3/8"	4	---
5	Connecting Plate	1	19154A
6	Screw, #10 x 1/2"	4	---
7	Angle	1	19147B
8	Top Cover, 13"	1	20015B

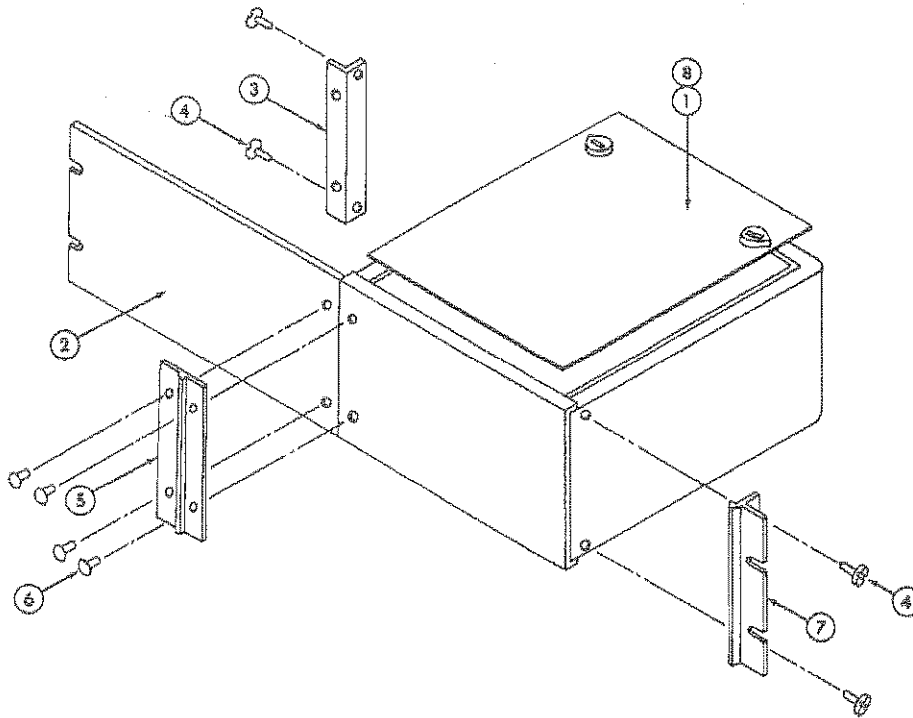

Model 4007 Rack Mounting Kit

Description:

The Model 4007 is a rack mounting kit with overall dimensions, 7 inches high x 19 inches wide. Two top covers are provided for use with either 10 inch or 13 inch deep instruments.

Application:

The Model 4007 converts the instrument from bench mounting to rack mounting. It is suitable for mounting two instruments in a standard 19-inch rack.

Parts List:

Item No.	Description	Qty. Per Assembly	Keithley Part No.
1	Top Cover, 10"	2	20016B
4	Screw, #10 x 1/2"	8	---
5	Connecting Plate	1	19154A
6	Screw, #10 x 1/2"	4	---
7	Angle	2	14147B
8	Top Cover, 13"	2	20015B
9	Zee Bracket	1	19167A
10	Plate	1	19700A

SECTION 6. REPLACEABLE PARTS

6-1. REPLACEABLE PARTS LIST: This section contains a list of components used in this instrument for user reference. The Replaceable Parts List describes the individual parts giving Circuit Designation, Description, Suggested Manufacturer (Code Number),

Manufacturer's Part Number, and the Keithley Part Number. Also included is a Figure Reference Number where applicable. The complete name and address of each Manufacturer is listed in the CODE-TO-NAME Listing following the parts list.

TABLE 6-1.
Abbreviations and Symbols

A	ampere	F	farad	Ω	ohm
CbVar	Carbon Variable	Fig	Figure	p	pico (10 ⁻¹²)
CerD	Ceramic Disc	GCb	Glass enclosed Carbon	PC	Printed Circuit
Cer Trimmer	Ceramic Trimmer	k	kilo (10 ³)	Poly	Polystyrene
Comp	Composition	μ	micro (10 ⁻⁶)	Ref.	Reference
DCb	Deposited Carbon	M	Meg (10 ⁶)	TCu	Tinner Copperweld
Desig.	Designation	Mfr.	Manufacturer	V	volt
EAL	Electrolytic, Aluminum	MtF	Metal Film	W	watt
ETB	Electrolytic, tubular	My	Mylar	WW	Wirewound
ETT	Electrolytic, tantalum	No.	Number	WWVar	Wirewound Variable

6-2. ELECTRICAL SCHEMATICS AND DIAGRAMS. Schematics and diagrams are included to describe the electrical circuits as discussed in Section 3.

Sales Service Department, Keithley Instruments, Inc. or your nearest Keithley representative.

b. When ordering parts, include the following information.

6-3. HOW TO USE THE REPLACEABLE PARTS LIST. This Parts List is arranged such that the individual types of components are listed in alphabetical order. Main Chassis parts are listed followed by printed circuit boards and other subassemblies.

1. Instrument Model Number.
2. Instrument Serial Number.
3. Part Description.
4. Schematic Circuit Designation.
5. Keithley Part Number.

6-4. HOW TO ORDER PARTS.

c. All parts listed are maintained in Keithley Spare Parts Stock. Any part not listed can be made available upon request. Parts identified by the Keithley Manufacturing Code Number 80164 should be ordered directly from Keithley Instruments, Inc.

a. Replaceable parts may be ordered through the

MODEL 604 REPLACEABLE PARTS LIST
(Refer to Schematic Diagram 22820E for circuit designations)

CAPACITORS

Circuit Desig.	Value	Rating	Type	Mfg. Code	Mfg. Part No.	Keithley Part No.	Fig. Ref.
C101	10 μ F	6 V	ETP	07436	NG106A	C182-10M	16
C102	100 μ F	40 V	EAL	73445	C437AR/G100	C150-100M	16
C103	100 μ F	40 V	EAL	73445	C437AR/G100	C150-100M	16
C104	100 μ F	40 V	EAL	73445	C437AR/G100	C150-100M	16
C105	100 μ F	40 V	EAL	73445	C437AR/G100	C150-100M	16
C106	100 μ F	40 V	EAL	73445	C437AR/G100	C150-100M	16
C107	100 μ F	40 V	EAL	73445	C437AR/G100	C150-100M	16
C108	.001 μ F	600 V	CerD	72982	ED-.001	C22-.001M	16
C109	1.2 μ F	20 V	ETP	05397	K1R2J20K	C80-1.2M	16
C110	100 μ F	40 V	EAL	73445	C437AR/G100	C150-100M	16
C111	100 μ F	40 V	EAL	73445	C437AR/G100	C150-100M	16
C112	.001 μ F	600 V	CerD	72982	ED-.001	C22-.001M	16
C113	1.2 μ F	20 V	ETP	05397	K1R2J20K	C80-1.2M	16
C114	7-25 μ F	200-300 V		72982	538-037	C175-7-25P	16
C115	10 μ F	600 V	CerD	72982	ED-10	C22-10P	16
C116	5 μ F	600 V	CerD	72982	ED-5	C22-5P	16
C117	22 μ F	600 V	CerD	72982	ED-22	C22-22P	14
C118	Not Used						
C119	10 μ F	600 V	CerD	72982	ED-10	C22-10P	14
C120	33 μ F	600 V	CerD	72982	ED-33	C22-33P	14
C121	500 μ F	600 V	CerD	72982	ED-500	C22-500P	15
C122	1500 μ F	600 V	CerD	72982	ED-1500	C22-1500P	15
C123	.005 μ F	600 V	CerD	72982	ED.005	C22-.005M	15
C124	.015 μ F	600 V	CerD	72982	ED.015	C22-.015M	15
C125	.05 μ F	200 V		56289	2PS-S50	C176-.05M	15
C126	.15 μ F	75 V	Poly	56289	225P1549R752A3	C167-.15M	15
C127	*10 μ F	600 V	CerD	72982	ED-10	C22-10P	--

CONNECTORS AND TERMINALS

Circuit Desig.	Description	Mfg. Code	Mfg. Part No.	Keithley Part No.	Fig. Ref.
J101	Receptacle, triaxial, +INPUT	95712	33050-NT-34	CS-181	1
J102	Receptacle, triaxial, -INPUT	95712	33050-NT-34	CS-181	1
---	Plug, triaxial, mate of of J101 and J102 (2 req'd)	95712	30197-1	CS-141	--
J103	Receptacle, microphone, AMPLIFIER OUTPUT	02660	80-PC2F	CS-32	2
---	Plug, microphone, mate of J103	02660	80-MC2M	CS-33	--
J104	Receptacle, BNC, FROM -INPUT UNITY GAIN OUTPUT (Mil. No. UG-1094/U)	02660	31-221	CS-15	2
J105	Receptacle, NC, FROM +INPUT UNITY GAIN OUTPUT (Mil. No. UG-1094/U)	02660	31-221	CS-15	2
---	Plug, BNC, mate of J104 and J105, 2 req'd (Mil. No. UG-88/U)	02660	31-002	CS-44	--
J106	Card edge connector to AR101	09922	PSC44SS15-12	CS-175	--
J107	Card edge connector to AR102	09922	PSC44SS15-12	CS-175	--
P101	Plug, coaxial, -Input of AR101	02660	FXR30775	CS-179	--
---	Hooded Shield for P101	02660	FXR2275	CS-180	--
---	Coaxial Receptacle, mate of P101	02660	FXR2175	CS-178	--
P102	Plug, coaxial, +Input of AR101	02660	FXR30775	CS-179	--
---	Hooded shield for P102	02660	FXR2275	CS-180	--
---	Coaxial Receptacle, mate of P102	02660	FXR2175	CS-178	--
P103	Plug, coaxial, -Input of AR102	02660	FXR30775	CS-179	--
---	Hooded Shield for P103	02660	FXR2275	CS-180	--
---	Coaxial Receptacle, mate of P103	02660	FXR2175	CS-178	--

*Nominal Value, factory set.

CONNECTORS AND TERMINALS (Cont'd)

Circuit Desig.	Description	Mfg. Code	Mfg. Part No.	Keithley Part No.	Fig. Ref.
P104	Plug, Coaxial, +Input of AR102	02660	FXR30775	CS-179	--
---	Hooded Shield for P104	02660	FXR2275	CS-180	--
---	Coaxial Receptacle, mate of P104	02660	FXR2175	CS-178	--
---	Binding Post, ground	08811	33-286	BP-15	--

DIODES

Circuit Desig.	Type	Number	Mfg. Code	Keithley Part No.	Fig. Ref.
D101	Silicon	1N645	01295	RF-14	16
D102	Silicon	1N645	01295	RF-14	16
D103	Silicon	1N645	01295	RF-14	16
D104	Silicon	1N645	01295	RF-14	16
D105	Silicon	1N645	01295	RF-14	16
D106	Silicon	1N645	01295	RF-14	16
D107	Silicon	1N645	01295	RF-14	16
D108	Silicon	1N645	01295	RF-14	16
D109	Silicon	1N645	01295	RF-14	16
D110	Silicon	1N645	01295	RF-14	16
D111	Silicon	1N645	01295	RF-14	16
D112	Silicon	1N645	01295	RF-14	16
D113	Zener	1N715	12954	DZ-22	16
D114	Zener	1N715	12954	DZ-22	16
D115	Zener	1N715	12954	DZ-22	16
D116	Zener	1N715	12954	DZ-22	16
D117	Zener	1N715	12954	DZ-22	16
D118	Zener	1N715	12954	DZ-22	16
D119	Zener	1N715	12954	DZ-22	16
D120	Zener	1N715	12954	DZ-22	16
D121	Zener	1N702A	01295	DZ-33	16
D122	Zener	1N709	12954	DZ-21	16
D123	Silicon	1N645	01295	RF-14	16
D124	Zener	1N709	12954	DZ-21	--
D125	Silicon	1N645	01295	RF-14	16
D126	Zener	1N702A	01295	DZ-33	16
D127	Zener	1N935	04713	DZ-7	16
D128	Zener	1N935	04713	DZ-7	16

INTEGRATED CIRCUITS AND OPERATIONAL AMPLIFIERS
(For Parts List of AR101 and AR102, See Supplied Model 301 Manual)

Circuit Desig.	Description	Mfg. Code	Mfg. Part No.	Keithley Part No.	Fig. Ref.
AR101	Operational Amplifier to +INPUT Receptacle	80164	Model 301	Model 301	14
AR102	Operational Amplifier to -INPUT Receptacle	80164	Model 301	Model 301	14
QA101.	Integrated Circuit, Differential Amplifier	12040	LM301AH*	27225A	16
QA102	Integrated Circuit, Auxiliary Amplifier	12040	LM301AH*	27225A	16
QA103	Integrated Circuit, Output Amplifier	12040	LM301AH*	27225A	16

*Selected for slew rate of 0.5V per Microsecond.

MISCELLANEOUS PARTS

Circuit Desig.	Description	Mfg. Code	Keithley Part No.	Fig. Ref.
DS-101	Pilot Light (Mfg. No. 2100)	91802	PL-38	1
F101 (117V)	Fuse, Slow Blow, 1/8 A (Mfg. Type HDL)	71400	FU-20	2
F101 (234V)	Fuse, Slow Blow, 1/16 A (Mfg. Type HDL)			
---	Fuse Holder (Mfg. No. 342012)	75915	FH-3	--
M101	Meter	80164	ME-83A	14
P105	Cord Set, 6 feet (Mfg. No. 4638-13)	93656	CO-5	2
---	Cable Clamp (Mfg. No. SR-SP-1)	28520	CC-4	--
T101	Transformer	80164	TR-117	16

RESISTORS

Circuit Desig.	Value	Rating	Type	Mfg. Code	Mfg. Part No.	Keithley Part No.	Fig. Ref.
R101	**47 kΩ						
R102	1 kΩ	10%, 1/2 W	Comp	01121	EB	R1-1K	--
R103	1 kΩ	10%, 1/2 W	Comp	01121	EB	R1-1K	17
R104	1 kΩ	10%, 1/2 W	Comp	01121	EB	R1-1K	17
R105	1 kΩ	10%, 1/2 W	Comp	01121	EB	R1-1K	17
R106	2.2 kΩ	10%, 1/2 W	Comp	01121	EB	R1-2.2K	17
R107	2.2 kΩ	10%, 1/2 W	Comp	01121	EB	R1-2.2K	17
R108	1 kΩ	10%, 1/2 W	Comp	01121	EB	R1-1K	17
R109	15 Ω	10%, 1/2 W	Comp	01121	EB	R1-15	17
R110	1 kΩ	10%, 1/2 W	Comp	01121	EB	R1-1K	17
R111	5.6 kΩ	10%, 1/2 W	Comp	01121	EB	R1-5.6K	17
R112	2 kΩ	10%, 1/4 W	Cb	37942	MTC-L4	RP67-2K	17
R113	4.7 kΩ	10%, 1/2 W	Comp	01121	EB	R1-4.7K	17
R114	2.2 kΩ	10%, 1/2 W	Comp	01121	EB	R1-2.2K	17
R115	2.2 kΩ	10%, 1/2 W	Comp	01121	EB	R1-2.2K	17
R116	1 kΩ	10%, 1/2 W	Comp	01121	EB	R1-1K	17
R117	15 Ω	10%, 1/2 W	Comp	01121	EB	R1-15	17
R118	1 kΩ	10%, 1/2 W	Comp	01121	EB	R1-1K	17
R119	4.7 kΩ	10%, 1/2 W	Comp	01121	EB	R1-4.7K	17
R120	2 kΩ	10%, 1/4 W	Cb	37942	MTC-L4	RP67-2K	17
R121	5.6 kΩ	10%, 1/2 W	Comp	01121	EB	R1-5.6K	
R122	10 kΩ	±5%, 2 W	WWVar	12697	Series 62	RP70-10K	14
R123	4.02 kΩ	1%, 1/2 W	MtF	07716	CEC	R94-4.02K	15
R124	4.02 kΩ	1%, 1/2 W	MtF	07716	CEC	R94-4.02K	15
R125	4.02 kΩ	1%, 1/2 W	MtF	07716	CEC	R94-4.02K	15
R126	4.02 kΩ	1%, 1/2 W	MtF	07716	CEC	R94-4.02K	15
R127	4.02 kΩ	1%, 1/2 W	MtF	07716	CEC	R94-4.02K	15
R128	4.02 kΩ	1%, 1/2 W	MtF	07716	CEC	R94-4.02K	15
R129	4.02 kΩ	1%, 1/2 W	MtF	07716	CEC	R94-4.02K	15
R130	4.02 kΩ	1%, 1/2 W	MtF	07716	CEC	R94-4.02K	15
R131	4.02 kΩ	1%, 1/2 W	MtF	07716	CEC	R94-4.02K	15
R132	15 kΩ	1%, 1/2 W	MtF	07716	CEC	R94-15K	15
R133	15 kΩ	1%, 1/2 W	MtF	07716	CEC	R94-15K	15
R134	15 kΩ	1%, 1/2 W	MtF	07716	CEC	R94-15K	15
R135	15 kΩ	1%, 1/2 W	MtF	07716	CEC	R94-15K	15
R136	15 kΩ	1%, 1/2 W	MtF	07716	CEC	R94-15K	15
R137	15 kΩ	1%, 1/2 W	MtF	07716	CEC	R94-15K	15
R138	15 kΩ	1%, 1/2 W	MtF	07716	CEC	R94-15K	15
R139	15 kΩ	1%, 1/2 W	MtF	07716	CEC	R94-15K	15
R140	15 kΩ	1%, 1/2 W	MtF	07716	CEC	R94-15K	15
R141	402 kΩ	1%, 1/2 W	MtF	07716	CEC	R94-402K	17
R142	402 kΩ	1%, 1/2 W	MtF	07716	CEC	R94-402K	17
R143	801 Ω	1%, 1/2 W	MtF	07716	CEC	R94-801	17
R144	801 Ω	1%, 1/2 W	MtF	07716	CEC	R94-801	17
R145	10 kΩ	0.1%, 1/2 W	MtF	07716	CEC T-1	R135-10K	17

**Resistor R101 is an integral part of lamp DS101 and may be obtained by ordering this lamp from Keithley Instruments under the part number PL-38.

RESISTORS (Cont'd)

Circuit Desig.	Value	Rating	Type	Mfg. Code	Mfg. Part No.	Keithley Part No.	Fig. Ref.
R146	10 k Ω	0.1%, 1/2 W	MtF	07716	CEC T-1	R135-10K	17
R147	99.5 k Ω	0.1%, 1/2 W	MtF	07716	CEC T-1	R135-99.5K	17
R148	1 k Ω	0.1%, 1/4 W	Cb	37942	MTC-L4	RP67-1K	17
R149	100 k Ω	0.1%, 1/2 W	MtF	07716	CEC T-1	R135-100K	17
R150	3.45 k Ω	0.1%, 1/2 W	MtF	07716	CEC T-1	R135-3.45K	17
R151	100 k Ω	0.1%, 1/2 W	MtF	07716	CEC T-1	R135-100K	17
R152	10 k Ω	0.1%, 1/2 W	MtF	07716	CEC T-1	R135-10K	17
R153	900 Ω	0.1%, 1/2 W	MtF	07716	CEC T-1	R135-900	14
R154	300 Ω	0.1%, 1/2 W	MtF	07716	CEC T-1	R135-300	14
R155	1 k Ω	0.1%, 1/2 W	MtF	07716	CEC T-1	R135-1K	14
R156	3 k Ω	0.1%, 1/2 W	MtF	07716	CEC T-1	R135-3K	14
R157	10 k Ω	0.1%, 1/2 W	MtF	07716	CEC T-1	R135-10K	14
R158	2 k Ω	1/4 W	Cb	37942	MTC-L4	RP67-2K	17
R159	28.7 k Ω	1%, 1/8 W	MtF	07716	CEA	R88-28.7K	17
R160	9.76 k Ω	1%, 1/8 W	MtF	07716	CEA	R88-9.76K	17
R161	1 k Ω	1/4 W	Cb	37942	MTC-L4	RP67-1K	17
R162	47 ⁹ Ω	10%, 1/2 W	Comp	01121	EB	R1-47 ⁹	--
R163	10 ⁹ Ω	20%, 1/2 W	Comp	75042	GBT	R37-10 ⁹	--
R164	10 ⁹ Ω	20%, 1/2 W	Comp	75042	GBT	R37-10 ⁹	--

STRUCTURAL PARTS

Circuit Desig.	Description	Mfg. Code	Mfg. Part No.	Keithley Part No.	Fig. Ref.
---	Top Cover Assembly	80164	---	20906B	
---	Bottom Cover Assembly	80164	---	19298C	
---	Foot, 4 req'd	72512	4004A	FE-5	
---	Ball, one for each foot	80164	---	FE-6	

SWITCHES AND CONTROLS

Circuit Desig.	Description	Mfg. Code	Keithley Part No.	Fig. Ref.
S101	Push Button Switch, +INPUT ZERO CHECK	80164	14376A	1
---	Knob, +Input Zero Check Button	80164	14376A	1
S102	Push Button Switch, -INPUT ZERO CHECK	80164	14376A	1
---	Knob, -Input Zero Check Button	80164	14376A	1
S103	Slide Switch, GUARD-OFF	80164	SW-45	1
S104	Slide Switch, LINE VOLTAGE	80164	SW-151	2
S105	Rotary Switch, METER	80164	SW-165	1
---	Knob Assembly, Meter Switch	80164	14838A	1
S106	Potentiometer, FINE ADJ. (R122)	12697	RP70-10K	1
---	Knob, Fine Adj.	80164	16373A	1
S107(A&B)	Rotary Switch less components, MEDIUM and COARSE	80164	SW-267	1
---	Rotary Switch with components, Medium and Coarse	80164	22973B	--
---	Knob Assembly, Medium Switch	80164	16993A	1
---	Knob Assembly, Coarse Switch	80164	16995A	1
S108	Rotary Switch less components, VOLTS	80164	SW-268	1
---	Rotary Switch with components, Volts	80164	22980B	--
---	Knob Assembly, Volts Switch	80164	14838A	1
S109	Rotary Switch less components, HIGH CUT HZ	80164	SW-266	1
---	Rotary Switch with components, High Cut HZ	80164	22974B	--
---	Knob Assembly, High Cut HZ Switch	80164	14838A	1

TRANSISTORS

Circuit Desig.	Number	Mfg. Code	Keithley Part No.	Fig. Ref.
Q101	2N3565	07263	TG-39	16
Q102	2N3638	07263	TG-33	16
Q103	2N3565	07263	TG-39	16
Q104	2N3638	07263	TG-33	16
Q105	40317	02734	TG-43	16
Q106	2N3565	07263	TG-39	16
Q107	2N3565	07263	TG-39	16
Q108	2N3638	07263	TG-33	16
Q109	40319	02734	TG-50	16
Q110	2N3638	07263	TG-33	16

MODEL 6041 REPLACEABLE PARTS LIST
(Refer to Schematic Diagram 23458C for circuit designations)

CONNECTORS AND TERMINALS

Circuit Desig.	Description	Mfg. Code	Mfg. Part No.	Keithley Part No.	Fig. Ref.
J101	Receptacle, triaxial, +INPUT	95712	33050-NT-34	CS-181	3
---	Plug, triaxial, mate of J101	95712	30197-1	CS-141	--
---	Cap, +INPUT Receptacle	02660	31-007	CAP-18	--
J102	Receptacle, triaxial, -INPUT	95712	33050-NT-34	CS-181	3
---	Plug, triaxial, mate of J102	95712	30197-1	CS-141	--
---	Cap, -INPUT Receptacle	02660	31-007	CAP-18	--
J103	Binding Post, GND	08811	33-286	BP-15	3
P101	Connector, triaxial, TO 604 INPUT:+	95712	30197-1	CS-141	--
---	Connector Assembly with cable	80164			--
P102	Connector, triaxial, TO 604 INPUT:-	95712	30197-1	CS-141	3
---	Connector Assembly with cable	80164			--

RESISTORS**

Circuit Desig.	Value	Rating	Type	Mfg. Code	Mfg. Part No.	Keithley Part No.	Fig. Ref.
R101	10 ¹¹ Ω	+3-0%, 1/R W	GCb	63060	RX-1	R20-10 ¹¹	--
R102	10 ¹⁰ Ω	+3-0%, 1/R W	GCb	63060	RX-1	R20-10 ¹⁰	--
R103	10 ⁹ Ω	+3-0%, 1/R W	GCb	63060	RX-1	R20-10 ⁹	--
R104	100MΩ	1%, 2W	DCb	91637	DC-2	R14-100M	--
R105	10 MΩ	1%, 1/2W	DCb	91637	DCF-1/2	R12-10M	--
R106	1 MΩ	1%, 1/2W	DCb	91637	DCF-1/2	R12-1M	--
R107	10 ¹¹ Ω	+3-0%, 1/R W	GCb	63060	RX-1	R20-10 ¹¹	--
R108	10 ¹⁰ Ω	+3-0%, 1/R W	GCb	63060	RX-1	R20-10 ¹⁰	--
R109	10 ⁹ Ω	+3-0%, 1/R W	GCb	63060	RX-1	R20-10 ⁹	--
R110	100MΩ	1%, 2W	DCb	91637	DC-2	R14-100M	--
R111	10 MΩ	1%, 1/2W	DCb	91637	DCF-1/2	R12-10M	--
R112	1 MΩ	1%, 1/2W	DCb	91637	DCF-1/2	R12-1M	--

SWITCHES AND CONTROLS

Circuit Desig.	Description	Mfg. Code	Keithley Part No.	Fig. Ref.
S101	Rotary Switch, +INPUT	80164	Model 3011	3
---	Knob Assembly, +Input Switch	80164	16338A	--
S102	Rotary Switch, -INPUT	80164	Model 3011	3
---	Knob Assembly, -Input Switch	80164	16338A	--

** A complete set of resistor for the Model 6041 may be purchased from Keithley Instruments under the Model Number of 6033. The Model 6033 contains resistor pairs matched to within ±2%. It is advised that upon ordering resistors for the Model 6041 the user purchase matched pairs to assure accuracy.

TABLE 14. Code List of Suggested Manufacturers.
 (Based on Federal Supply Code for Manufacturers, Cataloging Handbook H4-1).

01121	Allen-Bradley Corp. 1201 South 2nd Street Milwaukee, Wis. 53204	28520	Heyman Mfg. Co. 147 N. Michigan Avenue Kenilworth, N. J.
01295	Texas Instruments, Inc. Semiconductor-Components Division 13500 North Central Expressway Dallas, Texas 75231	37942	Mallory, P. R. and Co., Inc. 3029 E. Washington Street Indianapolis, Ind. 46206
02660	Amphenol Corp. 2801 South 25th Avenue Broadview, Ill. 60153	56289	Sprague Electric Co. North Adams, Mass.
02734	Radio Corp. of America Defense Electronic Products Camden, N. J.	63060	Victoreen Instruments Co. 5806 Hough Avenue Cleveland, Ohio 44103
04713	Motorola Semiconductor Products Inc. 5005 East McDowell Road Phoenix, Ariz. 85008	71400	Bussmann Mfg. Div. of McGraw-Edison Co. 2538 W. University Street St. Louis, Mo.
05397	Union Carbide Corp. Linde Div. Kemet Dept. 11901 Madison Cleveland, Ohio 44107	72982	Erie Technological Products, Inc. 644 W. 12th Street Erie, PA. 16512
07263	Fairchild Camera & Instru. Corp. Semiconductor Division 313 Frontage Road Mountain View, Cal.	73445	Amperex Electronic Co., Div. of North American Philips Co., Inc. Hicksville, N. Y.
07716	IRC, Inc. 2850 Mt. Pleasant Burlington, Iowa 52601	75042	IRC, Inc. 401 North Broad Street Philadelphia, PA. 19108
08811	GL Electronics Division of GL Industries Inc. 300 Harvard Avenue Westville, N. J. 08093	75915	Littlefuse, Inc. 800 E. Northwest Hwy. Des Plaines, Ill. 60016
09922	Burndy Corp. Richards Avenue Norwalk, Conn. 06852	80164	Keithley Instruments, Inc. 28775 Aurora Road Cleveland, Ohio 44139
12040	National Semiconductor Corp. Commerce Drive Post Office Box 443 Danbury, Conn. 06813	91802	Industrial Devices Inc. 982 River Road Edgewater, N. J. 07020
12697	Clarostat Mfg. Co., Inc. Lower Washington Street Dover, N. H. 03820	93656	Electric Cord Co. 1275 Bloomfield Avenue Caldwell, N. J.
12954	Dickson Electronics Corp. 302 S. Wells Fargo Avenue Scottsdale, Arizona	95712	Dage Electric Co., Inc. Hurricane Road Franklin, Indiana

Mechanical Parts List

Description	Quantity Per Assembly	Keithley Part No.
1) Chassis	1	22636B
1.1) Front Panel	1	22306C
Top Cover Assembly	--	20906B
12) Cover, Sheet Metal	1	24561D
13) Screws	4	--
Handle Assembly	--	--
14) Handle	1	HH-18
15) Screws #6-32 x 3/8" R.H. slotted	2	--
Bottom Cover Assembly	--	19298C
2) Cover	1	17149C
3) Fastener	2	FA-54
Feet Assembly	--	--
4) Feet	4	FE-5
5) Ball	4	FE-6
6) Screws #8-32 x 3/8" Phillips, Pan Head	4	--
Tilt Bail Assembly	--	--
7) Bail	1	17147B
8) Right Assembly	1	19206B
9) Left Assembly	1	19205B
10) Screws #6-32 x 1/4" Phillips, Pan Head	2	--

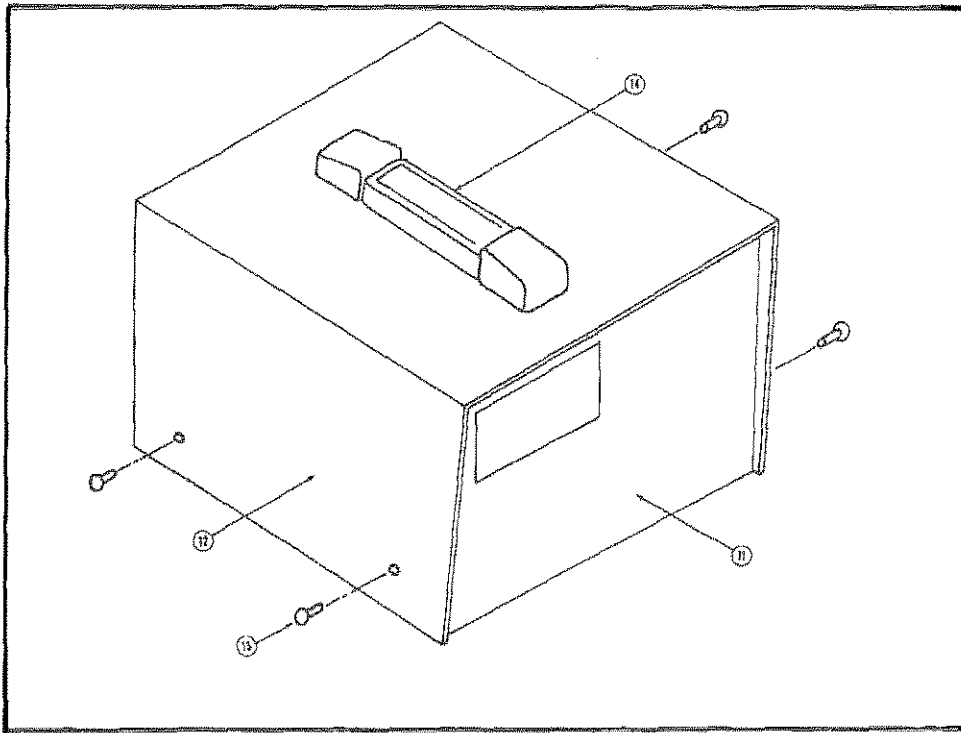

FIGURE 18. Top Cover Assembly.

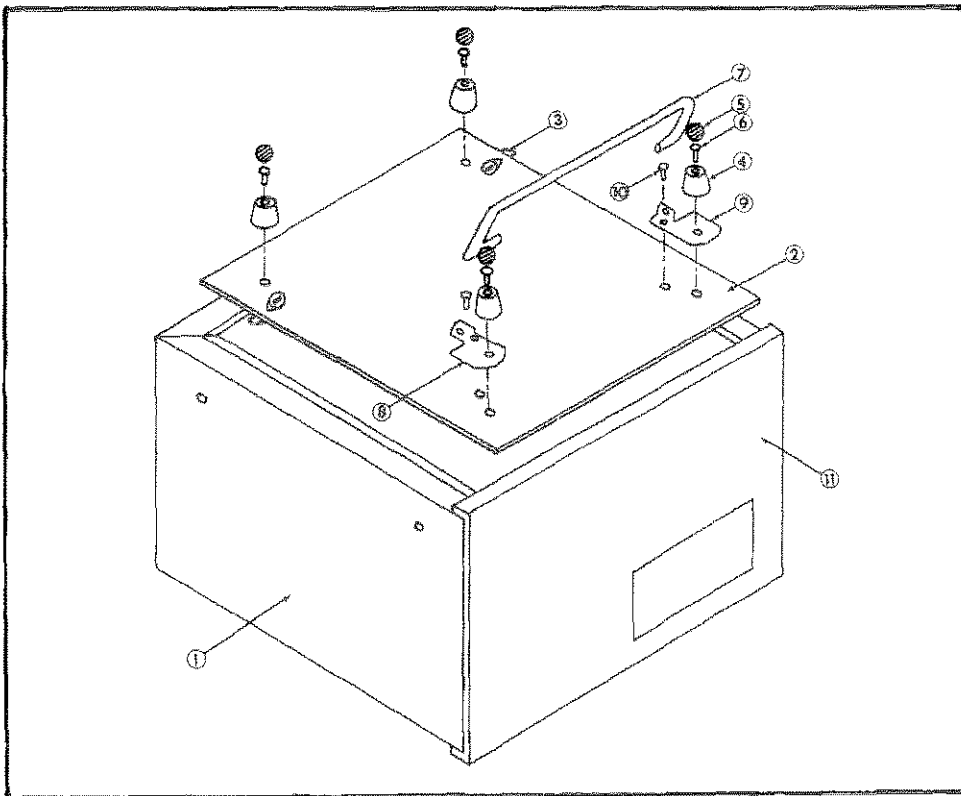
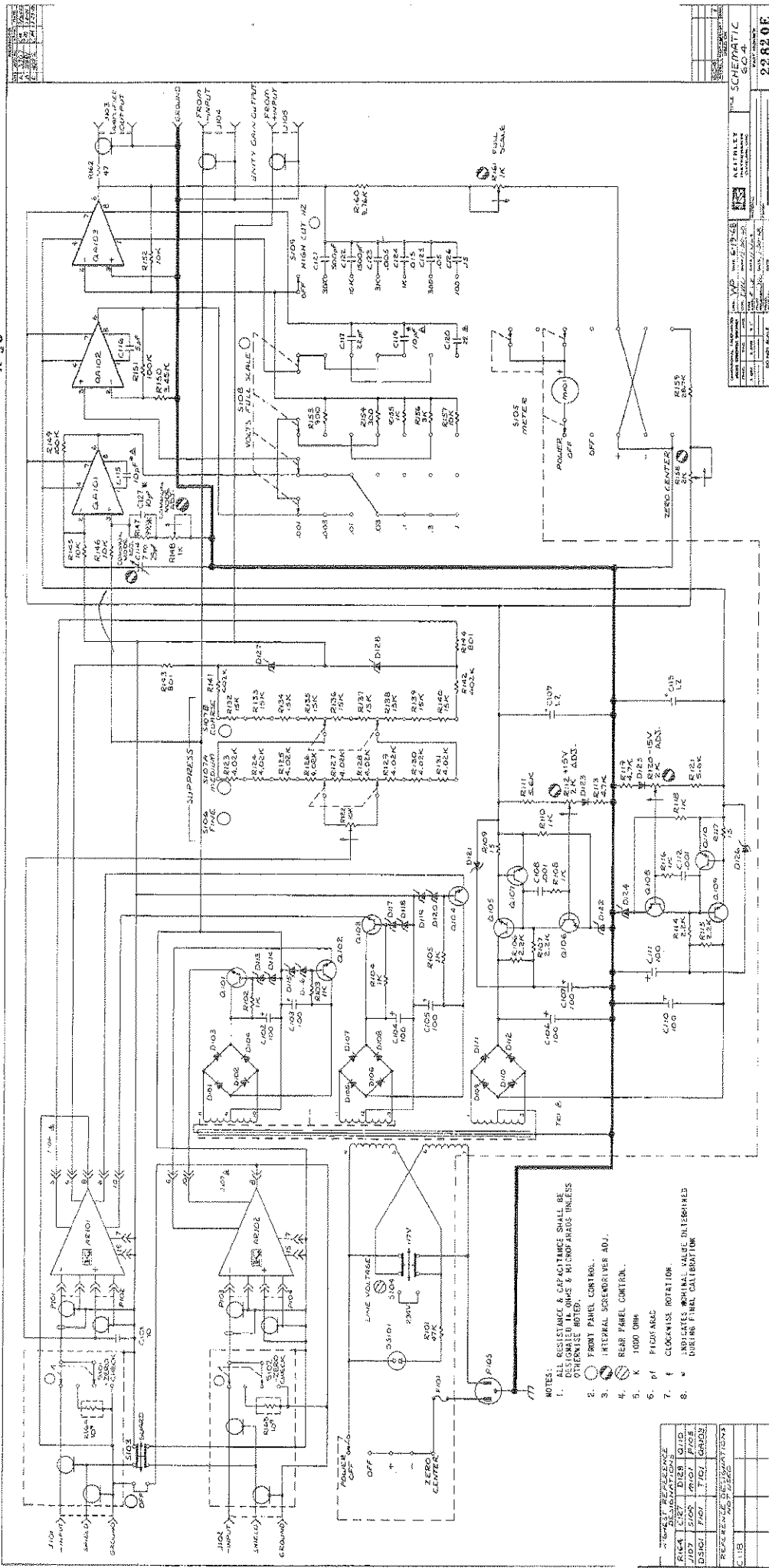

FIGURE 19. Bottom Cover Assembly.

K 10 X 30



- NOTES:
1. ALL RESISTANCE & CAPACITANCE SHALL BE PERCENTAGE TOLERANCES UNLESS INDICATED OTHERWISE.
 2. FRONT PANEL CONTROL.
 3. INTERNAL SCREWDRIVER ADJ.
 4. REAR PANEL CONTROL.
 5. K 1000 OHM
 6. P1 FIDUCIAL
 7. CLOCKWISE ROTATION.
 8. * INDICATES NOMINAL VALUE DETERMINED DURING FINAL CALIBRATION.

REV.	DATE	BY	CHKD.	DESCRIPTION
1				ISSUED FOR CONSTRUCTION
2				REVISION
3				REVISION
4				REVISION
5				REVISION
6				REVISION
7				REVISION
8				REVISION
9				REVISION
10				REVISION
11				REVISION
12				REVISION
13				REVISION
14				REVISION
15				REVISION
16				REVISION
17				REVISION
18				REVISION
19				REVISION
20				REVISION
21				REVISION
22				REVISION
23				REVISION
24				REVISION
25				REVISION
26				REVISION
27				REVISION
28				REVISION
29				REVISION
30				REVISION
31				REVISION
32				REVISION
33				REVISION
34				REVISION
35				REVISION
36				REVISION
37				REVISION
38				REVISION
39				REVISION
40				REVISION
41				REVISION
42				REVISION
43				REVISION
44				REVISION
45				REVISION
46				REVISION
47				REVISION
48				REVISION
49				REVISION
50				REVISION
51				REVISION
52				REVISION
53				REVISION
54				REVISION
55				REVISION
56				REVISION
57				REVISION
58				REVISION
59				REVISION
60				REVISION
61				REVISION
62				REVISION
63				REVISION
64				REVISION
65				REVISION
66				REVISION
67				REVISION
68				REVISION
69				REVISION
70				REVISION
71				REVISION
72				REVISION
73				REVISION
74				REVISION
75				REVISION
76				REVISION
77				REVISION
78				REVISION
79				REVISION
80				REVISION
81				REVISION
82				REVISION
83				REVISION
84				REVISION
85				REVISION
86				REVISION
87				REVISION
88				REVISION
89				REVISION
90				REVISION
91				REVISION
92				REVISION
93				REVISION
94				REVISION
95				REVISION
96				REVISION
97				REVISION
98				REVISION
99				REVISION
100				REVISION

SCHEMATIC
S.O. 4
22820E

REVISIONS		
LIST	REVISION	DATE
A		

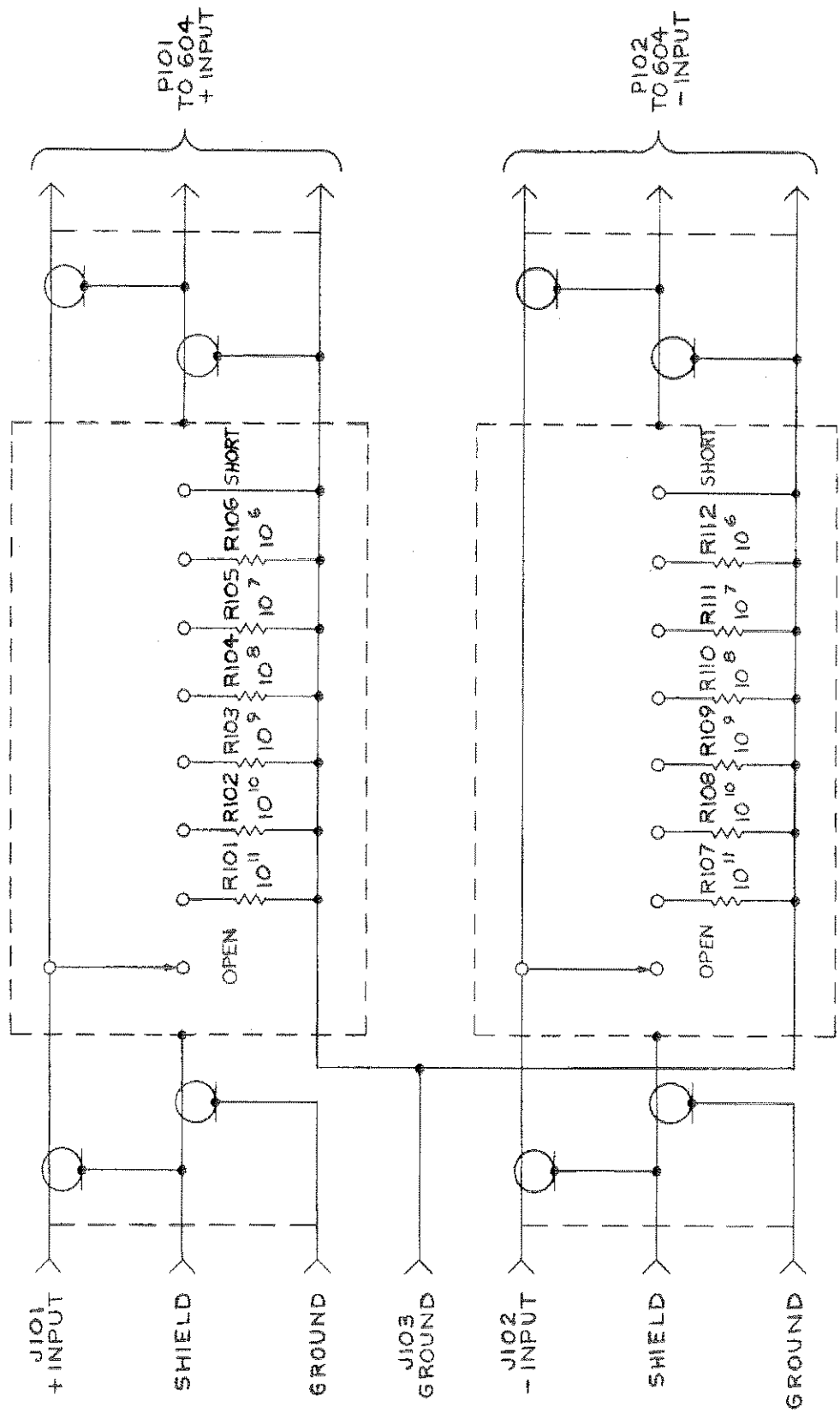

NOTES:
 1. ALL RESISTANCE & CAPACITANCE SHALL BE DESIGNATED IN OHMS & MICROFARADS UNLESS OTHERWISE NOTED.

HIGHEST REFERENCE DESIGNATION	DESIGNATION
R112	J103 P102
REFERENCE DESIGNATION NOT USED	

GOAL	MODEL	CLASSIFICATION	ISSUE
			1
DATE: 8/6/50		DATE: 2-5-50	DATE: 1-1-50
BY: [Signature]		BY: [Signature]	BY: [Signature]
CHECKED: [Signature]		CHECKED: [Signature]	CHECKED: [Signature]
DO NOT SCALE		INCREASE	DATE
PART NUMBER		PART NUMBER	
KETTLEBYE INSTRUMENTS		KETTLEBYE INSTRUMENTS	
LANSING, MICH.		LANSING, MICH.	
TITLE		TITLE	
GO4 DIFFERENTIAL CURRENT SHUNT SCHEMATIC		GO4 DIFFERENTIAL CURRENT SHUNT SCHEMATIC	
23458C		23458C	



KEITHLEY INSTRUMENTS, INC.

INSTRUCTION MANUAL
CHANGE NOTICE
MODEL 604 ELECTROMETER AMPLIFIER

INTRODUCTION: Since Keithley Instruments is continually improving product performance and reliability, it is often necessary to make changes to Instruction Manuals to reflect these improvements. Also, errors in Instruction Manuals occasionally occur that require changes. Sometimes, due to printing lead time and shipping requirements, we can't get these changes immediately into printed Manuals. The following new change information is supplied as a supplement to this Manual in order to provide the user with the latest improvements and corrections in the shortest possible time. Many users will transfer this change information directly to a Manual to minimize user error. All changes or additions are indicated in *italics*.

CHANGES:

C114 *1.9pF-15.7pF* 200-300 V 13050 C-284-*1.9P-15.7P* 16

KEITHLEY INSTRUMENTS, INC.
28775 AURORA ROAD
CLEVELAND, OHIO 44139
SERVICE FORM

MODEL NO. _____ SERIAL NO. _____ P.O. NO. _____ DATE _____ R-

NAME _____ PHONE _____

COMPANY _____

ADDRESS _____ CITY _____ STATE _____ ZIP _____

1. Describe problem and symptoms using quantitative data whenever possible (enclose readings, chart recordings, etc.) _____

_____ (Attach additional sheets as necessary).

2. Show a block diagram of your measurement system including all instruments connected (whether power is turned on or not). Also describe signal source.

3. List the positions of all controls and switches on both front and rear panels of the instrument. _____

4. Describe input signal source levels, frequencies, etc. _____

5. List and describe all cables used in the experiment (length, shielding, etc.). _____

6. List and describe all other equipment used in the experiment. Give control settings for each. _____

7. Environment:
Where is the measurement being performed? (Factory, controlled laboratory, out-of-doors, etc.) _____
What power line voltage is used? _____ Variation? _____ Frequency? _____
Ambient temperature? _____ °F. Variation? _____ °F. Rel. Humidity? _____
Other _____

8. Additional Information. (If special modifications have been made by the user, please describe below.) _____