

20 MHz Selective Level Measuring Set

Comprising :

20 MHz Level Oscillator TF 2356

Code Nos. 52356-900D
52356-301U
52356-302Y
52356-303N

20 MHz Selective Level Meter TF 2357A

Code Nos. 52357-910J
52357-304X
52357-305M
52357-306C

©

1980

MARCONI INSTRUMENTS LIMITED
ST. ALBANS HERTFORDSHIRE ENGLAND.

Part No. 46881-393P

CONTENTS

PRELIMINARIES

Title page
 Contents
 Notes and cautions

CHAPTERS

1	General information	
2	Installation	
3	Operation	
4-1	Brief technical description	
4-2	Technical description	} These chapters are contained in a separate volume avail- able as an optional extra; TF 2356 : H 52356-900D, TF 2357A : H 52357-910J.
5	Maintenance	
6	Replaceable parts	
7	Servicing diagrams	

Note...

Each page bears the date of the original issue or the code number and date of the latest amendment (Am. 1, Am. 2 etc.). New or amended material of technical importance introduced by the latest amendment is indicated by triangles positioned thus ►.....◄ to show the extent of the change. When a chapter is reissued the triangles do not appear.

Any changes subsequent to the latest amendment state of the manual are included on inserted sheets coded C1, C2 etc.

NOTES AND CAUTIONS

ELECTRICAL SAFETY PRECAUTIONS

This equipment is protected in accordance with IEC Safety Class 1. It has been designed and tested according to IEC Publication 348, 'Safety Requirements for Electronic Measuring Apparatus', and has been supplied in a safe condition. The following precautions must be observed by the user to ensure safe operation and to retain the equipment in a safe condition.

Defects and abnormal stresses

Whenever it is likely that protection has been impaired, for example as a result of damage caused by severe conditions of transport or storage, the equipment shall be made inoperative and be secured against any unintended operation.

Removal of covers

Removal of the covers is likely to expose live parts although reasonable precautions have been taken in the design of the equipment to shield such parts. The equipment shall be disconnected from the supply before carrying out any adjustment, replacement or maintenance and repair during which the equipment shall be opened. If any adjustment, maintenance or repair under voltage is inevitable it shall only be carried out by a skilled person who is aware of the hazard involved.

Note that capacitors inside the equipment may still be charged when the equipment has been disconnected from the supply. Before carrying out any work inside the equipment, capacitors connected to high voltage points should be discharged; to discharge mains filter capacitors, if fitted, short together the L (live) and N (neutral) pins of the mains plug.

Mains plug

The mains plug shall only be inserted in a socket outlet provided with a protective earth contact. The protective action shall not be negated by the use of an extension lead without protective conductor. Any interruption of the protective conductor inside or outside the equipment is likely to make the equipment dangerous.

Fuses

Versions 52356-900D, -301U; 52357-910J, -304X : Note that there is a supply fuse in both the live and neutral wires of the supply lead. If only one of these fuses should rupture, certain parts of the equipment could remain at supply potential.

Versions 52356-302Y, -303N; 52357-305M, -306C : Note that the supply fuse is connected in series with the brown (live) wire of the supply lead. If the equipment is connected to the supply via a two-pin plug, it will be possible for the fuse to become connected to the neutral side depending upon the orientation of the plug in its socket. In these circumstances certain parts of the instrument could remain at supply potential even after the fuse has ruptured.

Make sure that only fuses with the required rated current and of the specified type are used for replacement. The use of mended fuses and the short-circuiting of fuse holders shall be avoided.

CAUTION : STATIC SENSITIVE COMPONENTS

Components identified with the symbol  on the circuit diagrams and/or parts lists are static sensitive devices. The presence of such devices is also indicated in the equipment by orange discs, flags or labels bearing the same symbol. Certain handling precautions must be observed to prevent these components being permanently damaged by static charges or fast surges.

- (1) If a printed board containing static sensitive components (as indicated by a warning disc or flag) is removed, it must be temporarily stored in a conductive plastic bag.
- (2) If a static sensitive component is to be removed or replaced the following anti-static equipment must be used.

A work bench with an earthed conductive surface.

Metallic tools earthed either permanently or by repeated discharges.

A low-voltage earthed soldering iron.

An earthed wrist strap and a conductive earthed seat cover for the operator, whose outer clothing must not be of man-made fibre.

- (3) As a general precaution, avoid touching the leads of a static sensitive component. When handling a new one, leave it in its conducting mount until it is required for use.

Chapter 1

GENERAL INFORMATION

CONTENTS

Para.				
1	Introduction			
5	20 MHz Level Oscillator TF 2356			
6	Tuning			
9	Level setting			
12	Sequence mode operation			
13	Frequency selection			
14	Level selection			
15	Mode selection			
16	Sequence selection			
17	20 MHz Selective Level Meter TF 2357A			
18	Tuning			
22	Automatic frequency control			
23	Level measurement			
26	Automatic calibration			
27	Filter bandwidths			
28	Tracking generator			
29	Control mode operation			
30	Frequency selection			
31	Level, mode and sequence selection			
32	Printout			
33	General bus control and associated equipment			
34	Coaxial Switch Unit TF 2365			
35	Baseband Filter Unit TK 2366			
36	Automatic Baseband Monitor OA 2358			
38	Performance data			
38	20 MHz Level Oscillator TF 2356			
51	20 MHz Selective Level Meter TF 2357A			
72	Alternative versions			
73	Accessories			
73	Supplied accessories			
74	Optional accessories			
Fig.				Page
1	Level Oscillator TF 2356 and Selective Level Meter TF 2357A	...		2
2	Typical balanced output level below 6 kHz	3
3	Typical balanced output level above 250 kHz	3
4	Typical unbalanced low frequency performance	5

INTRODUCTION

1. The selective level measuring set which comprises Level Oscillator TF 2356 (the sender) and Selective Level Meter TF 2357A (the receiver) provides for both synchronous and independent manual operation as well as two levels of programmable operation. Both instruments are microprocessor controlled and each incorporates a high stability 5 Hz resolution frequency synthesizer. The application of such techniques enables the instruments to provide a high degree of measurement versatility coupled with extreme simplicity of operation.

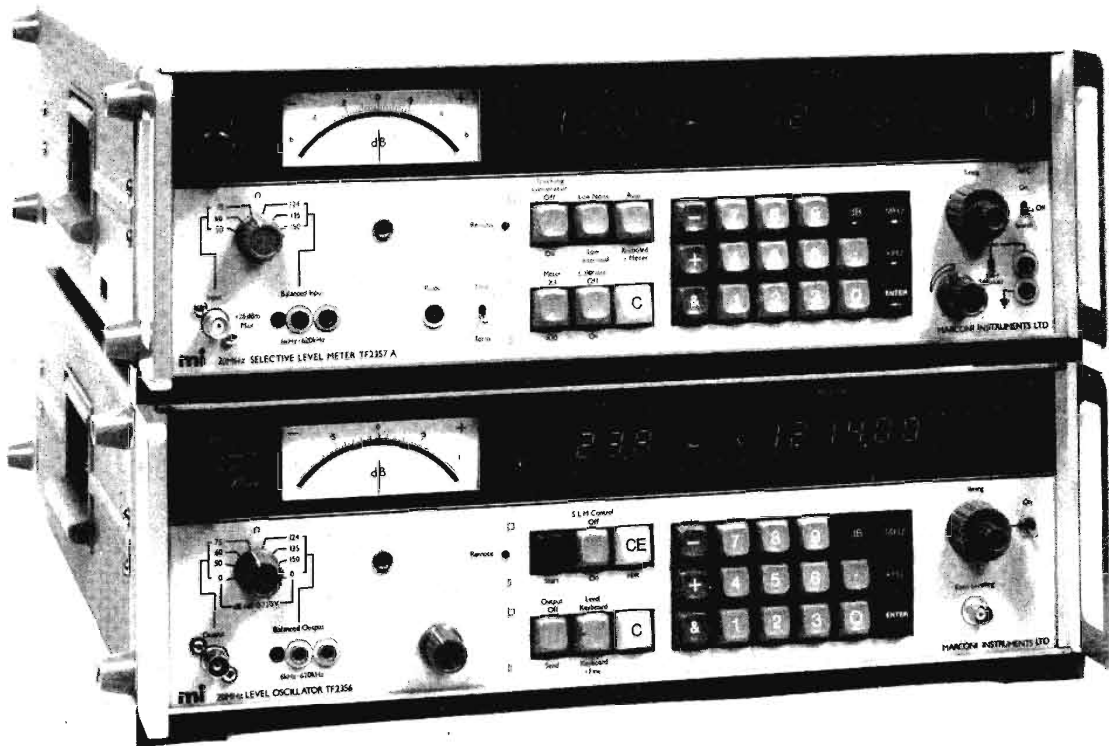

Fig. 1 Level Oscillator TF 2356 and Selective Level Meter TF 2357A

Power levels may be measured over a wide range with the 0.1 dB resolution digital display in the receiver auto balancing mode or with a 0.01 dB resolution combined analogue and digital display in the differential level mode. An r.m.s. responding detector is incorporated and level indication is in dBm or dB relative to 0.775 V. Frequency is digitally displayed to 10 Hz resolution.

2. For manual operation the sender and receiver may be operated independently. In sequence mode operation, the sender automatically steps through a sequence of frequency/level increments. For synchronous operation, coaxial cable interconnection permits sender frequency to be controlled from the receiver. The addition of optional GPIB* interfaces greatly extends the versatility of both instruments and provides two levels of programmable operation. Firstly, the sender acts as a bus controller of the receiver and, optionally, a printer. This control capability gives the selective level measuring set several powerful modes of automatic operation. Secondly, both sender and receiver may be programmed via the bus as part of a larger automatic measurement system, in which case the sender's own control capability is overridden. Sender versions 52356-301U, -302Y and receiver versions 52357-304X, -305M are factory fitted with GPIB interfaces but for other versions conversion is a simple retrofitting exercise.

*GPIB - Marconi Instruments General Purpose Interface Bus in accordance with IEEE Standard 488-1978 and IEC Publication 625-1.

3. Both instruments may be fitted with an optional rechargeable battery pack providing approximately 4 hours continuous operation following approximately 14 hours charge and the instruments conform to IEC 348 and BS 4743 safety regulations.

4. Application of the instruments may be considerably extended by the addition of associated MI bus-controllable instruments. These include a coaxial switch unit for scanning up to 56 separate inputs and a baseband filter unit to extend the receiver's bandwidth capability to 'blocks' of telephone channels from group power measurement up to total baseband power.

20 MHZ LEVEL OSCILLATOR TF 2356

5. The level oscillator generates signals which are highly stable both in frequency and amplitude. Frequency may be set between 100 Hz and 19.999995 MHz to 5 Hz resolution. In the range -70 dB to +10 dB output power may be set to 0.1 dB resolution or, alternatively, to 1 dB resolution with continuous fine tuning to ± 1.1 dB. Balanced and unbalanced outputs may be selected over a wide range of impedances. Frequency and level are read from digital displays which flash when an out-of-range condition is selected in error. Typical balanced output levels are given in Figs. 2 and 3.

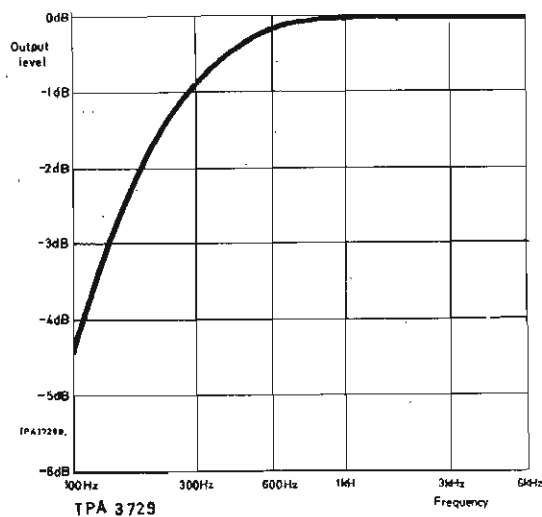

Fig. 2 Typical balanced output level below 6 kHz (ref. to -22dBm, 150 Ω)

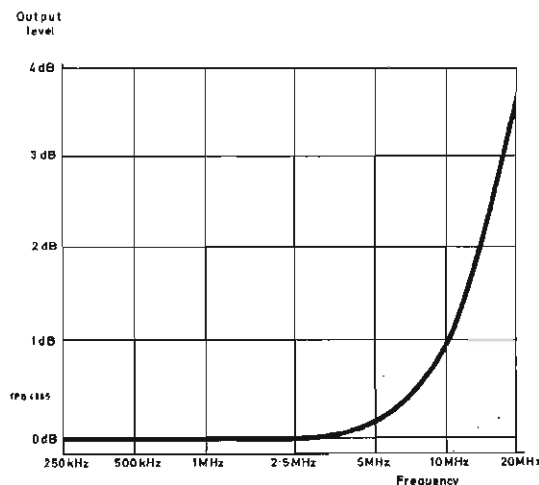

Fig. 3 Typical balanced output level above 250 kHz

Tuning

The tuning synthesizer may be controlled either by the keyboard or by a conventional tuning knob; in both cases the frequency is indicated on a 7-digit display to 10 Hz resolution. In addition to synchronous operation from the receiver, the sender may be tuned using either the keyboard or the manual TUNING control.

Keyboard tuning

7. This is achieved in two ways:-

Direct entry : The required frequency is entered on the keyboard.

Incremental : This mode is used to increase or decrease the tuned frequency by a set amount. For example, to increase frequency by 4 kHz, press the & (increment) key, enter +4 kHz on the keyboard, then press the ENTER key : The frequency is then incremented by 4 kHz each time the ENTER key is pressed.

Manual tuning

8. There are two methods of tuning manually:-

Normal mode : Turning the control increments the synthesizer in 5 Hz steps.

Incremental mode : The step value may be entered on the keyboard as in incremental keyboard tuning. The manual tuning will then increment at the chosen value across the whole frequency range.

Spin tuning : Spinning the TUNING control causes a motor drive to operate, giving the effect of a mechanical flywheel. Having spun the control it will normally continue to rotate until either limit of the frequency range is reached, but it may also be stopped at any time either manually or by pressing any data key on the keyboard. Normally, spin tuning provides quasi-logarithmic stepping since different increment values are automatically selected for the frequency bands 100 Hz to 100 kHz, 100 kHz to 1 MHz and 1 MHz to 20 MHz. However, as for manual tuning, entering an increment on the keyboard provides linear steps across the entire frequency range.

Level setting

9. Output level may be entered in dB via the keyboard and displayed to 1 dB resolution on a 3 digit display. Fractions of a dB are then set with a continuously variable control in conjunction with a meter scaled ± 1.1 dB. Alternatively, level may be entered to 0.1 dB resolution with the LEVEL selector in the KEYBOARD position, in which case the meter and continuously variable control are both disabled.

10. Level increments may be entered via the keyboard using the & (increment) key allowing the output level to be changed a preset number of dB each time the ENTER key is pressed. Level calibration is switchable to dBm or dB relative to 0.775 V (1 mW into 600 Ω). Provision is made for the selection of automatic disabling of the output during changes in level or frequency. Manual output disable is also provided.

11. Though level accuracy is high, level uncertainty may be further reduced by applying an external levelling signal from a monitor such as a standard mW test set equipped with d.c. error output.

SEQUENCE MODE OPERATION

12. In this mode of operation, the sender automatically steps through a sequence of frequency and/or level steps with the optional inclusion of a delay to allow the recording of results.

Frequency selection

13. The following frequency conditions may be set:-

single frequency : Sender set to one frequency.

Incrementing : Sender increments over a preset frequency range in preset increments.

Level selection

14. The following level conditions may be set:-

Single level : Sender set to a single level.

Level incrementing : Sender increments over a preset range of levels in preset increments.

Output disable : Disables output prior to implementing Single Level and Level Incrementing.

Mode selection

15. The following modes may be set:-

Manual : Each measurement within the preset sequence is initiated by a manual command.

Single cycle : One complete automatic sequence (cycle) of measurements is made; a further cycle may be started manually.

Repeat cycle : Further cycles are initiated automatically.

Delay : Can be used in any of the above modes to delay measurement following any change of frequency or level over the range 1 second to 1 hour. This mode is especially useful where the system under test requires a few seconds settling time or measurements are to be recorded at, for example, 30 minute intervals.

Sequence selection

16. When both frequency and level increments have been entered, the sequence can be preset to provide all measurements at one frequency before incrementing to the next level, or vice versa.

20 MHZ SELECTIVE LEVEL METER TF 2357A

17. The selective level meter is a high stability receiver, usable to 300 Hz (see Fig. 4) and tunable to 20 MHz, which measures power levels accurately from -121 dBm to +26 dBm. Three measuring filter bandwidths are provided : a 50 Hz pilot filter, a 3.1 kHz channel filter and a 48 kHz group filter. A wide range of 'thro' or terminated impedances may be switch selected and a high impedance zero loss probe is available. As in the sender, frequency and level are read from digital displays which flash to indicate that an out-of-range condition has been incor-rectly selected.

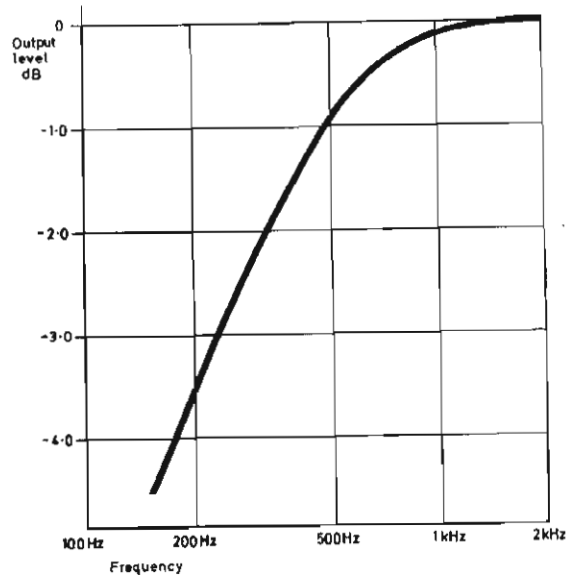

Fig. 4 Typical 75 Ω unbalanced low frequency performance

Tuning

18. The tuning arrangement is similar to that for the sender. The four tuning modes considerably simplify measurements on f.d.m. systems.

Keyboard tuning

19. There are two methods of keyboard tuning:-

Direct entry : To measure the level of a known frequency such as a reference pilot, the frequency is entered directly.

Incremental : This mode may be used when measuring a series of equally spaced signals such as adjacent channels in a group.

Manual tuning

20. There are two methods of tuning manually:-

Normal mode : Manual tuning using the rotary control is very useful when searching for spurious tones or when plotting filter responses.

Spin tuning : Spin tuning greatly facilitates searching for high level tones since the instrument can be set to scan automatically an entire f.d.m. base-band, locking automatically to any signal which exceeds a preset threshold.

Synchronous tuning

21. Outputs of the internal 10 MHz standard and variable local oscillator are available at rear sockets for connection to the sender by coaxial cables in the conventional way. The tuning of the sender is then controlled entirely from the receiver and all four tuning modes are operative.

Automatic frequency control (AFC)

22. Switch selection of automatic frequency control locks the receiver to an incoming signal. The capture range is a function of the filter bandwidth selected, but the hold range extends over the full frequency range up to 20 MHz since the a.f.c. operates by digitally retuning the synthesizer. In this mode, signals are held within ± 8 Hz of the centre frequency of the measuring filter.

Level measurement

23. The versatility of the receiver is enhanced by its ability to measure level in two ways, either automatically with a digital display or manually with a meter display. Level indication is switch selected in dBm or dB relative to 0.775 V and a warning lamp lights if the total wide band input power exceeds a level which might cause errors due to internal intermodulation products. Low noise or low intermodulation measurement is available.

Auto

24. The receiver attenuators automatically balance to the tuned signal and the level is presented on a 4 digit display with 0.1 dB resolution (the meter is inoperative). This mode is ideal for fast precision measurements. Low noise or low intermodulation is selected adaptively.

Keyboard + meter

25. The meter is used to display the level difference between the incoming signal and a reference level entered on the keyboard and displayed on the digital readout. This facility is especially useful when setting a signal to a desired level since an analogue movement is easier to follow than changing digits on a digital display. Low noise or low intermodulation may be selected manually. The meter, which is centre-zero with switched scales of ± 6 dB and ± 0.6 dB giving 0.01 dB resolution, may also be externally monitored via RECORDER OUTPUT.

Automatic calibration

26. Errors due to both frequency response and r.f. attenuation are compensated by an automatic calibrator which injects into the input circuits a standard level at the tuned frequency. The process is initiated at switch-on and subsequently whenever frequency or level alter significantly. In steady state conditions the receiver automatically calibrates at approximately 8 minute intervals.

Filter bandwidths

27. Three switch selected filters are provided as standard equipment.

50 Hz pilot filter : This high selectivity filter, with a 60 dB/3 dB shape factor close to 6:1, is suitable for measuring pilot tones in traffic, particularly when they are adjacent to signalling tones or suppressed carriers.

3.1 kHz channel filter (not suitable for making measurements below 2 kHz) : Entering the frequency of the suppressed carrier and selecting upper or lower sideband applies automatic carrier shift to give a correctly demodulated output. A built-in loudspeaker with volume control is also provided.

48 kHz group filter (not suitable for making measurements below 36 kHz) : The filter is suitable for measuring the total power in a group of twelve channels.

Tracking generator

28. A 0 dBm output signal at the tuned frequency is provided to allow characterization of circuits without the need for the companion sender.

CONTROL MODE OPERATION

29. When fitted with GPIB interfaces the sender and receiver may be connected to a printer via the bus. Simple data entry on the sender keyboard provides a number of powerful automatic measurement sequences without the need for a separate bus controller or the preparation of customized software.

Frequency selection

30. The following frequency conditions may be set:-

Single frequency (synchronous) : Sender and receiver set to same frequency.

Incrementing (synchronous) : Sender and receiver increment synchronously over a preset frequency range in preset increments.

Incrementing with offset : Sender and receiver automatically increment over a preset frequency range with a preset constant frequency offset.

Inverted incrementing with offset : Similar to Incrementing with offset except that the receiver steps downward in frequency as the sender steps upward.

Level, mode and sequence selection

31. These are the same as for sequence mode operation.

Printout

32. All initial data values (frequencies, levels, mode and delay) are recorded at the beginning of the first cycle. During a measurement sequence, receive frequency and level data are produced and, under certain circumstances, sender frequency and level are also printed. When a printer is not connected, the manual or delay modes may be selected to allow time for sender and receiver displays to be noted.

GENERAL BUS CONTROL AND ASSOCIATED EQUIPMENT

33. Both sender and receiver may form part of a more complex test configuration in which case the sender will act as a listener, its own controller capability being overridden. Such configurations may include, for example, a programmable calculator with plotter or video display unit for network characterization and other bus controlled equipments to test additional parameters. As part of an automatic test system, the capabilities of the receiver can be considerably extended by the addition of other MI bus controllable units.

Coaxial Switch Unit TF 2365

34. This unit scans any number of 75 Ω sources for input to the receiver. A series of four-way switch modules is assembled to provide between 4 and 56 inputs per unit. The coaxial switch units are stackable for requirements in excess of 56 inputs and may be controlled manually, via the instrument bus or using b.c.d./t.t.l. logic.

Baseband Filter Unit TK 2366

35. The addition of this unit enables the bandwidth capability of the receiver to be extended beyond the single telephone channel and group to include supergroup (240 kHz) and mastergroup (1200 kHz) all tunable over the full 20 MHz range. Included are high- and low-pass filters for hypergroup (supermastergroup) and total baseband power measurement. For evaluation of inter-supergroup slot noise, a range of band-pass filters acts as receiver pre-filters to provide the equivalent of 80 dB inherent n.p.r. performance. TK 2366 is addressed over the bus via the receiver.

Automatic Baseband Monitor OA 2358

36. A particular application of the receiver and its associated equipment is automatic baseband monitoring. OA 2358 scans up to 56 f.d.m. basebands (with

one TF 2365) sequentially under the control of an 1800 series controller. The operator holds a conversational dialogue via a video display unit for initializing the system, selecting test sequences, choosing fault reporting methods and other routines. Measurements may be selected from the following with a further choice of different modes during pre-assigned routine and peak traffic times : All pilot levels, Selected pilot levels, Inter-supergroup slot noise, Baseband power, Hypergroup power, Mastergroup power, Supergroup power, Group power, Channel power, Carrier leak.

37. All measurements are compared with limits set by the operator. Faults may be reported immediately or retained for summary reporting at set times. Diagnostic sub-routines can be incorporated in order to localize the source of faults. The monitor contains non-volatile memory and is self-starting after supply interruption. It is particularly suitable, therefore, in remote locations from where it may be interrogated or controlled from a central computer.

PERFORMANCE DATA

20 MHz Level Oscillator TF 2356

38. Frequency

Range : 200 Hz to 20 MHz (unbalanced) usable down to 100 Hz. 6 kHz to 1.6 MHz (balanced) usable from 100 Hz to 20 MHz with restrictions.

Resolution : 5 Hz; display resolution 10 Hz.

Accuracy : ± 1 in 10^6 /year ageing rate.
 ± 1 in $10^7/^\circ\text{C}$ temperature coefficient relative to 23°C .
 (Or use external standard.)

Control : Keyboard entry and manual tuning control.

Display : 7 digits with decimal point and units (e.g. 12345.67 kHz).

39. Level

Switchable to dBm or dB relative to 0.775 V.

Range :

Ω		Maximum output level	
		dBm	dB
Unbalanced	75	+10	+0.9
"	60	+3	-7.0
"	50	+3	-7.7
"	0	-	0
Balanced	150	+10	+3.9
"	135	+10	+3.5
"	124	+10	+3.1
"	0	-	0

Balanced below 6 kHz - maximum output level decreases typically at 10 dB/octave with respect to 3 kHz.

Ω	<i>Minimum output level</i>	
	<i>dBm</i>	<i>dB</i>
All impedances	-70	-80

- Manual : As table in 1 dB steps via keyboard plus ± 1.1 dB continuously variable, or 0.1 dB steps via keyboard.
- Remote : As table, variable in 0.1 dB steps.
- Display :
- Keyboard + Fine 2 digits, keyboard-entered to 1 dB resolution. Meter scaled ± 1.1 dB in 0.1 dB divisions.
 - Keyboard 3 digits, level entered on keyboard to 0.1 dB resolution (meter inoperative).
- Output disable : The output may be suppressed by at least 60 dB.
- Output muting : Automatic muting during a frequency and/or level change may be selected by a rear panel switch.
- Level accuracy : ± 0.08 dB at 0 dBm, 100 kHz, 75 Ω . For balanced impedances add a further ± 0.07 dB.
- Frequency response at 0 dBm with respect to 100 kHz, 75 Ω : Unbalanced, typically with +0.5 dB at 100 Hz.
 200 Hz to 1 kHz : $< +0.25$ dB
 1 kHz to 6 kHz : ± 0.1 dB
 6 kHz to 12.5 MHz : ± 0.05 dB
 12.5 MHz to 20 MHz : ± 0.08 dB.
 Balanced 124 Ω , 135 Ω and 150 Ω
 6 kHz to 620 kHz : ± 0.07 dB
 620 kHz to 1.6 MHz : ± 0.1 dB.

Attenuator accuracy (75 Ω unbalanced, and balanced impedances up to 1.6 MHz) :

<i>dB below max. rated output</i>	<i>Frequency</i>	
	<i>200 Hz to 12.5 MHz</i>	<i>12.5 to 20 MHz</i>
0 to -20dB	0.05dB*	0.10 dB
-20dB to -50dB	0.10dB	0.15dB
<-50dB	0.15dB	0.20dB

For balanced impedances only:-

- In range 6 kHz to 20 kHz add ± 0.04 dB.
- In range 20 kHz to 1.6 MHz add ± 0.02 dB.

40. Output impedance 0 Ω , 50 Ω , 60 Ω , 75 Ω .
- Unbalanced (6 kHz to 20 MHz) : Return loss >34 dB at 75 Ω and \leq 0 dBm output.
- Balanced (6 kHz to 620 kHz) : 0 Ω , 124 Ω , 135 Ω , 150 Ω .
Return loss >34 dB.
Balance ratio >40 dB.
41. Spurious signals
- Harmonically related : Better than -50 dB at 1 MHz and +10 dBm.
- Non-harmonically related : Better than -60 dB.
42. Inputs
- External 10 MHz standard : 50 Ω input impedance nominal.
Level -10 to 0 dBm.
(DC path of less than 10 k Ω must be present to disable internal standard.)
- 30 to 50 MHz : 50 Ω input from receiver for synchronized operation.
Level -10 dBm \pm 3 dB (d.c. path of less than 10 k Ω must be present to disable internal oscillator).
- External levelling : Approx. 30 mV/dB over range \pm 1 dB
(approximately 2 mV r.m.s. per 1% a.m.).
Bandwidth d.c. to 100 kHz.
Impedance 10 k Ω .
Application : to enable sender levelling over the range 6 kHz to 20 MHz within typically \pm 0.01 dB of the response of a standard mW test set with d.c. error output of 30 mV/0.01 dB sensitivity.
43. Remote control
- The sender is remotely programmable when fitted with GPIB kit except under battery operation (see Optional accessories/ Alternative versions).
- Subset reference list : SH1, AH1, T6, L4, SR1, RL1, DC1, E1. As limited controller : C1, C2, C3, C4, C28.
- Remote command : Remote initiation of pre-programmed sequences is controlled by contact closure at a rear panel socket. TTL compatible.
- Sync output : Output changes state while frequency or level is changing. High state indicates settled condition. TTL compatible.

**Where GPIB is Marconi Instruments implementation of the General Purpose Interface Bus in accordance with IEEE Standard 488-1978 and IEC Publication 625-1 (First Edition).*

44. Automatic sequence modes

- Sender only : Keyboard entry of an instruction string allows automatic frequency and/or level increments, single-shot or repetitive with variable time per increment.
- Sender + receiver : When fitted with GPIB kit and connected to TF 2357A via the bus and optionally a printer, the sender acts as a dedicated bus controller. This allows sender only modes as above plus frequency and level control of the receiver.

45. Push-buttons and lamps

Colours of push-buttons and lamps conform to IEC 73 and BS 4099 requirements.

46. Safety regulations

Complies with IEC 348 and BS 4743 safety requirements.

47. Limit range of operation

- Temperature : 0 to 55°C.

48. Conditions of storage and transport

- Temperature : -40°C to +70°C (except battery unit type 43113-004K, -40°C to +60°C).
- Humidity : Up to 90% relative humidity.
- Altitude : Up to 2500 m (pressurised freight at 27 kPa differential, i.e. 3.9 lbf/in²).

49. Power requirements

- AC supply : 95 to 130 V or 190 to 260 V.
45 to 65 Hz, 70 VA (including GPIB option) at nominal supply voltage.
- Battery option : See optional accessories.
- Operation time : Approx. 5 hours continuous.
- Charging time : Approx. 14 hours (trickle charges when a.c. supply operated).

50. Dimensions and weight

- Height : 135 mm (5.25 in).
Width : 430 mm (17 in).
Depth : 570 mm (22.5 in).
Weight : 16.3 kg (36 lb).

20 MHz Selective Level Meter TF 2357A51. Frequency

Range : 6 kHz to 20 MHz (unbalanced) usable to 300 Hz.
6 kHz to 620 kHz (balanced) usable to 1.6 MHz.

Resolution : 5 Hz.
Display resolution 10 Hz.

Accuracy : ± 1 in 10^6 /year ageing rate.
 ± 1 in 10^7 /°C temperature coefficient
relative to 23°C.
(Or use external standard.)

Control : Keyboard entry and manual tuning control.

Display : 7 digits with decimal point and units
(e.g. 10000.00 kHz).

52. Level measurement

Switchable to dBm, or dB relative to 0.775 V.

Range : For Pilot & Channel Bandwidths :-
-121 dBm (-131 dB) to +26 dBm (+16 dB).
For Group Bandwidth :-
-101 dBm (-111 dB) to +16 dBm (+6 dB).

MODE	DISPLAY	RESOLUTION
Autobalance †	4 digit	0.1 dB
Manual KEYBOARD + METER	3 digit + meter x1 scaled ± 0.6 dB x10 scaled ± 6 dB	0.02 dB* 0.2 dB
Remote † autobalance	4 digit	0.01 dB* 0.1 dB
Remote Preset	3 digit + meter	0.01 dB* 0.1 dB

*For Pilot and Channel bandwidths when fine resolution is selected, range is limited to -115.6 dBm (-125.6 dB) to +20.6 dBm (+10.6 dB). For Group measurements range is limited to -95.6 dBm (-105.6 dB) to +10.6 dBm (+0.6 dB).

†For highest measurement speed of time varying signals (e.g. speech) the x1/x10 function should be set to x10.

Note...

With AFC switch in ON or OFF position, the rounded autobalance value is displayed as the reference level when selecting manual following autobalance mode.

Maximum safe input :

Unbalanced terminated : 0.5 W continuous (a.c. and/or d.c.).

Unbalanced through : 5.5 V r.m.s. and 50 V d.c. continuous.

Balanced (term and thro): 0.5 W or 7.8 V continuous - no d.c. permitted.

Noise floor :

Noise floor at max. sensitivity with BFO off (input set to 75 Ω terminated).

Bandwidth	Noise floor (dBm)	
	6kHz-60kHz	60kHz-20MHz
Pilot 50 Hz	≤ -131	≤ -139
Channel 3.1 kHz	≤ -118	≤ -124
Group 48 kHz	-	$\leq -106^*$

* Down to 84 kHz centre frequency.

For measurements of Group A (36 kHz centre frequency) typically below -70 dBm.

53. Level measurement accuracy

Pilot and Channel Bandwidths

Low noise and remote low noise mode :

Input level range dBm	Level accuracy (dB) with calibrator on at 75 Ω impedance with meter range $\times 1$		
	6kHz-60kHz	60kHz-6MHz	6MHz-20MHz
+20 to +11	± 0.35	± 0.25	± 0.35
+10 to -89	± 0.15	± 0.1	± 0.2
-90 to -99	$\pm 0.3^*$	± 0.25	± 0.3
-100 to -115	$\pm 1.5^\dagger$	± 0.5	± 1.0

* Below 10 kHz add 0.05 dB.

† Applies over input level range from -100 dBm to -110 dBm only.

Notes...

- (1) For 3.1 kHz channel bandwidth measurements below -100 dBm extend upper accuracy limit by 0.25 dB.
- (2) For 50 Ω impedance add a further ± 0.1 dB to all level accuracies.
For 60 Ω impedance add a further ± 0.1 dB to level accuracies below 6 MHz and ± 0.2 dB to level accuracies above 6 MHz.

- (3) For all balanced impedances extend the lower limit of level accuracy by 0.2 dB.
- (4) Pilot bandwidth. With a.f.c. off, input frequency to be within ± 2.5 Hz of SLM centre frequency. With a.f.c. on add a further ± 0.05 dB to all level accuracies unless input frequency is within ± 2.5 Hz of SLM centre frequency.
- (5) Channel bandwidth. Input frequency to be within ± 25 Hz of SLM centre frequency. This condition is satisfied with a.f.c. on (see Automatic frequency control).

Low intermod and remote low intermod mode :

Input level range dBm	Level accuracy (dB) with calibrator on at 75 Ω impedance with meter range $\times 1$		
	6kHz-60kHz	60kHz-6MHz	6MHz-20MHz
+20 to +11	± 0.35	± 0.25	± 0.35
+10 to -69	$\pm 0.2^*$	± 0.1	± 0.2
-70 to -89	$\pm 0.25^x$	± 0.2	± 0.25
-90 to -115	$\pm 1.5^\dagger$	± 0.5	± 1.0

* Below 10 kHz add 0.05 dB.

^x Below 10 kHz add 0.2 dB.

[†] Applies over input level range of -90 to -110 dBm only.

Notes (1) to (5) of low noise and remote low noise mode also apply.

Autobalance and remote autobalance mode :

Input level range dBm	Level accuracy (dB) with calibrator on at 75 Ω impedance		
	6kHz-60kHz	60kHz-6MHz	6MHz-20MHz
+20 to 0	± 0.35	± 0.25	± 0.35
0 to -49	± 0.15	± 0.1	± 0.2
-49 to -99	$\pm 0.3^*$	± 0.25	± 0.3
-99 to -115	$\pm 1.5^\dagger$	± 0.5	± 1.0

* Below 10 kHz add 0.1 dB.

[†] Applies over input level range from -100 to -110 dBm only.

Above accuracies apply to remote autobalance mode. For autobalance mode there is an additional uncertainty of 0.05 dB.

Notes (1) to (5) of low noise and remote low noise mode also apply.

Group Bandwidth

Low intermod and remote low intermod mode :

Input level range dBm	Level accuracy (dB) with calibrator ON at 75 Ω impedance meter range (x1). Columns refer to centre frequency.		
	36kHz	84kHz-6MHz	6MHz-20MHz
+10 to -29	± 1.0	± 0.2	± 0.25
-30 to -89	-	± 0.2	± 0.25
-90 to -95	-	± 0.5	± 1.0

Notes...

- (1) For 50 Ω impedance add a further ± 0.1 dB to all level accuracies.
For 60 Ω impedance add a further ± 0.1 dB to all accuracies below 6 MHz and ± 0.2 dB to level accuracies above 6 MHz.
- (2) For all balanced impedance extend the lower limit of level accuracy by 0.2 dB.
- (3) Input frequency to be within ± 25 Hz of SLM centre frequency.
- (4) For Group A measurements (36 kHz) below -29 dBm use autobalance mode.
- (5) Irrespective of the position of the low noise/low intermod button the instrument always operates in the low intermod mode.

Autobalance and remote autobalance mode :

Input level range dBm	Level accuracy (dB) with calibrator ON at 75 Ω impedance. Columns refer to centre frequency.		
	36kHz	84kHz-6MHz	6MHz-20MHz
+10 to -69	± 1.0	± 0.2	± 0.25
-69 to -89	-	± 0.2	± 0.25
-89 to -95	-	± 0.25	± 0.3

Notes (1) to (4) of low intermod and remote low intermod mode apply.

54. Measurements in the presence of wideband loads

To avoid overloading the SLM the maximum wideband powers shown in the table should not be exceeded when the instrument is set to the reference level shown. Exceeding these conditions will cause the wideband overload lamp to be illuminated.

For optimum accuracy on pilot and channel bandwidths, use low noise mode unless the wideband overload lamp is illuminated when low intermodulation mode must be used. For all bandwidths if the wideband overload lamp is illuminated in the low intermodulation mode, then autobalance mode should be used.

Keyboard entered Reference level dBm	Maximum wideband input power dBm .		
	Pilot & Channel bandwidths		Group Bandwidth
	Low noise mode	Low intermod mode	Low intermod mode
+20 to +11	+26	+26	-
+10 to +1	+18	+18	+18
0 to -9	+8	+8	+8
-10 to -19	-2	-2	-2
-20 to -29	-12	-2	-2
-30 to -39	-22	-2	-2
-40 to -49	-32	-2	-2
-50 to -59	-32	-2	-12
-60 to -69	-32	-12	-12
-70 to -79	-32	-12	-22
-80 to -89	-32	-22	-32
-90 to -95	-42	-32	-42
-96 to -99	-42	-32	-
-100 to -115	-42	-42	-

55. Calibrate :

Operates near tuned frequency to compensate for frequency response and r.f. attenuation error. When selected, operates whenever frequency or level is changed, approx. every 8 minutes and at switch on. When not selected, operates when mode is switched from KEYBOARD + METER to AUTO and vice versa or when the bandwidth is changed in auto.

56. Measurement time constant/integration time

Bandwidth	Time ms	
	Local or Remote	
	Autobalance- low noise	Manual/Preset- low noise & low intermod. Autobalance- low intermod.
Pilot	20	20
Channel (Centre)	20	80
Channel (USB/LSB)	20	40
Group	80	80

When in Autobalance mode, for all bandwidths the LOW NOISE/LOW INTERMOD push button (or remote function) changes the integration time only as shown in the table.

In remote modes these integration times are provided unless other times (100,140,200 ms) are programmed.

57. Input impedance

Unbalanced :	50 Ω , 60 Ω , 75 Ω terminated and 7.5 k Ω through shunted by approximately 100 pF.
Return loss :	> 34 dB when terminated.
Balanced :	124 Ω , 135 Ω , 150 Ω terminated and through.
Return loss	
12 kHz to 60 kHz :	> 30 dB when terminated.
60 kHz to 620 kHz :	> 34 dB when terminated.
Balanced ratio	
12 kHz to 620 kHz :	> 40 dB when terminated.

58. Bandwidths :

<i>50 Hz Pilot filter</i>	
Response at ± 15 Hz :	$\leq \pm 0.1$ dB
-3 dB :	59 ± 5 Hz
± 80 Hz :	≤ -34 dB
355 ± 30 Hz :	≤ -60 dB

The equivalent noise bandwidth is nominally equal to 60 Hz.

<i>3.1 kHz Channel filter</i>	
Response at ± 1 kHz :	≤ 0.5 dB*
-3 dB :	3.1 $\left\{ \begin{array}{l} +0 \\ -0.3 \end{array} \right.$ kHz
± 2 kHz :	≤ -55 dB

*Typically ≤ 0.3 dB over 2 kHz bandwidth.
The equivalent noise bandwidth is nominally equal to 3.1 kHz.

<i>48 kHz Group filter</i>	
Response at ± 15 kHz :	≤ 0.75 dB
-3 dB :	48 kHz $\left\{ \begin{array}{l} +2 \\ -4 \end{array} \right.$ kHz
± 60 kHz :	≤ -40 dB

The equivalent noise bandwidth is nominally equal to 48 kHz.

59. Automatic frequency control

Manual and remote preset modes (pilot and channel bandwidths only)

Function : Receiver locks to within 8 Hz of the input signal. Lock is then held over the full frequency range.

Frequency indication : Final tuned frequency is displayed.

AFC modes : (1) AFC ON : Locks to the largest signal in the pass band exceeding -6 dB with respect to the preset reference level.

(2) *SEARCH MODE* :Automatic frequency incrementing initiated by spinning manual tuning control. AFC locks onto any signal exceeding the preset threshold level by at least 0.3 dB.

Note...

With AFC switch in SEARCH position, the previously set reference or preset level is restored when reverting to manual from autobalance mode.

60. Distortion (Pilot & channel bandwidths)

Harmonic : In the autobalance mode with a 1 MHz signal applied to the input the second and third order distortion will be at least 65 dB below the fundamental.

For pilot and channel bandwidths with a 1 MHz signal applied to the input in low noise and low intermodulation modes and the sensitivity increased by 59 dB, the second and third order distortion will be at least 65 dB below the fundamental (with WIDE BAND OVERLOAD lamp off).

Note...

For Group bandwidths the sensitivity increase is limited to a max. of 57 dB - see 'wideband loads' table.

Residual responses : Typically <-125 dBm.

IF and image rejection : IF rejection >80 dB.
1st i.f. image rejection >80 dB.

Other spurious : -70 dB relative to input or -121 dBm whichever is greater.

61. Input

External 10 MHz standard : 50 Ω input impedance. Level in range 0 dBm to -10 dBm (d.c. path of less than 10 k Ω must be present to disable internal standard).

62. Outputs

Audio : When selected, level can be set to 0 dBm when meter reads 0 dB. Upper or lower sideband demodulation by switch selection of 3.1 kHz bandwidth. Output impedance 600 Ω .

Loudspeaker : When selected, permits audible monitoring of demodulated output. Level adjustable with volume control.

- Recorder : ± 0.6 V corresponding to f.s.d. of centre zero meter across 1 k Ω load.
- Tracking generator/BFO output: Selected by front panel on/off switch. Frequency equal to that of SLM. BFO is muted during calibration cycle.
- Impedance : 75 Ω nominal.
- Level : 0 dBm ± 0.1 dB at 1 MHz.
- Frequency response : ± 0.1 dB, 6 kHz to 20 MHz w.r.t. level at 1 MHz.
- Synchronizing for Level Oscillator TF 2356 :
For optimum accuracy the output of the level oscillator, if connected, should be disabled during calibration for receiver input levels above -10 dBm.
Internal 10 MHz standard, 50 Ω output impedance. Level -10 dBm nominal.
30-50 MHz output, 50 Ω output impedance. Level -10 dBm nominal.
- Probe supply : Supply available at front panel socket to power Zero Loss Probe, TK 2374/1.
- 2.1 MHz narrowband : Provides for group power measurement using TK 2366. Frequency response :
 ± 15 kHz < 0.5 dB.
48 ± 5 kHz -3 dB.
 ± 125 kHz -50 dB.
- 2.1 MHz wideband : Provides for CCITT mastergroup and super-group power measurement using TK 2366. Frequency response : 1.2 MHz ± 120 kHz -3 dB.
- Wideband : Provides for baseband, hypergroup and Bell mastergroup power measurement using TK 2366.
- TK 2366 interface : Provides control signals for Baseband Filter Unit TK 2366 when TF 2357A is under remote control.
63. Remote control : The receiver is remotely programmable when fitted with GPIB kit except under battery operation (see Optional accessories/ Alternative versions).

*Where GPIB is Marconi Instruments implementation of the General Purpose Interface Bus in accordance with IEEE Standard 488-1978 and IEC Publication 625-1 (First Edition).
- Subset reference list : SH1, AH1, T6, L4, SR1, RL1, DT1, DC1, E1.

64. Push-buttons and lamps : Colours of push-buttons and lamps conform to IEC 73 and BS4099 requirements.
65. Conducted mains interference : Complies with the requirements of EEC Directive 76/889, Nov. 1976.
66. Safety regulations : Complies with IEC 348 and BS 4743 safety requirements.
67. Limit range of operation
 Temperature : 0°C to 55°C.
68. Rated range of use : 10°C to 35°C.
69. Conditions of storage and transport
 Temperature : -40°C to +70°C (except battery unit type 43113-004K, -40°C to +60°C).
 Humidity : Up to 90% relative humidity.
 Altitude : Up to 2500 m (pressurized freight at 27 kPa differential, i.e. 3.9 lbf/in²).
70. Power requirements
 AC mains : 95 to 130 V or 190 to 260 V.
 45 to 65 Hz, 80 VA (including GPIB option),
 70 VA (excluding GPIB option).
 Battery operation : See optional accessories.
 Operation time : Approx. 4 hours continuous.
 Charging time : Approx. 14 hours (trickle charges when mains operated).
71. Dimensions and weight
 Height : 135 mm (5.25 in)
 Width : 430 mm (17 in)
 Depth : 570 mm (22 in)
 Weight : 18 kg (41 lb)

ALTERNATIVE VERSIONS

72. The following alternative versions of the instruments are available:-
- 52356-900D Level Oscillator TF 2356.
- 52356-303N Level Oscillator TF 2356 fitted with P.O. No. 1 output connector.
- 52356-301U Level Oscillator TF 2356 factory fitted with GPIB interface option.
- 52356-302Y Level Oscillator TF 2356 factory fitted with GPIB interface option and P.O. No. 1 output connector.

52357-910J	Selective Level Meter TF 2357A.
52357-306C	Selective Level Meter TF 2357A fitted with P.O. No.1 input connector, plus probe TK 2374/1.
52357-304X	Selective Level Meter TF 2357A factory fitted with GPIB interface option.
52357-305M	Selective Level Meter TF 2357A factory fitted with GPIB interface option and P.O. No.1 input connector, plus probe TK 2374/1.

ACCESSORIES

Supplied accessories

73. Unless stated otherwise, the following accessories are supplied with each instrument:-

Front panel cover assembly (with storage for leads), 41690-219Z. Operating summary; TF 2356 46881-328M, -407Z; TF 2357A 46881-394X, -406A.

Plastic cover, 37490-325S.

Fuse, 400 mA (2 off), 23411-053D.

Supply lead (side entry), 3.5 m, 43129-550S.

Operating manual, H 52355-910V, 46881-393P.

Optional accessories

74. Unless stated otherwise the following optional accessories apply to both instruments:-

Board extractor kit, 46883-406R.

Battery unit (incl. battery pack of 24 x 1.2 V NiCd D type cells), 43113-004K.

Lead kit, (contains lead, BNC-BNC, 50 Ω , 1.5 m, 43126-012S) 46883-407B.

GPIB lead, 1 m (Amphenol 57, 24-way connectors), 43129-189U.

600 Ω balanced/75 Ω unbalanced matching transformer, 54481-041X.

Extender board, 37-way, 44827-868H.

Extender board, 12-way plus lead, 46883-395T.

Service Manual for TF 2357A, H 52357-910J, 46881-395M.

Service Manual for TF 2356, H 52356-900D, 46881-315J.

The GPIB Manual, H 54811-010P, 46881-365R.

GPIB Interface kit, 46883-319F.

Zero Loss Probe, 75 Ω version (for use with TF 2357A) TK 2374/1, 52374-901R.

Rack mounting kit, 54127-071H.

Cover kit, 2 ventilating covers for rack mounting, 46883-441R.

Lead BNC-BNC, 75 Ω 1.8 m, 54351-011F.

GPIB adapter block kit, IEEE to IEC, 46883-408K.

Attenuator pad, 30 dB, 75 Ω , 44429-028Y.

Chapter 2

INSTALLATION

CONTENTS

Para.

- 1 Unpacking and repacking
- 3 Rack mounting instructions
- 4 Attaching battery unit
- 5 Power supplies
- 5 DC power supply
- 6 AC power supply
- 8 Safety testing
- 9 Interface bus cable connection
- 10 Control socket TO TK 2366
- 11 Fitting GPIB boards

Fig.

	Page
1 Interface bus connector contact assignments	4
2 Socket for control cable to TK 2366	4

UNPACKING AND REPACKING

1. Retain the container, packing materials and the packing instruction note (if included) in case it is necessary to reship the instrument.

2. If the instrument is to be returned for servicing attach a label indicating the service required, type or model number (on rear label), serial number and your return address. Pack the instrument in accordance with the general instructions below or with the more detailed information in the packing instruction note.

- (1) Place a pad in the bottom of the container.
- (2) Place pads in the front and rear ends of the container with the plywood load spreader(s) facing inwards.
- (3) Put the polythene cover over the instrument and place it in the container with the front handles and rear projections (where applicable) against the plywood load spreaders.
- (4) Place pads in the two sides of the container with cushioning facing inwards.
- (5) Place the top pad in position.
- (6) Wrap the container in waterproof paper and secure with adhesive tape.
- (7) Mark the package FRAGILE to encourage careful handling.

Note...

If the original container or materials are not available, use a strong double-wall carton packed with a 7 to 10 cm layer of shock

absorbing material around all sides of the instrument to hold it firmly. Protect the front panel controls with a plywood or cardboard load spreader; if the rear panel has guard plates or other projections a rear load spreader is also advisable.

RACK MOUNTING INSTRUCTIONS

3. The instruments are normally supplied ready for bench mounting. A rack mounting kit, consisting essentially of a pair of mounting brackets is available as an optional accessory for each instrument. To fit the brackets proceed as follows:-

- (1) Remove the feet, after temporarily removing the bottom cover.
- (2) Remove side feet and the trim strip, if fitted in the front panel handle recess.
- (3) Fit the brackets in these recesses and secure by fitting the M4 screws provided into the tapped holes.
- (4) To give support to the rear of the instrument, slides or runners must be fitted. However, since customer's racks will not be standard these are not supplied.
- (5) If forced air cooling is used, it is recommended that the ventilated covers available as an optional accessory be fitted.

ATTACHING BATTERY UNIT

4. The battery unit is attached to the sender or receiver as follows:-

- (1) Position the instrument over the battery unit and locate the instrument rear feet in the holes provided in the battery unit cover.
- (2) Clip the four battery unit latches into the corresponding cutouts provided in the instrument case and connect the battery connector to the BATTERY socket on the instrument rear panel.

POWER SUPPLIES

DC power supply

5. For d.c. operation a 28.8 V 4 Ah rechargeable nickel cadmium battery is available as an optional accessory. Position the battery container underneath the instrument and latch into position. Ensure that the SUPPLY selector is in the OFF position and connect the 3-pin plug to the BATTERY socket on the instrument rear panel. To operate the instrument turn the SUPPLY selector to BATT. To charge the battery set the SUPPLY selector to the CHARGE position and note that the CHARGE Lamp lights. Recharging time is approximately 14 hours. 2 A fuses are fitted in the positive and negative outputs.

AC power supply

6. Both instruments operate on 95 to 130 V or 190 to 260 V a.c. mains, 45 to 65 Hz. The required SUPPLY fuses are 800 mA for 95 to 130 V or 400 mA for 190 to 260 V. Before switching on ensure that the rear panel 115/230 V voltage selector is in the correct position and that the correct fuses are fitted. To change the mains voltage setting reverse the L-shaped plate after setting the slide switch to its alternative position. Connect the instrument to the mains by the lead supplied and turn the SUPPLY selector to the \sim position. If fitted, the battery is trickle charged in this position.

7. The supply lead is a cable fitted at one end with a side-entry female plug which connects to the instrument. When fitting a suitable supply plug, note that the wires are colour coded as follows :

Earth (ground)	- Green/Yellow
Neutral	- Blue
Line (phase)	- Brown

Safety testing

8. Where safety tests on the mains input circuit are required, the following procedures can be applied. These comply with BS4743 and IEC Publication 348. Tests are to be carried out as follows and in the order given, under ambient conditions, to ensure that mains input circuit components and wiring (including earthing) are safe.

(1) Earth lead continuity test from any part of the metal frame to the bared end of the flexible lead for the earth pin of the user's mains plug. Preferably a heavy current (about 25 A) should be applied for not more than 5 seconds.

Test limit : not greater than 0.5 Ω .

(2) 500 V d.c. insulation test from the mains circuit to earth.

Test limit : not less than 2 M Ω .

INTERFACE BUS CABLE CONNECTION

9. The cables for the interface bus use special male-female connectors at both ends. This allows several connectors to be stacked one on top of another permitting several cables to be connected to the same source and secured by a lockscrew mechanism. Too large a stack however, may form a cantilevered structure which might cause damage and should be avoided. The piggyback arrangement permits star or linear interconnection between the devices forming a system with the restriction that the total cable length for the system must be :-

(1) No greater than 20 m (65 ft).

(2) No greater than 2 m (6 ft) times the total number of devices (including the controller) connected to the bus.

The connector contact assignments are shown in Fig. 1.

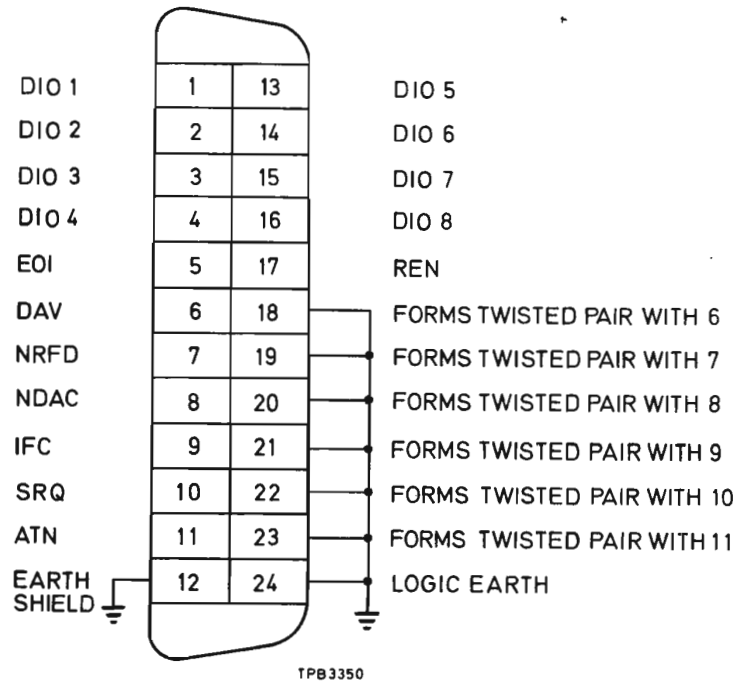

Fig. 1 Interface bus connector contact assignments

CONTROL SOCKET TO TK 2366

10. The control cable supplied with the Base Band Filter Unit TK 2366 connects to the 14-way T0 TK 2366 socket on the receiver rear panel. Contact assignments for the socket are shown in Fig. 2. When fitting the cable secure it by means of the locking screws.

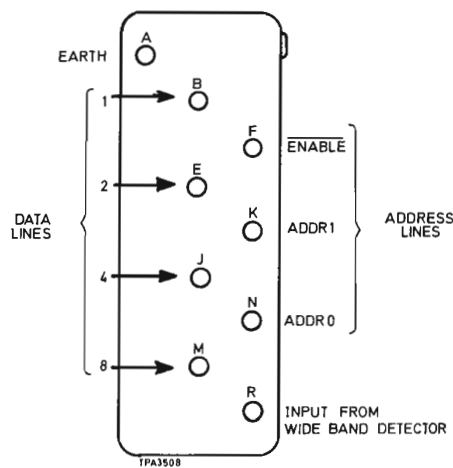

Fig. 2 Socket for control cable to TK 2366

FITTING GPIB BOARDS

11. To fit GPIB interface kit 46883-319F proceed as follows:-

- (1) Removal of case. Lift off upper half of case after removing four M4 screws located at sides of instrument.
- (2) Removal of control unit cover. Remove two M3 screws located at rear of middle of three internal covers. Unlock 4 captive studs by turning each anticlockwise until slot heads are aligned with bars marked on cover. Lift off cover.
- (3) Insertion of boards. Insert boards from above (ensuring component sides face rearwards) in order AB7, AB6, AB5 and AB16 from rear. The board positions are marked on instrument.
- (4) After replacing covers affix self-adhesive label, identifying modified instrument version, above serial number plate on rear of instrument. 2356-900D becomes version -301U and 2357-910J becomes version -304X.

Chapter 3

OPERATION

CONTENTS

Para.	
1	Modes of operation
2	Areas of application
3	FDM basebands
9	Frequency translation equipment
10	Non-f.d.m. applications
11	Controls and connectors
11	Sender front panel
12	Sender rear panel
13	Receiver front panel
14	Receiver rear panel
15	Manual sender operation
15	Supply
16	Output impedance
17	Frequency
18	Errors
19	Level
20	Output disable
21	External levelling
22	Synchronous operation
23	Sequence mode operation
24	Control mode operation
25	Manual receiver operation
25	Supply
26	Terminating loads
27	Input impedance
28	Frequency
29	Errors
30	Automatic frequency control
31	Level
32	Low noise/low intermodulation
33	Bandwidth
34	Calibrator
35	Audio output
36	Tracking generator output
37	Recorder output
38	Synchronous operation
39	Sequence mode operation
39	General
40	Front panel controls
41	Data entry formats
44	Control mode operation
44	General
45	Rear panel switch settings
46	Connections
47	Front panel controls
48	Data entry formats
53	Printer format

CONTENTS (continued)

Para.				
55	General bus control			
55	Introduction			
57	Initial conditions			
58	Operators			
59	Sender instruction set			
64	Receiver instruction set			
72	Status byte			
76	Output formats			
80	Making a measurement			
Fig.				Page
1	TF 2356 - Front panel controls and connectors	5
2	TF 2356 - Rear panel controls and connectors	7
3	TF 2357A - Front panel controls and connectors	8
4	TF 2357A - Rear panel controls and connectors	11
5	Connections for synchronous operation	18
6	Additional errors	19
7	Control mode switch settings	21
8	Connections for control mode operation	22
9	Data entry formats	23
10	Control mode printout example	26
11	Sender instruction string example	29
12	Receiver instruction string example	32
13	Status byte coding	34

MODES OF OPERATION

1. Various modes of operation are possible with the selective level measuring set as detailed in the relevant sections and which are summarized below:-

Manual operation : In this mode sender and receiver are operated independently. Particularly with regard to tuning, methods of operation are similar for both sender and receiver.

Synchronous operation : Synchronous tuning of the sender from the receiver requires their interconnection with two coaxial cables.

Sequence mode operation : The sender automatically steps through a sequence of frequency and/or level steps with the optional inclusion of a delay for manual recording of results.

Control mode operation : When both sender and receiver are fitted with GPIB interfaces to provide an automatic measurement capability, the sender may be used to control the receiver and a printer.

General bus control : For incorporation within an automatic testing system both sender and receiver may be remotely controlled via the instrument bus.

AREAS OF APPLICATION

2. The major application of selective level measuring sets is within the field of multichannel telephony using frequency division multiplex. The following paragraphs describe in more detail some of these f.d.m. applications. Elsewhere the selective level measuring set finds use in areas where a stable accurate signal source and a high sensitivity selective receiver are required. Some examples of non f.d.m. applications are also described.

FDM basebands

Introduction

3. During research, development or production cable terminal equipments may be tested by connection back to back. In the case of radio systems the transmitter and receiver may be connected at r.f. or i.f. The most common measurement application is that of gain frequency response from baseband input to output; however the instruments are also suitable for testing linearity by the evaluation of harmonic or intermodulation products.

4. Where send and receive frequencies are the same the measurement process is simplified by the synchronous tuning facility. Where large numbers of measurements are required tedium is overcome and measurement time considerably reduced by using the bus control capability to set completely automatic test sequences which provide the added advantage of hard copy results. Typical examples include the environmental evaluation of engineering prototypes and the automatic characterization of quantity production items such as cable repeaters.

Commissioning

5. During commissioning where the system under test is 'looped around' synchronous tuning and bus control are both of significant advantage. During end to end commissioning or out of service maintenance testing the requirement for manual control of the sender and operator communication via the order wire may be obviated by the use of a data link and bus-modem interfaces to allow remote control of the receiver from the sender.

In-service maintenance

6. Routine in-service maintenance measurements are simplified by particular features of the receiver. The time required to measure all supergroup or all group reference pilots, for example, is not only reduced by the automatic level measurement capability but primarily by the receiver's synthesizer tuning and incremental frequency facility. The ability to search a baseband for spurious signals due to parasitic oscillations, howling channels, etc. has always been important. The tedious nature of the test has, in the past, sometimes resulted in its being carried out less often than desirable. The automatic search above threshold facility of the receiver is particularly suitable for this application.

7. The receiver's automatic carrier offset facility simplifies the monitoring of telephone channels since entering the frequency of the suppressed carrier and selecting u.s.b. or l.s.b. automatically provides correct audio demodulation. Switching from CHANNEL to PILOT is the only operation then required to measure carrier leak when required. The KEYBOARD + METER receiver operating mode is particularly suitable for stability measurements of e.g. continuity or regulating pilots where results will normally be monitored with a pen recorder.

Automatic baseband monitoring

8. The probable future trends in maintenance techniques towards automated baseband surveillance are provided for by the addition to the selective level measuring set of associated programmable equipment.

Frequency translation equipment

9. On modern sub-marine cables, the one cable is used for both directions of transmission with the HI band undergoing frequency translation and inversion at both terminal stations whilst the LO band remains unaltered in frequency. Gain frequency response of the HI/LO receive translator and the LO/HI send translator can both be automatically evaluated out of service using the inverted increment with offset condition during control mode operation. This operating condition is also of particular application to the testing of translation equipments where both gain frequency response and crosstalk may be automatically evaluated. The frequency range of the instruments allows measurement across group, supergroup, mastergroup and hypergroup (supermastergroup) translation equipments.

Non-f.d.m. applications

10. Manual or automatic characterization of a wide variety of system components including amplifiers, attenuators, mixers and filters may be carried out with high accuracy of both level and frequency. Control mode operation allows automatic gain/frequency responses to be taken on system components incorporating both frequency translation and inversion. Where the input and output frequencies of the test item are the same, the tracking generator facility of the receiver obviates the need for a sender.

CONTROLS AND CONNECTORS

Sender front panel

11. Front panel controls and connectors shown in Fig. 1 are as follows:-

- (1) SUPPLY selector and CHARGE Lamp. The 4-position switch selects :
- BATT - for battery operation.
 - OFF - Mains and battery power disconnected.
 - ~ - For mains operation. If fitted, battery is trickle-charged in this switch position.

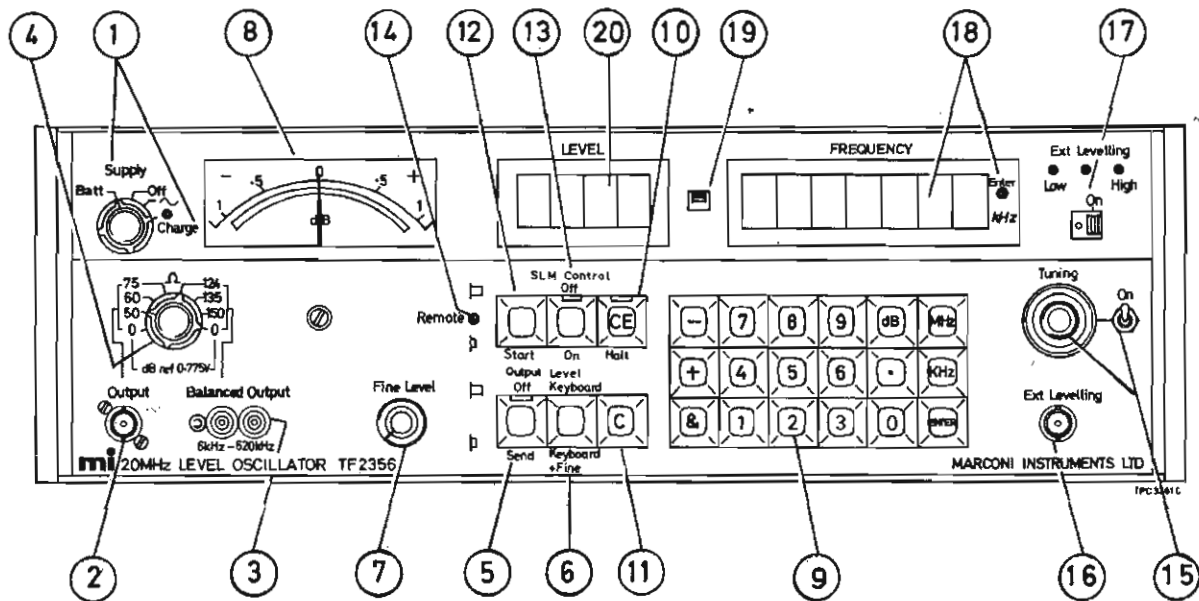

Fig. 1 TF 2356 - Front panel controls and connectors

CHARGE - Battery is charged at full rate and CHARGE lamp is lit.
The instrument is non-operational in this switch position.

(2) OUTPUT socket. BNC type. For 75 Ω , 60 Ω , 50 Ω or 0 Ω unbalanced coaxial outputs.

(3) BALANCED OUTPUT socket. 3-pin balanced outlet for 124 Ω , 135 Ω , 150 Ω and 0 Ω outputs. 4 mm sockets for banana plugs (12 mm pitch with earth at 9 mm pitch).

(4) OUTPUT IMPEDANCE Ω switch. The 4 left-hand positions are for unbalanced outputs from OUTPUT socket (2). The 4 right-hand positions are for balanced outputs from the BALANCED OUTPUT sockets (3). For both 0 Ω positions output level is calibrated in dB relative 0.775 V and is independent of the dB/dBm switch (19) position.

(5) OUTPUT - OFF/SEND switch. When OFF, output is suppressed and LEVEL display is blanked (EXT LEVELLING LOW lamp (17) also illuminates).

(6) LEVEL - KEYBOARD/KEYBOARD + FINE selector. In the KEYBOARD position, level is entered via KEYBOARD (9) to 0.1 dB resolution with METER (8) and FINE LEVEL (7) inoperative. In the KEYBOARD + FINE position, level is the sum of the KEYBOARD - entered level to 1 dB resolution plus that displayed by the FINE LEVEL controlled METER.

(7) FINE LEVEL control. For fine adjustment of signal output level and used in conjunction with METER (8). Operative only when the LEVEL selector (6) is in the KEYBOARD + FINE position.

(8) METER. Centre-zero instrument that displays the setting of the FINE LEVEL control (7) to a maximum of ± 1.1 dB. The output level is the sum of the reading in the LEVEL window (20) and METER reading.

- (9) KEYBOARD. For entering frequency and level and also time delay during sequence mode and control mode operation. The output can be disabled automatically during changes of frequency or level when AUTO MUTE ENABLE (32) is selected. Frequency and level increments are entered preceded by &. Settings are entered and increments are executed by the ENTER key.
- (10) CE (CLEAR ENTRY)/HALT switch. Used to clear the current entry or to halt a sequence during sequence mode or control mode operation.
- (11) C (CLEAR) switch. Used to clear an entry (e.g. an incorrect data string) or an error.
- (12) SLM CONTROL - START key. Used to initiate a measurement sequence during sequence mode operation or control mode operation. Full operating instructions using this key appear in the Sequence Mode and Control Mode paragraphs. The operation of this key may be achieved remotely by means of the REMOTE COMMAND socket (27).
- (13) SLM CONTROL - OFF/ON key. Used when the instrument is in the control mode and controlling the receiver via the GPIB. Full operating instructions using this key appear under Control Mode Operation.
- (14) REMOTE lamp. Lights when the instrument is remotely controlled via the GPIB.
- (15) Manual TUNING control and ON switch. Provides 'continuous' tuning when switch is set to ON and may be used for fine tuning in conjunction with the KEYBOARD (9). Turning the TUNING control alters the frequency in 5 Hz steps. Alternatively, the step value may be entered on the KEYBOARD as for an increment. When the knob is spun quickly in either direction and then released, an electronic flywheel keeps the knob turning to provide a continuous tuning facility. Knob rotation may be stopped manually or by making any data entry on the KEYBOARD.
- (16) EXT LEVELLING socket. BNC type. Enables a levelling signal to be applied from an external source. This input is selected by the EXT LEVELLING switch (17).
- (17) EXT LEVELLING ON switch and lamps. Switched to ON to accept an input from the EXT LEVELLING socket (16). Centre lamp (flashing green) indicates internal level within design range of instrument. Level too high or too low indicated by yellow HIGH or LOW lamps.
- (18) FREQUENCY window and ENTER lamp. Displays frequency on 7 digit 7-segment l.e.d. display. Readout is in kHz with automatic decimal location. Display flashes for an out of range or invalid entry condition (i.e. one outside the level or frequency range of the instrument). When level is entered on the KEYBOARD (9) it is displayed in the FREQUENCY window until the dB key is pressed. Operation of the dB key transfers the data to the LEVEL window (20) and the frequency readout is restored. The ENTER lamp lit indicates that the frequency or level has not yet been set. Pressing ENTER key extinguishes the lamp and sets instrument to the desired frequency or level. At switch on, the software version number is displayed momentarily.
- (19) dB/dBm switch. Selects calibration in dBm or dB relative to 0.775 V. Set prior to making a measurement.

(20) LEVEL window. Displays level by 3 digit, 7-segment l.e.d. display. Level entered on the KEYBOARD (9) appears in the LEVEL window when the dB key is pressed. Pressing ENTER key extinguishes ENTER lamp and sets instrument to the desired level. Display flashes for an invalid entry condition (i.e. one outside the level range of the instrument). The level display is blanked when OUTPUT OFF is selected on the OUTPUT - OFF/SEND switch (5).

Sender rear panel

12. Rear panel controls and connectors shown in Fig. 2 are as follows:-

(21) 10 MHz STD-EXT IN socket. Provides for an external 10 MHz standard to drive the sender. This may be from the receiver in, for example, synchronous operation. The standard must provide a d.c. path of less than 10 k Ω to disable the sender's internal standard, and a level in the range -10 dBm to 0 dBm at 50 Ω is necessary.

(22) 30 - 50 MHz IN socket. Local oscillator input from TF 2357A used when both instruments are used in Synchronous Operation. Level -10 dBm. Impedance 50 Ω . A d.c. path of less than 10 k Ω must be present to disable the internal oscillator.

(23) AC supply socket. 3-pin a.c. supply input connector.

(24) DC supply socket. 3-pin socket for connection to battery.

(25) Supply voltage selector. 230 V position for 190-260 V, 115 V position for 95 to 130 V. To change range, reverse locking plate.

(26) Supply fuses. 400 mA for 190-260 V range, 800 mA for 95-130 V range. Versions -302Y, -303N are single-fused.

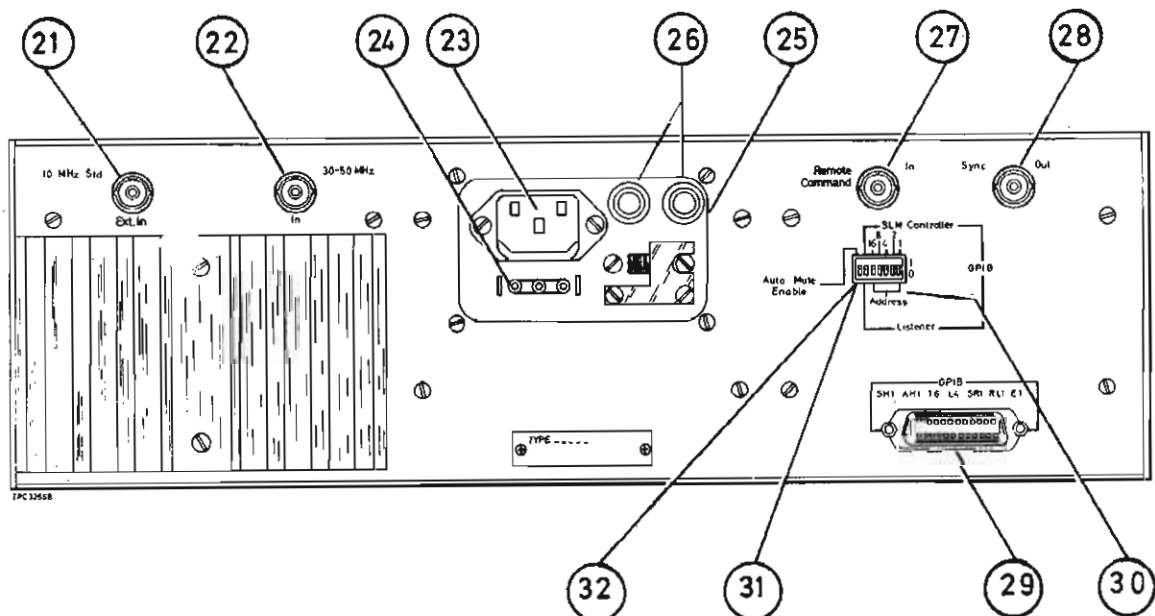

Fig. 2 TF 2356 - Rear panel controls and connectors

(27) REMOTE COMMAND IN socket. TTL compatible. Operated by remote contact closure (low level) and performs the same function as the front panel START key (12). Minimum contact closure time 200 ms.

(28) SYNC OUT socket. TTL compatible. Produces a negative pulse output whenever a change in level or frequency takes place. Used for synchronizing purposes.

(29) GPIB socket. Socket for 24-way GPIB. Used for programmable operation when the sender is fitted with a GPIB interface (versions 52356-301U, -302Y).

(30) ADDRESS switches. The address is set on five switches with least significant bit on right-hand switch.

(31) LISTENER/CONTROLLER selector. Normally set to the LISTENER position. Set to CONTROLLER when sender is used to control the receiver in Control Mode Operation.

(32) AUTO MUTE ENABLE. With the switch set to '1' the output is muted during changes in level or frequency entered via the keyboard.

Receiver front panel

13. The front panel controls and connectors shown in Fig. 3 are as follows:-

- (1) SUPPLY selector and CHARGE Lamp. The 4-position switch selects :
- BATT - For battery operation.
 - OFF - Mains and battery power disconnected.
 - ~ - For mains operation. If fitted, battery is trickle-charged in this switch position.

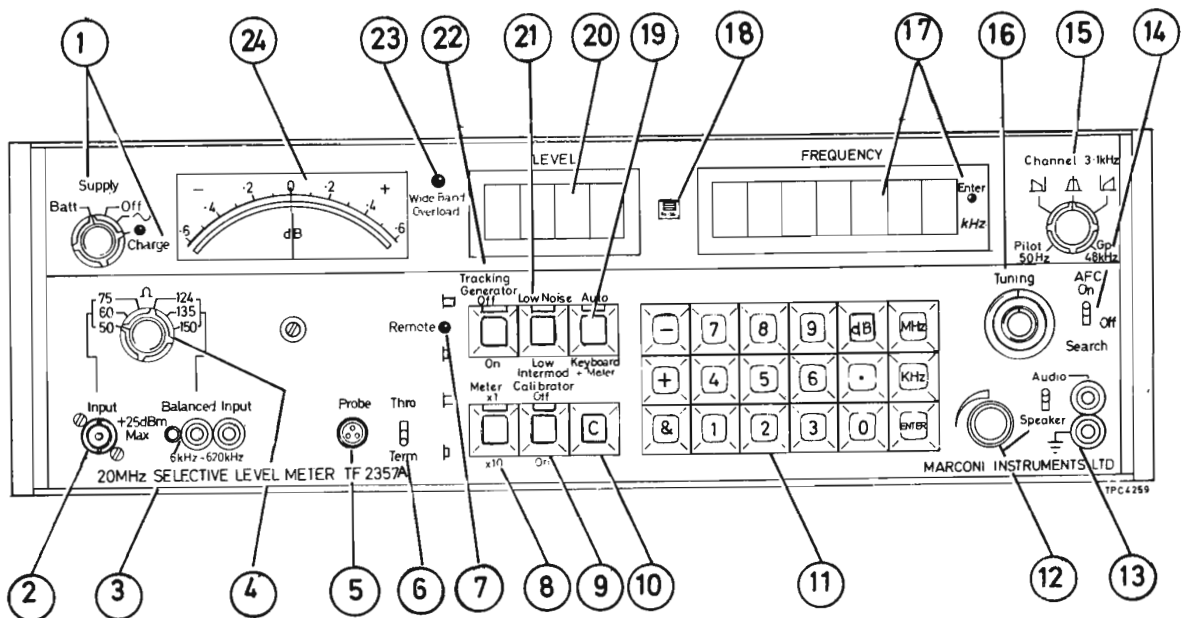

Fig. 3 TF 2357A - Front panel controls and connectors

CHARGE - Battery is charged at full rate and CHARGE lamp is lit.
The instrument is non-operational in this switch position.

- (2) INPUT socket. BNC type. For 75 Ω , 60 Ω and 50 Ω unbalanced coaxial inputs.
- (3) BALANCED INPUT socket. 3-pin balanced inlets for 124 Ω , 135 Ω and 150 Ω . 4 mm sockets for banana plugs (12 mm pitch with earth at 9 mm pitch).
- (4) INPUT IMPEDANCE Ω switch. The 3 left-hand positions are for unbalanced inputs to the INPUT socket (2). The 3 right-hand positions are for inputs to the BALANCED INPUT sockets (3).
- (5) PROBE socket. Supplies -7.5 V power for the optional Zero Loss Probe TK 2374/1 used when high impedance measurements are being made. When using the probe, the INPUT IMPEDANCE switch (4) should be set to the 75 Ω position and TERM (6) selected.
- (6) THRO'/TERM switch. For terminated or unterminated measurements. In the THRO' position, internal impedance is set to a nominal 7.5 k Ω for an unbalanced input and to a nominal 3.6 k Ω for a balanced input.
- (7) REMOTE lamp. Lights when the instrument is remotely controlled via the GPIB.
- (8) METER - x1/x10 switch. METER (24) range is set to ± 0.6 dB in the x1 position and extended to ± 6 dB in the x10 position.
- (9) CALIBRATOR - ON/OFF switch. For switching the automatic calibration facility on or off. In the ON position, the instrument calibrates against an internal standard signal at the tuned frequency whenever frequency or level are changed. In steady state conditions the receiver automatically calibrates at approximately 8 minute intervals.
- (10) C (CLEAR) key. Clears an entry or an error.
- (11) KEYBOARD. For entering frequency and level. Frequency and level increments are entered preceded by &. Settings are entered and increments are executed by the ENTER key.
- (12) AUDIO/SPEAKER switch and volume control. When switched to SPEAKER, controls the volume of the loudspeaker whose output is a demodulated version of the s.s.b. channel being monitored. Used for channel content recognition i.e. noise, voice, tones, etc. When switched to AUDIO, permits the output level to be set to 0 dBm in 600 Ω when the meter reads zero or a steady (varying by less than by 1 dB) autobalance reading is obtained.
- (13) AUDIO socket. Provides an audio output to headphones for s.s.b. channel monitoring when switch (12) is set to AUDIO.
- (14) AFC - ON/OFF/SEARCH switch. For ON behaves like normal a.f.c. system i.e. instrument remains tuned to signal providing its level is within the ± 6 dB displayed on the METER (24). SEARCH position enables instrument to lock to any signal which exceeds threshold level set on KEYBOARD (11) when manual TUNING control (16) is spun.

- (15) Bandwidth selector. This 5-position switch selects :
- PILOT 50 Hz. Selects 50 Hz bandwidth.
 - CHANNEL 3.1 kHz. The three positions select upper or lower 3.1 kHz sidebands, or 3.1 kHz bandwidth.
 - GP 48 kHz. Selects 48 kHz group bandwidth.
- (16) Manual TUNING control. Provides tuning in 5 Hz steps and may be used for fine tuning in conjunction with the KEYBOARD (11). Inoperative when AUTO (19) is selected. When KEYBOARD + METER (19) is selected and the knob is spun quickly in either direction, an electronic flywheel keeps the knob turning to provide a continuous tuning facility. The maximum tuning rate is determined by the bandwidth selected. Knob rotation may be stopped manually or by making any data entry on the KEYBOARD.
- (17) FREQUENCY window and ENTER lamp. Displays frequency by 7 digit 7-segment l.e.d. display. Readout is in kHz with automatic decimal location. Display flashes for an out of range or invalid entry condition (i.e. one outside the level or frequency range of the instrument). When level is entered on the KEYBOARD (11) it is displayed in the FREQUENCY window before the dB key is pressed. Operation of the dB key transfers the data to LEVEL window (20) and frequency readout is restored. ENTER lamp lit indicates that frequency or level has not yet been set. Pressing ENTER key extinguishes the lamp and sets instrument to the desired frequency or level. At switch on, the software version number is displayed momentarily.
- (18) dB/dBm switch. Selects calibration in dBm or dB relative to 0.775 V. Set prior to a measurement being made.
- (19) AUTO/KEYBOARD + METER selector. For auto-balanced or differential mode level measurements. In the KEYBOARD + METER position the level measured is the sum of the values appearing in the LEVEL window (20) and the METER (24) reading. In the AUTO position the METER is inoperative and the level is read directly from the LEVEL window.
- (20) LEVEL window. Displays level by 4 digit, 7-segment l.e.d. display. In the KEYBOARD + METER position of the AUTO/KEYBOARD + METER selector (19), level is displayed to 1 dB resolution to which the METER (24) reading is added. In the AUTO position, the level is displayed in the window to 0.1 dB resolution. Display flashes for an overload or invalid entry condition (i.e. one outside the level range of the instrument).
- (21) LOW NOISE/LOW INTERMOD selector. The LOW INTERMOD position may be selected for frequency analysis and harmonic distortion measurements. The LOW NOISE position may be chosen for measuring small signal levels. This selection is only operative in the KEYBOARD + METER position of the AUTO/KEYBOARD + METER selector (19) since automatic optimization occurs in the AUTO position. When AUTO is selected, instrument settling time depends upon selector position : fast for LOW NOISE, slow for LOW INTERMOD.
- (22) TRACKING GENERATOR ON/OFF switch. When switched to ON provides a constant level tracking generator output at the BFO socket (25).
- (23) WIDEBAND OVERLOAD lamp. Warning lamp lights when the wide band input power exceeds a level which might cause errors due to internal intermodulation products.

(24) METER. Centre-zero instrument only operative when the AUTO/KEYBOARD + METER selector (19) is in the KEYBOARD + METER position and complements the reading in the LEVEL window (20). METER range of ± 0.6 dB or ± 6 dB is selected by METER x1/x10 switch (8). An output from the METER is taken to the RECORDER O/P (37) on the rear panel.

Receiver rear panel

14. The receiver rear panel controls and connectors shown in Fig. 4 are as follows:-

(25) BFO socket. With (22) switched to ON, provides a constant level tracking generator output at the frequency setting of the instrument. May be used for frequency response measurements. Impedance 75Ω , level 0 dBm.

(26) 10 MHz STD - EXT IN socket. Enables an external standard to be used in place of the internal one; automatic disabling is achieved by providing a d.c. path of less than $10 \text{ k}\Omega$ in the external connection.

(27) 10 MHz STD - INT OUT socket. Provides the frequency standard for TF 2356. Impedance 50Ω . Must be terminated with load (40) when not in use.

(28) 30 - 50 MHz OUT socket. Local oscillator output for synchronizing TF 2356. Impedance 50Ω . Must be terminated with load (40) when not in use.

(29) AC SUPPLY socket. 3-pin a.c. supply input connector.

(30) BATTERY NOMINAL VOLTS +16.8 -12 V socket. Supply socket for battery.

(31) Supply fuses. 400 mA for 190 to 260 V range, 800 mA for 95 to 130 V range. Versions -305M, -306C are single-fused.

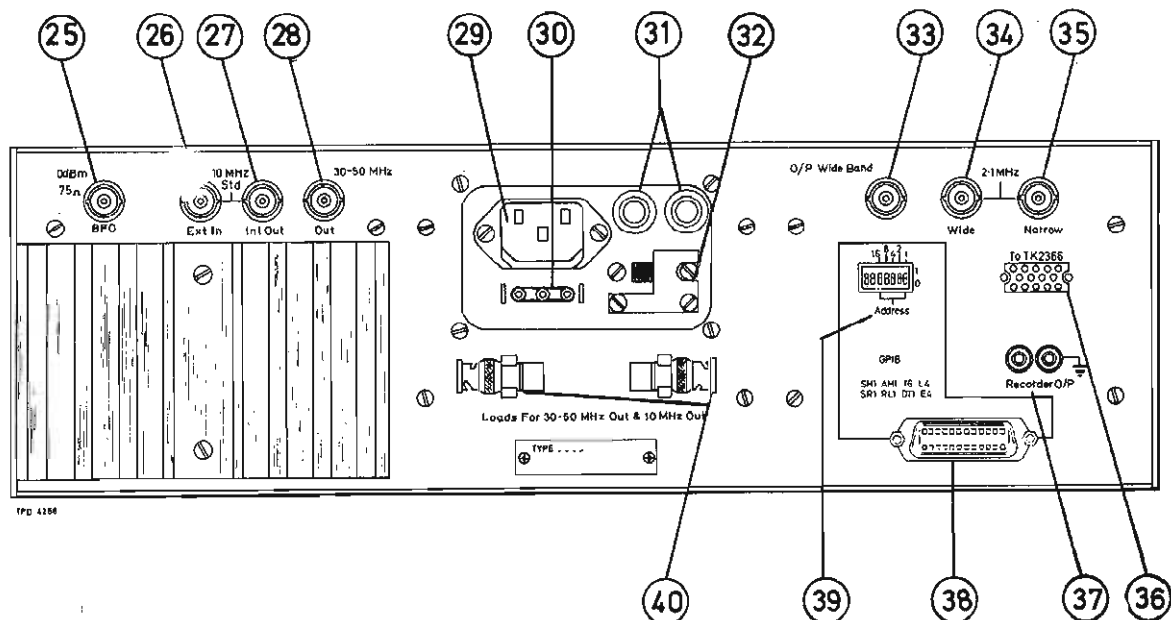

Fig. 4 TF 2357A - Rear panel controls and connectors

- (32) SUPPLY VOLTAGE selector. 230 V position for 190 to 260 V, 115 V position for 95 to 130 V range. Reverse locking plate when changing range.
- (33) O/P WIDE BAND socket. Provides an output to the TK 2366 Baseband Filter Unit for wide band power measurements. 75 Ω impedance.
- (34) 2.1 MHz - WIDE socket. 1.2 MHz bandwidth output which may be used for mastergroup and supergroup power measurements via TK 2366 Baseband Filter Unit.
- (35) 2.1 MHz - NARROW socket. 48 kHz bandwidth output which may be used for group power measurements via TK 2366 Baseband Filter Unit. 75 Ω impedance.
- (36) TO TK 2366 socket. 14-pin socket for controlling the Baseband Filter Unit TK 2366.
- (37) RECORDER O/P terminals. Provide an output in parallel with the METER (24). Output is linear in dB and across a 1 k Ω load the output voltage is 0 to ± 600 mV corresponding to either ± 0.6 dB or ± 6 dB depending upon setting of the METER x1/x10 switch (8). Only usable in the KEYBOARD + METER position of AUTO/KEYBOARD + METER selector (19).
- (38) GPIB socket. (For versions 52357-304X, -305M). Socket for 24-way GPIB. Used for programmable operation when receiver fitted with GPIB interface.
- (39) ADDRESS switches. The address is set on five switches with least significant bit on right-hand switch.
- (40) TERMINATING LOADS. For use when the selective level meter is not used synchronously with Level Oscillator TF 2356. Terminate 30 - 50 MHz OUT socket (28) and 10 MHz STD-INT OUT socket (27) with the 50 Ω loads supplied.

MANUAL SENDER OPERATION

Supply

15. AC mains or battery operation is selected as follows:-

Mains operation : Select \sim on SUPPLY switch after ensuring that voltage range selector is set correctly and correct value of fuse is fitted. Battery, if fitted, is trickle charged.

Battery operation : Select BATT on SUPPLY switch. To charge battery at full rate set SUPPLY switch to CHARGE. In this switch position the sender is inoperative.

Output impedance

16. Output impedance is selected as follows:-

Unbalanced : Select 0 Ω , 50 Ω , 60 Ω or 75 Ω by Ω switch.

Balanced : Select 0 Ω , 124 Ω , 135 Ω or 150 Ω by Ω switch.

For both 0 Ω positions, output level is calibrated in dB relative to 0.775 V. This calibration is independent of the position of the dB/dBm switch.

Frequency

17. Enter frequency on keyboard or by manual TUNING control as follows:-

Keyboard entry

Entering a frequency : Key required frequency in kHz or MHz, e.g. 1.536 MHz. This appears in FREQUENCY window as 1536.00 kHz with ENTER lamp lit, meaning that frequency is not yet set. Press ENTER key to set frequency. ENTER lamp goes out and instrument sets to required frequency.

Incrementing or decrementing a frequency : Key required change by pressing & (increment key) followed by sign, increment and kHz or MHz, e.g. & + 4 kHz. Enter change in frequency by pressing ENTER key. Repeat as often as required by pressing ENTER key for each change in frequency. Sign may be changed without re-entering increment value, e.g. & - ENTER will reverse sign of previously entered increment.

Manual tuning

Manual : Switch TUNING ON. TUNING control sets frequency to a maximum resolution of 5 Hz. To tune in larger increments enter desired increment as for 'Incrementing or decrementing a frequency'.

Spin tuning : Spin TUNING control to produce electronic flywheel effect which keeps knob turning. Stop knob rotation manually or by pressing C (clear).* Press ENTER to display frequency. There are two spin modes:-

(1) Normal (quasi-logarithmic) - frequency changes at approximately 10 - 15 steps/second and increment size is dependent upon frequency as follows:-

100 Hz to 100 kHz	900 Hz increments
100 kHz to 1 MHz	9 kHz increments
1 MHz to 20 MHz	90 kHz increments

(2) Linear - Frequency increment is constant and entered as for 'Incrementing and decrementing a frequency'. Increment sign must be entered but direction of frequency change depends only upon direction of spin of TUNING control. Restore normal operation by pressing C key to clear and pressing ENTER key to display frequency.

Errors

18. To correct an entry, press C and start entry again (do not press ENTER key until the correct frequency is displayed). If an invalid entry is made (e.g. one outside the 100 Hz to 19.99999 MHz range) display flashes. Press C to clear. To display last valid entry, press ENTER key.

*Pressing any data key will stop the tuning knob. If a sequence has been entered, clear by pressing the C key. Press ENTER to display the frequency.

Level

19. Select indication in dBm or dB relative to 0.775 V.

KEYBOARD + FINE : Key sign then level in whole numbers. Data appears in FREQUENCY window. Press dB key to transfer data to LEVEL window and restore FREQUENCY reading. Press ENTER to set level. Set fractions of a dB by adjusting FINE LEVEL control in conjunction with meter. Output level is sum of LEVEL reading and meter reading.

KEYBOARD : Both meter and FINE LEVEL control are inoperative in this mode. Key sign then level to 0.1 dB resolution. Level appears in FREQUENCY window. Press dB key to transfer data to LEVEL window and press ENTER key to set level.

Incrementing or decrementing a level : Key required change by pressing & followed by sign, increment and dB, e.g. & + 3 dB . Enter change in level by pressing ENTER key. Repeat as often as required by pressing ENTER key for each change in level. Sign may be changed without re-entering increment value, e.g. & - ENTER will reverse sign of previously entered increment.

Output disable

20. The output may be disabled manually or automatically as follows:-

Manual disable : Select OUTPUT OFF. LEVEL display is blanked.

Auto mute enable : This rear panel switch automatically disables the output for a keyboard-entered change in frequency or level. Disable is effective from time of ENTER key being depressed until new frequency or level is established. Changing frequency by TUNING control also disables output provided tuning increment selected on keyboard.

External levelling

21. Sender output amplitude may be controlled from an external monitoring source connected to the EXT LEVELLING socket with the EXT LEVELLING switch set to ON (negative modulation - increasing control voltage decreases output level).

Synchronous operation

22. Connection of two coaxial cables between sender and receiver allows the sender to operate synchronously with, and on command from, the receiver. Sender frequency setting controls are disabled and the FREQUENCY display is blanked. Output is not suppressed during frequency changes. Method of operation is described under 'SYNCHRONOUS OPERATION'.

Sequence mode operation

23. This method of operation enables the sender to step in frequency and/or level automatically with the sequences initiated by pressing the START key. Method of operation is described under 'SEQUENCE MODE OPERATION'.

Control mode operation

24. This mode of operation is enabled by the CONTROL key when the sender and receiver are both fitted with the General Purpose Instrument Bus (GPIB) interface options and connected together via the instrument bus. The sender operates as bus controller of the receiver and a printer. This configuration allows automatic level and frequency incrementing with each sequence initiated by the START key. Operating modes are described under 'CONTROL MODE OPERATION'.

MANUAL RECEIVER OPERATION

Supply

25. AC mains or battery operation is selected as follows:-

Mains operation : Select \sim on SUPPLY switch after ensuring that voltage range selector is set correctly and correct value of fuse is fitted. Battery, if fitted, is trickle charged.

Battery operation : Select BATT on SUPPLY switch. To charge battery at full rate set SUPPLY switch to CHARGE. In this switch position the receiver is inoperative.

Terminating loads

26. When the receiver is not used to tune the sender synchronously, the 30 - 50 MHz OUT and the 10 MHz STD INT OUT sockets must be terminated with the loads supplied to prevent spurious radiation.

Input impedance

27. Input impedance is selected as follows:-

Unbalanced or balanced : Select 50 Ω , 60 Ω or 75 Ω for unbalanced, or 124 Ω , 135 Ω or 150 Ω for balanced, inputs.

Terminated or unterminated : Set to TERM or THRO'.

High impedance : Use Zero Loss Probe TK 2374/1 and select 75 Ω . Connect probe lead to PROBE socket. TERM/THRO' switch to be in TERM position.

Frequency

28. In AUTO mode, tuning knob is disabled. Enter frequency on keyboard or by manual TUNING control as follows:-

Keyboard entry

Entering a frequency : Key required frequency in kHz or MHz, e.g. 1.536 MHz. This appears in FREQUENCY window as 1536.00 kHz with ENTER lamp lit, meaning that frequency is not yet set. Press ENTER key to set frequency. ENTER lamp goes out and instrument sets to required frequency.

Incrementing or decrementing a frequency : Key required change by pressing & (increment key) followed by sign, increment and kHz or MHz, e.g. & + 4 kHz. Enter change in frequency by pressing ENTER key. Repeat as often as required by pressing ENTER key for each change in frequency.

Manual tuning

Manual : Select KEYBOARD + METER. TUNING control sets frequency to a maximum resolution of 5 Hz. To tune in larger increments enter desired increment as for 'Incrementing or decrementing a frequency'.

Spin tuning : Spin TUNING control to produce electronic flywheel effect which keeps knob turning. Stop knob rotation manually, by pressing C (clear) or any data key. Press ENTER to display frequency. There are two spin modes:-

(i) Normal - TUNING rate is automatically selected to suit bandwidth.

(ii) Linear - Frequency increment is constant and entered as for 'Incrementing and decrementing a frequency'. Increment sign must be entered but direction of frequency change depends only upon direction of spin of TUNING control. Restore normal operation by pressing C key to clear and pressing ENTER key to display frequency.

Errors

29. To correct an entry, press C and start entry again. If an invalid entry is made (e.g. one outside the 100 Hz to 19.99999 MHz range) display flashes. Press C to clear. To restore last valid entry press ENTER key.

Automatic frequency control

30. AFC is used as follows:-

KEYBOARD + METER : Tune signal within receiver pass band and select AFC ON. Receiver remains locked to signal throughout entire frequency range provided signal is above -5 dB with respect to reference level entered on keyboard. Instrument tunes to place tone in centre of selected bandwidth filter and displays actual frequency of tune. For an upper or lower sideband, frequency measured is that of sideband minus or plus 1.85 kHz respectively. Note that a.f.c. is inoperative when a frequency increment has been entered.

AUTO : AFC is not available in this mode.

Level

31. Select indication in dBm or dB relative to 0.775 V.

AUTO : Meter is inoperative and level is displayed to 0.1 dB resolution in LEVEL window. Low noise or low intermodulation is adaptively selected depending upon input level. Instrument settling time is fast for LOW NOISE and slow for LOW INTERMOD. Display flashes if input level exceeds +21.6 dBm. If wideband input level is sufficiently high to cause distortion, WIDE BAND OVERLOAD warning lamp lights.

KEYBOARD + METER : Select LOW NOISE or LOW INTERMOD. Key sign then level in whole numbers. Data appears in FREQUENCY window. Press dB key to transfer data to LEVEL window and restore FREQUENCY reading. Press ENTER to set level. Level measured is sum of LEVEL reading and meter reading. Meter range is ± 0.6 dB for METER $\times 1$ and ± 6 dB for METER $\times 10$. If KEYBOARD + METER is selected after AUTO with AFC SEARCH off, reference level is rounded value of AUTO reading.

Incrementing or decrementing a level : Select KEYBOARD + METER. Key required change by pressing & followed by sign, increment and dB, e.g. $\boxed{\& - 1 \text{ dB}}$. Enter change in level by pressing ENTER key. Repeat as often as required by pressing ENTER key for each change in level.

Search above threshold : For this the electronic flywheel function is used. Set the controls as follows:-

- (1) Select AFC SEARCH and KEYBOARD + METER.
- (2) Enter required threshold level on keyboard.
- (3) Enter start frequency for search.
- (4) Spin TUNING knob in appropriate direction.

When a signal above threshold is found, TUNING knob stops rotating and instrument locks onto signal. Level may be read from meter. If meter reads over full-scale select AUTO to read level. Reselect KEYBOARD + METER to recall previously set threshold. Recommence search by spinning knob again.

Low noise/low intermodulation

32. Select as follows:-

LOW NOISE : select to minimize effect of receiver inherent noise on low signal levels.



LOW INTERMOD : select for distortion analysis or for measurements on a broadband signal.

For optimum accuracy use low noise mode unless the wideband overload lamp is illuminated when low intermodulation mode must be used. If the wideband overload lamp is illuminated in the low intermodulation mode also, the Autobalance mode should be used. A table of maximum wideband input power levels is given in Chap. 1.

Bandwidth

33. The following bandwidths are available:-

50 Hz bandwidth : Select PILOT 50 Hz.

3.1 kHz lower or upper sideband : Enter frequency of suppressed carrier and select  for lower sideband, or select  for upper sideband.

3.1 kHz bandwidth : Select CHANNEL 3.1 kHz



48 kHz bandwidth : Select GP 48 kHz.

Calibrator

34. The receiver automatically calibrates at switch on. With CALIBRATOR ON, the instrument calibrates whenever bandwidth frequency or level alter significantly, at approx. 8 minute intervals and whenever ENTER key is pressed. For KEYBOARD + METER calibrator is inoperative during changes of frequency using the TUNING control. For a single calibration, switch CALIBRATOR ON and then after measurement is displayed, switch CALIBRATOR OFF.

Audio output

35. For single sideband signals, output at AUDIO socket may be set to 0 dBm in 600 Ω when meter reads zero, or audible output level is adjustable by volume control.

Tracking generator output

36. Obtain 0 dBm, 75 Ω output signal at frequency to which instrument is tuned by connecting to BFO socket on rear panel and switching TRACKING GENERATOR ON. Switch OFF when not in use.

Recorder output

37. To obtain long-term drift measurements use the RECORDER O/P terminals which monitor the meter to provide an output to the Y input of an X-Y recorder or for a d.v.m. or chart recorder. The output is linear in dB and across a 1 k Ω load the output voltage is 0 to ± 600 mV corresponding to either ± 0.6 dB for METER x1 or ± 6 dB for METER x10.

SYNCHRONOUS OPERATION

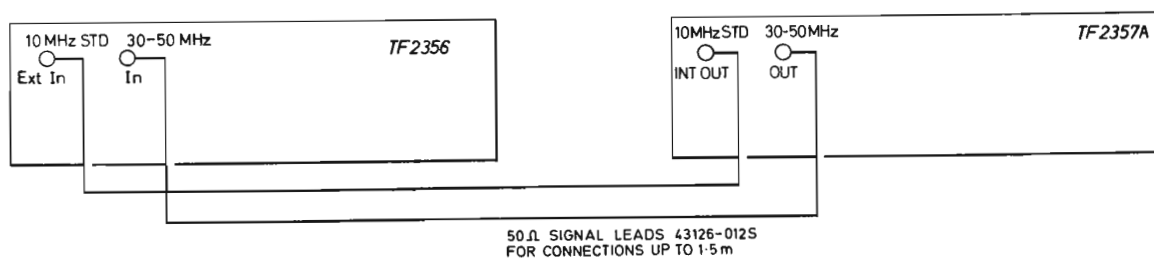

Fig. 5 Connections for synchronous operation

38. All frequency setting modes are transferred to TF 2357A Selective Level Meter by connection of two 50 Ω coaxial cables between sender and receiver. Connect 30-50 MHz IN socket on TF 2356 to 30-50 MHz OUT socket on TF 2357A. Connect 10 MHz STD - EXT IN socket on TF 2356 to 10 MHz STD - INT OUT on TF 2357A. Establishing these connections automatically disables all frequency setting controls as well as blanking FREQUENCY display on the sender. Sender now operates synchronously with, and on command from, the receiver. Output is not suppressed during frequency changes for this method of operation. Performance may be degraded at high frequencies and at input levels above -10 dBm (see Fig. 6).

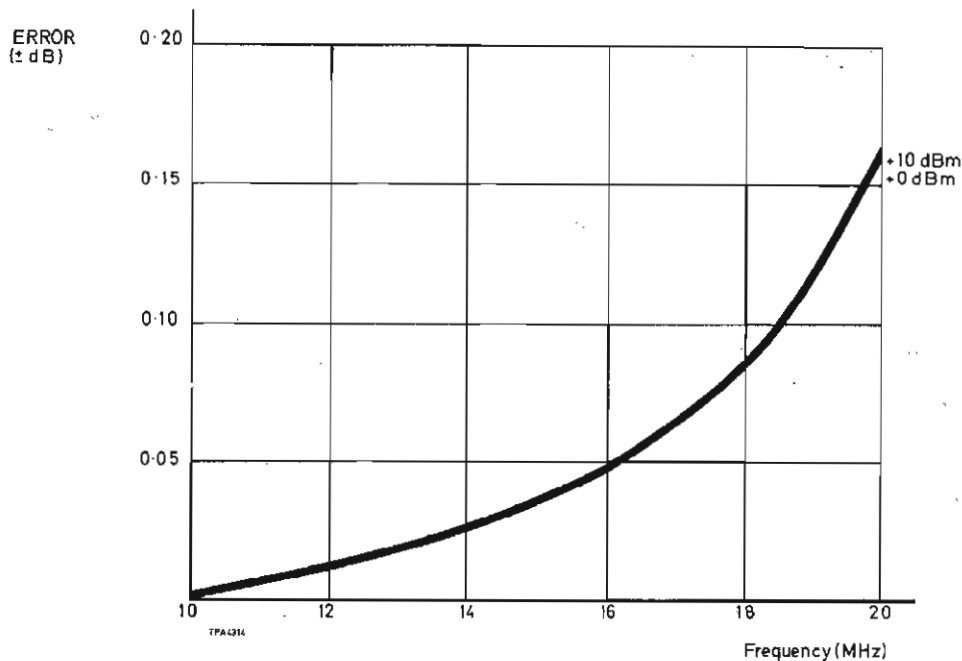

Fig. 6 Errors in calibration during synchronous operation (if the input is not disconnected while calibrating)

SEQUENCE MODE OPERATION

General

39. In this mode of operation Level Oscillator TF 2356 is caused to step through a previously entered sequence of frequency and/or level steps automatically, with the optional inclusion of a delay to allow the manual recording of results.

Front panel controls

40. For the sequence mode of operation all front panel facilities, including OUTPUT OFF, are available as for manual operation. Set controls as required with the exception of :-

SLM CONTROL - Set to OFF (if left ON display flashes to indicate an error condition - receiver not connected or not fitted with GPIB or address incorrect).

Data entry formats

41. A sequence of frequency and/or level steps is entered in the following order:-

FREQUENCY, LEVEL, TIME, MODE
 or LEVEL, FREQUENCY, TIME, MODE

Data entry formats are detailed in the following paras. and summarized in Fig.7.

42. The sequence may be controlled as follows:-

Start or restart - press
 Single step - press
 Halt - press
 Reset - press
 Clear sequence - press

To change sequence, enter new data and re-enter rest of data string. To correct mistakes during data entry i.e. before is pressed, press and enter correct data.

43. Data is entered as follows. Note that FREQUENCY and/or LEVEL may be single values or sequences as shown below:-

(1) Frequency:

(FS₁) (F) (FS₂) Frequency is incremented from FS₁ to FS₂ in steps of F.

(2) Level (entered level, including zero, must include a sign) :

(LS₁)[†] (L)* (LS₂) Level is incremented from LS₁ to LS₂ in steps of L.

(LS₁)[†] (L)* (LS₂) As above but output is initially OFF.

(3) Time (may be omitted for Single Step) :

(T) One sequence step occurs each time START is pressed.

(T) A single cycle is executed.

(T) As above but continuous cycles.

(T) is time delay in seconds between steps.
 If (T) is omitted, sequence is executed at maximum rate.

(4) Mode (only needed if both frequency and level sequences are entered):

The frequency sequence is completed at each level in turn.

The level sequence is completed at each frequency in turn.

+ LS₁ must include a decimal point:

e.g. & ENTER
LS₁ L LS₂

* The increment may only be positive and must include a positive sign.

CONTROL MODE OPERATION

General

44. The control mode of Level Oscillator TF 2356 (sender) requires that both sender and Selective Level Meter TF 2357A (receiver) be already factory fitted with GPIB boards (instrument code numbers 52356-301U, 52357-304X) or fitted retrospectively with GPIB kit 46883-319F. Operation may include a suitable bus-compatible printer with at least 20 columns. This enables initial conditioning and measurement results to be printed. Alternatively, all modes may be operated without a printer using a delay of from 1 second to 1 hour to allow the manual recording of results.

Rear panel switch settings

45. Set the rear panel switches as follows:-

	16	8	4	2	1	
(1) Sender	X	X	X	X	X	X = Don't care
(2) Receiver	'0'	'0'	'0'	'0'	'1'	System including printer
	'0'	'0'	'0'	'0'	'0'	System excluding printer
(3) Printer	'0'	'0'	'0'	'0'	'0'	

Set the sender LISTENER/CONTROLLER switch to CONTROLLER as shown in Fig. 7.

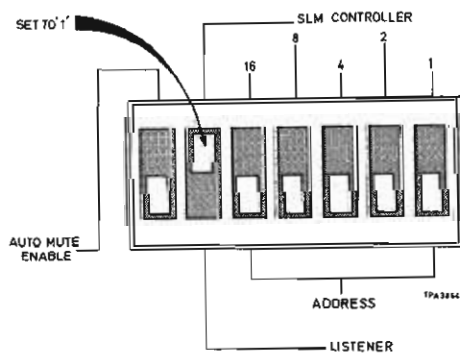

Fig. 7 GPIB switch settings for control mode operation (auto mute enable shown not selected)

Connections

46. Sender, receiver and printer rear panel GPIB sockets are inter-connected using two GPIB leads (43129-189U) as shown in Fig. 8. For greatest accuracy in measurements of pilots at high frequencies, connect the receiver's 10 MHz STD-INT OUT socket to the sender's 10 MHz STD-EXT IN socket.

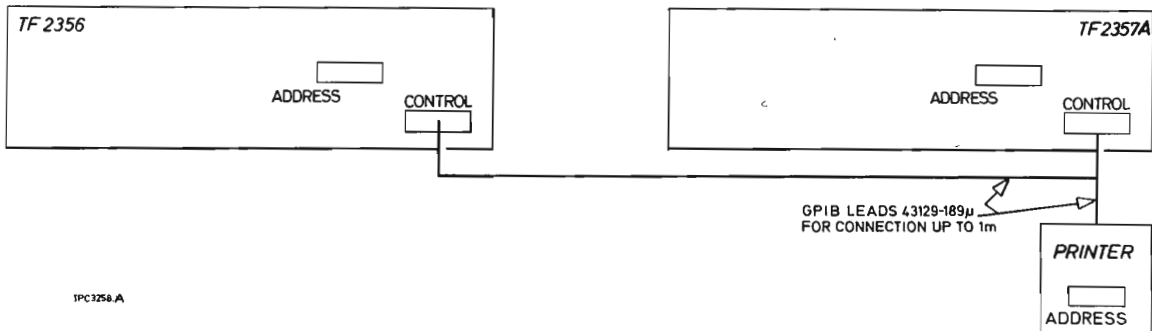

Fig. 8 Connections for control mode operation

Front panel controls

47. All front panel facilities, are available as for manual operation with the following restrictions:-

Receiver : Set controls required with the exception of:-

AFC - Set to OFF.

Bandwidth - Set to PILOT 50 Hz, CHANNEL 3.1 kHz  or GP 48 kHz.

Sender : Set controls as required with the exception of:-

SLM CONTROL - Set to ON. If display flashes, check:-
 GPIB kits fitted to both sender and receiver.
 GPIB leads securely fitted.
 Sender is switched to SLM CONTROLLER.
 Receiver and printer ADDRESS settings are correct.

Data entry formats

48. All the data entry formats shown in Fig. 9 and discussed under sequence mode operation are applicable to control mode operation with the addition that the receiver frequency is slaved to that of the sender. Thus for Single Frequency and Incrementing conditions, the receiver sets to FS1, FS2 and increments &F in step with the sender. The inclusion of the receiver allows two additional operating conditions to be implemented - Incrementing With Offset and Inverted Incrementing With Offset (see Fig. 9 and below).

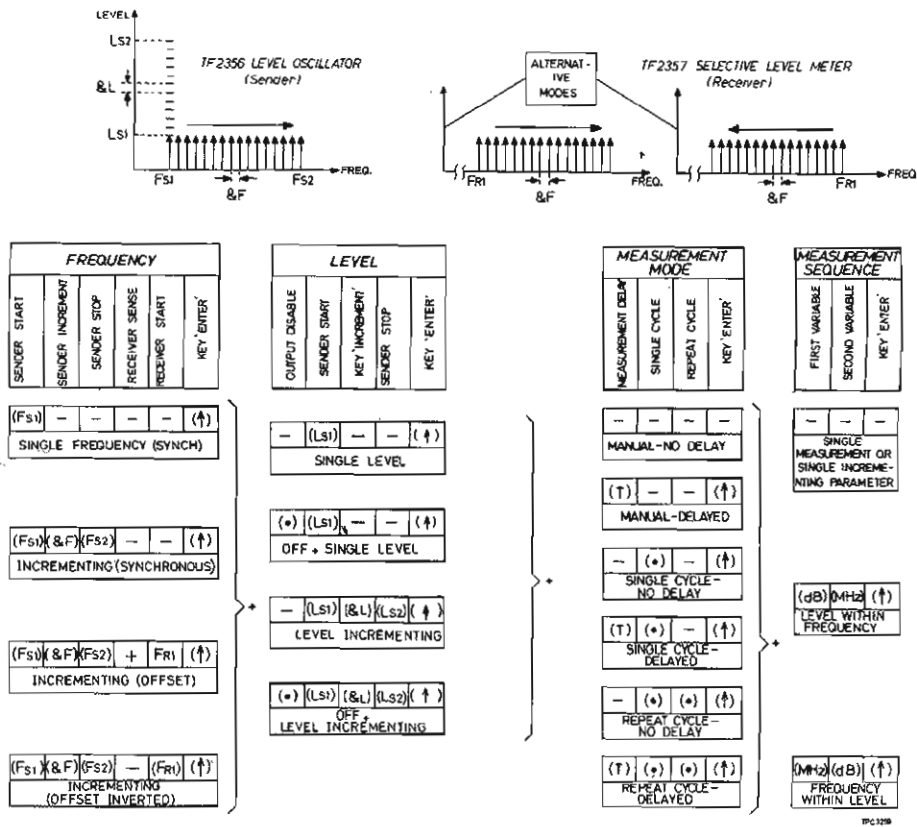

Fig. 9 Data entry format summary

Single/synchronous frequency incrementing

49. To make a single measurement at the sender frequency - Press **START**. To carry out a sequence of measurements with the sender and receiver frequencies synchronized - enter the required sequence as described in Sequence Mode Operation.

Frequency incrementing with offset or inverted increments

50. To carry out a sequence of measurements with the receiver frequency offset from the sender frequency - enter the required sequence as above but with the frequency data modified as follows:-

(FS₁) **&** **+** (F) (FS₂) **+** (FR₁) **ENTER** The sender frequency is incremented from FS₁ to FS₂ in steps of F. The receiver frequency is incremented from FR₁ in the same number of steps of F.

(FS₁) **&** **+** (F) (FS₂) **-** (FR₁) **ENTER** Sender - as above. The receiver frequency is decremented from FR₁ in the same number of steps of F.

Mode selection

51. Sequences may be manual or single or repeat cycle. Delay may be selected between measurements. Operation is exactly as described under Sequence Mode Operation.

Sequence selection

52. Increments of frequency within level or level within frequency may be selected as for Sequence Mode Operation.

Printer format

53. The printer format is as follows:-

Receiver control conditions : The printout heading includes a record of receiver settings as follows. Spaces are indicated by ^.

```

Z (1) (2) (3)
  ^-----^^^-----
LOW (4) (5)
  ^-----^^^-----
(6) (6) (7)
  ^-----^^^-----
      (8)      KHZ
  ^-----^^^-----

```

- (1) Impedance, 50, 60, 75, 124, 135, 150.
- (2) Termination condition, TERM or THRO.
- (3) Bandwidth, 50HZ, 3.1KHZC (centre), 3.1KHZU (u.s.b.), 3.1KHZL (l.s.b.), 48KHZ.
- (4) NOISE or I/M.
- (5) Calibrator on - no entry, Calibrator off - UNCAL.
- (6) Auto mode - no entry, Keyboard + meter mode - REF_LEVEL.
- (7) Auto mode - no entry, Keyboard + meter mode - ref. level value.
- (8) Measurement units - DB or DBM.

Sender control conditions : The printout heading includes a record of sender settings as follows.

```

Z (1) LEVEL (2)
  ^-----^^-----

```

- (1) Impedance, 0, 50, 60, 75, 124, 135, 150, OBAL.
- (2) Level condition - DB, DBM, EXT, FINE.

Data conditions : The following heading information (with example values) is printed when the measurement sequence is initiated by the 'START' key.

```

^^^1.50^FS1           Sender start frequency (1.5 kHz)
^^^1.00^INC           Frequency increment (1 kHz steps)
^^10.50^FS2           Sender stop frequency (10.5 kHz)
^^105.00^FR1^INV      Receiver start frequency (105 kHz)
                      (INV denotes receiver decrementing)
^-50.5^LS1            Sender start level (-50.5 dB)
^^1.0^INC             Level increment (+1 dB steps)
^-10.5^LS2            Sender stop level (-10.5 dB)
^^20^SECS^DELAY       Measurement delay time

```

If the frequency statements are printed before the level statements, frequency increments take place at each level in turn. If level statements are printed first, then all level increments take place at each frequency in turn.

Example of data entry and printout

54. The example which follows shows a measurement sequence to evaluate the performance of a mastergroup translation equipment.

(1) It is desired to increment the sender frequency from 808 kHz to 2048 kHz in 248 kHz steps whilst the receiver decrements from 12392 kHz. The sender is initially disabled to measure the output noise then measurements are to be made at send levels of -56 dBm and -46 dBm. A delay of 5 seconds has been programmed before printing each measurement. All frequency steps are to be carried out before the level is changed.

(2) The variables are identified as:-

```

FS1 = 808 kHz      &F = 248 kHz      FS2 = 2048 kHz      FR1 = 12392 kHz
LS1 = -56 dBm     &L = +10 dBm     LS2 = -46 dBm      T   = 5 seconds

```

(3) And the selected formats and keyboard entries will be:-

Frequency : Inverted incrementing with offset

```

(808 kHz) [ & ] [ + ] (248 kHz)(208 kHz) [ - ] (12392 kHz) [ ENTER ]

```

Level : Sender off and level incrementing

```

[ . ] (-56. dB) [ & ] [ + ] (10 dB)(-46 dB) [ ENTER ]

```

Mode : Single cycle delayed

```

(5) [ . ] [ ENTER ]

```

Sequence : Frequency within level

```

[ MHz ] [ dB ] [ ENTER ]
[ START ]

```

(4) The resulting printout is shown in Fig. 10.

<pre> 808.00 FS1 240.00 INC 2048.00 FS2 12392.00 FR1 INV DISABLED -56.0 LS1 10.0 INC -46.0 LS2 5 SEC DELAY SINGLE SEQUENCE SEQUENCE FREQ LEVEL 808.00 FS1 240.00 INC 2048.00 FS2 12392.00 FR1 INV DISABLED -56.0 LS1 10.0 INC -46.0 LS2 5 SEC DELAY Z75 LEVEL DBM Z75 TERM 3.1 KHZC LOW I/MOD **UNCAL** DBM KHZ DISABLED FS 808.00 L -109.30 F 12392.00 FS 1056.00 L -109.00 F 12144.00 FS 2040.00 L -108.40 F 11152.00 LS -56.0 FS 808.00 L -53.42 F 12392.00 FS 2040.00 L -50.30 F 11152.00 LS -46.0 FS 808.00 L -43.24 F 12392.00 FS 2040.00 L -43.20 F 11152.00 </pre>	<p>Sender start frequency (808kHz). Sender frequency increment (240kHz). Sender stop frequency (2048kHz). Receiver decrements from start frequency (12392kHz).</p> <p>Sender output initially disabled. Sender start level (-56dB). Sender level increment (10dB). Sender stop level (-46dB).</p> <p>Delay before measurement is made (5 seconds).</p> <p>Single automatic measurement cycle.</p> <p>Sequence (frequency stepped within each level).</p> <p>Initial conditions printed following START to confirm data entry.</p> <p>Sender output impedance (75Ω) and level units (dBm). Receiver input impedance (75Ω terminated) and bandwidth (3.1 kHz). Receiver measurement type (low intermod with calibrator off).</p> <p>Level and frequency units heading.</p> <p>First sender frequency with output initially disabled. First receiver level measurement and frequency.</p> <p>Second sender frequency with output initially disabled. Second receiver level measurement and frequency.</p> <p>Level measurement at sixth (and final) frequency.</p> <p>First of six measurements with -56dBm send level.</p> <p>Last of six measurements with -56dBm send level.</p> <p>First of six measurements with -46dBm send level.</p> <p>Last of six measurements with -46dBm send level.</p>
--	--

Fig. 10 Example of control mode printout.
The sender is acting as controller.

GENERAL BUS CONTROL

Introduction

55. When fitted with GPIB interfaces, both sender and receiver may be remotely controlled via the bus. The user is assumed to be familiar with the general programming concepts and procedures of the bus as set out in IEEE Standard 488-1978 and IEC Publication 625-1 (First Edition). An introduction to the instrument bus and its procedures for commands, data transfer, etc. is given in a separate publication - The GPIB Manual (see Optional accessories).

56. The following paras. describe the programming instruction sets for both instruments, which in general comply with the IEC proposals. The exception is the use of multipliers K (kHz) and M (MHz) which have been retained to simplify both instrument software and user programming. Instructions are grouped so that similar types have the same prefix which where possible has some significance (e.g. F for frequency, L for level). Instructions are separated by commas and an instruction string is terminated by line feed (Lf) or carriage return (Cr). Note that EOI will not be recognized.

Note...

All instructions have a single letter prefix.

Initial conditions

57. At switch on, the equipment will adopt conditions as preset by front panel controls. Where no preset condition is possible, the following conditions will be automatically set.

Sender	Frequency : 1 MHz Level : -70 dBm (-80 dB)
Receiver	Frequency : 1 MHz Level (if KEYBOARD + METER selected) : 0 dBm (0 dB) Calibrate (if switched off) : One shot.

Operators

58. The operators for sender and receiver are as follows:-

<i>ISO 7 character</i>	<i>Hexadecimal equivalent</i>
Plus sign +	2B
Minus sign -	2D
Increment flag &	26

Sender instruction set (0 represents zero)

59. Preliminary settings

<i>Function</i>	<i>Instruction characters</i>	<i>ISO 7 hexadecimal equivalent</i>
Display off	P0	5030
Display on	P01	503031
Calibration in dBm	P1	5031
Calibration in dB	P11	503131
External levelling off	P2	5032
External levelling on	P21	503231
Output off	P3	5033
Output on	P31	503331
Auto mute off	P4	5034
Auto mute on	P41	503431
Print level	P6	5036
Print level and frequency	P61	503631
Print heading	P7	5037

60. Impedance

<i>Function</i>	<i>Instruction characters</i>	<i>ISO 7 hexadecimal equivalent</i>
0 Ω unbalanced	Z0	5A30
50 Ω unbalanced	Z1	5A31
60 Ω unbalanced	Z2	5A32
75 Ω unbalanced	Z3	5A33
124 Ω balanced	Z4	5A34
135 Ω balanced	Z5	5A35
150 Ω balanced	Z6	5A36
0 Ω balanced	Z7	5A37

61. Level

<i>Function</i>	<i>Instruction characters</i>	<i>ISO 7 hexadecimal equivalent</i>
Positive level	L + (value) D *	4C2B-----44
Negative level	L - (value) D *	4C2D-----44
Increment	L & + (value) D *	4C262B-----44
Decrement	L & - (value) D *	4C262D-----44
Repeat increment/ decrement	L Lf	4COA

* (value) : program to 0.1 dB resolution, e.g. +6.0 or -45.2.

62. Frequency

<i>Function</i>	<i>Instruction characters</i>	<i>ISO 7 hexadecimal equivalent</i>
Fixed frequency	F (value)* K or M	46....4B or 46....4D
Increment	F&+ (value)*K or M	46262B...4B or 26262B...4D
Decrement	F&- (value)*K or M	46262D...4B or 46262D...4D
Repeat increment/ decrement	F Lf	460A

* (value) : program to maximum resolution of 5 Hz, e.g. 2.345675M or 2345.675K

Note that maximum number of entered digits, including leading zeros is 7.

63. Example

To set the sender to, for example, a level of -40 dBm at 108 kHz with 75 Ω output impedance, the string of instructions shown in Fig. 11 should follow the sender's listen address. The sequence of instructions preceding line feed is immaterial. For subsequent instruction strings only the altered instructions need be sent followed by line feed.* To reduce frequency by, for example, 4 kHz, the instruction would be F & -4K Lf. A further 4 kHz reduction would occur each time the instruction F Lf was sent.

*For a frequency or level change however, any increment must be re-entered.

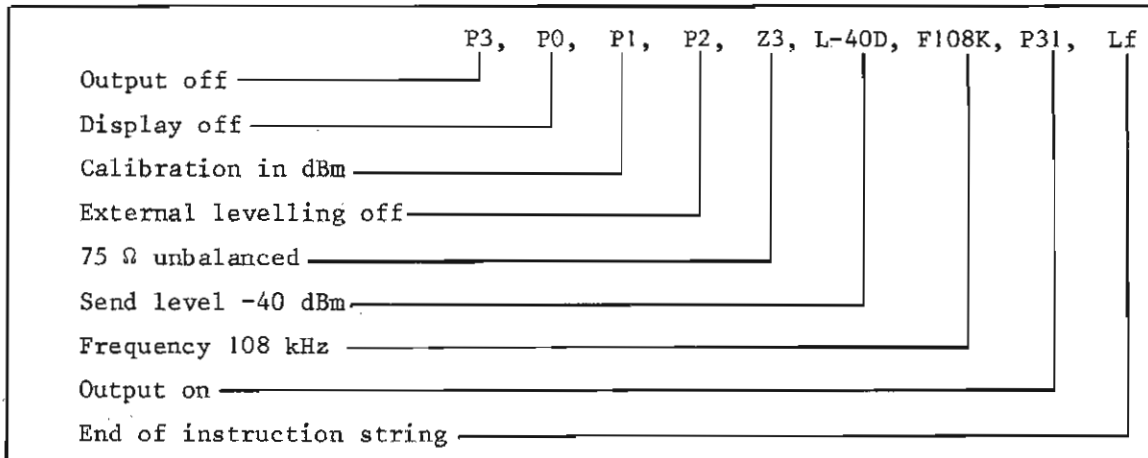

Fig. 11 Example of sender instruction string

Receiver instruction set (0 represents zero)

64. Preliminary settings

<i>Function</i>	<i>Instruction characters</i>	<i>ISO 7 hexadecimal equivalent</i>
Display off	P0	5030
Display on	P01	503031
Calibration in dBm	P1	5031
Calibration in dB	P11	503131

<i>Function</i>	<i>Instruction characters</i>	<i>ISO 7 hexadecimal equivalent</i>	
Measurement mode select †	Autobalance	P2	5032
	±0.6 dB Relative/ High resolution (0.01 dB)	P21	503231
	±6.0 dB Relative/ Low resolution (0.1 dB)	P22	503232
Low noise	P3	5033	
Low intermodulation	P31	503331	
Calibrator off	P4	5034	
Calibrator one shot	P41	503431	
Calibrator on	P42	503432	
AFC off	P5	5035	
AFC on	P51	503531	
Do not write frequency	P6	5036	
Write frequency one shot	P61	503631	
Write frequency each measurement	P62	503632	
Write receiver status	P7	5037	
Tracking gen. off	P8	5038	
Tracking gen. on	P81	503831	

† Instructions P21 and P22 cause measurements to be made with respect to a preset reference level with high and low level resolution respectively. The resolution remains unchanged when Autobalance (P2) is selected. Thus: P21, P2 selects High resolution Autobalance (for best accuracy). P22, P2 selects Low resolution Autobalance (for best speed).

65. Impedance

<i>Function</i>	<i>Instruction characters</i>	<i>ISO 7 hexadecimal equivalent</i>
50 Ω unbalanced term.	Z1	5A31
50 Ω unbalanced thro.	Z11	5A3131
60 Ω unbalanced term.	Z2	5A32
60 Ω unbalanced thro.	Z21	5A3231
75 Ω unbalanced term.	Z3	5A33
75 Ω unbalanced thro.	Z31	5A3331
124 Ω balanced term.	Z4	5A34
124 Ω balanced thro.	Z41	5A3431
135 Ω balanced term.	Z5	5A35
135 Ω balanced thro.	Z51	5A3531
150 Ω balanced term.	Z6	5A36
150 Ω balanced thro.	Z61	5A3631

66. Level (KEYBOARD + METER)

<i>Function</i>	<i>Instruction characters</i>	<i>ISO 7 hexadecimal equivalent</i>
Positive level reference	L + (value) D*	4C2B.....44
Negative level reference	L - (value) D*	4C2D.....44
Increment level reference	L& + (value) D*	4C262B.....44
Decrement level reference	L& - (value) D*	4C262D.....44
Repeat increment/decrement	L Lf	4C0A

* (value) : program to 1 dB resolution, e.g. -96 D

67. Frequency

<i>Function</i>	<i>Instruction characters</i>	<i>ISO 7 hexadecimal equivalent</i>
Fixed frequency	F (value) * K or M	46....4B or 46....4D
Increment	F & + (value) * K or M	46262B...4B or 46262B...4D
Decrement	F & - (value) * K or M	46262D...4B or 46262D...4D
Repeat increment/ decrement	F Lf	460A

* Program to maximum resolution of 5 Hz, e.g. 2.345675M or 2345.675K.

68. Time constant

<i>Function</i>	<i>Instruction characters</i>	<i>ISO 7 hexadecimal equivalent</i>
20 ms	T0	5430
40 ms	T1	5431
80 ms	T2	5432
100 ms	T3	5433
140 ms	T4	5434
200 ms	T5	5435
Restore automatic time constant selection	T6	5436

Time constant selected automatically:

AUTO, LOW NOISE (P2,P3) : T2 if 48 kHz (B5) filter selected
: T0 for other filters.

AUTO, LOW INTERMOD (P2,P31) : T0 if 50 Hz (B1) filter selected
: T2 if 48 kHz (B5) or 3.1 kHz centre (B2)
filter selected
: T1 if 3.1 kHz l.s.b. (B3) or u.s.b. (B4)
filter selected.

69. Bandwidth

<i>Function</i>	<i>Instruction characters</i>	<i>ISO 7 hexadecimal equivalent</i>
50 Hz Pilot	B1	4231
3.1 kHz Channel centre	B2	4232
3.1 kHz Channel LSB	B3	4233
3.1 kHz Channel USB	B4	4234
48 kHz Group	B5	4235

70. Example

To set the receiver to measure, for example, a pilot tone at 4092 kHz to 0.1 dB resolution with 75 Ω input impedance, initial calibration, and a print-out of both level and frequency, the instruction string shown in Fig. 12 could follow the receiver listen address. The sequence of instructions preceding line feed is immaterial. For subsequent instruction strings only the altered instructions need be sent followed by line feed.

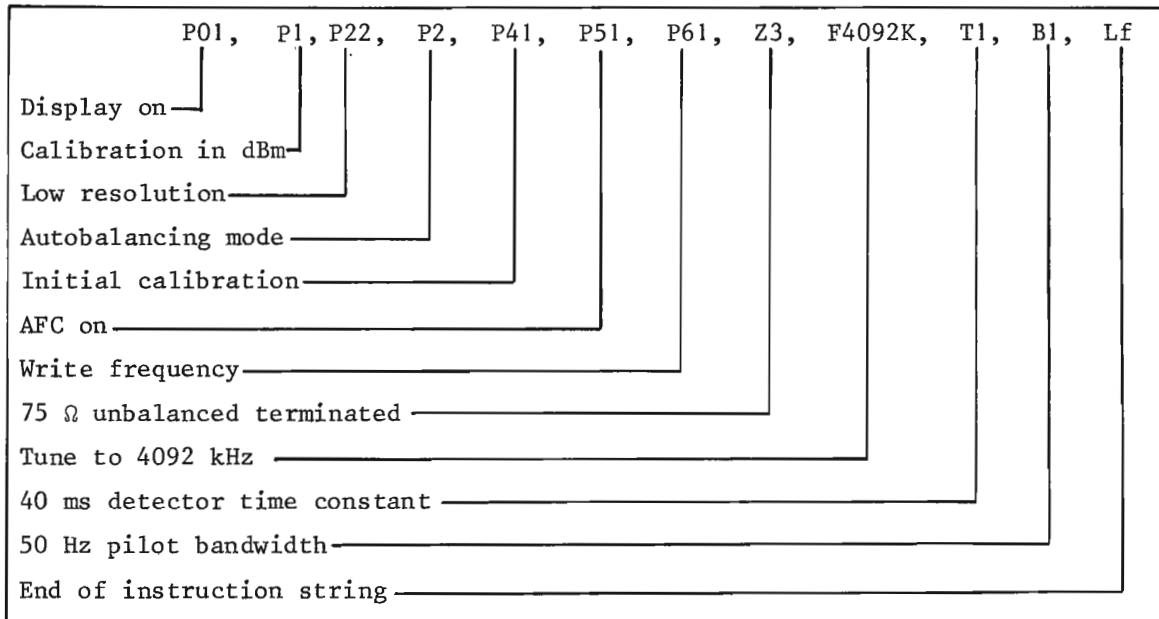

Fig. 12 Example of receiver instruction string

71. Measurement sequence

In order to ensure reliable results, measurements should only be made in a triggered mode of operation. Non-triggered measurements may be incorrect. As soon as the receiver has been set, as for example, with an instruction string similar to that of Fig. 12 it will begin to take measurements on a continuous basis. When it receives a GET (Group Execute Trigger) command via the bus it will complete the measurement and generate a request for service (rsv). One of two actions can then be taken by the controller:-

- (i) (Preferred). Send SPE (Serial Poll Enable), address the receiver as a talker and read the status byte, send SPD (Serial Poll Disable).

If the result is valid, readdress the receiver as a talker and read the result.

(ii) (Non-preferred). Address the receiver as a talker and read the result. Send the UNT (Untalk) command. In this case the service request line will not be reset. To reset the service request line the serial poll procedure must be carried out.

An alternative method of obtaining trigger measurements which does not involve the service request routine is to address the receiver as a talker, read the result and then to send UNT. Sufficient delay must be allowed for the instrument to make a measurement before reading the next result.

Note...

If the receiver is in the preset mode (P21 or P22) the first valid result after the GET command will be latched into the message buffer.

Status byte

72. General

A status byte is prepared by the sender or receiver either when the instrument receives a 'serial poll enable' (SPE) message or when the instrument is requesting services (rsv) for any reason. Service is normally requested to report that a measurement has been completed following a GET message, that a valid measurement could not be made, or that instructions received were invalid, the particular condition being indicated by the state of the status byte. If service has not been requested, the status byte normally reports the operational status of the instrument (i.e. busy or idle). When receiving a string of instructions the instrument counts the instructions, checks them for validity and then processes them sequentially. Should a faulty instruction be received, it is deleted along with all following instructions in the string and the instrument requests service. The number in the string of the last valid instruction is then available immediately following the status byte thus enabling the controller to identify the faulty instructions and re-input the string starting at the error.* Although this facility is not normally included in GPIB instruments, the likely use of remote control methods via modem/data links for the sender and receiver make it important that some immunity from line errors should be built in as standard.

73. Sender

The status byte is used to indicate 3 alternative conditions.

- (1) Frequency instruction out of range.
- (2) Level instruction out of range.
- (3) Invalid data. A secondary byte gives the position of the first faulty instruction in the string.

The status byte coding is shown in Fig. 13.

*The instrument will not accept further instructions or remove SRQ until a serial poll has been carried out.

74. Receiver

The status byte is used to indicate 8 alternative conditions.

- (1), (2), (3) as for sender.
 - (4) Unable to measure, out of range high.
 - (5) Unable to measure, out of range low.
 - (6) Measurement complete*.
 - (7) Receiver busy
 - (8) Receiver idle
- } initiated by request for service
- } no request for service

The status byte coding is shown in Fig. 13.

*If measurement complete is sent with bit 6 set, i.e. fault condition, it indicates that the wide band overload lamp is on.

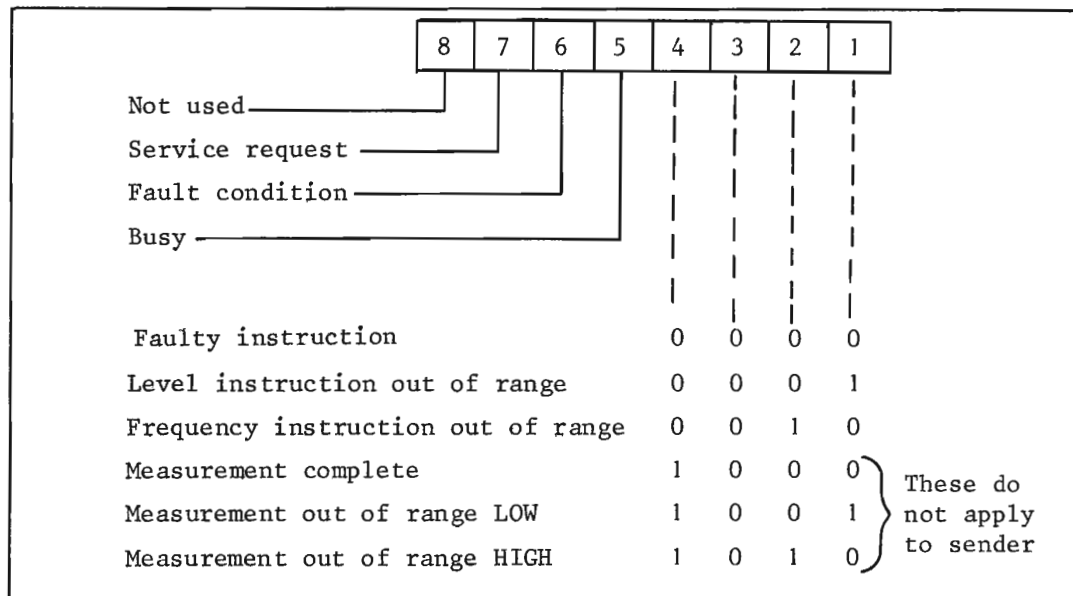

Fig. 13 Status byte coding

75. When the status byte indicates receipt of a faulty instruction i.e. (0)1100000, the secondary information byte may be read during serial poll to indicate the position from the start of the string, of the first faulty instruction, e.g. 00110100 indicates a fault in the fourth instruction. The controller need only then re-transmit from this point in the string. Alternatively the entire instruction string may be re-transmitted following the serial poll disable (having re-addressed the instrument to listen).

Output formats

76. These have been chosen to suit a 20 column printer.

77. Level

Format depends upon mode selected viz. P2, P21, P22 but all formats use 9 print spaces with 2 following the decimal point (space is indicated by ^).

(1) Autobalance mode (P2). Resolution is 0.01 dB or 0.1 dB and format is:-

e.g. $\underbrace{L_{\wedge-110.75} \text{ or } L_{\wedge\wedge\wedge\wedge 3.15}}_{\text{High resolution (P21,P2)}\dagger}$ or $\underbrace{L_{\wedge-110.7\wedge} \text{ or } L_{\wedge\wedge\wedge\wedge 3.1\wedge}}_{\text{Low resolution (P22,P2)}}$

(2) Differential mode plus 0.6 dB meter range (P21). Resolution is 0.05 dB within ± 0.6 dB range. Outside this range HI or LO is printed.

e.g. $L_{\wedge-\wedge\wedge 0.60}$ or $L_{\wedge\wedge\wedge\wedge 0.60}$
 $L_{\wedge\wedge\wedge\wedge\wedge\wedge LO}$ or $L_{\wedge\wedge\wedge\wedge\wedge\wedge HI}$

(3) Differential mode plus 6 dB meter range (P22). Resolution is 0.1 dB within ± 6 dB range with hundredths of dB suppressed. Outside ± 6 dB range HI or LO is printed.

e.g. $L_{\wedge-\wedge\wedge 3.0}$ or $L_{\wedge\wedge\wedge\wedge 3.0\wedge}$
 $L_{\wedge\wedge\wedge\wedge\wedge\wedge LO}$ or $L_{\wedge\wedge\wedge\wedge\wedge\wedge HI}$

(4) Wide band overload is indicated on the output (as well as in the status byte) by an asterisk.

e.g. $L^*-\wedge 60.55$

78. Frequency

This is only sent following a level output if P61 or P62 are selected. The format is 11 print spaces including 2 following the decimal point and all printout is in kHz.

e.g. $L_{\wedge-100.05\wedge F_{\wedge} 12345.67}$
 or $L_{\wedge\wedge\wedge\wedge 3.25\wedge F_{\wedge\wedge\wedge\wedge} 6.25}$

79. Receiver status

On receipt of P7 the status of certain receiver controls may be output as a printer header to precede a measurement sequence under control mode operation when the sender is acting as bus controller. This facility is not normally relevant to General Bus Control.

† If, for any reason, the instrument is unable to make a high resolution reading, this format becomes $L^*-110.7\wedge$ or $L^*_{\wedge\wedge\wedge} 3.1\wedge$

Making a measurement

80. In order to obtain reliable performance when making measurements under bus control, the following sequence should be used:-

- (1) Address receiver to listen.
- (2) Send measurement conditions (e.g. frequency, bandwidth, measurement mode, etc.) followed by line feed.
- (3) Send GET (Group Execute Trigger).
- (4) Send unlisten command.
- (5) Wait for service request (this is best handled as an interrupt).
- (6) Send SPE (Serial Poll Enable).
- (7) Address receiver to talk.
- (8) Read status byte.
- (9) Send untalk command.
- (10) Send SPD (Serial Poll Disable).
- (11) Address receiver to talk.
- (12) Read result from receiver.
- (13) Send untalk command.

81. To read the level, level and frequency or front panel settings from the sender or the front panel settings from the receiver, the following sequence should be used:-

- (1) Send receiver/sender listen address.
- (2) Send appropriate command (P6, P61 or P7) followed by line feed.
- (3) Send unlisten command.
- (4) Send receiver/sender talk address.
- (5) Read information.
- (6) Send untalk command.

Remote/local operation

82. The CLEAR key may be used to return an instrument, under remote control, to local operation. If this facility is not wanted use the local lock out command. As this is a universal command it is only necessary to send the LLO command.

Speed hints

83. The following hints are given to increase the speed of operation:-

- (1) A measurement cannot take place until all the necessary data have been read and processed. For a string of equally spaced frequencies, therefore, it is much faster to send an increment and then to use the repeat increment F LF command.
- (2) Where the approximate level is known, it is faster to measure in the the preset mode.

(3) Low Noise mode has the shortest time constant.

(4) Switch off the receiver display by command P0.

Example (A)

84. The example shown below is of an HP 9825A program to make a single level measurement at 1 MHz in a 50 Hz bandwidth.

```

0: dim A$ [20]
1: wrt 705,"B1,P3,P21,L+0D,F1M"
2: trg 705
3: oni 7,"srq"
4: cfg 0
5: eir 7
6: if flg0=0;jmp 0
7: red 705,A$
8: dsp A$,A
9: stp
10: "srq":rds(705)→A
11: sfg 0
12: iret
13: end
*26679

```

<i>Line</i>	<i>Description</i>
0	Dimension a string to accept 20 characters.
1	Select 50 Hz pilot filter, low noise, ± 0.6 dB meter range, preset level 0 dBm, frequency 1 MHz.
[This could be written as a formatted input statement as follows:	
fmt 1,"B",f1.0,"P",f2.0,"P",f2.0,"L+",f4.0,"D,F",f7.5,"M"]
wrt 705.1,A,B,C,D,E	
2	Send Group Execute Trigger (GET) to TF 2357A.
3	Specify jump to sub-routine 'srq' when interrupt occurs.
4	Clear flag 0.
5	Enable interrupt.
6	Wait for TF 2357A to assert Service Request (SRQ).
7	Read measured value from TF 2357A into string variable A\$.
8	Display measured value and status byte.
9	Stop.
10	Sub-routine 'srq' : serial poll TF 2357A and store status byte in simple variable A.

<i>Line</i>	<i>Description</i>
-------------	--------------------

11	Set flag 0.
12	Interrupt return.
13	End.

Notes...

- (1) In the above example, bus port 7 is used on the HP 9825A and the device address is 5 giving a talk/listen address of 705.
- (2) Flag 0 in lines 6 and 11 is used as an indicator to show when SRQ has been asserted. A simple variable could have been used to produce the same effect.
- (3) The status byte will be displayed in decimal.

Example (B)

85. The example shown below is of a Commodore PET program to make a single level measurement at 1 MHz in a 50 Hz bandwidth.

```

0  REM MAIN PROGRAM
1  CLR:P=PEEK (59426)
2  OPEN 11,11,0
3  PRINT #11,"B1,P3,P21,L+0D,F1M"
4  GOSUB 1000
5  PRINT RESULT$
6  PRINT ASC(BYTE$)
7  PRINT #11,"P01"
8  END
1000 REM GET RESULT
1020 CMD 11:POKE(59456),251:PRINT CHR$(8):POKE(59456),255
1030 IF PEEK(59427)<128 THEN 1030
1040 POKE(59456),251:PRINT CHR$(24):POKE(59456),255
1050 GET #11,BYTE$
1055 IF ST THEN 1050
1060 CMD 11:POKE(59456),251:PRINT CHR$(25):POKE(59456),255:P=PEEK(59426)
1070 INPUT #11,RESULT$
1075 IF ST THEN 1070
1080 RETURN

```

<i>Line</i>	<i>Description</i>
-------------	--------------------

1	Clear : Reset PET latched SRQ.
2	Open output file.
3	Select 50 Hz pilot filter, low noise, ± 0.6 dB meter range, preset level 0 dBm, frequency 1 MHz.
4	Goto subroutine to get result.
5	Print measurement
6	Print status byte.

<i>Line</i>	<i>Description</i>
7	Restore TF 2357A display.
8	End.
1020	Send Group Execute Trigger (GET) to TF 2357A.
1030	Wait for TF 2357A to assert Service Request (SRQ).
1040	Send Serial Poll Enable (SPE).
1050	Read status byte.
1060	Send Serial Poll Disable (SPD) : Reset PET latched SRQ.
1070	Read result.
1080	Return to main program.

Notes...

- (1) In the above example the device address is 11.
- (2) The status byte will be displayed in decimal.

Chapter 4-1

BRIEF TECHNICAL DESCRIPTION

CONTENTS

Para.

- 1 Introduction
- 2 Sender circuit summary
- 8 Receiver circuit summary

Fig.

1	Block diagram TF 2356	1
2	Block diagram TF 2357A	3

INTRODUCTION

1. The following summaries are outline circuit descriptions of the sender and receiver which are intended to be read in conjunction with their respective block diagrams (Figs. 1 and 2). Detailed descriptions of each board are given in the respective service manuals.

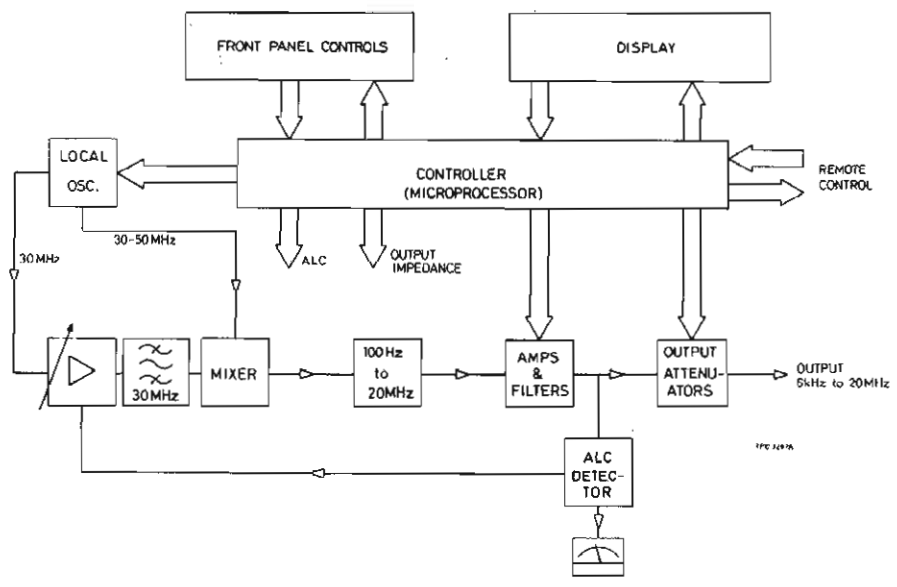

Fig. 1 Block diagram TF 2356

SENDER CIRCUIT SUMMARY

Microprocessor

2. TF 2356 uses a microprocessor system to translate front panel instructions into control signals. This system replaces conventional logic by storing program sequences in memory rather than implementing the sequences with gates and bistables. Programs are stored in programmable read only memories (PROM's).

Local oscillator

3. The local oscillator is a frequency synthesizer which uses three phase locked loops to generate frequencies in the range 30 to 50 MHz in 5 Hz steps. Overall stability is ensured by phase locking to a temperature compensated 10 MHz crystal standard.

Automatic level control

4. The output from the amplifiers and filters is taken to the a.l.c. detector and the resultant direct voltage compared with a reference direct voltage and the error signal fed to the level control circuit. The output level may be varied by means of the fine level control in conjunction with the meter.

5. The incoming signal from the a.l.c. at 30 MHz is mixed with a signal in the range 30 - 50 MHz from the synthesized local oscillator to produce an output in the range 200 Hz to 20 MHz.

Amplifiers and filters

6. Following the mixer are several amplifying stages with associated 20 MHz low-pass filters.

Output attenuators

7. The attenuators set the output signal level to correspond to the level entered on the keyboard.

RECEIVER CIRCUIT SUMMARY

Microprocessor

8. The TF 2357A uses a microprocessor to translate front panel instructions into control signals in a similar manner to that used in the sender. Programs are stored in programmable read only memories (PROM's).

Local oscillator

9. The local oscillator is frequency synthesized and uses three phase locked loops to generate frequencies in the range 30 to 50 MHz in 5 Hz steps. For stability the oscillator is phase locked to a temperature controlled 10 MHz crystal standard.

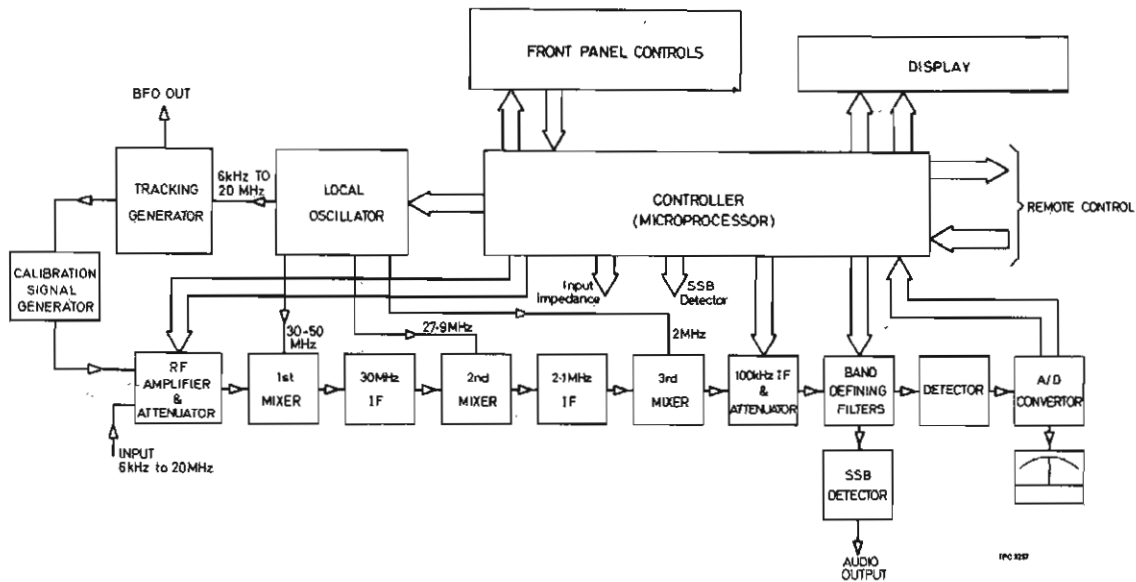

Fig. 2 Block diagram TR 8357A

Tracking generator

10. Provides a 0 dBm output signal at the tuned frequency of the receiver.

Calibrator and r.f. attenuators

11. An accurately set limiter provides a calibrated level at -45 dBm for comparison with, and at the same frequency as, the incoming signal. With the r.f. attenuator held at the measurement value, the high accuracy transformer ratio arm i.f. attenuator is adjusted to compensate for inaccuracies in both frequency response and r.f. attenuation level.

First mixer and i.f. amplifier

12. The incoming signal in the range 100 Hz to 20 MHz is mixed with a 30 to 50 MHz input from the synthesized local oscillator to produce a first i.f. of 30 MHz.

Second mixer and i.f. amplifier

13. The 30 MHz input is mixed with the output from a 27.9 MHz crystal oscillator to produce the 2.1 MHz second i.f. The 27.9 MHz oscillator is phase-locked to the 100 kHz which is derived from the 10 MHz standard.

Third mixer, i.f. amplifier and attenuators

14. To produce the 100 kHz third i.f. the 2.1 MHz input is mixed with a 2 MHz signal from the local oscillator. The i.f. attenuators, in conjunction

with the r.f. attenuators, are inserted to balance the incoming signal. For low noise measurements the bulk of the attenuation is supplied by the i.f. attenuators.

Band defining filters and s.s.b. detector

15. The 100 kHz signal then passes through a succession of crystal band-pass filters resulting in 100 kHz outputs at 48 kHz, 3.1 kHz and 50 Hz bandwidths. The 3.1 kHz bandwidth signal is mixed with switched crystal oscillators to produce upper or lower s.s.b. outputs.

Detector and A/D converter

16. The A/D converter converts the analogue output to the meter into a corresponding digital output to the microprocessor with sign information provided by a zero-crossing detector.

MARCONI INSTRUMENTS LIMITED

UK

Service Division
The Airport
LUTON
Bedfordshire LU2 9NS
Telephone: (0582) 33866
Telex: 825248

Head Office
Longacres
ST. ALBANS
Hertfordshire AL4 0JN
Telephone: (0727) 59292
Telex: 23350

Microwave Products Division
Sales and Service
PO Box 10
Gunnels Wood Road
STEVENAGE
Hertfordshire SG1 2AU
Telephone: (0438) 2311
Telex: 82159

A GEC-Marconi Electronics Company

Printed in England

FRANCE

MARCONI INSTRUMENTS
3 Avenue du Maréchal Devaux
91550 PARAY-VIEILLE-POSTE
Telephone: 687 36 25
Telex: 203882

WEST GERMANY

MARCONI MESSTECHNIK GmbH
Postfach 153
Landsberger Strasse 65
8034 GERMERING
Telephone: 089-84 50 85
Telex: 05-212 642

USA

MARCONI INSTRUMENTS
Division of Marconi Electronics Inc.
100 Stonehurst Court
NORTHVALE
New Jersey 07647
Telephone: (201) 767-7250
TWX: 710-991-9752