

Operators Manual for Model 2250 Digital Analyzing Voltmeter

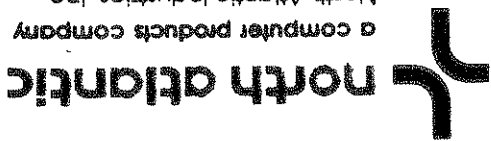

a computer products company
North Atlantic Industries, Inc.
60 Plant Avenue
Hempstead, NY 11788-3890

This capacitance will be charged to the peak input voltage applied to the measurement channel. During self-calibration, this capacitance is rapidly discharged into the system power supply producing a change in channel ground potential. This change will upset the digital circuits causing the contents of latches to be corrupted and thus affecting hardware controls. Any attempt to limit discharge current or bleed off charge would result in degradation of isolation. Therefore, the following methods should be employed to calibrate the Model 2250.

reference figure 1.
circuit ground with a typical value of 500 pfd per channel, design has a capacitance between each measurement channel and engineering has identified that the high quality isolation of the channel isolation circuitry. North Atlantic Industries up is an occurrence that appears to be likely due to the design frequency and not for each range change. High voltage hang-up is an occurrence that appears to be likely due to the design Calibration of the Model 2250 need only be done on not been clearly specified.

is an area where the proper application of the Model 2250 has during the calibration sequence. This is not a failure, it failure may be thought to exist when the Model 2250 hangs up inputs. Since this area is not specified in the manual, a calibrating the Model 2250, especially with high voltage level identified a potential hang-up problem that exists in North Atlantic Industries equipment engineers have

REFERENCE: MODEL 2250 CALIBRATION HANG-UPS

Service Bulletin #146
Page 1 of 3

Instrument Division
September 27, 1990

METHOD 1:

Disconnect the inputs to the signal and reference channels. Depress the front panel FREQ key and then enter the numeric value of the frequency that will be calibrated on the keypad, next depress the ENTER key and then the CAL key. This will activate the self-calibration sequence at the frequency entered.

METHOD 2:

If it is not possible to disconnect the incoming signal, it is recommended that the input level not exceed 10 Vrms for self-calibration, this is also the recommended limit of the AUTOCAL function.

When self-calibration is performed, it is valid for all voltage ranges. For example, if self-calibration is performed with 1 V applied to the front panel inputs, all voltage ranges, 20 mV through 500 V, are calibrated. This calibration is valid at the FREQUENCY at which self-calibration was performed, $\pm 5\%$ of that frequency.

Fig. 1

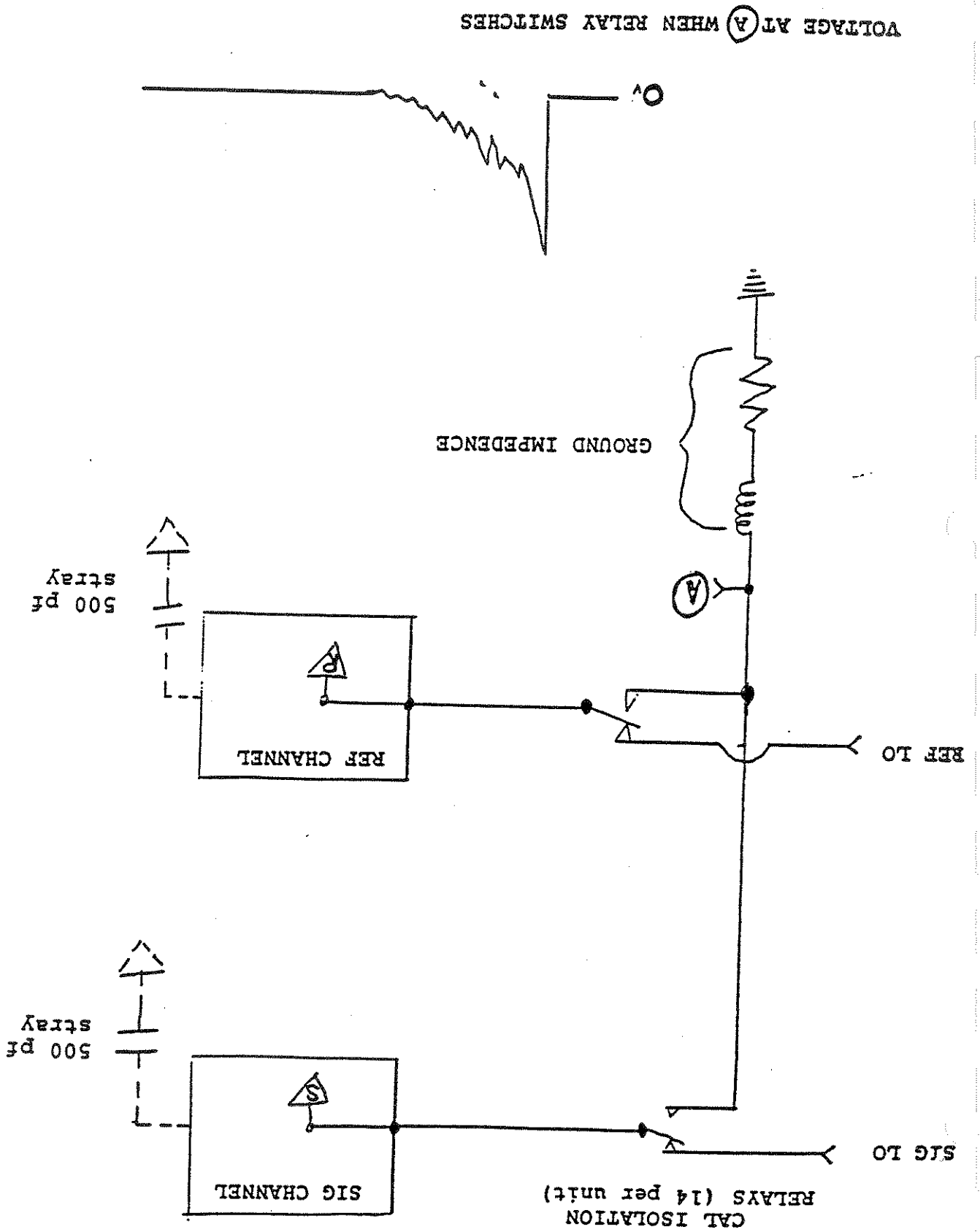

SOFTWARE CONTAINED IN PROM(S) HAS BEEN
COPYRIGHTED BY NORTH ATLANTIC INDUSTRIES, INC.
1989

Original - April 1989
Change 1 - October 1989
Change 2 - January 1990
Change 3 - July 1990

This manual applies to units with single Feature/Option numbers (FX) only.

Publication No. OM-I-5026B

STATUS OF PUBLICATION

OM-I-5026B

where: R = Total (SUM) and FUND mode ratio accuracy listed above
 θ -Phase angle of input signal
 ϕ -Phase angle accuracy at input signal

Add the following to specifications (R) listed above:
 $R + \frac{SIG\ FUND}{REF\ FUND} \times | \cos \theta - \cos(\theta - \phi) |$

QUAD RATIO

Add the following to specifications (R) listed above:
 $R + \frac{SIG\ FUND}{REF\ FUND} \times | \cos \theta - \cos(\theta - \phi) |$

IN PHASE RATIO

Specifications	Item
----------------	------

In Section I table I-5 change the following:

3-10.1 Ten Frequency Self-Calibration Storage. The DAV is capable of storing self-calibration data for any ten unique frequencies in a first-in-first-out buffer in nonvolatile memory. Self-calibration will be valid within $\pm 5\%$ of a frequency for which data was stored. The LED on the front panel CAL key will flash when no self-calibration data is stored for the frequency being measured. Note that self-calibration corrects errors in all voltage ranges regardless of voltage level. The stored value will be applied to all modes except TOTAL (AVG), which requires a separate self-calibration. There are two ways to initiate self-calibration:

2. In Section 3 replace paragraph 3-10.1 as follows:

Item	Specification
Maximum signal input during self-calibration	10 V rms

1. In Section 1 table 1-5, add the following specification:

TABLE OF CONTENTS

1-1	Introduction	1-1
1-1	Section 1 - General Information	1-1.1
1-1	Section 2 - Installation and Preparation for Use	1-1.2
1-1	Section 3 - Operation	1-1.3
1-1	Section 4 - IEEE-488 Standard Digital Interface	1-1.4
1-1	Programming	1-1.5
1-1	Section 5 - IEEE MATE Control Interface	1-1.5
1-1	Intermediate Language Option	1-1.6
1-1	Section 6 - Theory of Operation	1-1.7
1-1	Section 7 - Update Information	1-1.7
1-2	Features and Options	1-2
1-3	Functional Description	1-3
1-4	Physical Description	1-4
1-5	Specifications	1-5
SECTION 2		
2-1	INSTALLATION AND PREPARATION FOR USE	2-1
2-1	Introduction	2-1
2-1	Unpacking	2-2
2-3	Inspection	2-3
2-4	Installation	2-4
2-5	Power Requirements	2-5
2-5.1	Line Voltage Selection Circuit Card	2-5.1
2-6	Grounding	2-5.2
2-6	Mounting Procedures	2-6
2-7	Initial DAV Setup	2-7
2-7.1	Initial Factory Switch Settings	2-7.1
2-7.2	Emulation of NAI Model 225	2-7.2
2-8	Selecting Custom DAV Setups	2-8
2-8.1	Top Cover Removal	2-8.1
2-8.2	Selection of Remote Programming (IEEE-488)	2-8.2
2-10	Interface Language	2-8.3
2-11	Model 225 Device Clear (DCL) Options	2-8.4
2-11	Channel Selection for Phase Lock	2-8.4
2-11	Model 2250 Operation	2-8.4.1
2-11	Model 225 Emulation	2-8.4.2
2-12	Selection of SUM or AVG TOTAL Mode	2-8.5
2-12	Types of TOTAL modes	2-8.5.1
2-12	TOTAL (SUM) Mode	2-8.5.1.1
2-12	TOTAL (AVG) Mode	2-8.5.1.2
2-13	Recorder Output Voltage Selection (I/O Circuit Card Assembly)	2-8.6
2-9	Operational Checkout Procedure	2-9
2-9.1	Test Equipment Required	2-9.1
2-9.2	Continuity and Isolation Checks	2-9.2
2-9.2.1	Continuity Tests	2-9.2.1
2-9.2.2	Isolation Checks	2-9.2.2
2-9.2.3	Hipot Tests	2-9.2.3
2-9.3	Function Verification	2-9.3
2-9.4	Amplitude Accuracy and Phase Check, 400 Hz	2-9.4

TABLE OF CONTENTS (Continued)

2-23	Amplitude Accuracy and Phase Check, Wideband	2-9.5
2-23	IEEE-488 Interface Test	2-9.6
3-1	OPERATION	SECTION 3
3-1	Introduction	3-1
3-1	Model 225 Compatible Operation	3-1.1
3-1	Custom DAV Setups	3-1.2
3-1	Remote Programmed Operation	3-1.3
3-1	Front Panel Controls and Indicators	3-2
3-1	Rear Panel Controls and Indicators	3-3
3-12	Modes of Operation	3-4
3-12	TOTAL Mode	3-4.1
3-12	TOTAL Mode Measuring Techniques	3-4.1.1
3-12	Measurement Modifiers	3-4.1.2
3-12	Display Math Modifiers	3-4.1.3
3-13	FUNDAMENTAL Mode	3-4.2
3-13	Measurement Modifiers	3-4.2.1
3-13	Display Math Modifiers	3-4.2.2
3-13	IN PHASE Mode	3-4.3
3-14	Measurement Modifiers	3-4.3.1
3-14	Display Math Modifiers	3-4.3.2
3-14	QUADRATURE Mode	3-4.4
3-14	Measurement Modifiers	3-4.4.1
3-14	Display Math Modifiers	3-4.4.2
3-15	PHASE ANGLE Mode	3-4.5
3-15	Measurement Modifiers	3-4.5.1
3-15	Display Math Modifiers	3-4.5.2
3-16	THD Mode	3-4.6
3-16	Measurement Modifiers	3-4.6.1
3-16	Display Math Modifiers	3-4.6.2
3-16	RATIO R Modes	3-4.7
3-16	RATIO R Submodes	3-4.7.1
3-17	Measurement Modifiers	3-4.7.2
3-18	Display Math Modifiers	3-4.7.3
3-18	Ranges of Operation	3-5
3-18	Voltage Ranges	3-5.1
3-18	Ratio Ranges	3-5.2
3-18	Measurement Channels	3-6
3-19	REFERENCE Channel	3-6.1
3-19	SIGNAL Channel	3-6.2
3-19	Phase Lock Synchronization Reference	3-6.3
3-19	Measurement Modifiers	3-7
3-19	Harmonic Measurement	3-7.1
3-20	Frequency Preset	3-7.2
3-20	Display Averaging	3-7.3
3-20	Track/Hold	3-7.4
3-20	Display Math Modifiers	3-8
3-20	Phase Offset	3-8.1
3-21	Variable Scale	3-8.2
3-21	Offset	3-8.3
3-21	+180° Phase	3-8.4

TABLE OF CONTENTS (Continued)

Page		Sec./Para.
3-21	Percent Deviation	3-8.5
3-21	dB.	3-8.6
3-22	Keypad Operation	3-9
3-22	Enter Data.	3-9.1
3-22	Read/Modify Data.	3-9.2
3-22	Clear Data.	3-9.3
3-23	Self-Calibration	3-10
3-23	Ten Frequency Self-Calibration Storage.	3-10.1
3-23	TOTAL (AVG) Calibration	3-10.2
3-23	AUTOCAL Operation	3-10.3
3-23	Recorder Output	3-11
3-24	Output Options.	3-11.1
3-24	Recorder Outputs in Various Operating Modes	3-11.2
3-24	Typical Applications	3-12
3-25	AC Voltage Measurement	3-12.1
3-26	Phase Sensitive AC Voltage Measurement.	3-12.2
3-27	Phase Angle Measurement	3-12.3
3-28	Frequency Response Measurements in dB	3-12.4
3-28	Setup Frequencies	3-12.4.1
3-28	Measure Response.	3-12.4.2
3-29	THD Measurements.	3-12.5
3-29	Percent Deviation Measurements.	3-12.6
3-30	Harmonics Measurements.	3-12.7
3-30	Harmonic Fundamental Amplitude.	3-12.7.1
3-30	Harmonic Inphase Component Amplitude.	3-12.7.2
3-31	Harmonic Quadrature Component Amplitude.	3-12.7.3
3-31	Harmonic Phase Angle Measurement.	3-12.7.4
3-32	Transformation Ratio Measurement.	3-12.8
3-33	Synchro/Resolver Bridge Null Indicator.	3-12.9
3-34	Synchro Electrical Zero (Null) Tests.	3-12.10
3-35	Impedance Angle and Power Factor Measurements	3-12.11
3-36	Impedance Magnitude	3-12.12
3-37	AC Resistance and Reactance Measurements.	3-12.13
3-38	Condition Transducer Output for Convenient Display.	3-12.14
4-1	INTRODUCTION	4-1
4-1	Interface Functions Supported	4-1.1
4-1	Remote Program Language Selection	4-1.2
4-2	DAV Address	4-1.3
4-2	IEEE-488 Interface Connections.	4-1.4
4-2	Power-Up.	4-1.5
4-5	DAV Front Panel Annunciators.	4-1.6
4-5	Bus Commands	4-2
4-5	Bus Command Descriptions.	4-2.1
4-6	Default Settings.	4-2.2
4-6	Serial Poll	4-2.3
4-6	Model 2250 NATIVE Language Device Dependent Messages	4-3
4-6	Mode Programming.	4-3.1
4-6	Mode Programming Examples	4-3.1.1
4-7	Ratio R Mode Programming Examples	4-3.1.2
4-1	IEEE-488 STANDARD DIGITAL INTERFACE PROGRAMMING	SECTION 4

4-3.2	Range Programming	4-8
4-3.2.1	Voltage Range Programming	4-8
4-3.2.2	Ratio Range Programming	4-8
4-3.3	Measurement Channel Programming	4-8
4-3.4	Measurement Modifier Programming	4-9
4-3.4.1	Harmonic Measurement Programming	4-9
4-3.4.2	Frequency Preset	4-9
4-3.4.3	Data Averaging	4-10
4-3.4.4	Track/Hold Programming	4-10
4-3.5	Data Math Modifier Programming	4-10
4-3.5.1	Phase Offset Programming	4-10
4-3.5.2	Variable Scale Programming	4-10
4-3.5.3	Offset Programming	4-11
4-3.5.4	+180° Phase Programming	4-11
4-3.5.5	Percent Deviation Programming	4-12
4-3.5.6	dB Programming	4-12
4-3.6	Self-Calibration Programming	4-12
4-3.7	AUTO CAL Function Programming	4-13
4-4	Model 2250 NATIVE Language Talk Messages	4-13
4-4.1	TALK Message Format Programming	4-13
4-4.2	Main Display Transmission Format	4-14
4-4.3	Frequency Display Transmission Format	4-14
4-4.4	Status Transmission Format	4-14
4-5	Model 2250 NATIVE Language Serial Poll	4-15
4-6	Model 2250 NATIVE Language Service Request Programming	4-15
4-6.1	Assert SRQ With Stable Data or Measurement Timeout	4-16
4-6.2	Assert SRQ Continuously Programming	4-16
4-6.3	Assert SRQ On External Trigger Programming	4-16
4-6.4	Cancel SRQ Function Programming	4-17
4-7	Model 2250 NATIVE Language Group Execute	4-17
4-8	Trigger Programming	4-17
4-8	Model 225 Emulation Listen Message Programming	4-20
4-8.1	Listen Message Data Format	4-20
4-8.1.1	Long Format Listen Syntax	4-20
4-8.1.2	Short Format Listen Syntax	4-20
4-8.2	Model 225 Emulation Listen Instructions and Arguments	4-21
4-8.2.1	Listen Instructions	4-21
4-8.2.2	Mode Arguments	4-21
4-8.2.3	Range Arguments	4-21
4-8.2.4	Frequency Arguments	4-22
4-8.2.5	Reference (Phase) Offset Arguments	4-22
4-8.2.6	Variable Scale Arguments	4-22
4-8.2.7	Data Output Format Programming	4-23
4-8.3	Modifier Value Storage	4-23
4-8.4	Self-Calibration Programming	4-23
4-9	Model 225 Emulation Talk Messages	4-24
4-9.1	Talk Message Data Format	4-24
4-9.1.1	Long Talk Message Format	4-24
4-9.1.2	Short Talk Message Format	4-24
4-10	Model 225 Emulation Serial Poll	4-25
4-11.1	Assert SRQ With Stable Data or Measurement Timeout	4-25

TABLE OF CONTENTS (Continued)

TABLE OF CONTENTS (Continued)

4-11.2	Assert SRQ On Second Reading Programming.	4-26
4-11.3	Assert SRQ Continuously Programming.	4-26
4-12	Model 225 Emulation Group Execute Trigger	4-26
4-13	Request Programming	4-26
	Model 225 Emulation Device Clear Options	4-26
SECTION 5		
5-1	Introduction	5-1
5-1.1	Input/Output String Notation.	5-1
5-1.2	Selection of IEEE-488 MATE Operation.	5-1
5-1.3	Initial Setup	5-2
5-2	Inputs	5-2.1
5-2.1	Format of Inputs.	5-2.2
5-2.2	Format of FNC.	5-2.3
5-2.3	Noun.	5-2.4
5-2.4	MCHAR.	5-2.5
5-2.5	Channel Number.	5-2.6
5-2.6	Modifier Fields	5-2.6.1
5-2.6.1	Set Codes	5-2.6.2
5-2.6.2	Modifier.	5-2.6.3
5-3	Nonstandard Form.	5-3
5-3.1	TOTAL Mode.	5-3.1
5-3.2	FUNDAMENTAL Mode.	5-3.2
5-3.3	IN PHASE Mode.	5-3.3
5-3.4	QUADRATURE Mode.	5-3.4
5-3.5	PHASE ANGLE Mode.	5-3.5
5-3.6	Total Harmonic Distortion (THD)	5-3.6
5-3.7	Harmonic Phase.	5-3.7
5-3.8	Harmonic Voltage.	5-3.8
5-3.9	Frequency	5-3.9
5-3.10	Averaging	5-3.10
5-3.11	Voltage Ranging	5-3.11
5-3.12	Track/Hold Mode	5-3.12
5-3.13	Reference Channel Measurements.	5-3.13
5-3.14	Calibration	5-3.14
5-4	Format of INX	5-4
5-5	Format of FTH	5-5
5-6	Format of CLS	5-6
5-7	Format of OPN	5-7
5-8	Format of RST	5-8
5-9	Format of STA	5-9
5-10	Format of IST	5-10
5-11	Format of CNF	5-11
5-12	Outputs	5-12
5-12.1	Errors.	5-12.1
5-12.2	Response to INX	5-12.2
5-12.3	Response to FTH	5-12.3
5-12.4	Response to STA	5-12.4
5-13	Atlas Constructions	5-13

Sec./Para.

Page

TABLE OF CONTENTS (continued)

Page		Sec./Para.
5-14	Calibration	5-13.1
5-14	Standard (Non-Referenced) AC Voltage Measurement (True Rms Voltage)	5-13.2
5-14	Referenced AC Voltage Measurements (True Rms Voltage)	5-13.3
5-15	Referenced AC Voltage Measurements - Fundamental Component	5-13.4
5-15	Referenced AC Voltage Measurements - IN PHASE Component	5-13.5
5-16	Referenced AC Voltage Measurements - QUADRATURE Component	5-13.6
5-16	Referenced AC Voltage Measurements - Harmonic Component	5-13.7
5-17	Referenced AC Voltage Measurements - Harmonic Component	5-13.8
5-18	PHASE ANGLE Measurements - Fundamental Component	5-13.9
5-18	PHASE ANGLE Measurements - Harmonic Component	5-13.10
5-19	Total Harmonic Distortion Measurement	5-14
5-20	CITL Railroad Diagrams	5-14.1
5-20	Standard (Non-Referenced) AC Voltage Measurement True RMS	5-14.2
5-21	Standard (Referenced) AC Voltage Measurement True RMS	5-14.3
5-22	Referenced AC Voltage Measurement Fundamental Component	5-14.4
5-23	Referenced AC Voltage Measurement IN PHASE Component	5-14.5
5-24	Calibration	5-14.6
5-25	Referenced AC Voltage Measurement QUADRATURE Component	5-14.7
5-26	Referenced AC Voltage Measurement Harmonic Component	5-14.8
5-27	PHASE ANGLE Measurement Fundamental Component	5-14.9
5-28	PHASE ANGLE Measurement Harmonic Component	5-14.10
5-29	Total Harmonic Distortion	5-14.11
5-30	Summary of MATE Programming Syntax	
SECTION 6		
6-1	THEORY OF OPERATION	
6-1	Introduction	6-1
6-1	Overall Block Diagram Discussion	6-2
6-1	Front-End Section	6-2.1
6-1	Input Signal Path	6-2.1.1
6-1	Reference Signal Path	6-2.1.2
6-3	Analog to Digital Converters	6-2.2
6-3	Filter CCA	6-2.3
6-3	The Accumulator (2)	6-2.4
6-3	Timing and Control CCA	6-2.5
6-3	Phase-Locked Loop (PLL) CCA	6-2.6
6-3	Autocalibration CCA	6-2.7
6-3	Microprocessor CCA	6-2.8
6-3	ROM and RAM (Memory CCA)	6-2.9
6-4	Input/Output CCA	6-2.10
6-4	The Display Driver CCA	6-2.11
6-4	Keyboard and Display CCA	6-2.12
6-3	Power Supplies	6-3
6-3.1	System Level Power Supply	6-3.1
6-3.2	Isolated Power Supplies	6-3.2
SECTION 7		
7-1	UPDATE INFORMATION	
7-1	Introduction	7-1

LIST OF ILLUSTRATIONS

Page	1-5	Model 2250 Digital Analyzing Voltmeter	Figure	1-1
------	-----	--	--------	-----

Page	2-1	DAV Outline and Dimension Drawing	Figure	2-1
Page	2-2	Inserting Voltage Selection Circuit Card	Figure	2-2
Page	2-3	Top Cover Removal	Figure	2-3
Page	2-10	Optional Function Switch Locations	Figure	2-4
Page	2-11	Function Verification	Figure	2-5
Page	2-22	Amplitude Accuracy and Phase Check, (400 Hz)	Figure	2-6

Page	3-1	Front Panel Controls and Indicators	Figure	3-1
Page	3-10	Rear Panel Controls and Connectors	Figure	3-2

Page	4-1	Rear Panel DIP Switches	Figure	4-1
Page	4-2	Long Format Listener Format	Figure	4-2
Page	4-20	Short Format Listener Format	Figure	4-3
Page	4-24	Long Format Talk Message	Figure	4-4
Page	4-24	Short Format Talk Message	Figure	4-5

Page	5-2	IEEE-488 MATE Address Switch Selection	Figure	5-1
Page	6-2	Model 2250 DAV Overall Block Diagram	Figure	6-1

LIST OF TABLES

Page	1-1	F1/F1X Model Identification Chart	Table	1-1
------	-----	-----------------------------------	-------	-----

Page	1-2	F2/F2X Model Identification Chart	Table	1-2
Page	1-3	Features and Options	Table	1-3
Page	1-4	Model 2250 Major Assemblies	Table	1-4
Page	1-6	Specifications	Table	1-5

Page	2-1	Initial Factory Switch Settings for F1 Option	Table	2-1
Page	2-2	Initial Factory Switch Settings for F2 Option	Table	2-2
Page	2-3	Initial Factory Switch Settings for F3 Option	Table	2-3
Page	2-4	Test Equipment	Table	2-4
Page	2-5	Function Verification Procedure	Table	2-5
Page	2-6	Amplitude Accuracy and Phase Check	Table	2-6
Page	2-7	Amplitude Accuracy and Phase Check (Wideband)	Table	2-7
Page	2-24	IEEE-488 Test Program	Table	2-8

Page	3-1	Front Panel Controls and Indicators	Table	3-1
Page	3-2	Rear Panel Controls and Connectors	Table	3-2
Page	3-10	Rear Panel Mating Connector Contacts	Table	3-3
Page	3-11	Channel Used For Phase Lock	Table	3-4
Page	3-19	Dc Recorder Outputs vs. Mode	Table	3-5

Page	4-1	IEEE-488 Interface Functions and Descriptions	Table	4-1
Page	4-2	IEEE-488 Interface Language Selection	Table	4-2
Page	4-3	Device Address Codes	Table	4-3
Page	4-4	IEEE-488 Interface Connector Pin Assignments	Table	4-4
Page	4-5	Bus Commands	Table	4-5

LIST OF TABLES (continued)

Page		Table
4-6	Mode Programming Mnemonics	4-6
4-7	Modifiers Allowed In Each Mode	4-7
4-8	Voltage Range Codes	4-8
4-9	Ratio Range Codes	4-9
4-9	Serial Poll Status Byte	4-9
4-10	2250 Native Language Reference Guide	4-10
4-11	Calibration Error Descriptions	4-11
4-12	Model 225 Emulation Listen Instructions	4-12
4-13	Mode Programming	4-13
4-14	Range Arguments	4-14
4-15	Frequency Arguments	4-15
4-16	Reference Offset Arguments	4-16
4-17	Variable Scale Arguments	4-17
4-18	Data Output Format Arguments	4-18
4-19	Model 225 Emulation Serial Poll Status Byte	4-19
4-20	Service Request Arguments	4-20
4-21	Group Trigger Enable Arguments	4-21
4-22	225 Emulation Device Clear Options	4-22
4-23	Model 225 Emulation Programming Guide	4-23
4-24	Model 225 Emulation Long Talk Message Summary	4-24
5-1	Voltage Range Selection	5-1
5-2	Error Messages	5-2
5-3	CIL Codes	5-3
5-4	Modifier Limits	5-4

The front SIG and REF binding posts are connected to the corresponding rear panel connectors. If a high voltage is applied to the front input binding posts, high voltages capable of causing personal injury or death will appear at the rear input connectors. Similarly, if a high voltage is applied at the rear input connectors, a high voltage capable of causing personal injury or death will appear at the front binding posts.

WARNING

If the top cover of the Model 2250 is removed while the guard terminals are driven with a voltage, operator and maintenance personnel could come in contact with high voltages capable of causing personal injury or death.

WARNING

Failure to ground the chassis could bring operator and maintenance personnel in contact with high voltages capable of causing personal injury or death.

WARNING

WARNING

Table I-1. F1/FIX Model Identification Chart

NAI	Model	Version	Check Sum
2250	1.0	1.0	3B1C
	1.1	1.1	DAB0
	1.2	1.2	E4A0
	1.3	1.3	3BDF
	1.4	1.4	46BF
	2.0	2.0	b767
	2.1	2.1	6767
	2.2	2.2	F9C5
	2.3	2.3	9595
	2.4	2.4	A7F4
	2.5	2.5	6044
2250	3.0	3.0	13AB
	3.1	3.1	8FB6
	4.0	4.0	F8C9
	5.0	5.0	52CF
	5.1	5.1	8E65
	5.2	5.2	7458
	5.3	5.3	C3A3
	5.4	5.4	54D1
	5.5	5.5	2619
	6.0	6.0	016E
	6.1	6.1	1299

Table I-2. F2/F2X Model Identification Chart

NAI	Model	Version	Check Sum
2250	1.0	1.0	DE24
	1.1*	1.1*	FD8e
	1.2	1.2	C5D0
	1.3	1.3	F5A0
	1.4	1.4	0P26
	1.5	1.5	0EB6
	1.6	1.6	0993
	1.7	1.7	097E
	2.0**	2.0**	FB2E
	2.1	2.1	FB46
	2.2	2.2	B634
	2.3	2.3	B61F

*In 2250 Model Versions 1.4 - 1.5 and lower PROMS UI, U2, U5, and U6 are NAI P/N 887904.
 **In 2250 Model Versions 2.0 and higher PROMS UI and U2 are NAI P/N 888672.

GENERAL INFORMATION

1-1 INTRODUCTION

This manual provides operational instructions for the Digital Analyzing Voltmeter Model 2250 shown in figure 1-1, hereinafter referred to as the DAV. The manual is divided into six sections as follows:

1-1.1 Section 1 - General Information. This section provides general physical and functional descriptions of the DAV. It includes a table of specifications, feature/option information with version type and corresponding check sum numbers for unit feature identification, and how-to-order information.

1-1.2 Section 2 - Installation and Preparation for Use. This section gives instructions for unpacking, general inspection, installation and mounting procedures, power requirements, initial setups, custom setups, and a comprehensive operational check-out procedure for the DAV.

1-1.3 Section 3 - Operation. This section illustrates and explains specific operation of controls and indicators, general unit operation, and includes examples of practical applications.

1-1.4 Section 4 - IEEE-488 Standard Digital Interface Programming. This section contains procedures and programming examples for remote operation of the DAV using the IEEE-488 digital interface and for NAI Model 225 Phase Angle Voltmeter emulation.

1-1.5 Section 5 - IEEE MATE Control Interface Intermediate Language Option. This section describes the operation and programming of the DAV using the IEEE-488 MATE CONTROL INTERFACE INTERMEDIATE LANGUAGE (CIIL) OPTION.

1-1.6 Section 6 - Theory of Operation. This section describes functional theory of operation for the DAV. It includes a block diagram illustrating major system components and basic signal paths.

1-1.7 Section 7 - Update Information. As NAI continues to improve the performance of the DAV, corrections and modifications to the manual may be received. This section contains Product Revision Sheet (PRS) data which updates the unit to the most current configuration available.

The manual reflects current and previous configurations of the Model 2250. For model identification purposes, on power-up the unit displays a check sum number for two seconds. Refer to tables 1-1 and 1-2 to determine versions and corresponding check sum numbers. Version numbers are assigned as follows: 1.0, 1.1, 1.2...1.X; 2.0, 2.1, 2.2...2.X; etc. The X indicates all features are applicable to that particular version.

The Model 2250 has been manufactured in two different hardware configurations. These units either have the TOTAL/AVG function or they do not. Unit versions can be identified by their check sum numbers. Table 1-1 identifies model versions and check sum number data as well as the NAI manual that should accompany the unit.

1-2 FEATURES AND OPTIONS

The DAV is available with various options and custom configurations. To determine features and options, a single digit number is assigned in accordance with table 1-3.

For example, a DAV with Native IEEE Interface (standard 2250) would have a feature/option number of F1.

F
 1
 F1

Table 1-3. Features and Options

Feature		No.	Description
Option			
Interface Feature		F1	
NOTE			
1. Native IEEE Interface			
2. MATE-CIIL and Native IEEE Interface			
3. 225 Emulation IEEE Interface			
The Model 2250 chassis is supplied with mounting holes to accommodate Jonathan Interior Slides P/N 1302541B-R and 1302541B-L. Refer to Figure 1-3 for details.			

1-3 FUNCTIONAL DESCRIPTION

The Model 2250 (figure 1-1) is a 16-bit microprocessor-based Digital Analyzing Voltmeter that utilizes waveform sampling technology and sophisticated signal processing techniques. The unit is used to measure all conventional phase angle voltmeter signals parameters (phase angle, fundamental, inphase, and quadrature); in addition, the unit contains extensive signal analysis features used for determination of magnitude, phases and harmonic parameters of measured signals. The DAV is a dual-channel measurement system comprising identical signal and reference circuitry. Reference autoring allows operation with reference levels ranging from 2 mV to 500 V rms. The reference and signal channel isolation features enable the input voltages to float with respect to the circuit ground.

Front panel controls permit easy selection of functions including six input signal ranges from 20 mV through 500 V and autoring. All front panel mode selections, including data input through keyboard and calibration data, are stored in a non-volatile RAM with battery backup. The lower multisegmented horizontal bar display graph is a digital null meter equivalent to an analog edge reading meter. It provides the operator with an "analog" indication when measuring the relative magnitude and direction of the voltage. It is particularly useful in "nulling" applications such as in the zeroing of a synchro or when adjusting a potentiometer.

1-4 PHYSICAL DESCRIPTION

The Model 2250 DAV is designed for bench or rack mounted use. It has fourteen circuit card assemblies mounted in a circuit card cage. In addition, there are two display circuit card assemblies located behind the front display panel and three separate power supply assemblies in the rear section of the unit. Refer to table 1-4.

Ref Des	Description
A1	Microprocessor Circuit Card Assembly (CCA)
A2	Memory CCA (ROM/RAM)
A3	I/O CCA (IEEE-488, REC Out, TRIG In)
A4	Timing and Control CCA
A5	Phase-Locked Loop CCA
A6	Reference Accumulator CCA
A7	Signal Accumulator CCA
A8	Auto Calibration CCA
A9	Reference A/D Converter CCA
A10	Reference Filter CCA
A11	Reference Front End CCA
A12	Signal A/D Converter CCA
A13	Signal Filter CCA
A14	Signal Front End CCA
A15	Front Bezel Assembly
A15A1	Keyboard Assembly
A15A2	Display Driver CCA
A15A3	Display CCA
A15A4, A15A5	Isolation CCA
A16	Chassis Assembly
A16A1	Motherboard CCA
A17	Rear Panel Assembly
A17B1	Fan Assembly
A17PS1	System Level Power Supply Assembly
A17PS2	Reference Isolated Power Supply Assembly
A17PS3	Signal Isolated Power Supply Assembly
A17T1	Main Transformer Assembly

Table 1-4. Model 2250 Major Assemblies

Figure 1-1. Model 2250 Digital Analyzing Voltmeter

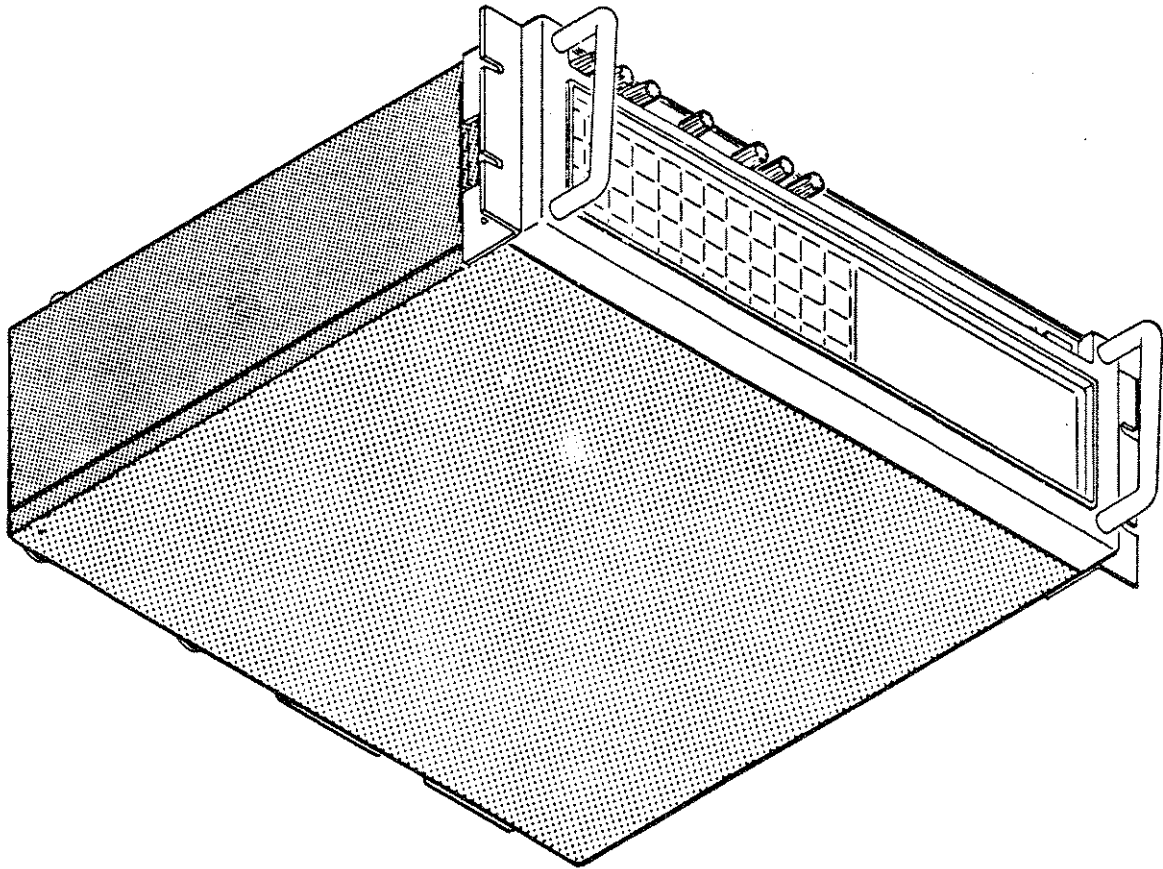

Table 1-5 provides electrical and mechanical specifications for the Model 2250 DAV.

Table 1-5. Specifications

Item	Specifications
Voltage range	20 mV to 500 V * rms full scale in six ranges.
Maximum signal input	500 V rms \pm 400 V dc, total to 700 V peak maximum.
Reference voltage range	2 mV to 500 V * rms, autoranging (no adjustment necessary); 400 V dc, total of 700 V peak maximum.
Signal autoranging	Up ranges at approximately 109% of range. Down ranges at approximately 10% of range.
Ratio autoranging	Up ranges at 160% of range. Down ranges at 10% of range.
Maximum signal input during self-calibration	10 V rms
Display	0.56-inch LED main display.
Voltage	4-1/2 digits, 0.005% full range resolution.
Phase	+0.0° to +359.99° phase lead, 0.01° resolution or 0.0° \pm 180° resolution.
Frequency range, all modes	10 Hz to 100 KHz.
Operating temperature range	100°C to 40°C ambient temperature.
Warmup time	30 minutes, for rated accuracy. (Depress "CAL" switch after warmup period.) Calibration for 10 operating frequencies plus TOTAL (AVG) may be stored in nonvolatile memory. See paragraph 3.10.
Voltage and ratio accuracy**	Specified at 23° \pm 5°C ambient temperature.

*500 V range is actually a 2000 V range with maximum signal limitations of 500 V. Use "2000 V full scale" figure to calculate accuracy specification. DO NOT apply voltages in excess of 500 V.

**Phase sensitive measurements are also affected by phase angle specifications. TOTAL mode voltage and ratio specifications apply within autorange limits only. 35 V TOTAL mode noise specification alters TOTAL mode voltage and ratio accuracy limits on signals measured on 20 mV range.

Table 1-5. Specifications (Continued)

Item	Specifications
------	----------------

TOTAL (Sum) and FUND 200V Range and 500V Range (% Full Scale + % Reading)
 modes (% Full Scale + % Reading)

IN PHASE Mode
 Same as column above
 e.g., $\pm 0.12\% \text{ FSC} + 1.2\% \text{ rdng} + \text{FUND} \times [\cos \theta - \cos(\theta - \phi)]$
 QUAD Mode
 Same as column above
 e.g., $\pm 0.12\% \text{ FSC} + 1.2\% \text{ rdng} + \text{FUND} \times [\sin \theta - \sin(\theta - \phi)]$
 where: θ = Phase angle of input signal
 ϕ = Phase angle accuracy at input frequency

TOTAL (AVG) Mode

Ratio range	Full Scale Ratio	Autorange Uprange Point	Maximum Display
10 Hz to 26 Hz	0.25% FSC	0.25% FSC	0.5% reading
>26 Hz to 10 KHz	0.125% FSC	0.125% FSC	0.25% reading
>10 KHz to 30 KHz	0.25% FSC	0.25% FSC	0.5% reading
>30 KHz to 100 KHz	0.50% FSC	0.50% FSC	1.0% reading

Ratio modes
 Reference input voltage:
 2 mV rms to 500 V rms continuous.

Ratio range	Full Scale Ratio	Autorange Uprange Point	Maximum Display
.01	10.000 x 10 ⁻³	16.000	99.999 x 10 ⁻³
.1	100.00 x 10 ⁻³	160.000	999.999 x 10 ⁻³
1	1.0000	1.6000	9.9999
10	10.000	16.000	99.999
100	100.00	160.00	999.99
1000	R 1000.0		9999.99

Table I-5. Specifications (Continued)

Item	Specifications
------	----------------

NOTE

The Main Display SCALE prompt flags excessive ratio when not in autoranging mode. Signal and reference voltage ranges always autorange when in ratio mode.

Ratio accuracy

@23 +50C ambient temperature where:
 V_{ref} = The actual voltage applied to the REF input. (This may be displayed by going out of Ratio mode and into TOTAL and READ REF.)
 V_{rng} = The reference voltage range (in volts) being used. (This range is annunciated when the reference voltage is read as described above.)
 R_{rng} = ratio range
 R = ratio tolerance

TOTAL (Sum) and FUND

200 V Range and

All Other Ranges

modes

10 Hz to 30 Hz	$R = (0.0020 R_{rng}) \frac{V_{rng}}{V_{ref}}$	$+ 0.0020 \times \text{Reading}$
>30 Hz to 1.5 kHz	$R = (0.0010 R_{rng}) \frac{V_{rng}}{V_{ref}}$	$+ 0.0020 \times \text{Reading}$
> 1.5 kHz to 5 kHz	$R = (0.0012 R_{rng}) \frac{V_{rng}}{V_{ref}}$	$+ 0.0024 \times \text{Reading}$
> 5 kHz to 20 kHz	$R = (0.0012 R_{rng}) \frac{V_{rng}}{V_{ref}}$	$+ 0.0042 \times \text{Reading}$
>20 kHz to 32 kHz	$R = (0.0024 R_{rng}) \frac{V_{rng}}{V_{ref}}$	$+ 0.0068 \times \text{Reading}$
>32 kHz to 54 kHz	$R = (0.0024 R_{rng}) \frac{V_{rng}}{V_{ref}}$	$+ 0.0160 \times \text{Reading}$
>54 kHz to 100 kHz	$R = (0.0024 R_{rng}) \frac{V_{rng}}{V_{ref}}$	$+ 0.0240 \times \text{Reading}$

Table I-5. Specifications (Continued)

Specifications	Item
$R + \frac{\text{SIG FUND}}{\text{REF FUND}} \times [\cos \theta - \cos(\theta - \phi)]$	IN PHASE RATIO
$R + \frac{\text{SIG FUND}}{\text{REF FUND}} \times [\cos \theta - \cos(\theta - \phi)]$	Same as column above QUAD RATIO
$R + \frac{\text{SIG FUND}}{\text{REF FUND}} \times [\cos \theta - \cos(\theta - \phi)]$	Same as column above where: θ = phase angle of input signal ϕ = phase angle accuracy at input signal
$\frac{f(\text{in KHz})}{100} \text{ degrees}$ $+0.10^\circ$ $\pm 0.05^\circ$	Orthogonality 10 Hz to 30 Hz > 30 Hz to 5.0 KHz > 5.0 KHz to 100 KHz
Equal to full scale accuracy spec. 35 V maximum. 1 V	0 Volt input accuracy Total mode noise, 20 mV range Nulling sensitivity Phase angle accuracy
Accuracy specifications apply in "Autorange" only.	10 Hz to 30 Hz > 30 Hz to 5 KHz > 5 KHz to 100 KHz Harmonic rejection (Fundamental and phase sensitive modes)
$\frac{f(\text{in KHz})}{100} \text{ degrees}$ $+0.10^\circ$ $\pm 0.05^\circ$ 2nd Harmonic: 3rd Harmonic: All high order harmonics at fundamental frequency of 400 Hz: -60 dB -80 dB -86 dB	

Table 1-5. Specifications (Continued)

Specifications	Item
<p>Harmonics evaluated:</p> <p>2nd to 30th</p> <p>2nd to 10th</p> <p>2nd and 3rd</p> <p>None</p>	<p>Total harmonic distortion</p> <p>Frequency of fundamental</p> <p>10 Hz to 3.159 kHz</p> <p>3.16 kHz to 10.599 kHz</p> <p>10.6 kHz to 28.499 kHz</p> <p>28.5 kHz to 100 kHz</p>
<p>For THD readings $\geq 2\%$: $\pm 0.015 \times \text{reading}$</p> <p>For THD readings $< 2\%$: $+[0.03 + (0.015 \times \frac{\text{ERMS}}{\text{VSCALE}})]$</p> <p>where: VSCALE is the voltage scale announced ERMS is the signal voltage</p> <p>0.00% to 999.99%</p> <p>The 2250 DAV evaluates THD relative to the fundamental by using the harmonics evaluated at the frequency of interest in accordance with the table above and the following formula:</p> $\text{THD} = \sqrt{\frac{\text{EF1}}{(\text{EF2})^2 + (\text{EF3})^2 + \dots + (\text{EFn})^2}}$ <p>where: EF1 = true rms voltage of fundamental. EF2 = true rms voltage of the second harmonic. Efn = true rms voltage of the highest harmonic evaluated for that particular fundamental frequency, per table above.</p>	<p>THD accuracy (For fundamental frequency of 10 Hz to 10 kHz)*</p> <p>THD range of evaluation</p> <p>THD method of evaluation</p> <p>THD formula</p>
<p>*See "Harmonics Evaluated" above. Measurements of signals containing high amplitude harmonics of higher orders than those evaluated may incur additional error.</p>	

Specifications	Item
<p>THD may be displayed as percent or in decibels relative to the fundamental. Excluded, as it is not an element of Total Harmonic Distortion.</p>	<p>THD display</p> <p>Random noise measurement</p> <p>Harmonic phase:</p> <p>Method of measurement</p>
<p>The phase of the selected harmonic component is measured relative to the fundamental of that signal. In READ REF mode, phase angle of the selected harmonic component of the reference is measured relative to the fundamental component of the reference.</p> <p>The phase accuracy (related to the phase of the fundamental) is n times the fundamental phase specification, where n equals the harmonic order.</p> <p>Harmonic amplitude accuracy is equal to the fundamental accuracy specification times n, where n equals the harmonic order.</p> <p>The signal and reference channel precision filters allow signals rich in harmonics (including square waves) to be evaluated for fundamental frequency phase-sensitive parameters.</p> <p>Filters are automatically switched in when in "FUND", "IN PHASE", "QUAD", and "PHASE ANGLE" modes.</p> <p>Filters are automatically switched out when in "TOTAL", or "THD" modes and during all harmonic measurements.</p>	<p>Harmonic amplitude</p> <p>Filters</p> <p>Filters switched in</p> <p>Filters switched out</p> <p>Frequency readout accuracy:</p> <p>10 Hz to 100 Hz 100 Hz to 100 KHz</p>
<p>2 Megohms shunted by 180 pF (typical).</p> <p>2 Megohms shunted by 180 pF (typical).</p> <p>+2% +0.5% -0.5%</p>	<p>REF input impedance</p> <p>SIG input impedance</p>

Table 1-5. Specifications (Continued)

Table I-5. Specifications (Continued)

Specifications	Item
<p>126 dB minimum 110 dB minimum 100 dB minimum 91 dB minimum</p>	<p>10 Hz to 999 Hz 1 kHz to 5 kHz > 5 kHz to 32 kHz > 32 kHz to 54 kHz</p>
<p>TTL compatible input, negative edge triggered. Minimum pulse width is 30 ns.</p>	<p>Trigger input</p>
<p>Separate inphase and quadrature outputs are provided.</p>	<p>*Recorder output for DAV equipped with I/O board (P/N 787172-2)</p>
<p>Full scale equals +2.00 V dc. (8.75 V optional) +0.5% of full scale added to specification for mode, range, and frequency.</p>	<p>Range Accuracy</p>
<p>1 mV nominal.</p>	<p>Resolution</p>
<p>115/230 V rms +15%, 47 to 67 Hz, 70 VA</p>	<p>Power requirements</p>
<p>2 A for 115 V operation. 1 A for 230 V operation (included in separate bag marked "for 230V operation").</p>	<p>Fuse</p>
<p>Type</p>	<p>Connectors</p>
<p>5 way binding post 5 way binding post MS3102A14S-2P MS3102A14S-2P BNC female MS3102A14S-2S IEEE-488 standard connector IEC standard 115/230 V connector</p>	<p>Front SIG input Front REF input Rear SIG input Rear REF input Trigger input Recorder output Remote Interface Power input</p>
<p>Horizontal +30°</p>	<p>Operating Position Maximum tilt angle</p>
<p>5-1/4" x 16-3/4" x 19"D</p>	<p>Dimensions</p>
<p>35 pounds (15.9 kg)</p>	<p>Weight</p>

*Refer to paragraph 2-8.6

The DAV operates from either 115 V rms $\pm 15\%$ (70 VA fused for 2 A at 115 V rms) or 230 V rms $\pm 15\%$ (1 A fuse), 47 Hz to 67 Hz.

2-5 POWER REQUIREMENTS

The DAV contains mercury-wetted relays and must be operated in a horizontal position. If the DAV is tilted more than $\pm 30^\circ$ during operation, it will not operate properly; in some instances, the DAV may be damaged if operated while tilted more than $\pm 30^\circ$.

CAUTION

The DAV is designed for bench use or rack mounting. An outline and dimension drawing of the DAV is shown in figure 2-1. The DAV requires no special cooling equipment, but it should be placed in such a way as to allow free flow of air around it. Do not obstruct the air intake slots at the front, bottom and sides of the DAV.

2-4 INSTALLATION

- a. Visually check the contents of the shipping container against the shipping list.
- b. Check for damage to unit and notify the carrier if it is damaged.
- c. Check that nothing is loose or disconnected in the unit.

2-3 INSPECTION

- a. Place the cardboard container with the shipping label on the top.
 - b. Cut tapes in the center and two sides to open the top flaps.
 - c. Remove the top foam cover to expose the unit.
 - d. Remove the unit from the container. Save the container for future use in storing or shipping.
- The DAV is shipped in a cardboard container with the unit cushioned by foam to avoid damage during shipment. Unpack the unit as follows:

2-2 UNPACKING

This section provides instructions for unpacking, inspecting, installing, and initial checkout of the Model 2250 Digital Analyzing Voltmeter (DAV).

2-1 INTRODUCTION

INSTALLATION AND PREPARATION FOR USE

SECTION 2

Figure 2-1. DAV Outline and Dimension Drawing

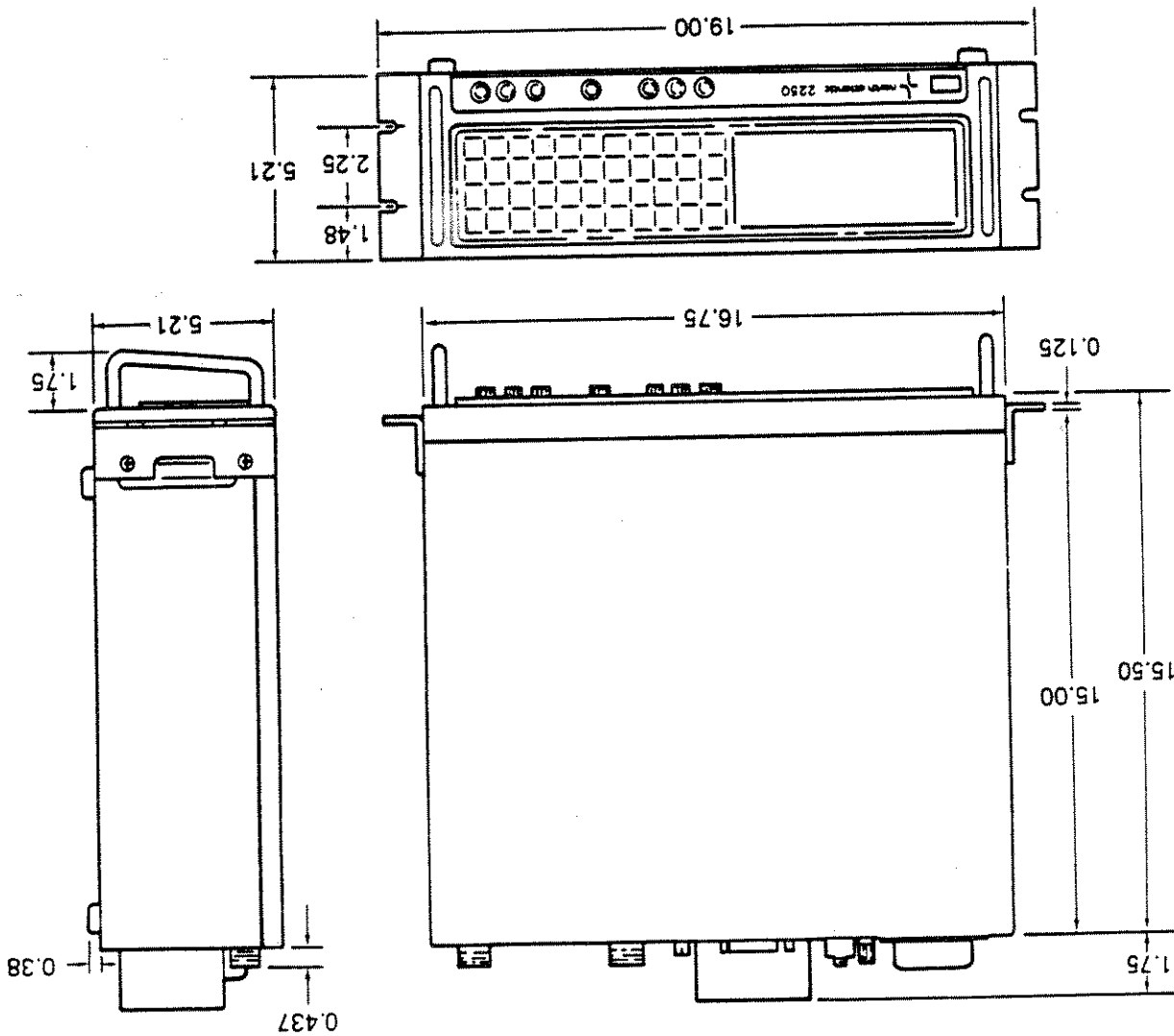

2-5.1 Line Voltage Selection Circuit Card. All Model 2250 Digital Analyzing Volt-meters are factory set for 115 V ac operation, but can operate using 115 V ac (120 on voltage card) and 230 V ac (240 on voltage card). To select the desired voltage, proceed as follows:

CAUTION

Do not plug DAV ac line cord into an ac receptacle at this time. Connection to the wrong voltage source will damage unit.

a. Remove CAUTION label.

b. To expose the voltage selection circuit card, refer to figure 2-2, slide the fuse cover to the left, and note the placarded voltage value (120 or 240).
 c. Using a needle nose pliers, grip the voltage selection circuit card and gently extract it (figure 2-2).

d. To install voltage selection card, choose new voltage and insert card with desired voltage marking facing operator.

e. To remove the existing fuse, pull the fuse ejector handle out and fuse will eject.

f. To install a 3AG 2 ampere fuse for 120 V ac input, or a 3AG 1 ampere fuse (provided in shipping carton) for 240 V ac input, simply insert the fuse in the holder and push it in until it is secure.

g. Slide fuse cover to the right and connect the ac line to DAV input power receptacle.

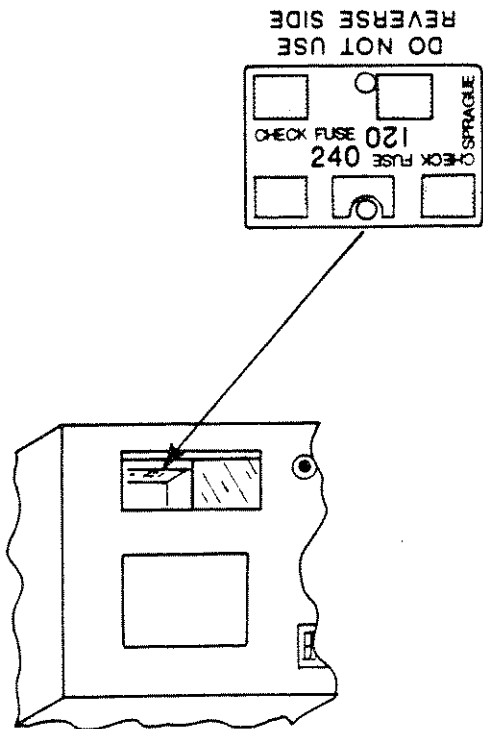

Figure 2-2. Inserting Voltage Selection Circuit Card

Switch	Position	Description	Manual Reference
A3-SW1-1	ON	225 Mode Device Clear - Frequency Select = F4	Para. 4-13, Table 4-22
	ON	2250 Native IEEE-488 Selected	Para. 4-1.2
	OFF	225 Mode Device Clear - Data Format = Long	Para. 4-13, Table 4-22
	OFF	225 Mode Device Clear - F1 = VOLTAGE	Para. 4-13, Table 4-22
	OFF	225 Mode Device Clear - F2 = VOLTAGE	Para. 4-13, Table 4-22
	OFF	225 Mode Device Clear - F3 = VOLTAGE	Para. 4-13, Table 4-22
	OFF	225 Mode Device Clear - F4 = VOLTAGE	Para. 4-13, Table 4-22
A3-SW2-1	OFF	225 Mode Device Clear - Variable Scale Disabled	Para. 4-13, Table 4-22
	OFF	225 Mode Device Clear - Offset Disabled	Para. 4-13, Table 4-22

When switch actuator is away from the circuit card assembly the switch is OPEN (OFF). When actuator is next to the circuit card assembly it is CLOSED (ON).

NOTE

Table 2-1. Initial Factory Switch Settings for F1 Option

2-7.1 Initial Factory Switch Settings.

The DAV has DIP switch selectable standard and optional features that are either factory set or selected by the operator. Table 2-1 lists and describes the initial factory switch settings for the rear panel ADDRESS switch and circuit card assemblies A3 (SW1 and SW2) and A8 (SW1) for option F1. Tables 2-2 and 2-3 have similar information for F2 and F3 options.

2-7 INITIAL DAV SETUP

The Model 2250 DAV is designed for either rack mounting or bench use. It needs no support shelf if rack mounted and comes with rack mounting hardware.

2-6 MOUNTING PROCEDURES

2-5.2 Grounding. The DAV chassis ground and the power line ground are connected to the CHAS GND terminal (green) on the rear panel. The circuit ground is connected to the CKT GND terminal (black) on the rear panel (figure 3-2). Both grounds can be connected together by the shorting link on the rear panel or externally in a test setup. Caution should be taken whenever the power line ground is disconnected.

Table 2-1. Initial Factory Switch Settings for FI Option (Continued)

Manual Reference	Description	Position	Switch
Para. 4-13	225 Mode Device Clear - Range = 10 mV	OFF	-3
Table 4-22		OFF	-4
Table 4-22		OFF	-5
Para. 4-13	225 Mode Device Clear - Mode = Phase Angle	ON	-6
Table 4-22		OFF	-7
Table 4-22		OFF	-8
See maintenance manual	SLO CAL Disabled (For Troubleshooting Only) NOTE: When enabled, press ENTER button to step through calibration sequence.	OFF	A8-SW1-1
Para. 2-8.4	Reserved for factory test only. Do not change.	OFF	-2
Para. 2-8.5	REFERENCE Channel Lock selected	ON	-3
Para. 2-8.5	TOTAL (SUM) Selected	ON	-4
See maintenance manual	No test mode selected	OFF	-5
		OFF	-6
		OFF	-7
		OFF	-8

NOTE

When Rear Panel ADDRESS switch actuator is flush with the bottom of the switch it is OPEN (OFF). When it is flush with the top of the switch it is CLOSED (ON).

Manual Reference	Description	Position	Switch
Para. 4-1.3, Table 4-3	ADDRESS set to binary 5. This factory setting is arbitrary and can be set as desired.	CLOSED	A1
		OPEN	A2
		CLOSED	A3
		OPEN	A4
		OPEN	A5
Para. 5-1.2	IEEE-488 MATE Option deactivated	OPEN	A6
		OPEN	A7
Para. 4-13	225 mode OFFSET and VAR SCALE storage disabled	OPEN	A8

REAR PANEL ADDRESS SW

Table 2-2. Initial Factory Switch Settings for F2 Option

NOTE

When switch actuator is away from the circuit card assembly the switch is OPEN (OFF). When actuator is next to the circuit card assembly it is CLOSED (ON).

Manual Reference	Description	Position	Switch
Para. 4-13, Table 4-22	225 Mode Device Clear - Frequency Select = F4	ON	A3-SW1-1 -2
Para. 4-1.2	2250 Native IEEE-488 Selected	ON	-3
Para. 4-13, Table 4-22	225 Mode Device Clear - Data Format = Long	OFF	-4
Para. 4-13, Table 4-22	225 Mode Device Clear - F1 = VOLTAGE	OFF	-5
Para. 4-13, Table 4-22	225 Mode Device Clear - F2 = VOLTAGE	OFF	-6
Para. 4-13, Table 4-22	225 Mode Device Clear - F3 = VOLTAGE	OFF	-7
Para. 4-13, Table 4-22	225 Mode Device Clear - F4 = VOLTAGE	OFF	-8
Para. 4-13, Table 4-22	225 Mode Device Clear - Variable Scale Disabled	OFF	A3-SW2-1
Para. 4-13, Table 4-22	225 Mode Device Clear - Offset Disabled	OFF	-2
Para. 4-13, Table 4-22	225 Mode Device Clear - Range = 10 mV	OFF	-3
Para. 4-13, Table 4-22	225 Mode Device Clear - Mode = Phase Angle	ON	A3-SW2-6 -7
See maintenance manual	SLO CAL Disabled (For Troubleshooting Only) NOTE: When enabled, press ENTER button to step through calibration sequence.	OFF	A8-SW1-1 -8

Table 2-2. Initial Factory Switch Settings for F2 Option (Continued)

OM-I-5026B

Manual Reference	Description	Position	Switch
	Reserved for factory test only. Do not change.	OFF	-2
Para. 2-8.4	REFERENCE Channel Lock selected	ON	-3
Para. 2-8.5	TOTAL (SUM) Selected	ON	-4
See maintenance manual	No test mode selected	OFF	-5
		OFF	-6
		OFF	-7
		OFF	-8
NOTE			
When Rear Panel ADDRESS switch actuator is flush with the bottom of the switch it is OPEN (OFF). When it is flush with the top of the switch it is CLOSED (ON).			
Para. 4-1.3, Table 4-3	ADDRESS set to binary 5. This factory setting is arbitrary and can be set as desired.	CLOSED	A1
		OPEN	A2
		CLOSED	A3
		OPEN	A4
		OPEN	A5
Para. 5-1.2	IEEE-488 MATE Option activated	CLOSED	A6
		CLOSED	A7
Para. 4-13	225 mode OFFSET and VAR SCALE storage disabled.	OPEN	A8
REAR PANEL ADDRESS SW			

Table 2-3. Initial Factory Switch Settings for F3 Option

OM-I-5026B

NOTE

When switch actuator is away from the circuit card assembly the switch is OPEN (OFF). When actuator is next to the circuit card assembly it is CLOSED (ON).

Manual Reference	Description	Position	Switch
Para. 4-13, Table 4-22	225 Mode Device Clear - Frequency Select = F1	OFF	A3-SW1-1 -2
Para. 4-13, Table 4-22	225 Stimulator IEEE-488 Selected	OFF	-3
Para. 4-13, Table 4-22	225 Mode Device Clear - Data Format = Long	OFF	-4
Para. 4-13, Table 4-22	225 Mode Device Clear - F1 = VOLTAGE	OFF	-5
Para. 4-13, Table 4-22	225 Mode Device Clear - F2 = VOLTAGE	OFF	-6
Para. 4-13, Table 4-22	225 Mode Device Clear - F3 = VOLTAGE	OFF	-7
Para. 4-13, Table 4-22	225 Mode Device Clear - F4 = VOLTAGE	OFF	-8
Para. 4-13, Table 4-22	225 Mode Device Clear - Variable Scale Disabled	OFF	A3-SW2-1 -3
Para. 4-13, Table 4-22	225 Mode Device Clear - Offset Disabled	OFF	-2
Para. 4-13, Table 4-22	225 Mode Device Clear - Range = AUTO	ON	-3
Para. 4-13, Table 4-22	225 Mode Device Clear - Mode = IN PHASE	ON	-4
Para. 4-13, Table 4-22	225 Mode Device Clear -	ON	-5
Para. 4-13, Table 4-22	225 Mode Device Clear -	OFF	-6
Para. 4-13, Table 4-22	225 Mode Device Clear -	OFF	-7
Para. 4-13, Table 4-22	225 Mode Device Clear -	OFF	-8

Table 2-3. Initial Factory Switch Settings for F3 Option (Continued)

Manual Reference	Description	Position	Switch
See maintenance manual	SLO CAL Disabled (For Troubleshooting Only) NOTE: When enabled, press ENTER button to step through calibration sequence.	OFF	A8-SW1-1
	Reserved for factory test only. Do not change.	OFF	-2
Para. 2-8.4	SIGNAL Channel Lock selected	OFF	-3
Para. 2-8.5	TOTAL (AVG) Selected	OFF	-4
See maintenance manual	No test mode selected	OFF	-5
		OFF	-6
		OFF	-7
		OFF	-8
NOTE			
When Rear Panel ADDRESS switch actuator is flush with the bottom of the switch it is OPEN (OFF). When it is flush with the top of the switch it is CLOSED (ON).			
Para. 4-1.3, Table 4-3	ADDRESS set to binary 5. This factory setting is arbitrary and can be set as desired.	CLOSED OPEN CLOSED OPEN OPEN OPEN	A1 A2 A3 A4 A5
Para. 5-1.2	IEEE-488 MATE Option deactivated	OPEN OPEN	A6 A7
Para. 4-13	225 mode OFFSET and VAR SCALE storage disabled.	OPEN	A8

REAR PANEL ADDRESS SW

2-7.2 Emulation of NAI Model 225. To emulate the NAI Model 225 Phase Angle Volt-meter the initial factory settings of the DAV must be changed to the following combination (refer to para. 4-6 and table 4-9 for details):

- a. Select TOTAL (AVG) mode (refer to para. 2-8.5).
- b. Select SIGNAL channel lock (refer to para. 2-8.4).
- c. Select Model 225 IEEE-488 remote program language (refer to para. 2-8.2).
- d. Select Model 225 OFFSET and VARIABLE SCALE storage mode for nonvolatile storage of values for Remote Programming (refer to para. 4-8.3).
- e. Set recorder output for 10,000 count display = 8.75 V output (refer to para. 2-8.6).
- f. Activate Model 225 Device Clear options (refer to para. 2-8.3, 4-13, and table 4-22).
- g. Deactivate IEEE-488 MATE option (refer to para. 5-1.2).

2-8 SELECTING CUSTOM DAV SETUPS

The DAV can be configured for specific system setups depending upon application. The following paragraphs describe how to locate controls and select these various modes of operation.

2-8.1 Top Cover Removal. The top cover must be removed to gain access to switches on circuit card assemblies A3 and A8 (figure 2-3). Proceed as follows:

- a. Turn off power to unit.
- b. Remove four screws securing top cover panel.
- c. To install cover, reverse removal procedure.

2-8.2 Selection of Remote Programming (IEEE-488) Interface Language. The DAV can optionally select IEEE-488 interface software enabling either Model 225 or Model 2250 compatibility (see Section 5 for IEEE-MATE software). Remove cover and set switch SW1-3 on circuit card A3 as follows:

- 225 Software = OFF (OPEN)
- 2250 Software = ON (CLOSED)

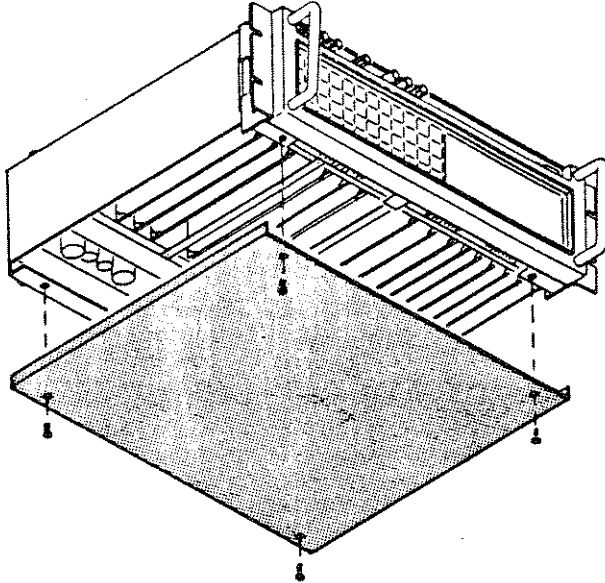

Figure 2-3. Top Cover Removal

a. The phase-lock signal needed for the TOTAL (SUM) mode may be set to use the SIGNAL channel input so no REFERENCE channel input is required. TOTAL (AVG) mode does not require phase lock.

2-8.4.1 Model 2250 Operation.

The following paragraphs list conditions which may help the user determine which channel needs to be selected:

- SIG channel = OFF (OPEN)
- REF channel = ON (CLOSED)

follows (figure 2-4):

2-8.4 Channel Selection for Phase Lock. During DAV operation or when emulating the NAI Model 225 the REFERENCE or SIGNAL channel can be selected to generate a phase-lock signal. FUNDAMENTAL and TOTAL modes lock through the REFERENCE or SIGNAL channel as selected. Phase sensitive modes PHASE ANGLE, IN PHASE, and QUADRATURE always lock through the REFERENCE channel regardless of the position of switch A8 SW1-3. To select channel, remove top cover and set circuit card A8 switch SW1-3 as

Figure 2-4. Optional Function Switch Locations

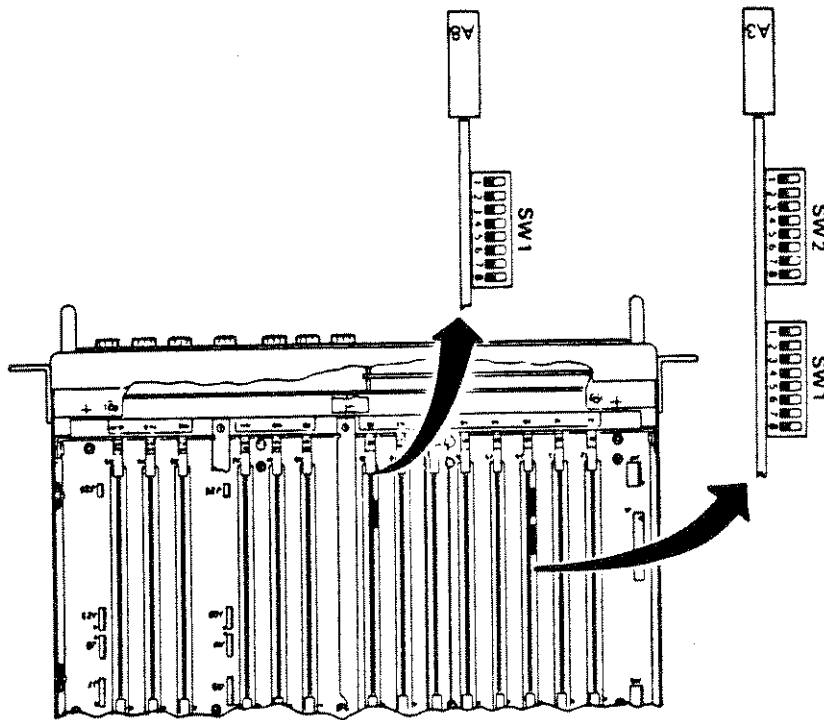

2-8.3 Model 225 Device Clear (DCL) Options. The Device Clear Option switches provide selection of Model 225 remote mode emulation default settings for Mode, Range, Frequency, Voltage/Ratio, Offset, Variable Scale, and Data Format (paragraph 2-7.2). The 225 IEEE-488 remote program language option must be selected first (paragraph 2-8.2) or Device Clear Options will not function. Remove top cover and refer to table 4-22 to set circuit card A3 switches SW1 and SW2 accordingly. Refer to figure 2-4.

The TOTAL (AVG) measurement is average responding and scaled to the rms of the fundamental, harmonics, and all noise within the passband. Phase lock is not required.

2-8.5.1.2 TOTAL (AVG) Mode. The TOTAL (AVG) mode is designed to emulate the NAI Model 225 Phase Angle Voltmeter total mode.

The result is the true rms value of a sine wave or other waveform measurement (excluding effects of asynchronous components). Phase lock is required.

This measurement includes fundamental component and all synchronous (harmonically related) noise. All asynchronous (nonharmonically related) noise is rejected.

2-8.5.1.1 TOTAL (SUM) Mode. The TOTAL (SUM) mode is calculated as the square root of the sum of the squares of the fundamental component and each harmonic component within the range of harmonics being evaluated.

2-8.5.1 Types of TOTAL modes. The TOTAL mode permits various total voltage measurements depending upon the application needed and the particular DAV version. The following paragraphs define the types of TOTAL mode voltage measurements available.

AVG = OFF (OPEN)
SUM = ON (CLOSED)

2-8.5 Selection of SUM or AVG TOTAL Mode. The DAV can select either the AVERAGE or SUM TOTAL mode depending upon the application desired (refer to paragraph 3-4.1.1). Remove top cover and set circuit card 8 switch SW1-4 as follows:

- a. The TOTAL mode voltage measurement is made only with the SIGNAL channel (reference voltage is not required).
- b. FUNDAMENTAL mode measurements are only made with the SIGNAL channel and therefore requires SIGNAL channel lock.
- c. IN PHASE, QUADRATURE, and PHASE ANGLE mode measurements require a reference voltage on the REFERENCE channel.

2-8.4.2 Model 225 Emulation.

- a. Phase lock for the FUNDAMENTAL mode may be set to use the SIGNAL channel input so no REFERENCE channel input is required.
- b. IN PHASE, QUADRATURE, and PHASE ANGLE mode measurements require a REFERENCE channel input.
- c. For signal channel measurements of nulls or very low level signals in TOTAL (SUM) or FUNDAMENTAL mode it is recommended that a separate reference signal be supplied (2 mV or greater) and that the phase-lock signal channel selection be set for REFERENCE.

- a. Remove top cover assembly (refer to paragraph 2-8.1).
- b. Locate I/O CCA A3 and remove.
- c. To select 2.000 V = 20000 display install jumper block as follows:
 - (1) IN PHASE Output. Install jumper block at W2 (W1 open).
 - (2) QUADRATURE Output. Install jumper block at W4 (W3 open).
- d. To select 8.75 V = 10000 display install jumper block as follows:
 - (1) IN PHASE Output. Install jumper block at W1 (W2 open).
 - (2) QUADRATURE Output. Install jumper block at W3 (W4 open).

Factory set for 2 Volts.

NOTE

To select the voltage option for 16-bit Output Circuit Card Assemblies (I/O CCA P/N 787172-2), proceed as follows:

When an 8.75 V = 10000 display output is selected, the display may read up to 20000; however, the recorder output is limited to 12 V dc.

NOTE

2-8.6 Recorder Output Voltage Selection (I/O Circuit Card Assembly). The DAV recorder output full scale voltage used to drive external data recorders can be selected by the operator depending upon the needed application. 2 V or 8.75 V (Model 225 emulation) may be selected. A "jumper block" is applied to the appropriate pins on the I/O circuit card assembly. The following paragraph describes how to select the recorder output voltage options.

Any distortion to the sine wave or other waveform types will result in a reading that is not the true rms value.

NOTE

The DAV uses a precision hardware full-wave rectifier and filter to convert an input signal to a dc voltage which is the average value of the ac signal. The dc voltage is scaled to equal the rms value of a sine wave.

2-9 OPERATIONAL CHECKOUT PROCEDURE

2-9.1 Test Equipment Required. Table 2-4 lists standard test equipment required for Model 2250 operational checkout. The equipment listed or their equivalents may be used.

NOTE

If an AC voltage calibrator is not available, another signal source with appropriate voltage and frequency range may be substituted, provided the Fluke 8506A multimeter is depended upon to verify amplitude accuracy (Fluke 8506A accuracy is not sufficient for the 8 mV tests). Otherwise, the accuracy specification for these tests is equal to the accuracy specification for the DAV plus the accuracy specification of the signal source used.

Table 2-4. Test Equipment

Equipment	Manufacturer	Model No.
Ac Voltage Calibrator Amplifier	John Fluke	5200A
Ac Voltage Calibrator Amplifier	John Fluke	5215A
Digital Multimeter	John Fluke	8506A
Frequency Counter	Data Precision	5740
Phase Generator	Wavetek	650
IEEE-488 Controller	Clark-Hess	5000
	Hewlett Packard	HP-85B Personal Computer
Megohmmeter	Freed Transformer	1620
Hipot	Associated Research	412
High Z Ohmmeter	Hewlett Packard	HP-412

2-9.2 Continuity and Isolation Checks.

WARNING

Hipot and megohmmeter produce dangerous voltages. Use proper precautions during these tests.

2-9.2.1 Continuity Tests. Remove front and rear panel shorting links and check continuity between the points indicated below. All resistances will typically be less than 0.5 ohm. Refer to Section 3 for front and rear panel controls and connectors.

- Line cord ground prong to Rear panel chassis gnd
- Line cord ground prong to Front panel chassis gnd
- Line cord ground prong to Top cover screw head

For all Model 2250 DAV tests, unless otherwise noted, the GUARD terminal must be linked to the LO terminal of each channel.

CAUTION

2-9.3 Function Verification. Connect the DAV as shown in figure 2-5. Adjust the variable phase generator to SINE OUTPUT, approximately 400 Hz, 0.00 degree, and 7.0 V rms into both channels. Connect the DAV to the power line and depress the power switch. Follow the sequence of keystrokes and input signal settings as shown in table 2-5 and verify that the results agree with those shown.

Line cord HI to Line cord chassis gnd

Remove rear panel ground shorting link, install the line cord, and connect a jumper between the HI and neutral prongs (gnd) of the line cord. Set Hipot at 700 V rms for 2 seconds with 2250 DAV power switch on between the following points:

SIG LO to Chassis gnd
REF LO to Chassis gnd

2-9.2.3 Hipot Tests. Reconnect front and rear panel ground links and install a shorting jumper between SIG HI and SIG LO. Install another jumper between REF HI and REF LO. Set Hipot at 400 V rms for 2 seconds between the following points:

The DAV has been hipot tested at the factory to 700 V rms and 1200 V rms as needed. Since hipot tests are cumulatively destructive, tests should be performed at the reduced levels shown below to prevent permanent damage to the DAV.

CAUTION

Rear panel CHS ground to Rear panel CKT ground
SIG LO to SIG guard
REF LO to REF guard

2-9.2.2 Isolation Checks. Disconnect line cord from power line and measure resistance between points indicated below. Resistance must be greater than 100 megohms at 500 V dc using the megohmmeter.

SIG HI Input to Rear panel J1-A
SIG LO Input to Rear panel J1-B
SIG GUARD Input to Rear panel J1-C
CASE (chassis) to Rear panel J1-D
CASE (chassis) to Rear panel J2-D
REF HI Input to Rear panel J2-A
REF LO Input to Rear panel J2-B
REF GUARD Input to Rear panel J2-C

Table 2-5. Function Verification Procedure

Check	Indication	Step
	<p>The main display indicates one of the following check sums:</p> <p>Refer to tables I-1 and I-2.</p> <p>FUND, AUTO RANGE LEDs are lit</p> <p>Main display sequences through CALibration steps.</p> <p>NOTE</p> <p>If the DAV cannot complete the calibration sequence, an error number will appear on the main display, see table 5-3 for error code descriptions.</p> <p>CAL LED off, main display: approximately 7.0 V FREQ display: approximately 400 Hz</p> <p>TOTAL LED lit.</p> <p>IN PHASE LED lit.</p> <p>QUAD LED lit.</p> <p>PHASE ANGLE key lit. approximately 0.00 deg. display.</p> <p>Display reads approximately 90.00 degrees.</p> <p>Display reads approximately 270.00 degrees.</p> <p>Display reads approximately -90.00 degrees.</p> <p>Display reads approximately 270.00 degrees.</p>	<p>Turn system power ON. The following Model 2250 versions correspond to displayed check sums:</p> <p>Refer to tables I-1 and I-2.</p> <p>Press CLEAR VAR, FUND, AUTO RANGE keys</p> <p>Press CAL key</p> <p>(Observe at end of CALibration sequence)</p> <p>Press TOTAL key</p> <p>Press IN PHASE key</p> <p>Press QUAD key</p> <p>Press PHASE ANGLE key</p> <p>Adjust variable phase generator to 90.00 degrees</p> <p>Adjust variable phase generator to 270.00 degrees</p> <p>Press +180 PHASE key</p> <p>Press +180 PHASE key again</p>

Table 2-5. Function Verification Procedure (Continued)

Step	Indication	Check
Press PHASE OFFSET key then ENTER key	Display reads approximately 0.00 degrees.	
Press CLEAR VAR key	Display reads approximately 270.00 degrees.	
Press VAR SCALE key, "." key, "5" key, then ENTER key (.5)	Display reads approximately 135.00 degrees.	
Press CLEAR VAR key	Display reads approximately 270.00 degrees.	
Adjust variable phase generator for TRIANGLE WAVE output (both channels). Press THD key	Display reads approximately 12.08%	
Press FUND key	Display reads approximately 5.670 V	
Press HMNC key, "3" key, then ENTER key	HMNC LED is lit; harmonic display reads 03 HMNC; main display reads approximately 0.625 V.	
Press CLEAR VAR key	HMNC LED goes out.	
Adjust variable phase generator for SINE OUTPUT (both channels): 7.0 V REF, 3.5 V SIG, then press FUND and RATIO R keys	Display reads approximately 0.5000	
Press RATIO R key again	Display reads approximately 3.500 V	
Press 20MV key	20MV LED is lit; display reads HHHHHH.	
Press 200MV key	200MV LED is lit; display reads HHHHHH.	
Press 2V key	2V LED is lit; display reads HHHHHH.	
Press 20V key	20V LED is lit; display reads approximately 3.500 V	
Press 200V key	200V LED is lit; display reads approximately 3.50 V	
Press 500V key	500V LED is lit; display reads approximately 3.5 V	

Table 2-5. Function Verification Procedure (Continued)

Check	Indication	Step
	FREQ LED is lit.	Press AUTO RANGE key, FREQ key, "4" key, "2" key, "0" key, then ENTER key
	FREQ LED goes out.	Press CLEAR VAR key
	AVG LED is lit.	Press AVG key, "2" key, then ENTER key
	AVG LED goes out.	Press CLEAR VAR key
	READ REF LED is lit; display reads approximately 1.0 V.	Press READ REF key
	READ REF LED goes out; display reads approx 3.5 V.	Press READ REF key again
	AUTO CAL LED is lit; CAL LED is lit; calibration begins.	Adjust variable phase generator to 450 Hz. Press AUTO CAL key
	Calibration begins at 400 Hz.	After calibration sequence is finished, readjust frequency to 400 Hz
	AUTO CAL LED goes out.	After calibration sequence is finished, press AUTO CAL key
	TRACK HOLD LED is lit; ENTER LED is flashing; display does not change.	Press TRACK HOLD key
	Display does not change.	Disconnect SIG input
	Display updates once. (ENTER LED is still flashing.)	Press ENTER key
	Display does not change.	Reconnect SIG input
	Display reads approximately 3.5 V	Press ENTER key
	TRACK HOLD LED goes out; ENTER LED goes out.	Press TRACK HOLD key
	LOCAL LED is lit.	Press LOCAL key
	LOCAL LED goes out.	Press LOCAL key
	Display reads 10,000; VAR SCALE LED is lit.	Press VAR SCALE key, then ENTER key

Table 2-5. Function Verification Procedure (Continued)

Check	Indication	Step
	Display reads approximately 7,000; VAR SCALE LED is lit.	Press VAR SCALE key, "2" key, then ENTER key
	Display reads approximately 3,500 V; VAR SCALE LED goes out.	Press CLEAR VAR key
	Display reads 0.000; OFFSET LED is lit.	Press OFFSET key, then ENTER key
	Display reads approximately 2,500 V; OFFSET LED is lit.	Press OFFSET key, "1" key, then ENTER key
	Display reads approximately 3,500 V; OFFSET LED goes out.	Press CLEAR VAR key
	Display reads approximately 0.00%; % DEVN LED is lit.	Press % DEVN key, then ENTER key
	Display reads approximately 250%; % DEVN LED is lit.	Press % DEVN key, "1" key, then ENTER key
	Display reads approximately 3,500 V; % DEVN LED goes out.	Press CLEAR VAR key
	Display reads approximately 6.0 dB; RATIO and DB LED are lit.	Press RATIO key, and DB key
	Display reads approximately 20.00 dB; DB LED is lit.	Press RATIO, CLEAR VAR, DB keys, "1" key, "3" key, "5" key, then ENTER key
	Display reads 0.3500; ENTER LED is flashing.	Press db key, and READ VAR key
	Display reads approximately 3,500 V.	Press ENTER, DB, and CLEAR VAR keys

Table 2-8. IEEE-488 Test Program

Interface Test Program	
10 OUTPUT 705; "INX MAIN"	REM: REQUEST MAIN DISPLAY DATA
15 WAIT 2000	
20 ENTER 705; V	REM: READ MAIN DISPLAY
30 OUTPUT 705; "INX FREQ"	REM: REQUEST FREQUENCY DATA
35 WAIT 2000	
40 ENTER 705; F	REM: READ FREQUENCY DATA
50 DISP "V="; V; "F="; F	REM: DISPLAY VOLTAGE & FREQUENCY
60 GOTO 10	REM: REPEAT
70 END	

This section contains general operating procedures, descriptions of controls and indicators and practical applications for the Model 2250 DAV.

3-1.1 Model 225 Compatible Operation. For applications in which the DAV is to directly replace a North Atlantic Model 225 Digital Phase Angle Voltmeter, change the initial factory switch settings as shown in paragraph 2-8.2.

3-1.2 Custom DAV Setups. Several user selectable setup options are available which make the DAV usable in a wide variety of applications. Refer to paragraph 2-8 for selection of custom setups.

3-1.3 Remote Programmed Operation. The DAV is capable of remote programmed operation using the IEEE-488 1978 interface standard. Three distinct modes of operation are possible. These modes are the Model 2250 NATIVE remote program language, the Model 225 EMULATION remote program language, and the optional MATE-CIIL remote program language. Refer to paragraph 4-1 for general information concerning remote programming of the DAV. Refer to paragraph 4-3 for Model 2250 NATIVE remote programming. Refer to paragraph 4-8 for Model 225 EMULATION remote programming. Refer to section 5 for MATE-CIIL remote programming. When the MATE-CIIL option is used, full Model 225 EMULATION capability is not available. In this case all Model 225 EMULATION remote program commands are still available, but settling and response timing may be different.

3-2 FRONT PANEL CONTROLS AND INDICATORS

Table 3-1 and figure 3-1 describe and illustrate the controls and indicators located on the front panel.

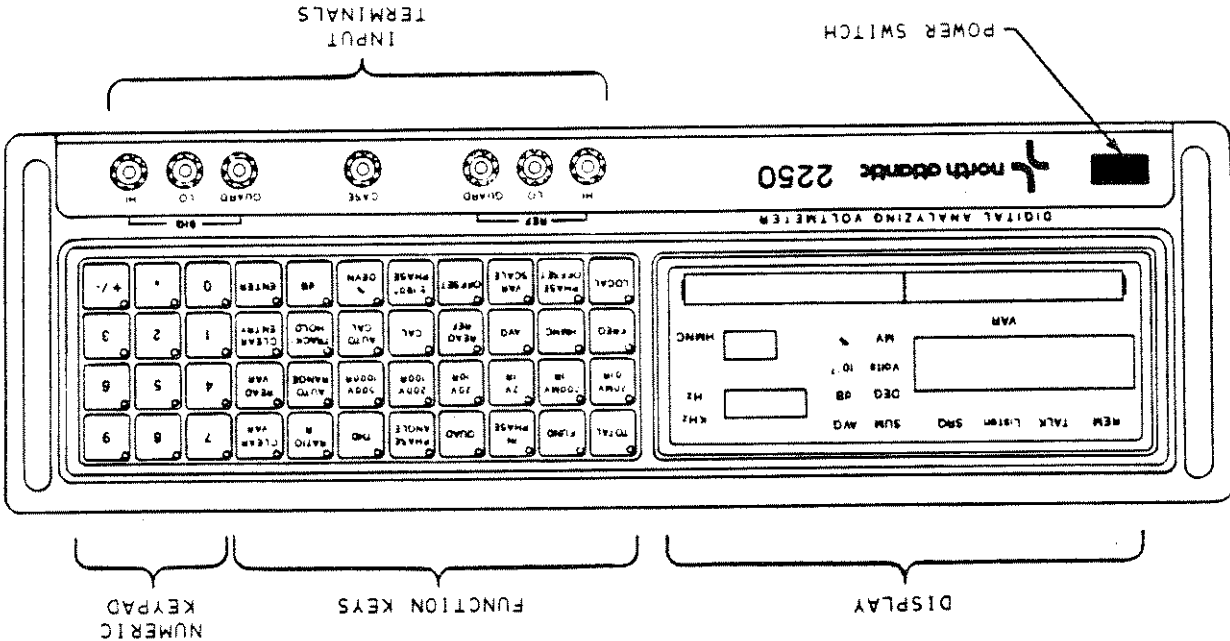

Figure 3-1. Front Panel Controls and Indicators

Selects the IN PHASE mode of operation. The IN PHASE mode initiates the measurement and display of the magnitude of the vector voltage component which is inphase with the reference frequency (0° or 180°). No sign preceding the readout represents a signal inphase with the reference; a "-" sign indicates the signal is 180° out-of-phase with the reference.

IN PHASE

Selects the FUNDAMENTAL mode of operation. The FUND mode initiates the measurement and display of the fundamental frequency voltage component (true rms) of the input signal.

FUND

Selects the TOTAL mode of operation. Two distinct types of TOTAL mode operation are possible: SUM or AVERAGE. The TOTAL mode initiates a measurement of the fundamental and harmonics up to 100 kHz. Measurement of asynchronous noise and higher order harmonics depends upon the type of TOTAL mode selected. Refer to Section 3-4.1 for a description of the two types of TOTAL mode. Refer to paragraph 2-8 to select TOTAL mode type. Note: SUM or AVG annunciator illuminates depending upon mode selected.

TOTAL

The remainder of the keys (4 rows of 7 columns) are function keys. The topmost row of keys is used to select the basic operating modes of the unit.

The four rightmost columns of keys are associated with the keypad numerics and are dark grey (numerics, decimal point, and +) and light grey (CLEAR VAR, READ VAR, CLEAR ENTRY, and ENTER).

Each key has a small red annunciator light located in the upper left corner of the switch key which comes on to indicate that it was selected and is active.

The following keyboard switches and indicators used by the operator are located on the membrane switch panel at the right portion of the front panel.

NOTE

Control/Indicator	Function
-------------------	----------

Table 3-1. Front Panel Controls and Indicators

Table 3-1. Front Panel Controls and Indicators (Continued)

Control/Indicator	Function
QUAD	<p>Selects the QUADRATURE mode of operation. The QUAD mode initiates the measurement and display of magnitude of the vector voltage component which is in quadrature with the reference frequency (90° or 270°). No sign preceding the readout represents a signal 90° out-of-phase with the reference; a "-" sign indicates the signal is 270° out-of-phase with the reference.</p>
PHASE ANGLE	<p>Selects and displays the phase angle measurement mode. The phase angle mode initiates measurement of the phase shift between the fundamental component of the signal with respect to the fundamental component of the reference. The phase angle is displayed in degrees (the DEG annunciator illuminates). Note: The FUNDAMENTAL measurement and the phase angle comprise the polar coordinate components of the input signal.</p>
THD	<p>Selects the total harmonic distortion mode and displays the total harmonic distortion in percent of the fundamental.</p>
RATIO R	<p>Alternate-action (ON/OFF) key selects/defaults a modification operation which displays a signal-to-reference ratio. RATIO R operates with the TOTAL, FUND, IN PHASE, and QUAD modes only as follows:</p>
MODE	INPUT
TOTAL	SIG
FUND	SIG
IN PHASE	SIG
QUAD	SIG
TOTAL	TOTAL
FUND	FUND
IN PHASE	FUND
QUAD	FUND
RATIO DISPLAYED	

Table 3-1. Front Panel Controls and Indicators (Continued)

Function	Control/Indicator
<p>Allows scale factor modification of a displayed value by multiplying the value by a factor. Data is entered using the keypad.</p>	VAR SCALE
<p>Allows a fixed number to be subtracted or added to the display reading. Data is entered using the keypad.</p>	OFFSET
<p>Selects/deselects modification of PHASE ANGLE reading from 0-359.99° scale to ±180° scale. Used to determine ± percentage of deviation between measurement and established nominal reading.</p>	±180° PHASE
<p>Permits various voltage gain or attenuation measurements in db. Measurements are calculated with respect to a previously stored numeric keypad entry representing a signal level.</p>	dB
<p>Sets the following variables to their default value as shown below:</p>	CLEAR VAR
<p>FREQ - Frequency preset cleared HARMONIC = 1 AVERAGE = 0.3 PHASE OFFSET = 0 VARIABLE SCALE = 1 OFFSET = 0 ±180° PHASE = OFF dB = OFF % DEVN = OFF</p>	READ VAR
<p>Variables are cleared in all modes. Press to read previously input variable value. Note: After READ VAR is executed, variable value must be entered again. Press ENTER to execute.</p>	CLEAR ENTRY
<p>Clears present entry data on display to allow corrections when using numeric keypad. Executes desired operation. (ENTER key LED blinks to indicate when needed.)</p>	ENTER
<p>Numeric keypad consists of numerals 0 through 9, decimal point (.) and +/- symbol. Used for entry of variable data.</p>	Keypad

Table 3-1. Front Panel Controls and Indicators (Continued)

FUNCTION	CONTROL/INDICATOR
<p>Red push button switch located at left bottom, recessed portion of the unit. Controls application of 115 or 230 V ac, 47 to 67 Hz input power.</p>	<p>Power Switch</p>
<p>Binding post terminals used to connect reference channel input.</p> <p>Reference input HI terminal.</p> <p>Reference return (inner shield).</p> <p>Shield connection. Terminal must be driven by a low impedance source potential or strapped to the LO terminal of the same channel.</p> <p>Instrument case ground.</p>	<p>REFERENCE TERMINALS</p> <p>HI</p> <p>LO</p> <p>GUARD</p> <p>CASE Terminal</p> <p>SIGNAL Terminals</p>
<p>Binding post terminals used to connect signal-to-be-measured input.</p> <p>Signal input HI terminal.</p> <p>Signal return (inner shield).</p> <p>Shield connection. Terminal must be driven by a low impedance source potential or strapped to the LO terminal of the same channel.</p> <p>Located on left side of unit front panel and provides information readouts such as LED annunciators, numerics, status displays, and a horizontal LED bargraph meter.</p>	<p>Display Area</p> <p>Main Numeric Display</p>
<p>Provides the main numeric readout (six seven-segment LED digits). Provides four 1/2 digit plus sign readouts of voltage in TOTAL, FUNDAMENTAL, IN PHASE, and QUADRATURE modes; ratio in RATIO mode; dB in dB mode; total harmonic distortion in THD mode; and percent in % DEVN mode. Various status report readouts are also displayed, such as: no Loc, CAL, Error, SCALE, HHHHHH, and -----.</p> <p>Indicates on main display that DAV is unable to lock because reference input is less than 2 mV or frequency is out of range.</p> <p>Indicates unit is self-calibrating.</p>	<p>"no Loc" Indication</p> <p>"CAL" Indication</p>

Table 3-1. Front Panel Controls and Indicators (Continued)

Function	Control/Indicator
<p>Indicates that a function selection has been made improperly. For example: When the DAV is in the HMNC mode and the RATIO mode selector key is pressed, an "Error" indication appears.</p>	<p>"Error" Indication</p>
<p>Indicates that the number to be displayed is out of range of the scale being used when in RATIO mode or when using VAR SCALE, OFFSET, or % DEVN. For example: When in the IR range, which restricts the maximum display to 9.9999, the number 10.000 can not be displayed.</p>	<p>"SCALE" Indication</p>
<p>Indicates that voltage applied is too high for the range selected.</p>	<p>"HHHHHH" Indication</p>
<p>Indicates THD mode is selected above 28.5 kHz or harmonic selected is not available at input frequency.</p>	<p>"-----" Indication</p>
<p>Three-digit numeric display and appropriate annunciator (Hz or kHz) indicate the internal phase-locked loop frequency.</p>	<p>Frequency display, Hz and kHz annunciators.</p>
<p>Annunciator comes on to indicate that the harmonic mode has been selected and the two-digit numeric display provides the order of the harmonic being measured (e.g., 02 = second, 03 = third, etc.).</p>	<p>Harmonic display and HMNC annunciator.</p>
<p>Indicators located in the display area which illuminate to indicate the category or description of the numeric readout on the main display or the status of the remote interface.</p>	<p>Annunciators</p>
<p>Indicates when the DAV is in the IEEE-488 REMOTE mode.</p>	<p>REM</p>
<p>Indicates when the DAV is addressed to IEEE-488 TALK mode.</p>	<p>TALK</p>
<p>Indicates when the DAV is addressed to IEEE-488 LISTEN mode.</p>	<p>LISTEN</p>
<p>Indicates when the DAV has asserted the IEEE-488 SRQ (Service Request) bus line.</p>	<p>SRQ</p>

Control/Indicator	Function
VAR	Illuminates to indicate that the main display reading has been modified by input from the control panel (e.g., if a variable scale factor of .5 was introduced, a true measurement of 10 volts is displayed as 5 volts).
DEG	Indicates degrees displayed in the phase angle mode.
VOLTS	Indicates volts displayed.
MV	Indicates millivolts displayed.
dB	Indicates decibels displayed in the dB mode.
10-3	Used only in ratio mode. Indicates that the displayed value is to be multiplied by .001 (scientific notation).
%	Indicates that percent applies to the reading displayed; used in percent deviation measurements and THD mode.
SUM	Indicates Total "SUM" mode is in use.
AVG	Indicates Total "AVG" mode is in use.
Digital Null Meter	A multisegmented digital null meter (equivalent to an analog edge meter) provides an analog indication of the voltage in the main display. The meter is located at the bottom of the display area and is 6 inches wide; the highest sensitivity null area is 5 increments on each side of the center scale mark. Each bar in that area is equal to 1 least significant digit of the scale selected. The scale becomes logarithmically compressed such that the entire 3 inches on either side of the center scale mark represent the positive and negative limits of the scale selected.

Table 3-1. Front Panel Controls and Indicators (Continued)

3-3 REAR PANEL CONTROLS AND INDICATORS

Table 3-2 and Figure 3-2 describe and illustrate the controls and connectors located on the rear panel. Table 3-3 provides rear panel mating connector types and contact information.

Table 3-2. Rear Panel Controls and Connectors

Function	Control/Indicator
Rear panel connector for signal input (refer to table 3-3). Connector type: MS3102A14S-2P	Signal connector
Rear panel connector for reference input (refer to table 3-3). Connector type: MS3102A14S-2P	Reference connector
BNC female connector for external trigger (TTL) input.	TRIGGER connector
Connects IEEE-488 standard I/O bus to unit.	IEEE connector
DIP switches A1-A5 set unit address for IEEE-488 bus. Switch A8 is used to store phase offset and variable scale values for Model 225 compatible use. Switches A6 and A7 are used to select/deselect IEEE-488 MATE option when installed.	ADDRESS switches
Connects unit outputs to recorder (refer to table 3-3). Connector type: MS3102A14S-2S	RECORDER connector
Circuit (black) and chassis (green) ground terminals linked together with a shorting link. Depending on the test setup, shorting link can be disconnected when ground loop problems occur.	KCT and CHAS GND
Power cable connector for 115 V input or 230 V input.	Input power receptacle

To configure the input power circuit for the desired input voltage (115 or 230 V ac), carefully extract the small circuit card below the fuse and insert on the circuit card so that the desired input voltage and the placarded voltage on the card agree (only one placarded voltage value is visible when the circuit card is installed). Install a 3AG 2-ampere fuse for 115 V ac input or a 3AG 1-ampere fuse for 230 V ac input. Refer to paragraph 2-5 for details.

A sliding guard cover allows access to the fuse only when the input power cable is disconnected from the rear panel receptacle. The fuse-ejector lever should be pulled forward to eject the fuse.

NOTE

Figure 3-2. Rear Panel Controls and Connectors

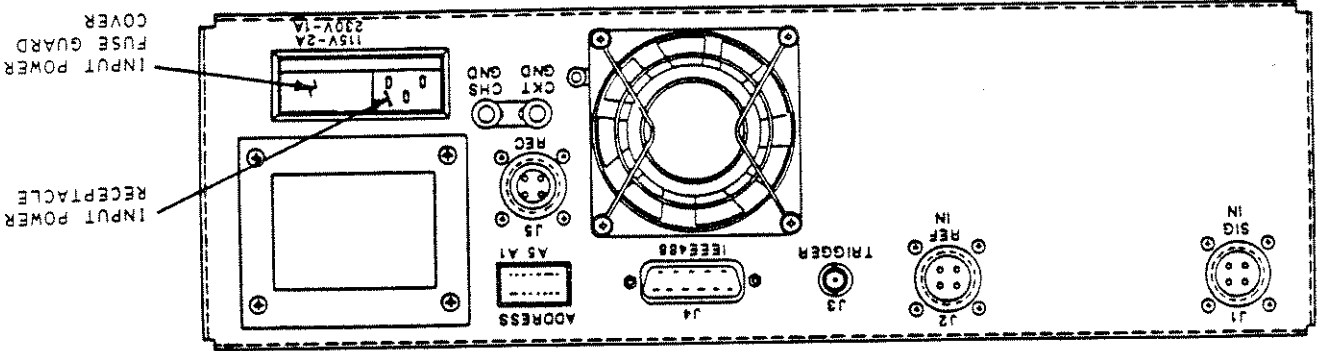

Number in parenthesis after GND indicates signal ground return of the referenced contact. EOI and REN return on contact 24.

NOTE

Signal	Contact	Connector
Signal HI	A	J1 SIG
Signal LO	B	Connector type: MS3106A14S-2S
Guard	C	
Chassis	D	
Reference HI	A	J2 REF
Reference LO	B	Connector type: MS3106A14S-2S
Guard	C	
Chassis	D	
Inphase HI	A	J5 REC
Inphase LO	B	Connector type: MS3106A14S-2P
Quad HI	C	
Quad LO	D	
D101	1	IEEE-488
D102	2	
D103	3	
D104	4	
EOI(24)	5	
DAV	6	
NRFD	7	
NDAC	8	
IFC	9	
SRQ	10	
ATN	11	
SHIELD	12	
D105	13	
D106	14	
D107	15	
D108	16	
REN(24)	17	
GND,(6)	18	
GND,(7)	19	
GND,(8)	20	
GND,(9)	21	
GND,(10)	22	
GND,(11)	23	
GND,(Logic)	24	

Table 3-3. Rear Panel Mating Connector Contacts

3-4 MODES OF OPERATION

The mode is the basic measurement function performed by the DAV and is selected with the top row of dark blue keys on the front panel keyboard.

3-4.1 TOTAL Mode. The TOTAL mode is selected by pressing the front panel TOTAL key. The TOTAL mode permits measurement of the total voltage present at the input of the DAV. Two distinct types of total voltage measurement are possible: SUM and AVG. Refer to paragraph 2-8.5 for DIP switch settings for TOTAL mode selection.

3-4.1.1 TOTAL Mode Measuring Techniques. The TOTAL mode measures voltage as follows:
a. SUM - Measures the true rms voltage of the sum of the fundamental and all harmonics within the range of evaluation of the DAV (refer to table 1-5 for harmonics evaluated). Asynchronous noise is not measured. The TOTAL (SUM) mode requires that a reference of at least 0.2 millivolts be applied to provide phase lock. Refer to paragraph 2-8.4 if it is desired to lock on the signal channel. A self-calibration must have been previously done at the frequency being measured.
b. AVG - Measures the average voltage value of the fundamental, harmonics up to and beyond 100 KHz, and noise. This average voltage measurement is scaled to equal the true rms value for a sine wave only. For other waveforms the measurement will be the average value times 1.11. The TOTAL (AVG) mode does not require that the DAV phase lock to the input signal and therefore permits measurements down to 0 volts without a reference. The TOTAL (AVG) mode requires a single self-calibration for its entire frequency range. This self-calibration is separate from the 10 stored calibrations for the other operating modes.

3-4.1.2 Measurement Modifiers (refer to paragraph 3-7). The following describes measurement modifiers that are available or not applicable in TOTAL mode:
a. Harmonic measurement - Not applicable.
b. Frequency Preset - Available in TOTAL (SUM) mode; not applicable to TOTAL (AVG) mode.
c. Display Averaging - Available.
d. Track/Hold - Available.

3-4.1.3 Display Math Modifiers (refer to paragraph 3-8). The following describes display math modifiers that are available or not applicable in TOTAL mode:
a. Phase Offset - Phase Offset value may be entered when in TOTAL mode but it does not modify the value displayed.
b. Variable Scale - A variable scale value may be stored for TOTAL mode. This value will not apply to other modes.
c. Offset - An offset value may be stored for TOTAL mode. This value will not apply to other modes.
d. +180° Phase - Not applicable.

e. Percent Deviation - A reference point for deviation measurements may be stored for TOTAL mode. This value will not apply to other modes. When Percent Deviation is active for this mode, db may not be used.
f. DB - A db reference point may be stored for TOTAL mode. This value will not apply to other modes. When db is active for this mode, Percent Deviation may not be used.

3-4.3 IN PHASE Mode. The IN PHASE mode is selected by pressing the front panel IN PHASE key. The IN PHASE mode measures the rectangular vector voltage component which is inphase with the input to the reference channel. A negative indication on the display indicates the IN PHASE vector component is 180° out of phase with the reference. Since the Phase Offset function rotates the rectangular vector coordinate system, it will affect the value displayed in the IN PHASE mode. A reference input of at least 0.2 millivolts is required to provide a phase reference and to synchronize the phase-locked loop.

- f. dB - A dB reference point may be stored for FUND mode. This value will not apply to other modes. When dB is active for this mode, Percent Deviation may not be used.
- e. Percent Deviation - A reference point for deviation measurements may be stored for FUND mode. This value will not apply to other modes. When Percent Deviation is active for this mode, dB may not be used.
- d. ±180° Phase - Not applicable.
- c. Offset - An offset value may be stored for FUND mode. This value will not apply to other modes.
- b. Variable Scale - A variable scale value may be stored for FUND mode. This value will not apply to other modes.
- a. Phase Offset - Phase Offset value may be entered when in FUND mode but it does not modify the value displayed.

3-4.2.2 Display Math Modifiers. The following describes display math modifiers that are available or not applicable in FUND mode:

- a. Harmonic measurement - A harmonic measurement in FUND mode gives the magnitude polar component of the harmonic selected.
- b. Frequency Preset - Available.
- c. Display Averaging - Available.
- d. Track/Hold - Available.

3-4.2.1 Measurement Modifiers. The following describes measurement modifiers that are available or not applicable in FUND mode:

- a. Fundamental Mode. The FUND mode is selected by pressing the front panel FUND key. The FUND mode measures the true rms value of the fundamental voltage component excluding any harmonics or noise. This value is the magnitude component of a polar coordinate measurement of the input voltage, where phase angle is the phase component. It is necessary that a reference of at least 0.2 millivolts be applied to provide phase lock. Refer to paragraph 2-8.4 if it desired to lock on the signal channel.

3-4.3.1 Measurement Modifiers. The following describes measurement modifiers that are available or not applicable in IN PHASE mode:

a. Harmonic measurement - A harmonic measurement in the IN PHASE mode gives the rectangular vector voltage component which, in the case of signal channel measurement, is inphase with or 180° out of phase with the fundamental of the signal input (not the reference) for the harmonic selected. A similar measurement may be made for harmonics of the reference input.

b. Frequency Preset - Available.

c. Display Averaging - Available.

d. Track/Hold - Available.

3-4.3.2 Display Math Modifiers. The following describes display math modifiers that are available or not applicable in IN PHASE mode:

a. Phase Offset - Phase Offset produces a rotation of the vector coordinate system which will modify the displayed value. Refer to paragraph 3-8.1 for the relationship between Phase Offset and IN PHASE measurement.

b. Variable Scale - A variable scale value may be stored for IN PHASE mode. This value will not apply to other modes.

c. Offset - An offset value may be stored for IN PHASE mode. This value will not apply to other modes.

d. ±180° Phase - Not applicable.

e. Percent Deviation - A reference point for deviation measurements may be stored for IN PHASE mode. This value will not apply to other modes. When Percent Deviation is active for this mode, db may not be used.

f. dB - A dB reference point may be stored for IN PHASE mode. This value will not apply to other modes. When db is active for this mode, Percent Deviation may not be used.

3-4.4 QUADRATURE Mode. The QUAD mode is selected by pressing the front panel QUAD key. The QUAD mode measures the rectangular vector voltage component which is in quadrature (90° or 270°) with the input to the reference channel. A negative indication on the display indicates the QUAD vector component is 270° out of phase with the reference. Since the Phase Offset function rotates the rectangular vector coordinate system, it will affect the value displayed in the QUAD mode. A reference input of at least 0.2 millivolts is required to provide a phase reference and to synchronize the phase-locked loop.

3-4.4.1 Measurement Modifiers. The following describes measurement modifiers that are available or not applicable in QUAD mode:

a. Harmonic measurement - A harmonic measurement in QUAD mode gives the rectangular vector voltage component which, in the case of signal channel measurement, is inphase with or 180° out of phase with the fundamental of the signal input (not the reference) for the harmonic selected. A similar measurement may be made for harmonics of the reference input.

b. Frequency Preset - Available.

c. Display Averaging - Available.

d. Track/Hold - Available.

- 3-4.4.2 Display Match Modifiers. The following describes display match modifiers that are available or not applicable in QUAD mode:
- a. Phase Offset - Phase Offset produces a rotation of the vector coordinate system which will modify the displayed value. Refer to paragraph 3-8.1 for the relationship between Phase Offset and QUAD measurements.
 - b. Variable Scale - A variable scale value may be stored for QUAD mode. This value will not apply to other modes.
 - c. Offset - An offset value may be stored for QUAD mode. This value will not apply to other modes.
 - d. $\pm 180^\circ$ Phase - Not applicable.
 - e. Percent Deviation - A reference point for deviation measurements may be stored for QUAD mode. This value will not apply to other modes. When Percent Deviation is active for this mode, db may not be used.
 - f. dB - A dB reference point may be stored for QUAD mode. This value will not apply to other modes. When db is active for this mode, Percent Deviation may not be used.
- 3-4.5 PHASE ANGLE Mode. The PHASE ANGLE mode is selected by pressing the front panel PHASE ANGLE key. The PHASE ANGLE mode measures the phase angle difference in degrees between the fundamental component of the reference input and the fundamental of the signal being measured. The PHASE ANGLE measurement is the phase component of a polar coordinate representation of the signal input where the FUNDAMENTAL represents the magnitude component. A positive phase angle reading indicates that the signal being measured leads the reference input. When phase angle mode is selected, the DAV will automatically select the autorange function. It is possible to manually select the range after selecting PHASE ANGLE mode but best accuracy is achieved when the DAV is allowed to select the range. A reference input of at least 2.0 mV is required in this mode.
- 3-4.5.1 Measurement Modifiers. The following describes measurement modifiers that are available or not applicable in PHASE ANGLE mode:
- a. Harmonic measurement - A harmonic measurement in PHASE ANGLE mode gives an indication of the angular difference between the selected harmonic and the fundamental of the signal being measured in units of degrees where 360 degrees equals one cycle of the selected harmonic (not of the fundamental). In other words, this is the actual phase difference times the order of the harmonic. A similar measurement may be made for harmonics of the reference input.
 - b. Frequency Preset - Available.
 - c. Display Averaging - Available.
 - d. Track/Hold - Available.
- 3-4.5.2 Display Match Modifiers. The following describes display match modifiers that are available or not applicable in PHASE ANGLE mode:
- a. Phase Offset - Phase Offset produces a rotation of the vector coordinate system which will directly subtract from the displayed phase angle value.

$$\text{RATIO R (TOTAL)} = \frac{\text{SIG TOTAL}}{\text{REF TOTAL}}$$

a. RATIO R (TOTAL) - Signal and Reference channel TOTAL is measured (refer to paragraph 3-4.1) and the ratio is displayed.

3-4.7.1 RATIO R Submodes. The following are RATIO R submodes:

3-4.7 RATIO R Modes. RATIO R mode is selected by pressing the front panel RATIO R key while in TOTAL, FUND, IN PHASE, or QUAD modes. RATIO R mode gives a measurement of the signal-to-reference voltage ratio.

f. dB - The THD reading may be displayed in units of dB instead of percent by pressing the front panel dB key. If the THD mode is exited, the dB function will be turned off.

e. Percent Deviation - Not applicable.

d. $\pm 180^\circ$ Phase - Not applicable.

c. Offset - Not applicable.

b. Variable Scale - Not applicable.

a. Phase Offset - Phase Offset value may be entered when in THD mode, but it does not modify the value displayed.

3-4.6.2 Display Math Modifiers. The following describes display math modifiers that are available or not applicable in IN PHASE mode:

d. Track/hold - Available.

c. Display Averaging - Available.

b. Frequency Preset - Available.

a. Harmonic measurement - Not applicable.

3-4.6.1 Measurement Modifiers. The following describes measurement modifiers that are available or not applicable in THD mode:

3-4.6 THD Mode. The THD (Total Harmonic Distortion) mode is selected by pressing the front panel THD key. Refer to table 1-5 for a description of the method of evaluation of Total Harmonic Distortion. THD measurements are not available above 28.5 KHz. THD measurements are available on either the signal or reference channels. A reference input of at least 0.2 millivolts is required to synchronize the phase-locked loop.

f. dB - Not applicable.

e. Percent Deviation - Not applicable.

d. $\pm 180^\circ$ Phase - Available.

c. Offset - Not applicable.

b. Variable Scale - A variable scale value may be stored for PHASE ANGLE mode. This value will not apply to other modes.

a. Harmonic Measurement - See paragraph 3-4.7.1.c above. A harmonic may be selected for all RATIO R modes except RATIO R (TOTAL). When the RATIO R mode is exited, the harmonic selection will remain in effect.

3-4.7.2 Measurement Modifiers. The following describes measurement modifiers that are available or not applicable in RATIO R modes:

$$\text{RATIO R (HMNC QUAD) (REF channel)} = \frac{\text{REF FUND}}{\text{REF HMNC QUAD (REF channel)}}$$

- OR -

$$\text{RATIO R (HMNC QUAD) (SIG channel)} = \frac{\text{SIG FUND}}{\text{SIG HMNC QUAD (SIG channel)}}$$

g. RATIO R (HMNC QUAD) - If a harmonic is selected, the quadrature component of that harmonic is measured (refer to paragraph 3-4.4), the FUNDAMENTAL is measured and the ratio is displayed.

$$\text{RATIO R (QUAD) (QUAD)} = \frac{\text{REF FUND}}{\text{SIG QUAD}}$$

f. RATIO R (QUAD) - Signal channel QUAD and Reference channel FUNDAMENTAL are measured and the ratio is displayed.

$$\text{RATIO R (HMNC IN PHASE) (REF channel)} = \frac{\text{REF FUND}}{\text{REF HMNC IN PHASE (REF channel)}}$$

- OR -

$$\text{RATIO R (HMNC IN PHASE) (SIG channel)} = \frac{\text{SIG FUND}}{\text{SIG HMNC IN PHASE (SIG channel)}}$$

e. RATIO R (HMNC IN PHASE) - If a harmonic is selected, the inphase component of that harmonic is measured (refer to paragraph 3-4.3), the FUNDAMENTAL is measured, and the ratio is displayed.

$$\text{RATIO R (IN PHASE) (IN PHASE)} = \frac{\text{REF FUND}}{\text{SIG IN PHASE}}$$

d. RATIO R (IN PHASE) - Signal channel IN PHASE and Reference channel FUNDAMENTAL are measured and the ratio is displayed.

$$\text{RATIO R (HMNC FUND) (for REF channel)} = \frac{\text{REF FUND}}{\text{REF HMNC (for REF channel)}}$$

- OR -

$$\text{RATIO R (HMNC FUND) (for SIG channel)} = \frac{\text{SIG FUND}}{\text{SIG HMNC (for SIG channel)}}$$

c. RATIO R (HMNC FUND) - If a harmonic is selected, that harmonic is measured (refer to paragraph 3-4.2), the FUNDAMENTAL is measured, and the ratio is displayed.

$$\text{RATIO R (FUND) (FUND)} = \frac{\text{REF FUND}}{\text{SIG FUND}}$$

b. RATIO R (FUND) - Signal and Reference channel FUNDAMENTALS are measured (refer to paragraph 3-4.2) and the ratio is displayed.

The DAV has two identical input channels: signal and reference. Some measurements modes by definition require the use of both channels while others can be made using only one channel (refer to paragraph 3-4). The DAV is normally set for phase lock on the reference channel but signal channel phase lock may be optionally selected.

3-6 MEASUREMENT CHANNELS

3-5.2 Ratio Ranges. When in RATIO R modes, voltage ranging is set to AUTO RANGE and the front panel range keys are used for RATIO RANGE selection. There is a front panel key for each ratio range: .01R, .1R, 1R, 10R, 100R, and 1000R. When the AUTO RANGE key is pressed, the DAV automatically upranges at about 160% of the ratio range and downranges at about 10% of the ratio range. Manual or auto ratio range selection is available for both the signal and reference channels.

3-5.1 Voltage Ranges. There is a front panel key for each voltage range: 20mV, 200mV, 2V, 20V, 200V, and 500V (500 V range is actually a 2000 V range with an input limitation of 500 V). When the AUTO RANGE key is pressed, the DAV automatically upranges at about 110% of range and downranges at about 10% of range. The reference channel (READ REF on) always has AUTO RANGE selected. If it is desired to know what voltage range the reference channel is on, select READ REF and read the range by observing the LED's on the front panel keys. AUTO RANGE will automatically be selected by the DAV when PHASE ANGLE or RATIO R modes are selected. Manual range selection may be used after entering the PHASE ANGLE mode.

The DAV allows selection of 1 of 6 voltage ranges plus autorange by using the appropriate front panel range key. When in RATIO R modes, 1 of 6 ratio ranges may be selected with the same keys.

3-5 RANGES OF OPERATION

f. dB - The RATIO R value may be displayed in dB units by pressing the front panel db key.

e. Percent Deviation - Not applicable.

d. $\pm 180^\circ$ Phase - Not applicable.

c. Offset - An offset value may be stored for RATIO R mode and will apply to all RATIO R submodes, but will not apply to other modes.

b. Variable Scale - A variable scale value may be stored for RATIO R mode and will apply to all RATIO R submodes, but will not apply to other modes.

a. Phase Offset - A value may be entered in any RATIO R mode but it will only effect the reading in RATIO R (IN PHASE) and RATIO R (QUAD) modes. When RATIO R mode is exited, the PHASE OFFSET value will remain stored and will apply to any phase sensitive mode.

3-4.7.3 Display Math Modifiers. The following describes display math modifiers that are available or not applicable in RATIO R modes:

d. Track/Hold - Available.

c. Display Averaging - Available.

b. Frequency Preset - Available.

3-7.1 Harmonic Measurement. The DAV allows magnitude, phase, and ratio measurements of harmonics within its range of evaluation. Harmonic measurement is selected by pressing the front panel HMNC key followed by entry of the harmonic order number with the keypad. The ENTER key is pressed to store the selection. Refer

The DAV allows modifications of the basic measurement when measuring harmonics and also allows simplification of certain measurements.

3-7 MEASUREMENT MODIFIERS

Mode	With REF Lock (A8SWM1-3 ON) DAV Locks On	With SIG Lock (A8SWM1-3 OFF) DAV Locks On
TOTAL (SUM)	REF	SIG
FUND	REF	SIG
IN PHASE	REF	REF
QUAD	REF	REF
PHASE ANGLE	REF	REF
THD	REF	SIG
RATIO R (TOTAL)	REF	SIG
RATIO R (FUND)	REF	SIG
RATIO R (IN PHASE)	REF	REF
RATIO R (QUAD)	REF	REF

Table 3-4. Channel Used For Phase Lock

3-6.3 Phase Lock Synchronization Reference. Although the DAV is normally set for phase lock on the reference channel, phase lock on the signal channel can be optionally selected to emulate the operation of North Atlantic Model 225 in FUND mode. If it is desired to use FUND mode or TOTAL (SUM) mode without a reference input, signal channel phase lock may also be selected. Table 3-4 summarizes which channel is used for phase lock during various mode and lock channel selection combinations.

3-6.2 Signal Channel. SIG channel measurement is the normal operating mode of the DAV. The SIG channel measurement is displayed by observing that the LED on the READ REF key is out; if not, press the key. All measurement modes and modifiers are available on the SIG channel.

3-6.1 Reference Channel. The REF channel measurement may be displayed by pressing the READ REF key and observing that the LED on the key is lit. The REF channel is used to provide a point of reference for phase sensitive measurements (PHASE ANGLE, IN PHASE, QUAD) and is normally used to provide synchronization for the DAV phase-locked loop which is needed in FUND and TOTAL (SUM) modes. TOTAL, THD, and RATIO R HMNC measurements may be made directly on the REF channel.

3-7.2 Frequency Preset. The Frequency Preset feature reduces measurement time for noisy input signals by eliminating the need for the DAV to search for the correct Phase-Locked Loop band and internal Programmable Filter setting. This feature also allows for self-calibration at a desired frequency without any input to the DAV (refer to paragraph 3-10). Frequency Preset is selected by pressing the front panel FREQ key followed by entry of the desired frequency, in Hertz, between 10 and 100,000 using the keypad. The ENTER key is pressed to store the selection. The LED on the FREQ key will light. The DAV will not allow an invalid entry. The Programmable Filter is set in 1 Hz increments from 10 Hz to 1 kHz and 100 Hz increments from > 1 kHz to 100 kHz. The Phase-Locked Loop is set to one of its 8 bands: 10 Hz to 31 Hz, 32 Hz to 100 Hz, 101 Hz to 316 Hz, 317 Hz to 1000 Hz, 1001 Hz to 3.159 kHz, 3.16 kHz to 10.599, 10.6 kHz to 28.499 kHz, or 28.5 to 100 kHz.

3-7.3 Display Averaging. The DAV averages successive readings together to smooth small variations and produce a stable display. This averaging may be adjusted lower to produce quicker response or higher to produce a more stable display of quickly changing signals. This adjustment is accomplished by pressing the front panel AVG key and entering the new average constant using the keypad. The ENTER key is pressed to store the selection. The LED on the AVG key will light. The average constant has a range of 0.00 to 9.99 and is approximately equal to a time constant in seconds. The default value is 0.30.

The DAV acquires a new reading about every 50 to 60 milliseconds, for most operating modes. This new reading is averaged into the previously displayed reading as follows:

$$\text{DISPLAY} = \text{NEW READING} \times (1/K) + \text{OLD READING} \times (1 - 1/K)$$

where K is approximately equal to 32 times the AVG constant entered.

3-7.4 Track/Hold. The DAV Track/Hold function is selected by pressing the front panel TRACK/HOLD key (alternate acting). The front panel TRACK/HOLD key LED will light to indicate that the function has been selected and the ENTER key LED will flash. When the TRACK/HOLD function is selected the front panel display reading will only be updated when the front panel ENTER key is pressed or a TTL pulse (negative edge) is applied to the rear panel TRIGGER input. The DAV will continue to calculate new readings internally but the latest result will not be displayed. This function is useful for triggering a measurement at a specific time to synchronize to an external event. The TRACK/HOLD function will automatically be cancelled if any change is made to the measurement setup.

3-8 DISPLAY MATH MODIFIERS

The DAV allows several types of modification to the displayed reading to provide data in convenient or more easily read units of measure. These modifiers may be combined except where noted otherwise.

3-8.1 Phase Offset. The Phase Offset function is selected by pressing the front panel PHASE OFFSET key and entering a value on the keypad. The ENTER key is pressed to store the selection. Any value in the range of ± 359.990 may be entered. Simply

to table 1-5 for highest harmonic available at each frequency. The LED on HMNC key will light and the HMNC annunciator will come on. The harmonic order will be displayed on the numeric Harmonic Display. If an invalid harmonic is selected, the main display will show "-----". Refer to paragraph 3-4 for measurement of harmonics in each mode.

3-8.6 dB. When in a voltage measurement mode (TOTAL, FUND, IN PHASE, QUAD), the dB function is selected by pressing the front panel dB key and entering a value on the keypad. The ENTER key is pressed to store the selection. Any value within the limits of the DAV range selected may be entered (e.g., +1.9999 on the 2 V range). Simply pressing the dB key followed by the ENTER key will automatically enter a value which will cause the displayed value to be 0.00 dB. The LED on the dB key will light and dB annunciator will come on. When in THD or RATIO R modes the dB function is selected or deselected by pressing the front panel dB key. When selected the display is

$$\% \text{ DEVN} = (\text{Display Reading}) - (\text{Reference Value Entered})$$

Reference Value Entered

3-8.5 Percent Deviation. The Percent Deviation function is selected by pressing the front panel % DEVN key and entering a value on the keypad. The ENTER key is pressed to store the selection. Any value within the limits of the DAV range selected may be entered (e.g., +1.9999 on the 2V range). Simply pressing the % DEVN key followed by the ENTER key will automatically enter a value which will cause the displayed value to be 0.00%. The LED on the % DEVN key will light and the % annunciator will come on. The Percent Deviation function operates by storing a reference point voltage then calculating and displaying the percentage difference from that reference point for each new measurement:

3-8.4 +180° Phase. The +180° phase function is selected by pressing the alternate acting front panel +180° PHASE key when in PHASE ANGLE mode. The LED on the +180° PHASE key will light and the phase angle will be displayed with values of +179.990° instead of 0.00° to 359.990°.

3-8.3 Offset. The Offset function is selected by pressing the front panel OFFSET key and entering a value on the keypad. The ENTER key is pressed to store the selection. Any value within the limits of the DAV range selected may be entered (e.g., +1.9999 on the 2 V range). Simply pressing the OFFSET key followed by the ENTER key will automatically enter a value which will cause the displayed value to be 00000. The location of the decimal point will depend on the range selected. The LED on the OFFSET key will light and the VAR annunciator will come on. The Offset function operates by subtracting a user defined value from the displayed value.

3-8.2 Variable Scale. The Variable Scale function is selected by pressing the front panel VAR SCALE key and entering a value on the keypad. The ENTER key is pressed to store the selection. Any value in the range of +9.9999 may be entered. Simply pressing the VAR SCALE key followed by the ENTER key will automatically enter a value which will cause the displayed value to be 10000. The location of the decimal point will depend on the range selected. The LED on the VAR SCALE key will light and the VAR annunciator will come on. The Variable Scale function allows a user defined full scale value by multiplying the displayed value by a number which will give the desired scale factor. For example, to display a 26 V rms full scale transducer output as 200.00 on the display (200 V range), enter a VAR SCALE value of 7.6923 (200/26). To display the same transducer output as 100.00 on the display, simply apply the 26 V input and press VAR SCALE and ENTER keys on the front panel keyboard.

pressing the PHASE OFFSET key followed by the ENTER keys will automatically enter a value which will cause the PHASE ANGLE display to be 0.00°. The LED on the PHASE OFFSET key will light and the VAR annunciator will come on. The PHASE OFFSET function rotates the vector system (equivalent to phase shifting the reference) by subtracting the value entered from the current PHASE ANGLE. IN PHASE and QUAD readings will be affected accordingly.

converted to dB values. In voltage modes the dB function operates by storing a reference point voltage, then calculating and displaying the difference from that reference point in decibel units for each new measurement. This is based on the formula:

$$dB = 20 \log_{10} \frac{\text{Measured Value}}{\text{Stored Reference Value}}$$

In THD and RATIO R modes the dB function is based on the formula

$$dB = 20 \log_{10} \times \text{Measured Value}$$

3-9 KEYPAD OPERATION

The three rightmost columns of dark grey keys on the front panel keyboard comprise a numeric keypad for data entry. A column of light grey keys to the left of the keypad contain the CLEAR VAR, READ VAR, CLEAR ENTRY, and ENTER keys which are related to the function of the keypad. The operation of the keypad for data entry, examination, and modification is summarized below.

3-9.1 Enter Data. The general format for entering variable data is as follows:

- a. Press appropriate variable key.
- b. Press keypad keys including numerals 0 through 9, "+/-", and decimal point to enter desired value.

NOTE

The DAV will not permit invalid data entry for most functions.

- c. If an error is made during entry of data, press the CLEAR ENTRY key and reenter data.

- d. Press ENTER key to store value.

3-9.2 Read/Modify Data. The general format for reading stored variables is as follows:

- a. Press appropriate variable key.
- b. Press the READ VAR key. The stored value will be displayed on the Main Display.
- c. To retain the same value, press the READ VAR key again.

- d. To modify the value, press the CLEAR ENTRY key and enter new data using the keypad. The CLEAR ENTRY and ENTER keys are used in the same manner as for initial data entry.

3-9.3 Clear Data. The general format for clearing stored variables is as follows:

- a. Press appropriate variable key.
- b. Press CLEAR VAR key to restore default value

- OR -

- c. Simply press CLEAR VAR key to restore all variables in all modes to the default values.

3-10 SELF-CALIBRATION

The accuracy of the DAV is maintained by periodic self-calibration of the internal circuitry. This self-calibration sequence requires between 20 and 60 seconds, on average, depending upon the measurement frequency at which it is done. It is suggested that self-calibration be done when there are significant changes in ambient temperature or when best accuracy is needed for a critical measurement; otherwise, self-calibration need not be repeated for at least 7 days.

3-10.1 Ten Frequency Self-Calibration Storage. The DAV is capable of storing self-calibration data for any ten unique frequencies in a first-in-first-out buffer in nonvolatile memory. Self-calibration will be valid within +5% of a frequency for which data was stored. The LED on the front panel CAL key will flash when no self-calibration data is stored for the frequency being measured. The stored value will be applied to all modes except TOTAL (AVG), which requires a separate self-calibration. There are two ways to initiate self-calibration:

a. Apply an input to the DAV and allow the DAV to phase lock to it. Press the front panel CAL key and observe that the LED on the key lights and the main display shows the ongoing status of the self-calibration process. When complete, the DAV will once again display the current measurement. This self-calibration process may be repeated for nine more user-defined frequencies when the appropriate signals are input.

b. To self-calibrate without an input signal use the FREQUENCY entry function. Press the front panel FREQ key and enter the desired frequency with the keypad. Press ENTER to store the frequency. Press the front panel CAL key to start self-calibration. The DAV will self-calibrate at the preset frequency regardless of the signal at the inputs. This process may be repeated for the remaining nine frequencies.

3-10.2 TOTAL (AVG) Calibration. A single self-calibration is required for TOTAL (AVG) mode which applies to TOTAL (AVG) measurements made at any frequency. This data is stored in nonvolatile memory separately from the ten frequency-dependent self-calibrations. To initiate TOTAL (AVG) self-calibration set DAV to TOTAL (AVG) mode and press the front panel CAL key.

3-10.3 AUTOCAL Operation. The AUTOCAL function allows self-calibration to be performed automatically whenever a measurement is attempted at a frequency where no previous self-calibration data is stored. The AUTOCAL function is selected by pressing the front panel AUTOCAL key. The LED on the key will light to indicate that the function is active. Whenever the input frequency is greater than 5% from a frequency where self-calibration data are stored, the self-calibration sequence will be automatically started. The main display will indicate the ongoing status of the self-calibration. If the input frequency is changed slowly, self-calibration may occur at intermediate frequencies prior to the input reaching its final frequency value. When in TOTAL (AVG) mode, self-calibration will be initiated if no self-calibration data for this mode has been previously stored.

3-11 RECORDER OUTPUT

The DAV provides rear panel dc voltage outputs proportional to the IN PHASE and QUAD front panel readings. These outputs have 16-bit digital resolution and are suitable for driving analog data recorders and similar devices.

The following typical application examples illustrate the basic operations of the Model 2250 DAV. These examples present typical signal measurement and analysis techniques, and basic unit under test (UUT) situations.

3-12 TYPICAL APPLICATIONS

Mode	IN PHASE Output	QUAD Output
TOTAL (AVG)	TOTAL (AVG) VALUE	VALUE 0 VOLTS
TOTAL (SUM)	TOTAL (SUM) VALUE	VALUE 0 VOLTS
FUND	FUND VALUE	VALUE 0 VOLTS
IN PHASE	IN PHASE VALUE	QUAD VALUE
QUAD	IN PHASE VALUE	QUAD VALUE
PHASE ANGLE	IN PHASE VALUE	QUAD VALUE
THD	0 VOLTS	0 VOLTS
RATIO R MODES	0 VOLTS	0 VOLTS

Table 3-5. Dc Recorder Outputs vs. Mode

3-11.2 Recorder Outputs in Various Operating Modes. Table 3-5 summarizes the voltages at the IN PHASE and QUAD recorder outputs in various operating modes.

A full scale display of 2,000 will cause the recorder output to saturate because the maximum dc output voltage is approximately 10 to 11 V dc.

NOTE

- a. Full scale display of 2,000 (for example) gives 2,000 V dc at recorder output. This is the normal 2250 output.
- b. Full scale display of 1,000 gives 8.750 V dc at recorder output. This is the Model 225 Emulation output.

examples:

3-11.1 Output Options. The full scale output voltage for the dc recorder output may be set to one of two values. Refer to paragraph 2-8.6 for dc recorder output voltage selection. The available output options are presented in the following

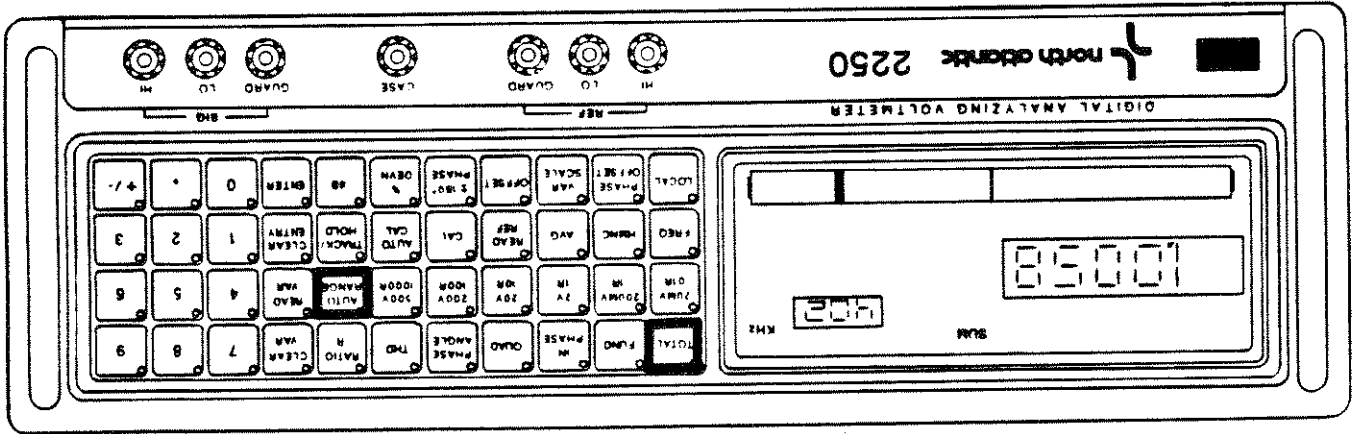

- a. Press TOTAL key. The DAV will automatically select range for REF channel.
- b. Read voltage on the main display.

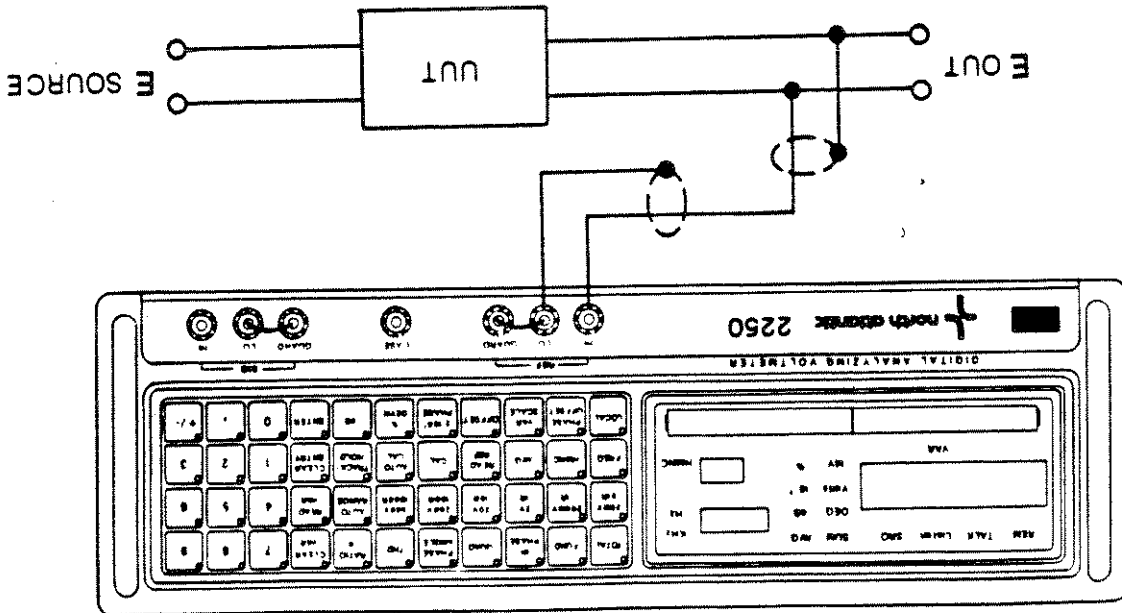

3-12.1 AC Voltage Measurement. For simple voltage measurements, apply the signal to be measured to the REF channel input and press the READ REF key and the appropriate mode key (TOTAL or FUND). For example, with equipment set up as shown,

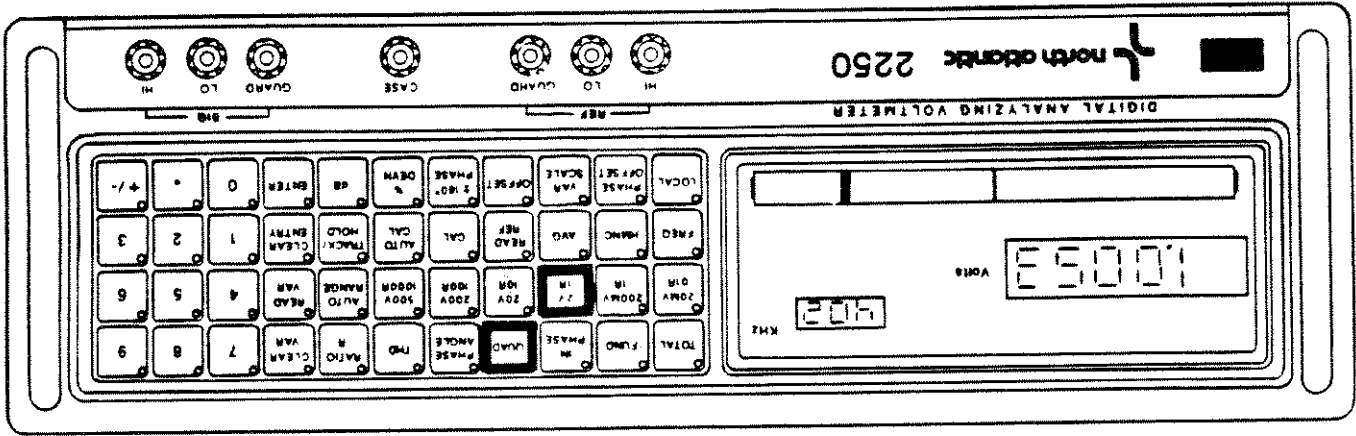

- a. Press QUAD key.
- b. Press 2V range key.
- c. Verify that LED on READ REF key is out; if not, press key.
- d. Read voltage on the main display.

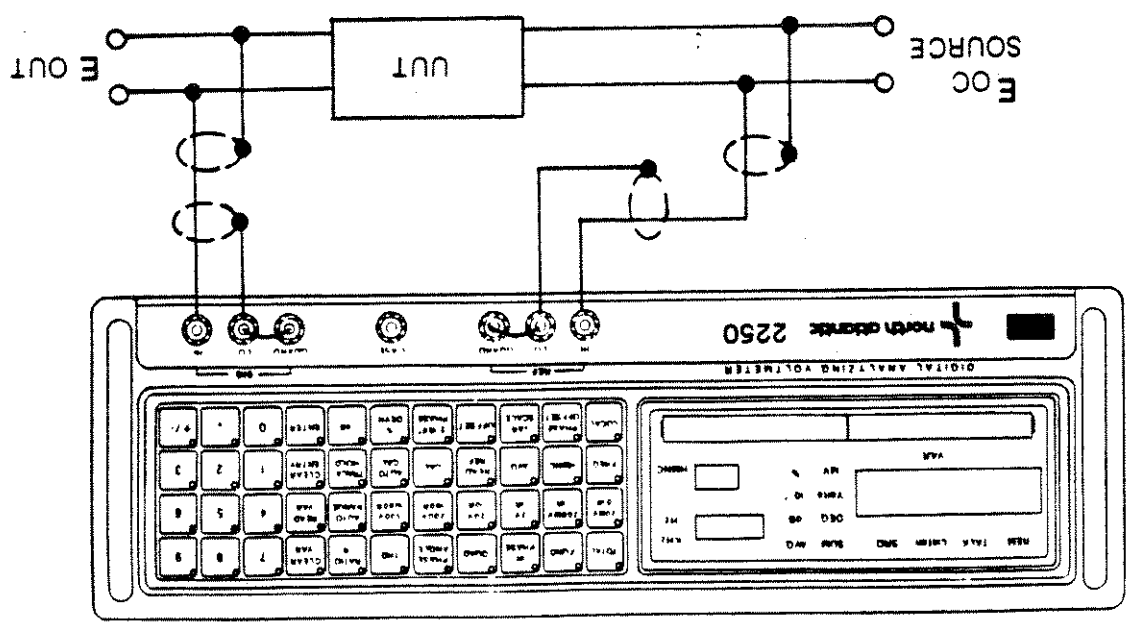

3-12.2 Phase Sensitive AC Voltage Measurement. A separate reference input is required for all Phase Sensitive voltage measurements (IN PHASE, QUAD). For example, to measure QUAD component of an amplifier output with equipment as shown,

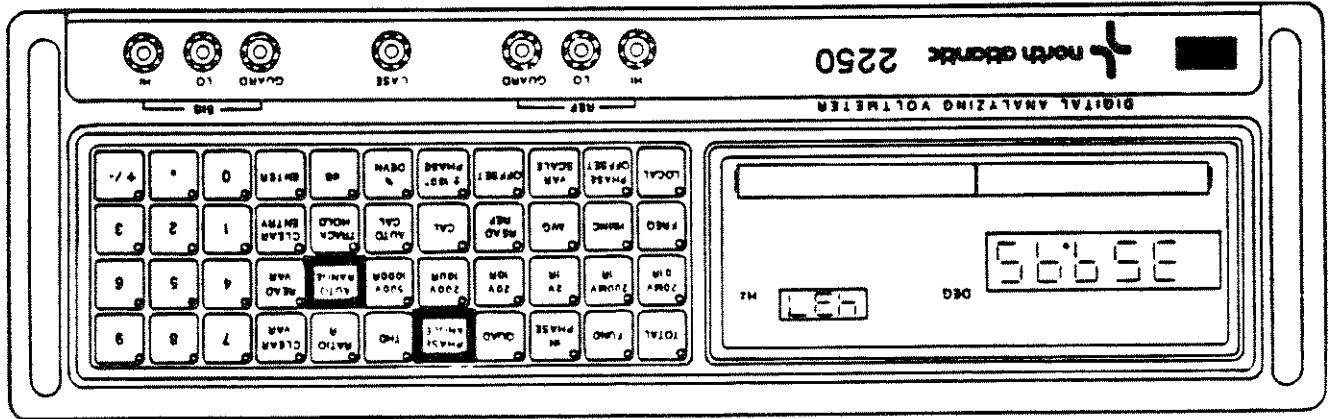

- a. Press PHASE ANGLE key. The DAV will automatically select AUTO RANGE.
- b. Read Phase Angle on main display.

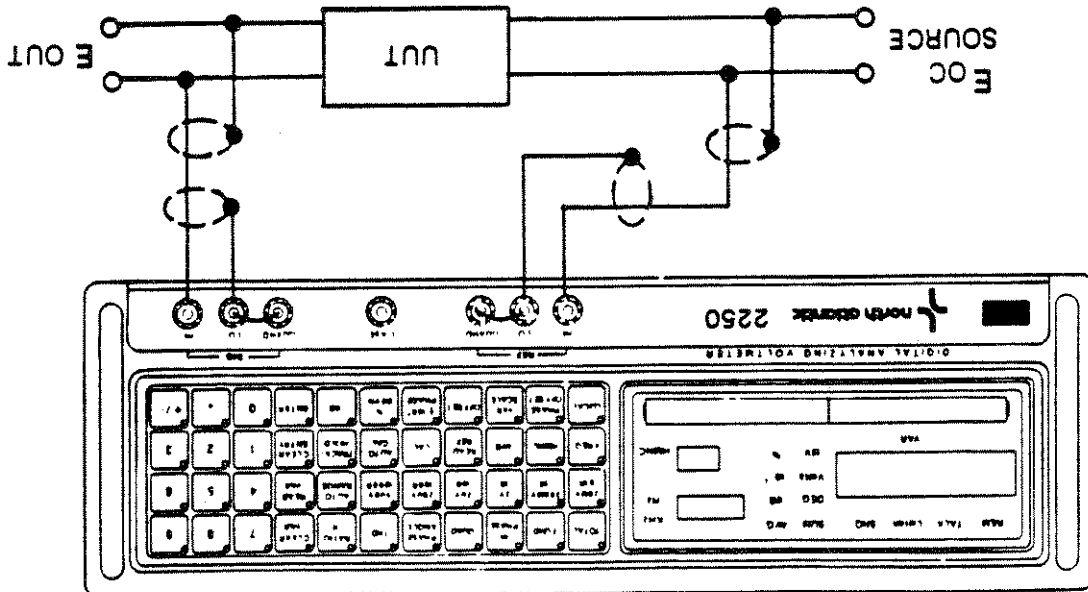

3-12.3 Phase Angle Measurement. A separate reference input is required for phase angle measurements. For example, to measure the phase shift of a filter in degrees with equipment set up as shown,

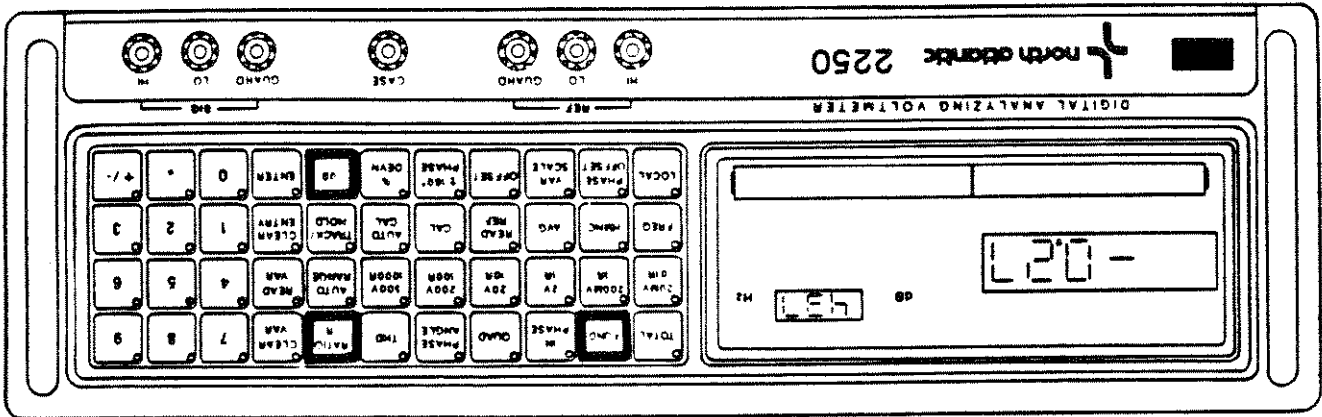

- a. Press FUND key.
- b. Press RATIO R and dB keys.
- c. Read Gain/Loss in dB on the main display.

3-12.4.2 Measure Response. Proceed as follows:

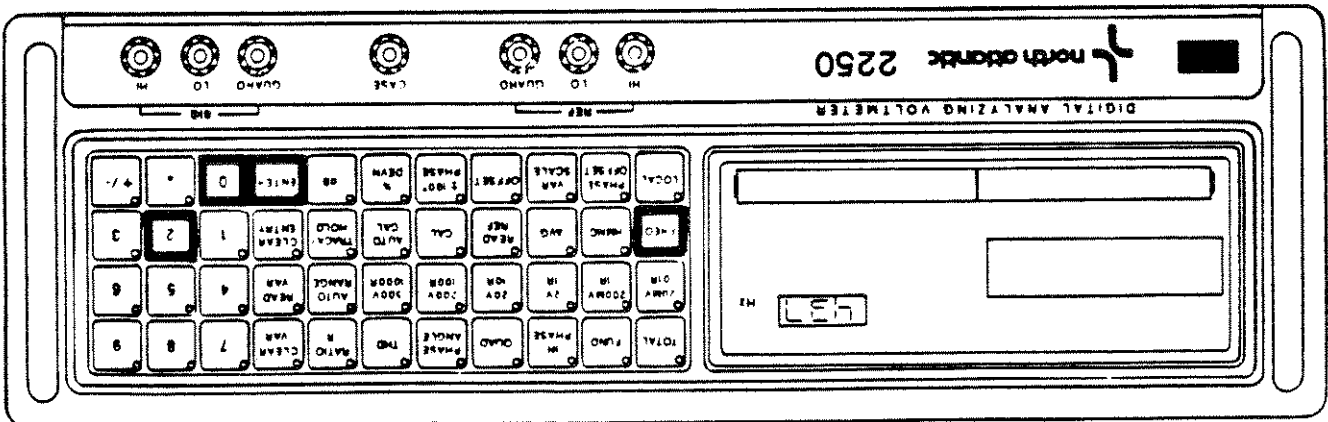

- a. Press FREQ key.
- b. On keypad, press 2, 0, and ENTER (20 Hz) keys.
- c. Press CAL key and wait for calibration to complete.
- d. Repeat for each of ten frequencies from source.
- e. Press CLEAR VAR key to clear FREQ preset.

3-12.4.1 Setup Frequencies. The frequencies for the response test may be calibrated in advance. Proceed as follows:

3-12.4 Frequency Response Measurements in dB. With equipment connected as in the previous example, frequency response of an amplifier or filter may be measured as described in the following paragraphs.

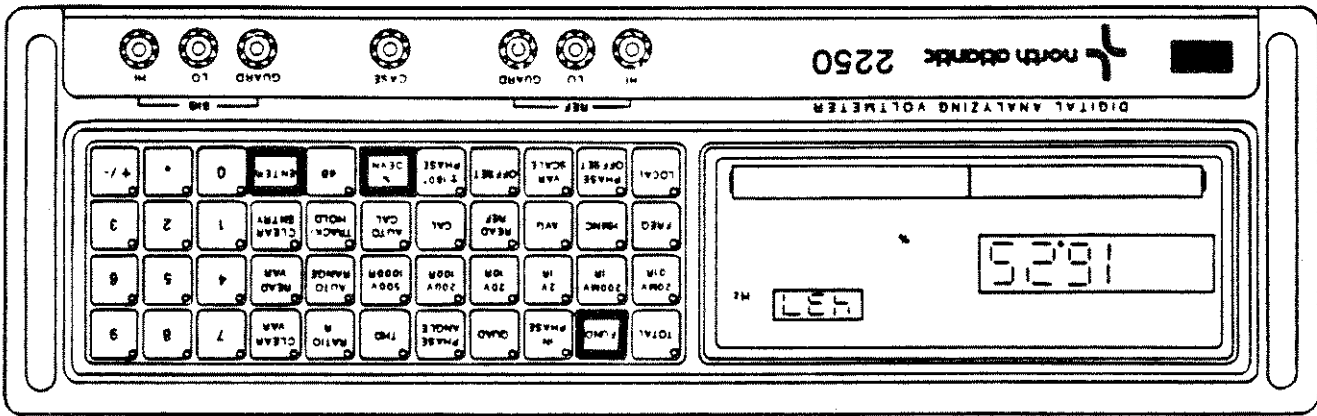

- a. With output of UVT at nominal value, press FUND, % DEVN, and ENTER keys.
- b. Read deviation from nominal value in percent.

3-12.6 Percent Deviation Measurements. With equipment connected as in the previous example, temperature related circuit gain/loss changes may be evaluated. For

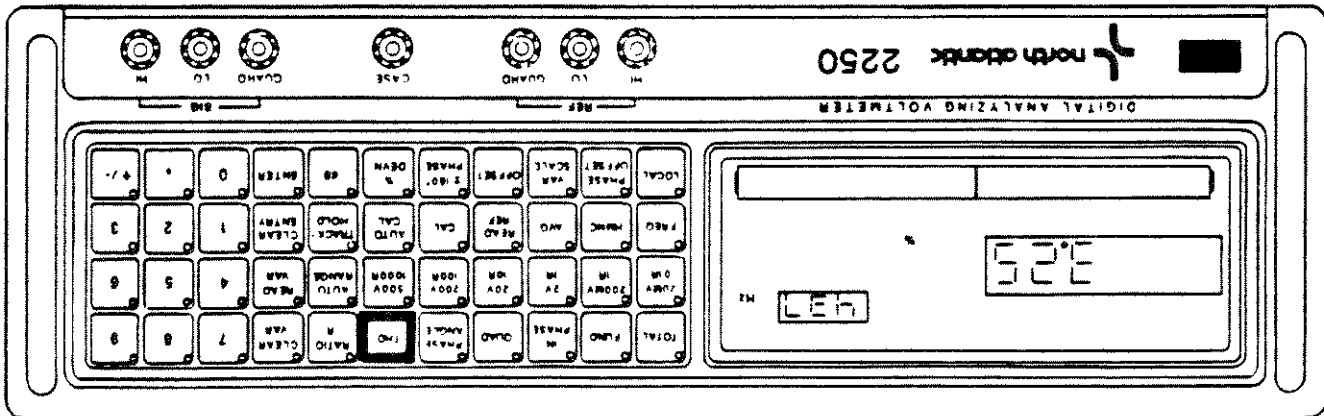

- a. Press THD key.
- b. Read value on main display.

3-12.5 THD Measurements. With equipment set up as in previous example, measure THD as follows:

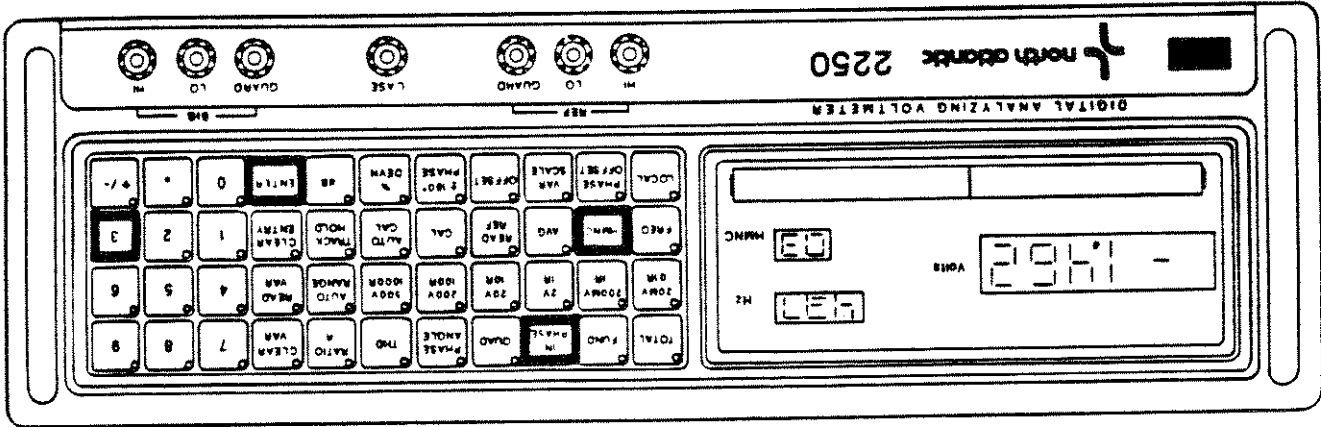

- a. Press IN PHASE, HMNC, 3, and ENTER keys.
- b. Read inphase of third harmonic on main display.

3-12.7.2 Harmonic Inphase Component Amplitude. To measure, proceed as follows:

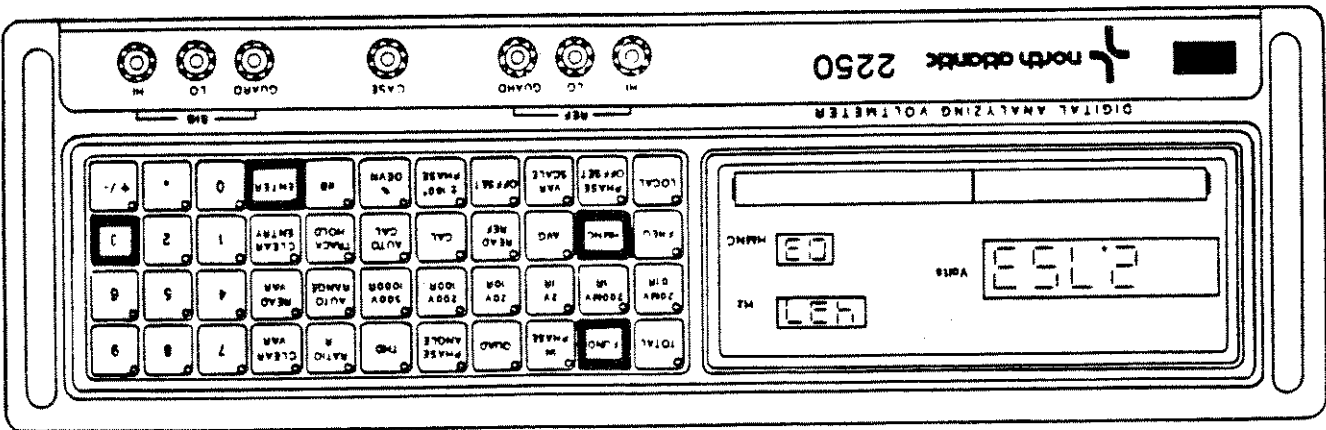

- a. Press FUND, HMNC, 3, and ENTER keys.
- b. Read amplitude of third harmonic on main display.

3-12.7.1 Harmonic Fundamental Amplitude. To measure, proceed as follows:

3-12.7 Harmonics Measurements. With equipment connected as in previous example, amplitude and phase of harmonics produced by the UUT may be measured.

3-12.7.3 Harmonic Quadrature Component Amplitude. To measure, proceed as follows:

- Press QUAD, HMNC, 3, and ENTER keys.
- Read quadrature of third harmonic on main display.

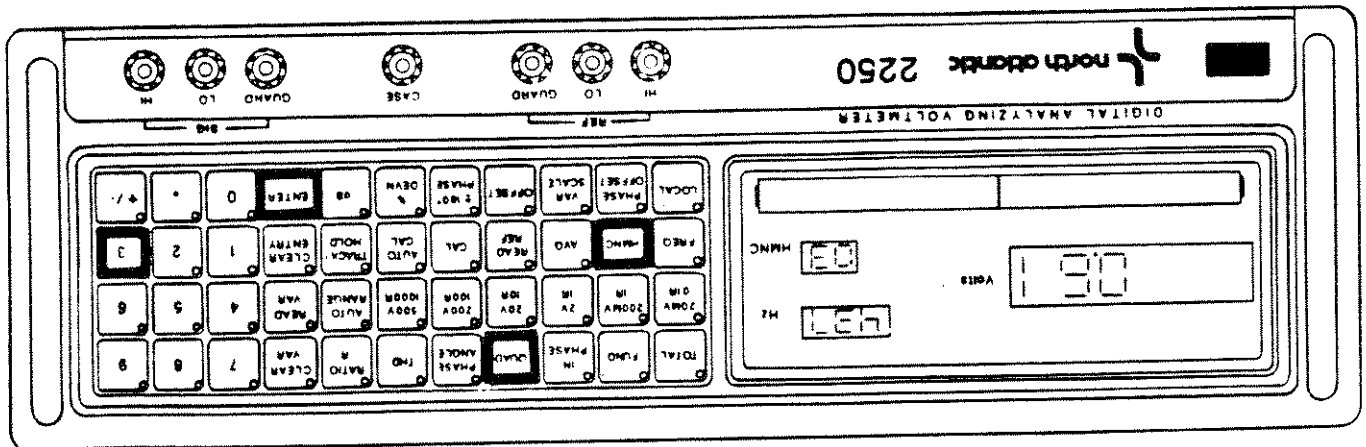

3-12.7.4 Harmonic Phase Angle Measurement. To measure, proceed as follows:

- Press PHASE ANGLE, HMNC, 3, and ENTER keys.
- Read third harmonic phase angle on main display.

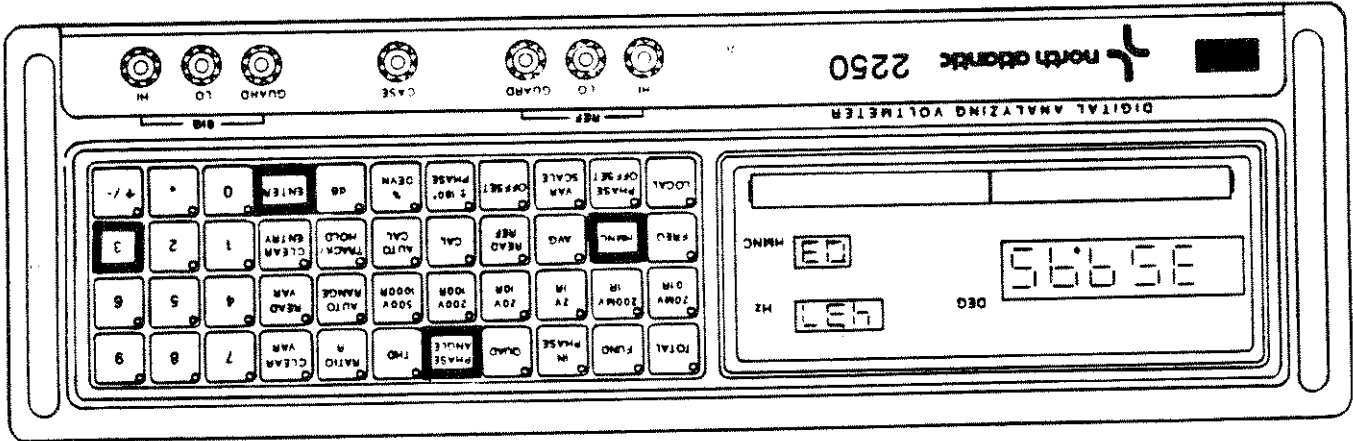

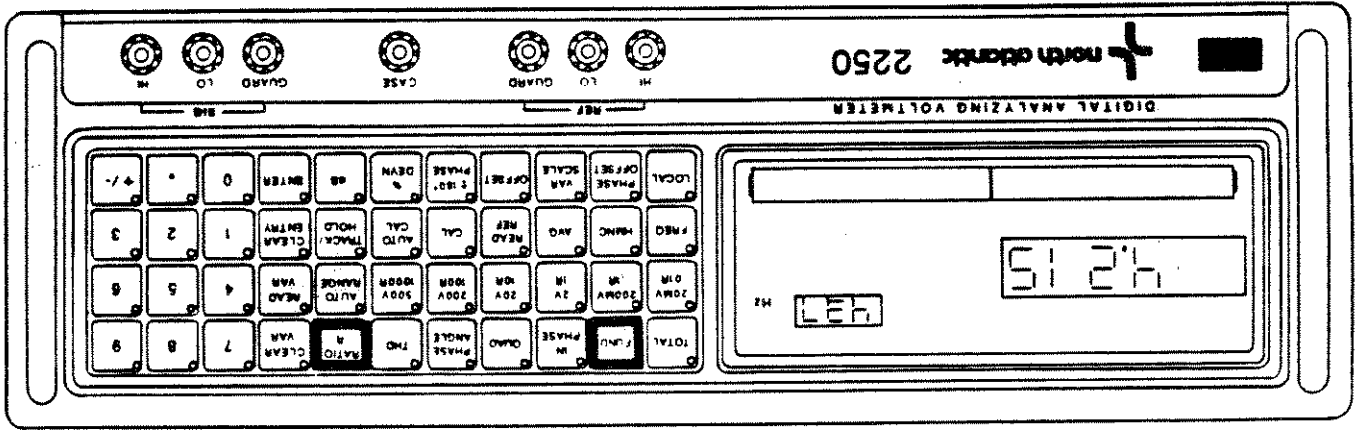

- a. Press FUND and RATIO R keys.
- b. Read transformation ratio on the main display.

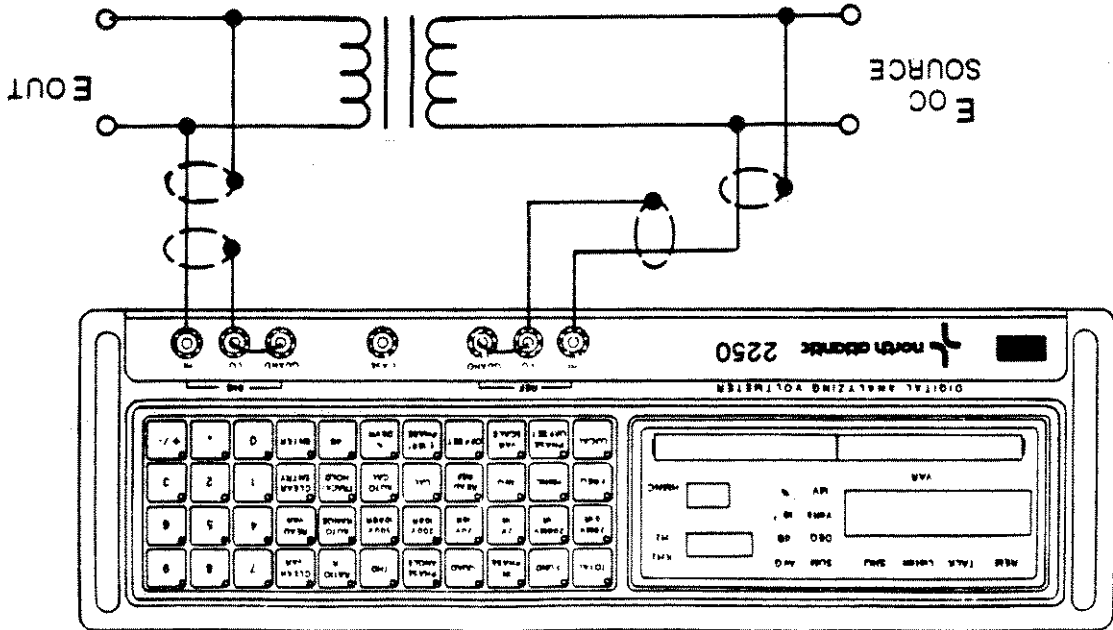

3-12.8 Transformation Ratio Measurement. The transformation ratio of a transformer may be measured by the DAV. Set up equipment as shown and proceed as follows:

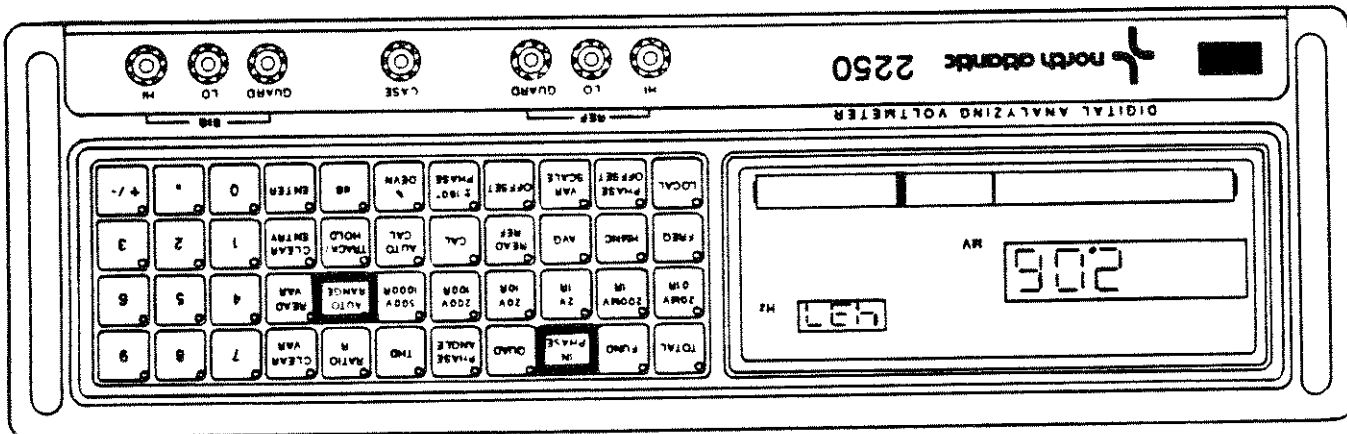

- a. Press IN PHASE key.
- b. Press AUTO RANGE key.
- c. Adjust synchro/resolver bridge until bargraph null meter reads as close to zero as possible.

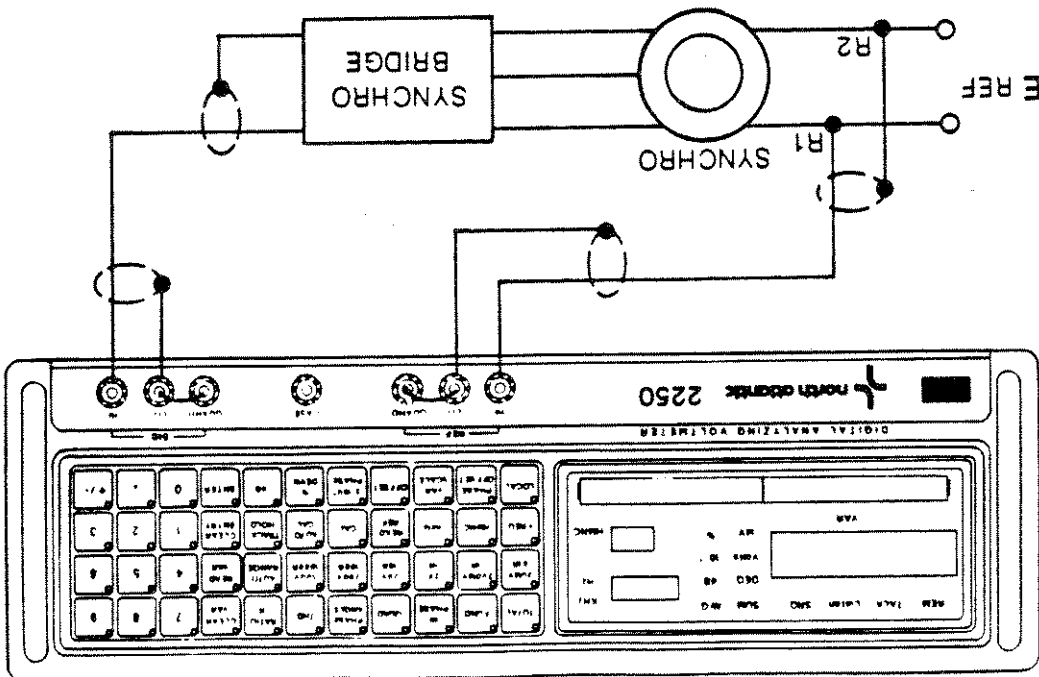

3-12.9 Synchro/Resolver Bridge Null Indicator. The DAV may be used as a null detector at the output of a synchro/resolver bridge. For example, set up the equipment as shown and proceed as follows:

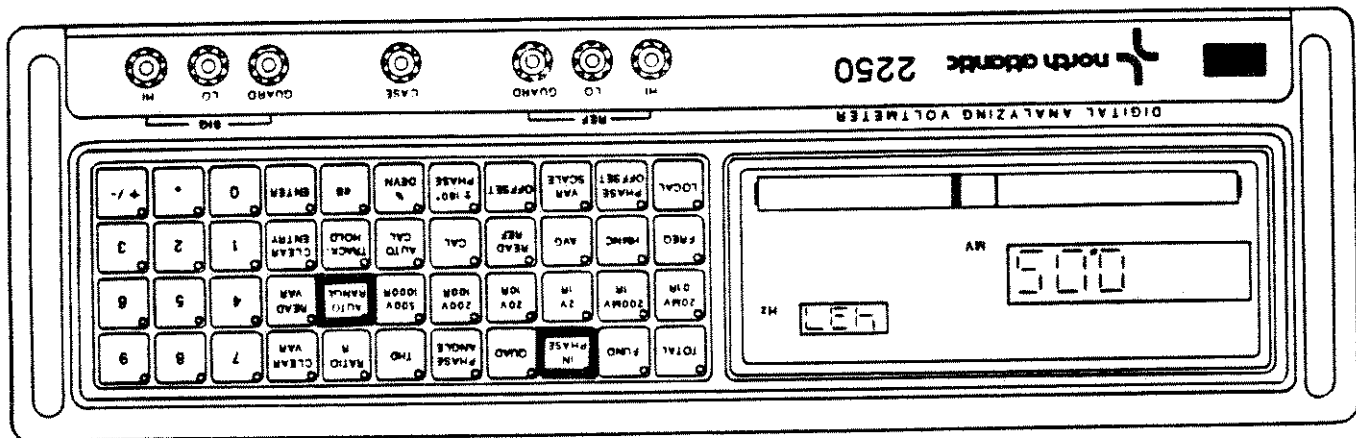

- a. Press IN PHASE key.
- b. Press AUTO RANGE key.
- c. Adjust mechanical position of shaft to give best null on bargraph null meter.

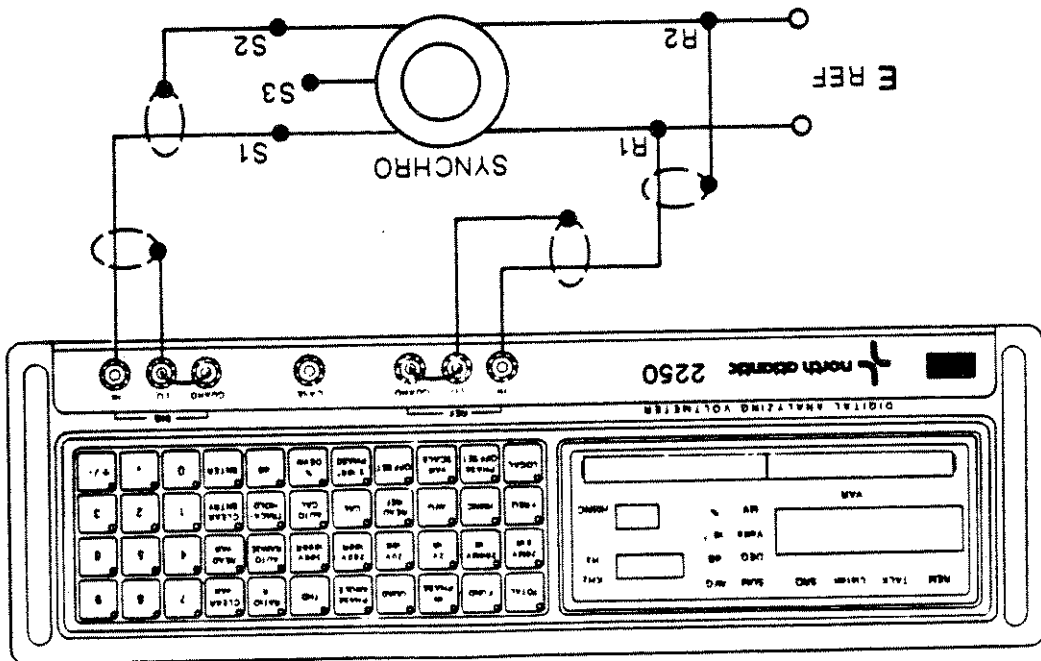

3-12.10 Synchro Electrical Zero (Null) Tests. When installing a synchro as a position sensor, mechanical and electrical zero points may be aligned. For example, set up equipment as shown and proceed as follows:

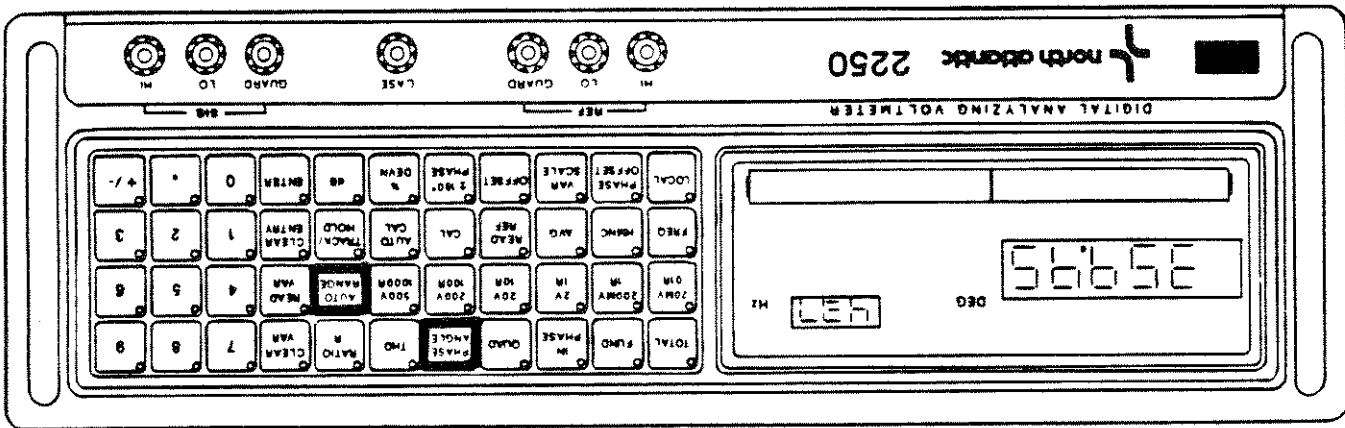

- a. Press PHASE ANGLE key. The DAV will select AUTO RANGE.
- b. Read the angle of the impedance on the main display. The power factor will be: $\cos(\text{displayed angle})$.

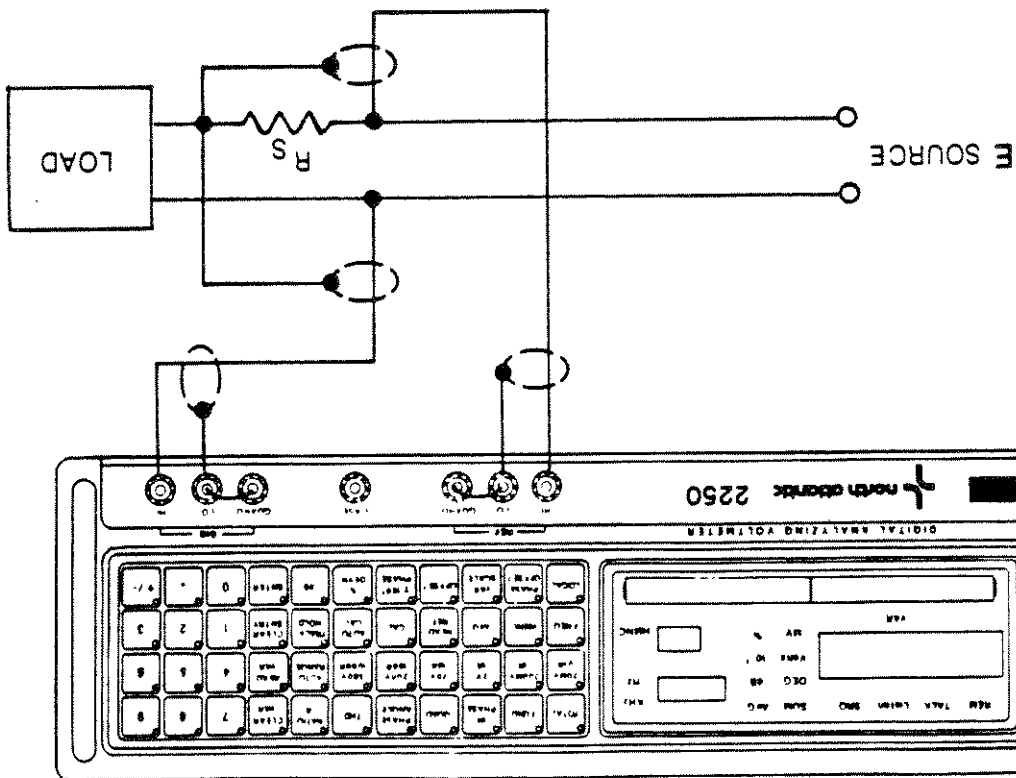

3-12.11 Impedance Angle and Power Factor Measurements. Both power factor angle and impedance angle are defined as the angle which a current vector makes with the voltage reference. For example, set up equipment as shown and proceed as follows:

Using a decade step value for R_s allows for easy calculations.

$$0.215 \times 10 \text{ k} = 2.15 \text{ k ohms}$$

If $R_s = 10 \text{ k}$ and the display reads 0.215, the ac resistance is:

For example,

$$\text{Impedance Magnitude} = \text{Reading} \times R_s$$

used as follows:

- a. Press FUND and RATIO R keys
- b. Verify that a Signal Channel measurement is being made by observing that LED on READ REF key is out.
- c. Read impedance magnitude at the frequency of interest according to R_s value

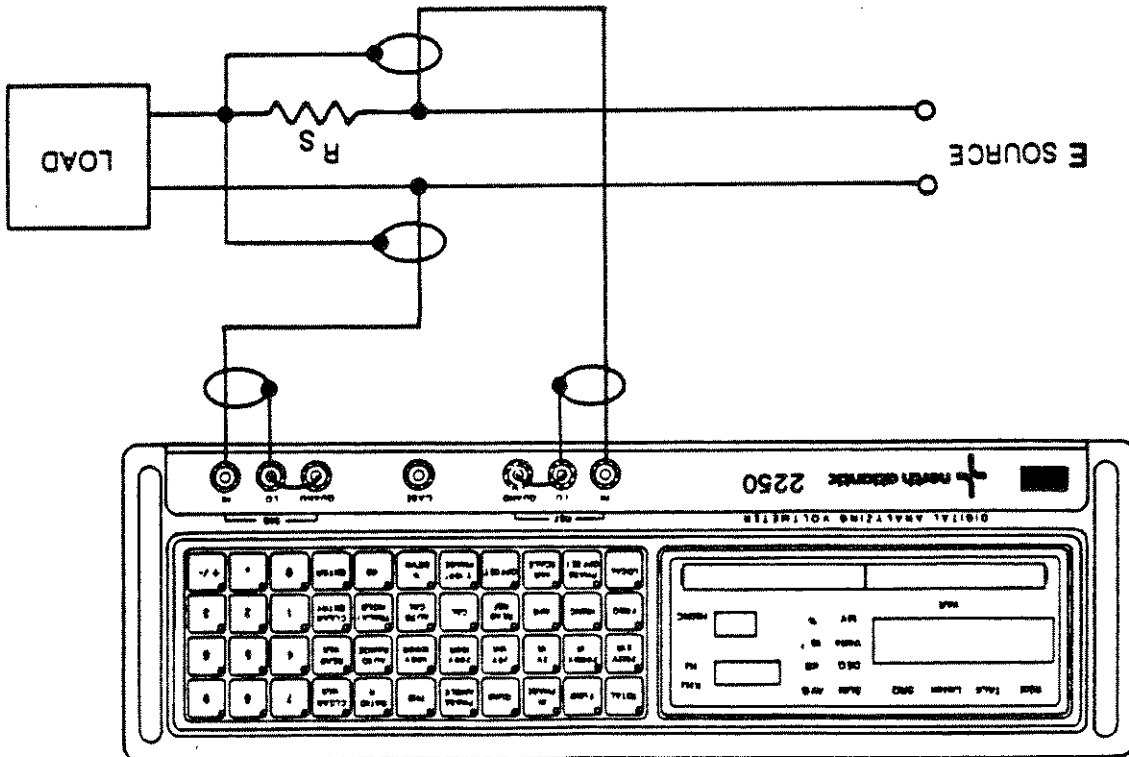

3-12.12 Impedance Magnitude. The magnitude of an impedance may be measured conveniently using some of the DAV math modifier functions. For example, with equipment connected as shown, select a convenient value of series resistance R_s (10 k, 1 k, 100 ohms, etc.). Proceed as follows:

A negative value indicates a predominately inductive reactance and a positive value indicates a predominately capacitive reactance.

NOTE

Reactance = QUAD reading x R_S

- d. Press QUAD key.
- e. Read the imaginary resistance component of the measured impedance as follows:

Resistance = | IN PHASE Reading | x R_S

- c. Read the real resistance component of the measured impedance as follows:
- b. Verify that a Signal Channel measurement is being made by observing that LED on READ REF key is out.
- a. Press IN PHASE and RATIO R keys.

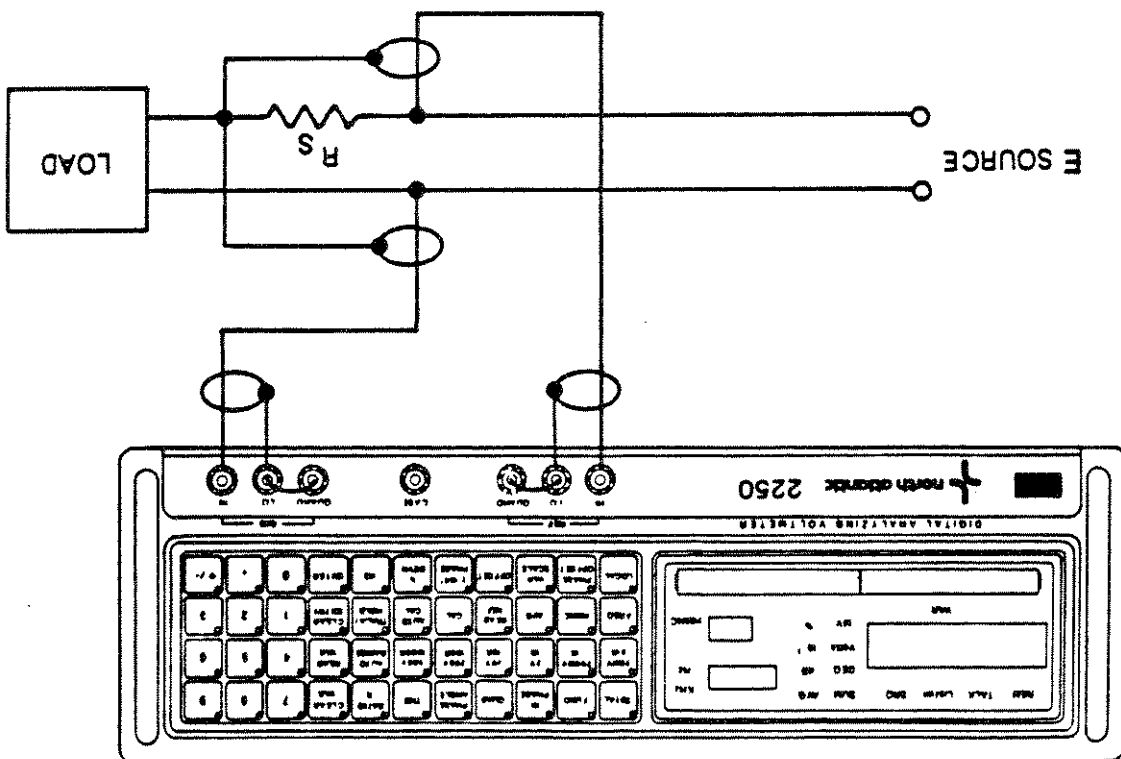

3-12.13 AC Resistance and Reactance Measurements. The real and imaginary components of an impedance can be measured directly using the current as the reference input as shown. Select the R_S value as in the previous example and proceed as follows:

3-12.14 Condition Transducer Output for Convenient Display. The DAV math functions allow input to be displayed in convenient units. The OFFSET and VAR SCALE functions may be combined per the linear equation

$$y = mx + b$$

where
 y = final display value
 x = input signal
 m = VAR SCALE factor
 b = OFFSET value

For example, a pressure transducer output is conditioned by a circuit which gives an ac voltage output of 2 V = 0 PSI to 8 V = 500 PSI (0 to 500 PSI = 6 Volt change). Set up equipment as shown and proceed as follows:

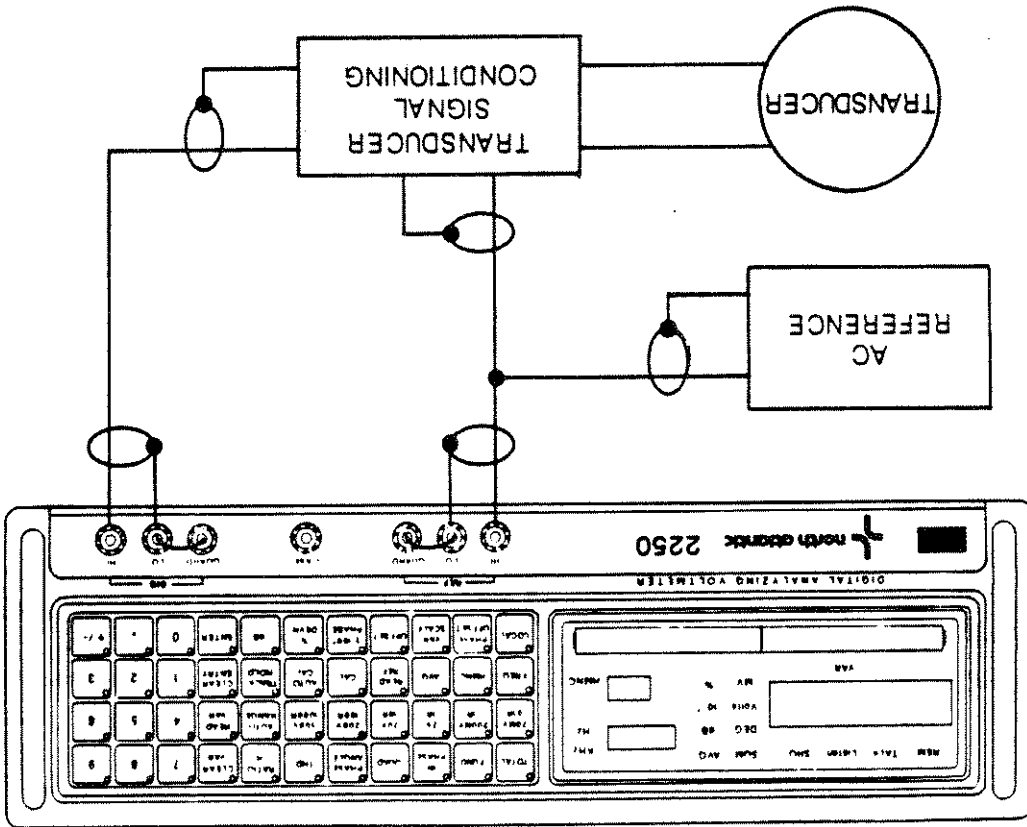

- a. To display 500 PSI as 50,000, press FUND, 20 V RANGE, VAR SCALE, 8, ., 3, 3, 3, 3, ENTER (50/6 = 8.3333).
- b. To eliminate the 2 V offset press OFFSET, 1, 6, ., 6, 6, 6, ENTER (8.3333 x 2 = 16.666).
- c. Read the display as PSI x 0.1.

X = DON'T CARE

Language	A3SW1-3	Address Switch	
		A7	A6
NATIVE	ON	OFF	OFF
225 EMULATION	OFF	OFF	OFF
MATE-CIIL	X	ON	ON

Table 4-2. IEEE-488 Interface Language Selection

4-1.2 Remote Program Language Selection. The DAV operates with one of three interface languages. The standard DAV allows selection of the NATIVE IEEE-488 interface language or MODEL 225 EMULATION IEEE-488 interface language. If the MATE-CIIL interface language option (see Section 5) is installed, activation of this option will override any other language selection. Refer to table 4-2 for language selection.

Interface Function	Subset	Function
Source Handshake	SHI	Complete Capability
Acceptor Handshake	AHI	Complete Capability
Talker	T6	Basic Talker, Serial Poll, Unaddress if MLA
Extended Talker	TEO	No Capability
Listener	L4	Basic Listener Unaddress if MLA
Extended Listener	LEO	No Capability
Service Request	SR	Complete Capability
Remote Local	RLI	Complete Capability
Parallel Poll	PP0	No Capability
Device Clear	DCI	Complete Capability
Device Trigger	DTI	Complete Capability
Controller	CO	No Capability

Table 4-1. IEEE-488 Interface Functions and Descriptions

4-1.1 Interface Functions Supported. The interface functions and subsets that the DAV responds to are listed in table 4-1.

This section describes the remote operation of the Digital Analyzing Voltmeter (DAV) using the IEEE-STD 488-1978, Standard Digital Interface for Programmable Instrumentation, and IEEE-STD 891, Remote Instrument Programming Language.

4-1 INTRODUCTION

IEEE-488 STANDARD DIGITAL INTERFACE PROGRAMMING

SECTION 4

4-1.5 Power-Up. The DAV will be in the Local mode at power-up and assume the operating conditions defined by Device Clear (see paragraphs 4-2.2 and 4-13).

4-1.4 IEEE-488 Interface Connections. The IEEE-488 Interface I/O pin connections and data signal names are listed in table 4-4. The rear panel connector (Amphenol 57-10240 or equal) connects to a IEEE-488 bus cable for data communication between the DAV and an external IEEE-488 bus controller.

Figure 4-1. Rear Panel DIP Switches

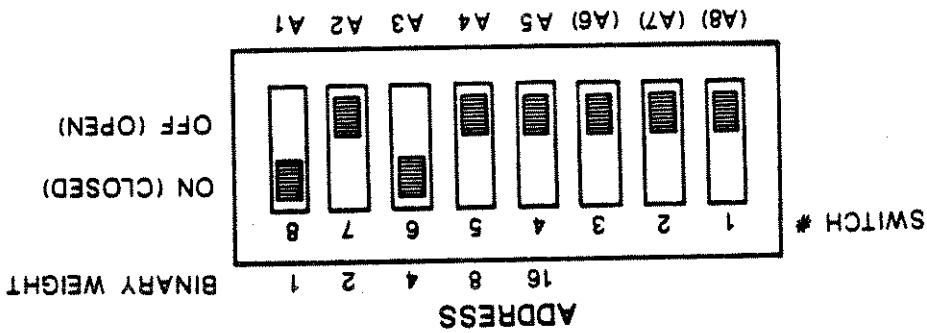

A8, A7, and A6 reference designations are not marked on rear panel.

NOTE

- a. Set switches A3 and A1 to ON position.
 - b. Set switches A5, A4, and A2 to OFF position.
- The address switches are only checked upon power-up. To change address, turn power off, set switches for new address, and then power up.

NOTE

4-1.3 DAV Address. The addresses that the DAV will respond to are set by the rear panel ADDRESS DIP switches A5 through A1 (see figure 4-1 and table 4-3). Figure 4-1 shows the rear panel DIP switch and table 4-3 shows the available device address codes. The IEEE-488 address is programmed by setting address switches A5 through A1 to the binary value of the desired address. For example, to set the DAV to address 5:

Table 4-3. Device Address Codes

Device	ASCII		ADDRESS				Hexadecimal	
	LISTEN	TALK	A5	A4	A3	A2	A1	TALK
0	SP	@	0	0	0	0	0	20
1	"	A	0	0	0	0	1	21
2	"	B	0	0	0	0	0	22
3	#	C	0	0	0	1	1	23
4	\$	D	0	0	0	0	0	24
5	%	E	0	0	0	0	1	25
6	&	F	0	0	0	1	0	26
7	'	G	0	0	0	1	1	27
8	(H	0	0	0	0	0	28
9)	I	0	0	0	1	0	29
10	*	J	0	0	0	1	0	2A
11	+	K	0	0	0	1	1	2B
12	,	L	0	0	0	1	0	2C
13	-	M	0	0	0	1	0	2D
14	.	N	0	0	0	1	0	2E
15	/	O	0	0	0	1	1	2F
16	0	P	0	0	0	0	0	30
17	1	Q	0	0	0	0	1	31
18	2	R	0	0	0	1	0	32
19	3	S	0	0	0	1	1	33
20	4	T	0	0	0	0	0	34
21	5	U	0	0	0	0	1	35
22	6	V	0	0	0	1	0	36
23	7	W	0	0	1	1	1	37
24	8	X	0	1	0	0	0	38
25	9	Y	0	1	0	0	1	39
26	:	Z	0	1	0	1	0	3A
27	;	[0	1	1	0	1	3B
28	<	\	0	1	1	0	0	3C
29	=]	0	1	1	1	0	3D
30	>	~	0	1	1	1	1	3E

Table 4-4. IEEE-488 Interface Connector Pin Assignments

Pin	Signal
1	DIO1
2	DIO2
3	DIO3
4	DIO4
5	EOI
6	DAV
7	NRFD
8	NDAC
9	IFC
10	SRQ
11	ATN
12	Safety Gnd
13	DIO5
14	DIO6
15	DIO7
16	DIO8
17	REN
18	
19	
20	
21	
22	
23	
24	

4-1.6 DAV Front Panel Annunciators. Located in the front panel display area are four IEEE-488 bus status indicators; REM, TALK, LISTEN, and SRQ. Also, the front panel LOCAL affects the IEEE-488 bus communication. Their operation is as follows:

- a. REM - Illuminates when the DAV is in Remote mode.
- b. TALK - Illuminates when the DAV is addressed to talk.
- c. LISTEN - Illuminates when the DAV is addressed to listen.
- d. SRQ - Illuminates when the DAV is asserting the SRQ bus line.
- e. LOCAL key - When in REMOTE operation, press to select LOCAL operation. The LOCAL key LED will light and REMOTE operation will be locked out. Press the LOCAL key again, the LED will go out and REMOTE operation will be permitted. A LOCAL LOCKOUT (LLO) bus command will allow the controller to seize control of the DAV regardless of the state of the LOCAL key.

4-2 BUS COMMANDS

4-2.1 Bus Command Descriptions. Table 4-5 describes the action of the IEEE-488 bus commands recognized by the DAV. Note that these are not mnemonics to be sent to the DAV. The exact form of these commands will depend on the controller used. Refer to operating instructions for your controller to determine how to send each bus command.

Table 4-5. Bus Commands

Command	Function
GTL	Go To Local - This command instructs the DAV to go to local mode. All front panel controls are active.
SDC	Selected Device Clear - If the DAV is addressed to listen, when received, this command will initialize the DAV to its default settings. See paragraph 4-2.2.
DCL	Device Clear - When received, the DAV will be initialized to its default settings. Device Clear is sent to all devices on the IEEE-488 bus simultaneously.
GET	Group Execute Trigger - If the DAV previously received commands with its internal Group Execute Trigger mode (not the bus command) active, these commands were not executed by the DAV. If the DAV is addressed to listen, when the Group Execute Trigger BUS COMMAND is received, the previously sent commands are executed.
LLO	Local Lockout - This command disables the front panel LOCAL key. It gives the controller complete control over whether the DAV is in remote or local operation.
SPE	Serial Poll Enable - After this command is received, the DAV will transmit the Serial Poll Status Byte when addressed to talk by the controller (see paragraphs 4-5 and 4-10 for content of the Status Byte).
SPD	Serial Poll Disable - This command cancels the SPE command and allows the DAV to send data or status information when addressed to talk.
UNT	Unaddresses DAV Listen Address.
UNT	Unaddresses DAV Talk Address.

FNC PANG <CR><LF>

b. Example 2 - Program the DAV to Phase Angle mode by sending the ASCII string:

FNC RMSV <CR><LF>

a. Example 1 - Program the DAV to Total Mode by sending the ASCII string:

4-3.1.1 Mode Programming Examples. The following are examples of mode programming other than Ratio R mode programming:

Mode	Mode Mnemonic
Total (SUM OR AVG)	RMSV
Fundamental	FUND
In Phase	INPH
Quadrature	QUAD
Phase Angle	PANG
THD	DSTR

Table 4-6. Mode Programming Mnemonics

4-3.1 Mode Programming. Mode programming is accomplished using the function of code (FNC) followed by the desired mode mnemonic listed in table 4-6. Note that remote RATIO R mode programming is handled differently from manual RATIO R programming. Remote RATIO R is handled as a modifier to the mode. Table 4-7 lists the modifiers allowed in each mode. The function of each mode is described in Section 3.

All programming messages sent to the DAV must consist of a string of ASCII characters terminated by the ASCII carriage return and line feed characters (<CR><LF>).

4-3 MODEL 2250 NATIVE LANGUAGE DEVICE DEPENDENT MESSAGES

4-2.3 Serial Poll. The Serial Poll status byte output from the DAV is used to give a quick verification of the operational status of the DAV, to report errors and to indicate whether a Service Request has been asserted. See paragraphs 4-5 and 4-10 for content of the Status Byte.

MODE	= TOTAL	TRACK/HOLD	= OFF
VOLTAGE RANGE	= AUTO	PHASE OFFSET	= 0.00
RATIO R	= OFF	VARIABLE SCALE	= 1.0000
RATIO RANGE	= AUTO	OFFSET	= 0.0000
FREQUENCY	= OFF	+180 PHASE	= OFF
HARMONIC	= 1	% DEVIATION	= OFF
AVG	= 0.30	PB	= OFF
READ REF	= OFF	GET	= OFF
AUTO CAL	= OFF	SRQ	= OFF

4-2.2 Default Settings. The operation of the DCL and SDC bus commands is to reset the DAV to its default settings. For the Model 225 EMULATION language these default settings are selectable and are described in paragraph 4-13. The default settings for the DAV NATIVE language are:

1. Y = yes, N = no.
2. % Deviation or dB modes may be active but not both.
3. For each mode, including Ratio R mode, a separate value is stored for Variable Scale and Offset. A separate value for % Deviation is stored for all modes except Ratio R.
4. When the THD or Ratio R mode is active, dB mode converts the measured value to its equivalent value in decibels.

NOTES:

Modifier	Mode									
	RMSV	FUND	INPH	QUAD	PANG	DSTR	RMSV	FUND	INPH	QUAD
Frequency	Y	Y	Y	Y	Y	Y	Y	Y	Y	Y
Harmonic	N	Y	Y	Y	Y	Y	N	Y	Y	Y
Average	Y	Y	Y	Y	Y	Y	Y	Y	Y	Y
Track/Hold	Y	Y	Y	Y	Y	Y	Y	Y	Y	Y
Phase Offset	N	N	Y	Y	Y	Y	N	Y	Y	Y
Variable Scale	Y	Y	Y	Y	Y	Y	Y	Y	Y	Y
Offset	Y	Y	Y	Y	Y	Y	Y	Y	Y	Y
+180	N	N	N	N	Y	N	N	N	N	N
% Deviation	Y	Y	Y	Y	Y	N	N	N	N	N
dB	Y	Y	Y	Y	Y	N	Y	Y	Y	Y

Table 4-7. Modifiers Allowed in Each Mode

4-3.1.2 Ratio R Mode Programming Examples. The following are examples of mode programming for Ratio R mode:

- a. Example 1 - Program the DAV to Ratio R (IN PHASE) mode by sending the ASCII string:
 FNC IN PHASE SET RTIO ON <CR><LF>
- b. Example 2 - Program the DAV to Ratio R (QUADRATURE) mode by sending the ASCII string:
 FNC QUAD SET RTIO ON <CR><LF>
- c. Example 3 - Program the DAV Ratio R mode off by sending the ASCII string:
 SET RTIO OFF <CR><LF>

SET RREF ON <CR><LF>

ASCII string:

a. Example 1 - Program READ RFF (reference channel measurement) on by sending the

data from each channel in the various operating modes.
 code (SET) followed by RREF followed by ON or OFF. See Section 3 for the meaning of
 measurements for transmission over the IEEE-488 bus is accomplished using the set of
 4-3.3 Measurement Channel Programming. Selection of SIGNAL or REFERENCE channel

SRX RTIO 1 <CR><LF>

For example, to program the ratio range to 1 R send the ASCII string:

Range	Range Code
.01 R	.01
.1 R	.1
1 R	1
10 R	10
100 R	100
1000 R	1000
Auto Range	AUTO

Table 4-9. Ratio Range Codes

4-3.2.2 Ratio Range Programming. To program a ratio range, SRX is followed by RTIO
 and then the desired range code as indicated in table 4-9.

SRX VOLT AUTO <CR><LF>

string:

c. Example 3 - Program the voltage range to automatic by sending the ASCII

FNC QUAD SRX VOLT .02 <CR><LF>

sending the ASCII string:

b. Example 2 - Program mode to QUADRATURE and the voltage range to 20 mV by

SRX VOLT 20 <CR><LF>

a. Example 1 - Program the voltage range to 20 Volts by sending the ASCII string:

Range	Range Code
20 mV	.02
200 mV	.2
2 V	2
20 V	20
200 V	200
500 V	500
Auto Range	AUTO

Table 4-8. Voltage Range Codes

4-3.2.1 Voltage Range Programming. To program a voltage range, SRX is followed by
 VOLT and then the desired range code as indicated in table 4-8.

4-3.2 Range Programming. Range programming utilizes the set maximum of code (SRX).

b. Example 2 - Program READ REF off by sending the ASCII string:

SET RREF OFF <CR><LF>

- OR -

SET RREF <CR><LF>

4-3.4 Measurement Modifier Programming. A modifier (Harmonic, Frequency, Averaging, or Track/Hold) may be applied to the current measurement using the set of code (SET). The format for numeric specifications may be NR1, NR2 or NR3 as defined in IEEE STD 728-1982, IEEE Recommended Practice for Code and Format Conventions. Refer to Section 3 for description of each measurement modifier.

4-3.4.1 Harmonic Measurement Programming. Measurement of the desired harmonic can be selected using the set of code (SET) followed by HARM and the harmonic number. Only the harmonic numbers 1 through 30 will be accepted by the DAV. An attempt to program any other number will result in the default harmonic (1) being programmed.

a. Example 1 - Program the DAV to measure the 5th harmonic by sending the ASCII string:

SET HARM 5 <CR><LF>

b. Example 2 - Return the DAV to the 1st harmonic (default) by sending the ASCII string:

SET HARM 1 <CR><LF>

- OR -

SET HARM <CR><LF>

4-3.4.2 Frequency Preset. The DAV filter and PLL may be preset by means of the frequency preset function. Any frequency from 10 Hz to 99,999 Hz may be programmed in 1 Hz increments. To program, the set of code (SET) is followed by FREQ, and then the desired frequency in Hertz.

a. Example 1 - Program the DAV to a frequency preset of 400 Hz by sending the ASCII string:

SET FREQ 400 <CR><LF>

b. Example 2 - Program the DAV to a frequency preset of 10 kHz by sending the ASCII string:

SET FREQ 10000 <CR><LF>

- OR -

SET FREQ 10E3 <CR><LF>

c. Example 3 - Cancel frequency preset and restore the DAV to automatic selection of PLL band and filter frequency by setting by sending the ASCII string:

SET FREQ 0 <CR><LF>

- OR -

SET FREQ <CR><LF>

4-3.5.2 Variable Scale Programming. To program Variable Scale the set of code (SET) is followed by VARI and then the desired Variable Scale multiplier value. The range of allowable Variable Scale values is +0.0000 to 9.9999. Attempts to program values outside this range will result in the default Variable Scale factor value of 1.0000 being programmed. If the db function is active when Variable Scale is programmed, the value will be applied to db. Otherwise, the Variable Scale value will be applied

SET POFF <CR><LF>

- OR -

SET POFF 0 <CR><LF>

c. Example 3 - Program no Phase Offset with the following ASCII string:

SET POFF -45 <CR><LF>

- OR -

SET POFF 315 <CR><LF>

ASCII string:

b. Example 2 - Program a Phase Offset of 315.00 degrees with the following

SET POFF 58.4 <CR><LF>

ASCII string:

a. Example 1 - Program a Phase Offset of 58.24 degrees with the following

4-3.5.1 Phase Offset Programming. To program Phase Offset the set of code (SET) is followed by POFF and then the desired Phase Offset value. The range of allowed Phase Offset values is +0.00 to 359.99 degrees. Attempts to program angles outside of this range will result in the default value of 0.00 degrees being programmed.

4-3.5 Data Math Modifier Programming. A data math modifier (Phase Offset, Variable Scale, Offset, +180° Phase, Percent Deviation, or db) may be applied to the current measurement using the set of code (SET). The format for numeric specifications may be NR1, NR2 or NR3 as defined in IEEE STD 728-1982, IEEE Recommended Practice for Code and Format Conventions. Refer to Section 3 for descriptions of each data math modifier.

SET TKHD OFF <CR><LF>

b. Example 2 - Disable the Track/Hold function with the ASCII string:

SET TKHD ON <CR><LF>

a. Example 1 - Enable the Track/Hold function with the ASCII string:

4-3.4.4 Track/Hold Programming. The Track/Hold function freezes or inhibits the update of data available to the IEEE-488 interface and enables a remote signal to update the data at a time selected by the user. A negative going edge on the rear panel trigger input updates the available data once. To enable the Track/Hold function the set of code (SET) is followed by TKHD and ON. To disable the Track/Hold function requires TKHD followed by OFF.

4-3.4.3 Data Averaging. The data averaging time constant may be programmed using the set of code (SET) followed by AVRG, and then the average time constant in seconds. Times of 0 to 9.99 seconds will be accepted by the DAV.

SET P180 OFF <CR><LF>

b. Example 2 - Disable +180° Phase function with the ASCII string:

SET P180 ON <CR><LF>

a. Example 1 - Enable +180° Phase function with the ASCII string:

4-3.5.4 +180° Phase Programming. The +180° Phase function is enabled with the set op code (SET) followed by P180 and ON. To disable the +180° Phase function requires that P180 be followed by OFF.

FNC RMSV SET OFFS <CR><LF>

- OR -

FNC RMSV SET OFFS 0 <CR><LF>

b. Example 2 - Clear Offset from TOTAL mode with the following ASCII string:

SET OFFS 3E-3 <CR><LF>

- OR -

SET OFFS .003 <CR><LF>

a. Example 1 - Program a 3 mV Offset to the current mode with the following ASCII string:

4-3.5.3 Offset Programming. To program an Offset the set op code (SET) is followed by OFFS and then the desired Offset value. All Offsets are entered in units equivalent to volts in the allowable range of +0.0000 to 9.9999. Attempts to program values outside this range will result in the default Offset factor value of 0 being programmed.

SET VARI <CR><LF>

- OR -

SET VARI 1 <CR><LF>

- OR -

SET VARI 1.0000 <CR><LF>

c. Example 3 - Clear a Variable Scale factor value with the ASCII string:

FNC PANG SET VARI 1.1111 <CR><LF>

b. Example 2 - Program a Variable Scale value for PHASE ANGLE mode of 1.1111 with the ASCII string:

SET VARI 3.1415 <CR><LF>

a. Example 1 - Program a Variable Scale value of 3.1415 for the current mode with the ASCII string:

to RATIO R If it is the current operating mode or to whatever operating mode is currently being used.

4-3.5.5 Percent Deviation Programming. The Percent Deviation function can be activated when using any voltage mode. Attempts to program Percent Deviation when in RATIO R modes or while the db function is activated will be ignored. To program the Percent Deviation function the set op code (SET) is followed by DEVI and the deviation reference point value. The DAV will not check the range of the value entered for Percent Deviation, but the user should restrict this value to the maximum that can be displayed for the current mode and range.

a. Example 1 - Set the Percent Deviation reference point to 5.33 V for the current measurement mode with the ASCII string:

```
SET DEVI 5.33 <CR><LF>
```

b. Example 2 - Disable the Percent Deviation function for the current mode with the ASCII string:

```
SET DEVI <CR><LF>
```

4-3.5.6 dB Programming. In RATIO R and THD modes the db function is enabled using the set op code (SET) followed by DECI and ON. To disable the db function in these modes DECI is followed by OFF. In the other modes where the db function is allowed, it is programmed using the set op code (SET) followed by DECI and then the db reference point value. The db reference point value must be within the range of values which can be displayed in the current mode and range.

a. Example 1 - Program the DAV to RATIO R mode with the db math modifier with the ASCII string:

```
SET RATIO ON SET DECI ON <CR><LF>
```

b. Example 2 - Program the db function with a reference point of 1 V when the DAV is not in RATIO R or THD modes with the ASCII string:

```
SET DECI 1 <CR><LF>
```

c. Example 3 - Disable the db function and reference point for the current mode with the ASCII string:

```
SET DECI OFF <CR><LF>
```

- OR -

```
SET DECI <CR><LF>
```

4-3.6 Self-Calibration Programming. Self-calibration of the DAV can be remotely initiated with the following ASCII string:

```
SET CALB <CR><LF>
```

During the calibration process (less than 60 seconds, typically), output data is not available. Requests for data from the DAV during this interval will result in the ASCII message CALB being transmitted to the controller instead of data. Calibration status can also be checked using the Serial Poll Status Byte. See paragraph 4-5.

If the DAV can not successfully complete the calibration process, an error message (ERR) will appear on the main display and the IEEE-488 interface will transmit an

STA <CR><LF>

c. TALK STATUS Programming - The status message contains complete information on the DAV setup. To have the DAV send a status message string when addressed to TALK, send the ASCII string:

INX FREQ <CR><LF> OR
FTH FREQ <CR><LF>

b. TALK Frequency Display Programming - To have the DAV send the frequency display data to the controller when it is addressed to TALK, send the ASCII string:

INX MAIN <CR><LF> OR
FTH MAIN <CR><LF> OR
INX <CR><LF> OR
FTH <CR><LF>

a. TALK MAIN DISPLAY Programming - To have the DAV send the main display data to the controller when it is addressed to TALK, send one of the following ASCII strings:

4-4.1 TALK Message Format Programming. To program the Talk Message Format use one of the messages shown below:

The DAV can transmit three basic types of messages when it is addressed to TALK by the controller. It can send to the controller the Main Display reading (or error indication), the Frequency Display reading, or the current DAV setup. A special case TALK message, the Serial Poll Status Byte, is described in paragraph 4-5. All DAV Talk messages are terminated with ASCII <CR><LF> (carriage return, line feed).

4-4 MODEL 2250 NATIVE LANGUAGE TALK MESSAGES

SET ACAL OFF <CR><LF>

b. Example 2 - Turn AUTO CAL function off with the ASCII string:

SET ACAL ON <CR><LF>

a. Example 1 - Turn AUTO CAL function on with the ASCII string:

4-3.7 AUTO CAL Function Programming. The AUTO CAL function allows the DAV to automatically initiate a self-calibration sequence when the input frequency changes by more than five percent. To activate this mode, the set op code (SET) is followed by ACAL and ON. To turn off the AUTO CAL function, ACAL is followed by OFF.

Refer to table 4-11 for description of Calibration Error Codes.

Calibration Complete (Bit D7 clear)
Calibration Needed (Bit D1 set)
Error Condition (Bit D5 set)

error message when addressed to TALK (refer to paragraph 4-4.2). At this time an examination of the Serial Poll Status Byte will indicate:

MODEL 225 EMULATION TALK MESSAGES

Model 225 Emulation Talk Messages consist of a string of ASCII characters, including the numeric value of the measurement.

1. Talk Message Data Format. Model 225 Emulation messages sent to the Controller the DAV may be in one of two formats: long or short. Long format messages give complete information on the instrument's setup, and short format messages are more compact and easier for the controller to process. See table 4-24 for a description of Talk Messages.

9.1.1 Long Talk Message Format. The long format Talk message is of the form shown in figure 4-3. The length of the string will depend on the range and type of data.

<M=T,D=+XX.XXXMV,R=1,F=1,N=T,L=T,O=T,V=T,S=T<CR><LF>
F
I
Q
2 2 XXX.XXXV
3 3 XXXX.XMV
4 4 XX.XXXV
5 5 XXX.XXV
6 6 XXXX.XV
(FOR DEGREES READOUT)
XXX.X' (FOR DEGREES READOUT)

(Less Than Sign): Beginning delimiter for long format message
(Equal Sign): Separates instruction text from argument text
(Comma): Separates Talker fields
(Single Quote Mark): Indicates degree readout
(CR) <CR> (ASCII carriage return): Message terminator
(LF) <LF> (ASCII line feed): Message terminator
Figure 4-4. Long Format Talk Message

4-9.1.2 Short Talk Message Format. The short format Talk message is of the form shown in figure 4-4. The length of the string will depend on the range and type of data.

D+XX.XXXMV<CR><LF>
XXX.XXXV
XXXX.XMV
XX.XXXV
XXX.XXV
XXXX.XV
XXX.X' (FOR DEGREES READOUT)

(Letter "D"): Short format message beginning delimiter
(Single Quote Mark): Indicates degrees readout
(CR) <CR> (ASCII carriage return): Message Terminator
(LF) <LF> (ASCII line feed): Message Terminator
Figure 4-5. Short Format Talk Message

The Serial Poll Status Byte is read by the controller during a serial poll sequence. The meaning of the individual bits of the status byte are indicated in table 4-19. The Serial Poll Status Byte may be used to determine which device has asserted a Service Request (SRQ), or to determine if data are stable and not overloaded.

Table 4-19. Model 225 Emulation Serial Poll Status Byte

D7	D6	D5	D4	D3	D2	D1	D0
CAL	RQS	*	STAB	*	LOCK	*	OVLID

Command	Function
---------	----------

CAL When set, the DAV is in the process of self-calibration. Note that this bit is not active in the Model 225, but is necessary in the Model 2250 DAV due to the self-calibration function.

RQS When set, the DAV has asserted the Service Request line on the bus (SRQ).

* Not active, reset to zero.

STAB When set, the display is stable. Stability is defined as 20 consecutive display updates that are within ± 2 LSBS of each other.

LOCK When set, the DAV is locked onto the incoming signal on the channel selected for lock (usually the reference channel).

OVLID When clear, the front-end amplifiers are overloaded or the display value will not fit on the front panel display.

4-11 MODEL 225 EMULATION SERVICE REQUEST

The Service Request function provides a means for the DAV to interrupt the controller. The DAV may be programmed to assert the Service Request line on the bus if data is stable or if stability has not been achieved within a specified timeout period, or when the display has been updated twice, or after every display update. Whenever the DAV asserts the SRQ line, the current data and status are internally latched and will be transmitted to the controller the next time the DAV is addressed to TALK.

NOTE

Once SRQ is asserted, it will not be asserted again until data is read from the DAV. When data is read, it will be the value which was displayed when SRQ was asserted, regardless of how many new readings have been taken.

4-11.1 Assert SRQ With Stable Data or Measurement Timeout. To have the DAV assert the Service Request line when the DAV is locked, not overloaded, and the display reading is stable, the Service Request Instruction (S) is set true (1). Stability is defined as 20 consecutive display updates that are within ± 2 least significant bits of each other. Once the service-request-on-stable-data function is turned on, the DAV will assert the SRQ line when the display becomes stable following every message

When the DAV receives a Device Clear or Selected Device Clear bus command it resets switches located on the I/O circuit card (A3). Table 4-22 summarizes the function of each DIP switch.

MODEL 225 EMULATION DEVICE CLEAR OPTIONS 4-13

GET (G)	Long Format	GET Enabled GET Disabled
Short Format	<G=T<CR><LF> <G=F<CR><LF>	\$GT<CR><LF> \$GF<CR><LF>

Table 4-21. Group Trigger Enable Arguments

To program the Group Execute Trigger Enable (GET) function use the GET enable instruction (G) followed by T or F to set it true or false. When the Group Execute Trigger function is active, a device dependent program string may be sent to the DAV but there will be no change to the setup of the DAV, that is the string will not be executed. The string will be executed when the Controller sends the GET bus command. See table 4-21 for arguments to the Group Execute Trigger Enable instruction.

MODEL 225 EMULATION GROUP EXECUTE TRIGGER REQUEST PROGRAMMING 4-12

SRQ (S)	Long Format	SRQ on Stable Data SRQ on Timeout SRQ on 2nd Reading SRQ Continuously SRQ Off
Short Format	<S=T<CR><LF> <S=T<CR><LF> <S=2<CR><LF> <S=C<CR><LF> <S=F<CR><LF>	\$ST<CR><LF> \$ST<CR><LF> \$S2<CR><LF> \$SC<CR><LF> \$SF<CR><LF>

Table 4-20. Service Request Arguments

4-11.3 Assert SRQ Continuously Programming. To program the DAV to assert the SRQ line continuously, the Service Request Instruction (S) is set to continuous (C). In this variation of the service request function the SRQ bus line is asserted after every display update. This function does not require that the display be stable to assert SRQ. The stability bit in the serial poll status byte may be checked to determine whether the DAV reading is stable (see paragraph 4-10). See table 4-20 for arguments to the Service Request Instruction.

4-11.2 Assert SRQ On Second Reading Programming. To have the DAV to assert the SRQ line on the second reading, the Service Request Instruction (S) is set to second reading (2). In this variation of the service request function the SRQ bus line is asserted after the second display update. This function does not require that the display be stable to assert SRQ. The stability bit in the serial poll status byte may be checked to determine whether the DAV reading is stable (see paragraph 4-10). See table 4-20 for arguments to the Service Request Instruction.

This SRQ function times out in 27.5 seconds (nominal). If the data does not meet the stability requirement within this time, SRQ is asserted and the STAB bit of the serial poll status byte is set low (not stable).

transmitted to the DAV until this function is turned off. See table 4-19 for arguments to the Service Request Instruction.

Table 4-22. 225 Emulation Device Clear Options

Mode	SW2-8	SW2-7	SW2-6	TOTAL	FUND	INPHASE	QUAD	PHASE	THD	THD	THD	THD	THD	THD	THD	THD	THD	THD	
Mode	SW2-8	SW2-7	SW2-6	C	C	C	C	C	C	C	C	C	C	C	C	C	C	C	C
Range	SW2-5	SW2-4	SW2-3	C	C	C	C	C	C	C	C	C	C	C	C	C	C	C	C
AUTO	C	C	C	C	C	C	C	C	C	C	C	C	C	C	C	C	C	C	C
AUTO	C	C	C	C	C	C	C	C	C	C	C	C	C	C	C	C	C	C	C
500 V	C	C	C	C	C	C	C	C	C	C	C	C	C	C	C	C	C	C	C
100 V	C	C	C	C	C	C	C	C	C	C	C	C	C	C	C	C	C	C	C
10 V	C	C	C	C	C	C	C	C	C	C	C	C	C	C	C	C	C	C	C
1 V	C	C	C	C	C	C	C	C	C	C	C	C	C	C	C	C	C	C	C
100 mV	C	C	C	C	C	C	C	C	C	C	C	C	C	C	C	C	C	C	C
10 mV	C	C	C	C	C	C	C	C	C	C	C	C	C	C	C	C	C	C	C
Frequency Select	SW1-1	SW1-2	SW1-1	C	C	C	C	C	C	C	C	C	C	C	C	C	C	C	C
F1	C	0	0	0	0	0	0	0	0	0	0	0	0	0	0	0	0	0	0
F2	C	0	0	0	0	0	0	0	0	0	0	0	0	0	0	0	0	0	0
F3	C	0	0	0	0	0	0	0	0	0	0	0	0	0	0	0	0	0	0
F4	C	0	0	0	0	0	0	0	0	0	0	0	0	0	0	0	0	0	0
Voltage/Ratio Select	Voltage		Ratio	C	C	C	C	C	C	C	C	C	C	C	C	C	C	C	C
F1 (SW1-5)	C	0	0	C	C	C	C	C	C	C	C	C	C	C	C	C	C	C	C
F2 (SW1-6)	C	0	0	C	C	C	C	C	C	C	C	C	C	C	C	C	C	C	C
F3 (SW1-7)	C	0	0	C	C	C	C	C	C	C	C	C	C	C	C	C	C	C	C
F4 (SW1-8)	C	0	0	C	C	C	C	C	C	C	C	C	C	C	C	C	C	C	C
NOTE: "0" = OPEN, "C" = CLOSED.																			

Offset	SW2-2	Enabled	C	0
Offset	SW2-2	Enabled	C	0
Offset	SW2-2	Disabled	0	C
VAR Scale	SW2-1	Enabled	C	0
VAR Scale	SW2-1	Disabled	0	C
Data Format	SW1-4	Long	0	C
Data Format	SW1-4	Short	C	0
225/2250	SW1-3	Software Select	0	C
225 Software		2250 Software	0	C

Parameter	Variation	
	Long Format	Short Format
Modes	>M=T >M=F >M=I >M=Q >M=P	\$MT \$MF \$MI \$MQ \$MP
Ranges	10 MV 100 MV 1000 MV 10 V 100 V 1000 V AUTO RANGE	\$R1 \$R2 \$R3 \$R4 \$R5 \$R6 \$RA
Frequency	F1 F2 F3 F4	\$F1 \$F2 \$F3 \$F4
Reference Offset	ON (TRUE) OFF (FALSE)	>O=T >O=F
Variable Scale	ON (TRUE) OFF (FALSE)	>V=T >V=F
Data Format	LONG SHORT	>D=L >D=S
Service Request	ON STABLE DATA ON TIMEOUT ON 2ND READING CONTINUOUSLY OFF	>S=T >S=T >S=2 >S=C >S=F
GET Request	ON (TRUE) OFF (FALSE)	>G=T >G=F

Table 4-23. Model 225 Emulation Programming Guide

Table 4-24. Model 225 Emulation Long Talk Message Summary

Parameter	Variation	Meaning
Mode (M=)	T F I Q P	TOTAL FUND IN PHASE QUAD PHASE ANGLE
Display Reading	D=+XXX.XXXM D=+XXX.X'	VOLTAGE OR RATIO PHASE ANGLE
Range (R=)	1 2 3 4 5 6 A	10 MV 100 MV 1000 MV 10 V 100 V 1000 V AUTO
Frequency (F=)	1 2 3 4	F1 F2 F3 F4
Not Locked (N=)	T F	NOT LOCKED LOCKED
Overloaded (L=)	T F	OVERLOADED NOT OVERLOADED
REF Offset (O=)	T F	REF OFFSET ON REF OFFSET OFF
VAR Scale (V=)	T F	VAR SCALE ON VAR SCALE OFF
SRQ (S=)	T	SRQ ON STABLE READING OR TIMEOUT
	2	ON 2ND DREADING CONTINUOUSLY OFF
	C F	

A7	A6	Selection
C	C	IEEE-488 MATE
0	0	Standard Operation

5-1.2 Selection of IEEE-488 MATE Operation. The IEEE-488 MATE Control Interface Intermediate Language (CIIL) option or standard DAV operation is selected by setting the rear panel address switch as follows:

- | = exclusive OR
- < > = the boundaries of a field or structure of inseparable items
- = one ASCII blank
- [] = an optional field, item, or structure
- ... = the field or structure may be repeated as often as required
- <setcode> : = SET | SRX | SRN
- <noun> : = ACS
- <mchar> : = four ASCII encoded characters. See table 5-2 for a complete list.
- <modifier> : = four ASCII encoded characters. See table 5-2 for a complete list.
- <chan num> : = 1 or 2 digit ASCII number indicating the channel number (0 | 1 | 00 | 01)
- <value> : = any ASCII encoded number in floating point, engineering, or integer notation.
- <cr, lf> : = ASCII encoded carriage return followed by encoded line feed.
- <nsf> : = nonstandard form.

5-1.1 Input/Output String Notation. The following notation shall be used to describe the various input and output strings:

- o Accepts control computer input and translates the standard program instructions of the MATE Control Interface Intermediate Language into that required by the DAV.
 - o Upon command sends measurement responses to the control computer.
 - o Provides the means to perform Confidence and Self testing.
 - o Controls the isolation relays.
 - o Generates status messages.
 - Recommended reference documents for use with this option include:
 - o MOD 1 - MATE User's Group Action Traveler - CIIL Definitions.
 - o MATE Control Interface Intermediate Language - Standard 2806763, Rev. B.
- This section describes the operation and programming of the DAV using the IEEE-488 (MATE) Modular Automatic Test Equipment Control Interface Intermediate Language (CIIL) option. The CIIL option allows the DAV to communicate with the MATE controller and provides the following functions:

5-1 INTRODUCTION

IEEE-488 MATE CONTROL INTERFACE INTERMEDIATE LANGUAGE OPTION

SECTION 5

Figure 5-1 illustrates the rear panel address switch set for IEEE-488 MATE operation and address 6 (binary).

NOTE

A8, A7, and A6 reference designations are not marked on rear panel.

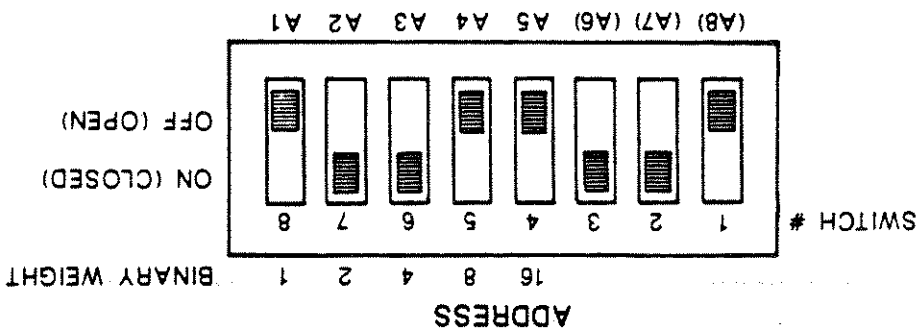

Figure 5-1. IEEE-488 MATE Address Switch Selection

5-1.3 Initial Setup. The control computer must be equipped with an IEEE-488 Control Interface circuit card and have the appropriate IEEE I/O connector.

Connect the IEEE-488 connector from the control computer to the IEEE-488 connector located on the rear panel of the DAV. The user can now program and transmit specific data strings to the DAV and have it perform accordingly.

5-2 INPUTS

5-2.1 Format of Inputs. There are nine transmission types applicable to the DAV in the GIL Language. At the start of each type the instrument will be "listen addressed" by the control computer. The end of the transmission will be indicated by <cr,<lf>. Each transmission type begins with its own characteristic <verb>. They are as follows:

FNC	Setup the instrument
INX	Initiate a measurement
FTH	Transmit the measurement result to the control computer.
CLS	Close the input path
OPN	Open the input path
RST	Reset the instrument
STA	Report status
IST	Initiate built-in-test
CNF	Initiate confidence test

As a general rule, anywhere one blank, , is indicated, the DAV will accept multiple blanks as if they were one blank.

5-2.2 Format of FNC. The FNC string is used to setup the instrument prior to making a measurement and to calibrate the unit. The general format of the FNC string is:

FNC<noun><mchar>:CH<chan num>
[<setcode><modifier><value>[<nsf>]]<cr,lf>

5-2.3 Noun. There is only one <noun> applicable to the DAV. This is

ACS

If any other <noun> appears, an error message will be generated.

5-2.4 MCHAR. The applicable <mchars> are:

- ZPNG - To setup to calibrate the DAV
- VOLT - To setup for a voltage measurement
- VRMS - Same as volt
- PANG - To setup for a phase angle measurement
- HARV - To setup for a harmonic voltage measurement
- HARP - To setup for a harmonic phase angle measurement
- DSTR - To setup for a THD measurement

If any other <mchar> appears, an error message will be generated.

5-2.5 Channel Number. All <mchars> will accept channels 0,1,00, or 01. In addition, the ZPNG <mchar> will accept channel 2 or 02. In this instance the calibration will be done in Total mode in order to calibrate the AVG Total mode if selected. (Refer to paragraph 3-4.1)

5-2.6 Modifier Fields. As indicated in paragraph 5-1, each <modifier> optional field appears as follows:

<set code><modifier><value>[<nsf>]

5-2.6.1 Set Codes. The <set code> is defined as the ASCII sequences of SRX, SET, or SRN. If the same <modifier> appears more than once with a different <set code>, the DAV will use the one with the highest priority. The order of priority is:

- a. SRX
- b. SET
- c. SRN

5-2.6.2 Modifier. The <modifier> field programs other features of the DAV. The allowable <modifiers> are:

- ZPNG - Has no effect
- VOLT - Selects voltage range of SIG channels (0,00)
- VRMS - Same as VOLT
- PANG - Has no effect
- HARV - Selects Harmonic number
- DSTR - Has no effect
- HARP - Selects harmonic number
- GAMD - Programs AVG
- FREQ - Programs FREQ
- TRSC - Programs TRACK/HOLD mode
- TRSL - Has no effect
- TRLV - Has no effect
- MAXT - Selects maximum measurement time

FNCACSVOLT:CHOSETVOLT2.OE2SETVOLT2.OE2IN-PHASE<cr,lf>

200 V range:

5-3.3 IN PHASE Mode. The string below programs the DAV for IN PHASE mode and the

FNCACSVOLT:CHOSETVOLT1.5SETVOLT1.5FUND<cr,lf>

following string

5-3.2 FUNDAMENTAL Mode. To program the DAV to FUND mode and 2 V range, use the

To change the range, replace the <value> after the <modifier> VOLT or VRMS to a <value> that falls in the range desired.

FNCACSVRMS:CHOSETVRMS20<cr,lf>
FNCACSVOLT:CHOSETVOLT20<cr,lf>

20 V range:

5-3.1 TOTAL Mode. The following strings program the DAV for TOTAL mode and the

5-3 PROGRAMMING APPLICATIONS (FNC)

If any other <nsf> appears, an error message will be generated. The <ascii integer> programs the harmonic number and must be in the range of 2 to 30 or an error message will be generated.

 <ascii integer>

If the <nsf> field is missing for these <modifier> fields, an error message will be generated. The only applicable <nsf> for these <modifiers> is:

HARV
HARP

The <nsf> field is required for the following <modifiers>:

 FUND to program the DAV to FUNDAMENTAL mode
 IN-PHASE to program the DAV to INPHASE mode
 QUAD to program the DAV to QUAD mode

follows:

The allowable <nsf> fields for these <modifiers> are listed below. If any other <nsf> field appears, the entire <modifier> field will be ignored. They are as

The standard VOLT or VRMS <modifier> field should be present. In addition, a <modifier> field containing <nsf> may also be present. The voltage range will be set by the <modifier> field received last.

VRMS
VOLT

5-2.6.3 Nonstandard Form. Several <modifiers> may use the <nsf> field. This field is optional for the following <modifiers>:

Any other <modifier> appearing in the FNC string will cause an error message to be generated.

5-3.4 QUADRATURE Mode. To measure the QUAD component in the 20 mv range, use the following string:

```
FNC<b>ACS<b>VOLT<b>:CHO<b>SET<b>VOLT<b>2OE-3<b>SET<b>VOLT<b>2OE-3<b>QUAD<b>cr,lf<>
```

5-3.5 PHASE ANGLE Mode. The DAV can be set to the PHASE ANGLE mode and the 2 V range by using the following string:

```
FNC<b>ACS<b>PANG<b>:CHO<b>SET<b>VOLT<b>2<b>SET<b>PANG<b>0<b>cr,lf<>
```

5-3.6 Total Harmonic Distortion (THD). The following string programs the DAV for THD mode and the 200 mv range:

```
FNC<b>ACS<b>DSTR<b>:CHO<b>SET<b>VOLT<b>.2<b>SET<b>DSTR<b>0<b>cr,lf<>
```

5-3.7 Harmonic Phase. To set up the DAV to measure the phase angle of a harmonic, the HARP <modifier> is used to select the desired harmonic. The example below sets up the DAV to measure the phase angle of the 5th harmonic:

```
FNC<b>ACS<b>HARP<b>:CHO<b>SET<b>VOLT<b>20<b>SET<b>HARP<b>5<b>5<b>cr,lf<>
```

The <value> after the <modifier> HARP is not checked by the DAV. However, the <nsf> after the <value> contains the desired harmonic number. This number must be an integer in the range of 2 through 30. Any other number will cause an error message to be generated.

5-3.8 Harmonic Voltage. To measure the voltage of a harmonic the HARV <modifier> is used. The <nsf> is used to select the desired harmonic. In addition, the <nsf> of the VOLT <modifier> is used to select between FUND, IN PHASE, and QUAD. The string below programs the DAV to measure the FUNDAMENTAL component of the 3rd harmonic:

```
FNC<b>ACS<b>HARV<b>:CHO<b>SET<b>VOLT<b>20<b>SET<b>VOLT<b>20<b>FUND<b>SET<b>HARV<b>3<b>3<b>cr,lf<>
```

The next example measures the IN PHASE voltage of the 5th harmonic:

```
FNC<b>ACS<b>HARV<b>:CHO<b>SET<b>VOLT<b>20<b>SET<b>VOLT<b>20<b>IN-PHASE<b>SET<b>HARV<b>5<b>5<b>cr,lf<>
```

Finally, the last example sets the DAV to measure the QUAD component of the 7th harmonic:

```
FNC<b>ACS<b>HARV<b>:CHO<b>SET<b>VOLT<b>20<b>SET<b>VOLT<b>20<b>QUAD<b>SET<b>HARV<b>7<b>7<b>cr,lf<>
```

5-3.9 Frequency. When noisy signals are present the DAV may not lock properly. Programming the frequency will generally help to prevent this. The frequency is programmed using the FREQ <modifier>. The <value> following FREQ selects the desired frequency. This <value> must be in the range of 10 Hz to 100 KHz. Any value outside of this range will cause an error message to be generated. The following string sets the unit to FUND mode and sets the frequency to 400 Hz:

```
FNC<b>ACS<b>VOLT<b>:CHO<b>SET<b>VOLT<b>22<b>SET<b>VOLT<b>22<b>FUND<b>SET<b>FREQ<b>400<b>cr,lf<>
```

The FREQ <modifier> may be used for any type of measurement and is required for the ZPNG <mchar>.

5-3.10 Averaging. Averaging can be used to reduce display jitter when noisy signals are being measured. The averaging constant is programmed by the GAWD <modifier>. The <value> following the GAWD <modifier> selects the time constant and any value in the range of 0 through 9.99 may be specified. Values outside this range will cause an error message to be generated. The following example sets the averaging constant to 1.5 seconds for a Total mode measurement:

```
FNC<b>ACS<b>VOLT<b>:CHO<b>SET<b>VOLT<b>20<b>SET<b>GAWD<b>1.5<b>cr,lf<>
```

If a <value> of 0 is used for the GAWD <modifier> no check for settling of the measurement will be done. The measurement result will be transmitted if the DAV is locked and not overloaded.

The GAWD <modifier> may be used for any measurement except the ZPNG <mchar>. If not specified, the GAWD value defaults to 0.3.

5-3.11 Voltage Ranging. The signal channel (:CHO) is programmable using the VOLT or RMS <modifiers>. The reference channel (:CHI) is not programmable. The <value> following the VOLT or RMS <modifier> is checked in order to select the proper voltage range. If a second VOLT or RMS SET code containing a <nsf> field is present then the last <modifier> received is used to select the voltage range. Table 5-1 indicates how the selection is made.

Table 5-1. Voltage Range Selection

<value> range	DAV Voltage Range Selected
0 < value <= 20E-3	20 mV
.02 < value <= x.2	200 mV
.2 < value <= 2	2 V
2 < value <= 20	20 V
20 < value <= 200	200 V
200 < value <= 500	500 V

The following example will select the 200 mV range:

```
FNC<b>ACS<b>VOLT<b>:CHO<b>SET<b>VOLT<b>1.75E-1<b>cr,lf<>
```

The VOLT or RMS <modifier> is required for all measurement except for the ZPNG <mchar>.

5-3.12 Track/Hold Mode. The Track/Hold mode is programmed using the TRSC <modifier>. The <value> field can only contain the ASCII string "EXT". Any other value will cause an error message to be-generated.

The Track/Hold mode waits for an external negative going edge on the rear panel trigger input before completing a measurement.

The following string will turn on the Track/Hold mode for a QVAD measurement:

```
FNC<b>ACS<b>VOLT<b>:CHO<b>SET<b>VOLT<b>1.75E1<b>SET<b>VOLT<b>1.75E1<b>QUAD<b>SET<b>TRSC<b>EXT<b>cr,lf<b>
```

NOTE

The TRSC <modifier> may be used for any measurement with the exception of the ZPNG <uchar>.

5-3.13 Reference Channel Measurements. Any measurement can also be made on the reference channel by using: CHI instead of: CHO. The following example measures the TOTAL mode voltage on the reference channel:

```
FNC<b>ACS<b>VOLT<b>:CHI<b>SET<b>VOLT<b>1.75E-1<b>cr,lf<b>
```

5-3.14 Calibration. Calibration is performed using the FNC command with an <uchar> of ZPNG. The calibration FNC string requires the use of the FREQ <modifier> and the ZPNG <modifier>. The following example will setup the DAV to calibrate at 400 Hz:

```
FNC<b>ACS<b>ZPNG<b>:CHO<b>SET<b>FREQ<b>400<b>SET<b>ZPNG<b>0<b>cr,lf<b>
```

Specifying channels 0 or 1 has no effect. However, if channel 2 is specified, the DAV will be calibrated in AVG Total mode if selected.

The INX command will initiate the calibration. The response time to the INX command when using the ZPNG <uchar> will be 45 seconds. A successful calibration is indicated by 0 <value> being returned in response to the FTH command.

5-4 FORMAT OF INX

The INX string instructs the DAV to make a measurement. After the DAV receives the INX string it sets its internal clock to <time> and begins to make the measurement. If the measurement cannot be made within <time>, an error message is generated. Typically this would happen if the DAV could not lock on the input signal. The <time> value is computed by the DAV based on the GAMD and MAXT <modifier> and is transmitted to the control computer if the DAV is addressed to talk following the INX string.

```
<time> = 20 + (GAMD<value>x10)
```

If the TRACK/HOLD mode is programmed (TRSC = EXT) then <time> is also modified by MAXT.

```
<time> = 20 + (GAMD<value>x10) + MAXT
```

If not specified, MAXT defaults to 10.

The format for the INX string is as follows:

```
INX<b><uchar><b>cr,lf<b>
```

The <uchar> in this string must match the <uchar> in the previous FNC string. If it does not, an error message will be generated and the command will not be executed.

OPN:CH<chan num><cr,lf>

The OPN command opens the DAV isolation relays. The format of the OPN command is:

5-7 FORMAT OF OPN

CLS:CH0<cr,lf>

Channel number 0 or 1 may be specified; however, specifying either channel closes both channel 0 and channel 1. For example, the following string closes the input path:

CLS:CH<chan num><cr,lf>

The CLS command closes the isolation relays of the DAV and is normally used before a measurement is taken. The format of the CLS command is:

5-6 FORMAT OF CLS

These messages would indicate that the instrument is being requested to return an answer to the control computer without having first taken a reading.

IEEE-488 bus command DCL or SDC
RST
IST
CNF

An error message will also be generated if any of the following messages are received between the INX and FTH strings:

The <uchar> must match that of the previous INX string or an error message will be generated and transmitted to the control computer the next time the DAV is addressed to talk.

FTH<uchar><cr,lf>

The format of the FTH string is:

The FTH command instructs the DAV to return the measurement result to the control computer. After receiving this command and being addressed to talk the DAV will transmit the measurement result.

5-5 FORMAT OF FTH

These messages would indicate that the DAV is being instructed to make a measurement without having been setup correctly.

IEEE-488 bus command DCL or SDC
RST
IST
CNF

An error message will also be generated if any of the following messages are received between the FNC and INX string:

Channel number 0 or 1 may be specified; however, specifying either channel opens both channel 0 and channel 1. For example, the following string opens the input path:

OPNCHI<cr,lf>

5-8 FORMAT OF RST

The RST command causes the DAV to reset the current measurement and to open the isolation relays. The format of RST is:

RST<noun><mchar>:CH<chan num><cr,lf>

This command will be ignored if the <mchar> does not match the <mchar> of the previous FNC string.

If the <mchar> does match, the DAV will go to the following state:

Both relays open
TOTAL mode
20 V range
All other variables cleared

If the channel number specified is any other than 0,00,01, or 1 an error message will be generated and the RST command will not be executed.

5-9 FORMAT OF STA

The STA command instructs the instrument to return the status of the DAV. The format of this command is:

STA<cr,lf>

When addressed to talk after this command the DAV will respond with either <cr,lf>, if there are no errors, or an error message in the case of errors. Typically STA will be used after the completion of built-in-test or confidence test.

5-10 FORMAT OF IST

The IST command instructs the DAV to perform an internal self-test. When the DAV receives this command it will perform a unit calibration at 400 Hz. If the calibration is successful then a <cr,lf> message will be returned in response to a STA command. If a failure occurs then an error message will be generated.

The format of IST is as follows:

IST<cr,lf>

The control computer must wait 45 seconds before attempting to send another command to the DAV after it has received the IST command. Any attempt to send a new string before this time will result in an error message being generated.

5-11 FORMAT OF CNF

The CNF command instructs the DAV to perform an internal confidence test. Upon receipt the DAV will perform a calibration at 400 Hz. If the calibration is

successful, then a <cr,<lf> message will be returned in response to a STA command. If a failure occurs then an error message will be generated.

The format of CNF is as follows:

CNF<<cr,<lf>

The control computer must wait 45 seconds before attempting to send another command to the DAV after it has received the CNF command. Any attempt to send a new string before this time will result in an error message being generated.

5-12 OUTPUTS

5-12.1 Errors. Error messages are generated for the following basic reasons:

- a. Syntax errors
- b. Values out of range
- c. Failure of CNF or IST
- d. Measurement timeouts

Once an error message is loaded into the output buffer it will remain there until read by the control computer. The only exception is that the receipt of an RST or IEH-488 DCL will clear the error message. The error messages will then be transmitted instead of the normal data expected. Error messages have the following forms:

```
FO0DAV00 (MOD): <ASCII message><<cr,<lf>
FO5DAV00 (MOD): <ASCII message><<cr,<lf>
FO6DAV00 (MOD): <ASCII message><<cr,<lf>
FO7DAV00 (MOD): <ASCII message><<cr,<lf>
```

The first form (FO0DAV1) is used to indicate an overrange condition. The second form (FO5DAV1) is used when measurements cannot be completed in the allotted amount of time.

The third form (FO6DAV1) is used when a trigger input is not received within the allotted time.

The fourth form (FO7DAV00) is used to report syntax errors, CNF and IST problems, and <value> range errors.

See table 5-3 for a complete list of error messages.

Table 5-2. ERROR MESSAGES

Error Number	Description
--------------	-------------

FO7DAV00 (MOD):	MATE NOUN SYNTAX ERROR
FO7DAV00 (MOD):	MATE <MCHAR> SYNTAX ERROR
FO7DAV00 (MOD):	BAD INX STRING
FO7DAV00 (MOD):	BAD <MAXT> VALUE
FO5DAV00 (MOD):	DEVICE TIMEOUT
FO7DAV00 (MOD):	ILLEGAL CHANNEL NUMBER
FO7DAV00 (MOD):	ILLEGAL SET PROG
FO7DAV00 (MOD):	ILLEGAL MODIFIER
FO7DAV00 (MOD):	IMPROPER STRING TERMINATOR
FO7DAV00 (MOD):	BAD SETUP DATA
FO7DAV00 (MOD):	SYNTAX ERROR
FO7DAV00 (MOD):	ILLEGAL GATE TIME

23<cr,lf>

A typical response to INX would be:

where <time> is an ASCII integer in seconds. See paragraph 5-4 for information on how <time> is calculated.

<time><cr,lf>

<time><cr,lf>

5-12.2 Response to INX. After receipt of the INX command the DAV will load the output buffer with the maximum amount of time in seconds that it will take to make the requested measurement. The format of the transmission is:

F07DAV00 (MOD):	ILLEGAL FREQUENCY
F07DAV00 (MOD):	ILLEGAL HARMONIC NUMBER
F07DAV00 (MOD):	BAD T/H SPEC
F07DAV00 (MOD):	RANGE ERROR
F07DAV00 (MOD):	CALIBRATION IN PROGRESS
F07DAV00 (MOD):	BAD FTH STRING
F07DAV00 (MOD):	CALIBRATION STRING ERROR
F07DAV00 (MOD):	CALIBRATION ERROR
F07DAV00 (MOD):	STATUS STRING ERROR
F07DAV00 (MOD):	MATE VERB SYNTAX ERROR
F07DAV00 (MOD):	<GNF> OUT OF SEQUENCE
F07DAV00 (MOD):	<IST> OUT OF SEQUENCE
F07DAV00 (MOD):	<RST> OUT OF SEQUENCE
F07DAV00 (MOD):	<DCL> OUT OF SEQUENCE
F07DAV00 (MOD):	MATE MESSAGE DURING INTERNAL TEST
F07DAV00 (MOD):	SLOPE SETUP ERROR
F07DAV00 (MOD):	NO FREQUENCY SPECIFIED
F00DAV00 (MOD):	FRONT END OVERLOAD
F07DAV00 (MOD):	NOT IN REMOTE MODE
F06DAV00 (MOD):	TRIGGER TIMEOUT
F07DAV00 (MOD):	BAD CNF STRING
F07DAV00 (MOD):	BAD IST STRING
F05DAV00 (MOD):	TIMEOUT - HARMONIC EXCEEDED
F05DAV00 (MOD):	TIMEOUT - NOT LOCKED
F00DAV00 (MOD):	DISPLAY OVERLOAD
F07DAV00 (MOD):	DAV NOT SETUP
F07DAV00 (MOD):	MEASUREMENT NOT INITIATED
F07DAV00 (MOD):	MAXT RECEIVED WITHOUT TRSC
F07DAV00 (MOD):	TRSL RECEIVED WITHOUT TRSC
F07DAV00 (MOD):	TRLV RECEIVED WITHOUT TRSC
F07DAV00 (MOD):	INX RECEIVED WITHOUT VALID FNC
F05DAV00 (MOD):	NOT LOCKED
F05DAV00 (MOD):	HARMONIC EXCEEDED
F07DAV00 (MOD):	HARV MODIFIER WITHOUT HARV (MCHAR)
F07DAV00 (MOD):	HARF MODIFIER WITHOUT HARF (MCHAR)
F07DAV00 (MOD):	DSTR MODIFIER WITHOUT DSTR (MCHAR)
F07DAV00 (MOD):	MISSING PANG MODIFIER
F07DAV00 (MOD):	MISSING DSTR MODIFIER
F07DAV00 (MOD):	PANG MODIFIER WITHOUT PANG (MCHAR)
F07DAV00 (MOD):	MISSING ZPNG MODIFIER
F07DAV00 (MOD):	ZPNG MODIFIER WITHOUT ZPNG (MCHAR)

Error Number Description

Table 5-2. ERROR MESSAGES (Continued)

DESCRIPTION	CIIIL
function	FNC
open	OPN
close	CLS
status	STA
reset	RST
confidence test	CNF
BIT test	IST
go to alternate language	GAL
initiate	INX
fetch	FTH
set	SFT
set maximum	SRX
set minimum	SRN

Table 5-3. CIIIL CODES

5-12.4 Response to STA. The response to STA will be either
 <cr,<lf> or an error message.
 In general, the response of <cr,<lf> indicates that there are no problems to
 report or that a CNF or IST was successfully completed.

If the calibration is successful, otherwise an error message will be generated.
 If the measurement cannot be completed in the amount of time reported by the INX
 command an error message will be generated.

In the case of calibration <ZPNG>, the value returned by FTN will be:
 3.2157<cr,<lf>
 <cr,<lf>

A typical response to FTN might be:

0 1 2 3 4 5 6 7 8 9 + - . E

<value> is an ASCII encoded number containing the following characters:
 <value><cr,<lf>

5-12.3 Response to FTN. Upon receipt of the FTN command, and after the measurement
 is completed, the DAV will load the output buffer with the measurement result. The
 format of this transmission is:

This would indicate that the DAV will take a maximum of 23 seconds to complete the
 measurement.

Table 5-3. CIIL CODES (Continued)

CIIL	Description
<nouns>	AC SIGNAL
<chars>	ZPNG
	VOLT
	VRMS
	PANG
	HARV
	DSTR
	HARP
<modifiers>	ZPNG
	VOLT
	VRMS
	PANG
	HARV
	DSTR
	HARP
	GAMD
	FREQ
	TRSC
	TRSL
	TRLV
	MAXT
	ZPNG
	VOLT
	VRMS
	PANG
	HARV
	DSTR
	HARP
	GAMD
	FREQ
	TRSC
	TRSL
	TRLV
	MAXT

Table 5-4. Modifier Limits

<modifier>	<value> limits
ZPNG	any value *
VOLT	0 < <value> < 500
VRMS	any value
PANG	any value
HARV	1 < <value> < 30**
HARP	any value
DSTR	any value
GAMD	0 < <value> < 9.99
FREQ	10 < <value> < 99,999
TRSC	EXT (only)
TRSL	NEG (only)
TRLV	any value*
MAXT	0 < <value> < 101

*Any value will be accepted but will have no effect. Trigger level (TRLV) is always 2.5 V regardless of value programmed. **<nsf> programs the harmonic number. <value> may have any value but should be programmed same as <nsf>.

5-13 ATLAS CONSTRUCTIONS

The following are typical ATLAS program syntax constructions for programming the Model 2250 DAV with the IEEE-488 interface.

5-13.1 Calibration.

[verb], (ZERO-PHASE-ANGLE), AC SIGNAL, ZERO-PHASE-ANGLE MAX [value] DEG, FREQ [value] Hz > 1

> CNX HI [pin] LO [pin] GUARD [pin] REF HI [pin] LO [pin] GUARD [pin] \$

NOTES

1. Calibration zeros out phase-angle errors and adjusts the front end amplifier and A/D converters.
2. The ZERO-PHASE-ANGLE response back to this statement is zero when the calibration is successful.
3. The request can be made via either channel 0 or channel 1 (the same process will still occur).
4. Request with channel 2 calibrates Total (AVG) mode.

5-13.2 Standard (Non-Referenced) AC Voltage Measurement (True Rms Voltage).

[verb], (VOLTAGE), AC SIGNAL, VOLTAGE MAX [value] V,
 (VOLTAGE-T RMS), AC SIGNAL, VOLTAGE-T RMS MAX [value] V,
 GATE WIDTH [value] SEC, default = .3

> FREQ [value] HZ, TRIG-SOURCE EXT, TRIG-SLOPE NEG, default = NEG,
 TRIG-LEVEL 2.5V, default = 2.5,
 MAX-TIME [value] SEC, V, default = 10

> CNX HI [pin] LO [pin] GUARD [pin] TRIG-IN [pin] \$

NOTE

FREQ should be used for very noisy input signals where the instrument cannot properly lock onto the fundamental frequency.

5-13.3 Referenced AC Voltage Measurements (True Rms Voltage).

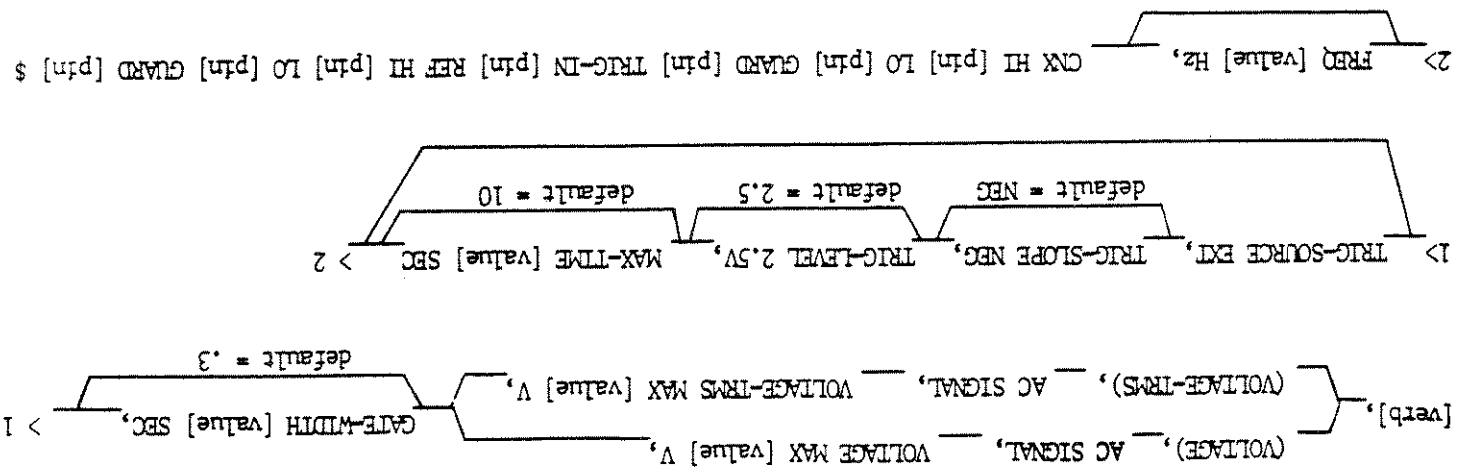

NOTE

FREQ should be used for very noisy reference input signals where the instrument cannot properly lock onto the fundamental frequency.

5-13.4 Referenced AC Voltage Measurements - Fundamental Component.

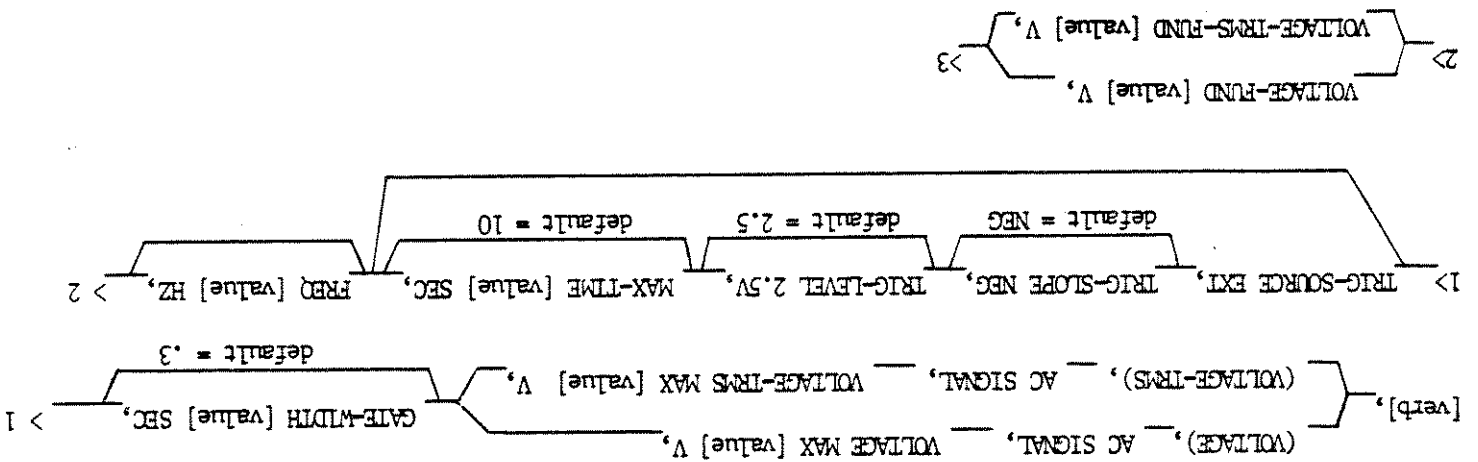

NOTE

FREQ should be used for very noisy reference input signals where the instrument cannot properly lock onto the fundamental frequency.

3 > CNX HI [pin] LO [pin] GUARD [pin] TRIG-IN [pin] REF HI [pin] LO [pin] GUARD [pin] \$

5-13.5 Referenced AC Voltage Measurements - IN PHASE Component.

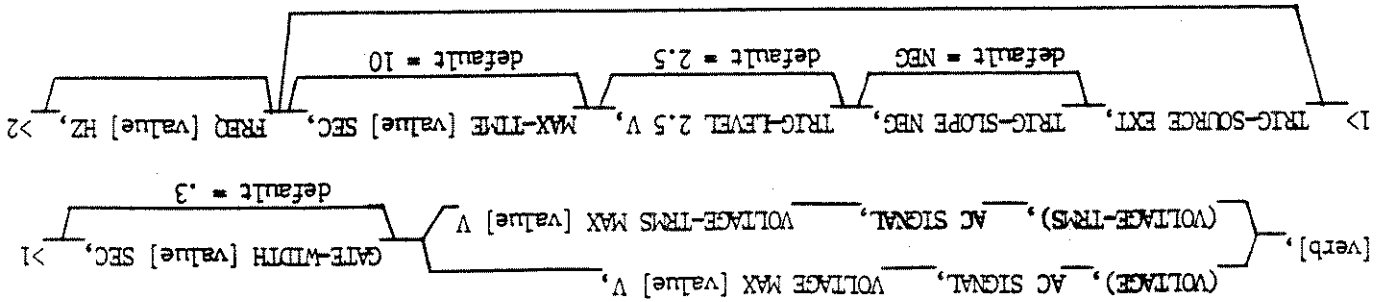

1. FREQ should be used for very noisy reference input signals where the instrument cannot properly lock onto the fundamental frequency.
2. The component in phase is determined with respect to the fundamental of the reference signal.

NOTES

3 > CNX HI [pin] LO [pin] GUARD [pin] TRIG-IN [pin] REF HI [pin] LO [pin] GUARD [pin] \$

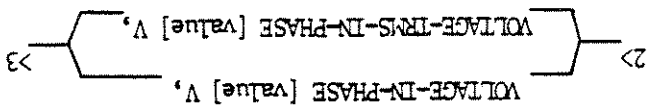

5-13.6 Referenced AC Voltage Measurements - QUADRATURE Component.

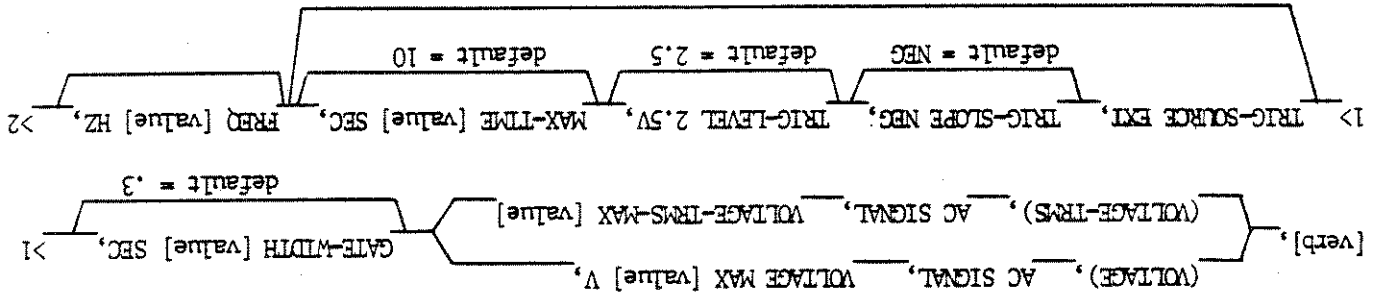

1. FREQ should be used for very noisy reference input signals where the instrument cannot properly lock onto the fundamental frequency.
2. The quadrature component is determined with respect to the fundamental of the reference signal.

NOTES

3 > CNX HI [pin] LO [pin] GUARD [pin] TRIG-IN [pin] REF HI [pin] LO [pin] GUARD [pin] \$

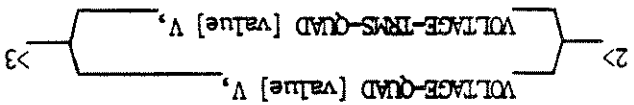

1. FREQ should be used for very noisy reference input signals where the instrument cannot properly lock onto the fundamental frequency.
2. The harmonic component is determined with respect to the fundamental signal input.
3. The IN PHASE and QUAD components of the voltage are of the specified harmonic.

NOTES

3> CNX HI [pin] LO [pin] GUARD [pin] TRIG-IN [pin] REF HI [pin] LO [pin] GUARD [pin] \$

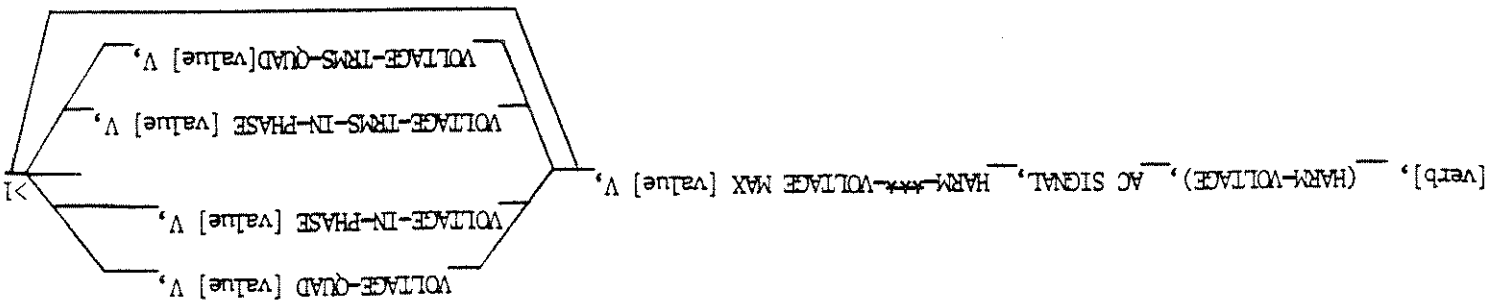
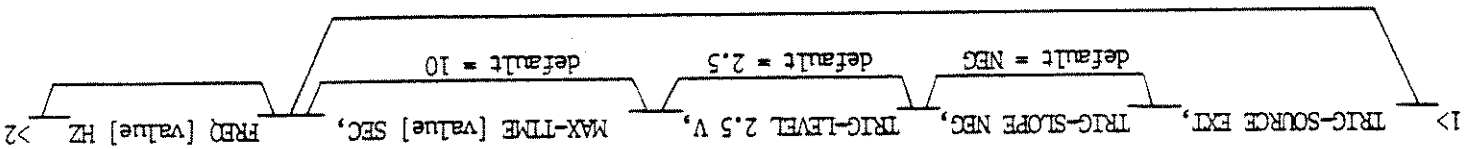
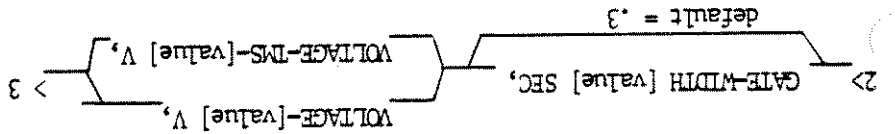

5-13.7 Referenced AC Voltage Measurements - Harmonic Component.

5-13.8 PHASE ANGLE Measurements - FUNDAMENTAL Component.

[verb], (PHASE-ANGLE), AC SIGNAL, PHASE-ANGLE MAX [value] DEG, > 1

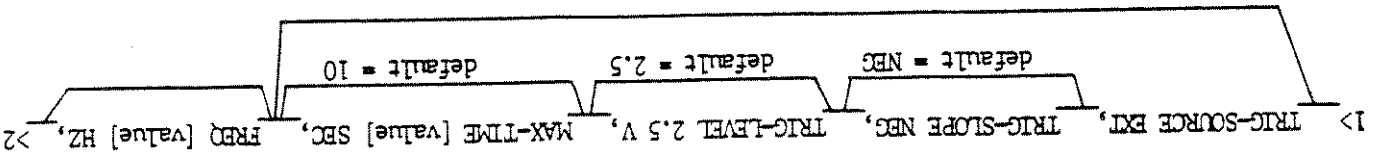

NOTES

1. FREQ should be used for very noisy reference input signals where the instrument cannot properly lock onto the fundamental frequency.
2. PHASE ANGLE is measured with respect to the fundamental of the reference signal.

5-13.9 PHASE ANGLE Measurement - Harmonic Component.

[verb], (HARM-PHASE), AC SIGNAL, HARM-PHASE MAX [value] DEG, > 1

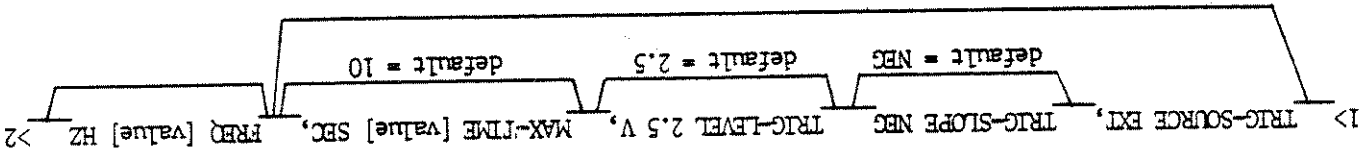

NOTES

1. FREQ should be used for very noisy reference input signals where the instrument cannot properly lock onto the fundamental frequency.
2. PHASE ANGLE is measured with respect to the fundamental of the signal input.

> 3 CNX HI [pin] LO [pin] GUARD [pin] TRIG-IN [pin] REF HI [pin] LO [pin] GUARD [pin] \$

[verb], (DISTORTION), AC SIGNAL, DISTORTION MAX [value]PC, FREQ [value] HZ, GATE-WIDTH [value]SEC, >1
 default = .3

>2 TRIG-SOURCE EXT, TRIG-SLOPE NEG, TRIG-LEVEL 2.5 V, MAX-TIME [value] SEC, >2
 default = NEG
 default = 2.5
 default = 10

>3 VOLTAGE [value]V,
 VOLTAGE-RMS [value] V, >3

>3 CNK HI [pin] LO [pin] GUARD [pin] TRIG-IN [pin] REF HI [pin] LO [pin] GUARD [pin] \$

NOTE

FREQ should be used for very noisy reference signals where the instrument cannot lock onto the fundamental frequency.

5-14 CILR RAILROAD DIAGRAMS

5-14.1 Standard (Non-Referenced AC Voltage Measurement True RMS.

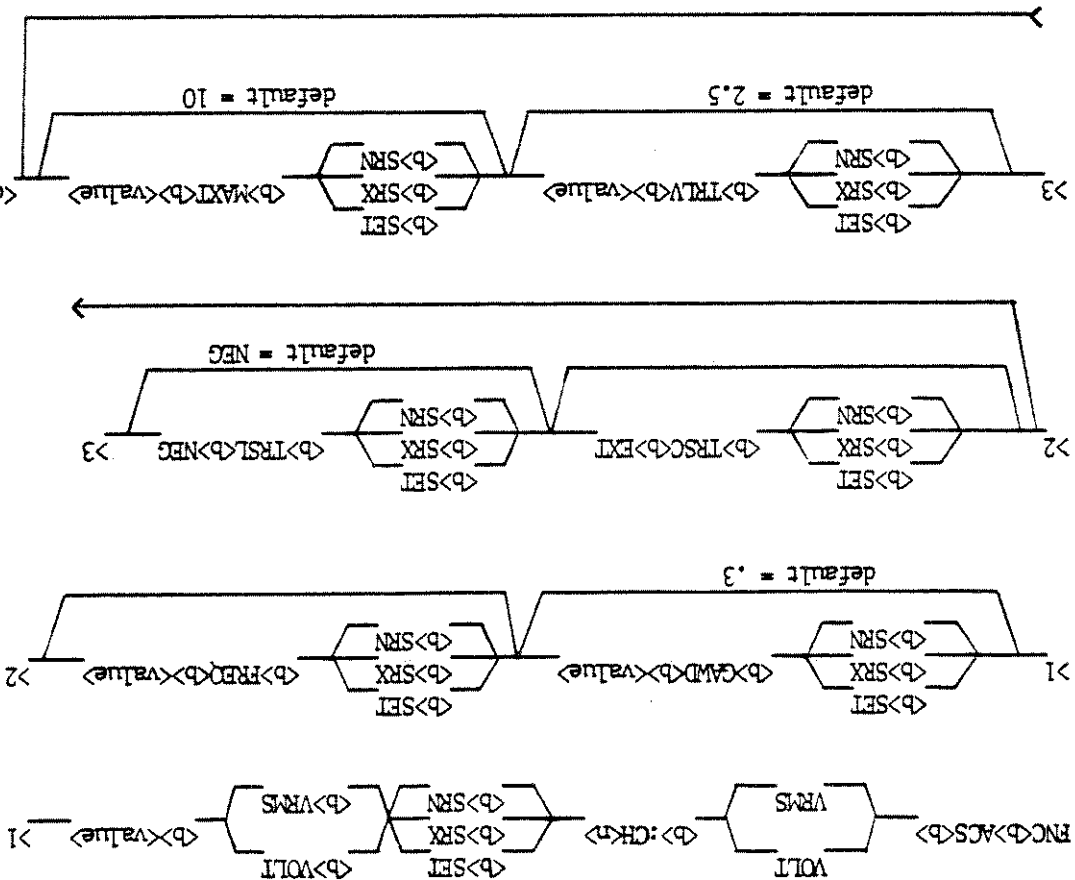

NOTES

1. n = 0 selects SIG channel; n = 1 selects RFF channel.
2. TRLV value must be 2.5.
3. Use FREQ for noisy signals where the unit will not lock properly.

1. <n> = 0 selects SIG channel; <n> = 1 selects REF channel.
2. TRLV <value> must be 2.5.
3. Use FREQ for noisy signals where the unit will not lock properly.

NOTES

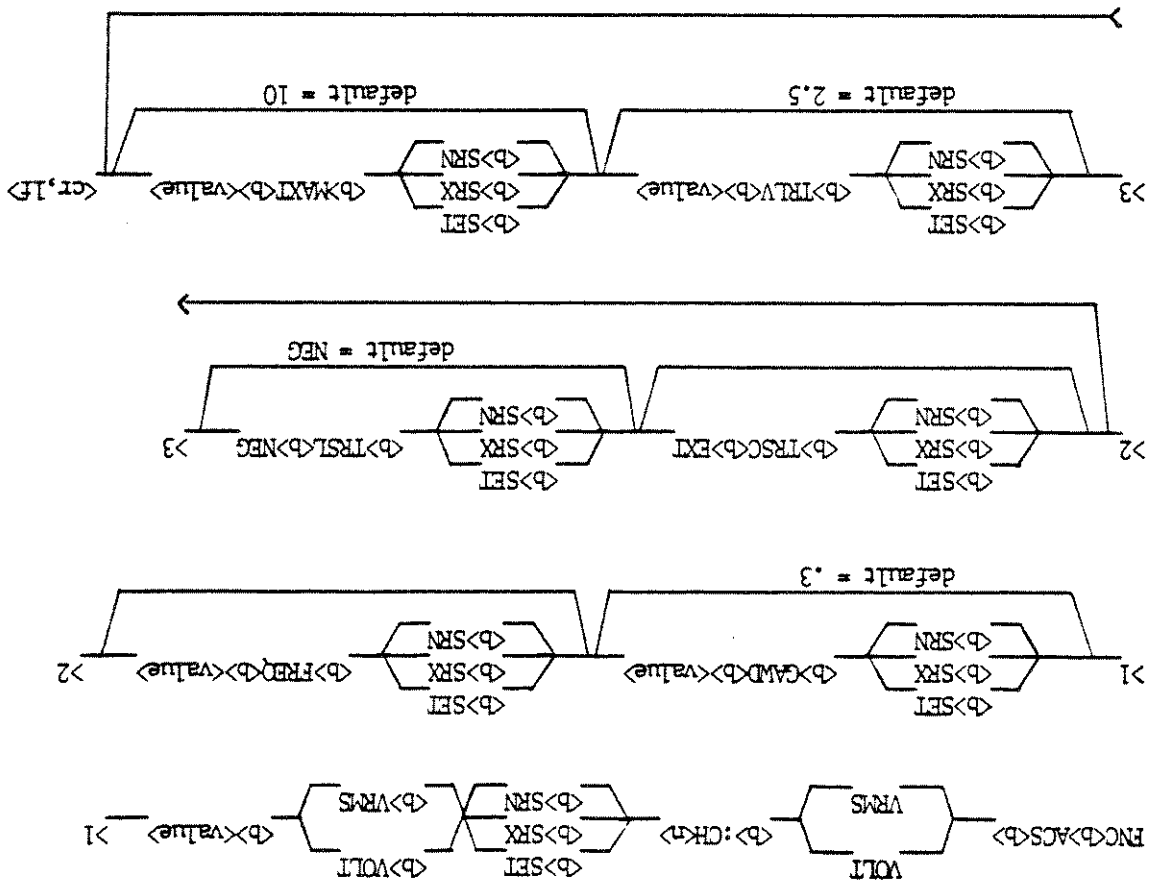

5-14.2 Standard (Referenced) AC Voltage Measurement True RMS.

5-14.3 Referenced AC Voltage Measurement Fundamental Component.

OM-I-5026B

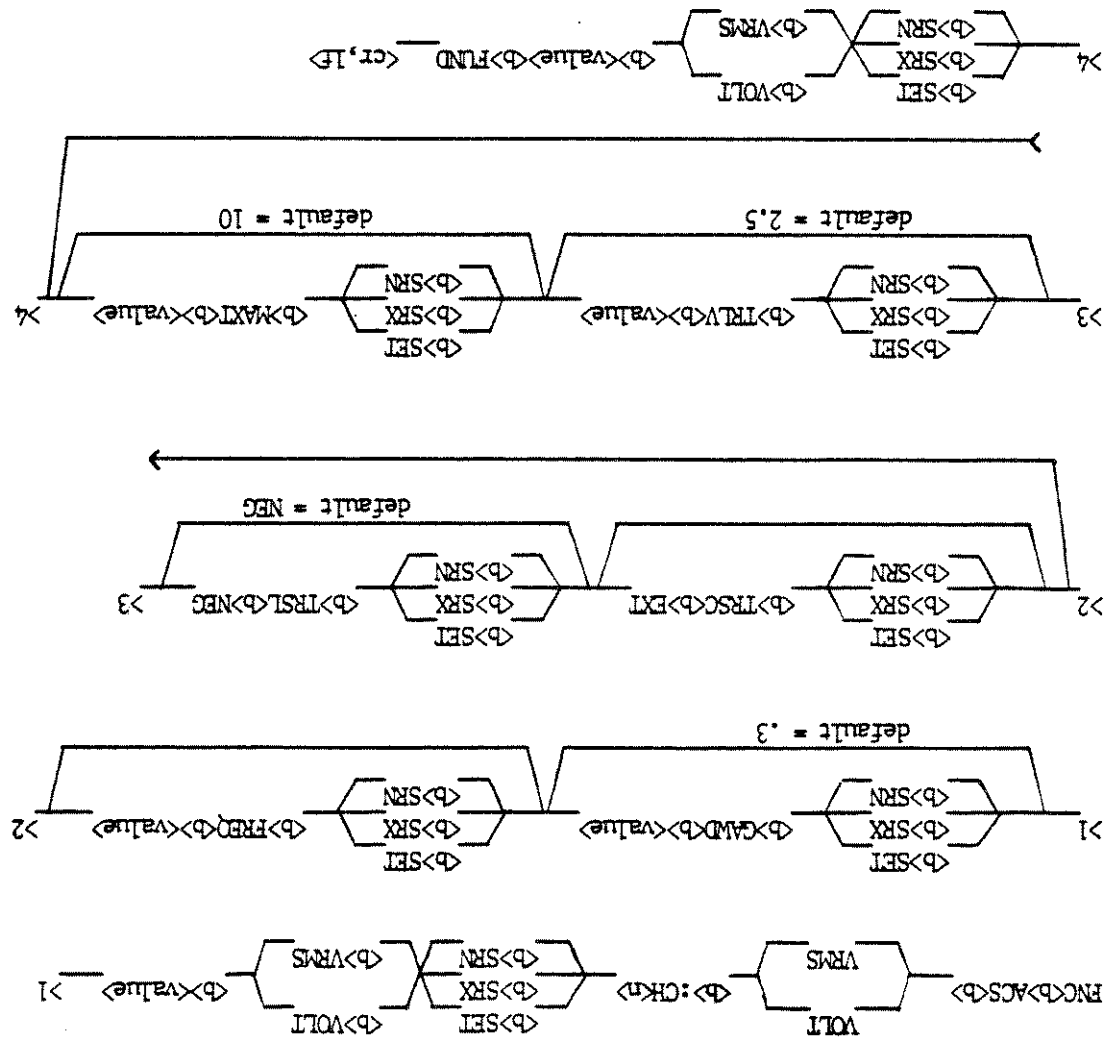

NOTES

1. $\langle n \rangle = 0$ selects SIG channel; $\langle n \rangle = 1$ selects REF channel.
2. $\text{TRLV} \langle \text{value} \rangle$ must be 2.5.
3. Use FREQ for noisy signals where the unit will not lock properly.

5-14.4 Referenced AC Voltage Measurement IN PHASE Component.

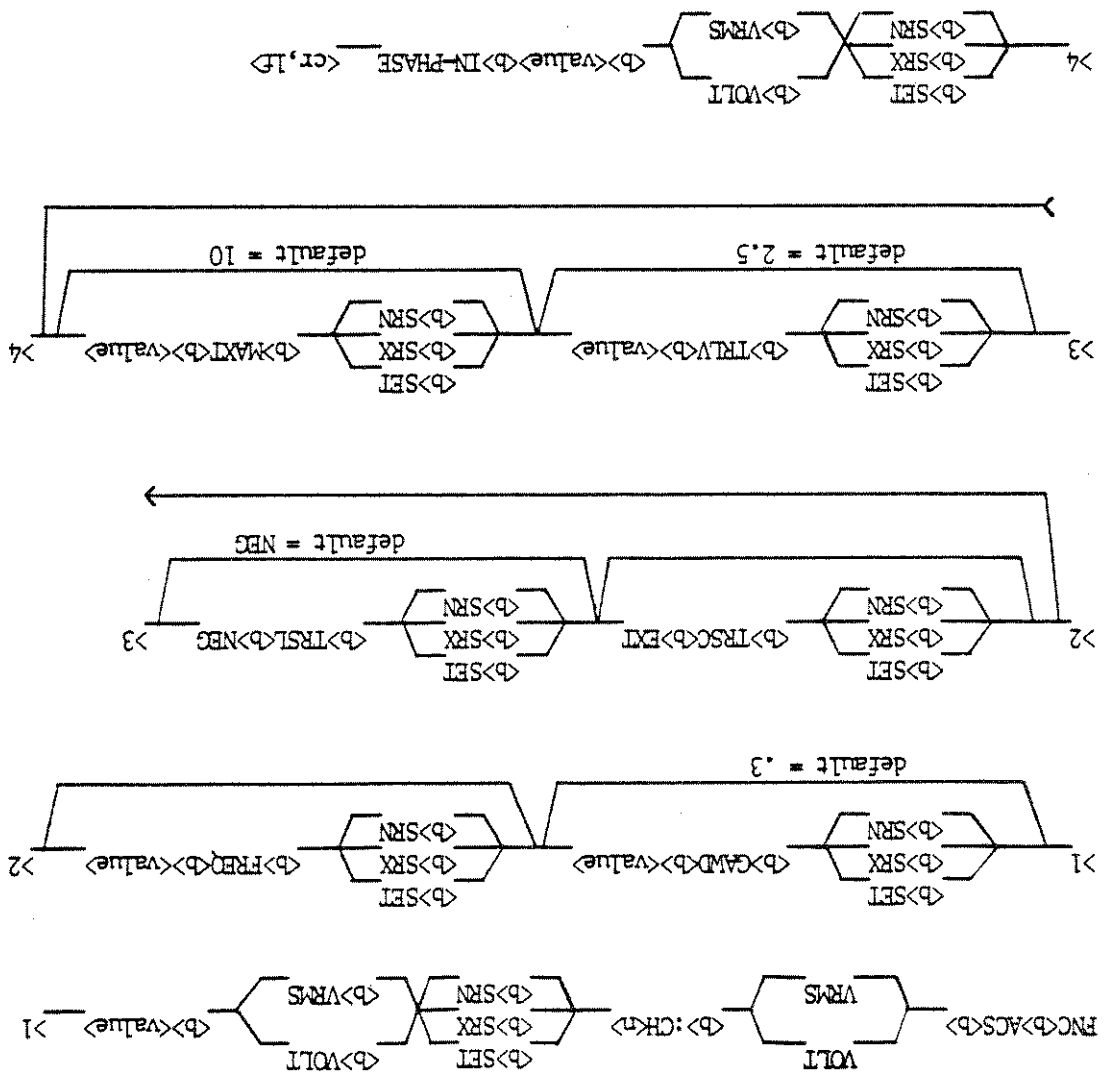

NOTES

1. <n> = 0 selects SIG channel; <n> = 1 selects REF channel.
2. TRLV <value> must be 2.5.
3. Use FREQ for noisy signals where the unit will not lock properly.

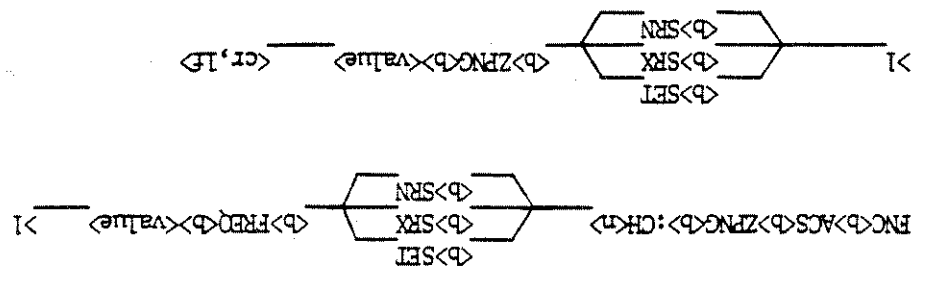

1. The same calibration process takes place if either channel is selected.
2. A zero (0) response indicates a successful calibration.

NOTES

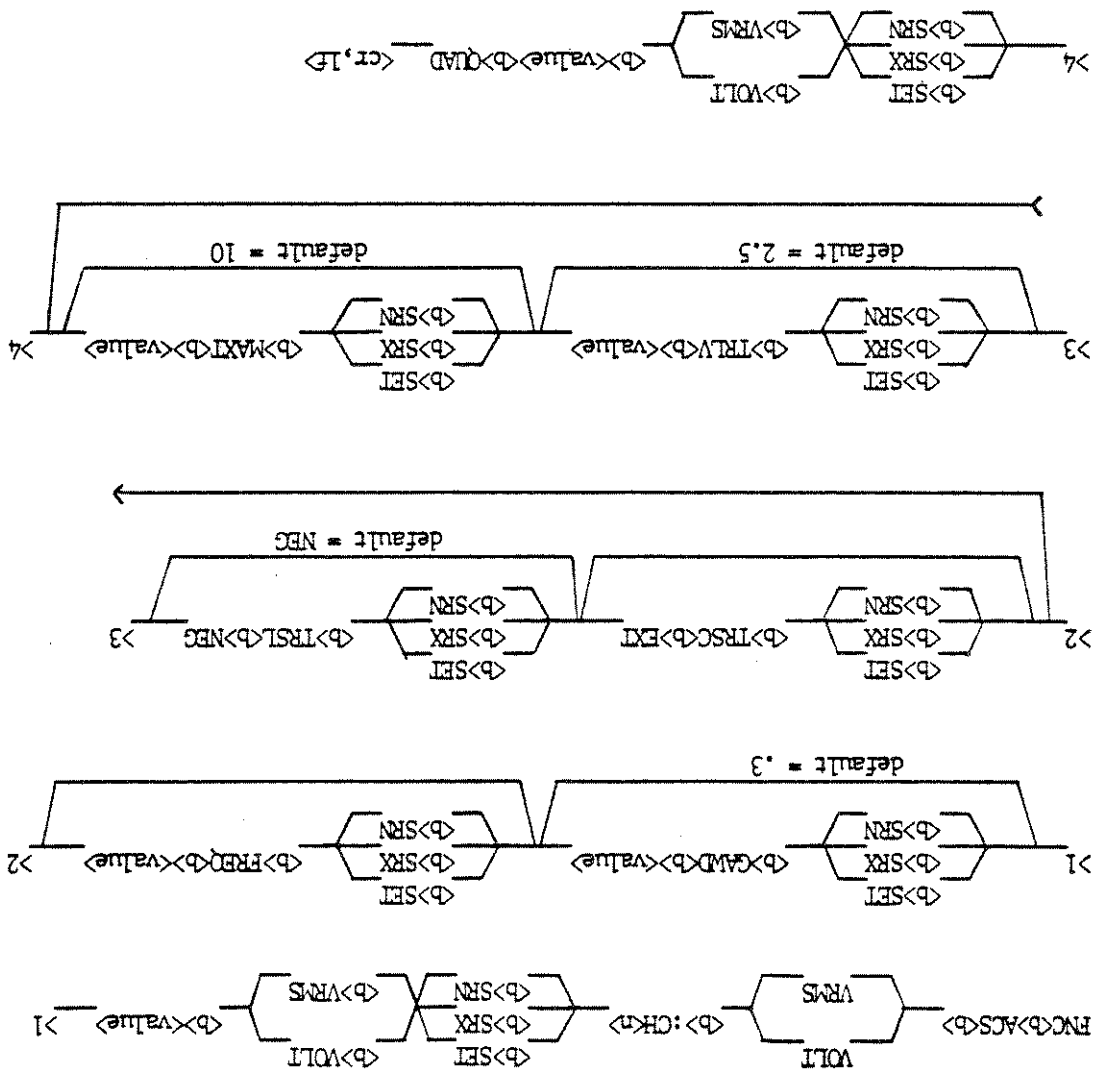

NOTES

1. <n> = 0 selects SIG channel; <n> = 1 selects REF channel.
2. TRLV <value> must be 2.5.
3. Use FREQ for noisy signals where the unit will not lock properly.

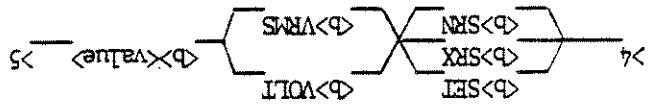
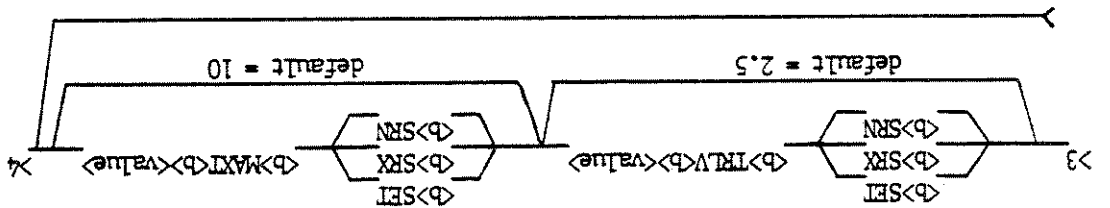
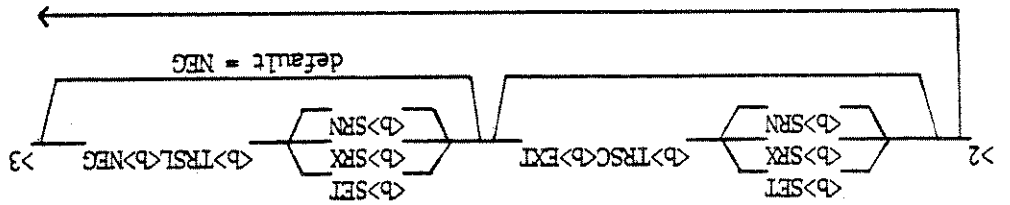
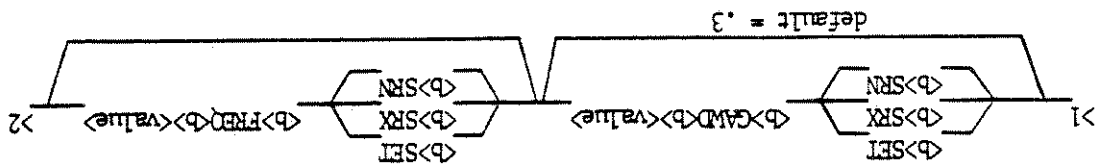
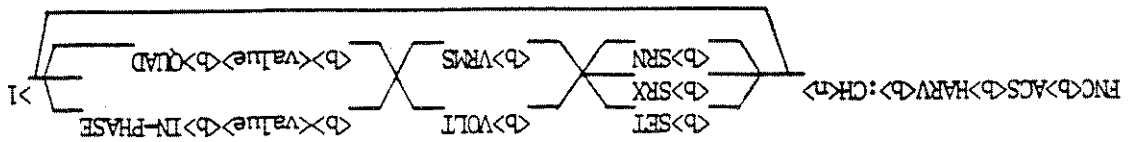

NOTES

1. <n> = 0 selects SIG channel; <n> = 1 selects REF channel.
2. TRLV <value> must be 2.5.
3. Use FREQ for noisy signals where the unit will not lock properly.
4. <nsf> is an integer which specifies harmonic number.

5-14.8 PHASE ANGLE Measurement Fundamental Component.

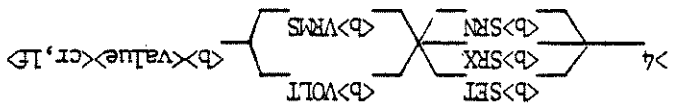
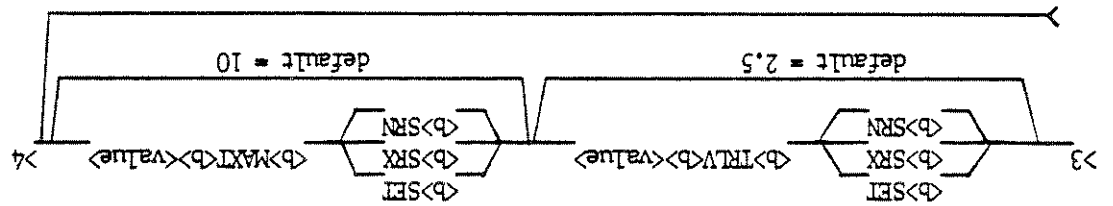
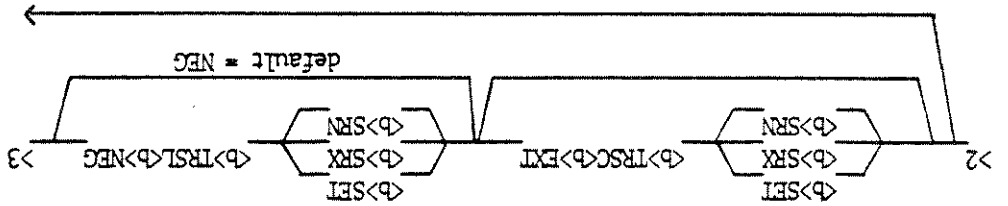
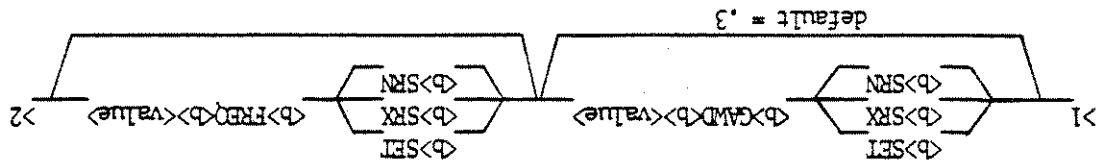
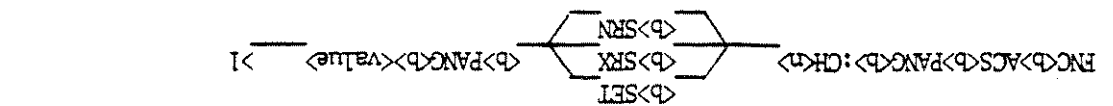

NOTES

1. <n> = 0 selects SIG channel; <n> = 1 selects REF channel.
2. TRLV value must be 2.5.
3. Use FREQ for noisy signals where the unit will not lock properly.
4. PANG is measured with respect to the fundamental of the REF signal.

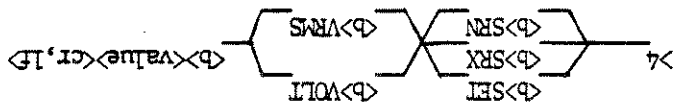
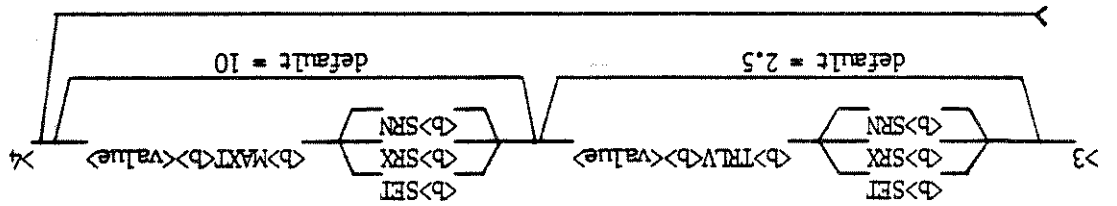
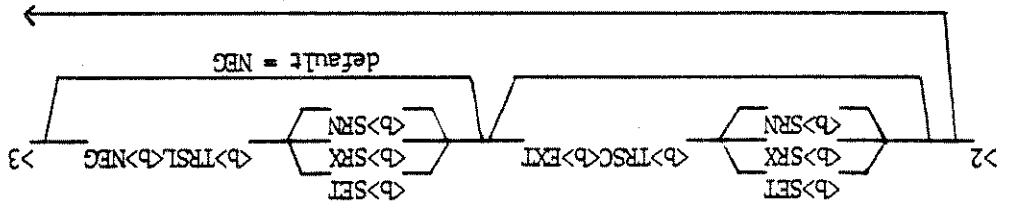
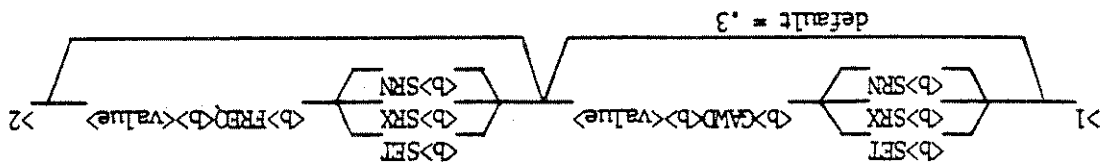

NOTES

1. <n> = 0 selects SIG channel; <n> = 1 selects REF channel.
2. TRLV <value> must be 2.5.
3. Use FREQ for noisy signals where the unit will not lock properly.
4. HARF is measured with respect to the fundamental of the input signal.
5. <nsf> is an integer which specifies harmonic number.

1. <n> = 0 selects SIG channel; <n> = 1 selects REF channel.
2. TRLV <value> must be 2.5.
3. Use FREQ for noisy signals where the unit will not lock properly.

NOTES

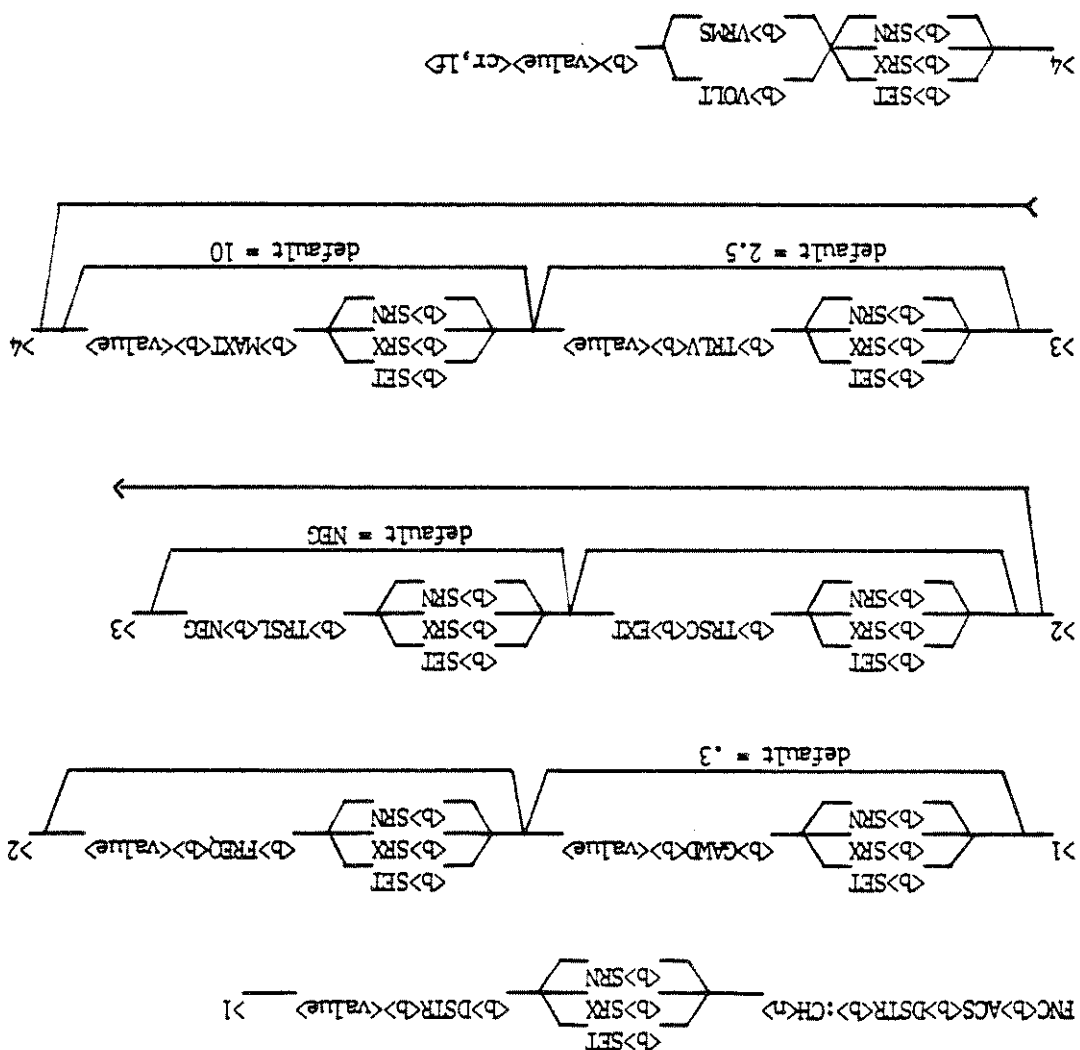

5-14.10 Total Harmonic Distortion.

5-14.11 Summary of MATE Programming Syntax.

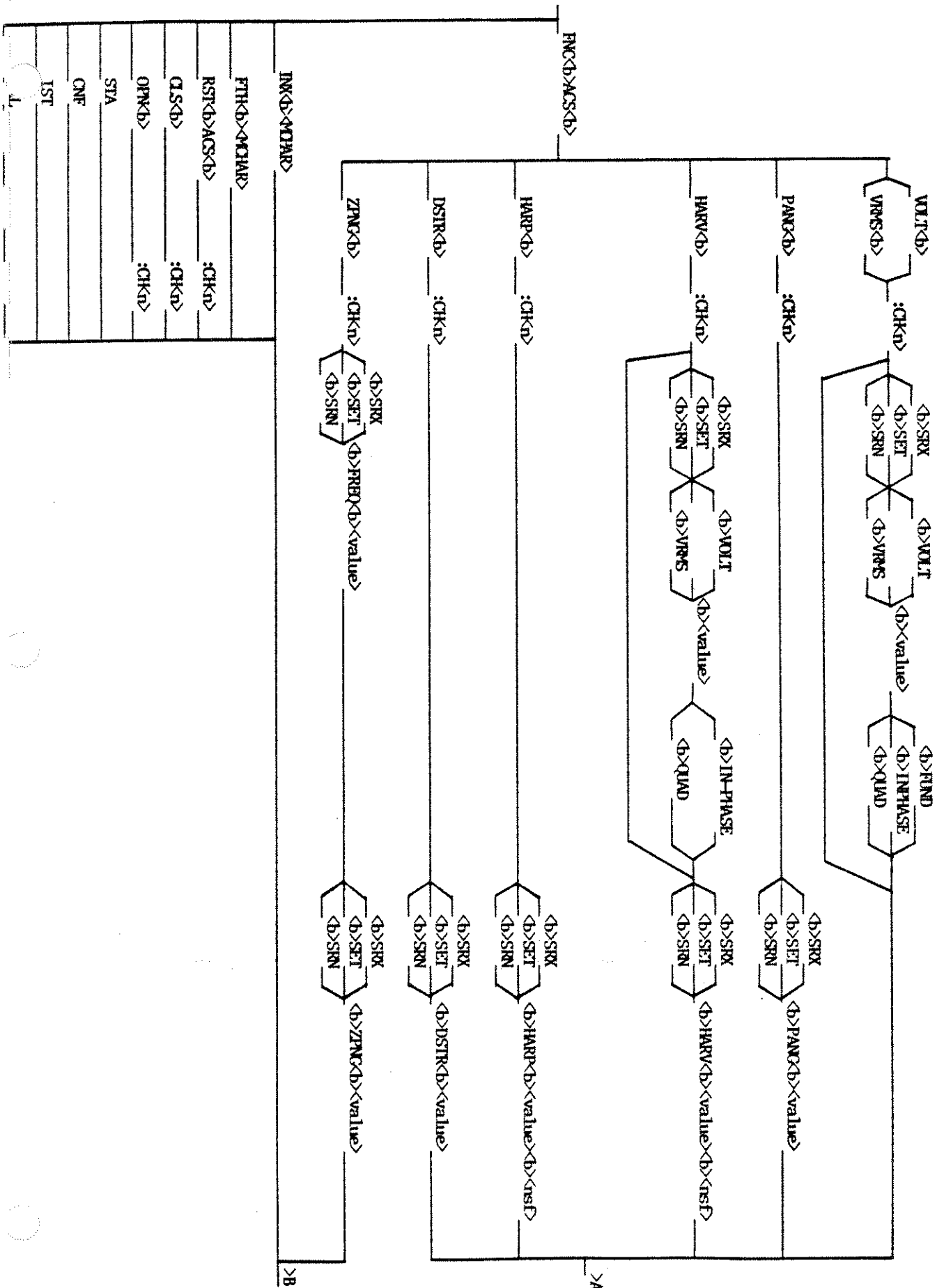

OM-1-5026B

A) SRX
SET
SRN

VOLT
VRMS

<value>
SRX
SET
SRN

FREQ<value>

SRX
SET
SRN

CAMD<value>

SRX
SET
SRN

TRSCEXT

SRX
SET
SRN

TRSLNEG

SRX
SET
SRN

TRLV<value>

SRX
SET
SRN

MAVT<value>

<cr, lf>

B)

6-2.1.2 Reference Signal Path. The ac reference is input and processed through a separate channel utilizing front-end signal paths basically the same as the ac input signal path. In addition, the signal is output to another input of the A/D converter circuit card assembly where it is attenuated and then processed through a low pass filter. The filtered sinusoidal output is then squared and optically coupled to the timing and control circuit card assembly and phase-locked loop circuitry for system timing control. This applies to the SIG channel when SIG channel phase lock option is used.

c. Other locations in RAM.

- b. I/O ports for external communication (e.g., IEEE-488 Interface bus and recorder).
- a. The front display panel.

The data is then made available to the following points:
The output signal is A/D converted and the digitized signal is optically coupled to the Accumulator. The Accumulator arithmetically calculates the average value of several cycles of the input ac signal, stores the results in RAM, and makes the data available to the system data bus for processing. The data bus distributes this digitized representation of the ac signal to the microprocessor for calculation of amplitude and phase. (Other types of processing takes place at this time as well.)

The data is then made available to the following points:
The output signal is A/D converted and the digitized signal is optically coupled to the Accumulator. The Accumulator arithmetically calculates the average value of several cycles of the input ac signal, stores the results in RAM, and makes the data available to the system data bus for processing. The data bus distributes this digitized representation of the ac signal to the microprocessor for calculation of amplitude and phase. (Other types of processing takes place at this time as well.)

6-2.1.1 Input Signal Path. An external ac signal to be measured can be applied to each shielded front-end circuit card assembly there is a high-voltage mercury relay (K1) which allows switching between the incoming signal (500 V ac maximum input), or the auto calibration signal (generated internally). The ac signal is attenuated according to its input voltage level and then amplified in the first gain stage. The ac signal is then sent to a programmable low pass filter. Selection and deselection of the filter is dependent on mode of operation. After filtering, the input signal is attenuated again and amplified in an output gain stage.

6-2.1 Front-End Section. The DAV has two separate, but identical, front-end circuit card assemblies which process the signal to be measured (SIG IN) and the reference signal (REF IN).

6-2 OVERALL BLOCK DIAGRAM DISCUSSION

A simplified block diagram of the DAV is illustrated in figure 6-1. The following is an overview of the basic signal processing paths of the reference signal and the input signal to be measured.

This section provides the functional theory of operation for the Model 2250 Digital Analyzing Voltmeter (DAV). It includes a block diagram that illustrates the major system components and basic signal paths.

6-1 INTRODUCTION

THEORY OF OPERATION

SECTION 6

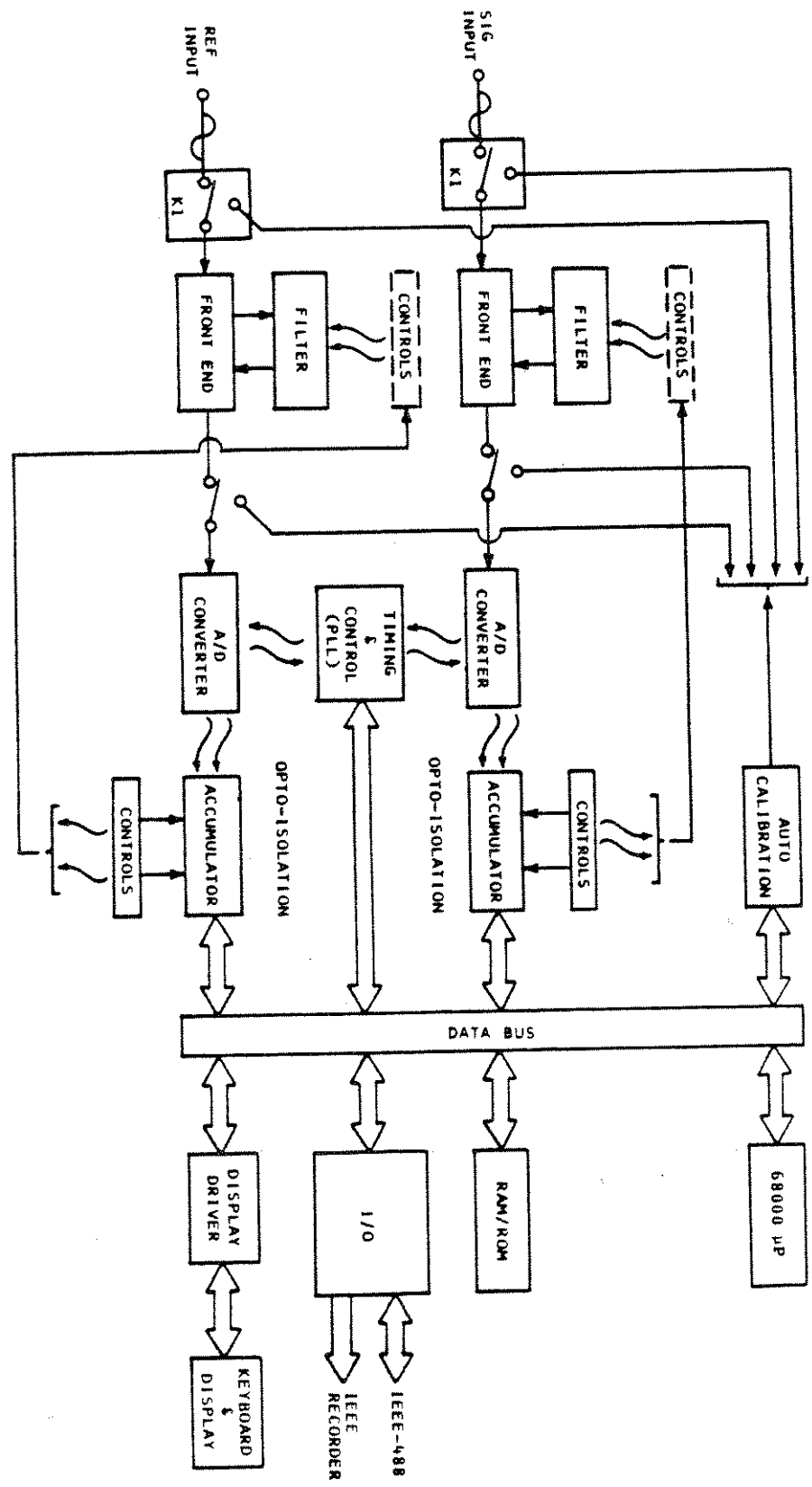

Figure 6-1. Model 2250 DAV Overall Block Diagram

6-2.9 ROM and RAM (Memory CCA). The main function of the Memory circuit card assemblies are to supply read only memory (ROM) for storing system programs and random access memory (RAM) for reading, writing, and storing system calculations and variables. (The RAM is nonvolatile with battery backup.) It provides memory address bus and data bus buffers and generates decoding signals for all memory locations.

6-2.8 Microprocessor CCA. The microprocessor circuit card assembly incorporates the Motorola 68000 16-bit microprocessor to control the 2250 system circuit cards. It also provides the system clock, buffered address and data lines, program interrupt logic for encoding interrupt vectors, and power-up reset circuitry. In addition, the microprocessor circuit card generates various DAV control signals and is responsible for all system computations.

6-2.7 Autocalibration CCA. The function of the autocalibration circuit card assembly is to produce a computer controlled sine wave, ranging in frequency from 10 Hz to 100 kHz, for user selectable autocalibration of DAV.

6-2.6 Phase-Locked Loop (PLL) CCA. The phase-locked loop receives the squared timing reference signal from the A/D converter CCA and uses it to synchronize the timing and control circuit to the external ac signal. The PLL consists of an 8 band phase-locked loop circuit, frequency multiplication counters, and out-of-lock detection circuits. Band rate selection is made by program control. The PLL outputs sample synchronizing pulses, buffered timing reference signals, and out-of-lock indicators.

6-2.5 Timing and Control CCA. The function of the timing and control circuit card assembly is to set and control all miscellaneous timing tasks for the DAV. It generates clock timing pulses for the A/D conversion of input signals and includes a timing circuit which measures input frequency. It also has I/O ports, which control the front-end, the phase-locked loop, and frequency band selection. In addition, it manipulates the majority of system memory address decoding including the autocalibration circuit card assembly, the accumulators, and the phase-locked loop.

6-2.4 The Accumulator (2). The Accumulator is a hardware device independent of software control. Its basic function is to arithmetically obtain the average value of several cycles of digitized ac input signal data received from the A/D converter. The accumulator converts this serial binary representation of the ac signal into 12-bit parallel data, arithmetically manipulates it, temporarily stores it in RAM, and then makes it available to the microprocessor via the RAM data bus. Control of this averaging signal process is directly initiated by control signals from the timing and control circuit card assembly.

6-2.3 Filter CCA. There are two identical filter card assemblies (SIG and REF) in the system. Each filter is a digitally controlled low pass filter used to reduce noise in the signal to be measured. The filters may be controlled by the system program or by user input.

6-2.2 Analog to Digital Converters. There are two A/D converter circuit card assemblies in the system. One processes the signal input to be measured and the other processes the reference input. Both are switched to receive an autocalibration signal for system calibration. The basic function of the A/D converter is to create a binary representation (digitized data) of the input waveforms. The A/D converter has two major signal processing paths: ac signal sampling and comparator signal processing.

- a. +5 V dc (digital)
- b. +15 and -15 V dc

6-3.2 Isolated Power Supplies. There are two isolated power supply assemblies, one for each input path (signal and reference). These separate isolated power supplies provide power for the front-end, filter section, and A/D converter circuit card assemblies of each path. Voltages provided from each power supply are:

- a. +5 V dc (analog)
- b. +5 V dc (digital)
- c. +15 and -15 V dc

6-3.1 System Level Power Supply. This power supply provides power for all digital circuitry and system control functions. Power outputs supplied are:

There are three separate power supply sections in the unit.

6-3 POWER SUPPLIES

The Display Driver CCA drives the Display circuit card assembly which consists of all the LEDs and annunciators for front panel display, including: the main, frequency, and harmonic displays, SRQ, LISTEN, TALK, REM, HZ, KHZ, HMNC, DEG, DB, VAR, mV, V, RX, 10⁻³, %, RAD and GRAD, SUM and AVG, and the null meter.

a 4 x 11 matrix.

6-2.12 Keyboard and Display CCA. The front panel numeric keyboard and function keys are composed of standard mechanically activated nontactile membrane switches in

6-2.11 The Display Driver CCA. The main function of the Display Driver circuit card assembly is to control the illumination of all the LEDs and annunciators on the Display CCA via software control and the system data bus. It receives and decodes 8-bit data and address codes to drive the front panel display and the multisegmented digital null meter, the function keys, and the numeric keyboard display. In addition, it generates interrupt signals when input data to the numeric keyboard needs to be read by the microprocessor.

6-2.10 Input/Output CCA. The I/O circuit card assembly contains the IEEE-488 Standard Digital Interface for operation of programmable instrumentation. It allows manual selection of IEEE interface bus address codes via rear panel switches. The input trigger, located on the rear panel, can receive remote data for updating the front panel display. It can also assert service requests from an external signal source. In phase sensitive modes, the REC/OUTPUT jack enables information to be converted to inphase and quadrature data. Circuit card switches SW1 and SW2 allow for manual selection of the Model 2250 configuration or emulation of the Model 225 Digital Phase Angle Voltmeter.

As NAI continues to improve the performance of the DAV, corrections and modifications to the manual may be required. This section contains Product Revision Sheet (PRS) data which updates the unit to the most current configuration available.

7-1 INTRODUCTION

UPDATE INFORMATION

SECTION 7

OM-I-5026B

1.0 ASSEMBLIES AND REVISION LEVELS AFFECTED:

Top Assembly NAI P/N 402250 Revision F.

2.0 CHANGES:

In Section I table I-2 add the following:

Model Version	Check Sum Number
1.8	OAD4
2.4	B676

On products to be returned under warranty, await receipt of shipping instructions then forward the instrument prepaid to the destination indicated. The original shipping containers with their appropriate blocking and sealing material is the preferred method of packaging. Any other suitably strong container may be used providing the product is wrapped in a sealed plastic bag and surrounded with at least four inches of shock absorbing material to cushion firmly, preventing movement inside the container.

SHIPPING

The purchaser should inspect and functionally test the product(s) in accordance with the instruction manual as soon as it is received. If the product is damaged in any way, including concealed damage, a claim should be filed immediately with the carrier, or if insured separately, with the purchaser's insurance company.

CLAIMS FOR DAMAGE IN SHIPMENT

- A. The seller warrants products against defects in material and workmanship for twelve months from the date of original shipment. The seller's liability is limited to the repair or replacement of products which prove to be defective during the warranty period. There is no charge under the warranty except for transportation charges. The purchaser shall be responsible for products shipped until received by the seller.
- B. The seller specifically excludes from the warranty 1) calibration, 2) fuses, life on assemblies such as switches, printheads, recording heads, etc. is dependent upon number of operations or hours of use, and end-of-life may occur within the warranty period.
- C. The seller is not liable for consequential damages or for any injury or damage to persons or property resulting from the operation or application of products.
- D. The warranty is voided if there is evidence that products have been operated beyond their design range, improperly installed, improperly maintained or physically mistreated.
- E. The seller reserves the right to make changes and improvements to products without any liability for incorporating such changes or improvements in any products previously sold, or for any notification to the purchaser prior to shipment. In the event the purchaser should require subsequent manufacturer's products to be identical to those covered by this quotation, the seller will, upon written request, provide a quotation upon a change control program.
- F. No other warranty expressed or implied is offered by the seller other than the foregoing.

LIMITED WARRANTY

NORTH ATLANTIC SERVICE CENTERS

The following list identifies authorized repair service centers. These centers are authorized to provide warranty service, spare parts sales and out of warranty repairs.

DOMESTIC

Electrical Standards Repair Service
7337 Greenbush Avenue
N. Hollywood, CA 91605
(818) 765-4224
Service Manager

Pat Lind Electronics
7411 Lake Drive
P.O. Box 125
Circle Pines, MN 55014
(612) 786-5770
Service Manager

North Atlantic Industries, Inc.
60 Plant Avenue
Hauppauge, NY 11788-3890
(516) 582-6500
Service Manager

INTERNATIONAL

Applied Measurement Pty. Ltd.
27 Dalgety Street
Oakleigh, Victoria, Australia 3166
(03) 568-0588
Service Manager

Associated Electronics Pty. Ltd.
P.O. Box 31094
Braamfontein 2017
Johannesburg, So. Africa
839-1824
Service Manager

Racom Electronics Co., Ltd.
P.O. Box 21120
Tel-Aviv, Israel 61210
(011) 972-3-491922
Service Manager

Seki Technical Center
3-2-6, Sennin-cho
Hachioji-Shi
Tokyo 193, Japan
(011) 81-42-664-3011
Service Manager

Technitron Sys. France
8, Ave. Aristide Briand
92220, Bagneux, France
(011) 331-4-657-1147
Service Manager

Technitron GmbH Germany
Charles deGaulle Str. 4
D-8000 Munich 83, Germany
(011) 49-89-637-3090
Service Manager

Eurotronics UK Ltd.
Lattice House
Baughurst Road
Baughurst, Basingstoke
Hampshire, RG2651J England
Phone: (011) 44-734-819970
FAX: (011) 44-734-819786
Service Manager

north atlantic
a computer products company

