

CHAPTER 1 INTRODUCTION

1.1 GENERAL

This technical manual provides description, operation, and servicing instructions for the model 5300-S3412 programmable Resolver/Synchro Standard (RSS), manufactured by North Atlantic Instruments, Inc. (NAI), of Bohemia, New York. This manual is intended for maintenance personnel who operate and/or maintain the RSS.

1.2 SCOPE

The technical manual consists of seven chapters. Chapter 1, Introduction, introduces and describes the RSS, its purpose and capabilities. Figure 1-1 shows the major assemblies of the RSS, and table 1-1 lists their reference designations. Table 1-2 lists the RSS specifications and table 1-3 lists equipment and materials supplied with the RSS. Chapter 2, Installation, provides instructions for unpacking and inspecting the RSS prior to installation. The installation procedures include bench mounting and mounting the RSS to a standard 19-inch equipment rack using the rack adapters provided. Repacking instructions for shipment or storage, and tables listing pin-outs for panel terminals and the IEEE-488 I/O connector are included. Chapter 3, Operation, consists of two sections. Section I describes and locates each control, switch, and indicator on the RSS. Section II describes the Consolidated Automatic Support System (CASS) programming language used to operate the RSS via the interface connector on the rear panel. Chapter 4, Principles of Operation, provides an overview of synchro and resolver conventions, software overview, and a system and functional block diagram description written to support an intermediate maintenance level. Chapter 5, Maintenance, consists of five sections. Section I contains a list of material and procedures for performing preventive maintenance. Section II contains the performance test used to check the accuracy and function of the RSS. Section III

contains a fault isolation table used to detect and isolate defective shop replaceable assemblies (SRA) within the RSS. Section IV contains removal and replacement procedures for the SRA's. Section V contains test and adjustment procedures. Chapter 6, Parts List, contains illustrations to locate parts on the RSS, and detail part lists contain component description, part number and quantity used. Chapter 7, Diagrams, contain the schematic diagrams for the RSS. Following chapter 7 is a glossary and appendix A, Update Information. This appendix contains service bulletins, Tech-Tips, and repair data furnished periodically by the manufacturer to enhance RSS performance and facilitate service and repair.

1.3 INTRODUCTION

The RSS is a laboratory-grade instrument capable of simulating the output of a synchro or resolver. As such, the RSS may be used as a standard for calibrating or testing automatic test equipment (ATE), or used to measure angle position indicators (API) and synchro-to-digital converters. The output parameters can be varied and modulated over a wide range as determined by the operator. The RSS is self-contained and can be remotely controlled by a computer via the interface connector on the rear panel. The RSS has provision for sensing its applied output at the load and comparing it to its set output. In this manner, the RSS can automatically compensate for differences due to line losses.

The RSS may also use an external reference waveform. The external inputs utilize protected autoranging technology that make connection and setup safe, easy, and efficient. The RSS outputs completely isolate the load in the event of an overload.

1.4 DESCRIPTION

The RSS is a self-contained instrument within a

metal enclosure and consists of a front and rear panel assembly, system board, sine/cosine board, analog board, main power supply board, isolation power transformer, two isolation/tapped transformers, an interconnect board assembly, and two isolated power supply assemblies. The front panel houses the display/keyboard assembly, power on/off switch, and binding posts whereby synchro/resolver and external inputs and outputs may be connected. The rear panel houses the power entry module, cooling fan and

filter assembly, main power transformer, terminal block, calibration bridge transformer, and IEEE-488 interface connector. Figure 1-1 locates the main assemblies of the RSS, and table 1-1 lists their assigned reference designation and NAI part number. The assembly reference designation is used to distinguish between components having the same designation on each assembly. For example, R1 on the sine/cosine board is designated A2R1 whereas R1 on the analog board is designated A3R1.

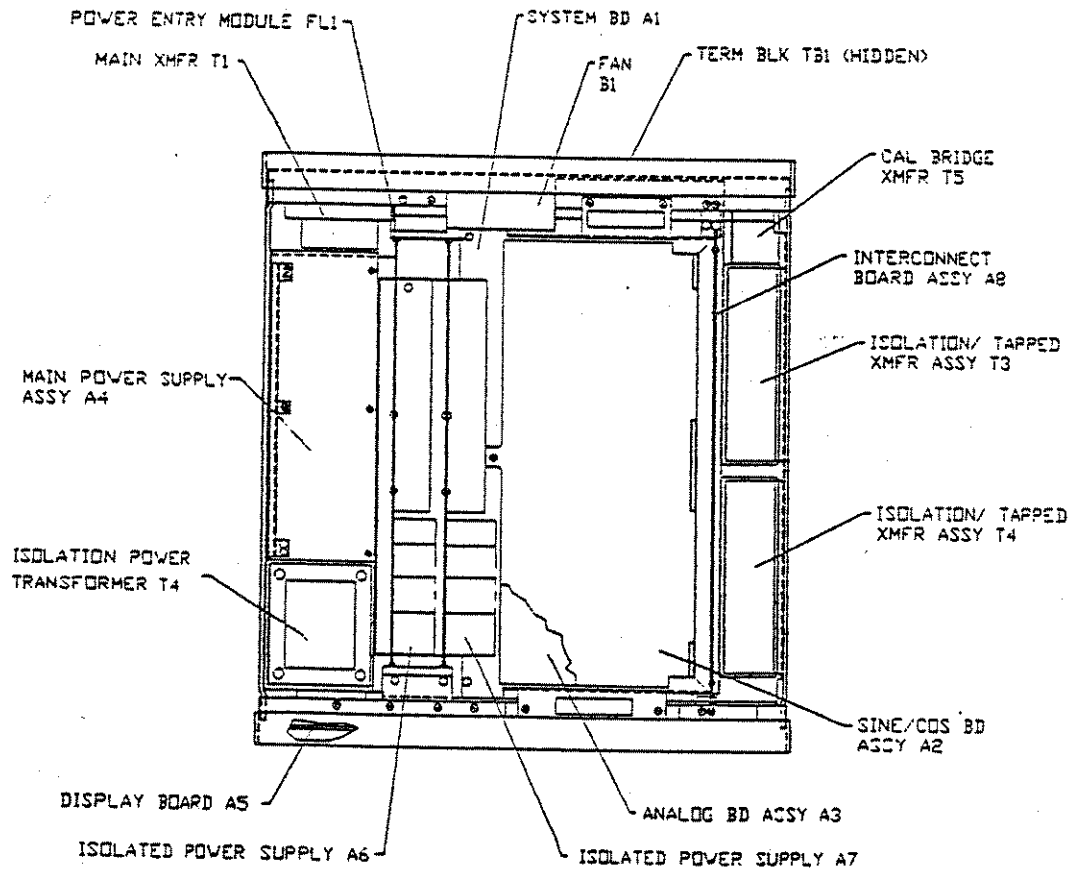

Figure 1-1. RSS Assembly Location

Table 1-1. RSS Assemblies and Reference Designations

REF DES	NOMENCLATURE	NAI P/N
A1	System Board Assembly	784009
A2	Sine/Cosine Board Assembly	784003
A3	Analog Board Assembly	784008
A4	Main Power Supply Board Assembly	784012
A5	Display Board Assembly	784006
A6, A7	Isolated Power Supply Assembly	784007
A8	Interconnect Board Assembly	784011
B1	Fan Assembly	784020
FL1	Power Entry Module Assembly	784019
TB1	Rear Terminal Block	549004
T1	Main Transformer Assembly	810117
T2	Isolation Power Transformer Assembly	810104
T3, T4	Isolation/Tapped Transformer Assembly	784021
T5	Calibration Bridge Transformer Assembly	784018

1.5 SAFETY

The RSS uses power that can cause physical injury or death if contacted. The following is a list of general safety precautions that should be observed when performing maintenance on the RSS. Observe all WARNINGS and CAUTIONS when they appear in this manual.

WARNING

INDICATES THAT PERSONAL INJURY OR DEATH MAY RESULT IF THE PROCEDURE IS NOT CORRECTLY FOLLOWED OR SAFETY PRECAUTIONS ARE NOT OBSERVED.

CAUTION

INDICATES THAT THE RSS MAY BE DAMAGED IF THE PROCEDURE IS NOT CORRECTLY FOLLOWED.

Observe the following general safety precautions:

LIVE CIRCUITS

USE EXTREME CAUTION WHEN PERFORMING MAINTENANCE OR MAKING ADJUSTMENTS WHEN POWER IS ON. NEVER TOUCH THE EQUIPMENT CHASSIS WITH YOUR FREE HAND WHILE TESTING, ADJUSTING, OR PERFORMING FAULT ISOLATION.

WORKING ALONE

IT IS UNSAFE TO WORK ALONE. ALWAYS ENSURE THAT SOMEONE IS PRESENT TO PERFORM FIRST AID OR BE ABLE TO CALL FOR HELP SHOULD AN EMERGENCY OCCUR.

The following WARNINGS and CAUTIONS appear in the manual and are repeated here for emphasis.

WARNING

DO NOT PLUG LINE CORD INTO AC RECEPTACLE AT THIS TIME. CONNECTION TO THE WRONG VOLTAGE SOURCE WILL CAUSE DAMAGE TO THE RSS AND MAY CAUSE INJURY OR DEATH OF THE OPERATOR (Chapt. 2, p. 1).

WARNING - DANGEROUS VOLTAGE!

TURN FRONT PANEL SWITCH OFF AND UNPLUG LINE CORD **BEFORE** PERFORMING THE PROCEDURES LISTED IN THIS SECTION (Chapt. 5, pp. 3, 53).

WARNING - DANGEROUS VOLTAGE!

DANGEROUS VOLTAGES ARE PRESENT WITHIN THE RSS. BE CAREFUL WHEN WORKING AROUND HIGH-VOLTAGE CIRCUITS. TO PREVENT ELECTRICAL SHOCK, DO NOT TOUCH THE RSS CHASSIS WITH ANY PART OF YOUR BODY. DO NOT PERFORM THESE

PROCEDURES ALONE. MAKE SURE SOMEONE IS AVAILABLE TO GIVE YOU ASSISTANCE OR CALL FOR HELP (Chapt. 5, pp. 43, 59).

WARNING

DANGEROUS VOLTAGES PRESENT! USE EXTREME CARE WHEN PERFORMING THIS PROCEDURE (Chapt. 5, pp. 60 and 61).

CAUTION

THIS EQUIPMENT IS SENSITIVE TO DAMAGE BY ELECTROSTATIC DISCHARGE (ESD). ALWAYS USE ESD PRECAUTIONARY PROCEDURES WHEN HANDLING EQUIPMENT (Chapt. 5, pp 3, 43, 53, 59).

CAUTION

GRASP CONNECTOR, NOT RIBBON CABLE IN FOLLOWING STEP (Chapt. 5, pp. 55, 56, 57).

1.6 SPECIFICATIONS

Table 1-2 lists the specifications for the RSS.

Table 1-2. RSS Specifications

SPECIFICATION	SYNCHRO MODE	RESOLVER MODE
Reference Input		
Operating frequency range	60 Hz to 1 kHz	360 Hz to 1 kHz
Voltage Range:		
60 Hz to 1 kHz	.2 to 115 V _{RMS}	
Input impedance	200 kohms minimum	
Reference Output		
Voltage range vs Frequency:		
60 Hz to 1 kHz	2 to 115 V _{RMS}	
Output impedance	< 0.25 ohms	
Voltage Accuracy	±3 % of setting	

Table 1-2. RSS Specifications

(Cont'd.)

SPECIFICATION	SYNCHRO MODE	RESOLVER MODE
Voltage resolution	3 digits	
Output current:		
2 to 26 V _{RMS}	100 mA _{RMS} maximum	
>26 to 115 V _{RMS}	25 mA _{RMS} maximum	
DC Offset	5 mV maximum	
Phase shift range	0 to $\pm 180^\circ$ to 0.001° resolution	
Phase shift accuracy:		
60 to 1 kHz	$\pm 0.5^\circ$	
Outputs (isolated)		
Voltage Accuracy	2% of setting	
Voltage resolution	1% of setting minimum	
DC Offset	5 mV maximum	
Voltage range (line-to-line)	1 to 90 V _{RMS}	
Angular accuracy vs F:		
60 Hz (90 V _{L-L})	$\pm 0.0023^\circ$	—
400 Hz (11.8 V _{L-L})	$\pm 0.0012^\circ$	$\pm 0.00095^\circ$
400 Hz (26 V _{L-L})	-	$\pm 0.0012^\circ$
400 Hz (90 V _{L-L})	$\pm 0.0018^\circ$	-
800 Hz (11.8 V _{L-L})	-	$\pm 0.0015^\circ$
Other frequencies and V _{L-L} ^(a) combinations	$\pm 0.0023^\circ$	$\pm 0.0015^\circ$
Angular resolution	0.0001° (0.36 arc-sec)	
Output drive capability ^(b) :		
2 to 26 V _{RMS}	4 VA maximum limited to 330 mA _{RMS} maximum	
>26 to 90 V _{RMS}	4 VA maximum limited to 33 mA _{RMS} maximum	
Output impedance (maximum):		

CHANGE 2

Table 1-2. RSS Specifications

(Cont'd.)

SPECIFICATION	SYNCHRO MODE	RESOLVER MODE
60 to 1 kHz	< 0.25 ohms	
Radius (sinusoidal) accuracy	±0.005 % typical	
Dynamic angular modulation		
Continuous (CW or CCW)	To 100,000°/sec (278 rps)	
Cyclical	Sine, triangle or square wave to 1 kHz or between preset angle	
Incremental	Successive equal angles on command	
Other		
Front panel control	Push buttons; additional rotary control for manual angular positioning	
Remote control	IEEE-488	
Temperature	0° C to 50° C operating, -40° C to 71° C storage per MIL-T-28800E, Type III, Class 6, Style E	
Dimensions	19" (48.3 cm) W x 3.5" (8.9 cm) H x 18 7/16" (48.8 cm) D, bench or rack mounting	
Power	115/220 VAC ±10%, 47 to 440 Hz, 115 VA	

^(a) Accuracy applies between 47Hz to 1000Hz and derates linearly from 6 V to 1 V

^(b) 0° to 70° inductive load; outputs are overload and short-circuit protected

CHANGE 2

1.7 EQUIPMENT/MATERIALS SUPPLIED

supplied with the RSS. Table 1-4 list the optional equipment and materials that are not supplied but required to perform maintenance and testing of the RSS.

Table 1-3 list the equipment and materials

Table 1-3. Equipment/Materials Supplied

DESCRIPTION	NAI MODEL/PART NUMBER
Resolver/Synchro Standard	Model 5300-S3412
Line cord	870165
Operation/Maintenance manual	TM-I-6004
115 V line fuse (2 A slo-blo)	800935
230 V line fuse (1 A slo-blo)	800118
Rack mounting handles (2)	210079

Table 1-4. Optional Test Equipment, Tools, and Materials Required

DESCRIPTION	MANUFACTURER/PART NUMBER*
Extender frame assembly	NAI 784014
Digital multimeter	Fluke 8506A
Oscilloscope	Tektronix 465
Oscillator	Krohn-Hite Model 4000AR
75-Watt Amplifier	Krohn-Hite Model 7500
Ratio Box	Electro Scientific Industries, Inc. - Model 73
Bridge Transformer	NAI Model TFI-0010
Synchro/Resolver bridge	NAI - Model 540/11
Digital Analyzing Voltmeter (DAV)	NAI Model 2250-F1

* Equivalent equipment is acceptable

1.8 STATEMENT OF WARRANTY

The RSS is warranted by NAI (seller) to the purchaser in accordance with the following terms and conditions.

1.8.1 LIMITED WARRANTY

The seller warrants products against defects in material and workmanship for twelve months from the date of original shipment. The seller's liability is limited to the repair or replacement of

products which prove to be defective during the warranty period. There is no charge under the warranty except for transportation charges. The purchaser shall be responsible for products shipped until received by the seller.

The seller specifically excludes from the warranty 1) calibration, 2) fuses, 3) source inspection, 4) test data, 5) normal mechanical wear, e.g., end-of-life on assemblies such as switches, print heads, recording heads, etc., is dependent upon number of operations or hours of use, and end-of-life may occur within the warranty period.

The seller is not liable for consequential damage or for any injury or damage to persons or property resulting from the operation or application of products. The warranty is voided if there is evidence that products have been operated beyond their design range, improperly installed, improperly maintained, or physically mistreated. The seller reserves the right to make

changes and improvements to products without any liability for incorporating such changes or improvements in any products previously sold, or for any notification to the purchaser prior to shipment. In the event the purchaser should require substantially manufactured lots to be identical to those covered by this quotation, the seller will, upon written request, provide a quotation upon a change control program. No other warranty expressed or implied is offered by the seller other than the foregoing.

1.8.2 CLAIMS FOR DAMAGE IN SHIPMENT

The purchaser should inspect and functionally test the product(s) in accordance with the instruction manual as soon as it is received. If the product is damaged in any way, including immediately with the carrier, or if insured separately, with the purchaser's insurance company.

1.8.3 SHIPPING

On products to be returned under warranty, await receipt of shipping instructions then forward the instrument prepaid to the destination indicated. The original shipping containers with their appropriate blocking and isolating material is the preferred method of packing. Any other suitably strong container may be used provided the product is wrapped in a sealed plastic bag and surrounded with at least four inches of shock absorbing material to cushion firmly, preventing movement inside the container.

CHAPTER 2 INSTALLATION

2.1 GENERAL

This section describes the installation of the Model 5300 Resolver/Synchro Standard (RSS).

2.2 UNPACKING AND INSPECTION

The RSS has been thoroughly tested, inspected and evaluated at the factory. Care has been taken in the design of the wrapping and packaging material to insure that no damage results from mishandling. To unpack the RSS, perform the following:

1. Remove RSS from the shipping container. Save container for future use in storing or shipping.
2. Visually check contents of the shipping container against the packing list.
3. Check for damage to RSS and notify the carrier if damage is discovered.

2.3 MECHANICAL

The RSS is designed for bench use or rack mounting. An outline and dimension drawing is shown in figure 2-1.

2.4 LINE VOLTAGE SELECTION

The RSS operates from either 115 Vrms (10%, 2 A slo-blo) or 230 Vrms (10%, 1 A slo-blo fuse), 47 Hz to 440 Hz. Each RSS is set for 115 VAC operation at the factory.

The rotary voltage selection switch is located inside the rear panel power entry module. To select the desired voltage switch position,

perform the following:

WARNING

DO NOT PLUG LINE CORD INTO AC RECEPTACLE AT THIS TIME. CONNECTION TO THE WRONG VOLTAGE SOURCE WILL CAUSE DAMAGE TO THE RSS AND MAY CAUSE INJURY OR DEATH OF THE OPERATOR.

1. Place on/off switch to off (O) position.
2. Disconnect line cord from RSS.
3. Using a flat screwdriver blade, pry open the fuse guard cover on power entry module .
4. Rotate the selection switch until the desired voltage indicator appears.
5. Replace existing fuse with appropriate size fuse (115V = 2 A slo lo; 230V = 1 A slo-blo).
- 6 . Close fuse guard cover.

2.5 FRONT PANEL TERMINALS

All front panel terminals accept double prong banana type plugs or stripped wire. Table 2-1 shows the signals available via the front panel terminals.

2.6 REAR PANEL TERMINALS

The rear panel contains connector J23 (and J22, optional) and a terminal block. J23 is used to connect to an IEEE-488 controller, and J22 (when present) allows access to the analog signals and digital angle output. The terminal block allows access to the analog signals.

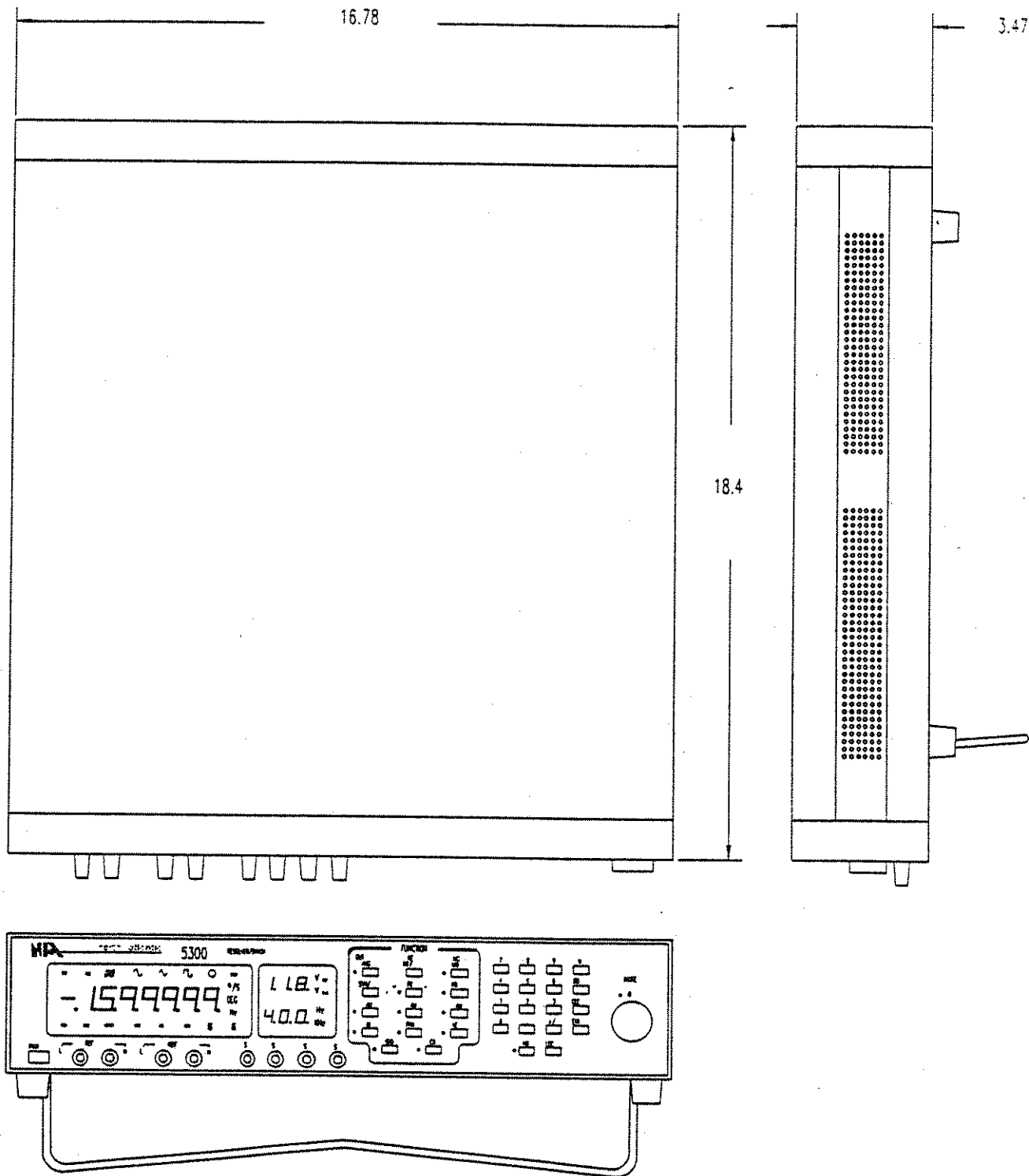

Figure 2-1. RSS Outline and Dimension Drawing

Table 2-1. Front Panel Terminals

SIGNAL	FUNCTION
S1	Synchro/Resolver S1
S2	Synchro/Resolver S2
S3	Synchro/Resolver S3
S4	Resolver S4
REF INPUT - HI	External Reference input +
REF INPUT - LO	External Reference input -
REF OUTPUT - HI	Internal Reference output +
REF OUTPUT - LO	Internal Reference ground

Table 2-2 Terminal Block Connections

SIGNAL	FUNCTION
S1	Synchro/Resolver S1
S2	Synchro/Resolver S2
S3	Synchro/Resolver S3
S4	Resolver S4
SENSE1	Remote sense for S1
SENSE2	Remote sense for S2
SENSE3	Remote sense for S3
SENSE4	Remote sense for S4
REF IN +	External Reference input +
REF IN -	External Reference input -
REF	Internal Reference output
REF GND	Internal Reference ground
AGND	Analog Ground
CHASSIS	Chassis Ground

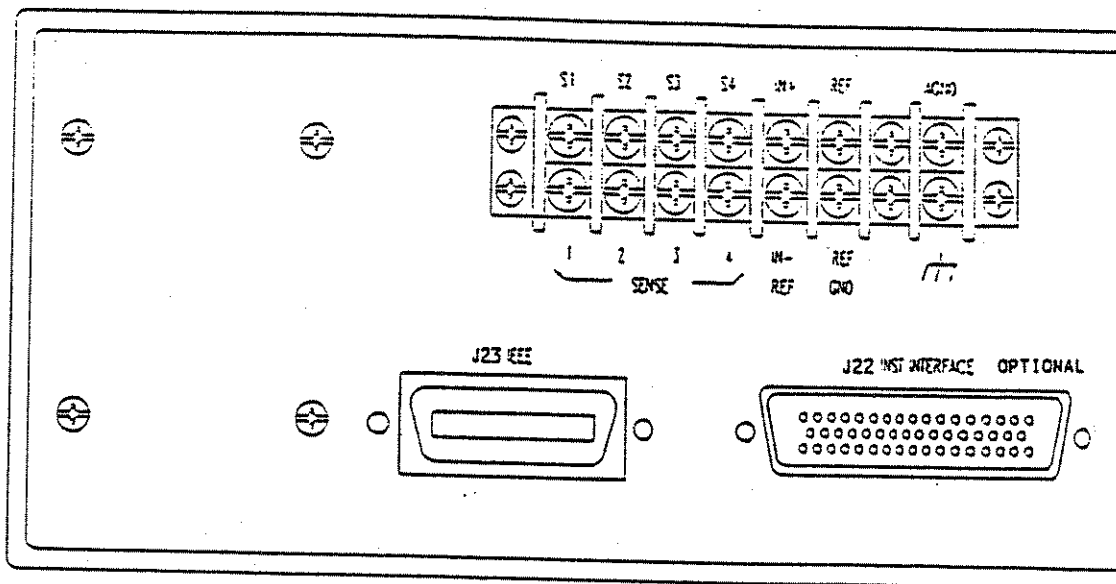

Figure 2-2. RSS Rear Panel Terminals

2.6.1 TERMINAL BLOCK

A terminal block is provided to allow access from the rear panel to the analog signals (see figure 2-2). Refer to table 2-2 for a description of the signals on the terminal block.

2.6.2 J23 IEEE-488 CABLE INSTALLATION

The IEEE-488 interface connector, J23 is used to control the RSS from an external IEEE-488 controller. Table 2-3 lists the pin designations. To attach this connector perform the following:

1. Place power on/off switch to the off (O) position.
2. Insert 24-pin IEEE-488 interface connector into J23 rear panel connector.
3. Tighten IEEE-488 interface connector screws using a small screwdriver.
4. Connect opposite end of I/O connector to host or computer.

2.6.3 J22 INST. INTERFACE CABLE INSTALLATION (OPTIONAL)

The RSS interface cable allows access from the rear panel to the analog signals and digital angle outputs. Table 2-4 lists the pin designations.

1. Place power on/off switch to the off (O) position.
2. Insert 50-pin I/O connector into J22 rear panel connector.
3. Tighten I/O connector screws using a small screwdriver.
4. Connect opposite end of I/O connector as required.

2.7 GROUNDING

In a high accuracy RSS, it is necessary for chassis and signal (AGND) ground to be tied together. The RSS is shipped from the factory with a shorting link, on the rear panel terminal

block, making this connection.

Note

Ground loops should be avoided in system applications.

2.8 INSTALLATION

The RSS is designed for either bench or equipment rack mounting. To install the RSS, select one of the following options and perform the procedure:

2.8.1 BENCH INSTALLATION

To install the RSS on a bench, perform the following:

1. Select an appropriate area that permits access to front and rear panels of RSS. Check that air flow into RSS rear panel fan is not restricted.
2. Place RSS on bench and attach interface cables (paragraph 2.6)
3. Turn front panel on/off switch on (I) and check that RSS powers up.
4. Refer to Chapter 5, Maintenance, Section II, and run performance test.

2.8.2 RACK MOUNT INSTALLATION

The RSS is shipped with two rack attachment handles to facilitate attaching the RSS to an equipment rack. To attach the handles, perform the following.

1. Remove handles and attaching hardware from shipping container.
2. Attach a handle to each side of RSS using hardware supplied.

Note

The rack mounting method used is the responsibility of the user (slides, tray, etc.).

3. Place RSS in rack and attach to rack through mounting handles.
4. Attach interface cables (paragraph 2.6).
5. Turn front panel on/off switch on (I) and check that RSS powers up.
6. Refer to Chapter 5, Maintenance, Section II, and run performance test.

Table 2-3. J23 IEEE-488 Interface Connector Pin Assignments

PIN	SIGNAL	PIN	SIGNAL
1	DIO1	13	DIO5
2	DIO2	14	DIO6
3	DIO3	15	DIO7
4	DIO4	16	DIO8
5	EOI	17	REN
6	DAV	18	GND (6)
7	NRFD	19	GND (7)
8	NDAC	20	GND (8)
9	IFC	21	GND (9)
10	SRQ	22	GND (10)
11	ATN	23	GND (11)
12	SHIELD	24	GND LOGIC

Table 2-4. J22 Pin Designations

PIN	SIGNAL	PIN	SIGNAL
1	S1	13	BIT 12 *
2	S3	14	BIT 13 *
3	S3 Sense	15	BIT 18 *
4	RL Out	16	BIT 19 *
5	S1 Sense	17	DGND
6	RH In	18	S1, S3 GND
7	RH In	19	S2, S4 GND
8	RL In	20	CASE
9		21	
10	BIT 1 *	22	
11	BIT 6 *	23	
12	BIT 7 *	24	SYNC 2 *

Table 2-4 Optional J22 Pin Designations

PIN	SIGNAL	PIN	SIGNAL
25	SYNC 1 *	38	S2 SENSE
26		39	
27	BIT 2 *	40	
28	BIT 5 *	41	
29	BIT 8 *	42	
30	BIT 11 *	43	BIT 3 *
31	BIT 14 *	44	BIT 4 *
32	BIT 17 *	45	BIT 9 *
33	BIT 20 *	46	BIT 10 *
34	S2	47	BIT 15 *
35	S4	48	BIT 16 *
36	S4 SENSE	49	BIT 21 *
37	RH OUT	50	BIT 22 *

* NOTE: These signals are optional.

CHANGE 1 (Table 2-4)

**CHAPTER 3
OPERATION****SUPPLEMENTAL INFORMATION****IMPORTANT**

INTERNAL MODE. After changing the internal frequency or L-L voltage (below 200 Hz) via the front panel or computer interface, wait approximately 8 seconds before initiating a calibration.

EXTERNAL MODE. After applying (or changing) an external reference signal to the REF INPUT terminals, or changing the L-L voltage below 200 Hz, wait approximately 8 seconds before initiating a calibration or measurement.

IF THIS DELAY IS NOT OBSERVED, AN ERROR MAY OCCUR.

SETTING L-L VOLTAGE AFTER AN OVERLOAD. If an overload occurs (OVLD and 0.0 V_{LL} displayed), wait approximately 5 seconds before resetting the L-L voltage.

CHAPTER 3 OPERATION

Section I. Controls and Indicators

3.1 INTRODUCTION

This section contains general operating procedures, descriptions of controls and indicators and practical applications for the Model 5300 Resolver/Synchro Standard (RSS).

3.2 NUMERIC DISPLAYS

The RSS has three numeric displays which indicate the reference frequency, output Line-to-Line amplitude or reference amplitude, and the current shaft angle. Refer to figure 3-1 for the location of each display.

3.2.1 MAIN DISPLAY

The main display normally indicates the current shaft angle being generated. This display is also used during data entry for the following keys:

- Increment
- Phase
- Modulation Frequency
- Modulation Amplitude
- Modulation Velocity

Normally after entering data the main display will switch back to displaying the current shaft angle. If HOLD mode is active, then the main display will remain in data entry mode.

3.2.2 AMPLITUDE DISPLAY

The Amplitude display can display one of the following:

- Output Line-to-Line Amplitude
- External Reference Amplitude
- Internal Reference Amplitude

The value displayed depends on whether the RSS is in Internal or External Reference mode and whether Reference Amplitude or Output Amplitude key was selected last.

Data entry for the above is also accomplished on the Amplitude display.

3.2.3 FREQUENCY DISPLAY

The Frequency display shows the frequency of the Internal or External reference signal. When the RSS is in External Reference mode the incoming reference signal's frequency is measured and displayed. In Internal Reference mode the display indicates the internal oscillator's programmed frequency.

3.3 INDICATORS

Indicators are located near the main display, amplitude display, frequency display and the keyboard to indicate a mode, unit or warning. Refer to figure 3-1 for the location of each indicator.

3.3.1 SYN INDICATOR

Figure 3-1
Front Panel Displays and Indicators

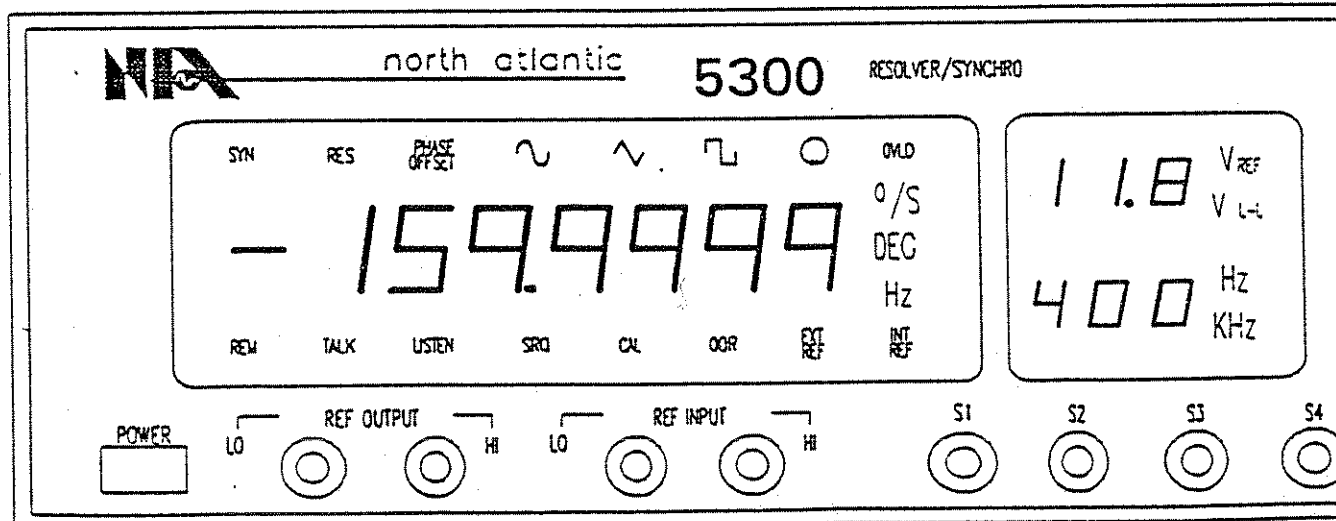

When lit, the RSS is generating 3 wire Synchro signals. S1, S2 and S3 are active. S4 is not active.

3.3.2 RES INDICATOR

When lit, the RSS is generating 4 wire Resolver signals. S1, S2, S3 and S4 are active.

3.3.3 PHASE OFFSET INDICATOR

When lit, the Synchro or Resolver output signals have a programmed phase offset from the internally generated reference signal.

3.3.4 SINE WAVE INDICATOR

When lit, the RSS is performing Sine Wave modulation.

3.3.5 TRIANGLE WAVE INDICATOR

When lit, the RSS is performing Triangle Wave modulation.

3.3.6 SQUARE WAVE INDICATOR

When lit, the RSS is performing Square Wave modulation.

3.3.7 ROTATION INDICATOR

When lit, the output shaft angle is rotating in a CW or CCW direction.

3.3.8 OVERLOAD INDICATOR

When flashing, either the reference or signal amplifiers are overloaded. When an overload is detected the amplifier outputs are disconnected and the output level is turned down to its minimum value. To reset this condition, program a new output amplitude.

3.3.9 %S INDICATOR

When lit, the value in the main display is modulation velocity in degrees per second.

3.3.10 DEG INDICATOR

When lit, the value in the main display is the output shaft angle or phase offset in degrees.

3.3.11 Hz INDICATOR

When lit, the value in the main display is the modulation frequency in Hertz.

3.3.12 INT REF INDICATOR

When lit, the RSS is operating in Internal Reference mode.

3.3.13 EXT REF INDICATOR

When lit, the SRS is operating in the External Reference mode. In this mode an external reference signal must be applied to the REF INPUT terminals.

3.3.14 OOR INDICATOR

When lit, the RSS is operating outside of the published limits. When the OOR indicator is on, accuracy is not guaranteed.

3.3.15 CAL INDICATOR

This indicator lights when a Calibration is in progress.

3.3.16 SRO INDICATOR

When lit, the RSS is requesting service over the IEEE 488 interface bus.

3.3.17 LISTEN INDICATOR

When lit, the RSS is addressed to listen over the IEEE 488 interface bus.

3.3.18 TALK INDICATOR

When lit, the RSS is addressed to talk over the IEEE 488 interface bus.

3.3.19 REM INDICATOR

When lit, the RSS is in remote mode. To exit remote mode hit the LOCAL pushbutton.

3.3.20 V REF INDICATOR

When lit, the Voltage display is showing either the Reference amplitude in volts.

3.3.21 V-L-L INDICATOR

When lit, the Voltage display is showing the Output Line-to-Line voltage.

3.3.22 Hz INDICATOR

When lit, the Frequency display is indicating the Reference frequency in Hertz.

3.3.23 KHz INDICATOR

When lit, the Frequency display is indicating the Reference frequency in kilohertz.

3.4 KEYBOARD CONTROLS

The Keyboard controls consist of three functional groups; OUTPUT, REFERENCE and MODULATION, and a numeric keypad and other miscellaneous controls.

3.4.1 OUTPUT CONTROLS

The Output group controls the major parameters of the shaft angle generation. These controls allow the operator to set the shaft angle, select Synchro or Resolver, set the output Line-to-Line Voltage and enter Increment values. Refer to figure 3-2 for the location of each control.

3.4.1.1 ANGLE Switch. When the ANGLE button is pressed, the unit enters angle input mode. This mode is indicated by the LED adjacent to the ANGLE button being on.

When the ANGLE button is first hit, the last programmed angle appears in the main display. A new angle may now be entered. To enter the new angle, use the numeric keypad and follow the angle with the ENTER key.

The new angle is applied to the unit when the ENTER key or any other function key is hit. If HOLD mode is off, The ANGLE LED will go off and the new output angle will appear in the main display. To change the angle again press the ANGLE key and repeat the process again. If HOLD mode is on, it is not necessary to hit the ANGLE key for each angle change.

The output angle can also be changed with the Increment knob when the ANGLE switch led is on. Turning the Increment knob clockwise will add the programmed increment angle to the current angle for each detent. Turning the Increment knob counterclockwise will subtract the programmed from the current angle for each detent.

The UP and DOWN keys function the same as the Increment Knob. Pressing the UP Key adds the programmed increment angle to the current angle. Pressing the DOWN key subtracts the programmed increment angle from the current angle.

The output angle entry range is ± 360.0000°.

3.4.1.2 SYN/RES Switch. This key alternately selects a 3 wire Synchro output or a four wire Resolver output.

3.4.1.3 AMPL Switch. The AMPL switch is used to change the output Line-to-Line voltage.

When the AMPL button is pressed, the unit enters output amplitude input mode. This mode is indicated by the LED adjacent to the AMPL button being on.

new Line-to-Line voltage may now be entered. To enter the new Line-to-Line voltage, use the numeric keypad and follow the voltage with the ENTER key.

The new Line-to-Line voltage is set when the ENTER key is hit. If HOLD mode is off, The Output AMPL LED will go off and the new Output Line-to-Line voltage will appear in the voltage display. To change the Line-to-Line voltage again press the AMPL key and repeat the process again. If HOLD mode is on, it is not necessary to hit the AMPL key for each Line-to-line change.

The allowable range of the output Line-to-Line is 0 or 1 to 90V. At power-up the Line-to-Line defaults to 0V.

3.4.1.4 INCR Switch. The INCR switch is used to change the Increment variable. The increment variable is added or subtracted when the INCREMENT Knob is turned or when the UP and DOWN keys are hit. The Increment function works in the following data entry modes:

- ANGLE
- Modulation Velocity
- Modulation Frequency

Each mode has its own Increment variable. To use, press the INCR key followed by the mode (ANGLE, MOD VEL, MOD FREQ) and then the desired Increment value followed by the ENTER key. The Increment is set when the ENTER key is pressed.

When the INCR and a mode key are hit, the last

Figure 3-2 Front Panel Controls

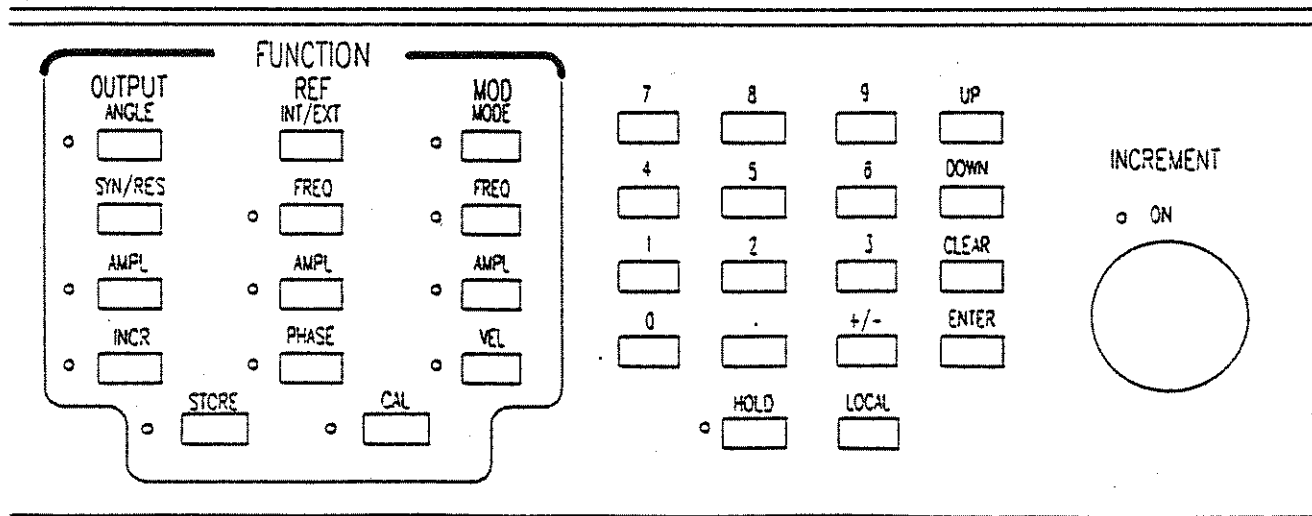

When the AMPL button is first hit, the last programmed Line-to-Line voltage appears in the Voltage display. A

programmed increment is shown on the main display. The unit is now in Increment entry mode. This mode

indicated by the LED adjacent to the INCR button being on.

3.4.2 REFERENCE CONTROLS

The REF group controls the Reference mode and the operating characteristics of the internal reference source.

3.4.2.1 *INT/EXT* Switch. This key alternately selects the signal applied to the REF INPUT terminals or the Internally generated reference as input to the simulator.

When the unit is in EXT mode the EXT REF indicator will illuminate and the REF OUTPUT terminal are disconnected.

In INT mode the INT REF indicator will light and the internal reference signal will appear at the REF OUTPUT terminals.

3.4.2.2 *FREQ* Switch. The FREQ switch is used to change the frequency of the internally generated reference signal. This switch only works when the instrument is in Internal reference mode.

When the FREQ button is pressed, the unit enters reference frequency input mode. This mode is indicated by the LED adjacent to the REF FREQ button being on.

When the FREQ button is first hit, the last programmed frequency appears in the Frequency display. A new frequency may now be entered. To enter the new frequency use the numeric keypad and follow the frequency with the ENTER key.

The new frequency is set when the ENTER key is hit. If HOLD mode is off, The REF FREQ LED will go off and the new frequency will appear in the frequency display. To change the frequency again press the FREQ key and repeat the process again. If HOLD mode is on, it is not necessary to hit the FREQ key for each frequency change.

The allowable range of the internal reference frequency is 47 to 20,000 Hz. At power-up the frequency defaults to 400 Hz.

3.4.2.3 *AMPL* Switch. The AMPL switch performs two functions depending on the current reference mode.

If the current reference mode is EXT, hitting this key displays the External reference voltage measurement in the voltage display.

When the reference mode is INT, the AMPL switch is used to change the output voltage of the internal reference.

When the AMPL button is pressed and the unit is in INT REF mode, the unit enters reference amplitude input mode. This mode is indicated by the LED adjacent to the REF AMPL button being on.

When the AMPL button is first hit and the unit is in INT REF mode, the last programmed reference voltage appears in the Voltage display. A new reference voltage may now be entered. To enter the new reference voltage, use the numeric keypad and follow the voltage with the ENTER key.

The new reference voltage is set when the ENTER key is hit. If HOLD mode is off, The REF AMPL LED will go off and the new reference voltage will appear in the voltage display. To change the reference voltage again press the AMPL key and repeat the process again. If HOLD mode is on, it is not necessary to hit the AMPL key for each reference voltage change.

The allowable range of the reference voltage is 0 or 2 to 115V. At power-up the reference voltage defaults to 0V.

3.4.2.4 *PHASE* Switch. The PHASE switch is used to change the phase shift between the internally generated reference signal and the Synchro or Resolver output signals. This key is active only when the unit is in INT REF mode.

When the PHASE button is pressed, the unit enters reference phase input mode. This mode is indicated by the LED adjacent to the PHASE button being on.

When the PHASE button is first hit, the last programmed Phase shift voltage appears in the main display. A new Phase shift may now be entered. To enter the new Phase shift, use the numeric keypad and follow the phase with the ENTER key.

The new Phase shift is set when the ENTER key is hit. If HOLD mode is off, The REF PHASE LED will go off and the new Phase shift voltage will appear in the main display. To change the Phase shift again press the PHASE key and repeat the process again. If HOLD mode is on, it is not necessary to hit the PHASE key for each Phase shift change.

The allowable range of the output Phase shift is $\pm 180^\circ$. At power-up the Phase shift defaults to 0.0000° .

NOTE

When the reference mode is changed to EXT REF mode, the phase shift is set back to 0.0000° .

3.4.3 MODULATION CONTROLS

The MOD group selects the modulation mode and the modulation parameters. Four modulation modes are provided, Sine Wave, Triangle Wave, Square Wave and Continuous Rotation.

3.4.3.1 *MODE* Switch. This key allows the selection of the desired modulation mode. The first time the MODE key is pressed the SINE indicator light up. Repeatedly

pressing the MODE key cycles the modulation indicators in the following sequence:

SINE - TRIANGLE - SQUARE - ROTATION - OFF

To start the desired mode press ENTER when the desired mode indicator is illuminated. If ENTER is not pressed within 5 seconds the modulation mode is canceled and the unit will return to static operation.

3.4.3.2 *FREQ* Switch. The *FREQ* switch is used to change the frequency of the modulation.

When the *FREQ* button is pressed, the unit enters modulation frequency input mode. This mode is indicated by the LED adjacent to the MOD *FREQ* button being on.

When the *FREQ* button is first hit, the last programmed modulation frequency appears in the main display. A new frequency may now be entered. To enter the new frequency use the numeric keypad and follow the frequency with the ENTER key.

The new frequency is set when the ENTER key is hit. If HOLD mode is off, The MOD *FREQ* LED will go off and the new frequency will appear in the main display. To change the frequency again press the *FREQ* key and repeat the process again. If HOLD mode is on, it is not necessary to hit the *FREQ* key for each frequency change.

The allowable range of the modulation frequency is 0 to 1,000 Hz. At power-up the frequency defaults to 0 Hz.

The modulation frequency can also be changed with the Increment Knob or the UP and DOWN keys.

3.4.3.3 *AMPL* Switch. The *AMPL* switch is used to change the peak modulation amplitude in degrees.

When the *AMPL* button is pressed, the unit enters modulation amplitude input mode. This mode is indicated by the LED adjacent to the MOD *AMPL* button being on.

When the *AMPL* button is first hit, the last programmed modulation amplitude appears in the main display. A new modulation amplitude may now be entered. To enter the new modulation amplitude, use the numeric keypad and follow the amplitude with the ENTER key.

The new modulation amplitude is set when the ENTER key is hit. If HOLD mode is off, The MOD *AMPL* LED will go off and the modulation amplitude will appear in the main display. To change the modulation amplitude again press the *AMPL* key and repeat the process again. If HOLD mode is on, it is not necessary to hit the *AMPL* key for each modulation amplitude change.

The allowable range of the modulation amplitude is 0 to 180 degrees. At power-up the modulation defaults to 0°.

3.4.3.4 *VEL* Switch. The *VEL* switch is used to change the peak modulation Velocity in degrees/sec.

When the *VEL* button is pressed, the unit enters modulation Velocity input mode. This mode is indicated by the LED adjacent to the MOD *VEL* button being on.

When the *VEL* button is first hit, the last programmed modulation Velocity appears in the main display. A new modulation Velocity may now be entered. To enter the new modulation Velocity, use the numeric keypad and follow the Velocity with the ENTER key.

The new modulation Velocity is set when the ENTER key is hit. If HOLD mode is off, The MOD *VEL* LED will go off and the modulation Velocity will appear in the main display. To change the modulation Velocity again press the *VEL* key and repeat the process again. If HOLD mode is on, it is not necessary to hit the *VEL* key for each modulation Velocity change.

The allowable range of the modulation Velocity is 0 to 100,000 degrees/second. At power-up the modulation defaults to 0 °/sec.

3.4.4 MISCELLANEOUS CONTROLS

3.4.4.1 *CAL* Switch. This key initiates a self calibration allowing the unit to achieve its full accuracy. A calibration should be performed anytime the frequency or the output Line-to-Line voltage changes by more than 5%.

Calibration can be performed in either Internal or External Reference mode, however when in External Mode reference signal must be connected to the REF INPUT terminals before calibration is started

NOTE

Calibration is not permitted if an overload condition exists (OVL and 0.0 VL-L displayed) or L-L voltage is set to zero.

When the *CAL* key is pressed, the *CAL* indicator illuminates indicating a Calibration is in progress. During Calibration the signal outputs (S1, S2, S3, and S4) are isolated. Calibration requires approximately 12 seconds to complete. When completed the *CAL* indicator goes off.

3.4.4.2 *STORE* Switch. This switch does not function.

3.4.4.3 *HOLD* Switch. The *HOLD* switch alternately turns on and off Hold mode. Hold mode is active when the *HOLD* LED is turned on. When the unit is not in Hold mode, the main display reverts back to displaying the current shaft angle after any data entry. When Hold mode is active, instead of the main display switching back to the shaft angle, the unit remains in data entry mode. This allows the data to be changed again without having to hit the appropriate function switch.

3.4.4.4 **LOCAL Switch.** This key requests a return from IEEE 488 control to local control. If local lockout was set by the IEEE 488 controller third request will be ignored.

The REM indicator shows if the request was accepted.

3.4.4.5 **UP Switch.** This key adds a stored increment value to the displayed parameter. This key is active only in the following modes.

- Angle
- Modulation Velocity
- Modulation Frequency

3.4.4.5 **DOWN Switch.** This key subtracts a stored increment value to the displayed parameter. This key is active only in the following modes.

- Angle
- Modulation Velocity
- Modulation Frequency

3.4.4.5 **INCREMENT Knob.** This control performs the same function as the UP and DOWN keys. Turning the knob clockwise increments the parameter and turning the knob counter clockwise decrements the parameter by the stored increment value. The INCREMENT knob is active only in the following modes.

- Angle
- Modulation Velocity
- Modulation Frequency

3.4.4.6 **ENTER Switch.** This key causes keyboard numeric data to be applied to the unit.

3.4.4.7 **CLEAR Switch.** This key clears any numeric enter prior to hitting the ENTER key.

3.4.4.8 **+/- Switch.** This key changes the sign of the data currently being entered.

3.4.4.6 **0- 9 and . Switch.** These keys are used to enter numeric data.

3.5 SETTING UP THE REFERENCE

Before the RSS can be used the reference source must be specified. If an external reference source is to be used, connect it to the REF INPUT terminals and press

REF

one or two times until the EXT REF indicator illuminates.

If the Internal reference oscillator is to be used, three items must be programmed. First Internal reference mode must

be selected. Then the frequency and output voltage must be set. Set the mode to internal reference by pressing

REF

one or two times until the INT REF indicator illuminates.

Next set the oscillators frequency. For example, to set the frequency to 1000 Hz. press the following keys:

REF

Finally, set the reference oscillator's output voltage. For example, for 115V output, press the following keys:

REF

3.6 PHASE SHIFTING THE OUTPUT SIGNALS

The Model RSS's phase shifting capability provides for a more accurate simulation of a real Synchro or Resolver. The output signals may be phase shifted ± 180 degrees with respect to the reference. The phase shift is independent of the programmed frequency of output voltage level.

Phase shifting works only when the unit is set to Internal Reference mode.

Example: Simulate a phase lag of 7.5 degrees. Press:

REF

ENTER

3.7 SETTING THE LINE-TO-LINE VOLTAGE

The Line-to-Line voltage setting determines the maximum RMS voltage that will appear across the outputs. To set the output Line-to-Line voltage to 11.8 volts, press:

OUTPUT AMPL
 1
 1
 .
 8
 ENTER

3.8 SETTING THE OUTPUT ANGLE

The static output shaft angle can be changed 3 different ways. Method 1 is the direct entry of the angle on the keypad. For example, set the simulator to 135.0001 degrees. Press:

OUTPUT ANGLE
 1
 3
 5
 .
 0
 0
 0
 1
 ENTER

If HOLD mode is active, the ANGLE key does not have to be hit when changing the angle again.

The second method of changing the angle involves the use of the UP and DOWN keys. This method saves a lot of keystrokes if the desired angles are a fixed increment apart.

For example: If we wish to simulate the angles 0, 45, 90, 135 etc. First program an angle increment of 45 degrees by pressing:

OUTPUT INCR
 OUTPUT ANGLE
 4
 5
 ENTER

Next set the static angle to 0.0000 degrees

OUTPUT ANGLE
 0
 ENTER

The simulator is now set to 0.0000 degrees.

OUTPUT ANGLE
 UP

The simulator is now set to 45.0000 degrees.

UP

The simulator is now set to 90.0000 degrees.

UP

The simulator is now set to 135.0000 degrees.

DOWN

The simulator is now set to 90.0000 degrees.

The third method is similar, first program the desired increment as above and hit the

ANGLE

key. Now rotate the increment knob. Each clockwise detent increases the angle by the increment and each counterclockwise detent decrements the angle by the programmed increment.

3.9 SINE WAVE MODULATION

When sine wave modulation is active, the output angle is sinusoidal modulated about the current static angle.

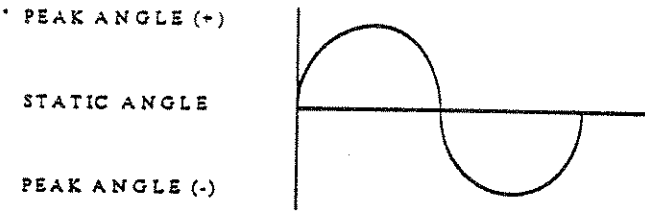

Figure 3-3. Sine Wave Modulation

The modulation characteristics are set using any two of the following parameters:

- Modulation Frequency
- Modulation Velocity
- Modulation Amplitude

These parameters can be modified dynamically while the unit is modulating. Modulation Velocity specifies the peak velocity and Modulation Amplitude specifies the peak deviation from the current angle.

The last two parameters entered determine the output waveform. These three parameters are related by the following formula:

$$A = \frac{V}{2 * \pi * F}$$

where A is the peak amplitude in degrees
 V is the peak velocity in degrees/sec
 F is the modulation frequency in Hz

Example: Program sine modulation at 15 Hz , 20° peak centered about 30°.

First set the static angle to 30 degrees

OUTPUT

Set the modulation frequency

MOD

Set the modulation amplitude

MOD

Finally, turn on sine modulation mode. Hit

MOD

until the SINE indicator lights, then

within 5 seconds to start sine modulation.

To turn sine wave mode off, hit

MOD

until all modulation indicators are off , then

3.10 TRIANGLE MODULATION

In triangle mode the output angle traverses back and forth between two angles at a constant velocity. The starting angle is the static angle, the angle then increases linearly to the static angle + the modulation amplitude, to the static angle - the modulation amplitude and back to the static angle.

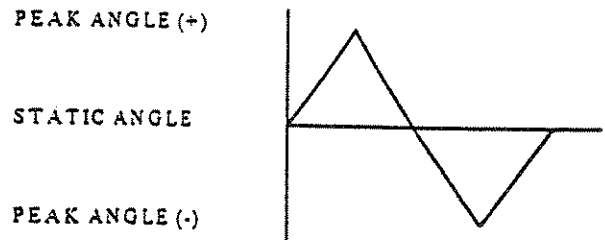

Figure 3-4. Triangle Wave Modulation

The modulation characteristics are set using any two of the following parameters:

- Modulation Frequency
- Modulation Velocity
- Modulation Amplitude

These parameters can be modified dynamically while the unit is modulating. Modulation Velocity specifies the peak velocity and Modulation Amplitude specifies the peak deviation from the current static angle.

The last two parameters entered determine the output waveform. These three parameters are related by the following formula:

$$A = \frac{V}{F}$$

where A is the peak amplitude in degrees
 V is the peak velocity in degrees/sec
 F is the modulation frequency in Hz

Example: Program triangle modulation at 100 °/sec , 10° peak centered about 90°.

First set the static angle to 90 degrees

OUTPUT

Set the modulation velocity

MOD

Set the modulation amplitude

MOD

Finally, turn on triangle modulation mode. Hit

MOD

until the TRIANGLE indicator lights, then

within 5 seconds to start triangle modulation.

To turn triangle wave mode off, hit

MOD

until all modulation indicators are off , then

3.11 SQUARE WAVE MODULATION

In square wave mode the output angle switches back and forth between the static angle and the static angle + peak angle.

The modulation characteristics are set by specifying the following parameters:

- Modulation Frequency
- Modulation Amplitude

These parameters can be modified dynamically while the unit is modulating. Modulation Velocity specifies the peak velocity and Modulation Amplitude specifies the peak deviation from the current static angle.

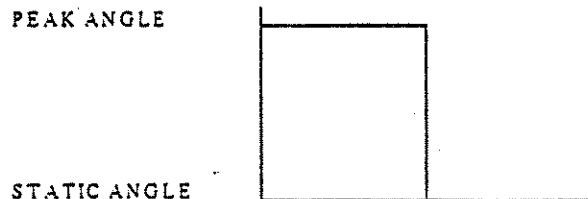

Figure 3-5. Square Wave Modulation

Example: Set the unit to square wave modulation mode, switch between 0 ° and 180 ° at a 1 Hz rate.

First set the static angle to 0.0000 degrees

OUTPUT

0

ENTER

Set the modulation frequency

MOD **FREQ**

1

ENTER

Set the modulation amplitude

MOD **AMPL**

1

8

0

ENTER

Finally, turn on square wave modulation mode. Hit

MOD **MODE**

until the SQUARE indicator lights, then

ENTER

within 5 seconds to start sine modulation.

To turn square wave mode off, hit

MOD **MODE**

until all modulation indicators are off , then

ENTER

3.12 CONTINUOUS ROTATION

In Rotation mode the output angle advances Clockwise or Counter Clockwise at a constant velocity. If the velocity is specifies as positive, Counter Clockwise rotation occurs. Negative velocities cause a clockwise rotation.

Example: Program the unit to run at 1000 °/sec in a counter clockwise direction.

First set the modulation velocity

MOD **VEL**

1

0

0

0

ENTER

Finally, turn on rotation mode. Hit

MOD **MODE**

until the ROTATION indicator lights, then

ENTER

within 5 seconds to start rotation.

To turn rotation off, hit

MOD **MODE**

until all modulation indicators are off , then

ENTER

CHAPTER 3 OPERATION

Section II. CASS Programming Mode

3.13 GENERAL

This section describes the remote operation of the Model 5300 Resolver/Synchro Standard (RSS) using the ANSI/IEEE-STD 488.1-1987, Standard Digital Interface for Programmable Instrumentation. The Standard programming language (SPL) is described.

3.13.1 INTERFACE FUNCTIONS SUPPORTED

The RSS is a listen only device for the Standard Programming Language. The interface functions and subsets that the RSS responds to are listed in Table 3-1.

Table 3-1. IEEE-488 Interface Functions and Descriptions

Interface Function	Subset	Function
Source Handshake	SH0	No Capability
Acceptor Handshake		Complete Capability
Talker	T0	No Capability
Extended Talker	TE0	No Capability
Listener	L4	Basic Listener, Unaddress if MLA
Extended Listener	LE0	No Capability
Service Request	SR0	No Capability
Remote Local	RL1	Complete Capability
Parallel Poll	PP0	No Capability
Device Clear	DC0	No Capability
Device Trigger	DT0	No Capability
Controller	C0	No Capability

3.13.2 SETTING IEEE 488-BUS ADDRESS

The device address that the RSS will respond to is set by the following sequence of front panel keystrokes:

With the unit in local mode, press

LOCAL

The main display shows

IEEE 6

This indicates that the current IEEE address is set to address 6. To change this to another address, press the UP key to increment the address, or press the DOWN key to

decrement the address. For example, to set IEEE address 10, press the following keys:

LOCAL

UP

UP

UP

UP

ENTER

The IEEE address is stored in EEPROM when set. Once set to the desired address, it is not necessary to set it each time the unit is powered up.

If a mistake is made when changing the IEEE address, press the

CLEAR

key to exit without modifying the address.

3.14 COMMAND FORMAT

Instrument functions are bus programmable through the use of "data strings" and/or "Command codes. Numeric data is sent in the following format:

"DDD.DDDD"

All numeric data must have a decimal point present (except for numeric data of zero). No more than three digits to the left of the decimal point will be accepted. Any non-significant digits can be omitted; they will simply default to zero. Any non-numeric data, except the decimal point and the asterisk (*), will be ignored in the data string.

Command codes are sent in the following format:

*A (Asterisk + single character)

All Command codes characters must follow an asterisk (*). The asterisk acts as a delimiter to separate commands from data. The asterisk must always be sent first. All illegal commands will be ignored.

Multiple commands may be sent in a message. All command strings should be terminated with an ASCII line feed and or the IEEE-488 EOI signal. All commands are case sensitive.

Table 3-2 lists the commands available in the RSS.

When the RSS is addressed to listen, the instrument will go into remote mode operation. Local control can again be selected by pressing the "LOCAL" button on the front panel, if local lockout has not been enabled. Local control can also be restored by cycling power to the unit.

3.14.1 ANGLE COMMAND

The Angle Command is used to direct all input data to the current shaft angle position value. The Angle command is:

*A

After the *A command is received, any input data that follows, automatically updates the current angle.

Example:

```
*A
222.2222   Simulated Angle is 222.2222
111.1111   Angle changes to 111.111
```

3.14.2 FUNCTION COMMAND

The Function command latches the present angle data. All subsequent data will NOT automatically update the angle value. The format of the function command is:

*B

3.14.3 SYNCHRO COMMAND

This command sets the operating mode to 3 wire Synchro. The following string sets Synchro Mode.

*S

3.14.4 RESOLVER COMMAND

This command sets the operating mode to 4 wire Resolver. The following string set Resolver Mode.

*R

3.14.5 INTERNAL REFERENCE COMMAND

This command allows the selection of the internal reference oscillator. Once received the oscillator is internally connected to the shaft position generation circuits. The oscillator output also appears on the REF OUT terminals.

To select the internal reference source, send the following:

*N

3.14.6 EXTERNAL REFERENCE COMMAND

This command selects an external reference source to be used in generating the shaft angle. The external source should be connected to the EXT REF terminals.

To select the external reference, send the following:

*E

3.14.7 PHASE SHIFT 0° COMMAND

The Phase Shift 0° Command Turns off the Phase shifting circuits of the RSS. The command format is:

*F

3.14.8 PHASE SHIFT COMMAND

The Phase Shift command enables the programmed reference to signal phase shift. To use the phase shifting capability, first set the desired phase shift and then enable it using the phase shift command. The phase shift command is:

*I

For Example: To set the phase shift to 20 degrees, send the following message:

```
*B           latch current angle data
20.0000*p   set phase shift
*C           latch phase shift value
*I           Apply programmed phase shift
*A           reenable angle select function
```

3.14.9 STATIC ANGLE COMMAND

This command cancels any modulation modes currently executing and sets the RSS to static operation. The Static Angel command is:

*D

3.14.10 DYNAMIC ANGLE COMMAND

The Dynamic Angle Command enables the programmed modulation mode. The format of this command is:

*T

Example: Set the RSS to sine wave modulation:

```
*X*M       set sine modulation
*T         enable modulation
```

3.14.11 SIGNAL VOLTAGE COMMANDS

The Signal Voltage Commands program the output Line-to-Line Voltage. Three of these set the Output Voltage to commonly used voltages and the fourth allows the user to specify an alternate voltage.

Preset Voltages (11.8, 26, and 90 V RMS) can be set using the following 3 commands.

```
*1       sets 11.8 V
```

- *2 sets 26 V
- *9 sets 90 V

For other voltages a two-step process is required. First, store the signal voltage with the *o command and then apply it to the RSS with the *5 command.

Example: set the RSS for 6V Line-to-Line

6*o*5 set 6 volts and apply in one command.

3.14.12 REFERENCE VOLTAGE COMMANDS

These commands program the internal reference output voltage. Three of these set the voltage to commonly used voltages and the fourth allows the user to specify an alternate voltage.

Preset Voltages (26, 115 and 6.8 V RMS) can be set using the following 3 commands.

- *L sets 26 V
- *H sets 115 V
- *l (lower case L)sets 6.8 V

For other voltages a two step process is required. First, store the reference voltage with the *r command and then apply it to the RSS with the *h command.

Example: Set the internal oscillator for 20 V output.

20*r*h set 20 volts and apply in one command.

3.14.13 REFERENCE FREQUENCY COMMANDS

These commands program the internal reference frequency. Three of these set the RSS to commonly used frequencies and the fourth allows the user to specify an alternate frequency.

Preset Frequencies (400 Hz, 60 Hz, and 800 Hz) can be set using the following 3 commands.

- *4 sets 400 Hz
- *6 sets 60 Hz
- *8 sets 800 Hz

For other voltages a two step process is required. First, store the reference frequency with the *f command and then apply it to the RSS with the *7 command.

Example: Set the internal oscillator for 100 Hz.

.1*f*7 set frequency and apply in one command.

Note: The frequency is specified in Khz. Also this command will change the output angle to .1 degrees if the *B command was not issued previously. An alternative is:

- *B latch current angle data

- .1*f*7 set frequency
- *A reenable angle select function

3.14.14 DYNAMIC MODE COMMANDS

The dynamic mode commands are used to set the desired modulation mode. Once set modulation can be enabled by the *T command. The available modulation mode commands are:

- *+ set CW Rotation mode
- *- set CCW Rotation mode
- *X*M set Sine modulation mode
- *Y*M set Triangle modulation mode
- *Z*M set Square wave modulation mode

In addition to setting the modulation mode, the modulation parameters must be set. These include modulation frequency, peak modulation rate and square wave amplitude.

- *a sets modulation frequency
- *b sets peak modulation rate, or square wave amplitude

Example: Program the RSS for 1000°/sec Clockwise rotation.

- 1*b load 1000°/sec rate
- *C latch rate data
- *+ select clockwise rotation
- *T enable dynamic angle operation

Example: Set the RSS to 45° square wave operation.

- 45*b set square wave amplitude to 45°
- *C latch amplitude data
- *Z*M select square wave mode
- *T enable dynamic angle operation

3.14.15 PRESET COMMAND

The Preset command puts the RSS into a predefined state. The format of the preset command is:

*P

This command is equivalent to:

*A*R*N*F*D*2*L*4*M*X

Upon receipt the RSS will be in the following state:

- Angle entry mode
- Resolver mode
- Internal Reference

- Phase shift 0°
- Static Angle mode
- 26 V Line-to-Line
- 26 V Reference
- 400 Hz
- Sine modulation mode set (but not enabled)

3.14.16 LATCH DATA COMMAND

This command is used to latch the data for the following commands: *o *r *f *p *a *b. If the latch command is not sent, the subsequent data will update the last selected function. The Latch Data command is:

*C

3.14.17 CALIBRATION COMMAND

This command calibrates the RSS at the present voltage and frequency. Calibration requires approximately 12

seconds to complete. Additional commands sent while the RSS is calibrating will be delayed until the calibration is complete and then executed.

NOTE

Calibration is not permitted when an overload condition exists (OVLD and 0.0 VL-L displayed) or if L-L voltage is set to zero.

The format of the calibration command is

*c

When the RSS is in remote mode, the RSS will automatically perform a calibration anytime the frequency or Line-to-Line voltage is changed more than 10% from its last value. All subsequent messages will be delayed by the interface until the calibration is complete and then executed.

Table 3-2
Commands

	<u>Command</u>	
Angle	*A	Data will enter the angle buffer, subsequent data will automatically update the angle value.
Function	*B	Function data select. The present angle data is latched, subsequent data will NOT automatically update the angle value.
Synchro Mode	*S	Places the RSS in Synchro output format mode
Resolver Mode	*R	Places the RSS in Resolver output format mode
Internal Reference	*N	Selects internal reference mode
External Reference	*E	Selects external reference mode
Phase Shift 0°	*F	Selects zero degrees signal / reference phase shift
Phase Shift	*I	(Capital i) Enables programmed signal / reference phase shift
Static Angle	*D	Selects static angle operation mode
Dynamic Angle	*T	Selects dynamic angle operation mode
Signal Voltage		
11.8	*1	Programs 11.8 Vrms line-to-line voltage
26	*2	Programs 26.0 Vrms line-to-line voltage
90	*9	Programs 90.0 Vrms line-to-line voltage
Programmed	*5	Programs the output line-to-line voltage to the stored value
Reference Voltage		
26	*L	Programs 26.0 Vrms line-to-line reference voltage
115	*H	Programs 115 Vrms line-to-line reference voltage
6.8	*1	Programs 6.8 Vrms line-to-line reference voltage
Programmed	*h	Programs the line-to-line reference voltage to the stored value
Reference Frequency		
400 Hz	*4	Programs the reference frequency to 400 Hz
60 Hz	*6	Programs the reference frequency to 60 Hz
800 Hz	*8	Programs the reference frequency to 800 Hz
Programmed	*7	Programs the reference frequency to the stored value
Dynamic Modes		
CW	*+	Constant velocity Clockwise
CCW	*-	Constant velocity Counterclockwise
Sine	*X*M	Sine wave modulation
Triangle	*Y*M	Triangular wave modulation
Square	*Z*M	Square wave modulation
Preset	*P	Equivalent to *A*R*N*F*D*2*L*4*M*X
Data Input		
Angle Data	*A	DDD.DDDD*A (°)
Signal Voltage	*o	DDD.DDDD*o (Vrms)
Ref. Voltage	*r	DDD.DDDD*r (Vrms)
Ref. Frequency	*f	DDD.DDDD*f (KHz)
Phase Shift	*p	DDD.DDDD*p (°)
Dynamic Data		
Frequency	*a	000.DDDD*r (KHz)
Peak Rate	*b	DDD.DDDD*b (1000°/sec)
Sq. Wave Ampl.	*b	DDD.DDDD*b (° pk-pk)
Latch Data	*C	This command is used to latch the data for the following commands: *o *r *f *p *a *b. If the latch command (*C) is not sent, the subsequent data will update the last selected function.
Calibrate	*c	Perform calibration at the current signal voltage and frequency

Note: When programming data other than angle data, the function data select command (*B) must always precede the data. Otherwise the angle data will also be changed.

CHAPTER 4 PRINCIPLES OF OPERATION

4.1 SCOPE

This chapter contains the principles of operation for the Model 5300 Resolver/Synchro Standard (RSS). The principles are prefaced by an overview of synchro and resolver conventions.

The principles of operation for the RSS are described in two levels. The system level description uses a system block diagram that shows the overall tie-in between the major functional assemblies of the RSS. The functional level description uses block diagrams of each functional assembly and describes the essential control and data signals that the assembly processes.

The principles of operation support an intermediate maintenance level wherein defective shop replaceable assemblies (SRA) are fault-isolated and the RSS is repaired by removal and replacement of the defective SRA.

4.2 SYNCHRO AND RESOLVER CONVENTIONS

Conventions for polarities, terminal designation and direction of shaft rotation for synchros and resolvers are most frequently defined in accordance with military specifications MIL-S-20708 (synchros) and MIL-R-2153 (resolvers). The RSS is provided with terminal designations and electrical characteristics to these specifications.

Note

- In applying the conventions, exercise caution that the manufacturer has followed the MIL convention.
- Check that the system use has not dictated a change in convention for a different characteristic (for example, direction reversal or angular offset).

4.2.1 SYNCHRO TRANSMITTER CONVENTIONS

$$\begin{aligned} E(S1-S3) &= -NE(R1-R2) \sin \theta \\ E(S3-S2) &= -NE(R1-R2) \sin (\theta + 120^\circ) \\ E(S2-S1) &= -NE(R1-R2) \sin (\theta + 240^\circ) \end{aligned}$$

Where E(S1-S3) is the stator voltage S1 with respect to S3. Other stator and rotor voltages are similarly defined. N is the ratio of the maximum voltage across a pair of stator terminals to the voltage across the rotor terminals. θ is the shaft angle displacement from electrical zero which satisfies these equations. A schematic of the synchro transmitter is shown in figure 4-1.

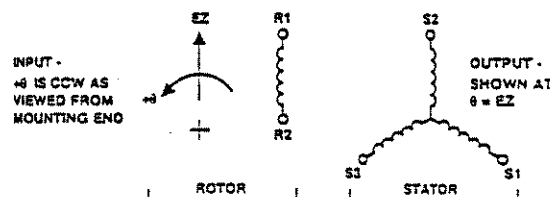

Figure 4-1. Synchro Transmitter, Schematic

4.2.2 RESOLVER TRANSMITTER CONVENTIONS

For rotor energized resolvers, the following equations apply:

$$\begin{aligned} E(S1-S3) &= -NE(R1-R3)\cos \theta - NE(R2-R4)\sin \theta \\ E(S2-S4) &= -NE(R2-R4)\cos \theta - NE(R1-R3)\sin \theta \end{aligned}$$

A rotor energized resolver transmitter schematic is shown in figure 4-2. Input and output may be reversed for stator energized devices.

Because the NAI standard assumes an R2R4

energized resolver, the resolver outputs become:

$$E(S1-S3) = -NE(R2-R4)\sin \theta$$

$$E(S2-S4) = +NE(R2-R4)\cos \theta$$

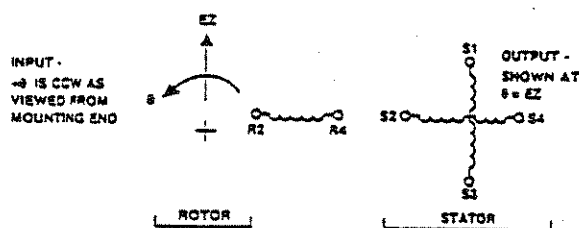

Figure 4-2. Resolver Transmitter, Schematic

4.3 SYSTEM LEVEL PRINCIPLES OF OPERATION

The RSS system block diagram is shown in figure 4-3. The RSS consists of five major functional assemblies; the analog board, the sine/cosine board, the system board, the display/keyboard assembly, and the power supply system. These functional assemblies and an overview of the software are described in the following paragraphs.

4.3.1 ANALOG BOARD

The analog board generates a precise reference waveform that drives isolation/tapped transformers T3 and T4 for the sine and cosine channels of the sine/cosine board. The analog board also provides an externally generated reference output to jacks on the front panel and terminals on the rear panel terminal block whereby a reference voltage may be applied to simulate the rotor of a synchro or resolver.

The input to the analog board may be from an external source, in which case the internal reference circuits are not selected. The external reference is precisely level adjusted with the (protected) autoranging and AGC circuits. Control of the analog board is provided by the system board. The analog board also contains the measurement circuits, fine level and

electrical phase control circuits, and the calibration circuits.

4.3.2 SINE/COSINE BOARD

The sine/cosine board consists of two similar (but isolated) channels enabled by the analog board to provide precise, low impedance outputs to simulate the stator windings of a synchro or resolver. Precision, 21-bit resolution, for the dynamic rotational angles for each channel is achieved with fast-switched transformers/MUX circuits and an MDAC circuit. The tapped transformer/MUX circuit provides the upper four most significant bits (MSB), the MDAC circuits provide the lower 16-bits, and the isolation transformer/MUX circuit provides the sign bit. The isolation transformer/MUX circuit feeds the tapped transformer which subsequently feeds the MDAC circuit. The combination of outputs from the tapped transformer/MUX circuit and the MDAC circuit are summed and provide the input for a power amplifier. The outputs for the power amplifier are accessible from front panel jacks and the rear panel terminal block. The sine/cosine board is controlled by the system board.

4.3.3 SYSTEM BOARD

The system board provides microprocessor control over all functions of the RSS. Programmed by firmware residing in an Erasable Programmable Read Only Memory (EPROM), the system board drives the display board and samples the keyboard assembly, performs digital signal processing to compute angle and reference data, samples IEEE-488 connector J23 on the rear panel, and provides handshaking with an external computer during remote operation. The system board functions as a distribution bus for all dc power supplies, and as a mother board for the interconnect board. The interconnect board functions as a daughter board for the analog and sine/cosine boards mounted in the card file.

4.3.4 DISPLAY/KEYBOARD ASSEMBLY

The display/keyboard assembly consists of a

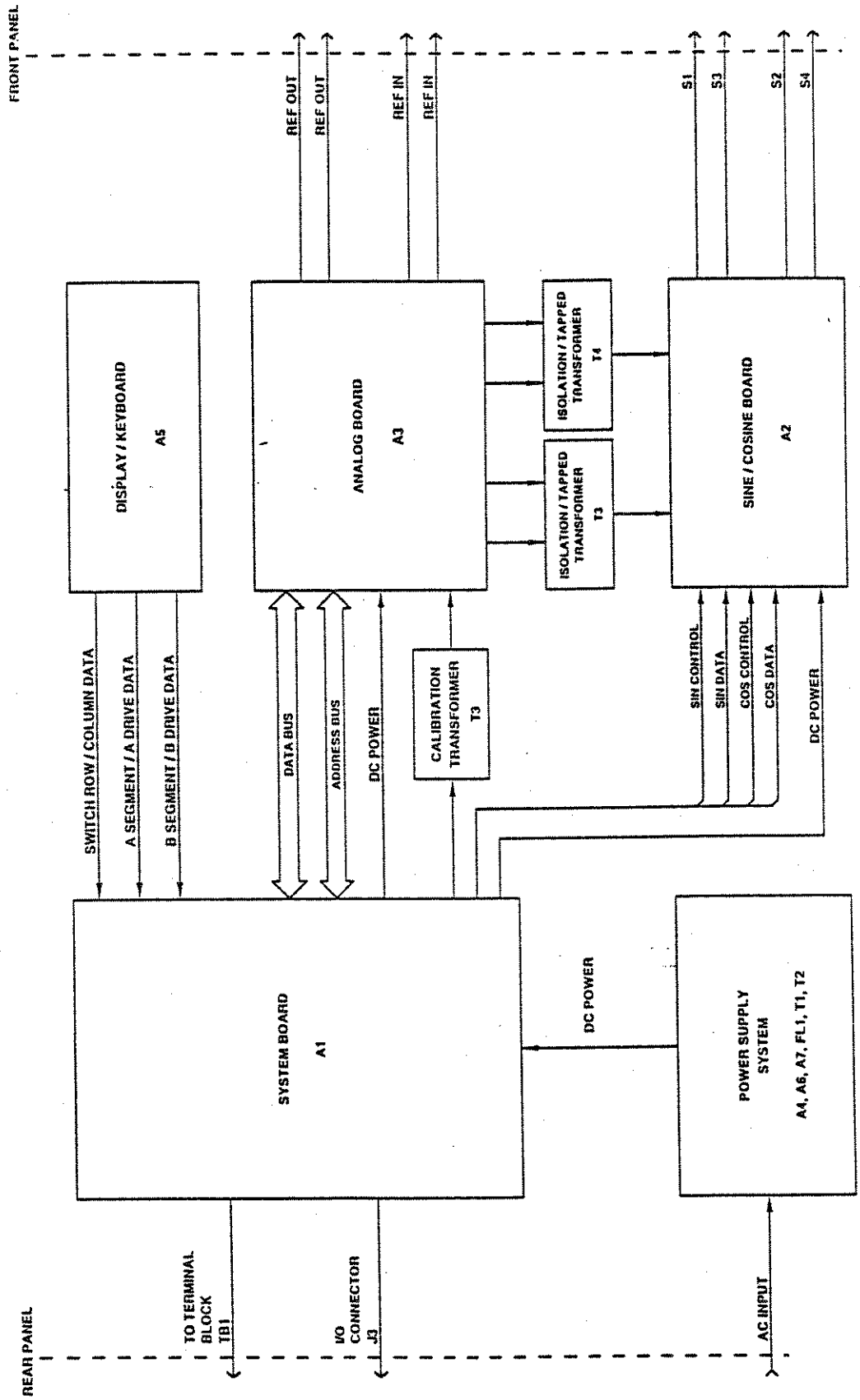

Figure 4-3. System Block Diagram

Light Emitting Diode (LED) display and a keyboard assembly. The display indicates operating conditions of the RSS, and the keyboard provides the operator with a means of entering data into the RSS. The display consists of two panels; a primary 8-digit numerical panel with 19 LED indicators (SYN, RES, PHASE OFFSET, Sine wave symbol, Triangle wave symbol, Square wave symbol, Rotational symbol, OVLD, °/S, DEG, Hz, INT REF, EXT REF, OOR, CAL, SRQ, LISTEN, TALK, and REM) and a secondary numerical panel displaying 3-digit voltage and frequency with four LED indicators (V_{REF} , V_{L-L} , Hz, and KHz).

The keyboard assembly contains 20 push button switches, a 12-key (see following note) numeric pad (digits 0 through 9, \pm , and decimal point), and an optical encoder.

Note

The front panel STORE push button switch, if installed, does not function.

4.3.5 POWER SUPPLY SYSTEM

The power supply system consists of a main power supply board and two, identical, isolated power supply assemblies.

4.3.5.1 Main Power Supply Board. The main power supply board receives AC input from main transformer T1 and performs rectification, filtering, and regulation to provide continuous +5 Vdc and ± 15 Vdc power to the system board and analog board.

Note

The system board acts as a distribution bus for all dc power.

The main power supply board also provides, after a turn-on delay, ± 48 Vdc and ± 175 Vdc to the RSS circuits. These outputs are switched from the RSS system by relays. The main power supply board has a hi-voltage overload sense circuit that detects reference output overloads and subsequently relay-isolates all outputs upon overload. The main power supply

board switches ac power to the isolated power transformer via a relay.

4.5.3.2 Isolated Power Supply. The isolated power supplies are identical and provide separate ± 15 Vdc, ± 20 Vdc, ± 48 Vdc, and ± 150 Vdc to each channel of the sine/cosine board. Similar to the main power supply board, each isolated power supply has a hi-voltage overload sense circuit that detects simulator output S1 through S4 overloads and isolates all the outputs. The main power supply board is attached to the chassis, whereas the isolated power supplies plug into connectors on the system board. The isolated power supplies are identical and may be used in either connector location.

4.3.6 SOFTWARE OVERVIEW

This overview describes the two major sections of the software; the Startup Code and the Operational Code.

4.3.6.1 STARTUP CODE. The startup code is responsible for determining operability of the basic hardware components, initializing the hardware, and starting the operating system. When the RSS is turned on, the startup code causes the RSS signals to be isolated, runs the power-up tests to test the display, CPU, RAM, ROM, EEPROM, and two digital signal processors (DSP). If the power-up test detects an error, an error message is displayed, if possible, and processing is halted.

Assuming that an error has not occurred, the startup code next initializes the system stack and heap, programmable timer, keyboard and remote interface hardware, main display, voltage display and frequency displays.

The RSS is then set to its default values, the signals are connected, and the main loop is entered.

4.3.6.2 OPERATIONAL CODE. The operational code is a system of tasks that are run in a real-time, multitasking environment. These tasks are the timer, overload handler, keystroke

processor, remote interrupt processor, and the main loop.

The timer task is a synchronous task that runs in response to the programmable timer interrupt. This task handles interprocess synchronization and the main system coordination.

The overload handler task is a high priority asynchronous task that runs in response to a RSS detected overload condition. The handler turns down and isolates the output to prevent harm to the RSS and possible injury to the operator.

The keystroke processor is an asynchronous task that runs in response to a key being depressed. The handler debounces the key, and decodes and buffers the keystroke. Keystroke buffer status is tracked by the operating system.

The remote interrupt processor is an asynchronous task that runs in response to a remote command or a status change at the IEEE-488 interface. The remote command processor buffers incoming command characters, sends outgoing message characters, and informs the operating system of remote status changes.

The main loop is a background task that monitors the status of the keystroke buffer and remote processor buffer. If a remote command has been buffered, the command processor is called. If a keystroke has been buffered, the keystroke processor is called. The main loop also coordinates the measurement and display of the reference voltage and frequency, and auto-ranging when the RSS is operating in external reference mode.

The keystroke processor interprets local inputs using lower level data input routines, and calls the appropriate RSS interface routines. If the interface routine returns an error status, the error number is posted on the main display of the RSS.

The remote interpreter interprets commands and returns status via the IEEE-488 interface. As the syntax is checked and parameters are converted, an error message is queued if an

invalid command is detected. The error message is returned on the next error query command. When a valid command is parsed, the RSS routine is called with the input parameters. If the interface routine returns an error status, an error message is queued and returned for the next error query command. In the case of a query command, the RSS interface routine is called to obtain the RSS setting returned by the IEEE-488 interface.

The RSS interface routines provide a common interface to the remote command and keystroke processors and are used to set or query RSS parameters. Parameters are tested for limit errors and settings conflicts.

The lower level instrument drivers and DSP interface routines are called to carry out the intended process. These routines return an integer value that indicates success or failure status.

Note

The instrument drivers are at the lowest level and handle the details of writing values to the RSS registers.

4.4 FUNCTIONAL LEVEL PRINCIPLES OF OPERATION

The functional block diagrams for the RSS are shown in figure 4-4 through 4-9. The analog board, the sine/cosine board, the system board, the display/keyboard assembly, and the power supply system are described in the following paragraphs.

Note

For reference, the corresponding schematic diagram figure number (Chapter 7) is shown with the figure for the block diagram.

4.4.1 ANALOG BOARD (Figure 4-4, 7-1)

The analog board produces two types of output waveforms: One output drives isolation/tapped transformers for the sine/cosine board, enabling it to produce signals to drive, or simulate, the stator windings of a synchro or resolver; the

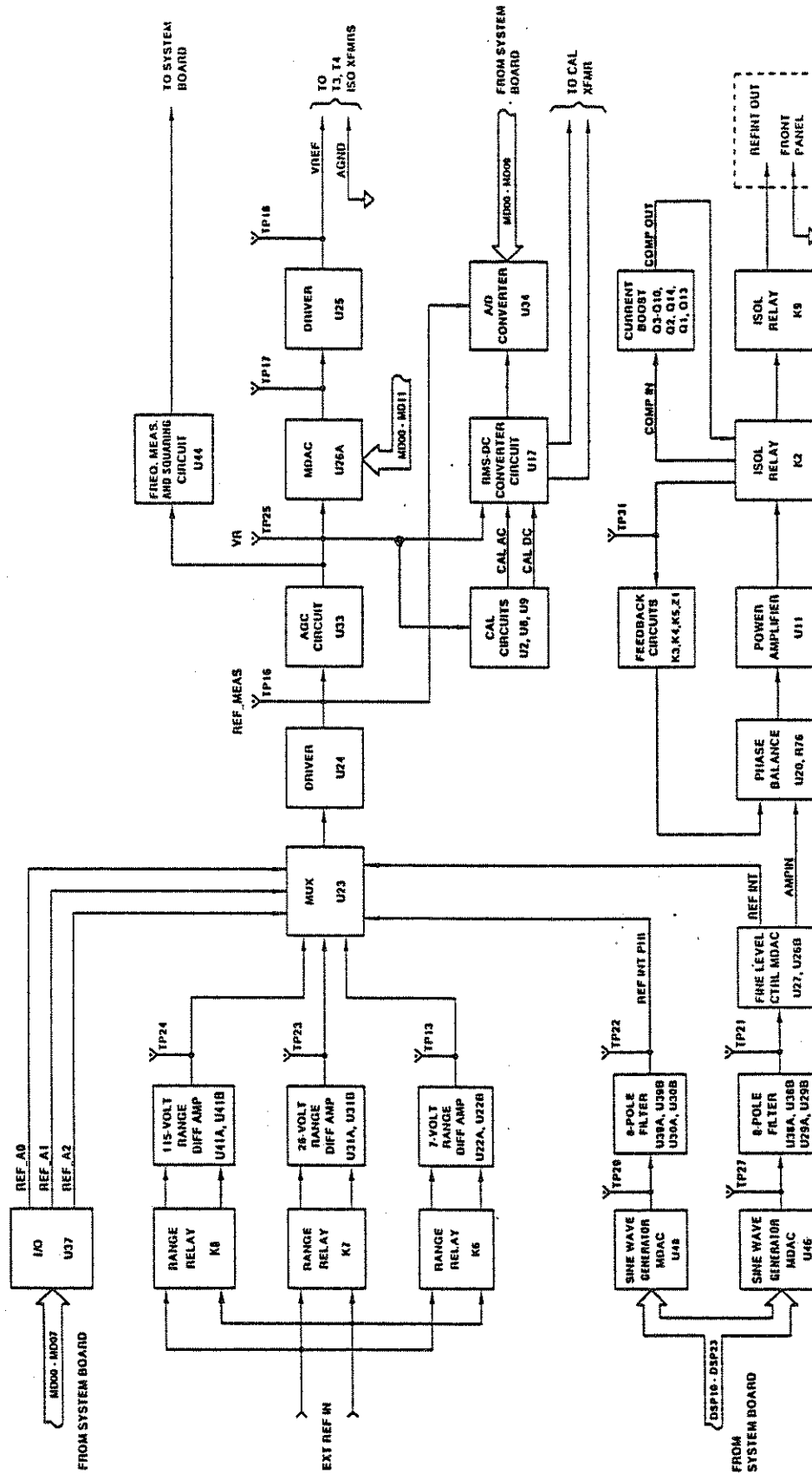

Figure 4-4. Analog Board, Block Diagram

second output is an internal generated reference waveform used to drive, or simulate, the rotor windings of a synchro or resolver. The analog board is controlled by the system board data and Reference DSP bus. In addition to the output waveforms, the analog board has the means to measure and calibrate the sine/cosine board simulator outputs

Note

The waveform that drives the sine/cosine board is internally generated or provided from an external reference source via jacks on the front panel of the RSS or the terminal block on the rear panel of the RSS.

4.4.1.1 Internal Reference Output. A reference voltage produced by MDAC U48 and signals from the system board DSP bus drive the input of sine generator MDAC U46 and U48 to produce two pseudo sine waveforms consisting of voltage level steps. The waveforms are processed by 8-pole, low pass filter circuits to remove the high frequency components and the results are two sine waveforms. The output of U29B is applied to fine level control MDAC U26B and MUX U23 via U27. The phase shifted waveform (REFINT_PHI) is applied to MUX U23 only.

MDAC U26B provides a programmable fine level control (AMPIN) to the input of the phase balance circuits. The output of the phase balance circuits is applied to power amplifier U11. The output amplitude range is determined by the feedback and attenuation/compensation select circuits in the power amplifier, and the output level is determined by the combination of the range selected and the fine level control MDAC U26B. With the power amplifier in the highest range (26V to 115V), the output of U11 is connected to the front panel REF OUTPUT jacks and rear terminal block and may be used to drive or simulate the rotor winding of a synchro or resolver.

Note

For operation below 26 V, the output of U11 is

switched to the complimentary pair/driver circuits by relay K2 (COMPIN). The output of this circuit (COMPOUT) provides a current boost to the device connected to the outputs.

4.4.1.2 Sine/Cosine Board Input. MUX U23 selects one of three input waveforms; the normal reference waveform (REFINT), the phase shifted reference waveform (REFINT_PHI), or an external input waveform applied via the front panel REF INPUT jacks or terminal block on the rear panel.

Note

The range for the external input waveform is automatically selected (autoranging) by range relays and difference amplifiers shown on figure 4-4.

The selected input waveform (REF_MEAS) is applied to the AGC circuits to develop a constant amplitude waveform (VR) to MDAC U26A. REF_MEAS is also applied to the measurement/calibration circuits (paragraph 4.4.1.3).

The output amplitude of MDAC U26A is adjusted by data (MD00 - MD11) from the system board data bus and connected in parallel (via driver U25) to the primary winding of isolation/tapped transformers T3 and T4. The secondary winding of T3 and T4 drive each channel of the sine/cosine board. MDAC U26A provides programmable fine level control of the L-L output.

4.4.1.3 Measurement/Calibration Circuits. In external reference mode, the REF_MEAS signal is processed by RMS-to-DC converter U17 and applied to A/D converter U34. The output of U34 is placed on the data bus to drive the amplitude display on the front panel. When calibration is selected, switch U16A connects CAL_AC from the calibration circuits to RMS-to-DC converter U17 and processes the data with A/D converter U34. Optimal ranging of the sine, cosine null signal is performed. CAL_DC is applied directly to A/D converter U34 to measure the in-phase null with respect to VR and subsequently determine optimal

correction. REF_MEAS is also applied to frequency measurement (hard squaring) circuit U44 to drive the frequency display on the front panel.

4.4.2 SINE/COSINE BOARD (Figure 4-5, 7-2)

The sine/cosine board contains two identical, galvanic isolated channels that provide outputs

that drive or simulate the stator windings of a synchro or resolver.

Note

The sine channel has an additional phase balance adjustment.

The sine/cosine board receives its input from the isolation/tapped transformers as previously described. The sine/cosine board is controlled by the sine register, cosine register, and sine/cosine control register located on the system board.

Note

Since the two channels are identical, only the sine channel function will be discussed. The reference designation for cosine channel components are enclosed in a bracket [].

Inputs from the secondary of isolation/tapped transformer T4 [T3] are applied to the quadrant select circuit where the correct polarity is assigned. The output of the quadrant select circuit is applied to the tapped secondary of T4 [T3]. This 15-tapped (positive) winding is used with MUX U47 [U58] to provide 4-bit (coarse) resolution for the selected angle. The tapped secondary has an additional negative tap winding used by MDAC U23 [U28] to provide 16-bit (fine) resolution of the selected angle. The output of the MUX and MDAC are added by summation circuit U22 [U27] and together provide 20-bit resolution plus sign (or 21-bits) of the selected sine [cosine] of the angle.

As an example, if a particular angle and voltage range is selected with no modulation applied, the system board Angle DSP circuitry determines

the appropriate data and applies it, via the system board sine and cosine registers, to MUX U47 [U48] and MDAC U23 [U28]. The MUX selects the appropriate tap, and the MDAC output is adjusted to provide the correct value for that angle. One bit also select the proper polarity.

When the signal is modulated, the system board Angle DSP circuitry rapidly computes each data value and applies it in real time, selecting various transformer taps and MDAC outputs.

To prevent glitches on the output when switching between different taps of the transformer, as well as switching the MDAC, a track and hold (T/H) circuit is used to hold the output a short period of time through the transition. The output from the T/H circuit is applied to power amplifier U38 [U14]. The output of this amplifier is connected (via isolation relays) to the rear panel terminal block and front panel jacks S1 - S3 [S2 - S4] and may be used to drive or simulate the stator windings of a synchro or resolver.

Note

Sense data SS1 - SS3 [SS2 - SS4] at the load may be connected to corresponding inputs to the rear panel terminal board to enable the sine/cosine circuits to compensate for line losses.

4.4.3 SYSTEM BOARD (Figure 4-6, 7-3)

The system board circuits are responsible for controlling the entire operation of the RSS and are described in the following paragraphs.

4.4.3.1 CPU. The CPU U34 runs the program (firmware) stored in EPROM U21, 22 at 10 MHz and controls RSS hardware components via its address bus (MA01 - MA23) and data bus (MD00-MD15). Upon turn on, the start up code in firmware runs the power-up tests to check the display FPGA's (U29, 48), CPU (U34), RAM (U15), EPROM (U21, 22), and two DSP's (U2, 4). After power-up tests are completed and no errors are detected, the CPU sets the RSS to its default values and polls the interface and keyboard assembly for inputs. The system board

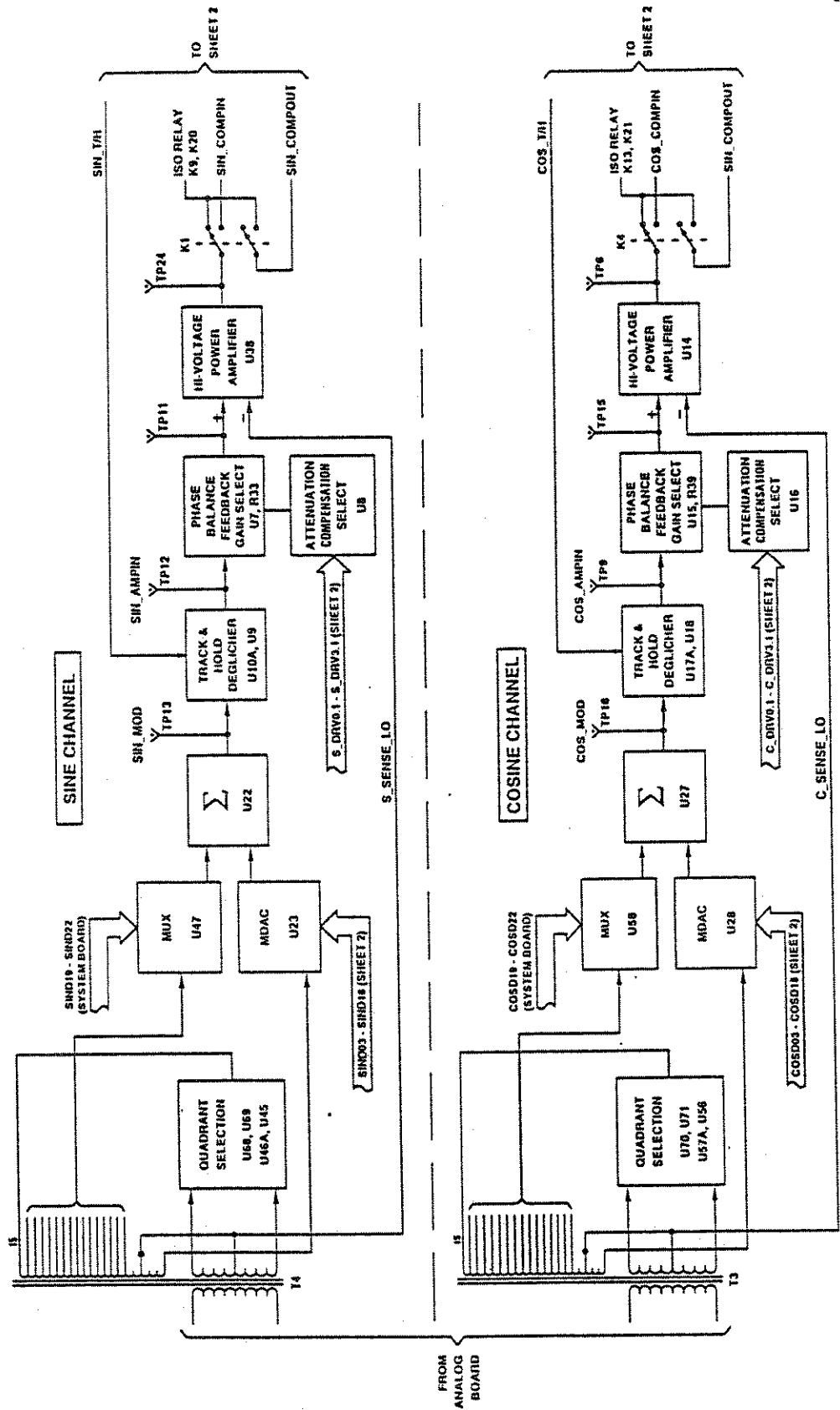

Figure 4-5. Sine/Cosine Board, Block Diagram (Sheet 1 of 2)

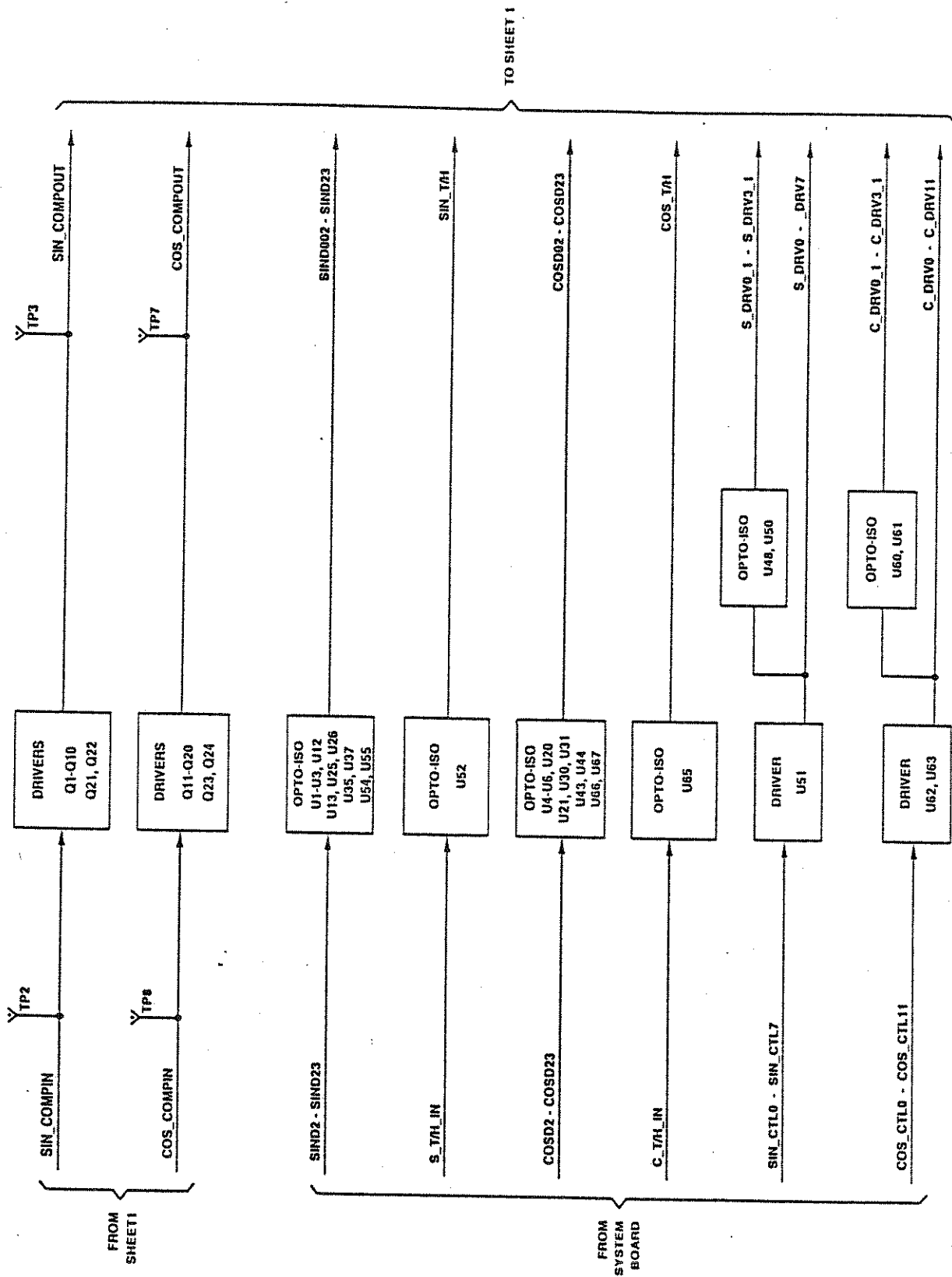

Figure 4-5. Sine/Cosine Board, Block Diagram (Sheet 2 of 2)

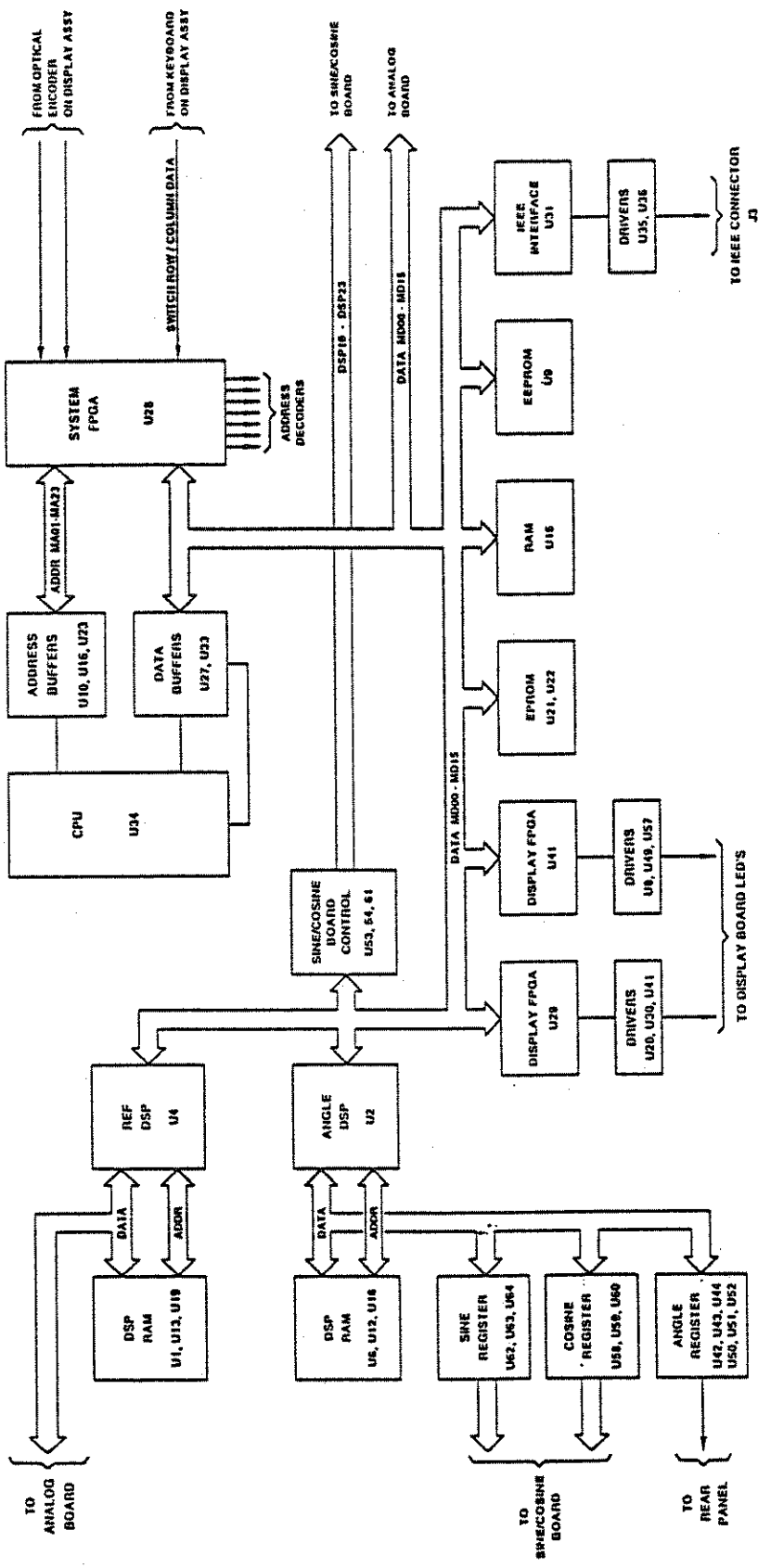

Figure 4-6. System board, block diagram

controls the sine/cosine board via the sine register (U62, 63, 64), cosine register (U58, 59, 60), and sine/cosine control register (U53, 54, 61). The system board controls the analog board via reference DSP U4 and DSP RAM U7, 13, 19).

4.4.3.2 **System FPGA.** The system FPGA U28 is connected to the CPU address and data busses. The system FPGA samples keyboard and optical encoder outputs and provides address decodes [list here].

4.4.3.3 **Interface U31.** With drivers U35 and U36, interface U31 enables communication between the RSS and an external computer using IEEE-488 interface protocol.

4.4.3.4 **EPROM U21, U22.** These chips contain the firmware for CPU U34.

4.4.3.5 **EEPROM U9.** The EEPROM stores the IEEE-488 address entered via the front panel.

Figure 4-6. System Board, Block Diagram

4.4.3.6 **RAM U1, U14.** The RAM is used by the CPU as a scratch-pad memory to store temporary data.

4.4.3.7 **Display FPGA U29, U48.** The display FPGA's are connected to data bus (MD00 - MD07) and address bus (MA01 - MA04). With LED drivers U20, U30 U41, (U29), and U8, U49, U57 (U48), the display FPGA's control operation of the LED segments on the display/keyboard assembly.

4.4.3.8 **Angle DSP U2.** Angle DSP U2 is connected to address bus (MA01 - MA03) and data bus (MD00 - MD07). Upon initialization, the CPU writes sine and cosine subtables to DSP RAM U6, 12, 18. Using data from the RAM subtable, the DSP calculates the sine and cosine of the entered angle and writes the values to the sine/cosine board. The DSP also performs modulation when enabled. The 24-bit output word (BDSP1D00 - BDSP1D23) is bussed to sine register (U62, U63, U64), cosine register (U58, U59, U60), and angle register (U42, U43, U44, U50, U51, U52) via bus drivers U5, U11,

U17. The sine, cosine, and angle registers are enabled by -SINE, -COSINE, and -DSPANGLE, respectively.

4.4.3.9. **Reference DSP U4.** Reference DSP U4 is connected to address bus (MA01 - MA03) and data bus (MD00 - MD07). Upon initialization, the CPU writes sine and cosine subtables to DSP RAM U7, 13, 19. Using data from the RAM subtable, the DSP generates the internal reference waveform. A 14-bit output word (DSP2D10 - DSP2D13) is bussed to the analog board.

4.4.3.10 Sine/Cosine Board Control Registers U53, U54, U61.

The CPU controls operation of the sine/cosine board by storing sine control data (MD00 - MD07) and cosine control data (MD00 - MD15) into the sine/cosine control register U53, 54 61).

4.4.3.11 **Sine Register.** The sine register (U62, 63, 64) stores sine data from the angle DSP for use by the sine/cosine board circuits.

4.4.3.12 **Cosine Register.** The cosine register (U58, 59, 60) stores cosine data from the angle DSP for use by the sine/cosine board circuits.

4.4.3.13 **Angle Register.** The angle register (U42-44, 50-52) stores data from the angle DSP and presents it to the RSS rear panel.

4.4.4 DISPLAY/KEYBOARD ASSEMBLY (Figure 4-7, 7-4)

The display/keyboard assembly consists of a main display, voltage display, and keyboard assembly.

Note

Refer to Chapter 3, section I for a description of push button switches and indicators.

The display segments are turned on by the application of ASEG9-ASEG24 (main display) or BSEG9-BSEG24 (voltage display) signals with a ADRAIN1-ADRAIN4 (main display) or BDRAIN1-BDRAIN4 (voltage display) pulse. As the segments share common ASEG## or

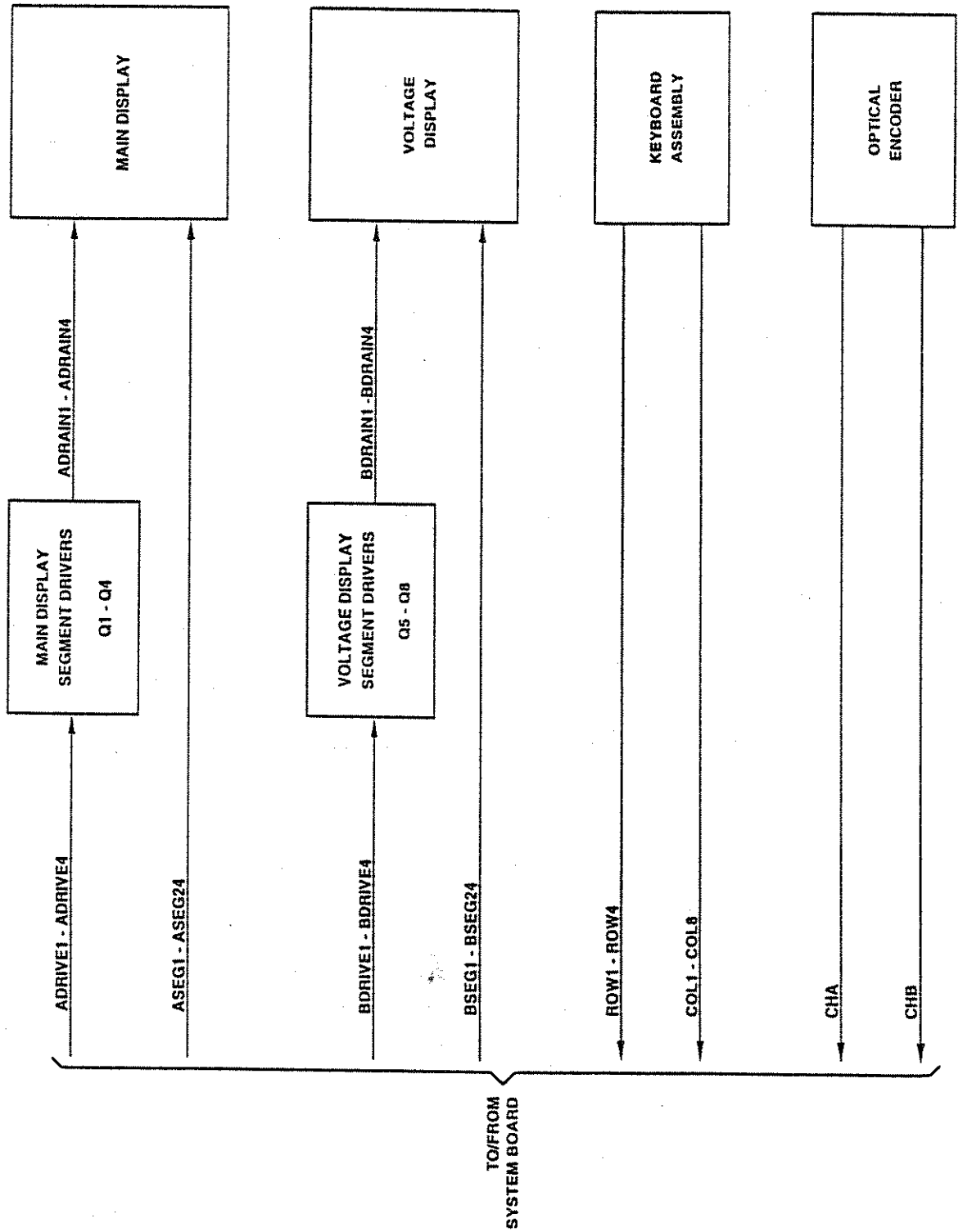

Figure 4-7. Display/Keyboard Block Diagram

BSEG## connections, the DRAIN signals are multiplexed to enable selection of individual LED's. The system board DISPLAY_FPGA U48 provides the segment signals and Drain signals are provided by system board SYSFPGA U28.

The remaining indicators on the main display, voltage display, and keyboard are individual LED's and are controlled in the same manner as the segmented displays (see figure 7-4 for specific LED's).

The keyboard assembly consists of 32 push button switches and an optical encoder. System board SYSFGPA U28 polls the keyboard and detects a specific push button by its ROW and COL position. As an example (see fig 7-4), if the OUTPUT ANGLE push button is pressed, U28 detects continuity between ROW1 and COL1 and initiates the function of the push button.

System board SYSFPGA U28 monitors the optical encoder and responds to pulses generated when the encoder is rotated.

4.4.5 MAIN POWER SUPPLY BOARD (Figure 4-8, 7-5)

The main power supply board provides +5 Vdc, ± 15 Vdc, ± 48 Vdc, and ± 175 Vdc to the system and analog boards. With the exception of the +5 Vdc and ± 15 Vdc outputs, all other outputs of the main power supply board are switched by relay K1 and K3. This feature allows the analog and sine/cosine boards to be set up during power-up before turning on the high voltages.

4.4.5.1 +5 Vdc Circuits. When power is applied to the RSS, 115 (or 230) Vac is applied to the primary of main transformer T1. As excitation appears at the secondary winding of T1, full wave rectification is accomplished by bridge rectifier CR9. At the positive (+) output of CR9, the unregulated voltage is filtered by C9, C10, C11 and applied to the input of voltage regulator U3. The regulated +5 Vdc output is filtered by C14, C15, and C16 and applied to the system and analog boards.

4.4.5.2 ± 15 Vdc Circuits. As excitation appears at the secondary winding of T1, full wave rectification is accomplished by CR1 and CR2 (+), and CR3 and CR4 (-). The positive (+) unregulated output of CR1 and CR2 is filtered by C1 and C3 and applied to the input of regulator U1. The regulated +15 Vdc is filtered by C5 and C7 and applied to the system and analog boards. The negative (-) unregulated output of CR3 and CR4 is filtered by C2 and C4 and applied to the input of regulator U2. The regulated -15 Vdc is filtered by C6 and C8 and applied to the system and analog boards.

4.4.5.3 Time Delay. After a short delay following turn-on, PWR_CTL is received from the system board and turns on Q3 and K3. When K3 contacts close, excitation is applied to the ± 48 Vdc circuits via contacts C and D, and to the ± 175 Vdc circuits via contacts A and B. PWR_CTL also turns on Q4 and K1 to apply excitation to the primary of isolation transformer T2 (contacts 13 and 12).

Note

Isolation transformer T2 provides excitation for the isolated power supplies.

4.4.5.4 ± 48 Vdc Circuits. After a time delay (previously described), full wave rectification is accomplished by CR13 and CR14 (+), and CR15 and CR16 (-). The positive (+) unregulated output of CR13 and CR14 is filtered by C17 and C20 and applied to the input of regulator U4. The regulated +48 Vdc output is filtered by C22, C24, and C26 and applied to the reference power amplifier complimentary pair driver.

Note

CR12 acts as a half wave rectifier to energize relay K2 and provide input to the high voltage overload sense circuits. When power is turned off, K2 deenergizes and causes the high voltage to bleed to ground.

The negative (-) unregulated output of CR15 and CR16 is filtered by C18 and C21 and applied to

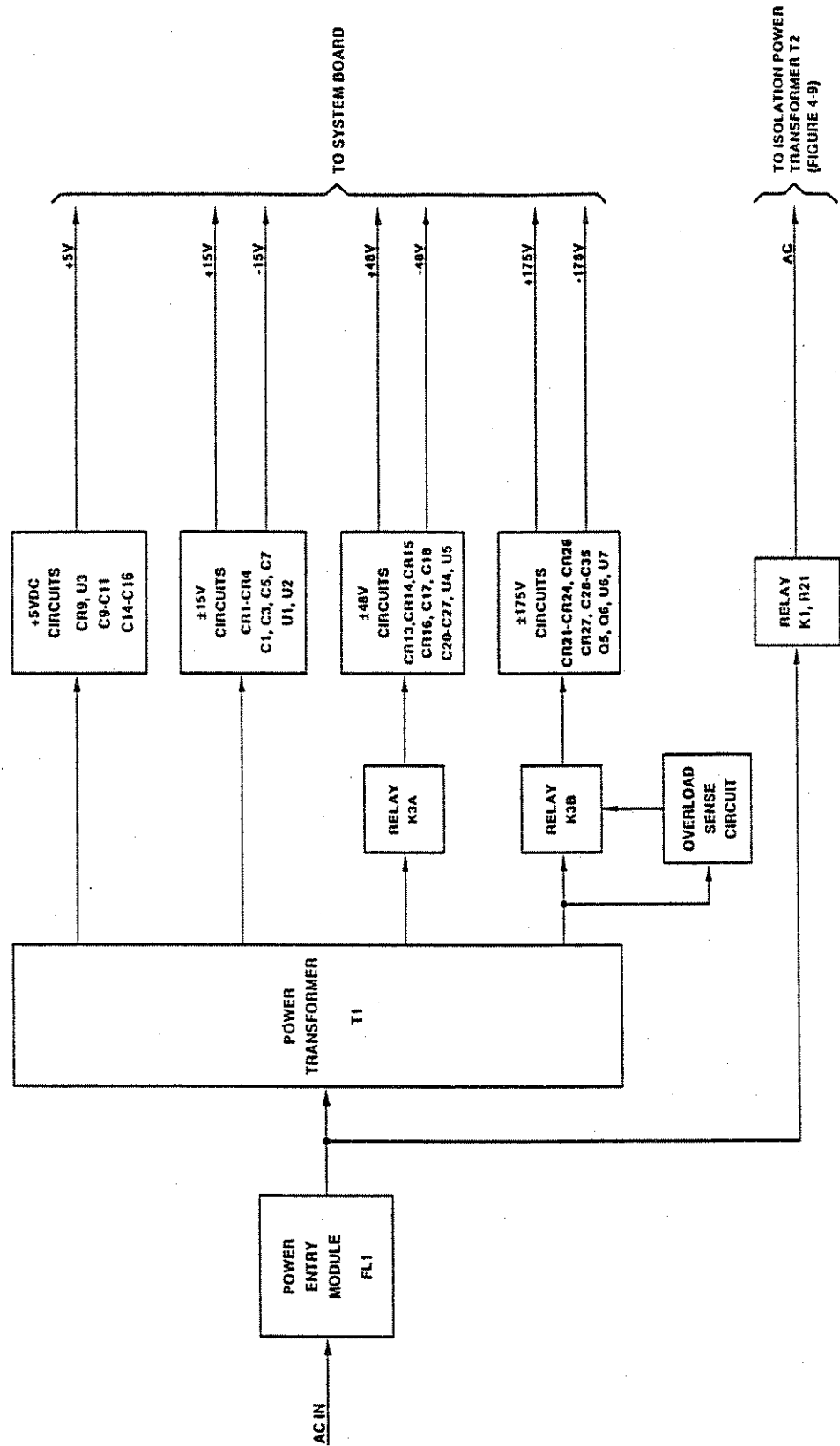

Figure 4-8. Main Power Supply Board, Block Diagram

the input of regulator U5. The regulated -48 Vdc output is filtered by C23, C25, and C27 and applied to the reference power amplifier complimentary pair driver.

4.4.5.5 ± 175 Vdc Circuits. After a time delay (previously described), full wave rectification is accomplished by CR21 and CR22 (+) and CR23 and CR24 (-). The positive (+) unregulated output of CR21 and CR22 is filtered by C28 and C30 and applied to the cathode of zener diode CR25 and the collector of pass transistor Q5. The zener diodes provide approximately +200 Vdc reference to the base of pass transistor Q5, thereby applying a semi-regulated +200 Vdc to the input of regulator U6. The regulated +175 volt output is filtered by C32 and C34 and used for reference channel high voltage operational amplifier U11. The negative (-) unregulated output of CR23 and CR24 is filtered by C29 and C31 and applied to the anode of zener diodes CR28 and the collector of pass transistor Q6. The zener diodes provide approximately -200 Vdc reference to the base of pass transistor Q6, thereby applying a semi-regulated -200 Vdc to the input of regulator U7. The regulated -175 Vdc output is filtered by C33 and C35 and used for reference channel high voltage operational amplifier U11.

4.4.5.6 High Voltage Overload Sense Circuit.

In the case of an overload, the ground current sensed by overload resistor R21 reaches a predetermined value and the overload sense circuits trip and output a low to digital circuits on the system board.

4.4.6 ISOLATED POWER SUPPLIES (Figure 4-9, 7-6)

The RSS uses two identical isolated supplies to provide separate ± 15 , ± 48 , ± 20 , and ± 150 Vdc to each channel of the sine/cosine board. Unless otherwise indicated, isolated power supply A6 is described.

4.4.6.1 ± 15 Vdc Circuits. When ac power is applied to the primary of isolation transformer T2, excitation appears at the secondary winding.

Full wave rectification is accomplished by CR1 and CR2 (+), and CR3 and CR4 (-). The positive (+) unregulated output is filtered by C1 and C3 and applied to the input of regulator U1. The regulated +15 Vdc output is filtered by C5 and C7 and applied to the sine channel of the sine/cosine board. The negative (-) unregulated output is filtered by C2 and C4 and applied to the input of regulator U2. The regulated -15 Vdc output is filtered by C6 and C8 and applied to the sine channel of the sine/cosine board.

Isolated supply A7 functions identically and provides regulated ± 15 Vdc to the cosine channel of the sine/cosine board.

4.4.6.2 ± 48 Vdc Circuits. When ac power is applied to the primary of isolation transformer T2, excitation appears at the secondary winding. Full wave rectification is accomplished by CR9 and CR10 (+), and CR11 and CR12 (-). The positive (+) unregulated output from the rectifiers is filtered by C25 and C27 and applied to the input of regulator U7. The regulated +48 Vdc output is filtered by C29, C31, and C35 and applied to the sine channel of the sine/cosine board. The negative (-) unregulated output from the rectifiers is filtered by C26 and C28 and applied to the input of regulator U8. The regulated -48 Vdc output is filtered by C30, C32, and C36 and applied to the sine channel of the sine/cosine board.

Isolated supply A7 functions identically and provides ± 48 Vdc to the cosine channel of the sine/cosine board.

Note

The ± 48 Vdc outputs power the complimentary pair drivers on the sine/cosine board assembly and provide the input for the ± 20 Vdc circuits.

4.4.6.3 ± 20 Vdc Circuits. +48 Vdc is applied to the input of regulator U9. The regulated +20 volt output is filtered by C37 and C39 and applied to the sine channel of the sine/cosine board.

-48 Vdc is applied to the input of regulator U10. The regulated -20 Vdc output is filtered by C38

and C40 and applied to the sine channel of the sine/cosine board.

Isolated supply A7 functions identically and provides regulated ± 20 Vdc to the cosine channel of the sine/cosine board.

4.4.6.4 ± 150 Vdc Circuits. When ac power is applied to the primary of isolation transformer T2, excitation appears at the secondary winding. Full wave rectification is accomplished by CR5 and CR6 (+), and CR7 and CR8 (-). The positive (+) unregulated output from the rectifiers is filtered by C9 and applied to the collector of pass transistor Q1, R5, and the cathode of zener diode CR17. The zener diodes provide a +150 volt reference to the base of pass transistor Q1, thereby regulating the +150 Vdc level at the emitter. The regulated +150 Vdc is filtered by C15, C17, and C19 and applied to the sine channel of the sine/cosine board. The negative (-) unregulated output from

the rectifiers is filtered by C10 and applied to the collector of pass transistor Q2, R6, and the anode of zener diode CR20. The zener diodes provide a -150 volt reference to the base of pass transistor Q2, thereby regulating the -150 Vdc level at the emitter. The regulated -150 Vdc is filtered by C16, C18, and C20 and applied to the sine channel of the sine/cosine board. The regulated ± 150 Vdc outputs connect the overload circuits.

Isolated supply A7 functions identically and provides regulated ± 150 Vdc to the cosine channel of the sine/cosine board.

4.4.6.5 High Voltage Overload Sense Circuit.

In the case of an overload, the ground current sensed by overload resistor R9 reaches a predetermined value and the overload sense circuits trip and output a low to digital circuits on the system board.

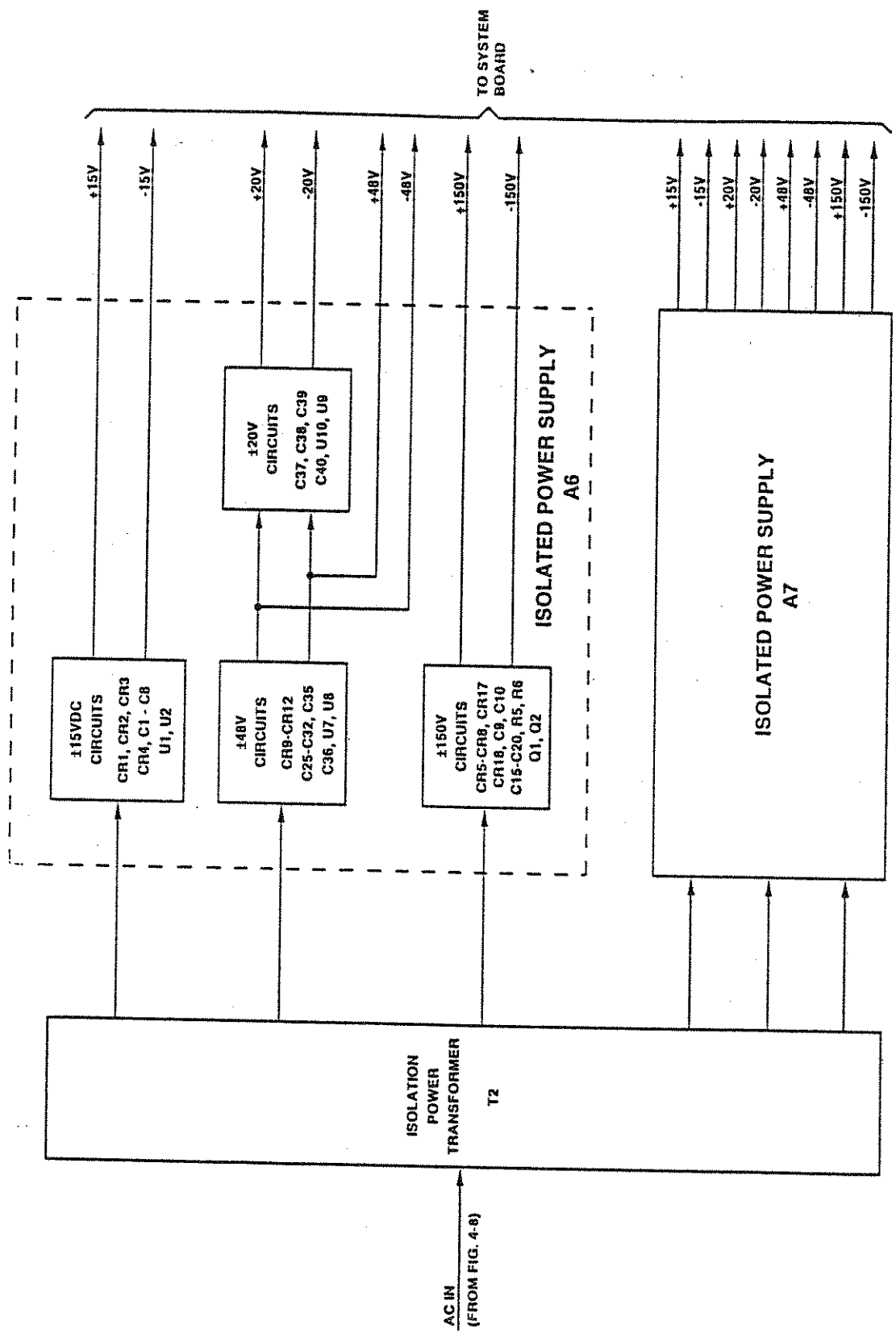

Figure 4-9. Isolated Power Supply, Block Diagram