

50 MHz Dual Time Base Oscilloscope

PM3055

PM3057

Operation Manual/Gebrauchsanleitung/Notice d'emploi

4822 872 00351

861222/1



I&E

Industrial & Electro-acoustic Systems Division



**Industrial &
Electro-acoustic Systems**

PHILIPS



PHILIPS

Service Information

Advanced Automation Systems
Audio-communications
Broadcast Equipment
Electronic Security & Recording Systems
Industrial Automation
Scientific & Analytical Equipment
Test and Measurement

Industrial &
Electro-acoustic
Systems
Division

870129

TEST AND MEASURING EQUIPMENT

ESU305501.1.

SUPPLEMENT TO OPERATING MANUAL PM3055-PM3057
4822 872 00351

This ESU replaces ESU: -

Subject: APPLICATION SELECT

This instrument offers the possibility to pre-select different applications by using the "AS" -APPLICATION SELECT- service menu.
To enter this menu, proceed as follows:

- Press the MENU softkey and keep it pressed.
- Then press also the AUTO SET softkey.
- Now the LCD should indicate "1", "2", "AS" and "3".
- To enter the AS menu, press the RESET softkey.

Having entered this menu, the following applications can be chosen:

* SINGLE SHOT

Is selected by pressing "v" of channel A UP-DOWN control, indicated in LCD by 0 or 1.

Selecting "0" means that when using in alternated multi channel mode and the SINGLE SHOT mode, only one signal is displayed on the screen.

Selecting "1" means that when using in alternated multi channel mode and the SINGLE SHOT mode, all signals are displayed on the screen.

* TV TRIGGERING AFTER AUTO SET

Is selected by pressing "v" of channel B UP-DOWN control, indicated in LCD by 0 or 1.

Selecting "0" means that if TVF or TVL trigger coupling was selected, after AUTO SET always TVF is chosen as MTB trigger coupling.

Selecting "1" means that if TVF or TVL trigger coupling was selected, after AUTO SET the already selected TV trigger coupling will be chosen.

4822 872 09357

PRINTED IN THE NETHERLANDS

ACTIVE DTB AFTER AUTO SET

Is selected by pressing "<-" of DTM UP-DOWN control, indicated in LCD by "0 or 1".

Selecting "0" means that for all horizontal display modes, after AUTO SET the time base is set to the MTB mode.

Selecting "1" means that for all horizontal display modes, after AUTO SET the horizontal display mode stays in its previous setting. So the DTB is still active if selected before AUTO SET.

JTN

50 MHz Dual Time Base Oscilloscope

PM3055 PM3057

Operation Manual/Gebrauchsanleitung/Notice d'emploi

4822 872 00351
861222/1



MAT2220



PHILIPS

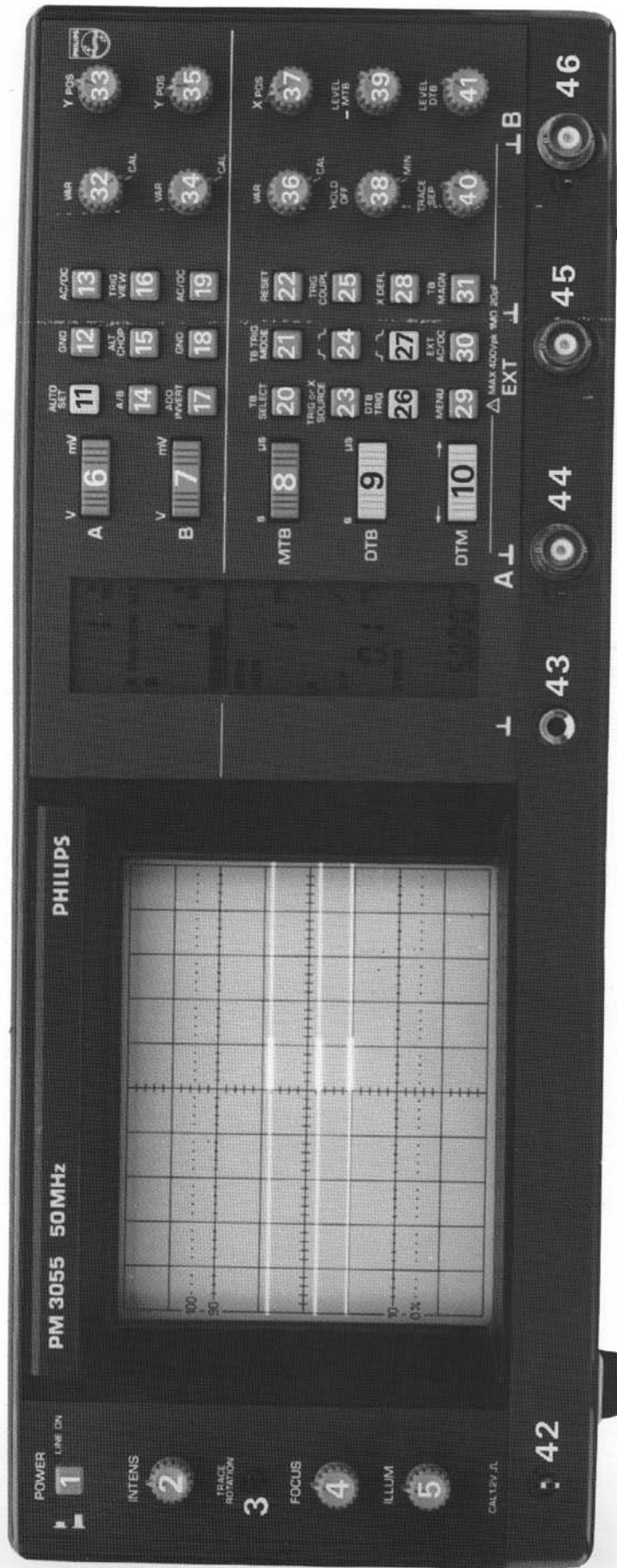

MAT 2245

CONTENTS

Page

1. OPERATORS SAFETY	1-1E
1.1 Introduction	1-1E
1.2 Safety precautions	1-1E
1.3 Caution and warning statement	1-1E
1.4 Symbols	1-1E
1.5 Impaired safety-protection	1-1E
2. INSTALLATION INSTRUCTIONS	2-1E
2.1 Initial inspection	2-1E
2.2 Safety instructions	2-1E
2.2.1 Earthing	2-1E
2.2.2 Mains voltage cord and fuses	2-1E
2.3 Operating position of the instrument	2-2E
2.4 Rackmount version	2-2E
3. OPERATING INSTRUCTIONS	3-1E
3.1 Switching-on and auto-set	3-1E
3.1.1 Switching-on	3-1E
3.1.2 Auto set	3-1E
3.2 Explanation of controls and sockets	3-2E
3.2.1 Introduction	3-2E
3.2.2 C.R.T. control area	3-4E
3.2.3 Up-down control area	3-4E
3.2.4 Function control area	3-5E
3.2.5 Potentiometer area	3-11E
3.2.6 Inputs and outputs	3-12E
3.2.7 Rear panel	3-12E
3.3 Principle of operation	3-14E
3.3.1 Control section	3-14E
3.3.2 Vertical deflection	3-14E
3.3.3 Horizontal deflection	3-15E
3.3.4 C.R.T. Display	3-16E
3.3.5 Power supply	3-16E
3.4 Brief checking procedure	3-17E
3.4.1 General information	3-17E
3.4.2 Entering the brief checking procedure	3-17E
3.4.3 Brief checking of controls and functions	3-17E

4. PREVENTIVE MAINTENANCE	4-1E
4.1 General information	4-1E
4.2 Removing the bezel and contrast filter	4-1E
4.3 Recalibration	4-1E
5. CHARACTERISTICS	5-1E
5.1 Display	5-2E
5.2 Vertical deflection or Y axis	5-2E
5.2.1 Channels A and B	5-2E
5.2.2 Triggerview	5-3E
5.3 Horizontal deflection X axis	5-4E
5.3.1 Main Time Base	5-4E
5.3.2 Delay Time Base	5-5E
5.3.3 X-deflection	5-5E
5.3.4 EXT input	5-5E
5.4 Triggering	5-6E
5.4.1 MTB triggering	5-6E
5.4.2 DTB triggering	5-7E
5.5 Power supply	5-7E
5.6 Auxiliary in or outputs	5-7E
5.7 Environmental characteristics	5-8E
5.8 Safety	5-9E
5.9 Accessories	5-10E
5.9.1 Accessory information	5-10E
6. GLOSSARY OF TERMS	6-1E
APPENDIX A	A1
APPENDIX B	B1

1. OPERATORS SAFETY

Read this page carefully before installation and use of the instrument.

1.1 INTRODUCTION

The instrument described in this manual is designed to be used by properly-trained personnel only. Adjustment, maintenance and repair of the exposed equipment shall be carried out only by qualified personnel.

1.2 SAFETY PRECAUTIONS

For the correct and safe use of this instrument it is essential that both operating and servicing personnel follow generally-accepted safety procedures in addition to the safety precautions specified in this manual. Specific warning and caution statements, where they apply, will be found throughout the manual. Where necessary, the warning and caution statements and/or symbols are marked on the apparatus.

1.3 CAUTION AND WARNING STATEMENTS

CAUTION: is used to indicate correct operating or maintenance procedures in order to prevent damage to or destruction of the equipment or other property.

WARNING: calls attention to a potential danger that requires correct procedures or practices in order to prevent personal injury.

1.4 SYMBOLS



Read the operating instructions.



Protective earth (grounding) terminal (black)

1.5 IMPAIRED SAFETY—PROTECTION

Whenever it is likely that safety-protection has been impaired, the instrument must be made inoperative and be secured against any unintended operation. The matter should then be referred to qualified technicians. Safety protection is likely to be impaired if, for example, the instrument fails to perform the intended measurements or shows visible damage.

2. INSTALLATION INSTRUCTIONS

ATTENTION: You are strongly advised to read this chapter thoroughly before installing your oscilloscope.

2.1 INITIAL INSPECTION

Check the contents of the shipment for completeness and note whether any damage has occurred during transport. If the contents are incomplete, or there is damage, a claim should be filed with the carrier immediately, and the Philips Sales or Service organisation should be notified in order to facilitate the repair or replacement of the instrument.

2.2 SAFETY INSTRUCTIONS

2.2.1 Earthing

Before any connection to the input connectors is made, the instrument shall be connected to a protective earth conductor via the three-core mains cable; the mains plug shall be inserted only into a socket outlet provided with a protective earth contact. The protective action shall not be negated by the use of an extension cord without protective conductor.

WARNING: Any interruption of the protective conductor inside or outside the instrument is likely to make the instrument dangerous. Intentional interruption is prohibited.

When an instrument is brought from a cold into a warm environment, condensation may cause a hazardous condition. Therefore, make sure that the earthing requirements are strictly adhered to.

2.2.2 Mains voltage cord and fuses.

Different power cords are available for the various local mains voltage outlets. The power cord version delivered is determined by the particular instrument version ordered.

NOTE: *If the mains plug has to be adapted to the local situation, such adaptation should be done only by a qualified technician.*

This oscilloscope has a tapless switched-mode power supply that covers most nominal voltage ranges in use: 100 V...240 V a.c. (r.m.s.). This obviates the need to adapt to the local mains voltage. The mains frequency range is 50 Hz...400 Hz.

WARNING: The instrument shall be disconnected from all voltage sources when renewing a fuse.



Mains fuse rating: 1,6 A delayed-action, 250 V.

The mains fuseholder is located on the rear panel (see Figure 2.1). If the mains fuse needs replacing, proceed as follows:

- remove the cover of the fuseholder by means of a screwdriver.
- fit a new fuse of the correct rating and refit the cover of the fuseholder.

WARNING: Make sure that only fuses of the required current and voltage rating, and of the specified type, are used for renewal. The use of the repaired fuses, and/or short-circuiting of the fuseholder, is prohibited.

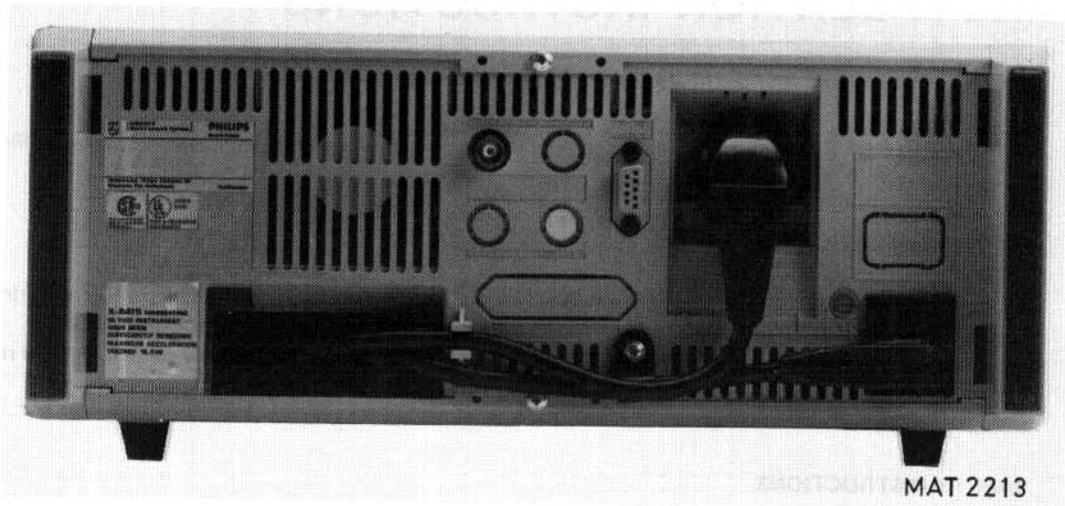

Figure 2.1 Rear view of the oscilloscope.

2.3 OPERATING POSITION OF THE INSTRUMENT

The oscilloscope may be used in the following positions:

- horizontally on its bottom feet;
- vertically on its rear feet;
- on the carrying handle in two sloping positions (see Figure 2.2)

The available oscilloscope angles with respect to the working surface are 13° and 20° selected after pulling the carrying handle arms outwards and rotating.

The characteristics given in Chapter 5 are fully guaranteed for all the above-mentioned positions.

ATTENTION: Do not position the oscilloscope on any surface which radiates heat, or in direct sunlight.

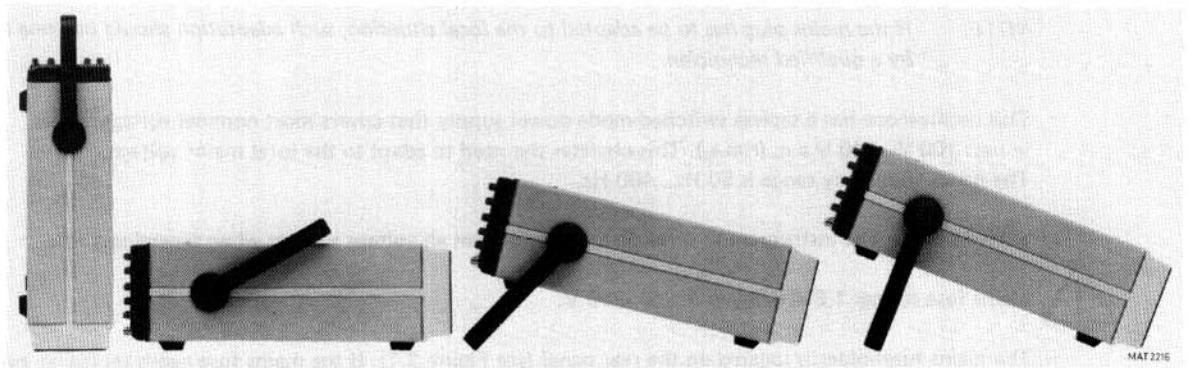

Figure 2.2 Handle in different positions.

2.4 RACKMOUNT VERSION

The PM3057 is provided with a rackmount cabinet without carrying handle. This offers the possibility to built the instrument in a 19 inch rack, using the delivered screws.

3. OPERATING INSTRUCTIONS

This chapter outlines the procedures and precautions necessary for operation. It identifies and briefly describes the functions of the front and rear panel controls and indicators, and explains the practical aspects of operation to enable an operator to evaluate quickly the instrument's main functions.

3.1 SWITCHING-ON AND AUTO-SET

3.1.1 Switching-on

After the oscilloscope has been connected to the mains (line) voltage in accordance with Section 2.2.1 and 2.2.2 it can be switched on with the POWER ON pushbutton on the front panel.

Immediately the oscilloscope is switched on, all segments of the L.C.D. light up for 1 sec. approx. and the oscilloscope is set in the RESTART condition (see Figure 3.1).

With normal installation, according to Chapter 2, and after a warming-up time of 30 minutes, the characteristics according to Chapter 5 are valid.

Attention: Take care that the time between switching-off and switching-on again is at least 5 s. A shorter time interval might activate a protection circuit in the power supply that prevents it from starting up. If this protection circuit is yet activated, (a squeaking noise can be heard), it can be de-activated simply by switching off the instrument for 5 s.

3.1.2 Auto set

Attention: The AUTO SET is only effective when an input signal is applied to the channel A or B BNC input socket.

The AUTO SET allows you to set all softkeys and UP-DOWN controls with one single pushbutton for a clear display of any input signal. This can be used as a starting point for any refinements in the setting of the softkeys which may be needed for a thorough investigation of complex waveforms.

For this, proceed as follows:

- Apply the signal to input A and/or B.
- Set both Y POS and X POS controls to their mid-position.
- Press AUTO SET
- Notice that a clear display with 2 signal periods approx. and 2...5 DIV amplitude is visible on the screen.

Note: When no signal is applied to any BNC-input socket, the RESTART procedure can be used to obtain a presetting of the softkeys and UP-DOWN controls. The instrument can be restarted by pressing MENU and AUTO SET in sequence.

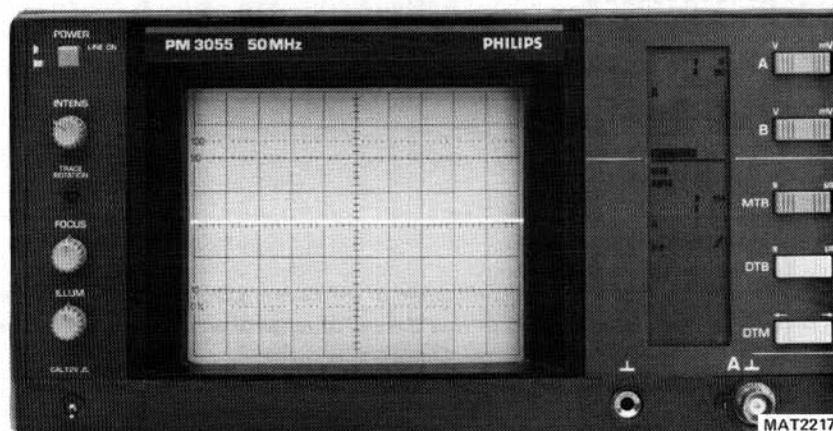

Figure 3.1 RESTART condition.

3.2 EXPLANATION OF CONTROLS AND SOCKETS

3.2.1 Introduction

The front panel is designed with optimum ergonomic and logical- order placing of the controls: from left to right and from top to bottom, like reading a book.

For ease of access to the oscilloscope controls and sockets, the frontpanel is divided into six main areas (see Appendix A).

- C.R.T. control area (see section 3.2.2)
- Viewing area, (C.R.T. including L.C.D.)
- Up-down control area (see section 3.2.3)
- Function control area (see section 3.2.4)
- Potentiometer area (see section 3.2.5)
- Inputs and outputs (see section 3.2.6)

Liquid Crystal Display (L.C.D.)

The L.C.D. displays the different switch and control functions in one place on the front panel. The L.C.D. area is divided into the following parts.

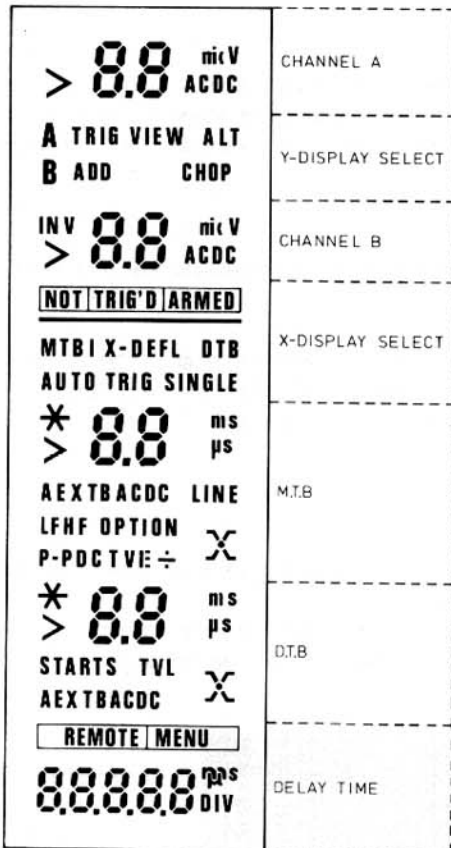

MA17144
851115

Figure 3.2 Liquid Crystal Display

Note: A flashing segment indicates that a wrong combination of softkeys is selected, that a VAR (variable) control is in UNCAL position (segment : >) or that the end of range of an UP-DOWN control has been reached.

3.2 EXPLANATION OF CONTROLS AND SOCKETS

3.2.1 Introduction

The front panel is designed with optimum ergonomic and logical- order placing of the controls: from left to right and from top to bottom, like reading a book.

For ease of access to the oscilloscope controls and sockets, the frontpanel is divided into six main areas (see Appendix A).

- C.R.T. control area (see section 3.2.2)
- Viewing area, (C.R.T. including L.C.D.)
- Up-down control area (see section 3.2.3)
- Function control area (see section 3.2.4)
- Potentiometer area (see section 3.2.5)
- Inputs and outputs (see section 3.2.6)

Liquid Crystal Display (L.C.D.)

The L.C.D. displays the different switch and control functions in one place on the front panel. The L.C.D. area is divided into the following parts.

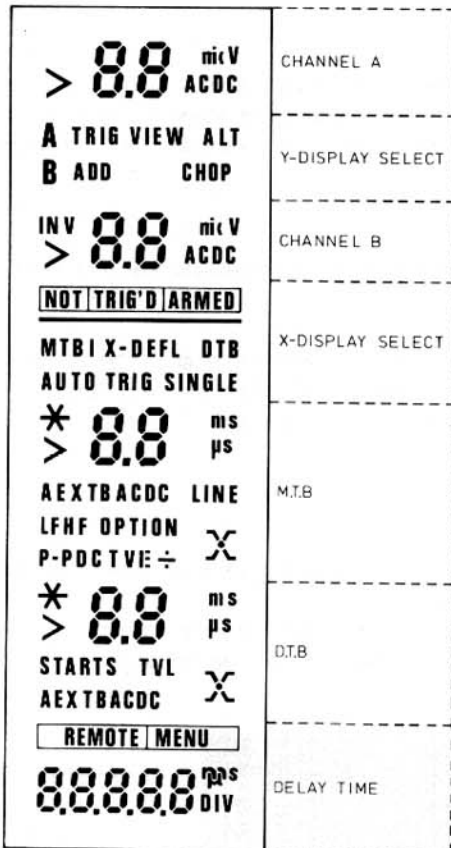

MAT2144
851115

Figure 3.2 Liquid Crystal Display

Note: A flashing segment indicates that a wrong combination of softkeys is selected, that a VAR (variable) control is in UNCAL position (segment : >) or that the end of range of an UP-DOWN control has been reached.

Up-Down controls

These switches permit selection of the deflection coefficients or correct display time in a up-going or down-going sequence dependent on which part of the pushbutton is depressed.



MAT1804

Softkeys

This oscilloscope features the possibility to select several functions with a single pushbutton in sequential order under control of the microcomputer. To obtain the correct function it is necessary to press the particular pushbutton repeatedly until the correct indication is visible in the L.C.D.

The sequence of the softkeys with the related L.C.display is given in the following figure.

Note that, after the last function in line, the sequence starts again.

Example:





MAT2141E
851115

Figure 3.3 Sequence of the A/B softkey.

3.2.2 C.R.T. control area

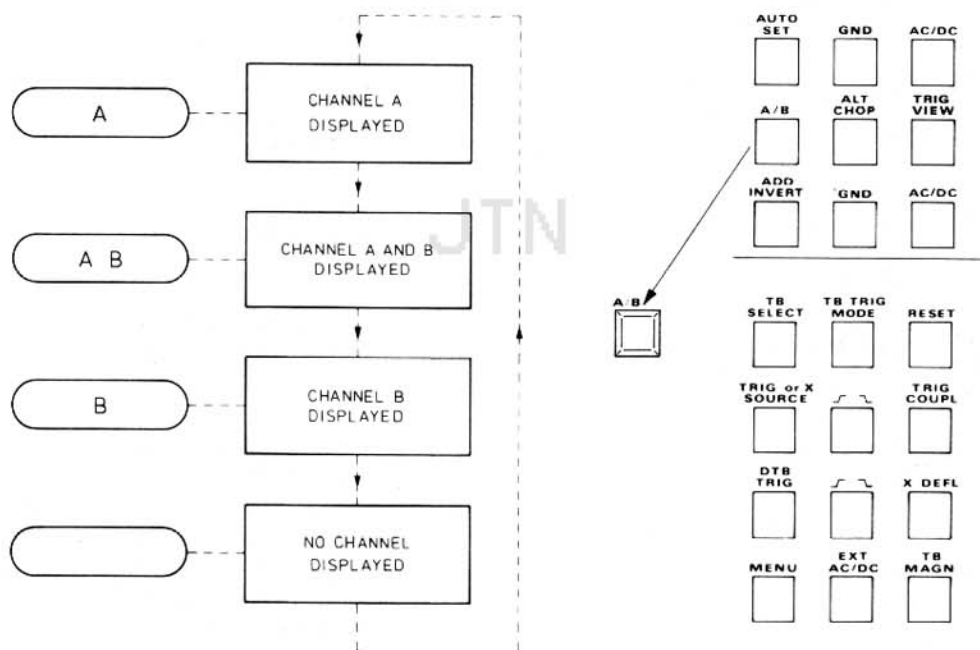
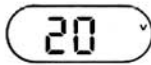
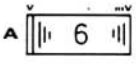

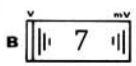

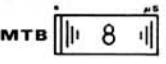
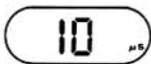
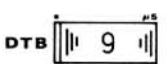
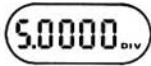
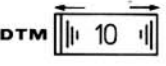





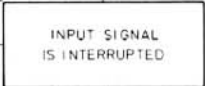

Knob/control	Description
POWER	Mains ON/OFF switch
INTENS	Continuously-variable control of the trace brilliance on the C.R.T. screen.
TRACE ROTATION	Screwdriver control for aligning the trace in parallel with the horizontal graticule lines.
FOCUS	Continuously-variable control of the focussing of the C.R.T. electron beam.
ILLUM	Continuously-variable control of the graticule illumination.

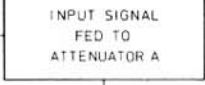
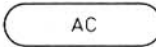
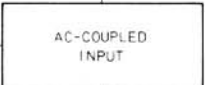
3.2.3 Up-down control area

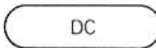
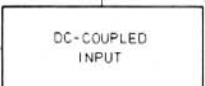
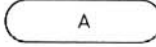
LCD	UP-DOWN switch	Description
		Selection of the ch.A deflection coefficients from 2 mV/DIV...10 V/DIV in a 1-2-5 sequence.
		Selection of the ch.B deflection coefficients from 2 mV/DIV...10 V/DIV in a 1-2-5 sequence.
		Selection of the main time base deflection coefficients from 50 ns/DIV...0,5 s/DIV in a 1-2-5 sequence.
		Selection of the delayed time base deflection coefficients from 50 ns/DIV...1 ms/DIV in a 1-2-5 sequence. The DTB control is electrically coupled with the MTB up-down control. The DTB time coefficient can never be slower than one step faster than the value of the MTB time coefficient. (exception is the fastest position of the MTB-speed).
		Delay time multiplier control. <ul style="list-style-type: none"> - LCD is time-related when the MTB is calibrated and when STARTS is selected as DTB trigger source - LCD is division-related when the MTB is not calibrated or when DTB is in triggered condition

NOTE: when switch is depressed for a short period, delay time changes step by step.

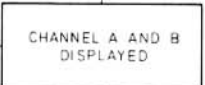
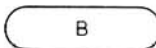
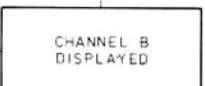
3.2.4 Function control area

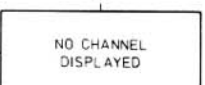
LCD	sequence	SOFTKEY	REMARKS
		 11	Softkey to set automatically the attenuator/s V/DIV and time speed s/DIV to an optimal display, provided that the Y POS and X POS controls are in mid-position.
		 12	Interruption of channel A input signal, while the attenuator is connected to ground. <i>Note: 1. When grounded the trig. mode will automatically set to auto free-run. 2. When grounded the composite trig. source will automatically set to ch. B trig. source, provided that a signal is applied to ch. B.</i>
			
		 13	Channel A input coupling.
			
		 14	Selection for the vertical display modes channel A and channel B.
			
			
			

LCD sequence SOFTKEY REMARKS

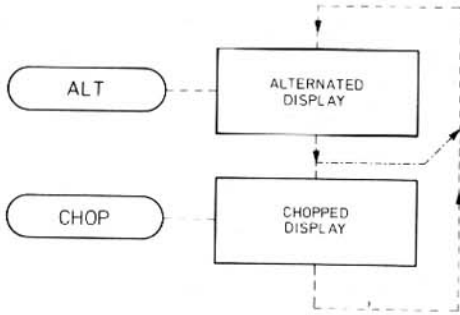

**ALT
CHOP**
15

Selection for the ALTERNate and the CHOPped display mode when more channels are selected.
*Note: ALT not used in X DEFL
 CHOP not used in COMP. TRIG.*

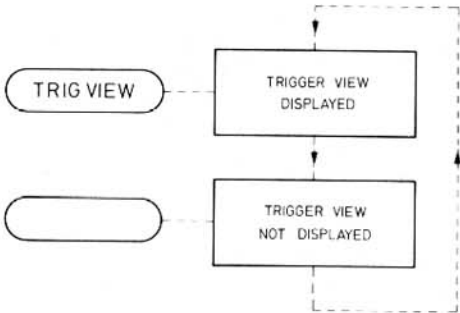

**TRIG
VIEW**
16

Selection for TRIGGER VIEW.
Note: Not active when X DEFL is selected.

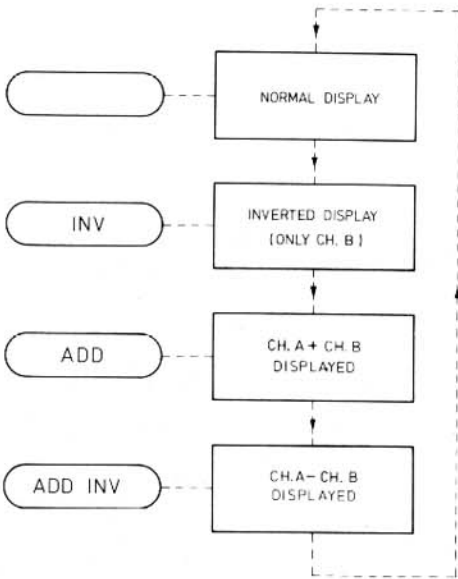

**ADD
INVERT**
17

Switch for inversion of the channel B polarity and for the addition or subtraction of channel A and B.

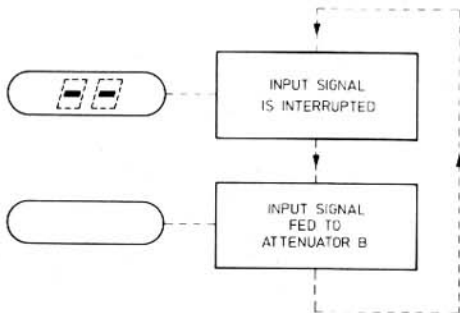

GND
18

Interruption of channel B input signal, while the attenuator is connected to earth (ground).
*Note: 1. When grounded the trig. mode will automatically set to auto free-run.
 2. When grounded the composite trig. source will automatically set to ch. A trig. source, provided that a signal is applied to ch. A.*

LCD	sequence	SOFTKEY	REMARKS
AC		^{AC DC} 19	Channel B input coupling.
DC			
MTB		^{TB SELECT} 20	Selection for the different horizontal display modes. <i>Note: Releases the X DEFL function.</i>
MTBI			
MTBI DTB			
DTB			
AUTO		^{TB TRIG MODE} 21	Selection for the main time-base trigger mode. <i>Note: 1. When AUTO selected, the MTB is free running in the absence of trigger signals.</i> <i>2. When SINGLE selected, ARMED is visible in the L.C.D. SINGLE is possible for ch. A or ch. B only or for ch. A and ch. B when chopped.</i>
TRIG			
SINGLE			
ARMED	(IN SINGLE SHOT)	^{RESET} 22	Reset knob for the MTB and DTB. When SINGLE selected, enables the MTB for receiving a trigger pulse. <i>Note: Not active when X DEFL is selected.</i>
NOT TRIG'D	(IN AUTO OR TRIGGER MODE)		

LCD sequence SOFTKEY REMARKS

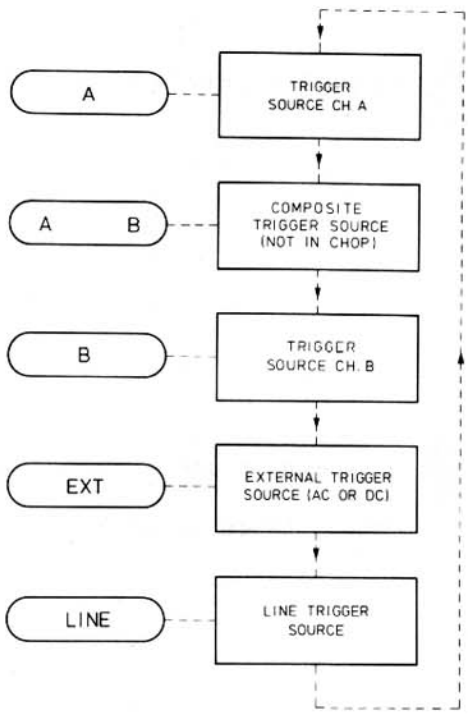

TRIG or X SOURCE
23

Selection for the main time-base TRIGGER SOURCE, or X source for X Deflection.
 Note: 1. EXT AC or EXT DC selectable by EXT AC/DC softkey (see key 30).
 2. Composite not active when X DEFL is selected.

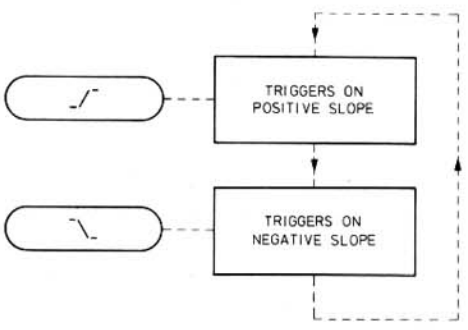

24

Trigger slope selection of the input signal via the main time base or selection for X DEFL polarity.
 Note: when TVF, TVL or X DEFL selected, the LCD indication is + or - resp., for pos. or neg. video.

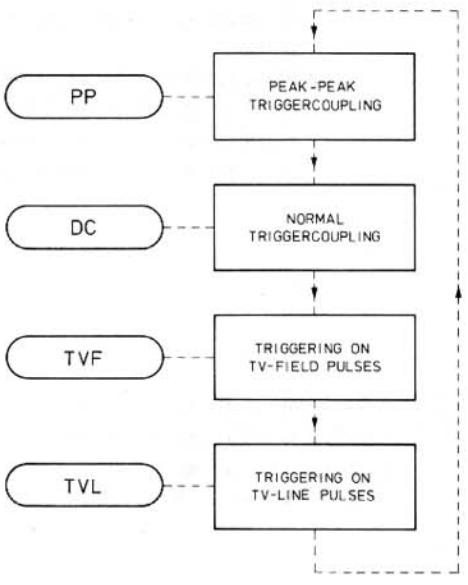

TRIG COUPL
25

Selection for the main time-base TRIGGER COUPLING.

JTN

LCD	sequence	SOFTKEY	REMARKS
	<pre> graph TD A([A]) --- CH_A[CH. A TRIGGER SOURCE] CH_A --- COMPOSITE[COMPOSITE TRIGGER SOURCE] COMPOSITE --- CH_B[CH. B TRIGGER SOURCE] CH_B --- EXT[EXTERNAL TRIGGER SOURCE (AC OR DC)] EXT --- TVL[TV LINE TRIGGER SOURCE] TVL --- STARTS[STARTS AFTER DELAY TIME] STARTS --- DTB_TRIG[DTB TRIG] </pre>	DTB TRIG 26	Selection for the delayed time-base TRIGGER SOURCE. <i>Note: EXT AC or EXT DC selected by EXT AC/DC softkey.</i>
	<pre> graph TD POS([/]) --- POS_SLOPE[TRIGGERS ON POSITIVE SLOPE] POS_SLOPE --- NEG_SLOPE[TRIGGERS ON NEGATIVE SLOPE] NEG_SLOPE --- DTB_TRIG[DTB TRIG] </pre>	 27	Trigger slope selection of the input signal via the delayed time-base. <i>Note: Not active when DTB TRIGGER source STARTS or TVL is selected.</i>
	<pre> graph TD X_DEFL([X DEFL]) --- X_DEFL_MODE[HORIZONTAL DEFLECTION BY X-DEFLECTION] X_DEFL_MODE --- TIME_BASE[HORIZONTAL DEFLECTION BY TIME BASE] TIME_BASE --- DTB_TRIG[DTB TRIG] </pre>	X DEFL 28	Selection for horizontal deflection mode. Horizontal deflection is achieved by X DEFL or by time base (-s).

LCD sequence SOFTKEY REMARKS

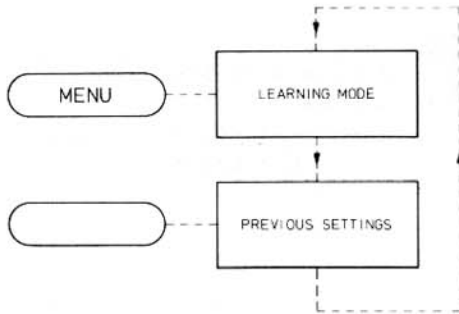

MENU
29

- Selection for learning mode.**
- Depressing MENU once blanks the L.C.D. and activates the learning mode. Only "MENU" is visible on the L.C.D.
 - After pressing a softkey (one at a time), any function behind that softkey will be displayed in the L.C.D. in a half-second step sequence. All softkeys can be random selected.
 - Depressing MENU a second time means that the previous settings before the learning mode are displayed again in the L.C.D.

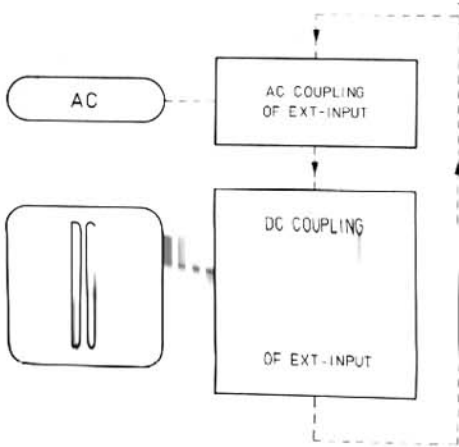

EXT
AC DC
30

Input coupling for EXT-input as a trigger source for MTB or DTB.

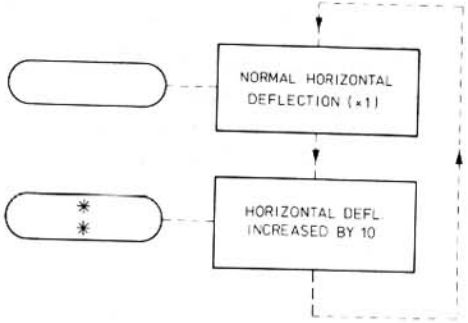













TB
MAGN
31

- Time-base magnification by a factor of 10.**
- Note 1. Horizontal deflection coefficient in L.C.D. is pre-calculated.*
- Note 2. Not active when X DEFL is selected.*

JTN

3.2.5 Potentiometer area

LCD	Control	Description
FLASHING  (WHEN NOT IN CAL POSITION)	VAR 	VAR control ch. A Continuously-variable control of the channel A deflection coefficients. CAL position selected when fully clockwise.
	Y POS 	Y POS control ch. A Continuously-variable control for the channel A trace shift over the screen.
FLASHING  (WHEN NOT IN CAL POSITION)	VAR 	VAR control ch. B Continuously-variable control of the channel B deflection coefficients. CAL position selected when fully clockwise.
	Y POS 	Y POS control ch. B Continuously-variable control for the channel B trace shift over the screen.
FLASHING  (WHEN NOT IN CAL POSITION)	VAR 	VAR control MTB Continuously-variable control of the time coefficients. The MTB and DTB are in CAL position when fully clockwise.
	X POS 	X POS control Continuously-variable control for the horizontal shift over the screen.
	HOLD OFF 	HOLD OFF control This control determines the HOLD OFF time between the main time-base sweeps. Normal operation: control is fully clockwise, i.e. minimum HOLD OFF.
	LEVEL MTB 	LEVEL MTB control Continuously-variable control to set the level of the trigger point at which the main time-base starts.
	TRACE SEP 	TRACE SEP control Continuously-variable control to set the DTB signal position when MTBI and DTB are selected.
	LEVEL DTB 	LEVEL DTB control Continuously-variable control to set the level of the trigger-point at which the delayed time-base starts.

3.2.6 Inputs and outputs

Socket	Description
CAL	Output socket providing a 1,2 Vp-p, 2 kHz approx. square wave voltage (zero-line is at the top of the signal). To be used for probe compensation or to calibrate the vertical deflection AMPL. control.
⚠  A	Measuring earth socket.
⚠ EXT	BNC input socket for channel A with probe indication detector for pre-calculation in L.C.D. of vertical deflection coefficients. BNC input socket <ul style="list-style-type: none"> – When EXT input is selected via MTB or DTB, the signal input is used for external triggering. – When EXT input is selected via X DEFL, the horizontal deflection is determined by the signal applied to this socket.
⚠ B	BNC input socket for channel B with probe indication detector for pre-calculation in L.C.D. of vertical deflection coefficients.

3.2.7 Rear panel

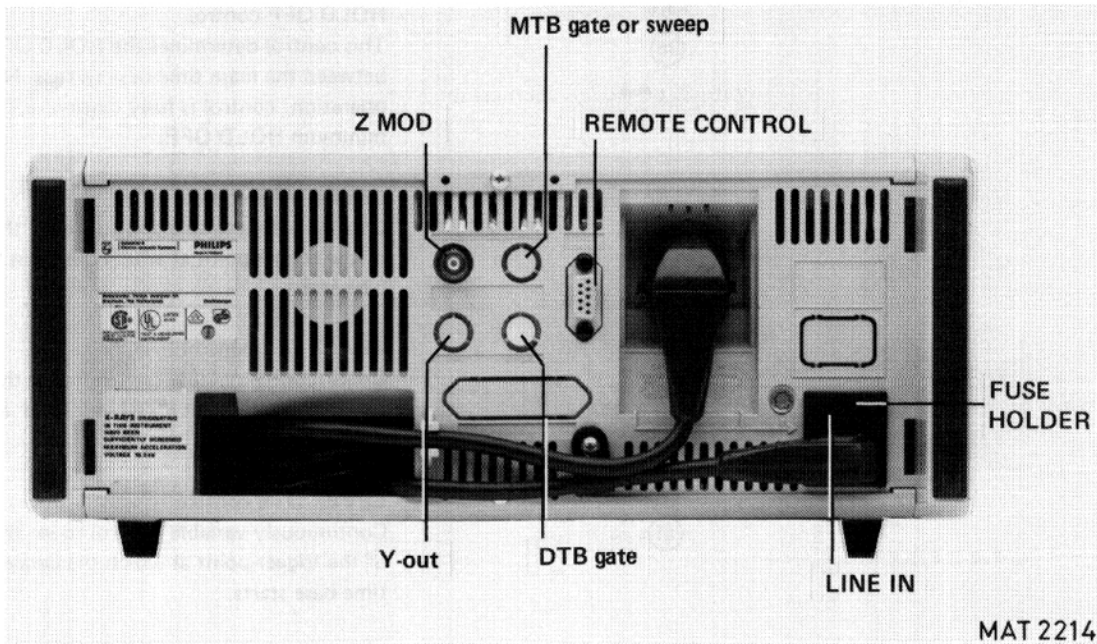

Figure 3.4 Rear view of the oscilloscope.

3.2.7.1 Standard

- Z-MOD** Input socket for Z-modulation of the c.r.t. trace. The trace is blanked when this input is "high" (+2,5 V or more)
Maximum limit voltages: 0–12 V.
- REMOTE CONTROL** See Section 3.2.7.3.
- LINE IN** Mains input socket, 90 V...264 V a.c., 45 Hz...440 Hz. For safety instructions, please read Section 2.2.
- FUSE HOLDER** Fuse rating 1,6 A delayed action. For safety instructions, please read Section 2.2.

3.2.7.2 Optional

- MTB gate** Output socket of a TTL-compatible signal, which is "high" during the MTB sweep and "low" for other conditions.
Maximum limit voltages: 0–12 V.
- MTB sweep** Output socket of the MTB sawtooth signal.
Maximum limit voltages: 0–12 V.
- DTB gate** Output socket of a TTL-compatible signal, which is "high" during the DTB sweep and "low" for other conditions.
Maximum limit voltages: 0–12 V.
- Y-out** Output socket of the vertical (Y) signal. This source can be selected with the MTB trigger source A and B.
Maximum limit voltages: 0–12 V.

3.2.7.3 Remote control socket

Connector: D-subminiature connector with 9 female contacts.

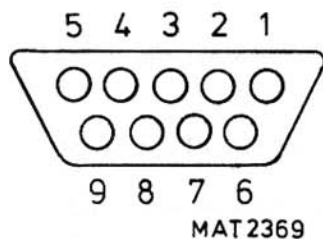

Connector specification:

Connector	Name	Additional information
1	SDA	Bidirectional data line for communication according to Philips IIC bus protocol.
2	SCL	Bidirectional clock line for communication according to Philips IIC bus protocol.
3	GND	Ground for power supply and communication signals.
4	FOOTN	Remote AUTO SET. Command line to initiate the AUTO SET function.
5	REMRQN	REMOte ReQuest Not. Command line to initiate transfer to/from oscilloscope.
6	+5 V	
7	GND	
8	+5 V	
9	GND	

3.3 PRINCIPLE OF OPERATION

This section describes the principle of operation and should be read in conjunction with the overall block diagram (see Appendix B).

The oscilloscope circuit consists of five functional main sections:

- Control section (see section 3.3.1)
- Vertical deflection (see section 3.3.2)
- Horizontal deflection (see section 3.3.3)
- CRT display section (see section 3.3.4)
- Power supply section (see section 3.3.5)

3.3.1 Control section

The knobs in the key-matrix on the front panel drive the various circuits via the software control lines. These lines are generated by the microcomputer, which also drives the L.C.D. (Liquid Crystal Display) for the correct knob and control setting indication.

AUTO SET enables vertical and horizontal functions to be set depending on the value of the input signal.

MENU permits checking of all possible knob setting with their L.C.display.

The continuous controls and the knob LINE ON are directly connected to their control circuits (no REMOTE control facility).

3.3.2 Vertical deflection

As the vertical channels A and B are identical, only one is described. The input signals of channels A and B are fed via the ATTENUATORS to the VERTICAL CHANNEL SELECTION circuit.

The following ATTENUATOR functions are controlled by the front panel softkeys via the microcomputer.

GND	}	input signal coupling
AC/DC		
V—mV		Vertical deflection coefficient
VAR		Continuously-variable attenuation control UNCAL indicated in LCD
INV (only ch.B)		Input signal inversion

The VERTICAL CHANNEL SELECTION selects the input signals A, B or TRIG VIEW, depending on which function is activated via the softkeys.

The TRIG VIEW signal is derived from the MTB TRIGGER AMPLIFIER. The following vertical display modes can be selected:

A	channel A only
B	channel B only
A and B	channels A and B displayed together.
	ALT or CHOP mode is selected by its softkey.
TRIG VIEW	MTB Trigger signal displayed.

Vertical shifting of the displayed signal is achieved by the Y POS control, while the TRACE SEP control determines the distance between the MTB and DTB traces (when DTB is on).

The DELAY LINE permits the viewing of leading edges of fast input signals.

The selected input signal is fed, via the DELAY LINE and the FINAL VERTICAL AMPLIFIER to the vertical deflection plates (Y) of the C.R.T.

3.3.3 Horizontal deflection

This oscilloscope has a MAIN and a DELAYED time-base.

MAIN TIME-BASE (MTB)

The MTB is triggered on the signal selected in the TRIGGER SELECTOR stage. Trigger selection can be made by the TRIG SOURCE or X softkey for:

A	signal derived from channel A
B	signal derived from channel B
COMP	composite triggering of both channels A and B
EXT	external input via BNC socket
LINE	signal derived from mains (line) voltage

Positive or negative triggering is selected by the SLOPE softkey. A display of the trigger signal is made possible by trigger view facility, if TRIG VIEW is selected by TRIG VIEW softkey.

This trigger signal can be displayed together with the input signal(s) of the selected vertical channel(s).

After selection of the source, selection of the MTB trigger mode or coupling can be made in the TRIGGER AMPLIFIER. The TB TRIG MODE softkey allows selection of:

AUTO	Automatic free run in the absence of trigger signals
TRIG	Normal triggering
SINGLE	MTB sweep started once

The TRIG COUPL softkey allows selection of

P-P	Peak-to-peak triggering
DC	Normal triggering
TVF	Triggering on TV FIELD synchronisation pulses.
TVL	Triggering on TV LINE synchronisation pulses.

The level at which the MTB starts is determined by adjustment of the LEVEL control.

The MAIN TIME-BASE GENERATOR determines the horizontal deflection coefficient via the MTB s- μ s UP-DOWN control and the VAR control. The LCD displays the correct deflection simultaneously.

DELAYED TIME-BASE (DTB)

Like the MTB, the DTB is routed via the DTB TRIGGER SELECTION, TRIGGER AMPLIFIER and DELAYED TIME-BASE GENERATOR.

When STARTS is selected by the DTB TRIG softkey, the COMPARATOR compares the MTB sawtooth with the adjustable delay time and gives a trigger signal to the DELAYED TIME BASE GENERATOR. This delay time is selected by the DTM up-down control.

The HORIZONTAL SELECTION stage selects the horizontal deflection source by the TB SELECT softkey or the X DEFL softkey.

The following deflection sources are possible:

MTB	MTB sawtooth only
MTBI	MTB and intensified part of DTB
MTBI + DTB	See MTBI, plus DTB sawtooth
DTB	DTB sawtooth only
X DEFL	Deflection by signal selected by TRIG SOURCE or X softkey.

The selected horizontal deflection signal is fed to the FINAL HORIZONTAL AMPLIFIER.

The TB MAGN softkey enables the horizontal deflection coefficient to be magnified by a factor of 10.

Horizontal shift of the trace is achieved by the X POS control.

The FINAL HORIZONTAL AMPLIFIER drives the horizontal deflection plates (X) of the CRT.

3.3.4 CRT Display

The trace intensity on the c.r.t. is controlled by the Z AMPLIFIER. The Z AMPLIFIER blanks the flyback on the trace and also the switching intervals between the traces. For the vertical switching modes, ALT and CHOP, the Z AMPLIFIER is driven by a Z-blanking signal from the VERTICAL CHANNEL SELECTION (CHOP) or the HORIZONTAL SELECTION (ALT). External trace blanking is obtained via an applied signal to the Z MOD BNC-input.

The FOCUS control drives the focus electrodes of the c.r.t. via the FOCUS control unit, to give trace sharpness.

Trace alignment is achieved by the TRACE ROT control, which drives the trace rotation coil.

The ILLUM control provides illumination of the graticule by means of two lamps.

3.3.5 Power supply

The oscilloscope may be powered by any a.c. voltage between 90 V and 264 V. When switched off, the LINE ON switch interrupts the primary circuit. This switch is the only front panel pushbutton that is **not** controlled by the microcomputer.

After rectification, the relevant d.c. supply voltages feed the various circuits in the instrument.

When the instrument is operating from an a.c. mains voltage, a related signal at mains frequency is fed to the MTB TRIGGER SELECTION for LINE triggering.

The EHT CONVERTER produces 14,5 kV via the HT (High Tension) MULTIPLIER for the accelerator anode of the c.r.t. and -2,1 kV for the FOCUS CONTROL.

The calibration square-wave signal is generated in the CALIBRATION GENERATOR and fed to the CAL socket.

3.4 BRIEF CHECKING PROCEDURE

3.4.1 General information

This procedure is intended to check the oscilloscope performance with a minimum of test steps and actions required.

It is assumed that the operator doing this test is familiar with oscilloscopes and their characteristics.

WARNING: Before switching-on, ensure that the oscilloscope has been installed in accordance with the instructions mentioned in Chapter 2.

NOTE: *The procedure does not check every facet of the instrument's calibration; rather, it is concerned primarily with those parts of the instrument that are essential to measurement accuracy and correct operation.*

It is not necessary to remove the instrument covers to perform this procedure. All checks are made from the outside of the instrument.

If this test is started a few minutes after switching-on, bear in mind that test steps may be out of specification, due to insufficient warm-up time. Therefore, to ensure accuracy, allow the full indicated warm-up time.

The following abbreviations are used: CW = Clockwise
CCW = Counter clockwise

The brief checking procedure is set up in such a way that in a fixed sequence of ten steps the most important functions, including all front panel controls, are shown and checked. At the end of each step, the continuously controls must be reset to the previous setting.

As stated, the procedure can be performed without removing the instrument covers.

For a complete check of every facet of the instruments calibration, refer to the section "Performance Check" in the Service Manual (for qualified personnel only).

3.4.2 Entering the brief checking procedure

To enter the procedure, proceed as follows:

- Press MENU and keep it pressed.
- Press also AUTO SET.
- The L.C.D. should indicate: "1", "2" and "3".
- Press V-ch. B (i.e. the left side of the ch. B UP-DOWN control).
- The L.C.D. should indicate: "2", which is the start for the checking procedure.
- Check that the trace lies parallel with the horizontal graticule lines; if necessary readjust the TRACE ROTATION control (see Appendix A).
- Connect the CAL output to the channel A and B input sockets via 10:1 passive probes.
- The LCD indicates the stepnumbers.
- Each step (2.0...2.9) can now be selected by pressing the "MENU" key.

- For leaving the brief checking procedure, press AUTO SET two times.

3.4.3 Brief checking of controls and functions.

Step sequence	Controls	Requirements
STEP 2.0 DC input coupling	<ul style="list-style-type: none"> - Y POS A or B: CCW - Y POS A or B: CW 	<ul style="list-style-type: none"> - Square-wave of 6 div.p-p (compensate both probes) - Check that the signals shift downwards. - Check that the signals shift upwards.
STEP 2.1 AC input coupling	<ul style="list-style-type: none"> - VAR A or B: CCW 	<ul style="list-style-type: none"> - Check that the signals shift downwards since the attenuator inputs are AC-coupled. - Check that the amplitude decreases.
STEP 2.2 Alternated display		<ul style="list-style-type: none"> - Check that the signals are displayed alternately.
STEP 2.3 Chopped display		<ul style="list-style-type: none"> - Check that the signals are displayed simultaneously.

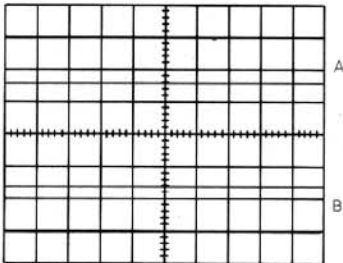
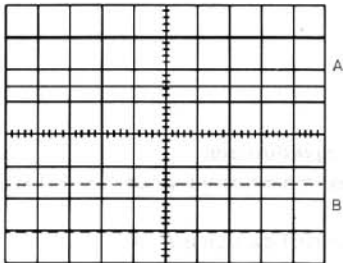
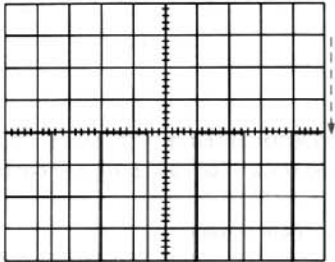
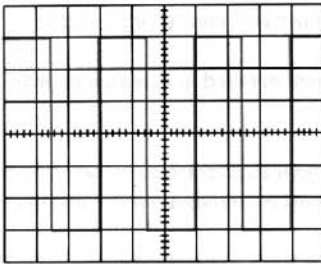

JTN

Step sequence	Controls	Requirements
STEP 2.4 Added display	<ul style="list-style-type: none"> - Y POS A or Y POS B: CW or CCW 	<ul style="list-style-type: none"> - Three signals visible on screen: ch. A signal, ADDED signal and ch. B signal. - Check that both position controls influence the vertical position of the added signal.
STEP 2.5 TB MAGNIFIER	<ul style="list-style-type: none"> - X POS: CW or CCW 	<ul style="list-style-type: none"> - Check that the horizontal deflection is magnified by a factor of 10. - Check that the trace can shift horizontally over more than 10 div.
STEP 2.6 X DEFL		<ul style="list-style-type: none"> - A signal is displayed under an angle of 45° approx.
STEP 2.7 Trigger view	<ul style="list-style-type: none"> - X POS: CW or CCW - HOLD OFF: CCW 	<ul style="list-style-type: none"> - Trigger view signal visible on screen. - Check that the trace shifts horizontally over the screen. - Check that the intensity of the displayed signal decreases.

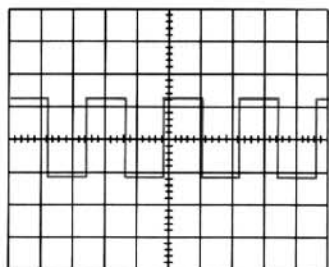
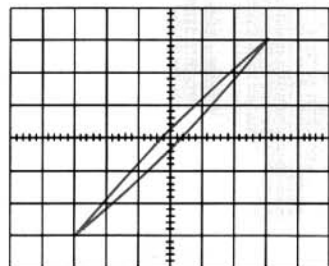
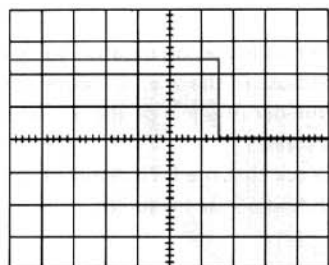
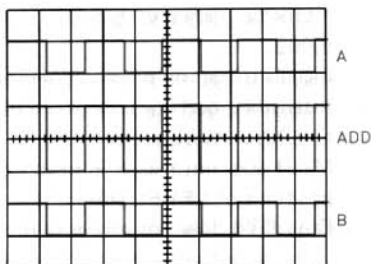

Step sequence	Controls	Requirements
---------------	----------	--------------

STEP 2.8 MTBI and DTB, DC triggered

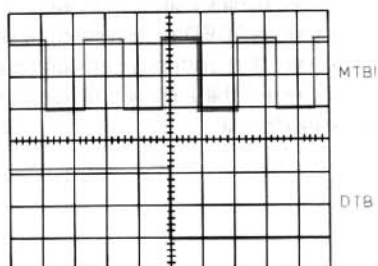

- LEVEL MTB and LEVEL DTB in mid-position

- LEVEL MTB: CW or CCW
- LEVEL DTB: CW or CCW

- Display via MTBI and DTB time axis visible on screen, with delay time 5.000.
- Signals trigger on positive-going edge.
- Intensified part starts between 6th and 9th vertical graticule line.
- MTBI does not trigger in most extreme positions of LEVEL control.
- Only DTB does not trigger in most extreme positions of LEVEL control.

STEP 2.9 MTBI and DTB, P-P triggered

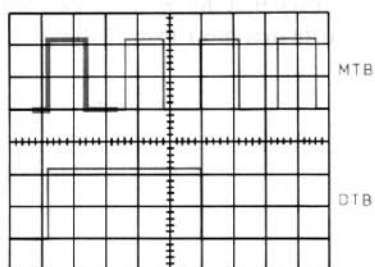

- VAR MTB: CCW
- TRACE SEP: CW or CCW

- Signals trigger on negative-going edge because of the selected negative slope.
- Number of signal periods on screen increases.
- Check that the DTB display can be shifted across the screen.

JTN

Note: Leave this procedure by pressing the AUTO SET softkey two times.

4. PREVENTIVE MAINTENANCE

4.1 GENERAL INFORMATION

This instrument normally requires no maintenance, since none of its components is subject to wear. However, to ensure reliable and trouble-free operation, the instrument should not be exposed to moisture, heat, corrosive elements or excessive dust.

4.2 REMOVING THE BEZEL AND CONTRAST FILTER (to clean the contrast filter)

- Insert a screwdriver in the slot on the upperside of the bezel and gently loose the bezel.
- Ease the bezel away from the front panel.
- Press the contrast filter from the bezel.
- To prevent scratches, when cleaning the filter, always use a clean soft cloth, free from dust and abrasive particles.

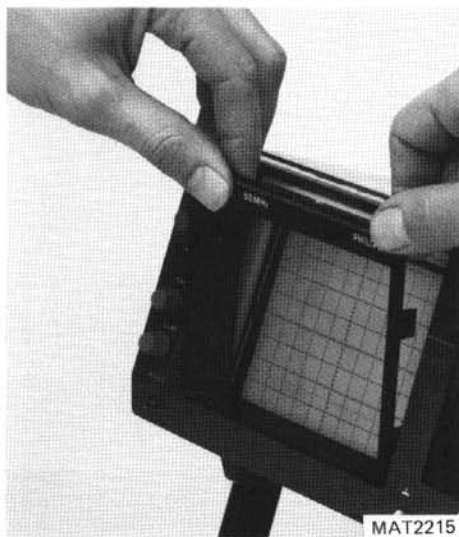

Figure 4.1 Removing the bezel and the contrast filter.

4.3 RECALIBRATION

To ensure accurate measurements, check the calibration of the instrument after specified recalibration intervals. Recalibration must be carried out by qualified personnel only.

5. CHARACTERISTICS

A. Performance Characteristics

- Properties expressed in numerical values with stated tolerance are guaranteed by PHILIPS. Specified non-tolerance numerical values indicate those that could be nominally expected from the mean of a range of identical instruments.
- This specification is valid after the instrument has warmed up for 30 minutes (reference temperature 23°C).
- For definitions of terms, reference is made to IEC Publication 351-1.

B. Safety Characteristics

This apparatus has been designed and tested in accordance with Safety Class I requirements of IEC Publication 348, Safety requirements for Electronic Measuring Apparatus, UL 1244 and CSA 556B and has been supplied in a safe condition.

C. Initial Characteristics

● Overall dimensions:

- Width

Included handle	: 387 mm	
Excluded handle	: 350 mm	
- Length

Included handle, excluded knobs	: 518,5 mm	530,5 mm included knobs.
Excluded handle, excluded knobs	: 443,5 mm	455,5 mm included knobs.
- Height

Included feet	: 146,5 mm
Excluded feet	: 134,5 mm
Excluded under cabinet	: 132,5 mm

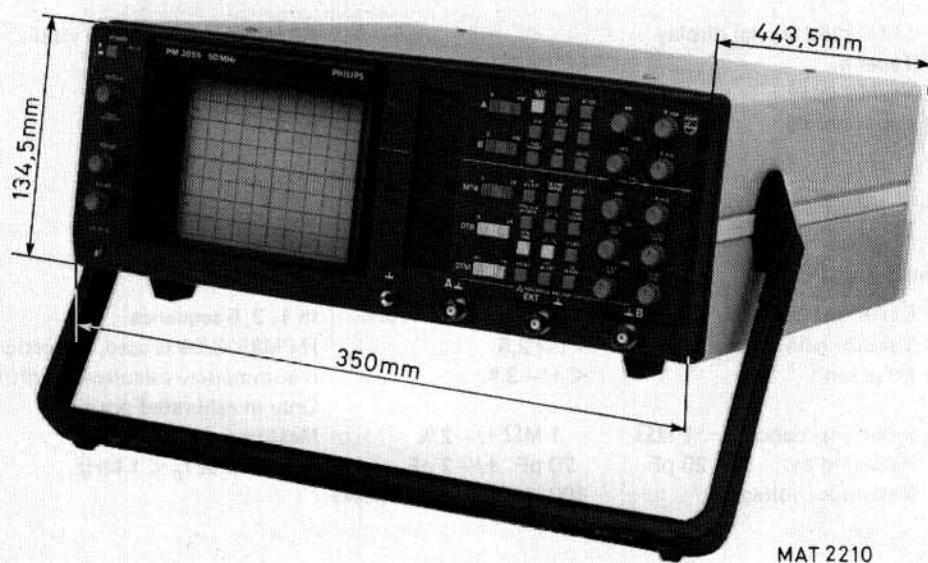

- Mass : 7,5 kg

- Operating positions:
 - a. Horizontally on bottom feet
 - b. Vertically on rear feet
 - c. On the carrying handle in two sloping positions.

D. Contents

- 5.1 Display
- 5.2 Vertical deflection or Y axis
- 5.3 Horizontal deflection or X axis
- 5.4 Triggering
- 5.5 Power Supply
- 5.6 Auxiliary out- and inputs
- 5.7 Environmental specification
- 5.8 Safety
- 5.9 Accessories

5.1 DISPLAY

CHARACTERISTICS	SPECIFICATION	ADDITIONAL INFORMATION
● C.R.T. Typeno. Measuring area (h x w)	PHILIPS D 14-372 80 x 100 mm	8 x 10 div. 1 div. = 10 mm 1 subdiv. (sd) = 2 mm
● Screen type Standard Option	GH (P 31) GM (P 7)	Long persistence
● Total acceleration voltage	16 kV	
● Illumination	Continuously variable	
● LCD liquid crystal display Typeno. Visible area Back lighting	LC 9438130 25,4 x 88,8 mm Constant on	All relevant settings are visible in display

5.2 VERTICAL DEFLECTION OR Y AXIS

5.2.1 Channels A and B

● Deflection coeff.	2 mV/div. ... 10 V/div.	In 1, 2, 5 sequence.
● Variable gain control range	1 : > 2,5	If PM8936/09 is used, deflection coeff.
● Error limit	< +/- 3 %	is automatically calculated in display.
● Input impedance	1 M Ω	Only in calibrated position.
Paralleled by	20 pF	Measured at $f_o < 1$ MHz.
Max. input voltage	400 V (d.c. + a.c. peak)	Measured at $f_o < 1$ MHz.



CHARACTERISTICS	SPECIFICATION	ADDITIONAL INFORMATION
● Bandwidth 20 mV up to 10 V @ 25°C (50 MHz & 6 div.)	> 50 MHz	Input 6 div. sinewave.
Bandwidth 2 mV, 5 mV and 10 mV @ 25°C (35 MHz & 6 div.)	> 35 MHz	Input 6 div. sinewave.
● Rise time	Calculated from 350/f-3 dB	
● Pulse aberration Overshoot, ringing and rounding < 1,5 sd peak to peak		Input pulse 5 div, +/- 2,5 div. from screen centre, positive as well as negative pulse.
● Lower - 3 dB point Amplitude 6 div. 10 Hz @ 25°C	< 10 Hz	In AC position, 6 div. sinewave.
● Dynamic range @ 10 MHz	> +/- 24 div.	Vernier in cal. position.
@ 50 MHz	> 8 div.	Vernier in cal. position.
● Position range	> +/- 8 div.	Vernier in cal position.
● Decoupling factor between channels @ 10 MHz	1 : > 100	Both channels same attenuator setting. Input max. 8 div. sinewave. 2,5 and 10 mV are excluded.
@ 50 MHz	1 : > 50	2,5 and 10 mV are excluded.
● COMMON Mode Rejection Ratio @ 1 MHz	1 : > 100	Both channels same attenuator setting, vernier adjusted for best CMMR; measured with max. 8 div. (+/- 4 div.) each channel.
● Visible signal delay	> 15 ns	Max. intensity, measured from line start to trigger point
● Base line jump Between attenuator steps 20 mV ... 10 V	< 1 sd	
Addition jump between 10 mV ... 20 mV	< 1,5 sd	
Normal - Invert Jump	< 1 sd	Only channel B.
ADD Jump	< 0,6 div.	When A and B are positioned in screen centre (20 mV ... 10 V).
Variable jump	< 1 sd	Max. jump in any position of the vernier.

5.2.2 Triggerview

● Bandwidth Via A or B channel 20 mV up to 10 V @ 25°C	> 50 MHz	6 div. sinewave
Via EXT. input	> 50 MHz	6 div. sinewave (+/- 3 div. from screen centre).
● Deflection coeff. Via channel A or B Via EXT. input Error limit	2 mV ... 10 V/div. 100 mV/div. < 5 %	1, 2, 5 sequence (see Channel A, B). INTERNAL, EXTERNAL.

CHARACTERISTICS	SPECIFICATION	ADDITIONAL INFORMATION
● Lower - 3 dB point AC coupling EXT. input @ 25°C input sine wave 6 div. 10 Hz	< 10 Hz	Only when trigger mode is DC.
● Line jump trigger source	< 2 sd	Jump between trigger source A, B, composite and EXT.
● OFFSET trig. point from screen centre	< 1,5 sd	
● Delay EXT. trigger view and channel A or B	< 10 ns	
● Dynamic range EXT. input @ 1 MHz @ 50 MHz	> +/- 12 div. > 6 div.	

5.3 HORIZONTAL DEFLECTION X AXIS



5.3.1 Main Time Base

● Time coeff. Error limit	0,5 sec. ... 50 ns < 3 %	1, 2, 5 sequence (magnifier off). Measured at -4 ... +4 div. from screen centre.
● Horizontal position range	Start of sweep and 10th div. must be shifted over screen centre	
● Variable control ratio	1 :> 2,5	
● Time Base Magnifier	Expansion *10	Not valid in X-deflection.
● Error limit	< 4 %	Measured at +4 ... -4 div. from screen centre.
● Horizontal magnifier balance *10 → *1	< 2,5 sd	Shift start of sweep in *10 in mid-screen position then switch to *1.
● Hold off Minimum to maximum hold off time ratio	1 :> 10	Minimum hold off time is related to time base setting.

CHARACTERISTICS	SPECIFICATION	ADDITIONAL INFORMATION
5.3.2 Delayed Time Base		
<ul style="list-style-type: none"> ● Time coeff. Error limit ● Horizontal position range ● Variable control ratio ● Time Base Magnifier 	1 ms ... 50 ns	Sequence 1, 2, 5. See MTB See MTB See MTB See MTB
<ul style="list-style-type: none"> ● Delay Time Multiplier Error limit 	3 % + 1 % incremental delay error + 25 ns +/- 5 ns	* 1 only.
<ul style="list-style-type: none"> Incremental delay time error 	< 1 %	* 1 only.
<ul style="list-style-type: none"> ● Resolution 	1 : 10.000	
<ul style="list-style-type: none"> ● Delay Time Jitter 	1 : > 20.000	
<ul style="list-style-type: none"> ● Trace separation Shift range 	> +/- 4 div.	Only valid in alternate time base. DTB shifts only.
5.3.3 X-deflection		
<ul style="list-style-type: none"> ● Deflection coeff. Via channel A or B Via EXT. input 	2 mV ... 10 V/div. 100 mV/div.	1, 2, 5 sequence.
<ul style="list-style-type: none"> ● Error limit Via channel A or B Via EXT. input 	< +/- 5 % < +/- 5 %	
<ul style="list-style-type: none"> ● Bandwidth Amplitude @ input signal 6 div. 2 MHz. 	DC > 2 MHz	DC coupled
<ul style="list-style-type: none"> ● Phase shift between X and Y-defl. 	< 3° @ 100 kHz	
<ul style="list-style-type: none"> ● Dynamic range 	> +/- 12 div. @ 100 kHz	
5.3.4 EXT input		
 <ul style="list-style-type: none"> ● Input impedance 1 MΩ Paralleled by 20 pF 	1 MΩ +/- 2 % 20 pF +/- 2 pF	f _o < 1 MHz f _o < 1 MHz
<ul style="list-style-type: none"> ● Max. input voltage 	400 V (d.c. + a.c. peak)	
<ul style="list-style-type: none"> Max. test voltage (rms) 	500 V	Max. duration 60 sec.
<ul style="list-style-type: none"> ● Lower - 3 dB point 	< 10 Hz	AC coupled.

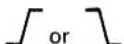
5.4 TRIGGERING

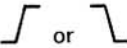
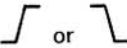
CHARACTERISTICS	SPECIFICATION	ADDITIONAL INFORMATION
5.4.1 MTB triggering		
<ul style="list-style-type: none"> ● Trig- mode AUTO (auto free run) 	Bright line in absent of trigger signal	Auto free run start 100 ms (typ) after no trig-pulse.
Triggered Single		Switch automaticly to auto free run if one of the display channels is grounded. In multi-channel mode (alternate) each channel is armed after reset; if sweep is already started, sweep is not finished.
<ul style="list-style-type: none"> ● Trigger source A, B, Composite (AB), EXT, Line 		Line trigger source always triggers on main frequency. Line trigger amplitude is depended on line input voltage. Approx. 6 div. @ 220 V a.c. input voltage.
<ul style="list-style-type: none"> ● Trigger coupling Peak to peak (p/p), DC, TVL, TVF 		
<ul style="list-style-type: none"> ● Level range Peak to peak 	Related to peak to peak value.	p/p coupling is DC rejected.
DC		
INTERNAL	> +/- 8 div.	
EXTERNAL	> +/- 800 mV	
TVL/TVF	Fixed level	
<ul style="list-style-type: none"> ● Trigger slope 	 or	Slope sign in LCD + for POS. and - for NEG. VIDEO
<ul style="list-style-type: none"> ● Trigger sensivity 		
INTERNAL		
0 - 10 MHz	< 0,5 div.	Trig. coupling DC.
@ 50 MHz	< 1,0 div.	Trig. coupling DC.
@ 100 MHz	< 2,0 div.	Trig. coupling DC.
EXTERNAL		
0 - 10 MHz	< 50 mV	Trig. coupling DC.
@ 50 MHz	< 150 mV	Trig. coupling DC.
@ 100 MHz	< 500 mV	Trig. coupling DC.
TVL/TVF		
INTERNAL	< 0,7 div.	Sync. pulse.
EXTERNAL	< 70 mV	Sync. pulse.

CHARACTERISTICS	SPECIFICATION	ADDITIONAL INFORMATION
5.4.2 DTB Triggering		
<ul style="list-style-type: none"> ● DTB trigger source Starts, A, B, Composite (AB) and TVL 		TVL has same trig.source as MTB trig.source TVL only valid if MTB trig.coupling TVL or TVF is choosen.
<ul style="list-style-type: none"> ● Coupling 	DC	
<ul style="list-style-type: none"> ● Trigger sensivity 	See MTB	
<ul style="list-style-type: none"> ● Trigger level range 	> +/- 8 div.	
<ul style="list-style-type: none"> ● Trigger slope 	 or 	Slope sign in LCD, if TVL is choosen slope sign is not valid.
5.5 POWER SUPPLY		
	<ul style="list-style-type: none"> ● Line input voltage a.c. Nominal Limits of operation 	One range. 100 – 240 V 90 – 264 V
	<ul style="list-style-type: none"> ● Line frequency Nominal Limits of operation 	50 – 400 Hz 45 – 440 Hz
	<ul style="list-style-type: none"> ● Safety requirements within specification of : IEC 348 CLASS I UL 1244 VDE 0411 CSA 556 B 	
	<ul style="list-style-type: none"> ● Power consumption 	45 W
5.6 AUXILIARY IN OR OUTPUTS		
<ul style="list-style-type: none"> ● Z-MOD ViH ViL 	> 2,0 V < 0,8 V	TTL compatible. Blanks display. Max. intensity Analog control between ViH and ViL is possible.
<ul style="list-style-type: none"> ● DIN plug 9 pins-female 		For IEEE control, front panel memory back-up
<ul style="list-style-type: none"> ● CAL Output voltage Frequency The output may be short-circuit to ground. 	1,2 V +/- 1 % 2 kHz	To calibrate drop or tilt probes. Rectangular output pulse.

5.7 ENVIRONMENTAL CHARACTERISTICS

The environmental data mentioned in this manual are based on the results of the manufacturer's checking procedures.

Details on these procedures and failure criteria are supplied on request by the PHILIPS organisation in your country, or by PHILIPS, INDUSTRIAL AND ELECTRO-ACOUSTIC SYSTEMS DIVISION, EINDHOVEN, THE NETHERLANDS.

CHARACTERISTICS	SPECIFICATION	ADDITIONAL INFORMATION
● Meets environmental requirements of	MIL-T-28800 C, type III, CLASS 5 Style D	
● Temperature		
Operation temp. range within specification	10° - 40°C	MIL-T-28800 C par. 3.9.2.3 tested c.f. par. 4.5.5.1.1.
Limits of operation temperature range	0 - 50°C	Idem.
Non operating (Storage)	-40°C/+ 75°C	MIL-T-28800C par. 3.9.2.3 tested c.f. par. 4.5.5.1.1.
● Max. humidity operating non operating	95 % RH	
● Max. altitude		C.f. MIL-TL-28800 C par. 3.9.3. tested c.f. par. 4.5.5.2.
Operating	4,5 km (15000 feet)	Maximum (Operating Temperature derated 3°C for each km (for each 3000 feet) above see level.
Non operating (storage)	12 km (40.000 feet)	
● Vibration (operating)		C.f. MIL-T-28800 C par. 3.9.4.1 tested c.f. par. 4.5.5.3.1.
Freq. 5.....15 Hz Sweep Time	7 min.	
Excursion (p/p)	1,5 mm	
max. Acceleration	7 m/s ² (0,7 x g)	@ 15 Hz
Freq. 15.....25 Hz Sweep Time	3 min.	
Excursion (p/p)	1 mm	
max. Acceleration	13 m/s ² (1,3 x g)	@ 25 Hz
Freq. 25.....55 Hz Sweep Time	5 min.	
Excursion (p/p)	0,5 mm	
max. Acceleration	30 m/s ² (3 x g)	@ 55 Hz
Resonance Dwell	10 min.	@ each resonance freq. (or @ 33 Hz if no resonance was found).
● Shock (operating)		C.f. MIL-T-28800 C par. 3.9.5.1 tested c.f. par. 4.5.5.4.1.
Amount of shocks	total 18	
each axis	6	(3 in each direction).
Shock Wave Form	Half sinewave	
Duration	11 ms	
Peak Acceleration	300 m/s ² (30 x g)	

CHARACTERISTICS	SPECIFICATION	ADDITIONAL INFORMATION
<ul style="list-style-type: none"> ● Bench handling 		C.f. MIL-T-28800 C par. 3.9.5.3 tested c.f. par. 4.5.5.4.3.
Meets requirements of	MIL-STD-810 methode 516, proced.V	
<ul style="list-style-type: none"> ● Salt Atmosphere 		C.f. MIL-T-28800 C par. 3.9.8.1 tested c.f. par. 4.5.6.2.1.
Structural parts meet requirements of	MIL-STD-810 methode 509, proced.I salt solution 20 %	
<ul style="list-style-type: none"> ● EMI (Electronic Magnetic Interference) 	MIL-STD-461 CLASS B VDE 0871 and VDE 0875, Grenzwertklasse B	Applicable requirements of part 7 : CE03 CS01, CS02, CS06, RE02, RS03
<ul style="list-style-type: none"> ● Magnetic Radiated Maximum Susceptibility Deflection Factor 	7 mm/mT (0,7 mm/gauss)	Tested conforming IEC 351-1 par. 5.1.3.1. Measured with instrument in a homogeneous magnetic field (in any direction with respect to instrument) with a Flux intensity (p-p value) of 1,42 mT (14,2 gauss) and of symmetrical Sine wave form with a frequency of 45...66 Hz.

5.8 SAFETY

<ul style="list-style-type: none"> ● Meets requirements of 	IEC 348 CLASS I VDE 0411	Except for power cord, unless shipped with Universal European power plug.
	UL 1244 CSA 556 B	Except for power cord, unless shipped with North American power plug.
<ul style="list-style-type: none"> ● Max. X-Radiation 		Measured @ 5 cm from surface of instrument for a target area of 10 cm ²
<ul style="list-style-type: none"> ● Recovery time 	15 min.	-10°C + 25°C ambient temp.
	30 min.	-20°C + 25°C ambient temp.
	45 min.	-30°C + 25°C ambient temp.
	60 min.	-40°C + 40°C ambient temp.

5.9 ACCESSORIES

- Optional accessory 10 : 1 passive probe set PM8936/09

5.9.1 Accessory information

● DELIVERIES

The PM8936/09 probe set consist of:

- 2x 10 : 1 probe PM8926/09, incl. * spring-loaded test clip
* earth cable
- Instruction card

● INTRODUCTION

The PM8936/09 is a 10x attenuator modular probe with automatic range indication possibility, designed for oscilloscopes. The cable length is 1,5 m. At delivery the probe has been adjusted to an oscilloscope with an input capacitance of 20 pF.

● CHARACTERISTICS

- | | |
|---|--------------------------|
| – Attenuation (d.c.) | 10x |
| – Bandwidth | d.c...200 MHz (–3 dB) |
| – Useful system bandwidth | d.c...100 MHz (–3 dB) |
| – Input resistance at d.c. | 10 M Ω +or– 1,5 % |
| – Input capacitance at d.c. | 13,5 pF |
| – Compensation range | 5 pF...40 pF |
| – Max. non destructive input voltage (d.c. + a.c. peak) at d.c. | 500 V |

● DISMANTLING

- * The probe body can be removed by sliding the probe body from the cable assembly.
- * The compensation box can be slid off the cable assy **after** the knurled nut has been unscrewed in a counter clockwise direction.
- * To expose the h.f. adjustment controls the terminating box cover can be slid off the compensation box.

● ADJUSTMENTS

Matching the probe to the oscilloscope:

Connect the probe to the CAL socket of the oscilloscope.

A trimmer can be adjusted for the l.f. response through a hole in the compensation box to obtain optimum square-wave response.

6. GLOSSARY OF TERMS

ALT: Alternate display. To display more than one vertical channel, the display switches over from one channel to another at the end of each time-base sweep. Is suitable for the higher sweep speeds (more than 0,1 ms/div).

ALT TB: Alternate time-base. To display the main time-base signal and the delayed time-base signal. The horizontal deflection switches between MTB and DTB at the end of each time base sweep.

AUTO: The MTB generator is free-running 100 ms after the last trigger pulse. This means that even in the absence of trigger pulses a line is written on the screen. As soon as triggers appear, the time-base circuit switches to the normal trigger mode (cannot be employed for signals with low repetition rates, 20 Hz or lower).

CHOP: Chopped display. To display more than one vertical channel, the display switches over from one channel to another at a fixed (chopper-) frequency. The channel that is displayed is also selected as a trigger source. Is suitable for the lower sweep speeds (less than 0,1 ms/div).

COMP: Composite triggering. Offers a stable display of two signals applied to channel A and B that are not time related. Works only in conjunction with the ALT-display mode.

DTB: Delayed time-base. Views an expanded display which can be positioned anywhere along the 10 div. of the main sweep. The delay time-base multiplier control (DTM) determines the starting point of the DTB.

HOLD OFF: During the HOLD OFF time, the MTB cannot be started by a trigger pulse. When the HOLD OFF control is not in CAL-position, the HOLD OFF time can be increased in order to obtain a stable display in digital and computer applications, where complex pulse patterns need to be measured. When a complex pulse pattern is displayed and this pattern is also used for triggering, a multiple-picture display may occur. These effects can be corrected by adjusting the HOLD OFF control to increase the hold-off time, so that certain trigger pulses do not start the MTB.

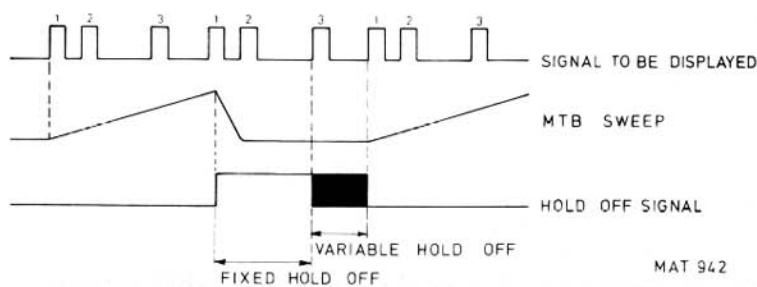

INPUT COUPLING: Input coupling, can be a.c.— or d.c.—coupled.

AC-coupled: only the a.c.—component of the input signal is fed to the attenuator, via a blocking capacitor. This mode can be used when a signal with an a.c. component that is superimposed on a high d.c. voltage must be displayed.

DC-coupled: the complete input signal (both a.c. and d.c. components) is fed to the attenuator.

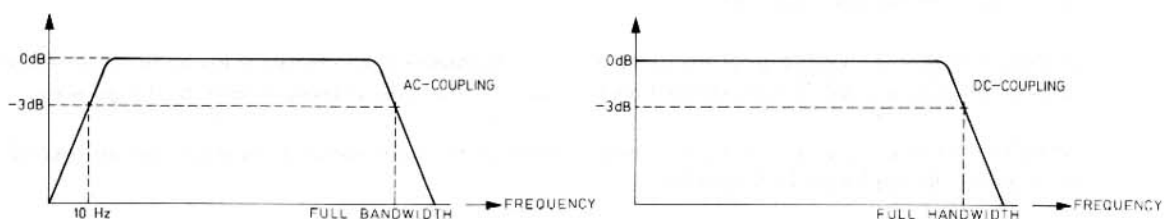

LEVEL: Determination of the starting point of the time-base can be varied by the LEVEL control. The time-base starts when the trigger signal reaches the voltage level of the LEVEL control.

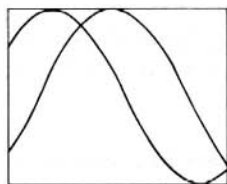
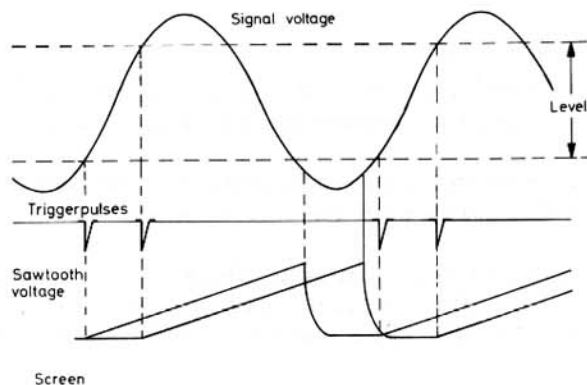

MAT577

LINE: Main time-base triggering on a signal derived from the mains voltage. Can be used when examining the mains ripple on the d.c. output voltage of a power supply. Line triggering is not available when the instrument is operated from a battery supply.

MTBI: Main time-base intensified. The horizontal deflection is supplied by the MTB. One part of the trace, representing the DTB, is intensified. The length of the intensified part depends on the settings of the DTB and MTB controls. The intensified part can be shifted along the MTB trace by the DTM control. Can be used to locate a particular part of the signal.

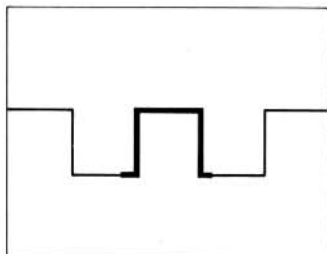

MAT2143

P-P: Peak-to-peak triggering, gives automatic ranging of the LEVEL control. The LEVEL range is determined by the peak-to-peak value of the trigger signal.

Example: with a 4 division signal on the screen, the LEVEL control is adjustable from +1,8 div. (CW) to -1,8 div. (CCW) with a total range of 3,6 div.

SINGLE: The MTB runs only once after receipt of a trigger pulse. Pre-determination of the required trigger level can be obtained in TRIG VIEW mode. When ARMED, the time-base is ready on receipt of a trigger pulse. The RESET softkey resets the time-base so that it can start again on a new trigger pulse. Can be used to display non-repetitive waveforms.

SLOPE: Determines on which slope the sweep is started. If positive, the time-base starts on the positive-going slope of the trigger signal. If negative, the time-base starts on the negative-going slope of the trigger signal.

STARTS: In the MTBI or DTB mode, the delayed time-base generator starts immediately after the selected delay time, adjusted by the DTM control.

TB MAGN: Fixed expansion of the TIME/DIV setting by a factor of 10. Now the portion of the signal formerly displayed over a width of one division occupies the full width of the screen (10 DIV.).

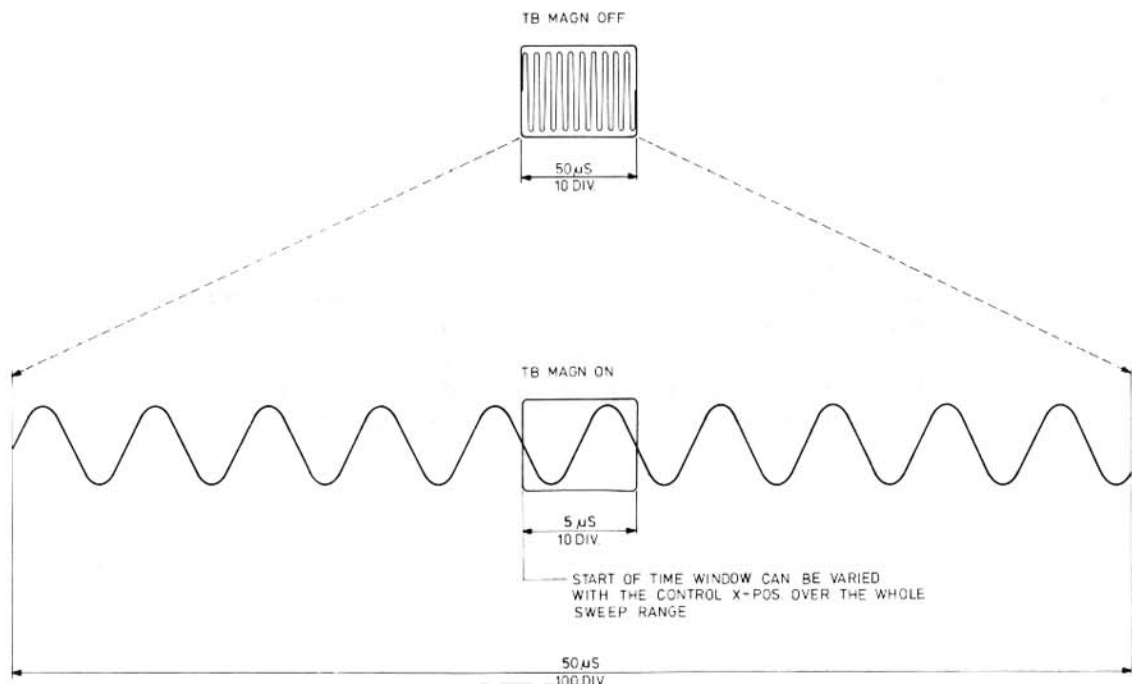
MAT 1619
841012

TRACE SEP: Control to adjust the vertical distance between the traces of MTB and DTB signals, provided that ALT TB is selected.

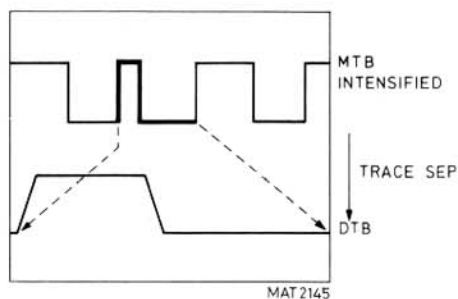

TRIG: Trigger mode. The MTB starts upon a signal derived from a selected trigger source (A, B, EXT, or LINE). The DTB starts after the selected delay time upon a signal derived from a selected trigger source (A, B or EXT). The MTB or DTB will not run without trigger pulses.

TRIG VIEW: The signal on which the MTB triggers, is displayed on the screen. Can be used for:

- Third vertical channel facility when EXT triggering of the MTB is selected and a signal is applied to the EXT BNC socket.
- Observation of the level of the trigger signal at which the MTB starts. This trigger level can be adjusted by the LEVEL control.
- Observation of the internal trigger sources.
- Pre-determining the d.c. trigger level without the aid of an input signal, when SINGLE is selected.

TVL, TVF: Triggering of the time-base on the TV line (TVL) synchronisation pulses or TV frame (TVF) synchronisation pulses (MTB only). In this mode a fixed level is set and the LEVEL control is inoperative.

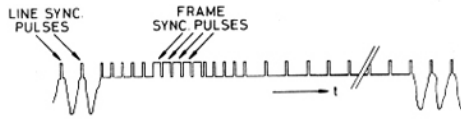

MAT2185

X DEFL: Horizontal deflection (XY) is under control of the signal selected by the TRIG or X SOURCE softkey (A, B, EXT or LINE). The filters AC or DC remain active in the XY mode. Can be used for:

- Frequency response of circuits and filters, where amplitude must be displayed against frequency.
- Semiconductor measurements where output current must be displayed against input voltage.
- Frequency or phase shift comparisons by displaying Lissajous patterns.

JTN

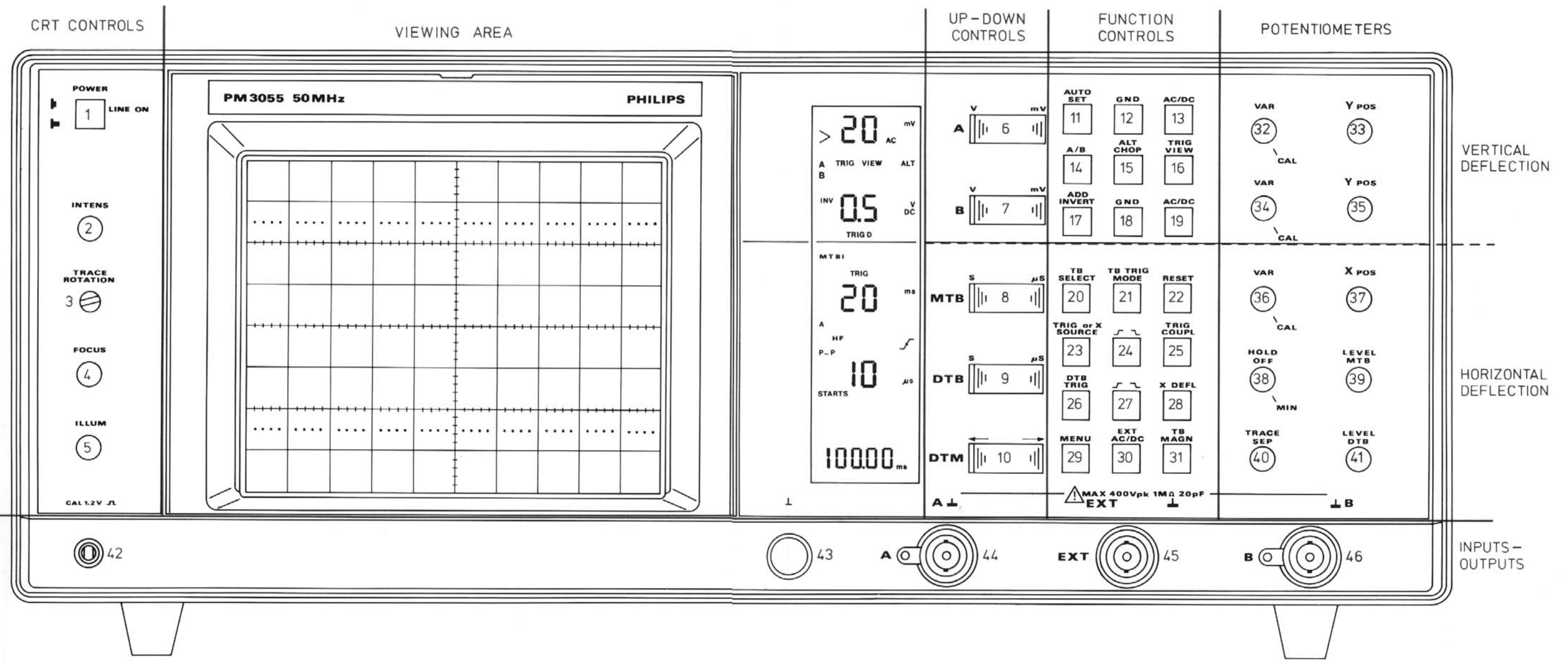

MAT 1801
851220

Front view of the oscilloscope
Vorderanzicht des Oszilloskops
Vue antérieure de l'oscilloscope

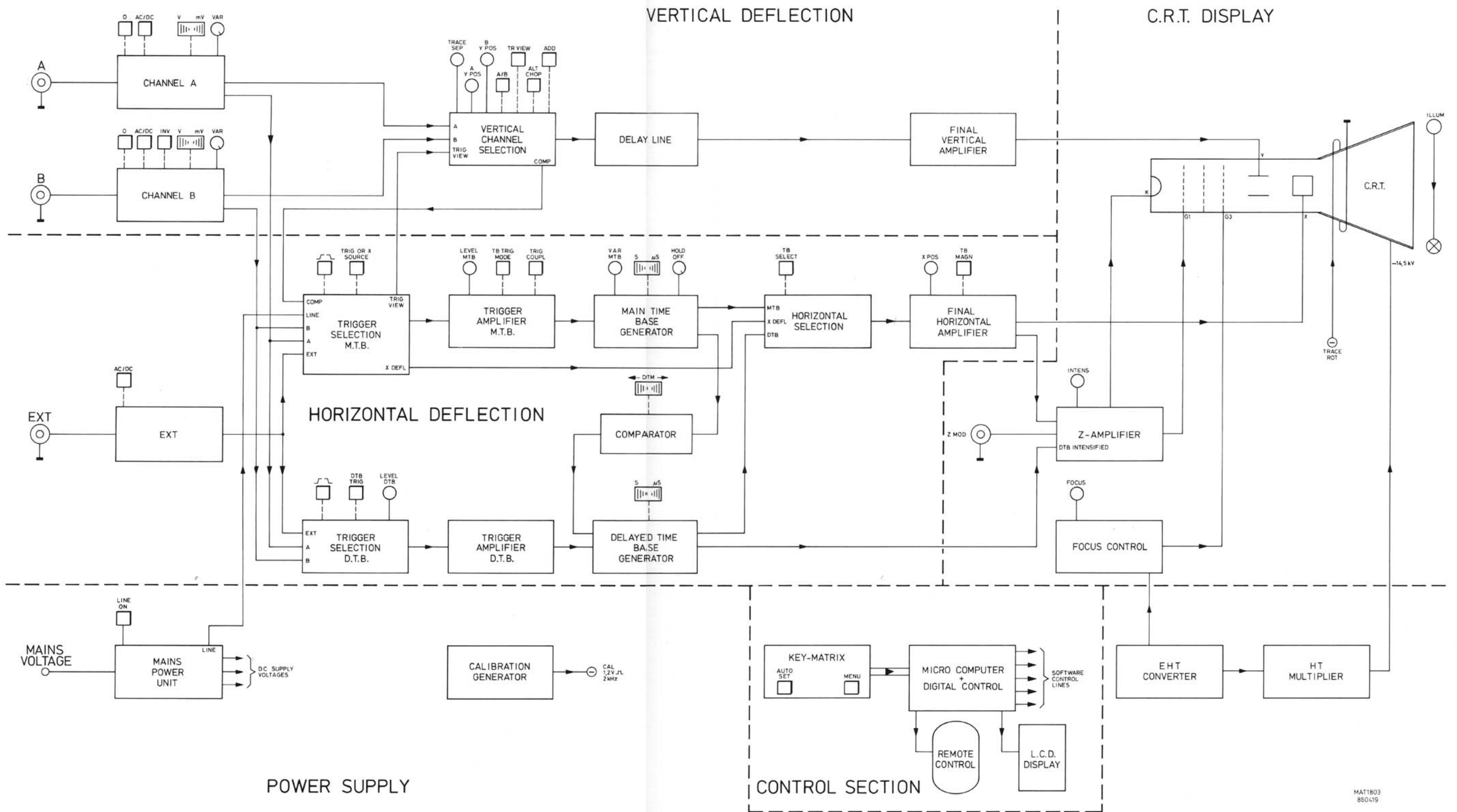

MAT1803
850/19

Block diagram
Blockdiagramm
Schéma par blocks