



PHILIPS

60MHz Digital Storage Oscilloscope PM3335-PM3337

TEST & MEASUREMENT

CUSTOMER SUPPORT

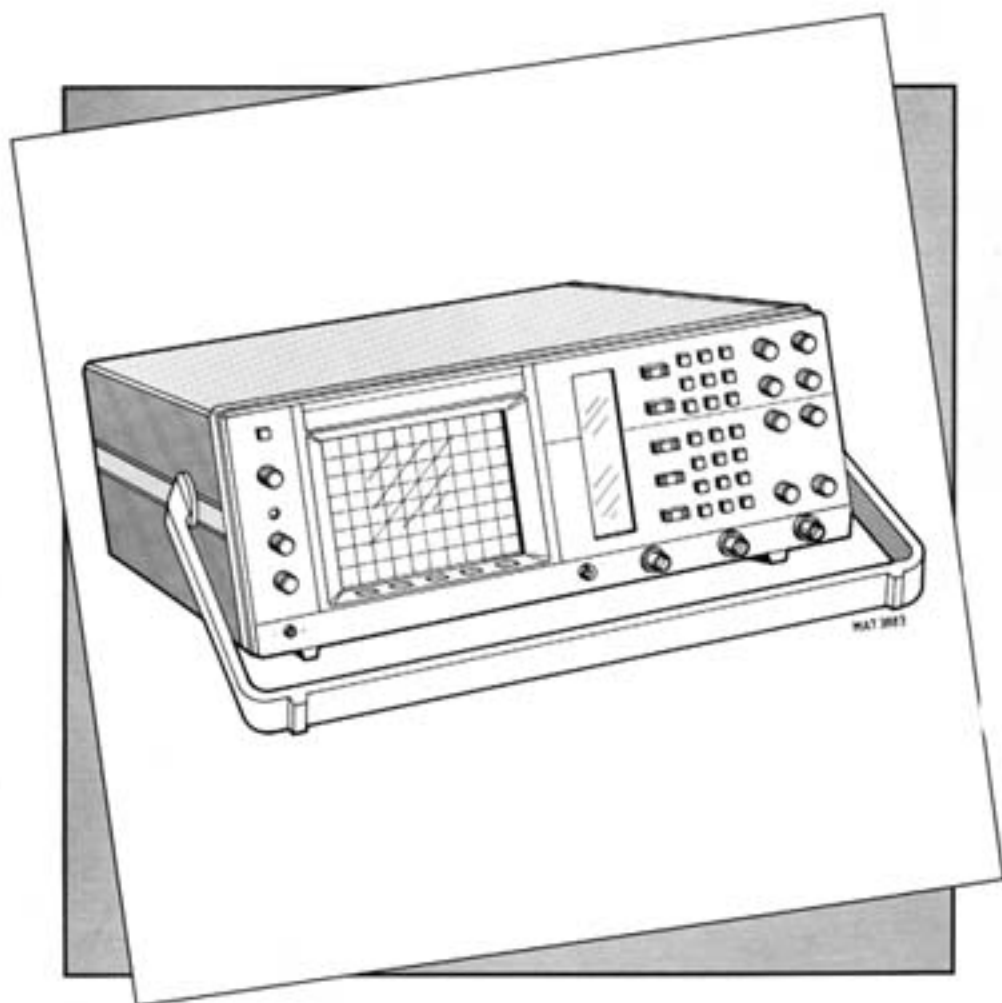

4822 872 00431
900601

Reference Manual

60 MHz Digital Storage Oscilloscope PM3335/PM3337

Reference Manual

4822 872 00431
900601

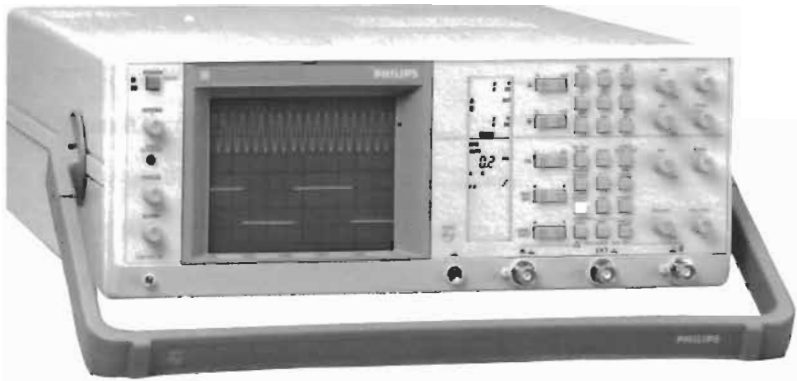

PHILIPS

Table of Contents

1 CHARACTERISTICS	1 - 1
1.1 DISPLAY	1 - 3
1.2 VERTICAL DEFLECTION OR Y AXIS	1 - 3
1.3 HORIZONTAL DEFLECTION OR X AXIS	1 - 5
1.3.1 TIME BASE	1 - 5
1.3.2 X-DEFLECTION.....	1 - 6
1.3.3 EXT INPUT	1 - 7
1.4 TRIGGERING.....	1 - 7
1.5 SIGNAL ACQUISITION.....	1 - 8
1.6 CHANNELS A AND B.....	1 - 10
1.7 TIME BASE	1 - 10
1.8 TRIGGER	1 - 11
1.9 MEMORY.....	1 - 11
1.10 DISPLAY	1 - 12
1.11 CALCULATION FACILITIES	1 - 12
1.12 AUTO SETTING	1 - 12
1.13 CURSORS.....	1 - 12
1.14 POWER SUPPLY	1 - 13
1.15 SUNDRIES	1 - 14
1.16 ENVIRONMENTAL CHARACTERISTICS.....	1 - 15
1.17 SAFETY.....	1 - 18
1.18 OPTIONAL VERSIONS.....	1 - 19

2 PRINCIPLE OF OPERATION	2 - 3
2.1. CONTROL SECTION	2 - 3
2.2 VERTICAL DEFLECTION	2 - 3
2.3 HORIZONTAL DEFLECTION.....	2 - 5
2.4 CRT DISPLAY	2 - 7
2.5 INTERFACE SECTION.....	2 - 7
2.6 POWER SUPPLY SECTION.....	2 - 8
3 BRIEF CHECKING PROCEDURE	3 - 1
3.1 GENERAL INFORMATION	3 - 1
3.2 STARTING THE BRIEF CHECKING PROCEDURE.	3 - 2
3.3 VERTICAL SECTION, DIGITAL MEMORY OFF.....	3 - 3
3.4 HORIZONTAL SECTION, DIGITAL MEMORY OFF.	3 - 4
3.5 VERTICAL SECTION, DIGITAL MEMORY ON.	3 - 6
3.6 HORIZONTAL SECTION, DIGITAL MEMORY ON.	3 - 7
3.7 CURSOR SECTION, DIGITAL MEMORY ON.	3 - 9
4 PERFORMANCE TEST	4 - 1
4.1 GENERAL INFORMATION	4 - 1
4.2 RECOMMENDED TEST EQUIPMENT.....	4 - 2
4.3 TEST PROCEDURE.....	4 - 3
4.3.1 Preliminary settings.....	4 - 4
4.3.2 Power supply	4 - 4
4.3.3 Power consumption.....	4 - 5
4.3.4 Auto set.....	4 - 6

4.3.5	Orthogonality	4 - 7
4.3.6	Vertical deflection; deflection coefficients.....	4 - 8
4.3.7	Vertical deflection; variable gain control range	4 - 9
4.3.8	Vertical deflection; input coupling	4 - 10
4.3.9	Vertical deflection; frequency response.....	4 - 10
4.3.10	Vertical deflection; rise-time.....	4 - 11
4.3.11	Vertical deflection; noise.....	4 - 13
4.3.12	Vertical deflection; dynamic range at 10 MHz.....	4 - 13
4.3.13	Vertical deflection; position range	4 - 14
4.3.14	Vertical deflection; cross talk between A and B at 10 MHz	4 - 15
4.3.15	Vertical deflection; cross talk between A and B at 60 MHz	4 - 16
4.3.16	Vertical deflection; common mode rejection ratio.....	4 - 17
4.3.17	Vertical deflection; visual signal delay	4 - 18
4.3.18	Vertical deflection; base line jump.....	4 - 20
4.3.19	Horizontal deflection; X deflection.....	4 - 21
4.3.20	Horizontal deflection; time-base deflection coefficients	4 - 22
4.3.21	Horizontal deflection; variable control ratio (VAR TB).....	4 - 24
4.3.22	Horizontal deflection; TB magnifier balance.....	4 - 25
4.3.23	Horizontal deflection; X deflection coefficient via A.....	4 - 26
4.3.24	Horizontal deflection; X deflection coefficient via EXT.....	4 - 27
4.3.25	Horizontal deflection; frequency response 1	4 - 28
4.3.26	Horizontal deflection; frequency response 2.....	4 - 29
4.3.27	Maximum phase shift between horizontal and vertical deflection.	4 - 29
4.3.28	Triggering; sources and coupling	4 - 31
4.3.29	Triggering; slope selection and level control range	4 - 32
4.3.30	Triggering; trigger sensitivity via A and B.....	4 - 33
4.3.31	Triggering; trigger sensitivity via EXT.....	4 - 34
4.3.32	Triggering; trigger sensitivity TVL-TVF	4 - 35
4.3.33	Cursors; voltage cursor accuracy.....	4 - 36
4.3.34	Cursors; time cursor accuracy.....	4 - 37
4.3.35	Z-MOD sensitivity.....	4 - 39
4.3.36	CAL signal; frequency and output voltage	4 - 40

5. PREVENTIVE MAINTENANCE	5 - 1
5.1 GENERAL INFORMATION	5 - 1
5.2 REMOVING THE BEZEL AND CONTRAST FILTER	5 - 1
5.3 RECALIBRATION	5 - 1

1 CHARACTERISTICS

A. Performance Characteristics

Properties expressed in numerical values with stated tolerance are guaranteed by PHILIPS. Specified non-tolerance numerical values indicate those that could be nominally expected from the mean of a range of identical instruments.

This specification is valid after the instrument has warmed up for 30 minutes (reference temperature 23°C).

For definitions of terms, reference is made to IEC Publication 351-1.

B. Safety Characteristics

This apparatus has been designed and tested in accordance with Safety Class I requirements of IEC Publication 348, Safety requirements for Electronic Measuring Apparatus, UL 1244 and CSA 556B and has been supplied in a safe condition.

C. Mechanical Characteristics

Overall dimensions:

Width

Including handle : 387 mm

Excluding handle : 350 mm

Length

Including handle : 518,5 mm

Excluding handle, excl. knobs : 443,5 mm

Excluding handle, incl. knobs : 455,5 mm

Height

Including feet : 146,5 mm

Excluding feet : 134,5 mm

Excl. under-cabinet : 132,5 mm



Figure 1.1 Dimensions of oscilloscope PM3335.

Mass : 8,5 kg

Operating positions:

- a. Horizontally on bottom feet
- b. Vertically on rear feet
- c. On the carrying handle in two sloping positions.

CHARACTERISTICS	SPECIFICATION	ADDITIONAL INFORMATION
1.1 DISPLAY		
* CRT		
Type number	PHILIPS D14-372	
Measuring area (h x w)	80 x 100 mm	8 x 10 div., 1 div. = 10 mm, 1 subdiv. (sd) = 2 mm
* Screen type		
Standard	GH (P31)	Standard persistence (7 ms)
Option	GM (P7)	Long persistence (30 ms)
* Total acceleration voltage	16 kV	
* Graticule:		
Engravings	Internal fixed	
Division lines	1 cm	Horizontal as well as vertical
Subdivisions	2 mm	Horizontal as well as vertical
Dotted lines	1,5 and 6,5 cm from top	Only horizontal
Percentages	0%, 10%, 90%, 100%	Left side of screen
* Orthogonality	90° +/- 1°	Measured in zero point
* Illumination	Continuously variable	By means of potentiometer

1.2 VERTICAL DEFLECTION OR Y AXIS

* Auto set	Automatic setting according to input signal	
* Deflection modes and sources	Channel A and/or B or ADDED (A + B, A-B)	Channel B can be inverted. All combinations are possible in ALTERNATE as well as CHOP mode

CHARACTERISTICS	SPECIFICATION	ADDITIONAL INFORMATION
* Deflection coefficients	2 mV/div...10 V/div	In 1, 2, 5 sequence. If probe with range indicator is used, deflection coeff. is automatically calculated in display
* Variable gain control range	1 : > 2,5	
* Error limit	± 3%	Only in calibrated position
* Input impedance Paralleled by	1 M Ω ± 2% 20 pF ± 2 pF	Measured below 1 MHz Measured below 1 MHz
 * Max. input voltage	400 V (d.c. + a.c. peak)	
Max. test voltage (rms)	500 V	Max. duration 60 s.
* Bandwidth for 20 mV...10 V	60 MHz (-3dB, amb. 15...35°C)	Input 6 div. sine-wave. Deviation max. 5MHz for ambient 0...50°C
* Bandwidth for 2 mV, 5 mV and 10 mV	> 35 MHz	Input 6 div. sine-wave.
* Rise-time	7 ns or less	Calculated from 0,35/f-3 dB
* Noise 20 mV...10 V	< 0,5 sd	Measured visually. Pick up on open BNC excluded.
* Lower -3 dB point	< 10Hz	In AC position, 6 div. sine-wave
* Dynamic range		
At 1 MHz	+/- 12 div.	Vernier in CAL position.
At 50 MHz	> 8 div.	Vernier in CAL position.
* Position range	+/- 8 div	Vernier in CAL position.

CHARACTERISTICS	SPECIFICATION	ADDITIONAL INFORMATION
* Cross talk between channels		Both channels same attenuator setting. Input max. 8 div. sine-wave.
At 10 MHz	1 : > 100	2, 5 and 10V are excluded.
At 50 MHz	1 : > 50	2, 5 and 10V are excluded.
* Common Mode Rejection Ratio at 1MHz	1 : > 100	Both channels same attenuator setting, vernier adjusted for best CMMR; measured with max. 8 div. (+/- 4 div.) each channel.
* Visible signal delay	> 15 ns	Max. intensity, measured from line start to trigger point.
* Base line jump: between attenuator steps 20 mV...10 V	< 1sd	
Additional jump between 10 mV...20 mV	< 1,5 sd	
Normal Invert jump	< 1sd	
ADD jump	typ. 0,6 div.	Only channel B
Variable jump	< 1sd	When A and B are positioned in screen centre (20 mV...10V). Max. jump in any two positions of the VARIABLE control.

1.3 HORIZONTAL DEFLECTION OR X AXIS

1.3.1 TIME BASE

* Time coefficient	0,5 s...50 ns	1, 2, 5 sequence (magn. off)
Error limit	± 3 %	Measured at -4... +4 div. from screen centre.

CHARACTERISTICS	SPECIFICATION	ADDITIONAL INFORMATION
* Horizontal position range	Start of sweep and 10th div. must be shifted over screen centre	
* Variable control ratio	1 : >2,5	
* Time Base magnifier	Expansion x10	Not valid in X-deflection.
Error limit	$\pm 4 \%$	Measured at +4...-4 div. from screen centre. Excluding first 50 ns and last 50 ns.
* Horizontal magnifier balance x10 --> x1	< 2,5 sd	Shift start of sweep in x10 in mid-screen position, then switch to x1.
* Hold-Off. Minimum to maximum hold-off time ratio	1 : > 10	Minimum hold off time is related to time base setting.
1.3.2 X-DEFLECTION		
* Deflection coefficients Via channel A or B Via EXT input	2 mV...10 V/div 100 mV/div	1, 2, 5 sequence.
* Error limit Via channel A or B Via EXT input	$\pm 5\%$ $\pm 5\%$	
* Bandwidth	DC... > 2 MHz	DC coupled
* Phase shift between X and Y-deflection	< 3° at 100 kHz	DC coupled
* Dynamic range	> 24 div. DC...100 kHz	DC coupled

CHARACTERISTICS	SPECIFICATION	ADDITIONAL INFORMATION
1.3.3 EXT INPUT		
* Input impedance Paralleled by	1 M Ω \pm 2% 20 pF \pm 2 pF	Measured below 1 MHz Measured below 1 MHz
 * Max. input voltage Max. test voltage (rms)	400V (d.c. + a.c. peak) 500 V	Max. duration 60 s.
* Lower -3 dB point	< 10 Hz	AC coupled
1.4 TRIGGERING		
* Trig. mode AUTO (auto free run)	Bright line in absence of trigger signal	Auto free run starts 100 ms (typ.) after no trigger pulse.
TRIGGERed		Switches automatically to free run if one of the display channels is grounded.
SINGLE		In multi-channel mode (alternated) each channel is armed after reset; if sweep has already started, sweep is not finished. Not applicable in peak-to-peak coupling
* Trigger source A, B, Composite (A/B), EXT, Line		Line trigger source always triggers on mains frequency. Line trigger amplitude depends on line input voltage. Approx. 6 div. at 220 VAC/50 Hz input voltage.
* Trigger coupling Peak-to-peak (p-p), DC, TVL, TVF		

CHARACTERISTICS	SPECIFICATION	ADDITIONAL INFORMATION
* Level range Peak-to-peak: DC internal DC EXTERNAL TVL/TVF	Related to peak-to-peak value > (+ or - 8 div.) > (+ or - 800 mV) Fixed level	p-p coupling is DC rejected
* Trigger slope	+/-	Slope sign in LCD. For TVL/TVF use + or - to choose positive or negative video
* Trigger sensitivity INTERNAL		
0...10 MHz	> 1,0 div.	Trig. coupling DC.
At 50 MHz	> 1,0 div.	Trig. coupling DC
At 100 MHz	> 3,0 div.	Trig. coupling DC
EXTERNAL		
0...10 MHz	> 100 mV	Trig. coupling DC.
At 50 MHz	> 150 mV	Trig. coupling DC
At 100 MHz	> 500 mV	Trig. coupling DC
TVL/TVF INTERNAL	> 0,7 div.	Sync. pulse
TVL/TVF EXTERNAL	> 70 mV	Sync. pulse

1.5 SIGNAL ACQUISITION

* Sampling type at 10 μ s/div...50s/div.	Real time	
* Maximum sample rate: single channel dual channel	20 Megasamples/s 20 Megasamples/s	Sample rate depends on time/div setting
* Vertical (= voltage) Resolution	8 bits	(= 0,4% of full range of 10 div.)

CHARACTERISTICS	SPECIFICATION	ADDITIONAL INFORMATION
* Horizontal (= time) Resolution: in single channel acquisition In $20\mu\text{s} \dots 50\text{s}/\text{div}$	8192 samp./acquisition	1 Sample = 0,012% of full record.
In $10\mu\text{s}/\text{div}$ in dual channel acquisition In $10\mu\text{s} \dots 50\text{s}/\text{div}$	4096 samp./acquisition	1 Sample = 0,024% of full record.
* Record length	20,4 x time/div	Display in unmagnified position.
* Acquisition time real time $10\mu\text{s}/\text{div} \dots 50\text{s}/\text{div}$	20,4 x time/div + 0...20ms	excluding delay time
* Sources	Channel A, Channel B	Channel B can be inverted before acquisition.
* Acquisition modes	1 Channel only 2 Channels	Full memory available for 1 channel. Simultaneously sampled; 2 channels share memory.

CHARACTERISTICS	SPECIFICATION	ADDITIONAL INFORMATION
1.6 CHANNELS A AND B		
* Frequency response:		
Lower transition point of BW		
Input coupling in DC position	d.c.	
Input coupling in AC position	≤ 10 Hz	
Upper transition point of BW		
In memory on mode (Ambient 15...35°C)	≥ 10 MHz (-3 dB)	Deviation max. 3 MHz for ambient 0...50°C.
In memory off mode (Ambient 15...35°C)	≥ 60 MHz (-3 dB)	Deviation max. 5 MHz for ambient 0...50°C.
* Max. base line instability:		
Jump (Ambient: 15...35°C):		Add 25% for ambient 0...50°C.
when switching to memory mode:	0,3 div	
when actuating INVertor switch:	0,3 div	
between any time/div positions:	0,5 div	
Drift:	0,1 div/h	Measured in 20 mV/div position
Temperature coefficient:	$\pm 0,05$ div/K	Measured in 20 mV/div position
1.7 TIME BASE		
* Modes		
	Recurrent, Single shot, Multiple shot	Up to 2 shots in multiple shot mode

CHARACTERISTICS	SPECIFICATION	ADDITIONAL INFORMATION
* Time coefficients: in recurrent in single shot & multiple shot error limit (Ambient: 15...35°C) in real time mode	10 μ s/div...50s/div 10 μ s/div...50s/div $\pm 1\%$	
up to memory	$\pm 0,1\%$	Add 0,5 % for ambient 0...50°C

1.8 TRIGGER

* Trigger delay: range accuracy	-20...0 div $\pm 0,3$ div	Selectable in divisions.
* Trigger level view inaccuracy	$\leq 0,5$ div	Indication in LCD

1.9 MEMORY

* Memory size: registers	2	
register depth: acquisition	8K words	
register	8K words	
wordlength	8 bits	
* Functions	Clear Load Lock	Contents of acquisition are saved in register Memory system is locked. If lock is not active, the signal is written into the acquisition memory.

CHARACTERISTICS	SPECIFICATION	ADDITIONAL INFORMATION
1.10 DISPLAY		
* Sources	Channel A, Channel B, Register A, Register B	In any combination
* Display expansion horizontal	0,5x, 1x, 2x, 4x, 8x, 16x, 32x	
* Number of displayed samples:		
single trace	4K/channel	
two traces	2K/channel	
three traces	1K/channel	
four traces	1K/channel	

1.11 CALCULATION FACILITIES

* Functions	Ratio, Phase, dV, dt, 1/dt
-------------	----------------------------

1.12 AUTO SETTING

* Settling time	3s (typ.)	Auto set is done in analog mode.
-----------------	-----------	----------------------------------

1.13 CURSORS

* Horizontal resolution:		
in single channel mode	1 : 1000	Over 10 div
in dual channel mode	1 : 1000	
* Vertical resolution	1 : 200	8 div
* Read out resolution	3 Digits	

CHARACTERISTICS	SPECIFICATION	ADDITIONAL INFORMATION
* Voltage cursors: error limit ambient 15...35°C	± 3 %	Referred to input at BNC, error of probes etc. excluded. Add 3% for ambient 0...40°C.
cursor range	Full screen	Cursors can not pass each other. X-position is neglected.
* Time cursors error limit	± 0,1%	

1.14 POWER SUPPLY



* Line input voltage

a.c. (r.m.s.):

Nominal	100...240 V
Limits of operation	90...250 V

* Line frequency:

Nominal	50...400 Hz
Limits of operation	43...445 Hz

* Safety requirements
within specification of:

IEC 348 CLASS I

UL 1244

VDE 0411

CSA 556 B

* Power consumption
(a.c. source)

55 W nominal

At nominal source
voltage

CHARACTERISTICS	SPECIFICATION	ADDITIONAL INFORMATION
1.15 SUNDRIES		
* Z-MODulation ViH ViL	2,0 V <0,8 V	TTL-compatible Blanks display. Max. intensity. Analog control between ViH and ViL is possible.
* CAL output		To calibrate drop or tilt of probes. The output may be short-circuited to ground.
Output voltage	1,2 V \pm 1%	Rectangular output voltage.
Frequency	2 kHz \pm 20%	
* Data and settings retention:		When instrument is switched off or during mains failure. The oscilloscope settings and traces are saved before instrument goes down.
memory back-up voltage	2...3,5 V	
memory back-up current drain	Typical 100 μ A	At 25°C
recommended batteries		According to IEC285 (= Alkaline Manganese Penlight Battery)
type	LR 6	e.g. PHILIPS LR 6.
quantity	2 pcs	Delivered with the instrument.
temperature rise of batteries	20K	After warming up period of instrument.
retention time	typical 3 years	At 25°C, with recommended (fresh) batteries.

CHARACTERISTICS	SPECIFICATION	ADDITIONAL INFORMATION
* Temperature range	0... +70°C	At -40...0°C settings retention is uncertain. It is advised to remove batteries from the instrument when it is stored during longer (24h) period below -30°C or above 60°C. WARNING: UNDER NO CIRCUMSTANCES BATTERIES SHOULD BE LEFT IN INSTRUMENT AT TEMPERATURES BEYOND THE RATED RANGE OF THE BATTERY SPECIFICATIONS!

1.16 ENVIRONMENTAL CHARACTERISTICS

The environmental data mentioned in this manual are based on the results of the manufacturer's checking procedures. Details on these procedures and failure criteria are supplied on request by the PHILIPS/FLUKE organisation in your country, or by PHILIPS, INDUSTRIAL AND ELECTRO-ACOUSTIC SYSTEMS DIVISION, EINDHOVEN, THE NETHERLANDS.

* Meets environmental requirements of:	MIL-T-28800 C, type III, CLASS 5 Style D	Class 5, except for operating temperature 0...40°C. Style D, except for front cover.
--	--	--

CHARACTERISTICS	SPECIFICATION	ADDITIONAL INFORMATION
* Temperature:		Memory back-up batteries removed from instrument, unless batteries meet temperature specifications (see also 1.15).
operating:		
min. low temperature	0°C	Cf. MIL-T-28800 C parr. 3.9.2.3. tested cf. par. 4.5.5.1.1.
max. high temperature	+ 50°C	Cf. MIL-T-28800 C parr. 3.9.2.4. tested cf. par. 4.5.5.1.1.
non-operating (storage):		
min. low temperature	-40°C	Cf. MIL-T-28800 C parr. 3.9.2.3. tested cf. par. 4.5.5.1.1.
max. high temperature	+ 75°C	Cf. MIL-T-28800 C parr. 3.9.2.4. tested cf. par. 4.5.5.1.1.
* Max. humidity operating/non-operating	95% RH	+ 10...30°C
* Max. altitude:		MIL-T-28800 C par. 3.9.3. tested, par. 4.5.5.2.
operating	4,5 km (15000 feet)	Maximum. Operating temperature derated 3 °C for each km or for each 3000 feet, above sea level.
non-operating (storage)	12 km (40 000 feet)	

CHARACTERISTICS	SPECIFICATION	ADDITIONAL INFORMATION
* Vibration (operating)		MIL-T-28800 C par. 3.9.4.1. tested, par. 4.5.5.3.1.
Freq. 5...15 Hz Sweep time	7 min.	
Excursion (p-p)	1,5 mm	
Max acceleration	7m/s^2 (0,7 x g)	At 15Hz
Freq. 15...25 Hz Sweep time	3 min.	
Excursion (p-p)	1 mm	
Max acceleration	13m/s^2 (1,3 x g)	At 25Hz
Freq. 25...55 Hz Sweep time	5 min.	
Excursion (p-p)	0,5 mm	
Max acceleration	30m/s^2 (3 x g)	At 55Hz
Resonance dwell	10 min.	At each resonance freq. (or at 33Hz if no resonance was found). Excursion, 9.7.1. to 9.7.2.
* Shock (operating)		MIL-T-28800 C par. 3.9.5.1. tested, par. 4.5.5.4.1.
Amount of shocks total each axis	18 6	3 in each direction
Shock Wave-form	Half sine-wave	
Duration	11 ms	
Peak acceleration	300m/s^2 (30 x g)	
* Bench handling		MIL-T-28800 C par. 3.9.5.3. tested, cf. par. 4.5.5.4.3.
Meets requirements of	MIL-STD-810 method 516, proced. V	
* Salt atmosphere		MIL-T-28800 C par. 3.9.8.1. tested, par. 4.5.6.2.1.
Structural parts meet requirements of	MIL-STD-810 method 509, proced. I salt solution 20%	

CHARACTERISTICS	SPECIFICATION	ADDITIONAL INFORMATION
* EMI (Electro Magnetic Interference) meets requirements of	MIL-STD-461 CLASS B VDE 0871 and VDE 0875 Grenzwertklasse B	Applicable requirements of part 7: CE03, CS01, CS02, CS06, RE02, RS03

1.17 SAFETY

* Meets requirements of	IEC 348 CLASS I VDE 0411	except for power cord, unless shipped with Universal European power plug.
	UL 1244, CSA 556B	Except for power cord, unless shipped with North American power plug

CHARACTERISTICS	SPECIFICATION	ADDITIONAL INFORMATION
1.18 OPTIONAL VERSIONS		
* General		These options can be factory installed only
* Power cord	Universal European	Length 2,1 m (82,7 in) VDE, KEMA listed (option .01)
	North American	CSA, UL listed (option .03)
	United Kingdom	BSI listed (option .04)
	Australian	SAA listed (option .08)
	Swiss	SAV listed (option .05)
* Cabinet	Rack mount	PM3337. PM3337/40 with IEEE + RS-232C interface installed.
* Interfaces	IEEE-488/IEC-625 including RS-232C	Option 40. Dump to plotters: PM 8153/1, PM 8153/6, PM 8154, PM 8155, HP 7475A and HP 7550. Dump to printers: FX80 and HP 2225 Thinkjet.
	RS-232C dump only	Option 50 Dump to plotters: PM 8153/1, PM 8153/6, PM 8154, PM 8155, HP 7475A and HP 7550. Dump to printers: FX80 and HP 2225 Thinkjet.

2 PRINCIPLE OF OPERATION

This section describes the principle of operation and should be read in conjunction with the block diagram (see Figure 2.1).

The instrument can be used as an analog real time oscilloscope and as a digital storage oscilloscope. This selection can be made by means of the front panel key DIGITAL MEMORY , that selects an analog or a digital signal path. At the same time, selection is made between an analog time-base circuit and a digital time base circuit.

The oscilloscope circuit consists of six functional main sections:

- Control section (see Section 2.1.)
- Vertical deflection (see Section 2.2.)
- Horizontal deflection (see Section 2.3.)
- CRT display section (see Section 2.4.)
- Interface section (see Section 2.5.)
- Power supply section (see Section 2.6.)

2.1. CONTROL SECTION

The knobs in the key-matrix on the front panel are read by the microprocessor that drives the various circuits via the software control lines. The microprocessor drives also the LCD (Liquid Crystal Display) that displays the instrument's settings.

AUTO SET enables vertical and horizontal functions to be set depending on the value of the input signal.

The rotary controls and the switch LINE ON are directly connected to their control circuits. The microprocessor reads if the three rotary knobs VAR are in their CAL position or not.

2.2 VERTICAL DEFLECTION

As the vertical channels A and B are identical, only one channel is described. The input signals of channels A and B are fed via the ATTENUATORS to the DIGITAL MODE SWITCH.

The next ATTENUATOR functions are controlled by the front panel keys via the microprocessor.

GND	Disconnects the input and grounds the attenuator
AC/DC	Input signal coupling
V-mV	Vertical deflection coefficient
VAR	Continuously-variable attenuation control
	UNCAL indicated in LCD

The DIGITAL MODE SWITCH has the following functions:

DIGITAL MEMORY	Selection for real time mode or digital memory mode.
INV (ch. B only)	Input signal and polarity inversion in digital memory mode.

Vertical shifting of the displayed signal is achieved by the Y POS rotary knob.

Real-time mode:

In real-time mode the signal is fed directly to the ANALOG VERTICAL CHANNEL SELECTION.

The ANALOG VERTICAL CHANNEL SELECTION selects the input signals A or B, depending on which function is activated via the front panel keys.

The following vertical display modes can be selected:

A	channel A only
B	channel B only
A and B	channels A and B displayed simultaneously. ALT or CHOP mode is selected by its key.
ADD/	channel A added to channel B is displayed.
INV (ch. B only)	input signal inversion in real time mode.

Digital memory mode:

In digital memory mode, the signal of channel A and/or B is applied to the analog-to-digital converter with belonging control logic (ADC + LOGIC). This block takes samples of the analog signal and converts them into digital information. The digitised signal is placed into the ACQUISITION MEMORY + belonging CONTROL LOGIC. The timing of the conversion process is determined by the DIGITAL TIME BASE GENERATOR. The TRIGgger DELay function is made via the control LOGIC belonging to the ACQUISITION MEMORY.

The digitised signal(s) are placed in a MEMORY + belonging LOGIC. This memory consists of the DISPLAY MEMORY (is loaded with the signal that is normally displayed on the CRT) and an additional REGISTER MEMORY. This memory can be used as a background memory and its contents can also be displayed on the CRT via the front panel key REGISTER DISPlay.

The digital output information of the DISPLAY MEMORY/REGISTER MEMORY is converted again into analog in VERTICAL and HORIZONTAL DIGITAL-TO-ANALOG CONVERTERS (Y-DAC and X-DAC).

The output of the Y-DAC is applied to the DIGITAL VERTICAL CHANNEL SELECTION.

The DIGITAL MEMORY key enables the digital memory to be displayed on the screen.

LEVEL VIEW permits displaying of the trigger level. This trigger level can be adjusted by means of the LEVEL rotary knob.

IN analog mode the DELAY LINE permits the viewing of leading edges of fast input signals; the signal delay in the delay line compensates for delay in the trigger circuits.

The selected signal derived from the analog path or digital path is fed, via the DELAY LINE and the FINAL VERTICAL AMPLIFIER to the vertical deflection plates (Y) of the CRT.

2.3 HORIZONTAL DEFLECTION

The analog time-base is triggered on the signal selected in the TRIGGER SELECTOR stage.

Trigger selection can be made by the TRIG SOURCE or X key for:

A	signal derived from channel A
B	signal derived from channel B
COMP	composite triggering of both channels A and B
EXT	external input via BNC socket
LINE	signal derived from mains (line) voltage

Positive or negative triggering is selected by the SLOPE key.

After selection of the source, selection of the TB trigger mode or coupling can be made in the TRIGGER AMPLIFIER. The TB TRIG MODE key allows selection of:

AUTO	Automatic free-run in the absence of trigger signals
TRIG	Normal triggering
MULTIPLE	TB sweep runs twice for REGISTER and DISPLAY MEMORY
SINGLE	TB sweep started once

The TRIG COUPL softkey allows selection of:

P-P	Peak-to-peak triggering
DC	Normal triggering
TVF	Triggering on TV FIELD synchronisation pulses
TVL	Triggering on TV LINE synchronisation pulses

The level at which the TB starts is determined by adjustment of the LEVEL rotary knob. This trigger level is displayed by operating the LEVEL VIEW key.

The ANALOG TIME-BASE GENERATOR determines the horizontal deflection coefficient in the real time mode via the TB $s-\mu s$ UP-DOWN control and the VAR rotary knob.

The LCD displays the correct deflection simultaneously.

The DIGITAL TIME-BASE GENERATOR is under control of the MICROPROCESSOR CONTROL SYSTEM.

The DIGITAL TIME-BASE GENERATOR determines the horizontal deflection coefficient in the digital memory mode via the $s-\mu s$ UP-DOWN control. The output of this block controls the ACQUISITION logic.

The X-DAC receives its digital information from the DISPLAY MEMORY and converts it into the analog horizontal deflection signal. The output of the X-DAC is applied to the HORIZONTAL DEFLECTION.

The HORIZONTAL SELECTION stage selects the horizontal deflection source by the DIGITAL MEMORY key or the X DEFL key.

The following deflection sources are possible:

ANALOG TIME BASE

DIGITAL TIME BASE

X DEFLECTION

The X MAGN key enables the analog horizontal deflection coefficient to be magnified by a factor of 10.

Horizontal shift of the trace is achieved by the X POS rotary knob. The FINAL HORIZONTAL AMPLIFIER drives the horizontal deflection plates (X) of the CRT.

2.4 CRT DISPLAY

The trace intensity on the CRT is controlled by the Z AMPLIFIER. The Z AMPLIFIER blanks the flyback on the trace and also the switching intervals between the traces. For the vertical switching modes in real-time mode, ALT and CHOP, the Z AMPLIFIER is driven by a Z-blanking signal from the ANALOG VERTICAL CHANNEL SELECTION (CHOP) or the HORIZONTAL SELECTION (ALT). In the digital mode the blanking pulse is derived from the DISPLAY Logic. External trace blanking is obtained via an applied signal to the Z MOD BNC-input.

The FOCUS rotary knob drives the focus electrodes of the CRT via the FOCUS control unit, to give adjustable trace sharpness.

Trace alignment is achieved by the TRACE ROTation screw-driver operated control, which drives the trace rotation coil.

The ILLUM rotary control provides illumination of the graticule by means of two lamps.

2.5 INTERFACE SECTION

The oscilloscope can be equipped with one out of two types of optional interfaces:

The most extensive one of these two (PM8959, oscilloscope version /40) is a unit that incorporates two interfaces: an IEEE-488 interface and an RS-232C interface. Both they can be used to control the oscilloscope together with other compatible equipment by a controller. The interfaces can also be used to make a hard copy of the information on the scope's CRT via a digital plotter or printer. For this, the plotter/printer must be equipped with an IEEE-488 or RS-232C interface. The plot or print action is initiated by pressing the front panel PLOT key.

The other interface (PM8961, oscilloscope version /50) comprises an RS-232C interface. This unit is suitable to make a hard copy of the information on the CRT via a plotter/printer.

2.6 POWER SUPPLY SECTION

The oscilloscope may be powered by any a.c. voltage between 100 V and 240 V.

When switched off, the LINE ON switch interrupts the primary circuit. This switch is the only front-panel pushbutton that is not read by the microprocessor.

After rectification, the relevant d.c. supply voltages feed the various circuits in the instrument.

When the instrument is operating from an a.c. mains voltage, a related signal at mains frequency is fed to the TB TRIGGER SELECTION for LINE triggering.

The EHT CONVERTER produces 14,5 kV via the HT MULTIPLIER for the accelerator anode of the CRT and -2,1 kV for the FOCUS CONTROL.

The calibration square-wave signal is generated in the CALIBRATION GENERATOR and fed to the CAL socket.

3 BRIEF CHECKING PROCEDURE

3.1 GENERAL INFORMATION

This procedure is intended to check the oscilloscope performance with a minimum of test steps and actions required.

It is assumed that the operator doing this test is familiar with oscilloscopes and their characteristics.

WARNING: Before switching-on, ensure that the oscilloscope has been installed in accordance with the instructions mentioned in Chapter 2 of the Operating guide.

NOTE: The procedure does not check every facet of the instrument's calibration; rather, it is concerned primarily with those parts of the instrument that are essential to correct operation.

It is not necessary to remove the instrument covers to perform this procedure. All checks are made from the outside of the instrument. The measuring results that should be obtained during this test are those for an average oscilloscope. An extensive check of every facet of the instrument's calibration together with allowable tolerances can be found in the chapter "Performance Check" in the Service Manual.

The brief checking procedure is set up in such a way that all important front-panel-selectable functions are checked. For these checks no additional equipment is necessary; the instrument's internal CALibration generator voltage is used. This voltage is applied to input A and B via the 10:1 attenuator probes that are delivered with the oscilloscope. Also a small adjustment scrow-driver is necessary for some simple initial alignments.

If this test is started a few minutes after switching-on, bear in mind that test steps may be out of specification, due to insufficient warming-up time. Therefore, to ensure accuracy, allow the full indicated warming-up time. The following abbreviations are used:

CW = Clockwise

CCW = Counter clockwise

3.2 STARTING THE BRIEF CHECKING PROCEDURE.

Initial adjustment of rotary knobs:

- Put the 3 rotary knobs VAR in their CAL position.
- Put the following rotary knobs in their mid position: Y POS (2x), X POS, TRIG LEVEL, INTENS and FOCUS.
- Put the HOLD OFF rotary knob in its MIN position.
- Switch the oscilloscope on with the POWER LINE ON pushbutton.
- Press the green key AUTO SET.
- Check that a horizontal line is displayed on the Cathode Ray Tube (CRT).
- Adjust rotary knob ILLUMINATION so that the measuring raster of the CRT is lighted according to your personal taste.
- Adjust the rotary knobs INTENSITY and FOCUS so that the line on the CRT looks sharp and well-defined.

Trace alignment:

Check that the line on the CRT is exactly in parallel with the horizontal lines of the measuring raster; if not this can be corrected with a small screw-driver on rotary control TRACE ROTATION.

Probe adjustment:

- Connect the probes to the channel A and B inputs.
- Connect the probe tips both to the CALIBRATION output voltage.
- Press the AUTO SET key.
- Check that 2 square-waves are displayed on the CRT.
- Shift the square-waves out of each other to top half and bottom half of the CRT respectively; to achieve this turn Y POS A slightly CW and Y POS B slightly CCW.
- Check that top and bottom of both square-waves are straight and in line with the horizontal raster lines.
- If not this must be corrected by adjustment of the probes; this can be done with a small screw-driver operated adjustment in the box at the oscilloscope side of the probe.

Finally:

- The rotary knobs Y POS A, Y POS B and X POS need readjustment during this brief checking procedure in order to align the waveform with the measuring raster.
- Also small readjustments of the INTENSITY and FOCUS rotary knobs may be necessary.
- Information about active instrument settings is indicated in the Liquid Crystal Display (LCD) and in DIGITAL MEMORY mode also on the CRT.

3.3 VERTICAL SECTION, DIGITAL MEMORY OFF.

- If LCD shows "DIGITAL MEMORY" press key DIGITAL MEMORY once to switch it off.
- Press the green AUTO SET key.
- Check that 2 square-waves are displayed and that their amplitude is 2,4 div if the vertical sensitivity of channel A and B is 0,5 V/div. If the time base is in 0,1 ms/div the display is equal to figure 3.1.
- Turn the rotary knobs Y POS A and Y POS B between their utmost CW and CCW positions and check that the waveforms can be vertically shifted out of the screen.
- Adjust the rotary knobs Y POS A and Y POS B so that the situation of figure 3.1 is obtained again.
- Press key ADD INVERT once; check that the B display is inverted compared with A. Refer to figure 3.2 for this.
- Press key ADD INVERT again.
- Press key A/B twice and check that one square-wave with an amplitude of 4,8 div. is displayed (channel A and B are added).

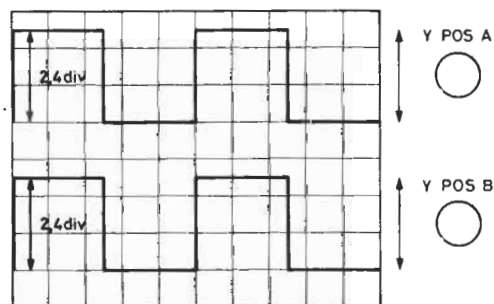

Figure 3.1

MAT3429

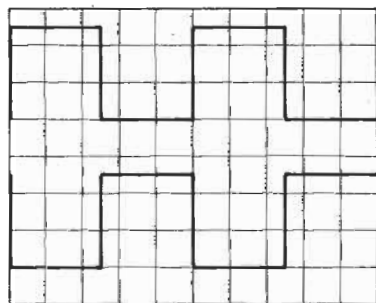

Figure 3.2

MAT3430

- Press the AUTO SET key.
- Select 1 V/div with the V/mV key of channel A and B.
- Check for an amplitude of 1,2 div.
- Select 0,2 V/div with the V/mV key of channel A and B.
- Check for an amplitude of 6 div.
- Turn the VAR A and VAR B rotary knobs CCW and check that the amplitudes decrease into 2,4 div (the LCD should indicate flashing > signs for channel A and B).
- Put the VAR A and VAR B rotary knobs back to CAL.

- Press the AUTO SET key.
- Press the the AC/DC key of channel A and B; DC input coupling is selected. This is indicated for channel A and B in the LCD.
- Press the GND key of channel A and B; the channel inputs are grounded. This is indicated in the LCD by the -- sign.
- Check for 2 horizontal lines on the CRT.
- Shift one line in the vertical mid of the raster with Y POS A; shift the other line on the bottom of the raster with Y POS B.
- Press the GND key of channel A and B and check that the bottom levels of the 2 square-waves are at the mid and bottom raster lines.
- Press the green key AUTO SET and check that the waveforms are shifted downwards over a distance equal to half the signal amplitude.

3.4 HORIZONTAL SECTION, DIGITAL MEMORY OFF.

- Remove the probe from channel B.
- Press the AUTO SET key.
- Select 0,2 V/div with the V/mV key; a square-wave of 6 div is displayed.
- Press the X DEFL/LEVEL VIEW key once.
- Check that 2 points are displayed that have 6 div vertical and horizontal distance. Refer to figure 3.3 for this.

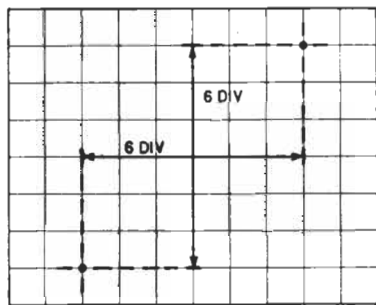

MAT3431

Figure 3.3

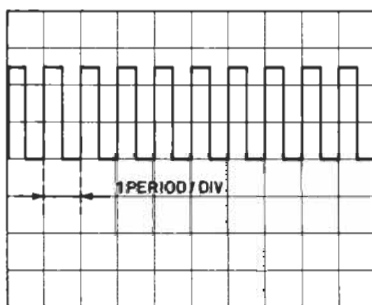

MAT3432

Figure 3.4

- Press the AUTO SET key.
- Select 0,5 ms/div for the time base with the s/us key.
- Check that 1 signal period is displayed per horizontal division. Refer to fig 3.4 for this.

- Press the X-MAGN key and check that at least 10 signal periods can be shifted inside the measuring raster with the X POS rotary knob.
- Check also that 1 signal period is displayed per 10 div. Refer to figure 3.5 for this.
- Press the AUTO SET key.
- Select 50 us/div for the time base with the s/us key.
- Check that 1 signal period is displayed per 10 div.
- Turn the rotary knob VAR of the time base CCW and check that one signal period is displayed over ≤ 4 div (the LCD should indicate a flashing > sign).
- Put the rotary knob VAR back in the CAL position.

- Press the AUTO SET key.
- Press the TRIG COUPL key once so that DC trigger coupling is obtained (this is indicated in the LCD).
- Check if the waveform can become triggered and not triggered (indicated in LCD) depending on the position of the rotary knob TRIG LEVEL; not triggered gives an unstable waveform on the screen and NOT TRIG'D is indicated in the LCD.

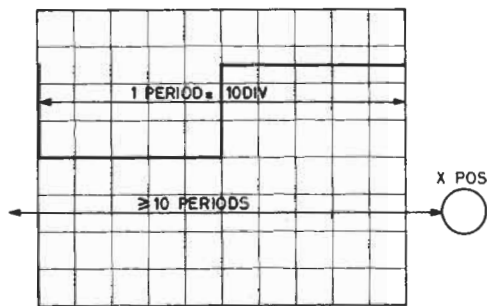

MAT3433

Figure 3.5

3.5 VERTICAL SECTION, DIGITAL MEMORY ON.

- If LCD does not show "DIGITAL MEMORY" press key DIGITAL MEMORY once to switch the digital memory mode on.
- Connect the probes to the channel A and B inputs.
- Press the AUTO SET key.
- Check that 2 square-waves are displayed and that their amplitude is 2,4 div if the vertical sensitivity of channel A and B is 0,5 V/div. If the time base is in 0,1 ms/div the display is equal to fig. 3.6.
- Turn the rotary knobs Y POS A and Y POS B between their utmost CW and CCW positions and check that the waveforms can be vertically shifted out of the screen.
- Adjust the rotary knobs Y POS A and Y POS B so that the situation of fig. 3.6 is obtained again.

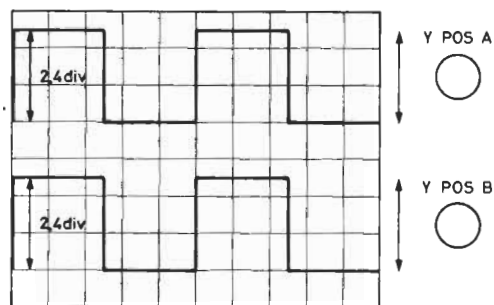

MAT3429

Figure 3.6

- Select 0,2 V/div with the V/mV key of channel A and B.
- Check for an amplitude of 6 div.
- Turn the VAR A and VAR B rotary knobs CCW and check that the amplitudes decrease into 2,4 div (the LCD should indicate a flashing > sign).
- Put the VAR A and VAR B rotary knobs back to CAL.
- Select 1 V/div with the V/mV key of channel A and B.
- Check for an amplitude of 1,2 div.
- Position both traces in the top half of the CRT.
- Press the REGISTER LOAD key.
- Position both traces to the bottom half of the CRT.
- Select 0,2 ms/div with the time base s/us key.

- Press the REGISTER DISPLay key once.
- Check that 4 traces are displayed now; the channels A and B in the normal way via the display memory and the same channels at another time base setting via the register memory. This is shown in the figure 3.7.
- Press the LOCK key and check that the text LOCK appears in the LCD.
- Press AUTO SET and check that this last command has no effect; nothing must happen.
- Press the LOCK key again and check that the text LOCK disappears from the LCD again.

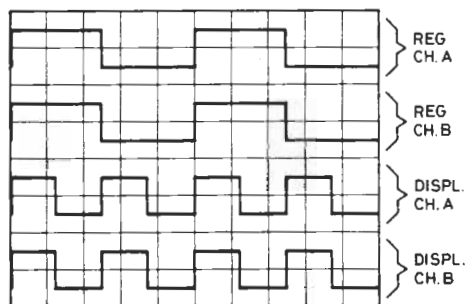

MAT3434

Figure 3.7

3.6 HORIZONTAL SECTION, DIGITAL MEMORY ON.

- Remove the probe from channel B.
- Press the AUTO SET key.
- Select 0,2 V/div with the V/mV key; a square-wave of 6 div is displayed.
- Select 0,5 ms/div for the time base with the s/us key.
- Check that 1 signal period is displayed per division.
- Select 0,1 ms/div for the time base with the s/us key.
- Check that 2 signal periods are displayed per 10 div.
- Select 50 us/div for the time base with the s/us key.
- Check that 1 signal period is displayed per 10 div.

- Select a TRIGger DELay of -6 div with the TRIG DEL key.
- Check for a display as shown in the figure 3.8.
- Select a TRIGger DELay of 0 div.

- Operate the DISPLay PART key so that the belonging bar graph in the LCD starts exactly at 1/4 of the memory width.
- Check for a display as shown in the figure 3.9.
- Operate the DISPLay PART key so that the bar graph starts exactly at 1/2 of the memory width.
- Check for a display as shown in the figure 3.10.

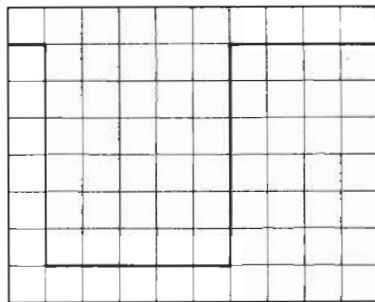

MAT 3435

Figure 3.8

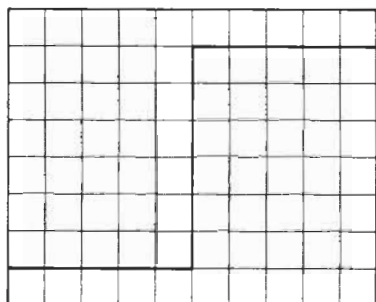

MAT 3436

Figure 3.9

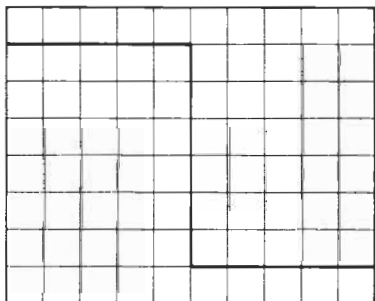

MAT 3437

Figure 3.10

3.7 CURSOR SECTION, DIGITAL MEMORY ON.

With the cursors accurate measurements of time and voltage can be done without using the measuring raster. The cursors can be controlled with the softkeys under the CRT. The cursor read out values are displayed in the top text area of the CRT.

- Press the AUTO SET key.
- Select 0,2 V/div with the V/mV key so that a square-wave of 6 div is displayed.
- Select 0,1 ms/div for the time base with the s/us key so that 2 signal periods are displayed.

The now following manipulations are done via the 5 softkeys. First the time cursors are checked now:

- Press softkey CURSORS.
- Press softkey MODE.
- Press softkey V-CURS ON/OFF so that OFF is intensified; the text ON belonging to softkey T-CURS ON/OFF should be intensified and 2 vertical time cursor lines must be visible on the CRT.
- If necessary press softkey T/PH/RATIO so often that T is intensified; the normal Time measuring mode is active now.
- Press softkey RETURN.
- Press softkey T-CTRL; this gives access to a menu with 2 softkeys to position the REFERENCE cursor and another 2 to position the Δ cursor.
- Press the REF positioning softkeys so that the REFERENCE cursor coincides with the first negative signal slope on the CRT.
- Press the Δ positioning softkeys so that the Δ cursor coincides with the second negative slope of the signal.
- Check that the cursor read out gives a time difference between the cursors of 500 us. Refer to figure 3.11 for this.

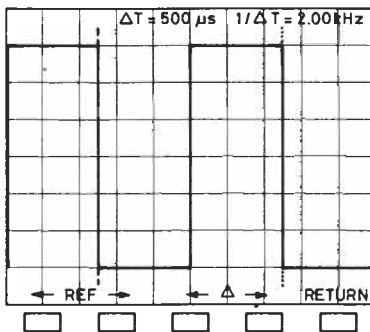

MAT3438

Figure 3.11

Check of the voltage cursors:

- Press softkey RETURN.
- Press softkey MODE.
Press softkey T-CURS ON/OFF one time so that OFF is intensified; the text ON belonging to softkey V-CURS ON/OFF should be intensified and 2 horizontal voltage cursor lines must be visible on the CRT.
- If necessary press softkey V/RATIO so that V is intensified; the normal Voltage measuring mode is active now.
Press softkey RETURN.
Press softkey V-CTRL; this gives access to a menu with 2 softkeys to position the REFERENCE cursor and another 2 to position the Δ cursor.
- Press the REF positioning softkeys so that the REFERENCE cursor coincides with the bottom level of the signal.
- Press the Δ positioning softkeys so that the Δ cursor coincides with the top level of the signal.
- Check that the cursor read out gives a voltage difference of 1,20 V. Refer to figure 3.12 for this.

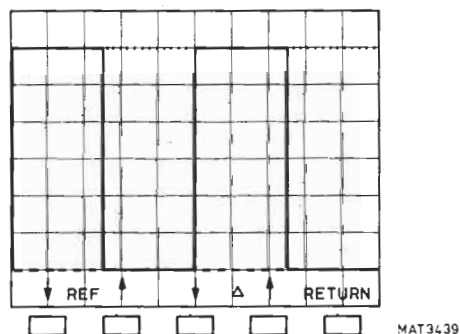

Figure 3.12

- Press softkey RETURN 2 times to leave the cursors menu.

4 PERFORMANCE TEST

4.1 GENERAL INFORMATION

WARNING: Before switching-on, ensure that the instrument has been installed in accordance with the Installation Instructions, outlined in Section 2 of the Operation Guide.

This procedure is intended to:

- Check the instrument's specification.
- Be used for incoming inspection to determine the acceptability of newly purchased instruments and/or recently recalibrated instruments.
- Check the necessity of recalibration after the specified recalibration intervals.

NOTE: The procedure does not check every facet of the instrument's calibration; rather, it is concerned primarily with those parts of the instrument which are essential to measurement accuracy and correct operation. Removing the instrument's covers is not necessary to perform this procedure. All tests are made from the outside of the instrument.

If the test is started within a short period after switching-on, bear in mind that steps may be out of specification, due to insufficient warming-up time.

Warming-up time under average conditions is 30 minutes.

The tests are made with a stable, well-focussed, low-intensity display. Unless otherwise noted, adjust the intensity and trigger-level controls as needed.

IMPORTANT NOTES

- Unless otherwise stated, set the 3 VAR controls into position CAL, the 3 POS controls and TRIG LEVEL into the centre position, HOLD OFF at MIN.
- The input voltage has to be supplied to the A-input; unless otherwise stated. Set the TB switch to a suitable position; unless otherwise stated.
- Tolerances given are for the instrument under test and do not include test equipment error. Bear in mind that the test equipment is properly terminated.

- In some tests, channel B appears in parentheses after channel A, e.g. A(B). This indicates that the channel A test should be performed first, then the test for channel B.

4.2 RECOMMENDED TEST EQUIPMENT

Type of instrument	Required specification	Example of recommended instrument
Function generator	Freq: 1 MHz ... 10 MHz Sine-wave/square-wave Ampl: 0...20 V (pp) DC offset - 5 ... +5 V Rise-time \leq 30 ns Duty cycle 50 %	Philips PM 5134
Constant amplitude sine-wave generator	Frequency: 50 kHz ... 100 MHz. Constant pp. amplitude of 120 mV and 3 V.	Tektronix SG 503
Square-wave calibration generator	For ampl. calibration: Freq: 1 kHz Ampl: 10 mV... 50 V For rise-time measurements: Freq: 1 MHz Ampl: 10 ... 500 mV Rise-time: \leq 1 ns	Tektronix PG 506
Time marker generator	Repetition rate: 0,5 s ... 5 ns	Tektronix TG 501
Digital multimeter	Wide voltage and current ranges.	Philips PM 2525 with AC, DC and resistance ranges. High-voltage probe. Required: 1 % accuracy, PM 9246
Variable voltage transformer (VARIAC)	Well insulated output voltage 90 ... 264 V (ac)	Philips order. number 2422 529 00005
Watt meter		NORMA type D 1150

TV pattern generator with video output		Philips PM 5518
Oscilloscope	The bandwidth must be the same or higher than the bandwidth of the instrument under test.	Philips PM 3055
50 Ω cables, 75 Ω cable, 50 Ω terminations, 75 Ω termination, 10:1 attenuator, T-piece, power splitter	Tektronix and Philips BNC types for fast rise-time square-wave, high freq. sine-wave and other applications	TEK 012-0482-00 TEK 012-0074-00 TEK 011-0049-01 TEK 011-0055-01 TEK 011-0059-02 PHI PM 9067 PHI PM 9584/02
Trimming tools		Philips 800NTX (ord. kit number 4822 310 50095) or Bernstein nr. 1-250

4.3 TEST PROCEDURE

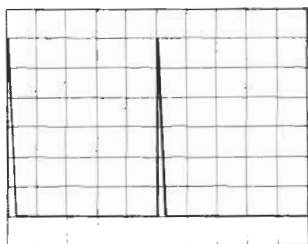

VAR IN CAL POSITION

MAT3839

Figure 4.1 SOFTSTART condition.

4.3.1 Preliminary settings

test equipment:

None

*settings/procedure
and requirements:*

- 1 - Switch-on the oscilloscope under test.
- 2 - Check that all LCD segments on the frontpanel of the oscilloscope are on for approximately 1 second.
- 3 - Press pushbutton RESET and keep it pressed, then press AUTO SET, the LCD will show an asterisk (*) and a flashing 0.0.
- 4 - Press the CRT function control APPL, the LCD will show 1.0 flashing.
- 5 - Press the CRT function control STANDARD SETTING.
- 6 - Check that the front controls of the oscilloscope are set in the softstart condition as indicated in figure 4.1.
- 7 - At the start of every test, the AUTO SET button must be pressed (after the input signal is applied).
- 8 - Press the AUTO SET button to leave the softstart condition.

4.3.2 Power supply

In this test the correct working of the power supply at all possible line voltages is tested.

test equipment:

Variable voltage transformer (VARIAC)

test set-up:

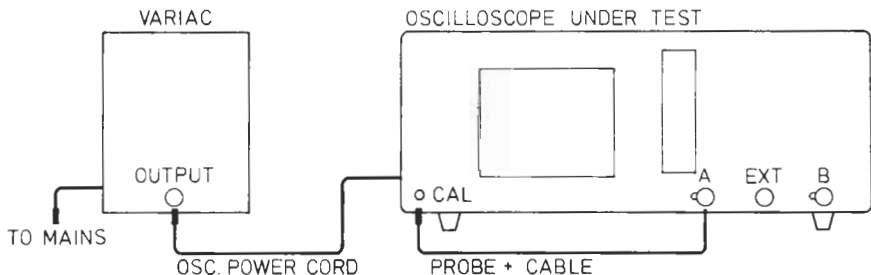

settings/procedure:

- 1 - Adjust the input line voltage to the oscilloscope (output from VARIAC) to a desired value between 100 and 240 V (r.m.s.), frequency 50...400 Hz.
- 2 - Press POWER ON button of the oscilloscope.
- 3 - Apply the CAL signal provided on the front panel of the oscilloscope to input A, e.g. by means of a probe.
- 4 - Press the AUTO SET button.

requirements:

- 1 - Oscilloscope must start at any input voltage between 100 and 240 V.
- 2 - The instrument's performance does not change over the indicated voltage range; the displayed CAL signal is distortion-free and has equal intensity.

4.3.3 Power consumption

This test checks the power consumption of the oscilloscope.

test equipment:

- Variable voltage transformer (VARIAC)
- Watt meter

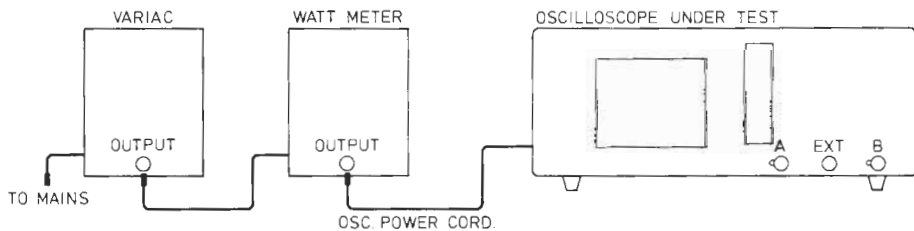
test set-up:

MAT3828
900511

settings/procedure:

- 1 - Adjust the input voltage (output from VARIAC) to the oscilloscope to the nominal line voltage.
- 2 - Press POWER ON button of the oscilloscope.

requirements:

Power consumption is maximum 55 W.

4.3.4 Auto set

This test checks the correct working of the auto set function.

test equipment:

Constant amplitude sine-wave generator (SG 503)

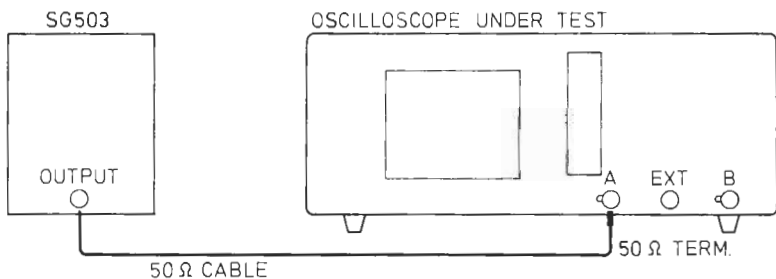
test set-up:

MAT 3830
900511

settings/procedure:

- 1 - Set channels A and B to 20 mV/div; the other settings are not relevant.
- 2 - Apply a 50 MHz sine-wave signal of 60 mV (pp) to input A; use a 50 Ω termination.
- 3 - Press the AUTO SET button.

requirements:

Check that the display is stable and well-triggered.

Repeat settings/procedure for channel B.

4.3.5 Orthogonality

In this test the angle between the horizontal and vertical deflection plates, the so called orthogonality, is checked.

test equipment:

LF sine-wave generator (function generator, PM 5134)

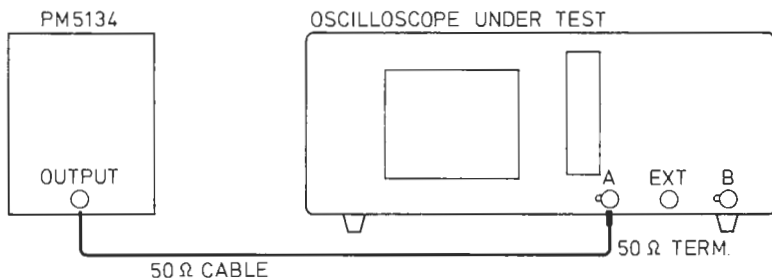
test set-up:

MAT 3834
900511

settings/procedure:

- 1 - Apply a 50 Hz sine-wave signal of 8 V (pp) to input A; use a 50 Ω termination.
- 2 - Press the AUTO SET button and adjust the input signal to a trace-height of 8 div.
- 3 - Press the GND button and check that the straight line is exactly in parallel with the horizontal graticule lines. If not, readjust the trace rotation.
- 4 - Press the GND button again and check that the signal of 8 div is displayed.
- 5 - Press X DEFL.
- 6 - Press TRIG or X SOURCE and select B as trigger source.
- 7 - Shift the line to the centre of the screen with X POS.

requirements:

- 1 - Check that the vertical line is in parallel with the vertical graticule line in the centre of the screen.
- 2 - Verify that the angle with respect to the horizontal graticule lines is $90^\circ \pm 1^\circ$ as indicated in figure 4.2.

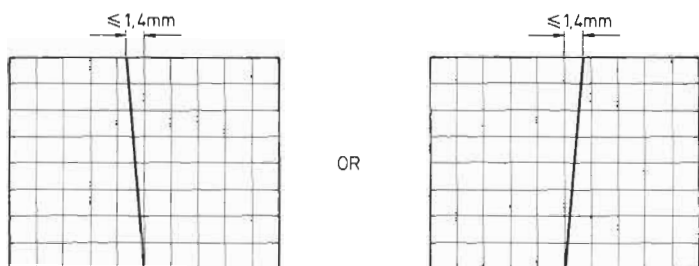

MAT3913
900503

Figure 4.2. Orthogonality

4.3.6 Vertical deflection; deflection coefficients

The vertical deflection coefficients of both channels A and B are checked by means of a calibrated signal.

test equipment:

Square-wave calibration generator (PG 506)

test set-up:

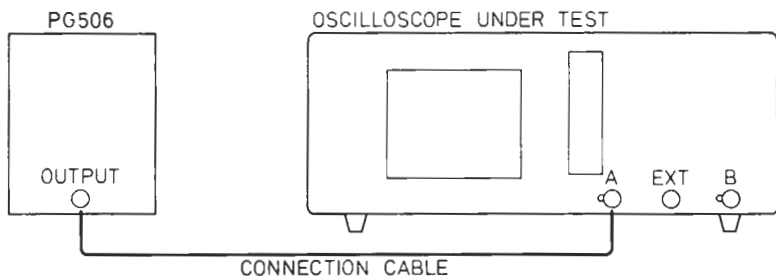

MAT3829
900511

settings/procedure:

- 1 – Apply a 1 kHz square-wave signal of 10 mV to input A.
Generator in position STD AMPL.
- 2 – Press the AUTO SET button.
- 3 – Set channel A to 2 mV/div and to DC.
- 4 – Change the input voltage and the setting of channel A according to the table below and check that the amplitude of the signal agrees with this table.

requirements:

Input voltage (pp)	A(B) setting	Requirements
10 mV	2 mV	4,85...5,15 div
20 mV	5 mV	3,88...4,12 div
50 mV	10 mV	4,85...5,15 div
0,1 V	20 mV	4,85...5,15 div
0,2 V	50 mV	3,88...4,12 div
0,5 V	0,1 V	4,85...5,15 div
1 V	0,2 V	4,85...5,15 div
2 V	0,5 V	3,88...4,12 div
5 V	1 V	4,85...5,15 div
10 V	2 V	4,85...5,15 div
20 V	5 V	3,88...4,12 div
50 V	10 V	4,85...5,15 div

Repeat settings/procedure for channel B.

4.3.7 Vertical deflection; variable gain control range (continuation of 4.3.6)

In this test the range of the vertical variable gain control is checked.

settings/procedure:

- 1 – Apply a square-wave signal of 5 V to input A and press AUTO SET.
- 2 – Set channel A to 1 V/div and to DC.
- 3 – Turn the VAR control of channel A fully counter clockwise.

requirements:

Verify that the displayed amplitude is not more than 2 div (ratio 1 : 2,5) and turn VAR back to CAL position.

Repeat settings/procedure for channel B.

4.3.8 Vertical deflection; input coupling (continuation of 4.3.7)

The function of the AC input capacitor is checked, as well as the grounding function of the coupling switch.

settings/procedure:

Turn the VAR control knob fully clockwise.

requirements:

Check for both channel A and B.

- 1 - Press the GND button and check that the signal disappears and that a straight line is displayed.
- 2 - Press the GND button again, then the AC/DC button and check that the signal shifts upwards when DC is pressed.

4.3.9 Vertical deflection; frequency response

This test is performed to verify the vertical bandwidth.

test equipment:

Constant amplitude sine-wave generator (SG 503)

test set-up:

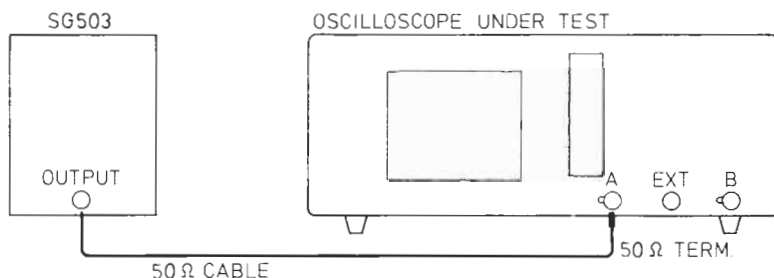

MAT 3830
900511

settings/procedure:

- 1 - Apply a 50 kHz sine-wave signal of 120 mV (pp) to input A and press the AUTO SET button; use a 50 Ω termination.
- 2 - Set channel A to 20 mV/div and VAR to CAL.
- 3 - Adjust the input signal to a trace-height of exactly 6 div.
- 4 - Increase the frequency up to 60 MHz (slowly) and verify that the vertical deflection is 4,2 div or more over the complete bandwidth range.
- 5 - Reduce the amplitude of the input signal to 12 mV and the frequency to 50 kHz.
- 6 - Set channel A to 2 mV/div and adjust the input signal to a trace-height of exactly 6 div.
- 7 - Increase the frequency up to 35 MHz (slowly) and check that the vertical deflection is 4,2 div or more over the complete bandwidth range.

requirements:

The vertical deflection must be 4,2 div or more.

Repeat settings/procedure for channel B.

4.3.10 Vertical deflection; rise-time

By means of a fast rise-time pulse the rise-time of the oscilloscope is checked.

test equipment:

Fast rise-time square-wave generator (PG 506)

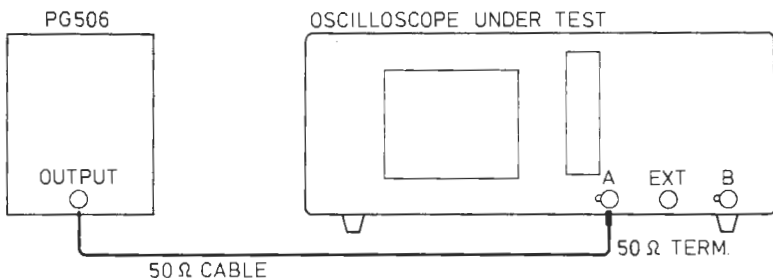
test set-up:MAT 3831
900511*settings/procedure:*

- 1 - Apply a fast rise-time pulse, repetition frequency 1 MHz, to input A; use a 50 Ω termination. Generator in position FAST RISE.
- 2 - Set A to 100 mV/div.
- 3 - Press X MAGN.
- 4 - Set TB to 5 ns/div.
- 5 - Position the rising edge of the signal to the horizontal centre of the screen, by means of the X POS control.
- 6 - Adjust the trace-height exactly between the dotted lines 0 % and 100 % (5 div).

requirements:

$$\text{Important: } tr(\text{measured}) = \sqrt{tr(\text{input signal})^2 + tr(\text{oscilloscope})^2}$$

- 1 - Check the rise-time, measured between the 10 % and 90 % lines (4 div).
- 2 - The rise-time measured must be 5,8 ns (1,16 div) or less.

Repeat settings/procedure for channel B.

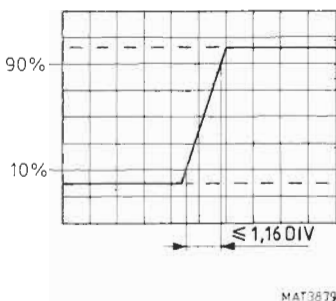

Figure 4.3 Rise-time.

4.3.11 Vertical deflection; noise

The noise, caused by the instrument's amplifiers, may not exceed a certain value. This value is checked by the following procedure.

test equipment:

None

settings/procedure:

- 1 - Press A/B: channel A and B on.
- 2 - Set channel A and B to 20 mV/div.
- 3 - Press ALT/CHOP for CHOP mode.
- 4 - Press GND of both channels, for grounded input coupling.

requirements:

Ensure that the traces are not thicker than 0,1 div (0,5 subdiv).

4.3.12 Vertical deflection; dynamic range at 10 MHz

A certain overdrive of the oscilloscope must be allowed. In practice, a signal of 24 divisions must be displayed distortion-free at low frequencies.

test equipment:

Constant amplitude sine-wave generator (SG 503)

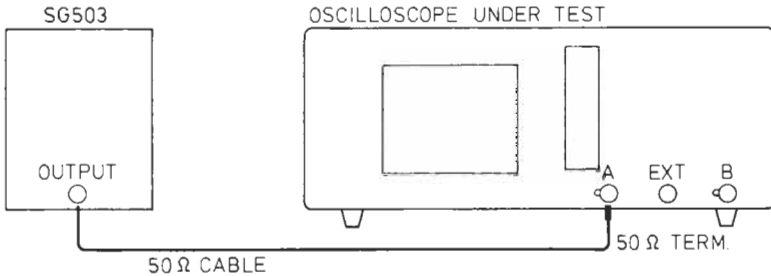
test set-up:

MAT 3830
900511

settings/procedure:

- 1 - Apply a 10 MHz sine-wave signal of 2,4 V (pp) to input A; use a 50 Ω termination.
- 2 - Press the AUTO SET button and set A to 0,1 V/div.
- 3 - Shift the sine-wave vertically over the screen by means of the Y POS control.

requirements:

Verify that top and bottom of the sine-wave signal of 24 divisions can be displayed distortion-free.

Repeat settings/procedure for channel B.

4.3.13 Vertical deflection; position range

The range of the vertical shift is checked by means of a signal of 16 divisions.

test equipment:

LF sine-wave generator (function generator, PM 5134)

test set-up:

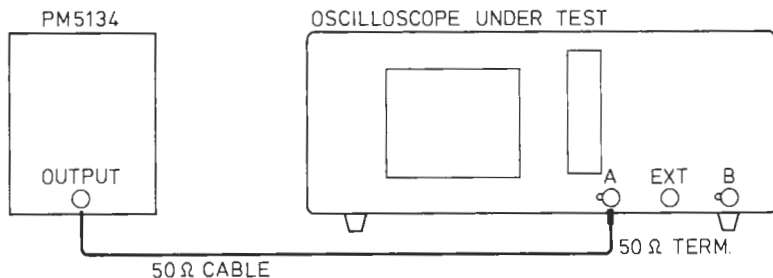

MAT 3834
900511

settings/procedure:

- 1 – Apply a 1 kHz sine-wave signal of 8 V (pp) to input A; use a 50 Ω termination.
- 2 – Press the AUTO SET button and set A to 0,5 V/div.

requirements:

Rotate the Y POS control of channel A fully clockwise and counter clockwise and check that the top and bottom of the signal can be positioned on the vertical centre of the screen.

Repeat settings/procedure for channel B.

4.3.14 Vertical deflection; cross talk between A and B at 10 MHz

Both channels A and B influence each other. A certain amount of interference is allowed, this is checked here.

test equipment:

Constant amplitude sine-wave generator (SG 503)

test set-up:

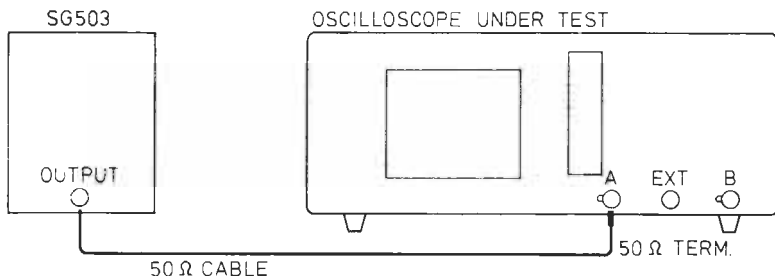

MAT 3830
900511

settings/procedure:

- 1 - Apply a 10 MHz sine-wave signal of 4 V (pp) to input A; use a 50 Ω termination.
- 2 - Press the AUTO SET button.
- 3 - Press A/B (both channels displayed).
- 4 - Set channel A and B to 0,5 V/div.
- 5 - Press A/B, to display channel B and press GND of channel B.

requirements:

Verify that the trace-height of the channel without input signal is less than 0,08 div, (better than 1 : 100).

4.3.15 Vertical deflection; cross talk between A and B at 60 MHz

At higher frequencies the interference between the two channels is more. Now, the test is carried out at a high frequency.

test equipment:

Constant amplitude sine-wave generator (SG 503)

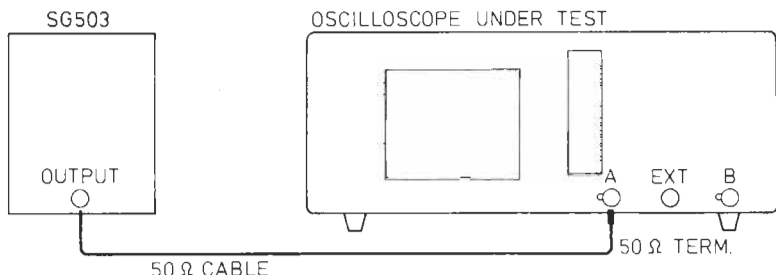
test set-up:

MAT 3830
900511

settings/procedure:

- 1 - Apply a 60 MHz sine-wave signal of 4 V (pp) to input A; use a 50 Ω termination.
- 2 - Press the AUTO SET button.
- 3 - Press A/B (both channels displayed).
- 4 - Set channel A and B to 0,5 V/div.
- 5 - Press A/B, to display channel B and press GND of channel B.

requirements:

Verify that the trace-height of the channel without input signal is less than 0,16 div, (better than 1 : 50).

Repeat settings/procedure for channel B.

4.3.16 Vertical deflection; common mode rejection ratio

The common mode rejection ratio (CMRR) indicates the susceptibility to common mode signals, this is checked in this test.

test equipment:

- HF constant amplitude sine-wave generator (SG 503)
- Power splitter

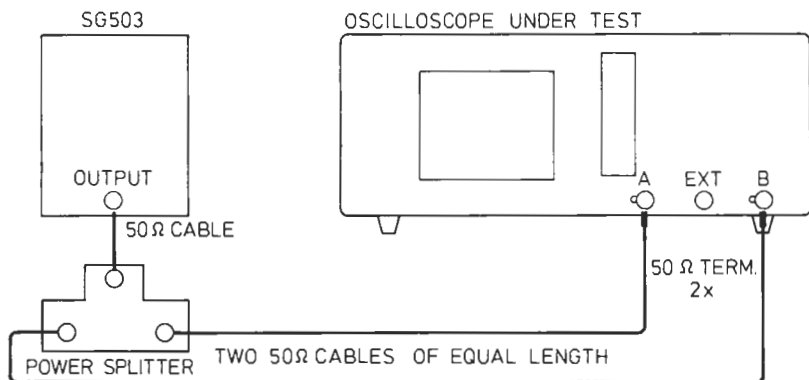
test set-up:MAT3835
900511*settings/procedure:*

- 1 - Apply a 1 MHz sine-wave signal of 4 V (pp) to inputs A and B. Use a power splitter and two cables of equal length to A and B. Use 50 Ω terminations.
- 2 - Press the AUTO SET button.
- 3 - Set A and B to 0,5 V/div and adjust the input voltage to exactly 4 div.
- 4 - Set A and B to 0,2 V/div and input coupling to DC.
- 5 - Press ADD/INVERT 3 times (ADD and INVERT on).
- 6 - Adjust the VAR controls of A and B for minimum trace-height of the straight line.
- 7 - Press A/B 2 times, only the straight line is visible now.
- 8 - Readjust one of the VAR controls for minimum trace-height.

requirements:

Check that the trace-height of the A - B signal is less than 0,1 div.

4.3.17 Vertical deflection; visual signal delay

It must be possible to observe the rising edge of a pulse. Therefore, a certain signal delay is introduced in the instrument. This delay is checked in this test.

test equipment:

Square-wave calibration generator (PG 506)

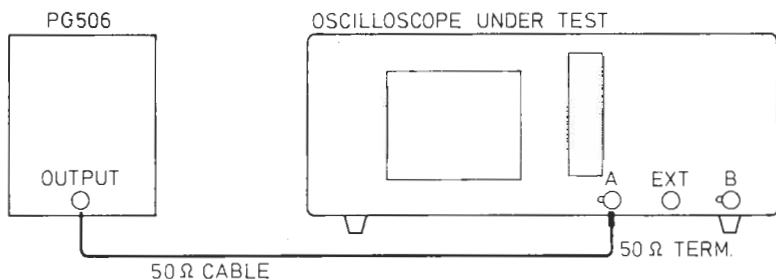
test set-up:

MAT3831
9C0511

settings/procedure:

- 1 - Apply a fast rise-time (≤ 1 ns) signal of 0,5 V, frequency 1 MHz, to input A; use a 50 Ω termination. Generator in position FAST RISE.
- 2 - Press the AUTO SET button and set A to 0,1 V/div.
- 3 - Set TB to 50 ns/div.
- 4 - Press X MAGN and turn X POS to display the rising edge.
- 5 - Turn INTENSITY fully clockwise.
- 6 - Set trigger coupling to DC.
- 7 - Adjust TRIG LEVEL for maximum visual signal delay.

requirements:

Verify that the visual signal delay is at least 15 ns (3 div).

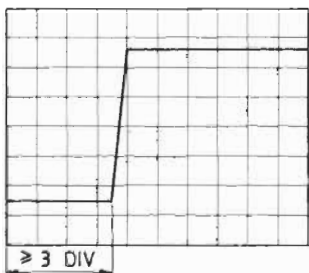

MAT3916

Figure 4.4 Visual signal delay.

4.3.18 Vertical deflection; base line jump

Several adjustments of balance, offset and jump, are checked here.

test equipment:

None

*settings/procedure
and requirements:*

This test must be done in the service menu OFFS-A.

To enter this menu proceed as follows:

Press RESET and keep it pressed, then press AUTO SET,
the LCD will show an asterisk (*).

Attenuator balance:

- 1 - Select OFFS-A of CRT function controls.
- 2 - Check LCD display: "3.0" flashing.
- 3 - The attenuator is switched between the 1-2-5 positions.
- 4 - Verify that both spots do not jump more than 0,2 div (1 subdiv).
If necessary, turn Y POS to show 2 spots.

VAR balance:

- 1 - Press mV of channel A UP-DOWN control.
- 2 - Check LCD display: "3.1" flashing.
- 3 - Rotate VAR control of channel A.
- 4 - Verify that spot A does not shift more than 0,2 div (1 subdiv).
- 5 - Reset VAR control back to CAL.
- 6 - Rotate VAR control of channel B.
- 7 - Verify that spot B does not shift more than 0,2 div (1 subdiv).
- 8 - Reset VAR control back to CAL.

x1/x10 attenuator offset:

- 1 - Press mV of channel A UP-DOWN control
- 2 - Check LCD display: "3.2" flashing.
- 3 - Verify that both spots do not jump more than 0,3 div (1,5 subdiv).

NORMAL-INVERT jump:

- 1 - Press mV of channel A UP-DOWN control 4 times.
- 2 - Check LCD display: "3.6" flashing.
- 3 - Verify that the spot does not jump more than 0,2 div (1 subdiv).
- 4 - Press AUTO SET 2 times to leave the service menu.

4.3.19 Horizontal deflection; X deflection

The correct working of the X-Y mode is tested.

test equipment:

LF sine-wave generator (function generator, PM 5134)

test set-up:

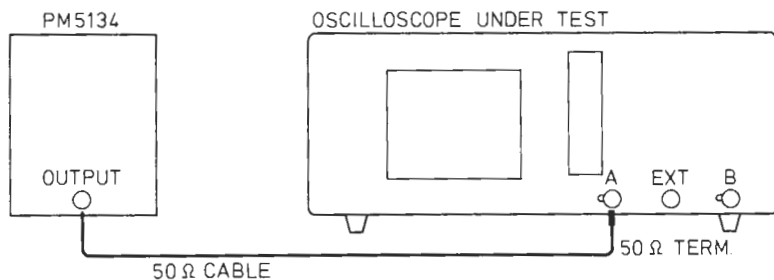

MAT 3834
900511

settings/procedure:

- 1 - Apply a 2 kHz sine-wave signal of 800 mV (pp) to input A; use a 50 Ω termination.
- 2 - Press the AUTO SET button and set A to 0,1 V/div.
- 3 - Adjust the input signal to a trace-height of 8 div.
- 4 - Press X DEFL and check that only the X DEFL is on.

requirements:

Verify that a line with an angle of 45° is displayed.

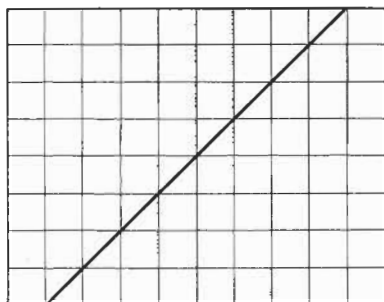

MAT3837
900503

Figure 4.5 X deflection

4.3.20 Horizontal deflection; time-base deflection coefficients

The deflection coefficients of the time-base generator are verified by means of a calibration signal.

test equipment:

Time marker generator (TG 501)

test set-up:

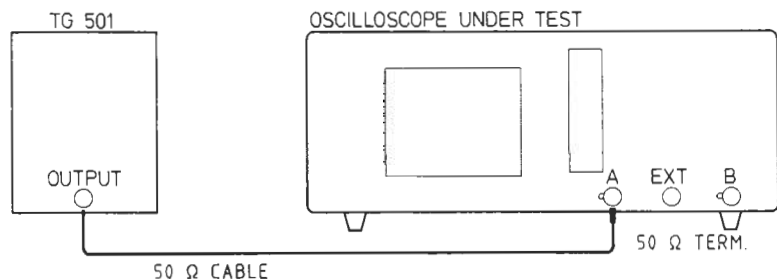

MAT3838
900503

settings/procedure:

- 1 - Apply a 50 ns time marker signal to input A; use a 50 Ω termination.
- 2 - Press the AUTO SET button.
- 3 - Verify the deflection coefficients in TB x1 and TB x10 according to the table in requirements. Make use of the deflection error facility of the TG 501.

NOTE: – Error limits must be measured between the 2nd and 10th graticule line; there are 11 graticule lines.
 – In TB x10 measured on the central 10 div of the expanded TB of 100 div.

requirements:

Marker pulse at:		TB setting	Max. error at:	
TB x1	TB x10		TB x1	TB x10
50 ns	5 ns	50 ns	± 3 %	± 4 %
0,1 μs	10 ns	0,1 μs	± 3 %	± 4 %
0,2 μs	20 ns	0,2 μs	± 3 %	± 4 %
0,5 μs	50 ns	0,5 μs	± 3 %	± 4 %
1 μs	0,1 μs	1 μs	± 3 %	± 4 %
2 μs	0,2 μs	2 μs	± 3 %	± 4 %
5 μs	0,5 μs	5 μs	± 3 %	± 4 %
10 μs	1 μs	10 μs	± 3 %	± 4 %
20 μs	2 μs	20 μs	± 3 %	± 4 %
50 μs	5 μs	50 μs	± 3 %	± 4 %
0,1 ms	10 μs	0,1 ms	± 3 %	± 4 %
0,2 ms	20 μs	0,2 ms	± 3 %	± 4 %
0,5 ms	50 μs	0,5 ms	± 3 %	± 4 %
1 ms	0,1 ms	1 ms	± 3 %	± 4 %
2 ms	0,2 ms	2ms	± 3 %	± 4 %
5 ms	0,5 ms	5 ms	± 3 %	± 4 %
10 ms	1 ms	10 ms	± 3 %	± 4 %
20 ms	2 ms	20 ms	± 3 %	± 4 %
50 ms	5 ms	50 ms	± 3 %	± 4 %
0,1 s	10 ms	0,1 s	± 3 %	± 4 %
0,2 s	20 ms	0,2 s	± 3 %	± 4 %
0,5 s	50 ms	0,5 s	± 3 %	± 4 %

4.3.21 Horizontal deflection; variable control ratio (VAR TB)

The horizontal deflection coefficients can be varied by a variable control. Here, the range of this control is checked.

test equipment:

Time marker generator (TG 501)

test set-up:

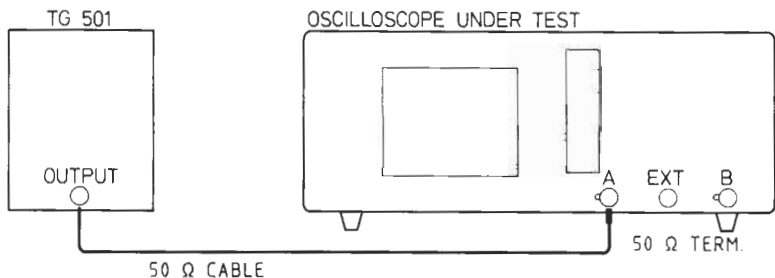

MAT 3838
900503

settings/procedure:

- 1 - Apply a $1 \mu\text{s}$ time marker signal to input A; use a 50Ω termination.
- 2 - Press the AUTO SET button.
- 3 - Set TB to $0,2 \mu\text{s}/\text{div}$ and VAR to CAL; time marker on the first and sixth graticule line. (distance between markers 5 div)
- 4 - Turn the TB VAR fully counter clockwise.

requirements:

Verify that the second marker is placed between the second and third graticule line. This means that the VAR control overlaps the time-base steps $0,2$ to $0,5 \mu\text{s}$ (ratio $2,5 : 1$).

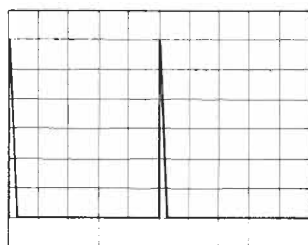

VAR IN CAL POSITION

MAT 3839

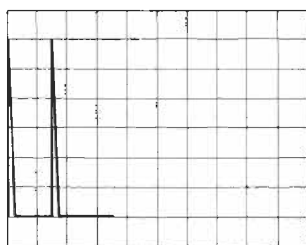

VAR FULLY COUNTER CLOCKWISE

MAT 3840
900503

Figure 4.6 TB VAR range

4.3.22 Horizontal deflection; TB magnifier balance

The magnitude of the horizontal amplification can be increased by 10. When switching from x1 to x10 a certain shift can appear. The maximum allowed shift is checked here.

test equipment:

Time marker generator (TG 501)

test set-up:

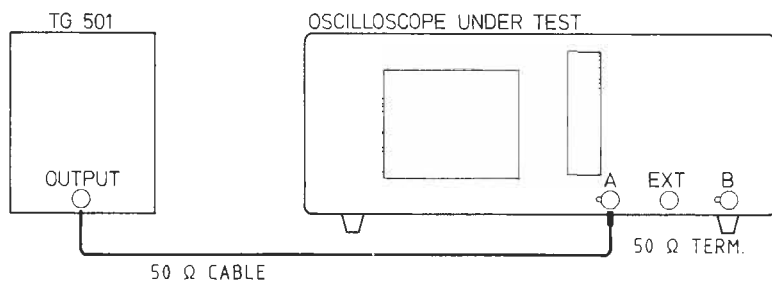
MAT 3838
900503

settings/procedure:

- 1 - Apply a $1 \mu\text{s}$ time marker signal to input A; use a 50Ω termination.
- 2 - Set TB to $0,2 \mu\text{s}/\text{div}$ and VAR to CAL; time marker on the first and sixth graticule line.
- 3 - Set X MAGN on.
- 4 - Set the top of the second marker pulse exactly at the vertical centre of the graticule.
- 5 - Set X MAGN to off.

requirements:

Verify that the top of the second marker pulse is not shifted more than $0,5 \text{ div}$, when X MAGN is switched to off.

4.3.23 Horizontal deflection; X deflection coefficient via A

The amplification of the horizontal amplifier via the vertical amplifier is checked.

test equipment:

Sine-wave generator (function generator, PM 5134)

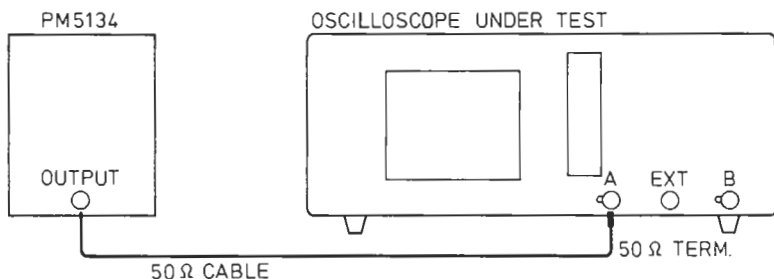
test set-up:

MAT 3834
900511

settings/procedure:

- 1 - Apply a 2 kHz sine-wave signal of 800 mV (pp) to input A; use a 50 Ω termination.
- 2 - Press the AUTO SET button.
- 3 - Set for a trace-height of 4 div.
- 4 - Press X DEFL.
- 5 - Press A/B twice for only channel B display.

requirements:

Verify that a horizontal line of 3,8...4,2 div is displayed.

4.3.24 Horizontal deflection; X deflection coefficient via EXT

The amplification of the horizontal amplifier via the external input is checked.

test equipment:

Sine-wave generator (function generator, PM 5134)

test set-up:

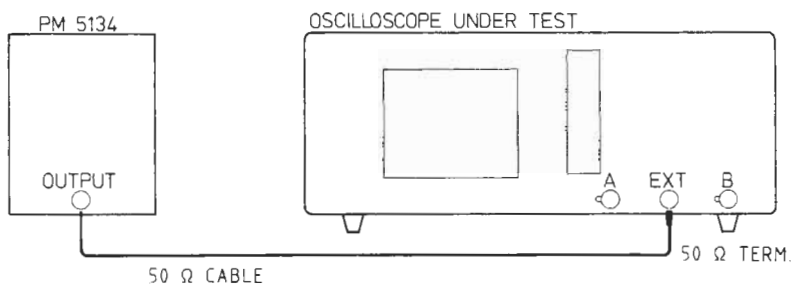

settings/procedure:

- 1 - Apply a 2 kHz sine-wave signal of 1 V (pp) to input EXT; use a 50 Ω termination.
- 2 - Select EXT with TRIG or X SOURCE.
- 3 - Press X DEFL.

requirements:

Verify that a horizontal line of 9,5...10,5 div is displayed.

4.3.25 Horizontal deflection; frequency response 1

In this test, the bandwidth of the horizontal amplifier is verified.

test equipment:

Constant amplitude sine-wave generator (SG 503).

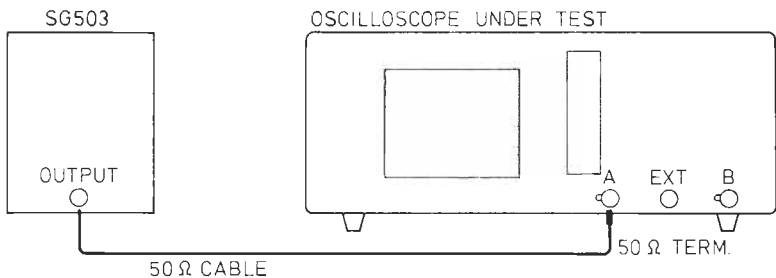
test set-up:

MAT 3830
900511

settings/procedure:

- 1 – Apply a 50 kHz sine-wave signal of 30 mV (pp) to input A; use a 50 Ω termination.
- 2 – Press the AUTO SET button and set A to 5 mV/div.
- 3 – Press X DEFL.
- 4 – Press A/B twice for channel B as vertical deflection.
- 5 – Adjust the input voltage for exactly 6 div horizontal deflection.
- 6 – Increase the input frequency up to 2 MHz.

requirements:

Verify that the trace width is at least 4,2 div over the complete bandwidth range.

4.3.26 Horizontal deflection; frequency response 2

In this test, the function of the horizontal amplifier at low frequencies is checked.

test equipment:

LF sine-wave generator (function generator, PM 5134)

test set-up:

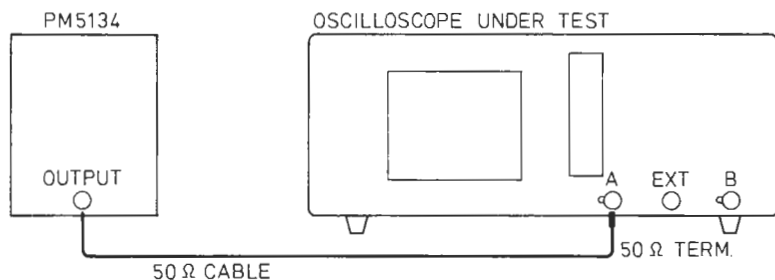

MAT 3834
900511

settings/procedure:

- 1 - Apply a 10 Hz sine-wave signal of 30 mV (pp) to input A; use a 50 Ω termination.
- 2 - Press the AUTO SET button and set A to 5 mV/div.
- 3 - Set the vertical deflection of A to exactly 6 div.
- 4 - Select X DEFL.
- 5 - Press A/B twice for channel B as vertical deflection.

requirements:

Ensure that the trace width is at least 4,2 div.

4.3.27 Maximum phase shift between horizontal and vertical deflection

There will be a certain phase shift between the horizontal and vertical amplifier. The value of this shift is measured here.

test equipment:

LF sine-wave generator (function generator, PM 5134)

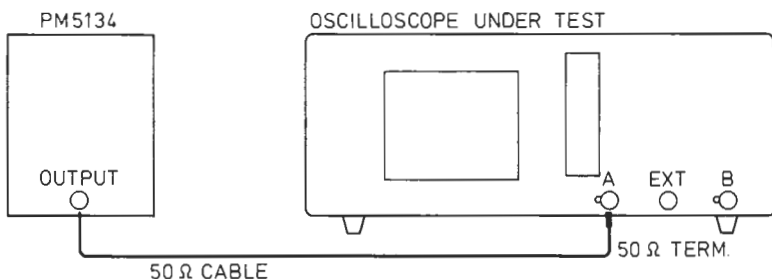
test set-up:

MAT 3834
900511

settings/procedure:

- 1 - Apply a 2 kHz sine-wave signal of 1,2 V (pp) to channel A; use a 50 Ω termination.
- 2 - Press the AUTO SET button and set for a trace-height of exactly 6 div.
- 3 - Press X DEFL.
- 4 - Increase the input frequency to 100 kHz.

requirements:

Verify that the phase shift is less than 3°; this results in the display as shown in figure 4.7.

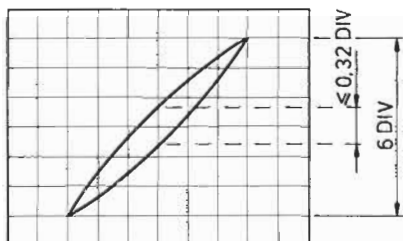

MAT 3842
900503

Figure 4.7 Phase shift

4.3.28 Triggering; sources and coupling

In this test, the various trigger sources and coupling modes are tested.

test equipment:

Sine-wave generator (function generator, PM 5134)

test set-up:

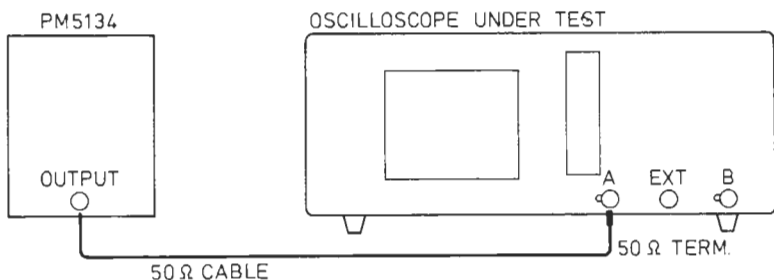

MAT 3834
900511

*settings/procedure
and requirements:*

- 1 - Apply a 2 kHz sine-wave signal of 800 mV (pp) to input A; use a 50 Ω termination.
- 2 - Press AUTO SET and set the trace-height to 4 div.
- 3 - Press TRIG COUPL and select DC.
- 4 - Adjust TRIG LEVEL for a triggered signal.
- 5 - Check that a sine-wave signal of 4 div is displayed.
- 6 - Press TRIG COUPL and select p-p.
- 7 - Turn TRIG LEVEL and check that the signal is triggered over the complete range of this control.
- 8 - Connect the CAL signal to input B.
- 9 - Press A/B to display both channels.
- 10- Set channel B to 0,2 V/div.
- 11- Select B as trigger source with TRIG or X SOURCE, (A is not triggered and moves, B is triggered now and stable).
- 12- Check that a square-wave of 6 div is displayed.
- 13- Increase the input frequency to input A to 20 kHz (CAL signal to B).
- 14- Press TRIG or X SOURCE 5 times, (A and B selected).
- 15- Check that 2 well-triggered traces are displayed.

4.3.29 Triggering; slope selection and level control range

This test checks the range of the trigger level control and the correct working of the slope selection.

test equipment:

- LF sine-wave generator (function generator, PM 5134)
- T-piece

test set-up:

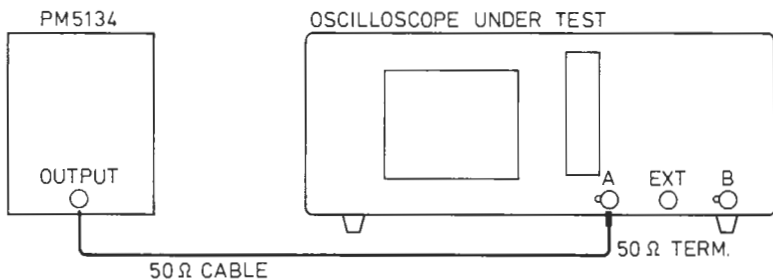

MAT 3834
900511

*settings/procedure
and requirements:*

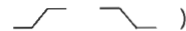
- 1 - Apply a 2 kHz sine-wave signal of 1,6 V (pp) to input A; use a 50 Ω termination.
- 2 - Press AUTO SET and set A to 0,2 V/div at DC input coupling.
- 3 - Set TRIG COUPL for p-p triggering.
- 4 - Turn TRIG LEVEL fully clockwise and fully counter clockwise.
- 5 - Check that the signal is well-triggered over the complete TRIG LEVEL range.
- 6 - Set the TRIG LEVEL control in its mid-position.
- 7 - The start of the signal display must be in the vertical centre.
- 8 - Press TB TRIG MODE.
- 9 - Press SLOPE. ()
- 10- Check that the sine-wave signal is inverted and that it is triggered on the negative slope.
 - Press SLOPE once again.
- 12- Press TRIG COUPL for DC coupling.
- 13- Set A to 100 mV/div (16 div trace-height).
- 14- Turn the TRIG LEVEL.
- 15- Verify that the LEVEL range is more than +8 div and -8 div and that the signal is triggered on the positive slope. Use Y POS control.

Repeat this procedure for channel B.

Repeat this procedure for the same signal to inputs A and EXT together, by means of a T-piece, and select after step 2 EXT triggering by means of TRIG or X SOURCE.

4.3.30 Triggering; trigger sensitivity via A and B

The trigger sensitivity depends on the amplitude and frequency of the trigger signal. In this test the sensitivity via the A and B inputs is checked.

test equipment:

Constant amplitude sine-wave generator (SG 503)

test set-up:

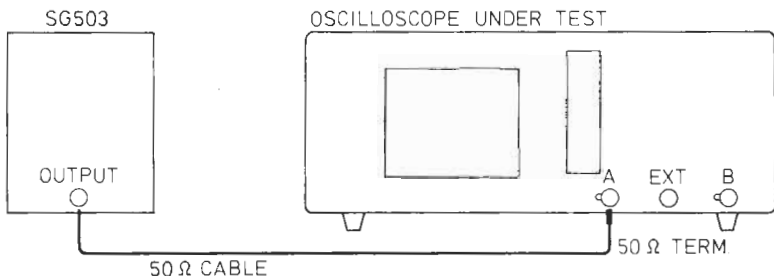

MAT 3830
900511

*settings/procedure
and requirements:*

- 1 - Apply a 10 MHz sine-wave signal of 250 mV (pp) to input A; use a 50 Ω termination.
- 2 - Press AUTO SET and set A to 0,2 V/div.
- 3 - Set AC/DC coupling of A to DC.
- 4 - Press TB TRIG MODE for TRIG mode.
- 5 - Press TRIG COUPL for DC trigger coupling.
- 6 - Turn TRIG LEVEL for a well-triggered signal.
- 7 - Decrease the amplitude of the input signal.
- 8 - Verify that the signal is well-triggered at amplitudes of 0,5 div and more.
- 9 - Decrease the input frequency to 50 kHz.
- 10- Verify that the signal stays well-triggered at amplitudes of 0,5 div and more.

- 11- Increase the input frequency to 50 MHz.
- 12- Increase the input voltage to 1 div.
- 13- Turn TRIG LEVEL.
- 14- Verify that the signal is well-triggered at amplitudes of 1 div and more.
- 15- Increase the input frequency to 100 MHz.
- 16- Increase the input voltage to 3 div.
- 17- Verify that the signal is well-triggered at amplitudes of 3 div and more.

Repeat this procedure for channel B.

4.3.31 Triggering; trigger sensitivity via EXT

The trigger sensitivity depends on the amplitude and frequency of the trigger signal. In this test the sensitivity via the trigger input EXT is checked.

test equipment:

- Constant amplitude sine-wave generator (SG 503)
- T-piece

test set-up:

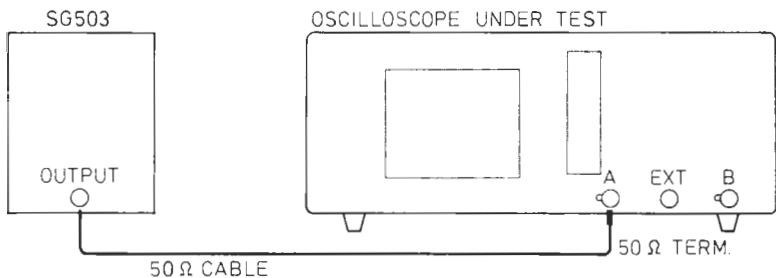

MAT 3830
900511

*settings/procedure
and requirements:*

- 1 - Apply a 10 MHz sine-wave signal of 250 mV (pp) to input A; use a 50 Ω termination.
- 2 - Press AUTO SET and set A to 0,2 V/div.
- 3 - Set AC/DC coupling of A to DC and connect the input signal, by means of a T-piece, to inputs EXT and A together.
- 4 - Select EXT as trigger source by means of TRIG or X SOURCE.
- 5 - Press TB TRIG MODE for TRIG mode.
- 6 - Press TRIG COUPL for DC trigger coupling.

- 7 - Turn TRIG LEVEL for a well-triggered signal.
- 8 - Decrease the amplitude of the input signal.
- 9 - Verify that the signal is well-triggered at amplitudes of 50 mV and more.
- 10- Decrease the input frequency to 50 kHz.
- 11- Verify that the signal stays well-triggered at amplitudes of 50 mV and more.
- 12- Increase the input frequency to 50 MHz.
- 13- Increase the input voltage to 150 mV.
- 14- Turn TRIG LEVEL.
- 15- Verify that the signal is well-triggered at amplitudes of 150 mV and more.
- 16- Increase the input frequency to 100 MHz.
- 17- Increase the input voltage to 500 mV.
- 18- Verify that the signal is well-triggered at amplitudes of 500 mV and more.

4.3.32 Triggering; trigger sensitivity TVL-TVF

This test checks the trigger sensitivity for television line- and frame signals.

test equipment:

TV pattern generator with video output (PM 5518)

test set-up:

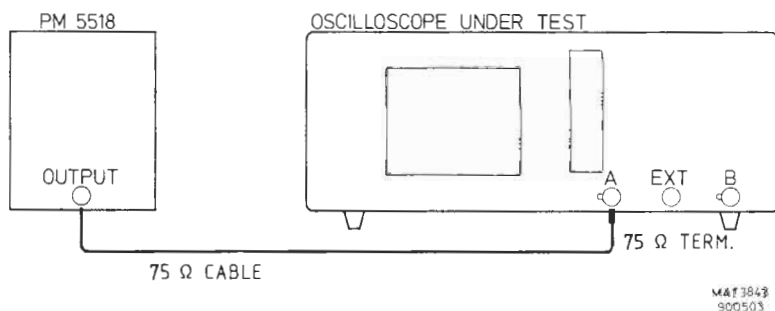

settings/procedure:

- 1 - Apply a video signal to input A with an amplitude of about 1 V sync pulse amplitude; use a 75 Ω termination.
- 2 - Press the AUTO SET button.
- 3 - Press TB TRIG mode for TRIG mode.
- 4 - Press AC/DC for DC input coupling.
- 5 - Press TRIG COUPL for TVL and TVF.

requirements:

Decrease the amplitude of the input signal and verify that the signal is well-triggered on the narrow TVL and the wide TVF pulse, at sync pulse amplitudes of 0,7 div and more.

Repeat settings/procedure for channel B.

4.3.33 Cursors; voltage cursor accuracy

In this test the accuracy of the voltage cursors is checked.

test equipment:

Square-wave calibration generator (PG 506)

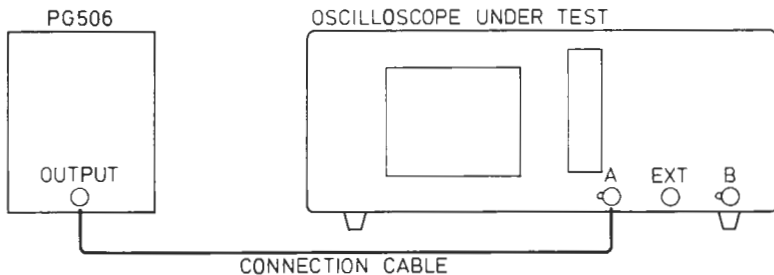
test set-up:

MAT3829
900511

settings/procedure:

- 1 - Apply a 1 kHz square-wave voltage of 1 V to the channel A input.
- 2 - Press the AUTO SET button. If the instrument is in the LOCK mode, first press DIGITAL MEMORY.
- 3 - Set channel A to 0,2 V/div and to DC.
- 4 - Press DIGITAL MEMORY to switch the digital memory ON.
- 5 - Press LOCK.
- 6 - Select CURSORS by means of the CRT function control CURSORS. If CURSORS is not shown, first press the CRT function control RETURN until CURSORS appears.
- 7 - Press the CRT function control MODE.
- 8 - Press the CRT function control V-CURS ON/OFF to ON.
- 9 - Press the CRT function control V/RATIO to V.
- 10- Press the CRT function control T-CURS ON/OFF to OFF.
- 11- Press the CRT function control RETURN.
- 12- Press the CRT function control V-CTRL.
- 13- Position the REF cursor to the bottom of the waveform (in the middle of the line) by means of the CRT function control ↑ or ↓.
- 14- Position the delta cursor (Δ) to the top of the waveform (in the middle of the line) by means of the CRT function control ↑ or ↓.

requirements:

Verify that the voltage cursor read-out at the top of the screen is 0,97...1,03 V.

4.3.34 Cursors; time cursor accuracy

In this test the accuracy of the time cursors is checked.

test equipment:

Time marker generator (TG 501)

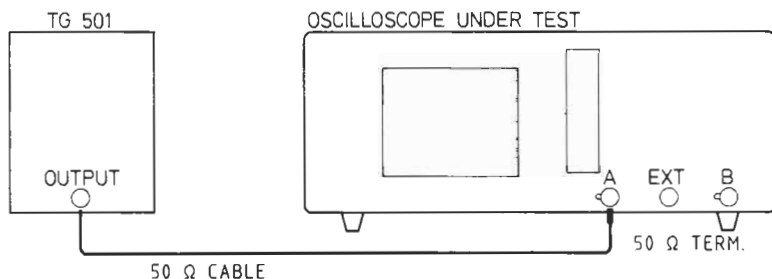
test set-up:MAT3838
900503*settings/procedure:*

- 1 - Apply a 1 ms time marker signal to input A; use a 50 Ω termination.
- 2 - Press the AUTO SET button. If the instrument is in the LOCK mode, first press DIGITAL MEMORY.
- 3 - Press DIGITAL MEMORY to switch the digital memory ON.
- 4 - Set TB to 1 ms/div.
- 5 - Press LOCK.
- 6 - Select CURSORS by means of the CRT function control CURSORS. If CURSORS is not shown, first press the CRT function control RETURN until CURSORS appears.
- 7 - Press the CRT function control MODE.
- 8 - Press the CRT function control T-CURS ON/OFF to ON.
- 9 - Press the CRT function control V-CURS ON/OFF to OFF.
- 10- Press the CRT function control T/PH/RATIO to T.
- 11- Press the CRT function control RETURN.
- 12- Press the CRT function control T-CTRL.
- 13- Position the REF cursor and the delta cursor (Δ) by means of the CRT function controls \leftarrow and \rightarrow so that they cover a distance of 8 time marker intervals; position the markers exactly to the top of the marker pulses.

requirements:

Check for a time cursor read-out of 7,99...8,01 ms.

Press DIGITAL MEMORY to switch the digital memory OFF.

4.3.35 Z-MOD sensitivity

This test checks the sensitivity of the Z modulation facility.

test equipment:

- Square-wave generator (function generator, PM 5134)
- T-piece

test set-up:

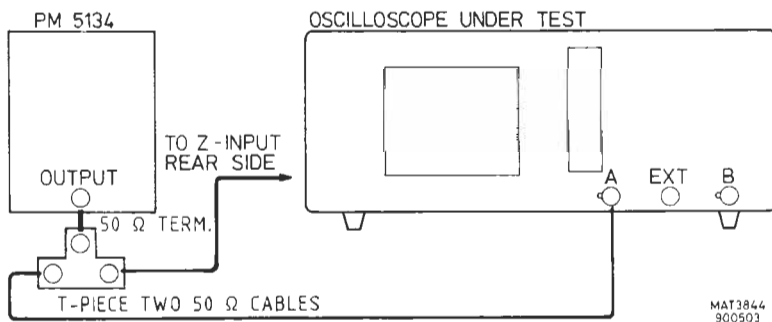

*settings/procedure
and requirements:*

- 1 - Apply a 1 kHz square-wave signal, duty cycle 50 %, amplitude 2,5 V, to input A.
- 2 - Press the AUTO SET button.
- 3 - Set TB to 0,5 ms/div.
- 4 - Set the trace of channel A in mid position.
- 5 - Apply the same signal by means of the T-piece to the Z-input (rear side).
- 6 - Check that only the bottom half of the square-wave signal is displayed. (500 μ s blanking and 500 μ s unblanking)
- 7 - Remove the Z-input.
- 8 - Decrease the input signal to 1 V.
- 9 - Reconnect the Z-input.
- 10- Set A to 0,5 V /div.
- 11- Check that the top half of the square-wave signal is visible with a lower intensity.
- 12- Check that the top half of the signal is completely unblanked (visible with full intensity) at an input signal less than 0,8 V.

4.3.36 CAL signal; frequency and output voltage

The CAL signal is a calibration signal with fixed frequency and voltage. In this test, the values of frequency and voltage are checked.

test equipment:

None

test set-up:

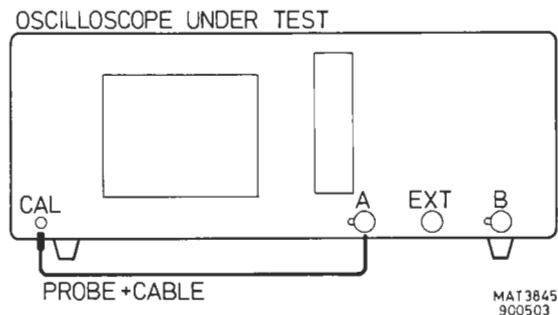

settings/procedure:

- 1 - Connect the CAL signal to input A and press the AUTO SET button.
- 2 - Press GND of channel A.
- 3 - Set the trace in the centre of the screen.
- 4 - Press GND of channel A again.
- 5 - Select DC of A input coupling.

requirements:

- 1 - Check that a positive going square-wave signal of 1,2 V (pp) is displayed, i.e. 2,4 div at 0,5 V/div.
- 2 - Check that the frequency of the displayed signal is about 2 kHz, i.e. 5 div at 0,1 ms/div.

5. PREVENTIVE MAINTENANCE

5.1 GENERAL INFORMATION

This instrument normally requires no maintenance, since none of its components is subject to wear. However, to ensure reliable and trouble-free operation, the instrument should not be exposed to moisture, heat, corrosive elements or excessive dust.

5.2 REMOVING THE BEZEL AND CONTRAST FILTER (to clean the contrast filter)

Insert a screwdriver in the slot on the upsideside of the bezel and gently loosen the bezel.

Ease the bezel away from the front panel.

Press the contrast filter from the bezel.

To prevent scratches, when cleaning the filter, always use a clean soft cloth, free from dust and abrasive particles.

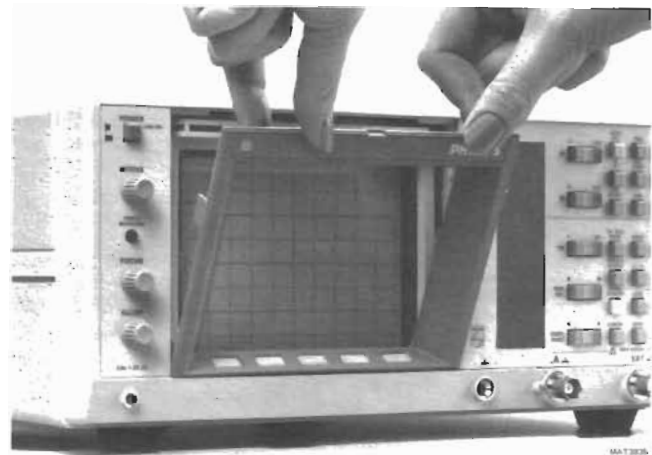

Figure 5.1. Removing the bezel and the contrast filter.

5.3 RECALIBRATION

To ensure accurate measurements, check the calibration of the instrument after 1200 hours of use, or after one year if used infrequently. Recalibration must be carried out by qualified personnel only.