



# PHILIPS

## Digital Storage Oscilloscopes

PM3350A/52A/55/57/65A/67A/75/77

TEST & MEASUREMENT

CUSTOMER SUPPORT

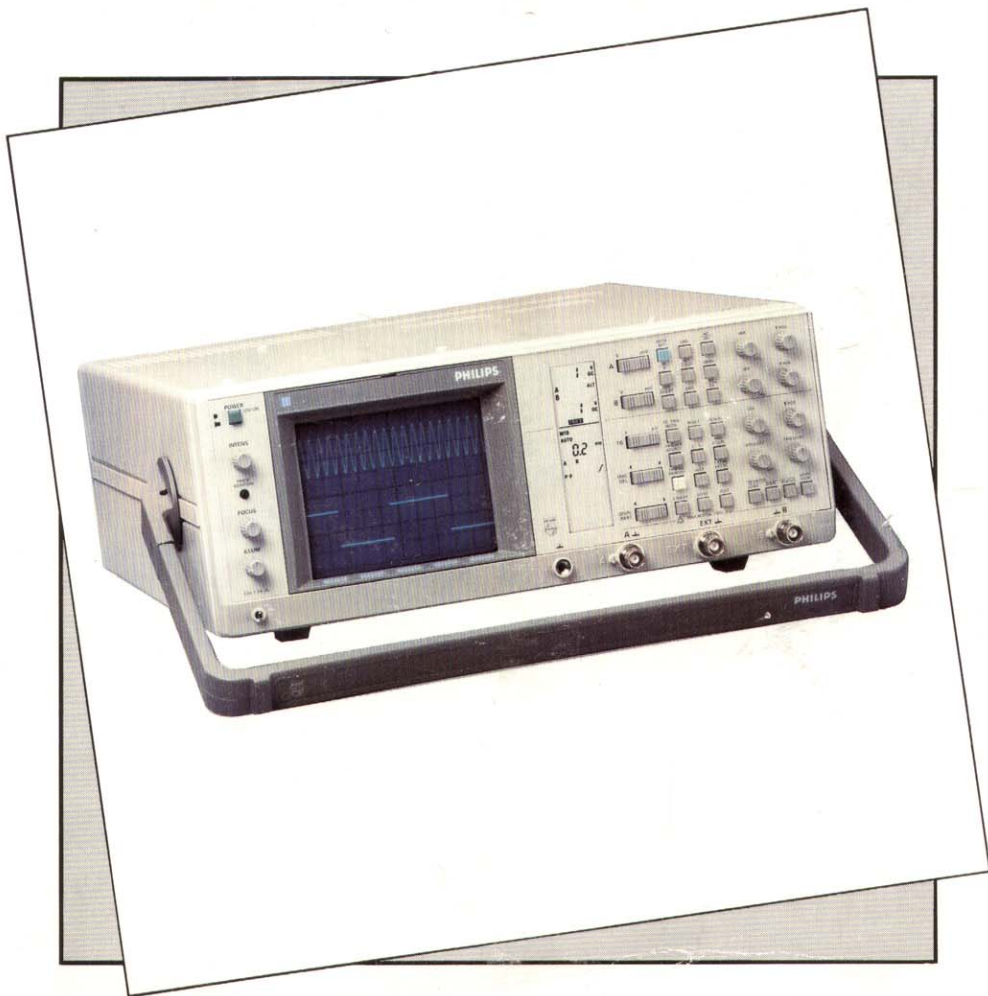

4822 872 00434

900605

Operation Guide

# Digital Storage Oscilloscopes

## PM3350A/52A/55/57/65A/67A/75/77

Operation Guide

4822 872 00434

900605

---

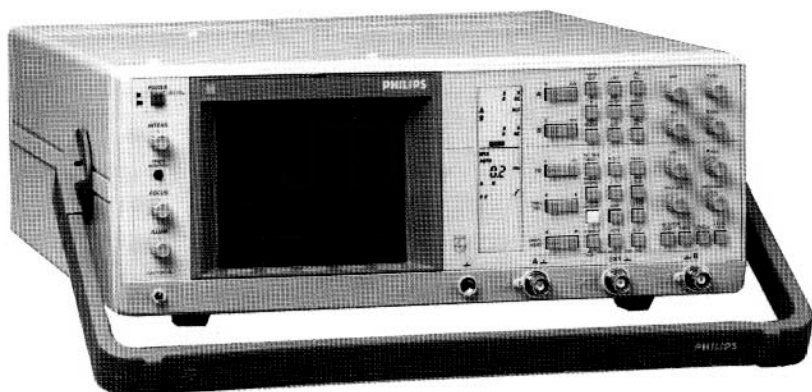

**PHILIPS**

**IMPORTANT:** In correspondence concerning this instrument please quote the typenumber and serial number as given on the type plate on the rear of the instrument.

**NOTE:** *The design of this instrument is subject to continuous development and improvement. Consequently, this instrument may incorporate minor changes in detail from the information contained in this manual.*

JTN

## Table of Contents

|                                                    |              |
|----------------------------------------------------|--------------|
| SHIPMENT NOTE.....                                 | i - i        |
| INITIAL INSPECTION.....                            | i - i        |
| ACCESSORIES.....                                   | i - i        |
| SERVICE REPLACEMENT PARTS.....                     | i - i        |
| <br>                                               |              |
| <b>1 OPERATORS SAFETY</b>                          | <b>1 - 1</b> |
| <br>                                               |              |
| 1.1 INTRODUCTION.....                              | 1 - 1        |
| 1.2 SAFETY PRECAUTIONS.....                        | 1 - 1        |
| 1.3 CAUTION AND WARNING STATEMENTS.....            | 1 - 1        |
| 1.4 SYMBOLS.....                                   | 1 - 1        |
| 1.5 IMPAIRED SAFETY-PROTECTION.....                | 1 - 2        |
| <br>                                               |              |
| <b>2 INSTALLATION INSTRUCTIONS</b>                 | <b>2 - 1</b> |
| <br>                                               |              |
| 2.1 SAFETY INSTRUCTIONS.....                       | 2 - 1        |
| 2.1.1 EARTHING (GROUNDING).....                    | 2 - 1        |
| 2.1.2 MAINS (LINE) VOLTAGE CORD AND FUSES.....     | 2 - 1        |
| 2.2 MEMORY BACK-UP.....                            | 2 - 2        |
| 2.3 HANDLE ADJUSTMENT AND OPERATING POSITIONS..... | 2 - 3        |
| 2.4 RACKMOUNT VERSION.....                         | 2 - 4        |
| <br>                                               |              |
| <b>3 OPERATING INSTRUCTIONS</b>                    | <b>3 - 1</b> |
| <br>                                               |              |
| 3.1 GETTING STARTED.....                           | 3 - 1        |
| 3.2 FRONT PANEL LAY OUT AND OPERATION.....         | 3 - 2        |

|                                                 |              |
|-------------------------------------------------|--------------|
| 3.2.1 FRONT PANEL LAY OUT .....                 | 3 - 2        |
| 3.2.2 SCREEN CONTROLS .....                     | 3 - 2        |
| 3.2.3 VIEWING AREA .....                        | 3 - 3        |
| 3.2.4 UP-DOWN KEYS .....                        | 3 - 4        |
| 3.2.5 FUNCTION KEYS .....                       | 3 - 7        |
| 3.2.6 ROTARY KNOBS .....                        | 3 - 9        |
| 3.2.7 SOFTKEYS .....                            | 3 - 10       |
| 3.2.8 INPUTS AND OUTPUTS .....                  | 3 - 12       |
| <br>                                            |              |
| <b>4 APPLICATIONS</b> .....                     | <b>4 - 1</b> |
| <br>                                            |              |
| 4.1 USE AS AN ANALOG OSCILLOSCOPE .....         | 4 - 1        |
| 4.1.1. VERTICAL MODE .....                      | 4 - 2        |
| 4.1.2. HORIZONTAL MODE .....                    | 4 - 8        |
| 4.1.3. TRIGGER MODE .....                       | 4 - 10       |
| 4.2 USE AS A DIGITAL STORAGE OSCILLOSCOPE ..... | 4 - 18       |
| 4.2.1. VERTICAL MODE .....                      | 4 - 18       |
| 4.2.2. HORIZONTAL MODE .....                    | 4 - 22       |
| 4.2.3. TRIGGER MODE .....                       | 4 - 28       |
| 4.3 MENUS AND MEASUREMENTS .....                | 4 - 34       |
| 4.3.1 EXPLANATION OF MENU-STRUCTURES .....      | 4 - 34       |
| 4.3.2 PERFORMING AMPLITUDE MEASUREMENTS .....   | 4 - 46       |
| 4.3.3 PERFORMING TIME MEASUREMENTS .....        | 4 - 50       |
| 4.3.4 ZOOM AND AUTO ZOOM FUNCTIONS .....        | 4 - 54       |
| 4.3.5 WAVE FORM COMPARISON .....                | 4 - 58       |
| <br>                                            |              |
| <b>5 PLOTTING AND PRINTING</b> .....            | <b>5 - 1</b> |
| <br>                                            |              |
| 5.1 INTRODUCTION .....                          | 5 - 1        |
| 5.2 ANALOG PLOT OUT TO XY RECORDERS .....       | 5 - 2        |
| 5.3 PLOT AND PRINT VIA IEEE-488 INTERFACE ..... | 5 - 4        |
| 5.4 PLOT AND PRINT VIA RS-232C INTERFACE .....  | 5 - 6        |
| 5.5 PLOTTING OR PRINTING RESULTS .....          | 5 - 9        |

|                                                  |              |
|--------------------------------------------------|--------------|
| <b>6 APPLICATION PRESELECT MENU</b>              | <b>6 - 1</b> |
| 6.1 INTRODUCTION .....                           | 6 - 1        |
| 6.2 SELECTION OF PLOTTER PARAMETERS (PLOT) ..... | 6 - 1        |
| 6.2.1 ANALOG PLOT MODE (PLOT_ANALOG) .....       | 6 - 1        |
| 6.2.2 DIGITAL PLOT MODE (PLOT_DIGITAL) .....     | 6 - 1        |
| 6.2.3 PRINT .....                                | 6 - 2        |
| 6.3 SINGLE SHOT (SNGL_SHOT) .....                | 6 - 2        |
| 6.4 TV TRIGGERING AFTER AUTOSET (AUTO) .....     | 6 - 2        |
| 6.5 IEEE-488: OPTIONAL (IEEE) .....              | 6 - 2        |
| 6.6 RS-232C: OPTIONAL (RS232) .....              | 6 - 2        |

JTN

---

## SHIPMENT NOTE

The following parts should be included in the shipment:

- 1 OSCILLOSCOPE
- 2 BATTERIES
- 1 FRONT COVER (PM3365A/PM3375 only)
- 1 OPERATION GUIDE or
- 1 BEDIENUNGSANLEITUNG or
- 1 NOTICE D'UTILISATION
- 1 MAINS VOLTAGE CORD
- 2 PROBES
- 1 SPARE FUSE, 1.6 AT (located inside fuse holder)
- 1 REFERENCE MANUAL

## INITIAL INSPECTION

Check the contents of the shipment for completeness and note whether any damage has occurred during transport. If the contents are incomplete, or there is damage, a claim should be filed with the carrier immediately, and the Philips/Fluke Sales or Service organisation should be notified in order to facilitate the repair or replacement of the instrument.

## ACCESSORIES

- PROBE 1:1                      PM8924/00
- PROBE 10:1                    PM8926/59
- PROBE 100:1                 PM8931/09
- FRONT COVER                 PM8988
  
- BATTERIES (2 pcs)            ALKALINE PENLIGHT, TYPE: LR6

## SERVICE REPLACEMENT PARTS

- 5322 480 30181                CRT CONTRAST FILTER
- 5322 459 20503                BEZEL
- 5322 321 21616                MAINS VOLTAGE CORD (EUROPEAN TYPE)
- 5322 321 10466                MAINS VOLTAGE CORD (USA TYPE)
- 5322 321 21617                MAINS VOLTAGE CORD (BRITISH TYPE)
- 5322 321 21618                MAINS VOLTAGE CORD (SWISS TYPE)
- 5322 321 21781                MAINS VOLTAGE CORD (AUSTRALIAN TYPE)
- 4822 253 30024                FUSE 1.6 AT



JTN

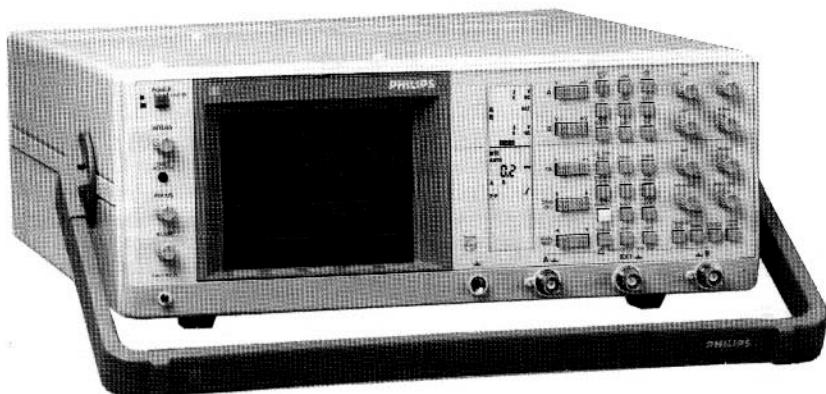

Thank you for purchasing this Philips oscilloscope. It has been designed and manufactured to the highest quality standards to give you many years of trouble free and accurate measurements.

The powerful measuring functions listed below have been combined with an easy logical operation to let you use the full power of this instrument each and every day.

Should you have any comments on how this product could be improved then please contact your local Fluke/Philips organisation.

All information given in this manual concerns the oscilloscopes PM3350A/52A/55/57/65A/67A/75/77. If an action is to be taken, that is specific for one member of the above mentioned family, this will be clearly indicated.

## Main Capabilities

This Philips Digital Storage Oscilloscope (DSO) range consists of four members (and derivatives), each of which has the following easy-to-use features:

- 60 MHz analog oscilloscope for PM3350A and PM3355
- 100 MHz analog oscilloscope for PM3365A and PM3375
- 100 Msamples/s single shot digital acquisition on both channels for PM3350A and PM3365A
- 250 Msamples/s single shot digital acquisition on both channels for PM3355 and PM3375
- Auto Set for instant signal viewing in both analog and digital oscilloscope modes
- Cursors for time and amplitude measurements in digital oscilloscope mode
- Reference memories and non-volatile storage of all waveforms
- Optional interface facilities for remote control and hard copy output
- Storage of 64 front settings

JTN



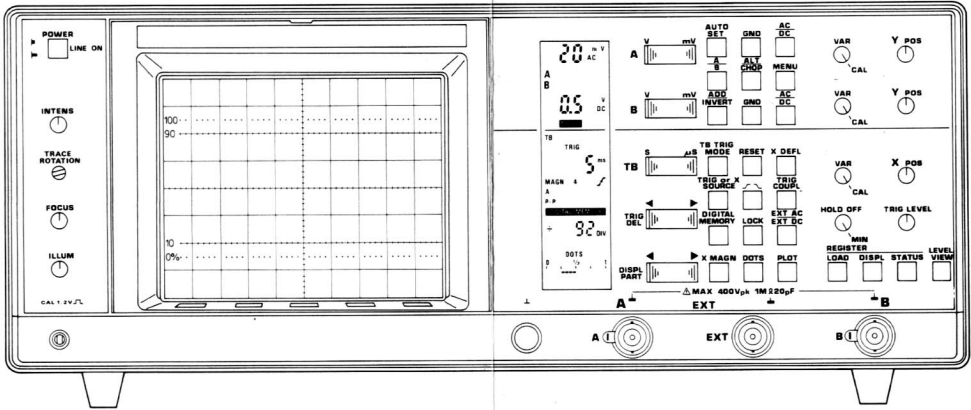

## FRONT VIEW OF OSCILLOSCOPE

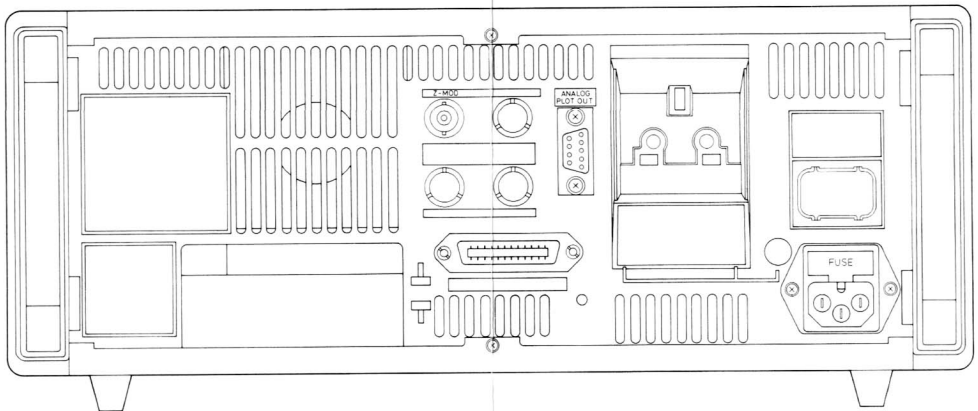



## REAR VIEW OF OSCILLOSCOPE

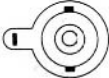

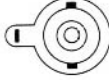
## FRONT PANEL CONNECTORS

|                                                                                   |                                                                                   |                                                      |
|-----------------------------------------------------------------------------------|-----------------------------------------------------------------------------------|------------------------------------------------------|
|  | CAL                                                                               | Amplitude calibrated output socket                   |
|  |  | Measuring earth (ground) socket (banana)             |
|   | A                                                                                 | BNC input socket for channel A with probe indication |
|  | EXT                                                                               | BNC input socket channel EXTERNAL                    |
|   | B                                                                                 | BNC input socket for channel B with probe indication |

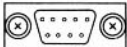
## REAR PANEL CONNECTORS

|                                                                                    |                 |                                                                        |
|------------------------------------------------------------------------------------|-----------------|------------------------------------------------------------------------|
|   | Z-MOD           | BNC input socket for Z-modulation of the CRT trace.                    |
|   | ANALOG PLOT OUT | Plot output socket to connect the oscilloscope to an analog XY plotter |
|  | LINE IN         | Mains (line) input socket including fuse holder.                       |

## OPTIONAL REAR PANEL CONNECTORS

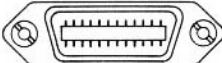
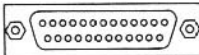
|                                                                                    |                  |                                                                                  |
|------------------------------------------------------------------------------------|------------------|----------------------------------------------------------------------------------|
|  | IEEE BUS OPTION  | Input/output socket to connect the oscilloscope to a IEEE 488/IEC 625 interface. |
|                                                                                    | OR               |                                                                                  |
|  | RS232 BUS OPTION | Input/output socket to connect the oscilloscope to an RS-232C/V24 interface.     |

# 1 OPERATORS SAFETY

**ATTENTION:** *Read this page carefully before installation and use of the instrument.*

## 1.1 INTRODUCTION

The instrument described in this manual is designed to be used by properly-trained personnel only. Adjustment, maintenance and repair of the exposed equipment shall be carried out only by qualified personnel.

## 1.2 SAFETY PRECAUTIONS

For the correct and safe use of this instrument it is essential that both operating and servicing personnel follow generally-accepted safety procedures in addition to the safety precautions specified in this manual. Specific warning and caution statements, where they apply, will be found throughout the manual. Where necessary, the warning and caution statements and/or symbols are marked on the apparatus.

## 1.3 CAUTION AND WARNING STATEMENTS

**CAUTION:** Is used to indicate correct operating or maintenance procedures in order to prevent damage to or destruction of the equipment or other property.

**WARNING:** Calls attention to a potential danger that requires correct procedures or practices in order to prevent personal injury.

## 1.4 SYMBOLS



Read the operating instructions.



Protective earth (grounding) terminal (black)

## 1.5 IMPAIRED SAFETY-PROTECTION

Whenever it is likely that safety-protection has been impaired, the instrument must be made inoperative and be secured against any unintended operation. The matter should then be referred to qualified technicians. Safety protection is likely to be impaired if, for example, the instrument fails to perform the intended measurements or shows visible damage.

JTN

## 2 INSTALLATION INSTRUCTIONS

**ATTENTION:** *You are strongly advised to read this chapter thoroughly before installing your oscilloscope.*

### 2.1 SAFETY INSTRUCTIONS

#### 2.1.1 EARTHING (GROUNDING)

Before any connection to the inputs is made, the instrument must be connected to protective earth (ground) via the three-core mains (line) cable. The mains (line) plug must be inserted only into a socket outlet provided with a protective earth (ground) contact. The protective action must not be negated by the use of an extension cord without protective conductor.

**WARNING:** **Any interruption of the protective conductor inside or outside the instrument is likely to make the instrument dangerous. Intentional interruption is prohibited.**

When an instrument is brought from a cold into a warm environment, condensation may cause a hazardous condition. Therefore, make sure that the earthing (grounding) requirements are strictly adhered to.

#### 2.1.2 MAINS (LINE) VOLTAGE CORD AND FUSES

Different power cords are available for the various local mains (line) voltage outlets. The power cord version delivered is determined by the particular instrument version ordered.

**NOTE:** *If the mains (line) plug has to be adapted to the local situation, such adaptation should be done only by a qualified technician.*

This oscilloscope has a tapless switched-mode power supply that covers most nominal voltage ranges in use:

AC voltages from 100 V...240 V (r.m.s.).

This obviates the need to adapt to the local mains (line) voltage. The nominal mains (line) frequency range is 50 Hz...400 Hz.

**WARNING:** **The instrument shall be disconnected from all voltage sources when renewing a fuse.**



Mains (line) fuse rating: 1,6 AT delayed-action, 250 V  
(for ordering code, see page i).



The mains (line) fuseholder is located on the rear panel in the mains (line) input socket. If the mains (line) fuse needs replacing, proceed as follows:

- disconnect the instrument from the mains (line).
- remove the cover of the fuseholder by means of a screwdriver.
- fit a new fuse of the correct rating and refit the cover of the fuseholder.

**WARNING: Make sure that only fuses of the required current and voltage rating, and of the specified type, are used for renewal. The use of the repaired fuses, and/or short-circuiting of the fuseholder, is prohibited.**

## 2.2 MEMORY BACK-UP

This instrument is provided with a built-in memory back-up circuit, if batteries are fitted.

*NOTE: The batteries are not factory installed and must be fitted at delivery*

Upon power down, only front settings are stored when in the analog mode of use, or the front settings and traces are stored when in the digital mode of use. The oscilloscope returns to these settings on power on.

This memory function works when the oscilloscope is switched off from the front panel or when the mains (line) supply is interrupted more than 20 ms.

The memory back-up batteries (2\*LR6 Alkaline Penlight) placement and replacement must be carried out only by a qualified technician.

Replacing the batteries:

- The instrument must be disconnected from the mains (line).
- Remove the screw that holds the top cover at the rear of the instrument.
- Gently push the cover backwards until it can be lifted.
- Remove the cover by lifting it clear of the instrument. The memory battery back-up unit is now accessible. This unit is located on the instrument's rear panel.
- Ease off the clip that holds the memory back up unit to the chassis.
- Gently slide the battery holder out of the chassis.
- Install both batteries in their holders. The installation direction of the batteries is shown on the battery holder.

*NOTE: When replacing the memory back-up unit, take care not to damage the wiring in the vicinity of the battery holder.*

### 2.3 HANDLE ADJUSTMENT AND OPERATING POSITIONS

By pulling both handle ends outwards away from the instrument the handle can be rotated to allow the following instrument positions:

- vertically on its rear feet;
- horizontally on its bottom feet;
- in two sloping positions on the handle.

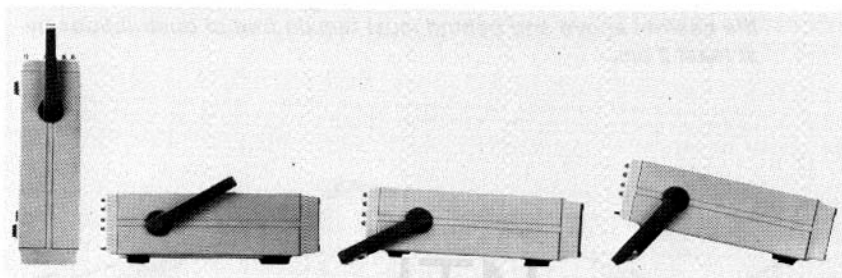

**ATTENTION:** Do not position the oscilloscope on any surface which radiates heat, or in direct sunlight. Ensure that the ventilation holes at the rear and top are free from obstruction.

## 2.4 RACKMOUNT VERSION

The PM3352A/57/67A/77 are provided with a rackmount cabinet without handle. This offers the possibility to build the instrument into a standard 19 inch rack. Apart from the rackmount cabinet these instruments are identical to the PM3350A/55/65A/75 and are not described separately.

The above mentioned oscilloscopes are delivered with spacers and screws [4 \*European (metric) type and 4 \* American (standard) type].

**ATTENTION:** *To maintain adequate instrument cooling, all ventilation holes of the cabinet above and behind must remain free of obstructions by at least 2 cm.*

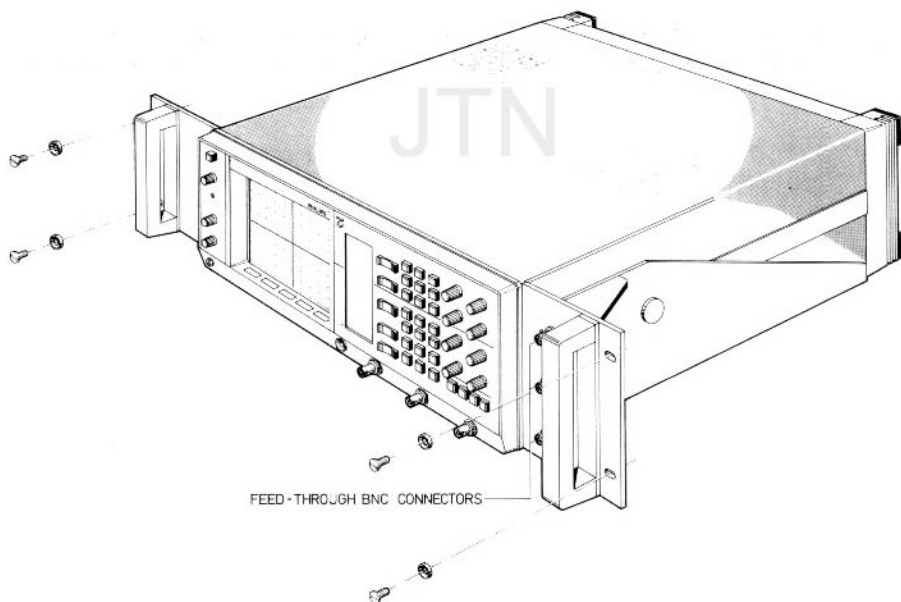

## 3 OPERATING INSTRUCTIONS

### 3.1 GETTING STARTED

- Connect the oscilloscope to the mains (line) voltage.
- Switch the oscilloscope on by means of the push-button POWER LINE ON.
- Adjust the TRACE ROTATION by means of a screwdriver so that the trace is parallel with the horizontal graticule lines.
- Connect a probe to input A of the oscilloscope.
- Connect the other end of the probe to the CAL output of the oscilloscope.
- Press the AUTO SET key.

**The AUTO SET function will set automatically all relevant parameters of the oscilloscope (attenuator setting, time base setting and trigger source setting) for an optimum trace.**

If the probe you use is an attenuator probe 10:1 or 100:1, it may be necessary to adjust it for the correct compensation, according to the instructions in the probe manual.

JTN

## 3.2 FRONTPANEL LAY OUT AND OPERATION

### 3.2.1 FRONTPANEL LAY OUT

The frontpanel is designed with optimum ergonomic and logical lay-out of the controls: from left to right and from top to bottom, like reading a book. For ease of access to the oscilloscope the front panel is divided into seven main areas, which will be described in the following sections.

- Screen controls
- Viewing area (screen + LCD)
- Up-down keys
- Function keys
- Rotary knobs
- Softkeys
- Inputs and outputs

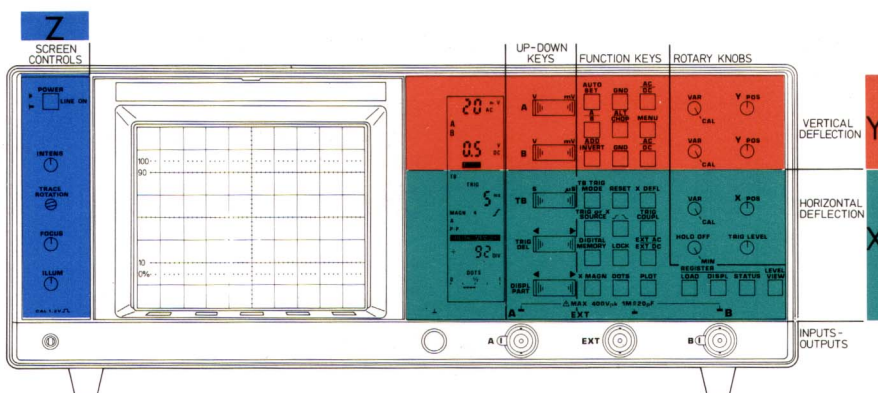

### 3.2.2 SCREEN CONTROLS

After switch-on with the POWER LINE ON push button, the screen controls can be adjusted for optimum illumination, trace and spot quality.

The trace and text intensity is set by the INTENS rotary knob, and a sharp display is obtained by the FOCUS rotary knob.

The screw driver control TRACE ROTATION is used to set a grounded trace parallel with the horizontal graticule lines.

The graticule of the screen can be lit-up by the ILLUMINATION rotary knob, this can be used in dark environment or for making photographs.

### 3.2.3 VIEWING AREA

The viewing area consists of the screen of the Cathode Ray Tube (CRT) and a Liquid Crystal Display (LCD).

The CRT screen is divided in a 10 \* 8 divisions area. Each division contains five sub-divisions. On the left side of the CRT screen four lines are marked with the values 100% 90% 10% and 0%. These marked lines can be used for percentage measurements or rise time measurements.

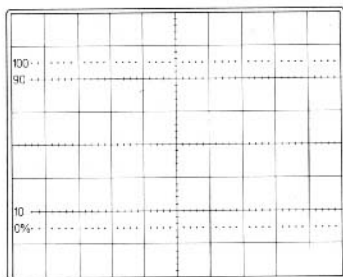

The LCD indicates all the selected active functions, settings and parameters. Its layout is logically divided into areas according to the keys and knobs.

A flashing segment indicates a situation that requires your special attention, for example:

- an incorrect selection of knobs/keys controls,
- a VAR rotary knob in uncal position,
- the end of a UP-DOWN control range,
- a key has been operated during the PLOT action,
- the DISPL PART UP-DOWN key has been pressed in TB MAGN \*1 mode.
- display of register only.

### 3.2.4 UP-DOWN KEYS

The UP-DOWN key selects the required setting out of the range of settings possible for that function.

They are used for the attenuator setting, the time base setting, the trigger delay setting and the display part setting.

#### RANGES OF UP-DOWN KEYS



#### VERTICAL ATTENUATOR SETTING CHANNEL A

Selection of vertical attenuation of channel A

*Analog*: 2 mV/div ... 10 V/div in 1-2-5 sequence

*Digital*: 2 mV/div ... 10 V/div in 1-2-5 sequence

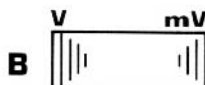

#### VERTICAL ATTENUATOR SETTING CHANNEL B

Selection of vertical attenuation of channel B

*Analog*: 2 mV/div ... 10 V/div in 1-2-5 sequence

*Digital*: 2 mV/div ... 10 V/div in 1-2-5 sequence



#### HORIZONTAL TIME-BASE SETTING

Selection of time-base speed

*Analog*: 0,5 s/div ... 50 ns/div in 1-2-5 sequence

*Digital*:

PM3350A: 50 s/div ... 0,5 μs/div in 1-2-5 sequence

PM3355 : 50 s/div ... 0,2 μs/div in 1-2-5 sequence

PM3365A: 50 s/div ... 20 ns/div in 1-2-5 sequence

PM3375 : 50 s/div ... 20 ns/div in 1-2-5 sequence

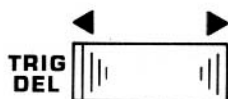

#### TRIGGER DELAY SETTING

Selection of trigger delay

*Analog*: not available

*Digital*:

PM3350A: -10 div ... +2500 div in 1 div sequence  
(in TB = 50 s/div ... 0,5 μs/div)

PM3355 : -10 div ... +5000 div in 1 div sequence  
(in TB = 50 s/div ... 0,2 μs/div)

PM3365A: -10 div ... +2500 div in 1 div sequence  
(in TB = 50 s/div ... 0,5 μs/div)

0 div ... +20 div in 1 div sequence

(in TB = 0,2 μs/div ... 20 ns/div)

PM3375 : -10 div ... +5000 div in 1 div sequence  
(in TB = 50 s/div ... 0,2 μs/div)

0 div ... +20 div in 1 div sequence

(in TB = 0,1 μs/div ... 20 ns/div)

**DISPLAY PART SETTING**

Selection of the displayed part of a magnified trace

*Analog*: not available

*Digital* : 1/16 ... 16/16 sequence depending on  
TB MAGNIFY value.



JTN

### 3.2.5 FUNCTION KEYS

This oscilloscope features the possibility to select several functions with a single key in sequential order. To obtain the correct function it is necessary to press the particular key repeatedly until the correct function is visible in the LCD. After the last function in line, the sequence starts again. An overview of the functions is given below. The positions of the keys in this picture are according their actual positions on the front panel of the oscilloscope.

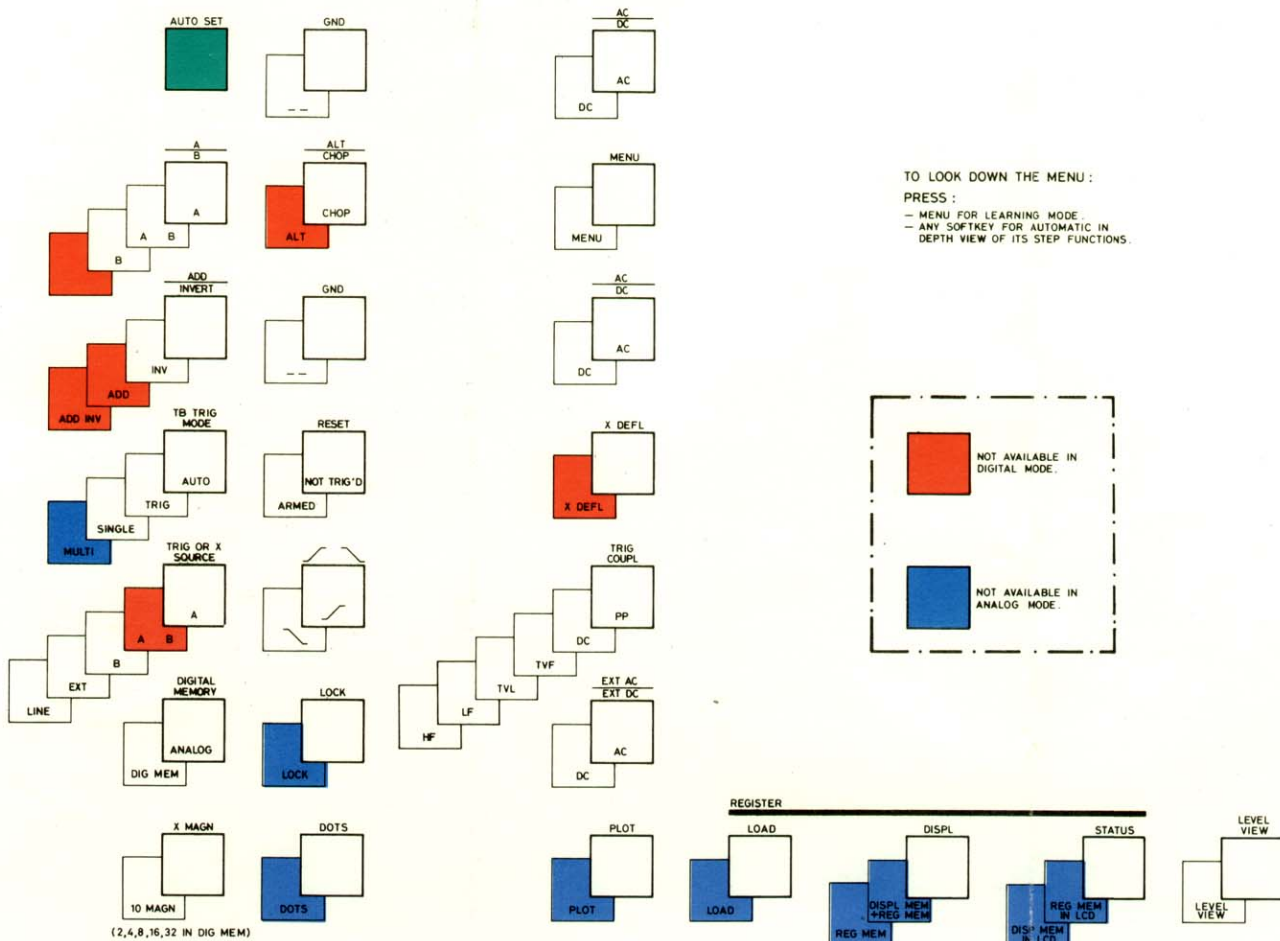

OPERATING INSTRUCTIONS  
The following instructions apply to the  
operation of the instrument. The  
instructions are given in the order  
in which they should be carried out.  
The instructions are given in the  
order in which they should be carried out.



### 3.2.6 ROTARY KNOBS

With the ROTARY knobs, continuously-variable adjustment of the function is obtained. ROTARY knobs are available for the functions:

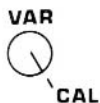

**Y POS**  
Vertical screen position channel A

**VAR A**  
Variable attenuation channel A  
(Is in CALibrated position when fully clockwise)



**Y POS**  
Vertical screen position channel B

**VAR B**  
Variable attenuation channel B  
(Is in CALibrated position when fully clockwise)



**X POS**  
Horizontal screen position time-base

**VAR**  
Variable time-base (not in DIGITAL MEMORY)  
(Is in CALibrated position when fully clockwise)



**TRIG LEVEL**  
Trigger level

**HOLD OFF**  
Hold off time  
(Is in normal position when fully clockwise,  
i.e. minimum HOLD OFF)

### 3.2.7 SOFTKEYS

The five softkeys located below the CRT can be used for different functions in digital memory mode, e.g. AMPLITUDE CALCULATIONS, TIME CALCULATIONS, PROCESS MEASUREMENTS, choice of REGISTER MEMORY and the ZOOM facility. All calculation and manipulation facilities are activated via successive steps through the softkey menu structure. When the menu has been activated, the CRT screen contains two area's for text. The top text area shows all calculation information and channel settings and the bottom text area shows all functions assigned to the five softkeys.

JTN

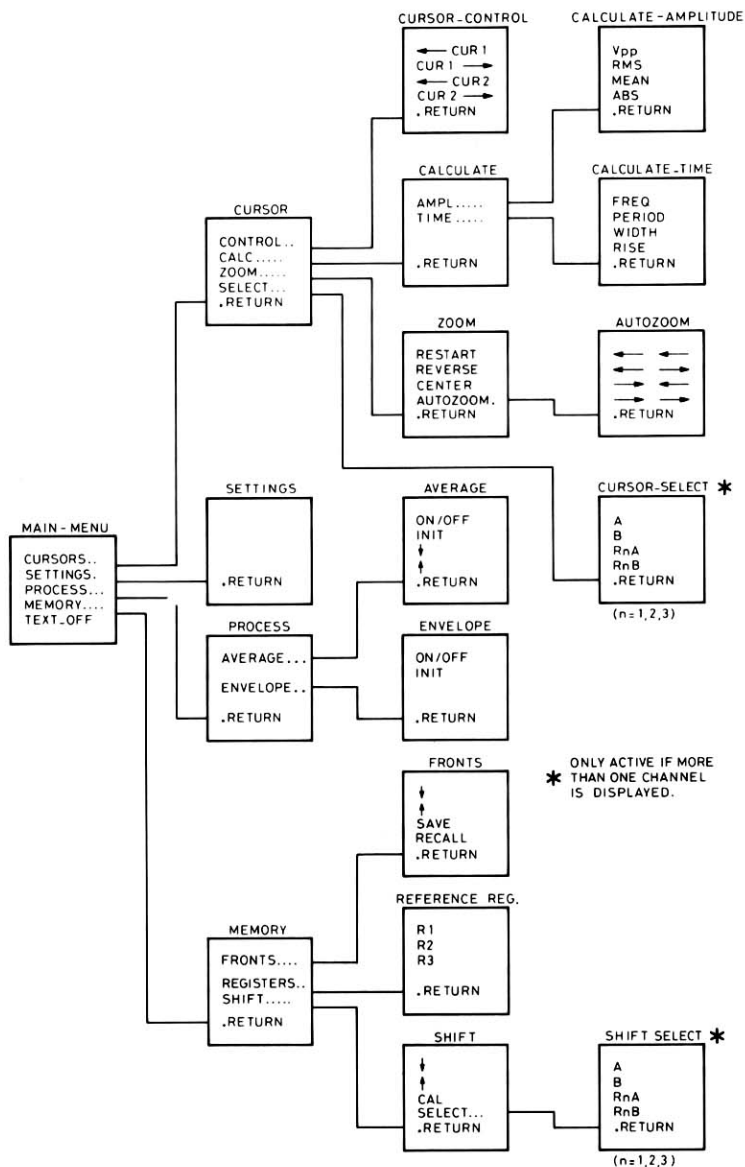

### 3.2.8 INPUTS AND OUTPUTS

The oscilloscope is equipped with several inputs and outputs to provide special functions and applications.

All standard and optional sockets are described below:

#### 3.2.8.1 Standard

| SOCKET                 | DESCRIPTION                                                                                                                                                                                                                                        |
|------------------------|----------------------------------------------------------------------------------------------------------------------------------------------------------------------------------------------------------------------------------------------------|
| <b>A</b>               | BNC input socket for channel A. Probe range indicator identifies attenuation of probe connected and this is compensated for in the LCD display for vertical deflection. (only active with probes that are provided with range indicator).          |
| <b>B</b>               | BNC input socket for channel B. Probe range indicator identifies attenuation of probe connected and this is compensated for in the LCD display for vertical deflection. (only active with probes that are provided with range indicator).          |
| <b>EXT</b>             | BNC input socket;<br>When EXT input is selected via the time-base the signal input is used for external triggering.<br>When EXT input socket is selected via X DEFL, the horizontal deflection is determined by the signal applied to this socket. |
| <b>CAL</b>             | Output socket providing a 1,2 V(p-p), 2 kHz approx. square-wave voltage. To be used for probe compensation or to calibrate the vertical deflection AMPL. control.                                                                                  |
| <b>LINE IN</b>         | Input socket for mains supply: 100 V...240 V(ac), 45 Hz...440 Hz.                                                                                                                                                                                  |
| <b>ANALOG PLOT OUT</b> | Output socket providing the plot signals Y PLOT, X PLOT and PENLIFT. Penlift can be defined in "APPL" application preselect (see chapter 7).<br>Sensitivity PLOT X and PLOT Y: 100 mV/div<br>Penlift: open collector                               |

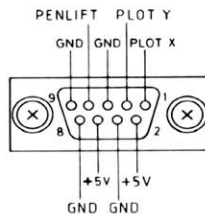

|               |                    |
|---------------|--------------------|
| <b>SOCKET</b> | <b>DESCRIPTION</b> |
|---------------|--------------------|

|              |                                                                                                                                                                              |
|--------------|------------------------------------------------------------------------------------------------------------------------------------------------------------------------------|
| <b>Z-MOD</b> | Input socket for Z-modulation of the CRT trace. The trace is blanked when this input is "high" ( $> +2,5\text{ V}$ ). Input voltage range: $0\text{ V} \dots +12\text{ V}$ . |
|--------------|------------------------------------------------------------------------------------------------------------------------------------------------------------------------------|

### 3.2.8.2 Optional

|                     |                                                                                                                       |
|---------------------|-----------------------------------------------------------------------------------------------------------------------|
| <b>IEEE 488 BUS</b> | Input/output connector to connect the oscilloscope to an IEEE 488/IEC 625 interface (24 pole micro-ribbon connector). |
|---------------------|-----------------------------------------------------------------------------------------------------------------------|

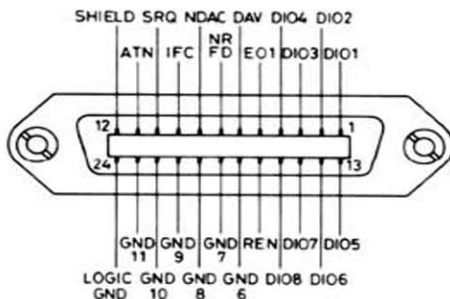

|                    |                                                                                                           |
|--------------------|-----------------------------------------------------------------------------------------------------------|
| <b>RS-232C BUS</b> | Input/output connector to connect the oscilloscope to a RS-232 C/V 24 interface (25 pole male connector). |
|--------------------|-----------------------------------------------------------------------------------------------------------|

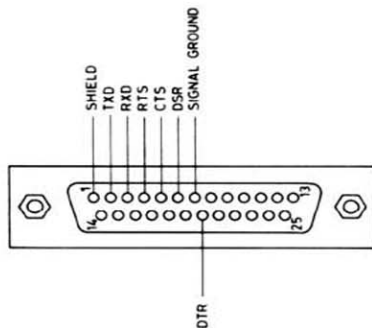



JTN

## 4 APPLICATIONS

### 4.1 USE AS AN ANALOG OSCILLOSCOPE

First ensure the oscilloscope is operating in the analog mode (DIGITAL MEMORY indication in LCD is off), otherwise press the DIGITAL MEMORY key.

By pressing the AUTO SET key, the oscilloscope will automatically set the main functions to a near optimal setting. Further adjustments and selections can then be made by operating the various keys and knobs.

To use the instrument as an analog oscilloscope three main functions need first to be defined:

- Vertical mode
- Horizontal mode
- Trigger mode

(These modes also exist when using the instrument as a digital storage oscilloscope, see Section 4.2.)

JTN

### 4.1.1. VERTICAL MODE

In vertical mode the following adjustments can be made:

- **Vertical display mode selection**  
by pressing the A/B key.

Select the channel you want to see A, B or A and B simultaneously. If the ADD function is in use, it is possible to switch off the channels A and B (see page 4.7).

- **Adjustment of the absolute zero level**  
by using the GND key and the Y POS rotary knob, the zero level can be positioned anywhere on the screen.

By pressing the GND key the input signal is interrupted and the input signal path is grounded. With the Y POS rotary knob the zero level can be adjusted to any level on the screen. By pressing the GND key once again the signal is once more connected to the input.

The zero level adjustment is necessary for all DC measurements.

JTN

- **Channel coupling**  
by pressing the AC/DC key.

In AC position the DC component of the measuring signal is rejected.  
In DC position the full bandwidth is available.

AC coupling is used when a small AC signal has to be measured that is superimposed on a large DC voltage.

For example, noise measurements on power supply voltages.

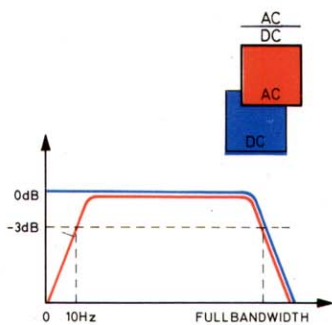
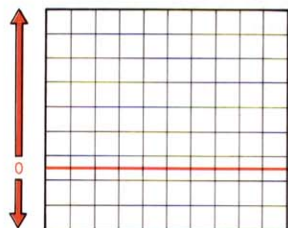
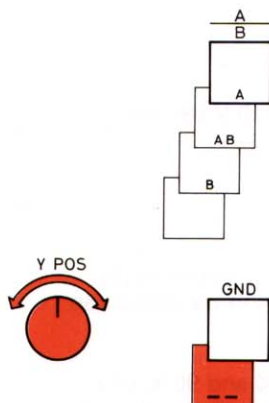

- **Vertical amplitude adjustment**  
by operating the V...mV UP-DOWN key for best setting.

The setting can be chosen out of a range from 2 mV up to 10 V per division in a fixed 1-2-5 sequence.

- **Vertical variable attenuation**  
by adjusting the VAR rotary knob.

The UNCAL position is used when the measurement is taken in percentages (UNCAL indication ">" flashes in the LCD). With the rotary knob the measured signal can be set to 100 %

For example rise-time measurements are made between 10 % and 90 % of a waveforms edge. If a measured square-wave signal has a peak-peak value of 6,2 divisions it can be attenuated to 5,0 divisions (= 100%) by adjusting the VAR rotary knob. As 5 divisions is now 100 %, the 10 % and the 90 % levels and the time between these levels can easily be read from the screen.

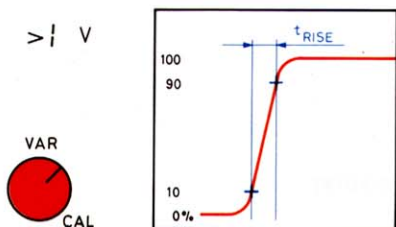
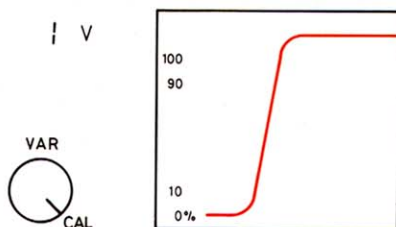
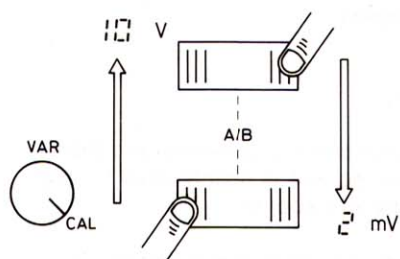

- **Selection of ALTERNATED or CHOPPED display**  
by pressing the ALT/CHOP key

This selection is used if two signals are displayed.

In alternate mode, the CRT beam alternately traces one signal sweep and then the other. At low repetition rates this can be seen, so ALT is mainly used for high speed time-base settings (from around 0,1 ms/div and above).

In chop mode, the beam chops from one signal to the other at a fast switching frequency and is therefore suitable for low speed signals.  
At high frequencies interference can occur between the switching signal and the measured signal, so take care when using the chop mode with high frequency signals.

- **Selection of ADD, NORMAL or INVERTED display**  
by pressing the ADD/INVERT key.

"INVERT" is active on channel B.

In the ADD mode, channel B is added to channel A ( $A + B$ ).

In the ADD INVERT mode, channel B is subtracted from channel A ( $A - B$ ).

The differential mode ( $A - B$ ) is useful for rejecting common-mode signals. By measuring in differential mode, the common-mode signal on one channel cancels out the common-mode signal on the other channel, leaving the actual signal visible on the display.

A practical application of the differential mode is to eliminate hum from a signal.

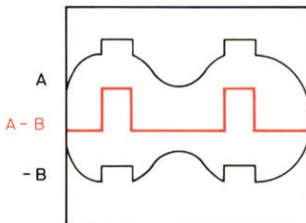
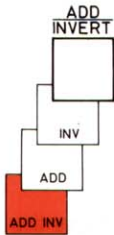
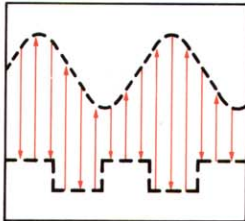
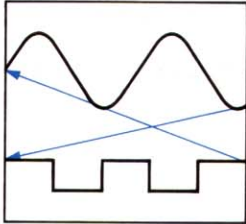
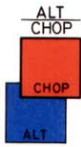

4.1 USE AS AN ANALOG OSCILLOSCOPE



### 4.1.2. HORIZONTAL MODE

In horizontal mode the following selections can be made:

- **Selection of X deflection or horizontal time-base**  
by pressing the X DEFL key.

In the X deflection mode the oscilloscope shows one signal to be displayed as a function of another signal (X-Y graph).

The required X-axis signal is selected by the TRIG OR X SOURCE key (A, B, EXT or LINE).

The X-Y mode has a wide range of applications, for example:

- amplitude vs frequency of circuits and filters;
- output current vs input voltage of semiconductors;
- comparison of frequency or phase shift using Lissajous figures.

In horizontal time-base mode the display shows the measured signal vs time (Y-t graph). The time coefficient can be selected with the TB s... $\mu$ s UP-DOWN key.

- **Selection of horizontal time scale**  
by using the TB s... $\mu$ s UP-DOWN key,  
the VAR rotary knob, or  
the X MAGN key.

With the TB s... $\mu$ s UP-DOWN key you can make a selection of the time-base speed in a 1-2-5 sequence.

With the rotary knob VAR you can make fine adjustments between the 1-2-5 steps.

With the X MAGN key you can expand the time-base 10 times.

By operating the X POS rotary knob the trace can be shifted across the screen in horizontal direction.

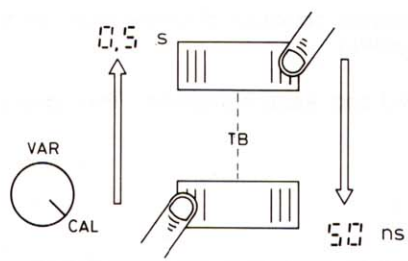
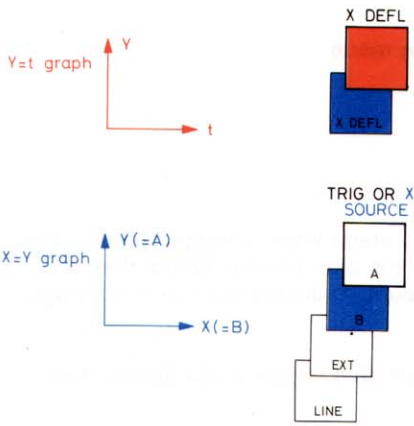

### 4.1.3. TRIGGER MODE

In trigger mode the following selections can be made:

- **Time-base trigger mode**  
by using the TB TRIG MODE key.

The time base can operate in three modes:

- AUTO**            the horizontal sweep normally starts when a trigger occurs. If no trigger is detected within 100 ms after the last sweep then a sweep start automatically occurs. This means a trace is always visible on the display.
- TRIG**            horizontal sweep will only start on a trigger pulse derived from the selected trigger source.
- SINGLE**           horizontal sweep runs only once after it is armed by the RESET key and the receipt of a trigger pulse derived from the selected trigger source. The mode is very useful to capture single events.

If the display mode is ALT (alternate), a special selection of single shot can be made in the application preselect menu (APPL),

- enter the APPL menu by pressing MENU and keep it pressed. Then press AUTO SET,
- select the CRT softkey APPL,
- select the CRT softkey SNGL\_SHOT,
- select the CRT softkey FIRST or MULTI

**FIRST =**        single shot is always done on channel A (provided this channel is active).

**MULTI =**        single shot alternates between A, B and ADD (provided these functions are active).

Leave the application preselect menu again by pressing the AUTO SET key. The chosen SNGL\_SHOT setting remains selected after leaving the application preselect menu.

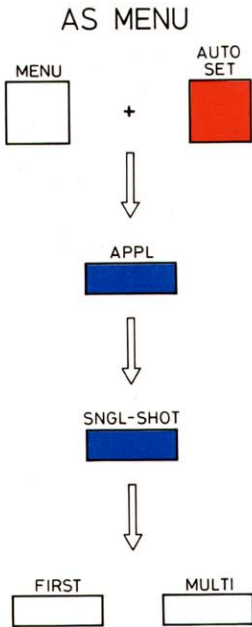
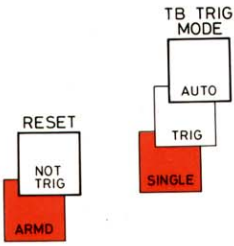

**- Trigger source selection**

by pressing the TRIG OR X SOURCE key.

The trigger sources can be selected from:

|      |                                                         |
|------|---------------------------------------------------------|
| A    | channel A                                               |
| A B  | composite channel A and channel B                       |
| B    | channel B                                               |
| EXT  | channel EXTERNAL                                        |
| LINE | 50 Hz or 60 Hz sine-wave derived from the line voltage. |

In composite triggering (A B) the trigger source alternates between A and B, therefore this trigger mode is only possible in the alternated display mode. Notice that in this mode the displayed traces are NOT time related while the trigger pulses indicate different time moments. An example of composite triggering is shown on the next page.

Line triggering is used where signals have to be measured that are time related to the LINE frequency; e.g. measurements of hum.

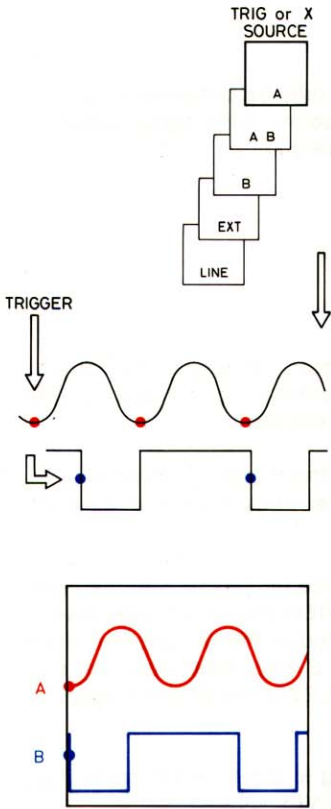

**- Trigger level**

by adjusting the TRIG LEVEL rotary knob.

For repetitive signals, a stable, jitter-free display will only be obtained if each time-base sweep is triggered at precisely the same point on the signal waveform. The trigger level is adjusted with the TRIG LEVEL rotary knob.

**- Trigger coupling**

by the TRIG COUPL key.

Six modes can be selected for trigger coupling:

**P-P** Peak-to-peak triggering gives automatic ranging of the TRIG LEVEL knob, the ranging being determined by the peak-to-peak value of the signal. DC signals are rejected.

**DC** DC triggering; the full bandwidth of the trigger channel is available, while the level range of the rotary knob is more than  $\pm 8$  divisions.

In this mode, the trigger level can also be shown with the LEVEL VIEW key. By pressing the LEVEL VIEW key, the trigger level will be shown as a DC voltage, related to the vertical mid of the oscilloscope screen (vertical mid = 0 volt). After adjusting the TRIG LEVEL rotary knob press the LEVEL VIEW knob again to return to the original screen.

**TVF** TV frame triggering allows triggering at the slow TV frame (field) synchronisation pulses; the TRIG LEVEL rotary knob is inoperative.

**TVL** TV line triggering allows triggering at the fast TV line synchronisation pulses; the TRIG LEVEL rotary knob is inoperative.

**LF** In this mode the signal used for triggering is first passed through a low-pass filter with a cut-off frequency of 50 kHz. All components with high frequencies are rejected.

**HF** In this mode the signal used for triggering is first passed through a high-pass filter with a cut-off frequency of 50 kHz. All components with low frequencies are rejected.

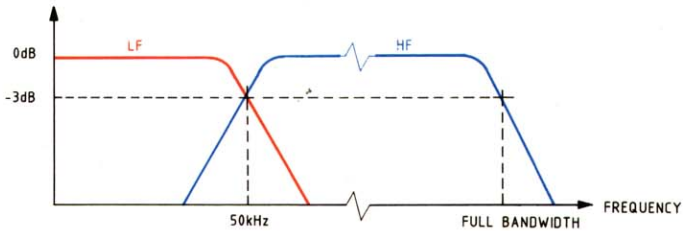
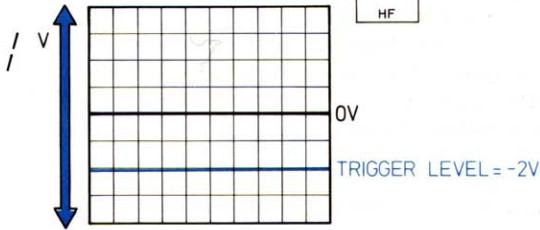
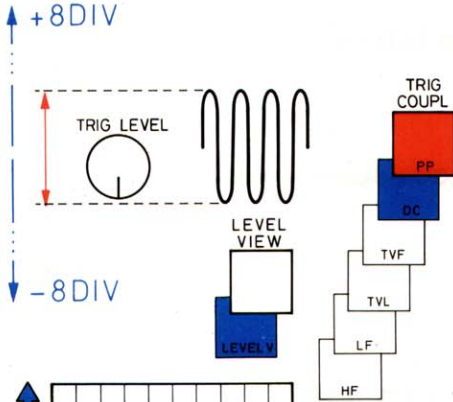



- **Trigger slope selection**  
by pressing the  $\int \setminus$  key.

For triggering on a positive-going slope select  $\int$ , for triggering on a negative-going slope select  $\setminus$ .

If trigger coupling TVF or TFL is selected, LCD indicates + and - instead of  $\int$  and  $\setminus$ .

- + = positive video,
- = negative video.

If horizontal mode X DEFL is selected, LCD indicates + and - instead of  $\int$  and  $\setminus$ .

- + = signal not inverted,
- = signal inverted.

- **Hold-off time**  
by using the HOLD OFF rotary knob.

The HOLD OFF rotary knob is used to prevent "false" triggering and "double writing" when examining multiple pulse signals. After the horizontal sweep is completed triggering is inhibited for period of time set by the HOLD OFF knob. Adjustment of the HOLD OFF enables triggering to be synchronized on the same pulse in the pulse train and so gives a stable display.

For example, consider a double pulse repetitive input signal. The selected trigger signal sees the same condition on the second pulse as the first pulse, and so the time base sweep starts too soon. The double-writing effect is seen as an extended base-line on the upper trace. Adjusting the hold-off time will inhibit the trigger unit until it sees the first pulse again.

TRIG LEVEL

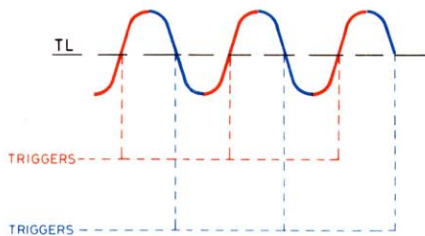
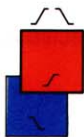

HOLD OFF

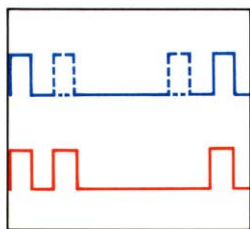

TRIGGERS



SWEEP



SWEEP



## 4.2 USE AS A DIGITAL STORAGE OSCILLOSCOPE

To use the instrument as a digital storage oscilloscope three main functions should be defined:

- Vertical mode
- Horizontal mode
- Trigger mode

First ensure the oscilloscope is operating in the digital mode (DIGITAL MEMORY indication in LCD is on), if not then press the key DIGITAL MEMORY.

By pressing the AUTO SET key the oscilloscope will automatically set the main functions to the most convenient setting.

Further adjustments should be made by operating the keys. In DIGITAL MEMORY mode there are more functions available than in the analog mode. The use of the identical analog functions is described in Section 4.1 "Use as an Analog Oscilloscope".

The analog functions which are not available in DIGITAL MEMORY mode are: ADD, ALT/CHOP, X DEFL, COMP TRIG, X VAR.

In this section only the DIGITAL functions are described.

### 4.2.1. VERTICAL MODE

In vertical mode the following additional choices can be made:

- **Dotted or joined display**  
by pressing the DOTS key.

In digital memory mode the traces are built-up by "dots" of samples. Selection of "dotted" or interpolated (dotjoined) display can be made.

In dotjoined mode the dots are interconnected by a line, so the display appears continuous.

In dotted mode every dot is displayed separately. The vertical resolution is 256 dot positions over 10 divisions, the horizontal display resolution is 1000 dot positions over 10 divisions when the expansion factor is x1.

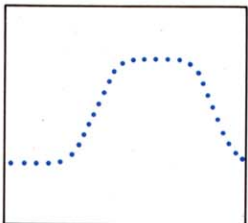
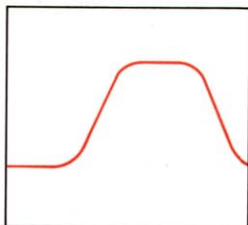

- **Loading of register memory**  
by pressing the register LOAD key.

The oscilloscope has two types of memory:

- a display memory, which you see in normal operation,
- three register memories, which are used to store reference waveforms.

If you want to store a waveform in a register, first select destination register R1 or R2 or R3. This is done by operating the softkeys MEMORY and REGISTERS (see Section 4.3). When one of these registers is chosen, you only have to press the LOAD key to store the signal into this register. Provided the oscilloscope is equipped with a battery back-up, the waveforms in all registers are still stored after power down for recall at the next power up.

- **Display of register memory**  
by pressing the DISPLAY key.

Pressing the DISPLAY key once will show the contents of the display memory and the selected register memory (R1 or R2 or R3) together on the screen. Now the two signals can be compared with each other.

Pressing the DISPLAY key a second time will show only the contents of the selected register memory (R1 or R2 or R3).

Pressing the DISPLAY key a third time will result in displaying the contents of the display memory again.

*NOTE: Only one of the register memories can be displayed at the same time (with the display memory).*

- **Status of register memory**  
by pressing the STATUS key.

Pressing the STATUS key once and keep it pressed enables the LCD to show the full settings of the selected register memory (R1 or R2 or R3).

Pressing the STATUS key twice within one second and keep it pressed, the LCD will show the complete settings of the display memory (R0).

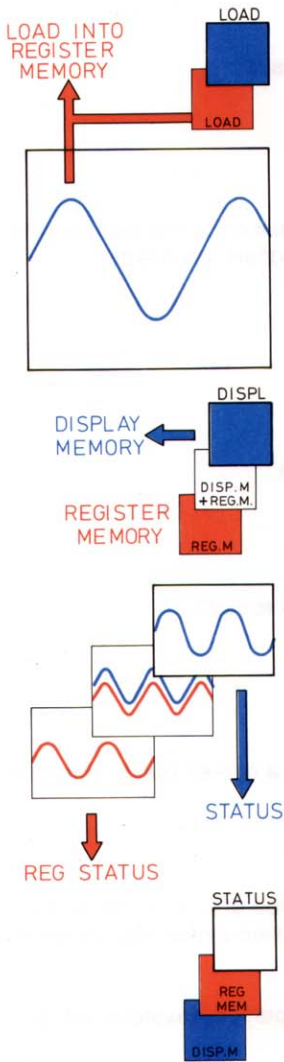

### 4.2.2. HORIZONTAL MODE

In horizontal mode the following selections can be made:

- **Selection of horizontal time scale**  
by the TB s... $\mu$ s UP-DOWN key,  
the X MAGN key.

The adjacent figure shows the time-base ranges in relation to the sample rate and resolution. Only in SAMPLING mode repetitive signals are needed (see also page 4.26).

The digital time-base has three modes:

#### ROLL

50 s/div ... 1 s/div (PM3350A/55/65A/75)

In ROLL mode the screen build-up is from right to left.

#### RECURRENT

0,5 s/div ... 0,5  $\mu$ s/div (PM3350A/65A)

0,5 s/div ... 0,2  $\mu$ s/div (PM3355/75)

In RECURRENT mode the screen build-up is from left to right.

#### SAMPLING

0,2  $\mu$ s/div ... 20 ns/div (PM3365A)

0,1  $\mu$ s/div ... 20 ns/div (PM3375)

In SAMPLING mode repetitive signals are needed for a screen build-up from left to right.

*NOTE: The PM3350A/55 have no sampling mode !*

By pressing the X MAGN key, a horizontal magnification of 2, 4, 8, 16, or 32 times can be obtained. Any part of interest in a magnified signal may be selected for display by the DISPL PART UP-DOWN key.

By operating the DISPL PART UP-DOWN key, the displayed waveform will scroll across the screen in the selected direction.

The LCD bar shows the actual position of the displayed part of the magnified signal in relationship to the memory length.

*NOTE: You can return to the default value of \*1 magnification by pressing the X MAGN key and then the RESET key simultaneously. Next, pressing the DISPL PART key and RESET key results that the displayed part is in the horizontal mid-position again.*

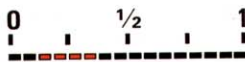
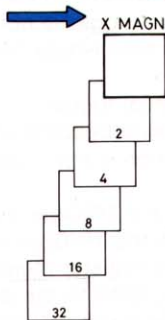
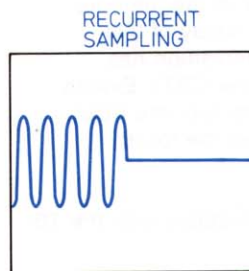
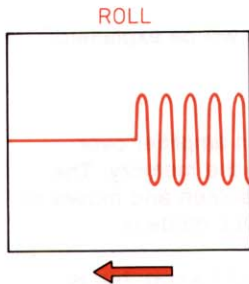



In the following part the already mentioned time-base modes will be explained:

## ROLL MODE

Lower frequency signals, such as reference voltage drift in an amplifier over periods of several hours, can now be captured and stored in the memory. The signal is built up point-by-point at the right-hand side of the screen and moves to the left. The ROLL segment on the LCD indicates that the ROLL mode is operative.

The ROLL mode is usually started with the release of the RESET knob, but is also started when changing the triggering or amplitude control.

The TRIGGER DELAY defines the amount of the stored signal in the memory before and after the trigger. As an example: In case a trigger delay of 0 is selected, the ROLL mode stops when the startpoint of the acquisition has reached the far left vertical graticule line (the extreme left of the CRT). Exactly one screen is filled this way. If a TRIGGER DELAY of -3 is selected, the ROLL mode stops when the startpoint of the acquisition has reached the fourth graticule line (related to the left of the CRT).

The following TRIGGER MODE conditions can be applied, selectable with the TB TRIG MODE button:

- AUTO            The stop condition of the ROLL mode in auto trigger is not the trigger level crossing point, but that point in time where the ROLL mode was first activated.
- TRIG            The stop condition is now defined by the actual trigger point, so trigger source, trigger coupling, slope and level become valid. After receiving the trigger pulse, the acquisition is then copied to the display memory.
- SINGLE        In this case the single shot acts identical to the TRIGGER mode.
- MULTI         The principle of operation is also identical to the TRIGGER mode. The first acquisition is copied to the selected register memory (R1 or R2 or R3), the second acquisition is copied to the display memory (R0), see also page 4-30. This mode is not selectable if one of the PROCESS functions (ENVELOPE or AVERAGE) is active (see page 4.40).

**ATTENTION:** *Take note that the lower transition point of the bandwidth for TRIGGER COUPLING P-P is limited to 20 Hz. So the peak-to-peak is not applicable for the ROLL mode. The trigger coupling should be set to DC.*

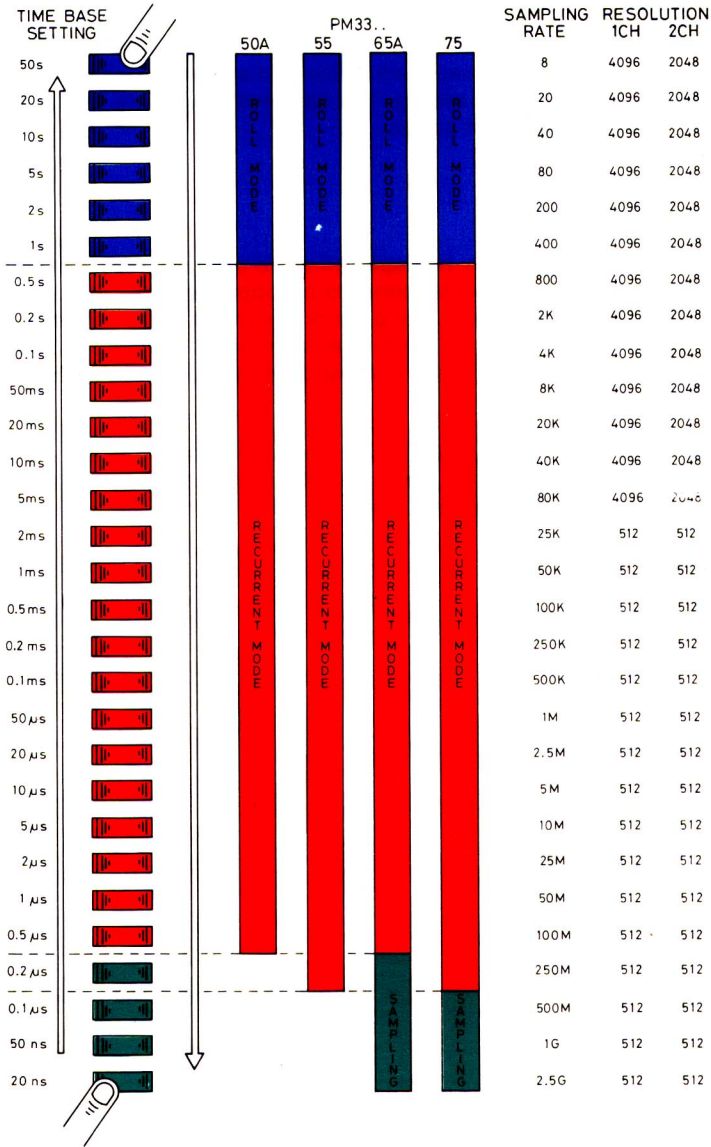

## RECURRENT MODE

Signals with intermediate frequencies can be made visible in the RECURRENT mode. In this mode the signal is sampled at fixed time intervals, the length of which depends on the time-base setting. The sampled values are written in the display memory and displayed on screen.

## SAMPLING (PM3365A/75 only)

Higher frequency signals can now be captured up to the full bandwidth of the oscilloscope, provided that the signal consists of repetitive and identical pulses. With sequential sampling, one point along the waveform is sampled per sweep until enough points are acquired by the display memory. The number of sweeps needed to capture a signal will therefore depend on the number of points required to fill the memory.

**ATTENTION:** *Because of the fixed time relationship between sample and trigger point, sequential sampling is NOT suitable for showing fast edges of short widely-spaced pulses.*

JTN

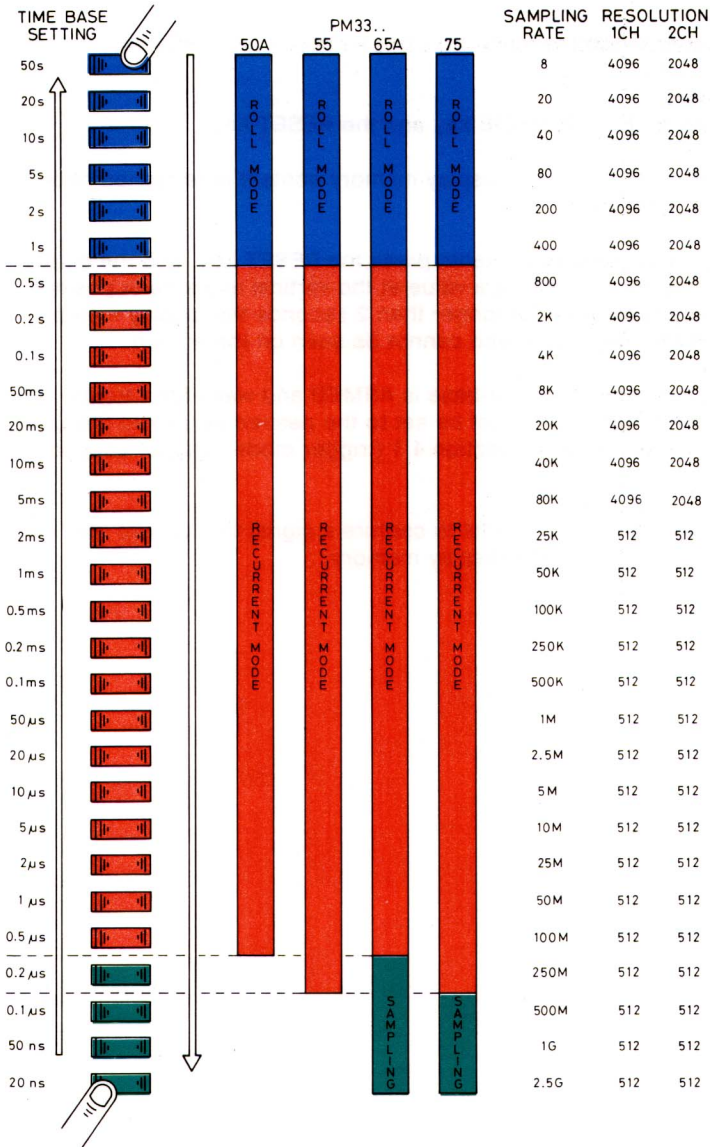

### 4.2.3. TRIGGER MODE

In DIGITAL trigger mode the following extra functions are available:

- **SINGLE SHOT**

by pressing the TB TRIG MODE key and the RESET key.

In DIGITAL MEMORY mode the display memory content is refreshed once after a suitable trigger is received.

To clear the display memory contents press the RESET key, and the display memory contents are then set to a value at the vertical mid screen position. If the RESET key is pressed for longer than 2 seconds the display memory contents are set to the value 0 and cannot be seen on the screen.

After a RESET operation the time-base is ARMED and waits for a trigger. For a good trigger, the trigger level must be set to the desired value and the LEVEL VIEW function as described in Section 4.1 (trigger mode - trigger coupling) can be of help.

The single-shot mode is very useful to capture a signal that occurs only once. The signal is then stored in the display memory.

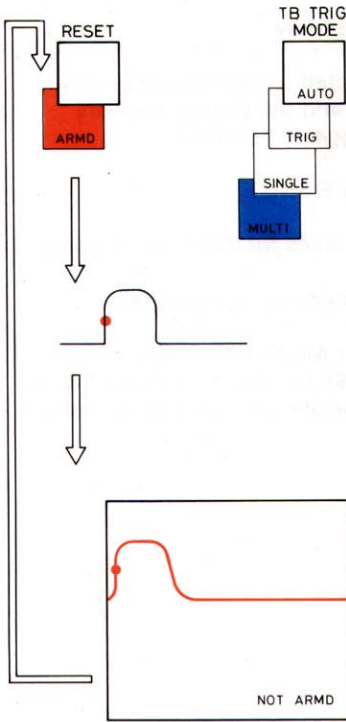

**- MULTIPLE SHOT**

by pressing the TB TRIG MODE key and the RESET key.

In DIGITAL MEMORY mode the contents of the selected register memory are refreshed ONCE after the FIRST trigger is received, and the display memory contents are refreshed ONCE after the SECOND trigger is received.

To CLEAR the contents of the memories , see SINGLE SHOT.

After a reset operation the time base is ARMED and waits for TWO new triggers.

*NOTE: In this mode the content of the register memory is overwritten.*

When one of the PROCESS functions (ENVELOPE or AVERAGE) is active, MULTIPLE SHOT mode is not available. If a PROCESS function is activated while in the MULTIPLE SHOT mode, the oscilloscope automatically switches to SINGLE SHOT mode.

JTN

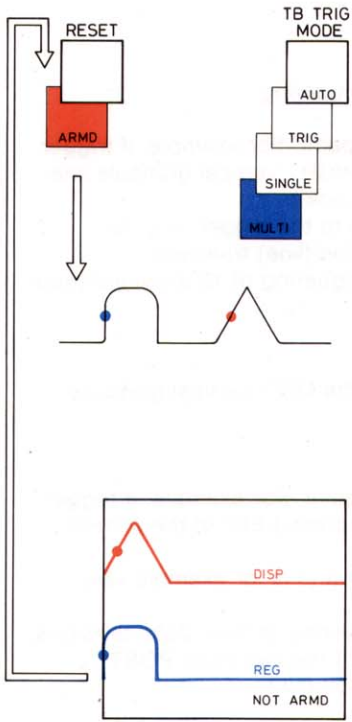



**- TRIGGER DELAY SETTING**

by pressing the TRIG DEL UP-DOWN key.

The TRIGger DELay setting offers PRE- and POST triggering.

In PRE triggering you can look BEFORE the trigger point. For example, if trigger delay = -10 divisions, the trigger point is at the far RIGHT vertical graticule line. What you see is then the signal BEFORE the trigger point.

This mode enables observation of events leading up to the trigger; e.g. to pin-point the cause of a problem, for instance, a mains (line) transient.

The PM3350A/55/65A/75 all have a maximum PRE triggering of 10 divisions (max. TRIG DEL = -10 div.).

In trigger delay = 0 divisions the trigger point is at the LEFT vertical graticule line.

In POST triggering you can look AFTER the trigger point. For example, if trigger delay = +10 divisions, the trigger point is one full screen LEFT of the screen that you see.

This mode effectively stretches the memory capacity and is for example very useful when measuring a certain line in a TV pattern.

The PM3350A/65A have the disposal of a POST triggering of max. 2500 divisions (max. TRIG DEL = + 2500 div.). With the PM3355/75 the maximum POST triggering is 5000 divisions (max. TRIG DEL = + 5000 div.).

*NOTE: You can return to the default value of 0 divisions trigger delay by pressing the TRIG DEL key and then the RESET key simultaneously.*

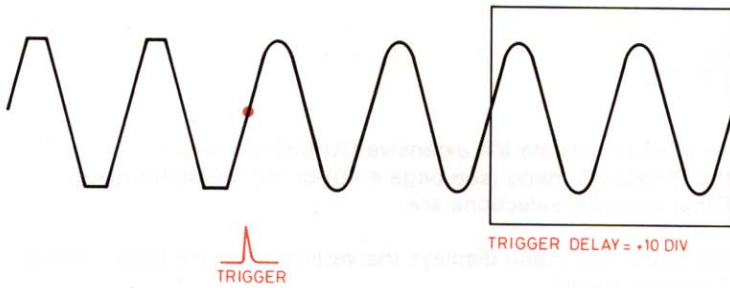
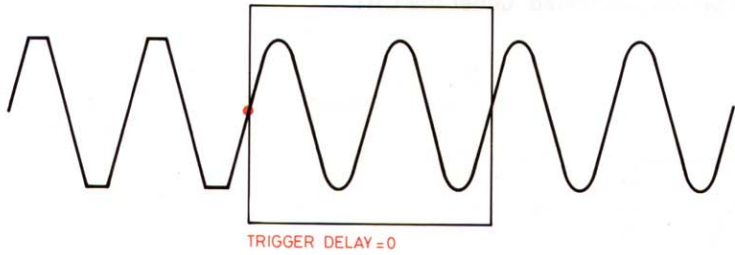
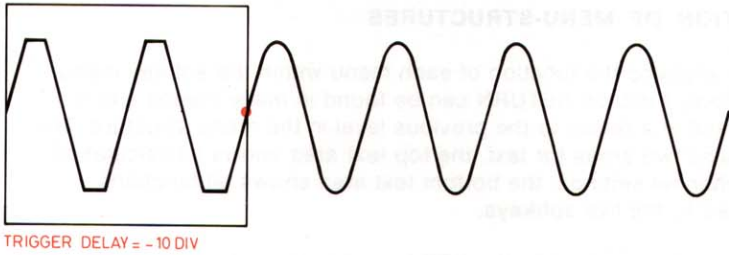

## 4.3 MENUS AND MEASUREMENTS

*NOTE: The menus that are described here and the cursor measurements performed in this section are only available in DIGITAL MODE.*

### 4.3.1 EXPLANATION OF MENU-STRUCTURES

The following text explains the function of each menu within the softkey menu structure. The softkey function RETURN can be found in many menus and if activated it will result in a return to the previous level in the menu structure. The CRT screen contains two areas for text, the top text area shows all calculation information and channel settings, the bottom text area shows all functions selections assigned to the five softkeys.

When in DIGITAL mode, the text on the CRT can be activated by pressing one of the five softkeys that are positioned under the CRT

#### MAIN MENU

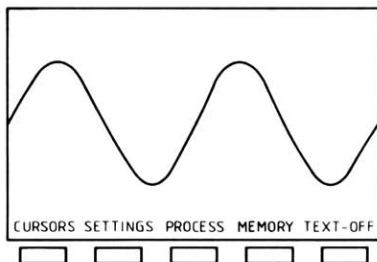

This menu is mainly used to activate the extensive CURSORS menu (see page 4-36), the PROCESS menu (see page 4-40) or the MEMORY menu (see page 4-43). Other possible selections are:

- **SETTINGS.** When active, this menu displays the vertical and time base settings relating to the displayed traces.
- **TEXT-OFF.** When this key is pressed, all text disappears from the screen. The text is placed on the screen again by pressing one of the five softkeys.

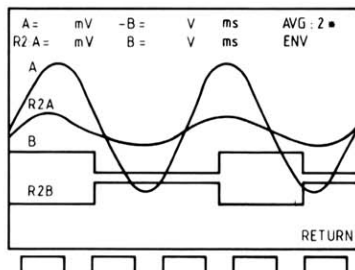

This menu shows all vertical and horizontal setting information of the active signals and the stored and displayed signals in the top text area of the CRT screen. The traces are marked A and B (for channel A and B in display memory), R1A and R1B (for channel A and B in register memory 1), R2A and R2B (for channel A and B in register memory 2) and R3A and R3B (for channel A and B in register memory 3).

The SETTINGS menu can be very useful for making a hardcopy (photographs, printouts, plot-outs) of the screen traces, including the settings.

## CURSORS menu

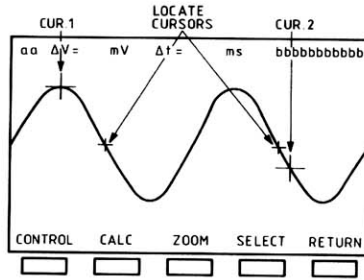

Once activated two cross-shaped MAIN CURSORS are positioned on the waveform. The trace on which the CURSORS operate can be selected in the SELECT menu. Via the CONTROL menu the two MAIN CURSORS can be separately positioned horizontally on the waveform. Positioning to the left and to the right is possible. CURSOR 1 and CURSOR 2 can not pass each other to avoid erroneous negative time. Depending on previous measurement selections either a horizontal dotted line or two so-called LOCATE cursors may also be visible. The dotted line serves as a ground reference point for certain AMPLITUDE measurements. The small LOCATE cursors are placed on the waveform inbetween the MAIN cursors. Their position is used to indicate exactly where on the waveform the selected automatic measurement is being calculated. The result of the cursor measurements are shown on the top text line.

## CALCULATE menu

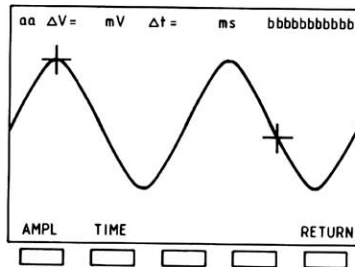

A pre-selection of either AMPLitude or TIME measurements is made via this menu. The following explanation gives details of each measurement possibility.

## CALCULATE-AMPLITUDE menu

This menu is entered from the CALCULATE menu by pressing the AMPL-softkey

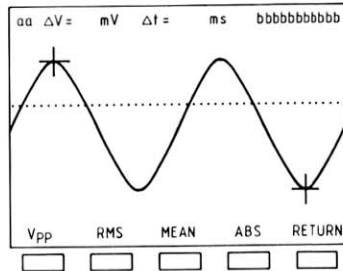

The following selections can be made:

- Vpp calculates the peak to peak value of the signal part between the MAIN CURSORS. The LOCATE CURSORS indicate the signal top and bottom the calculation is related. The calculation result is displayed in the right corner of the top text area of the CRT.
- RMS calculates the Root Mean Square value of the waveform between the MAIN cursors. This value is referenced to the dotted ground line. This line can be vertically positioned by grounding (GND key) the relevant channel and then adjusting (Y POS) the line to the desired vertical position. The calculation will start again when the GND is released.
- MEAN calculates the mean value of the waveform between the MAIN cursors. This value is referenced to the dotted ground line. This line can be positioned in the screen as explained under the RMS mode.
- ABSolute calculates the vertical voltage differences between the dotted ground line and MAIN Cursor 1 (C1 value) and MAIN Cursor 2 (C2 value). The results are displayed in the top text area of the CRT. The reference line can be positioned across the screen as explained under the RMS mode.

## CALCULATE-TIME menu

This menu is entered from the CALCULATE menu by pressing the TIME-softkey.

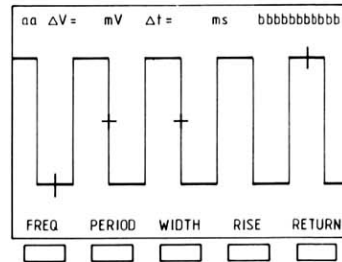

The following selections can be made:

- FREQUENCY calculates the signal frequency (indicated on the CRT with "f") provided that at least one signal period is present between the MAIN cursors. Only one cycle is used in the calculation, this is the nearest to the left cursor. The LOCATE cursors indicate the signal period over which the calculation is made.
- PERIOD calculates the duration of one signal period ("T") provided that at least one signal period is present between the MAIN cursors. Only one cycle is used in the calculation, this is the nearest to the left cursor. The LOCATE cursors indicate the signal period over which the calculation is made.
- WIDTH calculates the width of the first pulse ("t<sub>w</sub>") seen from the left cursor provided that there is at least one pulse present between the MAIN cursors. The LOCATE cursors indicate the signal part over which the calculation is made. The pulse may be negative- or positive-going.
- RISE calculates the rise- or fall-time ("t<sub>r</sub>") of the first signal slope seen from the left cursor provided that there is at least one slope between the MAIN cursors. The 100% level is taken to be the vertical value between the MAIN cursors. The LOCATE cursors indicate the part of the slope over which the calculation is made. The rise time is automatically calculated between the 10% and 90% level of the dV-amplitude or to the nearest sample to these points.

## ZOOM menu

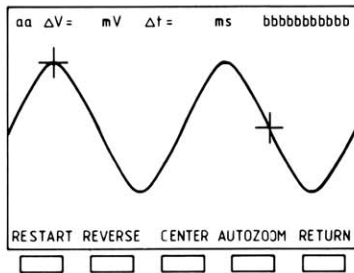

This menu is used to magnify a part of the signal while the sample resolution stays unchanged. This is only possible if the instrument is out of the LOCK mode because a new signal acquisition is necessary with adapted time-base and TRIG DELAY setting. The possible softkey selections are:

- RESTART expands the part of the waveform between the MAIN cursors. This part can then be examined in more detail.
- REVERSE resets the instrument to the situation immediately before the RESTART command and then resamples the signal. This function is only available after use of the RESTART function.
- CENTER replaces the MAIN cursors horizontally to +2 div and -2 div of the screen centre after which the RESTART can be used again.
- AUTOZOOM accesses the menu where the cursors can be shifted both to the left, away from each other, towards each other or both to the right. When shifting the cursors an automatic RESTART is made when the time between the cursors is suitable for another time-base and/or TRIG DEL setting to be used.



## PROCESS menu

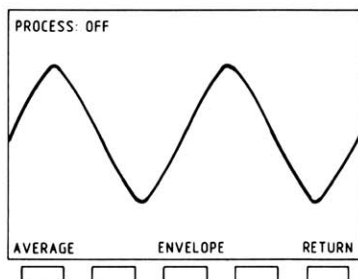

This menu is an intermediate menu to define which of the two processes, AVERAGE or ENVELOPE, is activated. The two processes can never be active at the same time !

De-activating a selected function can be done by:

- switching-off the process in the sub-menu,
- switching-on the other process,
- performing an AUTOSET or SOFTSTART,
- switching-off and on the instrument.

The choosen AVERAGE or ENVELOPE function remains selected when leaving the PROCESS menu .

The functions AVERAGE and ENVELOPE are temporarily switched-off in the ROLL mode (for TIME/DIV positions slower than 0,5 s/div). This will be indicated by a message on the screen (see pages 4-41 and 4-42).

The ENVELOPE function is switched-off in case of re-definition of the reference register. This will be indicated by a message on the screen (see page 4-41).

## PROCESS AVERAGE menu

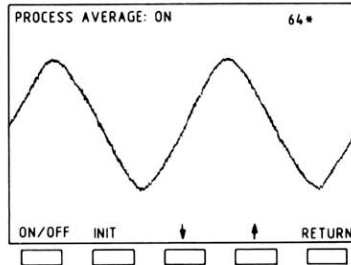

With this function you can suppress noise without losing bandwidth. Every dot is calculated after every sweep in the following way:

$$\text{new} = \text{previous} + \frac{\text{measured} - \text{previous}}{C}$$

In this formula "previous" is a sample on the same position of the previous sweep. "C" is the average-factor; the bigger C is, the slower the dot positions change. The following values for C can be selected: 2, 4, 8, 16, 32, 64, 128 or 256.

Once activated, AVERAGE is a continuous process until it is switched off. The process is started again when the INIT softkey is pressed or when the triggering or amplitude control is changed. In this case the display memory is cleared.

In SINGLE SHOT trigger mode the number of acquisitions is equal to the average factor C.

In ROLL mode, AVERAGE is temporarily switched-off. This is indicated by the message:

**AVERAGE suspended because of ROLL mode**

During AUTOZOOM, AVERAGE is also temporarily switched-off. This is then indicated by the message:

**AVERAGE suspended because of AUTOZOOM**

In this case, the AVERAGE process can be re-activated again by pressing the RETURN key. This is indicated by the message:

**AVERAGE re-activated**

Activating or de-activating of the AVERAGE process can be done by using the ON/OFF softkey.

## PROCESS ENVELOPE menu

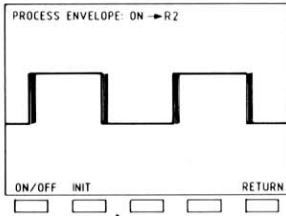

This function stores alternating the minimum and the maximum of each sample position over the sweeps taken. The ENVELOPE is stored in the reference register (R1, R2 or R3) and default displayed together with the acquired signal (display memory R0).

Once activated, this is a continuous process until it is switched-off. The ENVELOPE process is started again when the INIT softkey is pressed or when the triggering or amplitude control is changed. In this case the display memory is cleared.

In ROLL mode, ENVELOPE is temporarily switched-off. This is indicated by the message:

**ENVELOPE suspended because of ROLL mode**

During AUTOZOOM, ENVELOPE is also temporarily switched-off. This is then indicated by the message:

**ENVELOPE suspended because of AUTOZOOM**

In this case, the ENVELOPE process can be re-activated again by pressing the RETURN key. This is indicated by the message:

**ENVELOPE re-activated**

Activating or de-activating of the ENVELOPE process can be done by using the ON/OFF softkey. When de-activated, only the display memory R0 is displayed again.

Redefining the reference register will stop the ENVELOPE process. This is indicated by the message:

**ENVELOPE de-activated**

## MEMORY menu

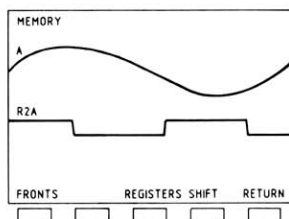

This menu is an intermediate menu, used to choose between the FRONTS menu, REGISTERS menu and SHIFT menu.

With the FRONTS menu it is possible to store up to 63 different settings of the front panel keys in the oscilloscope memory.

In the REGISTERS menu it is possible to choose between R1 or R2 or R3 for the active register memory, upon which operations can be performed.

The traces on the screen can be shifted with the SHIFT menu.

## FRONTS menu

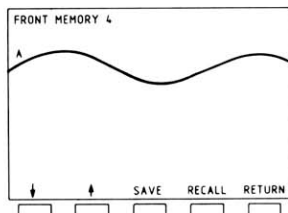

With this menu it is possible to store up to 63 (1 ... 63) different front panel key settings. When the oscilloscope is controlled via the optional IEEE-488 or RS-232C interface, 64 (0 ... 63) different front key settings can be stored (see Communication Interface Manual). The front panel key settings are still stored in the oscilloscope memory after power down for recall at the next power up (if backup batteries are fitted). One of the FRONT MEMORIES can be selected with the up-down softkeys. The actual front panel key setting can be stored in the selected FRONT MEMORY by pressing the SAVE softkey. If the selected FRONT MEMORY already contains a front panel key setting, this can be activated by pressing the RECALL softkey.

### 3.2.8 INPUTS AND OUTPUTS

The oscilloscope is equipped with several inputs and outputs to provide special functions and applications.

All standard and optional sockets are described below:

#### 3.2.8.1 Standard

| SOCKET                 | DESCRIPTION                                                                                                                                                                                                                                        |
|------------------------|----------------------------------------------------------------------------------------------------------------------------------------------------------------------------------------------------------------------------------------------------|
| <b>A</b>               | BNC input socket for channel A. Probe range indicator identifies attenuation of probe connected and this is compensated for in the LCD display for vertical deflection. (only active with probes that are provided with range indicator).          |
| <b>B</b>               | BNC input socket for channel B. Probe range indicator identifies attenuation of probe connected and this is compensated for in the LCD display for vertical deflection. (only active with probes that are provided with range indicator).          |
| <b>EXT</b>             | BNC input socket;<br>When EXT input is selected via the time-base the signal input is used for external triggering.<br>When EXT input socket is selected via X DEFL, the horizontal deflection is determined by the signal applied to this socket. |
| <b>CAL</b>             | Output socket providing a 1,2 V(p-p), 2 kHz approx. square-wave voltage. To be used for probe compensation or to calibrate the vertical deflection AMPL. control.                                                                                  |
| <b>LINE IN</b>         | Input socket for mains supply: 100 V...240 V(ac), 45 Hz...440 Hz.                                                                                                                                                                                  |
| <b>ANALOG PLOT OUT</b> | Output socket providing the plot signals Y PLOT, X PLOT and PENLIFT. Penlift can be defined in "APPL" application preselect (see chapter 7).<br>Sensitivity PLOT X and PLOT Y: 100 mV/div<br>Penlift: open collector                               |

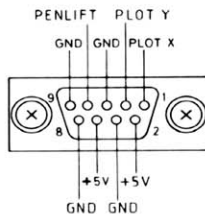

## REGISTERS menu

In this menu one of the register memories R1 or R2 or R3 can be selected as the REFERENCE REGISTER MEMORY upon which operations can be performed. This can be done by pressing one of the softkeys R1, R2 or R3.

## SHIFT menu

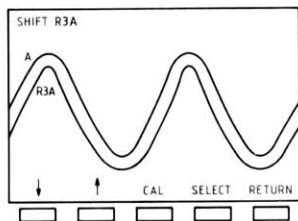

In this menu a displayed trace can be positioned UPwards or DOWNwards on the screen. If CAL is pressed the trace returns to its original position. The SELECT menu permits selection of the trace to be positioned. This menu is only active if more than one trace is visible on the screen. Correct positioning of trace A and B is only possible in LOCK mode, as this is a post acquisition facility. This can be useful for overlaying single shot signals where the normal position controls can not be used.

In the following sections will be described how to perform various measurements using the cursors (section 4.3.2) and the PROCESS functions (section 4.3.5).

JTN

### 4.3.2 PERFORMING AMPLITUDE MEASUREMENTS

*NOTE: In the following sections the MAIN cursors are always printed in BLUE, the LOCATE cursors in RED*

#### **Vpp**                      **Peak-to-peak voltage**

The Vpp amplitude measurement is calculated over the signal lying between the MAIN CURSORS. It is necessary to set the main cursors on the wanted trace, using the CURSOR-SELECT menu and on the required part of the signal, using the CURSOR-CONTROL menu.

By activating the Vpp calculation function, the oscilloscope will automatically measure the peak-to-peak voltage, and will show the measuring points by two small LOCATE CURSORS.

The measuring result is shown in the top text area. If the VAR rotary knob of the channel is in CAL position, the result will be displayed in Volts. If the VAR rotary knob is in UNCAL position, the result will be displayed in Divisions:

Vpp = ... mV, or Vpp = ... DIV

#### **ABS**                      **Absolute**

The ABS amplitude measurement will be calculated from the MAIN CURSORS related to the absolute zero level. This zero level is indicated as a horizontal dotted line and is related to the grounded Y position. The correct way to use this function is:

- activate the ABS function,
- ground the trace and adjust the zero level anywhere on the screen, by means of the Y POS rotary knob.
- press the GND key once again (the signal is now connected to the channel).  
**Do not** re-adjust the Y POS rotary knob anymore.

The measuring result is shown in the top text area. If the VAR rotary knob of the channel is in CAL position, the result will be displayed in Volts. If the VAR rotary knob is in UNCAL position, the result will be displayed in Divisions:

ABS: C1 = ... mV, C2 = ... mV, or C1 = .. DIV, C2 = .. DIV



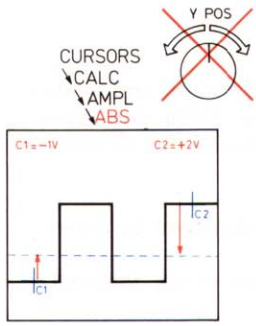
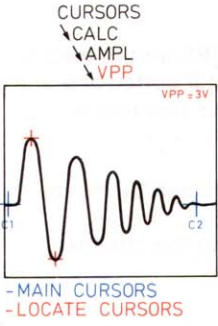

**RMS**                      **Root mean square voltage**

The RMS measurement is calculated between the MAIN CURSORS and related to the absolute zero level. This zero level is indicated as a horizontal dotted line and is related to the grounded Y position. The correct way to use this function is:

- activate the RMS function,
- ground the trace and adjust the zero level anywhere on the screen by means of the Y POS rotary knob,
- press the GND key once again (the signal is now connected to the channel).  
**Do not** re-adjust the Y POS rotary knob anymore.

The measuring result is shown in the top text area.

If the VAR rotary knob of the channel is in CAL position, the result will be displayed in Volts. If the VAR rotary knob is in UNCAL position, the result will be displayed in Divisions:

RMS = ... mV, or RMS = ... DIV

**MEAN**                      **Mean voltage**

The MEAN measurement is calculated between the MAIN CURSORS and related to the absolute zero level. This zero level is indicated as a horizontal dotted line and is related to the grounded Y position. The correct way to use this function is:

- activate the MEAN function,
- ground the trace and adjust the zero level anywhere on the screen by means of the Y POS rotary knob,
- press the GND key once again (the signal is now connected to the channel).  
**Do not** re-adjust the Y POS rotary knob anymore.

The measuring result is shown in the top text area.

If the VAR rotary knob of the channel is in CAL position, the result will be displayed in Volts. If the VAR rotary knob is in UNCAL position, the result will be displayed in Divisions:

MEAN = ... mV, or MEAN = ... DIV

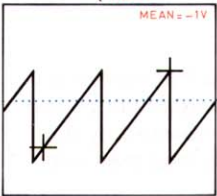
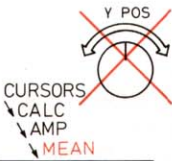
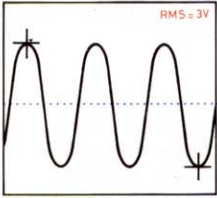
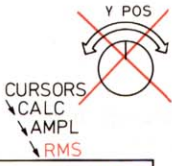

### 4.3.3 PERFORMING TIME MEASUREMENTS

#### **FREQ**            **Frequency**

The FREQ measurement is calculated between the MAIN CURSORS. It is necessary to set the main cursors on the wanted trace, using the CURSOR-SELECT menu, and on the required part of the signal using the CURSOR-CONTROL menu (see also Section 3.2.7).

By activating the FREQ calculation function the oscilloscope will automatically measure the period time of the signal and will show the measuring points by two small LOCATE CURSORS. Minimal one signal period should be covered by the MAIN CURSORS. If the distance between the MAIN CURSORS is less then one signal period, an error message is given.

The measuring result is shown in the right corner of the top text area.

FREQ    : f = ... kHz

#### **PERIOD**        **Period**

The PERIOD measurement is calculated between the MAIN CURSORS. It is necessary to set the main cursors on the wanted trace, using the CURSOR-SELECT menu, and on the required part of the signal using the CURSOR-CONTROL menu (see also Section 3.2.7).

By activating the PERIOD calculation function the oscilloscope will automatically measure the period time of the signal and will show the measuring points by two small LOCATE CURSORS. Minimal one signal period should be covered by the MAIN CURSORS. If the distance between the MAIN CURSORS is less then one signal period, an error message is displayed.

The measuring result is shown in the top text area.

PERIOD : T = ... s

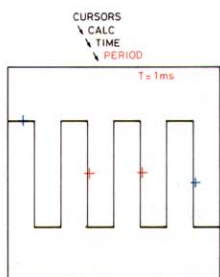
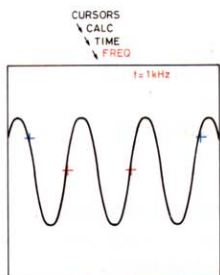

**WIDTH**            **Pulse width**

The WIDTH measurement is calculated between the MAIN CURSORS. It is necessary to set the main cursors on the wanted trace, using the CURSOR-SELECT menu, and on the required part of the signal using the CURSOR-CONTROL menu (see also Section 3.2.7).

By activating the WIDTH calculation function the oscilloscope will automatically measure the pulse width of the first pulse seen from the left cursor. The pulse width is determined on the half peak-to-peak amplitude between the MAIN CURSORS. There must be at least one upgoing edge and one downgoing edge between the two MAIN CURSORS, otherwise an error message is given. The measuring result is shown in the right corner of the top text area.

WIDTH :  $t_w = \dots$  s

**RISE**            **Rise-time**

The RISE (or FALL) measurement is calculated between the MAIN CURSORS. It is necessary to set the main cursors on the wanted trace, using the CURSOR-SELECT menu, and on the required part of the signal using the CURSOR-CONTROL menu.

By activating the RISE calculation function, the oscilloscope will automatically measure the rise-time (or the fall-time, if the first signal edge is negative-going) of the first signal edge seen from the left cursor. The rise-time is determined on the nearest sample to the 10 % and the 90 % level of the amplitude between the MAIN CURSORS.

The measuring result is shown in the right corner of the top text area.

RISE :  $t_r = \dots$  ns

CURSORS  
CALC  
TIME  
WIDTH

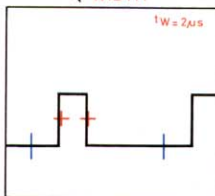

CURSORS  
CALC  
TIME  
RISE

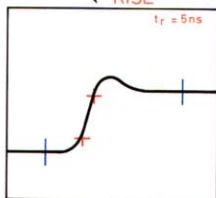

### 4.3.4 ZOOM AND AUTO ZOOM FUNCTIONS

The ZOOM and AUTO ZOOM functions are used to magnify a part of signal while retaining full sample resolution over the selected part.

#### ZOOM

If part of the signal needs to be examined in more detail the ZOOM function can be used. The main cursors can be set on the wanted trace and on the signal part of interest, using the CURSOR SELECT menu and the CURSOR CONTROL menu.

Then by entering the ZOOM menu and activating the RESTART function, if within the limits of time base and delay range, a new acquisition will be made in the adapted time base setting and delay time. This means that the the selected part is resampled using full memory and at a higher sample rate and so higher resolution is used only on the part of interest.

The REVERSE function resamples at the previous settings (This function is only active after use of the RESTART function).

The CENTER function sets the MAIN CURSORS horizontally to +2 DIV and -2 DIV from the screen centre. This helps to continuously zoom in on the signal part of interest without having to return to the CURSOR CONTROL menu and then back to the ZOOM menu.

After CENTERING the MAIN CURSORS, a new RESTART can be made.

The limitations for the ZOOM function are given as error messages on the screen. The three possible error messages are:

**NO RESTART, timebase limit reached**  
**NO RESTART, trigger delay limit reached**  
**NO RESTART,  $\Delta t$  between cursors too big**

The ZOOM mode is not active if the signal memory is locked. When locked, the following error message is shown on the screen:

**WARNING, oscilloscope is in lock mode**



ZOOM

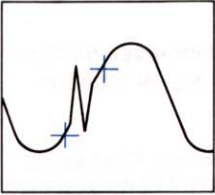

RESTART

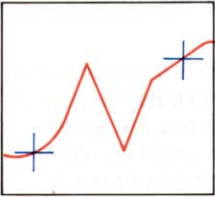

## AUTO ZOOM

In this mode it is possible to simulate the operation of a delay time-base function by displaying a main time-base signal and a delayed time-base signal together on the screen.

The main time-base signal is stored in one of the register memories. First select one of the register memories by pressing the MEMORY and REGISTERS softkeys (see page 4-44). Now load the signal to be examined into the selected register memory and display this on the screen. Move the live signal away from the stored signal by use of the channel position control.

When AUTO ZOOM is activated, the MAIN CURSORS are set on the stored signal and the LOCATE CURSORS on the live signal. These cursors indicate the part of the signal that is displayed in more detail and can be shifted across the screen or the time-base can be expanded up or down by means of the softkeys. When the distance between the LOCATE CURSORS is less than 3 divisions or more than 9 divisions, then the time-base is automatically set to a more suitable setting (if possible). The result is that the live signal shows the adapted situation. This mode is not active if the signal memory is locked.

JTN

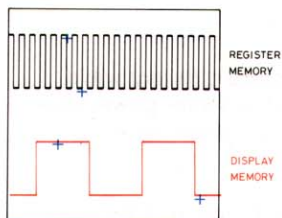

### 4.3.5 WAVEFORM COMPARISON

The register memories R1, R2 and R3 make it possible to store different waveforms in the oscilloscope memory. These signals remain stored after power down and can be displayed on screen whenever needed. A possible application is signal comparison.

First select one of the register memories with the REGISTERS menu. This menu is entered by pressing the MEMORY softkey and then pressing the REGISTERS softkey. Now load a reference signal into the selected register memory by pressing the LOAD key. In this way all three register memories can be selected and filled with reference signals.

Now a measured ("live") signal (R0) can be compared with one of the stored reference signals by displaying the signals on screen simultaneously.

The measured signal can be moved on the screen by means of the Y POS rotary knob. But when the instrument is in the LOCK-mode, the measured signal **and** the stored signal can be moved on the screen by using the SHIFT function (see page 4-44).

JTN

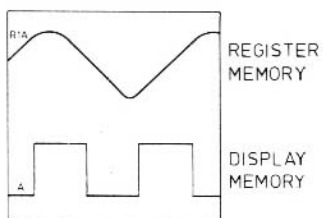

JTN

## 5 PLOTTING AND PRINTING

### 5.1 INTRODUCTION

The oscilloscope has facilities to make a hard copy of the information on the CRT via a plotter or a printer. The plot out can consist of the recorded waveform(s), the belonging oscilloscope settings, the trace identification, cursors, results of measurements and a measuring graticule. Different options exist depending upon the version of the oscilloscope (indicated on type plate on rear panel).

- The standard or /00 version of the oscilloscope has no interface options installed. Consequently the plot out facilities are limited to analog plot out via an analog XY plotter.
- Version /40 has an IEEE-488 option installed. Plot out via a number of digital XY plotters (compatible with HPGL and PHILIPS GL) and via Epson FX-80 and compatible dot-matrix printers or HP Thinkjet (HP 2225) is possible if they are equipped with an IEEE-488 interface.
- Version /50 has an RS-232C option installed. Plot out via a number of digital XY plotters (compatible with HPGL and PHILIPS GL) and via Epson FX-80 and compatible dot-matrix printers or HP Thinkjet (HP 2225) is possible if they are equipped with a RS-232C interface.

Before you are able to plot or print a hard copy of the information on the CRT it is necessary to make some preparations:

- Oscilloscope and printer/plotter must be interconnected via a suitable cable.
- The oscilloscope and the printer/plotter must be set up to the correct interface parameters.

All set up actions are done under the APPLication preselect menu which can be entered by performing the following action: press the front panel key MENU and keep it pressed. Then press AUTO SET. After this the APPL softkey must be pressed. Selected parameters are visible in the top text area of the CRT.

The plot action is started by pressing the front panel PLOT key. Please note that during the plot action the signal acquisition stops and all softkeys are inactive. Plotting can be stopped by pressing the PLOT key again.

The following pages explain how to set up the IEEE-488 interface and the RS-232C interface for the analog plot out. Also the features and limitations are discussed. In order to make a correct set up possible it is necessary to have an operator's manual available of the plotter/printer that is to be connected to the oscilloscope.

## 5.2 ANALOG PLOT OUT TO XY RECORDERS.

This mode is possible for all versions of all mentioned oscilloscopes. The things that can be plotted out are the waveform(s), the channel identification on the CRT and the measuring graticule. The analog plot out can be used to make a hard copy of the screen information including all mentioned facilities. The set up is done as follows (selections marked with # are recorder dependent. Refer the operator's manual of the recorder):

- Enter the service menu by pressing MENU and keep this key pressed. Now also press the AUTO SET key and \* becomes visible in the LCD.
- Press softkey APPL to enter the applications select menu.
- Press softkey PLOT.
- If present, press softkey PLOT-KEY until "plot analog" appears in the top text area of the CRT. This has the result that the analog plot action is started if the front panel key PLOT is pressed. (When the instrument is not provided with an IEEE or RS-232 option, the PLOT-KEY softkey is not available.)
- Press softkey PLOT-A: this gives access to the set up menu for the analog plot mode. Via this menu the PLOTSPEED (#, range 20 ... 2000 ms/dot) for slow-rate limitations and the PENLIFT (#, pen on paper at high or low level) can be adapted to the plotter. Moreover with GRID on, a graticule is plotted.
- Press front panel key AUTO SET in order to leave the service menu.

The plot out information becomes available at the 9 pin D-connector. This connector is at the rear of the oscilloscope. The output signal consists of X and Y deflection signals of 1V (100 mV/div) and the penlift signal at TTL level. For interconnection between oscilloscope and XY recorder two cable types are available. Both are equipped with a 9 pin connector that fits in the analog plot out connector of the oscilloscope. The connector on the other end depends on the type that is ordered:

- The PM9076/01 type has 6 banana plugs: black = neutral (3x), red = Y-deflection, blue = X-deflection, green = pen lift.
- The PM9076/02 type has a 14 pole amphenol connector.

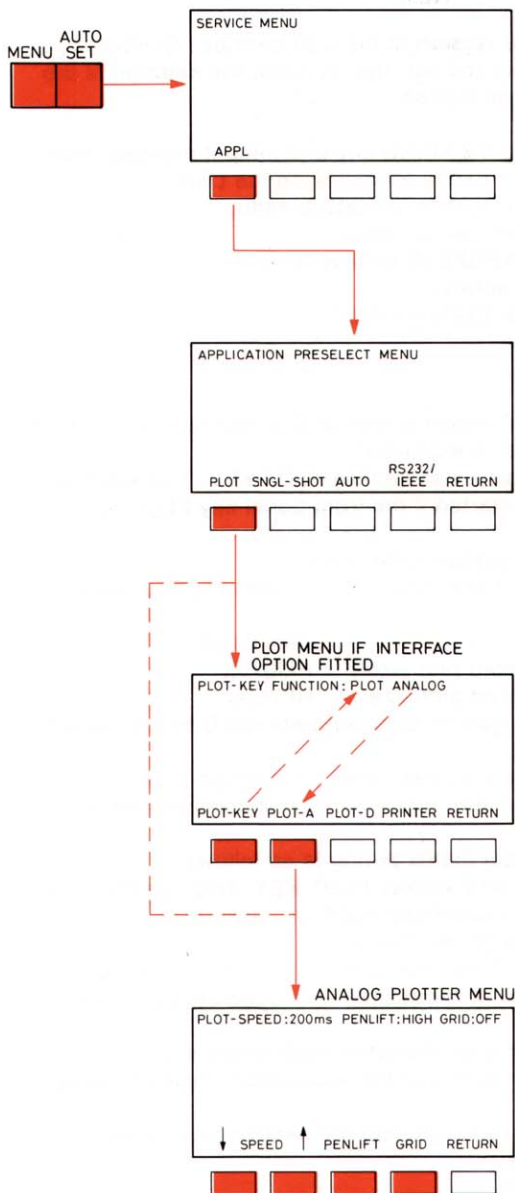



### 5.3 PLOT AND PRINT VIA IEEE-488 INTERFACE

This mode is only possible for the /40 version of the oscilloscope. All information on the screen will be plotted out or printed out: this includes the settings of the displayed traces. The set up is done as follows:

- Enter the service menu by pressing the MENU key and keep it pressed. Now also press the AUTO SET key and \* becomes visible on the LCD.
- Press softkey APPL to enter the application preselect menu.
- Press softkey IEEE to enter the IEEE set up menu.
- Select the IEEE address with the ADDRESS softkey (0..30).
- Select the IEEE mode with the T/L softkey (TALKER/LISTENER, TALK ONLY or LISTEN ONLY).
- Press softkey RETURN.
- Press softkey PLOT.

From now on the set up procedure for digital plotter and printer is different; first the procedure for the digital XY plotter is explained:

- Select "plot-digital" in the top text area with softkey PLOT-KEY. This has the result that the digital plot action is started if the front panel key PLOT is pressed.
- Press softkey PLOT-D to enter the digital plotter menu.
- Select the plotter type with softkey TYPE; the selected plotter is indicated in the top text area.

These types are:

|          |                      |          |
|----------|----------------------|----------|
| PM8153/1 |                      | PM8153/6 |
| PM8154   | (limited plot-size!) | PM8155   |
| HP7475A  | (limited plot-size!) | HP7550   |

- Select the format of the hard copy; can be chosen between 0,5x and 2x the screen size via softkey FORMAT.
- If you select AUTO:on, a hard copy is plotted after each single shot.
- Press front panel key AUTO SET once to return to normal oscilloscope use.

The procedure for the set up for the dot matrix printer is as follows:

- Select "printer" in the top text area with softkey PLOT-KEY. This has the result that the printer is started if the front panel key PLOT is pressed.
- Press softkey PRINTER to enter the printer menu.
- Select the printer type with softkey TYPE; the selected printer is indicated in the top text area of the CRT screen. It is possible to choose between FX80 and HP2225.
- If you select AUTO:on, a hard copy is printed after each single shot.
- Press front panel key AUTO SET once to exit the application preselect menu..

Philips offers three different cable types to connect the oscilloscope to the plotter or printer via the IEEE-488 bus:

- Type PM2295/05: cable length 0,5m.
- Type PM2295/10: cable length 1 m.
- Type PM2295/20: cable length 2 m.

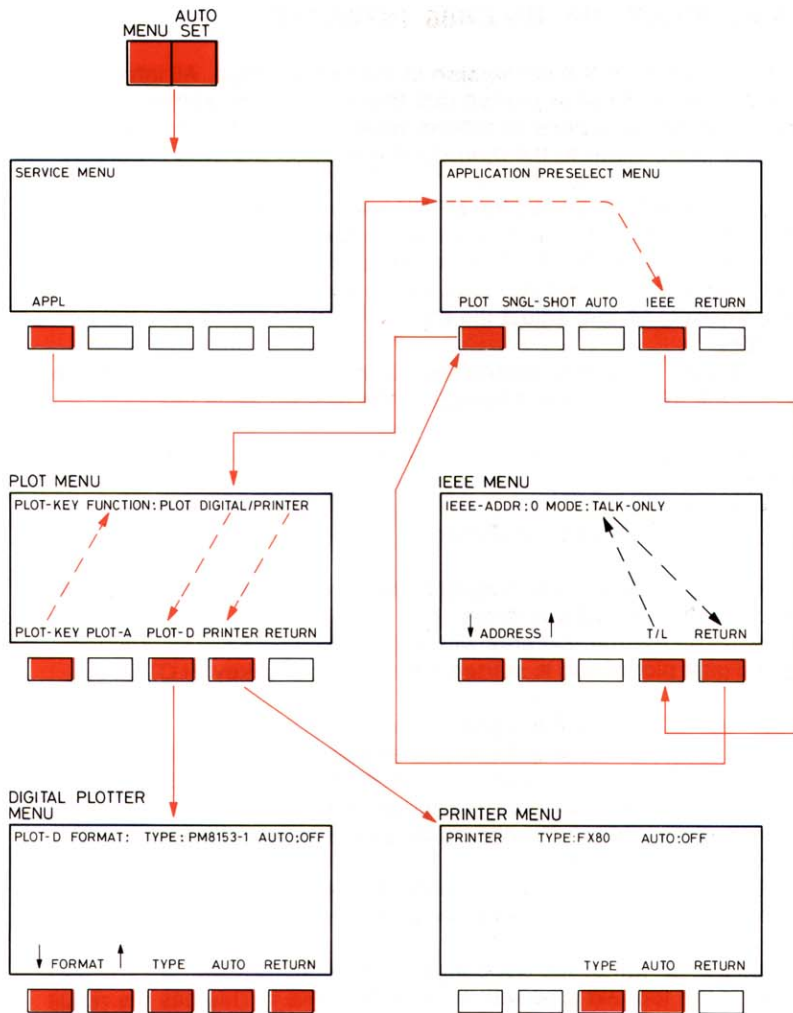

## 5.4 PLOT AND PRINT VIA RS-232C INTERFACE

This mode is only possible for the /50 version of the oscilloscope. All information on the screen will be plotted out or printed out; this includes the settings of the displayed traces. The set up is done as follows (selections marked with # are plotter/printer dependent. Refer to the operator's manual of the plotter/printer):

- Enter the service menu by pressing the MENU key and keep it pressed. Now also press the AUTO SET key and \* becomes visible on the LCD.
- Press softkey APPL to enter the application preselect menu.
- Press softkey RS232 to enter the RS-232C set up menu.
- Press softkey BAUDRATE and adjust the OUT-SPD (output speed) to the desired value (#).
- If a software protocol is used to control the communication with the plotter or printer, also set the INP\_SPD (input speed) to the desired value (#).
- Press softkey RETURN.
- Press softkey DATA and adjust PARITY, STOP BIT and DATA BIT to the desired value (#).
- Press softkey RETURN twice.
- Press softkey PLOT to enter the PLOT menu.

From now on the set up procedure for digital plotter and printer is different; first the procedure for digital XY plotter is explained:

- Select "plot-digital" in the top text area with softkey PLOT-KEY. This has the result that the digital plot action is started if the front panel key PLOT is pressed.
- Press softkey PLOT-D to enter the digital plotter menu.
- Select the plotter type with softkey TYPE; the selected plotter is indicated in the top text area. The types to be selected are: PM8153/1, PM8153/6, PM8154 (limited plotsize !), PM8155, HP7475A (limited plotsize !), HP7550.
- Select the format of the hard copy; can be chosen between 0,5x and 2x the screen size via softkey FORMAT.
- If you select AUTO:on, a hard copy is plotted after each single shot.
- Press front panel key AUTO SET to exit the application preselect menu..

The procedure for the set up for the dot matrix printer is as follows:

- Select "printer" in the top text area with softkey PLOT-KEY. This has the result that the printer is started, if the front panel key PLOT is pressed.
- Press softkey PRINTER to enter the printer menu.
- Select the printer type with softkey TYPE; the selected printer is indicated in the top text area of the CRT screen. It is possible to choose between FX80 and HP2225.
- If you select AUTO:on, a hard copy is plotted out after each single shot and re-arming.
- Press front panel key AUTO SET to return to normal oscilloscope use.

The diagrams on the page 5-8 show the necessary interconnections between the oscilloscope and plotter.

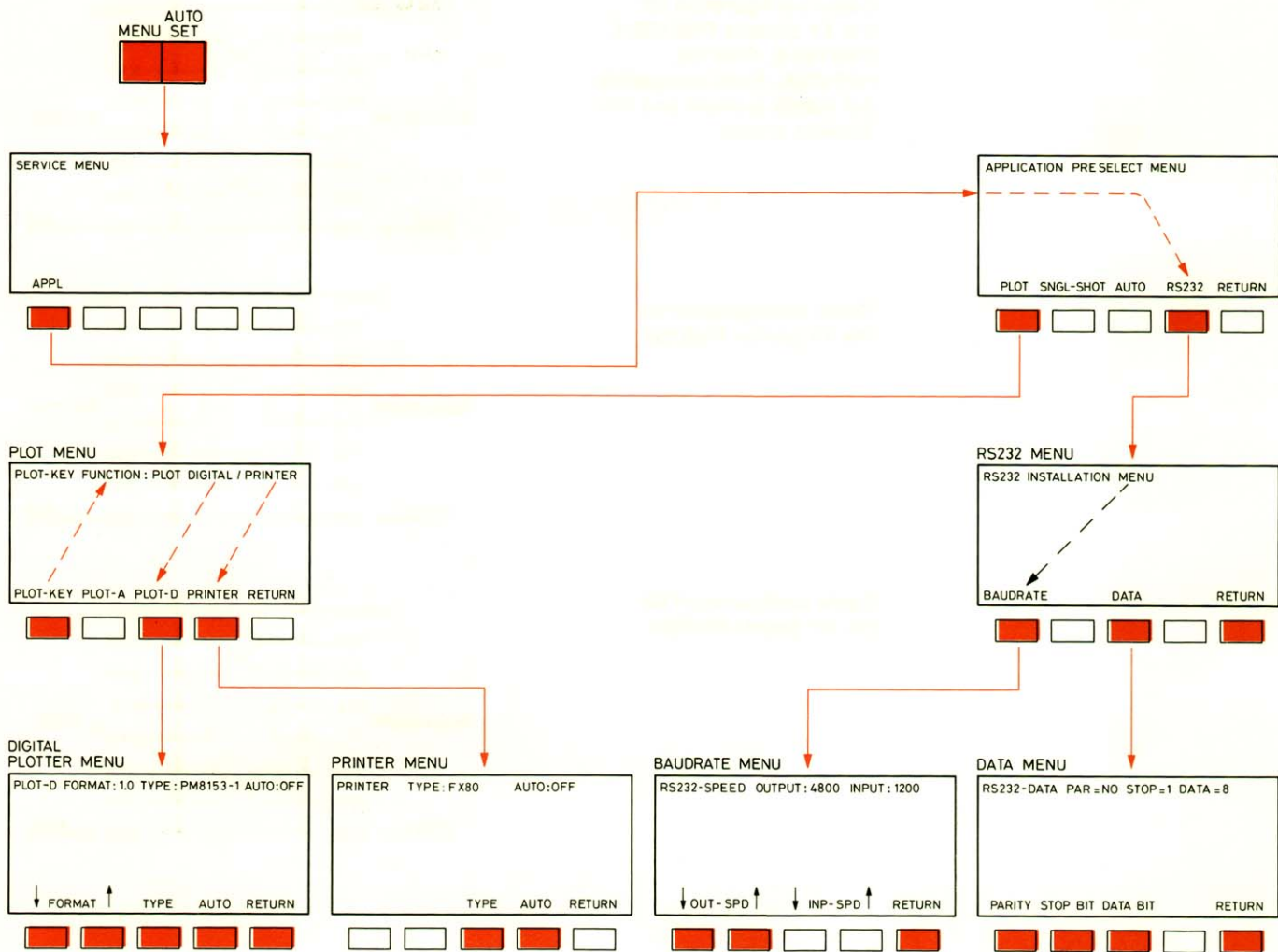

Cable configuration for the XY plotters PM8153-1, PM8153-6, PM8155, HP7475A, FX80 compatible dot matrix printers and HP-Thinkjet printer.

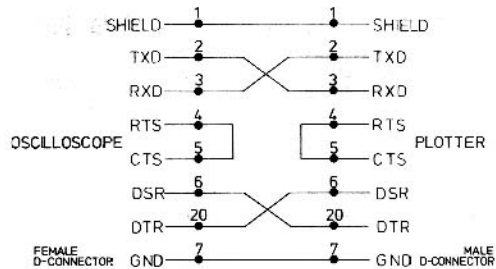

Cable configuration for the XY plotter PM8154.

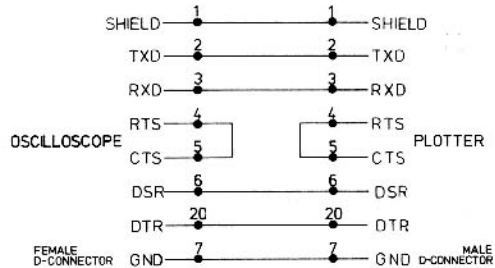

Cable configuration for the XY plotter HP7550.

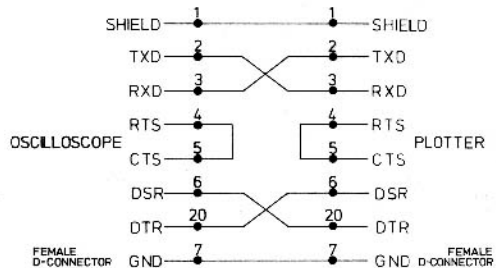

## 5.5 PLOTTING OR PRINTING RESULTS

This section shows examples of the three possible hard copy results, obtained with this oscilloscope. The three possibilities to make a hard copy of the screen are:

- plot-out by an analog plotter (X-Y recorder)
- plot-out by a digital plotter
- print-out by a printer.

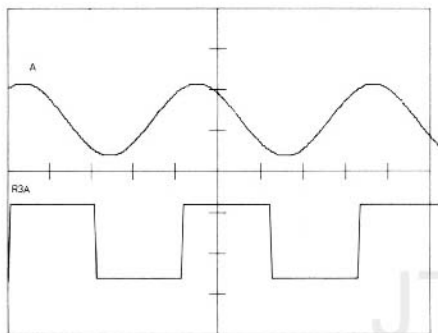

*Example plot-out by an analog plotter (X-Y recorder)*

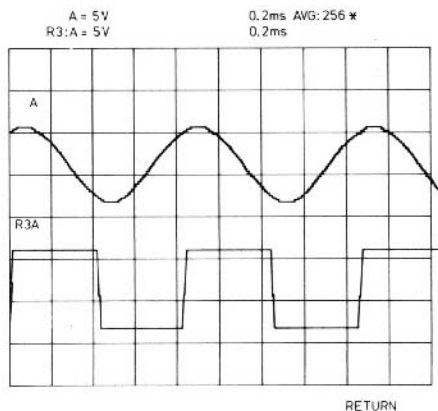

*Example plot-out by a digital plotter*

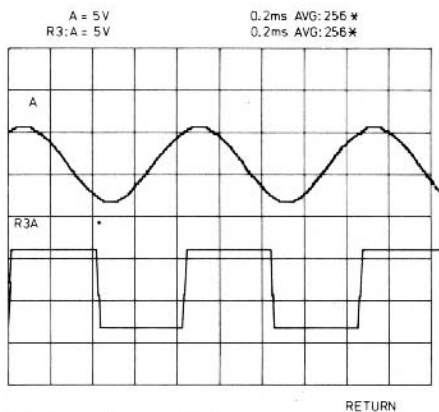

*Print-out by a printer*

JTN

## 6 APPLICATION PRESELECT MENU

### 6.1 INTRODUCTION

Within this menu a number of operating functions can be selected, that normally do not need to be altered frequently. These functions have relation with the SINGLE SHOT mode, TV triggering and adjustment of plotter/printer- and interface parameters. The APPLICATION PRESELECT menu is part of the SERVICE menu. (The other selections in the SERVICE menu are used for service and repair and are described in the Service Manual.)

Proceed as follows to enter the APPLICATION PRESELECT menu:

- Press MENU and keep it pressed. Now also press AUTO SET.
- Now the Service menu has been entered, the LCD should indicate "\*\*".
- Press APPL, which is one of the CRT softkeys.
- The CRT should indicate "APPLICATION PRESELECT MENU" on the upper side of the screen.

The selections are made with the softkeys under the CRT. The selected functions are displayed in the top text line of the CRT.

### 6.2 SELECTION OF PLOTTER PARAMETERS (PLOT)

By pressing the PLOT softkey a menu is entered, in which the plotter- and printer parameters can be adjusted.

When an IEEE-488 or RS-232C interface option is installed, the PLOT menu first offers a selection between PLOT\_A (analog plot), PLOT\_D (digital plot) or PRINTER (selection with PLOT-KEY). If the oscilloscope comes without an interface, after pressing the PLOT key directly the ANALOG PLOT mode is entered.

#### 6.2.1 ANALOG PLOT MODE

This menu is entered from the PLOT menu by pressing the PLOT\_A softkey. You now can define various parameters of the analog plot:

- PLOT SPEED: 20 ms...2000 ms in 20 or 100 steps sequence
- PENLIFT LEVEL: active high or active low
- GRID: plotting or not plotting a grid in the picture

#### 6.2.2 DIGITAL PLOT MODE

This menu is entered from the PLOT menu by pressing the PLOT\_D softkey. You now can define the plotter FORMAT, TYPE of plotter and AUTOplot mode:

- FORMAT: 0,5 \* normal screen ... 2 \* normal screen (in steps of 0,1).
- TYPE: PM8153/1, PM8153/6, PM8154, PM8155, HP7475A and HP7550
- AUTO: ON for a plot after each single-shot and re-arming  
OFF for a plot after pressing the PLOT key



### 6.2.3 PRINT

Selected by pressing PRINTER.

You now can define the AUTO MODE:

- AUTO: ON for a print after each single-shot and re-arming  
OFF for a print after pressing the PLOT key

### 6.3 SINGLE SHOT (SNGL\_SHOT)

This menu can be selected from the APPLICATION PRESELECT menu by pressing the SNGL\_SHOT softkey.

In analog single shot mode you can define the single shot sequence when the instrument is in alternated mode.

- FIRST: single shot is always done on channel A (provided it is active)
- MULTI: single shot is always done alternated between channel A, B and ADD (provided these are active)

### 6.4 TV TRIGGERING AFTER AUTOSET (AUTO)

With the AUTO softkey you enter the AUTOSET menu. In this menu it is possible to select the TV triggermode after an AUTOSET command.

Selection of TVF forces the trigger coupling in TVFrame mode after an AUTOSET. This in case that TVF or TVL was already active before the AUTOSET command. If there is no trigger found, after AUTOSET in TVF mode the oscilloscope jumps back to AUTO P-P.

If TVF/TVL is selected, the trigger coupling returns to the previous mode (TVFrame or TVLine) that was active before the AUTOSET command. If there is no trigger found after AUTOSET, the oscilloscope jumps back to AUTO P-P.

### 6.5 IEEE-488: OPTIONAL (IEEE)

This menu is selected by pressing the CRT softkey marked IEEE. (Only if IEEE option is present !). You can now define the IEEE MODE and IEEE ADDRESS:

- ADDRESS: between 0..30 (default address: 8)
- MODE: TALK\_ONLY, LISTEN\_ONLY and TALKER/LISTENER

### 6.6 RS-232C: OPTIONAL (RS232)

This menu is selected by pressing CRT softkey RS232. (Only if RS-232C option is present !). You can now define the RS-232C parameters:

- OUTPUT SPEED: between 75 ... 19200 bits/sec
- INPUT SPEED: between 75 ... 1200 bits/sec
- PARITY: EVEN, ODD or NONE
- STOP BIT: 1 or 2
- DATA BIT: 7 or 8

# Index

## A

A/B key, 4-2  
ABSolute, 4-37, 4-46  
AC/DC key, 4-2  
ACCESSORIES, I-I  
ADD, 4-6  
ADD/INVERT key, 4-6  
ADDRESS, 6-2  
ALT/CHOP key, 4-6  
ALTERNATED, 4-6  
AMPLITUDE MEASUREMENTS, 4-46  
ANALOG MODE, 4-1  
ANALOG PLOT OUT, I-vi, 3-12, 5-2/...3  
APPLICATION PRESELECT MENU, 4-10, 6-1  
ARMED, 4-28  
AUTO, 4-10, 4-24, 5-6, 6-1/...2  
AUTO SET key, 3-1, 4-1, 4-18  
AUTOZOOM, 4-39, 4-56  
AVERAGE, 4-24, 4-40  
AVERAGE FACTOR, 4-41

## B

BATTERIES, 2-2  
BAUDRATE, 5-6

## C

CABLE CONFIGURATION, 5-8  
CAL, I-vi, 4-44  
CAL OUTPUT, 3-1, 3-12  
CALCULATE MENU, 4-36  
CALCULATE-AMPLITUDE MENU, 4-37  
CALCULATE-TIME MENU, 4-38

CAPABILITIES, I-iii  
CATHODE RAY TUBE, 3-3  
CAUTION, 1-1  
CENTER, 4-39, 4-54  
CHANNEL COUPLING, 4-2  
CHOPPED, 4-6  
CONNECTORS, I-vi  
CONTROL MENU, 4-36  
CRT SCREEN, 3-3  
CURSOR MENU, 4-36  
CURSORS MENU, 4-34

## D

DATA BIT, 5-6, 6-2  
DC TRIGGERING, 4-14  
DIGITAL MEMORY key, 4-1, 4-18  
DIGITAL STORAGE OSCILLOSCOPE, 4-18  
DISPL PART UP-DOWN key, 4-22  
DISPLAY key, 4-20  
DISPLAY MEMORY, 4-20  
DISPLAY PART, 3-5  
DOT MATRIX PRINTER, 5-4  
DOTS key, 4-18  
DOTTED OR JOINED DISPLAY, 4-18

## E

EARTHING, 2-1  
ENVELOPE, 4-24, 4-40  
EXT, I-vi

## F

FALL-TIME, 4-52  
FIRST, 4-10, 6-2  
FLASHING SEGMENT, 3-3  
FORMAT, 5-6, 6-1  
FREQuency, 4-38, 4-50

FRONT PANEL, I-vi  
FRONT PANEL KEY SETTINGS, 4-43  
FRONT PANEL LAY OUT, 3-2  
FRONT VIEW, I-v  
FRONTS MENU, 4-43  
FUNCTION KEYS, 3-7  
FUSES, 2-1

## G

GETTING STARTED, 3-1  
GND key, 4-2  
GRID, 6-1

## H

HANDLE ADJUSTMENT, 2-3  
HF, 4-14  
HOLD OFF, 3-9, 4-16  
HORIZONTAL MODE, 4-8, 4-22  
HORIZONTAL RESOLUTION, 4-18  
HORIZONTAL TIME SCALE, 4-8

## I

IEEE-488 BUS, I-vi  
ILLUMINATION rotary knob, 3-2  
INITIAL INSPECTION, I-I  
INPUT SPEED (INP\_SPD), 5-6, 6-2  
INPUTS AND OUTPUTS, 3-12  
INSTALLATION, 2-1/...4  
INTENS rotary knob, 3-2  
INVERTED, 4-6

## L

LCD, 3-3  
LEVEL VIEW, 4-14, 4-28  
LF, 4-14  
LIMITATIONS (ZOOM MODE), 4-54

LINE IN, I-vi, 3-12  
LOAD key, 4-20  
LOCATE CURSORS, 4-36, 4-56  
LOCK MODE, 4-44

## M

MAIN CURSORS, 4-36  
MAIN MENU, 4-34  
MAINS VOLTAGE CORD, 2-1  
MEAN, 4-37, 4-48  
MEAN VOLTAGE, 4-48  
MEMORY BACK-UP, 2-2  
MEMORY MENU, 4-43  
MENU-STRUCTURES, 4-34  
MODE, 6-2  
MULTI, 4-10, 6-2  
MULTIPLE SHOT, 4-24, 4-30

## N

NEGATIVE VIDEO, 4-16  
NO SAMPLING MODE, 4-22  
NORMAL, 4-6  
NOT AVAILABLE, 4-18

## O

OUTPUT SPEED, 6-2

## P

P-P, 4-14  
PARITY, 5-6, 6-2  
PEAK-TO-PEAK VOLTAGE, 4-46  
PENLIFT, 5-2  
PENLIFT LEVEL, 6-1  
PERIOD, 4-38, 4-50  
PLOT, 6-1  
PLOT AND PRINT, 5-4/...8

PLOT SPEED, 6-1  
PLOT-KEY, 5-2  
PLOT\_ANALOG, 6-1  
PLOT\_DIGITAL, 6-1  
PLOTSPEED, 5-2  
PLOTTER PARAMETERS, 6-1  
PLOTTER TYPES (DIGITAL), 5-4  
PLOTING, 5-1/...10  
PLOTING OR PRINTING RESULTS, 5-9/...10  
POSITIVE VIDEO, 4-16  
PRE- AND POST TRIGGERING, 4-32  
PRINT, 6-2  
PRINTER, 5-6  
PRINTER TYPES, 5-4  
PRINTING, 5-1/...10  
PROCESS, 4-24  
PROCESS MENU, 4-40  
PULSE WIDTH, 4-52

**R**

RACKMOUNT, 2-4  
REAR PANEL, i-vi  
REAR VIEW, i-v  
RECALL, 4-43  
RECURRENT MODE, 4-22  
REFERENCE REGISTER MENU, 4-44  
REGISTER MEMORY, 4-20  
REGISTERS (R1, R2, R3), 4-20  
REGISTERS MENU, 4-43/...44  
REPLACEMENT PARTS, i-i  
RESET key, 4-28  
RESTART, 4-39, 4-54  
REVERSE, 4-39, 4-54  
RISE, 4-38, 4-52  
RMS, 4-37, 4-48  
ROLL MODE, 4-22, 4-40

ROOT MEAN SQUARE VOLTAGE, 4-48  
ROTARY KNOBS, 3-9  
RS-232C BUS, 3-13  
RS232-C BUS, i-vi

**S**

SAFETY, 1-1/...2  
SAFETY INSTRUCTIONS, 2-1  
SAMPLING MODE, 4-22, 4-26  
SAVE, 4-43  
SCREEN CONTROLS, 3-2  
SETTINGS MENU, 4-34  
SHIFT MENU, 4-35, 4-43/...44  
SHIPMENT, i-i  
SINGLE, 4-10  
SINGLE SHOT, 6-2  
SINGLE SHOT (SNGL\_SHOT), 4-10, 4-24, 4-28, 6-2  
SLOPE key, 4-16  
SLOPE SELECTION, 4-16  
SOFTKEYS, 3-10  
STATUS key, 4-20  
STOP BIT, 5-6, 6-2

**T**

TB s...us UP-DOWN key, 4-8, 4-22  
TB TRIG MODE key, 4-10, 4-28, 4-30  
TEXT-OFF, 4-34  
TIME MEASUREMENTS, 4-50  
TRACE ROTATION, 3-2  
TRIG, 4-10, 4-24  
TRIG COUPL key, 4-14  
TRIG DEL UP-DOWN key, 4-32  
TRIG LEVEL, 3-9, 4-14  
TRIG OR X SOURCE key, 4-8, 4-12  
TRIGGER DELAY, 3-4, 4-24, 4-32

TRIGGER MODE, 4-10, 4-28

TVF, 4-14

TVL, 4-14

TYPE, 6-1

## U

UP-DOWN KEYS, 3-4

## V

V...mV UP-DOWN key, 4-4

VAR, 3-9

VERSION /40, 5-1

VERSION /50, 5-1

VERTICAL AMPLITUDE ADJUSTMENT, 4-4

VERTICAL MODE, 4-2, 4-18

VERTICAL RESOLUTION, 4-18

VIEWING AREA, 3-3

Vpp, 4-37, 4-46

## W

WARNING, 1-1

WAVE FORM COMPARISON, 4-58

WIDTH, 4-38, 4-52

## X

X DEFL key, 4-8

X DEFLECTION, 4-8

X MAGN, 4-8

X POS, 3-9

XY RECORDERS, 5-2/...3

## Y

Y POS, 3-9

## Z

Z-MOD, i-vi, 3-13

ZOOM, 4-54

ZOOM MENU, 4-39

JTN