



# PHILIPS

## 50 MHz Digital Storage Oscilloscope PM3335 - PM3337

TEST & MEASUREMENT

CUSTOMER SUPPORT

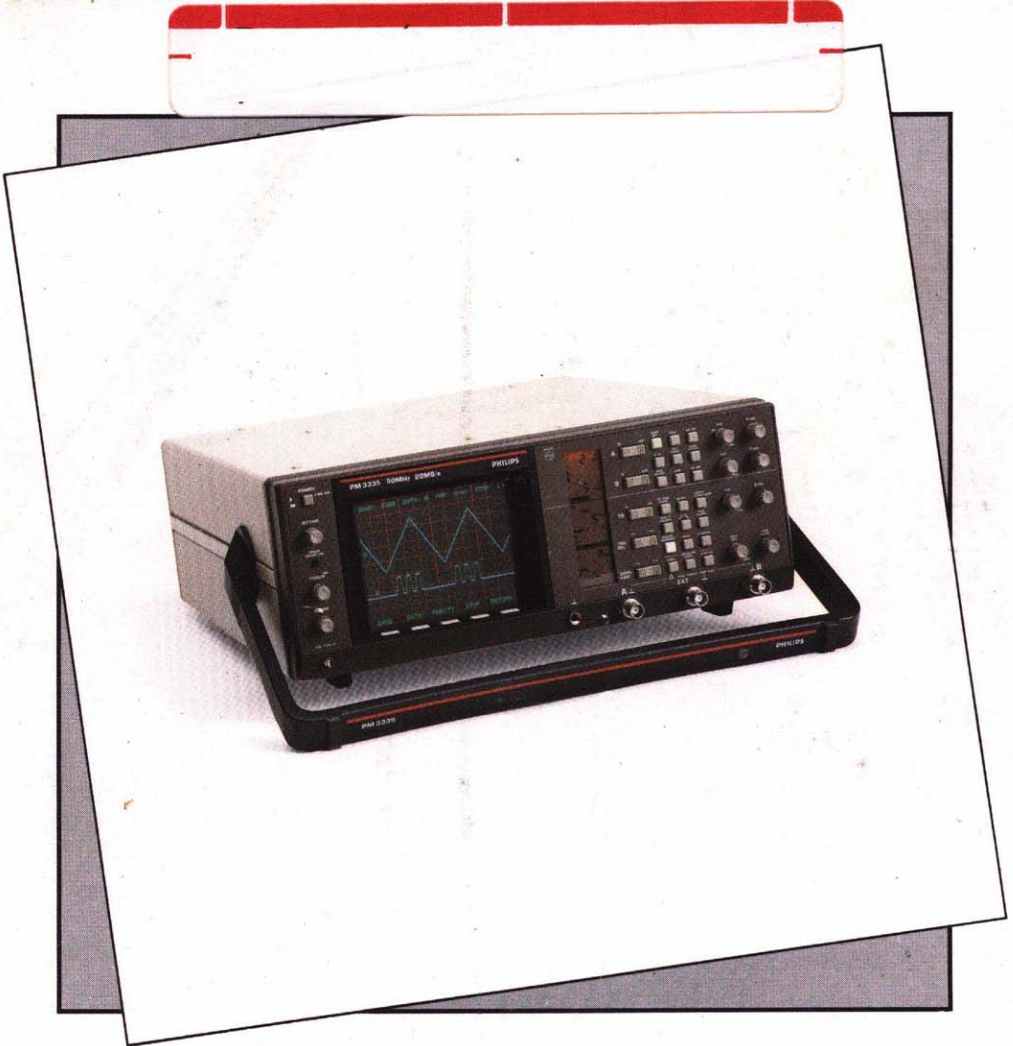

4822 872 00386

890201

Operation Guide

# 50 MHz Digital Storage Oscilloscope PM3335 - PM3337

Operation Guide

4822 872 00386  
890201

---



**PHILIPS**

**IMPORTANT:** In correspondence concerning this instrument please quote the typenumber and serial number as given on the type plate on the rear of the instrument.

**NOTE:** The design of this instrument is subject to continuous development and improvement. Consequently, this instrument may incorporate minor changes in detail from the information contained in this manual.

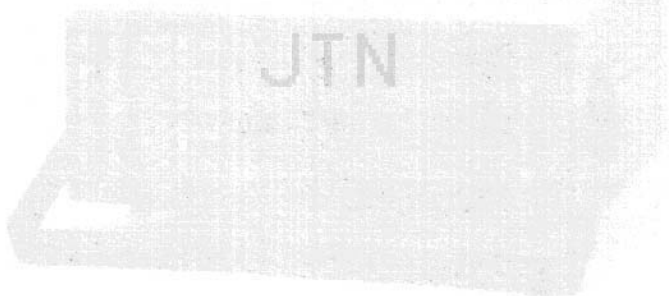

PHILIPS

## SHIPMENT NOTE

The following parts should be included in the shipment:

- 2 BATTERIES
- 1 OPERATION GUIDE or
- 1 BEDIENUNGSANLEITUNG or
- 1 NOTICE D'UTILISATION
- 1 MAINS VOLTAGE CORD
- 2 PROBES
- 1 REFERENCE MANUAL

## INITIAL INSPECTION

Check the contents of the shipment for completeness and note whether any damage has occurred during transport. If the contents are incomplete, or there is damage, a claim should be filed with the carrier immediately, and the Philips/Fluke Sales or Service organisation should be notified in order to facilitate the repair or replacement of the instrument (see rear cover of the reference manual).

JTN



# Table of Contents

<b>1 OPERATORS SAFETY</b>	<b>1 - 1</b>
1.1 INTRODUCTION .....	1 - 1
1.2 SAFETY PRECAUTIONS .....	1 - 1
1.3 CAUTION AND WARNING STATEMENTS .....	1 - 1
1.4 SYMBOLS .....	1 - 1
1.5 IMPAIRED SAFETY-PROTECTION .....	1 - 2
<b>2 INSTALLATION INSTRUCTIONS</b>	<b>2 - 1</b>
2.1 SAFETY INSTRUCTIONS .....	2 - 1
2.1.1 EARTHING .....	2 - 1
2.1.2 MAINS VOLTAGE CORD AND FUSES .....	2 - 1
2.2 MEMORY BACK-UP .....	2 - 2
2.3 HANDLE ADJUSTMENT AND OPERATING POSITIONS .....	2 - 3
2.4 RACKMOUNT VERSION .....	2 - 4
<b>3 OPERATING INSTRUCTIONS</b>	<b>3 - 1</b>
3.1 GETTING STARTED .....	3 - 1
3.2 FRONTPANEL LAY OUT AND OPERATION .....	3 - 2
3.2.1 FRONTPANEL LAY OUT .....	3 - 2
3.2.2 SCREEN CONTROLS .....	3 - 2
3.2.3 VIEWING AREA .....	3 - 3
3.2.4 UP-DOWN KEYS .....	3 - 4
3.2.5 FUNCTION KEYS .....	3 - 5

3.2.6 ROTARY KNOBS .....	3 - 8
3.2.7 SOFTKEYS .....	3 - 8
3.2.8 INPUTS AND OUTPUTS .....	3 - 11
<b>4 APPLICATIONS</b> .....	<b>4 - 1</b>
4.1 USE AS AN ANALOG OSCILLOSCOPE .....	4 - 1
4.1.1. VERTICAL MODE .....	4 - 2
4.1.2. HORIZONTAL MODE .....	4 - 8
4.1.3. TRIGGER MODE .....	4 - 10
4.2 USE AS A DIGITAL STORAGE OSCILLOSCOPE .....	4 - 18
4.2.1. VERTICAL MODE .....	4 - 20
4.2.2. HORIZONTAL MODE .....	4 - 22
4.2.3. TRIGGER MODE .....	4 - 24
4.3 CURSOR MEASUREMENTS .....	4 - 30
4.3.1 GENERAL .....	4 - 30
4.3.2 CURSOR CONTROL MENUS .....	4 - 32
4.3.3 AMPLITUDE MEASUREMENTS .....	4 - 38
4.3.4 TIME MEASUREMENTS .....	4 - 42
<b>5 PLOTTING AND PRINTING</b> .....	<b>5 - 1</b>
5.1 INTRODUCTION .....	5 - 1
5.2 PLOT OUT AND PRINT OUT .....	5 - 2
5.2.1 VIA THE IEEE-488 INTERFACE .....	5 - 2
5.2.2 VIA THE RS-232C INTERFACE .....	5 - 5
5.3 PLOTTING OR PRINTING RESULTS .....	5 - 7
<b>6 APPLICATION PRESELECT MENU</b> .....	<b>6 - 1</b>



Thank you for purchasing this Philips oscilloscope. It has been designed and manufactured to the highest quality standards to give you many years of trouble free and accurate measurements. The powerful measuring functions listed below have been combined with an easy logical operation to let you use the full power of this instrument each and every day.

JTM

Should you have any suggestions on how this product could be improved then please contact your local Fluke/Philips organisation.

### **PM 3335/PM 3337 Main Capabilities**

- 50 MHz analog oscilloscope
- 20 Msamples/s signal acquisition in digital mode
- large 8K acquisition memory
- Auto Set for instant signal viewing in both analog and digital oscilloscope modes
- Cursors for time and amplitude measurements in digital oscilloscope mode
- Reference memories and non-volatile storage of all waveforms
- Optional interface facilities for remote control and hard copy output

This page intentionally left blank.

JTN

### FRONT VIEW OF OSCILLOSCOPE

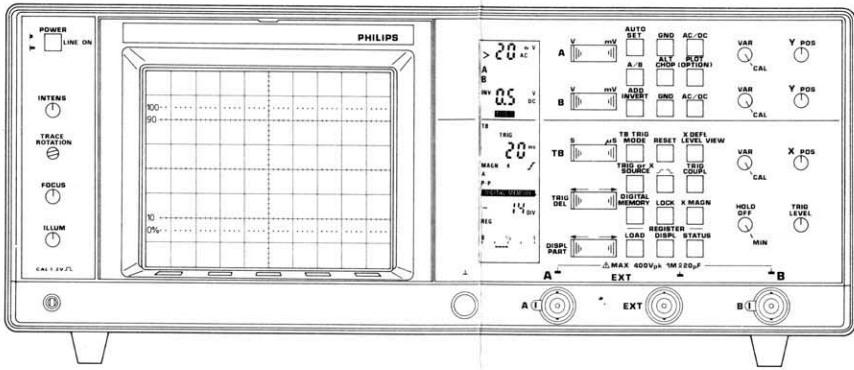



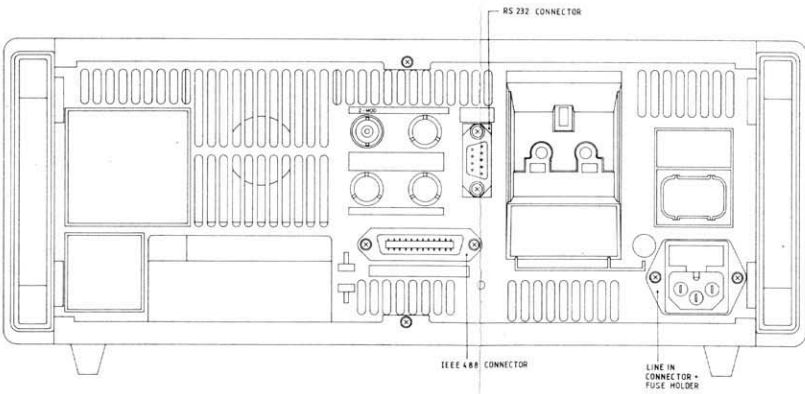

### REAR VIEW OF OSCILLOSCOPE



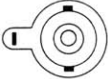

Note: RS232 and/or IEEE488 connector only present with interface option

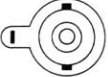
**FRONT PANEL CONNECTORS**

	<b>CAL</b>	Amplitude calibrated output socket
		Measuring earth socket.
	<b>A</b>	BNC input socket for channel A with probe indication
	<b>EXT</b>	BNC input socket channel EXTERNAL
	<b>B</b>	BNC input socket for channel B with probe indication

**REAR PANEL CONNECTORS**

	<b>Z-MOD</b>	Input socket for Z-modulation of the CRT trace.
	<b>LINE IN</b>	Mains input socket including fuse holder.

**OPTIONAL REAR PANEL CONNECTORS**

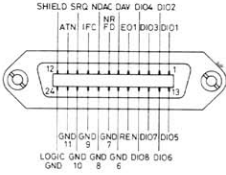
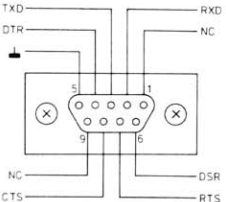
	<b>IEEE BUS OPTION</b>	Input/output socket to connect the oscilloscope to a IEEE 488/IEC 625 interface.
<b>AND</b>		
	<b>RS232 BUS OPTION</b>	Input/output socket to connect the oscilloscope to a RS-232C/V24 interface.

NC = NOT CONNECTED

# 1 OPERATORS SAFETY

**ATTENTION:** *Read this page carefully before installation and use of the instrument.*

## 1.1 INTRODUCTION

The instrument described in this manual is designed to be used by properly-trained personnel only. Adjustment, maintenance and repair of the exposed equipment shall be carried out only by qualified personnel.

## 1.2 SAFETY PRECAUTIONS

For the correct and safe use of this instrument it is essential that both operating and servicing personnel follow generally-accepted safety procedures in addition to the safety precautions specified in this manual. Specific warning and caution statements, where they apply, will be found throughout the manual. Where necessary, the warning and caution statements and/or symbols are marked on the apparatus.

## 1.3 CAUTION AND WARNING STATEMENTS

**CAUTION:** Is used to indicate correct operating or maintenance procedures in order to prevent damage to or destruction of the equipment or other property.

**WARNING:** Calls attention to a potential danger that requires correct procedures or practices in order to prevent personal injury.

## 1.4 SYMBOLS



Read the operating instructions.



Protective earth (black) (grounding) terminal

## 1.5 IMPAIRED SAFETY-PROTECTION

Whenever it is likely that safety-protection has been impaired, the instrument must be made inoperative and be secured against any unintended operation. The matter should then be referred to qualified technicians. Safety protection is likely to be impaired if, for example, the instrument fails to perform the intended measurements or shows visible damage.



## 2 INSTALLATION INSTRUCTIONS

**ATTENTION:** *You are strongly advised to read this chapter thoroughly before installing your oscilloscope.*

### 2.1 SAFETY INSTRUCTIONS

#### 2.1.1 EARTHING

Before any connection to the inputs is made, the instrument must be connected to protective earth via the three-core mains cable. The mains plug must be inserted only into a socket outlet provided with a protective earth contact. The protective action must not be negated by the use of an extension cord without protective conductor.

**WARNING:** **Any interruption of the protective conductor inside or outside the instrument is likely to make the instrument dangerous. Intentional interruption is prohibited.**

When an instrument is brought from a cold into a warm environment, condensation may cause a hazardous condition. Therefore, make sure that the earthing requirements are strictly adhered to.

#### 2.1.2 MAINS VOLTAGE CORD AND FUSES

Different power cords are available for the various local mains voltage outlets. The power cord version delivered is determined by the particular instrument version ordered.

**NOTE:** *If the mains plug has to be adapted to the local situation, such adaptation should be done only by a qualified technician.*

This oscilloscope has a tapless switched-mode power supply that covers most nominal voltage ranges in use: AC voltages from 100 V...240 V (r.m.s.) This obviates the need to adapt to the local mains voltage. The nominal mains frequency range is 50 Hz...400 Hz.

**WARNING:** **The instrument shall be disconnected from all voltage sources when renewing a fuse.**



Mains fuse rating: 1,6 A delayed-action, 250 V.

The mains fuseholder is located on the rear panel in the mains input socket. If the mains fuse needs replacing, proceed as follows:

- the instrument must be disconnected from the mains.
- remove the cover of the fuseholder by means of a screwdriver.
- fit a new fuse of the correct rating and refit the cover of the fuseholder.

**WARNING: Make sure that only fuses of the required current and voltage rating, and of the specified type, are used for renewal. The use of the repaired fuses, and/or short-circuiting of the fuseholder, is prohibited.**

## 2.2 MEMORY BACK-UP

This instrument is provided with a built-in memory back-up circuit if batteries are fitted. Upon power down front settings are stored when in the analog mode of use or the front settings and traces are stored when in the digital mode of use. The oscilloscope returns to these settings on power on. This memory function works when the oscilloscope is switched off from the front panel or when the mains supply is interrupted more than 20 ms.

The memory back-up batteries (2\*LR6 Alkaline Penlight) placement and replacement must be carried out only by a qualified technician.

Replacing the batteries:

- The instrument must be disconnected from the mains.
- Remove the screw that holds the top cover at the rear of the instrument.
- Gently push the cover backwards until it can be lifted.
- Remove the cover by lifting it clear of the instrument. The memory battery back-up unit is now accessible. This unit is located on the instrument's rear panel.
- Ease off the clip that holds the memory back up unit to the chassis.
- Gently slide the battery holder out of the chassis.
- Install both batteries in their holders. The correct position of the batteries is shown on the battery holder.

**NOTE: When replacing the memory back-up unit, take care not to damage the wiring in the vicinity of the battery holder.**

### 2.3 HANDLE ADJUSTMENT AND OPERATING POSITIONS

By pulling both handle ends outwards away from the instrument the handle can be rotated to allow the following instrument positions:

- vertically on its rear feet;
- horizontally on its bottom feet;
- in two sloping positions on the handle.

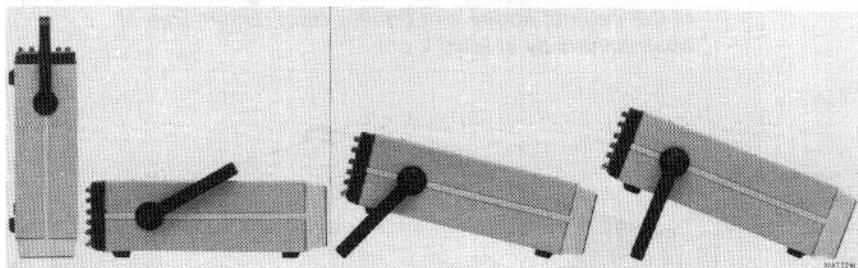

**ATTENTION:** Do not position the oscilloscope on any surface which radiates heat, or in direct sunlight. Ensure that the ventilation holes at the rear and top are free from obstruction.

## 2.4 RACKMOUNT VERSION

The PM3337 is provided with a rackmount cabinet without handle. This offers the possibility to build the instrument into a standard 19 inch rack.

The PM3337 is delivered with spacers and screws (4 \*European type and 4 \* American type). The rackmount is provided with three feed-through BNC-connectors.

**ATTENTION:** *To maintain adequate instrument cooling, all ventilation holes of the cabinet above and behind must remain free of obstructions by at least 2 cm.*

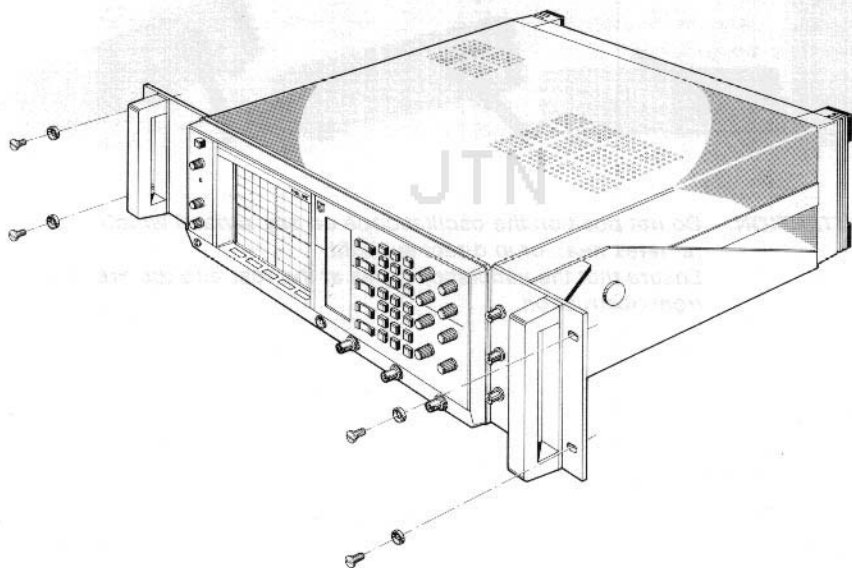

## 3 OPERATING INSTRUCTIONS

### 3.1 GETTING STARTED

- Connect the oscilloscope to the mains voltage.
- Switch the oscilloscope on by means of the push-button POWER LINE ON.
- Adjust the TRACE ROTATION by means of a screwdriver so that the trace is parallel with the horizontal graticule lines.
- Connect a probe to input A of the oscilloscope.
- Connect the probe tip to the CAL output of the oscilloscope.
- Press the AUTO SET key.

**The AUTO SET function will set automatically all relevant parameters of the oscilloscope (attenuator setting, time base setting and trigger source setting) for an optimum trace.**

If the probe you use is an attenuator probe 10:1 or 100:1 then you may have to adjust it for the correct compensation, according to the probe instructions.

## 3.2 FRONTPANEL LAY OUT AND OPERATION

### 3.2.1 FRONTPANEL LAY OUT

The frontpanel is designed with optimum ergonomic and logical lay-out of the controls: from left to right and from top to bottom, like reading a book. For ease of access to the oscilloscope the front panel is divided into seven main areas.

- Screen controls
- Viewing area (screen + LCD)
- Up-down keys
- Function keys
- Rotary knobs
- Softkeys
- Inputs and outputs

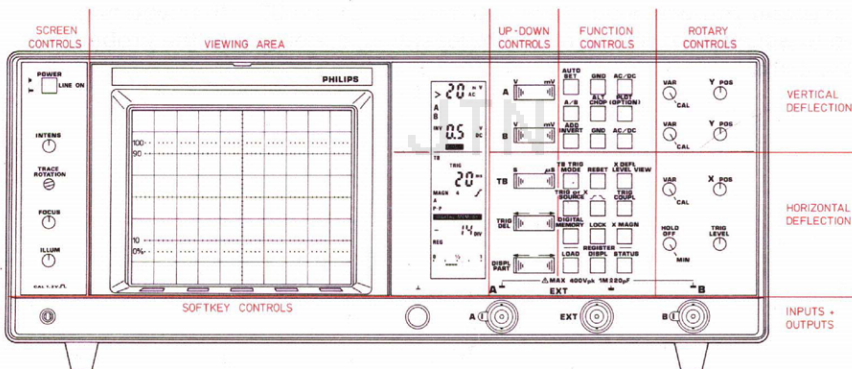

### 3.2.2 SCREEN CONTROLS

After switch-on with the POWER LINE ON push button, the screen controls can be adjusted for optimum illumination, trace and spot quality.

The trace and text intensity is set by the INTENS rotary knob, and a sharp display is obtained by the FOCUS rotary knob.

The screw driver control TRACE ROTATION is used to set a grounded trace parallel with the horizontal graticule lines.

The graticule of the screen can be lit-up by the ILLUMINATION rotary knob, this can be used in dark environment or for making photographs.

### 3.2.3 VIEWING AREA

The viewing area consists of the screen of the Cathode Ray Tube (CRT) and a Liquid Crystal Display (LCD).

The CRT screen is divided in a 10 x 8 divisions area. Each division contains five sub-divisions. On the left side of the CRT screen four lines are marked with the values 100% 90% 10% and 0%. These marked lines can be used for percentage measurements or rise time measurements.

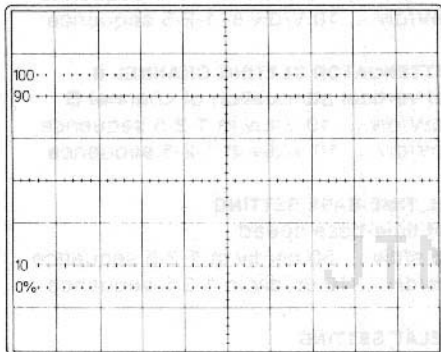

The LCD indicates all the selected active functions, settings and parameters.

Its layout is logically divided into areas according to the keys and knobs.

A flashing segment indicates:

- an incorrect selection of knobs/keys controls,
- a VAR rotary knob in uncal position,
- the end of a UP-DOWN control range,
- a key has been operated during the PLOT action,
- the DISPL PART UP-DOWN key has been pressed in TB MAGN \*1 mode.

### 3.2.4 UP-DOWN KEYS

The UP-DOWN key selects the required setting out of the range of settings possible for that function.

They are used for the attenuator setting, the time base setting, the trigger delay setting and the display part setting.

#### RANGES OF UP-DOWN KEYS

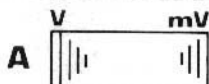

##### VERTICAL ATTENUATOR SETTING CHANNEL A

Selection of vertical attenuation of channel A  
Analog: 2 mV/div ... 10 V/div in 1-2-5 sequence  
Digital: 2 mV/div ... 10 V/div in 1-2-5 sequence

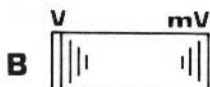

##### VERTICAL ATTENUATOR SETTING CHANNEL B

Selection of vertical attenuation of channel B  
Analog: 2 mV/div ... 10 V/div in 1-2-5 sequence  
Digital: 2 mV/div ... 10 V/div in 1-2-5 sequence

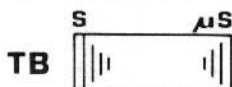

##### HORIZONTAL TIME-BASE SETTING

Selection of time-base speed  
Analog: 0,5 s/div ... 50 ns/div in 1-2-5 sequence  
Digital: 50 s/div ... 10 us/div in 1-2-5 sequence



##### TRIGGER DELAY SETTING

Selection of trigger delay  
Analog: not available  
Digital: -20 div...0 div in 1 div steps



##### DISPLAY PART SETTING

Selection of the displayed part out of the total memory depth  
Analog: not available  
Digital: 1/16 ... 16/16 sequence depending on TB MAGNIFY value.



### 3.2.5 FUNCTION KEYS



= NOT IN  
DIGITAL  
MEMORY  
MODE



= NOT IN  
ANALOG  
MODE

JTN

This oscilloscope features the possibility to select several functions with a single key in sequential order. To obtain the correct function it is necessary to press the particular key repeatedly until the correct function is visible in the LCD. After the last function in line, the sequence starts again. An overview of the functions is given below:

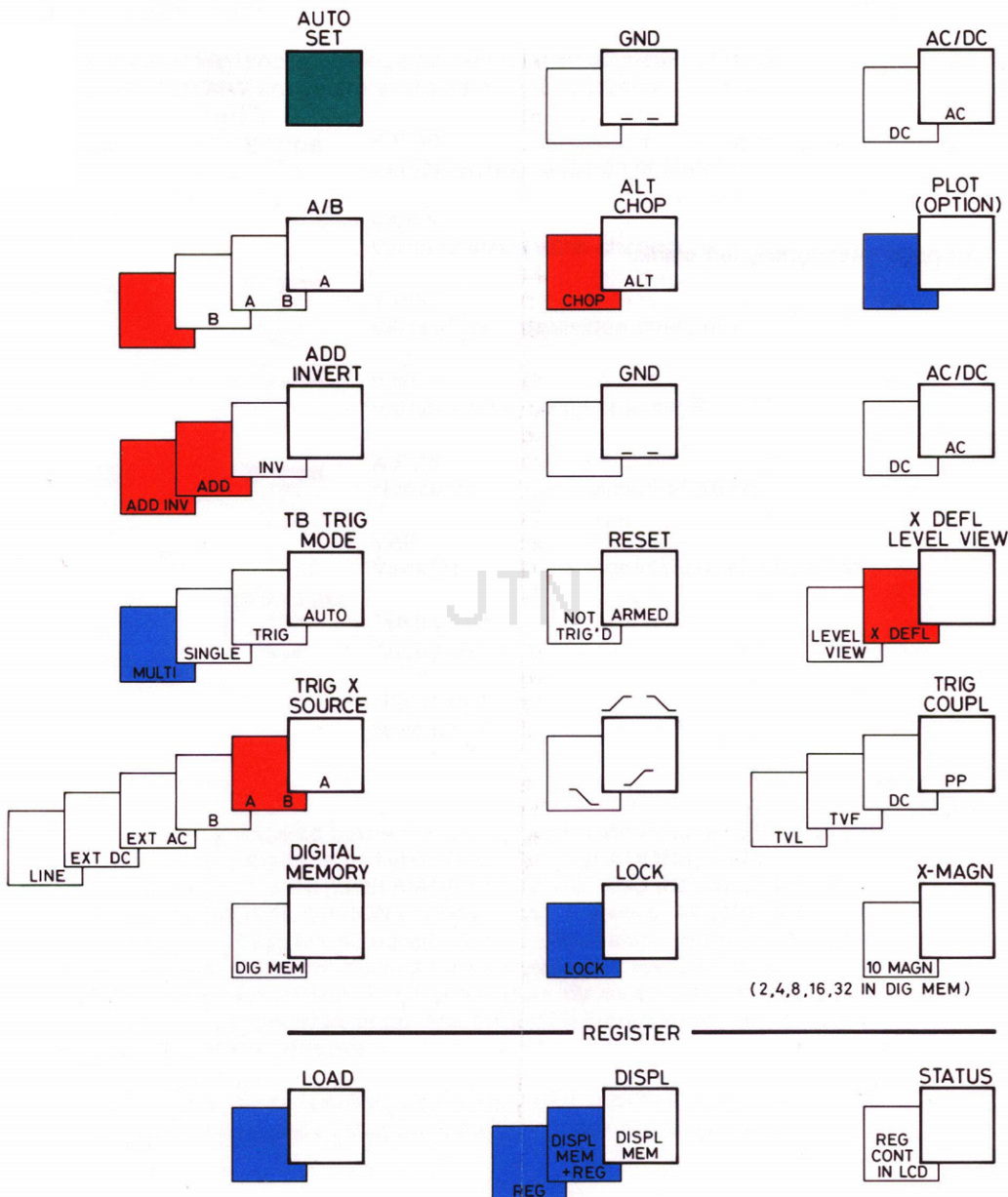









This page intentionally left blank.

JTN

### 3.2.6 ROTARY KNOBS

With the ROTARY knobs, continuously-variable adjustment of the function is obtained. ROTARY knobs are available for the functions:

		Y POS Vertical screen position channel A
		VAR A Variable attenuation channel A
		Y POS Vertical screen position channel B
		VAR B Variable attenuation channel B
		X POS Horizontal screen position of traces
		VAR Variable time-base (not in DIGITAL MEMORY)
		TRIG LEVEL Trigger level
		HOLD OFF Hold off time

### 3.2.7 SOFTKEYS

The five softkeys located below the CRT can be used for different functions in digital memory mode, e.g. AMPLITUDE CALCULATIONS, TIME CALCULATIONS and CURSOR MANIPULATIONS. Also the set up for the (optional) INTERFACE OPTION is done via the softkeys. All calculation and manipulation facilities are activated via successive steps through the softkey menu structure. When the menu has been activated, the CRT screen contains two area's for text. The top text area shows all calculation information and channel settings. The bottom text area shows all functions assigned to the five softkeys.

How to operate the calculation and manipulation facilities under the softkeys is extensively explained in chapter 4.3 and 5 of this operating guide.

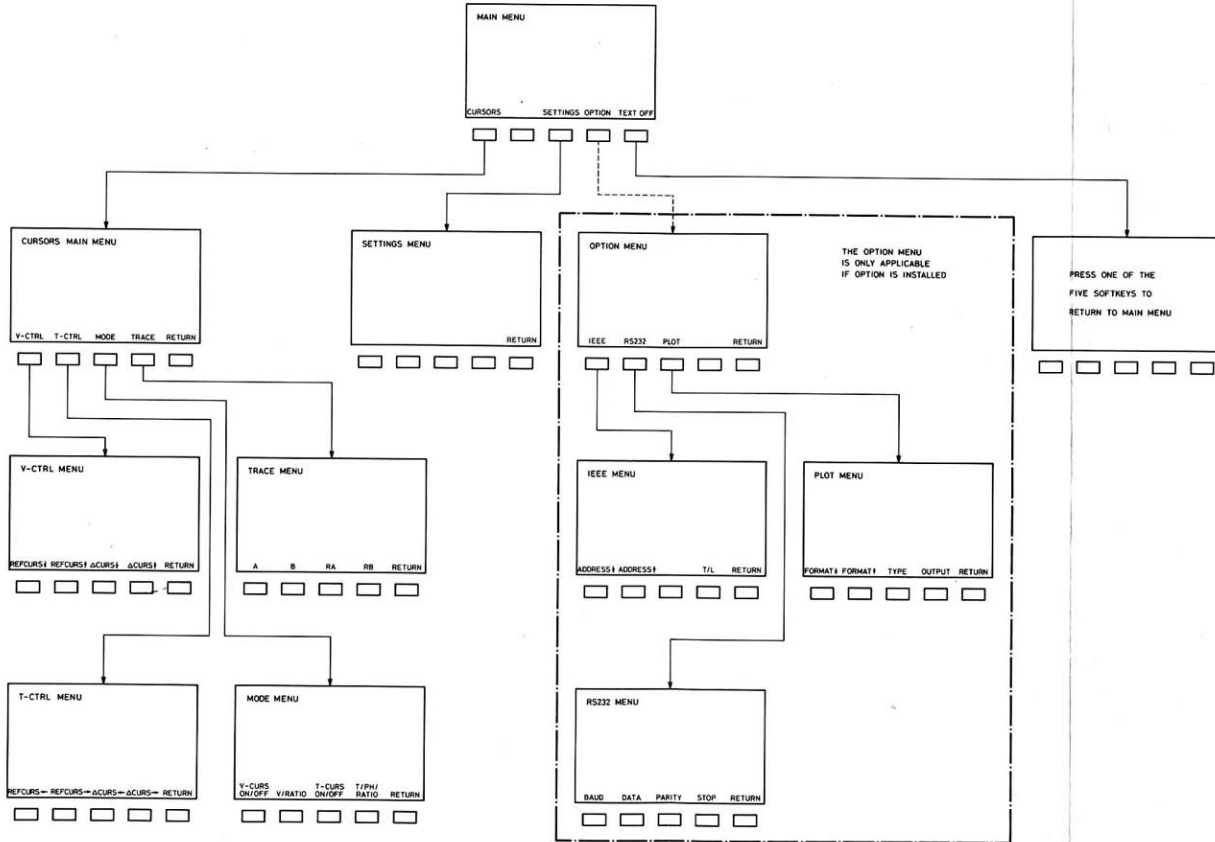

### 3.2.8 INPUTS AND OUTPUTS

In addition to the measuring inputs A, EXT and B, the oscilloscope is equipped with several inputs and outputs to provide special functions and applications.

All standard and optional sockets are described below:

#### 3.2.8.1 Standard

SOCKET	DESCRIPTION
<b>A</b>	BNC input socket for channel A. Probe range indicator identifies attenuation of probe connected and this is compensated for in the LCD display for vertical deflection.
<b>B</b>	BNC input socket for channel B. Probe range indicator identifies attenuation of probe connected and this is compensated for in the LCD display for vertical deflection.
<b>EXT</b>	BNC input socket; When EXT input is selected via the time-base the signal input is used for external triggering. When EXT input socket is selected via X DEFL, the horizontal deflection is determined by the signal applied to this socket.
<b>CAL</b>	Output socket providing a 1,2 V(p-p), 2 kHz approx. square-wave voltage. To be used for probe compensation or to calibrate the vertical deflection AMPL. control.
<b>LINE IN</b>	Input socket for mains supply: 100 V...240 V(ac), 45 Hz...440 Hz or 127 V...370 V(dc).
<b>Z-MOD</b>	Input socket for Z-modulation of the CRT trace. The trace is blanked when this input is "high" ( $> +2,5 \text{ V}$ ). Input voltage range: 0 V... + 12 V.

3.2.8.2 *Optional*

**SOCKET**                      **DESCRIPTION**

**IEEE 488 BUS**            Input/output connector to connect the oscilloscope to an IEEE 488/IEC 625 interface.

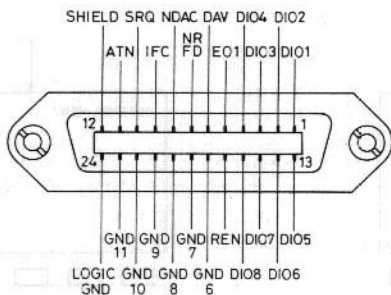

**RS-232C BUS**            Input/output connector to connect the oscilloscope to an RS-232 C/V 24 interface.

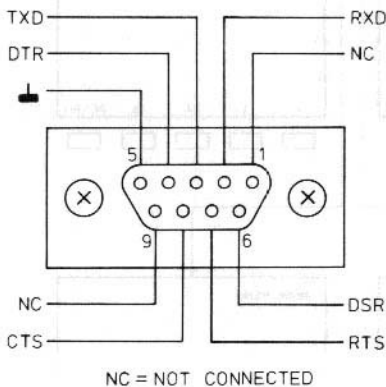

## 4 APPLICATIONS

### 4.1 USE AS AN ANALOG OSCILLOSCOPE

To use the instrument as an analog oscilloscope three main functions need first to be defined:

- Vertical mode
- Horizontal mode
- Trigger mode

First ensure the oscilloscope is operating in the analog mode (DIGITAL MEMORY indication in LCD is off), if not press the DIGITAL MEMORY key. By pressing the AUTO SET key, the oscilloscope will automatically set the main functions to a near optimal setting. Further adjustments and selections can then be made by operating the various keys and knobs.

JTN



#### 4.1.1. VERTICAL MODE

In vertical mode the following adjustments can be made:

- **Vertical display mode selection**  
by operating the A/B key.

Select the channel you want to see A, B or A and B simultaneously. If the ADD function is in use, it is possible to switch off the channels A and B (see page 4.7).

- **Adjustment of the absolute zero level**  
by using the GND key and the Y POS rotary knob the zero level can be positioned anywhere on the screen.

By pressing the GND key the input signal is interrupted and the input signal path is grounded. With the Y POS rotary knob the zero level can be adjusted to any level on the screen. By pressing the GND key once again the signal is once more connected to the input.

The zero level adjustment is necessary for all DC measurements.

- **Channel coupling**  
by the AC/DC key.

In AC position the DC component of the measuring signal is rejected.  
In DC position the full bandwidth is available.

AC coupling is used when a small AC signal has to be measured that is superimposed on a large DC voltage.

For example, noise measurements on power supply voltages.

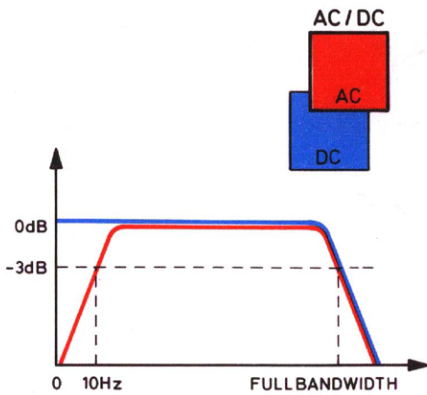
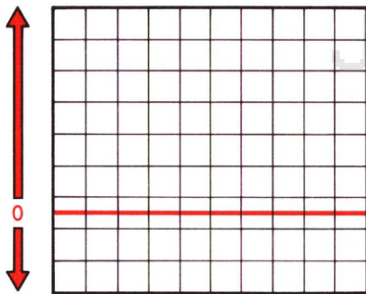
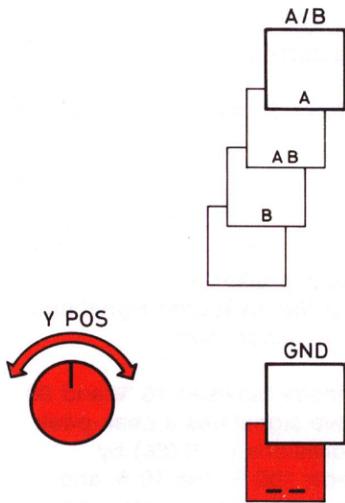

4.1 USE AS AN ANALOG OSCILLOSCOPE

- **Vertical amplitude adjustment**  
by operating the V...mV UP-DOWN key for best setting.

The setting can be chosen out of a range from 2 mV up to 10 V per division in a fixed 1-2-5 sequence.

- Vertical variable attenuation  
by adjusting the VAR rotary knob.

The UNCAL position is used when the measurement is taken in percentages, with the rotary knob the amplitude of the measured signal can be set to 100 %. The LCD now shows a flashing ">" uncal sign.

For example rise-time measurements are mostly made between 10 % and 90 % of a waveforms edge. If a measured square-wave signal has a peak-peak value of 6,2 divisions it can be attenuated to 5,0 divisions (= 100%) by adjusting the VAR rotary knob. As 5 divisions is now 100 %, the 10 % and the 90 % levels and the time between these levels can easily be read from the screen.



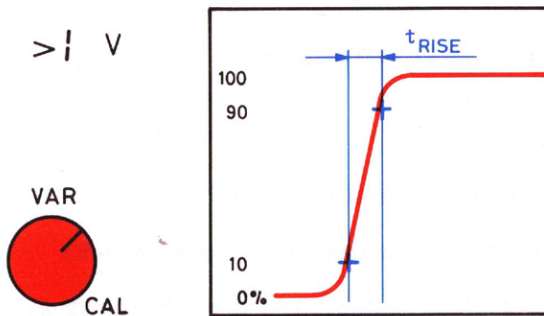
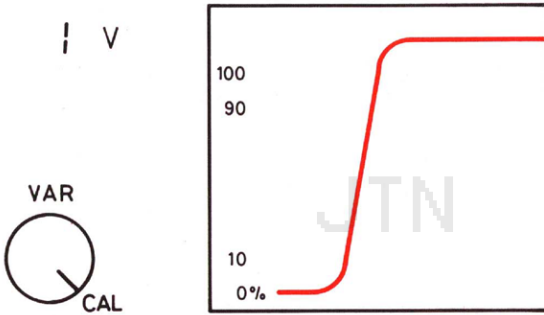
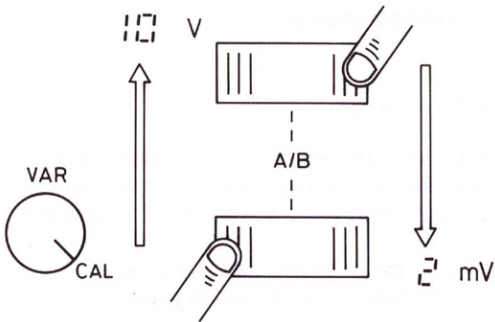

- **Selection of ALTERNATED or CHOPPED display**  
by using the ALT/CHOP key

This selection is used if two signals are displayed.

In alternate mode, the CRT beam alternately traces one signal sweep and then the other. At low repetition rates this can be seen, so ALT is mainly used for high speed time-base settings (from around 0,1 ms/div and above).

In chop mode, the beam chops from one signal to the other at a fast switching frequency and is therefore suitable for low speed signals.



- **Selection of ADD, NORMAL or INVERTED display**  
by the ADD/INVERT key.

"INVERT" is active on channel B.

In the ADD mode, channel B is added to channel A ( $A + B$ ).

In the ADD INVERT mode, channel B is subtracted from channel A ( $A - B$ ).

The differential mode ( $A - B$ ) is useful for rejecting common-mode signals. By measuring in differential mode, the common-mode signal on one channel cancels out the common-mode signal on the other channel leaving the actual signal visible on the display.

An application of the differential mode is to eliminate hum from a signal.

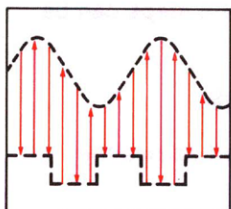
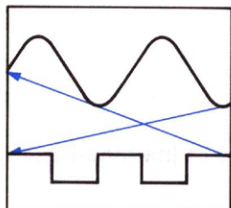
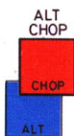

JTN

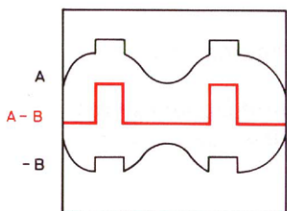
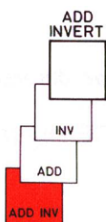

#### 4.1.2. HORIZONTAL MODE

In horizontal mode the following selections can be made:

- **Selection of horizontal time scale**  
by the TB s... $\mu$ s UP-DOWN key,  
the VAR rotary knob, or  
the TB MAGN key.

With the TB s... $\mu$ s UP-DOWN key a selection can be made of the time-base speed in a 1-2-5 sequence.

With the rotary knob VAR fine adjustments between the 1-2-5 steps can be made.

With the TB MAGN the time-base can be expanded 10 times.

By operating the X POS rotary knob the trace can be shifted across the screen in a horizontal direction.

- **Selection of X deflection or horizontal time-base**  
by the X DEFL key.

In the X deflection mode the oscilloscope shows one signal to be displayed as a function of another signal (X-Y graph).

The required X-axis signal is selected by the TRIG OR X SOURCE key (A, B, EXT AC, EXT DC or LINE).

The X-Y mode has a wide range of applications, for example:

- amplitude vs frequency of circuits and filters;
- output current vs input voltage of semiconductors;
- comparison of frequency or phase shift using Lissajous figures.

In horizontal time-base mode the display shows the measured signal vs time (Y-t graph). The time coefficient can be selected with the TB s... $\mu$ s UP-DOWN key.

The function LEVEL VIEW appears only if DC trigger coupling is active. This is explained in chapter 4.1.3 under "trigger coupling".

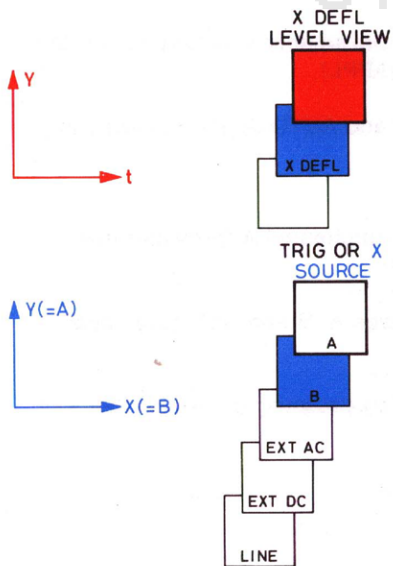
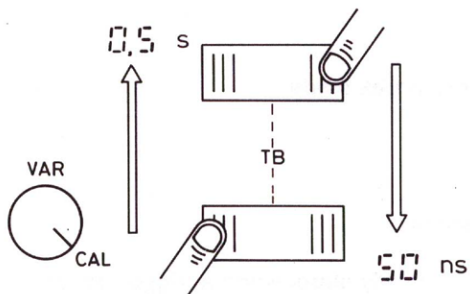

4.1 USE AS AN ANALOG OSCILLOSCOPE



#### 4.1.3. TRIGGER MODE

In trigger mode the following selections can be made:

- **Time-base trigger mode**  
by the TB TRIG MODE key.

The time base can operate in three modes:

- AUTO**            the horizontal sweep normally starts when a trigger occurs. If no trigger is detected within 100 ms after the last sweep, then a sweep start automatically occurs. This means that a trace is always visible on the display.
- TRIG**            horizontal sweep will only start on a trigger pulse derived from the selected trigger source. The rotary knob TRIG LEVEL must be adjusted to the desired trigger level.
- SINGLE**          horizontal sweep runs only once after it is armed by the RESET key upon the receipt of a trigger pulse. This pulse is derived from the selected trigger source. The mode is very useful to capture single events.

If the display mode is ALT (alternate), a special selection of single shot can be made in the application preselect menu (APPL),

- enter the APPL menu by pressing RESET and AUTO SET simultaneously,
- select CRT softkey APPL,
- select CRT softkey FIRST or MULTI

**FIRST =**          single shot is always done on channel A (provided this channel is active).

**MULTI =**          single shot alternates between A, B and ADD (provided these functions are active).

Leave the application preselect menu again by pressing the AUTO SET key.

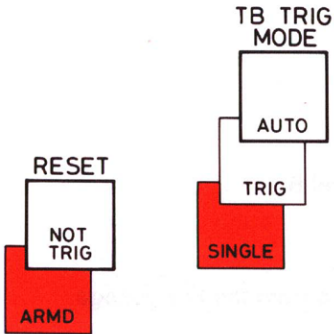

### AS MENU

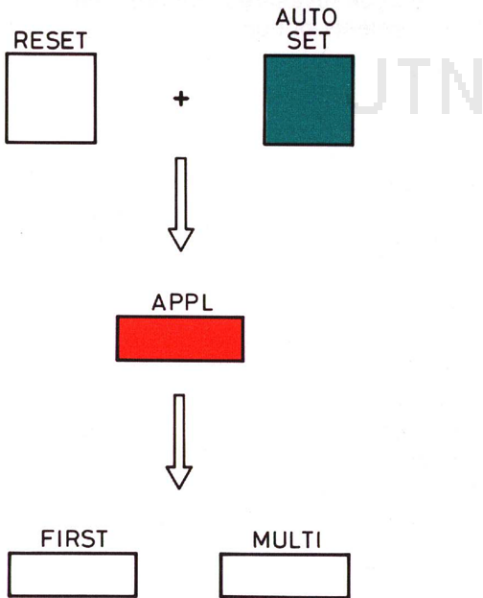

- **Trigger source selection**  
by the TRIG OR X SOURCE key.

The trigger sources can be selected from:

A	channel A
A B	composite channel A and channel B
B	channel B
EXT AC	channel EXTERNAL AC coupled
EXT DC	channel EXTERNAL DC coupled
LINE	50 Hz or 60 Hz sine-wave derived from the line voltage.

In composite triggering A B the trigger source alternates between A and B, therefore this trigger mode is only possible in the alternated display mode. Notice that in this mode the displayed traces are NOT time related while the trigger pulses indicate different time moments. An example of composite triggering is shown on the next page.

Line triggering is used where signals have to be measured that are time related to the LINE frequency; e.g. measurements of hum.

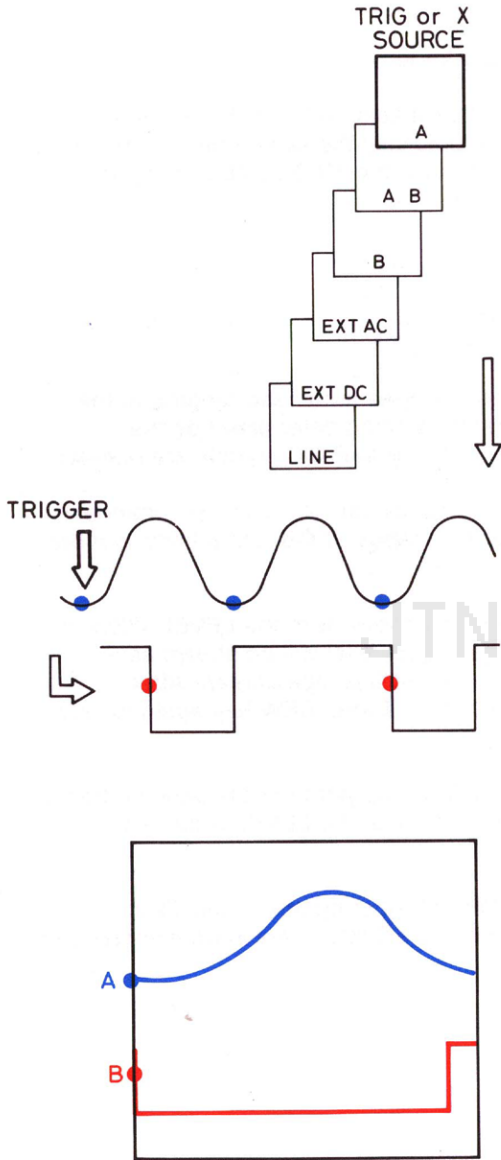

**- Trigger level**

by adjusting the TRIG LEVEL rotary knob.

For repetitive signals, a stable, jitter-free display will only be obtained if each time-base sweep is triggered at precisely the same point on the signal waveform. The trigger level is adjusted with the TRIG LEVEL rotary knob.

**- Trigger coupling**

by the TRIG COUPL key.

Four modes can be selected for trigger coupling:

**P-P** Peak-to-peak triggering gives automatic ranging of the LEVEL knob, the ranging being determined by the peak-to-peak value of the signal. DC signals are rejected.

**DC** DC triggering; the full bandwidth of the trigger channel is available, while the level range of the rotary knob is more than  $\pm 8$  divisions.

In this mode, the trigger level can also be shown with the LEVEL VIEW key. By pressing the LEVEL VIEW key, the trigger level will be shown as a DC voltage, related to the vertical mid of the oscilloscope screen. After adjusting the LEVEL rotary knob press the LEVEL VIEW key again to return to the original screen.

**TVF** TV frame triggering allows triggering at the slow TV frame (field) synchronisation pulses; the LEVEL rotary knob is inoperative.

**TVL** TV line triggering allows triggering at the fast TV line synchronising pulses; the LEVEL rotary knob is inoperative.

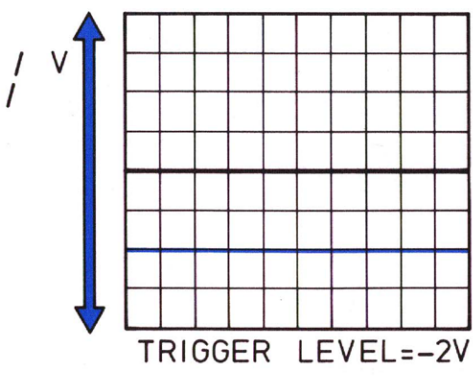
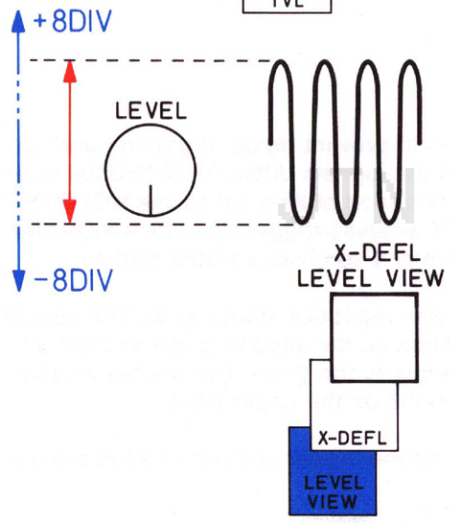
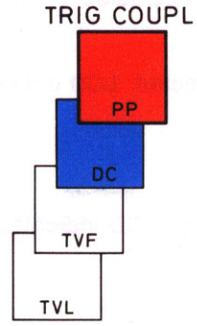

4.1 USE AS AN ANALOG OSCILLOSCOPE

- **Trigger slope selection**  
by the  $f \setminus$  key.

For triggering on a positive-going slope select  $f$ , for triggering on a negative-going slope select  $\setminus$ .

If trigger coupling TVF or TFL is selected, LCD indicates + and - instead of  $f$  and  $\setminus$ .

- + = positive video,
- = negative video.

If horizontal mode X DEFL is selected, LCD indicates + and - instead of  $f$  and  $\setminus$ .

- + = signal not inverted,
- = signal inverted.

- **Hold-off time**  
by the HOLD-OFF rotary knob.

The HOLD-OFF rotary knob is used to prevent "false" triggering and "double writing" when examining multiple pulse signals. After the horizontal sweep is completed triggering is inhibited for period of time set by the HOLD-OFF knob. Adjustment of the HOLD-OFF enables triggering to be synchronized on the same pulse in the pulse train and so gives a stable display.

For example, consider a double pulse repetitive input signal. The selected trigger signal sees the same condition on the second pulse as the first pulse, and so the time base sweep starts too soon. The double-writing effect is seen as an extended base-line on the upper trace.

Adjusting the hold-off time will inhibit the trigger unit until it sees the first pulse again.

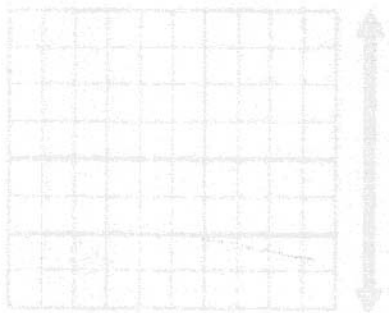

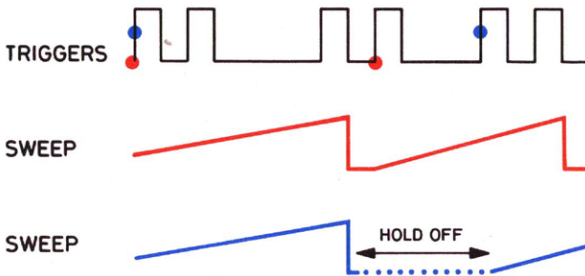
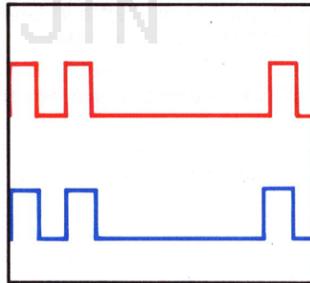
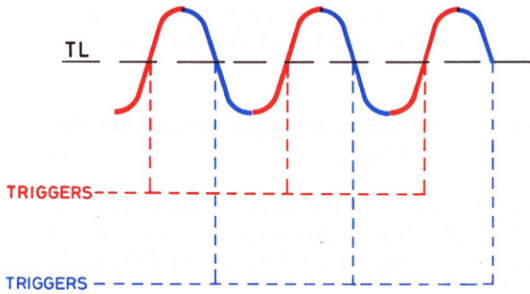
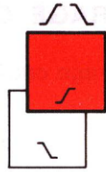



## 4.2 USE AS A DIGITAL STORAGE OSCILLOSCOPE

To use the instrument as a digital storage oscilloscope three main functions should be defined:

- Vertical mode
- Horizontal mode
- Trigger mode

First ensure that the oscilloscope is operating in the digital mode (DIGITAL MEMORY indication in LCD is on), if not then press the key DIGITAL MEMORY.

By pressing the AUTO SET key the oscilloscope will automatically set the main functions to the most convenient setting.

Further adjustments can be made by operating the keys. In DIGITAL MEMORY mode there are more available than in the analog mode. The use of the identical functions is described in section 4.1 "Use as an Analog Oscilloscope".

The analog functions which are not available in DIGITAL MEMORY mode are: ADD, ALT/CHOP, X DEFL, COMP TRIG, X VAR.

In this section only the DIGITAL functions are described.

This page intentionally left blank

#### 4.2.1. VERTICAL MODE

In vertical mode the following additional choices can be made:

- **Loading of register memory**  
by pressing the register LOAD key.

The oscilloscope has two memories:

- a display memory, which you see in normal operation, and a register memory, which is used to store reference wave forms.

If you want to store a wave form in the register, simply press the LOAD key. The wave form is now stored into the register. Provided the oscilloscope is equipped with a battery back-up, all wave forms are still stored after power down for recall after the next power up.

- **Display of register memory**  
by pressing the DISPLAY key.

Pressing the DISPLAY key once will show the contents of the display memory and the register memory together on the screen. Now the two signals can be compared with each other.

Pressing the DISPLAY key a second time will show only the contents of the register memory.

Pressing the DISPLAY key a third time will result in displaying the contents of the display memory again.

- **Status of register memory**  
by pressing the STATUS key.

Pressing the STATUS key enables the LCD to show the full settings of the register memory.

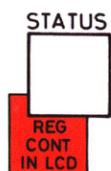
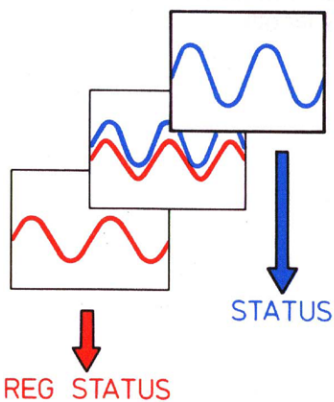
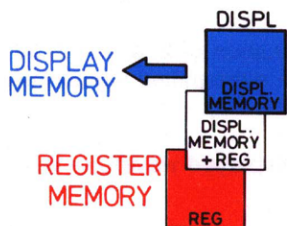
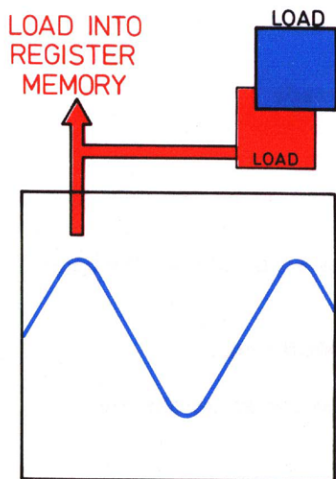

#### 4.2.2. HORIZONTAL MODE

In horizontal mode the following selections can be made:

- **Selection of horizontal time scale**  
by the TB s... $\mu$ s UP-DOWN key,  
the TB MAGN key.

With the TB s... $\mu$ s UP-DOWN key you can make a selection of the time-base speed in a 1-2-5 sequence.

The rotary knob VAR is inactive in the DIGITAL MEMORY mode.

By operating the X POS rotary knob the trace can be shifted across the screen in a horizontal direction.

By pressing the TB MAGN key, a horizontal magnification of 2, 4, 8, 16, 32 or 0,5 times can be obtained. Any part of interest in a magnified signal may be selected for display by the DISPL PART UP-DOWN key.

By operating the DISPL PART UP-DOWN key, the displayed waveform will scroll across the screen in horizontal direction.

The LCD bar shows the relative position of the displayed part of the magnified signal in relationship to the total memory length.

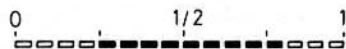
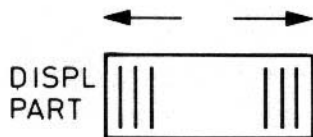
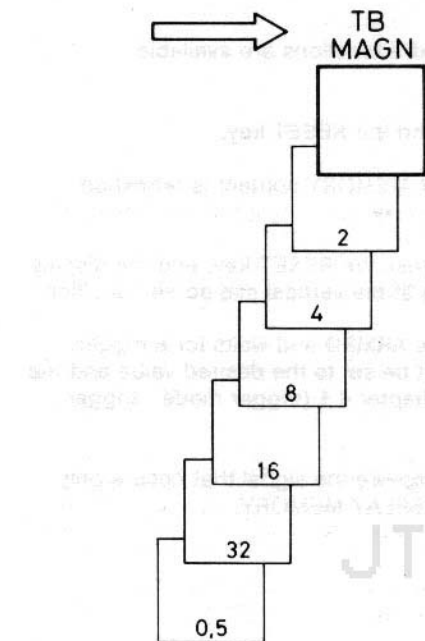

### 4.2.3. TRIGGER MODE

In DIGITAL trigger mode the following extra functions are available:

- **SINGLE SHOT**

by pressing the TB TRIG MODE key and the RESET key.

In DIGITAL MEMORY mode the DISPLAY MEMORY content is refreshed once after a suitable trigger is received.

To clear the display memory contents press the RESET key, and the display memory contents are then set to a value at the vertical mid screen position.

After a RESET operation the time-base is ARMED and waits for a trigger. For a good trigger, the trigger level must be set to the desired value and the LEVEL VIEW function as described in Chapter 4.1 (trigger mode - trigger coupling) can be of help.

The single-shot mode is very useful to capture the signal that occurs only once. The signal is then stored in the DISPLAY MEMORY.

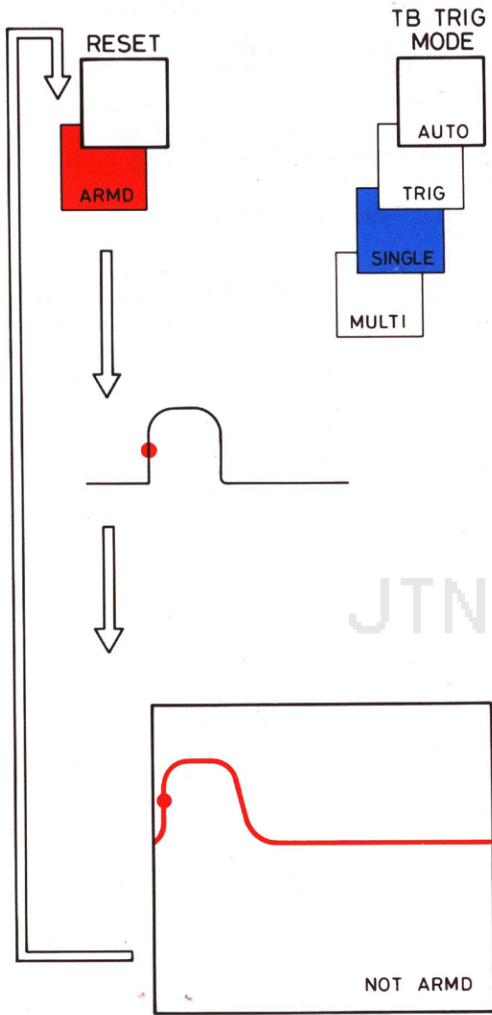

JTN



**- MULTIPLE SHOT**

by pressing the TB TRIG MODE key and the RESET key.

In DIGITAL MEMORY mode the REGISTER MEMORY contents are refreshed ONCE after the FIRST trigger is received, and the DISPLAY MEMORY contents are refreshed ONCE after the SECOND trigger is received.

To CLEAR the contents of the MEMORIES , see SINGLE SHOT.

After a reset operation the time base is ARMED and waits for TWO new triggers.

*NOTE: In this mode the content of the REGISTER MEMORY is overwritten.*

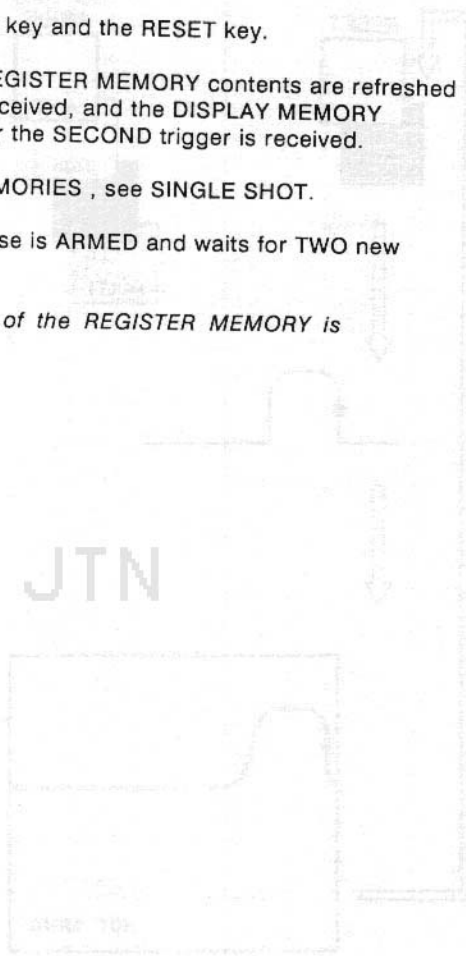

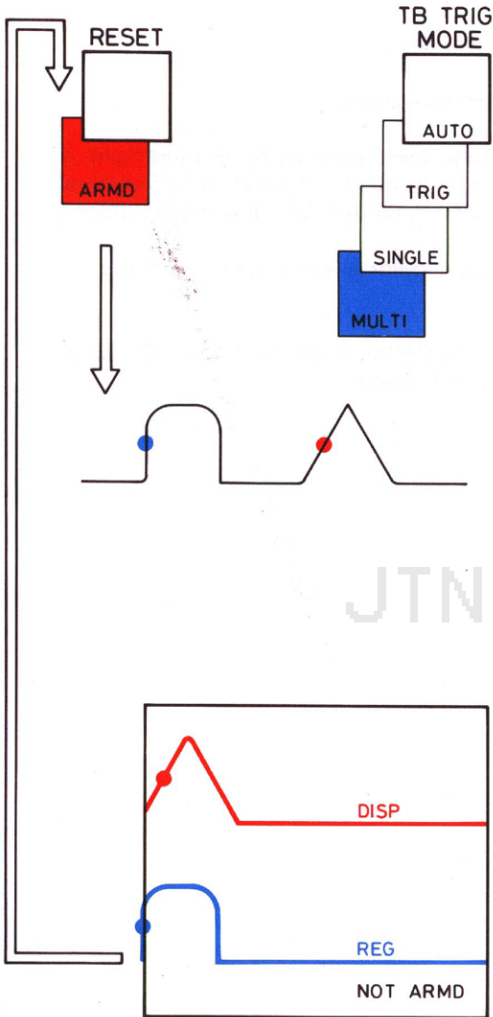

4.2 USE AS A DIGITAL STORAGE OSCILLOSCOPE

**- TRIGGER DELAY SETTING**

by pressing the TRIG DEL UP-DOWN key.

The TRIGGER DELAY setting offers PRE-triggering.

In PRE triggering you can look BEFORE the trigger point. For example, if trigger delay = -10 divisions, the trigger point is at the far RIGHT vertical graticule line. What you see is then the signal BEFORE the trigger point.

In trigger delay = 0 divisions the trigger point is at the LEFT vertical graticule line.

The trigger delay range that can be adjusted is between 0 and -20 divisions. The adjustment can be done in 1 division steps.



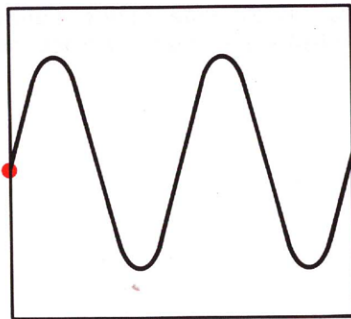
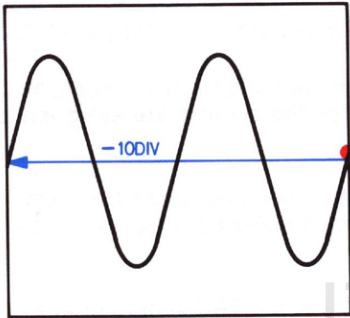

## 4.3 CURSOR MEASUREMENTS

### 4.3.1 GENERAL

The cursors enable accurate voltage and time measurements to be made. They are controlled via the five softkey controls that are located below the CRT.

The cursors are activated with the softkey CURSORS. The cursors consist of two sets of parallel lines that can be positioned on the screen. The set of horizontal lines is intended for voltage measurements. These are activated via the softkeys MODE and then V-CURS ON. The set of vertical lines makes time measurements possible. These are activated via the softkeys MODE and then T-CURS ON.

The softkey function TRACE appears if more than one trace is displayed on the screen. The selection of the trace to which the cursors are assigned is possible via the menu under TRACE.

The cursors are screen-related and do not automatically follow the trace. For measurements it is necessary to position the cursors upon the trace details of interest.

The voltage cursors are positioned via the menu V-CTRL under softkey control. In this menu two softkeys are available to move the REFERENCE cursor up and down the screen and another two to move the  $\Delta$  cursor.

The time cursors are positioned via the menu T-CTRL under softkey control. This menu gives two softkeys to position the REFERENCE cursor across the screen and the other two for the  $\Delta$  cursor.

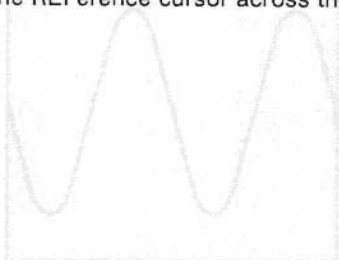

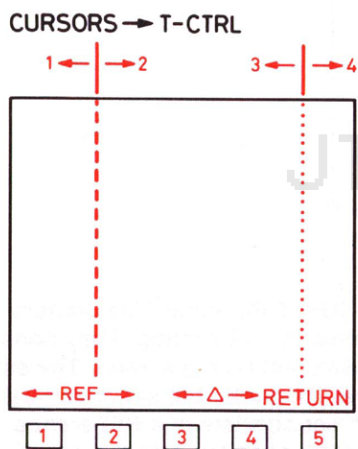
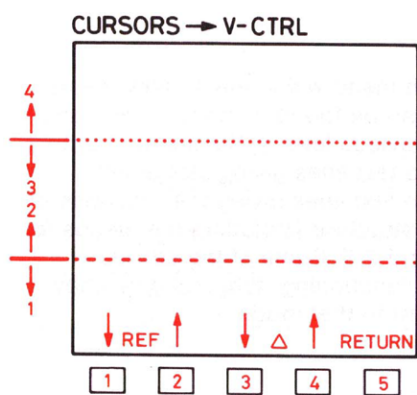

### 4.3.2 CURSOR CONTROL MENUS

The following explains the function of each menu within the softkey menu structure. The softkey function RETURN can be found in many menus and if activated it will result into a jump to the previous level in the menu structure. The text shown on the CRT consists of top text lines giving instrument settings and measuring results and bottom text lines giving the functions of the softkeys. The complete softkey menu structure (including the menus for the option) is given in the figure in chapter 3.2.7. Some of the softkey selections are dependent on the mode of functioning: they will only show up in the menu structure if they are relevant to that mode.

#### MAIN menu

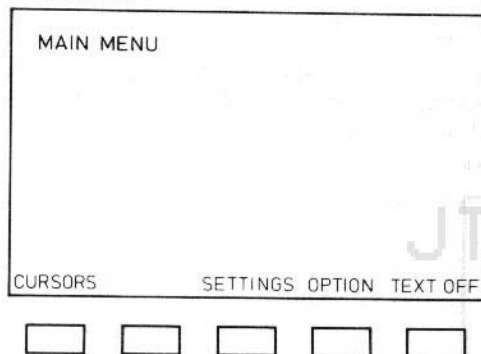

Main purpose is to activate the extensive CURSORS menu. The cursors enable accurate voltage and time measurements to be made. They consist of two sets of parallel lines that can be positioned on the screen. The set of horizontal lines is intended for voltage measurements; the set of vertical lines is used for time measurements. Each set consists of a REFERENCE cursor and a  $\Delta$  cursor. They can be separately positioned on the signal detail of interest. The measurement results are displayed in the top area of the CRT.

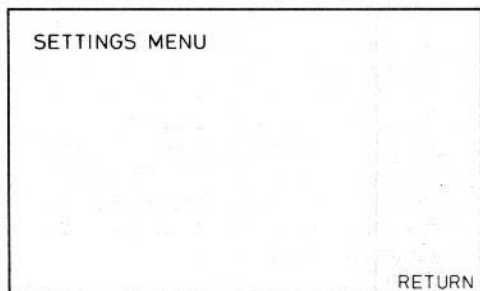
**SETTINGS menu**

When active this menu displays the vertical and time base settings belonging to the traces that are displayed. This feature may be used for making photographs or plot outs from the screen.

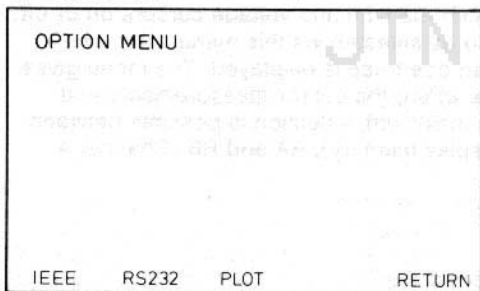
**OPTION menu**

This menu only appears if the interface option is installed in the oscilloscope. It enables to set up the interface parameters. Refer to chapter 5 for a description of the menu and the plot out features of the interface option.

**TEXT OFF**

switches the CRT text off. The trace identification is not influenced by this softkey. The CRT text is switched on again by pressing one of the softkeys.



## CURSORS main menu

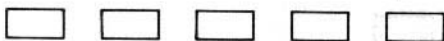
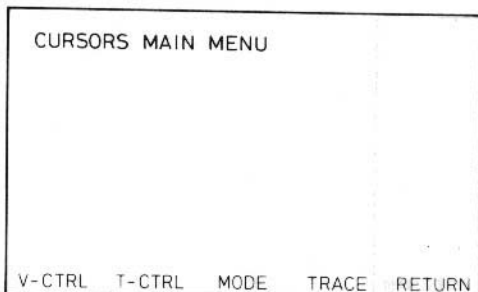

This menu enables access to the main cursor functions:

- V-CTRL gives access to the voltage cursor control menu where the voltage cursors can be positioned.
- T-CTRL gives access to the time cursor control menu where the time cursors can be positioned.
- MODE: this menu is used to switch the time and voltage cursors on or off. The calculation facilities can also be selected via this menu.
- TRACE appears only if more than one trace is displayed. The menu gives the possibility to select the trace where the cursor measurements and calculations are related to. As a maximum, selection is possible between A, B (Channel A and B in the display memory), RA and RB (Channel A and B in the register).

## V-CTRL menu

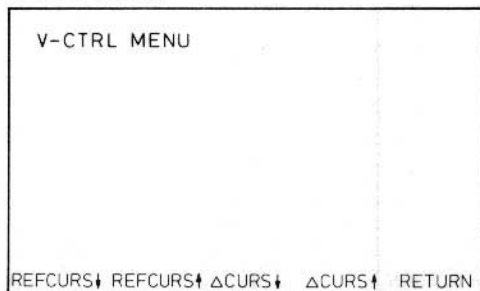

This menu gives two softkeys to position the REFerence cursor up and down. Another two softkeys are used to position the  $\Delta$  cursor up and down. Positioning control is arranged so that the  $\Delta$  cursor can not come lower than the REFerence cursor; if you try to do so, the REFerence cursor is moved together with the  $\Delta$  cursor. Identical to this the REFerence cursor can not come higher than the  $\Delta$  cursor. When pressing two softkeys at a time it is possible to position the cursors both upwards, both downwards, towards each other or out of each other.

## T-CTRL menu

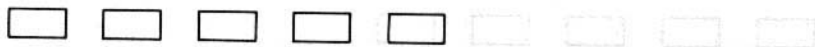
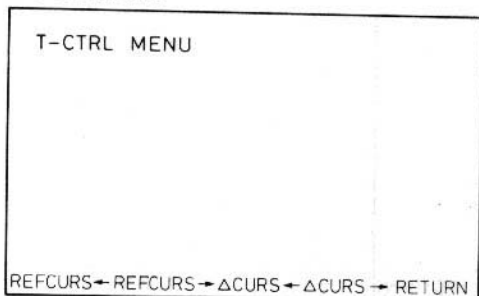

This menu gives two softkeys to position the REFERENCE cursor to the left or to the right. Another two softkeys are used to position the  $\Delta$  cursor to the left or to the right. Positioning control is arranged so that the  $\Delta$  cursor can not come more to the left than the REFERENCE cursor; if you try to do so, the REFERENCE cursor is moved together with the  $\Delta$  cursor. Identical to this the REFERENCE cursor can not come more to the right than the  $\Delta$  cursor. When pressing two softkeys at a time it is possible to position the cursors both to the left, to the right, towards each other or out of each other.

## MODE menu

MODE MENU				
V-CURS ON/OFF	V/RATIO	T-CURS ON/OFF	T/PH/ RATIO	RETURN
<input type="checkbox"/>	<input type="checkbox"/>	<input type="checkbox"/>	<input type="checkbox"/>	<input type="checkbox"/>

Via this menu the the voltage and time cursors can be switched on and off. Moreover calculation facilities can be activated via this menu.

- V-CURS ON/OFF switches the voltage cursors on or off.
- V/RATIO permits selection between Voltage and RATIO modes. Voltage mode gives a read out of the volts measured between the cursors. This is related to vertical input sensitivity of the measured trace. If the trace is not in CAL the read out is given in DIVisions of the measuring graticule. Activating RATIO resets the read out to 100,0 %. This percentage is adapted if you move the cursor(s) again; this makes percentage comparisons possible in the amplitude domain.
- T-CURS ON/OFF switches the time cursors on and off.
- T/PH/RATIO permits selection between Time, PHase and RATIO modes. The Time mode gives a read out of the time measured between the cursors. This is related to the time base setting of the measured trace. Moreover the 1/t value is calculated and displayed in the top of the CRT. Activating PHase resets the read out to 360°. Activating RATIO resets the read out to 100,0 %. This phase/percentage is adapted if you move the cursor(s) again; this makes PHase measurements and percentage comparisons in the time domain possible.

### 4.3.3 AMPLITUDE MEASUREMENTS

Voltage measurement.

To illustrate the use of the voltage cursors, the measurement of the peak-to-peak value of a sinewave is given as an example.

First the voltage cursor menu needs to be activated by following the softkey sequence CURSORS, MODE, V-CURS ON where V indicates voltage.

Following this, the cursors then need to be positioned on the waveform. To enter the V-CTRL menu press RETURN and then V-CRTL. The peak-to-peak measurement can then be made by positioning the REFERENCE cursor on top peak of the sine-wave and the  $\Delta$  cursor on the bottom peak of it. Now the peak-to-peak value of the sine-wave can be read out in the left-hand top corner of the CRT.

Note: the peak-to-peak value is given in DIVisions if the rotary control VAR is not in its CAL position.

CURSORS → MODE → V-CURS ON → V

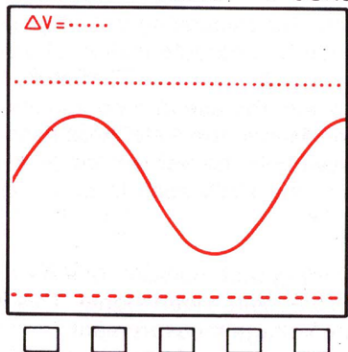

RETURN → V-CTRL

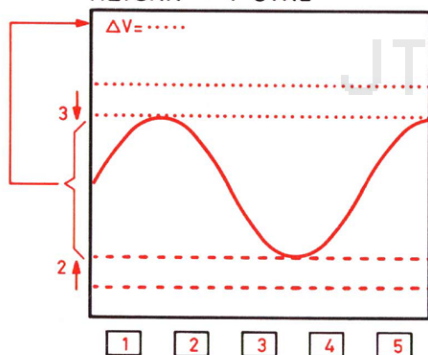

### Ratio measurement.

The ratio measurement facility is very useful for calculating circuit gain or attenuation. It is also of extreme importance for characterisation of video signals such as found in monitor applications. An example illustrating the use of the ratio measurement is explained with the use of a composite video signal. Such a signal consists of two components: the SYNChronisation pulses and the video component. In this example the percentage level of the SYNC pulses is measured in relationship to the 100% peak-to-peak value of the complete video signal.

First the 100% level must be set by positioning both cursors, one on the top and the other on the bottom peak of the composite video signal. This is done in the same way as explained for the voltage measurement.

The ratio mode is activated by operating the softkeys RETURN, MODE and RATIO in sequence. The result is that the CRT read-out is set to 100%.

Now operate the softkeys RETURN and then V-CTRL, and position the REFERENCE cursor on the signal level between SYNC and VIDEO. The CRT read-out now indicates the percentage of the SYNC pulses compared with 100% of the total composite video signal.



RETURN → MODE → RATIO

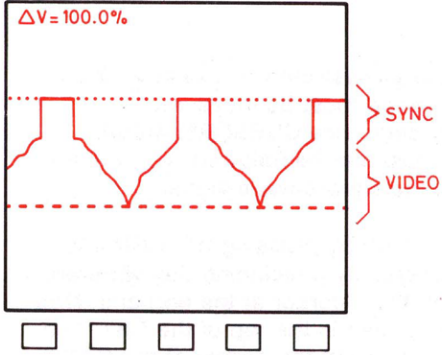

RETURN → V-CTRL

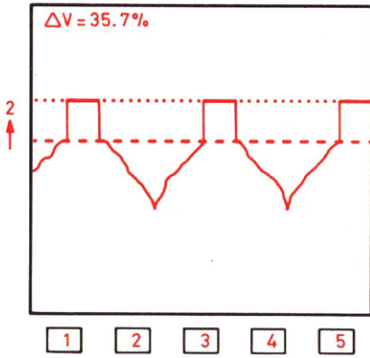



#### 4.3.4 TIME MEASUREMENTS

Time measurement.

The use of the time measurement cursors is illustrated by example of a square-wave signal of which the signal period must be measured. To activate the time cursors, the softkey sequence **CURSORS, MODE, T-CURS ON** where T is indicating time, must first be followed. You will then see on screen the two time cursors and the square-wave signal.

Now activate the time cursors position control by pressing **RETURN** and then **T-CTRL**. The measurement is completed by positioning the **RE** cursor on the start of a signal period and the **Δ** cursor at the end of it. Now the period time of the square-wave can be read in the top of the CRT. The value  $1/(\text{period time})$  can also be read in the right top corner of the CRT. This value equals the signal frequency if there is one signal period between both cursors.

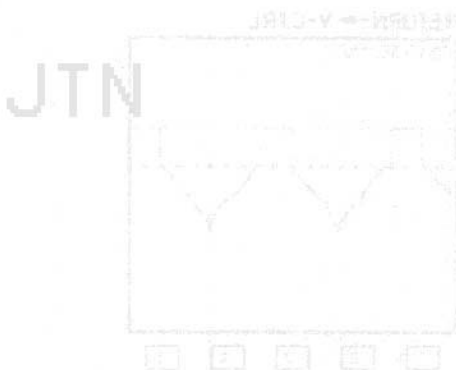

CURSORS → MODE → T-CURS ON → T

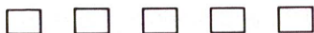
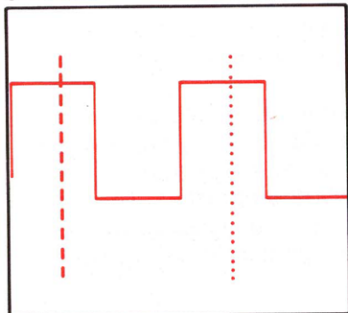

RETURN → T-CTRL

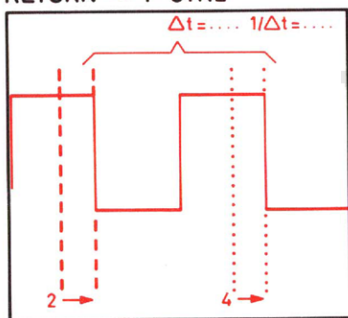

### Phase measurement.

This is explained with a square-wave signal. The signal is such that the high-time is longer than the low-time. This example explains how the low-to-high signal phase is measured.

The measurement is started by positioning both cursors on the start of a signal period and the end of it respectively. This is done in the same way as explained for the time measurement. The phase mode is activated by successively operating the softkeys RETURN, MODE and PHase. This has the result that the CRT read-out is reset to  $360^\circ$ , i.e. one signal period. The phase of the start of the period where the REFerence cursor stands equals  $0^\circ$ .

Now operate the softkeys RETURN and then T-CTRL and position the delta cursor on the low-to-high transition of the square-wave. The read out indicates the phase of this phenomenon.

RETURN → MODE → PH

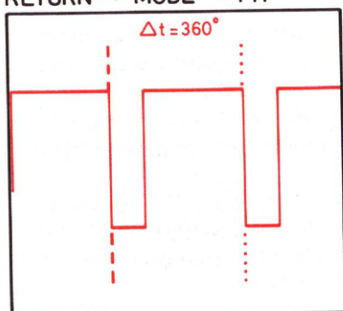

RETURN → T-CTRL

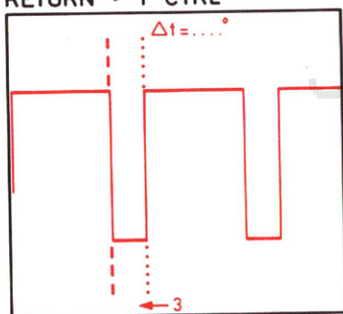

### Ratio measurement.

Time ratio measurements enable the "duty cycle", also known as the "mark to space ratio" to be calculated directly. The example illustrated shows this function using a square-wave signal. First the 100% reference level must be established; use the T-CTRL menu to position the REFERENCE cursor on the first positive edge of the signal and the  $\Delta$  cursor on the next positive edge.

Now activate RATIO by following the softkey sequence RETURN, MODE and RATIO. This sets the 100% reference. Next return to the T-CTRL menu and place the  $\Delta$  cursor on the negative edge towards the REFERENCE cursor. The percentage read-out now shows the "mark to space ratio".

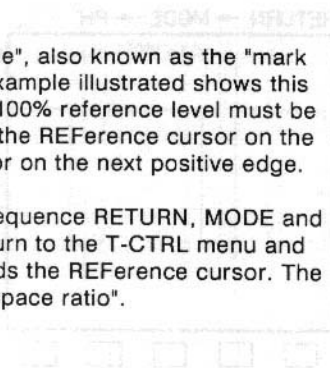

RETURN → MODE → RATIO

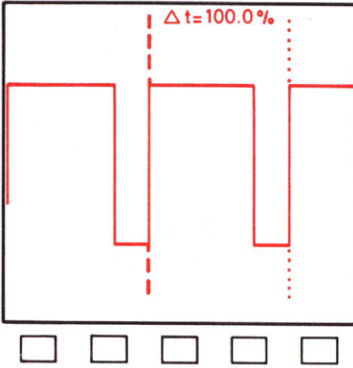

RETURN → T-CRTL

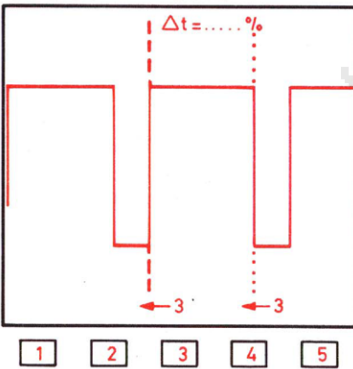

This page is intentionally left blank.



JTN



## 5 PLOTTING AND PRINTING

### 5.1 INTRODUCTION

The oscilloscope has facilities to make a hard copy of the information on the CRT if provided with option /40 or option /50. This can be done on a digital XY plotter, on an Epson FX-80 or compatible dot matrix printer or on a HP 2225 Thinkjet printer. The printer or plotter must be equipped with an IEEE-488 or a RS-232C interface.

The following options for plotting and printing are available:

- A combined IEEE-488/RS-232C interface option of the type PM8959. This option can be used for plotting and printing. It can also be used to control the oscilloscope from an external computer; for this feature refer to the separate "PM8959 communications interface manual". Oscilloscopes where this option is factory-installed are of version /40; refer to identification plate at rear side.
- An option of the type PM8961 with an RS-232C interface that can be used for plotting and printing. Oscilloscopes where this option is factory-installed are of version /50.

Before you are able to press the front panel key PLOT in order to make a hard copy of the information on the CRT, it is necessary to make some preparations:

- Oscilloscope and plotter or printer must be interconnected via a suitable cable.
- The oscilloscope and the printer or plotter must be set up to the correct interface parameters.

All set up actions are made via the OPTION MENU that is shown in the figure on page 5-3. This can be reached by pressing softkey OPTION in the MAIN MENU. Selected parameters are visible in the top text area of the CRT. How to set up the interface parameters and how to make the interconnections for a plot out is explained in separate chapters for the IEEE-488 and for the RS-232C interface.



## 5.2 PLOT OUT AND PRINT OUT

### 5.2.1 VIA THE IEEE-488 INTERFACE

The interconnection between the IEEE connector at the rear panel of the oscilloscope and the IEEE connector at the printer or plotter can be made via a standardised IEEE cable. Examples of such cables are the types that are available in the PHILIPS program:

- Type PM2295/05: cable length 0,5 m.
- Type PM2295/10: cable length 1 m.
- Type PM2295/20: cable length 2 m.

The set up is done as follows in the "memory on" mode:

- Press softkey OPTION in the MAIN MENU; this gives access to the OPTION menu.
- The ADDRESS and talker/listener T/L are automatically adjusted. So it is not necessary to enter the IEEE menu.
- Press softkey PLOT in the OPTION MENU; this gives access to PLOT MENU.
- Select IEEE via softkey OUTPUT: this has the result that the digital plot/print action occurs via the IEEE output socket.
- Select the plotter TYPE: selection of a number of plotter types is possible. Selecting FX80 gives the possibility to make a CRT screen copy on a dot matrix printer (Epson FX-80 or compatible). Selecting HP2225 gives the possibility to make a CRT screen copy on a HP2225 Thinkjet printer.
- Select (if applicable) the format of the hard copy; can be chosen between 0,5 and 2x the screen size via the softkeys FORMAT up and FORMAT down.
- Press softkey RETURN twice in order to return to normal oscilloscope use.

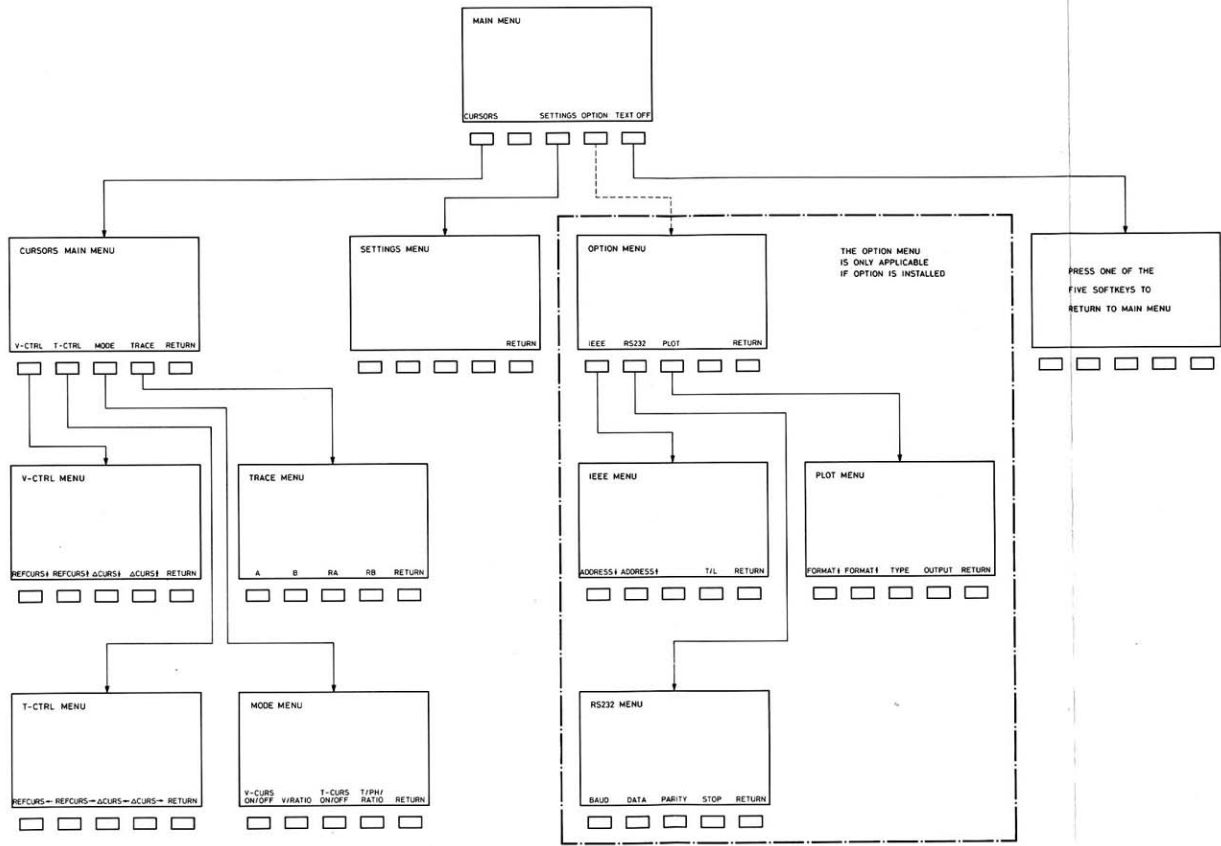

## 5.2.2 VIA THE RS-232C INTERFACE.

The interconnection between the 9-pole RS-232C connector at the rear panel of the oscilloscope and the RS-232C connector at the printer or plotter can be made via an interconnection cable of which the configuration depends on the plotter/printer type that is used. Three different cable configurations A, B or C are necessary to cover most plotter types and the printers. The required configuration is given on the CRT screen during the display of the set-up menu.

Cable configuration A for the XY plotters PM8153-1, PM8153-6, PM8155, HP7475A HP2225 and FX-80 compatible dot matrix printers.

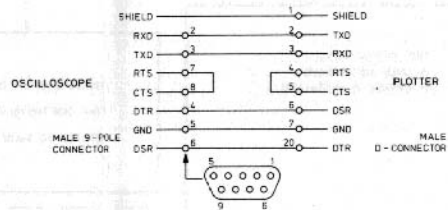

Cable configuration B for the XY plotter HP7550.

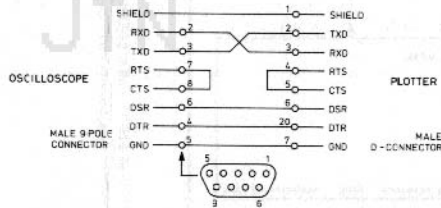

Cable configuration C for the XY plotter PM8154.

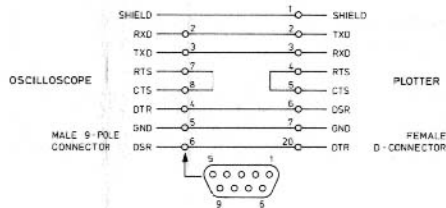

The set up is done as follows in the "memory on" mode (the steps marked with @ are plotter/printer dependent. Refer to the operator's manual of the plotter/printer for the exact data):

- Press softkey OPTION in the MAIN MENU.
- Press softkey RS232 in the OPTION MENU; this gives access to the RS232 MENU.
- Select the BAUDrate(@) with softkey BAUD, the number of data bits(@) with softkey DATA, the parity(@) with softkey PARITY and the the number of stop bits (@) with softkey STOP
- Press softkey RETURN to return to the OPTION MENU.
- Press softkey PLOT in the OPTION MENU; this gives access to PLOT MENU.
- Select RS232 via softkey OUTPUT: this has the result that the digital plot/print action occurs via the RS-232 C output socket.
- Select the plotter TYPE: selection of a number of plotter types is possible. Selecting FX80 gives the possibility to make a CRT screen copy on a dot matrix printer (Epson FX-80 or compatible). Selecting HP2225 gives the possibility to make a CRT screen copy on a HP2225 Thinkjet printer.
- Select the format (if applicable) of the hard copy; can be choosen between 0,5 and 2x the screen size via the softkeys FORMAT up and FORMAT down.
- Press softkey RETURN twice in order to return to normal oscilloscope use.

### 5.3 PLOTTING OR PRINTING RESULTS.

This section shows examples of the two possible results that can be obtained with this oscilloscope. The two possibilities to make a hard copy of the screen are:

- plot-out of a digital plotter.
- print-out of a printer.

plot-out of a digital plotter:

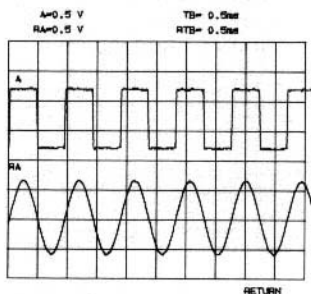

Plot-out of a printer:

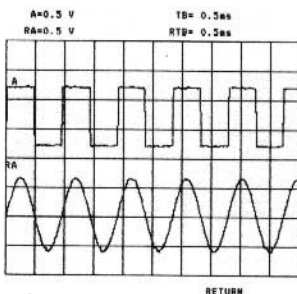

## 5.3 PLOTTING OR PRINTING RESULTS

This section shows examples of the two possible results that can be obtained with this procedure. The two possibilities to have a hard copy of the screen are:

Print-out of a digital plotter.

Print-out of a dither plotter.

This page intentionally left blank.

JTN

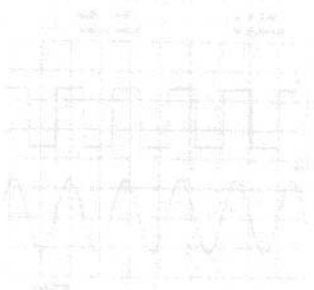

Print-out of a dither plotter.

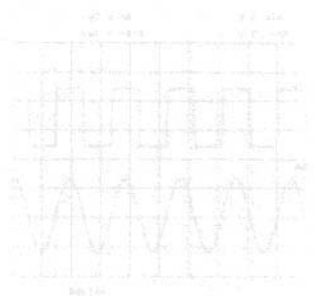

## 6 APPLICATION PRESELECT MENU

Within this menu a number of functions can be selected that normally do not need to be altered frequently. These functions have to do with single shot mode, TV triggering and channel identification. The menu is part of the service menu. Proceed as follows to enter the application preselect menu:

- Press front panel key RESET and keep it pressed.
- At the same time press front panel key AUTO SET; now the service menu has been entered which is indicated by the sign "\*" in the LCD.
- Press softkey APPL under the CRT to enter the APPLication preselect menu.

The selections are done with the softkeys under the CRT. The selected functions are displayed in the top text line of the CRT. The following selections are possible via the APPLications select menu:

- STANDARD SETTING: pressing this softkey forces the oscilloscope to a standard setting. After that the APPL and service menu are automatically left. The standard settings can be used as a starting point for performance checks and/or calibration steps; refer to the "service manual" for this. The standard settings are identical to those that appear if the scope is switched on with no memory back up batteries installed.
- FIRST/MULTI is of use for the analog single shot mode; it gives the possibility to select the vertical display sequence if the oscilloscope is in the multi channel alternate display mode. Selection FIRST gives that single shot is always done on channel A (provided it is active). Selection MULTI gives that the single shot is done alternately between the vertical channels A, B and ADD (provided that they are active).
- TVF/TVL is of use for the TV trigger mode after an AUTO SET command. Selection of TVF gives the result that the trigger coupling is forced to TVFrame mode after an AUTO SET. This in case that TVF or TVL was already active before the AUTO SET command. If there is no trigger found after AUTO SET in TVF mode, the oscilloscope jumps back to AUTO P-P. Selection of TVF/TVL gives the result that the trigger coupling returns to the TV trigger mode that was selected before the AUTO SET command. If there is no trigger found after AUTO SET, the oscilloscope jumps back to AUTO P-P.
- CHAN-ID ON/OFF is used to switch the channel identification on and off.

The APPL select and SERVICE menu can be left by pressing softkey RETURN and then front panel key AUTO SET.





# Index

## A

- A/B key, 4-2
- AC/DC key, 4-2
- ADD/INVERT key, 4-6
- ALT/CHOP key, 4-6
- AMPLITUDE MEASUREMENTS, 4-38
- ANALOG OSCILLOSCOPE, 4-1/...17
- APPLICATION PRESELECT MENU, 4-10, 6-1/...2
- APPLICATIONS, 4-1/...48
- AUTO SET key, 3-1, 4-1, 4-18

## C

- CAL, 1-vi
- CAL OUT, 3-11
- CAL OUTPUT, 3-1
- CATHODE RAY TUBE, 3-3
- CRT SCREEN, 3-3
- CURSOR CONTROL MENUS, 4-32
- CURSOR MEASUREMENTS, 4-30/...48

## D

- DIGITAL MEMORY key, 4-1, 4-18
- DIGITAL OSCILLOSCOPE, 4-18/...29
- DISPL PART UP-DOWN key, 4-22
- DISPLAY key, 4-20
- DISPLAY MEMORY, 4-20
- DISPLAY PART, 3-4

## E

- EARTHING, 2-1

## F

- FRONT PANEL, 1-vi
- FRONT-PANEL LAY OUT, 3-2/...12
- FUNCTION KEYS, 3-5
- FUSES, 2-1

## G

- GENERAL, 4-30
- GND key, 4-2

## H

- HANDLE ADJUSTMENT, 2-3
- HOLD-OFF, 4-16
- HORIZONTAL MODE, 4-8, 4-22

## I

- IEEE BUS OPTION, 1-vi
- IEEE-488 BUS, 3-12
- ILLUMINATION rotary knob, 3-2
- INPUTS AND OUTPUTS, 3-11
- INTENS rotary knob, 3-2

## L

- LCD, 3-3
- LEVEL VIEW key, 4-14
- LINE IN, 1-vi, 3-11
- LOAD key, 4-20

## M

- MAINS VOLTAGE CORD, 2-1
- MEMORY BACK-UP, 2-2
- MODE, 4-34
- MULTIPLE SHOT, 4-26

**P**

PHase, 4-37, 4-44  
 PLOTTING, 5-1/...8  
 PRINTING, 5-1/...8

**R**

RACKMOUNT, 2-4  
 RATIO, 4-37, 4-40  
 REAR PANEL, 1-vi  
 REFerence cursor, 4-30, 4-35, 4-42  
 REGISTER MEMORY, 4-20  
 RESET key, 4-24  
 ROTARY KNOBS, 3-8  
 RS-232C BUS, 3-12  
 RS232 BUS OPTION, 1-vi

**S**

SAFETY INSTRUCTIONS, 2-1  
 SAFETY PRECAUTIONS, 1-1  
 SCREEN CONTROLS, 3-2  
 SINGLE SHOT, 4-24  
 SLOPE key, 4-16  
 SOFTKEYS, 3-8  
 STATUS key, 4-20

**T**

T-CRTL, 4-34  
 TB MAGN key, 4-8, 4-22  
 TB s...us UP-DOWN key, 4-8, 4-22  
 TB TRIG MODE key, 4-10, 4-24, 4-26  
 TIME MEASUREMENTS, 4-42  
 TRACE, 4-34  
 TRACE ROTATION, 3-2  
 TRIG COUPL key, 4-14  
 TRIG DEL UP-DOWN key, 4-28

TRIG LEVEL, 4-14

TRIG OR X SOURCE key, 4-8, 4-12

TRIGGER DELAY, 3-4, 4-28

TRIGGER MODE, 4-1, 4-10, 4-24

TV TRIGGERING, 4-14

**U**

UP-DOWN KEYS, 3-4

**V**

V-CRTL, 4-34  
 V...mV UP-DOWN key, 4-4  
 VERTICAL MODE, 4-2, 4-18  
 VIEWING AREA, 3-3

**X**

X DEFL key, 4-8

**Z**

Z-MOD, 1-vi, 3-11