



ROHDE & SCHWARZ

Test and Measurement
Division

Operating Manual

Software Option: Bluetooth[®] for CMU

R&S[®] CMU-K53

1115.5000.02

Including the software extension:

Audio Profiles (R&S[®] CMU-K54)

1200.8900.02

Printed in Germany

Dear Customer,

throughout this manual, CMU-K53 is generally used as an abbreviation for software option R&S[®] CMU-K53.
The Universal Radio Communication Tester R&S[®] CMU 200 is abbreviated as CMU200.

R&S[®] is a registered trademark of Rohde & Schwarz GmbH & Co. KG.
Trade names are trademarks of the owners.

The *Bluetooth* word mark and logos are owned by Bluetooth SIG, Inc. and any use of such marks
by Rohde & Schwarz is under license.

Tabbed Divider Overview

List of Figures and Tables

Certificate of Quality
List of R&S Representatives

Contents of Manuals for Universal Radio Communication Tester CMU

Tabbed Divider

1	Chapter 1: Installation
2	Chapter 2: Getting Started
3	Chapter 3: Manual Operation
4	Chapter 4: Functions and their Application
5	Chapter 5: Remote Control – Basics
6	Chapter 6: Remote Control – Commands
6	Chapter 7: Remote Control – Program Examples
9	Chapter 9: Error Messages
10	Index

Contents of Manuals for Universal Radio Communication Tester R&S CMU 200/300

The user documentation for the R&S CMU 200/300 is divided in a Quick Start Guide, the operating manual for the basic instrument (including options R&S CMU-B41, R&S CMU-B17, R&S CMU-K14) and separate manuals for individual software and hardware options. The complete documentation is available on CD-ROM, stock no. 0758.1070.52.



For an overview and order information about printed manuals refer to the beginning of the Quick Start Guide. The latest revisions of all manuals are also posted on the R&S CMU Customer Web on GLORIS.

Operating Manual CMU-K53 (Software Option: Bluetooth for CMU)

The present operating manual describes the application of the CMU200 for Bluetooth device tests. It gives comprehensive information about the installation of the required software options and about manual and remote control of the instrument. For introduction, some typical measurement tasks are explained in detail using the functions of the graphical user interface.

The manual is organized as follows:

- | | |
|-------------------|--|
| Chapter 1 | Describes the steps necessary for installing the software and putting the instrument into operation. |
| Chapter 2 | Gives an introduction to the application of the CMU for Bluetooth device tests and presents some typical measurement examples. |
| Chapter 3 | Gives an overview of the user interface and describes the concepts of measurement control and instrument configuration. |
| Chapter 4 | Represents the reference chapter providing detailed information on all functions of the user interface and their application. |
| Chapter 5 | Describes the basics of remote control of the instrument for GSM base station tests. |
| Chapter 6 | Lists all remote control commands for Bluetooth device tests. At the end of the chapter the commands are grouped together according to their function (measurement groups or configurations) and sorted in alphabetical order. |
| Chapter 9 | Contains a list of error messages that may occur during operation. |
| Chapter 10 | Contains an index for the operating manual. |

What's new in this Revision?

This operating manual describes version V5.00 and higher of the CMU-K53 software option. The new features since firmware version V4.30 are listed below.

New Features	Description	Refer to...
Autoranging (FW V4.35)	In <i>Bluetooth Signalling</i> mode, the R&S CMU can automatically adjust its input path to the peak power of the received bursts (default setting since FW V4.50)	Chapter 4, → Bluetooth Signalling Mode → Connection Control → Analyzer Settings
Measurement Preconfiguration (FW V4.35)	The <i>Spectrum – ACP</i> and <i>Spectrum – Frequency Range</i> measurements suspend the the default hopping scheme. The measurements are performed on a single channel.	Chapter 4, → Bluetooth Signalling Mode → Connection Control → Slave Signal
Store Link Keys (FW V4.37)	The R&S CMU can store the link keys which a DUT sends to it during the authentication (pairing) process (default settings since FW V5.00).	Chapter 4, → Bluetooth Signalling Mode → Connection Control → Network
Power Control State (FW V4.37)	New command <code>PROCEDURE:PCONTROL:STATE?</code> queries the power control state of the connected DUT.	Chapter 6, → Bluetooth Signalling Mode → Connection Control
Reduced default TX levels (FW V4.35 / V4.37)	The default TX levels for the master signal and the BER test (test setup 1) have been reduced to –40 dBm.	Chapter 6, → Bluetooth Signalling Mode
Enable ACL data transfer (FW V5.00)	New command <code>SOURCE:ACLData:ENABLE</code> enables the transfer of SCL data via <code>SOURCE:ACLData</code> or <code>[SENSE:]ACLData</code> .	Chapter 6, → Bluetooth Signalling Mode → ACL Data

Frequently Used Abbreviations

ACL	<i>Asynchronous connection-less link</i>
AF	<i>Audio frequency</i>
Att.	<i>Attenuation</i>
BD_ADDR	<i>Bluetooth device address</i>
BER	<i>Bit error rate</i>
Chan.	<i>Channel</i>
CRC	<i>Cyclic redundancy check</i>
Dev	<i>Device</i>
DHn	<i>Data high rate (packets)</i>
Disp.	<i>Display Mode</i>
DUT	<i>Device under test</i>
EDR	<i>Enhanced Data Rate</i>
Ext.	<i>External</i>
Freq.	<i>Frequency</i>
HEC	<i>Header error check</i>
IF	<i>Intermediate frequency</i>
LAP	<i>Lower address part</i>
LMP	<i>Link manager protocol</i>
NAP	<i>Non-specific address part</i>
NS	<i>Non Signalling</i>
PER	<i>Packet error rate</i>
PRBS	<i>Pseudo random bit sequence</i>
Ref.	<i>Reference (marker)</i>
Rel.	<i>Relative</i>
RF	<i>Radio Frequency</i>
RX	<i>Receiver</i>
SCO	<i>Synchronous connection-oriented (link)</i>
Sig	<i>Signalling</i>
TX	<i>Transmitter</i>
UAP	<i>Upper address part</i>

Contents

- 1 Introduction 1.1**
- Installation Instructions 1.1**
- Software Installation or Update 1.1**
 - Creating a new Software Configuration 1.4
- Enabling Software Options 1.6**

1 Introduction

This chapter describes the installation and update of the *Bluetooth* software option R&S CMU-K53 for the Universal Radio Communication Tester CMU200.

Installation Instructions

Before proceeding to perform any of the steps described in this manual, please make sure that the instrument is properly connected and put into operation according to the instructions given in chapter 1 of the CMU200/CMU300 manual. The hardware and software options available are shown in the *Startup* menu. The status of the software option required for Bluetooth device tests is indicated in the line *Bluetooth*:

- If a version number is indicated, the CMU is ready to use the software option. In this case you may skip this chapter, except if you wish to update the current software version.
- If *disabled* is indicated, the software option must be enabled using a key code; see section [Enabling Software Options](#) on p. 1.6.
- If *not available* is indicated, the software must be installed via the PCMCIA interface or the floppy disk drive.

Software Installation or Update

The CMU is always delivered with the latest software version available. New CMU software versions are available for download on the R&S Lotus Notes Service board. To be loaded via the CMU's PCMCIA interface, the software must be copied to one or several flash disks/memory cards or PCMCIA hard disks as explained in the instructions supplied with the software download version. An appropriate memory card CMU-Z1, order no. 1100.7490.02, can be obtained from Rohde & Schwarz.

Note: *If your CMU is equipped with a floppy disk drive (option CMU-U61), a set of installation floppy disks must be generated instead of a flash disk. All other steps do not depend on the storage medium.*

To install the *Bluetooth* software option proceed as follows:

- Switch off the CMU.
- Insert the flash disk into one of the two slots of the PCMCIA interface.
- Switch on the CMU.

The installation is started automatically while the CMU performs its start-up procedure. To this end the *VersionManager* is called up (for a detailed description of the *VersionManager* refer to chapter 1 of the CMU operating manual or to the on-line help accessible via *Info*):

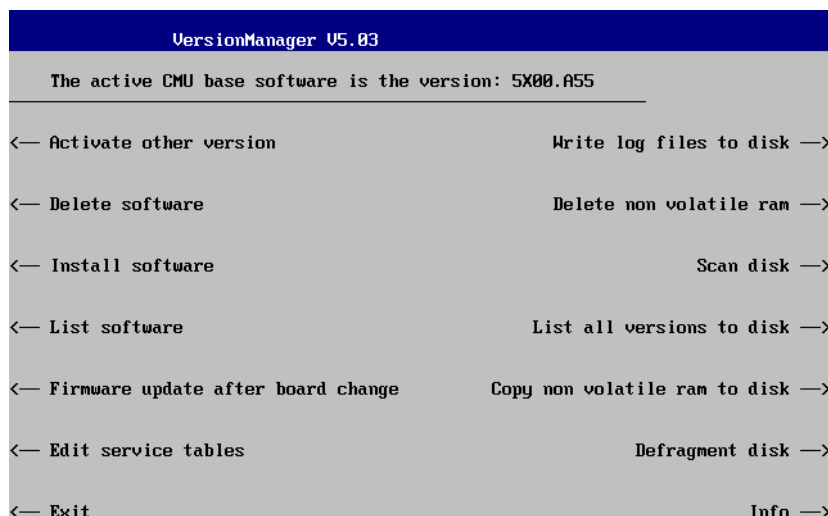

Softkey no. 5 on the left softkey bar, *Install software...*, is used to install new software from an external storage medium. The CMU automatically recognizes the storage medium and indicates the corresponding slot number: Slot 0 or 1 denotes the left or right slot of the PCMCIA interface. If a floppy disk is used the menu option reads *Install software version <version> from floppy*.

- Press left softkey no. 5 (*Install software...*) to start the installation.

If your storage medium contains several installation versions, the software version selection dialog is opened:

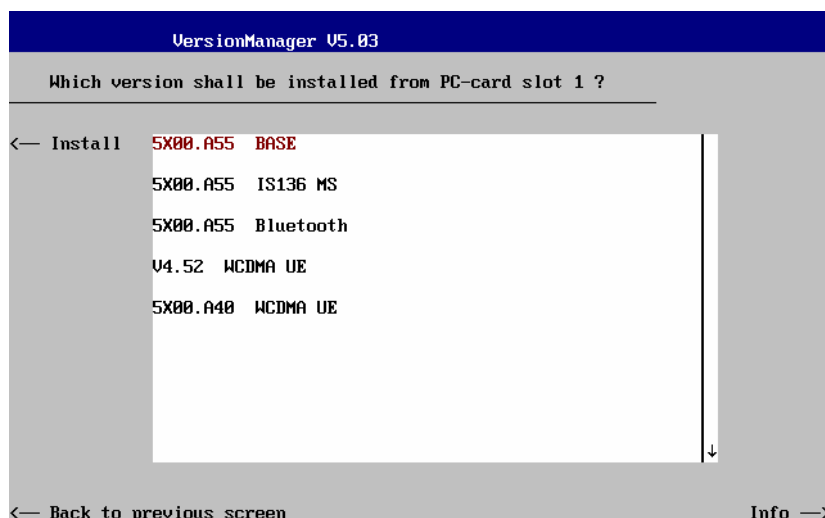

- Use the rotary knob or the cursor keys to scroll the list and select the *Bluetooth* software version you intend to install.
- Press *Install* to start the installation.

The installation is started. To be operable on your instrument, a network option must be combined with a compatible version of the CMU base software. Any base software version installed on the CMU hard disk can be combined with one or several network options to form an independent software configuration. If none of the configurations is compatible to the new *Bluetooth* option, the *VersionManager* displays an error message and takes you back to the software selection dialog; see section [Creating a new Software Configuration](#) on page 1.4. Otherwise, the following upgrade selection dialog is opened:

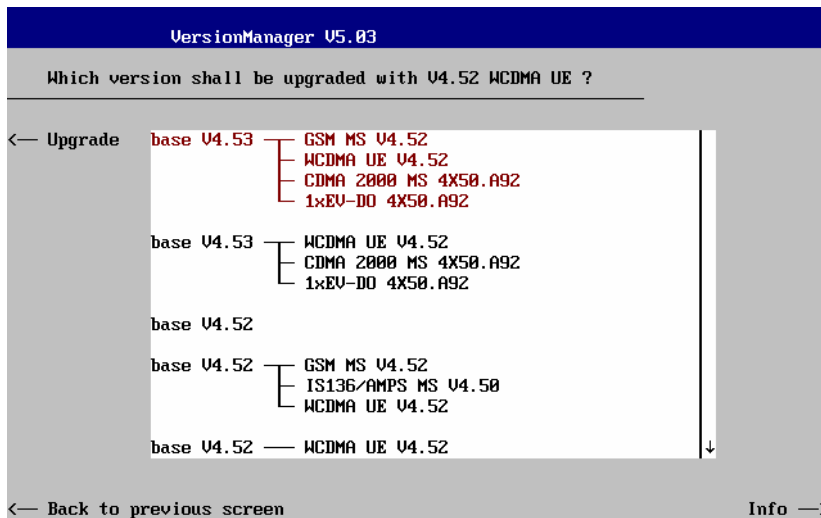

The upgrade selection dialog displays a list of base software versions that can be combined with the new *bluetooth* software.

- Select the appropriate base version and press *Upgrade*.

The new *Bluetooth* option is added to the configuration or updates the previous *Bluetooth* version of the configuration. To indicate that the storage medium must be changed the CMU issues the *Change volume* message:

```

= Change volume =
Process next volume
Exit
  
```

- Replace the current disk with the disk requested.
- Use the cursor up/down keys to select "Process next volume" (default setting).
- Press *ENTER* to confirm that the new disk has been inserted and to continue the installation.

After processing the last disk the CMU displays the following screen:

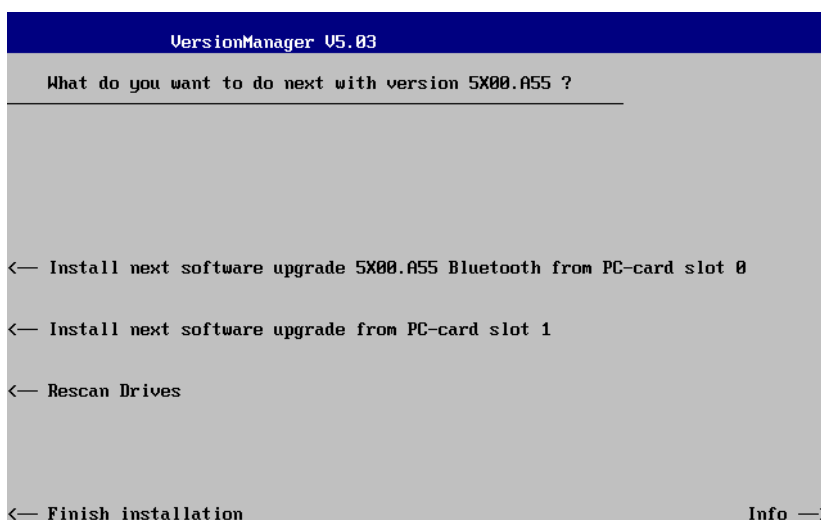

- If you wish to install or upgrade other software versions, press left softkey no 4 or 5 (*Install next software...*) or insert new storage medium into the PCMCIA slot or floppy disk drive and press *Change disks*.
- To finish the installation, remove all disks from the drive and press *Finish installation*.

The *VersionManager* is closed and the CMU is rebooted. The new firmware options are now operational and listed in the *Menu Select* menu together with their version number. Besides, the last software configuration installed is automatically taken as the active one in the next measurement session.

Creating a new Software Configuration

The CMU handles base software versions and network options on a separate basis. Different versions of the base software can be combined with different options to create new firmware configurations. For example, it is possible to update the base software without affecting the associated network options or vice versa. Moreover, the same base software version can be installed several times and combined with different network options (and vice versa), so it may enter into several firmware configurations.

If no compatible base software version can be found on the hard disk, then the CMU will refuse to install a new *Bluetooth* software option selected in the software selection dialog (see previous section). Instead, it displays the following error message:

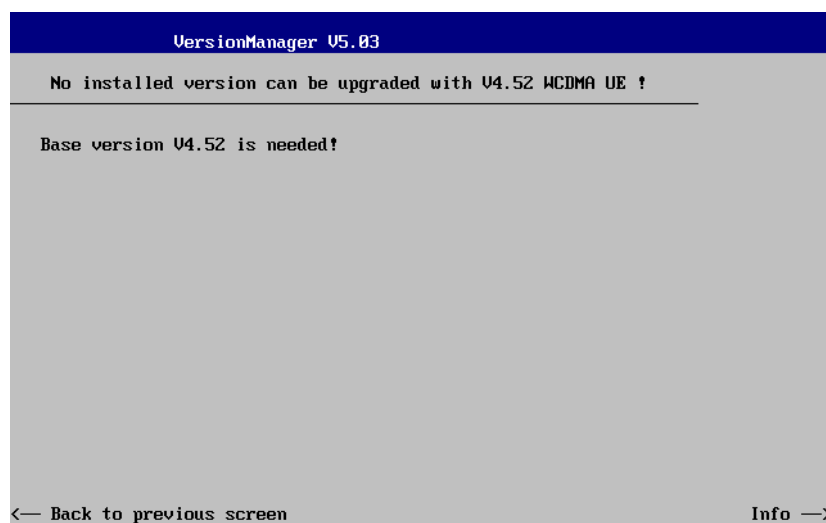

- Press *Back to installation* to return to the software version selection dialog.

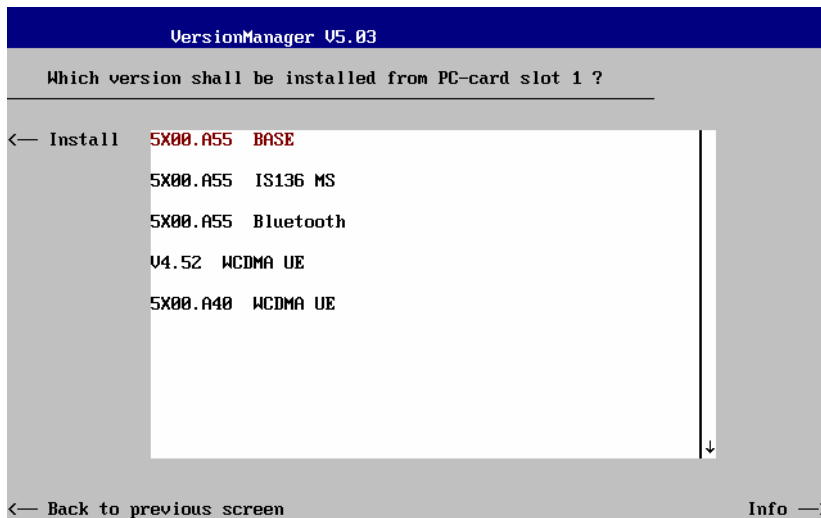

- Select a base software version that is compatible to your *Bluetooth* software option and press *Install*.

Note: As a rule, firmware versions for the base system and for network options are compatible if they differ only in the last digit. Bluetooth firmware versions 3.10 to 3.19 (if available) can be run together with base system version 3.10 to 3.19 (if available).

With a new base software version, it is possible to either update an existing configuration or create a new one. A dialog selecting between the two alternatives is opened:

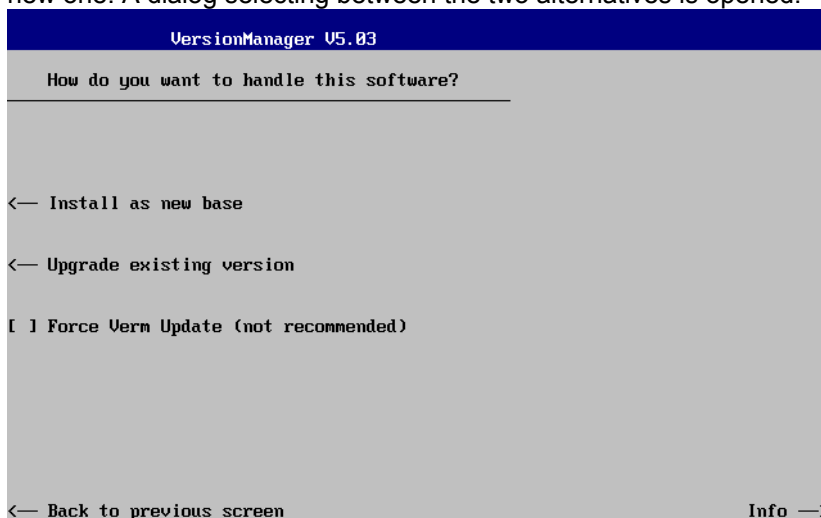

Note: This dialog is skipped if the new base software version is not compatible with any of the existing configurations. An incompatible new base software must be installed as a new base software.

- If you wish to add a new configuration to your hard disk, press *Install as new base*.
- To upgrade an existing configuration with the selected base software version in order to make it compatible to the new *Bluetooth* software option, press *Upgrade existing version*. The existing version to be upgraded must be selected in an additional dialog.

The installation is performed as described in section [Software Installation or Update](#) on p. 1.1. After adding the new base software as a new configuration or updating the existing configuration, the CMU displays the following screen:

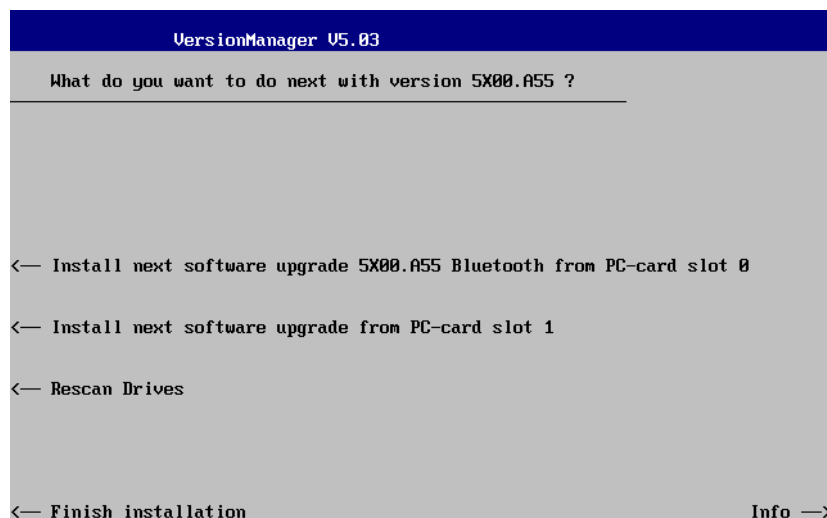

- Press left softkey no 4 or 5 (*Install next software...*) and proceed as described in section [Software Installation or Update](#) on p. 1.1. to install the new *Bluetooth* version and assign it to the new configuration.

Enabling Software Options

A new CMU software option purchased is ready to operate after it is enabled by means of a key code supplied with the option. This key code is to be entered into the *Option Enable* popup window which in turn can be opened via from the *Setup – Options* menu. For details refer to Chapter 4 of the CMU200/CMU300 operating manual.

Note: *The CMU software is delivered in complete versions containing all software options available. Software installation and enabling of software options are completely independent from each other.*

Contents

2 Getting Started	2.1
Preparing a Bluetooth Device Test.....	2.2
Non Signalling Mode.....	2.6
Signalling Mode.....	2.8
Call Setup and Signalling Parameters	2.8
Power Measurements	2.12
Modulation Measurements.....	2.16
Spectrum Measurements.....	2.18
Receiver Quality Measurements	2.20

2 Getting Started

The following chapter presents a sample Bluetooth device test with the universal radio communication tester R&S CMU. It is intended to provide a quick overview of the function groups *Bluetooth Non Signalling* and *Bluetooth Signalling* and to lead through the most common tests which are performed on Bluetooth devices.

Before starting any measurement with the R&S CMU, please note the instructions given in chapter 1 of the operating manual for the R&S CMU basic unit for putting the instrument into operation. In chapters 2 to 4 of that manual you will also find information on customizing the instrument and the display according to your personal preferences. For installation instructions for the *Bluetooth* software (R&S CMU-K53) refer to chapter 1 of the present manual.

The tests reported below include

- Connection of the phone and selection of the *Bluetooth* function group
- Basic settings in the *Non Signalling* mode
- Signalling parameters and call setup
- *Power, Modulation, Spectrum, and Receiver Quality* measurements in *Signalling* mode

The steps to perform are explained on the left side of each double-page together with the results obtained on the R&S CMU screen. On the right side, additional information is given. We also point out alternative settings and related measurements which could not be reported in detail.

The principles of manual operation are discussed in chapter 3. For a systematic explanation of all menus, functions and parameters including Bluetooth background information refer to the reference part in chapter 4.

Preparing a Bluetooth Device Test

This chapter describes how to use the R&S CMU for Bluetooth device tests. As a prerequisite for starting the session, the instrument must be correctly set up and connected to the AC power supply as described in chapter 1 of the R&S CMU operating manual. Furthermore, the Bluetooth software must be properly installed following the instructions given in chapter 1 of the present manual.

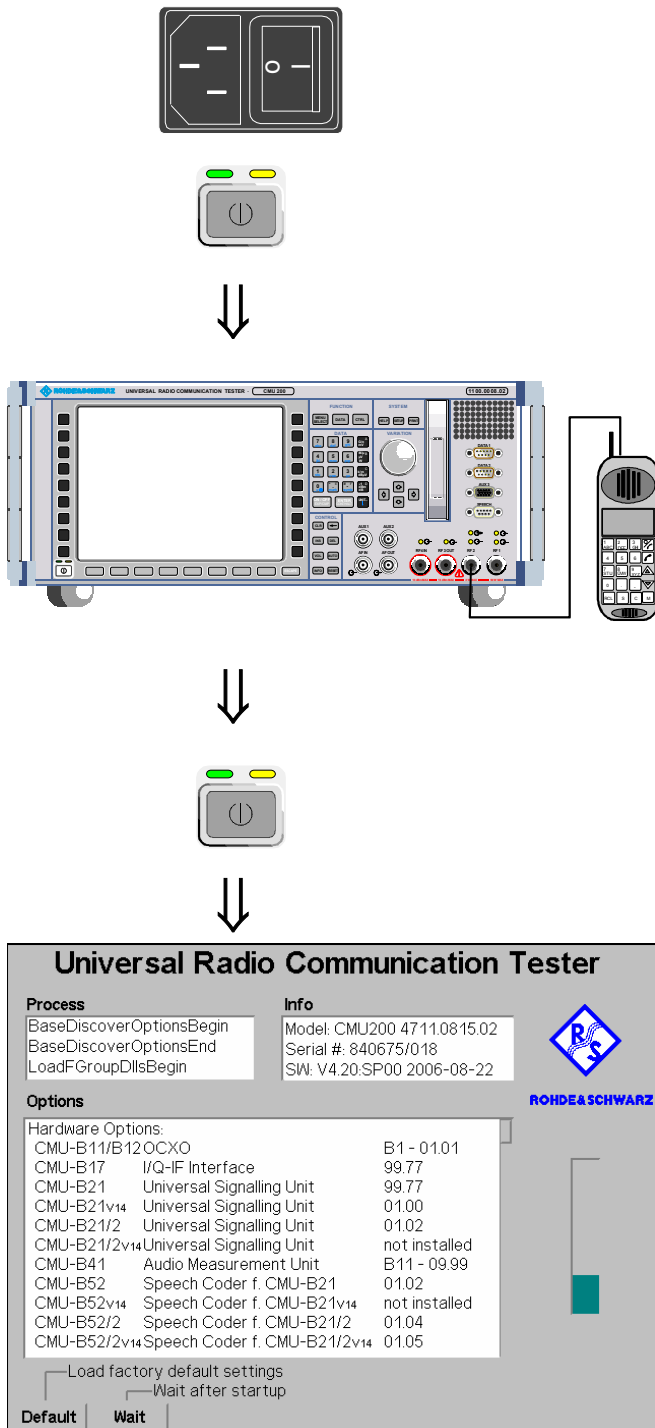

Step 1

- Switch on the R&S CMU using the mains switch at the rear. ①
- Check the operating mode of the instrument at the ON/STANDBY key on the front panel. ②

Step 2

- Connect the bi-directional RF connector RF 2 of the R&S CMU to the connector of your Bluetooth device. ③
- Make sure that the device is supplied with the correct operating voltage (battery or power supply) ④ and that the internal test mode is locally enabled. ⑤

Step 3

- Switch on the R&S CMU by pressing the ON/STANDBY key on the front panel.

The startup menu is displayed while the R&S CMU performs a power-up test. ⑥

After a few seconds the R&S CMU displays the last menu used in the previous session.

Additional Information...

... on Step 1

① Mains switch on the rear panel

When the mains switch at the rear is set to the *OFF* position, the complete instrument is disconnected from the power supply. When the mains switch is set to the *ON* position, the instrument is in standby mode or in operation, depending on the position of the power switch on the front panel.

② ON/STANDBY key on the front panel

The ON/STANDBY key at the front of the instrument determines whether the instrument is in standby mode or in operation.

Standby mode:

Only the reference frequency oscillator is supplied with operating voltage, and the yellow LED (STANDBY) is illuminated.

Operation:

The green LED (ON) is illuminated and all modules of the instrument are supplied with operating voltage.

... on Step 2

③ RF connection of the device

A high-quality cable should be used for this connection, ideally with an attenuation of less than 0.5 dB.

④ Power supply of the device

In case the device is operated from an external power supply, make sure that it is capable of supplying the maximum peak current required. As Bluetooth devices generate bursted RF signals with a pulse-shaped current consumption. Problems may arise if power supplies are used which cannot provide such currents with a constant voltage.

⑤ Test mode of a Bluetooth device

The internal test mode is a special state of the Bluetooth model designed for testing the Bluetooth transmitter and receiver. Before a connection between the tester and the Bluetooth device is attempted (see section *Call Setup and Signalling Parameters* on p. 2.8 ff), this mode must be locally enabled according to the prescription of the Bluetooth standard. Otherwise, the connection will fail, and the R&S CMU will display the message *Device is not enabled for test mode*.

Alternative Settings and Measurements

☞ Chapter 1 of R&S CMU manual

☞ Data sheet and chapter 4, section *RF Connectors*

The R&S CMU provides two bi-directional RF connectors RF1 and RF2 differing by their input and output level ranges. RF2 is the recommended standard connector for Bluetooth devices.

The unidirectional connectors RF4 IN and RF3 OUT are intended for connection of modules requiring high input levels or modules with low RF output levels. RF4 IN and RF3 OUT can also be used to connect Bluetooth devices off the air via antennas.

Input and output connectors can be selected in the RF  tab of the *Connect. Control* menu.

☞ Chapter 4, section *Signalling Control in Test Mode (Connected)*

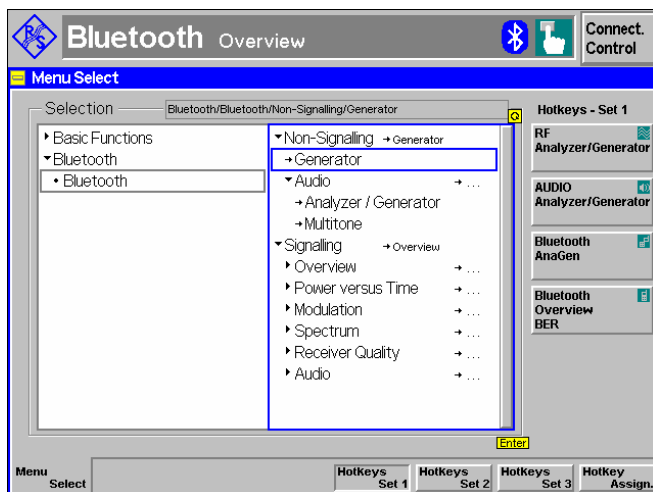
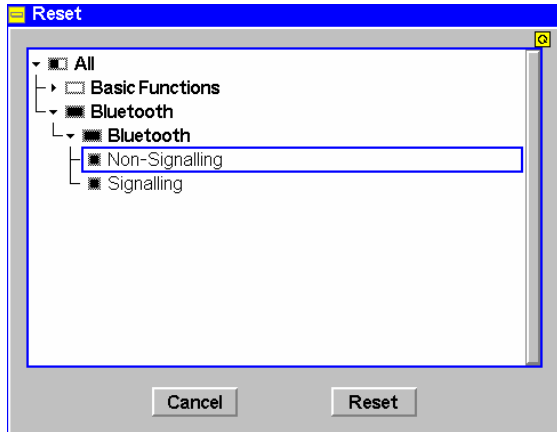
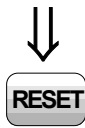

Step 4

- Press the *RESET* key.

The *Reset* popup menu is opened.

- Proceed as described in Chapter 4 of the R&S CMU200/300 operating manual, section *Reset of Instrument Settings*, to expand the tree of function groups.
- Select all Bluetooth function groups to be reset (all nodes must be black).
- Use the cursor keys to activate the *Reset* button and press *ENTER*.
- In the popup window opened (*Are you sure?*), select *Yes* to confirm the instrument reset.

The R&S CMU indicates that it performs a general reset of all device settings and is then ready to carry out the following steps. The *Reset* popup menu is closed automatically.

Step 5

- Press the *Menu Select* key to open the *Menu Select* menu. ⑦

The *Menu Select* menu indicates the function groups available. If a function group is selected the corresponding modes and measurement menus are indicated.

- Select the *Bluetooth* function group.
- Select the *Non Signalling* test mode.
- Select the *Generator* menu.
- Press the *Enter* key to activate the measurement selected and open the *Generator* menu.

Additional Information...

... on Step 3

⑥ Startup menu (see p. 2.2)

The startup menu displays the following information:

- The status of the startup test (*Process*)
- The device name, serial number and software version (*Info*)
- The options and equipment installed (*Options*)
- The progress of the startup test (*Startup* bar graph)

Before starting a measurement, a reset is recommended to set the instrument with all its functions into a definite state.

... on Step 5

⑦ Menu Select menu

The *Menu Select* menu shows all function groups installed on your R&S CMU. Function Group *Bluetooth* is subdivided in the two measurement modes *Non Signalling* and *Signalling*.

Alternative Settings and Measurements

☞ Chapter 4 of R&S CMU manual

That chapter also contains information on customizing the R&S CMU.

☞ Chapter 3

This chapter gives an overview of the graphical user interface with all configurations and measurement groups and defines the basic notions encountered during operation. It also describes the general measurement settings and the principles of data processing.

Non Signalling Mode

In the Bluetooth *Non Signalling* mode, the R&S CMU generates an RF test signal with Bluetooth specifications, i.e. a Bluetooth packet with variable level, frequency and payload. It is possible to configure the RF inputs and outputs of the R&S CMU but no measurements can be performed.

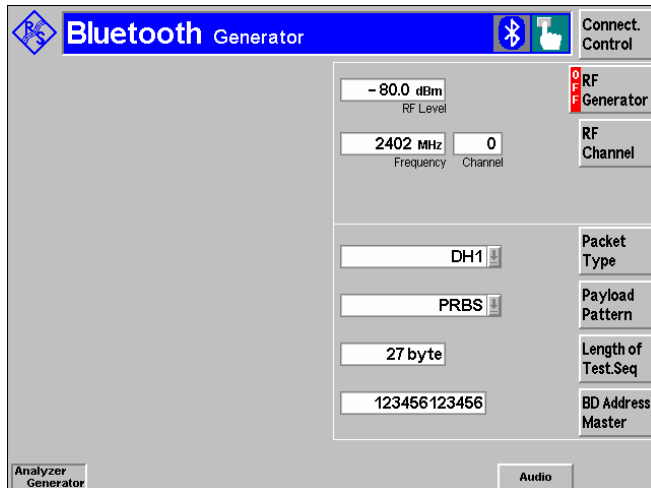

**MENU
SELECT**

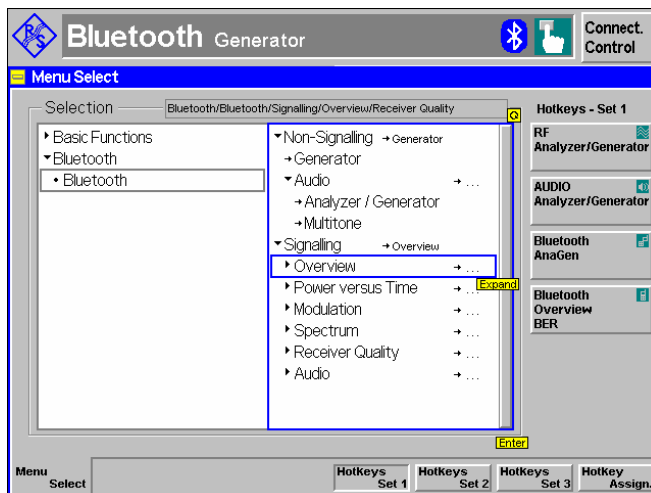

Step 1

The *Generator* menu configures the RF output signal of the R&S CMU. ①

At present, all parameters are set to default values. They can be changed directly in the menu. User-defined settings will be saved for later sessions when the R&S CMU is switched off.

The *RF Generator* softkey, which is the control softkey of the *Generator* menu, indicates that the generator is switched *OFF*. ②

- Select (press) the *RF Generator* softkey and press the *ON/OFF* toggle key to switch the generator on.
- Select the *RF Channel* softkey to activate the *Frequency* input field. Enter an RF frequency or use the right cursor key to activate the *Channel* input field and enter a Bluetooth channel number. ③

Step 2

- Press the *Menu Select* key to open the *Menu Select* menu again.
- Select the *Signalling* test mode.
- Select the *Overview* menu.
- Press the *Enter* key to activate the measurement selected.

Additional Information...

... on Step 1

① Generator menu

The *Generator* menu contains two configuration panels to configure the RF generator and to select a bit modulation sequence for the generated Bluetooth signal (*Payload*).

② Generator and measurement state

The state indication of the different generators and measurements is included in the control softkeys. For ongoing measurements, the results in the output fields are constantly updated.

For various reasons, an output field may fail to show a valid measurement result (indication "---"):

- The analyzer settings and the properties of the input signal do not match.
- The input signal is missing.
- The measurement is switched off (*OFF* is indicated in the softkey controlling the measurement).

③ Bluetooth channels and frequencies

The assignment between carrier frequency and channel number is according to Bluetooth specifications. In *Non Signalling* mode, it is possible to select channels independent from the geographical hopping schemes: The channel structure is as follows:

$$f_k = 2402.0 \text{ MHz} + k \cdot 1 \text{ MHz}, \quad k = 0, \dots, 93$$

The RF frequency can be set in multiples of 1 MHz. With an additional *Frequency Offset*, an RF signal with an arbitrary frequency that is in the range between 2402 MHz and 2495 MHz can be generated.

Alternative Settings and Measurements

☞ Chapter 4

To facilitate and speed up the operation, many R&S CMU settings are accessible from different menus. The RF generator settings are also part of the *Connect. Control* menu (*Generator tab*).

☞ Chapters 3 and 5 of R&S CMU operating manual

The signal generators of the are either in the *RUN* or in the *OFF* state. For measurements, a third state, *HLT*, occurs after a single-shot measurement is terminated (see p. 2.13).

Once selected, a measurement or a generator can be switched off and on by means of the toggle key *ON/OFF*.

☞ Chapter 4

In *Signalling* mode, the geographical hopping scheme of the *Bluetooth DUT* must be reported to the tester. The measurement is then restricted to a subrange of the entire Bluetooth channel range available in *Non Signalling* mode.

☞ Chapter 4

In *Non Signalling* mode, the R&S CBT does not provide any measurement menus. However, with a suitably configured *Bluetooth DUT*, it is possible to perform non signalling *Power* and *Modulation* measurements using the *Signalling* measurement menus.

Signalling Mode

In the *Signalling* mode the R&S CMU first transmits an inquiry signal to detect connectable Bluetooth devices within its domain. From the list of devices compiled during this stage, one target device can be selected. The R&S CMU transmits a signal to synchronize to the target device and attempt a connection. After the connection is established, the DUT is put into its internal test mode where transmitter and receiver tests can be performed.

Call Setup and Signalling Parameters

The signalling process is controlled via the *Connection Control* popup menu. The first of four *Connection* tabs contained in the *Connection Control* popup menu is automatically displayed when the *Signalling* mode is selected (see *Menu Select* menu on page 2.4; for the following examples, *Bluetooth Signalling* with the *Overview* menu was selected).

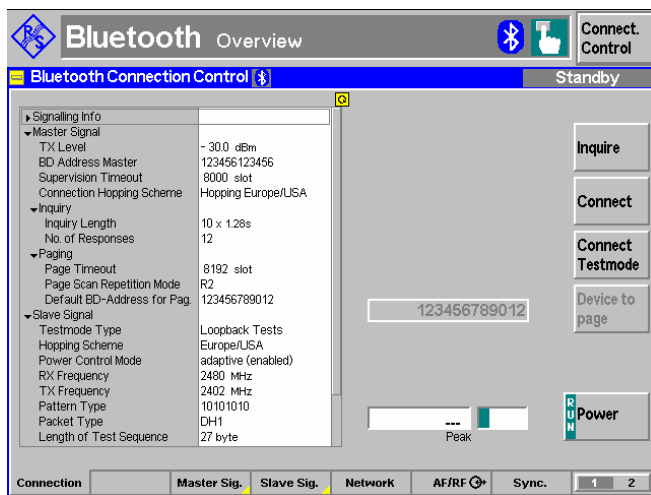

Step 1

The *Connection (Standby)* tab indicates how the R&S CMU will inquire for Bluetooth devices in its range (*Master Signal*).^① In addition the paging mode (*Paging*) and the characteristics of the DUT in its test mode (*Slave Sig.*) are shown.

In the softkey bar on the right side, the *Device to page* softkey allows you to select a device that is to be connected to.^②

Below, the *Power* softkey shows the current status and the result of the wide-band power measurement for RF input signals.^③



Step 2

➤ Press the *Master Sig.* hotkey.

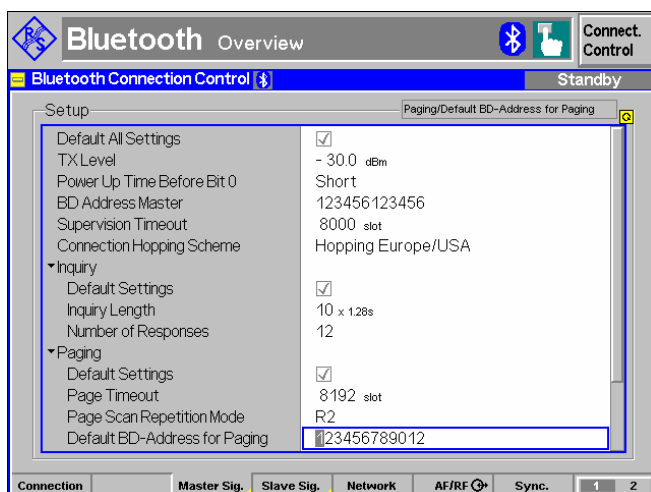

The *Master Sig.* tab is displayed. The R&S CMU provides two versions of this tab that can be toggled by pressing *Master Sig.* repeatedly.^④

➤ Press the *ON/OFF* key to expand the menu tables.

➤ Select the *Default BD-Address for Paging* field and enter the Bluetooth device address of your device.^②

➤ Select the *Connection Hopping Scheme* field and enter the geographical hopping scheme of your device.

➤ Press the *Connection* hotkey to switch back to the *Connection* tab.

Additional Information...

... on Step 1

① Master signal

Once a connection has been set up (see below), the R&S CMU and the DUT represent a Bluetooth piconet where the R&S CMU acts as a Bluetooth master, the DUT as a slave. The *Master Signal* section in the *Connection (Standby)* tab contains the parameters that the R&S CMU uses to inquire for Bluetooth devices in its range and set up a connection.

② Bluetooth device address and inquiry

Any Bluetooth device is identified by its Bluetooth device address (BD_address), a unique hex value consisting of the 6 digit lower address part (LAP), the 2 digit upper address part (UAP), and the 4 digit non-specific address part (NAP). The R&S CMU is able to transmit inquiry packets and compile a list of all Bluetooth devices within its range that responded. As an alternative, a known BD_address can be entered in the *Master Sig.* tab (see below) and used as a default address for attempting a connection. In this way it is possible to skip the *Inquiry* state and accelerate the measurement.

To better simulate what happens in a real Bluetooth network, the R&S CMU is also assigned BD_address.

③ Input power

The softkey *Power* has no configuration menu assigned but can be used like any other softkey controlling a measurement. In particular, it is used to switch over between the measurement states *RUN* and *OFF* (softkey selection plus *ON/OFF* key) and *RUN/HLT* (softkey selection plus *CONT/HALT* key).

The *Peak* power output field shows the power of the RF input signal, measured with a wideband filter. Its purpose is to check whether an input signal is available and whether a change of the input path configuration is necessary. At present, no RF connection is established so the output field shows an invalid result ("---").

... on Step 2

④ Master Sig. parameters

The *Master Sig.* tab defines a variety of parameters to configure how the connection is set up. In particular, the *Paging* parameters are used to configure how the R&S CMU will attempt to page to a device under test. i.e. time-outs used, paging modes and a default BD_address of the DUT.

Alternative Settings and Measurements

☞ Chapter 4

The master signalling parameters are configured in the *Master Sig.* tab of the *Connection Control* menu; see below on this page.

☞ Chapter 4

See section *Signalling Control: Inquiry State*

Tip: Quick Connection

After an inquiry, the R&S CMU remembers the information on the DUT to reuse it for all later connection attempts. To further speed up the connection, the *Read Signalling Info* parameter is provided in the *Master Sig.* tab; see Chapter 4.

☞ R&S CMU manual, chapter 3

See also the diagrams on measurement control in chapter 5 of the R&S CMU manual.

☞ Chapter 4

See section *Master Sig. Parameters (Connection Control – Master Sig.)*

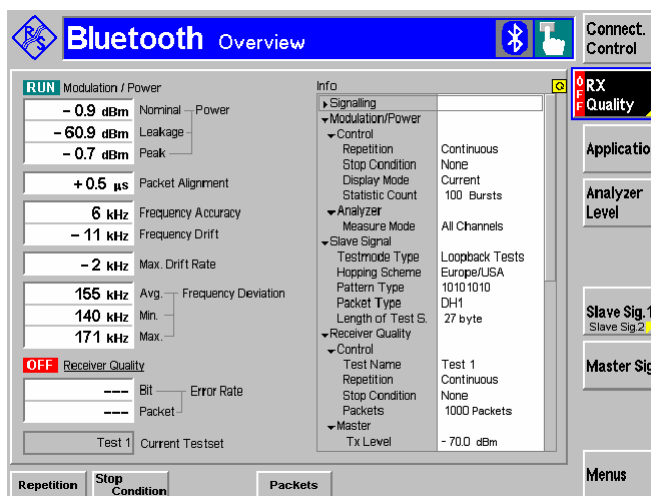
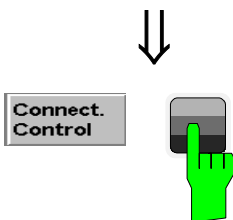
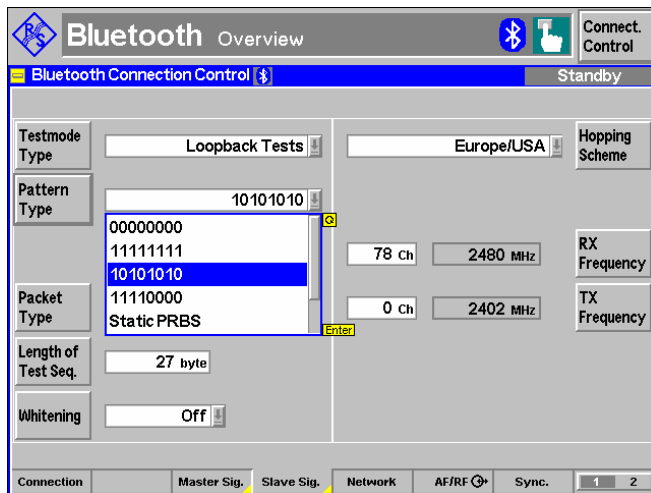
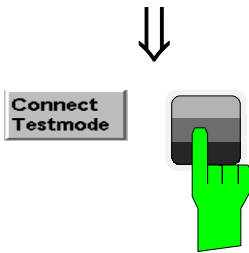

Step 3

- Press the *Connect Testmode* softkey.

The *Connected (Paging)* tab is displayed. ⑤ As soon as the connection is OK, the *Connection (Connected)* tab is displayed (by default, this tab is closed automatically after a short while but can be reopened by pressing the *Connect. Control* softkey).

- Press *Slave Sig.* to open the *Slave Sig.* tab and check the test mode settings of the DUT.

The *Slave Sig.* tab controls the behavior of the DUT in its test mode. In particular, it selects the *Testmode Type*, the *Pattern Type* and the *Hopping Scheme* ⑥.

- To continue, make sure that the DUT transmits an alternating 1010101010 pattern. ⑦

Step 4

- Press the *Connect. Control* softkey or the *ESCAPE* key.
- The *Connect. Control* menu is closed; the R&S CMU displays the *Overview* menu.

The *Overview* menu indicates the signalling information retrieved from the device (*Info* table) ⑧ and the main settings and results of the *Power*, *Modulation* and *Receiver Quality* measurements.

While the *Receiver Quality* measurement is running, the R&S CMU uses a PRBS *Pattern Type* by default so that some *Modulation* parameters can not be measured.

- Press *Application*, select the *Receiver Quality* hotkey, select the *RX Quality* and the ON/OFF key to switch off the *Receiver Quality* measurement.

The R&S CMU now uses the 1010101010 *Pattern Type* selected above and displays all *Modulation* results.

Additional Information...

... on Step 3

⑤ Paging state

In the *Paging* state, the R&S CMU attempts to connect to a selected device. The header message *Connecting to Device* is displayed in the *Connection Control* menu. Once connected to the device the R&S CMU will then provide the necessary signalling to place the DUT into its internal test mode. Connection to test mode will be made using the parameters specified in the *Slave Sig.* tab.

Unless the internal test mode of the device to page is locally enabled (see p. 2.3) the connection will fail, and the R&S CMU will display the message *Device is not enabled for test mode – Cancel/Retry*. The connection process can be continued after enabling the device and pressing *Retry*.

⑥ Test mode and hopping scheme

The test mode is a special state of the Bluetooth model designed for testing the Bluetooth transmitter and receiver. In this mode, the R&S CMU and the DUT form a piconet where the R&S CMU acts as a master and has full control over the test procedure. The DUT acts as a slave. While in test mode, the DUT must not support normal operation.

Bluetooth channels are defined in the frequency range between 2402 MHz and 2495 MHz. Different subranges of this frequency band are used in different countries. In a Bluetooth piconet, the hopping sequence defining the RF channels to be used and their order is determined by the BD_address of the master. Analogously, a *Hopping Scheme* supported by the DUT must be used by the R&S CMU.

⑦ Testmode Types and Pattern Types

The testmode type defines the timing of the slave signal relative to the master signal and the data sequence that the slave will transmit. The Bluetooth standard defines transmitter tests and loopback tests. *Power* and *Modulation* measurements can be performed in both testmode types; *Receiver Quality* measurements require a loopback testmode type.

The R&S CMU instructs the DUT to transmit a definite bit pattern. According to the standard, the measurement of many modulation parameters requires a periodic 10101010 bit pattern. For other bit patterns, the output fields in the *Overview* menu show invalid results "-".

... on Step 4

⑧ Signalling Info

The *Signalling Info* table shows the basic properties of the connected device. Note that the values shown are no settings (like the *Paging* and *Master Signalling* parameters set in the *Master Sig.* tab) but represent the information provided by the device and transferred to the R&S CMU. The parameters are therefore available in the *Connected* signalling state only.

Alternative Settings and Measurements

☞ Chapter 4.

See section *Signalling Control: Paging State*

☞ Chapter 4.

See section *Behavior of the DUT (Connection Control – Slave Sig.)*

Besides the four geographical hopping schemes (Europe/USA, Japan, France, Spain), the *reduced hopping sequence* was defined to support quick testing over the whole frequency range, including the channels of the Europe/USA scheme and the schemes of the other countries.

☞ Chapter 4.

See sections *Behavior of the DUT (Connection Control – Slave Sig.)* and *Modulation Measurements*.

The testmode and pattern type can be changed directly from the measurement menus (without opening the *Connection Control* menu) by pressing *Slave Sig. 1 – Slave Sig. 2 – Testmode Type/Pattern Type*.

☞ Chapter 4.

For a comprehensive overview of signalling states and possible transitions refer to the diagram at the beginning of section *Bluetooth Signalling Mode*.

Power Measurements

As described above, all measurement menus in *Bluetooth Signalling* mode can be called up from the *Menu Select* menu. Once a measurement menu is opened, hotkeys can be used to switch over to any of the other measurements.



Step 1

- Press the *Power* hotkey to switch over to the graphical measurement menu *Power*.

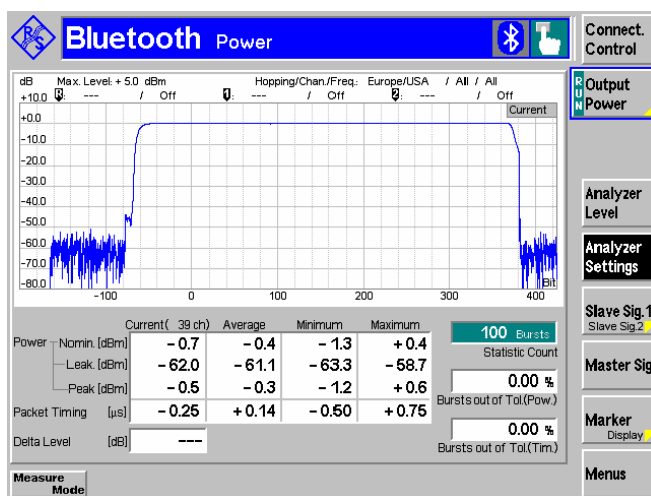

The *Power* menu shows the power of the current burst as a function of time. ①

The burst power is displayed in a graphical test diagram. Test settings (at present, the default settings) and values at particular points are displayed in two parameter lines above the diagram. Below the diagram, an output table plus three output fields provide a statistical evaluation of the measurement curve.

Various tools allowing to take a closer look at the measurement results are provided in the graphical measurement menu.

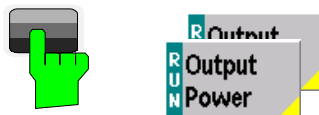

Step 2

- Select (press) the *Output Power* softkey.
- Press the selected *Output Power* softkey again to call up the *Power Configuration* menu.

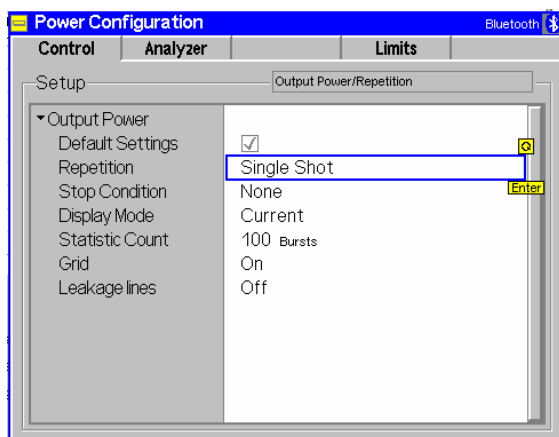

The *Power Configuration* menu defines the scope of the *Power* measurement. To pick just one example of the settings, we limit the number of bursts measured. ②

- Press the *ON/OFF* key to expand the menu table.
- Select *Single Shot* in the *Repetition* field. ③
- Press the *ESCAPE* key to close the *Power Configuration* menu and return to the main menu.

The *Power* measurement is stopped after one statistics cycle. The status indication next to the *Power* softkey is set to *HLT*. ④

Additional Information...

... on Step 1

① Power menu

By default the diagram in the *Power* menu shows the burst power within one timeslot with a length of 625 bits. The time scale can be adjusted, e.g. to measure the rising edge of the burst and to account for bursts of different length (see below).

... on Step 2

② Power Configuration menu

The *Power Configuration* menu contains three tabs defining

- The parameters controlling the measurement statistics (*Control*)
- The analyzer settings for *Power* measurements (*Analyzer*)
- The limit lines (*Limit Lines*)

Many of the settings of the *Power Configuration* menu are directly accessible from the measurement menus (without opening the *Power Configuration* menu). E.g. most *Control* parameters can be accessed via hotkeys after pressing the *Output Power* measurement control softkey. See also [Softkeys and Hotkeys](#) on p. 2.15.

③ Repetition mode and Stop Condition

If no stop condition is imposed (*Stop Condition = None*), the *Repetition* mode determines whether the measurement is

- Continued until explicitly stopped by the operator (*Continuous*)
- Stopped after one statistics cycle (*Single Shot*)

By default, a statistics cycle (*Statistic Count*) comprises 100 bursts. With *Stop Condition = On Limit Failure*, the measurement is stopped after the first burst which is out of tolerance.

④ Measurement in the HLT state

While the *Power* measurement is in the *HLT* state, the diagram and the output table show the measurement results of the last burst measured.

Alternative Settings and Measurements

☞ chapter 4.

See section *Power Measurements*.

☞ chapter 3.

Settings made in the *Power Configuration* menu apply to power measurements only.

Settings made in the *Connect. Control* menus apply to the entire function group *Bluetooth Signalling*.

☞ chapter 3.

The stop condition *On Limit Failure* should be selected if the limit check represents the main purpose of the measurement.

The limits can be modified in the *Limits* tab of the *Power Configuration* menu.

☞ R&S CMU manual

See the sections on measurement control in chapter 3 and 5.

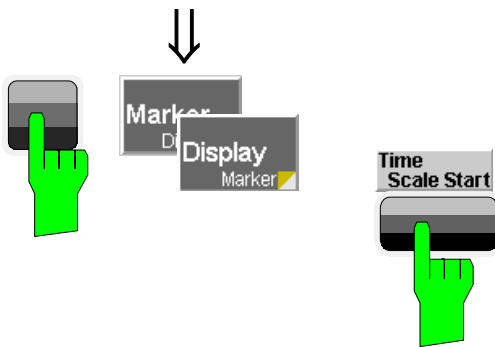

Step 3

- Press the *Marker/Display* softkey twice to toggle to the *Display/Marker* hotkey bar. ⑤
- Press the *Time Scale Start* hotkey to modify the x-axis and view the rising edge of the burst.

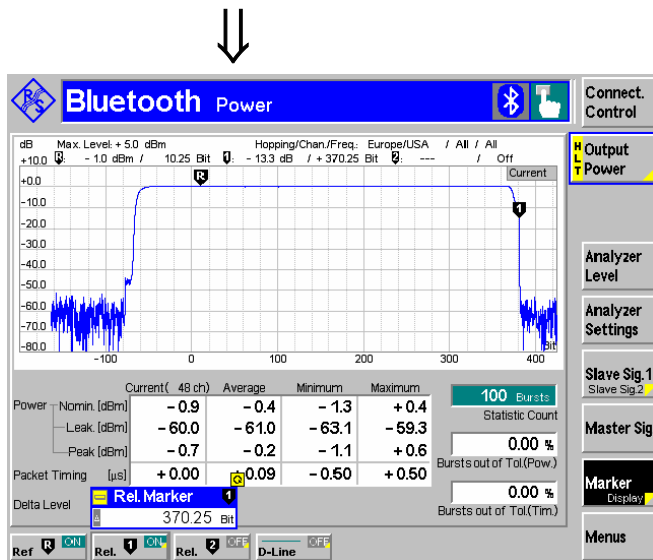

The whole display range is shifted, however, the total span remains unchanged.

- Press the *Display/Marker* softkey again to toggle back to the *Marker/Display* hotkey bar.
- Press the *Ref R* hotkey. Enter an abscissa value (in bits) to position a reference marker onto the trace. In the same way, place a *Rel. Marker* to a different position. ⑥

The coordinates (time and burst power) of the reference marker are displayed in the second parameter line.

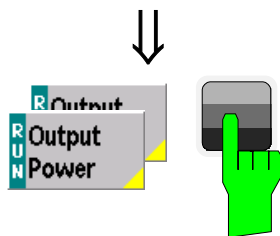

Step 4

- Press the *Output Power* softkey twice to reopen the *Power Configuration* menu.

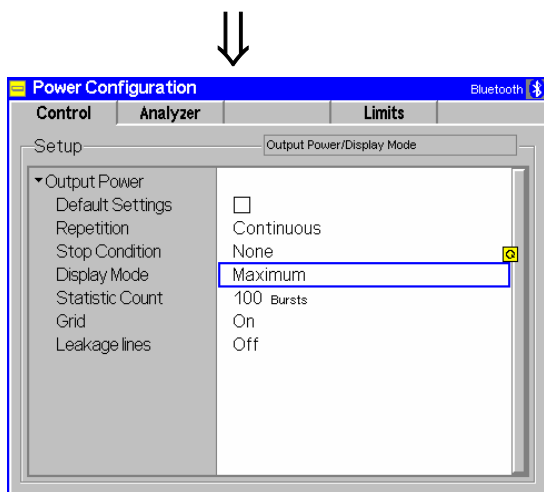

- Select the *Control* tab.
- Select *Continuous* from the *Repetition* group of toggle switches to restart the measurement.
- From the *Display Mode* field, select *Maximum*. ⑦

Instead of the current burst power, the diagram now shows the maximum burst power ever measured at each point in time. As no stop condition is set, the measurement will be running until explicitly terminated.

Additional Information...

... on Step 3



⑤ Softkeys and Hotkeys

The functionality of each softkey on the right side is extended by hotkeys assigned to the softkeys. These hotkeys are displayed across the hotkey bar below the diagram when the softkey is selected.

Most of the softkey/hotkey combinations provide settings that can also be accessed via configuration menus. For example, the settings offered by the *Analyzer Level* softkey are equivalent to the *Analyzer* and *Trigger* tabs in the *Connection Control* menu. Identical settings overwrite each other; the last value entered is valid for the whole function group.

⑥ Markers

Markers are a graphical tool used to locate points on a trace and read out their coordinates. A reference marker and two delta markers may be defined in the *Power* menu.

The reference marker  measures the absolute level of the trace, the delta markers  and  measure the distance between their position and the reference marker.

... on Step 4

⑦ Display mode

If the measurement extends over several bursts the R&S CMU calculates four different traces one of which can be selected in the *Display Mode* panel. The purpose of the four traces is to give an overview of the range and arithmetic mean value of the levels detected at any point on the time axis. The following traces can be displayed:

<i>Current</i>	Current burst level
<i>Maximum</i>	Maximum of all burst levels measured
<i>Minimum</i>	Minimum of all burst levels measured
<i>Average</i>	Burst levels averaged according to the prescription in chapter 3

The *Statistic Count* parameter defines how many evaluation periods form a statistics cycle. In our example the statistics cycle comprises 100 bursts (default value).

Alternative Settings and Measurements

 chapter 4.

The *Power Control* softkey sends power control commands to the DUT.

Analyzer Level controls the level in the RF input signal path and the trigger.

Analyzer Settings determines which RF channels are monitored during the measurement.

Slave Sig. controls the behavior of the DUT in its test mode.

Master Sig. defines how the R&S CMU sets up a connection to the DUT.

Marker/Display sets markers and D-lines.

Display/Marker defines the start of the time axis and the display area.

 chapter 4.

In addition to markers, a D-line can be used to measure a particular level in the diagram.

 chapter 3.

To refine the statistical evaluation, a suitable combination of the statistic count, repetition mode, stop condition and display mode should be selected.

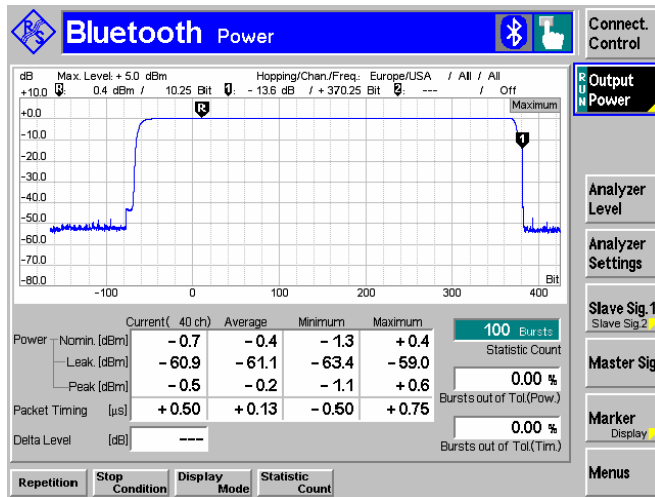

Step 6

Press the *ESCAPE* key to close the *Power Configuration* menu and return to the main menu.

The trace is now continuously measured and updated in the display. With the display mode *Maximum*, trace values will be replaced only if a current measured value at a particular test point exceeds all values measured previously.

Modulation Measurements

To switch over to the *Modulation* measurement, we use again the hotkey bar.

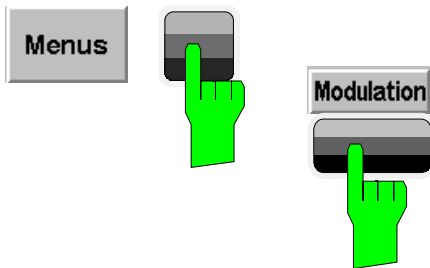

Step 1

- Press the *Menus* softkey to display the measurement groups available in the hotkey bar.
- Press the *Modulation* hotkey to open the *Modulation* menu.
- Press the *Connect. Control* softkey and make sure that a transmitter or loop-back test with a 01010101 pattern is active. ①

The *Modulation* menu shows the frequency deviation in the current burst as a function of time.

The frequency deviation is displayed in a graphical test diagram. Below the diagram, an output table plus three output fields display additional modulation parameters.

If a result in the table exceeds the tolerances, the corresponding output field is red, and an arrow pointing upwards/downwards indicates that the result is above/below the limit. ②

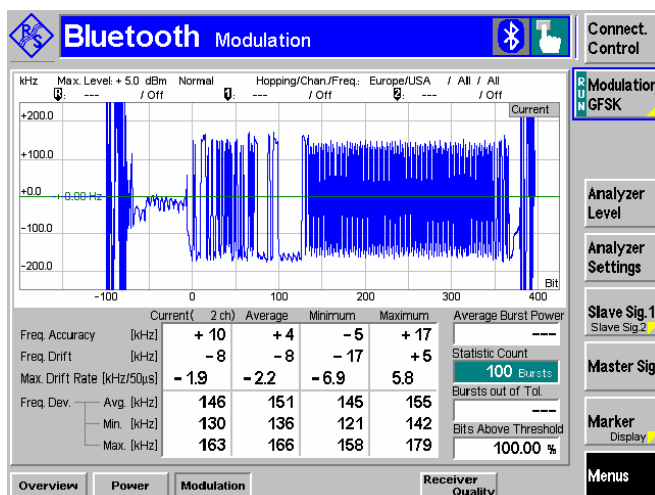

Out-of-tolerance power measurements

If a power measurement is out of tolerance, please ensure that the attenuation of any cables and/or antenna couplers used is being taken into account by the R&S CMU. If tight limits to the nominal and peak burst power are set, even a small attenuation can result in an out-of-tolerance measurement.

External attenuation values for each input/output may be entered in the *RF*  tab of the *Connect Control* menu

The cables, RF connections and antenna couplers must also be in good condition for satisfactory measurements. Dirty or broken RF connections can cause problems at the high frequencies used by Bluetooth networks.

If a *Power* measurement doesn't yield any valid results, check whether the conditions listed at the beginning of section *Power Measurements* in chapter 4 are fulfilled.

Additional Information...

... on Step 1

① Modulation measurement and statistical quantities

If some of the results of the *Modulation* measurement are invalid, check whether the conditions listed at the beginning of section *Modulation Measurements* in chapter 4 are fulfilled.

The table in the *Modulation* menu reports a statistical evaluation of quantities characterizing the signal modulation. The values in the three columns of the table are calculated as follows:

- The *Current* column contains the results for the current burst.
- The *Average* column contains the currents results averaged over the last statistics cycle.
- The *Maximum* and *Minimum* columns contain the extreme values of the current results for all bursts measured.

② Measured values and limits

The limits may be modified in the *Limits* tab of the *Modulation Configuration* Menu which is opened by pressing the *Modulation GFSK* softkey twice. The *Modulation Configuration* menu is analogous to the *Power Configuration* menu explained on the previous pages.

 Chapter 4

The averaging rules for the different results in the table is explained in detail in chapter 3 and in chapter 4, section *Modulation Measurements – Measurement Results*.

The quantities *Frequency Accuracy*, *Frequency Drift*, *Max. Drift Rate*, and *Frequency Deviation* are explained in detail in section *Modulation Measurements*.

 Chapter 4

The principle of *Modulation* measurements and the measured quantities are explained at the beginning of section *Modulation Measurements*.

Spectrum Measurements

To switch over to the *Spectrum* measurement, you can again use the hotkey bar.

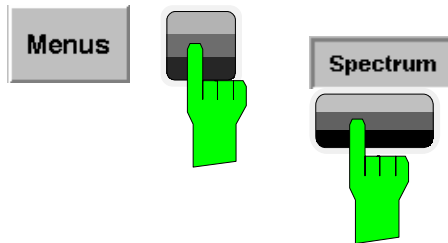

Step 1

- Press the *Menus* softkey to display the measurement groups available in the hotkey bar.
- Press the *Spectrum* hotkey to open the *Spectrum* menu.
- Press *Application – ACP* to measure the off-carrier channel power (adjacent channel power).
- Press the *Connect. Control* softkey, open the *Slave Sig. Tab*, and disable frequency hopping (*Hopping Scheme: RX/TX single freq.*). ①
- Make sure that the *Packet Type* is DH1 and that the *Pattern Type* is a PRBS sequence as required by the conformance test specification.
- Close the *Connection Control* menu.

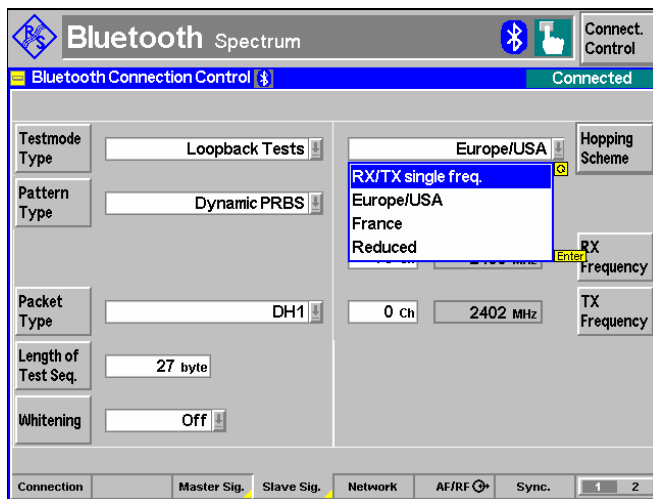

Step 2

The diagram in the *Spectrum – ACP* menu shows the absolute power (in dBm) that the Bluetooth device transmits in its nominal TX channel (here: 2402 MHz) and in the three channels to the right and left of the nominal channel (numbered -3 to +3). Red triangles denote the limits for the ACP.

The absolute powers appear in the output fields below the diagram, too. The R&S CMU displays current, average and maximum results (see *Modulation* measurements above). ②

If a result in the table exceeds the tolerances, the corresponding output field turns red, and an arrow pointing upwards/downwards indicates that the result is above/below the limit.

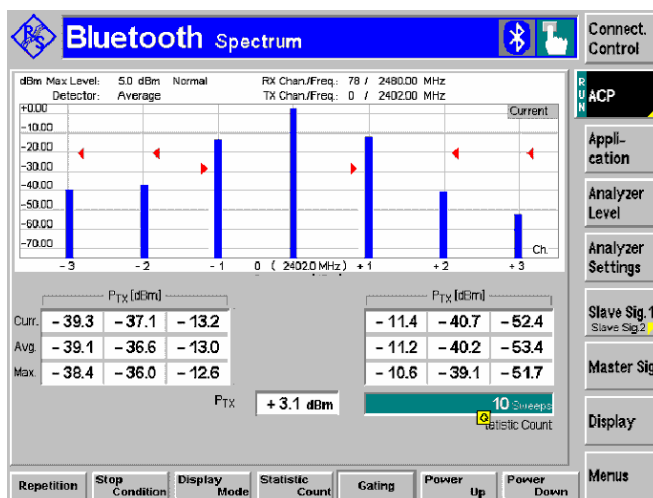

Additional Information...**... on Step 1****① Spectrum measurement settings**

The Bluetooth conformance specification stipulates different test settings for the different *Spectrum* measurement applications:

- The *ACP* measurement is performed at constant frequency (hopping disabled), with a DH1 packet type and a PRBS pattern.
- The *20 dB Bandwidth* measurement is performed with frequency hopping, the longest packet type supported by the DUT, the longest supported test sequence, and a PRBS pattern.
- The *Frequency Range* measurement is performed at constant frequency (hopping disabled) and in two different measurement windows around the lower and upper edge of the nominal Bluetooth band.

Alternative Settings and Measurements

☞ Chapter 4

The different *Spectrum* applications, the test requirements, and the measurement results are explained in detail in section *Spectrum Measurements*.

Receiver Quality Measurements

Receiver Quality measurements evaluate parameters which characterize the quality of the receiver in the device under test (DUT). To this purpose the bits sent to the DUT are looped back to the R&S CMU. The R&S CMU compares the bits received with those sent and can thus calculate the percentage of faulty bits. Therefore, the R&S CMU automatically activates a loopback test when a *Receiver Quality* measurement is active. ①

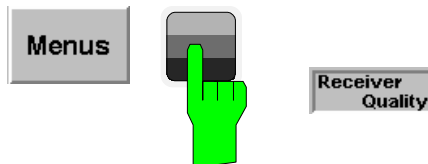

Step 1

- Press the *Menu* softkey to change the measurement group.
- Press the *Receiver Quality* hotkey to open the *Receiver Quality* menu.
- Press the *BER* measurement control softkey and *ON/OFF* to switch on the measurement.

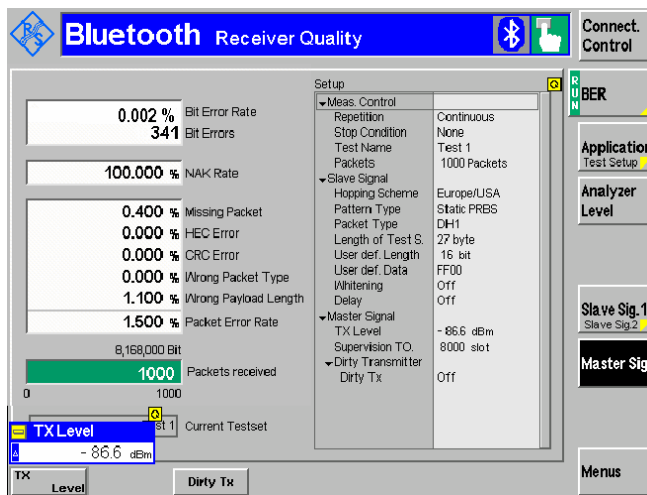

The *Receiver Quality* menu shows the results of the bit error rate test and the most important test settings. The R&S CMU's default RF generator signal is at a relatively high level so the detected bit error rates are low.

- Press the *Master Sig.* softkey and the *TX Level* hotkey to reduce the level of the RF generator signal.

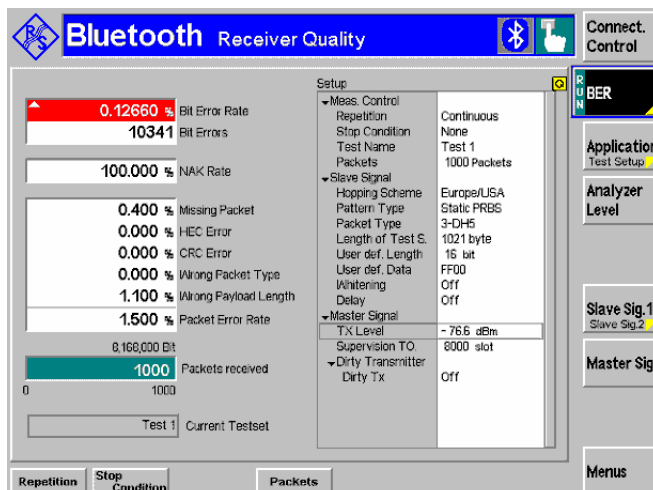

As the *TX Level* decreases, the R&S CMU measures a higher bit error rate. The R&S CMU is also able to search for the *TX Level* that corresponds to a particular bit error rate:

- Press the *Application* softkey to display all applications of the *Receiver Quality* measurement group. ②
- Select the *BER Search* application and search for the *TX Level* corresponding to a bit error rate of 2%.

Additional Information...

... on Step 1**① Loopback test mode**

In a loopback test, the R&S CMU transmits normal baseband packets. The DUT (acting as a Bluetooth slave) decodes the received packets and sends back the payload using the same packet type. The return packet is sent back either in the slave TX timeslot directly following the transmission of the R&S CMU or with a *Delay* of one slave and one master timeslot.

The R&S CMU provides a selection of bit patterns (*Pattern Type*) to be used for loopback tests. The data may or may not be whitened (scrambled with a particular bit sequence). Moreover, the *Packet Type* for test packets and the *Length of the test sequence* can be set

... on Step 2**② Applications**

Applications are different measurements belonging to the same measurement group. Each application is assigned its own set of configuration parameters. Therefore, the applications of a measurement group can be configured individually and serviced in parallel.

Within the *Receiver Quality* measurement group, the applications *BER* (bit error rate tests) and *BER Search* (search for an RF output level corresponding to a definite bit error rate) are available. For single shot BER measurements, up to five different test setups with independent parameters can be configured (see *Control* tab in the *Receiver Quality Configuration* menu).

Failed Receiver Quality Test

If a BER test fails ensure that the attenuation of any antenna coupler and/or cables used is being taken into account by the R&S CMU. During the test the mobile receiver is being tested with very low RF signal levels, and even a small attenuation can cause the R&S CMU to show a fail indication.

Alternative Settings and Measurements

☞ Chapter 4

See section *Behavior of the DUT (Connection Control – Slave Sig.)*

☞ Chapter 4

For a general discussion of measurement control and applications see chapters 3 and 5 of the R&S CMU manual.

Contents

- 3 Manual Control3.1**
- Menu Structure 3.1**
- Test Modes 3.1
- Configurations 3.2
- Measurement Groups 3.3
- General Settings 3.4**

3 Manual Control

This chapter gives a brief survey of the operating concept and the structure of the user interface for Bluetooth device tests. The CMU was designed for maximum operating convenience and flexibility. All instrument functions are grouped together in menus, each of them provides a number of related configuration settings or displays a group of measured quantities. All menus show a similar structure so that many settings, once defined, can be used in several measurements. Switchover between the different menu groups and test modes (*Signalling – Non Signalling*) is possible at any time.

In the following, the different measurement modes and measured quantities are discussed. Settings and measurement parameters frequently encountered are explained from a general point of view.

The formal aspects of measurement control are discussed in more detail in chapter 5 (*Remote Control – Basics*). For a presentation of the CMU's control elements, menu types and dialog elements within the menus refer to chapter 3 of the operating manual for the CMU basic unit.

Menu Structure

The menus used to control Bluetooth measurements can be arranged in different ways. From the functional point of view, they form the following groups:

- The two test modes Signalling and Non Signalling
- General configurations (Connection Control), configurations specific to a measured quantity (Power Configuration, Modulation Configuration, Receiver Quality Configuration), and menus displaying the results of the measurement (Generator, Overview, Power, Modulation, Receiver Quality).

In a more formal sense, the CMU uses main menus, popup menus, graphical measurement menus and dialog windows of various size. This aspect is discussed in chapter 3 of the operating manual for the CMU basic unit.

Test Modes

Bluetooth measurements are performed in one of the two modes *Signalling* or *Non Signalling*. The *Non Signalling* mode can be used to generate an RF signal with Bluetooth specifications and to configure the RF inputs and outputs of the CMU. The *Signalling* mode serves to measure the performance of the Bluetooth device under test (DUT) under realistic operating conditions where the CMU mimics a Bluetooth master.

Definition The term signalling denotes all actions necessary to establish, control and terminate a communication between the Bluetooth master (CMU) and the DUT. The signalling messages conveyed allow the Bluetooth device and the network to discuss the management of issues either related to the user or concerning technical aspects of the communication.

Non Signalling Mode In the Bluetooth *Non Signalling* mode, the CMU generates an RF test signal with Bluetooth specifications, i.e. a Bluetooth packet with variable level, frequency and payload. It is possible to configure the RF inputs and outputs of the CMU and to perform *Power* and *Modulation* measurements.

Signalling Mode In the *Signalling* mode, when pressing the Inquiry button, the CMU transmits an inquiry signal to detect connectable Bluetooth devices within its domain. From the list of devices compiled during this stage, one target device can be selected for paging. The CMU transmits a signal to synchronize and attempt a connection to the target device. After the connection is established, the DUT can be placed either into its internal test mode or into one of the submodes *Audio*, *Sniff*, *Hold*, *Park*. In the submodes special measurements can be carried out.

The CMU is able to configure a broad range of network and test mode parameters and to determine the parameters characterizing the Bluetooth device under test. Measurements of the burst power versus time, the modulation parameters, and the receiver quality.

Configurations

The CMU offers a wide range of settings for the signal generators and analyzers, the signalling procedures, and the individual measurements. Configurations may apply to the whole function group (*Connection Control*) or to a particular measurement.

Connection Control The *Connect. Control* softkey is located to the right of the title bar in each main and graphical measurement menu. It opens a popup menu with several tabs to define

- The RF signal generator of the instrument (Generator in Non Signalling mode)
- The RF connectors to be used and the external attenuation (RF Input/Output)
- The reference signal and the system clock (Sync.)
- In Signalling mode, all actions changing the CMU's signalling state (Connection)
- In Signalling mode, the properties of the signal that the CMU transmits to set up a connection (Master Sig.) and the behavior of the DUT in its test mode (Slave Sig.)
- The signal generators and RF analyzers settings, the input path configuration (Analyzer in Non Signalling, BS Signal in Signalling mode), and the trigger settings (Trigger in Non Signalling, BS Signal in Signalling mode)
- Other settings concerning the automatic display of menus and the coupling of parameter values (Misc. in Non Signalling, BS Signal in Signalling mode)

All settings made in the *Connect. Control* menu are valid for the whole function group. Most of them can be overwritten, however, by means of the softkeys and hotkeys offered in the graphical measurement menus.

Configuration of measurements A popup menu offering specific settings is assigned to each measurement group (*Overview*, *Power*, *Modulation*, *Receiver Quality*). The following parameters can be defined in separate tabs:

- The repetition mode, stop condition, statistic count and display mode for the measurement (Control)
- The input signal settings (Analyzer)
- Tolerances for the measured quantities (Limits, Limit Lines)

The *Control* settings are explained in more detail below (see section [General Settings](#) on page 3.4).

Configuration via hotkeys The softkeys and associated hotkeys in the graphical measurement menus provide the most important configurations for the current measurement; see chapter 4 and chapter 3 of the CMU operating manual. Settings made via hotkeys supersede the corresponding *Connection Control* settings.

Measurement Groups

Bluetooth measurements are generally performed in the *Signalling* test mode. Before any measurement results can be obtained, a connection between the CMU and the DUT must be established and the DUT must be set to the *Connected* mode or to one of the submodes *Test Mode*, *Audio*, *Sniff*, *Hold*, *Park* (see table in section *Connection Setup* in Chapter 4). The measurement results are indicated in two different ways:

- Discrete values and parameters are displayed in output fields, lists and tables. In remote control, these results are referred to as scalars.
- Traces are displayed in a Cartesian coordinate system, the time forming the x-axis scale. In remote control, results of this type are referred to as arrays.

While the measurement is running in repetition mode *Continuous* (see page 3.4), the results are constantly updated. An overview of the measurements is given in the table below.

Table 3-1 Measurement Groups

Measurement Group	Functionality
Overview	Indication of the scalar <i>Power</i> , <i>Modulation</i> , and <i>Receiver Quality</i> results and display of the most important signalling parameters.
Power	Measurement of the transmitter output power of the Bluetooth DUT as a function of time with evaluation of the nominal power, peak power, leakage power and packet timing plus a power control check. A statistical evaluation and a limit check is done for the measured quantities (except the power control check).
Modulation	Measurement of the frequency deviation over the whole Bluetooth packet and calculation of the frequency accuracy, the frequency drift, the maximum drift rate and a conformance check for the bits satisfying a threshold condition for the frequency deviation. A statistical evaluation and a limit check is done for all modulation results.
Spectrum	Measurement of the off-carrier power and calculation of the Adjacent Channel Power (ACP), the 20 dB bandwidth, and the frequency range where the power is above a specified threshold. A statistical evaluation and a limit check is done for all spectrum results.
Receiver Quality	Measurement of the bit error rate and the packet error rate at variable receiver input level of the DUT (application <i>BER</i>) or search for the receiver input level corresponding to a particular bit error rate (application <i>BER Search</i>). A broad range of parameters configure the <i>Receiver Quality</i> measurements; up to five different configurations can be stored in separate (and pre-configured) <i>Test Setups</i> .

General Settings

A number of settings can be made in several of the configuration menus assigned to the measurement groups. In combination, these settings define the scope of the measurement, i.e. the number of bursts measured and the results displayed. The following brief overview is intended to avoid confusion of terms.

Application *Applications* are different measurements belonging to the same measurement group. They effectively split up a measurement group into various related subgroups which can be configured separately.

They are selected via the *Application* softkey in the measurement menus.

Statistic Count The *statistic count* denotes the integer number of evaluation periods which form one statistics cycle. An evaluation period corresponds to the duration of a Bluetooth packet comprising up 1, 3, or 5 timeslots. Together with the *repetition mode* and the *stop condition*, the statistic count determines when exactly the measurement is stopped.

The *statistic count* is set in the *Statistics* page of the configuration popup-menus assigned to the two measurement groups *Power*, *Modulation* and *Receiver Quality*.

Repetition Mode The *repetition mode* defines when a measurement that is not stopped by a limit failure (see stop condition *On Limit Failure* below) will be terminated. Two modes are available for all measurements:

Single Shot The measurement is stopped after one *statistic count*.

Continuous The measurement is continued until explicitly terminated by the user; the results are periodically updated.

A third repetition mode is available with remote control:

Counting Repeated single shot measurement with a fixed number of statistic counts.

The *repetition mode* is set in the *Control* tab of the configuration popup-menus assigned to the three measurement groups *Power*, *Modulation* and *Receiver Quality*.

Note: *In contrast to other measurement settings, these repetition modes in manual and remote control are independent and do not overwrite each other. In most measurements, the default repetition mode in manual control is Continuous (observe results over an extended period of time), the default mode in remote control is Single Shot (perform one measurement and retrieve results).*

Stop Condition A *stop condition* can be set for most measurements:

None The measurement is performed according to its repetition mode, irrespective of the measurement results and the limits set.

On Limit Failure The measurement is stopped as soon as one of the limits is exceeded, irrespective of the repetition mode set. If no limit failure occurs, it is performed according to its repetition mode.

The *stop condition* is set in the *Control* tab of the configuration popup-menus assigned to the measurement groups.

Display Mode

In graphical measurement diagrams, the *display mode* defines which of the measured and calculated traces is displayed if the measurement extends over several bursts. In general, traces are evaluated at a set of fixed, equidistant test points (samples). After n bursts, n measurement results per test point have been taken. After a single shot measurement extending over c bursts, c measurement results per test point have been taken.

<i>Current</i>	The current burst, i.e. the last result for all test points, is displayed.
<i>Minimum</i>	At each test point, the minimum value of all bursts measured is displayed.
<i>Maximum</i>	At each test point, the maximum value of all bursts measured is displayed.
<i>Average</i>	At each test point, a suitably defined average over all bursts measured is displayed; see paragraph entitled <i>Calculation of average quantities</i> below.

Note the difference in the calculation of *Average* on one hand, *Minimum* and *Maximum* on the other hand, if the measurement extends over more than one statistic count (repetition mode *Continuous*, measurement time longer than one statistic count).

The *display mode* is set in the *Statistics* tab of the configuration popup-menus assigned to the measurement groups *Power* and *Modulation*.

Calculation of average quantities

The *Average* traces in the *Power* and *Modulation* menus are obtained as follows:

Let c be the number of bursts forming one statistics cycle (one *statistic count*) and assume that n bursts have been measured since the start of the measurement. In calculating the *Average* trace, the following two situations are distinguished:

$n \leq c$ Single shot measurement or continuous measurement during the first statistics cycle: At each test point, *Average* trace no. n is calculated from *Average* trace no. $n - 1$ and *Current* trace no. n according to the following recurrence:

$$Avg(n) = \frac{n-1}{n} Avg(n-1) + \frac{1}{n} Curr(n) \quad (n = 1, \dots, c)$$

Equation 3-1

The *Average* trace represents the arithmetic mean value over all n bursts measured.

$n > c$ Continuous measurement after the first statistics cycle: At each test point, *Average* trace no. n is calculated from *Average* trace no. $n - 1$ and *Current* trace no. n according to:

$$Avg(n) = \frac{c-1}{c} Avg(n-1) + \frac{1}{c} Curr(n) \quad (n > c)$$

Equation 3-2

The formulas hold for $c = 1$ (statistics off) where the average trace is equal to the current trace. Scalar quantities are averaged in analogy to *Average* traces.

Calculation of statistical quantities

In *Power* and *Modulation* measurements the statistical functions *Average*, *Minimum*, and *Maximum* are applied to a set of test points depending on two independent parameters:

- The time, i.e. the abscissa values t_i , i ranging from 1 to the total number of test points comprising the trace.

- The burst number ranging from 1 to the number n of the current burst.

The result of the statistical operations depends on the parameter range considered and – in the case of statistics functions evaluated over several parameters – on the order of evaluations. This is why the definition of statistical quantities deserves some attention and is explained in the relevant sections in chapter 4.

In the *Power* menu, the quantities *Nominal Power* and *Leakage Power* represent the power averaged over different areas of the burst, i.e. each measurement result corresponds to the arithmetical mean value of all test points t_i within a given time range. For each burst, these quantities are entered in the *Current* column of the output table. The results in the *Minimum* and *Maximum* column correspond to the largest and smallest of all *Current* results ever measured. The results in the *Average* column correspond to the arithmetical mean value of the *Current* results averaged according to Equation 3-1 and Equation 3-2 above.

Contents

4	Functions and their Application	4.1
	Bluetooth Non Signalling Mode	4.2
	Measurement Menu Analyzer/Generator	4.2
	RF Generator Panel	4.3
	Generator Modulation Panel	4.5
	Connection Control	4.7
	Control of RF Output Signals (Connection Control – Generator)	4.7
	AF/RF Connectors (Connection Control – AF/RF Connectors)	4.8
	Reference Frequency (Connection Control – Sync.)	4.9
	TX Tests in Non Signalling Mode	4.9
	Audio Measurements	4.11
	Bluetooth Signalling Mode	4.12
	Connection Setup	4.12
	Connection Control: Standby State	4.14
	Connection Control: Inquiry State	4.16
	Connection Control: Paging State	4.17
	Overview of the Function Group	4.19
	Test Settings	4.20
	Measurement Control	4.21
	Selecting the Application	4.21
	Application-Specific Settings	4.22
	Measurement Results	4.23
	Measurement Configurations (Overview Configuration)	4.24
	Measurement Control (Overview Configuration – Control)	4.24
	Analyzer Settings (Overview Configuration – Analyzer)	4.25
	BER Levels (Overview Configuration – Master)	4.26
	BER Loopback Settings (Overview Configuration – Slave)	4.26
	Limit Values (Overview Configuration – Limits)	4.27
	Power Measurements	4.28
	Measurement Menu (Power)	4.28
	Test Settings	4.29
	Measurement Results	4.35
	Measurement Configurations (Power Configuration)	4.38
	Measurement Control (Power Configuration – Control)	4.38
	Analyzer Settings (Power Configuration – Analyzer)	4.40
	Limit Values (Power Configuration – Limits)	4.42
	Modulation Measurements	4.44
	Measurement Menu (Modulation)	4.45
	Test Settings	4.46
	Measurement Results	4.47
	Measurement Configurations (Modulation Configuration)	4.51
	Measurement Control (Modulation Configuration – Control)	4.51
	Analyzer Settings (Modulation Configuration – Analyzer)	4.51
	Limit Values (Modulation Configuration – Limits)	4.53
	Spectrum Measurements	4.55
	Frequency Range Application	4.57

Measurement Menu (Spectrum)	4.58
Test Settings	4.59
Measurement Results	4.61
Measurement Configurations (Spectrum).....	4.68
Measurement Control (Spectrum Configuration – Control)	4.68
Analyzer Settings (Spectrum Configuration – Analyzer)	4.69
Spectrum Limits (Spectrum Configuration – Limits)	4.70
Receiver Quality Measurements.....	4.73
Packet Error Tests outside of Testmode	4.74
Measurement Menu (Receiver Quality).....	4.75
Test Settings	4.76
Measurement Results	4.79
Measurement Configurations (Receiver Quality Configuration).....	4.82
Measurement Control (Receiver Quality Configuration – Control)	4.82
BER Levels (Receiver Quality Configuration – Master).....	4.84
BER Loopback Settings (Receiver Quality Configuration – Slave)	4.85
Limit Values (Receiver Quality Configuration – Limits)	4.86
Audio Measurements	4.87
Audio Test Scenarios.....	4.87
Connection Control (Contd.)	4.90
Connection Control in Connected State	4.90
Connection Control in Test Mode (Test Mode).....	4.92
Connection Control in Sniff State	4.96
Connection Control in Hold State	4.97
Connection Control in Park State	4.98
Connection Control in Audio State	4.100
Signal of the R&S CMU (Connection Control – Master Sig.)	4.102
Panel Oriented Version.....	4.102
Table Oriented Version	4.102
Behavior of the DUT (Connection Control – Slave Sig.)	4.107
Panel Oriented Version.....	4.107
Table Oriented Version	4.108
Network Parameters (Connection Control – Network)	4.113
AF/RF Connectors (Connection Control – AF/RF)	4.117
Reference Frequency (Connection Control – Sync.).....	4.118
Trigger (Group Configuration – Trigger).....	4.119
Input Path (Connection Control – Analyzer).....	4.120
Display Control (Connection Control – Misc).....	4.122
Audio Profiles (Option R&S CMU-K54)	4.124

4 Functions and their Application

This chapter explains in detail all functions for the measurement of Bluetooth devices.

It is divided into two sections describing the following function groups and test modes:

- Configuration of RF signals (Bluetooth Non Signalling)
- Bluetooth device tests (Bluetooth Signalling)

This reference chapter is organized according to the provided measurements and measurement configurations. In contrast to chapter 6, *Remote Control – Commands*, general measurement configurations are described at the end of each section. The description of each softkey, select or input field is followed by the corresponding remote-control commands. Similarly, the description of the commands in chapter 6 also contains the corresponding menus of the user interface.

Each menu and each panel is briefly described first and then illustrated together with its call button. The menu functions are explained in the following way:

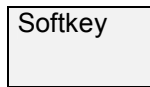

Short function definition

Designation of
select/input field

Detailed definition of the function.

Further description of the function: purpose, interaction with other settings, notes...

Parameter 1 Description of parameter 1

Parameter 2 Description of parameter 2

...

Further description of the parameters: purpose, interaction with other settings, notes...

Remote control

Remote-control command (long form) Parameter1 | Parameter2 ...

For all numerical values, including their ranges and default settings, please refer to the description of the remote-control commands in chapter 6.

The description of the operating concept is to be found in chapter 3 of the operating manual for the CMU basic instrument; besides, a description of measurement control and the essential settings and an overview of the most important menus is given at the end of chapter 3 in the present *Bluetooth* manual. A comprehensive index listing important keywords and the proper names of all menus, dialog elements and softkeys is appended to the end of this manual.

Bluetooth Non Signalling Mode

This section provides detailed information on function group *Bluetooth Non Signalling*. In this mode, it is possible to generate an RF signal with Bluetooth specifications, to configure the RF input and output connectors of the R&S® CMU, and to define RF reference and synchronization signals.

It is also possible to measure the *Power* and *Modulation* of the received *Bluetooth* packets. To perform *Spectrum* and *Receiver Quality* measurements on Bluetooth devices, the Signalling mode must be active; see section [Bluetooth Signalling Mode](#) on page 4.12.

Measurement Menu Analyzer/Generator

The *Analyzer/Generator* menu configures the RF output signal of the R&S® CMU.

The RF output signal carries Bluetooth packets with a definite *RF Level* and *Frequency* and with a *Payload* pattern that can be selected via the softkeys of the *Analyzer/Generator* menu. The signal is bursted; the transmission of a packet starts every 6.25 ms, which means that there is one packet transmitted every 10th slot.

The *Packet Type*, the *Length of Test Sequence*, and the *BD Address Master* can also be set in the *Analyzer/Generator* menu, so that the Bluetooth generator signal in *Non Signalling* mode carries Bluetooth packets with configurable type and length. The transmitted Bluetooth address is the same as the CMU uses in *Signalling* mode. The parameters correspond to the Signalling parameters *BD Address CMU*, *Packet Type*, and *Length of Test Sequence*; for a detailed description refer to sections *Bluetooth Signalling Mode – Connection Control – Master Sig.* and *Bluetooth Signalling Mode – Connection Control – Slave Sig.*

The *Analyzer/Generator* menu is opened from the *Menu Select* menu (with associated key at the front of instrument).

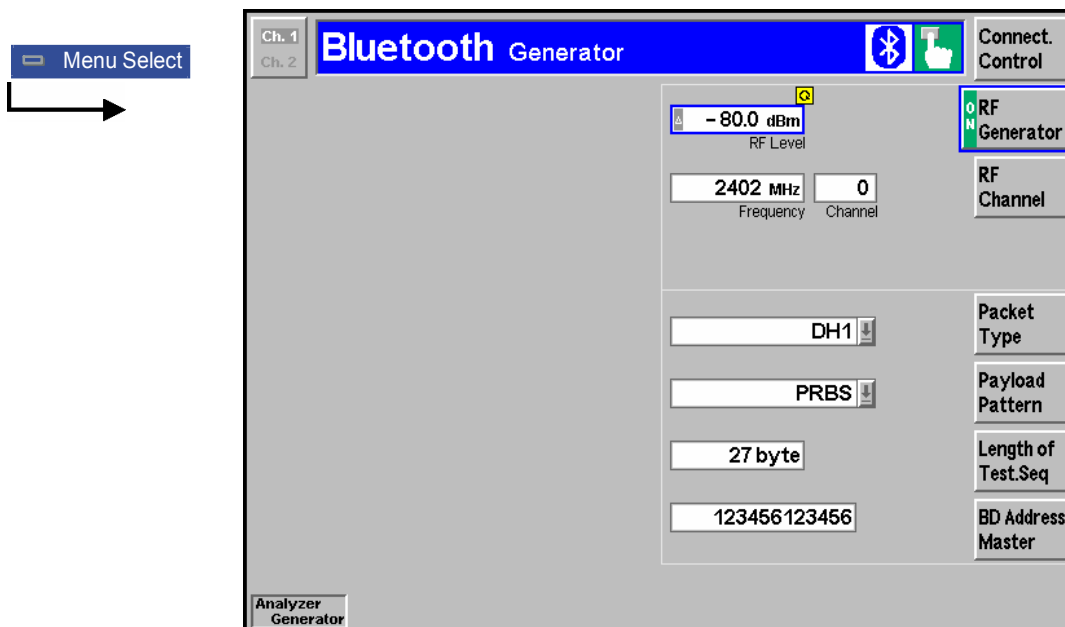
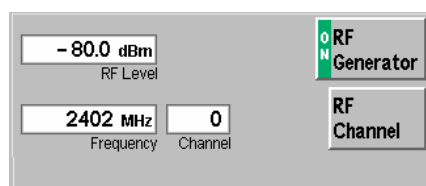

Fig. 4-36 Measurement menu Analyzer/Generator

RF Generator Panel



The *RF Generator* panel contains softkeys which allow the configuration of:

- The *RF Level* of the generator
- The *RF Channel* number or *Frequency*
-

RF Generator

The *RF Generator* softkey controls the RF generator and indicates its operating status (*ON* | *OFF*).

The level is entered in dBm. The value range depends on the selected RF output (RF 1, RF 2 or RF 3 OUT). The RF generator can be switched on or off after softkey selection (press once) using the *ON/OFF* key.

Remote control

```
INITiate:RFGenerator; ABORT:RFGenerator
FETCh:RFGenerator:STATus?
SOURce:RFGenerator:LEVel <Level>
```

External attenuation

If an external gain or attenuation is used and reported to the instrument (see softkey *Ext. Att. Output*) the RF generator level is adjusted to maintain the specified power after the attenuation or gain. As a consequence, all levels indicated are referenced to the input of the DUT and no longer correspond to the actual level at the output connectors of the R&S® CMU (see section [AF/RF Connectors \(Connection Control – AF/RF Connectors\)](#) on page 4.7). The default value for the generator power is also shifted provided that the generator can output the required power, compensating for the external attenuation or gain.

Error messages

If the level defined for *RF Level* is too high or too low, a window will appear with the error message "*<RF_Level> is out of range. <Permissible max/min. value> is limit.*" and three buttons:

<i>Accept</i>	Permissible max/min. value is accepted as <i>Level</i> ,
<i>Re-edit</i>	The <i>Level</i> is entered once again,
<i>Cancel</i>	The last valid input is maintained.

When switching to a different output connector, the R&S CMU automatically adjusts the *Level*, if necessary. The current value can be

- Decreased to the maximum permissible value of the new output connector
- Increased to the minimum value of the new output connector

RF Channel

The *RF Channel* softkey defines the channel number (if applicable) or the frequency of the generated RF signal.

RF frequencies can be entered in multiples of the Bluetooth channel width of 1 MHz. Bluetooth channel numbers and frequencies are unambiguously defined for the USA and most of Europe and the rest of the world (see the description of the different frequency hopping schemes on page 4.110). Following this specification, the channel structure is as follows:

$$f_k = 2402.0 \text{ MHz} + k \cdot 1 \text{ MHz}, \quad k = 0, \dots, 93$$

In this frequency band (i.e. in the range from 2402 MHz up to and including 2495 MHz), it is sufficient to enter only one value (frequency **or** channel number); the other one is automatically determined by the R&S® CMU. Out-of-band frequencies are not allowed.

Remote control

```
SOURCe:RFGenerator:FREQuency:UNIT <Unit>
SOURCe:RFGenerator:FREQuency <Frequency>
```

Reference Frequency

The *Reference Frequency* softkey determines the source and the frequency of the reference signal.

The associated field permits to select between two alternatives:

Int. (10 MHz) internal synchronization with 10 MHz (TCXO or OCXO, CMU-B11/-B12) applied to output REF OUT 1 at the rear of the instrument.

Ext. (at REF IN) external reference signal to be fed in via input REF IN and applied to output REF OUT 1 at the rear of the instrument.

The frequency of the external reference signal must be entered in the input field next to the *External* button.

The reference signal used is applied to output REF OUT 1 so that it can be fed to other instruments as well. It can be used for synchronization to another instrument.

Notes:

With external synchronization selected, the header cyclically displays a warning if no synchronization has been performed e.g. because of a missing or faulty input signal. At the same time, bit no. 6 (RFNL, Reference Frequency Not Locked) is set in the STATUS:OPERation:CMU:SUM1:CMU1 sub-register associated with the CMU base system.

In the case of external synchronization with squarewave signals (TTL) ensure correct signal matching to avoid reflections. Otherwise, resulting overshoots may cause trigger problems at the CMU input. A possible remedy is to use a lowpass filter or an attenuator pad directly at the CMU input. Correct synchronization may be checked by comparing the signal REF OUT 1 or REF OUT 2 with the input signal.

*This configuration is valid in **all** CMU function groups.*

Remote control

The commands for the reference frequency are part of the CMU base system (see CMU200/300 operating manual):

```
CONFigure:SYNChronize:FREQuency:REFerence:MODE
    INTernal | EXTernal
CONFigure:SYNChronize:FREQuency:REFerence <Frequency>
```

REF OUT 2

The softkey *REF OUT 2* configures a network-specific system clock REF OUT 2 to be fed to the output *REF OUT 2* at the rear of the instrument.

The associated field permits selection between two alternatives:

OFF (other network) The clock frequency of the current function group is not fed to the output *REF OUT 2*.

With this setting the system clock of another active function group (e.g. the GSM1800 network while the current network is Bluetooth) is still applied to *REF OUT 2* provided that the output *REF OUT 2* is switched on in the other function group. However, if *REF OUT 2* is explicitly switched over from *On* to *Off* the clock signal is definitely removed.

On (current network) The network-specific system clock of the current function group is fed to output REF OUT 2. The system clock of any other function group applied to REF OUT 2 before is replaced.

The following clock frequencies may be selected:

40.000 MHz,	20.000 MHz,	13.334 MHz,	10.000 MHz,	8.000 MHz,
6.667 MHz,	5.715 MHz,			
5.000 MHz,	4.445 MHz,	4.000 MHz,	3.637 MHz,	3.334 MHz,
3.077 MHz,	2.858 MHz,			
2.667 MHz,	2.500 MHz,	2.353 MHz,	2.223 MHz,	2.106 MHz,
2.000 MHz,	1.905 MHz,			
1.819 MHz,	1.740 MHz,	1.667 MHz,	1.600 MHz,	1.539 MHz,
1.482 MHz,	1.429 MHz,			
1.380 MHz,	1.334 MHz,	1.291 MHz,	1.250 MHz	

(The values are calculated according to the formula $F_{out} = 40.00 \text{ MHz} / n$ where $n = 1, \dots, 32$.)

The clock frequency can be used to synchronize other instruments.

Remote control

```
SOURce:DM:CLOCK:STATE ON | OFF
SOURce:DM:CLOCK:FREQuency <Frequency>
```

Generator Modulation Panel

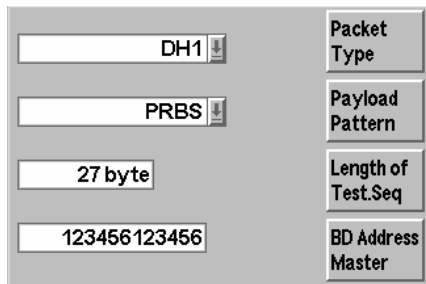

The *Generator Modulation* panel contains the softkeys for configuration of the RF generator signal. These softkeys allow the selection of packet type and length of test sequence, configuration of the payload pattern, and setting of the Bluetooth Device address (Master).

Packet Type

The *Packet Type* softkey identifies which type of packet will be transmitted by the R&S CMU on its generator signal.

Valid entries for packet type are as follows:

- DH1, DH3, DH5
- OFF – No signal superimposed, 'empty' carrier (continuous wave)

Remote control

```
SOURce:RFGenerator:PTYPE
DH1 | DH3 | DH5
```

Description of Packet Types

The packet types supported by the R&S CMU are described below:

Type	Header (Bytes)	User Payload (Bytes)	Timeslots (Max)
DH1	1	0 to 27	1
DH3	2	0 to 183	3
DH5	2	0 to 339	5

All supported packet types have the same format as shown below:

Access Code	Header	Payload	CRC
72 bits	54 bits	0 - 1021 bytes (see table above)	16 bits

Payload Pattern

The *Payload Pattern* softkey defines a bit sequence that is modulated onto the RF generator signal.

The following bit sequences can be selected:

- OFFPRBS* Pseudo random bit sequence (PRBS-9 sequence)
- All 0* Continuous sequence consisting of zeros only
- All 1* Continuous sequence consisting of ones only
- 11110000 etc.* Specific bit sequences, to be periodically repeated

Remote control

SOURCE:RFGenerator:BMODulation <pattern>
 PRBS | ALL0 | ALL1 | P44 | P22 | P11

Length of Test Sequence

The *Length of Test Sequence* softkey defines the payload length for the transmitted packets. The allowable range of values depends on the type of packet transmitted.

The valid lengths, in bytes, for each packet type are as follows:

- OFF No signal superimposed, "empty" carrier (continuous wave)
- DH1 0 to 27
- DH3 0 to 183
- DH5 0 to 339

Remote control

SOURCE:RFGenerator:PLENght <Length>

BD Address Master

The *BD Address Master* softkey is used to set the Bluetooth Device address for the R&S CMU.

Remote Control

SOURCE:RFGenerator:BDADdress <string>

Connection Control

The popup menu *Connection Control* contains three tabs to configure the inputs and outputs of the R&S® CMU and the respective signals in the function group *Bluetooth Non Signalling*.

The menu group is activated via the softkey *Connect. Control* to the right of the header of each measurement menu. The individual tabs (*Generator*, *AF/RF* ↻ and *Sync.*) can be accessed via the hotkeys at the lower edge of the screen.

Control of RF Output Signals (Connection Control – Generator)

The *Generator* tab configures the signals generated by the RF generator of the R&S® CMU.

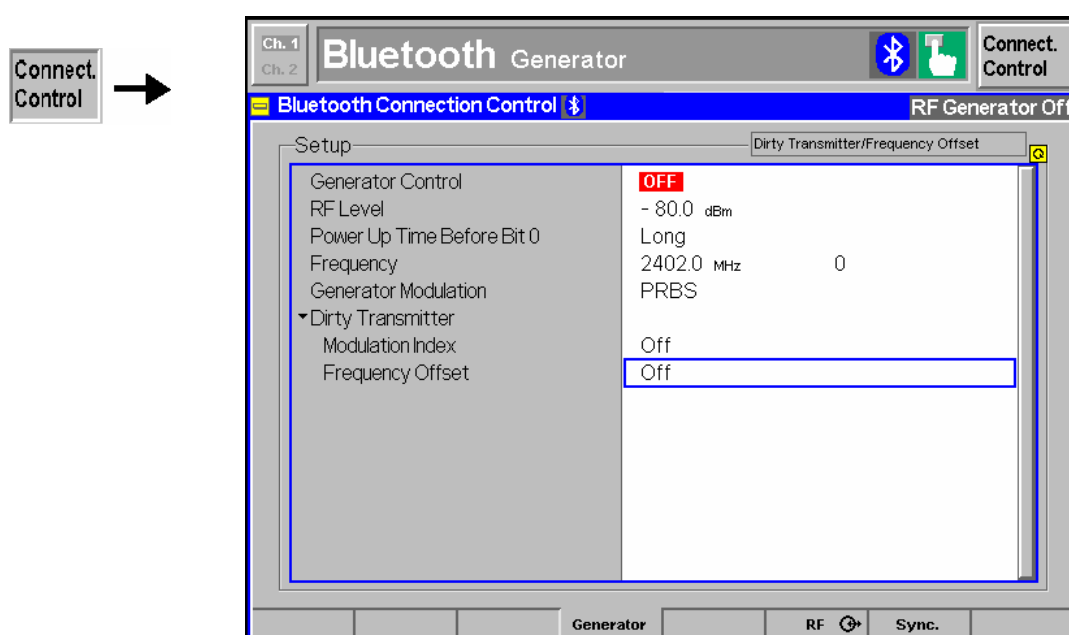

Fig. 4-37 Connection Control – output signals

This tab provides settings in addition to those for signal configurations in the *Generator* menu (see page 4.2), and includes the single-valued *Dirty Transmitter* settings (which are a subset of the *Dirty Transmitter* settings available in *Signalling* mode; see section *Signal of the R&S CMU (Connection Control – Master Sig.)* on p. 4.102).

Power-up Time before Bit Zero The time interval between the start of the power ramp and the time of bit zero (t_{p0}) can be set to either *Long* or *Short*. Note that setting a *Short* time corresponds to 3 μ s, which is the value quoted in the Bluetooth RF test specification.

Remote control `SOURce:RFGenerator:PTBZero <Time>`

Frequency Offset The *Frequency Offset* softkey defines an offset for the frequency set under *RF Channel*. The range of the *Frequency Offset* is such that any intermediate frequency between two *RF Channels* can be covered.

Remote control `SOURce:RFGenerator:FOFFset <Freq. Offset>`

Modulation Index The *Modulation Index* softkey defines the ratio between the actual frequency deviation of the R&S CMU and a frequency deviation of 500 kHz.

$$\text{Modulation Index} * 500 \text{ kHz} = \text{Frequency deviation of RF signal.}$$

Off is equivalent to a modulation index of 0.32, corresponding to the nominal Bluetooth frequency deviation of 160 kHz.

Remote control `SOURce:RFGenerator:MINdex <Mod. Index>`

AF/RF Connectors (Connection Control – AF/RF Connectors)

The *AF/RF*  tab selects the connectors for RF signals. This includes the setting of

- The RF input and output connector used on the CMU (RF Output, RF Input)
- An external attenuation at that connector (Ext. Att. Output, Ext. Att. Input), i.e. the known attenuation of a cable connection (RF lead) or over-the-air connection (antennas) to the device under test

The tab also indicates the name and function of the AF connectors.

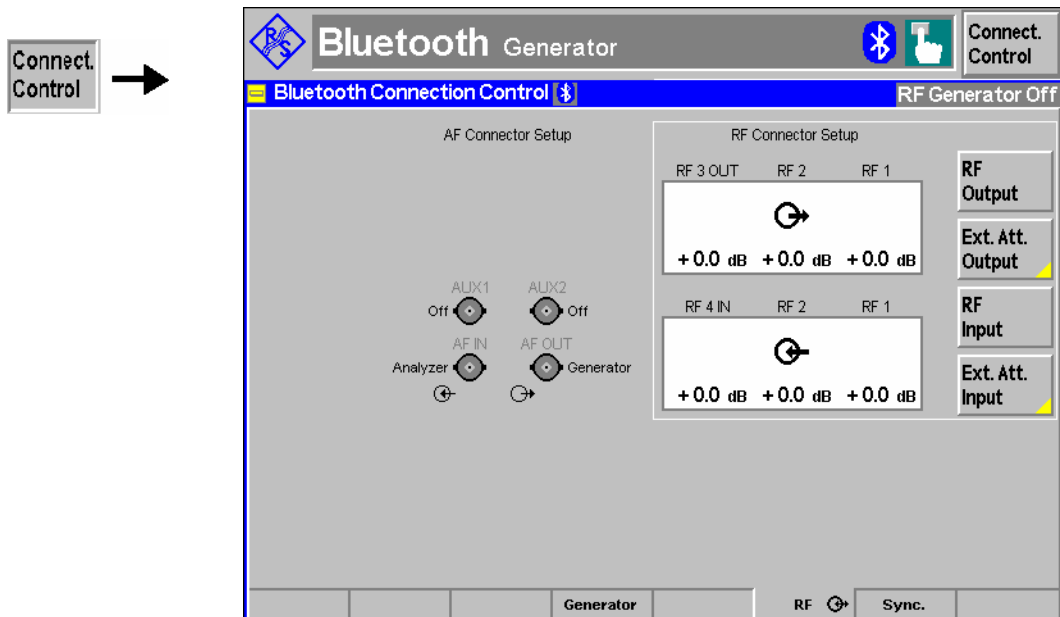

Fig. 4-38 Connection Control – RF connectors

Reference Frequency (Connection Control – Sync.)

The *Sync.* tab defines the reference signals for synchronization. This includes

- The internal or external *Reference Frequency*
- The output mode for the network-specific system clock (*REF OUT 2*)

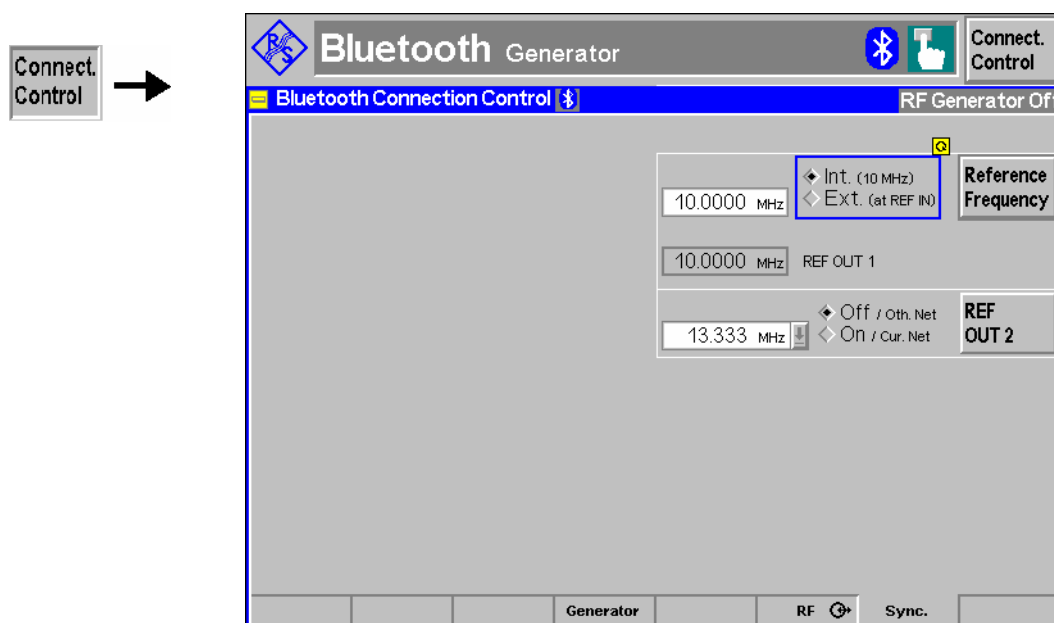

Fig. 4-39 Connection Control – Synchronization

TX Tests in Non Signalling Mode

In *Non Signalling* mode, the R&S CBT does not provide any measurement menus. However, with a suitably configured *Bluetooth* DUT, it is possible to perform non signalling *Power* and *Modulation* measurements using the *Signalling* measurement menus. The R&S CMU uses a power trigger and the known access code of the received *Bluetooth* packets to establish timing synchronization. No transfer of signalling information and no connection setup is required.

Test procedure To perform non signalling measurements,

1. Command your DUT into a standalone non signalling TX mode where it transmits *Bluetooth* packets of a definite type and on a single channel.
2. Press the *Menu Select* key on the front panel of the instrument and select *Bluetooth – Signalling – Power versus Time*.
3. In the *Connection Control* menu opened, select the *Master Sig.* tab and set the *BD Address Master* equal to the address that the DUT uses to generate its access code.

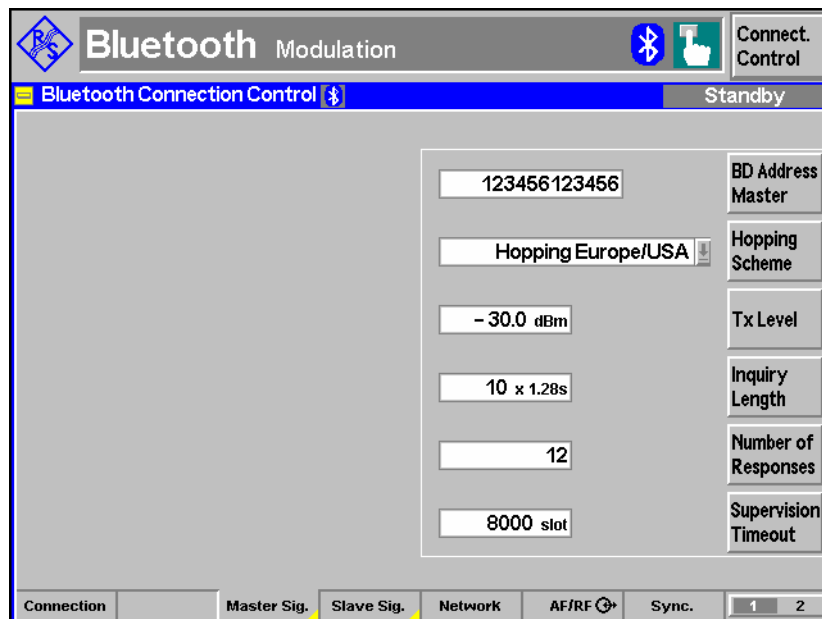

The DUT derives its access code from the Lower Address Part (LAP, the last 6 hex digits) of the *BD Address Master*.

4. Press *ESCAPE* to close the *Connection Control* menu and access the *Power* measurement menu.
5. Use the softkeys and hotkeys in the *Power* menu to perform the following settings:
Analyzer Level – Trigger Source: Power
Analyzer Level – RF Max. Level: <expected nominal power> + 5 dB
Analyzer Settings – Measure Mode: Single
Analyzer Settings – Measured Channel: <Bluetooth Channel of the DUT>
Slave Sig. 1 – Packet Type: <Packet Type of the DUT>
Slave Sig. 1 – Pattern Type: <Transmitted bit pattern>

The diagram shows the measured packets:

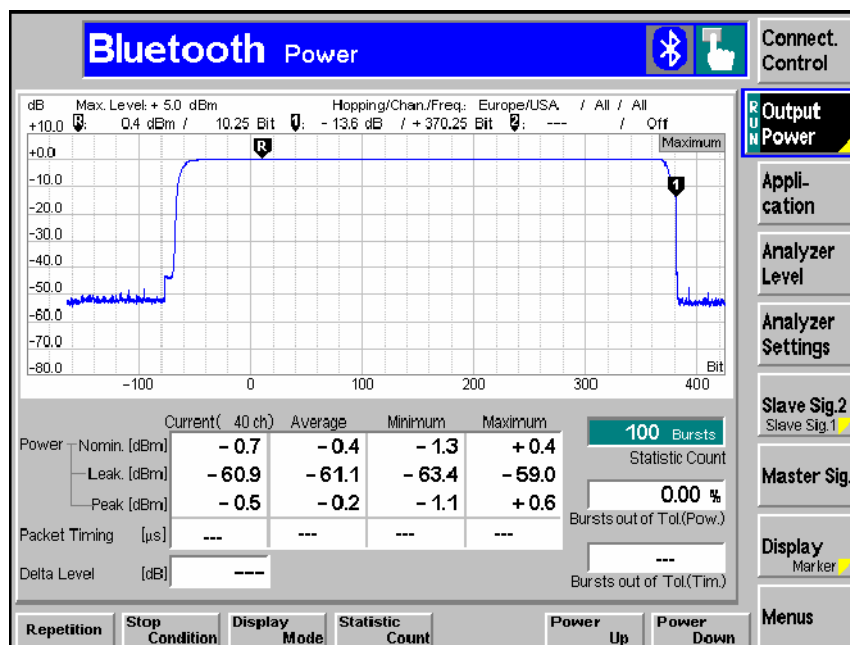

The *Packet Timing* and *Delta Level* results are not available in non signalling mode. The same holds for the derived *Bursts out of Tol (Tim.)* result; see below.

Measurement results

The non signalling measurement provides the *Power* and *Modulation* results with the exceptions listed below. *Spectrum* measurements and RX tests (*Receiver Quality*) are not supported.

The R&S CMU supports all *Bluetooth* packet types for non signalling tests.

Table 4-3 Invalid measurement results in non signalling mode

Result	Comment
Packet Timing	Requires a timing reference, derived from the master signal
Burst out of Tol. (Tim.)	Statistical value, derived from the <i>Packet Timing</i> results
Delta Level	Requires power up/down commands to be sent to the DUT
Modulation – Encoding	To be measured with a hopping slave signal

Audio Measurements

The menu group *Audio* comprises the functions for generating and measuring single or multitone audio signals. The menu group is available with option CMU-B41, *Audio Generator and Analyzer*. All *Audio* menus and remote-control commands are described in the CMU 200/300 operating manual.

The *Audio* option supports two independent test circuits. In *Non Signalling* mode the input and output connectors for both circuits are fixed; they are indicated in the *AF/RF*  tab of the *Connection Control* menu; see section [AF/RF Connectors \(Connection Control – AF/RF Connectors\)](#) on p. 4.8. This test mode corresponds to the standalone Audio tests described in the CMU 200/300 operating manual.

In *Signalling* mode, a special *Audio* signalling state is defined (see section [Connection Control in Audio State](#) on p. 4.100.) and audio tests with an SCO radio link between the CMU and the DUT can be performed according to different test scenarios (see section [Audio Test Scenarios](#) on p. 4.87.).

Bluetooth Signalling Mode

This section provides detailed information on the measurement and configuration menus defined in function group *Bluetooth Signalling*. It is organized like a typical measurement session including the following stages:

- Connection to a device under test (*Connection Control – Signalling*),
- Overview of measurements (*Overview*),
- Measurement menus (*Power, Modulation, Receiver Quality*): Performing measurements, acquiring measurement results, specific measurement configurations,
- Global configurations and general settings (*Connection Control, Group Configuration*).

The most important menus of the function group *Bluetooth Signalling* are shown in an overview at the end of Chapter 3.

Connection Setup (Connection Control – Signalling)

The popup menu *Connection Control* controls the signalling procedures (connection setup and release, services, signalling parameters) and determines the input connector and output connector with the external attenuation values, the reference frequency, RF input path and trigger settings.

Signalling measurements are performed with a connection to the DUT via radio link (test mode, signalling state *Test Mode*), so the first tabs for setting up the connection (*Connection Control – Connection*) appear immediately after selection of the function group *Bluetooth Signalling* in the *Menu Select* menu. Alternatively, pressing the *Connect. Control* softkey at the top right in every measurement menu can also activate the *Connection Control* menu; the individual tabs can be accessed via the hotkey bar at the lower edge of the screen. Pressing the *Escape* key closes the *Connection Control* menu and activates one of the measurement menus.

In the following the first three tabs *Connection Control – Connection* displayed immediately after activation of the function group are described. A description of the remaining tab of the *Connection Control* menu is relegated to the end of this chapter (see section [Connection Control](#) on page 4.92).

The term “signalling” refers to all procedures that are required for connection setup and release and for control of a connection in the radio network. A distinction is made between different signalling states; see [Table 4-3 below](#).

A number of control commands which can be initiated from the R&S® CMU switch between these states. In addition, transitions between the states may occur accidentally (e.g. *Connection failed*; in Fig. 4-1, processes of this type are indicated by dashed lines). The signalling states are explained in more detail in the following sections.

A lot of applications within the function group *Bluetooth Signalling* are only possible or useful in a particular signalling state (for example, an Inquiry can be attempted in the Standby state only, see [Fig. 4-40 below](#)). Accordingly, the appearance of the *Connection Control* menu changes depending on the signalling state.

Table 4-3 Short description of R&S® CMU signalling states

Signalling State	Description	Measurements possible	See page
Standby	The R&S® CMU transmits no signal	–	4.14
Inquiry	The R&S® CMU transmits an inquiry signal to detect Bluetooth devices within its domain. A list of all connectable devices is compiled during this phase, and the R&S® CMU remembers information about the devices.	–	4.16

Signalling State	Description	Measurements possible	See page
Paging	The R&S® CMU transmits a signal to synchronize and try to connect to a known Bluetooth device. From this state, either the <i>Test Mode</i> or the <i>Connected</i> state can be reached.	–	4.17
Connected	An ACL (Asynchronous Connection-Less link) connection has been established. The R&S® CMU acts as a master in the <i>Active</i> state and can command the DUT to one of the special modes (submodes) <i>Hold</i> , <i>Sniff</i> , <i>Park</i> , <i>Audio</i> , but also to its internal <i>Test Mode</i> .	TX measurements on NULL packets returned by the DUT	4.90
Test Mode	An ACL connection to the Bluetooth device under test has been established. The R&S® CMU acts as a Bluetooth master and the DUT has been commanded into its internal test mode. Note: Before attempting a connection to the <i>Test Mode</i> , the internal test mode of the DUT must be locally enabled according to the instructions of the Bluetooth standard.	All TX and RX measurements	4.92
Hold	An ACL connection to the DUT has been established and the DUT is in its <i>Hold</i> state.	Power consumption of the DUT (locally)	4.97
Sniff	An ACL connection to the DUT has been established and the DUT is in its <i>Sniff</i> state.	Power consumption of the DUT (locally)	4.96
Park	An ACL connection to the DUT has been established and the DUT is in its <i>Park</i> state.	Power consumption of the DUT (locally)	4.98
Audio	The R&S® CMU has established an SCO (Synchronous Connection-Oriented) link on top of the ACL connection.	Audio meas. according to different scenarios and TX measurements on SCO packets returned by the DUT	4.100

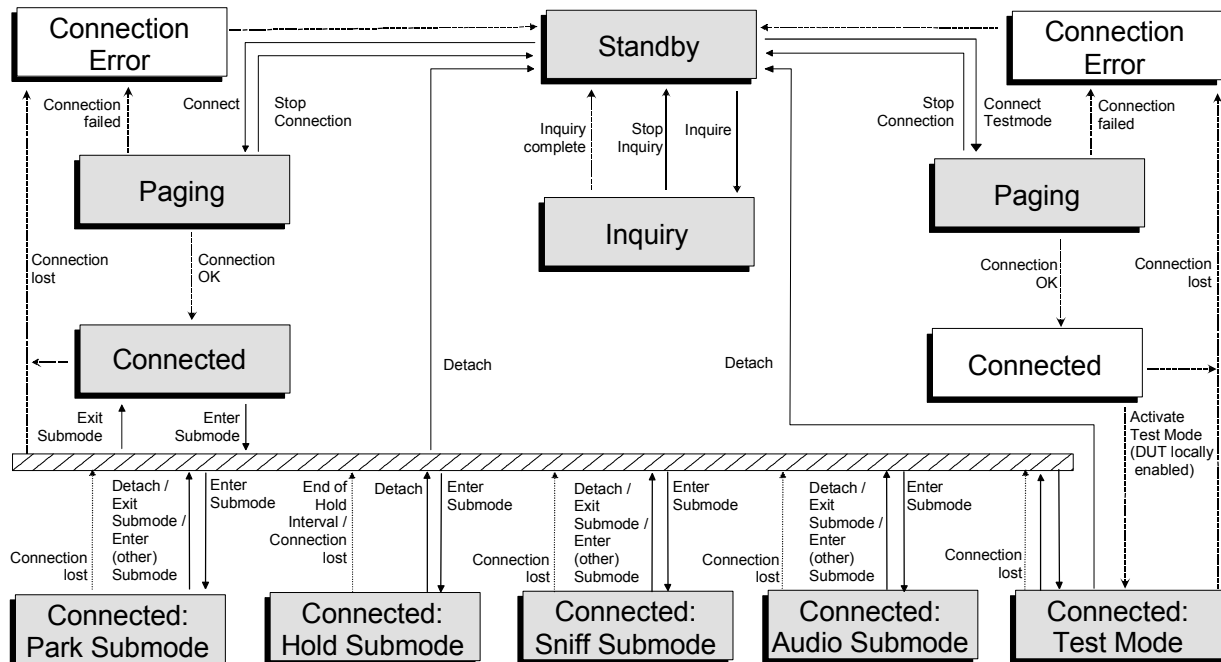

Fig. 4-40 Bluetooth signalling state machine

Corresponding to the different signalling states, different versions of the *Connection* menu are displayed. When a signalling state is reached, the corresponding menu is opened automatically (exceptions: see *Connect. Control Guidance* parameter in section [Display Control \(Connection Control – Misc\)](#) on p. 4.122.).

Connection Control: Standby State

The *Connection (Standby)* tab provides information on:

- The master and slave signal parameters
- The paging mode
- Status and result of the wide-band peak-power measurement (Power)
- Besides, it activates an inquiry or a connection to a particular Bluetooth device.

The *Connection (Standby)* tab is opened when the function group *Bluetooth Signalling* is selected, or if a connection is dropped (*Stop connection* softkey in the *Paging* state or *Detach* softkey in the *Test Mode* state). It is replaced by the *Connection (Inquiry)* menu while the R&S® CMU searches for the Bluetooth devices within its range or by the *Connection (Paging)* menu when it attempts a connection.

In the standby state, the R&S® CMU does not transmit anything to a potential DUT. All signalling is off. Prior to an inquiry, the Bluetooth devices that are within range are not known by the R&S® CMU. A default device or a device with a known *BD_Address* (Bluetooth Device Address) can be connected to (this will be the only device shown within the *Device to page* pull down list).

When an inquiry is finished, a list of potential DUTs (devices that are within the R&S® CMU domain) is compiled and the R&S® CMU remembers information about the DUTs, e.g. the *Page Scan Repetition Mode* or the clock offset. A device to connect to can be selected from the *Device to page* pull down list containing the default device to page and all devices found during inquiry. The R&S® CMU uses the information obtained from the DUTs to optimize the connection setup; in particular it overwrites the *Page Scan Repetition Mode* setting (see p. 4.104).

Note: *It is not necessary that an inquiry be made if a device's BD_Address is known. Connections without previous inquiry can still be very fast, provided that the Page Scan Repetition Mode in the MMI matches the DUT's setting and the DUT's page scan is optimally configured.*

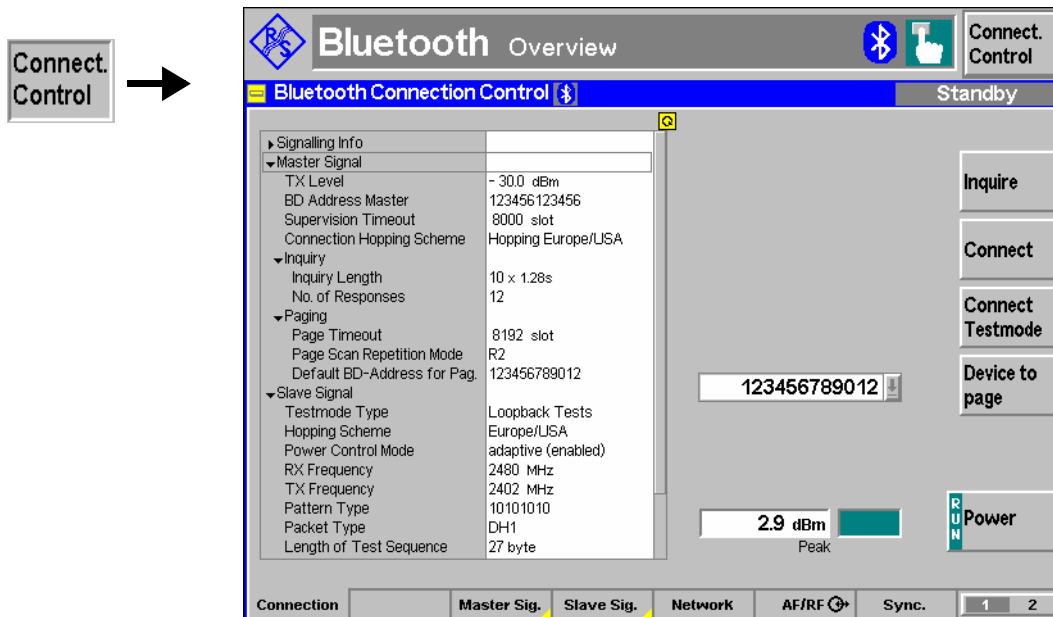

Fig. 4-41 Connection Control – Connection (Standby)

Signalling Info The table *Signalling Info* is to display signalling information retrieved from the DUT.

Remote control SENSE: SINFO...?

Master Signal The table *Master Signal* indicates important signalling parameters that the R&S® CMU (acting as a Bluetooth master) uses to inquire and page Bluetooth slaves in its range. These parameters are set in the *Master Sig.* tab and explained in more detail there (see section [Signal of the R&S CMU \(Connection Control – Master Sig.\)](#) on p. 4.102.).

Remote control `CONFigure:NETWork:MSIGNalling...?`

Slave Signal The table *Slave Signal* indicates parameters that control the behavior of the DUT (acting as a Bluetooth slave) while it is in its test mode. These parameters are set in the *Slave Sig.* tab and explained in more detail there (see section [Behavior of the DUT \(Connection Control – Slave Sig.\)](#) on p. 4.102.).

Remote control `CONFigure:SSIGNal...?`
`PROCEDURE:SSIGNal...?`

Inquire

The *Inquire* softkey is used to search for all devices that are in the R&S® CMU's domain. This will switch the menu to the *Inquiry* state.

Remote control `PROCEDURE:SIGNalling:ACTion INquiry`

Connect

The *Connect* softkey is used to set up an ACL connection to a DUT using the address selected in the *Device to page* editor.

This will switch the menu to the *Paging* and then to the *Connected* state from where it can be placed to either one of the special substates (*Hold, Sniff, Park, Audio*) or the *Test Mode* state.

Remote control `PROCEDURE:SIGNalling:ACTion PAGE`

Connect Testmode

The *Connect Testmode* softkey is used to connect to a DUT using the address selected in the *Device to page* editor in order to force it into its internal test mode.

This will switch the menu to the *Paging* and then to the *Test Mode* state.

Remote control `PROCEDURE:SIGNalling:ACTion TEST`

Device to Page

The *Device to Page* softkey activates a pull-down list to select a device that the R&S® CMU can connect to.

Prior to an inquiry the list will only contain a default device address which can be set in the paging parameter configuration menu.

Remote control `FETCH:SIGNalling:PTARGETS?`
`CONFigure:SIGNalling:PTARGET <Target>`

Power

The *Power* softkey controls the wide-band power measurement and indicates its status (*RUN* | *HLT* | *OFF*).

The status can be changed after softkey selection (pressing once) by means of the *ON/OFF* key or the *CONT/HALT* key. In the associated fields, the peak power of the received signal is indicated as an absolute numerical value and relative to a typical Bluetooth power scale (analog bar). The analog bar views the RF input power range between –30 dBm and +10 dBm.

The wideband power measurement is performed at the RF Frontend of the CMU and yields the peak power of the input signal inside a wide frequency range. The result of the wideband power measurement is usually slightly different from the result of the *Power* measurement which is obtained with different filter characteristics. The main purpose of the wideband power measurement is to indicate whether an input signal is available and whether it is advisable to change the *Max Level* settings.

Remote control

```
INITiate:WPOWer
FETCh:WPOWer:STATus?
READ[:SCALar]:WPOWer?
FETCh[:SCALar]:WPOWer?
SAMPle[:SCALar]:WPOWer?
```

Connection Control: Inquiry State

The *Connection (Inquiry)* tab provides information on:

- The master and slave signal parameters
- The paging mode
- Status and result of the wide-band peak-power measurement (*Power*)
- Besides, it contains a softkey (*Stop Inquiry*) that stops the inquiry and leads back to the *Connection (Standby)* tab.

The *Connection (Inquiry)* tab is opened when an inquiry is attempted from the *Standby* state. The R&S® CMU returns back to the *Connection (Standby)* tab after the inquiry is completed or deliberately stopped (*Stop Inquiry*).

Within the *Inquiry* state, the R&S® CMU continuously transmits inquiry packets. The length of the inquiry period (*Inquiry Length*) and all other inquiry parameters can be set in the *Master Signal* tab, see section [Signal of the R&S CMU \(Connection Control – Master Sig.\)](#) on p. 4.102. All devices that are within range will acknowledge this inquiry and inform the R&S® CMU that they are within range. The R&S® CMU will create a list of all devices that responded. The inquiry may be stopped at any point in time.

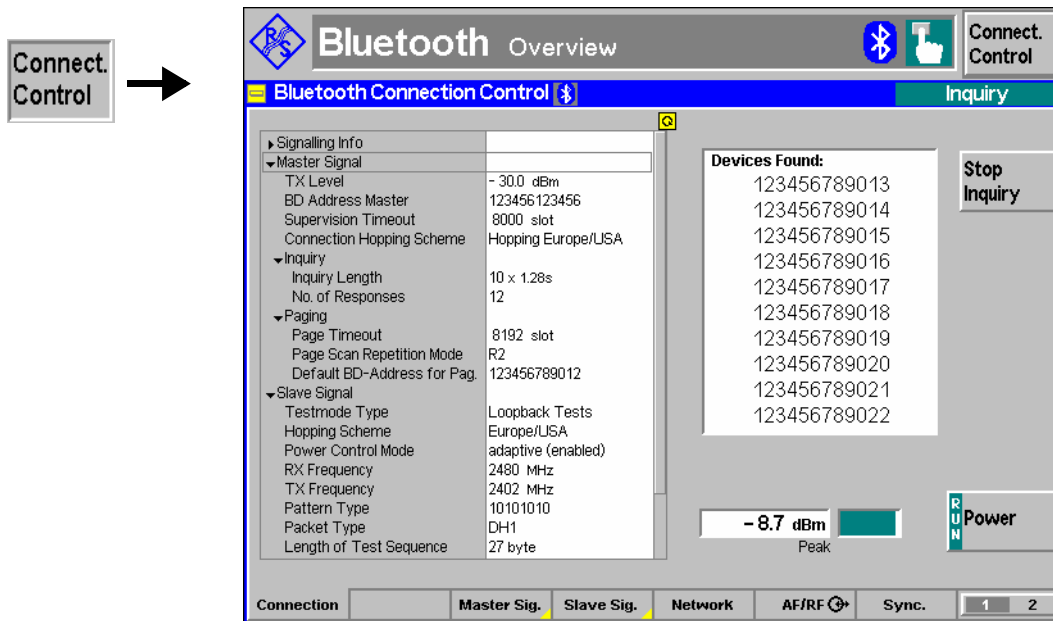

Fig. 4-42 Connection Control – Connection (Inquiry)

The info table in the left half of the menu and the *Power* softkey is described in section [Connection Control: Standby State](#) on page 4.14.

Devices found The *Devices found* table lists the BD_Addresses of all Bluetooth devices that responded to the inquiry. The entries are written to the *Device to page* pull-down list from where a particular device can be selected once the R&S® CMU has returned back to the *Standby* state (see section [Connection Control: Standby State](#) on page 4.14.).

Remote control `FETCh:SIGNalling:PTARgets?`



The *Stop Inquiry* softkey stops the inquiry phase. This will return the CMU to the *Standby* state.

The inquiry is also stopped after the *Inquiry Length* which can be set in the *Master Signal* tab, see section *Signal of the R&S CMU (Connection Control – Master Sig.)* on p. 4.102.

Remote control `PROCedure:SIGNalling:ACTion SINquiry`

Connection Control: Paging State

The *Connection (Paging)* tab provides information on

- The master and slave signal parameters
- The paging mode
- Status and result of the wide-band peak-power measurement (*Power*)
- Besides, it allows to stop the connection setup to a particular Bluetooth device (*Stop Connect*).

The *Connection (Paging)* tab is opened while the R&S® CMU (acting as a Bluetooth master) attempts a connection to a particular Bluetooth device (*Connect* or *Connect Testmode* softkeys in the *Standby* state). It is replaced by the *Connection (Test Mode)* or *Connection (Connected)* tab as soon as the

connection is OK¹ or by the *Connection (Standby)* tab when the connection is deliberately stopped or when a connection error occurred (see Fig. 4-40 on page 4.13).

In the *Paging* state, the R&S® CMU attempts to connect to a selected device. Two types of connections are provided:

- If a test mode connection is set up (softkey *Connect Testmode* in the *Connection (Standby)* tab), the R&S® CMU establishes an ACL connection, acting as a Bluetooth master, and immediately provides the necessary signalling to place the DUT into its internal test mode.
- If a normal ACL connection is set up (softkey *Connect* in the *Connection (Standby)* tab), the R&S® CMU establishes an ACL connection, acting as a Bluetooth master in the *Active* state.

Any type of connection will be made using the parameters specified in the *Master Signal* tab, see section *Signal of the R&S CMU (Connection Control – Master Sig.)* on p. 4.102.

Note: Before attempting a test mode connection, the internal test mode of the DUT must be locally enabled according to the instructions of the Bluetooth standard. Otherwise, the connection will fail, and the R&S® CMU will display the message Device is not enabled for test mode – Cancel/Retry. The connection process can be continued after enabling the device and pressing Retry.

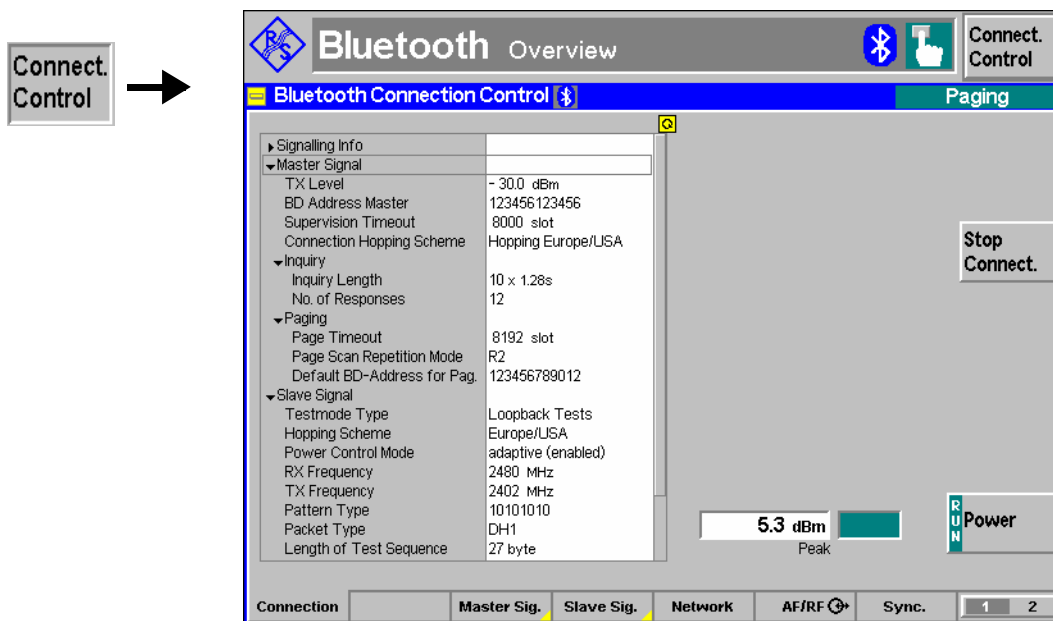

Fig. 4-43 Connection Control – Connection (Paging)

The info table in the left half of the menu and the *Power* softkey is described in section *Connection Control: Standby State* on page 4.14.

Stop Connect

The *Stop Connect.* softkey stops the connection phase. This will return the R&S® CMU to the *Standby* state.

Remote control PROCedure:SIGNalling:ACTion SCONnect

¹ By default, the R&S® CMU skips the *Connection (Test Mode)* menu and opens the selected measurement menu; see section Display Control (Connection Control – Misc) on p. 4.122.

Overview of the Function Group

The *Overview* menu displays the essential results of the *Power*, *Modulation* and *Receiver Quality* measurements and provides access to the most important measurement settings. In particular, it configures the signal transmitted by the R&S® CMU (*Master Sig.*) and controls the behavior of the Bluetooth DUT in test mode (*Slave Sig.*).

- The measurement control softkey *Modulation/Power* below the *Connect. Control* softkey changes to *RX Quality*, depending on the application selected. This softkey controls the measurement, indicates its status (*RUN* | *HALT* | *OFF*), and opens the configuration menu *Overview Configuration*. The hotkeys associated with the measurement control softkey define the scope of the measurement.
- The other softkeys on the right side are combined with various hotkeys (e.g. the hotkey *Measure Mode* belongs to the softkey *Analyzer Settings*). The softkey/hotkey combinations provide test settings and switch between different measurements.

Types of settings The purpose of the *Overview* menu is to provide quick access to the most common *Modulation*, *Power* and *Receiver Quality* measurements and to present the basic measurement results at a glance. The two measurement applications *Modulation/Power* and *Receiver Quality* can be selected with the *Application* softkey. The remaining softkeys/hotkey combinations provide two different types of settings:

- General settings are valid for all Bluetooth applications in *Signalling* mode. Changing general settings in any application will have an impact on all measurements and applications of the function group. All general settings are also provided in the *Connection Control* menu (see p. 4.87.). Examples of general settings are the RF input level and trigger settings (softkey *Analyzer Level*) and the configuration of the RF generator (softkey *Master Sig.*).
- Specific settings are relevant for one application only, or they can be set independently for several applications. Changing specific settings in an application will not affect the other measurements and applications of the function group. No specific settings are provided in the *Connection Control* menu (see p. 4.87.). Examples of specific settings are the *Repetition* mode (to be set independently for all applications) and *Frequency Deviation Algorithm* (relevant for the *Modulation* application only).

Measurement results The output fields in the left half of the *Overview* menu show the current measurement results. The results depend on the application selected. They are described in detail in section [Measurement Results](#) on p. 4.23 f.

The results displayed in the *Overview* menu represent only a small fraction of the power, modulation and receiver quality results that the R&S® CMU is able to acquire. A comprehensive set of test results is displayed in the *Power*, *Modulation* and *Receiver Quality* measurement menus; see sections [Power Measurements](#) on p. 4.28., [Modulation Measurements](#) on p. 4.44., and [Receiver Quality Measurements](#) on p. 4.73. In particular, the *Power* and *Modulation* menus show many quantities as functions of time.

Note: *Several parameters can be set independently for the Modulation/Power and for the Receiver Quality measurement. As long as the Receiver Quality measurement is running (measurement status RUN or HLT), the corresponding settings are valid for all Overview measurements. In particular, the R&S® CMU uses a loopback test mode and the Master Sig. and Slave Sig. settings for Receiver Quality tests. The Modulation/Power settings come into effect as soon as the Receiver Quality measurement is switched OFF.*

The *Overview* menu is opened from the *Menu Select* menu (with associated key at the front of the instrument) and after closing the configuration menu *Connection Control - Connection* (using the *Escape* key or automatically after establishing a connection). From the *Overview* menu, the remaining measurement menus of the function group (*Power*, *Modulation*, *Receiver Quality*) are accessible via hotkeys.

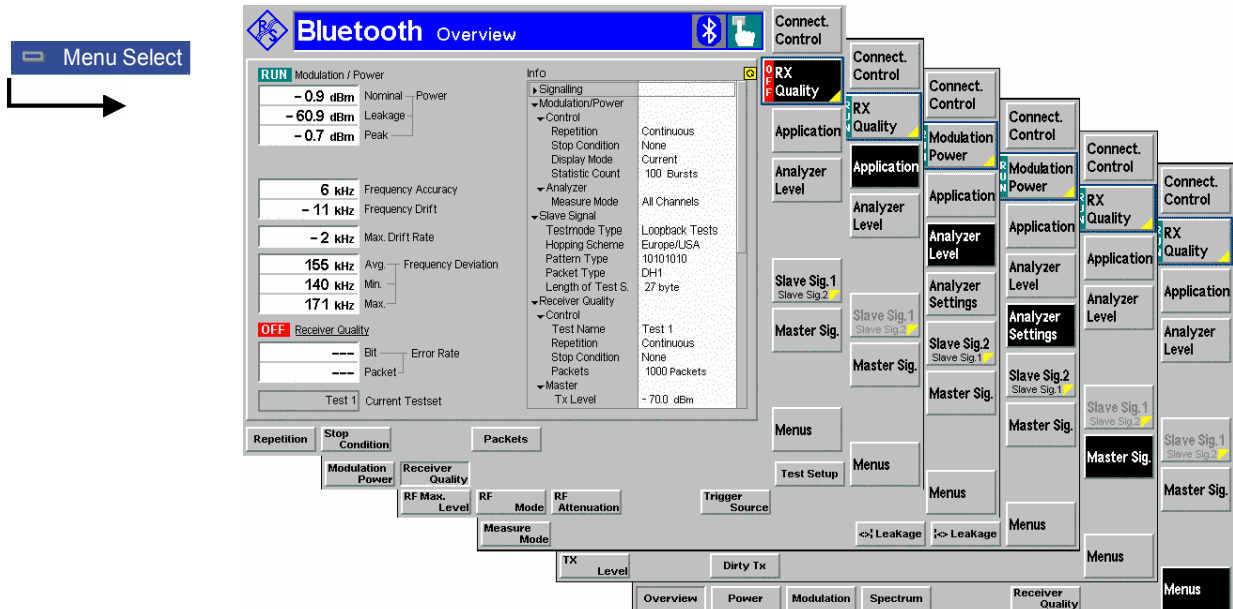

Fig. 4-44 Overview of measurements – Overview menu

Test Settings

The settings for the *Overview* menu are accessible via softkey/hotkey combinations. If a softkey (located in the softkey bar on the right side of the menu) is selected and an associated hotkey (displayed across the bottom of the menu) is pressed, a popup window indicating the current setting and enabling an entry will appear.

Example:

Slave Sig.

The *Slave Sig.* softkey displays a hotkey bar including the hotkey labeled *Testmode Type*.

Testmode Type

The *Testmode Type* hotkey opens the input window *Testmode Type*.

Testmode Type
TX Tests

Input windows indicate the current parameter value (in this case: the current test mode of the DUT) or a list of the possible settings. Parameters are changed by

- Overwriting/incrementing numerical values (for numerical parameters)
- Selecting from the list of parameters (for select parameters)

Measurement Control

Each *Overview* application is controlled by means of the measurement control softkey below the *Connect. Control* softkey and the associated hotkeys.

Modulation Power

The *Modulation Power* softkey (which changes to *RX Quality*, depending on the application selected) controls the measurement application and indicates its status (*RUN* | *HLT* | *OFF*). This status can be changed after softkey selection (pressing once) by means of the *ON/OFF* key or the *CONT/HALT* key. The status can be set independently for both applications.

The applications *Modulation/Power* and *Receiver Quality* can be run in parallel, so the results for both applications are displayed simultaneously. Switchover between these two applications does not change the course of the measurement.

Note 1: *The combined Modulation/Power measurement is independent of the separate Power and Modulation measurements: It can be run or stopped regardless of the current measurement state of the separate measurements. It corresponds to the POWER:MPR command group in remote control.*

Note 2: *The combined Modulation/Power measurement uses the Frequency Deviation Algorithm and the Filter Bandwidth settings defined in the Modulation Configuration menu (see section [Measurement Control \(Modulation Configuration – Control\)](#) on p. 4.51.).*

Remote control

```
INITiate:POWer:MPR etc.
FETCh:POWer:MPR:STATus?
INITiate:RXQuality:BER etc.
FETCh:RXQuality:BER?
```

Measurement configuration

The configuration settings for the *Modulation/Power* and *Receiver Quality* measurements are directly accessible from the *Overview* menu. They are collected in a common configuration menu that is opened on pressing the measurement control softkey a second time.

Selecting the Application

Appli- cation

The *Application* softkey selects the measurement application. The measurement control softkey (second softkey below *Connect. Control*) indicates the current application. Some of the hotkeys associated with the different softkeys, the *Setup* table, and the results in the *Analyzer/Generator* menu also vary as a function of the application. The corresponding measurement results are explained in section [Measurement Results](#) on p. 4.23.

Modulation Power

The *Modulation Power* hotkey selects the combined measurement of essential power and modulation results excluding the measurement curves.

Remote control

The *Modulation/Power* application is selected by the keyword *MPR* in the 3rd level of the *POWER* commands, e.g. `CONFigure:POWer:MPR...`

RX Quality

The *RX Quality* hotkey selects the measurement of essential receiver quality results.

Note: When a Receiver Quality measurement is initiated the settings of the current test setup are used; see section [Measurement Configurations \(Overview Configuration\)](#) on p. 4.24.

Remote control

The *Receiver Quality* application is selected by the keyword `BER` in the 3rd level of the `RXQuality` commands, e.g. `CONFigure:RXQuality:BER...`

Application-Specific Settings

As outlined in section [Overview of the Function Group on p. 4.19.](#), some of the hotkey/softkey combinations in the *Overview* menu change when selecting a different application. However, most *Overview* settings are coupled to the corresponding settings in the *Power*, *Modulation* and *Receiver Quality* menus. Changes made in the *Overview* menu overwrite these *Power*, *Modulation* and *Receiver Quality* settings and vice versa. Exceptions are listed below.

Independent Settings

The scope of the *Power Modulation* measurement and its measurement mode is not coupled to the corresponding settings in the *Power* or in the *Modulation* measurement. The following hotkeys do not overwrite the settings in any other measurement menus:

Modulation Power – Repetition
Modulation Power – Stop Condition
Modulation Power – Display Mode
Modulation Power – Statistic Count
Analyzer Settings – Measure Mode
Analyzer Settings – Measured Channel
Analyzer Settings – Measured Frequency

Remote control

In remote control, the independent settings are accessed by the following `POWER:MPR` configuration commands:

```
CONFigure:POWer:MPR:CONTRol:STATistics <Statistic_Count>
CONFigure:POWer:MPR:CONTRol:REPetition
    <Repetition>, <Stop_Cond>, <Step_Mode>
CONFigure:POWer:MPR:MMODE <Mode>
CONFigure:POWer:MPR:FREQuency <Meas_Frequency>
CONFigure:POWer:MPR:FREQuency:UNIT <Unit>
```

The display mode has no direct equivalent in remote control. The results of the four display modes are always returned together.

Description of settings

- The settings to be made in the *Modulation/Power* application are described in sections [Test Settings](#) on p. 4.29. and on p. 4.46.
- The settings to be made in the *Receiver Quality* application are described in section [Test Settings](#) on p. 4.76..

Setup table

The *Setup* table in the right half of the *Overview* menu contains a comprehensive list of features supported by the DUT. This information is collected during the connection phase; it is also indicated in the *Connection (Test Mode)* menu. For a detailed description see page [4.92](#).

After the first start of the R&S® CMU, the default values for all *Signalling Info*

parameters (listed in the remote control command description in Chapter 6) are displayed. For some parameters (e.g. *Version*, *Class of Dev.* etc.) there are no default values, so the R&S® CMU indicates invalid results ("---"). After a *Detach* from a DUT the info about that DUT is still displayed unless a different "device to page" is selected by the user.

The table also gives an overview of the measurement settings belonging to the different applications. The roll-key scrolls and expands the *Setup* table.

Measurement Results

All results of the *Overview* menu display in the left half of the menu:

RUN Modulation / Power	
- 0.9 dBm	Nominal Power
- 60.9 dBm	Leakage
- 0.7 dBm	Peak
6 kHz	Frequency Accuracy
- 11 kHz	Frequency Drift
- 2 kHz	Max. Drift Rate
155 kHz	Avg. Frequency Deviation
140 kHz	Min.
171 kHz	Max.

The results for the *Modulation/Power* application are displayed in the upper part of the menu. The results appear in several output fields. A header line indicates the name of the application and its measurement status. The name of the selected application is underlined.

All results are measured according to the current test settings made in via softkey/hotkey combinations or in the configuration menu (see section [Measurement Configurations \(Overview Configuration\)](#) on p. 4.24.). In particular, the values represent *Current*, *Average*, *Maximum* or *Minimum* results, depending on the *Display Mode* setting in the *Control* tab of the configuration menu.

Results

The results for the *Modulation/Power* application are explained in the following sections:

- The power results Nominal Power, Leakage Power and Peak Power are described in section [Measurement Results](#) on p. 4.35.
- The modulation results below are described in section [Measurement Results](#) on p. 4.47.

Remote control

```
READ[:SCALar]:POWER:MPR?
FETCh[:SCALar]:POWER:MPR?
```

Limit Check

A red output field and an arrow pointing upwards or downwards indicates that the measurement exceeds the upper or lower limit set in the *Limits* tab of the configuration menu; see section [Limit Values \(Overview Configuration – Limits\)](#) on p. 4.27.

Remote control

```
CALCulate[:SCALar]:POWER:MPR:MATCHing:LIMit?
```

RUN	Receiver Quality		
	45.103 %	Bit	Error Rate
	31.114 %	Packet	
	Test 1	Current Testset	

The results for the *Receiver Quality* application are displayed in the lower part of the menu. The results appear in several output fields. A header line indicates the name of the application and its measurement status. The name of the selected application is underlined.

Results

The results for the *Receiver Quality* application are explained in section [Measurement Results](#) on p. 4.79.

All results are measured according to the current test settings made in via softkey/hotkey combinations or in the configuration menu.

Note: *When a Receiver Quality measurement is initiated the settings of the current test setup are used; see section [Measurement Configurations \(Overview Configuration\)](#) on p. 4.24.*

Remote control

```
READ[:SCALar]:RXQuality:BER?
FETCh[:SCALar]:RXQuality:BER?
```

Limit Check

A red output field and an arrow pointing upwards or downwards indicates that the measurement exceeds the upper or lower limit set in the *Limits* tab of the configuration menu; see section [Limit Values \(Overview Configuration – Limits\)](#) on p. 4.27..

Remote control

```
CALCulate[:SCALar]:RXQuality:BER:MATCHing:LIMit?
```

Measurement Configurations (Overview Configuration)

The popup menu *Overview Configuration* contains five tabs which determine the parameters of the *Modulation/Power* and the *Receiver Quality* measurement including the error tolerances.

The popup menu *Overview Configuration* is activated by pressing the measurement control softkey in the *Overview* menu a second time. It is possible to change between the tabs by pressing the associated hotkeys.

Measurement Control (Overview Configuration – Control)

The *Control* tab controls the measurement by determining:

- The *Repetition mode*, *Stop Condition*, *Display Mode* and *Statistic Count* for the *Modulation/Power* application.
- The *Test Name*, *Repetition mode*, *Stop Condition* and *Number of Packets* to be sent for each *Receiver Quality* setup.

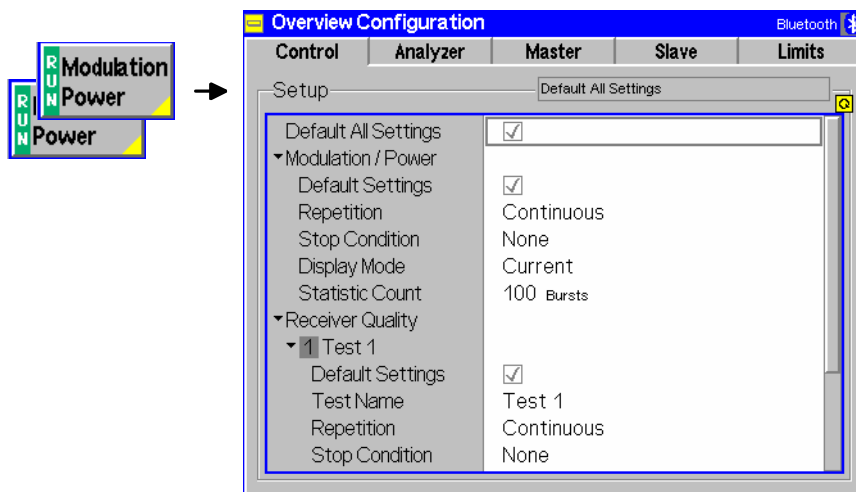

Fig. 4-45 Overview Configuration – Control

Default Settings The *Default All Settings* switch assigns default values to all settings in the *Control* tab (the default values are quoted in the command description in chapter 6 of this manual). Besides, independent default switches are provided for the *Modulation/Power* application and the different *Receiver Quality* test setups.

Remote Control `DEfault:POWer:MPR:CONTRol ON | OFF`
`DEfault:RXQuality:BER:TSEtup<nr> ON | OFF`

Modulation/Power The *Modulation/Power* settings define the scope of the *Modulation/Power* application. The meaning of the settings is as explained in section [Measurement Control \(Power Configuration – Control\)](#) on p. 4.38.

Note: *The scope of the Modulation/Power measurement is not coupled to the corresponding settings in the Power or in the Modulation measurement. The parameters in the Control tab do not overwrite the settings in any other measurement menus.*

Remote control

```
CONfигure:POWer:MPR:CONTRol:STATistics <Statistic_Count>
CONfигure:POWer:MPR:CONTRol:REPetition
    <Repetition>, <Stop_Cond>, <Step_Mode>
```

The display mode has no direct equivalent in remote control. The results of the four display modes are always returned together.

Receiver Quality The *Receiver Quality* settings define the scope of the *Receiver Quality* application in up to 5 different test setups. The meaning of the settings is as explained in section [Measurement Control \(Receiver Quality Configuration – Control\)](#) on p. 4.82.

Note: *The Receiver Quality settings overwrite the corresponding settings in the Receiver Quality Configuration menu and vice versa.*

Analyzer Settings (Overview Configuration – Analyzer)

The *Analyzer* tab defines the R&S® CMU analyzer settings for the *Modulation/Power* application. It sets:

- The number of channels to be measured (*Measure Mode*).
- The channel numbers for the simultaneous (*Simult. Meas.*) and single (*Single Meas.*) measurement mode

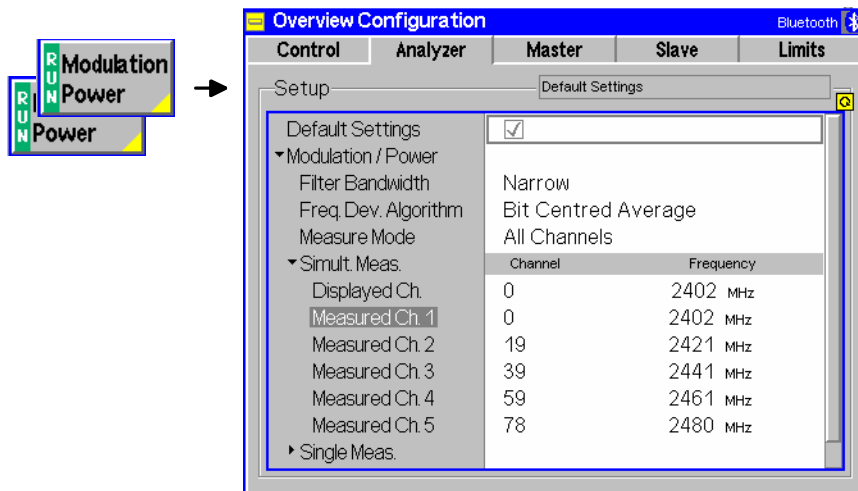

Fig. 4-46 Overview Configuration – Analyzer

Default Settings The *Default All Settings* switch assigns default values to all settings in the *Analyzer* tab (the default values are quoted in the command description in chapter 6 of this manual).

Remote Control –

Modulation/ Power The *Modulation/Power* settings define the analyzer settings for the *Modulation/Power* application. The meaning of the settings is as explained in section *Analyzer Settings (Power Configuration – Analyzer)* on p. 4.40..

Note: *The analyzer settings for the Power Modulation measurement are not coupled to the corresponding settings in the Power or in the Modulation measurement. The parameters in the Analyzer tab do not overwrite the settings in any other measurement menus.*

Remote control

```

CONFIGure:POWer:MPR:MMODE <Mode>
CONFIGure:POWer:MPR:FREQuency <Meas_Frequency>
CONFIGure:POWer:MPR:FREQuency:UNIT <Unit>
    
```

BER Levels (Overview Configuration – Master)

The *Master* tab defines the RF generator level of the R&S® CMU at which the *Receiver Quality* measurement is performed. The settings are identical to the *BER* settings in the *Master* tab of the *Receiver Quality Configuration* menu; see section *BER Levels (Receiver Quality Configuration – Master)* on p. 4.84.

BER Loopback Settings (Overview Configuration – Slave)

The *Slave* tab defines the properties of the loopback test mode that is used for the *Receiver Quality* measurement. The settings are identical to the *BER* settings in the *Slave* tab of the *Receiver Quality Configuration* menu; see section *BER Loopback Settings (Receiver Quality Configuration – Slave)* on p. 4.85..

Limit Values (Overview Configuration – Limits)

The *Limits* tab defines tolerances for all measured results in the *Modulation/Power* and the *Receiver Quality* application.

Note: All Limit settings overwrite the corresponding settings in the Power, Modulation and Receiver Quality Configuration menu and vice versa. In remote control, the commands of the *POWer:TIME*, *MODulation:DEVIation* and *RXQuality:BER:TSETup<nr>* subsystems must be used to set limit values for the Overview measurement.

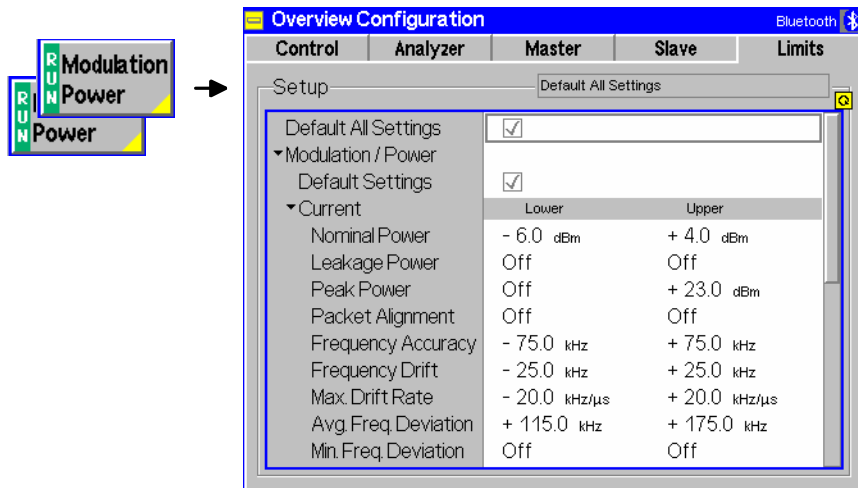

Fig. 4-1 Overview Configuration – Limits

Default Settings The *Default All Settings* switch assigns default values to all settings in the *Limits* tab (the default values are quoted in the command description in chapter 6 of this manual). Besides, independent default switches are provided for the *Modulation/Power* application and the different *Receiver Quality* test setups.

Remote Control `Default:POWer:TIME:LIMit ON | OFF`
`Default:MODulation:DEVIation:LIMit ON | OFF`
`Default:RXQuality:BER:TSETup<nr>:LIMit ON | OFF`

Modulation/Power The *Modulation/Power* settings define limits for the *Modulation/Power* application. The settings are explained in sections [Limit Values \(Power Configuration – Limits\)](#) on p. 4.42. and [Limit Values \(Modulation Configuration – Limits\)](#) on p. 4.53.

Remote control
`CONFigure:POWer:TIME...:LIMIT...`
`CONFigure:MODulation:DEVIation...:LIMIT...`

Receiver Quality The *Receiver Quality* settings define limits for the *Receiver Quality* application in up to 5 different test setups. The meaning of the settings is as explained in section

[Limit Values \(Receiver Quality Configuration – Limits\)](#) on p. 4.86.

Power Measurements

The menu group *Power* comprises the functions for measuring the power of the received RF burst signal as a function of time. The measurement results are displayed in the graphical measurement menu *Power*, with the popup menu *Power Configuration* being used for configuration of the measurements.

The *Power* measurement group determines the transmitter output power of the *Bluetooth* DUT and verifies whether the peak and average RF-output power and the emissions inside the operating frequency range are within the limits. A simple application example for Power measurements is given in chapter 2, *Getting Started*.

The *Power* measurement is performed in the time domain (zero span mode) and on consecutive packets with a length of 1, 3, or 5 timeslots (one timeslot comprising 625 bits corresponding to a transmission time of 625 μ s). The R&S® CMU takes measurement curves over the whole display range and calculates the *Peak Power*, *Nominal Power*, *Leakage Power* and the timing error of the packet (*Packet Timing*).

In addition, a limit check is performed on all the measured quantities.

To obtain valid power results, the following conditions must be fulfilled:

- A trigger is provided.
- The preamble of the measured Bluetooth signal is correct (i.e. either 0101 or 1010).
- The R&S® CMU correlates to the expected access code in order to detect bit zero.
- The power in the center of the burst is above a threshold of approx. –35 dB below full scale.
- The power in the preamble and at the end of the burst is above 50% of the power in the center of the burst.
- The power ramp down center is detected in the window between –10 μ s and +35 μ s after the last bit in the burst.

Measurement Menu (Power)

The graphical measurement menu *Power* shows the results of the burst analysis (power vs. time measurement).

- The measurement control softkey *Output Power* controls the power vs. time measurement, indicates its status (*RUN* | *HLT* | *OFF*) and opens the configuration menu *Power Config*.
- The other softkeys to the right of the test diagram are combined with various hotkeys (e.g. the hotkeys *RF Max. Level*, *RF Mode*, and *RF Attenuation* etc. belong to the softkey *Analyzer Level*). The softkey/hotkey combinations provide test settings and switch over between different measurements.

The measurement menu *Power* can be accessed from any other measurement menu of the *Bluetooth Signalling* function group using the *Power* hotkey. It can also be opened from the *Menu Select* menu (with the associated key at the front of the instrument).

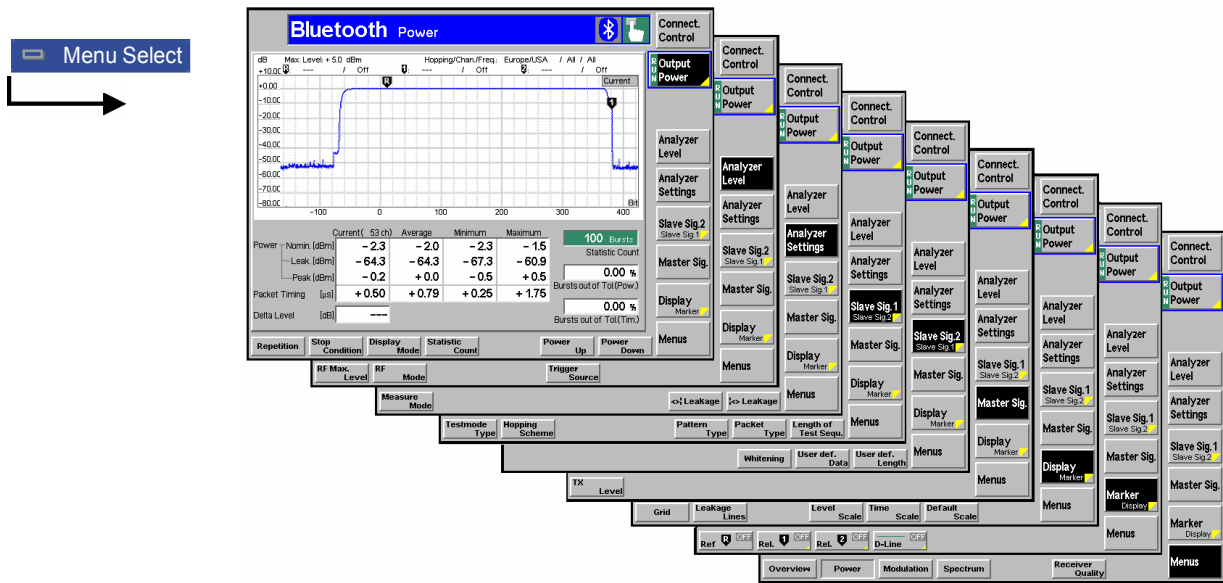

Fig. 4-47 Measurement menu Power

Test Settings

The basic settings for the *Power* measurement are directly accessible from the measurement menu via softkey/hotkey combinations. The entry of values is described in section [Test Settings](#) on p. 4.20. The *Power* menu provides general settings (*Analyzer Level*, *Slave Sig.*, *Master Sig.*) and settings that are specific to the *Power* measurement; see definition in section [Overview of the Function Group](#) on p. 4.19.

Many of the basic settings are also accessible from the *Power Configuration* popup menu. They are explained in more detail in the [Measurement Configurations \(Power Configuration\)](#) section on page 4.38.

Measurement Control

The *Power* measurement is controlled by the measurement control softkey below the *Connect. Control* softkey and the associated hotkeys.



The *Power/Time* softkey controls the power measurement and indicates its status (*RUN | HLT | OFF*). This status can be changed after softkey selection (pressing once) by means of the *ON/OFF* key or the *CONT/HALT* key.

Remote control

```
INITiate:POWER:TIME
ABORT:POWER:TIME
STOP:POWER:TIME
CONTINUE:POWER:TIME
FETCh:POWER:TIME:STATus?
```

Measurement configuration	Pressing the <i>Output Power</i> softkey a second time opens the popup menu <i>Power Configuration</i> (see page 4.38). In addition, the measurement control softkey provides hotkeys to define the scope of the measurement. All these settings are described in more detail in section <i>Measurement Control (Power Configuration – Control)</i> on page 4.38.
Repetition	<p>The hotkey <i>Repetition</i> determines the repetition mode of the measurement (<i>Single Shot</i> or <i>Continuous</i> measurement).</p> <p>Remote control CONFigure:POWer:TIME:CONTRol:REPetition <Repetition>,<StopCond>,<Stepmode></p>
Stop Condition	<p>The <i>Stop Condition</i> hotkey sets a stop condition for the measurement (<i>None</i> or <i>On Limit Failure</i>).</p> <p>Remote control CONFigure:POWer:TIME:CONTRol:REPetition <Repetition>,<StopCond>,<Stepmode></p>
Display Mode	<p>The hotkey <i>Display Mode</i> determines the display mode of the measurement curve.</p> <p>Remote control no display mode set, the four measurement curves are accessible via FETCh:ARRAy:POWer:TIME:CURRent? FETCh:ARRAy:POWer:TIME:MINimum? FETCh:ARRAy:POWer:TIME:MAXimum? FETCh:ARRAy:POWer:TIME:AVERAge? etc.</p>
Statistic Count	<p>The <i>Statistic Count</i> hotkey defines the number of bursts per statistic cycle.</p> <p>Remote control CONFigure:POWer:TIME:CONTRol <Mode>,<1 ... 1000 NONE</p>
Power Up	<p>The <i>Power Up</i> hotkey sends an increase power request to the DUT. This softkey can be pressed repeatedly; the resulting power increase is indicated as <i>Delta Power</i> in the output table in the <i>Power</i> measurement menu.</p> <p>Remote control PROCedure:PCONTRol:STEP UP PROCedure:PCONTRol:STATe? (query power control state of the DUT)</p>
Power Down	<p>The <i>Power Down</i> hotkey sends a decrease power request to the DUT. This softkey can be pressed repeatedly; the resulting power decrease is indicated as <i>Delta Power</i> in the output table in the <i>Power</i> measurement menu.</p> <p>Remote control PROCedure:PCONTRol:STEP DOWN PROCedure:PCONTRol:STATe? (query power control state of the DUT)</p>

General Settings

The settings of the following softkeys are valid for all Bluetooth measurement groups and therefore also available in the *Connection Control* menu.

Analyzer Level

The *Analyzer Level* softkey controls the level in the RF input signal path and provides the trigger settings for the *Power* measurement.

The input level and trigger settings are also provided in the *Trigger* and *Analyzer* tabs of the *Connection Control* menu. For a detailed description see section [Trigger \(Group Configuration – Trigger\)](#) on p. 4.119. and section [Input Path \(Connection Control – Analyzer\)](#) on p. 4.120.

Slave Sig.

The *Slave Sig.* softkey controls the behavior of the DUT (acting as a Bluetooth slave) while it is in its test mode.

The settings are also provided in the *Slave Sig.* tab of the *Connection Control* menu. For a detailed description see section [Behavior of the DUT \(Connection Control – Slave Sig.\)](#) on p. 4.107.

Master Sig.

The *Master Sig.* softkey sets various parameters to configure how the R&S® CMU (acting as a Bluetooth master) performs an inquiry and sets up a connection.

The *Master Sig.* settings are also provided in the *Master Sig.* tab of the *Connection Control* menu. For a detailed description see section [Signal of the R&S CMU \(Connection Control – Master Sig.\)](#) on p. 4.102.

Specific Power Settings

The settings of the following softkeys are specific to *Power* measurements. They are not available in the *Connection Control* menu.

Analyzer Settings

The *Analyzer Settings* softkey determines the RF channels that are being monitored within the measurement. The settings are also provided in the *Power Configuration* menu. For a detailed description see section [Analyzer Settings \(Power Configuration – Analyzer\)](#) on p. 4.40.

Measure Mode

The *Measure Mode* hotkey selects how many channels are to be measured and whether the results are to be kept separate or aggregated.

Remote control

```
CONFigure:POWer:TIME:MMODE ALL | SINGLE | SIMultaneous
```

Measured Channel

The *Measured Channel* hotkey sets the RF channel to be measured if the *Measure Mode* is set to *Single*. The R&S® CMU will monitor only signals on the selected Bluetooth *Measured Channel*. No other channels will be measured and displayed.

When a *Measured Channel* is selected, the *Measured Frequency* is updated to correspond to the selected channel.

Remote control

```
CONFigure:POWer:TIME:MFRequency:UNIT CH
CONFigure:POWer:TIME:MFRequency <Channel>
```

Displayed Channel

The *Displayed Channel* hotkey sets the RF channel to be displayed if the *Measure Mode* is set to *Simultaneous*. More specifically, *Displayed Channel* selects the channel that all scalar results in the output fields below the diagram, including the limit check, belong to. The measurement curve, on the other hand, corresponds to the currently measured channel and is updated each time that another channel is measured; see section [Analyzer Settings \(Power Configuration – Analyzer\)](#) on p. 4.40. and section [Measurement Results](#) on page 4.47.

The scalar measurement results of all five channels are always stored separately until the end of the measurement cycle. In the *HLT* state, it is possible to step through the *Displayed Channels* and compare the five sets of results.

When a *Displayed Channel* is selected, the *Displayed Frequency* is updated to correspond to the selected channel.

The entire channel sequence for the *Simultaneous* mode is set in the configuration menu; see section [Analyzer Settings \(Power Configuration – Analyzer\)](#) on p. 4.40.

Remote control

No command, screen configuration only.

(Pre) Leakage

The *(Pre) Leakage* hotkey selects the *Start* and the *Span* of the leakage pre-area. The leakage pre-area is a time domain before the ramp-up of the burst where the leakage power is measured; see [Fig. 4-49](#) on p. 4.37. The leakage areas can be marked in the diagram; see [Leakage Lines](#) hotkey on p. 4.34.

The start of the pre-leakage area is defined relative to bit 0 of the packet. The leakage area doesn't have to be outside the burst. A possible application is to measure the power at the burst edges, averaged over a variable time interval.

Remote control

-

(Post
Leakage

The (Post) Leakage hotkey selects the Start and the Span of the leakage post-area. The leakage post-area is a time domain after the ramp-down of the burst where the leakage power is measured; see [Fig. 4-49](#) on p. 4.37. The leakage areas can be marked in the diagram; see [Leakage Lines](#) hotkey on p. 4.34.

The start of the post-leakage area is defined relative to the last bit of the packet. The leakage area doesn't have to be outside the burst. A possible application is to measure the power at the burst edges, averaged over a variable time interval.

Remote control

-

Marker
Display

The *Marker/Display* softkey positions up to 3 markers and a D-line in the test diagram and displays their values.

If pressed once again, the selected *Marker/Display* softkey changes to the *Display/Marker* softkey, see below.

Markers are graphical tools for marking points on the measurement curve and for numerical output of measured values. The measurement menu Power provides a reference marker and two further markers which permit to measure spacings (delta marker 1 and 2).

The coordinates of the three markers are indicated in the format Ordinate value (level)/abscissa value (time) in a parameter line above the test diagram. The position of the reference marker is expressed in absolute units (level in dBm and time in bits), the delta marker by absolute or relative values (relative level in dB or time differences from the reference marker).

D-line The D-line (display line) is a horizontal line that can be positioned on the test diagram at will to mark and read out level values.

Ref 

The hotkey *Ref. R* switches the reference marker on or off (use the *ON/OFF* key).

The reference marker is represented by the symbol  in the test diagram. The marker position (abscissa) is defined in the input field *Ref. Marker R*. The marker can be positioned to arbitrary time values. It is switched off in the default setting (*Off*). The marker level is given by the measurement curve at the marker position.

The position of all markers can be varied using the rotary knob.

Remote control

No command, screen configuration only.

Rel 

The *Rel. 1* hotkey switches the delta marker 1 on or off (use the *ON/OFF* key).

The delta marker 1 is represented by the symbol  in the test diagram. The marker position (abscissa) is defined in the input field *Rel. Marker 1*. The marker can be positioned to arbitrary time values. If its position is outside the diagram area it will be invisible and its coordinates will be "- - - / <abscissa_value>". The marker is switched off in the default setting (*Off*). The marker level is given by the measurement curve at the marker position.

The toggle switch *Rel 1 Config* pops up when the hotkey is pressed for the second time. It defines whether the position of delta marker 1 is measured and indicated in absolute units (dBm) or relative to the reference marker.

Remote control

No command, screen configuration only.

Rel 

The *Rel. 2* hotkey switches the delta marker 2 on or off (use the *ON/OFF* key). Functions and remote control are analogous to delta marker 1.

D-Line

The *D-Line* hotkey switches the D-line in the test diagram on or off.

The D-line is a horizontal, colored auxiliary line in the test diagram and is used for marking a level value and for measuring level differences. The level (ordinate) is determined in the input field *D-Line* and indicated on the D-line. The permissible value range is the diagram area, the default setting is Off.

The switch *D-Line Config.* is opened by pressing *D-Line* a second time and determines whether the D-line level is expressed in absolute units (in dBm, setting absolute) or relative to the Max. Level (in dB, setting relative).

Remote control

No command, screen configuration only.

**Display
Marker**

The *Display/Marker* softkey zooms, shifts and configures the graphical display. It is selected by pressing the *Marker/Display* softkey a second time. If pressed once again, the selected *Display/Marker* softkey changes back to the *Marker/Display* softkey, see above.

Grid

The *Grid* hotkey switches the grid in the test diagram on or off.

Remote control

No command, screen configuration only.

**Leakage
Lines**

The *Leakage Lines* hotkey switches the leakage lines in the test diagram on or off. Leakage lines are vertical lines marking the position of the pre-leakage and post-leakage areas in the diagram; see [Leakage](#) softkeys on p. 4.32. Switching off the leakage lines only affects the diagram; the leakage power is still available.

Remote control

No command, screen configuration only.

**Level
Scale**

The *Level Scale* hotkey defines the y-axis (level) scale of the diagram. The entered *Max.* value defines the upper edge of the diagram relative to the average burst power. *Max. – Span* defines the lower edge of the diagram.

Remote control

No command, screen configuration only.

**Time
Scale**

The *Time Scale* hotkey defines the x-axis (time) scale of the diagram and the measurement range. The entered *Start* value defines the left edge of the diagram relative to the first bit of the preamble (bit 0); see [Fig. 4-49](#) on p. 4.37. The *Span* defines the whole diagram width.

- The Start must be entered in bits. The minimum time (initial value) on the axis can be set between –200 bits and +3200 bits.
- The Span must be entered in timeslots. A Span of 1/16 slot, 1/8 slot, 1/4 slot, 1/2 slot, 1, 2, 3, 4, or 5 slots can be selected.

The sampling rate for the measurement curve is 4 samples per bit for 1-slot packets (DH1, see Packet Type parameter in section [Behavior of the DUT \(Connection Control – Slave Sig.\)](#) on p. 4.107.), 2 samples per bit for 3-slot packets (DH3), 1 sample per bit for 5-slot packets (DH5). For further information see remote control description in chapter 6.

Note: *This setting does not just scale the display, it also defines the area where the graph is measured. Therefore it may be necessary to set the measurement range even in remote control mode.*

Remote control

CONFigure:POWer:TIME:MRANge <Start>,

Default Scale

The *Default Scale* hotkey resets the x-axis (time) and the y-axis (level) scale to default.

Remote control

No command, screen configuration only.

Menus

The *Menus* softkey displays the hotkey bar for changing to other measurement menus.

Measurement Results

The values shown in the measurement menu *Power* can be divided into three groups:

- Setting values
- Scalar measurement results (single values)
- Arrays (the measurement curve represented as a function of time)

These values are indicated in two parameter lines, the test diagram, an output table plus additional output fields:

Parameter line 1|2

Test diagram

Output table and output fields

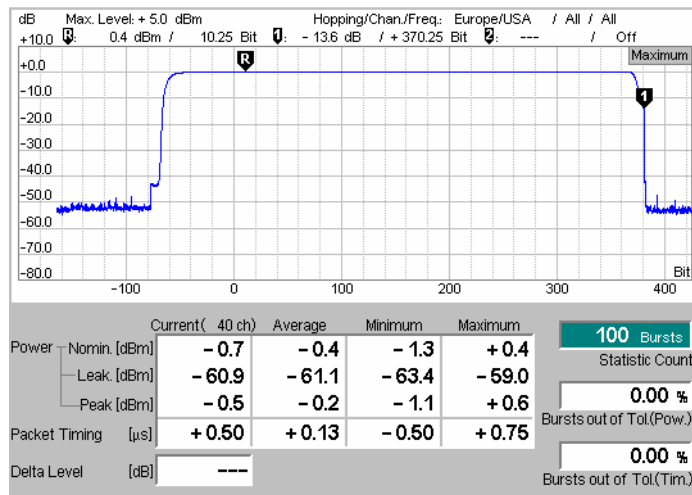

Fig. 4-48 Display of measurement results (*Output Power*)

**Settings/
scalar measurement results**

Settings and scalar measurement results are indicated in the two parameter lines above and in the table and output fields below the test diagram.

1st parameter line

The first parameter line contains the following settings:

Max. Level Maximum expected input level as set in *Max. Level* (see p. 4.120).

Attenuation Setting for the attenuation of the input level (*Normal, Low Noise, Low Distortion*)

Hopping/Chan./Freq Hopping scheme used by Signalling, measured RF channel and associated frequency

2 nd parameter line	<p>The second parameter line contains the following marker values:</p> <p>R Level and time of reference marker</p> <p>1 Level and time of delta marker 1 (setting <i>absolute</i>) or difference from reference marker (setting <i>relative</i>)</p> <p>2 Level and time of delta marker 2 (setting <i>absolute</i>) or difference from reference marker (setting <i>relative</i>)</p>
Output fields	<p>The output fields show the following setting value:</p> <p><i>Statistic Count</i> Number of bursts per statistics cycle. The colored bar indicates the relative measurement progress in the cycle.</p> <p>In addition, the following scalar results are indicated:</p> <p><i>Burst out of Tol.</i> Percentage of bursts measured that violate the tolerance limits for current bursts defined in the <i>Limits</i> tab of the configuration menu, see page 4.42. Two results are indicated, the first one refers to the power limits, the second one to the packet timing limits.</p> <p><i>Delta Level</i> Difference between the previous and the current value of the <i>Average Nominal Power</i>, if an <i>Up</i> or <i>Down</i> power control message was sent to the DUT; see Power Up and Power Down softkeys on page 4.30. The display changes back to invalid results (“- -”) for a new connection.</p>
Output table	<p>The following scalar values are calculated for the current burst first (<i>Current</i>). From the current results the average referenced to a statistic count (<i>Average</i>, see averaging rules in chapter 3) and the maximum and minimum values over all bursts measured so far (<i>Maximum</i>, <i>Minimum</i>) are calculated. Measurements that are not within their limits are indicated with a red background.</p> <p><i>Nominal Power</i> Average burst power during the carrier-on state. The nominal power is measured as the part of the burst starting at the detected 1st bit of the preamble (bit 0) to the last bit of the burst (see Fig. 4-49 below). The nominal power determines the 0-dB line in the test diagram.</p> <p><i>Leakage Power</i> Average power during the carrier-off state. The leakage power is measured as the part of the slot comprising the leakage pre-area and the leakage post-area (see Fig. 4-49 below).</p> <p><i>Peak Power</i> Maximum power level within the whole burst, i.e. between the first sample of the leakage pre-area and the last sample of the leakage post-area.</p> <p><i>Packet Timing</i> Offset between the measured burst time and the slot time derived from the master’s (R&S® CMU’s) clock (this means when bit 0 of a packet arrives in terms of the start of the slot).</p> <p>Note: <i>The Packet Timing results are invalid unless the Signalling Trigger is set; see section Trigger (Group Configuration – Trigger) on p. 4.119.</i></p>
Limit Check	<p>A red output field and an arrow pointing upwards or downwards indicates that the measurement result exceeds the upper or lower limit set in the <i>Limits</i> tab of the <i>Power Configuration</i> menu, see p. 4.42.</p>

Remote control Settings are read out using the query corresponding to the setting command (setting command with appended question mark). Results are read out using queries. For scalar measurement results:

```
READ[:SCALar]:POWer:TIME
```

```
FETCh[:SCALar]:POWer:TIME?
```

(to determine the *Delta Level*, two power results must be subtracted from each other)

```
CALCulate[:SCALar]:POWer:TIME:MATChing:LIMit?
```

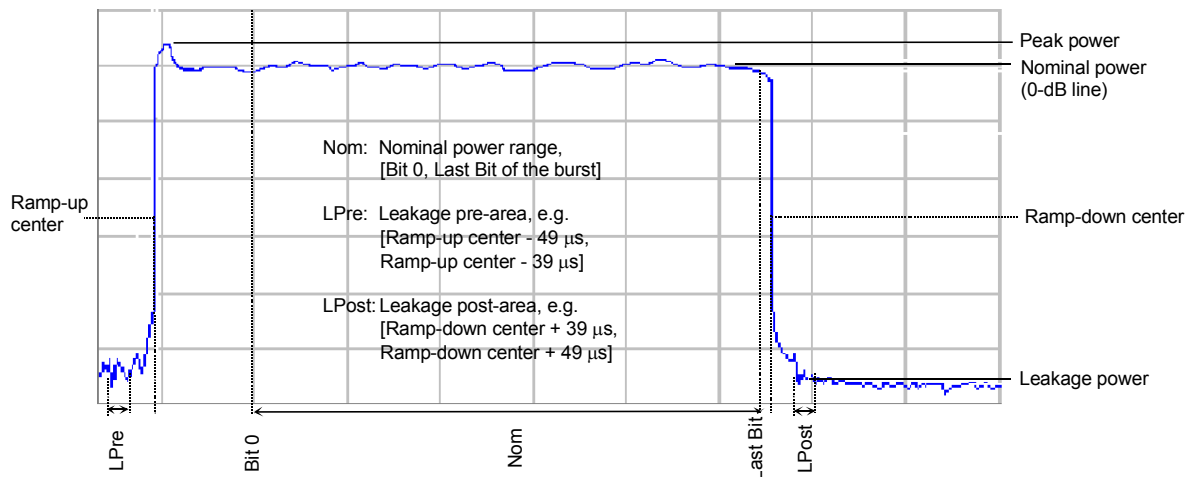

Fig. 4-49 Definition of Peak, Nominal, and Leakage Power

Measurement curves (arrays) The measurement result is displayed as a continuous measurement curve (trace) in the test diagram together with the limit lines, markers and the D-line, if activated.

The trace in the *Power* measurement menu shows the measured burst power (in dB) as a function of time (in bits). The display result depends on the test settings made before, especially on the display mode for the trace (*Minimum*, *Maximum*, *Average*, *Current*), which is indicated in the upper right corner of the diagram.

The scale of the x-axis can be adjusted via the *Time Scale Start* and *Time Scale Span* hotkeys.

Aggregated vs. separate results In the *Simultaneous* measure mode (see [Measure Mode](#) softkey on p. 4.32), the measurement curve is either aggregated over all measured channels (Display Mode *Average*, *Minimum*, *Maximum*) or belongs to the last measured channel (Display Mode *Current*). All scalar results including the *Statistic Count* and the limit check correspond to the channel selected via the hotkey *Displayed Channel*.

Remote control `READ:ARRay:POWer:TIME:CURRent?`
`FETCh:ARRay:POWer:TIME:CURRent? etc.`

Configurable leakage area It is possible to display and change the areas where leakage power is measured (leakage pre-area, leakage post-area).

- To vary the start and span of the leakage areas, select *Analyzer Settings* – `<>|Leakage` or `|<>Leakage` (for a full description of the hotkeys and how to use them see [Leakage](#) softkeys on p. 4.32.)
- To display or hide the leakage lines, which mark the current leakage measurement areas, select *Display* – *Leakage Lines* (see [Leakage Lines](#) hotkey on p. 4.34).

Note that the leakage area is not required to be outside the burst. A possible application is to measure the power at the burst edges, averaged over a variable time interval.

Remote control –

Measurement Configurations (Power Configuration)

The popup menu *Power Configuration* contains three tabs to determine the parameters of the power measurement including the error tolerances.

The popup menu *Power Configuration* is activated by pressing the softkey *Power* a second time. It is possible to change between the tabs by pressing the associated hotkeys.

Measurement Control (Power Configuration – Control)

The *Control* tab controls the power measurement by defining

- The Repetition mode
- The Stop Condition for the measurement
- The type of measurement curve displayed (Display Mode)
- The number of bursts/evaluation periods forming a statistics cycle (Statistic Count)

Besides, it configures the graphical diagram by adding or removing the *Grid*.

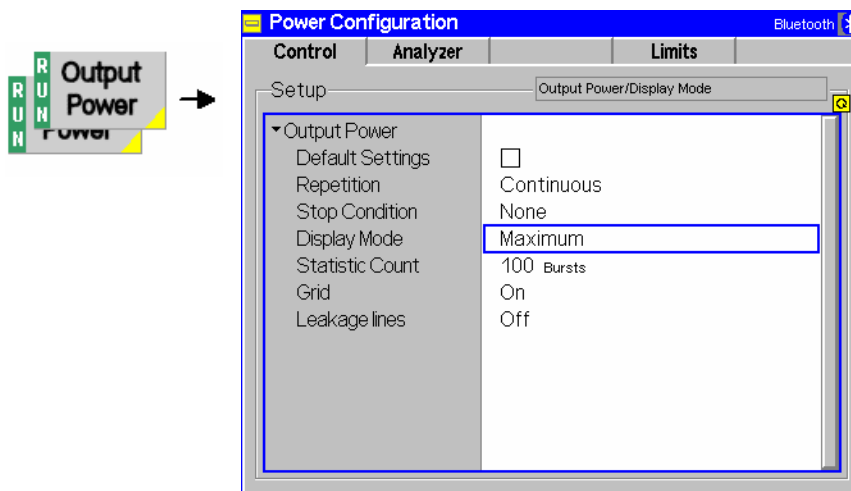

Fig. 4-52 Power Configuration – Control

Default Settings The *Default* switch assigns default values to all settings in the *Control* tab (the default values are quoted in the command description in chapter 6 of this manual).

Remote Control `DEfault:Power:TIME:CONTRol ON | OFF`

Repetition *Repetition* determines the repetition mode:

Single Shot Single-shot measurement: The measurement is stopped after a statistics cycle, i.e. after the number of bursts/evaluation periods set in the configuration menu *Statistics* (page 4.40). It is stopped

even earlier if the stop condition *On Limit failure* is set and if any of the tolerances are exceeded during this cycle. A stopped measurement is indicated by the status display *HLT* in the softkey *Power*.

Continuous Continuous measurement: The R&S® CMU continues the measurement until it is terminated explicitly, or until the stop condition (see below) is met. The output is continuously updated. An ongoing measurement is indicated by the status display *RUN* in the softkey *Power*.

Single shot should be selected to obtain a measurement result under fixed conditions. The continuous mode is suitable for monitoring the evolution of a measured quantity in time, for example for adjustments.

Note: *In remote mode, the counting measurement (counting mode) is available as a further measurement mode with a defined number of measurement cycles to be performed, see chapter 6 of this manual.*

The Repetition mode set in manual control is valid in manual control only. Changing this parameter in manual control does not alter the repetition mode in remote control and vice versa. The default repetition mode in remote control is SINGleshot.

Remote control `CONFigure:Power:TIME:CONTRol:REPetition
CONTinuous | SINGleshot | 1 ... 10000,<StopCondition>,
<Stepmode>`

Stop Condition *Stop Condition* defines a stop condition for the measurement:
None Continue measurement even if tolerance is exceeded
On Limit Failure Stop measurement if tolerance is exceeded

Remote control `CONFigure:Power:TIME:CONTRol:REPetition
<REPetition>,<SONerror | NONE,<Stepmode>`

Display Mode *Display Mode* defines which of the four measured and calculated traces is displayed. The traces differ in the way the burst power $p(t)$ at a fixed point in time t is calculated if the measurement extends over several bursts (see also chapter 3):

Current Measured value for current burst
Average Average value over a number of bursts
Minimum Minimum over all measured bursts
Maximum Maximum over all measured bursts

The number of bursts for calculation of the statistics values *Minimum*, *Maximum* and *Average* – and thus the result – depends on the repetition mode set (see section [Measurement Control \(Power Configuration – Control\)](#) on page 4.38). In detail, this implies:

Single shot Display of minimum, maximum and average value from the performed statistics cycle.
Continuous Display of minimum and maximum from all bursts already measured. The **average value**, however, is calculated according to the rules in chapter 3, section *General Settings*.

Remote control No display mode needs to be set, the four traces are accessible via

`FETCh:ARRAy:POWer:TIME:CURRent?`
`FETCh:ARRAy:POWer:TIME:AVERAge?`
`FETCh:ARRAy:POWer:TIME:MINimum?`
`FETCh:ARRAy:POWer:TIME:MAXimum? etc.`

Statistic Count *Statistic Count* defines the length of the statistics cycle in bursts.

The settings *1* and *Off* (press *ON/OFF* key) are equivalent. A statistics cycle is equal to the duration of one single-shot measurement (see section [Measurement Control \(Power Configuration – Control\)](#) on page 4.38).

Remote control `CONFIgure:Power:TIME:CONTRol`
`<MODE>,1 ... 1000 | OFF`

Grid The *Grid* parameter switches the grid in the graphical test diagram on or off. In the default setting, the grid is switched on.

Remote control No command, screen configuration only

Analyzer Settings (Power Configuration – Analyzer)

The *Analyzer* tab defines the R&S® CMU analyzer settings for *Power* measurements. It sets:

- The number of channels to be measured (*Measure Mode*).
- The channel numbers for the simultaneous (*Simult. Meas.*) and single (*Single Meas.*) measurement mode

Note: *The analyzer settings for the Power measurement are not coupled to the corresponding settings in the Overview or in the Modulation measurement. The parameters in the Analyzer tab do not overwrite the settings in any other measurement menus.*

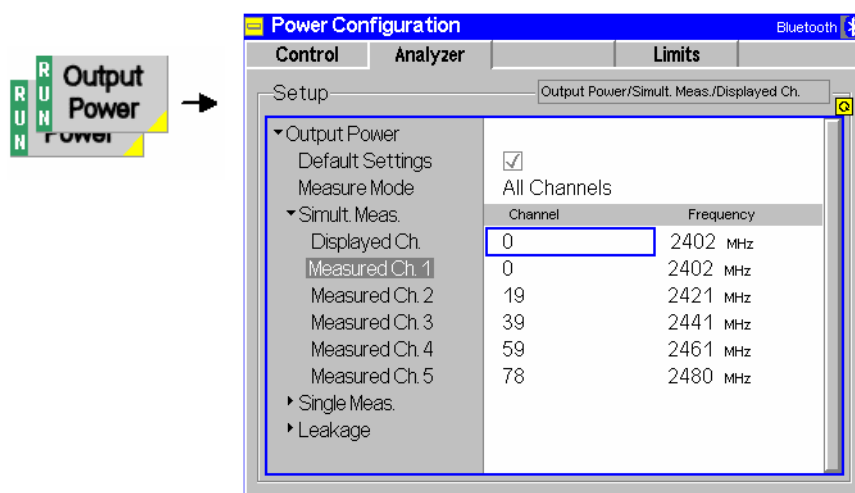

Fig. 4-53 Power Configuration – Analyzer

Default Settings The *Default All Settings* switch assigns default values to all settings in the *Analyzer* tab (the default values are quoted in the command description in chapter 6 of this manual).

Remote Control -

Measure Mode The *Measure Mode* hotkey selects how many channels are to be measured and whether the results are to be kept separate or aggregated. The following options are available:

All channels All available channels are measured. In this mode, the *Simult. Meas.* and the *Single Meas.* settings are not taken into account.

The current channel is displayed in brackets above the scalar result table in the measurement menu so it is always clear which channel the current results belong to.

Single Measurements are performed only on bursts from the channel selected via the *Measured Channel* hotkey.

Simultaneous Measurements are performed in the *Measured Ch(annel)* sequence selected in the *Simult. Meas.* section and the scalar results are kept separate for each channel. One single shot is terminated when all five channels have reached the *statistic count*. All scalar results in the output fields and the table below the diagram including the limit check correspond to the *Displayed Ch.* in the *Simult. Meas.* section. In contrast, the measurement curve corresponds to the currently measured channel and is updated each time that another channel is measured.

Note: *The Measure Mode only selects the channels that are considered for measurement or for display. It does not affect the actual channel sequence generated by the Bluetooth DUT. This sequence is independently configured via the Hopping Scheme parameter, see p. 4.110.*

When selecting Single or Simultaneous Measure Mode, make sure that your Hopping Scheme settings are compatible! In particular, to perform a Simultaneous measurement, the Bluetooth DUT must be able to transmit on all of up to five selected measurement channels. If a channel is not supported, the R&S® CMU will wait for signals from this channel and cease to update results on the other channels. The output table will show invalid results ("---") for the missing channel. This might seem as if the measurement had stopped although the Output Power softkey still indicates RUN.

Remote control

CONFigure:POWer:TIME:MMODE <Mode>

Simult. Meas. The *Simult. Meas.* section selects the RF channel to be displayed and indicates the five measured channels if the *Measure Mode* is set to *Simultaneous*. More specifically, *Displayed Channel* selects the channel for which all scalar results in the output fields and the table below the diagram including the limit check are displayed. The measurement curve corresponds to the currently measured channel and is updated each time that another channel is measured.

When a *Channel* is selected, the *Frequency* is updated to correspond with the selected channel.

It is possible to measure on less than five channels simultaneously by switching any of the five channels *Off* (using the *ON/OFF* key). If two channels are set to the same channel number the new setting prevails and the other channel is switched *Off*.

Remote control

```
CONFigure:POWer:TIME:MFRequency:SIMultaneous
```

Single Meas.

The *Single Meas.* section selects the RF channel to be measured if the *Measure Mode* is set to *Single*. The R&S® CMU will monitor only for signals on the selected Bluetooth *Measured Channel*. No other channels will be measured and displayed.

When a *Channel* is selected, the *Frequency* is updated to correspond with the selected channel and vice versa.

Remote control

```
CONFigure:POWer:TIME:MMODE <Mode>
CONFigure:POWer:TIME:MFRequency <Meas_Frequency>
CONFigure:POWer:TIME:MFRequency:UNIT <Unit>
```

Limit Values (Power Configuration – Limits)

The *Limits* tab defines tolerances for the *Nominal Power*, *Leakage Power*, *Peak Power* and *Packet Timing*. Upper and lower limits can be set independently for the *Current*, *Average*, *Minimum* and *Maximum* values indicated in the output table of the *Power* measurement menu (see section [Measurement Results](#) on page 4.35.).

Bluetooth devices are divided into three power classes according to their maximum output power; see [Table 4-4 below](#). For power class 1 equipment power control capability is required in the output power range between +4 dBm and +20 dBm in order to optimize power consumption and the overall interference level. The power steps shall form a monotonic sequence with a step size between 2 dB and 8 dB. Power control is tested by means of the *Power Up* and *Power Down* hotkeys; they are described on p.4.30.

Table 4-4 Bluetooth power classes

Power Class	Maximum Output Power P _{max} (⇒ Peak Power)	Nominal Output Power (⇒ Nominal Power)	Min. Output Power P _{min} (at max. power setting)	Power Control
1	20 dBm	not applicable	0 dBm	P _{min} < +4 dBm to P _{max} Optional: P _{min} ^{*)} to P _{max}
2	4 dBm	0 dBm	-6 dBm	Optional: P _{min} ^{*)} to P _{max}
3	0 dBm	not applicable	not applicable	Optional: P _{min} ^{*)} to P _{max}

*) A lower power limit P_{min} < -30 dBm is suggested but not mandatory.

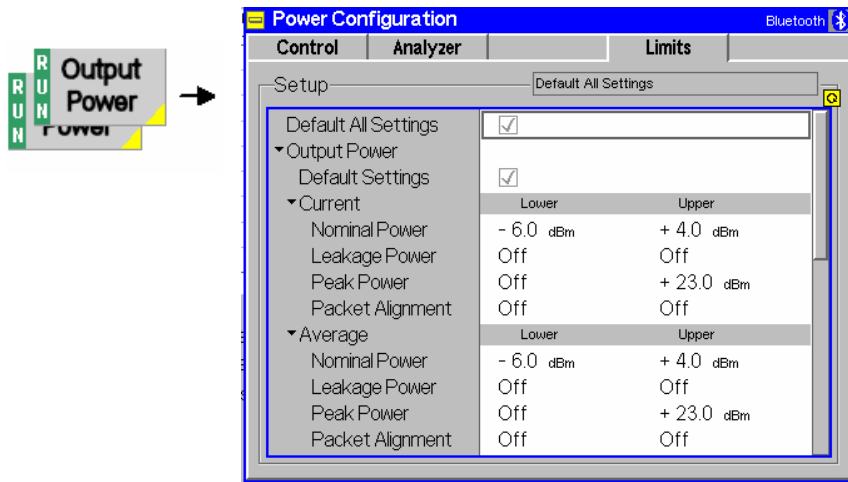

Fig. 4-54 Power Configuration – Limits

The table in the *Limits* tab contains four sets of parameters, which are the limits for the *Nominal Power*, the *Leakage Power*, the *Peak Power*, and the *Packet Timing* measurement. The four parameter sets are arranged as follows:

Default The *Default* switch assigns default values to all limit settings of the current measured quantity (the default values are quoted in the command description in Chapter 6 of this manual).

Remote control `DEfault:POWer:TIME:LIMit ON | OFF`

Burst Power/ Packet Timing The table sets upper and lower limits for the measurement and enables or disables the limit check. The burst power limits are set independently for the *Current*, *Average*, *Maximum*, and *Minimum* burst power results; see *Display Mode* setting in section [Measurement Control \(Power Configuration – Control\)](#) on p. 4.38. They are expressed in absolute power units (in dBm, for the *Nominal Power*, the *Leakage Power*, and the *Peak Power*) or in μ s (*Packet Timing*).

Lower Lower limit of a particular measurement and trace. If the measurement falls below this value then the result will be out of tolerance.

Upper Upper limit of a particular measurement and trace. If the measurement rises above this value then the result will be out of tolerance.

Any lower or upper limit check can be disabled by means of the *ON/OFF* key.

Remote control `CONFigure:POWer:CURRent:LIMit:SCALar:ASYMmetric:UPPER:VALue`
`CONFigure:POWer:CURRent:LIMit:SCALar:ASYMmetric:LOWER:VALue`
`<Nom_Power>,<Leak_Power>,<Peak_Power>`
`CONFigure:POWer:CURRent:LIMit:SCALar:ASYMmetric:UPPER:ENABle`
`CONFigure:POWer:CURRent:LIMit:SCALar:ASYMmetric:LOWER:ENABle`
`ON | OFF`
`CONFigure:POWer:PTIMing:CAMMax:LIMit:SCALar:ASYMmetric:... etc.`

Modulation Measurements

The menu group *Modulation* comprises the functions for measurement of the modulation parameters described below and for matching of the respective tolerance limits.

The measurement results are displayed in the graphical measurement menu *Modulation*, and the popup menu *Modulation Configuration* is used for configuration of the measurements.

The purpose of the *Modulation* measurement is to verify modulation accuracy and carrier frequency stability for the RF signal from the DUT, and also to check that performance meets the requirements of the standard. The modulation scheme used in a Bluetooth system is GFSK (Gaussian Frequency Shift Keying), with a BT = 0.5.

GFSK is a binary frequency modulation technique in which a binary one is represented by a positive frequency deviation, a binary zero by a negative frequency deviation. The data rate transmitted is 1 Mbit per second.

The following quantities are measured, and checked for tolerance matching:

<i>Frequency Accuracy</i>	Difference between the measured transmitted frequency and the intended transmitted frequency in the preamble at the beginning of the packet.
<i>Frequency Drift</i>	Maximum of the difference between the measured frequency at the start of the packet and the frequencies in the payload in kHz.
<i>Maximum Drift Rate</i>	Maximum slope of the frequency drift in the payload.
<i>Frequency Deviation</i>	Frequency deviation originating from the frequency modulation, measured and displayed over the whole packet.

The measurement of these quantities is explained in more detail in section [Measurement Results](#) on page 4.46. Two measurement filters with different bandwidths and two different algorithms for averaging are provided; see section [Analyzer Settings \(Modulation Configuration – Analyzer\)](#) on p. 4.51.

To obtain valid modulation results, the following conditions must be fulfilled:

- A trigger is provided.
- The preamble of the measured Bluetooth signal is correct (i.e. either 0101 or 1010).
- The R&S® CMU correlates to the expected access code in order to detect bit zero.
- Power ramp up and ramp down are detected.
- The DUT transmits the correct payload data length as defined in the transmitter test mode configuration; see [Length of Test Sequence](#) on p. 4.111.
- Most modulation results are valid only if a transmitter [Testmode Type](#) with an appropriate payload pattern

Table 4–5 Validity of modulation measurement results

Payload Pattern	1010	11110000	0000, 1111, PRBS, User Defined
Frequency accuracy	X	X	X
Frequency drift	X		
Maximum drift rate	X		
Frequency deviation	X	X	

Note: To make sure that the modulation measurement is not performed on incorrect packets, which would lead to incorrect measurement results, the modulation measurement checks the packet type and payload pattern of the received packets. If the packet type and payload is not what is expected, the packet is rejected and an error message Burst has wrong packet type / Burst has wrong payload is generated (see Chapter 9).

The packet type is always checked, except in the case of whitened loopback where the header is scrambled and therefore the packet type ID can't be checked.

The Basic Rate packet payload is always checked, in non-whitened loopback mode, if a 1010 or 11110000 pattern is expected.

Measurement Menu (Modulation)

The graphical measurement menu *Modulation* shows the results of the burst analysis (frequency deviation versus time measurement).

- The measurement control softkey *Modulation GFSK* indicates the measurement status (*RUN | HLT | OFF*) and opens the configuration menu *Modulation Configuration* (press a second time).
- The other softkeys to the right of the test diagram are combined with various hotkeys. If a softkey is selected and an associated hotkey pressed, a popup window will appear which indicates a setting or enables an entry (see section *Measurement Menu (Power)* on page 4.28).

The measurement menu *Modulation* can be accessed from any other measurement menu of function group *Bluetooth Signalling* using the *Modulation* hotkey. It can be opened also from the *Menu Select* menu (with the associated key at the front of the instrument).

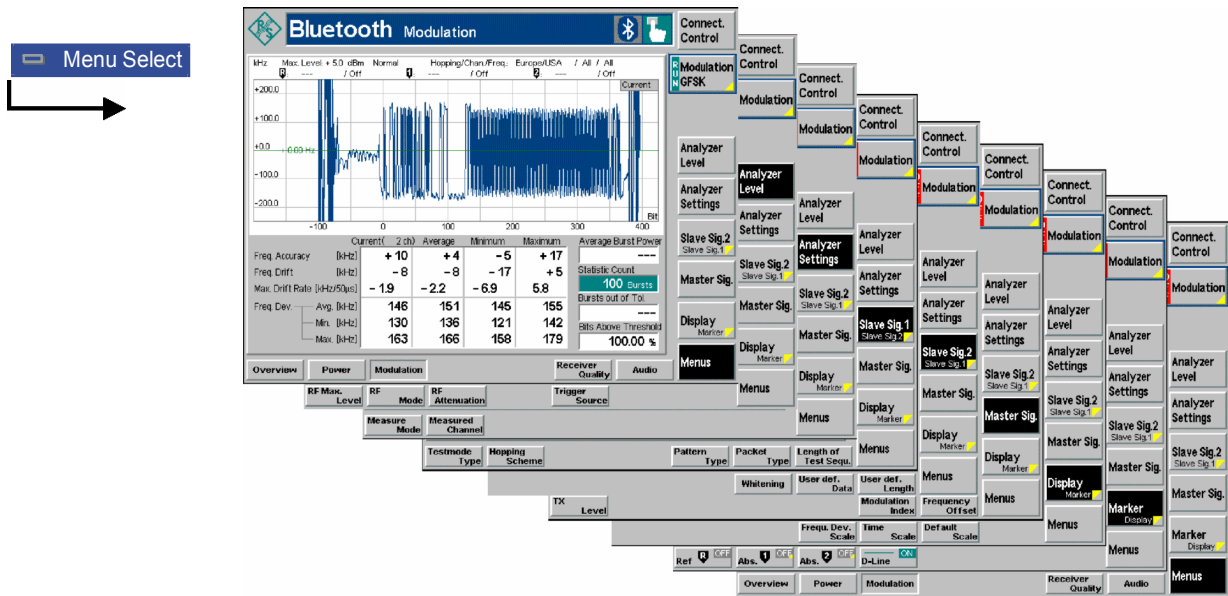

Fig. 4-56 Measurement menu Modulation

Test Settings

The *Analyzer Level*, *Analyzer Settings*, *Slave Sig.*, *Master Sig.*, *Marker/Display* and *Menus* test settings are identical with those in the *Power* menu (see section *Test Settings* on page 4.29). The *Modulation* measurement control softkey is analogous to the *Output Power* softkey described in section *Test Settings* on page 4.29. The *Modulation* test diagram is scaled like the *Power* diagram but with different ranges for the start value and span of the axis and obviously a different unit for the y-axis.

Display Marker

The *Display/Marker* softkey zooms or shifts the graphical display. It is selected by pressing the *Marker/Display* softkey a second time. If pressed once again, the selected *Display/Marker* softkey changes back to the *Marker/Display* softkey.

Freq. Dev. Scale

The *Freq. Dev. Scale* hotkey defines the y-axis (frequency deviation) scale of the diagram. The entered *Max.* value (in kHz) defines the upper edge of the diagram. *Max. – Span* defines the lower edge of the diagram.

Remote control
No command, screen configuration only.

Time Scale

The *Time Scale* hotkey defines the x-axis (time) scale of the diagram and the measurement range. The entered *Start* value defines the left edge of the diagram relative to the first bit of the preamble (bit 0); see Fig. 4-49 on p. 4.37. The *Span* defines the whole diagram width.

- The *Start* must be entered in bits. The minimum time (initial value) on the axis can be set between –200 and +3200 bits.
- The *Span* must be entered in timeslots. A *Span* of 1/16 slot, 1/8 slot, 1/4 slot, 1/2 slot, or 1 slot can be selected.

The sampling rate for the measurement curve is 4 samples per bit, irrespective of the *Time Scale Span* set. For further information see remote control description in chapter 6.

Note: *This setting does not just scale the display, it also defines the area where the graph is measured. Therefore it may be necessary to set the measurement range even in remote control mode.*

Remote control
CONFigure:MODulation:DEViation:MRANge <Start>,

Default Scale

The *Default Scale* hotkey resets the x-axis (time) and the y-axis (level) scale to their defaults.

Remote control
No command, screen configuration only.

Zoom

The *Zoom* hotkey scales and shifts the *I/Q Analyzer* diagrams; see section *Measurement Control (Modulation Configuration – Control)* on p. 4.51.

Remote control
No command, screen configuration only.

Measurement Results

The values shown in the *Modulation* measurement menu can be divided into three groups:

- Setting values
- Scalar measurement results (single values)
- Arrays (traces plotted as a function of time)

The results are indicated in two parameter lines, the test diagram, an output table plus additional output fields.

Modulation GFSK, Modulation DPSK

Parameter line

Test diagram

Output fields

and table

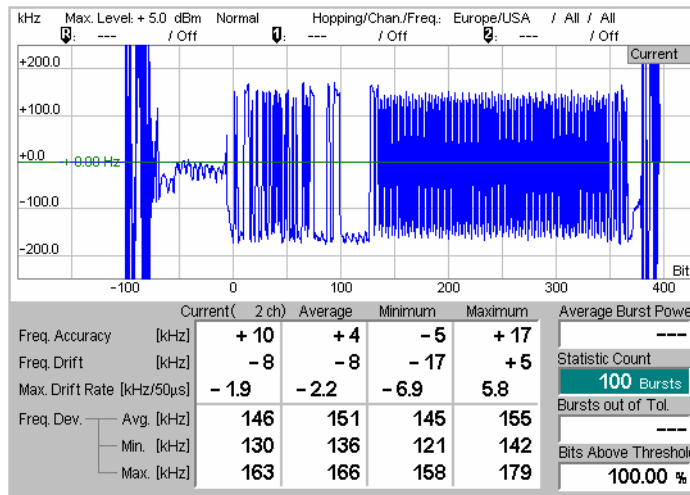

Fig. 4-57 Display of measurement results (Modulation menu)

Settings/ Scalar results

Scalar measurement results and settings are indicated in the two parameter lines above the test diagram and in the output table below.

1st parameter line

The first parameter line contains the following settings:

- Max. Level* Maximum input level set as in *Input Level - Mode* (see section *Input Path (Connection Control – Analyzer)* on page 4.120).
- Attenuation* Input path setting (*Normal, Low Noise, Low Distortion*).
- Hopping Chan./Freq.* Hopping scheme used by Signalling (see section *Connection Control in Test Mode (Test Mode)* on page 4.92.), measured RF channel and associated frequency.
- Packet Type* Packet type currently selected for the DUT (DH1, DH3, etc.).

Remote control

The settings are read out using the query corresponding to the setting command (setting command with appended question mark).

2 nd parameter line	<p>The second parameter line contains the following marker values:</p> <p>R Level and time of reference marker</p> <p>1 Level and time of delta marker 1 (setting <i>absolute</i>) or difference from reference marker (setting <i>relative</i>)</p> <p>2 Level and time of delta marker 2 (setting <i>absolute</i>) or difference from reference marker (setting <i>relative</i>)</p>
Output fields	<p>The following scalar values are displayed next to the output table, on the right hand side:</p> <p><i>Avg. Burst Power</i> Nominal power of the current burst; see Fig. 4-49 on p. 4.37. The limit check of the <i>Average Burst Power</i> is independent of the limit settings in the <i>Power Configuration</i> menu (see section Limit Values (Power Configuration – Limits) on p. 4.42.): The background of the display goes red if the measured nominal power is less than 12 dB below the <i>Max. Level</i> (see above, 1st parameter line). This is an indication that the TX power of the DUT should be increased or the <i>Max. Level</i> reduced.</p> <p><i>Statistic Count</i> Length of statistics cycle in bursts/packets. The colored bar indicates the relative measurement progress in the statistics cycle.</p> <p><i>Bursts out of Tolerance</i> Percentage of bursts that exceed the tolerance limits.</p> <p><i>Bits above Threshold</i> Percentage of bits in the current statistics cycle where the frequency deviation is above the tolerance limit. This result is relevant for test cases stipulating that the frequency deviation at a given minimum percentage of bits must be above a limit, e.g. the test of the modulation index (TRM/CA/07/C). The tolerance limit and the minimum percentage are set in the <i>Modulation Configuration</i> menu; see section Limit Values (Modulation Configuration - Limits) on p. 4.53.</p> <p>In accordance with the test specification this result is only calculated while the test is performed with an alternating 01010101 pattern.</p>
Output table	<p>The following scalar values are calculated for the current burst first (<i>Current</i>). From the current results the average referenced to a statistic count (<i>Average</i>, see averaging rules in chapter 3) and the maximum and minimum values over all bursts measured so far (<i>Maximum</i>, <i>Minimum</i>) are calculated.</p> <p>Note: <i>To obtain valid modulation measurement results, a number of conditions must be fulfilled. In particular, the measurement depends on payload pattern selected via the Testmode Type softkey (see p. 4.109); for an overview see Table 4–5 on page 4.44.</i></p> <p>The following quantities are calculated in accordance with <i>Bluetooth RF Specification 1.1, Rev. 0.91</i>.</p> <p><i>Frequency Accuracy</i> Difference between the measured transmitted frequency and the intended transmitted frequency (the nominal Bluetooth channel frequency) at the beginning of the packet (4-bit</p>

constant preamble preceding the information bits) in kHz. To obtain the measured frequency, integration is done from the center of the 1st bit in the preamble to the center of the 1st bit following the preamble (4 complete bit periods, see Fig. 4-59 below).

Frequency Drift

Difference between the measured frequency at the start of the packet (the value used to calculate the *Frequency Accuracy*) and the frequency in the payload in kHz. To obtain the latter, the payload is grouped into 10-bit groups and the maximum of the individual frequency drifts is calculated:

$$\text{Frequency Drift} = \text{Max}_n [f(t_n) - f(t_0)]; \quad n = 1, \dots, n_{\text{max}}$$

where the t_n denote the time at the 10-bit groups, t_0 the time at the start of the packet. The first and the last bit of the payload is not considered; the same holds for incomplete 10-bit groups at the end of the payload (spare bits, see Fig. 4-59 below). The R&S® CMU expects the pattern type and the payload length as configured in the test mode settings (see section *Behavior of the DUT (Connection Control – Slave Sig.)* on p. 4.107.).

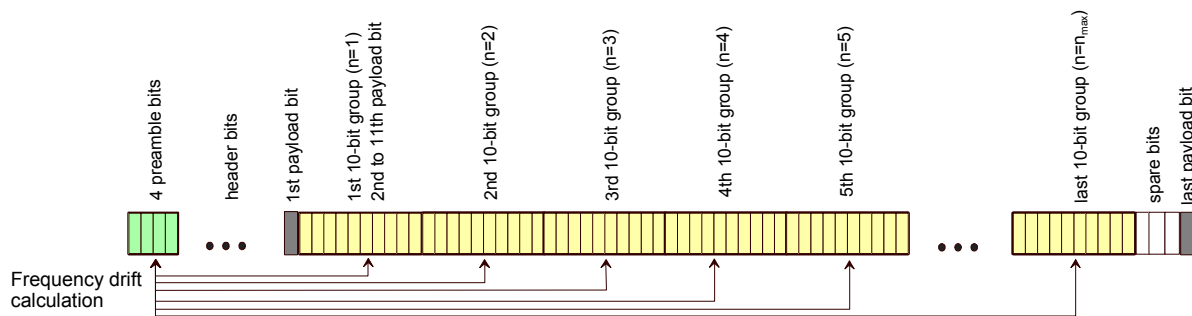

Fig. 4-59 Calculation of Frequency Drift

Maximum Drift Rate The maximum of the drift rate anywhere within the packet payload. The drift rate is a function of time; it is an estimate for the first derivative of the frequency drift with respect to time. In practice, the maximum drift rate is calculated from the measured frequency f in the burst as follows:

$$\text{Max. Drift Rate} = \text{Max}_n \frac{f(t_n) - f(t_{n-5})}{t_n - t_{n-5}}; \quad n = 6, \dots, n_{\text{max}}$$

where the t_n denote the time at the 10-bit groups used to calculate the frequency drift and the time difference of any 2 compared 10-bit groups $t_n - t_{n-5}$ amounts to 50 μs (i.e. 50 bit periods or 5 10-bit groups).

Again, the first and the last bit of the payload is not considered; the same holds for incomplete 10-bit groups at the end of the payload (spare bits). This implies that the payload length must at least 62 bits, otherwise the *Maximum Drift Rate* measurement result will be invalid.

Frequency Deviation The frequency deviation is first calculated over the whole packet payload without border bits¹. Each bit is oversampled four times. This yields the measurement curve in the

¹ The definition of border bits depends on the payload type. For a 0101 pattern they comprise one bit at the beginning and one bit at the end of the packet. For a 00001111 pattern they comprise 4 bits at the beginning and 4 bits at the end of the packet.

graphical display.

To obtain the scalar results *Freq. Dev. Avg./Max./Min.*, the whole payload is divided into adjacent segments with a length of 8 bits and the average frequency f_{avg} on each of these segments is calculated. The next steps depend on the payload pattern type:

- For a 0101 pattern, the maximum frequency deviation from f_{avg} is calculated for each bit i within the segment ($i = 1$ to 8). All these positive values are recorded as $\Delta f_{max,i}$.
- For a 00001111 pattern, the average frequency deviation from f_{avg} is calculated for bits 2, 3, 6 and 7 of the segment. These 4 positive values are recorded as $\Delta f_{max,i}$.

The quantities *Freq. Dev. Avg./Max./Min* represent the arithmetic mean value, the maximum, and the minimum of all $\Delta f_{max,i}$ within the payload.

Limit Check	A red output field and an arrow pointing upwards or downwards indicates that the measurement result exceeds the upper or lower limit set in the <i>Limits</i> tab of the <i>Modulation Configuration</i> menu, see p. 4.53.
Remote control	<pre> READ[:SCALar]:MODulation:DEViation? FETCH[:SCALar]:MODulation:DEViation:BATHreshold? CALCulate:MODulation:DEViation:LIMit:MATChing? </pre> <p style="text-align: right;">etc.</p>
Traces (arrays)	<p>The continuous trace in the test diagram shows the frequency deviation (in kHz) in the packet as a function of time (in bits). The display mode (<i>Current, Average, Minimum, Maximum</i>) for the trace is indicated in the upper right corner of the diagram.</p> <p>The display range of the trace can be adjusted by means of the <i>Freq. Dev Scale</i> and <i>Time Scale</i> hotkeys; see section Test Settings on page 4.46.</p>
Aggregated vs. separate results	In the <i>Simultaneous</i> measure mode (see Measure Mode softkey on p. 4.32), the measurement curve is either aggregated over all measured channels (Display Mode Average, Minimum, Maximum) or belongs to the last measured channel (Display Mode Current). All scalar results, including the <i>Statistic Count</i> and the limit check, correspond to the channel selected via the hotkey <i>Displayed Channel</i> .
Remote control	<pre> READ:ARRay:MODulation:DEViation:CURRent? </pre>

Measurement Configurations (Modulation Configuration)

The popup menu *Modulation Configuration* contains three tabs which determine the parameters of the *Modulation* measurement.

The popup menu *Modulation Configuration* is activated by pressing the *Modulation* measurement control softkey in the top right of the graphical measurement menu *Modulation* a second time. By pressing the associated hotkeys, it is possible to change between the tabs.

Measurement Control (Modulation Configuration – Control)

The *Control* tab controls the *Modulation* measurement by defining statistical settings (*Repetition* mode, *Stop Condition*, *Display Mode*, *Statistic Count*). In addition, it configures the graphical diagram by adding or removing the *Grid*.

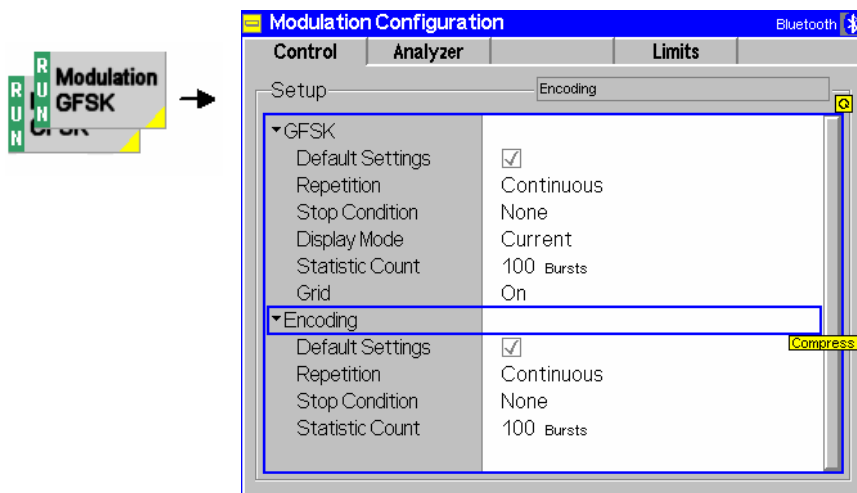

Fig. 4-61 Modulation Configuration – Control

The statistical settings are consistent with those of the *Control* tab in the *Power Configuration* menu (see page 4.38). In the remote-control commands, the keywords `POWER:TIME` are replaced by `MODULATION:DEVIATION`.

Analyzer Settings (Modulation Configuration – Analyzer)

The *Analyzer* tab defines the R&S® CMU analyzer settings for *Modulation* measurements. It provides the following types of settings:

- Settings related to signal processing and data acquisition (*Filter Bandwidth*, *Freq. Dev. Algorithm*)
- The number of channels to be measured (*Measure Mode*)
- The channel numbers for the simultaneous (*Simult. Meas.*) and single (*Single Meas.*) measurement mode

Note: *The Measure Mode and channel settings for the Modulation measurement are not coupled to the corresponding settings in the Overview or in the Power measurement. The parameters in the Analyzer tab do not overwrite the settings in any other measurement menus. In contrast the Frequency Deviation Algorithm and the Filter Bandwidth settings are also used for the Power/Modulation application in the Overview measurement.*

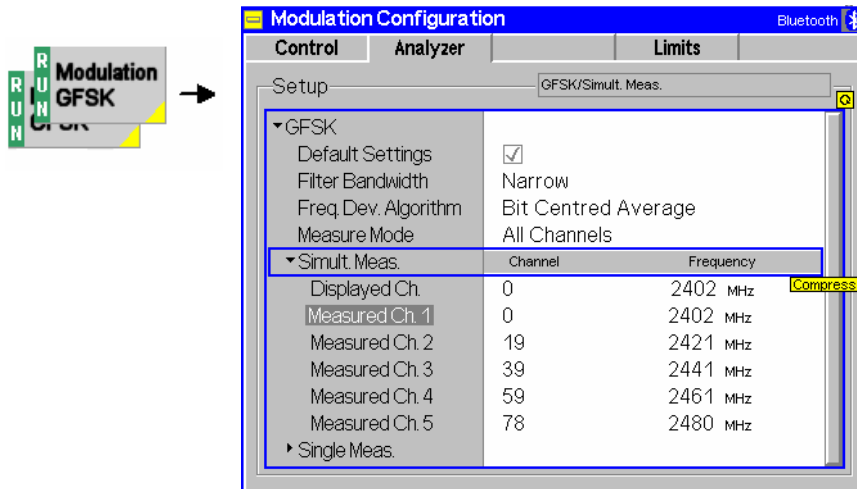

Fig. 4-62 Modulation Configuration – Analyzer

All *Measure Mode* related settings are analogous to those of the *Analyzer* tab in the *Power Configuration* menu (see page 4.40). In the remote-control commands, the keywords `POWER:TIME` are replaced by `MODulation:DEVIation`. The following settings are not provided in the *Power Configuration* menu:

Filter Bandwidth Selects the resolution bandwidth of the measurement filter used for *Modulation* measurements. The (default) *wide* band and the *narrow* band filter match the two alternative filter settings stipulated in the revised Bluetooth RF test specification. The bandwidths are 1.3 MHz (*Narrow*) and approx. 2.0 MHz (*Wide*).

Remote control `CONFigure:MODulation:DEVIation:FBANdwidth WIDE | NARR`

Freq. Deviation Algorithm Defines how the R&S® CMU averages the frequency deviation and calculates the average frequency over a 01010101 bit sequence. The following options are provided to take into account differing interpretations of the Bluetooth RF Test Specification:

Integration Average The R&S® CMU calculates the mean value of all samples acquired during the bit sequence. This is the same algorithm used for a 00001111 bit sequence.

Bit Centered Average The R&S® CMU calculates the mean value of all samples at the centers of all bits of the sequence.

With an asymmetrical frequency deviation signal, the algorithms can give slightly different measurement results.

Remote control `CONFigure:MODulation:DEVIation:FDALgorithm BCAV | IAV`

Limit Values (Modulation Configuration – Limits)

The tab *Limits* defines upper and lower error limits for the results obtained in the *Modulation* measurement. All relevant quantities are explained in section *Measurement Results* on p. 4.47.

Conformance requirements

A poor modulation accuracy of the transmitter increases the transmission errors in the radio channel from a Bluetooth slave to the master. According to the Bluetooth test specification, the following limits apply to the *Modulation* measurement results-

Modulation GFSK

In the *Modulation GFSK* measurement (TRM/CA/07/C, TRM/CA/08/C, TRM/CA/09/C), all *Current* results must fulfill the following conditions:

- Frequency accuracy between -75 kHz and +75 kHz
- Frequency drift between -25 kHz and +25 kHz for one slot packets, between -40 kHz and +40 kHz for three or five slot packets
- Maximum drift rate between -20 kHz / 50 μs and +20 kHz / 50 μs
- Average frequency deviation between +115 kHz and +175 kHz
- At least 99.9% of all frequency deviations above the threshold value of +115 kHz

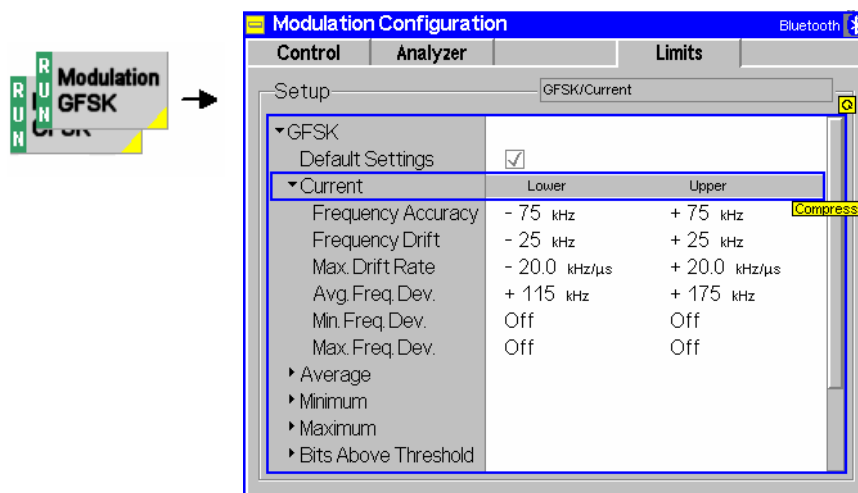

Fig. 4-63 Modulation Configuration – Limits

The table in the *Limits* tab provides six parameter sets, defining limits for the *Frequency Accuracy*, the *Frequency Drift*, the *Maximum Drift Rate*, and the *Frequency Deviation* measurement. Independent limits can be set for the average of the frequency deviation over the whole packet, for its maximum, and for its minimum value.

The parameter sets are arranged as follows:

Default

The *Default* switch assigns default values to all limit settings of the current measured quantity (the default values are quoted in the command description in chapter 6 of this manual).

Remote control

DEFAult:MODulation:DEVIation:LIMit ON | OFF

**Current/
Average/
Minimum/
Maximum**

The table sets upper and lower limits for the current measurement and enables or disables the limit check. The limits are set independently for the *Current*, *Average*, *Maximum*, and *Minimum* modulation results; see *Display Mode* setting in section [Measurement Control \(Power Configuration – Control\)](#) on p. 4.38.

- Lower* Lower limit of a particular measurement and trace. If the measurement falls below this value then the result will be out of tolerance.
- Upper* Upper limit of a particular measurement and trace. If the measurement rises above this value then the result will be out of tolerance.

Any lower or upper limit check can be disabled by means of the *ON/OFF* key.

Remote control

```

CONFigure:MODulation:DEVIation:CURRent:LIMit:SCALar:
    ASYMMetric:UPPer:VALue
CONFigure:MODulation:DEVIation:CURRent:LIMit:SCALar:
    ASYMMetric:LOWer:VALue
CONFigure:MODulation:DEVIation:CURRent:LIMit:SCALar:
    ASYMMetric:UPPer:ENABle ON | OFF
CONFigure:MODulation:DEVIation:CURRent:LIMit:SCALar:
    ASYMMetric:LOWer:ENABle ON | OFF etc.
    
```

**Bits Above
Threshold**

The table sets the criteria for the *Bits Above Threshold* result displayed in the measurement menu:

- Threshold* Lower limit for the frequency deviation.
- Conformance Limit* Minimum percentage of bits where the frequency deviation must lie above the *Threshold*.

The DUT passes the test if the frequency deviation is above the *Threshold* for at least *Conformance Limit* % of all measured bits.

Remote control

```

CONFigure:MODulation:DEVIation:BATHreshold:
    THreshold[:VALue]
CONFigure:MODulation:DEVIation:BATHreshold:
    THreshold:ENABle ON | OFF
CONFigure:MODulation:DEVIation:BATHreshold:
    CLIMit[:VALue]
CONFigure:MODulation:DEVIation:BATHreshold:
    ENABle ON | OFF
    
```

Spectrum Measurements

The *Spectrum* menu group measures the output RF spectrum emissions in the frequency domain. The measurement results are displayed in the graphical measurement menu *Spectrum*, with the popup menu *Spectrum Configuration* providing all measurement settings.

The *Spectrum* measurement is to verify that emissions in the Bluetooth operating frequency range are within the limits. An excess amount of off-carrier power increases interference and decreases the system capacity. The off-carrier power can be assessed by different parameters:

ACP

The Adjacent Channel Power (ACP) corresponds to the absolute power that the Bluetooth device transmits in an off-carrier Bluetooth channel. According to the Bluetooth radio specification (test case TRM/CA/06), the ACP must be measured at 10 distinct, equidistant frequencies distributed across the channel width and with a *Statistic Count* of 10 sweeps at each of the measured frequencies. The sweep points must be smoothed out using an *Average* detector before the maximum value of each sweep is calculated. The relevant ACP values are obtained from the sweep maxima using the *Maximum* display mode.

The standard specifies a 100-kHz resolution bandwidth, no hopping, and DH1 packets with a PRBS 9 payload to be transmitted to the DUT. The measurement procedure of the R&S CMU is faster than is required by the test procedure of the Bluetooth radio specification, but it provides equivalent results.

20 dB bandwidth

The 20 dB bandwidth is the width of the frequency band around the peak of the emission where the transmit power drops by less than 20 dB. It is measured as the difference between the two frequencies $f_H - f_L$, where:

- f_H denotes the highest frequency at which the transmit power drops not more than 20 dB below the peak power.
- f_L denotes the smallest frequency at which the transmit power drops not more than 20 dB below the peak power.

According to the Bluetooth radio specification, the 20 dB bandwidth must be measured in a 10-kHz resolution bandwidth using the *Maximum* display mode, no hopping, and the longest supported packets (i.e. DH5 if possible). A small 20 dB bandwidth means that the transmit power is well focused, and hence the off-carrier emissions are small. An example is shown in Fig. 4-65 below.

Frequency Range

The *Frequency Range* measurement provides the lower and upper limit frequencies where the signal power crosses a specified power threshold; see section [Frequency Range Application](#) on p. 4.57.

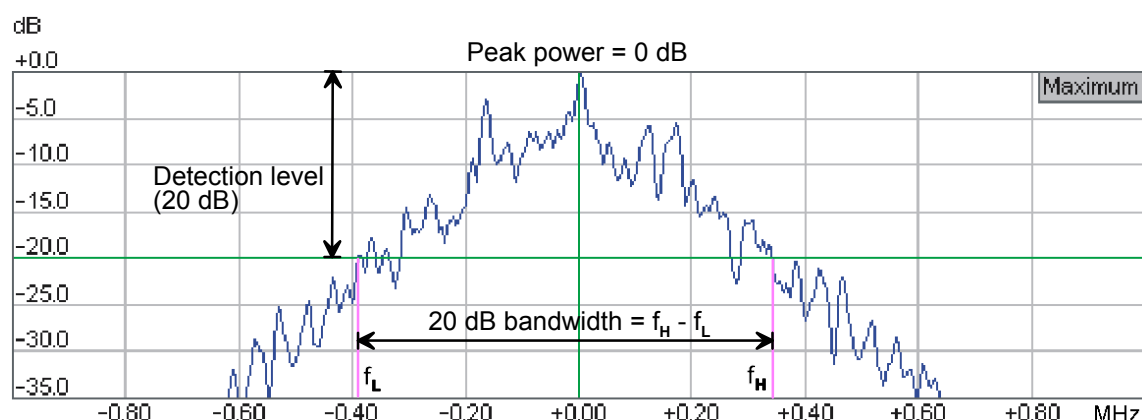
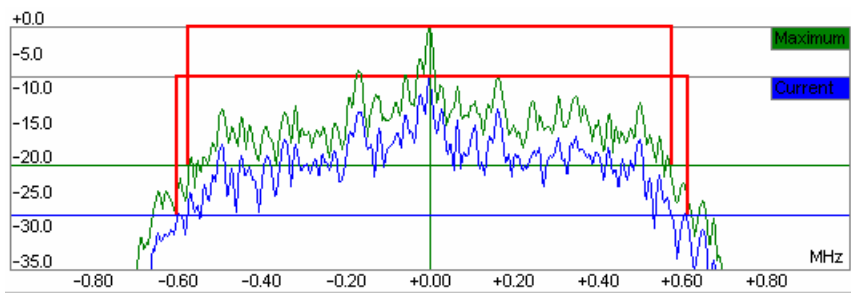

Fig. 4-65 20 dB bandwidth measurement

The 20 dB bandwidth for the *Maximum* measurement curve quite often turns out to be **smaller** than the *Current* 20 dB bandwidth (refer to Chapter 3 for a description of the display modes *Current*, *Minimum*, *Maximum*, *Average*). This effect is due to variations in the DUTs TX power in the center of the channel which lead to a sharp peak of the *Maximum* trace. An example of a maximum curve with a relatively high central power (and thus a small 20 dB bandwidth) is shown in the figure below.



Performing a measurement

In the default configuration most of the *Spectrum* measurement settings comply with the requirements for the ACP and 20 dB bandwidth test cases in the Bluetooth radio specification. The settings to be made manually are listed below.

ACP

With a firmware version V4.37 and higher, frequency hopping is automatically disabled while the ACP application is active (equivalent to *Connection Control – Slave Sig. – Hopping Scheme: RX/TX single freq.*; the *Slave Sig. 1 – Hopping Scheme* hotkey is suppressed). The packet type is DH1 as required by the specification. The payload pattern can be adjusted in addition; see below.

20 dB Bandwidth The payload pattern and the packet type should be adjusted:

- In the measurement menu, press *Slave Sig. 1 – Pattern Type* and select a PRBS pattern (preferably the *Dynamic PRBS* pattern).
- Press *Slave Sig. 1 – Packet Type* and select the longest packet type supported by your EUT (preferably DH5). In addition, select the longest *Length of Test Sequence* (for DH5 packets:339 bytes).

The measurement is performed on the *Maximum* measurement curve, in loopback mode and with hopping enabled. If desired (e.g. for production tests) it is possible to disable hopping and measure on a single frequency (see above).

Frequency Range

With a firmware version V4.37 and higher, frequency hopping is automatically disabled while the *Frequency Range* application is active (equivalent to *Connection Control – Slave Sig. – Hopping Scheme: RX/TX single freq.*; the *Slave Sig. 1 – Hopping Scheme* hotkey is suppressed).

According to the test specification, the measurement must be performed in two different frequency ranges. Suppose your Bluetooth device operates in the range between 2402 MHz (channel 0) and 2480 MHz (channel 78).

- To determine the lower limit frequency f_L , set the DUT to the lowest TX frequency (*Slave Sig. 1 – TX Frequency: 0*), then press *Analyzer Settings* and select the following measurement window: *Start Channel: -3* (2399 MHz), *Meas. Window Size: 7 Ch*.
- To determine the upper limit frequency f_H , set the DUT to the highest TX frequency (*Slave Sig. 1 – TX Frequency: 78*), then press *Analyzer Settings* and select the following measurement window: *Start Channel: 73* (2475 MHz), *Meas. Window Size: 11 Ch*.

A condensed programming example for a *Frequency Range* measurement is reported in chapter 6.

Note:

While the Spectrum measurement is running the Supervision Timeout is automatically set to zero (i.e. to infinite timeout period) and grayed; the Master Sig. tab indicates 0 due to spectrum measurement. This ensures that the connection is not lost while the CBT measures at off-carrier frequencies. During a Spectrum measurement a discontinued

signal will generally not terminate the connection. The previous Supervision Timeout is restored after another TX or RX measurement is selected.

Frequency Range Application

The *Frequency Range* application (SPECTrum:FRANge...) of the *Spectrum* measurement covers test case TRM/CA/04/C of the Bluetooth Radio Specification. The application measures the power of the Bluetooth signal from the DUT at up to 110 frequency points using a fixed 100 kHz partition. The power results are used to interpolate the lower and upper limit frequencies where the signal power crosses a specified power threshold.

Test Procedure The R&S CMU analyzer settings are the same as for the *Spectrum – ACP* measurement. The Bluetooth signal is measured in a resolution bandwidth of 100 kHz and with a video bandwidth of 300 kHz, with a peak detector, and with a configurable number of averaged sweeps. The R&S measures 1 complete burst at each measured frequency point. The frequency points are set by means of two parameters, *Start Channel* (start frequency f_{Start}) and *Meas. Window Size* (frequency span). The parameters can be accessed via the *Analyzer Settings* softkey or in the *Analyzer* tab of the *Connection Control* menu.

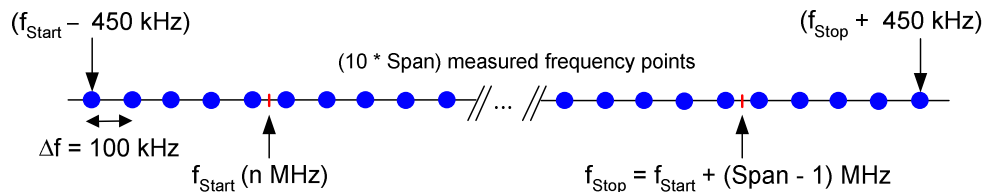

Interpolation

From the signal power at each frequency point, the R&S CMU calculates the limit frequencies of f_L and f_H from the test specification by linear interpolation of the measured logarithmic power values:

- f_L is the lowest frequency in the measured range where the power drops below the threshold value p_{Thr} (*Threshold* value in the *Analyzer* tab of the *Connection Control* menu), which is predefined as -30 dBm in accordance with the specification.
- f_H is the highest frequency in the measured range where the power drops below the threshold value.

The two limit frequencies f_x ($x = L$ or H) are calculated as follows:

$$f_x = \left(\frac{f_b - f_a}{p_b - p_a} \right) \cdot (p_{\text{Thr}} - p_a) + f_a$$

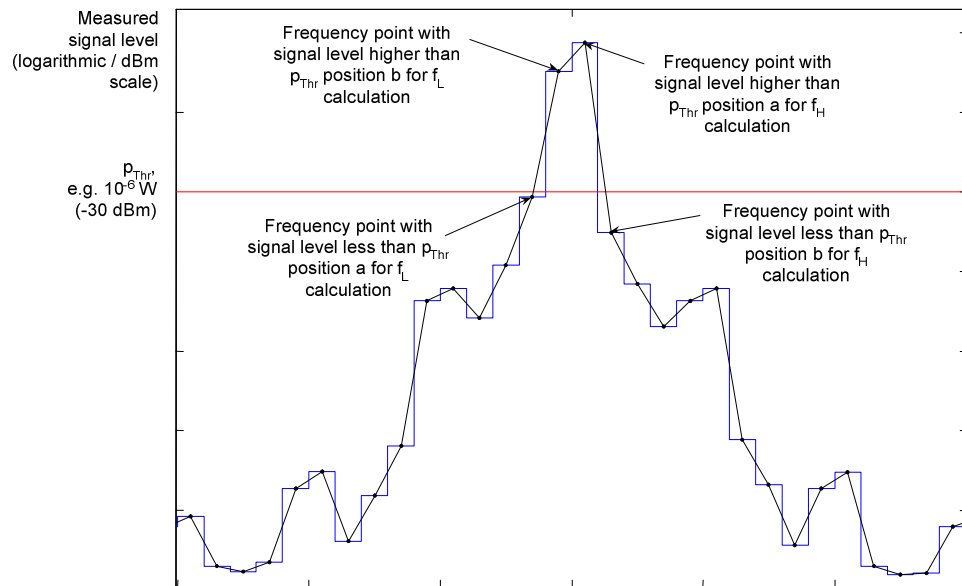

Measurement Menu (Spectrum)

The graphical measurement menu *Spectrum* displays the measurement results for the output RF spectrum emissions.

- The measurement control softkey *ACP* (which changes to *Bandwidth* if this application is selected) controls the measurement, indicates its status (*RUN* | *HLT* | *OFF*) and opens the configuration menu *Spectrum Configuration*. The hotkeys associated to the measurement control softkey define the scope of the *Spectrum* measurement.
- The softkeys *Application*, *Analyzer Level*, *Analyzer Settings*, *Slave Sig.*, *Master Sig.*, *Display* and *Menus* to the right of the test diagram are combined with various hotkeys. The softkey/hotkey combinations provide test settings and switch over between different measurements. The entry of values is described in section [Measurement Menu \(Power\)](#) on page 4.28.

The measurement menu *Spectrum* can be accessed from any other measurement menu of the Bluetooth function group using the *Spectrum* hotkey. It can be opened also from the *Menu Select* main menu (with the associated key at the front of the instrument).

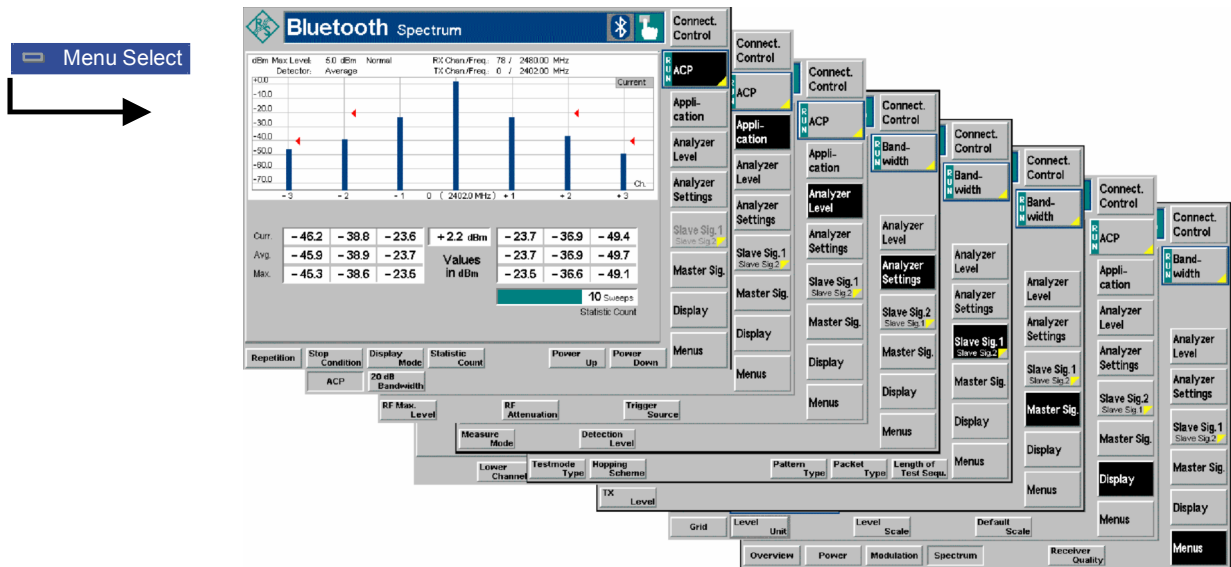

Fig. 4-66 Measurement menu Spectrum

Test Settings

Most of the softkey/hotkey settings are identical with those in the *Power* menu described on page 4.28. The following softkeys and hotkeys differ from the *Power* measurement:

ACP

The *ACP* softkey (which changes to *Bandwidth* if this application is selected) controls the *Spectrum* measurement and indicates its status (*RUN* | *HLT* | *OFF*).

This status can be changed after softkey selection (pressing once) by means of the *ON/OFF* key or the *CONT/HALT* key.

Remote control

INITiate:SPECTrum:<Application>
 ABORT:SPECTrum:<Application>
 STOP:SPECTrum:<Application>
 CONTinue:SPECTrum:<Application> etc.
 Where <Application> = ACPower | BWIDth

Measurement configuration

Pressing the measurement control softkey twice opens the popup menu *Spectrum Configuration* (see page 4.68.). Besides various hotkeys defining the scope of the measurement are associated to the measurement control softkey. These hotkeys are identical with the parameters set in the *Control* tab of the *Spectrum Configuration* menu (see section *Measurement Control (Spectrum Configuration – Control)* on page 4.68.).

Application

The *Application* softkey selects the measurement method and the measured quantities. For a detailed description see background information in section *Spectrum Measurements* on p. 4.54.

Each application has its own measurement menu. The configuration settings for all *Spectrum* applications are listed in a common popup menu (see p. 4.66.).

ACP

Selects the measurement of the Adjacent Channel Power in seven distinct channels (in the active channel (*Center Channel*), in three channels below, and in three channels above the active channel).

Remote control

The *ACP* application is identified by the keyword `:ACPower` in the 3rd level of the `Spectrum` commands, e.g. `CONFigure:SPECTrum:ACPower...`

**20 dB
Bandwidth**

Selects the measurement of the 20 dB bandwidth of the active channel.

Remote control

The *20 dB Bandwidth* application is identified by the keyword `:BWIDth` in the 3rd level of the `Spectrum` commands, e.g. `CONFigure:SPECTrum:BWIDth...`

**Frequency
Range**

Selects the measurement of the lower and upper limit frequencies where the signal power crosses a specified power threshold.

Remote control

The *Frequency Range* application is identified by the keyword `:FRANge` in the 3rd level of the `Spectrum` commands, e.g. `CONFigure:SPECTrum:FRANge...`

**Analyzer
Settings**

Selects the measured RF channels. The settings depend on the application; they are also provided in the *Analyzer* tab of the *Spectrum Configuration* menu (see section [Measurement Control \(Spectrum Configuration – Control\)](#) on page 4.68).

The following additional hotkey is available in the *ACP* application:

**Detector
Mode**

Selects the detector for the ACP measurement. The detector mode defines a first data processing stage where an averaged or maximized curve is calculated from the entire set of raw measurement points obtained during a sweep at fixed frequency.

Average

Several consecutive sweep points are replaced by their linear average so that the measurement curve is smoothed out. If combined with the *Maximum* display mode this detector mode yields the adjacent channel power according to the Bluetooth radio specification.

Peak

The signal level is the maximum of all sweep points.

RMS

Several consecutive sweep points are replaced by their RMS average so that the signal power is correctly averaged. Like the *Average* detector this setting smoothes out the measurement curve.

The R&S® CMU detector settings are analogous to the detector settings known from spectrum analyzers.

Remote control

`CONFigure:SPECTrum:ACPower:DMODE AVG | RMS | PEAK`

The following additional hotkey is available in the *20 dB Bandwidth* application:

Measure Mode

Defines which channels are measured if frequency hopping is enabled.

All Channels

All channels that are part of the current hopping scheme are measured. If the hopping scheme *Europe/USA* is active, the measured channel (the *Current Channel* displayed in the measurement menu) changes continuously. If hopping is disabled (*RX/TX single freq.*), the *Spectrum* measurement is performed on this single frequency.

Single

Measurements are performed on the *Measured Channel* that appears next to *Measure Mode* if *Single* is selected. The *Measured Channel* can be set in the in the configuration menu as well; see section [Analyzer Settings \(Spectrum Configuration – Analyzer\)](#) on p. 4.69. If the hopping scheme *Europe/USA* is active, the measurement rate is slowed down because new measurement results can be acquired only when the hop channel coincides with the *Measured Channel*. If hopping is disabled, then the *Measured Channel* must be set equal to the *RX/TX single freq.* of the DUT; otherwise the measurement would wait forever for the selected *Measured Channel* to occur.

Remote control

CONFigure:SPECTrum:BWIDth:MMODE <Level>

Display

Provides hotkeys to change the appearance of the diagrams. Changing the *Display* settings has no impact on the number and position of the measurement points.

Level Unit

Changes between absolute (dBm) and relative (dB) display of the adjacent channel powers in the output table below the *ACP* bar graph. The relative values are referenced to the center channel power.

Remote control

CONFigure:SPECTrum:ACPower:LUNit

The remaining hotkeys show or hide the grid and change the level scale of the diagrams. These functions have no remote control commands assigned.

Measurement Results

The *Spectrum* menu group contains two separate measurement menus corresponding to the applications *ACP* and *20 dB Bandwidth*. These menus contain different test diagrams.

Adjacent Channel Power (ACP)

The *ACP* measurement menu shows the Adjacent Channel Power in seven distinct channels (in the active channel (*Center Channel*), in three channels below, and in three channels above the active channel). The results and the corresponding measurement settings are indicated in two parameter lines, the test diagram (bar graph) and a tabular overview:

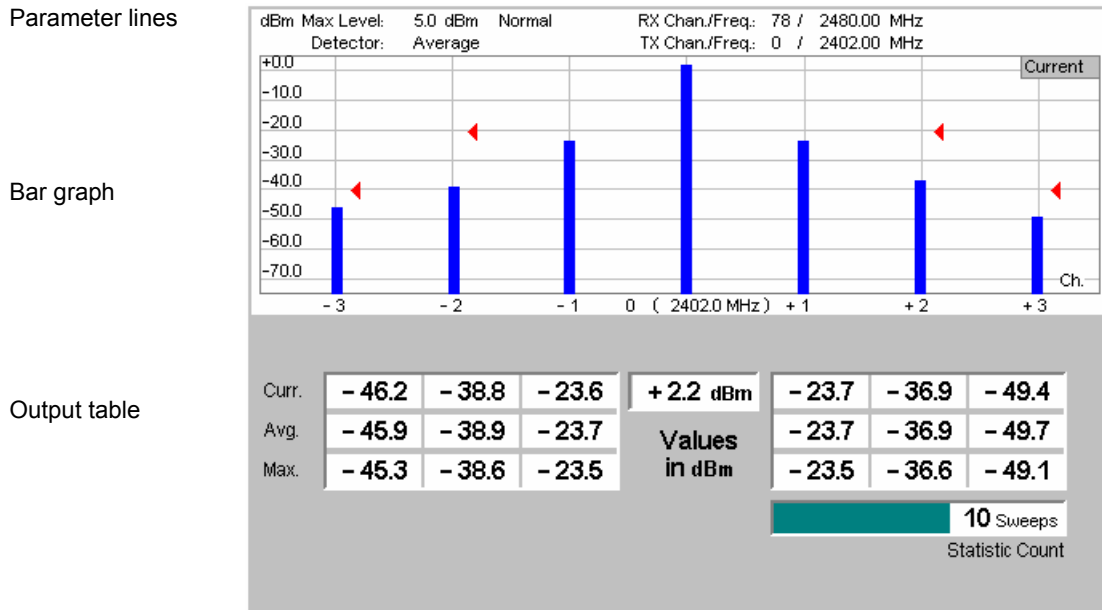

Fig. 4-67 Display of results (ACP)

Parameter lines The essential analyzer settings (as set via the *Analyzer Level* and the *Analyzer Settings* softkeys) are indicated in two parameter lines across the top of the measurement menu:

- Max. Level* Maximum input level (*Analyzer Level – Max. Level*)
- Attenuation* Input path setting (*Analyzer Level – RF Attenuation*; set to *Normal*, *Low Noise* or *Low Distortion*)
- RX Chan./Freq.* Current receive frequency of the DUT and corresponding channel
- Detector* Detector mode (*ACP – Detector Mode*)
- TX Chan./Freq.* Current transmit frequency of the DUT and corresponding channel.

Remote control

The settings are read out using the query corresponding to the setting command (setting command with appended question mark).

Bar graph

The bar graph shows the channel power P_{TX} in the *Center Channel* (active Tx channel of the DUT, central bar) and the ACP in three *Upper Channels* and in three *Lower Channels*. The upper channels are at frequencies above the center channel frequency; the lower channels are at frequencies below the center channel frequency. All channels can be selected using the *Analyzer Settings* softkey or the *Analyzer* tab of the *Spectrum Configuration* menu.

The bar graph uses an absolute power scale (in dBm). The appearance of the diagram and the scale can be changed using the *Display* softkey and the associated hotkeys. The *Display Mode* (*ACP – Display Mode*, set to *Current* by default) is also indicated in the diagram.

The red triangles indicate the upper relative limits for the ACP in the upper and lower channels, to be defined in the *Spectrum Configuration – Limits* menu (see section [Spectrum Limits \(Spectrum Configuration – Limits\)](#) on p. 4.70).

Remote control:

See below: READ[:SCALar]:SPECTrum:ACPower? etc.

Output values The output table below the bar graph shows the ACP in three *Upper Channels* and in three *Lower Channels* (P_{TX} values). The three rows contain the *Current ACP* values and the average (*Avg.*) and maximum (*Max.*) ACP values of the entire measurement. The power in the *Center Channel* P_{TX} is displayed below.

In accordance with the Bluetooth Test Specification, all P_{TX} results are summed over 10 different frequencies at -450 kHz, -350 kHz... $+450$ kHz relative to the channel frequency.

Display – Level Scale changes the unit of the ACP values between dBm (absolute powers) and dB (relative to the center channel power). The *Statistic Count* field indicates the number of sweeps per statistics cycle (*ACP – Statistic Count*). The colored bar indicates the relative measurement progress within the statistics cycle.

Note: *Due to the measurement algorithm the meaning of the Current ACP results and of the Statistic Count differs from other R&S® CMU measurements. The Current ACP results correspond to the results of an internal sweep; their update interval is much smaller than the duration of a single shot measurement, which requires several sweeps at different frequencies.*

Remote control

```
READ[:SCALar]:SPECTrum:ACPower?
FETCh[:SCALar]:SPECTrum:ACPower?
FETCh:SPECTrum:ACPower:STATus?
```

Limit Check A red output field in the in the output table indicates that the ACP exceeds the upper limit set in the *Limits* tab of the *Spectrum* configuration menu. The limit check can be disabled, see section [Spectrum Limits \(Spectrum Configuration – Limits\)](#) on p. 4.70.

Remote control:

```
CALCulate[:SCALAR]:SPECTrum:ACPower:MATCHing:LIMit?
```

20 dB Bandwidth

The *20 dB Bandwidth* measurement menu shows the spectrum emissions in a frequency range around the center frequency of the *Current Channel* plus a statistical evaluation of the bandwidth. The results and the corresponding measurement settings are indicated in two parameter lines, the test diagram and a tabular overview:

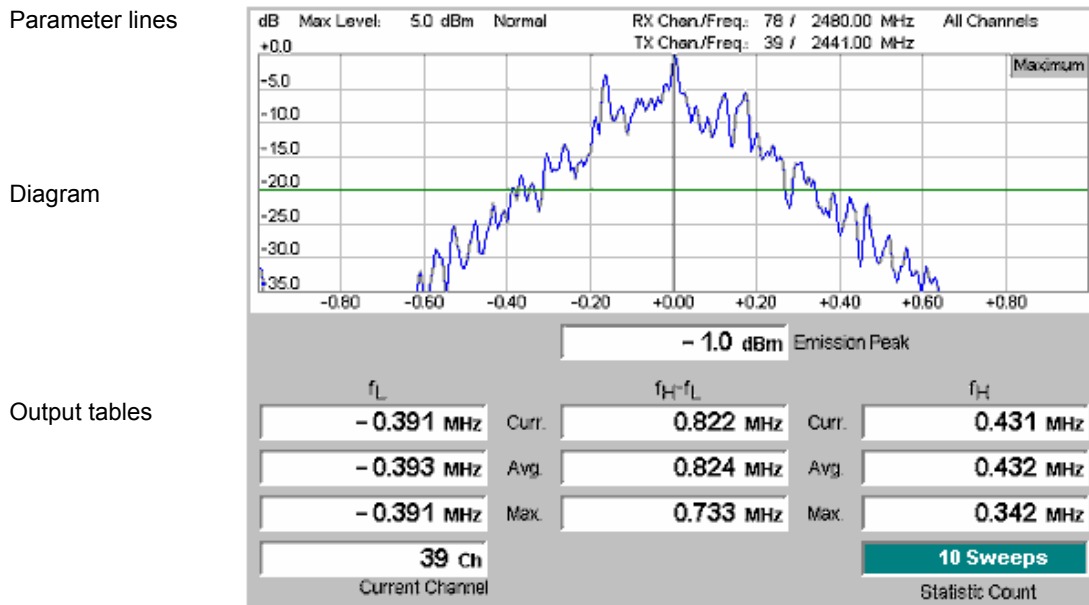

Fig. 4-68 Display of results (20 dB Bandwidth)

Parameter lines The essential analyzer settings (as set via the *Analyzer Level* and the *Analyzer Settings* softkeys) are indicated in two parameter lines across the top of the measurement menu:

<i>Max. Level</i>	Maximum input level (<i>Analyzer Level</i> – <i>Max. Level</i>)
<i>Attenuation</i>	Input path setting (<i>Analyzer Level</i> – <i>Mode</i> ; set to <i>Normal</i> , <i>Low Noise</i> or <i>Low Distortion</i>)
<i>RX Chan./Freq.</i>	Current receive frequency of the DUT and corresponding channel
<i>Measure Mode</i>	Measured channels (<i>Analyzer Settings</i> – <i>Measure Mode</i>)
<i>TX Chan./Freq.</i>	Current transmit frequency of the DUT and corresponding channel. This can be different from the measured channel; see description of the <i>Meas. Mode</i> on p. 4.61.

Remote control

The settings are read out using the query corresponding to the setting command (setting command with appended question mark).

Diagram The diagram shows the spectrum emissions in a frequency range around the center frequency of the *Current Channel*. The default scale corresponds to the situation in Fig. 4-68 on p. 4.64:

- The horizontal axis covers a symmetrical, 2-MHz wide frequency range around the nominal center frequency of the measured Bluetooth channel.
- The vertical axis shows the output power relative to the emission peak power which is normalized to 0 dB. The absolute value Emission Peak is indicated below the diagram.

The diagram scaling can be changed using the *Frequency Scale* and *Level Scale* hotkeys associated with the *Display* softkey. The *Display Mode* (*Bandwidth* – *Display Mode*, set to *Maximum* by default) is also indicated in the diagram.

A horizontal colored line shows the *Detection Level* (*Analyzer Settings* – *Detection Level*); a vertical colored line crosses the emission peak. The measurement curve changes when a different bit pattern with a shorter period is transferred (*Slave Sig. 1* – *Pattern Type*).

Remote control: READ:ARRAY:SPECTrum:BWIDth?
 FETCh:ARRAY:SPECTrum:BWIDth?

Output values

The output table below the diagram shows the following values:

Emission Peak Absolute power at the peak of the emission in dBm. Like the measurement curve in the diagram, the *Emission Peak* power is measured in a narrow (10-kHz) resolution bandwidth, so its value is generally below the *Nominal Power* obtained in a *Power* measurement.

$f_L, f_H - f_L, f_H$ Frequencies f_L and f_H where the transmit power drops 20 dB below the emission peak power and 20 dB bandwidth; see [Fig. 4-65](#) on p. 4.55. The 20 dB value can be varied using *Analyzer Settings – Detection Level*. Results are provided for the *Current*, the *Average* and the *Maximum* measurement curve (see description of the display mode in chapter 3 of the operating manual).

Current Channel Current measured channel; see description of the *Meas. Mode* on p. 4.61.

Statistic Count Number of sweeps per statistics cycle. The colored bar indicates the relative measurement progress in the statistics cycle.

Remote control

READ[:SCALar]:SPECTrum:BWIDth?
 FETCh[:SCALar]:SPECTrum:BWIDth?

Limit Check

A red output field in the $f_H - f_L$ column indicates that the bandwidth exceeds the upper limit set in the *Limits* tab of the *Spectrum* configuration menu. The limit check can be disabled, see section [Spectrum Limits \(Spectrum Configuration – Limits\)](#) on p. 4.70.

Remote control:

CALCulate[:SCALar]:SPECTrum:BWIDth:MATChing:LIMIt?

Frequency Range

The *Frequency Range* measurement menu shows the spectrum emissions in a frequency range around the TX frequency of the DUT. For a description of the measurement refer to section [Frequency Range Application](#) on p. 4.57.

The results and the corresponding measurement settings are indicated in two parameter lines, the test diagram and a tabular overview:

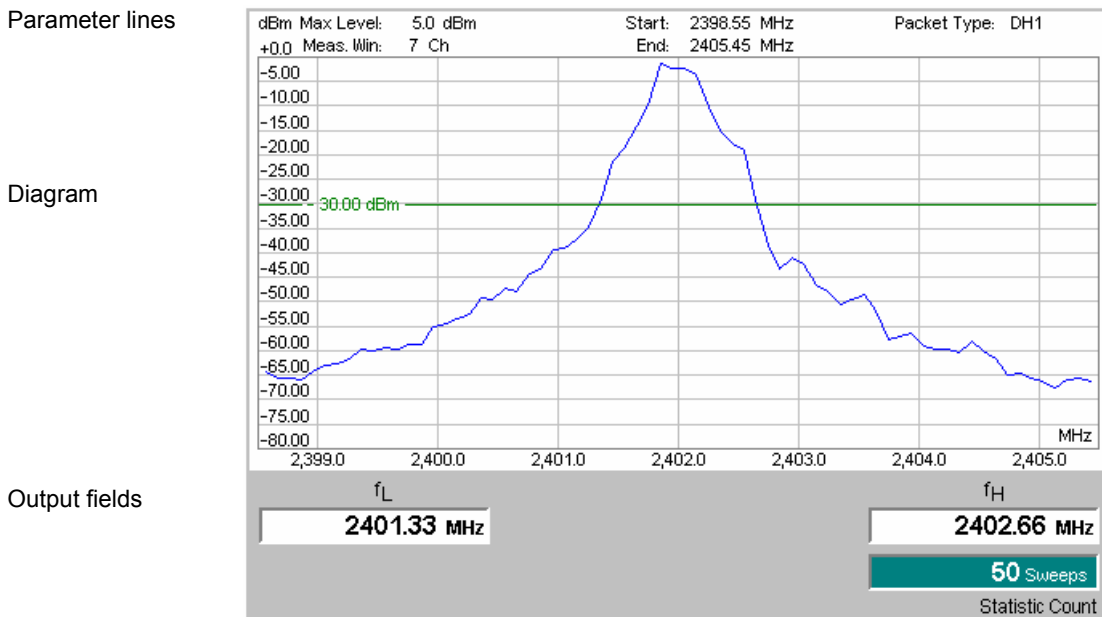

Fig. 4-69 Display of results (Frequency Range)

Parameter lines The essential analyzer settings (as set via the *Analyzer Level* and the *Analyzer Settings* softkeys) are indicated in two parameter lines across the top of the measurement menu:

<i>Max. Level</i>	Maximum input level (<i>Analyzer Level</i> – <i>Max. Level</i>)
<i>Meas. Win.</i>	Width (span) of the measurement window, integer number of channels
<i>Start/End</i>	Start and end frequency of the measurement window (first and last frequency point measured)
<i>Packet Type</i>	Packet type currently selected for the DUT (DH1, DH3, etc.).

Remote control

The settings are read out using the query corresponding to the setting command (setting command with appended question mark).

Diagram

The diagram shows the spectrum emissions in a frequency range (*Analyzer Settings* – *Measurement Window*) around the current TX frequency of the DUT (*Slave Sig. 1* – TX Frequency with hopping disabled). The default scale corresponds to the situation in [Fig. 4-69](#) on p. 4.66:

- The horizontal axis covers a 7-MHz (7 channel) wide frequency range around the TX frequency.
- The vertical axis shows the absolute output power in dBm.

The vertical diagram scaling can be changed using the *Level Scale* hotkey associated with the *Display* softkey.

A horizontal colored line shows the *Threshold* value p_{Thr} for the calculation of the two limit frequencies f_L and f_H (*Analyzer Settings – Threshold*). The measurement curve changes when a different bit pattern with a shorter period is transferred (*Slave Sig. 1 – Pattern Type*).

Remote control: READ:ARRAY:SPECTrum:FRANge?
FETCh:ARRAY:SPECTrum:FRANge?

Output values

The output fields below the diagram show the following values:

f_L Lower limit frequency; the lowest frequency in the measurement window where the power drops below the threshold value p_{Thr} .

f_H Upper limit frequency; the highest frequency in the measurement window where the power drops below the threshold value p_{Thr} .

Statistic Count Number of sweeps per statistics cycle. Each sweep yields a complete measurement curve. The colored bar indicates the relative measurement progress in the first statistics cycle.

Remote control

READ[:SCALar]:SPECTrum:FRANge:LFRequency?
READ[:SCALar]:SPECTrum:FRANge:HFRequency?
FETCh[:SCALar]:SPECTrum:FRANge:LFRequency?
FETCh[:SCALar]:SPECTrum:FRANge:HFRequency?

Limit Check

A red output field f_L or f_H and an arrow pointing upwards/downwards indicates that the lower or upper limit value is out of tolerance. Limits for f_L and f_H are defined in the *Limits* tab of the *Spectrum* configuration menu. The limit check can be disabled, see section [Spectrum Limits \(Spectrum Configuration – Limits\)](#) on p. 4.70.

Remote control:

CALCulate[:SCALar]:SPECTrum:FRANge:MATCHing:LIMit?

Measurement Configurations (Spectrum)

The popup menu *Spectrum Configuration* contains three tabs to define the parameters of the *Spectrum* measurement including the error tolerances.

The popup menu *Spectrum Configuration* is called up by pressing the measurement control softkey in the top right of the graphical measurement menu *Spectrum* twice (this softkey reads *ACP* or *Bandwidth*, depending on the selected application). The associated hotkeys change between the tabs.

Measurement Control (Spectrum Configuration – Control)

The settings in the *Control* tab define

- The Repetition mode
- The Stop Condition for the measurement
- The measurement curve displayed (Display Mode)
- The number of sweeps forming a statistics cycle (Statistic Count). In the ACP application this corresponds to the number of sweeps to be measured at each frequency.

The default statistical settings ensure that the *Spectrum* measurement is performed in accordance with the Bluetooth radio specification.

As a further option, display of the *Grid* in the measurement diagram may be switched off.

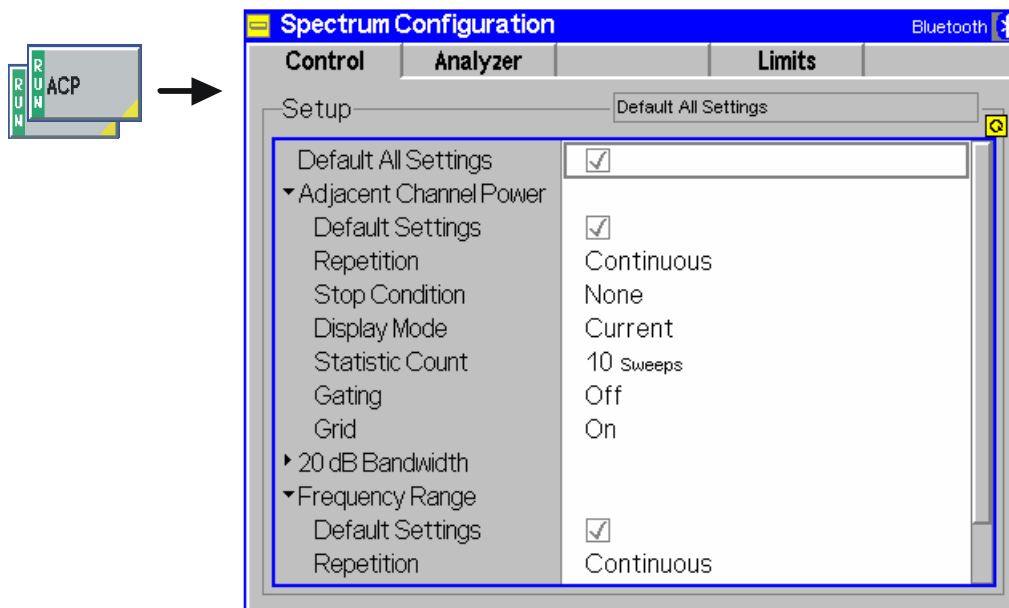

Fig. 4-70 Spectrum Configuration – Control

The settings comply with those of the *Control* tab of the *Power Configuration* menu described in the operating manual. In the remote-control commands, the keywords `POWer:<Pow_Application>` are to be replaced by `SPECTrum:<Spec_Application>`.

Analyzer Settings (Spectrum Configuration – Analyzer)

The settings in the *Analyzer* tab define

- All channels for the ACP measurement
- The (fixed) TX channel of the DUT (Measured Channel) for the 20 dB bandwidth measurement and the off-peak signal level at which the bandwidth is measured (*Detection Level*)
- The *Start Channel* and *Measurement Window* for the *Frequency Range* measurement and the *Threshold* power for the calculation of the lower and upper limit frequencies.

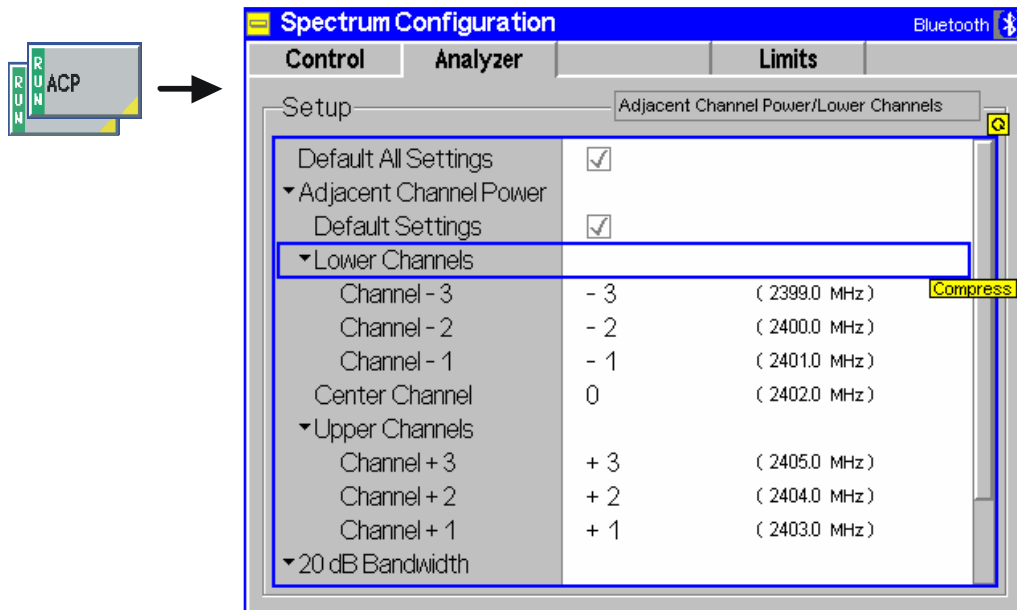

Fig. 4-71 Spectrum Configuration – Analyzer

The following settings apply to the *ACP* application:

Default Settings

The *Default All Settings* switch assigns default values to all settings in the *Analyzer* tab (the default values are quoted in the command description in chapter 6 of this manual). In addition, default switches for the individual applications are provided.

Remote control: -

Lower Channels / Center Channel / Upper Channels

Selects the Bluetooth channels where the ACP is measured. Channels can be set in the frequency range between 2398 MHz and 2499 MHz.

An adjacent channel number of n means that the adjacent channel frequency is equal to the center channel frequency + n MHz. n must be negative or zero for lower channels, it must be positive or zero for upper channels. Entering frequencies or (relative) channel numbers is equivalent.

Remote control

```
CONFigure:SPECTrum:ACPower:MChannel:RELative
CONFigure:SPECTrum:ACPower:CChannel
```

The following settings apply to the *20 dB Bandwidth* application:

Measured Channel Defines the Bluetooth TX channel of the DUT where the 20 dB Bandwidth is measured. The setting is only relevant for *Single* measurement mode; see description of the *Measure Mode* on p. 4.61.

Remote control

CONFigure:SPECTrum:BWIDth:MCHannel <Channel>

Detection Level Defines the off-peak signal level at which the bandwidth is measured; see Fig. 4-65 on p. 4.55. The default setting yields the 20 dB bandwidth from the Bluetooth radio specification.

Remote control

CONFigure:SPECTrum:BWIDth:DLEVel <Level>

The following settings apply to the *Frequency Range* application:

Threshold Threshold power in dBm for the calculation of the lower and upper limit frequencies f_L and f_H . The limit frequencies are calculated by linear interpolation; see section *Frequency Range Application* on p. 4.57.

Remote control

CONFigure:SPECTrum:FRANge:THReshold <Threshold>

Start Channel, Meas. Window Defines the frequency interval where the R&S CMU acquires measurement data; see section *Frequency Range Application* on p. 4.57.

Remote control

CONFigure:SPECTrum:FRANge:MWINDow <Start>,

Spectrum Limits (Spectrum Configuration – Limits)

The *Limits* tab defines upper limits for the ACP and the 20 dB bandwidth. The Bluetooth radio specification defines the following limits:

- The Adjacent Channel Power (ACP) in channels ± 2 away from the center channel, measured with an *Avg.* detector, must be smaller than -20 dBm. The ACP in channels ≤ -3 and $\geq +3$ must be smaller than -40 dBm². Nothing is specified for the ACP measured with different detector modes.

The 20-dB bandwidth, measured under the conditions described in section *Spectrum Measurements* on p. 4.54, must not exceed 1 MHz. Nothing is specified for the bandwidth derived from the *Current* and *Average* curves.

- The upper and lower limit frequencies f_L and f_H , measured under the conditions of the *Frequency Range* measurement, must be in the allowed frequency band 2.4 GHz to 2.4835 GHz.

² The standard allows exceptions in up to three bands of 1 MHz width, where the ACP must be below -20 dBm. The R&S CMU uses a default limit of -20 dBm for channels ± 3 .

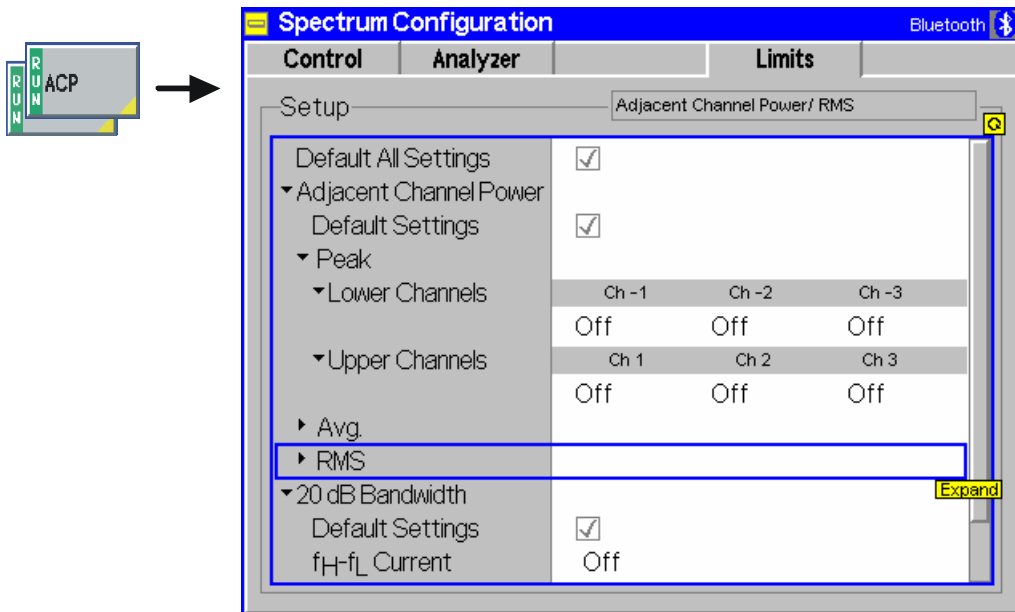

Fig. 4-72 Spectrum Configuration – Limits

Default Settings The *Default All Settings* switch assigns default values to all settings in the *Limits* tab (the default values are quoted in the command description in chapter 6 of this manual). In addition, default switches for the individual applications are provided. Remote control: –

The following limits apply to the *ACP* application:

Lower Chan. / Upper Channels Upper limits for the *ACP* calculated with the *Peak*, *Average* and *RMS* detector mode, respectively. *Off* disables the limit check. The result of the limit check appears in the output fields for the *ACP*; see section [Adjacent Channel P](#) on p. 4.61.

Remote control

```

CONFIGure:SPECTrum:ACPower:<Display>:<Detector>:
    LIMit:SCALar:ASYMmetric:<Channel>:VALue <Limit>
CONFIGure:SPECTrum:ACPower:<Display>:<Detector>:
    LIMit:SCALar:ASYMmetric:<Channel>:ENABle <Enable>
CONFIGure:SPECTrum:ACPower:<Display>:
    LIMit:SCALar:ASYMmetric:<Channel>:ENABle <Enable>
where <Display> = CURRent | AVERAge | MAXimum
      <Detector> = PEAK | AVERAge | RMS
      <Channel> = UChannel | LChannel
    
```

The following limits apply to the *20 dB Bandwidth* application:

f_H – f_L Current / f_H – f_L Average / f_H – f_L Maximum Upper limits for the bandwidths calculated from the *Current*, *Average* and *Maximum* measurement curves, respectively. *Off* disables the limit check. The result of the limit check appears in the output fields for the bandwidths; see section [20 dB Bandwidth](#) on p. 4.63.

Remote control

```

CONFIGure:SPECTrum:BWIDth:CURRent:LIMit:SCALar:ASYMmetric
    
```

```
:UPPer:VALue <Limit>  
CONFigure:SPECTrum:BWIDth:AVERAge:LIMit:SCALar:ASYMmetric  
:UPPer:VALue <Limit>  
CONFigure:SPECTrum:BWIDth:MAXimum:LIMit:SCALar:ASYMmetric  
:UPPer:VALue <Limit>
```

The following limits apply to the *Frequency Range* application:

**f_H and f_L
Upper/Lower
Limit**

Upper and lower limits for the limit frequencies of the *Frequency Range* measurement (see section [Frequency Range Application](#) on p. 4.57). *Off* disables the limit check. The result of the limit check appears in the output fields for the limit frequencies; see section [Frequency Range](#) on p. 4.66.

Remote control

```
CONFigure:SPECTrum:FRANge:LIMit:SCALar:ASYMmetric  
[:COMBined]:VALue <FL_FH_Upper>, <FL_FH_Lower>  
CONFigure:SPECTrum:FRANge:LIMit:SCALar:ASYMmetric  
[:COMBined]:ENable <FL_FH_Upper>, <FL_FH_Lower>
```

Receiver Quality Measurements

The menu group *Receiver Quality* measures parameters that describe the sensitivity of the receiver of a Bluetooth device under test, in particular at low RF power levels.

The popup menu *Receiver Quality Configuration* is used for configuration of the measurements; the measurement results are directly indicated in the *Receiver Quality* menu.

Note: *The evaluation of the receiver quality is based on the bit by bit comparison of the payload transmitted by the R&S® CMU with the signal received, decoded, and returned by the device under test.*

Therefore, a Loopback testmode type must be active where the DUT returns the signal received from the R&S® CMU unchanged; see [Testmode Type](#) softkey on p. 4.109. The R&S® CMU automatically activates a loopback mode when performing Receiver Quality tests. When the Receiver Quality measurement is switched off, the original testmode type settings will be restored.

In addition to the loopback mode the Receiver Quality measurement uses specific Slave Sig. and Master Sig. settings. Receiver Quality measurements with restricted functionality are available outside of the testmode; see p. 4.74.

Measured quantities

The basic evaluation periods in the *Receiver Quality* measurement are packets of different type and with variable data content. The R&S® CMU provides two complementary measurement results to assess the quality of the DUT receiver and the number of packets distorted in the DUT or on the return path to the R&S® CMU:

- The Bit Error Rate (BER) is the ratio of payload bits received in error to the total number of received payload bits in percent:

$$\text{BER} = \text{bit errors} / \text{total number of received payload bits} * 100\%$$

A receiver quality measurement is only meaningful under the assumption that the return path from the DUT to the tester is perfect and has no impact on the BER results. Therefore only packets looped back with correct CRC and packet header are considered for the BER calculation (see [Table 4-6](#) below). According to the requirements of the Bluetooth RF Test Specification, a minimum number of 1 600 000 payload bits must be received.

- The Packet Error Rate (PER) is the ratio of packets that are not considered for the BER calculation to the total number of transmitted packets in percent:

$$\text{PER} = \text{bad packets} / \text{total number of packets transmitted} * 100\%$$

Bad packets comprise those that the DUT is unable to loop back (e.g. because the sync word is not found or the header error check (HEC) fails) and the ones that are looped back in error (see [Table 4-6](#) below).

A NAK or ACK in the received packet has no influence on the BER/PER calculation, however, the percentage of NAKed packets is also displayed in the measurement menu.

In addition to the BER and PER results and the NAK rate the R&S® CMU displays information concerning the cause for packet errors; see section [Measurement Results](#) on p. 4.79.

BER Search

In the *BER Search* mode, the R&S® CMU performs repeated single shot BER measurements at decreasing RF output levels (*TX levels*) until the target bit error rate (*Search Value BER*) is found or the maximum number of search cycles is exceeded. The TX level corresponding to the target bit error rate is returned as the *Search Result*. With an appropriate setting of the target bit error rate (0.10% according to the Bluetooth standard), this search result yields the *actual sensitivity level* of the receiver.

Table 4-6 BER and PER measurement scenarios

R&S® CMU receives	Packet increases the PER	Packet considered for BER
Packet with correct CRC and correct packet header (HEC)	NO	YES
Packet with payload failure (CRC)	YES	NO
Packet with failure in the packet header (HEC)	YES	NO
Packet with wrong payload length	YES	NO
Null packet	YES	NO
No packet	YES	NO

Packet Error Tests outside of Testmode

While the R&S® CMU is connected to a DUT, but test mode is **not** active, the BER screen shows no bit error rates but displays the packet error rates described below.

Measurement settings

The packet error tests described here may be performed with a "raw" connection (without any submode) or in the submodes that the R&S® CMU provides as an alternative to the test mode. No particular settings are required. All the loopback settings are only applicable to test mode, so none are relevant outside of test mode.

Principle of the measurement

The measurement uses the POLL/NULL pairs which are sent when the connection is idle, which is the state when in a "raw" connection. The CMU periodically sends a POLL, and the DUT (should) reply with a NULL. With a degraded link, for example because the CMU is transmitting at a very low RF power level, the DUT may not "hear" the POLL, in which case it won't reply, causing one *Missing Packet* error. This represents a simple test of the receiver sensitivity, if one assumes the DUT to CMU path is perfect.

Note that the DUT **may** reply with a packet type other than NULL. It may reply with an ACL data packet, if it has data to send to the CMU. In audio mode it will normally send HV packets. This will not affect the measurement, which simply looks for the presence/absence of a packet from the DUT.

Measurement results Outside of test mode, the R&S® CMU counts the packets received from the DUT and provides the following results (see description in section [Measurement Results](#) on p. 4.79):

- The percentage of *Missing Packets*
- The percentage of *HEC Errors*
- The total *Packet Error Rate*, which is the sum of the two percentages.

Bit error measurements are only possible in test mode (with packet loopback).

Important note:

*Since bit error measurements aren't possible, the "statistic count" (packets received) can no longer be the count of packets taken into account for the BER measurement. Therefore, when **not** in test mode, this counter is re-defined as the number of opportunities for a packet to be received. Or, the number of times the CMU expects to receive a packet, whether or not a packet was actually successfully received.*

Remote Control The results are also available in remote control mode. All the results which have no meaning outside of test mode (BER, other packet errors) are returned as NAN.

Measurement Menu (Receiver Quality)

The *Receiver Quality* menu shows the results and the most important parameters of the *Receiver Quality* measurement.

- The measurement control softkey BER (which changes to BER Search if this application is selected) indicates the status of the Receiver Quality measurement (RUN, HLT, OFF) and opens the configuration menu Receiver Quality Configuration.
- The other softkeys on the right softkey bar are combined with various hotkeys. When a softkey is selected and an associated hotkey pressed, a popup window appears which indicates a setting or allows the user to enter a value (see section [Test Settings](#) on page 4.29).
- In the tables in the center of the menu, the test settings of the current *Receiver Quality* measurement and the results are displayed.

The measurement menu *Receiver Quality* can be opened from the *Menu Select* menu (with the associated key at the front of the instrument) or from any other measurement menu in function group *Bluetooth Signalling* using the hotkey *Receiver Quality*.

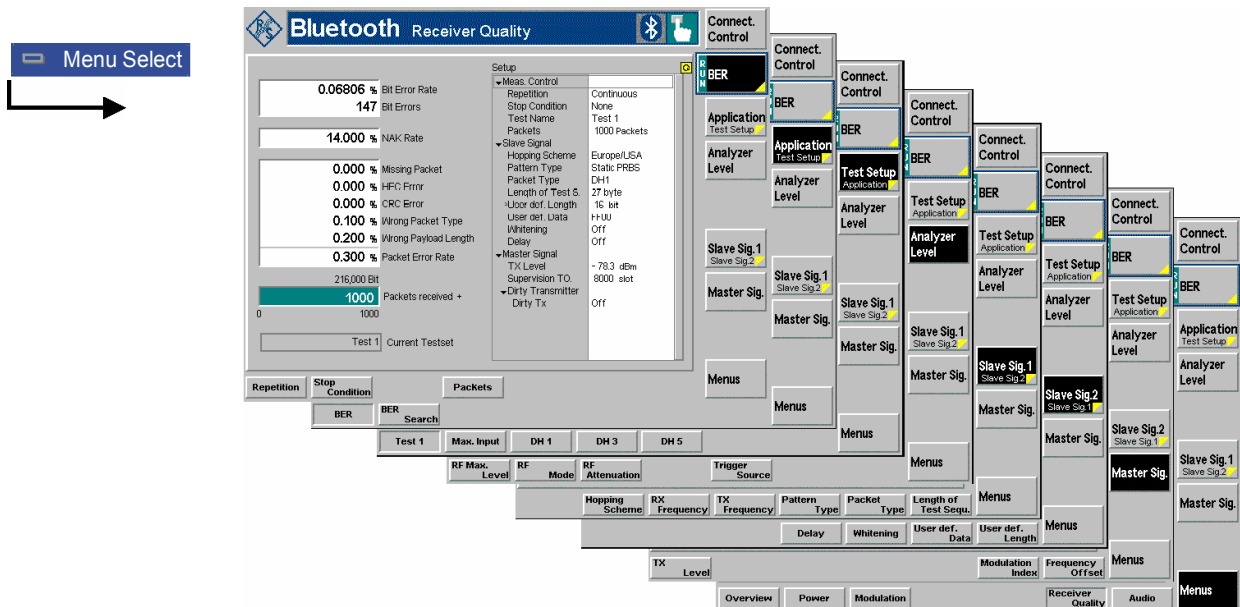

Fig. 4-73 Receiver Quality (BER)

Test Settings

The *Analyzer Level*, *Slave Sig.*, and *Menus* test settings are mostly identical with those in the *Power* menu (see section *Test Settings* on page 4.29). The *BER* measurement control softkey (which changes to *BER Search* if this application is selected) is analogous to the *Output Power* softkey described in section *Test Settings* on page 4.29. The remaining softkeys and hotkeys have no direct equivalent in other measurement menus. The differences to *Power* and *Modulation* measurements are:

- No *Meas. Mode* can be set in the *Receiver Quality* measurement group. The measurement is always performed on all channels of the current hopping scheme (corresponding to the *Meas. Mode* setting All). If the BER has to be measured on only one channel then the Single Frequency Hopping Scheme can be used.
- The *Slave Sig. 1* section doesn't offer a *Testmode Type* setting, the testmode type for receiver quality measurements is always *Loopback*.
- The *Slave Sig. 2* section allows to configure the *Loopback Delay* which is only relevant for receiver quality measurements.

Measurement Control

The *Receiver Quality* measurement is controlled by means of the measurement control softkey below the *Connect. Control* softkey and the associated hotkeys.

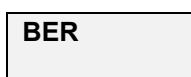

The *BER* softkey (which changes to *BER Search* if this application is selected) controls the measurement application and indicates its status (*RUN* | *HLT* | *OFF*). This status can be changed after softkey selection (pressing once) by means of the *ON/OFF* key or the *CONT/HALT* key. The status can be set independently for both applications.

Remote control	<pre>INITiate:RXQuality:<application> ABORt:RXQuality:<application> STOP:RXQuality:<application> CONTINUE:RXQuality:<application> FETCh:RXQuality:<application>:STATUs? where <application> = BER SBER</pre>
Measurement configuration	<p>Pressing the <i>BER</i> softkey a second time opens the popup menu <i>Receiver Quality Configuration</i> (see page 4.82). Besides, the measurement control softkey provides hotkeys to define the scope of the measurement. All these settings are described in more detail in section Measurement Control (Receiver Quality Configuration – Control) on p. 4.82.</p>
Repetition	<p>The hotkey <i>Repetition</i> determines the repetition mode of the measurement (<i>Single Shot</i> or <i>Continuous</i> measurement); see section Measurement Control (Power Configuration – Control) on page 4.38). The hotkey is not available in <i>BER Search</i> mode.</p> <p>Remote control</p> <pre>CONFigure:RXQuality:BER:CONTRol:REPetition <Repetition>,<StopCond>,<Stepmode></pre>
Stop Condition	<p>The <i>Stop Condition</i> hotkey sets a stop condition for the <i>BER</i> measurement (<i>None</i> or <i>On Limit Failure</i>). The hotkey is not available in <i>BER Search</i> mode.</p> <p>Remote control</p> <pre>CONFigure:RXQuality:BER:CONTRol:REPetition <Repetition>,<StopCond>,<Stepmode></pre>
Packets	<p>The <i>Packets</i> hotkey determines the number of packets to be sent in a single shot <i>BER</i> measurement or in a single iteration cycle within a <i>BER Search</i> measurement. The hotkey is not available in <i>BER Search</i> mode.</p> <p>Remote control</p> <pre>CONFigure:RXQuality:BER:TSEUp<nr>:CONTRol:STATistics <Packets> CONFigure:RXQuality:SBER:CONTRol:STATistics <Packets>,<Search_Value>,<Search_Cycles></pre>
Search Value	<p>The <i>Search Value</i> hotkey determines the target bit error rate for the <i>BER Search</i> measurement. The hotkey is not available while the <i>BER</i> application is active.</p> <p>Remote control</p> <pre>CONFigure:RXQuality:SBER:CONTRol:STATistics <Packets>,<Search_Value>,<Search_Cycles></pre>
Search Cycles	<p>The <i>Search Cycles</i> hotkey determines the number of iteration cycles within a <i>BER Search</i> measurement. The hotkey is not available while the <i>BER</i> application is active.</p> <p>Remote control</p> <pre>CONFigure:RXQuality:SBER:CONTRol:STATistics <Packets>,<Search_Value>,<Search_Cycles></pre>

Specific Receiver Quality Settings

The settings of the following softkeys are specific to *Receiver Quality* measurements. They are not available in the *Connection Control* menu.

Application
TestSetup

The *Application/Test Setup* softkey selects the application, the test setup, and the repetition mode. If pressed once again in the *BER* application, the selected *Application/Test Setup* softkey changes to the *Test Setup/Application* softkey, see below.

The alternative applications *BER* and *BER Search* are displayed in separate measurement menus. When an application is selected, the corresponding measurement menu is displayed. The configuration settings for both applications, however, are listed in a common popup-menu (see p. 4.82.).

BER

The *BER* hotkey selects the bit error rate measurement. In this mode, the bit error rate (*BER*) and the packet error rate (*PER*) can be measured under various conditions, see section [Measurement Results](#) on page 4.79.

Remote control

No explicit switchover command. All single shot measurements are identified by the 2nd/3rd level keywords `...RXQuality:BER...`

BER
Search

The *BER Search* hotkey selects the measurement of the TX level corresponding to a definite target bit error rate. The *Search* mode consists of a repeated single-shot BER measurement with decreasing RF output level until a certain bit error rate is found or the maximum number of search cycles is exceeded (see *Search Cycles* hotkey below). The search algorithm is explained in the paragraph on [Search Cycles](#) on page 4.84.

The bit error rate searched for is defined via the *Search Value* softkey associated with the *BER Search* measurement control softkey. The search is restricted to a particular range of TX levels (see *Master Sig.* softkey below).

Remote control

No explicit switchover command. All single shot measurements are identified by the 2nd/3rd level keywords `...RXQuality:SBER...`

Test Setup
Application

The *Test Setup/Application* softkey selects the test setup for BER measurements. The softkey is not available in *BER Search* mode.

If pressed once again, the selected *Test Setup/Application* softkey changes to the *Application/Test Setup* softkey, see above.

Test 1

The *Test 1* hotkey selects the test setup named *Test 1*.

Test setups are BER configuration files defined in the *Receiver Quality Configuration* menu (see page 4.82). By default the five available test setups are named *Test 1*, *Max. Input*, *DH1*, *DH3*, *DH5*; the first five hotkeys associated with the *Test Setup/Application* softkey are labeled with the same names. The test setup names can be defined from within the configuration menu.

Remote control

CONFigure:RXQuality:BER:TSETup <TestSetup>

The test setup number is referenced by a numeric suffix in the BER commands (`...RXQuality:BER:TSETup<nr>:...`).

Master Sig.

The *Master Sig.* softkey sets the R&S® CMU output level for the *BER* application or the level range to be used in the *BER Search* application. These settings are only used for *Receiver Quality* tests; they are described in more detail in section [BER Levels \(Receiver Quality Configuration – Master\)](#) on p. 4.84.

Moreover the *Dirty Tx* hotkey associated with the *Master Sig.* softkey defines the parameters for the non-ideal master signal (dirty transmitter). The dirty transmitter settings are also provided in the *Master Sig.* tab of the *Connection Control* menu; see detailed description on p. 4.106. The *Dirty Transmitter Scope* parameter in the *Master Sig.* tab defines whether the dirty transmitter is always active or only used while a *Receiver Quality* measurement is running.

Measurement Results

The test settings of the current *Receiver Quality* measurement and the results are displayed in the tables of the menu.

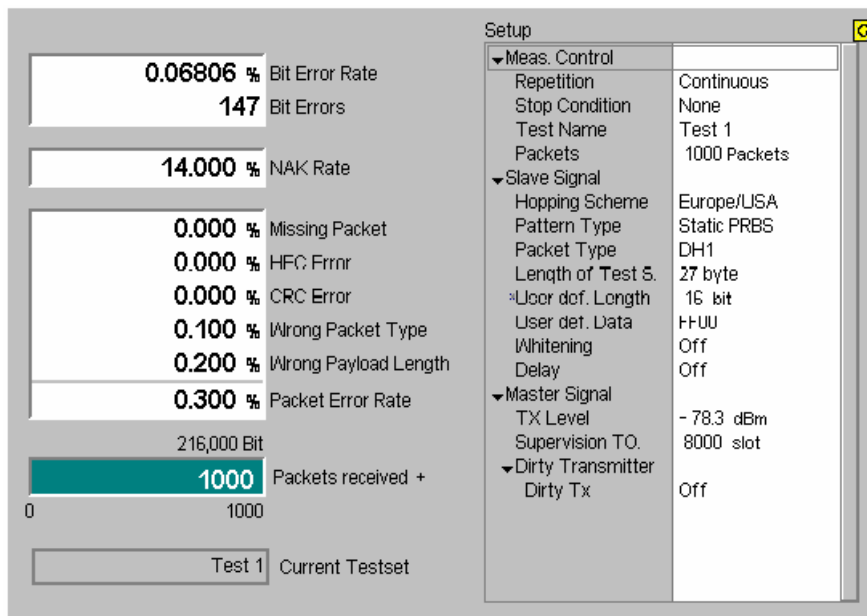

Fig. 4-74 Display of test settings and measurement results (BER)

The measurement results in the left upper table depend on the selected application (see definitions at the beginning of section [Receiver Quality Measurements](#) on page 4.73).

BER

In the *BER* application the following results are displayed:

<i>Bit Error Rate</i>	Bit error rate, percentage of faulty bits received
<i>Bit Errors</i>	Total number of faulty bits received
<i>NAK Rate</i>	Percentage of packets transmitted by the R&S CMU which were not acknowledged by the DUT, i.e. which would normally require retransmission (but note that data packets are not actually retransmitted when in test mode).

To acknowledge a packet, the DUT must respond with a packet whose acknowledgment indication (ARQN) header bit is set, so a “not acknowledge” condition can be signified either explicitly (by the DUT returning a packet with the ARQN header bit set to zero) or implicitly (by no ARQN header bit being received; this condition would also count as a missing packet or HEC error, see below).

The events causing a packet to contribute to the packet error rate are mutually exclusive and form the following hierarchy.

Missing Packet The transmitted packet could not be received by the R&S CMU. Either the packet was not looped back, or the R&S CMU did not find a valid access code.

HEC Error The packet was looped back and received by the R&S CMU, however, the Header Error Check at the R&S CMU failed. The received packet contained unrecoverable bit errors in the header.

CRC Error The packet is received by the DUT without HEC error and looped back, however, Cyclic Redundancy Check at the R&S CMU failed. A failed CRC indicates at least one bit error in the payload.

Wrong packet type None of the previous errors occurred, however, the received packet is of a different type to that originally transmitted by the R&S CMU.

Wrong payload length None of the previous errors occurred, however, the received packet contains a different payload length to that transmitted by the R&S CMU.

Packet Error Rate Packet error rate, percentage of bad packets received. This is equal to the sum of the percentages of the individual packet error types.

Packets received Total number of packets successfully received, i.e. packets that are taken into account for the BER measurement. Received bad packets only contribute to the PER measurement but do not affect this packet counter (see Table 4-6 on p. 4.74). The number of bits received is displayed above the *Packets received* field.

Packets Graphical information box showing the progression through the current statistics cycle. The total length of the statistics cycle (*Statistic count*) is indicated below the progress bar.

Curr. Test Setup Name of the test setups currently used. The name and properties of the test setups can be defined in the configuration menu; see section [Measurement Control \(Receiver Quality Configuration – Control\)](#) on p. 4.82.

Remote Control	<p>READ[:SCALar]:RXQuality:BER? etc. READ[:SCALar]:RXQuality:BER:DETail? etc.</p>
BER Search	<p>In the <i>BER Search</i> application the following results are displayed:</p> <p><i>Bit Error Rate</i> Bit error rate in the last iteration cycle.</p> <p><i>Packet Error Rate</i> Packet error rate in the last iteration cycle.</p> <p><i>Packets received</i> Total number of packets successfully received, i.e. packets that are taken into account for the BER measurement. The graphical information box shows the progression through the current statistics cycle. The total length of the current statistics cycle (<i>statistic count</i>) is indicated below the progress bar.</p> <p><i>TX Level</i> Current TX level of the R&S® CMU.</p> <p><i>Search Result</i> RF generator level of the R&S® CMU (i.e. the input level of the DUT, if a possible external attenuation is correctly reported, see p. 4.8.) for which the target bit error rate is met. With an appropriate definition of the target bit error rate, this yields the <i>actual sensitivity level</i> of the DUT.</p>
Remote Control	<p>READ[:SCALar]:RXQuality:SBER? etc.</p>
Limit Check	<p>A red output field and an arrow pointing upwards or downwards indicates that the measurement result exceeds the upper or lower limit set in the <i>Limits</i> tab of the <i>Receiver Quality</i> menu, see p. 4.86.</p> <p>There is no limit check for the <i>BER Search</i> application; if the search fails, an invalid <i>Search Result</i> ("---") is indicated.</p>
Remote Control	<p>CALCulate:RXQuality:BER:MATching:LIMit?</p>
Setup	<p>The table <i>Setup</i> gives an overview of the configuration of the current measurement. This includes the settings made via the softkeys and hotkeys of the <i>Receiver Quality</i> menu or in the <i>Receiver Quality Configuration</i> menu; see p. 4.82. The parameter list depends on the current application.</p>
Remote control	<p>See sections Test Settings on page 4.76 and description of the <i>Receiver Quality Configuration</i> menu on p. 4.82.</p>

Measurement Configurations (Receiver Quality Configuration)

The popup menu *Receiver Quality Configuration* contains four tabs to determine the parameters for the bit error rate measurement.

The popup menu *Receiver Quality Configuration* is opened by pressing the measurement control softkey *BER/BER Search* in the *Receiver Quality* menu a second time. It is possible to change between the tabs by pressing the associated hotkeys.

Measurement Control (Receiver Quality Configuration – Control)

The *Control* tab controls the *Receiver Quality* measurement by defining:

- The names of the individual BER test setups (*Test Name*)
- The *Repetition* mode and *Stop Condition* for the individual BER test setups
- The number of packets to be sent in a single shot *BER* measurement or in a *BER Search* iteration cycle (*Packets*)
- The target bit error rate (*Search Value*) and the number of *Search Cycles* for the *BER Search* application (*Packets*)

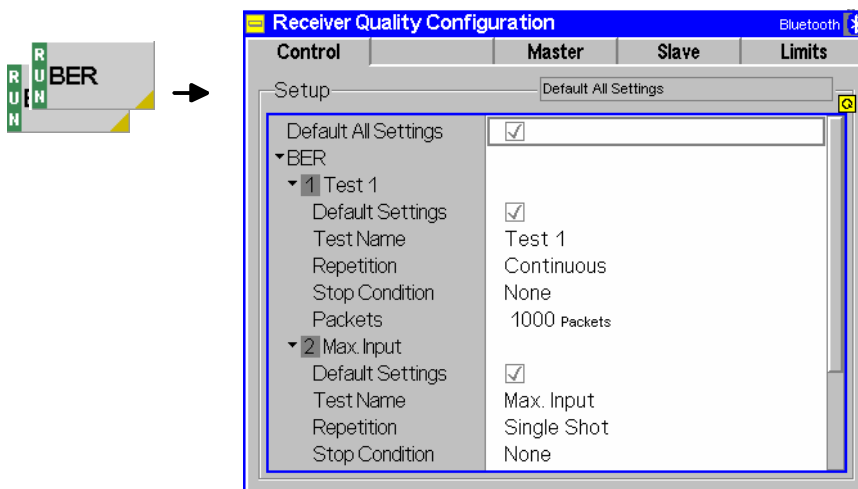

Fig. 4-75 Receiver Quality – Control

Default Settings The *Default All Settings* switch overwrites all settings in the *Control* tab with default values (the default values are quoted in the command description in chapter 6 of this manual). Besides, there are default switches acting on every individual *BER* test setup and on the *BER Search* mode.

Remote control `DEFAult:RXQuality:BER:TSETup<nr>`
`DEFAult:RXQuality:SBER`

BER – Test Setup The *BER* table section defines up to five user-specific configuration files for *Receiver Quality* measurements (application *BER* only). The test setups are named *Test 1*, *Max. Input*, *DH1*, *DH3*, *DH5* and can be selected via the first five hotkeys associated with the *Test Setup* softkey.

The parameters of the five test setups have predefined values. These values have been selected according to the different test conditions stipulated in the Bluetooth RF Test Specification but can be changed any time:

Test 1 Standard TX level for BER measurements, DH1 packets, limited

		number of bits per measurement cycle for quick evaluation
	<i>Max. Input</i>	Like <i>Test 1</i> but with a much higher TX level
	<i>DH1</i>	Like <i>Test 1</i> but with a higher number of packets in order to reach a minimum number of 1.6 million transferred bits
	<i>DH3</i>	Like <i>DH1</i> but with DH3 packets
	<i>DH5</i>	Like <i>DH1</i> but with DH5 packets
Remote control	A numeric suffix in the RXQuality commands (...RXQuality:BER:TSETup<nr>:...) denotes the application number.	
Test Name	The <i>Test Name</i> option assigns a name to each of the 5 test setups (application <i>BER</i> only). In the <i>Test Setup</i> hotkeys, the individual test setups are referenced with their <i>Test Names</i> .	
Remote control	–	
Repetition	The <i>Repetition</i> parameter defines whether the measurement is to be performed in <i>Single Shot</i> or in <i>Continuous</i> mode (application <i>BER</i> only). All settings are analogous to the <i>Power</i> menu; see section Measurement Control (Power Configuration – Control) on p. 4.38.	
Remote control	CONFigure:RXQuality:TSETup<nr>:CONTrol:REPetition <Repetition>, <Stop_Condition>	
Stop Condition	The <i>Stop Condition</i> parameter defines whether or not the measurement is to be stopped when a limit check fails (application <i>BER</i> only). All settings are analogous to the <i>Power</i> menu; see section Measurement Control (Power Configuration – Control) on p. 4.38.	
Remote control	CONFigure:RXQuality:TSETup<nr>:CONTrol:REPetition <Repetition>, <Stop_Condition>	
Packets	The <i>Packets</i> parameters define the number of packets within a statistics cycle. The statistics cycle comprises a definite number of packets that the R&S CMU could receive successfully; see description of Packets received on p. 4.80. The settings <i>1</i> and <i>Off</i> (press <i>ON/OFF</i> key) are equivalent. <ul style="list-style-type: none"> • In <i>BER</i> application, the duration of each single-shot measurement equals to the statistics cycle. • In <i>BER Search</i> application, each iteration step comprises one statistics cycle. 	
Remote control	CONFigure:RXQuality:BER:TSETup<nr>:CONTrol:STATistics <Packets> CONFigure:RXQuality:SBER:CONTrol:STATistics <Packets>, <Search_Value>, <Search_Cycles>	
Search Value	<i>Search Value</i> defines the target bit error rate for the <i>BER Search</i> application. The <i>BER Search</i> consists of determining the TX Level of the R&S® CMU at which the <i>Search Value</i> is met.	
Remote control	CONFigure:RXQuality:SBER:CONTrol:STATistics <Packets>, <Search_Value>, <Search_Cycles>	

Search Cycles The *Search Cycles* parameter defines the number of search cycles to conduct the *BER Search* measurement over. Each cycle consists of the number of packets declared in the *Packet* field.

The BER Search is performed as follows:

The TX level range between the *Srch. Lower Level* and *Srch. Upper Level* is covered with *n* equidistant test points where *n* is the number of search cycles. The search is started at *Srch. Upper Level* and continued point by point until the difference between the actual BER value and the *Search Value* changes sign. The corresponding TX Level represents the *Search Result*.

If no *Search Result* can be found (e.g. because the TX level range was not appropriately defined), then the search ends after the last cycle and the search result is invalid ("---").

Remote control `CONFigure:RXQuality:SBER:CONTROL:STATISTICS`
`<Packets>, <Search_Value>, <Search_Cycles>`

BER Levels (Receiver Quality Configuration – Master)

The *Master* tab defines the R&S® CMU RF generator level (*TX Level*) settings for the *Receiver Quality* measurement. The levels are independent of the *TX Level* for transmitter tests which is set in the *Master Sig.* tab of the *Connection Control* menu (see p. 4.102.).

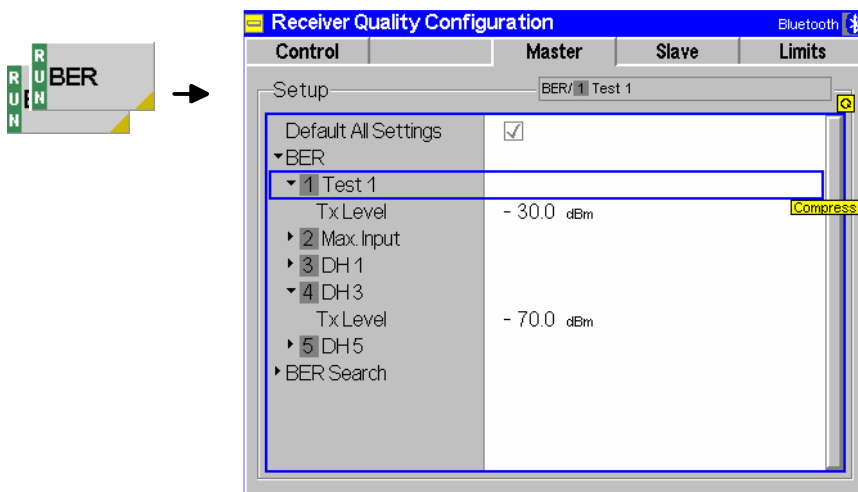

Fig. 4-76 Receiver Quality – Master

Default Settings The *Default All Settings* switch overwrites all settings in the *Master* tab with default values (the default values are quoted in the command description in chapter 6 of this manual).

Remote control –

TX Level The *TX Level* parameter defines the RF generator level of the R&S® CMU at which the *Receiver Quality* measurement is performed. The purpose of the TX Level depends on the application:

- In a *BER* measurement, a single TX level is defined. The R&S® CMU measures the bit error rate at this TX level.
- In a *BER Search* measurement, a TX level range with an upper and a lower limit (*Srch. Lower Level*, *Srch. Upper Level*) is defined. Within this range, the R&S® CMU determines a TX level corresponding to a particular bit error

rate. The search algorithm is explained in the paragraph on [Search Cycles](#) on page 4.84.

Remote control `CONFigure:RXQuality:BER:TSETup<nr>:LEVel <Level>`
 `CONFigure:RXQuality:SBER:LEVel <Lower_Level>, <Upper_Level>`

BER Loopback Settings (Receiver Quality Configuration – Slave)

The *Slave* tab defines the characteristics of the *Loopback* test mode used for *Receiver Quality* measurements.

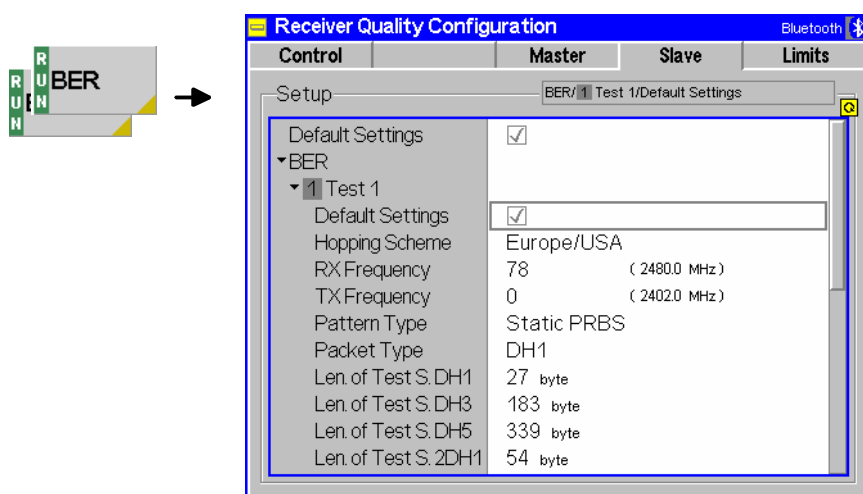

Fig. 4-77 Receiver Quality – Slave

Default Settings The *Default All Settings* switch overwrites all settings in the *Slave* tab with default values (the default values are quoted in the command description in chapter 6 of this manual). Besides, there are default switches acting on every individual *BER* test setup and on the *BER Search* mode.

Remote control –

**BER/
BER Search** The table sets the parameters of the particular loopback test mode that is used for the *Receiver Quality* measurement. The parameters can be set independently for the individual *BER* test setups and for the *BER Search* application.

All settings are analogous to the *Loopback* test settings accessible from the *Slave Sig.* tab of the *Connection Control* menu; see p. 4.107. Note, however, that the *Slave Sig.* settings (that are used for *Power* and *Modulation* measurements) and the *Receiver Quality Configuration* settings represent different parameter sets that do not overwrite each other.

The following parameter is provided for *Receiver Quality* measurements only:

Delay Defines the timing for loopback tests (normal loopback or loopback with delay; see [Fig. 4-94](#) on page 4.110). This setting is only relevant for receiver quality measurements.

Note: *If the loopback delay setting does not correspond to the configuration of the DUT the R&S® CMU will not be able to associate the data looped back with the data transmitted and the Receiver Quality measurement will fail.*

Remote control `CONFigure:RXQuality:BER:TSETup<nr>...`
 `CONFigure:RXQuality:SBER...`

Limit Values (Receiver Quality Configuration – Limits)

The *Limits* tab defines upper limits for the *Receiver Quality* parameters. All limits are defined independently for the individual *BER* test setups.

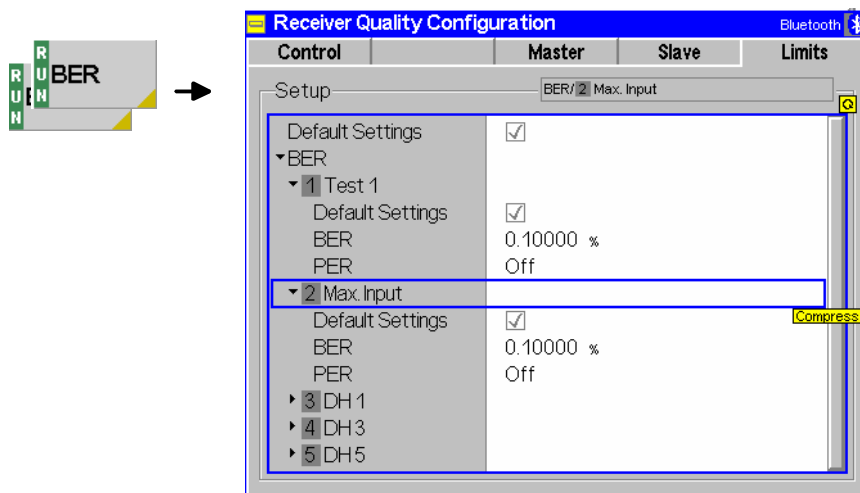

Fig. 4-78 Receiver Quality Configuration – Limits

Default Settings The *Default All Settings* switch overwrites all settings in the *Limits* tab with default values (the default values are quoted in the command description in chapter 6 of this manual). Besides, there are default switches acting on every individual *BER* test setup and on the *BER Search* mode.

Remote control `DEfault:RXQuality:BER:TSETup<nr>:LIMit ON | OFF`

BER Upper limit for the raw bit error rate in the value range 0% to 100%. According to the standard, the measured BER must be $\leq 0.1\%$ at a reference TX level of -70 dBm at the input of the DUT receiver. A value of 100% effectively disables the limit check.

PER Upper limit for the packet error rate in the value range 0% to 100%.

Remote control `CONFigure:RXQuality:BER:TSETup<nr>:LIMit...`

Audio Measurements

The menu group *Audio* comprises the functions for generating and measuring single or multitone audio signals. The menu group is available with option CMU-B41, *Audio Generator and Analyzer*. All *Audio* menus and remote-control commands are described in the CMU 200/300 operating manual.

In the context of *Bluetooth* measurements, the *Audio* option supports receive and transmit audio tests and makes it easier to generate test signals and evaluate results; see section [Audio Test Scenarios below](#). As a prerequisite, the CMU must be placed to its *Audio* signalling state; see section [Connection Control in Audio State](#) on p. 4.100. The necessary signal routing is configured in the *AF/RF*  tab of the *Connection Control* menu; see section [AF/RF Connectors \(Connection Control – AF/RF\)](#) on p. 4.117.

Audio Test Scenarios

In the *Audio* signalling state a variety of audio measurements can be carried out. The tests depend on the external test setup, the assignment of the speech codec input and output signals, and the test equipment and additional options available.

In principle audio measurements don't require any additional equipment or options. However, they are made easier if option CMU-B41, *Audio Generator and Analyzer*, is available. Below we list some typical test scenarios and operating sequences.

Scenario 1: Receive Audio

A receive audio test consists of demodulating the SCO speech data from the RF signal transmitted by a Bluetooth DUT and converting the data stream into an analog audio signal which can be evaluated either directly at the SPEECH connector (with no additional option) or by means of option CMU-B41.

Note: This test scenario may be combined with scenario 2, transmit audio.

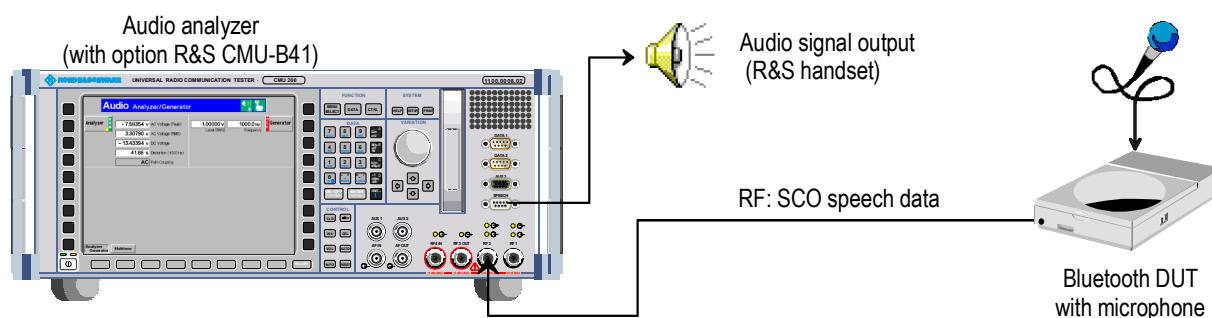

Fig. 4-79 Receive audio tests

To perform a receive audio test,

1. Connect your Bluetooth device to the R&S CBT using the standard bidirectional RF connector RF2.
2. Set up a connection to the DUT (see Chapter 2). Before accessing the *Audio* signalling state, open the *Network* tab of the *Connection Control* menu and make sure that the *Bit Stream* is set either to *Analog In/Out* or, for lower sensitivity of the speech coder, to *Analog In/Out (Low)*.
3. Activate the *Audio* signalling state to establish an SCO link between the R&S CBT and the DUT.
4. Configure your DUT to provide an RF signal modulated with SCO speech data.

The R&S CBT receives the RF signal, demodulates the speech data and routes it to the speech codec where it is converted to an analog audio signal. The following steps depend on how the audio signal is to be evaluated:

5. To tap off the signal at the SPEECH connector, open the *AF/RF* \odot tab of the *Connection Control* menu and set the *Speech Decoder* output to *Handset*.
6. To analyze the signal internally, set the *Speech Decoder* output to *Analyzer*. Close the *Connection Control* menu, press the *Audio* hotkey to access *Analyzer/Generator* menu in the *Audio* function group (option CMU-B41), switch on the *Analyzer* and evaluate the results.

Scenario 2: Transmit Audio

A transmit audio test consists of generating a Bluetooth RF signal carrying SCO speech data that the DUT will demodulate and possibly convert into an analog audio signal. The audio input signal may be fed in at the SPEECH connector (with no additional option) or generated internally by means of option R&S CMU-B41, *Audio Generator and Analyzer*.

Note: This test scenario may be combined with scenario 1, receive audio.

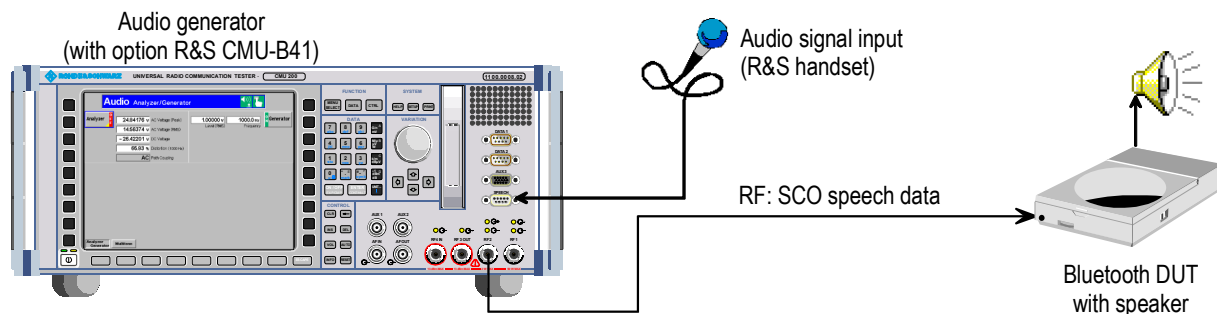

Fig. 4-80 Transmit audio tests

To perform a transmit audio test,

1. Connect your Bluetooth device to the R&S CBT using the standard bidirectional RF connector RF2.
2. Set up a connection to the DUT (see Chapter 2). Before accessing the *Audio* signalling state, open the *Network* tab of the *Connection Control* menu and make sure that the *Bit Stream* is set to *Analog In/Out* or, for lower sensitivity of the speech coder, to *Analog In/Out (Low)*.
3. Activate the *Audio* signalling state to establish an SCO link between the R&S CBT and the DUT.

The following steps depend on how the audio signal is generated.

4. When using an external audio signal fed in at the SPEECH connector, open the *AF/RF* \odot tab of the *Connection Control* menu and set the *Speech Encoder* input to *Handset*.
5. When using the internal audio signal from the audio generator (with option CMU-B41), set the *Speech Encoder* input to *Generator*. Close the *Connection Control* menu, press the *Audio* hotkey to access the *Analyzer/Generator* menu in the *Audio* function group (option CMU-B41) and switch on the *Generator*.
6. Evaluate the SCO speech data at the DUT.

Scenario 3: Echo

In an echo test scenario the R&S® CMU receives SCO speech data from the DUT and loops back this data after a specific delay time.

Note: This test scenario cannot be combined with scenarios 1 and 2.

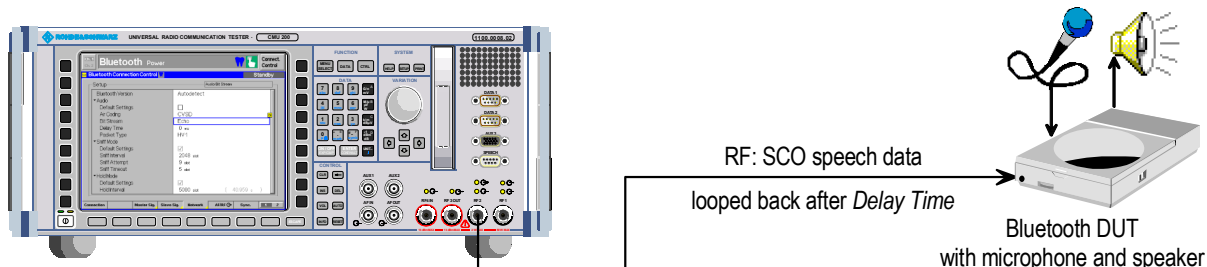

Fig. 4-81 Echo tests

To perform an echo test,

1. Connect your Bluetooth device to the R&S® CMU using the standard bidirectional RF connector R&S® RF2.
2. Set up a connection to the DUT (see Chapter 2). Before accessing the *Audio* signalling state, open the *Network* tab of the *Connection Control* menu and set the *Bit Stream* to *Echo*.
3. In the same tab, select the *Delay Time*, i.e. the time after which the R&S® CMU loops back the received speech data to the DUT.
4. Activate the *Audio* signalling state to establish an SCO link between the R&S® CMU and the DUT.
5. Configure your DUT to provide an RF signal modulated with SCO speech data and evaluate the looped-back speech data at the DUT.

Connection Control (Contd.)

The popup menu *Connection Control* controls the signalling procedures (connection setup and release, services, signalling parameters) and determines the inputs and outputs with the external attenuation values, the reference frequency, RF input path and trigger settings.

Signalling measurements are performed with a connection to the DUT via radio link (test mode, signalling state *Test Mode* or special submodes), so the first tabs for setting up the connection (*Connection Control – Signalling*) appear immediately after selection of the function group *Bluetooth Signalling* in the *Menu Select* menu. Alternatively, the *Connection Control* menu can be displayed by pressing the softkey *Connect. Control* at the top right in every measurement menu; the individual tabs can be accessed via the hotkey bar at the lower edge of the screen. By pressing the *Escape* key, the *Connection Control* menu is closed and the R&S® CMU changes to the test mode.

The tabs *Connection Control – Connection* displayed immediately after the function group is activated are described at the beginning of section [Bluetooth Signalling](#) on p. 4.12. The remaining tabs of the *Connection Control - Connection* menu are described below.

Connection Control in Connected State

The *Connection (Connected)* tab provides information on

- A selection of signalling parameters of the DUT (*Signalling Info*)
- The master and slave signal parameters
- Status and result of the wide-band peak-power measurement (Power)
- It contains softkeys that lead to other signalling states (see [Fig. 4-40](#)):
- Release connection to DUT, quit the test mode (*Detach -> state Standby*)
- Activate a special submode (*Enter Submode -> Submode state*)

The *Connection (Connected)* tab is opened after an attempted ACL connection to the DUT could be established. It is replaced by the *Connection (Standby)* tab when the connection is lost or deliberately released (*Detach* softkey), see [Fig. 4-40](#). It is replaced by the *Connection (<Submode>)* tab after the selected submode is activated.

Note: *If the connection is lost during operation (e.g. because of a low signal level), a warning will appear. At the same time, bit 2 is set in the STATUS:OPERation register. Prior to further operation, confirm the reception of the message by pressing the ENTER key.*

In the *Connected* state the R&S® CMU maintains an ACL link to the DUT, acting as a Bluetooth master capable of forcing the DUT (slave) into one of the special submodes.

In this "just connected" state, only link control information needs to be exchanged so that the DUT transmits NULL packets. Measurements are still possible:

- *Power* and *Modulation* measurements will measure the NULL packets returned by the DUT and display as much information as possible. Null packets are packets with a fixed total length of 126 bit. They have no payload and therefore consist of the channel access code and packet header only. The results are basically the same as the results for a DH1 packet with payload length zero: All power results (including *Power Control* tests) are available. The *Modulation* measurement returns only the frequency accuracy as the other quantities must be determined with a definite payload pattern.
- Receiver quality measurements are not possible in *Connected* state since there is no payload.

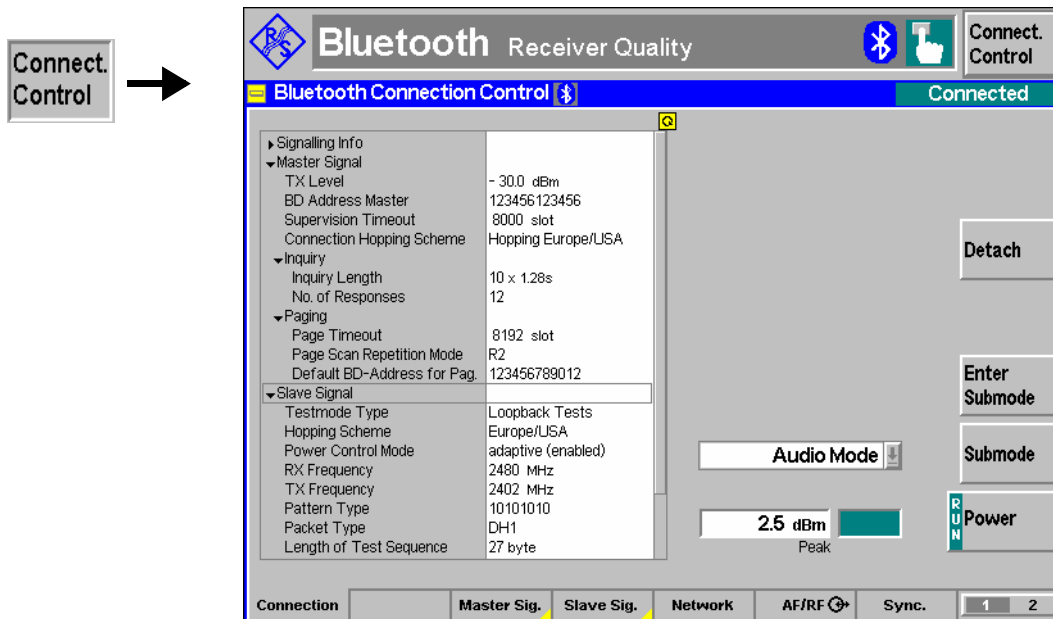

Fig. 4-82 Connection Control – Connection (Connected)

The info table in the left half of the menu and the *Power* softkey is described in section [Connection Control: Standby State](#) on page 4.14.

Detach

The *Detach* softkey releases the connection between the R&S® CMU and the DUT.

The R&S® CMU returns to the *Standby* signalling state; see [Fig. 4-40](#) on p. 4.13.

Note: *The detach procedure can take some time during which the R&S® CMU enters the transitory Disconnecting state and waits for confirmation from the DUT. In the Disconnecting state the Force Standby softkey allows to immediately terminating the disconnecting procedure and forcer the R&S® CMU into the Standby state.*

Remote control

PROCedure:SIGNalling:ACTion DETach
Force Standby: PROCedure:SIGNalling:ACTion FSTY

Enter Submode

The *Enter Submode* softkey activates the special mode selected in the *Submode* pull-down list.

Note: *The Enter Submode softkey is provided in the Connected state as well as in the submodes Test Mode, Audio, Sniff, Park, and Hold. Depending on the DUT, switchover between different submodes may be limited. If a particular transition fails, first return to the Connected state and then enter the desired submode.*

Remote control

PROCedure:SIGNalling:ACTion SNIFF | HOLD | PARK | AUDio | TEST

Submode

The *Submode* softkey activates a pull-down list to select one of the following submodes:

Test Mode The DUT is in its internal test mode; all TX and RX measurements are possible; see section [Connection Control in Test Mode \(Test Mode\)](#) on p. 4.92.

<i>Hold</i>	The DUT is in its special <i>Hold</i> state; power consumption measurements can be made; see section Connection Control in Hold State on p. 4.97.
<i>Sniff</i>	The DUT is in its special <i>Sniff</i> state; power consumption measurements can be made; see section Connection Control in Sniff State on p. 4.96.
<i>Park</i>	The DUT is in its special <i>Park</i> state; power consumption measurements can be made; see section Connection Control in Park State on p. 4.98.
<i>Audio</i>	An SCO link is established on top of the ACL link; audio measurements can be made; see section Connection Control in Audio State on p. 4.100.

Pressing the *Enter Submode* softkey activates the selected submode.

Remote control No separate command; see *Enter Submode* softkey.

Connection Control in Test Mode (Test Mode)

The *Connection (Test Mode)* tab provides information on

- A selection of signalling parameters of the DUT (*Signalling Info*)
- The master and slave signal parameters
- Status and result of the wide-band peak-power measurement (Power)
- It contains softkeys that lead to other signalling states (see [Fig. 4-40](#)):
- Activate a different submode (*Enter Submode* -> *Submode* state)
- Deactivate the test mode of the DUT (*Exit Testmode* -> state *Connected*)
- Deactivate the test mode and release connection to DUT (*Detach* -> state *Standby*)

The *Connection (Test Mode)* tab is opened after an attempted test mode connection to the DUT could be established, or if the test mode is activated while the R&S® CMU is in the *Connected* state or in the *Sniff*, *Park* or *Audio* substates. It is replaced by the *Connection (Standby)* tab when the connection is lost or deliberately released (*Detach* softkey). It is replaced by the *Connection (Connected)* tab if the test mode of the DUT is deactivated (*Exit Test Mode* softkey). It is replaced by the *Connection (Audio)*, *Connection (Hold)*, *Connection (Sniff)* or *Connection (Park)* tab if one of the corresponding submodes is activated (*Enter Submode* softkey); see [Fig. 4-40](#).

Note: *If the connection is lost during operation (e.g. because of a low signal level), a warning will appear. At the same time, bit 2 is set in the STATus:OPERation register. Prior to further operation, of the user has to acknowledge the message by pressing the ENTER key.*

The **test mode** is a special state of the Bluetooth model designed for testing the Bluetooth transmitter and receiver. In this mode, the R&S® CMU and the DUT form a piconet where the R&S® CMU acts as a master and has full control over the test procedure. The DUT acts as a slave. While in test mode, the DUT must not support normal operation. All transmitter and receiver measurements described in this manual can be made in the test mode.

The R&S® CMU is able to configure a broad range of test mode parameters. These parameters are set in the *Slave Sig.* tab (see p. 4.102.) which is available in all signalling states of the R&S® CMU.

The DUT is in test mode as soon as the *Test Mode* signalling state is reached. After leaving the test mode (*Detach* softkey, power-off etc.), the DUT and the R&S® CMU return to the *Standby* state.

Note: *Before attempting a connection, the internal test mode of the device to be tested must be locally enabled according to the instructions of the Bluetooth standard. Otherwise, the connection will fail, and the R&S® CMU will display the message Device is not enabled for test mode – Cancel/Retry. The connection process can be continued after enabling the device and pressing Retry.*

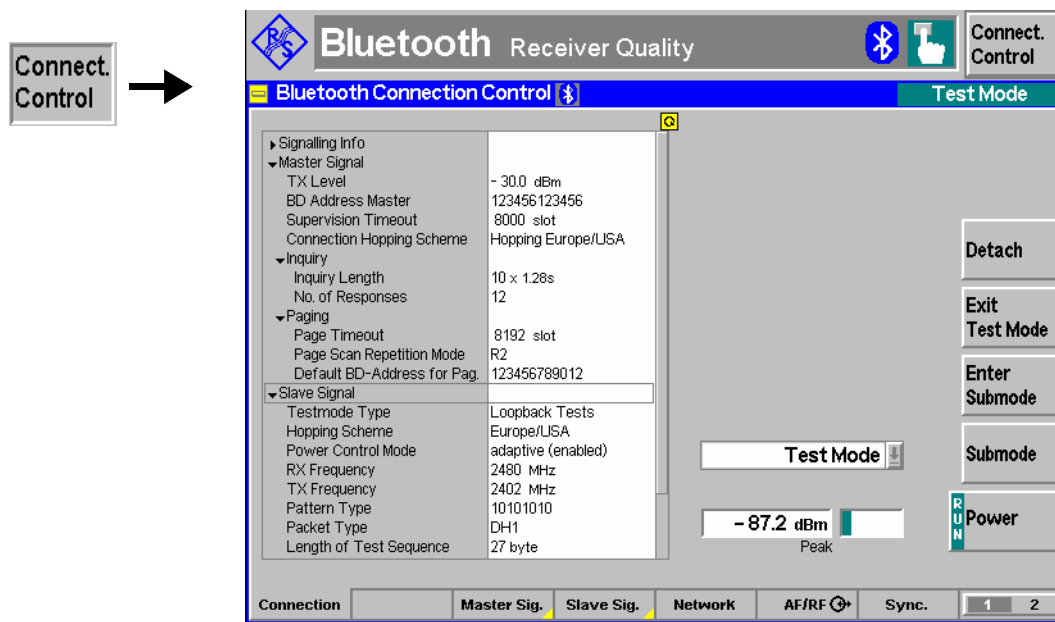

Fig. 4-83 Connection Control – Connection (Test Mode)

The info table in the left half of the menu and the *Power* softkey is described in section [Connection Control: Standby State](#) on page 4.14. The *Detach*, *Enter Submode* and *Submode* softkeys are described in section [Connection Control in Connected State](#) on p. 4.90.

Signalling Info The *Signalling Info* table displays signalling information that was retrieved from the DUT. The information is available only if an *Inquiry* was done before establishing the connection.

Note: *To speed up the connection, it is possible to prevent the R&S® CMU from reading the Device Name, Version, and Supported Features signalling parameters, see parameter [Read Signalling Info](#) on p. 4.105. The Class of Device and Paging parameters are filled in when a device was found during inquiry.*

Device Name *Device Name* contains a textual description of the DUTs name. The name received from the DUT can be up to 255 characters long, however, this name is truncated to display only what can fit within the list.

Remote control [:SENSE] :SINFo:NAME?

Version The *Version* section contains a set of version values of the DUT.

LMP Version LMP (Link Manager Protocol) version is the Bluetooth LMP version retrieved from the DUT (e.g. 1.1 or 2.0). The information whether the LMP version is 1.0 or ≥ 1.1 is used by the R&S® CMU in test mode. The R&S CMU reports version V2.0 as its own Bluetooth version.

Company ID The Company ID is the manufacturer code of the DUT. The value returned from the device is a 16-bit value, however, the value corresponds to a textual description i.e. 0 = Ericsson; 1 = Nokia; 2 = Intel; 3= IBM; 4 = Toshiba; etc.

Device Version The device version is a company's internal version number, this is represented as a 16-bit value.

Remote control [:SENSE] :SINFo:VERSion?
[:SENSE] :SINFo:COMPany?

BD_Addr *BD_Address* contains the BD_address of the DUT. The field is a 12 digit hex value. There are three sub fields for this field: LAP, NAP and UAP:

LAP Lower address part. The field is a 6 digit hex value (24 bit).
NAP Non-specific address part. The field is a 2 digit hex value (8 bit).
UAP Upper address part. The field is a 4 digit hex value (16 bit).

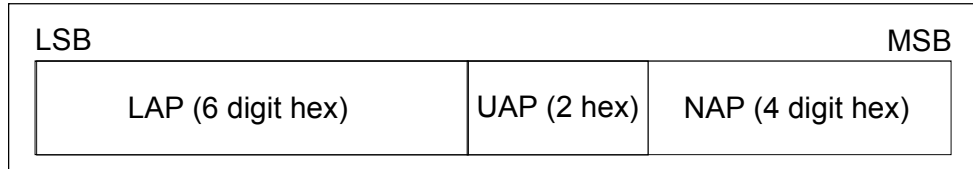

Fig. 4-84 Bluetooth address format

Remote control [:SENSe]:SINFo:BDAddress? Response: '<address>'

Class of Device The *Class of Device* section consists of three sets of fields. These are *Service Classes*, *Major Device Class* and *Minor Device Class*.

Service Classes Lists a set of fields that represent the services the DUT supports, each being a yes or no value (whether the service is supported or not). The following services are available:

<i>Limited Discoverable Mode</i>	<i>Object Transfer</i>
<i>Networking</i>	<i>Audio</i>
<i>Rendering</i>	<i>Telephony</i>
<i>Capturing</i>	<i>Information</i>

Major Device Class Gives the type of the DUT, this is determined by the main function of the DUT. There is a possibility of up to 32 different possible classes (most of which are reserved for future use). The possible *Major Device Classes* are:

<i>Miscellaneous</i>	<i>Audio</i>
<i>Computer</i>	<i>Peripheral</i>
<i>Phone</i>	<i>LAN Access Point</i>
<i>Unclassified (specific device code not assigned)</i>	

Major Device Class The minor class devices are to be interpreted only in the context of the major device class. The minor device class gives a more descriptive use of the DUT.

[Table 4-7 below](#) contains the possible values for the minor device class for each major device class.

Remote control [:SENSe]:SINFo:CLASs:SERVice?
 [:SENSe]:SINFo:CLASs?

Table 4-7 Major and minor device classes

Computer Major Class	Phone Major Class	LAN Access Point Major Class	Audio Major Class
Unclassified Desktop workstation Server-class computer Laptop Handheld PC/PDA Pal sized PC/PDA	Unclassified Cellular Cordless Smart phone Wired modem	Fully available 1-17% utilized 17-33% utilized 33-50% utilized 50-67% utilized 67-83% utilized 83-99% utilized No service available	Unclassified Device conforms to headset profile

Paging	<p>The <i>Paging</i> section shows the paging properties of the device under test. The paging properties of the device under test are Page scan mode, Scan Period and Scan repetition.</p> <p><i>Page Scan Mode</i> Bluetooth currently specifies four page scan modes for use during paging, one mandatory and three optional.</p> <p><i>Scan Period</i> Indicates the period in which the page scan mode is applied. Currently three modes exist P0, P1 and P2.</p> <p><i>Scan Repetition</i> Indicates the interval between two consecutive page scan windows. Currently three modes exist: R0, R1 and R2.</p>																										
Remote control	[SENSe:]SINFo:PAging?																										
Supported Features	<p>The <i>Supported Features</i> list determines the capabilities of the device under test, each is giving a YES or NO value indicating whether the feature is available. All features are optional; they may or may not be supported by a Bluetooth device. The features list is listed below.</p> <table border="0" style="margin-left: 40px;"> <tr> <td><i>3-Slot Packets</i></td> <td><i>5-Slot Packets</i></td> </tr> <tr> <td><i>Encryption</i></td> <td><i>Slot offset</i></td> </tr> <tr> <td><i>Timing Accuracy</i></td> <td><i>Role Switch</i></td> </tr> <tr> <td><i>Hold Mode</i></td> <td><i>Sniff Mode</i></td> </tr> <tr> <td><i>Park Mode</i></td> <td><i>RSSI</i></td> </tr> <tr> <td><i>Channel Quality driven Data Rate</i></td> <td><i>SCO Link</i></td> </tr> <tr> <td><i>HV2 Packets</i></td> <td><i>HV3 Packets</i></td> </tr> <tr> <td><i>μ-law log</i></td> <td><i>A-law log</i></td> </tr> <tr> <td><i>CVSD</i></td> <td><i>Paging Scheme</i></td> </tr> <tr> <td><i>Power Control</i></td> <td><i>Transparent SCO</i></td> </tr> <tr> <td><i>Flow Control Lag</i></td> <td></td> </tr> <tr> <td><i>EDR ACL 2 Mbps</i></td> <td><i>EDR ACL 3 Mbps</i></td> </tr> <tr> <td><i>3-Slot EDR ACL Packets</i></td> <td><i>5-Slot EDR ACL Packets</i></td> </tr> </table> <p>Note: <i>If an attempt is made to send power control messages to a DUT that does not support power control (see Power Up hotkey on p. 4.30), then the R&S® CMU prompts with an error message.</i></p>	<i>3-Slot Packets</i>	<i>5-Slot Packets</i>	<i>Encryption</i>	<i>Slot offset</i>	<i>Timing Accuracy</i>	<i>Role Switch</i>	<i>Hold Mode</i>	<i>Sniff Mode</i>	<i>Park Mode</i>	<i>RSSI</i>	<i>Channel Quality driven Data Rate</i>	<i>SCO Link</i>	<i>HV2 Packets</i>	<i>HV3 Packets</i>	<i>μ-law log</i>	<i>A-law log</i>	<i>CVSD</i>	<i>Paging Scheme</i>	<i>Power Control</i>	<i>Transparent SCO</i>	<i>Flow Control Lag</i>		<i>EDR ACL 2 Mbps</i>	<i>EDR ACL 3 Mbps</i>	<i>3-Slot EDR ACL Packets</i>	<i>5-Slot EDR ACL Packets</i>
<i>3-Slot Packets</i>	<i>5-Slot Packets</i>																										
<i>Encryption</i>	<i>Slot offset</i>																										
<i>Timing Accuracy</i>	<i>Role Switch</i>																										
<i>Hold Mode</i>	<i>Sniff Mode</i>																										
<i>Park Mode</i>	<i>RSSI</i>																										
<i>Channel Quality driven Data Rate</i>	<i>SCO Link</i>																										
<i>HV2 Packets</i>	<i>HV3 Packets</i>																										
<i>μ-law log</i>	<i>A-law log</i>																										
<i>CVSD</i>	<i>Paging Scheme</i>																										
<i>Power Control</i>	<i>Transparent SCO</i>																										
<i>Flow Control Lag</i>																											
<i>EDR ACL 2 Mbps</i>	<i>EDR ACL 3 Mbps</i>																										
<i>3-Slot EDR ACL Packets</i>	<i>5-Slot EDR ACL Packets</i>																										
Remote control	[SENSe:]SINFo:FEATure...? [SENSe:]SINFo:FEATure:LFRrequest?																										
Master Signal	<p>The table <i>Master Signal</i> indicates important signalling parameters that the R&S® CMU (acting as a Bluetooth master) uses to inquire for Bluetooth slaves in its range. These parameters are set in the <i>Master Sig.</i> tab and explained in more detail there (see section Signal of the R&S CMU (Connection Control – Master Sig.) on p. 4.102.).</p>																										
Remote control	CONFigure:MSIGnal...?																										
Slave Signal	<p>The table <i>Slave Signal</i> indicates important signal parameters of the DUT acting as a Bluetooth slave. These parameters are set in the <i>Slave Sig.</i> tab and explained in more detail there (see section Behavior of the DUT (Connection Control – Slave Sig.) on p. 4.102.).</p>																										
Remote control	CONFigure:MSIGnal...?																										

Paging The table *Paging* indicates paging parameters to be used for connection and synchronization to a DUT. These parameters are set in the *Master Sig.* tab and explained there in more detail (see section [Signal of the R&S CMU \(Connection Control – Master Sig.\)](#) on p. 4.102.).

Remote control CONFigure:MSIGnal:PAGing...?

**Exit
Testmode**

The *Exit Testmode* softkey deactivates the test mode at the DUT.

The DUT leaves its internal test mode. The R&S® CMU returns to the *Connected* signalling state; see [Fig. 4-40](#) on p. 4.13.

Remote control PROCedure:SIGNalling:ACTion STeSt

Detach

The *Detach* softkey releases the connection between the R&S® CMU and the DUT.

The R&S® CMU returns to the *Standby* signalling state; see [Fig. 4-40](#) on p. 4.13.

Note: *The detach procedure can take some time during which the R&S® CMU enters the transitory Disconnecting state and waits for confirmation from the DUT. In the Disconnecting state the Force Standby softkey allows to immediately terminating the disconnecting procedure and forset the R&S® CMU into the Standby state.*

Remote control PROCedure:SIGNalling:ACTion DETach
Force Standby: PROCedure:SIGNalling:ACTion FSTY

Connection Control in Sniff State

The *Connection (Sniff)* tab provides information on

- A selection of signalling parameters of the DUT (*Signalling Info*)
- The master and slave signal parameters
- Status and result of the wide-band peak-power measurement (Power)
- It contains softkeys that lead to another signalling state (see [Fig. 4-40](#)):
- Activate a different submode (*Enter Submode* -> *Submode* state)
- Release the Sniff state (*Exit Sniff Mode* -> *Connected* state)
- Release connection to DUT (*Detach* -> state *Standby*)

The *Connection (Sniff)* tab is opened if the *Sniff* mode is activated while the R&S® CMU is in the *Connected* state or in the *Test Mode*, *Park*, or *Audio* substates. It is replaced by the *Connection (Standby)* tab when the connection is lost or deliberately released (*Detach* softkey). It is replaced by the *Connection (Connected)* tab if the *Sniff* mode of the DUT is deactivated (*Exit Sniff Mode* softkey). It is replaced by the *Connection (Audio)*, *Connection (Hold)*, *Connection (Park)* or *Connection (Test Mode)* tab if one of the corresponding submodes is activated (*Enter Submode* softkey); see [Fig. 4-40](#).

Note: *If the connection is lost during operation (e.g. because of a low signal level), a warning will appear. At the same time, bit 2 is set in the STATus:OPERation register. Prior to further operation, confirm the reception of the message by pressing the ENTER key.*

In the **Sniff** state the R&S® CMU allows the DUT to participate in the piconet only in periodic intervals (*Sniff Intervals*). During the intervals the DUT wakes up to listen for transmissions from the R&S® CMU and re-synchronize its clock offset. In-between the intervals, the DUT's listen activity is suspended so that the R&S® CMU can not start transmission. The *Sniff Interval* and the other parameters of the Sniff mode can be set in the *Network* tab before the *Sniff* state is reached; see page 4.113. The Sniff mode must be terminated explicitly by the R&S® CMU; see *Exit Sniff Mode* below.

The main application of the *Sniff* state is to test the power consumption of the DUT. This must be done locally at the DUT.

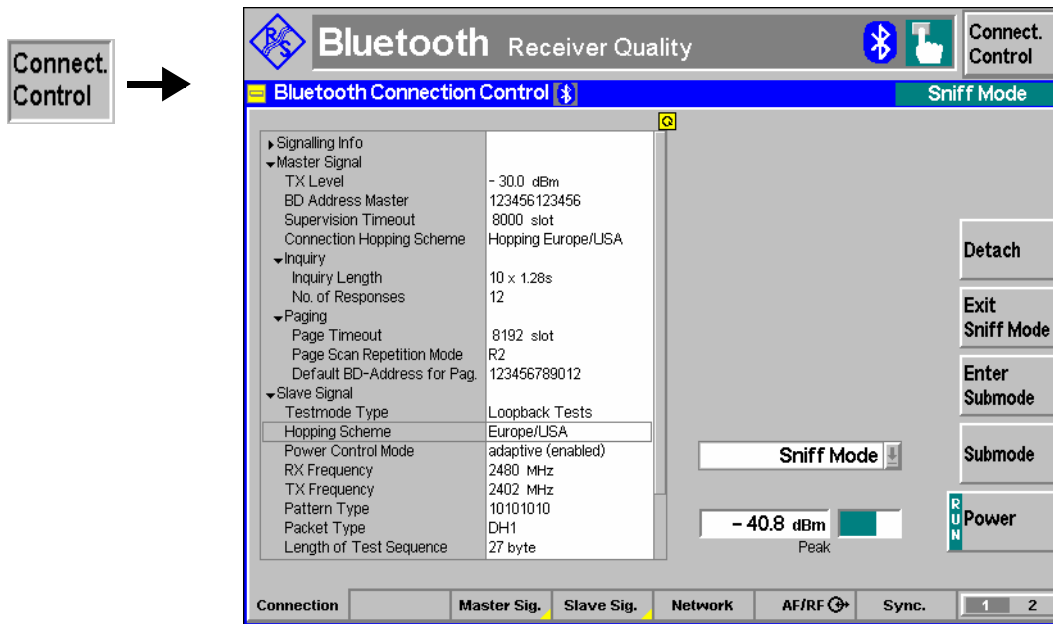

Fig. 4-85 Connection Control – Connection (Sniff)

The info table in the left half of the menu and the *Power* softkey is described in section [Connection Control: Standby State](#) on page 4.14. The *Detach*, *Enter Submode* and *Submode* softkeys are described in section [Connection Control in Connected State](#) on p. 4.90.

Exit Sniff Mode

The *Exit Sniff Mode* softkey releases the *Sniff* mode at the DUT.

The DUT returns to the active state. The R&S® CMU returns to the *Connected* signalling state; see [Fig. 4-40](#) on p. 4.13.

Remote control PROCedure:SIGNalling:ACTion SSniff

Connection Control in Hold State

The *Connection (Hold)* tab provides information on

- A selection of signalling parameters of the DUT (*Signalling Info*)
- The master and slave signal parameters
- Status and result of the wide-band peak-power measurement (*Power*)
- It contains softkeys that lead to another signalling state (see [Fig. 4-40](#)):
- Release connection to DUT (*Detach* -> state *Standby*)

The *Connection (Hold)* tab is opened if the *Hold* mode is activated while the R&S® CMU is in the *Connected* state or in the *Sniff*, *Park* or *Audio* substates. It is replaced by the *Connection (Standby)* tab when the connection is lost or deliberately released (*Detach* softkey); see Fig. 4-40.

Note: If the connection is lost during operation (e.g. because of a low signal level), a warning will appear. At the same time, bit 2 is set in the STATUS:OPERation register. Prior to further operation, confirm the reception of the message by pressing the ENTER key.

In the **Hold** state the R&S® CMU prevents the DUT from participating in the connection during a given length (*Hold Interval*). The *Hold Interval* can be set in the *Network* tab before the *Hold* state is reached; see page 4.113. In the hold mode, a Bluetooth transceiver neither receives nor transmits information. The *Hold* is automatically terminated after the *Hold Interval* (→ *Connected* state) but can also be released explicitly *Detach* → *Standby*).

The main application of the *Hold* state is to test the power consumption of the DUT. This must be done locally at the DUT.

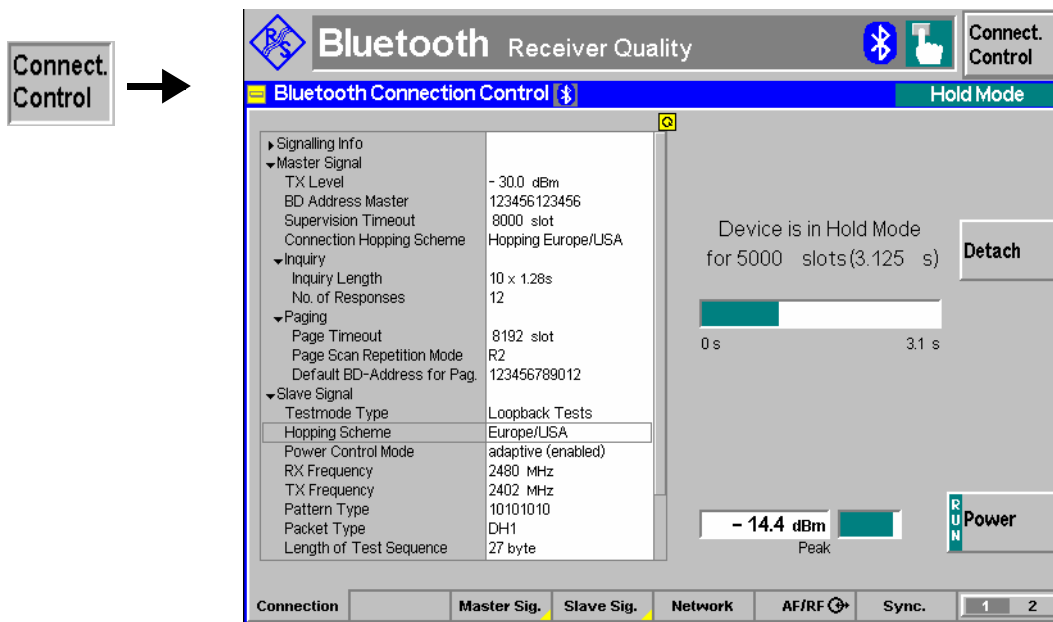

Fig. 4-86 Connection Control – Connection (Hold)

The info table in the left half of the menu and the *Power* softkey is described in section [Connection Control: Standby State](#) on page 4.14. The *Detach* softkey is described in section [Connection Control in Connected State](#) on p. 4.90.

Connection Control in Park State

The *Connection (Park)* tab provides information on

- A selection of signalling parameters of the DUT (*Signalling Info*)
- The master and slave signal parameters
- Status and result of the wide-band peak-power measurement (*Power*)
- It contains softkeys that lead to another signalling state (see Fig. 4-40):
- Activate a different submode (*Enter Submode* → *Submode* state)
- Release the Park state (*Unpark* → *Connected* state)
- Release connection to DUT (*Detach* → state *Standby*)

The *Connection (Park)* tab is opened if the *Park* mode is activated while the R&S® CMU is in the *Connected* state or in the *Test Mode*, *Sniff* or *Audio* substates. It is replaced by the *Connection (Standby)* tab when the connection is lost or deliberately released (*Detach* softkey). It is replaced by the *Connection (Connected)* tab if the *Park* mode of the DUT is deactivated (*Unpark* softkey). It is replaced by the *Connection (Audio)*, *Connection (Hold)*, *Connection (Sniff)* or *Connection (Test Mode)* tab if one of the corresponding submodes is activated (*Enter Submode* softkey); see Fig. 4-40.

Note: If the connection is lost during operation (e.g. because of a low signal level), a warning will appear. At the same time, bit 2 is set in the STATus:OPERation register. Prior to further operation, confirm the reception of the message by pressing the ENTER key.

In the **Park** state the DUT gives up its Active Member Address and no longer participates in the connection but still re-synchronizes to the channel by waking up at the beacon instants separated by periodic intervals (*Beacon Intervals*). At the beacon instants the R&S® CMU can re-activate (*Unpark*) the DUT. The *Beacon Interval* can be set in the *Network* tab before the *Park* state is reached; see page 4.113. The *Park* mode must be terminated explicitly by the R&S® CMU; see *Unpark* below.

The main application of the *Park* state is to test the power consumption of the DUT. This must be done locally at the DUT.

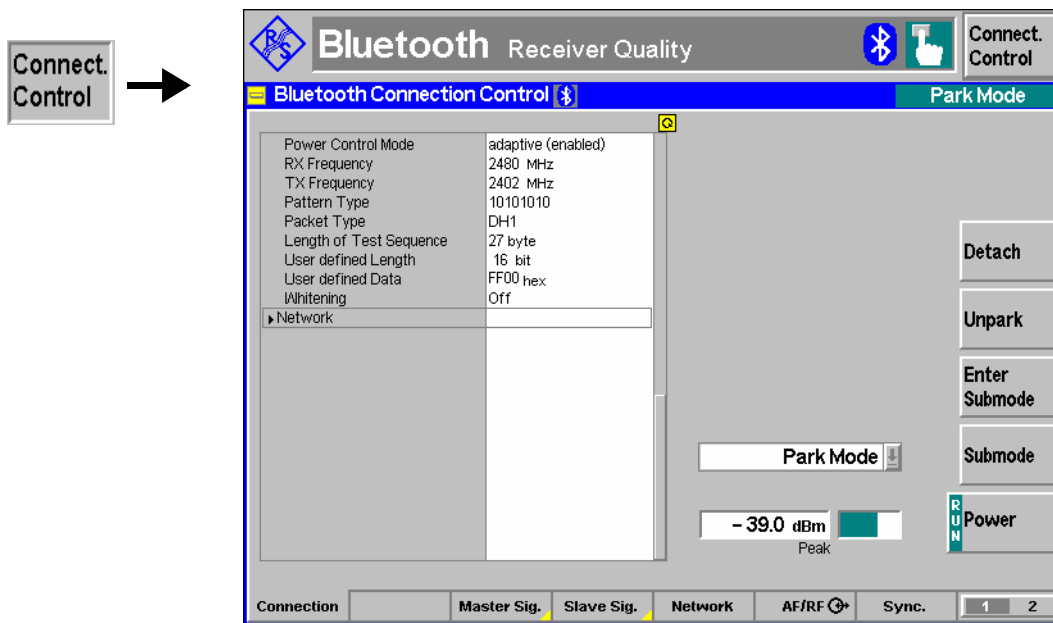

Fig. 4-87 Connection Control – Connection (*Park*)

The info table in the left half of the menu and the *Power* softkey is described in section *Connection Control: Standby State* on page 4.14. The *Detach*, *Enter Submode* and *Submode* softkeys are described in section *Connection Control in Connected State* on p. 4.90.

Unpark

The *Unpark* softkey releases the *Park* mode at the DUT.

The DUT returns to the active state. The R&S® CMU returns to the *Connected* signalling state; see Fig. 4-40 on p. 4.13.

Remote control PROCedure:SIGNalling:ACTion SPARK

Connection Control in Audio State

The *Connection (Audio)* tab provides information on

- A selection of signalling parameters of the DUT (*Signalling Info*)
- The paging mode
- The master and slave signal parameters
- Status and result of the wide-band peak-power measurement (*Power*)
-

It contains softkeys that lead to another signalling state (see Fig. 4-40):

- Activate a different submode (*Enter Submode* -> *Submode* state)
- Release connection to DUT (*Detach* -> state *Standby*)

The *Connection (Audio)* tab is opened if the *Audio* mode is activated while the R&S® CMU is in the *Connected* state or in the *Test Mode*, *Park* or *Sniff* substates. It is replaced by the *Connection (Standby)* tab when the connection is lost or deliberately released (*Detach* softkey). It is replaced by the *Connection (Connected)* tab if the *Audio* mode of the DUT is deactivated (*Exit Audio Mode* softkey). It is replaced by the *Connection (Sniff)*, *Connection (Hold)*, *Connection (Park)* or *Connection (Test Mode)* tab if one of the corresponding submodes is activated (*Enter Submode* softkey); see Fig. 4-40.

Note: *If the connection is lost during operation (e.g. because of a low signal level), a warning will appear. At the same time, bit 2 is set in the STATUS:OPERation register. Prior to further operation, confirm the reception of the message by pressing the ENTER key.*

In the **Audio** state the R&S® CMU establishes an SCO (Synchronous Connection-Oriented) link on top of the existing baseband ACL (Asynchronous Connection-Less) link. On this link the R&S® CMU can receive audio data from the DUT, transmit audio data to the DUT or loop back audio data received from the DUT. Possible test scenarios are described in section [Audio Test Scenarios](#) on p. 4.87. The parameters of the Audio mode can be set in the *Network* tab before the *Audio* state is reached; see page 4.113. The Audio mode must be terminated explicitly from the R&S® CMU; see *Exit Audio Mode* below.

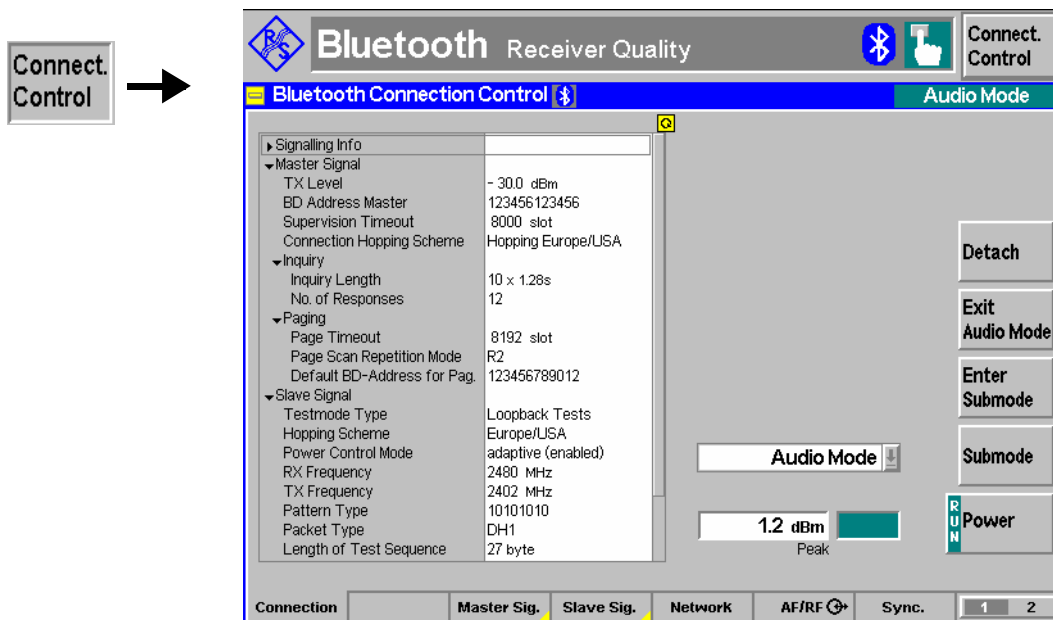

Fig. 4-88 Connection Control – Connection (Audio)

The info table in the left half of the menu and the *Power* softkey is described in section [Connection Control: Standby State](#) on page 4.14. The *Detach*, *Enter Submode* and *Submode* softkeys are described in section [Connection Control in Connected State](#) on p. 4.90.

Exit Audio Mode

The *Exit Audio Mode* softkey releases the *Audio* mode at the DUT.

The DUT returns to the active state. The R&S® CMU returns to the *Connected* signalling state; see [Fig. 4-40](#) on p. 4.13.

Remote control PROCEDURE:SIGNALLING:ACTION SAUDIO

Signal of the R&S CMU (Connection Control – Master Sig.)

The *Master Sig.* tab of the *Connection Control* popup menu configures the RF signal generated by the R&S® CMU including the *Dirty Transmitter* parameters and sets various parameters to define how an inquiry is made and a connection is set up. The R&S® CMU provides a panel oriented version of the *Master Sig.* tab and a table oriented version with extended functionality. The *Master Sig.* hotkey toggles between the two versions if it is pressed repeatedly.

Note: The *Master Sig.* tab is always available, however, some parameters may not be available for editing in some signalling states. For reference see the Sig. State field in the command tables in Chapter 6.

Panel Oriented Version

The panel oriented version of the *Master Sig.* tab provides softkeys to define the following settings for the R&S® CMU acting as a Bluetooth master:

- The master BD_address (BD Address CMU)
- The connection hopping scheme while not in test mode (*Hopping Scheme*)
- The RF output signal level while signalling (*TX Level*)
- The timeout parameters for an inquiry (*Inquiry Length*, *Number of Responses*)
- The Supervision Timeout

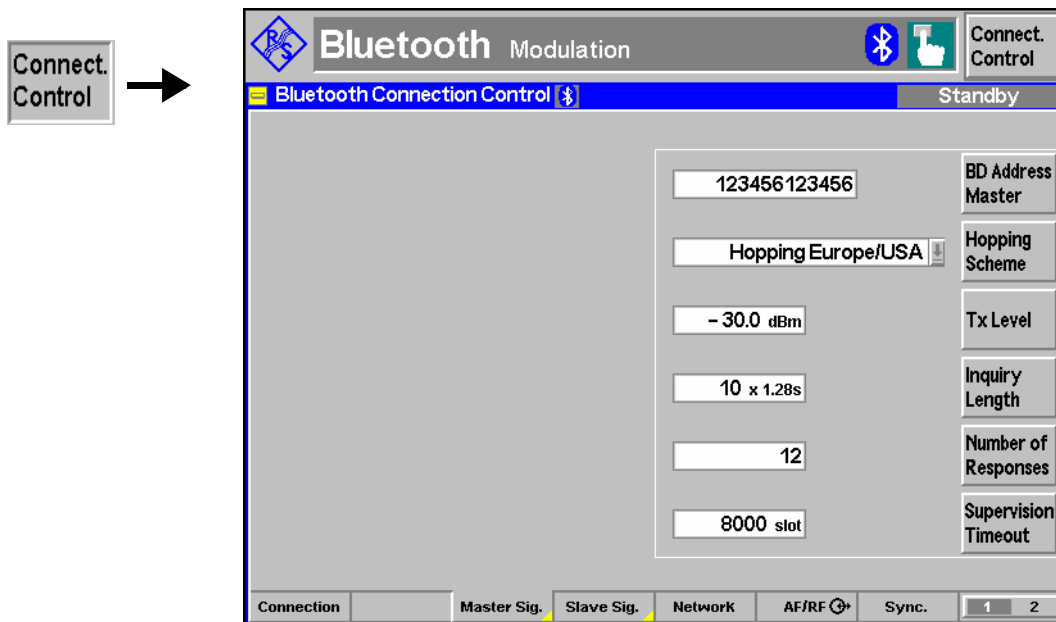

Fig. 4-89 Connection Control – Master Sig. (panel)

For a detailed description of the parameters see section [Table Oriented Version](#) below.

Table Oriented Version

The table oriented version of the *Master Sig.* tab provides softkeys to define the following settings for the R&S® CMU acting as a Bluetooth master:

- The RF output signal level while signalling (*TX Level*)

- Timing of the Power-up ramp (*Power-up Time before Bit 0*)
- The master BD_address (*BD Address CMU*)
- The Supervision Timeout
- The hopping scheme and the frequencies used to inquire and set up the connection (*Connection Hopping Scheme, RX Frequency, TX Frequency*)
- The timeout parameters for an inquiry (*Inquiry*)
- Parameters to define how the R&S® CMU will attempt to page to a DUT (*Paging*)
- Parameters to modify and impair the master signal (*Dirty Transmitter*)

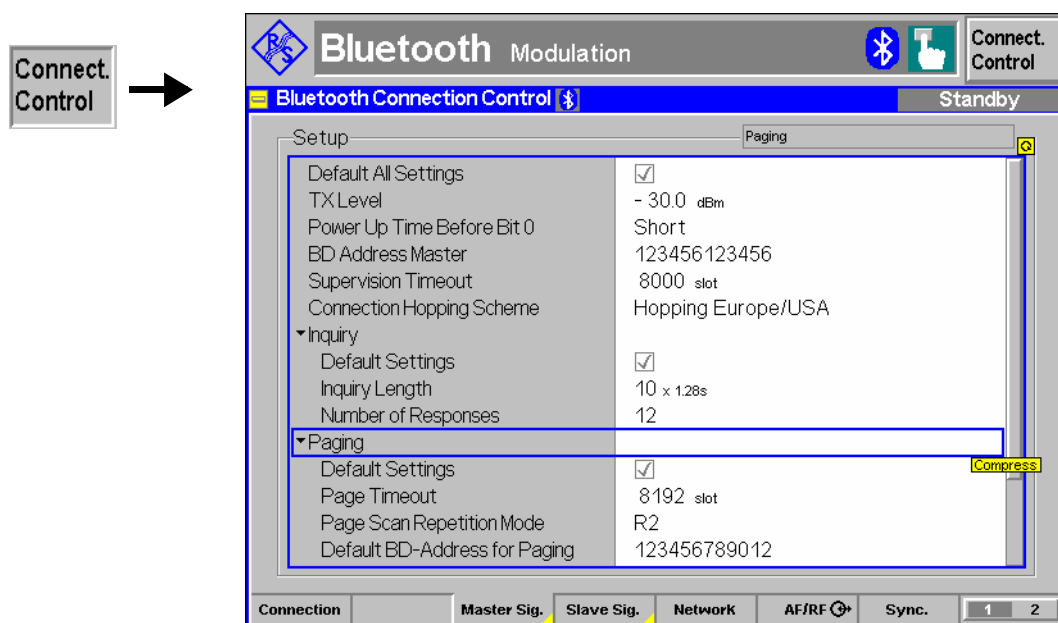

Fig. 4-90 Connection Control – Master Sig. (table)

Default Settings The *Default All Settings* switch assigns default values to all settings in the *Master Sig.* tab (the default values are quoted in the command description in chapter 6 of this manual). Additional *Default Settings* switches are provided for the individual sections in the *Setup* table.

Remote control
 DEFault:MSIGnal ON | OFF

TX Level Transmit level for the R&S® CMU while signalling. This level is different from the level used during the BER tests.

Remote control
 CONFigure:MSIGnal:TXLevel <Level>

Power-up Time before Bit Zero The time interval between the start of the power ramp and the time of bit zero (t_{P0}) can be set to either *Long* or *Short*. Note that setting a *Short* time corresponds to 3 μ s, which is the value quoted in the Bluetooth RF test specification.

Remote control
 PROCedure:SIGNalling:PTBZero <Time>

BD Address CMU	<p>BD_address of the R&S® CMU. This address is used for connection phases. The value is a 12 digit hex value, see Fig. 4-84 on page 4.94.</p>
Supervision Timeout	<p>Remote control <code>CONFigure:MSIGnal:BDAddress <String></code></p> <p>Number of slots of non-communication between the R&S® CMU and the DUT that can occur before the two devices detach from each other. A supervision timeout is set to ensure link control in case that the connection temporarily breaks down.</p> <p>Remote control <code>CONFigure:MSIGnal:SVTout <Slots></code></p>
Connection Hopping Scheme	<p>Hopping scheme used for the inquiry, paging and connection to test mode phases. For a definition and a list of hopping schemes see Hopping Scheme softkey on page 4.110.</p> <p>Note: RX/TX single freq. <i>cannot be used as a connection hopping scheme.</i></p> <p>Remote control <code>CONFigure:MSIGnal:HSCHEME <Scheme></code></p>
RX Frequency/ TX Frequency	<p><i>Fixed RX and TX frequencies to be used if the Connection Hopping Scheme (see above) is set to RX/TX single freq.</i></p> <p>Remote control <code>CONFigure:MSIGnal:HSCHEME:FREQUENCY <TX_Freq>, <RX_Freq></code></p>
Inquiry	<p>The <i>Inquiry</i> section sets timeout parameters for an inquiry.</p> <p><i>Inquiry Length</i> Sets the maximum amount of time specified before an inquiry is halted.</p> <p><i>Number of Responses</i> Maximum number of responses from Bluetooth devices before the inquiry is halted.</p> <p>Remote control <code>CONFigure:MSIGnal:INquiry:ILENgtH <Timeout></code> <code>CONFigure:MSIGnal:INquiry:NOResponses <Responses></code></p>
Paging	<p><i>Paging</i> parameters are used to configure how the R&S® CMU will attempt to page to a device under test, i.e. time-outs used, paging modes and a default BD_address of the DUT.</p> <p><i>Page Timeout</i> The <i>Page Timeout</i> is the maximum time the R&S® CMU will wait for the DUT to respond before the connection attempt will be considered to have failed. The parameter is set as a number of timeslots.</p> <p><i>Page Scan Repetition Mode</i> Paging mode that determines the interval between the beginnings of two consecutive page scans while the R&S® CMU attempts a connection and synchronization to the DUT. The possible page scan repetition modes are <i>R0</i>, <i>R1</i>, <i>R2</i>. The page scan repetition mode has an impact on the speed of a connection.</p> <p>Note: <i>During an inquiry the R&S® CMU reads the allowed page scan repetition mode from the DUT. This value always overrides the initial setting, ensuring that the following connection is set up at optimal speed.</i></p>

Connections without previous inquiry can still be very fast, provided that the Page Scan Repetition Mode in the MMI matches the DUT's setting and the DUT's page scan is configured optimal.

Default

BD_Address for P. Sets the address of a default device to attempt a connection to. The value is a 12 digit hex value.

Read Signalling Info If this parameter is set to *Off*, the R&S® CMU will not issue commands to read supported features or other signalling information from the DUT. Usually these commands are sent to the DUT to find out about its properties and to fill in some of the signalling information in the *Signalling Info* tree (see section [Connection Control in Test Mode \(Test Mode\)](#) on p. 4.92.), namely *Device Name*, *Version* and *Supported Features* (the *Class of Device* and *Paging* are filled in when a device was found during inquiry).

Disabling the signalling info has 2 consequences:

- The connection is made quicker, since there are less LMP packets exchanged between master and slave when connecting
- The R&S® CMU assumes that the LMP version of the DUT is ≥ 1.1 . This information is relevant for test mode settings.

Remote control

```
CONFigure:MSIGnal:PAGing:TOUT <Timeout>
CONFigure:MSIGnal:PAGing:PSRMode <Mode>
CONFigure:MSIGnal:PAGing:TARGet <Address>
CONFigure:MSIGnal:PAGing:RSINfo <Enable>
```

The following two parameters are used to test and control the authentication procedure between the R&S® CMU and the DUT.

Authentication Required Specifies how the R&S® CMU will attempt to set up a connection to the Bluetooth DUT:

On The R&S® CMU requires authentication with the specified PIN code. The connection can be established if the DUT responds with the correct code; it will fail if the DUT does not support authentication, or if it responds with the wrong code.

Off The R&S® CMU does not require authentication. If the DUT requires authentication, it must use the specified PIN. Otherwise the connection can be set up without authentication.

Note: *The DUT may use either a fixed PIN or a manually entered PIN. If the PIN is manually entered, the Page Timeout must be sufficiently long to ensure that the R&S® CMU will not stop attempting a connection before the entry is complete.*

Remote control

```
CONFigure:DUT:AUTHentic:ENABLE ON | OFF
[SENSe:]DUT:AUTHentic? (Query only)
```

Pin Code Specifies the PIN code to be used for authentication. This parameter is relevant even if authentication by the R&S® CMU is disabled; see above.

The PIN code is a 48 bit value, to be entered as a hexadecimal number with 1 to 12 digits.

Remote control
 CONFigure:DUT:PINCode <Code>

Store Link Keys Specifies whether the R&S CMU stores the link keys which a DUT sends to it during the authentication (pairing) process. The benefit is that a subsequent connection to the same DUT should be quicker. Besides, some Bluetooth devices expect the link key to be stored.

Remote control
 CONFigure:DUT:STORE:LINK:KEYS

Dirty Transmitter The Dirty Transmitter section contains parameters to impair the master signal in order to test the connection under 'dirty transmitter' conditions and measure the impact on the receiver quality (bit error rate tests).

Dirty Transmitter

Scope Qualifies whether the dirty transmitter settings are active all the time (setting Global) or only while a Receiver Quality measurement is running.

Modulation Index Ratio between the actual frequency deviation of the CMU and a frequency deviation of 500 kHz:

$$\text{Mod. Index} * 500 \text{ kHz} = \text{Freq. deviation of master signal}$$

The setting Off is equivalent to a modulation index of 0.32, corresponding to the nominal Bluetooth frequency deviation of 160 kHz. According to the Bluetooth radio specification, the modulation index must be between 0.28 and 0.35.

Frequency Offset Deviation of the actual frequency of the master signal from the nominal Bluetooth channel frequency; see section RF Generator Panel on p. 4.3.

Remote control
 CONFigure:MSIGnal:DTRansmitter:SCOPE <Scope>
 CONFigure:MSIGnal:DTRansmitter:MINdex <ModulationIndex>
 CONFigure:MSIGnal:DTRansmitter:FOFFset <FrequencyOffset>

Behavior of the DUT (Connection Control – Slave Sig.)

The *Slave Sig.* tab of the *Connection Control* popup menu controls the behavior of the DUT (acting as a Bluetooth slave) while it is in its test mode. The R&S® CMU provides a panel oriented version of the *Slave Sig.* tab and a table oriented version with extended functionality. The *Slave Sig.* hotkey toggles between the two versions if it is pressed repeatedly.

Note 1: Signalling states

The Slave Sig. tab is always available, however, some parameters may not be available for editing in some signalling states. For reference see the Sig. State field in the command tables in Chapter 6.

Note 2: Automatic Measurement Preconfiguration

The conditions for various test purposes in the Bluetooth test specification differ from the default settings in the Connection Control menu. With a firmware version V4.37 and higher, the R&S® CMU suspends some Connection Control settings while a particular measurement application is active and sets the parameter in accordance with the requirements of the test specification. The following table gives an overview.

Application	Parameter	Connection Control setting	Application-specific setting
Spectrum – ACP	Slave Sig. – Hopping Scheme	Europe/USA	RX/TX single freq.
Spectrum – Frequency Range	Slave Sig. – Hopping Scheme	Europe/USA	RX/TX single freq.

The Connection Control settings are resumed when a different application is started.

Panel Oriented Version

The panel oriented version of the *Slave Sig.* tab provides softkeys to define the following settings for the RF signal that the DUT transmits in its test mode:

- The basic test mode settings (*Testmode Type*)
- The data pattern transmitted by the DUT in the current testmode type (*Pattern Type*)
- The packet type transmitted by the DUT in the current testmode type (*Packet Type*)
- The length of the payload in the current testmode type (*Length of Test Seq.*)
- Whitening of the ACL packets that the DUT transmits in loopback mode
- A sequence of Bluetooth channels to be used for the measurements (*Hopping Scheme*)
- Channel number and frequency of the signals to be transmitted and received by the DUT in the current testmode type (*TX Frequency, RX Frequency*)

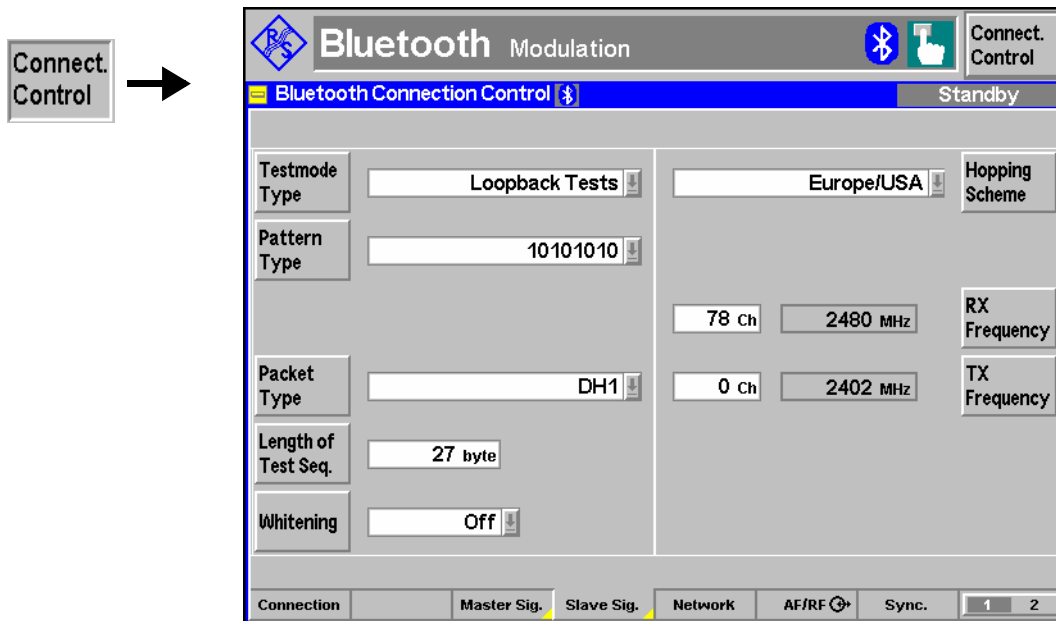

Fig. 4-91 Connection Control – Slave Sig. (panel)

For a detailed description of the parameters see section [Table Oriented Version](#) below.

Table Oriented Version

The table oriented version of the *Slave Sig.* tab provides the following settings for the RF signal that the DUT transmits in its test mode:

- The basic test mode settings (*Testmode Type*)
- A sequence of Bluetooth channels to be used for the measurements (Hopping Scheme)
- The transmitter output power control (Power Control Mode)
- The parameters for TX Tests and for Loopback Tests

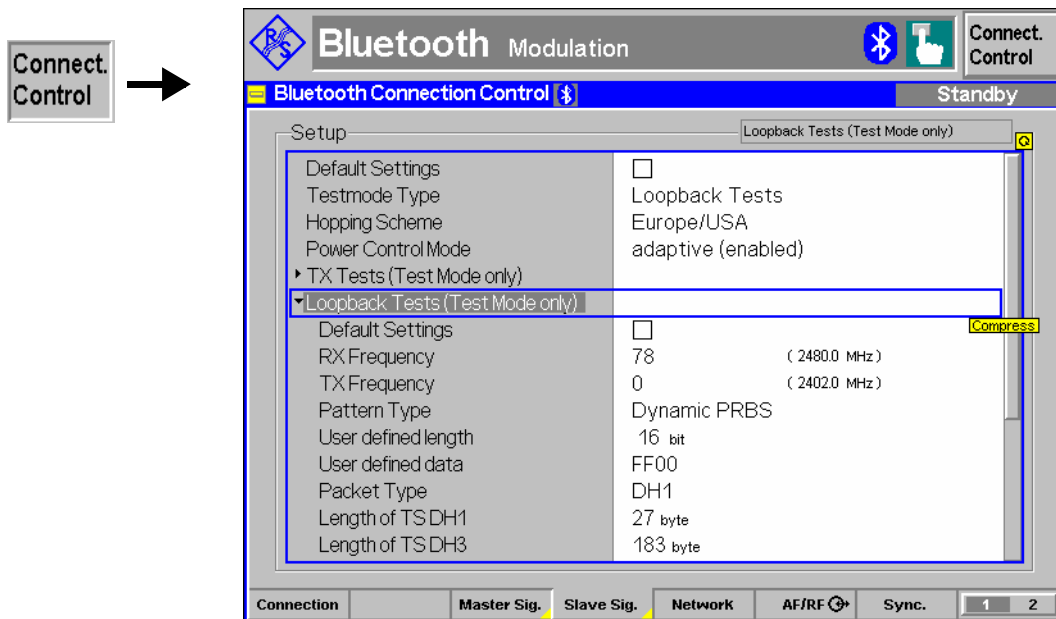

Fig. 4-92 Connection Control – Slave Sig. (table)

Default Settings The *Default Settings* switch assigns default values to all settings in the *Slave Sig.* tab (the default values are quoted in the command description in chapter 6 of this manual). Further *Default Settings* switches are provided for the *TX Tests* and *Loopback Tests* sections.

Remote control
 DEFault:SSIGnal ON | OFF etc.

Testmode Type The *Testmode Type* parameter defines the basic type of test scenario. The following testmode types are provided:

TX Tests Transmitter test mode
Loopback Tests Closed loopback mode

Note that some measurements require certain testmode types, e.g. a *Loopback* testmode type is automatically activated when a *Receiver Quality* measurement is switched on. The two testmode types are described below in more detail.

Remote control CONFigure:SSIGnal:TMODE:TMTYPE <Type>
 PROCedure:SSIGnal:TMODE:TMTYPE <Type>

In a **transmitter test**, the R&S® CMU controls the timing of the piconet, transmitting poll packets at the beginning of its master TX slots. The DUT (acting as a Bluetooth slave) starts test packet transmission in the following slave TX slot where it transmits a definite bit pattern in the payload that is periodically repeated. A test packet may extend over one or several consecutive timeslots. This implies that the period between two consecutive poll packets from the tester (*Poll Period*) is also variable (see Fig. 4-93 below).

Transmitter tests with various bit patterns can be configured. Moreover, the *Poll Period*, the *Packet Type* for test packets and the *Length of the test sequence* can be set; see *TX Tests* section below.

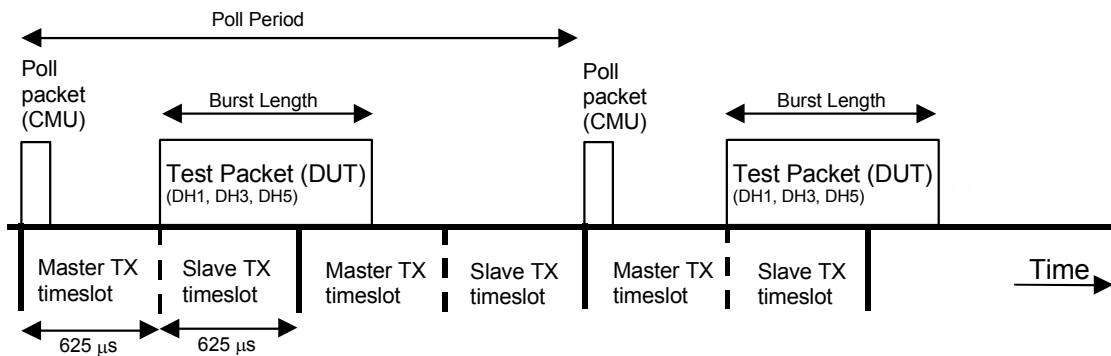

Fig. 4-93 Timing for transmitter tests

In a **loopback test**, the R&S® CMU transmits normal baseband packets. The DUT (acting as a Bluetooth slave) decodes the received packets and sends back the payload using the same packet type. The return packet is sent back either in the slave TX timeslot directly following the transmission of the R&S® CMU or with a delay of one slave and one master timeslot. For *Receiver Quality* tests the correct Loopback Delay setting for the connected DUT has to be used, otherwise the measurement will not work correctly; see p. 4.85.

The R&S® CMU provides a selection of bit patterns (*Pattern Type*) to be used for loopback tests. The data may or may not be whitened (scrambled with a particular bit sequence). Moreover, the *Packet Type* for test packets and the *Length of the test sequence* can be set; see *Loopback Tests* section below.

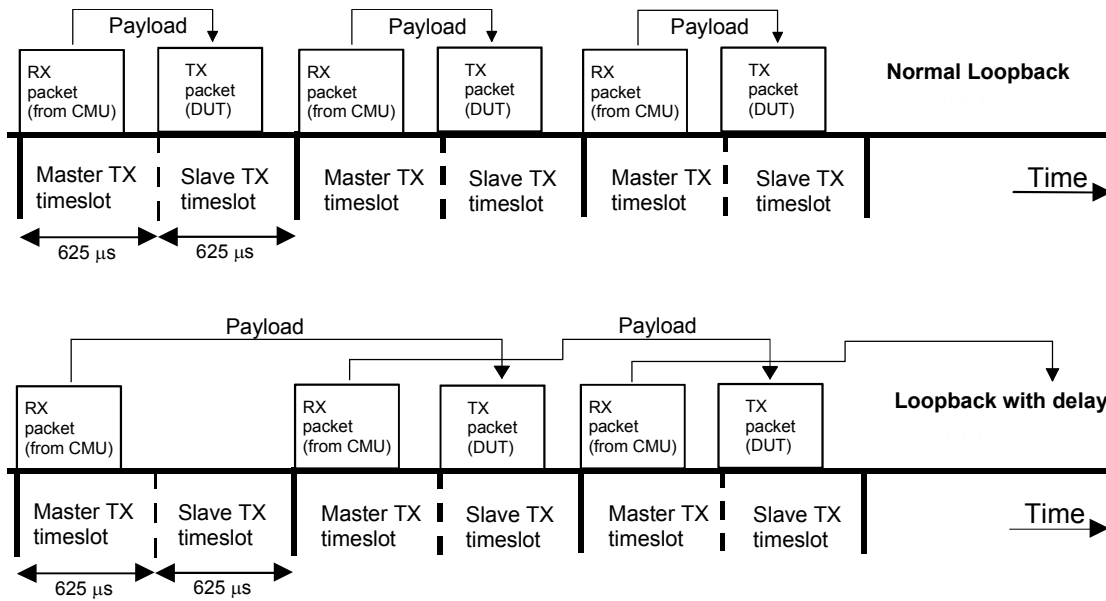

Fig. 4-94 Timing for loopback tests

Hopping Scheme

The *Hopping Scheme* parameter selects a sequence of *Bluetooth* channels to be used for the measurements. The following hopping schemes are provided:

RX/TX single freq. The DUT transmits at a constant TX frequency and receives a signal at a constant RX frequency from the R&S® CMU.

Note: For transmitter tests, the *Bluetooth* specification requires the same RX and TX frequency if no hopping is enabled. The frequency is set with a single RX/TX Frequency parameter. For loopback tests, it is possible to use different RX and TX frequencies which can be set by means of two different parameters.

Europe/USA The R&S® CMU uses Europe's and USA's hopping scheme

France The R&S® CMU uses France's hopping scheme

Reduced Hopping The R&S® CMU uses the reduced hopping scheme, see below

Note: The reduced hopping scheme is not supported by all *Bluetooth* devices.

Remote control `CONFigure:SSIGnal:TMODE:HSCHeme <Scheme>`
`PROCedure:SSIGnal:TMODE:HSCHeme <Scheme>`

Frequency hopping is used in *Bluetooth* networks mainly as a spread spectrum technique and to reduce interference. The RF channel is changed in a pseudo-random way after each timeslot (i. e. after each 625 μs, corresponding to a rate of approx 1600 hops per second), so that the whole available frequency spectrum can be used. A hopping sequence defines the order the RF channels. This hopping sequence is determined by the *Bluetooth* device address of the master and must be used by all *Bluetooth* devices in the piconet. The timing is based on the clock of the *Bluetooth* master.

The following channels and frequency ranges are available in the different countries:

Europe/USA	2400 MHz to 2483.5 MHz,	Channel _k : $f_k = 2402 + k$ MHz, $k = 0$ to 78
France	2446.5 MHz to 2483.5 MHz,	Channel _k : $f_k = 2454 + k$ MHz, $k = 0$ to 22

The **reduced hopping sequence** was defined to support quick testing over the whole frequency range, including the 79 channels of the Europe/USA scheme and the schemes of the other countries. It consists of the channel sequence 0, 23, 46, 69, 93 where the frequency/channel assignment is according to $f_k = 2402 + k$ MHz, $k = 0$ to 93. The five channels are periodically repeated.

Power Control Mode	<p>The <i>Power Control Mode</i> parameter specifies the transmit power control mode of the DUT. The following modes are provided:</p> <p><i>Fixed (disabled)</i> Power control functionality of the DUT disabled. The DUT transmits at a fixed power level and does not accept power up/down commands (see Power Up hotkey on p. 4.30). This mode can be used to force the DUT to transmit at fixed power while a transmitter test is performed.</p> <p><i>Adaptive (enabled)</i> Power control functionality of the DUT enabled. This mode must be active to test power control; see Power Up hotkey on p. 4.30.</p> <p>Note: <i>The power control mode is valid in the test mode only. In the Connected state, the DUT accepts power control commands irrespective of the power control mode setting.</i></p>						
Remote control	<pre>CONFigure:SSIGnal:PCTR FIXed ADAPtive PROCedure:SSIGnal:PCTR FIXed ADAPtive</pre>						
TX Tests	<p>Sets the parameters for transmitter tests; see explanation on page 4.109. The following transmitter test parameters can be set:</p> <p><i>RX/TX Freq.</i> Sets the receiver and transmitter frequency of the DUT for transmitter testmode types where both frequencies must be identical. Independent receiver and transmitter frequencies can be used in loopback test mode; see below.</p> <p><i>Pattern Type</i> Bit pattern that the DUT is to transmit in test mode. The selected patterns 01010101, 11110000, 11111111 or 00000000 are periodically repeated. In the <i>Static PRBS</i> setting, a definite PRBS-9 sequence is used for each transmission, i.e. the DUT transmits a series of identical packets.</p> <p><i>Packet Type</i> This function determines what type of packet is to be transmitted by the DUT during test mode. The following data packet types are supported:</p> <p><i>DH1</i> Data – High rate packet carrying up to 27 information bytes plus a 16-bit CRC code. A DH1 packet covers up to 1 timeslot.</p> <p><i>DH3</i> Data – High rate packet carrying up to 183 information bytes plus a 16-bit CRC code. A DH3 packet covers up to 3 timeslots.</p> <p><i>DH5</i> Data – High rate packet carrying up to 339 information bytes plus a 16-bit CRC code. A DH5 packet covers up to 5 timeslots.</p> <p><i>Length of Test Sequence</i> This function defines the length of the payload for the transmitted packet in bytes. The ranges for the lengths depend on the packet type selected:</p> <table border="0" style="margin-left: 20px;"> <tr> <td><i>DH1 packet</i></td> <td><i>Length ≤ 27 bytes</i></td> </tr> <tr> <td><i>DH3 packet</i></td> <td><i>Length ≤ 183 bytes</i></td> </tr> <tr> <td><i>DH5 packet</i></td> <td><i>Length ≤ 339 bytes</i></td> </tr> </table>	<i>DH1 packet</i>	<i>Length ≤ 27 bytes</i>	<i>DH3 packet</i>	<i>Length ≤ 183 bytes</i>	<i>DH5 packet</i>	<i>Length ≤ 339 bytes</i>
<i>DH1 packet</i>	<i>Length ≤ 27 bytes</i>						
<i>DH3 packet</i>	<i>Length ≤ 183 bytes</i>						
<i>DH5 packet</i>	<i>Length ≤ 339 bytes</i>						

	<i>Poll Period</i>	This function defines how often a poll packet from the R&S® CMU occurs. The parameter represents an even number of slots, i.e. 2, 4, 6,... slots.
Remote control		CONFigure:SSIGnal:TMODE:TXTests... PROCEDURE:SSIGnal:TMODE:TXTests...
Loopback Tests		Sets the parameters for loopback tests; see explanation on page 4.109. The following loopback test parameters can be set:
	<i>RX Frequency</i>	Sets the receiver frequency of the DUT for loopback test modes.
	<i>TX Frequency</i>	Sets the transmitter frequency of the DUT for loopback test modes.
	<i>Pattern Type</i>	This function defines the data sequence to be modulated on the RF signal used in loopback test mode. The selected patterns 01010101, 11110000, 11111111 or 00000000 are periodically repeated. Further options are: <i>Dynamic PRBS</i> (pseudo random sequence PRBS-9) <i>Static PRBS</i> (pseudo random sequence PRBS-9) <i>User-defined</i> (see next two settings)
		A static pseudo random sequence means that the PRBS sequence generation re-starts at the beginning of each packet. The same bit sequence is used in every packet payload so the DUT transmits a series of identical packets. A dynamic pseudo random sequence means that the PRBS sequence is continued so that a different bit sequence is used in each packet payload.
		The next two options are available only if a user-defined <i>Pattern Type</i> is selected:
	<i>User defined Length</i>	Length of the user-defined bit sequence before it is repeated. The value of this function may be set from 3 to 64 bits.
	<i>User defined Data</i>	Bit stream to be used for the user-defined data. The bit stream is repeated until the complete payload is filled, removing any extra bits from the end of the stream. The data is represented as a hex value. The length of the function depends upon the function <i>User defined length</i> . The user-defined data can be up to 64 bits long, therefore a maximum of 16 hex characters shall be entered. The data is entered least significant bit last, i.e. to the right.
	<i>Packet Type</i>	This function determines what type of packet is to be transmitted by the DUT during test mode. The supported packets are <i>DH1</i> , <i>DH3</i> , <i>DH5</i> (see paragraph on <i>TX Tests</i> above).
	<i>Length of Test Sequence</i>	This function defines the length of the payload for the transmitted packet in bytes. The ranges for the lengths depend on the packet type selected; see paragraph on <i>TX Tests</i> above.
	<i>Whitening</i>	Closed loopback mode with whitening switched <i>On</i> or <i>Off</i> . Whitening means that the DUT transmits ACL (Asynchronous connection-less link) packets that are scrambled with a particular data sequence (whitening word).
Remote control		CONFigure:SSIGnal:TMODE:LBTests... PROCEDURE:SSIGnal:TMODE:LBTests...

Network Parameters (Connection Control – Network)

The *Network* tab sets parameters to control the DUT while it is in the *Audio*, *Sniff*, *Park* and *Hold* submode or in *Test* mode.

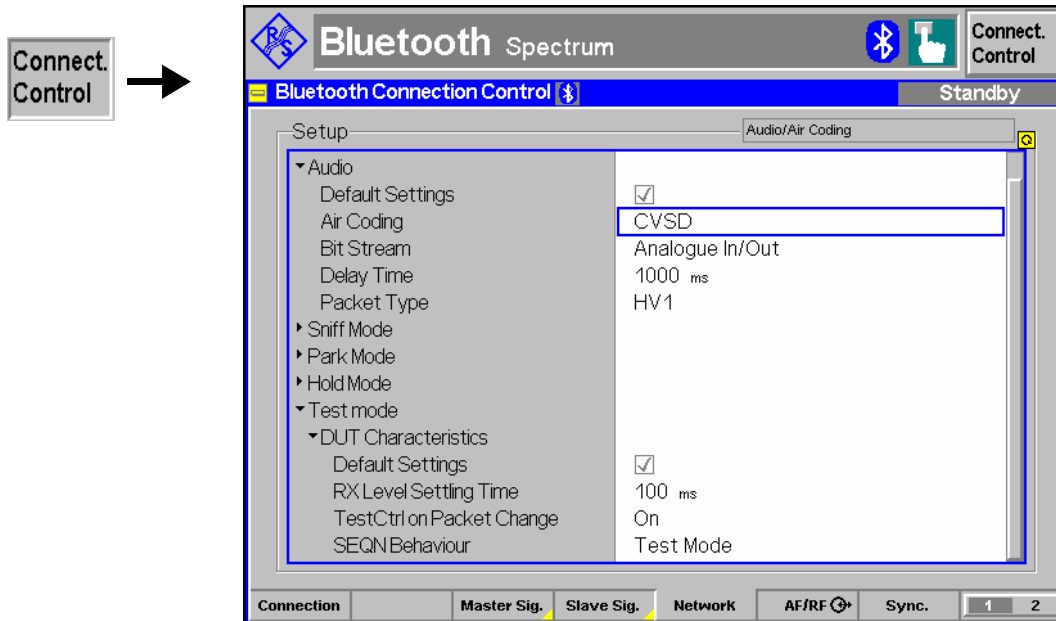

Fig. 4-95 Connection Control – Network (table)

Default Settings The *Default Settings* switches assign default values to all settings in the *Audio*, *Sniff Mode*, *Hold Mode* and *Park Mode* sections of the *Network* tab, respectively (the default values are quoted in the command description in chapter 6 of this manual).

Remote control

DEFault:NETWork:... ON | OFF etc.

Audio

The *Audio* section sets the parameters for audio measurements, to be performed in the *Audio* submode (see section [Connection Control in Audio State](#) on p. 4.100.):

Air Coding Voice coding format used on the air interface (i.e. in uplink as well as in downlink direction). In the *Audio* state, the R&S® CMU establishes an SCO link to the DUT with either CVSD (Continuous Variable Slope Delta modulation), μ -law log PCM (Pulse Coded Modulation) or A-law log PCM air coding.

Bit Stream Routing of the SCO bits in the R&S® CMU. To perform receive audio or transmit audio tests (test scenarios 1 and 2 in section [Audio Test Scenarios](#) on p. 4.87.) one of the two options *Analog In/Out* or *Analog In/Out (Low)* must be selected.

Analog In/Out

The bidirectional SPEECH connector is connected to the Bluetooth speech codec. The analog input level for a full scale digital signal is approx. 1.4 V(peak). The analog output level for a full scale digital signal is approx. 1.0 V(peak); see *Encoder Cal* and *Decoder Cal* below.

Analog In/Out (Low)

Similar to *Analog In/Out* but for lower analog input levels: The analog input level for a full scale digital signal is approx. 0.1 V(peak). The analog output level for a full scale digital signal is

approx. 1.0 V(peak).

Echo

The R&S® CMU loops back the data received from the DUT after the *Delay Time* set below (audio test scenario 3)..

Decoder Cal

The internal speech codec of the R&S CMU (option R&S CMU-B41) provides a 1 kHz sinewave signal at its analog output, corresponding to a full scale digital signal. The analog signal is routed to the front panel connector labeled SPEECH and can be used for external calibration of the analog output path; see background information below.

Encoder Cal

The speech codec converts the analog signal from the input connector SPEECH into a digital signal and loops it back to the analog output. This signal is used for external calibration of the analog input path; see background information below.

Delay Time For test scenario no. 3 (*Bit Stream = Echo*), the time to elapse before the R&S® CMU loops back data received from the DUT. A longer delay time can be useful for manual audio tests using a headset connected to the DUT.

Packet Type Type of SCO packet initially transmitted in the *Audio* state (i.e. in uplink as well as in downlink direction): HV1, HV2 or HV3 where HV stands for High quality Voice. The three packet types differ in the number of information bytes, the error protection, and the amount of speech data (length of speech) transported; see Bluetooth baseband specification. Once in the audio state, the DUT may change the packet type from this initial setting.

Note: *The Air Coding, Delay Time and Packet Type settings are unavailable while the R&S CMU is in Audio submode. The settings must be changed outside the submode.*

Remote control

```
CONFigure:NETWork:AUDio:AIRCoding CVSD | ULAW | ALAW
CONFigure:NETWork:AUDio:BITStream
    AIO | AIOL | ECHO | DCAL | ECAL
CONFigure:NETWork:AUDio:DELTime <DelayTime>
CONFigure:NETWork:AUDio:PTYPE HV1 | HV2 | HV3
```

The purpose of a **decoder calibration** is to determine the correlation between analog output amplitudes (in V(peak)) and the amplitude of the digital signal that the speech decoder receives over the Bluetooth link. To perform a decoder calibration, select *Bit Stream: Decoder Cal* and measure the 1kHz output signal at the SPEECH connector using external equipment (e.g. a second R&S CMU). The expected analog output amplitude is approx. 1.0 V(peak); it corresponds to a full scale (FS) digital input signal of the decoder. This pins down the entire scale of digital input amplitudes, because the relation between analog and digital amplitudes is linear.

The purpose of an **encoder calibration** is to determine the correlation between analog input amplitudes (in V(peak)) and the amplitude of the digital signal that the speech encoder transmits over the Bluetooth link. To perform an encoder calibration, proceed as follows:

1. Perform a decoder calibration as described above, note down the analog output amplitude.
2. Select *Bit Stream: Encoder Cal* and supply the SPEECH connector with a 1 kHz audio input signal using external equipment (e.g. a second R&S CMU).
3. Measure the looped-back 1kHz signal at the analog output connector.
4. Adjust the analog input amplitude until the amplitude of the looped-back signal is equal to the output amplitude determined in the first step.

The expected analog input level is approx. 1.4 V(peak); it corresponds to a full scale (FS) digital output signal of the encoder. This pins down the entire scale of digital output amplitudes, because the relation between analog and digital amplitudes is linear.

Sniff

The *Sniff* section sets the parameters for the *Sniff* submode (see section [Connection Control in Sniff State](#) on p. 4.96. and Bluetooth baseband specification):

- Sniff Interval* Even number of slots between two consecutive so-called *sniff slots* where the DUT listens to the master signal and the R&S® CMU can start transmission. The sniff interval is an even number of slots because the master is allowed to start transmission in every second slot only.
- Sniff Attempts* Minimum number of consecutive receive slots within each sniff interval (starting with a sniff slot) where the DUT listens to the master signal. *Sniff Attempts* must be > 0. The DUT may listen even longer if the R&S® CMU sends packets with matching Active Member Address (AM_ADDR) and if the *Sniff Timeout* is >0.
- Sniff Timeout* Minimum number of consecutive receive slots where the DUT keeps listening to the master signal after receiving a packet with a matching AM_ADDR. For *Sniff Timeout* = 0, the DUT listens at *Sniff Attempts* consecutive sniff slots, irrespective of the AM_ADDR received. For *Sniff Timeout* > 0, the DUT continues listening as long as it receives only packets with matching AM_ADDR.

The *Sniff* mode timing for a single packet with matching AM_ADDR is shown in Fig. 4-96 below.

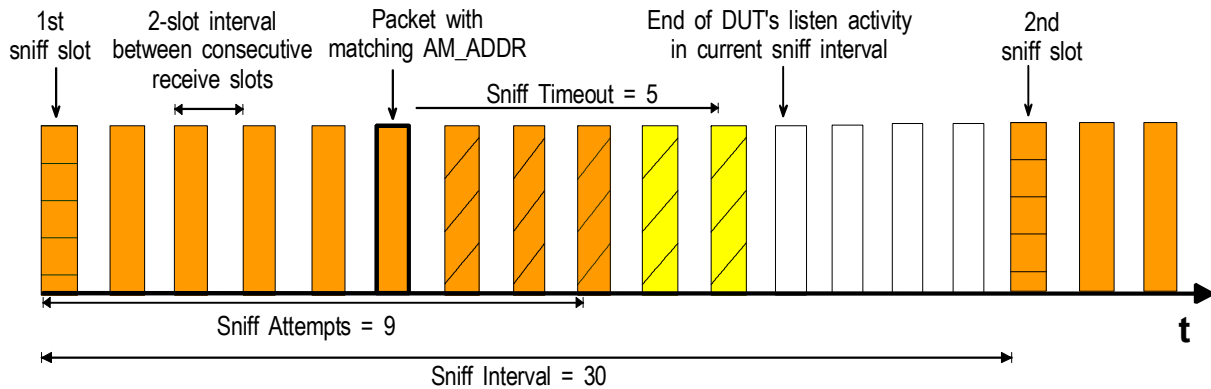

Fig. 4-96 Sniff mode parameters

Remote control

```

CONFigure:NETWork:SNIFf:INTerval.<Slots>
CONFigure:NETWork:SNIFf:ATTEMpt <Attempts>
CONFigure:NETWork:SNIFf:TOUt <Timeout>
    
```

Hold The *Hold* section sets the parameters for the *Hold* submode (see section [Connection Control in Hold State](#) on p. 4.97. and Bluetooth baseband specification):

Hold Interval Integer number of slots during which support of ACL packets is suspended. During the *Hold Interval* the DUT keeps its active member address (AM_ADDR). After the *Hold Interval*, the DUT wakes up and synchronizes to the master signal, and the R&S® CMU returns to the *Connected* signalling state.

Remote control

CONFigure:NETWork:HOLD:INTerval <Slots>

Park The *Park* section sets the parameters for the *Park* submode (see section [Connection Control in Park State](#) on p. 4.98.) and Bluetooth baseband specification):

Beacon Interval Integer number of slots between two consecutive beacon instants. In *Park* mode the DUT gives up its active member address (AM_ADDR). At the periodic beacon instants after each *Beacon Interval*, the DUT wakes up and re-synchronizes to the master signal, so the R&S® CMU can *Unpark* the DUT and return to the *Connected* signalling state.

Remote control

CONFigure:NETWork:PAK:BINInterval <Slots>

Test Mode – DUT Characteristics The parameters in the *Test Mode – DUT Characteristics* section configure the behavior of the R&S® CMU in test mode for specific DUT characteristics. The test mode settings should be checked in case of problems during test mode operation.

RX Level Settling Time Sets a delay time between the activation of a new measurement and the start of data acquisition. This can be relevant if the new measurement involves a drastic change of the receive level at the DUT (i.e. the R&S® CMU's master signal level), especially if a *RX Quality* test at low level is started after a TX test. The setting takes effect in loopback test mode only.

- A sufficient settling time generally ensures that no side effects from the level change impair the *RX Quality* test.
- Small values of the settling time improve the total measurement time. Some DUT's don't require any settling time, so the parameter can be set to zero.

Remote control

CONFigure:NETWork:TESt:RLSettling <Time>

TestCtrl on Packet Change Qualifies whether a new *Test Control Command* is set after a change of the packet type (DH1, DH3, DH5). The setting takes effect in loopback test mode only.

- Activating the test control command ensures that the DUT recognizes a packet change.
- Most DUTs don't need the test control command to recognize the packet type, so the parameter can be set to *Off*.

Remote control

CONFigure:NETWork:TESt:TCPChange <Enable>

- SEQN Behavior** Defines the sequential numbering scheme of the packets.
- Test Mode* The SEQN bit is toggled after each packet, which may be *ACNknown* or *NACKknown*.
 - Normal* The SEQN bit is toggled after each *ACKknown* packet only. This behavior is in accordance with Bluetooth specifications.

The parameter can be used to check and compare the behavior of the DUT in both modes.

Remote control
 CONFIGure:NETWork:TEST:SNBehaviour <Mode>

AF/RF Connectors (Connection Control – AF/RF)

The AF/RF  tab selects the connectors for RF and AF signals. This includes the setting of:

- The RF input and output at the CMU (RF Output, RF Input)
- An external attenuation at the connectors (*Ext. Att. Output, Ext. Att. Input*)
- The audio signal routing and the state of all audio connectors of the R&S CMU

If the *Audio Generator and Analyzer* (option R&S CMU-B41) is not fitted, the speech codec (option R&S CMU-B52) is connected to the 9-pin *SPEECH* (handset) connector on the CMU front panel, see chapter 8 of the CMU 200/300 operating manual. The *Speech Encoder* and *Speech Decoder* settings are not available.

Note: *The Speech Encoder and Speech Decoder settings are unavailable while the R&S CMU is in Audio submode. The settings must be changed outside these submodes.*

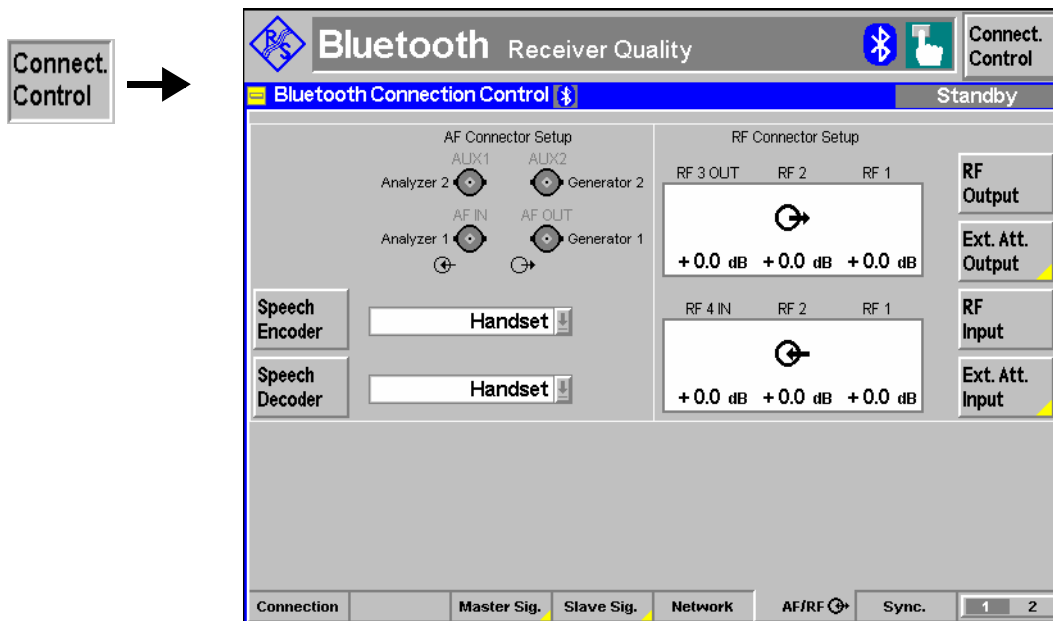

Fig. 4-97 Connection Control – AF/RF connectors

With the exception of the *Speech Encoder* and *Speech Decoder* settings, all functions of this menu are described in the *RF Non Signalling – RF Connectors (Connection Control – RF)* section above in this chapter.

Speech Encoder

The *Speech Encoder* softkey selects the input source for the R&S CMU speech encoder (option CMU-B52). The following two input sources are available:

- Speech Codec In* Use the signal of the front panel connector labeled *SPEECH* (handset)
- Generator 1* Use the audio generator signal which is also fed to the *AF OUT* connector on the R&S CMU front panel

Remote control

ROUTE:SPENcoder[:INPut] HANDset | GENERator

Speech Decoder

The *Speech Decoder* softkey selects the output destination for the R&S CMU speech decoder (option CMU-B52). The following output destinations are available:

- Speech Codec Out* Route speech decoder output to the 9-pin *SPEECH* (handset) connector on the R&S CMU front panel
- Analyzer 1* Route speech decoder output to primary audio analyzer. The standard analyzer input socket *AF IN* is disabled (*Off*).
- Analyzer 2* Route speech decoder output to secondary audio analyzer. The standard secondary analyzer input socket *AUX 1* is disabled (*Off*).
- Analyzer 1&2* Route speech decoder output to both audio analyzers. The standard primary and secondary analyzer input sockets *AF IN* and *AUX 1* are disabled (*Off*).

The primary and secondary audio circuits are described in detail in chapters 4 and 6 of the CMU200/300 operating manual.

Remote control

ROUTE:SPDecoder[:OUTPut] HANDset | ANALyzer | ANA2 | ABOTH

AF Connector Overview

The *AF Connector Overview* shows the destination of the input signals fed in via *AF IN* and *AUX 1* and the signals sources for the two audio output connectors *AF OUT* and *AUX 2*. The routing of input and output signals does not depend on the *Speech Encoder* settings but is a function of the *Speech Decoder* output destination. In the default configuration (*Speech Decoder = Speech Codec Out*), the connectors *AF IN* and *AF OUT* are used as input and output for the primary audio circuit (*Analyzer 1*, *Generator 1*). *AUX 1* and *AUX 2* are used as input and output for the secondary audio circuit (*Analyzer 2*, *Generator 2*). If the *Speech Decoder* output is routed to one of the *Analyzers*, it replaces the external audio input signal. The corresponding input connector is disabled (*Off*).

Reference Frequency (Connection Control – Sync.)

The *Sync.* tab of the *Connection Control* popup menu determines the reference signal for synchronization. The functions of this menu are described in section [Reference Frequency \(Connection Control – Sync.\)](#) on page 4.9.

Trigger (Group Configuration – Trigger)

The *Trigger* tab is part of the second group of tabs in the *Connection Control* menu. It is accessible after pressing the 1 / 2 toggle hotkey once. Pressing 1 / 2 again switches back to the first group of tabs described above.

The *Trigger* tab defines the trigger condition for the measurement.

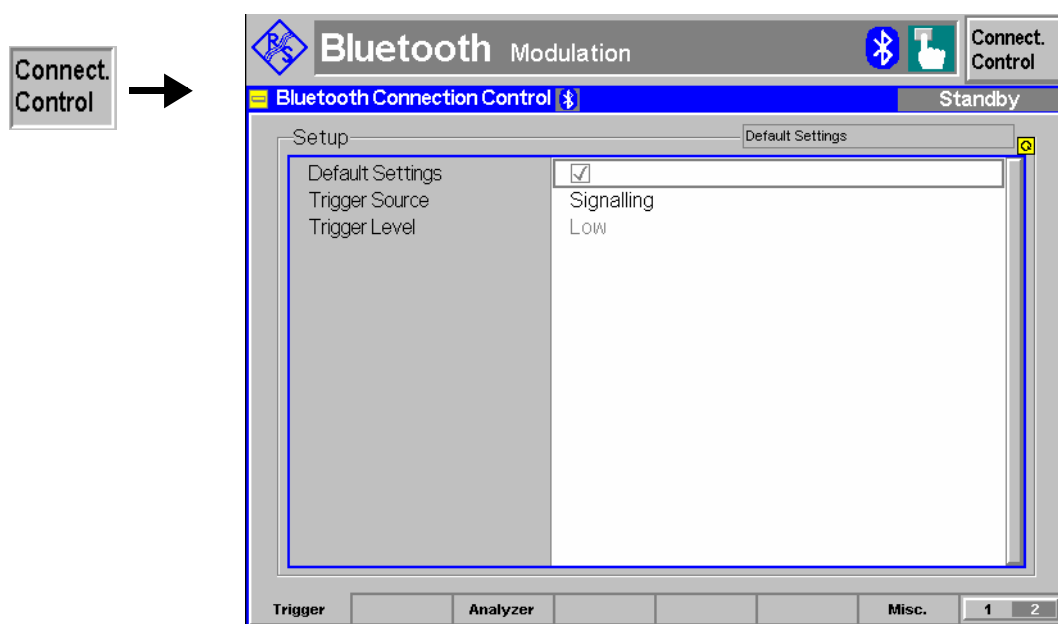

Fig. 4-98 Group Configuration – Trigger

Default The *Default* checkbox assigns the default setting to all parameters of the tab *Trigger*.

Remote control `CONFigure:TRIGger:DEFault ON | OFF`

Trigger The *Trigger* parameter determines how the measurement is to be triggered:

Signalling Trigger signal provided by the signalling unit of the instrument. The trigger signal is also output on pin 2 (second from the right on the top row) of the AUX3 connector on the front panel. This signal is

- *High* (about +4 V) during Bluetooth slots when the R&S® CMU is transmitting; the rising edge corresponds to bit zero of the packet.
- *Low* (about 0 V) during Bluetooth slots when the R&S® CMU is receiving; the falling edge corresponds to bit zero of the packet.

This is also true for the Bluetooth Non-Signalling generator mode.

RF Power Trigger on the power (rising edge) of the incoming burst, broadband trigger

IF Power Narrow-band trigger

For the *RF Power* and *IF Power* parameters the signal to be measured must be a burst signal. To measure the *Packet Timing* in a *Power* measurement, the *Signalling* trigger must be used.

Remote control `TRIGger[:SEquence]:SOURce SIGNalling | RFPower | IFPower | EXTern| IFPower`

Level The *Trigger Level* parameter determines the trigger threshold if the measurement is triggered by the *RF Power* or *IF Power*.

The trigger threshold is the signal level beyond which the trigger condition is satisfied and a measurement is initiated. With *Signalling* trigger the *Trigger Level* parameter is disabled.

Low Low trigger threshold, equal to approx. the *RF Max. Level* – 26 dB

Medium Medium trigger threshold, equal to approx. the *RF Max. Level* – 16 dB

High High trigger threshold, equal to approx. the *RF Max. Level* – 6 dB

Remote control `TRIGger[:SEquence]:THReshold:RFPower LOW | MEDIUM | HIGH`
`TRIGger[:SEquence]:THReshold:IFPower <Power>`

Input Path (Connection Control – Analyzer)

The *Analyzer* tab is part of the second group of tabs in the *Connection Control* menu. It is accessible after pressing the 1 / 2 toggle hotkey once. Pressing 1 / 2 again switches back to the first group of tabs described above.

The *Analyzer* tab configures the RF input path by defining the maximum level that the CMU can measure (Max. Level) and an attenuation or gain factor (Attenuation).

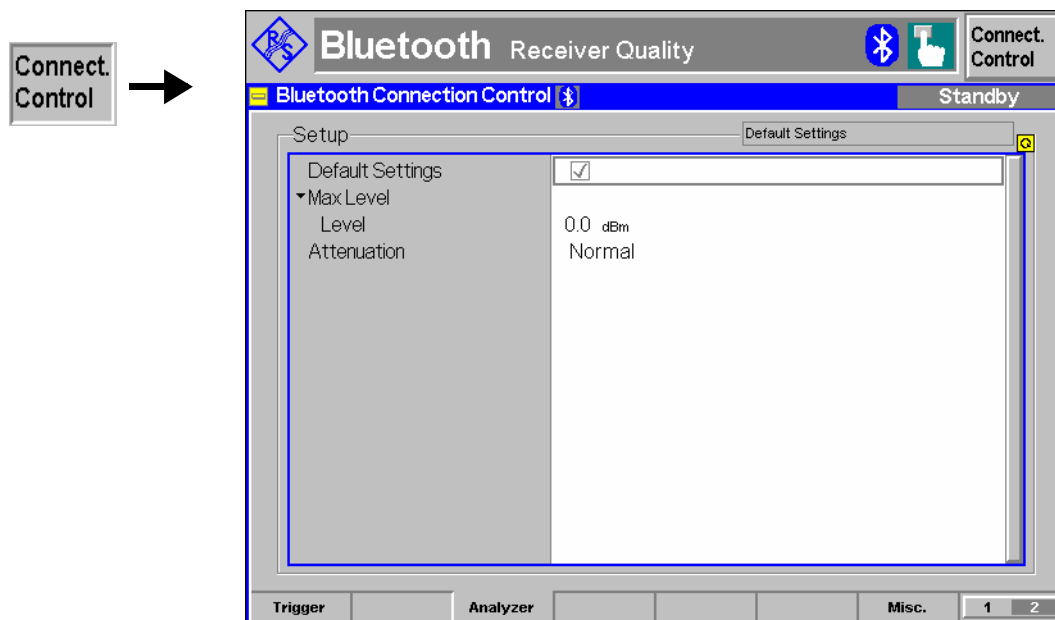

Fig. 4-99 Group Configuration – Input level

Default Settings The Default Settings switch overwrites all settings in the *Input Level* tab with their default values. See command description in chapter 6.

Max Level – Mode	<p>The <i>Max. Level</i> table section sets the maximum input level which can be measured. <i>Mode</i> configures the RF analyzer for manual or automatic input path setting.</p> <p><i>Manual</i> Manual entry of maximum input level via <i>Level</i></p> <p><i>Auto</i> Automatic setting according to the peak power of received bursts (autoranging). The autoranging procedure uses the manual level as an initial value. It only operates while a Bluetooth connection is present, or during inquiry and paging.</p> <p>Autoranging does not operate while the R&S CMU is in the <i>Standby</i> state, when the ACP measurement is in the <i>Run</i> state, or when the frequency range measurement is in the <i>Run</i> state.</p>
Remote control	[SENSe:]LEVel:MODE
Max Level – Level	<p>The range of values depends on the RF input connector used. If an external input attenuation is set (see section AF/RF Connectors (Connection Control – AF/RF Connectors) on page 4.7), all levels measured are referenced to the output of the DUT and therefore shifted with respect to the actual level at the input connectors of the CMU. The level ranges for the input connectors are shifted as well.</p> <p>Input signals exceeding the <i>Max. Level</i> can not be measured (input is overdriven); the corresponding measurement result boxes indicate “--”.</p>
Error messages	<p>If the value entered for <i>Max. Level</i> is too high or too low, a window with the error message “<Max_Level> is out of range. <permissible max/min. value> is limit.” and three buttons will appear:</p> <p><i>Accept</i> The permissible max/min. value is accepted as <i>Max. Level</i>,</p> <p><i>Re-edit</i> <i>Max. Level</i> is entered once again,</p> <p><i>Cancel</i> The last valid input value is maintained.</p> <p>When switching to a different input connector, the current value of <i>Max. Level</i> is automatically adapted, if required:</p> <ul style="list-style-type: none"> • Decreased to the maximum value of the new input connector • Increased to the minimum value of the new input connector
Remote control	[SENSe:]LEVel:MAXimum <Level>
Attenuation	<p>The <i>Attenuation</i> parameter defines how the RF analyzer of the CMU is tuned to meet the requirements of the current measurement type. In general, a compromise between the acceptable noise level in the displayed result and the contribution of internally generated distortion must be reached.</p> <p><i>Normal</i> Mixer level in normal range,</p> <p><i>Low noise</i> Mixer level enhanced by +10 dB (full dynamic range of CMU, therefore recommended for <i>Power vs time</i> and <i>Spectrum</i> measurements),</p> <p><i>Low distortion</i> Mixer level reduced by –10 dB (high intermodulation spacing, therefore recommended for modulation measurements).</p> <p>The <i>Attenuation</i> setting permits the CMU to be adapted to the requirements of the measurement. The advantages and disadvantages of the settings <i>Low noise</i> and <i>Low distortion</i> are listed in the following table.</p>

	Advantages	Disadvantages
Low noise	Low noise High dynamic range	No RF overdrive reserve Risk of intermodulation
Low distortion	High intermodulation suppression	Lower dynamic range

Remote control [SENSe:]LEVel:ATTenuation NORMal | LNOise | LDISTortion

Display Control (Connection Control – Misc)

The *Misc* tab is part of the second group of tabs in the *Connection Control* menu. It is accessible after pressing the 1 / 2 toggle hotkey once. Pressing 1 / 2 again switches back to the first group of tabs described above.

The *Misc* tab defines whether the *Connection Control* popup menu is automatically opened or closed (*Connect. Control Guidance*).

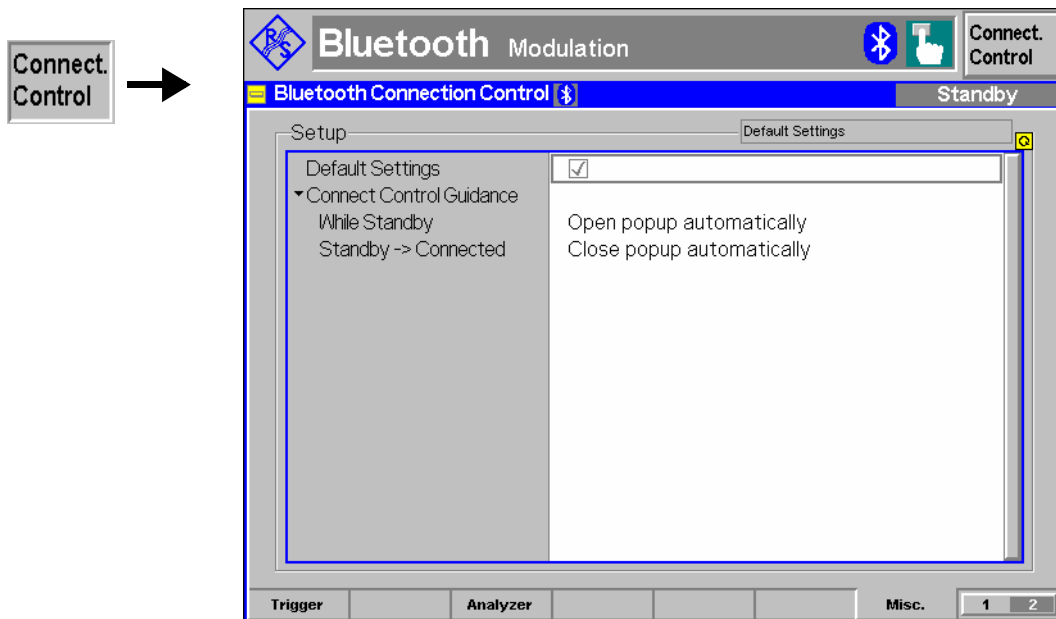

Fig. 4-100 Connection Control – Misc

Default Settings The *Default All Settings* switch sets all parameters of the *Misc* tab to their default values (see command description in chapter 6).

Remote control No command; screen configuration only.

Connect. Control Guidance Defines whether the *Connection Control* popup menu is automatically opened or closed:

While Standby In the *Open popup automatically* mode, the *Connection Control* menu is automatically opened each time the Bluetooth function group is accessed in *Signalling* test mode, each time a measurement menu is opened while the DUT is not connected and each time the connection with the DUT is lost. Otherwise the menu must be opened manually.

Standby -> connected

In the *Close popup automatically* mode, the *Connection Control* menu is automatically closed as soon as the R&S® CMU reaches the “*Connected*”, “*Connected (Test Mode)*” or “*Connected (Audio)*” state. Otherwise the menu must be closed manually.

Remote control No command; screen configuration only.

Audio Profiles (Option R&S CMU-K54)

A profile defines the requirements for Bluetooth devices to support a particular use case. Compliance with the profile specification ensures interoperability between different Bluetooth devices. With option R&S CMU-K54, the R&S CMU provides the following profiles:

- **Headset** (HS) profile. This profile is used by headsets, sometimes also by personal computers, cellular phones etc. Equipment using the headset profile is wirelessly connected to another Bluetooth device, e.g. a cellular phone. The phone plays the role of a bidirectional audio gateway, whereas the headset acts as the gateway’s remote audio input and output.
- **Hands-Free** (HF) profile. This profile is used by hands-free units that are commonly used together with cellular phones. A typical example is a car’s embedded hands-free unit that is wirelessly connected to a cellular phone. Again, the cellular phone plays the role of an audio gateway, with the hands-free unit acting as the gateway’s remote audio input and output. The CMU supports the hands-free profile version V1.5.

The R&S CMU can test Bluetooth devices acting as headset/hands-free units or as audio gateways. The role of the R&S CMU and the DUT is implicitly defined together with the profile selection.

Connecting a DUT for audio profile tests

The audio profiles extend the list of available submodes in the *Connection* tab of the *Connection Control* menu. This means that the audio profile modes can be activated like any other submode of the *Connected* signalling state (see Bluetooth signalling state machine on p. 4.51 of the R&S CMU operating manual).

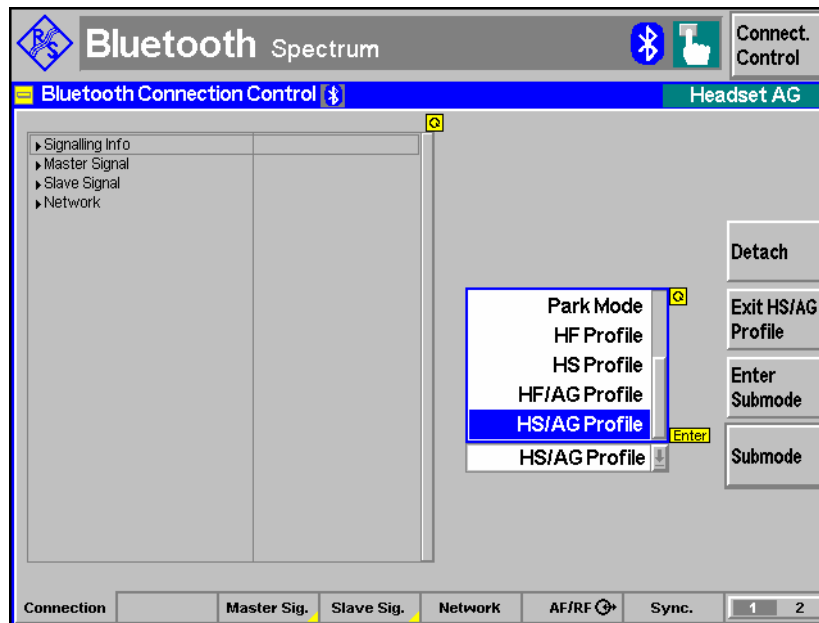

Fig. 4-2 Audio profile modes

Preparatives

Prior to connection, the Bluetooth DUT must be paired with the tester. On the R&S CMU, this involves an inquiry and detection of the DUT’s Bluetooth device address. Moreover, most DUTs require a correct PIN code from the R&S CMU in order to set up the connection or enter the selected audio profile submode.

1. Establish an RF connection between the RF connector *RF IN/OUT* of the R&S CMU and the DUT, switch on both devices.
2. Ensure that the R&S R&S CMU is in *Standby* signalling state and that the pairing mode at the DUT is enabled.
3. Press *Connection Control – Connect – Inquire* and wait until the R&S CMU has stored the DUT’s Bluetooth address.

4. Press *Master Sig. – Paging – PIN Code* and enter the PIN code of the device, if necessary (many devices use the default PIN „0000“).

Note: *Some devices also require authentication to be turned on (Authentication Required: On).*

5. Return to the *Connection* tab, press *Connect*, and wait until the R&S CMU has entered the *Connected* state. If necessary, reopen the *Connection Control* menu.

Submode selection

6. Press *Submode* and select an appropriate audio profile mode. If your DUT is a headset/hands-free unit, select the *HS Profile* or *HF Profile*, respectively. The R&S CMU will mimic the corresponding audio gateway. If your DUT is a phone (or another device acting as an audio gateway), select *HS/AG Profile* or *HF/AG Profile*. The R&S CMU will mimic the corresponding handset or hands-free device.

Note: *If you connect to a cellular phone you might be prompted to enter an appropriate PIN. You can lengthen the time you have to enter the PIN by increasing the page timeout value, e.g. to a value around 30,000 slots (Connection Control – Master Sig. – Paging – Page Timeout).*

Performing audio tests

Audio tests in the audio profile submodes can be performed as described in section *Audio Measurements* on p. 4.129 of the R&S CMU operating manual, with a speaker and a microphone connected to the analog output and input connectors *SPEECH CODEC OUT / IN* of the R&S CMU.

If the audio option R&S CMU-B41 is available in addition, it is possible to provide a controlled audio signal for the DUT and route the audio signals from the DUT to the audio analyzer; see section *Audio Option* in this chapter.

Note: *A Bluetooth device that complies with one of the audio profiles does not necessarily have to support the low-level Audio submode.*

Remote Control

The audio profiles extend the following remote control commands (see chapter 6 of this manual):

```
PROCedure:SIGNalling:ACTion
[SENSe:]SIGNalling:XState?
[SENSe:]SIGNalling:StAtE?
```

Contents

5 Remote Control – Basics.....5.1

Structure of the Bluetooth Function Group5.1

Quick Connection Setup5.2

Measurement Control5.3

 Measurement Groups5.3

 Measurement Statistics.....5.3

 Specifying Limits5.5

Status Reporting System5.5

Special Terms and Notation.....5.6

5 Remote Control – Basics

This chapter gives a survey of the basic features and concepts of Bluetooth remote control commands. Remote control can be described in terms analogous to the ones used in chapter 3 for the classification of measurement and configuration menus. In the following, we will particularly point out the similarities and differences between manual and remote control.

Structure of the Bluetooth Function Group

Chapter 6 of this manual gives a description of all Bluetooth remote control commands, including their parameters, as well as the default values and ranges of all numerical parameters.

Test modes The commands for the two test modes *Non Signalling* and *Signalling* are listed separately although some of them (e.g. the commands setting the input and output connectors, the external attenuation, and the reference frequency) have the same syntax. To perform the non signalling TX tests described in chapter 4, use the *Signalling* commands for *POWER* and *MODulation* measurements.

Addressing The CMU uses extended addressing: The instrument is assigned a primary address while each function group and test mode is identified via a secondary address. This allows the same remote commands to be used in several function groups and modes:

```
ibwrt(Bluetooth_SIG, "INPut RF1")
ibwrt(Bluetooth_NSIG, "INPut RF1")
```

provided that the variables *Bluetooth_SIG*, etc. have been appropriately defined, see program examples in chapter 7 of the CMU operating manual.

The remote control commands for first (*SYST:COMM:GPIB:ADDR*) and secondary (*SYST:REM:ADDR:SEC*) addressing are described in the CMU operating manual. The *SYST:REM:ADDR:SEC* command uses the following names to address the GSM network tests described in this manual:

BLUETOOTH_NSig *BLUETOOTH_Sig*

Order of commands The commands are arranged to form groups belonging to the same measurement or to the same type of configurations. These command groups are identified by the second-level keyword (as in *POWER*). Applications belonging to a measurement group (see chapter 5 of the CMU operating manual) are identified by the third-level keyword of each command (as in *RXQuality:BER*). Chapter 6 is organized as follows:

Bluetooth Non Signalling:

General configurations and RF generator control (second/third level keywords *RFGenerator*, *INPut*, *OUTPut*, *CORRection:LOSS*, *DM:CLOCK*)

Bluetooth Signalling:

General configurations and signalling (*SIGNalling*, *MSIGNAL*, *SSIGNAL*, *INPut*, *OUTPut*, *CORRection:LOSS*, *DM:CLOCK*, *LEVel*, *TRIGger*, *SINFO*, *ACLData*).

Measurement groups (*WPOWER*, *POWER...*, *MODulation...*, *SPECTrum...*, *RXQuality...*).

The structure of chapter 6 differs from chapter 4 (*Functions and their Application*) where the measurements are presented first and configurations pertaining to the whole function group and test mode are reported at the end of each section.

The menu of the graphical user interface corresponding to a group of commands is quoted at the beginning of each section. Alphabetical lists of all commands are annexed to chapter 6.

SCPI Conformity

In view of the particular requirements of Bluetooth measurements not all commands could be taken from the SCPI standard. However, the syntax and structure of all commands is based on SCPI rules. For a detailed description of the SCPI standard refer to chapter 5 of the CMU operating manual.

SCPI confirmed and SPCI approved commands are explicitly marked throughout chapter 6.

Remote Control

All commands may be used for control of the CMU via GPIB interface or serial (RS-232) interface.

Quick Connection Setup

The CMU provides several features that are primarily intended to simplify and speed up a connection to a Bluetooth device and make measurements faster. A program example is reported in Chapter 7.

Table 5-1 CMU settings for quick connection and measurements

Setting	Description	Command syntax
Read Signalling Info = Off	Do not request signalling info from the DUT to avoid exchange of unnecessary information	CONF:MSIG:PAG:RSIN OFF
Number of Responses = 1	Stop the inquiry after the first response if only one Bluetooth device is connected	CONF:MSIG:INQ:NOR 1
– (automatic function)	The CMU remembers the information acquired during an inquiry. Subsequent inquiries to the same DUT will be faster.	–
Connect Testmode	To perform TX and RX measurements, directly access the test mode, skipping the CONN state	PROC:SIGN:ACT TEST SIGN:XST?
Overview – Power/Modulation	If no traces are needed, use the combined POWER:MPR measurement rather than POWER:TIME and MODulation:DEVIation	INIT:POW:MPR FETC:POW:MPR? ABOR:POW:MPR

Measurement Control

The commands in the measurement groups quoted above (`WPOWer`, `POWer...`, `MODulation...`, `SPEctrum...`, `RXQuality...` etc.) have an analogous structure and syntax. The measurements are controlled according to the common concepts outlined in Chapter 5 of the CMU operating manual. The following sections show how the general concepts are applied to Bluetooth measurements.

Measurement Groups

The commands for *Bluetooth* measurements belong to the *Signalling* function group. The following measurement groups and applications are defined:

Table 5-2 Bluetooth measurement groups and applications

Measurement	Description
<code>WPOWer</code>	Wide-band peak power measurement of the RF input signal.
<code>POWer:TIME</code>	Measurement of the power of the transmitter output power of the Bluetooth DUT as a function of time with evaluation of the nominal power, peak power, leakage power and packet timing plus a power control check. A statistical evaluation and a limit check is done for the measured quantities (except the power control check).
<code>POWer:MPR</code>	Combined <code>POWer:TIME</code> and <code>MODulation:DEVIation</code> measurement.
<code>MODulation:DEVIation</code>	Measurement of the frequency deviation over the whole Bluetooth packet and calculation of the frequency accuracy, the frequency drift, and the maximum drift rate. A statistical evaluation and a limit check is done for all modulation results.
<code>SPEctrum:ACPowEr</code> <code>SPEctrum:BWIDth</code> <code>SPEctrum:FRANge</code>	Measurement of the off-carrier power and calculation of the Adjacent Channel Power (ACP), the 20 dB bandwidth, and the frequency range where the power is above a specified threshold. A statistical evaluation and a limit check is done for all spectrum results.
<code>RXQuality:BER</code> <code>RXQuality:SBER</code>	Measurement of the bit error rate and the packet error rate at variable receiver input level of the DUT (application <code>BER</code>) or search for the receiver input level corresponding to a particular bit error rate (application <code>SBER</code>). A broad range of parameters configure the <i>Receiver Quality</i> measurements; up to five different configurations can be stored in separate (and pre-configured) <i>Test Setups</i> identified with the keyword <code>TSETup<nr></code> where <code><nr></code> = 1, ..., 5.

The measurement objects in [Table 5-2](#) are complemented by groups of commands that are used to retrieve results that are automatically provided by the mobile station (e.g. the signalling information `SINFO` reported by the DUT). These command groups do not represent real measurement objects; they consist of queries only and are called pseudo measurement objects. For an overview, see the list of remote control commands at the end of chapter 6.

Measurement Statistics

The Bluetooth RF signal consists of periodic packets serving as basic evaluation periods for the measurement and for the calculation of statistical results (see also Chapter 3, section *General Settings*).

Together with the *Statistic Count*, the *Repetition Mode* defines how many evaluation periods are measured if the measurement is not stopped explicitly (measurement control commands `STOP...`,

ABORT. . .) or by a limit failure. With remote control the three repetition modes *Single Shot*, *Continuous* and *Counting* are available (*Counting* is not available in manual control).

In many measurement applications, different traces corresponding to the result in the current evaluation period, the maximum, minimum, or average over a set of evaluation periods (bursts) are determined. These results can be queried independently.

Table 5-3 Statistics in remote control

Setting	Description	Command
Statistic Count	<p>Integer number of evaluation periods forming one statistics cycle. An evaluation period is equal to a burst (POWER MODulation) or a packet (RXQuality).</p> <p>In an RXQuality:SBER measurement, the STATistics parameter denotes the number of packets to be averaged per iteration step (search cycle).</p>	<pre> CONFigure:<meas_obj>:CONTrol:STATistics 1 ... 1000 NONE (<meas_obj> = POWER:TIME WPower MODulation:DEVIation RXQuality:BER:TSETup<nr>)... CONFigure:RXQuality:SBER:CONTrol:STATistics 1 ... 1000 NONE, <Search_Value>, <Cycles> </pre>
Repetition mode Single Shot	The measurement is stopped after one statistics cycle.	<pre> CONFigure:<meas_obj>:CONTrol:REPetition SINGleshot, <StopCondition>, <Stepmode> (<meas_obj> = POWER:TIME WPower MODulation:DEVIation RXQuality:BER:TSETup<nr>)... </pre>
Continuous	The measurement is continued until stopped explicitly or by a limit failure. Average results are calculated according to the rules given in chapter 3.	<pre> CONFigure:<meas_obj>:CONTrol:REPetition CONTinuous, <StopCondition>, <Stepmode> (<meas_obj> = POWER:TIME WPower MODulation:DEVIation RXQuality:BER:TSETup<nr>)... </pre>
Counting	Repeated single shot measurement with configured statistics cycles.	<pre> CONFigure:<meas_obj>:CONTrol:REPetition 1 ... 1000, <StopCondition>, <Stepmode> (<meas_obj> = POWER:TIME WPower MODulation:DEVIation RXQuality:BER:TSETup<nr>)... A counting measurement with 1 evaluation period is equivalent to a single shot measurement.. </pre>
Traces	<p>The specifiers CURRENT, MAXimum, MINimum, and AVERage denote the traces for the current evaluation period, the maximum, minimum, extreme value, or average of a set of evaluation periods. They correspond to the <i>Display Mode</i> set in the measurement configuration menus.</p> <p>In general all four traces are evaluated during the measurement. They are selected via the specifiers used as last keywords in the READ. . . , FETCh. . . or SAMPlE. . . queries.</p>	<pre> Measurement results: READ:ARRay:<meas_obj>:<disp>? READ:SUBarrays:POWER...<disp>? ... Limit matching: CALCULATE:ARRay:<meas_obj>:<disp>: MATChing:LIMit? <disp> = :CURRENT :AVERage :MAXimum MINimum <meas_obj> = POWER:TIME MODulation:DEVIation... </pre>

Specifying Limits

The following table gives an overview of the types of limits and possible results of the limit check.

Table 5-4 Limits and limit check

Type	Description	Command
Scalar limits	Limit values for a single (scalar) measured quantity. Depending on the measured quantity, either an upper limit or upper and lower limits can be defined.	<pre> CONFigure:<meas_obj>:<disp>:LIMit: SCALar:ASYMmetric:<Spec.>:VALue <disp> = :CURRent :AVERAge :MAXimum MINimum <meas_obj> = POWer:TIME MODula- tion:DEVIation... <Spec.> = UPPer LOWer [:COMBined] for upper limits, lower limits, or combined upper and lower limits. CONFig- ure:RXQuality:BER:TSETup<nr>:LIMit:SCAL ar:ASYMmetric[:COMBined]:VALue </pre>
Limit check	The command on the right side performs the scalar limit check and returns all results within a measurement group.	<pre> CALCulate[:SCALar]:<meas_obj.> :MATCHing:LIMit? <meas_obj> = POWer:TIME MODula- tion:DEVIation BER... </pre>
	<p>Possible results of the scalar limit check are listed on the right side. Further messages assessing, e.g., the power ramp or the result of the BER test in general, may be issued in particular cases (see detailed command description in chapter 6).</p> <p>For <meas_obj> = POWer:TIME MODulation:DEVIation, the output list contains four sets of results corresponding to the four display modes CURRent AVERAge MAXimum MINimum (see section Measurement Statistics on page 5.3).</p>	<pre> NMAU not matching, underflow NMAL not matching, overflow INV measured value invalid OK no limit failure </pre>

Status Reporting System

A general description of SCPI status registers and of the status reporting system is given in chapter 5 of the CMU operating manual. This section is devoted to the particular features concerning Bluetooth measurements.

The CMU offers 30 independent `STATus:OPERation:CMU:SUM1|2:CMU<nr>` sub-registers (<nr>=1 ... 15) which are implemented in hierarchical form. The bits of the 30 `STATus:OPERation` registers are set only after the registers are assigned to a function group and measurement mode.

In the `CONDition` part, the `STATus:OPERation` register contains information on which actions the instrument is being executing or, in the `EVENT` part, information on which actions the instrument has executed since the last readout. All five parts of the registers can be read using one of the commands of the subsystem `STATus:OPERation:SUM1|2:CMU<nr>:...`

Bluetooth mobile tests comprise the two signalling modes *Non Signalling* and *Signalling* so that 2 different secondary addresses are used. In *Non Signalling* mode, no bits are assigned.

In the status register for the *Signalling* mode the bit assignment is as follows:

Table 5-5 Meaning of the bits used in the `STATUS:OPERation:CMU:SUM1 | 2:CMU<nr>` sub-registers assigned to *Bluetooth Signalling*

Bit-No.	Meaning	Symbol in <code>STAT:OPER:SYMB...</code>
1	DUT disconnected This bit is set when the connection to the DUT is released.	DUTD
2	Connection lost This bit is set if the CMU had to leave the signalling state "Connected" (e.g. because of a connection timeout).	CONL
3	Inquiry done and at least one DUT found This bit is set after a successful inquiry.	INQD
12	Test mode parameters rejected by DUT This bit is set if test mode parameters on the CMU are changed and the DUT does not acknowledge that.	TMPR
13	Test mode not enabled on DUT This bit is set if a connection is attempted to a DUT on which the test mode is not locally enabled.	TMNE
14	Sub-mode not supported by DUT This bit is set if the CMU attempts to place the DUT into a sub-mode (Hold, Sniff, Park, Audio, ...) that is not supported by the DUT.	SMNS

Special Terms and Notation

Below we list some particular features in the syntax of the Bluetooth commands. The general description of the SCPI command syntax can be found in chapter 5 of the CMU operating manual, section "*Structure and Syntax of Device Messages*".

Description of commands

The commands are arranged in tables. From top to bottom, the table rows contain the following entries:

1. Complete command syntax including the parameter list and a short description of the command
2. List and description of the parameters with their default values and units
3. Detailed description of the command, signalling state required for command execution (in *Signalling* mode), required firmware version

Detailed lists of default values are annexed to the command description. Occasionally, groups of analogous commands are described in common tables.

Order of commands

The commands are arranged according to their function specified by the keyword in the second level or in the second/third level combined. Lower-level keywords define the command in more detail. This means that commands with the same second-level, third-level etc. keywords are generally grouped together in the same sections.

Example: `CONFigure:WPOWer:CONTrol:REPetition`

Commands with the keyword *WPOWER* in the second level belong to the wide-band power measurement. The keywords in the third and fourth level indicate that the command controls the repetition mode of the power measurement.

Measurement object The term *measurement object* denotes a group of remote control commands belonging to the same group of measured quantities. E.g., all commands concerning the wide-band power measurement form a common measurement object.

A pseudo measurement object concerns quantities which do not actually have to be measured because they are automatically obtained during the signalling process (e.g. the receiver parameters reported by the mobile phone).

Combined measurements To limit the number of remote control commands, scalar results are always measured together and output in lists. Arrays (e.g. the traces for *POWER* and *MODULATION* measurements) are output as lists of values separated by commas; it is possible to retrieve either the whole list (see commands *READ:ARRAY...* etc.) or the values located in a number of subranges that are part of the total measurement range (see commands *READ:SUBARRAYS...*; the subarrays are defined via *CONFIGURE:SUBARRAYS...*).

Parameters Setting commands are usually supplemented by a parameter or a list of several parameters. Parameters either provide alternative options (setting a or setting b or setting c ..., see special character "|"), or they form a list separated by commas (setting x,y).

<Par_Name> In the command tables and lists, parameters are generally described by a name (literal) written in angle brackets (<>). This literal merely serves as a parameter description; in an application program it must be replaced by one of the possible settings reported in the detailed parameter description.

Example: `CONFIGURE:POWER:TIME:CONTROL`
`<Mode>,<Statistics>,...`
 with `<Mode>` = SCALAR | ARRAY
`<Statistics>` = 1 ... 10000 | NONE
...

possible command syntax: `CONF:POW:TIME:CONT SCAL,NONE,...`

NAN NAN (not a number) is generally used to represent missing data, e.g. if a portion of a trace has not been acquired yet. It is also returned after invalid mathematical operations such as division by zero. As defined in the SCPI standard, NAN is represented as 9.91 E 37.

INV INV (invalid) is returned if a limit check is performed without defining the appropriate tolerance values.

Upper / lower case Upper/lower case characters characterize the long and short form of the keywords in a command. The short form consists of all upper-case characters, the long form of all upper case plus all lower case characters. On the CMU, either the short form or the long form are allowed; mixed forms will generally not be recognized. Note that the instrument itself does not distinguish upper case and lower case characters.

Special characters

| A vertical stroke in the parameter list characterizes alternative parameter settings. Only one of the parameters separated by | must be selected.

Example: The following command has two alternative settings:

```
DEFault:TRIGger:SEQUence ON | OFF
```

[] *Key words* in square brackets can be omitted when composing the command header (see chapter 5 of the CMU manual, section "Structure of a Command"). The complete command must be recognized by the instrument for reasons of compatibility with the SCPI standard.

Parameters in square brackets are optional as well. They may be entered in the command or omitted.

{ } Braces or curly brackets enclose one or more parameters that may be included zero or more times.

<nr> This symbol denotes a numeric suffix, e.g. an enumeration index for input and output connectors.

Lists of commands

Command: The *Command* column of the table contains all remote control commands arranged according to their function (configurations or measurement objects). Within a section, the commands are listed in alphabetical order.

Parameters: The *Parameter* column lists the parameters of the commands.

Remarks: The *Remarks* column gives additional information about the commands which

- Have no query form (*no query*)
- Have only a query form (*query only*)
- Can be used both as setting commands and as queries (*with query*, this applies to all commands belonging to none of the two preceding categories)

Alphabetical Lists Chapter 6 concludes with alphabetical command lists for both test modes.

Contents

6 Remote Control – Commands	6.1
Bluetooth Module Tests (Non Signalling)	6.1
Subsystem RFGenerator – Generator control.....	6.1
Generator Settings – Subsystem RFGenerator.....	6.2
Subsystem RFGenerator:BMODulation.....	6.4
Subsystems INPut, OUTPut, CORRection:LOSS.....	6.4
Subsystem DM:CLOCK (Synchronization).....	6.5
Bluetooth Device Tests (Signalling Mode)	6.6
Connection Control.....	6.6
Signalling – Subsystem SIGNalling (Connection Setup and Cleardown).....	6.7
Subsystem MSIGnal (Master Signal).....	6.11
Subsystem MSIGnal:PAGing.....	6.12
Subsystem MSIGnal:DTRansmitter (Dirty Transmitter).....	6.14
Subsystem DUT (Authentication).....	6.14
Subsystem SSIGnal (Slave Signal).....	6.15
Subsystem SSIGnal:TMODE (Test Mode).....	6.15
Subsystem NETWork (Network Parameters).....	6.21
Subsystem NETWork:AUDio (Audio Submode).....	6.21
Subsystem NETWork:SNIFf (SNIFf Submode).....	6.22
Subsystem NETWork:HOLD (HOLD Submode).....	6.23
Subsystem NETWork:PARk (PARk Submode).....	6.23
Subsystem NETWork:TEST (Testmode).....	6.23
Subsystems INPut, OUTPut, CORRection:LOSS.....	6.24
Subsystem DM:CLOCK (Synchronization).....	6.25
Subsystem LEVel (Input Level).....	6.26
Subsystem TRIGger (Trigger Mode).....	6.27
SINFo (Signalling information).....	6.28
ACLData (Exchange of Raw Data with the DUT).....	6.35
WPOWER (Wideband Power).....	6.37
POWER Measurements.....	6.39
Subsystem POWER:TIME.....	6.39
Measurement Control.....	6.39
Subsystem POWER:CONTRol.....	6.43
Test Configuration.....	6.44
Measured Values.....	6.50
POWER:MPR Measurement.....	6.53
Measurement Control.....	6.53
Subsystem POWER:MPR:CONTRol.....	6.55
Measured Values.....	6.57
MODulation Measurements.....	6.59
Subsystem Modulation:DEViation.....	6.59
Control of Measurement – Subsystem Modulation.....	6.59
Subsystem MODulation:DEViation:CONTRol.....	6.62
Limits – Subsystem MODulation:DEViation:LIMit.....	6.64
Subsystem SUBarrays:MODulation:DEViation.....	6.68
Measured Values.....	6.69

Spectrum Measurements.....	6.74
SPECTrum:ACPoweR.....	6.74
Measurement Control	6.74
Subsystem SPECTrum:ACPoweR:CONTRol.....	6.76
Test Configuration.....	6.77
Limits (Subsystem SPECTrum:ACPoweR:..:LIMit).....	6.79
Measured Values	6.81
SPECTrum:BWIDth.....	6.82
Control of Measurement	6.82
Subsystem SPECTrum:..:CONTRol	6.83
Test Configuration.....	6.84
Limits (Subsystem SPECTrum:BWIDth:..:LIMit).....	6.85
Measured Values	6.86
SPECTrum:FRANge.....	6.88
Limits (Subsystem SPECTrum:FRANge:..:LIMit).....	6.90
Measured Values	6.90
Receiver Quality Measurements.....	6.92
Receiver Quality – BER Application	6.92
Measurement Control	6.92
Subsystem RXQuality:BER:..:CONTRol	6.94
Subsystem RXQuality:BER:..:LEVel.....	6.95
BER Test Signal.....	6.96
Subsystem RXQuality:BER:..:LIMit.....	6.98
Measured Values	6.99
Receiver Quality – BER Search Application.....	6.101
Measurement Control	6.101
Subsystem RXQuality:SBER:CONTRol.....	6.102
Subsystem RXQuality:SBER:..:LEVel	6.102
Subsystem RXQuality:SBER	6.103
Measured Values	6.106
List of Commands	6.107
Commands in Bluetooth Non Signalling Mode	6.107
Commands in Bluetooth Signalling Mode.....	6.108
Alphabetical Command Lists	6.128

6 Remote Control – Commands

In the following, all remote-control commands for the function group *Bluetooth* will be presented in tabular form with their parameters and the permissible ranges of values. The structure of this chapter is analogous to that of the reference part for manual operation (chapter 4).

- The measurement modes *Non Signalling* and *Signalling* are presented separately.
- Within the measurement modes, first the general configuration and then the individual measurement groups (test items) are dealt with.

General notes on remote control in the function group *Bluetooth* can be found in Chapter 5. An introduction to remote control according to SCPI standard and the status registers of the CMU is given in chapter 5 of the operating manual for the CMU basic instrument.

A program example in Chapter 7 illustrates how to set up a connection, force the DUT into its test mode and make fast power and modulation measurements.

Bluetooth Module Tests (Non Signalling)

In the *Bluetooth Non Signalling* mode, it is possible to generate an RF signal with Bluetooth specifications, to configure the RF input and output connectors of the R&S® CMU and to define the synchronization signal.

Subsystem RFGenerator – Generator control

The subsystem *RFGenerator* controls the RF generator. It corresponds to the *Generator Control* parameter in the *Generator* tab of the *Connect. Control* menu and the *RF Generator* softkey in the measurement menu *Analyzer/Generator*.

INITiate:RFGenerator	Start RF generator, reserve resources	⇒	<i>RUN</i>
ABORt:RFGenerator	Switch off RF generator, release resources	⇒	<i>OFF</i>
Description of command			FW vers.
These commands have no query form. They start and stop the RF generator, setting it to the status indicated in the top right column.			V2.60

FETCh:RFGenerator:STATus?		Generator Status		
<i>Returned values</i>	Description of parameters	Def. value	Def. unit	FW vers.
OFF	Generator switched off (ABORt or *RST)	OFF	–	V2.60
RUN	Running (INITiate)			
ERR	Switched off (could not be started)			
Description of command				
This command is always a query. It returns the current generator status.				

Generator Settings – Subsystem RFGenerator...

The commands in this section determine the level and frequency of the generated RF signals. The settings are provided in the *Generator* tab of the *Connect. Control* menu.

SOURce:RFGenerator:LEVEL <Level>		RF Max. Level		
<Level>	Description of parameters	Def. value	Def. unit	FW vers.
-137.0 to -27.0 dBm	RF generator level at output RF1	-80.0	dBm	V2.60
-137.0 to -10.0 dBm	RF generator level at output RF2	-80.0	dBm	
-90.0 to +13.0 dBm	RF generator level at output RF 3 OUT	-80.0		
Description of command				
This command determines the RF generator level. The permissible value range depends on the used RF output of the CMU and the external attenuation (see [SENSe:]CORRection:LOSS:OUTPut<nr>[:MAGNitude]. If option R&S CMU-U99 (RF 1 with RF 2 Level Range) is fitted, RF 1 takes on the level range of RF2.).				

SOURce:RFGenerator:PTBZero <Time>		Power-up Time before Bit Zero		
<Time>	Description of parameters	Def. value	Def. unit	FW vers.
LONG SHORT	Approx. 25 µs Approx. 3 µs	SHORT	–	V3.80
Description of command				
This commands specifies the time interval between the start of the power ramp and the time of bit zero.				

SOURce:RFGenerator:FREQUENCY <Frequency>		RF Frequency		
<Number>	Description of parameters	Def. value	Def. unit	FW vers.
2402 MHz to 2495 MHz	Output frequency (in multiples of the Bluetooth channel width of 1 MHz)	2 402 000 000	Hz	V2.60
Description of command				
This command defines the frequency of the generated Bluetooth RF carrier signal. With the command SOURce:RFGenerator:FREQUENCY:UNIT, the default frequency unit can be changed, and even Bluetooth channel numbers can be entered instead of frequencies.				

SOURce:RFGenerator:FREQUENCY:UNIT <Unit>		Frequency Unit		
<Unit>	Description of parameters	Def. value	Def. unit	FW vers.
HZ KHZ MHZ GHZ CH	Frequency unit Channel number	HZ	–	V2.60
Description of command				
This command defines whether the frequency of the RF signal generated is specified in frequency units or as an Bluetooth channel number. Frequency units must be used to select input signals that are outside the designated Bluetooth channel range. The command does not affect the default unit of the frequency offset (command SOURce:RFGenerator:FOFFset).				

SOURce:RFGenerator:FOFFset <FrequencyOffset>		Frequency Offset		
<FrequencyOffset>	Description of parameters	Def. value	Def. unit	FW vers.
-500.0 kHz to +500.0 kHz	Frequency offset	0	kHz	V2.60
Description of command				
This command determines a frequency offset for the generated signal in the selected RF channel.				

SOURce:RFGenerator:MINdex <Index>		Modulation Index		
<Index>	Description of parameters	Def. value	Def. unit	FW vers.
0.20 to 0.44 OFF	Modulation index of RF signal Modulation index 0.32, nominal Bluetooth freq. dev.	OFF	–	V3.50
Description of command				
This command sets the modulation index of the RF generator signal, i.e. the ratio between the actual frequency deviation of the signal and a frequency deviation of 500 kHz.				

SOURce:RFGenerator:PTYPE <Type>		Packet Type		
<Type>	Description of parameters	Def. value	Def. unit	FW vers.
DH1 DH3 DH5	DH1 packet DH3 packet DH5 packet	DH1	–	V3.80
Description of command				
This command specifies what type of packets the R&S® CMU transmits on its generator signal.				

SOURce:RFGenerator:PLENlength <Length>		Length of Test Sequence		
<Length>	Description of parameters	Def. value	Def. unit	FW vers.
0 to 27 0 to 183 0 to 339	Length of test sequence in byte for a DH1 packet Length of test sequence in byte for a DH3 packet Length of test sequence in byte for a DH5 packet	27 183 339	(bytes) (bytes) (bytes)	V3.80
Description of command				
This commands specifies the length of the payload for the transmitted packets. The allowed value range depends on the packet type (see command <code>SOURce:RFGenerator:PTYPE</code>).				

SOURce:RFGenerator:BDAddress <Address>		BD_Address CMU		
<Address>	Description of parameters	Def. value	Def. unit	FW vers.
"<12-digit hex value>"	BD_address of the R&S® CMU	"123456123456"	–	V3.80
Description of command				
This command sets the Bluetooth device address of the R&S® CMU which is transmitted on the Bluetooth generator signal.				

Subsystem RFGenerator:BMODulation

The subsystem *RFGenerator:BMODulation* determines the bit sequence that is modulated onto the RF carrier signal. It corresponds to the *Generator Modulation* parameter in the *Generator* tab of the *Connect. Control* menu.

SOURce:RFGenerator:BMODulation <Pattern>		Generator Modulation		
<Pattern>	Description of parameters	Def. value	Def. unit	FW vers.
PRBS	Pseudo-random bit sequence	PRBS	–	V2.60
ALL0	All zeros			
ALL1	All ones			
P44	Four ones, then four zeros			
P22	Two ones, then two zeros			
P11	Alternative ones and zeros			
Description of command				
The command selects a bit sequence used to modulate the RF generator signal.				

Subsystems INPut, OUTPut, CORRection:LOSS

The subsystems in this section contain the commands for configuration of the input and output connectors and the external attenuation factors. The subsystems correspond to the *RF*  tab in the popup menu *Connect. Control*.

INPut[:STATe] <State>		RF Input		
<State>	Description of parameters	Def. value	Def. unit	FW vers.
RF1	Connector RF 1 used as input	RF2	–	V2.60
RF2	Connector RF 2 used as input			
RF4	Connector RF 4 IN used as input			
Description of command				
This command determines the connector to be used for incoming RF signals. The bidirectional connectors RF 1 and RF 2 can be used both as input and output connectors in the same measurement (see <i>OUTPut[:STATe]</i>).				

OUTPut[:STATe] <State>		RF Output		
<State>	Description of parameters	Def. value	Def. unit	FW vers.
RF1	Connector RF 1 used as output	RF2	–	V2.60
RF2	Connector RF 2 used as output			
RF3	Connector RF 3 OUT used as output			
Description of command				
This command selects the connector to be used for outgoing RF signals. The bidirectional connectors RF 1 and RF 2 can be used both as input and output connectors in the same measurement.				

[SENSe:]CORRection:LOSS:INPut<nr>[:MAGNitude] <Absorption>		Ext. Att. Input		
<Absorption>	Description of parameters	Def. value	Def. unit	FW vers.
–50 dB to +90 dB	External input attenuation	0.0	dB	V2.60
Description of command				
This command assigns an external attenuation value to the inputs of the instrument (<i>RF 1, RF 2, RF 4 IN</i>).				

[SENSe:]CORRection:LOSS:OUTPut<nr>[:MAGNitude] <Absorption>		Ext. Att. Output		
SOURce:CORRection:LOSS:OUTPut<nr>[:MAGNitude] <Absorption>				
<Absorption>	Description of parameters	Def. value	Def. unit	FW vers.
-50 dB to +90 dB	External input attenuation	0.0	dB	V2.60
Description of command				
This command assigns an external attenuation value to the inputs of the instrument (<i>RF 1, RF 2, RF 3 OUT</i>).				

Subsystem DM:CLOCK (Synchronization)

The subsystem *DM:CLOCK* sets a system clock specific to the network. This frequency is set in the *Sync.* tab of the *Connect. Control* menu.

SOURce:DM:CLOCK:STATe <Mode>		REF OUT 2 on/off		
<Mode>	Description of parameters	Def. value	Def. unit	FW vers.
ON OFF	Switch on/off system clock	OFF	-	V2.60
Description of command				
This commands switches the system clock specific to the network at the <i>REF OUT 2</i> connector on or off.				

SOURce:DM:CLOCK:FREQuency <Frequency>		REF OUT 2				
<Frequency>	Description of parameters	Def. value	Def. unit	FW vers.		
1.250 MHz to 40.000 MHz	Input value for reference frequency	13.333	MHz	V2.60		
Description of command						
This command defines the reference frequency applied to output <i>REF OUT 2</i> . The frequency entered is rounded to one of the following discrete values:						
40.000 MHz,	20.000 MHz,	13.333 MHz,	10.000 MHz,	8.000 MHz,	6.667 MHz,	5.714 MHz,
5.000 MHz,	4.444 MHz,	4.000 MHz,	3.636 MHz,	3.333 MHz,	3.077 MHz,	2.857 MHz,
2.667 MHz,	2.500 MHz,	2.353 MHz,	2.222 MHz,	2.105 MHz,	2.000 MHz,	1.905 MHz,
1.818 MHz,	1.739 MHz,	1.667 MHz,	1.600 MHz,	1.538 MHz,	1.481 MHz,	1.429 MHz,
1.379 MHz,	1.333 MHz,	1.290 MHz,	1.250 MHz			

Bluetooth Device Tests (Signalling Mode)

In the *Signalling* mode, the R&S[®] CMU is able to generate a master signal and to attempt a connection to the DUT. A broad range of signalling parameters can be configured and measurements may be performed with a connection established.

Connection Control

The remote-control commands presented in this section control the signalling (inquiry, connection, detach and signalling parameters), determine the inputs and outputs as well as the reference frequency. They correspond to the settings in the popup menu of the softkey *Connect. Control* located to the right of the headline of each main menu (see Chapter 4).

Important note: current vs. default values

From firmware V3.80 the coupling between current and default parameters in the Connection Control menu has been removed, and all parameters are now independent.

- *The `CONFigure:MISC:CCDefault` command (see below) is no longer needed.*
- *In the independent (decoupled) mode, default values and current values can be different. The default value is used to attempt a connection; it can be modified in the signalling states `SBY`, `INQ` and `PAG`. The current value is valid during the connection (signalling state `CONN`). Whenever the CMU goes into the `CONN` state the default value overwrites the current value. The current value during the connection can still be changed, however, modifying this current value does not alter the default value.*

The parameters for the signalling states `INQ` and `PAG` must be set before these states are reached. For examples refer to sections [Subsystem MSIGNAL:PAGing](#) on p. 6.12 and [Subsystem MSIGNAL \(Master Signal\)](#) on p. 6.11.

CONFigure:MISC:CCDefault <Enable>		Couple Current Default		
<Enable>	Description of parameters	Def. value	Def. unit	FW vers.
ON 	Coupled current and default values Independent (decoupled) current and default values	ON	–	V3.80
Description of command				Sig. State
This command was used (v3.07) to define whether the current and default values of all double parameters in the Bluetooth Signalling function group were coupled or independent. From firmware v3.80 the coupling between current and default parameters in the Connection Control menu has been removed, and all parameters are now independent.				all

Signalling – Subsystem SIGNalling (Connection Setup and Cleardown)

The subsystem *SIGNalling* controls the setup and release of a connection between the R&S® CMU and the Bluetooth DUT and determines the signalling parameters. Together with the subsystem *WPOWER* (see below) it corresponds to the different *Connection* tabs (for four different signalling states, see command `PROCEDURE:SIGNalling:ACTion`) in the popup menu *Connect. Control*.

PROCEDURE:SIGNalling:ACTion <Action>		Connection Control		
<Action>	Description of parameters	Def. value	Def. unit	FW vers.
INquiry	Switch on master signal and start inquiry for Bluetooth devices within range	–	–	V2.60*
SINquiry	Stop inquiry and switch off master signal			
TEST	Switch on master signal, start paging the selected Bluetooth device, and activate its test mode as soon as the connection is established In CONN state or one of the substates: Force the DUT into its test mode			
STEST	Interrupt an ongoing paging procedure, switch off the master signal and return to SBY state In TEST state: Release the test mode and return to the CONN state			
PAGE	Switch on master signal, start paging the selected Bluetooth device and establish an ACL connection			
SPAGe	Interrupt an ongoing connection setup, switch off the master signal and return to SBY state			
DETach	Detach an established connection and switch off master signal			
FSTY	Force the R&S® CMU into Standby without detaching			V3.40
SNIFF	Force the DUT to <i>Sniff</i> mode			V3.08
SSNIff	Release the <i>Sniff</i> mode			
HOLD	Force the DUT to <i>Hold</i> mode			
AUDio	Establish an SCO link on top of the existing ACL connection in order to perform audio measurements			
SAUDio	Release the <i>Audio</i> mode			
PARK	Force the DUT to <i>Park</i> mode			V3.10
SPARK	Release the <i>Park</i> mode			
HEADset	Activate <i>headset</i> profile*			V4.25
SHEADset	Deactivate the <i>headset</i> profile*			
HFRee	Activate <i>hands-free</i> profile*			
SHFRee	Deactivate the <i>hands-free</i> profile*			
HAGateway	Activate <i>headset audio gateway</i> profile*			
SHAGateway	Deactivate the <i>headset audio gateway</i> profile*			
HFAGateway	Activate <i>hands-free audio gateway</i> profile*			
SHFgateway	Deactivate the <i>hands-free audio gateway</i> profile*			
Description of command				Sig. State
This command has no query form and no default value. It changes between the different signalling states of the R&S® CMU (see state diagram below).				See below
*) These audio profile actions are supported in V4.25 onwards when the R&S CMU-K54 option is enabled.				

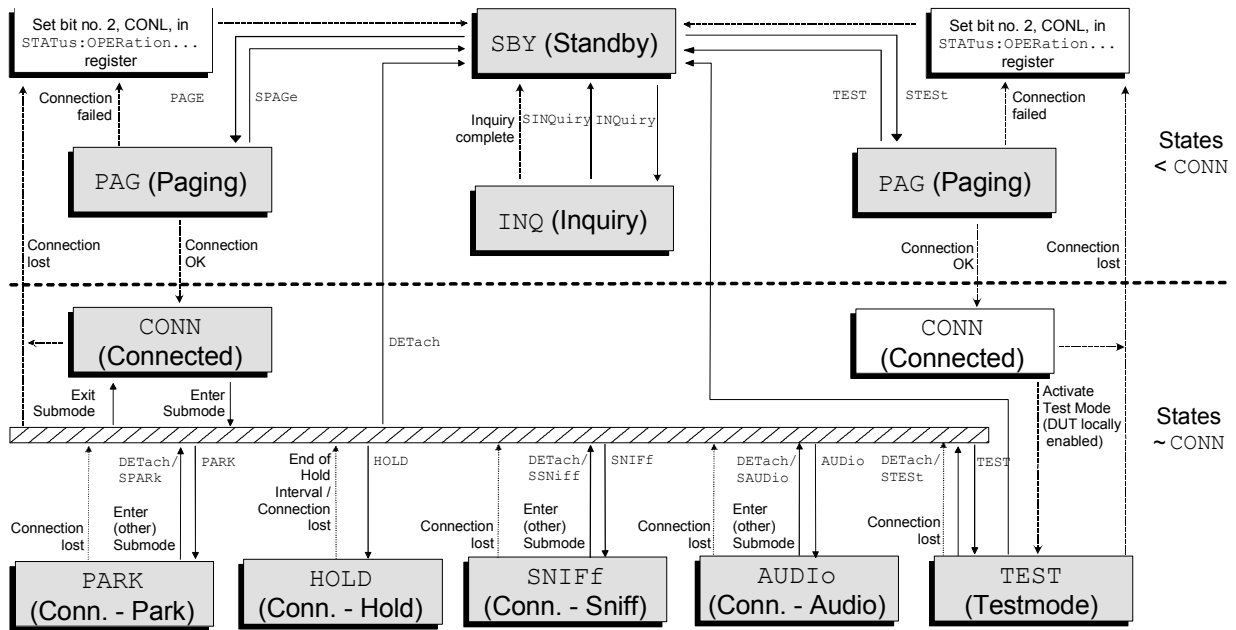

Fig. 6-1 Signalling states (shaded) of the R&S[®] CMU and transitions

Signalling states: See next command, [SENSe:]SIGNalling:STATe?

Actions (initiated from the R&S[®] CMU): See description of command [PROCedure:]SIGNalling:ACTIon

Further transitions between the signalling states (not shown in Fig. 6-1) may occur, e.g. in case of errors.

[SENSe:]SIGNalling:XState?				Signalling State	
Return	Description of parameters	Def. value	Def. unit	FW vers.	
SBY	Standby; no RF signal is generated	SBY	–	V2.60	
INQ	Inquiry for <i>Bluetooth</i> devices within range in progress				
PAG	Paging in progress (trying to establish a connection)				
CONN	Connection to a Bluetooth device is established				
TEST	Connection established, DUT in test mode				
HOLD	Connection established, DUT in Hold mode				
SNIF	Connection established, DUT in Sniff mode				
PARK	Connection established, DUT in Park mode				
AUD	Connection established, DUT in Audio mode				
DET	Disconnecting/detaching (trying to detach from a connection)				
HFR	Connection established, DUT in hands-free profile*			V4.25	
HEAD	Connection established, DUT in headset profile*				
HFAG	Conn. established, DUT in hands-free audio gateway profile*				
HAG	Connection established, DUT in headset audio gateway profile*				
Description of command				Sig. State	
<p>This command is always a query. It returns the current signalling state. This command gives you specific information about the submode that the device under test (DUT) is in, whereas the [SENSe:]SIGNalling:State? command does not. The distinction between CONN and TEST and the states HOLD, SNIF, AUD are available for FW versions ≥V3.08. PARK is available for FW versions ≥V3.10. DET is available for FW versions ≥V3.40. See also command [SENSe:]SIGNalling:STATE?</p> <p>In the CONN state and in the TEST, HOLD, SNIF, AUD, and PARK substates, the R&S® CMU maintains a connection to the DUT. The states are grouped together as the ~CONN states. The remaining states are grouped together as <CONN states.</p> <p>*) These audio profile states are supported in V4.25 onwards when the R&S CBT-K54 option is enabled.</p>				all	

[SENSe:]SIGNalling:STATE?				Signalling State	
Return	Description of parameters	Def. value	Def. unit	FW vers.	
SBY	Standby; no RF signal is generated	SBY	–	V2.60	
INQ	Inquiry for <i>Bluetooth</i> devices within range in progress				
PAG	Paging in progress (trying to establish a connection)				
CONN	Connection to a Bluetooth device is established				
DET	Detaching (trying to detach from a connection)				
Description of command				Sig. State	
<p>This command is always a query. It returns the current signalling state. You can use the [SENSe:]SIGNalling:XState? command to differentiate between the various submodes of a DUT in the CONN state (Hold, Park, Sniff, Audio, Test).</p>				all	

FETCH:SIGNalling:PTARgets?				Device to Page List
Return	Description of parameters	Def. value	Def. unit	FW vers.
0 to 12,	Total number of devices found	0,	–	V2.60
"BD00",	Device number of first inquired device	"BD00",		
"BD_address_00"	BD_address of the first inquired device	"12345678		
{,"BDxx",	Up to 11 further device numbers BD01 to BD11	9012"		
"BD_address_xx"}"	and BD addresses			
Description of command				Sig. State
<p>This command is always a query. It returns a list of all targets available for paging. The first parameter is the total number of devices available for paging. A list of devices follows, each entry consisting of the device number (string "BDxx") and the device's <i>Bluetooth</i> device address. The first device "BD00" is always the default target as set in the <i>Network</i> tab. The following targets are the devices found during inquiry.</p> <p>If no inquiry was done or no device was found during inquiry, 0 will be returned for the number of devices found, meaning that there is only the default device available for paging.</p>				all

CONFigure:SIGNalling:PTARget				Device to Page
Parameters for setting:		<Target>		
Parameters for query:		<Target>, <BD_address>		
<Target>	Description of parameters	Def. value	Def. unit	FW vers.
BD00 to BD11	Current number of paging target	BD00	–	
<BD_address>	Description of parameters	Def. value	Def. unit	FW vers.
"<12-digit hex value>"	Paging target's BD address	"123456789012"	–	V2.60
Description of command				Sig. State
<p>This command selects one of the paging targets to be the device to page. If used as a query, it returns the number and BD address of the currently selected device to page. To be selected, the device must appear in the device to page list; see <code>FETCH:SIGNalling:PTARgets?</code>. If another device is selected, an error message is returned.</p>				<CONN Query:all

PROCedure:SIGNalling:PTBZero <Time>		Power-up Time before Bit Zero		
<Time>	Description of parameters	Def. value	Def. unit	FW vers.
LONG 	Approx. 25 µs	SHORT	–	V3.80
SHORT	Approx. 3 µs			
Description of command				Sig. State
<p>This commands specifies the time interval between the start of the power ramp and the time of bit zero.</p>				<CONN Query:all

PROCedure:PCONTrol:STEP		Power Control Up/Down		
<Enable>	Description of parameters	Def. value	Def. unit	FW vers.
UP 	Send increase power request to the DUT	–	–	V3.08
DOWN	Send decrease power request to the DUT			
Description of command				Sig. State
<p>This command sends power control commands to the DUT so that its power control capabilities can be tested.</p>				CONN, TEST

PROCedure:PCONtrol:STATE?		Read power control state		
Returned values	Description of parameters	Def. value	Def. unit	FW vers.
RMAX	DUT has reached its maximum power	–	–	V4.37
RMIN	DUT has reached its maximum power			
NNM	No maximum or minimum power reached ("no new message")			
Description of command				Sig. State
This query returns the power control state of the DUT.				~CONN

Subsystem MSIGnal (Master Signal)

The subsystem *MSIGnal* configures how the R&S[®] CMU will act as a *Bluetooth* master. The subsystem corresponds to the *Master Sig.* tab in the popup menu *Connect. Control.*

CONFigure:MSIGnal:TXLevel <Level>		TX Level		
<Level>	Description of parameters	Def. value	Def. unit	FW vers.
–137.0 to –27.0 dBm	TX level at output RF1	–40.0	dBm	V3.07
–137.0 to –10.0 dBm	TX level at output RF2	–40.0	dBm	
–90.0 to +13.0 dBm	TX level at output RF 3 OUT	–40.0	dBm	
Description of command				Sig. State
This command sets the transmit level for the R&S [®] CMU while signalling. (Note that this is different from the level used during the BER tests.)				all

CONFigure:MSIGnal:BDAddress <Address>		BD_Address CMU		
<Address>	Description of parameters	Def. value	Def. unit	FW vers.
"<12-digit hex value>"	BD_address of the R&S [®] CMU	"123456123456"	–	V3.07
Description of command				Sig. State
This command sets the Bluetooth device address of the R&S [®] CMU. BD_addresses can be set in single or double quotes.				SBY Q: all

CONFigure:MSIGnal:SVTout <Number>		Supervision Timeout		
<Number>	Description of parameters	Def. value	Def. unit	FW vers.
0 to 65535	Timeout in slots	8000	–	V3.07
Description of command				Sig. State
This value set with this command represents the number of slots of non-communication between the R&S [®] CMU and the DUT that can occur before the two devices detach from each other.				SBY Q: all

CONFigure:MSIGnal:HSCHEME <Scheme>		Connection Hopping Scheme		
<Scheme>	Description of parameters	Def. value	Def. unit	FW vers.
EUSA	Europe's and USA's hopping scheme	EUSA	–	V3.07
FRANce	France's hopping scheme			
Description of command				Sig. State
This command selects the hopping scheme for the R&S® CMU while signalling. Channels and frequency ranges are:				SBY
Europe/USA	2400 MHz to 2483.5 MHz,	Channel _k : $f_k = 2402+k$ MHz, $k = 0$ to 78		
France	2446.5 MHz to 2483.5 MHz,	Channel _k : $f_k = 2454+k$ MHz, $k = 0$ to 22		

CONFigure:MSIGnal:HSCHEME:FREQUENCY <TX_Freq>,<RX_Freq>		TX/RX Frequency		
<TX_Freq>	Description of parameters	Def. value	Def. unit	
2 402 MHz to 2 495 MHz,	TX frequency	2480000000	Hz	
<RX_Freq>	Description of parameters	Def. value	Def. unit	FW vers.
2 402 MHz to 2 495 MHz	RX frequency	2402000000	Hz	V3.40
Description of command				Sig. State
This command defines the frequency of the RF signals that will be generated and received by the DUT during inquiry and paging. Both frequencies must be entered in multiples of the <i>Bluetooth</i> channel width of 1 MHz.				SBY

CONFigure:MSIGnal:INquiry:ILENght <Number>		Inquiry Length		
<Number>	Description of parameters	Def. value	Def. unit	FW vers.
1 to 24	Inquiry length; integer number to be multiplied by 1.28 s	10	(1.28 s)	V3.07
Description of command				Sig. State
This command determines the maximum amount of time specified before the inquiry is halted.				SBY
				Q: all

CONFigure:MSIGnal:INquiry:NOResponses <Number>		Number of Responses		
<Number>	Description of parameters	Def. value	Def. unit	FW vers.
1 to 12	Number of responses	12	–	V3.07
Description of command				Sig. State
This command determines the maximum number of responses from the inquiry before the inquiry is halted.				SBY

Subsystem MSIGnal:PAGing

The subsystem *MSIGnal:PAGing* configures how the R&S® CMU will attempt to page to a device under test. The subsystem corresponds to the section *Paging* of the *Master Sig.* tab in the popup menu *Connect. Control*.

CONFigure:MSIGnal:PAGing:TOUT <Timeout>			Page Timeout	
<Timeout>	Description of parameters	Def. value	Def. unit	FW vers.
1 to 65535	Number of slots for the timeout; the minimum value is 128 in paging mode R1 and 256 in paging mode R2	8192	(slots)	V3.07
Description of command				Sig. State
This command determines the maximum time the local LM will wait for a baseband page response from the DUT. If the time expires and the remote device has not responded to the page at baseband level, the connection attempt will be considered to have failed.				≠ PAG

CONFigure:MSIGnal:PAGing:PSRMode <Mode>			Page Scan Repetition mode	
<Mode>	Description of parameters	Def. value	Def. unit	FW vers.
R0 	Paging mode R0	R2	–	V3.07
R1 	Paging mode R1			
R2	Paging mode R2			
Description of command				Sig. State
This command determines the paging mode that is to be used for connection and synchronisation to a DUT.				≠ PAG

CONFigure:MSIGnal:PAGing:TARGet <Address>			Default BD_Address for Paging	
<Address>	Description of parameters	Def. value	Def. unit	FW vers.
"<12-digit hex value>"	Default BD_address of device to page	"123456789012"	–	V3.07
Description of command				Sig. State
This command determines the address of a default device to attempt a connection to. If no inquiry was made before, this BD_address is used for paging a DUT; otherwise, the device to page can be set via CONFigure:SIGNalling:PTARget. BD_addresses can be set in single or double quotes.				≠ PAG

CONFigure:MSIGnal:PAGing:RSInfo <Enable>			Read Signalling Info	
<Enable>	Description of parameters	Def. value	Def. unit	FW vers.
ON 	Read signalling info from the DUT	ON	–	V3.08
OFF	Do not read signalling info from the DUT			
Description of command				Sig. State
This command defines whether the R&S [®] CMU issues commands to read supported features or other signalling information from the DUT. In the OFF setting the connection is made quicker, since there are less LMP packets exchanged between master and slave when connecting.				all

DEFault:MSIGnal:PAGing <Enable>			Default Settings	
<Enable>	Description of parameters	Def. value	Def. unit	FW vers.
ON 	The parameters are set to their default values	ON	–	V3.07
OFF	The parameters differ from the default values (partially or totally)			
Description of command				Sig. State
If used as a setting command with the parameter ON this command sets all parameters of the subsystem to their default values (the setting OFF results in an error message). If used as a query the command returns whether all parameters are set to their default values (ON) or not (OFF).				SBY INQ

DEFault:MSIGnal <Enable>		Default Settings		
<Enable>	Description of parameters	Def. value	Def. unit	FW vers.
ON 	The parameters are set to their default values	ON	–	V3.07
OFF	The parameters differ from the default values (partially or totally)			
Description of command				Sig. State
If used as a setting command with the parameter <i>ON</i> this command sets all parameters of the subsystem to their default values (the setting <i>OFF</i> results in an error message).				SBY
If used as a query the command returns whether all parameters are set to their default values (<i>ON</i>) or not (<i>OFF</i>).				

Subsystem MSIGnal:DTRansmitter (Dirty Transmitter)

The subsystem *MSIGnal:DTRansmitter* provides parameters to impair the master signal. The subsystem corresponds to the *Dirty Transmitter* section of the *Master Sig.* tab in the popup menu *Connect. Control*.

CONFigure:MSIGnal:DTRansmitter:SCOPE <Scope>		Dirty Transmitter Scope		
<Scope>	Description of parameters	Def. value	Def. unit	FW vers.
RXQuality 	Dirty transmitter settings active while a RX Quality measurement is running	RXQuality	–	V3.40
GLOBal	Settings always active			
Description of command				Sig. State
This command defines for which measurements the dirty transmitter settings are active.				all

CONFigure:MSIGnal:DTRansmitter:MINdex <Index>		Modulation Index		
<Index>	Description of parameters	Def. value	Def. unit	FW vers.
0.20 to 0.44 	Modulation index of master signal	OFF	–	V3.08
OFF	Modulation index 0.32, nominal Bluetooth freq. dev.			
Description of command				Sig. State
This command sets the modulation index of the master signal, i.e. the ratio between the actual frequency deviation of the CMU and a frequency deviation of 500 kHz.				all

CONFigure:MSIGnal:DTRansmitter:FOFFset <Offset>		Frequency Offset		
<Enable>	Description of parameters	Def. value	Def. unit	FW vers.
–500 kHz to +500 kHz 	Frequency offset of master signal	OFF	kHz	V3.08
OFF	Frequency offset 0 kHz.			
Description of command				Sig. State
This command defines an offset of the actual frequency of the master signal from the nominal Bluetooth channel frequency.				all

Subsystem DUT (Authentication)

The subsystem *DUT* is used to test the authentication procedure between the R&S® CMU and the DUT. The parameters are in the *Paging* section of the *Master Sig.* tab in the popup menu *Connect. Control*.

CONFigure:DUT:AUTHeNtic:ENABle <Enable>				Authentication Required
<Mode>	Description of parameters	Def. value	Def. unit	FW vers.
ON OFF	Require / do not require authentication	OFF	–	V3.57
Description of command				Sig. State
This command enables or disables authentication required by the R&S® CMU.				all

CONFigure:DUT:PINCode <Code>				Pin Code
<Code>	Description of parameters	Def. value	Def. unit	FW vers.
'<12-digit hex>'	PIN code specified as a string containing a 1 to 12-digit hexadecimal number	'0000'	–	V3.57
Description of command				Sig. State
This command specifies the PIN code to be used for authentication.				all

CONFigure:DUT:STORE:LINK:KEYS <Enable>				Store Link Keys
<Mode>	Description of parameters	Def. value	Def. unit	FW vers.
ON OFF	Store link keys No link keys stored	OFF ON	–	V4.37 V5.00
Description of command				
This command qualifies whether the link keys which a DUT sends during the authentication (pairing) process are stored.				

Subsystem SSIGnal (Slave Signal)

The subsystem *SSIGnal* configures the properties of the slave signal in the *Connected* or *Test Mode* signalling states. The subsystem corresponds to the general settings in the *Slave Sig.* tab in the popup menu *Connect. Control*.

CONFigure:SSIGnal:PCTR <Mode>				Power Control Mode
PROCedure:SSIGnal:PCTR <Mode>				
<Mode>	Description of parameters	Def. value	Def. unit	FW vers.
ADAPtive FIXed	Power control enabled Power control disabled	ADAP	–	V3.08
Description of command				Sig. State
These commands define whether or not the DUT supports adaptive power control.				all

Subsystem SSIGnal:TMODe (Test Mode)

The subsystem *SSIGnal:TMODe* configures testmode types and data to be used for tests. The subsystem corresponds to the *Testmode Type* section of the *Slave Sig.* tab in the popup menu *Connect. Control*.

The following *SSIGnal:TMODe*... subsystems are listed in separate sections:

- TX Tests (see p. 6.16 ff)
- Loopback Tests (see p. 6.18 ff)

CONFigure:SSIGnal:TMODe:TMTYpe <Type>				Testmode Type
PROCedure:SSIGnal:TMODe:TMTYpe <Type>				
<Type>	Description of parameters	Def. value	Def. unit	FW vers.
LBT	Loopback Tests	LBT	–	V3.07
TXT	TX Tests			
Description of command				Sig. State
This command selects the testmode type for TX measurements (POWer, MODulation, SPECTrum). In the STB, INQ and PAG states, the PROCedure... command can be used as a query only.				all

CONFigure:SSIGnal:TMODe:HSCHeM <Scheme>				Test Mode Hopping Scheme
PROCedure:SSIGnal:TMODe:HSCHeM <Scheme>				
<Scheme>	Description of parameters	Def. value	Def. unit	FW vers.
RXTX	RX/TX on single frequency	EUSA	–	V3.07
EUSA	Europe's and USA's hopping scheme			
FRANce	France's hopping scheme			
RHOP	Test mode's reduced hopping scheme			
Description of command				Sig. State
This command selects the hopping scheme to be used in test mode. Channels and frequency ranges are:				all
Europe/USA	2400 MHz to 2483.5 MHz, Channel _k : $f_k = 2402+k$ MHz, $k = 0$ to 78			
France	2446.5 MHz to 2483.5 MHz, Channel _k : $f_k = 2454+k$ MHz, $k = 0$ to 22			
In the STB, INQ and PAG states, the PROCedure... command can be used as a query only.				

CONFigure:SSIGnal:TMODe:FREQUency:UNIT <Unit>				Frequency Unit
<Unit>	Description of parameters	Def. value	Def. unit	FW vers.
HZ KHZ MHZ GHZ	Frequency unit	HZ	–	V2.65
CH	Channel number			
Description of command				Sig. State
This command defines whether the frequency of the RF signal generated is specified in frequency units or as a Bluetooth channel number.				all

Subsystem SSIGnal:TMOD:TXTests (Transmitter Tests)

The subsystem *SSIGnal:TMOD:TXTests* configures the transmitter tests on *Bluetooth* devices. The subsystem corresponds to the *TX Tests* section of the *Slave Sig.* tab in the popup menu *Connect. Control.*

CONFigure:SSIGnal:TMODe:TXTTests:FREQuency <RXTX_Freq>		RX/TX Frequency, Transmitter Test		
PROCedure:SSIGnal:TMODe:TXTTests:FREQuency <RXTX_Freq>				
<RXTX_Freq>	Description of parameters	Def. value	Def. unit	FW vers.
2 402 MHz to 2 495 MHz	RX frequency	2402 000 000	Hz	V2.65
Description of command				Sig. State
This command defines the common RX and TX frequency of the DUT in the test mode and for transmitter <i>Testmode Types</i> . The frequency must be entered in multiples of the <i>Bluetooth</i> channel width of 1 MHz. With the command <code>CONFigure:SSIGnal:TMODe:FREQuency:UNIT</code> , the default frequency unit can be changed, and even <i>Bluetooth</i> channel numbers can be entered instead of frequencies. In the <i>STB</i> , <i>INQ</i> and <i>PAG</i> states, the <code>PROCedure...</code> command can be used as a query only.				all

CONFigure:SSIGnal:TMODe:TXTTests:PATTType <Type>		Pattern Type		
PROCedure:SSIGnal:TMODe:TXTTests:PATTType <Type>				
<Type>	Description of parameters	Def. value	Def. unit	FW vers.
SPRS 	Static pseudo random sequence	P11	–	V3.07
ALL1 	All ones			
ALL0 	All zeros			
P11 	Alternative ones and zeros			
P44	Four ones then four zeros			
Description of command				Sig. State
This command sets the bit pattern for TX test mode. The specified pattern type will be used if the testmode type is set to transmitter tests (see <code>CONFigure:SSIGnal:TMODe:TMTType</code>). In the <i>STB</i> , <i>INQ</i> and <i>PAG</i> states, the <code>PROCedure...</code> command can be used as a query only.				all

CONFigure:SSIGnal:TMODe:TXTTests:PTYPe <Type>		Packet Type		
PROCedure:SSIGnal:TMODe:TXTTests:PTYPe <Type>				
<Type>	Description of parameters	Def. value	Def. unit	FW vers.
DH1 	DH1 packet	DH1	–	V3.07
DH3 	DH3 packet			
DH5	DH5 packet			
Description of command				Sig. State
This command determines what type of packet is to be transmitted by the DUT during test mode. This command is only available if the testmode type is not set to loopback (see command <code>CONFigure:SSIGnal:TMODe:TMTType</code>). In the <i>STB</i> , <i>INQ</i> and <i>PAG</i> states, the <code>PROCedure...</code> command can be used as a query only. In the <i>STB</i> , <i>INQ</i> and <i>PAG</i> states, the <code>PROCedure...</code> command can be used as a query only.				all

CONFigure:SSIGnal:TMODe:TXTests:LOTSequence:DH1Packet <Length>				Length of Test Sequence
PROCEdure:SSIGnal:TMODe:TXTests:LOTSequence:DH1Packet <Length>				
CONFigure:SSIGnal:TMODe:TXTests:LOTSequence:DH3Packet <Length>				
PROCEdure:SSIGnal:TMODe:TXTests:LOTSequence:DH3Packet <Length>				
CONFigure:SSIGnal:TMODe:TXTests:LOTSequence:DH5Packet <Length>				
PROCEdure:SSIGnal:TMODe:TXTests:LOTSequence:DH5Packet <Length>				
<Length>	Description of parameters	Def. value	Def. unit	FW vers.
0 .. 27	Length of test sequence in byte for a DH1 packet	27	bytes	V3.07
0 .. 183	Length of test sequence in byte for a DH3 packet	183	bytes	
0 .. 339	Length of test sequence in byte for a DH5 packet	339	bytes	
Description of command				Sig. State
<p>These commands determine the length of the payload for the transmitted packet. The allowed value range depends on the packet type (see command <code>CONFigure:SSIGnal:TMODe:TXTests:PTYPE</code>). The commands are only available if the testmode type is not set to loopback (see command <code>CONFigure:SSIGnal:TMODe:TMTYPE</code>). In the <code>STB</code>, <code>INQ</code> and <code>PAG</code> states, the <code>PROCEdure...</code> command can be used as a query only.</p>				all

CONFigure:SSIGnal:TMODe:TXTests:PPERiod <Period>				Poll Period
PROCEdure:SSIGnal:TMODe:TXTests:PPERiod <Period>				
<Period>	Description of parameters	Def. value	Def. unit	FW vers.
2 to 254	Poll period in slots (even numbers only)	2	(slots)	V3.07
Description of command				Sig. State
<p>This command determines how often the poll packet from the R&S® CMU occurs. This command is only available if the testmode type is not set to loopback (see command <code>CONFigure:SSIGnal:TMODe:TMTYPE</code>). In the <code>STB</code>, <code>INQ</code> and <code>PAG</code> states, the <code>PROCEdure...</code> command can be used as a query only.</p>				all

Subsystem SSIGnal:TMODe:LBTests (Loopback Tests)

The subsystem `SSIGnal:TMODe:LBTests` configures the loopback test mode. The subsystem corresponds to the *Loopback Tests* section of the *Slave Sig.* tab in the popup menu *Connect. Control*.

CONFigure:SSIGnal:TMODe:LBTests:FREQUENCY <TX_Freq>,<RX_Freq>				TX/RX Frequency, Loopback
PROCEdure:SSIGnal:TMODe:LBTests:FREQUENCY <TX_Freq>,<RX_Freq>				
<TX_Freq>	Description of parameters	Def. value	Def. unit	FW vers.
2 402 MHz to 2 495 MHz,	TX frequency	2402000000	Hz	
<RX_Freq>	Description of parameters	Def. value	Def. unit	FW vers.
2 402 MHz to 2 495 MHz	RX frequency	2480000000	Hz	V2.65
Description of command				Sig. State
<p>This command defines the frequency of the RF signals that will be generated and received by the DUT in the test mode and for loopback <i>Testmode Types</i>. Both frequencies must be entered in multiples of the <i>Bluetooth</i> channel width of 1 MHz. With the command <code>CONFigure:SSIGnal:TMODe:FREQUENCY:UNIT</code>, the default frequency unit can be changed, and even <i>Bluetooth</i> channel numbers can be entered instead of frequencies. In the <code>STB</code>, <code>INQ</code> and <code>PAG</code> states, the <code>PROCEdure...</code> command can be used as a query only.</p>				all

CONFigure:SSIGnal:TMODe:LBTests:PATType <Type>				Pattern Type
PROCedure:SSIGnal:TMODe:LBTests:PATType <Type>				
<Type>	Description of parameters	Def. value	Def. unit	FW vers.
DPRS	Dynamic pseudo random sequence	P11	–	V3.07
SPRS	Static pseudo random sequence			
ALL1	All ones			
ALL0	All zeros			
P11	Alternative ones and zeros			
P44	Four ones then four zeros			
USER	User defined			
Description of command				Sig. State
This command sets the bit pattern for loopback mode. The specified pattern type will be used if the testmode type is set to loopback tests (see <code>CONFigure:SSIGnal:TMODe:TMTType</code>). In the <code>STB</code> , <code>INQ</code> and <code>PAG</code> states, the <code>PROCedure...</code> command can be used as a query only.				all

CONFigure:SSIGnal:TMODe:LBTests:UDLength <Length>				User-defined Length
PROCedure:SSIGnal:TMODe:LBTests:UDLength <Length>				
<Length>	Description of parameters	Def. value	Def. unit	FW vers.
3 to 64	Length of user defined data in bit	16	–	V3.07
Description of command				Sig. State
This command determines the length of the user defined bit sequence before it is repeated. This command is only available if a loopback testmode type is selected (see command <code>CONFigure:SSIGnal:TMODe:TMTType</code>) and the loopback pattern is user defined (see command <code>CONFigure:SSIGnal:TMODe:LBTests:PATtern</code>). In the <code>STB</code> , <code>INQ</code> and <code>PAG</code> states, the <code>PROCedure...</code> command can be used as a query only.				all

CONFigure:SSIGnal:TMODe:LBTests:UDData <Data>				User-defined Data
PROCedure:SSIGnal:TMODe:LBTests:UDData <Data>				
<Data>	Description of parameters	Def. value	Def. unit	FW vers.
<HEX Data>	Up to 64 user defined data bits; represented by max. 16 hex characters, least significant bit last, i.e. to the right	"FF00"	–	V3.07
Description of command				Sig. State
This command determines the bit stream to be used for the user defined data. The bit stream is repeated until the complete payload is filled, removing any extra bits from the end of the stream. This command is only available if a loopback testmode type is selected (see command <code>CONFigure:SSIGnal:TMODe:TMTType</code>) and if the loopback pattern is user defined (see command <code>CONFigure:SSIGnal:TMODe:LBTests:PATtern</code>). In the <code>STB</code> , <code>INQ</code> and <code>PAG</code> states, the <code>PROCedure...</code> command can be used as a query only.				all

CONFigure:SSIGnal:TMODe:LBTests:PTYPE <Type>				Packet Type
PROCedure:SSIGnal:TMODe:LBTests:PTYPE <Type>				
<Type>	Description of parameters	Def. value	Def. unit	FW vers.
DH1	DH1 packet	DH1	–	V3.07
DH3	DH3 packet			
DH5	DH5 packet			
Description of command				Sig. State
<p>This command determines what type of packet is to be transmitted by the DUT during loopback mode. This command is only available if a loopback testmode type is selected (see command <code>CONFigure:SSIGnal:TMODe:TMTYPE</code>). In the <code>STB</code>, <code>INQ</code> and <code>PAG</code> states, the <code>PROCedure...</code> command can be used as a query only. In the <code>STB</code>, <code>INQ</code> and <code>PAG</code> states, the <code>PROCedure...</code> command can be used as a query only.</p>				all

CONFigure:SSIGnal:TMODe:LBTests:LOTSequence:DH1Packet <Length>				Length of Test Sequence
PROCedure:SSIGnal:TMODe:LBTests:LOTSequence:DH1Packet <Length>				
CONFigure:SSIGnal:TMODe:LBTests:LOTSequence:DH3Packet <Length>				
PROCedure:SSIGnal:TMODe:LBTests:LOTSequence:DH3Packet <Length>				
CONFigure:SSIGnal:TMODe:LBTests:LOTSequence:DH5Packet <Length>				
PROCedure:SSIGnal:TMODe:LBTests:LOTSequence:DH5Packet <Length>				
<Length>	Description of parameters	Def. value	Def. unit	FW vers.
0 .. 27	Length of test sequence in byte for a DH1 packet	27	–	V3.07
0 .. 183	Length of test sequence in byte for a DH3 packet	183		
0 .. 339	Length of test sequence in byte for a DH5 packet	339		
Description of command				Sig. State
<p>These commands determine the length of the payload for the transmitted packet. The allowed value range depends on the packet type (see command <code>CONFigure:SSIGnal:TMODe:LBTests:PTYPE</code>). This command is only available if a loopback testmode type is selected (see command <code>CONFigure:SSIGnal:TMODe:TMTYPE</code>). In the <code>STB</code>, <code>INQ</code> and <code>PAG</code> states, the <code>PROCedure...</code> command can be used as a query only.</p>				all

CONFigure:SSIGnal:TMODe:LBTests:WHITening <Enable>				Whitening
PROCedure:SSIGnal:TMODe:LBTests:WHITening <Enable>				
<Enable>	Description of parameters	Def. value	Def. unit	FW vers.
ON	Whitening enabled	OFF	–	V3.07
OFF	Whitening disabled			
Description of command				Sig. State
<p>This command switches whitening on or off. This command is only available if a loopback testmode type is selected (see command <code>CONFigure:SSIGnal:TMODe:TMTYPE</code>). In the <code>STB</code>, <code>INQ</code> and <code>PAG</code> states, the <code>PROCedure...</code> command can be used as a query only.</p>				all

DEFault:SSIGnal:TMODe <Enable>			Default Settings	
<Enable>	Description of parameters	Def. value	Def. unit	FW vers.
ON 	The parameters are set to their default values	ON	–	V3.07
OFF	The parameters differ from the default values (partially or totally)			
Description of command				Sig. State
If used as a setting command with the parameter <i>ON</i> this command sets all parameters of the subsystem to their default values (the setting <i>OFF</i> results in an error message).				all
If used as a query the command returns whether all parameters are set to their default values (<i>ON</i>) or not (<i>OFF</i>).				

Subsystem NETWork (Network Parameters)

The subsystem *NETWork* sets parameters to control the DUT while it is in the *Audio*, *Sniff*, and *Hold* submode. It corresponds to the *Network* tab in the popup menu *Connection Control*.

DEFault:NETWork			Default Settings	
<Enable>	Description of parameters	Def. value	Def. unit	FW vers.
ON 	The parameters are set to their default values	ON	–	V2.60
OFF	Some or all parameters differ from the default values			
Description of command				Sig. State
If used as a setting command with the parameter <i>ON</i> this command sets all parameters of the subsystem to their default values (the setting <i>OFF</i> results in an error message).				all
If used as a query the command returns whether all parameters are set to their default values (<i>ON</i>) or not (<i>OFF</i>).				

Subsystem NETWork:AUDio (Audio Submode)

The subsystem *NETWork:AUDio* sets parameters to control the DUT while it is in the *Audio* submode. It corresponds to the *Audio* section of the *Network* tab in the popup menu *Connection Control*.

CONFigure:NETWork:AUDio:AIrCoding <Coding>			Air Coding	
<Version>	Description of parameters	Def. value	Def. unit	FW vers.
CVSD 	CVSD modulation	CVSD	–	V3.08
ULAW 	μ-law log PCM			
ALAW	A-law log PCM			
Description of command				Sig. State
This command defines the voice coding format used on the air interface (i.e. in uplink as well as in downlink direction).				≠ AUD, Q: all

CONFigure:NETWork:AUDio:BITStream <Bit_Stream>				Bit Stream
<Bit_Stream>	Description of parameters	Def. value	Def. unit	FW vers.
ECHO AIO AIOL DCAL ECAL	Loopback after <i>Delay Time</i> Analog In/Out Analog In/Out (Low) Decoder calibration Encoder calibration	AIO	–	V3.08 V3.80 V4.30
Description of command				Sig. State
This command defines the routing of the SCO bits in the R&S [®] CMU and the routing of the speech codec signals for calibration purposes.				all

CONFigure:NETWork:AUDio:DELTime <Bit_Stream>				Delay Time
<Bit_Stream>	Description of parameters	Def. value	Def. unit	FW vers.
0 ms to 2000 ms	Delay time	1000	ms	V3.08
Description of command				Sig. State
This command defines the time after which the R&S [®] CMU loops back the data received from the DUT if <i>Bit Stream = Echo</i> is set.				≠ AUD, Q: all

CONFigure:NETWork:AUDio:PTYPe <Type>				Packet Type
<Type>	Description of parameters	Def. value	Def. unit	FW vers.
HV1 HV2 HV3	Packet type	HV1	–	V3.08
Description of command				Sig. State
This command defines the packet format of the SCO packets transmitted in the <i>Audio</i> state.				≠ AUD, Q: all

Subsystem NETWork:SNIFf (SNIFf Submode)

The subsystem *NETWork:SNIFf* sets parameters to control the DUT while it is in the *SNIFf* submode. It corresponds to the *Sniff Mode* section of the *Network* tab in the popup menu *Connection Control*.

CONFigure:NETWork:SNIFf:INTerval <Slots>				Sniff Interval
<Version>	Description of parameters	Def. value	Def. unit	FW vers.
2 slots to 65534 slots	Sniff interval, even number of slots	2048	(slots)	V3.08
Description of command				Sig. State
This command defines an even number of slots between two consecutive so-called <i>sniff slots</i> where the DUT listens to the master signal and the R&S [®] CMU can start transmission.				≠ SNIF, Q: all

CONFigure:NETWork:SNIFf:ATTempT <Slots>				Sniff Attempts
<Version>	Description of parameters	Def. value	Def. unit	FW vers.
1 to 65535	Sniff interval	9	–	V3.08
Description of command				Sig. State
This command defines the minimum number of sniff attempts within each sniff interval. The number is usually set smaller than half the sniff interval (CONFigure:NETWork: SNIFf:INTerval).				≠ SNIFf, Q: all

CONFigure:NETWork:SNIFf:TOUT <Slots>				Sniff Timeout
<Version>	Description of parameters	Def. value	Def. unit	FW vers.
0 to 65535	Sniff timeout	5	–	V3.08
Description of command				Sig. State
This command defines the minimum number of consecutive receive slots where the DUT keeps listening to the master signal after receiving a packet with a matching AM_ADDR. The number is usually set smaller than half the sniff interval (CONFigure:NETWork:SNIFf:INTErval).				≠ SNIFf, Q: all

Subsystem NETWork:HOLD (HOLD Submode)

The subsystem *NETWork:HOLD* sets parameters to control the DUT while it is in the *HOLD* submode. It corresponds to the *Hold Mode* section of the *Network* tab in the popup menu *Connection Control*.

CONFigure:NETWork:HOLD:INTErval <Slots>				Hold Interval
<Version>	Description of parameters	Def. value	Def. unit	FW vers.
1 slot to 65535 slots	HOLD interval	5000	(slots)	V3.08
Description of command				Sig. State
This command defines a number of slots that the DUT remains in the <i>HOLD</i> state.				≠ HOLD, Q: all

Subsystem NETWork:PARK (PARK Submode)

The subsystem *NETWork:PARK* sets parameters to control the DUT while it is in the *PARK* submode. It corresponds to the *Park Mode* section of the *Network* tab in the popup menu *Connection Control*.

CONFigure:NETWork:PARK:BINTErval <Slots>				Beacon Interval
<Version>	Description of parameters	Def. value	Def. unit	FW vers.
1 slot to 65535 slots	Beacon interval	1600	(slots)	V3.10
Description of command				Sig. State
This command defines the beacon interval for the <i>PARK</i> mode.				≠ PARK, Q: all

Subsystem NETWork:TEST (Testmode)

The subsystem *NETWork:PARK* configures the behavior of the R&S® CMU in testmode for specific DUT characteristics. It corresponds to the *Test Mode – DUT Characteristics* section of the *Network* tab in the popup menu *Connection Control*.

CONFigure:NETWork:TEST:RLSettling <Time>				RX Level Settling Time
<Time>	Description of parameters	Def. value	Def. unit	FW vers.
0 ms to 200 ms	Settling time after a level change	0.1	s	V3.54
Description of command				Sig. State
This command sets a delay time between the activation of a new measurement and the start of data acquisition.				all

CONFigure:NETWork:TEST:TCPChange <Enable>		Test Ctrl on Packet Change		
<Mode>	Description of parameters	Def. value	Def. unit	FW vers.
ON OFF	Enable or disable test control command	ON	–	V3.54
Description of command				Sig. State
This command qualifies whether a new <i>Test Control Command</i> is set after a change of the packet type (DH1, DH3, DH5).				all

CONFigure:NETWork:TEST:SNBehaviour <Enable>		SEQN Behavior		
<Mode>	Description of parameters	Def. value	Def. unit	FW vers.
TEST NORM	Test mode behavior: SEQN bit with constant value Normal mode behavior: SEQN bit toggled	TEST	–	V3.54
Description of command				Sig. State
This command defines the sequential numbering scheme of the packets.				all

Subsystems INPut, OUTPut, CORRection:LOSS

The subsystems in this section contain the commands for configuration of the input and output connectors and the external attenuation factors. The subsystems correspond to the *RF*  tab in the popup menu *Connect. Control*.

INPut[:STATe] <State>		RF Input		
<State>	Description of parameters	Def. value	Def. unit	FW vers.
RF1 RF2 RF4	Connector RF 1 used as input Connector RF 2 used as input Connector RF 4 IN used as input	RF2	–	V2.60
Description of command				
This command determines the connector to be used for incoming RF signals. The bidirectional connectors RF 1 and RF 2 can be used both as input and output connectors in the same measurement (see <i>OUTPut[:STATe]</i>).				

OUTPut[:STATe] <State>		RF Output		
<State>	Description of parameters	Def. value	Def. unit	FW vers.
RF1 RF2 RF3	Connector RF 1 used as output Connector RF 2 used as output Connector RF 3 OUT used as output	RF2	–	V2.60
Description of command				
This command selects the connector to be used for outgoing RF signals. The bidirectional connectors RF 1 and RF 2 can be used both as input and output connectors in the same measurement.				

[SENSe:]CORRection:LOSS:INPut<nr>[:MAGNitude] <Absorption>		Ext. Att. Input		
<Absorption>	Description of parameters	Def. value	Def. unit	FW vers.
–50 dB to +90 dB	External input attenuation	0.0	dB	V2.60
Description of command				
This command assigns an external attenuation value to the inputs of the instrument (<i>RF 1, RF 2, RF 4 IN</i>).				

[SENSe:]CORREction:LOSS:OUTPut<nr>[:MAGNitude] <Absorption>				
SOURce:CORREction:LOSS:OUTPut<nr>[:MAGNitude] <Absorption>				Ext. Att. Output
<Absorption>	Description of parameters	Def. value	Def. unit	FW vers.
-50 dB to +90 dB	External input attenuation	0.0	dB	V2.60
Description of command				
This command assigns an external attenuation value to the inputs of the instrument (<i>RF 1, RF 2, RF 3 OUT</i>).				

ROUTE:SPENcoder[:INPut] <Source>					Speech Encoder
<Source>	Description of parameters	Def. value	Def. unit	FW vers.	
HANDset 	SPEECH CODEC IN connector is used as source	HAND	–	V3.08	
GENerator	AF generator is used as source				
Description of command					Sig. State
This command determines the input source that feeds the R&S CMU speech encoder.					≠ AUD, HFR, HEAD, HFAG, HAG Q: all

ROUTE:SPDecoder[:OUTPut] <Destination>					Speech Decoder
<Destination>	Description of parameters	Def. value	Def. unit	FW vers.	
HANDset 	Speech decoder output routed to the SPEECH CODEC OUT connector	HAND	–	V3.08	
ANALyzer 	Output routed to primary AF analyzer				
ANA2 	Output routed to secondary AF analyzer				
ABOth	Output routed to both AF analyzers				
Description of command					Sig. State
This command routes the R&S CMU speech decoder output.					≠ AUD, HFR, HEAD, HFAG, HAG Q: all

Subsystem DM:CLOCK (Synchronization)

The subsystem *DM:CLOCK* sets a system clock specific to the network. This frequency is set in the *Sync.* tab of the *Connect. Control* menu.

SOURce:DM:CLOCK:STATe <Mode>					REF OUT 2 on/off
<Mode>	Description of parameters	Def. value	Def. unit	FW vers.	
ON OFF	Switch on/off system clock	OFF	–	V2.60	
Description of command					
This commands switches the system clock specific to the network at the <i>REF OUT 2</i> connector on or off.					

SOURce:DM:CLOCK:FREQuency <Frequency>				REF OUT 2		
<Frequency>	Description of parameters	Def. value	Def. unit	FW vers.		
1.250 MHz to 40.000 MHz	Input value for reference frequency	13.333	MHz	V2.60		
Description of command						
This command defines the reference frequency applied to output <i>REF OUT 2</i> . The frequency entered is rounded to one of the following discrete values:						
40.000 MHz,	20.000 MHz,	13.333 MHz,	10.000 MHz,	8.000 MHz,	6.667 MHz,	5.714 MHz,
5.000 MHz,	4.444 MHz,	4.000 MHz,	3.636 MHz,	3.333 MHz,	3.077 MHz,	2.857 MHz,
2.667 MHz,	2.500 MHz,	2.353 MHz,	2.222 MHz,	2.105 MHz,	2.000 MHz,	1.905 MHz,
1.818 MHz,	1.739 MHz,	1.667 MHz,	1.600 MHz,	1.538 MHz,	1.481 MHz,	1.429 MHz,
1.379 MHz,	1.333 MHz,	1.290 MHz,	1.250 MHz			

Subsystem LElVel (Input Level)

The subsystem *LElVel* controls the level in the RF input signal path. It corresponds to the *Analyzer* tab in the popup menu *Connection Control*.

[SENSE:]LElVel:MODE <Mode>			Input level – Mode	
<Mode>	Description of parameters	Def. value	Def. unit	FW vers.
MANual 	Manual entry of maximum input level	MAN	-	V4.35
AUTomatic	Automatic setting corresponding to peak power of received bursts	AUT		V4.50
Description of command				
This command configures the RF analyzer for manual or automatic input path setting. In firmware versions <V4.50, the def. value is MANual.				

[SENSE:]LElVel:MAXimum <Level>				Max. Level
<Level>	Description of parameters	Def. value	Def. unit	FW vers.
-40 dBm to +53 dBm	Max. input level for RF 1	0.0	dBm	V2.60
-54 dBm to 39 dBm	Max. input level for RF 2	0.0	dBm	
-77 dBm to 0 dBm	Max. input level for RF 4 IN	0.0	dBm	
Description of command				Sig. State
This command defines the expected maximum RF input level and sets the input measurement path accordingly. The value range depends on the used RF input and the external attenuation.				all

[SENSE:]LElVel:ATTenuation <Mode>				Attenuation
<Mode>	Description of parameters	Def. value	Def. unit	FW vers.
NORMal 	Mixer level in normal range	NORMal	-	V2.60
LNOise 	Low noise (mixer level 10 dB higher than in normal setting)			
LDISortion	Low distortion (mixer level 10 dB lower than in normal setting)			
Description of command				Sig. State
This command tunes the RF analyzer for normal setting, low noise level (full dynamic range), or low distortion (high intermodulation spacing).				all

DEFAult:LEVel			Default Settings	
<Enable>	Description of parameters	Def. value	Def. unit	FW vers.
ON 	The parameters are set to their default values	ON	–	V2.60
OFF	Some or all parameters differ from the default values			
Description of command				Sig. State
If used as a setting command with the parameter <i>ON</i> this command sets all parameters of the subsystem to their default values (the setting <i>OFF</i> results in an error message). If used as a query the command returns whether all parameters are set to their default values (<i>ON</i>) or not (<i>OFF</i>).				all

Subsystem TRIGger (Trigger Mode)

The subsystem *TRIGger* defines the trigger mode. It corresponds to the *Trigger* tab in the popup menu *Connection Control*.

TRIGger[:SEQuence]:SOURce <Source>				Source
<Source>	Description of parameters	Def. value	Def. unit	FW vers.
SIGNalling 	The measurement is triggered by the signalling unit	SIGN	–	V2.60
RFPower 	Trigger by RF input signal level (TRIG:SEQ:THR, wide-band power trigger)			
IFPower	Trigger by IF signal level (TRIG:SEQ:THR, narrow-band power trigger)			
Description of command				Sig. State
This command determines the source of the trigger event for the measurements.				all

TRIGger[:SEQuence]:THREshold <Threshold>				Level
<Threshold>	Description of parameters	Def. value	Def. unit	FW vers.
LOW 	Low trigger threshold (<i>RF Max. Level</i> – 26 dB)	MEDium	–	V2.60
MEDium 	Medium trigger threshold (<i>RF Max. Level</i> – 16 dB)			
HIGH	High trigger threshold (<i>RF Max. Level</i> – 6 dB)			
Description of command				Sig. State
This command sets the RF input signal level at which the measurement is triggered relative to the maximum RF input level; see [SENSe:]LEVel:MAXimum. The setting takes effect for trigger source <i>RFPower</i> and <i>IFPower</i> only (see TRIG:SEQ:SOUR).				all

DEFAult:TRIGger[:SEQuence]			Default Settings	
<Enable>	Description of parameters	Def. value	Def. unit	FW vers.
ON 	The parameters are set to their default values	ON	–	V2.60
OFF	Some or all parameters differ from the default values			
Description of command				Sig. State
If used as a setting command with the parameter <i>ON</i> this command sets all parameters of the subsystem to their default values (the setting <i>OFF</i> results in an error message). If used as a query the command returns whether all parameters are set to their default values (<i>ON</i>) or not (<i>OFF</i>).				all

SINFo (Signalling information)

The subsystem *SINFo* contains the commands for requesting the characteristics of the device under test. The subsystem corresponds to the *Signalling Info* output table in the menu *Bluetooth Connection Control (Connected)*. The device characteristics do not actually represent a measured value, the values are provided by the device under test when a connection is established.

Note: *To speed up the connection it is possible to prevent the R&S® CMU from inquiring the DUT's properties (see command CONFigure:MSIGNAL:PAGING:RSINfo). In this case some of the signalling information retrieved with the SINFo commands is not available.*

[SENSe:]SINFo:NAME?				Device Name
<Name>	Description of parameters	Def. value	Def. unit	FW vers.
<string>	Device name string, up to 255 characters	""	-	V2.60
Description of command				Sig. State
This command is always a query. It returns a textual description of the DUT's name.				~CONN*)
*) Valid results are available when a connection is established, i.e. in the CONN, TEST, AUD, SNIF and HOLD states. This holds for all . . . SINFo . . . commands described in this section.				

[SENSe:]SINFo:VERsion? <LMP>, <Company>, <Device>				Version
<LMP>	Description of parameters	Def. value	Def. unit	
0 1,	LMP version according to Bluetooth spec., 1.0 or 1.1*)	NAN	-	
<Company>	Description of parameters	Def. value	Def. unit	
0 to 65535,	Company ID number, corresponding to a textual description (e.g. 0 = Ericsson; 1 = Nokia; 2 = Intel; 3 = IBM; 4 = Toshiba)	NAN	-	
<Device>	Description of parameters	Def. value	Def. unit	FW vers.
0 to 65535	Device version; company internal version number	NAN	-	V2.60
Description of command				Sig. State
This command is always a query. It returns the device's version and a code number for the manufacturer.				~CONN
*) Numbers 0 to 65535 are reserved. At present 0 or 1 are the only possible output values.				

[SENSe:]SINFo:COMPany? <Company>				Company Name
<Company>	Description of parameters	Def. value	Def. unit	
"<name>"	Company name, returned as a text string, e.g. "Rohde & Schwarz GmbH & Co. KG"	""	-	V3.80
Description of command				Sig. State
This command is always a query. It returns the company name of the device's manufacturer.				~CONN

[SENSe:]SINFo:BDAddress?			BD_Address	
<BD_Address>	Description of parameters	Def. value	Def. unit	FW vers.
	BD address of the device under test; 12 digit hex value, returned as:			V2.60
<6-digit hex value>,&br/><2-digit hex value>,&br/><4-digit hex value>,&br/>Description of command	Lower address part (LAP) Non-specific address part (NAP) Upper address part (UAP)	–, –, –	– – –	
This command is always a query. It returns the BD address of the device under test. The three address parts are preceded by #H to indicate the hex format.				Sig. State ~CONN

[SENSe:]SINFo:CLASs:SERvice?			Class of Device, Service Class	
Returned Value	Description of parameters	Def. value	Def. unit	FW vers.
"<Service_Class1>" "" , "<Service_Class2>" "" , ...	Identifier for service class or "", if service class is not supported	–"" , "" , ...	–	V2.60
Description of command				Sig. State
This command is always a query. It returns a list of the <i>Service Class</i> services supported by the device under test. For a Bluetooth device that supports all services the list will read: "Limited Discoverable Mode", "Networking", "Rendering", "Capturing", "Object Transfer", "Audio", "Telephony", "Information" If a service is not supported, the corresponding entry in the list is replaced by "".				~CONN

[SENSe:]SINFo:CLASs?			Class of Device	
Returned Values	Description of parameters	Def. value	Def. unit	FW vers.
<MajorDC> , <MinorDC>	Major device class Minor device class	– –	– –	V2.60
Description of command				Sig. State
This command is always a query. It returns the major and the minor device class of the DUT.				~CONN
For the major device class <MajorDC>, which describes the type of the DUT, one of the following values is returned:				
MISC	Miscellaneous	AUD	Audio	
COMP	Computer	PERI	Peripheral	
PHON	Phone	UNCL	Unclassified	
LAN	LAN Access Point			
For the minor device class <MinorDC>, which details the type of the DUT depending on the corresponding major device class (see Chapter 4), one of the following values is returned:				
UNCL	Unclassified	FULL	LAN — Fully available	
DESK	Computer — Desktop workstation	U17	LAN — 1-17% utilized	
SERV	Computer — Server-class computer	U33	LAN — 17-33% utilized	
HAND	Computer — Handheld PC/PDA	U50	LAN — 33-50% utilized	
PAL	Computer — Pal sized PC/PDA	U67	LAN — 50-67% utilized	
CELL	Phone — Cellular	U83	LAN — 67-83% utilized	
CORD	Phone — Cordless	U99	LAN — 83-99% utilized	
SMAR	Phone — Smart phone	HEAD	Audio — Device conforms to headset profile	
WIRE	Phone — Wired modem			

[SENSe:]SINFo:PAging? <Mode>, <Period>, <Repetition>		Page Scan Mode, Period and Repetition		
<Mode>	Description of parameters	Def. value	Def. unit	
MAND	Page scan mode <i>Mandatory</i>	–	–	
OPT1	Page scan mode <i>Optional 1</i>			
OPT2	Page scan mode <i>Optional 2</i>			
OPT3 ,	Page scan mode <i>Optional 3</i>			
<Period>	Description of parameters	Def. value	Def. unit	
P0	Scan Period P0	–	–	
P1	Scan Period P1			
P2 ,	Scan Period P2			
<Repetition>	Description of parameters	Def. value	Def. unit	FW vers.
R0	Scan Repetition R0	–	–	V2.60
R1	Scan Repetition R1			
R2	Scan Repetition R2			
Description of command				Sig. State
This command is always a query. It returns settings of the DUT's paging properties.				~CONN

[SENSe:]SINFo:FEATure:MS3S?		3-Slot Packets		
<State>	Description of parameters	Def. value	Def. unit	FW vers.
ON	The feature is supported	–	–	V2.60
OFF	The feature is not supported			
Description of command				Sig. State
This command is always a query. It returns whether or not the feature “3 slot packets” is supported by the DUT.				~CONN

[SENSe:]SINFo:FEATure:MS5S?		5-Slot Packets		
<State>	Description of parameters	Def. value	Def. unit	FW vers.
ON	The feature is supported	–	–	V2.60
OFF	The feature is not supported			
Description of command				Sig. State
This command is always a query. It returns whether or not the feature “5 slot packets” is supported by the DUT.				~CONN

[SENSe:]SINFo:FEATure:ENCRyption?		Encryption		
<State>	Description of parameters	Def. value	Def. unit	FW vers.
ON	The feature is supported	–	–	V2.60
OFF	The feature is not supported			
Description of command				Sig. State
This command is always a query. It returns whether or not the feature “Encryption” is supported by the DUT.				~CONN

[SENSe:]SINFo:FEATure:SOFFset?		Slot Offset		
<State>	Description of parameters	Def. value	Def. unit	FW vers.
ON	The feature is supported	–	–	V2.60
OFF	The feature is not supported			
Description of command				Sig. State
This command is always a query. It returns whether or not the feature “Slot offset” is supported by the DUT.				~CONN

[SENSe:]SINFo:FEATure:TACCuracy?		Timing Accuracy		
<State>	Description of parameters	Def. value	Def. unit	FW vers.
ON 	The feature is supported	–	–	V2.60
OFF	The feature is not supported			
Description of command				Sig. State
This command is always a query. It returns whether or not the feature “Timing accuracy” is supported by the DUT.				~CONN

[SENSe:]SINFo:FEATure:SWITCh?		Switch		
<State>	Description of parameters	Def. value	Def. unit	FW vers.
ON 	The feature is supported	–	–	V2.60
OFF	The feature is not supported			
Description of command				Sig. State
This command is always a query. It returns whether or not the feature “Switching between master and slave” is supported by the DUT.				~CONN

[SENSe:]SINFo:FEATure:HOLD?		Hold Mode		
<State>	Description of parameters	Def. value	Def. unit	FW vers.
ON 	The feature is supported	–	–	V2.60
OFF	The feature is not supported			
Description of command				Sig. State
This command is always a query. It returns whether or not the feature “Hold mode” is supported by the DUT.				~CONN

[SENSe:]SINFo:FEATure:SNIFf?		Sniff Mode		
<State>	Description of parameters	Def. value	Def. unit	FW vers.
ON 	The feature is supported	–	–	V2.60
OFF	The feature is not supported			
Description of command				Sig. State
This command is always a query. It returns whether or not the feature “Sniff mode” is supported by the DUT.				~CONN

[SENSe:]SINFo:FEATure:PAKk?		Park Mode		
<State>	Description of parameters	Def. value	Def. unit	FW vers.
ON 	The feature is supported	–	–	V2.60
OFF	The feature is not supported			
Description of command				Sig. State
This command is always a query. It returns whether or not the feature “Park mode” is supported by the DUT.				~CONN

[SENSe:]SINFo:FEATure:RSSI?		RSSI		
<State>	Description of parameters	Def. value	Def. unit	FW vers.
ON 	The feature is supported	–	–	V2.60
OFF	The feature is not supported			
Description of command				Sig. State
This command is always a query. It returns whether or not the feature “RSSI” is supported by the DUT.				~CONN

[SENSe:]SINFo:FEATure:PCONtrol?		Power Control		
<State>	Description of parameters	Def. value	Def. unit	FW vers.
ON 	The feature is supported	–	–	V2.60
OFF	The feature is not supported			
Description of command				Sig. State
This command is always a query. It returns whether or not the feature “Power control” is supported by the DUT.				~CONN

[SENSe:]SINFo:FEATure:CQDD?		Channel Quality Driven Data Rate		
<State>	Description of parameters	Def. value	Def. unit	FW vers.
ON 	The feature is supported	–	–	V2.60
OFF	The feature is not supported			
Description of command				Sig. State
This command is always a query. It returns whether or not the feature “Channel quality driven data rate” is supported by the DUT.				~CONN

[SENSe:]SINFo:FEATure:SCOLink?		SCO Link		
<State>	Description of parameters	Def. value	Def. unit	FW vers.
ON 	The feature is supported	–	–	V2.60
OFF	The feature is not supported			
Description of command				Sig. State
This command is always a query. It returns whether or not the feature “SCO link” is supported by the DUT.				~CONN

[SENSe:]SINFo:FEATure:HV2P?		HV2 packets		
<State>	Description of parameters	Def. value	Def. unit	FW vers.
ON 	The feature is supported	–	–	V2.60
OFF	The feature is not supported			
Description of command				Sig. State
This command is always a query. It returns whether or not the feature “HV2 packets” is supported by the DUT.				~CONN

[SENSe:]SINFo:FEATure:HV3P?		HV3 Packets		
<State>	Description of parameters	Def. value	Def. unit	FW vers.
ON 	The feature is supported	–	–	V2.60
OFF	The feature is not supported			
Description of command				Sig. State
This command is always a query. It returns whether or not the feature “HV3 packets” is supported by the DUT.				~CONN

[SENSe:]SINFo:FEATure:ULAW?		μ-law log		
<State>	Description of parameters	Def. value	Def. unit	FW vers.
ON 	The feature is supported	–	–	V2.60
OFF	The feature is not supported			
Description of command				Sig. State
This command is always a query. It returns whether or not the feature “μ-law log” is supported by the DUT.				~CONN

[SENSe:]SINFo:FEATure:ALAW?				A-law log
<State>	Description of parameters	Def. value	Def. unit	FW vers.
ON	The feature is supported	–	–	V2.60
OFF	The feature is not supported			
Description of command				Sig. State
This command is always a query. It returns whether or not the feature “A-law log” is supported by the DUT.				~CONN

[SENSe:]SINFo:FEATure:CVSD?				CVSD
<State>	Description of parameters	Def. value	Def. unit	FW vers.
ON	The feature is supported	–	–	V2.60
OFF	The feature is not supported			
Description of command				Sig. State
This command is always a query. It returns whether or not the feature “CVSD” is supported by the DUT.				~CONN

[SENSe:]SINFo:FEATure:PSCHeme?				Paging Scheme
<State>	Description of parameters	Def. value	Def. unit	FW vers.
ON	The feature is supported	–	–	V2.60
OFF	The feature is not supported			
Description of command				Sig. State
This command is always a query. It returns whether or not the feature “Optional paging scheme” is supported by the DUT.				~CONN

[SENSe:]SINFo:FEATure:TSData?				Transparent SCO Data
<State>	Description of parameters	Def. value	Def. unit	FW vers.
ON	The feature is supported	–	–	V3.08
OFF	The feature is not supported			
Description of command				Sig. State
This command is always a query. It returns whether or not the feature “Transparent SCO Data” is supported by the DUT.				~CONN

[SENSe:]SINFo:FEATure:FCLag?				Flow Control Lag
<State>	Description of parameters	Def. value	Def. unit	FW vers.
0 to 7	Flow control lag (3 bit value)	–	–	V3.08
Description of command				Sig. State
This command is always a query. It returns the 3 “Flow Control Lag” bits in decimal representation.				~CONN

[SENSe:]SINFo:FEATure:PSCHeme?				Paging Scheme
<State>	Description of parameters	Def. value	Def. unit	FW vers.
ON	The feature is supported	–	–	V2.60
OFF	The feature is not supported			
Description of command				Sig. State
This command is always a query. It returns whether or not the feature “Optional paging scheme” is supported by the DUT.				~CONN

[SENSe:]SINFo:FEATure:EA2Mbps?		EDR ACL 2 Mbps		
<State>	Description of parameters	Def. value	Def. unit	FW vers.
ON	The feature is supported	–	–	V3.60
OFF	The feature is not supported			
Description of command				Sig. State
This command is always a query. It returns whether or not the feature “EDR ACL 2 Mbps” is supported by the DUT.				~CONN

[SENSe:]SINFo:FEATure:EA3Mbps?		EDR ACL 3 Mbps		
<State>	Description of parameters	Def. value	Def. unit	FW vers.
ON	The feature is supported	–	–	V3.60
OFF	The feature is not supported			
Description of command				Sig. State
This command is always a query. It returns whether or not the feature “EDR ACL 3 Mbps” is supported by the DUT.				~CONN

[SENSe:]SINFo:FEATure:EA3Slot?		3-slot EDR ACL Packets		
<State>	Description of parameters	Def. value	Def. unit	FW vers.
ON	The feature is supported	–	–	V3.60
OFF	The feature is not supported			
Description of command				Sig. State
This command is always a query. It returns whether or not the feature “3-slot EDR ACL Packets” is supported by the DUT.				~CONN

[SENSe:]SINFo:FEATure:EA5Slot?		5-slot EDR ACL Packets		
<State>	Description of parameters	Def. value	Def. unit	FW vers.
ON	The feature is supported	–	–	V3.60
OFF	The feature is not supported			
Description of command				Sig. State
This command is always a query. It returns whether or not the feature “5-slot EDR ACL Packets” is supported by the DUT.				~CONN

[SENSe:]SINFo:FEATure:LFRequest?		All DUT Features		
Response	Description of parameters	Def. value	Def. unit	FW vers.
0 to 255,	Byte 0 in decimal representation	–	–	V3.08
...,	...			
0 to 255	Byte 7 in decimal representation			
Description of command				Sig. State
This command is always a query. It returns the complete feature list of the DUT according to the Bluetooth specification.				~CONN

[SENSe:]SINFo:FEATure:EA2Mbps?		EDR ACL 2 Mbps		
<State>	Description of parameters	Def. value	Def. unit	FW vers.
ON	The feature is supported	–	–	V2.60
OFF	The feature is not supported			
Description of command				Sig. State
This command is always a query. It returns whether or not the DUT supports the Enhanced Data Rate ACL 2Mbps mode.				~CONN

[SENSe:]SINFo:FEATure:EA3Mbps?		EDR ACL 3 Mbps		
<State>	Description of parameters	Def. value	Def. unit	FW vers.
ON	The feature is supported	–	–	V2.60
OFF	The feature is not supported			
Description of command				Sig. State
This command is always a query. It returns whether or not the DUT supports the Enhanced Data Rate ACL 3Mbps mode.				~CONN

[SENSe:]SINFo:FEATure:EA3Slot?		3-Slot EDR ACL Packets		
<State>	Description of parameters	Def. value	Def. unit	FW vers.
ON	The feature is supported	–	–	V2.60
OFF	The feature is not supported			
Description of command				Sig. State
This command is always a query. It returns whether or not the DUT supports 3-slot Enhanced Data Rate ACL packets.				~CONN

[SENSe:]SINFo:FEATure:EA5Slot?		5-Slot EDR ACL Packets		
<State>	Description of parameters	Def. value	Def. unit	FW vers.
ON	The feature is supported	–	–	V2.60
OFF	The feature is not supported			
Description of command				Sig. State
This command is always a query. It returns whether or not the DUT supports 5-slot Enhanced Data Rate ACL packets.				~CONN

ACLData (Exchange of Raw Data with the DUT)

The subsystem *ACLData* contains the commands for exchanging data between the R&S[®] CMU and the DUT using an ACL connection. The data stream may consist of user or control data, e.g. of audio data or HCI commands to be executed on the DUT. The subsystem has no equivalent in manual control.

Note 1: *Starting with firmware version V5.00, ACL data transfer via `SOURCE:ACLData` or `[SENSe:]ACLData` must be enabled explicitly using `SOURCE:ACLData:ENABLE`.*

In older firmware versions, the data transfer via `...:ACLData` is automatically enabled until an audio profile is active. With an active audio profile, any incoming ACL data is sent to the profile.

Note 2: *The `ACLData` commands require the R&S[®] CMU to have a “normal” ACL connection established (signalling state `CONN`; no data transfer is possible in the substates `TEST`, `AUDio`, `SNIFf`, `HOLD`, `PARK`). The instrument uses the HCI ACL data packet header*

information of the current connection (4 hex bytes to encode the 12-bit connection handle, 2-bit PB flag and 2-bit BC flag) and appends the user data.

Example: *PROC:SIGNall:ACT PAGE* Request a connection with the DUT
SOUR:ACLD "080010002003040001004000" Send data to the DUT.
 If the current HCI header is "00200C00", then the first data packet transferred reads
 00200C00080010002003...

SOURce:ACLDData:ENABLE <State>		Enable ACL Data Transfer		
<State>	Description of parameters	Def. value	Def. unit	FW vers.
ON 	Enable ACL data transfer via . . . :ACLDData	OFF	–	V5.00
OFF	Disable ACL data transfer via . . . :ACLDData			
Description of command				Sig. State
This command enables or disables the transfer of ACL data via SOURce:ACLDData or [SENSe:]ACLDData. With disabled ACL data transfer, incoming ACL data is routed to the audio profiles.				all

SOURce:ACLDData <Data>		Send ACL Data		
<Data>	Description of parameters	Def. value	Def. unit	FW vers.
"<string>"	Stream of hex bytes, e.g. "414243" is used to send "ABC", which is 65 66 67 decimal ASCII or 41 42 43 hex.	""	–	V3.50
Description of command				Sig. State
This command sends a stream of hex bytes to the DUT. The query returns the last data string sent to the DUT. The maximum size of the data string is 39 hex bytes (78 hexadecimal characters). The hex bytes take 2 characters and must not be separated by white space.				CONN

[SENSe:]ACLDData?		Receive ACL Data		
Return	Description of return values	Def. value	Def. unit	FW vers.
"<string>"	Stream of hex bytes	"- - -"	–	V3.50
Description of command				Sig. State
This command is always a query. It returns a stream of hex bytes received from the DUT. The maximum size of the data string is 39 hex bytes (78 hexadecimal characters).				CONN

WPOWer (Wideband Power)

The subsystem *WPOWer* contains the commands for measuring the peak power of the RF input signal using a wide-band filter. It corresponds to the softkey *Power* of the tab *Signalling* in the menu group *Connect. Control*.

Note:

In contrast to the measurement groups reported in the following sections, the WPOWer measurement can be performed in all signalling states.

INITiate:WPOWer	Start new measurement	⇒ <i>RUN</i>
ABORT:WPOWer	Abort running measurement and switch off	⇒ <i>OFF</i>
STOP:WPOWer	Stop measurement after current stat. cycle	⇒ <i>STOP</i>
CONTinue:WPOWer	Next measurement step (only <i>stepping mode</i>)	⇒ <i>RUN</i>
Description of command		Sig. State
These commands do not exist as queries. They start or stop the measurement, setting it to the status given in the top right column.		all
		FW vers.
		V2.60

CONFigure:WPOWer:EREPorting <Mode>		Event Reporting		
<Mode>	Description of parameters	Def. value	Def. unit	FW vers.
SRQ 	Service request	OFF	–	V2.60
SOPC 	Single operation complete			
SRSQ 	SRQ and SOPC			
OFF	No reporting			
Description of command				Sig. State
This command defines the events generated when the measurement is terminated or stopped (<i>event reporting</i> , see chapter 5 of CMU manual).				all

FETCh[:SCALar]:WPOWer:STATus?		Measurement Status		
<i>Return</i>	Description of parameters	Def. value	Def. unit	FW vers.
OFF 	Measurement in the <i>OFF</i> state (* <i>RST</i> or <i>ABORT</i>)	OFF	–	V2.60
RUN 	Running (after <i>INITiate</i> , <i>CONTinue</i> or <i>READ</i>)			
STOP 	Stopped (<i>STOP</i>)			
ERR 	<i>OFF</i> (could not be started)			
STEP 	Stepping mode (< <i>stepmode</i> >= <i>STEP</i>)			
RDY,	Stopped according to repetition mode and stop condition			
1 to 10000 	Counter for current statistics cycle			
NONE,	No counting mode set	NONE	–	
Description of command				Sig. State
This command is always a query. It returns the status of the measurement (see chapters 3 and 5 of CMU manual).				all

CONFigure:WPOWER:CONTRol:REPetition <Repetition>,<StopCond>,<Stepmode>				Test cycles
<Repetition>	Description of parameters	Def. value	Def. unit	
CONTInuous SINGleshot 1 to 10000	Continuous measurement (until STOP or ABORT) Single shot measurement (until Status = RDY) Multiple measurement (counting, until Status = STEP RDY)	SING	–	
<StopCond>	Description of parameters	Def. value	Def. unit	
NONE	Continue measurement even in case of error	NONE	–	
<Stepmode>	Description of parameters	Def. value	Def. unit	FW vers.
STEP NONE	Interrupt measurement after each statistics cycle Continue measurement according to its rep. mode	NONE	–	V2.60
Description of command				Sig. State
This command determines the number of statistics cycles, the stop condition and the stepping mode for the measurement.				all
<p>Note: In the case of READ commands (READ:...), the <Repetition> parameter has no effect; the measurement is always aborted after a single shot.</p> <p>The Repetition parameter is valid in remote control only. Changing this parameter in remote control does not alter the repetition mode in manual control and vice versa. The default repetition mode in manual control is Continuous.</p>				

READ[:SCALar]:WPOWER?		Start single shot measurement and return results		
FETCh[:SCALar]:WPOWER?		Read out measurement results (unsynchronized)		
SAMPle[:SCALar]:WPOWER?		Read out measurement results (synchronized)		
Return	Description of parameters	Def. value	Def. unit	FW vers.
–30.0 dBm to +30.0 dBm	Maximum burst power (not averaged)	NAN	dBm	V2.60
Description of command				Sig. State
These commands are always queries. They start the measurement of the peak power of the received RF signal and output the result.				all

POWER Measurements

The subsystem *POWER* covers two different power measurement applications:

- The *POWER:TIME* subsystem measures the DUT's output carrier power versus time. The subsystem corresponds to the measurement menu *Power* and the associated popup menu *Power Configuration*.
- The *POWER:MPR* subsystem measures the scalar *Power* and *Modulation* parameters simultaneously and has no equivalent in manual control.

Note:

In order to perform any kind of measurement and obtain a meaningful result, an appropriate test setup is required (see application examples in Chapter 2 of this manual). Consequently, for the measurements reported in this and the following sections, the CONNECTED signalling state must be reached before any of the commands retrieving test results (READ...?, FETCH...?, or CALCulate...LIMIT?) can be used. Test configurations, however, can be defined any time.

Subsystem POWER:TIME

The subsystem *POWER:TIME* measures the DUT's output carrier power versus time. The subsystem corresponds to the measurement menu *Power*, application *Output Power*, and the associated popup menu *Power Configuration*.

Measurement Control

The subsystem *POWER:TIME*... controls the power vs. time measurement. It corresponds to the softkey *Power/Time* in the measurement menu *Power* and the associated hotkeys.

INITiate:POWER:TIME	Start new measurement	⇒	<i>RUN</i>
ABORT:POWER:TIME	Abort measurement and switch off	⇒	<i>OFF</i>
STOP:POWER:TIME	Stop measurement after current stat. cycle	⇒	<i>STOP</i>
CONTinue:POWER:TIME	Next meas. step (only <i>stepping mode</i>)	⇒	<i>RUN</i>
Description of command		Sig. State	FW vers.
These commands have no query form. They start or stop the measurement, setting it to the status indicated in the top right column.		all	V2.60

CONFigure:POWER:TIME:EREPorting <Mode>		Event Reporting		
<Mode>	Description of parameters	Def. value	Def. unit	FW vers.
SRQ	Service request	OFF	–	V2.60
SOPC	Single operation complete			
SRSQ	SRQ and SOPC			
OFF	No reporting			
Description of command			Sig. State	
This command defines the events generated when the measurement is terminated or stopped (<i>event reporting</i> , see Chapter 5 of R&S CMU manual).			all	

FETCh[:SCALar]:POWer:TIME:STATus?			Measurement Status	
Returned values	Description of parameters	Def. value	Def. unit	FW vers.
OFF	Measurement in the <i>OFF</i> state (*RST or ABORT)	OFF	–	V2.60
RUN	Running (after INITiate, CONTinue or READ)			
STOP	Stopped (STOP)			
ERR	OFF (could not be started)			
STEP	Stepping mode (<stepmode>=STEP)			
RDY,	Stopped according to repetition mode and stop condition			
1 to 10000	Counter for current statistics cycle	NONE	–	
NONE,	No counting mode set			
0 to 1000	Counter for current evaluation period within a cycle	NONE	–	
NONE	Statistic count set to off			
Description of command				Sig. State
This command is always a query. It returns the status of the measurement (see Chapters 3 and 5 of R&S CMU manual).				all

CONFigure:POWer:TIME:MMODE <Mode>			Measurement Mode	
<Mode>	Description of parameters	Def. value	Def. unit	FW vers.
ALL	Measure and aggregate all channels of the current hop scheme	ALL	–	V2.60
SINGLE	Measure bursts from a definite channel only			
SIMultaneous	Simultaneous measurement on the five channels selected with CONFigure:POWer:TIME:MFRequency:SIMultaneous.			
Description of command				Sig. State
This command sets how many channels are to measured and whether the results are to be kept separate or aggregated. In <i>ALL</i> mode, the measurement is performed on every available burst, no matter what frequency it is on. In <i>SINGLE</i> mode, the R&S® CMU measures the channel selected via CONFigure:POWer:TIME:MFRequency. In <i>SIMultaneous</i> mode, the R&S® CMU acquires and returns five complete sets of results; see description of the READ:...POWer... and FETCh:...POWer... commands.				all

CONFigure:POWer:TIME:MFRequency:SIMultaneous <Meas_Freq_1>, ..., <Meas_Freq_5>			Simult. Meas. – Measured Ch.	
<Meas_Freq_1> to <Meas_Freq_5>	Description of parameters	Def. value	Def. unit	FW vers.
2 402 MHz to 2 495 MHz	Measured frequency	see below	Hz	V3.08
OFF	Measurement switched off			
Description of command				Sig. State
This command defines the five frequencies to be measured if the measurement mode is set to <i>SIMultaneous</i> (see command CONFigure:POWer:TIME:MMODE). With the command CONFigure:POWer:TIME:MFRequency:UNIT, the default frequency unit can be changed, and even <i>Bluetooth</i> channel numbers can be entered instead of frequencies. The default frequencies correspond to the channel sequence 0, 19, 39, 59, 78.				all

CONFigure:POWer:TIME:MFRrequency <Meas_Freq>			Single Meas. – Measured Ch.	
<Meas_Freq>	Description of parameters	Def. value	Def. unit	FW vers.
2 402 MHz to 2 495 MHz	Measured frequency	2 402 000 000	Hz	V2.60
Description of command				Sig. State
This command defines the frequency to be measured if the measurement mode is set to <code>SINGLE</code> (see command <code>CONFigure:POWer:TIME:MMode</code>). With the command <code>CONFigure:POWer:TIME:MFRrequency:UNIT</code> , the default frequency unit can be changed, and even <i>Bluetooth</i> channel numbers can be entered instead of frequencies.				all

CONFigure:POWer:TIME:MFRrequency:UNIT <Unit>			Frequency Unit	
<Unit>	Description of parameters	Def. value	Def. unit	FW vers.
HZ KHZ MHZ GHZ CH	Frequency unit Channel number	HZ	–	V2.60
Description of command				Sig. State
This command defines whether the measured frequency (see command <code>CONFigure:POWer:TIME:MFRrequency</code>) is specified in frequency units or as an <i>Bluetooth</i> channel number.				all

CONFigure:POWer:TIME:MRANge <Start>, 		Time Scale Start, Time Scale Span			
<Start>	Description of parameters	Def. value	Def. unit		
-200 bit to 3200 bit	Start of measurement range	-200	bit		
	Description of parameters	Def. value	Def. unit	FW vers.	
0.0625 to 5	Span of measurement range	1	(slots)	V2.60	
Description of command				Sig. State	
This command defines the measurement range for the POWer:TIME measurement. The second input value is rounded to one of the following discrete values:				all	
0.0625 (1/16 slot)	0.125 (1/8 slot)	0.25 (1/4 slot)	0.5 (1/2 slot)		
1 (slot)	2 (slots)	3 (slots)	4 (slots)	5 (slots)	
2- and 3-slot spans can not be set for 1-slot packets, 4- and 5-slot spans can not be set for 1- and 3-slot packets.					
The number of test points in the POWer measurement (i.e. the length of the arrays output via the READ:ARRay:POWer:TIME... commands) follows from the span, rounded again to correspond to an integer number of bits, and the sampling rate of the measurement. The latter depends on the packet length; it is, at most, 4 test points per bit for one-slot packets (DH1, see commands CONFigure:SSIGnal:TMODe:...PTYPE), 2 test points per bit for three-slot packets and 1 test point per bit for five-slot packets. If necessary the sampling rate is reduced by an appropriate factor to prevent that the number of test points exceeds the upper limit of 2500 (i.e. for of 2, 3, 4 and 5). This results in the following table:					
	0.0625	0.125	0.25	0.5	
Symbols	39	78	156	312	
No. of test points:					
1 slot packet types	157	313	625	1249	
3 slot packet types	49	157	313	625	
5 slot packet types	40	79	157	313	
	1	2	3	4	5
Symbols	625	1250	1875	2500	3125
No. of test points:					
1 slot packet types	2500	2500	2500	2500	2500
3 slot packet types	1251	2500	2500	2500	2500
5 slot packet types	626	1251	1876	2500	2500

Subsystem POWER:CONTROL

The subsystem *POWER:CONTROL* defines the repetition mode, statistic count, and stop condition of the measurement. These settings are provided in the *Control* tab of the popup menu *Power Configuration*.

CONFigure:POWER:TIME:CONTROL <Mode>, <Statistics>, <Repetition>, <StopCond>, <Stepmode>				Scope of Measurement
<Mode>	Description of parameters	Def. value	Def. unit	
SCALar ARRay,	Scalar values only (incl. limit matching) Scalar measured values and arrays	ARRay	–	
<Statistics>	Description of parameters	Def. value	Def. unit	
1 to 1000 NONE	Number of bursts per statistics cycle Statistics off	100	–	
<Repetition>	Description of parameters	Def. value	Def. unit	
CONTInuous SINGleshot 1 to 10000,	Continuous measurement (until STOP or ABORT) Single shot measurement (until Status = RDY) Multiple measurement (counting, until Status = STEP RDY)	SING	–	
<StopCond>	Description of parameters	Def. value	Def. unit	
SONerror NONE,	Stop measurement in case of error (stop on error) Continue measurement even in case of error	NONE	–	
<Stepmode>	Description of parameters	Def. value	Def. unit	FW vers.
STEP NONE	Interrupt measurement after each statistics cycle Continue measurement according to its rep. mode	NONE	–	V2.60
Description of command				Sig. State
This command restricts the type of measured values to accelerate the measurement and determines the number of bursts within a statistics cycle.				all
Note: In the case of READ commands (READ:...), the <Repetition> parameter has no effect; the measurement is always stopped after a single shot.				
The <i>Repetition</i> parameter is valid in remote control only. Changing this parameter in remote control does not alter the repetition mode in manual control and vice versa. The default repetition mode in manual control is <i>Continuous</i> .				

CONFigure:POWER:TIME:CONTROL:RMODE <Mode>				Result mode
<Mode>	Description of parameters	Def. value	Def. unit	FW vers.
SCALar ARRay	Scalar values only (incl. limit matching) Scalar measured values and arrays available	ARRay	–	V2.60
Description of command				Sig. State
This command specifies the type of measured values. If the parameter SCALar is set, the measurement curves (arrays, see commands READ:ARRay:POWER:TIME... , READ:SUBarray:POWER:TIME...) are no longer available but the measurement is speeded up considerably.				all

CONFigure:POWER:TIME:CONTRol:STATistics <Statistics>				Statistics Count
<Statistics>	Description of parameters	Def. value	Def. unit	FW vers.
1 to 1000	Number of bursts per statistics cycle	100	–	V2.60
NONE	Statistics off			
Description of command				Sig. State
This command specifies the type of measured values and defines the number of bursts forming a statistics cycle.				all

CONFigure:POWER:TIME:CONTRol:REPetition <Repetition>, <StopCond>, <Stepmode>				Test Cycles
<Repetition>	Description of parameters	Def. value	Def. unit	
CONTinuous	Continuous measurement (until STOP or ABORT)	SING	–	
SINGleshot	Single shot measurement (until Status = RDY)			
1 to 10000	Multiple measurement (counting, until Status = STEP RDY)			
<StopCondition>	Description of parameters	Def. value	Def. unit	
SONerror	Stop measurement in case of error (stop on error)	NONE	–	
NONE	Continue measurement even in case of error			
<Stepmode>	Description of parameters	Def. value	Def. unit	FW vers.
STEP	Interrupt measurement after each statistics cycle	NONE	–	V2.60
NONE	Continue measurement according to its rep. mode			
Description of command				Sig. State
This command determines the number of statistics cycles, the stop condition and the stepping mode for the measurement.				all
Note: In the case of READ commands (READ:…), the <Repetition> parameter has no effect; the measurement is always stopped after a single shot.				
The <i>Repetition</i> parameter is valid in remote control only. Changing this parameter in remote control does not alter the repetition mode in manual control and vice versa. The default repetition mode in manual control is <i>Continuous</i> .				

DEFault:POWER:TIME:CONTRol				Default Settings
<Enable>	Description of parameters	Def. value	Def. unit	FW vers.
ON	The parameters are set to their default values	ON	–	V2.60
OFF	The parameters differ from the default values (partially or totally)			
Description of command				Sig. State
If used as a setting command with the parameter ON this command sets all parameters of the subsystem to their default values (the setting OFF results in an error message).				all
If used as a query the command returns whether all parameters are set to their default values (ON) or not (OFF).				

Test Configuration

The commands of the following subsystems determine the parameters of the signal power measurement. They correspond to the *Power Configuration* popup menu.

Subsystem POWER...:LIMit

The subsystem *POWER...:LIMit* defines the limit values for the power measurement. The subsystem corresponds to the tab *Limits* in the popup menu *Power Configuration*.

Upper Power Limits				
CONFigure:POWer:TIME:CURRent:LIMit:SCALAr:ASYMmetric:UPPer:VALue CONFigure:POWer:TIME:AVERAge:LIMit:SCALAr:ASYMmetric:UPPer:VALue CONFigure:POWer:TIME:MAXimum:LIMit:SCALAr:ASYMmetric:UPPer:VALue CONFigure:POWer:TIME:MINimum:LIMit:SCALAr:ASYMmetric:UPPer:VALue <Nom_Power>, <Leak_Power>, <Peak_Power>				
Parameters	Description of parameters	Def. value	Def. unit	FW vers.
-10 dBm to +30 dBm,	Upper limit for nominal power	+4.0	dBm	V2.60
-120 dBm to 0 dBm	Upper limit for leakage power	-40 *)	dBm	
-10 dBm to +30 dBm	Upper limit for peak power	+23.0	dBm	
Description of command				Sig. State
These commands define upper limits for the nominal, leakage and peak power of the current (CURRent), average (AVERAge), minimum (MINimum), and maximum (MAXimum) measurement curve, respectively. If a measurement rises above the limit then the result will be out of tolerance. OFF means that the limit check is disabled.				all
*) By default the limit check is effectively disabled.				

Upper Limits on or off				
CONFigure:POWer:TIME:CURRent:LIMit:SCALAr:ASYMmetric:UPPer:ENABLE <Mode> CONFigure:POWer:TIME:AVERAge:LIMit:SCALAr:ASYMmetric:UPPer:ENABLE <Mode> CONFigure:POWer:TIME:MAXimum:LIMit:SCALAr:ASYMmetric:UPPer:ENABLE <Mode> CONFigure:POWer:TIME:MINimum:LIMit:SCALAr:ASYMmetric:UPPer:ENABLE <Mode>				
<Mode>	Description of parameters	Def. value	Def. unit	FW vers.
ON OFF,	Enable/disable upper limit check for nominal power	ON	-	V2.60
ON OFF,	Enable/disable upper limit check for leakage power	OFF	-	
ON OFF	Enable/disable upper limit check for peak power	ON	-	
Description of command				Sig. State
These commands enable or disable the upper limit check for the nominal, leakage and peak power.				all

Lower Power Limits				
CONFigure:POWer:TIME:CURRent:LIMit:SCALAr:ASYMmetric:LOWer:VALue CONFigure:POWer:TIME:AVERAge:LIMit:SCALAr:ASYMmetric:LOWer:VALue CONFigure:POWer:TIME:MAXimum:LIMit:SCALAr:ASYMmetric:LOWer:VALue CONFigure:POWer:TIME:MINimum:LIMit:SCALAr:ASYMmetric:LOWer:VALue <Nom_Power>, <Leak_Power>, <Peak_Power>				
<Limit>	Description of parameters	Def. value	Def. unit	FW vers.
-10 dBm to +30 dBm,	Lower limit for nominal power	-6.0	dBm	V2.60
-120 dBm to 0 dBm,	Lower limit for leakage power	-120 *)	dBm	
-10 dBm to +30 dBm	Lower limit for peak power	-5 *)	dBm	
Description of command				Sig. State
These commands define lower limits for the nominal, leakage and peak power of the current (CURRent), average (AVERAge), minimum (MINimum), and maximum (MAXimum) measurement curve, respectively. If a measurement falls below the limit then the result will be out of tolerance. OFF means that the limit check is disabled.				all
*) By default the limit check is effectively disabled.				

CONFigure:POWER:TIME:CURRent:LIMit:SCALar:ASYMmetric:LOWer:ENABLE <Mode>
CONFigure:POWER:TIME:AVERAge:LIMit:SCALar:ASYMmetric:LOWer:ENABLE <Mode>
CONFigure:POWER:TIME:MAXimum:LIMit:SCALar:ASYMmetric:LOWer:ENABLE <Mode>
CONFigure:POWER:TIME:MINimum:LIMit:SCALar:ASYMmetric:LOWer:ENABLE <Mode>

Lower Limits on or off

<Mode>	Description of parameters	Def. value	Def. unit	FW vers.
ON OFF,	Enable/disable lower limit check for nominal power	ON	–	V2.60
ON OFF,	Enable/disable lower limit check for leakage power	OFF	–	
ON OFF	Enable/disable lower limit check for peak power	OFF	–	
Description of command				Sig. State
These commands enable or disable the lower limit check for the nominal, leakage and peak power.				all

CONFigure:POWER:TIME:CURRent:LIMit:SCALar:ASYMmetric[:COMBined]:VALue <Limit>
CONFigure:POWER:TIME:AVERAge:LIMit:SCALar:ASYMmetric[:COMBined]:VALue <Limit>
CONFigure:POWER:TIME:MAXimum:LIMit:SCALar:ASYMmetric[:COMBined]:VALue <Limit>
CONFigure:POWER:TIME:MINimum:LIMit:SCALar:ASYMmetric[:COMBined]:VALue <Limit>
**<Nom_Power_Upp>, <Nom_Power_Low>, <Leak_Power_Upp>,
 <Leak_Power_Low>, <Peak_Power_Upp>, <Peak_Power_Low>**

Upper and Lower Power Limits

<Limit>	Description of parameters	Def. value	Def. unit	FW vers.
–10 dBm to +30 dBm,	Upper limit for nominal power	+4.0	dBm	V2.60
–120 dBm to 0 dBm,	Lower limit for nominal power	–6.0	dBm	
–10 dBm to +30 dBm,	Upper limit for leakage power	–40 *)	dBm	
–10 dBm to +30 dBm,	Lower limit for leakage power	–120 *)	dBm	
–120 dBm to 0 dBm,	Upper limit for peak power	+23.0	dBm	
–10 dBm to +30 dBm	Lower limit for peak power	–5 *)	dBm	
Description of command				Sig. State
These commands define lower limits for the nominal, leakage and peak power of the current (CURRent), average (AVERAge), minimum (MINimum), and maximum (MAXimum) measurement curve, respectively. OFF means that the limit check is disabled.				all
*) By default the limit check is effectively disabled.				

CONFigure:POWER:TIME:CURRent:LIMit:SCALar:ASYMmetric[:COMBined]:ENABLE <Mode>
CONFigure:POWER:TIME:AVERAge:LIMit:SCALar:ASYMmetric[:COMBined]:ENABLE <Mode>
CONFigure:POWER:TIME:MAXimum:LIMit:SCALar:ASYMmetric[:COMBined]:ENABLE <Mode>
CONFigure:POWER:TIME:MINimum:LIMit:SCALar:ASYMmetric[:COMBined]:ENABLE <Mode>

Upper and Lower Limits on or off

<Mode>	Description of parameters	Def. value	Def. unit	FW vers.
ON OFF,	Enable or disable upper limit check for nominal power	ON	–	V2.60
ON OFF,	Enable or disable lower limit check for nominal power	ON	–	
ON OFF,	Enable or disable upper limit check for leakage power	OFF	–	
ON OFF,	Enable or disable lower limit check for leakage power	OFF	–	
ON OFF,	Enable or disable upper limit check for peak power	ON	–	
ON OFF	Enable or disable lower limit check for peak power	ON	–	
Description of command				Sig. State
These commands enable or disable the upper and lower limit check for the nominal, leakage and peak power.				all

CONFigure:POWer:TIME:PTIMing:CURRent:LIMit:SCALar:ASYMmetric:UPPer:VALue <Limit>
CONFigure:POWer:TIME:PTIMing:AVERAge:LIMit:SCALar:ASYMmetric:UPPer:VALue <Limit>
CONFigure:POWer:TIME:PTIMing:MAXimum:LIMit:SCALar:ASYMmetric:UPPer:VALue <Limit>
CONFigure:POWer:TIME:PTIMing:MINimum:LIMit:SCALar:ASYMmetric:UPPer:VALue <Limit>

Upper Limits for Packet Timing

<Limit>	Description of parameters	Def. value	Def. unit	FW vers.
-15 µs to 15 µs	Upper limit for packet timing	+10 ^{*)}	µs	V3.11
Description of command				Sig. State
These commands define upper limits for the packet timing of the current (CURRent), average (AVERAge), minimum (MINimum), and maximum (MAXimum) measurement curve, respectively. If a measurement rises above the limit then the result will be out of tolerance. OFF means that the limit check is disabled.				all
*) By default the limit check is effectively disabled.				

CONFigure:POWer:TIME:PTIMing:CURRent:LIMit:SCALar:ASYMmetric:UPPer:ENABLE <Mode>
CONFigure:POWer:TIME:PTIMing:AVERAge:LIMit:SCALar:ASYMmetric:UPPer:ENABLE <Mode>
CONFigure:POWer:TIME:PTIMing:MAXimum:LIMit:SCALar:ASYMmetric:UPPer:ENABLE <Mode>
CONFigure:POWer:TIME:PTIMing:MINimum:LIMit:SCALar:ASYMmetric:UPPer:ENABLE <Mode>

Upper Limits on or off

<Mode>	Description of parameters	Def. value	Def. unit	FW vers.
ON OFF	Enable or disable the upper limit check	OFF	–	V3.11
Description of command				Sig. State
These commands enable or disable the upper limit check for the packet timing.				all

CONFigure:POWer:TIME:PTIMing:CURRent:LIMit:SCALar:ASYMmetric:LOWer:VALue <Limit>
CONFigure:POWer:TIME:PTIMing:AVERAge:LIMit:SCALar:ASYMmetric:LOWer:VALue <Limit>
CONFigure:POWer:TIME:PTIMing:MAXimum:LIMit:SCALar:ASYMmetric:LOWer:VALue <Limit>
CONFigure:POWer:TIME:PTIMing:MINimum:LIMit:SCALar:ASYMmetric:LOWer:VALue <Limit>

Lower Limits for Packet Timing

<Limit>	Description of parameters	Def. value	Def. unit	FW vers.
-15 µs to 15 µs	Lower limit for packet timing	-10 ^{*)}	µs	V3.11
Description of command				Sig. State
These commands define lower limits for the packet timing of the current (CURRent), average (AVERAge), minimum (MINimum), and maximum (MAXimum) measurement curve, respectively. If a measurement falls below the limit then the result will be out of tolerance. OFF means that the limit check is disabled.				all
*) By default the limit check is effectively disabled.				

CONFigure:POWer:TIME:PTIMing:CURRent:LIMit:SCALar:ASYMmetric:LOWer:ENABLE <Mode>
CONFigure:POWer:TIME:PTIMing:AVERAge:LIMit:SCALar:ASYMmetric:LOWer:ENABLE <Mode>
CONFigure:POWer:TIME:PTIMing:MAXimum:LIMit:SCALar:ASYMmetric:LOWer:ENABLE <Mode>
CONFigure:POWer:TIME:PTIMing:MINimum:LIMit:SCALar:ASYMmetric:LOWer:ENABLE <Mode>

Lower Limits on or off

<Mode>	Description of parameters	Def. value	Def. unit	FW vers.
ON OFF	Enable or disable the entire limit check	OFF	–	V3.11
Description of command				Sig. State
These commands enable or disable the upper and lower limit check for the packet timing.				all

CONFigure:POWer:TIME:PTIMing:CURRent:LIMit:SCALar:ASYMmetric[:COMBined]:VALue CONFigure:POWer:TIME:PTIMing:AVERAge:LIMit:SCALar:ASYMmetric[:COMBined]:VALue CONFigure:POWer:TIME:PTIMing:MAXimum:LIMit:SCALar:ASYMmetric[:COMBined]:VALue CONFigure:POWer:TIME:PTIMing:MINimum:LIMit:SCALar:ASYMmetric[:COMBined]:VALue <Upper>,<Lower> Upper and Lower Limits for Packet Timing				
Parameters	Description of parameters	Def. value	Def. unit	FW vers.
-15 µs to 15 µs,	Upper limit for packet timing	+10 ^{*)}	µs	V3.11
-15 µs to 15 µs	Lower limit for packet timing	-10 ^{*)}	µs	
Description of command				Sig. State
These commands define upper and lower limits for the packet timing of the current (CURRent), average (AVERAge), minimum (MINimum), and maximum (MAXimum) measurement curve, respectively. OFF means that the limit check is disabled.				all
*) By default the limit check is effectively disabled.				

CONFigure:POWer:TIME:PTIMing:CURRent:LIMit:SCALar:ASYMmetric[:COMBined]:ENABLE CONFigure:POWer:TIME:PTIMing:AVERAge:LIMit:SCALar:ASYMmetric[:COMBined]:ENABLE CONFigure:POWer:TIME:PTIMing:MAXimum:LIMit:SCALar:ASYMmetric[:COMBined]:ENABLE CONFigure:POWer:TIME:PTIMing:MINimum:LIMit:SCALar:ASYMmetric[:COMBined]:ENABLE <Mode> Upper and Lower Limits on or off				
<Mode>	Description of parameters	Def. value	Def. unit	FW vers.
ON OFF,	Enable or disable the upper limit check	OFF	-	V3.11
ON OFF	Enable or disable the lower limit check	OFF	-	
Description of command				Sig. State
These commands enable or disable the upper and lower limit check for the packet timing.				all

DEFault:POWer:TIME:LIMit Default Settings				
<Enable>	Description of parameters	Def. value	Def. unit	FW vers.
ON	The parameters are set to their default values	ON	-	V2.60
OFF	The parameters differ from the default values (partially or totally)			
Description of command				Sig. State
If used as a setting command with the parameter ON this command sets all parameters of the subsystem to their default values (the setting OFF results in an error message).				all
If used as a query the command returns whether all parameters are set to their default values (ON) or not (OFF).				

Subsystem SUBarrays:POWER:TIME

The subsystem *SUBarrays:POWER:TIME* defines the measurement range and the type of output values.

CONFigure:SUBarrays:POWER:TIME		Definition of Subarrays		
<Mode>,<Start>,<Samples>{,<Start>,<Samples>}				
<Mode>	Description of parameters	Def. value	Def. unit	FW vers.
ALL 	Return all measurement values	ALL	–	V2.60
ARITHmetical 	Return arithm. mean value in every subrange			
MINimum 	Return minimum value in every subrange			
MAXimum 	Return maximum value in every subrange			
IVAL 	Return single interpolated value at <Start>			
XMAXimum 	Return x-axis value of maximum and maximum			
XMINimum 	Return x-axis value of minimum and minimum			
PAVG,	Return arithmetic mean value in every subrange			V5.00
<Start>	Description of parameters	Def. value	Def. unit	
–200 bit to 3200 bit,	Start time in current range	NAN	bit	
<Samples>	Description of parameters	Def. value	Def. unit	
1 to 2500	No. of samples in range	NAN 2500	–	
Description of command				Sig. State
<p>This command configures the <code>READ:SUBarrays:POWER:TIME...</code>, <code>FETCH:SUBarrays:POWER:TIME...</code> commands. It restricts the measurement to up to 32 subranges where either all measurement results (the number of which is given by the second numerical parameter) or a single statistical value is returned. The subranges are defined by a start time and the number of test points which are located on a fixed, equidistant grid.</p> <p>For <Mode> = IVAL, the <Samples> parameter is ignored and the R&S CMU returns a single measurement value corresponding to the abscissa value <Start>. If <Start> is located between two test points with valid results then the result is calculated from the results at these two adjacent test points by linear interpolation.</p> <p>The subranges may overlap but must be within the total range of the <i>POWER:TIME</i> measurement defined via <code>CONFigure:POWER:TIME:MRANge</code>. Test points outside this range are not measured (result <i>NAN</i>) and do not enter into the <i>ARITHmetical</i>, <i>MINimum</i> and <i>MAXimum</i> values. By default, only one range corresponding to the total measurement range is used and all measurement values are returned.</p>				all

Measured Values

The commands in the following section determine and return the results of the power versus time measurement. They correspond to the graphical menu *Power* with its various display elements.

				Scalar results:	
READ[:SCALar]:POWER:TIME?				Start single shot measurement and return results	
FETCh[:SCALar]:POWER:TIME?				Read out measurement results (unsynchronized)	
Returned values	Description of parameters	Def. value	Def. unit	FW vers.	
-128 dBm to 30 dBm,	Nominal power for current meas. curve	NAN	dBm	V2.60	
-128 dBm to 30 dBm,	Nominal power for average curve	NAN	dBm		
-128 dBm to 30 dBm,	Nominal power for minimum curve	NAN	dBm		
-128 dBm to 30 dBm,	Nominal power for maximum curve	NAN	dBm		
-128 dBm to 30 dBm,	Leakage power (x4)	NAN	dBm		
-128 dBm to 30 dBm,	Peak power (x4)	NAN	dBm		
-20 µs to 20 µs,	Packet timing (x4)	NAN	µs		
0% to 100%,	Burst out of tolerance (power)	NAN	%		
0% to 100%	Burst out of tolerance (packet timing)	NAN	%		
Description of commands				Sig. State	
<p>These commands are always queries. They start a measurement (<code>READ . . .</code>) and return all scalar measurement results. The symbol (x4) behind a value indicates that the list contains four results corresponding to the <i>Current</i>, the <i>Average</i>, the <i>Minimum</i>, and the <i>Maximum</i> measurement curve, respectively.</p> <ul style="list-style-type: none"> • <code>READ</code> starts a single shot measurement and returns the results. • <code>FETCh</code> outputs the results without taking care of the measurement state. <p>The meaning and the number of the returned values depends on the measurement mode set via <code>CONFigure:POWer:TIME:MMODE</code></p> <ul style="list-style-type: none"> • In the <code>ALL</code> mode, the R&S® CMU measures all channels and returns the average result. • In <code>SINGLE</code> mode, the R&S® CMU measures the channel selected via <code>CONFigure:POWer:TIME:MFRequency</code> and returns the corresponding result. • In <code>SIMultaneous</code> mode, the R&S® CMU acquires and returns five complete sets of results corresponding to the five channels selected with <code>CONFigure:POWer:TIME:MFRequency:SIMultaneous..</code> This means that the whole list described in the <i>Returned Values</i> column above is repeated five times. <p>For more details refer to the description of aggregated and separate channels in Chapter 4.</p>				TEST, CONN	

CALCulate[:SCALar]:POWER:TIME:MATChing:LIMit?		Scalar Limit Matching										
<Result>	Description of parameters	Def. value	Def. unit	FW vers.								
Nominal Power (4x), Leakage Power (4x), Peak Power (4x), Packet Timing (4x)	For all measured values: NMAU NMAL INV OK	INV INV INV INV	–	V2.60								
Description of commands				Sig. State								
<p>This command is always a query. It indicates whether and in which way the permissible tolerances for the scalar measured values (see commands above) have been exceeded. The symbol (x4) behind a value indicates that the list contains four results corresponding to the <i>Current</i>, the <i>Average</i>, the <i>Minimum</i>, and the <i>Maximum</i> measurement curve, respectively.</p> <p>Possible values are:</p> <table border="0"> <tr> <td>NMAU</td> <td>Result is above the limit</td> </tr> <tr> <td>NMAL</td> <td>Result is below the limit</td> </tr> <tr> <td>INV</td> <td>Result is invalid</td> </tr> <tr> <td>OK</td> <td>Result is valid</td> </tr> </table> <p>The meaning and the number of the returned values depends on the measurement mode set via <code>CONFigure:POWER:TIME:MMODE</code>; see description of <code>READ...?</code>, <code>FETCH...?</code> commands above.</p>				NMAU	Result is above the limit	NMAL	Result is below the limit	INV	Result is invalid	OK	Result is valid	TEST, CONN
NMAU	Result is above the limit											
NMAL	Result is below the limit											
INV	Result is invalid											
OK	Result is valid											

READ:ARRay:POWER:TIME:CURRent? READ:ARRay:POWER:TIME:AVERAge? READ:ARRay:POWER:TIME:MAXimum? READ:ARRay:POWER:TIME:MINimum? FETCH:ARRay:POWER:TIME:CURRent? FETCH:ARRay:POWER:TIME:AVERAge? FETCH:ARRay:POWER:TIME:MAXimum? FETCH:ARRay:POWER:TIME:MINimum?		Burst Power		
		Start single shot measurement and return results		
		Read measurement results (unsynchronized)		
Returned values	Description of parameters	Def. value	Def. unit	FW vers.
–128.0 dB to + 30.0 dB	BurstPower[1], 1 st value for burst power	NAN	dB	V2.60
...	
–128.0 dB to + 30.0 dB	BurstPower[n], n th value for burst power	NAN	dB	
Description of command				Sig. State
<p>These commands are always queries. They return the burst power versus time at fixed, equidistant test points. The total number n of samples and their position on the time axis depends on the measurement range and the packet type. For an overview see command <code>CONFigure:POWER:TIME:MRANge</code>.</p> <p>The meaning of the returned values depends on the measurement mode set via <code>CONFigure:POWER:TIME:MMODE</code>:</p> <ul style="list-style-type: none"> In ALL mode, the R&S® CMU measures all available channels and returns the trace averaged over all these channels. In SINGLE mode, the R&S® CMU measures the channel selected via <code>CONFigure:POWER:TIME:MFRequency</code> and returns the corresponding trace. In SIMultaneous mode, the R&S® CMU measures the channels selected with <code>CONFigure:POWER:TIME:MFRequency:SIMultaneous</code> and returns the trace averaged over these channels. <p>The calculation of <i>current</i>, <i>average</i>, <i>maximum</i> and <i>minimum</i> values is explained in Chapter 3 (<i>display mode</i>).</p>				TEST, CONN

READ:SUBarrays:POWER:TIME:CURRENT? READ:SUBarrays:POWER:TIME:AVERAGE? READ:SUBarrays:POWER:TIME:MAXIMUM? READ:SUBarrays:POWER:TIME:MINIMUM? FETCH:SUBarrays:POWER:TIME:CURRENT? FETCH:SUBarrays:POWER:TIME:AVERAGE? FETCH:SUBarrays:POWER:TIME:MAXIMUM? FETCH:SUBarrays:POWER:TIME:MINIMUM?		Subarray Results		
		Start single shot measurement and return results		
		Read measurement results (unsynchronized)		
<i>Ret. values per subrange</i>	Description of parameters	Def. value	Def. unit	FW vers.
-128.0 dB... + 30.0 dB	BurstPower[1], 1 st value for burst power	NAN	dB	V2.60
...	
-128.0 dB... + 30.0 dB	BurstPower[n], nth value for burst power	NAN	dB	
Description of command				Sig. State
<p>These commands are always queries. They output the burst power versus time in the subranges defined by means of the <code>CONFigure:SUBarrays:POWER:TIME</code> command. A valid subrange must be defined before the <code>READ:SUBarrays...</code>, <code>FETCH:SUBarrays...</code> command group can be used.</p> <p>The <code>CONFigure:SUBarrays:POWER:TIME</code> command defines a maximum of 32 subranges. If one of the statistical modes (<code>ARITHmetical</code>, <code>MINimum</code>, <code>MAXimum...</code>) is set, only one value is returned per subrange.</p> <p>The calculation of <i>current</i>, <i>average</i>, <i>minimum</i>, and <i>maximum</i> results is explained in Chapter 3 (see <i>display mode</i>).</p>				TEST, CONN

POWER:MPR Measurement

The subsystem *POWER:MPR* combines the *MODulation* and *POWER* systems, i.e. it measures the scalar *Modulation* and *Power* parameters simultaneously. The subsystem contains all commands for measurement control and for the output of measurement results. Configurations such as limits must be defined separately in the *POWER:TIME* and *MODulation:DEVIation* systems.

Due to the restriction to scalar results, the combined *POWER:MPR* measurement is quicker than the separate *POWER:TIME* and *MODulationDEVIation* measurements and should be used whenever the measurement curves (arrays) are not needed. It corresponds to the *Modulation Power* measurement control softkey and the associated output fields in the *Overview* measurement menu.

Measurement Control

The commands in this section control the combined power and modulation measurement.

INITiate:POWER:MPR	Start new measurement	⇒ <i>RUN</i>
ABORT:POWER:MPR	Abort running measurement and switch off	⇒ <i>OFF</i>
STOP:POWER:MPR	Stop measurement after current stat. cycle	⇒ <i>STOP</i>
CONTinue:POWER:MPR	Next meas. step (only <i>stepping mode</i>)	⇒ <i>RUN</i>
Description of command		Sig. State
These commands have no query form. They start and stop the combined power and modulation measurement, setting it to the status indicated in the top right column.		all
		FW vers.
		V2.65

CONFigure:POWER:MPR:EREPorting <Mode>			Event Reporting	
<Mode>	Description of parameters	Def. value	Def. unit	FW vers.
SRQ	Service request	OFF	–	V2.65
SOPC	Single operation complete			
SRSQ	SRQ and SOPC			
OFF	No reporting			
Description of command				Sig. State
This command defines the events generated when the measurement is terminated or stopped (<i>event reporting</i> , see Chapter 5 of R&S CMU manual).				all

FETCh:POWer:MPR:STATus?			Measurement Status	
Return	Description of parameters	Def. value	Def. unit	FW vers.
OFF	Measurement in the <i>OFF</i> state (*RST or ABORt)	OFF	–	V2.65
RUN	Running (after INITiate, CONTinue or READ)			
STOP	Stopped (STOP)			
ERR	OFF (could not be started)			
STEP	Stepping mode (<stepmode>=STEP)			
RDY,	Stopped according to repetition mode and stop condition			
1 to 10000	Counter for current statistics cycle	NONE	–	
NONE,	No counting mode set			
1 to 1000	Counter for current evaluation period within a cycle	NONE	–	
NONE	Statistic count set to off			
Description of command				Sig. State
This command is always a query. It returns the status of the measurement (see Chapters 3 and 5 of R&S CMU manual).				all

CONFigure:POWer:MPR:MMODE <Mode>			Measurement Mode	
<Mode>	Description of parameters	Def. value	Def. unit	FW vers.
ALL	Measure and aggregate all channels of the current hop scheme	ALL	–	V2.65
SINGLE	Measure bursts from a definite channel only			
SIMultaneous	Simultaneous measurement on the five channels selected with CONFigure:POWer:MPR:MFRequency:SIMultaneous.			
Description of command				Sig. State
This command sets how many channels are to measured and whether the results are to be kept separate or aggregated. In <i>ALL</i> mode, the measurement is performed on every available burst, no matter what frequency it is on. In <i>SINGLE</i> mode, the R&S® CMU measures the channel selected via CONFigure:POWer:MPR:MFRequency. In <i>SIMultaneous</i> mode, the R&S® CMU takes and returns five complete sets of results; see description of the READ:...POWer..., FETCh:...POWer... commands.				all

CONFigure:POWer:MPR:MFRequency:SIMultaneous <Meas_Freq_1>,..., <Meas_Freq_5>			Simult. Meas. – Measured Ch.	
<Meas_Freq_1> to <Meas_Freq_5>	Description of parameters	Def. value	Def. unit	FW vers.
2 402 MHz to 2 495 MHz	Measured frequency	see below	Hz	V3.08
OFF	Measurement switched off			
Description of command				Sig. State
This command defines the five frequencies to be measured if the measurement mode is set to <i>SIMultaneous</i> (see command CONFigure:POWer:MPR:MMODE). With the command CONFigure:POWer:MPR:MFRequency:UNIT, the default frequency unit can be changed, and even <i>Bluetooth</i> channel numbers can be entered instead of frequencies. The default frequencies correspond to the channel sequence 0, 19, 39, 59, 78.				all

CONFigure:POWer:MPR:MFRequency <Meas_Freq>				Display Frequency	
<Meas_Freq>	Description of parameters	Def. value	Def. unit	FW vers.	
2 402 MHz to 2 495 MHz	Measured frequency	2402 000 000	Hz	V2.65	
Description of command				Sig. State	
This command defines the frequency to be measured if the measurement mode is set to <code>SINGLE</code> (see command <code>CONFigure:POWer:MPR:MMODE</code>). With the command <code>CONFigure:POWer:MPR:MFRequency:UNIT</code> , the default frequency unit can be changed, and even <i>Bluetooth</i> channel numbers can be entered instead of frequencies.				all	

CONFigure:POWer:MPR:MFRequency:UNIT <Unit>				Frequency Unit	
<Unit>	Description of parameters	Def. value	Def. unit	FW vers.	
HZ KHZ MHZ GHZ CH	Frequency unit Channel number	HZ	–	V2.65	
Description of command				Sig. State	
This command defines whether the measured frequency (see command <code>CONFigure:POWer:MPR:MFRequency</code>) is specified in frequency units or as an <i>Bluetooth</i> channel number.				all	

CONFigure:POWer:MPR:FILTer:BWIDth <Width>				Filter Bandwidth	
<Width>	Description of parameters	Def. value	Def. unit	FW vers.	
WIDE NARR	2 MHz bandwidth filter 1.3 MHz bandwidth filter	NARR	–	V3.85	
Description of command				Sig. State	
Selects the resolution bandwidth of the measurement filter used for <code>POWer:MPR</code> measurements.				all	

Subsystem P^{OW}er:MPR:CONTRol

The subsystem `POWer:MPR:CONTRol` defines the repetition mode, statistic count, and stop condition of the measurement.

CONFigure:POWer:MPR:CONTRol:STATistics <Statistics>				Statistics Count	
<Statistics>	Description of parameters	Def. value	Def. unit	FW vers.	
1 to 1000 NONE	Number of bursts per statistics cycle Statistics off	100	–	V2.65	
Description of command				Sig. State	
This command specifies the type of measured values and defines the number of bursts forming a statistics cycle.				all	

CONFigure:POWer:MPR:CONTRol:REPetition <Repetition>,<StopCond>,<Stepmode>				Test Cycles
<Repetition>	Description of parameters	Def. value	Def. unit	
CONTinuous SINGleshot 1 to 10000	Continuous measurement (until <i>STOP</i> or <i>ABORT</i>) Single shot measurement (until <i>Status = RDY</i>) Multiple measurement (<i>counting</i> , until <i>Status = STEP RDY</i>)	SING	–	
<StopCondition>	Description of parameters	Def. value	Def. unit	
SONerror NONE	Stop measurement in case of error (<i>stop on error</i>) Continue measurement even in case of error	NONE	–	
<Stepmode>	Description of parameters	Def. value	Def. unit	FW vers.
STEP NONE	Interrupt measurement after each statistics cycle Continue measurement according to its rep. mode	NONE	–	V2.65
Description of command				Sig. State
This command determines the number of statistics cycles, the stop condition and the stepping mode for the measurement.				all
Note:	In the case of READ commands (<i>READ:...</i>), the <Repetition> parameter has no effect; the measurement is always stopped after a single shot.			

DEFault:POWer:MPR:CONTRol				Default Settings
<Enable>	Description of parameters	Def. value	Def. unit	FW vers.
ON OFF	The parameters are set to their default values Some or all parameters differ from the default values	ON	–	V2.65
Description of command				Sig. State
If used as a setting command with the parameter <i>ON</i> this command sets all parameters of the subsystem to their default values (the setting <i>OFF</i> has no effect). If used as a query the command returns whether all parameters are set to their default values (<i>ON</i>) or not (<i>OFF</i>).				all

Measured Values

The following commands determine and return the results of the combined power and modulation measurement.

		Scalar Results:		
READ[:SCALar]:POWer:MPR?		Start single shot measurement and return results		
FETCh[:SCALar]:POWer:MPR?		Read out measurement results (unsynchronized)		
Returned values	Description of parameters	Def. value	Def. unit	FW vers.
-128 dBm to 30 dBm,	Nominal Power (x4)	NAN	dBm	V2.65
-128 dBm to 30 dBm,	Leakage Power (x4)	NAN	dBm	
-128 dBm to 30 dBm,	Peak Power (x4)	NAN	dBm	
-20 µs to 20 µs,	Packet Timing (x4)	NAN	µs	
-250 kHz to +250 kHz,	Frequency Accuracy (x4)	NAN	kHz	
-250 kHz to +250 kHz,	Frequency Drift (x4)	NAN	kHz	
-999 kHz/50 µs to 999 kHz/50 µs,	Maximum Drift Rate (x4)	NAN	kHz/50 µs	
0 kHz to 250 kHz	Average Frequency Deviation (x4)	NAN	kHz	
0 kHz to 250 kHz	Minimum Frequency Deviation (x4)	NAN	kHz	
0 kHz to 250 kHz	Maximum Frequency Deviation (x4)	NAN	kHz	
0% to 100%	Bursts out of Tolerance (Power)	NAN	%	
0% to 100%	Bursts out of Tolerance (Timing)	NAN	%	
0% to 100%	Bursts out of Tolerance (Modulation)	NAN	%	
Description of command				Sig. State
<p>These commands are always queries. They start a combined power and modulation measurement and output all scalar measurement results. The symbol (x4) behind a value indicates that the list contains four results corresponding to the <i>Current</i>, the <i>Average</i>, the <i>Minimum</i>, and the <i>Maximum</i> measurement, respectively.</p> <ul style="list-style-type: none"> • READ starts a single shot measurement and returns the results. • FETCh outputs the results without taking care of the measurement state. <p>The meaning and the number of the returned values depends on the measurement mode set via <code>CONFigure:POWer:MPR:MMODE</code></p> <ul style="list-style-type: none"> • In the <code>ALL</code> mode, the R&S® CMU measures all channels and returns the average result. • In <code>SINGLE</code> mode, the R&S® CMU measures the channel selected via <code>CONFigure:POWer:MPR:MFRrequency</code> and returns the corresponding result. • In <code>SIMultaneous</code> mode, the R&S® CMU takes and returns five complete sets of results corresponding to the channel sequence 0, 23, 46, 69, 93. This means that the whole list described in the <i>Returned Values</i> column above is repeated five times. <p>For more details refer to the description of aggregated and separate channels in Chapter 4.</p>				TEST, CONN

CALCulate:POWER:MPR:MATChing:LIMit?				Limit Matching	
Returned values	Value range	Def. value	Def. unit	FW vers.	
Nominal power (x4),		INV	–	V2.65	
Leakage power (x4),		INV	–		
Peak power (x4),	For all measured values:	INV	–		
Packet timing (x4),		INV	–		
Frequency Accuracy (x4),	NMAU NMAL INV OK	INV	–		
Frequency Drift (x4),		INV	–		
Maximum Drift Rate (x4),		INV	–		
Average Frequency Deviation (x4)		INV	–		
Minimum Frequency Deviation (x4)					
Maximum Frequency Deviation (x4)					
Description of command				Sig. State	
This command is always a query. It indicates whether and in which way the permissible tolerances for the scalar results (see above command) in the <i>power vs time</i> and the <i>modulation</i> measurement have been exceeded.				TEST, CONN	
The following messages may be output for all values:					
NMAU	Tolerance value underflow	<i>not matching, underflow</i>			
NMAL	Tolerance value exceeded	<i>not matching, overflow</i>			
INV	Measurement invalid	<i>invalid</i>			
OK	Tolerance value matched				

MODulation Measurements

The subsystem *MODulation* covers the following modulation measurement application:

- The *MODulation:DEViation* subsystem measures the modulation accuracy of GFSK-modulated Basic Rate packets.

Subsystem Modulation:DEViation

The subsystem *MODulation:DEViation* measures the modulation parameters, i.e. the frequency errors, for GFSK-modulated Basic Rate packets. The subsystem corresponds to the measurement menu *Modulation*, application *Modulation GFSK*, and the associated popup menu *Modulation Configuration*.

Control of Measurement – Subsystem Modulation

The commands in this section control the modulation measurement. They correspond to the measurement control softkey *Modulation GFSK* in the measurement menu *Modulation* and the associated hotkeys.

INITiate:MODulation:DEViation	Start new measurement	⇒ <i>RUN</i>
ABORt:MODulation:DEViation	Abort running measurement and switch off	⇒ <i>OFF</i>
STOP:MODulation:DEViation	Stop measurement after current stat. cycle	⇒ <i>STOP</i>
CONTinue:MODulation:DEViation	Next measurement step (only <i>stepping mode</i>)	⇒ <i>RUN</i>
Description of command		Sig. State
These commands have no query form. They start and stop the modulation measurement, setting it to the status indicated in the top right column.		all
		FW vers.
		V2.60

CONFigure: MODulation:DEViation:EREPorting <Mode>			Event Reporting	
<Mode>	Description of parameters	Def. value	Def. unit	FW vers.
SRQ	Service request	OFF	–	V2.60
SOPC	Single operation complete			
SRSQ	SRQ and SRSQ			
OFF	No reporting			
Description of command				Sig. State
This command defines the events generated when the measurement is terminated or stopped (<i>event reporting</i> , see Chapter 5 of R&S CMU manual).				all

FETCh:MODulation:DEVIation:STATus?				Measurement Status
Ret. values	Description of parameters	Def. value	Def. unit	FW vers.
OFF	Measurement in the <i>OFF</i> state (*RST or ABORT)	OFF	–	V2.60
RUN	Running (after INITiate, CONTinue or READ)			
STOP	Stopped (STOP)			
ERR	OFF (could not be started)			
STEP	Stepping mode (<stepmode>=STEP)			
RDY,	Stopped according to repetition mode and stop condition			
1 to 10000	Counter for current statistics cycle			
NONE,	No counting mode set	NONE	–	
1 to 1000	Counter for current evaluation period within a cycle			
NONE	Statistic count set to off	NONE	–	
Description of command				Sig. State
This command is always a query. It returns the status of the measurement (see Chapters 3 and 5 of R&S CMU manual).				all

CONFIgure:MODulation:DEVIation:MMODE <Mode>				Measurement Mode
<Mode>	Description of parameters	Def. value	Def. unit	FW vers.
ALL	Measure and aggregate all channels of the current hop scheme	ALL	–	V2.60
SINGLE	Measure bursts from a definite channel only			
SIMultaneous	Simultaneous measurement on the five channels selected with CONFIgure:MODulation:DEVIation:MFRequency:SIMultaneous.			
Description of command				Sig. State
This command sets how many channels are to measured and whether the results are to be kept separate or aggregated. In <i>ALL</i> mode, the measurement is performed on every available burst, no matter what frequency it is on. In <i>SINGLE</i> mode, the R&S® CMU measures the channel selected via CONFIgure:MODulation:DEVIation:MFRequency. In <i>SIMultaneous</i> mode, the R&S® CMU takes and returns five complete sets of results; see description of the READ:...MODulation..., FETCh:...MODulation... commands.				all

CONFIgure:MODulation:DEVIation:MFRequency:SIMultaneous <Meas_Freq_1>,..., <Meas_Freq_5>				Simult. Meas. – Measured Ch.
<Meas_Freq_1> to <Meas_Freq_5>	Description of parameters	Def. value	Def. unit	FW vers.
2 402 MHz to 2 495 MHz	Measured frequency	see below	Hz	V3.08
OFF	Measurement switched off			
Description of command				Sig. State
This command defines the five frequencies to be measured if the measurement mode is set to <i>SIMultaneous</i> (see command CONFIgure:MODulation:DEVIation:MMODE). With the command CONFIgure:MODulation:DEVIation:MFRequency:UNIT, the default frequency unit can be changed, and even <i>Bluetooth</i> channel numbers can be entered instead of frequencies. The default frequencies correspond to the channel sequence 0, 19, 39, 59, 78.				all

CONFigure:MODulation:DEVIation:MFRequency <Meas_Freq>				Display Frequency
<Meas_Freq>	Description of parameters	Def. value	Def. unit	FW vers.
2 402 MHz to 2 495 MHz	Measured frequency	2 402000 000	Hz	V2.60
Description of command				Sig. State
This command defines the frequency to be measured if the measurement mode is set to <code>SINGLE</code> (see command <code>CONFigure:MODulation:DEVIation:MMode</code>). With the command <code>CONFigure:MODulation:DEVIation:MFRequency:UNIT</code> , the default frequency unit can be changed, and even <i>Bluetooth</i> channel numbers can be entered instead of frequencies.				all

CONFigure:MODulation:DEVIation:MFRequency:UNIT <Unit>				Frequency Unit
<Unit>	Description of parameters	Def. value	Def. unit	FW vers.
HZ KHZ MHZ GHZ CH	Frequency unit Channel number	HZ	–	V2.60
Description of command				Sig. State
This command defines whether the measured frequency (see command <code>CONFigure:MODulation:DEVIation:MFRequency</code>) is specified in frequency units or as an <i>Bluetooth</i> channel number.				all

CONFigure:MODulation:DEVIation:MRANge <Start>, 				Time Scale Start, Time Scale Span	
<Start>	Description of parameters	Def. value	Def. unit	FW vers.	
–200 bit to 3200 bit	Start of measurement range	–200	bit		
	Description of parameters	Def. value	Def. unit	FW vers.	
0.0625 to 1	Span of measurement range	1	(slots)	V2.60	
Description of command				Sig. State	
This command defines the measurement range for the <code>MODulation:DEVIation</code> measurement. The second input value <code></code> is rounded to one of the following discrete values:				all	
0.0625 (1/16 slot)	0.125 (1/8 slot)	0.25 (1/4 slot)	0.5 (1/2 slot)	1 (slot)	
The number of test points in the <code>MODulation</code> measurement (i.e. the length of the arrays output via the <code>READ:ARRay:MODulation:DEVIation...</code> commands) follows from the span, rounded again to correspond to an integer number of bits, and a constant sampling rate of 4 test points per bit. This results in the following table:					
	0.0625	0.125	0.25	0.5	1
Symbols	39	78	156	313	625
No. of test points	157	313	625	1249	2500

CONFigure:MODulation:DEVIation:FILTer:BWIDth <Width>				Filter Bandwidth
<Width>	Description of parameters	Def. value	Def. unit	FW vers.
WIDE NARR	2 MHz bandwidth filter 1.3 MHz bandwidth filter	NARR	–	V3.85
Description of command				Sig. State
Selects the resolution bandwidth of the measurement filter used for <i>Modulation GFSK</i> measurements.				all

CONFigure:MODulation:DEVIation:FDALgorithm <Algorithm>		Freq. Dev. Algorithm		
<Mode>	Description of parameters	Def. value	Def. unit	FW vers.
BCAV IAV	Bit centered average Integration average	BCAV	–	V3.08
Description of command				Sig. State
Defines how the R&S® CMU averages the frequency deviation and calculates the average frequency over a 01010101 bit sequence. The algorithm is used for MODulation and for POWER:MPR measurements.				all

Subsystem MODulation:DEVIation:CONTROL

The subsystem *MODulation:DEVIation:CONTROL* defines the scope of the modulation measurement. The settings are provided in the *Control* tab of the popup menu *Modulation Configuration*.

CONFigure:MODulation:DEVIation:CONTROL <Mode>, <Statistics>, <Repetition>, <StopCond>, <Stepmode>		Scope of Measurement		
<Mode>	Description of parameters	Def. value	Def. unit	
SCALAR ARRAY,	Scalar values only (incl. limit matching) Scalar measured values and arrays	ARRAY	–	
<Statistics>	Description of parameters	Def. value	Def. unit	
1 to 1000 NONE	Number of bursts per statistics cycle Statistics off	100	–	
<Repetition>	Description of parameters	Def. value	Def. unit	
CONTinuous SINGleshot 1 to 10000,	Continuous measurement (until STOP or ABORT) Single shot measurement (until Status = RDY) Multiple measurement (counting, until Status = STEP RDY)	SING	–	
<StopCond>	Description of parameters	Def. value	Def. unit	
SONerror NONE,	Stop measurement in case of error (<i>stop on error</i>) Continue measurement even in case of error	NONE	–	
<Stepmode>	Description of parameters	Def. value	Def. unit	FW vers.
STEP NONE	Interrupt measurement after each statistics cycle Continue measurement according to its rep. mode	NONE	–	V2.60
Description of command				Sig. State
This command restricts the type of measured values to accelerate the measurement and determines the number of bursts within a statistics cycle.				all
Note: In the case of READ commands (READ:...), the <Repetition> parameter has no effect; the measurement is always stopped after a single shot.				
The <i>Repetition</i> parameter is valid in remote control only. Changing this parameter in remote control does not alter the repetition mode in manual control and vice versa. The default repetition mode in manual control is <i>Continuous</i> .				

CONFigure:MODulation:DEVIation:CONTRol:RMODE <Mode>				Result mode
<Mode>	Description of parameters	Def. value	Def. unit	FW vers.
SCALar	Scalar values only (incl. limit matching)	ARRay	–	V2.60
ARRay	Scalar measured values and arrays available			
Description of command				Sig. State
This command specifies the type of measured values. If the parameter SCALar is set, the measurement curves (arrays, see commands READ:ARRay:POWer:TIME... , READ:SUBarray:POWer:TIME...) are no longer available but the measurement is speeded up considerably.				all

CONFigure:MODulation:DEVIation:CONTRol:STATistics <Statistics>				Statistics Count
<Statistics>	Description of parameters	Def. value	Def. unit	FW vers.
1 to 1000	Number of bursts per statistics cycle	100	–	V2.60
NONE	Statistics off			
Description of command				Sig. State
This command specifies the type of measured values and defines the number of bursts forming a statistics cycle.				all

CONFigure:MODulation:DEVIation:CONTRol:REPetition <Repetition>, <StopCond>, <Stepmode>				Test Cycles
<Repetition>	Description of parameters	Def. value	Def. unit	
CONTInuous	Continuous measurement (until STOP or ABORT)	SING	–	
SINGleshot	Single shot measurement (until Status = RDY)			
1 to 10000	Multiple measurement (<i>counting</i> , until Status = STEP RDY)			
<StopCondition>	Description of parameters	Def. value	Def. unit	
SONerror	Stop measurement in case of error (<i>stop on error</i>)	NONE	–	
NONE	Continue measurement even in case of error			
<Stepmode>	Description of parameters	Def. value	Def. unit	FW vers.
STEP	Interrupt measurement after each statistics cycle	NONE	–	V2.60
NONE	Continue measurement according to its rep. mode			
Description of command				Sig. State
This command determines the number of statistics cycles, the stop condition and the stepping mode for the measurement.				all
Note: <i>In the case of READ commands (READ:...), the <Repetition> parameter has no effect; the measurement is always stopped after a single shot.</i>				
The <i>Repetition</i> parameter is valid in remote control only. Changing this parameter in remote control does not alter the repetition mode in manual control and vice versa. The default repetition mode in manual control is <i>Continuous</i> .				

DEFault:MODulation:DEViation:CONTRol			Default Settings	
<Enable>	Description of parameters	Def. value	Def. unit	FW vers.
ON	The parameters are set to their default values	ON	–	V2.60
OFF	The parameters differ from the default values (partially or totally)			
Description of command				Sig. State
If used as a setting command with the parameter <i>ON</i> this command sets all parameters of the subsystem to their default values (the setting <i>OFF</i> results in an error message). If used as a query the command returns whether all parameters are set to their default values (<i>ON</i>) or not (<i>OFF</i>).				all

Limits – Subsystem MODulation:DEViation:LIMit

The subsystem *MODulation:DEViation:LIMit* defines tolerance values for the modulation measurement. The subsystem corresponds to the tab *Limits* in the popup menu *Modulation*.

CONFigure:MODulation:DEViation:CURRent:LIMit:SCALAr:ASYMmetric:UPPer:VALue CONFigure:MODulation:DEViation:AVERAge:LIMit:SCALAr:ASYMmetric:UPPer:VALue CONFigure:MODulation:DEViation:MAXimum:LIMit:SCALAr:ASYMmetric:UPPer:VALue CONFigure:MODulation:DEViation:MINimum:LIMit:SCALAr:ASYMmetric:UPPer:VALue <Freq_Acc>, <Freq_Drift>, <Max_Drift_Rate>, <Freq_Dev_Aver>, <Freq_Dev_Max>, <Freq_Dev_Min>				
				Upper Modulation Limits
<Limit>	Description of parameters	Def. value	Def. unit	FW vers.
–250 kHz to +250 kHz,	Upper limit for frequency accuracy	+75	kHz	V2.60
–250 kHz to +250 kHz,	Upper limit for frequency drift	+25	kHz	
–500 kHz/50 µs to	Upper limit for max. drift rate	20	kHz/50 µs	
+500 kHz/50 µs,				
0 kHz to +250 kHz,	Upper limit for average frequency deviation	175	kHz	
0 kHz to +250 kHz,	Upper limit for minimum freq. dev.	175	kHz	
0 kHz to +250 kHz,	Upper limit for maximum freq. dev.	175 ^{*)}	kHz	
Description of command				Sig. State
These commands define upper limits for the nominal power of the current (<i>CURRent</i>), average (<i>AVERAge</i>), minimum (<i>MINimum</i>), and maximum (<i>MAXimum</i>) measurement curve, respectively. If a measurement rises above the limit then the result will be out of tolerance. <i>OFF</i> means that the limit check is switched off.				all
*) By default the limit check is effectively disabled.				

CONFigure:MODulation:DEVIation:CURRent:LIMit:SCALar:ASYMmetric:UPPer:ENABLE
CONFigure:MODulation:DEVIation:AVERAge:LIMit:SCALar:ASYMmetric:UPPer:ENABLE
CONFigure:MODulation:DEVIation:MAXimum:LIMit:SCALar:ASYMmetric:UPPer:ENABLE
CONFigure:MODulation:DEVIation:MINimum:LIMit:SCALar:ASYMmetric:UPPer:ENABLE
 <Mode_1>, ..., <Mode_6> Upper Limits on or off

<Mode_n>	Description of parameters	Def. value	Def. unit	FW vers.
	Enable or disable the upper limit check for:			V2.60
ON OFF,	Frequency accuracy	ON	–	
ON OFF,	Frequency drift	ON	–	
ON OFF,	Max. drift rate	ON	–	
ON OFF,	Average frequency deviation	ON	–	
ON OFF,	Minimum freq. dev.	OFF	–	
ON OFF	Maximum freq. dev.	OFF	–	
Description of command				Sig. State
These commands enable or disable the upper limit check of the modulation quantities.				all

CONFigure:MODulation:DEVIation:CURRent:LIMit:SCALar:ASYMmetric:LOWer:VALue
CONFigure:MODulation:DEVIation:AVERAge:LIMit:SCALar:ASYMmetric:LOWer:VALue
CONFigure:MODulation:DEVIation:MAXimum:LIMit:SCALar:ASYMmetric:LOWer:VALue
CONFigure:MODulation:DEVIation:MINimum:LIMit:SCALar:ASYMmetric:LOWer:VALue
 <Freq_Acc>, <Freq_Drift>, <Max_Drift_Rate>, <Freq_Dev_Aver>, <Freq_Dev_Max>, <Freq_Dev_Min> Lower Modulation Limits

<Limit>	Description of parameters	Def. value	Def. unit	FW vers.
–250 kHz to +250 kHz	Lower limit for frequency accuracy	–75	kHz	V2.60
–250 kHz to +250 kHz	Lower limit for frequency drift	–25	kHz	
–500 kHz/50 µs to +500 kHz/50 µs,	Lower limit for max. drift rate	–20	kHz/50 µs	
0 kHz to +250 kHz	Lower limit for average frequency deviation	115	kHz	
0 kHz to +250 kHz	Lower limit for minimum freq. dev.	115	kHz	
0 kHz to +250 kHz	Lower limit for maximum freq. dev.	115 ^{*)}	kHz	
Description of command				Sig. State
These commands define lower limits for the nominal power of the current (CURRent), average (AVERAge), minimum (MINimum), and maximum (MAXimum) measurement curve, respectively. If a measurement falls below the limit then the result will be out of tolerance. OFF means that the limit check is switched off.				all
*) By default the limit check is effectively disabled.				

CONFigure:MODulation:DEVIation:CURRent:LIMit:SCALar:ASYMmetric:LOWER:ENABLE
CONFigure:MODulation:DEVIation:AVERAge:LIMit:SCALar:ASYMmetric:LOWER:ENABLE
CONFigure:MODulation:DEVIation:MAXimum:LIMit:SCALar:ASYMmetric:LOWER:ENABLE
CONFigure:MODulation:DEVIation:MINimum:LIMit:SCALar:ASYMmetric:LOWER:ENABLE
 <Mode_1>, ..., <Mode_6> Lower Limits on or off

<Mode_n>	Description of parameters	Def. value	Def. unit	FW vers.
	Enable or disable the lower limit check for:			V2.60
ON OFF,	Frequency accuracy	ON	–	
ON OFF,	Frequency drift	ON	–	
ON OFF,	Max. drift rate	ON	–	
ON OFF,	Average frequency deviation	ON	–	
ON OFF,	Minimum freq. dev.	OFF	–	
ON OFF	Maximum freq. dev.	OFF	–	
Description of command				Sig. State
These commands enable or disable the lower limit check of the modulation quantities.				all

CONFigure:MODulation:DEVIation:CURRent:LIMit:SCALar:ASYMmetric[:COMBined]:VALue
CONFigure:MODulation:DEVIation:AVERAge:LIMit:SCALar:ASYMmetric[:COMBined]:VALue
CONFigure:MODulation:DEVIation:MAXimum:LIMit:SCALar:ASYMmetric[:COMBined]:VALue
CONFigure:MODulation:DEVIation:MINimum:LIMit:SCALar:ASYMmetric[:COMBined]:VALue
 <Freq_Acc_Upp>, <Freq_Acc_Low>, <Freq_Drift_Upp>, <Freq_Drift_Low>,
 <Max_Drift_Rate_Upp>, <Max_Drift_Rate_Low>, <Freq_Dev_Upp_Aver>, <Freq_Dev_Low_Aver>
 <Freq_Dev_Upp_Max>, <Freq_Dev_Low_Max> <Freq_Dev_Upp_Min>, <Freq_Dev_Low_Min>
 Upper and Lower Modulation Limits

<Limit>	Description of parameters	Def. value	Def. unit	FW vers.
–250 kHz to +250 kHz	Upper limit for frequency accuracy	+75	kHz	V2.60
–250 kHz to +250 kHz	Lower limit for frequency accuracy	–75	kHz	
–250 kHz to +250 kHz	Upper limit for frequency drift	+25	kHz	
–250 kHz to +250 kHz	Lower limit for frequency drift	–25	kHz	
–500 kHz/50 µs to +500 kHz/50 µs,	Upper limit for max. drift rate	+20	kHz/ 50 µs	
–500 kHz/50 µs to +500 kHz/50 µs,	Lower limit for max. drift rate	–20	kHz/ 50 µs	
0 kHz to +250 kHz	Upper limit for average frequency deviation	175	kHz	
0 kHz to +250 kHz	Lower limit for average freq. dev.	115	kHz	
0 kHz to +250 kHz	Upper limit for minimum freq. dev.	175	kHz	
0 kHz to +250 kHz	Lower limit for minimum freq. dev.	115	kHz	
0 kHz to +250 kHz	Upper limit for maximum freq. dev.	175 *)	kHz	
0 kHz to +250 kHz	Lower limit for maximum freq. dev.	115 *)	kHz	
Description of command				Sig. State
These commands define upper and lower limits for the nominal power of the current (CURRent), average (AVERAge), minimum (MINimum), and maximum (MAXimum) measurement curve, respectively. If a measurement falls below the limit then the result will be out of tolerance. OFF means that the limit check is switched off.				all
*) By default the limit check is effectively disabled.				

CONFigure:MODulation:DEVIation:CURRent:LIMit:SCALar:ASYMmetric[:COMBined]:ENABLE CONFigure:MODulation:DEVIation:AVERAge:LIMit:SCALar:ASYMmetric[:COMBined]:ENABLE CONFigure:MODulation:DEVIation:MAXimum:LIMit:SCALar:ASYMmetric[:COMBined]:ENABLE CONFigure:MODulation:DEVIation:MINimum:LIMit:SCALar:ASYMmetric[:COMBined]:ENABLE <Mode_1>, ..., <Mode_12>				
All Limits on or off				
<Mode_n>	Description of parameters	Def. value	Def. unit	FW vers.
	Enable or disable the limit check for:			V2.60
ON OFF, ON OFF,	Frequency accuracy (upper, lower)	ON, ON	–	
ON OFF, ON OFF,	Frequency drift (upper, lower)	ON, ON	–	
ON OFF, ON OFF,	Max. drift rate (upper, lower)	ON, ON	–	
ON OFF, ON OFF,	Average freq. Dev. (upper, lower)	ON, ON	–	
ON OFF, ON OFF,	Minimum freq. dev. (upper, lower)	OFF, OFF	–	
ON OFF, ON OFF	Maximum freq. dev. (upper, lower)	OFF, OFF	–	
Description of command				Sig. State
These commands enable or disable the upper and lower limit check of the modulation quantities.				all

Bits out of Tolerance – Threshold				
CONFigure:MODulation:DEVIation:BATHreshold:THReshold[:VALue] <Freq_Dev>				
<Freq_Dev>	Description of parameters	Def. value	Def. unit	FW vers.
0 kHz to +250 kHz	Lower limit for frequency deviation	115	kHz	V3.08
Description of command				Sig. State
This command defines the lower limit for the frequency deviation, to be used for the calculation of the <i>Bits out of Tolerance</i> result (command <code>FETCh[:SCALar]:MODulation:DEVIation:BATHreshold?</code>)				all

Bits out of Tolerance – Conformance Limit				
CONFigure:MODulation:DEVIation:BATHreshold:CLIMit[:VALue] <Percentage>				
<Percentage>	Description of parameters	Def. value	Def. unit	FW vers.
0.00 % to +100.00 %	Conformance limit	99.90	%	V3.08
Description of command				Sig. State
This command defines the minimum percentage of bits where the frequency deviation must lie above the <i>Threshold</i> , to be used for the calculation of the <i>Bits out of Tolerance</i> result (command <code>FETCh[:SCALar]:MODulation:DEVIation:BATHreshold?</code>)				all

Bits out of Tolerance – Enable Limit Check				
CONFigure:MODulation:DEVIation:BATHreshold:CLIMit:ENABLE <Enable>				
<Limit>	Description of parameters	Def. value	Def. unit	FW vers.
ON OFF	Enable or disable limit check	ON	–	V3.08
Description of command				Sig. State
This command enables or disables the limit check for the <i>Bits out of Tolerance</i> result (command <code>FETCh[:SCALar]:MODulation:DEVIation:BATHreshold?</code>)				all

DEFault:MODulation:DEViation:LIMit <Mode>				Default Settings	
<Mode>	Description of parameters	Def. value	Def. unit	FW vers.	
ON	The parameters are set to their default values	ON	–	V2.60	
OFF	Some or all parameters differ from the default values				
Description of command				Sig. State	
If used as a setting command with the parameter ON this command sets all parameters of the subsystem to their default values (the setting OFF results in an error message). If used as a query the command returns whether all parameters are set to their default values (ON) or not (OFF).				all	

Subsystem SUBarrays:MODulation:DEViation

The subsystem *SUBarrays:MODulation:DEViation* defines the measurement range and the type of output values.

CONFigure:SUBarrays:MODulation:DEViation				Definition of Subarrays	
<Mode>,<Start>,<Samples>{,<Start>,<Samples>}					
<Mode>	Description of parameters	Def. value	Def. unit	FW vers.	
ALL	Return all measurement values	ALL	–	V2.60	
ARITHmetical	Return arithm. mean value in every subrange				
MINimum	Return minimum value in every subrange				
MAXimum	Return maximum value in every subrange				
IVAL	Return single interpolated value at <Start>				
XMAXimum	Return x-axis value of maximum and maximum				
XMINimum	Return x-axis value of minimum and minimum				
PAVG,	Return arithmetic mean value in every subrange			V5.00	
<Start>	Description of parameters	Def. value	Def. unit		
–200 bit to 3200 bit,	Start time in current range	NAN	bit		
<Samples>	Description of parameters	Def. value	Def. unit		
0 to 2500 ^{*)}	No. of samples in range	NAN	–		
Description of command				Sig. State	
This command configures the READ:SUBarrays:MODulation:DEViation... , FETCh:SUBarrays:MODulation:DEViation... commands. It restricts the measurement to up to 32 subranges where either all measurement results (the number of which is given by the second numerical parameter) or a single statistical value is returned. The subranges are defined by a start time and the number of test points which are located on a fixed, equidistant grid.				all	
For <Mode> = IVAL, the <Samples> parameter is ignored and the R&S CMU returns a single measurement value corresponding to the abscissa value <Start>. If <Start> is located between two test points with valid results then the result is calculated from the results at these two adjacent test points by linear interpolation.					
The subranges may overlap but must be within the total range of the MODulation:DEViation measurement defined via CONFigure:MODulation:DEViation:MRANge. Test points outside this range are not measured (result NAN) and do not enter into the ARITHmetical, MINimum and MAXimum values. By default, only one range corresponding to the total measurement range is used and all measurement values are returned.					
^{*) Useful range; see CONFigure:MODulation:DEViation:MRANge. The command also accepts values >2500.}					

Measured Values

The following commands start a measurement and return the measurement results. They correspond to the different output elements in the graphical measurement menu *MODulation:DEViation*.

				Scalar Results	
READ[:SCALar]:MODulation:DEViation?				Start single shot measurement and return results	
FETCh[:SCALar]:MODulation:DEViation?				Read out meas. results (unsynchronized)	
Returned values	Description of parameters	Def. value	Def. unit	FW vers.	
-250 kHz to +250 kHz,	Frequency Accuracy (x4),	NAN	kHz	V2.60	
-250 kHz to +250 kHz,	Frequency Drift (x4),	NAN	kHz		
-999 kHz/50 μs to 999 kHz/50 μs,	Maximum Drift Rate (x4)	NAN	kHz/50μs		
0 kHz to +250 kHz,	Average Frequency Deviation (x4),	NAN	kHz		
0 kHz to +250 kHz,	Minimum Frequency Deviation (x4),	NAN	kHz		
0 kHz to +250 kHz,	Maximum Frequency Deviation (x4),	NAN	kHz		
-128 dBm to 30 dBm,	Average Burst Power	NAN	dBm		
0% to 100%	Burst out of Tolerance	NAN	%		
Description of command				Sig. State	
<p>These commands are always queries. They start a measurement (<code>READ . . .</code>) and return all scalar measurement results. The symbol (x4) behind a value indicates that the list contains four results corresponding to the <i>Current</i>, the <i>Average</i>, the <i>Minimum</i>, and the <i>Maximum</i> measurement curve, respectively.</p> <p>The meaning and the number of the returned values depends on the measurement mode set via <code>CONFigure:MODulation:DEViation:MMODE</code></p> <ul style="list-style-type: none"> • In the <code>ALL</code> mode, the R&S® CMU measures all channels and returns the average result. • In <code>SINGLE</code> mode, the R&S® CMU measures the channel selected via <code>CONFigure:MODulation:DEViation:MFrequency</code> and returns the corresponding result. • In <code>SIMultaneous</code> mode, the R&S® CMU acquires and returns five complete sets of results corresponding to the five channels selected with <code>CONFigure:MODulation:DEViation:MFrequency:SIMultaneous</code>. This means that the whole list described in the <i>Returned Values</i> column above is repeated five times. <p>For more details refer to the description of aggregated and separate channels in Chapter 4.</p>				TEST	

		Scalar Results incl. "Bits out of Tolerance"		
READ[:SCALar]:MODulation:DEVIation:EXTended?		Start single shot measurement and return results		
FETCh[:SCALar]:MODulation:DEVIation:EXTended?		Read out meas. results (unsynchronized)		
Returned values	Description of parameters	Def. value	Def. unit	FW vers.
-250 kHz to +250 kHz,	Frequency Accuracy (x4),	NAN	kHz	V3.08
-250 kHz to +250 kHz,	Frequency Drift (x4),	NAN	kHz	
-999 kHz/50 µs to 999 kHz/50 µs,	Maximum Drift Rate (x4)	NAN	kHz/50 µs	
0 kHz to +250 kHz,	Average Frequency Deviation (x4),	NAN	kHz	
0 kHz to +250 kHz,	Minimum Frequency Deviation (x4),	NAN	kHz	
0 kHz to +250 kHz,	Maximum Frequency Deviation (x4),	NAN	kHz	
0% to 100%,	Bits above threshold	NAN	%	
-128 dBm to 30 dBm,	Average Burst Power	NAN	dBm	
0% to 100%	Burst out of Tolerance	NAN	%	
Description of command				Sig. State
<p>These commands are always queries. They start a measurement (READ . . .) and return all scalar measurement results. The symbol (x4) behind a value indicates that the list contains four results corresponding to the <i>Current</i>, the <i>Average</i>, the <i>Minimum</i>, and the <i>Maximum</i> measurement curve, respectively.</p> <p>The meaning and the number of the returned values depends on the measurement mode set via <code>CONFigure:MODulation:DEVIation:MMODE</code></p> <ul style="list-style-type: none"> In the <code>ALL</code> mode, the R&S® CMU measures all channels and returns the average result. In <code>SINGLE</code> mode, the R&S® CMU measures the channel selected via <code>CONFigure:MODulation:DEVIation:MFRequency</code> and returns the corresponding result. In <code>SIMultaneous</code> mode, the R&S® CMU acquires and returns five complete sets of results corresponding to the five channels selected with <code>CONFigure:MODulation:DEVIation:MFRequency:SIMultaneous</code>. This means that the whole list described in the <i>Returned Values</i> column above is repeated five times. <p>For more details refer to the description of aggregated and separate channels in Chapter 4.</p>				TEST

		Bits out of Tolerance		
FETCh[:SCALar]:MODulation:DEVIation:BATHreshold?		Read out meas. results (unsynchronized)		
Returned values	Description of parameters	Def. value	Def. unit	FW vers.
0% to 100%	Bits out of Tolerance	NAN	%	V3.08
Description of command				Sig. State
<p>These commands are always queries. They start a measurement (READ . . .) and return the <i>Bits out of Tolerance</i> result. The meaning and the number of the returned values depends on the measurement mode set via <code>CONFigure:MODulation:DEVIation:MMODE</code></p> <ul style="list-style-type: none"> In the <code>ALL</code> mode, the R&S® CMU measures all channels and returns the average result. In <code>SINGLE</code> mode, the R&S® CMU measures the channel selected via <code>CONFigure:MODulation:DEVIation:MFRequency</code> and returns the corresponding result. In <code>SIMultaneous</code> mode, the R&S® CMU takes and returns five complete sets of results corresponding to the channel sequence selected with <code>CONFigure:MODulation:DEVIation:MFRequency:SIMultaneous</code>. This means that the value is repeated five times. <p>For more details refer to the description of aggregated and separate channels in Chapter 4.</p>				TEST

CALCulate:MODulation:DEVIation:MATChing:LIMit?			Limit Matching									
Returned values	Value range	Def. value	Def. unit	FW vers.								
Frequency Accuracy (x4),		INV	–	V2.60								
Frequency Drift (x4),		INV	–									
Maximum Drift Rate (x4),	For all measured values:	INV	–									
Average Freq. Deviation (x4),	NMAU NMAL INV OK	INV	–									
Minimum Freq. Deviation (x4),		INV	–									
Maximum Freq. Deviation (x4)		INV	–									
Description of command				Sig. State								
<p>This command is always a query. It indicates whether and in which way the permissible error limits for the scalar measured values (see command above) have been exceeded. The symbol (x4) behind a value indicates that the list contains four results corresponding to the <i>Current</i>, the <i>Average</i>, the <i>Minimum</i>, and the <i>Maximum</i> measurement curve, respectively.</p> <p>Possible values are:</p> <table border="0"> <tr> <td><i>NMAU</i></td> <td>Result is above the limit</td> </tr> <tr> <td><i>NMAL</i></td> <td>Result is below the limit</td> </tr> <tr> <td><i>INV</i></td> <td>Result is invalid</td> </tr> <tr> <td><i>OK</i></td> <td>Result is valid</td> </tr> </table> <p>The meaning and the number of the returned values depends on the measurement mode set via <code>CONFigure:MODulation:DEVIation:MMODE</code>; see description of <code>READ...?</code>, <code>FETCh...?</code> commands above.</p>				<i>NMAU</i>	Result is above the limit	<i>NMAL</i>	Result is below the limit	<i>INV</i>	Result is invalid	<i>OK</i>	Result is valid	TEST
<i>NMAU</i>	Result is above the limit											
<i>NMAL</i>	Result is below the limit											
<i>INV</i>	Result is invalid											
<i>OK</i>	Result is valid											

READ:ARRay:MODulation:DEVIation:CURRent? READ:ARRay:MODulation:DEVIation:AVERage? READ:ARRay:MODulation:DEVIation:MINimum? READ:ARRay:MODulation:DEVIation:MAXimum?		Frequency Deviation		
Start single shot measurement and return results		⇒ <i>RUN</i>		
FETCh:ARRay:MODulation:DEVIation:CURRent? FETCh:ARRay:MODulation:DEVIation:AVERage? FETCh:ARRay:MODulation:DEVIation:MINimum? FETCh:ARRay:MODulation:DEVIation:MAXimum?		Read measurement results (unsynchronized)		
		⇒ <i>RUN</i>		
Returned values	Description of parameters	Def. value	Def. unit	FW vers.
-250.0 kHz to +250 kHz,	1 st value for frequency deviation,	NAN	kHz	V2.60
... ,	
-250.0 kHz to +200 kHz	n th value for frequency deviation	NAN	kHz	
Description of command				Sig. State
These commands are always queries. They return the frequency deviation versus time at fixed, equidistant test points. With a constant sampling rate of 4 test points per bit, the number n and the position of the test points depends on the measurement range, see command <code>CONFigure:MODulation: DEVIation:MRANge</code> .				TEST
The meaning of the returned values depends on the measurement mode set via <code>CONFigure:MODulation:DEVIation:MMODE</code> :				
<ul style="list-style-type: none"> • In <i>ALL</i> mode, the R&S[®] CMU measures all available channels and returns the trace averaged over all these channels. • In <i>SINGLE</i> mode, the R&S[®] CMU measures the channel selected via <code>CONFigure:MODulation:DEVIation:MFRequency</code> and returns the corresponding trace. • In <i>SIMultaneous</i> mode, the R&S[®] CMU measures the channels selected with <code>CONFigure:MODulation:DEVIation:MFRequency:SIMultaneous</code> and returns the trace averaged over these channels. 				
The calculation of <i>current</i> , <i>average</i> , <i>maximum</i> and <i>minimum</i> values is explained in Chapter 3 (<i>display mode</i>).				

READ:SUBarrays:MODulation:DEVIation:CURRent? READ:SUBarrays:MODulation:DEVIation:AVERAge? READ:SUBarrays:MODulation:DEVIation:MINimum? READ:SUBarrays:MODulation:DEVIation:MAXimum? Start single shot measurement and return results ⇒ <i>RUN</i>				
FETCh:SUBarrays:MODulation:DEVIation:CURRent? FETCh:SUBarrays:MODulation:DEVIation:AVERAge? FETCh:SUBarrays:MODulation:DEVIation:MINimum? FETCh:SUBarrays:MODulation:DEVIation:MAXimum? Read measurement results (unsynchronized) ⇒ <i>RUN</i>				
Returned values	Description of parameters	Def. value	Def. unit	FW vers.
-250.0 kHz to +250 kHz,	1 st value for frequency deviation,	NAN	kHz	V2.60
... ,	
-250.0 kHz to +250 kHz	xth value for frequency deviation	NAN	kHz	
Description of command				Sig. State
These commands are always queries. They output the frequency deviation versus time in the subranges defined by means of the <code>CONFigure:SUBarrays:MODulation:DEVIation</code> command. A valid subrange must be defined before the <code>READ:SUBarrays...</code> , <code>FETCh:SUBarrays...</code> command group can be used.				TEST
The <code>CONFigure:SUBarrays:MODulation:DEVIation</code> command defines a maximum of 32 subranges. If one of the statistical modes (<code>ARIThmetical</code> , <code>MINimum</code> , <code>MAXimum...</code>) is set, only one value is returned per subrange.				
The calculation of <i>current</i> , <i>average</i> , <i>minimum</i> , and <i>maximum</i> results is explained in Chapter 3 (see <i>display mode</i>).				

Spectrum Measurements

The subsystem *SPECTrum* covers two different power measurement applications:

- The *SPECTrum:ACPower* subsystem measures the Adjacent Channel Power. The subsystem corresponds *ACP* application of the *Spectrum* measurement.
- The *SPECTrum:BWIDth* subsystem measures the 20 dB bandwidth. The subsystem corresponds *20 dB Bandwidth* application of the *Spectrum* measurement.

SPECTrum:ACPower

The subsystem *SPECTrum:ACPower* measures the Adjacent Channel Power. The subsystem corresponds to the measurement menu *Spectrum*, application *ACP*, and the associated popup menu *Spectrum Configuration*.

Measurement Control

The commands in this section control the spectrum measurement. They correspond to the softkey *ACP* in the measurement menu *Spectrum*.

INITiate:SPECTrum:ACPower	Start new measurement	⇒	<i>RUN</i>
ABORT:SPECTrum:ACPower	Abort measurement and switch off	⇒	<i>OFF</i>
STOP:SPECTrum:ACPower	Stop measurement after current stat. cycle	⇒	<i>STOP</i>
CONTinue:SPECTrum:ACPower	Next meas. step (only <i>stepping mode</i>)	⇒	<i>RUN</i>
Description of command		Sig. State	FW vers.
These commands have no query form. They start or stop the measurement, setting it to the status indicated in the top right column.		all	V3.57

CONFigure:SPECTrum:ACPower:EREPorting <Mode>		Event Reporting		
<Mode>	Description of parameters	Def. value	Def. unit	FW vers.
SRQ 	Service request	OFF	–	V3.57
SOPC 	Single operation complete			
SRSQ 	SRQ and SOPC			
OFF	No reporting			
Description of command			Sig. State	
This command defines the events generated when the measurement is terminated or stopped (<i>event reporting</i> , see Chapter 5 of the R&S CMU manual).			all	

FETCh[:SCALar]:SPECtrum:ACPower:STATus?				Measurement Status
Ret. values	Description of parameters	Def. value	Def. unit	FW vers.
OFF 	Measurement in the <i>OFF</i> state (*RST or ABORT)	OFF	–	V3.57
RUN 	Running (after INITiate, CONTinue or READ)			
STOP 	Stopped (STOP)			
ERR 	<i>OFF</i> (could not be started)			
STEP 	Stepping mode (<stepmode>=STEP)			
RDY,	Stopped according to repetition mode and stop condition			
1 to 10000 	Counter for current statistics cycle	NONE	–	
NONE,	No counting mode set			
0 to 1000 	Counter for current evaluation period within a cycle	NONE	–	
NONE	Statistic count set to off			
Description of command				Sig. State
This command is always a query. It returns the status of the measurement (see Chapters 3 and 5 of the R&S CMU manual).				all

Subsystem SPECTrum:ACPower:CONTRol

The subsystem *SPECTrum:...CONTRol* defines the statistics (repetition mode, statistic count, and stop condition) of the measurement. These settings are provided in the *Control* tab of the popup menu *Spectrum Configuration*.

CONFigure:SPECTrum:ACPower:CONTRol <Mode>, <Statistics>, <Repetition>, <StopCond>, <Stepmode>				
Scope of Measurement				
<Mode>	Description of parameters	Def. value	Def. unit	FW vers.
SCALar,	Scalar values only (incl. limit matching)	SCALar	–	V3.57
<Statistics>	Description of parameters	Def. value	Def. unit	
1 to 1000 NONE	Number of sweeps per statistics cycle Statistics off (equivalent to 1)	10	–	
<Repetition>	Description of parameters	Def. value	Def. unit	
CONTInuous SINGleshot 1 to 10000,	Continuous measurement (until <i>STOP</i> or <i>ABORT</i>) Single shot measurement (until <i>Status = RDY</i>) Multiple measurement (<i>counting</i> , until <i>Status = STEP RDY</i>)	SING	–	
<StopCond>	Description of parameters	Def. value	Def. unit	
SONerror NONE,	Stop measurement in case of error (<i>stop on error</i>) Continue measurement even in case of error	NONE	–	
<Stepmode>	Description of parameters	Def. value	Def. unit	FW vers.
STEP NONE	Interrupt measurement after each statistics cycle Continue measurement according to its rep. mode	NONE	–	V3.57
Description of command				Sig. State
This command restricts the type of measured values to accelerate the measurement and determines the number of sweeps within a statistics cycle.				all
Note: In the case of READ commands (<i>READ:...</i>), the <Repetition> parameter has no effect; the measurement is always stopped after a single shot.				
The <i>Repetition</i> parameter is valid in remote control only. Changing this parameter in remote control does not alter the repetition mode in manual control and vice versa. The default repetition mode in manual control is <i>Continuous</i> .				

CONFigure:SPECTrum:ACPower:CONTRol:STATistics <Statistics>				
Statistics Count				
<Statistics>	Description of parameters	Def. value	Def. unit	FW vers.
1 to 1000 NONE	Number of sweeps per statistics cycle Statistics off (equivalent to 1)	10	–	V3.57
Description of command				Sig. State
This command specifies the type of measured values and defines the number of sweeps forming a statistics cycle.				all

CONFigure:SPECTrum:ACPoweR:CONTRol:REPetition <Repetition>, <StopCond>, <Stepmode>				Test Cycles
<Repetition>	Description of parameters	Def. value	Def. unit	
CONTInuous SINGleshot 1 to 10000	Continuous measurement (until STOP or ABORT) Single shot measurement (until Status = RDY) Multiple measurement (counting, until Status = STEP RDY)	SING	–	
<StopCondition>	Description of parameters	Def. value	Def. unit	
SONerror NONE	Stop measurement in case of error (stop on error) Continue measurement even in case of error	NONE	–	
<Stepmode>	Description of parameters	Def. value	Def. unit	FW vers.
STEP NONE	Interrupt measurement after each statistics cycle Continue measurement according to its rep. mode	NONE	–	V3.57
Description of command				Sig. State
This command determines the number of statistics cycles, the stop condition and the stepping mode for the measurement.				all
Note: In the case of READ commands (READ: ...), the <Repetition> parameter has no effect; the measurement is always stopped after a single shot.				
The <i>Repetition</i> parameter is valid in remote control only. Changing this parameter in remote control does not alter the repetition mode in manual control and vice versa. The default repetition mode in manual control is <i>Continuous</i> .				

Test Configuration

The commands of the following subsystems determine the parameters of the signal power measurement. The settings are part of the *Control* and of the *Analyzer* tab in the *Spectrum Configuration* menu.

CONFigure:SPECTrum:ACPoweR:CCHannel <Channel>				Center Channel
<Meas_Freq>	Description of parameters	Def. value	Def. unit	FW vers.
0 to 93	Center channel	0	–	V3.57
Description of command				Sig. State
This command selects the center channel for the ACP measurement.				all

CONFigure:SPECTrum:ACPoweR:MCHannel:RELative <Ch_-3>, <Ch_-2>, <Ch_-1>, <Ch_+1>, <Ch_+2>, <Ch_+3>				Lower/Upper Channels
<Ch_-3> <Ch_-2> <Ch_-1>	Description of parameters	Def. value	Def. unit	FW vers.
–97 to 0, –97 to 0, –97 to 0,	Lower channels	–3, –2, –1,	–	V3.57
<Ch_+1> <Ch_+2> <Ch_+3>	Description of parameters	Def. value	Def. unit	FW vers.
0 to +97, 0 to +97, 0 to +97	Upper channels	+1, +2, +3	–	V3.57
Description of command				Sig. State
This command selects the lower and upper channels for the ACP measurement in units relative to the center channel (CONFigure:SPECTrum:ACPoweR:CCHannel). The frequency of each channel (calculated as the center channel frequency plus n times 1 MHz where n is the relative channel number) must be in the range between 2398 MHz and 2499 MHz.				all
Each channel number can be replaced by OFF to disable the measurement at this channel.				

CONFigure:SPECTrum:ACPower:DMODE <Mode>				Detector Mode
<Mode>	Description of parameters	Def. value	Def. unit	FW vers.
AVG	Average detector	AVG	–	V3.57
PEAK	Peak detector			
RMS	RMS detector			
Description of command				Sig. State
This command selects the detector mode for the ACP measurement.				all

CONFigure:SPECTrum:ACPower:LUNit <Mode>				Level Unit
<Mode>	Description of parameters	Def. value	Def. unit	FW vers.
ABS	Absolute ACP results (in dBm)	ABS	–	V3.57
REL	ACP relative to the center channel power (in dB)			
Description of command				Sig. State
This command selects the level unit for the ACP measurement. The setting is relevant for the ACP results returned by <code>READ[:SCALar]:SPECTrum:ACPower?</code> etc.				all

Limits (Subsystem SPECTrum:ACPower:....:LIMit)

The subsystem *SPECTrum:ACPower:....:LIMit* defines the limit values for the ACP measurement. The settings are part of the *Limits* tab in the *Spectrum Configuration* menu.

Spectrum Limits, Upper Channels				
CONFigure:SPECTrum:ACPower:PEAK:LIMit:SCALAr:ASYMmetric:UCHannel:VALue <Limits>				
CONFigure:SPECTrum:ACPower:AVERAge:LIMit:SCALAr:ASYMmetric:UCHannel:VALue <Limits>				
CONFigure:SPECTrum:ACPower:RMS:LIMit:SCALAr:ASYMmetric:UCHannel:VALue <Limits>				
<Limits>	Description of parameters	Def. value	Def. unit	FW vers.
-40 dBm to 0 dBm,	Upper limit for ACP: Ch +1,	See below	dBm	V3.57
-40 dBm to 0 dBm,	Upper limit for ACP: Ch +2,			
-40 dBm to 0 dBm	Upper limit for ACP: Ch +3			
Description of command				Sig. State
These commands define upper limits for the ACP measurement in the upper channels. The fourth-level keywords (<i>PEAK</i> , <i>AVERAge</i> , <i>RMS</i>) denote the detector mode (<i>CONFigure:SPECTrum:ACPower:DMode</i>). <i>OFF</i> means that the limit check is switched off.				all
The default limits for the <i>AVERAge</i> and <i>RMS</i> detectors and channels no. +3, +2, and +1 are -20 dBm, -20 dBm, and -5 dBm. The default values for the <i>PEAK</i> detector are +5 dB higher.				

Spectrum Limits, Lower Channels				
CONFigure:SPECTrum:ACPower:PEAK:LIMit:SCALAr:ASYMmetric:LCHannel:VALue <Limits>				
CONFigure:SPECTrum:ACPower:AVERAge:LIMit:SCALAr:ASYMmetric:LCHannel:VALue <Limits>				
CONFigure:SPECTrum:ACPower:RMS:LIMit:SCALAr:ASYMmetric:LCHannel:VALue <Limits>				
<Limits>	Description of parameters	Def. value	Def. unit	FW vers.
-40 dBm to 0 dBm,	Upper limit for ACP: Ch -3,	See below	dBm	V3.57
-40 dBm to 0 dBm,	Upper limit for ACP: Ch -2,			
-40 dBm to 0 dBm	Upper limit for ACP: Ch -1			
Description of command				Sig. State
These commands define upper limits for the ACP measurement in the lower channels. The fourth-level keywords (<i>PEAK</i> , <i>AVERAge</i> , <i>RMS</i>) denote the detector mode (<i>CONFigure:SPECTrum:ACPower:DMode</i>). <i>OFF</i> means that the limit check is switched off.				all
The default limits for the <i>AVERAge</i> and <i>RMS</i> detectors and channels no. -3, -2, and -1 are -20 dBm, -20 dBm, and -5 dBm. The default values for the <i>PEAK</i> detector are +5 dB higher.				

Enable/Disable Spectrum Limits, Upper Channels				
CONFigure:SPECTrum:ACPower:PEAK:LIMit:SCALAr:ASYMmetric:UCHannel:ENABle <Enable>				
CONFigure:SPECTrum:ACPower:AVERAge:LIMit:SCALAr:ASYMmetric:UCHannel:ENABle <Enable>				
CONFigure:SPECTrum:ACPower:RMS:LIMit:SCALAr:ASYMmetric:UCHannel:ENABle <Enable>				
<Enable>	Description of parameters	Def. value	Def. unit	FW vers.
ON OFF,	Upper limit for ACP: Ch +1,	See below	dBm	V3.57
ON OFF,	Upper limit for ACP: Ch +2,			
ON OFF	Upper limit for ACP: Ch +3			
Description of command				Sig. State
These commands enable or (<i>ON</i>) or disable (<i>OFF</i>) the ACP limit check in the upper channels. The fourth-level keywords (<i>PEAK</i> , <i>AVERAge</i> , <i>RMS</i>) denote the detector mode (<i>CONFigure:SPECTrum:ACPower:DMode</i>). By default the limit check is <i>ON</i> for the <i>AVERAge</i> detector and channels +2 and +3. For all other channels and detectors, the limit check is <i>OFF</i> .				all

Enable/Disable Spectrum Limits, Lower Channels				
CONFigure:SPECTrum:ACPpower:PEAK:LIMit:SCALar:ASYMmetric:LCHannel:ENABle <Enable>				
CONFigure:SPECTrum:ACPpower:AVERage:LIMit:SCALar:ASYMmetric:LCHannel:ENABle <Enable>				
CONFigure:SPECTrum:ACPpower:RMS:LIMit:SCALar:ASYMmetric:LCHannel:ENABle <Enable>				
<Enable>	Description of parameters	Def. value	Def. unit	FW vers.
ON OFF,	Upper limit for ACP: Ch -3,	See below	dBm	V3.57
ON OFF,	Upper limit for ACP: Ch -2,			
ON OFF	Upper limit for ACP: Ch -1			
Description of command				Sig. State
These commands enable or (<i>ON</i>) or disable (<i>OFF</i>) the ACP limit check in the lower channels. The fourth-level keywords (<i>PEAK</i> , <i>AVERage</i> , <i>RMS</i>) denote the detector mode (<i>CONFigure:SPECTrum:ACPpower:DMODE</i>). By default the limit check is <i>ON</i> for the <i>AVERage</i> detector and channels -2 and -3. For all other channels and detectors, the limit check is <i>OFF</i> .				all

Measured Values

The commands in the following section determine and return the results of the ACP measurement. They correspond to the graphical menu *Spectrum* with its various display elements.

		Scalar results:		
READ[:SCALar]:SPECTrum:ACPowEr?		Start single shot measurement and return results		
FETCh[:SCALar]:SPECTrum:ACPowEr?		Read out measurement results (unsynchronized)		
Returned values	Description of parameters	Def. value	Def. unit	FW vers.
-100 dBm to +30 dBm (x6),	ACP (Current),	NAN	dBm	V3.57
-100 dBm to +30 dBm (x6),	ACP (Average),	NAN	dBm	
-100 dBm to +30 dBm (x6),	ACP (Maximum),	NAN	dBm	
-100 dBm to +30 dBm	Center channel power (Current)	NAN	dBm	
Description of commands				Sig. State
These commands are always queries. They start a measurement (READ . . .) and/or return all scalar measurement results. The symbol (x6) behind a value indicates that the list contains six results corresponding to the lower channels -3, -2, -1 and the upper channels +1, +2, +3, respectively. READ... starts a single shot measurement and returns the results. • FETCh... reads the results without taking care of the measurement state..				TEST, CONN

		Scalar Limit Matching								
CALCulate[:SCALar]:SPECTrum:ACPowEr:MATCHing:LIMit?										
<Result>	Description of parameters	Def. value	Def. unit	FW vers.						
ACP (Current) (x6), ACP (Average) (x6), ACP (Maximum) (x6)	For all measured values: NMAU INV OK	INV INV INV	-	V3.57						
Description of commands				Sig. State						
This command is always a query. It indicates whether and in which way the permissible tolerances for the scalar measured values (see commands above) have been exceeded. The symbol (x6) behind a value indicates that the list contains six results corresponding to the lower channels -3, -2, -1 and the upper channels +1, +2, +3, respectively. Possible values are: <table style="display: inline-table; vertical-align: top; margin-left: 20px;"> <tr> <td>NMAU</td> <td>Result is above the limit</td> </tr> <tr> <td>INV</td> <td>Result is invalid</td> </tr> <tr> <td>OK</td> <td>Limit check passed</td> </tr> </table>				NMAU	Result is above the limit	INV	Result is invalid	OK	Limit check passed	TEST, CONN
NMAU	Result is above the limit									
INV	Result is invalid									
OK	Limit check passed									

SPECTrum:BWIDth...

The subsystem *SPECTrum:BWIDth* measures the 20 dB bandwidth. The subsystem corresponds to the measurement menu *Spectrum*, application *20 dB Bandwidth*, and the associated popup menu *Spectrum Configuration*.

Control of Measurement

The commands in this section control the spectrum measurement. They correspond to the softkey *Bandwidth* in the measurement menu *Spectrum*.

INITiate:SPECTrum:BWIDth	Start new measurement	⇒	<i>RUN</i>
ABORt:SPECTrum:BWIDth	Abort measurement and switch off	⇒	<i>OFF</i>
STOP:SPECTrum:BWIDth	Stop measurement after current stat. cycle	⇒	<i>STOP</i>
CONTinue:SPECTrum:BWIDth	Next meas. step (only <i>stepping mode</i>)	⇒	<i>RUN</i>
Description of command			Sig. State
These commands have no query form. They start or stop the measurement, setting it to the status indicated in the top right column.			FW vers.
			all
			V3.54

CONFigure:SPECTrum:BWIDth:EREPorting <Mode>		Event Reporting		
<Mode>	Description of parameters	Def. value	Def. unit	FW vers.
SRQ 	Service request	OFF	–	V3.54
SOPC 	Single operation complete			
SRSQ 	SRQ and SOPC			
OFF	No reporting			
Description of command				Sig. State
This command defines the events generated when the measurement is terminated or stopped (<i>event reporting</i> , see Chapter 5 of the R&S CMU manual).				all

FETCH[:SCALar]:SPECTrum:BWIDth:STATus?		Measurement Status		
Ret. values	Description of parameters	Def. value	Def. unit	FW vers.
OFF 	Measurement in the <i>OFF</i> state (*RST or ABORt)	OFF	–	V3.54
RUN 	Running (after INITiate, CONTinue or READ)			
STOP 	Stopped (STOP)			
ERR 	OFF (could not be started)			
STEP 	Stepping mode (<stepmode>=STEP)			
RDY,	Stopped according to repetition mode and stop condition			
1 to 10000 	Counter for current statistics cycle	NONE	–	
NONE,	No counting mode set			
0 to 1000 	Counter for current evaluation period within a cycle	NONE	–	
NONE	Statistic count set to off			
Description of command				Sig. State
This command is always a query. It returns the status of the measurement (see Chapters 3 and 5 of the R&S CMU manual).				all

Subsystem SPECTrum:...CONTrol

The subsystem *SPECTrum:...CONTrol* defines the statistics (repetition mode, statistic count, and stop condition) of the measurement. These settings are in the *Control* tab of the popup menu *Spectrum Configuration*.

CONFigure:SPECTrum:BWIDth:CONTrol <Mode>, <Statistics>, <Repetition>, <StopCond>, <Stepmode>				
Scope of Measurement				
<Mode>	Description of parameters	Def. value	Def. unit	FW vers.
SCALar ARRAy,	Scalar values only (incl. limit matching) Scalar measured values and arrays	ARRay	–	V3.54
<Statistics>	Description of parameters	Def. value	Def. unit	FW vers.
1 to 1000 NONE	Number of sweeps per statistics cycle Statistics off (equivalent to 1)	10	–	V3.54
<Repetition>	Description of parameters	Def. value	Def. unit	FW vers.
CONTInuous SINGleshot 1 to 10000,	Continuous measurement (until STOP or ABORT) Single shot measurement (until Status = RDY) Multiple measurement (counting, until Status = STEP RDY)	SING	–	V3.54
<StopCond>	Description of parameters	Def. value	Def. unit	FW vers.
SONerror NONE,	Stop measurement in case of error (stop on error) Continue measurement even in case of error	NONE	–	V3.54
<Stepmode>	Description of parameters	Def. value	Def. unit	FW vers.
STEP NONE	Interrupt measurement after each statistics cycle Continue measurement according to its rep. mode	NONE	–	V3.54
Description of command				Sig. State
This command restricts the type of measured values to accelerate the measurement and determines the number of sweeps within a statistics cycle.				all
Note: In the case of READ commands (READ:...), the <Repetition> parameter has no effect; the measurement is always stopped after a single shot.				
The <i>Repetition</i> parameter is valid in remote control only. Changing this parameter in remote control does not alter the repetition mode in manual control and vice versa. The default repetition mode in manual control is <i>Continuous</i> .				

CONFigure:SPECTrum:BWIDth:CONTrol:RMODE <Mode>				
Result mode				
<Mode>	Description of parameters	Def. value	Def. unit	FW vers.
SCALar ARRAy	Scalar values only (incl. limit matching) Scalar measured values and arrays available	ARRay	–	V3.54
Description of command				Sig. State
This command specifies the type of measured values. If the parameter SCALar is set, the measurement curves (arrays, see commands READ:ARRay:SPECTrum:BWIDth... , READ:SUBarray:SPECTrum:BWIDth...) are no longer available but the measurement is speeded up considerably.				all

CONFigure:SPECTrum:BWIDth:CONTRol:STATistics <Statistics>				Statistics Count
<Statistics>	Description of parameters	Def. value	Def. unit	FW vers.
1 to 1000 NONE	Number of sweeps per statistics cycle Statistics off (equivalent to 1)	10	–	V3.54
Description of command				Sig. State
This command specifies the type of measured values and defines the number of sweeps forming a statistics cycle.				all

CONFigure:SPECTrum:BWIDth:CONTRol:REPetition <Repetition>, <StopCond>, <Stepmode>				Test Cycles
<Repetition>	Description of parameters	Def. value	Def. unit	
CONTinuous SINGleshot 1 to 10000	Continuous measurement (until STOP or ABORT) Single shot measurement (until Status = RDY) Multiple measurement (counting, until Status = STEP RDY)	SING	–	
<StopCondition>	Description of parameters	Def. value	Def. unit	
SONerror NONE	Stop measurement in case of error (stop on error) Continue measurement even in case of error	NONE	–	
<Stepmode>	Description of parameters	Def. value	Def. unit	FW vers.
STEP NONE	Interrupt measurement after each statistics cycle Continue measurement according to its rep. mode	NONE	–	V3.54
Description of command				Sig. State
This command determines the number of statistics cycles, the stop condition and the stepping mode for the measurement.				all
Note: In the case of READ commands (READ: ...), the <Repetition> parameter has no effect; the measurement is always stopped after a single shot.				
The <i>Repetition</i> parameter is valid in remote control only. Changing this parameter in remote control does not alter the repetition mode in manual control and vice versa. The default repetition mode in manual control is <i>Continuous</i> .				

Test Configuration

The commands of the following subsystems determine the parameters of the signal power measurement. The settings are part of the *Control* and of the *Analyzer* tab in the *Spectrum Configuration* menu.

CONFigure:SPECTrum:BWIDth:MMODE <Mode>				Measurement Mode
<Mode>	Description of parameters	Def. value	Def. unit	FW vers.
ALL SINGLE	Measure all channels of the current hop scheme Measure bursts from a definite channel only	ALL	–	V3.54
Description of command				Sig. State
This command sets which channels are to be measured. In ALL mode, the measurement is performed on every available burst, no matter what frequency it is on. In SINGLE mode, the R&S® CMU measures the channel selected via CONFigure:SPECTrum:BWIDth:MCHannel.				all

CONFigure:SPECTrum:BWIDth:MFRequency <Frequency>		Single Freq. Meas. – Measured Frequency		
<Frequency>	Description of parameters	Def. value	Def. unit	FW vers.
2 402 MHz to 2 495 MHz	Measured frequency	2402 000 000	Hz	V3.54
Description of command				Sig. State
This command defines the frequency to be measured if the measurement mode is set to <code>SINGLE</code> (see command <code>CONFigure:SPECTrum:BWIDth:MMode</code>). With the command <code>CONFigure:SPECTrum:BWIDth:MFRequency:UNIT</code> , the default frequency unit can be changed, and even <i>Bluetooth</i> channel numbers can be entered instead of frequencies. The default frequency corresponds to the channel 0.				all

CONFigure:SPECTrum:BWIDth:MFRequency:UNIT <Unit>		Frequency Unit		
<Unit>	Description of parameters	Def. value	Def. unit	FW vers.
HZ KHZ MHZ GHZ CH	Frequency unit Channel number	HZ	–	V3.54
Description of command				Sig. State
This command defines whether the measured frequency (see command <code>CONFigure:SPECTrum:BWIDth:MFRequency</code>) is specified in frequency units or as an <i>Bluetooth</i> channel number.				all

CONFigure:SPECTrum:BWIDth:DLEVel <Level>		Detection Level		
<Meas_Freq>	Description of parameters	Def. value	Def. unit	FW vers.
–0.1 dB to –50.0 dB	Detection level	–20	dB	V3.54
Description of command				Sig. State
This command defines the off-peak signal level at which the bandwidth is measured.				all

Limits (Subsystem `SPECTrum:BWIDth...:LIMit`)

The subsystem `SPECTrum:BWIDth...:LIMit` defines the limit values for the 20 dB bandwidth measurement. The settings are part of the *Limits* tab in the *Spectrum Configuration* menu.

CONFigure:SPECTrum:BWIDth:CURRent:LIMit:SCALAr:ASYMmetric:UPPer:VALue		Spectrum Limits		
CONFigure:SPECTrum:BWIDth:AVERAge:LIMit:SCALAr:ASYMmetric:UPPer:VALue				
CONFigure:SPECTrum:BWIDth:MAXimum:LIMit:SCALAr:ASYMmetric:UPPer:VALue <Limit>				
<Limit>	Description of parameters	Def. value	Def. unit	FW vers.
0.05 MHz to 3.30 MHz	Upper limit for bandwidth	1	MHz	V3.54
Description of command				Sig. State
These commands define upper limits for the bandwidth of the current (<code>CURRent</code>), average (<code>AVERAge</code>), and maximum (<code>MAXimum</code>) measurement curve, respectively. OFF means that the limit check is switched off.				all

CONFigure:SPEctrum:BWIDth:CURRent:LIMit:SCALar:ASYMmetric:UPPer:ENABLE Spectrum Limits CONFigure:SPEctrum:BWIDth:AVERage:LIMit:SCALar:ASYMmetric:UPPer:ENABLE CONFigure:SPEctrum:BWIDth:MAXimum:LIMit:SCALar:ASYMmetric:UPPer:ENABLE <Enable>				
<Enable>	Description of parameters	Def. value	Def. unit	FW vers.
ON OFF	Enable or disable limit check	See below	–	V3.54
Description of command				Sig. State
These commands switches the limit check for the current (CURRent), average (AVERage), and maximum (MAXimum) measurement curve on or off. By default, the limit check is enabled for the maximum curve, disabled for the current and average curves.				all

Measured Values

The commands in the following section determine and return the results of the 20 dB bandwidth measurement. They correspond to the graphical menu *Spectrum* with its various display elements.

READ[:SCALar]:SPEctrum:BWIDth? Start single shot measurement and return results FETCh[:SCALar]:SPEctrum:BWIDth? Read out measurement results (unsynchronized)				
Scalar results:				
Returned values	Description of parameters	Def. value	Def. unit	FW vers.
–100 dBm to +30 dBm,	Emission Peak (Current),	NAN	dBm	V3.54
–100 dBm to +30 dBm,	Emission Peak (Average),	NAN	dBm	
–100 dBm to +30 dBm,	Emission Peak (Maximum),	NAN	dBm	
–1.65 MHz to 0 MHz,	f _L (Current),	NAN	Hz	
0 MHz to +1.65 MHz,	f _H (Current),	NAN	Hz	
0 MHz to 3.3 MHz,	f _H – f _L (Current),	NAN	Hz	
–1.65 MHz to 0 MHz,	f _L (Average),	NAN	Hz	
0 MHz to +1.65 MHz,	f _H (Average),	NAN	Hz	
0 MHz to 3.3 MHz,	f _H – f _L (Average),	NAN	Hz	
–1.65 MHz to 0 MHz,	f _L (Maximum),	NAN	Hz	
0 MHz to +1.65 MHz	f _H (Maximum),	NAN	Hz	
0 MHz to 3.3 MHz,	f _H – f _L (Maximum),	NAN	Hz	
Description of commands				Sig. State
These commands are always queries. They start a measurement (READ...) and/or return all scalar measurement results. The symbol (x4) behind a value indicates that the list contains four results corresponding to the <i>Current</i> , the <i>Average</i> , the <i>Minimum</i> , and the <i>Maximum</i> measurement curve, respectively.				TEST, CONN
<ul style="list-style-type: none"> • READ... starts a single shot measurement and returns the results. • FETCh... reads the results without taking care of the measurement state. 				

CALCulate[:SCALar]:SPECTrum:BWIDth:MATChing:LIMit?				Scalar Limit Matching
<Result>	Description of parameters	Def. value	Def. unit	FW vers.
Bandwidth limit (current), Bandwidth limit (average), Bandwidth limit (maximum)		INV	–	V3.57
	For all measured values:	INV		
	NMAU INV OK	INV		
Description of commands				Sig. State
This command is always a query. It indicates whether and in which way the permissible tolerances for the scalar measured values (see commands above) have been exceeded.				TEST, CONN
Possible values are: <i>NMAU</i> Result is above the limit <i>INV</i> Result is invalid <i>OK</i> Limit check passed				

READ:ARRay:SPECTrum:BWIDth:CURRent? READ:ARRay:SPECTrum:BWIDth:AVERAge? READ:ARRay:SPECTrum:BWIDth:MAXimum?				Spectrum Curve
FETCh:ARRay:SPECTrum:BWIDth:CURRent? FETCh:ARRay:SPECTrum:BWIDth:AVERAge? FETCh:ARRay:SPECTrum:BWIDth:MAXimum?				Start single shot measurement and return results Read measurement results (unsynchronized)
Returned values	Description of parameters	Def. value	Def. unit	FW vers.
–128.0 dB to + 0.0 dB	Power[1], 1 st value for emission power	NAN	dB	V3.57
...	
–128.0 dB to + 0.0 dB	Power[n], 564 th value for emission power	NAN	dB	
Description of command				Sig. State
These commands are always queries. They return the normalized output power fixed, equidistant frequency points. The total number n of samples is 564; their position is between –1.1 MHz and +1.1 MHz relative to the center frequency of the measured Bluetooth channel with an approximate interval of 3.9KHz between points.				TEST, CONN
The meaning of the returned values depends on the measurement mode set via CONFigure:SPECTrum:BWIDth:MMODE:				
<ul style="list-style-type: none"> In ALL mode, the R&S CMU measures all available channels and returns the trace averaged over all these channels. In SINGLe mode, the R&S CMU measures the channel selected via CONFigure:SPECTrum:BWIDth:MFRequency and returns the corresponding trace. 				
The calculation of <i>current</i> , <i>average</i> and <i>maximum</i> values is explained in Chapter 3 (<i>display mode</i>).				

SPECTrum:FRANge...

The `SPECTrum:FRANge...` subsystem measures the power of the Bluetooth signal from the DUT at up to 110 frequency points using a fixed 100 kHz partition. The subsystem corresponds to the measurement menu *Spectrum*, application *Frequency Range*, and the associated popup menu *Spectrum Configuration*.

Condensed programming example

The following command sequence illustrates the basic steps for a *Frequency Range* measurement. Suppose your Bluetooth device operates in the frequency range between 2402 MHz and 2480 MHz:

```

CMUBT: *RST
    Reset instrument
CMUBT: CONFigure:SSIGnal:TMODe:HSCHeM RXTX
    Frequency hopping off
CMUBT: CONFigure:SSIGnal:TMODe:LBTests:FREQuency 2402MHz, 2402MHz
    Set DUT to lowest TX (and RX) frequency
CMUBT: CONFigure:SPECTrum:FRANge:CONTRol:STATistics 50
    Average over 50 measurements
CMUBT: CONFigure:SPECTrum:FRANge:MWINDow -3, 7
    Select a start frequency of 2399 MHz and a stop frequency of 2405 MHz
CMUBT: READ[:SCALar]:SPECTrum:FRANge:LFRrequency?
    Start measurement, return the lower limit frequency fL. To comply with the
    specification the value must be ≥ 2400 MHz.
CMUBT: CONFigure:SPECTrum:FRANge:MWINDow 73, 11
    Select a start frequency of 2475 MHz and a stop frequency of 2485 MHz
CMUBT: READ[:SCALar]:SPECTrum:FRANge:HFRrequency?
    Start measurement, return the upper limit frequency fH. To comply with the
    specification the value must be ≤ 2483.5 MHz.
    
```

INITiate:SPECTrum:FRANge	Start new measurement	⇒ RUN
ABORT:SPECTrum:FRANge	Abort running measurement and switch off	⇒ OFF
STOP: SPECTrum:FRANge	Stop measurement after current stat. cycle	⇒ STOP
CONTinue: SPECTrum:FRANge	Next measurement step (only <i>stepping mode</i>)	⇒ RUN
Description of command		Sig. State
These commands have no query form. They start and stop the frequency range measurement, setting it to the status indicated in the top right column.		all
		FW vers.
		V4.30

CONFigure: SPECTrum:FRANge:EREPorting <Mode>			Event Reporting	
<Mode>	Description of parameters	Def. value	Def. unit	FW vers.
SRQ 	Service request	OFF	–	V4.30
SOPC 	Single operation complete			
SRSQ 	SRQ and SRSQ			
OFF	No reporting			
Description of command				Sig. State
This command defines the events generated when the measurement is terminated or stopped (<i>event reporting</i> , see Chapter 5 of R&S CMU manual).				all

FETCh: SPECTrum:FRANge:STATus?				Measurement Status
Ret. values	Description of parameters	Def. value	Def. unit	FW vers.
OFF RUN STOP ERR STEP RDY,	Measurement in the <i>OFF</i> state (*RST or ABORT) Running (after INITiate, CONTinue or READ) Stopped (STOP) <i>OFF</i> (could not be started) Stepping mode (<stepmode>=STEP) Stopped according to repetition mode and stop condition	OFF	–	V4.30
1 to 1000 NONE,	Counter for current statistics cycle No counting mode set	NONE	–	
1 to 1000 NONE	Counter for current evaluation period within a cycle Statistic count set to off	NONE	–	
Description of command				Sig. State
This command is always a query. It returns the status of the measurement (see Chapters 3 and 5 of R&S CMU manual).				all

CONFIgure: SPECTrum:FRANge:CONTRol:STATistics <Statistics>				Statistics Count
<Statistics>	Description of parameters	Def. value	Def. unit	FW vers.
1 to 1000 NONE	Number of measurements to be averaged Single measurement, no averaging	50	–	V4.30
Description of command				Sig. State
This command specifies the number of measurements the R&S CMU performs in order to obtain an averaged result. Each measurement provide power results at each frequency .				all

CONFIgure: SPECTrum:FRANge:MWINDow <Start>,				Measurement Window
<Start>, 	Description of parameters	Def. value	Def. unit	FW vers.
–4 to 73, (2398 MHz to 2475 MHz)	Starting channel (frequency) of the measurement window	–3	–	V4.30
1 to 11 (1 MHz to 11 MHz)	Measurement window span	7		
Description of command				Sig. State
This command specifies the starting point and the span of the measurement window. The number of results returned by the frequency range READ:ARRAy... and READ:SCALAr... commands is ten times the measurement window span.				all

CONFIgure: SPECTrum:FRANge:THReshold <Threshold>				Power Threshold Count
<Threshold>	Description of parameters	Def. value	Def. unit	FW vers.
–100 dBm to 0 dBm	The value of the threshold to calculate f_H and f_L results	–30 dBm	–	V4.30
Description of command				Sig. State
This command specifies the threshold value for the frequency range measurement. The default value is corresponding to the Bluetooth specification.				all

Limits (Subsystem SPECTrum:FRANge...:LIMit)

The subsystem *SPECTrum:FRANge...:LIMit* defines the limit values for the *Frequency Range* measurement. The settings are part of the *Limits* tab in the *Spectrum Configuration* menu.

CONFigure:SPECTrum:FRANge:LIMit:SCALAR:ASYMmetric[:COMBined]:VALue				
<FL_FH_Upper>, <FL_FH_Lower>		Upper and Lower f_L and f_H Limits		
<FL_FH_Upper>, <FL_FH_Lower>	Description of parameters	Def. value	Def. unit	FW vers.
2397.55 MHz to 2485.45 MHz,	Upper limit for f_L and f_H	2483.5	MHz	V4.30
2397.55 MHz to 2485.45 MHz	Lower limit for f_L and f_H	2400.0	MHz	
Description of command				Sig. State
These commands define upper and lower limits for f_L and f_H . OFF means that the limit check is disabled.				all

CONFigure:SPECTrum:FRANge:LIMit:SCALAR:ASYMmetric[:COMBined]:ENABLE				
<FL_FH_Upper>, <FL_FH_Lower>		Upper and Lower Limits on or off		
<FL_FH_Upper>, <FL_FH_Lower>	Description of parameters	Def. value	Def. unit	FW vers.
ON OFF,	Enable or disable upper limit check for f_L and f_H	ON	–	V4.30
ON OFF	Enable or disable lower limit check for f_L and f_H	ON	–	
Description of command				Sig. State
These commands enable or disable the upper and lower limit check for the f_L and f_H measurements.				all

Measured Values

The commands in the following section determine and return the results of the *Frequency Range* measurement. They correspond to the graphical menu *Spectrum* with its various display elements.

				Power results
READ:ARRay:SPECTrum:FRANge?		Start single shot measurement and return results		⇒ RUN
FETCh:ARRay:SPECTrum:FRANge?		Read measurement results (unsynchronized)		⇒ RUN
Returned values	Description of parameters	Def. value	Def. unit	FW vers.
–140 dBm to 0 dBm,	1 st power measured at 100 KHz interval	NAN	dBm	V4.30
...		
–140 dBm to 0 dBm	n th power measured at 100 KHz interval	NAN	dBm	
Description of command				Sig. State
These commands are always queries. They return the power measured at 100 kHz intervals in the range specified by the <code>CONFigure:SPECTrum:FRANge:MWIndow</code> command. For this command the detector is always peak and the result mode is average. The number n of results is ten times the measurement window span (see <code>CONFigure:SPECTrum:FRANge:MWIndow</code>).				TEST

READ[:SCALar]:SPECTrum:FRANge:LFRequency?		Limit frequencies		
READ[:SCALar]:SPECTrum:FRANge:HFRequency?				
		Start single shot measurement and return results		⇒ RUN
FETCh[:SCALar]:SPECTrum:FRANge: LFRequency?				
FETCh[:SCALar]:SPECTrum:FRANge: HFRequency?				
		Read measurement results (unsynchronized)		⇒ RUN
Returned values	Description of parameters	Def. value	Def. unit	FW vers.
2397.55 MHz to 2475.45 MHz	The lowest (f_L) or the highest (f_H) frequency below the threshold	NAN	MHz	V4.30
Description of command				Sig. State
These commands are always queries. They return the f_L and f_H values as the specified in the test spec.				TEST
<ul style="list-style-type: none"> • READ[:SCALar]:SPECTrum:FRANge:LFRequency? command should be used with the measurement window set to 2399 MHz to 2405 MHz (7 channels window from Ch -3 to Ch 3) and the DUT transmitting at the lowest frequency (2402 MHz, Ch 0). • READ[:SCALar]:SPECTrum:FRANge: HFRequency? should be used with the measurement window set to 2475 MHz to 2485 MHz (11 channels window from Ch. 73 to Ch 83) and the DUT transmitting at the highest frequency (2480 MHz, Ch 78). 				
For setting the measurement window parameters see CONFigure:SPECTrum:FRANge:MWINDow command.				

CALCulate[:SCALar]:SPECTrum:FRANge:MATCHing:LIMit?		Scalar Limit Matching		
<Result>	Description of parameters	Def. value	Def. unit	FW vers.
f_L limit check , f_H limit check	For all measured values: NMAU NMAL INV OK	INV INV	- -	V4.30
Description of commands				Sig. State
This command is always a query. It indicates whether and in which way the permissible tolerances for the scalar measured values (see commands above) have been exceeded.				TEST, CONN
Possible values are:	<i>NMAU</i>	Result is above the limit		
	<i>NMAL</i>	Result is below the limit		
	<i>INV</i>	Result is invalid		
	<i>OK</i>	Result is valid		

Receiver Quality Measurements

The subsystem *Receiver Quality* comprises the commands for all measurements of the receiver quality context. The settings are used to assess the quality of the device under test's receiver. The subsystem corresponds to the main menu *Receiver Quality* and the associated popup menu *Receiver Quality Configuration*.

Receiver Quality – BER Application

The subsystem *RXQuality:BER* contains the commands for receiver quality measurements in the BER mode. The subsystem corresponds to the main menu *Receiver Quality*, application *BER* and the corresponding parts of the associated popup menu *Receiver Quality Configuration*.

Measurement Control

The following commands control the BER measurement.

INITiate:RXQuality:BER	Start new measurement	⇒	<i>RUN</i>
ABORT:RXQuality:BER	Abort running measurement and switch off	⇒	<i>OFF</i>
STOP:RXQuality:BER	Stop measurement	⇒	<i>STOP</i>
CONTinue:RXQuality:BER	Next measurement step (only <i>stepping mode</i>)	⇒	<i>RUN</i>
Description of command		Sig. State	FW vers.
These commands have no query form. They start or stop the current BER measurement, setting it to the status indicated in the top right column.		all	V2.60

CONFigure:RXQuality:BER:EREPorting <Mode>			Event Reporting	
<Mode>	Description of parameters	Def. value	Def. unit	FW vers.
SRQ 	Service request	OFF	–	V2.60
SOPC 	Single operation complete			
SRSQ 	SRQ and SRSQ			
OFF	No reporting			
Description of command				Sig. State
This command defines the events generated when the measurement is terminated or stopped (<i>event reporting</i> , see Chapter 5 of R&S CMU manual).				all

FETCh:RXQuality:BER:STATus?				Measurement Status
Return	Description of parameters	Def. value	Def. unit	FW vers.
OFF 	Measurement in the <i>OFF</i> state (*RST or ABORT)	OFF	–	V2.60
RUN 	Running (after INITiate, CONTInue or READ)			
STOP 	Stopped (STOP)			
ERR 	<i>OFF</i> (could not be started)			
STEP 	Stepping mode (<stepmode>=STEP)			
RDY,	Stopped according to repetition mode and stop condition			
1 to 10000 	Counter for current statistics cycle	NONE	–	
NONE,	No counting mode set			
1 to 400 000 	Counter for current evaluation period within a cycle	NONE	–	
NONE	Statistic count set to off			
Description of command				Sig. State
This command is always a query. It returns the status of the measurement (see Chapter 5 of R&S CMU manual).				all

CONFigure:RXQuality:BER:TSETup <TestSetup>				Test Setup
<Test Setup>	Description of parameters	Def. value	Def. unit	FW vers.
T1 	BER Application Test Setup 1	T1	–	V2.60
T2 	BER Application Test Setup 2			
T3 	BER Application Test Setup 3			
T4 	BER Application Test Setup 4			
T5	BER Application Test Setup 5			
Description of command				Sig. State
This command selects one out of 5 test setups, i.e. one data set holding the parameters of a particular BER receiver quality measurement. When the test setup is changed, the running measurement is stopped and all measured values are invalidated.				all

Subsystem RXQuality:BER:...CONTROL

The subsystem *RXQuality:BER:...CONTROL* defines the scope of the BER measurement. The settings are provided in the *Control* tab of the popup menu *Receiver Quality Configuration*.

CONFigure:RXQuality:BER:TSETup<nr>:CONTROL				Statistics	
<Statistics>, <Repetition>, <Stop Condition>, <Stepmode>					
<Statistics>	Description of parameters	Def. value	Def. unit		
1 to 400 000 NONE,	Number of packets per statistic cycle No statistics (equivalent to 1)	1000 ^{*)}	–		
<Repetition>	Description of parameters	Def. value	Def. unit		
CONTInuous SINGleshot 1 to 10000,	Continuous measurement (until STOP or ABORT) Single shot measurement (until Status = RDY) Multiple measurement (counting, until Status = STEP RDY)	SING	–		
<Stop Condition>	Description of parameters	Def. value	Def. unit		
SONerror NONE,	Stop measurement in case of error (stop on limit failure, tolerance exceeded) Continue measurement even in case of error	NONE	–		
<Stepmode>	Description of parameters	Def. value	Def. unit	FW vers.	
STEP NONE	Interrupt measurement after each statistics cycle Continue measurement according to its rep. mode	NONE	–	V2.60	
Description of command				Sig. State	
This command defines the number of packets to be measured in a BER measurement cycle. The suffix <nr> refers to the selected test setup (<nr> = 1 to 5).				all	
Note: In the case of READ commands (READ: ...), the <Repetition> parameter has no effect; the measurement is always stopped after a single shot.					
The <i>Repetition</i> parameter is valid in remote control only. Changing this parameter in remote control does not alter the repetition mode in manual control and vice versa. The default repetition mode in manual control is <i>Continuous</i> .					
*) The default values depend on the test setup:					
Test Setup	T1	T2	T3	T4	T5
<Statistics>	1000	7408	7408	1093	590
<Repetition>	SING	SING	SING	SING	SING
<Stop Condition>	None	None	None	None	None

CONFigure:RXQuality:BER:TSETup<nr>:CONTROL:STATistics <Statistics>				Statistics
<Statistics>	Description of parameters	Def. value	Def. unit	FW vers.
1 to 400 000 NONE	Number of packets per statistic cycle No statistics (equivalent to 1)	1000 ^{*)}	–	V2.60
Description of command				Sig. State
This command defines the number of packets to be measured in a BER measurement cycle. The suffix <nr> refers to the selected test setup (<nr> = 1 to 5).				all
*) The default values depend on the test setup; see command				
CONFigure:RXQuality:BER:TSETup<nr>:CONTROL				

CONFigure:RXQuality:BER:TSETup<nr>:CONTRol:REPetition <Repetition>, <Stop Condition>				Test Cycles
<Repetition>	Description of parameters	Def. value*)	Def. unit	
CONTInuous SINGleshot 1 to 10000	Continuous measurement (until STOP or ABORT) Single shot measurement (until Status = RDY) Multiple measurement (counting, until Status = STEP RDY)	SING	–	
<Stop Condition>	Description of parameters	Def. value		
SONerror NONE	Stop measurement in case of error (stop on limit failure, tolerance exceeded) Continue measurement even in case of error	NONE	–	
<Stepmode>	Description of parameters	Def. value	Def. unit	FW vers.
STEP NONE	Interrupt measurement after each statistics cycle Continue measurement according to its rep. mode	NONE	–	V2.60
Description of command				Sig. State
This command determines the repetition mode and the stop condition for the measurement. The suffix <nr> refers to the selected test setup (<nr> = 1 to 5).				all
Note: In the case of READ commands (READ:...), the <Repetition> parameter has no effect; the measurement is always stopped after a single shot.				
The Repetition parameter is valid in remote control only. Changing this parameter in remote control does not alter the repetition mode in manual control and vice versa. The default repetition mode in manual control is Continuous.				
*) The default values depend on the test setup; see command CONFigure:RXQuality:BER:TSETup<nr> :CONTRol				

Subsystem RXQuality:BER:...LEVel

The subsystem *RXQuality:BER:...LEVel* sets the R&S® CMU TX level used for BER receiver quality measurements. The subsystem corresponds to the *TX Level* parameter in the *Master Sig.* tab in the popup menu *Receiver Quality Configuration*.

CONFigure:RXQuality:BER:TSETup<nr>:LEVel <Level>				TX Level
<Level>	Description of parameters	Def. value	Def. unit	FW vers.
–137 dBm to –27 dBm –137 dBm to –10 dBm –90 dBm to +13 dBm	RF1 TX level for BER RF2 TX level for BER RF3 OUT TX level for BER	–70.0 –70.0 –70.0*	dBm dBm dBm	V2.60
Description of command				Sig. State
This command defines the output power of the R&S® CMU transmitter for a BER test. The suffix <nr> refers to the selected test setup (<nr> = 1 to 5). The BER TX level does not affect any other measurements (see command CONFigure:MSIGnal:TXLevel <Level>).				all
*) The default value for test setup T1 is –40 dBm. The default value for test setup T2 is –20 dBm.				

BER Test Signal

The commands in the following section define the test signal that the R&S CMU generates for the BER measurement. The subsystem corresponds to the subsection *Loopback* of tab *Control*, BER application, in the popup menu *Receiver Quality Configuration*.

CONFigure:RXQuality:BER:TSETup<nr>:HSCHEME <Scheme>				BER Hopping Scheme	
<Scheme>	Description of parameters	Def. value	Def. unit	FW vers.	
RXTX EUSA FRANce RHOP	RX/TX on single frequency Europe's and USA's hopping scheme France's hopping scheme Test mode's reduced hopping scheme	EUSA	–	V3.07	
Description of command					Sig. State
These commands select the hopping scheme to be used in test mode. Channels and frequency ranges are:					all
Europe/USA	2400 MHz to 2483.5 MHz,	Channel _k : $f_k = 2402+k$ MHz, $k = 0$ to 78			
France	2446.5 MHz to 2483.5 MHz,	Channel _k : $f_k = 2454+k$ MHz, $k = 0$ to 22			

CONFigure:RXQuality:BER:TSETup<nr>:FREQUENCY <TX_Freq>,<RX_Freq>				TX/RX Frequency, BER	
<TX_Freq>	Description of parameters	Def. value	Def. unit	FW vers.	
2 402 MHz to 2 495 MHz,	TX frequency	2480000000	Hz		
<RX_Freq>	Description of parameters	Def. value	Def. unit	FW vers.	
2 402 MHz to 2 495 MHz	RX frequency	2402000000	Hz	V3.07	
Description of command					Sig. State
These commands define the frequency of the RF signals that will be generated and received by the DUT during <i>RXQuality:BER</i> measurements. Both frequencies must be entered in multiples of the <i>Bluetooth</i> channel width of 1 MHz.					all

CONFigure:RXQuality:BER:TSETup<nr>:PATType <Type>				Pattern Type	
<Type>	Description of parameters	Def. value	Def. unit	FW vers.	
DPRS SPRS ALL1 ALL0 P11 P44 USER	Dynamic pseudo random sequence Static pseudo random sequence All ones All zeros Alternative ones and zeros Four ones then four zeros User defined	SPRS	–	V2.60	
Description of command					Sig. State
This command sets the bit pattern for BER measurements. The suffix <nr> refers to the selected test setup (<nr> = 1 to 5).					all

CONFigure:RXQuality:BER:TSETup<nr>:PTYPE <Type>				Packet Type
<Type>	Description of parameters	Def. value	Def. unit	FW vers.
DH1	DH1 packet	**DH1	–	V2.60
DH3	DH3 packet			
DH5	DH5 packet			
Description of command				Sig. State
This command determines what type of packet is to be transmitted by the DUT during loopback mode. The suffix <nr> refers to the selected test setup (<nr> = 1 to 5).				all
** The default packet type for test setup T4 (T5) is DH3 (DH5).				

				Length of Test Sequence
CONFigure:RXQuality:BER:TSETup<nr>:LOTSequence:DH1Packet <Length>				
CONFigure:RXQuality:BER:TSETup<nr>:LOTSequence:DH3Packet <Length>				
CONFigure:RXQuality:BER:TSETup<nr>:LOTSequence:DH5Packet <Length>				
<Length>	Description of parameters	Def. value	Def. unit	FW vers.
0 to 27	Length of test sequence, in bytes, for a DH1 packet	27	bytes	V2.60
0 to 183	Length of test sequence, in bytes, for a DH3 packet	183		
0 to 339	Length of test sequence, in bytes, for a DH5 packet	339		
Description of command				Sig. State
This command determines the length of the payload for the transmitted packet. The allowed value range depends on the packet type (see command CONFigure:RXQuality:BER:TSETup<nr>:PTYPE). The suffix <nr> refers to the selected test setup (<nr> = 1 to 5).				all

CONFigure:RXQuality:BER:TSETup<nr>:UDLength <Length>				User defined Length
<Length>	Description of parameters	Def. value	Def. unit	FW vers.
3 to 64	Length of user defined data in bit	16	–	V2.60
Description of command				Sig. State
This command determines the length of the user defined bit sequence before it is repeated. The suffix <nr> refers to the selected test setup (<nr> = 1 to 5). The specified value will be used if the loopback pattern is user defined (see command CONFigure:RXQuality:BER:TSETup<nr>:PATType).				all

CONFigure:RXQuality:BER:TSETup<nr>:UDData <Data>				User defined Data
<Data>	Description of parameters	Def. value	Def. unit	FW vers.
<HEX Data>	Up to 64 user defined data bits; represented by max. 16 hex characters, least significant bit last, i.e. to the right	“FF00”	–	V2.60
Description of command				Sig. State
This command determines the bit stream to be used for the user defined data. The bit stream is repeated until the complete payload is filled, removing any extra bits from the end of the stream. The suffix <nr> refers to the selected test setup (<nr> = 1 to 5). The specified value will be used if the loopback pattern is user defined (see command CONFigure:RXQuality:BER:TSETup<nr>:LBACK:PATType).				all

CONFigure:RXQuality:BER:TSETup<nr>:WHITening <Enable>				Whitening
<Enable>	Description of parameters	Def. value	Def. unit	FW vers.
ON OFF	Whitening enabled Whitening disabled	OFF	–	V3.08
Description of command				Sig. State
These commands switch whitening on or off.				all

CONFigure:RXQuality:BER:TSETup<nr>:DELay <Delay>				Delay
<Delay>	Description of parameters	Def. value	Def. unit	FW vers.
ON OFF	Use loopback with delay Do not use loopback with delay	OFF	–	V2.65
Description of command				Sig. State
This command determines whether delayed loopback should be used in the DUT. The suffix <nr> refers to the selected test setup (<nr> = 1 to 5).				all

DEFault:RXQuality:BER:TSETup<nr>				Default Settings
<Enable>	Description of parameters	Def. value	Def. unit	FW vers.
ON OFF	The parameters are set to default values Some or all parameters differ from the default values	ON	–	V2.60
Description of command				Sig. State
As a <i>setting command</i> with the setting <i>ON</i> this command sets all parameters of the subsystem to default values (the setting <i>OFF</i> results in an error message). This also includes the <code>BER:LIMit</code> settings.				all
As a query, this command returns whether all parameters are set to default values (<i>ON</i>) or not (<i>OFF</i>). The suffix <nr> refers to the selected test setup (<nr> = 1 to 5).				

Subsystem RXQuality:BER...:LIMit

The subsystem `RXQuality:BER...:LIMit` defines tolerance values for the BER measurement. The subsystem corresponds to the tab *Limits* in the popup menu *Receiver Quality Configuration*.

CONFigure:RXQuality:BER:TSETup<nr>:LIMit:SCALar:ASYMmetric[:COMBined]				BER Limit
<BER>, <BER_Enable>, <PER>, <PER_Enable>				
Parameters	Description of parameters	Def. value	Def. unit	FW vers.
0% to 100%, ON OFF	Upper limit for bit error rate (BER) Enable or disable BER limit check	0.10 ON	% –	V2.60
0% to 100%, ON OFF	Upper limit for packet error rate (PER) Enable or disable PER limit check	0.01 OFF	% –	
Description of command				Sig. State
This command defines an upper limit for the bit error rate and the packet error rate for test setup number <nr> and switches the limit checks on or off.				all

CONFigure:RXQuality:BER:TSEUp<nr>:LIMit:SCALar:ASYMmetric[:COMBined]:VALue <BER>, <PER>				BER Limit
Parameters	Description of parameters	Def. value	Def. unit	FW vers.
0% to 100%,	Upper limit for bit error rate (BER)	0.10	%	V2.60
0% to 100%	Upper limit for packet error rate (PER)	0.01	%	
Description of command				Sig. State
This command defines an upper limit for the bit error rate and the packet error rate for test setup number <nr>.				all

CONFigure:RXQuality:BER:TSEUp<nr>:LIMit:SCALar:ASYMmetric[:COMBined]:ENABLE <BER_Enable>, <PER_Enable>				BER Limit On/Off
Parameters	Description of parameters	Def. value	Def. unit	FW vers.
ON OFF,	Enable or disable BER limit check	ON	–	V2.60
ON OFF	Enable or disable PER limit check	OFF	–	
Description of command				Sig. State
This command switches the BER or PER limit checks on or off.				

DEFault:RXQuality:BER:TSEUp<nr>:LIMit				Default Settings
<Enable>	Description of parameters	Def. value	Def. unit	FW vers.
ON OFF	The parameters are set to default values	ON	–	V2.60
OFF	Some or all parameters differ from the default value			
Description of command				Sig. State
As a <i>setting command</i> with the setting ON this command sets all parameters of the subsystem to default values (the setting OFF results in an error message).				all
As a query, this command returns whether all parameters are set to default values (ON) or not (OFF). The suffix <nr> refers to the selected test setup (<nr> = 1 to 5).				

Measured Values

The following commands measure and return the bit error rate and compares it with the tolerance values. The subsystem corresponds to the output elements in the measurement menu *Receiver Quality* for the BER application.

READ[:SCALar]:RXQuality:BER? FETCh[:SCALar]:RXQuality:BER?				Scalar Results: Start BER measurement and return results Read out meas. results (unsynchronized)
<BER>	Description of parameters	Def. value	Def. unit	
0 % to 100 %,	Percentage of bit errors that occurred within the current statistical cycle	NAN	%	
<PER>	Description of parameters	Def. value	Def. unit	
0 % to 100 %,	Percentage of packet errors that occurred within the current statistical cycle	NAN	%	
<Packets received>	Description of parameters	Def. value	Def. unit	FW vers.
0 to 1000	Total number of packets received successfully	NAN	–	V2.60
Description of command				Sig. State
These commands are always queries. They start a bit-error-rate test and output the measurement results (see also detailed explanation of measured values in Chapter 4).				TEST

FETCh[:SCALar]:RXQuality:BER:DETail?				Scalar Results
				Read out meas. results (unsynchronized)
Returned values	Description of parameters	Def. value	Def. unit	FW vers.
0 % to 100 %,	Bit error rate,	NAN	%	V4.20
0 % to 100 %,	Not acknowledged (NAK) rate,	NAN	%	
0 % to 100 %,	Missing packet rate (PER detail),	NAN	%	
0 % to 100 %,	HEC error rate (PER detail),	NAN	%	
0 % to 100 %,	CRC error rate (PER detail),	NAN	%	
0 % to 100 %,	Wrong packet type rate (PER detail),	NAN	%	
0 % to 100 %,	Wrong payload length rate (PER detail),	NAN	%	
0 % to 100 %	Packet error rate (PER total)	NAN	%	
Description of command				Sig. State
This command is always a query. An <code>INIT:RXQuality:BER</code> command must have been issued prior to the <code>FETCh...</code> in order to receive valid results.				TEST

CALCulate:RXQuality:BER:MATChing:LIMit?				Limit Matching
<BER>	Value range	Def. value	Def. unit	
NMAU	BER result is above the limit	INV	-	
INV	BER result is invalid			
OK	BER result is valid			
<PER>	Value range	Def. value	Def. unit	FW vers.
NMAU	PER result is above the limit	INV	-	V2.60
INV	PER result is invalid			
OK	PER result is valid			
Description of command				Sig. State
This command is always a query. It indicates whether and in which way the permissible error limits for the measured values of the bit error rate test (see command above) have been exceeded.				TEST

Receiver Quality – BER Search Application

The subsystem *RXQuality:SBER* contains the commands for receiver quality measurement in *BER Search* mode. The subsystem corresponds to the main menu *Receiver Quality*, application *BER Search* and the corresponding sections in the associated popup menu *Receiver Quality Configuration*.

Measurement Control

The following commands control the *BER Search* measurement. They correspond to the *BER Search* measurement control softkey.

INITiate:RXQuality:SBER	Start new measurement	⇒	<i>RUN</i>
ABORt:RXQuality:SBER	Abort running measurement and switch off	⇒	<i>OFF</i>
STOP:RXQuality:SBER	Stop measurement	⇒	<i>STOP</i>
CONTinue:RXQuality:SBER	Next measurement step (only <i>stepping mode</i>)	⇒	<i>RUN</i>
Description of command		Sig. State	FW vers.
These commands have no query form. They start or stop the <i>BER Search</i> measurement, setting it to the status indicated in the top right column.		all	V2.60

CONFigure: RXQuality:SBER:EREPorting <Mode>			Event Reporting	
<Mode>	Description of parameters	Def. value	Def. unit	FW vers.
SRQ 	Service request	OFF	–	V2.60
SOPC 	Single operation complete			
SRSQ 	SRQ and SRSQ			
OFF	No reporting			
Description of command			Sig. State	
This command defines the events generated when the measurement is terminated or stopped (<i>event reporting</i> , see Chapter 5 of R&S CMU manual).			all	

FETCh:RXQuality:SBER:STATus?		Measurement Status		
Return	Description of parameters	Def. value	Def. unit	FW vers.
OFF 	Measurement in the <i>OFF</i> state (*RST or ABORt)	OFF	–	V2.60
RUN 	Running (after INITiate, CONTinue or READ)			
STOP 	Stopped (STOP)			
ERR 	OFF (could not be started)			
STEP 	Stepping mode (<stepmode>=STEP)			
RDY,	Stopped according to repetition mode and stop condition			
1 to 1000 	Number of packets to average	NONE	–	
NONE	No averaging (equivalent to 1)			
Description of command			Sig. State	
This command is always a query. It returns the status of the measurement (see Chapter 5 of R&S CMU manual).			all	

Subsystem RXQuality:SBER:CONTRol

The subsystem *RXQuality:SBER:CONTRol* defines the scope of the *BER Search* measurement. The settings are provided in the *Control* tab of the popup menu *Receiver Quality Configuration*.

CONFigure:RXQuality:SBER:CONTRol:STATistics <Packets>, <Search Value>, <Search Cycles>				BER Search Statistics	
<Packets>	Description of parameters	Def. value	Def. unit		
1 to 10000 NONE,	Number of packets to calculate the average values for the measurement with no averaging	20	–		
<Search Value>	Description of parameters	Def. value	Def. unit		
0% to 100%,	Condition to look for to terminate the measurement, i.e. the condition to represent the sensitivity level of the DUT's receiver; percentage of bit errors (BER) within the BER test	0.1	%		
<Search Cycles>	Description of parameters	Def. value	Def. unit	FW vers.	
1 to 100	Number of cycles to conduct the measurement over. One cycle consists of the number of packets declared in the <i>Packets</i> field.	41	–		V2.60
Description of command					Sig. State
This command defines the parameters for the <i>BER Search</i> application.					all

Subsystem RXQuality:SBER:...LEVel

The subsystem *RXQuality:BER:...LEVel* sets the R&S® CMU TX level used for *BER Search* measurements. The subsystem corresponds to the *TX Level* parameter in the *Master Sig.* tab in the popup menu *Receiver Quality Configuration*.

CONFigure:RXQuality:SBER:LEVel <Lower_Level>, <Upper_Level>				Srch. Upper/Lower Level	
<Lower_Level>	Description of parameters	Def. value	Def. unit		
–137 dBm to –27 dBm	RF1 lowest TX level	–90.0	dBm		
–137 dBm to –10 dBm	RF2 lowest TX level	–90.0	dBm		
–90 dBm to +13 dBm,	RF3 OUT lowest TX level	–90.0	dBm		
<Upper_Level>	Description of parameters	Def. value	Def. unit	FW vers.	
–137 dBm to –27 dBm	RF1 lowest TX level	–70.0	dBm		V2.60
–137 dBm to –10 dBm	RF2 lowest TX level	–70.0	dBm		
–90 dBm to +13 dBm	RF3 OUT lowest TX level	–70.0	dBm		
Description of command					Sig. State
This command defines the lowest and the highest output power of the R&S® CMU transmitter to use in the <i>BER Search</i> application.					all

Subsystem RXQuality:SBER

The subsystem *RXQuality:SBER* defines the test signal that the R&S CMU generates for *BER Search* measurements. The subsystem corresponds to the subsection *Loopback* of tab *Control*, *BER Search* application, in the popup menu *Receiver Quality Configuration*.

CONFigure:RXQuality:SBER[:LBACK]:HSCHEME <Scheme>				SBER Hopping Scheme		
<Scheme>	Description of parameters			Def. value	Def. unit	FW vers.
RXTX 	RX/TX on single frequency			RXTX	–	V3.08
EUSA 	Europe's and USA's hopping scheme					
FRANce 	France's hopping scheme					
RHOP	Test mode's reduced hopping scheme					
Description of command						Sig. State
These commands select the hopping scheme to be used in test mode. Channels and frequency ranges are:						all
Europe/USA	2400 MHz	to	2483.5 MHz,	Channel _k : $f_k = 2402 + k$ MHz,	$k = 0$ to 78	
France	2446.5 MHz	to	2483.5 MHz,	Channel _k : $f_k = 2454 + k$ MHz,	$k = 0$ to 22	

CONFigure:RXQuality:SBER:FREQUENCY <TX_Freq>,<RX_Freq>				TX/RX Frequency, SBER		
<TX_Freq>	Description of parameters			Def. value	Def. unit	
2 402 MHz to 2 495 MHz,	TX frequency			2402000000	Hz	
<RX_Freq>	Description of parameters			Def. value	Def. unit	FW vers.
2 402 MHz to 2 495 MHz	RX frequency			2480000000	Hz	V3.08
Description of command						Sig. State
These commands define the frequency of the RF signals that will be generated and received by the DUT during <i>RXQuality:BER</i> measurements. Both frequencies must be entered in multiples of the <i>Bluetooth</i> channel width of 1 MHz. With the command <i>CONFigure:RXQuality:SBER:FREQUENCY:UNIT</i> , the default frequency unit can be changed, and even <i>Bluetooth</i> channel numbers can be entered instead of frequencies.						all

CONFigure:RXQuality:SBER:PATTtype <Type>				Pattern Type		
<Type>	Description of parameters			Def. value	Def. unit	FW vers.
DPRS 	Dynamic pseudo random sequence			SPRS	–	V2.60
SPRS 	Static pseudo random sequence					
ALL1 	All ones					
ALL0 	All zeros					
P11 	Alternative ones and zeros					
P44 	Four ones then four zeros					
USER	User defined					
Description of command						Sig. State
This command sets the bit pattern for BER Search tests.						all

CONFigure:RXQuality:SBER:PTYPE <Type>				Packet Type
<Type>	Description of parameters	Def. value	Def. unit	FW vers.
DH1	DH1 packet	**DH1	–	V2.60
DH3	DH3 packet			
DH5	DH5 packet			
Description of command				Sig. State
This command determines what type of packet is to be transmitted by the DUT during loopback mode. The suffix <nr> refers to the selected test setup (<nr> = 1 to 5).				all
** The default packet type for test setup T4 (T5) is DH3 (DH5).				

CONFigure:RXQuality:SBER:LOTSequence:DH1Packet <Length>				Length of Test Sequence	
<Length>	Description of parameters	Def. value	Def. unit	FW vers.	
0 to 27	Length of test sequence, in bytes, for a DH1 packet	27	bytes	V2.60	
0 to 183	Length of test sequence, in bytes, for a DH3 packet	183			
0 to 339	Length of test sequence, in bytes, for a DH5 packet	339			
Description of command				Sig. State	
This command determines the length of the payload for the transmitted packet. The allowed value range depends on the packet type (see command <code>CONFigure:RXQuality:SBER:PTYPE</code>). The suffix <nr> refers to the selected test setup (<nr> = 1 to 5).				all	

CONFigure:RXQuality:SBER:UDLength <Length>				User defined Length	
<Length>	Description of parameters	Def. value	Def. unit	FW vers.	
3 to 64	Length of user defined data in bit	16	–	V2.60	
Description of command				Sig. State	
This command determines the length of the user defined bit sequence before it is repeated. The specified value will be used if the loopback pattern is user defined (see command <code>CONFigure:RXQuality:SBER:PATType</code>).				all	

CONFigure:RXQuality:SBER:UDData <Data>				User defined Data	
<Data>	Description of parameters	Def. value	Def. unit	FW vers.	
<HEX Data>	Up to 64 user defined data bits; represented by max. 16 hex characters, least significant bit last, i.e. to the right	“FF00”	–	V2.60	
Description of command				Sig. State	
This command determines the bit stream to be used for the user defined data. The bit stream is repeated until the complete payload is filled, removing any extra bits from the end of the stream. This command is only available if the loopback pattern is user defined (see command <code>CONFigure:RXQuality:SBER:PATtern</code>).				all	

CONFigure:RXQuality:SBER:WHITening <Enable>				Whitening
<Enable>	Description of parameters	Def. value	Def. unit	FW vers.
ON 	Whitening enabled	OFF	–	V3.08
OFF	Whitening disabled			
Description of command				Sig. State
These commands switch whitening on or off.				all

CONFigure:RXQuality:SBER:DELay <Delay>				Delay
<Delay>	Description of parameters	Def. value	Def. unit	FW vers.
ON 	Use loopback delay	OFF	–	V2.65
OFF	Do not use loopback delay			
Description of command				Sig. State
This command determines whether delayed loopback should be used in the DUT.				all

DEFault:RXQuality:SBER				Default Settings
<Enable>	Description of parameters	Def. value	Def. unit	FW vers.
ON 	The parameters are set to default values	ON	–	V2.60
OFF	Some or all parameters differ from the default values			
Description of command				Sig. State
As a <i>setting command</i> with the setting <i>ON</i> this command sets all parameters of the subsystem to default values (the setting <i>OFF</i> results in an error message). This also includes the <code>SBER:LIMIt</code> settings.				all
As a query, this command returns whether all parameters are set to default values (<i>ON</i>) or not (<i>OFF</i>).				

Measured Values

The following commands measure and return the results of the *BER Search* application. The subsystem corresponds to the measurement menu *Receiver Quality* for the *BER Search* application.

				Scalar Results:
READ[:SCALar]:RXQuality:SBER?		Start BER Search measurement and return results		
FETCh[:SCALar]: RXQuality:SBER?		Read out results (unsynchronized)		
<BER>	Description of parameters	Def. value	Def. unit	
0 to 100 %	Percentage of bit errors that have occurred within the current statistical cycle	NAN	%	
<PER>	Description of parameters	Def. value	Def. unit	
0 to 100 %	Percentage of packet errors that have occurred within the current statistical cycle	NAN	%	
<TX_Level>	Description of parameters	Def. value	Def. unit	
-137 dBm to 13 dBm	Current R&S [®] CMU generator level	NAN	dBm	
<Packets received>	Description of parameters	Def. value	Def. unit	
0 to 1000	Total number of packets received successfully	NAN	–	
<Search Result>	Description of parameters	Def. value	Def. unit	FW vers.
-137 dBm to 13 dBm	Result of the BER search iteration	NAN	dBm	V2.60
Description of command				Sig. State
These commands are always queries. They start a bit-error-rate test (<code>READ...</code>) and return the measurement results (see also detailed explanation of measured values in Chapter 4). <code><TX_Level></code> is available while the R&S [®] CMU transmits a BER test signal; a <code><Search Result></code> is available only after the iteration has been terminated successfully.				TEST

List of Commands

In the following, all remote-control commands of the function group *Bluetooth* implemented in the CMU will be listed with their parameters and page numbers. They are arranged alphabetically according to the **second** keyword of the command so that related commands belong to the same group.

Commands in Bluetooth Non Signalling Mode

Table 6-1 Remote-control commands: Non Signalling

Command	Parameter	Remark	Page
Inputs and outputs			
[SENSe:]CORRection:LOSS:INPut<nr>[:MAGNitude]	-50 dB to +90 dB	with query	6.4
SOURce:CORRection:LOSS:INPut<nr>[:MAGNitude]	-50 dB to +90 dB	with query	6.4
[SENSe:]CORRection:LOSS:OUTPut<nr>[:MAGNitude]	-50 dB to +90 dB	with query	6.5
SOURce:CORRection:LOSS:OUTPut<nr>[:MAGNitude]	-50 dB to +90 dB	with query	6.5
SOURce:DM:CLOCK:FREQuency	1.250 MHz to 40.000 MHz	with query	6.5
SOURce:DM:CLOCK:STATe	ON OFF	with query	6.5
INPut[:STATe]	RF1 RF2 RF4	with query	6.4
OUTPut[:STATe]	RF1 RF2 RF3	with query	6.4
RF Generator			
INITiate:RFGenerator	-	no query	6.1
ABORt:RFGenerator	-	no query	6.1
SOURce:RFGenerator:BDADdress	"<BD address>"	with query	6.3
CONFigure:RFGenerator:BMODulation	PRBS ALL0 ALL1 P44 P22 P11	with query	6.4
SOURce:RFGenerator:FOFFset	-500 kHz to 500 kHz	with query	6.2
SOURce:RFGenerator:FREQuency	2402 MHz to 2495 MHz	with query	6.2
SOURce:RFGenerator:FREQuency:UNIT	HZ KHZ MHZ GHZ CH	with query	6.2
SOURce:RFGenerator:LEVel	-137.0 to +13.0 dBm	depending on RF connector	6.2
SOURce:RFGenerator:MINdex	0.20 to 0.44 OFF	with query	6.3
CONFigure:RFGenerator:PLENght	<dep. on packet type>	with query	6.3

Command	Parameter	Remark	Page
SOURce:RFGenerator:PTBZero	LONG SHORT	with query	6.2
CONFigure:RFGenerator:PTYPE	DH1 DH3 DH5	with query	6.3
FETCh:RFGenerator:STATus?	OFF RUN ERR	query only	6.1

Commands in Bluetooth Signalling Mode

Table 6-2 Remote-control commands: Signalling

Command	Parameter	Remark	Page
ACL data transfer			
SOURce:ACLData	"<string>"	with query	6.36
SOURce:ACLData:ENABLE	ON OFF	with query	6.36
[SENSe:]ACLData?	"<string>"	query only	6.36
Inputs and outputs			
[SENSe:]CORRection:LOSS:INPut<nr>[:MAGNitude]	-50 dB to +50 dB	with query	6.24
SOURce:CORRection:LOSS:INPut<nr>[:MAGNitude]	-50 dB to +90 dB	with query	6.24
[SENSe:]CORRection:LOSS:OUTPut<nr>[:MAGNitude]	-50 dB to 50 dB	with query	6.25
SOURce:CORRection:LOSS:OUTPut<nr>[:MAGNitude]	-50 dB to 90 dB	with query	6.25
SOURce:DM:CLOCK:FREQuency	1.250 MHz to 40.000 MHz	with query	6.26
SOURce:DM:CLOCK:STATe	ON OFF	with query	6.25
INPut[:STATe]	RF1 RF2 RF4	with query	6.24
OUTPut[:STATe]	RF1 RF2 RF3	with query	6.24
Authentication			
CONFigure:DUT:AUTHeNtic:ENABLE	ON OFF	with query	6.15
CONFigure:DUT:PINCode	'<12-digit hex>'	with query	6.15
CONFigure:DUT:STORe:LINK:KEYS	ON OFF	with query	6.15
Input level			
DEFault:LEVel	ON OFF	with query	6.27

Command	Parameter	Remark	Page
[SENSe:]LEVel:ATTenuation	NORMal LNOise LDISTortion	with query	6.26
[SENSe:]LEVel:MAXimum	-77 dBm to 53 dBm	depending on RF connector	6.26
[SENSe:]LEVel:MODE	MANual AUTomatic	with query	6.26
Miscellaneous settings			
CONFigure:MISC:CCDefault	ON OFF	with query	6.6
Modulation measurements			
INITiate:MODulation:DEViation	-	no query	6.59
ABORt:MODulation:DEViation	-	no query	6.59
STOP:MODulation:DEViation	-	no query	6.59
CONTinue:MODulation:DEViation	-	no query	6.59
CONFigure:SUBarrays:MODulation:DEViation	ALL ARITHmetical MINimum MAXimum IVAL XMINimum XMAXimum PAVG, <Start>, <Samples>{, <Start>, <Samples>}	with query	6.68
CONFigure:MODulation:DEViation:AVERage:LIMit:SCALar:ASYMmetric:LOWer:ENABLE	ON OFF, ON OFF, ON OFF, ON OFF, ON OFF, ON OFF, ON OFF	with query	6.66
CONFigure:MODulation:DEViation:AVERage:LIMit:SCALar:ASYMmetric:LOWer:VALue	<Freq_Acc>, <Freq_Drift>, <Max_Drift_Rate>, <Freq_Dev_Aver>, <Freq_Dev_Max>, <Freq_Dev_Min>	with query	6.65
CONFigure:MODulation:DEViation:AVERage:LIMit:SCALar:ASYMmetric:UPPer:ENABLE	ON OFF, ON OFF, ON OFF, ON OFF, ON OFF, ON OFF, ON OFF	with query	6.65
CONFigure:MODulation:DEViation:AVERage:LIMit:SCALar:ASYMmetric:UPPer:VALue	<Freq_Acc>, <Freq_Drift>, <Max_Drift_Rate>, <Freq_Dev_Aver>, <Freq_Dev_Max>, <Freq_Dev_Min>	with query	6.64
CONFigure:MODulation:DEViation:AVERage:LIMit:SCALar:ASYMmetric:COMBined]:ENABLE	ON OFF, ON OFF, ON OFF, ON OFF, ON OFF, ON OFF, ON OFF, ON OFF, ON OFF, ON OFF	with query	6.67
CONFigure:MODulation:DEViation:AVERage:LIMit:SCALar:ASYMmetric:COMBined]:VALue	<Freq_Acc_Upp>, <Freq_Acc_Low>, <Freq_Drift_Upp>, <Freq_Drift_Low>, <Max_Drift_Rate_Upp>, <Max_Drift_Rate_Low>, <Freq_Dev_Upp_Aver>, <Freq_Dev_Low_Aver>, <Freq_Dev_Upp_Max>, <Freq_Dev_Low_Max>, <Freq_Dev_Upp_Min>, <Freq_Dev_Low_Min>	with query	6.66

Command	Parameter	Remark	Page
READ:ARRAY:MODulation:DEVIation:AVERage?	-200.0 kHz to +200.0 kHz	query only	6.72
FETCh:ARRAY:MODulation:DEVIation:AVERage?	-200.0 kHz to +200.0 kHz	query only	6.72
READ:SUBarrays:MODulation:DEVIation:AVERage?	-200.0 kHz to +200.0 kHz	query only	6.73
FETCh:SUBarrays:MODulation:DEVIation:AVERage?	-200.0 kHz to +200.0 kHz	query only	6.73
CONFigure:MODulation:DEVIation:BATHreshold:CLIMit:ENABle	<Enable>	with query	6.67
CONFigure:MODulation:DEVIation:BATHreshold:CLIMit[:VALue]	<Percentage>	with query	6.67
CONFigure:MODulation:DEVIation:BATHreshold:THReshold[:VALue]	<Freq_Dev>	with query	6.67
FETCh[:SCALar]:MODulation:DEVIation:BATHreshold?	<Result>	query only	6.70
CONFigure:MODulation:DEVIation:CONTRol	SCALar ARRy, 1 to 1000 NONE, CONTInuous SINGleshot 1 to 10000, SONerror NONE, STEP NONE	with query	6.62
DEFault:MODulation:DEVIation:CONTRol	ON OFF	with query	6.64
CONFigure:MODulation:DEVIation:CONTRol:REPetition	CONTInuous SINGleshot 1 to 10000, SONerror NONE,STEP NONE	with query	6.63
CONFigure:MODulation:DEVIation:CONTRol:RMODE	SCALar ARRy	with query	6.63
CONFigure:MODulation:DEVIation:CONTRol:STATistics	1 to 1000 NONE	with query	6.63
CONFigure:MODulation:DEVIation:CURRent:LIMit:SCALar:ASYMmetric:LOWer:ENABle	ON OFF, ON OFF, ON OFF, ON OFF, ON OFF, ON OFF, ON OFF	with query	6.66
CONFigure:MODulation:DEVIation:CURRent:LIMit:SCALar:ASYMmetric:LOWer:VALue	<Freq_Acc>, <Freq_Drift>, <Max_Drift_Rate>, <Freq_Dev_Aver>, <Freq_Dev_Max>, <Freq_Dev_Min>	with query	6.65
CONFigure:MODulation:DEVIation:CURRent:LIMit:SCALar:ASYMmetric:UPPer:ENABle	ON OFF, ON OFF, ON OFF, ON OFF, ON OFF, ON OFF, ON OFF	with query	6.65
CONFigure:MODulation:DEVIation:CURRent:LIMit:SCALar:ASYMmetric:UPPer:VALue	<Freq_Acc>, <Freq_Drift>, <Max_Drift_Rate>, <Freq_Dev_Aver>, <Freq_Dev_Max>, <Freq_Dev_Min>	with query	6.64
CONFigure:MODulation:DEVIation:CURRent:LIMit:SCALar:ASYMmetric[:COMBined]:ENABle	ON OFF, ON OFF, ON OFF, ON OFF, ON OFF, ON OFF, ON OFF, ON OFF, ON OFF	with query	6.67
CONFigure:MODulation:DEVIation:CURRent:LIMit:SCALar:ASYMmetric[:COMBined]:VALue	<Freq_Acc_Upp>, <Freq_Acc_Low>, <Freq_Drift_Upp>, <Freq_Drift_Low>, <Max_Drift_Rate_Upp>, <Max_Drift_Rate_Low>, <Freq_Dev_Upp_Aver>	with query	6.66

Command	Parameter	Remark	Page
	<Freq_Dev_Low_Aver> <Freq_Dev_Upp_Max>, <Freq_Dev_Low_Max> <Freq_Dev_Upp_Min>, <Freq_Dev_Low_Min>		
READ:ARRAY:MODulation:DEVIation:CURRent?	-200.0 kHz to +200.0 kHz	query only	6.72
FETCh:ARRAY:MODulation:DEVIation:CURRent?	-200.0 kHz to +200.0 kHz	query only	6.72
READ:SUBarrays:MODulation:DEVIation:CURRent?	-200.0 kHz to +200.0 kHz	query only	6.73
FETCh:SUBarrays:MODulation:DEVIation:CURRent?	-200.0 kHz to +200.0 kHz	query only	6.73
CONFigure:MODulation:DEVIation:EREPorting	SRQ SOPC SRSQ OFF	with query	6.59
READ[:SCALar]:MODulation:DEVIation:EXTended?	<Result>	query only	6.70
FETCh[:SCALar]:MODulation:DEVIation:EXTended?	<Result>	query only	6.70
CONFigure:MODulation:DEVIation:FDALgorithm	BCAV IAV	with query	6.62
DEFault:MODulation:DEVIation:LIMit	ON OFF	with query	6.68
CALCulate:MODulation:DEVIation:MATChing:LIMit?	<Result>	query only	6.71
CONFigure:MODulation:DEVIation:MAXimum:LIMit:SCALar:ASYMmetric:LOWer:ENABLE	ON OFF, ON OFF, ON OFF, ON OFF, ON OFF, ON OFF	with query	6.66
CONFigure:MODulation:DEVIation:MAXimum:LIMit:SCALar:ASYMmetric:LOWer:VALue	<Freq_Acc>, <Freq_Drift>, <Max_Drift_Rate>, <Freq_Dev_Aver>, <Freq_Dev_Max>, <Freq_Dev_Min>	with query	6.65
CONFigure:MODulation:DEVIation:MAXimum:LIMit:SCALar:ASYMmetric:UPPer:ENABLE	ON OFF, ON OFF, ON OFF, ON OFF, ON OFF, ON OFF	with query	6.65
CONFigure:MODulation:DEVIation:MAXimum:LIMit:SCALar:ASYMmetric:UPPer:VALue	<Freq_Acc>, <Freq_Drift>, <Max_Drift_Rate>, <Freq_Dev_Aver>, <Freq_Dev_Max>, <Freq_Dev_Min>	with query	6.64
CONFigure:MODulation:DEVIation:MAXimum:LIMit:SCALar:ASYMmetric[:COMBined]:ENABLE	ON OFF, ON OFF, ON OFF, ON OFF, ON OFF, ON OFF, ON OFF, ON OFF, ON OFF	with query	6.67
CONFigure:MODulation:DEVIation:MAXimum:LIMit:SCALar:ASYMmetric[:COMBined]:VALue	<Freq_Acc_Upp>, <Freq_Acc_Low>, <Freq_Drift_Upp>, <Freq_Drift_Low>, <Max_Drift_Rate_Upp>, <Max_Drift_Rate_Low>, <Freq_Dev_Upp_Aver>, <Freq_Dev_Low_Aver> <Freq_Dev_Upp_Max>, <Freq_Dev_Low_Max> <Freq_Dev_Upp_Min>, <Freq_Dev_Low_Min>	with query	6.66
READ:ARRAY:MODulation:DEVIation:MAXimum?	-200.0 kHz to +200.0 kHz	query only	6.72

Command	Parameter	Remark	Page
FETCh:ARRAy:MODulation:DEVIation:MAXimum?	-200.0 kHz to +200.0 kHz	query only	6.72
READ:SUBBarrays:MODulation:DEVIation:MAXimum?	-200.0 kHz to +200.0 kHz	query only	6.73
FETCh:SUBBarrays:MODulation:DEVIation:MAXimum?	-200.0 kHz to +200.0 kHz	query only	6.73
CONFIgure:MODulation:DEVIation:MFRequency	2402 MHz to 2495 MHz	with query	6.61
CONFIgure:MODulation:DEVIation:MFRequency:SIMultaneo us	2402 MHz to 2495 MHz	with query	6.60
CONFIgure:MODulation:DEVIation:MFRequency:UNIT	HZ KHZ MHZ GHZ CH	with query	6.61
CONFIgure:MODulation:DEVIation:MINimum:LIMit:SCALar: ASYMmetric:LOWer:ENABLE	ON OFF, ON OFF, ON OFF, ON OFF, ON OFF, ON OFF	with query	6.66
CONFIgure:MODulation:DEVIation:MINimum:LIMit:SCALar: ASYMmetric:LOWer:VALue	<Freq_Acc>, <Freq_Drift>, <Max_Drift_Rate>, <Freq_Dev_Aver>, <Freq_Dev_Max>, <Freq_Dev_Min>	with query	6.65
CONFIgure:MODulation:DEVIation:MINimum:LIMit:SCALar: ASYMmetric:UPPer:ENABLE	ON OFF, ON OFF, ON OFF, ON OFF, ON OFF, ON OFF	with query	6.65
CONFIgure:MODulation:DEVIation:MINimum:LIMit:SCALar: ASYMmetric:UPPer:VALue	<Freq_Acc>, <Freq_Drift>, <Max_Drift_Rate>, <Freq_Dev_Aver>, <Freq_Dev_Max>, <Freq_Dev_Min>	with query	6.64
CONFIgure:MODulation:DEVIation:MINimum:LIMit:SCALar: ASYMmetric:COMBined]:ENABLE	ON OFF, ON OFF, ON OFF, ON OFF, ON OFF, ON OFF, ON OFF, ON OFF, ON OFF, ON OFF, ON OFF, ON OFF	with query	6.67
CONFIgure:MODulation:DEVIation:MINimum:LIMit:SCALar: ASYMmetric:COMBined]:VALue	<Freq_Acc_Upp>, <Freq_Acc_Low>, <Freq_Drift_Upp>, <Freq_Drift_Low>, <Max_Drift_Rate_Upp>, <Max_Drift_Rate_Low>, <Freq_Dev_Upp_Aver>, <Freq_Dev_Low_Aver> <Freq_Dev_Upp_Max>, <Freq_Dev_Low_Max> <Freq_Dev_Upp_Min>, <Freq_Dev_Low_Min>	with query	6.66
READ:ARRAy:MODulation:DEVIation:MINimum?	-200.0 kHz to +200.0 kHz	query only	6.72
FETCh:ARRAy:MODulation:DEVIation:MINimum?	-200.0 kHz to +200.0 kHz	query only	6.72
READ:SUBBarrays:MODulation:DEVIation:MINimum?	-200.0 kHz to +200.0 kHz	query only	6.73
FETCh:SUBBarrays:MODulation:DEVIation:MINimum?	-200.0 kHz to +200.0 kHz	query only	6.73
CONFIgure:MODulation:DEVIation:MMODE	ALL SINGLE SIMultaneous	with query	6.60
CONFIgure:MODulation:DEVIation:MRANge	<Start>, 	with query	6.61
FETCh:MODulation:DEVIation:STATus?	OFF RUN STOP ERR STEP RDY, 1 to 10000 NONE , 1 to 1000	query only	6.60

Command	Parameter	Remark	Page
	NONE		
READ[:SCALar]:MODulation:DEViation?	<Result>	query only	6.69
FETCh[:SCALar]:MODulation:DEViation?	<Result>	query only	6.69
Master Signal Parameters			
DEFault:MSIGnal	ON OFF	with query	6.14
CONFigure:MSIGnal:BDADdress	"<BD address>"	with query	6.11
CONFigure:MSIGnal:DTRansmitter:FOFFset	-500 kHz to 500 kHz OFF	with query	6.14
CONFigure:MSIGnal:DTRansmitter:MINdex	0.20 to 0.44 OFF	with query	6.14
CONFigure:MSIGnal:DTRansmitter:SCOPex	GLOBal RXQuality	with query	6.14
CONFigure:MSIGnal:HSCHeme	EUSA FRANce	with query	6.12
CONFigure:MSIGnal:HSCHeme:FREQuency	<TX Freq.>, RX Frequ	with query	6.12
CONFigure:MSIGnal:INQuiry:ILENght	1 to 24	with query	6.12
CONFigure:MSIGnal:INQuiry:NOResponses	1 to 12	with query	6.12
DEFault:MSIGnal:PAGing	ON OFF	with query	6.13
CONFigure:MSIGnal:PAGing:PSRMode	R0 R1 R2	with query	6.13
CONFigure:MSIGnal:PAGing:RSINfo	ON OFF	with query	6.13
CONFigure:MSIGnal:PAGing:TARGet	"<BD_Address>"	with query	6.13
CONFigure:MSIGnal:PAGing:TOUT	1 to 65535	with query	6.13
CONFigure:MSIGnal:SVTout	0 to 65535	with query	6.11
CONFigure:MSIGnal:TXLevel	-137.0 to +13.0 dBm	depending on RF connector	6.11
Substate parameters (Network)			
DEFault:NETWork	ON OFF	with query	6.21
CONFigure:NETWork:AUDio:AIRCoding	CVSD ULAW ALAW	with query	6.21
CONFigure:NETWork:AUDio:BITStream	AIO ECHO	with query	6.22
CONFigure:NETWork:AUDio:DELTime	AIO ECHO	with query	6.22
CONFigure:NETWork:AUDio:PTYPE	HV1 HV2 HV3	with query	6.22
CONFigure:NETWork:HOLD:INTerval	1 slots to 65535 slots	with query	6.23
CONFigure:NETWork:HOLD:INTerval	1 slots to 65535 slots	with query	6.23

Command	Parameter	Remark	Page
CONFigure:NETWork:SNIFF:ATTempT	1 to 65535	with query	6.22
CONFigure:NETWork:SNIFF:INTerval	2 slots to 65534 slots	with query	6.22
CONFigure:NETWork:SNIFF:TOUT	1 to 65535	with query	6.23
CONFigure:NETWork:TEST:RLSettling	0 ms to 200 ms	with query	6.23
CONFigure:NETWork:TEST:SNBehaviour	NORM TEST	with query	6.24
CONFigure:NETWork:TEST:TCPChange	ON OFF	with query	6.24
Power measurements			
PROCedure:PCONtrol:STATe?	–	query only	6.11
PROCedure:PCONtrol:STEP	UP DOWN	no query	6.10
INITiate:POWer:MPR	–	no query	6.53
ABORt:POWer:MPR	–	no query	6.53
STOP:POWer:MPR	–	no query	6.53
CONTinue:POWer:MPR	–	no query	6.53
DEFault:POWer:MPR:CONtrol	ON OFF	with query	6.56
CONFigure:POWer:MPR:CONtrol:REPetition	CONTinuous SINGleshot 1 to 10000, SONerror NONE, STEP NONE	with query	6.56
CONFigure:POWer:MPR:CONtrol:STATistics	1 to 1000 NONE	with query	6.55
CONFigure:POWer:MPR:EREPorting	SRQ SOPC SRSQ OFF	with query	6.53
CALCulate:POWer:MPR:MATCHing:LIMit?	<Result>	query only	6.58
CONFigure:POWer:MPR:MFRequency	2402 MHz to 2495 MHz	with query	6.55
CONFigure:POWer:MPR:MFRequency:SIMultaneous	2402 MHz to 2495 MHz	with query	6.54
CONFigure:POWer:MPR:MFRequency:UNIT	Hz KHZ MHZ GHZ CH	with query	6.55
CONFigure:POWer:MPR:MMODE	ALL SINGle SIMultaneous	with query	6.54
FETCh:POWer:MPR:STATus?	OFF RUN STOP ERR STEP RDY, 1 to 10000 NONE, 1 to 1000 NONE	query only	6.54
READ[:SCALar]:POWer:MPR?	<Result>	query only	6.57
FETCh[:SCALar]:POWer:MPR?	<Result>	query only	6.57
INITiate:POWer:TIME	–	no query	6.39
ABORt:POWer:TIME	–	no query	6.39

Command	Parameter	Remark	Page
STOP:POWer:TIME	–	no query	6.39
CONTInue:POWer:TIME	–	no query	6.39
CONFigure:SUBarrays:POWer:TIME	ALL ARITHmetical MINimum MAXimum IVAL XMINimum XMAXimum PAVG,<Start>,<Samples>{,<Start>,<Samples>}	with query	6.49
CONFigure:POWer:TIME:AVERage:LIMit:SCALar:ASYMmetric:LOWer:ENABLE	ON OFF, ON OFF, ON OFF	with query	6.46
CONFigure:POWer:TIME:AVERage:LIMit:SCALar:ASYMmetric:LOWer:VALue	–10 dBm to +30 dBm, –10 dBm to +30 dBm, –10 dBm to +30 dBm	with query	6.45
CONFigure:POWer:TIME:AVERage:LIMit:SCALar:ASYMmetric:UPPer:ENABLE	ON OFF, ON OFF, ON OFF	with query	6.45
CONFigure:POWer:TIME:AVERage:LIMit:SCALar:ASYMmetric:UPPer:VALue	–10 dBm to +30 dBm, –120 dBm to 0 dBm, –10 dBm to +30 dBm	with query	6.45
CONFigure:POWer:TIME:AVERage:LIMit:SCALar:ASYMmetric[:COMBined]:ENABLE	ON OFF, ON OFF, ON OFF	with query	6.46
CONFigure:POWer:TIME:AVERage:LIMit:SCALar:ASYMmetric[:COMBined]:VALue	–10 dBm to +30 dBm, –10 dBm to +30 dBm, –10 dBm to +30 dBm, –10 dBm to +30 dBm, –10 dBm to +30 dBm	with query	6.46
READ:ARRAY:POWer:TIME:AVERage?	–100.0 to +30.0	query only	6.51
FETCh:ARRAY:POWer:TIME:AVERage?	–100.0 to +30.0	query only	6.51
READ:ARRAY:POWer:TIME:AVERage?	–100.0 to +30.0	query only	6.52
FETCh:ARRAY:POWer:TIME:AVERage?	–100.0 to +30.0	query only	6.52
CONFigure:POWer:TIME:CONTRol	SCALar ARRy, 1 to 1000 NONE, CONTInuous SINGleshot 1 to 10000, SONerror NONE, STEP NONE	with query	6.43
DEFault:POWer:TIME:CONTRol	ON OFF	with query	6.44
CONFigure:POWer:TIME:CONTRol:REPetition	CONTInuous SINGleshot 1 to 10000, SONerror NONE, STEP NONE	with query	6.44
CONFigure:POWer:TIME:CONTRol:RMODe	SCALar ARRy	with query	6.43
CONFigure:POWer:TIME:CONTRol:STATistics	1 to 1000 NONE	with query	6.44
CONFigure:POWer:TIME:CURRent:LIMit:SCALar:ASYMmetric:LOWer:ENABLE	ON OFF, ON OFF, ON OFF	with query	6.46
CONFigure:POWer:TIME:CURRent:LIMit:SCALar:ASYMmetric:LOWer:VALue	–10 dBm to +30 dBm, –10 dBm to +30 dBm, –10 dBm to +30 dBm	with query	6.45

Command	Parameter	Remark	Page
CONFigure:POWer:TIME:CURRent:LIMit:SCALar:ASYMmetric:UPPer:ENABle	ON OFF, ON OFF, ON OFF	with query	6.45
CONFigure:POWer:TIME:CURRent:LIMit:SCALar:ASYMmetric:UPPer:VALue	-10 dBm to +30 dBm, -120 dBm to 0 dBm, -10 dBm to +30 dBm	with query	6.45
CONFigure:POWer:TIME:CURRent:LIMit:SCALar:ASYMmetric[:COMBined]:ENABle	ON OFF, ON OFF, ON OFF	with query	6.46
CONFigure:POWer:TIME:CURRent:LIMit:SCALar:ASYMmetric[:COMBined]:VALue	-10 dBm to +30 dBm, -10 dBm to +30 dBm, -10 dBm to +30 dBm, -10 dBm to +30 dBm, -10 dBm to +30 dBm	with query	6.46
READ:ARRAy:POWer:TIME:CURRent?	-100.0 to +30.0	query only	6.51
FETCh:ARRAy:POWer:TIME:CURRent?	-100.0 to +30.0	query only	6.51
READ:ARRAy:POWer:TIME:CURRent?	-100.0 to +30.0	query only	6.52
FETCh:ARRAy:POWer:TIME:CURRent?	-100.0 to +30.0	query only	6.52
CONFigure:POWer:TIME:EREPorting	SRQ SOPC SRSQ OFF	with query	6.39
DEFault:POWer:TIME:LIMit	ON OFF	with query	6.48
CALCulate[:SCALar]:POWer:TIME:MATChing:LIMit?	<Result>	query only	6.51
CONFigure:POWer:TIME:MAXimum:LIMit:SCALar:ASYMmetric:LOWer:ENABle	ON OFF, ON OFF, ON OFF	with query	6.46
CONFigure:POWer:TIME:MAXimum:LIMit:SCALar:ASYMmetric:LOWer:VALue	-10 dBm to +30 dBm, -10 dBm to +30 dBm, -10 dBm to +30 dBm	with query	6.45
CONFigure:POWer:TIME:MAXimum:LIMit:SCALar:ASYMmetric:UPPer:ENABle	ON OFF, ON OFF, ON OFF	with query	6.45
CONFigure:POWer:TIME:MAXimum:LIMit:SCALar:ASYMmetric:UPPer:VALue	-10 dBm to +30 dBm, -120 dBm to 0 dBm, -10 dBm to +30 dBm	with query	6.45
CONFigure:POWer:TIME:MAXimum:LIMit:SCALar:ASYMmetric[:COMBined]:ENABle	ON OFF, ON OFF, ON OFF	with query	6.46
CONFigure:POWer:TIME:MAXimum:LIMit:SCALar:ASYMmetric[:COMBined]:VALue	-10 dBm to +30 dBm, -10 dBm to +30 dBm, -10 dBm to +30 dBm, -10 dBm to +30 dBm, -10 dBm to +30 dBm	with query	6.46
READ:ARRAy:POWer:TIME:MAXimum?	-100.0 to +30.0	query only	6.51
FETCh:ARRAy:POWer:TIME:MAXimum?	-100.0 to +30.0	query only	6.51
READ:ARRAy:POWer:TIME:MAXimum?	-100.0 to +30.0	query only	6.52
FETCh:ARRAy:POWer:TIME:MAXimum?	-100.0 to +30.0	query only	6.52
CONFigure:POWer:TIME:MFRequency	2402 MHz to 2495 MHz	with query	6.41
CONFigure:POWer:TIME:MFRequency:SIMultaneous	2402 MHz to 2495 MHz	with query	6.40

Command	Parameter	Remark	Page
CONFigure:POWer:TIME:MFRequency:UNIT	HZ KHZ MHZ GHZ CH	with query	6.41
CONFigure:POWer:TIME:MINimum:LIMit:SCALar:ASYMmetric:LOWer:ENABle	ON OFF, ON OFF, ON OFF	with query	6.46
CONFigure:POWer:TIME:MINimum:LIMit:SCALar:ASYMmetric:LOWer:VALue	-10 dBm to +30 dBm, -10 dBm to +30 dBm,-10 dBm to +30 dBm	with query	6.45
CONFigure:POWer:TIME:MINimum:LIMit:SCALar:ASYMmetric:UPPer:ENABle	ON OFF, ON OFF, ON OFF	with query	6.45
CONFigure:POWer:TIME:MINimum:LIMit:SCALar:ASYMmetric:UPPer:VALue	-10 dBm to +30 dBm, -120 dBm to 0 dBm,-10 dBm to +30 dBm	with query	6.45
CONFigure:POWer:TIME:MINimum:LIMit:SCALar:ASYMmetric[:COMBined]:ENABle	ON OFF, ON OFF, ON OFF	with query	6.46
CONFigure:POWer:TIME:MINimum:LIMit:SCALar:ASYMmetric[:COMBined]:VALue	-10 dBm to +30 dBm, -10 dBm to +30 dBm,-10 dBm to +30 dBm, -10 dBm to +30 dBm,-10 dBm to +30 dBm	with query	6.46
READ:ARRAy:POWer:TIME:MINimum?	-100.0 to +30.0	query only	6.51
FETCh:ARRAy:POWer:TIME:MINimum?	-100.0 to +30.0	query only	6.51
READ:ARRAy:POWer:TIME:MINimum?	-100.0 to +30.0	query only	6.52
FETCh:ARRAy:POWer:TIME:MINimum?	-100.0 to +30.0	query only	6.52
CONFigure:POWer:TIME:MMODE	ALL SINGLE SIMultaneous	with query	6.40
CONFigure:POWer:TIME:MRANge	<Start>, 	with query	6.42
CONFigure:POWer:TIME:PTIMing:AVERage:LIMit:SCALar:ASYMmetric:LOWer:ENABle	ON OFF	with query	6.47
CONFigure:POWer:TIME:PTIMing:AVERage:LIMit:SCALar:ASYMmetric:LOWer:VALue	-15 µs to 15 µs	with query	6.47
CONFigure:POWer:TIME:PTIMing:AVERage:LIMit:SCALar:ASYMmetric:UPPer:ENABle	ON OFF	with query	6.47
CONFigure:POWer:TIME:PTIMing:AVERage:LIMit:SCALar:ASYMmetric:UPPer:VALue	-15 µs to 15 µs	with query	6.47
CONFigure:POWer:TIME:PTIMing:AVERage:LIMit:SCALar:ASYMmetric[:COMBined]:ENABle	ON OFF	with query	6.48
CONFigure:POWer:TIME:PTIMing:AVERage:LIMit:SCALar:ASYMmetric[:COMBined]:VALue	-15 µs to 15 µs	with query	6.48
CONFigure:POWer:TIME:PTIMing:CURREnt:LIMit:SCALar:ASYMmetric:LOWer:ENABle	ON OFF	with query	6.47
CONFigure:POWer:TIME:PTIMing:CURREnt:LIMit:SCALar:ASYMmetric:LOWer:VALue	-15 µs to 15 µs	with query	6.47
CONFigure:POWer:TIME:PTIMing:CURREnt:LIMit:SCALar:ASYMmetric:UPPer:ENABle	ON OFF	with query	6.47

Command	Parameter	Remark	Page
CONFigure:POWer:TIME:PTIMing:CURRent:LIMit:SCALar:ASYMmetric:UPPer:VALue	-15 μ s to 15 μ s	with query	6.47
CONFigure:POWer:TIME:PTIMing:CURRent:LIMit:SCALar:ASYMmetric[:COMBined]:ENABle	ON OFF	with query	6.48
CONFigure:POWer:TIME:PTIMing:CURRent:LIMit:SCALar:ASYMmetric[:COMBined]:VALue	-15 μ s to 15 μ s	with query	6.48
CONFigure:POWer:TIME:PTIMing:MAXimum:LIMit:SCALar:ASYMmetric:LOWer:ENABle	ON OFF	with query	6.47
CONFigure:POWer:TIME:PTIMing:MAXimum:LIMit:SCALar:ASYMmetric:LOWer:VALue	-15 μ s to 15 μ s	with query	6.47
CONFigure:POWer:TIME:PTIMing:MAXimum:LIMit:SCALar:ASYMmetric:UPPer:ENABle	ON OFF	with query	6.47
CONFigure:POWer:TIME:PTIMing:MAXimum:LIMit:SCALar:ASYMmetric:UPPer:VALue	-15 μ s to 15 μ s	with query	6.47
CONFigure:POWer:TIME:PTIMing:MAXimum:LIMit:SCALar:ASYMmetric[:COMBined]:ENABle	ON OFF	with query	6.48
CONFigure:POWer:TIME:PTIMing:MAXimum:LIMit:SCALar:ASYMmetric[:COMBined]:VALue	-15 μ s to 15 μ s	with query	6.48
CONFigure:POWer:TIME:PTIMing:MINimum:LIMit:SCALar:ASYMmetric:LOWer:ENABle	ON OFF	with query	6.47
CONFigure:POWer:TIME:PTIMing:MINimum:LIMit:SCALar:ASYMmetric:LOWer:VALue	-15 μ s to 15 μ s	with query	6.47
CONFigure:POWer:TIME:PTIMing:MINimum:LIMit:SCALar:ASYMmetric:UPPer:ENABle	ON OFF	with query	6.47
CONFigure:POWer:TIME:PTIMing:MINimum:LIMit:SCALar:ASYMmetric:UPPer:VALue	-15 μ s to 15 μ s	with query	6.47
CONFigure:POWer:TIME:PTIMing:MINimum:LIMit:SCALar:ASYMmetric[:COMBined]:ENABle	ON OFF	with query	6.48
CONFigure:POWer:TIME:PTIMing:MINimum:LIMit:SCALar:ASYMmetric[:COMBined]:VALue	-15 μ s to 15 μ s	with query	6.48
FEtCh[:SCALar]:POWer:TIME:STATus?	OFF RUN STOP ERR STEP RDY, 1 to 10000 NONE, 1 to 1000 NONE	query only	6.40
READ[:SCALar]:POWer:TIME?	<Result>	query only	6.50
FEtCh[:SCALar]:POWer:TIME?	<Result>	query only	6.50
Receiver quality measurements			
INIte:RXQuality:BER	-	no query	6.92
ABORt:RXQuality:BER	-	no query	6.92

Command	Parameter	Remark	Page
STOP:RXQuality:BER	–	no query	6.92
CONTInue:RXQuality:BER	–	no query	6.92
FETCh[:SCALAr]:RXQuality:BER:DETail?	<Result>	query only	6.100
CONFigure:RXQuality:BER:EREPorting	SRQ SOPC SRSQ OFF	with query	6.92
CALCulate:RXQuality:BER:MATChing:LIMit?	<Result>	query only	6.100
FETCh:RXQuality:BER:STATus?	OFF RUN STOP ERR STEP RDY, 1 to 10000 NONE, 1 to 10000 NONE	query only	6.93
CONFigure:RXQuality:BER:TSETup	T1 T2 T3 T4 T5	with query	6.93
DEFault:RXQuality:BER:TSETup<nr>	ON OFF	with query	6.98
CONFigure:RXQuality:BER:TSETup<nr>:CONTRol	1 to 40000, 1 to 10000, SONerror NONE, STEP NONE	with query	6.94
CONFigure:RXQuality:BER:TSETup<nr>:CONTRol:REPetition	CONTInuous SINGleshot 1 to 10000, SONerror NONE, STEP NONE	with query	6.95
CONFigure:RXQuality:BER:TSETup<nr>:CONTRol:STATistics	1 to 40000	with query	6.94
CONFigure:RXQuality:BER:TSETup<nr>:DELay	ON OFF	with query	6.98
CONFigure:RXQuality:BER:TSETup<nr>:FREQuency	2402 MHz to 2495 MHz, 2402 MHz to 2495 MHz	with query	6.96
CONFigure:RXQuality:BER:TSETup<nr>:HSCHEME	RXTX EUSA JAPan FRANce SPAIN RHOP	with query	6.96
CONFigure:RXQuality:BER:TSETup<nr>:LEVel	<Level>	with query	6.95
CONFigure:RXQuality:BER:TSETup<nr>:LIMit	ON OFF	with query	6.99
CONFigure:RXQuality:BER:TSETup<nr>:LIMit:SCALAr:ASYMmetric[:COMBined]	0% to 100%, ON OFF, 0% to 100%, ON OFF	with query	6.98
CONFigure:RXQuality:BER:TSETup<nr>:LIMit:SCALAr:ASYMmetric[:COMBined]:ENABLE	ON OFF, ON OFF	with query	6.99
CONFigure:RXQuality:BER:TSETup<nr>:LIMit:SCALAr:ASYMmetric[:COMBined]:VALue	0% to 100%, 0% to 100%	with query	6.99
CONFigure:RXQuality:BER:TSETup<nr>:LOTSequence:DH1Packet	1 to 27	with query	6.97
CONFigure:RXQuality:BER:TSETup<nr>:LOTSequence:DH3Packet	1 to 183	with query	6.97
CONFigure:RXQuality:BER:TSETup<nr>:LOTSequence:DH5Packet	1 to 339	with query	6.97
CONFigure:RXQuality:BER:TSETup<nr>:PATTtype	DPRS SPRS ALL1 ALL0 P11 P44 USER	with query	6.96

Command	Parameter	Remark	Page
CONFigure:RXQuality:BER:TSEUp<nr>:PTYPE	DH1 DH3 DH5	with query	6.97
CONFigure:RXQuality:BER:TSEUp<nr>:UDData	<hex data>	with query	6.97
CONFigure:RXQuality:BER:TSEUp<nr>:UDLength	3 to 64	with query	6.97
CONFigure:RXQuality:BER:TSEUp<nr>:WHITening	ON OFF	with query	6.98
READ[:SCALar]:RXQuality:BER?	<Result>	query only	6.99
FETCh[:SCALar]:RXQuality:BER?	<Result>	query only	6.99
INITiate:RXQuality:SBER	–	no query	6.101
ABORt:RXQuality:SBER	–	no query	6.101
STOP:RXQuality:SBER	–	no query	6.101
CONTInue:RXQuality:SBER	–	no query	6.101
DEFault:RXQuality:SBER	ON OFF	with query	6.105
CONFigure:RXQuality:SBER:CONTRol:STATistics	1 to 10000, 0% to 100%, 1 to 100	with query	6.102
CONFigure:RXQuality:SBER:DELay	ON OFF	with query	6.105
CONFigure:RXQuality:SBER:EREPorting	SRQ SOPC SRSQ OFF	with query	6.101
CONFigure:RXQuality:SBER:FREQuency	2402 MHz to 2495 MHz, 2402 MHz to 2495 MHz	with query	6.103
CONFigure:RXQuality:SBER:LEVEl	<Low_Lev>, <Upp_Lev>	with query	6.102
CONFigure:RXQuality:SBER:LOTSequence:DH1Packet	1 to 27	with query	6.104
CONFigure:RXQuality:SBER:LOTSequence:DH3Packet	1 to 183	with query	6.104
CONFigure:RXQuality:SBER:LOTSequence:DH5Packet	1 to 339	with query	6.104
CONFigure:RXQuality:SBER:PATTtype	DPRS SPRS ALL1 ALL0 P11 P44 USER	with query	6.103
CONFigure:RXQuality:SBER:PTYPE	DH1 DH3 DH5	with query	6.104
FETCh:RXQuality:SBER:STATus?	OFF RUN STOP ERR STEP RDY, 1 to 500 NONE	query only	6.101
CONFigure:RXQuality:SBER:UDData	<hex data>	with query	6.104
CONFigure:RXQuality:SBER:UDLength	3 to 64	with query	6.104
CONFigure:RXQuality:SBER:WHITening	ON OFF	with query	6.105
READ[:SCALar]:RXQuality:SBER?	<Result>	query only	6.106
FETCh[:SCALar]:RXQuality:SBER?	<Result>	query only	6.106

Command	Parameter	Remark	Page
CONFigure:RXQuality:SBER[:LBACK]:HSCHEME	RXTX EUSA JAPan FRANce SPAin RHOP	with query	6.103
Signalling			
PROCedure:SIGNalling:ACTion	INQuiry SINQuiry PAGE SPAGe CONNect SCONnect TEST STESt DETach SNIFf SSNIff PARK SPARK HOLD AUDio SAUDio FSTY	with query	6.7
CONFigure:SIGNalling:PTARget	"BD00" to "BD11"	with query	6.10
FETCh:SIGNalling:PTARgets?	0 to 12, "BD00", "BD_address_00" {"BDxx", "BD_address_xx"}	query only	6.10
PROCedure:SIGNalling:PTBZero	LONG SHORT	with query	6.10
[SENSe:]SIGNalling:STATe?	SBY INQ PAG CONN	query only	6.9
[SENSe:]SIGNalling:XSTate?	SBY INQ PAG CONN TEST HOLD SNIF AUD PARK DET	query only	6.9
Signalling info			
[SENSe:]SINFo:BDADdress?	<BD address>	query only	6.29
[SENSe:]SINFo:CLASs:SERVice?	"<Service_Class1>" "", "<Service_Class2>" "", ...	query only	6.29
[SENSe:]SINFo:CLASs?	<MajorDC><MinorDC>	query only	6.29
[SENSe:]SINFo:COMPany?	"<Company_Name>"	query only	6.28
[SENSe:]SINFo:FEATure:ALAW?	ON OFF	query only	6.33
[SENSe:]SINFo:FEATure:CQDD?	ON OFF	query only	6.32
[SENSe:]SINFo:FEATure:CVSD?	ON OFF	query only	6.33
[SENSe:]SINFo:FEATure:EA2Mbps?	ON OFF	query only	6.34
[SENSe:]SINFo:FEATure:EA2Mbps?	ON OFF	query only	6.35
[SENSe:]SINFo:FEATure:EA3Mbps?	ON OFF	query only	6.34
[SENSe:]SINFo:FEATure:EA3Mbps?	ON OFF	query only	6.35
[SENSe:]SINFo:FEATure:EA3Slot?	ON OFF	query only	6.34
[SENSe:]SINFo:FEATure:EA3Slot?	ON OFF	query only	6.35
[SENSe:]SINFo:FEATure:EA5Slot?	ON OFF	query only	6.34
[SENSe:]SINFo:FEATure:EA5Slot?	ON OFF	query only	6.35
[SENSe:]SINFo:FEATure:ENCRyption?	ON OFF	query only	6.30

Command	Parameter	Remark	Page
[SENSe:]SINFo:FEATure:FCLag?	ON OFF	query only	6.33
[SENSe:]SINFo:FEATure:HOLD?	ON OFF	query only	6.31
[SENSe:]SINFo:FEATure:HV2P?	ON OFF	query only	6.32
[SENSe:]SINFo:FEATure:HV3P?	ON OFF	query only	6.32
[SENSe:]SINFo:FEATure:LFRRequest?	8 feature bytes	query only	6.34
[SENSe:]SINFo:FEATure:MS3S?	ON OFF	query only	6.30
[SENSe:]SINFo:FEATure:MS5S?	ON OFF	query only	6.30
[SENSe:]SINFo:FEATure:PARK?	ON OFF	query only	6.31
[SENSe:]SINFo:FEATure:PCONtrol?	ON OFF	query only	6.32
[SENSe:]SINFo:FEATure:PSCHeme?	ON OFF	query only	6.33
[SENSe:]SINFo:FEATure:PSCHeme?	ON OFF	query only	6.33
[SENSe:]SINFo:FEATure:RSSI?	ON OFF	query only	6.31
[SENSe:]SINFo:FEATure:SCOL?	ON OFF	query only	6.32
[SENSe:]SINFo:FEATure:SNIFF?	ON OFF	query only	6.31
[SENSe:]SINFo:FEATure:SOFF?	ON OFF	query only	6.30
[SENSe:]SINFo:FEATure:SWITch?	ON OFF	query only	6.31
[SENSe:]SINFo:FEATure:TACCuracy?	ON OFF	query only	6.31
[SENSe:]SINFo:FEATure:TSDData?	ON OFF	query only	6.33
[SENSe:]SINFo:FEATure:ULAW?	ON OFF	query only	6.32
[SENSe:]SINFo:NAME?	<string>	query only	6.28
[SENSe:]SINFo:PAGing?	MAND OPT1 OPT2 OPT3, P0 P1 P2, R0 R1 R2	query only	6.30
[SENSe:]SINFo:VERSion?	0 1, 0 to 65535, 0 to 65535	query only	6.28
Speech codec			
ROUTe:SPDecoder:OUTPut	HANDset ANALyzer ANA2 ABOTH	with query	6.25
ROUTe:SPENcoder[:INPut]	HANDset GENerator	with query	6.25
Spectrum measurements			
INITiate:SPECTrum:ACPpower	–	no query	6.74

Command	Parameter	Remark	Page
ABORt:SPECTrum:ACPoweR	–	no query	6.74
STOP:SPECTrum:ACPoweR	–	no query	6.74
CONTInue:SPECTrum:ACPoweR	–	no query	6.74
CONFIgure:SPECTrum:ACPoweR:AVERAge:LIMit:SCALar: ASYMmetric:LCHannel:ENABLE	ON OFF	with query	6.80
CONFIgure:SPECTrum:ACPoweR:AVERAge:LIMit:SCALar: ASYMmetric:LCHannel:VALue	–40 dBm to 0 dBm	with query	6.79
CONFIgure:SPECTrum:ACPoweR:AVERAge:LIMit:SCALar: ASYMmetric:UCHannel:ENABLE	ON OFF	with query	6.79
CONFIgure:SPECTrum:ACPoweR:AVERAge:LIMit:SCALar: ASYMmetric:UCHannel:VALue	–40 dBm to 0 dBm	with query	6.79
CONFIgure:SPECTrum:ACPoweR:CCHannel	0 to 78	with query	6.77
CONFIgure:SPECTrum:ACPoweR:CONTRol	SCALar ARRAy, 1 to 1000 NONE, CONTInuous SINGleshot 1 to 10000, SONerror NONE, STEP NONE	with query	6.76
CONFIgure:SPECTrum:ACPoweR:CONTRol:REPetition	CONTInuous SINGleshot 1 to 10000, SONerror NONE,STEP NONE	with query	6.77
CONFIgure:SPECTrum:ACPoweR:CONTRol:STATistics	1 to 1000 NONE	with query	6.76
CONFIgure:SPECTrum:ACPoweR:DMODE	AVG RMS PEAK	with query	6.78
CONFIgure:SPECTrum:ACPoweR:EREPorting	SRQ SOPC SRSQ OFF	with query	6.74
CONFIgure:SPECTrum:ACPoweR:LUNit	ABS REL	with query	6.78
CALCulate[SCALar]:SPECTrum:ACPoweR:MATChing:LIMit?	NMAU INV OK	query only	6.81
CONFIgure:SPECTrum:ACPoweR:MCHannel:RELative	–97 to 0, ..., 0 to 97	with query	6.77
CONFIgure:SPECTrum:ACPoweR:PEAK:LIMit:SCALar: ASYMmetric:LCHannel:ENABLE	ON OFF	with query	6.80
CONFIgure:SPECTrum:ACPoweR:PEAK:LIMit:SCALar: ASYMmetric:LCHannel:VALue	–40 dBm to 0 dBm	with query	6.79
CONFIgure:SPECTrum:ACPoweR:PEAK:LIMit:SCALar: ASYMmetric:UCHannel:ENABLE	ON OFF	with query	6.79
CONFIgure:SPECTrum:ACPoweR:PEAK:LIMit:SCALar: ASYMmetric:UCHannel:VALue	–40 dBm to 0 dBm	with query	6.79
CONFIgure:SPECTrum:ACPoweR:RMS:LIMit:SCALar: ASYMmetric:LCHannel:ENABLE	ON OFF	with query	6.80
CONFIgure:SPECTrum:ACPoweR:RMS:LIMit:SCALar: ASYMmetric:LCHannel:VALue	–40 dBm to 0 dBm	with query	6.79

Command	Parameter	Remark	Page
CONFigure:SPECTrum:ACPower:RMS:LIMit:SCALar: ASYMmetric:UCHannel:ENABLE	ON OFF	with query	6.79
CONFigure:SPECTrum:ACPower:RMS:LIMit:SCALar: ASYMmetric:UCHannel:VALue	-40 dBm to 0 dBm	with query	6.79
FETCh[:SCALar]:SPECTrum:ACPower:STATus?	OFF RUN STOP ERR STEP RDY, 1 to 10000 NONE , 1 to 1000 NONE	query only	6.75
READ[:SCALar]:SPECTrum:ACPower?	<Result>	query only	6.81
FETCh[:SCALar]:SPECTrum:ACPower?	<Result>	query only	6.81
INITiate:SPECTrum:BWIDth	-	no query	6.82
ABORt:SPECTrum:BWIDth	-	no query	6.82
STOP:SPECTrum:BWIDth	-	no query	6.82
CONTinue:SPECTrum:BWIDth	-	no query	6.82
CONFigure:SPECTrum:BWIDth:AVERage:LIMit:SCALar: ASYMmetric:UPPer:ENABLE	ON OFF	with query	6.86
CONFigure:SPECTrum:BWIDth:AVERage:LIMit:SCALar: ASYMmetric:UPPer:VALue	0.05 MHz to 3.30 MHz	with query	6.85
READ:ARRAY:SPECTrum:BWIDth:AVERage?	-100.0 to 0.0	query only	6.87
FETCh:ARRAY:SPECTrum:BWIDth:AVERage?	-100.0 to 0.0	query only	6.87
CONFigure:SPECTrum:BWIDth:CONTrol	SCALar ARRAy, 1 to 1000 NONE, CONTInuous SINGleshot 1 to 10000, SONerror NONE, STEP NONE	with query	6.83
CONFigure:SPECTrum:BWIDth:CONTrol:REPetition	CONTInuous SINGleshot 1 to 10000, SONerror NONE,STEP NONE	with query	6.84
CONFigure:SPECTrum:BWIDth:CONTrol:RMODE	SCALar ARRAy	with query	6.83
CONFigure:SPECTrum:BWIDth:CONTrol:STATistics	1 to 1000 NONE	with query	6.84
CONFigure:SPECTrum:BWIDth:CURREnt:LIMit:SCALar: ASYMmetric:UPPer:ENABLE	ON OFF	with query	6.86
CONFigure:SPECTrum:BWIDth:CURREnt:LIMit:SCALar: ASYMmetric:UPPer:VALue	0.05 MHz to 3.30 MHz	with query	6.85
READ:ARRAY:SPECTrum:BWIDth:CURREnt?	-100.0 to 0.0	query only	6.87
FETCh:ARRAY:SPECTrum:BWIDth:CURREnt?	-100.0 to 0.0	query only	6.87
CONFigure:SPECTrum:BWIDth:DLEVel	-0.1 dB to -50.0 dB	with query	6.85
CONFigure:SPECTrum:BWIDth:EREPorting	SRQ SOPC SRSQ OFF	with query	6.82

Command	Parameter	Remark	Page
CALCulate[:SCALar]:SPECTrum:BWIDth:MATChing:LIMit?	NMAU INV OK	query only	6.87
CONFigure:SPECTrum:BWIDth:MAXimum:LIMit:SCALar:ASYMmetric:UPPer:ENABle	ON OFF	with query	6.86
CONFigure:SPECTrum:BWIDth:MAXimum:LIMit:SCALar:ASYMmetric:UPPer:VALue	0.05 MHz to 3.30 MHz	with query	6.85
READ:ARRAY:SPECTrum:BWIDth:MAXimum?	-100.0 to 0.0	query only	6.87
FETCh:ARRAY:SPECTrum:BWIDth:MAXimum?	-100.0 to 0.0	query only	6.87
CONFigure:SPECTrum:BWIDth:MFRequency:SIMultaneous	2402 MHz to 2495 MHz	with query	6.85
CONFigure:SPECTrum:BWIDth:MFRequency:UNIT	HZ KHZ MHZ GHZ CH	with query	6.85
CONFigure:SPECTrum:BWIDth:MMODE	ALL SINGLE	with query	6.84
FETCh[:SCALar]:SPECTrum:BWIDth:STATus?	OFF RUN STOP ERR STEP RDY, 1 to 10000 NONE, 1 to 1000 NONE	query only	6.82
READ[:SCALar]:SPECTrum:BWIDth?	<Result>	query only	6.86
FETCh[:SCALar]:SPECTrum:BWIDth?	<Result>	query only	6.86
INITiate:SPECTrum:FRANge	-	no query	6.88
ABORt:SPECTrum:FRANge	-	no query	6.88
STOP:SPECTrum:FRANge	-	no query	6.88
CONTinue:SPECTrum:FRANge	-	no query	6.88
CONFigure:SPECTrum:FRANge:CONTrol:STATistics	1 to 1000 NONE	with query	6.89
CONFigure:SPECTrum:FRANge:CURRent:LIMit:SCALar:ASYMmetric[:COMBined]:ENABle	ON OFF, ON OFF	with query	6.90
CONFigure:SPECTrum:FRANge:EREPorting	SRQ SOPC SRSQ OFF	with query	6.88
READ[:SCALar]:SPECTrum:FRANge:LFRequency?	-140.0 dBm to +0.0 dBm	query only	6.91
READ[:SCALar]:SPECTrum:FRANge:LFRequency?	-140.0 dBm to +0.0 dBm	query only	6.91
FETCh[:SCALar]:SPECTrum:FRANge:LFRequency?	-140.0 dBm to +0.0 dBm	query only	6.91
FETCh[:SCALar]:SPECTrum:FRANge:LFRequency?	-140.0 dBm to +0.0 dBm	query only	6.91
CONFigure:SPECTrum:FRANge:LIMit:SCALar:ASYMmetric[:COMBined]:VALue	2397.55 MHz to 2485.45 MHz, 2397.55 MHz to 2485.45 MHz	with query	6.90
CALCulate[:SCALar]:SPECTrum:FRANge:MATChing:LIMit?	Fl limit check, Fh limit check	query only	6.91
CONFigure:SPECTrum:FRANge:MWINDow	-4 to 73, 1 to 11	with query	6.89

Command	Parameter	Remark	Page
FETCh:SPECtrum:FRANge:STATus?	OFF RUN STOP ERR STEP RDY, 1 to 10000 NONE , 1 to 1000 NONE	query only	6.89
CONFigure:SPECtrum:FRANge:THReshold	-100 dBm to 0 dBm	with query	6.89
READ:ARRAy:SPECtrum:FRANge?	<Result>	query only	6.90
FETCh:ARRAy:SPECtrum:FRANge?	<Result>	query only	6.90
Slave Signal			
CONFigure:SSIGnal:PCTR	ADAPtive FIXed	with query	6.15
DEFault:SSIGnal:TMODE	ON OFF	with query	6.21
CONFigure:SSIGnal:TMODE:FREQuency:UNIT	HZ KHZ MHZ GHZ CH	with query	6.16
CONFigure:SSIGnal:TMODE:HSCHEME	RXTX EUSA JAPAN FRANCE SPAIN RHOP	with query	6.16
CONFigure:SSIGnal:TMODE:LBTests:FREQuency	2402 MHz to 2495 MHz, 2402 MHz to 2495 MHz	with query	6.18
CONFigure:SSIGnal:TMODE:LBTests:LOTSequence:DH1Packet	0 to 27	with query	6.20
CONFigure:SSIGnal:TMODE:LBTests:LOTSequence:DH3Packet	0 to 183	with query	6.20
CONFigure:SSIGnal:TMODE:LBTests:LOTSequence:DH5Packet	0 to 339	with query	6.20
CONFigure:SSIGnal:TMODE:LBTests:PATType	DPRS SPRS ALL1 ALL0 P11 P44 USER	with query	6.19
CONFigure:SSIGnal:TMODE:LBTests:PTYPE	DH1 DH3 DH5	with query	6.20
CONFigure:SSIGnal:TMODE:LBTests:UDData	<hex data>	with query	6.19
CONFigure:SSIGnal:TMODE:LBTests:UDLength	3 to 64	with query	6.19
CONFigure:SSIGnal:TMODE:LBTests:WHITening	ON OFF	with query	6.20
CONFigure:SSIGnal:TMODE:TMTYPE	LBT TXT	with query	6.16
CONFigure:SSIGnal:TMODE:TXTests:FREQuency	2402 MHz to 2495 MHz, 2402 MHz to 2495 MHz	with query	6.17
CONFigure:SSIGnal:TMODE:TXTests:LOTSequence:DH1Packet	0 to 27	with query	6.18
CONFigure:SSIGnal:TMODE:TXTests:LOTSequence:DH3Packet	0 to 183	with query	6.18
CONFigure:SSIGnal:TMODE:TXTests:LOTSequence:DH5Packet	0 to 339	with query	6.18

Command	Parameter	Remark	Page
CONFigure:SSIGnal:TMODe:TXTests:PATType	DPRS SPRS ALL1 ALL0 P11 P44	with query	6.17
CONFigure:SSIGnal:TMODe:TXTests:PPERiod	2 to 254	with query	6.18
CONFigure:SSIGnal:TMODe:TXTests:PTYPe	DH1 DH3 DH5	with query	6.17
Trigger			
DEFault:TRIGger[:SEQuence]	ON OFF	with query	6.27
TRIGger[:SEQuence]:SOURce	SIGNalling RFPower IFPower	with query	6.27
TRIGger[:SEQuence]:THReshold	LOW MEDium HIGH	with query	6.27
Wide-band power			
INITiate:WPOWER	–	no query	6.37
ABORt:WPOWER	–	no query	6.37
STOP:WPOWER	–	no query	6.37
CONTinue:WPOWER	–	no query	6.37
CONFigure:WPOWER:CONTRol:REPetition	CONTinuous SINGleshot 1 to 10000, NONE,STEP NONE	with query	6.38
CONFigure:WPOWER:EREPorting	SRQ SOPC SRSQ OFF	with query	6.37
FETCh[:SCALar]:WPOWER:STATus?	OFF RUN STOP ERR STEP RDY, 1 to 10000 NONE	query only	6.37
READ[:SCALar]:WPOWER?	–30 dBm to 30 dBm	query only	6.38
FETCh[:SCALar]:WPOWER?	–30 dBm to 30 dBm	query only	6.38
SAMPle[:SCALar]:WPOWER?	–30 dBm to 30 dBm	query only	6.38

Alphabetical Command Lists

Table 6-3 Remote-control commands: *Non Signalling* mode

Command (Non Signalling, alphabetical)	Page
ABORt:RFGenerator	6.1
CONFigure:RFGenerator:BMODulation	6.4
CONFigure:RFGenerator:PLENght	6.3
CONFigure:RFGenerator:PTYPE	6.3
FETCh:RFGenerator:STATus?	6.1
INITiate:RFGenerator	6.1
INPut[:STATe]	6.4
OUTPut[:STATe]	6.4
[SENSe:]CORRection:LOSS:INPut<nr>[:MAGNitude]	6.4
[SENSe:]CORRection:LOSS:OUTPut<nr>[:MAGNitude]	6.5
SOURce:CORRection:LOSS:INPut<nr>[:MAGNitude]	6.4
SOURce:CORRection:LOSS:OUTPut<nr>[:MAGNitude]	6.5
SOURce:DM:CLOCK:FREQuency	6.5
SOURce:DM:CLOCK:STATe	6.5
SOURce:RFGenerator:BDADdress	6.3
SOURce:RFGenerator:FOFFset	6.2
SOURce:RFGenerator:FREQuency	6.2
SOURce:RFGenerator:FREQuency:UNIT	6.2
SOURce:RFGenerator:LEVel	6.2
SOURce:RFGenerator:MINdex	6.3
SOURce:RFGenerator:PTBZero	6.2

Table 6-4 Remote-control commands: *Signalling* mode

Command (Signalling, alphabetical)	Page
ABORt:MODulation:DEViation	6.59
ABORt:POWer:MPR	6.53
ABORt:POWer:TIME	6.39
ABORt:RXQuality:BER	6.92
ABORt:RXQuality:SBER	6.101
ABORt:SPECTrum:ACPower	6.74
ABORt:SPECTrum:BWIDth	6.82
ABORt:SPECTrum:FRANge	6.88
ABORt:WPOWer	6.37
CALCulate:MODulation:DEViation:MATChing:LIMit?	6.71
CALCulate:POWer:MPR:MATChing:LIMit?	6.58
CALCulate:RXQuality:BER:MATChing:LIMit?	6.100
CALCulate[:SCALar]:POWer:TIME:MATChing:LIMit?	6.51
CALCulate[:SCALar]:SPECTrum:ACPower:MATChing:LIMit?	6.81
CALCulate[:SCALar]:SPECTrum:BWIDth:MATChing:LIMit?	6.87
CALCulate[:SCALar]:SPECTrum:FRANge:MATChing:LIMit?	6.91
CONFigure:DUT:AUTHentic:ENABLE	6.15
CONFigure:DUT:PINCode	6.15
CONFigure:DUT:STORe:LINK:KEYS	6.15
CONFigure:MISC:CCDefault	6.6
CONFigure:MODulation:DEViation:AVERage:LIMit:SCALar:ASYMmetric:LOWer:ENABLE	6.66
CONFigure:MODulation:DEViation:AVERage:LIMit:SCALar:ASYMmetric:LOWer:VALue	6.65
CONFigure:MODulation:DEViation:AVERage:LIMit:SCALar:ASYMmetric:UPPer:ENABLE	6.65
CONFigure:MODulation:DEViation:AVERage:LIMit:SCALar:ASYMmetric:UPPer:VALue	6.64
CONFigure:MODulation:DEViation:AVERage:LIMit:SCALar:ASYMmetric[:COMBined]:ENABLE	6.67
CONFigure:MODulation:DEViation:AVERage:LIMit:SCALar:ASYMmetric[:COMBined]:VALue	6.66
CONFigure:MODulation:DEViation:BATHreshold:CLIMit:ENABLE	6.67

CONFigure:MODulation:DEViation:BATHreshold:CLIMit[:VALue]	6.67
CONFigure:MODulation:DEViation:BATHreshold:THReshold[:VALue]	6.67
CONFigure:MODulation:DEViation:CONTRol	6.62
CONFigure:MODulation:DEViation:CONTRol:REPetition	6.63
CONFigure:MODulation:DEViation:CONTRol:RMODE	6.63
CONFigure:MODulation:DEViation:CONTRol:STATistics	6.63
CONFigure:MODulation:DEViation:CURRent:LIMit:SCALar:ASYMmetric:LOWer:ENABLE	6.66
CONFigure:MODulation:DEViation:CURRent:LIMit:SCALar:ASYMmetric:LOWer:VALue	6.65
CONFigure:MODulation:DEViation:CURRent:LIMit:SCALar:ASYMmetric:UPPer:ENABLE	6.65
CONFigure:MODulation:DEViation:CURRent:LIMit:SCALar:ASYMmetric:UPPer:VALue	6.64
CONFigure:MODulation:DEViation:CURRent:LIMit:SCALar:ASYMmetric[:COMBined]:ENABLE	6.67
CONFigure:MODulation:DEViation:CURRent:LIMit:SCALar:ASYMmetric[:COMBined]:VALue	6.66
CONFigure:MODulation:DEViation:EREPorting	6.59
CONFigure:MODulation:DEViation:FDALgorithm	6.62
CONFigure:MODulation:DEViation:MAXimum:LIMit:SCALar:ASYMmetric:LOWer:ENABLE	6.66
CONFigure:MODulation:DEViation:MAXimum:LIMit:SCALar:ASYMmetric:LOWer:VALue	6.65
CONFigure:MODulation:DEViation:MAXimum:LIMit:SCALar:ASYMmetric:UPPer:ENABLE	6.65
CONFigure:MODulation:DEViation:MAXimum:LIMit:SCALar:ASYMmetric:UPPer:VALue	6.64
CONFigure:MODulation:DEViation:MAXimum:LIMit:SCALar:ASYMmetric[:COMBined]:ENABLE	6.67
CONFigure:MODulation:DEViation:MAXimum:LIMit:SCALar:ASYMmetric[:COMBined]:VALue	6.66
CONFigure:MODulation:DEViation:MFRequency	6.61
CONFigure:MODulation:DEViation:MFRequency:SIMultaneous	6.60
CONFigure:MODulation:DEViation:MFRequency:UNIT	6.61
CONFigure:MODulation:DEViation:MINimum:LIMit:SCALar:ASYMmetric:LOWer:ENABLE	6.66
CONFigure:MODulation:DEViation:MINimum:LIMit:SCALar:ASYMmetric:LOWer:VALue	6.65
CONFigure:MODulation:DEViation:MINimum:LIMit:SCALar:ASYMmetric:UPPer:ENABLE	6.65
CONFigure:MODulation:DEViation:MINimum:LIMit:SCALar:ASYMmetric:UPPer:VALue	6.64
CONFigure:MODulation:DEViation:MINimum:LIMit:SCALar:ASYMmetric[:COMBined]:ENABLE	6.67
CONFigure:MODulation:DEViation:MINimum:LIMit:SCALar:ASYMmetric[:COMBined]:VALue	6.66
CONFigure:MODulation:DEViation:MMODE	6.60
CONFigure:MODulation:DEViation:MRANge	6.61
CONFigure:MSIGnal:BDADdress	6.11
CONFigure:MSIGnal:DTRansmitter:FOFFset	6.14
CONFigure:MSIGnal:DTRansmitter:MINDEX	6.14
CONFigure:MSIGnal:DTRansmitter:SCOPex	6.14
CONFigure:MSIGnal:HSCHEME	6.12
CONFigure:MSIGnal:HSCHEME:FREquency	6.12
CONFigure:MSIGnal:INQUIry:ILENght	6.12
CONFigure:MSIGnal:INQUIry:NResponses	6.12
CONFigure:MSIGnal:PAGing:PSRMode	6.13
CONFigure:MSIGnal:PAGing:RSINfo	6.13
CONFigure:MSIGnal:PAGing:TARGeT	6.13
CONFigure:MSIGnal:PAGing:TOUT	6.13
CONFigure:MSIGnal:SVTouT	6.11
CONFigure:MSIGnal:TXLeveL	6.11
CONFigure:NETWork:AUDio:AIRCoding	6.21
CONFigure:NETWork:AUDio:BITStream	6.22
CONFigure:NETWork:AUDio:DELTime	6.22
CONFigure:NETWork:AUDio:PTYPE	6.22
CONFigure:NETWork:HOLD:INTerval	6.23
CONFigure:NETWork:HOLD:INTerval	6.23
CONFigure:NETWork:SNIFF:ATTempT	6.22
CONFigure:NETWork:SNIFF:INTerval	6.22
CONFigure:NETWork:SNIFF:TOUT	6.23
CONFigure:NETWork:TEST:RLSettling	6.23
CONFigure:NETWork:TEST:SNBehaviour	6.24
CONFigure:NETWork:TEST:TCPChange	6.24
CONFigure:POWer:MPR:CONTRol:REPetition	6.56
CONFigure:POWer:MPR:CONTRol:STATistics	6.55
CONFigure:POWer:MPR:EREPorting	6.53

CONFigure:POWer:MPR:MFRequency.....	6.55
CONFigure:POWer:MPR:MFRequency:SIMultaneous.....	6.54
CONFigure:POWer:MPR:MFRequency:UNIT.....	6.55
CONFigure:POWer:MPR:MMODE.....	6.54
CONFigure:POWer:TIME:AVERage:LIMit:SCALar:ASYMmetric:LOWer:ENABLE.....	6.46
CONFigure:POWer:TIME:AVERage:LIMit:SCALar:ASYMmetric:LOWer:VALue.....	6.45
CONFigure:POWer:TIME:AVERage:LIMit:SCALar:ASYMmetric:UPPer:ENABLE.....	6.45
CONFigure:POWer:TIME:AVERage:LIMit:SCALar:ASYMmetric:UPPer:VALue.....	6.45
CONFigure:POWer:TIME:AVERage:LIMit:SCALar:ASYMmetric[:COMBined]:ENABLE.....	6.46
CONFigure:POWer:TIME:AVERage:LIMit:SCALar:ASYMmetric[:COMBined]:VALue.....	6.46
CONFigure:POWer:TIME:CONTRol.....	6.43
CONFigure:POWer:TIME:CONTRol:REPetition.....	6.44
CONFigure:POWer:TIME:CONTRol:RMODE.....	6.43
CONFigure:POWer:TIME:CONTRol:STATistics.....	6.44
CONFigure:POWer:TIME:CURREnt:LIMit:SCALar:ASYMmetric:LOWer:ENABLE.....	6.46
CONFigure:POWer:TIME:CURREnt:LIMit:SCALar:ASYMmetric:LOWer:VALue.....	6.45
CONFigure:POWer:TIME:CURREnt:LIMit:SCALar:ASYMmetric:UPPer:ENABLE.....	6.45
CONFigure:POWer:TIME:CURREnt:LIMit:SCALar:ASYMmetric:UPPer:VALue.....	6.45
CONFigure:POWer:TIME:CURREnt:LIMit:SCALar:ASYMmetric[:COMBined]:ENABLE.....	6.46
CONFigure:POWer:TIME:CURREnt:LIMit:SCALar:ASYMmetric[:COMBined]:VALue.....	6.46
CONFigure:POWer:TIME:EREPorting.....	6.39
CONFigure:POWer:TIME:MAXimum:LIMit:SCALar:ASYMmetric:LOWer:ENABLE.....	6.46
CONFigure:POWer:TIME:MAXimum:LIMit:SCALar:ASYMmetric:LOWer:VALue.....	6.45
CONFigure:POWer:TIME:MAXimum:LIMit:SCALar:ASYMmetric:UPPer:ENABLE.....	6.45
CONFigure:POWer:TIME:MAXimum:LIMit:SCALar:ASYMmetric:UPPer:VALue.....	6.45
CONFigure:POWer:TIME:MAXimum:LIMit:SCALar:ASYMmetric[:COMBined]:ENABLE.....	6.46
CONFigure:POWer:TIME:MAXimum:LIMit:SCALar:ASYMmetric[:COMBined]:VALue.....	6.46
CONFigure:POWer:TIME:MFRequency.....	6.41
CONFigure:POWer:TIME:MFRequency:SIMultaneous.....	6.40
CONFigure:POWer:TIME:MFRequency:UNIT.....	6.41
CONFigure:POWer:TIME:MINimum:LIMit:SCALar:ASYMmetric:LOWer:ENABLE.....	6.46
CONFigure:POWer:TIME:MINimum:LIMit:SCALar:ASYMmetric:LOWer:VALue.....	6.45
CONFigure:POWer:TIME:MINimum:LIMit:SCALar:ASYMmetric:UPPer:ENABLE.....	6.45
CONFigure:POWer:TIME:MINimum:LIMit:SCALar:ASYMmetric:UPPer:VALue.....	6.45
CONFigure:POWer:TIME:MINimum:LIMit:SCALar:ASYMmetric[:COMBined]:ENABLE.....	6.46
CONFigure:POWer:TIME:MINimum:LIMit:SCALar:ASYMmetric[:COMBined]:VALue.....	6.46
CONFigure:POWer:TIME:MMODE.....	6.40
CONFigure:POWer:TIME:MRANge.....	6.42
CONFigure:POWer:TIME:PTIMing:AVERage:LIMit:SCALar:ASYMmetric:LOWer:ENABLE.....	6.47
CONFigure:POWer:TIME:PTIMing:AVERage:LIMit:SCALar:ASYMmetric:LOWer:VALue.....	6.47
CONFigure:POWer:TIME:PTIMing:AVERage:LIMit:SCALar:ASYMmetric:UPPer:ENABLE.....	6.47
CONFigure:POWer:TIME:PTIMing:AVERage:LIMit:SCALar:ASYMmetric:UPPer:VALue.....	6.47
CONFigure:POWer:TIME:PTIMing:AVERage:LIMit:SCALar:ASYMmetric[:COMBined]:ENABLE.....	6.48
CONFigure:POWer:TIME:PTIMing:AVERage:LIMit:SCALar:ASYMmetric[:COMBined]:VALue.....	6.48
CONFigure:POWer:TIME:PTIMing:CURREnt:LIMit:SCALar:ASYMmetric:LOWer:ENABLE.....	6.47
CONFigure:POWer:TIME:PTIMing:CURREnt:LIMit:SCALar:ASYMmetric:LOWer:VALue.....	6.47
CONFigure:POWer:TIME:PTIMing:CURREnt:LIMit:SCALar:ASYMmetric:UPPer:ENABLE.....	6.47
CONFigure:POWer:TIME:PTIMing:CURREnt:LIMit:SCALar:ASYMmetric:UPPer:VALue.....	6.47
CONFigure:POWer:TIME:PTIMing:CURREnt:LIMit:SCALar:ASYMmetric[:COMBined]:ENABLE.....	6.48
CONFigure:POWer:TIME:PTIMing:CURREnt:LIMit:SCALar:ASYMmetric[:COMBined]:VALue.....	6.48
CONFigure:POWer:TIME:PTIMing:MAXimum:LIMit:SCALar:ASYMmetric:LOWer:ENABLE.....	6.47
CONFigure:POWer:TIME:PTIMing:MAXimum:LIMit:SCALar:ASYMmetric:LOWer:VALue.....	6.47
CONFigure:POWer:TIME:PTIMing:MAXimum:LIMit:SCALar:ASYMmetric:UPPer:ENABLE.....	6.47
CONFigure:POWer:TIME:PTIMing:MAXimum:LIMit:SCALar:ASYMmetric:UPPer:VALue.....	6.47
CONFigure:POWer:TIME:PTIMing:MAXimum:LIMit:SCALar:ASYMmetric[:COMBined]:ENABLE.....	6.48
CONFigure:POWer:TIME:PTIMing:MAXimum:LIMit:SCALar:ASYMmetric[:COMBined]:VALue.....	6.48
CONFigure:POWer:TIME:PTIMing:MINimum:LIMit:SCALar:ASYMmetric:LOWer:ENABLE.....	6.47
CONFigure:POWer:TIME:PTIMing:MINimum:LIMit:SCALar:ASYMmetric:LOWer:VALue.....	6.47
CONFigure:POWer:TIME:PTIMing:MINimum:LIMit:SCALar:ASYMmetric:UPPer:ENABLE.....	6.47
CONFigure:POWer:TIME:PTIMing:MINimum:LIMit:SCALar:ASYMmetric:UPPer:VALue.....	6.47

CONFigure:POWer:TIME:PTIMing:MINimum:LIMit:SCALar:ASYMmetric[:COMBined]:ENABle	6.48
CONFigure:POWer:TIME:PTIMing:MINimum:LIMit:SCALar:ASYMmetric[:COMBined]:VALue	6.48
CONFigure:RXQuality:BER:EREPorting	6.92
CONFigure:RXQuality:BER:TSETup	6.93
CONFigure:RXQuality:BER:TSETup<nr>:CONTRol	6.94
CONFigure:RXQuality:BER:TSETup<nr>:CONTRol:REPetition	6.95
CONFigure:RXQuality:BER:TSETup<nr>:CONTRol:STATistics	6.94
CONFigure:RXQuality:BER:TSETup<nr>:DELay	6.98
CONFigure:RXQuality:BER:TSETup<nr>:FREQuency	6.96
CONFigure:RXQuality:BER:TSETup<nr>:HSCHEME	6.96
CONFigure:RXQuality:BER:TSETup<nr>:LEVel	6.95
CONFigure:RXQuality:BER:TSETup<nr>:LIMit	6.99
CONFigure:RXQuality:BER:TSETup<nr>:LIMit:SCALar:ASYMmetric[:COMBined]	6.98
CONFigure:RXQuality:BER:TSETup<nr>:LIMit:SCALar:ASYMmetric[:COMBined]:ENABle	6.99
CONFigure:RXQuality:BER:TSETup<nr>:LIMit:SCALar:ASYMmetric[:COMBined]:VALue	6.99
CONFigure:RXQuality:BER:TSETup<nr>:LOTSequence:DH1Packet	6.97
CONFigure:RXQuality:BER:TSETup<nr>:LOTSequence:DH3Packet	6.97
CONFigure:RXQuality:BER:TSETup<nr>:LOTSequence:DH5Packet	6.97
CONFigure:RXQuality:BER:TSETup<nr>:PATType	6.96
CONFigure:RXQuality:BER:TSETup<nr>:PTYPE	6.97
CONFigure:RXQuality:BER:TSETup<nr>:UDData	6.97
CONFigure:RXQuality:BER:TSETup<nr>:UDLength	6.97
CONFigure:RXQuality:BER:TSETup<nr>:WHITening	6.98
CONFigure:RXQuality:SBER:CONTRol:STATistics	6.102
CONFigure:RXQuality:SBER:DELay	6.105
CONFigure:RXQuality:SBER:EREPorting	6.101
CONFigure:RXQuality:SBER:FREQuency	6.103
CONFigure:RXQuality:SBER:LEVel	6.102
CONFigure:RXQuality:SBER:LOTSequence:DH1Packet	6.104
CONFigure:RXQuality:SBER:LOTSequence:DH3Packet	6.104
CONFigure:RXQuality:SBER:LOTSequence:DH5Packet	6.104
CONFigure:RXQuality:SBER:PATType	6.103
CONFigure:RXQuality:SBER:PTYPE	6.104
CONFigure:RXQuality:SBER:UDData	6.104
CONFigure:RXQuality:SBER:UDLength	6.104
CONFigure:RXQuality:SBER:WHITening	6.105
CONFigure:RXQuality:SBER[:LBACK]:HSCHEME	6.103
CONFigure:SIGNalling:PTARget	6.10
CONFigure:SPECTrum:ACPower:AVERAge:LIMit:SCALar:ASYMmetric:LCHannel:ENABle	6.80
CONFigure:SPECTrum:ACPower:AVERAge:LIMit:SCALar:ASYMmetric:LCHannel:VALue	6.79
CONFigure:SPECTrum:ACPower:AVERAge:LIMit:SCALar:ASYMmetric:UCHannel:ENABle	6.79
CONFigure:SPECTrum:ACPower:AVERAge:LIMit:SCALar:ASYMmetric:UCHannel:VALue	6.79
CONFigure:SPECTrum:ACPower:CCHannel	6.77
CONFigure:SPECTrum:ACPower:CONTRol	6.76
CONFigure:SPECTrum:ACPower:CONTRol:REPetition	6.77
CONFigure:SPECTrum:ACPower:CONTRol:STATistics	6.76
CONFigure:SPECTrum:ACPower:DMODE	6.78
CONFigure:SPECTrum:ACPower:EREPorting	6.74
CONFigure:SPECTrum:ACPower:LUNit	6.78
CONFigure:SPECTrum:ACPower:MCHannel:RELative	6.77
CONFigure:SPECTrum:ACPower:PEAK:LIMit:SCALar:ASYMmetric:LCHannel:ENABle	6.80
CONFigure:SPECTrum:ACPower:PEAK:LIMit:SCALar:ASYMmetric:LCHannel:VALue	6.79
CONFigure:SPECTrum:ACPower:PEAK:LIMit:SCALar:ASYMmetric:UCHannel:ENABle	6.79
CONFigure:SPECTrum:ACPower:PEAK:LIMit:SCALar:ASYMmetric:UCHannel:VALue	6.79
CONFigure:SPECTrum:ACPower:RMS:LIMit:SCALar:ASYMmetric:LCHannel:ENABle	6.80
CONFigure:SPECTrum:ACPower:RMS:LIMit:SCALar:ASYMmetric:LCHannel:VALue	6.79
CONFigure:SPECTrum:ACPower:RMS:LIMit:SCALar:ASYMmetric:UCHannel:ENABle	6.79
CONFigure:SPECTrum:ACPower:RMS:LIMit:SCALar:ASYMmetric:UCHannel:VALue	6.79
CONFigure:SPECTrum:BWIDth:AVERAge:LIMit:SCALar:ASYMmetric:UPPer:ENABle	6.86
CONFigure:SPECTrum:BWIDth:AVERAge:LIMit:SCALar:ASYMmetric:UPPer:VALue	6.85

CONFigure:SPECTrum:BWIDth:CONTRol	6.83
CONFigure:SPECTrum:BWIDth:CONTRol:REPetition	6.84
CONFigure:SPECTrum:BWIDth:CONTRol:RMODE	6.83
CONFigure:SPECTrum:BWIDth:CONTRol:STATistics	6.84
CONFigure:SPECTrum:BWIDth:CURRent:LIMit:SCALar:ASYMmetric:UPPer:ENABLE	6.86
CONFigure:SPECTrum:BWIDth:CURRent:LIMit:SCALar:ASYMmetric:UPPer:VALue	6.85
CONFigure:SPECTrum:BWIDth:DLEVel	6.85
CONFigure:SPECTrum:BWIDth:EREPorting	6.82
CONFigure:SPECTrum:BWIDth:MAXimum:LIMit:SCALar:ASYMmetric:UPPer:ENABLE	6.86
CONFigure:SPECTrum:BWIDth:MAXimum:LIMit:SCALar:ASYMmetric:UPPer:VALue	6.85
CONFigure:SPECTrum:BWIDth:MFRequency:SIMultaneous	6.85
CONFigure:SPECTrum:BWIDth:MFRequency:UNIT	6.85
CONFigure:SPECTrum:BWIDth:MMODE	6.84
CONFigure:SPECTrum:FRANge:CONTRol:STATistics	6.89
CONFigure:SPECTrum:FRANge:CURRent:LIMit:SCALar:ASYMmetric[COMBined]:ENABLE	6.90
CONFigure:SPECTrum:FRANge:EREPorting	6.88
CONFigure:SPECTrum:FRANge:LIMit:SCALar:ASYMmetric[COMBined]:VALue	6.90
CONFigure:SPECTrum:FRANge:MWINDow	6.89
CONFigure:SPECTrum:FRANge:THREshold	6.89
CONFigure:SSIGNal:PCTR	6.15
CONFigure:SSIGNal:TMODE:FREQuency:UNIT	6.16
CONFigure:SSIGNal:TMODE:HSCHEME	6.16
CONFigure:SSIGNal:TMODE:LBTests:FREQuency	6.18
CONFigure:SSIGNal:TMODE:LBTests:LOTSequence:DH1Packet	6.20
CONFigure:SSIGNal:TMODE:LBTests:LOTSequence:DH3Packet	6.20
CONFigure:SSIGNal:TMODE:LBTests:LOTSequence:DH5Packet	6.20
CONFigure:SSIGNal:TMODE:LBTests:PATType	6.19
CONFigure:SSIGNal:TMODE:LBTests:PTYPE	6.20
CONFigure:SSIGNal:TMODE:LBTests:UDData	6.19
CONFigure:SSIGNal:TMODE:LBTests:UDLength	6.19
CONFigure:SSIGNal:TMODE:LBTests:WHITening	6.20
CONFigure:SSIGNal:TMODE:TMTYPE	6.16
CONFigure:SSIGNal:TMODE:TXTests:FREQuency	6.17
CONFigure:SSIGNal:TMODE:TXTests:LOTSequence:DH1Packet	6.18
CONFigure:SSIGNal:TMODE:TXTests:LOTSequence:DH3Packet	6.18
CONFigure:SSIGNal:TMODE:TXTests:LOTSequence:DH5Packet	6.18
CONFigure:SSIGNal:TMODE:TXTests:PATType	6.17
CONFigure:SSIGNal:TMODE:TXTests:PPERiod	6.18
CONFigure:SSIGNal:TMODE:TXTests:PTYPE	6.17
CONFigure:SUBarrays:MODulation:DEVIation	6.68
CONFigure:SUBarrays:POWer:TIME	6.49
CONFigure:WPOWer:CONTRol:REPetition	6.38
CONFigure:WPOWer:EREPorting	6.37
CONTinue:MODulation:DEVIation	6.59
CONTinue:POWer:MPR	6.53
CONTinue:POWer:TIME	6.39
CONTinue:RXQuality:BER	6.92
CONTinue:RXQuality:SBER	6.101
CONTinue:SPECTrum:ACPower	6.74
CONTinue:SPECTrum:BWIDth	6.82
CONTinue:SPECTrum:FRANge	6.88
CONTinue:WPOWer	6.37
DEFault:LEVel	6.27
DEFault:MODulation:DEVIation:CONTRol	6.64
DEFault:MODulation:DEVIation:LIMit	6.68
DEFault:MSIGNal	6.14
DEFault:MSIGNal:PAGing	6.13
DEFault:NETWork	6.21
DEFault:POWer:MPR:CONTRol	6.56
DEFault:POWer:TIME:CONTRol	6.44

DEFault:POWer:TIME:LIMit	6.48
DEFault:RXQuality:BER:TSETup<nr>.....	6.98
DEFault:RXQuality:SBER.....	6.105
DEFault:SSIGnal:TMODe.....	6.21
DEFault:TRIGger[:SEQuence].....	6.27
FETCh:ARRAy:MODulation:DEViation:AVERage?	6.72
FETCh:ARRAy:MODulation:DEViation:CURRent?	6.72
FETCh:ARRAy:MODulation:DEViation:MAXimum?	6.72
FETCh:ARRAy:MODulation:DEViation:MINimum?	6.72
FETCh:ARRAy:POWer:TIME:AVERage?	6.51
FETCh:ARRAy:POWer:TIME:AVERage?	6.52
FETCh:ARRAy:POWer:TIME:CURRent?	6.51
FETCh:ARRAy:POWer:TIME:CURRent?	6.52
FETCh:ARRAy:POWer:TIME:MAXimum?	6.51
FETCh:ARRAy:POWer:TIME:MAXimum?	6.52
FETCh:ARRAy:POWer:TIME:MINimum?	6.51
FETCh:ARRAy:POWer:TIME:MINimum?	6.52
FETCh:ARRAy:SPECTrum:BWIDth:AVERage?	6.87
FETCh:ARRAy:SPECTrum:BWIDth:CURRent?	6.87
FETCh:ARRAy:SPECTrum:BWIDth:MAXimum?	6.87
FETCh:ARRAy:SPECTrum:FRANge?	6.90
FETCh:MODulation:DEViation:STATus?.....	6.60
FETCh:POWer:MPR:STATus?.....	6.54
FETCh:RXQuality:BER:STATus?	6.93
FETCh:RXQuality:SBER:STATus?.....	6.101
FETCh:SIGNalling:PTARgets?.....	6.10
FETCh:SPECTrum:FRANge:STATus?.....	6.89
FETCh:SUBarrays:MODulation:DEViation:AVERage?	6.73
FETCh:SUBarrays:MODulation:DEViation:CURRent?	6.73
FETCh:SUBarrays:MODulation:DEViation:MAXimum?	6.73
FETCh:SUBarrays:MODulation:DEViation:MINimum?	6.73
FETCh[:SCALar]:MODulation:DEViation:BATHreshold?	6.70
FETCh[:SCALar]:MODulation:DEViation:EXTended?	6.70
FETCh[:SCALar]:MODulation:DEViation?	6.69
FETCh[:SCALar]:POWer:MPR?	6.57
FETCh[:SCALar]:POWer:TIME:STATus?.....	6.40
FETCh[:SCALar]:POWer:TIME?	6.50
FETCh[:SCALar]:RXQuality:BER:DETail?	6.100
FETCh[:SCALar]:RXQuality:BER?	6.99
FETCh[:SCALar]:RXQuality:SBER?.....	6.106
FETCh[:SCALar]:SPECTrum:ACPoweR:STATus?	6.75
FETCh[:SCALar]:SPECTrum:ACPoweR?	6.81
FETCh[:SCALar]:SPECTrum:BWIDth:STATus?	6.82
FETCh[:SCALar]:SPECTrum:BWIDth?	6.86
FETCh[:SCALar]:SPECTrum:FRANge:LFRequency?	6.91
FETCh[:SCALar]:SPECTrum:FRANge:LFRequency?	6.91
FETCh[:SCALar]:WPOWer:STATus?.....	6.37
FETCh[:SCALar]:WPOWer?	6.38
INITiate:MODulation:DEViation	6.59
INITiate:POWer:MPR	6.53
INITiate:POWer:TIME	6.39
INITiate:RXQuality:BER	6.92
INITiate:RXQuality:SBER	6.101
INITiate:SPECTrum:ACPoweR	6.74
INITiate:SPECTrum:BWIDth.....	6.82
INITiate:SPECTrum:FRANge	6.88
INITiate:WPOWer	6.37
INPut[:STATe].....	6.24
OUTPut[:STATe].....	6.24
PROcedure:PCONtrol:STATe?.....	6.11

PROCedure:PCONTrol:STEP	6.10
PROCedure:SIGNalling:ACTion	6.7
PROCedure:SIGNalling:PTBZero	6.10
READ:ARRAy:MODulation:DEViation:AVERage?	6.72
READ:ARRAy:MODulation:DEViation:CURRent?	6.72
READ:ARRAy:MODulation:DEViation:MAXimum?	6.72
READ:ARRAy:MODulation:DEViation:MINimum?	6.72
READ:ARRAy:POWer:TIME:AVERage?	6.51
READ:ARRAy:POWer:TIME:AVERage?	6.52
READ:ARRAy:POWer:TIME:CURRent?	6.51
READ:ARRAy:POWer:TIME:CURRent?	6.52
READ:ARRAy:POWer:TIME:MAXimum?	6.51
READ:ARRAy:POWer:TIME:MAXimum?	6.52
READ:ARRAy:POWer:TIME:MINimum?	6.51
READ:ARRAy:POWer:TIME:MINimum?	6.52
READ:ARRAy:SPECTrum:BWIDth:AVERage?	6.87
READ:ARRAy:SPECTrum:BWIDth:CURRent?	6.87
READ:ARRAy:SPECTrum:BWIDth:MAXimum?	6.87
READ:ARRAy:SPECTrum:FRANge?	6.90
READ:SUBarrays:MODulation:DEViation:AVERage?	6.73
READ:SUBarrays:MODulation:DEViation:CURRent?	6.73
READ:SUBarrays:MODulation:DEViation:MAXimum?	6.73
READ:SUBarrays:MODulation:DEViation:MINimum?	6.73
READ[:SCALar]:MODulation:DEViation:EXTended?	6.70
READ[:SCALar]:MODulation:DEViation?	6.69
READ[:SCALar]:POWer:MPR?	6.57
READ[:SCALar]:POWer:TIME?	6.50
READ[:SCALar]:RXQuality:BER?	6.99
READ[:SCALar]:RXQuality:SBER?	6.106
READ[:SCALar]:SPECTrum:ACPower?	6.81
READ[:SCALar]:SPECTrum:BWIDth?	6.86
READ[:SCALar]:SPECTrum:FRANge:LFRequency?	6.91
READ[:SCALar]:SPECTrum:FRANge:LFRequency?	6.91
READ[:SCALar]:WPOWer?	6.38
ROUTe:SPDecoder:OUTPut	6.25
ROUTe:SPENcoder[:INPut]	6.25
SAMPlE[:SCALar]:WPOWer?	6.38
[SENSe:]ACLData?	6.36
[SENSe:]CORRection:LOSS:INPut<nr>[:MAGNitude]	6.24
[SENSe:]CORRection:LOSS:OUTPut<nr>[:MAGNitude]	6.25
[SENSe:]LEVel:ATTenuation	6.26
[SENSe:]LEVel:MAXimum	6.26
[SENSe:]LEVel:MODE	6.26
[SENSe:]SIGNalling:STATe?	6.9
[SENSe:]SIGNalling:XSTATe?	6.9
[SENSe:]SINFo:BDADdress?	6.29
[SENSe:]SINFo:CLASs:SERVice?	6.29
[SENSe:]SINFo:CLASs?	6.29
[SENSe:]SINFo:COMPany?	6.28
[SENSe:]SINFo:FEATure:ALAW?	6.33
[SENSe:]SINFo:FEATure:CQDD?	6.32
[SENSe:]SINFo:FEATure:CVSD?	6.33
[SENSe:]SINFo:FEATure:EA2Mbps?	6.34
[SENSe:]SINFo:FEATure:EA2Mbps?	6.35
[SENSe:]SINFo:FEATure:EA3Mbps?	6.34
[SENSe:]SINFo:FEATure:EA3Mbps?	6.35
[SENSe:]SINFo:FEATure:EA3Slot?	6.34
[SENSe:]SINFo:FEATure:EA3Slot?	6.35
[SENSe:]SINFo:FEATure:EA5Slot?	6.34
[SENSe:]SINFo:FEATure:EA5Slot?	6.35

[SENSe:]SINFo:FEATure:ENCRyption?	6.30
[SENSe:]SINFo:FEATure:FCLag?	6.33
[SENSe:]SINFo:FEATure:HOLD?	6.31
[SENSe:]SINFo:FEATure:HV2P?	6.32
[SENSe:]SINFo:FEATure:HV3P?	6.32
[SENSe:]SINFo:FEATure:LFRRequest?	6.34
[SENSe:]SINFo:FEATure:MS3S?	6.30
[SENSe:]SINFo:FEATure:MS5S?	6.30
[SENSe:]SINFo:FEATure:PArk?	6.31
[SENSe:]SINFo:FEATure:PCONtrol?	6.32
[SENSe:]SINFo:FEATure:PSCHeMe?	6.33
[SENSe:]SINFo:FEATure:PSCHeMe?	6.33
[SENSe:]SINFo:FEATure:RSSI?	6.31
[SENSe:]SINFo:FEATure:SCOL?	6.32
[SENSe:]SINFo:FEATure:SNIFf?	6.31
[SENSe:]SINFo:FEATure:SOFF?	6.30
[SENSe:]SINFo:FEATure:SWITCh?	6.31
[SENSe:]SINFo:FEATure:TACCuracy?	6.31
[SENSe:]SINFo:FEATure:TSDaTa?	6.33
[SENSe:]SINFo:FEATure:ULAW?	6.32
[SENSe:]SINFo:NAME?	6.28
[SENSe:]SINFo:PAging?	6.30
[SENSe:]SINFo:VERSIon?	6.28
SOURce:ACLData	6.36
SOURce:ACLData:ENABle	6.36
SOURce:CORRection:LOSS:INPut<nr>[:MAGNitude]	6.24
SOURce:CORRection:LOSS:OUTPut<nr>[:MAGNitude]	6.25
SOURce:DM:CLOCK:FREQUency	6.26
SOURce:DM:CLOCK:STATe	6.25
STOP:MODulation:DEViation	6.59
STOP:POWer:MPR	6.53
STOP:POWer:TIME	6.39
STOP:RXQuality:BER	6.92
STOP:RXQuality:SBER	6.101
STOP:SPECTrum:ACPower	6.74
STOP:SPECTrum:BWIDth	6.82
STOP:SPECTrum:FRANge	6.88
STOP:WPOWer	6.37
TRIGger[:SEQuence]:SOURce	6.27
TRIGger[:SEQuence]:THReShold	6.27

Contents

7 Remote Control – Program Examples 7.1
 Quick Connection Setup and Measurements7.1

7 Remote Control – Program Examples

The following program example illustrates how to solve a typical measurement task on *Bluetooth* devices. To keep the syntax as short and simple as possible, the program was written with the aid of *Winbatch*, a batch job tool organizing and simplifying the transfer of commands and data between the controller and the instrument.

Winbatch uses device names such as *CMUBASE*, *CMUBT* which are previously defined and assigned to the primary address, secondary address, and some general device settings. With these device names, a complete command line reads:

```
CMUBT: <CMU_Command>
```

where <CMU_Command> may be any of the commands (setting commands or queries) specified within the function group and mode identified by the device name *CMUBT*. Program sequences consisting of commands that are defined in several function groups and modes can be re-used with an exchanged device name.

In addition to these data transfer commands, *Winbatch* provides *WHILE*, *GOTO*, and *IF* statements to express conditions and define loops. With the statement

```
WHILE CMUBT: SIGN:STAT? <> SBY
```

the instrument waits until it has reached the signalling state *Standby* before it executes the following commands.

Quick Connection Setup and Measurements

The following example illustrates how to set up a connection, force the DUT into its test mode and make fast power and modulation measurements, exploiting several features that are primarily intended to simplify and accelerate the task (see also section *Connection Setup* in Chapter 5). The entire program can be executed within approx. 2 s. We assume that the remote control setup of the R&S® CMU (primary and secondary GPIB address) matches the "Remote" settings in *Winbatch* and that *CMUBT* denotes the Bluetooth function group.

; Perform a reset to make sure default settings are restored.

```
CMUBT: *RST;*OPC?
```

; Switch signalling info off for faster connection and to avoid

; unnecessary information being exchanged between the R&S® CMU and the DUT.

```
CMUBT: CONF:MSIG:PAG:RSIN OFF
```

; The DUT supports Bluetooth LMP version 1.1. With the previous setting

; (switch signalling info off), this is the default version that the R&S® CMU assumes.

; The Bluetooth version can be entered explicitly.

```
CMUBT: CONF:NETW:BTV V11
```

; Inquire a device: assume only one DUT is connected to the R&S® CMU with RF cable

; on connector RF 2 which is the default, stop the inquiry after the first response.

```
CMUBT: CONF:MSIG:INQ:NOR 1
```

```
CMUBT: PROC:SIGN:ACT INQ
```

```
WHILE CMUBT: SIGN:STAT? <> INQ
```

```
WHILE CMUBT: SIGN:STAT? <> SBY
```

; If a DUT was found during inquiry it is now selected as the device to page.

; Make a connection (page and go immediately into test mode). Use the extended signalling state

; query . . . :XST? to differentiate between the test mode and the other connected states

```
CMUBT: PROC:SIGN:ACT TEST
```

```
WHILE CMUBT:    SIGN:XST? <> TEST
; Perform combined power and modulation measurements. If no traces are needed
; use POW:MPR rather than POWER:TIME and MODulation:DEVIation
CMUBT:    INIT:POW:MPR
CMUBT:    FETC:POW:MPR?
CMUBT:    ABOR:POW:MPR

; Detach from connection
CMUBT:    PROC:SIGN:ACT DET
WHILE CMUBT:    SIGN:STAT? <> SBY
```

Contents

9 Error Messages 9.1

Notice Boxes during Signalling9.1

Notice Boxes during Measurements9.2

9 Error Messages

In case of an error during operation, the CMU displays a yellow notice box with a message describing the error and one or several buttons to close the box and continue operation. Many error messages are defined in the SCPI standard and not related to a particular function group. These SCPI error messages are listed in chapter 9 of the CMU operating manual. The notice boxes listed below are specific to the Bluetooth function groups.

Notice Boxes during Signalling

The following notice boxes are related to Bluetooth signalling:

Message	Explanation
<i>Connection Timeout</i>	The connection was lost. After pressing <i>ENTER</i> , the CMU returns to the <i>STANDBY</i> state.
<i>DUT not enabled for test mode</i>	During the connection phase the CMU tried to put the DUT into test mode and got an error message back. Enable the test mode on the DUT and press <i>RETRY</i> , or press <i>CANCEL</i> to stop connecting and return to the <i>STANDBY</i> state.
<i>Test mode parameters rejected by device</i>	The DUT does not acknowledge the change of a test mode parameter. The user may choose to <i>Retry</i> (i.e. send the test control command again to the DUT to configure it according to the test mode parameters) or <i>Cancel</i> (i.e. ignore this error). If <i>Cancel</i> is pressed, the configuration of the DUT might not match the test mode settings of the CMU!

Notice Boxes during Measurements

The following notice boxes may be generated during measurements:

Message	Explanation
<i>Bit zero not found</i>	The power ramp is OK, but the CMU cannot correlate to the bits of the packet because the sync word couldn't be found or is wrong. Reduce maximum input level (<i>Max. Level</i> parameter in <i>Connection Control – Analyzer</i>). If the CMU is not the master of the connection and just listens to a signal, check that the Master BD_ADDR of the CMU is the same as the BD_ADDR of the master of the connection.
<i>Burst has wrong payload</i>	Modulation measurement expects different payload data in the packet. Make DUT return the correct payload.
<i>Burst too long</i>	The burst is longer than expected. Make DUT return correct burst length.
<i>Burst too short</i>	The burst is shorter than expected. Make DUT return correct burst length.
<i>Burst has wrong packet type</i>	Modulation measurement expects a different packet type. Make DUT return correct packet type.
<i>No power in expected centre of burst</i>	The <i>Power</i> or <i>Modulation</i> measurement is underdriven. Reduce maximum input level (<i>Max. Level</i> parameter in <i>Connection Control – Analyzer</i>).
<i>No power in preamble</i>	The average power in the preamble is at least 6dB less than the power in center of the burst. No cure / measurement can't be performed in that case.
<i>No power ramp detected or No ramp detected</i>	The power ramp cannot be found, or too many ramps were detected. It is possible that the ramp down is not found because the expected length of the packet does not match the actually received packet. Check that the packet type and packet length matches the packet to be measured or reduce the expected input level (<i>Max. Level</i> parameter in <i>Connection Control – Analyzer</i>).
<i>Overload on RF...or Overload on connector...</i>	The input signal on the specified connector is too high to be measured, i.e. the A/D converter is in overflow. Reduce the input signal power or increase the expected input level (which defines the maximum level for the A/D converter).
<i>Preamble not found</i>	The preamble bits are different from 1010 or 0101. No cure / measurement can't be performed in that case.
<i>Signal too low / burst too short</i>	Either the input signal on the specified connector is too low to be measured or the burst is too short. Since the <i>Power</i> (and also the <i>Modulation</i> measurement) displays the measured graph even if the burst is too short or the signal is too low, it is possible to see on the screen what's going on and either correct the input level or reconfigure the burst length, depending on the measurement reading. To correct the input level, increase the input signal power or reduce the expected input level (<i>Max. Level</i> parameter in <i>Connection Control – Analyzer</i>) or use a different connector.
<i>Trigger not found</i>	The CMU cannot find the specified trigger. When measuring a signal without a Bluetooth connection with the CMU being the master, the trigger source must be set to IF or RF power.

Index

2

20 dB Bandwidth 4.55, 4.60
 results 4.63

3

3-Slot Packets 6.30

5

5-Slot Packets 6.30

A

ACL data 6.35
 receive 6.36
 send 6.36
 ACP 4.55, 4.60
 remote control 6.74
 results 4.61
 ACP (control)
 remote control 6.74
 Adaptive Power Control 4.111
 Address (secondary GPIB) 5.1
 Adjacent Channel Power 4.55
 AF Connector Overview 4.117, 4.118
 Aggregated channels 4.37, 4.38, 4.50
 Air Coding 4.113, 6.21
 A-law log 4.113, 6.33
 All 0 4.6
 All 1 4.6
 Analog In/Out 4.113
 Analyzer
 Modulation 4.51
 Overview 4.25
 Power 4.40
 remote control 6.26
 RF 4.120
 Signalling 4.119, 4.120
 Analyzer Level 4.31
 Analyzer Settings 4.32
 Analyzer/Generator 4.2
 Application 3.4
 Overview 4.21
 Receiver Quality 4.78
 Spectrum 4.59
 Attenuation 6.26
 input level 4.120, 4.121
 Audio
 parameters 4.113
 Signalling 4.87
 state 4.100
 test scenarios 4.87
 Audio Generator and Analyzer 4.117
 Authentication Required 4.105, 6.15
 Autoranging 4.120, 4.121
 Average (display) 4.39
 Average values (calculation) 3.5

B

BD Address Master 4.2
 BD_Address 4.14, 4.94, 6.29
 BD_Address (master) 4.104

BD_Address CMU 6.3, 6.11
 Beacon Interval 4.116
 BER 4.76, 4.78
 definition and measurement 4.73
 remote control 6.92
 BER Limit 6.98
 BER Search 4.78
 Bit error rate 4.73, see BER
 Bit Stream 4.113, 6.22
 Bits above Threshold 4.48
 Bluetooth Version 4.93
 Braces 5.8
 Burst Matching 4.36

C

Call setup 2.8
 CBT-B41 (option) 4.117
 Center Channel 4.69, 6.77
 Channel Quality Driven Data 6.32
 Class of Device 4.94, 6.29
 CMU-B41 (option) 4.117
 Command
 order 5.1, 5.6
 structure 5.1
 tables (description) 5.6
 Company ID 4.93
 Company Name 6.28
 Configuration file 4.82
 Configurations 3.2
 Connect 4.15
 Connect device 2.2
 Connect Testmode 4.15
 Connect. Control Guidance 4.122
 Connected state 4.90
 Connection
 Audio 4.100
 Connected 4.90
 Hold 4.97
 Inquiry 4.16
 Paging 4.17
 Park 4.98
 remote control 6.7
 Sniff 4.96
 speed up 2.9, 5.2, 6.1, 6.6, 7.1
 Standby 4.14
 Test Mode 4.92
 Connection Control
 Non Signalling 4.7
 remote control 6.6
 Signalling 4.12, 4.90
 Connection Hop Scheme 6.12
 Connection Hopping Scheme 4.104
 Connectors (RF) 2.3
 Continuous 4.39, 5.4
 Control
 Spectrum 4.68, 4.69
 Counting 5.4
 Couple Current Default 6.6
 CRC Error 4.80
 Current (display) 4.39
 Current values 6.6
 CVSD 4.113

D

Decoder Cal 4.114

Default BD_Address for Paging.....	4.105, 6.13
Default Scale	
Modulation.....	4.46
Power.....	4.35
Default values.....	4.25, 6.6
Delay	
BER.....	4.85, 6.98
BER Search.....	4.85, 6.105
Delay Time.....	4.114, 6.22
Delta marker.....	4.33
Detach.....	4.91, 4.96
Detection Level.....	4.70, 6.85
Detector Mode.....	6.78
Detector Mode (Spectrum).....	4.60
Device Name.....	4.93, 6.28
Device to Page.....	4.15, 6.10
Device Version.....	4.93
Devices found.....	4.17
DH1 (test setup).....	4.82
DH3 (test setup).....	4.82
DH5 (test setup).....	4.82
Diagram	
20 dB bandwidth.....	4.64
ACP.....	4.62
Frequency Range.....	4.66
Dirty Transmitter.....	4.106
Non Signalling.....	6.4
Signalling.....	6.14
Dirty Transmitter Scope.....	4.106, 6.14
Dirty Tx	
Receiver Quality.....	4.79
Dirty Tx (NSig).....	6.4
Dirty Tx (Sig).....	6.14
Disconnecting.....	4.91, 4.96
Display Frequency.....	6.55, 6.61
Display line.....	4.33
Display Mode.....	3.5
Power.....	4.30, 4.39
Display/Marker	
Modulation.....	4.46
Power.....	4.34
Displayed Channel.....	4.32
D-Line.....	4.34
Down (power control).....	4.30
Drift	
dirty transmitter.....	4.106
dirty transmitter (NSig).....	6.4
dirty transmitter (Sig).....	6.14
generator.....	4.8
Dynamic range.....	4.120, 4.122

E

Echo (bit stream).....	4.114
Echo test (audio).....	4.89
Enable software.....	1.6
Encoder Cal.....	4.114
Encryption.....	6.30
Enter Submode.....	4.91
Europe/USA.....	4.110
Exit Audio Mode.....	4.101
Exit Sniff Mode.....	4.97
Exit Testmode.....	4.96
Ext. Att. Input.....	6.4, 6.24
Ext. Att. Output.....	6.4, 6.5, 6.24, 6.25
External attenuation	
remote control (NSig).....	6.4, 6.24
remote control (Sig).....	6.26

F

Filter Bandwidth.....	4.52
Flow Control Lag.....	6.33
France.....	4.110
Freq. Dev. Algorithm.....	4.52, 6.62
Freq. Dev. Scale.....	4.46
Frequency Offset.....	6.2
dirty transmitter.....	4.106, 6.14
dirty transmitter (NSig).....	6.4
dirty transmitter (Sig).....	6.14
generator.....	4.7
Frequency Range.....	4.55, 4.60
general description.....	4.57
remote control.....	6.88
results.....	4.66
Frequency Unit.....	6.2, 6.16, 6.41, 6.55, 6.61, 6.85
Function group	
Bluetooth Non Signalling.....	4.2
Bluetooth Signalling.....	4.12

G

Gating.....	4.68
Gating (Spectrum – ACP).....	6.77
Generator	
connection control (NS).....	4.7
frequency.....	4.4
remote control (NSig).....	6.2
Generator Modulation.....	4.5, 6.4
remote control (NSig).....	6.4
Getting Started.....	2.1
Grid.....	4.34, 4.40

H

HEC Error.....	4.80
HLT state.....	2.13
Hold	
parameters.....	4.116
state.....	4.97
Hold Interval.....	4.116, 6.23
Hold Mode.....	6.31
Hopping Scheme.....	4.110
BER.....	6.96
BER Search.....	6.103
Hotkey.....	2.15
HV1, HV2, HV3 packets.....	4.114
HV2 Packets.....	6.32
HV3 Packets.....	6.32

I

Inputs/outputs	
Non Signalling.....	4.8
remote control (NSig).....	6.4, 6.24
Signalling.....	4.117
Inquire.....	4.15
Inquiry.....	4.104
state.....	4.16
Inquiry Length.....	4.104, 6.12
Installation.....	1.1
Intermodulation.....	4.120, 4.122
INV.....	5.7

L

LAP.....	4.94, 6.29
Leakage.....	4.32, 4.42
Leakage Lines.....	4.34, 4.40
Length of Test Sequence.....	4.2, 6.3

BER..... 6.97, 6.104
 Loopback Tests..... 4.112, 6.20
 TX Tests..... 4.111, 6.18
 Level (trigger)..... 6.27
 Level Scale..... 4.34
 Level Unit..... 6.78
 Level Unit (Spectrum)..... 4.61
 Limit
 check..... 5.5
 specify..... 5.5
 Limit Matching
 BER..... 6.100
 Modulation..... 6.71
 Power..... 6.51, 6.91
 POWer:MPR..... 6.58
 Spectrum..... 6.81, 6.87
 Limits, Spectrum..... 4.70
 Limits (Modulation)..... 4.53
 remote control..... 6.64
 Limits (Overview)..... 4.27
 Limits (Power)..... 4.42, 4.43
 remote control..... 6.45
 Limits (Receiver Quality)..... 4.86
 remote control..... 6.98
 Limits (Spectrum), remote control..... 6.79, 6.85
 List of Commands..... 6.107
 description..... 5.8
 Literal..... 5.7
 LMP Version..... 4.93
 Loopback
 mode..... 4.73
 remote control..... 6.18
 tests..... 4.109
 Low distortion..... 4.120, 4.121
 Low noise..... 4.120, 4.121
 Lower Channels..... 4.69
 Lower Channels (ACP)..... 6.77

M

Mains switch..... 2.2
 Major Device Class..... 4.94, 6.29
 Manual control..... 3.1
 Marker..... 2.15, 4.33
 Marker values..... 4.36, 4.48
 Marker/Display (Power)..... 4.33
 Master..... 2.11, 4.92
 Overview..... 4.26
 Master Sig.
 menu..... 4.102
 Power..... 4.31
 Receiver Quality..... 4.79
 Master Signal..... 2.9
 info table..... 4.95
 remote control..... 6.11
 Master Signal (info)..... 4.15
 Max. Input (test setup)..... 4.82
 Max. Level..... 4.120, 4.121
 Bluetooth (Sig)..... 6.26
 Maximum (display)..... 4.39
 Meas. Window..... 4.70, 6.89
 Measure Mode..... 4.32, 4.41
 Measure Mode (Spectrum)..... 4.61
 Measured Channel..... 4.32, 4.70, 6.85
 Measurement control..... 5.3
 Measurement groups..... 3.3
 Measurement Mode
 Modulation..... 6.60
 Power..... 6.40
 POWer:MPR..... 6.54
 Spectrum..... 6.84

Measurement object..... 5.7
 Menu Select..... 2.4
 Menu structure..... 3.1
 Menus..... 4.35
 Minimum (display)..... 4.39
 Minor Device Class..... 6.29
 Misc..... 4.122
 Missing Packet..... 4.80
 Mobile phone connection..... 2.2
 Mode..... 4.120, 4.121
 Modulation Configuration..... 4.51
 Modulation Index..... 4.106, 6.14
 dirty transmitter..... 4.106
 dirty transmitter (NS)..... 4.106
 dirty transmitter (NSig)..... 6.3, 6.4
 dirty transmitter (Sig)..... 6.14
 generator..... 4.8
 Modulation measurement..... 4.44
 example..... 2.16
 remote control..... 6.59
 Modulation measurement (control)..... 4.51
 remote control..... 6.59
 Modulation/Power..... 4.21

N

NAK Rate..... 4.80
 NAN..... 5.7
 NAP..... 4.94, 6.29
 Network
 remote control..... 6.21, 6.22, 6.23
 tab..... 4.113
 Non signalling measurements..... 4.9
 Non Signalling..... 2.6, 3.1, 4.2
 Notation (remote control)..... 5.6
 Number of Responses..... 4.104, 6.12

O

Operating concept..... 3.1
 OPERation status register..... 5.5
 Option
 CBT-B41..... 4.117
 CMU-B41..... 4.117
 Out-of-tolerance measurement (Power)..... 2.17
 Overview..... 4.19
 Overview Configuration..... 4.24
 Overview measurement (control)..... 4.24

P

Packet error rate..... See PER
 Packet Type..... 4.2, 4.5, 6.3
 audio..... 4.114, 6.22
 BER..... 6.97, 6.104
 loopback..... 4.112, 6.20
 TX tests..... 4.111, 6.17
 Packet Types, Description..... 4.6
 Packets..... 4.77, 4.83
 Page Scan Mode..... 4.95, 6.30
 Page Scan Repetition Mode..... 4.104, 6.13
 Page Timeout..... 4.104, 6.13
 Paging..... 4.95, 4.104
 info table..... 4.96
 remote control..... 6.12, 6.14
 state..... 4.17
 Paging Scheme..... 6.33
 Parameter (SCPI command)..... 5.7
 Parameter line..... 4.35
 Parameter, current vs. default..... 6.6
 Park

parameters 4.116
 state 4.98
 Park Mode 6.31
 Pattern Type 6.17, 6.19, 6.96
 BER Search 6.103
 Loopback 4.112
 TX Tests 4.111
 Payload 4.6
 PER 4.73
 definition and measurement 4.73
 Piconet 2.11, 4.92
 Pin Code 4.105, 6.15
 Poll Period 4.112, 6.18
 Power 4.28, 6.43
 Generator 4.3
 measurement example 2.12
 remote control 6.39, 6.74
 Power (control) 4.38
 remote control 6.39
 Power (wide band) 4.15, 4.16
 remote control 6.37, 6.38
 Power class 4.42
 Power configuration 4.38
 remote control 6.44
 Power Control 6.32
 Power Control Mode 4.111, 6.15
 Power supply 2.3
 Power switch 2.3
 Power/Time 4.29
 POWer:MPR (remote control) 6.53
 Power-up Time before Bit Zero 4.7, 4.103, 6.2, 6.10
 PRBS 4.6
 Program examples (remote control) 7.1
 Pseudo measurement object 5.7

Q

Quick Connection 2.9, 5.2, 6.1, 6.6, 7.1

R

Read Signalling Info 4.105
 Receive audio test 4.87
 Receiver Quality 4.73
 remote control 6.92
 Receiver Quality (control) 4.82
 Receiver Quality Configuration 4.82
 Receiver quality measurements, example 2.20
 Reduced Hopping 4.110
 REF OUT 2 4.4, 4.5, 6.5, 6.25
 Ref. R 4.33
 Reference Frequency
 Non Signalling 4.4
 remote control (NSig) 6.5, 6.25
 Signalling 4.118
 Reference marker 4.33
 Reference part 4.1
 Rel. 1 4.33
 Rel. 2 4.33
 Remote control
 basics 5.1
 commands 6.1
 notation 5.6
 program examples 7.1
 Repetition 4.38
 Modulation 6.63
 Power 4.30, 6.44, 6.56
 Receiver Quality 4.77
 Spectrum 6.77, 6.84
 Repetition mode 3.4, 5.4
 Result

Modulation 4.47
 Power 4.35
 POWer:MPR 6.57
 RXQuality – BER 4.79, 6.99
 RXQuality – SBER 4.79, 6.106
 Spectrum 4.61, 6.81, 6.86, 6.90
 Result mode
 Modulation 6.63
 Power 6.43
 Spectrum 6.83
 RF Channel 4.4
 RF connectors 2.2
 RF Frequency 6.2
 RF Generator 4.3
 remote control (Bluetooth NS) 6.1
 remote control (NSig) 6.2
 RF Input 6.4, 6.24
 RF Max. Level 6.2
 RF Output 6.4, 6.24
 RSSI 6.31
 RX Frequency 4.112
 connection 4.104
 RX Level Settling Time 4.116, 6.23
 RX Quality (Overview) 4.22
 RX/TX Frequency 4.111, 6.17
 RX/TX single freq. 4.110

S

Scalar result
 Modulation 4.47
 Power 4.35
 Scan Period 4.95, 6.30
 Scan Repetition 4.95, 6.30
 SCO Link 6.32
 Scope (Dirty Transmitter) 4.106
 SCPI conformity 5.2
 SCPI standard 5.2
 Search Cycles 4.84
 Search mode 4.78
 Search Value 4.83
 Secondary address 5.5
 Second-level keyword 5.1
 Separate channels 4.37, 4.38, 4.50
 SEQN Behavior 4.117, 6.24
 Service Class 4.94, 6.29
 Setup (table) 4.81
 Signalling 3.2, 4.12
 Signalling Info 4.14, 4.93, 6.28
 Signalling measurements 2.8
 Signalling State 6.7
 Audio 4.100
 Connected 4.90
 Hold 4.97
 Inquiry 4.16
 overview 4.12
 Paging 4.17
 Park 4.98
 Sniff 4.96
 Standby 4.14
 Test Mode 4.92
 Simult. Meas. 4.41, 6.40, 6.54, 6.60
 Single Meas. 4.42, 6.41
 Single Shot 4.38, 5.4
 Single Values (dirty transmitter) 4.106
 Slave 2.11, 4.92
 Overview 4.26
 Slave Sig. 4.107
 Power 4.31
 remote control 6.15
 Slave Signal (info) 4.15, 4.95

Slot Offset 6.30

Sniff
 parameters 4.115
 state 4.96

Sniff Attempts 4.115, 6.22

Sniff Interval 4.115, 6.22

Sniff Mode 6.31

Sniff Timeout 4.115, 6.23

Softkey 2.15

Software (enable) 1.6

Source 6.27

Spec Table (dirty transmitter) 4.106

Special character 5.8

Spectrum 6.76, 6.83
 remote control 6.74, 6.82

Spectrum, remote control 6.82

Spectrum configuration
 remote control 6.77, 6.84

Spectrum Configuration 4.68

Spectrum measurement, example 2.18

Spectrum measurements 4.55

Speech Decoder 4.117, 4.118, 6.24, 6.25

Speech Encoder 4.117, 4.118, 6.24, 6.25

Square brackets 5.8

Srch. Lower Level 6.102

Srch. Upper Level 6.102

Standby mode 2.3

Standby state 4.14

Start Channel 4.70, 6.89

Startup menu 1.1, 2.2

Statistic Count 3.4, 4.30, 4.40, 5.4
 Modulation 6.62, 6.63, 6.89
 Threshold (Frequency Range) 6.89
 Power 6.43, 6.44, 6.55
 Spectrum 6.76, 6.83, 6.84

Statistical quantities 3.6

Statistics
 BER 6.94
 BER Search 6.102
 remote control 5.3

Statistics cycle 3.4

Status indication 2.7

Status reporting system 5.5

STATus:OPERation register 5.5

Stepping mode
 Modulation 6.63
 Power 6.44, 6.56
 Spectrum 6.77, 6.84

Stop Condition 3.4, 4.30, 4.39, 4.77
 Modulation 6.63
 Power 6.44, 6.56
 Spectrum 6.77, 6.84

Stop Connect 4.18

Stop Inquiry 4.17

Store Link Keys 4.106

Subarrays
 MODulation 6.68
 Power 6.49

Submode 4.91

Supervision Timeout 4.104, 6.11

Supported Features 4.95

Switch 6.31

Symbol Time Error, generator 4.8

Symbol Timing Error
 dirty transmitter 4.106
 dirty transmitter (NSig) 6.4
 dirty transmitter (Sig) 6.14

Synchronization, remote control (NSig) 6.5, 6.25

System clock 4.9

T

Test 1 4.82

Test Ctrl on Packet Change 6.24

Test mode 2.3, 2.11, 3.1, 4.92, 6.15

Test Mode Hopping Scheme 6.16

Test Mode state 4.92

Test Setup 4.78, 6.93
 BER 4.82, 4.83

TestCtrl on Packet Change 4.116

Testmode Type 4.109, 6.16

Threshold (Frequency Range) 4.70

Time Scale
 Modulation 4.46
 Power 4.34

Time Scale Span 6.42, 6.61

Time Scale Start 6.42, 6.61

Timing Accuracy 6.31

Tolerance check 4.28

Tolerance values, Spectrum 4.70

Trace 5.4
 Modulation 4.50
 Power 4.37, 4.38

Transmission reserve 4.120, 4.121

Transmit audio test 4.88

Transmitter Test (remote control) 6.16

Transparent SCO Data 6.33

Trigger 4.119
 remote control 6.27

Trigger level 4.120

TX Frequency 4.112
 connection 4.104

TX Level 4.103, 6.11, 6.95

TX Tests 4.109

U

UAP 4.94, 6.29

Unpark 4.99

Up (power control) 4.30, 4.95, 4.111

Upper Channels 4.69

Upper Channels (ACP) 6.77

Upper/lower case characters 5.7

User Def. Table (dirty transmitter) 4.106

User defined Data 4.112, 6.97
 BER Search 6.104

User defined Length 4.112, 6.97
 BER Search 6.104

User-defined Data 6.19

User-defined Length 6.19

V

Version 4.93, 6.28

W

Whitening 4.112, 6.20, 6.98, 6.105

Wide band power 4.15, 4.16
 remote control 6.37, 6.38

Winbatch 7.1

Wrong packet type 4.80

Wrong payload length 4.80

Z

Zoom 4.51

μ

μ-law log 4.113, 6.32